

**Soutenance de thèse**

**Bruit quantique haute fréquence de systèmes  
mésoscopiques et relation courant-phase de  
jonctions hybrides**

**Julien BASSET**

**Groupe de Physique Mésoscopique**

**Sous la direction de:**

**Hélène BOUCHIAT et Richard DEBLOCK**

# Mesoscopic physics

## Mesoscopic systems:

- Systems of intermediate dimension between **atomic** (few Å) and **macroscopic** world (few mm)
- Obey **quantum mechanics** laws instead of **classical** laws  
(phase coherent samples)

## In practice :

- **Micro- or Nano-structured** samples
- **Low temperature** (<100mK)

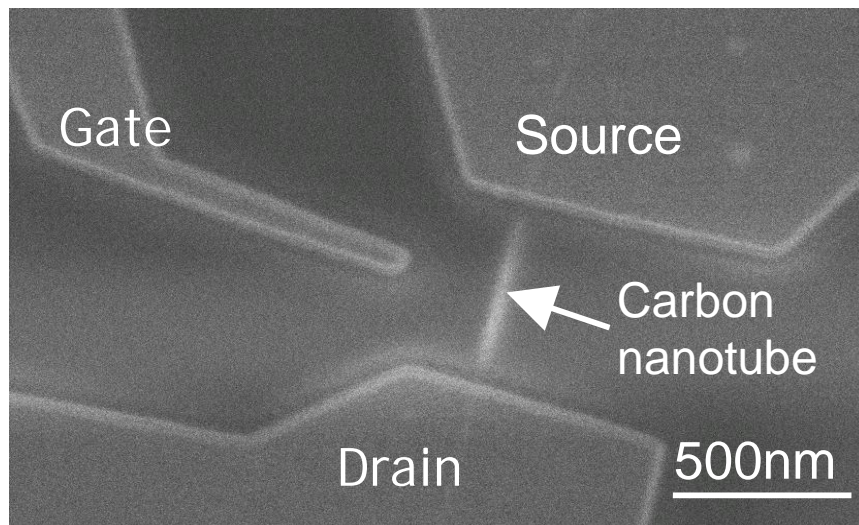

sample



experiment

**Aim: Understand and/or use quantum mechanics in designed systems**

# Metallic carbon nanotube as a mesoscopic system

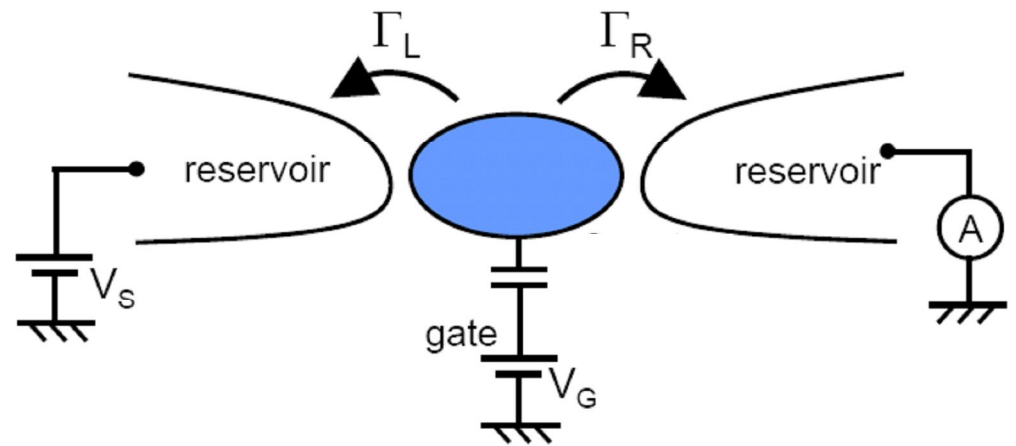
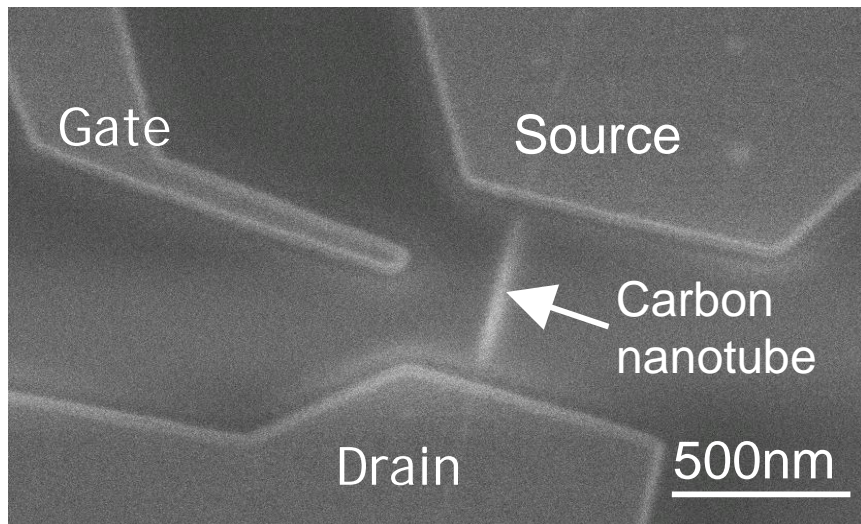

$$\Gamma = \Gamma_L + \Gamma_R : \text{coupling to the reservoirs}$$

- **Strong coupling  $\Gamma$**  (good contacts)
  - Electronic waveguide (Fabry-Pérot regime,...)
  - Proximity induced superconductivity
- **Weak coupling  $\Gamma$**  (bad contacts)
  - Strongly confined electrons (Coulombic interactions, spectroscopy of the nanotube,...)
  - No proximity effect
- **Intermediate coupling  $\Gamma$** 
  - Electronic correlations (Kondo effect, ...)
  - Non trivial proximity effect (spin state dependent)

# Two main experiments

- **Current-phase** relation of hybrid junctions

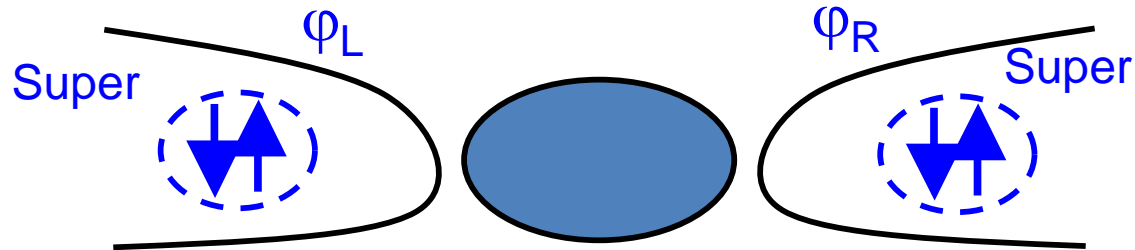

Just a glimpse -  
see manuscript for  
more details

- **High frequency quantum noise** ( $h \nu \gg k_B T$ ) of mesoscopic systems

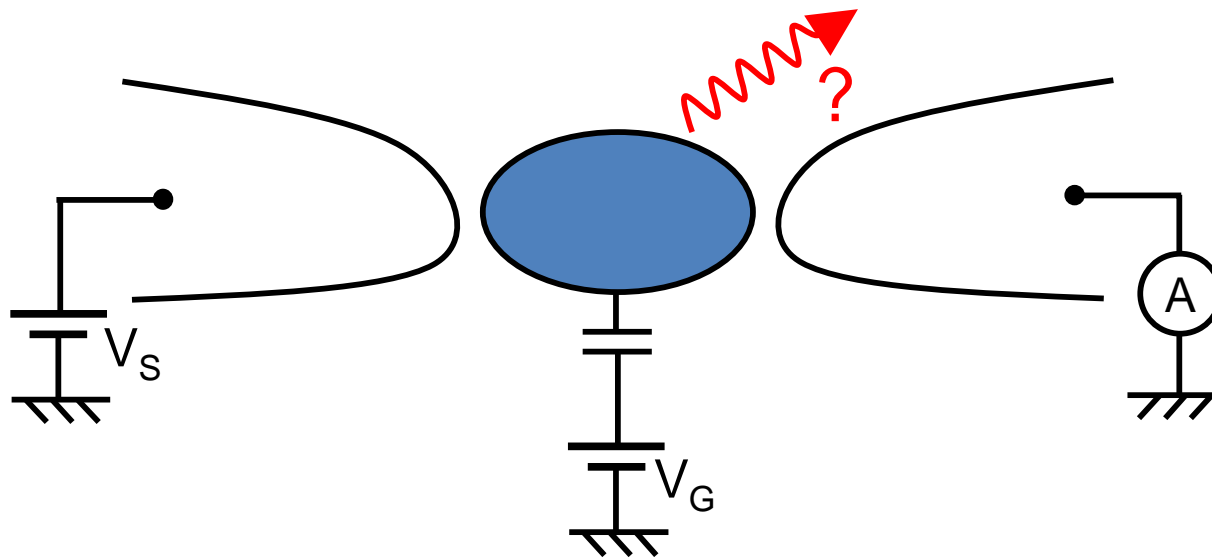

# Measurement principle of the Current-Phase Relation (CPR)

Asymmetric SQUID ( Della Rocca *et al.* PRL (2007) ) with refinement

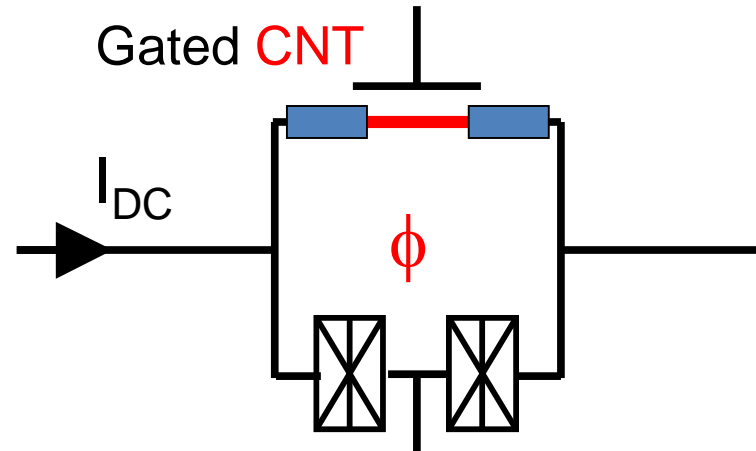

Two large Josephson Junctions with central contact

$$I_{C,SQUID}(\phi) = I_{C,LJ} + I_{C,WL} \cdot f(\pi - 2\pi\phi/\phi_0)$$

$$\varphi_{Tube} = \pi - 2\pi\phi/\phi_0$$

- Switching current oscillations with magnetic flux  $\rightarrow I(\phi)$  of the nanotube
- 3 points measurements: room temperature check of the CNT possible
- Central contact between two large junctions can be used as a switch in the superconducting state: nanotube  $I(V)$  accessible

# CPR sample in practice

PdAl/AlO<sub>x</sub>/Al → Good contacts with CNTs + Josephson junctions in **ONE** single step

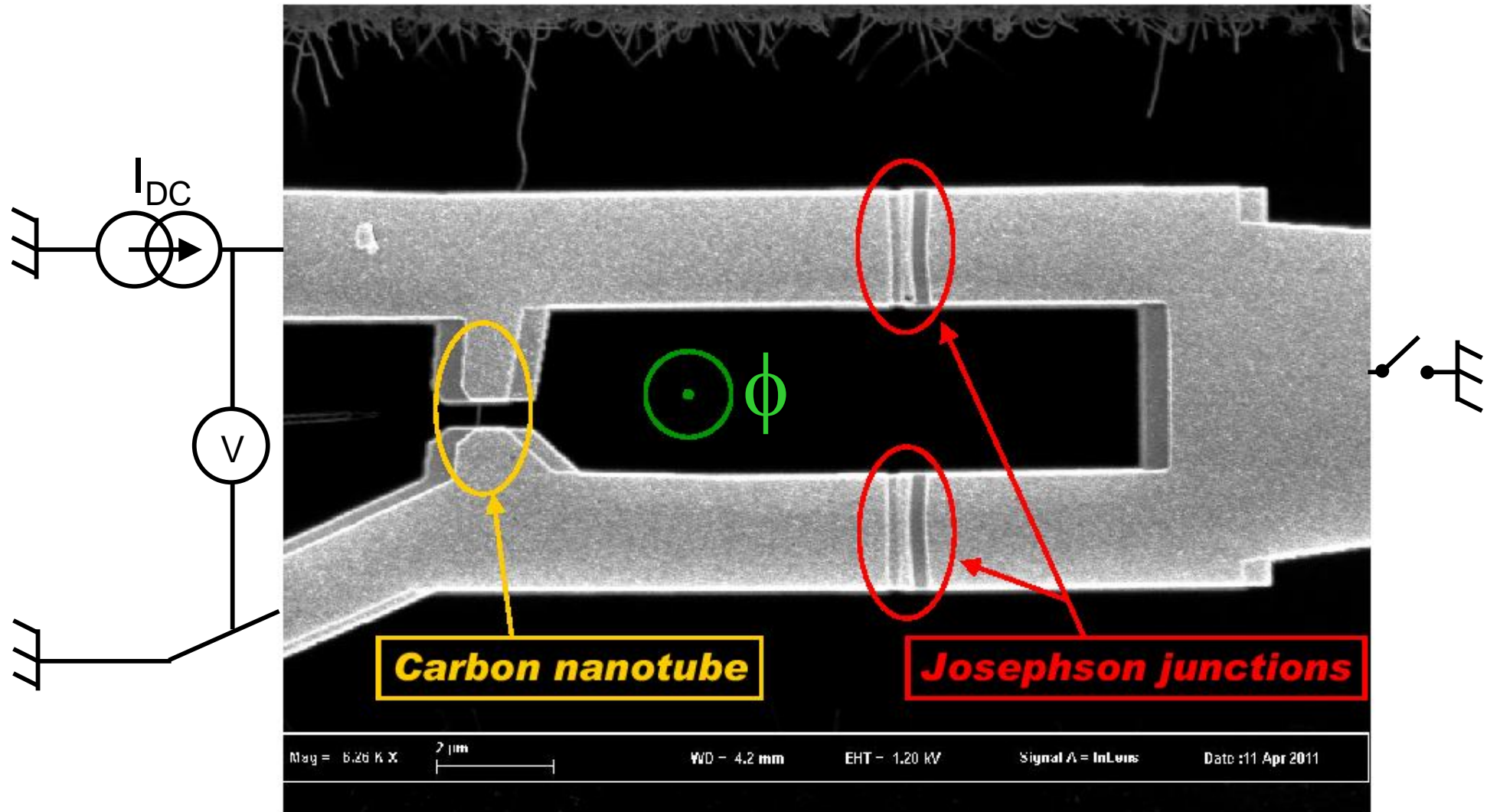

+ Backgate

Samples with R.Weil

# CPR measurement

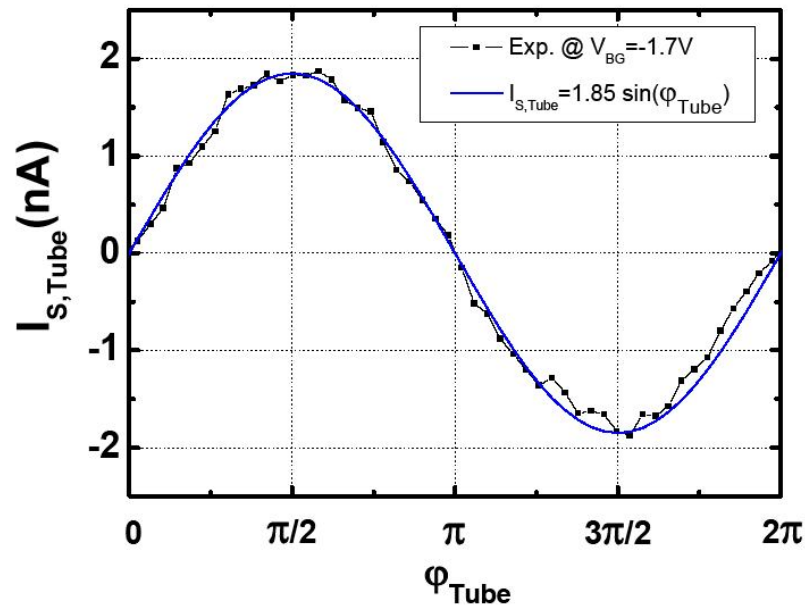

$V_{\text{Gate}} = -1.7\text{V} \Leftrightarrow G_N \sim e^2/h$   
 $I_{S,\text{Tube}} \sim 1.85\text{nA}$   
**Harmonic**

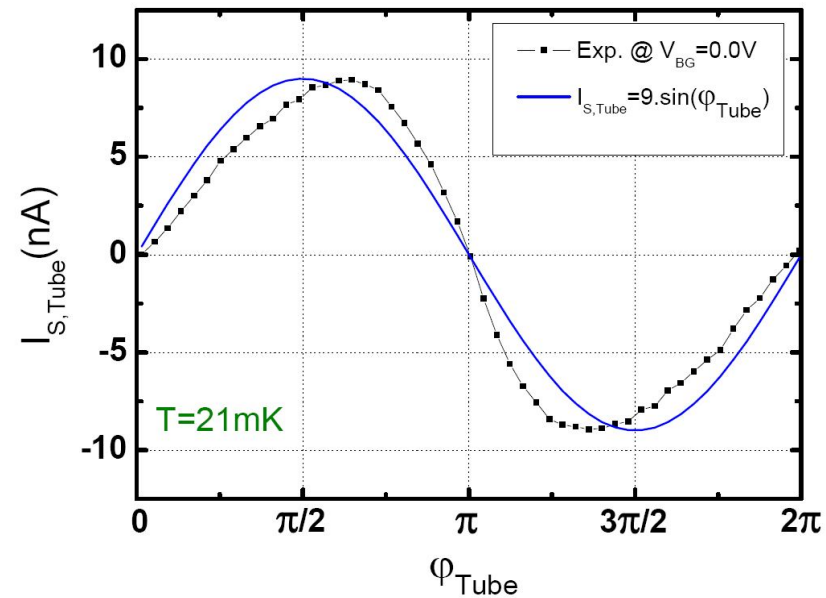

$V_{\text{Gate}} = 0.0\text{V} \Leftrightarrow G_N \sim 3.5e^2/h$   
 $I_{S,\text{Tube}} \sim 9.0\text{nA}$   
**Anharmonic**

- Supercurrent  $\sim 10\text{nA}$
- Anharmonic behaviour qualitatively consistent with transmission  $\tau$  channels interpretation  $\rightarrow$  **Still under investigation!**

# Outline

## High frequency quantum noise of mesoscopic systems

1. Introduction
2. Principle of the SIS junction as a quantum noise detector
3. Equilibrium Noise of the transmission line resonator
  - Noise asymmetry at very low temperature
4. Out of Equilibrium Emission Noise of a Josephson junction
  - Frequency dependence of quasiparticles shot noise
5. Emission Noise of a carbon nanotube quantum dot in the Kondo regime
  - Signature of Kondo screening dynamics and decoherence
6. Conclusions and perspectives



# Introduction to electronic noise

- What is electronic noise?

Conducting system

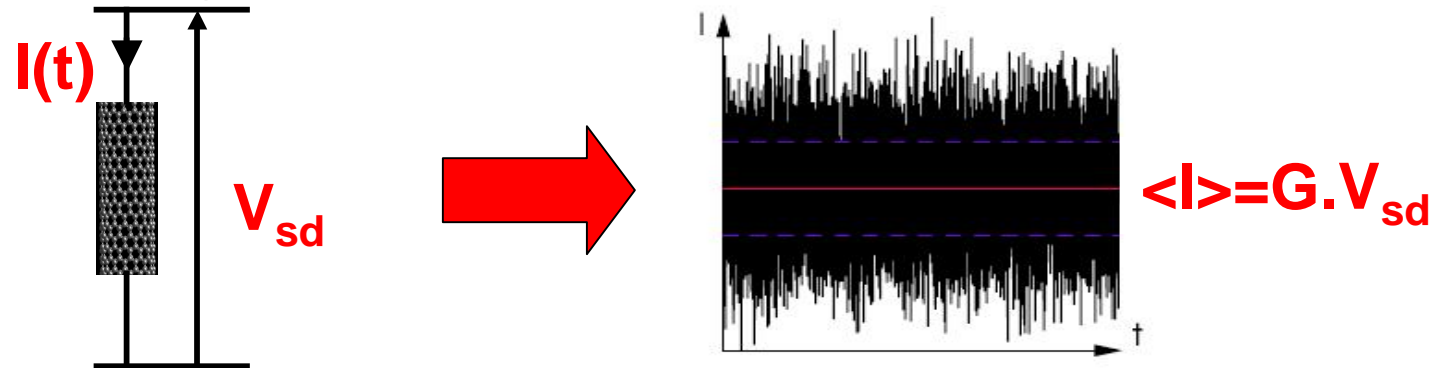

$$S_I(\omega) = \frac{1}{2\pi} \int_{-\infty}^{+\infty} d\tau e^{i\omega\tau} \langle \delta I(t + \tau) \delta I(t) \rangle$$

- Why noise measurement?

**Electronic correlations**, effective charge, characteristic energy scales  $E_c, \dots$

# Noise: from classical to quantum regime

$$S_I(\nu)$$

Low Frequency ( $h\nu \ll eV, k_B T$ )

- Thermal Noise (Johnson-Nyquist) ( $eV < k_B T$ ):

$$S_I = 4k_B T G$$

- Shot Noise ( $eV > k_B T$ ):

$$S_I = 2eI.F$$

with  $F$ : Fano factor

**White Noise**

High Frequency ( $h\nu \sim eV; h\nu \gg k_B T$ )  
(Quantum regime)

- Noise  $\Leftrightarrow$  Photons (microwave)

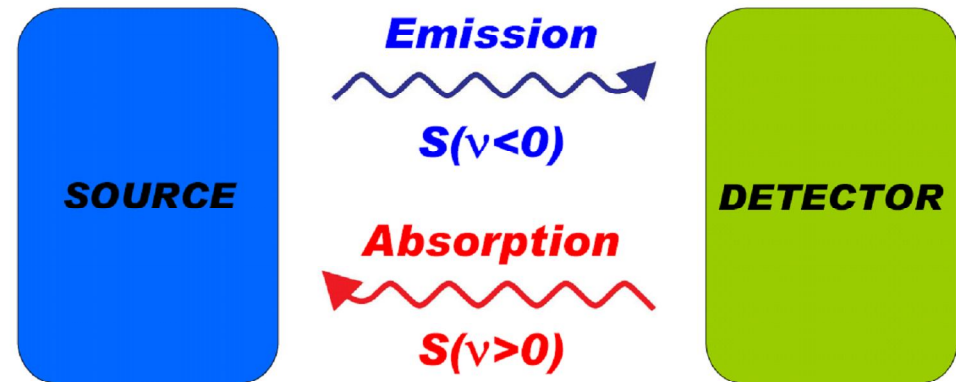

Emission  $\neq$  Absorption

**Strong frequency dependence**

# Emission and Absorption noise

Ex: resistor R at thermal equilibrium

$$S_I(\nu)$$

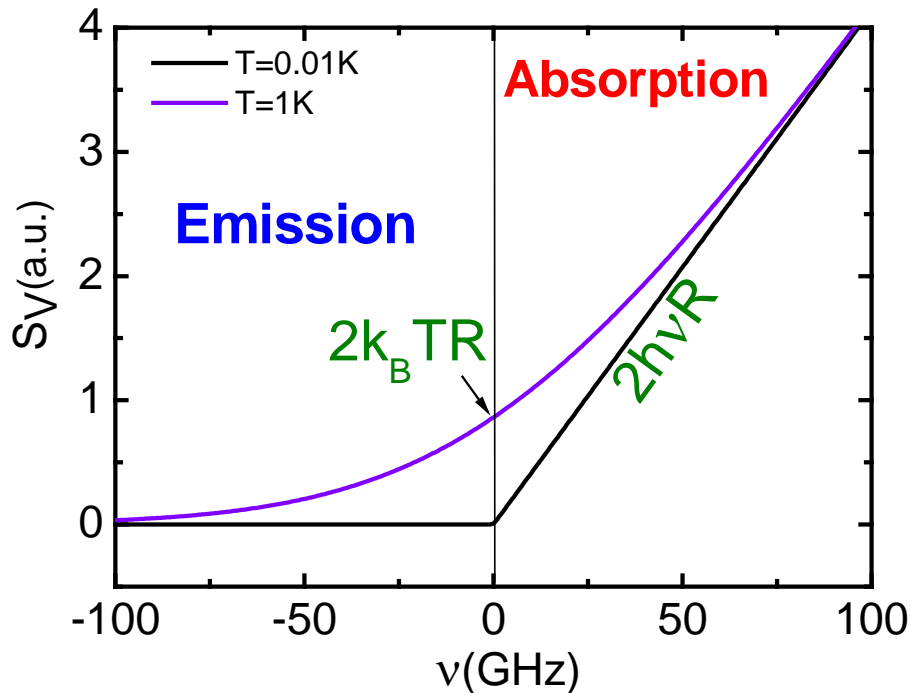

High Frequency ( $h\nu \sim \text{eV}; h\nu \gg k_B T$ )  
(Quantum Noise)

- Noise  $\Leftrightarrow$  Photons (microwave)

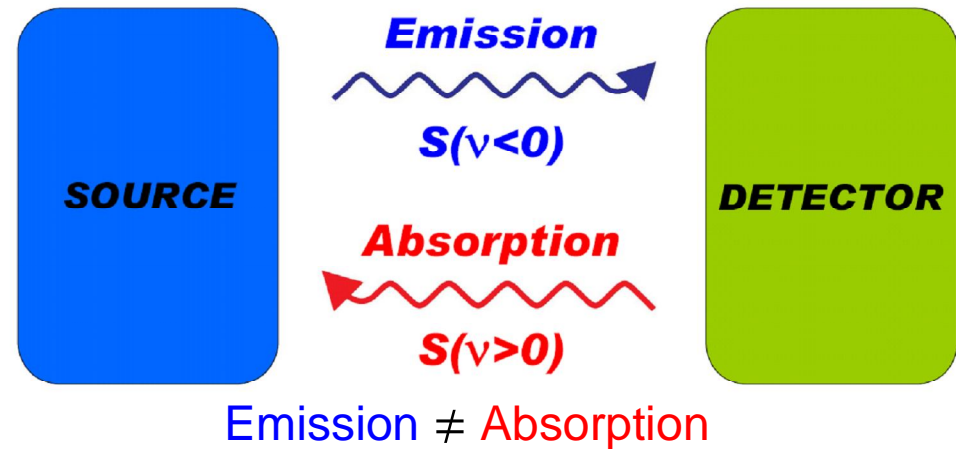

**→ Quantum noise detection scheme needed**

# Detecting noise at high frequency

- HF Electronics
- On-chip Quantum Detectors

SIS junction = Good quantum detector

R.Deblock *et al.* Science (2003),

P.-M. Billangeon *et al.* PRL (2006),...



Capacitive coupling

This thesis :

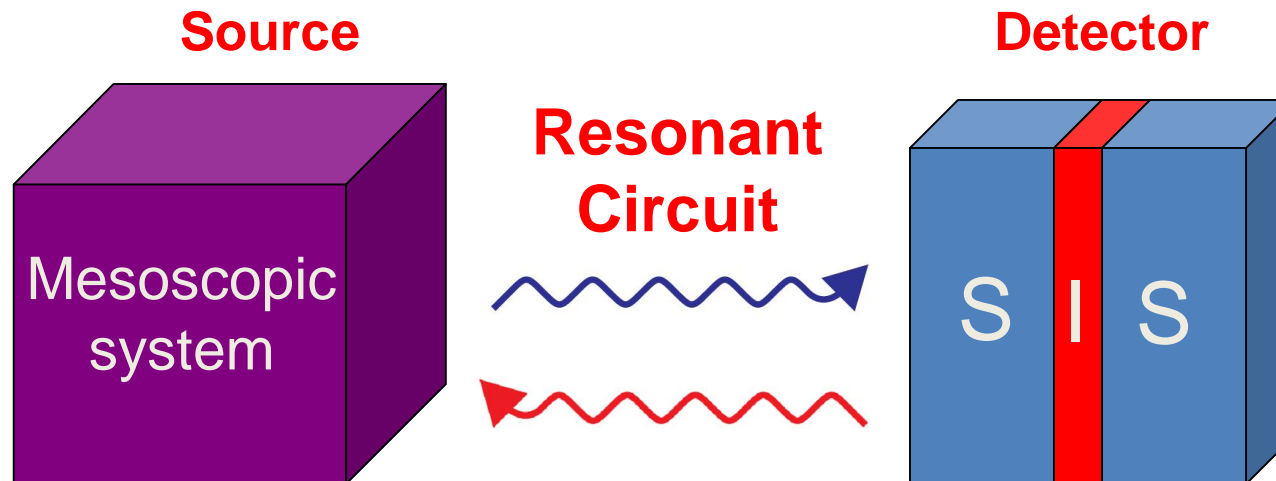

# Outline

## High frequency quantum noise of mesoscopic systems

1. Introduction
2. Principle of the SIS junction as a quantum noise detector
3. Equilibrium Noise of the transmission line resonator
  - Noise asymmetry at very low temperature
4. Out of Equilibrium Emission Noise of a Josephson junction
  - Frequency dependence of quasiparticles shot noise
5. Emission Noise of a carbon nanotube quantum dot in the Kondo regime
  - Signature of Kondo screening dynamics and decoherence
6. Conclusions and perspectives

# SIS Junction as a quantum noise detector

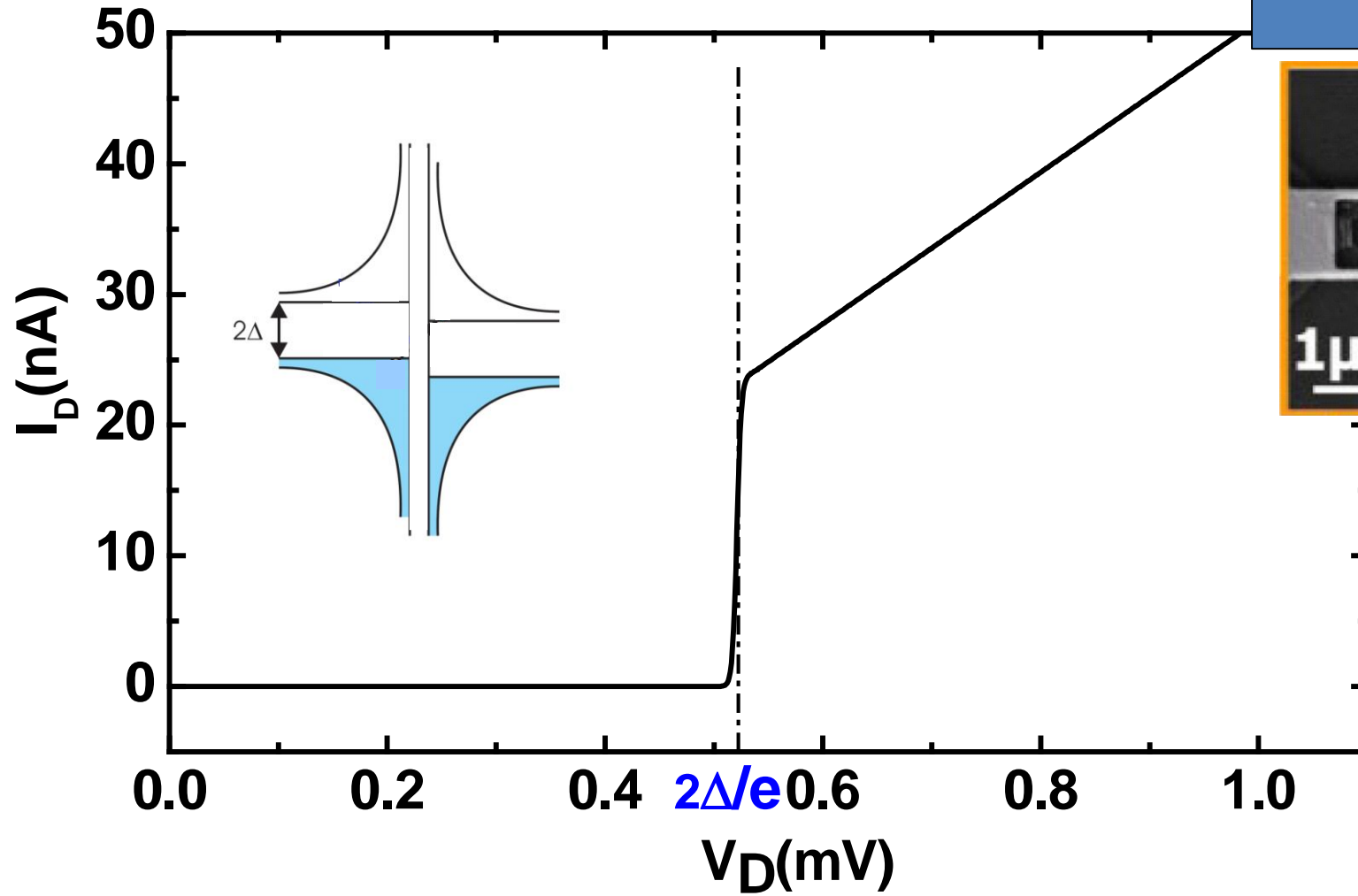
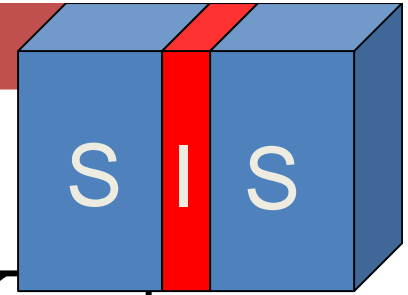

# SIS Junction as a quantum noise detector

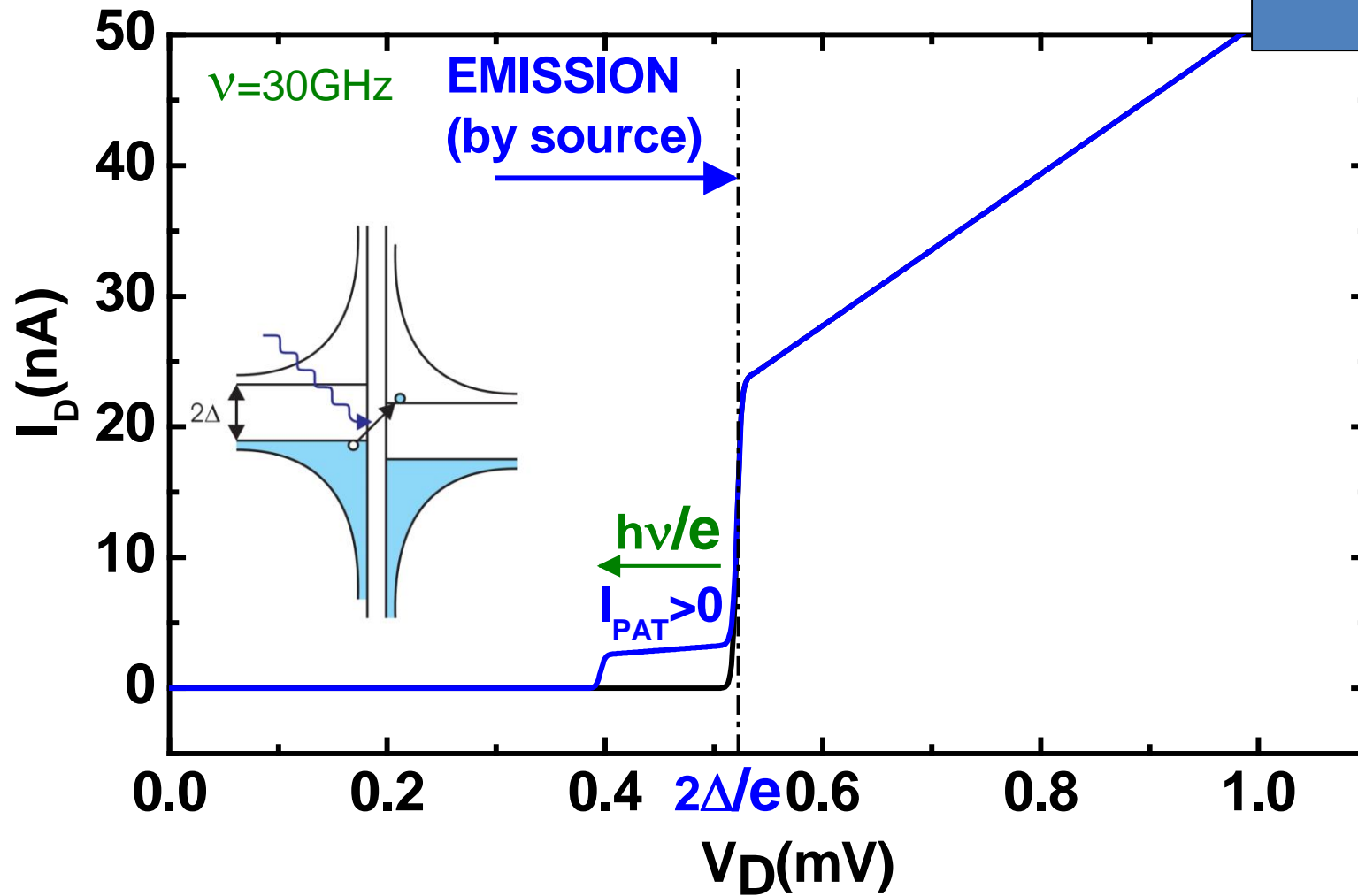
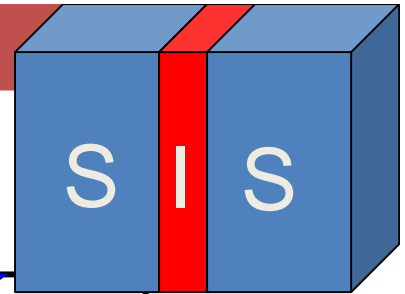

# SIS Junction as a quantum noise detector

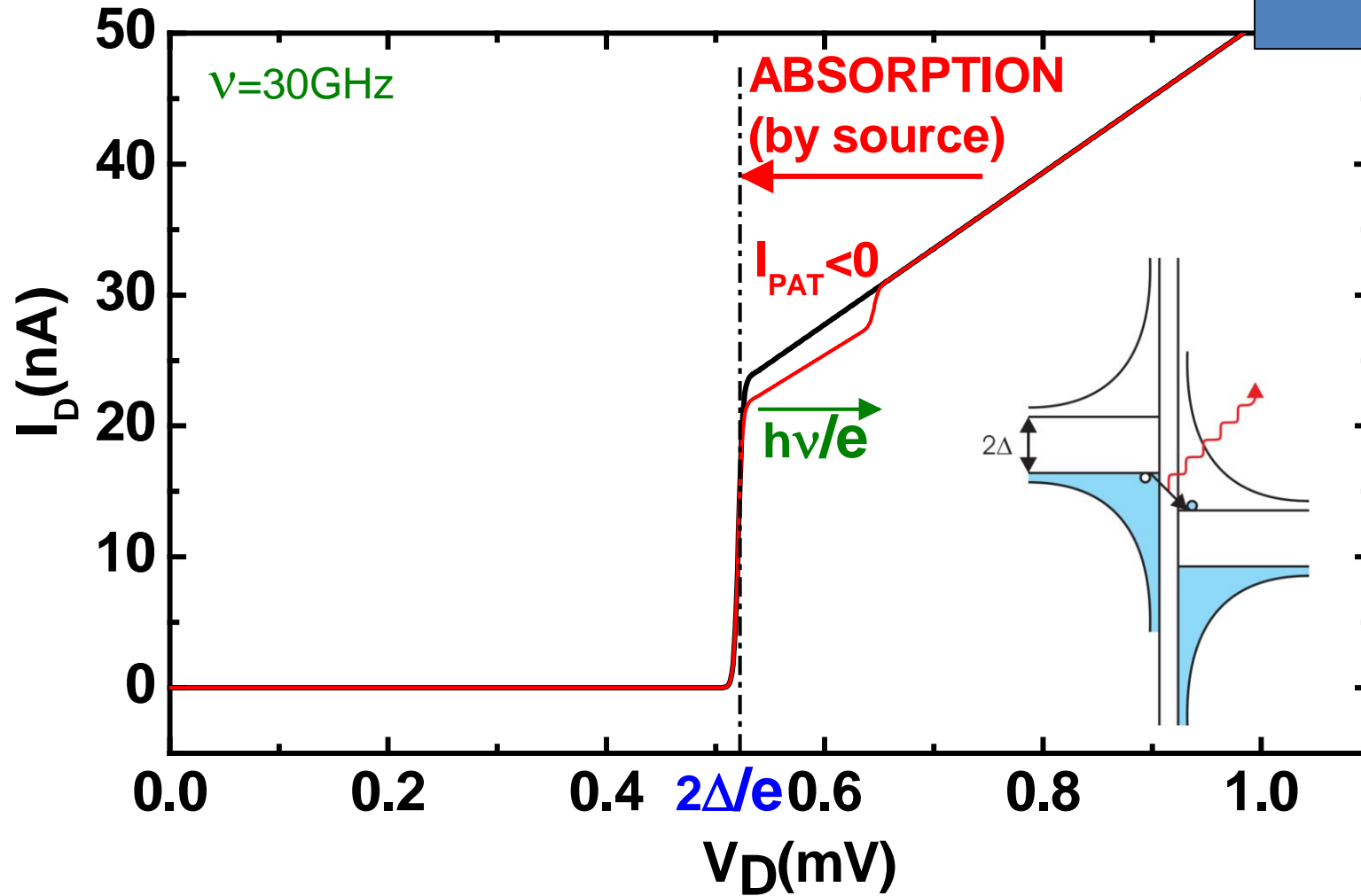
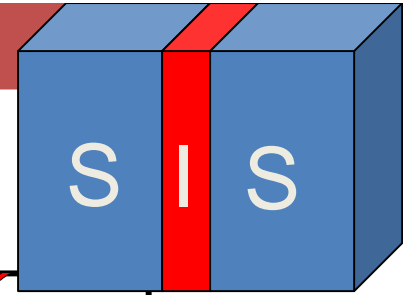



# SIS Junction as a quantum noise detector

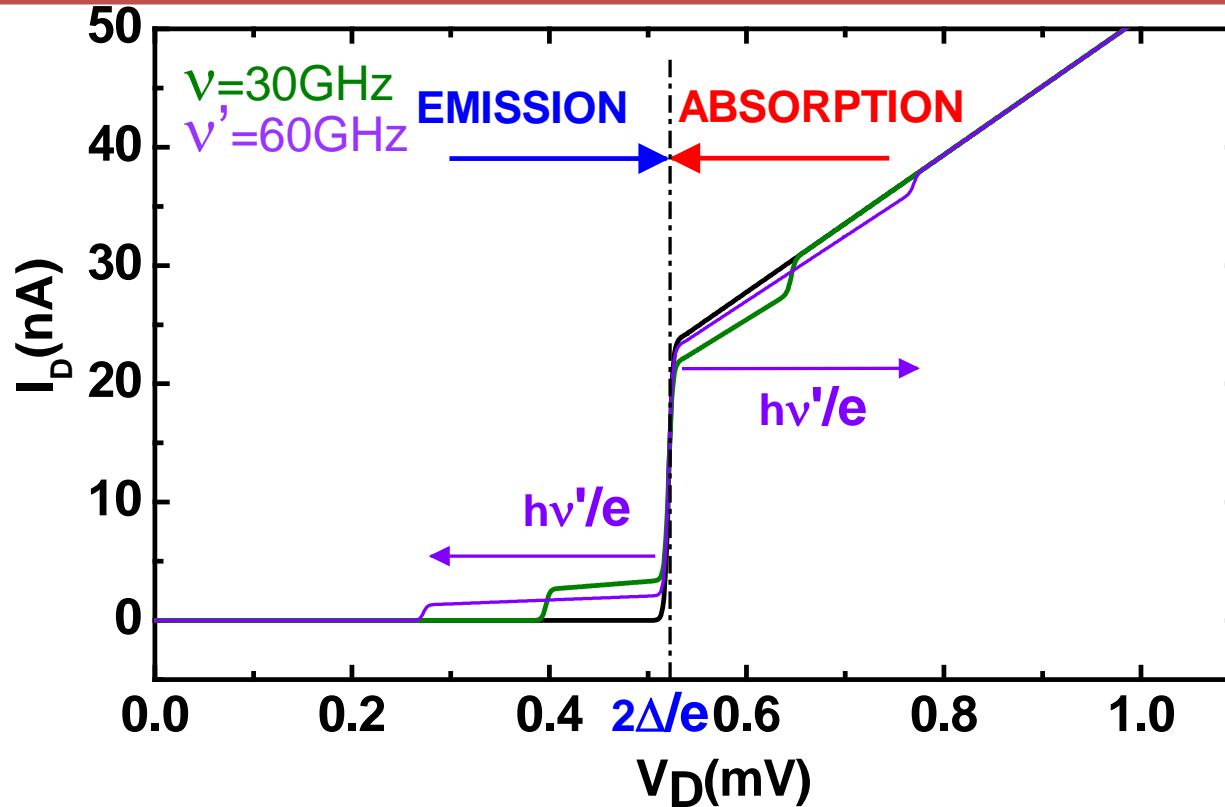

## Photo-assisted tunneling current (PAT)

$$I_{PAT}(V_D) = \int_0^{\infty} d\nu \left(\frac{e}{h\nu}\right)^2 S_V(-\nu) I_{QP,0}\left(V_D + \frac{h\nu}{e}\right) + \int_0^{eV_D/h} d\nu \left(\frac{e}{h\nu}\right)^2 S_V(\nu) I_{QP,0}\left(V_D - \frac{h\nu}{e}\right) - \int_{-\infty}^{+\infty} d\nu \left(\frac{e}{h\nu}\right)^2 S_V(\nu) I_{QP,0}(V_D)$$

# Source/detector coupling through a resonant circuit

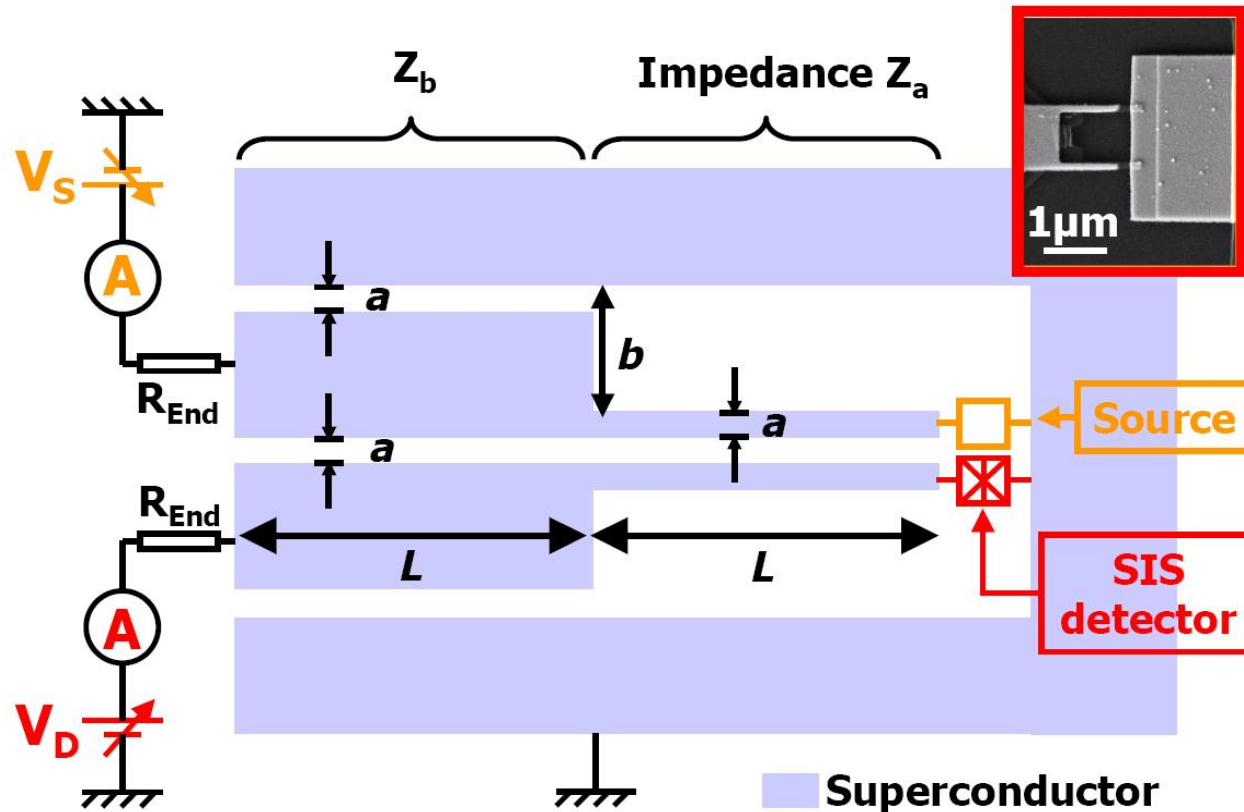

$L=1\text{mm}$   
 $a=5\ \mu\text{m}$   
 $b=100\ \mu\text{m}$

$$L=n\lambda/4$$

$n$  odd integer

- $\frac{1}{4}$  wavelength resonant circuit
- Independent DC polarisations of the source and the detector
- Coupling @ eigen frequencies of the resonator
- Coupling proportional to the quality factor

# Outline

## High frequency quantum noise of mesoscopic systems

1. Introduction
2. Principle of the SIS junction as a quantum noise detector
3. Equilibrium Noise of the transmission line resonator
  - Noise asymmetry at very low temperature
4. Out of Equilibrium Emission Noise of a Josephson junction
  - Frequency dependence of quasiparticles shot noise
5. Emission Noise of a carbon nanotube quantum dot in the Kondo regime
  - Signature of Kondo screening dynamics and decoherence
6. Conclusions and perspectives

# Equilibrium noise of the resonant circuit

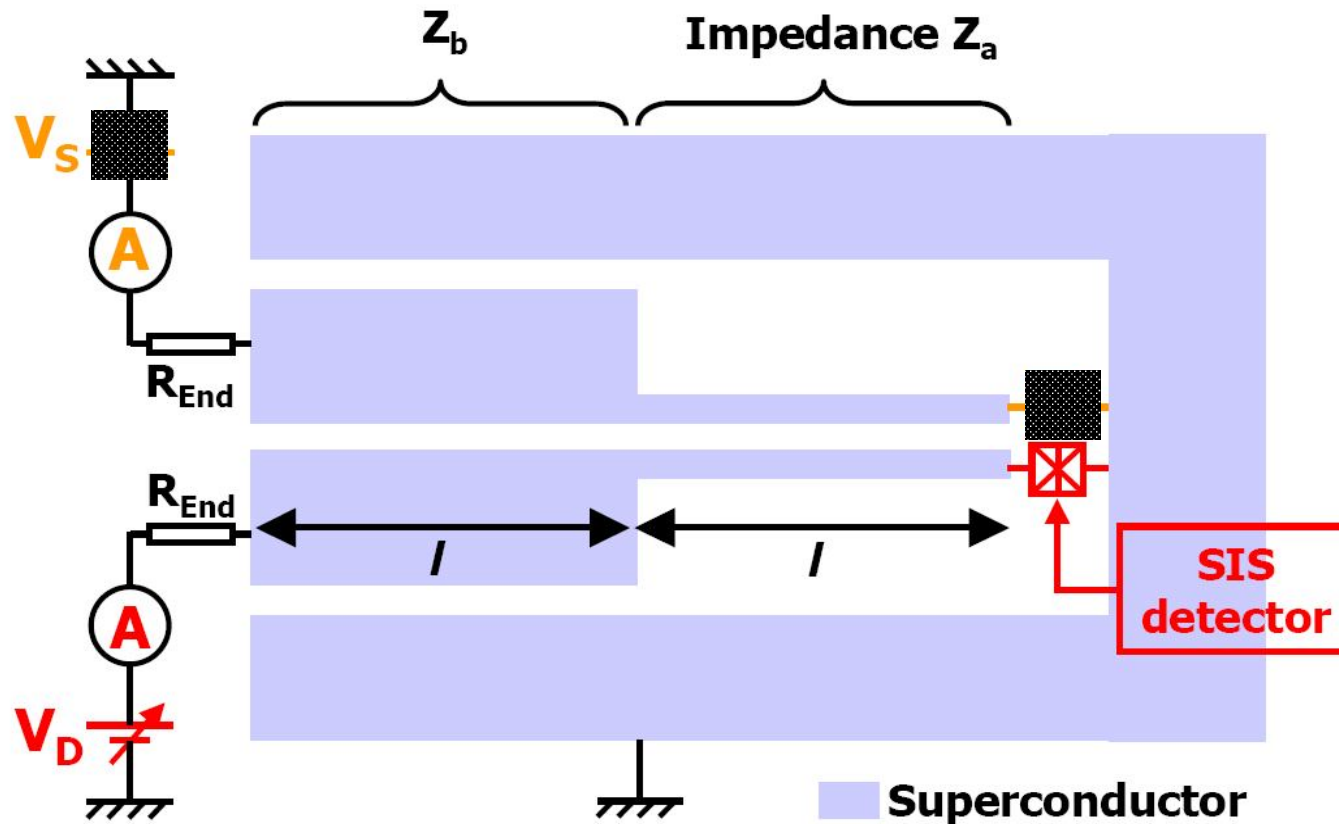

**No source bias**



**Detector only sensitive to Quantum Noise of the resonator at equilibrium**

# Signal associated to the resonant circuit Voltage Noise

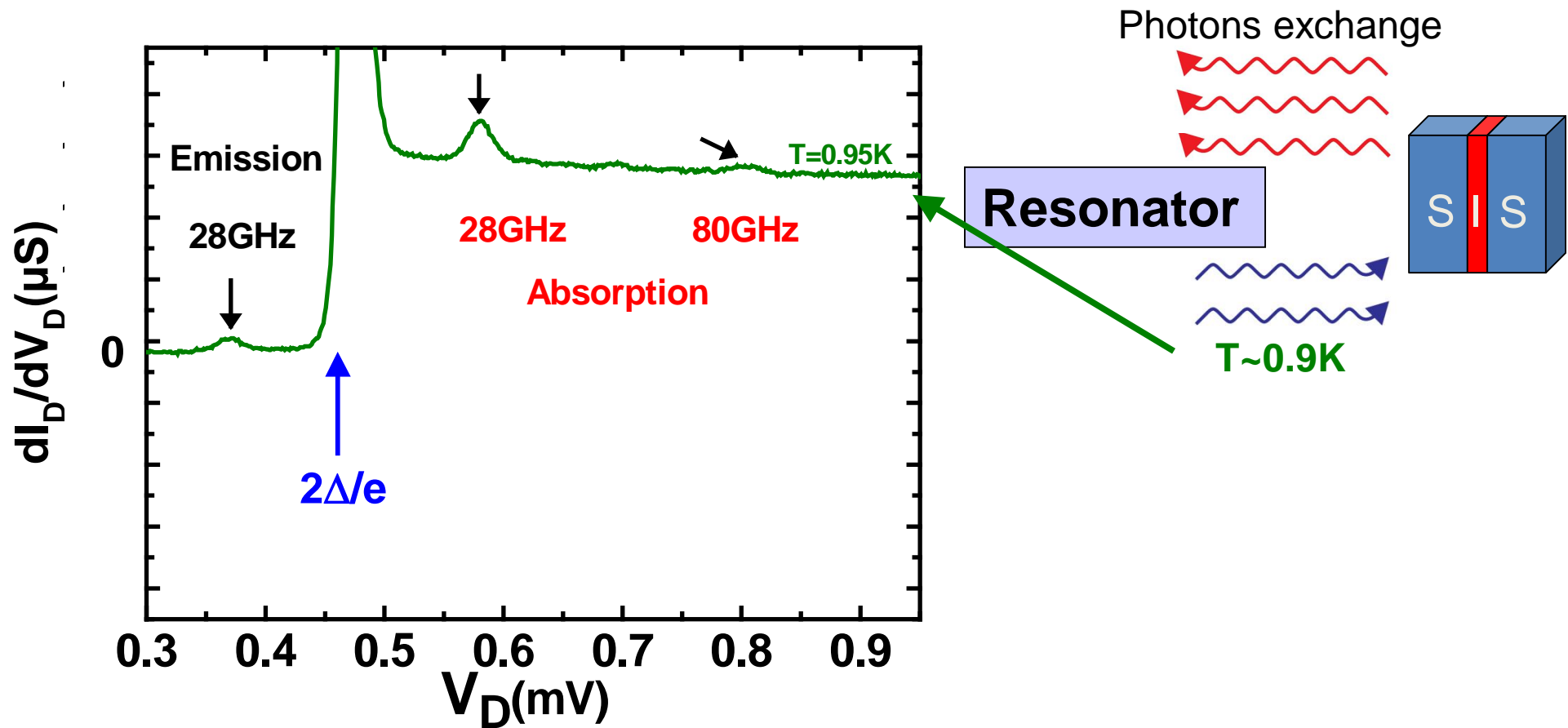

# Signal associated to the resonant circuit Voltage Noise

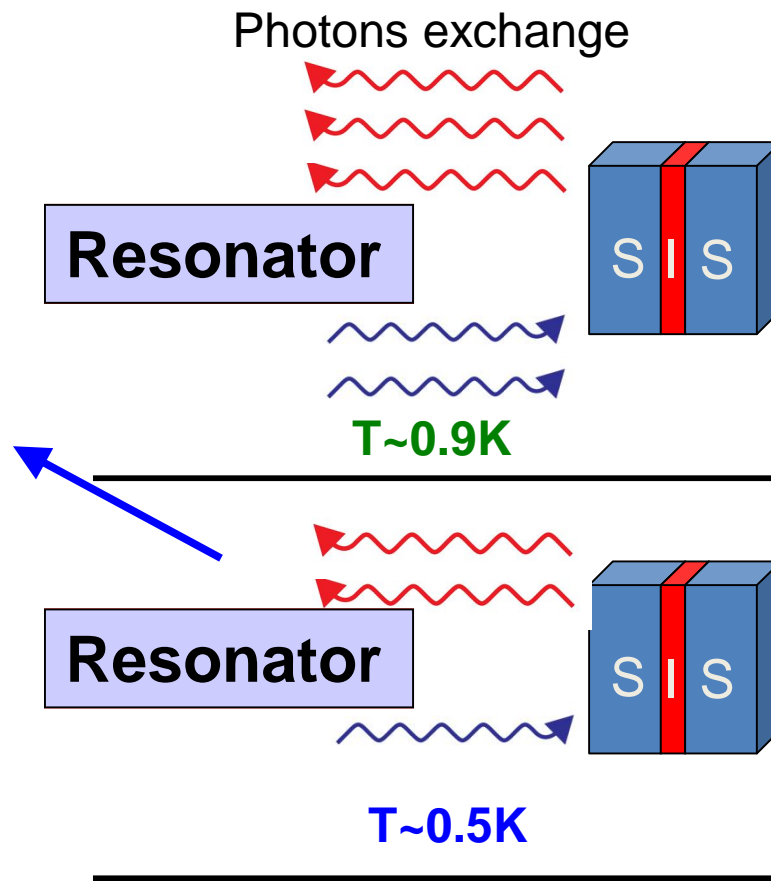
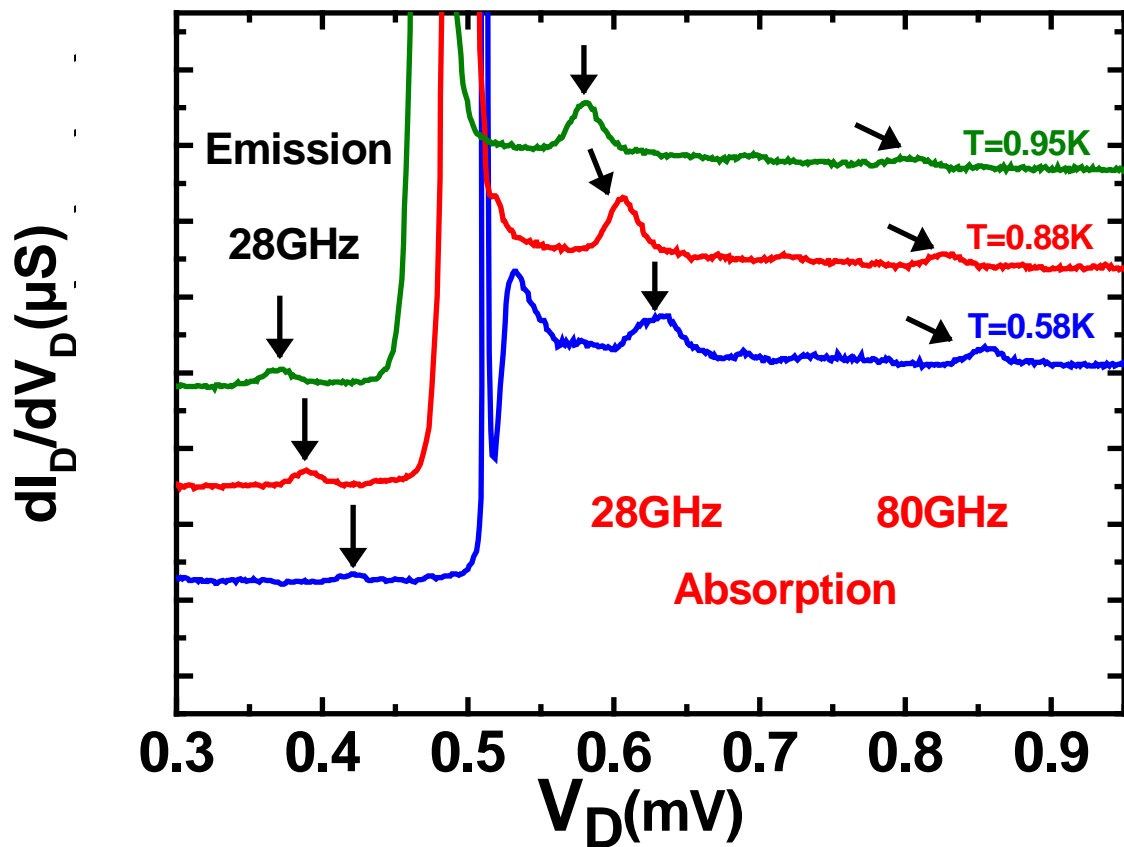

# Signal associated to the resonant circuit Voltage Noise

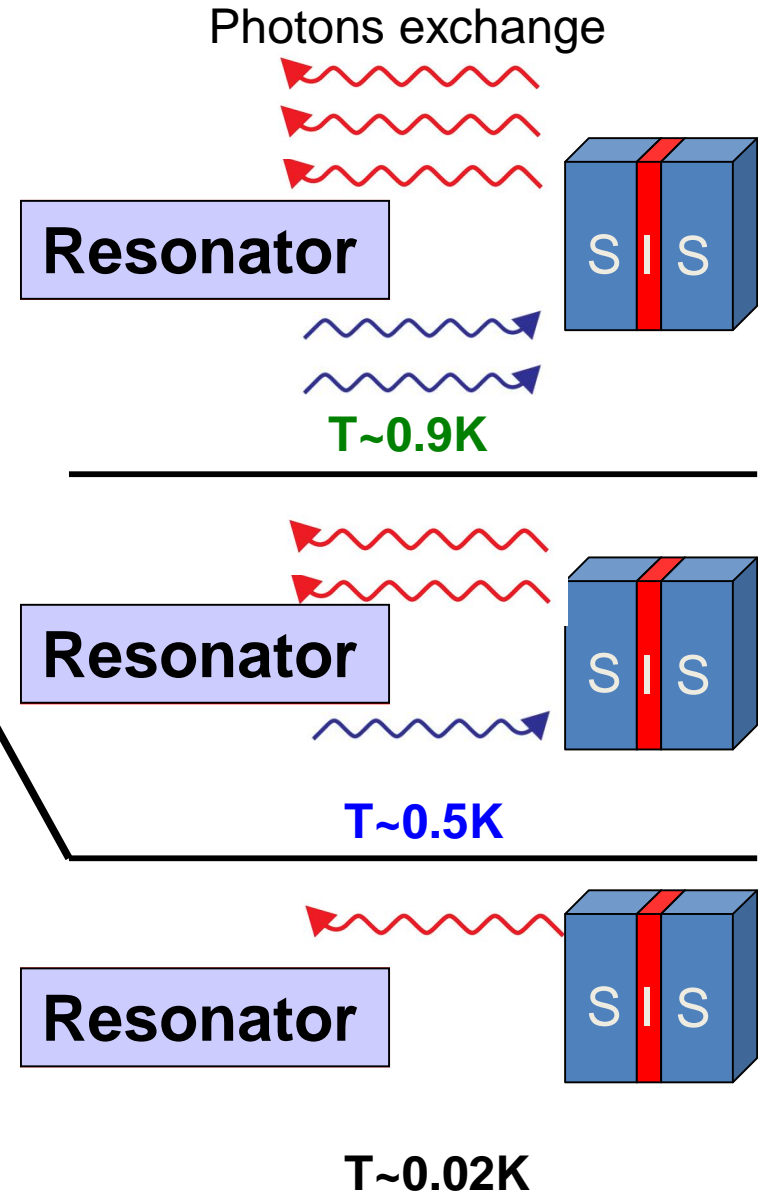
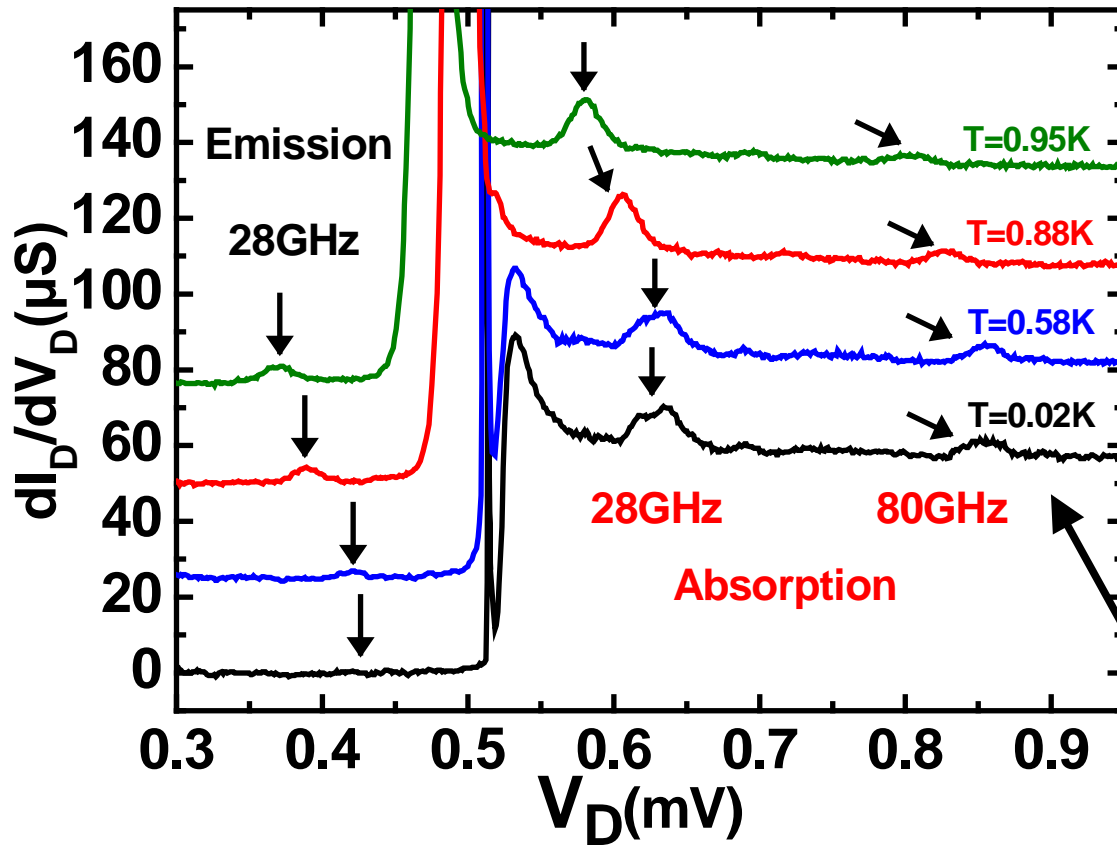

# Signal associated to the resonant circuit Voltage Noise

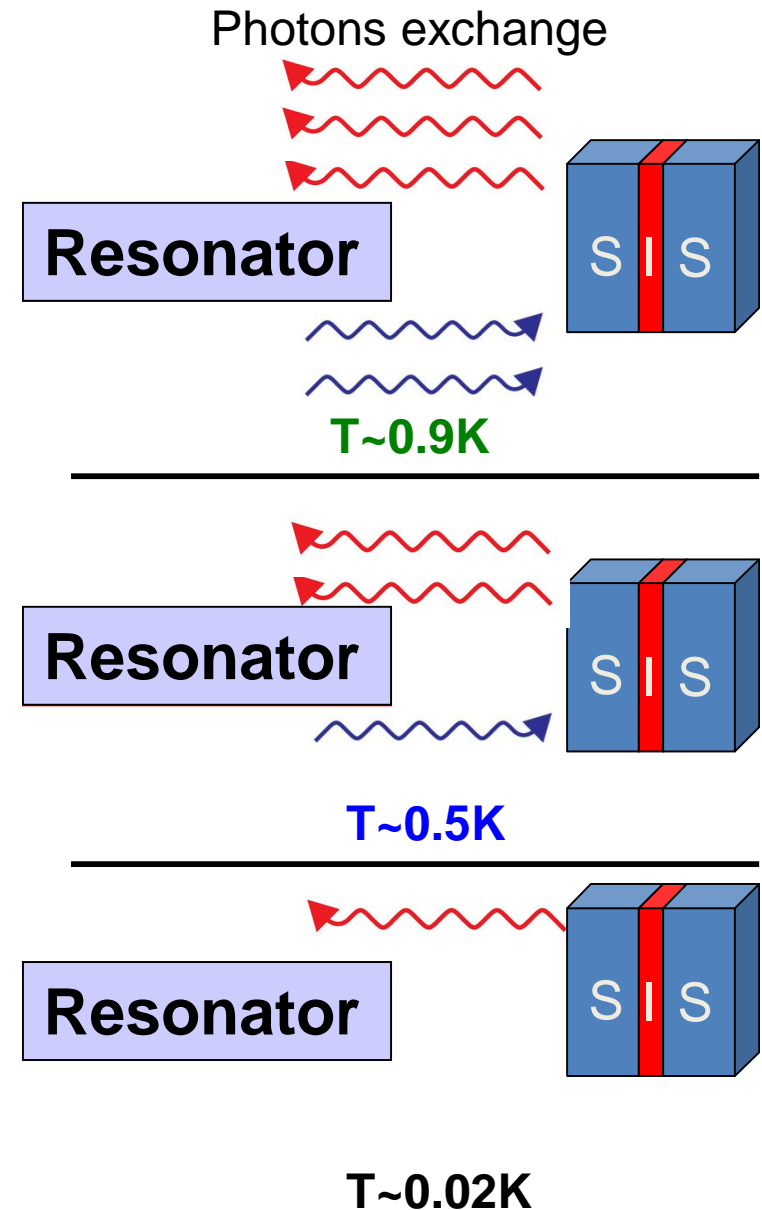
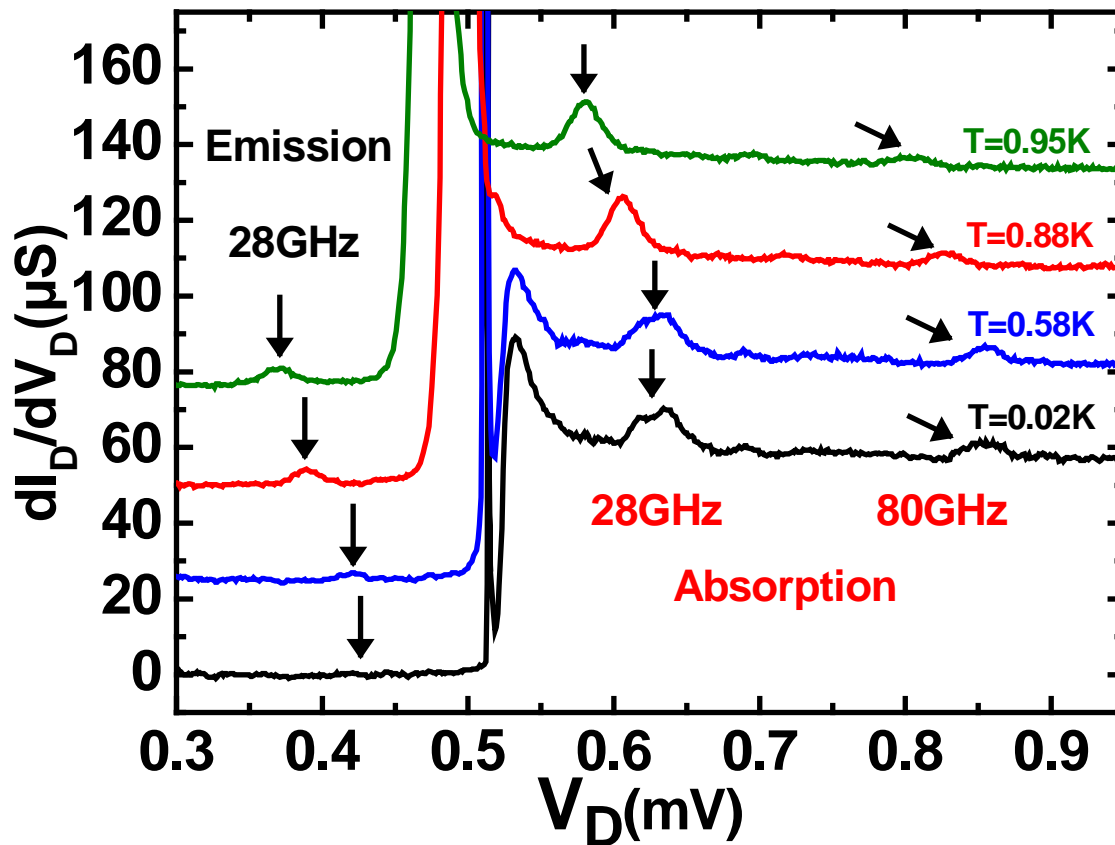

- $T=0$  (Zero Point fluctuations)  
 → **No Emission** noise but **Absorption**
- $T$  increases  
 → **Emission appears & Absorption increases**



# Asymmetry of quantum noise

dIdV integration

→  $I_{PAT}$   
 →  $S_V$

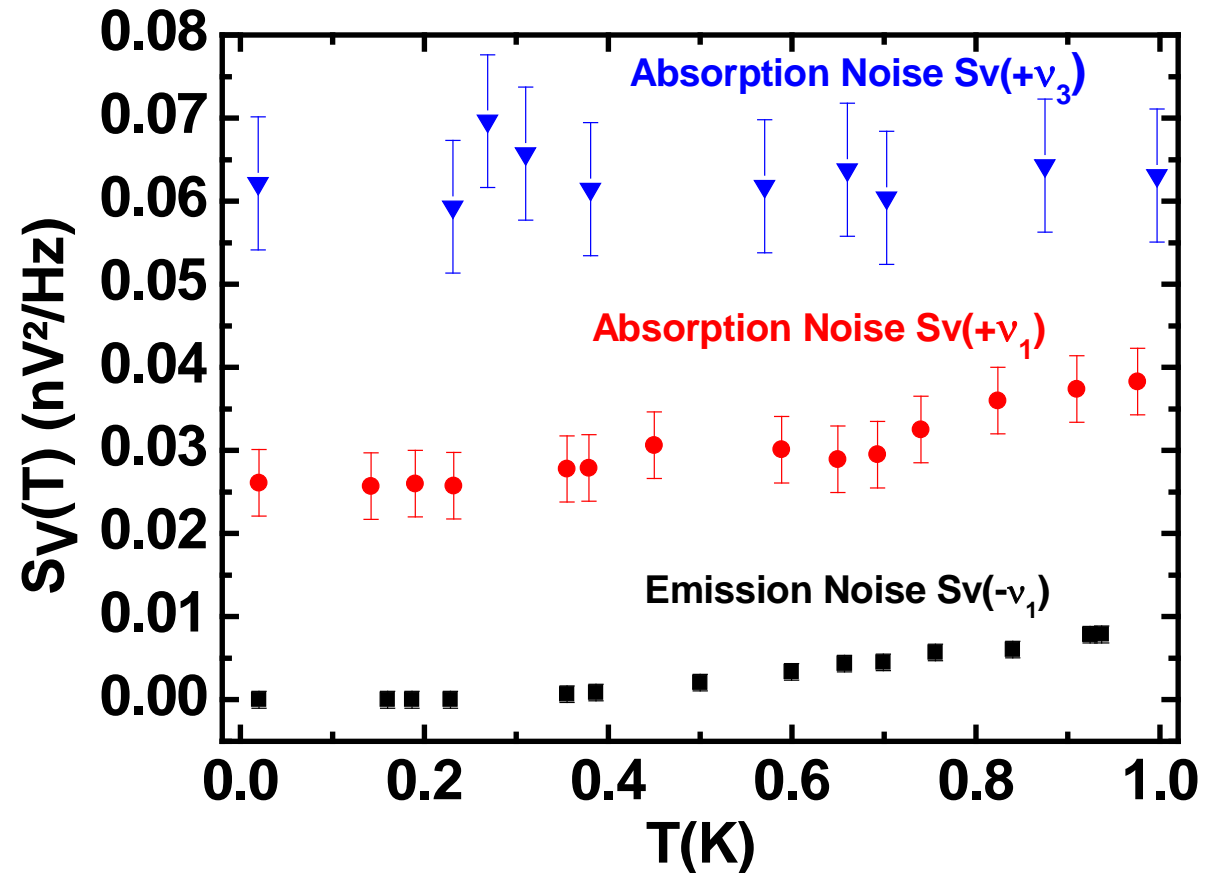

Comparison with fluctuation-dissipation theorem:

$$S_V(\nu, T) = \frac{2 \text{Re}[Z(\nu)] h \nu}{1 - \exp(-h \nu / k_B T)}$$

Calibration needed

# Resonant circuit calibration : $\text{Re}[Z(\nu)]$ extraction

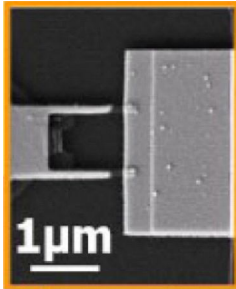

Maximized Josephson energy

→ IV modification due to eigen modes excitation

$$I(V) = \frac{I_C^2}{2} \frac{\text{Re}[Z(2eV/h)]}{V}$$

Holst *et al.* PRL (1994)

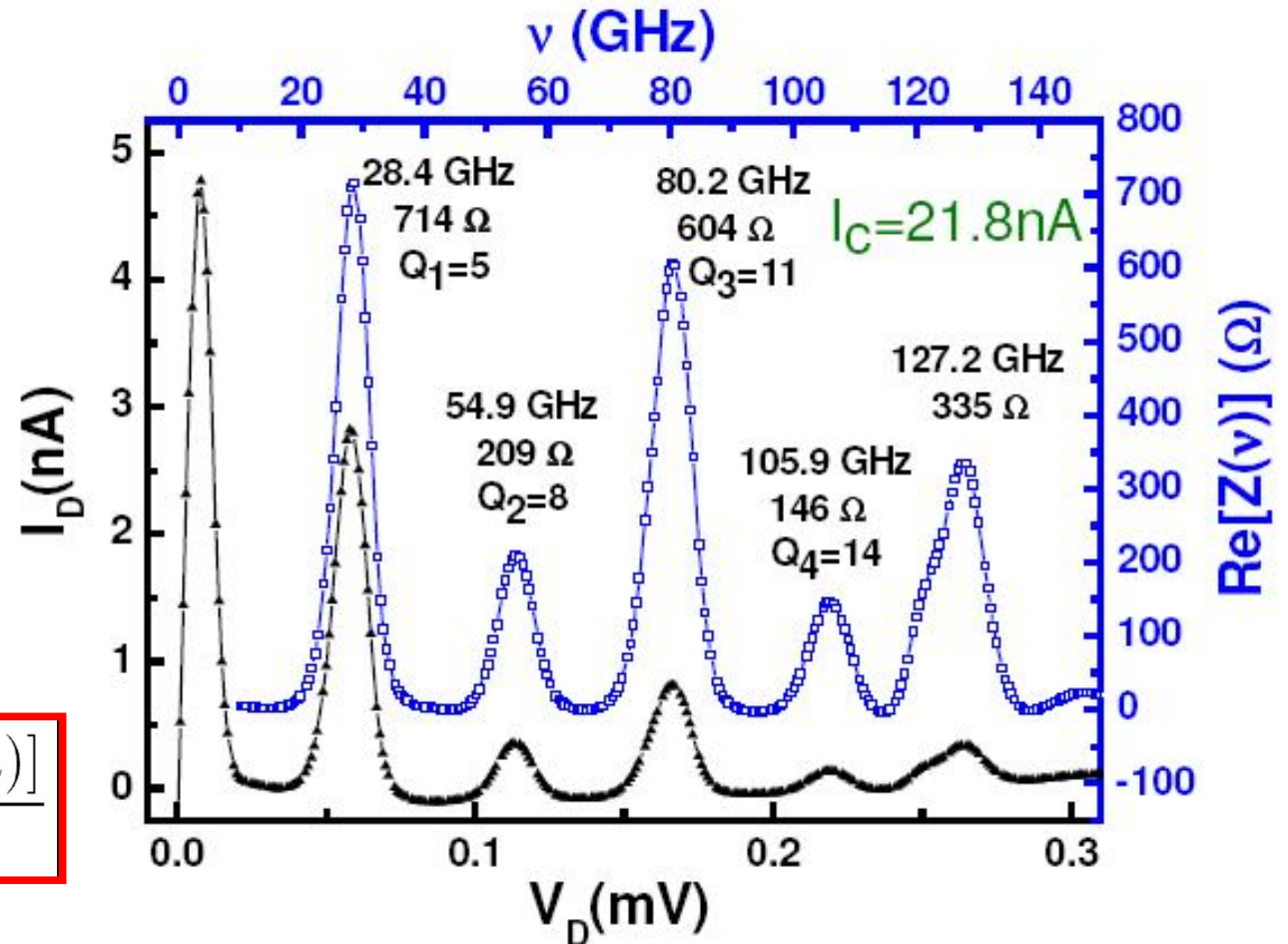

- **Low** quality factor due to direct connection
- **Even peaks** due to finite value of impedance mismatch
- **Anharmonicity** 28 GHz, 80 GHz,... due to  $C_{\text{geo}}$  of the junction

# Fluctuation-dissipation theorem

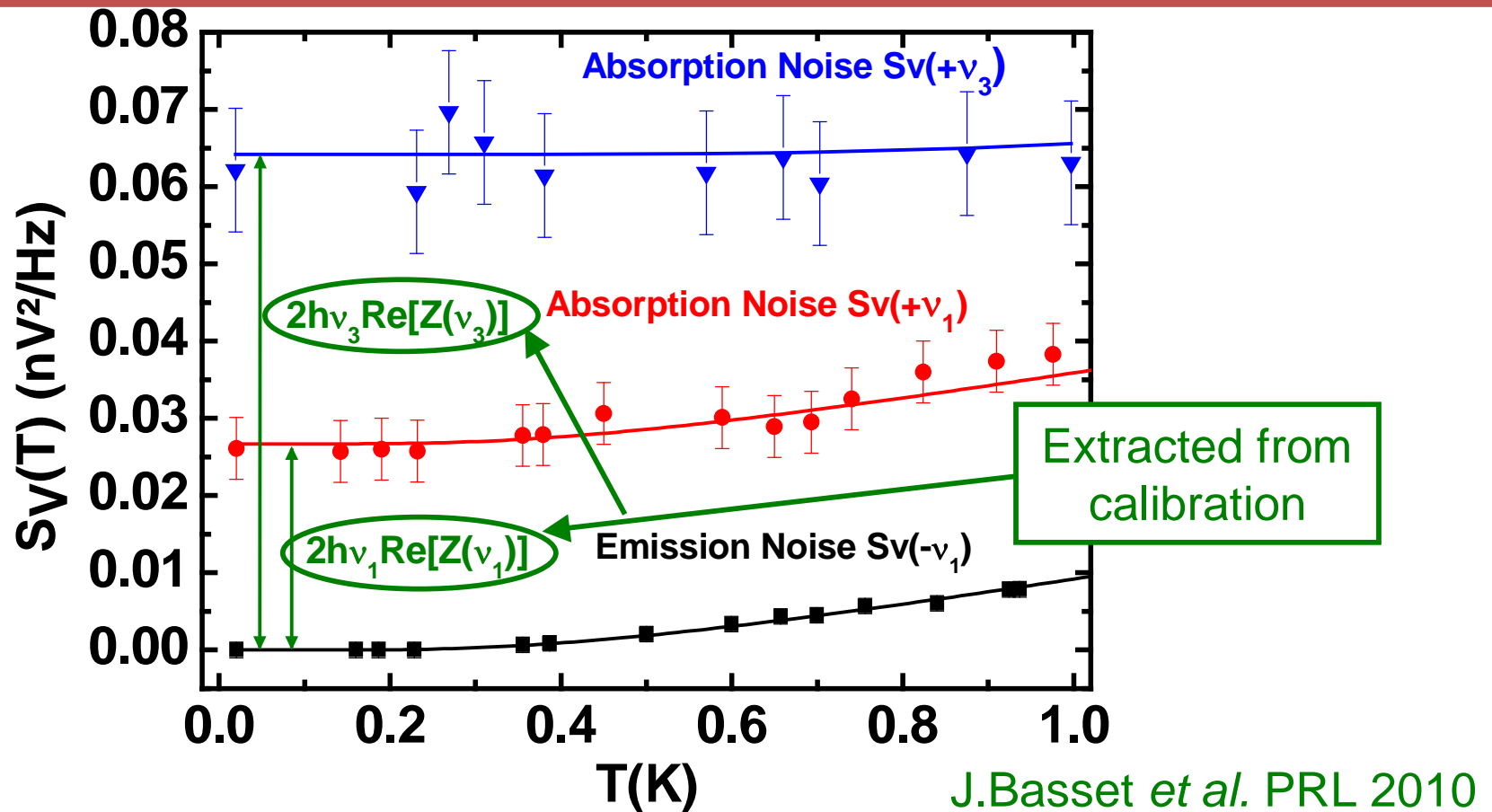

- $T=0$  (Zero Point fluctuations) : **No Emission** noise but **Absorption**
- $T$  increases: **Emission appears** & **Absorption increases** (Crossover from quantum to thermal noise)

# Outline

## High frequency quantum noise of mesoscopic systems

1. Introduction
2. Principle of the SIS junction as a quantum noise detector
3. Equilibrium Noise of the transmission line resonator
  - Noise asymmetry at very low temperature
4. Out of Equilibrium Emission Noise of a Josephson junction
  - Frequency dependence of quasiparticles shot noise
5. Emission Noise of a carbon nanotube quantum dot in the Kondo regime
  - Signature of Kondo screening dynamics and decoherence
6. Conclusions and perspectives

# Source and detector coupled via the resonant circuit

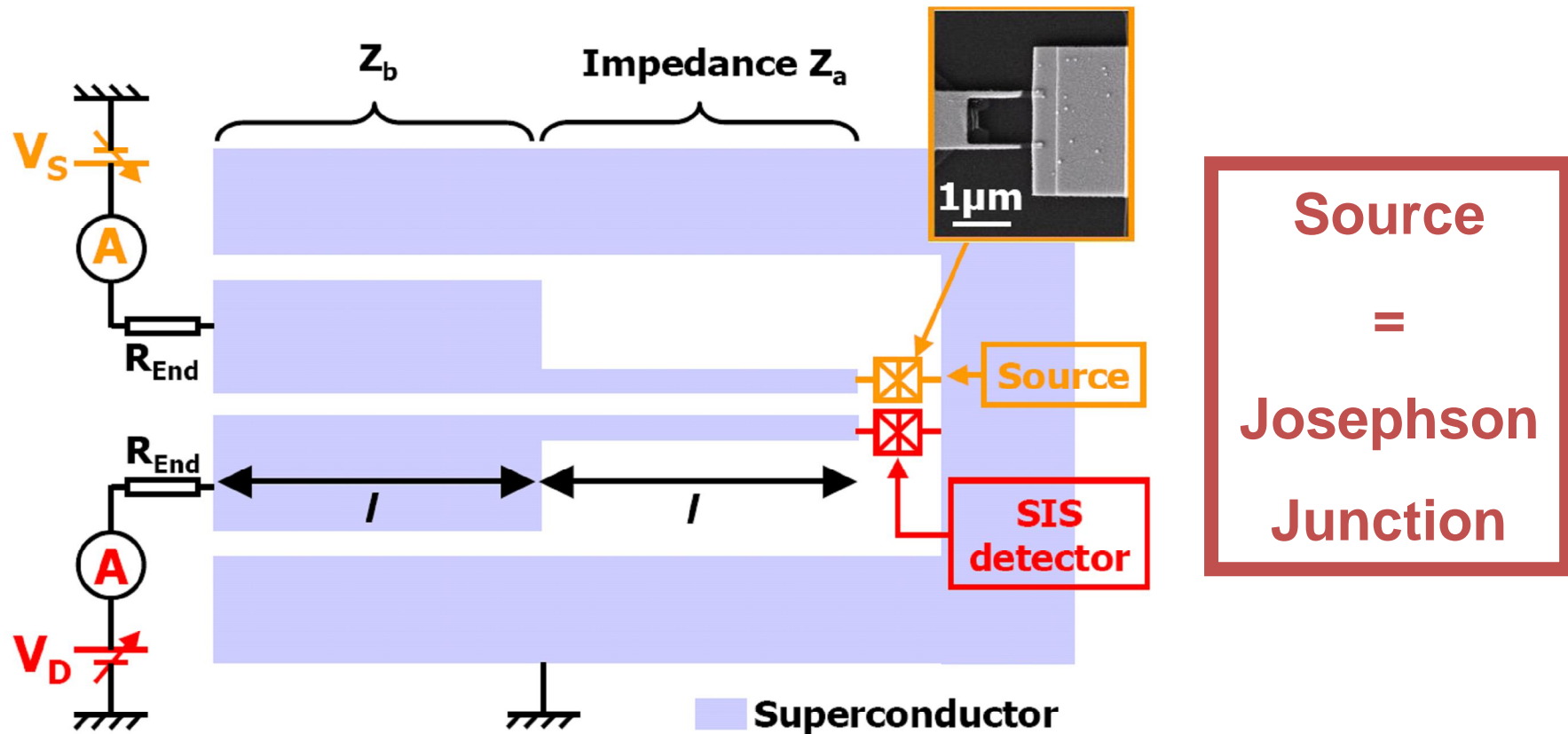

- Independent **DC polarisations** of the source and the detector
- **Coupling @ eigen** frequencies of the resonator
- **Coupling** proportional to the **transimpedance  $Z_t(v)$**

# Coupling calibration using AC Josephson effect

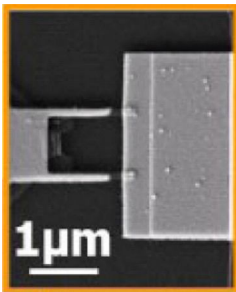
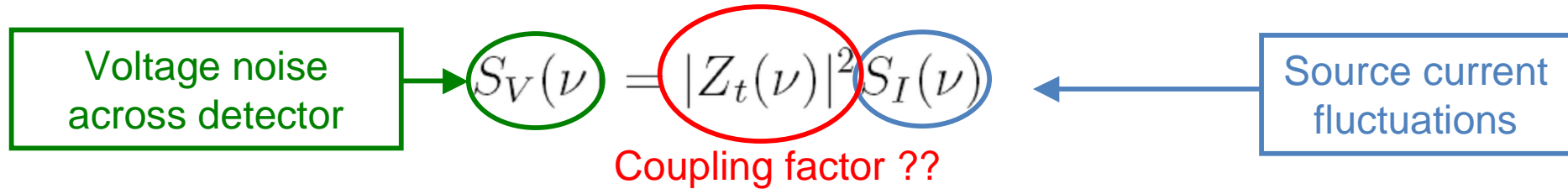

Maximize source Josephson current + detector in emission sensitive region

$$\rightarrow I_{PAT} \propto |Z_t(\nu)|^2$$

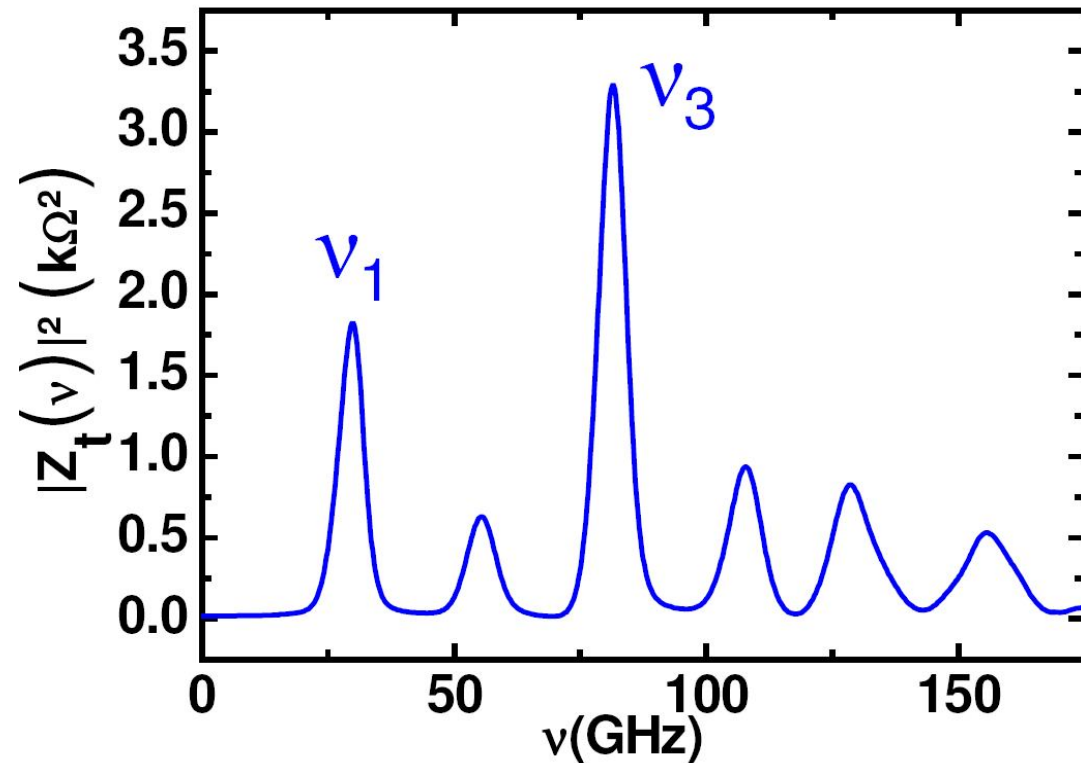

- Peaks at the same frequencies as  $\text{Re}[Z]$
- Sensitivity proportional to the quality factor

# PAT current associated to the tunneling of quasiparticles

T=20mK

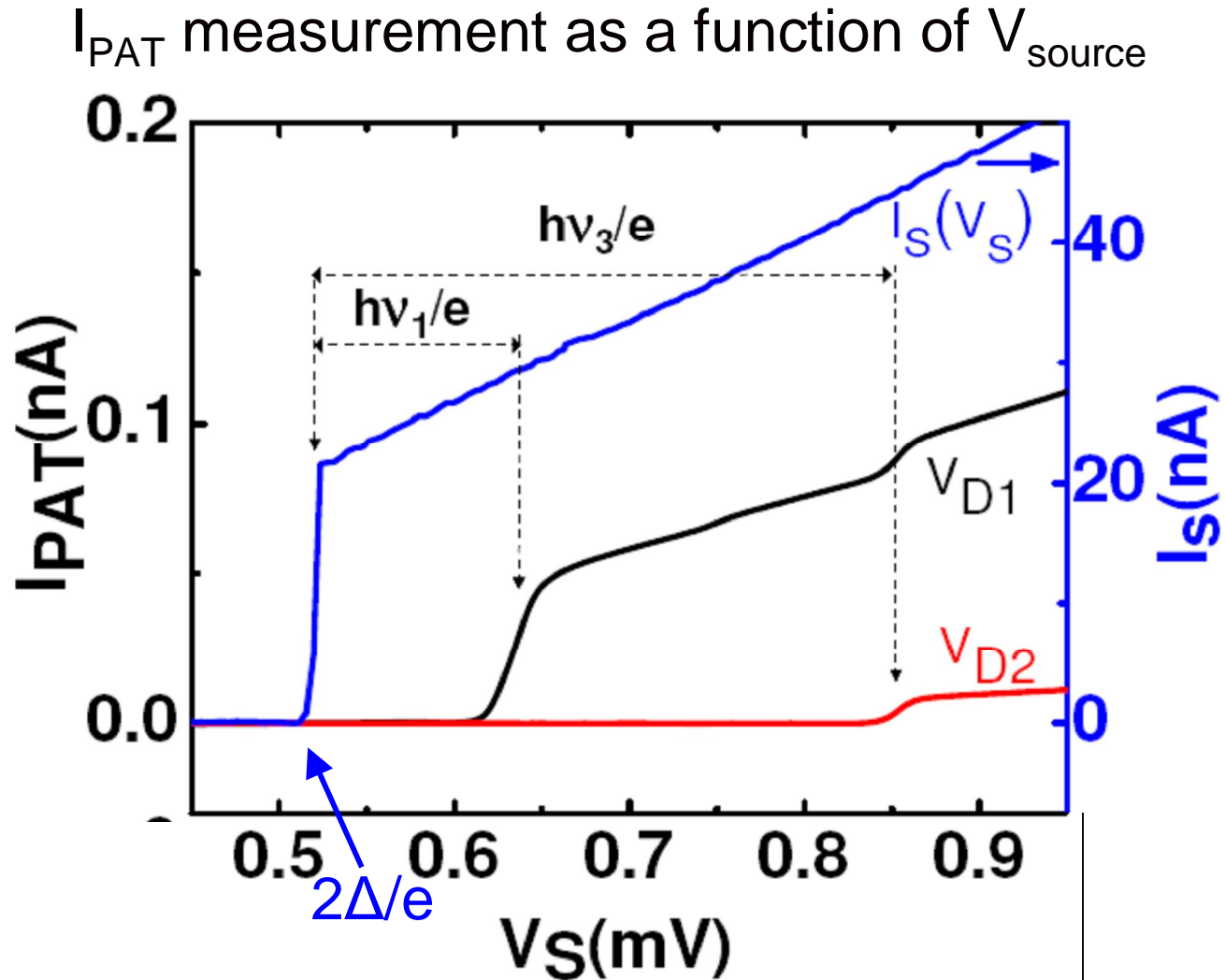

$V_{D1} \rightarrow$  sensitive to noise @  $\nu_1$  &  $\nu_3$   $V_{D2} \rightarrow$  sensitive to noise @  $\nu_3$

# Finite frequency emission shot noise of a Josephson junction

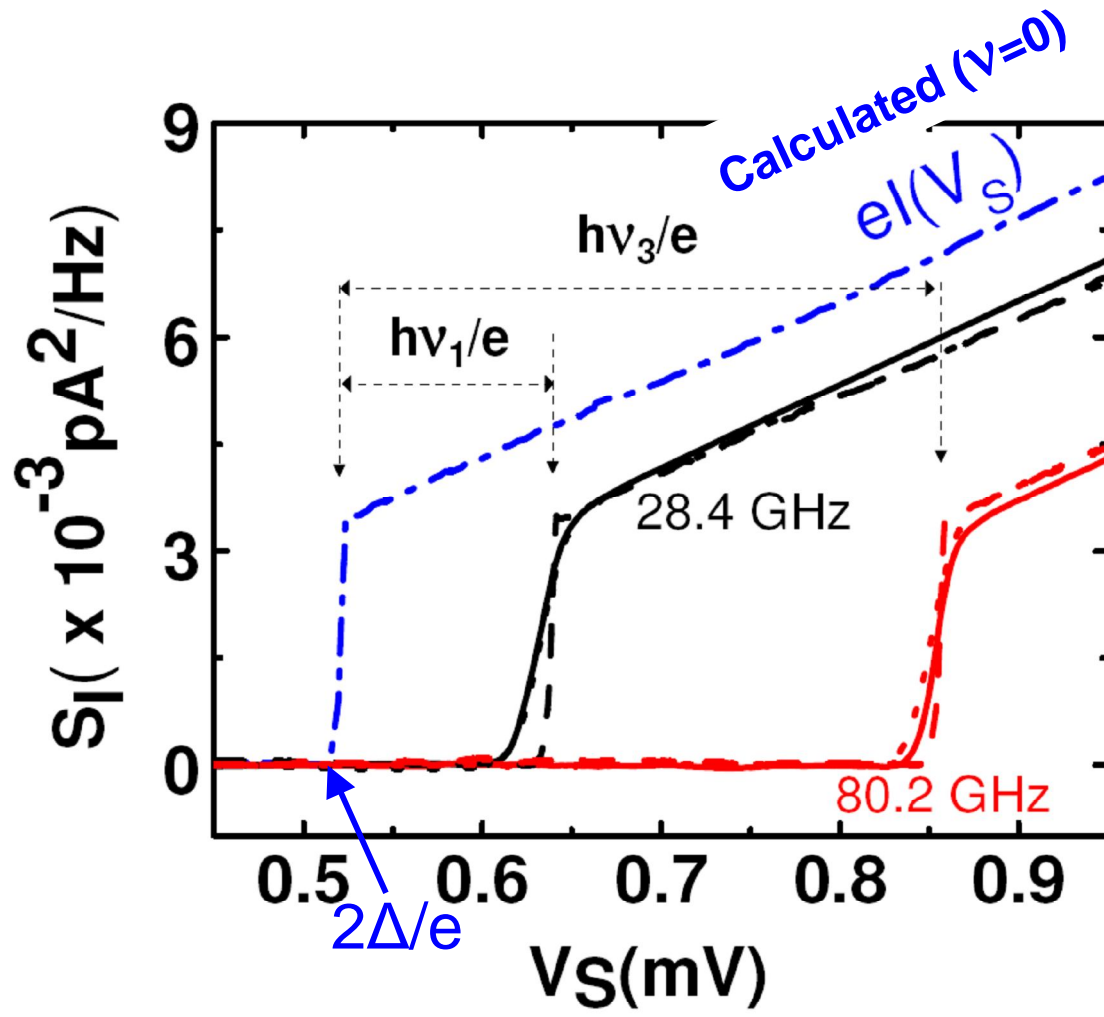

SIS junction emitting a photon  $h\nu = eV - 2\Delta$

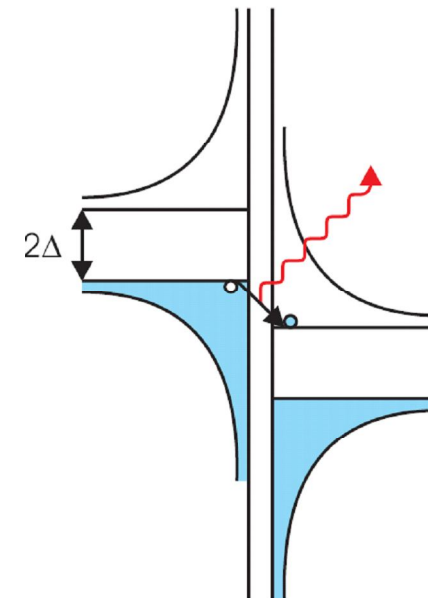

- - - Theory at  $\nu$

..... Theory at  $\nu$  & finite bandwidth

**Strong current** but **No emission noise** as long as  $eV < 2\Delta + h\nu_i$



# Outline

## High frequency quantum noise of mesoscopic systems

1. Introduction
2. Principle of the SIS junction as a quantum noise detector
3. Equilibrium Noise of the transmission line resonator
  - Noise asymmetry at very low temperature
4. Out of Equilibrium Emission Noise of a Josephson junction
  - Frequency dependence of quasiparticles shot noise
5. Emission Noise of a carbon nanotube quantum dot in the Kondo regime
  - Signature of Kondo screening dynamics and decoherence
6. Conclusions and perspectives

# Kondo effect and mesoscopic physics

- Kondo effect in **bulk materials** (dilute magnetic alloys)

→ **Screening of localized magnetic moments** by conduction electrons

→ Model system to study **electronic correlations**

Resistance increase in bulk materials ( $T < T_K$ )

Many-body problem

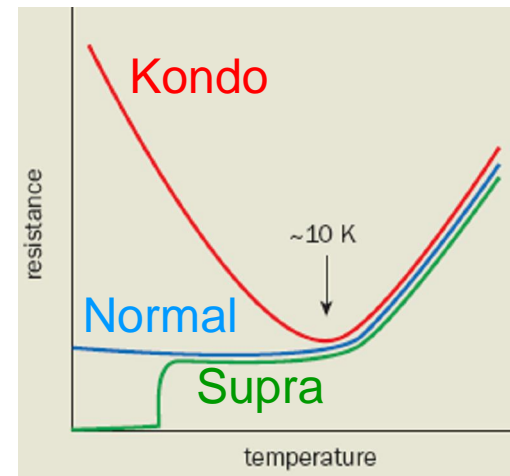
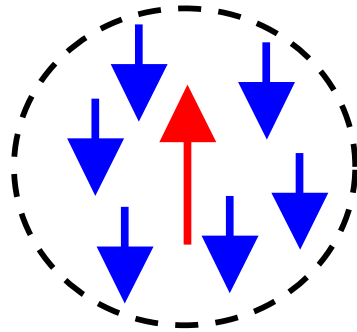

# Kondo effect and mesoscopic physics

- Kondo effect in **bulk materials** (dilute magnetic alloys)
  - **Screening of localized magnetic moments** by conduction electrons
  - Model system to study **electronic correlations**

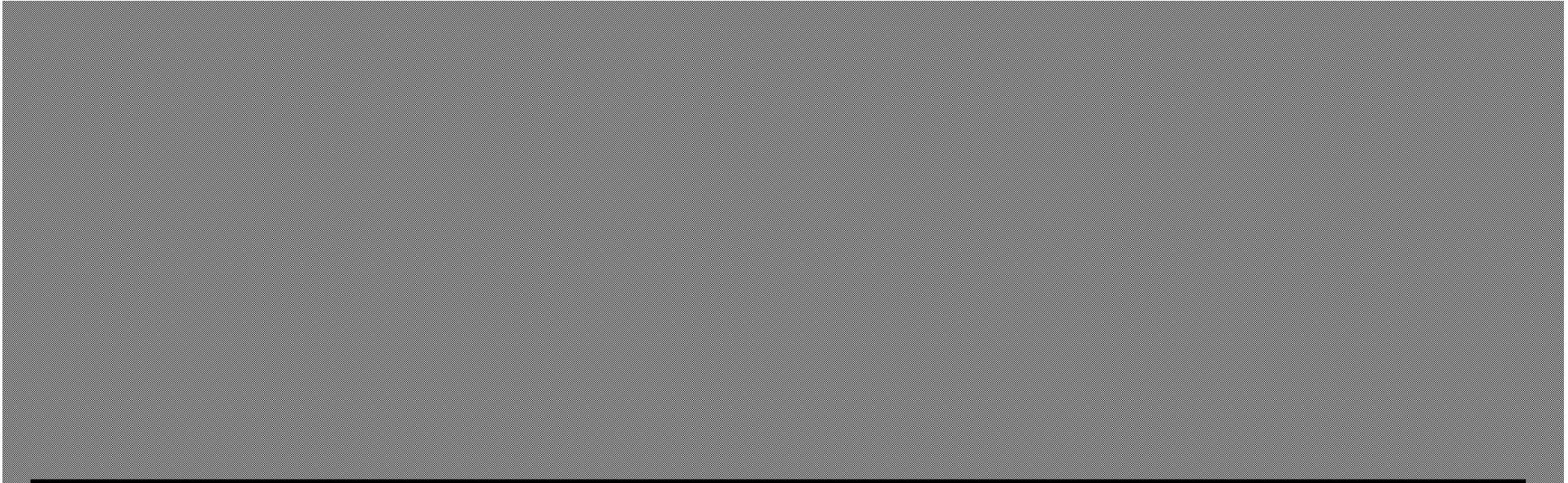

- In **nanophysics**
  - Kondo effect at a **single spin level** and in **out-of-equilibrium** situations
  - **In-situ control** of many parameters (voltage bias, dot's occupation,  $T_K$ )

# Kondo effect in quantum dots

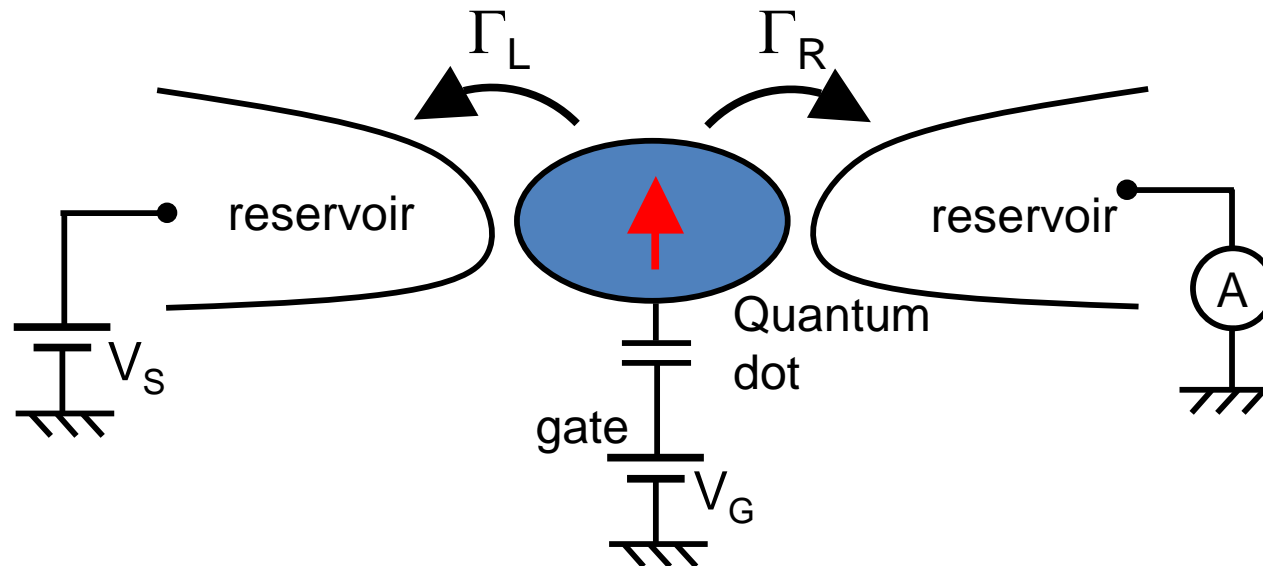

$U$  : charging energy;  $\varepsilon_0$ : energy level;  $\Gamma = \Gamma_L + \Gamma_R$  : coupling to the reservoirs

**Kondo effect : dynamical screening of the dot's spin**

Under specific conditions:

- **Odd number of electrons** in the dot
- **Intermediate transparency** of the contacts
- Temperature **below** Kondo temperature  $T_K$

# Kondo resonance in quantum dots

$$H_{\text{eff}} = J_{\text{eff}} \sigma \cdot S \quad \text{with } J_{\text{eff}} = \Gamma/v U \quad v: \text{DOS}$$

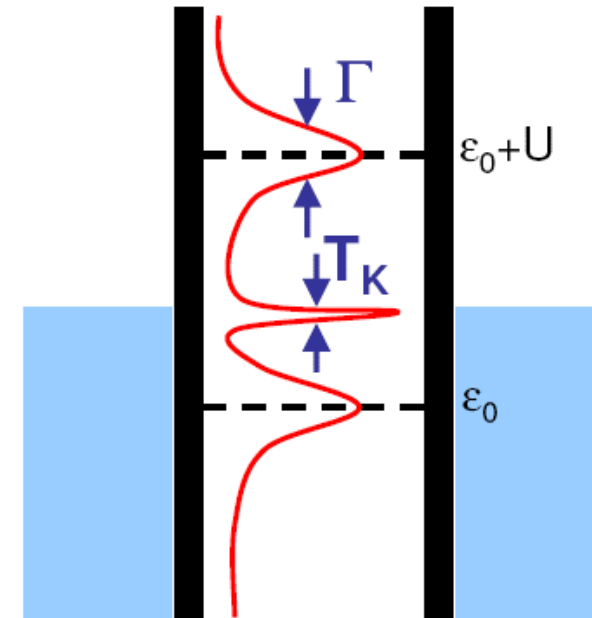
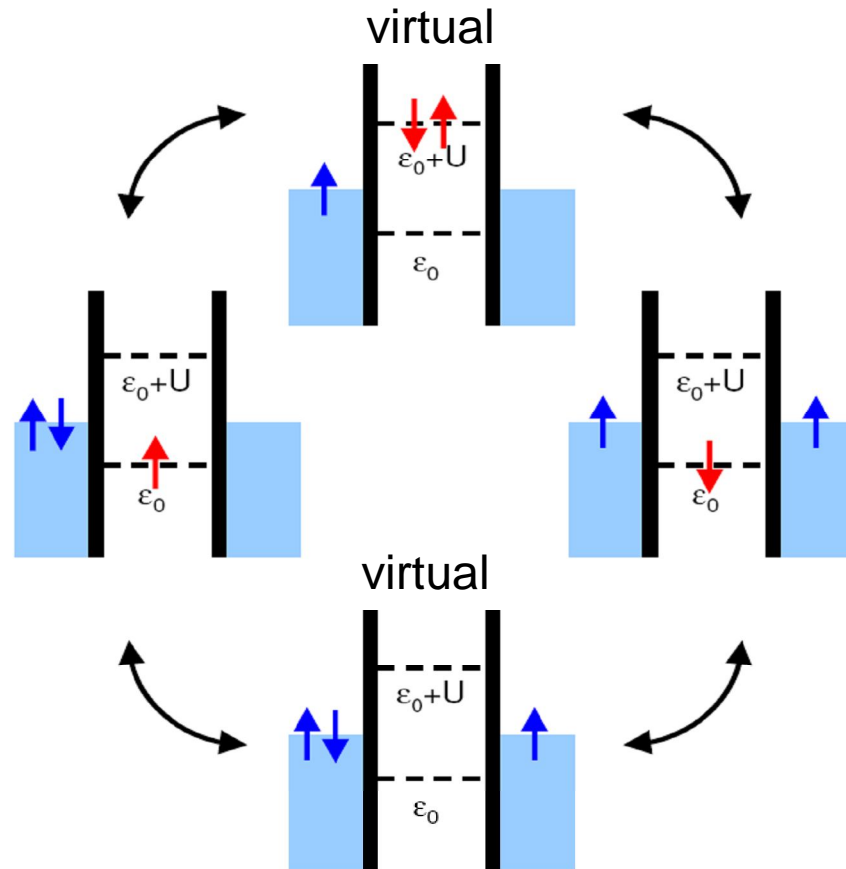

$$T_K = (U \Gamma)^{1/2} \exp(-1/J_{\text{eff}} v)$$

- Transport through **multiple order** spin flip events
- Formation of a **many body spin singlet** (spin of the dot + conduction electrons)
- Peak in the DOS of the dot at the Fermi energy of the leads → **Kondo resonance**

# Signature of the Kondo effect on conductance

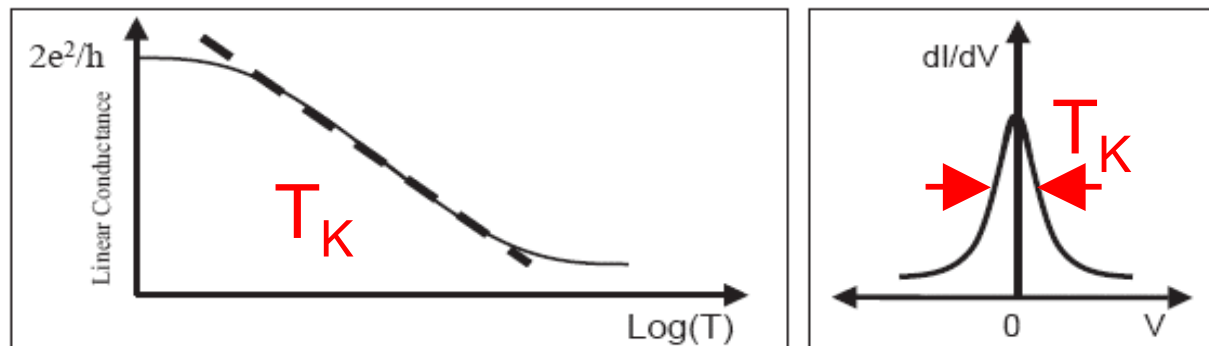

Universal scaling  
with temperature  
and bias voltage

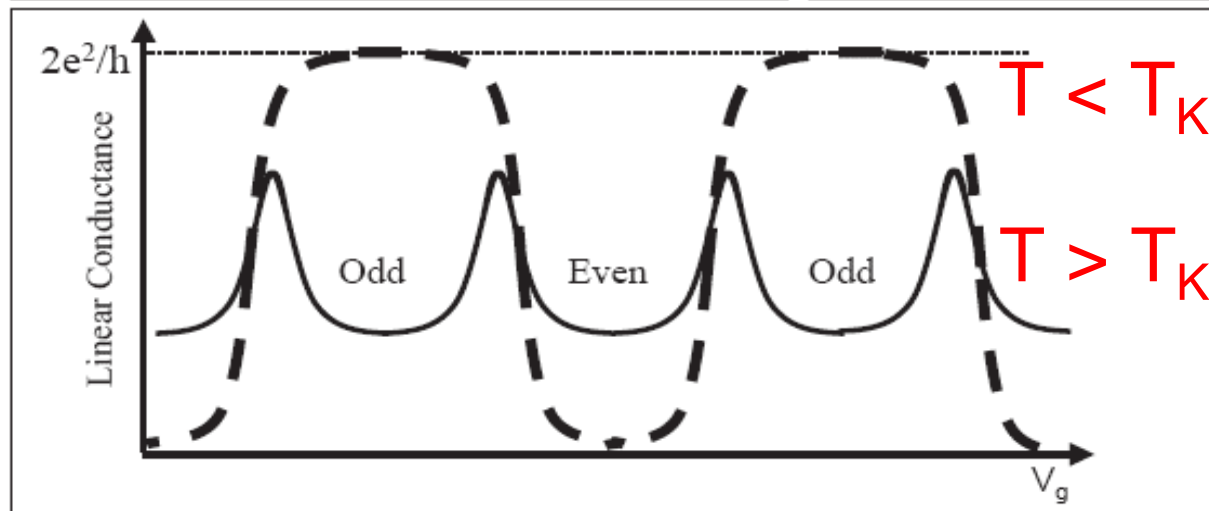

Kondo plateau when  
odd numbers of  $e^-$   
+  $T < T_K$

- If  $T < T_K$ , zero bias conductance can increase up to  $2e^2/h$   
→  $T_K$  and barrier asymmetry are the only relevant parameters

**What about Kondo dynamics?**

# What about emission noise?

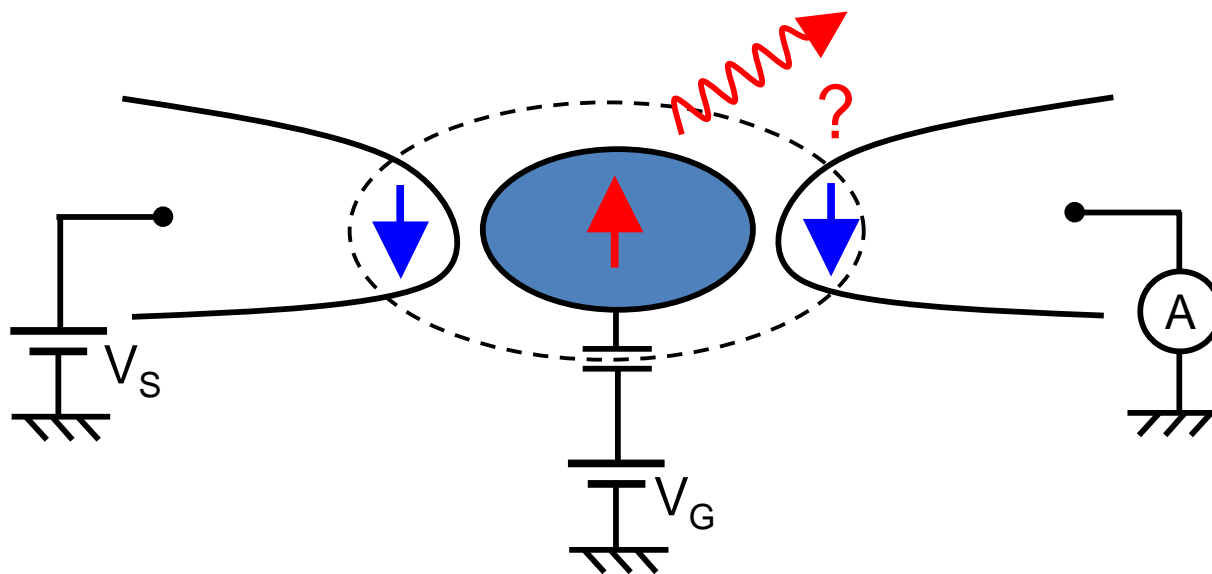

Out-of-equilibrium Kondo dynamics at frequencies  $h\nu \sim k_B T_K$ ?

# Carbon nanotube coupled to the SIS detector

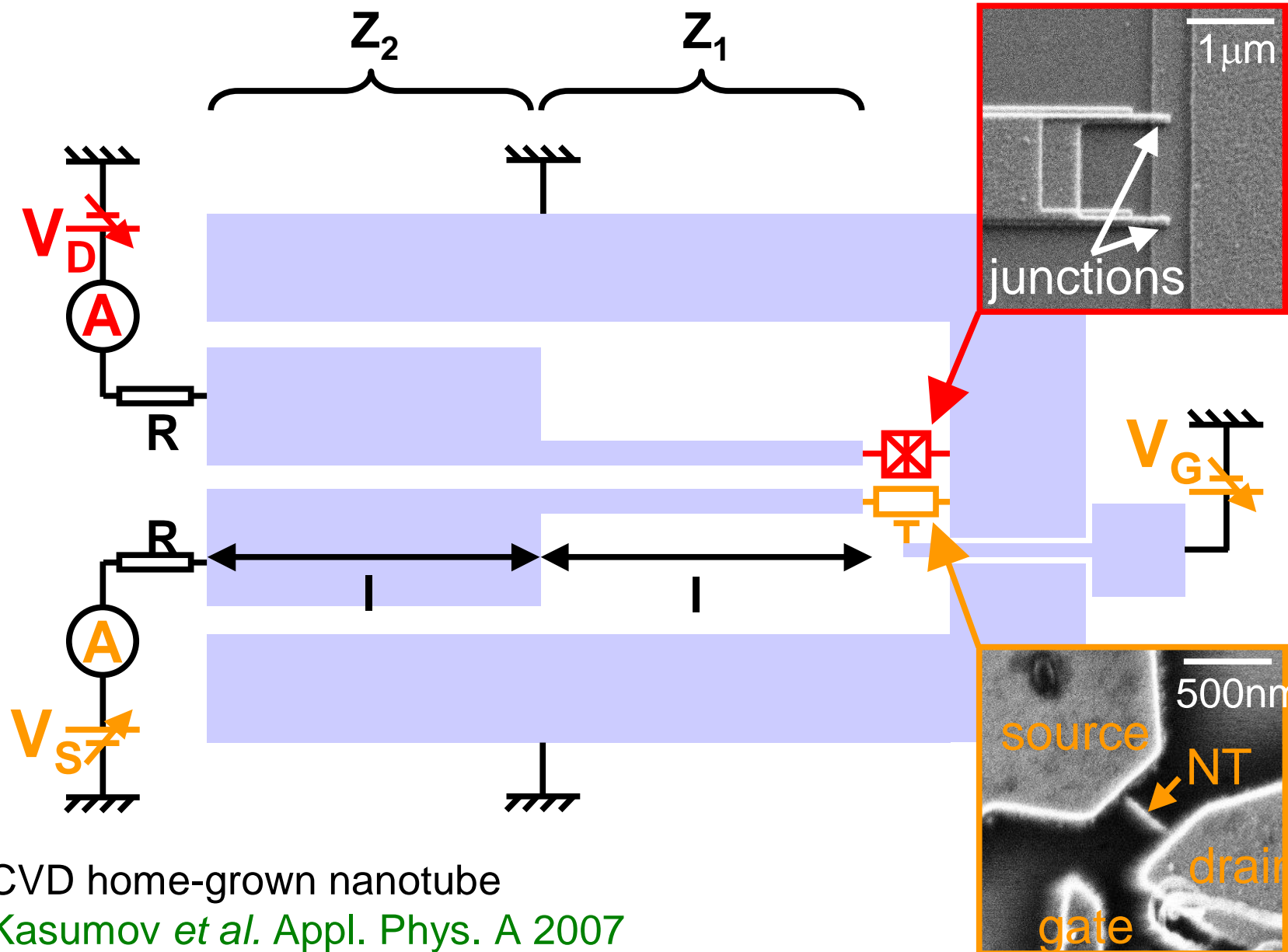

CVD home-grown nanotube  
Kasumov *et al.* Appl. Phys. A 2007  
+ Miguel Monteverde



# Kondo effect for the nanotube

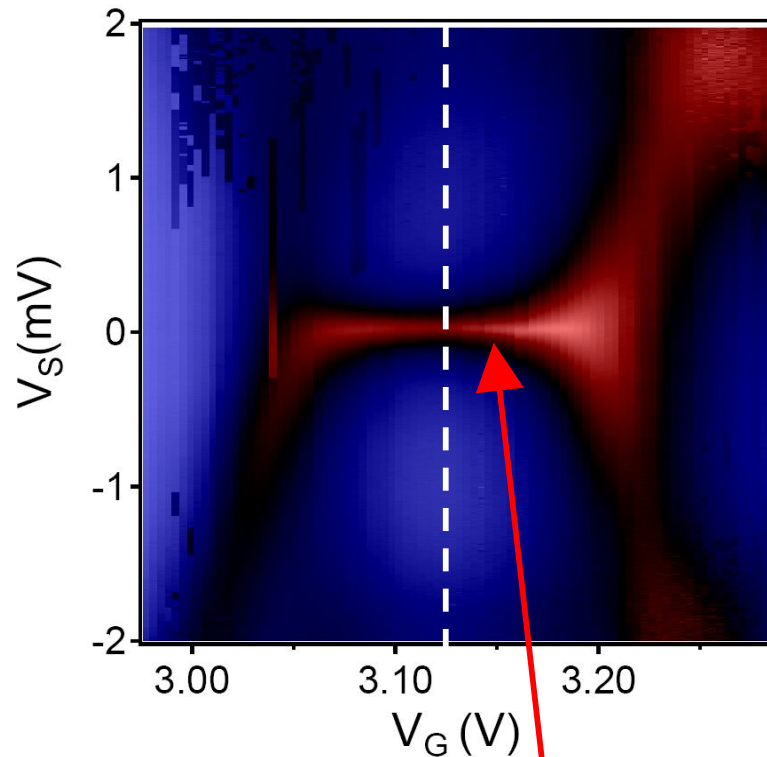

Kondo ridge

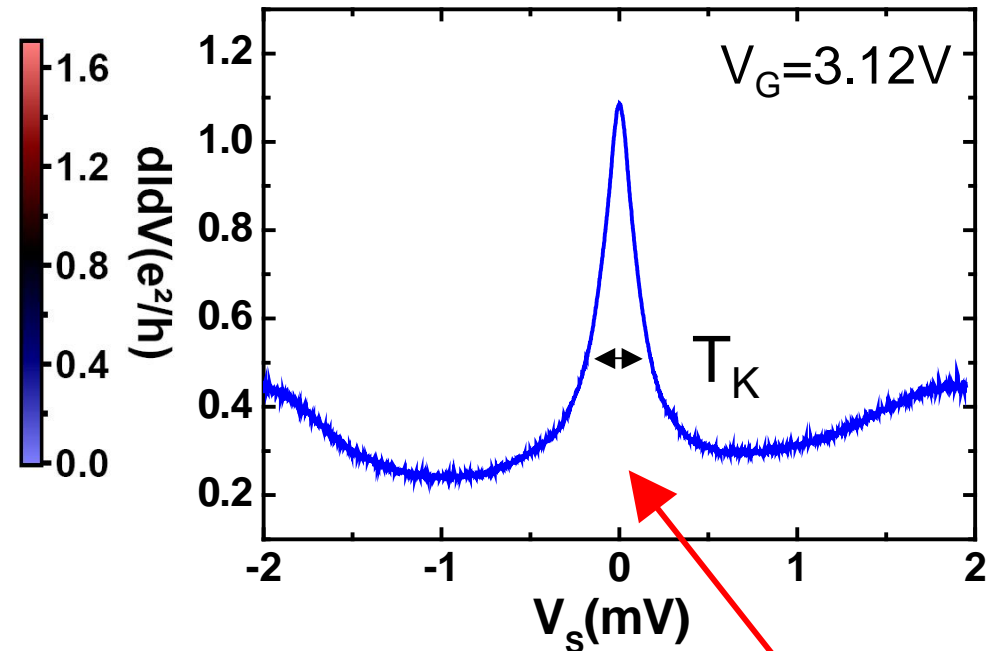

Zero bias peak

Center of the ridge  $\rightarrow T_K = 1.4\text{K} \Leftrightarrow \nu = 30\text{GHz}$

What about noise?

# Recent theoretical predictions

Signature of the Kondo effect on noise :  
Logarithmic singularity at  $V=hv/e$

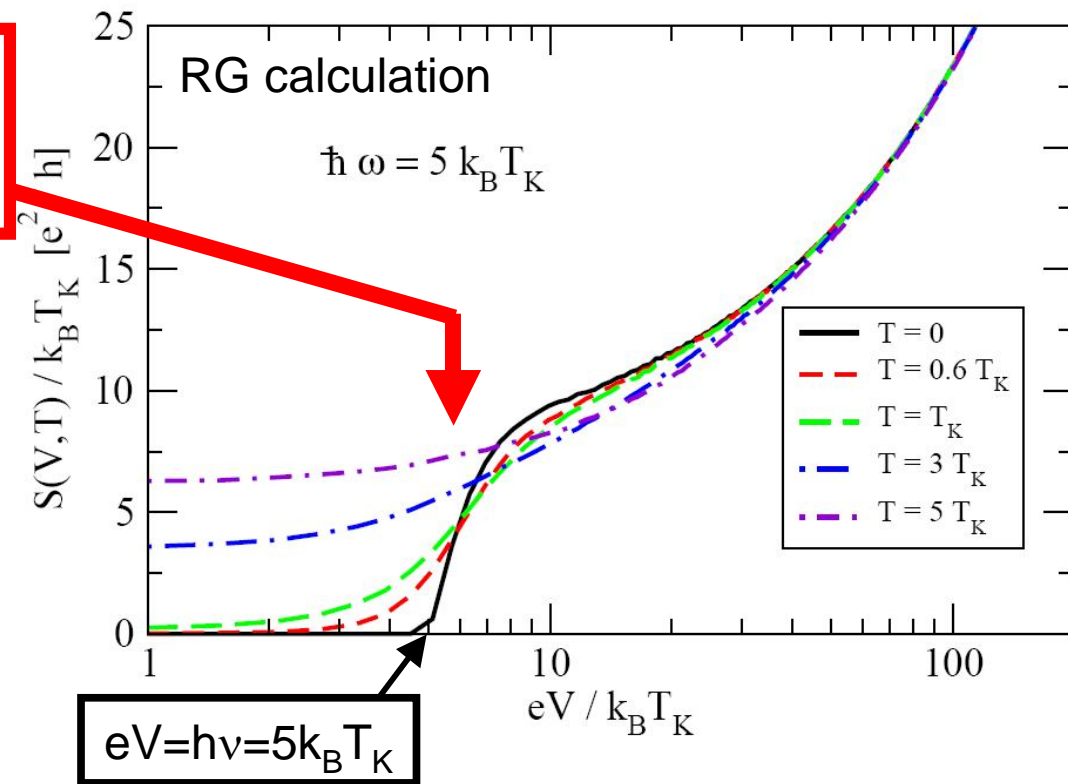
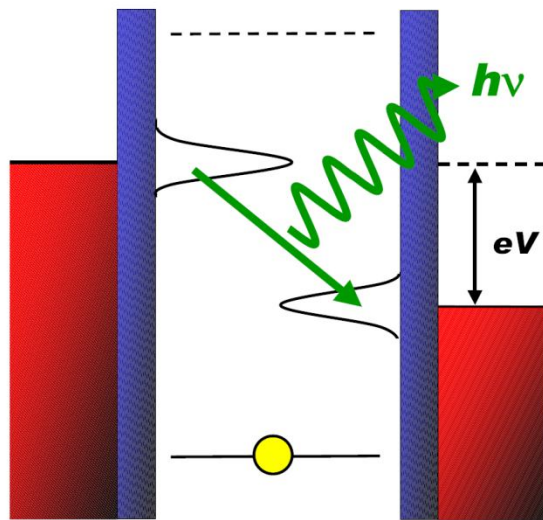

C.P. Moca *et al.*, PRB (2011)

- RG calculations at high frequency  $h\nu > k_B T_K$  and out-of-equilibrium
- Prediction of a logarithmic singularity at  $eV=h\nu$  even when  $h\nu \gg k_B T_K$

# High frequency noise in the Kondo regime

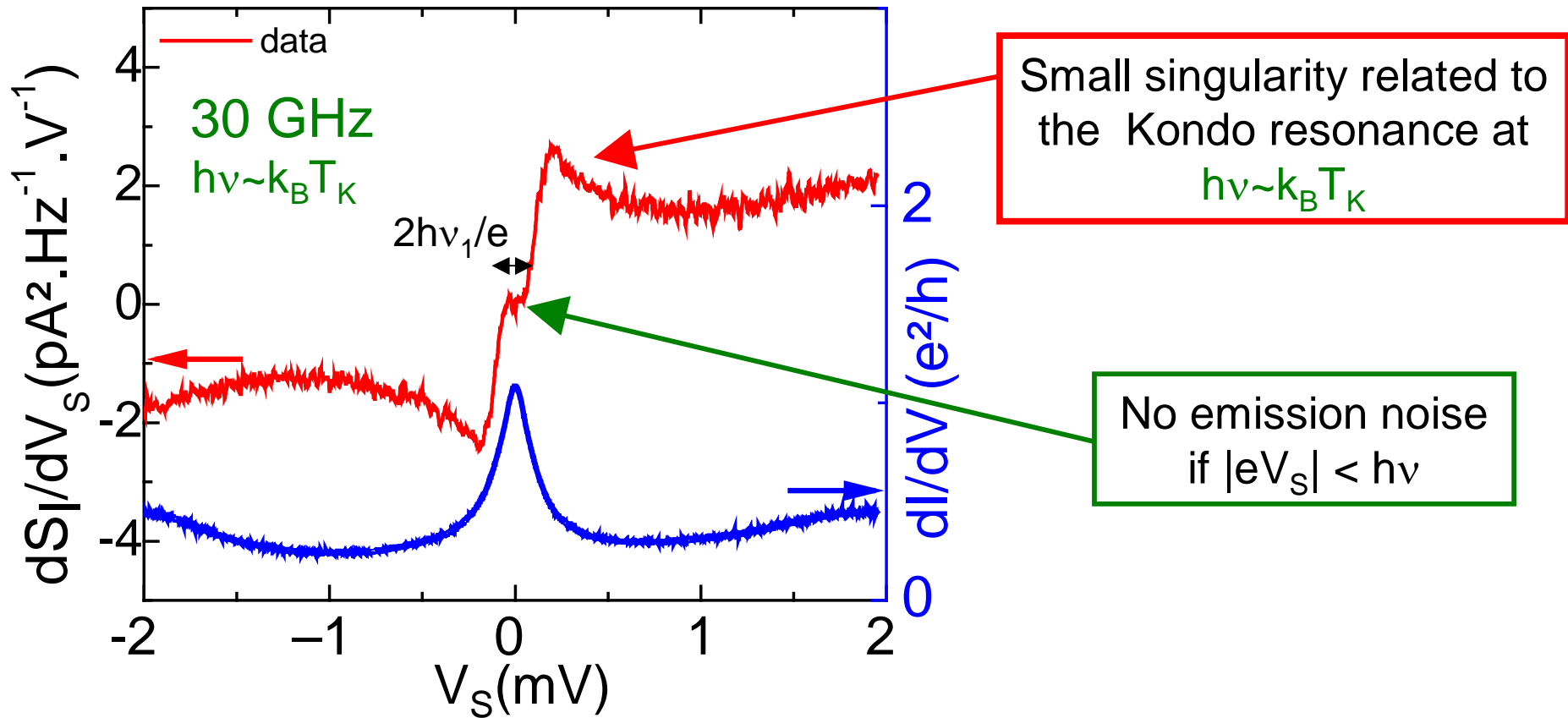

$h\nu \sim k_B T_K$ :

- Absence of emission noise if  $|eV_S| < h\nu$
- Singularity at  $|eV_S| = h\nu$  qualitatively consistent with predictions



# High frequency noise in the Kondo regime

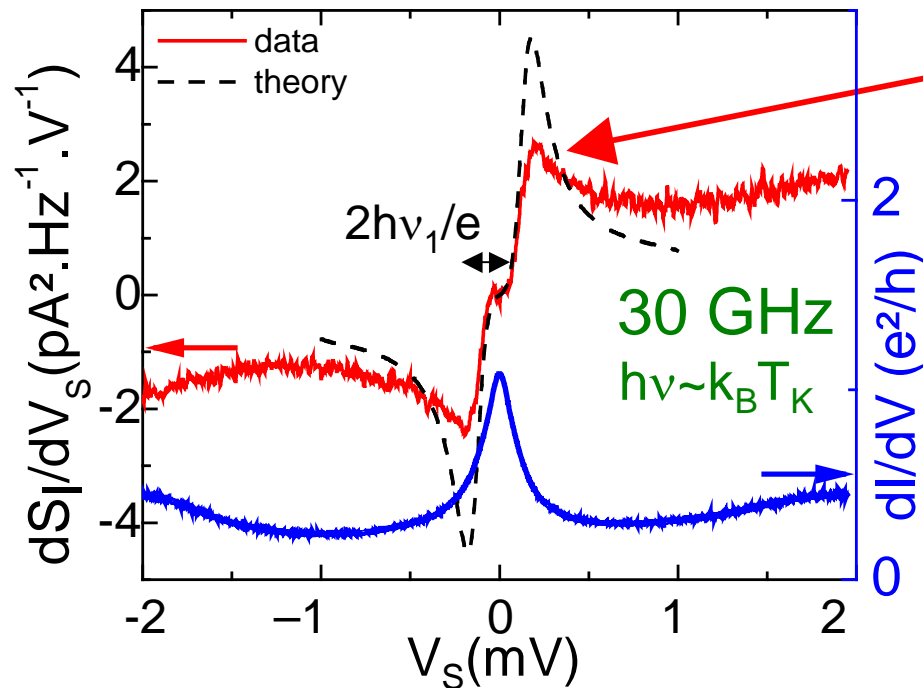

Singularity related to the Kondo resonance at  $\hbar v \sim k_B T_K$   
→ Qualitatively consistent but not quantitatively

Calculations by C.P. Moca, G. Zarand (Budapest) and P. Simon (Orsay)

- Theoretical comparison takes into account experimental data with no fitting parameter!
  - Kondo temperature  $T_K = 1.4\text{K} \Leftrightarrow T_K^{\text{RG}} = 0.38\text{K}$
  - asymmetry  $a = 0.67$
  - $U = 2.5\text{meV}$ ,  $\Gamma = 0.51\text{meV}$
- Theoretical predictions approximately 2 times higher than experimental result

# High frequency noise in the Kondo regime

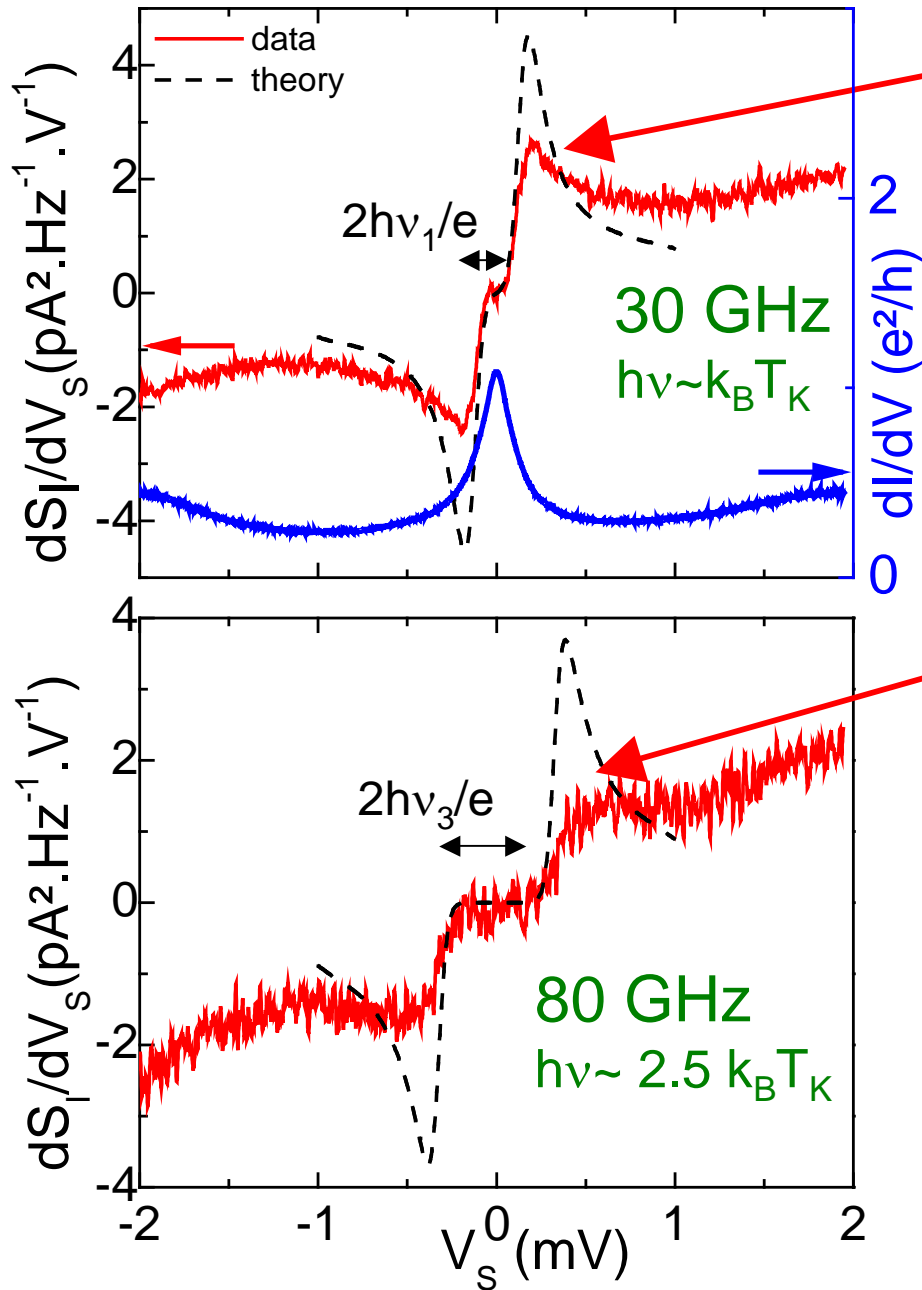

Singularity related to the Kondo resonance at  $h\nu \sim k_B T_K$   
 → Qualitatively consistent but not quantitatively

No singularity at  $h\nu \sim 2.5 k_B T_K$ !  
 → Not consistent with theory

ANY EXPLANATIONS???

# High frequency noise in the Kondo regime

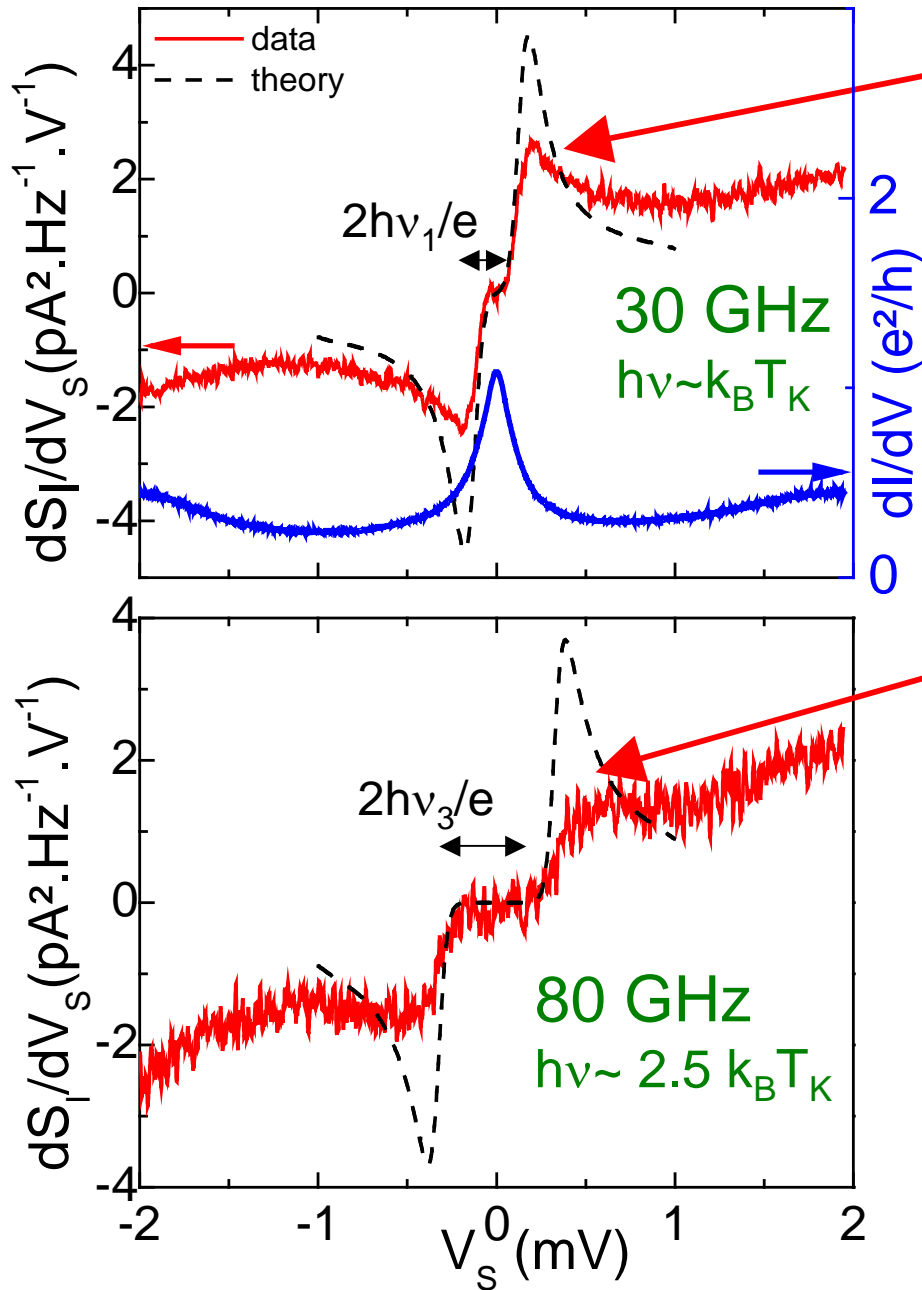

Singularity related to the Kondo resonance at  $h\nu \sim k_B T_K$   
 → **Qualitatively** consistent but **not quantitatively**

No singularity at  $h\nu \sim 2.5 k_B T_K$ !  
 → **Not consistent** with theory

ANY EXPLANATIONS??

→ Decoherence at high  $V_S$  ?

Monreal *et al.* PRB 05  
 Van Roermund *et al.* PRB 10  
 De Franceschi *et al.* PRL 02

Fit with additional spin decoherence rate

# Additional voltage bias induced decoherence

## - External decoherence rate : criteria

- Form similar to the **intrinsic** rate (C.P. Moca *et al.* PRB 2011)
- Consistent with **conductance**
- Consistent with noise power for **both frequencies**



$$h/\tau_S \approx \alpha k_B T_K^{\text{RG}} \operatorname{atan}\left(\frac{\beta e V_S}{k_B T_K^{\text{RG}}}\right)$$

$\alpha$  and  $\beta$  : fitting parameters

Spin lifetime in the dot reduces with applied bias  $V_S$

Calculations by C.P. Moca,  
G. Zarand (Budapest) and P. Simon (Orsay)

# Single decoherence rate function reproduce the data

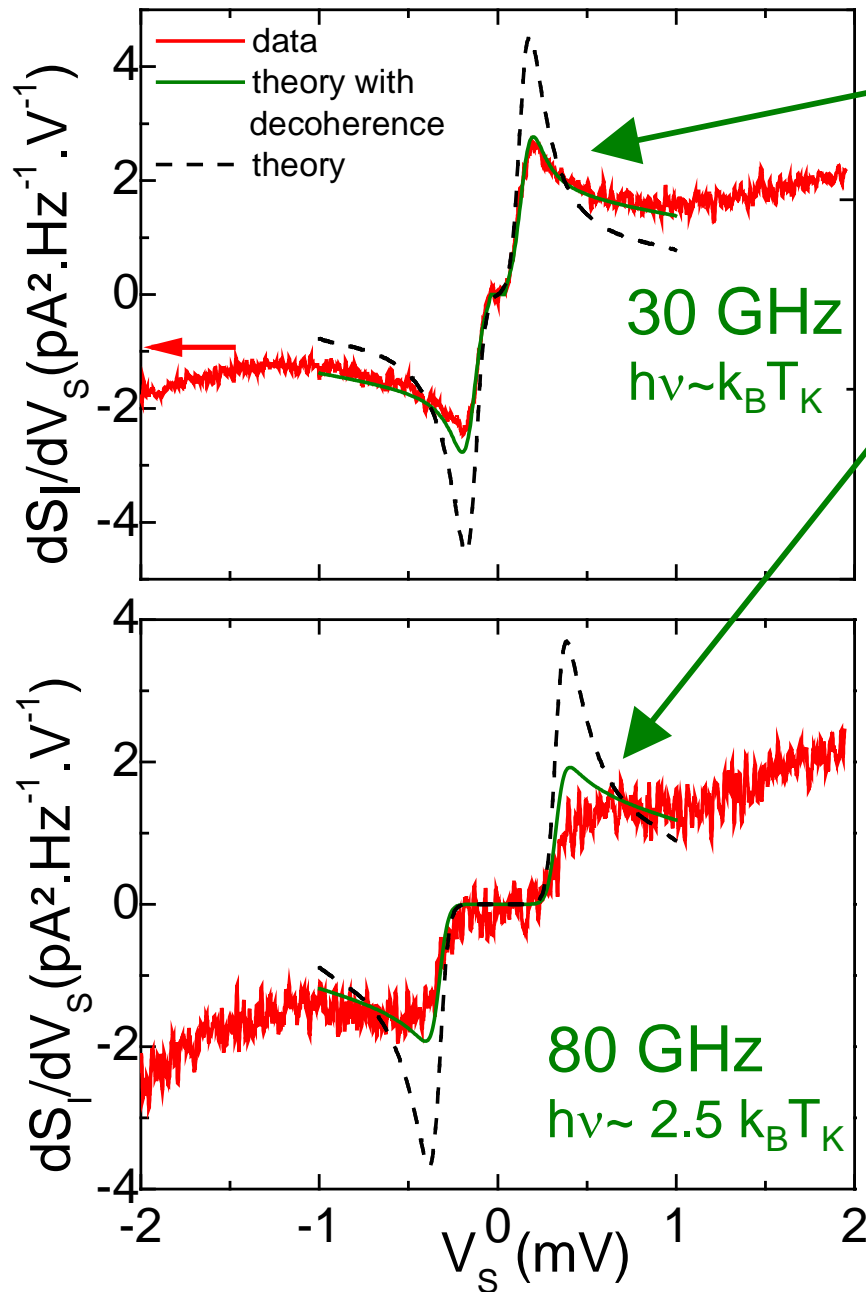

Fits OK using a single bias dependent spin decoherence rate function

$$h/\tau_S \approx \alpha k_B T_K^{\text{RG}} \operatorname{atan}\left(\frac{\beta e V_s}{k_B T_K^{\text{RG}}}\right)$$

with  $\alpha=14$ ,  $\beta=0.15$

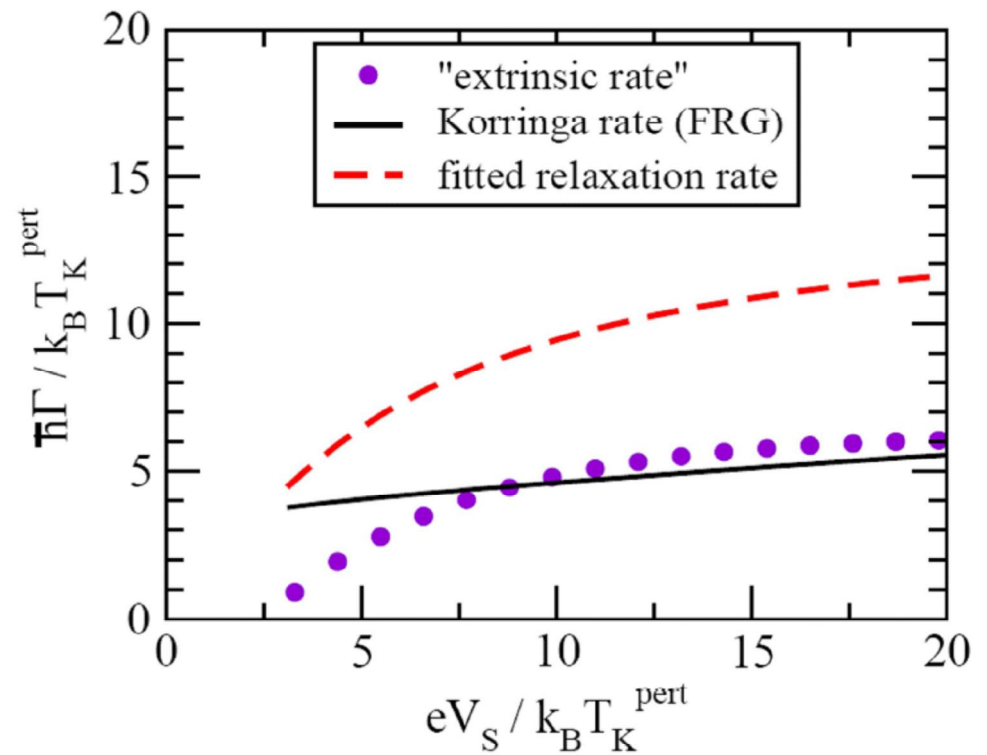



# Logarithmic singularity and decoherence effects

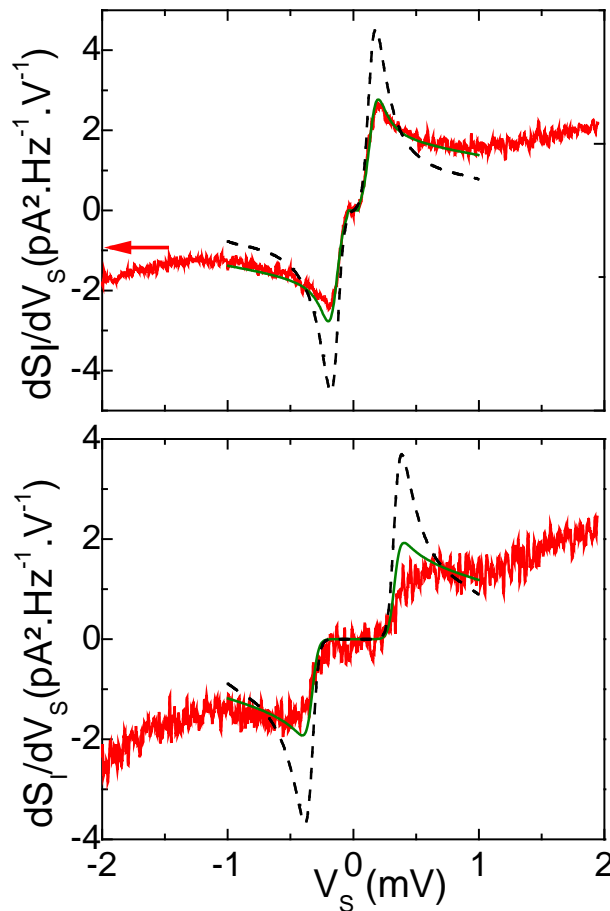

Many photons emitted at  $eV = hv_1$

Less photons emitted at  $eV = hv_3$

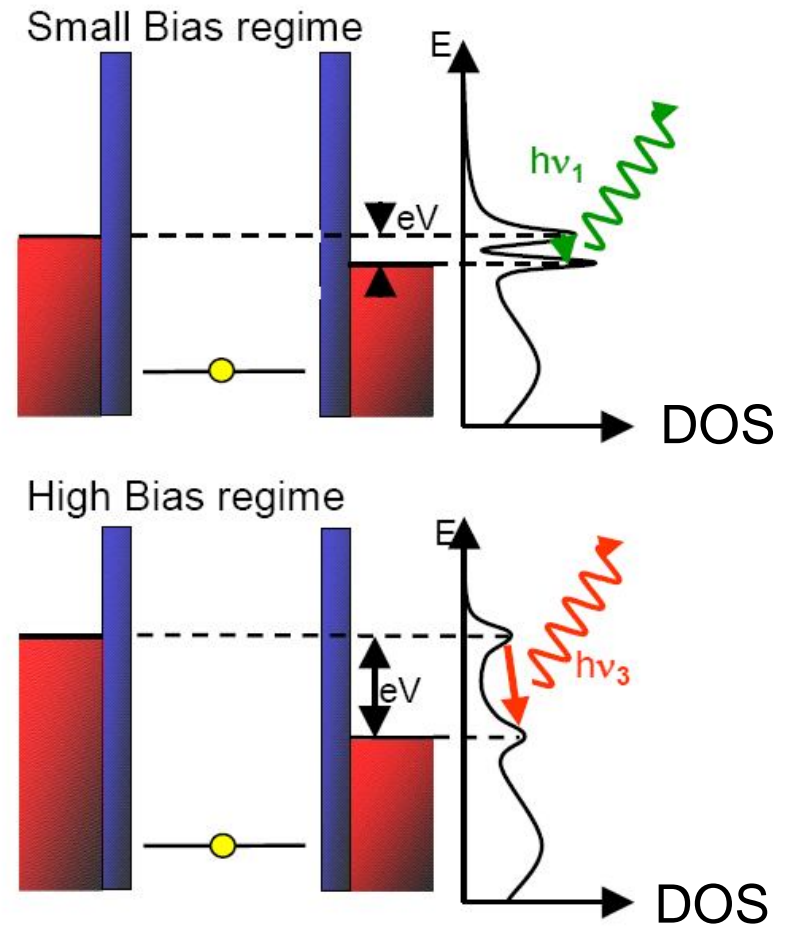

- $eV$  increases  $\rightarrow$  Kondo peaks in the density of states (attached to the leads) split and vanish due to decoherence
- Decoherence already pointed out

Exp. : De Franceschi *et al.* PRL 02, Leturcq *et al.* PRL 05

Th. : Monreal *et al.* PRB 05, Van Roermund *et al.* PRB 10

# High frequency Fano like factor in the Kondo regime

$$F(V) = \frac{dS_I/dV_S}{e dI/dV_S(V_S - h\nu/e)}$$

N.B. : Energy independent transmission  
→ Fano factor

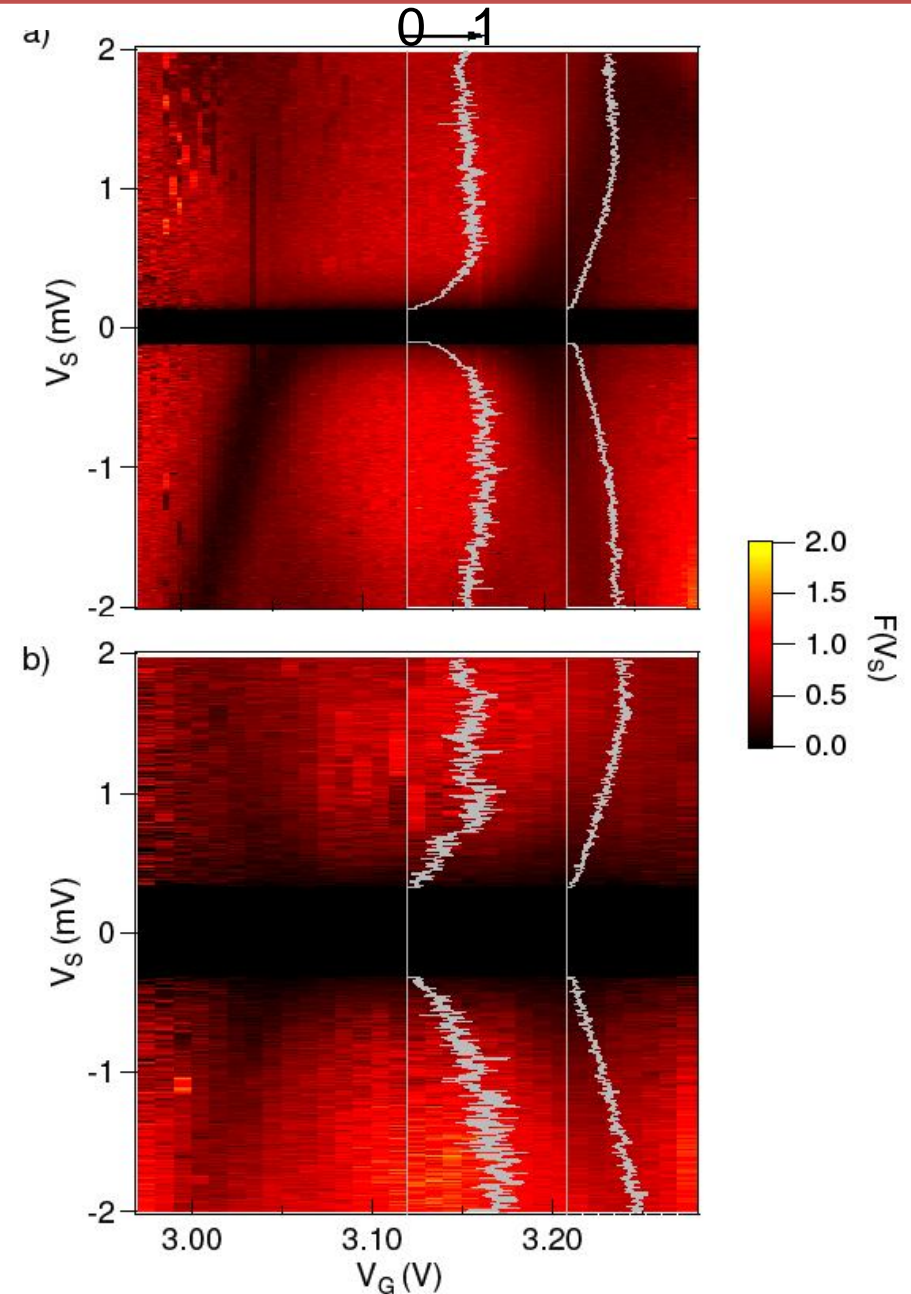
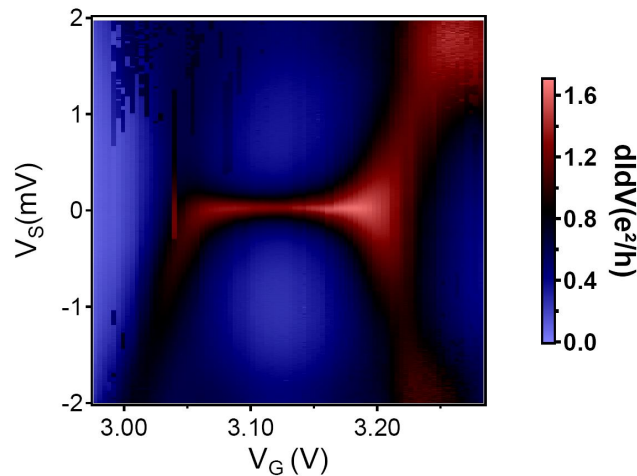

- Subpoissonian Noise  $F \leq 1$
- $F$  decreases when conductance increases
- Consistent with a highly transmitted channel

# Outline

## High frequency quantum noise of mesoscopic systems

1. Introduction
2. Principle of the SIS junction as a quantum noise detector
3. Equilibrium Noise of the transmission line resonator
  - Noise asymmetry at very low temperature
4. Out of Equilibrium Emission Noise of a Josephson junction
  - Frequency dependence of quasiparticles shot noise
5. Emission Noise of a carbon nanotube quantum dot in the Kondo regime
  - Signature of Kondo screening dynamics and decoherence
6. Conclusions and perspectives

# Conclusions and perspectives

## CONCLUSIONS

- Simultaneous measurement of the Emission and Absorption Quantum Noise of a resonator at equilibrium → **Zero Point Fluctuations**
- Quantitative measurement of the Quantum **Emission Noise** of an SIS junction at two different frequencies (PRL 105,166801 (2010))
- High frequency emission noise of a **carbon nanotube** in the **Kondo regime**
  - **Singularity** due to Kondo effect for  $h\nu \sim k_B T_K$
  - **No singularity** for  $h\nu \sim 2.5 k_B T_K$
  - Explained by **strong decoherence effects** (submitted arXiv:1110.1570v1)

## PERSPECTIVES

- Carbon nanotube quantum dots in other transport regimes
  - **Coulomb Blockade** → Coulomb gap  $E_c$ ?
  - **Fabry-Pérot** → nanotube length  $L$  via  $h\nu_F/L$ ?
  - **Superconducting contacts** → phase dynamics vs  $T_K$ , MAR signature...

# Acknowledgements

- The Jury:
- Norman Birge (Referee)
  - Silvano De Franceschi (Referee)
  - Benoît Douçot (Examiner)
  - Christian Glattli (Examiner)
  - Pascal Simon (Examiner)
  - **Hélène Bouchiat (Supervisor)**
  - **Richard Deblock (Supervisor)**



In Grenoble: Françoise Hippert, Joël Chevrier and Laurent Saminadayar

At LPS: Sophie Guéron, Meydi Ferrier, Alik Kasumov, Alexei Chepelianskii, Claudia Ojeda, Francesca Chiodi, Miguel Monteverde, Bastien Dassonneville, Katsuyoshi Komatsu, Sandrine Autier-Laurent, Raphaël Weil, Julien Gabelli, Marco Aprili, Bertrand Reulet, Inès Safi, Charis Quay, Jean-Yves Chauleau, administrative and technical services...

In Ardèche: Antoine, Emeline, Anselme, Lucas, Estelle, Jacky,...

At home: Claire

# THE END