

Stochastic Variational Inequalities and Applications to Random Vibrations and Mechanical Structures

PhD defense

Laurent Mertz, Jacques-Louis Lions Laboratory,
Pierre and Marie Curie University, Paris

December 2, 2011

Contexte de la thèse

- Doctorant au LJLL de 2008 à 2011 sous la direction d'Olivier Pironneau

Contexte de la thèse

- Doctorant au LJLL de 2008 à 2011 sous la direction d'Olivier Pironneau
- Séjour de recherche à l'université du Texas sous la direction d'Alain Bensoussan et Janos Turi

Contexte de la thèse

- Doctorant au LJLL de 2008 à 2011 sous la direction d'Olivier Pironneau
- Séjour de recherche à l'université du Texas sous la direction d'Alain Bensoussan et Janos Turi
- Séjour de recherche à l'université Polytechnique de Hong Kong sous la direction d'Alain Bensoussan

Contexte de la thèse

- Doctorant au LJLL de 2008 à 2011 sous la direction d'Olivier Pironneau
- Séjour de recherche à l'université du Texas sous la direction d'Alain Bensoussan et Janos Turi
- Séjour de recherche à l'université Polytechnique de Hong Kong sous la direction d'Alain Bensoussan
- Collaboration avec le CEA avec Cyril Feau et Laurent Borsoi grâce au soutien de Bertrand Mercier et Catherine Berge-Thierry

Contexte de la thèse

- Doctorant au LJLL de 2008 à 2011 sous la direction d'Olivier Pironneau
- Séjour de recherche à l'université du Texas sous la direction d'Alain Bensoussan et Janos Turi
- Séjour de recherche à l'université Polytechnique de Hong Kong sous la direction d'Alain Bensoussan
- Collaboration avec le CEA avec Cyril Feau et Laurent Borsoi grâce au soutien de Bertrand Mercier et Catherine Berge-Thierry
- Collaboration avec Stéphane Menozzi au LPMA-Paris 7 et avec Hector Jasso-Fuentes à CINVESTAV Mexico

Contexte de la thèse

- Doctorant au LJLL de 2008 à 2011 sous la direction d'Olivier Pironneau
- Séjour de recherche à l'université du Texas sous la direction d'Alain Bensoussan et Janos Turi
- Séjour de recherche à l'université Polytechnique de Hong Kong sous la direction d'Alain Bensoussan
- Collaboration avec le CEA avec Cyril Feau et Laurent Borsoi grâce au soutien de Bertrand Mercier et Catherine Berge-Thierry
- Collaboration avec Stéphane Menozzi au LPMA-Paris 7 et avec Hector Jasso-Fuentes à CINVESTAV Mexico
- Remerciements aux rapporteurs : François Dufour (Institut de math de Bordeaux) et Denis Talay (INRIA Nice)

Contexte de la thèse

- Doctorant au LJLL de 2008 à 2011 sous la direction d'Olivier Pironneau
- Séjour de recherche à l'université du Texas sous la direction d'Alain Bensoussan et Janos Turi
- Séjour de recherche à l'université Polytechnique de Hong Kong sous la direction d'Alain Bensoussan
- Collaboration avec le CEA avec Cyril Feau et Laurent Borsoi grâce au soutien de Bertrand Mercier et Catherine Berge-Thierry
- Collaboration avec Stéphane Menozzi au LPMA-Paris 7 et avec Hector Jasso-Fuentes à CINVESTAV Mexico
- Remerciements aux rapporteurs : François Dufour (Institut de math de Bordeaux) et Denis Talay (INRIA Nice)
- Remerciements aux examinateurs : Pierre Bernard (Université Blaise Pascal, Clermont Ferrand) et George Papanicolaou (Stanford University)

Mathematical interest and connection with applications

- Random vibrations of mechanical structures
→ **stochastic system with memory**

Mathematical interest and connection with applications

- Random vibrations of mechanical structures
→ **stochastic system with memory**
- Main application in **Earthquake engineering:**

Mathematical interest and connection with applications

- Random vibrations of mechanical structures
→ **stochastic system with memory**
- Main application in **Earthquake engineering**:
 - ▶ Risk analysis: quantification of plastic deformations
→ **probabilistic prediction of failure**

Mathematical interest and connection with applications

- Random vibrations of mechanical structures
→ **stochastic system with memory**
- Main application in **Earthquake engineering**:
 - ▶ Risk analysis: quantification of plastic deformations
→ **probabilistic prediction of failure**
 - ▶ **Collaboration CEA: Cyril Feau & Laurent Borsoi**
→ study the elastic perfectly plastic oscillator excited by a white noise

Reference:

Feau, 2007 Probabilistic response of an elastic-perfectly-plastic oscillator excitation white noise, Probabilistic Engineering Mechanics

Mathematical interest and connection with applications

- Random vibrations of mechanical structures
→ **stochastic system with memory**
- Main application in **Earthquake engineering**:
 - ▶ Risk analysis: quantification of plastic deformations
→ **probabilistic prediction of failure**
 - ▶ **Collaboration CEA: Cyril Feau & Laurent Borsoi**
→ study the elastic perfectly plastic oscillator excited by a white noise
Reference:
Feau, 2007 Probabilistic response of an elastic-perfectly-plastic oscillator excitation white noise, Probabilistic Engineering Mechanics
- **Mathematical Interest:** Theoretical and numerical aspects of **Stochastic Variational Inequalities** (SVI)

Outline of the presentation

- 1 Motivations: Elasto-plastic problems in probabilistic engineering mechanics
- 2 SVI for the elasto-plastic problem (characterization and computation of the stationary distribution)
- 3 Short cycles related to the SVI
- 4 Long cycles related to the SVI
- 5 SVI with jumps for artificial elastic-plastic phasing (transition plastic \rightarrow elastic)
- 6 Long time behavior of an elastic-perfectly-plastic oscillator excited by a filtered noise
- 7 Conclusion & Perspectives

tel-00653124, version 1 - 19 Dec 2011

Motivations: Elasto-plastic problems in probabilistic engineering mechanics

Illustrative example: piping system

For a class of structures: **A one dimensional (1d) model**

- global behavior of the structure



**Seismic excitation (left) / Mass displacement (right):
Test vs 1d model results**

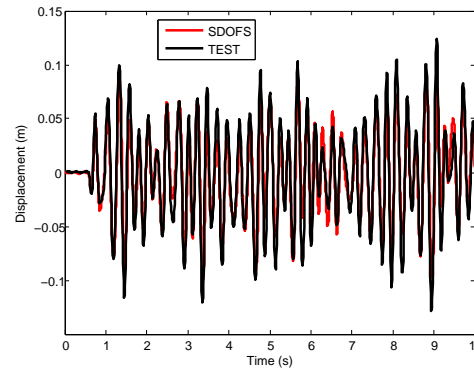
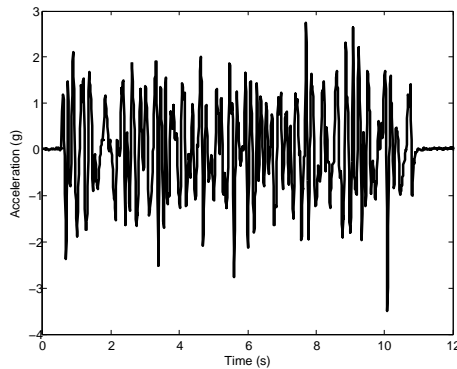

- nonlinear oscillator with memory

Elastic behavior: start with a linear oscillator ...

$c_0 > 0$: damping coefficient

$k > 0$: stiffness

“ $\frac{dw(t)}{dt}$ ” : external force white noise

$x(t)$: response of the oscillator

Elastic behavior: start with a linear oscillator ...

$c_0 > 0$: damping coefficient

$k > 0$: stiffness

„ $\frac{dw(t)}{dt}$ „ : external force white noise

$x(t)$: response of the oscillator

linear case: $x(t)$ solves

$$\ddot{x}(t) + c_0 \dot{x}(t) + F(t) = \frac{dw(t)}{dt}, \quad F(t) = kx(t)$$

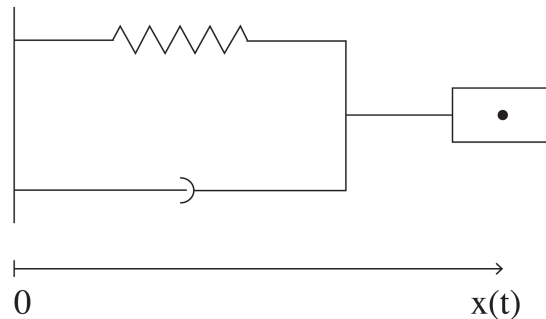

Elastic-perfectly-plastic behavior

elasto-perfectly-plastic case: $x(t)$ solves

$$\ddot{x}(t) + c_0 \dot{x}(t) + F(t) = \frac{dw(t)}{dt}$$

- $|F(t)| \leq kY$, Y : elasto-plastic bound
 θ_1 : first time going into plastic phase

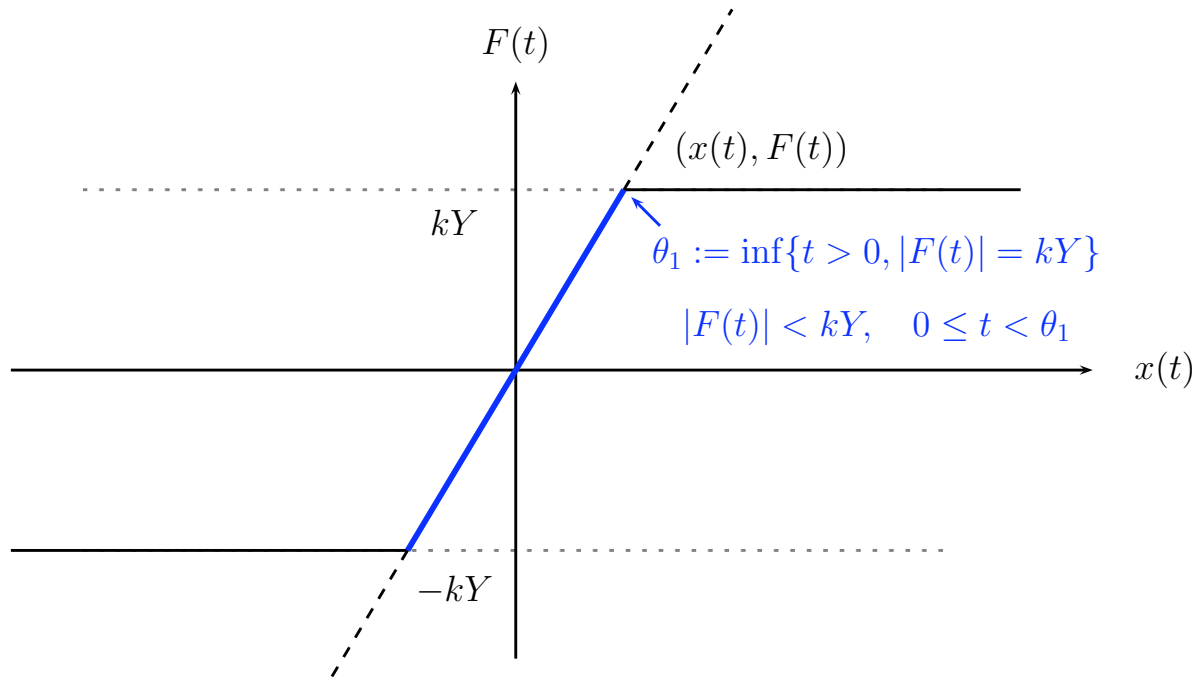

Elastic-perfectly-plastic behavior

elasto-perfectly-plastic case: $x(t)$ solves

$$\ddot{x}(t) + c_0 \dot{x}(t) + F(t) = \frac{dw(t)}{dt}, \quad F(t) = k(x(t) - \Delta(t))$$

- a plastic deformation $\Delta(t)$ occurs in $x(t)$ when $|F(t)| = kY$.
 τ_1 : first time going out of plastic phase

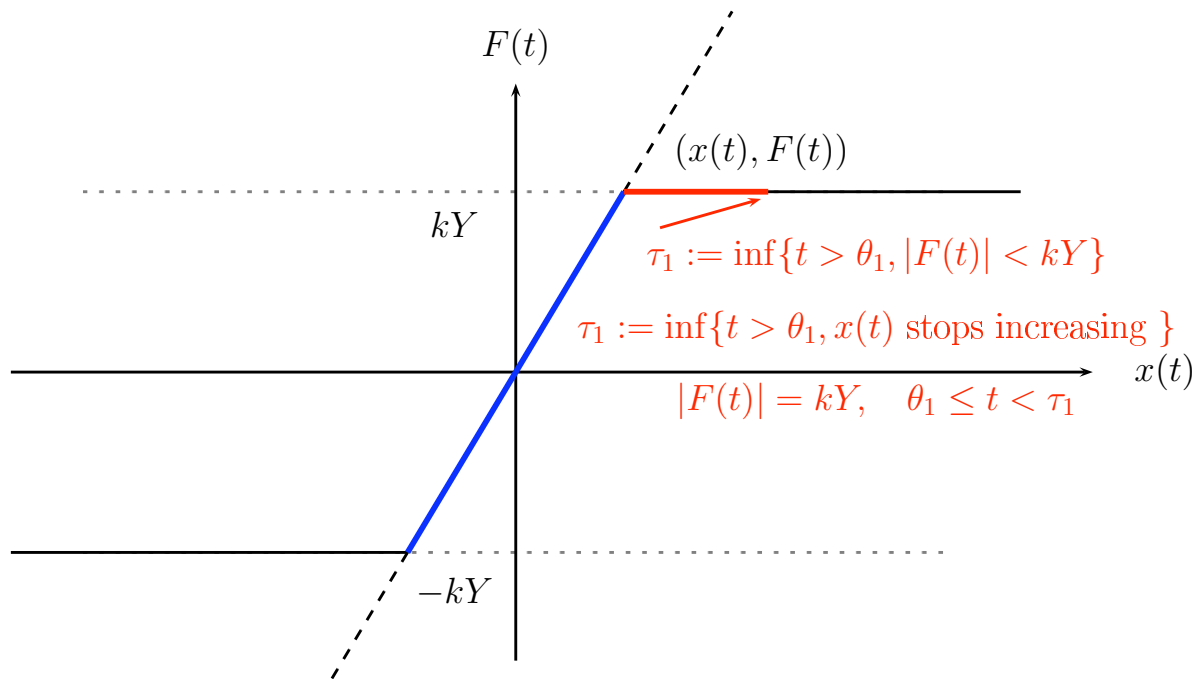

Elastic-perfectly-plastic behavior

elasto-perfectly-plastic case: $x(t)$ solves

$$\ddot{x}(t) + c_0 \dot{x}(t) + F(t) = \frac{dw(t)}{dt}, \quad F(t) = k(x(t) - \Delta(t))$$

$\Delta(t)$ stops increasing
when $x(t)$ stops increasing.

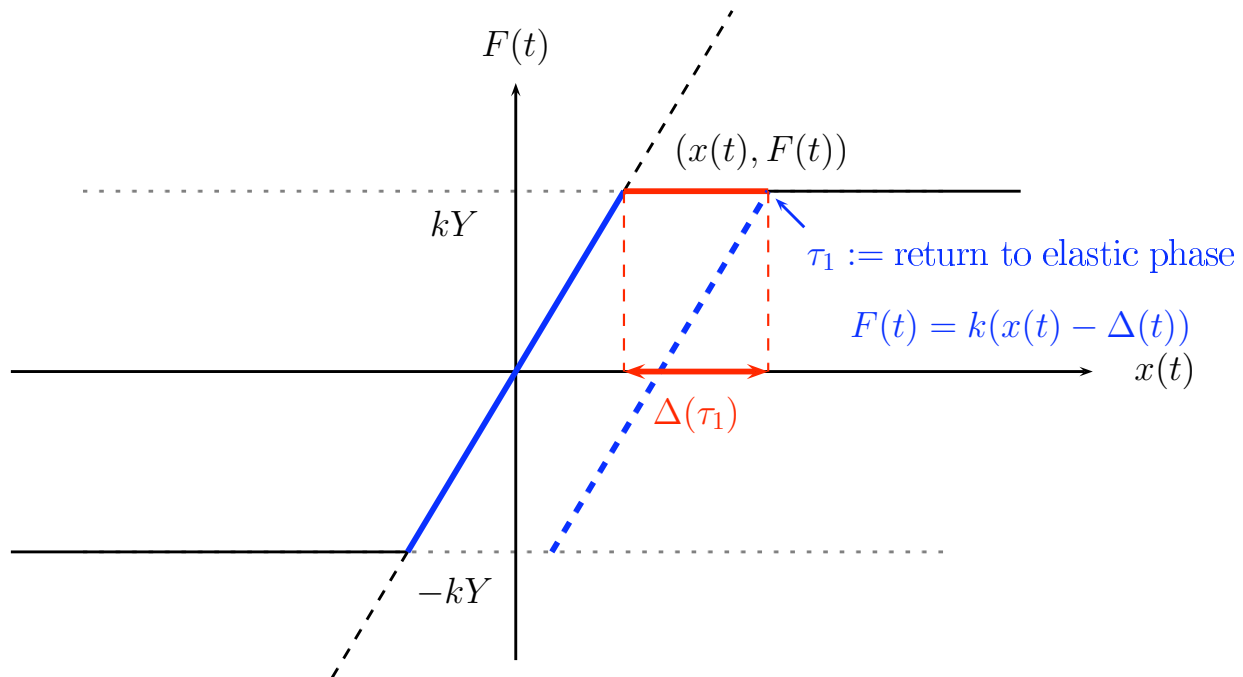

Balance between elastic and plastic

Denote

$$y(t) = \dot{x}(t) \quad , \quad z(t) = x(t) - \Delta(t)$$

then

$$\ddot{x}(t) + c_0 \dot{x}(t) + kz(t) = \text{“} \frac{dw(t)}{dt} \text{”}$$

becomes

- **elastic** $|z(t)| < Y$:

$$\begin{cases} \dot{y}(t) = -(c_0 y(t) + kz(t)) + \text{“} \frac{dw(t)}{dt} \text{”} , \\ \dot{z}(t) = y(t) \end{cases}$$

- **plastic** $z(t) = Y, y(t) > 0$ or $z(t) = -Y, y(t) < 0$:

$$\begin{cases} \dot{y}(t) = -(c_0 y(t) \pm kY) + \text{“} \frac{dw(t)}{dt} \text{”} , \\ \dot{z}(t) = 0 \end{cases}$$

Key idea: Switching between elastic and plastic phases

An example of phases transition

tel-00653121, version 1 - 19 Dec 2011

$$\left\{ \begin{array}{l} \text{1st elastic phase: } [0, \theta^1) \\ \dot{y}(t) = -(c_0 y(t) + kz(t)) + \frac{dw(t)}{dt}, \\ \dot{z}(t) = y(t) \end{array} \right.$$

$$\left\{ \begin{array}{l} \text{1st plastic phase: } [\theta^1, \tau^1) \\ \dot{y}(t) = -(c_0 y(t) + kY) + \frac{dw(t)}{dt}, \\ z(t) = Y \end{array} \right.$$

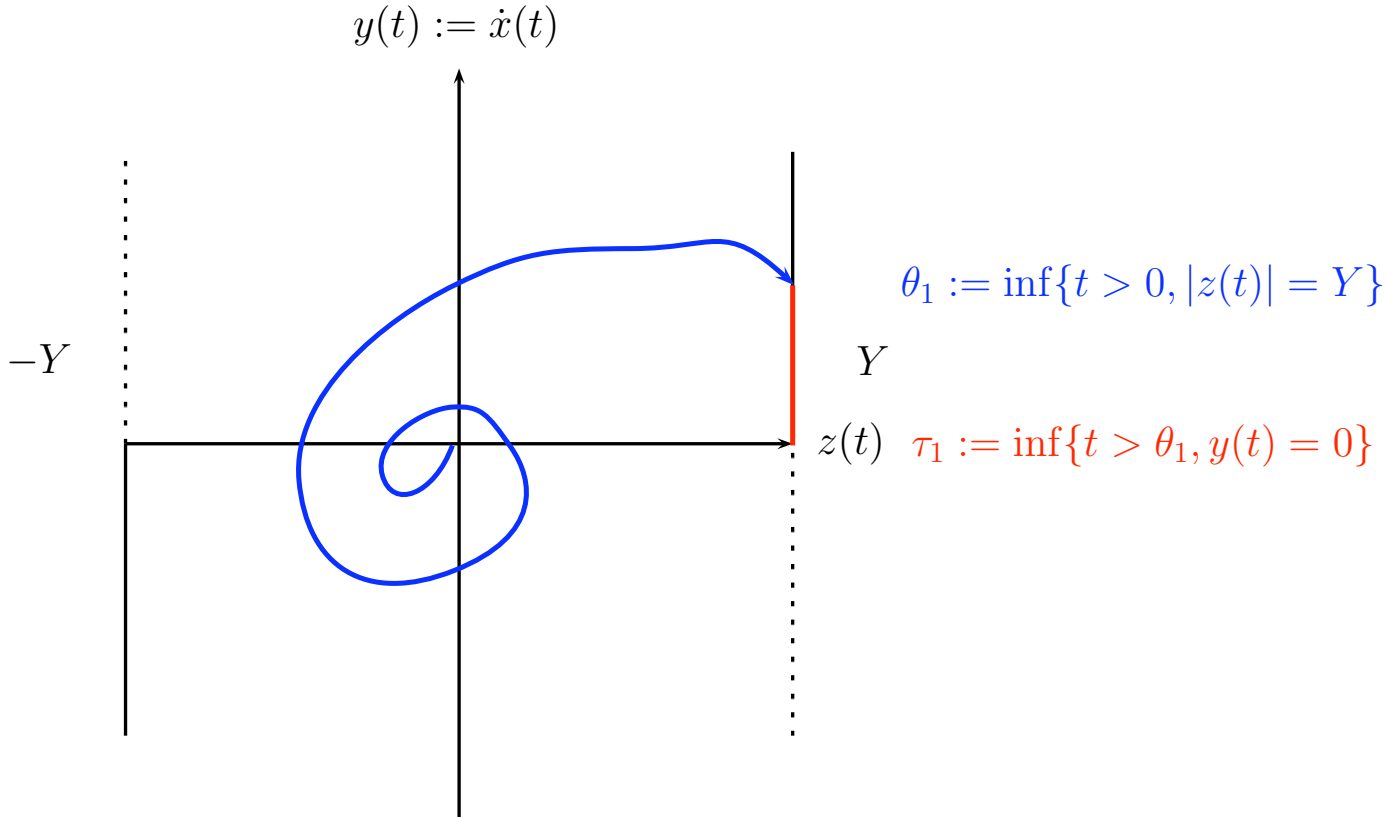

An example of phases transition

tel-00653121, version 1 - 19 Dec 2011

$$\left\{ \begin{array}{l} \text{2}^{\text{st}} \text{ elastic phase: } [\tau_1, \theta^2) \\ \dot{y}(t) = -(c_0 y(t) + kz(t)) + \frac{dw(t)}{dt}, \\ \dot{z}(t) = y(t) \end{array} \right.$$

$$\left\{ \begin{array}{l} \text{2}^{\text{st}} \text{ plastic phase: } [\theta^2, \tau^2) \\ \dot{y}(t) = -(c_0 y(t) - kY) + \frac{dw(t)}{dt}, \\ z(t) = -Y \end{array} \right.$$

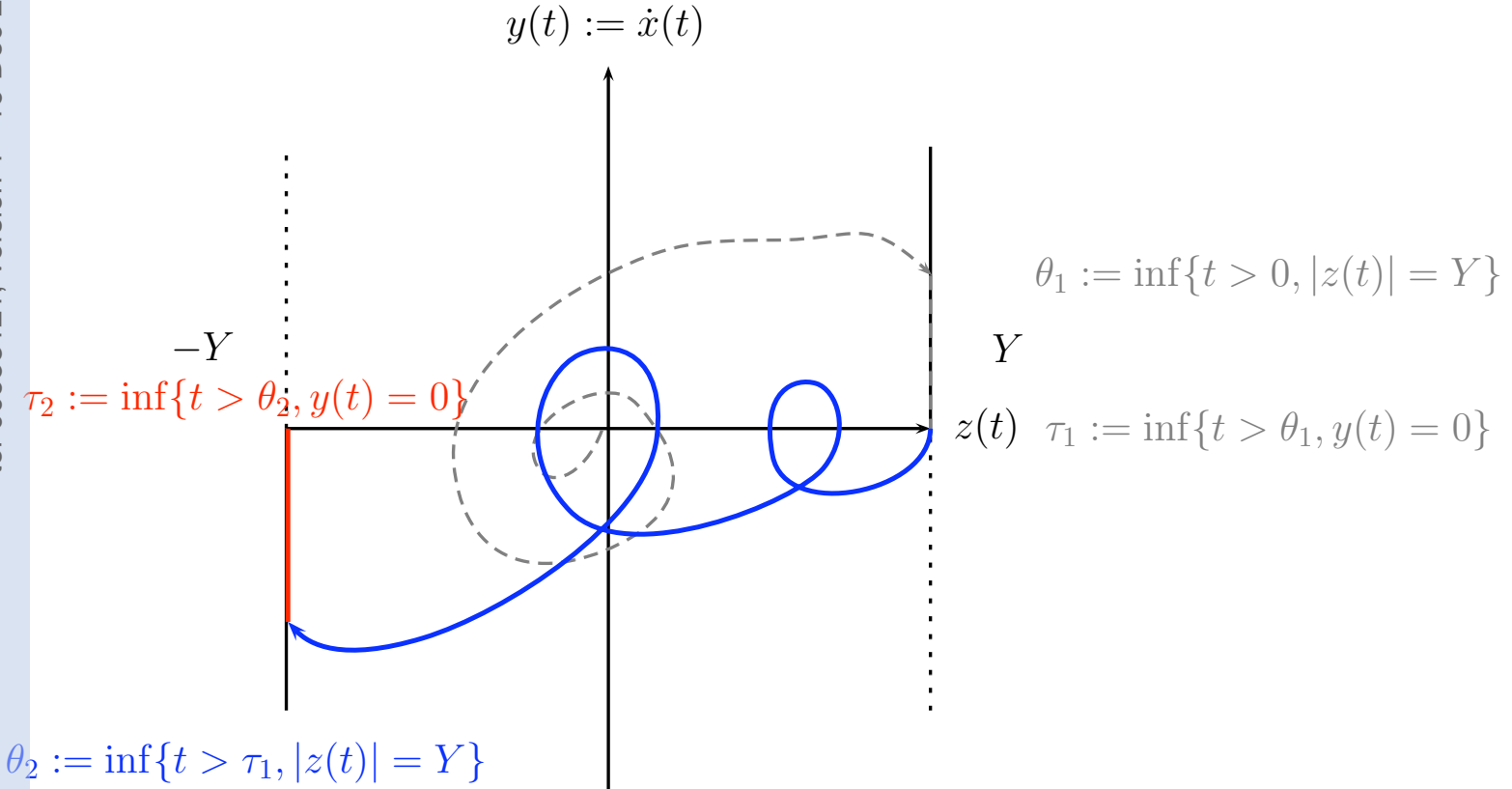

An example of the plastic drift of the oscillator

Figure: on the top $t, x(t)$ (red) $t, \Delta(t)$ (black : plastic deformation) and at the bottom $t, z(t)$ for $c_0 = 1, k = 1, Y = 1$

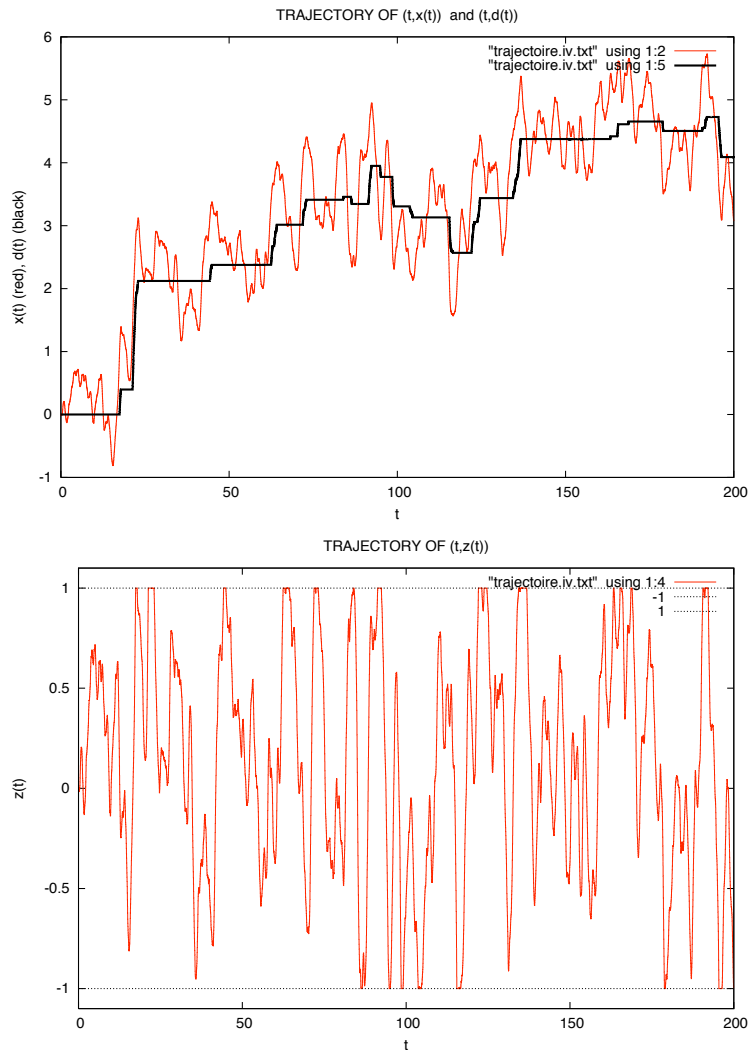

tel-00653121, version 1 - 19 Dec 2011

Part 2: Stochastic variational inequality for the elasto-plastic problem

Mathematical tool to describe the right dynamic : the stochastic variational inequality

Reformulation of the problem without the plastic deformation $\Delta(t)$ and without the instants of phase transition.

Theorem (Bensoussan-Turi 2007)

The process $(y(t), z(t))$ is the unique solution of the stochastic variational inequality (SVI) defined by the following conditions

$$dy(t) = -(c_0 y(t) + kz(t))dt + dw(t),$$

$$(dz(t) - y(t)dt)(\phi - z(t)) \geq 0, \quad \forall |\phi| \leq Y, \quad |z(t)| \leq Y$$

tel-00653121, version 1 - 19 Dec 2011

Mathematical tool to describe the right dynamic : the stochastic variational inequality

Reformulation of the problem without the plastic deformation $\Delta(t)$ and without the instants of phase transition.

Theorem (Bensoussan-Turi 2007)

The process $(y(t), z(t))$ is the unique solution of the stochastic variational inequality (SVI) defined by the following conditions

$$dy(t) = -(c_0 y(t) + kz(t))dt + dw(t),$$

$$(dz(t) - y(t)dt)(\phi - z(t)) \geq 0, \quad \forall |\phi| \leq Y, \quad |z(t)| \leq Y$$

- $(y(t), z(t))$ reflected diffusion, $\Delta(t)$: reflection process

References:

SVIs: [[Bensoussan-Lions1982](#)].

Mathematical tool to describe the right dynamic : the stochastic variational inequality

Reformulation of the problem without the plastic deformation $\Delta(t)$ and without the instants of phase transition.

Theorem (Bensoussan-Turi 2007)

The process $(y(t), z(t))$ is the unique solution of the stochastic variational inequality (SVI) defined by the following conditions

$$dy(t) = -(c_0 y(t) + kz(t))dt + dw(t),$$
$$(dz(t) - y(t)dt)(\phi - z(t)) \geq 0, \quad \forall |\phi| \leq Y, \quad |z(t)| \leq Y$$

- $(y(t), z(t))$ reflected diffusion, $\Delta(t)$: reflection process

References:

SVIs: [Bensoussan-Lions1982].

- **The variational inequality:** nicely adapted to plastic/elastic transition.
→ noise effect at the transition from plastic to elastic

tel-00653121, version 1 - 19 Dec 2011

Mathematical tool to describe the right dynamic : the stochastic variational inequality

Reformulation of the problem without the plastic deformation $\Delta(t)$ and without the instants of phase transition.

Theorem (Bensoussan-Turi 2007)

The process $(y(t), z(t))$ is the unique solution of the stochastic variational inequality (SVI) defined by the following conditions

$$dy(t) = -(c_0 y(t) + kz(t))dt + dw(t),$$
$$(dz(t) - y(t)dt)(\phi - z(t)) \geq 0, \quad \forall |\phi| \leq Y, \quad |z(t)| \leq Y$$

- $(y(t), z(t))$ reflected diffusion, $\Delta(t)$: reflection process

References:

SVIs: [[Bensoussan-Lions1982](#)].

- **The variational inequality:** nicely adapted to plastic/elastic transition.
→ noise effect at the transition from plastic to elastic

- References:

Deterministic VI for elasto-plasticity: [[Duvaut-Lions1977](#)].

→ Finally, it is not surprising to see arising stochastic variational inequalities in the framework of random vibrations.

Characterization of the stationary state (balance between elastic and plastic state)

Theorem (Bensoussan-Turi 2007)

$(y(t), z(t))$ ergodic Markov process

- unique invariant probability distribution ν for $(y(t), z(t))$ and $(y(t), z(t)) \xrightarrow[t \rightarrow \infty]{\mathcal{L}} \nu$ (independently of the initial condition).
- elastic domain: $D := (-\infty, +\infty) \times (-Y, Y)$

Characterization of the stationary state (balance between elastic and plastic state)

Theorem (Bensoussan-Turi 2007)

$(y(t), z(t))$ ergodic Markov process

- unique invariant probability distribution ν for $(y(t), z(t))$ and $(y(t), z(t)) \xrightarrow[t \rightarrow \infty]{\mathcal{L}} \nu$ (independently of the initial condition).
- elastic domain: $D := (-\infty, +\infty) \times (-Y, Y)$
- plastic domains: $D^+ := (-\infty, 0) \times \{-Y\}$ and $D^- := (0, +\infty) \times \{Y\}$

Characterization of the stationary state (balance between elastic and plastic state)

Theorem (Bensoussan-Turi 2007)

$(y(t), z(t))$ ergodic Markov process

- unique invariant probability distribution ν for $(y(t), z(t))$ and $(y(t), z(t)) \xrightarrow[t \rightarrow \infty]{\mathcal{L}} \nu$ (independently of the initial condition).

- elastic domain: $D := (-\infty, +\infty) \times (-Y, Y)$
- plastic domains: $D^+ := (-\infty, 0) \times \{-Y\}$ and $D^- := (0, +\infty) \times \{Y\}$
- ν has a density denoted by m is characterized by: $\forall \varphi$ smooth,

$$\begin{aligned} & \int_D m(y, z) \{y\varphi_z - (c_0 y + kz)\varphi_y + \frac{1}{2}\varphi_{yy}\} dy dz \\ & + \int_{D^+} m(y, Y) \{-(c_0 y + kY)\varphi_y(y, Y) + \frac{1}{2}\varphi_{yy}(y, Y)\} dy \\ & + \int_{D^-} m(y, -Y) \{-(c_0 y - kY)\varphi_y(y, -Y) + \frac{1}{2}\varphi_{yy}(y, -Y)\} dy = 0 \end{aligned}$$

Alternative method to the Monte-Carlo simulation (1): Start of my PhD research

From ergodic theory, we know the limiting behavior of $(y(t), z(t))$.

- For all bounded function f and $\forall (y_0, z_0) \in \bar{D}$,

$$\lim_{t \rightarrow \infty} \mathbb{E} f(y^{y_0}(t), z^{z_0}(t)) = \int_D f(y, z) m(y, z) dy dz + \int_{D^+} f(Y, y) m(Y, y) dy + \int_{D^-} f(-Y, y) m(-Y, y) dy.$$

Alternative method to the Monte-Carlo simulation (1): Start of my PhD research

From ergodic theory, we know the limiting behavior of $(y(t), z(t))$.

- For all bounded function f and $\forall (y_0, z_0) \in \bar{D}$,

$$\lim_{t \rightarrow \infty} \mathbb{E}f(y^{y_0}(t), z^{z_0}(t)) = \int_D f(y, z)m(y, z)dydz + \int_{D^+} f(Y, y)m(Y, y)dy + \int_{D^-} f(-Y, y)m(-Y, y)dy.$$

- But, it is also well known that

$$\lim_{t \rightarrow \infty} \mathbb{E}f(y^{y_0}(t), z^{z_0}(t)) = \lim_{\lambda \rightarrow 0} \lambda \int_0^\infty e^{-\lambda t} \mathbb{E}f(y^{y_0}(t), z^{z_0}(t))dt.$$

Alternative method to the Monte-Carlo simulation (2)

- Denote $u_\lambda(y_0, z_0; f) = \mathbb{E} \left[\int_0^\infty \exp(-\lambda t) f(y^{y_0}(t), z^{z_0}(t)) dt \right]$.

Alternative method to the Monte-Carlo simulation (2)

- Denote $u_\lambda(y_0, z_0; f) = \mathbb{E} \left[\int_0^\infty \exp(-\lambda t) f(y^{y_0}(t), z^{z_0}(t)) dt \right]$.
- Equivalent characterization of the asymptotic limit:

$$\begin{aligned}\lambda u_\lambda + Au_\lambda &= f(y, z) && \text{in } D \\ \lambda u_\lambda + B_+ u_\lambda &= f(y, Y) && \text{in } D^+ \\ \lambda u_\lambda + B_- u_\lambda &= f(y, -Y) && \text{in } D^-\end{aligned}$$

Nonlocal problem : $y \rightarrow u_\lambda(y, \pm Y; f)$ are continuous.

$$\forall (y_0, z_0) \in \bar{D}$$

$$\begin{aligned}\lim_{\lambda \rightarrow 0} \lambda u_\lambda(y_0, z_0; f) &= \int_D f(y, z) m(y, z) dy dz \\ &+ \int_{D^+} f(y, Y) m(y, Y) dy + \int_{D^-} f(y, -Y) m(y, -Y) dy\end{aligned}$$

Alternative method to the Monte-Carlo simulation (2)

- Denote $u_\lambda(y_0, z_0; f) = \mathbb{E} \left[\int_0^\infty \exp(-\lambda t) f(y^{y_0}(t), z^{z_0}(t)) dt \right]$.
- Equivalent characterization of the asymptotic limit:

$$\begin{aligned} \lambda u_\lambda + Au_\lambda &= f(y, z) && \text{in } D \\ \lambda u_\lambda + B_+ u_\lambda &= f(y, Y) && \text{in } D^+ \\ \lambda u_\lambda + B_- u_\lambda &= f(y, -Y) && \text{in } D^- \end{aligned}$$

Nonlocal problem : $y \rightarrow u_\lambda(y, \pm Y; f)$ are continuous.

$$\forall (y_0, z_0) \in \bar{D}$$

$$\begin{aligned} \lim_{\lambda \rightarrow 0} \lambda u_\lambda(y_0, z_0; f) &= \int_D f(y, z) m(y, z) dy dz \\ &+ \int_{D^+} f(y, Y) m(y, Y) dy + \int_{D^-} f(y, -Y) m(y, -Y) dy \end{aligned}$$

- This result is fundamental for the numerical resolution of m : alternative method to Monte-Carlo, **that requires simulations for long durations**.
Publication: [\[Bensoussan, Mertz, Pironneau, Turi 2009\]](#), [SIAM Journal on Numerical Analysis](#) , Volume 47 Issue 5

Alternative method to the Monte-Carlo simulation (3)

Superposition of three local problems:



$$\begin{cases} \lambda v_\lambda + Av_\lambda = f & \text{in } D, \\ \lambda v_\lambda + B_+ v_\lambda = f_+ & \text{in } D^+, \\ \lambda v_\lambda + B_- v_\lambda = f_- & \text{in } D^-, \end{cases}$$

with $v_\lambda(0^+, Y) = 0$, $v_\lambda(0^-, -Y) = 0$,

Alternative method to the Monte-Carlo simulation (3)

Superposition of three local problems:

$$\begin{cases} \lambda v_\lambda + Av_\lambda = f & \text{in } D, \\ \lambda v_\lambda + B_+ v_\lambda = f_+ & \text{in } D^+, \\ \lambda v_\lambda + B_- v_\lambda = f_- & \text{in } D^-, \end{cases}$$

with $v_\lambda(0^+, Y) = 0$, $v_\lambda(0^-, -Y) = 0$,

$$\begin{cases} \lambda \pi_\lambda^+ + A\pi_\lambda^+ = 0 & \text{in } D, \\ \lambda \pi_\lambda^+ + B_+ \pi_\lambda^+ = 0 & \text{in } D^+, \\ \lambda \pi_\lambda^+ + B_- \pi_\lambda^+ = 0 & \text{in } D^-, \end{cases}$$

with $\pi^+(0^+, Y) = 1$, $\pi^+(0^-, -Y) = 0$,

Alternative method to the Monte-Carlo simulation (3)

Superposition of three local problems:

$$\begin{cases} \lambda v_\lambda + Av_\lambda = f & \text{in } D, \\ \lambda v_\lambda + B_+ v_\lambda = f_+ & \text{in } D^+, \\ \lambda v_\lambda + B_- v_\lambda = f_- & \text{in } D^-, \end{cases}$$

with $v_\lambda(0^+, Y) = 0, v_\lambda(0^-, -Y) = 0,$

$$\begin{cases} \lambda \pi_\lambda^+ + A\pi_\lambda^+ = 0 & \text{in } D, \\ \lambda \pi_\lambda^+ + B_+ \pi_\lambda^+ = 0 & \text{in } D^+, \\ \lambda \pi_\lambda^+ + B_- \pi_\lambda^+ = 0 & \text{in } D^-, \end{cases}$$

with $\pi^+(0^+, Y) = 1, \pi^+(0^-, -Y) = 0,$

$$\begin{cases} \lambda \pi_\lambda^- + A\pi_\lambda^- = 0 & \text{in } D, \\ \lambda \pi_\lambda^- + B_+ \pi_\lambda^- = 0 & \text{in } D^+, \\ \lambda \pi_\lambda^- + B_- \pi_\lambda^- = 0 & \text{in } D^-, \end{cases}$$

with $\pi^+(0^+, Y) = 0, \pi^-(0^-, -Y) = 1.$

Alternative method to the Monte-Carlo simulation (4)

- We look for p_+ and p_- :

$$v_\lambda + p_+ \pi_\lambda^+ + p_- \pi_\lambda^- \quad \text{continuous in } (0, \pm Y)$$

Alternative method to the Monte-Carlo simulation (4)

- We look for p_+ and p_- :

$$v_\lambda + p_+ \pi_\lambda^+ + p_- \pi_\lambda^- \quad \text{continuous in } (0, \pm Y)$$

- Finally, we solve the following linear system:
with

$$\Pi := \begin{pmatrix} \pi^+(0^+, Y) - \pi^+(0^-, Y) & \pi^-(0^+, Y) - \pi^-(0^-, Y) \\ \pi^+(-0^+, -Y) - \pi^+(0^-, -Y) & \pi^-(0^+, -Y) - \pi^-(0^-, -Y) \end{pmatrix}$$

then

$$\Pi \begin{pmatrix} p_+ \\ p_- \end{pmatrix} = \begin{pmatrix} v_\lambda(0^-, Y) - v_\lambda(0^+, Y) \\ v_\lambda(0^-, -Y) - v_\lambda(0^+, -Y) \end{pmatrix}$$

Numerical result Vs Monte Carlo method : $Y = 1$

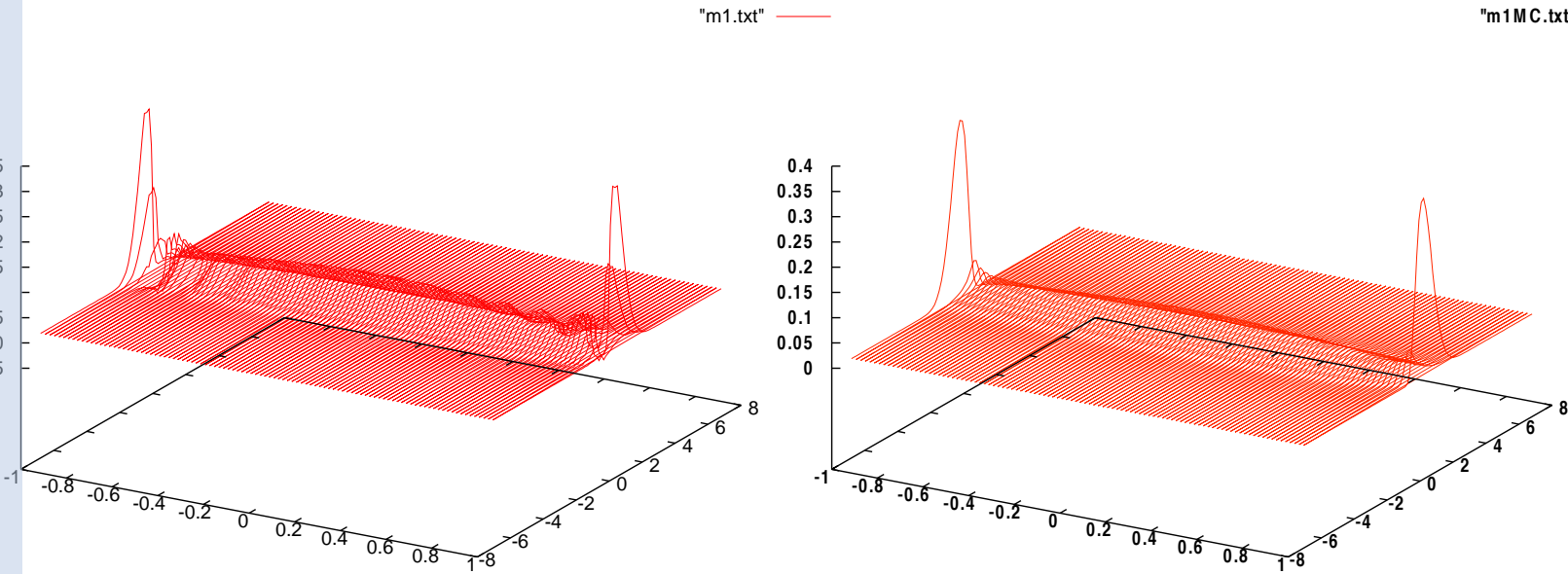

- **left:** plot of m with the deterministic method,
- **right:** plot of m with the Monte Carlo method,
 $T = 10$, $MC = 10^7$ (number of trajectories),
 $-1 \leq z \leq 1$, $-7 \leq y \leq 7$.

tel-00653121, v1.1, 18 Dec 2011

Numerical result Vs Monte Carlo method : $Y = 2$

tel-00653121, version 1 - 19 Dec 2011

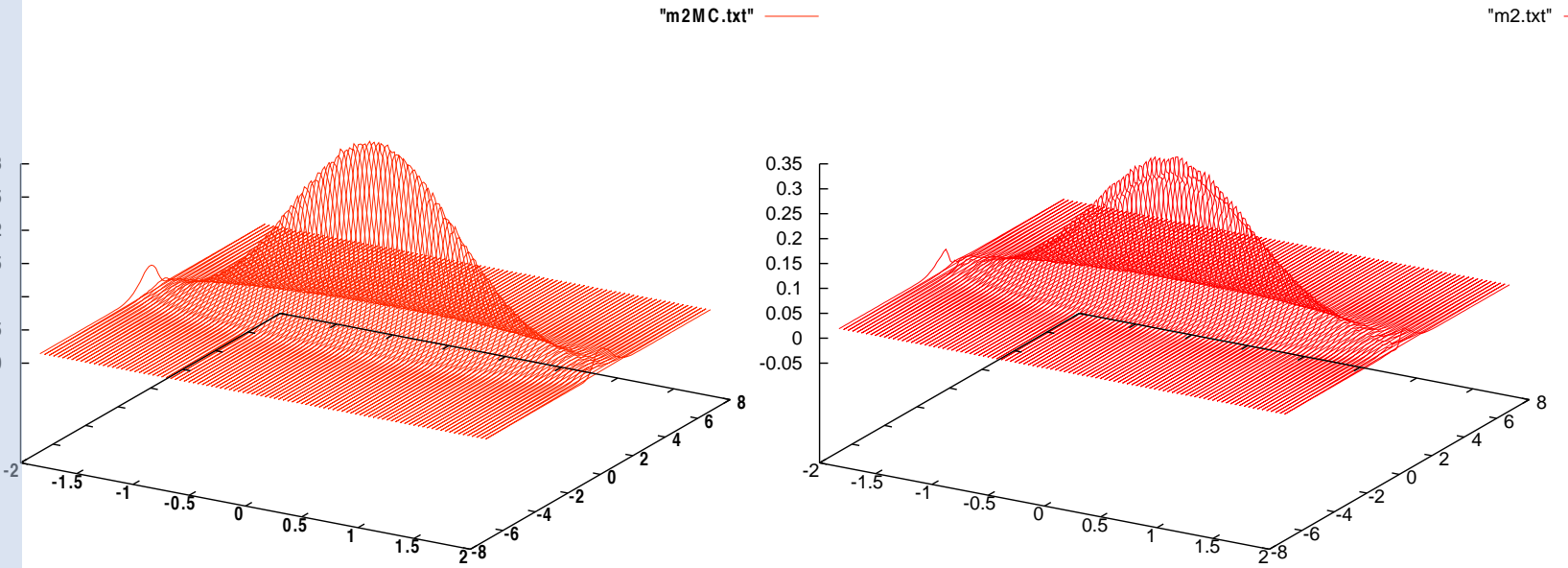

- **left:** plot of m with the deterministic method,
- **right:** plot of m with the Monte Carlo method,
 $T = 10$, $MC = 10^7$ (number of trajectories),
 $-2 \leq z \leq 2$, $-7 \leq y \leq 7$.

Part 3: Short cycles related to the stochastic variational inequality

Short cycle behavior

Short cycle: path, solution of the SVI, starting from a point $(y, z) \in D$ and which contains

- only one phase evolving in D (elastic domain)
- and only one phase evolving in D^+ or D^- (plastic domains).

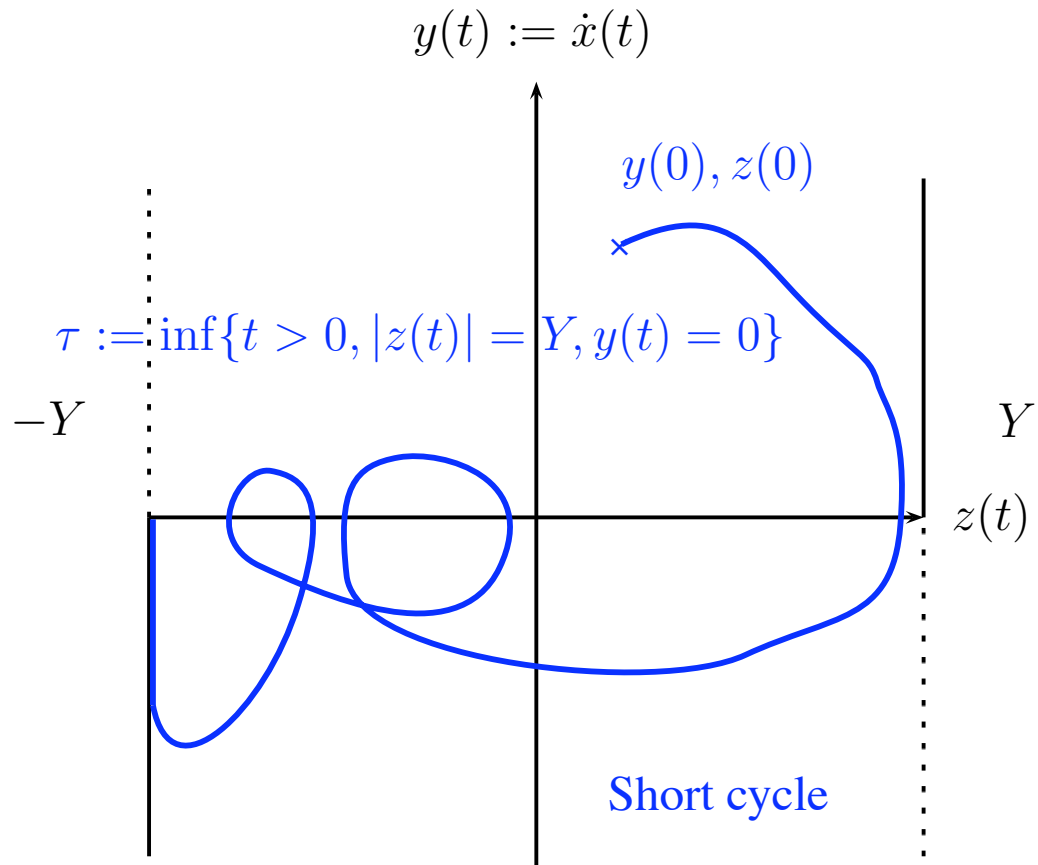

Short cycle behavior

- Short cycles: a new analytic characterization to the invariant measure of $(y(t), z(t))$.
- **Key finding:** connection between local problems and nonlocal problems.
→ interpretation of local problems in terms of trajectory of $(y(t), z(t))$.

Definition and analysis of short cycles

- Let f be a bounded function on D , define $v(y, z; f)$ the solution of

$$Av = f \text{ in } D, \quad B_+ v = f \text{ in } D^+, \quad B_- v = f \text{ in } D^- \quad (P_v)$$

with the local boundary conditions

$$v(0^+, Y) = 0 \text{ and } v(0^-, -Y) = 0$$

We call $v(y, z; f)$ a short cycle.

Definition and analysis of short cycles

- Let f be a bounded function on D , define $v(y, z; f)$ the solution of

$$Av = f \text{ in } D, \quad B_+v = f \text{ in } D^+, \quad B_-v = f \text{ in } D^- \quad (P_v)$$

with the local boundary conditions

$$v(0^+, Y) = 0 \text{ and } v(0^-, -Y) = 0$$

We call $v(y, z; f)$ a short cycle.

Theorem (Analysis of short cycles, A. Bensoussan, L.M.)

There exists a unique solution to (P_v) of the form

$$v(y, z; f) = \varphi^+(y; f)\mathbf{1}_{\{y>0\}} + \varphi^-(y; f)\mathbf{1}_{\{y<0\}} + w(y, z; f)$$

where

- ▶ w is a bounded function
- ▶ $B_+\varphi^+ = f(y, Y), \quad y > 0, \quad \varphi^+(0^+; f) = 0$
- ▶ $B_-\varphi^- = f(y, -Y), \quad y < 0, \quad \varphi^-(0^-; f) = 0.$

New ergodic theorem : Statement of the result

Theorem (New ergodic theorem, A. Bensoussan, L. M.)

- *A new characterization of the invariant distribution:*

$$\nu(f) = \frac{\nu(0^-, Y; f) + \nu(0^+, -Y; f)}{2\nu(0^-, Y; 1)}$$

submitted: [Bensoussan, Mertz 2011] [An analytic approach to the ergodic theory of stochastic variational inequalities](#)

New ergodic theorem : Statement of the result

Theorem (New ergodic theorem, A. Bensoussan, L. M.)

- A new characterization of the invariant distribution:

$$\nu(f) = \frac{\nu(0^-, Y; f) + \nu(0^+, -Y; f)}{2\nu(0^-, Y; 1)}$$

- Expansion of u_λ

$$u_\lambda(y, z; f) = u(y, z; f) + \frac{\nu(f)}{\lambda} + o\left(\frac{1}{\lambda}\right)$$

where

$$Au = f - \nu(f) \text{ in } D \quad B_+ u = f - \nu(f) \text{ in } D^+ \quad B_- u = f - \nu(f) \text{ in } D^-$$

with the non local boundary condition given by the fact that $y \rightarrow u(y, \pm Y; f)$ are continuous.

submitted: [\[Bensoussan, Mertz 2011\] An analytic approach to the ergodic theory of stochastic variational inequalities](#)

Probabilistic interpretation of the new characterization

Figure: $Av = f$, $B_+v = f$, $B_-v = f$ and $v(0^+, -Y) = 0$, $v(0^-, Y) = 0$

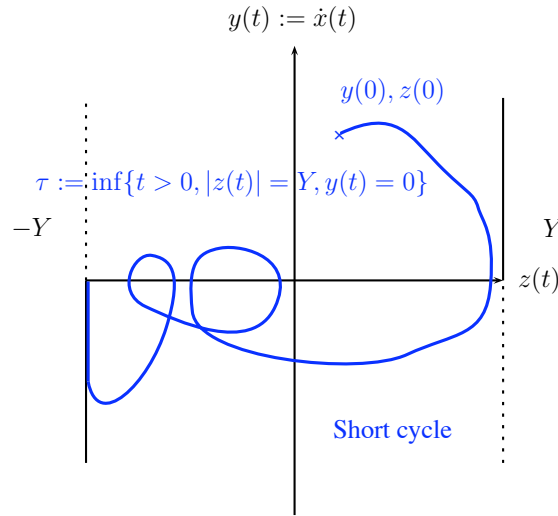

- A new characterization of the invariant distribution:

$$\nu(f) = \frac{\nu(0^-, Y; f) + \nu(0^+, -Y; f)}{2\nu(0^-, Y; 1)}$$

Probabilistic interpretation of the new characterization

Figure: $Av = f$, $B_+v = f$, $B_-v = f$ and $v(0^+, -Y) = 0$, $v(0^-, Y) = 0$

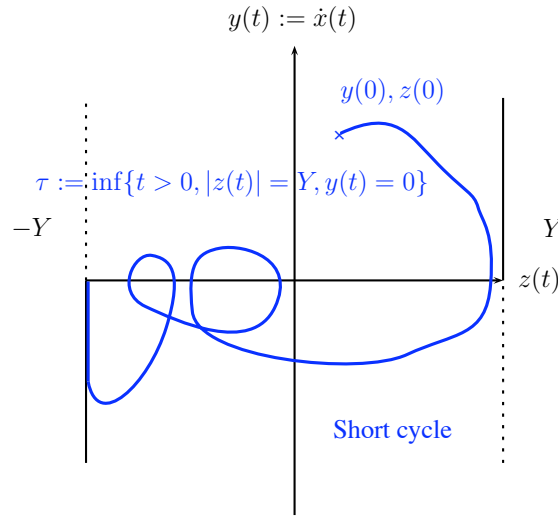

- A new characterization of the invariant distribution:

$$\nu(f) = \frac{v(0^-, Y; f) + v(0^+, -Y; f)}{2v(0^-, Y; 1)}$$

- means "formally"

$$\nu(f) = \frac{\frac{1}{2}\mathbb{E}_{(0^-, Y)}\left(\int_0^\tau f(y(s), z(s))ds\right) + \frac{1}{2}\mathbb{E}_{(0^+, -Y)}\left(\int_0^\tau f(y(s), z(s))ds\right)}{\frac{1}{2}\mathbb{E}_{(0^-, Y)}(\tau) + \frac{1}{2}\mathbb{E}_{(0^+, -Y)}(\tau)}$$

Part 4 : Long cycles related to the stochastic variational inequality

Long cycle behavior

- Independent sequences in the trajectory.

Long cycle behavior

- Independent sequences in the trajectory.
- Long cycle: path, solution of the SVI, starting and ending in one of the two points of $\{(0, Y), (0, -Y)\}$, knowing that the trajectory had a stop by the other point.

Long cycle behavior

- Independent sequences in the trajectory.
- Long cycle: path, solution of the SVI, starting and ending in one of the two points of $\{(0, Y), (0, -Y)\}$, knowing that the trajectory had a stop by the other point.
- Long cycles help to characterize the plastic behavior.

Definition and analysis of long cycles

- Define

$$\begin{cases} t_0 = \inf\{t > 0, & y(t) = 0, |z(t)| = Y\}, \\ \delta = \text{sign}(z(t_0)), \\ s_0 = \inf\{t > t_0, & y(t) = 0, z(t) = -\delta Y\}. \end{cases}$$

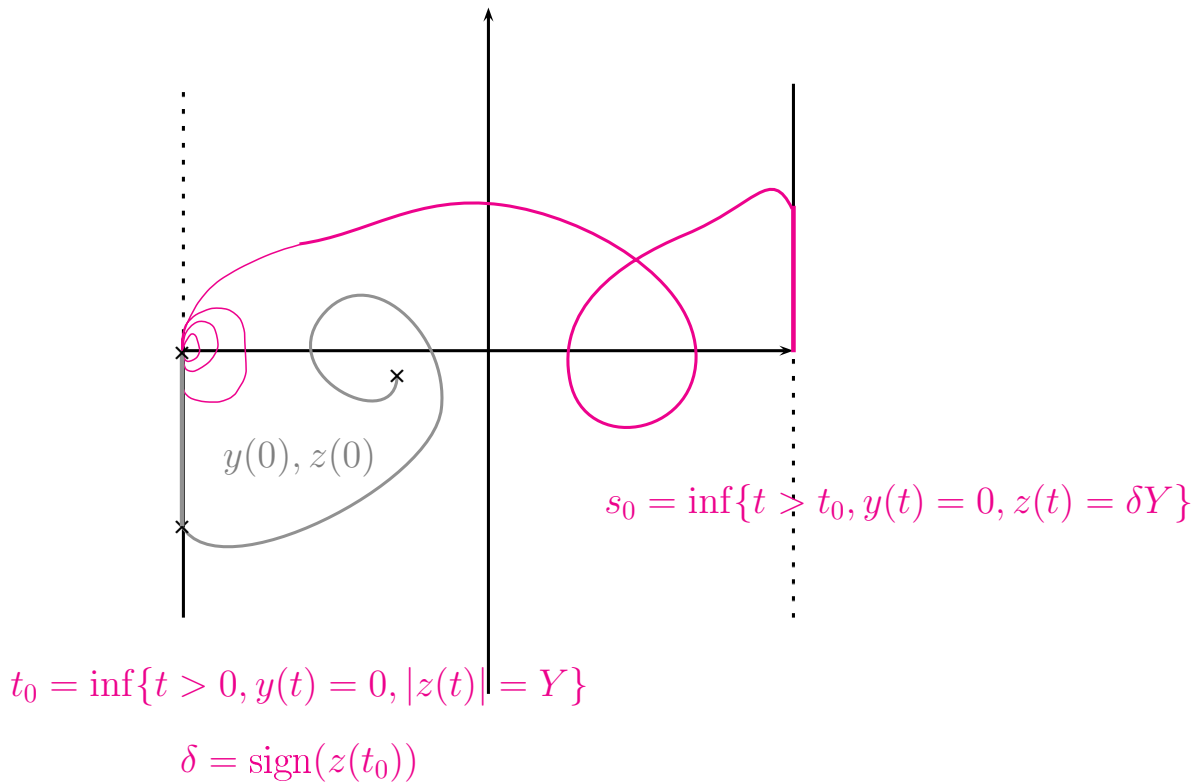

Definition and analysis of long cycles

- Define

$$t_1 = \inf\{t > s_0, \quad y(t) = 0, z(t) = \delta Y\},$$

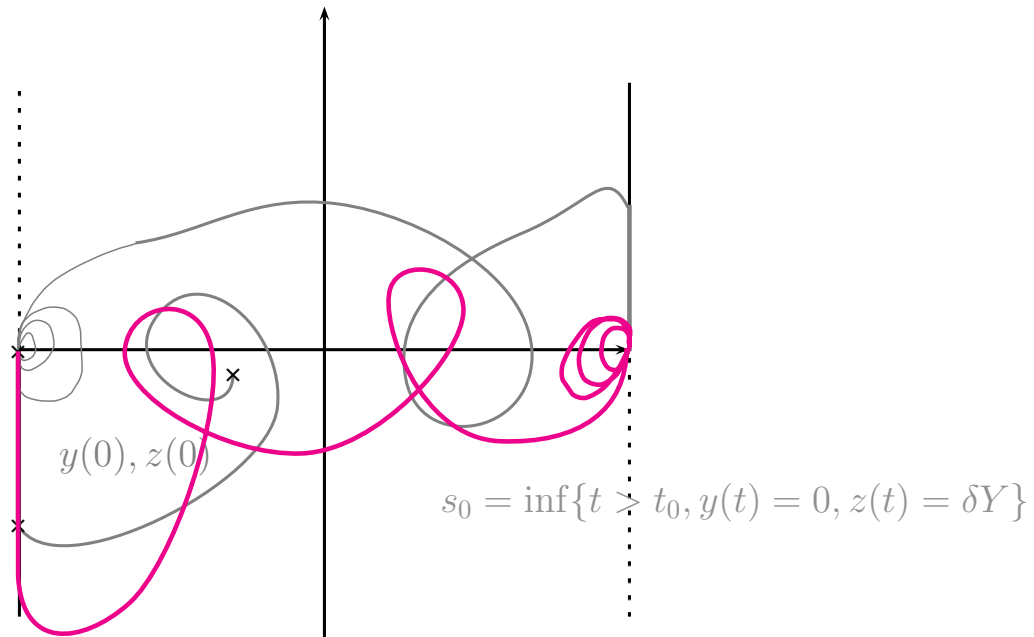

$$t_0 = \inf\{t > 0, y(t) = 0, |z(t)| = Y\}$$

$$\delta = \text{sign}(z(t_0))$$

$$t_1 = \inf\{t > 0, y(t) = 0, z(t) = \delta Y\}$$

Long cycle

Definition and analysis of long cycles

- Then in a recurrent manner, knowing t_n , we can define for $n \geq 0$

$$\begin{cases} t_{n+1} = \inf\{t > s_n, & y(t) = 0, z(t) = \delta Y\}, \\ s_{n+1} = \inf\{t > t_{n+1}, & y(t) = 0, z(t) = -\delta Y\}. \end{cases}$$

- Accordingly to these settings, we can define the n -th long cycle as the piece of trajectory enclosed by $[t_n, t_{n+1})$.

Definition and analysis of long cycles

Theorem (Long cycle behavior, A. Bensoussan, L.M.)

In this context, we have

$$\lim_{t \rightarrow +\infty} \frac{\sigma^2(x(t))}{t} = \frac{\mathbb{E}(\int_{t_0}^{t_1} y(s) ds)^2}{\mathbb{E}(t_1 - t_0)}$$

Key idea: PDEs related to long cycles and connection with short cycles.

submitted: [\[Bensoussan, Mertz 2011\] Behavior of the plastic deformation of an elasto-perfectly-plastic oscillator with noise](#)

tel-00653121, version 1 - 19 Dec 2011

PDEs related to Long cycles (type one way)

tel-00653121, version 1 - 19 Dec 2011

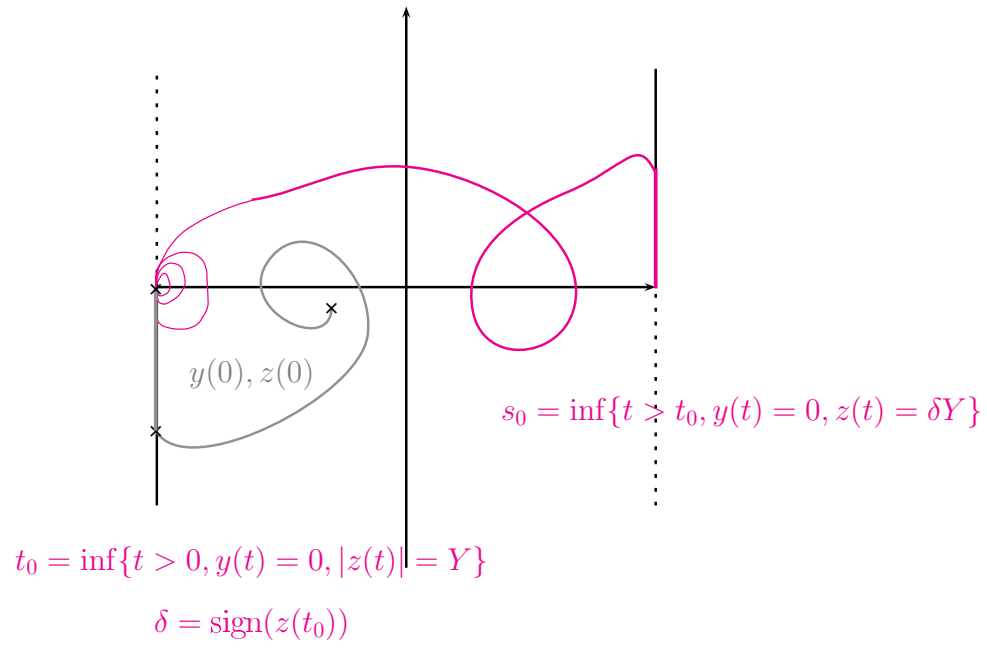

$$A\bar{v} = f, \quad B_+\bar{v} = f, \quad B_-\bar{v} = f \text{ and } \bar{v}(0^-, Y) = 0$$

where nonlocal problem : $y \rightarrow \bar{v}(y, -Y)$ is continuous

$$\bar{v}(0, -Y) = \mathbb{E}_{(0, -Y)} \left(\int_{t_0}^{s_0} f(y(s), z(s)) ds \right)$$

PDEs related to Long cycles (type return)

tel-00653121, version 1 - 19 Dec 2011

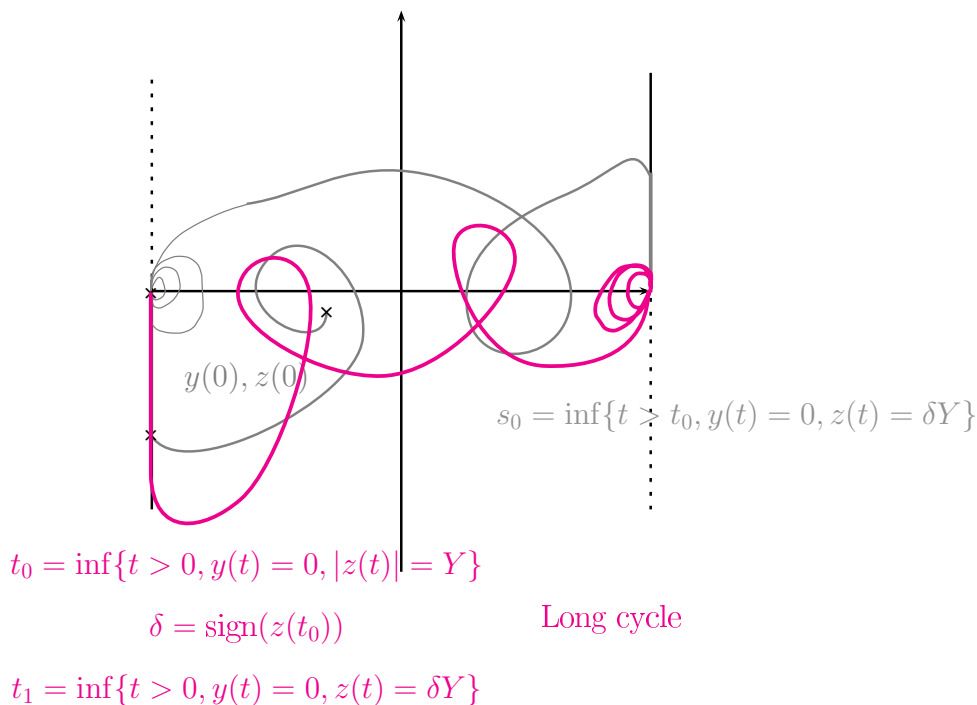

$$A\underline{v} = f, \quad B_+\underline{v} = f, \quad B_-\underline{v} = f \text{ and } \underline{v}(0^+, -Y) = 0$$

where nonlocal problem : $y \rightarrow \underline{v}(y, Y)$ is continuous

$$\underline{v}(0, Y) = \mathbb{E}_{(0, Y)} \left(\int_{s_0}^{t_1} f(y(s), z(s)) ds \right)$$

Numerical results in support of our result

In this section, we provide computational results which confirm our theoretical results.

$c_0 = 1, k = 1$				
Y	$\frac{\sigma^2(x(t))}{t}, t = 500$	$\frac{\mathbb{E}(\int_{t_0}^{t_1} y(s) ds)^2}{\mathbb{E}(t_1 - t_0)}$	$\mathbb{E}(t_1 - t_0)$	Relative error %
0.1	0.807 \pm 0.031	0.834 \pm 0.069	6.61 \pm 0.11	3.2
0.2	0.649 \pm 0.026	0.624 \pm 0.047	8.74 \pm 0.13	3.8
0.3	0.493 \pm 0.020	0.464 \pm 0.034	10.45 \pm 0.16	5.8
0.4	0.361 \pm 0.014	0.355 \pm 0.026	12.12 \pm 0.18	1.7
0.5	0.266 \pm 0.011	0.257 \pm 0.019	13.80 \pm 0.21	3.3
0.6	0.195 \pm 0.008	0.198 \pm 0.014	16.15 \pm 0.26	1.5
0.7	0.137 \pm 0.005	0.149 \pm 0.011	18.84 \pm 0.31	8
0.8	0.103 \pm 0.004	0.112 \pm 0.008	22.80 \pm 0.39	8
0.9	0.071 \pm 0.003	0.086 \pm 0.006	26.79 \pm 0.47	15

Table: Monte-Carlo simulations $t = 500$, $\delta t = 10^{-4}$ and $MC = 5000$.

tel-00653121, version 1 - 19 Dec 2011

Part 5 : Stochastic variational inequality with jumps for artificial elastic-plastic phasing

Why introducing jumps? 1/2

Micro-elastic phasing \rightarrow difficulties to compute plastic deformations. (Frequency of deformations tends to be overestimated because of the noise)

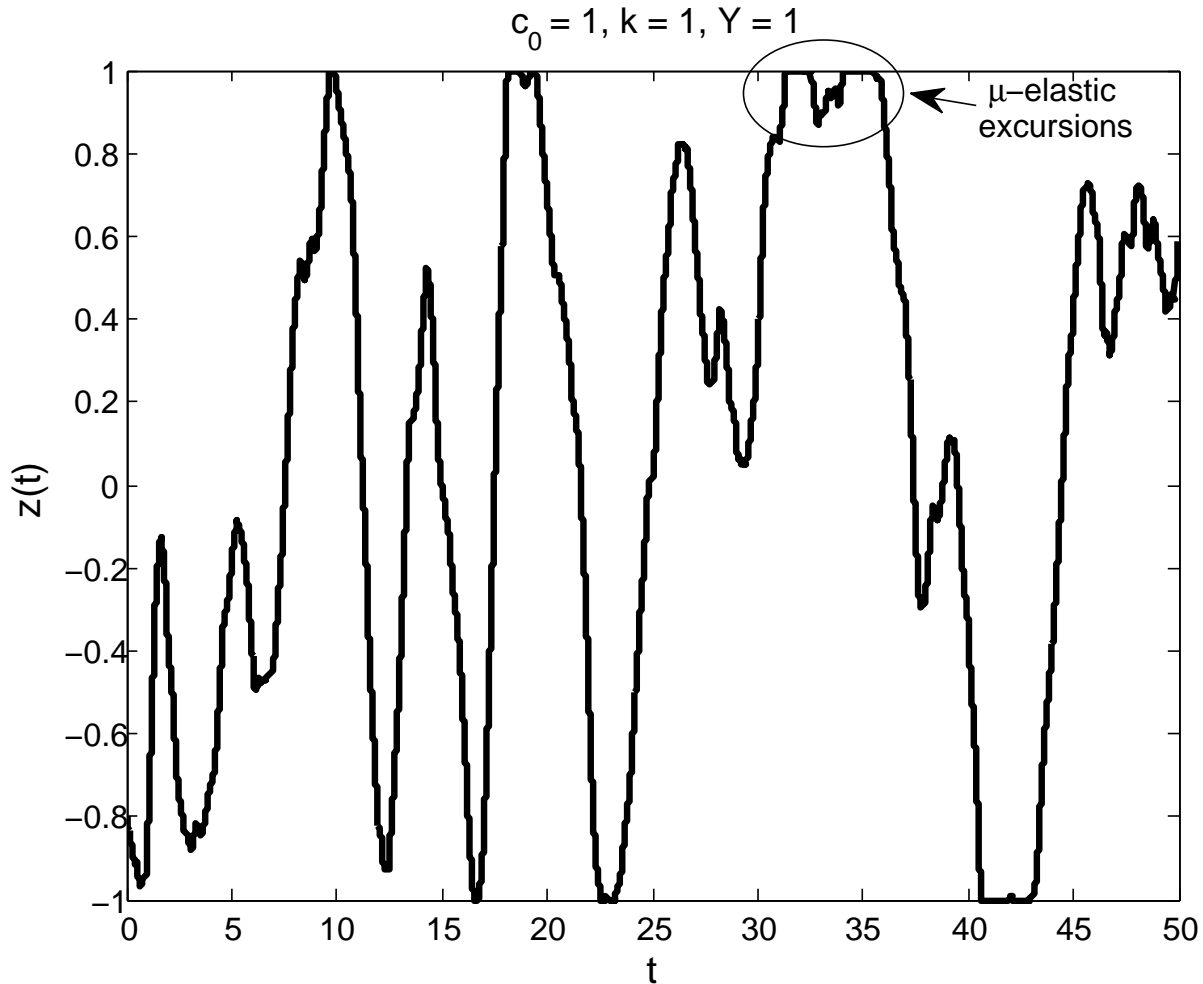

Why introducing jumps? 2/2

- Micro-elastic phases → negligible in deformations but they are very small as well as numerous.

Why introducing jumps? 2/2

- Micro-elastic phases → negligible in deformations but they are very small as well as numerous.
- **a SVI with artificial jumps → to help phase transition.**

Why introducing jumps? 2/2

- Micro-elastic phases → negligible in deformations but they are very small as well as numerous.
- **a SVI with artificial jumps → to help phase transition.**
- → an empirical criterion which could be useful to calibrate the size of the jump. submitted: [Feau, Mertz 2011] [An empirical study on plastic deformations of an elasto-plastic problem with noise](#)

Model definition of a model with jumps

- For some $\epsilon > 0$, we define the process $(y^\epsilon(t), z^\epsilon(t))$ on each interval of time $[\tau_n^\epsilon, \tau_{n+1}^\epsilon)$ where

$$\tau_n^\epsilon := \inf\{t > \tau_{n-1}^\epsilon \mid y^\epsilon(t) = 0 \text{ and } |z^\epsilon(t)| = Y\}$$

- as follows:

$$\begin{cases} \dot{y}^\epsilon(t) = -(c_0 y^\epsilon(t) + k z^\epsilon(t)) + \dot{w}(t), \\ (\dot{z}^\epsilon(t) - y^\epsilon(t))(\phi - z^\epsilon(t)) \geq 0, \quad \forall |\phi| \leq Y \quad ; \quad |z^\epsilon(t)| \leq Y \end{cases}$$

- with the following jump-conditions

$$\begin{aligned} y^\epsilon(\tau_n^\epsilon-) &= 0, & z^\epsilon(\tau_n^\epsilon-) &= \pm Y, \text{ and} \\ y^\epsilon(\tau_n^\epsilon) &= 0, & z^\epsilon(\tau_n^\epsilon) &= \text{sign}(z^\epsilon(\tau_n^\epsilon-))(Y - \epsilon). \end{aligned}$$

Model definition : example of a jump

jump-conditions:

BEFORE THE JUMP : $y^\epsilon(\tau_1^\epsilon-) = 0$, $z^\epsilon(\tau_1^\epsilon-) = \pm Y$

AFTER THE JUMP : $y^\epsilon(\tau_1^\epsilon) = 0$, $z^\epsilon(\tau_1^\epsilon) = \text{sign}(z^\epsilon(\tau_1^\epsilon-))(Y - \epsilon)$.

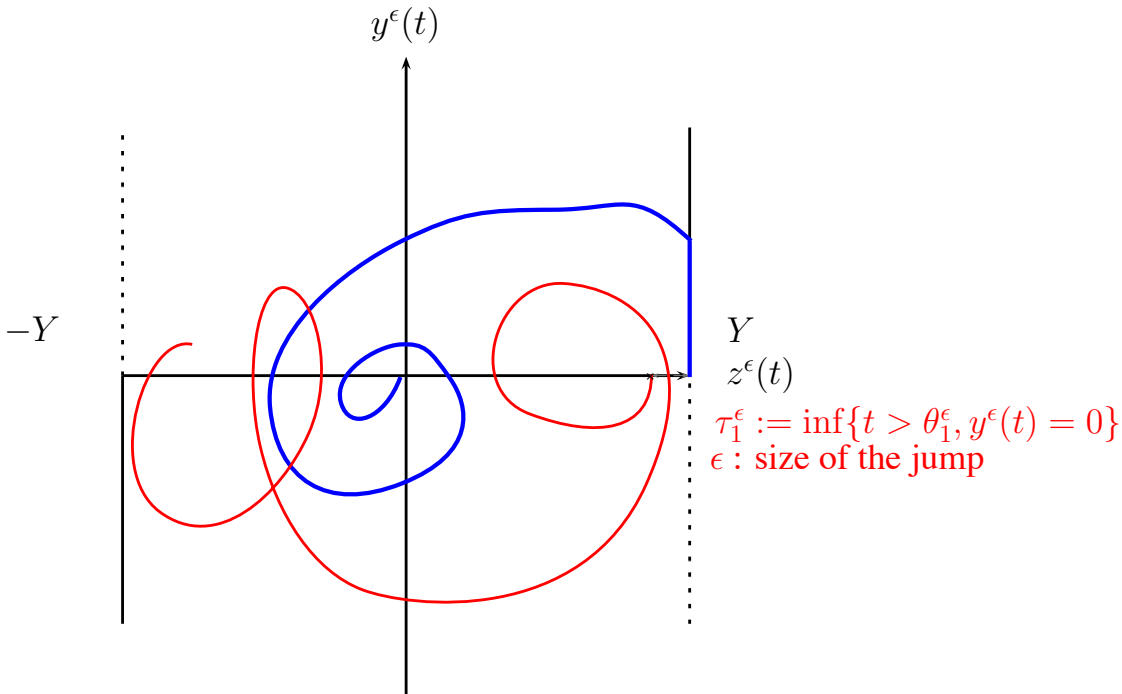

before the jump: $z^\epsilon(\tau_1^\epsilon-) = Y$

after the jump: $z^\epsilon(\tau_1^\epsilon) = Y - \epsilon$

Convergence to the continuous case as $\epsilon \rightarrow 0$: Statement of the result

Theorem (Convergence to the continuous case as $\epsilon \rightarrow 0$ A.
Bensoussan, H. Jasso-Fuentes, L.M., S. Menozzi)

Assume $k > \frac{1}{2} \left(-\frac{c_0}{3} + c_0 \sqrt{\frac{1}{9} + \frac{2c_0}{3}} \right)$. Fix $T > 0$ and consider the processes $(y(t), z(t))$ and $(y^\epsilon(t), z^\epsilon(t))$. Then,

$$\frac{1}{\epsilon} \mathbb{E} \left[\sup_{0 \leq t \leq T} \left\{ |y(t) - y^\epsilon(t)|^2 + k |z(t) - z^\epsilon(t)|^2 \right\} \right] \rightarrow 0 \quad \text{as } \epsilon \downarrow 0.$$

submitted: [Bensoussan, Jasso-Fuentes, Menozzi, Mertz. 2011]

Asymptotic analysis of stochastic variational inequalities
modeling an elasto-plastic problem with vanishing jumps

Convergence to the continuous case as $\epsilon \rightarrow 0$: Proof 1/3

- First, we define

$$\theta^\epsilon = \inf\{t > 0, \quad |z^\epsilon(t)| = Y\}$$

where

$$y^\epsilon(0) = 0 \text{ and } z^\epsilon(0) = Y - \epsilon$$

or

$$y^\epsilon(0) = 0 \text{ and } z^\epsilon(0) = -Y + \epsilon$$

with probability $1/2$.

Convergence to the continuous case as $\epsilon \rightarrow 0$: Proof 1/3

- First, we define

$$\theta^\epsilon = \inf\{t > 0, \quad |z^\epsilon(t)| = Y\}$$

where

$$y^\epsilon(0) = 0 \text{ and } z^\epsilon(0) = Y - \epsilon$$

or

$$y^\epsilon(0) = 0 \text{ and } z^\epsilon(0) = -Y + \epsilon$$

with probability $1/2$.

- We state that if $\frac{\epsilon}{\mathbb{P}(\theta^\epsilon > T)} \rightarrow 0$ we get the result.

Convergence to the continuous case as $\epsilon \rightarrow 0$: Proof 2/3

- Chapman-Kolmogorov equation : on p^ϵ and p^0 i.e

$$p_t - \frac{1}{2}p_{yy} - ((c_0y + kz)p)_y + yp_z = 0,$$

where $p^\epsilon(y, z, 0) = \delta_{0, Y-\epsilon}(y, z)$ and $p^0(y, z, 0) = \delta_{0, Y}(y, z)$.

Convergence to the continuous case as $\epsilon \rightarrow 0$: Proof 2/3

- Chapman-Kolmogorov equation : on p^ϵ and p^0 i.e

$$p_t - \frac{1}{2}p_{yy} - ((c_0y + kz)p)_y + yp_z = 0,$$

where $p^\epsilon(y, z, 0) = \delta_{0, Y-\epsilon}(y, z)$ and $p^0(y, z, 0) = \delta_{0, Y}(y, z)$.

- Hitting boundary problem $u(t, y, z)$ related to $\mathbb{P}_{(y,z)}(\theta^\epsilon > T - t)$.

Convergence to the continuous case as $\epsilon \rightarrow 0$: Proof 2/3

- Chapman-Kolmogorov equation : on p^ϵ and p^0 i.e

$$p_t - \frac{1}{2} p_{yy} - ((c_0 y + kz)p)_y + y p_z = 0,$$

where $p^\epsilon(y, z, 0) = \delta_{0, Y-\epsilon}(y, z)$ and $p^0(y, z, 0) = \delta_{0, Y}(y, z)$.

- Hitting boundary problem $u(t, y, z)$ related to $\mathbb{P}_{(y,z)}(\theta^\epsilon > T - t)$.
- By testing p^ϵ and p^0 with the hitting boundary problem, we can justify the following identity:

$$\begin{aligned} \mathbb{P}(\theta^\epsilon > T) &= \int_D [p^\epsilon(y, z, T) - p^0(y, z, T)] dydz \\ &\quad + \int_0^T \int_{-\infty}^0 y u(y, Y, t) [p^\epsilon(y, Y, t) - p^0(y, Y, t)] dt dy \\ &\quad - \int_0^T \int_0^\infty y u(y, -Y, t) [p^\epsilon(y, -Y, t) - p^0(y, -Y, t)] dt dy. \end{aligned}$$

Convergence to the continuous case as $\epsilon \rightarrow 0$: Proof 3/3

Lemma

- $\lim_{\epsilon \rightarrow 0} \frac{1}{\epsilon} \int_D [p^\epsilon(y, z, T) - p^0(y, z, T)] dydz$ is finite,
- $\lim_{\epsilon \rightarrow 0} \frac{1}{\epsilon} \int_0^T \int_0^\infty yu(y, -Y, t) [p^\epsilon(y, -Y, t) - p^0(y, -Y, t)] dt dy$ is finite,
- If we assume that $k > \frac{1}{2} \left(-\frac{c_0}{3} + c_0 \sqrt{\frac{1}{9} + \frac{2c_0}{3}} \right)$ then
 $\liminf_{\epsilon \rightarrow 0} \frac{1}{\epsilon} \int_0^T \int_{-\infty}^0 yu(y, Y, t) [p^\epsilon(y, Y, t) - p^0(y, Y, t)] dt dy = +\infty$

To conclude, we have

$$\lim_{\epsilon \rightarrow 0} \frac{\epsilon}{\mathbb{P}(\theta^\epsilon > T)} = 0.$$

that proves the theorem.

Part 6: Long time behavior of an elastic-plastic oscillator excited by a filtered noise

Why considering a filtered noise?

- ▶ Engineering point of view: a filtered noise → **more realistic**.
- ▶ Mathematical point of view: a **generalization** of the method proposed by Bensoussan-Turi.

Why considering a filtered noise?

- ▶ Engineering point of view: a filtered noise → **more realistic**.
- ▶ Mathematical point of view: a **generalization** of the method proposed by Bensoussan-Turi.

Consider $x(t)$ an Ornstein-Uhlenbeck process reflected by ξ_t :

$$dx(t) = \underbrace{-\alpha x(t)dt + dw(t)}_{\text{Ornstein-Uhlenbeck}} + \underbrace{\mathbf{1}_{\{|x(t)|=L\}} d\xi_t}_{\text{reflection}}$$

We have $-L \leq x(t) \leq L$, $L > 0$ and $\alpha > 0$, $w(t)$ is a Wiener process.

Why considering a filtered noise?

- ▶ Engineering point of view: a filtered noise → **more realistic**.
- ▶ Mathematical point of view: a **generalization** of the method proposed by Bensoussan-Turi.

Consider $x(t)$ an Ornstein-Uhlenbeck process reflected by ξ_t :

$$dx(t) = \underbrace{-\alpha x(t)dt + dw(t)}_{\text{Ornstein-Uhlenbeck}} + \underbrace{\mathbf{1}_{\{|x(t)|=L\}} d\xi_t}_{\text{reflection}}$$

We have $-L \leq x(t) \leq L$, $L > 0$ and $\alpha > 0$, $w(t)$ is a Wiener process.

We consider the external force given by

$$-\alpha x(t) + \underbrace{d\tilde{w}(t)}_{\substack{\text{uncorrelated} \\ \text{noise of } w(t)}}$$

Model definition

- The stochastic variational inequality is given by

$$\begin{cases} dx(t) = -\alpha x(t)dt + dw(t) + \mathbf{1}_{\{x(t)=-L\}} d\xi_t^1 - \mathbf{1}_{\{x(t)=-L\}} d\xi_t^2 \\ dy(t) = -(\alpha x(t) + c_0 y(t) + kz(t))dt + d\tilde{w}(t), \\ (dz(t) - y(t)dt)(\phi - z(t)) \geq 0, \quad \forall |\phi| \leq Y, \quad |z(t)| \leq Y \end{cases} \quad (*)$$

3D case

Model definition

- The stochastic variational inequality is given by

$$\begin{cases} dx(t) = -\alpha x(t)dt + dw(t) + \mathbf{1}_{\{x(t)=-L\}} d\xi_t^1 - \mathbf{1}_{\{x(t)=-L\}} d\xi_t^2 \\ dy(t) = -(\alpha x(t) + c_0 y(t) + kz(t))dt + d\tilde{w}(t), \\ (dz(t) - y(t)dt)(\phi - z(t)) \geq 0, \quad \forall |\phi| \leq Y, \quad |z(t)| \leq Y \end{cases} \quad (*)$$

3D case

- Note that if $\alpha = 0$, $x(t)$ is not involved in the dynamic of $y(t)$ and then $(y(t), z(t))$ satisfy the elasto-plastic problem studied by Bensoussan-Turi.

Model definition

- The stochastic variational inequality is given by

$$\begin{cases} dx(t) = -\alpha x(t)dt + dw(t) + \mathbf{1}_{\{x(t)=-L\}} d\xi_t^1 - \mathbf{1}_{\{x(t)=-L\}} d\xi_t^2 \\ dy(t) = -(\alpha x(t) + c_0 y(t) + kz(t))dt + d\tilde{w}(t), \\ (dz(t) - y(t)dt)(\phi - z(t)) \geq 0, \quad \forall |\phi| \leq Y, \quad |z(t)| \leq Y \end{cases} \quad (*)$$

3D case

- Note that if $\alpha = 0$, $x(t)$ is not involved in the dynamic of $y(t)$ and then $(y(t), z(t))$ satisfy the elasto-plastic problem studied by Bensoussan-Turi.
- Denote

$$\mathbf{R}u = \frac{1}{2}u_{xx} - \alpha x u_x - \alpha x u_y$$

In this case, the infinitesimal generator is given by :

- ▶ $\mathbf{A}u := Au + \mathbf{R}u$, on $(-L, L) \times \mathbb{R} \times (-Y, Y)$
- ▶ $\mathbf{B}_+ u := B_+ u + \mathbf{R}u$, on $(-L, L) \times (0, \infty) \times \{Y\}$
- ▶ $\mathbf{B}_- u := B_- u + \mathbf{R}u$, on $(-L, L) \times (-\infty, 0) \times \{-Y\}$

Ergodic Theorem: Statement of the result

Denote

- $\mathbf{D} := (-L, L) \times \mathbb{R} \times (-Y, Y)$
- $\mathbf{D}^+ := (-L, L) \times (0, +\infty) \times \{Y\}$
- $\mathbf{D}^- := (-L, L) \times (-\infty, 0) \times \{-Y\}$.

As the main result of this work we prove the following:

Theorem (Ergodic theorem, A. Bensoussan, L.M.)

There exists one and only one probability measure ν on $\mathbf{D} \cup \mathbf{D}^- \cup \mathbf{D}^+$ satisfying

$$\int_{\mathbf{D}} \mathbf{A}\phi d\nu + \int_{\mathbf{D}^-} \mathbf{B}_-\phi d\nu + \int_{\mathbf{D}^+} \mathbf{B}_+\phi d\nu = 0, \quad \forall \phi \text{ smooth.}$$

Moreover, ν has a probability density function m such that

$$\int_{\mathbf{D}} m(x, y, z) dx dy dz + \int_{\mathbf{D}^+} m(x, y, Y) dx dy + \int_{\mathbf{D}^-} m(x, y, -Y) dx dy = 1.$$

submitted: [Bensoussan, Mertz 2011] Degenerate Dirichlet problems related to the ergodic theory for an elasto-plastic oscillator excited by a filtered white noise

Part 6 : Conclusion & Perspectives

what we have done :

- 1: Numerical analysis of the invariant distribution related to a stochastic variational inequality

what we have done :

- 1: Numerical analysis of the invariant distribution related to a stochastic variational inequality
- 2: New characterization of the invariant distribution by short cycles

what we have done :

- 1: Numerical analysis of the invariant distribution related to a stochastic variational inequality
- 2: New characterization of the invariant distribution by short cycles
- 3: Characterization of the plastic drift by long cycles

what we have done :

- 1: Numerical analysis of the invariant distribution related to a stochastic variational inequality
- 2: New characterization of the invariant distribution by short cycles
- 3: Characterization of the plastic drift by long cycles
- 4: Convergence of an approximate solution of the svi to the original problem

what we have done :

- 1: Numerical analysis of the invariant distribution related to a stochastic variational inequality
- 2: New characterization of the invariant distribution by short cycles
- 3: Characterization of the plastic drift by long cycles
- 4: Convergence of an approximate solution of the svi to the original problem
- 5: Extension of the Bensoussan-Turi method for proving ergodicity of an elasto-plastic problem with a filtered noise.

Now, we wish to extend our work to the following (coming soon):

In preparation (with A. Bensoussan, H. Jasso-Fuentes, S. Menozzi): invariant distribution for the case with jumps (ν^ϵ) and convergence $\nu^\epsilon \rightarrow \nu$,

→ short cycle applied to the problem with jump.

- A characterization of the invariant distribution for the problem with jump:

$$\nu^\epsilon(f) = \frac{v(0, Y - \epsilon; f) + v(0, -Y + \epsilon; f)}{2v(0, Y - \epsilon; 1)}, \quad \nu^\epsilon(f) \rightarrow \nu(f)$$

Now, we wish to extend our work to the following (coming soon):

In preparation (with A. Bensoussan, H. Jasso-Fuentes, S. Menozzi): invariant distribution for the case with jumps (ν^ϵ) and convergence $\nu^\epsilon \rightarrow \nu$,

→ short cycle applied to the problem with jump.

- A characterization of the invariant distribution for the problem with jump:

$$\nu^\epsilon(f) = \frac{\nu(0, Y - \epsilon; f) + \nu(0, -Y + \epsilon; f)}{2\nu(0, Y - \epsilon; 1)}, \quad \nu^\epsilon(f) \rightarrow \nu(f)$$

- means “formally”

$$\nu(f) = \frac{\frac{1}{2}\mathbb{E}_{(0, Y-\epsilon)} \left(\int_0^\tau f(y(s), z(s)) ds \right) + \frac{1}{2}\mathbb{E}_{(0, -Y+\epsilon)} \left(\int_0^\tau f(y(s), z(s)) ds \right)}{\frac{1}{2}\mathbb{E}_{(0, Y-\epsilon)}(\tau) + \frac{1}{2}\mathbb{E}_{(0, -Y+\epsilon)}(\tau)}$$

tel-00653121, version 1 - 19 Dec 2011

Now, we wish to extend our work to the following :

- In preparation (with C. Feau): Engineering application of Long cycles to compute plastic deformation of an elasto-perfectly-plastic problem with noise,

Now, we wish to extend our work to the following :

- In preparation (with C. Feau): Engineering application of Long cycles to compute plastic deformation of an elasto-perfectly-plastic problem with noise,
- Speed of convergence of the distribution of $(y(t), z(t))$ to the invariant measure, and spectral analysis of A, B_+, B_- and density estimates.

Now, we wish to extend our work to the following :

- In preparation (with C. Feau): Engineering application of Long cycles to compute plastic deformation of an elasto-perfectly-plastic problem with noise,
- Speed of convergence of the distribution of $(y(t), z(t))$ to the invariant measure, and spectral analysis of A, B_+, B_- and density estimates.
- Short and long cycles in the case of the elastic-plastic problem excited with a filtered noise?

Now, we wish to extend our work to the following :

- Ergodicity for an elasto-plastic oscillator with bilinear force?
- Morally, seems to be more ergodic, but much more challenging mathematically.

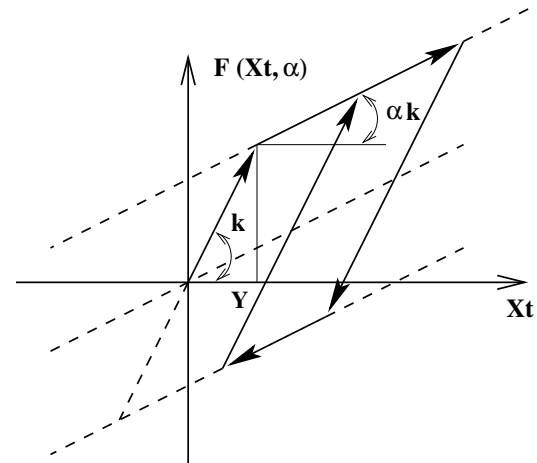
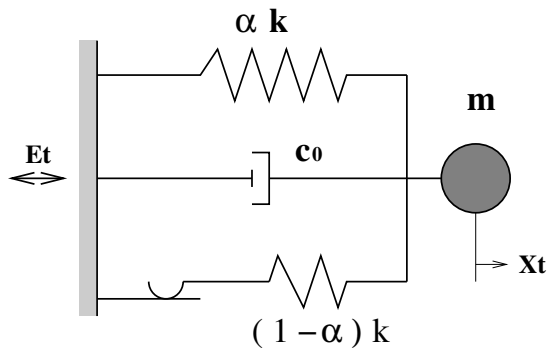

Merci de votre attention.