



HAL
open science

Marches aléatoires en milieux aléatoires et phénomènes de ralentissement

Alexander Fribergh

► **To cite this version:**

Alexander Fribergh. Marches aléatoires en milieux aléatoires et phénomènes de ralentissement. Mathématiques générales [math.GM]. Université Claude Bernard - Lyon I, 2009. Français. NNT : 2009LYO10078 . tel-00653469

HAL Id: tel-00653469

<https://theses.hal.science/tel-00653469v1>

Submitted on 19 Dec 2011

HAL is a multi-disciplinary open access archive for the deposit and dissemination of scientific research documents, whether they are published or not. The documents may come from teaching and research institutions in France or abroad, or from public or private research centers.

L'archive ouverte pluridisciplinaire **HAL**, est destinée au dépôt et à la diffusion de documents scientifiques de niveau recherche, publiés ou non, émanant des établissements d'enseignement et de recherche français ou étrangers, des laboratoires publics ou privés.

THESE DE DOCTORAT DE MATHEMATIQUES
DE L'UNIVERSITE CLAUDE BERNARD (LYON 1)
préparée à l'Institut Camille Jordan
Laboratoire des Mathématiques
UMR 5208 CNRS-UCBL

Thèse de doctorat
Specialité Mathématiques
présentée par
Alexander FRIBERGH

Marches aléatoires en milieux aléatoires et phénomènes de ralentissement

Rapporteurs : Noam BERGER Hebrew University of Jerusalem
Pierre MATHIEU Université de Provence

Soutenue le 3 Juin 2009 devant le jury composé de :

| | | | |
|------------|-----------|------------------------|--------------------|
| Stéphane | ATTAL | Université Lyon1 | Examineur |
| Vincent | BEFFARA | E.N.S. Lyon | Examineur |
| Gérard | BEN AROUS | New-York University | Examineur |
| Nina | GANTERT | Münster Universität | Examineur |
| Yueyun | HU | Université Paris 13 | Examineur |
| Pierre | MATHIEU | Université de Provence | Rapporteur |
| Christophe | SABOT | Université Lyon 1 | Directeur de thèse |

Remerciements

Je tiens à exprimer ma profonde reconnaissance à mon directeur de thèse, Christophe Sabot. Je tiens tout particulièrement à le remercier d'avoir ravivé mon intérêt pour les mathématiques au travers de mon stage de master et de cette thèse. Durant les moments difficiles de ces dernières années, ses idées, ses conseils avisés et son optimisme m'auront toujours permis de me remettre à l'ouvrage plein d'espoir. Nos discussions ont été un élément central dans ma formation de chercheur, avoir pu apprendre à ses côtés est un honneur.

Je suis extrêmement reconnaissant envers les différentes personnes et institutions qui m'ont accueilli durant cette thèse. En particulier, Nina Gantert à la Münster Universität, Serguei Popov à l'Universidade de São Paulo. Je suis également reconnaissant envers Gérard Ben Arous et Alan Hammond du Courant Institute (New-York) avec qui j'ai eu l'honneur de travailler. Finalement je remercie également l'Institut Mittag-Leffler où j'aurai eu le plaisir de passer plusieurs mois. Cette thèse doit énormément à toutes ces rencontres et ces voyages.

Je suis également très reconnaissant envers Noam Berger et Pierre Mathieu d'avoir accepté d'être rapporteurs de ma thèse, malgré la tâche que cela représente. Lors de nos rencontres, ils m'ont fait part de leur intérêt pour mon travail ce qui m'a fait le plus grand plaisir. Je remercie également Gérard Ben Arous, Nina Gantert, Yueyun Hu, Vincent Beffara et Stéphane Attal qui me font l'honneur de faire partie de mon jury.

Je tiens également à saluer Vincent Beffara pour sa disponibilité et son enthousiasme. Je suis certain que nos discussions m'ont inspiré à plusieurs reprises.

Je remercie toutes les équipes administratives et techniques de l'Université Lyon 1 et de L'École Normale Supérieure de Lyon pour leur gentillesse et leur efficacité.

Merci également à tous mes amis que j'ai pu cotoyer ces dernières années : Antoine, Damien, Eric, Frédéric, Gaël, Ion, Jean, Laurent, Maxime, Nicolas, Pierre ... j'en garde un souvenir exceptionnel.

Finalement je voulais remercier ma famille qui a toujours cru en moi.

Table des matières

| | | |
|----------|---|-----------|
| 1 | Introduction | 1 |
| 1 | Origines du modèle | 1 |
| 2 | Formulation mathématique | 2 |
| 3 | Organisation de la thèse | 4 |
| 2 | Quelques modèles d'importance | 7 |
| 1 | La marche aléatoire en environnement aléatoire uni-dimensionnelle | 7 |
| 1.1 | Le modèle et son histoire | 7 |
| 1.2 | Transience-réurrence et loi des grandes nombres | 8 |
| 1.3 | Le cas récurrent : le potentiel de Sinaiï | 9 |
| 1.4 | Le cas transient à vitesse nulle | 11 |
| 1.5 | Principes de grandes déviations | 12 |
| 2 | Marches aléatoires en milieu aléatoire sur des arbres | 12 |
| 2.1 | Modèle | 12 |
| 2.2 | Transience-réurrence | 14 |
| 2.3 | Loi des grands nombres | 14 |
| 2.4 | Principes de grandes déviations | 15 |
| 3 | Marches aléatoires en environnements aléatoires sur \mathbb{Z}^d avec $d \geq 2$ | 16 |
| 3.1 | Le modèle | 16 |
| 3.2 | Transience-réurrence | 17 |
| 3.3 | Existence et étude de la vitesse | 18 |
| 3.4 | Autres résultats | 19 |
| 4 | Marches aléatoires sur des clusters de percolation | 20 |
| 4.1 | La percolation par arêtes | 20 |
| 4.2 | La marche aléatoire simple | 21 |
| 4.3 | La marche aléatoire biaisée | 22 |
| 3 | Présentation des résultats | 25 |
| 1 | Comportement de la vitesse sur le cluster de percolation vis-à-vis des paramètres | 26 |

TABLE DES MATIÈRES

| | | |
|----------|---|-----------|
| 2 | Un lien entre les M.A.M.A. et un modèle de piège jouet | 29 |
| 3 | Déviations modérées pour la M.A.M.A. sur \mathbb{Z} | 36 |
| 4 | Biased random walks on Galton-Watson trees with leaves | 39 |
| 1 | Introduction and statement of the results | 40 |
| 2 | Constructing the environment and the walk in the appropriate way . . . | 44 |
| 3 | Constructing a trap | 47 |
| 4 | Sketch of the proof | 53 |
| 5 | The time is essentially spent in big traps | 54 |
| 6 | Number of visits to a big trap | 57 |
| 7 | The time spent in different traps is asymptotically independent | 62 |
| 8 | The time is spent at the bottom of the traps | 65 |
| 9 | Analysis of the time spent in big traps | 70 |
| 10 | Sums of i.i.d. random variables | 80 |
| 10.1 | Computation of the Lévy spectral function | 82 |
| 10.2 | Computation of d_λ | 84 |
| 10.3 | Computation of the variance | 85 |
| 11 | Limit theorems | 86 |
| 11.1 | Proof of Theorem 1.3 | 86 |
| 11.2 | Proof of Theorem 1.2 | 87 |
| 11.3 | Proof of Theorem 1.1 | 89 |
| 11.4 | Proof of Theorem 1.4 | 93 |
| 5 | The speed of a biased random walk on a percolation cluster at high density | 97 |
| 1 | Introduction | 97 |
| 2 | The model | 98 |
| 3 | Kalikow's auxiliary random walk | 103 |
| 4 | Resistance estimates | 106 |
| 5 | Percolation estimate | 115 |
| 6 | Continuity of the speed at high density | 123 |
| 7 | Derivative of the speed at high density | 128 |
| 7.1 | Another perturbed environment of Kalikow | 128 |
| 7.2 | Expansion of Green functions | 130 |
| 7.3 | First order expansion of the asymptotic speed | 135 |
| 8 | Estimate on Kalikow's environment | 139 |
| 8.1 | The perturbed hitting probabilities | 140 |
| 8.2 | Quenched estimates on perturbed Green functions | 143 |
| 8.3 | Decorrelation part | 146 |
| 9 | An increasing speed | 151 |

| | | |
|----------|--|------------|
| 6 | Slowdown and speedup of transient RWRE | 155 |
| 1 | Introduction and results | 156 |
| 2 | More notations and some basic facts | 161 |
| 3 | Estimates on the environment | 163 |
| 4 | Bounds on the probability of confinement | 169 |
| 5 | Induced random walk | 173 |
| 6 | Quenched slowdown | 177 |
| 6.1 | Time spent in a valley | 179 |
| 6.2 | Time spent for backtracking | 181 |
| 6.3 | Time spent for the direct crossing | 182 |
| 6.4 | Upper bound for the probability of quenched slowdown for the hitting time | 183 |
| 6.5 | Upper bound for the probability of quenched slowdown for the walk | 185 |
| 6.6 | Lower bound for quenched slowdown | 186 |
| 7 | Annealed slowdown | 188 |
| 7.1 | Lower bound for annealed slowdown | 188 |
| 7.2 | Upper bound for annealed slowdown | 190 |
| 8 | Backtracking | 191 |
| 8.1 | Quenched backtracking for the hitting time | 191 |
| 8.2 | Quenched backtracking for the position of the random walk | 192 |
| 8.3 | Annealed backtracking | 194 |
| 9 | Speedup | 194 |
| 9.1 | Lower bound for the quenched probability of speedup | 195 |
| 9.2 | Upper bound for the quenched probability of speedup | 197 |
| 9.3 | Annealed speedup | 198 |

TABLE DES MATIÈRES

1

Introduction

1 Origines du modèle

L'intérêt porté par les mathématiciens aux marches aléatoires est probablement lié à la simplicité du modèle qui permet cependant de modéliser des phénomènes naturels complexes et donne lieu à des problèmes mathématiques difficiles. L'un des modèles les plus simples que l'on puisse considérer, comme son nom l'indique, est la marche aléatoire simple sur \mathbb{Z}^d . On cherche à décrire le comportement d'un marcheur partant de l'origine du réseau de dimension d et qui saute à chaque unité de temps discrète vers l'un de ses $2d$ voisins, ce dernier étant choisi uniformément i.e. avec probabilité $1/(2d)$. Le cas le plus simple, celui de la dimension $d = 1$, décrit l'évolution de la fortune d'un joueur dans un jeu de pile ou face.

Des quantités de questions naturelles se posent rapidement, on ne retiendra pour l'instant que deux.

- Combien de fois le marcheur reviendra-t-il à l'origine ?
- Typiquement après un temps n où se situe le marcheur ?

La première question remonte à Polya qui la considéra en 1921. La légende veut que Polya réfléchissait à ce problème en marchant dans un parc près de Zürich alors qu'il rencontrait constamment un couple de promeneurs. Informellement on peut résumer le théorème qu'il démontra sous la forme suivante : en dimension $d \leq 2$ on revient

CHAPITRE 1. INTRODUCTION

infiniment souvent à l'origine, on dit alors que la marche est récurrente, alors qu'en dimension $d \geq 3$ on revient un nombre fini (aléatoire) de fois à l'origine auquel cas elle est dite transiente. On résume souvent ce résultat en disant qu'un homme ivre finira par rentrer chez lui alors qu'un poisson ivre peut se perdre à jamais.

La deuxième question est plus délicate à formuler mathématiquement. Cependant il est possible de dire qu'en un certain sens le marcheur se trouve à une distance \sqrt{n} de l'origine. De plus si on le regarde "de plus en plus loin", son comportement ressemble à celui d'un mouvement brownien. Cet objet tient son nom du biologiste Robert Brown qui en 1828 observa que des grains de pollen suspendus dans l'eau effectuaient un mouvement continu et désordonné. Il fut énormément étudié à partir du vingtième siècle, car il est omniprésent dans des domaines aussi différents que la finance (voir Bachelier [6]), la physique (citons Einstein [32]) et bien sûr les mathématiques.

Evidemment ce modèle a ses limites pour décrire à lui seul des problèmes plus complexes, en effet il ne permet pas de décrire un mouvement dans un milieu hétérogène ou inconnu. Il faut donc être capable de modéliser et tenir compte de l'aléatoire induit par un environnement. Par exemple, dans une portion de désert essentiellement plate, nous allons rencontrer des "imperfections", ce sont des dunes plus ou moins grandes qui vont influencer notre marcheur, ce dernier étant plus enclin à contourner un tel obstacle.

C'est dans le but de pouvoir décrire ce genre de phénomènes que nous étudions les marches aléatoires en milieux aléatoires. Nous utiliserons l'abréviation classique de M.A.M.A. pour désigner "marches aléatoires en milieux aléatoires".

2 Formulation mathématique

Nous ne cherchons pas ici à donner une formulation générale des modèles de M.A.M.A., i.e. sur des graphes généraux, on se contentera ici de formuler le problème sur le réseau \mathbb{Z}^d pour les marches à plus proches voisins.

On note \mathcal{S} le simplexe $2d$ -dimensionnel, posons $\Omega = \mathcal{S}^{\mathbb{Z}^d}$ et notons la coordonnée de $\omega \in \Omega$ au site $z \in \mathbb{Z}^d$ par $\omega(z, \cdot) = \{\omega(z, z + e)\}_{e \in \mathbb{Z}^d, |e|=1}$. Cette formulation peut paraître compliquée mais se représente assez simplement, on s'imagine qu'en chaque site z on choisit une mesure probabilité sur les voisins de z , chargeant $z + e$ avec un poids $\omega(z, z + e)$. Un exemple d'environnement est fourni dans la figure 1.1.

L'élément $\omega \in \Omega$ est appelé environnement et c'est dans celui-ci que la marche aléatoire va se déplacer. Etant donné un environnement ω on appelle marche aléatoire dans l'environnement ω partant de x , la chaîne de Markov $(X_n)_{n \geq 0}$ définie par $X_0 = x$ P_ω^x -p.s. et

$$\text{pour tout } n \geq 0 \text{ et } x \in \mathbb{Z}^d, \quad P_\omega^x[X_{n+1} = x + e \mid X_n = x] = \omega(x, x + e),$$

une loi que nous abrègerons dans le cas $x = 0$ par $P_\omega := P_\omega^0$.

2. FORMULATION MATHÉMATIQUE

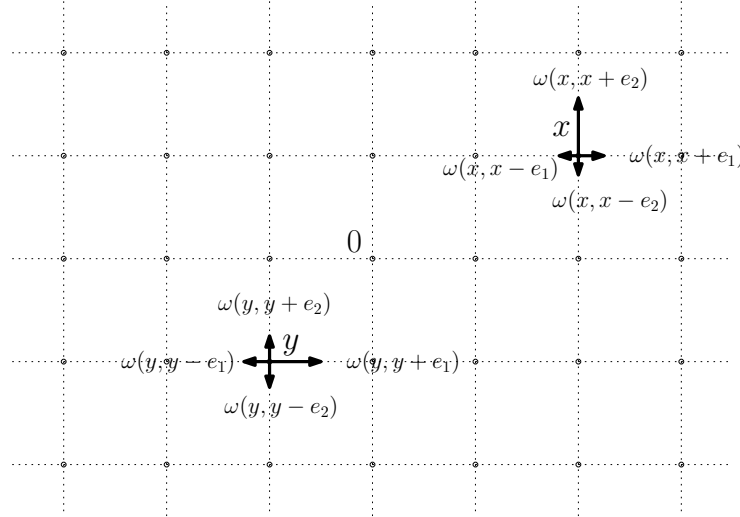

FIG. 1.1 – Exemple d’environnement

Cette loi P_ω est appelée *quenched*, un terme signifiant “trempee” qui provient de la métallurgie. Il est également utilisé en physique statistique pour désigner un système à désordre fixé, par exemple la position de particules magnétisées dans un alliage neutre. Cette loi a l’avantage d’être markovienne mais n’est pas invariante par translation car génériquement ω ne l’est pas. On considère maintenant un environnement aléatoire ce qui revient à mettre une probabilité \mathbf{P} sur l’espace Ω . Ce qui nous permet d’introduire la loi \mathbb{P} de la marche aléatoire moyennée sur l’environnement qui est définie comme produit semi-direct de \mathbf{P} et P_ω i.e.

$$\mathbb{P}(\cdot) = \int P_\omega(\cdot) d\mathbf{P}(\omega).$$

Cette loi est appelée *annealed*, ou également “recuite” dans le vocabulaire métallurgique. Elle n’est jamais markovienne si \mathbf{P} n’est pas un dirac, i.e. si l’environnement est réellement aléatoire, mais si l’environnement est invariante par translation (ce qui est commun) alors elle est invariante par translation.

Donnons deux types d’environnement communément utilisés :

- les marches aléatoires en environnements aléatoires où les probabilités de transitions sont i.i.d., i.e. $\mathbf{P} = \mu^{\otimes \mathbb{Z}^d}$ où μ est une probabilité sur $\{e \in \mathbb{Z}^d, |e| = 1\}$,
- les marches aléatoires en conductances aléatoires dont les probabilités de transitions sont données pour tout $x \in \mathbb{Z}^d$ et $e \in \mathbb{Z}^d$ avec $|e| = 1$ par,

$$P_\omega(x, x + e) = \frac{c_\omega(x, x + e)}{\sum_{e' \in \mathbb{Z}^d, |e'|=1} c_\omega(x, x + e')},$$

où les $c_\omega(x, x + e')$ sont des variables aléatoires i.i.d.. Ce modèle est naturel car il

permet de définir des marches aléatoires réversibles en milieux aléatoires et à ce titre est fortement lié à la théorie des réseaux électriques, voir [30] et [70].

3 Organisation de la thèse

Notre objectif n'est en aucun cas de faire une introduction aux M.A.M.A. dans un cadre complètement général, nous renvoyons le lecteur aux ouvrages de références [100] et [104] pour plus de généralités. Cependant les modèles que nous avons étudiés sont assez divers dans leur formulation et il nous sera donc nécessaire les présenter rapidement.

Nous allons rapidement expliquer les liens qu'il existe entre les modèles étudiés dans cette thèse. Ce qui les unit est leur mode de fonctionnement, il s'agit de modèles anisotropiques, où la particule est poussée dans une direction particulière, et qui de plus présentent des zones qui ralentissent fortement la marche.

Le modèle constituant le point de départ de cette thèse est celui de la marche aléatoire biaisée sur le cluster de percolation. Il s'agit d'un modèle très important, en effet il est à la fois naturel physiquement, ce qui explique l'intérêt que les physiciens lui ont porté, et il présente des questions mathématiques intéressantes et difficiles à traiter. Une présentation plus précise de ce modèle est faite à la Section 4.3.

Ce modèle étant apparemment hors de portée au début de la thèse, je me suis tourné vers l'étude d'un modèle proche sous beaucoup d'aspects mais plus simple à analyser. Il s'agit de la marche aléatoire biaisée sur un Galton-Watson avec des feuilles, sur lequel des comportements similaires à ceux qu'on observe sur le cluster de percolation ont été démontré mathématiquement. En étudiant ce modèle, j'ai très vite trouvé de fortes similarités avec les modèles uni-dimensionnels. En effet le biais pousse la marche dans une direction privilégiée et la trajectoire vue de loin est essentiellement uni-dimensionnelle. De plus les résultats plus fins obtenus par les physiciens étaient très similaires à ce que l'on avait obtenu sur \mathbb{Z} , il était donc naturel d'aller travailler également sur les marches aléatoires en milieu aléatoire sur \mathbb{Z} .

Comme souvent en recherche, on part d'un modèle complexe et l'on cherche des modèles plus simples ou mieux compris avec lesquels faire des parallèles. Le déroulement de cette thèse ne fait pas exception à la règle. Cependant pour la présentation des résultats qui permettent de replacer notre thèse dans le contexte nous allons suivre, autant que possible, l'ordre historique d'apparition des résultats. Ainsi nous étudierons des modèles de plus en plus difficiles. Plus précisément nous allons présenter les modèles en fonction de la dimension

- dans la section 1 on présentera les M.A.M.A. sur \mathbb{Z} ,
- dans la section 2 on présentera les M.A.M.A. sur les arbres,
- dans la section 3 on présentera les M.A.M.A. sur \mathbb{Z}^d avec $d \geq 2$.

Nos résultats sont présentés dans le chapitre 3 et leurs preuves sont incluses (en

3. ORGANISATION DE LA THÈSE

anglais) dans les chapitres 4, 5, 6.

CHAPITRE 1. INTRODUCTION

2

Quelques modèles d'importance

1 La marche aléatoire en environnement aléatoire uni-dimensionnelle

1.1 Le modèle et son histoire

La marche aléatoire en environnement aléatoire uni-dimensionnelle est le modèle le plus simple de M.A.M.A.. Il a été introduit en 1967 par le biophysicien Chernov [19] pour comprendre les phénomènes de duplication des brins d'A.D.N.. Plus récemment de nouveaux résultats sont apparus en biologie en lien avec des expériences de micro-manipulation des brins d'A.D.N., citons par exemple Lubensky et Nelson [64].

Ce modèle apparait également en métallurgie, comme l'indique les liens de vocabulaire étroits. En effet, en 1972, Temkin le réutilise pour étudier la cinétique des transitions de phase dans les alliages. Finalement pour des résultats obtenus en physique théorique sur ce modèle, nous renvoyons le lecteur à Le Doussal, Monthus et Fisher [61].

En raison de la simplicité du graphe portant l'environnement aléatoire les notations sont particulièrement simples. On se donne $\omega = (\omega_x)_{x \in \mathbb{Z}}$ une famille de variables aléatoires indépendantes et identiquement distribuées à valeurs dans $]0, 1[$. Les probabilités de transition de notre chaîne de Markov sont données pour $n \geq 0$ et $x \in \mathbb{Z}$ par

$$P_\omega[X_0 = 0] = 1 \text{ et } P_\omega[X_{n+1} = x + 1 \mid X_n = x] = \omega_x = 1 - P_\omega[X_{n+1} = x - 1 \mid X_n = x].$$

CHAPITRE 2. QUELQUES MODÈLES D'IMPORTANCE

Typiquement on représente l'environnement comme dans la figure 2.1.

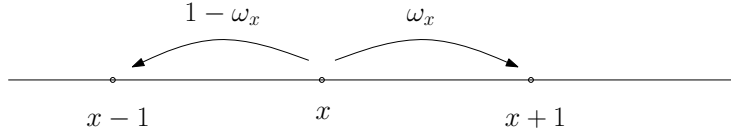

FIG. 2.1 – Exemple d'environnement sur \mathbb{Z}

On supposera dans la suite que l'environnement ω n'est pas déterministe. La chaîne $(X_n)_{n \geq 0}$ n'est donc pas markovienne, de plus dans ce cas la loi annealed est invariante par translation. Les résultats et les méthodes classiques concernant les marches aléatoires ne peuvent se transposer. La palette de phénomènes apparaissant en dimension 1 est déjà extrêmement riche. Elle a certainement contribué au fort intérêt que la communauté probabiliste a porté aux M.A.M.A..

Avant de rentrer dans la description des résultats liées à ce modèle, précisons qu'il existe d'autres modèles uni-dimensionnels qui ont été étudiés. Par exemple, on peut considérer des probabilités de transitions ergodiques, réversibles ou bien des marches qui ne sont pas à plus proches voisins. On renvoie par exemple le lecteur à [60], [3], [74].

1.2 Transience-réurrence et loi des grandes nombres

Les premiers résultats mathématiques sont apparus en 1975, Solomon [95] obtient un critère de récurrence-transience pour la M.A.M.A. uni-dimensionnelle. Il va même jusqu'à une loi des grands nombres. Contrairement au cas de l'environnement déterministe, ce n'est pas ici la dérive de la marche, i.e. $\mathbb{E}[X_1]$, qui apparait dans la loi des grands nombres. La variable aléatoire qui s'avère centrale est

$$\rho_0 = \frac{1 - \omega_0}{\omega_0}.$$

On supposera que la quantité $\mathbf{E}[\ln \rho_0]$ est bien définie (éventuellement infinie).

Théorème 1.1 (Solomon-1975). *On a deux cas.*

1. Si $\mathbf{E}[\ln \rho_0] < 0$ (resp. > 0) alors la marche est transiente et on a

$$\lim_{n \rightarrow \infty} X_n = \infty \quad (\text{resp. } -\infty) \quad \mathbb{P}\text{-p.s.}$$

2. SI $\mathbf{E}[\ln \rho_0] = 0$ alors la marche est récurrente et

$$\limsup_{n \rightarrow \infty} X_n = \infty \quad \text{et} \quad \liminf_{n \rightarrow \infty} X_n = -\infty \quad \mathbb{P}\text{-p.s.}$$

La loi des grands nombres se formule de la manière suivante

1. LA MARCHÉ ALÉATOIRE EN ENVIRONNEMENT ALÉATOIRE UNI-DIMENSIONNELLE

Théorème 1.2 (Solomon-1975). *On a*

$$\lim_{n \rightarrow \infty} \frac{X_n}{n} = v, \quad \mathbb{P}\text{-p.s.},$$

avec

$$v = \begin{cases} \frac{1-\mathbf{E}[\rho_0]}{1+\mathbf{E}[\rho_0]} & \text{si } \mathbf{E}[\rho_0] < 1 \\ \frac{\mathbf{E}[1/\rho_0]-1}{\mathbf{E}[1/\rho_0]+1} & \text{si } \mathbf{E}[1/\rho_0] < 1 \\ 0 & \text{si } 1/\mathbf{E}[1/\rho_0] \leq 1 \leq \mathbf{E}[\rho_0]. \end{cases}$$

Ce théorème constitue le tout premier résultat significatif et on peut déjà y voir les phénomènes de ralentissement qui constitue le coeur de cette thèse. Les deux points centraux sont les suivants

1. on a $|v| < |\mathbf{E}[X_1]|$,
2. il existe des régimes où la M.A.M.A. est transiente dans une direction avec cependant une vitesse nulle.

Le premier phénomène montre qu'en dimension 1, la marche est effectivement ralentie par l'aléatoire dans l'environnement. Comprendre la vitesse d'une M.A.M.A. est en fait une question très épineuse. Nous verrons plus tard, voir Section 3, qu'il existe des comportements plus riches en dimension $d \geq 2$ et que cette propriété n'est pas conservée. En dimension supérieure le seul outil pour étudier la vitesse d'une M.A.M.A. est de la relier à celle d'une marche aléatoire dans un environnement déterministe compliqué.

Le deuxième phénomène est annonciateur de l'existence de "nouveaux régimes" qui n'existaient pas dans le cadre des marches aléatoires classiques. Cela va de paire avec l'apparition de plusieurs nouvelles questions. En particulier il paraît naturel de se demander l'ordre de grandeur des mouvements de la marche. Peut-on trouver une fonction simple $f(n)$ (par exemple polynomiale) telle que $(X_n/f(n))_{n \geq 0}$ converge en loi? forme une famille tendue? etc.

Un régime similaire, de transience directionnelle à vitesse nulle, existe pour les marches aléatoires en conductances aléatoires sur les arbres et en dimension supérieure également. Il constitue en quelque sorte le véritable noyau de cette thèse.

1.3 Le cas récurrent : le potentiel de Sinai

Avant de revenir plus en détail sur le régime transient à vitesse nulle, nous allons introduire l'objet qui semble être le plus pertinent pour l'analyse de la M.A.M.A. uni-dimensionnelle. Il s'agit du potentiel dit de "Sinai" qui fut introduit en 1982, voir [94], et qui est défini de la manière suivante

$$V(x) := \begin{cases} \sum_{i=1}^x \ln \rho_i, & \text{si } x \geq 1, \\ 0, & \text{si } x = 0, \\ -\sum_{i=x+1}^0 \ln \rho_i, & \text{si } x \leq -1, \end{cases}$$

CHAPITRE 2. QUELQUES MODÈLES D'IMPORTANCE

D'un point de vue physique cette quantité correspond à une énergie potentielle, d'où le nom, et donne une interprétation visuelle des endroits où la marche aura tendance à rester bloquée. Mathématiquement on pourra noter les deux faits suivants

- $V(x)$ est une marche aléatoire (à valeurs réelles) de pas i.i.d. de loi $\ln \rho_0$,
- $V(x)$ permet de définir facilement une mesure invariante pour la marche dans l'environnement ω en posant $\pi(x) = e^{-V(x)} + e^{-V(x-1)}$.

Sous des hypothèses de moments sur les sauts du potentiel, ce dernier se comporte essentiellement comme un mouvement brownien. La figure 2.2 correspond à un exemple typique de potentiel.

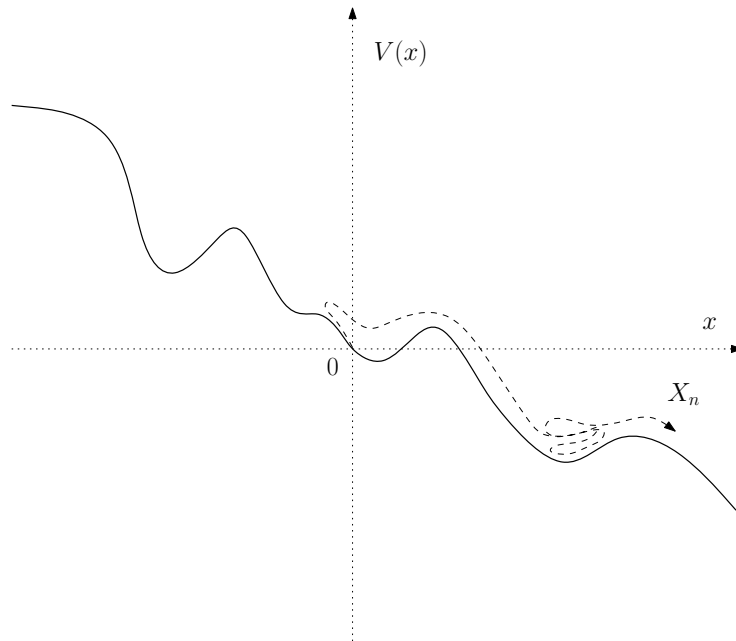

FIG. 2.2 – Exemple de potentiel dans le cas transient vers ∞

On peut ainsi facilement expliquer le résultat de transience obtenu par Solomon, si $\mathbf{E}[\ln \rho_0] < 0$ alors $V(x)$ va aller vers $-\infty$ seulement en $+\infty$. Or comme la marche est attirée par les zones qui sont chargées par la mesure invariante, i.e. de bas potentiel, elle va naturellement partir vers $+\infty$. En quelque sorte le potentiel de Sinai permet d'expliquer l'importance de la variable aléatoire $\ln \rho_0$.

Bien évidemment l'utilisation de ce potentiel va bien au delà de cette interprétation intuitive du critère de transience-réurrence. Originellement, il a permis de démontrer dans [94] le résultat suivant.

Théorème 1.3 (Sinai-1982). *Supposons que $\mathbf{P}[\omega_0 \in [\varepsilon, 1 - \varepsilon]] = 1$ pour $\varepsilon > 0$ et que $\mathbf{E}[\ln \rho_0] = 0$, alors*

$$\frac{X_n}{\ln^2 n} \xrightarrow{\text{loi}} b_\infty,$$

1. LA MARCHE ALÉATOIRE EN ENVIRONNEMENT ALÉATOIRE UNI-DIMENSIONNELLE

où b_∞ est non-dégénérée et non gaussienne qui ne dépend que de l'environnement.

L'expression explicite de la loi de b_∞ a ensuite été obtenue indépendamment par Kesten [57] et Golosov [44].

On notera que l'hypothèse $\mathbf{P}[\omega_0 \in [\varepsilon, 1 - \varepsilon]] = 1$ pour $\varepsilon > 0$, dite d'uniforme ellipticité, n'est pas seulement une hypothèse simplificatrice pour éviter des problèmes d'intégrabilité. Il permet en effet d'approximer le potentiel "vu de loin" par un mouvement brownien. Pour des potentiels plus irréguliers, le potentiel se comporte comme un processus stable d'indice α . Kawazu, Tamura et Tanaka [56] montrent que le déplacement de la marche est alors en $\ln^\alpha(n)$.

1.4 Le cas transient à vitesse nulle

Revenons-en maintenant au cas de la transience directionnelle à vitesse nulle. Ce régime fut étudié rapidement, le premier résultat remontant à Kesten, Kozlov et Spitzer [59]. Ce résultat est important dans l'histoire des M.A.M.A., à tel point qu'on parle souvent de "régime Kesten-Kozlov-Spitzer" ou bien "régime K.K.S.". Il a connu ces dernières années un regain d'intérêt sous l'impulsion du travail de Enriquez, Sabot et Zindy, voir [35] et [36].

Théorème 1.4 (Kesten, Kozlov, Spitzer - 1975). *Supposons que la famille de v.a.i.i.d. $\omega := (\omega_i, i \in \mathbb{Z})$ vérifie*

1. $-\infty \leq \mathbf{E}[\ln \rho_0] < 0$,
2. *il existe $0 < \kappa < 1$ tel que $\mathbf{E}[\rho_0^\kappa] = 1$ et $\mathbf{E}[\rho_0^\kappa \ln^+ \rho_0] < \infty$,*
3. *la distribution de $\ln \rho_0$ n'est pas concentrée sur un réseau,*

alors

$$\frac{\tau(n)}{n^{1/\kappa}} \xrightarrow{\text{loi}} \mathcal{S}_\kappa, \text{ et } \frac{X_n}{n^\kappa} \xrightarrow{\text{loi}} \mathcal{L}_\kappa,$$

où $\xrightarrow{\text{loi}}$ désigne la convergence en loi sous la mesure \mathbb{P} , \mathcal{S}_κ^{ca} une loi stable complètement asymétrique d'indice κ et \mathcal{L}_κ une loi de Mittag-Leffler d'indice κ .

Dans le même article il a également été démontré un comportement en $n/\ln n$ dans le cas où $\mathbf{E}[\rho_0] = 1$ ainsi que des résultats de fluctuations dans le cas balistique à variations non-gaussiennes.

Ce résultat a été raffiné dans [35] et [36] au sens où la description des lois limites est plus précises. De plus les méthodes de démonstration mises en oeuvre et utilisant le potentiel semblent assez robustes. Elles ont fourni une grande source d'inspiration pour deux des nouveaux résultats contenus dans cette thèse, voir ([39]) et ([8]).

Concernant les théorèmes limites quenched la situation est compliquée, on peut en fait démontrer qu'il n'y a pas convergence en loi [79].

1.5 Principes de grandes déviations

Un dernier type de résultat qu'il convient de citer, car il complète en quelque sorte les résultats obtenus précédemment, concerne les grandes déviations. Par exemple dans le cas d'une marche transiente à vitesse positive, on cherche à savoir à quelle vitesse va décroître la probabilité que $\mathbb{P}[X_n/n \leq c]$ pour $0 < c < v$ où v désigne la vitesse asymptotique.

Nous citerons le premier résultat concernant un principe de grandes déviations (P.G.D.) sous la loi quenched obtenu en 1994 par Greven et den Hollander [45]. Ce résultat fut démontré via des méthodes d'homogénéisation et a ceci de surprenant que la fonction de taux obtenue dans le P.G.D. est déterministe. Ce résultat fût complété par Comets, Gantert et Zeitouni dans [20] qui grâce à des méthodes différentes ont obtenu un P.G.D. quenched et annealed. De nombreuses propriétés sur les fonctions de taux sont obtenues, ce qui fait de cet article un recueil complet de résultats sur les grandes déviations pour la M.A.M.A. uni-dimensionnelle. Le cas "nestling" (voir [100] pour la définition précise) reste cependant partiellement laissé ouvert. En effet la fonction de taux obtenue est nulle aussi bien dans le cas quenched que annealed sur l'intervall $[0, v]$, ce qui nous indique seulement que la décroissance est sous-exponentielle.

D'autres résultats de grandes déviations peuvent-être trouvés dans [26], [27], [40], [41], [81] and [82].

2 Marches aléatoires en milieu aléatoire sur des arbres

2.1 Modèle

La M.A.M.A. en dimension 1 étant essentiellement bien comprise, la recherche s'est portée vers d'autres modèles plus complexes à analyser. Trois propriétés étaient à l'origine de la simplicité d'analyse du modèle

1. la marche sur \mathbb{Z} est systématiquement réversible, car \mathbb{Z} ne contient pas de cycle,
2. pour aller d'un point x à un point y , la marche doit passer par tous les points de $]x, y[$,
3. il n'y a, dans le cas transient, qu'une seule manière de partir à l'infini.

En passant directement à l'étude des M.A.M.A. dans \mathbb{Z}^d avec $d \geq 2$, nous perdons toutes ses propriétés et cela explique les difficultés éprouvées pour prouver de nouveaux résultats. Les mathématiciens se sont donc penchés sur l'étude d'un modèle intermédiaire, celui des marches aléatoires sur les arbres, Dans ce cas, seule la troisième propriété citée au-dessus est perdue. On peut également noter que le potentiel, provenant du caractère réversible de la marche, existe mais ne peut être représenté en terme de marche aléatoire comme en dimension 1.

2. MARCHES ALÉATOIRES EN MILIEU ALÉATOIRE SUR DES ARBRES

Jusqu'ici nous avons seulement fait référence à des marches aléatoires qui vivent sur un graphe sous-jacent fixé, par exemple \mathbb{Z}^d . Dans le cas des arbres, il est commun de considérer des marches sur un arbre de Galton-Watson qui est lui-même aléatoire, sur lequel on peut également rajouter un environnement aléatoire.

Précisons le modèle le plus communément étudié. Pour cela nous avons besoin

1. d'une suite de v.a.i.i.d. $(Z^{(i)})_{i \geq 0}$ suivant une loi de reproduction $P[Z^{(1)} = k] = p_k$ surcritique i.e. telle que $m = \sum_k k p_k \in (1, \infty)$,
2. et d'une suite de v.a.i.i.d. $(A_i)_{i \geq 0}$ à valeurs dans \mathbb{R}_+^* ,

où nous excluons évidemment le cas $p_1 = 1$ qui correspond à considérer une M.A.M.A. unidimensionnelle.

On fixe au départ deux sommets \vec{r} et r reliés par une arête et on attribue une génération à \vec{r} (resp. r) qui est -1 (resp. 0). On construit alors récursivement l'arbre aléatoire de la manière suivante : lorsque la génération n est construite nous pouvons noter les sommets de cette génération x_1, \dots, x_k . Pour un de ses sommets x_i nous ajoutons $Z^{(i)}$ (où la variable utilisée est indépendante de celles utilisées précédemment dans la construction) enfants chacun étant relié à x_i par une arête, de plus chacun de ses enfants est affecté d'une marque aléatoire tirée indépendamment suivant la loi A_i .

Ce processus fournit un Galton-Watson où les sommets sont marqués, nous le noterons \mathbb{T} . Notre mesure sur l'environnement est alors la loi de \mathbb{T} conditionnée à être infini, ce qui est un événement de probabilité positive car nous avons supposé que notre Galton-Watson était surcritique.

Conditionnellement à la donnée d'un tel arbre $\mathbb{T}(\omega)$ la marche aléatoire est définie de la manière suivante : pour tout $y \in \mathbb{T}$ et tout $n \geq 0$, on pose

$$P_\omega[X_0 = r] = 1 \text{ et } P_\omega[X_{n+1} = z \mid X_n = y] = \omega(y, z),$$

où $\omega(\vec{r}, r) = 1$ et pour tout $x \in \mathbb{T} \setminus \{\vec{r}\}$ qui admet x_1, \dots, x_k comme enfants

1. $\omega(x, x_i) = \frac{A(x_i)}{1 + \sum_{i=1}^k A(x_i)}$, pour $i = 1, \dots, k$,
2. $\omega(x, \vec{x}) = \frac{1}{1 + \sum_{i=1}^k A(x_i)}$, où \vec{x} est le père de x ,
3. $\omega(x, y) = 0$, sinon.

Ce nouveau type de M.A.M.A. se divise essentiellement en deux catégories bien distinctes, le cas où $p_0 > 0$ et le cas où $p_0 = 0$. Le premier se révèle plus difficile à analyser pour diverses raisons. Nous allons simplement citer le fait que dans ce cas nous perdons toute invariance par translation annealed car c'est le seul cas où notre mesure sur l'environnement correspond à un Galton-Watson conditionné à survivre. En particulier ce n'est pas parce qu'un arbre est transient que la descendance de n'importe quel point est un arbre transient (ce qui est le cas si $p_0 = 0$). Cela complique l'analyse du modèle.

2.2 Transience-réurrence

Les questions de transience-réurrence sur les arbres ont été énormément étudiées au début des années 1990. Les outils développés à cette époque (voir [77] ou [70]) en particulier les liens avec les réseaux électriques [30], se révèlent relativement robustes.

Dans le cas du modèle présenté ci-dessus nous avons, voir [66],

Théorème 2.1 (Lyons, Pemantle - 1992). *Nous avons le critère suivant*

1. *si $\inf_{t \in [0,1]} \mathbf{E}[A^t] > 1/m$ alors X_n est transiente,*
2. *si $\inf_{t \in [0,1]} \mathbf{E}[A^t] < 1/m$ alors X_n est récurrente.*

Lorsque le Galton-Watson est déterministe, Menshikov et Petretis [75] obtiennent un critère en utilisant un lien entre les M.A.M.A. et la cascade multiplicative de Mandelbrot.

Cette thèse est essentiellement concernée par le régime transient, pour cela nous n'allons pas entrer plus dans les détails des résultats sur le régime récurrent. Nous renvoyons seulement le lecteur aux articles de Hu et Shi [52], [53] qui montrent que le cas récurrent est également intéressant car il présente plusieurs régimes différents de ceux obtenus en dimension 1.

2.3 Loi des grands nombres

Dans le cas transient la première question qui apparait est de savoir si on part à l'infini à vitesse strictement positive ou non. En d'autres termes on cherche à démontrer une loi des grands nombres.

On a tout d'abord obtenu qu'il existe $v \geq 0$ déterministe tel que

$$\lim_{n \rightarrow \infty} \frac{|X_n|}{n} = v, \quad \mathbb{P}\text{-p.s.}$$

Ce résultat à été démontré par Gross [49] dans le cas où le Galton-Watson est déterministe et par Lyons, Pemantle et Peres [68] dans le cas où A est déterministe, leurs arguments s'étendant facilement au cas général.

La question est maintenant de savoir si $v > 0$. Elle fut d'abord traitée dans le cas de la marche aléatoire biaisée sur un Galton-Watson, i.e. dans le cas où A est déterministe. Le premier résultat fut obtenu dans [68]

Théorème 2.2. *Soit X_n une marche aléatoire biaisée avec un biais λ , i.e. $A = \lambda$ p.s. telle que X_n soit transiente, i.e. $\lambda > 1/m$, alors*

1. *si $p_0 = 0$ alors X_n admet une vitesse positive i.e. $v > 0$,*
2. *si $p_0 > 0$ alors X_n admet une vitesse positive si, et seulement si, $\lambda < 1/\mathbf{f}'(q)$ où $\mathbf{f}(x) = \sum_{k \geq 0} p_k z^k$ et q est l'unique point fixe de $\mathbf{f}(\cdot)$ différent de 1.*

2. MARCHES ALÉATOIRES EN MILIEU ALÉATOIRE SUR DES ARBRES

Le deuxième phénomène peut paraître surprenant à première vue. Il est en fait dû à un ralentissement de la marche qui reste coincée dans les pièges formés par les feuilles, i.e. les zones de l'arbre qui possèdent une descendance finie. Nous reviendrons sur ce phénomène dans la Section 2.

Il convient de noter que des questions plus précises concernant la vitesse sont extrêmement complexes et pour l'instant majoritairement ouvertes. Nous renvoyons à [69] pour une présentation assez détaillée de la question suivante : est-ce que la vitesse est une fonction croissante du biais λ si $p_0 = 0$? Malgré l'étonnante simplicité de l'énoncé du problème et le caractère "naturel" du résultat, elle demeure ouverte depuis plus de dix ans. Cette parenthèse montre la difficulté à obtenir des expressions explicites, où plus généralement des propriétés fines, sur la vitesse asymptotique. A ce jour seul le cas $\lambda = 1$, i.e. sans biais, est compris [67].

Revenons-on maintenant au cas plus général où A est aléatoire. Nous allons présenter un résultat obtenu dans le cadre $p_0 = 0$ par Aidekon, qui trouve un critère de ballisticité et identifie l'exposant de renormalisation de la marche dans le cas sous-balistique. Posons

$$\Lambda := \text{Leb} \left\{ t \in \mathbb{R}, \mathbf{E}[A^t] \leq 1/q_1 \right\},$$

qui est arbitrairement fixé à $\Lambda := \infty$ dans le cas $q_1 = 0$. On a alors, voir [2], le théorème suivant.

Théorème 2.3. *Si $\inf_{t \in [0,1]} \mathbf{E}[A^t] > 1/m$, i.e. dans le cas transient, alors*

- si $\Lambda > 1$, alors X_n admet une vitesse positive,
- si $\Lambda < 1$, alors X_n admet une vitesse nulle et

$$\lim_{n \rightarrow \infty} \frac{\ln(|X_n|)}{\ln n} = \Lambda, \quad \mathbb{P}\text{-}p.s..$$

On obtient donc également un régime de transience directionnelle avec vitesse nulle avec des variations d'ordre polynomiale comme dans le cas uni-dimensionnel.

2.4 Principes de grandes déviations

L'étude des M.A.M.A. sur les arbres étant assez récente, beaucoup de résultats restent encore à démontrer et cette partie resterait à remplir. Nous tenons juste à citer deux des principaux résultats existants. Le premier résultat remonte à Dembo et al. [25], où les auteurs démontrent un P.G.D. dans les cas quenched et annealed dans le cas des marches aléatoires biaisées (i.e. A déterministe). Ils obtiennent en particulier égalité des deux fonctions de taux. Plus récemment le cas $p_0 = 0$ et A aléatoire a été traité dans [1].

3 Marches aléatoires en environnements aléatoires sur \mathbb{Z}^d avec $d \geq 2$

Nous arrivons maintenant au cadre qui aura suscité le plus d'intérêt ses dix dernières années mais aussi sur lequel le moins de choses sont bien comprises. Nous allons séparer les M.A.M.A. sur \mathbb{Z}^d en deux parties. En effet il existe deux grandes catégories de M.A.M.A. qui ont été étudiées jusqu'à ce jour.

1. Les marches aléatoires en environnements aléatoires elliptiques, i.e. avec $\mathbf{P}[\omega(x, x+e) > 0] = 1$ pour tout $x \in \mathbb{Z}^d$ et $e \in \mathbb{Z}^d$ avec $|e| = 1$.
2. Les marches aléatoires sur un cluster de percolation qui sont définies de manière à être réversible et par nature ne sont pas elliptiques.

Cette distinction est à mettre en lien avec la disjonction de cas $p_0 = 0$, $p_0 > 0$ faite dans la section précédente dans le cadre des marches aléatoires sur les arbres. Nous allons commencer par traiter les marches aléatoires en environnements aléatoires.

3.1 Le modèle

Nous allons présenter le modèle quitte à faire une redite de la partie introductive pour rappeler les notations du modèle.

On se donne μ une loi elliptique sur le simplexe de \mathbb{R}_+^{2d} , i.e. une loi de probabilité sur

$$\mathcal{S}^* = \left\{ (p_1, \dots, p_{2d}) \in (0, 1)^{2d}, \text{ tel que } \sum_{i=1}^{2d} p_i = 1 \right\}.$$

On choisit ensuite un environnement aléatoire $\omega \in (\mathcal{S}^*)^{\mathbb{Z}^d}$ suivant la loi $\mathbf{P} = \mu^{\otimes \mathbb{Z}^d}$. La marche dans $\omega = ((\omega(x, e))_{e \in \mathbb{Z}^d, |e|=1})_{x \in \mathbb{Z}^d}$ a alors pour loi P_ω définie par

$$P_\omega[X_0 = 0] = 1,$$

et

$$P_\omega[X_{n+1} = X_n + e \mid X_0, \dots, X_n] = \omega(X_n, e), \quad e \in \mathbb{Z}^d, |e| = 1.$$

Nous insistons sur le fait que nous avons supposé que l'environnement est elliptique, i.e. que les probabilités de transition sont toujours positives. Une hypothèse supplémentaire sera faite de temps en temps, elle est dite d'uniforme ellipticité, et revient à supposer que

$$\text{il existe } \varepsilon > 0 \text{ tel que, } \quad \mathbf{P}[\omega(0, e) > \varepsilon] = 1, \text{ pour tout } e \in \mathbb{Z}^d \text{ avec } |e| = 1. \quad (3.1)$$

3.2 Transience-réurrence

Le premier résultat lié aux questions de transience-réurrence pour les M.A.M.A. en dimensions supérieures remonte à Kalikow [55]. Il démontre une loi du 0 – 1 et introduit la notion d’environnement de Kalikow dont nous reparlerons dans la Section 3.2.

Il introduit la notion de transience directionnelle, que nous avons évoqué précédemment sans en donner une définition précise. Nous dirons qu’une marche est transiente dans la direction $\ell \in S^{d-1}$ (où S^{d-1} désigne la sphère euclidienne de \mathbb{Z}^d) sur l’événement

$$A_\ell = \left\{ \lim_{n \rightarrow \infty} X_n \cdot \ell = +\infty \right\}.$$

Le résultat originel de Kalikow utilisait l’uniforme ellipticité, une hypothèse affaiblie plus tard par Merkl et Zerner dans [106]

Théorème 3.1 (Kalikow-1981). *Toute marche aléatoire en environnement aléatoire elliptique vérifie*

$$\mathbb{P}[A_\ell \cup A_{-\ell}] = 0 \text{ ou } 1.$$

La question “L’événement A_ℓ satisfait-il une loi du 0 – 1” a été posée dans [55], néanmoins la réponse à cette question n’a pas été trouvée, excepté en dimension $d = 2$, voir [106] ou [105] pour une preuve simplifiée de Zerner. Nous renvoyons aussi le lecteur au travail de Simenhaus [93] pour plus de résultats sur cette question.

Concernant la question de transience-réurrence proprement dite, nous devons pour l’instant nous contenter de savoir que le problème est bien posé au sens où

Théorème 3.2 (Kalikow - 1981). *L’événement $\{(X_n)_{n \geq 0} \text{ est récurrent sous } P_\omega\}$ est de probabilité 0 ou 1.*

Ce résultat est dû au fait que cet événement fait partie de la tribu de queue de l’environnement et le théorème est donc une conséquence de la loi du 0 – 1 de Kolmogorov.

Nous allons fournir un critère de transience directionnelle qui remonte à Kalikow [55]. La démonstration de ce critère fait appel à un outil intéressant qui permet de comparer des propriétés annealed d’une M.A.M.A. à des propriétés d’une chaîne de Markov. Il s’agit des environnements de Kalikow, il s’agit un des éléments clés pour la preuve de notre résultat principal dans [38], voir Section 1. Nous allons donc le présenter en détail.

Environnement de Kalikow

Pour $U \subset \mathbb{Z}^d$, on note $T_U = \inf\{n \geq 0, X_n \notin U\}$. Le but de l’environnement est de relier la loi annealed, qui n’est pas markovienne, à un environnement markovien. Si on suppose de plus que U est connexe et contient 0, on définit la chaîne de Markov qui admet $U \cup \partial U$ comme espace d’état et dont les probabilités de transition sont donnés par

$$\hat{\omega}_U(x, x + e) = \frac{\mathbf{E}[g_U^\omega(0, x)\omega(x, e)]}{\mathbf{E}[g_U^\omega(0, x)]}, \quad x \in U, |e| = 1,$$

CHAPITRE 2. QUELQUES MODÈLES D'IMPORTANCE

$$\hat{\omega}_U(x, x) = 1, \quad x \in \partial U,$$

où nous avons utilisé la notation $g_U^\omega(\cdot, \cdot)$ pour désigner

$$g_U^\omega(x, y) = E_\omega \left[\sum_{i=0}^{T_U} \mathbf{1}\{X_i = y\} \right].$$

Un lien entre les M.A.M.A. et la marche dans l'environnement de Kalikow, i.e. donnée par les probabilités de transition $\hat{p}_U(\cdot, \cdot)$, est énoncé dans le théorème suivant

Théorème 3.3 (Kalikow - 1981). *Notons $\hat{P}_{0,U}$ la loi d'une marche aléatoire issue de 0 donnée par les probabilités de transition $\hat{\omega}_U$. Si $\hat{P}_{0,U}[T_U < \infty] = 1$ alors $P_0[T_U < \infty] = 1$, de plus X_{T_U} a même loi sous \hat{P}_U et P_0 .*

Remarque 3.1. *D'autres propriétés existent, en particulier on notera que $\mathbf{E}[g_U^\omega(0, x)] = g_U^{\hat{\omega}_U}(0, x)$.*

Cet environnement peut-être utilisé en introduisant la dérive de Kalikow

$$\hat{d}_U(x) = \hat{E}_{x,U}[X_1 - X_0], \quad x \in U \cup \partial U,$$

qui permet de définir le critère de Kalikow relatif à $\ell \in S^{d-1}$

$$\inf_{U, x \in U} \hat{d}_U(x) \cdot \ell = \varepsilon(\ell, \mu) > 0.$$

Cette condition peut-être difficile à vérifier en général en dimensions supérieures. Des critères alternatifs plus simple à vérifier existent, voir [102]. Elle permet d'énoncer le premier résultat de transience directionnelle

Théorème 3.4 (Kalikow -1981). *Supposons avoir une M.A.M.A. dans \mathbb{Z}^d avec qui est uniformément elliptique et qui vérifie le critère de Kalikow relatif à $\ell \in S^{d-1}$, alors*

$$\lim X_n \cdot \ell \rightarrow \infty, \quad \mathbb{P}\text{-p.s.}$$

Nous allons tout de suite voir que cette condition est en réalité bien plus forte.

3.3 Existence et étude de la vitesse

Après ces premiers résultats de transience directionnelle de Kalikow, peu de résultats sont apparus pendant une période assez longue. Dans cette partie, nous ne cherchons en aucun cas à être exhaustif concernant la littérature concernant la loi des grands nombres. Nous allons simplement évoquer le premier résultat du genre qui est dû à Sznitman et Zerner en 1999 [102]. Ce résultat est important au sens où il a relancé les recherches sur les M.A.M.A. en dimensions supérieures.

3. MARCHES ALÉATOIRES EN ENVIRONNEMENTS ALÉATOIRES SUR \mathbb{Z}^D AVEC $D \geq 2$

Ce théorème utilise de manière centrale deux outils. Le premier est celui de l'existence d'une structure de régénération, nous renvoyons à l'article original [102] pour une description précise. L'idée est de découper l'environnement *et* la marche en blocs i.i.d., il suffit ensuite de mesurer l'avancée moyenne et le temps moyen passé dans un tel bloc pour obtenir une loi des grands nombres pour la marche. Le deuxième outil qu'ils utilisent est le lien existant entre les M.A.M.A. et les marches aléatoires dans les environnements de Kalikow.

Le résultat principal de [102] de la manière suivante

Théorème 3.5 (Sznitman, Zerner - 1999). *Supposons avoir une M.A.M.A. dans \mathbb{Z}^d avec qui est uniformément elliptique et qui vérifie le critère de Kalikow relatif à $\ell \in S^{d-1}$, alors il existe v déterministe tel que*

$$\frac{X_n}{n} \rightarrow v, \quad \mathbb{P}\text{-p.s.},$$

et de plus $v \cdot \ell > 0$.

La condition de Kalikow caractérise exactement les marches balistiques en dimension 1. En dimensions supérieures ce critère s'avère plus difficile à vérifier. On notera l'utilisation de ce critère par Enriquez et Sabot dans [33] pour montrer que certaines marches aléatoires dans les environnement de Dirichlet sont balistiques.

D'autres recherches pour caractériser la classe des marches balistiques ont permis d'obtenir plusieurs autres critères pour obtenir une vitesse positive. Le lecteur intéressé pourra consulter les travaux de Sznitman, voir [100], sur les conditions (T) et (T') pour plus d'informations.

Il n'existe quasiment aucun résultat plus précis sur le comportement de la vitesse, car la tâche est encore plus difficile que sur les arbres où les résultats sont déjà très rares. Nous citerons quand même un résultat de Sabot [90] qui étudie des environnements faiblement perturbés, i.e. du type $\omega(z, e) = p_0(e) + \varepsilon \xi(z, e)$ où les $\xi(z, e)$ sont i.i.d. et ε est suffisamment petit. Il obtient un développement asymptotique de la vitesse en fonction de ε . En particulier il démontre qu'en dimension supérieure il est possible que la marche soit accélérée par l'environnement aléatoire au sens où la vitesse asymptotique est plus grande que la dérive moyenne. Sa méthode d'étude repose sur l'étude de l'environnement de Kalikow associé, ne reviendrons plus en détails sur cela dans la Section 3.2.

3.4 Autres résultats

Théorème central limite

Il existe des critères pour obtenir des théorèmes du type théorème central limite annealed. Nous renvoyons le lecteur à [98] (Théorème 3.3) et au livre [100] (Chapitre 4) pour plus de précisions.

Il existe également des principes d'invariance quenched, voir [85], [86], [87] et [16].

Grandes déviations

Une nouvelle fois les questions des grandes déviations sont étudiées. On pourra trouver des plus amples précisions dans le livre de Sznitman [98] (Théorème 3.4) et dans un article récent de Berger [12].

4 Marches aléatoires sur des clusters de percolation

Encore une fois, il existe plusieurs types de marches aléatoires que l'on peut définir sur des clusters de percolation. Nous allons ici présenter la marche aléatoire simple et la marche aléatoire biaisée sur le cluster de percolation.

Ces modèles se différencient fortement des marches aléatoires en environnements aléatoires principalement pour deux raisons

1. ils ne sont pas elliptiques,
2. ils sont réversibles.

Ce dernier point rend plus facile l'analyse de la marche sous l'environnement quenched, la perte de l'invariance par translation sous la loi annealed peut être compensée par la réversibilité du modèle. Mais il est clair que les méthodes de démonstration vont fortement différer.

4.1 La percolation par arêtes

Il ne s'agit pas ici de présenter toute la théorie de la percolation, nous allons nous contenter d'introduire des notations et le minimum nécessaire pour comprendre la présentation des théorèmes. Pour de plus amples informations sur cet immense domaine, on pourra trouver une introduction dans l'ouvrage de Grimmett [46].

Nous allons seulement présenter la percolation par arêtes sur \mathbb{Z}^d . On fixe un paramètre $p \in [0, 1]$. Nous voulons étudier le graphe aléatoire obtenu en enlevant chaque arête avec probabilité p indépendamment de toutes les autres arêtes. Mathématiquement, on note $\Omega = \{0, 1\}^{\mathbb{E}^d}$ où \mathbb{E}^d désigne les arêtes de \mathbb{Z}^d , on dira qu'une arête est "présente" ou "ouverte" (resp. "absente" ou "fermée") si $\omega(e) = 1$ (resp. $\omega(e) = 0$). On munit cet espace de la mesure

$$P_p = (\text{Ber}(p))^{\otimes \mathbb{E}^d}.$$

Dans ce graphe aléatoire nous avons naturellement une notion de connexité et les composantes connexes de ce graphe sont appelées des clusters. L'un des résultats fondamentaux de percolation dont nous avons besoin est résumé dans le théorème suivant (voir Théorème 1.10 p.14 et Théorème 8.1 p.198 dans [46])

Théorème 4.1. *Pour tout $d \geq 2$, il existe $p_c(d) \in (0, 1)$ tel que,*

1. *pour $p < p_c$, P_p -p.s. tous les clusters sont finis,*

4. MARCHES ALÉATOIRES SUR DES CLUSTERS DE PERCOLATION

2. pour $p > p_c$, P_p -p.s. il existe un unique cluster infini.

La première phase est appelée sous-critique et la deuxième sur-critique. Donc seule la deuxième phase permet d'obtenir un graphe infini où des questions de types récurrence-transience pourront être étudiées. Nous allons donc nous restreindre à l'étude de ce régime.

On remarque que ce théorème implique que pour $p > p_c(d)$

$$P_p[|K(0)| = \infty] > 0,$$

où $K(0)$ désigne le cluster de 0 et $|K(0)|$ sa taille. Ainsi il est possible conditionner le cluster infini à passer par 0 en définissant la mesure

$$\mathbf{P}_p[\cdot] = P_p[\cdot \mid |K(0)| = \infty].$$

D'autres modèles existent, nous citerons l'étude des marches aléatoires sur le "cluster critique" [58] où les marches ralenties sur les clusters [23] et [83].

Dans la suite on fixe $p > p_c(d)$ et par soucis de légèreté nous omettons l'indice p dans \mathbf{P}_p lorsqu'aucune confusion n'est possible. De plus ω désignera un environnement tiré sous la mesure \mathbf{P} .

4.2 La marche aléatoire simple

Le modèle

La marche aléatoire simple sur un cluster de percolation est la chaîne de Markov définie sur $K(0)$ par

$$P_\omega[X_{n+1} = x + e \mid X_n = x] = \frac{\omega([x, x + e])}{\sum_{e', |e'|=1} \omega([x, x + e'])},$$

qui est une quantité bien définie car le dénominateur ne peut s'annuler sur $K(0)$.

Résultats

Transience-Réurrence Par un argument classique de réseaux électriques (le théorème de monotonie de Rayleigh voir [30] ou [70]) la marche aléatoire simple sur un cluster de percolation est récurrente en dimension $d \leq 2$, car intuitivement il y a moins de façons de partir à l'infini. Ce qui n'est pas aussi clair est le fait que la marche reste transiente en dimension $d \geq 3$, ce qui a été démontré dans [48].

Théorème 4.2 (Grimmett, Kesten, Zhang - 1992). *La marche aléatoire simple sur le cluster de percolation de paramètre $p > p_c(d)$ est transiente si, et seulement si, $d \geq 3$.*

Nous noterons qu'il existe une preuve alternative de ce résultat par Benjamini, Pemantle et Peres [11].

Le fait que la percolation ne change pas la nature transiente (ou bien évidemment récurrente) est un fait relativement général [5].

CHAPITRE 2. QUELQUES MODÈLES D'IMPORTANCE

Principe d'invariance Le principe d'invariance annealed remonte à [24] et à [47] pour obtenir que la variance limite est non nulle. Récemment de nombreux résultats ont permis d'obtenir des principes d'invariance quenched, en commençant par Sidoravicius et Sznitman [92] (pour $d \geq 4$) puis plus récemment par Berger et Biskup [13] parallèlement à un travail de Mathieu et Piatnitski [72].

Des résultats similaires existent dans des modèles plus généraux de conductances aléatoires i.i.d. [71]. Ces questions sont fortement liés à des questions d'isopérimétries.

Autres résultats Beaucoup d'autres questions sont liées à cette notion d'isopérimétrie. On renvoie le lecteur aux travaux de Rau [88] qui étudie le nombre de points visités par la marche aléatoire simple sur un cluster de percolation. D'autres questions concernent des estimées sur le noyau de la chaleur [73] et [14].

4.3 La marche aléatoire biaisée

Le modèle

Il existe plusieurs manières de définir une marche aléatoire biaisée sur un cluster de percolation, deux modèles ont été proposés l'un par Berger, Gantert et Peres [15] l'autre par Sznitman [99]. Nous présenterons le deuxième qui est légèrement plus général car il autorise un biais dans toutes les directions possible. On fixe $\vec{\ell} \in S^{d-1}$ et $\lambda > 0$, ce qui nous donne un biais $\ell = \lambda \vec{\ell}$ de force λ et de direction $\vec{\ell}$. On peut alors définir pour tout ω , la marche aléatoire biaisée sur un cluster de percolation comme la chaîne de Markov définie sur $K(0)$ par

$$P_\omega[X_{n+1} = x + e \mid X_n = x] = p^\omega(x, x + e) = \frac{e^{\ell \cdot e} \omega([x, x + e])}{\sum_{e', |e'|=1} e^{\ell \cdot e'} \omega([x, x + e'])}.$$

Les résultats

Il existe plusieurs articles dans la littérature physique concernant ce modèle, voir [28] et [29]. Cependant mathématiquement ce modèle reste difficile à traiter, les seuls travaux existant jusqu'à très récemment sont [15] et [99].

Ces deux articles démontrent essentiellement le même résultat qui est résumé dans le théorème suivant

Théorème 4.3 (Berger, Gantert, Peres - 2003; Sznitman -2003). *On a*

$$\lim_{n \rightarrow \infty} X_n \cdot \ell = \infty, \quad \mathbb{P}\text{-p.s.}$$

De plus, il existe $0 < \lambda_l \leq \lambda_u$ tel que

- si $\lambda < \lambda_l$ alors $\lim_{n \rightarrow \infty} X_n/n = v$ avec $v \cdot \ell > 0$,*

4. MARCHES ALÉATOIRES SUR DES CLUSTERS DE PERCOLATION

2. *si $\lambda > \lambda_u$ alors $\lim_{n \rightarrow \infty} X_n/n = 0$.*

Ce théorème confirme partiellement les conjectures des physiciens qui de plus s'attendent à pouvoir énoncer le théorème avec $\lambda_l = \lambda_u$. Cependant mathématiquement nous sommes encore incapable d'exclure l'existence d'un possible régime intermédiaire.

CHAPITRE 2. QUELQUES MODÈLES D'IMPORTANCE

3

Présentation des résultats

Comme il a été évoqué dans l'introduction de la thèse, le modèle qui a motivé la plupart de mes recherches est celui de la marche aléatoire biaisée sur un cluster de percolation. Les deux questions majeures qui restaient en suspens, ayant à voir avec des phénomènes de ralentissement, sont

1. l'étude de la vitesse, i.e. déterminer le régime balistique et comprendre la dépendance de la vitesse vis-à-vis des paramètres,
2. l'identification de l'ordre de grandeur des fluctuations de la marche.

Le premier type de problèmes est partiellement étudié dans la Section 1. Concernant la deuxième question, nous n'avons pas encore obtenu de résultats sur le cluster de percolation. Nous nous sommes donc tourné vers la marche aléatoire biaisée sur un Galton-Watson avec des feuilles, on pourra retrouver une présentation du résultat correspondant dans la Section 2. En étudiant ce problème nous avons eu l'occasion d'étudier en détails le comportement de la M.A.M.A. uni-dimensionnelle. Cela nous a permis d'étudier des questions de "déviations modérées" qui étaient restées ouvertes jusqu'ici, le résultat correspondant étant présenté dans la Section 3.

1 Comportement de la vitesse sur le cluster de percolation vis-à-vis des paramètres

Concernant l'étude de la dépendance de la vitesse vis-à-vis des paramètres du problème, deux questions sont envisageables : la dépendance par rapport au biais ou par rapport au paramètre de percolation. En particulier on s'intéresse à d'éventuelles propriétés de monotonie.

La question la plus abordable semble être la première, car il existe déjà des résultats qui, sur les arbres, vont dans ce sens (voir [18]) alors que concernant la dépendance vis-à-vis du biais la question est encore ouverte sur les arbres de Galton-Watson. Il paraît donc un peu trop ambitieux d'attaquer directement le problème sur \mathbb{Z}^d . La difficulté de cette question est à mettre en relation avec les exemples surprenants de [69].

L'un des résultats obtenus lors de cette thèse concerne l'étude de la vitesse en fonction du paramètre de percolation. Il est naturel de penser que la percolation crée des pièges, des "culs-de-sac" dans la direction de la dérive et diminue le nombre manières de partir à l'infini. Ainsi, intuitivement, effectuer une percolation ne devrait que pouvoir diminuer la vitesse de la marche. Pour tenter de répondre partiellement à cette question, nous avons calculé la dérivée de la vitesse au point $p = 1$ vis-à-vis du paramètre de percolation et nous avons montré que dans un large spectre de cas, la marche est effectivement ralentie.

Pour être plus précis, introduisons les fonctions de Green de la configuration ω

$$\text{pour tout } x, y \in \mathbb{Z}^d, \quad G^\omega(x, y) := E_x^\omega \left[\sum_{n \geq 0} \mathbf{1}\{X_n \in y\} \right].$$

Rappelons tout d'abord que $v_\ell(1) = \sum_{e \in \nu} p^{\omega_0}(0, e)e$, où ω_0 est l'environnement à $p = 1$, i.e. s'il n'y a pas eu percolation. De plus nous posons $p(e) = p^{\omega_0}(0, e)$ et ν les vecteurs unités de \mathbb{Z}^d .

Théorème 1.1. *Pour $d \geq 2$, $p \in (p_c(d), 1)$ et pour tout $\ell \in \mathbb{R}_*^d$, on a*

$$v_\ell(1 - \varepsilon) = v_\ell(1) - \varepsilon \sum_{e \in \nu} (v_\ell(1) \cdot e)(G^{\omega_0^\varepsilon}(0, 0) - G^{\omega_0^\varepsilon}(e, 0))(v_\ell(1) - d_e) + o(\varepsilon),$$

où pour tout $e \in \nu$ on note

$$\text{pour } f \in E(\mathbb{Z}^d), \quad \omega_0^\varepsilon(f) = \mathbf{1}\{f \neq e\} \text{ and } d_e = \sum_{e' \in \nu} p^{\omega_0^\varepsilon}(0, e')e',$$

respectivement l'environnement où seule l'arête $[0, e]$ est fermée et la dérivée correspondante en 0.

1. COMPORTEMENT DE LA VITESSE SUR LE CLUSTER DE PERCOLATION VIS-À-VIS DES PARAMÈTRES

Proposition 1.1. *Notons $J^e = G^{\omega_0}(0,0) - G^{\omega_0}(e,0)$ pour $e \in \nu$. On peut réécrire le terme d'ordre 1 dans le développement précédent de la manière suivante*

$$v'_\ell(1) = \sum_{e \in \nu} (v_\ell(1) \cdot e) \frac{p(e)J^e}{1 - p(e)J^e - p(-e)J^{-e}} (e - v_\ell(1)),$$

où les fonctions de Green intervenant ne dépendent que de l'environnement ω_0 . On peut ainsi montrer que si pour tout $e \in \nu$ tel que $v_\ell(1) \cdot e > 0$ on a $v_\ell(1) \cdot e \geq \|v_\ell(1)\|_2^2$ alors

$$v_\ell(1) \cdot v'_\ell(1) > 0,$$

ce qui montre que la percolation ralentit la marche au moins à $p = 1$.

La condition précédente est vérifiée dans les deux cas suivants

1. $\vec{\ell} \in \nu$, i.e. si la dérive est suivant un des axes,
2. $\ell = \lambda \vec{\ell}$, où $\lambda < \lambda_c(\vec{\ell})$ pour un certain $\lambda_c(\vec{\ell}) > 0$, i.e. quand la dérive de la marche est suffisamment faible.

Remarque 1.1. *La propriété de monotonie de la Proposition 1.1 devrait être vraie pour toutes dérives, mais pour des raisons techniques nous n'arrivons pas à faire aboutir les calculs. Plus généralement on s'attend à ce que cette propriété soit vraie dans une large gamme de cas, par exemple dans tout le régime sur-critique. Pour une conjecture reliée à ces phénomènes, voir [18].*

Remarque 1.2. *Une conséquence non triviale du théorème est que la vitesse est localement non nulle autour de $p = 1$.*

Remarque 1.3. *Finalement ce résultat nous donne quelques idées quant à la dépendance de la vitesse vis-à-vis du biais. En effet, fixons un biais ℓ et un certain $\mu > 1$, alors le Théorème 1.1 implique que pour tout $\varepsilon_0 = \varepsilon_0(\ell, \mu) > 0$ suffisamment petit, on a*

$$v_{\mu\ell}(1 - \varepsilon) \cdot \vec{\ell} > v_\ell(1 - \varepsilon) \cdot \vec{\ell} \text{ pour } \varepsilon < \varepsilon_0.$$

La démonstration de ce résultat s'inspire d'un résultat de Sabot [90] qui étudie un environnement invariant par translation déterministe soumis à une petite modification aléatoire et i.i.d. en chacun de ses sites. Ici le contexte est assez différent car notre environnement est soumis à une perturbation très forte, on perd l'ellipticité de la marche, mais rare. On doit en quelque sorte démontrer que les effets potentiellement non-bornés qui proviennent d'une arête enlevée, sont petits une fois que l'on a moyenné sur l'environnement.

L'outil central pour la démonstration de ce théorème est la fonction de Green, qui d'une part est reliée à la vitesse et d'autre part est un outil que nous savons étudier via les théorèmes de Kalikow.

CHAPITRE 3. PRÉSENTATION DES RÉSULTATS

Voici une rapide esquisse de la preuve de la continuité de la vitesse, les outils pour obtenir la dérivée étant essentiellement similaires. On note pour $x, y \in \mathbb{Z}^d$, P un opérateur Markovien et $\delta < 1$, la fonction de Green tuée géométriquement avec un paramètre $1 - \delta$

$$G_\delta^P(x, y) := E_x^P \left[\sum_{k=0}^{\infty} \delta^k \mathbf{1}\{X_k = y\} \right] \text{ and } G_\delta^\omega(x, y) := G_\delta^{P^\omega}(x, y),$$

où P^ω est l'opérateur Markovien associé à la marche dans l'environnement ω .

On introduit alors l'environnement de Kalikow associé au point 0 et à l'environnement $\mathbf{P}_{1-\varepsilon}[\cdot | \mathcal{I}]$, qui est donné pour $z \in \mathbb{Z}^d$, $\delta < 1$ et $e \in \nu$ par

$$\widehat{p}_\delta^\varepsilon(z, e) = \frac{\mathbf{E}_{1-\varepsilon}[G_\delta^\omega(0, z)p^\omega(z, e)|\mathcal{I}]}{\mathbf{E}_{1-\varepsilon}[G_\delta^\omega(0, z)|\mathcal{I}]}.$$

L'un des résultats démontrés par Kalikow [55], se généralise facilement de la manière suivante

Proposition 1.2. *Pour $z \in \mathbb{Z}^d$ et $\delta < 1$, on a*

$$\mathbf{E}_{1-\varepsilon} \left[G_\delta^\omega(0, z) | \mathcal{I} \right] = G_\delta^{\widehat{p}_\delta^\varepsilon}(0, z).$$

On peut directement adapter la preuve de la Proposition 1 de [90], qui ne nécessite pas d'hypothèse d'uniforme ellipticité dans le cas $\delta < 1$.

Le lien entre les fonctions de Green et la vitesse asymptotique vient de la proposition suivante

Proposition 1.3. *Pour tout $0 < \varepsilon < 1 - p_c(\mathbb{Z}^d)$, on a*

$$\lim_{\delta \rightarrow 1} \frac{\sum_{z \in \mathbb{Z}^d} G_\delta^{\widehat{\omega}_\delta^\varepsilon}(0, z) \widehat{d}_\delta^\varepsilon(z)}{\sum_{z \in \mathbb{Z}^d} G_\delta^{\widehat{\omega}_\delta^\varepsilon}(0, z)} = \lim_{\delta \rightarrow 1} \frac{\mathbb{E}[X_{\tau_\delta}]}{\mathbb{E}[\tau_\delta]} = v_\ell(1 - \varepsilon),$$

où $\widehat{d}_\delta^\varepsilon(z) = \sum_{e \in \nu} \widehat{p}_\delta^\varepsilon(z, e)e$.

En notant C_δ^ε l'enveloppe convexe des $\widehat{d}_\delta^\varepsilon(z)$ pour $z \in \mathbb{Z}^d$, une conséquence immédiate de la proposition précédente est que

Proposition 1.4. *Pour $\varepsilon > 0$ on a que $v_\ell(1 - \varepsilon)$ est un point d'accumulation de C_δ^ε quand δ tend vers 1.*

Ces deux propositions sont démontrées dans la preuve de la Proposition 2 de [90] et reposent uniquement sur l'existence d'une vitesse asymptotique, ce qui est vérifié par le résultat de [99]. Introduisons alors les notations

$$\mathcal{I} = \{\text{il existe un unique cluster infini passant par } 0\},$$

2. UN LIEN ENTRE LES M.A.M.A. ET UN MODÈLE DE PIÈGE JOUET

et

$$\mathcal{C}(z) = \{e \in \nu, [z, z + e] \text{ est fermée}\},$$

où $\mathcal{C}(z)$ désigne donc l'ensemble des arêtes adjacentes à z qui sont fermées dans la percolation.

En omettant l'indice ε dans $\mathbf{E}_{1-\varepsilon}[\cdot]$, on peut alors comprendre $\widehat{d}_\delta^\varepsilon(z)$ en décomposant la dérive de Kalikow suivant les configurations en z

$$\begin{aligned} \widehat{d}_\delta^\varepsilon(z) &= \sum_{e \in \nu} \sum_{A \subset \nu} \frac{\mathbf{E} \left[\mathbf{1}\{\mathcal{I}\} \mathbf{1}\{\mathcal{C}(z) = A\} G_\delta^\omega(0, z) p(z, e) e \right]}{\mathbf{E} \left[\mathbf{1}\{\mathcal{I}\} G_\delta^\omega(0, z) \right]} \\ &= \sum_{A \subset \nu, A \neq \nu} \frac{\mathbf{E} \left[\mathbf{1}\{\mathcal{I}\} \mathbf{1}\{\mathcal{C}(z) = A\} G_\delta^\omega(0, z) \right]}{\mathbf{E} \left[\mathbf{1}\{\mathcal{I}\} G_\delta^\omega(0, z) \right]} d_A \\ &= \sum_{A \subset \nu, A \neq \nu} \mathbf{P}[\mathcal{C}(z) = A] \frac{\mathbf{E} \left[\mathbf{1}\{\mathcal{I}\} G_\delta^\omega(0, z) | \mathcal{C}(z) = A \right]}{\mathbf{E} \left[\mathbf{1}\{\mathcal{I}\} G_\delta^\omega(0, z) \right]} d_A, \end{aligned} \tag{1.1}$$

où $d_A = \sum_{e \in A} p^A(e) e$ est la dérive sous la configuration A . Ici $p_A(\cdot)$ désigne donc $p^{\omega^A}(0, \cdot)$

où ω_0^A est l'environnement où toutes les arêtes sont ouvertes sauf les arêtes adjacentes à 0 dans $\nu \setminus A$ qui sont fermées.

Il est alors suffisant de montrer qu'uniformément en z et en A on peut avoir

$$\frac{\mathbf{E} \left[\mathbf{1}\{\mathcal{I}\} G_\delta^\omega(0, z) | \mathcal{C}(z) = A \right]}{\mathbf{E} \left[\mathbf{1}\{\mathcal{I}\} G_\delta^\omega(0, z) \right]} < C,$$

ce qui entraîne que

$$\widehat{d}_\delta^\varepsilon(z) = d_\emptyset + O(\varepsilon) = v_\ell(1) + O(\varepsilon),$$

ce qui permet d'obtenir appliquer la Proposition 1.4 et obtenir la continuité de la vitesse.

Cette estimée technique se révèle difficile à traiter et constitue une grosse partie de l'article.

2 Un lien entre les M.A.M.A. et un modèle de piège jouet

Le résultat principal obtenu dans [8] concerne la limite d'échelle de la marche aléatoire biaisée sur un Galton-Watson avec des feuilles.

CHAPITRE 3. PRÉSENTATION DES RÉSULTATS

Théorème 2.1. *Notons, $\gamma = -\ln f'(q)/\ln \beta$. Pour tout $\lambda > 0$, en notant $n_\lambda(k) = \lfloor \lambda f'(q)^{-k} \rfloor$, on a*

$$\frac{\Delta_{n_\lambda(k)}}{n_\lambda(k)^{1/\gamma}} \xrightarrow{d} Y_\lambda$$

où Y_λ a une loi infiniment divisible. Ce qui implique que

$$\frac{\ln |X_n|}{\ln n} \rightarrow \gamma.$$

Cependant pour β suffisamment grand, la suite $(\Delta_n/n^{1/\gamma})_{n \geq 0}$ ne converge pas en loi.

Cette section est dédiée à une explication de l'intuition qui se situe derrière la preuve de ce résultat. Nous cherchons à présenter les grandes lignes de la démonstration car nous pensons que la méthode d'analyse est suffisamment robuste pour s'étendre à plusieurs autres modèles.

Un point central des travaux effectués dans [35], [36], [34], [8] and [9] est la clarification des liens entre les M.A.M.A. qui sont réversibles, transientes dans une direction et à vitesse nulle avec un modèle de piège jouet.

Il est clair depuis longtemps que le ralentissement, qui provoque un régime sous-balistique, est essentiellement lié à l'existence de pièges dans l'environnement dans lesquels la marche demeure suffisamment longtemps. Cependant ce n'est que très récemment qu'une méthode d'analyse précise de ses modèles a commencé à prendre forme. La méthode n'est pas encore complète au sens où dans un cadre général nous ne savons pas comment définir la notion de piège et que l'analyse du temps passé dans un piège reste à faire au cas par cas, mais des similarités apparaissent. Le but de cette analyse est d'obtenir des théorèmes de convergence du type

$$\text{il existe } \gamma < 1, \quad \frac{X_n}{n^\gamma} \xrightarrow{\text{loi}} \mathcal{L}.$$

Nous allons essayer de donner les grandes étapes de la preuve type, en illustrant via deux modèles concrets qui sont aujourd'hui bien compris

1. la M.A.M.A. uni-dimensionnelle dans le régime transient vers l'infini à vitesse nulle,
2. la marche aléatoire biaisée sur un Galton-Watson avec des feuilles ($p_0 > 0$) dans le régime sous-balistique.

Nous commençons par nous intéresser au temps d'atteinte du niveau n dans la direction de la transience directionnelle qu'on l'on peut relié à X_n via un argument d'inversion classique. On pose donc $\Delta_n = \inf\{i \geq 0, |X_i| = n\}$ dans le cas de l'arbre et $\Delta_n = \inf\{i \geq 0, X_i = n\}$ sur \mathbb{Z} .

2. UN LIEN ENTRE LES M.A.M.A. ET UN MODÈLE DE PIÈGE JOUET

Tout d'abord nous avons besoin de l'existence d'une structure de régénération, ce qui nous assure que le nombre de sites vus pour atteindre le niveau n que l'on notera S_n vérifie

$$S_n \sim C_S n,$$

pour un certain $C_S > 0$. Cette propriété est naturelle, en effet dans un bloc de régénération la marche avance d'un nombre de pas d'espérance fini et voit un nombre fini de sites.

Lorsque la marche parcourt l'environnement elle rencontre des "pièges" qui sont à l'origine de son ralentissement. Pour simplifier nous allons nous imaginer qu'en chaque site notre marche rencontre un piège. Ainsi à chaque fois qu'on se situe sur un site particulier nous avons un temps d'attente dépendant du piège (qui est aléatoire) présent en ce site.

Vu de loin, la marche est essentiellement uni-dimensionnelle par transience directionnelle. Dans un souci de simplification nous allons supposer dans la suite que la marche est sur \mathbb{Z} . De plus nous allons supposer que la marche va toujours d'un piège au suivant, cette hypothèse est à première vue abusive, mais nous allons la justifier à postériori.

Finalement, nous avons donc assimilé nos deux modèles au modèle simplifié de M.A.M.A. sur \mathbb{N} suivant : $X_t = i$ pour $\sum_{j=1}^i T_{tot}^{(j)} \leq t < \sum_{j=1}^{i+1} T_{tot}^{(j)}$, où $T_{tot}^{(j)}$ est le temps total passé dans le j -ème piège vu. On peut espérer que cela soit une bonne représentation pour des modèles assez généraux de transience directionnelle à vitesse nulle. Nous représentons dans la figure 3.1 ce modèle simplifié, où les pièges sont en pointillé.

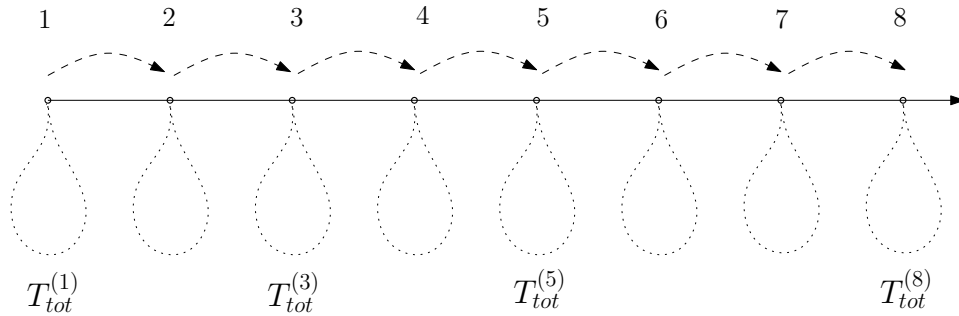

FIG. 3.1 – Modèle de piège simplifié

Après ces simplifications notre problème devient plus abordable en effet on remarque que Δ_n correspond essentiellement au temps passé dans les $C_S n$ premiers pièges et donc

$$\Delta_n \approx \sum_{i=1}^{C_S n} T_{tot}^{(i)},$$

est une somme de v.a.i.i.d..

CHAPITRE 3. PRÉSENTATION DES RÉSULTATS

Dans le cas de la M.A.M.A. uni-dimensionnelle, ces pièges sont caractérisés comme des puits de potentiel. Dans le régime transient vers ∞ , ces puits sont caractérisés par de grandes montées du potentiel (voir figure 3.2).

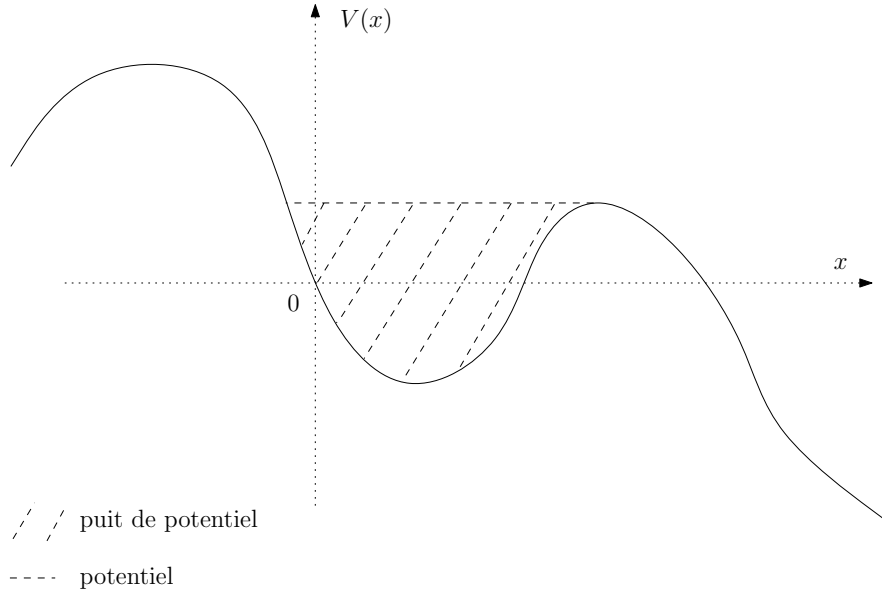

FIG. 3.2 – Puit de potentiel dans la régime transient vers ∞ sur \mathbb{Z}

Dans le cas des marches aléatoires biaisées sur un Galton-Watson avec feuilles, il s’agit des “feuilles” dans le sens où on considère l’ensemble des sommets qui possèdent une descendance finie (voir Figure 3.3).

La tâche difficile est d’identifier les pièges et d’être capable d’en décrire la structure. Dans ces deux modèles, on remarque que pour partir à l’infini à partir d’un piège, la marche doit nécessairement passer par des zones où la mesure invariante est beaucoup plus faible. Ceci est probablement une piste assez générale pour identifier les pièges.

En effet, supposons qu’à partir d’un point x la marche doit passer par un point y de mesure invariante inférieure. On peut alors, via un argument de réversibilité, obtenir une majoration de la probabilité de sortie d’un piège car

$$P_\omega^x[T_x^+ < \infty] \leq P_\omega^x[T_x^+ < T_y] \leq \frac{\pi(y)}{\pi(x)},$$

ce qui montre déjà que typiquement la marche va passer un temps de l’ordre de $\pi(x)/\pi(y)$ en x .

Dans le cadre de \mathbb{Z} , on obtient donc une majoration de la probabilité de sortie d’un piège en e^{-H} où H est l’augmentation du potentiel dans le piège, i.e.

$$H = \max_{x \in \text{piège}} \left[\max_{y \geq x, y \in \text{piège}} V(y) - V(x) \right].$$

2. UN LIEN ENTRE LES M.A.M.A. ET UN MODÈLE DE PIÈGE JOUET

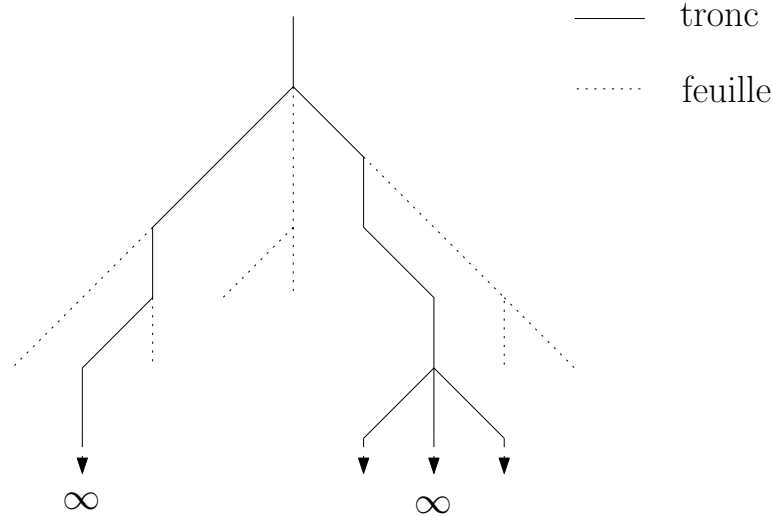

FIG. 3.3 – Les feuilles dans un Galton-Watson

Dans le cadre de la marche aléatoire biaisée sur le Galton-Watson avec des feuilles, la quantité qui nous intéresse est la hauteur du piège (qui est directement reliée à la mesure invariante) H , i.e. le nombre de niveaux distincts dans le piège, qui nous permet d’obtenir une majoration du temps de sortie du piège de l’ordre de β^{-H} .

Analysons le comportement de la marche dans un grand piège, sous l’hypothèse simplificatrice que ces deux majorations sont en fait des égalités. Deux points vont jouer un rôle important cette analyse,

1. tout d’abord il y a le fond du piège, i.e. le point de mesure invariante maximale, que le notera δ ,
2. ensuite il y a la sortie s (dans nos deux modèles on peut identifier cette sortie à un point) qui est un ensemble du piège à partir duquel il est facile de partir à l’infini.

Ce point de sortie est choisi, dans le cas de la marche aléatoire sur \mathbb{Z} comme le point qui est au sommet de la vallée du côté droit et dans le cas de la M.A.M.A. sur l’arbre comme le point du tronc auquel la feuille est attachée.

Le phénomène qui se produit est que la marche va effectuer un grand nombre d’excursions à partir du “fond” du piège avant d’atteindre la sortie. Ce nombre d’excursions est une géométrique de paramètre $p = P_\omega[T_\delta^+ < T_s \mid X_0 = \delta]$ et on peut alors approximer le temps passé durant un passage dans le piège par

$$T_{\text{piège}} = \sum_{i=1}^{\text{Geom}(p)} T_{\text{exc}}^{(i)} \approx \text{Geom}(p) E_\omega[T_{\text{exc}}^{(i)}] \approx \frac{1}{p} E_\omega[T_{\text{exc}}^{(i)}] \mathbf{e},$$

où \mathbf{e} désigne une exponentielle de paramètre 1 qui ne dépend que de la marche et les $T_{\text{exc}}^{(i)}$ sont des variables i.i.d. distribuées comme le temps d’une excursion à partir de δ qui ne

CHAPITRE 3. PRÉSENTATION DES RÉSULTATS

sort pas du piège. Ici nous avons utilisé une sorte de loi des grands nombres associée à une approximation d'une géométrie par une exponentielle. Elles sont toutes les deux justifiées par le fait que le comportement de la marche est essentiellement déterminé par ce qui se passe dans les grands pièges, i.e. dans le cas où p est petit, qui nous permet d'obtenir les approximations faites au-dessus.

Ensuite il est possible que la marche ayant atteint s puisse retourner au fond de celui-ci. Nous introduisons

$$W = \text{card}\{i \in \mathbb{N} \mid X_i = s, \exists j \geq i, X_j = \delta, X_k \neq s, \forall i < k < j\},$$

le nombre "d'entrées profondes" dans le piège. Le temps total passé dans un grand piège est donc

$$T_{\text{tot}} = \frac{1}{p} E_\omega [T_{\text{exc}}^{(1)}] \sum_{i=0}^W \mathbf{e}_i := Z_\infty \frac{1}{p}, \quad (2.1)$$

où les \mathbf{e}_i sont des v.a.i.i.d. indépendantes de loi exponentielle de paramètre 1. La variable aléatoire W est essentiellement indépendantes des autres variables aléatoires car elle dépend surtout de ce qui se passe à l'extérieur du piège.

Sans entrer trop dans les détails, la formule précédente signifie que T_{tot} est essentiellement déterminé par $1/p$ car il est possible de montrer que $\mathbb{E}[Z_\infty] < \infty$.

Dans les cas que nous développons ici, nous rappelons que $1/p \approx e^H$ (resp. $1/p \approx \beta^H$) dans le cas de la M.A.M.A. uni-dimensionnelle (resp. marche aléatoire biaisée sur un Galton-Watson avec des feuilles). Dans les deux cas, il paraît alors naturel de classer les pièges en fonction de leur impact qui est lié à leur "taille" qui est quantifié via la variable aléatoire H .

Il nous reste donc à déterminer l'ordre de grandeur de la queue de ces variables aléatoires. Dans le cas uni-dimensionnel, sous l'hypothèse que $\ln \rho_0$ a une distribution qui n'est pas concentrée sur un réseau, on a un résultat de Iglehart [54] qui nous permet d'obtenir que

$$\mathbf{P}[H \geq t] \sim C_I e^{-\kappa t} \text{ i.e. } \mathbf{P}[e^H \geq t] \sim C_I t^{-\kappa},$$

où κ est tel que $\mathbf{E}[\rho_0^\kappa] = 1$.

Dans le cadre de la marche sur l'arbre, nous utilisons un résultat de Heathcote, Seneta et Vere-Jones [50] qui nous permet de dire que

$$\mathbf{P}[H \geq n] \sim \alpha \mathbf{f}'(q)^n \text{ i.e. } \mathbf{P}[e^H \geq t] = \Theta(t^{-\gamma}),$$

où $\mathbf{f}(z) = \sum_{k \geq 0} p_k z^k$, q désigne son unique point fixe dans $(0, 1)$ et $\gamma = -\ln \mathbf{f}'(q) / \ln \beta$. Nous n'avons pas ici à proprement parler d'équivalent. En effet H est à valeurs entières, ceci qui correspond à ce que $\ln \rho_0$ soit concentrée sur un réseau en dimension 1.

En se remémorant (2.1), nous voyons dans le cas uni-dimensionnel

$$\mathbb{P}[T_{\text{tot}} \geq t] = \int P\left[\frac{1}{p}u \geq t\right] d\mathbb{P}[Z_\infty \in du] \sim \int C_I t^{-\kappa} u^\kappa d\mathbb{P}[Z_\infty \in du] = C_I \mathbb{E}[Z_\infty^\kappa] t^{-\kappa},$$

2. UN LIEN ENTRE LES M.A.M.A. ET UN MODÈLE DE PIÈGE JOUET

ce qui nous d'appliquer des théorèmes classiques sur les variables aléatoires à queues lourdes et à variations régulières, voir [31], pour montrer un théorème de convergence vers une loi stable. En notant $T_{\text{tot}}^{(i)}$ une suite de v.a.i.i.d. de loi T_{tot} , on a

$$\frac{\Delta_n}{n^{1/\kappa}} = \frac{\sum_{i=1}^{C_S n} T_{\text{tot}}^{(i)}}{n^{1/\kappa}} \rightarrow \mathcal{S}_\kappa,$$

où \mathcal{S}_κ est une loi stable complètement asymétrique d'indice κ , dont on peut calculer les autres paramètres de manière "explicite" en fonction de certain moments de la variable Z_∞ et de C_S .

Nous avons ici omis deux points importants,

1. les temps passés dans différents pièges ne sont pas indépendants,
2. la marche ne passe pas d'un piège au suivant sans jamais revenir en arrière.

Ces propriétés sont à proprement parler fausses, mais si nous regardons des événements génériques, i.e. des convergences en loi par opposition à des grandes déviations, ces deux propriétés sont essentiellement vérifiées. En effet, les sommes de v.a.i.i.d. à queues lourdes sont concentrées sur les plus gros termes, par exemple sur une somme de n la somme est concentrée sur les n^ε plus gros termes, elles correspondent donc aux plus grosses vallées qui sont génériquement à grande distance. Ainsi le nombre de retours dans chacune des grosses vallées sont essentiellement indépendants ce qui nous donne la première propriété. De plus une fois qu'une vallée est atteinte il est peu vraisemblable de revenir contre la direction de la transience entre deux grands pièges, i.e. sur une distance polynomiale. Cela fournit la deuxième propriété.

Un raisonnement similaire peut-être fait dans le cas de l'arbre. Seulement dans ce cas il n'y pas de possibilité de convergence en loi. En effet le temps d'atteinte du niveau n est réduit à l'étude de la convergence d'une suite de v.a.i.i.d. qui ont des queues qui ne sont pas à variations régulières et par des résultats généraux sur les tableaux triangulaires, voir [80], on ne peut pas trouver de renormalisation convenable. Cependant grâce à l'application d'un résultat de [80] (que l'on retrouvera reformulé dans le Théorème 10.6), on peut obtenir une convergence selon des sous-suites

$$\text{pour } \lambda \in [1, \beta), \quad \frac{\Delta_{(\lambda\beta)^{\gamma k}}}{(\lambda\beta)^k} = \frac{1}{\beta^k} \sum_{i=1}^{\lfloor \beta^{k\gamma} \rfloor} T_{\text{tot}}^{(i)} \xrightarrow{d} Y,$$

où Y est une variable aléatoire de loi infiniment divisible qui possède une partie brownienne nulle.

Ce raisonnement explique aussi essentiellement les résultats obtenus dans [35] et [36]. Il est le coeur de la démonstration dans [8] pour traiter le cas des marches biaisées sur un Galton-Watson avec des feuilles dont le résultat a été cité au début de cette section.

Plus généralement les résultats qu'on peut obtenir sont reliés au "Bouchaud's Trap Model" qui fut introduit dans [17]. Nous ne voulons pas introduire également ce modèle

et nous renvoyons le lecteur au mini-cours [7] pour une introduction générale. Nous signalons également l'article [107] qui est encore plus fortement relié aux modèles que nous avons considéré ici. En effet le modèle de Bouchaud dirigé qui est étudié dans cet article possède des propriétés similaires à celles des M.A.M.A. présentées ici même concernant les événements rares du types grandes déviations.

3 Déviations modérées pour la M.A.M.A. sur \mathbb{Z}

Nous venons de voir dans la section précédente que la M.A.M.A. uni-dimensionnelle était fortement lié à un modèle jouet, du moins dans le cas d'un comportement typique de la marche. Cependant lorsqu'il s'agit de regarder des événements rares certaines approximations faites dans la section précédente sont un peu abusives. En particulier il n'est pas vrai que la particule avance essentiellement d'un piège à un autre, il est en effet possible d'observer de grands retours en arrière. Une modélisation plus adéquate du modèle serait alors de conserver un temps d'attente à chaque site du type $e^H e$ où e une variable aléatoire exponentielle de paramètre 1 et H est une variable aléatoire distribuée comme la hauteur d'une vallée, mais de remplacer les sauts de la marche aléatoire qui étaient systématiquement vers la droite par une marche aléatoire biaisée vers la droite.

Cette représentation simplifiée nous permet d'aborder des problèmes de "déviations modérées". Sous les hypothèses du théorème de Kesten, Kozlov et Spitzer, i.e. si $\mathbf{E}[\ln \rho_0] < 0$ et $\mathbf{E}[\rho_0^\kappa] = 1$, nous avons que

$$\lim_{n \rightarrow \infty} \ln X_n / \ln n = \kappa, \quad \mathbb{P}\text{-p.s.}$$

Une question naturelle à considérer est de savoir la probabilité d'un écart par rapport à cet événement. Nous cherchons à comprendre les événements rares suivant

- le *ralentissement*, ce qui signifie qu'au temps n la particule est à gauche de n^{ν_0} où $\nu_0 < 1 \wedge \kappa$, ce qui signifie que la particule est beaucoup plus lente que son comportement typique,
- le *recul*, ce qui signifie qu'au temps n la particule est à gauche de $-n^\nu$,
- l'*accélération*, ce qui signifie que la particule est à droite de n^{ν_0} avec $\kappa < \nu_0 < 1$.

Nous désignons tous ces événements par des "déviations modérées". En effet, dans le cas de ralentissement, la fonction de taux pour les grandes déviations $I(\cdot)$ vérifie que $I(0) = 0$, ce qui nous permet seulement de dire que les probabilités décroissent de manière sous-exponentielle en n (voir [20]). Notre but est alors de préciser ce résultat en identifiant le coefficient de décroissance sous-exponentielle.

Nous obtenons plusieurs résultats, en particulier des déviations, quenched ou annealed, pour la marche ou pour le temps d'atteinte, dans le cas uni-dimensionnel normal ou bien réfléchi en 0. L'ensemble de ces résultats est assez longs à énoncer et nous renvoyons le lecteur à la Section 6 pour tous les énoncés.

3. DÉVIATIONS MODÉRÉES POUR LA M.A.M.A. SUR \mathbb{Z}

On peut résumer une partie des résultats sous la forme d'un graphique. Dans le cas sous-balistique, i.e. $\kappa \in (0, 1)$, les déviations modérées quenched pour la marche \mathbb{Z} sont représentées en 3.4 via le graphique de la fonction :

$$f(\nu) = \begin{cases} \lim_{n \rightarrow \infty} \ln(-\ln P_\omega[X_n < -n^{-\nu}]) / \ln n, & \text{si } \nu \in (-1, 0], \\ \lim_{n \rightarrow \infty} \ln(-\ln P_\omega[X_n < n^\nu]) / \ln n, & \text{si } \nu \in (0, \kappa), \\ \lim_{n \rightarrow \infty} \ln(-\ln P_\omega[X_n > n^\nu]) / \ln n, & \text{si } \nu \in [\kappa, 1). \end{cases}$$

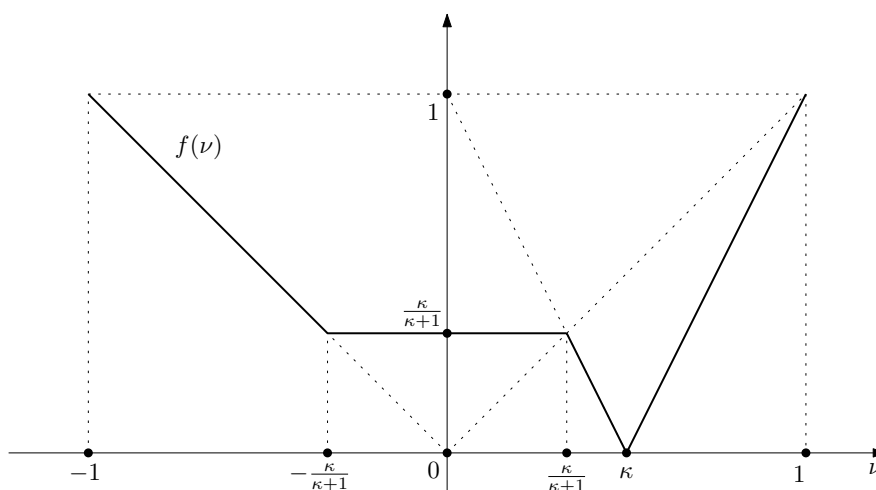

FIG. 3.4 – Graphique de $f(\nu)$, $-1 < \nu < 1$

Les résultats obtenus dans le cas du ralentissement, qui constitue le cas le plus difficile, sont en fait les mêmes que ce que l'on obtient en faisant les calculs dans le modèle simplifié présenté dans le début de cette section. Il faut analyser la compétition qu'il y a entre les deux possibilités suivantes

1. aller chercher de grandes vallées dans lesquelles il est naturel de passer beaucoup de temps,
2. passer un temps anormalement grand dans une vallée normale.

Une ébauche détaillée de preuve se trouve dans l'article [39].

CHAPITRE 3. PRÉSENTATION DES RÉSULTATS

4

Biased random walks on Galton-Watson trees with leaves

We consider a biased random walk X_n on a Galton-Watson tree with leaves in the sub-ballistic regime. We prove that there exists an explicit constant $\gamma = \gamma(\beta) \in (0, 1)$, depending on the bias β , such that X_n is of order n^γ . Denoting Δ_n the hitting time of level n , we prove that $\Delta_n/n^{1/\gamma}$ is tight. Moreover we show that $\Delta_n/n^{1/\gamma}$ does not converge in law (at least for large values of β). We prove that along the sequences $n_\lambda(k) = \lfloor \lambda\beta^{\gamma k} \rfloor$, $\Delta_n/n^{1/\gamma}$ converges to certain infinitely divisible laws. Key tools for the proof are the classical Harris decomposition for Galton-Watson trees, a new variant of regeneration times and the careful analysis of triangular arrays of i.i.d. heavy-tailed random variables.

The material of this chapter is a joint work with G. Ben Arous, N. Gantert and A. Hammond and has been submitted for publication, see [8].

1 Introduction and statement of the results

Consider a supercritical Galton-Watson branching process with generating function $\mathbf{f}(z) = \sum_{k \geq 0} p_k z^k$, i.e. the offspring of all individuals are i.i.d. copies of Z , where $\mathbf{P}[Z = k] = p_k$. We assume that the tree is supercritical and has leaves, i.e. $\mathbf{m} := \mathbf{E}[Z] = \mathbf{f}'(1) \in (1, \infty)$ and $p_0 > 0$. We denote by $q \in (0, 1)$ the extinction probability, which is characterized by $\mathbf{f}(q) = q$. Starting from a single progenitor called root and denoted by 0, this process yields a random tree T . We will always condition on the event of non-extinction, so that T is an infinite random tree. We denote (Ω, \mathbf{P}) the associated probability space : \mathbf{P} is the law of the original tree, conditioned on non-extinction.

For $\omega \in \Omega$, on the infinite Galton-Watson tree $T(\omega)$, we consider the β -biased random walk as in [68]. More precisely, we define, for $\beta > 1$, a Markov chain $(X_n)_{n \in \mathbb{N}}$ on the vertices of T , such that if $u \neq 0$ and u has k children v_1, \dots, v_k and parent \overleftarrow{u} , then

1. $P[X_{n+1} = \overleftarrow{u} | X_n = u] = \frac{1}{1+\beta k}$,
2. $P[X_{n+1} = v_i | X_n = u] = \frac{\beta}{1+\beta k}$, for $1 \leq i \leq k$,

and from 0 all transitions to its children are equally likely. This is a reversible Markov chain, and as such, can be described as an electrical network with conductances $c(\overleftarrow{x}, x) := \beta^{|\overleftarrow{x}|-1}$ on every edge of the tree (see [70] for background on electrical networks).

We always take $X_0 = 0$, that is we start the walk from the root of the tree. We denote by $P^\omega[\cdot]$ the law of $(X_n)_{n=0,1,2,\dots}$ and we define the averaged law as the semidirect product $\mathbb{P} = \mathbf{P} \times P^\omega$.

Many interesting facts are known about this walk (see [68]). As one might expect, it is transient. Denote by $|u| = d(0, u)$ the distance of u to the root. It is known that \mathbb{P} -a.s., $|X_n|/n$ converges to a deterministic limit v . Moreover, the random walk is *ballistic*, i.e. its limiting velocity $v > 0$, if and only if $\beta < \beta_c = 1/\mathbf{f}'(q)$. In the *subballistic* regime, i.e. if $\beta \geq \beta_c$, we have $v = 0$. The reason for the subballistic regime is that the walk loses time in traps of the tree, from where it cannot go to infinity without having to go for a long time against the drift which keeps it into the trap. The hypothesis $p_0 > 0$ is crucial for this to happen.

As in all subballistic models, a natural question comes up : what is the typical distance of the walker from the root after n steps? This is the question we address in this paper. We always assume that

$$\mathbf{E}[Z^2] < \infty$$

and

$$\beta > 1/\mathbf{f}'(q),$$

recalling that $1/\mathbf{f}'(q) > 1$. We introduce the exponent

$$\gamma := \frac{-\ln \mathbf{f}'(q)}{\ln \beta} = \frac{\ln \beta_c}{\ln \beta} < 1 \tag{1.1}$$

1. INTRODUCTION AND STATEMENT OF THE RESULTS

so that $\beta^\gamma = 1/f'(q)$.

Let Δ_n be the hitting time of the n -th level :

$$\Delta_n = \inf\{i \geq 0, |X_i| = n\}.$$

Theorem 1.1. (i) *The laws of $(\Delta_n/n^{1/\gamma})_{n \geq 0}$ under \mathbb{P} are tight.*

(ii) *The laws of $(|X_n|/n^\gamma)_{n \geq 0}$ under \mathbb{P} are tight.*

(iii) *We have*

$$\lim_{n \rightarrow \infty} \frac{\ln |X_n|}{\ln n} = \gamma, \quad \mathbb{P} - a.s.. \quad (1.2)$$

Of course, this raises the question of convergence in distribution of the sequence $(\Delta_n/n^{1/\gamma})_{n \geq 0}$. The next theorem gives a negative answer.

Theorem 1.2. *For β large enough, the sequence $(\Delta_n/n^{1/\gamma})_{n \geq 0}$ does not converge in distribution.*

However, we can establish convergence in distribution along certain subsequences.

Theorem 1.3. *For any $\lambda > 0$, denoting $n_\lambda(k) = \lfloor \lambda f'(q)^{-k} \rfloor$, we have*

$$\frac{\Delta_{n_\lambda(k)}}{n_\lambda(k)^{1/\gamma}} \xrightarrow{d} Y_\lambda$$

where the random variable Y_λ has an infinitely divisible law μ_λ .

We now describe the limit laws μ_λ . For some constants ρ and C_a (the constant ρ is defined in (2.2), the constant C_a in Lemma 6.1), we have

$$Y_\lambda = (\rho C_a \lambda)^{1/\gamma} \tilde{Y}_{(\rho C_a \lambda)^{1/\gamma}}$$

where

$$\tilde{Y}_\lambda \text{ has the law } \mathfrak{I}(d_\lambda, 0, \mathcal{L}_\lambda).$$

The infinitely divisible law $\mathfrak{I}(d_\lambda, 0, \mathcal{L}_\lambda)$ is given by its Lévy representation (see [80], p. 32). More precisely, the characteristic function of $\mathfrak{I}(d_\lambda, 0, \mathcal{L}_\lambda)$ can be written in the form

$$\mathbb{E} \left[e^{it\tilde{Y}_\lambda} \right] = \int e^{itx} \mathfrak{I}(d_\lambda, 0, \mathcal{L}_\lambda)(dx) = \exp \left(id_\lambda t + \int_0^\infty \left(e^{itx} - 1 - \frac{itx}{1+x^2} \right) d\mathcal{L}_\lambda(x) \right)$$

where d_λ is a real constant and \mathcal{L}_λ a real function which is non-decreasing on the interval $(0, \infty)$ and satisfies $\mathcal{L}_\lambda(x) \rightarrow 0$ for $x \rightarrow \infty$ and $\int_0^a x^2 d\mathcal{L}_\lambda(x) < \infty$ for every $a > 0$. Comparing to the general representation formula in [80], p. 32, we here have that

CHAPITRE 4. BIASED RANDOM WALKS ON GALTON-WATSON TREES WITH LEAVES

the gaussian part vanishes and $\mathcal{L}_\lambda(x) = 0$ for $x < 0$. The function \mathcal{L}_λ is called the Lévy spectral function. Note that \mathcal{L}_λ is not a Lévy-Khintchine spectral function.

In order to describe \mathcal{L}_λ , define the random variable

$$\mathcal{Z}_\infty = \frac{S_\infty}{1 - \beta^{-1}} \sum_{i=1}^{\text{Bin}(W_\infty, p_\infty)} \mathbf{e}_i, \quad (1.3)$$

where $p_\infty = 1 - \beta^{-1}$ is the escape probability of a β -biased random walk on \mathbb{N} . Further, the random variables \mathbf{e}_i in (1.3) are i.i.d. exponential random variables of parameter 1 and the non-negative random variables (\mathbf{e}_i) , W_∞ and S_∞ in (1.3) are independent. The random variables S_∞ and W_∞ will be described in (3.6) and Proposition 6.1 respectively. The random variable $\text{Bin}(W_\infty, p_\infty)$ is of law Binomial with parameters W_∞ and p_∞ . Now, denoting by $\bar{F}_\infty(x) = \mathbb{P}[\mathcal{Z}_\infty > x]$ the tail function of \mathcal{Z}_∞ , we have

Theorem 1.4. (i) *The Lévy spectral function \mathcal{L}_λ is given by*

$$\mathcal{L}_1(x) = \begin{cases} 0 & \text{if } x < 0, \\ -(1 - \beta^{-\gamma}) \sum_{k \in \mathbb{Z}} \beta^{\gamma k} \bar{F}_\infty(x \beta^k) & \text{if } x > 0. \end{cases}$$

(ii) *for all $\lambda \in [1, \beta)$ and $x \in \mathbb{R}$, $\mathcal{L}_\lambda(x) = \lambda^\gamma \mathcal{L}_1(\lambda x)$ and $\mathcal{L}_\beta(x) = \mathcal{L}_1(x)$.*

(iii) *d_λ is given by*

$$d_\lambda = \lambda^{1+\gamma} (1 - \beta^{-\gamma}) \sum_{k \in \mathbb{Z}} \beta^{(1+\gamma)k} E \left[\frac{\mathcal{Z}_\infty}{(\lambda \beta^k)^2 + \mathcal{Z}_\infty^2} \right].$$

(iv) *\mathcal{L}_λ is absolutely continuous.*

(v) *The following bounds hold*

$$\frac{1}{\beta^\gamma} \mathbb{E}[\mathcal{Z}_\infty^\gamma] \frac{1}{x^\gamma} \leq -\mathcal{L}_1(x) \leq \mathbb{E}[\mathcal{Z}_\infty^\gamma] \frac{1}{x^\gamma}. \quad (1.4)$$

(vi) *The measure μ_λ is absolutely continuous with respect to Lebesgue measure and has a moment of order α if and only if $\alpha < \gamma$.*

(vii) *When β is large enough, $x^\gamma \mathcal{L}_\lambda(x)$ is not a constant.*

(viii) *The random variable \mathcal{Z}_∞ has an atom at 0 and a smooth density ψ on $(0, \infty)$. Further, \mathcal{Z}_∞ has finite expectation.*

Remark 1.1. *We believe that Theorem 1.2 holds true for all values $\beta > \beta_c$. The proof would amount to showing that the function $x^\gamma \mathcal{L}_1(x)$, with $\mathcal{L}_1(x)$ given in Theorem 1.4, is not a constant.*

1. INTRODUCTION AND STATEMENT OF THE RESULTS

Next we explain briefly, using a toy example, the reason for the non-convergence of $(\Delta_n/n^{1/\gamma})_{n \geq 0}$ and the convergence of subsequences in Theorems 1.2 and 1.3. The reasons lie in the classical theory of sums of i.i.d. random variables. Consider a sequence of i.i.d. random variables G_i , geometrically distributed with parameter a . Let

$$S_n = \sum_{i=1}^n \beta^{G_i}.$$

It is easy to see, using classical results about triangular arrays of i.i.d. random variables (c.f. [80]), that for $\alpha = \frac{-\log(1-a)}{\log \beta}$, and $n_\lambda(k) = \beta^{-\alpha k}$, the distributions of

$$\frac{1}{n_\lambda(k)^{1/\alpha}} S_{n_\lambda(k)} \text{ converge to an infinitely divisible law}$$

(see Theorem 10.1 for a more general result). But obviously here $S_n/n^{1/\alpha}$ cannot converge in law, if $\alpha < 2$, because one easily checks that the distribution of β^{G_1} does not belong to the domain of attraction of any stable law. This is the basis of our belief that Theorem 1.2 should be valid for any $\beta > \beta_c$.

We now discuss the motivation for this work. If one considers a biased random walk on a supercritical percolation cluster on \mathbb{Z}^d , it is known that, at low bias, the random walk is ballistic (i.e. has a positive velocity) and has gaussian fluctuations, see [99] and [12]. It is also known that, at strong bias, the random walk is subballistic (i.e. the velocity vanishes). It should be noted that, in contrast to the Galton-Watson tree, the existence of a critical value separating the two regimes is not established for supercritical percolation clusters. The behaviour of the (law of) the random walk in the subballistic regime is a very interesting open problem. It was noted in [101] that the behaviour of the random walk in this regime is reminiscent of trap models introduced by Bouchaud (see [17] and [7]). Our work indeed substantiates this analogy in the simpler case of supercritical random trees. We show that most of the time spent by the random walk before reaching level n is spent in deep traps. These trapping times are roughly independent and are heavy-tailed. However, their distribution does not belong to the domain of attraction of a stable law, which explains the non-convergence result in Theorem 1.2.

We note that it is possible to obtain convergence results to stable laws if one gets rid of the inherent lattice structure. One way to do this is to randomize the bias β . This is the approach of the forthcoming paper [9].

For other recent interesting works about random walks on trees, we refer to [53], [2], and [78].

There is also an analogy with the one-dimensional random walk in an i.i.d. random environment (RWRE). This model also shows a ballistic and a subballistic regime, explicitly known in terms of the parameters of the model. We refer to [104] for a survey. In the subballistic regime, it was shown in [59] that depending on a certain parameter $\kappa \in (0, 1]$, and under a non-lattice assumption, $\frac{X_n}{n^\kappa}$ converges to a functional of a stable

CHAPITRE 4. BIASED RANDOM WALKS ON GALTON-WATSON TREES WITH LEAVES

law, if $\kappa < 1$, and $\frac{X_n}{n/\ln n}$ converges to a functional of a stable law, if $\kappa = 1$. Recently, using a precise description of the environment, [36] and [35] refined this last theorem by describing all the parameters of the stable law, in the case $\kappa < 1$.

Our method has some similarity to the one used in [35]. In comparison to [35], an additional difficulty arises from the fact the traps met depend not only on the environment but also on the walk. Moreover one has to take into account the number of times the walker enters a trap, which is a complicated matter because of the inhomogeneity of the tree. This major technical difficulty can be overcome by decomposing the tree and the walk into independent parts, which we do using a new variant of regeneration times.

The paper is organized as follows : In Section 2 and Section 3 we explain how to decompose the tree and the walk. In Section 4 we give a sketch of the proof of Theorem 1.3. Sections 5 - 9 prepare the proof of Theorem 1.3 and explain why the hitting time of level n is comparable to a sum i.i.d. random variables. Section 10 is self-contained and its main result, Theorem 10.1, is a classical limit theorem for sums of i.i.d. random variables which is tailored for our situation. In Section 11, we finally give the proofs of the results. In Subsection 11.1, we apply Theorem 10.1 to prove Theorem 1.3. Subsection 11.2 is devoted to the proof of Theorem 1.2, Subsection 11.3 gives the proof of Theorem 1.1 and Subsection 11.4 the proof of Theorem 1.4.

Let us give some conventions about notations. The parameters β and $(p_k)_{k \geq 0}$ will remain fixed so we will usually not point out that constants depend on them. Most constants will be denoted c or C and their value may change from line to line to ease notations. Specific constants will have a subscript as for example C_a . We will always denote by $G(a)$ a geometric random variable of parameter a , with law given by $P[G_a \geq k] = (1 - a)^{k-1}$ for $k \geq 1$.

2 Constructing the environment and the walk in the appropriate way

In order to understand properly the way the walk is slowed down, we need to decompose the tree. Set

$$\mathbf{g}(s) = \frac{\mathbf{f}((1 - q)s + q) - q}{1 - q} \text{ and } \mathbf{h}(s) = \frac{\mathbf{f}(qs)}{q}. \quad (2.1)$$

It is known (see [65]), that a \mathbf{f} -Galton-Watson tree (with $p_0 > 0$) can be generated by

- (i) growing a \mathbf{g} -Galton-Watson tree $T_{\mathbf{g}}$ called the backbone, where all vertices have an infinite line of descent,
- (ii) attaching on each vertex x of $T_{\mathbf{g}}$ a random number N_x of \mathbf{h} -Galton-Watson trees, acting as traps in the environment T ,

2. CONSTRUCTING THE ENVIRONMENT AND THE WALK IN THE APPROPRIATE WAY

where N_x has a distribution depending only on $\deg_{T_{\mathbf{g}}}(x)$ and given $T_{\mathbf{g}}$ and N_x the traps are i.i.d., see [65] for details.

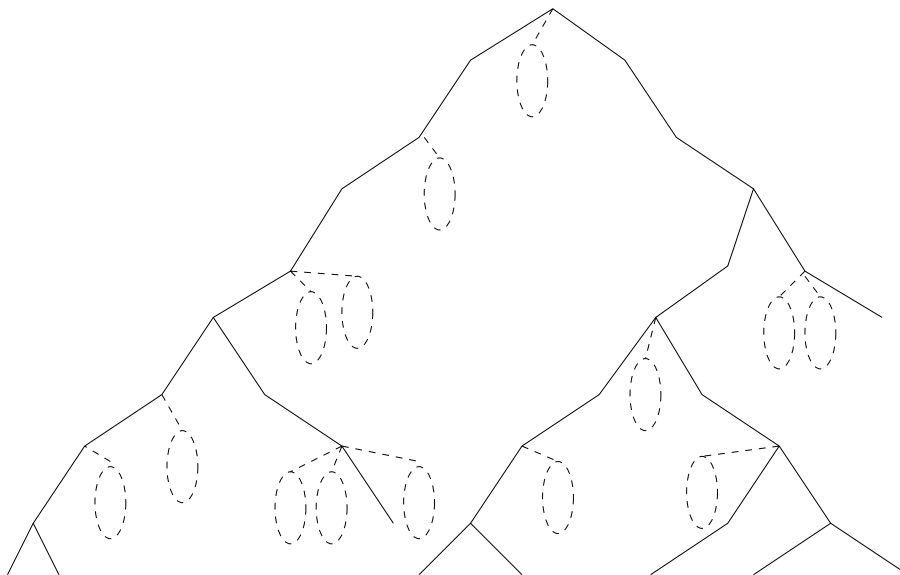

FIG. 4.1 – The Galton-Watson tree is decomposed into the backbone (solid lines) and the traps (dashed lines).

We will call bud a vertex at distance exactly one of the backbone. It is important to consider the backbone together with the buds to understand the number of visits to traps.

It will be convenient to consider the attached Galton-Watson trees together with the edge which connects them to the backbone. We define a *trap* to be a graph $(x \cup V, [x, y] \cup E)$, where x is a vertex of the backbone, y is a bud adjacent to x and V (resp. E) are the vertices (resp. edges) of the descendants of y . The traps can themselves be decomposed in a portion of \mathbb{Z} called the spine, to which smaller trees called subtraps are added, this construction is presented in detail in Section 3.

Let us now construct the random walk. We need to consider the walk on the backbone and on the buds, to this end we introduce

1. $\sigma_0 = \sigma'_0 = 0$,
2. $\sigma_{n+1} = \inf\{i > \sigma_n | X_{i-1}, X_i \in \text{backbone}\}$,
3. $\sigma'_{n+1} = \inf\{i > \sigma'_n | X_{i-1}, X_i \in \text{backbone} \cup \text{buds}\}$,

and we define $Y_n = X_{\sigma_n}$ the embedded walk on the backbone, respectively $Y'_n = X_{\sigma'_n}$ the embedded walk on the backbone and the buds.

Moreover define $\Delta_n^Y = \text{card}\{i \geq 0 | \sigma_i \leq \Delta_n\}$ the time spent on the backbone to reach level n and similarly $\Delta_n^{Y'} = \text{card}\{i \geq 0 | \sigma'_i \leq \Delta_n\}$.

CHAPITRE 4. BIASED RANDOM WALKS ON GALTON-WATSON TREES WITH LEAVES

Denote, for a set A in the tree $T_A^+ = \min\{n \geq 1 | X_n \in A\}$, $T_y^+ := T_{\{y\}}^+$, $T_A := \min\{n \geq 0 | X_n \in A\}$, and $T_y := T_{\{y\}}$.

Note that the process $(Y_n)_{n \geq 0}$ is a Markov chain on the backbone, which is independent of the traps and the time spent in the traps. Here one has to be aware that visits to *root* do not count as “time spent in a trap”, precise definitions will follow below. Hence, in order to generate Y_n we use a sequence of i.i.d. random variables U_i uniformly distributed on $[0, 1]$. If $Y_j = w$ with Z_1^* children on the backbone, then

1. $Y_{i+1} = \overleftarrow{w}$, if $U_i \in \left[0, \frac{1}{Z_1^* \beta + 1}\right]$,
2. $Y_{i+1} = \text{the } j^{\text{th}}\text{-child of } w$, if $U_i \in \left[1 - \frac{j\beta}{Z_1^* \beta + 1}, 1 - \frac{(j-1)\beta}{Z_1^* \beta + 1}\right]$.

For background on regeneration times we refer to [102] or [104]. In the case of a β -biased random walk \tilde{Y}_n on \mathbb{Z} , a time t is a regeneration time if

$$\tilde{Y}_t > \max_{s < t} \tilde{Y}_s \text{ and } \tilde{Y}_t < \min_{s > t} \tilde{Y}_s.$$

Definition 2.1. *A time t is a super-regeneration time for Y_n , if t is a regeneration time for the corresponding β -biased random walk \tilde{Y}_n on \mathbb{Z} defined by*

- (i) $\tilde{Y}_0 = 0$,
- (ii) $\tilde{Y}_{n+1} = \tilde{Y}_n - 1$, if $U_n \in \left[0, \frac{1}{\beta + 1}\right]$,
- (iii) $\tilde{Y}_{n+1} = \tilde{Y}_n + 1$ otherwise.

We denote t – SR the event that t is a super-regeneration time for Y_n .

It is obvious that a super-regeneration time for Y_n is a regeneration time for Y_n in the usual sense (the converse is false).

The walk can then be decomposed between the successive super-regeneration times

- (i) $\tau_0 = 0$,
- (ii) $\tau_{i+1} = \inf\{j \geq \tau_i | j - \text{SR}\}$.

Since the regeneration times of a β -biased random walk on \mathbb{Z} have some exponential moments, there exists $a > 1$ such that $\mathbb{E}[a^{\tau_2 - \tau_1}] < \infty$ and $\mathbb{E}[a^{\tau_1}] < \infty$.

Remark 2.1. *The advantage of super-regeneration times compared to classical regeneration times is that the presence of a super-regeneration time does not depend on the environment, but only on the sequence $(U_i)_{i \geq 0}$.*

Remark 2.2. *The drawback of super-regeneration times is that the event that k is a super-regeneration time depends on the random variables $(U_i)_{i \geq 0}$ and not only on the trajectory of the random walk $(Y_n)_{n \geq 0}$.*

Denoting for $k \geq 1$, the σ -field

$$\mathcal{G}_k = \sigma(\tau_1, \dots, \tau_k, (Y_{n \wedge \tau_k})_{n \geq 0}, \{x \in T(\omega), x \text{ is not a descendant of } Y_{\tau_k}\}).$$

We have the following proposition

Proposition 2.1. For $k \geq 1$,

$$\begin{aligned} & \mathbb{P}[(Y_{\tau_k+n} - Y_{\tau_k})_{n \geq 0} \in \cdot, \{x \in T(\omega), x \text{ is a descendant of } Y_{\tau_k}\} \in \cdot | \mathcal{G}_k] \\ &= \mathbb{P}[(Y_n)_{n \geq 0} \in \cdot, T(\omega) \in \cdot | 0 - SR]. \end{aligned}$$

Remark 2.3. The conditioning $0 - SR$ refers only to the walk on the backbone, hence it is obvious that the behaviour of the walk in the traps and the number of times the walker enters a trap is independent of that event.

We skip the proof of this Proposition for it is standard. A consequence of the proposition is that the environment and the walk can be subdivided into super-regeneration blocks which are i.i.d. (except for the first one). As a consequence we have that

$$\rho_n := \frac{\text{card}\{Y_1, \dots, Y_{\Delta_n^Y}\}}{n} \text{ satisfies } \rho_n \rightarrow \rho := \frac{\mathbb{E}[\text{card}\{Y_{\tau_1}, \dots, Y_{\tau_2-1}\}]}{\mathbb{E}[\tau_2 - \tau_1]}, \mathbb{P} - a.s \quad (2.2)$$

which is the average number of vertices per level visited by Y_n . This quantity is finite since it is bounded above by $1/v(\beta)$, where $v(\beta)$ is the speed of $|Y_n|$ which is strictly positive by a comparison to the β -biased random walk on \mathbb{Z} .

When applying the previous proposition, it will be convenient to use the time-shift for the random walk, which we will denote by θ .

3 Constructing a trap

In the decomposition theorem for Galton-Watson trees, we attach to the vertices of the backbone a (random) number of \mathbf{h} -Galton-Watson trees. We will denote their distribution with \mathbf{Q} , hence $\mathbf{Q}[Z = k] = q_k := p_k q^{k-1}$, where Z denotes the number of children of a given vertex. As stated before the object we will denote a trap has an additional edge : to describe a trap ℓ we take a vertex called *root* (or *root*(ℓ) to emphasize the trap), link it to another vertex (denoted $\overrightarrow{\text{root}}(\ell)$), which is the actual root of a random \mathbf{h} -Galton-Watson tree.

When we use random variables associated to a trap, we refer to the random part of that trap (the \mathbf{h} -Galton-Watson tree). For example the notation Z_n is the number of children at the generation n with $\overrightarrow{\text{root}}$ being generation 0. In particular, we introduce the height of a trap

$$H = \max\{n \geq 0, Z_n > 0\}, \quad (3.1)$$

and we say a trap has height k if $H(\ell) = k$, i.e. the distance between $\overrightarrow{\text{root}}$ and the bottom point of the trap is k .

This way of denoting the random variables has the advantage that Z_n (resp. H) are distributed under \mathbf{Q} , as the number of children at generation n (resp. the height) of a \mathbf{h} -Galton-Watson tree.

CHAPITRE 4. BIASED RANDOM WALKS ON GALTON-WATSON TREES WITH LEAVES

The biggest traps seen up to level n are of size $-\ln n / \ln \mathbf{f}'(q)$, therefore a trap will be considered big if its height is greater or equal to

$$h_n = \left\lceil (1 - \varepsilon) \frac{\ln n}{-\ln \mathbf{f}'(q)} \right\rceil, \quad (3.2)$$

for some $\varepsilon > 0$ which will eventually be chosen small enough. Such a trap will be called a h_n -trap or a big trap. It is in those traps that the walker will spend the majority of his time and therefore is important to have a good description of them.

The traps are (apart from the additional edge) subcritical Galton-Watson trees, as such, they can be grown from the bottom following a procedure described in [43], that we recall for completeness. We will denote by δ the starting point of the procedure, corresponding to the leftmost bottom point of the trap, this last notation will be kept for the whole paper.

With a slight abuse of notation, we will denote by \mathbf{Q} a probability measure on an enlarged probability space containing the following additional information.

We denote by (ϕ_{n+1}, ψ_{n+1}) with $n \geq 0$, a sequence of i.i.d pairs of random variables with joint law given by

$$\mathbf{Q}[\phi_{n+1} = j, \psi_{n+1} = k] = c_n q_k \mathbf{Q}[Z_n = 0]^{j-1} \mathbf{Q}[Z_{n+1} = 0]^{k-j}, \quad 1 \leq j \leq k, \quad k \geq 1, \quad (3.3)$$

where $c_n = \frac{Q[H=n]}{Q[H=n+1]}$.

Set $\mathcal{T}_0 = \{\delta\}$. Construct \mathcal{T}_{n+1} , $n \geq 0$ inductively as follows :

1. let the first generation size of \mathcal{T}_{n+1} be ψ_{n+1} ,
2. let \mathcal{T}_n be the subtree founded by the ϕ_{n+1} -th first generation vertex of \mathcal{T}_{n+1} ,
3. attach independent \mathbf{h} -Galton-Watson trees which are conditioned on having height strictly less than n to the $\phi_{n+1} - 1$ siblings to the left of the distinguished first generation vertex,
- (iv) attach independent \mathbf{h} -Galton-Watson trees which are conditioned on having height strictly less than $n + 1$ to the $\psi_{n+1} - \phi_{n+1}$ siblings to the right of the distinguished first generation vertex.

Then \mathcal{T}_{n+1} has the law of an \mathbf{h} -Galton-Watson tree conditioned to have height $n + 1$ (see [43]).

We denote \mathcal{T} the infinite tree asymptotically obtained by this procedure; from this tree we can obviously recover all \mathcal{T}_n . If we pick independently the height H of a \mathbf{h} -Galton-Watson tree and the infinite tree \mathcal{T} obtained by the previous algorithm, then \mathcal{T}_H has the same law as a \mathbf{h} -Galton-Watson tree.

We will call spine of this Galton-Watson tree the ancestors of δ . If $y \neq \delta$ is in the spine, \vec{y} denotes its only child in the spine. We define a subtrap to be a graph $(x \cup V, [x, y] \cup E)$, where x is a vertex of the spine, y is a descendant of x not on the

3. CONSTRUCTING A TRAP

spine and V (resp. E) are the vertices (resp. edges) of the descendants of y . The vertex x is called the root of the subtrap, and we denote

$$S_x \text{ the set of all subtraps rooted at } x. \quad (3.4)$$

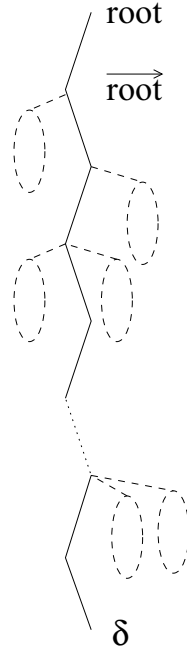

FIG. 4.2 – The trap is decomposed into the spine (solide lines) and the subtraps (dashed lines).

We denote by $S_{n+1}^{i,j,k}$ and $\Pi_{n+1}^{i,j,k}$ with $n, i, j \geq 0$ and $k = 1, 2$, two sequences of independent random variables, which are independent of $(\phi_n, \psi_n)_{n \geq 0}$ and given by

1. $S_n^{n+1,j,1}$ (resp. $S_n^{n,j,2}$) is the j -th subtrap conditioned to have height less than n added on the left (resp. right) of the $n + 1$ -th (resp. n -th) ancestor of δ ,
2. $\Pi_n^{i,j,k}$ is the weight of $S_n^{i,j,k}$ under the invariant measure associated to the conductances β^{i+1} between the level i and $i + 1$, the root of $S_n^{i,j,k}$ being counted as level 0.

These random variables describe the subtraps and their weights.

We denote $\Pi_{-1}^{i,j,k} = 0$ and

$$\Lambda_i(\omega) = \sum_{j=1}^{\phi_i-1} \Pi_{i-1}^{i,j,1} + \sum_{j=1}^{\psi_i-\phi_i} \Pi_i^{i,j,2}, \quad (3.5)$$

CHAPITRE 4. BIASED RANDOM WALKS ON GALTON-WATSON TREES WITH LEAVES

which is the weight of the subtraps added to the i -th ancestor of δ .

Due to the following lemma, the random variables Λ_i will be important to describe the time spent in traps.

Lemma 3.1. *Let $(G, c(e))$ be a finite or positive recurrent electrical network, $x \in G$ and P_x the law of the random walk started at x . If $\sum_{y \sim x} c([x, y]) = 1$, then*

$$E_x[T_x^+] = 2 \sum_{e \in G} c(e).$$

Démonstration. Denote $\hat{\pi}$ the invariant measure associated with the conductances of the network. Then $\hat{\pi}(\cdot)/\hat{\pi}(G)$ is the invariant probability of the network and the mean return time formula yields

$$E_x^\omega[T_x^+] = \frac{\hat{\pi}(G)}{\hat{\pi}(x)} = \hat{\pi}(G),$$

since $\hat{\pi}(x) = \sum_{y \sim x} c([x, y]) = 1$. Then we simply notice that

$$\hat{\pi}(G) = 2 \sum_{e \in G} c(e).$$

□

Let us introduce another important random variable

$$S_\infty = 2 \sum_{i=0}^{\infty} \beta^{-i} (1 + \Lambda_i), \quad (3.6)$$

which appears in the statement of our theorem. It is the mean return time to δ of the walk on the infinite tree \mathcal{T} described in the algorithm following (3.3).

Lemma 3.2. *There exists a constant C_ψ depending on $(p_k)_{k \geq 0}$, such that for $n \geq 0$ and $k \geq 0$,*

$$\mathbf{Q}[\psi_{n+1} = k] \leq C_\psi k q^k.$$

In particular, for another constant \tilde{C}_ψ , $\sup_{i \in \mathbb{N}} E_{\mathbf{Q}}[\psi_i] \leq \tilde{C}_\psi < \infty$.

Démonstration. Recalling (3.3), we get

$$\begin{aligned} \mathbf{Q}[\psi_{n+1} = k] &= \sum_{j=1}^k \mathbf{Q}[\phi_{n+1} = j, \psi_{n+1} = k] \\ &= c_n q_k \sum_{j=1}^k \mathbf{Q}[Z_n = 0]^{j-1} \mathbf{Q}[Z_{n+1} = 0]^{k-j} \end{aligned}$$

3. CONSTRUCTING A TRAP

$$\leq c_n k q_k.$$

It is enough to show that the sequence $(c_n)_{n \geq 0}$ is bounded from above. A Galton-Watson tree of height $n + 1$ can be obtained as *root* having j children, one of which produces a Galton-Watson tree of height n , the others having no children of their own. Thu-shi2s

$$1/c_n = \mathbf{Q}[H = n + 1] / \mathbf{Q}[H = n] \geq q_j q_0^{j-1},$$

for any $j \geq 1$. We fix $j_0 \geq 1$ so that $q_{j_0} > 0$ and we get

$$\mathbf{Q}[\psi_{n+1} = k] \leq \frac{1}{q_{j_0} q_0^{j_0-1}} k q^{k-1},$$

where we used $q_k = p_k q^{k-1} \leq q^{k-1}$. □

Using this lemma we can get a tail estimate for the height of traps.

Lemma 3.3. *There exists $\alpha > 0$ such that*

$$\mathbf{Q}[H \geq n] \sim \alpha \mathbf{f}'(q)^n.$$

Démonstration. It is classical (see [50]) that for any Galton-Watson tree of law \tilde{Q} with $E_{\tilde{Q}}[Z_1] = m < 1$ expected number of children, we have

$$\lim_{n \rightarrow \infty} \frac{\tilde{Q}[Z_n > 0]}{m^n} > 0 \iff E_{\tilde{Q}}[Z_1 \log^+ Z_1] < \infty.$$

The integrability condition is satisfied for \mathbf{Q} since $q_k = p_k q^{k-1} \leq q^{k-1}$, and the result follows. □

We also recall the following classical upper bound

$$\mathbf{Q}[H \geq n] = \mathbf{Q}[Z_n > 0] = \mathbf{Q}[Z_n \geq 1] \leq E_{\mathbf{Q}}[Z_n] = \mathbf{f}'(q)^n. \quad (3.7)$$

The following lemma seems obvious, but not standard, so we include its proof for the convenience of the reader.

Lemma 3.4. *We have for $k \geq 0$,*

$$\mathbf{Q}[Z_1 \leq k | Z_n = 0] \geq \mathbf{Q}[Z_1 \leq k].$$

In particular $E_{\mathbf{Q}}[Z_i | Z_n = 0] \leq \mathbf{f}'(q)^i$, for any $i \geq 0$ and $n \geq 0$.

CHAPITRE 4. BIASED RANDOM WALKS ON GALTON-WATSON TREES WITH LEAVES

Démonstration. Denoting D_n a geometric random variable of parameter $1 - \mathbf{Q}[Z_{n-1} = 0]$ which is independent of Z_1 , we have $\mathbf{Q}[Z_1 \leq k | Z_n = 0] = \mathbf{Q}[Z_1 \leq k | Z_1 < D_n]$. Then compute

$$\begin{aligned} \mathbf{Q}[Z_1 \leq k | Z_1 < D_n] &= \frac{\sum_{j=0}^k \mathbf{Q}[D_n > j] \mathbf{Q}[Z_1 = j]}{\sum_{j=0}^{\infty} \mathbf{Q}[D_n > j] \mathbf{Q}[Z_1 = j]} \\ &= \left(1 + \frac{\sum_{j=k+1}^{\infty} \mathbf{Q}[D_n > j] \mathbf{Q}[Z_1 = j]}{\sum_{j=0}^k \mathbf{Q}[D_n > j] \mathbf{Q}[Z_1 = j]} \right)^{-1}, \end{aligned}$$

now use that for all $j' < k < j$ we have $\mathbf{Q}[D_n > j] \leq \mathbf{Q}[D_n > k] \leq \mathbf{Q}[D_n > j']$, yielding

$$\mathbf{Q}[Z_1 \leq k | Z_1 < D_n] \geq \frac{\sum_{j=0}^k \mathbf{Q}[Z_1 = j]}{\sum_{j=0}^{\infty} \mathbf{Q}[Z_1 = j]} = \mathbf{Q}[Z_1 \leq k].$$

□

We can now estimate $E_{\mathbf{Q}}[\Lambda_i]$.

Lemma 3.5. *For all $i \geq 0$,*

$$E_{\mathbf{Q}}[\Lambda_i] \leq \frac{\tilde{C}_\psi}{1 - (\beta \mathbf{f}'(q))^{-1}} (\mathbf{f}'(q)\beta)^i.$$

Démonstration. Using (3.5), Lemma 3.2 and Lemma 3.4, we get

$$E_{\mathbf{Q}}[\Lambda_i] = E_{\mathbf{Q}}[\phi_i] E_{\mathbf{Q}}[\Pi_{i-1}] + E_{\mathbf{Q}}[\psi_i - \phi_i] E_{\mathbf{Q}}[\Pi_i] \leq E_{\mathbf{Q}}[\Pi_i] \sup_{i \in \mathbb{N}} E_{\mathbf{Q}}[\psi_i] \leq \tilde{C}_\psi \sum_{j=1}^i \mathbf{f}'(q)^j \beta^j,$$

and the result follows immediately, since $\beta \mathbf{f}'(q) > 1$.

□

Finally, we get the following

Proposition 3.1. *We have*

$$E_{\mathbf{Q}}[S_\infty] \leq \frac{2\tilde{C}_\psi}{1 - (\beta \mathbf{f}'(q))^{-1}} \left(\frac{\beta}{\beta - 1} + \frac{1}{1 - \mathbf{f}'(q)} \right) < \infty.$$

Démonstration. Recalling Lemma 3.5, we get

$$E_{\mathbf{Q}}[S_\infty] \leq 2 \sum_{i=0}^{\infty} \beta^{-i} E_{\mathbf{Q}}[1 + \Lambda_i] \leq \frac{2\tilde{C}_\psi}{1 - (\beta \mathbf{f}'(q))^{-1}} \sum_{i=0}^{\infty} \beta^{-i} (1 + (\beta \mathbf{f}'(q))^i) < \infty,$$

and we conclude using $\mathbf{f}'(q) < 1$.

□

4 Sketch of the proof

In the first step, we show (see Theorem 5.1) that the time is essentially spent in h_n -traps.

Then we show that these h_n -traps are far away from each other, and thus the correlation between the time spent in different h_n -traps can be neglected. Moreover the number of h_n -traps met before level n is roughly $\rho C_a n^\varepsilon$. Let

$$\chi_0(n) = \text{the time spent in the first } h_n \text{ - trap met} \quad (4.1)$$

where we point out that there can be several visits to this trap. At this point we have reduced our problem to estimating

$$\Delta_n \approx \chi_1(n) + \cdots + \chi_{\rho C_a n^\varepsilon}(n),$$

where $\chi_i(n)$ are i.i.d. copies of $\chi_0(n)$.

Now we decompose the time spent in the first h_n -trap according to the number of excursions in it starting from the *root*

$$\chi_1(n) = \sum_{i=1}^{W_n} T_0^{(i)},$$

where W_n denotes the number of visits of the trap until time n and $T_0^{(i)}$ an i.i.d. sequence of random variables measuring the time spent during an excursion in a big trap. It is important to notice that the presence of an h_n -trap at a vertex gives information on the number of traps at this vertex, and thus on the geometry of the backbone. So the law of W_n depends on n . Nevertheless we show that this dependence can be asymptotically neglected, and that for large n , W_n is close to some random variable W_∞ (Proposition 6.1).

Now we have essentially no more correlations between what happens on the backbone and on big traps. The only thing left to understand is the time spent during an excursion in a h_n -trap from the *root*. To simplify if the walker does not reach the point δ in the trap (this has probability $\approx 1 - p_\infty$), the time in the trap can be neglected. Otherwise, the time spent to go to δ , and to go directly from δ back to the *root* of the trap can also be neglected, in other words, only the successive excursions from δ contribute to the time spent in the trap. This is developed in Section 8, and we have

$$\chi_1(n) \approx \sum_{i=1}^{\text{Bin}(W_\infty, p_\infty)} \sum_{j=0}^{G^{(i)}-1} T_{exc}^{(i,j)}, \quad (4.2)$$

where $T_{exc}^{(i,j)}$ are i.i.d. random variables giving the lengths of the excursions from δ to δ . Further, $G^{(i)}$ is the number of excursions from δ during the i -th excursion in the trap : it

CHAPITRE 4. BIASED RANDOM WALKS ON GALTON-WATSON TREES WITH LEAVES

is a geometric random variable with a parameter of order β^{-H} . Since β^{-H} is very small (H being conditioned to be big), the law of large numbers should imply that

$$\sum_{j=0}^{G^{(i)}-1} T_{exc}^{(i,j)} \approx G^{(i)} E^\omega [T_{exc}^{(i,j)}] \approx G^{(i)} S_\infty,$$

and also we should have $G^{(i)} - 1 \approx \beta^H \mathbf{e}_i$. This explains why, recalling (1.3),

$$\chi_1(n) \approx \beta^H \mathcal{Z}_\infty.$$

We are then reduced to considering sums of i.i.d random variables of the form $Z_i \beta^{X_i}$ with X_i integer-valued. This is investigated in Section 10. We then finish the proof of Theorem 1.3 in Section 11.

Remark 4.1. *The reasoning fails in the critical case $\gamma = 1$, indeed in this case we have to consider a critical height h_n which is smaller. This causes many problems, in particular in big traps there can be big subtraps and so, for example, the time to go from the top to the bottom of a trap cannot be neglected anymore.*

5 The time is essentially spent in big traps

We recall that $h_n = \lceil -(1 - \varepsilon) \ln n / \ln \mathbf{f}'(q) \rceil$. Lemma 3.3 gives the probability that a trap is an h_n -trap :

$$\eta_n := \mathbf{Q}[H \geq h_n] \sim \alpha \mathbf{f}'(q)^{h_n}, \quad (5.1)$$

For $x \in \text{backbone}$, we denote

$$L_x \text{ the set of traps rooted at } x \quad (5.2)$$

(if x is not in the backbone then $L_x = \emptyset$). Let us denote the vertices in big traps by $L(h_n) = \{y \in T(\omega) \mid y \text{ is in a } h_n\text{-trap}\}$.

Our aim in this section is to show the following

Proposition 5.1. *For $\varepsilon > 0$, we have*

$$\text{for all } t \geq 0, \quad \mathbb{P} \left[\left| \frac{\Delta_n - \chi(n)}{n^{1/\gamma}} \right| \geq t \right] \rightarrow 0$$

where

$$\chi(n) = \text{card}\{1 \leq i \leq \Delta_n \mid X_{i-1}, X_i \in L(h_n)\} \quad (5.3)$$

is the time spent in big traps up to time Δ_n .

Define

5. THE TIME IS ESSENTIALLY SPENT IN BIG TRAPS

- (i) $A_1(n) = \{\Delta_n^Y \leq C_1 n\}$,
- (ii) $A_2(n) = \{\text{card} \cup_{i=1}^{\Delta_n^Y} L_{Y_i} \leq C_2 n\}$
- (iii) $A_3(n) = \left\{ \max_{\ell \in L_{Y_i}, i \leq \Delta_n^Y} \text{card}\{0 \leq i \leq \Delta_n^Y | Y_i \in \ell, X_{\sigma_{i+1}} \in \ell\} \leq C_3 \ln n \right\}$,
- (iv) $A(n) = A_1(n) \cap A_2(n) \cap A_3(n)$.

The following lemma tells us that typically the walk spends less than $C_1 n$ time units before reaching level n , sees less than $C_2 n$ traps and enters each trap at most $C_3 \ln n$ times.

Lemma 5.1. *For appropriate constants C_1, C_2 and C_3 , we have*

$$\mathbb{P}[A_1(n)^c] = o(n^{-2}) \text{ and } \mathbb{P}[A(n)^c] \rightarrow 0.$$

Démonstration. By a comparison to the β -biased random walk on \mathbb{Z} , standard large deviations estimates yields

$$\mathbb{P}[A_1(n)^c] = o(n^{-2}),$$

for C_1 large enough.

On $A_1(n)$, the number of different vertices visited by $(Y_i)_{i \geq 0}$ up to time Δ_n^Y is at most $C_1 n$. The descendants at each new vertex are drawn independently of the preceding vertices. Moreover at each vertex the mean number of traps at most the mean number of children, thus $\mathbf{E}[\text{card } L_0] \leq \mathbf{m}/(1-q)$. The law of large numbers yields for $C_2 > C_1 \mathbf{m}/(1-q)$ that

$$\mathbb{P}[A_2(n)^c] \leq \mathbb{P}\left[\sum_{i=0}^{C_1 n} \text{card } L_0^{(i)} > C_2 n\right] + \mathbb{P}[A_1(n)^c] \rightarrow 0,$$

where $\text{card } L_0^{(i)}$ are i.i.d. random variables with the law of $\text{card } L_0$. This yields the second part.

For $A_3(n)$, we want, given a vertex x in the backbone and any $\ell \in L_x$ to give an upper bound on the number of transitions from x to y , where y is the bud associated to ℓ . Let z be an offspring of x in the backbone. Then, at each visit to x , either the walker does not visit y or z , or it has probability $1/2$ to visit y first (or z first). Hence,

- (i) the number of transitions from x to y before reaching z is dominated by a geometric random variable of parameter $1/2$,
- (ii) the number of transitions from x to z is dominated by a geometric random variable of parameter p_∞ , since the escape probability from z is at least p_∞ .

Consequently the number of transitions from x to y is dominated by a geometric random variable of parameter $p_\infty/2$. Thus

$$\mathbb{P}[A_3(n)^c \cap A_2(n)] \leq C_2 n \mathbb{P}\left[G(p_\infty/2) \geq C_3 \ln n\right] \leq C n^{C_3 \ln(1-p_\infty/2)+1},$$

and if we take C_3 large enough we get the result. □

CHAPITRE 4. BIASED RANDOM WALKS ON GALTON-WATSON TREES WITH LEAVES

Now we can start proving Proposition 5.1. Decompose Δ_n into

$$\Delta_n = \Delta_n^Y + \chi(n) + \sum_{\ell \in \cup_{i=0}^{\Delta_n^Y} L_{Y_i} \setminus L(h_n)} N(\ell), \quad (5.4)$$

where $N(\ell) = \{1 \leq i \leq \Delta_n | X_{i-1} \in \ell, X_i \in \ell\}$.

The distribution of $N(\ell)$ conditionally on the backbone, the buds and $(Y'_i)_{i \leq \Delta_n^{Y'}}$, the walk on the backbone and the buds, is $\sum_{i=1}^{E_\ell} R_\ell^{(i)}$. Here we denoted E_ℓ the number of visits to ℓ and $R_\ell^{(i)}$ is the return time during the i -th excursion from the top of ℓ . These quantities are considered for traps ℓ , conditioned to have height at most h_n .

Obviously we get from (5.4) that

$$\Delta_n \geq \chi(n). \quad (5.5)$$

From (5.4) we get for $t > 0$,

$$\begin{aligned} \mathbb{P}\left[\frac{\Delta_n - \chi(n)}{n^{1/\gamma}} > t\right] &\leq \mathbb{P}[A(n)^c] + \mathbb{P}\left[C_1 n + \sum_{i=0}^{C_2 n} \sum_{j=0}^{C_3 \ln n} R_\ell^{(i)} \geq t n^{1/\gamma}\right] \\ &\leq o(1) + \mathbb{P}\left[\sum_{i=0}^{C_2 n} \sum_{j=0}^{C_3 \ln n} R_\ell^{(i)} \geq \frac{t}{2} n^{1/\gamma}\right], \end{aligned} \quad (5.6)$$

where we used Lemma 5.1.

Chebyshev's inequality yields,

$$\mathbb{P}\left[\sum_{i=0}^{C_2 n} \sum_{j=0}^{C_3 \ln n} R_\ell^{(i)} \geq \frac{t}{2} n^{1/\gamma}\right] \leq \frac{2}{t n^{1/\gamma}} \mathbb{E}\left[\sum_{i=0}^{C_2 n} \sum_{j=0}^{C_3 \ln n} R_\ell^{(i)}\right] \leq \frac{2C_2 C_3 n^{1-1/\gamma} \ln n}{t} \mathbb{E}[R_1^{(1)}].$$

Using Lemma 3.4 and Lemma 3.1, we have

$$\begin{aligned} \mathbb{E}[R_1^{(1)}] &= E_{\mathbf{Q}}[E_{root}^\omega[T_{root}^+ | H < h_n]] = 2 \sum_{i=0}^{h_n-1} \beta^i E_{\mathbf{Q}}[Z_n | H < h_n] \\ &\leq 2 \sum_{i=0}^{h_n-1} (\beta \mathbf{f}'(q))^i \leq C n^{(1-\varepsilon)(-1+1/\gamma)}. \end{aligned}$$

Plugging this in the previous inequality, we get for any $\varepsilon > 0$ and $t > 0$

$$\mathbb{P}\left[\sum_{i=0}^{C_2 n} \sum_{j=0}^{C_3 \ln n} R_\ell^{(i)} \geq \frac{t}{2} n^{1/\gamma}\right] = o(1),$$

thu-shi2s recalling (5.6) and (5.5) we have proved Proposition 5.1. □

6 Number of visits to a big trap

We denote $K_x = \max_{\ell \in L_x} H(\ell)$, the height of the biggest trap rooted at x for $x \in$ *backbone*, where we recall that H denotes the height of the trap from the bud and not from the *root*.

Lemma 6.1. *We have*

$$\mathbf{P}[K_0 \geq h_n] \sim C_a \mathbf{f}'(q)^{h_n},$$

where $C_a = \alpha q \frac{\mathbf{m} - \mathbf{f}'(q)}{1 - q}$, recalling Lemma 3.3 for the definition of α .

Démonstration. We denote Z the number of children of a the root and Z^* the number of children with an infinite line of descent. Let P be the law of a \mathbf{f} -Galton Watson tree which is not conditioned on non-extinction and E the corresponding expectation. Recall (5.1) and let $H^{(i)}$, $i = 1, 2, \dots$ be i.i.d. random variables which have the law of the height of a \mathbf{h} -Galton-Watson tree. Then

$$\mathbf{P}[K_0 \geq h_n] = \mathbf{P}\left[\max_{i=1, \dots, Z-Z^*} H^{(i)} \geq h_n\right] = 1 - \frac{E[(1 - \eta_n)^{Z-Z^*} (1 - \mathbf{1}\{Z^* = 0\})]}{1 - q},$$

where the indicator function comes from the conditioning on non-extinction, which corresponds to $Z^* \neq 0$.

Hence

$$\mathbf{P}[K_0 \geq h_n] = 1 - \frac{E[(1 - \eta_n)^{Z-Z^*}] - E[(1 - \eta_n)^{Z-Z^*} 0^{Z^*}]}{1 - q},$$

and using $E[s^{Z-Z^*} t^{Z^*}] = \mathbf{f}(sq + t(1 - q))$ (see [65]) we get

$$\mathbf{P}[K_0 \geq h_n] = 1 - \frac{\mathbf{f}((1 - \eta_n)q + 1 - q) - \mathbf{f}((1 - \eta_n)q)}{1 - q}.$$

Now, using (5.1) and the expansion $\mathbf{f}(z - x) = \mathbf{f}(z) - \mathbf{f}'(z)x + o(x)$ for $z \in \{q, 1\}$, we get the result. \square

Define the first time when we meet the root of a h_n -trap using the clock of Y_n ,

$$K(n) = \inf\{i \geq 0 \mid K_{Y_i} \geq h_n\}. \quad (6.1)$$

We also define $\ell(n)$ to be a h_n -trap rooted at $Y_{K(n)}$, if there are several possibilities we choose one trap according to some predetermined order. We denote $\mathbf{b}(n)$ the associated bud.

We describe, on the event $0 - \text{SR}$, the number of visits to $\ell(n)$, by the following random variable :

$$W_n = \text{card}\{i \mid X_i = Y_{K(n)}, X_{i+1} = \mathbf{b}(n)\}, \quad (6.2)$$

where ω is chosen under the law $\mathbf{P}[\cdot]$ and X_n under $P_0^\omega[\cdot \mid 0 - \text{SR}]$. We will need the following bounds for the random variables $(W_n)_{n \geq 1}$.

CHAPITRE 4. BIASED RANDOM WALKS ON GALTON-WATSON TREES WITH LEAVES

Lemma 6.2. *We have $W_n \preceq G(p_\infty/3)$ for $n \in \mathbb{N}$, i.e. the random variables W_n are stochastically dominated by a geometric random variable with parameter $p_\infty/3$.*

Démonstration. For $n \in \mathbb{N}$, starting from any point x of the backbone, the walker has probability at least $1/3$ to go to an offspring y of x on the backbone before going to $\mathbf{b}(n)$ or \overleftarrow{x} . But the first hitting time of y has probability at least p_∞ to be a super-regeneration time. The result follows as in the proof of Lemma 5.1. \square

Proposition 6.1. *There exists a random variable W_∞ such that*

$$W_n \xrightarrow{d} W_\infty.$$

where we recall that for the law of W_n , ω is chosen under the law $\mathbf{P}[\cdot]$ and X_n under $P_0^\omega[\cdot|0-SR]$.

Remark 6.1. *It follows from Lemma 6.2 that $W_\infty \preceq G(p_\infty/3)$.*

Fix $n \in \mathbb{N}^*$ and set $m \geq n$. We aim at comparing the law of W_m with that of W_n and to do that we want to study the behaviour of the random walk starting from the last super-regeneration time before a h_n -trap (resp. h_m -trap) is seen. This motivates the definition of the last super-regeneration time seen before time n ,

$$\Sigma(n) := \max\{0 \leq i \leq n \mid i - SR\}.$$

For our purpose it is convenient to introduce a modified version of W_m , which will coincide with high probability with it. For $m \geq n$, recall that θ denotes the time-shift for the walk and set

$$\overline{K}(m, n) = \inf\{j \geq 0 \mid K_{Y_j} \geq h_m, \ell(m) \circ \theta_{\Sigma(j)} = \ell(n) \circ \theta_{\Sigma(j)}\},$$

the first time the walker meets a h_m -trap which is the first h_n -trap of the current regeneration block and we denote by $b(m, n)$ the associated bud. Set

$$\overline{W}_{m,n} = \text{card}\{i \mid X_i = Y_{\overline{K}(m,n)}, X_{i+1} = b(m, n)\},$$

where ω is chosen under the law $\mathbf{P}[\cdot]$ and $(U_i)_{i \leq \overline{K}(m,n)}$ under $P_0^\omega[\cdot|0-SR]$.

Lemma 6.3. *For $m \geq n$ we have that*

$$\overline{W}_{m,n} \stackrel{d}{=} W_n.$$

Démonstration. To reach a vertex where an h_m -trap is rooted, the walker has to reach a vertex where an h_n -trap is rooted. Two cases can occur : either the first h_n -trap met is also a h_m -trap or it is not. In the former case, which has probability $\eta_m/\eta_n > 0$, since the height of the first h_n -trap met is independent of the sequence $(U_i)_{i \leq K(n)}$, the

6. NUMBER OF VISITS TO A BIG TRAP

random variables $\overline{W}_{m,n}$ and W_n coincide. In fact they coincide with the number of transitions from the backbone to the bud of the first h_n -trap met. In the latter case, by its definition, $\overline{K}(m,n)$ cannot occur before the next super-regeneration time, hence $\overline{K}(m,n) \geq \tau_1 \circ \theta_{K(n)}$. In this case $\overline{W}_{m,n} = \overline{W}_{m,n} \circ \theta_{K(n)}$ and then by Proposition 2.1,

$$\overline{W}_{m,n} \circ \theta_{\tau_1 \circ \theta_{K(n)}} \stackrel{d}{=} \overline{W}_{m,n},$$

and $\overline{W}_{m,n} \circ \theta_{\tau_1 \circ \theta_{K(n)}}$ is independent of $(U_i)_{i \leq \tau_1 \circ \theta_{K(n)} - 1}$.

The scenario repeats itself until the h_n -trap reached is in fact a h_m -trap, the number of attempts necessary to reach this h_m -trap is a geometric random variable of parameter η_m/η_n which is independent of the (U_i) 's.

This means that there is a family $(W_n^{(i)})_{i \geq 1}$ of i.i.d. random variables with the same law as W_n such that

$$\overline{W}_{m,n} = W_n^{(G)},$$

where G is a geometric random variable independent of the $(W_n^{(i)})_{i \geq 1}$. Then, note that we have

$$\overline{W}_{m,n} = W_n^{(G)} \stackrel{d}{=} W_n.$$

□

Now we need to show that $\overline{W}_{m,n}$ and W_m coincide with high probability, so we introduce the event

$$A_{m,n} = \{\ell(m) = \ell(n) \circ \theta_{\Sigma(K(m))}\},$$

on which clearly $\overline{W}_{m,n}$ and W_m are equal.

Lemma 6.4.

$$\sup_{m \geq n} \mathbb{P}[A_{m,n}^c | 0 - SR] \rightarrow 0 \quad \text{for } n \rightarrow \infty. \quad (6.3)$$

Démonstration. Let us denote, recalling (5.2)

$$V_j^i = \left\{ \text{card} \bigcup_{k=0}^{\tau_1} \{\ell \in L_{Y_k}, \ell \text{ is a } h_j\text{-trap}\} = i \right\},$$

and

$$V_j^{i,+} = \left\{ \text{card} \bigcup_{k=0}^{\tau_1} \{\ell \in L_{Y_k}, \ell \text{ is a } h_j\text{-trap}\} \geq i \right\}.$$

Then we have

$$\mathbb{P}[A_{m,n}^c | 0 - SR] \leq \mathbb{P}[V_n^{2,+} | V_m^{1,+}, 0 - SR]. \quad (6.4)$$

Let us denote card Trap the number of traps seen before τ_1 ,

$$\text{card Trap} = \text{card} \left\{ \ell \mid \ell \in \bigcup_{i=0}^{\tau_1} L_{Y_i} \right\},$$

CHAPITRE 4. BIASED RANDOM WALKS ON GALTON-WATSON TREES WITH LEAVES

and its generating function by

$$\varphi(s) := \mathbb{E} \left[s^{\text{card Trap}} | 0 - \text{SR} \right].$$

The probability of $A_{m,n}$ can be estimated with the following lemma, whose proof is deferred.

Lemma 6.5. *We have*

$$\forall m \geq n, \mathbb{P}[V_n^{2,+} | V_m^{1,+}, 0 - \text{SR}] \leq \varphi'(1) - \varphi'(1 - \eta_n).$$

Now we have $\mathbb{E} \left[\text{card Trap} | 0 - \text{SR} \right] \leq \mathbb{E}[\tau_1 | 0 - \text{SR}] \mathbb{E}[\text{card } L_0] < \infty$ because of Remark 2.1 and hence φ' is continuous at 1, and (6.3) follows from (6.4). \square

Applying Lemma 6.5, Lemma 6.3 and (6.3) we get,

$$\begin{aligned} \mathbb{P}[W_m \geq y | 0 - \text{SR}] &= \mathbb{P}[A_{m,n}, \bar{W}_{m,n} \geq y | 0 - \text{SR}] + o(m, n) \\ &= \mathbb{P}[\bar{W}_{m,n} \geq y | 0 - \text{SR}] + o(m, n) \\ &= \mathbb{P}[W_n \geq y | 0 - \text{SR}] + o(m, n), \end{aligned}$$

where $\sup_{m \geq n} o(m, n) \rightarrow 0$ as n goes to infinity.

The law of a random variable W_∞ can be defined as a limit of the laws of some subsequence of (W_m) , since the family $(W_m)_{m \geq 0}$ is tight by Lemma 6.2. Then taking m to infinity along this subsequence in the preceding equation yields

$$\forall t > 0, \mathbb{P}[W_\infty \leq t | 0 - \text{SR}] = \mathbb{P}[W_n \leq t | 0 - \text{SR}] + o(1).$$

This proves Proposition 6.1. \square

It remains to show Lemma 6.5.

Démonstration. Note that for $i \geq 1$,

$$\begin{aligned} \mathbb{P}[V_n^i | V_m^{1,+}, 0 - \text{SR}] &= \frac{\mathbb{P}[V_n^i | 0 - \text{SR}]}{\mathbb{P}[V_m^{1,+} | 0 - \text{SR}]} \mathbb{P}[V_m^{1,+} | V_n^i, 0 - \text{SR}] \\ &\leq \frac{\mathbb{P}[V_n^i | 0 - \text{SR}]}{\mathbb{P}[V_m^{1,+} | 0 - \text{SR}]} i \mathbf{Q}[H \geq h_m | H \geq h_n] \\ &= i \frac{\mathbb{P}[V_n^i | 0 - \text{SR}]}{\eta_n} \frac{\eta_m}{\mathbb{P}[V_m^{1,+} | 0 - \text{SR}]} \\ &\leq i \frac{\mathbb{P}[V_n^i | 0 - \text{SR}]}{\eta_n}. \end{aligned} \tag{6.5}$$

6. NUMBER OF VISITS TO A BIG TRAP

Then we have

$$\begin{aligned}
& \sum_{i \geq 2} i \mathbb{P}[V_n^i | 0 - \text{SR}] \\
&= \sum_{i \geq 2} \sum_{j \geq i} \mathbb{P}[\text{card Trap} = j | 0 - \text{SR}] i \binom{j}{i} \eta_n^i (1 - \eta_n)^{j-i} \\
&= \sum_{j \geq 0} j \mathbb{P}[\text{card Trap} = j | 0 - \text{SR}] \sum_{i=2}^j \binom{j-1}{i-1} \eta_n^i (1 - \eta_n)^{j-i} \\
&= \eta_n \sum_{j \geq 0} j \mathbb{P}[\text{card Trap} = j | 0 - \text{SR}] \sum_{i=1}^{j-1} \binom{j-1}{i} \eta_n^i (1 - \eta_n)^{(j-1)-i} \\
&= \eta_n \sum_{j \geq 0} j \mathbb{P}[\text{card Trap} = j | 0 - \text{SR}] \left(1 - (1 - \eta_n)^{j-1}\right) \\
&= \eta_n (\varphi'(1) - \varphi'(1 - \eta_n)).
\end{aligned}$$

Inserting this in (6.5) we get

$$\begin{aligned}
\mathbb{P}[V_n^{2,+} | V_m^{1,+}, 0 - \text{SR}] &= \sum_{i=2}^{\infty} \mathbb{P}[V_n^i | V_m^{1,+}, 0 - \text{SR}] \\
&\leq \frac{1}{\eta_n} \sum_{i \geq 2} i \mathbb{P}[V_n^i | 0 - \text{SR}] = \varphi'(1) - \varphi'(1 - \eta_n),
\end{aligned}$$

which concludes the proof of Lemma 6.5. □

We will need the following lower bound for the random variable W_∞ .

Lemma 6.6. *There exists a constant $c_W > 0$ depending only on $(p_i)_{i \geq 0}$, such that*

$$\mathbb{P}[W_\infty \geq 1] \geq c_W.$$

Démonstration. By Proposition 6.1, it is enough to show the lower bound for all W_n . First let us notice that

$$\mathbb{P}[W_n \geq 1 | 0 - \text{SR}] \geq \mathbb{E} \left[\left(\frac{1}{Z(K(n)) + 1} \right)^2 p_\infty \right] \geq (1 - \mathbf{f}'(q)) \mathbb{E} \left[\frac{1}{(Z(K(n)) + 1)^2} \right], \tag{6.6}$$

where $Z(K(n))$ is the number of offspring of $Y_{K(n)}$. To show (6.6), note that the particle has probability at least $\beta/(\beta Z(K(n)) + 1) \geq 1/(Z(K(n)) + 1)$ of going from $Y_{K(n)}$ to $\mathbf{b}(n)$ and when it comes back to $Y_{K(n)}$ again there is probability at least $1/(Z(K(n)) + 1)$ to go from $Y_{K(n)}$ to one of its descendants on the backbone and then there is a

CHAPITRE 4. BIASED RANDOM WALKS ON GALTON-WATSON TREES WITH LEAVES

probability of at least p_∞ that a super-regeneration occurs. The event we just described is in $\{W_n \geq 1\} \cap \{0 - \text{SR}\}$. For the second inequality in (6.6), use $\beta > \beta_c = \mathbf{f}'(q)^{-1}$ hence $p_\infty = 1 - \beta^{-1} \geq 1 - \mathbf{f}'(q)$.

Now, we notice that the law of the $Z(K(n))$ is that of Z_1 conditioned on the event $\{\text{an } h_n\text{-trap is rooted at } 0\}$. Denote j_0 the smallest index such that $j_0 > 1$ and $p_{j_0} > 0$ (which exists since $\mathbf{m} > 1$) and Z_1^* the number of descendants of 0 with an infinite line of descent. All $Z_1 - Z_1^*$ traps rooted at 0 have, independently of each other, probability η_n of being h_n -traps, so that

$$\begin{aligned} \mathbb{P}[Z(K(n)) = j_0] &= \mathbf{P}[Z_1 = j_0 \mid \text{an } h_n\text{-trap is rooted at } 0] \\ &= \frac{\mathbf{P}[Z_1 = j_0, \text{Bin}(Z_1 - Z_1^*, \eta_n) \geq 1]}{\mathbf{P}[\text{an } h_n\text{-trap is rooted at } 0]} \\ &\geq \frac{\eta_n \mathbf{P}[Z_1 = j_0, Z_1 - Z_1^* \geq 1]}{\mathbf{P}[\text{an } h_n\text{-trap is rooted at } 0]}. \end{aligned}$$

Further, since $\mathbf{P}[\text{Bin}(Z_1 - Z_1^*, \eta_n) \geq 1] \leq Z_1 \eta_n$, we have

$$\mathbf{P}[\text{an } h_n\text{-trap is rooted at } 0] \leq \sum_{j=0}^{\infty} \mathbf{P}[Z_1 - Z_1^* = j] j \eta_n \leq \mathbf{m} \eta_n.$$

Putting these equations together, we get that

$$\mathbb{P}[Z(K(n)) = j_0] \geq \frac{\mathbf{P}[Z_1 = j_0, Z_1 - Z_1^* \geq 1]}{\mathbf{m}}.$$

The last equation and (6.6) yield a lower bound for $\mathbb{P}[W_\infty \geq 1]$ which depends only on $(p_k)_{k \geq 0}$. \square

7 The time spent in different traps is asymptotically independent

In order to show the asymptotic independence of the time spent in different big traps we shall use super-regeneration times. First we show that the probability that there is a h_n -trap in the first super-regeneration block goes to 0 for $n \rightarrow \infty$.

Define

- (i) $B_1(n) = \{\forall i \in [1, n], \text{card}\{Y_{\tau_i}, \dots, Y_{\tau_{i+1}}\} \leq n^\varepsilon\}$,
- (ii) $B_2(n) = \{\forall i \in [0, \tau_1], \text{card } L_{Y_i} \leq n^{2\varepsilon}\}$,
- (iii) $B_3(n) = \{\forall i \in [0, \tau_1], \forall \ell \in L_{Y_i}, \ell \text{ is not a } h_n\text{-trap}\}$,
- (iv) $B_4(n) = \{\forall i \in [2, n], \text{card}\{L_{Y_j} \mid j \in [\tau_i, \tau_{i+1}], \text{ contains a } h_n\text{-trap}\} \leq 1\}$,
- (v) $B(n) = B_1(n) \cap B_2(n) \cap B_3(n) \cap B_4(n)$.

7. THE TIME SPENT IN DIFFERENT TRAPS IS ASYMPTOTICALLY INDEPENDENT

Lemma 7.1. *For $\varepsilon < 1/4$, we have*

$$\mathbb{P}[B_1(n)^c] = o(n^{-2}) \text{ and } \mathbb{P}[B(n)^c] \rightarrow 0.$$

Démonstration. Since $\tau_2 - \tau_1$ (resp. τ_1) has some positive exponential moments and $B_1(n)^c \subseteq \cup_{i=1}^n \{\tau_{i+1} - \tau_i \geq n^\varepsilon\}$,

$$\mathbb{P}[B_1(n)^c] = o(n^{-2}).$$

Using the fact that the number of traps at different vertices has the same law,

$$\mathbb{P}[B_2(n)^c] \leq \mathbb{P}[B_1(n)^c] + n^\varepsilon \mathbf{P}[\text{card } L_0 \geq n^{2\varepsilon}] \leq o(1) + n^{-\varepsilon} \frac{\mathbf{m}}{1-q} = o(1),$$

where we used Chebyshev's inequality and $\mathbf{E}[\text{card } L_0] \leq \mathbf{E}[Z_1] \leq \mathbf{m}/(1-q)$.

Then we have

$$\mathbb{P}[B_3(n)^c] \leq \mathbb{P}[B_2(n)^c] + n^{3\varepsilon} \eta_n = o(1),$$

yielding the result using (5.1), since $\varepsilon < 1/4$.

Finally, up to time n we have at most n super-regeneration blocks, on $B_1(n)$ they contain at most n^ε visited vertices. But the probability that among the n^ε first visited vertices after a super-regeneration time, two of them are adjacent to a big trap is bounded above by $n^{2\varepsilon} \mathbf{P}[K_0 \geq h_n]^2$ (here we implicitly used Remark (2.1)). Hence, we get

$$\mathbb{P}[B_4(n)^c] \leq \mathbb{P}[B_1(n)^c] + nn^{2\varepsilon} (Cn^{\varepsilon-1})^2 = O(n^{4\varepsilon-1}),$$

yielding the result for $\varepsilon < 1/4$. □

We define $R(n) = \text{card}\{Y_1, \dots, Y_{\Delta_n^Y}\}$ and l_n the number of vertices where an h_n -trap is rooted : $l_n = \text{card}\{i \in [0, \Delta_n^Y], L_{Y_i} \text{ contains a } h_n\text{-trap}\}$. Recall (2.2) and define

$$C_1(n) = \{(1 - n^{-1/4})\rho n \leq R(n) \leq (1 + n^{-1/4})\rho n\} \tag{7.1}$$

$$C_2(n) = \left\{ (1 - n^{-\varepsilon/4})\rho C_a n \mathbf{f}'(q)^{h_n} \leq l_n \leq (1 + n^{-\varepsilon/4})\rho C_a n \mathbf{f}'(q)^{h_n} \right\} \tag{7.2}$$

$$C_3(n) = \left\{ \forall 1 \leq i \leq \Delta_n^Y, \text{card}\{\ell \in L_{Y_i} | \ell \text{ is a } h_n\text{-trap}\} \leq 1 \right\} \tag{7.3}$$

and $C(n) = C_1(n) \cap C_2(n) \cap C_3(n)$.

Lemma 7.2. *For $\varepsilon < 1/4$, we have*

$$\mathbb{P}[C(n)^c] \rightarrow 0.$$

CHAPITRE 4. BIASED RANDOM WALKS ON GALTON-WATSON TREES WITH LEAVES

Démonstration. First, we notice that for $i \geq 0$ and with the convention $\tau_0 := 0$ we have

$$Z_i := \text{card}\{Y_{\tau_i+1}, \dots, Y_{\tau_{i+1}}\} \preceq G^{(i)}(p_\infty),$$

where the geometric random variables $G^{(i)}$ are i.i.d. Indeed at each new vertex visited we have probability at least p_∞ to have a super-regeneration time. Let us denote n_0 the smallest integer such that $\Delta_n^Y \leq \tau_{n_0}$, which satisfies $n_0 \leq n$ since $|X_{\tau_{i+1}}| - |X_{\tau_i}| \geq 1$. Now, since the random variables Z_i are i.i.d. and $\sum_{i=1}^{n_0-1} Z_i \leq \text{card}\{Y_1, \dots, Y_{\Delta_n^Y}\} \leq \sum_{i=1}^{n_0} Z_i$,

$$\begin{aligned} & \mathbb{P}\left[\left|\frac{\text{card}\{Y_1, \dots, Y_{\Delta_n^Y}\}}{n} - \rho\right| \geq n^{-1/4}\right] \\ & \leq n^{1/2} \text{Var}\left(\frac{\text{card}\{Y_1, \dots, Y_{\Delta_n^Y}\}}{n}\right) \\ & = n^{1/2} \left(\mathbb{E}\left[\left(\frac{\text{card}\{Y_1, \dots, Y_{\Delta_n^Y}\}}{n}\right)^2\right] - \mathbb{E}\left[\frac{\text{card}\{Y_1, \dots, Y_{\Delta_n^Y}\}}{n}\right]^2 \right) \\ & \leq n^{-3/2} \left(\mathbb{E}\left[\left(\sum_{i=1}^{n_0} Z_i\right)^2\right] - \mathbb{E}\left[\sum_{i=1}^{n_0-1} Z_i\right]^2 \right) \\ & \leq n^{-1/2} (E[G(p_\infty)^2] + E[G(p_\infty)]^2), \end{aligned}$$

yielding $\mathbb{P}[C_1(n)^c] \rightarrow 0$.

On $C_1(n)$ we know that there are $R(n) \in [\rho n(1-n^{-1/4}), \rho n(1+n^{-1/4})]$ vertices where we have independent trials to have h_n -traps. Hence l_n has the law $\text{Bin}(R(n), \mathbf{P}[K_0 \geq h_n])$, where the success probability satisfies $\mathbf{P}[K_0 \geq h_n] \leq Cn^{\varepsilon-1}$ has asymptotics given by Lemma 6.1. Now, standard estimates for Binomial distributions imply that $\mathbb{P}[C_2(n)^c \cap C_1(n)] \rightarrow 0$.

On $C_2(n)$, there are at most Cn^ε vertices where (at least) one h_n -trap can be rooted, we only need to prove that, with probability going to 1, those vertices do not contain more than two h_n -traps. Using the same reasoning as in Lemma 6.5 we get

$$\begin{aligned} & \mathbf{P}[0 \text{ has at least two } h_n\text{-traps} | 0 \text{ has at least one } h_n\text{-trap}, 0 - \text{SR}] \\ & \leq \mathbf{f}'(1) - \mathbf{f}'(1 - \eta_n) \leq C\eta_n, \end{aligned}$$

where we used that $\mathbf{E}[Z^2] < \infty$, which implies that $\mathbf{f}''(1) < \infty$.

The result follows from the fact that $\eta_n = o(n^{-\varepsilon})$ for $\varepsilon < 1/4$. □

Let us denote, recalling (3.1),

$$D(n) = \left\{ \ell \in \bigcup_{i=0, \dots, \Delta_n^Y} L_{Y_i} \mid H(\ell) \leq \frac{2 \ln n}{-\ln \mathbf{f}'(q)} \right\}.$$

8. THE TIME IS SPENT AT THE BOTTOM OF THE TRAPS

Lemma 7.3. *We have*

$$\mathbb{P}[D(n)^c] \rightarrow 0.$$

Démonstration. Due to (3.7), we know that $\mathbf{Q}[H \geq \frac{2 \ln n}{-\ln \mathbf{f}'(q)}] \leq n^{-2}$, so using Lemma 5.1

$$\mathbb{P}[D(n)^c] \leq \mathbb{P}[A_2(n)^c] + \mathbb{P}[A_2(n) \cap D(n)^c] \leq o(1) + C_2 n^{-1} = o(1),$$

which concludes the proof. □

On $B(n)$ there is no big trap in the first super-regeneration block, on $B(n) \cap C(n)$ all big traps are met in distinct super-regeneration blocks and $C_2(n)$ tells us the asymptotic number of such blocks. Moreover on $D(n)$, we know that to cross level n on a trap, it has to be rooted after level $n - (-2 \ln n / \ln \mathbf{f}'(q))$. Hence using Lemma 7.1, Lemma 7.2, Lemma 7.3, Proposition 2.1 and Remark 2.3, we get

Proposition 7.1. *Let $\chi_i(n)$ be i.i.d. copies of $\chi_0(n)$, see (4.1), and $\tilde{n} = n - (-2 \ln n / \ln \mathbf{f}'(q))$. Then we have*

$$\sum_{i=1}^{(1-\tilde{n}^{-\varepsilon/4})\rho_n C_a \tilde{n} \mathbf{f}'(q)^{h\tilde{n}}} \chi_i(n) \preceq \chi(n) \preceq \sum_{i=1}^{(1+n^{-\varepsilon/4})\rho_n C_a n \mathbf{f}'(q)^{hn}} \chi_i(n).$$

In the light of Proposition 5.1, our problem reduces to understanding the convergence in law of a sum of i.i.d. random variables. The aim of the next section is to reduce $\chi_1(n)$ to a specific type of random variable for which limit laws can be derived (see Section 10).

8 The time is spent at the bottom of the traps

We denote by $\delta_i(n)$ (resp. $root_i(n)$, $\mathbf{b}_i(n)$) the leftmost bottom point (the root, the bud) of the i -th h_n -trap seen which is called $\ell_j(n)$. In a similar fashion χ_i denotes the time spent in the i -th h_n -trap met.

We want to show that the time spent in the big traps is essentially spent at the bottom of them, i.e. during excursions from the the bottom leftmost point δ . In order to prove our claim, we introduce

$$\chi_j^*(n) = \text{card}\{k \geq 0 \mid X_k \in \ell_j(n), k \geq T_{\delta_j(n)}, T_{\delta_j(n)} \circ \theta_k < \infty\},$$

the time spent during excursions from the bottom in the j -th h_n -trap met. It is obvious that

$$\chi_j(n) \geq \chi_j^*(n).$$

We prove that

CHAPITRE 4. BIASED RANDOM WALKS ON GALTON-WATSON TREES WITH LEAVES

Proposition 8.1. *For $\varepsilon < 1/4$, we have that*

$$\text{for all } t > 0, \quad \mathbb{P} \left[\frac{1}{n^{1/\gamma}} \left| \sum_{j=1}^{\ell(n)} (\chi_j(n) - \chi_j^*(n)) \right| \geq t \right] \rightarrow 0.$$

In order to prove the preceding theorem, we mainly need to understand $\chi_1(n)$ and $\chi_1^*(n)$. Note that $\chi_1(n)$ is a sum of W_n successive i.i.d. times spent in $\ell(n)$ and $\chi_1^*(n)$ is a sum of W_n successive i.i.d. times spent during excursions from the bottom of $\ell(n)$. We can rewrite the theorem as follows

$$\text{for all } t > 0, \quad \mathbb{P} \left[\frac{1}{n^{1/\gamma}} \left| \sum_{i=1}^{\ell(n)} \sum_{j=1}^{W_n^{(i)}} (T_{root_i(n)}^j - T_{root_i(n)}^{*,j}) \right| \geq t \right] \rightarrow 0 \quad (8.1)$$

where

$$T_{root_i(n)}^j = \{k \geq 0 \mid X_k \in \ell_i(n), \text{ card}\{\tilde{k} \leq k, X_{\tilde{k}+1} = \mathbf{b}_i(n), X_{\tilde{k}} = root_i(n)\} = j\},$$

and

$$T_{root_i(n)}^{*,j} = \{k \geq 0 \mid X_k \in \ell_i(n), \text{ card}\{\tilde{k} \leq k, X_{\tilde{k}+1} = \mathbf{b}_i(n), X_{\tilde{k}} = root_i(n)\} = j, \\ k \geq T_{\delta_j(n)}, T_{\delta_j(n)} \circ \theta_k < \infty\},$$

and $(W_n^{(i)}), i \geq 1$ are i.i.d. copies of W_n .

Consequently, in this section we mainly investigate the walk on a big trap, which is a random walk in a finite random environment. Recall that $root$ is the vertex $Y_{K(n)}$ on the backbone where $\ell(n)$ is attached. Moreover set $\mathbf{Q}_n[\cdot] = \mathbf{Q}[\cdot \mid H \geq h_n]$, $E_{\mathbf{Q}_n}[\cdot] = E_{\mathbf{Q}}[\cdot \mid H \geq h_n]$, $E^\omega[\cdot] := E_{root}^\omega[\cdot]$ and $\mathbb{E}_{\mathbf{Q}_n}[\cdot] = E_{\mathbf{Q}_n}[E^\omega[\cdot]]$.

Remark 8.1. *To ease notations, we add to all these probability spaces an independent random variable W_n whose law is given by (6.2), under the law $\mathbb{P}[\cdot \mid 0 - SR]$ for $n \in \mathbb{N} \cup \{\infty\}$.*

We will extensively use the description of Section 3, in particular we recall that a trap is composed of $root$ which is linked by an edge to a \mathbf{h} -Galton-Watson tree.

We want to specify what $\ell(n)$ looks like. Denoting

$$h_n^+ = \left\lceil \frac{(1 + \varepsilon) \ln n}{-\ln \mathbf{f}'(q)} \right\rceil,$$

consider

- (i) $A_1(n) = \{H \leq h_n^+\}$,
- (ii) $A_2(n) = \{\text{there are fewer than } n^\varepsilon \text{ subtraps}\}$,

8. THE TIME IS SPENT AT THE BOTTOM OF THE TRAPS

- (iii) $A_3(n) = \{\text{all subtraps of } \ell(n) \text{ have height } \leq h_n\}$,
- (iv) $A(n) = A_1(n) \cap A_2(n) \cap A_3(n)$.

Lemma 8.1. *For $\varepsilon < 1/4$, we have*

$$\mathbf{Q}_n[A(n)^c] = o(n^{-\varepsilon}).$$

Démonstration. First

$$\mathbf{Q}_n[A_1(n)^c] \leq \frac{\mathbf{Q}[H \geq h_n^+]}{\mathbf{Q}[H \geq h_n]} \leq Cn^{-2\varepsilon} = o(n^{-\varepsilon}).$$

Furthermore using Lemma 3.2, Lemma 3.4 and (3.7), we get

$$\begin{aligned} & \mathbf{Q}_n[A_2(n)^c] \\ & \leq \mathbf{Q}_n[A_1(n)^c] + \mathbf{Q}_n[A_1(n), \text{ there are } n^\varepsilon/h_n^+ \text{ subtraps on a vertex of the spine}] \\ & \leq o(n^{-\varepsilon}) + h_n^+ C_\psi \frac{n^\varepsilon}{h_n^+} q^{n^\varepsilon/h_n^+} = o(n^{-\varepsilon}). \end{aligned}$$

Finally

$$\begin{aligned} & \mathbf{Q}_n[A_3(n)^c] \\ & \leq \mathbf{Q}_n[A_2(n)^c] + \mathbf{Q}_n[A_2(n), \text{ there exists a subtrap of height } \geq h_n] \\ & \leq o(n^{-\varepsilon}) + n^\varepsilon \eta_n = o(n^{-\varepsilon}), \end{aligned}$$

where we used (5.1) and $\varepsilon < 1/4$. □

Using Chebyshev's inequality we get, recalling (7.2),

$$\begin{aligned} & \mathbb{P}\left[\frac{1}{n^{1/\gamma}} \left| \sum_{i=1}^{l(n)} \sum_{j=1}^{W_n^{(i)}} (T_{root_i(n)}^j - T_{root_i(n)}^{*,j}) \right| \geq t\right] \\ & \leq \frac{1}{tn^{1/\gamma}} \mathbb{E}\left[\mathbf{1}\{C_2(n)\} \mathbf{1}\{A(n)\} \sum_{i=1}^{l(n)} \sum_{j=1}^{W_n^{(i)}} (T_{root_i(n)}^j - T_{root_i(n)}^{*,j})\right] + \mathbb{P}[C_2(n)^c] + \mathbf{Q}_n[A(n)^c] \\ & \leq \mathbb{P}[C_2(n)^c] + \mathbf{Q}_n[A(n)^c] + \frac{2\rho C_a c_\beta n^\varepsilon}{tn^{1/\gamma}} \mathbb{E}[\mathbf{1}\{A(n)\} (T_{root_1(n)}^1 - T_{root_1(n)}^{*,1})], \end{aligned}$$

where $c_\beta = E[G(p_\infty/3)]$, implying $\mathbb{E}[W_n^{(j)}] \leq c_\beta$. Hence using Lemma 8.1 and Lemma 7.2

$$\mathbb{P}\left[\frac{1}{n^{1/\gamma}} \left| \sum_{i=1}^{l(n)} \sum_{j=1}^{W_n^{(i)}} (T_{root_i(n)}^j - T_{root_i(n)}^{*,j}) \right| \geq t\right] - \frac{C}{t} n^{\varepsilon-1/\gamma} E_{\mathbf{Q}_n}[\mathbf{1}\{A(n)\} (T_{root_1(n)}^1 - T_{root_1(n)}^{*,1})] \rightarrow 0 \quad (8.2)$$

CHAPITRE 4. BIASED RANDOM WALKS ON GALTON-WATSON TREES WITH LEAVES

We have to estimate this last expectation. Consider an h_n -trap. Each time the walker enters the h_n -trap two cases can occur : either the walker will reach δ , or he will not reach δ before he comes back to $root$. In the former case, $T_{root}^+ - T_{root}^{*,+}$ is the time spent going from $root$ to δ for the first time plus the time coming back from δ to $root$ for the last time (starting from δ and going back to $root$ without returning to δ). In the latter case, $T_{root}^+ - T_{root}^{*,+}$ equals T_{root}^+ . This yields the following upper bound

$$\begin{aligned} & \mathbb{E}[\mathbf{1}\{A(n)\}(T_{root}^+ - T_{root}^{*,+})] \\ & \leq E_{\mathbf{Q}_n}[\mathbf{1}\{A(n)\}E_{root}^\omega[\mathbf{1}\{A(n)\}T_\delta^+ \mid T_\delta^+ < T_{root}^+]] + E_{\mathbf{Q}_n}[\mathbf{1}\{A(n)\}E_\delta^\omega[T_{root}^+ \mid T_{root}^+ < T_\delta^+]] \\ & \quad + E_{\mathbf{Q}_n}[\mathbf{1}\{A(n)\}E_{root}^\omega[T_{root}^+ \mid T_{root}^+ < T_\delta^+]]. \end{aligned} \tag{8.3}$$

To tackle the conditionings that appear, we shall use h -processes, see [35] and [104] for further references. For a given environment ω let us denote h^ω the voltage (see [70]) on the trap, given by $h^\omega(z) = P_z^\omega[T_{root}^+ < T_\delta^+]$, with $h^\omega(root) = 1$ and $h^\omega(\delta) = 0$. Then we have the following formula for the transition probabilities of the conditioned Markov chain

$$P_y^\omega[X_1 = z \mid T_{root}^+ < T_\delta^+] = \frac{h^\omega(z)}{h^\omega(y)} P_y^\omega[X_1 = z], \tag{8.4}$$

for y, z in the trap.

We recall that the voltage is harmonic except on δ and $root$. It can be computed using electrical networks :

$$h^\omega(y) = h^\omega(y \wedge \delta) = \beta^{-d(root, y \wedge \delta)} \frac{1 - \beta^{-(H+1-d(root, y \wedge \delta))}}{1 - \beta^{-(H+1)}}.$$

In particular, comparing the walk conditioned on the event $\{T_\delta^+ > T_{root}^+\}$ to the original walk, we have the following :

1. the walk remains unchanged on the subtraps,
2. for y on the spine and z a descendant of y not on the spine, we have

$$P_y^\omega[X_1 = \overleftarrow{y} \mid T_{root}^+ < T_\delta^+] > P_y^\omega[X_1 = z \mid T_{root}^+ < T_\delta^+],$$

3. for $y \notin \{\delta, root\}$ on the spine, we have

$$P_y^\omega[X_1 = \overleftarrow{y} \mid T_{root}^+ < T_\delta^+] > \beta P_y^\omega[X_1 = \overrightarrow{y} \mid T_{root}^+ < T_\delta^+].$$

The points (2) and (3) state respectively that the conditioned walk is more likely to go towards $root$ than to go to a given vertex of a subtrap and that restricted to the spine the conditioned walk is more than β -drifted towards $root$.

Lemma 8.2. *For $z \in \{\delta, root\}$, we have*

$$E_{\mathbf{Q}_n}[\mathbf{1}\{A(n)\}E_z^\omega[T_{root}^+ \mid T_{root}^+ < T_\delta^+]] \leq C(\ln n)n^{(1-\varepsilon)(1/\gamma-1)+\varepsilon}.$$

8. THE TIME IS SPENT AT THE BOTTOM OF THE TRAPS

Démonstration. First let us show that the walk cannot visit too often a vertex of the spine. Indeed let y be a vertex of the spine, using fact (3), we have $P_y^\omega[T_y^+ > T_{root}^+ | T_{root}^+ < T_\delta] \geq p_\infty$. Hence the random variable $N(y) = \text{card}\{n \leq T_{root}^+ | X_n = y\}$ with (X_n) conditioned on $\{T_{root}^+ < T_\delta\}$ is stochastically dominated by $G(p_\infty)$, a geometric random variable with parameter p_∞ .

Furthermore, we cannot visit often a given subtrap $s(y) \in S_y$ (recall 3.4). Indeed, if we denote the number of visits to $s(y)$ by $N(s(y)) = \text{card}\{n \leq T_{root}^+ | X_n = y, X_{n+1} \in s(y)\}$, using remark (2) and a reasoning similar to the one for the asymptotics on $A_3(n)$ in Lemma 5.1 we have that $N(s(y))$ with (X_n) conditioned on $\{T_{root}^+ < T_\delta\}$ is stochastically dominated by $G(p_\infty/2)$.

Let us now consider the following decomposition

$$T_{root}^+ = T_{spine} + \sum_{s \in \text{subtraps}} \sum_{j=1}^{N(s)} R_s^j,$$

where $T_{spine} = \text{card}\{n \leq T_{root}^+ | X_n \text{ is in the spine}\} = \sum_{x \in \text{spine}} N(x)$, and R_s^j is the time spent in the subtrap s during the j -th excursion in it. Moreover, on $A(n)$, the law of any subtrap s is that of a Galton-Watson tree conditioned to have height strictly less than $i+1$ for some $i \leq h_n$. Then Lemma 3.1 implies that for such a subtrap, $E^\omega[R_s^j]$ has the same law as $2\Pi_{i+1}^{i,1,1}$ which satisfies using Lemma 3.4 that $E_{\mathbf{Q}_n}[\Pi_j^i] \leq C(\beta f'(q))^i$. Moreover, on $A(n)$, there are at most h_n^+ vertices in the spine and at most n^ε subtraps, hence

$$\begin{aligned} E_{\mathbf{Q}_n}[\mathbf{1}\{A(n)\} E_\delta^\omega[T_{root}^+ | T_{root}^+ < T_\delta^+]] &\leq h_n^+ E[G(p_\infty)] \\ &\quad + h_n^+ n^\varepsilon E[G(p_\infty/2)] C(\beta f'(q))^{h_n}, \end{aligned}$$

and using $(\beta f'(q))^{h_n} \leq Cn^{(1-\varepsilon)(1/\gamma-1)}$ we get

$$E_{\mathbf{Q}_n}[\mathbf{1}\{A(n)\} E_\delta^\omega[T_{root}^+ | T_{root}^+ < T_\delta^+]] \leq C(\ln n) n^{(1-\varepsilon)(1/\gamma-1)+\varepsilon}.$$

□

The previous proof is mainly based on the three statements preceding the statement of Lemma 8.2. Similarly, one can show the following

Lemma 8.3. *For $z \in \{\delta, root\}$, we have*

$$E_{\mathbf{Q}_n}[\mathbf{1}\{A(n)\} E_z^\omega[T_\delta^+ | T_\delta^+ < T_{root}^+]] \leq C(\ln n) n^{(1-\varepsilon)(1/\gamma-1)+\varepsilon}.$$

Démonstration. To apply the same methods as in the proof of Lemma 8.2, we only need that the h -process corresponding to the conditioning on the event $\{T_\delta^+ < T_{root}^+\}$ satisfies that

CHAPITRE 4. BIASED RANDOM WALKS ON GALTON-WATSON TREES WITH LEAVES

1. the walk remains unchanged on the subtraps,
2. for y on the spine and z a descendant of y not on the spine, we have $P_y^\omega[X_1 = \overrightarrow{y} | T_\delta^+ < T_{root}^+] > P_y^\omega[X_1 = z | T_\delta^+ < T_{root}^+]$,
3. for $y \neq \{\delta, root\}$ on the spine, we have $P_y^\omega[X_1 = \overrightarrow{y} | T_\delta^+ < T_{root}^+] > \beta P_y^\omega[X_1 = \overleftarrow{y} | T_\delta^+ < T_{root}^+]$.

This immediately follows from the computation of the voltage \widehat{h}^ω , given by $\widehat{h}^\omega(z) = P_z^\omega[T_\delta^+ < T_{root}^+]$, with $\widehat{h}^\omega(root) = 0$ and $\widehat{h}^\omega(\delta) = 1$. A computation gives

$$\widehat{h}^\omega(y) = \widehat{h}^\omega(d(y \wedge \delta, \delta)) = \frac{\beta^{H+1} - \beta^{d(y \wedge \delta, \delta)}}{\beta^{H+1} - 1}. \quad (8.5)$$

□

From (8.3), Lemma 8.3 and Lemma 8.2, we deduce that

$$\mathbb{E}[\mathbf{1}\{A(n)\}(T_{root}^+ - T_{root}^{*,+})] \leq C(\ln n)n^{(1-\varepsilon)(1/\gamma-1)+\varepsilon} \quad (8.6)$$

Now using (8.6) and (8.2) we prove (8.1), more precisely

$$\text{for all } t > 0, \quad \mathbb{P}\left[\left|\frac{\sum_{i=1}^{l(n)} \chi_j(n) - \chi_j^*(n)}{n^{1/\gamma}}\right| \geq t\right] \leq o(1) + C(\ln n)n^{2\varepsilon-1-\varepsilon(1/\gamma-1)},$$

and thus Proposition 8.1 follows for $\varepsilon < 1/4$. □

9 Analysis of the time spent in big traps

Let us denote $\overline{\mathbf{Q}}_n := \mathbf{Q}[\cdot | H = h_n^0]$ where

$$h_n^0 = \lceil \ln n / -\ln \mathbf{f}'(q) \rceil.$$

Note that

$$p_1(H) := P_\delta^\omega[T_\delta^+ < T_{root}^+] = \frac{1 - \beta^{-1}}{1 - \beta^{-(H+1)}} \quad (9.1)$$

where we recall that the distance between $root$ and δ is $1 + H$. Moreover let us denote

$$p_2(H) := P_\delta^\omega[T_{root}^+ < T_\delta^+] = \frac{1 - \beta^{-1}}{\beta^H - \beta^{-1}}. \quad (9.2)$$

We have the following decomposition

$$\chi_1^*(n) = \sum_{i=1}^{\text{Bin}(W_n, p_1(H))} \sum_{j=1}^{G(p_2(H))^{(i)}-1} T_{exc}^{(i,j)}, \quad (9.3)$$

9. ANALYSIS OF THE TIME SPENT IN BIG TRAPS

where $T_{exc}^{(i,j)}$ is the time spent during the j -th excursion in the i -th trap, which is distributed under \mathbf{Q}_n as T_δ^+ under $P_\delta^\omega[\cdot | T_\delta^+ < T_{root}^+]$ with ω chosen according to \mathbf{Q}_n , for all (i, j) . The $T_{exc}^{(i,j)}$ are independent with respect to P^ω and for $i_1 \neq i_2$ $(T_{exc}^{(i_1,j)})_{j \geq 1}$ and $(T_{exc}^{(i_2,j)})_{j \geq 1}$ are independent with respect to \mathbf{Q}_n . For $k \in \mathbb{Z}$ and n large enough, let \mathcal{Z}_n^k be a random variable with the law of $\chi_1^*(n)/\beta^H$ under \mathbf{Q}_{n+k} and $\overline{\mathcal{Z}}_n^k$ be a random variable with the law of $\chi_1^*(n)/\beta^H$ under $\overline{\mathbf{Q}}_{n+k}$. Furthermore we define $\mathcal{Z}_\infty := \frac{S_\infty}{1-\beta^{-1}} \sum_{i=1}^{\text{Bin}(W_\infty, p_\infty)} \mathbf{e}_i$, see (1.3), where $(\mathbf{e}_i)_{i \geq 1}$ is a family of i.i.d. exponential random variables of parameter 1, chosen independently of the (independent) random variables S_∞ and W_∞ . Our aim is to show the following

Proposition 9.1. *We have*

$$\overline{\mathcal{Z}}_n^k \xrightarrow{d} \mathcal{Z}_\infty.$$

Moreover there exists a random variable \mathcal{Z}_{sup} such that

$$E[\mathcal{Z}_{sup}^{1-\varepsilon}] < \infty, \quad \text{for any } \varepsilon > 0,$$

and

$$\text{for } n \in \mathbb{N} \text{ and } k > -n, \quad \overline{\mathcal{Z}}_n^k \preceq \mathcal{Z}_{sup}.$$

Let us start by proving the convergence in law. The decomposition (9.3) for $\chi_1^*(n)$ can be rewritten using (9.2)

$$\chi_1^*(n) = \beta^H \sum_{i=1}^{\text{Bin}(W_n, p_1(H))} \frac{1 - \beta^{-H-1}}{1 - \beta^{-1}} \frac{\beta^H - 1}{\beta^H - \beta^{-1}} \frac{p_2(H)}{1 - p_2(H)} \sum_{j=1}^{G(p_2(H))^{(i)} - 1} T_{exc}^{(i,j)}, \quad (9.4)$$

which yields an explicit expression of \mathcal{Z}_n^k . We point out that $E[G(p_2(H)) - 1] = (1 - p_2(H))/p_2(H)$. The convergence in law is due to the following facts (more precise statements follow below) :

1. For H large,

$$\frac{(1 - \beta^{-H-1})(\beta^H - 1)}{(1 - \beta^{-1})(\beta^H - \beta^{-1})} \approx \frac{1}{1 - \beta^{-1}},$$

2. By the law of large numbers, we can expect

$$\sum_{j=1}^{G(p_2(H))^{(i)} - 1} T_{exc}^{(i,j)} \approx (G(p_2(H))^{(i)} - 1) E_\delta^\omega[T_{exc}],$$

3. Since $p_2(H)$ is small, $(G(p_2(H))^{(i)} - 1)/E[G(p_2(H))^{(i)} - 1] \approx \mathbf{e}_i$,
4. $E_\delta^\omega[T_{exc}^{(1,1)}] \approx S_\infty$ for H large enough,

CHAPITRE 4. BIASED RANDOM WALKS ON GALTON-WATSON TREES WITH LEAVES

5. $\text{Bin}(W_n, p_1(H)) \approx \text{Bin}(W_\infty, p_\infty)$ since $W_n \xrightarrow{d} W_\infty$ by Proposition 6.1 and $p_1(H) \rightarrow p_\infty$ as H goes to infinity.

Fact (1) is easily obtained, since for $\xi > 0$

$$\mathbf{Q}_n \left[(1 - \xi) \frac{1}{1 - \beta^{-1}} \leq \frac{1 - \beta^{-H+1}}{1 - \beta^{-1}} \frac{\beta^H - 1}{\beta^H - \beta^{-1}} \leq \frac{1}{1 - \beta^{-1}} \right] = 1, \quad (9.5)$$

for n large enough.

We start by computations with the measure \mathbf{Q}_n and we will be able to come back to $\overline{\mathbf{Q}}_{n+k}$.

For (2) and (4), we need to understand $P_\delta^\omega[\cdot | T_\delta^+ < T_{root}^+]$ and to this end we will consider the h -process associated with this conditioning. Recall the voltage \widehat{h}^ω given as $\widehat{h}^\omega(z) = P_z^\omega[T_\delta < T_{root}]$, with $\widehat{h}^\omega(\delta) = 1$ and $\widehat{h}^\omega(root) = 0$, see (8.5).

We shall enumerate the vertices of the backbone from 0 to $H + 1$, starting from δ up to $root$. With these new notations formula (8.5) becomes

$$\widehat{h}^\omega(y) = \widehat{h}^\omega(y \wedge \delta) = \frac{\beta^{H+1} - \beta^{y \wedge \delta}}{\beta^{H+1} - 1}, \quad (9.6)$$

where $y \wedge \delta$ is identified to its number which is $d(y \wedge \delta, \delta)$ as it is a vertex of the backbone.

The transition probabilities are then given as in (8.4). Obviously they arise from conductances, we may take

- (i) $\widehat{c}(0, 1) = 1$,
- (ii) $\widehat{c}(i, i + 1) = \widehat{c}(i - 1, i) \frac{P_i^\omega[X_1 = i + 1 | T_\delta^+ < T_{root}^+]}{P_i^\omega[X_1 = i - 1 | T_\delta^+ < T_{root}^+]}$, for $1 \leq i \leq H$,
- (iii) $\widehat{c}(i, z) = \widehat{c}(i, i - 1) \frac{P_i^\omega[X_1 = z | T_\delta^+ < T_{root}^+]}{P_i^\omega[X_1 = i - 1 | T_\delta^+ < T_{root}^+]}$, for $i \neq 0$ on the spine and z one of its descendants which is not on the spine,
- (iv) $\widehat{c}(y, z) = \beta \widehat{c}(\overleftarrow{y}, y)$ for any vertex y not on the spine and z one of its descendants.

We can easily deduce from this that for $y \neq root$ in the trap and denoting $z_0 = \delta, \dots, z_n = y$ the geodesic path from δ to y :

$$\widehat{c}(z_{n-1}, y) = \prod_{j=1}^{n-1} \frac{P_{z_j}^\omega[X_1 = z_{j+1} | T_\delta^+ < T_{root}^+]}{P_{z_j}^\omega[X_1 = z_{j-1} | T_\delta^+ < T_{root}^+]}$$

which gives using (9.6) that

$$\widehat{c}(i, i + 1) = \beta^{-i} \frac{\widehat{h}(i + 1)\widehat{h}(i)}{\widehat{h}(1)\widehat{h}(0)} = \beta^{-i} \frac{(1 - \beta^{i-H})(1 - \beta^{i-(H+1)})}{(1 - \beta^{-H})(1 - \beta^{-(H+1)})}. \quad (9.7)$$

For a vertex z not on the spine, we have

$$\widehat{c}(z, \overleftarrow{z}) = \beta^{d(\overleftarrow{z}, z \wedge \delta)} \frac{\widehat{h}(z \wedge \delta)}{\widehat{h}(z \wedge \delta - 1)} c(z \wedge \delta, z \wedge \delta - 1)$$

9. ANALYSIS OF THE TIME SPENT IN BIG TRAPS

$$= \beta^{d(\bar{z}, z \wedge \delta)} \frac{1 - \beta^{z \wedge \delta - (H+1)}}{1 - \beta^{z \wedge \delta - 1 - (H+1)}} c(z \wedge \delta, z \wedge \delta - 1). \quad (9.8)$$

Together with Lemma 3.1, this yields, with T_{exc} a generic random variable with the law of $T_{exc}^{(1,1)}$,

$$E_\delta^\omega[T_{exc}] = 2 \sum_{i=0}^{H-1} \beta^{-i} \frac{(1 - \beta^{i-H})(1 - \beta^{i-(H+1)})}{(1 - \beta^{-H})(1 - \beta^{-(H+1)})} \left(1 + \frac{1 - \beta^{i-(H+1)}}{1 - \beta^{(i-1)-(H+1)}} \Lambda_i(\omega) \right) \quad (9.9)$$

where Λ_i was defined in (3.5).

We see that the random variable S_∞ is the limit of the last quantity as H goes to infinity. More precisely, using (9.9) we have $0 \leq S_\infty - E_\delta^\omega[T_{exc}]$ and for n large enough such that

$$\text{for all } k \leq h_n/2, \quad \frac{(1 - \beta^{k-h_n})(1 - \beta^{k-(h_n+1)})}{(1 - \beta^{-h_n})(1 - \beta^{-(h_n+1)})} \geq 1 - 2\beta^{h_n},$$

we get

$$\begin{aligned} S_\infty - E_\delta^\omega[T_{exc}] &\leq 2 \left(\sum_{i=0}^{h_n/2} \beta^{-i} \left(1 - \frac{(1 - \beta^{i-H})(1 - \beta^{i-(H+1)})}{(1 - \beta^{-H})(1 - \beta^{-(H+1)})} \right) (1 + \Lambda_i) \right) \\ &\quad + 2 \left(\sum_{i=h_n/2+1}^{\infty} \beta^{-i} (1 + \Lambda_i) \right), \\ &\leq 4\beta^{-h_n/2} \left(\sum_{i=0}^{h_n/2} \beta^{-i} (1 + \Lambda_i) \right) + 2 \left(\sum_{i=h_n/2+1}^{\infty} \beta^{-i} (1 + \Lambda_i) \right). \end{aligned}$$

Hence, since $S_\infty \geq 1$ and using Chebyshev's inequality, we get

$$\begin{aligned} \mathbf{Q}_n \left[(1 - \xi) S_\infty < E_\delta^\omega[T_{exc}] < S_\infty \right] &\geq 1 - \mathbf{Q}_n [S_\infty - E_\delta^\omega[T_{exc}] \geq \xi] \quad (9.10) \\ &\geq 1 - \frac{1}{\xi} \beta^{-h_n/2} \frac{10}{1 - \beta^{-1}} \sup_{i \geq 0} E_{\mathbf{Q}}[1 + \Lambda_i] \\ &= 1 + o(1), \end{aligned}$$

where we used Lemma 3.5 and the fact that $\varepsilon < 1/4$, this proves (4).

In order to prove (2), we have to bound $E_\delta^\omega[T_1^2]$ from above. This is not possible for all ω , but we consider the event

$$A_5(n) = \left\{ E_\delta^\omega[T_1^2] \leq n^{\frac{1-2\varepsilon}{\gamma}} \right\},$$

and show that it satisfies the following.

CHAPITRE 4. BIASED RANDOM WALKS ON GALTON-WATSON TREES WITH LEAVES

Lemma 9.1. *For $0 < \varepsilon < \min(1/3, 2\gamma/3)$, we have*

$$\mathbf{Q}_n[A_5(n)^c] \rightarrow 0.$$

Démonstration. In this proof we denote for y in the trap, $N(y)$ the number of visits to y during an excursion from δ , which is distributed as $\text{card}\{0 \leq n \leq T_\delta^+ | X_n = y\}$ under $P_\delta^\omega[\cdot | T_\delta^+ < T_{root}^+]$. We have

$$\begin{aligned} E_\delta^\omega[T_{exc}^2] &= E_\delta^\omega\left[\left(\sum_{y \in \text{trap}} N(y)\right)^2\right] \\ &\leq \sum_{y, z \in \text{trap}} E_\delta^\omega[N(y)^2]^{1/2} E_\delta^\omega[N(z)^2]^{1/2} \\ &= \left(\sum_{y \in \text{trap}} E_\delta^\omega[N(y)^2]^{1/2}\right)^2. \end{aligned}$$

Now fix y in the trap, denote $q_1 = P_\delta^\omega[T_y^+ < T_\delta^+ | T_\delta^+ < T_{root}^+]$ and $q_2 = P_y^\omega[T_\delta^+ < T_y^+ | T_\delta^+ < T_{root}^+]$. Then we have

$$\forall k \geq 1, P_\delta^\omega[N(y) = k] = q_1(1 - q_2)^{k-1}q_2.$$

Hence

$$E_\delta^\omega[N(y)^2] = \sum_{n \geq 1} n^2 q_1 (1 - q_2)^{n-1} q_2 = q_1 \frac{2 - q_2}{q_2^2} \leq \frac{2q_1}{q_2^2}.$$

Then by reversibility of the walk, if $\hat{\pi}$ is the invariant measure associated with the conductances \hat{c} , we get $q_1 = \hat{\pi}(\delta)q_1 = \hat{\pi}(y)q_2$. This yields

$$E_\delta^\omega[N(y)^2] \leq \frac{2\hat{\pi}(y)}{q_2}. \tag{9.11}$$

Furthermore we have

$$q_2 \geq (1/(Z_1(y)\beta + 1))p_\infty\beta^{-d(\delta, \delta \wedge y)}/2. \tag{9.12}$$

Indeed suppose that y is not on the spine, otherwise the bound is simple. Starting from y , we reach the ancestor of y with probability at least $(1/(Z_1(y)\beta + 1))$ then the walker has probability at least $\beta^{-d(y, y \wedge \delta)}$ to reach $y \wedge \delta$ before y , next he has probability at least $1/2$ to go to $y \wedge \delta$ before going to z , where z is the first vertex on the geodesic path from $y \wedge \delta$ to y . Finally from $y \wedge \delta$, the walker has probability at least p_∞ to go to δ before coming back to $y \wedge \delta$.

We denote by π the invariant measure associated with the β -biased random walk (i.e. not conditioned on $T_\delta^+ < T_{root}^+$), normalized so as to have $\pi(\delta) = 1$. Then we have

9. ANALYSIS OF THE TIME SPENT IN BIG TRAPS

1. For any y in the trap, $\widehat{\pi}(y) \leq \pi(y)$ because of (9.7) and (9.8),
2. and by definition of the invariant measure $(Z_1(y)\beta + 1)\beta^{d(\delta, \delta \wedge y) - d(y, \delta \wedge y)} = \pi(y)$.

Now plugging (2) in (9.12) yields a lower bound on q_2 which can be used together with (1) in (9.11) to get

$$E_\delta^\omega [N(y)^2] \leq C\beta^{d(\delta, \delta \wedge y)}\pi(y)^2,$$

and

$$E_\delta^\omega [T_{exc}^2]^{1/2} \leq C \sum_{y \in \text{trap}} \beta^{d(\delta, \delta \wedge y)/2} \pi(y).$$

As a consequence, with $A(n)$ as in Lemma 8.1 we get

$$\begin{aligned} E_{\mathbf{Q}_n} [\mathbf{1}\{A(n)\} E_\delta^\omega [T_{exc}^2]^{1/2}] &\leq C E_{\mathbf{Q}_n} \left[\mathbf{1}\{A(n)\} \sum_{i=0}^{h_n^+} \beta^{-i/2} \Lambda_i \right] \\ &\leq C \sum_{i=0}^{h_n^+} (\beta^{1/2} \mathbf{f}'(q))^i \\ &\leq C \max(1, (\beta^{1/2} \mathbf{f}'(q))^{h_n^+}), \end{aligned}$$

where we used Lemma 3.1 and Lemma 3.4 for the first inequality.

Since $(\beta^{1/2} \mathbf{f}'(q))^{h_n^+} = n^{(1+\varepsilon)(1/2\gamma-1)}$, we get by Chebyshev's inequality that

$$\begin{aligned} \mathbf{Q}_n [\mathbf{1}\{A(n)\} E_\delta^\omega [T_{exc}^2]^{1/2} \geq n^{\frac{1-2\varepsilon}{2\gamma}}] &\leq \frac{1}{n^{\frac{1-2\varepsilon}{2\gamma}}} E_{\mathbf{Q}_n} [\mathbf{1}\{A(n)\} E_\delta^\omega [T_1^2]^{1/2}] \\ &\leq C \max(n^{-\frac{1-2\varepsilon}{2\gamma}}, n^{3\varepsilon/(2\gamma)-1-\varepsilon}). \end{aligned}$$

The conditions on ε ensures that this last term goes to 0 for $n \rightarrow \infty$. Hence

$$\mathbf{P}[A(n) \cap A_5(n)^c] \rightarrow 0$$

and the result follows using Lemma 8.1. □

We now turn to the study of

$$\frac{p_2(H)}{1 - p_2(H)} \sum_{i=1}^{G(p_2(H))-1} T_{exc}^{(i)}.$$

Consider the random variable

$$N_g = \left\lfloor \frac{-1}{\ln(1 - p_2(H))} \mathbf{e} \right\rfloor, \tag{9.13}$$

where \mathbf{e} is an exponential random variable of parameter 1. A simple computation shows that N_g has the law of $G(p_2(H)) - 1$.

CHAPITRE 4. BIASED RANDOM WALKS ON GALTON-WATSON TREES WITH LEAVES

Set $\xi > 0$, we have using Chebyshev's inequality,

$$\begin{aligned}
& \mathbf{Q}_n \left[(1 - \xi) N_g E_\delta^\omega [T_{exc}] \leq \sum_{i=1}^{N_g} T_{exc}^{(i)} \leq (1 + \xi) N_g E_\delta^\omega [T_{exc}] \right] \\
& \geq 1 - \mathbf{Q}_n \left[\left| \frac{\sum_{i=1}^{N_g} T_{exc}^{(i)}}{N_g} - E_\delta^\omega [T_{exc}] \right| > \xi E_\delta^\omega [T_{exc}], N_g \neq 0, E_\delta^\omega [T_{exc}^2] \leq n^{(1-2\varepsilon)/\gamma} \right] \\
& \quad - \mathbf{Q}_n [E^\omega [T_{exc}^2] \geq n^{(1-2\varepsilon)/\gamma}] - \mathbf{Q}_n [N_g = 0] \\
& \geq E_{\mathbf{Q}_n} \left[\frac{n^{(1-2\varepsilon)/\gamma}}{N_g} \mathbf{1}\{N_g \neq 0\} \frac{1}{\xi^2} \right] - \mathbf{Q}_n [E^\omega [T_{exc}^2] \geq n^{(1-2\varepsilon)/\gamma}] - \mathbf{Q}_n [N_g = 0].
\end{aligned}$$

We have $\mathbf{Q}_n [N_g = 0] = p_2(H) \leq p_2(h_n) \leq C n^{-(1-\varepsilon)/\gamma} \ln n$, and hence

$$E_{\mathbf{Q}_n} \left[\frac{\mathbf{1}\{N_g \neq 0\}}{N_g} \right] = \mathbb{E} \left[-\frac{p_2(H)}{1 - p_2(H)} \ln p_2(H) \right] \leq C n^{-(1-\varepsilon)/\gamma} (\ln n)^2.$$

Putting together the two previous equations, using Lemma 9.1, we get for $\xi < 1$,

$$\mathbf{Q}_n \left[(1 - \xi) N_g E_\delta^\omega [T_{exc}] < \sum_{i=1}^{N_g} T_{exc}^{(i)} < (1 + \xi) N_g E_\delta^\omega [T_{exc}] \right] \rightarrow 1. \quad (9.14)$$

This shows (2). Turning to prove (3), we have

$$\begin{aligned}
& \mathbf{Q}_n \left[(1 - \xi) \left[\frac{1}{-\ln(1 - p_2(H))} \mathbf{e} \right] \leq \frac{1 - p_2(H)}{p_2(H)} \mathbf{e} \leq (1 + \xi) \left[\frac{1}{-\ln(1 - p_2(H))} \mathbf{e} \right] \right] \\
& \geq 1 - \mathbf{Q}_n \left[\left(\frac{1 - p_2(H)}{p_2(H)} - \frac{1 - \xi}{-\ln(1 - p_2(H))} \right) \mathbf{e} < 1 \right] \\
& \quad - \mathbf{Q}_n \left[\left(\frac{1 - p_2(H)}{p_2(H)} - \frac{1 + \xi}{-\ln(1 - p_2(H))} \right) \mathbf{e} > -2 \right],
\end{aligned}$$

furthermore since $\left| \frac{1-p}{p} - \frac{1}{-\ln(1-p)} \right|$ is bounded on $(0, \varepsilon_1)$ by a certain $M > 0$ so that for n large enough with $p_2(h_n) < \varepsilon_1$, we get

$$\begin{aligned}
& \mathbf{Q}_n \left[(1 - \xi) \left[\frac{1}{-\ln(1 - p_2(H))} \mathbf{e} \right] \leq \frac{1 - p_2(H)}{p_2(H)} \mathbf{e} \leq (1 + \xi) \left[\frac{1}{-\ln(1 - p_2(H))} \mathbf{e} \right] \right] \quad (9.15) \\
& \geq 1 - \mathbf{Q}_n \left[\left(\frac{\xi}{-\ln(1 - p_2(H))} - M \right) \mathbf{e} < 1 \right] - \mathbf{Q}_n \left[\left(-\frac{\xi}{-\ln(1 - p_2(H))} + M \right) \mathbf{e} > -2 \right] \\
& \geq \exp \left(-\frac{2}{\xi / (-\ln(1 - p_2(h_n))) - M} \right) \geq 1 - (C/\xi) p_2(h_n),
\end{aligned}$$

which shows (3).

9. ANALYSIS OF THE TIME SPENT IN BIG TRAPS

As a consequence of (9.10), (9.14) and (9.15), we see that for all $\xi \in (0, 1)$,

$$\mathbf{Q}_n \left[(1 - \xi) S_\infty \mathbf{e} \leq \frac{p_2(H)}{1 - p_2(H)} \sum_{i=1}^{N_g} E^\omega [T_{exc}^{(i)}] \leq (1 + \xi) S_\infty \mathbf{e} \right] \rightarrow 1 \quad (9.16)$$

for $n \rightarrow \infty$. Using (9.2), (9.16) and (9.5) we get

$$\mathbf{Q}_n \left[(1 - \xi) \frac{S_\infty \mathbf{e}}{1 - \beta^{-1}} \leq \frac{1}{\beta^H} \sum_{i=1}^{N_g} E^\omega [T_{exc}^{(i)}] \leq (1 + \xi) \frac{S_\infty \mathbf{e}}{1 - \beta^{-1}} \right] \rightarrow 1 \quad (9.17)$$

for $n \rightarrow \infty$, which sums up (2), (3) and (4). For any $k > -n$, the equation (9.17) obviously holds replacing n with $n + k$, and since

$\mathbf{Q}_n[H = \lceil \ln(n + k) / \ln \mathbf{f}'(q) \rceil] \geq c_k > 0$ (this follows from Lemma 3.3), we have

$$\bar{\mathbf{Q}}_{n+k} \left[(1 - \xi) \frac{S_\infty \mathbf{e}}{1 - \beta^{-1}} \leq \frac{1}{\beta^H} \sum_{i=1}^{N_g} E^\omega [T_{exc}^{(i)}] \leq (1 + \xi) \frac{S_\infty \mathbf{e}}{1 - \beta^{-1}} \right] \rightarrow 1. \quad (9.18)$$

Only part (5) remains to be shown. Coupling $\text{Bin}(W_n, p_\infty)$ and $\text{Bin}(W_n, p_1(H))$ in the standard way,

$$\begin{aligned} & \bar{\mathbf{Q}}_{n+k} [\text{Bin}(W_n, p_\infty) \neq \text{Bin}(W_n, p_1(H))] \\ & \leq \sum_{j \geq 0} \mathbb{P}[W_n = j] \bar{\mathbf{Q}}_{n+k} [\text{Bin}(j, p_\infty) \neq \text{Bin}(j, p_1(H))] \\ & \leq \sum_{j \geq 0} \mathbb{P}[W_n = j] j (p_1(h_{n+k}^0) - p_\infty) \\ & \leq \mathbb{E}[W_n] (p_1(h_{n+k}^0) - p_\infty) \\ & \leq C (p_1(h_{n+k}^0) - p_\infty) \rightarrow 0, \quad \text{for } n \rightarrow \infty \end{aligned}$$

where $C := E[G(p_\infty/3)] \geq \mathbb{E}[W_n]$ by Lemma 6.2. Hence,

$$\bar{\mathbf{Q}}_{n+k} \left[\frac{1}{\beta^H} \sum_{i=1}^{\text{Bin}(W_n, p_1(H))} \sum_{j=1}^{G(p_2(H))-1} T_{exc}^{(i,j)} \geq t \right] - \bar{\mathbf{Q}}_{n+k} \left[\frac{1}{\beta^H} \sum_{i=1}^{\text{Bin}(W_n, p_\infty)} \sum_{j=1}^{G(p_2(H))-1} T_{exc}^{(i,j)} \geq t \right] \rightarrow 0$$

For $\varepsilon_1 > 0$, introduce $N(\varepsilon_1)$ such that $\max_{n \leq \infty} \mathbb{P}[W_n \geq N(\varepsilon_1)] \leq (1 - p_\infty/3)^{N(\varepsilon_1)} \leq \varepsilon_1$ and using the independence of W_n (for $n \in \mathbb{N} \cup \{\infty\}$) of the trap and the walk on the trap, we get for any $\varepsilon_1 > 0$,

$$\left| \bar{\mathbf{Q}}_{n+k} \left[\frac{1}{\beta^H} \sum_{i=1}^{\text{Bin}(W_n, p_\infty)} \sum_{j=1}^{G(p_2(H))-1} T_{exc}^{(i,j)} \geq t \right] - \bar{\mathbf{Q}}_{n+k} \left[\frac{1}{\beta^H} \sum_{i=1}^{\text{Bin}(W_\infty, p_\infty)} \sum_{j=1}^{G(p_2(H))-1} T_{exc}^{(i,j)} \geq t \right] \right|$$

CHAPITRE 4. BIASED RANDOM WALKS ON GALTON-WATSON TREES WITH LEAVES

$$\begin{aligned} &\leq \left| \sum_{j \geq 0} (\mathbb{P}[W_n = j] - \mathbb{P}[W_\infty = j]) \bar{\mathbf{Q}}_{n+k} \left[\frac{1}{\beta^H} \sum_{i=1}^{\text{Bin}(j, p_\infty)} \sum_{j=1}^{G(p_2(H))-1} T_{exc}^{(i,j)} \geq t \right] \right| \\ &\leq \left| \sum_{j \in [0, N(\varepsilon_1)]} (\mathbb{P}[W_n = j] - \mathbb{P}[W_\infty = j]) \bar{\mathbf{Q}}_{n+k} \left[\frac{1}{\beta^H} \sum_{i=1}^{\text{Bin}(j, p_\infty)} \sum_{j=1}^{G(p_2(H))-1} T_{exc}^{(i,j)} \geq t \right] \right| + \varepsilon_1 \end{aligned}$$

and the right-hand side goes to ε_1 as n goes to infinity since

$$\max_{j \leq N(\varepsilon_1)} |\mathbb{P}[W_n = j] - \mathbb{P}[W_\infty = j]| \rightarrow 0,$$

by Proposition 6.1. So letting ε_1 go to 0, we see that

$$\bar{\mathbf{Q}}_{n+k} \left[\frac{1}{\beta^H} \sum_{i=1}^{\text{Bin}(W_n, p_1(H))} \sum_{j=1}^{G(p_2(H))-1} T_{exc}^{(i,j)} \geq t \right] - \bar{\mathbf{Q}}_{n+k} \left[\frac{1}{\beta^H} \sum_{i=1}^{\text{Bin}(W_\infty, p_\infty)} \sum_{j=1}^{G(p_2(H))-1} T_{exc}^{(i,j)} \geq t \right] \rightarrow 0 \quad (9.19)$$

Let us introduce

$$\begin{aligned} A(\xi) &= \left\{ \text{for all } i \in [1, \text{Bin}(W_\infty, p_\infty)], \right. \\ &\quad \left. \frac{1}{\beta^H} \sum_{j=1}^{G^{(i)}(p_2(H))-1} T_{exc}^{(i,j)} \in \left[(1 - \xi) \frac{S_\infty}{1 - \beta^{-1}} \mathbf{e}_i, (1 + \xi) \frac{S_\infty}{1 - \beta^{-1}} \mathbf{e}_i \right] \right\}, \end{aligned}$$

where $(\mathbf{e}_i)_{i \geq 1}$ is a sequence of i.i.d. exponential random variables of parameter 1 which satisfy

$$G^{(i)}(p_2(H)) - 1 = \left\lfloor \frac{-1}{\ln(1 - p_2(H))} \mathbf{e}_i \right\rfloor.$$

We have, denoting $o_1(1)$ the left hand side of (9.19)

$$\begin{aligned} \bar{\mathbf{Q}}_{n+k}[A(\xi)] &\geq \sum_{i \geq 0} \mathbb{P}[\text{Bin}(W_\infty, p_\infty) = i] (1 - o_1(1))^i \\ &\geq \sum_{i \geq 0} \mathbb{P}[\text{Bin}(W_\infty, p_\infty) = i] (1 - i o_1(1)) \\ &= 1 - \mathbb{E}[W_\infty] o_1(1) \rightarrow 1 \quad \text{for } n \rightarrow \infty. \end{aligned}$$

Hence, for any $\xi > 0$, we get

$$\bar{\mathbf{Q}}_{n+k} \left[\frac{1}{\beta^H} \sum_{i=1}^{\text{Bin}(W_n, p_1(H))} \sum_{j=1}^{G(p_2(H))-1} T_{exc}^{(i,j)} \geq t \right] - \bar{\mathbb{P}} \left[\frac{S_\infty}{1 - \beta^{-1}} \sum_{i=1}^{\text{Bin}(W_\infty, p_\infty)} \mathbf{e}_i \geq \frac{t}{1 + \xi} \right] \rightarrow 0$$

9. ANALYSIS OF THE TIME SPENT IN BIG TRAPS

and

$$\overline{\mathbf{Q}}_{n+k} \left[\frac{1}{\beta^H} \sum_{i=1}^{\text{Bin}(W_n, p_1(H))} \sum_{j=1}^{G(p_2(H))-1} T_{exc}^{(i,j)} \geq x \right] - \overline{\mathbb{P}} \left[\frac{S_\infty}{1-\beta^{-1}} \sum_{i=1}^{\text{Bin}(W_\infty, p_\infty)} \mathbf{e}_i \geq \frac{t}{1-\xi} \right] \rightarrow 0$$

Concluding by using the two previous equations with ξ going to 0, we have the following convergence in law :

$$\overline{\mathcal{Z}}_n^k = \frac{1}{\beta^H} \sum_{i=1}^{\text{Bin}(W_n, p_1(H))} \sum_{j=1}^{G(p_2(H))-1} T_{exc}^{(i,j)} \xrightarrow{d} \frac{S_\infty}{1-\beta^{-1}} \sum_{i=1}^{\text{Bin}(W_\infty, p_\infty)} \mathbf{e}_i,$$

where we recall that $\overline{\mathcal{Z}}_n^k$ has the law of $\chi_1^*(n)/\beta^H$ under $\overline{\mathbf{Q}}_{n+k}$ and the \mathbf{e}_i are i.i.d. exponential random variables of parameter 1. This shows the first part of Proposition 9.1.

Now let us prove the stochastic domination part. First notice that

$$\text{Bin}(W_n, p_1(H)) \preceq G(p_\infty/3) \text{ and } E_\delta^\omega[T_1] \preceq T_{exc}^\infty,$$

where T_{exc}^∞ is distributed as the return time to δ , starting from δ , on an infinite trap. Hence for $k > -n$

$$\overline{\mathcal{Z}}_n^k \preceq \frac{1}{\beta^{h_{n+k}^0}} \sum_{i=1}^{G(p_\infty/3)} \sum_{j=1}^{G(p_2(h_{n+k}^0))} T_{exc}^{\infty, (i,j)},$$

where $(T_{exc}^{\infty, (i,j)})_{i,j \geq 1}$ are i.i.d. copies of T_{exc}^∞ . Now recalling that $\sum_{i=1}^{G(a)} G(b)^{(i)}$ has the same law as $G(ab)$, where all geometric random variables are independent, and using the fact that

$$\beta^{h_{n+k}^0} \geq cE[G(p_\infty p_2(h_{n+k}^0)/3)],$$

for some $c = c(\beta) > 0$, we get

$$\overline{\mathcal{Z}}_n^k \preceq \frac{C}{E[G(p_\infty p_2(h_{n+k}^0)/3)]} \sum_{i=1}^{G(p_\infty p_2(h_{n+k}^0)/3)} T_{exc}^{\infty, (i)}.$$

Now, we prove the following technical lemma

Lemma 9.2. *Let $(X_i)_{i \geq 0}$ a sequence of i.i.d. non-negative random variables such that $E[X_1] < \infty$ and set $Y_i := (X_1 + \dots + X_i)/i$. Then there exists a random variable Y_{sup} such that*

$$\text{for all } i \geq 0, \quad Y_i \preceq Y_{sup},$$

and $E[Y_{sup}^{1-\varepsilon}] < \infty$ for all $\varepsilon > 0$.

CHAPITRE 4. BIASED RANDOM WALKS ON GALTON-WATSON TREES WITH LEAVES

Démonstration. Using Chebyshev's inequality we get that for any $i \geq 0$,

$$\text{for all } t \geq 0, \quad P[Y_i > t] \leq \frac{1}{t} E[X_1].$$

If we choose Y_{sup} such that $P[Y_{\text{sup}} > t] = \min(1, E[X_1]/t)$ for $x \geq 0$, then Y_{sup} stochastically dominates all Y_n and has a finite $(1 - \varepsilon)$ -th moment for all $\varepsilon > 0$. \square

Now we apply this Lemma to the random variables $T_{\text{ext}}^{\infty, (i)}$ which are integrable under \mathbb{P} and we get a certain random variable T_{sup} . We add to our probability spaces a copy of T_{sup} which is independent of all other random variables. Then for any $t \geq 0$,

$$\begin{aligned} \overline{\mathbb{P}}[\overline{\mathcal{Z}}_n^k \geq t] &\leq \overline{\mathbb{P}}\left[\frac{C}{E[G(p_\infty p_2(h_{n+k}^0)/3)]} \sum_{i=1}^{G(p_\infty p_2(h_{n+k}^0)/3)} T_{\text{exc}}^{\infty, (i)} \geq t\right] \\ &\leq \sum_{k \geq 0} \overline{\mathbb{P}}[G(p_\infty p_2(h_{n+k}^0)/3) = k] \overline{\mathbb{P}}\left[\frac{C}{E[G(p_\infty p_2(h_{n+k}^0)/3)]} \sum_{i=1}^k T_{\text{exc}}^{\infty, (i)} \geq x\right] \\ &\leq \sum_{k \geq 0} \overline{\mathbb{P}}[G(p_\infty p_2(h_{n+k}^0)/3) = k] \overline{\mathbb{P}}\left[C \frac{k}{E[G(p_\infty p_2(h_{n+k}^0)/3)]} T_{\text{sup}} \geq t\right] \\ &\leq \overline{\mathbb{P}}\left[C \frac{G(p_\infty p_2(h_{n+k}^0)/3)}{E[G(p_\infty p_2(h_{n+k}^0)/3)]} T_{\text{sup}} \geq t\right], \end{aligned}$$

and since $p_\infty p_2(h_{n+k}^0)/3 < 1/3$, we can use the fact that for any $a < 1/3$ we have $G(a)/E[G(a)] \leq 3/2\mathbf{e}$. This shows that

$$\text{for all } n \geq 0, \text{ and } k > -n, \quad \overline{\mathcal{Z}}_n^k \leq C\mathbf{e}T_{\text{sup}},$$

where \mathbf{e} and T_{sup} are independent, so that the right-hand side has finite $(1 - \varepsilon)$ -th moment for all $\varepsilon > 0$. This finishes the proof of the second part in Proposition 9.1. \square

10 Sums of i.i.d. random variables

This section is completely self-contained and the notations used here are not related to those used previously.

Set $\beta > 1$ and let $(X_i)_{i \geq 0}$ be a sequence of i.i.d. integer-valued non-negative random variables such that

$$P[X_1 \geq n] \sim C_X \beta^{-\gamma n}, \quad (10.1)$$

for $C_X \in (0, \infty)$ and $\gamma > 0$.

Let $(X_i^{(l)})_{i \geq 0}$ be a sequence of i.i.d. integer-valued non negative random variables with the law of X_i conditioned on $X_i \geq f(l)$, where $f : \mathbb{N} \rightarrow \mathbb{N}$ is such that $l - f(l) \rightarrow \infty$.

10. SUMS OF I.I.D. RANDOM VARIABLES

Let $(Z_i^{(l)})_{i \geq 0, l \geq 0}$ be another sequence of i.i.d. non-negative random variables and let $Z_i^{(l),(k)}$ have the law of $Z_i^{(l)}$ under $P[\cdot | X_i^{(l)} = l + k]$, if this last probability is well defined, and as $Z_i^{(l),(k)} = 0$ otherwise. Define

$$\text{for } k \in \mathbb{Z}, l \geq 0, \quad \bar{F}_k^{(l)}(x) := P[Z_i^{(l),(k)} > x], \quad (10.2)$$

We introduce the following assumptions.

1. There exists a certain random variable Z_∞ such that

$$\text{for all } k \in \mathbb{Z} \text{ and } l \geq 0, \quad Z_i^{(l),(k)} \xrightarrow{d} Z_\infty.$$

2. There exists a random variable Z_{sup} such that

$$\text{for all } l \geq 0, k \geq -(l - f(l)) \text{ and } i \geq 0, \quad Z_i^{(l),(k)} \preceq Z_{\text{sup}},$$

and $E[Z_{\text{sup}}^{\gamma+\varepsilon}] < \infty$ for some $\varepsilon > 0$.

Moreover set

$$Y_i^{(l)} = Z_i^{(l)} \beta^{X_i^{(l)}} \text{ and } S_n^{(l)} = \sum_{i=1}^n Y_i^{(l)},$$

and for $\lambda \in [1, \beta)$, $(\lambda_l)_{l \geq 0}$ converging to λ and $l \in \mathbb{N}$, define

$$\begin{aligned} N_l^{(\lambda)} &= \lfloor \lambda_l^\gamma \beta^{\gamma(l-f(l))} \rfloor, \\ K_l^{(\lambda)} &= \lambda \beta^l. \end{aligned}$$

Finally we denote by $\bar{F}_\infty(x) = P[Z_\infty > x]$ the tail function of Z_∞ .

Theorem 10.1. *Suppose that $\gamma < 1$ and Assumptions (1) and (2) hold true. Then we have*

$$\text{for all } \lambda \in [1, \beta) \text{ and } (\lambda_l)_{l \geq 0} \text{ going to } \lambda, \quad \frac{S_{N_l^{(\lambda)}}^{(l)}}{K_l^{(\lambda)}} \rightarrow \mathfrak{I}(d_\lambda, 0, \mathcal{L}_\lambda),$$

where \mathfrak{I} is an infinitely divisible law. The Lévy spectral function \mathcal{L}_λ satisfies

$$\text{for all } \lambda > 0 \text{ and } x \in \mathbb{R}, \quad \mathcal{L}_\lambda(x) = \lambda^\gamma \mathcal{L}_1(\lambda x) \text{ and } \mathcal{L}_\beta(x) = \mathcal{L}_1(x), \quad (10.3)$$

and

$$\mathcal{L}_1(x) = \begin{cases} 0 & \text{if } x < 0, \\ -(1 - \beta^{-\gamma}) \sum_{k \in \mathbb{Z}} \beta^{\gamma k} \bar{F}_\infty(x \beta^k) & \text{if } x > 0. \end{cases} \quad (10.4)$$

In particular, $\mathfrak{I}(d_\lambda, 0, \mathcal{L}_\lambda)$ is continuous. Moreover, d_λ is given by

$$d_\lambda = \lambda^{1+\gamma} (1 - \beta^{-\gamma}) \sum_{k \in \mathbb{Z}} \beta^{(1+\gamma)k} E \left[\frac{Z_\infty}{(\lambda \beta^k)^2 + Z_\infty^2} \right]. \quad (10.5)$$

CHAPITRE 4. BIASED RANDOM WALKS ON GALTON-WATSON TREES WITH LEAVES

The fact that the quantities appearing above are well defined will be treated in the course of the proof.

In order to prove Theorem 10.1 we will apply Theorem 4 in [10], which is itself a consequence of Theorem IV.6 (p. 77) in [80].

Theorem 10.2. *Let $n(t) : [0, \infty) \rightarrow \mathbb{N}$ and for each t let $\{Y_k(t) : 1 \leq k \leq n(t)\}$ be a sequence of independent identically distributed random variables. Assume that for every $\varepsilon > 0$, it is true that*

$$\lim_{t \rightarrow \infty} P[Y_1(t) > \varepsilon] = 0. \quad (10.6)$$

Now let $\mathcal{L}(x) : \mathbb{R} \setminus \{0\} \rightarrow \mathbb{R}$ be a Lévy spectral function, $d \in \mathbb{R}$ and $\sigma > 0$. Then the following statements are equivalent :

(i)

$$\lim_{t \rightarrow \infty} \sum_{k=1}^{n(t)} Y_k(t) \xrightarrow{d} X_{d,\sigma,\mathcal{L}} \quad \text{for } t \rightarrow \infty$$

where $X_{d,\sigma,\mathcal{L}}$ has law $\mathfrak{J}(d, \sigma, \mathcal{L})$.

(ii) Define for $\tau > 0$ the random variable $Z_\tau(t) := Y_1(t) \mathbf{1}\{|Y_1(t)| \leq \tau\}$. Then if x is a continuity point of \mathcal{L} ,

$$\mathcal{L}(x) = \begin{cases} \lim_{t \rightarrow \infty} n(t) P[Y_1(t) \leq x], & \text{for } x < 0, \\ -\lim_{t \rightarrow \infty} n(t) P[Y_1(t) > x], & \text{for } x > 0, \end{cases}$$

$$\sigma^2 = \lim_{\tau \rightarrow 0} \limsup_{t \rightarrow \infty} (n(t) \text{Var}(Z_\tau(t))),$$

and for any $\tau > 0$ which is a continuity point of $\mathcal{L}(x)$,

$$d = \lim_{n \rightarrow \infty} n(t) E[Z_\tau(t)] + \int_{|x| > \tau} \frac{x}{1+x^2} d\mathcal{L}(x) - \int_{\tau \geq |x| > 0} \frac{x^3}{1+x^2} d\mathcal{L}(x).$$

The condition (10.6) is verified in the course of the proof, in our context $n(t)$ goes to infinity.

10.1 Computation of the Lévy spectral function

Fix $\lambda \in [1, \beta)$ and assume that $x > 0$ is a continuity point of \mathcal{L}_λ . We want to show that

$$-\lim_{l \rightarrow \infty} N_l^{(\lambda)} P \left[\frac{Y_1^{(l)}}{K_l^{(\lambda)}} > x \right] = \mathcal{L}_\lambda(x). \quad (10.7)$$

The discontinuity points of \mathcal{L}_λ are exactly $\mathcal{C}_\lambda = \{(\beta^k y_n)/\lambda, k \in \mathbb{Z}, n \in \mathbb{N}\}$ where $\{y_n, n \in \mathbb{N}\}$ are the discontinuity points of \overline{F}_∞ (these sets are possibly empty).

10. SUMS OF I.I.D. RANDOM VARIABLES

Let us introduce

$$\text{for } k \in \mathbb{Z}, \quad a_k^{(l)} := P[X_1^{(l)} \geq l + k]. \quad (10.8)$$

Since $N_l^{(\lambda)} \sim (\lambda\beta^{l-f(l)})^\gamma$, we can write, recalling(10.2)

$$\begin{aligned} & \beta^{\gamma(l-f(l))} P\left(\frac{Y_1^{(l)}}{K_l^{(\lambda)}} > x\right) \\ &= \sum_{k \in \mathbb{Z}} \mathbf{1}\{k \geq -(l-f(l))\} \bar{F}_k^{(l)}(\lambda x \beta^{-k}) \beta^{\gamma(l-f(l))} (a_k^{(l)} - a_{k+1}^{(l)}). \end{aligned}$$

Now recalling (10.1) and (10.8), we see that for $l \rightarrow \infty$,

$$\beta^{\gamma(l-f(l))} a_k^{(l)} \rightarrow \beta^{-\gamma k}. \quad (10.9)$$

using $l-f(l) \rightarrow \infty$, the fact that $\lambda x \beta^k$ is a continuity point of \bar{F}_∞ (because $x > 0$ is a continuity point of \mathcal{L}_λ) for any k and Assumption (1), we see that for all $k \in \mathbb{Z}$

$$\begin{aligned} & \mathbf{1}\{k \geq -(l-f(l))\} \bar{F}_k^{(l)}(\lambda x \beta^{-k}) \beta^{\gamma(l-f(l))} (a_k^{(l)} - a_{k+1}^{(l)}) \\ & \rightarrow \bar{F}_\infty(\lambda x \beta^{-k}) \beta^{-\gamma k} (1 - \beta^{-\gamma}) \quad \text{for } l \rightarrow \infty. \end{aligned} \quad (10.10)$$

In order to exchange limit and summation, we need to show that the terms of the sum are dominated by a function which does not depend on l and is summable. Recalling Assumption (2) and using (10.1) we see that $\beta^{\gamma(l-f(l))} a_k^{(l)} \leq C_1 \beta^{-\gamma k}$ and

$$\begin{aligned} & \sum_{k \in \mathbb{Z}} \mathbf{1}\{k \geq -(l-f(l))\} \bar{F}_k^{(l)}(\lambda x \beta^{-k}) \beta^{\gamma(l-f(l))} (a_k^{(l)} - a_{k+1}^{(l)}) \\ & \leq C \sum_{k \in \mathbb{Z}} \bar{F}_{\text{sup}}(\lambda x \beta^{-k}) \beta^{-\gamma k}, \end{aligned}$$

where $\bar{F}_{\text{sup}}(x) = P[Z_{\text{sup}} > x]$. This last sum converges clearly for $k \rightarrow \infty$, and to show that it converges for $k \rightarrow -\infty$ we simply notice that for any $y > 0$

$$\begin{aligned} \sum_{k>0} E[\mathbf{1}\{Z_{\text{sup}} > y\beta^k\}] \beta^{\gamma k} &= E\left[\sum_{0 < k \leq \lfloor \ln(Z_{\text{sup}}/y)/\ln \beta \rfloor} \beta^{\gamma k}\right] \\ &\leq (1 - \beta^{-\gamma})^{-1} E[\beta^{\gamma \ln(Z_{\text{sup}}/y)/\ln \beta}] < \infty, \end{aligned}$$

since we assume that $E[Z_{\text{sup}}^{\gamma+\varepsilon}] < \infty$.

Hence we can exchange limit and sum. Using (10.10) and the fact that $l-f(l) \rightarrow \infty$, we get

$$-\lim_{l \rightarrow \infty} N_l^{(\lambda)} P\left[\frac{Y_1^{(l)}}{K_l^{(\lambda)}} > x\right] = -\lambda^\gamma (1 - \beta^{-\gamma}) \sum_{k \in \mathbb{Z}} \bar{F}_\infty(\lambda x \beta^k) \beta^{\gamma k},$$

and, taking into account (10.3), this proves (10.7).

10.2 Computation of d_λ

Fix $\lambda \in [1, \beta)$. Since the integral $\int_0^\tau x d\mathcal{L}_\lambda$ is well defined, it suffices to show that for all $\tau \in \mathcal{C}_\lambda$, $\tau > 0$

$$d_\lambda = \lim_{l \rightarrow \infty} \frac{N_l^{(\lambda)}}{K_l^{(\lambda)}} E \left[Y_1^{(l)} \mathbf{1}\{Y_1^{(l)} < \tau K_l^{(\lambda)}\} \right] - \int_0^\tau x d\mathcal{L}_\lambda + \int_0^\infty \frac{x}{1+x^2} d\mathcal{L}_\lambda. \quad (10.11)$$

First let us notice that $N_l^{(\lambda)}/K_l^{(\lambda)} \sim (\lambda\beta^l)^{\gamma-1} \beta^{-\gamma f(l)}$. We introduce

$$\text{for all } u > 0, \quad G_k^{(l)}(u) = E \left[Z_1^{(l)} \mathbf{1}\{Z_1^{(l)} \leq u\} | X_1^{(l)} = k + l \right]. \quad (10.12)$$

Considering the first term in (10.11), we compute

$$\begin{aligned} & \beta^{(\gamma-1)l - \gamma f(l)} E \left[Y_1^{(l)} \mathbf{1}\{Y_1^{(l)} < \tau \lambda \beta^l\} \right] \\ &= \sum_{k \in \mathbb{Z}} \mathbf{1}\{k \geq -(l - f(l))\} \left[\left(a_k^{(l)} - a_{k+1}^{(l)} \right) \beta^{\gamma(l-f(l))} \right] \beta^k G_k^{(l)}(\tau \lambda \beta^{-k}). \end{aligned}$$

Using $l - f(l) \rightarrow \infty$, (10.9) and Assumption (1), we see that for all $k \in \mathbb{Z}$ and $\tau \in \mathcal{C}_\lambda$,

$$\begin{aligned} & \mathbf{1}\{k \geq -(l - f(l))\} \left[\left(a_k^{(l)} - a_{k+1}^{(l)} \right) \beta^{\gamma(l-f(l))} \right] \beta^k G_k^{(l)}(\tau \lambda \beta^{-k}) \\ & \rightarrow (1 - \beta^{-\gamma}) \beta^{(1-\gamma)k} G_\infty(\tau \lambda \beta^{-k}), \end{aligned} \quad (10.13)$$

where

$$G_\infty(x) = E[Z_\infty \mathbf{1}\{Z_\infty \leq x\}]. \quad (10.14)$$

Once again we need to show that we can exchange limit and sum, which amounts to find a summable dominating function which does not depend on l . Using the fact that for $u > 0$

$$G_k^{(l)}(u) \leq u \text{ and } \beta^{-(\gamma-1)k} G_k^{(l)}(u\beta^{-k}) \leq \beta^{\varepsilon k} u^{1-\gamma-\varepsilon} E[Z_{\text{sup}}^{\gamma+\varepsilon}],$$

(to see the second inequality, use $E[Y \mathbf{1}\{Y \leq s\}] \leq s^a E[Y^{1-a} \mathbf{1}\{Y \leq s\}]$ with $a = 1 - \gamma - \varepsilon$), we get that

$$\begin{aligned} & \sum_{k \in \mathbb{Z}} \mathbf{1}\{k \geq -(l - f(l))\} \left[\left(a_k^{(l)} - a_{k+1}^{(l)} \right) \beta^{\gamma(l-f(l))} \right] \beta^k G_k^{(l)}(\tau \lambda \beta^{-k}) \\ & \leq C \left(\tau \lambda \sum_{k \geq 0} \beta^{-\gamma k} + (\tau \lambda)^{1-\gamma-\varepsilon} E[Z_{\text{sup}}^{\gamma+\varepsilon}] \sum_{k < 0} \beta^{\varepsilon k} \right) < \infty, \end{aligned}$$

due to Assumption (2). Hence recalling (10.13), we get that for $\tau \in \mathcal{C}_\lambda$

$$\lim_{l \rightarrow \infty} \frac{N_l^{(\lambda)}}{K_l^{(\lambda)}} E \left[Y_1^{(l)} \mathbf{1}\{Y_1^{(l)} < \tau K_l^{(\lambda)}\} \right] = \lambda^{\gamma-1} (1 - \beta^{-\gamma}) \sum_{k \in \mathbb{Z}} \beta^{k(\gamma-1)} G_\infty(\tau \lambda \beta^k). \quad (10.15)$$

Furthermore, recalling (10.3) and (10.4), we get for $\tau \in \mathcal{C}_\lambda$

$$\begin{aligned} \int_0^\tau x d\mathcal{L}_\lambda &= \lambda^\gamma (1 - \beta^{-\gamma}) \int_{x \leq \tau} x \sum_{k \in \mathbb{Z}} \beta^{\gamma k} d(-\bar{F}_\infty)(\lambda x \beta^k) \\ &= \lambda^{\gamma-1} (1 - \beta^{-\gamma}) \sum_{k \in \mathbb{Z}} \beta^{(\gamma-1)k} \int_{\lambda x \beta^k \leq \lambda \tau \beta^k} \lambda x \beta^k d(-\bar{F}_\infty)(\lambda x \beta^k) \\ &= \lambda^{\gamma-1} (1 - \beta^{-\gamma}) \sum_{k \in \mathbb{Z}} \beta^{(\gamma-1)k} G_\infty(\tau \lambda \beta^k), \end{aligned}$$

and this term exactly compensates for (10.15). Hence, we are left to compute in a similar fashion,

$$\begin{aligned} d_\lambda &= \int_0^\infty \frac{x}{1+x^2} d\mathcal{L}_\lambda \\ &= \lambda^\gamma (1 - \beta^{-\gamma}) \int_0^\infty \frac{x}{1+x^2} \sum_{k \in \mathbb{Z}} \beta^{\gamma k} d(-\bar{F}_\infty)(\lambda x \beta^k) \\ &= \lambda^{1+\gamma} (1 - \beta^{-\gamma}) \sum_{k \in \mathbb{Z}} \beta^{(1+\gamma)k} \int_0^\infty \frac{\lambda x \beta^k}{(\lambda \beta^k)^2 + (\lambda x \beta^k)^2} d(-\bar{F}_\infty)(\lambda x \beta^k) \\ &= \lambda^{1+\gamma} (1 - \beta^{-\gamma}) \sum_{k \in \mathbb{Z}} \beta^{(1+\gamma)k} E \left[\frac{Z_\infty}{(\lambda \beta^k)^2 + Z_\infty^2} \right]. \end{aligned}$$

This sum is finite since the terms in the sum can be bounded from above by $C_1(\lambda) \beta^{-\varepsilon k} E[Z_{\text{sup}}^{\gamma+\varepsilon}]$ and $C_2(\lambda) \beta^{\gamma k}$, where $C_1(\lambda) = \max_{x \geq 0} (x^{1-\gamma}/(\lambda^2 + x^2))$ and $C_2(\lambda) = \max_{x \geq 0} x/(\lambda^2 + x^2)$. The first upper bound is summable for $k \rightarrow \infty$, the other for $k \rightarrow -\infty$ and so d_λ is well-defined.

10.3 Computation of the variance

We show that for any $\lambda \in [1, \beta)$ we have

$$\sigma^2 = \lim_{\tau \rightarrow 0} \limsup_{l \rightarrow \infty} \frac{N_l^{(\lambda)}}{(K_l^{(\lambda)})^2} \text{Var} \left(Y_1^{(l)} \mathbf{1}\{Y_1^{(l)} \leq \tau K_l^{(\lambda)}\} \right) = 0. \quad (10.16)$$

First, using (10.15), let us notice that

$$\lim_{l \rightarrow \infty} \frac{N_l^{(\lambda)}}{(K_l^{(\lambda)})^2} E \left[Y_1^{(l)} \mathbf{1}\{Y_1^{(l)} \leq \tau K_l^{(\lambda)}\} \right] = 0. \quad (10.17)$$

Further, we have $N_l^{(\lambda)}/(K_l^{(\lambda)})^2 \sim (\lambda \beta^l)^{\gamma-2} \beta^{-\gamma f(l)}$. Define

$$\text{for all } u \geq 0, \quad H_k^{(l)}(u) = E \left[\left(Z_1^{(l)} \right)^2 \mathbf{1}\{Z_1^{(l)} \leq u\} \mid X_1^{(l)} = k + l \right].$$

CHAPITRE 4. BIASED RANDOM WALKS ON GALTON-WATSON TREES WITH LEAVES

We compute

$$\begin{aligned} & \beta^{(\gamma-2)l-\gamma f(l)} E \left[\left(Y_1^{(l)} \right)^2 \mathbf{1}_{\{Y_1^{(l)} < \tau \lambda \beta^l\}} \right] \\ &= \sum_{k \in \mathbb{Z}} \mathbf{1}_{\{k \geq -(l - f(l))\}} \beta^{(\gamma-2)l-\gamma f(l)} \beta^{2(k+l)} H_k^{(l)}(\tau \lambda \beta^{-k}) \left(a_k^{(l)} - a_{k+1}^{(l)} \right). \end{aligned}$$

By (10.1) we have $a_k^{(l)} \beta^{\gamma(l-f(l))} \leq C_1 \beta^{-\gamma k}$, hence the terms of our sum are bounded above by $C_1 \beta^{(2-\gamma)k} H_k^{(l)}(\tau \lambda \beta^{-k})$. Note that $H_k^{(l)}(u) \leq u^2$, so that

$$\beta^{(2-\gamma)k} H_k^{(l)}(\tau \lambda \beta^{-k}) \leq \beta^{-\gamma k} (\tau \lambda)^2,$$

which gives an upper bound for $k \geq 0$. On the other hand, Assumption (2)

$$\beta^{(2-\gamma)k} H_k^{(l)}(\tau \lambda \beta^{-k}) \leq \beta^{\varepsilon k} (\tau \lambda)^{2-\gamma-\varepsilon} E[Z_{\text{sup}}^{\gamma+\varepsilon}].$$

These inequalities imply that

$$\limsup_{l \rightarrow \infty} \frac{N_l^{(\lambda)}}{(K_l^{(\lambda)})^2} \text{Var}(Y_1^{(l)} \mathbf{1}_{\{Y_1^{(l)} \leq \tau K_l^{(\lambda)}\}}) \leq C_2 \tau^{2-\gamma-\varepsilon},$$

where C_2 is finite and depends on ε and λ . Hence letting τ go to 0 yields the result, since in Assumption (2) we can assume ε to be as small as we need in particular it can be chosen such that $2 - \gamma - \varepsilon > 0$.

11 Limit theorems

11.1 Proof of Theorem 1.3

Assume $\varepsilon < \min(1/4, 2\gamma/3)$. For $\lambda > 0$, we will study the limit distributions of the hitting time properly renormalized along the subsequences defined as follows

$$\text{for } k \in \mathbb{N}, \quad n_\lambda(k) = \lfloor \lambda \mathbf{f}'(q)^{-k} \rfloor.$$

First, recalling (9.3), using Proposition 9.1 and Lemma 3.3, we can apply Theorem 10.1 to get

$$\text{for any } (\lambda_l)_{l \geq 0} \text{ going to } \lambda, \quad \frac{1}{\lambda \beta^k} \sum_{i=1}^{\lfloor \lambda_{n_\lambda(k)}^\gamma \beta^{\gamma(k-f(k))} \rfloor} \chi_i^*(n_\lambda(k)) \xrightarrow{d} Y_{d_\lambda, 0, \mathcal{L}_\lambda}, \quad (11.1)$$

where $f(k) := h_{n_\lambda(k)} = \lceil -(1 - \varepsilon) \ln(n_\lambda(k)) / \ln \mathbf{f}'(q) \rceil$ and $Y_{d_\lambda, 0, \mathcal{L}_\lambda}$ is a random variable whose law $\mathfrak{I}(d_\lambda, 0, \mathcal{L}_\lambda)$ is the infinitely divisible law characterized by (10.3), (10.3) and (10.5), where \mathcal{Z}_∞ is given by (1.3).

Using Proposition 8.1, (11.1) still holds if we replace $\chi_i^*(n)$ by $\chi_i(n)$.
Recalling Proposition 7.1 we have

$$\sum_{i=1}^{\lfloor (1+o_1(1))\lambda\rho C_a \mathbf{f}'(q)^{-(k-h_{n_\lambda(k)})} \rfloor} \chi_i(n_\lambda(k)) \preceq \chi_{n_\lambda(k)} \preceq \sum_{i=1}^{\lfloor (1+o_2(1))\lambda\rho C_a \mathbf{f}'(q)^{-(k-h_{n_\lambda(k)})} \rfloor} \chi_i(n_\lambda(k)),$$

where

$$1 + o_1(1) = (1 - \tilde{n}^{-\varepsilon/4}) \frac{\rho_n}{\rho} \frac{n}{\lambda \mathbf{f}'(q)^{-k}} \frac{\mathbf{f}'(q)^{h_{\tilde{n}}}}{\mathbf{f}'(q)^{h_n}} \text{ and } 1 + o_2(1) = (1 + 2n^{-\varepsilon/4}) \frac{\rho_n}{\rho} \frac{n}{\lambda \mathbf{f}'(q)^{-k}},$$

writing n for $n_\lambda(k) = \lfloor \lambda \mathbf{f}'(q)^{-k} \rfloor$ and $\tilde{n} = n - (-2 \ln n / \ln \mathbf{f}'(q))$.

Hence both sides of the previous equation, properly renormalized, converge in distribution to the same limit law, implying that (the law of) $\chi(n)$ converges to the same law as well. Recalling (5.3), this yields for any $\lambda > 0$

$$\frac{\chi(n_\lambda(k))}{(\rho C_a n_\lambda(k))^{1/\gamma}} \xrightarrow{d} Y_{d_{(\rho C_a \lambda)^{1/\gamma}, 0, \mathcal{L}_{(\rho C_a \lambda)^{1/\gamma}}}},$$

where $Y_{d_{(\rho C_a \lambda)^{1/\gamma}, 0, \mathcal{L}_{(\rho C_a \lambda)^{1/\gamma}}}}$ is a random variable with law $\mathfrak{J}(d_{(\rho C_a \lambda)^{1/\gamma}, 0, \mathcal{L}_{(\rho C_a \lambda)^{1/\gamma}}})$ and we used that $\beta^\gamma = 1/\mathbf{f}'(q)$.

Then by Proposition 5.1, we get that

$$\frac{\Delta_{n_\lambda(k)}}{(\rho C_a n_\lambda(k))^{1/\gamma}} \xrightarrow{d} Y_{d_{(\rho C_a \lambda)^{1/\gamma}, 0, \mathcal{L}_{(\rho C_a \lambda)^{1/\gamma}}}},$$

which proves Theorem 1.3. □

We note for further reference that

$$\mathfrak{J}(d_\lambda, 0, \mathcal{L}_\lambda) \text{ is continuous} \tag{11.2}$$

This follows from Theorem III.2 (p. 43) in [80], since, due to (10.4), $\lim_{x \rightarrow 0} \mathcal{L}_1(x) = -\infty$.

11.2 Proof of Theorem 1.2

In order to prove Theorem 1.2, assume that $(\Delta_n/n^{1/\gamma})_{n \geq 0}$ converges in law. It follows that all subsequential limits are the same, so that

$$\text{for all } \lambda \in [1, \beta) \text{ and } x \in \mathbb{R}^+, \quad \mathcal{L}_1(x) = \lambda^\gamma \mathcal{L}_1(\lambda x).$$

Plugging in the values $\lambda = \beta^{1/3}$ and $x = \beta^{-2/3}$ gives

$$\sum_{k \in \mathbb{Z}} \mathbf{f}'(q)^{-k} P[\mathcal{Z}_\infty > \beta^{k-2/3}] = \mathbf{f}'(q)^{-1/3} \sum_{k \in \mathbb{Z}} \mathbf{f}'(q)^{-k} P[\mathcal{Z}_\infty > \beta^{k-1/3}]. \tag{11.3}$$

CHAPITRE 4. BIASED RANDOM WALKS ON GALTON-WATSON TREES WITH LEAVES

We will show that for $\beta \rightarrow \infty$, the right hand side and the left hand side of (11.3) have different limits. First for $k \geq 1$, using Remark 6.1, we see that

$$\mathbb{P}[\mathcal{Z}_\infty > \beta^{k-1/3}] \leq \beta^{1/3-k} \mathbb{E}[\mathcal{Z}_\infty] \leq \beta^{1/3-k} \mathbb{E}[S_\infty] E[G(p_\infty/3)] = \beta^{-(k-1)} O(\beta^{-1/3}), \quad (11.4)$$

for $\beta \rightarrow \infty$ where $O(\beta^{-1/3}) = \beta^{-2/3} \mathbb{E}[S_\infty] E[G(p_\infty/3)]$ does not depend on k (recall Proposition 3.1 to see that $\mathbb{E}[S_\infty]$ is bounded in β). In the same way,

$$\mathbb{P}[\mathcal{Z}_\infty > \beta^{k-2/3}] = \beta^{-(k-1)} O(\beta^{-1/3}), \quad (11.5)$$

for $O(\cdot)$ independent of $k \geq 1$.

Hence,

$$\lim_{\beta \rightarrow \infty} \sum_{k=1}^{\infty} \mathbf{f}'(q)^{-k} P[\mathcal{Z}_\infty > \beta^{k-2/3}] = 0 = \lim_{\beta \rightarrow \infty} \sum_{k=1}^{\infty} \mathbf{f}'(q)^{-k} P[\mathcal{Z}_\infty > \beta^{k-1/3}]. \quad (11.6)$$

For $k \leq 0$, we have

$$\mathbb{P}[\mathcal{Z}_\infty > \beta^{k-1/3}] \leq \mathbb{P}[\mathcal{Z}_\infty > 0] \leq \mathbb{P}[\text{Bin}(W_\infty, p_\infty) > 0],$$

further, since $S_\infty \geq 1$, we see that

$$\text{on } \{\mathcal{Z}_\infty > 0\}, \quad \mathcal{Z}_\infty \geq S_\infty \mathbf{e}_1 \geq \mathbf{e}_1,$$

where \mathbf{e}_1 is independent of the event $\{\mathcal{Z}_\infty > 0\} = \{\text{Bin}(W_\infty, p_\infty) > 0\}$. Hence

$$\begin{aligned} \mathbb{P}[\mathcal{Z}_\infty > \beta^{k-1/3}] &= 1 - \mathbb{P}[\mathcal{Z}_\infty \leq \beta^{k-1/3}] \\ &\geq 1 - \mathbb{P}[\text{Bin}(W_\infty, p_\infty) = 0] - P[\mathbf{e}_1 \leq \beta^{-1/3}] \\ &= \mathbb{P}[\text{Bin}(W_\infty, p_\infty) > 0] + o(1), \end{aligned}$$

for $\beta \rightarrow \infty$ and hence

$$\mathbb{P}[\mathcal{Z}_\infty > \beta^{k-1/3}] = \mathbb{P}[\text{Bin}(W_\infty, p_\infty) > 0] + o(1), \quad (11.7)$$

where $o(\cdot)$ does not depend on k .

In the same way,

$$\mathbb{P}[\mathcal{Z}_\infty > \beta^{k-2/3}] = \mathbb{P}[\text{Bin}(W_\infty, p_\infty) > 0] + o(1) \quad (11.8)$$

for $\beta \rightarrow \infty$. Plugging (11.7) and (11.8) in equation (11.3) and taking into account (11.6) we see that

$$\lim_{\beta \rightarrow \infty} \sum_{k \in \mathbb{Z}} \mathbf{f}'(q)^{-k} P[\mathcal{Z}_\infty > \beta^{k-2/3}] = \lim_{\beta \rightarrow \infty} \frac{1}{1 - \mathbf{f}'(q)} P[\text{Bin}(W_\infty, p_\infty) > 0]$$

and

$$\lim_{\beta \rightarrow \infty} \sum_{k \in \mathbb{Z}} \mathbf{f}'(q)^{-k} P[\mathcal{Z}_\infty > \beta^{k-1/3}] = \lim_{\beta \rightarrow \infty} \frac{1}{1 - \mathbf{f}'(q)} P[\text{Bin}(W_\infty, p_\infty) > 0].$$

Hence, we would have

$$\lim_{\beta \rightarrow \infty} \frac{1}{1 - \mathbf{f}'(q)} P[\text{Bin}(W_\infty, p_\infty) > 0] = \lim_{\beta \rightarrow \infty} \mathbf{f}'(q)^{-1/3} \frac{1}{1 - \mathbf{f}'(q)} P[\text{Bin}(W_\infty, p_\infty) > 0].$$

This could only be possible if $P[\text{Bin}(W_\infty, p_\infty) > 0] \rightarrow 0$ for $\beta \rightarrow \infty$, but we know that

$$P[\text{Bin}(W_\infty, p_\infty) > 0] > p_\infty \mathbb{P}[W_\infty \geq 1] > c > 0,$$

where c does not depend on β , see Lemma 6.6. This proves Theorem 1.2. \square

In particular, if β is large enough, $\mathfrak{I}(d_1, 0, \mathcal{L}_1)$ is not a stable law and this implies (vii) in Theorem 1.4.

11.3 Proof of Theorem 1.1

We will show that

$$\lim_{M \rightarrow \infty} \limsup_{n \rightarrow \infty} \mathbb{P} \left[\frac{\Delta_n}{n^{1/\gamma}} \notin [1/M, M] \right] = 0. \quad (11.9)$$

This implies in particular that the family $(\Delta_n/n^{1/\gamma})_{n \geq 0}$ is tight. We will then prove

$$\lim_{M \rightarrow \infty} \limsup_{n \rightarrow \infty} \mathbb{P} \left[\frac{|X_n|}{n^\gamma} \notin [1/M, M] \right] = 0, \quad (11.10)$$

which implies that the family $(|X_n|/n^\gamma)_{n \geq 0}$ is tight. (1.2) is then a consequence of (11.9) and (11.10).

To show (11.9), note that for $n \in [\mathbf{f}'(q)^{-k}, \mathbf{f}'(q)^{-(k+1)})$

$$\begin{aligned} & \mathbb{P} \left[\frac{\Delta_n}{n^{1/\gamma}} \notin [1/M, M] \right] \\ & \leq \mathbb{P} \left[\frac{\Delta_{\mathbf{f}'(q)^{-k}}}{(\mathbf{f}'(q)^{-k} \rho C_a)^{1/\gamma}} < \frac{M}{(\mathbf{f}'(q) \rho C_a)^{1/\gamma}} \right] + \mathbb{P} \left[\frac{\Delta_{\mathbf{f}'(q)^{-(k+1)}}}{(\mathbf{f}'(q)^{k+1} \rho C_a)^{1/\gamma}} > \frac{1}{M(\mathbf{f}'(q)^{-1} \rho C_a)^{1/\gamma}} \right]. \end{aligned}$$

Using Theorem 1.3 we get

$$\begin{aligned} & \limsup_n \mathbb{P} \left[\frac{\Delta_n}{n^{1/\gamma}} \notin [1/M, M] \right] \\ & \leq \mathbb{P} \left[Y_{d_{(\rho C_a)^{1/\gamma}, 0, \mathcal{L}_{(\rho C_a)^{1/\gamma}}} \notin \left[\frac{1}{M(\mathbf{f}'(q)^{-1} \rho C_a)^{1/\gamma}}, \frac{M}{(\mathbf{f}'(q) \rho C_a)^{1/\gamma}} \right] \right]. \end{aligned}$$

CHAPITRE 4. BIASED RANDOM WALKS ON GALTON-WATSON TREES WITH LEAVES

where $Y_{d_{(\rho C_a)^{1/\gamma}}, 0, \mathcal{L}_{(\rho C_a)^{1/\gamma}}}$ is a random variable with law $\mathfrak{J}(d_{(\rho C_a)^{1/\gamma}}, 0, \mathcal{L}_{(\rho C_a)^{1/\gamma}})$. Here we used that the limiting law $\mathfrak{J}(d_x, 0, \mathcal{L}_x)$ is continuous, see (11.2), and has in particular no atom at 0, so we get that

$$\lim_{M \rightarrow \infty} P[Y_{d_x, 0, \mathcal{L}_x} \notin [1/M, M]] = 0,$$

which proves (11.9).

Let us prove (11.10). Let $n \geq 0$ and write $n^\gamma = \lambda_0 \mathbf{f}'(q)^{-i_0}$ for some $i_0 \in \mathbb{N}$ and $\lambda_0 \in [1, 1/\mathbf{f}'(q))$. Let $i \in \mathbb{N}$. To control the probability that $|X_n|$ is be much larger than n^γ , note that

$$\begin{aligned} \mathbb{P}\left[\frac{|X_n|}{n^\gamma} \geq \lambda_0^{-1} \mathbf{f}'(q)^{-i}\right] &\leq \mathbb{P}[\Delta_{\lfloor (\lambda_0^{-1} \mathbf{f}'(q)^{-i}) (\lambda_0 \mathbf{f}'(q)^{-i_0}) \rfloor} < (\lambda_0 \mathbf{f}'(q)^{-i_0})^{1/\gamma}] \\ &= \mathbb{P}\left[\frac{\Delta_{\lfloor \mathbf{f}'(q)^{-i-i_0} \rfloor}}{(\rho C_a \mathbf{f}'(q)^{-i-i_0})^{1/\gamma}} < (\lambda_0 \rho C_a \mathbf{f}'(q)^{-i})^{-1/\gamma}\right]. \end{aligned}$$

Hence for any $\varepsilon > 0$, and i large enough such that $(\rho C_a \mathbf{f}'(q)^{-i})^{-1/\gamma} < \varepsilon$,

$$\mathbb{P}\left[\frac{|X_n|}{n^\gamma} \geq \mathbf{f}'(q)^{-i-1}\right] \leq \mathbb{P}\left[\frac{|X_n|}{n^\gamma} \geq \lambda_0^{-1} \mathbf{f}'(q)^{-i}\right] \leq \mathbb{P}\left[\frac{\Delta_{\lfloor \mathbf{f}'(q)^{-i-i_0} \rfloor}}{(\rho C_a \mathbf{f}'(q)^{-i-i_0})^{1/\gamma}} < \varepsilon\right].$$

Now, using Theorem 1.3, taking n (i.e. i_0) to infinity, we get that for any $\varepsilon > 0$,

$$\text{for } i \text{ large enough, } \quad \limsup_n \mathbb{P}\left[\frac{|X_n|}{n^\gamma} \geq \mathbf{f}'(q)^{-i-1}\right] \leq P[Y_{d_1, 0, \mathcal{L}_1} \leq \varepsilon],$$

using (11.2) and hence

$$\limsup_{M \rightarrow \infty} \limsup_{n \rightarrow \infty} \mathbb{P}\left[\frac{|X_n|}{n^\gamma} \geq M\right] \leq \limsup_{\varepsilon \rightarrow 0} P[Y_{d_1, 0, \mathcal{L}_1} \leq \varepsilon] = 0. \quad (11.11)$$

Next, we will consider the probability that $|X_n|$ is much smaller than n^γ . Let us denote

$$\text{Back}(n) = \max_{i < j \leq n} (|X_i| - |X_j|),$$

the maximal backtracking of the random walk. It is easy to see that

$$\text{Back}(n) \leq \max_{2 \leq i \leq n} (\tau_i - \tau_{i-1}) \vee \tau_1.$$

Hence since τ_1 and $\tau_2 - \tau_1$ have exponential moments

$$\mathbb{P}[\text{Back}(n) \geq n^{\gamma/2}] \leq Cn \exp(-cn^{\gamma/2}). \quad (11.12)$$

If the walk is at a level inferior to $(1/M)n^\gamma$ at time n and has not backtracked more than $n^{\gamma/2}$, it has not reached $(2/M)n^\gamma$. This implies that for all $M > 0$,

$$\mathbb{P} \left[\frac{|X_n|}{n^\gamma} < 1/M \right] \leq \mathbb{P}[\text{Back}(n) \geq n^{\gamma/2}] + \mathbb{P} \left[\frac{\Delta_{\lfloor (2/M)n^\gamma \rfloor}}{(\rho C_a 2/M)^{1/\gamma} n} > (\rho C_a 2/M)^{1/\gamma} \right].$$

Hence, using a reasoning similar to the proof of (11.11), we have

$$\lim_{M \rightarrow \infty} \limsup_{n \rightarrow \infty} \mathbb{P} \left[\frac{|X_n|}{n^\gamma} < 1/M \right] \leq \liminf_{M \rightarrow \infty} P[Y_{d_1, 0, \mathcal{L}_1} \geq M] = 0. \quad (11.13)$$

Using (11.11) and (11.13), we get

$$\lim_{M \rightarrow \infty} \limsup_{n \rightarrow \infty} \mathbb{P} \left[\frac{|X_n|}{n^\gamma} \notin [1/M, M] \right] = 0, \quad (11.14)$$

which shows (11.10) in Theorem 1.1.

Let us prove (iii) in Theorem 1.1. We have

$$\mathbb{P} \left[\lim_{n \rightarrow \infty} \frac{\ln |X_n|}{\ln n} \neq \gamma \right] \leq \mathbb{P} \left[\limsup_{n \rightarrow \infty} \frac{\ln |X_n|}{\ln n} > \gamma \right] + \lim_{M \rightarrow \infty} \mathbb{P} \left[\liminf_{n \rightarrow \infty} \frac{|X_n|}{n^\gamma} \leq \frac{1}{M} \right]$$

Using Fatou's Lemma,

$$\mathbb{P} \left[\liminf_{n \rightarrow \infty} \frac{|X_n|}{n^\gamma} < \frac{1}{M} \right] \leq \liminf_{n \rightarrow \infty} \mathbb{P} \left[\frac{|X_n|}{n^\gamma} < 1/M \right],$$

and taking M to infinity we get

$$\mathbb{P} \left[\lim_{n \rightarrow \infty} \frac{\ln |X_n|}{\ln n} \neq \gamma \right] \leq \mathbb{P} \left[\limsup_{n \rightarrow \infty} \frac{\ln |X_n|}{\ln n} > \gamma \right].$$

Set $\varepsilon > 0$, we have

$$\begin{aligned} \mathbb{P} \left[\limsup_{n \rightarrow \infty} \frac{\ln |X_n|}{\ln n} > (1 + 2\varepsilon)\gamma \right] &\leq \mathbb{P} \left[\limsup_{n \rightarrow \infty} \frac{|X_n|}{n^{(1+\varepsilon)\gamma}} \geq 1 \right] \\ &\leq \mathbb{P} \left[\limsup_{n \rightarrow \infty} \frac{\sup_{i \leq n} |X_i|}{n^{(1+\varepsilon)\gamma}} \geq 1 \right]. \end{aligned}$$

Define

$$D'(n) = \left\{ \ell \in \cup_{i=0, \dots, \Delta_n^Y} L_{Y_i} \mid H(\ell) \leq \frac{4 \ln n}{-\ln \mathbf{f}'(q)} \right\}.$$

Denoting $t(n)$ such that $\sigma_{\tau_t(n)} \leq n < \sigma_{\tau_{t(n)+1}}$, we have

$$\text{for } \omega \in D'(n), \quad |X_{\sigma_{\tau_t(n)}}| \leq |X_n| \leq |X_{\sigma_{\tau_{t(n)+1}}}| + \frac{4 \ln n}{-\ln \mathbf{f}'(q)}, \quad (11.15)$$

CHAPITRE 4. BIASED RANDOM WALKS ON GALTON-WATSON TREES WITH LEAVES

and since using $B_1(n)$ defined right above Lemma 7.1, we get

$$\text{for } \omega \in B_1(n), \quad |X_{\sigma_{\tau_t(n)+1}}| \leq |X_{\sigma_{\tau_t(n)}}| + n^\varepsilon. \quad (11.16)$$

We have using Lemma 5.1 and (3.7)

$$\begin{aligned} \mathbb{P}[D'(n)^c] &\leq \mathbb{P}[A_1(n)^c] + \mathbb{P}\left[A_1(n), \text{card} \cup_{i=1}^{\Delta_Y^n} L_{Y_i} > n^2\right] + \mathbb{P}\left[\text{card} \cup_{i=1}^{\Delta_Y^n} L_{Y_i} \leq n^2, D'(n)^c\right] \\ &\leq O(n^{-2}) + \mathbb{P}\left[\sum_{i=0}^{C_1 n} \text{card} L_0^{(i)} > n^2\right] + n^2 \mathbf{Q}\left[H \geq \frac{4 \ln n}{-\ln \mathbf{f}'(q)}\right] \\ &\leq O(n^{-2}) + n^{-4} \text{Var}\left(\sum_{i=0}^{C_1 n} \text{card} L_0^{(i)}\right) + n^2 n^{-4} = O(n^{-2}), \end{aligned}$$

where we used that $\text{card} L_0^{(i)}$ are i.i.d. random variables which are L^2 since they are stochastically dominated by the number of offspring Z which is L^2 by our assumption.

By Lemma 7.1, the previous estimate and Borel-Cantelli we have $\omega \in B_1(n) \cap D(n)$ asymptotically, we get recalling (11.15) and (11.16) that for $\varepsilon < \gamma$

$$\mathbb{P}\left[\limsup_{n \rightarrow \infty} \frac{\sup_{i \leq n} |X_i|}{n^{(1+\varepsilon)\gamma}} \geq 1\right] \leq \mathbb{P}\left[\liminf_{n \rightarrow \infty} \left(\frac{|X_{\sigma_{\tau_t(n)}}|}{n^{(1+\varepsilon)\gamma}} + o(1)\right) \geq 1\right].$$

Since $|X_{\sigma_{\tau_t(n)}}| \leq |X_n|$ we have

$$\begin{aligned} \mathbb{P}\left[\lim_{n \rightarrow \infty} \frac{\sup_{i \leq n} |X_i|}{n^{(1+\varepsilon)\gamma}} \geq 1\right] &\leq \mathbb{P}\left[\liminf_{n \rightarrow \infty} \frac{|X_{\sigma_{\tau_t(n)}}|}{n^{(1+\varepsilon)\gamma}} \geq 1\right] \\ &\leq \liminf_{n \rightarrow \infty} \mathbb{P}\left[\frac{|X_n|}{n^{(1+\varepsilon)\gamma}} \geq 1\right] \\ &\leq \liminf_{M \rightarrow \infty} \liminf_{n \rightarrow \infty} \mathbb{P}\left[\frac{|X_n|}{n^\gamma} \geq M\right] = 0, \end{aligned}$$

where we used Fatou's Lemma and (ii) in Theorem 1.1.

Now since this result is true for all $\varepsilon > 0$ small enough we get

$$\begin{aligned} \mathbb{P}\left[\lim_{n \rightarrow \infty} \frac{\ln |X_n|}{\ln n} \neq \gamma\right] &\leq \mathbb{P}\left[\limsup_{n \rightarrow \infty} \frac{\ln |X_n|}{\ln n} > \gamma\right] \\ &\leq \liminf_{\varepsilon \rightarrow 0} \mathbb{P}\left[\limsup_{n \rightarrow \infty} \frac{\ln |X_n|}{\ln n} > (1 + 2\varepsilon)\gamma\right] = 0, \end{aligned}$$

which finishes the proof of (1.2). □

11.4 Proof of Theorem 1.4

It remains to show (iv), (v), (vi) and (viii) in Theorem 1.4.

Démonstration. We start by proving (viii). Recall

$$\mathcal{Z}_\infty = \frac{S_\infty}{1 - \beta^{-1}} \sum_{i=1}^{\text{Bin}(W_\infty, p_\infty)} \mathbf{e}_i,$$

and in particular the fact that S_∞ , W_∞ and the i.i.d. exponential random variables \mathbf{e}_i are independent. Let $\tilde{S}_\infty = S_\infty/p_\infty$ and denote its law by ν_∞ . Further, let $\alpha_k = \mathbb{P}[\text{Bin}(W_\infty, p_\infty) = k]$, $k = 0, 1, 2, \dots$. Conditioned on \tilde{S}_∞ and $\text{Bin}(W_\infty, p_\infty)$, the law of \mathcal{Z}_∞ is a Gamma distribution. More precisely, for any test function φ ,

$$\begin{aligned} \mathbb{E}[\varphi(\mathcal{Z}_\infty)] &= \alpha_0 \varphi(0) + \sum_{k=1}^{\infty} \int_0^{\infty} \left(\int_0^{\infty} \varphi(su) e^{-u} \frac{u^{k-1}}{(k-1)!} du \right) \nu_\infty(ds) \alpha_k \\ &= \alpha_0 \varphi(0) + \sum_{k=1}^{\infty} \int_0^{\infty} \left(\int_0^{\infty} \varphi(v) e^{-v/s} \frac{v^{k-1}}{(k-1)!} \frac{1}{s^k} dv \right) \nu_\infty(ds) \alpha_k \\ &= \alpha_0 \varphi(0) + \int_0^{\infty} \varphi(v) \sum_{k=1}^{\infty} \alpha_k \frac{v^{k-1}}{(k-1)!} E_{\mathbf{Q}} \left[e^{-v/\tilde{S}_\infty} \left(\tilde{S}_\infty \right)^{-k} \right] dv \end{aligned}$$

We point out that, due to Lemma 6.6, we have $0 < \alpha_0 < 1$. Hence, \mathcal{Z}_∞ has an atom of mass α_0 at 0 and the conditioned law of \mathcal{Z}_∞ , conditioned on $\mathcal{Z}_\infty > 0$, has the density ψ , where

$$\begin{aligned} \psi(v) &= \sum_{k=1}^{\infty} \alpha_k \frac{v^{k-1}}{(k-1)!} E_{\mathbf{Q}} \left[e^{-v/\tilde{S}_\infty} \left(\tilde{S}_\infty \right)^{-k} \right] \\ &= E_{\mathbf{Q}} \left[\frac{1}{\tilde{S}_\infty} e^{-v/\tilde{S}_\infty} \sum_{k=1}^{\infty} \frac{\alpha_k}{(k-1)!} \left(\frac{v}{\tilde{S}_\infty} \right)^{k-1} \right] \end{aligned}$$

Using the fact that $S_\infty \geq 2$ and $\limsup \frac{1}{k} \log \alpha_k < 0$ (see Lemma 6.2), we see that ψ is bounded and C_∞ . Note that since S_∞ and W_∞ have finite expectation, \mathcal{Z}_∞ has also finite expectation and in particular

$$\int_0^{\infty} v \psi(v) dv < \infty. \tag{11.17}$$

CHAPITRE 4. BIASED RANDOM WALKS ON GALTON-WATSON TREES WITH LEAVES

This shows (viii) in Theorem 1.4. We will later need that

$$\int_0^\infty v^{1+\gamma} |\psi'(v)| dv < \infty. \quad (11.18)$$

To show (11.18), note that $\psi'(v)$ equals

$$E_{\mathbf{Q}} \left[\frac{-1}{(\tilde{S}_\infty)^2} e^{-v/\tilde{S}_\infty} \sum_{k=1}^\infty \frac{\alpha_k}{(k-1)!} \left(\frac{v}{\tilde{S}_\infty} \right)^{k-1} + \frac{1}{(\tilde{S}_\infty)^2} e^{-v/\tilde{S}_\infty} \sum_{k=2}^\infty \frac{\alpha_k}{(k-2)!} \left(\frac{v}{\tilde{S}_\infty} \right)^{k-2} \right]$$

which implies, with $\alpha := \limsup \left(\alpha_k^{1/k} \right) < 1$,

$$|\psi'(v)| \leq C_1 E_{\mathbf{Q}} \left[\frac{1}{(\tilde{S}_\infty)^2} e^{-(1-\alpha)v/\tilde{S}_\infty} \right].$$

But, for $\delta \in (0, 1)$,

$$\begin{aligned} & E_{\mathbf{Q}} \left[\frac{1}{(\tilde{S}_\infty)^2} e^{-(1-\alpha)v/\tilde{S}_\infty} \right] \\ & \leq E_{\mathbf{Q}} \left[e^{-(1-\alpha)v/\tilde{S}_\infty} \mathbf{1}_{\{\tilde{S}_\infty < v^{1-\delta}\}} \right] + E_{\mathbf{Q}} \left[\frac{1}{(\tilde{S}_\infty)^2} \mathbf{1}_{\{\tilde{S}_\infty \geq v^{1-\delta}\}} \right] \\ & \leq e^{-(1-\alpha)v^\delta} + \frac{1}{v^{3-3\delta}} E_{\mathbf{Q}} \left[\tilde{S}_\infty \right] \end{aligned}$$

Now, choosing δ small enough such that $3\delta + \gamma < 1$ yields (11.18).

We next show that the function \mathcal{L}_1 is absolutely continuous. Recalling (i) in Theorem 1.4 we see that, for $x > 0$,

$$\begin{aligned} -(1 - \beta^{-\gamma})^{-1} \mathcal{L}_1(x) &= \sum_{k \in \mathbb{Z}} \beta^{\gamma k} \bar{F}_\infty(x\beta^k) \\ &= \sum_{k \in \mathbb{Z}} \beta^{\gamma k} \int_{x\beta^k}^\infty \psi(v) dv \\ &= \int_0^\infty \left(\sum_{k \in \mathbb{Z}} \beta^{\gamma k} \mathbf{1}_{\{v \geq x\beta^k\}} \right) \psi(v) dv. \end{aligned}$$

Now,

$$\sum_{k \in \mathbb{Z}} \beta^{\gamma k} \mathbf{1}_{\{v \geq x\beta^k\}} = \sum_{k \leq K(v/x)} \beta^{\gamma k} =: g\left(\frac{v}{x}\right)$$

where, setting $u = \frac{v}{x}$, $K(u) = \lfloor \frac{\log u}{\log \beta} \rfloor$. An easy computation gives

$$g(u) = \frac{\beta^{\gamma(K(u)+1)}}{\beta^\gamma - 1}. \quad (11.19)$$

Hence, for $x > 0$,

$$-(1 - \beta^{-\gamma})^{-1} \mathcal{L}_1(x) = \int_0^\infty g\left(\frac{v}{x}\right) \psi(v) dv = x \cdot \int_0^\infty g(u) \psi(xu) du. \quad (11.20)$$

The last formula shows, noting that $g(u)$ is of order u^γ for $u \rightarrow \infty$ and recalling (11.17) and (11.18), that \mathcal{L}_1 is C_1 and in particular absolutely continuous. Due to the scaling relation (ii), the same holds true for \mathcal{L}_λ . This shows (iv) in Theorem 1.4.

Due to (11.19), we have

$$\frac{1}{\beta^\gamma - 1} u^\gamma \leq g(u) \leq \frac{\beta^\gamma}{\beta^\gamma - 1} u^\gamma$$

Plugging this into the first equality in (11.20) yields (1.4). This proves (v) in Theorem 1.4. To show (vi), we use a result of [103] which says that an infinite divisible law is absolutely continuous if the absolutely continuous component \mathcal{L}^{ac} of its Lévy spectral function satisfies $\int_{-\infty}^\infty d\mathcal{L}^{\text{ac}}(x) = \infty$, see also [80], p. 37. In our case, this is satisfied since $\mathcal{L}_1^{\text{ac}}(x) = \mathcal{L}_1(x)$ and $\lim_{x \rightarrow 0} \mathcal{L}_1(x) = -\infty$. Further, the statement about the moments of μ_λ follows from the corresponding statement about the moments of \mathcal{L}_λ , see [84] or [80], p. 36. \square

Acknowledgements

A.F. would like to thank his advisor Christophe Sabot for his support and many useful discussions.

We also thank the “Institut Camille Jordan, Université de Lyon 1” the “Institut für Mathematische Statistik, Universität Münster” and “Courant Institute of Mathematical Sciences, New York University” for giving A.F. the possibility to visit Münster and A.F. and N.G. the possibility to visit New York.

**CHAPITRE 4. BIASED RANDOM WALKS ON GALTON-WATSON
TREES WITH LEAVES**

5

The speed of a biased random walk on a percolation cluster at high density

We study the speed of a biased random walk on a percolation cluster on \mathbb{Z}^d in function of the percolation parameter p . We obtain a first order expansion of the speed at $p = 1$ which proves that percolating slows down the random walk at least in the case where the drift is along a component of the lattice.

The material of this chapter has been submitted for publication, see [38].

1 Introduction

Random walks in reversible random environments are an important subfield of random walks in random media. In the last few years a lot of work has been done to understand these models on \mathbb{Z}^d , one of the most challenging being the model of reversible random walks on percolation clusters, which has raised many questions.

In this model, the walker is restrained to a locally inhomogeneous graph, making it difficult to transfer any method used for elliptic random walks in random media. In

CHAPITRE 5. THE SPEED OF A BIASED RANDOM WALK ON A PERCOLATION CLUSTER AT HIGH DENSITY

the beginning results concerned simple random walks, the question of recurrence and transience (see [48]) was first solved and latter on a quenched invariance principles was proved in [13] and [72]. More recently new results (e.g. [71] and [14]) appeared, but still under the assumption that the walker has no global drift.

The case of drifted random walks on percolation cluster features a very interesting phenomenon which was first described in the theoretical physics literature (see [28] and [29]), as the drift increases the model switches from a ballistic to a sub-ballistic regime. From a mathematical point of view, this conjecture was partially addressed in [15] and [99]. This slowdown is due to the fact that the percolation cluster contains arbitrarily large parts of the environment which act as traps for a biased random walk. This phenomenon, and more, is known to happen on inhomogeneous Galton-Watson trees, cf. [68], [9] and [8].

Nevertheless this model is still not well understood and many questions remain open, the most famous being the existence and the value of a critical drift for the expected phase transition. Another question of interest is the dependence of the limiting velocity with respect to the parameters of the problem i.e. the percolation parameter and the bias. This last question is not specific to this model, but understanding in a quantitative, or even qualitative way, the behaviour of speed of random walks in random media seems to be a difficult problem and very few results are currently available on \mathbb{Z}^d (see [90]).

In this article we study the dependence of the limiting velocity with respect to the percolation parameter around $p = 1$. We try to adapt the methods used in [90] which were introduced to study environments subject to small perturbations in a uniformly-elliptic setting. For biased-random walk on a percolation cluster of high density, the walk is subject to rare but arbitrarily big perturbations so that the problem is very different and appears to be more difficult.

The methods rely mainly on a careful study of Kalikow's auxiliary random walk which is known to be linked to the random walks in random environments (see [104] and [100]) and also to the limiting velocity of such walks when it exists (see [90]). Our main task is to show that the unbounded effects of the removal of edges, once averaged over all configurations, is small. This will enable us to consider Kalikow's auxiliary random walk as a small perturbation of the biased random walk on \mathbb{Z}^d . As far as we know it is the first time such methods are used to study a random conductance model or even a non-elliptic random walks in random media.

2 The model

The models presented in [15] and [99] are slightly different, we choose to consider the second one as it is a bit more general, since it allows the drift to be in any direction. Nevertheless all the following can be adapted without any difficulty to the model described in [15].

2. THE MODEL

Let us describe the environment, we consider the set of edges $E(\mathbb{Z}^d)$ of the lattice \mathbb{Z}^d for some $d \geq 2$. We fix $p \in (0, 1)$ and perform a Bernoulli bond-percolation, that is we pick a random configuration $\omega \in \Omega := \{0, 1\}^{E(\mathbb{Z}^d)}$ where each edge has probability p (resp. $1 - p$) of being open (resp. closed) independently of all other edges. Let us introduce the corresponding measure

$$\mathbf{P}_p = (p\delta_1 + (1 - p)\delta_0)^{\otimes E(\mathbb{Z}^d)}.$$

Hence an edge e will be called open (resp. closed) in the configuration ω if $\omega(e) = 1$ (resp. $\omega(e) = 0$). This naturally induces a subgraph of \mathbb{Z}^d which will be denoted ω and it also yields a partition of \mathbb{Z}^d into open clusters.

It is classical in percolation that for $p > p_c(d)$, where $p_c(d) \in (0, 1)$ denotes the critical percolation probability of \mathbb{Z}^d (see [46]), we have a unique infinite open cluster $K_\infty(\omega)$, \mathbf{P}_p -a.s.. Moreover the following event has positive \mathbf{P}_p -probability

$$\mathcal{I} = \{\text{there is a unique infinite cluster } K_\infty(\omega) \text{ and it contains } 0\}.$$

In order to define the random walk, we introduce a bias $\ell = \lambda \vec{\ell}$ of strength $\lambda > 0$ and a direction $\vec{\ell}$ which is in the unit sphere with respect to the Euclidian metric of \mathbb{R}^d . On a configuration $\omega \in \Omega$, we consider the Markov chain of law P_x^ω on \mathbb{Z}^d with transition probabilities $p^\omega(x, y)$ for $x, y \in \mathbb{Z}^d$ defined by

1. $X_0 = x$, P_x^ω -a.s.,
2. $p^\omega(x, x) = 1$, if x has no neighbour in ω ,
3. $p^\omega(x, y) = \frac{c^\omega(x, y)}{\sum_{z \sim x} c^\omega(x, z)}$,

where $x \sim y$ means that x and y are adjacent in \mathbb{Z}^d and also we set

$$\text{for all } x, y \in \mathbb{Z}^d, \quad c^\omega(x, y) = \begin{cases} e^{(y+x) \cdot \ell} & \text{if } x \sim y \text{ and } \omega(\{x, y\}) = 1, \\ 0 & \text{otherwise.} \end{cases}$$

We see that this Markov chain is reversible with invariant measure given by

$$\pi^\omega(x) = \sum_{y \sim x} c^\omega(x, y).$$

Let us call $c^\omega(x, y)$ the conductance between x and y in the configuration ω , this is natural because of the links existing between reversible Markov chains and electrical networks. We will be making extensive use of this relation and we refer the reader to [30] and [70] for a further background. Moreover for an edge $e = [x, y] \in E(\mathbb{Z}^d)$, we denote $c^\omega(e) = c^\omega(x, y)$ and $r^\omega(e) = 1/c^\omega(e)$.

Finally the annealed law of the biased random walk on the infinite percolation cluster will be the semi-direct product $\mathbb{P}_p = \mathbf{P}_p[\cdot \mid \mathcal{I}] \times P_0^\omega[\cdot]$.

CHAPITRE 5. THE SPEED OF A BIASED RANDOM WALK ON A PERCOLATION CLUSTER AT HIGH DENSITY

The starting point of our work is the existence of a constant limiting velocity which was proved in [99] and with some additional work sznitman-perco managed to obtain the following result

Theorem 2.1. *For any $d \geq 2$, $p \in (p_c(d), 1)$ and any $\ell \in \mathbb{R}_*^d$, there exists $v_\ell(p) \in \mathbb{R}^d$ such that*

$$\text{for } \omega - \mathbf{P}_p[\cdot | \mathcal{I}] - \text{a.s.}, \quad \lim_{n \rightarrow \infty} \frac{X_n}{n} = v_\ell(p), \quad P_0^\omega - \text{a.s.}.$$

Moreover there exist $\lambda_1(p, d, \ell), \lambda_2(p, d, \ell) \in \mathbb{R}_+$ such that

1. for $\lambda = \ell \cdot \vec{\ell} < \lambda_1(p, d, \ell)$, we have $v_\ell(p) \cdot \vec{\ell} > 0$,
2. for $\lambda = \ell \cdot \vec{\ell} > \lambda_2(p, d, \ell)$, we have $v_\ell(p) = 0$.

Our main result is a first order expansion of the limiting velocity with respect to the percolation parameter at $p = 1$. As in [90], the result depends on certain Green functions defined for a configuration ω as

$$\text{for any } x, y \in \mathbb{Z}^d, \quad G^\omega(x, y) := E_x^\omega \left[\sum_{n \geq 0} \mathbf{1}\{X_n \in y\} \right].$$

Before stating our main theorem we recall that $v_\ell(1) = \sum_{e \in \nu} p(e)e$, where ω_0 is the environment at $p = 1$, $p(e) = p^{\omega_0}(0, e)$, and ν is the set of unit vectors of \mathbb{Z}^d .

Theorem 2.2. *For $d \geq 2$, $p \in (p_c(d), 1)$ and for any $\ell \in \mathbb{R}_*^d$, we have*

$$v_\ell(1 - \varepsilon) = v_\ell(1) - \varepsilon \sum_{e \in \nu} (v_\ell(1) \cdot e)(G^{\omega_0^\varepsilon}(0, 0) - G^{\omega_0^\varepsilon}(e, 0))(v_\ell(1) - d_e) + o(\varepsilon),$$

where for any $e \in \nu$ we denote

$$\text{for } f \in E(\mathbb{Z}^d), \quad \omega_0^\varepsilon(f) = \mathbf{1}\{f \neq e\} \text{ and } d_e = \sum_{e' \in \nu} p^{\omega_0^\varepsilon}(0, e')e',$$

are respectively the environment where only the edge $[0, e]$ is closed and its corresponding mean drift at 0.

Proposition 2.1. *Let us denote $J^e = G^{\omega_0}(0, 0) - G^{\omega_0}(e, 0)$ for $e \in \nu$. We can rewrite the first term of the expansion in the following way*

$$v'_\ell(1) = \sum_{e \in \nu} (v_\ell(1) \cdot e) \frac{p(e)J^e}{1 - p(e)J^e - p(-e)J^{-e}} (e - v_\ell(1)),$$

so that if for $e \in \nu$ such that $v_\ell(1) \cdot e > 0$ we have $v_\ell(1) \cdot e \geq \|v_\ell(1)\|_2^2$ then

$$v_\ell(1) \cdot v'_\ell(1) > 0,$$

which in words means that the percolating slows down the random walk at least at $p = 1$.

The previous condition is verified for example in the following cases

1. $\vec{\ell} \in \nu$, i.e. when the drift is along a component of the lattice,
2. $\ell = \lambda \vec{\ell}$, where $\lambda < \lambda_c(\vec{\ell})$ for some $\lambda_c(\vec{\ell}) > 0$, i.e. when the drift is weak.

Remark 2.1. *The property of Proposition 2.1 is expected to hold for any drift, but we were unable to carry out the computations. More generally the previous should be true in a great variety of cases, in particular one could hope it holds in the whole supercritical regime. For a somewhat related conjecture, see [18].*

Remark 2.2. *Another natural consequence which is not completely obvious to prove is that the speed is positive for p close enough to 1.*

Remark 2.3. *Finally, this result can give some insight on the dependence of the speed with respect to the bias. Indeed, fix a bias ℓ and some $\mu > 1$, Theorem 2.2 implies that for $\varepsilon_0 = \varepsilon_0(\ell, \mu) > 0$ small enough we have*

$$v_{\mu\ell}(1 - \varepsilon) \cdot \vec{\ell} > v_{\ell}(1 - \varepsilon) \cdot \vec{\ell} \text{ for } \varepsilon < \varepsilon_0.$$

Before turning to the proof of this result, we introduce some further notations. Let us also point out that we will refer to the percolation parameter as $1 - \varepsilon$ instead of p and assume $\varepsilon < 1/2$. In particular we have $1 - \varepsilon > p_c(d)$ for all $d \geq 2$.

We denote by $\{x \leftrightarrow y\}$ the event that x and y are connected in ω . If we want to emphasize the configuration we will use $\{x \overset{\omega}{\leftrightarrow} y\}$. Accordingly, let us denote $K^\omega(x)$ the cluster (or connected component) of x in ω .

Given a set V of vertices of \mathbb{Z}^d we denote by $|V|$ its cardinality, by $E(V) = \{[x, y] \in E(\mathbb{Z}^d) \mid x, y \in V\}$ its edges and

$$\partial V = \{x \in V \mid y \in \mathbb{Z}^d \setminus V, x \sim y\}, \quad \partial_E V = \{[x, y] \in E(\mathbb{Z}^d) \mid x \in V, y \notin V\},$$

and also for B a set of edges of $E(\mathbb{Z}^d)$ we denote

$$\partial B = \{x \mid \exists y, z, [x, y] \in B, [x, z] \notin B\}, \quad \partial_E B = \{[x, y] \mid x \in \partial B, y \notin \partial B \cup V(B)\},$$

where $V(B) = \{x \in \mathbb{Z}^d \mid \exists y \in \mathbb{Z}^d [x, y] \in B\}$.

Given a subgraph G of \mathbb{Z}^d containing all vertices of \mathbb{Z}^d , we denote $d_G(x, y)$ the graph distance in G induced by \mathbb{Z}^d between x and y , moreover if x and y are not connected in G we set $d_G(x, y) = \infty$. In particular $d_\omega(x, y)$ is the distance in the percolation cluster if $\{x \leftrightarrow y\}$. Moreover for $x \in G$ and $k \in \mathbb{N}$, we denote the ball of radius k by

$$B_G(x, k) = \{y \in G, d_G(x, y) \leq k\} \text{ and } B_G^E(x, k) = E(B_G(x, k)),$$

where we will omit the subscript when $G = \mathbb{Z}^d$.

Let us denote by $(e^{(i)})_{i=1 \dots d}$ an orthonormal basis of \mathbb{Z}^d such that $e^{(1)} \cdot \vec{\ell} \geq e^{(2)} \cdot \vec{\ell} \geq \dots \geq e^{(d)} \cdot \vec{\ell} \geq 0$, in particular we have $e^{(1)} \cdot \vec{\ell} \geq 1/\sqrt{d}$.

CHAPITRE 5. THE SPEED OF A BIASED RANDOM WALK ON A PERCOLATION CLUSTER AT HIGH DENSITY

In order to control volume growth let us define ρ_d such that

$$\text{for all } r \geq 1, \quad |B(x, r)| \leq \rho_d r^d \text{ and } |\partial B(x, r)| \leq \rho_d r^{d-1}.$$

We will need to modify the configuration of the percolation cluster at certain vertices. So given $A_1, A_2 \in E(\mathbb{Z}^d)$, $B_1 \in \{0, 1\}^{A_1}$ and $B_2 \in \{0, 1\}^{A_2}$, let us denote $\omega_{A_2, B_2}^{A_1, B_1}$ the configuration such that

1. $\omega_{A_2, B_2}^{A_1, B_1}([x, y]) = \omega([x, y])$, if $[x, y] \notin A_1 \cup A_2$,
2. $\omega_{A_2, B_2}^{A_1, B_1}([x, y]) = \mathbf{1}\{[x, y] \notin B_1\}$, if $[x, y] \in A_1$,
3. $\omega_{A_2, B_2}^{A_1, B_1}([x, y]) = \mathbf{1}\{[x, y] \notin B_2\}$, if $[x, y] \in A_2 \setminus A_1$,

which in words means that we impose that the closed edges of A_1 (resp. A_2) are exactly those of B_1 (resp. B_2), and in case of an intersection between A_1 and A_2 the condition imposed by A_1 is most important. For $k_1, k_2 \geq 1$, $z_1, z_2 \in \mathbb{Z}^d$ and $B_1, B_2 \in \{0, 1\}^{B^E(z_1, k)} \times \{0, 1\}^{B^E(z_2, k)}$, we introduce

$$\omega_{(z_2, k_1), B_2}^{(z_1, k_1), B_1} := \omega_{B^E(z_2, k_2), B_2}^{B^E(z_1, k_1), B_1} \text{ and for } B_1, B_2 \in \{0, 1\}^\nu, \omega_{z_2, B_2}^{z_1, B_1} := \omega_{(z_2, 1), z+B_2}^{(z_1, 1), z+B_1}, \quad (2.1)$$

to describe configurations modified on balls. Moreover

$$\omega^{A, 1} := \omega^{A, \emptyset} \text{ and } \omega^{A, 0} := \omega^{A, A}, \quad (2.2)$$

to denote in particular the special cases where all (resp. no) edges of A are open. We will use of combinations of these notations, for example, $\omega^{(z, k), 1} := \omega_{B^E(z, k), \emptyset}^{B^E(z, k), \emptyset}$.

In connection with that, for a given configuration $\omega \in \Omega$, we call configuration of z and denote

$$\mathcal{C}(z) = \{e \in \nu, \omega([z, z + e]) = 0\},$$

the set of closed edges adjacent to z .

Hence we can denote $e \in \nu$ and $A \in \{0, 1\}^\nu$

$$p^A(e) = p^{\omega^{0, \nu \setminus A}}(0, e), \quad c(e) = c^{\omega^{0, 1}}(e) \text{ and } \pi^A = \pi^{\omega^{0, \nu \setminus A}}(0). \quad (2.3)$$

Furthermore the pseudo elliptic constant $\kappa_0 = \kappa_0(\ell, d) > 0$ will denote

$$\kappa_0 = \min_{A \in \{0, 1\}^\nu, e \notin A} p^A(e), \quad (2.4)$$

which is the minimal non-zero transition probability.

Similarly we fix $\kappa_1 = \kappa_1(\ell, d) > 0$ such that

$$\frac{1}{\kappa_1} \pi^{\omega^{z, A}}(z) \leq e^{2\lambda z \cdot \vec{\ell}} \leq \kappa_1 \pi^{\omega^{z, A}}(z), \quad (2.5)$$

for any $A \in \{0, 1\}^\nu \setminus \nu$ and $z \in \mathbb{Z}^d$.

3. KALIKOW'S AUXILIARY RANDOM WALK

Finally τ_δ will denote a geometric random variable of parameter $1 - \delta$ independent of the random walk and the environment moreover for $A \subset \mathbb{Z}^d$ set

$$T_A = \inf\{n \geq 0, X_n \in A\} \text{ and } T_A^+ = \inf\{n \geq 1, X_n \in A\},$$

and for $z \in \mathbb{Z}^d$ we denote T_z (resp. T_z^+) for $T_{\{z\}}$ (resp. $T_{\{z\}}^+$).

Concerning constants we choose to denote them by C_i for global constants, or γ_i for local constants and will implicitly be supposed to be in $(0, \infty)$. Their dependence with respect to d and ℓ will not always be specified.

Let us present the structure of the paper. In Section 3, we will introduce the central tool for the computation of the expansion of the speed : Kalikow's environment and link it to the asymptotic speed. Then, we will concentrate on getting the continuity of the speed, mathematically the problem is simply reduced to giving upper bounds on quantities depending on Green functions, on a more heuristical level our aim is to understand the slowdown induced by unlikely configurations where "traps" appear. Since getting the upper bound is a rather complicated and technical matter we will first give a quick sketch, as soon as further notations are in place, and try to motivate our approach at the end of the next section.

In Section 4 and Section 5, we will respectively give estimates on the behaviour of the random walk near traps and on the probability of appearance of such traps in the percolation cluster. Then in Section 6 we will put together the previous results to prove the continuity of the speed.

The proof of Theorem 2.2 will be done in Section 7. In order to obtain the first order expansion, the task is essentially similar to obtaining the continuity, but the computations are much more involved and will partly be postponed to Section 8.

Finally Proposition 2.1 is proved in Section 9.

3 Kalikow's auxiliary random walk

We denote for $x, y \in \mathbb{Z}^d$, P a Markov operator and $\delta < 1$, the Green function of the random walk killed at geometric rate $1 - \delta$ by

$$G_\delta^P(x, y) := E_x^P \left[\sum_{k=0}^{\infty} \delta^k \mathbf{1}\{X_k = y\} \right] \text{ and } G_\delta^\omega(x, y) := G_\delta^{P^\omega}(x, y),$$

where P^ω is the Markov operator associated with the random walk in the environment ω .

Then we introduce the so-called Kalikow environment associated with the point 0 and the environment $\mathbf{P}_{1-\varepsilon}[\cdot | \mathcal{I}]$, which is given for $z \in \mathbb{Z}^d$, $\delta < 1$ and $e \in \nu$ by

$$\tilde{p}_\delta^\varepsilon(z, e) = \frac{\mathbf{E}_{1-\varepsilon}[G_\delta^\omega(0, z)p^\omega(z, e)|\mathcal{I}]}{\mathbf{E}_{1-\varepsilon}[G_\delta^\omega(0, z)|\mathcal{I}]}.$$

CHAPITRE 5. THE SPEED OF A BIASED RANDOM WALK ON A PERCOLATION CLUSTER AT HIGH DENSITY

The family $(\widehat{p}_\delta^\varepsilon(z, e))_{z \in \mathbb{Z}^d, e \in \nu}$ defines transition probabilities of a certain Markov chain on \mathbb{Z}^d . It is called Kalikow's auxiliary random walk and its first appearance in a slightly different form goes back to [55].

This walk has proved to be useful because it links the annealed expectation of a Green function of a random walk in random media to the Green function of a Markov chain. This result is summarized in the following proposition.

Proposition 3.1. *For $z \in \mathbb{Z}^d$ and $\delta < 1$, we have*

$$\mathbf{E}_{1-\varepsilon} \left[G_\delta^\omega(0, z) | \mathcal{I} \right] = G_\delta^{\widehat{p}_\delta^\varepsilon}(0, z).$$

The proof of this result can be directly adapted from the proof of Proposition 1 in [90]. We emphasize that in the case $\delta < 1$, the uniform ellipticity condition is not needed.

Using the former property we can link the Kalikow's auxiliary random walk to the speed of our RWRE through the following proposition.

Proposition 3.2. *For any $0 < \varepsilon < 1 - p_c(\mathbb{Z}^d)$, we have*

$$\lim_{\delta \rightarrow 1} \frac{\sum_{z \in \mathbb{Z}^d} G_\delta^{\widehat{\omega}_\delta^\varepsilon}(0, z) \widehat{d}_\delta^\varepsilon(z)}{\sum_{z \in \mathbb{Z}^d} G_\delta^{\widehat{\omega}_\delta^\varepsilon}(0, z)} = \lim_{\delta \rightarrow 1} \frac{\mathbb{E}[X_{\tau_\delta}]}{\mathbb{E}[\tau_\delta]} = v_\ell(1 - \varepsilon),$$

where $\widehat{d}_\delta^\varepsilon(z) = \sum_{e \in \nu} \widehat{p}_\delta^\varepsilon(z, e)e$.

Let C_δ^ε be the convex hull of all $\widehat{d}_\delta^\varepsilon(z)$ for $z \in \mathbb{Z}^d$, then an immediate consequence of the previous proposition is the following

Proposition 3.3. *For $\varepsilon > 0$ we have that $v_\ell(1 - \varepsilon)$ is an accumulation point of C_δ^ε as δ goes to 1.*

The proofs of both propositions are contained in the proof of Proposition 2 in [90] and rely only on the existence of a limiting velocity, which is a consequence of Theorem 2.1.

In order to ease notations we will from time to time drop the dependence with respect to ε of the expectation $\mathbf{E}_{1-\varepsilon}[\cdot]$.

Let us now give a quick sketch of the proof of the continuity of the speed. A way of understanding $\widehat{d}_\delta^\varepsilon(z)$ is to decompose the expression of Kalikow's drift according to the possible configurations at z

$$\widehat{d}_\delta^\varepsilon(z) = \sum_{e \in \nu} \sum_{AC\nu} \frac{\mathbf{E} \left[\mathbf{1}\{\mathcal{I}\} \mathbf{1}\{\mathcal{C}(z) = A\} G_\delta^\omega(0, z) p(z, e) e \right]}{\mathbf{E} \left[\mathbf{1}\{\mathcal{I}\} G_\delta^\omega(0, z) \right]} \quad (3.1)$$

3. KALIKOW'S AUXILIARY RANDOM WALK

$$\begin{aligned}
&= \sum_{A \subset \nu, A \neq \nu} \frac{\mathbf{E}\left[\mathbf{1}\{\mathcal{I}\}\mathbf{1}\{\mathcal{C}(z) = A\}G_\delta^\omega(0, z)\right]}{\mathbf{E}\left[\mathbf{1}\{\mathcal{I}\}G_\delta^\omega(0, z)\right]}d_A \\
&= \sum_{A \subset \nu, A \neq \nu} \mathbf{P}[\mathcal{C}(z) = A] \frac{\mathbf{E}\left[\mathbf{1}\{\mathcal{I}\}G_\delta^\omega(0, z)|\mathcal{C}(z) = A\right]}{\mathbf{E}\left[\mathbf{1}\{\mathcal{I}\}G_\delta^\omega(0, z)\right]}d_A,
\end{aligned}$$

where $d_A = \sum_{e \in A} p^A(e)e$ is the drift under the configuration A .

Since $\mathbf{P}[\mathcal{C}(z) = A] \sim \varepsilon^{|A|}$ for any $A \in \nu$, if we want to find the limit of $\widehat{d}_\delta^\varepsilon(z)$ as ε goes to 0, it is natural to conjecture that the term corresponding to $\{\mathcal{C}(z) = \emptyset\}$ is dominant in (3.1). For this, recalling the notations from (2.1), we may find an upper bound on

$$\frac{\mathbf{E}\left[\mathbf{1}\{\mathcal{I}\}G_\delta^\omega(0, z)|\mathcal{C}(z) = A\right]}{\mathbf{E}\left[\mathbf{1}\{\mathcal{I}\}G_\delta^\omega(0, z)\right]} = \frac{\mathbf{E}\left[\mathbf{1}\{\mathcal{I}(\omega^{z,A})\}G_\delta^{\omega^{z,A}}(0, z)\right]}{\mathbf{E}\left[\mathbf{1}\{\mathcal{I}\}G_\delta^\omega(0, z)\right]}, \quad (3.2)$$

for $z \in \mathbb{Z}^d$, $A \in \{0, 1\}^\nu \setminus \nu$ and $\delta < 1$ which is uniform in z for δ close to 1, to be able to apply Proposition 3.3 and show that $|v_\ell(1 - \varepsilon) - d_\emptyset| = O(\varepsilon)$.

Let us show why the terms in (3.2) are upper bounded. It is easy to see that the denominator is greater than $\gamma_1 \mathbf{E}[\mathbf{1}\{\mathcal{I}(\omega^{z,1})\}G_\delta^{\omega^{z,1}}(0, z)]$, so we essentially need to show that closing some edges adjacent to z cannot increase the quantity appearing in (3.2) by a huge amount. That is : for $A \in \{0, 1\}^\nu$,

$$\mathbf{E}\left[\mathbf{1}\{\mathcal{I}(\omega^{z,A})\}G_\delta^{\omega^{z,A}}(0, z)\right] \leq \gamma_2 \mathbf{E}\left[\mathbf{1}\{\mathcal{I}(\omega^{z,1})\}G_\delta^{\omega^{z,1}}(0, z)\right]. \quad (3.3)$$

In order to show that closing edges cannot have such a tremendous effect, let us first remark that the Green function can be written as $G_\delta^\omega(0, z) = P_0^\omega[T_z < \tau_\delta]G_\delta^\omega(z, z)$. When we close some edges we might create a trap, for example a long ‘‘corridor’’ can be transformed into a ‘‘dead-end’’ and this effect can, in the quenched setting, increase arbitrarily $G_\delta^\omega(z, z)$, the number of returns to z .

The first step is to quantify this effect, we will essentially show in Section 4 that $G_\delta^{\omega^{z,\nu \setminus A}}(z, z) \leq G_\delta^{\omega^{z,1}}(z, z) + L_z(\omega)$ (see Proposition 4.2) where $L_z(\omega)$ is in some sense, to be defined later, a ‘‘local’’ quantity around z (see Proposition 4.1 and Proposition 5.2). With this random variable we try to quantify how far from z the random walk has to go to find a ‘‘regular’’ environment without traps where the effect of the modification around z is ‘‘forgotten’’. In this upper bound, we may get rid of the term $G_\delta^{\omega^{z,1}}(z, z)$ which is, once multiplied by $\mathbf{1}\{\mathcal{I}\}P_0^\omega[T_z < \tau_\delta] \leq \mathbf{1}\{\mathcal{I}(\omega^{z,1})\}P_0^{\omega^{z,1}}[T_z < \tau_\delta]$, of the same type as the terms on the right-hand side of (3.3).

The second step is to understand how the ‘‘local’’ quantity L_z is correlated with the hitting probability. The intuition here is that the hitting probability depends on the

CHAPITRE 5. THE SPEED OF A BIASED RANDOM WALK ON A PERCOLATION CLUSTER AT HIGH DENSITY

environment as a whole but that a very local modification of the environment cannot change tremendously the value of the hitting probability. On a more formal level this corresponds to (see Lemma 6.1) $\mathbf{E}[\mathbf{1}\{\mathcal{I}\}P_0^\omega[T_z < \tau_\delta]L_z(\omega)] \leq \gamma_3\mathbf{E}[\mathbf{1}\{\mathcal{I}\}P_0^\omega[T_z < \tau_\delta]]$ where γ_3 is some moment of L_z , which is a sufficient upper bound.

Before turning to the proof, we emphasize that the aim of Section 4 and Section 5, is mainly to introduce the so-called “local” quantities, which is done at the beginning of Section 4, and prove some properties on these quantities, see Proposition 4.2, Proposition 5.2 and Proposition 4.1. The corresponding proofs are essentially unrelated to the rest of the paper and may be skipped in a first reading, to concentrate on the actual proof of the continuity which is in Section 6.

4 Resistance estimates

In this section we shall introduce some elements of electrical networks theory (see [70]) to estimate the variations on the diagonal of the Green function induced by a local modification of the state of the edges around a vertex x . Our aim is to show that we can get efficient upper bounds using only the local shape of the environment.

Let us denote the effective resistance between $x \in \mathbb{Z}^d$ and a subgraph H' of a certain finite graph H by $R^H(x \leftrightarrow H')$. Denoting $V(H')$ the vertices of H' , it can be defined through Thomson’s principle (see [70])

$$R^H(x \leftrightarrow H') = \inf \left\{ \sum_{e \in H} r(e)\theta^2(e), \theta(\cdot) \text{ is a unit flow from } x \text{ to } V(H') \right\},$$

and this infimum is reached for the current flow from x to $V(H')$. Under the environment ω , we will denote the resistance between x and y by $R^\omega(x \leftrightarrow y)$.

For a fixed $\omega \in \Omega$, we add a cemetery point Δ which is linked to any vertex x of $K_\infty(\omega)$ with a conductance such that at x the probability of going to Δ is $1 - \delta$ and denote the associated weighted graph by $\omega(\delta)$. We denote $\pi^{\omega(\delta)}(x)$ the sum of the conductances of edges adjacent to x in $\omega(\delta)$ and we define $R^{\omega(\delta)}(x \leftrightarrow \Delta)$ to be the limit of $R^{\omega(\delta)}(x \leftrightarrow \omega \setminus \omega_n)$ where ω_n is any increasing exhaustion of subgraphs of ω . In this setting we have,

$$\pi^{\omega(\delta)}(x) = \frac{\pi^\omega(x)}{\delta} \text{ and } r^{\omega(\delta)}([x, \Delta]) = \frac{1}{\pi^{\omega(\delta)}(x)} \frac{1}{1 - \delta} = \frac{1}{\pi^\omega(x)} \frac{\delta}{1 - \delta}. \quad (4.1)$$

We emphasize the fact that changing the state of an edge $[x, y]$ changes the values of $r^{\omega(\delta)}([x, \Delta])$ and $r^{\omega(\delta)}([y, \Delta])$, it can nevertheless be noted that Rayleigh’s monotonicity principle (see [70]) is preserved, i.e. if we increase (resp. decrease) the resistance of one edge the resistance of the graph the effective increases (resp. decreases).

There is no ambiguity to simplify the notations by setting $R^\omega(x \leftrightarrow \Delta) := R^{\omega(\delta)}(x \leftrightarrow \Delta)$ for $x \in \mathbb{Z}^d$ and $r^\omega(e) := r^{\omega(\delta)}(e)$ for e any edge of $\omega(\delta)$. It is classic (and can be found as an exercise in chapter 2 of [70]) that

4. RESISTANCE ESTIMATES

Lemma 4.1. *For any $\delta < 1$, we have*

$$G_\delta^\omega(x, x) = \pi^{\omega(\delta)}(x) R^\omega(x \leftrightarrow \Delta).$$

Hence to understand, in a rough sense, how closing edges might increase the number of returns at z , we can concentrate on understanding the effect of closing edges on the effective resistance. By Rayleigh’s monotonicity principle, given a vertex x , the configuration in $A = B^E(x, r)$ which has the lowest resistance between any point and Δ is the one where all edges are open. Hence, for configurations $B \in \{0, 1\}^A$, we want to get an upper bound $R^{\omega^{A,B}}(x \leftrightarrow \Delta)$ in terms of $R^{\omega^{A,0}}(x \leftrightarrow \Delta)$ and of “local” quantities.

Let us begin with a heuristic description of configurations which are likely to increase strongly the number of returns when we close an edge. There are mainly two situations that can occur (see Figure 5.1)

1. the vertex x is in a long corridor, which is turned into a “dead-end” if we close only an edge, hence increasing the number of returns,
2. if closing an edge adjacent to x creates a new finite cluster K , the number of returns to x can be tremendously increased. Indeed because of the geometrical killing parameter, when the particle gets stuck in K for a long time it may die (i.e. go to Δ), hence by closing the edge linking x to K , we can remove this escape possibility and increase the number of returns to x .

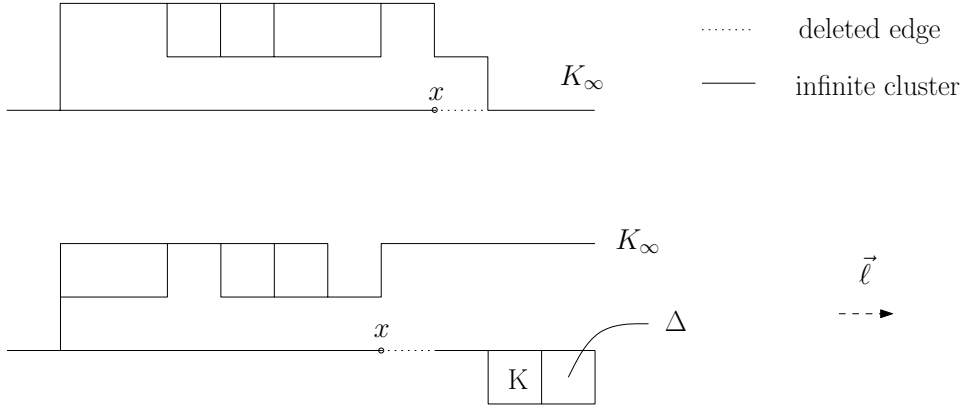

FIG. 5.1 – Configurations where one deleted edge increases $G_\delta(x, x)$

We want to find properties of the environment which will quantify how strongly the number of returns will increase. In order to find a quantity which controls the effect of the first type of configurations we denote, for $A = B^E(x, r)$,

$$M_A(\omega) = \begin{cases} \infty & \text{if } \forall y \in \partial A, y \notin K_\infty(\omega^{A,0}), \\ \max_{y_1, y_2 \in \partial A \cap K_\infty(\omega^{A,0})} d_{\omega^{A,0}}(y_1, y_2) & \text{otherwise,} \end{cases} \quad (4.2)$$

CHAPITRE 5. THE SPEED OF A BIASED RANDOM WALK ON A PERCOLATION CLUSTER AT HIGH DENSITY

which is the maximal distance between vertices of $\partial A \cap K_\infty(\omega^{A,0})$ in the infinite cluster of $\omega^{A,0}$. It is important to notice that the notation $K_\infty(\omega^{A,0})$ makes sense, since it is classical that **P**-a.s. modifying the states of a finite set of edges does not create multiple infinite clusters.

This quantity will help us give upper bounds on the number of returns to x after having closed some adjacent edges. Indeed even if the “best escape way to infinity” is closed, M_A tells us in some sense how much more the particle has to struggle to get back onto this good escape route, even though some additional edges are closed.

In order to control the effect of the second type of bad configurations, we first want to find out if we are likely to go to Δ during an excursion into the part we called K . For this we introduce a way to measure the size of the biggest finite cluster of $\omega^{A,0}$ which intersects ∂A ,

$$T_A(\omega) = \begin{cases} 0 & \text{if } \forall y \in \partial A, y \in K_\infty(\omega^{A,0}), \\ \max_{y \in \partial A, y \notin K_\infty(\omega^{A,0})} |\partial_E K_{\omega^{A,0}}(y)| & \text{otherwise,} \end{cases} \quad (4.3)$$

which gives an indication on the time of an excursion into K , hence on the probability of going to Δ during this excursion.

The idea now is to find an alternate trap close to x , in which the walker is likely to go to Δ before returning to x to replace the role of K . This alternate trap ensures that the number of return to x cannot be too big even in the case where all the accesses to parts such as K adjacent to x are closed. For this let us denote $\eta \geq 1$ depending on d and ℓ such that

$$\text{for all } n \geq 1, \quad e^{2\lambda(\eta-1)n} \geq \kappa_1^2(1 + |B(0, n)|), \quad (4.4)$$

and $H'_A(\omega)$ the hyperplane $\{y, y \cdot \vec{\ell} \geq x \cdot \vec{\ell} + \eta T_A(\omega)\}$. Any point of this hyperplane can be seen as an alternate trap since the particle is very unlikely to return to x when it reaches H'_A . Then a relevant quantity to control the effect of the second type of configurations is the distance between x and this hyperplane, which quantifies the difficulty to reach an alternate strong trap.

In order to define these quantities we need to know the infinite cluster K_∞ , hence they are not “local” quantities. Nevertheless we are able to define random variables which are “local” and fulfill the same functions. For $A = B^E(x, r)$, we denote $L_A^1(\omega)$ the smallest positive integer such that all $y \in \partial A$ which are connected to $\partial B(x, L_A^1(\omega))$ in $\omega^{A,0}$, are connected to each other using only edges of $B^E(x, L_A^1(\omega)) \cap \omega^{A,0}$. We always have $L_A^1(\omega) < \infty$ by uniqueness of the infinite cluster. Consequently there are two types of vertices in ∂A , first those which are not connected to $\partial B(x, L_A^1(\omega))$ in $\omega^{A,0}$ (hence in a finite cluster of $\omega^{A,0}$) and then those which are, the latter being all inter-connected in $B(x, L_A^1(\omega)) \cap \omega^{A,0}$.

Set $H_A(\omega)$ to be the hyperplane $\{y, y \cdot \vec{\ell} \geq x \cdot \vec{\ell} + \eta L_A^1(\omega)\}$ and finally let us define $L_A(\omega)$ the smallest integer such that

4. RESISTANCE ESTIMATES

1. either ∂A is connected to $H_A(\omega)$ using only edges of $B^E(x, L_A(\omega)) \cap \omega^{A,0}$,
 2. or ∂A is not connected to $B^E(x, L_A(\omega))$, which can only happen if $\partial A \cap K_\infty = \emptyset$,
- and in order to make the notations lighter we use

$$L_{z,k} := L_{B^E(z,k)} \text{ and } L_z = L_{z,1}. \quad (4.5)$$

Using this definition for L_A we get an upper bound for the quantities M_A and $d_\omega(x, H'_A)$ on the event that $x \in K_\infty$ which is the only case we will need to consider. Now we can easily obtain, the proof is left to the reader, the following proposition

Proposition 4.1. *For a ball $A = B^E(x, r)$, set $\mathcal{F}_{x,n}$ the σ -field generated by $\{\omega(e), e \in B^E(x, n)\}$, we have the following*

1. $L_A(\omega)$ does not depend on the state of the edges in A ,
2. $L_A(\omega)$ is a stopping time with respect to $(\mathcal{F}_{x,n})_{n \geq 0}$, in particular the event $\{L_A(\omega) = k\}$ does not depend on the state of the edges of $B^E(x, k)^c = E(\mathbb{Z}^d) \setminus B^E(x, k)$,
3. $r \leq L_A(\omega) < \infty$, **P**-a.s..

The second property is one of the two central properties for what we call a “local” quantity. Recalling the notations (2.1) and (2.2), let us prove the following

Proposition 4.2. *Set $A = B^E(x, r)$ with $r \geq 1$, $\delta < 1$ and $\omega \in \Omega$. Suppose that $y \in K_\infty(\omega)$ and $\partial A \cap K_\infty(\omega) \neq \emptyset$. We have*

$$R^\omega(y \leftrightarrow \Delta) \leq R^{\omega^{A,1}}(y \leftrightarrow \Delta) + C_1 L_A(\omega)^{C_2} e^{2\lambda(L_A(\omega) - x \cdot \vec{\ell})},$$

where C_1 and C_2 depend only on d and ℓ .

Here the correcting term is essentially of the same order as the largest between

1. the resistance of paths linking the vertices of $\partial A \cap K_\infty(\omega^{A,0})$ inside $B(x, L_A)$,
2. the resistance of paths linking x to H_A inside $B(x, L_A)$.

Démonstration. Let us introduce

$$A^+ = B(x, r) \cup \bigcup_{a \in \partial A, a \notin K_\infty(\omega^{A,0})} K_{\omega^{A,0}}(a) \text{ and } A^{+,\delta} = \bigcup_{a \in A^+} \{[a, \Delta]\},$$

moreover we set

$$A^- = B(x, r-1) \cup \bigcup_{a \in \partial A, a \notin K_\infty(\omega^{A,0})} K_{\omega^{A,0}}(a) \text{ and } A^{-,\delta} = \bigcup_{a \in A^-} \{[a, \Delta]\}.$$

CHAPITRE 5. THE SPEED OF A BIASED RANDOM WALK ON A PERCOLATION CLUSTER AT HIGH DENSITY

Let ω_n be an exhaustion of ω and n_0 such that $B(x, L_A(\omega)) \cap \omega \subset \omega_{n_0}$ and y is connected to ∂A in ω_{n_0} . Set $n \geq n_0$, we denote $\theta(\cdot)$ any unit flow from y to $\omega(\delta) \setminus \omega_n$ using only edges of $\omega_n(\delta)$. By Thomson's principle, we get

$$\begin{aligned} & R^{\omega(\delta)}(y \leftrightarrow \omega(\delta) \setminus \omega_n) - R^{\omega^{A,1}(\delta)}(y \leftrightarrow \omega^{A,1}(\delta) \setminus \omega_n^{A,1}) \\ & \leq \sum_{e \in \omega(\delta)} (r^\omega(e)\theta(e)^2 - r^{\omega^{A,1}}(e)i_0(e)^2), \end{aligned} \quad (4.6)$$

where $i_0(\cdot)$ denotes the unit current flow from z to $\omega^{A,1}(\delta) \setminus \omega_n^{A,1}$. We want to apply the previous equation with a flow $\theta(\cdot)$ which is close to the current flow $i_0(\cdot)$. Since the latter does not necessarily use only edges of ω we will need to redirect the part flowing through A .

For a vertex $a \in \partial A$, we denote $i_0^A(a) = \sum_{e \in \nu, [a, a+e] \in A} i_0([a, a+e])$ the quantity of current entering A through a . Hence we can partition ∂A into

1. a_1, \dots, a_k the vertices of $\partial A \cap K_\infty(\omega^{A,0})$ such that $i_0^A(a) \geq 0$,
2. a_{k+1}, \dots, a_l the vertices of $\partial A \cap K_\infty(\omega^{A,0})$ such that $i_0^A(a) < 0$,
3. a_{l+1}, \dots, a_m the vertices of $\partial A \setminus K_\infty(\omega^{A,0})$.

Moreover we denote

$$i_0^+(\Delta) = \sum_{e \in A^{+, \delta}} i_0(e) \text{ and } i_0^-(\Delta) = \sum_{e \in A^{-, \delta}} i_0(e).$$

Let us first assume $y \in K_\infty(\omega^{A,0})$, in particular $y \notin B(x, r-1)$. The following facts are classical (see e.g. [70] chapter 2)

1. for any $e \in E(\mathbb{Z}^d)$, we have $|i_0(e)| \leq 1$,
2. the intensity entering $B(x, r-1)$ is equal to the intensity leaving $B(x, r-1)$, i.e.

$$\sum_{i \leq k} i_0^A(a_i) = i_0^-(\Delta) - \sum_{j \in [k+1, l]} i_0^A(a_j).$$

Using the two previous remarks, we see it is possible to find a collection $\nu(i, j)$ with $i \in [1, k]$ and $j \in [k+1, l] \cup \{\Delta\}$ such that

1. for all i, j , we have $\nu(i, j) \in [0, 1]$,
2. for all $j \in [k+1, l]$, it holds that $\sum_{i \leq k} \nu(i, j) = -i_0^A(a_j)$,
3. for all $i \in [1, k]$, we have $\sum_{j \in [k+1, l] \cup \{\Delta\}} \nu(i, j) = i_0^A(a_i)$,
4. it holds that $\sum_{i \leq k} \nu(i, \Delta) = i_0^-(\Delta)$,

which should be seen as a way of matching the flow entering and leaving $B(x, r-1)$.

Let us denote $\vec{P}(i, j)$ one of the directed paths between a_i and a_j in $\omega^{A,0} \cap B^E(x, L_A^1(\omega))$. Let \vec{Q} be one of the directed paths from ∂A to $H_A(\omega)$ in $\omega^{A,0} \cap B^E(x, L_A(\omega))$ and let

4. RESISTANCE ESTIMATES

us denote a_{j_0} (with necessarily $j_0 \leq l$) its starting point and h_1 its endpoint. The existence of those paths is ensured by the definitions of L_A^1 , L_A and H_A and the fact that $\partial A \cap K_\infty \neq \emptyset$.

Finally let us notice that the values of the resistances $r^\omega([a, \Delta])$ and $r^{\omega^{A,1}}([a, \Delta])$ might differ for $a \in \partial A$ so that to get further simplifications in (4.6), it is convenient to redirect the flow using these edges too. We introduce the unique flow (see Figure 5.2) defined by

$$\theta_0(\vec{e}) = \begin{cases} 0 & \text{if } e \in A^{+, \delta}, \\ 0 & \text{if } e \in E(A^+), \\ i_0(\vec{e}) + i_0^+(\Delta) & \text{if } \vec{e} = [h_1, \Delta], \\ i_0(\vec{e}) + \sum_{i \leq k, j \in [k+1, l]} \nu(i, j) \mathbf{1}\{\vec{e} \in \vec{\mathcal{P}}(i, j)\} \\ + \sum_{i \leq k} \nu(i, \Delta) \mathbf{1}\{\vec{e} \in \vec{\mathcal{P}}(i, j_0)\} + i_0^+(\Delta) \mathbf{1}\{\vec{e} \in \vec{\mathcal{Q}}\} \\ + \sum_{i \leq l} i_0([a_i, \Delta]) \mathbf{1}\{\vec{e} \in \vec{\mathcal{P}}(i, j_0)\} & \text{else.} \end{cases}$$

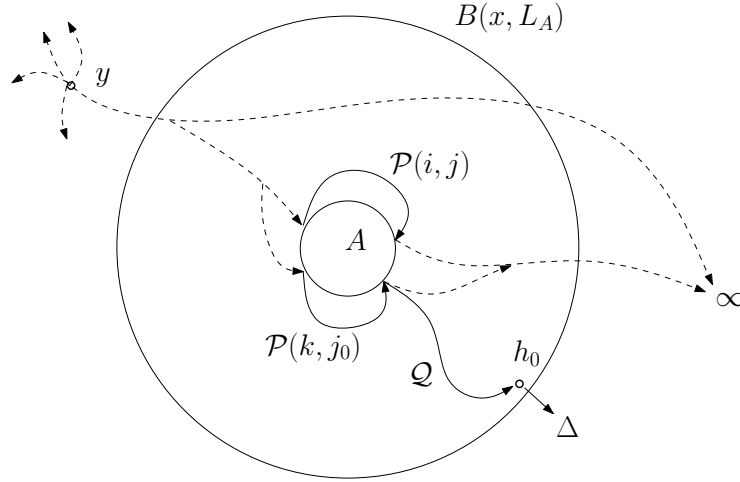

FIG. 5.2 – The flow $\theta_0(\cdot)$ in the case where $y \in K_\infty(\omega^{A,0})$

In words, we could say that we have redirected parts of $i_0(\cdot)$ in order to go around A and the flow going from A to Δ is first sent to a_{j_0} , then to h_1 and finally to Δ . We have the following properties

1. $\theta_0(\cdot)$ is a unit flow from y to $\omega(\delta) \setminus \omega_n$,
2. $|\theta_0(e)| \leq 5 |\partial A|^2$ for all $e \in E(\mathbb{Z}^d)$,
3. $\theta_0(\cdot)$ coincides with $i_0(\cdot)$ except on the edges of $E(A^+)$, $A^{+, \delta}$, \mathcal{Q} , $[h_1, \Delta]$ and $\mathcal{P}(i, j)$ for $i, j \leq k + l$,
4. $r^\omega(\cdot)$ coincides with $r^{\omega^{A,1}}(\cdot)$ except on the edges of $E(A^+)$ and $A^{+, \delta}$.

CHAPITRE 5. THE SPEED OF A BIASED RANDOM WALK ON A PERCOLATION CLUSTER AT HIGH DENSITY

Hence recalling (4.6) we get

$$\begin{aligned}
& R^{\omega(\delta)}(y \leftrightarrow \omega(\delta) \setminus \omega_n) - R^{\omega^{A,1}(\delta)}(y \leftrightarrow \omega^{A,1}(\delta) \setminus \omega_n^{A,1}) \\
\leq & \sum_{e \in \mathcal{P}(i,j) \cup \mathcal{Q}} r^\omega(e)(\theta_0(e)^2 - i_0(e)^2) + r^\omega([h_1, \Delta])(i_0^+(\Delta) + i_0([h_1, \Delta]))^2 \\
& - \sum_{e \in A^{+, \delta}} r^\omega(e)i_0(e)^2 - r^\omega([h_1, \Delta])i_0([h_1, \Delta])^2 \\
\leq & 50\rho_d |\partial A|^6 L_A^d e^{2\lambda(L_A - x \cdot \vec{\ell})} + r^\omega([h_1, \Delta])(i_0^+(\Delta) + i_0([h_1, \Delta]))^2 \\
& - \sum_{e \in A^{+, \delta}} r^\omega(e)i_0(e)^2 - r^\omega([h_1, \Delta])i_0([h_1, \Delta])^2,
\end{aligned} \tag{4.7}$$

where we used that $r^\omega(e) \leq e^{2\lambda(L_A - x \cdot \vec{\ell})}$ for $e \in \mathcal{P}(i, j) \cup \mathcal{Q}$ and that there are at most $(1 + |\partial A|^2)\rho_d L_A^d \leq 2\rho_d |\partial A|^2 L_A^d$ such edges in those paths. These properties being a consequence of the fact that $\mathcal{P}(i, j)$ and \mathcal{Q} are contained in $B^E(x, L_A^1(\omega))$.

Since $|\partial A| \leq \rho_d r^d \leq \rho_d L_A^d$ by the third property of Proposition 4.1, the first term is of the form announced in the proposition, the remaining issue is to control the remaining terms. First, we have by definition

$$\sum_{e \in A^{+, \delta}} r^\omega(e)i_0(e)^2 = \sum_{a \in A^+} r^\omega([a, \Delta])i_0([a, \Delta])^2,$$

and since for $a \in K_\infty(\omega)$, we have using (4.1) and (2.5) that

$$\kappa_1 e^{-2\lambda a \cdot \vec{\ell}} \frac{\delta}{1 - \delta} \geq r^\omega([a, \Delta]) \geq \frac{1}{\kappa_1} e^{-2\lambda a \cdot \vec{\ell}} \frac{\delta}{1 - \delta}.$$

Furthermore, since for any $a \in A^+$ we have $a \cdot \vec{\ell} \leq x \cdot \vec{\ell} + L_A^1$ and since $h_1 \in H_A(\omega)$ we have $h_1 \cdot \vec{\ell} \geq x \cdot \vec{\ell} + \eta L_A^1 \geq a \cdot \vec{\ell} + (\eta - 1)L_A^1$ so that the definition of η at (4.4) yields

$$\frac{1}{\kappa_1} e^{-2\lambda a \cdot \vec{\ell}} \geq \frac{1}{\kappa_1} e^{-2\lambda h_1 \cdot \vec{\ell}} e^{2\lambda(\eta-1)L_A^1(\omega)} \geq \kappa_1 (1 + |B(0, L_A^1)|) e^{-2\lambda h_1 \cdot \vec{\ell}}.$$

Since A^+ is contained in $B(x, L_A^1(\omega))$, the two previous equations yield

$$r^\omega([a, \Delta]) \geq \kappa_1 (1 + |A^+|) e^{-2\lambda h_1 \cdot \vec{\ell}} \frac{\delta}{1 - \delta} \geq (1 + |A^+|) r^\omega([h_1, \Delta]),$$

and hence

$$\begin{aligned}
& \sum_{e \in A^{+, \delta}} r^\omega(e)i_0(e)^2 + r^\omega([h_1, \Delta])i_0([h_1, \Delta])^2 \\
\geq & r^\omega([h_1, \Delta])(1 + |A^+|) \left(i_0([h_1, \Delta])^2 + \sum_{e \in A^+} i_0(e)^2 \right)
\end{aligned}$$

$$\geq r^\omega([h_1, \Delta])(i_0^+(\Delta) + i_0([h_1, \Delta]))^2,$$

where we used Cauchy-Schwarz in the last inequality.

Hence the remaining terms in (4.7) are non-positive and we have shown that

$$R^{\omega(\delta)}(y \leftrightarrow \omega(\delta) \setminus \omega_n) - R^{\omega^{A,1}(\delta)}(y \leftrightarrow \omega^{A,1}(\delta) \setminus \omega_n^{A,1}) \leq 50\rho_d^7 L_A^{7d} e^{2\lambda(L_A - x \cdot \vec{\ell})},$$

and letting n go to infinity yields the result in the case where $y \in K_\infty(\omega^{A,0})$.

Let us come back to the remaining case where $y \in K_\infty(\omega) \setminus K_\infty(\omega^{A,0})$. Keeping the same notations, we see that obviously there exists $j_1 \leq l$ such that $a_{j_1} \in K_\infty(\omega^{A,0})$ which is connected in ω to y using only vertices of A^+ , let us denote $\vec{\mathcal{R}}$ path connecting a_{j_1} and y in $\omega \cap A^+$.

Introducing the unique flow (see Figure 5.3) defined by

$$\theta'_0(\vec{e}) = \begin{cases} 1 & \text{if } \vec{e} \in \vec{\mathcal{R}}, \\ 0 & \text{if } e \in A^{+, \delta} \cup E(A^+) \setminus \mathcal{R}, \\ i_0(\Delta) + i_0([h_1, \Delta]) & \text{if } \vec{e} = [h_1, \Delta] \\ i_0(\vec{e}) + \sum_{j \leq l} i_0^A(j) \mathbf{1}\{\vec{e} \in \vec{\mathcal{P}}(j_1, j)\} \\ + \sum_{i \leq l} i_0([a_i, \Delta]) \mathbf{1}\{\vec{e} \in \vec{\mathcal{P}}(i, j_0)\} \\ + i_0^-(\Delta) \mathbf{1}\{\vec{e} \in \vec{\mathcal{P}}(j_1, j_0)\} + i_0^+(\Delta) \mathbf{1}\{\vec{e} \in \vec{\mathcal{Q}}\} & \text{else,} \end{cases}$$

for which we can get the same properties as for $\theta_0(\cdot)$.

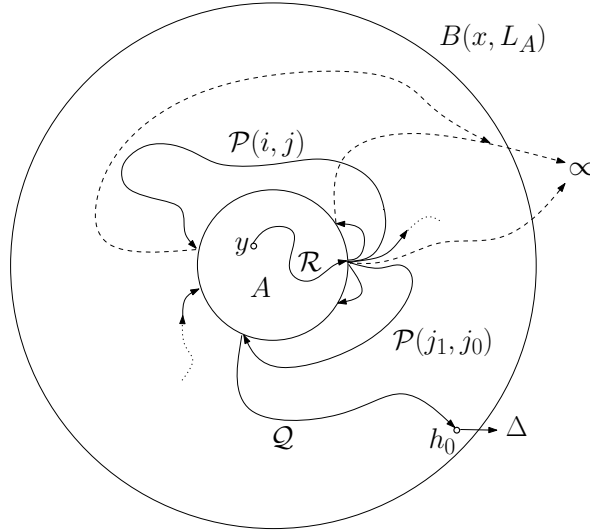

FIG. 5.3 – The flow $\theta'_0(\cdot)$ in the case where $y \in K_\infty(\omega) \setminus K_\infty(\omega^{A,0})$

The computation of the energy of $\theta'_0(\cdot)$ is essentially similar to that of $\theta_0(\cdot)$ and we get

$$R^{\omega(\delta)}(y \leftrightarrow \omega(\delta) \setminus \omega_n) - R^{\omega^{A,1}(\delta)}(y \leftrightarrow \omega^{A,1}(\delta) \setminus \omega_n^{A,1})$$

CHAPITRE 5. THE SPEED OF A BIASED RANDOM WALK ON A PERCOLATION CLUSTER AT HIGH DENSITY

$$\begin{aligned} &\leq CL_A^{7d} e^{2\lambda(L_A - x \cdot \vec{\ell})} + \sum_{e \in \mathcal{R}} r^\omega(e) \\ &\leq CL_A^{7d} e^{2\lambda(L_A - x \cdot \vec{\ell})}, \end{aligned}$$

since $|\mathcal{R}| \leq |A^+| \leq \rho_d L_A^d$ and $r^\omega(e) \leq e^{2\lambda(L_A - x \cdot \vec{\ell})}$ for $e \in \mathcal{R}$. The result follows. \square

We set for $x, y \in \mathbb{Z}^d$ and $Z \subset \mathbb{Z}^d$,

$$G_{\delta, Z}(x, y) = E_x^\omega \left[\sum_{k=0}^{T_Z} \delta^k \mathbf{1}\{X_k = y\} \right], \quad (4.8)$$

and similarly we can define $R^\omega(x \leftrightarrow Z \cup \Delta)$ to be the limit of $R^{\omega(\delta)}(x \leftrightarrow Z \cup \{\omega(\delta) \setminus \omega_n\})$ where ω_n is any increasing exhaustion of subgraphs of ω . We can get

Lemma 4.2. *For any $\delta < 1$, we have for $x, z \in \mathbb{Z}^d$,*

$$G_{\delta, \{z\}}^\omega(x, x) = \pi^{\omega(\delta)}(x) R^\omega(x \leftrightarrow z \cup \Delta).$$

In a way similar to the proof of Proposition 4.2, we get

Proposition 4.3. *Set $A = B^E(x, r)$, $B \in \{0, 1\}^A$, $\delta < 1$, $z \in \mathbb{Z}^d$ and $\omega \in \Omega$. Suppose that $y, z \in K_\infty(\omega)$ and $\partial A \cap K_\infty(\omega) \neq \emptyset$. We have*

$$R^\omega(y \leftrightarrow z \cup \Delta) \leq R^{\omega^{A,1}}(y \leftrightarrow z \cup \Delta) + C_1 L_A(\omega)^{C_2} e^{2\lambda(L_A(\omega) - x \cdot \vec{\ell})},$$

where C_1 and C_2 depend only on d and ℓ .

We assume without loss of generality the constants are the same as Proposition 4.2.

Démonstration. This time let us denote $i_0(\cdot)$ by the unit current flow from y to $z \cup \{\omega(\delta) \setminus \omega_n\}$.

The case where $z \in K_\infty(\omega^{A,0})$ can be treated using the same flows as in the proof of Proposition 4.2 and we will not give further details.

In order to treat the case where $z \notin K_\infty(\omega^{A,0})$ and $y \in K_\infty(\omega^{A,0})$. We keep the notations of the previous proof for the partition $(a_i)_{1 \leq i \leq m}$ of ∂A , $i_0^+(\Delta)$, $i_0^-(\Delta)$, A^+ and $A^{+, \delta}$. We set

$$i_0^z = \sum_{e \in \nu} i_0([z + e, z]).$$

Similarly, we can find a family $\nu(i, j)$ with $i \in [1, k]$ and $j \in [k + 1, l] \cup \{\Delta\} \cup \{z\}$ such that

1. for all i, j , we have $\nu(i, j) \in [0, 1]$,
2. for all $j \in [k + 1, l]$, it holds that $\sum_{i \leq k} \nu(i, j) = -i_0^A(a_j)$,

3. we have $\sum_{i \leq k} \nu(i, \Delta) = i_0^-(\Delta)$,
4. it holds that $\sum_{i \leq k} \nu(i, z) = i_0^z$,
5. for all $i \in [1, k]$ we have $\sum_{j \in [k+1, l] \cup \{\Delta\} \cup \{z\}} \nu(i, j) = i_0^A(a_i)$.

We use again the same notations for $\mathcal{P}(i, j)$, \mathcal{Q} , j_0 and h_1 and add an index $j_2 \leq l$ such that z is connected inside A^+ to a_{j_2} and $\vec{\mathcal{S}}$ the corresponding directed path. We set

$$\theta_0(\vec{e}) = \begin{cases} i_0^z(\vec{e}) & \text{if } \vec{e} \in \vec{\mathcal{S}}, \\ 0 & \text{if } e \in A^{+, \delta} \cup E(A^+) \setminus \mathcal{S}, \\ i_0(\Delta) + i_0([h_1, \Delta]) & \text{if } \vec{e} = [h_1, \Delta] \\ i_0(\vec{e}) + i_0^+(\Delta) \mathbf{1}\{\vec{e} \in \vec{\mathcal{Q}}\} \\ \quad + \sum_{i \leq k, j \in [k+1, l]} \nu(i, j) \mathbf{1}\{\vec{e} \in \vec{\mathcal{P}}(i, j)\} \\ \quad + \sum_{i \leq k} \nu(i, \Delta) \mathbf{1}\{\vec{e} \in \vec{\mathcal{P}}(i, j_0)\} \\ \quad + \sum_{i \leq k} \nu(i, z) \mathbf{1}\{\vec{e} \in \vec{\mathcal{P}}(i, j_2)\} \\ \quad + \sum_{i \leq l} i_0([a_i, \Delta]) \mathbf{1}\{\vec{e} \in \vec{\mathcal{P}}(i, j_0)\} & \text{else,} \end{cases}$$

which is similar to the flow considered in Proposition 4.2 except that the flow naturally supposed to escape at z is, instead of entering A , redirected to a_{j_2} and from there sent to z . Using this flow with Thomson's principle yields similar computations as in Proposition 4.2 and thus we obtain a similar result.

The case where $z \notin K_\infty(\omega^{A,0})$ and $0 \notin K_\infty(\omega^{A,0})$ can be easily adapted from the proof above and the second part of the proof of Proposition 4.2. □

5 Percolation estimate

We want to give tail estimates on L_A^1 and L_A for some ball $A = B(x, r)$. More precisely we want to show for any $C > 0$, we have $\mathbf{E}_{1-\varepsilon}[e^{CL_A}] < \infty$ for ε small enough, the exact statement can be found in Proposition 5.2. Let us recall the definitions of M_A and T_A at (4.2) and (4.3). We see that all vertices of ∂A are either in finite clusters of $\omega^{A,0}$, which are included in $B(x, r + T_A)$, or inter-connected in $B(x, r + M_A)$. Hence we get by the remarks above (4.5) that

$$L_A^1 \leq r + \max(M_A, T_A). \tag{5.1}$$

Recalling the definitions of L_A and H_A below (4.4), our overall strategy for proving the existence of arbitrarily large exponential moments is the following : if L_A is large then there are two cases.

CHAPITRE 5. THE SPEED OF A BIASED RANDOM WALK ON A PERCOLATION CLUSTER AT HIGH DENSITY

1. The random variable L_A^1 is large. This means by (5.1) that either M_A or T_A is large. The random variable T_A cannot be large with high probability, since the distance in the percolation cluster cannot be much larger than the distance in \mathbb{Z}^d (see Lemma 5.2) and neither can M_A since finite cluster are small in the supercritical regime (see Lemma 5.3).
2. Otherwise the distance from x to H_A in large in the percolation cluster is large even though it is not large in \mathbb{Z}^d . Once again this is unlikely, in fact for technical reasons it appears to be easier to show that the distance to $H_A \cap \mathbb{T}_x$ is small, where \mathbb{T}_x is some two-dimensional cone. For this we will need Lemma 5.5.

The following is fairly classical result about first passage percolation with a minor twist due to the conditioning on the edges in A , we will outline the main idea of the proof while skipping a topological argument. To get a fully detailed proof of the topological argument, we refer the reader to the proof of Theorem 1.4 in [42].

Lemma 5.1. *Set $A = B^E(x, r)$ and $y, z \in \mathbb{Z}^d \setminus B(x, r-1)$, there exists a non-increasing function $\alpha_1 : [0, 1] \rightarrow [0, 1]$ such that for $\varepsilon < \varepsilon_1$*

$$\mathbf{P}_{1-\varepsilon} \left[y \stackrel{\omega^{A,0}}{\leftrightarrow} z, d_{\omega^{A,0}}(y, z) \geq n + 2d_{\mathbb{Z}^d \setminus B(x, r-1)}(y, z) \right] \leq 2\alpha_1(\varepsilon)^{n+d_{\mathbb{Z}^d \setminus B(x, r-1)}(y, z)},$$

and

$$\mathbf{P}_{1-\varepsilon} \left[y \stackrel{\omega^{A,0}}{\leftrightarrow} z, d_{\omega^{A,0}}(y, z) \geq n + 2d_{\mathbb{Z}^d}(y, z) + 4dr \right] \leq 2\alpha_1(\varepsilon)^{n+d_{\mathbb{Z}^d}(y, z)},$$

where ε_1 and $\alpha_1(\cdot)$ depend only on d and $\lim_{\varepsilon \rightarrow 0} \alpha_1(\varepsilon) = 0$.

The main tool needed to prove Lemma 5.1 is a result of stochastic domination from [63]. We recall that a family $\{Y_u, u \in \mathbb{Z}^d\}$ of random variables is said to be k -dependent if for every $a \in \mathbb{Z}^d$, Y_a is independent of $\{Y_u : \|u - a\|_1 \geq k\}$.

Proposition 5.1. *Let d, k be positive integers. There exists a non-decreasing function $\alpha' : [0, 1] \rightarrow [0, 1]$ satisfying $\lim_{\tau \rightarrow 1} \alpha'(\tau) = 1$, such that the following holds : if $Y = \{Y_u, u \in \mathbb{Z}^d\}$ is a k -dependent family of random variables satisfying*

$$\text{for all } u \in \mathbb{Z}^d, \quad P(Y_u = 1) \geq \tau,$$

then $P_Y \succ (\alpha'(\tau)\delta_1 + (1 - \alpha'(\tau))\delta_0)^{\otimes \mathbb{Z}^d}$, where “ \succ ” means stochastically dominated.

Two vertices u, v are $*$ -neighbours if $\|u - v\|_\infty = 1$, this topology naturally induces a notion of $*$ -connected component on vertices.

Let us say that a vertex $u \in \mathbb{Z}^d$ is ω^A -wired if all edges $[s, t] \in E(\mathbb{Z}^d)$ with $\|u - s\|_\infty \leq 1$ and $\|u - t\|_\infty \leq 1$ are open in $\omega^{A,1}$ (recall that $A = B^E(x, r)$), otherwise it is called ω^A -unwired.

We say that a vertex $u \in \mathbb{Z}^d \setminus B(x, r-1)$ is ω^A -strongly-wired, if all $y \in \mathbb{Z}^d \setminus B(x, r-1)$ such that $\|u - y\|_\infty \leq 2$ are ω^A -wired, otherwise u is called ω^A -weakly-wired. It is plain

5. PERCOLATION ESTIMATE

that $\mathbf{1}\{u \text{ is } \omega^A\text{-strongly-wired}\}$ defines a γ_1 -dependent site percolation where γ_1 depends only on d . We can thus use Proposition 5.1 with this family of random variables since we have

$$\text{for all } u \in \mathbb{Z}^d, \quad \mathbf{P}_{1-\varepsilon}[\mathbf{1}\{u \text{ is } \omega^A\text{-strongly-wired}\} = 1] \geq (1 - \varepsilon)^{\gamma_1},$$

and that $\lim_{\varepsilon \rightarrow 0} (1 - \varepsilon)^{\gamma_1} = 1$. This yields a function $\alpha'(\cdot)$ which solely depends on d .

Démonstration. Let γ be one of the shortest paths in $\mathbb{Z}^d \setminus B(x, r - 1)$ connecting y to z . For $u \in \mathbb{Z}^d \setminus B(x, r - 1)$, we define $V(u)(\omega^A)$ to be the $*$ -connected component of the ω^A -unwired vertices of u and

$$V(\omega^A) = \bigcup_{u \in \gamma} V(u)(\omega^A).$$

Since y and z are connected in $\omega^{A,0}$, a topological argument (see Section 3 of [42] for details) proves there is an $\omega^{A,0}$ -open path \mathcal{P} from y to z using only vertices in $\gamma \cup (V(\omega^{A,0}) + \{-2, -1, 0, 1, 2\}^d)$. On the event $d_{\omega^{A,0}}(y, z) \geq n + 2d_{\mathbb{Z}^d \setminus B(x, r-1)}(y, z)$, this path \mathcal{P} has $m \geq n + 2d_{\mathbb{Z}^d \setminus B(x, r-1)}(y, z) + 1$ vertices and all vertices which are not in γ are ω^A -weakly-wired thus there are at least $m - d_{\mathbb{Z}^d \setminus B(x, r-1)}(y, z) - 1$ of them .

Since there are at most $(2d)^k$ paths of length k in $\mathbb{Z}^d \setminus B(x, r - 1)$ we get, through a straightforward counting argument, that

$$\begin{aligned} & \mathbf{P}_{1-\varepsilon} \left[y \stackrel{\omega^{A,0}}{\leftrightarrow} z, d_{\omega^{A,0}}(y, z) \geq n + d_{\mathbb{Z}^d \setminus B(x, r-1)}(y, z) \right] \\ & \leq \sum_{m \geq n + 2d_{\mathbb{Z}^d \setminus B(x, r-1)}(y, z) + 1} (2d)^m (1 - \alpha'((1 - \varepsilon)^{\gamma_1}))^{m - d_{\mathbb{Z}^d \setminus B(x, r-1)}(y, z) - 1} \\ & \leq \sum_{m \geq n + 2d_{\mathbb{Z}^d \setminus B(x, r-1)}(y, z) + 1} ((2d)^3 (1 - \alpha'((1 - \varepsilon)^{\gamma_1})))^{m - d_{\mathbb{Z}^d \setminus B(x, r-1)}(y, z) - 1}, \end{aligned}$$

where $\alpha'(\cdot)$ is given by Proposition 5.1 and verifies $\lim_{\varepsilon \rightarrow 0} 1 - \alpha'((1 - \varepsilon)^{\gamma_1}) = 0$. Thus, the first part of the proposition is verified with $\alpha_1(\varepsilon) := 1 - \alpha'((1 - \varepsilon)^{\gamma_1})$ and ε_1 small enough so that $1 - \alpha'((1 - \varepsilon_1)^{\gamma_1}) \leq (2d)^{-3}/2$.

The second part is a consequence of

$$d(y, z) \leq d_{\mathbb{Z}^d \setminus B(x, r-1)}(y, z) \leq d(y, z) + 2dr.$$

□

An easy consequence is the following tail estimate on M_A (defined at (4.2)).

CHAPITRE 5. THE SPEED OF A BIASED RANDOM WALK ON A PERCOLATION CLUSTER AT HIGH DENSITY

Lemma 5.2. *Set $A = B^E(x, r)$, there exists a non-increasing function $\alpha_1 : [0, 1] \rightarrow [0, 1]$ such that for $\varepsilon < \varepsilon_1$*

$$\mathbf{P}_{1-\varepsilon}[M_A \geq n + 4dr] \leq C_3 r^{2d} \alpha_1(\varepsilon)^n,$$

where C_3 , ε_1 and $\alpha_1(\cdot)$ depend only on d and $\lim_{\varepsilon \rightarrow 0} \alpha_1(\varepsilon) = 0$. The function $\alpha_1(\cdot)$ is the same as in Lemma 5.1.

Démonstration. Since $|\partial A| \leq \rho_d r^d$, we have

$$\begin{aligned} & \mathbf{P}_{1-\varepsilon}[M_A \geq n + 4dr] \\ & \leq (\rho_d r^d)^2 \max_{a, b \in \partial A} \mathbf{P}_{1-\varepsilon} \left[a \stackrel{\omega^{A,0}}{\leftrightarrow} b, d_{\omega^{A,0}}(a, b) \geq n + 4dr \right] \leq \gamma_1 r^{2d} \alpha_1(\varepsilon)^n, \end{aligned}$$

where we used Lemma 5.1 since $d_{\mathbb{Z}^d \setminus B(x, r-1)}(a, b) \leq 4dr$ for $a, b \in \partial A$. \square

A set of n edges F disconnecting x from infinity in \mathbb{Z} , that is any infinite simple path starting from x uses an edge of F , is called a Peierls' contour of size n . Asymptotics on the number μ_n of Peierls' contours of size n have been intensively studied, see for example [62], we will use the following bound proved in [89] and cited in [62],

$$\mu_n \leq 3^n.$$

This enables us to prove the following tail estimate on T_A (defined at (4.3)).

Lemma 5.3. *Set $A = B^E(x, r)$, there exists a non-increasing function $\alpha_2 : [0, 1] \rightarrow [0, 1]$ such that for $\varepsilon < \varepsilon_2$*

$$\mathbf{P}_{1-\varepsilon}[T_A \geq n] \leq C_4 r^d \alpha_2(\varepsilon)^n,$$

where C_4 , ε_2 and $\alpha_2(\cdot)$ depend only on d and $\lim_{\varepsilon \rightarrow 0} \alpha_2(\varepsilon) = 0$.

Démonstration. First we notice that for $n \geq 1$,

$$\mathbf{P}_{1-\varepsilon}[T_A \geq n] \leq \rho_d r^d \max_{a \in \partial A} \mathbf{P}_{1-\varepsilon} \left[a \notin K_\infty(\omega^{A,0}), \left| \partial_E K^{\omega^{A,0}}(a) \right| \geq n \right].$$

For any $a \in \partial A$ such that $a \notin K_\infty(\omega^{A,0})$, we have that $\partial_E K^{\omega^{A,0}}(a)$ is a finite Peierls' contour of size $\left| \partial_E K^{\omega^{A,0}}(a) \right|$ surrounding a which has to be closed in $\omega^{A,0}$.

Because A is a ball at least half of the edges of $\partial_E K^{\omega^{A,0}}(a)$ have to be closed in ω as well. Indeed, take $[x, y] \in A \cap \partial_E K^{\omega^{A,0}}(a)$ and denote x its endpoint in $K^{\omega^{A,0}}(a)$, then by definition of a Peierls' contour there is $i \geq 0$ such that $[x + i(x - y), x + (i + 1)(x - y)]$ is in $\partial_E K^{\omega^{A,0}}(a)$, let $i_0(x, y)$ be the smallest one. If $[x + i_0(x, y)(x - y), x + (i_0(x, y) + 1)(x - y)]$ were in A , since A is a ball all edges between x and $x + i_0(x, y)(x - y)$ would too. This would imply that all edges adjacent to y are in A which would contradict the fact that y is connected to $a \in \partial A$ in $\omega^{A,0}$. See Figure 5.4 for a two dimensionnal drawing.

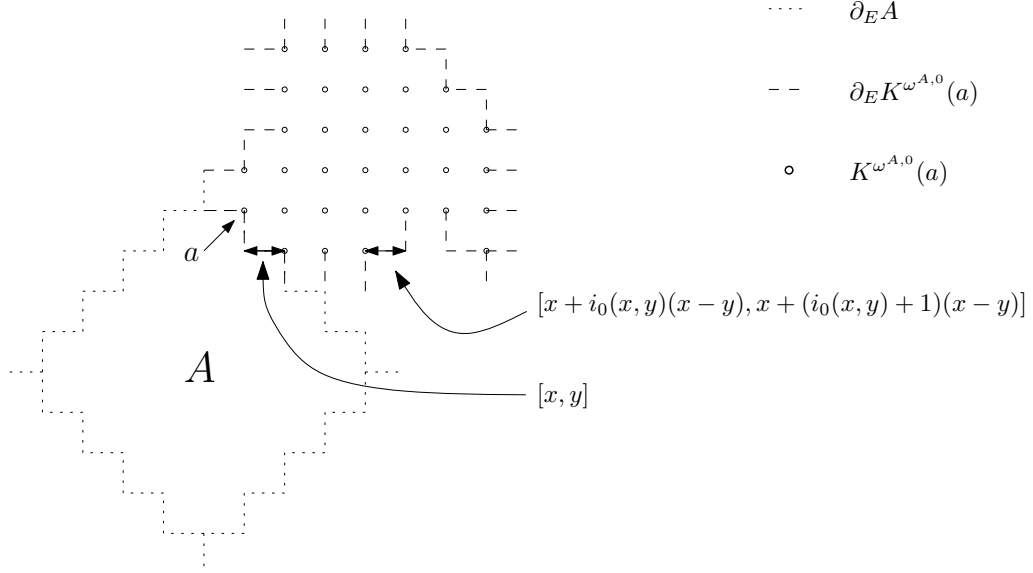
 FIG. 5.4 – Half of the edges of $\partial_E K^{\omega^{A,0}}(a)$ have to be closed in ω

Hence

$$\psi : \begin{cases} A \cap \partial_E K^{\omega^{A,0}}(a) & \rightarrow \partial_E K^{\omega^{A,0}}(a) \setminus A \\ [x, y] & \mapsto [x + i_0(x, y)(x - y), x + (i_0(x, y) + 1)(x - y)], \end{cases}$$

is an injection so that at least half of the edges of $\partial_E K^{\omega^{A,0}}(a)$ are indeed closed in ω . There are at most $\binom{m}{\lceil m/2 \rceil} \leq \gamma_1 2^m$ ways of choosing those edges, thus we get for any $a \in \partial A$

$$\begin{aligned} \mathbf{P}_{1-\varepsilon} \left[a \notin K_\infty(\omega^{A,0}), \left| \partial_E K^{\omega^{A,0}}(a) \right| \geq n \right] &\leq \sum_{m \geq n} \binom{m}{\lceil m/2 \rceil} \mu(n) \varepsilon^{m/2} \\ &\leq \gamma_1 \sum_{m \geq n} 6^m \varepsilon^{m/2} \leq \gamma_2 \varepsilon^{n/2}, \end{aligned}$$

for ε such that $\varepsilon^{1/2} < 1/12$. □

A direct consequence of (5.1), Lemma 5.2 and Lemma 5.3 is the following tail estimate on L_A^1 , defined below (4.4)

Lemma 5.4. *Set $A = B^E(x, r)$, there exists a non-increasing function $\alpha_3 : [0, 1] \rightarrow [0, 1]$ such that for $\varepsilon < \varepsilon_3$*

$$\mathbf{P}_{1-\varepsilon} [L_A^1 \geq n + C_5 r] \leq C_6 r^{2d} \alpha_3(\varepsilon)^n,$$

where C_5, C_6, ε_3 and $\alpha_3(\cdot)$ depend only on d and $\lim_{\varepsilon \rightarrow 0} \alpha_3(\varepsilon) = 0$.

CHAPITRE 5. THE SPEED OF A BIASED RANDOM WALK ON A PERCOLATION CLUSTER AT HIGH DENSITY

Recalling the definition of H_A above (4.5), let us introduce

$$L'_A(\omega) = \begin{cases} \infty & \text{if } \forall y \in \partial A, y \notin K_\infty(\omega^{A,0}) \\ d_{\omega^{A,0}}(\partial A, H_A(\omega)) & \text{otherwise,} \end{cases} \quad (5.2)$$

it is plain that $L_A \leq L'_A$.

We need one more estimate before turning to the tail of L'_A (and thus L_A). Define the cone $\mathbb{T} = \{ae^{(1)} + be^{(2)}, 0 \leq b \leq a/2 \text{ for } a, b \in \mathbb{N}\}$. It is a standard percolation result that $p_c(\mathbb{T}) < 1$ (see Section 11.5 of [46]) and well-known that the infinite cluster is unique. We denote $K_\infty^\mathbb{T}(\omega)$ the unique infinite cluster of \mathbb{T} induced by the percolation ω , provided $\varepsilon < 1 - p_c(\mathbb{T})$.

Lemma 5.5. *There exists a non-increasing function $\alpha_4 : [0, 1] \rightarrow [0, 1]$ so that for $\varepsilon < \varepsilon_4$*

$$\mathbf{P}_{1-\varepsilon} \left[d_{\mathbb{T}}(0, K_\infty^\mathbb{T}(\omega)) \geq 1 + n \right] \leq C_7 \alpha_4(\varepsilon)^n,$$

where $C_7, \alpha_4(\cdot)$ depend only on d and $\lim_{\varepsilon \rightarrow 0} \alpha_4(\varepsilon) = 0$.

Démonstration. Choose $\varepsilon < 1 - p_c(\mathbb{T})$, so that $K_\infty^\mathbb{T}(\omega)$ is well defined almost surely. We emphasize that the following reasoning is in essence two dimensional, so we are allowed to use duality arguments (see [46], Section 11.2). We recall that an edge of the dual lattice (i.e. of $\mathbb{Z}^2 + (1/2, 1/2)$) is called closed when it crosses a closed edge of the original lattice.

If $d_{\mathbb{T}}(0, K_\infty^\mathbb{T}(\omega)) = n + 1$, then let x be a point for which this distance is reached, x is one among at most $n + 2$ possible points. Consider an edge $e = [x, y]$ where $d_{\mathbb{T}}(0, y) = n$, let e' denote the corresponding edge in the dual lattice. From each endpoint of this edge there is a closed path in the dual lattice which has to cross out of \mathbb{T} , so that the sum of the lengths of these two paths is at least $n - 1$. Thus there has to be a closed path \mathcal{P} in the dual lattice of length $m \geq \lfloor (n + 1)/2 \rfloor$ (including e' in the largest of the previous two paths) starting from one of the endpoints of e' and crossing out of \mathbb{T} (see Figure 5.5).

Thus since there are at most 4^m paths of length m , we get for ε small enough

$$\mathbf{P}_{1-\varepsilon} \left[d_{\mathbb{T}}(0, K_\infty^\mathbb{T}(\omega)) = 1 + n \right] \leq 2(n + 2) \sum_{m \geq \frac{n}{2}} 4^m \varepsilon^m \leq 4(n + 2)(4\varepsilon)^{n/2},$$

and the result follows from $n + 2 \leq 2^{n+1}$ since

$$\mathbf{P}_{1-\varepsilon} \left[d_{\mathbb{T}}(0, K_\infty^\mathbb{T}(\omega)) \geq 1 + n \right] \leq \sum_{m \geq n} 4(n + 2)(4\varepsilon)^{n/2} \leq \gamma_1 (4\varepsilon^{1/2})^n.$$

□

Now we turn to the study of the asymptotics of L_A .

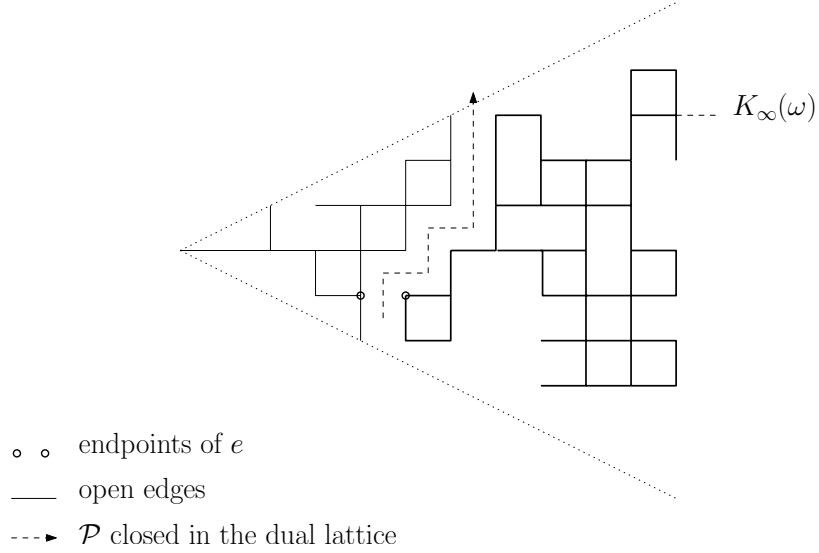

FIG. 5.5 – The closed path in the dual lattice

Proposition 5.2. *Set $A = B^E(x, r)$, there exists a non-increasing function $\alpha : [0, 1] \rightarrow [0, 1]$ so that for $\varepsilon < \varepsilon_0$*

$$\mathbf{P}_{1-\varepsilon}[L_A \geq n + C_8 r] \leq C_9 r^{2d} n \alpha(\varepsilon)^n,$$

where C_8, C_9, ε_0 and $\alpha(\cdot)$ depend only on d and ℓ and $\lim_{\varepsilon \rightarrow 0} \alpha(\varepsilon) = 0$.

Démonstration. Let us notice that two cases emerge. First let us consider that we are on the event $\{\partial A \cap K_\infty = \emptyset\}$ in which case we have

$$L_A(\omega) = \min\{n \geq 0, \partial A \text{ is not connected to } \partial B(x, n)\} \leq r + T_A(\omega) \leq L_A^1,$$

hence because of Lemma 5.4 we have for $C_8 > C_5$

$$\mathbf{P}[\partial A \cap K_\infty = \emptyset, L_A \geq n + C_8 r] \leq C_6 r^{2d} \alpha_3(\varepsilon)^n. \quad (5.3)$$

We are now interested in the case where $\partial A \cap K_\infty \neq \emptyset$. It is sufficient to give an upper bound for L'_A (defined at (5.2)) since $L_A \leq L'_A$. Set $\varepsilon < \varepsilon_1 \wedge \varepsilon_2 \wedge \varepsilon_3 \wedge \varepsilon_4$, we notice using Lemma 5.4 that

$$\begin{aligned} & \mathbf{P}_{1-\varepsilon}[\partial A \cap K_\infty \neq \emptyset, L'_A \geq n + C_8 r] \quad (5.4) \\ & \leq \mathbf{P}_{1-\varepsilon}[L_A^1 \geq n/(8\eta d) + C_5 r] \\ & \quad + \mathbf{P}_{1-\varepsilon}[\partial A \cap K_\infty \neq \emptyset, L_A^1 \leq n/(8\eta d) + C_5 r, L'_A \geq n + C_8 r] \\ & \leq \mathbf{P}_{1-\varepsilon}[\partial A \cap K_\infty \neq \emptyset, L_A^1 \leq n/(8\eta d) + C_5 r, L'_A \geq n + C_8 r] \end{aligned}$$

CHAPITRE 5. THE SPEED OF A BIASED RANDOM WALK ON A PERCOLATION CLUSTER AT HIGH DENSITY

$$+ C_6 r^{2d} \alpha_1(\varepsilon)^{n/(8\eta d)}.$$

We denote h_m^x the hyperplane $\{y, y \cdot \vec{\ell} \geq x \cdot \vec{\ell} + m\}$, we have

$$\begin{aligned} & \mathbf{P}_{1-\varepsilon}[\partial A \cap K_\infty \neq \emptyset, L_A^1 \leq n/(8\eta d) + C_5 r, L'_A \geq n + C_8 r] \\ & \leq \mathbf{P}_{1-\varepsilon}[\partial A \cap K_\infty \neq \emptyset, d_{\omega^{A,0}}(\partial A, h_{n/(8d)+\eta C_5 r}^x) \geq n + C_8 r] \\ & \leq |\partial A| \max_{y \in \partial A} \mathbf{P}_{1-\varepsilon}[y \stackrel{\omega^{A,0}}{\leftrightarrow} \infty, d_{\omega^{A,0}}(y, h_{n/(8d)+\gamma_1 r}^x) \geq n + C_8 r]. \end{aligned} \quad (5.5)$$

Set $y \in \partial A$ and let us denote γ_2 a constant which will be chosen large enough. Using the uniqueness of the infinite cluster we get

$$\begin{aligned} & \mathbf{P}_{1-\varepsilon} \left[d_{\mathbb{Z}^d} \left(y, K_\infty(\omega^{A,0}) \cap h_{n/(8d)+\gamma_1 r}^x \cap \{y + \mathbb{T}\} \right) \geq n/2 + \gamma_2 r \right] \\ & \leq \mathbf{P}_{1-\varepsilon} \left[d_{y+\mathbb{T}} \left(y, K_\infty^{y+\mathbb{T}}(\omega^{A,0}) \cap h_{n/(8d)+\gamma_1 r}^x \right) \geq n/2 + \gamma_2 r \right] \\ & \leq \mathbf{P}_{1-\varepsilon} \left[d_{y+\mathbb{T}} \left(y, K_\infty^{y+\mathbb{T}}(\omega) \cap h_{n/(8d)+\gamma_1 r}^x \right) \geq n/2 + \gamma_2 r \right], \end{aligned} \quad (5.6)$$

where we have to suppose that $\gamma_2 \geq 2$ for the last inequality. Indeed then $d_{y+\mathbb{T}}(y, K_\infty^{y+\mathbb{T}}(\omega)) = d_{y+\mathbb{T}}(y, K_\infty^{y+\mathbb{T}}(\omega^{A,0}))$ on the event $\{d_{y+\mathbb{T}}(y, K_\infty^{y+\mathbb{T}}(\omega)) \geq \gamma_2 r\}$ since the distance to the infinite cluster is greater than the radius of A .

Moreover since $e^{(1)} \cdot \vec{\ell} \geq 1/\sqrt{d}$, we notice that

$$\min_{y \in h_m^x \cap \mathbb{T}} d_{x+\mathbb{T}}(x, y) \geq 2\sqrt{d}m.$$

Applying this for $m = n/(8d) + \gamma_1 r$, we get that

$$\begin{aligned} & \mathbf{P}_{1-\varepsilon} \left[d_{y+\mathbb{T}} \left(y, K_\infty^{y+\mathbb{T}}(\omega) \cap h_{n/(8d)+\gamma_1 r}^y \right) \geq n/2 + \gamma_2 r \right] \\ & \leq \mathbf{P}_{1-\varepsilon} \left[d_{y+\mathbb{T}} \left(y, K_\infty^{y+\mathbb{T}}(\omega) \right) \geq n/2 + \gamma_2 r \right], \end{aligned} \quad (5.7)$$

where γ_2 is large enough so that $2\sqrt{d}(n/(8d) + \gamma_1 r) \leq n/2 + \gamma_2 r$.

The equations (5.6) and (5.7) used with Lemma 5.5 yield that for γ_3 large enough and any $y \in \partial A$,

$$\mathbf{P}_{1-\varepsilon} \left[d_{\mathbb{Z}^d} \left(y, K_\infty(\omega^{A,0}) \cap h_{n/(8d)+\gamma_1 r}^y \cap \{y + \mathbb{T}\} \right) \geq n/2 + \gamma_3 r \right] \leq \gamma_4 \alpha_4(\varepsilon)^{n/2}.$$

If we use Lemma 5.1 and the previous inequality, for C_8 large enough so that $n + C_8 r \geq 2(n/2 + \gamma_3 r) + 4dr$,

$$\mathbf{P}_{1-\varepsilon} \left[\partial A \cap K_\infty \neq \emptyset, d_{\omega^{A,0}} \left(y, h_{n/(8d)+\gamma_1 r}^y \right) \geq n + C_8 r \right] \quad (5.8)$$

6. CONTINUITY OF THE SPEED AT HIGH DENSITY

$$\begin{aligned}
&\leq \mathbf{P}_{1-\varepsilon} \left[d_{\mathbb{Z}^d} \left(y, K_\infty(\omega^{A,0}) \cap h_{n/(8d)+\gamma_1 r}^y \cap \{y + \mathbb{T}\} \right) \geq n/2 + \gamma_3 r \right] \\
&+ \sum_{z \in \partial B_{\mathbb{Z}^d}(y, \lceil n/2 + \gamma_3 r \rceil) \cap \{y + \mathbb{T}\}} \mathbf{P}_{1-\varepsilon} \left[z \overset{\omega^{A,0}}{\leftrightarrow} y, d_{\omega^{A,0}}(z, y) \geq 2d(y, z) + 4dr \right] \\
&\leq \gamma_4 \alpha_4(\varepsilon)^{n/2} + \gamma_5(n + \gamma_3 r) \alpha_1(\varepsilon)^{n/2} \leq \gamma_6 r n \alpha_5(\varepsilon)^n,
\end{aligned}$$

where $\varepsilon < \varepsilon_5$ depends only on d and ℓ for some $\alpha_5(\cdot)$ such that $\lim_{\varepsilon \rightarrow 0} \alpha_5(\varepsilon) = 0$.

Adding up (5.4), (5.5) and (5.8) we get

$$\begin{aligned}
\mathbf{P}_{1-\varepsilon}[\partial A \cap K_\infty \neq \emptyset, L'_A \geq n + C_8 r] &\leq \gamma_7 n r^d (\alpha_1(\varepsilon)^{n/(8\eta d)} + \alpha_5(\varepsilon)^n) \\
&\leq \gamma_8 n r^d \alpha(\varepsilon)^n,
\end{aligned}$$

where $\alpha(\varepsilon) := \alpha_1(\varepsilon)^{1/(8\eta d)} + \alpha_5(\varepsilon)$. As we have $\lim_{\varepsilon \rightarrow 0} \alpha(\varepsilon) = 0$, this last equation and (5.3) completes the proof of Proposition 5.2. \square

Essentially by replacing $(\mathbb{Z}^d, E(\mathbb{Z}^d))$ by $(\mathbb{Z}^d, E(\mathbb{Z}^d \setminus [z, z + e]))$ and ω by $\omega^{z,e}$ along with some minor modifications we obtain

Proposition 5.3. *Set $A = B^E(x, r)$, $z \in \mathbb{Z}^d$ and $e \in \nu$, there exists a non-increasing function $\alpha : [0, 1] \rightarrow [0, 1]$ so that for $\varepsilon < \varepsilon_0$*

$$\mathbf{P}_{1-\varepsilon}[L_A(\omega^{z,e}) \geq n + C_8 r] \leq C_9 r^d n \alpha(\varepsilon)^n,$$

where C_8, C_9, ε_0 and $\alpha(\cdot)$ depend only on d and ℓ and $\lim_{\varepsilon \rightarrow 0} \alpha(\varepsilon) = 0$.

Here we assume without loss of generality that the constants are the same as in Proposition 5.2.

6 Continuity of the speed at high density

We now have the necessary tools to study the central quantities which appeared in (3.2).

Proposition 6.1. *For $0 < \varepsilon < \varepsilon_5$, $A \in \{0, 1\}^\nu \setminus \nu$ and $\delta \geq 1/2$*

$$\frac{\mathbf{E}_{1-\varepsilon} \left[\mathbf{1}\{\mathcal{I}(\omega^{z,A})\} G_\delta^{\omega^{z,A}}(0, z) \right]}{\mathbf{E}_{1-\varepsilon} \left[\mathbf{1}\{\mathcal{I}\} G_\delta^\omega(0, z) \right]} < C,$$

where C and ε_5 depend only on ℓ and d .

CHAPITRE 5. THE SPEED OF A BIASED RANDOM WALK ON A PERCOLATION CLUSTER AT HIGH DENSITY

This section is devoted to the proof of this proposition. We have

$$\begin{aligned} \mathbf{E}\left[\mathbf{1}\{\mathcal{I}\}G_\delta^\omega(0, z)\right] &\geq \mathbf{E}\left[\mathbf{1}\{\mathcal{C}(z) = \emptyset\}\mathbf{1}\{\mathcal{I}\}G_\delta^\omega(0, z)\right] \\ &= \mathbf{E}\left[\mathbf{1}\{\mathcal{C}(z) = \emptyset\}\mathbf{1}\{\mathcal{I}(\omega^{z, \emptyset})\}G_\delta^{\omega^{z, \emptyset}}(0, z)\right] \\ &= \mathbf{P}[\mathcal{C}(z) = \emptyset]\mathbf{E}\left[\mathbf{1}\{\mathcal{I}(\omega^{z, \emptyset})\}G_\delta^{\omega^{z, \emptyset}}(0, z)\right]. \end{aligned}$$

For $\varepsilon < 1/4 \leq 1 - p_c(d)$, we have $\mathbf{P}[\mathcal{C}(z) = \emptyset] > \gamma_1 > 0$ for γ_1 independent of ε , so that

$$\mathbf{E}\left[\mathbf{1}\{\mathcal{I}\}G_\delta^\omega(0, z)\right] \geq \gamma_1 \mathbf{E}\left[\mathbf{1}\{\mathcal{I}(\omega^{z, \emptyset})\}G_\delta^{\omega^{z, \emptyset}}(0, z)\right]. \quad (6.1)$$

Now we want a similar upper bound for the numerator of Proposition 6.1. Let $A \in \{0, 1\}^\nu \setminus \nu$, then by (2.5) and (4.1) we obtain

$$\frac{1}{\kappa_1} e^{2\lambda z \cdot \vec{\ell}} \frac{1}{\delta} \leq \pi^{\omega^{z, A}(\delta)}(z) \leq \kappa_1 e^{2\lambda z \cdot \vec{\ell}} \frac{1}{\delta}. \quad (6.2)$$

This equation combined with Lemma 4.1 yields

$$\begin{aligned} &\mathbf{E}\left[\mathbf{1}\{\mathcal{I}(\omega^{z, A})\}G_\delta^{\omega^{z, A}}(0, z)\right] \\ &\leq \frac{\kappa_1 e^{2\lambda z \cdot \vec{\ell}}}{\delta} \mathbf{E}\left[\mathbf{1}\{\mathcal{I}(\omega^{z, A})\}P_0^{\omega^{z, A}}[T_z < \tau_\delta]R^{\omega^{z, A}}(z \leftrightarrow \Delta)\right]. \end{aligned} \quad (6.3)$$

If $z \notin K_\infty(\omega^{z, A})$ then $P_0^{\omega^{z, A}}[T_z < \tau_\delta] = 0$. Otherwise we can apply Proposition 4.2 to get

$$R_\delta^{\omega^{z, A}}(z \leftrightarrow \Delta) \leq R_\delta^{\omega^{z, \emptyset}}(z \leftrightarrow \Delta) + C_1 L_z(\omega)^{C_2} e^{2\lambda(L_z(\omega) - z \cdot \vec{\ell})}, \quad (6.4)$$

where we used notations from (4.5).

Moreover we notice that $P_0^{\omega^{z, A}}[T_z < \tau_\delta] \leq P_0^{\omega^{z, \emptyset}}[T_z < \tau_\delta]$ and $\mathbf{1}\{\mathcal{I}(\omega^{z, A})\} \leq \mathbf{1}\{\mathcal{I}(\omega^{z, \emptyset})\}$. Then inserting (6.4) into (6.3), using Lemma 4.1 and (6.2) we get since $\delta \geq 1/2$

$$\begin{aligned} \mathbf{E}\left[\mathbf{1}\{\mathcal{I}\}G_\delta^\omega(0, z)|\mathcal{C}(z) = A\right] &\leq \kappa_1^2 \mathbf{E}\left[\mathbf{1}\{\mathcal{I}(\omega^{z, \emptyset})\}G_\delta^{\omega^{z, \emptyset}}(0, z)\right] \\ &\quad + 2C_1 \kappa_1 \mathbf{E}\left[\mathbf{1}\{\mathcal{I}(\omega^{z, \emptyset})\}P_0^{\omega^{z, \emptyset}}[T_z < \tau_\delta]L_z(\omega)^{C_2} e^{2\lambda L_z(\omega)}\right]. \end{aligned} \quad (6.5)$$

Now we want to prove that the even though hitting probabilities depend on the whole environment their correlation with ‘‘local’’ quantities are weak in some sense. Let us now make explicit the two properties which are crucial for what we call ‘‘local quantity’’ which are the second property of Proposition 4.1 and that arbitrarily large exponential moments for ε small enough, like those obtained in Proposition 5.2. We obtain the following decorrelation lemma.

6. CONTINUITY OF THE SPEED AT HIGH DENSITY

Lemma 6.1. *Set $\delta \geq 1/2$, then*

$$\begin{aligned} & \mathbf{E} \left[\mathbf{1} \{ \mathcal{I}(\omega^{z, \emptyset}) \} P_0^{\omega^{z, \emptyset}} [T_z < \tau_\delta] L_z(\omega)^{C_2} e^{2\lambda L_z(\omega)} \right] \\ & \leq C_{10} \mathbf{E} \left[\mathbf{1} \{ \mathcal{I}(\omega^{z, \emptyset}) \} P_0^{\omega^{z, \emptyset}} [T_z < \tau_\delta] \right] \mathbf{E} \left[L_z(\omega)^{C_{11}} e^{C_{12} L_z(\omega)} \right], \end{aligned}$$

where C_{10} , C_{11} and C_{12} depend only on d and ℓ .

Démonstration. First let us notice that the third property in Proposition 4.1 implies that L_z is finite. Set $k \in \mathbb{N}^*$, recall that the event $\{L_z = k\}$ depends only on edges in $B^E(z, k)$ by the second property of Proposition 4.1.

We have $\mathbf{1} \{ \mathcal{I}(\omega^{z, \emptyset}) \} \leq \mathbf{1} \{ \partial B(z, k) \leftrightarrow \infty \}$. Assume first that $0 \notin B(z, k)$,

$$\begin{aligned} & \mathbf{E} \left[\mathbf{1} \{ \mathcal{I}(\omega^{z, \emptyset}) \} P_0^{\omega^{z, \emptyset}} [T_z < \tau_\delta] L_z(\omega)^{C_2} e^{2\lambda L_z(\omega)} \mid L_z = k \right] \tag{6.6} \\ & = k^{C_2} e^{2\lambda k} \mathbf{E} \left[\mathbf{1} \{ \mathcal{I}(\omega^{z, \emptyset}) \} P_0^{\omega^{z, \emptyset}} [T_z < \tau_\delta] \mid L_z = k \right] \\ & \leq \rho_d k^{\gamma_1} e^{2\lambda k} \mathbf{E} \left[\mathbf{1} \{ \partial B(z, k) \leftrightarrow \infty \} \max_{x \in \partial B(z, k)} P_0^\omega [T_x < \tau_\delta, T_x = T_{\partial B(z, k)}] \right], \end{aligned}$$

indeed $|\partial B(z, k)| \leq \rho_d k^d$, here we implicitly used that $0 \notin B(z, k)$. Now the integrand of the last term does not depend on the configuration of the edges in $B^E(z, k)$.

We denote $x_0(\omega)$ a vertex of $\partial B(z, k)$ connected in ω to infinity without using edges of $B^E(z, k)$ and accordingly we introduce $\{a \Leftrightarrow b\}$ the event that a is connected in ω to b using no edges of $B^E(z, k)$. Again we point out that the random variable $x_0(\omega)$ is measurable with respect to $\{\omega(e), e \notin B^E(z, k)\}$.

Let us set $x_1(\omega)$ the point for which the maximum in the last line of (6.6) is achieved, this random point also depends only on the set of configurations in $E(\mathbb{Z}^d) \setminus B^E(z, k)$, the same is true for $P_0^\omega [T_{x_0} < \tau_\delta, T_{x_0} = T_{\partial B(z, k)}]$.

In case there are multiple choices the definition of the random variables $x_0(\omega)$ or $x_1(\omega)$, we pick one of the choice according to some predetermined order on the vertices of \mathbb{Z}^d . In case $x_0(\omega)$ or $x_1(\omega)$ are not properly defined, i.e. when $\partial B(z, k)$ is not connected to infinity, we set $x_0(\omega) = z$. With this definition we have $\{x_0 \Leftrightarrow \infty\} = \{\partial B(z, k) \leftrightarrow \infty\}$.

The definition of x_1 implies that

$$x_1(\omega) \Leftrightarrow 0 \text{ if } \max_{x \in \partial B(z, k)} P_0^\omega [T_x < \tau_\delta, T_x = T_{\partial B(z, k)}] > 0.$$

Now let \mathcal{P}_0 be a path of k edges in \mathbb{Z}^d between z and x_0 and \mathcal{P}_1 a path of k edges in \mathbb{Z}^d between z and x_1 . As those paths are contained in $B^E(z, k)$, we get

$$\begin{aligned} & \mathbf{E} \left[\mathbf{1} \{ \partial B(z, k) \leftrightarrow \infty \} \mathbf{1} \{ x_1 \Leftrightarrow 0 \} P_0^\omega [T_{x_1} < \tau_\delta, T_{x_1} = T_{\partial B(z, k)}] \right] \tag{6.7} \\ & = \mathbf{E} \left[\mathbf{1} \{ x_0 \Leftrightarrow \infty \} \mathbf{1} \{ x_1 \Leftrightarrow 0 \} P_0^\omega [T_{x_1} < \tau_\delta, T_{x_1} = T_{\partial B(z, k)}] \mid \mathcal{P}_0 \cup \mathcal{P}_1 \in \omega \right] \end{aligned}$$

CHAPITRE 5. THE SPEED OF A BIASED RANDOM WALK ON A PERCOLATION CLUSTER AT HIGH DENSITY

$$\leq \frac{1}{\mathbf{P}[\mathcal{P}_0 \cup \mathcal{P}_1 \in \omega]} \mathbf{E} \left[\mathbf{1}\{\mathcal{P}_0 \cup \mathcal{P}_1 \in \omega\} \mathbf{1}\{x_0 \Leftrightarrow \infty\} \mathbf{1}\{x_1 \Leftrightarrow 0\} P_0^\omega [T_{x_1} < \tau_\delta] \right].$$

Then we see that since we have $\varepsilon < 1/2$

$$\mathbf{P}[\mathcal{P}_0 \cup \mathcal{P}_1 \in \omega] = (1 - \varepsilon)^{2k} \geq \frac{1}{4^k}. \quad (6.8)$$

Moreover, on the event $\mathcal{P}_0 \in \omega$, Markov's property yields

$$(\delta \kappa_0)^k P_0^\omega [T_{x_1} < \tau_\delta] \leq P_0^\omega [T_z < \tau_\delta].$$

Since $\delta \geq 1/2$,

$$\begin{aligned} & \mathbf{E} \left[\mathbf{1}\{\mathcal{P}_0 \cup \mathcal{P}_1 \in \omega\} \mathbf{1}\{x_0 \Leftrightarrow \infty\} \mathbf{1}\{x_1 \Leftrightarrow 0\} P_0^\omega [T_{x_1} < \tau_\delta] \right] \\ & \leq (2/\kappa_0)^k \mathbf{E} \left[\mathbf{1}\{\mathcal{P}_0 \cup \mathcal{P}_1 \in \omega\} \mathbf{1}\{x_0 \Leftrightarrow 0\} \mathbf{1}\{x_1 \Leftrightarrow \infty\} P_0^\omega [T_z < \tau_\delta] \right] \\ & \leq (2/\kappa_0)^k \mathbf{E} \left[\mathbf{1}\{\mathcal{I}\} P_0^\omega [T_z < \tau_\delta] \right], \end{aligned} \quad (6.9)$$

since on $\mathbf{1}\{\mathcal{P}_0 \cup \mathcal{P}_1 \in \omega\} \mathbf{1}\{x_0 \Leftrightarrow 0\} \mathbf{1}\{x_1 \Leftrightarrow \infty\}$ we have $0 \leftrightarrow x_0 \leftrightarrow z \leftrightarrow x_1 \leftrightarrow \infty$ and which means that \mathcal{I} occurs.

Adding up (6.6), (6.7), (6.8), (6.9), noticing that $\mathbf{1}\{\mathcal{I}\} \leq \mathbf{1}\{\mathcal{I}(\omega^{z,\emptyset})\}$ and $P_0^\omega [T_z < \tau_\delta] \leq P_0^{\omega^{z,\emptyset}} [T_z < \tau_\delta]$, we get

$$\begin{aligned} & \mathbf{E} \left[\mathbf{1}\{\mathcal{I}(\omega^{z,\emptyset})\} P_0^{\omega^{z,\emptyset}} [T_z < \tau_\delta] L_z(\omega)^{C_2} e^{2\lambda L_z(\omega)} \mid L_z = k \right] \\ & \leq \rho_d k^{\gamma_1} (8e^{2\lambda}/\kappa_0)^k \mathbf{E} \left[\mathbf{1}\{\mathcal{I}(\omega^{z,\emptyset})\} P_0^{\omega^{z,\emptyset}} [T_z < \tau_\delta] \right]. \end{aligned} \quad (6.10)$$

Let us come back to the case where $0 \in B(z, k)$. We can obtain the same result by saying that $P_0^{\omega^{z,\emptyset}} [T_z < \tau_\delta] \leq 1$ in (6.6) and formally replacing $P_0^\omega [T_x < \tau_\delta, T_x = T_{\partial B(z,k)}]$ by 1 for any $x \in \partial B(z, k)$ and x_1 by 0 in the whole previous proof. The conclusion of this is that (6.10) holds in any case.

The result follows from an integration over all the events $\{L_z = k\}$ for $k \in \mathbb{N}$ since by (6.10), we obtain

$$\begin{aligned} & \mathbf{E} \left[\mathbf{1}\{\mathcal{I}(\omega^{z,\emptyset})\} P_0^{\omega^{z,\emptyset}} [T_z < \tau_\delta] L_z(\omega)^{C_2} e^{2\lambda L_z(\omega)} \right] \\ & \leq \mathbf{E} \left[\sum_{k=1}^{\infty} \mathbf{P}[L_z = k] \mathbf{E} \left[\mathbf{1}\{\mathcal{I}(\omega^{z,\emptyset})\} P_0^{\omega^{z,\emptyset}} [T_z < \tau_\delta] L_z(\omega)^{C_2} e^{2\lambda L_z(\omega)} \mid L_z = k \right] \right] \\ & \leq \rho_d \mathbf{E} \left[\sum_{k=1}^{\infty} \mathbf{P}[L_z = k] k^{\gamma_1} (8e^{2\lambda}/\kappa_0)^k \mathbf{E} \left[\mathbf{1}\{\mathcal{I}(\omega^{z,\emptyset})\} P_0^{\omega^{z,\emptyset}} [T_z < \tau_\delta] \right] \right] \\ & = \rho_d \mathbf{E} \left[L_z^{\gamma_1} (8e^{2\lambda}/\kappa_0)^{L_z} \right] \mathbf{E} \left[\mathbf{1}\{\mathcal{I}(\omega^{z,\emptyset})\} P_0^{\omega^{z,\emptyset}} [T_z < \tau_\delta] \right]. \end{aligned}$$

□

6. CONTINUITY OF THE SPEED AT HIGH DENSITY

We can apply Proposition 5.2 to get that for $0 < \varepsilon < \varepsilon_6$

$$\mathbf{E}\left[L_z(\omega)^{C_{11}} e^{C_{12}L_z(\omega)}\right] \leq \sum_{k \geq 0} k^{C_{11}} e^{C_{12}k} \mathbf{P}[L_z \geq k] < C_{13} < \infty,$$

where ε_6 is such that $\alpha_0(\varepsilon_6) < e^{-C_{12}}/2$ and, as C_{13} , depends only on d and ℓ . Then recalling (6.5), using Lemma 6.1 with the previous equation we obtain

$$\begin{aligned} & \mathbf{E}\left[\mathbf{1}\{\mathcal{I}(\omega^{z,A})\}G_\delta^{\omega^{z,A}}(0, z)\right] \\ & \leq \kappa_1^2 \mathbf{E}\left[\mathbf{1}\{\mathcal{I}(\omega^{z,\emptyset})\}G_\delta^{\omega^{z,\emptyset}}(0, z)\right] + 2C_1 C_{10} C_{13} \kappa_1 \mathbf{E}\left[\mathbf{1}\{\mathcal{I}(\omega^{z,\emptyset})\}P_0^{\omega^{z,\emptyset}}[T_z < \tau_\delta]\right] \\ & \leq \gamma_2 \mathbf{E}\left[\mathbf{1}\{\mathcal{I}(\omega^{z,\emptyset})\}G_\delta^{\omega^{z,\emptyset}}(0, z)\right]. \end{aligned}$$

Using the preceding equation with (6.1) concludes the proof of Lemma 6.1.

We are now able to prove the following

Proposition 6.2. *For any $d \geq 2$, $\varepsilon < 1 - p_c(d)$ and $\ell \in \mathbb{R}^d$ we have*

$$v_\ell(1 - \varepsilon) = d_\emptyset + O(\varepsilon).$$

Démonstration. First notice that

$$\mathbf{P}[\mathcal{C}(z) = \emptyset] = 1 + O(\varepsilon) \text{ and } \mathbf{P}[\mathcal{C}(z) \neq \emptyset] = O(\varepsilon).$$

using (3.1) and Lemma 6.1 we get for $\delta \geq 1/2$,

$$\widehat{d}_\delta^\varepsilon(z) = d_\emptyset \frac{\mathbf{E}_{1-\varepsilon}\left[\mathbf{1}\{\mathcal{I}\}\mathbf{1}\{\mathcal{C}(z) = \emptyset\}G_\delta^\omega(0, z)\right]}{\mathbf{E}_{1-\varepsilon}\left[\mathbf{1}\{\mathcal{I}\}G_\delta^\omega(0, z)\right]} + O(\varepsilon), \quad (6.11)$$

where the $O(\cdot)$ depends only on d and ℓ . But using Lemma 6.1 again yields

$$\left| \frac{\mathbf{E}_{1-\varepsilon}\left[\mathbf{1}\{\mathcal{I}\}\mathbf{1}\{\mathcal{C}(z) = \emptyset\}G_\delta^\omega(0, z)\right]}{\mathbf{E}_{1-\varepsilon}\left[\mathbf{1}\{\mathcal{I}\}G_\delta^\omega(0, z)\right]} - 1 \right| \leq O(\varepsilon),$$

and thus

$$\widehat{d}_\delta^\varepsilon(z) - d_\emptyset = O(\varepsilon),$$

where the $O(\cdot)$ depends only on d and ℓ . Recalling Proposition 3.3, we get

$$v_\ell(1 - \varepsilon) = d_\emptyset + O(\varepsilon).$$

□

7 Derivative of the speed at high density

Next we want to obtain the derivative of the velocity with respect to the percolation parameter.

In this section we fix $z \in \mathbb{Z}^d$. Using (3.1) with Proposition 6.1 we can get the first order of Kalikow's drift

$$d_{\delta}^{\widehat{\omega}}(z) - d_{\emptyset} = \varepsilon \left(\sum_{e \in \nu} \frac{\mathbf{E}_{1-\varepsilon}[\mathbf{1}\{\mathcal{I}(\omega^{z,e})\} G_{\delta}^{\omega^{z,e}}(0, z)]}{\mathbf{E}_{1-\varepsilon}[\mathbf{1}\{\mathcal{I}(\omega)\} G_{\delta}^{\omega}(0, z)]} (d_e - d_{\emptyset}) \right) + O(\varepsilon^2), \quad (7.1)$$

where $O(\cdot)$ depends only on d and ℓ . The remaining issue is the dependence of the expectation with respect to ε .

7.1 Another perturbed environment of Kalikow

We can link the Green functions of two Markov operators P and P' , since for $n \geq 0$

$$G_{\delta}^{P'} = G_{\delta}^P + \sum_{k=1}^n \delta^k (G_{\delta}^P (P' - P))^k G_{\delta}^P + \delta^{n+1} (G_{\delta}^P (P' - P))^{n+1} G_{\delta}^{P'}. \quad (7.2)$$

In our case we close one edge which changes the transition probabilities at two sites, so that the previous formula applied for $n = 0$,

$$\begin{aligned} G_{\delta}^{\omega^{z,e}}(0, z) &= G_{\delta}^{\omega^{z,0}}(0, z) + \delta G_{\delta}^{\omega^{z,0}}(0, z) \sum_{e' \in \nu} (p^e(e') - p^{\emptyset}(e')) G_{\delta}^{\omega^{z,e}}(z + e', z) \\ &\quad + \delta G_{\delta}^{\omega^{z,0}}(0, z + e) \sum_{e' \in \nu} (p^{-e}(e') - p^{\emptyset}(e')) G_{\delta}^{\omega^{z,e}}(z + e + e', z), \end{aligned} \quad (7.3)$$

where we used a notation from (2.3).

Hence to compute the numerator of (7.1) using the expansion (7.3), we can look at quantities such as

$$\mathbf{E}[\mathbf{1}\{\mathcal{I}(\omega^{z,e})\} G_{\delta}^{\omega^{z,0}}(0, z) G_{\delta}^{\omega^{z,e}}(z + e', z)],$$

and

$$\mathbf{E}[\mathbf{1}\{\mathcal{I}(\omega^{z,e})\} G_{\delta}^{\omega^{z,0}}(0, z + e) G_{\delta}^{\omega^{z,e}}(z + e + e', z)],$$

for $e, e' \in \nu$.

From now on we fix $e \in \nu$. In order to handle the first type of terms (the proof is similar for the second type of terms) we introduce the measure

$$d\tilde{\mu}^z = \frac{\mathbf{1}\{\mathcal{I}\} \mathbf{1}\{\mathcal{C}(z) = e\} G_{\delta}^{\omega^{z,0}}(0, z)}{\mathbf{E}_{1-\varepsilon}[\mathbf{1}\{\mathcal{I}\} \mathbf{1}\{\mathcal{C}(z) = e\} G_{\delta}^{\omega^{z,0}}(0, z)]} d\mathbf{P}_{1-\varepsilon},$$

7. DERIVATIVE OF THE SPEED AT HIGH DENSITY

and for $e_+ \in \nu$ we introduce the Kalikow environment, corresponding to this measure on the environment and the point $z + e_+$, defined by

$$\begin{aligned} \tilde{p}_{z,e,z+e_+}(y, e') &= \frac{E_{\tilde{\mu}^z}[G_\delta^\omega(z + e_+, y)p^\omega(y, y + e')]}{E_{\tilde{\mu}^z}[G_\delta^\omega(z + e_+, y)]} \\ &= \frac{\mathbf{E}_{1-\varepsilon}[\mathbf{1}\{\mathcal{I}\}G_\delta^{\omega^{z,0}}(0, z)G_\delta^\omega(z + e_+, y)p^\omega(y, y + e') \mid \mathcal{C}(z) = e]}{\mathbf{E}_{1-\varepsilon}[\mathbf{1}\{\mathcal{I}\}G_\delta^{\omega^{z,0}}(0, z)G_\delta^\omega(z + e_+, y) \mid \mathcal{C}(z) = e]}. \end{aligned}$$

Once again Kalikow's property geometrically killed random walks does not use any properties on the measure on the environment, we have for any $z \in \mathbb{Z}^d$ and $e, e' \in \nu$

$$\frac{\mathbf{E}_{1-\varepsilon}[\mathbf{1}\{\mathcal{I}\}\mathbf{1}\{\mathcal{C}(z) = e\}G_\delta^{z,0}(0, z)G_\delta^\omega(z + e', z)]}{\mathbf{E}[\mathbf{1}\{\mathcal{I}\}\mathbf{1}\{\mathcal{C}(z) = e\}G_\delta^{\omega^{z,0}}(0, z)]} = G_\delta^{\tilde{p}_{z,e,z+e'}}(z + e', z). \quad (7.4)$$

Decomposing this according to the configurations at y and denoting $\mathbf{P}_{1-\varepsilon}^{z,e}[\cdot] = \mathbf{P}_{1-\varepsilon}[\cdot \mid \mathcal{C}(z) = e]$, we get

$$\begin{aligned} \tilde{p}_{z,e,z+e_+}(y, e') &= \sum_{A \in \{0,1\}^\nu} \mathbf{P}^{z,e}[\mathcal{C}(y) = A] \\ &\times \frac{\mathbf{E}_{1-\varepsilon}^{z,e}[\mathbf{1}\{\mathcal{I}\}G_\delta^{\omega^{z,0}}(0, z)G_\delta^\omega(z + e_+, y) \mid \mathcal{C}(y) = A]}{\mathbf{E}_{1-\varepsilon}^{z,e}[\mathbf{1}\{\mathcal{I}\}G_\delta^{\omega^{z,0}}(0, z)G_\delta^\omega(z + e_+, y)]} p^A(y, e'), \end{aligned} \quad (7.5)$$

where the conditional expectation is set to be 0 when it is not well-defined.

In the next proposition we will use $a^+ = 0 \vee a$ and from now on we will omit the subscript in $\tilde{p}_{z,e,z+e_+}$.

Proposition 7.1. *For $\varepsilon < \varepsilon_7$ and $z, e, e_+ \in \mathbb{Z}^d \times \nu^2$ and $\delta \geq 1/2$, we have for $y \in \mathbb{Z}^d$, $e' \in \nu$*

$$|\tilde{p}(y, e') - p_0^{z,e}(y, e')| \leq (C_{14}e^{C_{15}((z-y)\cdot\vec{\ell})^+})\varepsilon,$$

where ε_7 , C_{14} and C_{15} depends on ℓ and d .

This proposition will be used to link the Green function of $\tilde{p}_{z,e,z+e_+}$ to the one of $p_0^{z,e}$. In view of (7.5) the previous proposition comes from

Proposition 7.2. *For $0 < \varepsilon < \varepsilon_8$, $y, z \in \mathbb{Z}^d$, $A \in \{0, 1\}^\nu \setminus \nu$,*

$$\frac{\mathbf{E}_{1-\varepsilon}[\mathbf{1}\{\mathcal{I}(\omega^{z,e})\}G_\delta^{\omega^{z,0}}(0, z)G_\delta^{\omega^{z,e}}(z + e_+, y) \mid \mathcal{C}(y) = A]}{\mathbf{E}_{1-\varepsilon}[\mathbf{1}\{\mathcal{I}(\omega^{z,e})\}G_\delta^{\omega^{z,0}}(0, z)G_\delta^{\omega^{z,e}}(z + e_+, y) \mid \mathcal{C}(y) = \emptyset]} \leq C_{16}e^{C_{17}((z-y)\cdot\vec{\ell})^+},$$

for ε_8 , C_{16} , C_{17} depending only on ℓ and d for $\delta \geq 1/2$.

CHAPITRE 5. THE SPEED OF A BIASED RANDOM WALK ON A PERCOLATION CLUSTER AT HIGH DENSITY

In order to prove Proposition 7.1, once we have noticed that we have $\mathbf{P}[\mathcal{C}(y) = \emptyset] \geq \gamma_1$ and

$$\begin{aligned} & \mathbf{E}_{1-\varepsilon}^{z,e}[\mathbf{1}\{\mathcal{I}\}G_\delta^{\omega^{z,0}}(0,z)G_\delta^\omega(z+e_+,y)] \\ & \geq \mathbf{P}[\mathcal{C}(y) = \emptyset]\mathbf{E}_{1-\varepsilon}[\mathbf{1}\{\mathcal{I}(\omega^{z,e})\}G_\delta^{\omega^{z,0}}(0,z)G_\delta^{\omega^{z,e}}(z+e_+,y) \mid \mathcal{C}(y) = \emptyset], \end{aligned}$$

it suffices to use the Proposition 7.2 with arguments close to the ones appearing in the proof of Proposition 6.2 to show that the dominant term in (7.5) is the one corresponding to $\{\mathcal{C}(y) = \emptyset\}$.

Obviously Proposition 7.2 has strong similarities with Proposition 6.1, since the only difference is that the upper bound is weaker, which is simply due to technical reasons. Moreover, since the proof is rather technical and independent of the rest of the argument, we prefer to defer it to Section 8.

7.2 Expansion of Green functions

Once Proposition 7.1 is proved, we are able to approximate the Green functions through the same type of arguments as given in [90]. Heuristically, we may say that if environments are close then the Green functions should be close at least on short distance scales. Compared to [90], there is a twist due to the fact that we do not have uniform ellipticity and that our control on the environment in Proposition 7.1 is only uniform in the direction of the drift. Moreover our “limiting environment” as ε goes to 0 is not translation invariant (nor uniformly elliptic). Hence we need some extra work to adapt the methods of [90].

Proposition 7.3. *For any $z \in \mathbb{Z}^d$, $e, e' \in \nu$, $e'' \in \nu \cup \{0\}$ we get for $\delta \geq 1/2$*

$$\left| G_\delta^{\tilde{\omega}}(z+e'+e'',z) - G_\delta^{\omega_0^{z,e}}(z+e'+e'',z) \right| \leq o_\varepsilon(1),$$

where $o_\varepsilon(\cdot)$ depends only on ℓ and d .

Démonstration. The proof will be divided in two main steps :

1. prove that there exists transition probabilities \bar{p} that are uniformly close to those corresponding to the environment $\omega_0^{z,e}$ on the whole lattice and which has a Green function close to the one of the environment $\tilde{\omega}$,
2. prove the same statement as in Proposition 7.3 but for the environment \bar{p} . This is inspired from the proof of Lemma 3 in [90].

For the first step, we will show that the random walk is unlikely to visit often z and go far away in the direction opposite to the drift, i.e. we want to show that for any $\varepsilon_1 > 0$

$$G_\delta^{\tilde{\omega}}(z+e',z) - G_{\delta,\{x \in \mathbb{Z}^d, x \cdot \vec{\ell} < z \cdot \vec{\ell} - A\}}^{\bar{p}}(z+e',z) < \varepsilon_1 \text{ for } A \text{ large and } \varepsilon \text{ small,}$$

7. DERIVATIVE OF THE SPEED AT HIGH DENSITY

where we used a notation of (4.8). This inequality comes from the fact that except at z and $z + e$ the local drift under \tilde{p} can be set to be uniformly positive in the direction ℓ in any half-space $\{x \in \mathbb{Z}^d, x \cdot \ell > -A\}$ for ε small.

In a first time, we show that the escape probability from z and $z + e'$ is lower bounded in the environment \tilde{p} . For this we can easily adapt a classical super-martingale argument, see Lemma 1.1 in [97], to get that for any $\eta > 0$ there exists $f(\eta) > 0$ such that for any random walk on \mathbb{Z}^d defined by a Markov operator $P(x, y)$ such that $(\sum_{y \sim x} P(x, y)(y - x)) \cdot \vec{\ell} > \eta$, for x such that $x \cdot \vec{\ell} \geq 0$, we have

$$P_0[X_n \cdot \vec{\ell} \geq 0, n > 0] > f(\eta). \quad (7.6)$$

Now by Proposition 7.1, it is possible to fix a percolation parameter $1 - \varepsilon$ where ε is chosen small enough so that

- The drift $d(\tilde{p})(x) = \sum_{e \in \nu} \tilde{p}(x, x + e)e$ is such that $d^{\tilde{p}}(x) \cdot \vec{\ell} > d_\emptyset \cdot \vec{\ell}/2$ for x such that $x \cdot \vec{\ell} \geq (z + 2de^{(1)}) \cdot \vec{\ell}$ (this way we avoid the transitions probabilities at the vertices z and $z + e$ which are special).
- The transition probabilities on the shortest paths from z and $z + e'$ to $z + 2de^{(1)}$ (with length inferior to some γ_1) are greater than $\kappa_0/2$.

Hence we can get a lower bound for the escape probability under \tilde{p} :

$$\begin{aligned} & \min_{y \in \{z, z+e'\}} P_y^{\tilde{p}}[T_{\{z, z+e'\}}^+ = \infty] \\ & \geq \min_{y \in \{z, z+e'\}} P_y^{\tilde{p}}[T_{\{z, z+e'\}}^+ > T_{z+2de^{(1)}}] P_{z+2de^{(1)}}^{\tilde{p}}[(X_n - (z + 2de^{(1)})) \cdot \vec{\ell} \geq 0, n > 0] \\ & \geq f(d_\emptyset \cdot \vec{\ell}/2) \left(\frac{\kappa_0}{2}\right)^{\gamma_1} = \gamma_2. \end{aligned} \quad (7.7)$$

Now we need to show that the walk is unlikely to go far to the left. Consider any random walk on \mathbb{Z}^d given by a transition operator $P(x, y)$ such that $d^P(x) := \sum_{y \sim x} P(x, y)(y - x) \cdot \vec{\ell} > (d_\emptyset \cdot \vec{\ell})/2 = \gamma_3$. We know that

$$M_n^P = X_n - X_0 - \sum_{i=1}^{n-1} d^P(X_i),$$

is a martingale with jumps bounded by 2. Hence since $d^P(x) \geq \gamma_3$, we can use Azuma's inequality, see [4], to get

$$\begin{aligned} P_0[T_{\{x \in \mathbb{Z}^d, x \cdot \vec{\ell} < -A\}} < \infty] & \leq \sum_{n \geq 0} P_0[M_n^P \cdot \vec{\ell} < -A - \gamma_3 n] \\ & \leq \sum_{n \geq 0} \exp\left(-\frac{(A + \gamma_3 n)^2}{8n}\right) \leq \gamma_4 \exp\left(-\frac{\gamma_3 A}{4}\right). \end{aligned}$$

CHAPITRE 5. THE SPEED OF A BIASED RANDOM WALK ON A PERCOLATION CLUSTER AT HIGH DENSITY

Set $\varepsilon' > 0$ small enough. Taking $A = A(\varepsilon')$ large enough, depending also on d and ℓ , we can make the right-hand side lower than ε_1 . Now let us choose ε small enough so that for any $y \in \{x \in \mathbb{Z}^d, x \cdot \vec{\ell} \geq z \cdot \vec{\ell} - A - 1 \text{ and } x \neq \{z, z + e'\}\}$ we have $d^{\vec{\omega}}(y) \cdot \vec{\ell} > (d_\emptyset \cdot \vec{\ell})/2$. Then the previous imply

$$\begin{aligned} & \max_{y \in \{z, z + e'\}} P_y^{\vec{p}}[T_{\{x \in \mathbb{Z}^d, x \cdot \vec{\ell} < z \cdot \vec{\ell} - A - 1\}} < T_{\{z, z + e'\}}^+] \\ & \leq \max_{y \sim z \text{ or } y \sim z + e'} P_y^{\vec{p}}[T_{\{x \in \mathbb{Z}^d, x \cdot \vec{\ell} < z \cdot \vec{\ell} - A - 1\}} < T_{\{z, z + e'\}}^+] \leq \varepsilon', \end{aligned} \quad (7.8)$$

since the event in the middle depends only on the transitions probabilities at the vertices of $\{x \in \mathbb{Z}^d, x \cdot \ell \geq z \cdot \vec{\ell} - A - 1 \text{ and } x \neq \{z, z + e'\}\}$.

Moreover by (7.7) we have

$$G_\delta^{\vec{p}}(z + e', z + e') = P_{z + e'}^{\vec{p}}[T_{z + e'}^+ < \tau_\delta]^{-1} \leq \frac{1}{\gamma_2} \text{ and } G_\delta^{\vec{p}}(z, z) \leq \frac{1}{\gamma_2}, \quad (7.9)$$

which decomposing with respect to the number of excursions to z and $z + e'$ and using (7.8) yields

$$P_{z + e'}^{\vec{p}}[T_{\{x \in \mathbb{Z}^d, x \cdot \vec{\ell} < z \cdot \vec{\ell} - A - 1\}} < \infty] < \frac{2\varepsilon'}{\gamma_2}. \quad (7.10)$$

For ε small enough to verify the previous conditions we have using (7.9) and (7.10)

$$\begin{aligned} & G_\delta^{\vec{p}}(z + e', z) - G_{\delta, \{x \in \mathbb{Z}^d, x \cdot \vec{\ell} < z \cdot \vec{\ell} - A - 1\}}^{\vec{p}}(z + e', z) \\ & \leq P_{z + e'}^{\vec{p}}[T_{\{x \in \mathbb{Z}^d, x \cdot \vec{\ell} < z \cdot \vec{\ell} - A - 1\}} < \infty] \max_{y \in \{x \in \mathbb{Z}^d, x \cdot \vec{\ell} < z \cdot \vec{\ell} - A - 1\}} G_\delta^{\vec{p}}(y, z) \\ & \leq \frac{2\varepsilon'}{\gamma_2} G_\delta^{\vec{p}}(z, z) = \frac{2\varepsilon'}{\gamma_2}. \end{aligned} \quad (7.11)$$

So that introducing $\bar{\omega}(y, e')$ so that

$$\begin{aligned} \bar{p}(y, e') &= \tilde{p}(y, e') \text{ for } y \text{ such that } (y - z) \cdot \vec{\ell} \geq -A(\varepsilon') \\ \bar{p}(y, e') &= p^{\omega_0^{\vec{z}, e'}}(y, e') \text{ for } y \text{ such that } (y - z) \cdot \vec{\ell} < -A(\varepsilon') \end{aligned}$$

A consequence of (7.11) is that

$$\left| G_\delta^{\vec{p}}(z + e', z) - G_{\delta}^{\bar{p}}(z + e', z) \right| \leq \gamma_5 \varepsilon', \quad (7.12)$$

where, by Proposition 7.1, $\bar{\omega}$ (depending on ε') is such that

$$\max_{e' \in \nu, y \in \mathbb{Z}^d} \left| \bar{p}(y, e') - p^{\omega_0^{\vec{z}, e'}}(y, e') \right| \leq C_{14} e^{C_{15} A(\varepsilon')} \varepsilon \leq \varepsilon', \quad (7.13)$$

for ε small enough. This completes step (1).

7. DERIVATIVE OF THE SPEED AT HIGH DENSITY

We can start step (2) of the proof. Since our control on the environment is uniform and our remaining task is to use methods similar to those of [90] to prove that there exists a $o(\cdot)$ depending only on d and ℓ such that

$$\left| G_{\delta}^{\omega_0^{z,e}}(z + e' + e'', z) - G_{\delta}^{\bar{p}}(z + e' + e'', z) \right| = o(1), \quad (7.14)$$

which in view of (7.12) is enough to prove Proposition 7.3.

Let us define M the operator of multiplication by $(\pi^{\omega_0^{z,e}})^{1/2}$ given for $f : \mathbb{Z}^d \rightarrow \mathbb{R}$, by

$$M(f)(y) = (\pi^{\omega_0^{z,e}}(y))^{1/2} f(y).$$

We consider a transition operator $P^{s,\delta}$ of a random walk on $\mathbb{Z}^d \cup \{\Delta\}$ given by

$$\begin{aligned} P^{s,\delta}(x, x + e^{(i)}) &= P^{s,\delta}(x + e^{(i)}, x) \\ &= \delta(\pi^{\omega_0^{z,e}}(x))^{1/2} p^{\omega_0^{z,e}}(x, x + e^{(i)}) (\pi^{\omega_0^{z,e}}(x + e^{(i)}))^{-1/2} \\ &= \delta(\pi^{\omega_0^{z,e}}(x + e^{(i)}))^{1/2} p^{\omega_0^{z,e}}(x + e^{(i)}, x) (\pi^{\omega_0^{z,e}}(x))^{-1/2}, \end{aligned}$$

for any $i = 1, \dots, 2d$ and for $x \notin \{z, z + e, \Delta\}$

$$\begin{aligned} P^{s,\delta}(x, \Delta) &= (1 - \delta) + \delta \sum_{e^{(i)} \in \nu} (p^{\emptyset}(e^{(i)}) p^{\emptyset}(-e^{(i)}))^{1/2}, \\ P^{s,\delta}(z, \Delta) &= (1 - \delta) + \delta \sum_{e^{(i)} \in \nu \setminus \{e\}} (p^e(e^{(i)}) p^e(-e^{(i)}))^{1/2}, \\ P^{s,\delta}(z + e, \Delta) &= (1 - \delta) + \delta \sum_{e^{(i)} \in \nu \setminus \{-e\}} (p^{-e}(e^{(i)}) p^{-e}(-e^{(i)}))^{1/2}, \end{aligned}$$

and $P^{s,\delta}(\Delta, \Delta) = 1$.

We have for $x, y \neq \Delta$,

$$\begin{aligned} G_{\delta}^{\omega_0^{z,e}}(x, y) &= ((I - \delta P^{\omega_0^{z,e}})^{-1})(x, y) = (M^{-1}(I - P^{s,\delta})^{-1}M)(x, y) \\ &= (M^{-1}G^{s,\delta}M)(x, y), \end{aligned}$$

where $G^{s,\delta}$ is the Green function of $P^{s,\delta}$. In a similar way, we have for $x, y \neq \Delta$

$$G_{\delta}^{\bar{p}}(x, y) = (M^{-1}G^{\bar{s},\delta}M)(x, y),$$

where because of (7.13) the associated operator $P^{\bar{s},\delta} = M^{-1}P^{\bar{p}}M$ verifies

$$\begin{aligned} P^{\bar{s},\delta}(x, x + e) &= P^{s,\delta}(x, x + e) + \varepsilon \xi_{\varepsilon}(x, e) \\ \text{and } P^{\bar{s},\delta}(x, \Delta) &= P^{s,\delta}(x, \Delta) + \varepsilon \xi_{\varepsilon}(x, \Delta), \end{aligned}$$

CHAPITRE 5. THE SPEED OF A BIASED RANDOM WALK ON A PERCOLATION CLUSTER AT HIGH DENSITY

where $\xi_\varepsilon(\cdot, \cdot)$ are uniformly bounded.

Now, we expand the Green function, using (7.2) to obtain that for any n

$$G_\delta^{\bar{p}}(x, x') - G_\delta^{\omega_0^{z,e}}(x, x') = \sum_{i=1}^n (\delta\varepsilon)^k S_k(x, x') + (\delta\varepsilon)^{n+1} R_n(x, x'),$$

where

$$S_n(x, x') = \sum_{x_1, \dots, x_n} \sum_{e_1, \dots, e_n} G_\delta^{\omega_0^{z,e}}(x, x_1) \xi_\varepsilon(x_1, e_1) G_\delta^{\omega_0^{z,e}}(x_1 + e_1, x_2) \cdots \\ \times \xi_\varepsilon(x_n, e_n) G_\delta^{\omega_0^{z,e}}(x_n + e_n, x'),$$

and

$$R_n(x, x') = \sum_{x^* \in \mathbb{Z}^d} S_n(x, x^*) \sum_{e^* \in \nu} \xi_\varepsilon(x^*, e^*) G_\delta^{\bar{p}}(x^* + e^*, x').$$

Consider the transformation

$$S_n(x, x') = \left(\frac{\pi^{\omega_0^{z,e}}(x')}{\pi^{\omega_0^{z,e}}(x)} \right)^{1/2} \sum_{\substack{x_1, \dots, x_n \\ e_1, \dots, e_n}} G^{s,\delta}(x, x_1) \xi_\varepsilon(x_1, e_1) \left(\frac{\pi^{\omega_0^{z,e}}(x_1)}{\pi^{\omega_0^{z,e}}(x_1 + e_1)} \right)^{1/2} \\ \times G^{s,\delta}(x_1 + e_1, x_2) \cdots \left(\frac{\pi^{\omega_0^{z,e}}(x_n)}{\pi^{\omega_0^{z,e}}(x_n + e_n)} \right)^{1/2} G^{s,\delta}(x_n + e_n, x'),$$

and

$$R_n(x, x') = \left(\frac{\pi^{\omega_0^{z,e}}(x')}{\pi^{\omega_0^{z,e}}(x)} \right)^{1/2} \sum_{\substack{x_1, \dots, x_n \\ e_1, \dots, e_n}} G^{s,\delta}(x, x_1) \xi_\varepsilon(x_1, e_1) \left(\frac{\pi^{\omega_0^{z,e}}(x_1)}{\pi^{\omega_0^{z,e}}(x_1 + e_1)} \right)^{1/2} \\ \times G^{s,\delta}(x_1 + e_1, x_2) \cdots \left(\frac{\pi^{\omega_0^{z,e}}(x_n)}{\pi^{\omega_0^{z,e}}(x_n + e_n)} \right)^{1/2} G^{\bar{s},\delta}(x_n + e_n, x').$$

We have for any $x \in \mathbb{Z}^d$ and $\delta \geq 1/2$,

$$|1 - P^{s,\delta}(x, \Delta)| \geq \frac{\delta}{2} \min_{e_k \in \nu} \sum_{j=1}^d \left(\sqrt{p^{e_k}(e^{(j)})} - \sqrt{p^{e_k}(-e^{(j)})} \right)^2 = \gamma_6.$$

Moreover for any $x \in \mathbb{Z}^d$ and $e_i \in \nu$ we get by (2.5) that

$$\frac{\pi^{\omega_0^{z,e}}(x)}{\pi^{\omega_0^{z,e}}(x + e_i)} \leq \kappa_1^2 e^{2\lambda},$$

and for $x, x' \in \mathbb{Z}^d$ we obtain

$$\sum_{\substack{x_1, \dots, x_n \\ e_1, \dots, e_n}} G^{s,\delta}(x, x_1) G^{s,\delta}(x_1 + e_1, x_2) \cdots G^{s,\delta}(x_n + e_n, x')$$

7. DERIVATIVE OF THE SPEED AT HIGH DENSITY

$$\begin{aligned}
&\leq \left(\sum_{x_1} G^{s,\delta}(x, x_1)(2d) \right) \max_{x_* \in \mathbb{Z}^d} \sum_{\substack{x_2, \dots, x_n \\ e_2, \dots, e_n}} G^{s,\delta}(x_*, x_2) \dots G^{s,\delta}(x_n + e_n, x') \\
&\leq \frac{2d}{1 - \max_x P^{s,\delta}(x, \Delta)} \max_{x_* \in \mathbb{Z}^d} \sum_{\substack{x_2, \dots, x_n \\ e_2, \dots, e_n}} G^{s,\delta}(x_*, x_2) \dots G^{s,\delta}(x_n + e_n, x') \\
&\leq \dots \leq \left(\frac{2d}{1 - \gamma_6} \right)^n,
\end{aligned}$$

where we used an easy recursion to obtain the last inequality. Finally we get

$$\begin{aligned}
S_n(x, x') &= \left(\frac{\pi^{\omega_0^{z,e}}(x')}{\pi^{\omega_0^{z,e}}(x)} \right)^{1/2} \left(\kappa_1^2 e^{2\lambda} \left(\sup_{y,e} |\xi_\varepsilon(y, e)| \right) \frac{2d}{1 - \gamma_6} \right)^{n+1} \\
&\leq \left(\frac{\pi^{\omega_0^{z,e}}(x')}{\pi^{\omega_0^{z,e}}(x)} \right)^{1/2} \gamma_7^{n+1},
\end{aligned}$$

for some positive constant γ_7 , depending only on d and ℓ . We can get a similar estimate for the remaining term $R_n(x, x')$ considering that $1 - P^{s,\delta}(x, \Delta) \sim 1 - P^{\bar{s},\delta}(x, \Delta)$. This implies that for $\varepsilon < \gamma_7^{-1}/2$ small enough, the series $\sum_{k=0}^{\infty} (\varepsilon\delta)^k S_k(x, x')$ is convergent and upper bounded by a constant independent of δ and that

$$\begin{aligned}
G_\delta^{\bar{p}}(x, x') - G_\delta^{\omega_0^{z,e}}(x, x') &= \sum_{k=1}^{\infty} (\delta\varepsilon)^k S_k(x, x') \\
&= \left(\frac{\pi^{\omega_0^{z,e}}(x')}{\pi^{\omega_0^{z,e}}(x)} \right)^{1/2} O(\varepsilon),
\end{aligned}$$

where $O(\cdot)$ depends only on d and ℓ .

Applying this last result for all cases $x = z + e' + e''$ and $x' = z$ yields (7.14) and thus the result. \square

7.3 First order expansion of the asymptotic speed

We have now all the necessary tools to compute the asymptotic speed. Applying Proposition 7.3 (which relies on Proposition 7.1), we get

$$G_\delta^{\bar{p}_{z,e,z+e'}}(z + e', z) = G_\delta^{\omega_0^{z,e}}(z + e', z) + o(1),$$

where the $o(\cdot)$ depends only on d and ℓ . Hence putting the previous equation together with (7.4), we obtain

$$\begin{aligned}
&\mathbf{E}_{1-\varepsilon}[\mathbf{1}\{\mathcal{I}\}\mathbf{1}\{\mathcal{C}(z) = e\}G_\delta^{\omega_0^{z,0}}(0, z)G_\delta^\omega(z + e', z)] \\
&= (1 + o(1))\mathbf{E}[\mathbf{1}\{\mathcal{I}\}\mathbf{1}\{\mathcal{C}(z) = e\}G_\delta^{\omega_0^{z,0}}(0, z)]G_\delta^{\omega_0^{0,e}}(e', 0),
\end{aligned} \tag{7.15}$$

CHAPITRE 5. THE SPEED OF A BIASED RANDOM WALK ON A PERCOLATION CLUSTER AT HIGH DENSITY

where the $o(\cdot)$ depends only on d and ℓ .

Applying the same methods for $\tilde{p}_{z+e,-e,z+e+e'}$ yields

$$\begin{aligned} & \mathbf{E}[\mathbf{1}\{\mathcal{I}(\omega^{z,e})\}G_\delta^{\omega^{z,\emptyset}}(0, z+e)G_\delta^{\omega^{z,e}}(z+e+e', z)] \\ &= (1+o(1))\mathbf{E}[\mathbf{1}\{\mathcal{I}(\omega^{z,e})\}G_\delta^{\omega^{z,\emptyset}}(0, z+e)]G_\delta^{\omega_0^{0,e}}(e+e', 0), \end{aligned} \quad (7.16)$$

where the $o(\cdot)$ depends only on d and ℓ .

Let us denote

$$\phi(e) = \sum_{e' \in \nu} (p^e(e') - p^\emptyset(e'))G_\delta^{\omega_0^{0,e}}(e', 0),$$

and

$$\psi(e) = \sum_{e' \in \nu} (p^{-e}(e') - p^\emptyset(e'))G_\delta^{\omega_0^{0,e}}(e+e', 0).$$

Hence imputing the estimates (7.15) and (7.16) into the expression of (7.1) modified using (7.3), we get

$$\begin{aligned} & d_\delta^{\hat{\omega}}(z) - d_\emptyset \\ &= \frac{\varepsilon(1+o(1))}{\mathbf{E}_{1-\varepsilon}[\mathbf{1}\{\mathcal{I}\}G_\delta^\omega(0, z)]} \left[\mathbf{E}_{1-\varepsilon}[\mathbf{1}\{\mathcal{I}(\omega^{z,e})\}G_\delta^{\omega^{z,\emptyset}}(0, z)] \left(\sum_{e \in \nu} (1 + \delta\phi(e))(d_e - d_\emptyset) \right) \right. \\ & \quad \left. + \mathbf{E}_{1-\varepsilon}[\mathbf{1}\{\mathcal{I}(\omega^{z,e})\}G_\delta^{\omega^{z,\emptyset}}(0, z+e)] \left(\sum_{e \in \nu} \delta\psi(e)(d_e - d_\emptyset) \right) \right] + O(\varepsilon^2), \end{aligned} \quad (7.17)$$

where the $o(\cdot)$ and $O(\cdot)$ depend only on d and ℓ .

We are not able to derive uniform estimates for $d_\delta^{\hat{\omega}}(z)$, nevertheless we are still able to estimate the asymptotic speed.

Lemma 7.1. *We have for $\delta \geq 1/2$, $z \in \mathbb{Z}^d$ and $e \in \nu$,*

$$\left| \frac{\mathbf{E}[\mathbf{1}\{\mathcal{I}(\omega^{z,e})\}G_\delta^{\omega^{z,\emptyset}}(0, z)]}{\mathbf{E}[\mathbf{1}\{\mathcal{I}\}G_\delta^\omega(0, z)]} - 1 \right| \leq O(\varepsilon),$$

where the $O(\cdot)$ depends only on d and ℓ .

Démonstration. Recalling that $\mathbf{P}[\mathcal{C}(z) = \emptyset] = 1 + O(\varepsilon)$, we get

$$\frac{\mathbf{E}[\mathbf{1}\{\mathcal{I}(\omega^{z,e})\}G_\delta^{\omega^{z,\emptyset}}(0, z)]}{\mathbf{E}[\mathbf{1}\{\mathcal{I}\}G_\delta^\omega(0, z)]} \leq \frac{1}{\mathbf{P}[\mathcal{C}(z) = \emptyset]} \frac{\mathbf{E}[\mathbf{1}\{\mathcal{I}(\omega^{z,e})\}G_\delta^{\omega^{z,\emptyset}}(0, z)]}{\mathbf{E}[\mathbf{1}\{\mathcal{I}(\omega^{z,\emptyset})\}G_\delta^{\omega^{z,\emptyset}}(0, z)]} \leq 1 + O(\varepsilon).$$

In order to prove the other bound we will use methods very similar to those used before and we will not give a fully-detailed proof. In words the idea is that we can condition the environment to be open on any finite ball without changing, up to terms

7. DERIVATIVE OF THE SPEED AT HIGH DENSITY

of order ε , the value of the expectation of Green functions. Hence, up to a $O(\varepsilon)$, we may suppose that $B^E(z, 2)$ contains only open edges and with this conditioning the two terms appearing in the quotient of the lemma are the same. With more formalism, we have

$$\begin{aligned} \mathbf{E}[\mathbf{1}\{\mathcal{I}(\omega^{z,e})\}G_\delta^{\omega^{z,0}}(0, z)] &= \sum_{\substack{A \in \{0,1\}^{B^E(z,2)} \\ A \neq \emptyset}} \mathbf{P}[\{e \in B^E(z, 2), e \in \omega\} = A] \\ &\times \mathbf{E}[\mathbf{1}\{\mathcal{I}(\omega^{z,e})\}G_\delta^{\omega^{z,0}}(0, z) \mid \{e \in B^E(z, 2), e \in \omega\} = A], \end{aligned} \quad (7.18)$$

it can be shown that for any $A \subset B^E(z, 2)$, $A \neq \emptyset$

$$\frac{\mathbf{E}[\mathbf{1}\{\mathcal{I}(\omega^{z,e})\}G_\delta^{\omega^{z,0}}(0, z) \mid \{e \in B^E(z, 2), e \in \omega\} = A]}{\mathbf{E}[\mathbf{1}\{\mathcal{I}(\omega^{z,e})\}G_\delta^{\omega^{z,0}}(0, z)]} < \gamma_1, \quad (7.19)$$

where γ_1 depends only on d and ℓ . The method is the same as before

1. We apply Lemma 4.1 to decompose the Green function into a hitting probability and a resistance.
2. With Lemma 4.2 we decompose the resistance appearing in (1) into the same resistance in $\omega^{B^E(z,2),1}$ and a local perturbation.
3. By upper bounding the integrand by terms which do not depend on the state of the edges of $B^E(z, 2)$ and using the same trick as in (6.7) we prove that for ε small enough

$$\frac{\mathbf{E}\left[\mathbf{1}\{\mathcal{I}(\omega_{(z,2),A}^{z,e})\}P_0^{\omega_{(z,2),A}^{z,0}}[T_z < \tau_\delta]R^{\omega^{(z,2),1}}[z \leftrightarrow \Delta]\right]e^{2\lambda z \cdot \vec{\ell}}}{\mathbf{E}[\mathbf{1}\{\mathcal{I}(\omega^{z,e})\}G_\delta^{\omega^{z,0}}(0, z)]} < \gamma_2.$$

We can use arguments similar to the ones in the proof of Lemma 6.1 (essentially repeating the steps (6.6), (6.7), (6.8) and (6.9)) to prove that

$$\begin{aligned} &\frac{\mathbf{E}\left[\mathbf{1}\{\mathcal{I}(\omega_{(z,2),A}^{z,e})\}P_0^{\omega_{(z,2),A}^{z,0}}[T_z < \tau_\delta]L_{z,2}^{C_2}e^{2\lambda L_{z,2}}\right]}{\mathbf{E}[\mathbf{1}\{\mathcal{I}(\omega^{z,e})\}G_\delta^{\omega^{z,0}}(0, z)]} \\ &= \frac{\mathbf{E}\left[\mathbf{1}\{\mathcal{I}(\omega_{(z,2),A})\}P_0^{\omega_{(z,2),A}^{z,0}}[T_z < \tau_\delta]L_{z,2}^{C_2}e^{2\lambda L_{z,2}} \mid \mathcal{C}(z) = e\right]}{\mathbf{E}[\mathbf{1}\{\mathcal{I}\}G_\delta^{\omega^{z,0}}(0, z) \mid \mathcal{C}(z) = e]} < \gamma_3, \end{aligned}$$

since $L_{z,2}$ has arbitrarily large exponential moments under the measure $\mathbf{P}[\cdot \mid \mathcal{C}(z) = e]$, for ε small enough by Proposition 5.3. For the first equality in the previous equation, we implicitly used that $L_{z,2}$ does not depend on the configuration at z which is true by the first property of Proposition 4.1.

CHAPITRE 5. THE SPEED OF A BIASED RANDOM WALK ON A PERCOLATION CLUSTER AT HIGH DENSITY

This reasoning yields (7.19) with $\gamma_1 = \gamma_2 + C_1\gamma_3$. Now, the equations (7.19) and (7.18) imply that

$$\begin{aligned} \mathbf{E}[\mathbf{1}\{\mathcal{I}(\omega^{z,e})\}G_\delta^{\omega^{z,0}}(0,z)] &= O(\varepsilon)\mathbf{E}[\mathbf{1}\{\mathcal{I}(\omega^{z,e})\}G_\delta^{\omega^{z,0}}(0,z)] \\ &\quad + \mathbf{E}[\mathbf{1}\{\mathcal{I}(\omega^{z,e})\}G_\delta^{\omega^{z,0}}(0,z), \{\mathbf{1}\{e \in \omega\}, e \in B^E(z,2)\} = B^E(z,2)], \end{aligned}$$

and since on $\{\mathbf{1}\{e \in \omega\}, e \in B^E(z,2)\} = B^E(z,2)$ we have $\mathbf{1}\{\mathcal{I}\}G_\delta^\omega(0,z) = \mathbf{1}\{\mathcal{I}(\omega^{z,e})\}G_\delta^{\omega^{z,0}}(0,z)$, it follows that

$$\begin{aligned} &\mathbf{E}[\mathbf{1}\{\mathcal{I}(\omega^{z,e})\}G_\delta^{\omega^{z,0}}(0,z)] \\ &= (1 + O(\varepsilon))\mathbf{E}[\mathbf{1}\{\mathcal{I}\}G_\delta^\omega(0,z), \{\mathbf{1}\{e \in \omega\}, e \in B^E(z,2)\} = B^E(z,2)] \\ &\leq (1 + O(\varepsilon))\mathbf{E}[\mathbf{1}\{\mathcal{I}\}G_\delta^\omega(0,z)], \end{aligned}$$

which yields the other bound. □

Recalling Proposition 3.1, we can use (7.17) and Lemma 7.1 to get

$$\begin{aligned} &\frac{\sum_{z \in \mathbb{Z}^d} G_\delta^{\widehat{\omega}_\delta^\varepsilon}(0,z) \widehat{d}_\delta^\varepsilon(z)}{\sum_{z \in \mathbb{Z}^d} G_\delta^{\widehat{\omega}_\delta^\varepsilon}(0,z)} - d_\emptyset \\ &= \varepsilon(1 + o(1)) \frac{\sum_{z \in \mathbb{Z}^d} \sum_{e \in \nu} \mathbf{E}[\mathbf{1}\{\mathcal{I}\}G_\delta^\omega(0,z)](1 + \delta\phi(e))(d_e - d_\emptyset)}{\sum_{z \in \mathbb{Z}^d} \mathbf{E}[\mathbf{1}\{\mathcal{I}\}G_\delta^\omega(0,z)]} \\ &\quad + \varepsilon(1 + o(1)) \frac{\sum_{z \in \mathbb{Z}^d} \sum_{e \in \nu} \mathbf{E}[\mathbf{1}\{\mathcal{I}\}G_\delta^\omega(0,z+e)]\delta\psi(e)(d_e - d_\emptyset)}{\sum_{z \in \mathbb{Z}^d} \mathbf{E}[\mathbf{1}\{\mathcal{I}\}G_\delta^\omega(0,z)]} \\ &= \varepsilon \sum_{e \in \nu} (1 + \delta(\phi(e) + \psi(e)))(d_e - d_\emptyset) + o(\varepsilon), \end{aligned}$$

since $\sum_z \mathbf{E}[\mathbf{1}\{\mathcal{I}\}G_\delta^\omega(0,z)] = \sum_z \mathbf{E}[\mathbf{1}\{\mathcal{I}\}G_\delta^\omega(0,z+e)] = \mathbf{P}[\mathcal{I}]/(1-\delta)$.

In order to simplify the previous expression we prove

Lemma 7.2. *We have*

$$\begin{aligned} &\sum_{e' \in \nu} (p^e(e') - p^\emptyset(e'))G^{\omega^{0,e}}(e',0) + \sum_{e' \in \nu} (p^{-e}(e') - p^\emptyset(e'))G^{\omega^{0,e}}(e+e',0) \\ &= (p^\emptyset(e) - p^\emptyset(-e))(G^{\omega^{0,e}}(0,0) - G^{\omega^{0,e}}(e,0)) - p^\emptyset(e). \end{aligned}$$

Démonstration. Recalling the notations (2.3), we get

$$p^e(e') - p^\emptyset(e') = \begin{cases} \frac{c(e')c(e)}{\pi^\emptyset \pi^e} & \text{if } e \neq e', \\ -\frac{c(e')}{\pi^\emptyset} & \text{if } e = e'. \end{cases}$$

Hence we get that,

$$\sum_{e' \neq e} \frac{c(e')c(e)}{\pi^\emptyset \pi^e} G^{\omega_0^{0,e}}(e', 0) = \frac{c(e)}{\pi^\emptyset} (G^{\omega_0^{0,e}}(0, 0) - 1), \quad (7.20)$$

and

$$\sum_{e' \neq e} \frac{c(e')c(-e)}{\pi^\emptyset \pi^{-e}} G^{\omega_0^{0,e}}(e + e', 0) = \frac{c(-e)}{\pi^\emptyset} G^{\omega_0^{0,e}}(e, 0). \quad (7.21)$$

Finally using $\frac{c(e)}{\pi^\emptyset} = p^\emptyset(e)$ and the previous equations, the computations are straightforward. \square

Recalling that $p^\emptyset(e) - p^\emptyset(-e) = d_\emptyset \cdot e$ and $1 - p^\emptyset(e) = \pi^e / \pi^\emptyset$, we see that the previous lemma means that

$$\alpha(e) = \phi(e) + \psi(e) = \frac{\pi^e}{\pi^\emptyset} + (d_\emptyset \cdot e)(G^{\omega_0^{0,e}}(0, 0) - G^{\omega_0^{0,e}}(e, 0)),$$

and so Proposition 3.2 yields by letting δ go to 1

$$v_\ell(1 - \varepsilon) = d_\emptyset + \varepsilon \sum_{e \in \nu} \alpha(e)(d_e - d_\emptyset) + o(\varepsilon). \quad (7.22)$$

We still may simplify slightly the expression of the speed we obtained using the following

$$\sum_{e \in \nu} \pi^e d_e = \sum_{i=1}^{2d} \sum_{e \neq e^{(i)}} c(e)e = (2d - 1) \sum_{e \in \nu} c(e)e = (2d - 1)\pi^\emptyset d_\emptyset = \sum_{e \in \nu} \pi^e d_\emptyset,$$

Inserting this last equation into (7.22) yields

$$v_\ell(1 - \varepsilon) = d_\emptyset + \varepsilon \sum_{e \in \nu} (d_\emptyset \cdot e)(G^{\omega_0^{0,e}}(0, 0) - G^{\omega_0^{0,e}}(e, 0))(d_e - d_\emptyset) + o(\varepsilon),$$

which proves Theorem 2.2. \square

8 Estimate on Kalikow's environment

The section is devoted to the proof of Proposition 7.2 so that we still assume to have a fixed $z \in \mathbb{Z}^d$ and $e, e_+ \in \nu$. Before entering into the details let us present the main steps of the proof of the previous proposition which are rather similar to the ones in the proof of Proposition 6.1.

1. The Green functions behave essentially as a hitting probability multiplied by a resistance (normalized by the invariant measure). See (8.19).

CHAPITRE 5. THE SPEED OF A BIASED RANDOM WALK ON A PERCOLATION CLUSTER AT HIGH DENSITY

2. Then we use the estimates on resistances of Proposition 4.2. This procedure will essentially give an upper bound of the numerator in Proposition 7.2 as a finite sum of terms which are linked to the denominator but with a local correlation around y due to the presence of random variables similar to the random variable “ L_z ” which appeared in the proof of Proposition 6.1. See (8.27) and (8.28).
3. We finish the proof by decorrelation lemmas similar to Lemma 6.1 to handle the second type of terms we just described. See sub-section 8.3

Compared to Proposition 6.1 there is an extra difficulty added by the fact that we need to handle two Green functions instead of only one (in some sense we will even have three), hence we will apply Proposition 4.2 recursively, this is done in Proposition 8.2.

We point out that in addition, we cannot prove a decorrelation lemma involving one of the hitting probabilities coming from the Green functions appearing in Proposition 7.2. Hence we need to transform one of them into an expression which we will be able to decorrelate from a local modification of the environment and this will change slightly the outline of the proof given above. The aim of the next sub-section is to take care of this problem.

8.1 The perturbed hitting probabilities

We want to understand the effect of the change of configuration around y on the hitting probabilities $P_{z+e_+}^{\omega_{y,A}^{z,e}}[T_y < \tau_\delta]$ and $P_0^{\omega_{y,A}^{z,0}}[T_z \leq \tau_\delta]$. The former term can be estimated since if we denote $B^*(y, k) = \left\{ t \in B(y, k), t \stackrel{B^E(y,k) \setminus \{z, z+e\}}{\leftrightarrow} y \right\}$ and

$$p_z^\omega(y, k) = \begin{cases} \max_{u \in \partial B^*(y, k)} P_{z+e_+}^\omega[T_u = T_{\partial B^*(y, k)} < \tau_\delta] & \text{if } z + e_+ \notin B^*(y, k), \\ 1 & \text{otherwise.} \end{cases} \quad (8.1)$$

then for any $k \geq 1$ such that $0 \notin B^*(y, k)$, we have

$$P_{z+e_+}^{\omega_{y,A}^{z,e}}[T_y < \tau_\delta] \leq \rho_d k^d p_z^{\omega_{y,A}^{z,e}}(y, k), \quad (8.2)$$

the special notation $B^*(y, k)$ is useful because in the configuration $\omega^{z,e}$ the walker can only reach y by entering the ball $B(y, k)$ through $B^*(y, k)$.

As we announced previously, the second hitting probability is more difficult to treat. Let us introduce the following notations

$$p_1^\omega(y, k) = \begin{cases} \max_{u \in \partial B(y, k)} P_0^\omega[T_u = T_{\partial B(y, k)} < \tau_\delta] & \text{if } 0 \notin B(y, k), \\ 1 & \text{otherwise,} \end{cases} \quad (8.3)$$

8. ESTIMATE ON KALIKOW'S ENVIRONMENT

$$p_2^\omega(y, k) = \begin{cases} \max_{u \in \partial B(y, k)} P_u^\omega [T_z < \tau_\delta \wedge T_{\partial B(y, k)}^+] & \text{if } z \notin B(y, k), \\ 1 & \text{otherwise.} \end{cases} \quad (8.4)$$

To make notations lighter we also set

$$R_*^\omega(z) = e^{2\lambda z \cdot \vec{\ell}} R^\omega[z \leftrightarrow \Delta] \text{ and } R_*^\omega(y) = e^{2\lambda y \cdot \vec{\ell}} R^\omega[y \leftrightarrow \Delta], \quad (8.5)$$

and moreover we introduce

$$\overline{R}_*^\omega(y, k) = \begin{cases} \max_{u \in \partial B(y, k)} R_*^\omega[u \leftrightarrow z \cup \Delta] & \text{if } z \notin B(y, k), \\ 1 & \text{otherwise,} \end{cases} \quad (8.6)$$

where

$$\text{for any } u \in \mathbb{Z}^d, \quad R_*^\omega[u \leftrightarrow z \cup \Delta] = e^{2\lambda z \cdot \vec{\ell}} R^\omega[u \leftrightarrow z \cup \Delta]. \quad (8.7)$$

then we have the following proposition.

Proposition 8.1. *Take any configuration ω and set $y, z \in \mathbb{Z}^d$ and $B = B(y, r)$ with $r \geq 1$ and $\delta \geq 1/2$. If $0, z \notin B$ and $P_0^\omega [T_z < \tau_\delta] > 2P_0^\omega [T_z < T_{\partial B} \wedge \tau_\delta]$, then we have*

$$P_0^\omega [T_z < \tau_\delta] \leq C_{19} r^{2d} p_1^\omega(y, k) p_2^\omega(y, k) \overline{R}_*^\omega(y, k).$$

If $0 \in B$, $z \notin B$ and $P_0^\omega [T_z < \tau_\delta] > 2P_0^\omega [T_z < T_{\partial B} \wedge \tau_\delta]$, then

$$P_0^\omega [T_z < \tau_\delta] \leq C_{19} r^{2d} p_2^\omega(y, k) \overline{R}_*^\omega(y, k).$$

Finally if $0 \notin B$ and $z \in B$,

$$P_0^\omega [T_z < \tau_\delta] \leq C_{19} r^{2d} p_1^\omega(y, k).$$

Thanks to this lemma we can say that $P_0^\omega [T_z < \tau_\delta]$ is either not influenced much by a local modification around y (in the case where naturally the walk will not visit y when it goes from 0 to z), or upper bounded by a product of at most three random variables. Two of them behave as hitting probabilities which are well suited for our future decorrelation purposes, the third random variable is essentially a resistance for which we have estimates as well.

Démonstration. We will only consider the case $0, z \notin B$, the other being similar but simpler. Our hypothesis implies

$$P_0^\omega [T_z < \tau_\delta] \leq 2P_0^\omega [T_{\partial B} \leq T_z < \tau_\delta],$$

we can get an upper bound on the right-hand term by Markov's property

$$P_0^\omega [T_B \leq T_z < \tau_\delta] = \sum_{u \in \partial B} P_0^\omega [T_u = T_{\partial B} < \tau_\delta] P_u^\omega [T_z < \tau_\delta] \quad (8.8)$$

CHAPITRE 5. THE SPEED OF A BIASED RANDOM WALK ON A PERCOLATION CLUSTER AT HIGH DENSITY

$$\leq |\partial B| \max_{u \in \partial B} P_0^\omega [T_u = T_{\partial B} < \tau_\delta] \max_{u \in \partial B} P_u^\omega [T_z < \tau_\delta].$$

Denoting $z_1 \rightarrow \dots \rightarrow z_n$ the event that the n first vertices of $\partial B \cup z \cup \Delta$ visited are, in order, z_1, z_2, \dots, z_n , we can write for $u \in \partial B$

$$\begin{aligned} P_u^\omega [T_z < \tau_\delta] &= E_u^\omega \left[\sum_n \sum_{z_1, \dots, z_n \in \partial B} \mathbf{1}\{z_1 \rightarrow \dots \rightarrow z_n \rightarrow z\} \right] \\ &= \sum_n \sum_{z_1, \dots, z_n \in \partial B} E_u^\omega [\mathbf{1}\{z_1 \rightarrow \dots \rightarrow z_n\}] P_{z_n}^\omega [T_z < T_{\partial B}^+ \wedge \tau_\delta] \\ &\leq \max_{v \in \partial B} P_v^\omega [T_z < \tau_\delta \wedge T_{\partial B}^+] E_u^\omega \left[\sum_n \sum_{z_1, \dots, z_n \in \partial B} \mathbf{1}\{z_1 \rightarrow \dots \rightarrow z_n\} \right] \\ &= \max_{v \in \partial B} P_v^\omega [T_z < \tau_\delta \wedge T_{\partial B}^+] G_{\delta, \{z\}}^\omega(u, \partial B), \end{aligned} \quad (8.9)$$

where

$$G_{\delta, \{z\}}^\omega(u, \partial B) = E_u^\omega \left[\sum_{n=0}^{\tau_\delta \wedge T_z} \mathbf{1}\{X_n \in \partial B\} \right] \leq |\partial B| \max_{v \in \partial B} G_{\delta, \{z\}}^\omega(v, v). \quad (8.10)$$

Since by Lemma 4.2, (2.5) and (4.1) we have for $\delta \geq 1/2$ and any $v \in \partial B$

$$G_{\delta, \{z\}}^\omega(v, v) = \pi^{\omega(\delta)}(v) R^\omega(v \leftrightarrow z \cup \delta) \leq \gamma_1 \max_{u \in \partial B} R_*^\omega[u \leftrightarrow z \cup \Delta]. \quad (8.11)$$

Since $|\partial B| \leq \rho_d r^d$ adding up (8.9), (8.10) and (8.11) we get

$$\max_{u \in \partial B} P_u^\omega [T_z < \tau_\delta] \leq \gamma_2 r^d \max_{u \in \partial B} R_*^\omega[u \leftrightarrow z \cup \Delta] \max_{u \in \partial B} P_u^\omega [T_z < \tau_\delta \wedge T_{\partial B}^+].$$

Using the previous equation with (8.8) concludes the proof of the Proposition. \square

Recalling the notations from (2.1), (2.2) and (8.7), let us introduce

$$\underline{R}_*^\omega(y, k) = \begin{cases} \min_{u \in \partial B(y, k)} R_*^{\omega(y, k), 1}[u \leftrightarrow z \cup \Delta] & \text{if } z \notin B(y, k), \\ 1 & \text{otherwise,} \end{cases} \quad (8.12)$$

For the future decorrelation part we need to rewrite $\bar{R}_*^{\omega(y, r), 1}(y, r)$ in terms of $\underline{R}_*^\omega(y, r')$ and local quantities. This is done in the following lemma.

Lemma 8.1. *For any $B = B_E(y, r)$ and $r' \geq r$. Suppose that $z \in K_\infty(\omega)$ and $\partial B \cap K_\infty(\omega) \neq \emptyset$, we have*

$$\bar{R}_*^{\omega(y, r), 1}(y, r) \leq e^{4\lambda r'} \underline{R}_*^\omega(y, r') + C_{20} L_{y, r'}^{C_{21}} e^{C_{22} L_{y, r'}}.$$

8. ESTIMATE ON KALIKOW'S ENVIRONMENT

Démonstration. Let us denote $v \in \partial B(y, r)$ such that

$$\max_{u \in \partial B(y, k)} R_*^{\omega(y, r), 1}(u \leftrightarrow z \cup \Delta) = R^{\omega(y, r), 1}(v \leftrightarrow z \cup \Delta) e^{2\lambda v \cdot \vec{\ell}}, \quad (8.13)$$

applying Proposition 4.3 we get for any $r' \geq r$

$$\begin{aligned} R_*^{\omega(y, r), 1}(v \leftrightarrow z \cup \Delta) &\leq R^{\omega(y, r'), 1}(v \leftrightarrow z \cup \Delta) + C_1 L_{y, r'}^{C_2} e^{2\lambda(-y \cdot \vec{\ell} + L_{y, r'})} \\ &\leq R^{\omega(y, r'), 1}(v \leftrightarrow z \cup \Delta) + C_1 L_{y, r'}^{C_2} e^{2\lambda(-v \cdot \vec{\ell} + 2L_{y, r'})}, \end{aligned} \quad (8.14)$$

where we used that $y \cdot \vec{\ell} \geq v \cdot \vec{\ell} - r$ and that $L_{y, r'} \geq r' \geq r$ by the third property of Proposition 4.1.

For any $u \in \partial B(y, r')$, let us denote $i_0(\cdot)$ the unit current from u to $z \cup \{\Delta\}$ in $\omega_{(y, r'), 1}$ and \vec{Q} one of the shortest directed path from v to u included in $B(y, r')$. We can use Thompson's principle applied to the unit flow from v to $z \cup \{\Delta\}$ given by $\theta(e) = i_0(e) + (\mathbf{1}\{e \in \vec{Q}\} - \mathbf{1}\{-e \in \vec{Q}\})$ to get

$$R_{\omega_{(y, r'), 1}}(v \leftrightarrow z \cup \Delta) \leq R_{\omega_{(y, r'), 1}}^{z, \emptyset}(u \leftrightarrow z \cup \Delta) + 8r' e^{2\lambda(-y \cdot \vec{\ell} + r')}, \quad (8.15)$$

where we skipped a simple exhaustion argument.

Hence adding up (8.14) and (8.15), we get

$$\begin{aligned} R_*^{\omega(y, r), 1}(v \leftrightarrow z \cup \Delta) &\leq \min_{u \in \partial B(y, r')} R_*^{\omega(y, r'), 1}(v \leftrightarrow z \cup \Delta) \\ &\quad + \gamma_1 (L_{y, r'})^{\gamma_2} \gamma_3^{L_{y, r'}} e^{-2\lambda y \cdot \vec{\ell}}, \end{aligned}$$

since $L_{y, r'} \geq r' \geq r$.

We get multiplying the left side by $e^{2\lambda v \cdot \vec{\ell}}$ and the right one by $e^{2\lambda r'} e^{2\lambda y \cdot \vec{\ell}}$ (which is greater than $e^{2\lambda v \cdot \vec{\ell}}$) that

$$R_*^{\omega(y, r), 1}(v \leftrightarrow z \cup \Delta) e^{2\lambda v \cdot \vec{\ell}} \leq e^{4\lambda r'} \underline{R}_*(y, r') + \gamma_4 (L_{y, r'})^{\gamma_5} e^{\gamma_6 L_{y, r'}}$$

where we used that $\max_{u \in \partial B(y, r')} e^{2\lambda u \cdot \vec{\ell}} \leq e^{2\lambda r'} e^{2\lambda y \cdot \vec{\ell}}$. So by (8.13) we obtain the lemma. \square

8.2 Quenched estimates on perturbed Green functions

The aim of this subsection is to complete the first two steps of the sketch of proof at the beginning of Section 8. Let us introduce

$$R_*(z) = R_*^{\omega_{y, A}, z, \emptyset}(z) \text{ and } R_*(y) = R_*^{\omega_{y, A}, z, e}(y), \quad (8.16)$$

CHAPITRE 5. THE SPEED OF A BIASED RANDOM WALK ON A PERCOLATION CLUSTER AT HIGH DENSITY

and this way we reduce our problem of studying Green functions to studying resistances, indeed using Lemma 4.1 and (6.2) we get for $\delta \geq 1/2$,

$$\frac{1}{\kappa_1} G_\delta^{\omega_{y,A}^{z,\emptyset}}(z, z) \leq R_*(z) \leq 2\kappa_1 G_\delta^{\omega_{y,A}^{z,\emptyset}}(z, z), \quad (8.17)$$

and

$$\frac{1}{\kappa_1} G_\delta^{\omega_{y,A}^{z,e}}(y, y) \leq R_*(y) \leq 2\kappa_1 G_\delta^{\omega_{y,A}^{z,e}}(y, y). \quad (8.18)$$

Moreover we can now easily obtain the first step of our proof since

$$G_\delta^{\omega_{y,A}^{z,\emptyset}}(0, z) G_\delta^{\omega_{y,A}^{z,e}}(z + e_+, y) \leq 4\kappa_1^2 P_0^{\omega_{y,A}^{z,\emptyset}}[T_z \leq \tau_\delta] P_{z+e_+}^{\omega_{y,A}^{z,e}}[T_y \leq \tau_\delta] R_*(z) R_*(y). \quad (8.19)$$

As mentioned before, we will apply recursively the resistance estimates of Proposition 4.2, for this we introduce

$$l_y^{(0)} = 1, \quad l_y^{(1)} = L_{y,1}, \quad l_y^{(2)} = L_{y,l_y^{(1)}} \quad \text{and} \quad l_y^{(3)} = L_{y,l_y^{(2)}},$$

$L_y^{(i)}(\omega) = l_y^{(i)}(\omega^{z,\emptyset}) \vee l_y^{(i)}(\omega^{z,e})$ and $B_y^{(i)} = B^E(y, L_y^{(i)})$. Moreover we set

$$Z_{y,k} = C_{23} k^{C_{24}} e^{C_{25}k} e^{2\lambda((z-y)\cdot\vec{\ell})^+} \quad \text{and} \quad Z_y^{(i)} = Z_{y,L_y^{(i)}},$$

where and $C_{23} = 1 \vee C_1 \vee C_{19} \vee C_{20}$, $C_{24} = C_2 \vee C_{21} \vee 2d$ and $C_{25} = 4\lambda \vee C_{22}$. Moreover set, for $i = 0, \dots, 3$

$$R_*^{(i)}(y) = R_*^{\omega_{B_y^{(i)},1}^{z,e}}(y) \quad \text{and} \quad R_*^{(i)}(z) = R_*^{\omega_{B_y^{(i)},1}^{z,\emptyset}}(z). \quad (8.20)$$

Also recalling (8.12), we set

$$\underline{R}_*^{(i)} = \underline{R}_*^{\omega_{y,L_y^{(i)}}^{z,\emptyset}}(y, L_y^{(i)}) \quad \text{and} \quad \overline{R}_*^{(i)} = \overline{R}_*^{\omega_{y,L_y^{(i)}}^{z,e}}(y, L_y^{(i)}).$$

Finally we denote for $i = 1, 2, 3$ and $j = 0, 1, 2$

$$p_i^{(j)} = p_i^{\omega_{y,L_y^{(j)}}^{z,\emptyset}}(y, L_y^{(j)}) \quad \text{and} \quad p_z^{(j)} = p_z^{\omega_{y,L_y^{(j)}}^{z,e}}(y, L_y^{(j)}).$$

In particular, since we assumed $Z_y^{(i)}$ large enough, we can get from Proposition 8.1 that for any $z \in \mathbb{Z}^d$ and $i \in \{0, 1, 2\}$,

$$P_0^{\omega_{y,A}^{z,e}}[T_z < \tau_\delta] \leq Z_y^{(i)} p_1^{(i)} p_2^{(i)} \overline{R}_*^{(i)} + 2P_0^{\omega_{y,A}^{z,e}}[T_z < T_{\partial B_y^{(i)}} \wedge \tau_\delta], \quad (8.21)$$

and also from Lemma 8.1 we obtain that for any $y, z \in K_\infty(\omega_{y,A}^{z,e})$, we have for any $i \leq j$

$$\overline{R}_*^{(i)} \leq Z_y^{(j)} \underline{R}_*^{(j)} + Z_y^{(j+1)}. \quad (8.22)$$

8. ESTIMATE ON KALIKOW'S ENVIRONMENT

Moreover for $y, z \in K_\infty(\omega_{y,A}^{z,e})$, the random variables $Z_y^{(i)}$ are large enough for us to apply Proposition 4.2 so that we have for $i \in \{0, 1, 2\}$

$$R_*(z) \leq R_*^{(i)}(z) + Z_y^{(i+1)} \text{ and } R_*(y) \leq R_*^{(i)}(y) + Z_y^{(i+1)}. \quad (8.23)$$

The equations (8.21) and (8.22) yield that for any $y, z \in K_\infty(\omega_{y,A}^{z,e})$

$$\begin{aligned} & P_0^{\omega_{y,A}^{z,e}}[T_z < \tau_\delta] R_*(z) R_*(y) \\ & \leq \left(p_1^{(0)} p_2^{(0)} (Z_y^{(0)} \underline{R}^{(0)} + Z_y^{(1)}) + 2P_0^{\omega_{y,A}^{z,e}}[T_z < T_{\partial B_y^{(0)}} \wedge \tau_\delta] \right) R_*(z) R_*(y). \end{aligned} \quad (8.24)$$

The idea is now to use recursively (8.23), (8.21) and (8.22) to control all the previous terms. We can obtain the following proposition

Proposition 8.2. *For any ω such that $y, z \in K_\infty(\omega_{y,A}^{z,e})$,*

$$\begin{aligned} \underline{R}^{(0)} R_*(z) R_*(y) & \leq C_{26} \left[\underline{R}^{(0)} R_*^{(0)}(z) R_*^{(0)}(y) \right. \\ & \quad + (Z_y^{(1)})^2 (\underline{R}^{(1)} R_*^{(1)}(z) + \underline{R}^{(1)} R_*^{(1)}(z) + R_*^{(1)}(z) R_*^{(1)}(y)) \\ & \quad \left. + (Z_y^{(2)})^4 (\underline{R}^{(2)} + R_*^{(2)}(z) + R_*^{(2)}(y)) + (Z_y^{(3)})^4 \right], \end{aligned}$$

and

$$R_*(z) R_*(y) \leq C_{27} \left[R_*^{(1)}(z) R_*^{(1)}(y) + Z_y^{(2)} (R_*^{(2)}(z) + R_*^{(2)}(y)) + (Z_y^{(3)})^2 \right].$$

This is an interesting upper bound since the resistances are only multiplied with independent local quantities, e.g. $Z_y^{(2)}$ is independent of $R_*^{(2)}(y)$, since $Z_y^{(2)}$ depends only on the ‘‘stopping time’’ $L_y^{(2)}$, i.e. only on the edges of $B^E(y, L_y^{(2)})$ by the second property of Proposition 4.1.

Démonstration. Let us prove the first upper bound, we use (8.23) to get

$$\begin{aligned} \underline{R}^{(0)} R_*(z) R_*(y) & \leq \underline{R}^{(0)} (R_*^{(0)}(z) + Z_y^{(1)}) (R_*^{(0)}(y) + Z_y^{(1)}) \\ & \leq \underline{R}^{(0)} R_*^{(0)}(z) R_*^{(0)}(y) + Z_y^{(1)} (\underline{R}^{(0)} R_*^{(0)}(z) + \underline{R}^{(0)} R_*^{(0)}(y)) + (Z_y^{(1)})^2 \underline{R}^{(0)}. \end{aligned}$$

The first term of the right-hand side is of the form announced in the proposition. We need to simplify the remaining terms, we will continue the expansion for $\underline{R}^{(0)} R_*^{(0)}(z)$ (the method is similar for $\underline{R}^{(0)} R_*^{(0)}(y)$), using (8.23) and (8.22)

$$\begin{aligned} & \underline{R}^{(0)} R_*^{(0)}(z) \\ & \leq (Z_y^{(1)} \underline{R}^{(1)} + Z_y^{(2)}) (R_*^{(1)}(z) + Z_y^{(2)}) \\ & \leq Z_y^{(1)} \underline{R}^{(1)} R_*^{(1)}(z) + Z_y^{(2)} (Z_y^{(1)} \underline{R}^{(1)} + R_*^{(1)}(z)) + (Z_y^{(2)})^2 \\ & \leq Z_y^{(1)} \underline{R}^{(1)} R_*^{(1)}(z) + (Z_y^{(2)})^2 (Z_y^{(1)} \underline{R}^{(1)} + R_*^{(1)}(z) + 2Z_y^{(3)}) + (Z_y^{(2)})^2 \end{aligned}$$

CHAPITRE 5. THE SPEED OF A BIASED RANDOM WALK ON A PERCOLATION CLUSTER AT HIGH DENSITY

$$\leq Z_y^{(1)} \underline{R}_*^{(1)} R_*^{(1)}(z) + (Z_y^{(2)})^3 (\underline{R}_*^{(2)} + R_*^{(2)}(z)) + 3(Z_y^{(3)})^3,$$

where we used that for any $i \leq j$ we have $1 \leq Z_y^{(i)} \leq Z_y^{(j)}$. All terms here are of the same type as in the proposition.

The expansion for the term $(Z_y^{(1)})^2 \underline{R}_*^{(0)}$ is handled by applying (8.22) for $i = 0$ and $j = 1$. Once again our upper bound is correct.

The second upper bound is similar and simpler since it uses only (8.23), so we skip the details. \square

Recalling the notations (8.3), (8.4) and (8.1) we have for $j \in \{z, 1, 2\}$

$$\text{for } y \in \mathbb{Z}^d \text{ and } k_1 < k_2, \quad p_j^\omega(y, k_1) \leq \rho_d k_2^{d-1} p_j^\omega(y, k_2), \quad (8.25)$$

so that for $k_1 < k_2 \in \{0, 1, 2\}$,

$$p_j^{(k_1)} \leq \rho_d Z_y^{(k_2)} p_j^{(k_2)}. \quad (8.26)$$

Finally let us take notice of the trivial inequality $P_0^\omega[T_z < T_{\partial B_y^{(0)}} \wedge \tau_\delta] \leq P_0^\omega[T_z < T_{\partial B_y^{(i)}} \wedge \tau_\delta]$ which used with (8.25) and Proposition 8.2 can expand (8.24). We can apply Proposition 8.2 which can be applied since $y, z \in K_\infty(\omega_{y,A}^{z,e})$ if the integrand is positive. Then, imputing this expanded equation into (8.19) and using (8.2) we can show that it is possible to give an upper bound on $G_\delta^{\omega_{y,A}^{z,0}}(0, z) G_\delta^{\omega_{y,A}^{z,e}}(z, y)$ with a finite sum of terms of the form

$$\mathbf{1}\{\mathcal{I}(\omega^{y,A})\} (Z_y^{(i)})^{C_{28}} p_z^{(i)} p_1^{(i)} p_2^{(i)} \underline{R}_*^{(i)} R_*^{(i)}(z) R_*^{(i)}(y), \quad (8.27)$$

and

$$\mathbf{1}\{\mathcal{I}(\omega^{y,A})\} (Z_y^{(i)})^{C_{28}} p_z^{(i)} P_0^{\omega_{y,A}^{z,0}} [T_z < T_{\partial B_y^{(i)}} \wedge \tau_\delta] R_*^{(i)}(y) R_*^{(i)}(z), \quad (8.28)$$

for $i \in \{0, 1, 2, 3\}$ and also similar terms where $\underline{R}_*^{(i)}$, $R_*^{(i)}(z)$ or $R_*^{(i)}(y)$ are possibly replaced by 1.

This is what we aimed for at the beginning of the proof of Proposition 7.2 : the correlation term $Z_y^{(i)}$ is associated only with terms with which it is independent. Now we are only left with the third step of our proof that is the decorrelation part. Indeed, since we need to give an upper bound on $\mathbf{E} \left[G_\delta^{\omega_{y,A}^{z,0}}(0, z) G_\delta^{\omega_{y,A}^{z,e}}(z, y) \right]$, we shall look for an upper bound on the expectations of (8.27) and (8.28), which is the subject of the next sub-section.

8.3 Decorrelation part

Let us prove the first decorrelation lemma.

8. ESTIMATE ON KALIKOW'S ENVIRONMENT

Lemma 8.2. *We have for $i \in \{0, 1, 2, 3\}$ and $\delta \geq 1/2$*

$$\begin{aligned} & \mathbf{E} \left[\mathbf{1} \{ \mathcal{I}(\omega^{y,A}) \} (Z_y^{(i)})^{C_{28}} p_z^{(i)} p_1^{(i)} p_2^{(i)} \underline{R}_*^{(i)} R_*^{(i)}(z) R_*^{(i)}(y) \right] \\ & \leq C_{29} \mathbf{E} \left[(L_y^{(i)})^{C_{30}} e^{C_{31} L_y^{(i)}} \right] \mathbf{E} \left[\mathbf{1} \{ \mathcal{I}(\omega^{y,\emptyset}) \} G_\delta^{\omega_{y,\emptyset}^{z,0}}(0, z) G_\delta^{\omega_{y,\emptyset}^{z,e}}(z + e_+, y) \right] e^{C_{32}((y-z) \cdot \bar{\ell})^+}, \end{aligned}$$

where C_{29} , C_{30} , C_{31} and C_{32} depend only on d and ℓ .

The same lemma holds, with different constants, if we replace $\underline{R}_*^{(i)}$, $R_*^{(i)}(z)$ or $R_*^{(i)}(y)$ by 1. Indeed it can be seen using Rayleigh's monotonicity principle that for $\delta > 1/2$, these three quantities are lower bounded by

$$1 \wedge R^{\omega_0}(0) \wedge \min_{k \in \mathbb{N}} \min_{u \in \partial B(0,k), z \notin B(0,k)} R_*^{\omega_0}(u \leftrightarrow z \cup \Delta) \geq \gamma_1,$$

where γ_1 can be chosen independent of y , i and z . By Lemma 4.2,

$$\begin{aligned} R_*^{\omega_0}(u \leftrightarrow z \cup \Delta) & \geq \gamma_1 G_{\delta, \{z\}}^{\omega_0}(u, u) = \gamma_1 P_u^{\omega_0}[T_u^+ < T_z \wedge \tau_\delta]^{-1} \\ & \geq P_u^{\omega_0}[\tau_\delta > 2, X_1 = y, X_2 = u]^{-1} \geq \gamma_1 \kappa_0^2/4, \end{aligned}$$

where y is some neighbour of u which is not z .

Démonstration. First let us notice that if the integrand is positive then $\mathbf{1} \{ \mathcal{I}(\omega^{y,A}) \} p_1^{(i)}$ is positive and necessarily $\left\{ 0 \leftrightarrow \partial B_y^{(i)}, 0 \stackrel{\omega_{y,\emptyset}^{B_y^{(i)},0}}{\leftrightarrow} \infty \right\}$ which we denote $\{0 \Leftrightarrow y \Leftrightarrow \infty\}$, we recall $L_y^{(i)} < \infty$ by Proposition 4.1.

Let us condition on the event $\{L_y^{(i)} = k\}$ for $k < \infty$. First suppose that $0 \notin B(y, k)$, $z \notin B(y, k)$ and $z + e_+ \notin B^*(y, k)$, where we used a notation appearing above (8.1). Recalling the notations (8.1), (8.3) and (8.4), we may denote $x_0 \in \partial B^*(y, k)$ and $x_1, x_2 \in \partial B(y, k)$ such that

$$\begin{aligned} p_z^\omega(y, k) & = P_{z+e_+}^{\omega_{z+e_+}^{z,e}}[T_{x_0} = T_{\partial B^*(y,k)} < \tau_\delta], \\ p_1^\omega(y, k) & = P_0^{\omega_{z,\emptyset}^{z,0}}[T_{x_1} = T_{B(y,k)} < \tau_\delta], \\ p_2^\omega(y, k) & = P_{x_2}^{\omega_{x_2}^{z,\emptyset}}[T_z < \tau_\delta \wedge T_{B^*(y,k)}^+], \end{aligned}$$

where x_0 is connected to y in $B^E(y, k) \setminus [z, z+e]$ and we denote \mathcal{P}_0 one of the corresponding shortest such paths (hence of length $\leq k+2$). Moreover let us set x_3 connecting $\partial B(y, k)$ to infinity without edges of $B(y, k)$. Thus

$$\begin{aligned} & \mathbf{E} \left[\mathbf{1} \{ \mathcal{I}(\omega^{y,A}) \} (Z_y^{(i)})^{C_{28}} p_z^{(i)} p_1^{(i)} p_2^{(i)} \underline{R}_*^{(i)} R_*^{(i)}(y) R_*^{(i)}(z) \mid L_y^{(i)} = k \right] \\ & \leq \gamma_1 k^{\gamma_2} e^{\gamma_3 k} e^{\gamma_4((z-y) \cdot \bar{\ell})^+} \mathbf{E} \left[\mathbf{1} \{ 0 \Leftrightarrow y \Leftrightarrow \infty \} p_z^{(i)} p_1^{(i)} p_2^{(i)} \underline{R}_*^{(i)} R_*^{(i)}(y) R_*^{(i)}(z) \mid L_y^{(i)} = k \right], \end{aligned}$$

CHAPITRE 5. THE SPEED OF A BIASED RANDOM WALK ON A PERCOLATION CLUSTER AT HIGH DENSITY

where the integrand of the right-hand side depends only on the edges of $E(\mathbb{Z}^d) \setminus B^E(y, k)$, so that the conditioning is unnecessary.

Let us denote \mathcal{P}_1 , \mathcal{P}_2 and \mathcal{P}_3 one of the shortest paths from respectively x_1 , x_2 and x_3 to y and $\mathcal{P} = \mathcal{P}_0 \cup \mathcal{P}_1 \cup \mathcal{P}_2 \cup \mathcal{P}_3 \cup \{y + e, e \in \nu\}$. Hence we need to control

$$\begin{aligned} & \mathbf{E} \left[\mathbf{1}\{0 \Leftrightarrow y \Leftrightarrow \infty\} p_z^{(i)} p_1^{(i)} p_2^{(i)} \underline{R}_*^{(i)} R_*^{(i)}(z) R_*^{(i)}(y) \mid L_y^{(i)} = k \right] \\ & \leq \mathbf{E} \left[\mathbf{1}\{0 \Leftrightarrow y \Leftrightarrow \infty\} P_{z+e_+}^{\omega^{z,e}} [T_{x_0} = T_{\partial B^*(y,k)} < \tau_\delta] P_0^{\omega^{z,0}} [T_{x_1} = T_{\partial B(y,k)} < \tau_\delta] \right. \\ & \quad \times P_{x_2}^{\omega^{z,0}} [T_z < \tau_\delta \wedge T_{\partial B(y,k)}^+] R_*^{\omega^{(y,k),1}} [x_2 \leftrightarrow z \cup \Delta] R_*^{(0)}(z) R_*^{(0)}(y) \mid \mathcal{P} \in \omega \left. \right] \\ & \leq 2^{4k+4d+2} \mathbf{E} \left[\mathbf{1}\{0 \Leftrightarrow y \Leftrightarrow \infty\} \mathbf{1}\{\mathcal{P} \in \omega\} P_0^{\omega^{z,0}} [T_{x_1} = T_{\partial B(y,k)} < \tau_\delta] R_*^{(0)}(z) R_*^{(0)}(y) \right. \\ & \quad \left. \times P_{x_2}^{\omega^{z,0}} [T_z < \tau_\delta \wedge T_{\partial B(y,k)}^+] P_{z+e_+}^{\omega^{z,e}} [T_{x_0} = T_{\partial B^*(y,k)} < \tau_\delta] R_*^{\omega^{z,0}} [x_2 \leftrightarrow z \cup \Delta] \right], \end{aligned}$$

where we used that

1. $\mathbf{P}\{\mathcal{P} \in \omega\} \geq 2^{-(4k+4d+2)}$,
2. inequalities such as $P_{z+e_+}^{\omega^{z,e}} [T_{x_0} = T_{\partial B^*(y,k)} < \tau_\delta] = P_{z+e_+}^{\omega^{z,0}} [T_{x_0} = T_{\partial B^*(y,k)} < \tau_\delta]$,
3. Rayleigh's monotonicity principle yields, for example, that

$$R_*^{(i)}(y) \leq R_*^{(0)}(y) \text{ and } R_*^{\omega^{(y,k),1}} [x_2 \leftrightarrow z \cup \Delta] \leq R_*^{\omega^{z,0}} [x_2 \leftrightarrow z \cup \Delta].$$

Using (4.3) and $x_2 \in B(y, k)$, we get

$$\begin{aligned} & P_{x_2}^{\omega^{z,0}} [T_z < \tau_\delta \wedge T_{\partial B(y,k)}^+] R_*^{\omega^{z,0}} [x_2 \leftrightarrow z \cup \Delta] \\ & \leq \gamma_5 P_{x_2}^{\omega^{z,0}} [T_z < \tau_\delta \wedge T_{x_2}^+] \left(P_{x_2}^{\omega^{z,0}} [T_z \wedge \tau_\delta < T_{x_2}^+] \right)^{-1} \\ & = \gamma_5 P_{x_2}^{\omega^{z,0}} [T_z < \tau_\delta \wedge T_{x_2}^+ \mid T_z \wedge \tau_\delta < T_{x_2}^+] \\ & = \gamma_5 P_{x_2}^{\omega^{z,0}} [T_z < \tau_\delta], \end{aligned}$$

moreover on ω such that $\mathbf{1}\{\mathcal{P} \in \omega\}$,

$$P_{x_1}^{\omega^{z,0}} [T_{x_2} < \tau_\delta] \geq (\delta \kappa_0)^{2k},$$

and putting these last two equations together we get

$$\begin{aligned} & P_0^{\omega^{z,0}} [T_{x_1} = T_{\partial B(y,k)} < \tau_\delta] P_{x_2}^{\omega^{z,0}} [T_z < \tau_\delta \wedge T_{\partial B(y,k)}^+] R_*^{\omega^{z,0}} [x_2 \leftrightarrow z \cup \Delta] \\ & \leq \gamma_5 (\delta \kappa_0)^{-2k} P_0^{\omega^{z,0}} [T_{x_1} < \tau_\delta] P_{x_1}^{\omega^{z,0}} [T_{x_2} < \tau_\delta] P_{x_2}^{\omega^{z,0}} [T_z < \tau_\delta] \end{aligned}$$

8. ESTIMATE ON KALIKOW'S ENVIRONMENT

$$\leq \gamma_5 (\delta \kappa_0)^{-2k} P_0^{\omega_{y,0}^{z,0}} [T_z < \delta].$$

In a similar way, we get by Markov's property that

$$P_{z+e_+}^{\omega_{y,0}^{z,e}} [T_{x_0} = T_{\partial B^*(y,k)} < \tau_\delta] \leq (\delta \kappa_0)^{-(k+2)} P_{z+e_+}^{\omega_{y,0}^{z,e}} [T_y < \tau_\delta].$$

Finally

$$\mathbf{1}\{0 \Leftrightarrow y \Leftrightarrow \infty\} \mathbf{1}\{\mathcal{P} \in \omega\} \leq \mathbf{1}\{\mathcal{I}\}.$$

Hence for ω such that $\mathcal{P} \in \omega$ we have

$$\begin{aligned} & \mathbf{1}\{0 \Leftrightarrow y \Leftrightarrow \infty\} \mathbf{1}\{\mathcal{P} \in \omega\} P_0^{\omega_{y,0}^{z,0}} [T_{x_0} = T_{\partial B(y,k)} < \tau_\delta] P_{z+e_+}^{\omega_{y,0}^{z,e}} [T_{x_0} = T_{\partial B^*(y,k)} < \tau_\delta] \\ & \quad \times P_{x_2}^{\omega_{y,0}^{z,0}} [T_z < \tau_\delta \wedge T_{\partial B(y,k)}^+] R_*^{\omega_{y,0}^{z,0}} [x_2 \leftrightarrow z \cup \Delta] R_*^{(0)}(z) R_*^{(0)}(y) \\ & \leq \gamma_6 (2/\kappa_0)^{3k} \mathbf{1}\{\mathcal{I}\} P_0^{\omega_{y,0}^{z,0}} [T_z < \tau_\delta] P_{z+e_+}^{\omega_{y,0}^{z,e}} [T_y < \delta] R_*^{(0)}(z) R_*^{(0)}(y) \\ & \leq \gamma_7 e^{\gamma_8 k} \mathbf{1}\{\mathcal{I}\} G_\delta^{\omega_{y,0}^{z,0}}(0, z) G_\delta^{\omega_{y,0}^{z,e}}(z + e_+, y), \end{aligned}$$

where we used Rayleigh's monotonicity principle to say that $R_*^{(0)}(y) \leq R^{\omega_{y,0}^{z,e}}[y \leftrightarrow \Delta]$, (8.17) and (8.18).

The result follows by integrating over all possible values of $L_y^{(i)}$, since we have just proved that

$$\begin{aligned} & \mathbf{E} \left[\mathbf{1}\{\mathcal{I}(\omega^{y,A})\} (Z_y^{(i)})^{C_{28}} p_z^{(i)} p_1^{(i)} p_2^{(i)} \underline{R}_*^{(i)} R_*^{(i)}(z) R_*^{(i)}(y) \mid L_y^{(i)} = k \right] \\ & \leq \gamma_9 k^{\gamma_{10}} e^{\gamma_{11} k} \mathbf{E} \left[\mathbf{1}\{\mathcal{I}(\omega^{y,0})\} G_\delta^{\omega_{y,0}^{z,0}}(0, z) G_\delta^{\omega_{y,0}^{z,e}}(z + e_+, y) \right] e^{\gamma_{12}((y-z) \cdot \bar{\ell})^+}. \end{aligned}$$

For the remaining cases, we proceed as follows

1. if $0 \in B(y, k)$, then we formally replace $P_0^\omega [T_x = T_{\partial B(z,k)} < \tau_\delta]$ by 1 for any $x \in \partial B(z, k)$ and x_1 by 0,
2. if $z + e_+ \notin B^*(y, k)$, then we formally replace $P_{z+e_+}^\omega [T_x = T_{\partial B^*(z,k)} < \tau_\delta]$ by 1 for any $x \in \partial B^*(z, k)$ and x_0 by $z + e^+$,
3. if $z \in B(y, k)$, then we formally replace $P_x^\omega [T_z = T_{\partial B(z,k)}^+ \wedge \tau_\delta]$ by 1 for any $x \in \partial B(z, k)$, $R_*^{\omega_{y,0}^{z,0}} [x_2 \leftrightarrow z \cup \Delta]$ by 1 and x_2 by z ,

and the previous proof carries over with minor modifications. \square

We need another decorrelation lemma, which is essentially similar to the previous one but simpler to prove.

CHAPITRE 5. THE SPEED OF A BIASED RANDOM WALK ON A PERCOLATION CLUSTER AT HIGH DENSITY

Lemma 8.3. *We have for $i \in \{0, 1, 2, 3\}$ and $\delta \geq 1/2$,*

$$\begin{aligned} & \mathbf{E} \left[\mathbf{1}\{\mathcal{I}(\omega^{y,A})\} (Z_y^{(i)})^{C_{28}} p_z^{(i)} P_0^{\omega_{y,A}^{z,\emptyset}} [T_z < T_{\partial B_y^{(i)}} \wedge \tau_\delta] R_*^{(i)}(y) R_*^{(i)}(z) \right] \\ & \leq C_{33} \mathbf{E} \left[(L_y^{(i)})^{C_{34}} e^{C_{35} L_y^{(i)}} \right] \mathbf{E} \left[\mathbf{1}\{\mathcal{I}(\omega^{y,\emptyset})\} G_\delta^{\omega_{y,\emptyset}^{z,\emptyset}}(0, z) G_\delta^{\omega_{y,\emptyset}^{z,e}}(z + e_+, y) \right] e^{C_{36}((y-z) \cdot \bar{\ell})^+}, \end{aligned}$$

where the constants depend only on d and ℓ .

Démonstration. Once again we condition on $\{L_y^{(i)} = k\}$ for $k < \infty$ and suppose that $0 \notin B(y, k)$ and $z \notin B(y, k)$, the other cases can be handled in the same way as before. We see that

$$\mathbf{1}\{\mathcal{I}(\omega^{y,A})\} \leq \mathbf{1}\{0 \Leftrightarrow y \Leftrightarrow \infty\},$$

and we denote $x_0, x_1 \in \partial B(y, k)$ such that

$$p_z^{(i)} = P_z^{\omega_{z,e}^{z,e}} [T_{x_0} = T_{\partial B(y,k)} < \tau_\delta],$$

and x_1 is connected to ∞ without edges from $B(y, k)$. Moreover denote \mathcal{P}_0 one of the shortest paths connecting x_0 to y and \mathcal{P}_1 one of the shortest paths connecting x_1 to y .

Then, using the same type of arguments as in the proof of Lemma 8.2, we get for $\mathcal{P} = \mathcal{P}_0 \cup \mathcal{P}_1 \cup \{y + e, e \in \nu\}$, on ω such that $\{L_y^{(i)} = k\}$,

$$\begin{aligned} & \mathbf{E} \left[\mathbf{1}\{\mathcal{I}(\omega^{y,A})\} (Z_y^{(i)})^{C_{28}} p_z^{(i)} P_0^{\omega_{y,A}^{z,\emptyset}} [T_z < T_{\partial B_y^{(i)}} \wedge \tau_\delta] R_*^{(i)}(y) R_*^{(i)}(z) \mid L_y^{(i)} = k \right] \\ & \leq \gamma_1 k^{\gamma_2} e^{\gamma_3 k} e^{\gamma_4((y-z) \cdot \bar{\ell})^+} \mathbf{E} \left[\mathbf{1}\{0 \Leftrightarrow y \Leftrightarrow \infty\} P_z^{\omega_{z,e}^{z,e}} [T_{x_0} = T_{\partial B^*(y,k)} < \tau_\delta] \right. \\ & \quad \times P_0^{\omega_{y,A}^{z,\emptyset}} [T_z < T_{\partial B(y,k)} \wedge \tau_\delta] R_*^{(0)}(y) R_*^{(0)}(z) \mid \mathcal{P} \in \omega \left. \right] \\ & \leq \gamma_1 k^{\gamma_2} 2^{2k+4d+2} e^{\gamma_3 k} e^{\gamma_4((y-z) \cdot \bar{\ell})^+} \mathbf{E} \left[\mathbf{1}\{\mathcal{P} \in \omega\} \mathbf{1}\{0 \Leftrightarrow y \Leftrightarrow \infty\} \right. \\ & \quad \times P_z^{\omega_{z,e}^{z,e}} [T_{x_0} = T_{\partial B^*(y,k)} < \tau_\delta] P_0^{\omega_{y,A}^{z,\emptyset}} [T_z < T_{\partial B(y,k)} \wedge \tau_\delta] R_*^{(0)}(y) R_*^{(0)}(z) \left. \right]. \end{aligned}$$

Now on ω such that $\{\mathcal{P} \in \omega\}$, we have

$$P_0^{\omega_{y,A}^{z,\emptyset}} [T_z < T_{\partial B_y^{(i)}} \wedge \tau_\delta] = P_0^{\omega_{y,\emptyset}^{z,\emptyset}} [T_z < T_{\partial B_y^{(i)}} \wedge \tau_\delta] \leq P_0^{\omega_{y,\emptyset}^{z,\emptyset}} [T_z < \tau_\delta],$$

and

$$P_z^{\omega_{z,e}^{z,e}} [T_{x_0} = T_{\partial B^*(y,k)} < \tau_\delta] (\delta \kappa_0)^k \leq P_{z+e_+}^{\omega_{z,\emptyset}^{z,\emptyset}} [T_y < \tau_\delta].$$

Since we also have $\mathbf{1}\{\mathcal{P} \in \omega\} \mathbf{1}\{0 \Leftrightarrow y \Leftrightarrow \infty\} \leq \mathbf{1}\{\mathcal{I}(\omega^{z,\emptyset})\}$ so that,

$$\begin{aligned} & \mathbf{1}\{\mathcal{P} \in \omega\} \mathbf{1}\{0 \Leftrightarrow y \Leftrightarrow \infty\} p_z^{\omega_{z,e}^{z,e}}(y, k) P_0^{\omega_{y,A}^{z,\emptyset}} [T_z < T_{\partial B(y,k)} \wedge \tau_\delta] \\ & \quad \times R_*^{(0)}(y) R_*^{(0)}(z) \end{aligned}$$

$$\leq \gamma_5 k^{\gamma_6} e^{\gamma_7 k} \mathbf{1}\{\mathcal{I}(\omega^{y,0})\} G_\delta^{\omega^{z,0}}(0, z) G_\delta^{\omega^{z,e}}(z + e_+, y),$$

and the results follows by integration over the values of $L_y^{(i)}$. \square

Now, as we did to obtain the continuity of the speed, we need to show that the contribution due to the local modifications of the environment has a bounded effect. Hence we want to prove that the expectations appearing in Lemma 8.2 and Lemma 8.3 are finite for ε small enough. This is proved using the following lemma.

Lemma 8.4. *For ε_9 small enough and any $\varepsilon < \varepsilon_9$ we have*

$$\mathbf{E}[(L_y^{(3)})^{C_{30}+C_{34}} e^{(C_{31}+C_{35})L_y^{(3)}}] < C_{37},$$

where C_{37} depends only on d and ℓ .

Démonstration. Let us give an upper bound on the tail of $L_y^{(3)}$, we have

$$\begin{aligned} \mathbf{P}[L_y^{(3)} \geq n] &\leq \mathbf{P}[L_y^{(3)} \geq n, L_y^{(2)} \leq n/(2C_8)] \\ &\quad + \mathbf{P}[L_y^{(2)} \geq n/(2C_8), L_y^{(1)} \leq n/(2C_8)^2] \\ &\quad + \mathbf{P}[L_y^{(1)} \geq n/(2C_8)^2], \end{aligned}$$

and recalling Proposition 5.2 and Proposition 5.3 we get for $A = B(x, r)$

$$\mathbf{P}_{1-\varepsilon}[L_A(\omega) \vee L_A(\omega^{z,e}) \geq n + C_8 r] \leq 2C_9 r^d n \alpha(\varepsilon)^n,$$

so that we may use the second property of Proposition 4.1

$$\mathbf{P}[L_y^{(3)} \geq n] \leq 6C_9 \left(\frac{n}{2C_8}\right)^d n \alpha(\varepsilon)^{f(n)},$$

where $f(n) = (n/(2C_8)^2 - C_8)$ and $\alpha(\varepsilon)$ can be arbitrarily small if we take ε small enough. The result follows easily. \square

Now, Proposition 7.2 follows from the decomposition obtained at (8.27) and (8.28), the decorrelation part is handled by Lemma 8.2, Lemma 8.3 and the control on the multiplicative term appearing in these lemmas is upper bounded by Lemma 8.4 for ε small enough.

9 An increasing speed

We want to prove Proposition 2.1 and show that the walk slows down when we percolate, i.e. $v_\ell(1) \cdot v'_\ell(1) > 0$ under certain conditions. We recall $J^e = (G^{\omega_0}(0, 0) - G^{\omega_0}(e, 0)) > 0$ and we introduce $J_e^e = (G^{\omega_0^e}(0, 0) - G^{\omega_0^e}(e, 0)) > 0$.

CHAPITRE 5. THE SPEED OF A BIASED RANDOM WALK ON A PERCOLATION CLUSTER AT HIGH DENSITY

We use (7.2) to prove that

$$\begin{aligned} G^{\omega_0^{0,e}}(0,0) &= G^{\omega_0}(0,0) + G^{\omega_0}(0,0) \sum_{e' \in \nu} (p^e(e') - p^\emptyset(e')) G^{\omega_0^{0,e}}(e',0) \\ &\quad + G^{\omega_0}(0,e) \sum_{e' \in \nu} (p^{-e}(e') - p^\emptyset(e')) G^{\omega_0^{0,e}}(e+e',0), \end{aligned}$$

and

$$\begin{aligned} G^{\omega_0^{0,e}}(e,0) &= G^{\omega_0}(e,0) + G^{\omega_0}(e,0) \sum_{e' \in \nu} (p^e(e') - p^\emptyset(e')) G^{\omega_0^{0,e}}(e',0) \\ &\quad + G^{\omega_0}(e,e) \sum_{e' \in \nu} (p^{-e}(e') - p^\emptyset(e')) G^{\omega_0^{0,e}}(e+e',0). \end{aligned}$$

Now, recalling the proof of Lemma 7.2 (in particular (7.20) and (7.21)), noticing the relations, $G^{\omega_0}(e,e) = G^{\omega_0}(0,0)$ and by reversibility $G^{\omega_0}(e,0) = (\pi^{\omega_0}(0)/\pi^{\omega_0}(e))G^{\omega_0}(0,e) = (c(e)/c(-e))G^{\omega_0}(0,e)$, we get

$$\begin{aligned} J_e^e &= J^e + G^{\omega_0}(0,0) [p(e)(G^{\omega_0^{0,e}}(0,0) - 1) - p(e)G^{\omega_0^{0,e}}(e,0) \\ &\quad - (p(-e)G^{\omega_0^{0,e}}(e,0) - p(-e)G^{\omega_0^{0,e}}(0,0))] \\ &\quad + G^{\omega_0}(e,0) [(c(e)/c(-e))(p(-e)G^{\omega_0^{0,e}}(e,0) - p(-e)G^{\omega_0^{0,e}}(0,0)) \\ &\quad - (p(e)(G^{\omega_0^{0,e}}(0,0) - 1) - p(e)G^{\omega_0^{0,e}}(e,0))], \end{aligned}$$

which, recalling $p(e)c(-e) = p(-e)c(e)$, means that

$$J_e^e = J^e + G^{\omega_0}(0,0)((p(e) + p(-e))J_e^e - p(e)) + G^{\omega_0}(e,0)(-2p(e)J_e^e + p(e)).$$

Now rewriting $p(e)G^{\omega_0}(e,0) = p(-e)G^{\omega_0}(0,e) = p(-e)G^{\omega_0}(-e,0)$, we get

$$J_e^e = J^e + p(e)J^e J_e^e + p(-e)J^{-e} J_e^e - p(e)J_e^e,$$

i.e.

$$J_e^e = \frac{(1 - p(e))J^e}{1 - p(e)J^e - p(-e)J^{-e}}.$$

In order to obtain the alternative form of the derivative we only need to use that $1 - p(e) = \pi^e/\pi^\emptyset$ and

$$\pi^e(d_\emptyset - d_e) = \pi^e \left(- \sum_{e' \neq e} \frac{c(e')c(e)}{\pi^\emptyset \pi^e} e' + \frac{c(e)}{\pi^\emptyset} e \right) = c(e)(e - d_\emptyset),$$

which proves the first part of Proposition 2.1.

Now, we need to show that this derivative is in the same direction as $v_\ell(1)$, for this let us first notice that

$$\begin{aligned} & 1 - p(e)J^e - p(-e)J^{-e} \\ &= 1 - G^{\omega_0}(0, 0)(p(e)P_e^{\omega_0}[T_0^+ = \infty] + p(-e)P_{-e}^{\omega_0}[T_0^+ = \infty]) > 0, \end{aligned}$$

since $G^{\omega_0}(0, 0) = P_0^{\omega_0}[T_0^+ = \infty] = \sum_{e' \in \nu} p(e')P_{e'}^{\omega_0}[T_0^+ = \infty]$. Moreover the quantity in the previous display is the same for e and $-e$.

Now, fix $e \in \nu$ such that $e \cdot d_\emptyset > 0$, we will show that the contribution of the terms e and $-e$ together are in the same direction as d_\emptyset . In fact it is

$$H(|e|) := (d_\emptyset \cdot e) \left[\frac{p(e)J^e + p(-e)J^{-e}}{1 - p(e)J^e - p(-e)J^{-e}} e - \frac{p(e)J^e - p(-e)J^{-e}}{1 - p(e)J^e - p(-e)J^{-e}} d_\emptyset \right],$$

and since $\beta(|e|) := (d_\emptyset \cdot e)/(1 - p(e)J^e - p(-e)J^{-e}) > 0$ we get

$$H(|e|) \cdot d_\emptyset = \beta(|e|) [(p(e)J^e + p(-e)J^{-e})(d_\emptyset \cdot e) - (p(e)J^e - p(-e)J^{-e})(d_\emptyset \cdot d_\emptyset)] > 0,$$

if we suppose that

$$\text{for } i = 1, \dots, d \text{ such that } d_\emptyset \cdot e^{(i)} > 0, \quad d_\emptyset \cdot e^{(i)} \geq \|d_\emptyset\|^2.$$

Finally $v_\ell(1) \cdot v'_\ell(1) = \sum_{i=1}^d H(|e^{(i)}|) \cdot d_\emptyset > 0$, so that Proposition 2.1 is proved. \square

Acknowledgements

I would like to thank my advisor Christophe sabot for suggesting this problem and for his support.

I also would like to thank Pierre mathieu for useful discussions and comments.

My research was supported by the A.N.R. "MEMEMO".

**CHAPITRE 5. THE SPEED OF A BIASED RANDOM WALK ON A
PERCOLATION CLUSTER AT HIGH DENSITY**

6

On slowdown and speedup of transient random walks in random environment

We consider one-dimensional random walks in random environment which are transient to the right. Our main interest is in the study of the sub-ballistic regime, where at time n the particle is typically at a distance of order $O(n^\kappa)$ from the origin, $\kappa \in (0, 1)$. We investigate the probabilities of moderate deviations from this behaviour. Specifically, we are interested in quenched and annealed probabilities of slowdown (at time n , the particle is at a distance of order $O(n^{\nu_0})$ from the origin, $\nu_0 \in (0, \kappa)$), and speedup (at time n , the particle is at a distance of order n^{ν_1} from the origin, $\nu_1 \in (\kappa, 1)$), for the current location of the particle and for the hitting times. Also, we study probabilities of backtracking : at time n , the particle is located around $(-n^\nu)$, thus making an unusual excursion to the left. For the slowdown, our results are valid in the ballistic case as well.

The material of this chapter is a joint work with N. Gantert and S. Popov and has been accepted for publication in “Probability Theory and Related Fields”, see [39].

1 Introduction and results

Let $\omega := (\omega_i, i \in \mathbb{Z})$ be a family of i.i.d. random variables taking values in $(0, 1)$. Denote by \mathbf{P} the distribution of ω and by \mathbf{E} the corresponding expectation. After choosing an environment ω at random according to the law \mathbf{P} , we define the random walk in random environment (usually abbreviated as RWRE) as a nearest-neighbour random walk on \mathbb{Z} with transition probabilities given by $\omega : (X_n, n \geq 0)$ is the Markov chain satisfying $X_0 = z$ and for $n \geq 0$,

$$\begin{aligned} P_\omega^z[X_{n+1} = x + 1 \mid X_n = x] &= \omega_x, \\ P_\omega^z[X_{n+1} = x - 1 \mid X_n = x] &= 1 - \omega_x. \end{aligned}$$

As usual, P_ω^z is called the *quenched* law of $(X_n, n \geq 0)$ starting from $X_0 = z$, and we denote by E_ω^z the corresponding quenched expectation. Also, we denote by \mathbb{P}^z the semi-direct product $\mathbf{P} \times P_\omega^z$ and by \mathbb{E}^z the expectation with respect to \mathbb{P}^z ; \mathbb{P}^z and \mathbb{E}^z are called the *annealed* probability and expectation. When $z = 0$, we write simply P_ω , E_ω , \mathbb{P} , \mathbb{E} .

In this paper we will also consider RWRE on \mathbb{Z}_+ , with reflection to the right at the origin. This RWRE can be defined as above, in the environment $\tilde{\omega}$ given by

$$\tilde{\omega}_i = \begin{cases} \omega_i, & i \neq 0, \\ 1, & i = 0 \end{cases}$$

(provided, of course, that the starting point is nonnegative). We then write $P_{\tilde{\omega}}^z$, $E_{\tilde{\omega}}^z$ for the quenched probability and expectation in the case of RWRE reflected at the origin, $\tilde{\mathbb{P}}^z$ and $\tilde{\mathbb{E}}^z$ for the annealed probability and expectation, keeping the simplified notation $P_{\tilde{\omega}}$, $E_{\tilde{\omega}}$, $\tilde{\mathbb{P}}$, $\tilde{\mathbb{E}}$ for the RWRE starting at the origin.

For all $i \in \mathbb{Z}$, let us introduce

$$\rho_i := \frac{1 - \omega_i}{\omega_i}.$$

Throughout this paper, we assume that

$$\mathbf{E}[\ln \rho_0] < 0, \tag{1.1}$$

which implies (cf. [95]) that $\lim_{n \rightarrow \infty} X_n = +\infty$ P_ω -a.s. for \mathbf{P} -a.a. ω , so that the RWRE is transient to the right (or simply transient, in the case of RWRE with reflection at the origin).

We refer to [104] for a general overview of results on RWRE. In the following we always work under the assumption that

$$\text{there exists a unique } \kappa > 0, \text{ such that } \mathbf{E}[\rho_0^\kappa] = 1 \text{ and } \mathbf{E}[\rho_0^\kappa \ln^+ \rho_0] < \infty. \tag{1.2}$$

1. INTRODUCTION AND RESULTS

This constant plays a central role for RWRE, in particular when it exists, its value separates the *ballistic* from the *sub-ballistic* regime :

$$\kappa > 1 \text{ if and only if } \frac{X_n}{n} \rightarrow v > 0, \quad \mathbb{P}\text{-a.s.}$$

We refer to the case $\kappa > 1$ as the *ballistic* regime and to the case $\kappa \leq 1$ as the *sub-ballistic* regime. In this paper we mainly consider the case where the RWRE is transient (to the right) and *sub-ballistic*, i.e. the asymptotic speed is equal to 0. The following result was proved in [59] and partially refined in [35] :

Theorem 1.1. *Let $\omega := (\omega_i, i \in \mathbb{Z})$ be a family of independent and identically distributed random variables such that*

- (i) $-\infty \leq \mathbf{E}[\ln \rho_0] < 0$,
- (ii) *there exists $0 < \kappa \leq 1$ for which $\mathbf{E}[\rho_0^\kappa] = 1$ and $\mathbf{E}[\rho_0^\kappa \ln^+ \rho_0] < \infty$,*
- (iii) *the distribution of $\ln \rho_0$ is non-lattice.*

Then, if $\kappa < 1$, we have

$$\frac{X_n}{n^\kappa} \xrightarrow{\text{law}} C_1 \left(\frac{1}{\mathcal{S}_\kappa^{ca}} \right)^\kappa,$$

where $\xrightarrow{\text{law}}$ stands for convergence in distribution with respect to the annealed law \mathbb{P} , C_1 is a positive constant and \mathcal{S}_κ^{ca} is the completely asymmetric stable law of index κ . If $\kappa = 1$, we have

$$\frac{X_n}{n/\ln n} \xrightarrow{\text{law}} C_2 \frac{1}{\mathcal{S}_1^{ca}}.$$

In the quenched case, the limiting behaviour is more complicated, as discussed in [79]. However, one still can say that at time n the particle is “typically” at distance roughly n^κ from the origin, since the weaker result $\lim_{n \rightarrow \infty} \ln X_n / \ln n = \kappa$, \mathbb{P} -a.s., is still valid¹.

Besides the results about the location of the particle at time n , we are interested also in the first hitting times of certain regions in space. For any set $A \subset \mathbb{Z}$, define :

$$T_A := \min\{n \geq 0 : X_n \in A\}.$$

To simplify the notations, for one-point sets we write $T_a := T_{\{a\}}$. In the case where a is not an integer, the notation T_a will correspond to $T_{\lfloor a \rfloor}$.

In this paper we investigate the following types of unusual behaviour of the random walk :

- *slowdown*, which means that at time n the particle is around n^{ν_0} , $\nu_0 < 1 \wedge \kappa$, so that the particle goes to the right much slower than it typically does ;

¹apparently, this result is folklore, at least we were unable to find a precise reference in the literature. Anyhow, note that it is straightforward to obtain this result from Theorems 1.2 and 1.5

CHAPITRE 6. SLOWDOWN AND SPEEDUP OF TRANSIENT RWRE

- *backtracking*, that is, at time n the particle is found around $(-n^\nu)$, thus performing an unlikely excursion to the left instead of going to the right (this is, of course, only for RWRE without reflection);
- *speedup*, which means that the particle is going to the right faster than it should (but still with sublinear speed) : at time n the particle is around n^{ν_1} , $\kappa < \nu_1 < 1$ (this is possible only for $\kappa < 1$).

We refer to all of the above as *moderate deviations*, even for the slowdown in the ballistic case $\kappa > 1$. Indeed, in the latter case the deviation from the typical position is linear in time, but we have that the large deviation rate function I satisfies $I(0) = 0$, and the known large deviation results only tell us that slowdown probabilities decay slower than exponentially in n (see, for instance, [20]).

We mention here that in the literature one can find some results on moderate deviations for the case of recurrent RWRE (often referred to as RWRE in “Sinai’s regime”), see [21, 22], and also [51] for the continuous space and time version.

Now, we state the results we are going to prove in this paper. In addition to (1.2), we will use the following weak integrability hypothesis :

$$\text{there exists } \varepsilon_0 > 0 \text{ such that } \mathbf{E}[\rho_0^{-\varepsilon_0}] < \infty. \quad (1.3)$$

First, we discuss the results about quenched slowdown probabilities. It turns out that the quenched slowdown probabilities behave differently depending on whether one considers RWRE with or without reflection at the origin. Also, it matters which of the following two events is considered : (i) the position of the particle at time n is at most n^ν , $\nu < \kappa$ (i.e., the event $\{X_n < n^\nu\}$), or (ii) the hitting time of n^ν is greater than n (i.e., the event $\{T_{n^\nu} > n\}$). Here we prove that in all these cases the quenched probability of slowdown is roughly e^{-n^β} , where $\beta = 1 - \frac{\nu}{\kappa}$ for the “hitting time slowdown” in the reflected case, and $\beta = (1 - \frac{\nu}{\kappa}) \wedge \frac{\kappa}{\kappa+1}$ in the other cases. More precisely, we have

Theorem 1.2. Slowdown, quenched *Suppose that (1.1), (1.2) and (1.3) hold. For $\nu \in (0, 1 \wedge \kappa)$ the quenched slowdown probabilities behave in the following way. For the reflected RWRE,*

$$\lim_{n \rightarrow \infty} \frac{\ln(-\ln P_{\bar{\omega}}[T_{n^\nu} > n])}{\ln n} = 1 - \frac{\nu}{\kappa}, \quad \mathbf{P}\text{-a.s.}, \quad (1.4)$$

$$\lim_{n \rightarrow \infty} \frac{\ln(-\ln P_{\bar{\omega}}[X_n < n^\nu])}{\ln n} = \left(1 - \frac{\nu}{\kappa}\right) \wedge \frac{\kappa}{\kappa+1}, \quad \mathbf{P}\text{-a.s.} \quad (1.5)$$

For the RWRE without reflection, we obtain

$$\lim_{n \rightarrow \infty} \frac{\ln(-\ln P_{\omega}[T_{n^\nu} > n])}{\ln n} = \left(1 - \frac{\nu}{\kappa}\right) \wedge \frac{\kappa}{\kappa+1}, \quad \mathbf{P}\text{-a.s.}, \quad (1.6)$$

$$\lim_{n \rightarrow \infty} \frac{\ln(-\ln P_{\omega}[X_n < n^\nu])}{\ln n} = \left(1 - \frac{\nu}{\kappa}\right) \wedge \frac{\kappa}{\kappa+1}, \quad \mathbf{P}\text{-a.s.} \quad (1.7)$$

1. INTRODUCTION AND RESULTS

For a heuristical explanation of the reason for the different behaviours of the quenched slowdown probabilities we refer to the beginning of Section 6.

For the annealed slowdown probabilities, we obtain that there is no difference between reflecting/nonreflecting cases (at least on the level of precision we are working here) and also it does not matter which one of the slowdown events $\{T_{n^\nu} > n\}$, $\{X_n < n^\nu\}$ one considers. In all these cases, the annealed probability of slowdown decays polynomially, roughly as $n^{-(\kappa-\nu)}$:

Theorem 1.3. Slowdown, annealed *Suppose that (1.1), (1.2) and (1.3) hold. For $\nu \in (0, 1 \wedge \kappa)$,*

$$\lim_{n \rightarrow \infty} \frac{\ln \mathbb{P}[X_n < n^\nu]}{\ln n} = \lim_{n \rightarrow \infty} \frac{\ln \mathbb{P}[T_{n^\nu} > n]}{\ln n} = -(\kappa - \nu). \quad (1.8)$$

The same result holds if one changes \mathbb{P} to $\tilde{\mathbb{P}}$ in (1.8).

In the case of RWRE on \mathbb{Z} (i.e., without reflection at the origin) there is another kind of untypically slow escape to the right. Namely, before going to $+\infty$, the particle can make an untypically big excursion to the left of the origin. While it is easy to control the distribution of the leftmost site touched by this excursion (e.g., by means of the formula (2.8) below), it is interesting to study the probability that at time n the particle is far away to the left of the origin :

Theorem 1.4. Backtracking *Suppose that (1.1), (1.2) and (1.3) hold. For $\nu \in (0, 1)$, we have*

$$\lim_{n \rightarrow \infty} \frac{\ln(-\ln P_\omega[X_n < -n^\nu])}{\ln n} = \nu \vee \frac{\kappa}{\kappa + 1}, \quad \mathbf{P}\text{-a.s.} \quad (1.9)$$

$$\lim_{n \rightarrow \infty} \frac{\ln(-\ln \mathbb{P}[X_n < -n^\nu])}{\ln n} = \nu, \quad (1.10)$$

and

$$\lim_{n \rightarrow \infty} \frac{\ln(-\ln \mathbb{P}[T_{-n^\nu} < n])}{\ln n} = \lim_{n \rightarrow \infty} \frac{\ln(-\ln P_\omega[T_{-n^\nu} < n])}{\ln n} = \nu \quad \mathbf{P}\text{-a.s.} \quad (1.11)$$

Another kind of deviation from the typical behaviour is the speedup of the particle, i.e., at time n the particle is at a distance larger than n^κ from the origin (here we of course assume that $\kappa < 1$). There are results in the literature that cover the *large deviations* case, i.e., the case when at time n the particle is at distance $O(n)$ from the origin, see e.g. Section 2.3 of [104], or [20]. In this paper we are interested in the probabilities of moderate speedup : the displacement of the particle is sublinear, but still bigger than in the typical case. Namely, we show that the quenched probability that X_n is of order n^ν , $\kappa < \nu < 1$, is roughly e^{-n^β} , where $\beta = \frac{\nu-\kappa}{1-\kappa}$. It is remarkable that the annealed probability is roughly of the same order. More precisely, we are able to prove the following result :

CHAPITRE 6. SLOWDOWN AND SPEEDUP OF TRANSIENT RWRE

Theorem 1.5. Speedup *Suppose that (1.1), (1.2) and (1.3) hold. For $\nu \in (\kappa, 1)$ we can control the probabilities of the moderate speedup in the following way :*

$$\lim_{n \rightarrow \infty} \frac{\ln(-\ln P_\omega[X_n > n^\nu])}{\ln n} = \lim_{n \rightarrow \infty} \frac{\ln(-\ln P_\omega[T_{n^\nu} < n])}{\ln n} = \frac{\nu - \kappa}{1 - \kappa}, \quad \mathbf{P}\text{-a.s.}, \quad (1.12)$$

and

$$\lim_{n \rightarrow \infty} \frac{\ln(-\ln \mathbb{P}[X_n > n^\nu])}{\ln n} = \lim_{n \rightarrow \infty} \frac{\ln(-\ln \mathbb{P}[T_{n^\nu} < n])}{\ln n} = \frac{\nu - \kappa}{1 - \kappa}. \quad (1.13)$$

The same result holds for the RWRE with reflection at the origin.

For the case $\kappa \in (0, 1)$, the quenched moderate deviations for the random walk on \mathbb{Z} are well summed up by the plot of the following function on Figure 6.1 :

$$f(\nu) = \begin{cases} \lim_{n \rightarrow \infty} \ln(-\ln P_\omega[X_n < -n^{-\nu}]) / \ln n, & \text{if } \nu \in (-1, 0], \\ \lim_{n \rightarrow \infty} \ln(-\ln P_\omega[X_n < n^\nu]) / \ln n, & \text{if } \nu \in (0, \kappa), \\ \lim_{n \rightarrow \infty} \ln(-\ln P_\omega[X_n > n^\nu]) / \ln n, & \text{if } \nu \in [\kappa, 1]. \end{cases}$$

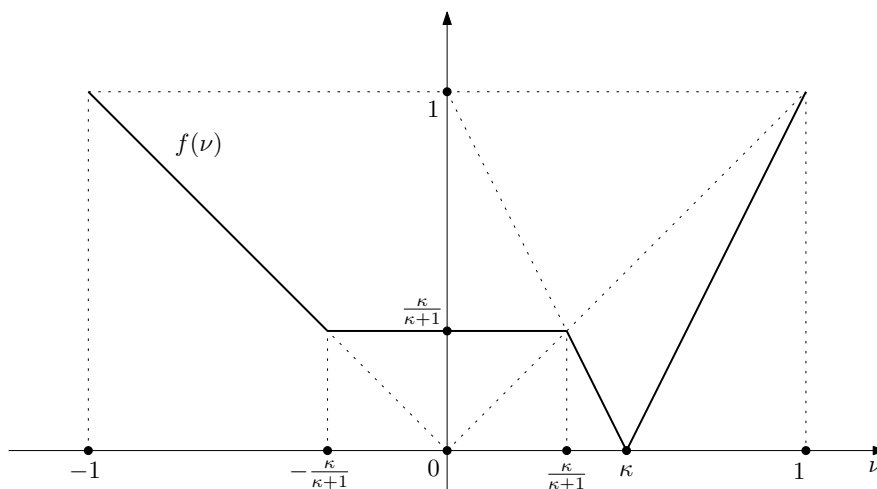

FIG. 6.1 – The plot of $f(\nu)$, $-1 < \nu < 1$

The rest of this paper is organized in the following way. In Section 2 we give the (standard) definition of the potential and the reversible measure for the RWRE. We then decompose the environment into a sequence of valleys. In this decomposition the valleys do not only depend on the environment but the construction is time-dependent. Also, we derive some basic facts about the valleys needed later. In Section 3 we mainly study the properties of that sequence of valleys. In Section 4, we recall some results concerning the spectral properties of RWRE restricted to a finite interval, and then obtain some bounds on the probability of confinement in a valley. In Section 5 we define the induced

2. MORE NOTATIONS AND SOME BASIC FACTS

random walk whose state is the current valley (more precisely, the last visited boundary between two neighbouring valleys) where the particle is located. Theorems 1.2, 1.3, 1.4, 1.5 are proved in Sections 6, 7, 8, 9 respectively. We denote by $\gamma, \gamma_0, \gamma_1, \gamma_2, \gamma_3, \dots$ the “important” constants (those that can be used far away from the place where they appear for the first time), and by C_1, C_2, C_3, \dots the “local” ones (those that are used only in a small neighbourhood of the place where they appear for the first time), restarting the numeration at the beginning of each section in the latter case. All these constants are either universal or depend only on the law of the environment.

2 More notations and some basic facts

An important ingredient of our proofs is the analysis of the *potential* associated with the environment, which was introduced by Sinai in [94]. The potential, denoted by $V = (V(x), x \in \mathbb{Z})$, is a function of the environment ω . It is defined in the following way :

$$V(x) := \begin{cases} \sum_{i=1}^x \ln \rho_i, & \text{if } x \geq 1, \\ 0, & \text{if } x = 0, \\ -\sum_{i=x+1}^0 \ln \rho_i, & \text{if } x \leq -1, \end{cases}$$

so it is a random walk with negative drift, because $\mathbf{E}[\ln \rho_0] < 0$. This notation is extended on \mathbb{R} by $V(x) := V(\lfloor x \rfloor)$. We also define a reversible measure

$$\pi(x) := e^{-V(x)} + e^{-V(x-1)}, \quad \text{for } x \in \mathbb{Z}, \quad (2.1)$$

(one easily verifies that $\omega_x \pi(x) = (1 - \omega_{x+1})\pi(x+1)$ for all x). We will also use the notation $\pi([x, y]) = \sum_{i=\lfloor x \rfloor}^{\lfloor y \rfloor} \pi(i)$, for $x < y$ two real numbers.

The function $V(\cdot)$ enables us to define the valleys, parts of the environment which acts as traps for the random walk. The valleys are responsible for the sub-ballistic behaviour and hence play a central role for slowdown and speedup phenomena.

We define by induction the following environment dependent sequence $(K_i(n))_{i \geq 0}$ by

$$\begin{aligned} K_0(n) &= -n, \\ K_{i+1}(n) &= \min \left\{ j \geq K_i(n) : V(K_i(n)) - \min_{k \in [K_i(n), j]} V(k) \geq \frac{3}{1 \wedge \kappa} \ln n, \right. \\ &\quad \left. V(j) = \max_{k \geq j} V(k) \right\}. \end{aligned}$$

The dependence with respect to n will be frequently omitted to ease the notations. The portion of the environment $[K_i, K_{i+1})$ is called the i -th valley, and we will prove that for n large enough the valleys are descending in the sense that $V(K_{i+1}) < V(K_i)$ for all $i \in [0, n]$. We associate to the i -th valley the bottom point

$$b_i = \inf \left\{ x \in [K_i, K_{i+1}) : V(x) = \min_{y \in [K_i, K_{i+1})} V(y) \right\},$$

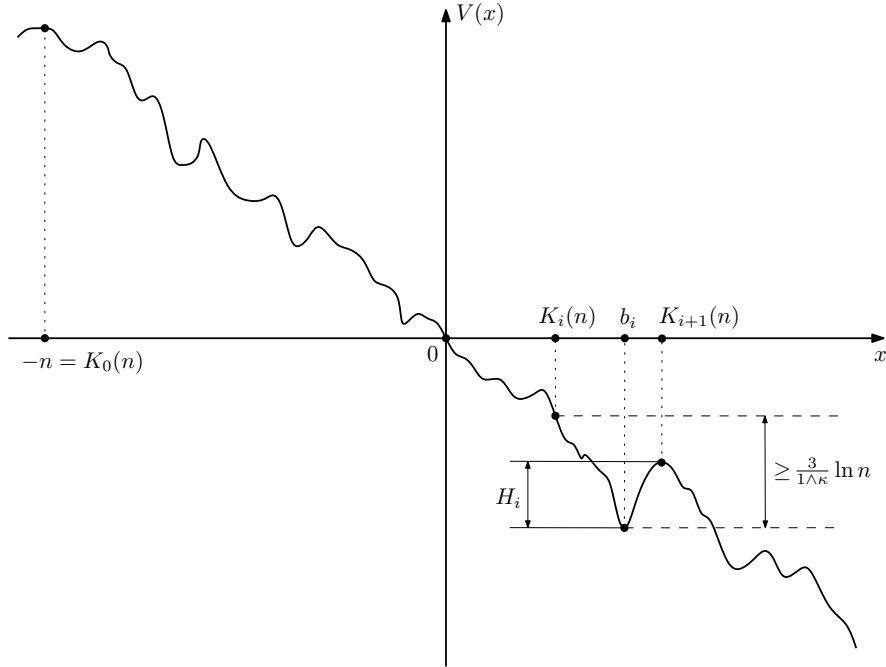

FIG. 6.2 – On the definition of the sequence of valleys

and the depth

$$\begin{aligned} H_i &= \max_{x \in [K_i, K_{i+1})} \left(\max_{y \in [x, K_{i+1})} V(y) - \min_{y \in [K_i, x]} V(y) \right) \\ &= \max_{K_i(n) \leq j < k < K_{i+1}(n)} (V(k) - V(j)), \end{aligned}$$

see Figure 6.2.

Let us denote

$$N_n(m, m') = \{i \geq 1 : [K_i, K_{i+1}) \cap [[m], [m']] \neq \emptyset\} \quad (2.2)$$

and again we will often omit the index n . Let us emphasize that we do not include the valley of index 0, which is different from the others because of border issues.

The valleys for $i \geq 1$ are non-overlapping parts of \mathbb{Z} , for any value of n . Moreover the potential in the valleys are i.i.d. up to space-shift, in the sense that for any n and $i \geq 1$ the sequence of vectors of random length $(V(j) - V(K_{i+1}(n)), j = K_i(n), \dots, K_{i+1}(n) - 1)$, $i \geq 1$, is i.i.d.

We introduce the two following indices which will be used regularly

$$i_0 = \text{card } N(-n, 0) \quad \text{and} \quad i_1 = \text{card } N(-n, n^\nu). \quad (2.3)$$

3. ESTIMATES ON THE ENVIRONMENT

To carry over the proofs easily to the reflected case, we introduce the following notation

$$\tilde{K}_{i_0} = 0 \quad \text{and} \quad \tilde{K}_i = K_i \quad \text{for } i \geq i_0. \quad (2.4)$$

We can estimate the depth of the valleys using a result of renewal theory which concerns the maximum of random walks with negative drift. We refer to [37] for a detailed introduction to renewal theory. Denoting $S = \max_{i \geq 0} V(i)$, under assumptions (1.1), (1.2) and (iii) of Theorem 1.1, we have

$$\mathbf{P}[S > h] \sim C_F e^{-\kappa h}, \quad h \rightarrow \infty, \quad (2.5)$$

which is a result due to Feller which can be found in this form in [54].

If (iii) in Theorem 1.1 fails, $\ln \rho_0$ is concentrated on $\lambda\mathbb{Z}$ for some $\lambda > 0$, so that $V(\cdot)$ is a Markov chain with i.i.d. increments of law $\ln \rho_i$. In this case, under our assumptions (1.1) and (1.2) we can use a result in [96] (p. 218) stating the discrete version of the previous equation. In the case of an aperiodic Markov chain we have

$$\mathbf{P}[S \geq n\lambda] \sim C'_F e^{-\kappa\lambda n}, \quad n \rightarrow \infty, \quad (2.6)$$

and in the general case we obtain similar asymptotics by noticing that $(V(nd + k))_{n \geq 0}$ is aperiodic for $k \in [0, d - 1]$ and d the period of $V(\cdot)$ (which is well defined and finite by (i) and (ii)).

Hence we can easily deduce from the assumptions (1.1) and (1.2) and equations (2.5) and (2.6) that

$$\mathbf{P}[S > h] = \Theta(e^{-\kappa h}), \quad (2.7)$$

where $f(n) = \Theta(g(n))$ means that $f(n) = O(g(n))$ and $g(n) = O(f(n))$.

Let us recall also the following basic fact. For any integers $a < x < b$, the (quenched) probability for RWRE to reach b before a starting from x can be easily computed :

$$P_\omega^x[T_b < T_a] = \frac{\sum_{y=a}^{x-1} e^{V(y)}}{\sum_{y=a}^{b-1} e^{V(y)}}, \quad (2.8)$$

see e.g. Lemma 1 in [94] or formula (2.1.4) in [104].

3 Estimates on the environment

Let us introduce the event

$$A(n) = \left\{ \max_{i \leq 2n} (K_{i+1} - K_i) \leq (\ln n)^2 \right\}. \quad (3.1)$$

The following lemma shows that the valleys are not very wide.

CHAPITRE 6. SLOWDOWN AND SPEEDUP OF TRANSIENT RWRE

Lemma 3.1. *We have*

$$\mathbf{P}[A(n)^c] = O\left(\frac{1}{n^2}\right).$$

Démonstration. We have

$$\begin{aligned} \mathbf{P}[A(n)^c] &= \mathbf{P}\left[\max_{i \leq 2n} (K_{i+1} - K_i) > (\ln n)^2\right] \\ &\leq 2n\mathbf{P}[K_2 - K_1 > (\ln n)^2] + \mathbf{P}[\bar{K}_1 > (\ln n)^2], \end{aligned} \quad (3.2)$$

where

$$\bar{K}_1(n) = \min\left\{j \geq 0 : -\min_{k \in [0, j]} V(k) \geq \frac{3}{1 \wedge \kappa} \ln n, \quad V(j) = \max_{k \geq j} V(k)\right\}.$$

Now

$$\begin{aligned} \mathbf{P}[K_2 - K_1 > (\ln n)^2] &= \mathbf{P}[\bar{K}_1 > (\ln n)^2 \mid \max_{i \geq 0} V(i) \leq 0] \\ &\leq \frac{\mathbf{P}[\bar{K}_1 > (\ln n)^2]}{\mathbf{P}[\max_{i \geq 0} V(i) \leq 0]}, \end{aligned}$$

where $\mathbf{P}[\max_{i \geq 0} V(i) \leq 0] > 0$ since $\mathbf{E}[\ln \rho_0] < 0$. Choose ℓ such that $\varepsilon_0 \ell > 3(1 \wedge \kappa)$, with ε_0 from (1.3). Note that if $V((\ln n)^2) \leq -\frac{3+3\ell}{1 \wedge \kappa} \ln n$, $\min_{j \leq (\ln n)^2} (V(j) - V(j-1)) \geq -\frac{\ell}{1 \wedge \kappa} \ln n$ and $\max_{j \geq (\ln n)^2} V(j) - V((\ln n)^2) \leq \frac{3}{1 \wedge \kappa} \ln n$, then the set

$$\left\{i \in [0, (\ln n)^2], V(i) \in \left(-\frac{3}{1 \wedge \kappa} \ln n, -\frac{3+2\ell}{1 \wedge \kappa} \ln n\right)\right\}$$

is non-empty. Moreover its largest element m is such that $\max_{j \geq m} V(j) = V(m)$, hence we have $\bar{K}_1 \leq (\ln n)^2$. This yields

$$\begin{aligned} \mathbf{P}[\bar{K}_1 > (\ln n)^2] &\leq \mathbf{P}\left[V((\ln n)^2) > -\frac{3+3\ell}{1 \wedge \kappa} \ln n\right] \\ &\text{or } \min_{j \leq (\ln n)^2} (V(j) - V(j-1)) < -\frac{\ell}{1 \wedge \kappa} \ln n \\ &\text{or } \max_{j \geq (\ln n)^2} V(j) - V((\ln n)^2) > \frac{3}{1 \wedge \kappa} \ln n. \end{aligned} \quad (3.3)$$

Using (2.7), we obtain

$$\mathbf{P}\left[\max_{j \geq (\ln n)^2} V(j) - V((\ln n)^2) > \frac{3}{1 \wedge \kappa} \ln n\right] = O(n^{-3}). \quad (3.4)$$

Furthermore, using Chebyshev's inequality and (1.3) we get

$$\mathbf{P}\left[\min_{j \leq (\ln n)^2} (V(j) - V(j-1)) < -\frac{\ell}{1 \wedge \kappa} \ln n\right]$$

3. ESTIMATES ON THE ENVIRONMENT

$$\begin{aligned}
&\leq (\ln n)^2 \mathbf{P} \left[\ln \rho_0 < -\frac{\ell}{1 \wedge \kappa} \ln n \right] \\
&\leq (\ln n)^2 \mathbf{P} \left[\rho_0^{-\varepsilon_0} > \exp \left(\varepsilon_0 \frac{\ell}{1 \wedge \kappa} \ln n \right) \right] \\
&\leq (\ln n)^2 \mathbf{E}[\rho_0^{-\varepsilon_0}] n^{-\varepsilon_0 \ell / (1 \wedge \kappa)} \\
&= o(n^{-3}). \tag{3.5}
\end{aligned}$$

Now, since $V(\cdot)$ is a sum of i.i.d. random variables with exponential moments by the assumptions (1.2) and (1.3), we can use large deviations techniques to get

$$\begin{aligned}
\mathbf{P}[V((\ln n)^2) > -C_1 \ln n] &\leq \mathbf{P}[|V((\ln n)^2) - \mathbf{E}[V(1)](\ln n)^2| > C_2(\ln n)^2] \tag{3.6} \\
&\leq \exp(-C_3(\ln n)^2) \\
&= o(n^{-3}),
\end{aligned}$$

since $\mathbf{E}[V(1)] = \mathbf{E}[\ln \rho_0] \in (-\infty, 0)$. Putting together (3.2), (3.3), (3.4), (3.5) and (3.6) we obtain the result. \square

Consider $a \in [0, \nu)$, and define the event

$$B(n, \nu, a)^c = \left\{ \text{card} \left\{ i \in N_n(-n^\nu, n^\nu) : H_i \geq \frac{a}{\kappa} \ln n + \ln \ln n \right\} \geq n^{\nu-a} \right\}.$$

The following lemma will tell us that asymptotically, between levels $-n^\nu$ and n^ν there are at most $n^{\nu-a}$ valleys of depth greater than $(a/\kappa) \ln n + \ln \ln n$.

Lemma 3.2. *For any $a \in [0, \nu)$, we have*

$$\mathbf{P}[B(n, \nu, a)^c] = O(n^{-2}).$$

Démonstration. We have easily that (“ \prec ” means “stochastically dominated”)

$$\begin{aligned}
&\text{card} \left\{ i \leq N_n(-n^\nu, n^\nu) : H_i \geq \frac{a}{\kappa} \ln n + \ln \ln n \right\} \\
&\prec \text{Bin} \left(2\lfloor n^\nu \rfloor + 2, \mathbf{P} \left[S \geq \frac{a}{\kappa} \ln n + \ln \ln n \right] \right),
\end{aligned}$$

since we have at most $2\lfloor n^\nu \rfloor + 2$ integers on the right of which we need an increase of potential of $(a/\kappa) \ln n + \ln \ln n$ to create a valley of sufficient depth.

Using (2.7), we have

$$\mathbf{P} \left[S \geq \frac{a}{\kappa} \ln n + \ln \ln n \right] = O \left(\frac{n^{-a}}{(\ln n)^\kappa} \right).$$

Now, using Chebyshev’s exponential inequality, we can write

$$\begin{aligned}
&\mathbf{P} \left[\text{Bin} \left(2\lfloor n^\nu \rfloor + 2, \mathbf{P} \left[S \geq \frac{a}{\kappa} \ln n + \ln \ln n \right] \right) \geq n^{\nu-a} \right] \\
&\leq C_4 \exp(-n^{\nu-a}) \exp(C_5 n^{\nu-a} (\ln n)^{-\kappa}),
\end{aligned}$$

and, since $\nu > a$, the result follows. \square

CHAPITRE 6. SLOWDOWN AND SPEEDUP OF TRANSIENT RWRE

We introduce for $m \in \mathbb{Z}^+$ the following event, which, by Lemma 3.2, has probability converging to 1,

$$B'(n, \nu, m) = \bigcap_{k=1}^{m-1} B(n, \nu, k\nu/m). \quad (3.7)$$

Also, set

$$G(n)^c = \left\{ \max_{k \geq n} (V(k) - V(n)) \geq \frac{1}{\kappa} (\ln n + 2 \ln \ln n) \right\} \\ \bigcup \left\{ \max_{k \geq -n} (V(k) - V(-n)) \geq \frac{1}{\kappa} (\ln n + 2 \ln \ln n) \right\}.$$

Lemma 3.3. *We have*

$$\mathbf{P}[G(n)^c] = O\left(\frac{1}{n(\ln n)^2}\right).$$

Démonstration. This is a direct consequence of (2.7). □

We now show that Lemma 3.3 implies that asymptotically, in the interval $[-n, n]$, the deepest valley we can find has depth lower than $\frac{1}{\kappa}(\ln n + 2 \ln \ln n)$. Let

$$G_1(n) = \left\{ \max_{i \in [-n, n]} \max_{k \geq i} (V(k) - V(i)) \leq \frac{1}{\kappa} (\ln n + 2 \ln \ln n) \right\}. \quad (3.8)$$

Lemma 3.4. *For \mathbf{P} -almost all ω , there is $N = N(\omega)$ such that $\omega \in G_1(n)$ for $n \geq N$.*

Démonstration. By symmetry, it suffices to give the proof for

$$G_2(n) = \left\{ \max_{i \in [0, n]} \max_{k \geq i} (V(k) - V(i)) \leq \frac{1}{\kappa} (\ln n + 2 \ln \ln n) \right\} \quad (3.9)$$

instead of $G_1(n)$. Let

$$n_0 := \min \left\{ j \geq 0 : \max_{k \geq i} (V(k) - V(i)) \leq \frac{1}{\kappa} (\ln i + 2 \ln \ln i), \forall i \geq j \right\}$$

and

$$K = \max_{0 \leq i \leq n_0} \max_{k \geq i} (V(k) - V(i)).$$

Due to Lemma 3.3, n_0 is finite \mathbf{P} -almost surely. Now, take N large enough such that $N \geq n_0$ and

$$\frac{1}{\kappa} (\ln N + 2 \ln \ln N) \geq K.$$

Then for $n \geq N$, let $\ell \in [0, n]$ be such that $\max_{i \in [0, n]} \max_{k \geq i} (V(k) - V(i)) = \max_{k \geq \ell} (V(k) - V(\ell))$. We have either $\ell \leq n_0$ and then $\max_{k \geq \ell} (V(k) - V(\ell)) \leq K$ by the definition of K , or $\ell > n_0$ and then, by the definition of n_0 , $\max_{k \geq \ell} (V(k) - V(\ell)) \leq \frac{1}{\kappa} (\ln \ell + 2 \ln \ln \ell) \leq \frac{1}{\kappa} (\ln n + 2 \ln \ln n)$. □

3. ESTIMATES ON THE ENVIRONMENT

Let us define

$$D(n)^c = \left\{ \max_{i \in [0, n]} \max_{k \geq i} (V(k) - V(i)) \leq \frac{1}{\kappa} (\ln n - 4 \ln \ln n) \right\} \\ \cup \left\{ \max_{i \in [-n, 0]} \max_{k \geq i} (V(k) - V(i)) \leq \frac{1}{\kappa} (\ln n - 4 \ln \ln n) \right\}.$$

Lemma 3.5. *We have*

$$\mathbf{P}[D(n)^c] = O(n^{-2}).$$

Démonstration. First, we notice that

$$\mathbf{P}[D(n)^c] \leq 2\mathbf{P} \left[\max_{i \in [0, \lfloor \frac{n}{(\ln n)^2} \rfloor]} \max_{k \leq (\ln n)^2} V(i(\ln n)^2 + k) - V(i(\ln n)^2) \right. \\ \left. \leq \frac{1}{\kappa} (\ln n - 4 \ln \ln n) \right] + \mathbf{P}[A(n)^c],$$

where $\mathbf{P}[A(n)^c] = O(n^{-2})$ by Lemma 3.1.

Let us introduce

$$D^{(1)}(n) = \left\{ \max_{k > \lfloor (\ln n)^2 \rfloor} V(k) - V(0) \geq \frac{1}{\kappa} (\ln n - 4 \ln \ln n) \right\},$$

then we have

$$\mathbf{P}[D^{(1)}(n)] \leq \mathbf{P} \left[\max_{k \geq 0} V(k) - V(0) > \frac{1}{\kappa} (\ln n - 4 \ln \ln n) \right] \\ + \mathbf{P} \left[\max_{k \geq 0} V(k) - V(0) \neq \max_{k \leq (\ln n)^2} V(k) - V(0) \right] = \Theta \left(\frac{(\ln n)^4}{n} \right),$$

using a reasoning similar to the proof of Lemma 3.1 (cf. equations (3.3) and (3.4)) to show that the second term is at most $O(n^{-2})$.

So, we obtain for n large enough

$$\mathbf{P}[D(n)^c] \leq 2 \left(1 - \frac{C_6 (\ln n)^4}{n} \right)^{n/(\ln n)^2} \leq 2 \exp(-C_7 (\ln n)^2),$$

hence the result. □

Finally, let us introduce

$$F(n) = \left\{ \min_{i \in [-n, n]} (1 - \omega_i) > n^{-3/\varepsilon_0} \right\}.$$

Lemma 3.6. *We have*

$$\mathbf{P}[F(n)^c] = O\left(\frac{1}{n^2}\right).$$

CHAPITRE 6. SLOWDOWN AND SPEEDUP OF TRANSIENT RWRE

Démonstration. We notice that $1 - \omega_i \geq \min(1/2, \rho_i/2)$, so that it is enough to prove that $\mathbf{P}[\rho_i < 2n^{-3/\varepsilon_0}] = O(n^{-3})$ which is a consequence of (1.3), since by Chebyshev's inequality

$$\mathbf{P}\left[\rho_i^{-1} > \frac{n^{3/\varepsilon_0}}{2}\right] \leq \frac{2^{\varepsilon_0} \mathbf{E}[\rho_0^{-\varepsilon_0}]}{n^3}.$$

□

Using the Borel-Cantelli Lemma one can obtain that for \mathbf{P} -almost all ω and n large enough, we have $\omega \in A(n) \cap B'(n, \nu, m) \cap G_1(n) \cap D(n) \cap F(n)$. That is, the width of the valleys is lower than $(\ln n)^2$, their depth lower than $(\ln n + 2 \ln \ln n)/\kappa$, we can control the number of valleys deeper than $\frac{\alpha}{\kappa} \ln n - \ln \ln n$, and there is at least one valley of depth $(\ln n - 4 \ln \ln n)/\kappa$.

Due to the definition of the valleys, the potential goes down at least by $\frac{3}{1 \wedge \kappa} \ln n$ in a valley and on $G_1(n)$ the biggest increase of potential is lower than $\frac{1}{\kappa}(\ln n + 2 \ln \ln n)$ for all valleys in $[-n, n]$. In particular, on $G_1(n)$, $(V(K_i))_{i \leq 2n}$ is a decreasing sequence and we have

$$\begin{aligned} V(b_{i+1}) &\leq V(b_i) - \frac{3}{1 \wedge \kappa} \ln n + \frac{1}{\kappa}(\ln n + 2 \ln \ln n) \\ &\leq V(b_i) - \frac{2}{1 \wedge \kappa} \ln n + \frac{2}{\kappa} \ln \ln n \end{aligned}$$

implying using (2.1) that for all valleys in $[-n, n]$,

$$\pi(b_i) \leq 2e^{-V(b_i)} \leq \frac{2(\ln n)^{2/\kappa}}{n^{2/(1 \wedge \kappa)}} \pi(b_{i+1}) \leq \frac{1}{2} \pi(b_{i+1}). \quad (3.10)$$

In a similar fashion, we can give an upper bound for $V(K_i) - V(b_i)$ on $G_1(n) \cap F(n)$. We claim that on $G_1(n) \cap F(n)$, for a constant γ_0 ,

$$V(K_i) - V(K_{i+1}) \leq V(K_i) - V(b_i) \leq \gamma_0 \ln n. \quad (3.11)$$

To show (3.11), let x be the smallest integer larger than K_i such that $V(x) \leq V(K_i) - (3/(1 \wedge \kappa)) \ln n$. By definition of K_{i+1} it satisfies $V(x) \leq V(K_{i+1})$. But on $F(n)$ we know that $V(x) \geq V(K_i) - (3/(1 \wedge \kappa) + 3/\varepsilon_0) \ln n$. Recalling that on $G_1(n)$ we have $V(b_i) \geq V(K_{i+1}) - (2/\kappa) \ln n$, we get for n large enough

$$\begin{aligned} V(K_i) - V(b_i) &\leq V(K_i) - (V(K_{i+1}) - \frac{2}{\kappa} \ln n) \\ &\leq V(K_i) - (V(x) - \frac{2}{\kappa} \ln n) \\ &\leq \left(\frac{3}{1 \wedge \kappa} + \frac{3}{\varepsilon_0} + \frac{2}{\kappa} \right) \ln n. \end{aligned}$$

4 Bounds on the probability of confinement

In this section, let $I = [a, c]$ be a finite interval of \mathbb{Z} containing at least four points and let the potential $V(x)$ be an arbitrary function defined for $x \in [a - 1, c]$, with $V(a - 1) = 0$. This potential defines transition probabilities given by $\omega_x = e^{-V(x)}/\pi(x)$, $x \in [a, c]$ where $\pi(x)$ is defined as in (2.1) (taking $V(a - 1) = 0$ is no loss of generality since the transition probabilities remain the same if we replace $V(x)$ by $V(x) + c$, $\forall x$). We denote by X the Markov chain restricted on I in the following way : the transition probability ω_a from a to $a + 1$ is defined as above, and with probability $1 - \omega_a$ the walk just stays in a ; in the same way, we define the reflection at the other border c . We denote

$$H_+ = \max_{x \in [a, c]} \left(\max_{y \in [x, c]} V(y) - \min_{y \in [a, x]} V(y) \right),$$

$$H_- = \max_{x \in [a, c]} \left(\max_{y \in [a, x]} V(y) - \min_{y \in (x, c]} V(y) \right),$$

and

$$H = H_+ \wedge H_-.$$

Let us denote also by

$$\tilde{M} = \max_{y \in [a, c]} V(y) - \min_{y \in [a, c]} V(y)$$

the maximal difference between the values of the potential in the interval $[a, c]$. Also, we set

$$f = \begin{cases} c, & \text{if } H = H_+, \\ a, & \text{otherwise.} \end{cases}$$

To avoid confusion, let us mention that the results of this section (Propositions 4.1, 4.2, 4.3) hold for both the unrestricted and restricted random walks (as long as the starting point belongs to I). First, we prove the following

Proposition 4.1. *There exists $\gamma_1 > 0$, such that for all $u \geq 1$*

$$\begin{aligned} & \max_{x \in I} P_\omega^x \left[\frac{T_{\{a, c\}}}{\gamma_1 (c - a)^3 ((c - a) + \tilde{M}) e^H} > u \right] \\ & \leq \max_{x \in I} P_\omega^x \left[\frac{T_f}{\gamma_1 (c - a)^3 ((c - a) + \tilde{M}) e^H} > u \right] \\ & \leq e^{-u}. \end{aligned}$$

Démonstration. The first inequality is trivial, we only need to prove the second one. In the following we will suppose that $H = H_+$ (so that $f = c$), otherwise we can apply the

CHAPITRE 6. SLOWDOWN AND SPEEDUP OF TRANSIENT RWRE

same argument by inverting the space. We denote by b the leftmost point in the interval $[a, c]$ with minimal potential.

We extend the Markov chain on the interval I to a Markov chain on the interval $I' = [a, c+1]$ in the following way. Let $V(c+1) := V(b)$, yielding $\omega_{c+1} = (1 + e^{-(V(c)-V(b))})^{-1}$. Again, with probability $1 - \omega_{c+1}$, the Markov chain goes from $c+1$ to c , and with probability ω_{c+1} , the Markov chain just stays in $c+1$.

Let us denote by \hat{X}_t the continuous time version of the Markov chain on I' (i.e., the transition probabilities become transition rates). The reason for considering continuous time is the following : we are going to use spectral gap estimates, and these are better suited for continuous time in this context (mainly due to the fact that the discrete-time random walk is periodic). We define the probability measure μ on I' which is reversible (and therefore invariant) for \hat{X} in the following way

$$\mu(x) = \pi(x) \left(\sum_{y \in I'} \pi(y) \right)^{-1},$$

for all $x \in I'$, where π is as in (2.1) with the potential defined above, satisfying $V(a-1) = 0$ and $V(c+1) = V(b)$. Now, the goal is to bound the spectral gap $\lambda(I')$ from below. We can do this using a result of [76] :

$$\frac{1}{4B^{I'}} \leq \lambda(I') \leq \frac{2}{B^{I'}}, \quad (4.1)$$

where $B^{I'} = \min_{i \in I'} (B_-^{I'}(i) \wedge B_+^{I'}(i))$ and

$$B_+^{I'}(i) = \max_{x > i} \left(\sum_{y=i+1}^x (\mu(y)(1 - \omega_y))^{-1} \right) \mu[x, c+1], \quad i \in [a, c]$$

$$B_-^{I'}(i) = \max_{x < i} \left(\sum_{y=x}^{i-1} (\mu(y)\omega_y)^{-1} \right) \mu[a, x], \quad i \in [a+1, c+1]$$

and $B_+^{I'}(c+1) = B_-^{I'}(a) = 0$. Obviously, we have $B^{I'} \leq B_-^{I'}(c+1)$. Moreover, since (2.1) implies that $\omega_x \pi(x) = e^{-V(x)}$ for any $x \in I'$, we can write

$$\begin{aligned} B_-^{I'}(c+1) &= \max_{x \leq c} \left(\sum_{y=x}^c \frac{1}{\omega_y \pi(y)} \right) \left(\sum_{y=a}^x \pi(y) \right) \\ &= \max_{x \leq c} \left(\sum_{y=x}^c e^{V(y)} \right) \left(\sum_{y=a}^x (e^{-V(y)} + e^{-V(y-1)}) \right) \\ &\leq 2 \max_{x \leq c} \left(\sum_{y=x}^c e^{V(y)} \right) \left(\sum_{y=a}^x e^{-V(y)} \right) \end{aligned}$$

4. BOUNDS ON THE PROBABILITY OF CONFINEMENT

$$\leq 2(c-a)^2 e^H.$$

This yields

$$\lambda(I') \geq \frac{1}{8(c-a)^2 e^H}.$$

Using Corollary 2.1.5 of [91], we obtain that for $x, y \in I'$ and $s > 0$

$$\left| P_\omega^x[\hat{X}_s = y] - \mu(y) \right| \leq \left(\frac{\mu(y)}{\mu(x)} \right)^{1/2} \exp(-\lambda(I')s).$$

We apply this formula for $y = c + 1$. Note that, using (2.1), we obtain that $(\mu(c+1)/\mu(x))^{1/2} \leq \sqrt{2}e^{\tilde{M}/2}$ for any $x \in (a, c)$. So, for $s := C_1(c-a)^2((c-a) + \tilde{M})e^H$, if $C_1 > 4$ is chosen large enough

$$\left| P_\omega^x[\hat{X}_s = c+1] - \mu(c+1) \right| \leq \sqrt{2}e^{-C_1(c-a)/8} < \frac{1}{8(c-a)},$$

and, since $\mu(c+1) \geq 1/2(c+1-a) \geq 1/(4(c-a))$, we obtain

$$\min_{x \in I'} P_\omega^x[\hat{X}_s = c+1] \geq \frac{1}{8(c-a)}.$$

Let us divide $[0, t]$ into $N := \lfloor t/s \rfloor$ subintervals. Using the above inequality and Markov's property we obtain (\hat{T} stands for the hitting time with respect to \hat{X})

$$\begin{aligned} P_\omega^x[\hat{T}_c > t] &\leq P_\omega^x[\hat{T}_{c+1} > t] \\ &\leq P_\omega^x[\hat{X}_{sk} \neq c+1, k = 1, \dots, N] \\ &\leq \left(1 - \frac{1}{8(c-a)} \right)^N \\ &\leq \exp\left(-\frac{N}{8(c-a)} \right) \\ &\leq \exp\left(-\frac{t}{8C_1(c-a)^3((c-a) + \tilde{M})e^H} \right) \exp\left(\frac{1}{8(c-a)} \right). \end{aligned}$$

The estimates on the continuous time Markov chain transfer to discrete time. Indeed, there exists a family $(\mathbf{e}_i)_{i \geq 1}$ of exponential random variables of parameter 1, such that the n -th jump of the continuous time random walk occurs at $\sum_{i=1}^n \mathbf{e}_i$. These random variables are independent of the environment and the discrete-time random walk. Moreover, $P[\mathbf{e}_1 + \dots + \mathbf{e}_n \geq n] \geq 1/3$, for all n . So, for any t ,

$$\frac{1}{3} \mathbf{P}[T_c \geq t] \leq \mathbf{P}[T_c \geq t] \mathbf{P}[\hat{T}_c \geq T_c] = \mathbf{P}[T_c \geq t, \hat{T}_c \geq T_c] \leq \mathbf{P}[\hat{T}_c \geq t],$$

CHAPITRE 6. SLOWDOWN AND SPEEDUP OF TRANSIENT RWRE

Hence, we have for all $v > 0$

$$\max_{x \in I} P_\omega^x \left[\frac{T_c}{8(1+v)C_1(c-a)^3((c-a) + \tilde{M})e^H} > u \right] \leq \left(3e^{1/8} e^{-vu} \right) e^{-u},$$

for all $u \geq 0$. Hence for $u \geq 1$, choosing v large enough in such a way that $3 \exp(\frac{1}{8} - v) \leq 1$, we obtain the result with $\gamma_1 = 8C_1(1+v)$. \square

Next, we recall the following simple upper bound on hitting probabilities :

Proposition 4.2. *There exists γ_2 such that for any x, y and $h \in [x, y]$ we have*

$$P_\omega^x [T_y < s] \leq \gamma_2(1+s) \frac{\pi(h)}{\pi(x)}.$$

Démonstration. We can adapt Lemma 3.4 of [21] (which used a uniform ellipticity condition). We remain in the continuous time setting and, considering the event that y is visited before time s and left again at least one time unit later (on which $\int_0^{s+1} \mathbf{1}\{\hat{X}_u = y\} du \geq 1$), we have

$$\int_0^{s+1} P_\omega^x [\hat{X}_u = y] du \geq P_\omega^x [\hat{T}_y < s] \cdot P[\mathbf{e}_1 \geq 1] \quad (4.2)$$

where \mathbf{e}_1 is an exponential random variable of parameter 1. Hence

$$\begin{aligned} P_\omega^x [\hat{T}_y < s] &\leq P_\omega^x [\hat{T}_h < s] \\ &\leq e \int_0^{s+1} P_\omega^x [\hat{X}_u = h] du \\ &= e \int_0^{s+1} \frac{\pi(h)}{\pi(x)} P_\omega^h [\hat{X}_u = x] du \\ &\leq e(s+1) \frac{\pi(h)}{\pi(x)}. \end{aligned}$$

Again, one can easily transfer the estimates on the continuous time Markov chain to discrete time. \square

Let us now introduce

$$\begin{aligned} H_+^* &= \max_{x \in [a+1, c-1]} \left(\max_{y \in [x, c-1]} V(y) - \min_{y \in [a+1, x]} V(y) \right), \\ H_-^* &= \max_{x \in [a+1, c-1]} \left(\max_{y \in [a+1, x]} V(y) - \min_{y \in (x, c-1]} V(y) \right), \end{aligned}$$

and

$$H^* = H_+^* \wedge H_-^*.$$

We obtain a lower bound on the confinement probability in the following proposition. Recall that b is the leftmost point in the interval $[a, c]$ with minimal potential.

Proposition 4.3. *Suppose that $c - 1$ has maximal potential on $[b, c - 1]$ and a has maximal potential on $[a, b]$. Then, there exists $\gamma_3 > 0$, such that for all $u \geq 1$*

$$\min_{x \in I} P_\omega^x \left[\gamma_3 \ln(2(c - a)) \frac{T_{\{a,c\}}}{e^{H^*}} \geq u \right] \geq \frac{1}{2(c - a)} e^{-u},$$

if $e^{H^*} \geq 16\gamma_2$.

Démonstration. Noticing that

$$\min_{b < h < c-1} \frac{\pi(h)}{\pi(b)} \leq 2e^{-H^*} \quad \text{and} \quad \min_{a+1 < h < b} \frac{\pi(h)}{\pi(b)} \leq 2e^{-H^*},$$

we can apply Proposition 4.2 to obtain that

$$\text{for all } s \geq 1, \quad P_\omega^b [T_{\{a,c\}} < s] \leq 8\gamma_2 s e^{-H^*}, \quad (4.3)$$

Hence for $s = e^{H^*}/(16\gamma_2) \geq 1$, the right-hand side of the previous inequality equals $1/2$.

Now, using the exit probability formula (2.8), we obtain that

$$\min_{x \in I} P_\omega^x [T_b < T_{\{a,c\}}] \geq (c - a)^{-1}. \quad (4.4)$$

Denoting $N = \lceil t/s \rceil$, we obtain for $x \in I$,

$$\begin{aligned} P_\omega^x [T_{\{a,c\}} > t] &\geq (2(c - a))^{-(N+1)} \\ &\geq \exp\left(-\frac{C_2 t \ln(2(c - a))}{e^{H^*}}\right) (2(c - a))^{-1}. \end{aligned}$$

We used the following reasoning in the above calculation. Start from any $x \in (a, c)$, by (4.4) the particle hits b before $\{a, c\}$ with probability at least $(c - a)^{-1}$. Then, during s time units, $\{a, c\}$ will not be hit with probability at least $1/2$. After that, the particle is found in some $x' \in (a, c)$ and at least s time units elapsed from the initial moment. So the cost of preventing the occurrence of $T_{\{a,c\}}$ during any time interval of length s is at most $(2(c - a))^{-1}$. The result follows for γ_3 large enough. \square

Our main application of Proposition 4.1 and Proposition 4.3, will be to control the exit times of valleys, more precisely we will be able to give upper bounds on the tail of $T_{\{K_i, K_{i+1}\}}$ and lower bounds on the tail of $T_{\{K_{i-1}, K_{i+1}+1\}}$ in terms of H_i .

5 Induced random walk

Let us denote $(s_k(n))_{k \geq 0}$ the sequence defined by

$$s_0(n) = 0,$$

CHAPITRE 6. SLOWDOWN AND SPEEDUP OF TRANSIENT RWRE

$$s_{i+1}(n) = \min\{j \geq s_i(n) : X_j \in \{K_l(n), l \geq 0\}\}.$$

Then, we define $Y_i = X_{s_i}$, the embedded random walk with state space $\{K_l, l \geq 0\}$, enumerating the successive valleys we visit and $l_n(\nu) = \max\{i : s_i \leq T_{n\nu}\}$ the numbers of steps made by the embedded random walk to reach $[n\nu; \infty)$. For the reflected case, we will use the same notation, replacing $\{K_l, l \geq 0\}$ with $\{\tilde{K}_l, l \geq 0\}$ defined in (2.4).

Recall (2.3) and let us denote

$$\xi^\nu(i) = \text{card}\{j \in [0, l_n(\nu)] : Y_j = K_{i+1}, Y_{j+1} = K_i\} \text{ for } i = i_0 + 1, \dots, i_1 - 1,$$

and in order to carry over the proofs to the reflected case

$$\tilde{\xi}^\nu(i) = \text{card}\{j \in [0, l_n(\nu)] : Y_j = \tilde{K}_{i+1}, Y_{j+1} = \tilde{K}_i\} \text{ for } i = i_0 + 1, \dots, i_1 - 1.$$

Moreover, we introduce the real time elapsed, i.e. in the clock of X_n , during the first left-right crossing of the i -th valley

$$T^{\text{next}}(i) = T_{K_{i+1}} \circ \theta(\text{next}(i)) - \text{next}(i),$$

where θ denotes the time-shift for the random walk and

$$\text{next}(i) = \inf\{n \geq 0 : X_n = K_i, T_{K_{i+1}} \circ \theta(n) < T_{K_{i-1}} \circ \theta(n)\}.$$

In this way, each time the embedded random walk backtracks, $T^{\text{next}}(i)$ is the time the walk will need to make the necessary left-right crossing of the corresponding valley. Recall (2.2). Conditionally on $(Y_i)_{i \geq 1}$ we have that (“dir” stands for “direct”, and “back” stands for “backtrack”)

$$T_{n\nu} = \mathcal{T}_{\text{init}} + \mathcal{T}_{\text{dir}} + \mathcal{T}_{\text{back}} + \mathcal{T}_{\text{left}} + \mathcal{T}_{\text{right}}, \quad (5.1)$$

where

$$\begin{aligned} \mathcal{T}_{\text{init}} &= \begin{cases} T_{K_{i_0+1}}, & \text{if } T_{K_{i_0+1}} < T_{K_{i_0}}, \\ T_{K_{i_0}} + T^{\text{next}}(i_0) \circ \theta(T_{K_{i_0}}), & \text{else,} \end{cases} \\ \mathcal{T}_{\text{left}} &= \begin{cases} \text{card}\{i \leq T_{n\nu} : X_i < K_1\} & \text{without reflection,} \\ \sum_{j=0}^{l_n(\nu)} \mathbf{1}\{Y_j = \tilde{K}_{i_0+1}, Y_{j+1} = \tilde{K}_{i_0}\} \\ \quad \times \left(T_{K_i} \circ \theta(s_j) - s_j + T^{\text{next}}(i) \circ (T_{K_i} \circ \theta(s_j)) \right) & \text{with reflection,} \end{cases} \\ \mathcal{T}_{\text{right}} &= T_{n\nu} \circ \theta(\text{next}^*(i_1)) - \text{next}^*(i_1), \\ \mathcal{T}_{\text{dir}} &= \sum_{i=i_0+1}^{i_1-1} T^{\text{next}}(i) \circ \theta(T_{K_i}), \end{aligned}$$

$$\mathcal{T}_{back} = \begin{cases} \left(\sum_{i=1}^{i_1-1} \sum_{j=0}^{l_n(\nu)} \mathbf{1}\{Y_j = K_{i+1}, Y_{j+1} = K_i\} \right. \\ \quad \left. \times \left(T_{K_i} \circ \theta(s_j) - s_j + T^{\text{next}}(i) \circ (T_{K_i} \circ \theta(s_j)) \right) \right) \text{ without reflection,} \\ \left(\sum_{i=i_0+1}^{i_1-1} \sum_{j=0}^{l_n(\nu)} \mathbf{1}\{Y_j = K_{i+1}, Y_{j+1} = K_i\} \right. \\ \quad \left. \times \left(T_{K_i} \circ \theta(s_j) - s_j + T^{\text{next}}(i) \circ (T_{K_i} \circ \theta(s_j)) \right) \right) \text{ with reflection,} \end{cases}$$

where $\text{next}^*(i_1) = \inf\{n \geq 0 : X_n = K_{i_1}, T_{n^\nu} \circ \theta(n) < T_{K_{i_1-1}} \circ \theta(n)\}$. In the reflected case, replace K_i with \tilde{K}_i in all the above definitions except for that of \mathcal{T}_{left} . This decomposition is illustrated on Figure 6.3 for the non-reflected case.

In the non-reflected case, we have the following equalities in law (for each ω) :

$$\mathcal{T}_{init} = \bar{\tau}(0), \tag{5.2}$$

$$\mathcal{T}_{right} = \bar{\tau}(n^\nu), \tag{5.3}$$

$$\mathcal{T}_{dir} = \sum_{i=i_0+1}^{i_1-1} \tau_+^{(0)}(i), \tag{5.4}$$

$$\begin{aligned} \mathcal{T}_{back} = & \sum_{i=1}^{i_1-2} (\tau_+^{(1)}(i) + \tau_-^{(1)}(i) + \dots + \tau_+^{(\xi^\nu(i))}(i) + \tau_-^{(\xi^\nu(i))}(i)) \\ & + \sum_{j=1}^{\xi^\nu(i_1-1)} \tau_+^{(j)}(i_1 - 1) + \tau_-^{\text{last},(j)}, \end{aligned} \tag{5.5}$$

where $\tau_+^{(j)}(i)$, $\tau_-^{(j)}(i)$ and $\tau_-^{\text{last},(j)}$ are independent sequences of i.i.d. random variables described as follows. First, $\tau_+^{(j)}(i)$ is a sequence of independent random variables with the same law as $T_{K_{i+1}}$ under $P_\omega^{K_i}[\cdot \mid T_{K_{i+1}} < T_{K_{i-1}}]$. Then, $\tau_-^{(j)}(i)$ is a sequence of independent random variables with the same law as T_{K_i} (under $P_\omega^{K_{i+1}}[\cdot \mid T_{K_i} < T_{K_{i+2}}]$) and $\tau_-^{\text{last},j}$ is a sequence of independent random variables with the same law as $T_{K_{i_1-1}}$ under $P_\omega^{K_{i_1}}[\cdot \mid T_{K_{i_1-1}} < T_{n^\nu}]$. Clearly, the random variable $\bar{\tau}(0)$ (respectively, $\bar{\tau}(n^\nu)$) has the same law as $T_{K_{i_0+1}}$ (respectively, T_{n^ν}) under $P_\omega[\cdot \mid T_{K_{i_0+1}} < T_{K_{i_0-1}}]$ (respectively, $P_\omega^{K_{i_1}}[\cdot \mid T_{n^\nu} < T_{K_{i_1-1}}]$).

In the reflected case, we simply replace K_i by \tilde{K}_i , $\xi^\nu(i)$ by $\tilde{\xi}_i^\nu$ and ω by $\tilde{\omega}$.

We want to give bounds on the number of backtracks between valleys before the walk reaches $[n^\nu]$. Denote

$$\mathfrak{B}(n) := \text{card}\{i \geq 1 : s_{i+1}(n) \leq T_{n^\nu}, Y_{i+1} < Y_i\} = \sum_{i=1}^{i_1-1} \xi^\nu(i). \tag{5.6}$$

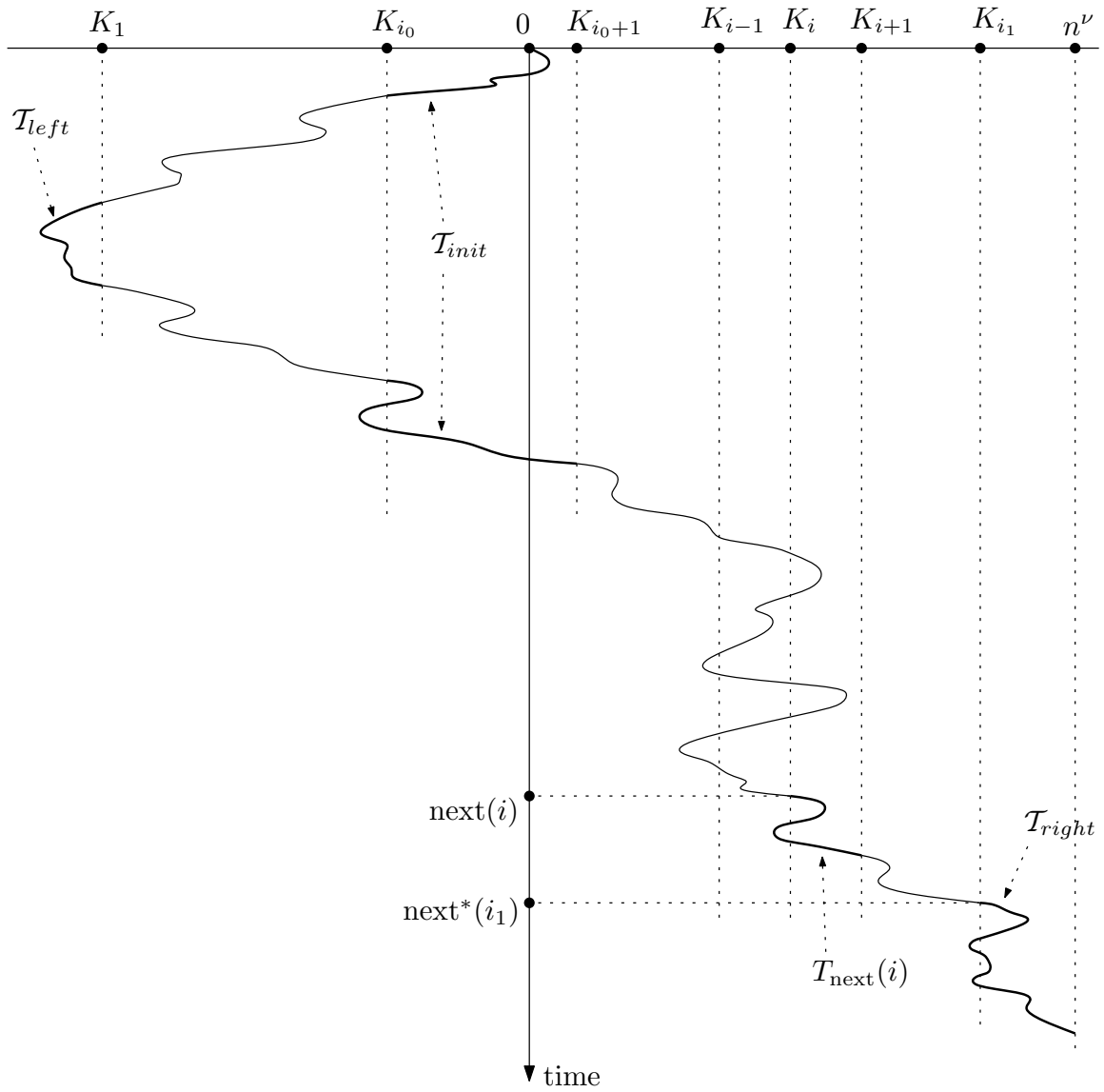

FIG. 6.3 – On the decomposition (5.1) of T_{n^ν}

By (2.8), we obtain that for $i \leq i_1$, \mathbf{P} -a.s. for n large enough,

$$\begin{aligned} P_\omega^{K_i}[T_{K_{i+1}} > T_{K_{i-1}}] &= \left(\sum_{j=K_{i-1}}^{K_{i+1}-1} e^{V(j)} \right)^{-1} \sum_{j=K_i}^{K_{i+1}-1} e^{V(j)} \\ &\leq \max_{i \leq n} (K_i - K_{i-1}) \frac{(\ln n)^{2/\kappa}}{n^{2/(1 \wedge \kappa)}} \\ &\leq n^{-3/2}, \end{aligned} \tag{5.7}$$

since $\max_{i \leq n} (K_{i+1} - K_i) \leq (\ln n)^2$ on $A(n)$ and, due to Lemma 3.4, with the same argument as for (3.10), we have $V(K_{i-1}) - V(x) \geq \frac{2}{1 \wedge \kappa} \ln n - \frac{2}{\kappa} \ln \ln n$ for $x \in [K_i, K_{i+1}]$.

Using (2.8) and (3.11), we obtain a lower bound : for $\omega \in A(n) \cap F(n) \cap G_1(n)$ we have

$$P_\omega^{K_i}[T_{K_{i+1}} > T_{K_{i-1}}] \geq \frac{1}{K_{i+1} - K_{i-1}} \frac{1}{e^{V(K_{i-1}) - V(K_{i+1})}} \geq n^{-(1+2\gamma_0)}. \tag{5.8}$$

During the first $3n$ steps of the embedded random walk there are two cases, either the walk has reached n^ν or there are at least n steps back. But then if n^ν is reached in less than $3n$ steps, $\mathfrak{B}(n)$ is stochastically dominated by a $\text{Bin}(3n, n^{-3/2})$ by (5.7). Moreover, we get for $f(\cdot)$ such that $f(n) = O(n)$, \mathbf{P} -a.s. for n large enough,

$$P_\omega[\mathfrak{B}(n) \geq f(n)] \leq \binom{3n}{n} \left(\frac{1}{n^{3/2}} \right)^n + P[\text{Bin}(3n, n^{-3/2}) \geq f(n)],$$

and so using Stirling's formula and Chebyshev's exponential inequality, \mathbf{P} -a.s. for n large enough,

$$\begin{aligned} P_\omega[\mathfrak{B}(n) \geq f(n)] &\leq \exp(-C_1 n) + C_2 \exp(-f(n)) \\ &\leq C_3 \exp(-f(n)). \end{aligned} \tag{5.9}$$

6 Quenched slowdown

In this section, we prove Theorem 1.2. Before going into technicalities, let us give an informal argument about why we obtain different answers in Theorem 1.2.

Suppose that $\frac{\kappa}{\kappa+1} < 1 - \frac{\nu}{\kappa}$, or equivalently, $\nu < \frac{\kappa}{\kappa+1}$. Consider the three strategies depicted on Figure 6.4 :

- 1 :** The particle goes to the biggest valley in the interval $[0, n^\nu]$, and stays there up to time n .
- 2 :** The particle goes to the biggest valley in the interval $[0, n^{\frac{\kappa}{\kappa+1}}]$, stays there up to time $n - n^{\frac{\kappa}{\kappa+1}}$, and then goes back to the interval $[0, n^\nu]$.
- 3 :** The particle goes to the biggest valley in the interval $[-n^{\frac{\kappa}{\kappa+1}}, 0]$ (so that typically it has to go roughly $n^{\frac{\kappa}{\kappa+1}}$ units to the left), and stays there up to time n .

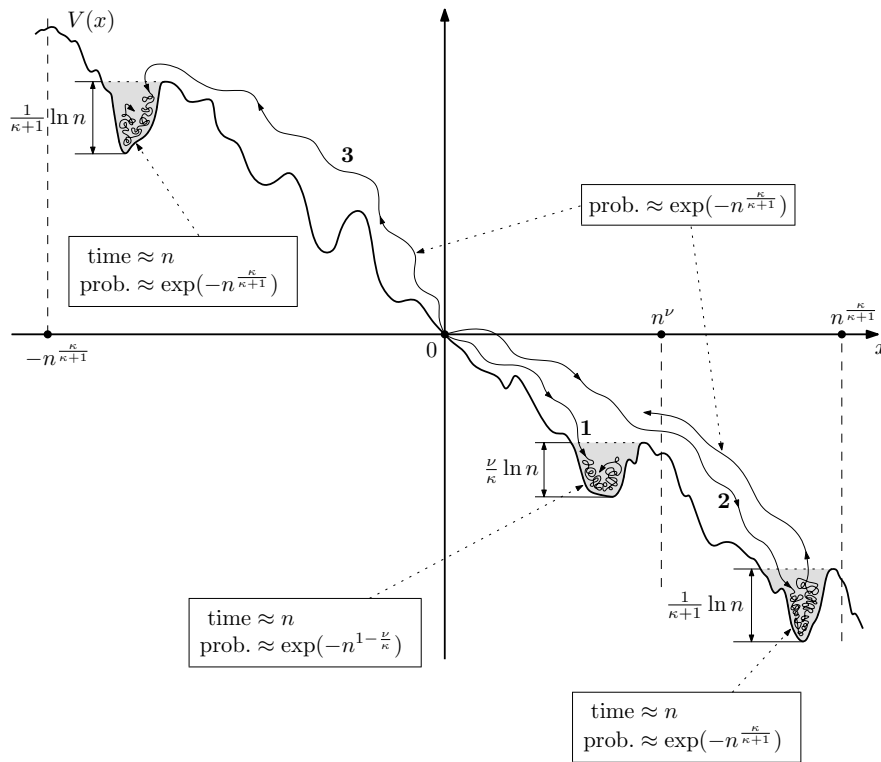

FIG. 6.4 – The three strategies for the slowdown

By Lemmas 3.4 and 3.5, the biggest valley in the interval $[0, n^\nu]$ has depth of approximately $\frac{\nu}{\kappa} \ln n$. Using Proposition 4.3, we obtain that the probability of staying there up to time n is roughly $\exp(-n^{1-\frac{\nu}{\kappa}})$. As for the strategy **2**, analogously we find that the biggest valley in the interval $[0, n^{\frac{\kappa}{\kappa+1}}]$ has depth around $\frac{1}{\kappa+1} \ln n$, and the probability of staying there is roughly $\exp(-n^{\frac{\kappa}{\kappa+1}})$. Then, the probability of backtracking is again around $\exp(-n^{\frac{\kappa}{\kappa+1}})$. The situation with the strategy **3** is the same as that with strategy **2** (for the strategy **3**, we first have to backtrack and then to stay in the valley, but the probabilities are roughly the same).

So, in the case $\nu < \frac{\kappa}{\kappa+1}$ the strategies **2** and **3** are better than the strategy **1**. The only situation when we cannot use neither **2** nor **3** is when the RWRE has reflection in the origin, and we are considering the hitting times.

6.1 Time spent in a valley

We have

Proposition 6.1. *There exists $\gamma_4 > 0$ such that for \mathbf{P} -almost all ω , for all n large enough we have for $i \leq 2n + 1$ and $u \geq 1$,*

$$\begin{aligned} P_\omega^{K_i} [T_{K_{i+1}} > u(\gamma_4(\ln n)^{10} e^{H_{i-1} \vee H_i}) \mid T_{K_{i+1}} < T_{K_{i-1}}] &\leq e^{-u}, \\ P_\omega^{K_i} [T_{K_{i-1}} > u(\gamma_4(\ln n)^{10} e^{H_{i-1} \vee H_i}) \mid T_{K_{i-1}} < T_{K_{i+1}}] &\leq e^{-u}. \end{aligned}$$

Démonstration. We prove only the second part of the proposition, the first one uses the same arguments. First, we have

$$\max_{x \in (K_{i-1}, K_{i+1})} \left(\max_{y \in [x, K_{i+1})} V(y) - \min_{y \in [K_{i-1}, x)} V(y) \right) = H_{i-1} \vee H_i.$$

Using (5.8) (or (5.7) for the first part of the proposition), we obtain \mathbf{P} -a.s. for n large enough,

$$\begin{aligned} P_\omega^{K_i} [T_{K_{i-1}} > u(\gamma_4(\ln n)^{10} e^{H_{i-1} \vee H_i}) \mid T_{K_{i+1}} > T_{K_{i-1}}] \\ \leq n^{1+2\gamma_0} P_\omega^{K_i} [T_{\{K_{i-1}, K_{i+1}\}} > u(\gamma_4(\ln n)^{10} e^{H_{i-1} \vee H_i}), T_{K_{i+1}} > T_{K_{i-1}}]. \end{aligned}$$

To estimate this last probability, we may consider the random walk reflected at K_{i-1} and K_{i+1} . On $A(n)$ we have $K_{i+1} - K_{i-1} \leq 2(\ln n)^2$ and on $G_1(n) \cap F(n)$ we have $\max_{y \in [K_{i-1}, K_{i+1}]} V(y) - \min_{y \in [K_{i-1}, K_{i+1})} V(y) \leq 2\gamma_0 \ln n$ by (3.11). Hence for n such that $\gamma_0 \leq (\ln n)^2$ we can apply Proposition 4.1 with $a = K_{i-1}$, $c = K_{i+1}$, $\tilde{M} \leq 2(\ln n)^2$ and $H = H_{i-1} \vee H_i$ to get

$$\begin{aligned} P_{\tilde{\omega}}^{K_i} [T_{\{K_{i-1}, K_{i+1}\}} > u(\gamma_4(\ln n)^{10} e^{H_{i-1} \vee H_i})] \\ \leq \exp(-u\gamma_4(\ln n)^2 / (32\gamma_1)), \end{aligned}$$

CHAPITRE 6. SLOWDOWN AND SPEEDUP OF TRANSIENT RWRE

where $\hat{\omega}$ denotes the environment with reflection at K_{i-1} and K_{i+1} , so that

$$\begin{aligned} P_{\omega}^{K_i} [T_{K_{i-1}} > u(\gamma_4(\ln n)^{10} e^{H_{i-1} \vee H_i}) \mid T_{K_{i+1}} > T_{K_{i-1}}] \\ \leq \exp(-u\gamma_4(\ln n)^2 / (32\gamma_1) + (1 + 2\gamma_0) \ln n) \\ \leq e^{-u}, \end{aligned}$$

for $\gamma_4 > 32\gamma_1((1 + 2\gamma_0) + 1)$ and n large enough. \square

Let Z_i be a random variable with the same law as $T_{K_{i+1}}$ under $P_{\omega}^{K_i}[\cdot \mid T_{K_{i+1}} < T_{K_{i-1}}]$. Then, for $i \in N(-n^a, n^b)$ and $H = \max_{i \in N(-n^a, n^b)} H_i$, we have that \mathbf{P} -a.s. for n large enough

$$\frac{Z_i}{\gamma_4 e^{H(\ln n)^{10}}} \prec 1 + \mathbf{e}, \quad (6.1)$$

where \mathbf{e} is an exponential random variable with parameter 1. Since $\omega \in G_1(n^{a \vee b})$ \mathbf{P} -a.s. for n large enough, there is a constant $\gamma > 0$ (depending only on κ) such that

$$\frac{Z_i}{\gamma_4 n^{(a \vee b)/\kappa} (\ln n)^{\gamma}} \prec 1 + \mathbf{e}. \quad (6.2)$$

The same inequality is true when K_{i-1} and K_{i+1} are exchanged. We point out that the same stochastic domination holds in the reflected case, even for $T_{\tilde{K}_{i_0+2}}$ under $P_{\tilde{\omega}}^{\tilde{K}_{i_0+1}}[\cdot \mid T_{\tilde{K}_{i_0+2}} < T_{\tilde{K}_{i_0}}] = P_{\tilde{\omega}}^{\tilde{K}_{i_0+1}}[\cdot]$ in which case it is a direct consequence of Proposition 4.1.

Using the same kind of arguments as in the proof of Proposition 6.1 we obtain

Proposition 6.2. *There exists a positive constant γ_4 (without restriction of generality, the same as in Proposition 6.1) such that for \mathbf{P} -almost all ω , we have for all n large enough, with $i_0 = \text{card } N_n(-n, 0)$ and $u \geq 1$,*

$$\begin{aligned} P_{\omega} [T_{K_{i_0+1}(n)} > u(\gamma_4(\ln n)^{10} e^{H_{i_0-1} \vee H_{i_0}}) \mid T_{K_{i_0+1}(n)} < T_{K_{i_0-1}(n)}] &\leq e^{-u}, \\ P_{\tilde{\omega}} [T_{K_{i_0+1}(n)} > u(\gamma_4(\ln n)^{10} e^{H_{i_0-1} \vee H_{i_0}})] &\leq e^{-u}. \end{aligned}$$

Similarly we obtain

Proposition 6.3. *There exists a positive constant γ_4 (without restriction of generality, the same as in Proposition 6.1) such that for \mathbf{P} -almost all ω , we have for all n large enough with $i_1 = \text{card } N_n(-n, n^{\nu})$ and $u \geq 1$,*

$$P_{\omega}^{K_{i_1}} [T_{n^{\nu}} > u(\gamma_4(\ln n)^{10} e^{H_{i_1-1} \vee H_{i_1}}) \mid T_{n^{\nu}} < T_{K_{i_1}(n)}] \leq e^{-u}.$$

and

$$P_{\omega}^{K_{i_1}} [T_{K_{i_1-1}} > u(\gamma_4(\ln n)^{10} e^{H_{i_1-1} \vee H_{i_1}}) \mid T_{K_{i_1-1}} < T_{n^{\nu}}] \leq e^{-u}.$$

This proposition implies that

$$\frac{\tau_{-}^{\text{last}}}{\gamma_4 n^{\nu/\kappa} (\ln n)^{\gamma}} \prec 1 + \mathbf{e}. \quad (6.3)$$

6.2 Time spent for backtracking

Recalling the definitions (5.5) and (5.6), we obtain, for the reflected case,

Proposition 6.4. *For $0 < a < b < c < 1$, we have \mathbf{P} -a.s. for n large enough,*

$$P_{\tilde{\omega}} \left[\frac{\mathcal{T}_{back}}{\gamma_4 n^{\nu/\kappa} (\ln n)^\gamma} \geq n^c, \mathfrak{B}(n) \in [n^a, n^b] \right] \leq \exp(-n^c/4),$$

where γ is as in (6.2).

Démonstration. On the event $\{\mathfrak{B}(n) \in [n^a, n^b]\}$, we have $\sum_{i \in N(0, n^\nu)} \xi^\nu(i) = \mathfrak{B}(n) < n^b$, so we can use (6.2) and (6.3) to get that \mathbf{P} -a.s. for n large enough,

$$\frac{\mathcal{T}_{back}}{\gamma_4 n^{\nu/\kappa} (\ln n)^\gamma} < 2n^b + \text{Gamma}(2n^b, 1). \quad (6.4)$$

(note that \mathcal{T}_{back} is the time spent in valleys from 0 to n^ν because we have a reflection at 0). The factor 2 arises from the fact that each backtracking creates one right-left crossing and one left-right crossing. We use the following bound on the tail of $\text{Gamma}(k, 1)$:

$$P[\text{Gamma}(k, 1) \geq u] \leq e^{-u/2} E[\exp(\text{Gamma}(k, 1)/2)] = e^{-u/2} 2^k. \quad (6.5)$$

Hence we have \mathbf{P} -a.s. for n large enough,

$$P_{\tilde{\omega}} \left[\frac{\mathcal{T}_{back}}{\gamma_4 n^{\nu/\kappa} (\ln n)^\gamma} \geq n^c, \mathfrak{B}(n) \in [n^a, n^b] \right] \leq P[\text{Gamma}(2n^b, 1) \geq n^c - 2n^b],$$

and since $(n^c - 2n^b)/2 - 2n^b \ln 2 \geq n^c/4$ for n large enough, we conclude with (6.4). \square

In the same way, we get, still for the reflected case

Proposition 6.5. *For $0 < a < b < c < 1$, we have \mathbf{P} -a.s. for n large enough,*

$$P_{\tilde{\omega}} \left[\frac{\mathcal{T}_{left}}{\gamma_4 n^{\nu/\kappa} (\ln n)^\gamma} \geq n^c, \mathfrak{B}(n) \in [n^a, n^b] \right] \leq \exp(-n^c/4),$$

where γ only depends on κ .

Démonstration. On the event $\{\mathfrak{B}(n) \in [n^a, n^b]\}$, \mathcal{T}_{left} is lower than the time spent in the valleys of indexes i_0 and $i_0 + 1$ during backtrackings from \tilde{K}_{i_0+1} to \tilde{K}_{i_0} . Since, there are at most n^b backtracks for this valley and since (6.2) is valid even for $T_{K_{i_0+2}}$ under $P_{\tilde{\omega}}^{K_{i_0+1}}[\cdot]$, we can use the same argument as in the proof of Proposition 6.4. \square

Next, recalling the definition (5.5), we obtain

Proposition 6.6. *For $0 < a < b < 1$ and $c \in (b \vee \nu, 1)$, we have \mathbf{P} -a.s. for n large enough,*

$$P_\omega \left[\frac{\mathcal{T}_{back}}{n^{(b \vee \nu)/\kappa} (\ln n)^\gamma} \geq n^c, \mathfrak{B}(n) \in [n^a, n^b] \right] \leq \exp(-n^c/4),$$

where γ only depends on κ .

Démonstration. On the event $\{\mathfrak{B}(n) \in [n^a, n^b]\}$, \mathcal{T}_{back} consists of the time spent in the valleys indexed by $N_n(-n^b, n^\nu)$, once this is noted we use the same argument as in the proof of Proposition 6.4. \square

6.3 Time spent for the direct crossing

We can control \mathcal{T}_{dir} with the following proposition. Recall (3.7) and (3.8).

Proposition 6.7. *For all $m \geq m_0(\kappa, \nu)$, we have for n large enough*

$$P_\omega [\mathcal{T}_{dir} \geq n] \leq C(m) \exp(-n^{1-(1+2/m)\frac{\nu}{\kappa}}).$$

Démonstration. Recall the definition (5.4) and let us take $\omega \in B'(n, \nu, m) \cap G_1(n)$. Let us introduce for $k = -1, \dots, m$,

$$N(k) = \text{card}\{i \in N(-n^\nu, n^\nu) : H_i \geq \frac{\nu k}{\kappa m} \ln n + 2 \ln \ln n\}, \quad (6.6)$$

$$\begin{aligned} \sigma(k) = \text{card}\{i \leq T_{n^\nu} : X_i \in [K_j(n), K_{j+1}(n)) \text{ for some } j \\ \text{with } H_j \in \left[\ln n \frac{\nu k}{\kappa m} + 2 \ln \ln n, \ln n \frac{\nu(k+1)}{\kappa m} + 2 \ln \ln n \right]\}. \end{aligned} \quad (6.7)$$

If $\mathcal{T}_{dir} \geq n$, then for some $k \in [-1, m]$ the particle spent an amount of time greater than $n/(4m)$ in the valleys of depth in $\left[\frac{\nu k}{\kappa m} \ln n + 2 \ln \ln n, \frac{\nu(k+1)}{\kappa m} \ln n + 2 \ln \ln n \right]$ because ω is in $G_1(n)$, so that

$$P_\omega[\mathcal{T}_{dir} > n] \leq 4m \max_{k \in [-1, m]} P_\omega[\sigma(k) \geq n/(4m)]. \quad (6.8)$$

Using Proposition 6.1, since $\omega \in B'(n, \nu, m) \cap G_1(n)$, we have $N(k) \leq n^{\nu(1-k/m)}$, and so

$$\frac{\sigma(k)}{\gamma_4 (\ln n)^{11} n^{\nu(k+1)/(\kappa m)}} \prec 2n^{\nu(1-k/m)} + \text{Gamma}(2n^{\nu(1-k/m)}, 1).$$

For $m > (1 - \nu)^{-1}$ we have that $n^{\nu(1-k/m)} = o(n^{1-\nu(k+1)/m} (\ln n)^{-11})$, and for n large enough (depending on ν and m), we use (6.5) to obtain

$$P_\omega[\sigma(k) \geq n/(4m)] \leq P \left[\text{Gamma}(2n^{\nu(1-k/m)}, 1) \geq \frac{n^{1-\nu(k+1)/(\kappa m)}}{(\ln n)^{12}} \right]$$

$$\begin{aligned} &\leq 4n^{\nu(1-k/m)} \exp\left(-\frac{n^{1-\nu(k+1)/(\kappa m)}}{(\ln n)^{12}}\right) \\ &\leq \exp\left(-2n^{1-\nu(k+2)/(\kappa m)} + \ln 4n^{\nu(1-k/m)}\right). \end{aligned}$$

We need to check that $n^{1-(1+2/m)\nu/\kappa} \geq \ln 4n^{\nu(1-k\varepsilon)}$ for any k , if we take m large enough, but this can be done by considering the cases $k = 0$ and $k = m$. Hence we get Proposition 6.7. \square

6.4 Upper bound for the probability of quenched slowdown for the hitting time

In this section we suppose that $\omega \in A(n) \cap G_1(n) \cap B'(n, \nu, m)$, which is satisfied **P**-a.s. for n large enough. First, we consider RWRE with reflection at the origin. Because of (5.1)

$$\begin{aligned} P_{\tilde{\omega}}[T_{n^\nu} > n] &\leq P_{\tilde{\omega}}[\mathcal{T}_{dir} \geq n/5] + P_{\tilde{\omega}}[\mathcal{T}_{back} \geq n/5] + P_{\tilde{\omega}}[\mathcal{T}_{init} \geq n/5] \\ &\quad + P_{\tilde{\omega}}[\mathcal{T}_{right} \geq n/5] + P_{\tilde{\omega}}[\mathcal{T}_{left} \geq n/5]. \end{aligned} \tag{6.9}$$

Let $\varepsilon > 0$ and recall (5.6), then

$$\begin{aligned} P_{\tilde{\omega}}[\mathcal{T}_{back} \geq n/5] &\leq P_{\tilde{\omega}}[\mathfrak{B}(n) > n^{1-(1+2/m)\nu/\kappa}] \\ &\quad + P_{\tilde{\omega}}[\mathcal{T}_{back} \geq n/5, \mathfrak{B}(n) \leq n^{1-(1+2/m)\nu/\kappa}]. \end{aligned}$$

Using (5.9), we can write

$$P_{\tilde{\omega}}[\mathfrak{B}(n) > n^{1-(1+2/m)\nu/\kappa}] \leq C_2 \exp(-n^{1-(1+2/m)\nu/\kappa}),$$

and for n large enough by Proposition 6.4,

$$\begin{aligned} &P_{\tilde{\omega}}[\mathcal{T}_{back} \geq n/5, \mathfrak{B}(n) \leq n^{1-(1+2/m)\nu/\kappa}] \\ &\leq P_{\tilde{\omega}}\left[\frac{\mathcal{T}_{back}}{n^{\nu/\kappa}(\ln n)^\gamma} \geq n^{1-(1+1/m)\nu/\kappa}, \mathfrak{B}(n) \leq n^{1-(1+2/m)\nu/\kappa}\right] \\ &\leq \exp(-n^{1-(1+1/m)\nu/\kappa}/4) \\ &\leq \exp(-n^{1-(1+2/m)\nu/\kappa}), \end{aligned}$$

so we obtain

$$P_{\tilde{\omega}}[\mathcal{T}_{back} \geq n/5] \leq \exp(-n^{1-(1+2/m)\nu/\kappa}). \tag{6.10}$$

By Proposition 6.2, recalling (5.2), we have

$$P_{\tilde{\omega}}[\mathcal{T}_{init} \geq n/5] \leq \exp(-n^{1-(1+2/m)\nu/\kappa}). \tag{6.11}$$

CHAPITRE 6. SLOWDOWN AND SPEEDUP OF TRANSIENT RWRE

Recalling 5.3, using Proposition 6.3 and the fact that $\omega \in G_1(n)$, we get

$$P_{\tilde{\omega}}[\mathcal{T}_{right} \geq n/5] \leq \exp(-n^{1-(1+2/m)\nu/\kappa}). \quad (6.12)$$

Finally, using (6.9), (6.10), (6.11), (6.12) and Proposition 6.7, we get that for all $\varepsilon > 0$

$$P_{\tilde{\omega}}[T_{n^\nu} > n] \leq C_3 \exp(-n^{1-(1+2/m)\nu/\kappa}).$$

Hence, letting m go to ∞ we obtain

$$\liminf_{n \rightarrow \infty} \frac{\ln(-\ln P_{\tilde{\omega}}[T_{n^\nu} > n])}{\ln n} \geq 1 - \frac{\nu}{\kappa}, \quad \mathbf{P}\text{-a.s.} \quad (6.13)$$

Now, we consider RWRE without reflection. All estimates remain true except (6.10) for \mathcal{T}_{back} . Concerning the estimates on \mathcal{T}_{left} it is easy to see that since $\{\mathcal{T}_{left} > 0\}$ implies that $\mathfrak{B}(n) \geq n/(\ln n)^2 - 1$, we have using (5.9)

$$P_\omega[\mathcal{T}_{left} \geq n/5] \leq \exp(-n^{1-(1+2/m)\nu/\kappa}). \quad (6.14)$$

It remains to estimate $P_\omega[\mathcal{T}_{back} \geq n]$, hence we take m and we note that

$$P_\omega[\mathcal{T}_{back} > n] \leq \sum_{k=0}^m P_\omega[\mathcal{T}_{back} > n, \mathfrak{B}(n) \in [n^{k/m}, n^{(k+1)/m}]].$$

Using (5.9), we obtain that \mathbf{P} -a.s. for n large enough,

$$P_\omega[\mathcal{T}_{back} > n, \mathfrak{B}(n) \in [n^{k/m}, n^{(k+1)/m}]] \leq C_3 \exp(-n^{k/m}).$$

Using Proposition 6.6, we obtain that

$$P_\omega[\mathcal{T}_{back} > n, \mathfrak{B}(n) \in [n^{k/m}, n^{(k+1)/m}]] \leq C_4 \exp(-C_5 n^{1-(\nu \vee ((k+1)/m))/\kappa}).$$

Hence, with these estimates on \mathcal{T}_{back} , (6.9), (6.11), (6.14), (6.12) and Proposition 6.7 we obtain that \mathbf{P} -a.s. for n large enough,

$$\liminf_{n \rightarrow \infty} \frac{\ln(-\ln P_\omega[T_{n^\nu} > n])}{\ln n} \geq \min_{k \in [-1, m+1]} \left(\frac{k}{m} \vee \left(1 - \frac{\nu \vee ((k+1)/m)}{\kappa} \right) \right),$$

minimizing we obtain,

$$\liminf_{n \rightarrow \infty} \frac{\ln(-\ln P_\omega[T_{n^\nu} > n])}{\ln n} \geq \left(1 - \frac{\nu}{\kappa} \right) \wedge \frac{\kappa}{\kappa + 1} - \frac{2}{(1 \wedge \kappa)m}, \quad \mathbf{P}\text{-a.s.}$$

Taking the limit as m goes to infinity yields the upper bound in (1.6), i.e.,

$$\liminf_{n \rightarrow \infty} \frac{\ln(-\ln P_\omega[T_{n^\nu} > n])}{\ln n} \geq \left(1 - \frac{\nu}{\kappa} \right) \wedge \frac{\kappa}{\kappa + 1}, \quad \mathbf{P}\text{-a.s.} \quad (6.15)$$

6.5 Upper bound for the probability of quenched slowdown for the walk

The argument of this section applies for both reflected and non-reflected RWREs, for the proof in the reflected case, just replace “ P_ω ” with “ $P_{\tilde{\omega}}$ ”. We assume that $\omega \in A(n) \cap G_1(n) \cap B'(n, \nu, m)$ which is satisfied **P**-a.s. for n large enough.

Set $m \in \mathbb{Z}^+$, we have using Markov’s property

$$P_\omega[X_n < n^\nu] \leq \sum_{k=0}^m P_\omega[T_{n^{\nu+(k-1)/m}} < n] \times \max_{i \leq n} P_\omega^{n^{\nu+(k-1)/m}}[X_i < n^\nu, T_{n^{\nu+k/m}} > n - i]. \quad (6.16)$$

First let us notice that

$$\begin{aligned} & \max_{i \leq n} P_\omega^{n^{\nu+(k-1)/m}}[X_i \leq n^\nu, T_{n^{\nu+k/m}} > n - i] \\ & \leq \left(\max_{i \leq n} P_\omega^{n^{\nu+(k-1)/m}}[X_i < n^\nu] \right) \wedge P_\omega^{n^{\nu+(k-1)/m}}[T_{n^{\nu+k/m}} > n]. \end{aligned} \quad (6.17)$$

Using reversibility we have for any $x \in \mathbb{Z}$ (omitting integer parts for simplicity),

$$P_\omega^{n^{\nu+(k-1)/m}}[X_i = x] \leq \frac{\pi(x)}{\pi(n^{\nu+(k-1)/m})},$$

hence

$$\max_{i \leq n} P_\omega^{n^{\nu+(k-1)/m}}[X_i < n^\nu] \leq 1 \wedge \frac{\pi([-n, n^\nu])}{\pi(n^{\nu+(k-1)/m})}.$$

Recall (2.3), then by (2.1) and the definition of b_i we get $\pi(b_{i_1}) \leq 2e^{-V(b_{i_1})}$ and

$$\pi(b_{i_1}) \leq 2e^{-V(b_{i_1})} \leq C_6(\ln n)^{2/\kappa} n^{1/\kappa} e^{-V(K_{i_1+1}(n))},$$

since, due to (3.8), the increase of potential in a valley is at most $\frac{1}{\kappa}(\ln n + 2 \ln \ln n)$. Hence, using (3.10) and the fact that the width of the valleys is at most $(\ln n)^2$, we get that

$$\pi([-n, n^\nu]) \leq C_7(\ln n)^{2+2/\kappa} n^{1/\kappa} e^{-V(K_{i_1+1}(n))}.$$

Furthermore, denoting by i_2 the index of the valley containing $n^{\nu+(k-1)/m}$, for n large enough we have using (2.1)

$$\pi(n^{\nu+(k-1)/m}) \geq \pi(K_{i_2-1}(n)),$$

since on the event $G(n)$ both $V(K_{i_2-1}(n))$ and $V(K_{i_2-1}(n)-1)$ are bigger than $V(n^{\nu+(k-1)/m})$ and $V(n^{\nu+(k-1)/m} - 1)$.

CHAPITRE 6. SLOWDOWN AND SPEEDUP OF TRANSIENT RWRE

On $A(n)$, we have $|(i_2 - 1) - i_1| \geq |n^{\nu+(k-1)\varepsilon} - n^\nu| / (\ln n)^2 - 2$. Since $V(K_i) - V(K_{i+1}) \geq 1/(1 \wedge \kappa) \ln n$ for $\omega \in G_1(n)$, we have for $k \geq 2$

$$\begin{aligned} \frac{\pi([-n, n^\nu])}{\pi(n^{\nu+(k-1)/m})} &\leq C_8 (\ln n)^{2+2/\kappa} n^{1/\kappa} \exp(-(V(K_{i_1+1}) - V(K_{i_2-1}))) \\ &\leq C_9 (\ln n)^{2+2/\kappa} n^{1/\kappa} \exp\left(-C_{10} \frac{n^{\nu+(k-1)/m} - n^\nu}{(\ln n)^2}\right). \end{aligned} \quad (6.18)$$

Moreover, using (1.6) in the non-reflected case (or (6.13) in the reflected case), we have

$$P_\omega^{n^{\nu+(k-1)/m}}[T_{n^{\nu+k/m}} > n] \leq \exp(-n^{(1-(\nu+(k/m))/\kappa) \wedge (\kappa/(\kappa+1)) - 1/m}).$$

Hence, using this last inequality and (6.18), the inequality (6.16) becomes

$$\begin{aligned} P_\omega[X_n < n^\nu] &\leq \max_{k \in [-1, m+1]} \left[1 \wedge \left[C_9 m n^{1/\kappa} (\ln n)^{2+2/\kappa} \exp\left(-C_{10} \frac{n^{\nu+(k-1)/m} - n^\nu}{(\ln n)^2}\right) \right] \right. \\ &\quad \left. \wedge \exp(-n^{(1-(\nu+(k/m))/\kappa) \wedge (\kappa/(\kappa+1)) - 1/m}) \right], \end{aligned}$$

so that **P**-a.s.,

$$\begin{aligned} \liminf_{n \rightarrow \infty} \frac{\ln(-\ln P_\omega[X_n < n^\nu])}{\ln n} &\geq \min_{k \in [-1, m+1]} \left[\left(\mathbf{1} \left\{ \frac{k-1}{m} \geq 0 \right\} \left(\nu + \frac{k-1}{m} \right) \right) \right. \\ &\quad \left. \vee \left(\left(1 - \frac{\nu + k/m}{\kappa} \right) \wedge \frac{\kappa}{\kappa+1} - \frac{1}{m} \right) \right]. \end{aligned}$$

Minimizing over k , we obtain

$$\liminf_{n \rightarrow \infty} \frac{\ln(-\ln P_\omega[X_n < n^\nu])}{\ln n} \geq \left(1 - \frac{\nu}{\kappa} \right) \wedge \frac{\kappa}{\kappa+1} - \frac{1}{m}, \quad \mathbf{P}\text{-a.s.}$$

Letting m goes to infinity, we obtain

$$\liminf_{n \rightarrow \infty} \frac{\ln(-\ln P_\omega[X_n < n^\nu])}{\ln n} \geq \left(1 - \frac{\nu}{\kappa} \right) \wedge \frac{\kappa}{\kappa+1}, \quad \mathbf{P}\text{-a.s.} \quad (6.19)$$

6.6 Lower bound for quenched slowdown

In this section we assume $\omega \in A(n) \cap D(n) \cap F(n)$ which is satisfied **P**-a.s. for n large enough. First, we consider RWRE with reflection at the origin.

For all $\varepsilon > 0$, note that for n large enough there is a valley of depth at least $\frac{(1-\varepsilon)\nu}{\kappa} \ln n$ strictly before level n^ν and denote by i_2 the index of the first such valley. Hence

$$P_{\tilde{\omega}}[T_{n^\nu} > n] \geq P_{\tilde{\omega}}^{\tilde{K}_{i_2}}[T_{\tilde{K}_{i_2+1+1}} > n],$$

and using Proposition 4.3 we obtain

$$P_{\tilde{\omega}}^{\tilde{K}_{i_2}} [T_{\tilde{K}_{i_2+1}+1} > n] \geq \exp(-n^{1-(1-\varepsilon)\nu/\kappa+\varepsilon}).$$

Letting ε go to 0, yields

$$\limsup_{n \rightarrow \infty} \frac{\ln(-\ln P_{\tilde{\omega}}[T_{n^\nu} > n])}{\ln n} \leq 1 - \frac{\nu}{\kappa}. \quad (6.20)$$

This yields the lower bound for the exit time, so, recalling (6.13), we obtain (1.4).

Now let us deduce the results on the slowdown. Set $a \in [0, \kappa - \nu)$, for n large enough there is a valley of depth $(\nu + (1 - \varepsilon)a)/\kappa \ln n$ strictly before $n^{\nu+a}$ whose index is denoted i_3 . One possible strategy for the walk is to enter the i_2 -th valley at $\tilde{K}_{i_2} + 1 \leq n^{\nu+a}$, stay there up to time $n - (n^{\nu+a} - n^\nu) - (\ln n)^2$, then go to the left up to time n . The probability of this event can be bounded from below by

$$\begin{aligned} P_{\tilde{\omega}}[X_n < n^\nu] &\geq P_{\tilde{\omega}}[T_{n^{\nu+a}} < n/2] \min_{j \leq n} P_{\tilde{\omega}}^{\tilde{K}_{i_3}+1} [T_{\{\tilde{K}_{i_3}-1, \tilde{K}_{i_3}+1\}} > j] \\ &\quad \times n^{-(3/\varepsilon_0)(n^{\nu+a} - n^\nu + (\ln n)^2)}. \end{aligned}$$

The first term is bigger than 1/2 for n large enough (one can see this by using e.g. (6.20)). The second can be bounded by Proposition 4.3

$$\min_{j \leq n} P_{\tilde{\omega}}^{\tilde{K}_{i_3}+1} [T_{\{\tilde{K}_{i_3}-1, \tilde{K}_{i_3}+1\}} > j] \geq \exp(-n^{1-(\nu+(1-\varepsilon)a)/\kappa+\varepsilon}),$$

for n large enough. Then, the last term (going left) was dealt with using the fact that $\omega \in F(n)$.

This yields for any $a \geq 0$,

$$\limsup_{n \rightarrow \infty} \frac{\ln(-\ln P_{\tilde{\omega}}[X_n < n^\nu])}{\ln n} \leq \mathbf{1}\{a > 0\}(\nu + a) \vee \left(1 - (1 - \varepsilon)\frac{\nu + a}{\kappa} + \varepsilon\right),$$

and if we choose $a = 0 \vee (\kappa/(\kappa + 1) - \nu)$, we obtain

$$\limsup_{n \rightarrow \infty} \frac{\ln(-\ln P_{\tilde{\omega}}[X_n < n^\nu])}{\ln n} \leq \left(1 - \frac{\nu}{\kappa}\right) \wedge \frac{\kappa}{\kappa + 1} + \frac{2\varepsilon}{\kappa} + \varepsilon, \quad \mathbf{P}\text{-a.s.}$$

Together with (6.19), this yields (1.5) by letting ε go to 0.

Now, we consider the case of RWRE without reflection. Using the same reasoning, we write

$$\limsup_{n \rightarrow \infty} \frac{\ln(-\ln P_{\omega}[T_{n^\nu} > n])}{\ln n} \leq 1 - \frac{\nu}{\kappa}, \quad \mathbf{P}\text{-a.s.} \quad (6.21)$$

CHAPITRE 6. SLOWDOWN AND SPEEDUP OF TRANSIENT RWRE

Now we can see that, if we denote by i_4 the index of a valley of depth at least $(1 - \varepsilon)/(\kappa + 1) \ln n$ between $-n^{\kappa/(\kappa+1)}$ and 0, since we are on $D(n)$, we can go to this valley before reaching n^ν and then stay there for a time at least n . This yields,

$$P_\omega[T_{n^\nu} > n] \geq P_\omega[T_{-n^{\kappa/(\kappa+1)}} < T_{n^\nu}] P_\omega^{K_{i_4}}[T_{K_{i_4+1}+1} > n],$$

bounding the first term by the probability of going to the left on the $n^{\kappa/(\kappa+1)}$ first steps, we get using Proposition 4.3 that for all n large enough

$$P_\omega^0[T_{n^\nu} > n] \geq n^{-(3/\varepsilon_0)n^{\kappa/(\kappa+1)}} \exp(-n^{1-(1-2\varepsilon)/(\kappa+1)}),$$

and hence

$$\limsup_{n \rightarrow \infty} \frac{\ln(-\ln P_\omega^0[T_{n^\nu} > n])}{\ln n} \leq \frac{\kappa}{\kappa + 1} + 2 \frac{\varepsilon}{\kappa + 1}, \quad \mathbf{P}\text{-a.s.} \quad (6.22)$$

Moreover, it is clear that

$$P_\omega[X_n < n^\nu] \geq P_\omega[T_{n^\nu} > n], \quad (6.23)$$

and letting ε go to 0 in (6.22) and using (6.21) and (6.15), we obtain (1.6) and (1.7). This finishes the proof of Theorem 1.2. \square

7 Annealed slowdown

7.1 Lower bound for annealed slowdown

Let us define the events

$$A'(n, \nu, a) = \left\{ \text{there exists } x \in [-n^\nu, n^\nu] : \max_{y \in [x, n^\nu]} V(y) - V(x) \geq (1 + a) \ln n \right\},$$

and

$$A'_+(n, \nu, a) = \left\{ \text{there exists } x \in [0, n^\nu] : \max_{y \in [x, n^\nu]} V(y) - V(x) \geq (1 + a) \ln n \right\}.$$

Lemma 7.1. *We have for $a \in (-1, 1)$,*

$$\lim_{n \rightarrow \infty} \frac{\ln \mathbf{P}[A'(n, \nu, a)]}{\ln n} = \lim_{n \rightarrow \infty} \frac{\ln \mathbf{P}[A'_+(n, \nu, a)]}{\ln n} = -(\kappa - \nu) - a\kappa.$$

Démonstration. From (2.7), it is straightforward to obtain that

$$\begin{aligned} \mathbf{P}[A'_+(n, \nu, a)] &\leq \mathbf{P}[A'(n, \nu, a)] \\ &\leq 2n^\nu \mathbf{P}\left[\max_{i \geq 0} V(i) \geq (1 + a) \ln n\right] \end{aligned}$$

$$= \Theta(n^{\nu-(1+a)\kappa}).$$

In order to give the corresponding lower bound, let us define the event

$$A_1(n, a) = \{ \text{there exists } k \in [0, (\ln n)^2] \text{ such that } V(k) \geq (1+a) \ln n \},$$

we have

$$\begin{aligned} \mathbf{P}[A_1(n, a)] &\geq \mathbf{P}\left[\max_{i \geq 0} V(i) \geq (1+a) \ln n\right] - \mathbf{P}[V(\ln n)^2 > -\ln n] \\ &\quad - \mathbf{P}\left[\max_{i \geq (\ln n)^2} V(i) - V((\ln n)^2) > (2+a) \ln n\right] \\ &= \Theta(n^{-(1+a)\kappa}), \end{aligned}$$

where we used (2.7) and a reasoning similar to the proof of Lemma 3.1. Now, we write

$$\mathbf{P}[A'(n, \nu, a)] \geq \mathbf{P}[A'_+(n, \nu, a)] \geq \frac{n^\nu}{[(\ln n)^2]} \mathbf{P}[A_1(n)] = \Theta\left(\frac{n^{\nu-(1+a)\kappa}}{(\ln n)^2}\right),$$

and Lemma 7.1 follows. □

For any $\varepsilon > 0$, on the event $A'_+(n, \nu, \varepsilon)$ there exists a valley $[K_i, K_{i+1}]$ with $V(K_{i+1}) - V(K_i) \geq (1+\varepsilon) \ln n$ contained in $[0, n^\nu)$ and we denote by i_5 its index. Then we have by Proposition 4.2

$$P_\omega[T_{n^\nu} > n] \geq P_\omega^{b_{i_5}}[T_{K_{i_5+1}+1} > n] \geq 1 - \gamma_2(1+n)e^{-(1+\varepsilon)\ln n} \geq \frac{1}{2}$$

for n large enough. So

$$\mathbb{P}[T_{n^\nu} > \tilde{n}] \geq E[\mathbf{1}\{A'_+(n, \nu, \varepsilon)\} P_\omega[T_{n^\nu} > n]] \geq \frac{1}{2} \mathbf{P}[A'_+(n, \nu, \varepsilon)].$$

Hence we obtain by Lemma 7.1 that for any $\varepsilon > 0$

$$\liminf_{n \rightarrow \infty} \frac{\ln \mathbb{P}[T_{n^\nu} > n]}{\ln n} \geq -(\nu - \kappa) - \kappa\varepsilon.$$

Using (6.23), we obtain the corresponding lower bound for $\mathbb{P}[X_n < n^\nu]$ as well. Replacing P_ω by \bar{P}_ω and \mathbb{P} by $\bar{\mathbb{P}}$, exactly the same argument can be used to obtain the result in the reflected case.

7.2 Upper bound for annealed slowdown

We prove the upper bound in the non-reflected case, the reflected case follows easily; indeed a simple coupling argument shows that T_{n^ν} in the environment $\tilde{\omega}$ is stochastically dominated by T_{n^ν} in the environment ω . For $m \in \mathbb{N}$ such that $1/m \in (0, \nu)$, we have

$$\mathbb{P}[T_{n^\nu} > n] \leq \mathbf{P}[A'(n, \nu, -1/m)] + \mathbf{E}(\mathbf{1}\{A'(n, \nu, -1/m)^c\}P_\omega^0[T_{n^\nu} > n]).$$

The second term can be further bounded by

$$\begin{aligned} & \mathbf{E}(\mathbf{1}\{A'(n, \nu, -1/m)^c\}P_\omega^0[T_{n^\nu} > n]) \\ & \leq \mathbf{P}[A(n)^c \cup B'(n, \nu, m)^c] \\ & \quad + \mathbf{E}(\mathbf{1}\{A'(n, \nu, -1/m)^c \cap A(n) \cap B'(n, \nu, m)\}P_\omega^0[T_{n^\nu} > n]), \end{aligned}$$

where $B'(n, \nu, m)$ is defined in (3.7).

Using Lemma 7.1 we have that $1/n = o(\mathbf{P}[A'(n, \nu, -1/m)])$, and thus Lemma 3.1 and Lemma 3.2 imply that

$$\mathbf{P}[A(n)^c \cup B'(n, \nu, m)^c] = o(\mathbf{P}[A'(n, \nu, -1/m)]).$$

We can turn (6.1) into the following, for $i \in N(-n^\varepsilon, n^\nu)$ we have

$$\text{on } A'(n, \nu, -1/m)^c \cap A(n) \cap B'(n, \nu, m), \quad \frac{Z}{C_8 n^{(1-1/m)} (\ln n)^\gamma} \prec 1 + \mathbf{e},$$

where Z has the same law as $T_{K_{i+1}(n)}$ under $P_\omega^{K_i(n)}[\cdot \mid T_{K_{i+1}(n)} < T_{K_{i-1}(n)}]$; $\gamma = \gamma(\kappa)$ and \mathbf{e} denotes an exponential random variable of parameter 1. The same inequality is true when $K_{i-1}(n)$ and $K_{i+1}(n)$ are exchanged.

This stochastic domination is the key argument for Section 6.4. We can adapt the proof of Proposition 6.4, so that on $A'(n, \nu, -1/m)^c \cap A(n) \cap B'(n, \nu, m)$ we obtain for all $u \geq 1$,

$$P_\omega \left[\frac{\mathcal{T}_{back}}{n^{1-1/m} (\ln n)^\gamma} \geq \exp(n^{1/(2m)}), \mathfrak{B}(n) \leq n^{1/(4m)} \right] \leq e^{-n^{1/(2m)}/4},$$

and

$$P_\omega \left[\mathcal{T}_{right} > \frac{n}{5} \right] \leq C_1 \exp(-n^{1/(4m)}).$$

Moreover, (5.9) still holds, so that

$$P_\omega[\mathfrak{B}(n) \geq n^{1/(4m)}] \leq C_2 \exp(-n^{1/(4m)}),$$

which yields

$$P_\omega \left[\mathcal{T}_{left} > \frac{n}{5} \right] \leq C_3 \exp(-n^{1/(4m)}).$$

Finally, recalling (5.2) and using Proposition 4.1 on $A'(n, \nu, -1/m)^c \cap A(n)$, we obtain

$$P_\omega \left[\mathcal{T}_{init} > \frac{n}{5} \right] \leq C_4 \exp(-n^{1/(4m)}).$$

Since Proposition 6.7 remains true and $A'(n, \nu, -1/m)^c \subset G(n)$, we get that for all $\omega \in A'(n, \nu, -1/m)^c \cap A(n) \cap B'(n, \nu, m)$

$$P_\omega [T_{n^\nu} > n] \leq C_5 \exp(-n^{1/(4m)}).$$

Loosely speaking it costs at least $\exp(-n^{1/(2m)})$ to backtrack $n^{1/m}$ times, hence, on $A'(n, \nu, -1/m)^c \cap A(n) \cap B'(n, \nu, m)$, we can only see valleys of size lower than $(1 - 1/m) \ln n$. To spend a time n in those valleys would cost at least $\exp(-n^{1/(2m)})$. This finally implies that for all $m > 0$,

$$\limsup_{n \rightarrow \infty} \frac{\ln \mathbf{E} \left[\mathbf{1}_{\{A'(n, \nu, -1/m)^c, A(n)^c, B'(n, \nu, m)^c\}} P_\omega^0 [T_{n^\nu} > n] \right]}{\ln n} = 0,$$

so that

$$\limsup_{n \rightarrow \infty} \frac{\ln \mathbb{P}[T_{n^\nu} > n]}{\ln n} \leq -(\kappa - \nu) + \frac{\kappa}{m}, \tag{7.1}$$

the result for the hitting time follows by letting m go to infinity.

It is simple to extend this result to the position of the walk, indeed if $X_n < n^\nu$ then $T_{n^{(1+1/m)\nu}} > n$ or $\mathfrak{B}(n) \geq n^{1/(2m)}$ and hence using (5.9), we get for all $m > 0$

$$\mathbb{P}[X_n < n^\nu] \leq \mathbb{P}[T_{n^{(1+1/m)\nu}} > n] + C_6 e^{-n^{1/(2m)}},$$

and the result follows by using (7.1) and letting m go to infinity.

This concludes the proof of Theorem 1.3. □

8 Backtracking

In this section we prove Theorem 1.4.

8.1 Quenched backtracking for the hitting time

Set $\nu \in (0, 1)$ and consider $P_\omega [T_{-n^\nu} < n]$. First, we get that

$$\text{for all } \omega \in F(n), \quad P_\omega [T_{-n^\nu} < n] \geq n^{-(3/\varepsilon_0)n^\nu},$$

since the particle can go straight to the left during the first n^ν steps, hence

$$\limsup_{n \rightarrow \infty} \frac{\ln(-\ln P_\omega [T_{-n^\nu} < n])}{\ln n} \leq \nu. \tag{8.1}$$

CHAPITRE 6. SLOWDOWN AND SPEEDUP OF TRANSIENT RWRE

Secondly, we remark that if $(-\infty, -n^\nu]$ has been hit before time n then, at some time $i \leq n$ the particle is at $X_i \in [-n, -n^\nu]$ and hence for all ω

$$\begin{aligned} P_\omega[T_{-n^\nu} < n] &\leq \sum_{i=1}^n P_\omega[X_i \in [-n, -n^\nu]] \\ &\leq n \max_{i \leq n} P_\omega[X_i \in [-n, -n^\nu]]. \end{aligned} \quad (8.2)$$

In order to estimate this quantity, we use arguments similar to those in Section 6.5, i.e., first we use the reversibility of the walk to write

$$\max_{i \leq n} P_\omega[X_i \in [-n, -n^\nu]] \leq \frac{\pi([-n, -n^\nu])}{\pi(0)},$$

then, the right-hand side can be estimated in the same way as we obtained (6.18), and so we get on $A(n) \cap G_1(n)$ that

$$\frac{\pi([-n, -n^\nu])}{\pi(0)} \leq C_1 (\ln n)^{2+2/\kappa} n^{1/\kappa} \exp(-C_2 n^\nu / (\ln n)^2).$$

The previous inequality and (8.2) yield

$$\text{for all } \omega \in A(n) \cap G(n), \quad P_\omega[T_{-n^\nu} < n] \leq C_3 n^{1+2/\kappa} \exp(-C_2 n^\nu / (\ln n)^2),$$

so that

$$\liminf_{n \rightarrow \infty} \frac{\ln(-\ln P_\omega[T_{-n^\nu} < n])}{\ln n} \geq \nu.$$

Together with (8.1), this proves (1.11).

8.2 Quenched backtracking for the position of the random walk

Let us denote $a_0 = \frac{\kappa}{\kappa+1} \vee \nu$. We give a lower bound for $P_\omega[X_n < -n^\nu]$. For n large enough, there exists \mathbf{P} -a.s. a valley of depth $(1-\varepsilon)(a_0/\kappa) \ln n$ of index i_2 , between $-n^{a_0}$ and 0. Consider the event that the walker goes to this valley directly and stays there up to time $n - n^{a_0}$ and then goes to the left for the next $n^{a_0} + 1$ steps. On this event we have $X_n < -n^{a_0}$, so we obtain

$$\begin{aligned} P_\omega[X_n < -n^\nu] &\geq n^{-(3/\varepsilon_0)2(n^{a_0}+1)} P_\omega^{K_{i_2+1}-1}[T_{\{K_{i_2}-1, K_{i_2+1}+1\}} \geq n] \\ &\geq n^{-(3/\varepsilon_0)2(n^{a_0}+1)} \exp(-n^{1-(1-2\varepsilon)a_0/\kappa}), \end{aligned}$$

where we used Proposition 4.3 and $\omega \in F(n)$. Hence we obtain

$$\limsup_{n \rightarrow \infty} \frac{\ln(-\ln P_\omega[X_n < -n^\nu])}{\ln n} \leq a_0 + \frac{2\varepsilon a_0}{\kappa},$$

and letting ε go to 0 we have

$$\limsup_{n \rightarrow \infty} \frac{\ln(-\ln P_\omega[X_n < -n^\nu])}{\ln n} \leq a_0. \quad (8.3)$$

Turning to the upper bound, we have for $m \in \mathbb{N}$,

$$P_\omega[X_n < -n^\nu] \leq \sum_{k=0}^m P_\omega[T_{n^{(k-1)/m}} < n] \max_{i \leq n} P_\omega^{n^{(k-1)/m}}[T_{n^{k/m}} > n - i, X_i < -n^\nu], \quad (8.4)$$

where once again

$$\begin{aligned} & \max_{i \leq n} P_\omega^{n^{(k-1)/m}}[T_{n^{k/m}} > n - i, X_i < -n^\nu] \\ & \leq \left(\max_{i \leq n} P_\omega^{n^{(k-1)/m}}[X_i < -n^\nu] \right) \wedge P_\omega^{n^{(k-1)/m}}[T_{n^{k/m}} > n]. \end{aligned}$$

First, using (1.6), for n large enough

$$P_\omega^{n^{(k-1)/m}}[T_{n^{k/m}} > n] \leq \exp(-n^{(1-(k/m)/\kappa) \wedge (\kappa/(\kappa+1)) - 1/m}). \quad (8.5)$$

Then, as in Section 6.5, the reversibility of the walk yields that

$$\max_{i \leq n} P_\omega^{n^{(k-1)/m}}[X_i \in [-n, -n^\nu]] \leq \frac{\pi([-n, -n^\nu])}{\pi(n^{(k-1)/m})}, \quad (8.6)$$

the right-hand side can be estimated in the same way we obtained (6.18) and we get on $A(n) \cap G(n)$

$$\frac{\pi([-n, -n^\nu])}{\pi(n^{(k-1)/m})} \leq C_4 \exp(-C_5(n^{(k-1)/m} + n^\nu)/(\ln n)^2). \quad (8.7)$$

Putting together (8.4), (8.5), (8.6), and (8.7), we obtain

$$\begin{aligned} & \liminf_{n \rightarrow \infty} \frac{\ln(-\ln P_\omega[X_n < -n^\nu])}{\ln n} \\ & \geq \min_{k \in [0, m]} \left(\left(\left(1 - \frac{k}{m\kappa} \right) \wedge \frac{\kappa}{\kappa + 1} \right) \vee \left(\frac{k-1}{m} \vee \nu \right) \right) - \frac{1}{m}, \end{aligned}$$

minimizing yields that

$$\liminf_{n \rightarrow \infty} \frac{\ln(-\ln P_\omega[X_n < -n^\nu])}{\ln n} \geq a_0 - \frac{2}{m},$$

letting m go to infinity and recalling (8.3) we obtain (1.9).

8.3 Annealed backtracking

Let $\theta_0 = \mathbf{E}[\ln \rho_0] < 0$. Define

$$\mathcal{R} = \left\{ \omega : V(x) \leq \frac{\theta_0}{3} n^\nu \text{ for } x \in [0, n], |V(x) + \theta_0 x| \leq \frac{|\theta_0|}{3} n^\nu \text{ for } x \in [-n^\nu, 0] \right\}.$$

Since V is a sum of i.i.d. random variables having some finite exponential moments, we can use large deviations techniques to obtain C_6 such that

$$\mathbf{P}[\mathcal{R}] \geq 1 - 2ne^{-C_6 n^\nu}. \quad (8.8)$$

Then, on \mathcal{R} , using (2.8), we obtain

$$\begin{aligned} P_\omega[T_{-n^\nu} < n] &\leq P_\omega[T_{-n^\nu} < T_n] \\ &\leq C_7 n \exp\left(-\frac{2\theta_0}{3} n^\nu\right). \end{aligned} \quad (8.9)$$

Using (8.8) and (8.9), we obtain

$$\mathbb{P}[X_n < -n^\nu] \leq \mathbb{P}[T_{-n^\nu} < n] \leq e^{-C_8 n^\nu}. \quad (8.10)$$

On the other hand, we easily obtain that

$$\mathbb{P}[T_{-n^\nu} < n] \geq \mathbb{P}[X_n < -n^\nu] \geq \left(\frac{\delta}{2}\right)^{n^\nu} n^{-C_9}, \quad (8.11)$$

where $\delta > 0$ is such that $\mathbf{P}[1 - \omega_0 \geq \delta] > 1/2$. Indeed on the event of probability at least $(1/2)^{n^\nu}$ that $1 - \omega_x \geq \delta$ for $x \in (-n^\nu, 0]$, the particle can go “directly” (to the left on each step) to $(-n^\nu)$, and then the cost of creating a valley of depth $2 \ln n$ there is polynomial and then it costs nothing to stay there for a time n by Proposition 4.2. Now, (8.10) and (8.11) imply (1.10). This finishes the proof of Theorem 1.4. \square

9 Speedup

In this section we prove Theorem 1.5. So, we have $\kappa < 1$, $\nu \in (\kappa, 1)$; let us denote $g(\alpha) = \nu + \frac{\alpha}{\kappa} - \alpha$, and let $\alpha_0 = \kappa \frac{1-\nu}{1-\kappa}$. Clearly, $g(\alpha)$ is a linear function, $g(0) = \nu < 1$, $g(\nu) = \frac{\nu}{\kappa} > 1$, and $g(\alpha_0) = 1$; note also that $\nu - \alpha_0 = \frac{\nu-\kappa}{1-\kappa}$.

The discussion in this section is for the RWRE on \mathbb{Z} (i.e., without reflection), the proof for the reflected case is quite analogous.

9.1 Lower bound for the quenched probability of speedup

We are going to obtain a lower bound for $P_\omega[X_n > n^\nu]$.

By Lemma 3.2 and Borel-Cantelli, for any fixed $m, \omega \in B'(n, \alpha_0, m) \cap A(n) \cap F(n)$ for all n large enough, **P**-a.s. (recall the definition of $A(n)$ and $B'(n, \alpha_0, m)$ from Section 3). So, from now on we suppose that $\omega \in B'(n, \alpha_0, m) \cap A(n)$.

Let us denote $M = N_n(0, n^\nu)$, define the index sets

$$\begin{aligned} \mathcal{I}_0 &= \{i \in M : H_{i-1} \vee H_i \leq \ln \ln n\}, \\ \mathcal{I}_k &= \left\{ i \in M : (H_{i-1} \vee H_i) - \ln \ln n \in \left[\frac{(k-1)\alpha_0}{m\kappa} \ln n, \frac{k\alpha_0}{m\kappa} \ln n \right) \right\} \end{aligned}$$

for $k \in [1, m-1]$, and

$$\mathcal{U} = \left\{ i \in M : H_{i-1} \vee H_i \geq \frac{(m-1)\alpha_0}{m\kappa} \ln n + \ln \ln n \right\}.$$

Note that on $B'(n, \alpha_0, m)$

$$\text{card } \mathcal{U} \leq n^{\nu - \alpha_0 + \frac{\alpha_0}{m}} = n^{\frac{\nu - \kappa}{1 - \kappa} + \frac{\alpha_0}{m}}, \quad (9.1)$$

$$\text{card } \mathcal{I}_k \leq n^{\nu - \frac{k\alpha_0}{m}}, \quad \text{for all } k = 1, \dots, m-1. \quad (9.2)$$

Recalling (2.3) we define the quantities $\sigma_{i_0} = T_{K_{i_0+1}}$, $\sigma_{i_1} = T_{n^\nu} - T_{K_{i_1}}$, and $\sigma_j = T_{K_{j+1}} - T_{K_j}$ for $j = i_0 + 1, \dots, i_1 - 1$. Then for $\varepsilon > 0$, we can write

$$\begin{aligned} P_\omega[X_n > n^{(1-\varepsilon)\nu}] &\geq P_\omega \left[\sum_{k=0}^{m-1} \sum_{i \in \mathcal{I}_k} \sigma_i \leq \frac{n}{2} \right] P_\omega \left[\sum_{i \in \mathcal{U}} \sigma_i \leq \frac{n}{2} \right] \\ &\quad \times P_\omega^{n^\nu} [X_j > n^{(1-\varepsilon)\nu} \text{ for all } i \in [0, n - n^\nu]]. \end{aligned} \quad (9.3)$$

Let us obtain lower bounds for the three terms in the right-hand side of (9.3). First, we write using (9.2)

$$\begin{aligned} P_\omega \left[\sum_{k=0}^{m-1} \sum_{i \in \mathcal{I}_k} \sigma_i \leq \frac{n}{2} \right] &\geq \prod_{k=0}^{m-1} P_\omega \left[\sum_{i \in \mathcal{I}_k} \sigma_i \leq \frac{n}{2m} \right] \\ &\geq \prod_{k=0}^{m-1} P_\omega \left[\sigma_i \leq \frac{1}{2m} n^{1 - (\nu - \frac{k\alpha_0}{m})} \text{ for all } i \in \mathcal{I}_k \right]. \end{aligned} \quad (9.4)$$

Now, consider any $\ell \in \mathcal{I}_k$ and write

$$P_\omega \left[\sigma_\ell \leq \frac{1}{2m} n^{1 - (\nu - \frac{k\alpha_0}{m})} \right]$$

$$\begin{aligned} &\geq P_\omega^{K_\ell} [T_{K_{\ell+1}} < T_{K_{\ell-1}}] \\ &\quad \times P_\omega^{K_\ell} \left[T_{\{K_{\ell-1}, K_{\ell+1}\}} \leq \frac{1}{2m} n^{1-(\nu-\frac{k\alpha_0}{m})} \mid T_{K_{\ell+1}} < T_{K_{\ell-1}} \right]. \end{aligned}$$

By the formula (5.7), on $A(n)$ we have

$$P_\omega^{K_\ell} [T_{K_{\ell+1}} < T_{K_{\ell-1}}] \geq 1 - n^{-3/2},$$

and by Proposition 6.1,

$$\begin{aligned} P_\omega^{K_\ell} \left[T_{\{K_{\ell-1}, K_{\ell+1}\}} \leq \frac{1}{2m} n^{1-(\nu-\frac{k\alpha_0}{m})} \mid T_{K_{\ell+1}} < T_{K_{\ell-1}} \right] \\ \geq 1 - \exp\left(-\frac{C_1}{m(\ln n)^\gamma} n^{1-(\nu-\frac{k\alpha_0}{m})-\frac{k\alpha_0}{m\kappa}}\right), \end{aligned}$$

so

$$P_\omega \left[\sigma_\ell \leq \frac{1}{2m} n^{1-(\nu-\frac{k\alpha_0}{m})} \right] \geq (1 - n^{-3/2}) \left(1 - \exp\left(-\frac{C_1}{m(\ln n)^\gamma} n^{1-g(\frac{k\alpha_0}{m})}\right) \right). \quad (9.5)$$

Now, for $k \leq m-1$ we have

$$1 - g\left(\frac{k\alpha_0}{m}\right) \geq \frac{(1-\kappa)\alpha_0}{m\kappa},$$

so (9.4) and (9.5) imply that

$$\begin{aligned} P_\omega \left[\sum_{k=0}^{m-1} \sum_{i \in \mathcal{I}_k} \sigma_i \leq \frac{n}{2} \right] &\geq \prod_{k=0}^{m-1} \left[(1 - n^{-3/2}) \left(1 - \exp\left(-\frac{C_1}{m(\ln n)^\gamma} n^{\frac{(1-\kappa)\alpha_0}{m\kappa}}\right) \right) \right]^{n^\nu} \\ &\rightarrow 1 \quad \text{as } n \rightarrow \infty. \end{aligned} \quad (9.6)$$

Now, we obtain a lower bound for the second term in the right-hand side of (9.3). On $G_1(n)$, we get an upper bound on ρ_i for $i \in [-n, n]$ and hence we have $\omega_x \geq n^{-C_2}$, we obtain for any $\ell \in \mathcal{U}$ (imagine that, to cross the corresponding interval, the particle just goes to the right at each step)

$$P_\omega \left[\sigma_\ell \leq \frac{1}{2} n^{1-(\nu-\alpha_0)-\frac{\alpha_0}{m}} \right] \geq n^{-C_2(\ln n)^2}, \quad (9.7)$$

so,

$$\begin{aligned} P_\omega \left[\sum_{i \in \mathcal{U}} \sigma_i \leq \frac{n}{2} \right] &\geq P_\omega \left[\sigma_\ell \leq \frac{1}{2} n^{1-(\nu-\alpha_0)-\frac{\alpha_0}{m}} \text{ for all } \ell \in \mathcal{U} \right] \\ &\geq \left(n^{-C_2(\ln n)^2} \right)^{n^{\frac{\nu-\kappa}{1-\kappa} + \frac{\alpha_0}{m}}} \end{aligned}$$

$$= \exp\left(-C_2(\ln n)^3 n^{\frac{\nu-\kappa}{1-\kappa} + \frac{\alpha_0}{m}}\right) \quad (9.8)$$

(recall that $\nu - \alpha_0 = \frac{\nu-\kappa}{1-\kappa}$).

As for the third term in (9.3), using (2.8) we easily obtain that, on $A(n) \cap G(n)$,

$$P_\omega^{n^\nu} [X_j > n^{(1-\varepsilon)\nu} \text{ for all } j \in [0, n - n^\nu]] \geq P_\omega^{n^\nu} [T_n < T_{n^{(1-\varepsilon)\nu}}] > C_3 > 0. \quad (9.9)$$

Now, plugging (9.6), (9.8), and (9.9) into (9.3) and sending m to ∞ , we obtain that

$$\limsup_{n \rightarrow \infty} \frac{\ln(-\ln P_\omega[X_n > n^{(1-\varepsilon)\nu}])}{\ln n} \leq \frac{\nu - \kappa}{1 - \kappa}, \quad \mathbf{P}\text{-a.s.}$$

applying this for $\nu' = \nu/(1 - \varepsilon)$ and letting ε go to 0,

$$\limsup_{n \rightarrow \infty} \frac{\ln(-\ln P_\omega[X_n > n^{\nu'}])}{\ln n} \leq \frac{\nu' - \kappa}{1 - \kappa}, \quad \mathbf{P}\text{-a.s.} \quad (9.10)$$

Since obviously $P_\omega[T_{n^\nu} < n] \geq P_\omega[X_n > n^\nu]$, (9.10) holds for $P_\omega[T_{n^\nu} < n]$ as well.

9.2 Upper bound for the quenched probability of speedup

Fix $\varepsilon > 0$ such that $\alpha_0 + \varepsilon < \nu$. Define

$$\begin{aligned} \mathcal{W} &= \left\{ i \in N_n(0, n^\nu) : H_i \geq \frac{\alpha_0 + \varepsilon}{\kappa} \ln n - 4 \ln \ln n \right\}, \\ \Psi_n^\varepsilon &= \left\{ \omega : \text{card } \mathcal{W} \geq \frac{1}{3} n^{\nu - \alpha_0 - \varepsilon} \right\}. \end{aligned}$$

By Lemma 3.5, on each subinterval of length $n^{\alpha_0 + \varepsilon}$ we find a valley of depth at least $\frac{\alpha_0 + \varepsilon}{\kappa} \ln n - 4 \ln \ln n$ with probability at least $1/2$. Since the interval $[0, n^\nu]$ contains $n^{\nu - \alpha_0 - \varepsilon}$ such subintervals, we have

$$\mathbf{P}[\Psi_n^\varepsilon] \geq 1 - \exp(-C_4 n^{\nu - \alpha_0 - \varepsilon}), \quad (9.11)$$

in particular by Borel-Cantelli's Lemma, \mathbf{P} -a.s. we have $\omega \in \Psi_n^\varepsilon$ for n large enough.

For $i \in \mathcal{W}$, define $\tilde{\sigma}_i = T_{K_{i+1}+1} - T_{K_i+1}$, and let

$$s_0 = \frac{1}{4\gamma_2(\ln n)^4} n^{\frac{\alpha_0 + \varepsilon}{\kappa}}.$$

Then, by Proposition 4.2, for any $i \in \mathcal{W}$,

$$\begin{aligned} P_\omega[\tilde{\sigma}_i < s_0] &\leq 2\gamma_2 s_0 \exp\left(-\frac{\alpha_0 + \varepsilon}{\kappa} \ln n + 4 \ln \ln n\right) \\ &= 2\gamma_2 s_0 n^{-\frac{\alpha_0 + \varepsilon}{\kappa}} (\ln n)^4 \end{aligned}$$

$$= \frac{1}{2}. \quad (9.12)$$

Define the family of random variables $\zeta_i = \mathbf{1}\{\tilde{\sigma}_i < s_0\}$, $i \in \mathcal{W}$. These random variables are independent with respect to P_ω , and $P_\omega[\zeta_i = 1] \leq 1/2$ by (9.12). Suppose without restriction of generality that (recall that $g(\alpha_0) = 1$)

$$\frac{1}{3}s_0 \times \frac{1}{3}n^{\nu-\alpha_0-\varepsilon} = \frac{1}{36\gamma_2(\ln n)^4}n^{g(\alpha_0+\varepsilon)} > n.$$

Then, since $\text{card } \mathcal{W} \geq \frac{1}{3}n^{\nu-\alpha_0-\varepsilon}$ for $\omega \in \Psi_n^\varepsilon$, we see using large deviations techniques that for n large enough

$$\begin{aligned} P_\omega[T_{n^\nu} < n] &\leq P_\omega\left[\sum_{i \in \mathcal{W}} \zeta_i > \frac{2}{3} \text{card } \mathcal{W}\right] \\ &\leq \exp(-C_5 n^{\frac{\nu-\kappa}{1-\kappa}-\varepsilon}) \end{aligned} \quad (9.13)$$

(recall that $\nu - \alpha_0 = \frac{\nu-\kappa}{1-\kappa}$). Since $\varepsilon > 0$ is arbitrary, we obtain

$$\liminf_{n \rightarrow \infty} \frac{\ln(-\ln P_\omega[T_{n^\nu} < n])}{\ln n} \geq \frac{\nu - \kappa}{1 - \kappa} \quad \mathbf{P}\text{-a.s.} \quad (9.14)$$

Together with (9.10), this shows (1.12).

9.3 Annealed speedup

As usual, the quenched lower bound obtained in Section 9.1 also yields the annealed one, i.e. (9.10) implies that

$$\limsup_{n \rightarrow \infty} \frac{\ln(-\ln \mathbb{P}[X_n > n^\nu])}{\ln n} \leq \frac{\nu - \kappa}{1 - \kappa}, \quad (9.15)$$

Turning to the upper bound, we have by (9.11) and (9.13) that

$$\begin{aligned} \mathbb{P}[T_{n^\nu} < n] &= \int P_\omega[T_{n^\nu} < n] d\mathbf{P} \\ &\leq \int_{\Psi_n^\varepsilon} P_\omega[T_{n^\nu} < n] d\mathbf{P} + \mathbf{P}[(\Psi_n^\varepsilon)^c] \\ &\leq \exp(-C_5 n^{\frac{\nu-\kappa}{1-\kappa}-\varepsilon}) + \exp(-C_4 n^{\frac{\nu-\kappa}{1-\kappa}-\varepsilon}), \end{aligned}$$

and this implies (1.13). This finishes the proof of Theorem 1.5. \square

Acknowledgements

A.F. would like to thank the ANR “MEMEMO”, the “Accord France-Brésil” and the ARCUS program.

S.P. is thankful to FAPESP (04/07276–2), CNPq (300328/2005–2 and 471925/2006–3), and N.G. and S. P. are thankful to CAPES/DAAD (Probral) for financial support.

We thank two anonymous referees whose extremely careful lecture of the first version lead to many improvements.

CHAPITRE 6. SLOWDOWN AND SPEEDUP OF TRANSIENT RWRE

Bibliographie

- [1] E. Aidekon. Large deviations for random walks in random environment on a galton-watson tree.
- [2] E. Aidekon. Transient random walks in random environment on a galton-watson tree. *Probab. Theory Related Fields*, 142(3-4) :525–559, 2008.
- [3] S. Alili. Asymptotic behaviour for random walks in random environments. *J. Appl. Probab.*, 36(2) :334–349, 1999.
- [4] N. Alon, J. Spencer, and P. Erdős. *The Probabilistic Method*. Wiley, New-York, 1992.
- [5] O. Angel, I. Benjamini, N. Berger, and Y. Peres. Transience of percolation clusters on wedges. *Electron. J. Probab.*, 11(25) :655–669, 2006.
- [6] L. Bachelier. Théorie de la spéculation. *Ann. Sc. de l'ENS*, 3(17) :21–86, 1900.
- [7] G. Ben Arous and J. Cerny. *Dynamics of trap models*. École de Physique des Houches, Session LXXXIII. Elsevier, Amsterdam, 2006.
- [8] G. Ben Arous, A. Fribergh, Gantert N., and Hammond A. Biased random walks on a galton-watson tree with leaves. Preprint, available via <http://arxiv.org/abs/0711.3686>.
- [9] G. Ben Arous and A. Hammond. Stable limit law for randomly biased walk on trees. In preparation.
- [10] G. Ben Arous, S. Molchanov, and A.F. Ramírez. Transition from the annealed to the quenched asymptotics for a random walk on random obstacles. *Ann. of Probab.*, 22(6) :2149–2187, 2005.
- [11] I. Benjamini, R. Pemantle, and Y. Peres. Unpredictable paths and percolation. *Ann. Probab.*, 26(3) :1198–1211, 1998.
- [12] N. Berger. Slowdown estimates for ballistic random walk in random environment.
- [13] N. Berger and M. Biskup. Quenched invariance principle for simple random walk on percolation clusters. *Probab. Theory Related Fields*, 137(1-2) :83–120, 2007.

BIBLIOGRAPHIE

- [14] N. Berger, M. Biskup, C. E. Hoffman, and G. Kozma. Anomalous heat-kernel decay for random walk among bounded random conductances. *Ann. Inst. Henri Poincaré Probab. Stat*, 44(2) :374–392, 2008.
- [15] N. Berger, N. Gantert, and Y. Peres. The speed of biased random walk on percolation clusters. *Probab. Theory Related Fields*, 126(2) :221–242, 2003.
- [16] N. Berger and O. Zeitouni. A quenched invariance principle for certain ballistic random walks in i.i.d. environments.
- [17] J.-P. Bouchaud. Weak ergodicity breaking and aging in disordered systems. *J. Phys. I (France)*, 2 :1705–1713, 1992.
- [18] D. Y. Chen and F. X. Z.g. On the monotonicity of the speed of random walks on a percolation cluster of trees. *Acta Math. Sin. (Engl. Ser.)*, 23(11) :1949–1954, 2007.
- [19] A. Chernov. Reduplication of a multicomponent chain by the mechanism of "lightning". *Biophysica*, 12 :297–301, 1967.
- [20] F. Comets, N. Gantert, and O. Zeitouni. Quenched, annealed and functional large deviations for one-dimensional random walk in random environment. *Probab. Theory Related Fields*, 118(1) :65–114, 2000.
- [21] F. Comets and S. Popov. Limit law for transition probabilities and moderate deviations for Sinai's random walk in random environment. *Probab. Theory Related Fields*, 126(4) :571–609, 2003.
- [22] F. Comets and S. Popov. A note on quenched moderate deviations for sinai's random walk in random environment. *ESAIM : Probab. Statist.*, 8 :56–65, 2004.
- [23] F. Comets and F. Simenhaus. Random walk delayed on percolation clusters. *J. Appl. Probab*, 45(3) :689–702, 2008.
- [24] A. De Masi, P. A. Ferrari, S. Goldstein, and W. D Wick. An invariance principle for reversible markov processes. applications to random motions in random environments. *J. Statist. Phys.*, 55(3-4) :787–855, 1989.
- [25] A. Dembo, N. Gantert, Y. Peres, and O. Zeitouni. Large deviations for random walks on Galton-Watson trees : averaging and uncertainty. *Probab. Theory Related Fields*, 122(2) :241–288, 2002.
- [26] A. Dembo, Y. Peres, and O. Zeitouni. Tail estimates for one-dimensional random walk in random environment. *Comm. Math. Phys.*, 181(3) :667–683, 1996.
- [27] A. Devulder. Some properties of the rate function of quenched large deviations for random walk in random environment. *Markov Process. Related Fields*, 12(1) :27–42, 2006.
- [28] D. Dhar. Diffusion and drift on percolation networks in an external field. *J. Phys. A*, 17(5) :257–259, 1984.

-
- [29] D. Dhar and D. Stauffer. Drift and trapping in biased diffusion on disordered lattices. *Int. J. Mod. Phys.*, 9(2) :349–355, 1998.
- [30] P.G. Doyle and E.J. Snell. *Random walks and electrical networks*. Carus Math. Monographs, Mathematical Association of America, Washington, DC, 1984.
- [31] R. Durrett. *Probability : theory and examples*. Duxbury Press, Belmont, CA, third edition, 2004.
- [32] A. Einstein. Über die von der molekularkinetischen theorie der wärme geforderte bewegung von in ruhenden flüssigkeiten suspendierten teilchen. *Annal. der Phys.*, 17 :549–560, 1905.
- [33] N. Enriquez and C. Sabot. Random walks in a Dirichlet environment. *Electron. J. Probab.*, 11 :no. 31, 802–817 (electronic), 2006.
- [34] N. Enriquez, C. Sabot, and O. Zindy. Aging and quenched localization for one-dimensional random walks in random environment in the sub-ballistic regime, 2007. Preprint, available via <http://arxiv.org/abs/0711.1095>.
- [35] N. Enriquez, C. Sabot, and O. Zindy. Limit laws for transient random walks in random environment on \mathbb{Z} , 2007. Preprint, available via <http://arxiv.org/abs/math/0703660>.
- [36] N. Enriquez, C. Sabot, and O. Zindy. A probabilistic representation of constants in Kesten’s renewal theorem, 2007. Preprint, available via <http://arxiv.org/abs/math/0703648>.
- [37] W. Feller. *An introduction to probability theory and its applications. Vol. II*. Second edition. John Wiley & Sons Inc., New York, 1971.
- [38] A. Fribergh. The speed of a biased random walk on a percolation cluster at high density. Preprint, available via <http://arxiv.org/abs/0812.2532>.
- [39] A. Fribergh, N. Gantert, and Popov. On slowdown and speedup of transient random walks in random environment. Preprint, available via <http://arxiv.org/abs/0806.0790>. To appear in *Probability Theory and Related Fields*.
- [40] N. Gantert and O. Zeitouni. Quenched sub-exponential tail estimates for one-dimensional random walk in random environment. *Comm. Math. Phys.*, 194(1) :177–190, 1998.
- [41] N. Gantert and O. Zeitouni. Large deviations for one-dimensional random walk in a random environment—a survey. In *Random walks (Budapest, 1998)*, volume 9 of *Bolyai Soc. Math. Stud.*, pages 127–165. János Bolyai Math. Soc., Budapest, 1999.
- [42] O. Garet and R. Marchand. Large deviations for the chemical distance in supercritical bernoulli percolation. *Ann. Probab.*, 35(3) :833–866, 2007.
- [43] J. Geiger and G. Kersting. The galton-watson tree conditioned on its height. *Proc. 7th Vilnius Conv. on Prob. and Math. Stat.*, 1998.
-

BIBLIOGRAPHIE

- [44] A. O. Golosov. Localization of random walks in one-dimensional random environments. *Comm. Math. Phys.*, 92(4) :491–506, 1984.
- [45] A. Greven and F. den Hollander. Large deviations for a random walk in random environment. *Ann. Probab.*, 22(3) :1381–1428, 1994.
- [46] G. Grimmett. *Percolation*, volume 321 of *Grundlehren der Mathematischen Wissenschaften*. Springer-Verlag, Berlin, second edition, 1999.
- [47] G. Grimmett and Marstrand J. The supercritical phase of percolation is well behaved. *Proc. Royal Society (London) Ser. A.*, 4306 :429–457, 1990.
- [48] G. Grimmett, H. Kesten, and Y. Zhang. Random walk on the infinite cluster of the percolation model. *Probab. Theory Related Fields*, 96(1) :33–44, 1993.
- [49] T. Gross. Marche aléatoire sur un arbre, 2004.
- [50] C. R. Heathcote, E. Seneta, and D. Vere-Jones. A refinement of two theorems in the theory of branching processes. *Teor. Verojatnost. i Primenen*, 12 :341–346, 1967.
- [51] Y. Hu and Z. Shi. Moderate deviations for diffusions with Brownian potentials. *Ann. Probab.*, 32(4) :3191–3220, 2004.
- [52] Y. Hu and Z. Shi. Slow movement of random walk in random environment on a regular tree. *Ann. Probab.*, 35(5) :1978–1997, 2007.
- [53] Y. Hu and Z. Shi. A subdiffusive behaviour of recurrent random walk in random environment on a regular tree. *Probab. Theory Related Fields*, 138(3-4) :521–549, 2008.
- [54] D. Iglehart. Extreme values in the $GI/G/1$ queue. *Ann. Math. Statist.*, 43 :627–635, 1972.
- [55] S. Kalikow. Generalized random walk in a random environment. *Ann. Probab.*, 9(5) :753–768, 1981.
- [56] K. Kawazu, Y. Tamura, and H. Tanaka. Localization of diffusion processes in one-dimensional random environment. *J. Math. Soc. Japan*, 44(3) :515–550, 1992.
- [57] H. Kesten. The limit distribution of Sinai’s random walk in random environment. *Phys. A*, 138(1-2) :299–309, 1986.
- [58] H. Kesten. Subdiffusive behavior of random walk on a random cluster. *Ann. Inst. H. Poincaré Probab. Statist.*, 22(4) :425–487, 1986.
- [59] H. Kesten, M. V. Kozlov, and F. Spitzer. A limit law for random walk in a random environment. *Compositio Math.*, 30 :145–168, 1975.
- [60] E. S. Key. Recurrence and transience criteria for random walk in a random environment. *Ann. Probab.*, 12(2) :529–560, 1984.
- [61] P. Le Doussal, C. Monthus, and D. Fisher. Random walkers in one-dimensional random environments : exact renormalization group analysis. *Phys. Rev.*, E 59 :4795–4840, 1999.

-
- [62] J.L. Lebowitz and A.E. Mazel. Improved peierls argument for high dimensional ising models. *J. Stat. Phys.*, 90(3-4) :1051–1059, 1998.
- [63] T.M. Liggett, R.H. Schonmann, and A.M. Stacey. Domination by product measures. *Ann. Probab.*, 24 :1711–1726, 1996.
- [64] D. K. Lubensky and D. R. Nelson. Single molecule statistics and the polynucleotide unzipping transition. *Physical Review*, E 65 :031917, 2002.
- [65] R. Lyons. Random walks, capacity and percolation on trees. *Ann. Probab.*, 20 :2043–2088, 1992.
- [66] R. Lyons and R. Pemantle. Random walk in a random environment and first-passage percolation on trees. *Ann. Probab.*, 20(1) :125–136, 1992.
- [67] R. Lyons, R. Pemantle, and Y. Peres. Ergodic theory on galton-watson trees : speed of random walk and dimension of harmonic measure. *Ergodic Theory Dynam. Systems*, 15(3) :593–619, 1995.
- [68] R. Lyons, R. Pemantle, and Y. Peres. Biased random walks on galton-watson trees. *Probab. Theory Related Fields*, 106(2) :249–264, 1996.
- [69] R. Lyons, R. Pemantle, and Y. Peres. Unsolved problems concerning random walks on trees. *IMA Vol. Math. Appl.*, 84 :223–237, 1997.
- [70] R. Lyons and Y. Peres. Probability on trees and networks. Available at <http://mypage.iu.edu/~rdlyons/prbtree/prbtree.html>, 2009.
- [71] P. Mathieu. Quenched invariance principles for random walks with random conductances. *J. Stat. Phys.*, 130(5) :1025–1046, 2008.
- [72] P. Mathieu and A. Piatnitski. Quenched invariance principles for random walks on percolation clusters. *Proc. R. Soc. Lond. Ser. A Math. Phys. Eng. Sci.*, 463(2085) :2287–2307, 2007.
- [73] P. Mathieu and Elisabeth Remy. Isoperimetry and heat kernel decay on percolation clusters. *Ann. Probab.*, 32(1A) :100–128, 2004.
- [74] E. Mayer-Wolf, A. Roitershtein, and O. Zeitouni. Limit theorems for one-dimensional transient random walks in Markov environments. *Ann. Inst. H. Poincaré Probab. Statist.*, 40(5) :635–659, 2004.
- [75] M. Menshikov and D. Petritis. On random walks in random environment on trees and their relationship with multiplicative chaos. *Trends Math.*, pages 415–422, 2002.
- [76] L. Miclo. An example of application of discrete hardy’s inequalities. *Markov Process. Relat. Fields*, 5 :319–330, 1999.
- [77] Y. Peres. Probability on trees : an introductory climb (saint-flour, 1997). In *Lectures on probability theory and statistics*, volume 1717 of *Lecture Notes in Math.*, pages 193–280. Springer, Berlin, 1999.
-

BIBLIOGRAPHIE

- [78] Y. Peres and O. Zeitouni. A central limit theorem for biased random walks on galton-watson trees. *Probab. Theory Related Fields*, 140 :595–629, 2008.
- [79] J. Peterson and O. Zeitouni. Quenched limits for transient, zero speed one-dimensional random walk in random environment, 2007. Preprint, available via <http://arxiv.org/abs/0704.1778>.
- [80] V. V. Petrov. *Sums of independent random variables*. Ergebnisse der Mathematik und ihrer Grenzgebiete, Springer-Verlag, New York-Heidelberg, 1974.
- [81] A. Pisztora and T. Povel. Large deviation principle for random walk in a quenched random environment in the low speed regime. *Ann. Probab.*, 27(3) :1389–1413, 1999.
- [82] A. Pisztora, T. Povel, and O. Zeitouni. Precise large deviation estimates for a one-dimensional random walk in a random environment. *Probab. Theory Related Fields*, 113(2) :191–219, 1999.
- [83] S. Popov and M. Vachkovskaia. Random walk attracted by percolation clusters. *Electron. Commun. Probab.*, 10(27) :263–272, 2005.
- [84] B. Ramachandran. On characteristic functions and moments. *Sankhya*, A31(1) :1–12, 1969.
- [85] F. Rassoul-Agha and T. Seppäläinen. An almost sure invariance principle for random walks in a space-time random environment. *Probab. Theory Related Fields*, 133(3) :299–314, 2005.
- [86] F. Rassoul-Agha and T. Seppäläinen. Ballistic random walk in a random environment with a forbidden direction. *ALEA Lat. Am. J. Probab. Math. Stat.*, 1 :111–147 (electronic), 2006.
- [87] F. Rassoul-Agha and T. Seppäläinen. An almost sure invariance principle for additive functionals of markov chains. *Statist. Probab. Lett.*, 78 :854–860, 2008.
- [88] C. Rau. Sur le nombre de points visités par une marche aléatoire sur un amas infini de percolation. *Bull. Soc. Math. France*, 135(1) :135–169, 2007.
- [89] D. Ruelle. *Statistical Mechanics. Rigorous Results*. Benjamin, New-York, 1969.
- [90] C. Sabot. Ballistic random walks in random environment at low disorder. *Ann. Probab.*, 32(4) :2996–3023, 2004.
- [91] L. Saloff-Coste. *Lectures on finite Markov chains*, volume 1665 of *Ecole d’Eté de Probabilités de Saint-Flour*. Lectures Notes in Mathematics, Springer., Berlin, 1997.
- [92] V. Sidoravicius and A.-S. Sznitman. Quenched invariance principles for walks on clusters of percolation or among random conductances. *Probab. Theory Related Fields*, 129(2) :219–244, 2004.

-
- [93] F. Simenhaus. Asymptotic direction for random walks in random environments, 2005. Preprint, available via <http://arxiv.org/abs/math.PR/0512388>. To appear in *Annales de l'Institut Henri Poincaré*.
- [94] Y. G. Sinai. The limit behavior of a one-dimensional random walk in a random environment. *Teor. Veroyatnost. i Primenen.*, 27(2) :247–258, 1982.
- [95] F. Solomon. Random walks in a random environment. *Ann. Probab.*, 3 :1–31, 1975.
- [96] F. Spitzer. *Principles of Random Walk*. Springer-Verlag, New-York, 2 edition, 1976.
- [97] A.-S. Sznitman. Slowdown estimates and central limit theorem for random walks in random environment. *J. Eur. Math. Soc. (JEMS)*, 2(2) :93–143, 2000.
- [98] A.-S. Sznitman. An effective criterion for ballistic behavior of random walks in random environment. *Probab. Theory Related Fields*, 122(4) :509–544, 2002.
- [99] A.-S. Sznitman. On the anisotropic walk on the supercritical percolation cluster. *Comm. Math. Phys.*, 240(1-2) :123–148, 2003.
- [100] A.-S. Sznitman. Topics in random walks in random environment. In *School and Conference on Probability Theory*, ICTP Lect. Notes, XVII, pages 203–266 (electronic). Abdus Salam Int. Cent. Theoret. Phys., Trieste, 2004.
- [101] A.-S. Sznitman. Random motions in random media. In *School and Conference on Probability Theory*, École de Physique des Houches, Session LXXXIII, pages 219–237. Elsevier, Amsterdam, 2006.
- [102] A.-S. Sznitman and M. Zerner. A law of large numbers for random walks in random environment. *Ann. Probab.*, 27(4) :1851–1869, 1999.
- [103] H. G. Tucker. On a necessary and sufficient condition that an infinitely divisible distribution be absolutely continuous. *Trans. Amer. Math. Soc.*, 118(6) :316–330, 1965.
- [104] O. Zeitouni. Random walks in random environment. In *Lectures on probability theory and statistics*, volume 1837 of *Lecture Notes in Math.*, pages 189–312. Springer, Berlin, 2004.
- [105] M. Zerner. The zero-one law for planar random walks in i.i.d. random environments revisited. *Electron. Comm. Probab.*, 12 :326–335 (electronic), 2007.
- [106] M. Zerner and F. Merkl. A zero-one law for planar random walks in random environment. *Ann. Probab.*, 29(4) :1716–1732, 2001.
- [107] O. Zindy. Scaling limit and aging for directed trap models.