



HAL
open science

Contribution to the emergy theory : application to recycling

Nana Yaw Amponsah

► **To cite this version:**

Nana Yaw Amponsah. Contribution to the emergy theory : application to recycling. Chemical and Process Engineering. Ecole des Mines de Nantes, 2011. English. NNT : 2011EMNA0002 . tel-00653840

HAL Id: tel-00653840

<https://theses.hal.science/tel-00653840>

Submitted on 20 Dec 2011

HAL is a multi-disciplinary open access archive for the deposit and dissemination of scientific research documents, whether they are published or not. The documents may come from teaching and research institutions in France or abroad, or from public or private research centers.

L'archive ouverte pluridisciplinaire **HAL**, est destinée au dépôt et à la diffusion de documents scientifiques de niveau recherche, publiés ou non, émanant des établissements d'enseignement et de recherche français ou étrangers, des laboratoires publics ou privés.

THESE

Nana Yaw Amponsah

**ECOLE DOCTORALE : SCIENCES POUR L'INGENIEUR, GEOSCIENCES, ARCHITECTURE
THESE N° 2011EMNA0002**

*Thèse présentée en vue de l'obtention du grade de
Docteur de l'Ecole des Mines
Sous le label de l'Université Nantes Angers Le Mans
Discipline: Thermique, Energétique et Génie des Procédés*

Soutenue le 23 Septembre 2011

**Contribution à la théorie
de l'éMergie: application
au recyclage
(Contribution to the
emergy theory –
application to recycling)**

DIRECTEUR DE THESE :

LE CORRE Olivier, Maitre-assistant, HDR, EMN, France

RESPONSABLE SCIENTIFIQUE:

LACARRIERE Bruno, Maitre-assistant, EMN, France

RAPPORTEURS DE THESE :

BROWN Mark, Professeur, Univ. Floride, USA

FEIDT Michel, Professeur, UHP, Nancy, France

PRESIDENT DU JURY :

LE COQ Laurence, Professeur, EMN, Nantes, France

MEMBRE DU JURY :

LEZSOVITS Ferenc, Ass. Prof. UTE, Budapest, Hongrie

INVITE :

LEMOULT Bernard, Dir. Rech., EMN, Nantes, France

Acknowledgements

I first of all give thanks to God for His mercies, love and strength. I would like to thank Professor Laurence Le Coq, Head of the Energy and Environmental Systems Department (DSEE) of the Ecole des Mines de Nantes (EMN) and president of this jury for the opportunity and the cordial working environment she offered me during these years of study.

I am indebted to my Academic supervisor and Director of this thesis, Dr. Olivier Le Corre, (H.D.R.) for the confidence entrusted in me to pursue this work successfully, the quality of advice, academic support, his constructive criticisms and ideas.

I express my profound gratitude to Dr. Bruno Lacarriere, Lecturer at the Ecole des Mines de Nantes and the scientific supervisor of this work, for his availability, his sense of criticism and the pains he took in proof reading this manuscript over and over again.

My personal appreciation to Prof. Mark Brown of the University of Florida, USA and Prof. Michel Feidt, UHP, Nancy, France who took pains to review and suggest corrections to help improve this work.

I again thank Ass. Prof. Lezsovits Ferenc of the Budapest University of Technology and Economics, Budapest Hungary and Dr. Bernard Lemoult, Director of research at the Ecole des Mines de Nantes for their acceptance to participate in this jury.

Special thanks to Dr. Camille Sollicec, Assistant Professor, Ecole des Mines de Nantes, Ms. Dominique Briand, Secretary, DSEE, Mme Sylvie Le Goff, Ecole Doctoral, EMN, Mme Michelle Dauvé, Secretary, Ecole Doctoral, EMN, Mme Françoise Palvadeau, Secrétariat, Ecole Doctorale, SPIGA and all my fellow PhD colleagues from Ecole des Mines de Nantes who in diverse ways inspired and believed in me during the course of this work.

I thank my family – my parents, siblings and in-laws for their moral and incessant encouragements throughout the course of my work.

Finally, I dedicate this to my dear wife Amma Nyamekye Amponsah for her love, patience and invaluable support which has enabled me to complete this work.

Nana Yaw Amponsah
September 2011

Table of Contents

Acknowledgements	2
Table of Contents	5
Nomenclature.....	9
Personal References	11
Extended Abstract in French	13
Preliminaire	13
1.0 Introduction	14
2.0 Algèbre de l'éMergie : réflexion.....	15
3.0 Notion de transformité : réflexion	18
4.0 Etat de l'art : éMergie et recyclage	20
5.0 Analyse émergétique pour un processus avec recyclage	21
6.0 Étude de cas	28
7.0 Discussion	32
8.0 Conclusion et perspectives	42
INTRODUCTION	43
CHAPTER 1: Overview of environmental systems analysis tools.....	53
1.1 Environmental Systems Analysis.....	54
1.2 Environmental System Aseessment tools.....	56
1.2.1 Exergy Analysis	57
1.2.2 Life Cycle Analysis (LCA)	59
1.2.3 Ecological Footprint Analysis.....	63
1.2.4 Energy Analysis	64
1.2.5 Emergy Analysis	64

1.3	Similarities and Differences	65
1.3.1	Similarities.....	65
1.3.2	Differences	66
1.4	Conclusion.....	68
CHAPTER 2: Review of the emergy concept and Recycling.....		69
2.1	Introduction	70
2.2	Problems with some methodological aspects of emergy.....	71
2.3	New proposition for the first rule	72
2.3.1	Drawback.....	72
2.3.2	Proposal	73
2.4	Transformity values and its current use	75
2.5	Case Study.....	79
2.6	Emergy and Recycling	86
2.7	Conclusion.....	91
Chapter 3: Effect of Different Time Scales on Emergy Synthesis		93
3.1	Analysis of feedback flows.....	95
3.2	A Case of Recycling Flows	100
3.3	Case Study – Reuse of some selected Building Materials.....	110
3.4	Consistency of the concept.....	118
3.5	Consequence of the concept	120
3.6	Defining the emergy ratios of products.....	122
3.7	Conclusions	124
Chapter 4: Emergy and Building Materials Recycle or Reuse – A Case study		125
4.1	Introduction	126
4.2	Low Energy Buildings.....	126

4.3	Tools and Indicators applied to the evaluation of buildings.....	129
4.4	LCA-based environmental assessment and design tools.....	135
4.5	Emergy Evaluation applied to buildings	138
4.6	Case Study.....	140
4.6.1	LCA applied to the evaluation of a 1-storey Low Energy Building in France.....	140
4.6.2	Emergy evaluation of a 1-storey Low Energy Building in France	149
4.7	Proposal of a model to evaluate materials reuse	153
4.8	Impact of material recycle or reuse on the emergy of the building.....	154
4.9	Impact on EYR	156
4.10	Conclusion.....	159
	Conclusions and Perspectives	161
	References.....	167
	Appendix A	191
	Appendix B	213
	Appendix C	217
	Appendix D.....	225
	PUBLICATION	

Nomenclature

Acronyms

ADEME	Environment and Energy Management Agency
DIREN	Regional Environment Directorates
CIDD	Inter-ministerial Committee for Sustainable Development
LCA	Life Cycle Assessment
EMA	Emergy Analysis
EF	Ecological Footprint
EA	Energy Analysis
ExA	Exergy Analysis
ICEC	Industrial Cumulative Exergy Consumption
EEA	Extended Exergy Accounting
UEVs	Unit Emergy Values
IELR	The industrial environmental loading ratio
EIR	The emergy investment ratio
ELR	The environmental loading ratio
BBC	Bâtiment de basse consommation énergétique
LEB	Low-Energy Building
BREEAM	Building Research Environmental Assessment Method
LEED	Leadership in Energy and Environmental Design
EIS	Emergy Index of Sustainability
GHG	Green House Gases
NGO	Non Governmental Organization
EYR	Emergy Yield Ratio
ELR	Environmental Loading Ratio
EIR	Emergy Investment Ratio
ESI	Emergy Index of Sustainability
RBR	Recycle Benefit Ratio
RYR	Recycle Yield Ratio
SEA	Strategic Environmental Assessment
EIA	Environmental Impact Assessment)
SFA	Substance Flow Analysis
MFA	Material Flow Accounting
IOA	Input-Output Analysis

Variables

U	Internal energy	J
Q	Heat	J
W	Work	J
T	Temperature	K
G	Gibbs free energy	J
P_x	Rate of change of exergy with time	W
O	Emergy	seJ
E_x	Exergy Output	J
R	Local renewable emergy	seJ
N	Local non-renewable emergy	seJ
F	Purchased Input emergy	seJ
seJ	Solar Emjoule	[-]
e	Emergy flow of pathway	J

t	Time	s
q	Amount of material to be recycled	kg
N	Number of times of recycle	[-]
O_c	Additional energy for recycle	seJ
O_i	Total initial energy input	seJ
O_p	Emergy of product	seJ
O_m	Emergy of raw material	seJ
O_R	Emergy for refining	seJ
O_T	Emergy for transformation	seJ
U	Overall heat transfer coefficient	$W/m^2.K$

Greek Letters

τ	Transformity	seJ/J
α	Feedback flow	[-]
Ψ	Correction factor	[-]

Personal References

Journal Publication:

- Amponsah N.Y., Le Corre O., Lacarriere B., 2011. Recycling flows in eMergy evaluation: a mathematical paradox? *Ecological Modelling*, Volume 222, Issue 17, pp. 3071-3081

Journal under Preparation:

- Amponsah N.Y., Le Corre O., Lacarriere B. Emergy assessment of a Low Energy Building: impact of material recycle on selected emergy ratios, *Resources, Conservation and Recycling*.

Conference Papers:

- Amponsah N.Y. and Le Corre O., Use of emergy analysis in comparing hydrogen production via steam methane reforming and electrolysis. *Emergy & Environmental Accounting: theories, applications and methodologies*, 6th Biennial Conference, January 14-16, University of Florida USA, in press (2010).
- Amponsah N.Y. and Le Corre O., Critical review of the usage of transformity values in recent studies. *Emergy & Environmental Accounting: theories, applications and methodologies*, 6th Biennial Conference, January 14-16, University of Florida USA, in press (2010).
- Amponsah N. Y. Le Corre O., Dincer I. emergy: back to Fundamentals, in *Buletinul Institutului Politehnic din Iasi, Tomul LVI (LX), Fasc. 3a, 2010, pages 115:122* Editura Politehnum, ISSN 1011-2855

Honorable Mention

- An honorable mention for a poster presentation: Use of Emergy Analysis in Comparing Hydrogen Production via Steam Methane Reforming and Electrolysis presented at the 6th Biennial Emergy Conference, January 14-16, 2010, University of Florida, USA.

Extended Abstract in French

Cette thèse est intitulée « *Contribution à la théorie de l'éMergie : application au recyclage* ». Elle est constituée, dans son corps principal, de 4 chapitres outre une introduction, une conclusion et des annexes. Le présent résumé étendu focalise le lecteur sur les apports scientifiques essentiels de cette thèse et renvoie le lecteur au texte original pour les détails. Le présent résumé n'a pas pour objectif l'exhaustivité mais de guider les lecteurs vers les contributions significatives.

Dans ce résumé étendu, les numérotations des tableaux, des équations et des figures sont celles du manuscrit principal. Ce choix permet au lecteur de conserver les mêmes références dans l'ensemble de la thèse.

Préliminaire

Une « énergie renouvelable » peut être définie comme une « source d'énergie » ayant un renouvellement suffisamment rapide pour être considérée comme inépuisable à l'échelle humaine. Les énergies renouvelables sont le résultat de phénomènes naturels récurrents provoqués par les astres, principalement le Soleil (rayonnement), mais aussi la Lune (marée) et la Terre (énergie géothermique). De plus, le caractère « renouvelable » d'une énergie dépend non seulement de la vitesse à laquelle la source « se régénère », mais aussi de la vitesse à laquelle elle est consommée.

- le bois n'est une énergie renouvelable que si sa consommation est inférieure ou égale à sa production (ex : la sur-exploitation de bois spéciaux induit la destruction de la ressource).
- le pétrole ou le gaz naturel ne sont pas des énergies « renouvelables » car il faudrait des millions d'années pour reformer la quantité d'énergie fossile consommée actuellement.
- l'énergie nucléaire n'est pas une énergie renouvelable car la réserve d'uranium disponible sur Terre est limitée.

L'énergie solaire, l'énergie marémotrice, l'énergie éolienne et la géothermie sont les principales énergies renouvelables. De plus, par un mécanisme plus ou moins complexe, toutes les énergies renouvelables (sauf l'énergie marémotrice) ont pour origine l'énergie nucléaire naturelle du soleil (par fusion nucléaire) ou de la Terre (par désintégration naturelle des roches de la croûte terrestre).

Les énergies propres et renouvelables sont souvent présentées comme une solution au problème du réchauffement climatique. D'une part, cela supposerait un recours suffisant des énergies renouvelables pour diminuer la consommation absolue (et non relative) d'énergies fossiles. D'autre part, les économies d'énergies et le recyclage sont aussi des enjeux majeurs.

Cette thèse propose de développer l'analyse éMergétique appliquée au recyclage.

1.0 Introduction

La notion de « développement durable » est de plus en plus répandue¹. Dans la littérature, différents modes d'analyse prennent en considération l'environnement, dans une acceptation large de ce dernier terme. Ainsi, dans le chapitre 1 section 1.1, la catégorisation de Wrisberg et al., 2002 sans exhaustivité est reprise:

- Méthodes procédurales :
 - *Strategic Environmental Assessment* (SEA) cf (Roth et Eklund, 2002, Hojer et al., 2008)
 - *Environmental Impact Assessment* (EIA) cf (Therivel et al., 2005)
- Méthodes analytiques :
 - *Substance Flow Analysis* (SFA) cf (Roth et Eklund, 2002)
 - *Material Flow Analysis* (MFA) cf (Ulgiati et al., 2003, Brunner et Rechberger, 2004)
 - *Input-Output Analysis* (IOA) cf (Engstrom et al., 2007)
 - *Life Cycle Analysis* (LCA) cf (Guinee et al., 2001) ou (Baumann et Tillman, 2005)

Dans la section 1.2, cinq méthodes d'analyses particulièrement pertinentes sont présentées :

1. analyse eXergétique, cf (Bejan et al., 1996, Szargut et al., 1988, Sciubba et al., 2003)
2. analyse du cycle de vie (LCA), cf (Burgess et Brennan, 2001, Ayres, 1995)
3. empreinte écologique, cf (Rees et Wackernagel, 1994)
4. analyse éNergétique, cf (Brown et Herendeen, 1996, Crawford et al., 2006, Giampietro et al., 1993, Kok et al., 2006)
5. **analyse éMergétique**

Basée sur les principes de l'énergétique (Lotka, 1922, 1945), de la théorie des systèmes (von Bertalanffy, 1968) et de l'écologie des systèmes (Odum, 1967, 1975, 1996), l'analyse émergétique (EMA) est une technique analytique quantitative permettant de déterminer la valeur de ressources, de services et de produits sur une même base (Brown et Herendeen, 1996). L'analyse éMergétique est basée sur l'hypothèse que toute chose sur Terre peut être exprimée en terme de « contenu solaire équivalent », i.e. quelle quantité d'énergie serait il nécessaire si et seulement si l'énergie solaire était l'unique entrée ?

L'**éMergie** d'une ressource ou d'un produit est définie en convertissant toutes les ressources (matières premières) et les entrées d'énergie sous la forme de leurs équivalents énergétiques solaires (solar energy unit, seJ), cf (Odum, 1996, 2000). Le résultat permet de définir la notion de **transformité**, correspond à l'éMergie spécifique. La transformité peut être exprimée par unité de matière ou d'énergie.

¹ Le développement durable est communément défini comme un développement répondant aux besoins du présent sans compromettre la capacité des générations futures de répondre aux leurs.

Rem : Le concept d'éMergie est présenté dans l'annexe A.

L'analyse éMergétique est de plus en plus utilisée dans des applications variées : production alimentaire (Maud, 2007, Rotolo et al., 2007), process industriel (Brown et McClanahan, 1996, Min et Feng, 2008, Pulselli et al., 2008).

2.0 Algèbre de l'éMergie : réflexion

Les règles de calcul pour l'évaluation de l'émergie sont désignées sous le nom de « algèbre de l'émergie », cf (Scienceman, 1987). Une explication détaillée de l'application de ces règles a été donnée dans le chapitre 6 du livre de Odum, 1996. Les règles de l'algèbre de l'émergie sont établies comme suit :

REGLE 1 : pour un système à l'équilibre, tous les apports d'émergie dans un processus de fabrication/conversion sont assignés aux sorties.

REGLE 2 : quand une jonction existe et crée deux ou plusieurs voies (de même type), l'entrée d'émergie est assignée à chaque voie au prorata de son pourcentage massique (ou énergétique) : la transformité (ou l'émergie spécifique) de chaque branche de la jonction est identique.

REGLE 3 : pour un processus avec plus d'un produit, c.a.d. avec des « co-produits », la totalité des entrées d'émergie du processus sont affectées à chaque co-produit. L'émergie n'est donc pas une grandeur qui se conserve.

REGLE 4 : les entrées d'émergie d'un système ne peuvent pas être comptées deux fois. Ainsi, si une entrée, ou une rétroaction, d'un composant est dérivée de lui-même, c.-à-d., si elle porte une émergie déjà comptée dans l'émergie du composant, cette émergie n'est pas comptée deux fois.

Rem : Une comparaison de l'application de ces règles de calcul avec celles applicables dans l'analyse de l'énergie cumulée a été développée par Brown et Herendeen (1996).

Dans la littérature, les auteurs ne sont pas en accord sur l'expression de la règle 1. Ainsi, Odum, 1996 écrit « *all source emergy to a process is assigned to the processes' output* », Lazzaretto, 2009 propose « *the emergy assigned to the process output is equal to the sum of the emergies associated with the process independent inputs* », Li et al., 2010 suggèrent « *for a system at steady state, all the emergy inflows to a production are assigned to the outputs* ».

Le principal problème des règles est qu'elles ne sont pas indépendantes, comme les principes de la thermodynamique. La règle 1 doit être appliquée en lien avec notamment la règle 4.

En prenant la figure 2.1 de la thèse, en appliquant la règle 1, on obtient le contenu éMergétique de la sortie comme étant la somme des entrées F et S .

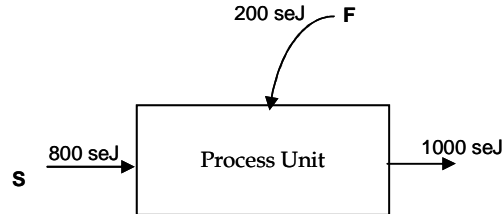

Figure 2.1: Scheme showing the 1st rule of emergy

La règle 2 peut amener à une représentation telle que proposée dans la figure 2.2 (avec une jonction prise à 50%-50% pour chaque sortie).

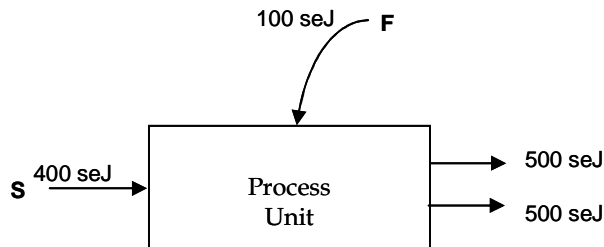

Figure 2.2: Scheme showing the 2nd rule of emergy

La figure 2.3 est un exemple d'application de la règle 3 (cumulant un co-produit et une jonction sur l'une des branches du co-produit).

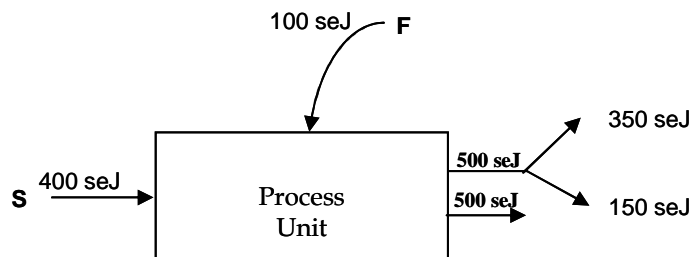
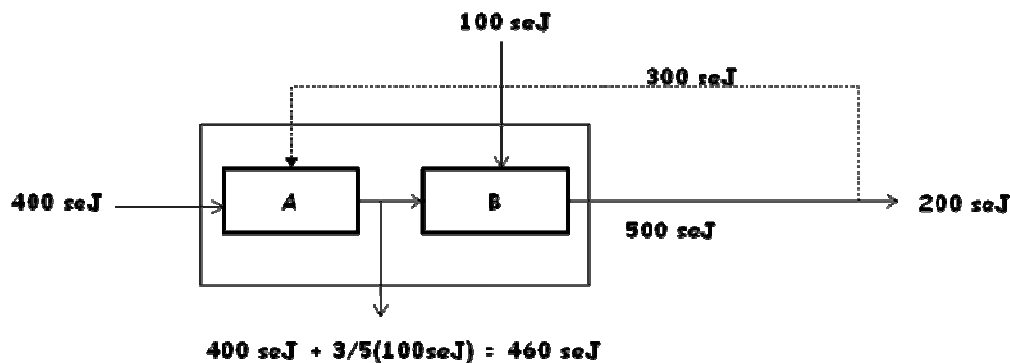

Figure 2.3: Scheme showing the 3rd rule of emergy

Sur cet exemple, il est déjà possible de constater que la règle 1 n'est pas respectée dans ce cas. Une des sorties a une valeur de 350 seJ, une autre 150 seJ, et une dernière 500 seJ.

La règle 4 amène des difficultés supplémentaires de calculs, cf la figure 2.4.

Figure 2.4: Scheme showing the 4th rule of emergy

Il est clair, des définitions et des illustrations ci-dessus, que la règle 1 « toutes les sources d'énergie à un processus sont assignés aux processus produits », ne peut pas être correcte sans considération de la quatrième règle. Dans le cas, des systèmes avec des rétroactions, toutes les sources d'énergie ne sont pas assignées à la sortie du processus, notamment du fait des jonctions, cf la figure 2.5 :

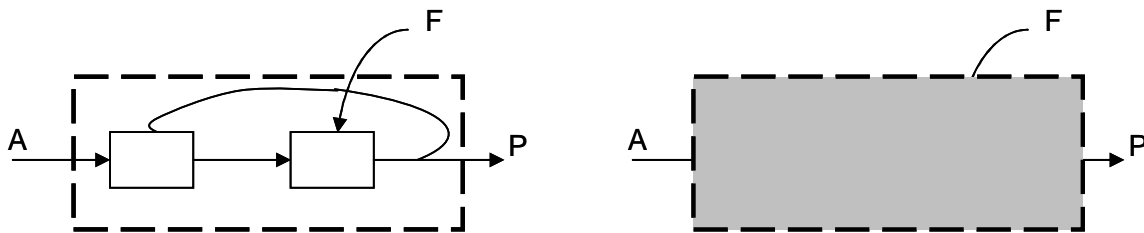

Figure 2.5: Scheme showing the effect of feedbacks on a system

Cette difficulté ne donne pas à la règle 1 de l'émergy une position « pleine » par rapport à d'autres principes scientifiques telles que les principes de la thermodynamique dans lesquelles chaque principe (ou loi) est « pleine ».

Rem : Cette traduction de la thèse demande une explication.

- Le premier principe de la thermodynamique s'applique indépendamment du second principe. Les résultats issus de l'application du premier principe ne sont pas contredits par le second, ils sont précisés.
- L'application de la règle 1 peut être contredite par l'application de la règle 4. Les règles se complètent mais s'interfèrent aussi, rendant leur application parfois plus délicate.

L'auteur de cette thèse propose de modifier la règle 1 pour en préciser l'application. Il reprend des énoncés antérieurs et propose :

Original Definition-1:

All source Energy to a process is assigned to the Process output (Odum, 2000).

All source Energy *without feedback* to a process is assigned to the process output (modified version).

Original Definition-2

The emergy assigned to the process output is equal to the sum of the emergies associated with the process independent inputs (Lazzaretto, 2009).

The Emergy assigned to the process output is equal to the sum of the emergies associated with the process *primary* independent inputs (modified version).

Original Definition-3

For a system at steady state, all the emergy inflows to a production process are assigned to the outputs (Li et al., 2010).

For a system at steady state, the emergy inflows *without feedback emergies* to a production process are assigned to the outputs (modified version).

3.0 Notion de transformité : réflexion

Lors du colloque biennal sur l'éMergie en Floride en 2010, une présentation sur l'usage des transformités a été effectué (Amponsah et LeCorre, 2010b). Dans la section 4 du chapitre 2, sont proposés les points essentiels de cette présentation. L'accent est mis sur 2 aspects essentiels : la nécessité d'une base de données avec un minimum d'hétérogénéité tant spatiale que temporelle, en s'appuyant sur les travaux de Ulgiati et al., 2010.

En prenant comme exemple la production d'électricité, la disparité des transformités est montré, cf Tab 2.2.

Author (s)	Value (seJ/J)
Feng et al., 2009	1.60E+05
Paoli et al., 2008	1.74E+05
Meillaud et al., 2005	1.88E+05
Cavalett et al., 2006	2.69E+05
Pizzigallo et al., 2008	2.00E+05

Table 2.2: Transformity values for electricity in recent studies and their respective authors.

La transformité est un concept central dans l'analyse émergétique. Bien que les valeurs de transformité, calculées par Odum et son équipe notamment, soient disponibles dans la littérature, il peut paraître important de revoir ces valeurs.

Une des principales critiques concernant l'analyse émergétique est cette évaluation des transformités qui réduit l'efficacité du concept vis-à-vis des décideurs notamment politiques. Pourtant, convaincre de la pertinence permettrait à l'analyse émergétique de trouver sa place avec les autres méthodes d'évaluation traditionnelles (Analyse du Cycle de Vie par exemple).

La section 2.4 reprend 14 critères (cf tableau 2.3) nécessaires pour donner de la consistance scientifique à l'analyse émergétique.

Etude de cas : Production H₂

Afin de familiariser avec le concept, un exemple de cas a été réalisé, cf section 2.5. La production d'hydrogène peut être réalisée à partir de différentes technologies. L'analyse émergétique peut donc permettre de comparer ces technologies et de déterminer celle mobilisant le moins de ressources. Lors du colloque biennal sur l'émergie en Floride en 2010, Amponsah et LeCorre, 2010a a réalisé une telle étude. Il a comparé ces résultats avec la bibliographie, cf le tableau 2.7 synthétisant ce travail.

Du tableau 2.7, il est clair que la valeur calculée de la transformité pour l'hydrogène par la technologie Steam Methane Reforming (Amponsah, LeCorre, 2010a*) est presque identique à celle obtenue par Bargigli. Ceci s'explique par le fait que les deux calculs ont été basés sur des données très semblables provenant de NREL (Johanna, 2004). Cependant, une différence est constatée par rapport à Feng et al., 2009, voir tableau 2.4 et 2.5 dans le cœur de la thèse.

Author (s)	Transformity Values	
	SMR (seJ/J)	Electrolysis (seJ/J)
Bargigli et al., 2004	7,34E+04	2,18E+05
Feng et al., 2009	1,15E+05	
Odum, 1996	...	1,10E+05
Brown, Ulgiati, 2004	...	1,39E+05
Amponsah, LeCorre, 2010a*	7,86E+04	3,45E+05

Table 2.7: Hydrogen transformity values in comparison with other systems

4.0 Etat de l'art : éMergie et recyclage

La gestion « soutenable » de flux de matière se produit à différentes échelles environnementales et vise à :

1. Réduire l'épuisement de ressources ;
2. Réduire les incidences sur l'environnement de l'extraction et/ou de l'utilisation de matières premières, telles que, non exclusivement, des effets écotoxiques, des changements physico-chimiques, la disparition de la biodiversité, des effets alimentaires, et des changements de paysage ;
3. Réduire l'évacuation des déchets.

Par conséquent, la sauvegarde du **capital de la Nature** et la réduction de la pression sur les ressources (matières premières et fossiles) peuvent être réalisées en mettant en application une stratégie de minimisation de rebut (voir figure 2.9). La définition de la notion de « minimisation de rebut » est un concept plus large que la prévention du gaspillage : elle inclut également des mesures de gestion des déchets telle que la réutilisation (Jacobsen et Kristofferson, 2002) qui impliquent fortement le recyclage de matériel et de produit. Gungor et Gupta, 1999 distinguent ainsi :

1. Réutilisation : action effectuée pour rechercher le contenu matériel des produits désuets ; exemple : les bricks de lait
2. Ré-usinage : action effectuée pour reconstituer des parties de produits comme un nouveau produit ; exemple : l'aluminium.

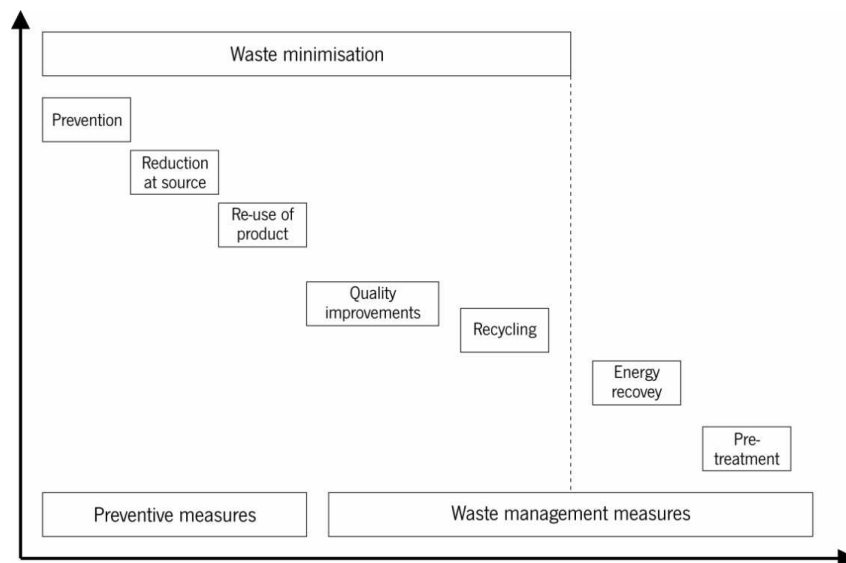

Figure 2.9. OECD working definition on waste minimization (Jacobsen et Kristofferson, 2002)

Malgré l'augmentation de la réutilisation largement observée dans la plupart des pays de l'Union européenne, la mise en décharge est toujours la principale solution de traitement des déchets (EEA, 2007). L'augmentation du recyclage est notamment induite par des instruments politiques tels que la directive d'emballage (EU, 1994) et la directive de remblai (EU, 1999), ou des règlements nationaux. La réutilisation est un concept important lors du cycle de vie

« écologique » des matériaux, dans lequel les pertes ou la production d'un système est une entrée d'un autre système. La réutilisation sert à amplifier et renforcer des processus de fabrication, et fournit un multiplicateur aux ressources d'entrée. Les systèmes ne développant pas un cycle complet des matériaux ne seront pas longtemps opérationnels (Odum, 1996; Buranakarn, 1998). L'analyse émergétique a été largement appliquée dans l'évaluation des systèmes écologiques, des systèmes énergétiques, et des incidences sur l'environnement des processus. La plupart des études d'émergie ont été appliquées aux systèmes éco-économiques.

- Ulgiati et Brown, 2002 ont proposé une méthode basée sur l'émergie pour étudier quantitativement les sous-produits d'absorption et de dilution d'un processus.
- Ulgiati et al., 2004 observent que la valeur de l'émergie des « déchets » a un rôle dans la partie terminale de la chaîne du processus et proposent des manières d'expliquer ses montants d'émergie pour éviter des erreurs, notamment au niveau de la règle 4.
- Bakshi, 2000 a présenté une méthode d'analyse d'émergie pour les systèmes industriels, dans lesquels le traitement des déchets est considéré. Les pertes sont non seulement manipulées par une dilution en fin de cycle, mais également par les techniques de rebut de réutilisation.
- Yang et al., 2003 ont proposé une nouvelle méthode d'analyse d'émergie pour le traitement des déchets. Si les pertes sont déchargées dans l'environnement, l'entrée fournie par la nature pour leur réduction par l'intermédiaire des processus normaux devrait être assignée au produit principal. Cependant si des pertes sont traitées et ré-introduites dans un processus de fabrication comme matériel de remplacement ou ressource, seule l'émergie investie dans le traitement et ré-utilisée dans le processus devrait être assignée aux ressources réutilisées. **Cette proposition revient clairement à rompre avec la règle 1.**

Il est clair qu'au cours des années, plusieurs chercheurs ont essayé d'employer la théorie de l'émergie pour évaluer les déchets solides lors d'un recyclage.

Le principal intérêt scientifique de cette thèse est d'élaborer une méthode émergétique applicable aux matériaux recyclés dans le respect des règles. Il est souligné en préalable que les règles ne fixent pas le post-traitement. De nouveaux ratios ont été introduits.

5.0 Analyse émergétique pour un processus avec recyclage

La principale référence de cette thèse est le travail de Buranakarn, 1998, « *Evaluation of recycling and reuse of buildings materials using the emergy analysis method* », *University of Florida, PhD thesis*.

Buranakarn a considéré deux systèmes agrégés.

- Le premier système, cf la figure 3.9, consiste à obtenir un produit en n'utilisant que des matières premières issues du sol, tout en mobilisant de l'énergie, des biens et des services pour cette production. Dans cet exemple, des matières premières sont raffinées, transformées, employées et jetées. La source (B) représente le flux des autres services, marchandises et énergétique. Intrinsèquement, le processus du raffinage exige une

entrée d'énergie (O_R). Le processus de transformation de la matière brute en produit fini exige également des entrées d'énergie (O_T) sous différentes formes (énergie, biens, service).

En appliquant la règle 1, l'énergie du produit (O_P) est égale à la somme des énergies mises en œuvre dans son élaboration :

$$O_P = O_m + O_R + O_T$$

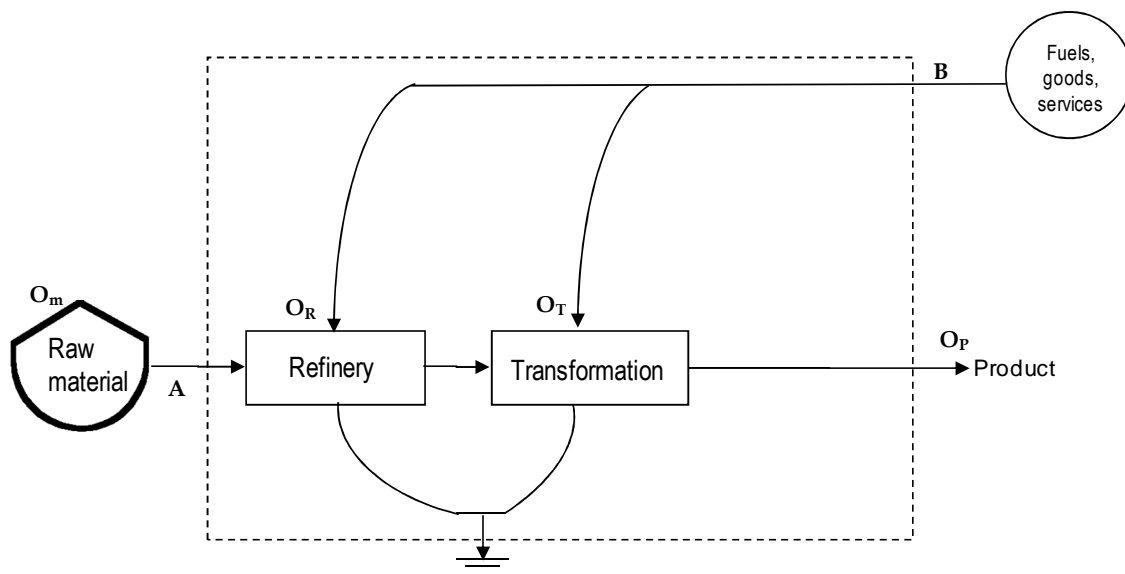

Figure 3.9: Système agrégé sans recyclage

- Le second système, cf figure 3.10, est un système semblable mais comportant un recyclage. La somme des énergies additionnelles du recyclage pour les services, les marchandises et les entrées de carburant est notée (O_C). L'énergie du produit (O_P) est alors la somme de l'énergie des matières premières et de toutes les entrées d'énergie mobilisées pour obtenir le produit :

$$O_P = O_m + O_R + O_T + O_C$$

Cette équation est celle utilisée dans la bibliographie mais est-ce bien en accord avec les règles ?

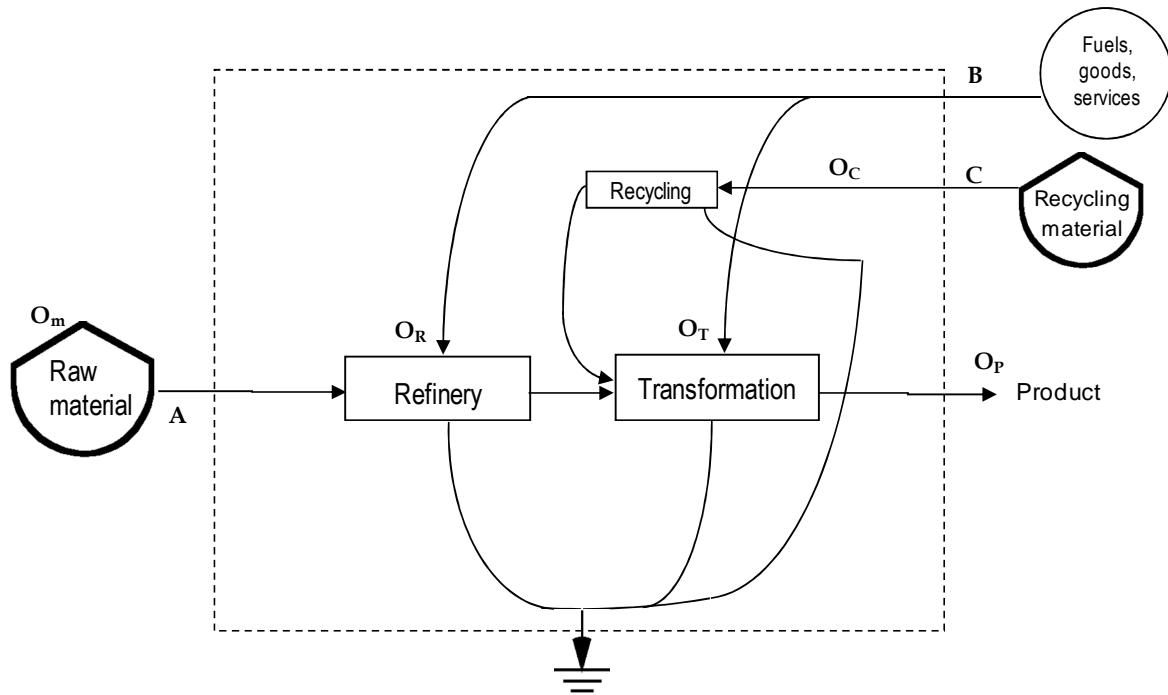

Figure 3.10 : Système agrégé avec recyclage

Le chemin de la matière, lors de ses différents recyclage, est présenté sur la figure 3.11. Le raisonnement est établi pour un **produit unitaire**.

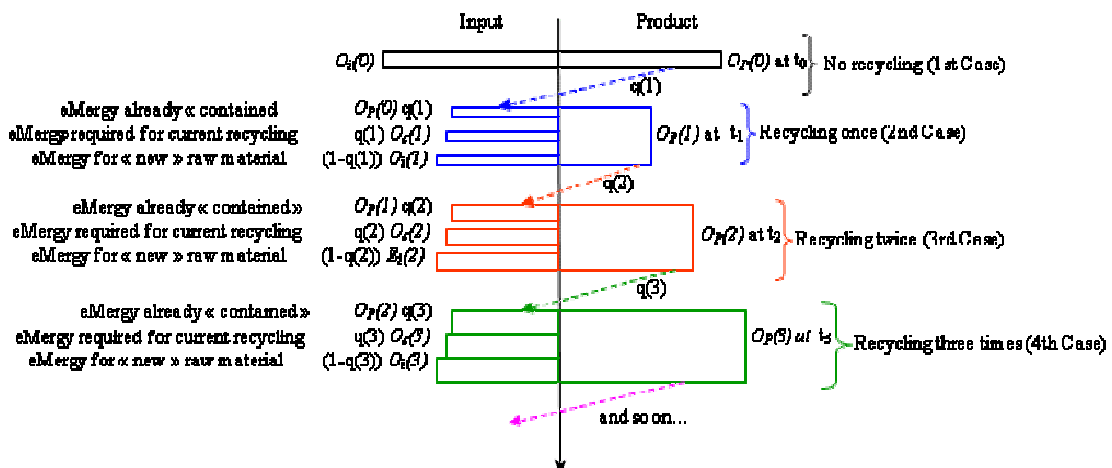

Figure 3.11 : Chemin de la matière recyclée dans une vision émergétique

- Lors de son extraction, son raffinage et sa première transformation, le produit fini a une énergie notée $O_p(0)$ égale à l'énergie initiale, notée $O_i(0)$, éq (3.20)).

$$O_p(0) = O_i(0) \tag{3-20}$$

- Lors de son premier recyclage, il est imaginé qu'une part, notée q , est recyclée. Cette part q a donc pour transformité $O_p(0)$. Il faut introduire sur cette part une énergie liée à la collecte (de cette matière à recycler), à la transformation, notée $O_c(1)$. L'indice (1) signifie : premier recyclage. Cette énergie intervient ultérieurement à l'énergie initiale $O_p(0)$. Il faut en plus extraire une matière première, correspondant à $1-q(0)$, nécessitant une énergie initiale correspondant à la date du recyclage, notée $O_i(1)$. Il est ainsi envisagé que les gisements s'épuisent et mobilisent une quantité d'énergie pour l'extraction et/ou le raffinage de plus en plus grande. L'équation 3.21 donne l'énergie du produit après un recyclage :

$$O_p(1) = q(1)O_c(1) + O_i(1)(1 - q(1)) + q(1)O_p(0) \tag{3-21}$$

Le schéma est ensuite itératif pour le second et les autres recyclages.

$$O_p(2) = q(2)O_c(2) + O_i(2)(1 - q(2)) + q(2)O_p(1) \tag{3-23}$$

On peut déjà noter que, sur cette description, l'énergie d'un produit recyclé à 100% est une fonction strictement croissante. Il n'est pas possible d'affecter une valeur d'énergie à un produit entièrement recyclé SANS préciser le nombre de recyclage.

La figure 3.12 correspond au cas général.

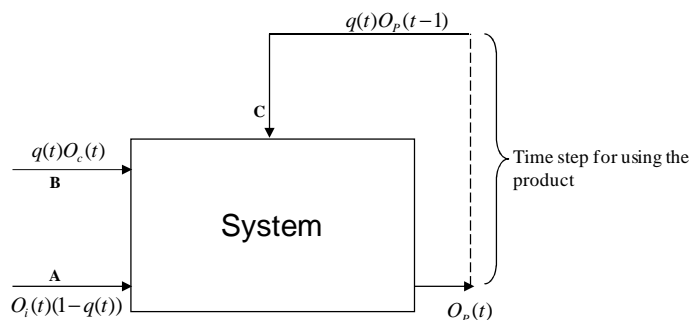

Figure 3.12 :Représentation des flux d'énergie dans le cas général d'un recyclage

En utilisant les notations introduites, on aboutit à l'énergie d'un produit contenant une part de recyclage sous la forme :

$$O_p(t) = q(t)O_c(t) + O_i(t)(1 - q(t)) + q(t)O_p(t-1) \quad (3-26)$$

Considérons le cas particulier dans lequel les énergies d'extraction, de transformation et de recyclage seraient constantes et supposons en plus que la part de produit recyclé est elle aussi constante. Les équations (3.21-3.26) deviennent :

$$O_p(1) = O_i + qO_c \quad (3-22)$$

$$O_p(2) = O_i + qO_c + q^2O_c \quad (3-24)$$

$$O_p(3) = O_i + qO_c + q^2O_c + q^3O_c \quad (3-25)$$

$$O_p^N = O_i + O_c(q + q^2 + q^3 + q^4 + \dots + \dots + q^N) \quad (3-27)$$

$$= O_i + qO_c(1 - q^N)/(1 - q) \quad (3-28)$$

Ainsi donc, l'énergie d'un produit ayant subi N recyclages dépend explicitement du nombre de fois qu'il a été recyclé. En outre, l'équation (3.28) présente une forme indéterminée pour 100% de recyclage, ce résultat est assez intuitif. La figure 3.8 illustre l'augmentation d'énergie du produit lors de chaque recyclage.

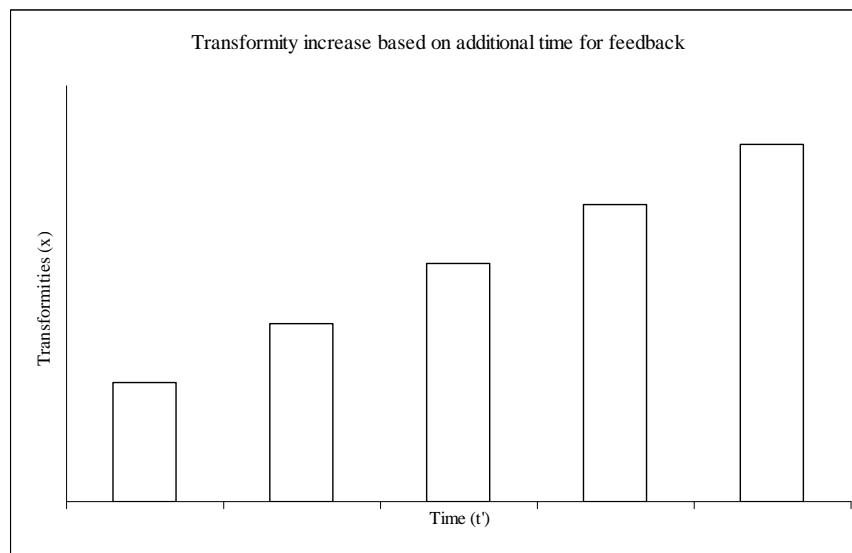

Figure 3.8 : Allure de l'énergie d'un produit en fonction de recyclage

Dans les hypothèses considérées, il est possible d'exprimer l'équation (3.28) en introduisant un facteur, noté ψ : $O_p^N = O_i + \psi O_c$

avec $\psi = q \frac{(1-q^N)}{1-q}$ avec N supérieur ou égal à 1.

La figure 3.13 illustre dès lors la transcription du schéma énergétique applicable pour les process faisant intervenir du recyclage. Le comportement du facteur ψ est tracé en fonction de la part et du nombre de recyclage, cf figure 3.15.

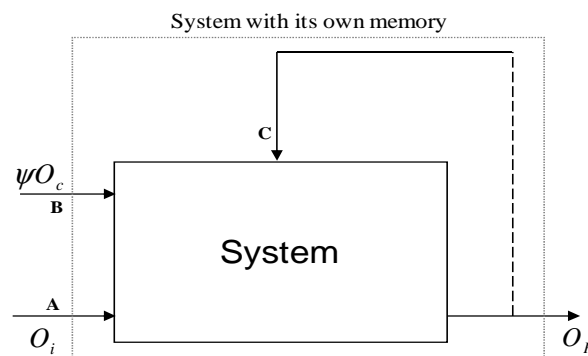

Figure 3.13 : Introduction d'un facteur de correction ψ

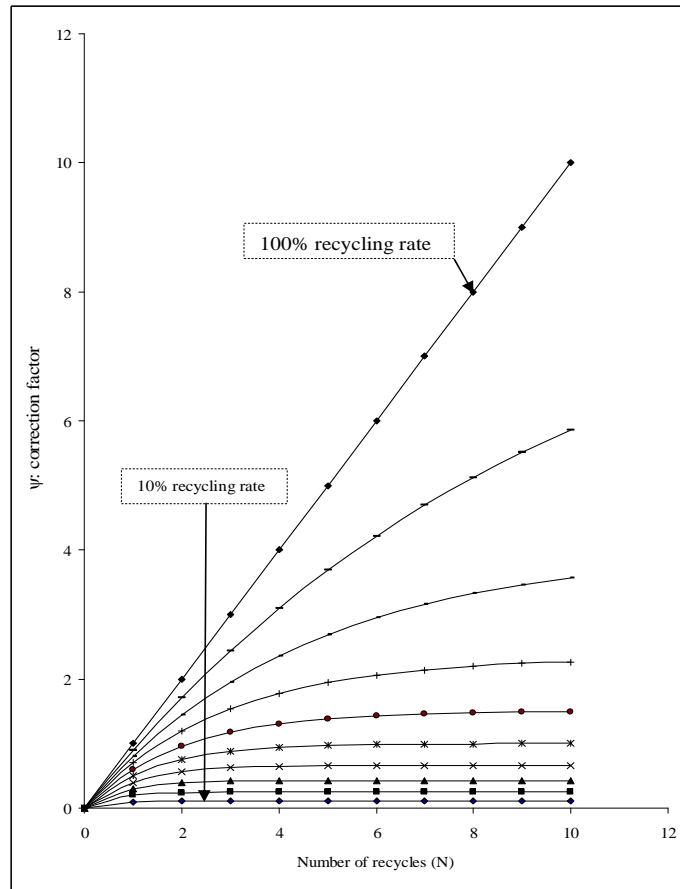

Figure 3.15 : Allure du facteur ψ en fonction de la part et du nombre de recyclage

Comparons deux fractions de recyclage, 10% et 100%. L'impact de ce facteur n'est pas significatif lors du premier cycle de recyclage. Cependant, la différence devient significativement grande en fonction du nombre de recyclages effectués. Il est important de souligner cela : l'information cachée (le chemin de la matière recyclée) ne peut pas être ignorée dans une synthèse d'énergie.

Pour des fraction de recyclages faibles, un comportement asymptotique est également observé : cette observation indique que le facteur peut être défini seulement en fonction du nombre de recyclages. En introduisant ϵ , l'écart entre deux cycles consécutifs, notés N-1 et N, on obtient :

$$\epsilon = \psi(q, N) - \psi(q, N-1) = q^N.$$

La fonction ϵ est tracée sur la figure (3.16).

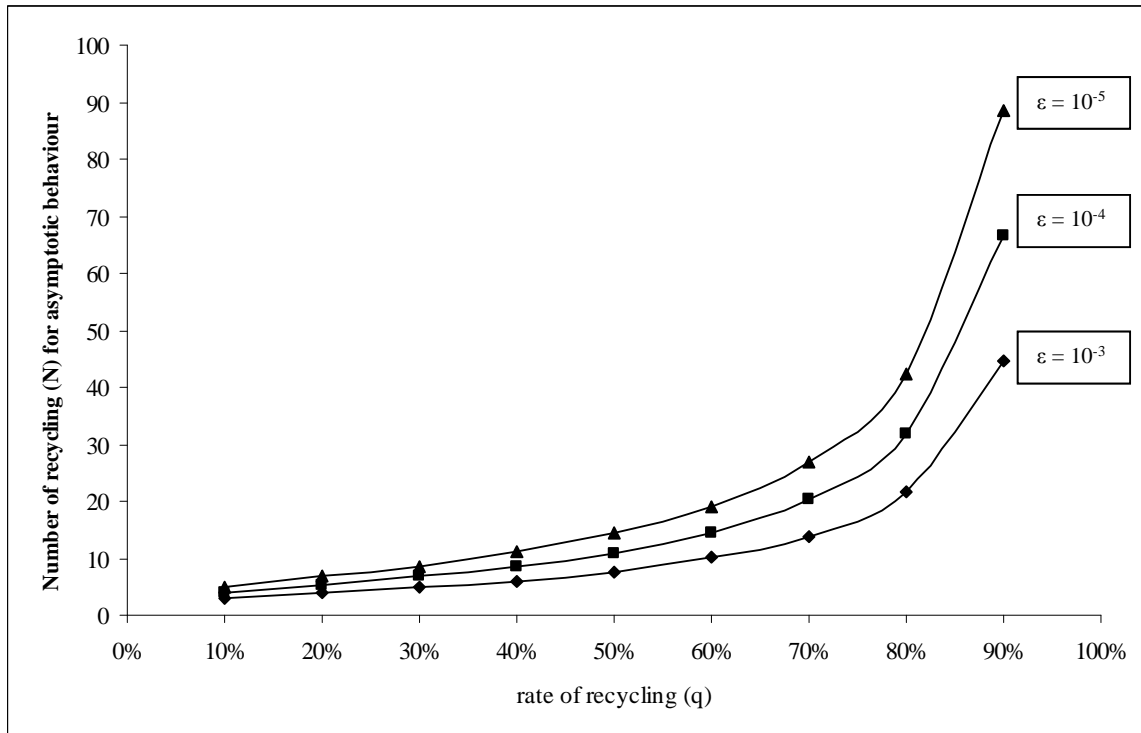

Figure 3.16 : Comportement asymptotique en fonction de la fraction recyclée

Ainsi, si on se fixe l'écart entre 2 cycles consécutifs et la précision désirée, le facteur ψ devient uniquement une fonction de la fraction recyclée, simplifiant son utilisation.

6.0 Étude de cas

Réutilisation de quelques matériaux de construction choisis (inspiré par Buranakarn, 1998)

Dans cette section, une étude de cas est présentée. Elle consiste à effectuer une évaluation d'énergie appliquée à quelques matériaux de construction, utilisés généralement dans l'industrie du bâtiment. Cette étude de cas est inspirée du travail conduit par Buranakarn Vorasun.

Dans ce travail, l'énergie de 9 matières employées dans la construction de bâtiments a été évalués: bois,

- béton, ciment, brique d'argile, carreau de céramique,
- verre,
- acier,
- plastique
- aluminium.

Pour chaque matière, une émergie initiale (sans recyclage) a été évaluée en analysant les entrées des ressources, de l'énergie, et du travail, à partir des statistiques nationales annuelle pour chaque filière. Les filières de recyclage ont aussi fait l'objet d'un travail identique.

(a) Évaluation du processus de réutilisation en acier dans l'industrie de bâtiment

L'acier est parmi les matériaux les plus utilisés et également les plus réutilisés dans l'économie mondiale (Zhang et al., 2009), particulièrement dans l'industrie du bâtiment. Dans cette industrie, l'acier est facilement repris et réutilisé. La récupération de l'acier des bâtiments démolis est une pratique courante et antique dans l'industrie sidérurgique. Un nouvel acier est souvent fait à partir de la chute d'ancien acier, réduisant les incidences sur l'environnement. Une comparaison entre la filière 100% recyclage et la filière « brute », l'opération de réutilisation courante de la production d'acier inoxydable représente une réduction de 66 % d'énergie (Johnson et al., 2008). La réutilisation de l'acier diminue également les émissions de CO₂ considérablement.

Les données pour cette étude de cas proviennent de la thèse présentée par Buranakarn, 1998.

Note Item	Unit/year	Input Resource	Solar energy per unit seJ/J	Emergy seJ/yr
Conventional steel product				
1 Pig iron	g	4,53E+13	2,83E+09	1,28E+23
2 Natural gas	J	3,17E+17	4,80E+04	1,52E+22
3 Other fuels	J	2,80E+16	6,60E+04	1,85E+21
4 Electricity	J	1,84E+17	1,74E+05	3,20E+22
5 Transportation	ton-mile	7,50E+09	9,65E+11	7,24E+21
6 Labour	\$	1,58E+09	1,20E+12	1,90E+21
7 Annual Yield	g	4,49E+13	4,15E+09	1,86E+23

Tableau 3.1 : Table d'évaluation d'émergie pour la production conventionnelle de l'acier par l'intermédiaire du processus de four d'arc électrique (données de Buranakarn, 1998)

Le tableau 3.1 montre une situation sans recyclage, c.-à-d. $q=0$; $O_c=0$ et en tant que tels : $O_p(0)=O_i(0)$. Cette évaluation d'émergie correspond à la production annuelle aux USA. Dans ce cas-ci, la somme de toutes les entrées d'émergie (fonte, gaz naturel, d'autres carburants etc.) basées sur leurs quantités annuelles respectives comme évalué, donne l'émergie du produit c.-à-d. $1.86E+23$ seJ/yr et une transformité de $4.15E+09$ seJ/g.

Note Item	Unit/year	Input Resource	Solar energy per unit seJ/J	Emergy seJ/yr
Material recycling and byproduct use steel product				
1 Post consumer steels	g	1,36E+13	2,83E+09	3,85E+22
2 Steel scrap or slag	g	3,17E+13	2,83E+09	8,97E+22
3 Post consumer steel collection	g	1,36E+13	2,51E+08	3,41E+21
4 Post consumer steel separation	g	1,36E+13	8,24E+06	1,12E+20
5 Natural gas	J	3,17E+17	4,80E+04	1,52E+22
6 Other fuels	J	2,80E+16	6,60E+04	1,85E+21
7 Electricity	J	1,84E+17	1,74E+05	3,20E+22
8 Transportation	ton-mile	7,50E+09	9,65E+11	7,24E+21
9 Labour	\$	1,58E+09	1,20E+12	1,90E+21
10 Annual Yield	g	4,49E+13	4,24E+09	1,90E+23

Tableau 3.2 : Table d'évaluation d'émergie lors d'un recyclage de l'acier par l'intermédiaire du processus de four d'arc électrique (données de Buranakarn, 1998)

La différence principale entre les deux tables présentées, est l'émergie additionnelle requise pour la collection et la séparation en acier pour le procédé de réutilisation (tableau 3.2). Ceci est représenté par le point 3 et 4 sur le tableau 3.2 avec des transformités de 2.51E+8 seJ/g et de 8.24E+6 seJ/g respectivement. Dans ce cas spécifique, q la fraction recyclée, est indiquée comme égale à 30%.

En utilisant l'équation (3.28) il est possible de donner l'émergie du produit recyclé (l'acier dans ce cas). Le tableau 3.3 présente les résultats pour différents nombre de recyclages pour une fraction de 30%.

O_i		1,86E+23 seJ/year	
O_c		1,17E+22 seJ/year	
q		0,3	

Number of times of recycle (N)	Correction factor (Ψ)	ΨO_c	O_p
0	0,00E+00	0,00E+00	1,86E+23
1	3,00E-01	3,50E+21	1,90E+23
2	3,90E-01	4,55E+21	1,91E+23
3	4,17E-01	4,87E+21	1,91E+23
4	4,25E-01	4,96E+21	1,91E+23
5	4,28E-01	4,99E+21	1,91E+23
6	4,28E-01	5,00E+21	1,91E+23
7	4,28E-01	5,00E+21	1,91E+23
8	4,29E-01	5,00E+21	1,91E+23
9	4,29E-01	5,00E+21	1,91E+23
10	4,29E-01	5,00E+21	1,91E+23

Tableau 3.3 : Résultats de la réutilisation continue de l'acier basée sur une fraction de recyclage de 30%.

On observe qu'à 30% de recyclage d'acier, il y a une accumulation progressive d'émergie.

(b) Évaluation du processus de réutilisation en aluminium

Les facteurs de correction ont été utilisés pour calculer pour l'analyse énergétique pour l'aluminium recyclé. Le Tableau 3.4a donne les résultats du processus conventionnel et le Tableau 3.4b récapitule les résultats obtenus pour toutes les valeurs d'énergie pour différents recyclages.

Note Item	Unit/year	Input Resource	Solar energy per unit seJ/J	Emergy seJ/yr
Conventional aluminium sheet production				
Primary aluminium (ingot)	g	4,17E+11	1,17E+10	4,88E+21
Electricity	J	1,08E+15	1,74E+05	1,88E+20
Labour	\$	2,09E+07	1,15E+12	2,40E+19
Annual Yield	g	4,00E+11	1,27E+10	5,08E+21
Recycling Process				
Used aluminium can	g	2,29E+11	1,17E+10	2,68E+21
Primary aluminium (ingot)	g	1,25E+11	1,17E+10	1,46E+21
Aluminium scrap	g	6,25E+10	1,17E+10	7,31E+20
Used Al. can collection	g	2,29E+11	2,51E+08	5,75E+19
Used Al. can separation	g	2,29E+11	8,24E+06	1,89E+18
Electricity	J	1,08E+15	1,74E+05	1,88E+20
Transport (Truck)	ton-mile	2,82E+07	9,65E+11	2,72E+19
Labour	\$	2,90E+07	1,15E+12	3,34E+19
Annual Yield	g	4,00E+11	1,29E+10	5,16E+21

Tableau 3.4a : Résultats d'évaluation d'énergie de production en aluminium conventionnelle et de la réutilisation des bidons en aluminium utilisés

O_i		5,10E+21 seJ/year	
O_c		1,20E+20 seJ/year	
q		0,3	
Number of times of recycle (N)	Correction factor (Ψ)	ΨO_c	O_p
0	0,00E+00	0,00E+00	5,10E+21
1	3,00E-01	3,60E+19	5,14E+21
2	3,90E-01	4,68E+19	5,15E+21
3	4,17E-01	5,00E+19	5,15E+21
4	4,25E-01	5,10E+19	5,15E+21
5	4,28E-01	5,13E+19	5,15E+21
6	4,28E-01	5,14E+19	5,15E+21
7	4,28E-01	5,14E+19	5,15E+21
8	4,29E-01	5,14E+19	5,15E+21
9	4,29E-01	5,14E+19	5,15E+21
10	4,29E-01	5,14E+19	5,15E+21

Tableau 3.4b : Résultats d'énergie en fonction du nombre de recyclages

7.0 Discussion

*Lors de la soumission d'un article à **Ecological Modeling**, un reviewer indiqua que ce travail « cassait » le lien entre eXergie et éMergie, par la description contenue dans l'équation (3.26). La discussion ci-après vise à s'assurer que cette équation (3.26) n'est pas « seulement » un paradoxe mathématique.*

Il est important de rappeler que l'émergie est une mesure cumulative et ne tient pas compte de la dépréciation (dans le temps). Il existe peu de documents publiés établissant la dépendance entre le temps et le concept d'émergie (Odum et Peterson, 1996 ; Tilley et Brown, 2006). Dans ces deux articles, cf section 3.3, la dépréciation vers l'environnement n'est pas intégrée dans le calcul de l'émergie.

Concernant l'approche présentée dans cette thèse, on peut arguer du fait qu'un produit semblable pourrait avoir différentes transformités, ceci reflétant son histoire. Cependant, ce travail démontre que le lien entre éMergie et eXergie n'est pas bijectif.

Ainsi, en prenant le premier principe de la thermodynamique, on a :

$$dU = \delta W_{ext} + \delta Q_{ou} m du + u dm = \delta W + \delta Q \quad (3.29)$$

où U est l'énergie interne, le travail W et Q la chaleur reçue.

Considérons le cas simple, de l'eau dans un réservoir présentant des déperditions thermique. Si on veut que cette eau garde la même énergie disponible utile, on doit ajouter de l'énergie externe (dans un cas des pertes de chaleur ($\delta Q_{loss} = hS\Delta T$)). Supposons $\delta W = 0$, si on veut que la température T soit constante, on doit ajouter l'énergie (par un convertisseur électrique, par exemple) $Q_{add}^{elec} = -Q_{loss}$ ce qui donne :

$$dU = \delta Q_{add}^{elec} + \delta Q_{loss} = 0 \quad (3.30)$$

On peut donc avoir une augmentation d'émergie sans changement de l'eXergie du produit considéré. Odum, 1996 a énoncé la première règle des calculs d'émergie comme : « toutes les sources d'émergie nécessaires pour un produit sont assignées à ce dernier. » En tant que tel Q_{add} doit être pris dans la valeur d'émergie de l'eau. En d'autres termes, si un produit est sous une dépréciation, pour garder le même travail disponible utile nous avons un « coût » à payer à la Nature, mais

$$dEx = \left(1 - \frac{T_0}{T}\right) C_v dT = 0$$

cf exemple Dincer et Rosen, 2007, pp17-19 pour l'eau dans le réservoir. A cet égard, l'utilisation d'un produit avec une dépréciation (dans le temps) comme peuvent le connaître les produits recyclables nécessite une éMergie additionnelle sans pour autant avoir un changement de valeur eXergétique.

Conséquences

Plusieurs indices ont été développés et ont servi pour des évaluations d'énergie (Brown et Ulgiati, 1997) :

- Recycle Benefit Ratio (RBR)
- Recycle Yield Ratio (RYR)

Néanmoins, ils ne sont pas adaptés puisque le chemin de la matière au cours des différents recyclages n'était pas réellement suivi.

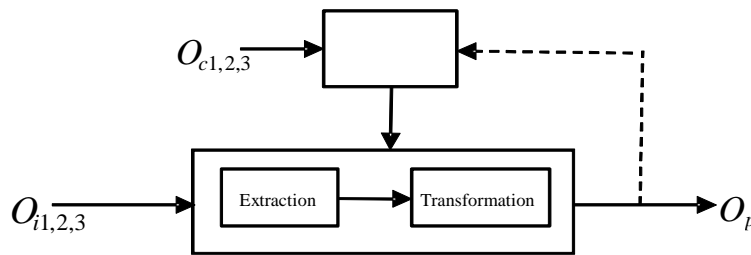

Dénotons O_i l'énergie « initiale », i.e. pour la matière première, et la somme de l'énergie d'extraction et de celle de transformation. Ainsi O_c l'énergie « additionnelle » requise pour le recyclage, c.-à-d. $O_c = O_{reuse}$. Maintenant distinguons la partie de l'économie (1), renouvelable (2) et non renouvelable (3). Avec cette notation, on aurait :

$$O_i = O_{i_1} + O_{i_2} + O_{i_3} \quad (3.31)$$

$$O_c = O_{c_1} + O_{c_2} + O_{c_3} \quad (3.32)$$

Le ratio EYR (emergy Yield ratio) se calcule comme étant le ratio entre l'énergie du produit divisée par l'énergie fossile. Il est donc possible d'étendre cette définition en fonction du nombre de cycle. En notant la part de l'énergie non renouvelable dans un produit (O_{PI}), on retrouve Buranakarn, 1998; Brown et Buranakarn, 2003.

$$(a) \ EYR_i = \frac{(O_{i,2,3} + qO_{c_{1,2,3}})}{O_{i_1} + qO_{c_1}} \quad (3.33)$$

Brown et Ulgiati, 1997 ont proposé un ratio prenant en compte uniquement la part additionnelle lors du recyclage :

$$(b) \ EYR_c = \frac{O_c}{O_{c_1}} \quad (3.34)$$

Sur la base de ces travaux, il est possible de définir ce ratio (en fonction du chemin parcouru, i.e. le nombre de recyclage) sous la forme :

$$(c) \ EYR_g = \frac{(O_{i,2,3} + \psi O_{c_{1,2,3}})}{(O_{i_1} + \psi O_{c_1})} \quad (3.35)$$

En outre, les autres ratio ELR and EIR, NRR (Brown et Ulgiati, 1997) peuvent aussi être étendus.

Energy Investment Ratio (EIR)

$$EIR_g = \frac{(O_{i_1} + \psi O_{c_1})}{(O_{i_3} + \psi O_{c_3}) + (O_{i_2} + \psi O_{c_2})} \quad (3.36)$$

Environmental Loading Ratio (ELR)

$$ELR_g = \frac{(O_{i_1} + \psi O_{c_1}) + (O_{i_3} + \psi O_{c_3})}{(O_{i_2} + \psi O_{c_2})} \quad (3.37)$$

Sur la figure 3.22, les différents ratios EYR (EYR_i , EYR_c , EYR_g) ont été tracés pour du plastique. Les ratios EYR_i ou EYR_c sont indépendants du nombre de recyclage et de la part de recyclage, le ratio EYR_g dépend clairement de ces paramètres. Ce ratio permet donc de faire un choix pour 2 configurations différentes (ce que les précédents ratios ne permettaient pas).

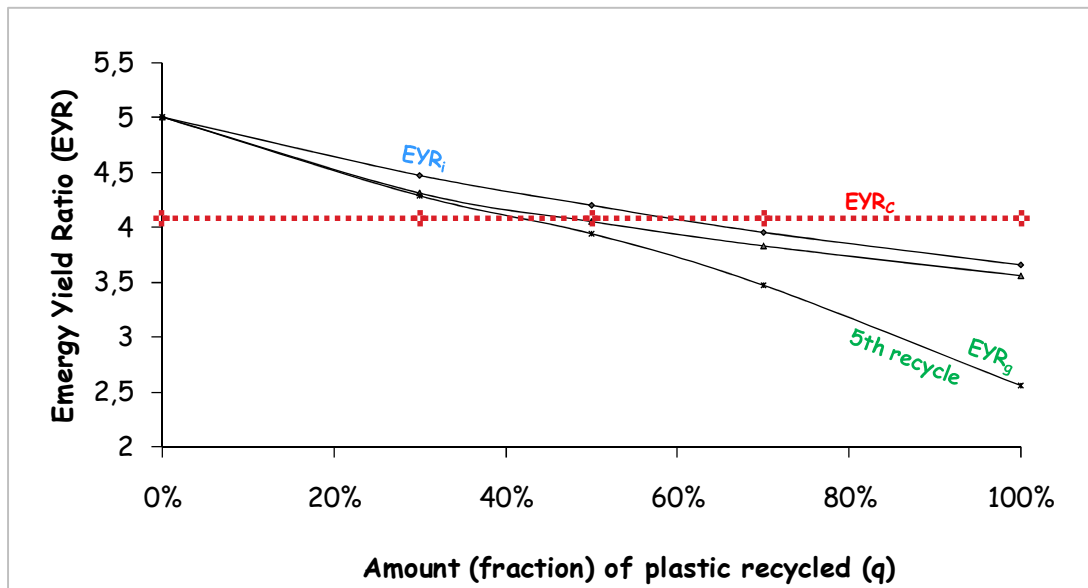

Fig. 3.22. Impact of plastic recycle on EYR

Application à une maison individuelle type « Bâtiment basse consommation »

- Élément de contexte

Les termes « maison basse consommation » ou « maison à énergie positive » sont de plus en plus fréquemment utilisés en l'Europe : la protection de l'environnement et des ressources sont des thèmes d'actualité. Les bâtiments à « énergie réduite » impliquent la réduction d'utilisation de combustible fossile tel que le pétrole, le gaz et le charbon, pour améliorer la partie « développement soutenable », introduite dans le préliminaire.

Il y a beaucoup d'aspects pour rendre un bâtiment efficace d'un point de vue énergétique :

- a. isolation thermique élevée,
- b. limitation des ponts thermiques,
- c. obtention d'une bonne étanchéité à l'air,
- d. installations techniques telles que la ventilation mécanique avec récupération de chaleur.

Même si l'efficacité énergétique est importante, la raison principale des bâtiments est de donner un bon confort intérieur, et un certain nombre d'études ont indiqué une relation significative entre *ventilation santé productivité* dans les bureaux, les écoles et les logements (Andersson et al., 2006; Wargocki et Wyon, 2007). Dans la perspective de confort intérieur, il est également

important d'éviter les problèmes d'humidité dans les constructions. Puisque le concept de maisons à « énergie réduite » ou « passives » n'est pas figé, le niveau des normes et des critères précis varient en Europe. Dans la jungle des définitions et des normes (voir figure 4.1), il est difficile pour les fabricants de construire et de développer des systèmes et/ou des unités de maisons à énergie réduite conformes sur le marché européen.

Diverses études et exemples réels montrent qu'un niveau de haute performance, par exemple une consommation d'énergie primaire en-dessous de 50 kWh.m⁻² par an (incluant chauffage, eau chaude, éclairage et ventilation), peut être accessible par une conception appropriée d'architecture combinée avec une haute isolation et une récupération thermique. Cette dernière technologie est particulièrement impactée par les flux d'air à travers l'enveloppe des bâtiment.

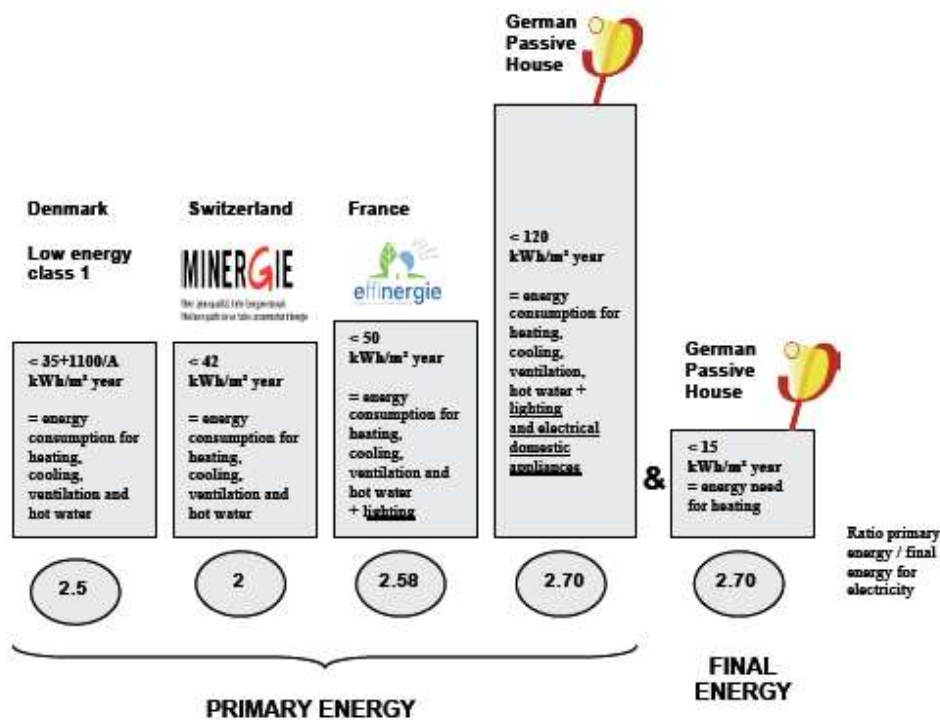

Figure 4.1: Examples of national definitions used for VLEB in DK, Switzerland, France and Germany. (Source: Eriksen et al., 2009)

Le décret ministériel français du 8 mai 2007 définit des exigences normalisées pour la construction des bâtiments Basse Consommation. Ce décret définit cinq niveaux : La maison à énergie réduite HPE, HPE EnR, THPE, THPE EnR², et BBC. Un bâtiment basse consommation (BBC) est un bâtiment qui respecte la loi française qui spécifie que pour les nouvelles constructions résidentielles, l'objectif de la consommation maximale d'énergie primaire est fixé à 50 kWh/m² par an avec une modulation selon des régions et l'altitude.

² HPE: Haute Performance Energétique; THPE: Tres Haute Performance Energétique ;HPE EnR : Haute Performance Energétique Energies Renouvelables

Maison BBC

Cette étude de cas est appliquée à un bâtiment typique correspondant à la norme actuelle de construction en France. Le bâtiment est situé à Theys (Isère) qui est une petite ville située à 30km de Grenoble. La surface habitable considérée est de 155 m². Un usage résidentiel est prévu. La maison est composée d'un sous-sol, d'un rez-de-chaussée et d'un étage. La structure se compose d'une armature de béton armé. Les murs sont faits de parpaings avec un plâtre interne. Le plafond de l'étage est couvert de laines minérales, et le toit de tuiles est recouvert de tuiles d'argile. Les fenêtres sont en double vitrage avec un support en aluminium.



Figure 4.4: View of the Low Energy Building – BBC located in France

Le logiciel PLEIADE/COMFIE, présenté en Annexe C, permet de réaliser des simulations dynamiques du comportement des bâtiments. Il est utilisé pour prédire les performances en vue de l'obtention de label énergétique.

Associé à ce logiciel, une application EQUER permet de réaliser une analyse de cycle de vie.

Connaissant la composition et les quantités nécessaires à la construction, une analyse émergétique (sans recyclage) a été effectuée et est synthétisée dans le tableau 4.4 (ci-après). Les transformités utilisées sont issues de :

- [a] Odum et al., 2000;
- [b] Simoncini, 2006;
- [c] Brown et Buranakarn, 2003;
- [d] Meillaud et al., 2005;
- [e] Odum et al., 1987;
- [f] Odum, 1996;
- [g] Brown et Arding, 1991;
- [h] Bastianoni et al., 2005.

Table 4.4: Energy evaluation of building construction process

1 Note	2 Item	Density (kg/m ³)	Volume (m ³)	3 Raw data	Unit	4 Solar energy/unit (seJ/unit)	5 Ref.	6 Emergy (seJ)
<i>Renewable Inputs</i>								
1	Sun			6,19E+11	J	1,00E+00	a	6,19E+11
2	Eau utilisee	1000	614,52	6,15E+05	kg	4,80E+04	a	2,95E+10
<i>Non Renewable Inputs</i>								
<i>Plancher sous sol bas</i>								
3	Sol du sous sol	1500	5,1	7718	kg	1,81E+12	b	1,40E+16
4	Calcaire tendre n°2	1500	1,0	1544	kg	1,68E+09	f	2,59E+12
5	Béton lourd	2300	0,5	1183	kg	1,81E+12	b	2,14E+15
<i>Plancher sous sol/rez</i>								
6	Hourdis de 16 en béton	1300	0,8	1071	kg	1,81E+12	b	1,94E+15
7	Béton lourd	2300	0,2	474	kg	1,81E+12	b	8,58E+14
8	Polyuréthane effisol	35	0,3	11	kg	8,85E+12	c	9,57E+13
9	Mortier	2000	0,3	618	kg	3,31E+12	c	2,05E+15
10	Carrelage	2300	0,1	118	kg	3,68E+12	c	4,36E+14
<i>Mur béton branché 20 sous sol</i>								
11	Sol du sous sol	1500	5,2	7803	kg	1,81E+12	b	1,41E+16
12	Béton lourd	2300	1,0	2393	kg	1,81E+12	b	4,33E+15
<i>Biomur 37 mur est ouest</i>								
13	Bois léger	500	0,2	110	kg	2,40E+12	f	2,64E+14
14	Fibre de bois bbc	40	0,6	23	kg	2,40E+12	f	5,64E+13
15	Brique biomur 37	741	2,8	2040	kg	3,68E+12	c	7,51E+15
16	Enduit à la chaux	1400	0,1	206	kg	3,29E+12	d	6,76E+14
<i>mur liege</i>								
17	Panneau de liège	120	0,02	2	kg	2,40E+12	f	5,74E+12
18	Plâtre + cellulose	1200	0,02	24	kg	3,29E+12	d	7,87E+13
<i>Biomur37 enduit</i>								
19	Enduit à la chaux	1400	0,1	73	kg	3,29E+12	d	2,41E+14
20	Brique biomur 37	741	1,0	727	kg	3,68E+12	c	2,67E+15
21	Enduit à la chaux	1400	0,1	73	kg	3,29E+12	d	2,41E+14
<i>Parpaing enduit chaux</i>								
22	Enduit à la chaux	1400	0,01	14	kg	3,29E+12	d	4,68E+13
23	Parpaing de 20	1300	0,10	132	kg	1,81E+12	b	2,39E+14
24	Enduit à la chaux	1400	0,01	14	kg	3,29E+12	d	4,68E+13

Table 4.4 (Continued)

1 Note	2 Item	Density (kg/m ³)	Volume (m ³)	3 Raw data	Unit	4 Solar emergy/unit (seJ/unit)	5 Ref.	6 Emergy (seJ)
Mur bois seaux								
25	Brique Porothermn 30	762	0,3	196	kg	3,68E+12	c	7,21E+14
26	Brique pleine de 10.5 cm	1700	0,1	153	kg	3,68E+12	c	5,63E+14
27	Brique pleine de 10.5 cm	1700	0,1	153	kg	3,68E+12	c	5,63E+14
Biomur 37 mur nord rez								
28	Sol du sous sol	1500	1,8	2694	kg	1,81E+12	b	4,88E+15
29	Brique biomur 37	741	0,7	499	kg	3,68E+12	c	1,84E+15
30	Fibre de bois bbc	40	0,1	3	kg	2,40E+12	f	6,90E+12
31	Bois léger	500	0,1	27	kg	2,40E+12	f	6,47E+13
Plancher intermédiaire								
32	Enduit plâtre	1500	0,1	154	kg	3,29E+12	d	5,07E+14
33	Hourdis de 12 en béton	1300	0,6	802	kg	1,81E+12	b	1,45E+15
34	Béton lourd	2300	0,2	473	kg	1,81E+12	b	8,56E+14
35	Polystyrène extrudé	35	0,3	11	kg	8,85E+12	c	9,55E+13
36	Mortier	2000	0,3	514	kg	3,31E+12	c	1,70E+15
37	Carrelage	2300	0,1	118	kg	3,68E+12	c	4,35E+14
Cloison fermacell								
38	Plâtre + cellulose	1200	0,1	74	kg	3,29E+12	d	2,44E+14
39	Fibre de bois bbc	40	0,5	20	kg	2,40E+12	b	4,75E+13
40	Plâtre + cellulose	1200	0,1	74	kg	3,29E+12	d	2,44E+14
Béton								
41	Béton cellulaire 600	600	0,1	73	kg	1,81E+12	b	1,33E+14
Toiture combles								
42	Terre cuite	1900	0,1	153	kg	1,68E+09	b	2,57E+11
43	Lame d'air > 1.3 cm	1	0,0	0,04	kg	6,97E+12	a	2,80E+11
44	Fibre de bois bbc	40	0,5	19	kg	2,40E+12	b	4,63E+13
45	Panneau de particule bois	800	0,1	43	kg	2,40E+12	b	1,03E+14

Table 4.4 (Continued)

1 Note	2 Item	Density (kg/m ³)	Volume (m ³)	3 Raw data	Unit	4 Solar energy/unit (seJ/unit)	5 Ref.	6 Emergy (seJ)
<i>Toiture étage</i>								
46	Terre cuite	1900	0,1	165	kg	1,68E+09	b	2,78E+11
47	Lame d'air > 1.3 cm	1	0,0	0,04	kg	6,97E+12	a	3,03E+11
48	Fibre de bois bbc	40	0,5	21	kg	2,40E+12	b	5,01E+13
49	Bois léger	800	0,1	46	kg	2,40E+12	b	1,11E+14
50	Porte bois intérieure	750	0,06	48	kg	2,40E+12	b	1,15E+14
60	Porte fenetre MINCO double vitrage 4,16,4 argon	2700	0,03	82	kg	2,13E+13	c	1,74E+15
61	Vitrage argon 4,16,4 MINCO	2700	0,02	44	kg	1,41E+12	e	6,18E+13
62	Porte bois extérieur	750	0,06	41	kg	2,40E+12	b	9,91E+13
63	Portail métallc	7874	0,01	48	kg	8,55E+08	a	4,12E+10
64	Système de drainage (PVC)			171	kg	9,86E+12	c	1,69E+15
65	Escalier (bois)			300	kg	2,40E+12	b	7,20E+14
<i>Purchased Inputs</i>								
66	Fuel (Transports)			1,74E+08	J	1,13E+05	h	1,96E+13
<i>Energie consommée (Electricity use on site)</i>								
67	Nuclear (78%)			8,88E+05	J	2,00E+05	g	1,78E+11
68	Hydro (14%)			1,59E+05	J	8,00E+04	a	1,28E+10
69	Gaz (4%)			4,56E+04	J	4,80E+04	a	2,19E+09
70	Charbon (4%)			4,56E+04	J	4,00E+04	a	1,82E+09
Total emergy for building manufacturing								7,11E+16

En reprenant les travaux réalisés au chapitre 3, il est possible de calculer le ratio EYR_g pour des briques (figures 4.16). D'autres matières recyclables ont été analysées et les résultats sont présentés dans l'annexe B.

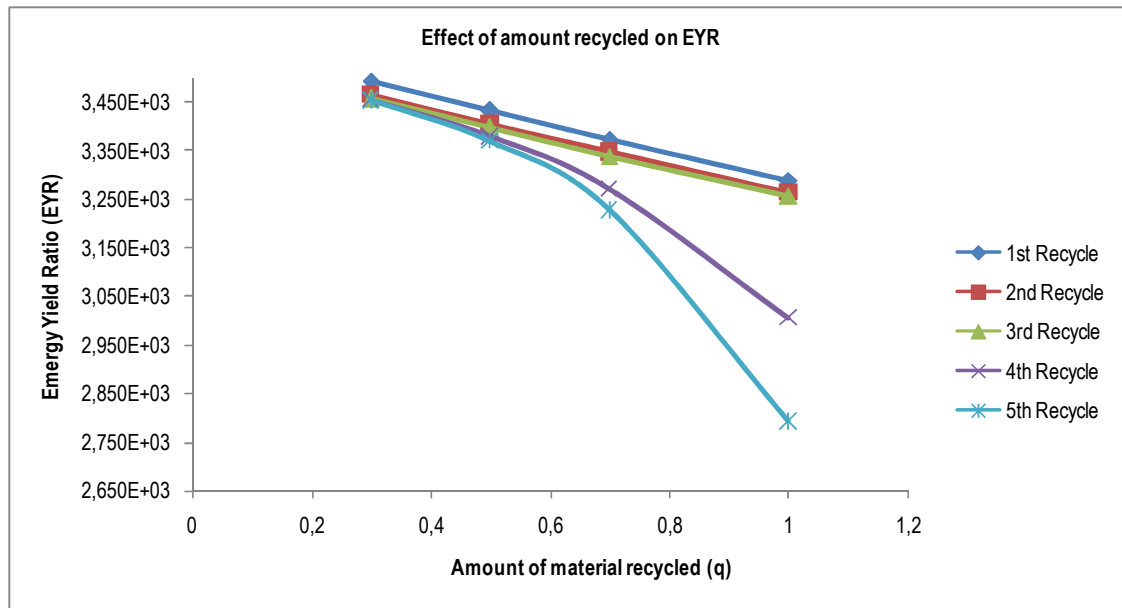

Figure 4.16: Effect of recycled bricks usage on EYR of building

Sur un cas concret, il est donc possible de comparer deux maisons avec comme objectif de minimiser EYR_g par exemple (les calculs sont présentés dans l'annexe D).

8.0 Conclusion et perspectives

Le but de cette thèse est d'améliorer l'application de l'analyse émergétique aux systèmes utilisant des matériaux recyclés. Ce travail présente des similitudes avec Patten, 1995. La compréhension de l'application de l'énergie, lors de recyclage, est une nécessité pressante, en partie parce que peu d'auteurs l'ont sérieusement considérée. Cette thèse réalisée à l'École des Mines, Nantes, a été principalement conduite sur la base des travaux suivants :

1. Ulgiati, S., Raugei M., Bargigli S., 2004. Dotting the I's and Crossing the T's of Emergy Synthesis: Material Flows, Information and Memory Aspects, and Performance Indicators, Proceedings from the Third Biennial Emergy Evaluation Research Conference, Gainesville, Florida.
2. Buranakan, V., 1998. Evaluation of recycling and reuse of building materials using the emergy evaluation method, a Ph.D dissertation, Department of Architecture, University of Florida, Gainesville, FL.

L'émergie d'un produit contenant une part de recyclage sous la forme s'exprime, à temps discret :

$$O_p(t) = q(t)O_c(t) + O_i(t)(1 - q(t)) + q(t)O_p(t-1) \quad (3-26)$$

Dans les hypothèses considérées, il est possible d'exprimer l'équation (3.28) en introduisant un facteur, noté ψ : $O_p^N = O_i + \psi O_c$ avec $\psi = q \frac{(1 - q^N)}{1 - q}$ avec N supérieur ou égal à 1.

Sur la base de ces travaux, il est possible de définir ce ratio (en fonction du chemin parcouru, i.e. le nombre de recyclage) sous la forme :

$$EYR_g = \frac{(O_{i,2,3} + \psi O_{c1,2,3})}{(O_{i_1} + \psi O_{c_1})} \quad (3.35)$$

En outre, les autres ratio ELR and EIR, NRR (Brown et Ulgiati, 1997) peuvent aussi être étendu.

$$\text{Emergy Investment Ratio (EIR)} \quad EIR_g = \frac{(O_{i_1} + \psi O_{c_1})}{(O_{i_3} + \psi O_{c_3}) + (O_{i_2} + \psi O_{c_2})} \quad (3.36)$$

$$\text{Environmental Loading Ratio (ELR)} \quad ELR_g = \frac{(O_{i_1} + \psi O_{c_1}) + (O_{i_3} + \psi O_{c_3})}{(O_{i_2} + \psi O_{c_2})} \quad (3.37)$$

Le lien entre éMergie et eXergie n'est pas « cassé ». Deux produits peuvent avoir le même contenu eXergetique et un contenu éMergétique différent. Par analogie avec l'énoncé de CARNOT, lors d'un recyclage il y a un prix éMergétique à payer. Les nouveaux indicateurs dépendent du nombre de recyclage et de la part recyclé. Ils permettent donc une comparaison entre deux solutions techniques.

INTRODUCTION

"Renewable energy" can be defined as a "source of energy" with sufficient rapid natural replenishment considered as inexhaustible. This kind of energy is as a result of recurring natural phenomena caused by the stars, mainly the sun (radiation), but also the moon (tides) and the Earth (geothermal energy). In addition, the nature of renewable energy does not only depend on the speed at which the source is regenerated and replenished, but also the speed at which it is consumed mainly by human activities.

- timber or wood is considered a renewable source of energy if its consumption is less than or equal to its production (as such, the over exploitation of timber specially induces the destruction of the resource).
- oil or natural gas are not "renewables" as it would take millions of years to replenish the amount of fossil energy consumed today.
- nuclear energy is not a renewable energy since the supply of uranium currently available on the Earth is far limited.

Solar energy, tidal energy, wind energy and geothermal energy are the main sources of renewable energy. In addition, by a more or less complex mechanism, all sources of renewable energy (except tidal energy) are derived from the natural nuclear energy from the sun (by nuclear fusion) or from the Earth (by the natural disintegration of the rocks of the earth's crust).

Clean and renewable energies are often presented as a solution to the problem of global warming. However, the success of this solution would require an efficient strategy to absolutely reduce (not relative) the consumption of fossil fuels. On the other hand, energy saving and recycling are also major issues to be considered.

This thesis proposes to develop energy analysis applied to recycling.

Context

More than half of global energy has been consumed in the last two decades since the industrial revolution, despite advances in efficiency and sustainability (Omer, 2007). As world populations grow, many faster than the average 2%, the need for more and more energy is exacerbated. This is shown in Figure 1. This exerts enormous amount of pressure on local energy demands. France for instance, uses a tremendous amount of energy resources annually for comfort, transportation, and industrial production.

Much of these raw resources (e.g. fossil fuels) can be more efficient in its use if recycling is encouraged. Currently (as of 2008), France is the second highest in Europe in the consumption of primary energy (EIA, 2008) whilst it produces less than half of what it uses. A certain amount of this energy is even still wasted due to a variety of inefficiencies, poor practices and inadequate information to make choices or decisions. Since a greater portion of its primary energy is not from renewable sources, it poses a greater risk to its environment and raises questions of sustainability. As limits to the unrestricted use of energy and resources have been felt in the last two decades, increased attention has been drawn to their wise use: efficiency in the use of resources and increase potential for recycle and reuse of these resources. This has posed important challenges to the scientific community in providing efficient but reliable tools to evaluate these targets (Ness et al., 2006).

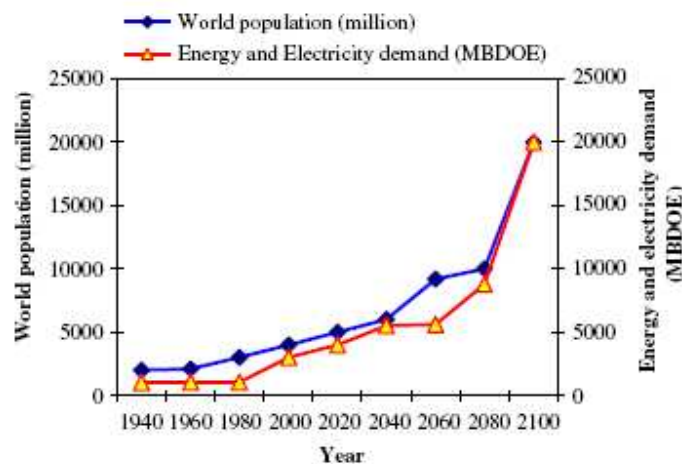

Figure 1: Annual and estimated world population and energy demand (source: Omer, 2007)

Figure 2 clearly demonstrates the increase in energy resource consumption which occurs in each passing year. Many individuals and organizations have voiced out their concerns that unless corrective measures are undertaken, difficulties would be encountered in providing energy for future needs. Energy security, economic growth and environment protection are the national energy policy drivers of any country of the world.

Technological progress has dramatically changed the world in a variety of ways. It has, however, also led to developments, e.g., environmental problems, which threaten man and nature. Build-up of carbon dioxide and other GHGs is leading to global warming with unpredictable but potentially catastrophic consequences.

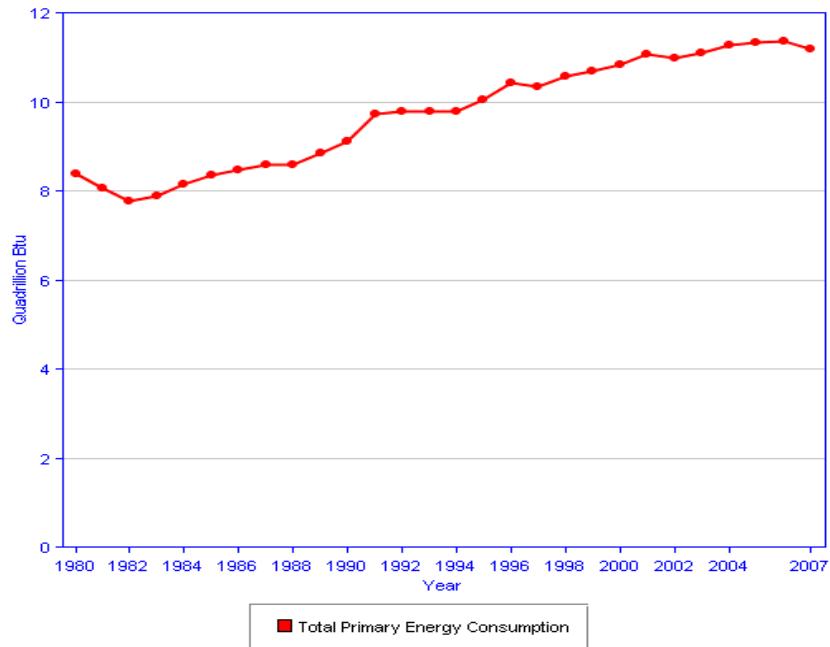

Figure 2: Total Primary energy consumption in France (source: EIA, 2008)

When fossil fuels burn, they emit toxic pollutants that damage the environment and people's health with over 700,000 deaths resulting each year, according to the World Bank review of 2000 (Omer, 2010). At the current rate of usage, taking into consideration population increases and higher consumption of energy by developing countries, oil resources, natural gas and uranium will be depleted within a few decades.

France has taken up this challenge and has been improving its energy consumption for a considerable number of years now. However, there is still more room for improvement. Options for solving the problem of providing sufficient energy resources for future needs are to stretch supplies through better utilization and also to increase its potential for recycling. Both approaches must be used. The first of these options merits serious consideration. A great and largely untapped potential for stretching energy resources exists through improvements in the ways they are utilized. The challenge then is to become more energy efficient and more environmentally conscious with a much greater responsibility of the ecological system upon which the human built systems largely depend on. This leads to the additional option of creating appropriate tools to assist in handling the challenges.

Sustainable Development – The Challenge for France

Sustainable development is a new form of development which integrates the production process with resource preservation and environmental enhancement (Campbell et al., 2006). The world today faces double challenges of resource depletion and population expansion. France, like most other industrialized countries, only developed genuine environmental policies in the last quarter of a century. However, it was one of the first countries to set up a Ministry for the Protection of Nature and the Environment. France's environmental policy between 1970 and 1998 was mainly concerned with establishing regulations and specialized institutions for the recovery and elimination of waste products (1976), air quality (1981) and energy management (1982). Since 1990, these institutions have been brought together in the Environment and Energy Management Agency (ADEME). France's policy also led to the adoption of a National Environment Plan in 1990, which brought about the first sweeping reform of the environmental administration and, more specifically, the creation of 26 Regional Environment Directorates (DIRENs) in 1991. The accent has been on sustainable development since 2002, with the drafting of a national strategy. This led to a proposal for a constitutional charter on the environment, implementation of water, nature, landscape and pollution policies, along with prevention and risk management policies, increases in capacities for environmental assessment and social and economic analysis, as well as international action. The national sustainable development policy is supervised by an Interministerial Committee for Sustainable Development (CIDD), which was set up in 2003 and is chaired by the Prime Minister. It has taken over the tasks of three earlier bodies: the Interministerial Environment Committee, the Interministerial Commission on Greenhouse Effects and the Interministerial Committee on the Prevention of Major Natural Hazards (CIDD press release, 2008).

According to Omer, 2007, a great challenge facing the global community today is to make the industrial economy more like the biosphere, that is, to make it a more curvy-closed system. This would then save energy, reduce waste and pollution, and reduce costs. In short, it would enhance sustainability.

Action

To meet these challenges, appropriate methods or tools of evaluating production systems are necessary to guarantee continuous energy supply and energy security without impairing the environment. The awareness of the international character and the complexity of environmental problems and the needed mitigation efforts has risen. Stakeholders in various situations want more information in this field. This has led to an increased need for tools to promote learning and give decision-support, providing knowledge that give environmental discussions more weight and focus.

Methods of energy evaluation

Several of these environmental systems evaluation tools have become available and accessible over the years. These tools facilitate the assessment of environmental impacts and/or natural resource use caused by the system studied through some sort of analysis. The system studied may be a product, a service, an economy or a project. Many of these tools are under continuous development and still more or less unstandardized, sometimes making it difficult to keep up with

the latest methodology. Tools such as exergy accounting, energy analysis, life cycle assessment and energy (spelled with an 'M') analysis, have been developed in the last thirty years to assess the sustainability of the production process. These tools are grounded in systems analysis principles as an approach to understanding how elements in the system interact. For example, in recent years, Life Cycle Assessment (LCA) has emerged as an important tool for environmental impact assessment. LCA focuses primarily on the environmental impact of emissions and non-renewable energy inputs. In other words, it considers the impact of all processes in the respective system in a product's life cycle, from extraction of the natural resource to the use and disposal of the product. However, although LCA has a very complete impact assessment technique, it ignores ecosystem services and products, and the final result of its analysis depends on subjective evaluation (Ulgiati et al., 2005). As such, it does not account for other factors such as ecological inputs and economic aspects (Liu et al., 2008) and study results are often difficult to compare (Fava et al., 1991).

An ideal method or tool for this purpose should consider ecological inputs and impact of emissions as well as all existing aspects of business as usual and, moreover, should allow comparison between ecological and economic variables (Hau, 2002). Ecological inputs should also be taken into account since ignoring them may significantly underestimate the real cost of an item.

Scope of this study

As an important part of social production, industrial production is of significant concern due to its great contribution to economy, its use of resources and the load this resource use places on the biosphere. Sustainable development of industrial systems requires optimum use of available resources for maximum power output. Clearly, it is necessary that insight be gained concerning the interplay of industry and environment to help improve industrial comprehensive performance. Traditional energy synthesis approach, as a system method (Odum, 1996) is often used in natural ecological systems and economical systems than in industrial systems. For example, it seldom considers the impact of wastes as there is almost no waste in general in a natural ecological system. This is because the waste of one life-form is usually the food of another life-form which eradicates pollution since all waste is assimilated and evolved by the environment. However, this is not the case in industrial systems. Yang et al., 2003 introduced an improved emergy analysis method that can effectively consider waste impact in industrial systems. This thesis focuses on the application of the emergy evaluation method to industrial recycling.

The continuous developments of tools to consider all global inputs led to emergy. Emergy is defined as the sum of the available energy of one kind previously required directly and indirectly through input pathways to make a product or service (Odum, 2000). The theoretical and conceptual basis for the emergy methodology is grounded in thermodynamics and general system theory. A comprehensive overview is presented in chapter 2 of this thesis. Evolution of the theory during the past 30 years was documented by Odum in *Environmental Accounting* (1996) and in the volume edited by Hall titled *Maximum Power* (Odum, 1995).

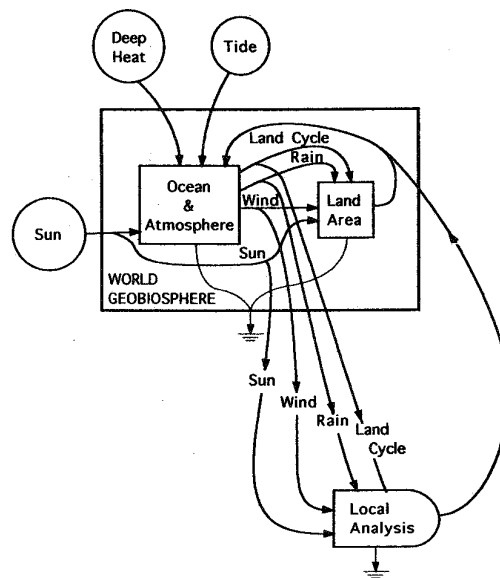

Figure 2: Energy flows from the biosphere support the functioning of local systems (Lagerberg, 1999)

As shown in figure 2, energy flows from the biosphere support the function of local systems. Emergy overcomes the obstacles of energy quality in the traditional energy analysis method and unifies different kinds of energy into the same unit. As such, in practice, the use of emergy as a quantitative measure, allows comparison across disparate materials, energies and processes that are not usually directly comparable (Brown and Ulgiati, 2004). As such, its use is wider and covers all sectors of an economy. This method assesses industrial systems based on the fundamental factors involving:

- Technology: how the systems turns resources into products (efficiency)
- Territory: how the investigated system interacts with the local environment
- Economy: putting values (price, labor) on resources and products
- Global environment: issues of sustainability.

By evaluating complex systems using emergy methods, the major inputs from the human economy and those coming from the environment which are often not considered in other traditional environmental system analysis tools can be integrated to analyze questions of public policy and environmental management holistically.

Objective of this work

In recent times, there has been a strong call to increase efficiency in the use of resources and increase potential for recycle and reuse of resources at all the different levels of society. Several methods have been employed to evaluate recycle and reuse benefits for different materials and processes. Most of the previous studies have focused on the application of LCA with quite a few on energy evaluations. Some authors (Pizzigallo et al., 2008; Hau, 2002; Liu et al., 2008) have also considered a combination of both methods, which presents a rather complex procedure due to the methodological differences between energy and LCA. Gradually, energy is gaining grounds as a competitive tool for environmental system evaluations. However, it is still in its infancy (especially in France) with many issues unresolved.

This work focuses on one major issue, that is, an effective way of accounting for recycle pathways in systems within the energy framework. It adapts the energy method of analysis to industrial recycling practices as a measure of testing the consistency of the rules of energy evaluation. It proposes additional parameters for consideration in recycling systems under energy evaluation and seeks to further extend the energy evaluation indices to give a clearer picture of the 'real' benefits in recycling. An application is conducted with different case studies. For example, a case study is presented of a building in which the effects of material recycle and reuse is evaluated.

Structure of the thesis

The thesis is organized in 5 different chapters.

- A comprehensive description and review of the various environmental systems analysis tools is presented in chapter 1. Methods such as LCA, Exergy Analysis, and Embodied Energy Analysis are described. A comparison is drawn amongst the major tools, where differences and similarities are clearly spelt out; a discussion on the conceptual theory with its relation with fundamental thermodynamics is discussed.
- In chapter 2, the energy theory is comprehensively revisited. Energy accounting is here proposed as the assessment methodology for effective assessments and evaluations. The application background to industrial systems is also discussed. The main areas considered, include: Problems linked to the application of energy to the evaluation of technological industrial processes.
- In chapter 3, the effect of different time scales due to feedback flows on the energy evaluation procedure is considered. A theoretical basis is established and a set of new modified indices are proposed. This is looked at more closely to industrial recycling, where a proposed correction factor to aid in such calculations is presented. A set of equations are presented to aid in such calculations.
- In Chapter 4, the proposed models and concepts are applied to evaluate a typical case study: applied to evaluate some building and construction materials recycle in buildings

- Chapter 5 concludes with a discussion of a comparison of the results to other assessment tools like LCA, points out aspects that might be improved in the future, possible integration with other methods and a general perspective for further research.

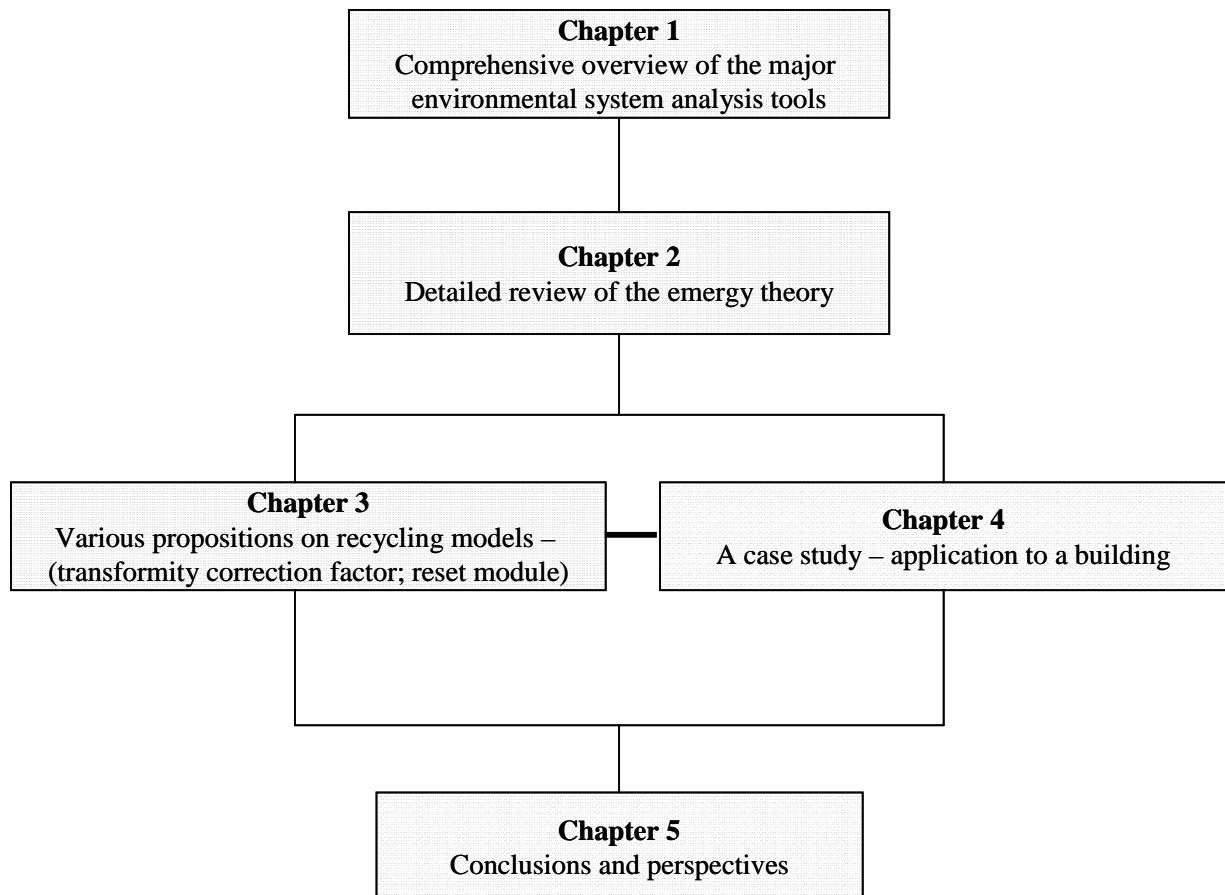

CHAPTER 1: Overview of environmental systems analysis tools

This chapter presents a comprehensive overview of some of the major environmental systems analysis tools. These include: Exergy Analysis (ExA), Life Cycle Analysis (LCA), Ecological Footprint (EF), Energy Analysis (EA) and Emergy Analysis (EMA). These tools have not been selected and reviewed based on its order of importance, but based on the author's view of the most commonly used ones. The relevance of this chapter is to demonstrate the need for a continuous development of the methods, including the extensions, additions, corrections and reformulations of these methods over the past years.

1.1 Environmental Systems Analysis

As mentioned in the introduction, the introduction of the term 'sustainability'³ set the agenda for research into evaluating and quantifying it. From that time, researchers began continuous attempts to develop and induce assessment methods to achieve this aim. Many were then able to not only evaluate systems on economic basis but also from its social and environmental visual angle. This became a very important step especially for companies, governments and even individuals.

The increasing importance of considering environmental aspects within a company's decisions demands a broader scope in management accounting. Eco-management accounting should enable management to integrate environmental issues into the decision-making process (Orbach and Liedtke, 1998). Estimating and accounting for the costs of environmental impacts is a rapidly evolving area of management, accounting, and finance. However, much greater input from ecological and environmental scientists and considerable research are both needed to improve the quality of these cost estimates. Although in its infancy, environmental accounting is increasingly recognized as essential. As more resources are devoted to this aspect of accounting, it definitely becomes a more powerful and effective tool to improve policy development, management, and consumer decision making. The Internet has made the search for needed information on health, social, and environmental costs much easier; and NGOs, businesses, trade groups, and various agencies and departments are using these new resources for better environmental accounting. Although there is still much to be done in accounting for true costs, even today reports can be prepared and costs can be estimated. This improved environmental accounting enables an

³ Several definitions of sustainable development have been put forth, including the following common one: development that meets the needs of the present without compromising the ability of future generations to meet their own needs (Bruntland, 1987).

organization and its stakeholders to more comprehensively evaluate the organization's performance using both economic and environmental measures and to make improvements that reduce risks and wastes, eliminate unwanted costs, and provide new opportunities for adding value. Environmental accounting can more accurately identify true costs by clarifying the environmental impacts caused by material acquisition and processing, manufacturing, sales, distribution, use, maintenance, and disposal. It can help companies and organizations to develop innovative solutions to change resource use and eliminate resource constraints, meet regulatory requirements, and avoid ecological crises. It can also provide consumers with the additional information they need to make more informed purchasing choices. While a growing number of 'tools'⁴ are now available to facilitate environmental accounting, much remains to be done to make them more useful, inclusive, effective, accurate, and user friendly.

Systems are by definition a group of parts which are connected and work together. The placement of a system's boundary is related to its complexity. The greater the scale of analysis, the more complex becomes the system. These system analyses break apart its constituents in order to understand the overall behavior. Several methodologies are used to evaluate the material and energy requirements of these systems. Among such tools are exergy analysis, embodied energy analysis, life cycle analysis and emergy analysis. These tools are commonly applied with the purpose of evaluating environmental impacts, systems efficiency, or resources management in different fields of production. Moberg, 1999 studied different environmental system analysis tools. The choice of a particular tool to be employed in a specific case depends on lots of factors. These factors could be determined based on an analysis of factors. These factors may include, knowing the overall purpose of the evaluation, what the results is intended to be used for etc. The overall purpose describes the main reason for the development of the tool. This can be described as communication or decision-support. The aim of the former is to provide others with information, while the latter advises the user in operative or strategic decision situations (Baumann and Cowell, 1998). In some cases the purpose may also be more of learning nature, not directly supporting decisions. Another factor to be considered is the extent of the system boundaries. Regarding the temporal boundaries, a method can either look at a snapshot in time, or several snapshots leading to a series conveying progress/change. Some tools look at a lifetime of a product or process or rather the lifetime of their impacts. Spatial boundaries can be the boundaries of a country or town; it can also be boundaries surrounding a section in a production chain and the boundary between nature and the human system.

There are other tools (e.g. Strategic Environmental Assessment, SEA and Environmental Impact Assessment, EIA) which are categorized as procedural tools (Wrisberg et al., 2002). These tools focus on procedures to guide the process, in contrast to analytical tools, which model systems quantitatively or qualitatively. However, procedural tools can include a number of different analytical tools such as Substance Flow Analysis (SFA), Material Flow Analysis (MFA), Input-Output Analysis (IOA), and Life Cycle Analysis amongst others.

⁴ Udo de Haes et al., 2000 stated that the term tool should be kept apart from the term concept, which relates to general principles, such as Industrial Ecology, and Baumann and Cowell, 1999 reserved the term concept, used for environmental management, for an idea to achieve sustainability. The latter authors also defined tools as "an approach that typically consists of a systematic step-by-step procedure and a mathematical model" (Baumann and Cowell, 1999, p. 111). Furthermore, Udo de Haes et al., 2000 divided tools into analytical tools and procedural tools. The analytical tools were described as principally consisting of mathematical models and correspond to the term tool as defined by Baumann and Cowell, 1999.

It is important to consider the various strengths and weaknesses of each tool. Each of the methods has its own proponents and such people always would want to persuade the other that their method is the best one on system sustainability analysis. Below is a summary of some of these tools not presented in detail in this study.

SEA (Strategic Environmental Assessment) is a comprehensive process of evaluating environmental impacts of policies, plans and programs (Roth and Eklund, 2002). Although SEA has traditionally often been portrayed as the provision of an impact report, in later years it has become increasingly considered to be a decision-support process that should run in parallel with the decision-making process and influence it in a strategic way so that SEA becomes a part of decision-making rather than just a tool to assess effects of decisions (Hojer et al., 2008). One significant setback of SEA is that although SEAs are, in theory, future-oriented, the analysis is in practice often static and does not account for changes in the evolving world within which the strategic decision alternatives will be implemented.

EIA (Environmental Impact Assessment) is a process by which information on environmental impacts of a specific project is collected (Therivel et al., 2005).

SFA (Substance Flow Analysis) is used to model the material stocks and flows of a substance. This procedure connects the human generated substances in the technosphere to its occurrence in the environment (Roth and Eklund, 2002).

Material Flow Accounting (MFA) is based on the calculation of input-output mass ratios and calculation of the mass of the by-products released per unit of main product. A careful accounting of mass flows provides a good description of the process, which can be further used for all environmental, energy and economic evaluations (Ulgiati et al., 2003).

The difference between SFA and MFA is mostly specified by the difference between the definition of a substance and material. A substance is defined as a single type of matter consisting of uniform units such as atoms or molecules. A material however, represents both goods and substances, and is used when one either does not want to specify the levels of analysis, or include both substances and goods in the analysis (Brunner and Rechberger, 2004).

Input-Output Analysis (IOA) is the method that describes the flow of goods and services from different sectors of the economy. The environmental IOA uses emission factors in order to calculate total emissions from the production (Engstrom et al., 2007).

However, some tools are recently in greater usage than others. The next section introduces in detail these various tools and looks at the advantages and disadvantages of its use.

1.2 Environmental System Assessment tools

Just the thought of building a system would require an evaluation tool to help one choose the best path or method. Even after systems have been created and implemented, it is still necessary to evaluate their performance and consider how improvements could be made, especially in answer to the increasing challenges promoted by regulation. Models that can help decision makers toward such goals are systems assessment tools. A simple introduction and comparison on five of these methods are presented in the next section. It begins with Exergy Analysis (ExA), Life

Cycle Analysis (LCA) which is obviously the most common and widely used method, Ecological Footprint (EF), Energy Analysis and Exergy Analysis.

1.2.1 Exergy Analysis

Exergy analysis is based upon the second law of thermodynamics, which stipulates that all macroscopic processes are irreversible. The exergy analysis method is a technique based on the concept of exergy, which is loosely defined as a universal measure of the work potential or quality of different forms of energy in relation to a given environment. It has been widely used to identify and eliminate thermodynamic imperfections of thermal processes (Szargut et al., 1988). It has also been used in Ecosystem Theory and Ecological modeling, to determine levels of organization of self-organized systems (Jorgensen, 1995). An exergy balance applied to a process or a whole plant reveals how much of the usable work potential, or exergy, supplied as the input to the system under consideration has been consumed (irretrievably lost) by the process (Kotas, 1985).

Exergy analysis is typically applied at the scale of the process or equipment, and does not account for the exergy consumed in earlier processes. Exergy analysis indicates how far a system deviates from its theoretical potential to do work. The method is useful to locate and quantify losses of energy quality in processes. This helps to optimize the use of resources with respect to their quality, in order to use energy more efficiently in a process or in the society as a whole. To estimate the total exergy input that is used in a production process it is necessary to take all the different inflows of exergy to the process into account. It is this type of budgeting which is often termed as exergy analysis.

Wall, 2010 identifies three different methods used to perform an Exergy Analysis: a process analysis, a statistical analysis or an input-output analysis. Process analysis which is focused on in this thesis, see Fig. (1.2) focuses on a particular process or sequence of processes for making a specific final commodity. It evaluates the total exergy use by summing the contributions from all the individual inputs, in a more or less detailed description of the production chain. It excludes services and support facilities, such as machinery, since they are not part of the material and energy inputs to the production process. Several cases with numerical examples are given in literature (Szargut et al., 1988; Ahern, 1990; Azzarone and Sciubba, 1995; Bejan et al., 1996; Sciubba and Ulgiati, 2005). According to Sciubba et al., 2003 the basic procedure in a typical exergy analysis involves:

- 1) Defining the control volume to which the analysis is to be applied. This volume must include the immediate surroundings of the system.
- 2) Drawing a detailed flow chart of the system under consideration, paying particular attention to the proper level of aggregation at which the representation is made. Sciubba et al., 2003 add that an excessive disaggregation (i.e. too much detail) requires more extensive calculations and demands for very detailed data, often not available in practice. However, a rather low disaggregation would possibly lead to formulation of assumptions that may detract from the reliability of the analysis.
- 3) Constructing a data (or use an existing one) of the components chosen to represent individual processes. For each process, identify incoming and out flowing fluxes of mass

- and energy, separating where possible ‘necessary’ from ‘accessory’ inputs and ‘useful products’ from ‘secondary’ and ‘by-products’.
- 4) Identifying the thermodynamic state of all fluxes, and quantifies their relevant properties (temperature, pressure, enthalpy, entropy, composition and concentration, chemical potentials, etc.)
 - 5) Performing an exergy balance of each component to compute the exergy destruction and extend to the system level.
 - 6) Computing the relevant efficiencies and exergetic costs.

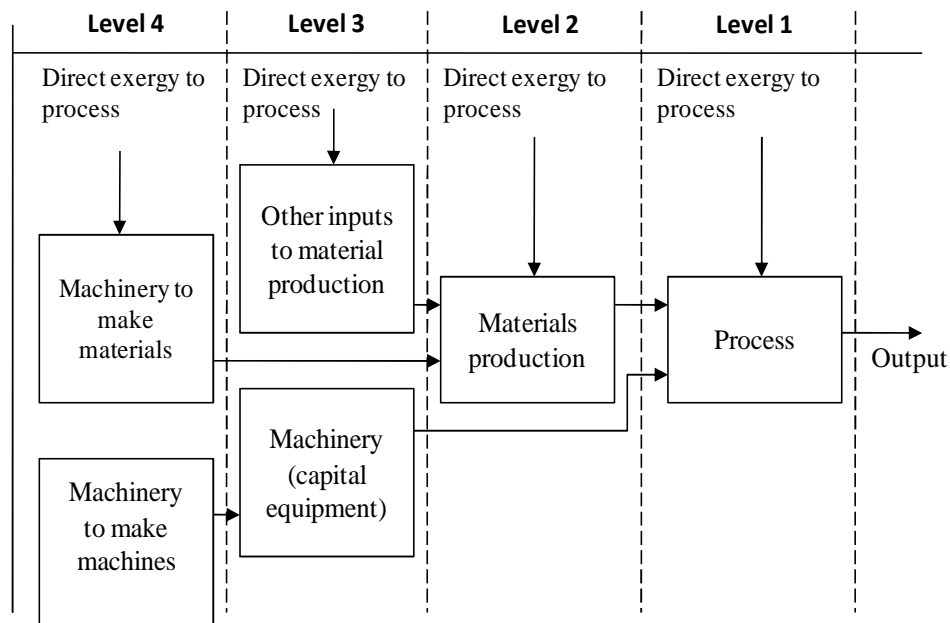

Figure 1.1: Levels of an exergy process analysis (Wall, 2010)

An exergy analysis offers useful insights for the correct assessment of the process itself. It identifies and quantifies the sources of irreversibility, and allows for an immediate comparison of different process structures. Furthermore, it provides a clear indication of the resource-to-end-use matching, thus allowing for a more proper resource allocation.

Its inability to account for externalities though limits its usefulness for a broader picture (Sciubba and Ulgiati, 2005). Exergy analysis has been used extensively for identifying inefficiencies and opportunities for saving energy in industrial systems. Exergy is a very useful concept and provides information only about the current state of the system and its future ability to do work.

However, it does not provide any information about the thermodynamic history or life cycle of the product or service, which is especially relevant in environmentally conscious decision-making.

Various extensions of exergy analysis such as Industrial Cumulative Exergy Consumption (ICEC) analysis (Szargut et al., 1988) and Exergetic LCA (Cornelissen and Hirs, 1997) have been developed in the past to analyze industrial systems. ICEC analysis considers cumulative

exergy consumption in the industrial links of a production chain, and has a strong basis in engineering thermodynamics. Similarly Extended Exergy Accounting (EEA) proposed by Sciubba determines cumulative exergy consumption associated with not only raw material inputs but also labor and capital inputs and non-energetic externalities (Sciubba, 2001). However, all the aforementioned exergy based methods ignore the contribution of ecosystems, and the impact of emissions.

In conclusion, exergy analysis is performed in the field of industrial ecology to use energy more efficiently. The great advantage of Exergy calculations over energy calculations is that Exergy calculation pinpoints exactly where the real losses appear in processes, which is the most useful point in order to make the necessary changes in the process to improve its sustainability by reducing the Exergy consumption.

1.2.2 Life Cycle Analysis (LCA)

Following the energy crisis of the 1970s methods for analyzing energy requirements in production processes were developed. LCA was developed in parallel and influenced by these energy focused approaches. LCA is an ISO-standardized methodology for inventorying the material and energy inputs and emissions associated with each stage of a product or service life cycle and translating this inventory data in terms of resource dependencies (Guinee et al., 2001; Baumann and Tillman, 2005).

The tool has become very popular in the last decade to analyze environmental problems associated with the production, use and disposal or recycling of products or product systems. The technique is being standardized and adopted by many corporations to obtain more holistic and complete information about the impact of their products and processes on the environment. Every product is assumed to be divided into three main 'life processes' (or from 'cradle to grave') which includes: Production, Use and Disposal or recycling (see Fig. 1.2) i.e. from raw material acquisition to eventual product and waste disposal.



Figure 1.2: The life cycle 'from cradle to grave'

This analysis tool (LCA) has many uses, such as providing a means to systematically compare inputs and outputs of two products or processes; to assist in guiding the development of new products; to provide information to decision makers in industry, government, and non-governmental organizations amongst several others. It is based on the concept that, all stages of the life of a material generate environmental impacts: raw materials extraction, processing, intermediate materials manufacture, product manufacture, installation, operation and maintenance, removal, recycling, reuse, or disposal. For every 'life process' the total inflow and outflow of energy and material is computed making it very similar to exergy analysis. LCAs consist of three main stages: inventory analysis; impact assessment, and improvement analysis. The inventory analysis involves defining the LCA's purpose, boundary conditions, and assumptions and data collection. The impact analysis stage of an LCA takes these data and

systematically quantifies the resulting environmental impacts. Thus, the LCA methodology yields numerical results that allow for direct, analytical comparison between the resulting impacts of the systems under study. Finally, the improvement analysis stage of the life cycle assessment is using the results⁵ of the study to determine ways in which the process or product under investigation can be improved. Table 1.1 presents the methodology for its use.

Phase	Step	Description
Goal Definition and Scoping	Goal definition	To define goals of the analysis
	Scoping	To set up the system boundaries and functional unit
Inventory Analysis	Recording	To collect information and data, refine the system boundaries, and validate the data
	Allocation	To allocate inputs and by-products to main product and co-products
Impact Assessment	Classification	To assign the inventory input and output data to potential environmental impacts
	Characterization	To combine different stressor-impact relationships into a common framework
	Valuation	To assign weighting factors to the different impact categories
Improvement	Interpretation	To identify the ecological weaknesses and potential improvements
	Prevention Activities	To analyze the improved situation

Table 1.1: General Methodology of LCA

- *Goal definition and Scoping*

Scoping or defining the scope of the LCA consists of setting the limits of the assessment. In this step, which processes is included in the study is decided. It is important to choose a feasible and realistic system. The larger the system is the more complex and expensive it becomes. Complexity and costs arise mainly from collecting data. More information requires more time and money and not necessarily is available. On the other side, excluding processes drives to oversimplified systems and underestimated results. The guidelines suggest excluding processes where no data is available or whose contribution to emissions to the environment is negligible when compared to others. Very often, transportation of inputs is ignored in the LCA study. Defining a functional unit is another objective of the scoping step. This functional unit should be

⁵ It is worth to note that depending on the functional units (or reference units) chosen for the LCA the results of the study can change a lot. Thus the specifics of each variable should be considered with regards to the purpose of the study performed.

measurable and clearly defined. All inputs and outputs are referred to this unit. In this way, there is a reference level for comparison of many products.

- *Inventory Analysis*

This consists of collecting all data and information of each process included in the LCA study, refining the system boundaries, and validating the data. This step often requires the most effort since a lot of considerations have to be kept in mind. The data can be site specific for a company or an area, or can be more general. It also can be qualitative or quantitative. The kind of data chosen depends on the goal of the LCA study. For example:

- When the purpose is comparing two specific systems, like two companies that produce tires for cars, quantitative and site specific data from the companies is necessary.
- When the purpose is comparison of two general activities, like growing corn and sugarcane in any place of the world, quantitative but not site specific data is necessary. In this case, the sources of the data could come from public databases or even different countries. Obtaining quantitative data is very often limited by its availability. However, some LCA goals might not need quantitative data.

The performance of the LCA strongly depends on the recording step, which is a part of the inventory stage. Data that is obsolete or comes from very different places might not give reliable results. Consequently, compatibility of the data is very important. Refining the system boundaries is also part of this step. Once the data is obtained, some unit processes included in the system might turn to be irrelevant and others that are excluded may be indispensable. A common reason for excluding a process is that its data is unavailable. Sensitivity analyses are repeatedly done to determine whether it is critical or not to include or exclude a unit. A similar scenario applies for inclusion and exclusion of material flows in the system. The validation of data has to be carried on before proceeding to the next step. Mass and energy balances must agree with the final datasheet. Disagreement is very common after collecting data from different sources.

- *Allocation:* Most processes are multi-input and multi-output. In the case of more than an output analyzed, the main product refers to the specie or output of interest. Outputs different from the main product with a positive market value are called co-products. The outputs with negative or neutral market value are called by-products. Pollutants emitted to the environment and wastes are then by-products. When there are co-products in a unit process, then inputs and byproducts need to be allocated, meaning that a fraction of them has to be assigned to the main product and co-products through some rules. As pointed out by Maillefer et al., 1996, “to perform allocation in the right way is one of the biggest difficulties of life cycle inventories.”
- *Impact Assessment:* This involves assigning the inventory input and output data to potential environmental impacts. This step requires considerable scientific knowledge for linking the output data to its impact. Since an output can contribute to more than one impact category, special care has to be taken to avoid double.
- *Characterization:* Characterization is the process of combining the effect of different substances on the same category of environmental impact. For example, what the environmental impact of methane is in equivalents of carbon dioxide.

- *Valuation*: Valuation is the process of assigning weighting factors to the different impact categories based on their perceived relative importance as set by social consensus. For example, an assessor or some international organization might choose to regard ozone depletion impact to be twice as important as the impact of loss of visibility, and apply weighting factors to the normalized impacts accordingly.
- *Improvement*: Interpretation and prevention activities systematically identify, qualify, check, and evaluate information from the results of the inventory analysis and impact assessment. It is the phase that often receives less attention. In this phase, extensive sensitivity and uncertainty analyses should be carried on.

▪ **Major Issues and Shortcomings of LCA**

Shortcomings of LCA have been motivation of many discussions and publications. Burgess and Brennan, 2001 offer a concise and complete review of these problems. Many of these shortcomings are not associated only with LCA, but to any approach that expands the scope of the unit under study to include other relevant units or activities. Many of the problems that now face LCA are characteristic of this concept of a whole. It is important to identify them for two main reasons.

The first reason is that the solution to some of these problems may be found in other approaches.

The second reason is that some problems, like for example development of database, can be solved in collaboration with the other approaches. In any case, even if avoiding the use of LCA, these problems still come up in any other approach. Setting the boundaries of the system can be a problem. Ideally, all units involved directly or indirectly in the production chain should be included. However, including more units in the system involves collecting more data, spending more money and increasing the complexity of the system. Besides, often some units play a less important role than others and therefore they might be excluded without affecting the results.

Allocation has been one of the most discussed difficulties in LCA. Allocation is a consequence of breaking down a network in subsystems. Deciding allocation becomes critical when two systems with strong interaction are studied. Then, the rules of allocation chosen for the LCA of one subsystem can strongly affect the results of the other. Physical parameters have generally been discredited for not being able to represent the economic reality. According to Stromberg et al., 1997 and Huppel and Schneider, 1994, economic value of products should be used as a basis for allocation because they justify the existence of the industrial activity. In Lee et al., 1995 the major difficulty in assigning monetary values to environmental costs is that it is difficult to place causality on environmental effects. In general, there is no agreement on which allocation method to use. Guinee et al., 1993 have proposed to apply sensitivity analyses to all significant allocation methods in future case studies.

Another difficulty is obtaining quantitative data which is very often limited by its availability. The performance of the LCA strongly depends on the quality of the data. Data that is too old, too sparse, too averaged may not be trustworthy. The costs of collecting data can increase at a level where it is not feasible to run a LCA. It is sometimes possible to reduce these costs by using general publicly available databases. To get some good quality data requires working in collaboration with the suppliers, distributors, etc. Other situation is that the data obtained does

not include some emissions or streams that are considered unimportant. Therefore, collecting such data often leads to inconsistencies like disappearance or creation of mass and energy. In such cases, LCA has no utility if physical data is wrong with respect to critical pollutants. Ayres, 1995 argues that most of the recent literature focuses on developing or finding an acceptable way to model environmental impact, i.e. to select, evaluate and compare different categories. Seldom one alternative is clearly preferable than others; they just vary from one category to another. Heiskanen, 2000 points out that LCA's results may confuse rather than enlighten the managers and therefore could make decision-making harder.

Moreover, LCA focuses mostly on the emissions from industrial processes and their impact and on consumption of nonrenewable resources. It does not account for the contribution of ecosystems to industrial activity.

- **LCA as a decision making tool**

Schaltegger, 1997 argues that from an economic point of view, today's LCA provides a small potential benefit given the high probability of potentially wrong decisions (because they are based on background inventory, unrepresentative, low quality and aggregated data) and high costs. Moreover, Heiskanen, 2000 questions whether LCA's results may be used to alleviate the pressure by spreading the impact to share it with the broader system, instead of creating a sense of responsibility. Other point of criticism in LCA is that the methodology makes the user think that it could influence environmental aspects outside their own organization, when in reality, the range of influence or decision-making potential is limited to the physical constraints of its organization. In general, the use of LCA as a decision-making tool is questionable given the facts that it can rarely point to the best technological choice and does not consider economic aspects. Moreover, LCA does not offer a compatible way to assist traditional cost-benefit analysis for decision-making. Huppel et al., 1996, argues that the "main option for expanding the domain of LCA seems to be in the combined analysis of environmental effects and costs".

1.2.3 Ecological Footprint Analysis

The most widely used indicator of carrying capacity in recent times is the Ecological Footprint (EF) analysis methods developed by Rees and Wackernagel, 1994. EF analysis is an accounting tool that estimates the resource consumption and waste assimilation requirements of a defined human population or economy in terms of a corresponding productive land area (Wackernagel and Rees, 1996). An Ecological Footprint is calculated by inventorying the material and energy flows required to support a given population or activity and re-expressing these flows as area of productive land required to furnish the requisite resources and absorb a subset of the resultant wastes (Wackernagel and Rees, 1996). The indicator therefore provides a measure of resource dependency expressed in a common currency, which can be used to compare performance between systems both spatially and temporally (Wackernagel et al., 2004). Complete ecological footprint analysis would include both the direct land requirements and indirect effects of all forms of material and energy consumption. It allows a cumulative approach to impact analysis. Ecological footprint method calculates the land-use implications of consumption-related resource flows and waste sinks required to support a system or a population, that is translating consumption into land areas, and simply, consumption is separated into five major categories: food, housing, transportation, consumer goods and services. Basically, comparison and analysis on systems could base on the calculation result of Ecological Deficit.

1.2.4 Energy Analysis

Energy analysis⁶ according to Brown and Herendeen, 1996 is the process of determining the energy required directly and indirectly to allow a system to produce a specified good or service. The basic motivation for energy analysis is to quantify the connection between human activities and the demand for this important resource. In energy analysis the requirements of energy for production of goods or services is estimated. Generally the aim is to investigate the potential to reduce energy costs or to compare energy use in different processes giving the same product. This includes energy inputs transformed at all stages of the production process. The system perspective is described hierarchically with respect to energy requirements. Direct energy from fuels used in the processes is traced backwards to the primary energy sources so that energy used for the extraction and refining of the fuels is accounted for. The system boundaries depend on the aim of the study. One problem in energy analysis is that different forms of energy have different usability. Whether sunlight and labor should be accounted for in an energy analysis or not is a disputed question, generally it is not accounted for. Energy analysis can include renewable energy sources. However, attentive bookkeeping is required to keep them separate from non-renewable sources. While energy analysis is based on the notion that energy is more important than most people think, it typically is not used to support an energy theory of value. The more moderate view is that energy analysis is one information input, like economics, to the process of making a decision (Herendeen, 1988). The framework of input output analysis is used for mathematically sound analysis of energy flow in ecological and economic systems (Hannon, 2001). The concept has also been used to study energy efficiencies in a broad range of economic activities (e.g. see Crawford et al., 2006, Giampietro et al., 1993, Kok et al., 2006).

1.2.5 Emergy Analysis⁷

Based on the principles of energetics (Lotka, 1922, 1945), systems theory (von Bertalanffy, 1968) and systems ecology (Odum, 1967, 1975, 1996), emergy analysis (EMA) is a quantitative analytical technique for determining the values of nonmonied and monied resources, services and commodities in common units of the solar energy it took to make them (Brown and Herendeen, 1996). Emergy analysis is based on the assumption that everything on the planet can be expressed in terms of equivalents of solar energy. The solar emergy of a resource or commodity is calculated by expressing all of the resource and energy inputs to its production in terms of their corresponding solar energy inputs (Solar emergy joules or seJ) (Odum, 1996, 2000). The resulting total can then be used to calculate the 'transformity' for the resource or commodity, which is a ratio of the total emergy used relative to the emergy produced (seJ/J).

⁶ Energy Analysis as introduced in this manuscript is the extension of the well known concept in which "Energy analysis uses the first law of thermodynamics to track the transformations of energy and to calculate the energy losses in a process or process unit as the difference between the enthalpy leaving and entering the process." (Brown and Herendeen, 1996).

⁷ Emergy evaluations are both synthetic and analytic. Synthesis is the act of combining elements into coherent wholes for understanding of the wholeness of systems, while analysis is the dissection or breaking apart of systems to build understanding from the pieces upward. In the emergy method of evaluation, sometimes called *emergy synthesis*, first the whole system is considered through diagramming, and then the flows of energy, resources and information that drive the system are analyzed. By evaluating complex systems using emergy methods, the major inputs from the human economy and those coming "free" from the environment are integrated to analyze questions of public policy and environmental management (EmergySystems.org, 2010).

In theory, emergy analysis can be applied to systems across scales. To date, emergy analysis has been and is increasingly applied to evaluate a variety of systems including geographical regions (Pulselli et al., 2008; Lei and Wang, 2008), food production (Maud, 2007; Rotolo et al., 2007) and industrial processes (Brown and McClanahan, 1996; Min and Feng, 2008; Pulselli et al., 2008). The concept of emergy developed from the basics of thermodynamics is presented in the Appendix [A].

1.3 Similarities and Differences

1.3.1 Similarities

Basically, the concept and original intention of the reviewed methods are nearly the same. They attempt to account for all the direct and indirect consumption or input of a system, aggregation of the factors relating to environmental support and impact including energy, material, emission etc., and assess the system as comprehensive as possible. The ecological footprint calculates all the consumption of a system or a population, life cycle assessment accounts for all the environmental impact of a product during its whole life, Exergy accounts for all the energy consumption in a process, and Emergy analysis method records all the material and energy flow input and output of the system. The methodology adopted by the emergy analysis method is based on unification of all input material and energy flows expressed in emergy units relating to the system under analysis which results in one identical unit. This makes it possible to compare among systems and makes the results of the analysis more easier to be understood for decision making. A summary of the main similarities is presented in Table 1.2.

Items	ExA	LCA	EF	EMA
Date	1956	1969	1992	1996
Original purpose	Use of energy in an economical way	Comprehensive environmental impact assessment	Cumulative Impact Analysis	Sustainable development level
Analysis scope	Boundary of process	Life cycle of product or process	Boundary of system	Boundary of system
Merit	Precise calculation and universally accepted	Easily accepted approach	Simple and could be easily understood	Extended research boundary to account for both energy and material
Criticism	Does not take ecological inputs to consideration	Uncertainties in the methodology	Single indicator resulting in weak analysis	Complicated methodology with abundance of calculations

Table 1.2: Main differences between four of the main environmental system analysis tools

1.3.2 Differences

Although the concept and original intention of these methods are similar as described above, they share different algebra and concrete accounting rules. This results in some differences in the outcome of calculating and offers each method its own advantage on system analysis.

a) Upstream and downstream method

Ulgiati et al., 2004 separates system analysis methods into “upstream” methods and “downstream” methods. The upstream methods are concerned with the inputs, and account for the depletion of environmental resources, while the downstream methods are applied to the outputs, and look at the environmental consequences of the emissions. From this opinion, ecological footprint method and Energy analysis method could be considered as upstream methods for their stress on material and energy input which support the system. But differently, the ecological footprint method pays more attention on material flow and as such transfers all the input into material, whereas, Energy analysis method pays more attention on energy flow and transfer all the input into energy.

Life cycle assessment could be considered as a downstream method because it stresses on the environmental impact from emission. Exergy method is not just an upstream method or a downstream method. It focuses on the whole process and aims to analyze the efficiency of it.

b) System Boundary (Time boundary)

For the methods described, except for emergy analysis, the system boundary is defined by the system under analysis, for example, the boundary of a country or a region, the boundary of a factory etc. at the specific time. But in fact, the Emergy analysis method has a different time boundary from the other methods, which reflects in its difference in calculations. The Emergy value of a certain kind of energy or material is the result of all the energy and material input during the whole time of its formation, and not just its exploitation or utilization. For this difference, Emergy value of energy or material is not just the material content of it.

c) Human labor and money flow

Human labor and money flow are also important parts supporting the operation of a system, but they have not been paid enough attention and seldom the system analysis method combine them with other factors. Emergy analysis method regards human labor and money flow to be equal with other factors from its beginning and it is also developing the calculation of the Emergy value of information, culture and other materials that conventionally was thought of as hard to be calculated.

d) Advantage on system analysis

The emerging characteristics and key points of every method endue them respective advantage on system analysis.

Exergy is good at tracing the energy depletion through the process, so it is advantaged on process improvement.

Life cycle assessment accounts for all the emissions released by all the systems involved in the life cycle of a product, and it contributes on standardization of impact assessment of a broad variety of emission. LCA could find the significant part contributing most pollution emission within the entire life of a product; consequently, it could help eco-design of product and improving environmental impact.

Ecological footprint and Emergy analysis method are all good at assessment of the sustainability of a system. Ecological footprint gives a compositive view on the sustainable level of a system, where as emergy evaluation gives a more accurate evaluation on the sustainable level of a system for accounts of the scarcity of energy and material and takes into account not only non-renewable energy but also renewable energy, which in most cases reflects the environmental support on the system.

1.4 Conclusion

- Comparing the tools described above reveals some similarities and differences. It is important to note that all tools are not intended to cover the same areas. Some are more directed to optimizing energy consumption, whilst others are environmentally focused. It could be much more interesting to combine some tools in order to give decision makers a social, economical⁸ and maybe also needed technical inputs, as well as environmental, to support a practicable decision.
- Exergy and emergy analyses put the focus on energy but in separate ways. The first emphasize the importance of the amount of energy quality used and is thereby very much a tool for maximizing efficiency. The second includes the input from nature, going all the way back to the energy from the sun, the tide and the geological earth heat. Exergy analysis is the physicist's or the engineer's tool and emergy the systems ecologist's to describe the tools focusing on origin. They are broad tools, applicable for economies/populations, products and projects. Both appear to be rather difficult to interpret. Using the emergy approach also, at least theoretically, facilitates the inclusion of labor, knowledge and biodiversity issues by the use of transformities and emergy/GDP ratios, as is described in detail in Chapter 2.
- Emergy is the only measure which is of a donor-value i.e. has a common metric to all inputs and outputs involved in any natural or economic system. Emergy evaluation presents a competitive approach by encompassing all necessary inputs as well as ecological inputs which gives it a great potential for the future.
- This chapter has presented an overview of some of the major environmental tools in use currently and has highlighted their significant differences; merits and deficiencies with the methods. The next chapter gives a detailed overview of the emergy concept.

⁸ A field has arisen that combines these analytical tools with traditional engineering economics, referred to as thermoeconomics, or exergoeconomics [Tsatsaronis, 1993]. This method is characterized by the assignment of monetary costs to exergetic flows. In this way, energy losses can be associated with traditional costs an engineered system, and design alternatives can be compared and optimized accordingly. Thermoeconomic analysis has been applied primarily to energy systems, such as power generation or heating and cooling [Rosen and Dincer, 2003; Tsatsaronis and Pisa, 1994].

One related study combines exergy analysis especially with traditional life cycle assessment, dubbed exergoenvironmental analysis, in effect using exergy to allocate impacts with the intent to prioritize improvement efforts [Meyer et al., 2009].

The link between the analytical tools presented and the economy is not largely presented in detail in this thesis as it lies out of the scope of this work.

CHAPTER 2: Review of the emergy concept and Recycling

This chapter (with an extended Appendix) deals comprehensively with the concept of emergy theory (Appendix A) which was discovered as one of the environmental system analysis tools from the previous chapter. It provides an overview of concepts and methods important for understanding and completing several kinds of emergy evaluations. It begins by laying the basic foundation leading to the formation of this concept (Appendix A). Discussions on the rules of emergy evaluation and use of transformity values in current emergy related works is presented. A case study is presented on hydrogen production to highlight the challenges with the choice of use of transformity values. The chapter seeks to present a state of art pertaining to emergy's concept of recycling and identifies some significant problems in this area.

Definition 2.1 – *Emergy is defined as the amount of available energy of one kind, usually solar, that is directly or indirectly required to make a given product or to support a given flow (Odum, 1996).*

2.1 Introduction

Emergy is a concept conceived by Howard T. Odum, resulting from several decades of research on energy quality in ecosystems and human systems throughout the 1960's, '70's and '80's (Brown and Ulgiati, 2004). The logic behind Odum's concept of embodied energy or emergy is based on the logic behind the Second Law of Thermodynamics as stated in the previous section (read further from Appendix A). This may also be known as the law of the dissipation or degradation of energy resulting in an increase in entropy. It is a measure of the recordable available energy of every process which has gone into the generation of a given product of nature or service in the economy. As in the case of several other concepts, theories, ideologies etc. having to go through difficult moments of total acceptance by the large scientific community in their developmental stages, emergy has had its own similar challenges. Bakshi and Hau in 2004 presented a detailed analysis on some of the problematic areas of the emergy concept facing general acceptance.

Emergy has been critiqued many times over the years. Some of the criticism is related to the basic formulation of emergy, while others are based upon the extension of emergy into economic systems and sustainability. The next section highlights some methodological aspects often subjected to debate.

2.2 *Problems with some methodological aspects of emergy*

Emergy theory has been characterized as simplistic, contradictory, misleading, and inaccurate (Ayres, 2000; Cleveland et al., 2000; Mansson and McGlade, 1993; Spreng, 1988). Odum's book (Odum, 1983, 1996), emergy folios (Odum et al., 2000; Odum, 2000; Brown and Bardi, 2001; Brandt-Williams, 2001), and existing emergy handbooks are important and essential tools to provide greater insight and understanding about emergy. It is important to note that many criticisms of the emergy theory and its use are also valid for other methods that are popular for joint analysis of industrial and environmental systems, including, Life Cycle Assessment, Cumulative Exergy analysis, Exergetic Life Cycle Assessment, and Material Flow analysis. Through the efforts of many of those in the scientific community involved in the development of the emergy concept, lots of previously misunderstood concepts and interpretations are now being embraced due to continuous development of the approach. However, there still remain some challenges with performing evaluations that provide results that are neither clearly understood nor useful to non-emergy analysts. In fact, some published papers contain interpretations that are far subjective and discussions that are quite controversial. It is for such reasons that a continuous collaboration involving all emergy analysts is necessary to avoid issues of such nature. With consistent research advancement in this direction, emergy could become a more useful environment accounting methodology than it is today. Indeed, when we say, that emergy is required to do something, then, it's really subjective (Bakshi and Hau, 2004):

- How to prove that without one process, the resource cannot be made?
- If a process is clearly present, is that a proof that it is necessary?
- In a productive chain, if we stop after a frontier we choose, is there any proof the part we don't account can be neglected or is even finite?
- If the part we neglect is finite, then is there any proof that it converges at a value in the same order of magnitude as the value we found?
- Is there a universal methodology to choose the borders of the system, thus allowing comparisons of emergy studies?
- When we choose the discretization scale of the system, what proves us the results we compute are a minimum stable with regard to the scale choice?

Maybe some thermodynamic criteria and norms could prevent emergy studies from such inconsistency, but current research on the emergy theory conforms to that of Hau and Bakshi, 2004 conclusions:

1. Independent Emergy studies cannot be compared because the borders are different and because the assumptions at the entries are different (sources transformities can be very different).
2. If independent studies seem to have similar results, the main reasons are:
 - (a) Input transformities probably come from the same Odum's book. However, if you look at the emergy algebra chapter it is seen that emergy and transformity are

systemic data that you cannot take from one system and inject in another as if it were mass or internal energy.

(b) Aggregation and Boundaries are probably inspired from the same previous study. This however does not proceed of any logical implication.

2.3 New proposition for the first rule

It is encouraged to refer to Appendix A for a review on the rules of emergy evaluation.

2.3.1 Drawback

Some definitions of the 1st rule of emergy in literature include but not limited to the following:

- All source emergy to a process is assigned to the processes' output (Odum, 1996).
- The emergy assigned to the process output is equal to the sum of the emergies associated with the process independent inputs (Lazzaretto, 2009).
- For a system at steady state, all the emergy inflows to a production process are assigned to the outputs (Li et al., 2010).

The first principles of emergy allot emergy of the input to the output. This is illustrated as follows:

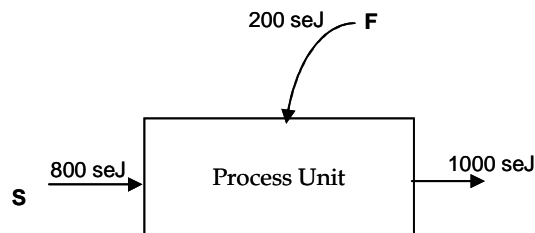

Figure 2.1: Scheme showing the 1st rule of emergy

The second rule also depicts that: by-products from a process have the total emergy assigned to each pathway. This is illustrated as:

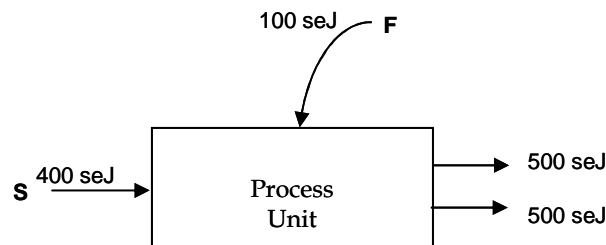

Figure 2.2: Scheme showing the 2nd rule of emergy

The third rule also states that: when a pathway splits, the energy is assigned to each ‘leg’ of the split based on its percentage of the total energy flow on the pathway. This could be illustrated as follows:

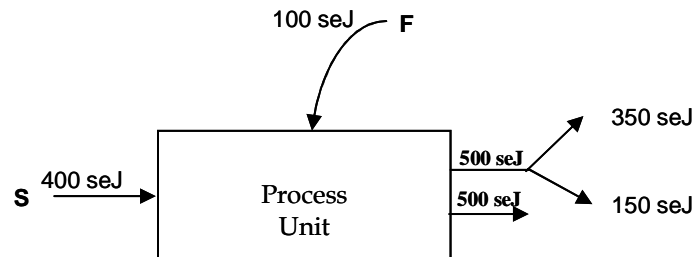

Figure 2.3: Scheme showing the 3rd rule of energy

The fourth rule describes how energy is assigned within systems of interconnected components. “Energy cannot be counted twice within a system: (a) energy in feedbacks cannot be double counted; (b) by-products, when reunited, cannot be added to equal a sum greater than the source energy from which they were derived”.

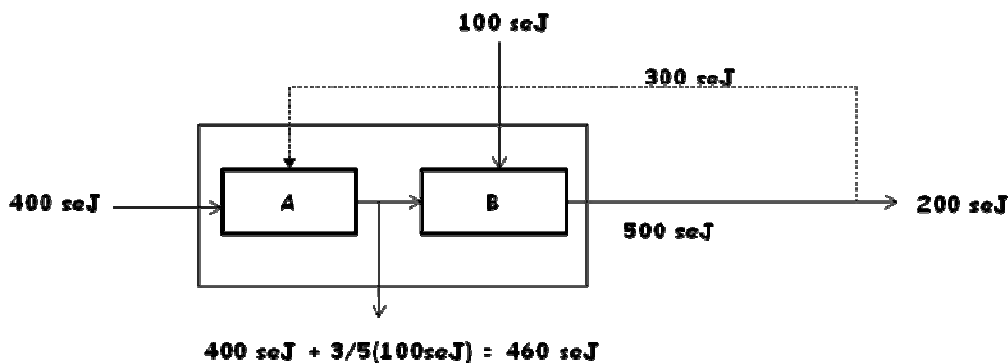

Figure 2.4: Scheme showing the 4th rule of energy

Fig 2.4 illustrates the fourth rule with a simple system of two components having two energy sources and a ‘feedback’ from component B to component A. Beginning on the left the output from A is the sum of 400 seJ from an initial source and 60 seJ from the 100seJ contained in the 300seJ, for a total Energy of 460 seJ. In this case only the portion of feedback from B that did not come from the initial source through A, is counted in the output of A. The 400 seJ coming originally from A cannot be counted a second time.

2.3.2 Proposal

It is clear from the above definitions and illustrations that the 1st rule: ‘all sources of energy to a process are assigned to the processes output’, cannot be correct without a consideration of the fourth law. This is because in the case of systems with feedbacks, all sources of energy are not assigned to the processes output. Let us consider the illustration below:

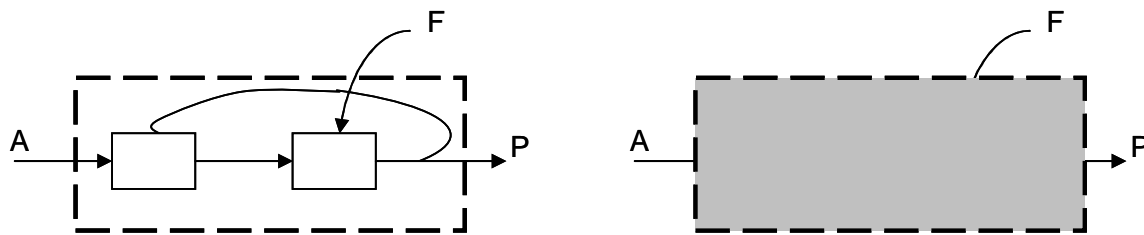

Figure 2.5: Scheme showing the effect of feedbacks on a system

This does not give the 1st principle of emergy a solid standing in comparison to other scientific principles such as laws of thermodynamics in which each principle or law is solid⁹ and could be applied independently without a necessary consideration of the other. The laws of thermodynamics describe the transport of heat and work in thermodynamic processes. These laws have become some of the most important in all of physics and other types of science associated with thermodynamics.

▪ **Incorporating the 4th Rule of Emergy in the definition of the 1st Rule**

With this background, an attempt is made in this thesis to propose a modification to adapt the first rule of emergy to incorporate the 4th rule. The following modifications¹⁰ are then considered:

Original Definition-1:

All source Emergy to a process is assigned to the Process output (Odum, 2000).

*All source Emergy **without feedback** to a process is assigned to the process output (modified version).*

Original Definition-2

The emergy assigned to the process output is equal to the sum of the emergies associated with the process independent inputs (Lazzaretto, 2009).

*The Emergy assigned to the process output is equal to the sum of the emergies associated with the process **primary** independent inputs (modified version).*

Original Definition-3

For a system at steady state, all the emergy inflows to a production process are assigned to the outputs (Li et al., 2010).

*For a system at steady state, the emergy inflows **without feedback emergies** to a production process are assigned to the outputs (modified version).*

⁹ The first law of thermodynamics is applied regardless of the second principle. The results of applying the first principle is moreover not contradicted by the second, they are each specific. However, for emergy, the application of the 1st rule may be contradicted by the application of the 4th rule. The rules are complementary but can also interfere with each other, sometimes making their application quite difficult.

¹⁰ The proposed modifications are presented in the rectangular boxes.

2.4 Transformity values and its current use

Definition 2.2 – *Transformity is defined as the amount of indirect and direct solar emergy required to produce one Joule of exergy of an item or process (Odum, 1996).*

In this section some aspects of transformity will be discussed (refer to Appendix A for a detailed overview of transformity, how it is calculated and its indication for an analyzed case study).

Theoretically, the transformity of an item is a property of the system from which the item was produced, and as such an item could have different transformities depending upon which system produced it.

To derive the transformity value of a resource or product, it is necessary to trace back through all the resource and energy flows that were used for its production, and express all the inputs in the amount of emergy that went into their own production process. To avoid the emergy calculation of resources and commodities every time a process is evaluated, unit transformity values established earlier are commonly used. In a situation where more than one process could yield a similar product independently, can we say then that the transformity of the product is the same independent of the technology or process used? According to the process efficiencies along a given pathway, more or less energy might have been required to reach the same result. The 2nd law of thermodynamics dictates that there is a low limit below which a product cannot be made. There is also some upper limit above which the process would not be feasible in practice although, in principle, one could invest an infinite amount of fuel in a process and thus have an infinitely high transformity. As such, transformities are not constant and do not have the same value for the same product everywhere, since many different pathways may be chosen to reach the same end state. As such there is no single unit emergy value for most products, but typically a range: average values are used whenever the exact origin of a resource or commodity is not known or not calculated separately (Brown and Herendeen, 1996).

Most emergy analysts commonly use transformity values derived from other studies, by assuming they are still valid under slightly different conditions (place or time). This assumption may be quite subjective and create doubts in readers or users minds. An incorrect choice of a transformity value could affect all the other calculations and thus affect the results thereof.

▪ What informs our choices?

Few emergy analysts in recent years recalculate transformity values to suit their specific condition in their evaluations. Most however make references which could be in doubt. Using Meillaud et al., 2005, as a fundamental basis, a further sense of the magnitude of errors could be established. Considering the transformity of electricity for example, several values could be found from literature which sometimes are rather confusing. Odum, 1996, published several transformity values for electricity depending on its source.

Source	Value (SeJ/J)
Coal	160000
	169444*
Hydro	80246*°
	165000**
Wood	203418**
	67222*
Lignite	151944*
	204384°°

*Thailand; *°Sweden; **Brazil; °°Texas

Table 2.1: Electricity transformity values by sources (Odum, 1996)

Table 2.1 presents different values of electricity transformity established for various places and types of electricity production processes: hydroelectricity is for example calculated for Sweden and Brazil with transformities equal to 8.0E+04 seJ/J and 1.65E+05 seJ/J respectively.



Figure 2.6: Showing the locations of electricity transformity values by Odum (1996)

Author	Value (SeJ/J)
Feng et al., 2009	1.60E+05
Paoli et al., 2008	1.74E+05
Meillaud et al., 2005	1.88E+05
Cavalett et al., 2006	2.69E+05
Pizzigallo et al., 2008	2.00E+05

Table 2.2: Transformity values for electricity in recent studies and their respective authors.

Obviously, it is seen from Table 2.2 that even with just a single product, there are different transformity values which exist. For example, in the case of Feng et al whose publication was in 2009 the transformity value selected was from Odum, 1996 publication. Same applies to Paoli in 2008 in which an average transformity value from Odum, 1996 was used. Until we conclude on less tedious ways of transformity calculations, should we consider carefully the context (location) of our evaluation in our choice of using transformity values from past studies? This is imperative and must inform our choice. At least selecting transformities with quite similar scenarios in our specific cases would help reduce some inconsistencies and doubts on this approach of evaluating systems.

▪ **Why should this work be pursued?**

Transformities are a very central concept in emergy accounting. Though transformity values calculated by Odum and his group and other transformity values are available in scientific literature on emergy for use in current and future studies, it is rather important to revisit these values and evaluate its significant value in our recent studies. When a large set of transformities is available, other natural and economic processes can be evaluated by calculating input flows, storages within the system, and the final products in emergy units. One of the main arguments of emergy critics is this issue of estimation of transformities in evaluations which could reduce the efficacy of convincing policy makers to prioritize emergy evaluations as they do with other traditional evaluation methods. Because the state of scientific knowledge is in perpetual flux, calculations of transformities are open to revision.

According to Ulgiati et al., 2010 the acceptability of a given transformity should be checked against strict and agreed upon criteria, that take into account the uncertainty of environmental resource parameters, the quality of the referred study, the assumptions underlying a given calculation procedure, and several other aspects that make a result reliable and applicable. Table 2.3 shows a set of preliminary criteria for the selection of acceptable and reliable values of transformities, towards a critically evaluated database in support of future studies. Some of the criteria identified in Table 2.3 also meet several concerns that not only apply to transformities but to all kinds of databases. Ulgiati et al., 2010 further explains that a reliable database must consist with values that are recent (criterion “H” as shown Table 2.3), checked for uncertainty (criterion “P”), expressed in comparable units (criterion “A”), representative of the most used or best available technologies (criterion “D”), and based on studies easily accessible to the international reader (criterion “G”).

Furthermore, data obtained as averages or ranges from a larger set of cases may be considered more representative than data only referring to a unique case investigated (criterion “C”); data and calculation procedures confirmed by several independent investigators worldwide may be more reliable than data only based on the authority on one single investigator or team (criterion “E”), data published in peer reviewed international Journals are more robust and validated than data published in working papers of the investigator’s institution without peer review (criterion “F”).

Again, the existence of time series (criterion “I”) is also of great importance, in that it reflects ongoing changes of technology as mentioned in earlier sections, resource availability, and economic performance capable to affect a given value of the emergy intensity. In fact, by having a clear picture of a value stability over time, it is much easier to figure out how the final result of a study is robust against potential changes occurring in one step of or one input to the process. As

a matter of fact, there are very fast changing technologies from which very fast changing transformities are generated. Indeed, such values cannot be transferred to other studies and the investigator needs to recalculate the transformity for the new specific case.

#	Criterion	Indicator	Issue
A	Standardization of accounting method	Numeraire used	What numeraires are used (Energy, Exergy, Mass, currency) in the calculation procedure as well as in the final result?
B	Standardization of biosphere reference	Biosphere Baseline	Reference to the most updated biosphere baseline (Odum, 2000) or previous ones
C	Numerical Representativeness	Number of investigated cases	How many different case studies were investigated in order to reach the final result?
D	Technological Representativeness	Process/technology referred to	Does the value rely on the best available or the most used technologies in the year the study was performed?
E	Consensus	Number of independent investigators	How many different authors have published data about a given process/product?
F	Scientific reliability	Quality of publication medium	Publication referred to (peer reviewed Journal, Book, Book of Proceedings, PhD thesis, etc)
G	Accessibility	Language	Is the result published in a paper using English language?
H	Up-to-datedness	Age of value	When was a given value published?
I	Trend	Time series	Are time series available for the value under consideration?
L	End-use sustainability	Accounting for the cost of environmental and social impact	Recovery of natural and human assets requires energy. Is such a care of GHG emissions, toxic effluents, solid waste, erosion, biodiversity loss, water infiltration accounted for?
M	Socio-economic inclusiveness	Inclusion of labor and services	Is the energy of labor and services included in the accounting? Is such an inclusion clearly shown as an independent component of the final value?
N	Renewability	Reliance on renewable sources	Does the evaluation show which fraction of each input flow is renewable versus nonrenewable?
O	Openness	Reliance on local sources	Does the evaluation show which fraction of each input flow is local versus imported?
P	Uncertainty	Error/sensitivity analysis	Is the value accompanied by a sensitivity evaluation that takes into account all sources of error/uncertainty/change?

Table 2.3: Criteria, indicators and issues addressing the quality and acceptability of Unit Emery Values (UEVs) adapted from: Ulgiati et al., 2010

2.5 Case Study

This case study is presented to highlight the different transformity values for the same product that can be achieved by different investigators due to the specific path of process route, location or even the time (year) of calculation.

Energy Evaluation for hydrogen production systems

Hydrogen occurs as a gas with a molecule made of two hydrogen atoms (H_2). When burned with atmospheric oxygen, hydrogen gas has the most intense heat of all the fuels with 29.1Calories per gram (121,813 joules/gram) (Brown et al., 1995). Compared with a gram of sugar (4 Calories per gram) its heat is intense. With an atomic weight of 1, hydrogen is also the lightest of all fuels. For these reasons, hydrogen is required for weight-dependent processes, such as sending rockets into space. Hydrogen is the most abundant element in the Universe but in the earth biosphere it is rare as a gas for two reasons:

- (1) At the top of the atmosphere molecular collisions give hydrogen molecules (H_2) enough velocity to exceed that required to escape the earth's gravity;
- (2) In the presence of sunlight or lightning, hydrogen combines with oxygen to form water.

Hydrogen is not a vapor at ordinary refrigerated temperatures, and must be compressed within heavy-walled containers to be stored. Hydrogen gas is amongst the alternative energy systems being considered for the future, when petroleum-based fuels are scarce and more expensive.

Alternatives for hydrogen production

There are several ways in which hydrogen can be concentrated for use as a fuel, including: separation from natural gas, by chemical processing from methane, and separation from water via electrolysis (Brown et al., 1995). Table 2.4 and Figure 2.7 summarize the energy evaluations of 5 alternative methods for deriving hydrogen.

Note	System	Solar transformity solar emjoules/Joule	Net EMERGY Yield Ratio
1	Natural gas	48,000	6.8
2	Hydrogen from Natural gas	76,300	4.5
3	Hydrogen from fossil fuel electric power plants	204,000	2.4
4	Hydrogen from hydropower	110,563	4.9
5	Hydrogen from nuclear power	203,956	4.7
6	Hydrogen from photovoltaic cells	69,000	1.007

Table 2.4: Transformity and Net energy yield ratio of hydrogen (Odum, 1996)

The steps of emergy accounting for a hydrogen production plant include: defining the goal of the analysis; defining the analysis boundary; analyzing the input and output state of each member of the hydrogen plant depending on the process under investigation; and analyzing the state of materials and energy exchange among the members; developing the emergy flow chart; collecting information and data about the relevant industrial, economic and ecological processes and products; and finally, analyzing and computing the emergy indices (Amponsah et al., 2010a).

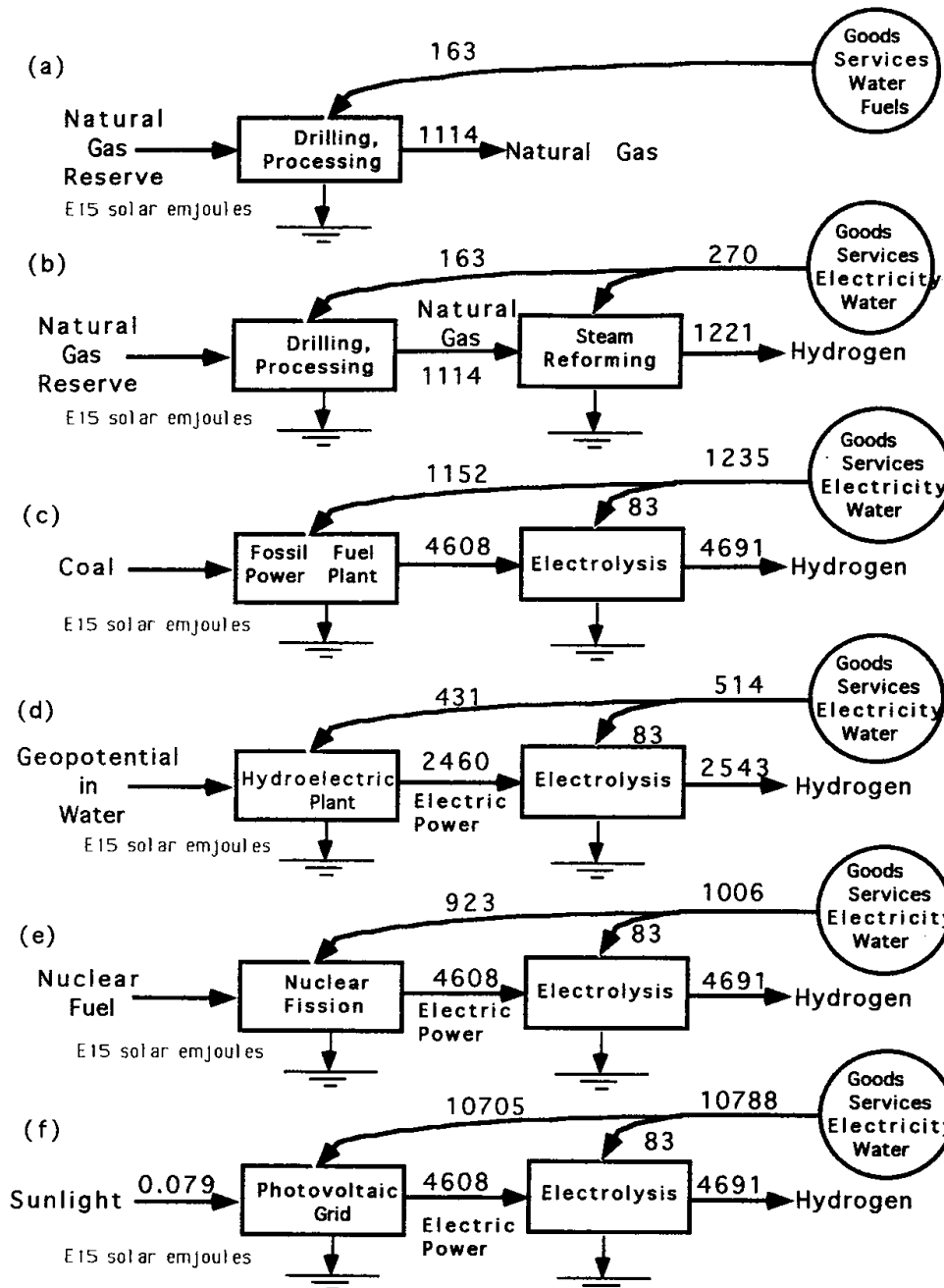

Figure 2.7: Summary diagrams of emergy evaluation of natural gas (a) and hydrogen (b-f) Odum (1996)

▪ Energy analysis for the hydrogen production system - natural gas via SMR

The evaluation was carried out using operating parameters from the internet and published literature (mainly data by NREL). Comparison is drawn with a previous work by Feng et al. (2009) and another publication by Bargigli et al. (2004). Table 2.4 shows a calculation based on the work done by Xiao Feng indicating the transformity of hydrogen achieved. Table 2.5 shows another emergy calculation based on a Life Cycle Assessment data of hydrogen production via Natural Gas Steam Reforming by the National Renewable Energy Laboratory (NREL) in the U.S. Some of the operating parameters were varied to adapt to the systems under investigation.

Operational resources		Consumption norm	Unit	Transformity (seJ/unit)	Industrial emergy (10^{14} seJ)	
N	Natural gas (raw material)	3.18×10^4	MJ		15.2	
	Natural gas (fuel)	1.11×10^4	MJ	4.80×10^4 [a]	5.33	
	Electric	3.42×10^3	MJ	1.6×10^5 [a]	5.47	
	Middle pressure steam (4.0 MPa, by-product)	-6.45×10^3	MJ	6.6×10^5 [b]	-4.26	
R	Water	4.60×10^2	MJ	6.6×10^5 [b]	3.04	
	Labor				5.99	
<i>Capital resources</i>						
F1	Fixed assets	Special	667	Yuan	1.77×10^{11} [a] and [c]	1.18
F2		Electric				
F3		General				
F4		Transport				
F5	Working capitals	Business	630	Yuan	1.77×10^{11} [a] and [c]	1.12
F6		Management				
F7		Finance				
All						34.75
Hydrogen			2.48×10^4	MJ	1.15×10^5 [d]	28.52

a: Odum, 1996; b: Lan et al., 2002; c: Dai, 2004; d: Ulgiati, 2001

Table 2.4: Emergy Analysis of hydrogen production via SMR (Feng et al., 2009)

Item	Units	Inputs	Transformity (seJ/unit)	Emergy flow (seJ/yr)
Plant Material Requirements				
Concrete	g	1,02E+05	1,35E+09	1,38E+14
Steam generators (steel)	g	8,20E+05	1,78E+09	1,46E+15
Steam condensers (steel)	g	8,20E+05	1,78E+09	1,46E+15
Pre-heaters for input water (steel)	g	8,17E+05	1,78E+09	1,45E+15
Pre-heaters for combustion air (steel)	g	8,17E+05	1,78E+09	1,45E+15
Aluminium	g	2,70E+05	1,17E+10	3,16E+15
Iron	g	4,00E+05	2,83E+09	1,13E+15
Steel for pipes	g	1,25E+07	1,78E+09	2,23E+16
Diesel for transportation	J	6,76E+07	1,10E+05	7,44E+12
Human Work	\$	3,25E+06	1,20E+12	3,90E+18
Resource Consumption				
Natural Gas (Feed)	J	3,92E+05	4,80E+04	1,88E+10
Natural Gas (Fuel)	J	4,30E+05	4,80E+04	2,06E+10
Electricity	J	1,53E+02	5,40E+04	8,28E+06
Water	L	1,98E+01	6,60E+05	1,31E+07
Human Work	\$	4,37E+03	1,20E+12	5,24E+15
Product				
Hydrogen	J	4,05E+13	9,72E+04	3,94E+18

Table 2.5: Emergy Analysis of hydrogen production via SMR (Amponsah and Le Corre, 2010a)
Transformities are from Buranakarn, 1998; Raw data inputs from Johanna, 2004.

▪ **Emergy analysis for the hydrogen production system via electrolysis**

This evaluation was also carried out based on a previous work by the National Renewable Energy Laboratory (NREL) in the U.S. Data was extracted from its publication on the Life Cycle Assessment of renewable hydrogen production via electrolysis (Spath and Man, 2001).

Item	Units	Inputs	Transformity (seJ/unit)	Emergy flow (seJ/yr)
Construction Phase				
Coal	J	3,30E+05	4,00E+04	1,32E+10
Iron scrap	J	2,70E+05	2,83E+09	7,64E+14
Iron	J	3,30E+04	2,83E+09	9,34E+13
Limestone	g	5,70E+04	1,00E+09	5,70E+13
Oil	J	7,00E+03	6,60E+04	4,62E+08
Natural Gas	J	2,00E+03	4,80E+04	9,60E+07
Human Work	\$	2,90E+06	1,15E+12	3,34E+18
Processing Phase				
<i>Renewable Inputs for electricity generation</i>				
Wind	J	2,46E+10	2,52E+03	6,21E+13
<i>Non Renewable Inputs</i>				
NaOH	J	1,88E+03	1,90E+09	3,57E+12
Water	g	4,18E+06	1,25E+06	5,22E+12
Electricity	J	1,42E+08	1,11E+05	1,58E+13
Human Work	\$	1,68E+04	1,15E+12	1,93E+16
Product				
hydrogen	J	4,05E+13	8,28E+04	3,36E+18

**Table 2.6: Emery Analysis of hydrogen production via electrolysis (Amponsah and Le Corre, 2010a)
Raw data inputs from Johanna, 2004.**

▪ **Comparison of hydrogen Transformity values - different hydrogen systems**

The transformity values of emergy analysis consider the total inputs: renewable, non-renewable, goods and services and other economic inputs to achieve its value. The transformity values calculated for both SMR and electrolysis are compared to already available values in literature. The results are shown in Table 2.7.

Author (s)	Transformity Values	
	SMR (seJ/J)	Electrolysis (seJ/J)
Bargigli et al. (2004)	7,34E+04	2,18E+05
Feng et al. (2009)	1,15E+05	
Odum (1996)	...	1,10E+05
Brown, Ulgiati (2004)	...	1,39E+05
Amponsah, Le Corre (2010)*	9,72E+04	8,28E+04

Table 2.7: Hydrogen transformity values in comparison with other systems

From Table 2.7, it is clear that the calculated hydrogen transformity value via SMR (Amponsah, Le Corre, 2010a*) is almost the same as that established by Bargigli et al., 2004. This is explained by the fact that both calculations were based on a very similar data. However, a rather

slight difference is realized (Fig. 2.8) when compared to that of the Chinese authors (Feng et al., 2009). This is because of the slight differences observed in the transformity values used. The transformity values used in (Amponsah and Le Corre, 2010a) were largely from Buranakarn, 1998 whilst that for Feng et al., 2009 were from several sources of transformity data.

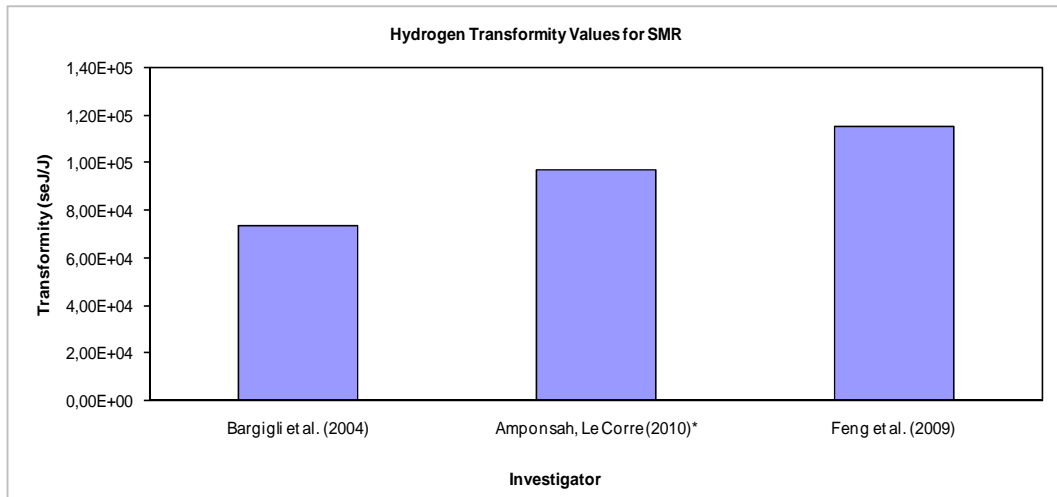

Fig 2.8: Hydrogen transformity values for SMR

Again it could be observed from Table 2.7 and Figure 2.9 that the evaluated transformity value (Amponsah, Le Corre, 2010a) achieved via electrolysis was rather close to that of Odum, 1996, and Brown and Ulgiati, 2004 as available in literature. This establishes a trend of consistency with our evaluated value.

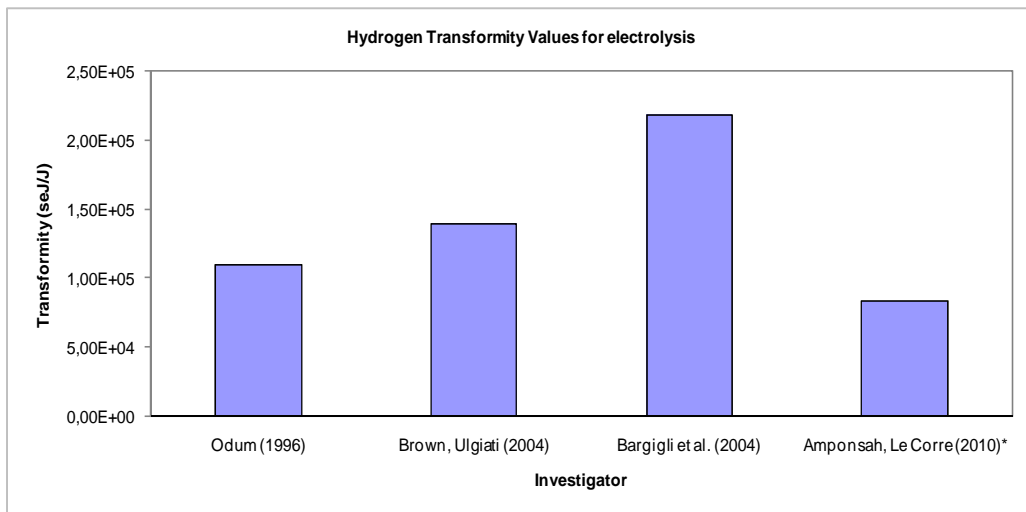

Fig 2.9: Hydrogen transformity values for electrolysis

As shown in the above case study, the introduction of newly calculated values for the same product or service would allow a range of values, the calculation of an average value within such a range, and finally an estimate of the uncertainty characterizing the value itself. The inclusion of high quality transformity in new studies will very likely generate much more reliable new results

(Amponsah, Le Corre, 2010b). In order to avoid misunderstandings, it is important to point out that criteria and scores apply to both individual values (calculated by a single investigator or based on a specific technology) as well as to average values or ranges derived from a selected number of case studies (different investigators exploring a given set of technologies). When more values converge from a diversity of cases towards an average estimate within a database (endowed with an uncertainty interval), the score is very likely to be higher as a consequence of increased consensus and representativeness. The construction of a database of high quality transformities and a set of criteria for their acceptance, use and improvement would certainly reinforce the efforts of the worldwide emergy community (Ulgiati et al., 2010).

▪ **Summary of Emergy theory**

Despite the controversies, so called contradictions, lack of firm scientific basis as some authors who oppose the theory have suggested, emergy still has great potential for extensive evaluation and synthesis and even more if it is well researched and developed.

- It provides a bridge that connects economic and ecological systems. Since emergy can be quantified for any system, their economic and ecological aspects can be compared on an objective basis that is independent of their monetary perception.
- It compensates for the inability of money to value non-market inputs in an objective manner. Therefore, emergy analysis provides the real value of goods and services.
- It is scientifically sound and shares the rigor of thermodynamic methods.
- Its common unit allows all resources to be compared on a fair basis. Emergy analysis recognizes the different qualities of energy or abilities to do work (Bakshi, 2002).
- Emergy analysis provides a more holistic alternative to many existing methods for environmentally conscious decision making. Most existing methods, such as life cycle assessment and exergy analysis, do expand the system boundary beyond the scope of a single process so that indirect effects of raw material consumption, energy use and pollutant emissions can be taken into account. However, these methods focus more on emissions and their impact, while ignoring the crucial contribution of ecosystems to human well being. The concept of critical natural capital and a framework to account for have been suggested recently (Ekins et al., 2003). Emergy analysis can quantify the contribution of natural capital for sustaining economic activity (Bakshi, 2002).

These features of emergy analysis are particularly impressive since emergy was developed many decades before the more recent engineering and corporate interest in life cycle assessment, industrial ecology, and sustainability. Partly due to being a theoretical concept whose application posed significant demands on data requirements, lack of adequate details about the underlying methodology, and sweeping generalizations that still remain unproven, emergy has encountered a lot of criticism, and has not been used much outside a small circle of researchers. However, there is no doubt that as an idea, it was truly revolutionary and is expected to have a huge impact.

2.6 Emergy and Recycling

Sustainable management of material flows occurs at different environmental scales and aims to:

- (i) Reduce resources depletion;
- (ii) Reduce environmental impacts of materials extraction and use, such as ecotoxic effects, physico-chemical changes, loss of biodiversity, nutritional effects, and landscape changes;
- (iii) Reduce waste disposal.

Therefore, saving natural capital and reducing pressure on natural carrying capacities may be achieved by implementing a waste minimization strategy (see Figure 2.10). Waste minimization definition is a broader concept than waste prevention, because it also includes waste management measures such as quality improvements and recycling (Jacobsen and Kristofferson, 2002) which heavily involve material and product recovery. Gungor and Gupta, 1999 categorize material and product recovery options in the following process categories:

- (i) Recycling: action performed to retrieve the material content of the obsolete products;
- (ii) Remanufacturing: action performed to restore parts of products into like-new conditions.

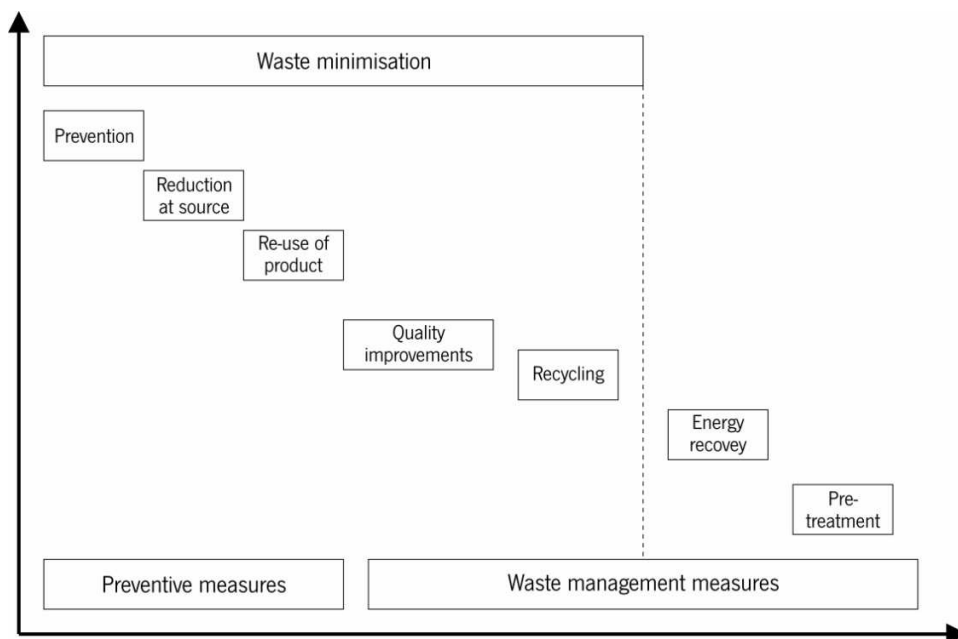

Figure 2.10. OECD working definition on waste minimization (Jacobsen and Kristofferson, 2002)

In spite of increases in recycling widely observed in most countries of the European Union, land filling is still the main waste treatment solution (EEA, 2007). The increase on recycling is due to policy instruments such as the Packaging Directive (EU, 1994) and the Landfill Directive (EU, 1999), or to earlier national regulations.

- The Impact of waste reduction options on the economy

According to Baojuan, 2007 the circular economy aims against the linear economy which is characterized as high consumption and high emission since industrialization. The circular economy is a closing-cycle economic model which is adopted to protect environment and maintain the ecological balance. It is formed under the pressure of resources and environment, and takes the efficient utilization and recycling as the core and “reduction, reuse and recycling” as the principles. It is used to alleviate the contradiction between the finiteness of resources and environment and the infiniteness of economic and social development, to solve the issues like increasingly severe shortage of resources, environmental pollution and ecological destruction, and to maintain the virtuous circle of social, economical and natural systems and sustainable development.

However, traditional economy is a single-flowing linear economy that is “resources—products—pollution emissions”. And its characteristics are high exploitation, high utilization and high emissions. The materials and resources are extracted from the earth in high intensity and then waste is heavily emitted to the environment. The utilization of resources is extensive and one-time. Humans continuously change resources into waste to realize the economic growth in quantity; in contrast, the circular economy is initiated by the establishment of economic development model based on recycling of materials. It requires to change the economic activity into a material-recycling process which is “resources—products—renewable resources” according to the model of natural eco-system. And its characteristics are low exploitation, high utilization and low emission. All of the materials and resources can be used reasonably and lastingly in such continuous economic recycling. So the impacts on the natural environment caused by economic activities are minimized.

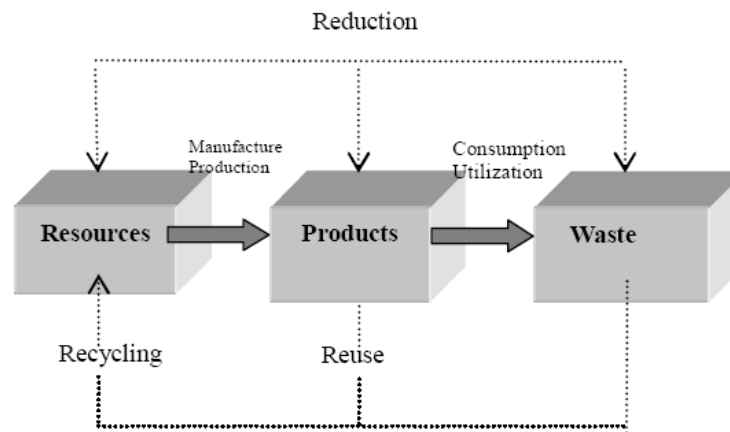

Figure 2.11. The 3R principles of circular economy

The reduction principle requires that the resource inputs should be reduced as much as possible when they are invested in order to achieve the fixed production purposes; the reuse principle requires that the manufacture of products and packing containers can be reused in the initial forms and the manufacturers should extend the using period of products as long as possible; and recycling principle requires that the finished products can turn into available resources again rather than unavailable waste after they have been used. 3R principles are not equally important in circular economy. People always simply think that circular economy is just to change waste

into resources. In fact, however, the fundamental goal of circular economy requires that waste should be avoided and reduced systematically in the economy. And the recycling of waste is one way to reduce the ultimate throughput of waste.

- **Emergy synthesis and solid wastes recycling value**

Recycling is a major concept in completing the ecological life cycle of materials, where waste or production output from one system is an input to another system. Recycling serves to amplify and reinforce production processes, and provides a multiplier to the input resources. Systems that do not develop a complete cycle of materials will not be long continued (Odum, 1996; Buranakarn, 1998). Recycling is a common vocabulary when dealing with waste. Emergy synthesis has been widely applied in the evaluation of ecological systems, energy systems, and environmental impacts of processes and a large number of studies. Most studies have applied the emergy theory to eco-economic systems in recent years. Ulgiati and Brown, 2002 proposed an emergy-based method to quantitatively study the function of the environment in absorbing and diluting by-products generated by a process. Ulgiati et al., 2004 observe that emergy indeed has a role in this terminal part of the process chain and propose ways of accounting for its emergy amounts to avoid mistakes when recycling waste. Bakshi, 2000 introduced an emergy analysis method for industrial systems, where waste treatment was considered. The wastes are not only handled by an end-of-pipe treatment approach and ecosystem dilution, but also by waste reuse techniques. It is clear that over the years, several researchers have tried using emergy theory and method to evaluate solid wastes recycling value.

Yang et al., 2003 proposed a new emergy analysis method for waste treatment, reuse and recycle. If the wastes are released into the environment, the input provided by nature for their abatement via natural processes should be accounted for and assigned to the main product. However if wastes are treated and re-enter a production process as a substitute material or resource, only the emergy invested in the treatment and recycling process should be assigned to the recycled resources.

- **Evaluating Indices for recycling systems**

As presented in detail in Appendix A on the emergy evaluation indices, some researchers establish user-definable emergy indices to measure the consumption of solid wastes treatment (Marchettini et al., 2007; Bastianoni et al., 2002). Brown and Ulgiati, 1997 suggested the use of several indices based on emergy evaluations of processes and economies to evaluate their net contributions and their relative sustainability for the future. The use of these indices according to the authors may help to increase understanding of the relative contributions of various alternative means of production and consumption. Brown and Buranakarn, 2003 also developed several recycle indices to evaluate the appropriateness of different recycle systems. Table 2.8 summarizes the recycle indices for the main building materials and the three recycle indices: RBR, RYR, and LRR. Taken together, these recycle indices provide information regarding the appropriateness of a particular material recycle system.

11

Material	RBR	RYR	LRR
Recycled lumber	0.4	1.4	1.4
Plastic lumber from recycled plastic	2.9	20.9	21.0
Ceramic tile from recycled glass	3.5	7.9	8.0
Concrete with recycled aggregate	4.9	25.1	25.1
Clay brick – sawdust fired	2.4	0.001	1.7
Recycled steel	14.6	17.0	17.0
Recycled aluminum	38.3	44.7	44.9
Cement with fly ash	16.8	645.2	646.9

Table 2.8. Recycle indices of building materials (adapted from Brown and Buranakarn, 2003)

It is quite apparent that steel and aluminum exhibit high ratios across all the indices. Primary materials like cement, concrete and clay brick exhibit moderate values for the ratios across all indices. Wood, on the other hand exhibits index values less than 1.0, calling into question the potential for large scale recycle of wood lumber. Individually, the recycle indices provide comparative analysis to evaluate various recycle systems relative to each other.

The RBR provides information relative to the potential savings that can result if a material is recycled and substituted for a raw resource. All the materials evaluated in this study by Brown and Buranakarn, 2003 with the exception of wood lumber had very high RBRs. The RBR for wood was less than 1.0 suggesting that there is little benefit from recycling. In some cases, either where wood is scarce, or the quality of the wood is very high, recycle would probably show positive RBRs.

The recycle yield ratio (RYR) evaluates the net benefit that society receives for recycling. It is a measure of what society gets in emergy for its emergy investment in recycle. Very high yields result from a small investment of emergy to transport aluminum and plastics and recycled concrete as aggregate. Recycled steel has a relatively high ratio as well, while the recycle of lumber is only 1.4/1 and sawdust does not provide a positive net yield. The recycle of fly ash has an extremely high RYR because the emergy of fly ash is very large.

The landfill recycle ratios (LRR) for all the material recycle systems studied (Brown and Buranakarn, 2003), were greater than one, indicating that investments in recycling these materials are beneficial in the long run. The LRR is calculated by adding the emergy used for land filling to the emergy of the material, since if land filled; a material is lost to society and represents a cost. The long term benefits of recycle were significant suggesting that it costs society between 1.5 and 650 times the emergy to land fill materials than to recycle them. The costs to society for land filling plastics, steel, and aluminum were between 21 and 45 times what it costs to recycle them.

¹¹ RBR, recycle benefit ratio: ratio of the emergy used in providing a material from raw resource to the emergy used in recycling the material. The larger the ratio the greater the advantage of recycle.

RYR, recycle yield ratio: ratio of the emergy in the material to the emergy used to recycle. A large ratio indicates greater yield.

LRR, landfill to recycle ratio: ratio of emergy used to land fill a material to the emergy used to recycle the material. The higher the ratio the larger the benefit from recycling (Brown and Buranakarn, 2003).

- **Application to buildings**

The environmental impacts of buildings have become an issue of interest since the building sector is identified as a major contributor to the environmental impacts resulting in many pollution, energy consumption and waste generation amongst others. The amount of emergy research in this area still leaves room for much work to be done. Much research is needed to improve the methodology and even more promote a joint methodology of LCA and emergy for buildings.

The concept of emergy has been also applied to building construction and recycle of building materials and several environmental indicators have been proposed (Buranakarn, 1998; Brown and Buranakarn, 2003; Huang and Hsu, 2003; Meillaud et al., 2005; Pulselli et al., 2008; Yuang and Li, 2008). For example, Buranakarn, 1998 made emergy calculations for recycling matter in building applications where he studied 4 material flows and recycling patterns based on emergy evaluation:

- conventional material flow where material is discarded after use;
- material recycle where material is recycled back to a stage in the transformation process and re-transformed;
- use of a by-product waste from another production process in place of some material;
- reuse of a material for some other purpose.

However, these available studies have not highlighted the introduction of a new time scale for recycling flows. Buranakarn, 1998 in his case study, took into consideration this approach in his calculation. It is therefore clear that for each complete recycle flow in a system, a new time is introduced which gives the system its own dynamic emergy.

According to the first rule of emergy analysis it is clear that the emergy assigned to the process output is equal to the sum of the emergy associated with the process independent inputs (Lazzaretto, 2009). This first rule does not explicitly take into account this internally generated 'dynamic emergy'. As such, this is hidden in most cases and gives a rather simplistic result which is not a true reflection of the reality. Most studies usually consider solid wastes recycling as one system with a single output (Machettini et al., 2007; Feng and Cao, 2007; Brown and Buranakarn, 2003). Some studies however, consider the recycling system as a multi-product system (Yang et al., 2003). Solid wastes could either be beneficial or not depending on the process under study. Two different kinds of wastes are normally observed in eco-economic systems. One serves as a potential resource to produce new goods whilst the other is the real waste (Yuang and Li, 2008). When the wastes are fully degraded so that the useful value of whatever their physical characteristics (concentration, pressure, chemical potential, temperature) is zero in relation to the reference level of the environment, they are no longer a resource (Ulgiati et al., 2004). These real wastes need resources and services to render them harmless.

When comparing recycling pathways with traditional waste treatment, it is important to consider these two kinds of wastes at the same time (Yuang and Li, 2008). However, most researchers focus on the harmful waste (Bastianoni et al., 2002; Yang et al., 2003; Lou et al., 2004) and neglect the resourceful waste which could be a resource for emergy inflows.

Another application of Emergy to building construction was published by Pulselli et al., 2008. The authors proposed a set of environmental indices to provide a basic approach to environmental impacts of buildings by accounting for the main energy and materials inflows

within the building construction process, maintenance, and use: (i) Building Emergy per volume (Em-building volume): this represent the 'environmental cost' of the building; (ii) Building Emergy to money ratio (Em-building/money ratio): this represents the ratio of total Emergy used to money (seJ/€); (iii) Building Emergy per person(Em-buildings per person): this represents the rate of Emergy use of human systems with relation to buildings. The proposed indices based on Emergy accounting provide a framework for evaluating and comparing different building typologies, technologies and materials, regarding different manufacturing processes, maintenance, use, thermal efficiency and energy consumption.

With reference to building materials, the most extensive study on Emergy and building materials was developed by Buranakarn, 1998 in which a subsequent paper was published in 2003 (Brown and Buranakarn, 2003). Some of the results have been presented in the previous section where the author made calculations for several common materials.

Many other works could be found for building materials in literature, yet the impact of these material recycle on the final emergy of buildings is rarely found. The re-definition of the emergy of a recycled material or reused material would thus definitely have an impact on the value of the emergy indices defined by the respective building. A much more detailed account of emergy evaluation of buildings is presented in chapter 4.

- **Development of recycle emergy indices**

Despite the several recycle emergy indices described in the previous sections, it proves that these user-definable indices are not enough systemic and compositive to establish emergy evaluation indices system in the light of continuous solid wastes recycling or reuse value on the overall emergy of a building (Detailed review in chapter 3). What is the impact of the usage of recycling materials on the emergy of buildings? Which of the recycled materials use in the building have greater benefits? Which new emergy indices can then be developed? This is much discussed and solutions proposed with case studies in chapters 3 and 4.

2.7 Conclusion

The emergy concept is eminently well-suited to environmental accounting techniques as any of the inputs into the productive process can be manipulated by means of transformity ratios to give data in terms of common units of measure in all of the sectors required for an appropriate environmental accounting method (Gourgau, 1997). In this thesis, discussions on a critical review of available transformity values which most emergy analysts use in their studies, is discussed. A case study of determining the transformity of hydrogen for different hydrogen production pathways was investigated with results presented. A preliminary step was to establish a consistency in the transformity values for hydrogen production for the different pathways with available data in previous publications. The calculated transformity values for hydrogen were seen to be consistent with published results. Again, results indicate that the transformities of hydrogen via electrolysis are higher than those transformities via steam methane reforming of natural gas. This shows that a larger amount of resources is required to get the product (increased environmental support). This is because of the high amount of electricity consumption in the electrolysis process. Thus, this technology only seems to be applicable in specific cases, where a surplus of largely renewable electricity is available.

It has been spelt out in this chapter that recycling flows as in the case of feedback is a dynamic process and as such the process introduces its own time period. However, emergy evaluations are completed based on a specific time frame, over a year for example. As such, a time 'gap' is created between the time introduced by the recycling flow and the period taken into consideration for the emergy evaluation. This can lead to over simplification of the evaluation if this internal time generation via the recycling flow is not taken into account.

In the next chapter, a methodology is introduced as an enhancement over previous studies on how such emergy evaluations can be carried out. The developed approach is then applied to a case study to give a better understanding of the concept.

Chapter 3: Effect of Different Time Scales on Emergy Synthesis

This chapter presents and highlights the major contributions of this thesis. The studies show the impact of material reuse or recycle to the emergy evaluation of systems. Emergy is carried by matter and its value is shown to be the product of specific energy with mass flow rate and its transformity. This transformity is commonly calculated over a specific period which makes it a function of time. Recycling flows as in the case of feedback is a dynamic process and as such the process introduces its own time period. However, emergy evaluations are completed based on a specific time frame, over a year for example. As such, a time ‘gap’ is created between the time introduced by the recycling flow and the period taken into consideration for the emergy evaluation. This can lead to over simplification of the evaluation if this internal time generation via the recycling flow is not taken into account. As a result, an internal factor (such as ‘internal memory’) is proposed under specific assumptions.

The rules for handling different flows in emergy evaluations including feedback pathways were first referred to as emergy algebra by Scienceman, 1987. A systematic statement of these rules was given in chapter 6 of Odum, 1996 and a comparison of the calculation rules for embodied energy and emergy was demonstrated by Brown and Herendeen, 1996. The rules of emergy algebra are as follows:

- 1) For a system at steady state, all the emergy inflows to a production process are assigned to the outputs.
- 2) When an output pathway splits into two or more pathways of the same type, the emergy input is assigned to each ‘leg’ of the split based on its fraction of the total energy or material flow on the pathway; therefore, the transformity or specific emergy of each branch of the split is the same.
- 3) For a process with more than one output, i.e., co-products, each output pathway from the process carries the total emergy input to the process, i.e., the entire emergy required for a process is also required for each of the products.
- 4) No emergy input to a system can be counted twice. Thus, if an input or feedback flow to a component is derived from itself, i.e., it carries emergy already counted in the emergy required for the component, then the input or feedback flow is not added to the emergy required for the component, i.e., input emergy is not double-counted.

3.1 Analysis of feedback flows

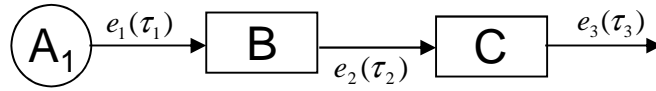

Fig. 3.0: Components without feedback

A single chain of components in which no feedback is realized has one emergy source A_1 (see Fig. 3.0, where e represents the emergy flow each pathway carries and τ represents the transformity of the pathway). As such, the emergy balance equations at steady state are:

$$B: e_1\tau_1 = e_2\tau_2 \tag{3-1}$$

$$C: e_2\tau_2 = e_3\tau_3 \tag{3-2}$$

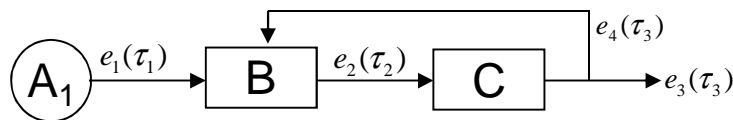

Figure 3.1: Components with single feedback

In this second scenario, there is a feedback flow from the output (C). According to the second rule of emergy as outlined above, ‘when an output pathway splits into two or more pathways of the same type (i.e. e_3 and e_4), the emergy input is assigned to each ‘leg’ of the split based on its fraction (α) of the total emergy or material flow on the pathway; therefore, the transformity or specific emergy of each branch of the split is the same’ (i.e. τ_3). As a result, the feedback flow from C into B should not be added to the input emergy of B to avoid double counting the input from A_1 . Thus, the emergy balance equations at steady state are:

$$*B: e_1\tau_1 = e_2\tau_2 \tag{3-3}$$

$$C: e_2\tau_2 = (e_3 + e_4)\tau_3 \tag{3-4}$$

Compartment B in real system values seem incorrect since it has limited outputs than inputs contrary to what appears in the figure. This is a clear case of establishing a significant difference of emergy analysis from other tools. Emergy analysis deliberately truncates feedback effects

* $e_4\tau_3$ is as a result of $e_1\tau_1$ and since no double counting is allowed, $\max(e_1\tau_1, e_4\tau_3) = e_2\tau_2$

when they have looped back to the source, maintaining an essence of hierarchy (Herendeen, 2004). The above equations constitute proof that emergy algebra, if its rules are properly applied, is congruent with the statement that emergy is a cumulative function of the inputs, because it ensures that the energy of streams is not double counted in the accounting procedure.

However, emergy concerns itself with the past and thus not accounting for any of the initial flows leading to the formation of a product could defeat its fundamental principle. The question then is how one can account for the initial emergy in a feedback flow without violating any of the emergy rules.

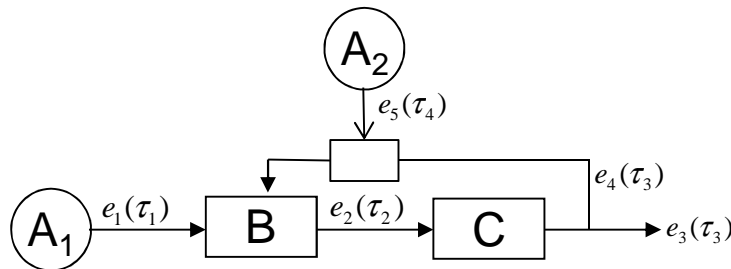

Figure 3.2: Introduction of additional emergy required (A_2)

$$B: e_2\tau_2 = e_1\tau_1 + e_5\tau_4 \tag{3-5}$$

$$C: e_2\tau_2 = e_3\tau_3 + e_4\tau_3 \tag{3-6}$$

In this specific case, $e_5\tau_4$ is taken into consideration since it is not from source A_1 and as such does not contain any of the embodied emergy from the initial configuration without feedback.

Now, assuming that the proportion of output that is feedback flow is given by α then:

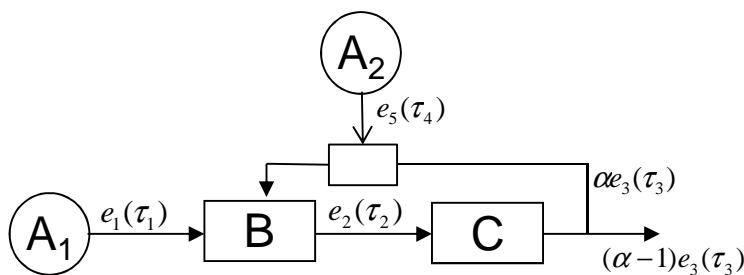

Figure 3.3: Diagram showing the recycled amount as α

Assuming a static calculation:

$$C: e_2 \tau_2 = (1 - \alpha) e_3 (\tau_3) + \alpha e_3 \tau_3 \tag{3-7}$$

$$e_2 \tau_2 = e_3 \tau_3 - \alpha e_3 \tau_3 + \alpha e_3 \tau_3 \tag{3-8}$$

$$e_2 \tau_2 = e_3 \tau_3 \tag{3-9}$$

Assuming a new boundary under steady state conditions:

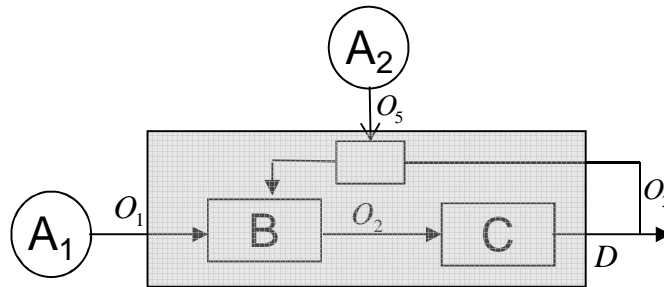

Figure 3.4: Diagram showing a defined boundary

$$D: \text{Emergy of } D = O_1 + O_5 \tag{3-10}$$

Where O_1 , O_2 and O_3 are emergy flows. In this case, the feedback, O_3 is not included in the calculation as already explained in previous sessions to avoid double counting since it is a function of the same system and is already embodied with energy from the system. However, emergy is time dependent as it is usually evaluated over a specific period of time, say 1 year.

Let us consider Fig. 3.5 below:

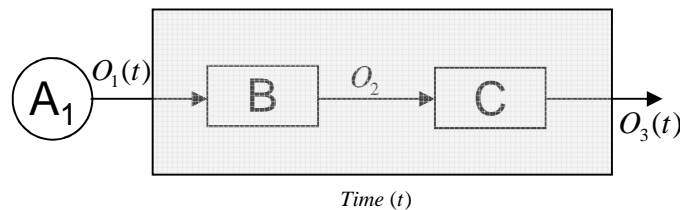

Figure 3.5: Simplified process system

¹²In this thesis the symbol of emergy is chosen as ‘O’ which refers to Odum, reflecting his enormous contributions to the concept of emergy. It also seek to avoid conflicts in the use of the letter ‘E’ which is been used for several other concepts.

Here in fig 3.5, the output emergy, $O_3(t)$ has been calculated based on a certain time (t) and from a transformity which is equally based on the specific time (t). From fig. 3.6, if a portion (α) of O_3 , returns to the system as feedback, it requires additional time (t') beyond the initial time which was used for its calculation. This accepted, and then requires that, emergy from feedbacks should not just be ignored, but has to be rightly evaluated in each specific case since the transformities from feedback flows could be different from the flow from which it generated.

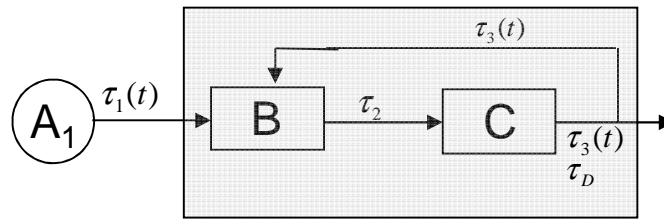

Figure 3.6: Simplified Process system with feed back

$$\tau_D: \tau_1(t) \tag{3-11}$$

Where τ_D is the transformity of the output flow (D). From the above, a product thus has a different transformity in a case of feedback flow. This is because in dynamic calculation, transformities can be calculated at any time during a product’s life, and transformities are slightly different with each time period (Brown and Cohen, 2008).

Updating fig. 3.4 with fig. 3.7, a general equation can be deduced to introduce this time factor for such evaluations.

13

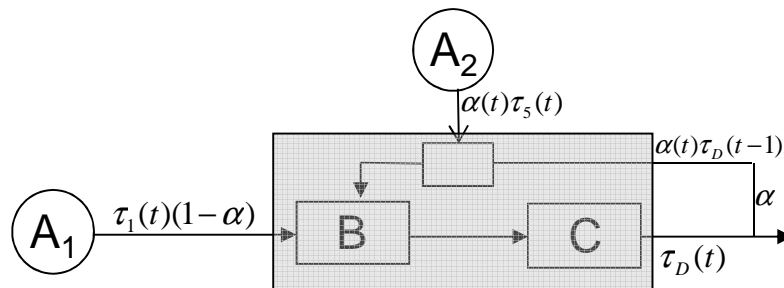

Figure 3.7: Process system showing additional energy needed for recycling

¹³ Here, (1- α) is the specific energy at time (t). This excludes any raw material.

τ_1 represents the transformity of the raw material input which excludes the transformity of the recycled or reused material. τ_5 however represents the transformity of the additional emergy needed for the recycling.

$$\tau_D(t)(1 - \alpha) = \alpha(t)\tau_5(t) + \tau_1(t)(1 - \alpha(t)) + \alpha(t)\tau_D(t-1) \quad (3-12)$$

From equation 3.12 above, in a case where $t=0$ and no feedback is realized:

$$\tau_D(0) = \tau_1(0) \quad (3-13)$$

In this case the transformity of the inputs equals that of the output transformity.

However, if $t=1$ for example and feedback flow is observed:

$$\tau_D(1) = \tau_1(1)(1 - \alpha(1)) + \alpha(1)\tau_5(1) + \alpha(1)\tau_D(1-1) \quad (3-14)$$

$$\tau_D(1) = \alpha(1)\tau_5(1) + \tau_1(1) \quad (3-15)$$

Now when $t=2$ for a feedback flow,

$$\tau_D(2) = \tau_1(2)(1 - \alpha(2)) + \alpha(2)\tau_5(2) + \alpha(2)\tau_D(2-1) \quad (3-16)$$

Substituting Equation 3.15 into equation 3.16 gives,

$$\tau_D(2) = \tau_1(2)(1 - \alpha(2)) + \alpha(2)\tau_5(2) + \alpha(2)[\alpha(1)\tau_5(1) + \tau_1(1)] \quad (3-17)$$

$$\tau_D(2) = \tau_1(2)(1 - \alpha(2)) + \tau_1(1)\alpha(2) + \tau_5(2)\alpha(2) + \alpha(2)\alpha(1)\tau_5(1) \quad (3-18)$$

$$\tau_D(2) = \tau_1 + \tau_5(\alpha + \alpha^2) \quad (3-19)$$

It is clear from the above equation that though the feedback transformity is taken into account in the calculation procedure, there is the avoidance of a double counting.

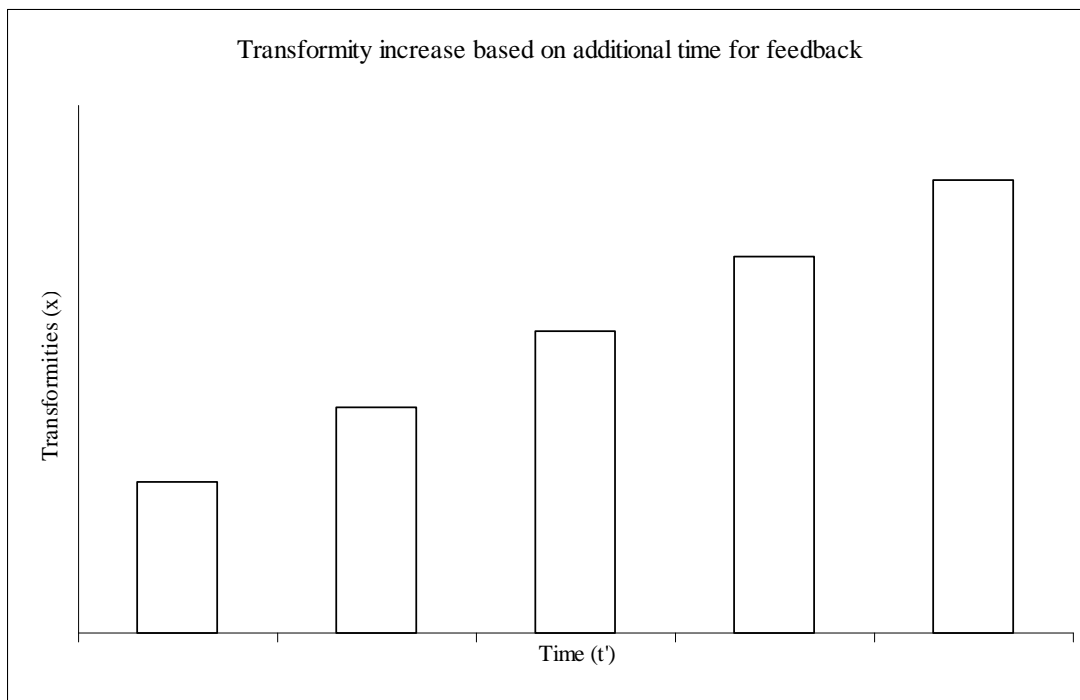

Figure 3.8: Transformity effects based on different time scales

Figure 3.8 shows clearly that for each feedback time, there is a potential increase of transformity and continues with each turn of increase in feedback time (t').

3.2 A Case of Recycling Flows

Recycling flows as in the case of feedback is a dynamic process and as such its behavior is in the same way as discussed above. Consider an aggregated system as in fig 3.9. With a raw material flow (Source A), into the system, not all internal processes might be known within the different process units. In this example, raw materials are refined, transformed, used and discarded. Source (B) represents the flow from other services, goods and fuel. As such, the process of refining requires an emergy input (O_R). The process of transforming the refined material into a finished product also requires emergy inputs of fuels, goods and services (O_T). If the emergy in the raw material is O_m then the emergy in the product (O_P) is the sum of the emergy in the raw materials and the emergy inputs for refining and transformation ($O_P = O_m + O_R + O_T$).

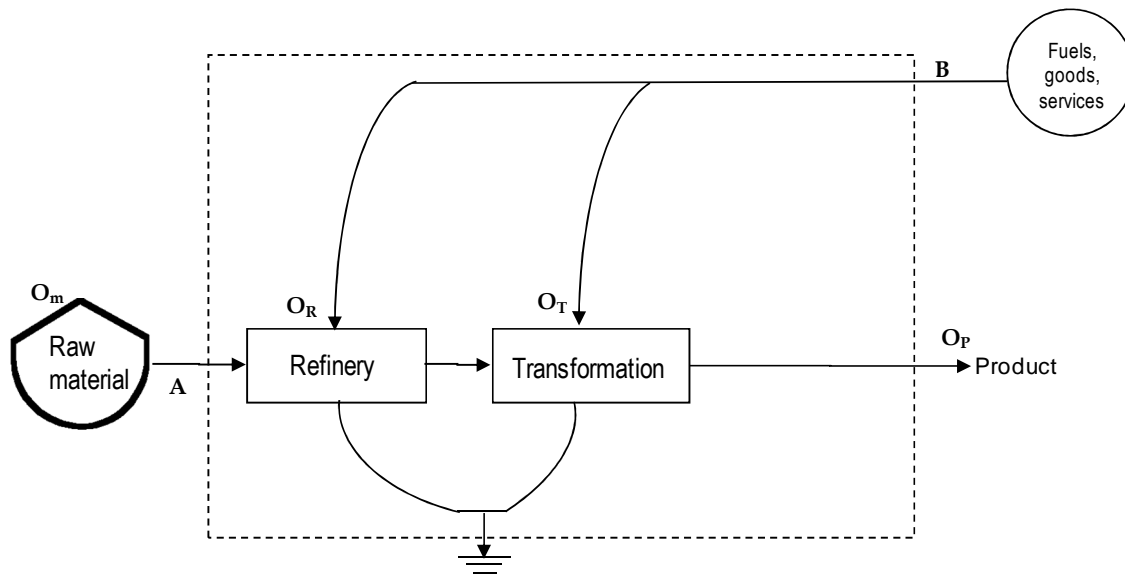

Figure 3.9: Aggregated system with no internal recycle flows

Considering a similar system which involves recycling, additional emergy through services, goods and fuel inputs would be required for recycling (O_c) from source (C) as shown in fig 3.10. The emergy in the product (O_P) is then the sum of the emergy in the raw materials and all the emergy inputs required to maintain the cycle of the material system ($O_P = O_m + O_R + O_T + O_C$)¹⁴.

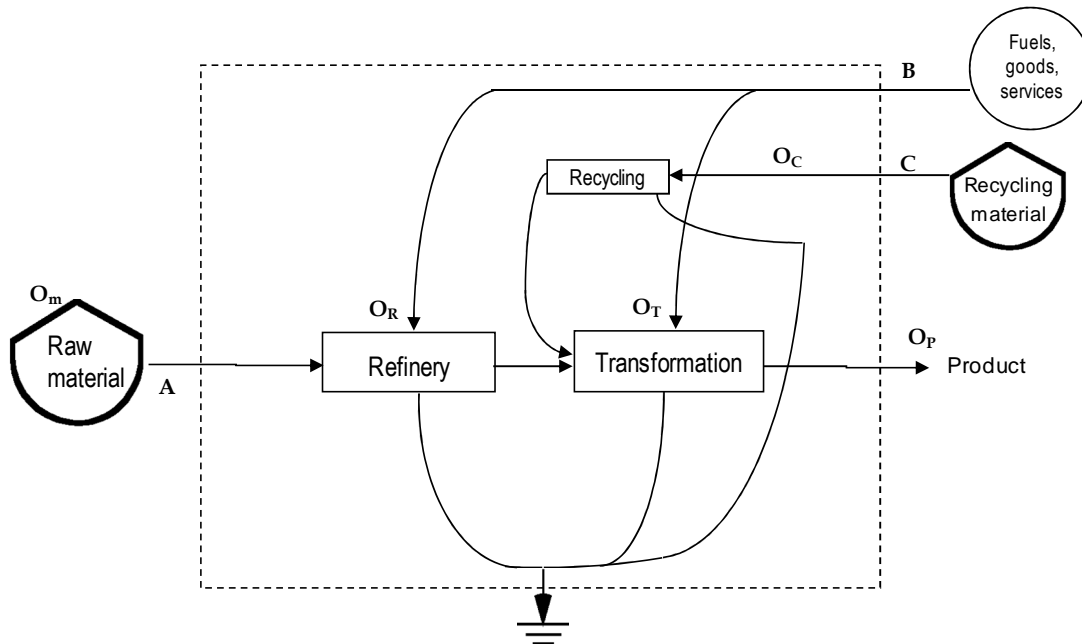

Figure 3.10: An aggregated system with recycle flows

¹⁴ Note: though O_m remains the same notation for both the conventional process and the recycling process, they vary in terms of real quantities i.e. O_m decreases since O_c is a substitute in the recycling scenario.

The transformity of the product is given as: $\tau_p = \frac{\sum O_i}{Q}$ which takes into account the individual energy flows (O_m, O_R, O_T, O_c) over a year and the product output (Q). Transformity (of raw material, fuels, goods, services, and so on...) is undoubtedly an important concept in emergy studies. There is still an ongoing research in developing the use of transformity values and its use in emergy evaluation (Ingwersen, 2010; Baral and Bakshi, 2010, Amponsah and Le Corre, 2010a, Ulgiati, 2010 etc). Systems with recycling flows as mentioned above have a rather peculiar nature. As such, due to the accumulative effect of its emergy, a new transformity would be defined by the system, which accounts for this ‘internal emergy’ accumulation.

Systems with recycling flows as mentioned above have a rather peculiar nature. The additional emergy (O_c) needed by a system involving recycling or material reuse obviously increases the output or final emergy compared to that of a conventional system. As such, a new transformity would be defined by this system involving recycle.

From the equations derived earlier, it is then extended to consider a system in which a single feedback flow in the form of recycle flow is followed several times as it passes through the system. Assuming perfect substitution, let us consider the loop in figure 3.11.

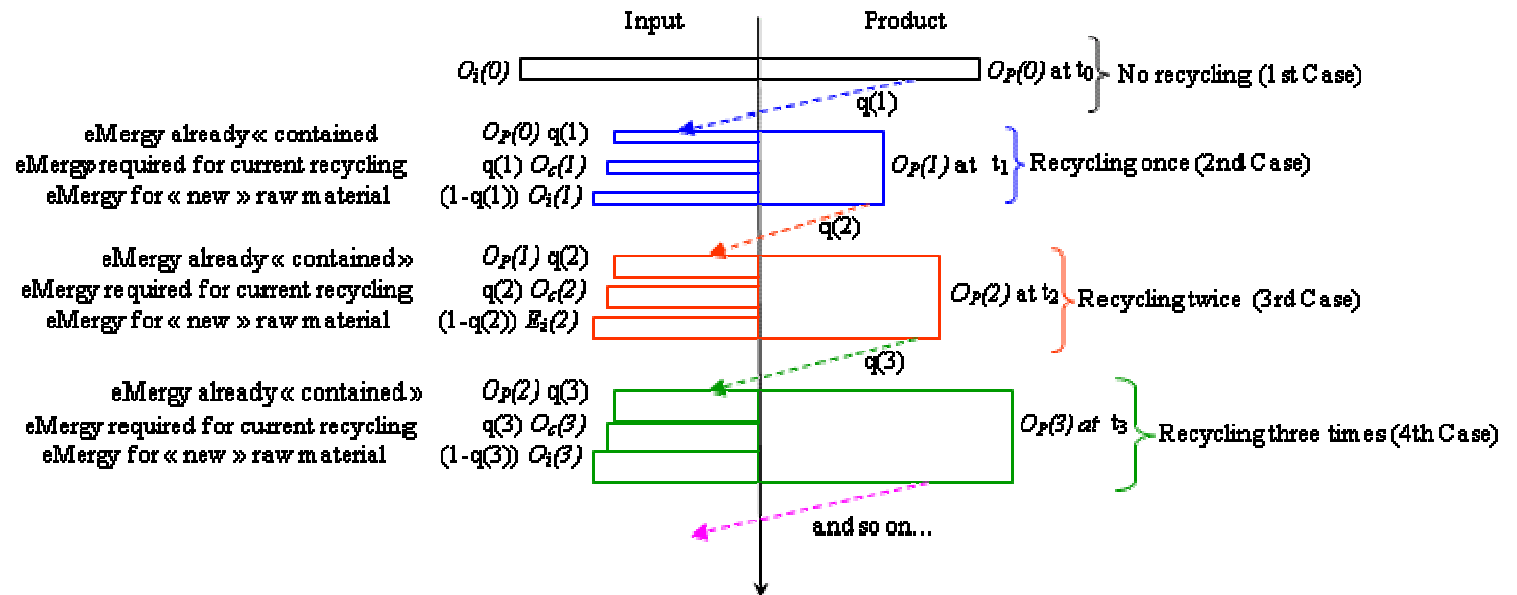
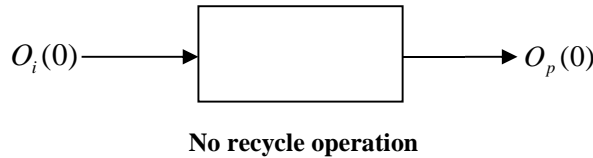

Figure 3.11: Opening out the time notion for emergy evaluation of recycling process

Where O_i is the specific total energy inputs (emergy of raw material, fuel, goods and services etc without recycle, from source (A) and (B)), O_c is the specific additional energy needed for recycling from source (C)¹⁵, O_p is the specific energy in the product, q is the amount of material to be recycled (α in the previous section) and t is the additional time needed for recycling. From fig. 3.11, it is therefore clear that in the first case, there is no recycle operation i.e. t_0 and $q=0$; $O_c=0$ and as such:



$$O_p(0) = O_i(0) \tag{3-20}$$

However, in the 2nd case, if $q(1)$ is the amount of material to be recycled and t_1 indicates the recycle time, it must be noted that it already contains a specific energy from the previous operation that led to its formation given as $O_p(0)q(1)$. Also, the additional specific energy needed for the current recycling (collection, sorting etc.) is given as $O_c(1)q(1)$ and the ‘specific’ emergy of the new raw material for the process, given as $O_i(1)(1 - q(1))$ resulting in $O_p(1)$ as the specific emergy of the product given as:

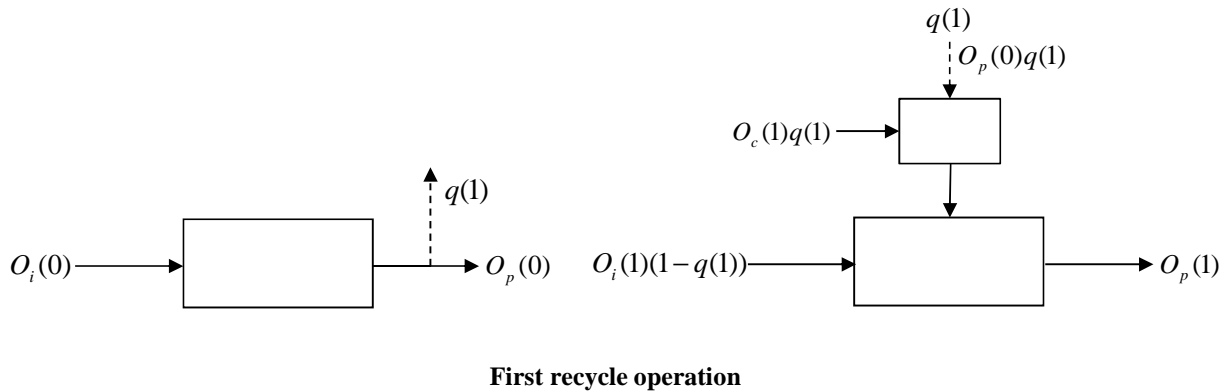

$$O_p(1) = q(1)O_c(1) + O_i(1)(1 - q(1)) + q(1)O_p(0) \tag{3-21}$$

In the special case where:

$$O_i = O_i(0) = O_i(1)$$

Equation (2) becomes:

$$O_p(1) = O_i + qO_c \tag{3-22}$$

¹⁵ O_c is calculated from the emergy of the additional activities needed before a material is successfully recycled or reused (e.g. sorting and collection). The total emergy of O_c is dependent on the fraction of material recycled, q

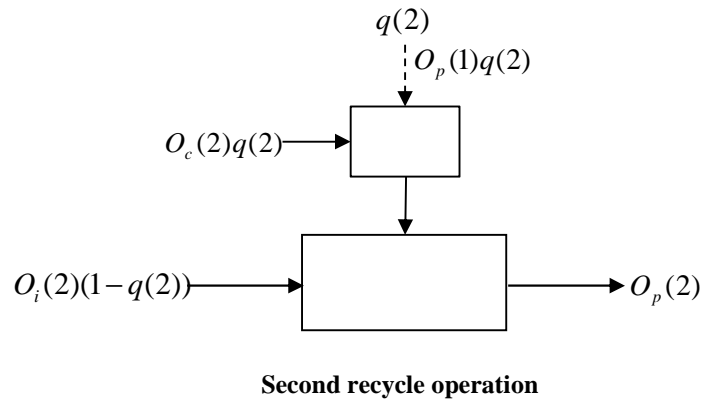

At a time t_2 , indicating a second recycle operation, if $q(2)$ is the amount of material from the first operation to undergo recycling, $O_p(1)q(2)$ is the specific energy it already contains. $O_c(2)q(2)$ is the additional specific energy it needs for the current recycling operation, $O_i(2)(1-q(2))$ is the specific energy of the new raw material to be inputted in the operation resulting in $O_p(2)$ as the energy of the product, it gives:

$$O_p(2) = q(2)O_c(2) + O_i(2)(1-q(2)) + q(2)O_p(1) \tag{3-23}$$

In the special case where we have O_i , O_c and q constant, equation (3.23) is:

$$O_p(2) = O_i + qO_c + q^2O_c \tag{3-24}$$

In the third recycling (t_3), it follows from the previous derivatives. Thus the specific energy output ($O_p(3)$) as in the special case where we have O_i , O_c and q constant is given as:

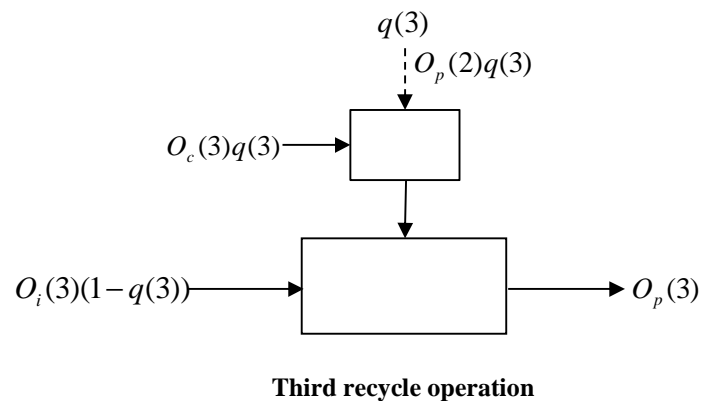

$$O_p(3) = O_i + qO_c + q^2O_c + q^3O_c \tag{3-25}$$

This continues for any other additional recycling. It is important to note that since there are more or less differences between each two recycling processes, due to conditions of manufacture, technological levels and material inputs, energy input for 100% material recycling O_c would definitely differ in terms of real values but remains as the notation, O_c , for all recycle times (1st, 2nd, 3rd, 4th ...nth)¹⁶. Moreover, the increase of proportion recycled (q) does not cause the proportional decrease of energy for new raw material input ($O_i(t)$).

It is also worthy to mention that in emergy accounting only the flows that are crossing the system boundaries must be accounted for. As such internal generated waste where part of it is recycled to another internal system in the process is not recounted to avoid double counting. In this case only the external energy used for the recycling is accounted for. However, where the waste generated by a system is used by another system, the flow is accounted for. With the different cases described above, a general equation could then be deduced to calculate the emergy in the product (O_p) at a recycle time t . Let us deduce this from the simplified flow diagram in fig. 3.12.

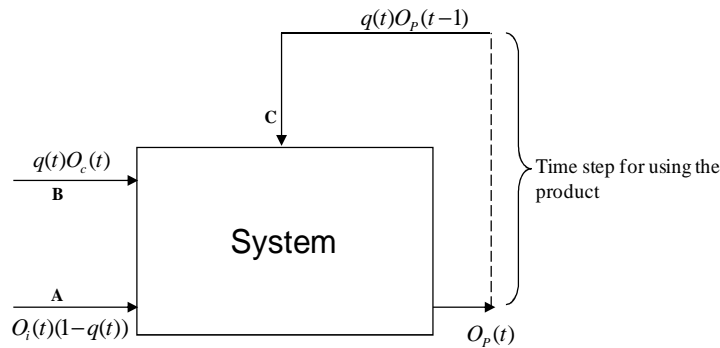

Figure 3.12: Simplified energy flow diagram (emergy flows during recycle operation)

Then, the specific energy balance is then written as:

$$O_p(t) = q(t)O_c(t) + O_i(t)(1 - q(t)) + q(t)O_p(t-1) \quad (3-26)$$

which results in the special case when q , O_i and O_c are independent of time, we have:

$$O_p(1) = O_i + qO_c \text{ for the 1}^{\text{st}} \text{ Recycle}$$

$$O_p(2) = O_i + O_c(q + q^2) \text{ for the 2}^{\text{nd}} \text{ Recycle}$$

$$O_p(3) = O_i + O_c(q + q^2 + q^3) \text{ for the 3}^{\text{rd}} \text{ Recycle}$$

$$O_p(4) = O_i + O_c(q + q^2 + q^3 + q^4) \text{ for the 4}^{\text{th}} \text{ and so on.}$$

¹⁶ As shown in the equations above, assuming that the initial energy amount (O_i) remains constant in all stages of the recycle, increasing the amount recycled (q ; i.e. a fraction between 0-1) does not cause the proportional reduction of ($O_i(t)$) in total though there is a reduction of new raw material needed for the recycle operation due to the substitution of the recycled material.

Therefore, for N number of recycles this then gives in the special case when q , O_i and O_c are independent of time, we have:

$$O_p^N = O_i + O_c(q + q^2 + q^3 + q^4 + \dots + \dots + q^N) \tag{3-27}$$

$$= O_i + qO_c(1 - q^N)/(1 - q) \tag{3-28}$$

Patten, 1995 discussed the effects on emergy of tracing the available energy used through multiple passages through an ecosystem network. Equations were derived based on the behavior of the multiple passages. An exponential increase was observed, creating a cumulative flow for such continuous passages through ecosystem networks. The exact formulae are proposed here (under assumptions) based on another approach. From the discussion above, it is clear that considering or ignoring the time pathway of a recycle flow in an emergy evaluation could have enormous impact on the final results. This is even more evident when recycling is done continuously for a specific number of times. Fig. 3.13 shows the effect of cycle times in recycling on the specific emergy of the recycle flows.

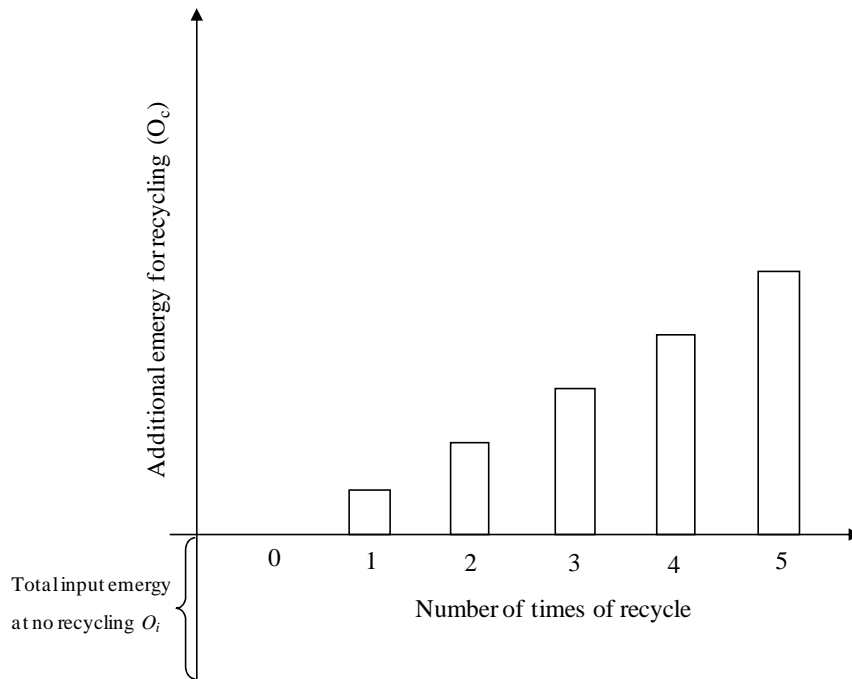

Figure 3.13: Effect of cycle times (number of times recycle) on specific emergy amount

It is observed that as cycle times (number of times a material undergoes recycle) increase in recycling flows, specific emergy increase which adds to the memory of the pathway. This is a continuous accumulation of specific emergy amounts as the number of times recycle is done increases. Since emergy accounts for the ‘past’ or the memory of a flow pathway, it is necessary to add this emergy introduced by the recycling effect at that discrete time. The scale of this discrete recycling is greater than the time taken into account for calculations of input emergy

involved in refining and transformation of the raw material to its final product. Especially in cases of encapsulation or system aggregation where detailed flow pathways are ignored, the evaluation could be over simplified, not accounting for this effect.

Depending on the number of times of internal feedback flows, it is then necessary to take into account a correction factor. From equation 3.27 above, in the special case when q , O_i , O_c are independent of time, this correction factor would be, $\Psi = (q + q^2 + q^3 + q^4 + \dots + q^N)$, which helps to correct emergy evaluations involving a number of recycles (N). This correction factor if introduced, i.e. Ψ , makes it easier for the calculations. As a matter of fact, the important thing is to calculate O_c and only multiply by the factor Ψ , depending on the number of times of recycle.

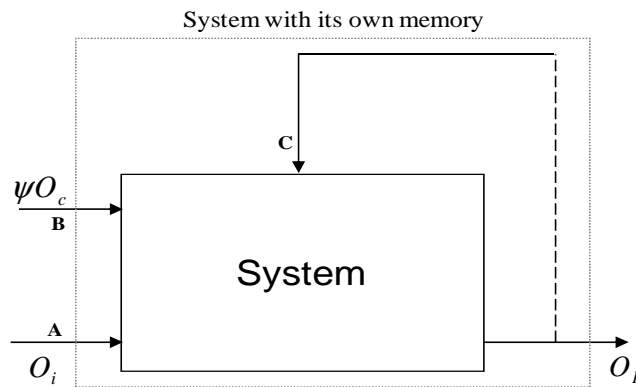

Figure 3.14: Introduction of a correction factor (ψ)

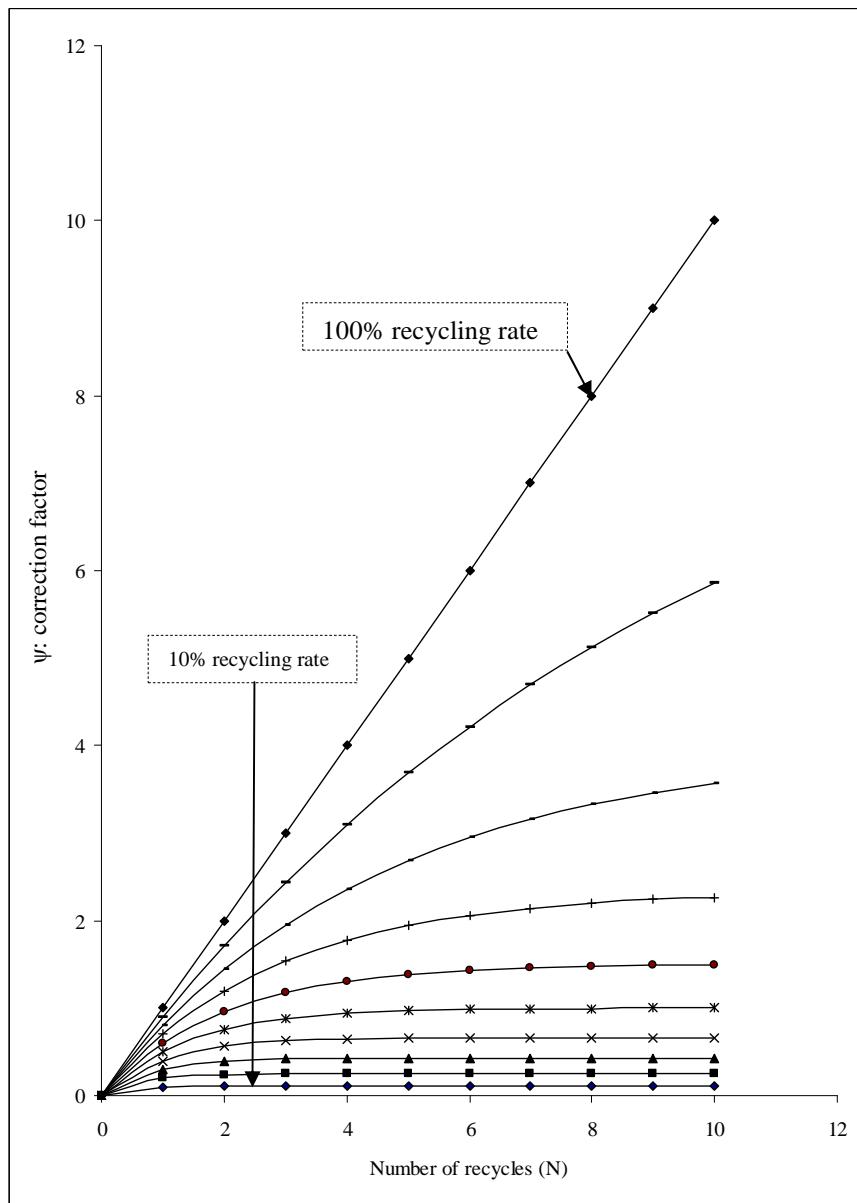

Figure 3.15: The impact of continuous recycling in a process

Fig. 3.15 shows the behavior of recycle patterns based on this factor on the number of times of recycle (N) and the rate of recycling (q). Comparing 10% and 100% recycling rates for example, the impact of this factor is not that significant for a first recycle operation. However, the significant difference is greater at higher recycle times. It is important to emphasize that; the hidden information within recycle flows in such emergy synthesis cannot be ignored. At lower recycle rates, a certain asymptotic behavior is also observed which indicates that at higher recycle rates (e.g. 100% recycle rate) emergy can be defined only as a function of the number of times of

recycle. The impact between recycle times (ε) i.e. between N-1 and N (between a current recycling and a preceding one) can also be determined considering the time step which results in an asymptotic behavior. As such, $\psi(q,N) - \psi(q, N-1) = \varepsilon$ gives q^N .

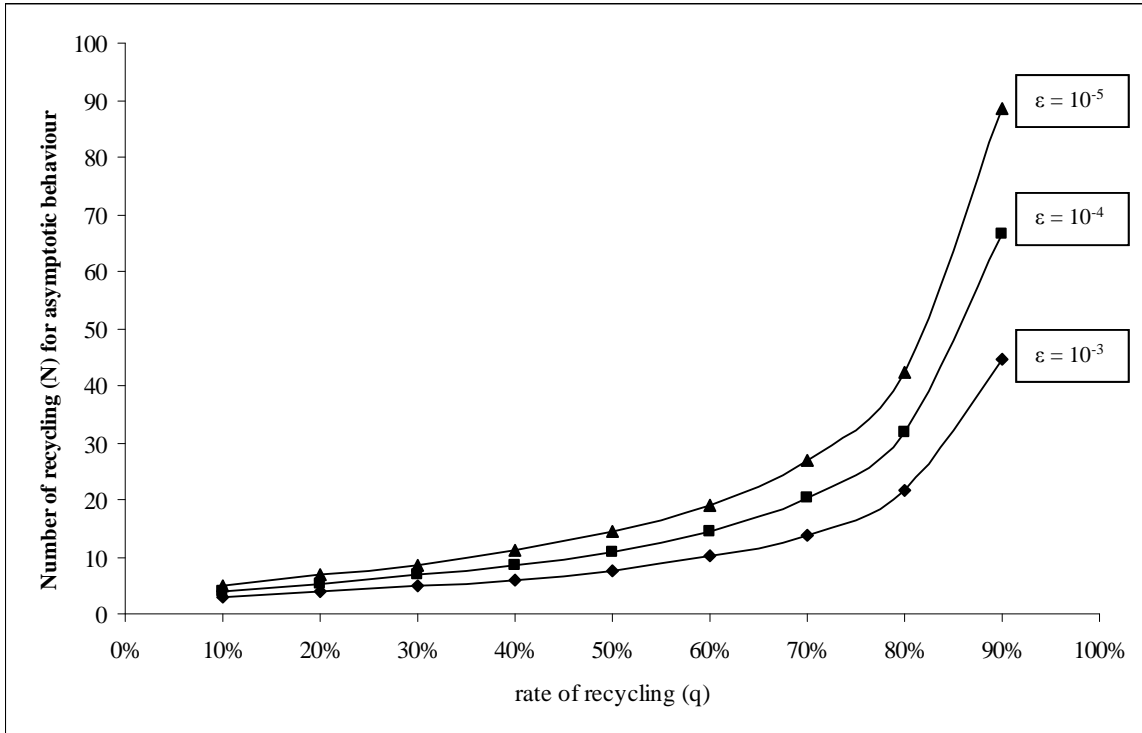

Figure 3.16: Shows the asymptotic behavior at different recycling rates

Therefore one can determine the number of times of recycling to consider to achieve a specific asymptotic behavior. Fig. 3.16 shows the asymptotic behavior at different rates of recycling. From the figure, it is observed that, asymptotic behavior is more favoured at lower recycling rates.

3.3 Case Study – Recycle of some selected Building Materials (Inspired by Buranakarn, 1998)

In this section, a case study is presented with an emergy evaluation applied to some building materials commonly used in the building and construction industry. This case study is inspired by the work conducted by Buranakarn Vorasun. In that work, Buranakarn, 1998, the emergy of nine materials used in buildings were evaluated, including: wood, concrete, cement, glass, clay brick, ceramic tile, steel, plastic, and aluminum. Emergy in materials was evaluated by analyzing inputs of raw resources, energy, and labor obtained from national statistics for each material. Inputs of materials, energy and labor were tabulated and converted to emergy using emergy per mass, transformities, and emergy per dollar ratio (Odum, 1996, 2000). Emergy for each input was then summed to obtain the total emergy per gram of material produced. In this work however, the conceptual approach discussed in the previous sections is applied to two different groups of materials from the study conducted by Buranakarn. The first comprises of metallic materials (steel, aluminum) and the second, non-metallic materials (glass and plastics).

(a) Evaluation of steel recycling process in the building and construction industry

Steel is among the most used and also recycled and important materials in world economy (Zhang et al., 2009) especially in the construction industry. In this particular industry, steel is easily reclaimed and reused in new building works. Reclaim of steel from demolished buildings for recycling is a common and ancient practice in the steel industry. New steel is often made in part or all from reclaimed steel scrap from different sources, reducing environmental impacts from steel production. Comparing the primary energy burden, when compared with the use of only virgin raw materials, current recycling operation of stainless steel production represents a reduction of 33%, and 100% recycling of stainless steel production would represent a reduction of 66% (Johnson et al., 2008).

Recycling of steel also decreases CO₂ emissions far more considerably. Data for this case study is collected from the thesis presented by Buranakarn, 1998 in which he studied the recycle options of some building materials. In clearly defining emergy intensity of recycling operations, he states that emergy intensity is not transformity or emergy per gram but rather reflects the energy inputs required to bring a material back to a previous stage, in which its transformity or emergy per gram is the same as a raw material input at that stage. Only the emergy required in recycling facilities is added into the evaluated processes to avoid double counting. He evaluated the recycling of steel via two recycling alternatives. He presented the options of using post consumer scrap steel as substitute for the pig iron input and also considered a combination of by product steel from the production process and post consumer scrap steel as substitute for pig iron input.

In the conventional steel process which does not involve any recycle, the pig iron is the largest input comprising about 70% of the total inputs. The fuels and electricity represent about 25% of total inputs. In the first recycle process additional emergy is used in collection and separation. These inputs add slightly to the total inputs of the production process.

Note Item	Unit/year	Input Resource	Solar emergy per unit (seJ/unit)	Emergy seJ/yr
Conventional steel product				
1 Pig iron	g	4,53E+13	2,83E+09	1,28E+23
2 Natural gas	J	3,17E+17	4,80E+04	1,52E+22
3 Other fuels	J	2,80E+16	6,60E+04	1,85E+21
4 Electricity	J	1,84E+17	1,74E+05	3,20E+22
5 Transportation	ton-mile	7,50E+09	9,65E+11	7,24E+21
6 Labour	\$	1,58E+09	1,20E+12	1,90E+21
7 Annual Yield	g	4,49E+13	4,15E+09	1,86E+23

Table 3.1: Emergy evaluation table for the conventional production of steel via the electric arc furnace process (Data from Buranakarn, 1998)

¹⁷As discussed above, table 3.1 shows a situation of the first case, where there is no recycle operation i.e. $q=0$; $O_c=0$ and as such: $O_p(0)=O_i(0)$. Performing such an emergy evaluation with an annual base period (i.e. per year) requires no additional time for recycling (i.e. t_0). In this case, the sum of the total emergy inputs (pig iron, natural gas, other fuels etc) based on their respective annual (yearly) quantities (Q) as evaluated, gives the emergy of the product i.e. $1.86E+23$ seJ/yr and a transformity of $4.15E+09$ seJ/g.

Note Item	Unit/year	Input Resource	Solar emergy per unit (seJ/unit)	Emergy seJ/yr
Material recycling and byproduct use steel product				
1 Post consumer steels	g	1,36E+13	2,83E+09	3,85E+22
2 Steel scrap or slag	g	3,17E+13	2,83E+09	8,97E+22
3 Post consumer steel collection	g	1,36E+13	2,51E+08	3,41E+21
4 Post consumer steel separation	g	1,36E+13	8,24E+06	1,12E+20
5 Natural gas	J	3,17E+17	4,80E+04	1,52E+22
6 Other fuels	J	2,80E+16	6,60E+04	1,85E+21
7 Electricity	J	1,84E+17	1,74E+05	3,20E+22
8 Transportation	ton-mile	7,50E+09	9,65E+11	7,24E+21
9 Labour	\$	1,58E+09	1,20E+12	1,90E+21
10 Annual Yield	g	4,49E+13	4,24E+09	1,90E+23

Table 3.2: Emergy evaluation table involving recycle of post-consumer steel via the electric arc furnace process (Data from Buranakarn, 1998)

¹⁷ In Table 3.2, Buranakarn, 1998 has taken into account the same labor for each raw material whatever the cycle (conventional or recycling). This assumption could be usefully revisited in a dedicated work, as indicated by an anonymous reviewer.

The main difference between the two tables presented, is the additional emergy needed for post consumer steel collection and separation for the recycle process (Table 3.2). This represents the additional emergy needed for the collection of used steel from landfills and other sources and the corresponding additional emergy needed for sorting or separation. This is represented by item 3 and 4 on Table 3.2 with transformities of $2.51E+8$ seJ/J and $8.24E+6$ seJ/J respectively. As such, Table 3.2 presents the system involving recycling. We consider that the 70% new raw material input represents $0.7O_i$. In this specific case, q , which is the rate of recycling, is given as 30%. As such, from equation 3.22, which was earlier on mentioned, $O_p(1) = O_i + qO_c$, where O_i is the emergy of the total inputs without recycle and equals O_p in that specific case. As such, the emergy contained in the material to be recycled is O_p where $O_p = O_i$ in the specific case, $O_i = 1.86E+23$ seJ. From the data (see Buranakarn, 1998 p52), the emergy needed for collection and separation for a 100% material recycle is $1.13E+22$ seJ and $3.70E+20$ seJ respectively.

Applying equation 3.22, then gives: $(1.86 \times 10^{23}) + 0.3(3.7 \times 10^{20} + 1.13 \times 10^{22}) \approx 1.90E+23 \text{ seJ/yr}$

However, this could also be done by the method explained in the previous sections. Therefore, calculating O_c and ψ , O_p could be calculated. Fig 3.16 presents the evaluated emergy results for different recycle times for recycling rates of 30% and 90%.

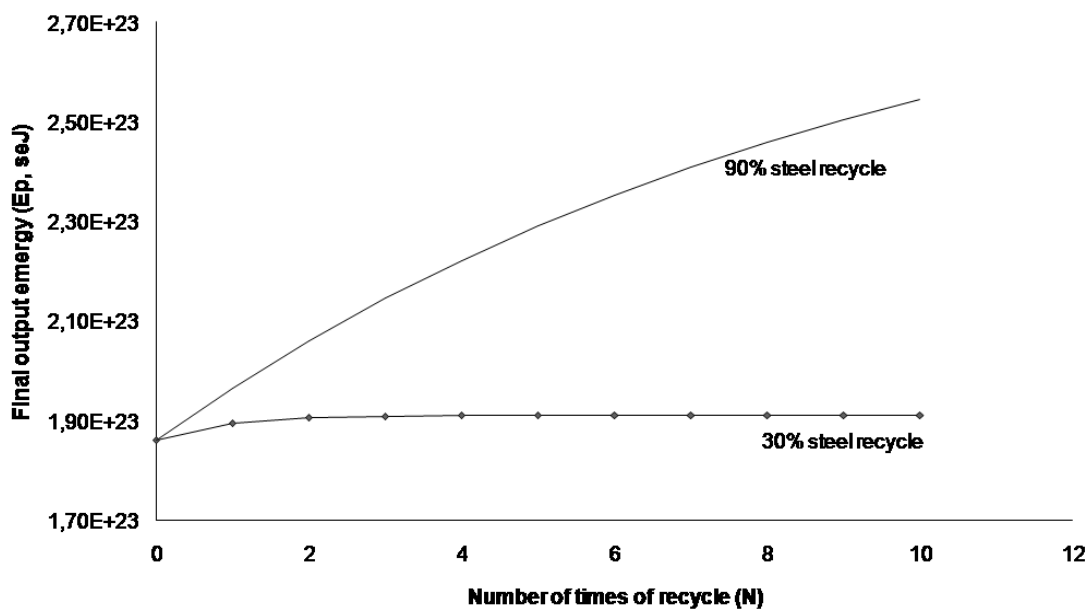

Figure

3.16: Results of Continuous recycling of steel based on 30% and 90% recycling rate.

It is observed that at both 30% and 90% recycle of steel scrap, there is a gradual accumulation of emergy from the first, second, third recycle and so on. In the third recycling, for example, it is seen that the material (q) undergoing recycling has already been subjected to a first ($1-q$), second ($q(1-q)$) and now a third (q^2) recycling. As such this accumulative effect must be considered in the final emergy output of the system. Note, that this is not double counting as already explained.

(b) Evaluation of Aluminum recycling process

The correction factors achieved was again extended to calculate for aluminum sheet recycle. Table 3.4a gives the results of the conventional process and Fig. 3.17 shows the behavior if the recycle continues for a number of times for different recycle rates (q=30% and 90%).

Note Item	Unit/year	Input Resource	Solar emergy per unit (seJ/unit)	Emergy seJ/yr
Conventional aluminium sheet production				
Primary aluminium (ingot)	g	4,17E+11	1,17E+10	4,88E+21
Electricity	J	1,08E+15	1,74E+05	1,88E+20
Labour	\$	2,09E+07	1,15E+12	2,40E+19
Annual Yield	g	4,00E+11	1,27E+10	5,08E+21
Recycling Process				
Used aluminium can	g	2,29E+11	1,17E+10	2,68E+21
Primary aluminium (ingot)	g	1,25E+11	1,17E+10	1,46E+21
Aluminium scrap	g	6,25E+10	1,17E+10	7,31E+20
Used Al. can collection	g	2,29E+11	2,51E+08	5,75E+19
Used Al. can separation	g	2,29E+11	8,24E+06	1,89E+18
Electricity	J	1,08E+15	1,74E+05	1,88E+20
Transport (Truck)	ton-mile	2,82E+07	9,65E+11	2,72E+19
Labour	\$	2,90E+07	1,15E+12	3,34E+19
Annual Yield	g	4,00E+11	1,29E+10	5,16E+21

Table 3.4a: Results of energy evaluation of conventional aluminum production and recycling of used aluminum cans (Data from Buranakarn, 1998)

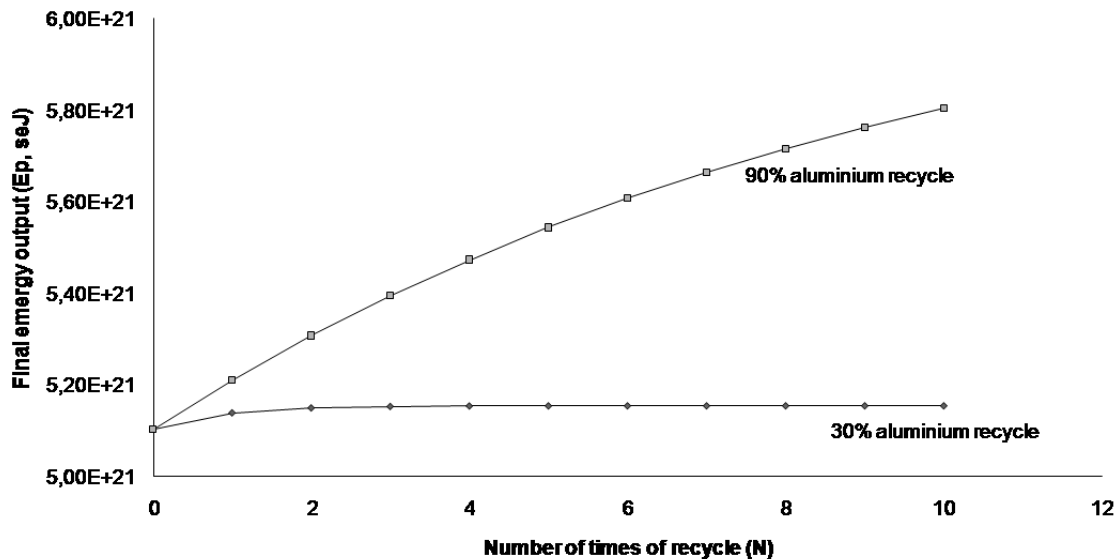

Fig 3.17: Continuous recycling of used aluminum cans for 30% and 90% of material recycle

(c) Emergy evaluation of plastic and glass (ceramic tile) recycling

This could be applied to several other material recycling options to evaluate the different impacts. Data for the emergy evaluation of plastics and glass (ceramic tile) were collected from an emergy synthesis study presented also by Buranakarn, 1998. In both recycle processes, there are associated costs of collection and sorting and as such the emergy per mass of the product from the recycle processes are higher than the conventional process (Tables 3.5 and 3.6).

In Table 3.5, the emergy evaluation of conventional plastic lumber production is given with that of a recycling process; assuming that post consumer plastic (e.g. milk bottles) and paper are substituted for the plastic resin and wood fiber. These are associated with costs of collection and sorting and as such, the emergy per mass reuse of post consumer plastic results in an emergy per mass of $6.33\text{E}+9$ seJ/g.

Note Item	Unit/year	Input Resource	Solar emergy per unit (seJ/unit)	Emergy seJ/yr
Conventional plastic product				
Wood fiber	J	2,67E+12	4,20E+04	1,12E+17
Plastic resin	g	7,22E+08	5,27E+09	3,80E+18
Electricity	J	1,08E+12	1,74E+05	1,88E+17
Transport (Truck)	ton-mile	1,87E+05	9,65E+11	1,80E+17
Machinery	g	4,84E+05	6,70E+09	3,24E+15
Labour	\$	5,27E+05	1,15E+12	6,06E+17
Annual Yield	g	8,50E+08	5,75E+09	4,89E+18
Recycling Process				
Post consumer paper	g	2,67E+12	1,42E+05	3,79E+17
Post consumer plastic	g	7,22E+08	5,27E+09	3,80E+18
Collection	g	8,49E+08	2,51E+08	2,13E+17
Separation	g	8,49E+08	8,24E+06	7,00E+15
Electricity	J	1,08E+12	1,74E+05	1,88E+17
Transport (Truck)	ton-mile	1,87E+05	9,65E+11	1,80E+17
Machinery	g	4,84E+05	6,70E+09	3,24E+15
Labour	\$	5,27E+05	1,15E+12	6,06E+17
Annual Yield	g	8,50E+08	6,33E+09	5,38E+18

Table 3.5: Emergy evaluation of conventional and recycle process of plastic lumber (Data: Buranakarn, 1998)

Note Item	Unit/year	Input Resource	Solar emergy per unit (seJ/unit)	Emergy seJ/yr
Conventional ceramic tile (glass) product				
Silica sand	g	3,38E+09	1,00E+09	3,38E+18
Sand	g	1,31E+08	1,00E+09	1,31E+17
Clay	g	1,09E+09	2,00E+09	2,18E+18
Others	g	2,18E+08	1,00E+09	2,18E+17
Water	J	1,08E+09	4,80E+04	5,18E+13
Natural gas	J	8,85E+13	4,80E+04	4,25E+18
Electricity	J	1,61E+12	1,74E+05	2,80E+17
Transport (Truck)	ton-mile	1,19E+06	9,65E+11	1,15E+18
Machinery	g	4,08E+07	6,70E+09	2,73E+17
Labour	\$	6,85E+05	1,20E+12	8,22E+17
Annual Yield	g	4,14E+09	3,06E+09	1,27E+19
Recycling Process				
Sand	g	1,31E+08	1,00E+09	1,31E+17
Clay	g	1,09E+09	2,00E+09	2,18E+18
Post consumer glass bottles	g	2,70E+09	1,90E+09	5,13E+18
Others	g	2,18E+08	1,00E+09	2,18E+17
Collection	g	2,70E+09	2,51E+08	6,78E+17
Separation	g	2,70E+09	1,32E+07	3,56E+16
Water	J	1,08E+09	4,80E+04	5,18E+13
Natural gas	J	6,65E+13	4,80E+04	3,19E+18
Electricity	J	1,21E+12	1,74E+05	2,11E+17
Transport (Truck)	ton-mile	1,19E+06	9,65E+11	1,15E+18
Machinery	g	4,08E+07	6,70E+09	2,73E+17
Labour	\$	6,85E+05	1,20E+12	8,22E+17
Annual Yield	g	4,14E+09	3,38E+09	1,40E+19

Table 3.6: Emergy evaluation of conventional and recycle process of glass (Data: Buranakarn, 1998)

Figure 3.18 shows the pattern of results obtained for the product emergy values ($O_{P_{\text{glass}}}$, $O_{P_{\text{plastic}}}$) when the correction factor is used in calculating these values for their respective recycle times and rates.

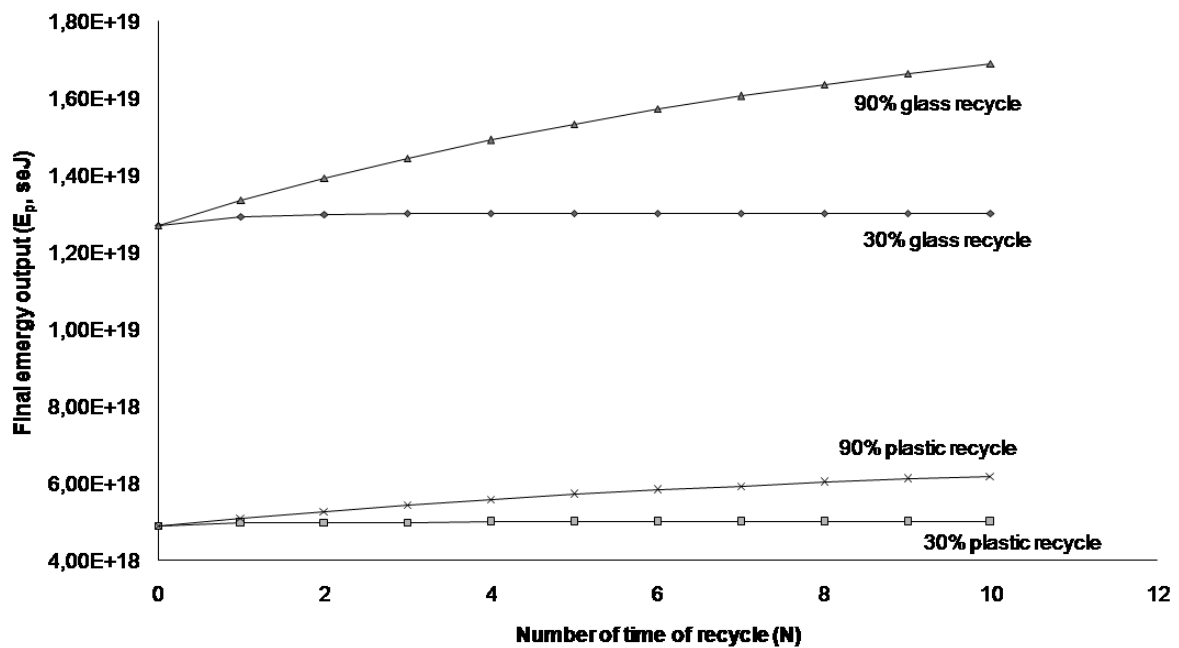

Fig 3.18: Continuous recycling of post consumer glass (ceramic tile) and plastic for 30% and 90% recycle.

The general principle is the same for each material, for example, the recycle of a material is much affected by the recycling rate (q) and the number of times the recycle is done. Criteria to judge appropriate optimum levels for both recycle times and rates depends on the asymptotic behavior of the respective patterns for the recycle operation. The output emergy values from the continuous recycling tables presented, further helps to emphasize the accumulation effect of continuous recycling at different increasing rates during material recycling. It shows the gradual increase of specific energy amounts between the first, second, third, etc recycle times. This is important to be accounted for during an emergy evaluation.

In many studies (Bastianoni et al., 2002; Meillaud et al., 2005; Odum, 2000), emergy is calculated as the product of energy (over a specific period) and its associated transformity (often selected from a reference database). However, in this thesis this strong relation seems broken. As was reported to a reviewer of a paper submitted to the journal of ecological modeling based on this work, this thesis reminds readers that an increase in the emergy of a product does not necessarily correspond to a change in the exergy (useful available energy) in the product. The reviewer reported that this work seems to break the link between eMerger and exergy of a product. The first question then relates to: is it a pure mathematical paradox in the rules of eMerger? Is it consistent with previous work? What were the previous solutions to avoid the cumulative problem in reuse scenarios? What are the consequences?

- A Mathematical Paradox?

It is important to recall that emergy is a ‘cumulative’ measure and again does not take into account the (time) depreciation. There are quite a few published papers which demonstrate the time dependence in the emergy concept (Odum and Peterson, 1996; Tilley and Brown, 2006). However, in these two examples (papers), depreciation to the environment is not taken into account for emergy. In respect to the approach presented in this thesis, one can argue that a similar product could have different transformities just because one has a portion of recycled material in its production. However, this work demonstrates that since transformity = emergy (input)/ exergy, emergy (input) can increase without a necessary change in exergy.

From the first law of thermodynamics:

$$dU = \delta W_{ext} + \delta Q \text{ or } m du + u dm = \delta W + \delta Q \tag{3.29}$$

where U is internal energy, W external work and Q received heat.

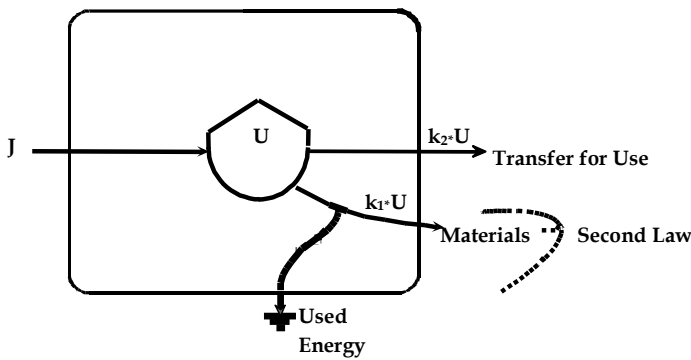

Energy U : $dU/dt = J - k_1*U - k_2*U$
 EMERGY: IF $dU > 0$ then $dEm/dt = Tr_j*J - Tr_w*k_2*U$
 IF $dU = 0$ then $dEm/dt = 0$
 IF $dU < 0$ then $dEm/dt - Tr_w*dU/dt$
 Where Transformity of $J = Tr_j$ and
 Transformity of water $Tr_w = Em/U$

Figure 3.19 - Lake model (Odum and Peterson, 1996)

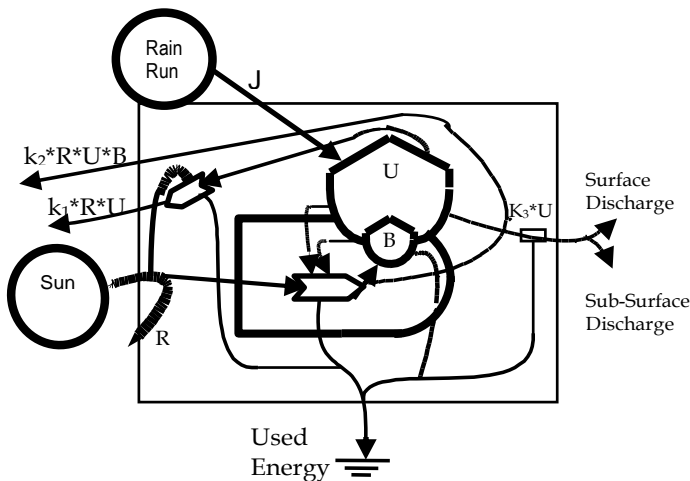

Water Stored (W): $dU/dt = J - k_1*R*U - k_2*R*U*B - k_3*U$
 Emergy Stored (Em): IF $dU/dt > 0$ then $dEm/dt = Tr_j*J - Tr_w*k_3*U$
 if $dU/dt < 0$ then $dEm/dt = Tr_w*dU/dt$
 if $dU/dt = 0$ then $dEm/dt = 0$
 Transformity of $W = Tr_w = Em/U$

Figure 3.20 - Lake model (Tilley and Brown, 2006)

Consider a product (water in a tank, for example in steady state: no input or output flow in which continuous electric power (input of emergy flow) balances heat losses to the environment) as shown in fig. 3.19 and 3.20 under (time) depreciation with its environment (heat losses for example). If one wants this product to keep the same useful available energy, one has to add external energy (in a case of heat losses ($\delta Q_{loss} = hS\Delta T$)). Assuming that $\delta W = 0$, if one wants that the temperature T is constant, then one has to add energy (by electric converter, for example) $Q_{add}^{elec} = -Q_{loss}$ which gives:

$$dU = \delta Q_{add}^{elec} + \delta Q_{loss} = 0 \quad (3.30)$$

As such, one could have an increase in emergy without a change in the exergy of the considered product. Odum, 1996 stated the first rule of emergy calculations as: “all sources of emergy to a process are assigned to the processes output.” As such Q_{add} must be taken into account for emergy value. In other words, if a product is under (time) depreciation, to keep the same useful available work we have a “cost” to pay to Nature (as “CARNOT formula” but in this case $dEx = \left(1 - \frac{T_0}{T}\right) C_v dT = 0$ (e.g. Dincer and Rosen, 2007, pp17-19) for the water in the tank). In this respect, use of a product under (time) depreciation (for example the mass losses for the “new production”) does not really damage its useful available “value” but require additional energy to recover the same useful available “value” (as a cost to pay to Nature). The formulae recounted in this thesis contain this same behavior.

3.4 Consistency of the concept

The inspiration from work conducted by Buranakarn and the subsequent publication of the results (Brown and Buranakarn, 2003) is consistent with the extension done in this work. Considering the work of Buranakarn, 1998, pp 53-58 for example, see Table 3.8, the production of steel from 100% pig iron resulted in the transformity of 4.15E+9seJ per gram whilst for another scenario in which 100% post consumer steel scrap was used, a transformity of 4.41E+9 seJ per gram was realized. In another scenario in which 70% steel scrap and 30% post consumer steel was employed in producing the same product as in the two previous cases, the transformity resulted in 4.24E+9 seJ per gram. This shows clearly that a product could have different transformities based on the composition of material inputs (in this case the ratio of raw material to percentage of material reuse or recycle).

In order to reuse or recycle waste material that still has a potential to be used, an emergy investment is needed. As already mentioned in the introduction, for an emergy evaluation to be reliable, the emergy input required for waste treatment, safe disposal, or recycling must be accounted for. Undertaking an emergy evaluation on such a system therefore means in principle that the transformity of the recycled material should be calculated accounting for both the investment for recycling and previous input to the process that generated the waste. However, evaluating a system in this manner would be double counting if one needs to assign to it the whole emergy it bore when it was still in the finished product form. Ulgiati et al., 2004 then

proposes a path of emergy allocation in order not to violate the emergy rules in which only the emergy invested in the treatment and recycling process should be assigned to the recycled resource. As such, the proposal suggests that wastes only bear the additional emergy inputs needed for their further processing. Though this is a way of solving such a problem, it might lead to over simplification of a system which leads to non-accounting of the past path way of the recycled material. As in this example, this work seeks to demonstrate a way of accounting for the emergy of a material which is reused without necessarily violating any of the emergy rules. This goes to show clearly that transformity is a function of the pathway: 4.15E+9 (0% recycling) versus 4.41E+9 (100% recycling) seJ per gram.

Note Item	Unit	Input Resource	Solar emergy per unit (seJ/unit)	Emergy seJ/yr	
A. Conventional steel product					
1	Pig iron	g	4.53E+13	2.83E+09	1283.00
2	Natural gas	J	3.17E+17	4.80E+04	152.38
3	Other fuels	J	2.80E+16	6.60E+04	18.51
4	Electricity	J	1.84E+17	1.74E+05	319.45
5	Transport (Railroad)	ton-mile	7.50E+09	5.07E+10	3.80
6	Transport (Truck)	ton-mile	7.50E+09	9.65E+11	72.34
7	Labor	\$	1.58E+09	1.20E+12	18.98
8	Annual Yield (Y) (EAF steel products)	g	4.49E+13	4.15E+09	1867.60
B. Material recycling steel product					
9	Post-consumer steels	g	4.53E+13	2.83E+09	1283.00
10	Post-consumer steel collection	g	4.53E+13	2.51E+08	113.00
11	Post-consumer steel separation	g	4.53E+13	8.24E+06	3.70
12	Natural gas	J	3.17E+17	4.80E+04	152.38
13	Other fuels	J	2.80E+16	6.60E+04	18.51
14	Electricity	J	1.84E+17	1.74E+05	319.45
15	Transport (Railroad)	ton-mile	7.50E+09	5.07E+10	3.80
16	Transport (Truck)	ton-mile	7.50E+09	9.65E+11	72.34
17	Labor	\$	1.58E+09	1.20E+12	18.98
18	Annual Yield (Y) (EAF steel products)	g	4.49E+13	4.41E+09	1983.30
C. Material recycling and byproduct use steel product					
19	Post-consumer steels	g	1.36E+13	2.83E+09	385.01
20	Steel scrap or slag	g	3.17E+13	2.83E+09	898.36
21	Post-consumer steel collection	g	1.36E+13	2.51E+08	34.13
22	Post-consumer steel separation	g	1.36E+13	8.24E+06	1.12
23	Natural gas	J	3.17E+17	4.80E+04	152.38
24	Other fuels	J	2.80E+16	6.60E+04	18.51
25	Electricity	J	1.84E+17	1.74E+05	319.45
26	Transport (Railroad)	ton-mile	7.50E+09	5.07E+10	3.80
27	Transport (Truck)	ton-mile	7.50E+09	9.65E+11	72.34
28	Labor	\$	1.58E+09	1.20E+12	18.98
29	Annual Yield (Y) (EAF steel products)	g	4.49E+13	4.24E+09	1904.09

Table 3.8: Emergy evaluation of steel and steel recycling alternatives (Electric Arc Furnace process)
(Adapted from Buranakarn, 1998)

3.5 Consequence of the concept

Two major consequences are highlighted based on the developed concept.

The first one concerns the calculations. As a result, in this work, as in the case of several papers (e.g. Odum, 2000 pp 389-393) where emergy tables are employed, it would be necessary to create an additional column. Actual table for eMergy evaluation is mainly composed of 4 columns: {*Item; Data unit; Solar emergy/unit; Solar emergy*}. For an *Item* with its own previous time pathway, authors suggest a sub-composition of the third column {*Solar emergy/unit (pure); Solar emergy/unit (its own time pathway)*} and e.g. for recycling {*Solar emergy/unit (raw); Solar emergy/unit (additional eMergy); correction factor Ψ* }.

The second one concerns the analysis. In order to reuse or recycle waste material that still has a potential to be used, an emergy investment is needed. As already mentioned in the introduction of this thesis, Ulgiati et al., 2004 pointed out that for an emergy evaluation to be reliable, the emergy input required for waste treatment, safe disposal, or recycling must be accounted for. Undertaking an emergy evaluation on such a system therefore means in principle that the transformity of the recycled material should be calculated accounting for both the investment for recycling and previous input to the process that generated the waste.

Ulgiati et al., 2004 have then amounted to ‘resetting’ the emergy content in recycling processes to eliminate the problem of cumulative emergy. They maintain a strong link between “effective available energy” and “emergy” but the cost is a broken of emergy rules as they pointed out themselves. Consequently, without providing a “reset block” (dimensionless number) that could cancel the previous emergy of the recycled material, the difference between 4.15E+9 and 4.41E+9 seJ per gram as in the example of Buranakarn, 1998 is explained by the time pathway. The idea presented in Ulgiati et al., 2004, is an alternative when no information concerning the number of recycling is available. Other alternatives are Brown’s proposition (Brown and Buranakarn, 2003) keeping the value for a single recycling or keeping the maximum value which is to say the asymptotic standard.

Impact on Emergy Indices

Several recycle indices have been developed and in use for emergy evaluations (Brown and Ulgiati, 1997). Individually, the indices provide comparative analysis to evaluate various systems relative to each other (see section 2.3). In the referred work (Buranakarn, 1998), several additional indices were developed to evaluate the appropriateness of the different recycle systems. The Recycle Benefit Ratio (RBR) is the ratio of the emergy required to provide a material from raw resources over the emergy required to recycle a post-consumer product that is substituted for the raw resource. It provides information relative to the potential savings that can result if a material is recycled and substituted for a raw resource. The Recycle Yield Ratio (RYR) for instance is the ratio of the emergy in a recycled material to emergy used for recycle. This evaluates the net benefit that society receives for recycling. It is a measure of what society receives in emergy for its emergy investment in recycle. The RYR is similar in concept to the Emergy Yield Ratio (EYR) used to express the net benefits to society from energy sources (Brown and Ulgiati, 1997).

This work does not seek to propose a change in the use of these indices but rather proposes new dimensionless numbers or indices to analyze results, just like the existing indices.

▪ **Extended Recycle Indices**

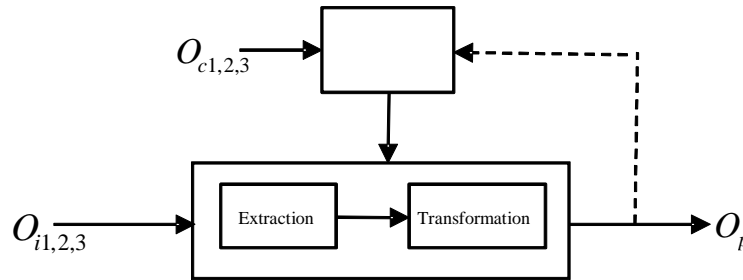

Figure 3.21: Emergy flows with additional energy for recycling

Let us denote O_i as the total “initial” solar emergy for the conventional process, i.e. for raw material, the emergy needed for processing which in this case involves both emergies for extraction and transformation. Then O_c the “additional” solar emergy needed for recycle, i.e. $O_c = O_{reuse}$. Let us now distinguish the purchased (1), renewable part (2) and the non renewable part (3). With this notation, one would have:

$$O_i = O_{i_1} + O_{i_2} + O_{i_3} \tag{3.31}$$

$$O_c = O_{c_1} + O_{c_2} + O_{c_3} \tag{3.32}$$

From the definitions above, some dimensionless numbers could be derived, as an extension of *EYR* (a) which can be defined as:

$$(a) \ EYR_i = \frac{(O_{i,2,3} + qO_{c1,2,3})}{O_{i_1} + qO_{c_1}} \tag{3.33}$$

As such, in the above index, the ratio represents the emergy in the product ($O_i + O_{PR}$) to the purchased or non renewable emergy needed in transforming the raw material into the product (O_{PR_i}). As such, the higher the ratio, the better benefit for invested emergy. This is represented also in Buranakarn, 1998; Brown and Buranakarn, 2003.

$$(b) \ EYR_c = \frac{O_c}{O_{c_1}} \tag{3.34}$$

The above (b) also represents the ratio of the total emergy needed for recycle to the emergy from non renewable or purchased sources as used and interpreted by Brown and Ulgiati (1997). In this case, a higher EYR_c indicates a greater amount of emergy for recycle. As such, the favourability of a material with a potential to be recycled depends on how low the value represents.

$$(c) \ EYR_g = \frac{(O_{i_{1,2,3}} + \psi O_{c_{1,2,3}})}{(O_{i_1} + \psi O_{c_1})} \quad (3.35)$$

The third scenario represents the developed concept in the previous sections of this work. This is the special case in which systems have recycled or reuse material as a part or percentage of its material inputs. As such the total emergy in the product is $O_i + \psi O_c$ which traces the time pathway of the material as proposed in this thesis. This indicates the ratio of material and energy conserved to the emergy required for recycle when recycle materials are used. As such, Eq. 3.35 traces the pathway of the material as proposed in this paper.

Indeed, ELR and EIR, NRR (Brown and Ulgiati, 1997) can be extended too. The most important is to calculate these dimensionless numbers to compare different systems.

Emergy Investment Ratio (EIR)

$$EIR_g = \frac{(O_{i_1} + \psi O_{c_1})}{(O_{i_3} + \psi O_{c_3}) + (O_{i_2} + \psi O_{c_2})} \quad (3.36)$$

Environmental Loading Ratio (ELR)

$$ELR_g = \frac{(O_{i_1} + \psi O_{c_1}) + (O_{i_3} + \psi O_{c_3})}{(O_{i_2} + \psi O_{c_2})} \quad (3.37)$$

3.6 Defining the emergy ratios of products

The emergy of a product is usually defined by the total emergy inputs of all resources (renewable and non-renewable) as well as emergy inputs of goods and services. However, this might be different in a specific case where a part(s) of the input materials are recycled materials based on the approach discussed above. Given that:

$$(q_j; N_j), \quad j \in \{1 \dots N_R\}$$

Where q is the amount recycled, j number of times of recycle and N_R maximum number of times of recycle.

This therefore means that if different recycled materials with different quantities and number of times in use are in effect, it becomes difficult to define the energy of the product. As such, in such cases, a possible range of energy values can be defined for which the investigator can carefully select from.

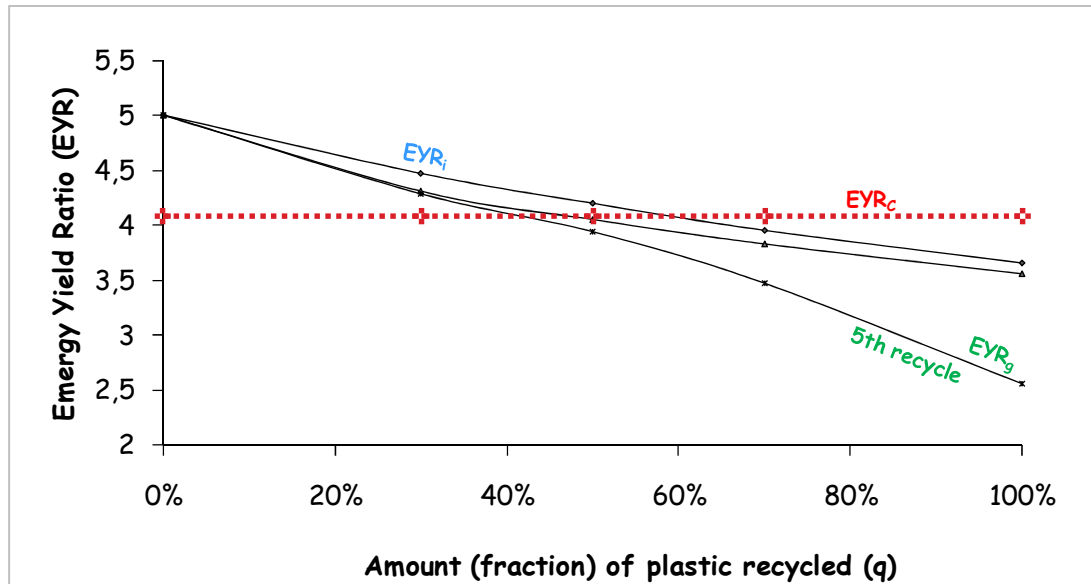

Fig. 3.22. Impact of plastic recycle on EYR

Fig. 3.22 presents a typical range of values for EYRs of plastic. The different EYRs explained above (EYR_i , EYR_c , EYR_g) have been plotted. It shows clear differences based on the approach for calculating the ratios. EYR_i is the calculated ratio based on work done by Buranakarn, 1998 which has similar results with EYR_g for the first recycle. EYR_c is calculated only based on the additional energy required for the recycle process (in this example, 25% of O_c is assumed to be from non renewable sources) and remains constant as well.

However, the extended energy ratio proposed in this paper (EYR_g) shows significant differences in EYRs based on the quantity of material recycled and the number of times of recycle. A steady decline of EYR is observed in all cases of N which is largely due to the additional energy required in the recycle operation.

In such scenarios where a material might have undergone several loops of recycling the energy ratio is defined within a range than having a specific value.

3.7 Conclusions

In this chapter an approach with the aim of contributing to the emergy evaluation of recycling processes has been presented. The following are the main points:

1. Researchers often adopt classical emergy indices such as EYR, EIR, ELR ESI etc., to evaluate solid wastes recycling value (Feng and Cao, 2007; Lou, 2004; Yang et al., 2003). Consequently, additional efforts to complement the calculation procedure to reflect a rather clearer picture of these indices are needed. Through this analogy, this work presents a way by which emergy information loss (internal 'memory') which is generated as a result of continuous recycle operations can be accounted for in emergy evaluations.
2. The analysis done, shows significant loss of emergy history when recycling is done severally and as such from our analysis; this concept must be given attention and developed further. Buranakarn, 1998 and Brown and Buranakarn, 2003 share in the view that emergy of a product increases with recycling process. As a result, a recycling process would increase the emergy content of a product only once (whatever the time pathway). This significantly stands out in this chapter.
3. The concept has been applied to examples of both metallic and non-metallic materials often used in the building and construction industry. This could be extended to evaluate other material recycling processes and options. A correction factor is proposed which would contribute to comprehensive and an easier emergy evaluation of systems with recycle. As a result, in this work, as in the case of several other works (e.g. Odum, 2000 pp 389-393) where emergy tables are employed, it would be necessary to create an additional column. Actual table for eMerger evaluation is mainly composed of 4 columns: {*Item; Data unit; Solar emergy/unit; Solar emergy*}. For an *Item* with its own previous time pathway, it is proposed that a sub-composition of the third column {*Solar emergy/unit (pure); Solar emergy/unit (its own time pathway)*} is created, and e.g. for recycling {*Solar emergy/unit (raw); Solar emergy/unit (additional eMerger); correction factor Ψ* }.
4. It is obvious that traditional economics based on money is not sufficient to fully evaluate waste recycling value. As such, the emergy theory presents a rather more rewarding path for the future. The contribution of this work adds to the maximum use of the emergy theory, especially in systems with recycling. The concepts mainly developed in this chapter are used in a real typical case study with sensitivity analysis to ascertain more clearly the impact of the method proposed on previous similar works.

Chapter 4: Emergy and Building Materials Recycle – A Case study

This chapter seeks to present a real case study based on the concept developed and detailed in the previous chapter. The case study concerns the emergy evaluation of a Low-Energy Building (LEB) (BBC-Bâtiment Basse Consommation énergétique in French) in which some input materials are recycled or reused materials. The first part of the chapter focuses on a review and analysis of existing LEB: main design principles, technologies and solutions in order to select the best methods for saving and producing energy from renewable energy sources in a building based on LCA results. The LCA is realized using thermal building simulation software, COMFIE¹⁸. Afterwards, an emergy evaluation is presented on the same building. Separate scenarios are then evaluated based on different recycling materials and quantities.

4.1 Introduction

A significant percentage of the total natural resources that are used in industrialized countries are exploited by the building industry (Peuportier et al., 1996). Almost 50% of this energy flow is used for weather conditioning (heating and cooling) in buildings. Almost 40% of the world's consumption of materials converts to the built environment, and about 30% of energy use is due to housing (Pulselli et al., 2007). In the E.U., the energy consumption for housing and services was 371.4 Mtoe (million tons of oil equivalent) in 2000 (Eurostat, 2000), which is higher than other sectors such as transport and industry. As a result, there have been developmental research works to significantly reduce the consumption of energy in the building industry.

4.2 Low Energy Buildings

In effect, terms such as low-energy and passive house are used more frequently all over Europe, as environmental protection and resource conservation are hot topics in these days. Low energy buildings involve the reduction of use of fossil fuel such as oil, gas and coal, which enhances sustainable building and development. There are many ways to make a building energy-efficient: by high insulation, using building components resulting in less thermal bridges, buildings with good air tightness or by technical installations such as mechanical heat recovery ventilation,

¹⁸ www.izuba.fr

which also benefits the indoor climate. Even if energy efficiency is important, the main reason for buildings is to give a good indoor climate, and a number of studies have indicated significant relationships between the ventilation and health and productivity in regard to offices, schools and dwellings (Andersson et al., 2006; Wargocki and Wyon, 2007). From an indoor environmental perspective it is also important to avoid possible moisture problems in the constructions. As the concept of low-energy- and passive houses is not as spread and common in some European countries as in others, the level of standards and precise criteria vary. Other influences on the variety of standards are different outdoor climates and historical demands on indoor climate. In the jungle of definitions and standards, even if a chosen system does not meet the required standard or target, it could be compared to others on the market and could be used in different combinations to match up with the requirements of the regulation. Various studies and real life instances show that a high performance level, e.g. primary energy consumption below 50 kWh.m⁻² per year (including heating, cooling, domestic hot water, lighting and ventilation), can be reached through appropriate architecture design combined with high insulation, free cooling and heat recovery on exhaust air. This last technology is particularly affected by airflows across the building envelope caused by low air tightness. There are different labels (fig. 4.1) as well as modeling tools developed to deal with this issue adequately.

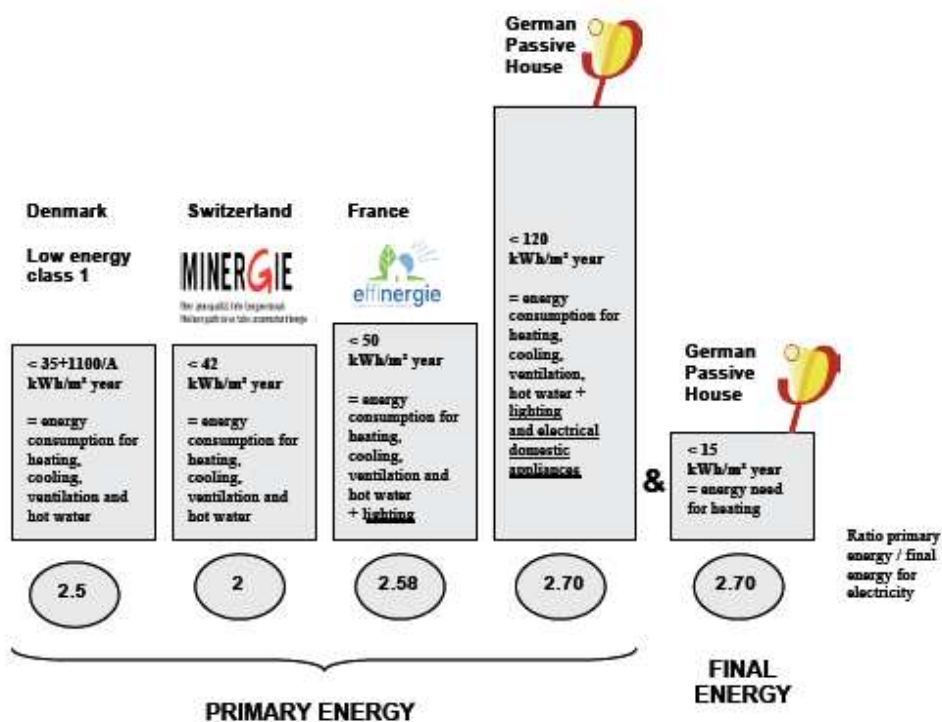

Figure 4.1: Examples of national definitions used for VLEB in DK, Switzerland, France and Germany. (Source: Eriksen et al., 2009)

Low Energy Buildings in France

In France, about 29.7 million residences are responsible for 42% of final energy consumption (ADEME, 2005). The building sector is the biggest consumption sector, before transports sector. The building consumption has to then be reduced to reach the French objective, defined in the “plan climat” (ADEME, 2011). Thus, very low consumption buildings are a key subject in France.

The French Ministerial decree from 8th May 2007 defines regulatory requirements for energy performance of buildings. This decree defines five levels: ¹⁹HPE, HPE EnR, THPE, THPE EnR, and BBC. A low-energy house (BBC-Bâtiment de basse consommation énergétique) is a building that respects the French law set up by the order of May 8th, 2007 published in the Official Journal (Journal Officiel de la République Française) of May 15, 2007 which specifies that for the new residential constructions, the objective of maximal consumption in primary energy is fixed to 50 kWh/m².year – to modulate according to regions and altitude. Taken into account is the consumption of so-called conventional primary energy: heating, cooling, ventilation, auxiliaries, production of domestic hot water and lighting facilities.

The French Environment and Energy Management Agency (ADEME) provides information about 1100 very low energy demonstration buildings that have been built in France since 2006. From the 1100 demonstration buildings, 60% are residential and 40% commercial, while 80% are new buildings. A survey on 124 of these new buildings shows that their cost remains acceptable: For 85% the cost is lower than 2000 €/m² and for 60% of the buildings the cost is lower than 1500 €/m². Several apartment or commercial buildings have a cost lower than 1200 €/m², which is the average value for classical new buildings of the same type (source: www2.ademe.fr). All these 124 new buildings have well insulated walls and roofs and very high envelope air tightness. They are all equipped with an efficient heating system (heat pump, condensing boiler, wood heating system), an efficient ventilation system (with heat recovery for 90% of the commercial buildings and 45% of the residential buildings) and with solar thermal systems for domestic hot water (in 90% of the residential buildings). In addition, solar photovoltaics are used in 35% of these buildings (55% in commercial buildings).

There are many techniques and methods for reducing a building’s energy consumption; this is why there are a lot of labels. The High Quality Environmental standard for « high eco-friendly quality » in France, aims to set out a coherent and global outline which applies the principles of sustainable development. It takes the building’s conception, construction, functioning and deconstruction into account. In Germany « Passivhaus » is used. Switzerland has created an equivalent label: « Minergie » and in France, the BBC Effinergie label is assigned to houses that meet the requirements of the label Low Consumption Building (BBC 2005-Bâtiment de basse consommation énergétique) with the constraint of the airtightness of the building with the obligation to measure the impermeability in the air. Regulations are often updated in France. For example, each five years, there is a new ‘Règlementation Thermique (RT)’, the recent one called ‘RT 2012’ published in 2010 which sets the new limit values. Consumption target levels sought by the current thermal regulations and the law of the ‘Grenelle Environnement’ (France’s Environmental Round Table) are presented in Table 4.1.

¹⁹ HPE: High Performance Energy; EnR: Renewable Energy; THPE: Thermal High Performance Energy

In the last few years, new sustainable building technologies have been developed and applied to buildings in order to achieve these set targets. An assessment of buildings is expected to evaluate building technologies and materials, and to define standards for making choices while taking into account the different steps for the building process “from the cradle to the grave”, from the extraction of raw materials to their assemblage and use and even until their disposal or recycling. Integrating several accounting methods and synthetic indicators are then expected to provide general information on the environmental sustainability of buildings.

Année	Cible	Niveau
2005	190 kWh/m ² /an	RT 2005 initiale
2008	150 kWh/m ² /an	RT 2005 renforcée
2010	120 kWh/m ² /an	Objectif pour RT 2010
2012	50 kWh/m ² /an	Objectif BBC pour tous
2020	0 kWh/m ² /an	bâtiment à énergie positive BEPOS

Table 4.1: Energy consumption target levels for buildings in France (source: ADEME, 2011)

4.3 Tools and Indicators applied to the evaluation of buildings

Environmental assessment tools vary to a great extent. A variety of different tools exist for building components, whole buildings and whole building assessment frameworks. The tools cover different phases of a building's life cycle and take different environmental issues into account. These tools are global, national and, in some cases, local. A few national tools can be used as global tools by changing the national databases. Tools are developed for different purposes, for example, research, consulting, decision making and maintenance. These issues lead to different users, such as designers, architects, researchers, consultants, owners, tenants and authorities. Different tools are used to assess new and existing buildings. Moreover, the type of the building (residential or office building) influences the choice of the environmental assessment tool.

According to Pulselli et al., 2007, an “indicator” is a tool able to give synthetic information regarding a more complex phenomenon within a wider sense; it works to make a trend or a process that is not immediately clear more visible. Indicators simplify information that is often relative to multiple factors, and enable investigators to communicate and compare results. The calculation of indicators follows different targets according to which of the two classes is noted:

- A. State-pressure environmental indicators account for specific parameters, through conventional physical units, in order to verify their compatibility with specific environmental variables; they often evaluate much localized factors based on data collected in a specific area. First-

level information is thus achieved, but this needs to be further processed in order to obtain truly synthetic information.

- B. Sustainability indicators provide a general evaluation based on a comprehensive balance, integrating a multiplicity of phenomena that may even be non-homogeneous; they attempt to evaluate general behaviors from the viewpoint of global sustainability, with special reference to the problems of resource overexploitation and energy waste.

Methods for evaluating buildings are usually based on environmental state-pressure indicators. These techniques are known worldwide and developed at the national level. Some examples are the Building Research Environmental Assessment Method (BREEAM in UK) and the Leadership in Energy and Environmental Design (LEED, in the USA). These methods provide a list of indicators, based on objective values that compare buildings' performances and impacts to their environmental constraints, which are defined as their sustainability threshold. Global sustainability indicators are obtained by processing data relative to different parameters (given in mass and energy units) through thermodynamics-based algorithms. Different measures can be involved in the creation of a unique synthetic balance. Some examples of these are the Life Cycle Analysis, Emergy analysis, the Ecological footprint, and the Exergy assessment. These methods enable the study of relationships between buildings and their environmental context, an ecosystem. A holistic approach is thus developed (the whole is more than its parts) by gathering information and providing general evaluations of buildings.

This chapter focuses on LCA which is a widely used tool in the analysis of buildings and emergy which is the subject of this dissertation.

LCA in Buildings: A Review

With ongoing developments, including energy certification schemes, environmental labeling and rating, etc., the interest in a life cycle perspective for buildings is steadily increasing. The demands from stake holders²⁰ for more sustainable buildings are becoming stronger. As already elaborated in the first chapter of this thesis, LCA is a tool used for the quantitative assessment of a material used, energy flows and environmental impacts of products. It is used to assess systematically the impact of each material and process. LCA is a technique for assessing various aspects associated with development of a product's life (i.e. cradle to grave) from raw material acquisition, processing, manufacturing, use and finally disposal (ISO, 1997).

- The Need for Life-Cycle Assessment in Buildings

Although LCA has been widely used in the building sector since 1990, and is an important tool for assessing buildings (Fava, 2006), it is less developed than in other industries, including perhaps the engineering and infrastructure sector. The building industry, governments, designers and researchers of buildings are all affected by the trend of sustainable production and eco-green strategies. The importance of obtaining environment-related product information by LCA is broadly recognized, and LCA is one of the tools to help achieve sustainable building practices. Applying LCA in the building sector has become a distinct working area within LCA practice.

²⁰ This includes clients, municipal authorities and property developers.

This is not only due to the complexity of buildings but also because of the following factors, which combine to make this sector unique in comparison to other complex products:

- First, buildings have long lifetimes, often more than 50 years, and it is difficult to predict the whole life-cycle from cradle-to-grave.
- Second, during its life span, the building may undergo many changes in its form and function, which can be as significant, or even more significant, than the original product. The ease with which changes can be made and the opportunity to minimize the environmental effects of changes are partly functions of the original design.
- Third, many of the environmental impacts of a building occur during its use. Proper design and material selection are critical to minimize those in-use environmental loads.
- Fourth, there are many stakeholders in the building industry. The designer, who makes the decisions about the final building or its required performance, does not produce the components, nor does he or she build the building. Traditionally, each building is unique and is designed as such. There is very little standardization in whole building design, so new choices have to be made for each specific situation.

The comparability of LCAs of distinct products and the way these LCAs are applied to design and construct environmentally sound buildings is a main point of attention in LCA practice. Several initiatives for harmonization and standardization of methodological developments and LCA practice in the building industry have taken place at national levels, but in general much scope remains for wider involvement and co-operation.

LCAs of buildings have mainly been conducted for research purposes (Thormark, 2002; Chen et al., 2001; Yohanis and Norton, 2002; Adalberth et al., 2001; Peuportier, 2001) and few professionals in the building sector currently have in-depth knowledge about LCA. Much of the research in especially European countries centers on developing or using building-specific LCA tools. The simplest and probably most common building-related application to date is the use of LCA for comparing the environmental impacts of different building materials (Ortiz et al., 2009; Nassén et al., 2007). The basic principle is a well-founded evaluation of the environmental impact and financial cost during the whole life cycle of the building and its installations, by coupling LCA and cost assessment with advanced optimization techniques. This results in concepts and guidelines for globally optimized extremely low energy building concepts. LCA methods represent a rational approach, which can evolve with the progress of knowledge, and this may help various actors to agree on common strategies. The interest and potential of new technologies like renewable energy systems can be assessed by this precise approach. Another advantage is the standardization of LCA allowing a link between evaluations concerning materials and buildings (Peuportier, 2001). A general framework for applying LCA in buildings has been elaborated in the European project REGENER, 1997.

- **Considered Life Cycle Phases**

The different phases considered in a building life cycle are the fabrication of components, the construction, the use of the building, the renovation and the renewal of components, the final dismantling and the treatment after use of components. The possible reuse and recycling of

components is also taken into account. As such, a typical life cycle of a building can be separated into three distinct phases, each consisting of one or several life cycle stages, as detailed in the first chapter of this thesis. The assembly phase refers to the collection of raw materials through resource extraction or recycling, the manufacture of these raw materials into products, the assembly of products into a building, the replacement of building products and assemblies, and intermediate transportation. The operation phase refers to heating and electricity requirements, water services and other services excluding material replacement. The disassembly phase refers to the decommissioning and demolition of the building, the disposal/recycling/reuse of building products and assemblies, and intermediate transportation steps. Each life cycle stage can consist of many unit processes.

The LCA database for building technologies covers the “cradle-to-gate” impacts, i.e. the environmental impacts from the raw material extraction to the manufacturing of building products and assemblies and the disassembly phase. Additionally the database covers the environmental impacts derived from the transport of the demolition waste to the treatment units and with its treatment. The considered processes are highlighted in Figure 4.2.

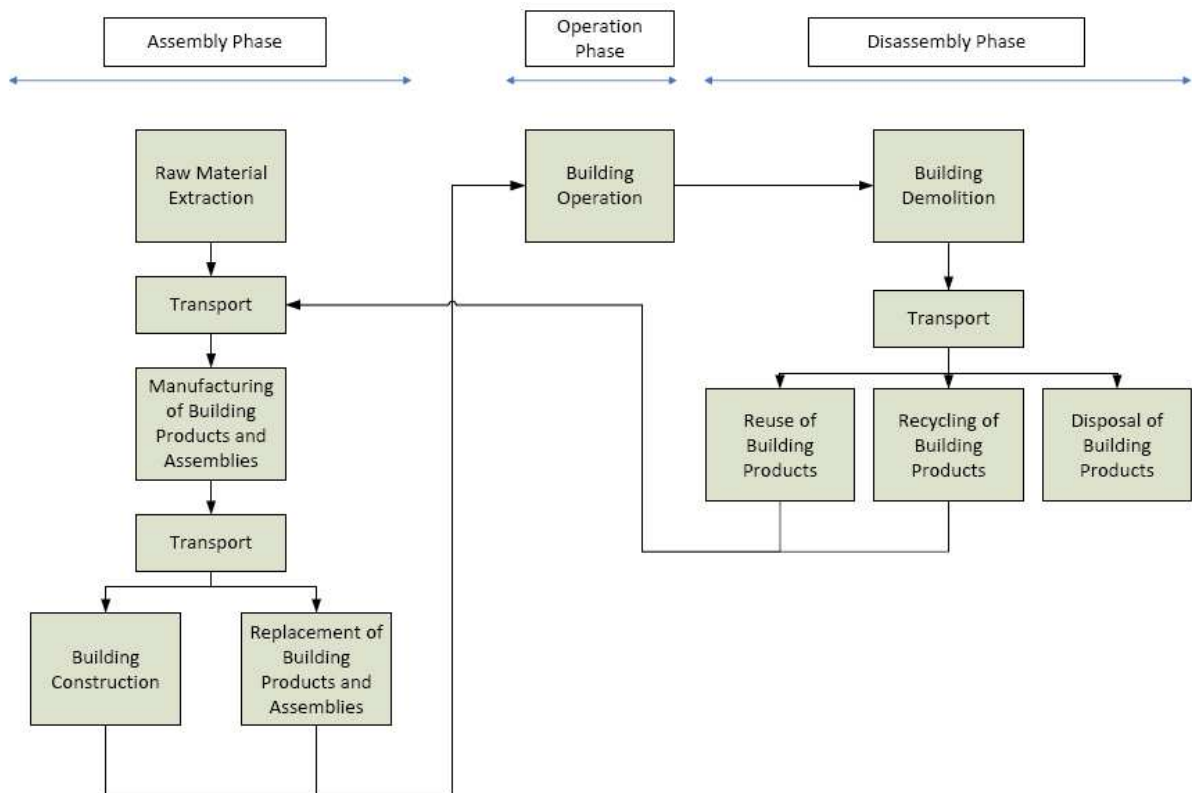

Figure 4.2. Life cycle of a building (Optis, 2005).

- Review of some published works

Adalberth et al., 2001 performed LCA on four multi-family buildings built in the year 1996 at Sweden. The functional unit was considered as usable floor area (m^2) and the lifetime of building was assumed to be 50 years. The main aim was to study different phases of life-cycle of all four buildings and to find out which phase has the highest environmental impact, and were there any differences in environmental impact due to the choice of building construction and framework. Different phases of a building considered were: manufacturing, transport, erection, occupation, renovation, demolition and removal phase. Value of energy consumption was calculated to be $6400 \text{ kWh}/m^2 \cdot 50 \text{ yrs}$. The occupation phase alone accounts for about 70-90% of total environmental impact caused by a building, so it is important to choose such constructions and installations options which have less environmental impact during its occupation phase.

Arena and Rosa, 2003 considered a school building and performed an LCA to compare different building technologies which have been applied in a rural school building for obtaining thermal comfort with minimum fossil energy consumption. This school building is situated in Lavalle, a small town in Northern Mendoza (Argentina). Life span of building was considered to be 50 years. A simplified LCA methodology was used and only construction and operational phases were considered. Environmental impacts which were considered in this study are; GWP, EP, ARP (Acid Rain Potential), PSP (Photo-Smog Potential), resource consumption and TP (Toxicity Potential). For all calculations regarding inventory, impact assessment and normalization phases the SBID (Society of British Interior Design) database was used (Petersen, 1997). The annual energy savings and global energy savings (for 50 years) were calculated and showed that the annual energy savings during use phase were 5307.5 MJ/year , and global energy savings for 50 years life span were 265374.5 MJ/year . This study showed that almost all the environmental aspects investigated were improved when conservative technologies were implemented.

Norman et al., 2006 compared high and low populated buildings for their energy use and GHG emissions. It illustrates that the choice of functional unit is highly relevant for full understanding of urban density effects and choose two functional units; living area (per m^2 basis) and number of lives in a house (per capita basis). Both the conditions were selected for Toronto (Canada). The EIO-LCA (Economic Input–Output based LCA) was used to estimate the environmental impacts of material manufacturing required for construction of infrastructure. EIO-LCA is a tool developed by researchers at Carnegie Mellon University (Myer and Chaffee, 1997). For building operations nationally averaged public datasets were utilized and detailed location-specific data for the Greater Toronto area were used for public and private transportation. Energy use and GHG emission estimates for per person-kilometre for different transportation models were taken from previously submitted report by Kennedy, 2002. This study shows that embodied energy and GHG emissions resulting from material production across the supply chain were approximately 1.5 times higher for low-density case study than the high-density case study on per capita basis; and the high-density development scenario becomes 1.25 times more energy and GHG emissions intensive than low-density if considered for unit living area basis.

Guggemos and Horvath, 2005 compared environmental effects of steel and concrete framed buildings using LCA. Two five-storey buildings with floor area of 4400 m^2 were considered which were located in the Midwestern US and were expected to be used for 50 years. In this study two methods, process based LCA and EIO-LCA, were used to evaluate life-cycle

environmental effects of each building through different phases: material manufacturing, construction, use, maintenance and demolition phase. The results showed that concrete structural-frame had more associate energy use and emissions due to longer installation process.

A study carried out in France as part of the EQUER project (evaluation of environmental quality of buildings) considered different phases of dwelling's life-cycle, using the functional unit of m² living area, with the sensitivity analyses based on alternative building materials, types of heating energy, and the transport distance of the timber. This study by Peuportier, 2001 showed that the dwellings with greatest environmental impact were not those whose area is larger, and emphasized the importance of choosing materials with low environmental impact during the pre-construction phase (i.e., employing LCA as a decision making supporting tool during the design stage).

Scheuer et al., 2003 employed an LCA to find the environmental burdens of a university building in Michigan (Khasreen et al., 2009). They set the study boundaries to include only the building itself (structure, envelope, interior and backfill), and set the life span to 75 years, which is very long compared to most other studies, which typically assume 50 years. The study neglected the insignificant contributions, e.g., impacts from facilities used for production, and omitted the factors which are not related to building design, e.g., furniture, movable partitions, street and side walk modifications, etc. Lack of data had its influence on the scope of the study due to data unavailability; the study holder was forced to omit materials used during the construction process, and small replacement materials. For this case the materials omitted did not affect the results significantly, but in other cases, unavailability of national and realistic data might drive the study in the wrong direction, or change its goal and scope (Khasreen at al., 2009).

- **Environmental impacts associated with buildings**

A number of different materials are used in the construction of a house. This section provides a brief detail of the environmental impacts associated with the main materials used in the construction process:

Concrete: The production of concrete is quite complex and environmentally impacting process as it releases various pollutants such as, carbon dioxide, heavy metals, organic hydrocarbons, carbon monoxide, sulphur dioxide, Nitrogen oxides and alkaline wastewater.

Wood: Wood is considered to be a recyclable material since at the end of its service life, a wooden product can be down-cycled and can be used for many purposes for example, in chipboard production, animal bedding or garden projects.

Glass: The two main environmental factors associated with glass production are the high primary energy consumption with related energy pollution and the material pollution.

Ceramic tiles: They have huge environmental impacts associated with their production. Potential polluting elements released as a direct result of their production include carbon dioxide, sulphur dioxide, fluorine and possible chromium.

Aluminum: It requires a great deal of energy to be produced. This energy consumption in itself brings environmental burdens besides the large amounts of pollutants released during the production process. The pollutants resulting from aluminum production process include substances like carbon dioxide (CO₂), acidic sulphur dioxide (SO₂), polyaromatic hydrocarbons (PAHs), and gases having global warming potential i.e. perfluorocarbons (PFCs), tetrafluoromethane (CF₄) and hexafluoroethane (C₂F₆) (Berge, 2001).

The impact assessment framework is a multi-step process, starting by selecting and defining impact categories, which are relevant to the buildings (such as, global warming, acidification, toxicity, etc.). This is followed by a classification step, which assigns LCI results to the impact categories, e.g., classifying carbon dioxide emissions as causing global warming, and modeling the impacts within impact categories using conversion factors, e.g., modeling the potential impact of carbon dioxide and methane on global warming using their respective GHG potentials (ISO 14044, 2006). These steps could be followed by optional steps to express potential impacts in ways that can be compared. For instance, comparing the global warming impact of carbon dioxide and methane for two options, weight them and identify the most significant ones. At the end of the study all the results should be evaluated and reported (SAIC, 2006). Impact categories could be grouped according to their region of effect, e.g., global warming has a global effect, whereas eutrophication has a local effect (ISO 14044, 2006).

The impact categories included within the LCA studies carried out by researchers of building environmental impacts differ according to the goal of the study, data availability, and significance of the impacts. For instance, among the researchers who produced whole construction process LCAs, Adalberth, 1997 studied four dwellings located in Sweden and calculated five different impacts (GW, A, E, OD, HT, EL)²¹, however Peuportier studied three types of houses with different specifications located in France, and calculated twelve different impact categories (Peuportier, 2001). Again among other researchers who produced LCAs of BMCCs²², Asif et al., 2007 studied eight different building materials in a Scottish dwelling, and calculated one impact (GW) but Saiz et al., 2006 studied green roofs in Spain and calculated eight different impacts. Within the literature of LCAs applied to whole buildings, the most commonly studied impacts were global warming, acidification, eutrophication, and ozone depletion, which were present in most studies.

4.4 LCA-based environmental assessment and design tools

Life cycle assessment (LCA) allows a quantification of indicators related to these issues and is widely used among industries as well as academics. This method has been applied in the building sector and several tools have been developed. The precision of these tools and their relevance as a design aid is often questioned. Some of the tools considered include but not limited to: ECO QUANTUM (W/E Sustainable Building, The Netherlands), LEGEP (ASCONA, Germany), OGIP (EMPA, Switzerland), EQUER (ARMINES, France), ENVEST (BRE, United Kingdom), Eco-Soft (IBO, Austria), BeCost (VTT, Finland), SIMA-PRO (BDA Milieu, The Netherlands),

²¹ GW, global warming potential; OD, photochemical ozone creation; A, acidification; HT, human toxicity; EL, energy consumption

²² BMCC, Building and Materials Components Combinations

ESCALE (CSTB, France). In general, the input data include a description of the studied building (geometry, techniques...) and its context (e.g. electricity production mix). The output is a multi indicator comparison of design alternatives, supporting decision making.

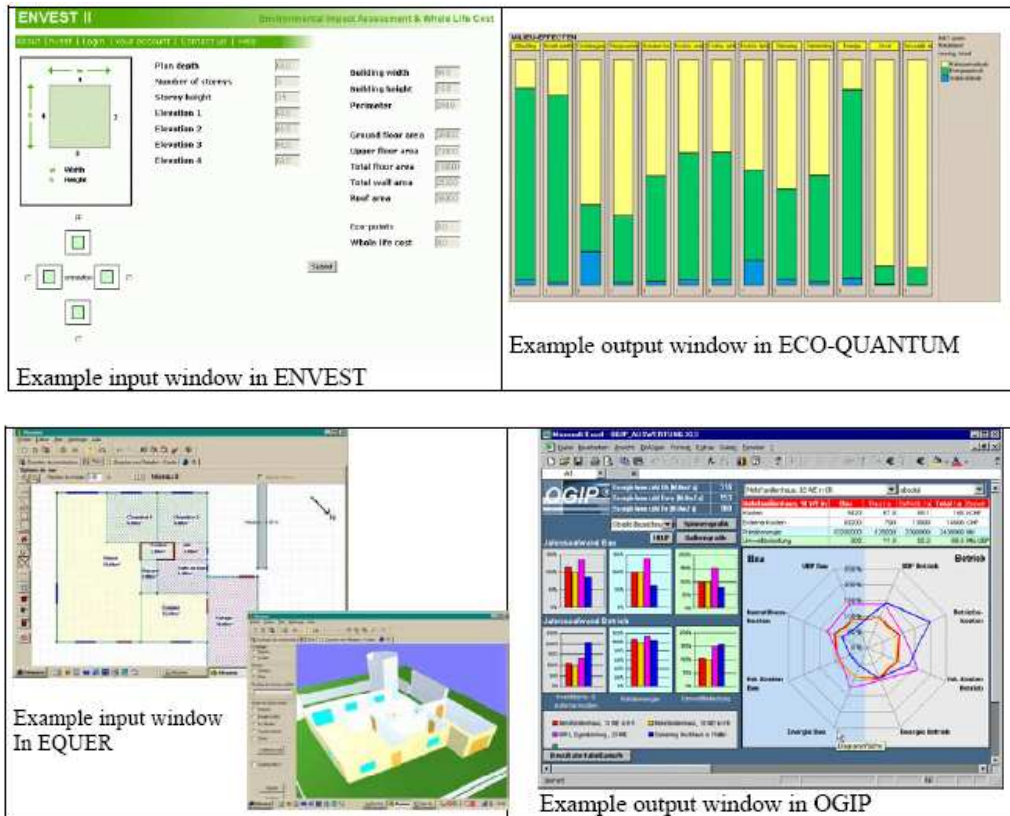

Figure 4.3: Sample interface of different tools

Peuportier et al., 2005 studied LCA results from the different tools and proposed ways of harmonizing the different outputs. The exercise allowed to improve the various softwares (tools) and aimed at increasing the confidence in the tools. The added value was also to clarify the main assumptions in each tool and to identify good practice based the recommendations. This was necessary since the different tools mostly gave varied results. Some good practice proposed by the group included for instance:

- account both for the use of recycled materials in construction and for recycling at the end of life, at each phase with 50% of the total possible avoided impacts compared to no recycling,
- include water consumption in the analysis,
- use product specific data when available with a consistent methodology, recent data being preferable,

- propose default values for transport distances to site and for each type of waste treatment process (incineration, landfill, recycling, ...).

Simulation tool for LCA adapted in this study

The simulation tool (Appendix C) used in the case study allows the comparison of alternative designs. The simulation tool EQUER (Polster et al., 1996) is based upon a building model structured in objects, compatible with the thermal simulation tool COMFIE (Peuportier et al., 1996). The functional unit considered is the whole building over certain duration. Impacts due to the activities of occupants (e.g. home-work transportation, domestic waste production, water consumption) may be taken into account, e.g. when comparing various building sites with different home-work distances, waste collection and treatment system, water network efficiency, etc.

Coupling LCA and energy calculations simplifies the use of the tool, and makes the comparison of design alternatives easier. The two models are linked according to a formalism taken from the STEP approach (standard for computer data exchange, Bjork and Wix, 1991). The main classes are the products (building materials or finishes), the components (manufactured set of products like windows, shading devices, etc.), the subsystems (onsite built set of products and components like walls or zones), the whole building and the building site. A zone is here meant as a thermal zone, i.e. a part of the building with a homogeneous thermal behavior. It may include several rooms with the same occupancy schedule, orientation, internal heat gains. This thermal-oriented description can be conflicting with other evaluations (e.g. acoustic, day-lighting).

A day-lighting module is added to the thermal simulation tool. This module uses another description, based upon rooms. The output of the software is an ecoprofile including the different CML indicators (global warming, acidification, eutrophication potentials, smog, etc.), plus some aggregated values like primary energy and water consumption, and generation of radioactive and other waste (Heijungs et al., 1992). These indicators are given either for the different phases or for different alternatives or projects.

Summary

As a matter of fact, LCA should be part of the design process as a decision making support tool, to be used by the designers of the building in parallel with other aspects like cost, and functional requirements. The balance between these three criteria is the task of the architect/designer to achieve the optimum performance of the building. Brainstorming during LCA in the early stages of the design will help find alternatives to the current proposals which better achieve this balance. It is very necessary to consider the functions of the studied construction itself, as the environmental impacts of civil constructions are different from those of buildings, which are dominated by energy consumption.

It has been estimated that the use phase in conventional buildings represents approximately 80% to 90% of the life-cycle energy use, while 10% to 20% is consumed by the material extraction and production and less than 1% through end-of-life treatments (Khasreen et al., 2009). Although, LCA is considered the best method available to assess the environmental performance

of a product, its application in construction is very complex. This is because of the huge number of different materials, products, actors, processes and also the wide life cycle span of a construction product. A full LCA of a product provides useful and accurate information, but is costly and time consuming, while using generic data and information in a specialized application could lead to a wrong choice. Again, almost all of the studies available were carried out in developed countries. In view of the vast potential for building construction in the less developed world, this should be addressed as a matter of urgency (Hunkeler and Rebitzer, 2005).

Despite the limitations presented by LCA, it is indeed a powerful tool for the evaluation of environmental impacts of buildings. It has the potential to make a strong contribution to the goal of sustainable development.

4.5 Emergy Evaluation applied to buildings

Emergy Evaluation has been widely applied in the evaluation of ecological systems, energy systems, and environmental impacts of processes and a large number of studies which is available in literature. Yet, despite such a wide debate, only a few studies have been produced concerning applications of Emergy Evaluation to building construction and to building materials. In most of these studies, Emergy evaluation is employed as an environmental indicator for construction activities, building materials production and recycling (Buranakarn, 1998; Odum, 2002; Brown and Buranakarn, 2003; Huang and Hsu, 2003; Meillaud et al., 2005; Pulselli et al., 2007). Odum, 2002 presents a broad approach to the relationships of building construction with materials circulation and energy hierarchy.

In the Emergy approach, buildings are a storage of materials that is the sum of the inputs during the construction process. This storage loses Emergy as building materials depreciate along time and become dispersed in the environment. New inputs by means of maintenance and repair actions keep the Emergy flow into the building system. The necessary symbiosis between Earth processes and building construction in the use of the global cycle of materials is described by Odum, 2002.

Processes of providing materials to construction start with the slow work of our planet in concentrating stored reserves, such as mineral ores and rocks, and continue with human work in mining and processing those resources into stocks of construction materials and products. Materials and products incorporated in buildings are released again to the global cycle, after reaching their end of life. Odum, 2002 identifies three pathways for materials after reaching their end of life:

- (i) Reuse of the highest quality components with some repair;
- (ii) Reprocessing of remnants that are still concentrated;
- (iii) Environmental recycle of the least concentrated waste materials.

An important assumption brought by Odum, 2002 is that Emergy per mass is an indicator for the most beneficial recovering path. Materials with the highest Emergy per mass have more economic and environmental advantages for being reused and reprocessed, when compared with low concentrated materials that are more easily processed by global cycles. Buranakarn, 1998 and Brown and Burnakarn, 2003 proposed a set of Emergy indexes to evaluate recycling patterns and

recyclability of building materials. These Emergy indexes are suggested to measure the environmental benefits of three recycling trajectories: material recycle, by-product use, and adaptive reuse, i.e. recycling the material for a different purpose. The reuse option in the sense of reusing a product elsewhere was not considered in these studies. Emergy per mass is also pointed as a good indicator for recyclability. Buranakarn, 1998 and Brown and Burnakarn, 2003 also recognizes that materials with higher Emergy per mass are more suitable for being recycled by human systems due to their 'quality', and have more environmental impacts when released to the environment. In the context of an environmental approach, Huang and Hsu, 2003 proposed a set of indicators based on Emergy to measure the effects of construction in Taipei's sustainability: (a) intensity of resource consumption; (b) inflow/outflow ratio; (c) urban livability; (d) efficiency of urban metabolism; and (e) Emergy evaluation of urban metabolism. The relevance of Emergy Analysis for that study was in the fact that it enabled the consideration of biophysical value of resources to the economic system. Evaluation of main Emergy flows of materials used due to urban construction provided both an understanding of their relative value and contribution to the ecological economic system (urban construction is equivalent to 44% of the Emergy used in Taipei), and a measure of the ecological interface of rapid urban development (environmental load of construction waste generation and recycling opportunities).

Meillaud et al., 2005 applied Emergy Analysis to evaluate an experimental building of three stories containing faculty and students' offices and a workshop, built in 1981, by including environmental, economical, and information flows. By including information flows generated by building occupants to the analysis of the whole building system, it was possible to calculate the outputs generated by the building usage: Emergy per educated student, Emergy per publications, Emergy per courses and Emergy per 'services'.

The significance of Emergy per unit values was highlighted by Meillaud et al., 2005 because there were few available Emergy per unit references for most commodities inputted into the building.

Aspects regarding the suitability of Emergy Analysis when compared with Embodied Energy Analysis, Exergy Analysis and Life Cycle Assessment (LCA) were also stressed by Meillaud et al., 2005:

- (i) Concerning Embodied Energy and Emergy, results show similar kind of information: the higher the specific energy and the embodied energy per mass, the more relevant its potential recycling;
- (ii) Concerning Embodied Energy, Exergy analysis and LCA, these methods were not able to evaluate information or monetary flows and just account for the energy on the information carrier, i.e. computers, paper, and disks.

Another application of Emergy to building construction was published by Pulselli et al., 2007. The authors proposed a set of environmental indices to provide a basic approach to environmental impacts of buildings by accounting for the main energy and materials inflows within the building construction process, maintenance, and use:

- (i) Building Emergy per volume (E_m -building volume): this represents the ‘environmental cost’ of the building;
- (ii) Building Emergy to money ratio (E_m -building/money ratio): this represents the ratio of total Emergy used to money (seJ/€);
- (iii) Building Emergy per person (E_m -buildings per person): this represents the rate of Emergy use of human systems with relation to buildings.

The proposed indices based on Emergy accounting provide a framework for evaluating and comparing different building typologies, technologies and materials, regarding different manufacturing processes, maintenance, use, thermal efficiency and energy consumption.

Pulselli et al., 2007 argue that buildings are like full Emergy reservoirs (storage) that persists in time, and that Emergy evaluation of a building highlights the durability of materials as a factor for sustainability. With reference to building materials, the most extensive study on Emergy and building materials was developed by Burnakarn, 1998 in order to identify recycling patterns. The author made calculations for several common materials.

However, the values presented for metals and plastics do not include the final stage of transforming the raw material into building products, such as extrusion of aluminum for profiles production. Other single reference values for building materials may be found dispersedly in literature, yet in general calculation procedures are omitted, thus hindering an analysis of their accuracy and data source.

4.6 Case Study

4.6.1 LCA applied to the evaluation of a 1-storey Low Energy Building in France

This case study is applied to a typical building corresponding to the present construction standard in France. The building under study is located in Theys (Isère) which is a small town situated on 30km from Grenoble. It is defined by a net area of 155 m² calculated as the sum of the living area plus the garage area. It is intended for residential use. It is comprised of a basement, a ground floor and one other floor. The structure consists of reinforced concrete frame with pillars and beams. The walls are made of concrete blocks with an internal insulation layer and gypsum plastering. The upper ceiling is covered with mineral wool, under clay tiles roof. The aluminum glass windows are double glazed with $U^{23}=1.13\text{W/m}^2\cdot\text{K}$.



Figure 4.4: View of the Low Energy Building – BBC located in France

²³ Overall heat transfer coefficient

The structure consists of a reinforced concrete frame with pillars and beams. The external wrapping is formed by two side walls (adjoining blocks), two facades (brickworks with cavities), an insulated basement, and a tile roof. The house is heated by a gas boiler. The ventilation is mechanical. The heating consumption is around 50kWh/m². In Fig. 4.5 a sketch of the studied building is shown, that represents the dimensions of the house. The involved materials were quantified through investigating the inventory reports.

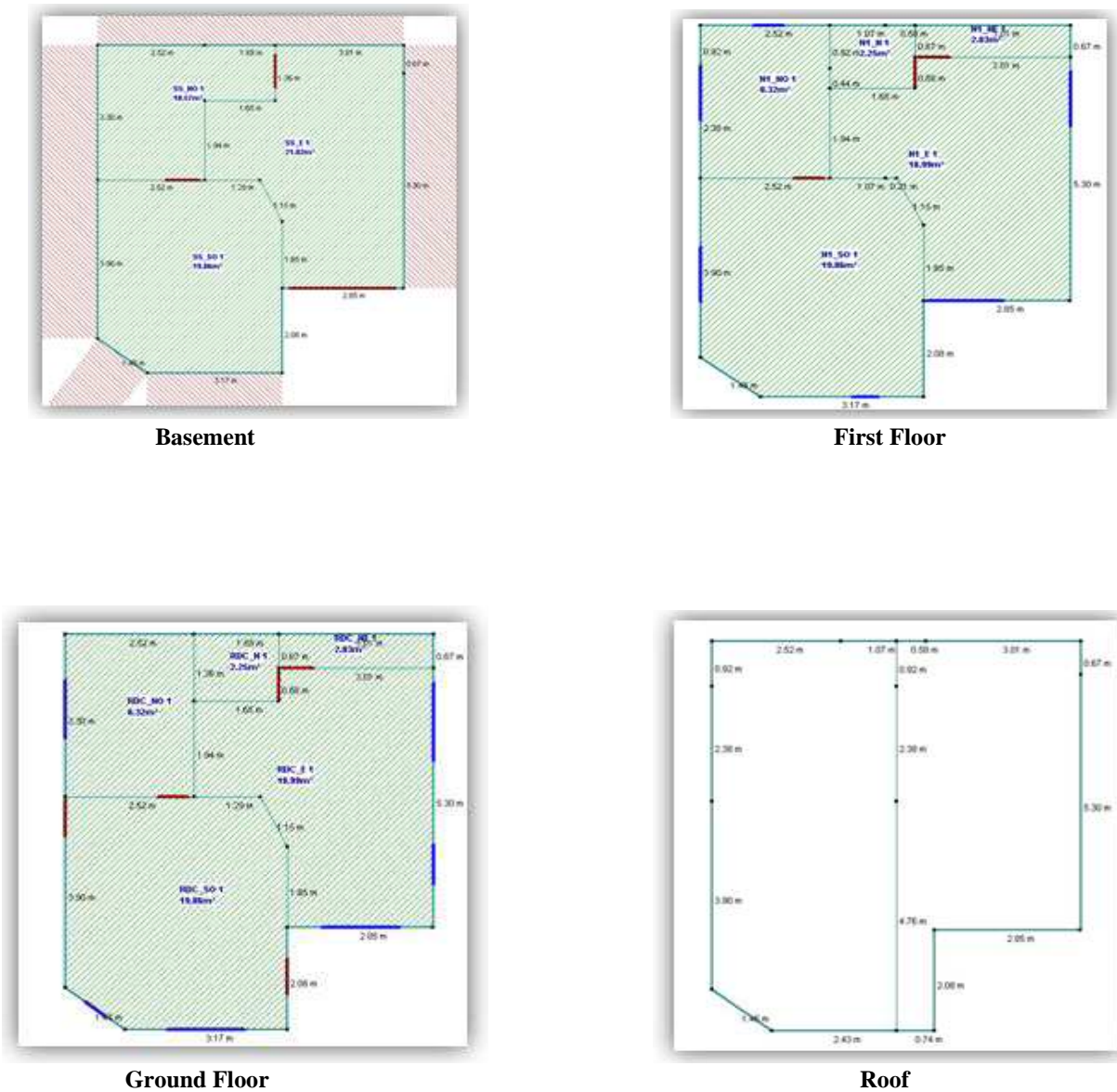

Figure 4.5: layouts of the different floors

- Simulation with EQUER

The project was assessed with the EQUER software to grade the house and to make any possible improvements to it until it reaches level A, which corresponds to a low energy building (<50kWh/m²/year). Firstly, the characteristics of the building were registered in order to model ALCYONE using the software PLEIADES. Then it was interesting to run the model under PLEIADES with adequate weather information to study the different developments of the energy consumption of the building during the entire year. The final phase of the project was to change certain values on the building structure in order to assess energy improvements using the PLEIADES simulation tool, and choose the best solutions to achieve the initial goal of at least 50kWh/m²/year.

- Methodology

A step by step layout plan²⁴ (basement, ground floor, first floor, roof) for the various stages were carried out.

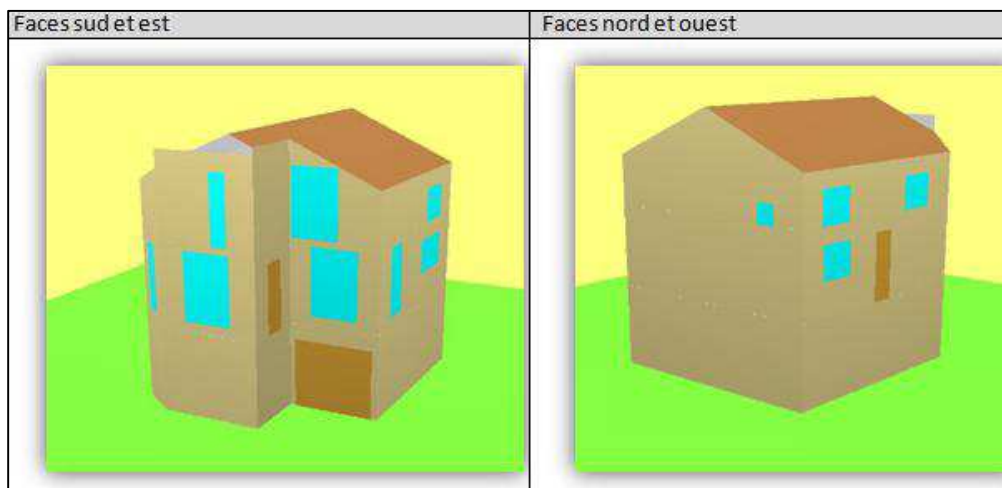

Figure 4.6: 3-dimensional image of the house

- Simulation in PLEIADES

Now a simulation is conducted via PLEIADES to achieve the energy profile of the building during the year under study. The procedure is as follows:

The data previously programmed in the ALCYONE software is transferred to PLEIADES. The model is refined by redefining the type and the structure of the various components (windows and partitions) and then a likely scenario of occupation is selected and adapted for the simulation.

²⁴ Lay out plans for the various stages are presented in fig 4.3

We define a scenario occupation²⁵ by launching the simulation using the software METEOCALC²⁶ to generate the temperature profile for the weather.

Since some types of materials do not exist in the PLEIADES database, there is the need to create one. This is for example the case for polyurethane effisol which is often used in insulation of the floor. Referring to the values of the document provided by the manufacturer helps one to define the different properties: conductivity, mass, density and specific heat. When these values are not available, assumptions are made by equating the brand template provided by a similar type of component. For example, for the windows MINCO (4 16 4 Argon), the exact characteristic values of this model can be found on the MINCO website which can then be used to define the windows and doors of the house.

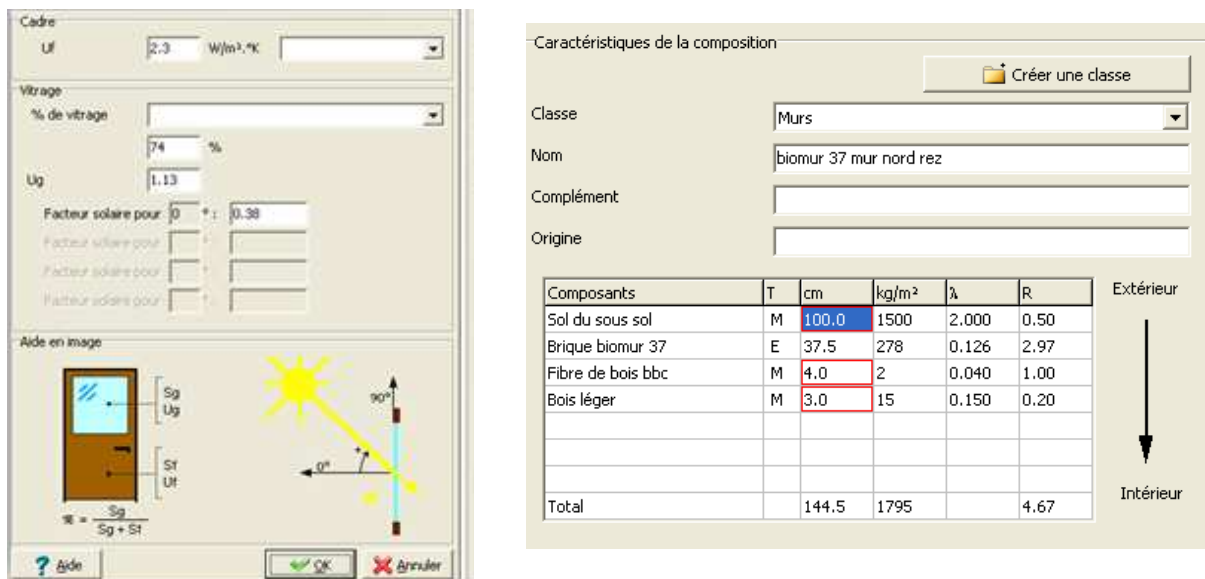

Figure 4.7: An example of creation under PLEIADES for windows and walls

- Results of the Simulation

A simulation is conducted to observe the behavior of the different zones of the house during the year by taking the climatic conditions of the city into consideration and setting the scenario of occupation as stated previously. To this end, an average annual total heating needs of 136kWh/m² is achieved.

²⁵The different characteristics of occupation of the house in terms of ventilation, set temperature and time of occupation are considered. Specific scenarios according to the separate residential areas or zones are considered. E.g. The family in this case consists of 4 persons: 2 adults, 2 children with assumptions based on the rhythms of different lives. The parents return home for Lunch and spend less time in their rooms than the children. During the day on weekdays, the house is unoccupied while on weekends it is busy.

²⁶ A powerful tool to quickly generate hourly weather data files for use in PLEIADES + COMFIE.

Zones	Besoins Ch.	Besoins Ch.
Année		
SS SO	0 kWh	0 kWh/m ²
SS NO	0 kWh	0 kWh/m ²
SS E	0 kWh	0 kWh/m ²
RDC SO	2495 kWh	125 kWh/m ²
RDC E	2578 kWh	136 kWh/m ²
RDC NO	1808 kWh	218 kWh/m ²
RDC N	0 kWh	0 kWh/m ²
RDC NE	0 kWh	0 kWh/m ²
N1 SO	1940 kWh	97 kWh/m ²
N1 E	2373 kWh	125 kWh/m ²
N1 NO	1668 kWh	201 kWh/m ²
N1 NE	0 kWh	0 kWh/m ²
N1 N	0 kWh	0 kWh/m ²
Total	12863 kWh	136 kWh/m ²

Figure 4.8: Zonal heating needs under PLEIADES

By observing the synthesis results, it can be seen that the area with the most consumed energy is the ground floor (RDC NO) with 218 kWh/m². The area with much less energy consumption is the first floor towards south-west (N1 SO) with 97 kWh/m². This difference is partly due to uneven solar energy gains. As such the part or area with greater solar energy gain requires less energy in total than vice versa. The chart displayed by Fig. 4.9 shows this patchy distribution. The chart shows in green the important contributions for the area N1 SO and that of the red RDC NO area.

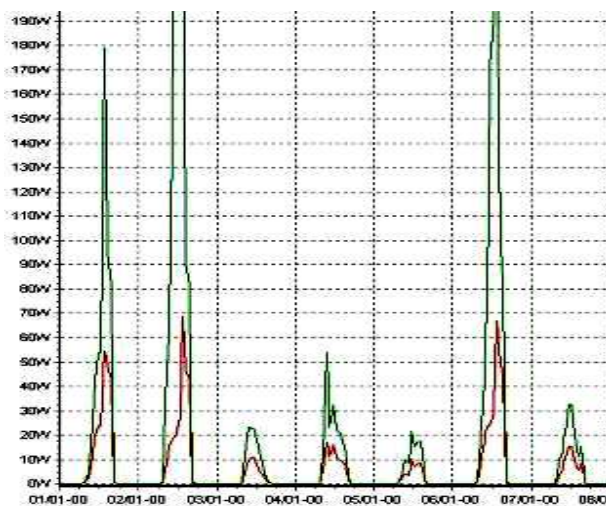

Figure 4.9: Distribution for solar energy gains for areas N1 SO (in green) and RDC NO (in red)

- Energy Performance Improvement

The goal now is to build on the results of the modeling to optimize the energy consumption of the house. Assuming the characteristics of the built envelope (materials of walls, floors, windows etc.) are optimal, the idea then is to install efficient energy systems to reduce the annual energy balance. It was decided then to estimate the gains achieved through the addition of a Canadian well²⁷ on one hand and then a Photovoltaic panel coupled to the Canadian well. By integrating the Canadian well to the simulation of the house, a new optimized value of heating power is achieved. This gives a final value of 90 kWh/m²/year resulting in an energy gain of 37% compared to the initial value of 136 kWh/m²/year.

Zones	Besoins Ch.	Besoins Ch.
Année		
SS SO	0 kWh	0 kWh/m
SS NO	0 kWh	0 kWh/m
SS E	0 kWh	0 kWh/m
RDC SO	1862 kWh	94 kWh/m
RDC E	1706 kWh	90 kWh/m
RDC NO	1145 kWh	138 kWh/m
RDC N	0 kWh	0 kWh/m
RDC NE	0 kWh	0 kWh/m
N1 SO	1309 kWh	66 kWh/m
N1 E	1519 kWh	80 kWh/m
N1 NO	995 kWh	120 kWh/m
N1 NE	0 kWh	0 kWh/m
N1 N	0 kWh	0 kWh/m
Entrée du puits	0 kWh	0 kWh/m
Milieu du puits	0 kWh	0 kWh/m
Sortie du puits	0 kWh	0 kWh/m
Total	8537 kWh	90 kWh/m

Figure 4.10: Optimized zonal heating needs under PLEIADES

²⁷ The Canadian well consists of passing a proportion of fresh air through pipes buried in the ground, before it enters the house. The principle is to make passive use of geothermal energy. A PVC or baked earth pipe is inserted in the ground at a depth of about 2m. Typically, its diameter will be between 20 and 30 cm, one of its ends is open to outside air, and it is provided with protection against water, insects and rodents. The other end may be fitted with a circulating fan (15 W for 200 m³) and carries air inside the room. In winter, the soil at this depth is warmer than the outside temperature, and therefore the cold air is preheated as it passes through the pipes. In summer, the soil is colder than the outside temperature, and therefore, the well will make use of the relative coolness of the ground to moderate the temperature of the air input into the residence. Some rules have to be respected to make sure that heat can be exchanged correctly between the ground and the air:

- The air volume that passes through the ground must not be blown too quickly (maximum 3 m/s).
- The ratio between the air volume and the exchange surface between the tube and the ground must not be more than 6.
- The installation must not operate continuously; otherwise the surrounding ground will be depleted. Operation for one hour out of two would appear to be a good solution.
- If the volume of the well is too small, all that is necessary is to make one or several other wells. A spacing of 10 m should be provided between the tubes. The efficiency of the well will drop as the spacing between the tubes reduces.

With the Canadian well, the simulation indicates a consumption of 90 kWh/m²/year which still remains above the standard BBC 50kWh/m²/year. As such, it is decided to then install in addition to the Canadian well a photovoltaic solar panel²⁸ to reduce the consumption. The calculated amount of annual electricity production gives 71.3 kWh/m²/year and thus, the home consume 18.67 kWh/m²/yr, which corresponds to the BBC Effinergie housing Standard.

	Consommation énergétique	Gain par rapport situation initiale
Situation initiale	136 kWh/m ² .an	0%
Puits canadien	90 kWh/m ² .an	34%
Puits canadien+ PV	18.7 kWh/m ² .an	86%

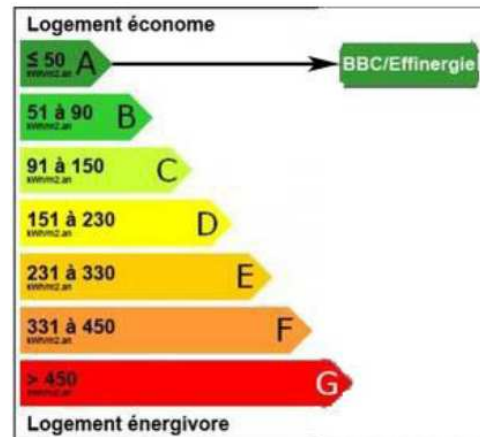

Figure 4.11: Balance of energy consumed and the BBC/effinergie standard

If the necessary materials for construction are selected carefully based on all the necessary considered factors²⁹, for optimized energy, then the only option is to optimize the energy systems as shown in this example to achieve the necessary target.

- Amounts of energy and building materials used in the case study

An inventory of inputs to the process with relative raw data has been collected from a project assignment by Post graduate students of the Ecole des Mines de Nantes. In this document, the quantity of materials and their compositions are reported in a succession of steps that cover from the first to the last brick settled.

²⁸ The roof has a total area of 56.1 square meters. It's hypothesized to cover 90% of the surface by photovoltaic panels. The study of datasheet from different manufacturers' panels solar PV Monocrystalline (Solarfun and Shüco) indicates power per m² of 135Wc/m². Thus, by covering 90% of the roof, we reach an installed capacity of 6.82 kWc.

In France, the annual production capacity of PV panels is about 1100kWh/kWc. A study conducted by the Hespul association (<http://www.hespul.org>) gives a clue of 93% yield for a facility from East or West and inclined 0° and 90% for a tilt 30°. In this case, the inclination is 23°, which gives after correlation, a performance index of 90.7%. By multiplying the installed capacity by the index 1100kWh/kWc performance, it gives an Annual Electricity production of. 6748kWh. Considering the living area of 94.6 square meters, the annual production amounted to 71.33 m² kWh / m²/year.

²⁹ As in Lynn Froeschle's article, "Environmental Assessment and Specification of Green Building Materials" in the October 1999 issue of The Construction Specifier, a publication for members of the Construction Specifications Institute (CSI).

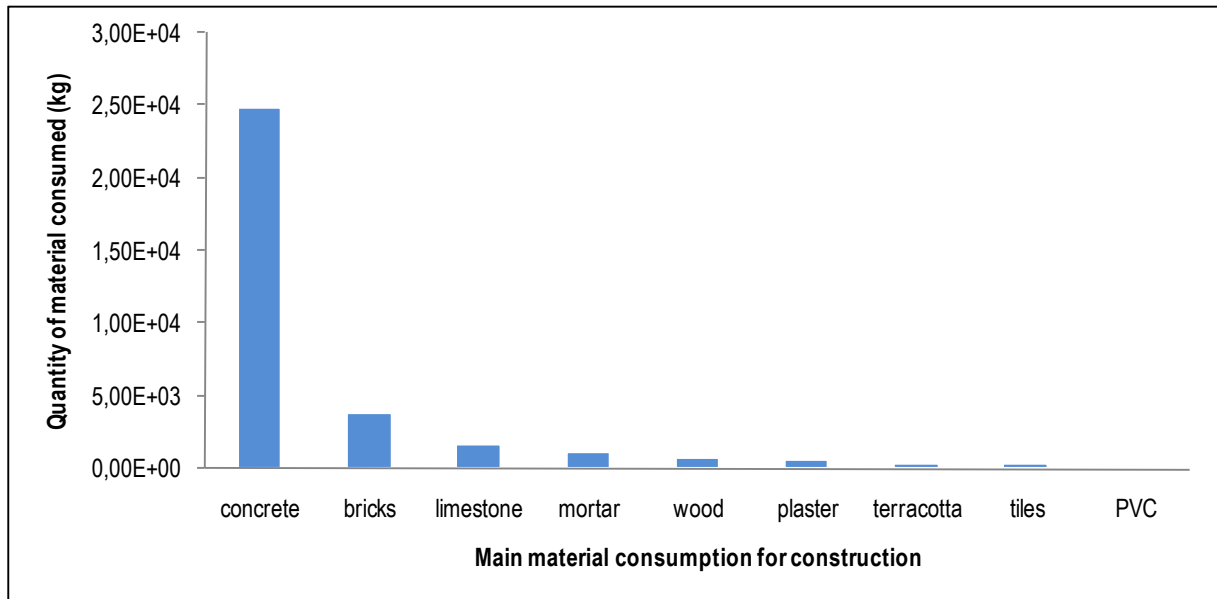

Figure 4.12: Main raw material inputs in constructing the building

From Figure 4.12, it could be seen that concrete (béton) takes about 74% in mass of the entire material inputs of the building followed by bricks (briques). This comprises mainly in the use of concrete for the groundwork, building frame and for the floors.

	<i>Construction</i>	<i>Usage</i>	<i>Renovation</i>	<i>Demolition</i>	<i>Total</i>
Energy consumed (GJ)					
Nuclear (78%)	888,4	3917,8	79,8	19,5	4905,5
Hydro (14%)	159,5	703,2	14,3	3,5	880,5
Natural gas (4%)	45,6	200,9	4,1	1,0	251,6
Coal (4%)	45,6	200,9	4,1	1,0	251,6
Used water (m³)	614,5	334,0	90,5	11,1	1050,1

**Table 4.2: Calculated energy and water quantities of the different phases of the project
(Data generated by EQUER)**

It is clear as expected that a greater amount of energy is consumed during the usage phase followed by the amount consumed during construction. Again, the consumption of water is higher during construction than during the utilization of the building.

- **Environmental impacts associated with the main materials used in the construction of the building**

A number of different materials were used in the construction of the studied home. This section provides a brief detail of the environmental impacts associated with the key materials used in the construction process.

Concrete: The production of concrete is quite complex and environmentally impacting process as it releases various pollutants such as, carbon dioxide, heavy metals, organic hydrocarbons, carbon monoxide, sulphur dioxide, Nitrogen oxides and alkaline wastewater. Concrete has a global warming potential (GWP) of 65 g/kg (Berge, 2001).

Timber: Timber is considered to be a recyclable material since at the end of its service life, a timber product can be down-cycled and can be used for many purposes for example, in chipboard production, animal bedding or garden projects. Timber is reported to have a GWP value of 116 g/kg (Berge, 2001).

Glass: The two main environmental factors associated with glass production are the high primary energy consumption with related energy pollution and the material pollution. Glass has a GWP of 569 g/kg (Berge, 2001).

Ceramic tiles: They have huge environmental impacts associated with their production. Potential polluting elements released as a direct result of their production include carbon dioxide, sulphur dioxide, fluorine and possible chromium. The GWP value for ceramic tiles is equivalent 571 g/kg (Berge, 2001).

Aluminum: It requires a great deal of energy to be produced. This energy consumption in itself brings environmental burdens besides the large amounts of pollutants released during the production process. The pollutants resulting from aluminum production process include substances like carbon dioxide (CO₂), acidic sulphur dioxide (SO₂), polyaromatic hydrocarbons (PAHs), and gases having global warming potential i.e. perfluorocarbons (PFCs), tetrafluoromethane (CF₄) and hexafluoroethane (C₂F₆) (Berge, 2001; International Aluminum Institute).

Impact	Construction	Usage	Renovation	Demolition	Total
Exhaustion abiotic resources (E-15)	0,4	1,4	1,2	0,0	2,9
Inert waste products (t eq)	9,9	22,0	0,8	0,8	33,5
Radioactive Waste (dm ³)	9,4	1,7	0,2	0,1	11,4
Greenhouse (t CO ₂)	61,3	270,6	2,7	1,5	336,1
Acidification (kg SO ₂)	287,5	320,9	19,7	17,0	645,2
Eutrophication (kg PO ₄)	35,7	38,2	1,2	2,6	77,7
Aquatic ecotoxicity (m ³)	781072,0	1204761,0	73186,2	49770,6	2108789,7
human toxicity (kg)	406,3	431,0	90,2	20,5	948,1
Photochemical ozone production (kg C ₂ H ₄)	225,4	271,7	6,6	18,4	522,0
Odor (Mm ³)	174,1	5135,6	6,9	1,8	5318,4

Table 4.3: Ecoprofile of the different phases of the project (Data generated by EQUER)

Table 4.3 presents a comparative ecoprofile (here to compare the different phases of the building cycle rather than the design approaches). The environmental impacts estimated for the ‘utilisation’ phase is observed to be rather high in all items. As such it could be said that the use of the building contributes the highest to the environmental impacts during the entire life cycle of the building. As such, a detailed analysis of this phase and subsequent improvement of the materials and equipments used could lead to a much better environmental performance.

4.6.2 Emergy evaluation of a 1-storey Low Energy Building in France

Raw data (mass quantities) in the building metric computation has been reported in Table 4.4, and has been aggregated into different structural parts; it has been processed through the relative transformities and expressed in terms of solar emergy joules. Emergy flows represent a measure of energy used in the process that could be conceived as the content of a reservoir, the building itself. References for transformities used in the table are from: Odum et al., 2000; Brown and Buranakarn, 2003; Meillaud et al., 2005; Odum, 1996.

Emergy flows have been reported relative to the materials used to build each component and structural part. Other factors have also been assessed in order to achieve a comprehensive evaluation of the entire construction process, such as solar irradiation (to the building yard during the complete process), soil erosion (the loss of organic matter content in the built area), machinery and fuel (Pulselli, 2007). Assuming that this case study is a likely example of a common approach to the manufacturing of contemporary buildings, emergy of building materials has been assessed for a 1,700 m³ building and then allocated to a unit of volume.

In Table 4.4 the composition of the main building materials used is shown. This assists in knowing the main material inputs for the construction of the building. The subsequent emergy results enable us to make a list of building materials based on their ‘environmental cost’ (in terms of seJ) that depends on both their quantity and their transformity (quality). In fact, since transformity is an indicator of energy hierarchy (for a more detailed study see Brown and Buranakarn, 2003) that accounts for all the inputs and transformations occurring in the production process (i.e. from raw material extraction to their final grade form), building materials have been evaluated through the emergy analysis by assessing both their environmental impact (quality) and their use in the building industry (quantity). The materials were diversely applied. Some of these applications include but not limited to: electrical-service distribution, lighting; finishes-wallboards, tiles, flooring, wall coverings, paint, wallpaper; masonry and stonework walls, roofing; mechanical-plumbing, refrigeration, air distribution, walls and fences; window and doors-hardware, carpentry, glazing, frames etc.

Emergy values of the main individual materials are also presented in Figure 4.13. It can again be observed that concrete still remains a significant material not only in quantity use but also in terms of its emergy input. This is because although concrete does not have a too high transformity value, it is used in a very large quantity proportion in the construction of the building and thus becomes responsible for a large share of the total emergy (65%) of the total material emergy input.

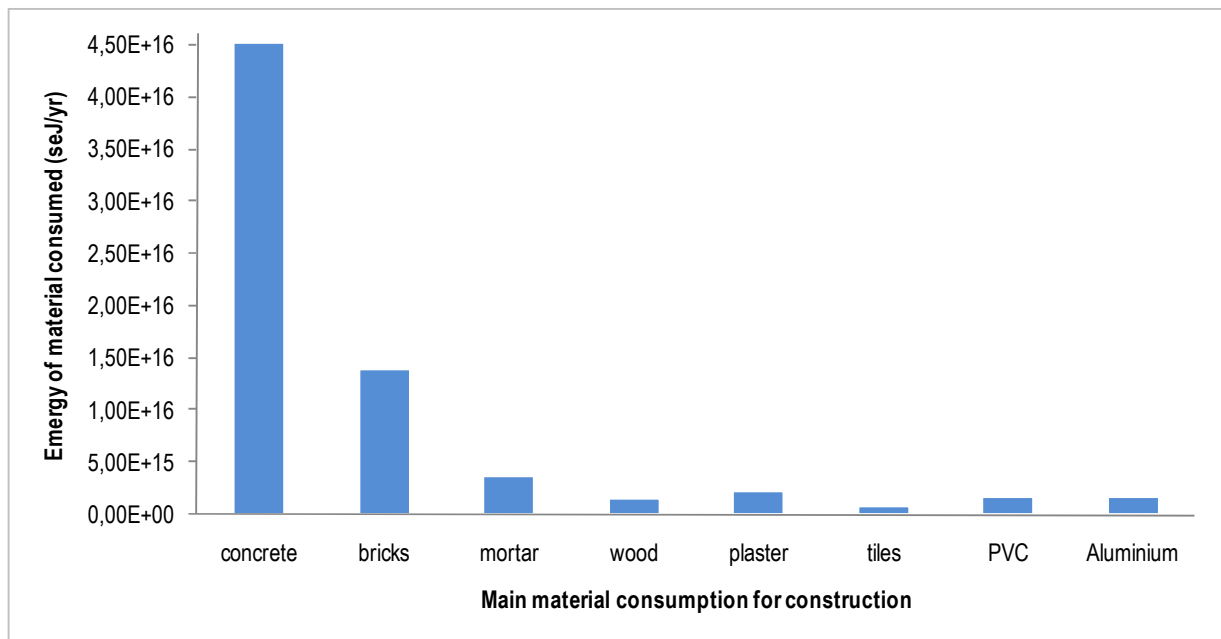

Figure 4.13: Emergy inputs of main raw materials in constructing the building

It however shows that limestone which was the third largest input falls out when emergies are considered. This is explained by the low transformity value ($1.68E+09$ seJ/kg) for limestone. PVC though slightly low in consumption rather gains energy input due to its high value of transformity. This makes PVC a good choice for recycling or reuse since it has high embodied energy.

In Table 4.4, the emergy flows have been presented relative to the materials used to build each component and structural part. Other factors have also been considered in order to achieve a comprehensive evaluation of the entire construction process, such as solar irradiation, machinery and fuel. Human work was assumably neglected. The description detailed here based on the emergy evaluation enables one to assess the emergy investment required for building construction.

Other structural elements, improved technologies, and reuse of materials from a demolished building could be selected in order to reduce the material consumption and thus decrease these values. This enables direct choices in the execution of such building projects.

Table 4.4: Energy evaluation of building construction process

1 Note	2 Item	Density (kg/m ³)	Volume (m ³)	3 Raw data	Unit	4 Transformity (seJ/unit)	5 Ref.	6 Energy (seJ)
	<i>Renewable Inputs</i>							
1	Sun			6,19E+11	J	1,00E+00	a	6,19E+11
2	water	1000	614,52	6,15E+05	kg	4,80E+04	a	2,95E+10
	<i>Non Renewable Inputs</i>							
	Basement (floor)							
3	concrete	1500	5,1	7718	kg	1,81E+12	b	1,40E+16
4	Soft limestone	1500	1,0	1544	kg	1,68E+09	f	2,59E+12
5	Heavy concrete	2300	0,5	1183	kg	1,81E+12	b	2,14E+15
	Ground floor (floor)							
6	concrete	1300	0,8	1071	kg	1,81E+12	b	1,94E+15
7	heavy concrete	2300	0,2	474	kg	1,81E+12	b	8,58E+14
8	Polyurethane effisol	35	0,3	11	kg	8,85E+12	c	9,57E+13
9	Mortar	2000	0,3	618	kg	3,31E+12	c	2,05E+15
10	Tiles	2300	0,1	118	kg	3,68E+12	c	4,36E+14
	Underground Wall							
11	Concrete	1500	5,2	7803	kg	1,81E+12	b	1,41E+16
12	Heavy concrete	2300	1,0	2393	kg	1,81E+12	b	4,33E+15
	Wall (on the west)							
13	Light wood	500	0,2	110	kg	2,40E+12	f	2,64E+14
14	Wooden fibre	40	0,6	23	kg	2,40E+12	f	5,64E+13
15	Bricks	741	2,8	2040	kg	3,68E+12	c	7,51E+15
16	Plaster	1400	0,1	206	kg	3,29E+12	d	6,76E+14
	Wall coating							
17	Wooden panel	120	0,02	2	kg	2,40E+12	f	5,74E+12
18	plaster	1200	0,02	24	kg	3,29E+12	d	7,87E+13
19	Lime plaster	1400	0,1	73	kg	3,29E+12	d	2,41E+14
20	Bricks	741	1,0	727	kg	3,68E+12	c	2,67E+15
21	Plaster	1400	0,1	73	kg	3,29E+12	d	2,41E+14
	Plastering							
22	Plaster	1400	0,01	14	kg	3,29E+12	d	4,68E+13
23	Concrete blocks	1300	0,10	132	kg	1,81E+12	b	2,39E+14
24	Lime plaster	1400	0,01	14	kg	3,29E+12	d	4,68E+13
	Wall (East)							
25	Porothermn bricks30	762	0,3	196	kg	3,68E+12	c	7,21E+14
26	Bricks 10.7 cm	1700	0,1	153	kg	3,68E+12	c	5,63E+14
27	Bricks 10.5 cm	1700	0,1	153	kg	3,68E+12	c	5,63E+14
	Wall (North)							
28	Concrete	1500	1,8	2694	kg	1,81E+12	b	4,88E+15
29	Bricks	741	0,7	499	kg	3,68E+12	c	1,84E+15
30	Wooden fibre	40	0,1	3	kg	2,40E+12	f	6,90E+12
31	Light wood	500	0,1	27	kg	2,40E+12	f	6,47E+13
	Intermediate Floor							
32	Plaster	1500	0,1	154	kg	3,29E+12	d	5,07E+14
33	Concrete	1300	0,6	802	kg	1,81E+12	b	1,45E+15
34	Heavy concrete	2300	0,2	473	kg	1,81E+12	b	8,56E+14
35	Polystyrene extrude	35	0,3	11	kg	8,85E+12	c	9,55E+13
36	Mortar	2000	0,3	514	kg	3,31E+12	c	1,70E+15
37	Tiles	2300	0,1	118	kg	3,68E+12	c	4,35E+14
	Room Partitioning							
38	Plaster	1200	0,1	74	kg	3,29E+12	d	2,44E+14
39	Wooden fibre	40	0,5	20	kg	2,40E+12	b	4,75E+13
40	Plaster+cellulose	1200	0,1	74	kg	3,29E+12	d	2,44E+14
41	Concrete	600	0,1	73	kg	1,81E+12	b	1,33E+14
	Roof rafters							
42	Terracotta	1900	0,1	153	kg	1,68E+09	b	2,57E+11
43	Air space	1	0,0	0,04	kg	6,97E+12	a	2,80E+11
44	Wooden fibre	40	0,5	19	kg	2,40E+12	b	4,63E+13
45	Wooden board	800	0,1	43	kg	2,40E+12	b	1,03E+14

Table 4.4 (Continued)

1	2			3		4	5	6
Note	Item	Density (kg/m ³)	Volume (m ³)	Raw data	Unit	Transformity (seJ/unit)	Ref.	Emergy (seJ)
	Upstairs Roofing							
46	Terracotta	1900	0,1	165	kg	1,68E+09	b	2,78E+11
47	Air space > 1.3 cm	1	0,0	0,04	kg	6,97E+12	a	3,03E+11
48	Wooden fibre	40	0,5	21	kg	2,40E+12	b	5,01E+13
49	Light wood	800	0,1	46	kg	2,40E+12	b	1,11E+14
50	Interior wooden door	750	0,06	48	kg	2,40E+12	b	1,15E+14
60	Double glass window for external door 4,16,4 argon	2700	0,03	82	kg	2,13E+13	c	1,74E+15
61	Glass Window	2700	0,02	44	kg	1,41E+12	e	6,18E+13
62	External wooden door	750	0,06	41	kg	2,40E+12	b	9,91E+13
63	metallic gate	7874	0,01	48	kg	8,55E+08	a	4,12E+10
64	Drainage system (PVC)			171	kg	9,86E+12	c	1,69E+15
65	Staircase (wood)			300	kg	2,40E+12	b	7,20E+14
	<i>Purchased Inputs</i>							
66	Fuel (Transports)			1,74E+08	J	1,13E+05	h	1,96E+13
	<i>Energy consumed (Electricity use on site)</i>							
67	Nuclear (78%)			8,88E+05	J	2,00E+05	g	1,78E+11
68	Hydro (14%)			1,59E+05	J	8,00E+04	a	1,28E+10
69	Natural gas (4%)			4,56E+04	J	4,80E+04	a	2,19E+09
70	Coal (4%)			4,56E+04	J	4,00E+04	a	1,82E+09
	Total emergy for building manufacturing							7,11E+16

References (Ref): [a] Odum et al. (2000); [b] Simoncini (2006); [c] Brown and Buranakarn (2003); [d] Meillaud et al. (2005); [e] Odum et al. (1987); [f] Odum (1996); [g] Brown and Arding (1991); [h] Bastianoni et al. (2005) (Raw data calculated with EQUER software)

Solar irradiation from the sun has been considered in the calculation. This is necessary in order not to neglect the ‘free energy’ required for certain areas during the manufacture of the building. A typical example is to aid in drying up of mortar and concrete amongst others which is most often not considered by several other tools. The calculation has been performed as follows:

Building area is given as 200m²; Solar irradiation per year is approximately 5.16E+9 J/m²; Estimated building time given as 9months; Albedo (diffuse reflectivity) given as 0.2. As such the solar irradiation is calculated as:

$$(200m^2) \cdot (5.16E + 9J / m^2) \cdot (1 - 0.2)$$

System Boundaries

In the emergy evaluation, raw materials extraction is not included as all materials are assumed to be in their processed and usable state. Transportation of building materials to the construction site is thus considered. Erection of the building envelope is also considered. However, for the

purposes of demonstrating the main ideas of this thesis, use of the building, demolition of the building and operation of recycling or treatment of the rubble are discussed but not included in the emergy evaluation.

4.7 *Proposal of a model to evaluate materials reuse*

The sustainability of the building and construction industry largely depends on the ability to reuse materials. This in a large extent helps to reduce the dependence on virgin raw materials and components (refer to chapter 3 for a detailed review on recycling in the B&C industry). Therefore, the evaluation of building construction with the use of such recoverable materials becomes an important goal to be achieved.

Different scenarios

Two different scenarios are considered in this work. The first is a reuse scenario and the latter is the recycled scenario. Figure 4.14 shows the path for the different scenarios.

(a) Reuse scenario (2nd Case)

Within this model, the reuse scenario is considered for those materials and components that:

- (i) Can be disassembled or partially removed;
- (ii) Keep their shape or function after being disassembled or partially removed;
- (iii) Have no hazardous materials.

It is important to note that structural and demountable components are usually suitable for reuse, such as steel sections, wood and engineered wood sections, and assembled precast concrete elements, as long as they meet the set standard requirements.

Non-structural materials may also be suitable for reuse such as finishing materials that could be resized if needed (e.g. wood floors, glass panels, window and door frames, or metallic panels).

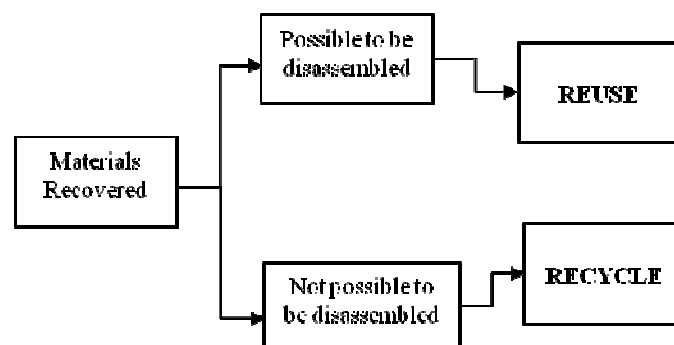

Figure 4.14: Allocation of the recovered materials to the different scenarios

(b) Recycling scenario (1st Case)

The recycling scenario option is considered for those materials and components that:

- (i) Cannot be disassembled;
- (ii) Do not keep their shape in spite of being disassembled;
- (iii) Cannot be separated by mechanical or chemical processes if being a composite material, or recycled as it is;
- (iv) Can be cleaned if being a contaminated material;
- (v) Not having hazardous materials.

However, materials which are not feasible to be separated for recycling purposes, such as glued materials could be allocated to heat recovery or land filled depending on their composition and level of contamination.

There could also be other different possibilities for the different scenarios presented. In reuse scenarios, materials or components may substitute the same product with the same function or the same product with a different function, or even part of a subassembly with the same or different function. Recyclates may also be substitutes of raw materials for the same material production or a substitute for a raw material in a different material manufacture.

4.8 Impact of material recycle or reuse on the emergy of the building

Bricks were found to be the second most used material in the construction of the building, accounting for about 19% of the total percentage of material input. Though it might not be the best example of a reusable or recyclable material in building, compared to PVC, steel etc, the idea is to illustrate the developed procedure for the emergy evaluation.

As a result, the emergy of the building is re-evaluated taken into account the different scenarios already mentioned. The 1st case is considered for a case of damaged bricks beyond reuse. As such, emergy for sorting, collection and transportation to the recycling plant is considered in addition to the emergy for the plant process. This emergy adds up to give the additional emergy for recycling (O_c). This is given as $6.20E+13$ seJ (with referenced calculation from Buranakarn, 1998). This then is multiplied by the quantity ($q= 30\%$ in this case) of bricks to be recycled. The result (ψO_c) is added up to the initial emergy of the building (ref. Table 4.4) $7.1E+16$ seJ to give an emergy difference of $5.4E+11$ seJ for the first recycling. This is continued for different number of times of recycle and for different quantities to assess the various impacts. Table 4.5 presents the results.

ψO_c , seJ	
Recycling	
1st	5,442E+11
2nd	7,074E+11
3rd	7,564E+11
4th	7,711E+11
5th	7,755E+11

Table 4.5: Results of bricks recycling for different number of recycling times

The difference in energy increases with increase in the number of times of recycle as noticed in the example in Chapter 3. This however highlights the key point much better.

The same is achieved in the case of material reuse. In this case, the additional energy needed (O_c) is generated from sorting and collection. As such O_c is given as $3.41E+13$ seJ. Table 4.6 presents the results of energy of the building achieved for a 30% recycle rate (q) and for different number of times of recycle.

	ψO_c , seJ	Difference with initial energy seJ
Reuse		
1st	2,99E+11	3,0E+11
2nd	3,89E+11	3,9E+11
3rd	4,15E+11	4,2E+11
4th	4,24E+11	4,2E+11
5th	4,26E+11	4,3E+11

Table 4.6: Results of new energy of building for reuse of bricks (e.g. in concrete mix)

4.9 Impact on EYR and ELR

Calculated values of the improved indicators are presented in the following tables and figures.

- Impact on the Emergy Yield Ratio

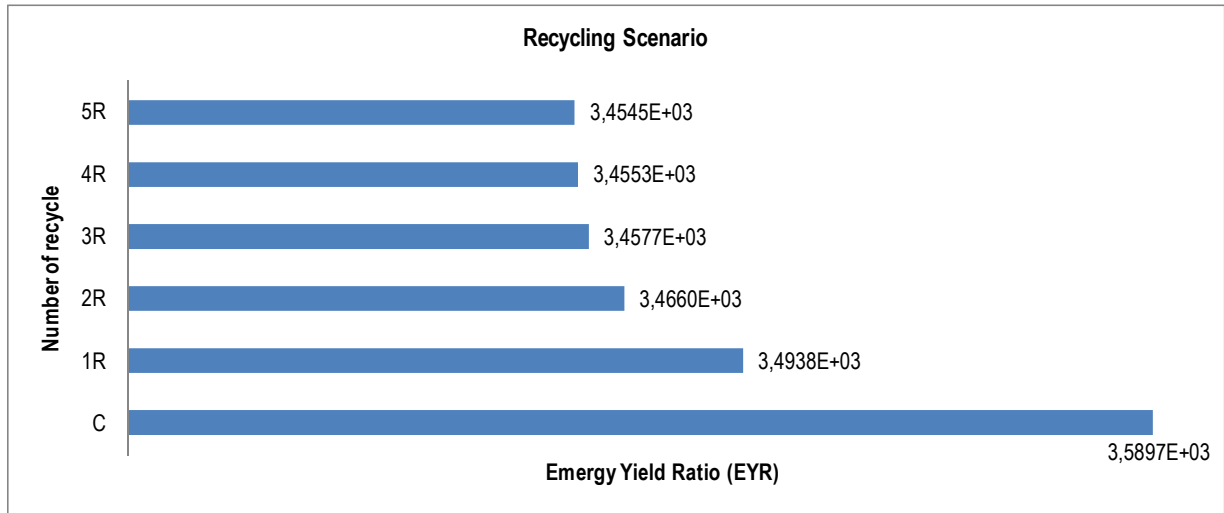

Figure 4.15: Results of recycle bricks use on EYR of the building (refer to Appendix D for EYR calculations)

It is seen from the results presented in Figure 4.15 that the EYR decreases with an increase in recycling times. This is explained by the increase in the additional goods and services purchased to aid in the recycling process. Figure 4.16 shows the impact of quantity of recycled bricks use on the emergy yield ratio (EYR) of the building.

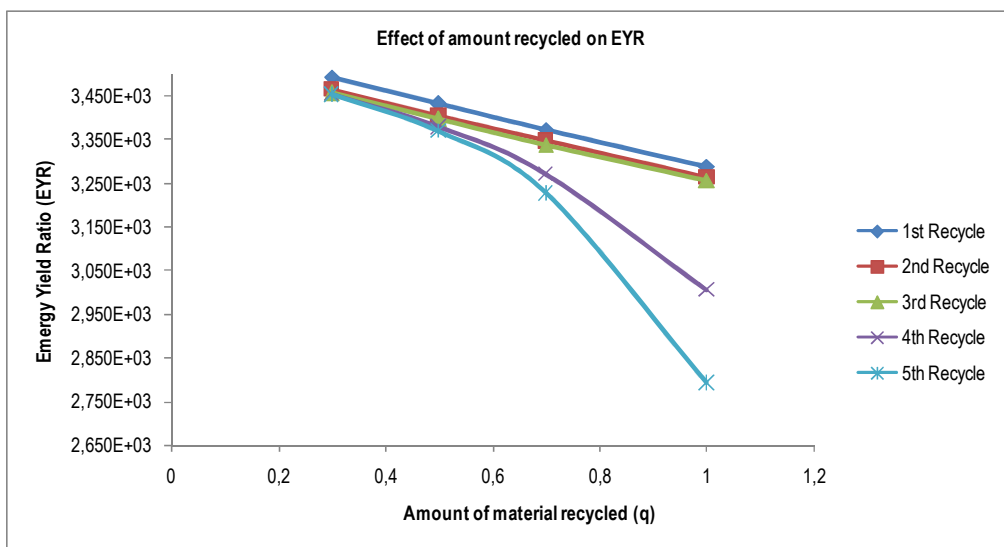

Figure 4.16: Effect of recycled bricks usage on EYR of building

Figure 4.17 also shows a similar result for the effect recycled plastic usage has on the EYR of the building construction. Figure 4.18 also displays another result in which the same quantity of plastic is sorted, collected and reused without undergoing process recycle.

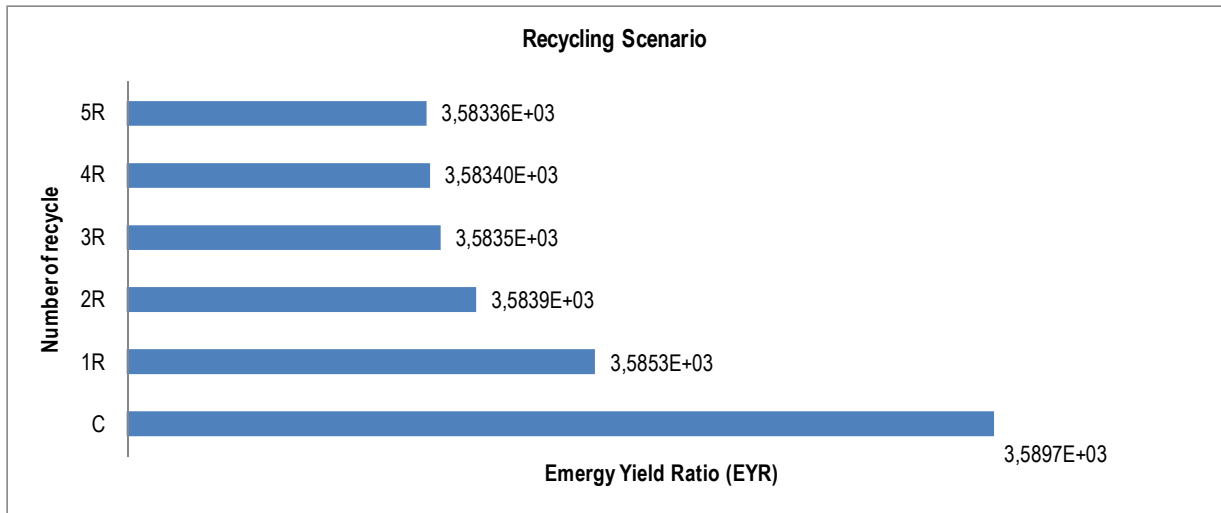

Figure 4.17: Effect of recycled plastic usage on EYR of building

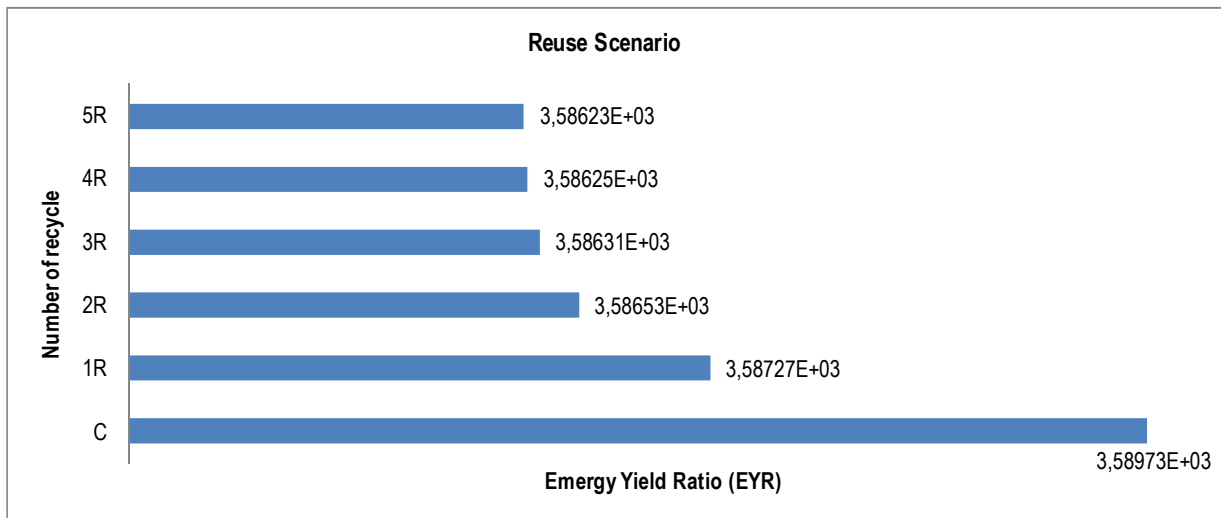

Figure 4.18: Effect of reused plastic on EYR of building

As can be seen in the results of the EYR, ignoring the impact of material reused or recycled leads to loss of significant information. Extending the traditional EYR to include the recyclable values from the additional emergy needed for recycling, increases the base value (purchased goods and services) and thus reduces the EYR. It is observed that EYRs are lower in higher recycling times than lower times. For instance, the difference in EYR for a 1st recycle and a 5th recycle could be

significant in a future case of higher O_c for recycling. This is due to the significant changes in the additional emergy amounts needed for the cycle of material recycle or reuse (Refer to Appendix B for additional results).

Results of Emergy Evaluation

The results achieved by the LCA tool are used as input data for the emergy evaluation. For the purpose of the study, only the energy and water inputs are considered. Transformities for the various energy sources (hydro, natural gas, coal) are referenced from Odum et al., 2000. The transformity of nuclear is from Ulgiati and Brown, 1999.

	Construction	Usage	Renovation	Demolition	Total	Transformity (seJ/J)	Emergy (seJ)
Energy consumed (GJ)							
Nuclear (78%)	888,4	3917,8	79,8	19,5	4905,5	3,35E+05	1,64E+09
Hydro (14%)	159,5	703,2	14,3	3,5	880,5	8,00E+04	7,04E+07
Natural gas (4%)	45,6	200,9	4,1	1,0	251,6	4,80E+04	1,21E+07
Coal (4%)	45,6	200,9	4,1	1,0	251,6	4,00E+04	1,01E+07
Used water (m³)	614,5	334,0	90,5	11,1	1050,1	4,80E+04	5,04E+07

Table 4.7: Emergy evaluation results

From the emergy evaluation results, it is clearer to compare the actual quantities of both energy and water consumption on a similar basis. The building is seen to consume about 90% more of energy for construction, usage, renovation and demolition than it consumes water. It is also observed to consume more energy from the nuclear source since it is also the most used energy source in France. However, due to the high transformity value of nuclear, it would be advisable to use more of natural gas for reasons of sustainability.

The transformity is an indicator of an energy hierarchy that accounts for all of the inputs and transformations that occur in the process (i.e. from raw material extraction to their final grade form) (Pulselli et al., 2007), which suggests that selecting raw materials at a lower energy hierarchy and reducing the environmental influence during material production are effective measures to reduce the transformity. For example, the transformity of nuclear is 3.35×10^5 seJ/J, which is much larger than the transformity of hydro (8.00×10^4 seJ/J). In fact, hydro is a renewable source of energy and as such is in favor of environmental protection. As a result, replacing with hydro definitely reduces the emergy amount.

4.10 Conclusion

In this chapter, different aspects of evaluations have been conducted. The emergy evaluation and another via an LCA tool (EQUER). Emergy evaluation is seen to be very useful for evaluating and improving industrial systems because, unlike other analytical tools, it accounts for the contribution of ecosystems to economic activity. Furthermore, it provides useful indicators for evaluating the economic and ecological feasibility as well as sustainability of the systems. The improved indicators proposed in this work provide a conceptually sound basis to quantify the impacts of recycling of materials in a typical Low Energy Building. The calculated indicators were shown to be consistent with the notion that investing in waste management must be expected to lead to less environmental stress largely dependent on the input materials either from renewable, non renewable or purchased sources. A good balance of these would enhance sustainability.

The next section summarizes the main conclusions of this work, highlight some recommendations and propose areas of further development and work.

Conclusions and Perspectives

Introduction

This thesis aim to improve emergy accounting for systems with "waste" recycling by introducing a recycling factor that is a function of the recycling rate and number of recycle loops. The effort holds similarities with Patten, 1995 on Network integration. It is rather essential since understanding emergy recycling is a pressing need, partly because not enough authors have seriously considered it. This thesis realized at the Ecole des Mines de Nantes has been mainly conducted based on the following works:

1. Ulgiati, S., Raugei M., Bargigli S., 2004. Dotted the I's and Crossing the T's of Emergy Synthesis: Material Flows, Information and Memory Aspects, and Performance Indicators, Proceedings from the Third Biennial Emergy Evaluation Research Conference, Gainesville, Florida.
2. Buranakarn, V., 1998. Evaluation of recycling and reuse of building materials using the emergy evaluation method, a Ph.D dissertation, Department of Architecture, University of Florida, Gainesville, FL.

The Emergy Theory

Of the many measures of value used in environmental accounting, viz economic value, the value of labor, available energy, material flow, emergy is the only measure which is of a donor-type i.e. has a common metric to all inputs and outputs involved in any natural or economic system. Any measure of real wealth requires a method of accounting which utilizes a donor-determined value. Emergy is a measure of the totality of what was required to generate a good or service. The techniques closest in essence to that of the Emergy Concept are the available energy, exergy, approaches and the various embodied energy analyses. These approaches have failed to relate one form of energy to another with respect to the quality of that energy via the transformity. They have not used a common unit of measure.

The Emergy Concept is eminently well-suited to environmental accounting techniques as any of the inputs into the productive process can be manipulated by means of transformity ratios or emergy/money ratios to give data in terms of common units of measure in all of the sectors required for an appropriate environmental accounting method (Gourgau, 1997)

One of the main tools for environmental assessments which is currently most used is LCA as pointed out in previous chapters. The chapter 4 of this thesis which presented a case study on the

energy evaluation of a building, sought to introduce a simplified LCA approach to a similar case. A summary of the main differences with both advantages and disadvantages between LCA and Emergy are as follows:

Life Cycle Assessment:

Advantages

- It accounts for emissions of pollutants
- It is supported by comprehensive and complete database
- It goes beyond the process boundary (« cradle to grave » analysis)

Disadvantages

- It does not account for ecological inputs (which can be important for e.g. water depletion)
- Accounting of labor and services using mixed approaches (IO and hybrid)
- It is Human oriented (Human point of view is applied in evaluation step)

Emergy Evaluation:

Advantages

- It provides account for all type of inputs, including labor and service
- It provides values expressed in the same common unit (seJ)
- It accounts for contribution of ecological inputs (sun, tide, wind, etc.)

Disadvantages

- It does not provide any information about emissions
- It lacks of details of some process phase (i.e. « cradle and grave » phase of process)
- It does not rely on comprehensive database, as for LCA processes
- It lacks of transparency of data

Emergy and Recycling

The work conducted centered on studying recycling at discrete times and proposed a set of equations to evaluate such systems involving recycling. This approach aims to contribute to the emergy evaluation of recycling processes. Since emergy researchers often adopt classical emergy indices such as EYR, EIR, ELR ESI etc., to evaluate solid wastes recycling value (Feng et al., 2007; Lou, 2004; Yang et al., 2003), consequently, additional efforts to complement the calculation procedure to reflect a rather clearer picture of these indices for recycling have been proposed with their impacts examined. Through this analogy, this thesis presents a way by which emergy information loss (internal 'memory') which is generated as a result of continuous recycle operations can be accounted for in emergy evaluations. The results show significant loss of emergy history when recycling is done severally and not accounted for in emergy evaluations. Buranakarn, 1998 and Brown and Buranakarn, 2003 share in the view that emergy of a product increases with use of a recycled material. As a result, a recycling process would increase the emergy content of a product only once (whatever the time pathway). The concept has been applied to examples of both metallic and non-metallic materials often used in the building and construction industry. This could be extended to evaluate other material recycling processes and options.

Principal contributions

Redefining the first rule of emergy to enhance its independence as in the case of other scientific rules and laws. This is intended to incorporate in the first rule the eventuality of recycle in an aggregated system.

Again, discussions on a critical review of available transformity values which most emergy analysts use in their studies is highlighted. In this light, a case study was conducted on the emergy analysis of different hydrogen production pathways (SMR and electrolysis). A preliminary step was to establish a consistency in the transformity values for hydrogen production for the different pathways with available data in previous publications. The calculated transformity values for hydrogen were seen to be consistent with published results. Moreover, results indicated that the transformities of hydrogen via electrolysis are higher than those transformities via steam methane reforming of natural gas. This shows that a larger amount of resources is required to get the product (increased environmental support). This is because of the high amount of electricity consumption in the electrolysis process. Thus, this technology only seems to be applicable in specific cases, where a surplus of largely renewable electricity is available. However, emergy investigators sometimes confuse these transformity values and select values notwithstanding their original sources. This definitely could influence the outcome of results and impact on decisions. As such, a set of guidelines adapted from Ulgiati et al., 2010 has been presented to enable the correct selection of transformity values. Thus available transformity values calculated from previous studies should be carefully selected if to be used in a recent study. If possible an idea of the context within which that value was reached would be useful.

Through the inspiration of previous emergy studies, this work has tried to develop formulae which could be used in cases of continuous recycling of material for example, in buildings. The developed approach is applied to a case study to give a better understanding of the application of the concept. As a result, a 'factor' is introduced which could be included on emergy evaluation tables to account for subsequent transformity changes in multiple recycling. This factor can be used to solve the difficulties in evaluating aggregated systems, serve as a correction factor to up-level such models keeping the correct evaluation and also solve problems of memory loss in emergy evaluation. These developed formulae which "unroll" the time pathway of a material has not as yet been considered in emergy publications³⁰. The current practice in eMergy evaluation is based on transformity as an input (for raw material). As such this proposition evolving different ideas is interesting for the emergy community and other researchers for the development of the theory.

³⁰ This was a remark by a reviewer on the submission of a paper : 'Recycling flows in eMergy evaluation: A Mathematical Paradox?' based on this work.

Highlights of contributions

- The emergy of a product containing a part of recycling as expressed in discrete time:

$$O_p(t) = q(t)O_c(t) + O_i(t)(1 - q(t)) + q(t)O_p(t-1) \quad (\text{cf. 3-26})$$

Based on the hypothesis (q, O_c, O_i constant) considered, it is possible to express equation (3.28) by introducing a factor, noted ψ : $O_p^{N,q} = O_i + \psi O_c$ with $\psi = q \frac{(1-q^N)}{1-q}$ with N greater than or equal to 1.

Based on this work, it is possible to re-define a ratio (depending on the pathway, i.e. the number of recycling) in the form:

$$EYR_g = \frac{(O_{i_{1,2,3}} + \psi O_{c_{1,2,3}})}{(O_{i_1} + \psi O_{c_1})} \quad (\text{cf. 3-35})$$

In addition, other ratios ELR and EIR, NRR (Brown and Ulgiati, 1997) can also be extended.

$$\text{Emergys Investment Ratio (EIR): } EIR_g = \frac{(O_{i_1} + \psi O_{c_1})}{(O_{i_3} + \psi O_{c_3}) + (O_{i_2} + \psi O_{c_2})} \quad (\text{cf. 3-36})$$

$$\text{Environmental Loading Ratio (ELR): } ELR_g = \frac{(O_{i_1} + \psi O_{c_1}) + (O_{i_3} + \psi O_{c_3})}{(O_{i_2} + \psi O_{c_2})} \quad (\text{cf. 3-37})$$

The link between emergy and exergy is not "broken". As two products could have the same exergy content but different emergy contents. By analogy with the statement of Carnot, then for recycling, there is an emergy price to pay. The new indicators depend on the number of recycling and the part recycled. They thus allow a comparison between two technical solutions.

Concluding remarks and future work

Based on the above discussion it is clear that an important future research should be based on developing the concept further to accurately define the transformities of recycled materials depending on how many times the respective material is reused.

Another important point to consider is to develop the model to highlight the benefits of recycling in emergy point of view. The model developed in this thesis, introduces a disadvantage to recycling. As discussed, the additional emergy from recycling which contributes to the final emergy of the product gives a result which makes recycling non-competitive in the emergy point of view. To correct this anomaly, an 'emergy reset' could be proposed as pointed out by Ulgiati

et al., 2004. Consequently, after any recycling process an energetic object (reset) is proposed. The 'reset' object cancels the energy amount. As such the energy of the recycled raw material is then comparable to that of the initial raw material from the bowels of the earth, but without that of extraction and refinery. By canceling the embodied energy amount from the recycling process, recycled raw material is then supported. As a result, the decision to invest in a recycling module becomes interesting and as such, under such limited resources, recycle is made favorable over raw material use even though the energy concept depict otherwise.

31

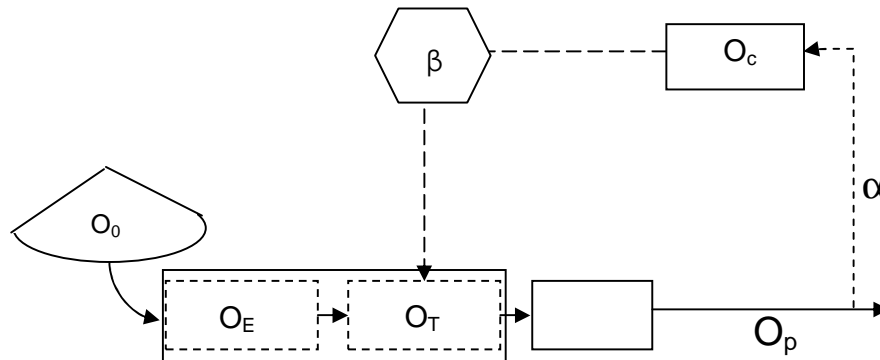

Schematic diagram of a recycle process with a 'reset' key (β)

This work certainly agrees that if an investigator has no idea on the internal rate of recycle, then Ulgiati's proposal stands. For this reason, results of its impact have also been presented on the measure of sustainability in Chapter 4 for the specific case. At a higher scale, recycled material behaves dynamically as storage, thus it accumulates energy over time, but it cannot keep giving new energy to the product flows. As a result, a recycling process would definitely increase the energy content of a product only once (whatever the time pathway).³² This significantly stands out in this thesis. Buranakarn, 1998 and Brown and Buranakarn, 2003 share in the view that energy of a product increases with recycling process. Additionally, the case study introduced in Chapter 4 of this thesis, shows significant impacts on the measure of sustainability when recycling is done severally and as such from the analysis; this concept must be given attention and developed further. It is worthy to note that the state of scientific knowledge is always changing and as such the contributions from this work add up to the information that drives the necessary changes and evolution.

³¹ O_0 - Energy of the raw material ; O_E -Energy of extraction ; O_T : Energy of transformation ; O_c -Additional energy for recycling ; O_p : Energy of the output material; β -Reset object

³² A response given to a journal reviewer on the possibility of continuous energy increase based on the proposed formulae.

References

French Extended Abstract

- Amponsah, N.Y., Le Corre, O., 2010a, Use of energy analysis in comparing hydrogen production via steam methane reforming and electrolysis, Energy & Environmental Accounting: theories, applications and methodologies, 6th Biennial Energy Conference, Florida, USA (at press).
- Amponsah, N.Y., Le Corre, O., 2010b. Critical review of the usage of transformity values in recent studies, presentation, Energy & Environmental Accounting: theories, applications and methodologies, 6th Biennial Energy Conference, Florida, USA (at press).
- Anderson, R., Christensen, C., Horowitz, S., 2006. Program Design Analysis using BEopt Building Energy Optimisation Software: Defining a Technology Pathway Leading to New Homes with Zero Peak Cooling Demand ACEEE, Summer Study Pacific Grove, California NREL/CP-550-39827.
- Ayres, R.U., 1995. Life Cycle Analysis: A Critique, Resources, Conservation and Recycling, vol. 14(3-4), pp. 199 -223.
- Bakshi, B.R., 2000. A thermodynamic framework for ecologically conscious process systems engineering, Computers and Chemical Engineering, vol. 24(2-7), pp. 1767–1773.
- Bargigli, S., Raugei, M., Ulgiati, S., 2004. Comparison of thermodynamic and environmental indexes of natural gas, syngas and hydrogen production processes. Energy, vol. 29(12-15), pp. 2145-2159.
- Bastianoni, S., Campbell, D., Susani, L., Tiezzi E., 2005. The solar transformity of oil and petroleum natural gas, Ecological Modelling, vol. 186(2), pp. 212–220.
- Baumann, H., Tillman, A., 2005. The Hitch Hiker's Guide to LCA: An orientation in life cycle assessment methodology and application, Journal of Cleaner Production, vol. 13(13-14), p. 1360
- Bejan, A., Tsatsaronis, G., Moran, M., 1996. Thermal Design and Optimization, Wiley, New York.
- Brown, M.T., Arding, J.E., 1991. Transformity Working Paper, Center for Wetlands, University of Florida, FL.
- Brown, M.T., Herendeen, R.A., 1996. Embodied energy analysis and emergy analysis: A comparative view, Ecological Economics, vol. 19(3), pp. 219- 235.
- Brown, M.T., McClanahan, T., 1996. Emergy Analysis Perspectives of Thailand and Mekong River Dam Proposals, Ecological Modelling, vol. 91(1-3), pp. 105-130.

- Brown, M.T., Ulgiati, S., 1997. Emergy-based indices and ratios to evaluate sustainability: monitoring economies and technology toward environmentally sound innovation, *Ecological Engineering*, vol. 9(1-2), pp. 51-69.
- Brown, M.T., Buranakarn, V., 2003, Emergy indices and ratios for sustainable material cycles and recycle options, *Resources, Conservation and Recycling*, vol. 38(1), pp. 1-22.
- Brown, M.T., Ulgiati, S., 2004. Emergy Analysis and Environmental Accounting, In: Editor-in-chief: Cleveland, J., *encyclopedia of Energy*, Elsevier, New York, pp. 329-354.
- Brunner, P. H., Rechberger, H., 2004. *Practical Handbook of Material Flow Analysis*, USA: CRC Press LLC, Lewis Publishers.
- Buranakan, V., 1998. Evaluation of recycling and reuse of building materials using the emergy evaluation method, a Ph.D dissertation, Department of Architecture, University of Florida, Gainesville, FL.
- Burgess, A.A., Brennan, D.J., 2001. Application of life cycle assessment to chemical processes, *Chemical Engineering Science*, vol. 56(8), pp. 2589-2604.
- Cavalett, O., Queiroz, J.F., Ortega, E., 2006. Emergy assessment of integrated production systems of grains, pig and fish in small farms in the South Brazil, *Ecological Modelling*, vol. 193(3-4), pp. 205-224.
- Crawford, R.H., Treloar, G.J., Fuller, R.J., Bazillan, M., 2006. Life-cycle energy analysis of building integrated photovoltaic systems (BiPVs) with heat recovery unit, *Renewable & Sustainable Energy Reviews*, vol. 10(6), pp. 559-575.
- Dincer, I., Rosen, M.A., 2007: Exergy analysis of renewable energy systems, *EXERGY, Environment and Sustainable Development*, Ed. Elsevier, Chapter 10, pp. 163-228.
- Engström, R., Wadeskog, A., Finnveden, G., 2007. Environmental assessment of Swedish agriculture, *Ecological Economics*, vol. 60(3), pp. 550-563.
- Eriksen, E., Dan, Z., Jim, M., 2009. After the Avalanche, *Transmission and Distribution World*, March 1, http://tdworld.com/overhead_distribution/avalanche_pronetransmission-lines-0903/index2.html.
- European Parliament and Council Directive [EU 1994] 94/62/EC of 20 December 1994 on packaging and packaging waste.
- European Parliament and Council Directive [EU 1999] Directive 1999/31/EC on the landfill of waste in the EU-15.

- European Environment Agency [EEA] 2007. Environmental Statement, Luxemburg office for international publications, ISBN : 978-92-9167-936-2.
- Feng, X., Wang, L., Min, S., 2009. Industrial energy evaluation for hydrogen production systems from biomass and natural gas, *Applied Energy*, vol. 86(9), pp. 1767-1773.
- Giampietro, M., Bukkens, S.G.F., Pimentel, D., 1993. Labor productivity: a biophysical definition and assessment, *Human Ecol.*, vol. 21(3), pp. 229–260.
- Guinée, J.B., Huppes, G., Heijungs, R., 2001. Developing an LCA guide for decision support, *Environmental Management and Health*, vol. 12(3), pp. 301-311.
- Gungor, A., Gupta, S.M., 1999. Issues in environmentally conscious manufacturing and product recovery: A survey, *Computers & Industrial Engineering*, vol. 36(4), pp. 811-853.
- Höjer, M., Ahlroth, S., Dreborg, K., Ekvall, T., Finnveden, G., Hjelm, O., Hochschorner, E., Nilsson, M., Palm, V., 2008. Scenarios in selected tools for environmental systems analysis, *Journal of Cleaner Production*, vol. 16(18), pp. 1958-1970.
- Jacobsen, M., Kristofferson, M., 2002. Case Studies on Waste Minimisation Practices in Europe, European Topic centre on waste, European Environment Agency, Topic report 2.
- Johanna, I., 2004. Summary of Electrolytic Hydrogen Production, Milestone Completion Report, National Renewable Energy Laboratory (NREL), U.S.A.
- Johnson, J., Reck, B.K., Wang, T., Graedel, T.E., 2008. The energy benefit of stainless steel recycling, *Energy Policy*, vol. 36(1), pp. 181-192.
- Kok, R., Benders, M.J., Moll, H.C., 2006. Measuring the environmental load of household consumption using some methods based on input–output energy analysis: A comparison of methods and a discussion of results, *Energy Policy*, vol. 34(17), pp. 2744-2761.
- Lazzaretto, A., 2009. A critical comparison between thermoeconomic and energy analyses algebra, *Energy*, vol. 34(12), pp. 2196-2205.
- Li, L., Lu, H., Campbell, D.E., Ren, H., 2010. Energy algebra: Improving matrix methods for calculating transformities, *Ecological Modelling*, vol. 221(3), pp. 411-422.
- Lotka, A., 1922. Contributions to the Energetics of Evolution: Natural Selection as a Physical Principle, *Proceedings of the National Academy of Science*, vol. 8(6), pp. 147-151.
- Lotka, A., 1945. The law of evolution as a maximal principle, *Human Biology*, vol. 17, pp. 167-194.

- Maud, S., 2007. A DirectScience: The synthesis of ScienceDirect and EmSim, *Ecological Modelling*, vol. 203(3-4), pp. 518-520.
- Meillaud, F., Gay, J.B., Brown, M.T., 2005. Evaluation of a building using the emergy method, *Solar Energy*, vol. 79(2), pp. 204–212.
- Min, S., Feng, X., 2008. Energy sources, Part B, Economics, Planning, and Policy, vol. 3(2), pp. 133-143.
- Odum, H.T., 1967. Energetics of food production. In: *The World Food Problems, Report of the President's Science Advisory Committee Panel on World Food Supply*, vol. 3, pp. 55-94.
- Odum, H.T., Odum, E.C., 1975. *Energy Basis for Man and Nature*, McGraw-Hill, NY.
- Odum, H.T., Odum, E.C., King, R., Richardson, R., 1987. *Ecology and Economy: Emergy Analysis and Public Policy in Texas. Energy System in Texas and The United States*, Policy Research Project Report Number 78, The Board of Regents, University of Texas, TX.
- Odum, H.T., 1996. *Environmental accounting: emergy and environmental decision making*, John Wiley and Sons, New York.
- Odum, H.T., Peterson, N., 1996. Simulation and evaluation with energy systems blocks, *Ecological Modelling*, vol. 93(1-3), pp. 155-173.
- Odum, H.T., 2000. Folio #2: Emergy of Global Processes, *Handbook of Emergy Evaluation*, Center for Environmental Policy, Environmental Engineering Sciences, University of Florida, Gainesville.
- Odum, H.T., Brown, M.T., Williams, S.B., 2000. *Handbook of Emergy Evaluation: A Compendium of Data for Emergy Computation Issued in a Series of Folios, Folio #1—Introduction and Global Budget*, Center for Environmental Policy, University of Florida, Gainesville, FL.
- Paoli, C., Vassallo, P., Fabiano, M., 2008. Solar power: An approach to transformity evaluation, *Ecological Engineering*, vol. 34(3), pp. 191-206.
- Patten, B.C., 1995. Network integration of ecological extremal principles: exergy, emergy, power, ascendancy, and indirect effects, *Ecological Modelling*, vol. 79(1-3), pp. 75-84.
- Pizzigallo, A.C., Granai, C., Borsa, S., 2008. The joint use of LCA and emergy evaluation for the analysis of two Italian wine farms, *Environ. Manage.*, vol. 86(2), pp. 396–406.

- Pulselli, R.M., Simoncini, E., Ridolfi, R., Bastianoni, S., 2008. Specific emergy of cement and concrete: An energy-based appraisal of building materials and their transport, *Ecological Indicators*, vol. 8(5), pp. 647-656.
- Rees, W. E., Wackernagel, M., 1994. Ecological footprints and appropriated carrying capacity: Measuring the natural capital requirements of the human economy, in Jansson, A. et al., *Investing in Natural Capital: The Ecological Economics Approach to Sustainability*, Washington D.C.:Island Press. ISBN 1-55963-316-6
- Roth, L., Eklund, M., 2002. Environmental evaluation of reuse of by-products as road construction materials in Sweden, *Waste Management*, vol. 23(2), pp. 107-116.
- Rótolo, G.C., Rydberg, T., Lieblein, G., Francis, C., 2007. Emergy evaluation of grazing cattle in Argentina's Pampas, *Agriculture, Ecosystems & Environment*, vol. 119(3-4), pp. 383-395.
- Scienceman, D.M., 1987. Energy and Emergy, In G. Pillet and T. Murota (eds), *Environmental Economics*, pp. 257–276.
- Sciubba, E., Susani, L., Tiezzi, E., 2003. Exergy and Extended Exergy Accounting of the Province of Siena. In Tiezzi, E., et al. (Eds.), *Ecosystems and Sustainable Development IV*, pp. 367–376.
- Simoncini, E., 2006. Analisi energetica di un edificio: effetti ambientali dimateriali e tecniche della bioarchitettura, Degree Thesis, available at: Dept. of Chemical and Biosystems Sciences, University of Siena, Italy.
- Szargut, J., Morris, D.R., Steward, F.R., 1988. *Exergy Analysis of Thermal, Chemical and Metallurgical Processes*, Hemisphere Pubs., New York, 332pp.
- Therivel, R., Glasson, J., Chadwick, A., 2005. *Introduction to Environmental Impact assessment*, Routledge, New York, 274pp.
- Tilley, D.R., Brown, M.T., 2006. Dynamic emergy accounting for assessing the environmental benefits of subtropical wetland storm water management systems, *Ecological Modelling*, vol. 192(3-4), pp. 327-361.
- Ulgiati, S., Brown, M.T., 2002. Quantifying the environmental support for dilution and abatement of process emissions: The case of electricity production, *Clean. Prod.*, vol. 10(4), pp. 335–348.
- Ulgiati, S., Bargigli, S., Raugei, M., 2003. Integrated indicators to assess design, performance and environmental sustainability of energy conversion processes, *Proceedings of the International Conference on Integrative Approaches Towards Sustainability*, Riga, Latvia.

- Ulgiati, S., Raugeri, M., Bargigli, S., 2004. Dotting the I's and Crossing the T's of Emergy Synthesis: Material Flows, Information and Memory Aspects, and Performance Indicators, Proceedings from the Third Biennial Emergy Evaluation Research Conference, Gainesville, Florida.
- Ulgiati, S., Lomas, P., Viglia, S., Zhang, P., Zucaro, A., 2010. Towards a database of unit emergy values, presentation, 6th Biennial Emergy Conference, Gainesville, Florida, USA.
- von Bertalanffy, L., 1968. General System Theory, New York: George Braziller, Inc.
- Wargocki, P., Wyon, D.P., 2007. The effects of outdoor air supply rate and supply air filter condition in classrooms on the performance of schoolwork by children, HVAC&R Research, vol.13(2), pp. 165-191.
- Wrisberg, N., Udo de Haes, H.A., Triebswetter, U, Eder, P., Clift, R., 2002. Analytical tools for Environmental Design and Management in a Systems Perspective, Kluwer Academic Publishers, Dordrecht.
- Yang, H., Li, Y.R., Shen, J.Z., Hu, S.Y., 2003. Evaluating waste treatment, recycle and reuse in industrial system: an application of the emergy approach, Ecol. Modell., vol. 160(1-2), pp. 13-21.
- Zhang, S.Y., Godfrey, E., Kockelmann, W., Paradowska, A., Bull, M.J., Korsunsky, A.M., Abbey, B., Xu, P., Tomota, Y., Liljedahl, D., Ellato, O., Fitzpatrick, M., Daymond, M.R., Toda, R.M., Holt, R.A., Elleher, J.K, Siano, S., Santisteban, J., 2009. High-tech composites to ancient metals, Materials Today, vol. 12(7-8), pp. 78-84.

Introduction

- Brown, M.T., Ulgiati, S., 2004. Emergy Analysis and Environmental Accounting, In: Editor-in-chief: Cleveland, J., encyclopedia of Energy, Elsevier, New York, pp. 329-354.
- Campbell, D.E., Lu, Z., Li, H., 2006. Emergy synthesis of an agro-forest restoration system in lower subtropical China, Ecological Engineering, vol. 27(3), pp. 175-192.
- CIDD Press Release. National Strategy for Sustainable Development 2010-2013: "Towards a fair and green economy" 2008 (Data Accessed: January 15 2011 on the World Wide Web at http://www.developpement-durable.gouv.fr/IMG/pdf/EN_-_dossier_presse_CIDD_-SNDD.pdf)
- EIA International Energy Outlook. World Energy Statistics 2008 (Data Accessed: January 15 2011 on the World Wide Web at: http://www.eia.doe.gov/country/country_energy_data.cfm?fips=FR)

- Fava, J. A., Denison, R., Jones, B., Curran, M. S., Vigon, B., Selke, S., Barnum J., 1991. A technical framework for life cycle assessments, Society of Environmental Toxicology and Chemistry (SETAC), Washington, DC.
- Hau, J.L., 2002. Integrating life cycle assessment, Exergy and Emergy analysis, PhD Thesis submitted to the Department of Chemical Engineering, The Ohio State University.
- Lagerberg, C., 1999. Emergy analysis of the resource use in greenhouse crop production and of the resource basis of the Swedish economy, Doctoral thesis presented to the Swedish University of Agricultural Sciences.
- Liu, J., Matsumoto, T., Xue, Y., 2008. Applicability of emergy analysis method to indicators for sustainable development by comparison with exergy, LCA and ecological footprint methods, proceedings of the 36th Annual meeting of environmental systems research, pp. 79-84.
- Ness, B., Urbel-Piirsalu, E., Anderberg, S., Olsson, L., 2006. Categorising tools for sustainable assessment, *Ecological Economics*, vol. 60(3), pp. 498-508.
- Odum, H.T., 1995. Self organization and maximum power, in *Maximum Power*, Ed. by C.A.S. Hall, University Press of Colorado, Niwot, pp. 311-364.
- Odum, H.T., 1996. Environmental accounting: emergy and environmental decision making, John Wiley and Sons, New York.
- Odum, H.T., 2000. Folio #2: Emergy of Global Processes, *Handbook of Emergy Evaluation*, Center for Environmental Policy, Environmental Engineering Sciences, University of Florida, Gainesville.
- Omer, A.M., 2007. Energy, environment and sustainable development, *Journal of Renewable and Sustainable Energy Reviews*, vol. 12(9), pp. 2265-2300.
- Omer, A.M., 2010. Sustainable Energy Development and Environment, *Research Journal of Environmental and Earth Sciences*, vol. 2(2), pp. 55-75.
- Pizzigallo, A.C., Granai, C., Borsa, S., 2008. The joint use of LCA and emergy evaluation for the analysis of two Italian wine farms, *Environ. Manage.*, vol. 86(2), pp. 396-406.
- Ulgiati, S., Raugei, M., Bargigli, S., 2005. A multi-criteria life cycle assessment of molten carbonate fuel cells (MCFC)—a comparison to natural gas turbines, *International Journal of Hydrogen Energy*, vol. 30(2), pp. 123-130.
- Yang, H., Li, Y.R., Shen, J.Z., Hu, S.Y., 2003. Evaluating waste treatment, recycle and reuse in industrial system: an application of the emergy approach, *Ecol. Modell.*, vol. 160(1-2), pp. 13-21.

Chapter 1

- Ahern, J.E., 1990. *The Exergy Method of Energy Systems Analysis*, Wiley, New York.
- Ayres, R.U., 1995. *Life Cycle Analysis: A Critique, Resources, Conservation and Recycling*, vol. 14(3-4), pp. 199 -223.
- Azzarone, F., Sciubba, E., 1995. *Analysis of the energetic and exergetic sustainability of complex systems*, ASME AES-37.
- Bejan, A., Tsatsaronis, G., Moran, M., 1996. *Thermal Design and Optimization*, Wiley, New York.
- Baumann, H., Cowell, S., 1998. *An Evaluative Framework for Environmental Management Approaches, Paper III, AFR report 183, Life Cycle Assessment and Decision Making – theories and practices*, Technical Environmental Planning, Chalmers University of Technology, Göteborg.
- Baumann, H., Cowell, S., 1999. *An Evaluative Framework for Conceptual and Analytical Approaches Used in Environmental Management*, *Greener Management International*, vol. 26, pp. 109-122.
- Baumann, H., Tillman, A., 2005. *The Hitch Hiker's Guide to LCA: An orientation in life cycle assessment methodology and application*, *Journal of Cleaner Production*, vol. 13(13-14), p. 1360
- Brown, M.T., Herendeen, R.A., 1996. *Embodied energy analysis and emergy analysis: A comparative view*, *Ecological Economics*, vol. 19(3), pp. 219- 235.
- Brown, M.T., McClanahan, T., 1996. *Emergy Analysis Perspectives of Thailand and Mekong River Dam Proposals*, *Ecological Modelling*, vol. 91(1-3), pp. 105-130.
- Bruntland, G.H., 1987. *Our common future: The World Commission on Environment and Development*, Oxford University Press: Oxford.
- Brunner, P. H., Rechberger, H., 2004. *Practical Handbook of Material Flow Analysis*, USA: CRC Press LLC, Lewis Publishers.
- Burgess, A.A., Brennan, D.J., 2001. *Application of life cycle assessment to chemical processes*, *Chemical Engineering Science*, vol. 56(8), pp. 2589-2604.
- Cornelissen, R. L., Hirs, G. G., 1997. *Exergetic optimization of a heat exchanger*, *Energy Conver. Mgmt.*, vol. 38(15-17), pp. 1567-1576.

- Crawford, R.H., Treloar, G.J., Fuller, R.J., Bazillan, M., 2006. Life-cycle energy analysis of building integrated photovoltaic systems (BiPVs) with heat recovery unit, *Renewable & Sustainable Energy Reviews*, vol. 10(6), pp. 559-575.
- Engström, R., Wadeskog, A., Finnveden, G., 2007. Environmental assessment of Swedish agriculture, *Ecological Economics*, vol. 60, pp. 550-563.
- Giampietro, M., Bukkens, S.G.F., Pimentel, D., 1993. Labor productivity: a biophysical definition and assessment, *Human Ecol.*, vol. 21(3), pp. 229-260.
- Guinée, J.B., Udo de Haes, H.A., Huppes, G., 1993. Quantitative Life Cycle Assessment of Products 1: Goal Definition and Inventory, *Journal of Cleaner Production*, vol. 1(1), pp. 3-13.
- Guinée, J.B., Huppes, G., Heijungs, R., 2001. Developing an LCA guide for decision support, *Environmental Management and Health*, vol. 12(3), pp. 301-311.
- Hall, C.A.S., 1995. Introduction: What is Maximum Power, In: Hall, C.A.S. (Ed.), *Maximum Power: The Ideas and Applications of H.T. Odum*, University Press of Colorado, Niwot.
- Hannon, B., 2001. Ecological pricing and economic efficiency, *Ecol. Econ.* vol. 36(1), pp. 19-30.
- Herendeen, R., 1988. Net energy considerations, R. West, F. Kreith, Editors, *Economic Analysis of Solar Thermal Energy Systems*, MIT Press, Cambridge, MA, pp. 255-273
- Heiskanen, E., 2000. Managers' Interpretations of LCA: Enlightenment and Responsibility or Confusion and Denial? *Business Strategy and the Environment*, vol. 9(4), pp. 239-254.
- Höjer, M., Ahlroth, S., Dreborg, K., Ekvall, T., Finnveden, G., Hjelm, O., Hochschorner, E., Nilsson, M., Palm, V., 2008. Scenarios in selected tools for environmental systems analysis, *Journal of Cleaner Production*, vol. 16(18), pp. 1958-1970.
- Huppes, G., Schneider, F., 1994. Allocation in LCA, SETAC - Europe.
- Huppes, J. B., Heijungs, R., Guinée, G., Lnakreijer, R. M., Udo de Haes, H. A., Wegener Sleeswijk, A., Ansems, A. M., Eggles, P. G., van Duin, R., de Goede, H. P., 1996. *Environmental Life Cycle Assessment of Products*, Center of Environmental Science (CML), Leiden University: Leiden, The Netherlands.
- Jørgensen, S.E., 1995. Exergy and ecological buffer capacities as measures of ecosystem health, *Ecosys. Health*, vol. 1(3), pp. 150-160.

- Kok, R., Benders, M.J., Moll, H.C., 2006. Measuring the environmental load of household consumption using some methods based on input-output energy analysis: A comparison of methods and a discussion of results, *Energy Policy*, vol. 34(17), pp. 2744-2761.
- Kotas, T.J., 1985. *The Exergy Method of Thermal Plant Analysis*, Butterworths, Academic Press, London.
- Lee, J.J., O'Callaghan, P., Allen, D., 1995. Critical review of life cycle analysis and assessment techniques and their application to commercial activities, *Resources Conservation and Recycling*, vol. 13(1), pp. 37-56.
- Lei, K., Wang, Z., 2008. Emergy synthesis of tourism-based urban ecosystem, *Journal of Environmental Management*, vol. 88(4), pp. 831-844.
- Lotka, A., 1922. Contributions to the Energetics of Evolution: Natural Selection as a Physical Principle, *Proceedings of the National Academy of Science*, vol. 8, pp. 147-154.
- Lotka, A., 1945. The law of evolution as a maximal principle, *Human Biology*, vol. 17(3), pp. 167-194.
- Maillefer, C., Braunschweig, A., Büchel, K., Dinkel, F., Frischknecht, R., Ménard, M., Peter, D., Pohl, C., Ros, M., Sturm, A., Waldeck, Zimmermann P., 1996. *Life Cycle Assessment (LCA) - Quo vadis? Swiss Priority Programme Environment of the Swiss National Science Foundation Synthesis*. Birkhäuser Verlag AG.
- Maud, S., 2007. A DirectScience: The synthesis of ScienceDirect and EmSim, *Ecological Modelling*, vol. 203(3-4), pp. 518-520.
- Meyer, L., Tsatsaronis, G., Buchgeister, J., Schebek, L., 2009. Exergoenvironmental analysis for evaluation of the environmental impact of energy conversion systems, *Energy*, vol. 34(1), pp. 75-89.
- Min, S., Feng, X., 2008. Energy sources, Part B, *Economics, Planning, and Policy*, vol. 3(2), pp. 133-143.
- Moberg, A., 1999. *Environmental Systems Analysis Tools – differences and similarities*, Master Degree thesis in Natural Resources Management presented to the Department of Systems Ecology, Stockholm University, Stockholm, Sweden.
- Odum, H.T., 1967. Energetics of food production. In: *The World Food Problems, Report of the President's Science Advisory Committee Panel on World Food Supply*, vol. 3, pp. 55-94.
- Odum, H.T., Odum, E.C., 1975. *Energy Basis for Man and Nature*, McGraw-Hill, NY.

- Odum, H.T., 1996. Environmental accounting: energy and environmental decision making, John Wiley and Sons, New York.
- Odum, H.T., 2000. Folio #2: Emergy of Global Processes, Handbook of Emergy Evaluation, Center for Environmental Policy, Environmental Engineering Sciences, University of Florida, Gainesville.
- Orbach, T., Liedtke, C., 1998. Eco-management Accounting in Germany: Concepts and Practical Implementation, No. 88, Wuppertal Institute, Wuppertal, Germany.
- Pulselli, R.M., Simoncini, E., Ridolfi, R., Bastianoni, S., 2008. Specific emergy of cement and concrete: An energy-based appraisal of building materials and their transport, Ecological Indicators, vol. 8(5), pp. 647-656.
- Rees, W.E., Wackernagel, M., 1994. Ecological footprints and appropriated carrying capacity: Measuring the natural capital requirements of the human economy, in Jansson, A. et al., Investing in Natural Capital: The Ecological Economics Approach to Sustainability. Washington D.C.:Island Press. ISBN 1-55963-316-6
- Rosen, M.A., Dincer, I., 2003. Thermo-economic analysis of power plants: An application to a coal fired electrical generating station, Energy Conversion and Management, vol. 44(17), pp. 2743–2761.
- Roth, L., Eklund, M., 2002. Environmental evaluation of reuse of by-products as road construction materials in Sweden, Waste Management, vol. 23(2), pp. 107-116.
- Rótolo, G.C., Rydberg, T., Lieblein, G., Francis, C., 2007. Emergy evaluation of grazing cattle in Argentina's Pampas, Agriculture, Ecosystems & Environment, vol. 119(3-4), pp. 383-395.
- Schaltegger, S., 1997. Economics of Life Cycle Assessment (LCA). Inefficiency of the Present Approach, Business Strategy and the Environment, vol. 6(1-8), pp. 207-213.
- Sciubba, E., 2001. Beyond Thermo-economics? The Concept of Extended Exergy Accounting and its Application to the Analysis and Design of Thermal Systems, Exergy, vol. 1(2), pp. 68-84.
- Sciubba, E., Susani, L., Tiezzi, E., 2003. Exergy and Extended Exergy Accounting of the Province of Siena. In Tiezzi, E., et al. (Eds.), Ecosystems and Sustainable Development IV, vol. 28(13), pp. 367–376.
- Sciubba, E., Ulgiati, S., 2005. Emergy and exergy analyses: complementary methods or irreducible ideological options? Energy, vol. 30(10), pp. 1953–1988.

- Strömberg, L., Haglund, I., Jacobsson, B., Ekvall, T., Eriksson, E., Kärnä, A., Pajula, T., 1997. Guidelines on Life Cycle Inventory Analysis of Pulp and Paper, NordPap DP 2/30, Scanforsk rapport 669, Nordisk Industrifond, Oslo, Norway.
- Szargut, J., Morris, D.R., Steward, F.R., 1988. Exergy Analysis of Thermal, Chemical and Metallurgical Processes, Hemisphere Pubs., New York, 332pp.
- Therivel, R., Glasson, J., Chadwick, A., 2005. Introduction to Environmental Impact assessment, Routledge, New York, 274pp.
- Tsatsaronis, G., 1993. Thermoeconomic analysis and optimization of energy systems, Progress in Energy and Combustion Science, vol. 19(3), pp. 227–257.
- Tsatsaronis, G., Pisa, J., 1994. Exergoeconomic evaluation and optimization of energy systems - application to the CGAM problem, Energy, vol. 19(3), pp. 287–321.
- Udo de Haes, H., Heijungs, R., Huppes, G., van der Voet, E., Hettelingh, J., 2000. Full Mode and Attribution Mode in Environmental Analysis. Journal of Industrial Ecology, vol. 4(1), pp. 45-56.
- Ulgiati, S., Bargigli, S., Raugei, M., 2003. Integrated indicators to assess design, performance and environmental sustainability of energy conversion processes, Proceedings of the International Conference on Integrative Approaches Towards Sustainability, Riga, Latvia.
- Ulgiati, S., Raugei, M., Bargigli, S., 2004. Dotted the I's and Crossing the T's of Emergy Synthesis: Material Flows, Information and Memory Aspects, and Performance Indicators, Proceedings from the Third Biennial Emergy Evaluation Research Conference, Gainesville, Florida.
- von Bertalanffy, L., 1968. General System Theory, New York: George Braziller, Inc
- Wackernagel, M., Monfreda, C., Schulz, N., Erb, K., Haberl, H., Krausmann, F., 2004. Calculating national and global ecological footprint time series: resolving conceptual challenges, Land Use Policy, vol. 21(3), pp. 271-278.
- Wall, G., 2010. On Exergy and Sustainable Development in Environmental Engineering, The Open Environmental Engineering Journal, vol. 3, pp. 21-32.
- Wrisberg, N., Udo de Haes, H.A., Triebswetter, U, Eder, P., Clift, R., 2002. Analytical tools for Environmental Design and Management in a Systems Perspective, Kluwer Academic Publishers, Dordrecht.
- Website on emergy at the University of Florida: <http://www.emergysystems.org> (Accessed on 20 October 2008).

Chapter 2

- Amponsah, N.Y., Le Corre, O., 2010a, Use of emergy analysis in comparing hydrogen production via steam methane reforming and electrolysis, *Emergy & Environmental Accounting: theories, applications and methodologies*, 6th Biennial Emergy Conference, Florida, USA (in press).
- Amponsah, N.Y., Le Corre, O., 2010b. Critical review of the usage of transformity values in recent studies, presentation, *Emergy & Environmental Accounting: theories, applications and methodologies*, 6th Biennial Emergy Conference, Florida, USA (in press).
- Ayres, R.U., 2000. Commentary on the utility of the ecological footprint concept, *Ecological Economics*, vol. 32(3), pp. 347-349.
- Bakshi, B.R., 2000. A thermodynamic framework for ecologically conscious process systems engineering, *Computers and Chemical Engineering*, vol. 24(2-7), pp. 1767–1773.
- Bakshi, B.R., 2002. A thermodynamic framework for ecologically conscious process systems engineering, *Computers and Chemical Engineering*, vol. 26(2), pp. 269-282.
- Bakshi B.R., Hau, J.L., 2004. Expanding exergy analysis to account for ecosystem products and services, *Environmental Science & Technology*, vol. 38(13), pp. 3768–3777.
- Baojuan, S., 2007. Analysis on the Barriers of Developing Recycling Economy in Enterprise, *Market Modernization*, vol. 4z, pp. 380-381.
- Bargigli, S., Raugei, M., Ulgiati, S., 2004. Comparison of thermodynamic and environmental indexes of natural gas, syngas and hydrogen production processes. *Energy*, vol. 29(12-15), pp. 2145-2159.
- Bastianoni, S., Porcelli, M., Pulselli, F. M., 2002. Emergy evaluation of composting municipal solid waste, Brebbia, C.A., Almorza, D., Sale, D., Popov, V. (Eds.), *waste management and the environment*, WIT Press, Southampton, pp. 575-583.
- Brandt-Williams, S., 2001. Folio #4, Emergy of Florida Agriculture, *Handbook of Emergy Evaluation*, Center for Environmental Policy, Environmental Engineering Sciences, University of Florida, Gainesville.
- Brown, M.T., Odum, H.T., Murphy, R.C., Christianson, R.A., Doherty, S.J., McClanahan, T.R., Tennenbaum, S.E., 1995. Title. In: C.A.S. Hall, *Maximum Power - The Ideas and Applications of H.T. Odum*, University Press of Colorado, Niwot, 393 pp.
- Brown, M.T., Herendeen, R.A., 1996. Embodied energy analysis and emergy analysis: A comparative view, *Ecological Economics*, vol. 19(3), pp. 219- 235.

- Brown, M.T., Ulgiati, S., 1997. Emergy-based indices and ratios to evaluate sustainability: monitoring economies and technology toward environmentally sound innovation, *Ecological Engineering*, vol. 9(1-2), pp. 51-69.
- Brown, M.T., Bardi, E., 2001. Folio #3, Emergy of Ecosystems. Handbook of Emergy Evaluation. Center for Environmental Policy, Environmental Engineering Sciences, University of Florida, Gainesville.
- Brown, M.T., Buranakarn, V., 2003, Emergy indices and ratios for sustainable material cycles and recycle options, *Resources, Conservation and Recycling*, vol. 38(1), pp. 1-22.
- Brown, M.T., Ulgiati, S., 2004. Emergy Analysis and Environmental Accounting, In: Editor-in-chief: Cleveland, J., *encyclopedia of Energy*, Elsevier, New York, pp. 329-354.
- Buranakan, V., 1998. Evaluation of recycling and reuse of building materials using the emergy evaluation method, a Ph.D dissertation, Department of Architecture, University of Florida, Gainesville, FL.
- Cavalett, O., Queiroz, J.F., Ortega, E., 2006. Emergy assessment of integrated production systems of grains, pig and fish in small farms in the South Brazil, *Ecological Modelling*, vol. 193(3-4), pp. 205-224.
- Cleveland, C.J., Kaufmann, R.K., Stern, D.I., 2000. Aggregation and the role of energy in the economy, *Ecol. Econ.*, vol. 32(2), pp. 301–317.
- Dai, Y.L., 2004. Emergy Evaluation of Industry System, Xi'an Jiaotong University, Xi'an Press, China.
- Ekins, P., Simon, S., Deutch, L., Folke, C., De Groot, R., 2003. A framework for the practical application of the concepts of critical natural capital and strong sustainability, *Ecol. Econ.*, vol. 44(2-3), pp. 165–185.
- European Parliament and Council Directive [EU 1994] 94/62/EC of 20 December 1994 on packaging and packaging waste.
- European Parliament and Council Directive [EU 1999] Directive 1999/31/EC on the landfill of waste in the EU-15.
- European Environment Agency [EEA] 2007. Environmental Statement, Luxemburg office for international publications, ISBN : 978-92-9167-936-2.
- Feng, X., Cao, K., 2007. The emergy analysis of multi-product systems, *Process Safety and Environmental Protection*, vol. 85(5), pp. 494-500.
- Feng, X., Wang, L., Min, S., 2009. Industrial emergy evaluation for hydrogen production systems from biomass and natural gas, *Applied Energy*, vol. 86(9), pp. 1767-1773.

- Gourgaud, S., 1997. The use of the emergy theory of value in environmental accounting, website of Shirley Gourgaud and Darryl Seto: <http://sego.id.au>, date accessed: 16 January, 2011.
- Gungor, A., Gupta, S.M., 1999. Issues in environmentally conscious manufacturing and product recovery: A survey. *Computers & Industrial Engineering*, vol. 36(4), pp. 811-853.
- Hau, J.L., Bakshi, B.R., 2004. Promise and Problems of Emergy Analysis, *Ecological Modelling*, vol. 178(1-2), pp. 215-225.
- Huang, S.L., Hsu, W.L., 2003. Materials flow analysis and emergy evaluation of Taipei's urban construction, *Landscape and Urban Planning*, vol. 63(2), pp. 61–74.
- Jacobsen, H., Kristofferson, M., 2002. Case Studies on Waste Minimisation Practices in Europe, European Environment Agency.
- Johanna, I., 2004. Summary of Electrolytic Hydrogen Production, Milestone Completion Report, National Renewable Energy Laboratory (NREL), U.S.A.
- Lan, S.F., Qin, P., Lu, H.F., 2002. Emergy Analysis of Eco-economic System, Chemical Industry Press, Beijing, 427pp.
- Lazzaretto, A., 2009. A critical comparison between thermoeconomic and emergy analyses algebra, *Energy*, vol. 34(12), pp. 2196-2205.
- Li, L., Lu, H., Campbell, D.E., Ren, H., 2010. Emergy algebra: Improving matrix methods for calculating transformities, *Ecological Modelling*, vol. 221(3), pp. 411-422.
- Lou, H.H., Kulkarni, M.A., Singh, A., Hopper, J.R., 2004. Sustainability assessment of industrial systems, *Ind. Eng. Chem. Res.*, vol. 43(15), pp. 4233–4242.
- Marchettini, N., Ridolfi, R., Rustici, M. 2007. An environmental analysis for comparing waste management options and strategies, *Waste Manage.*, vol. 27(4), pp. 562–571.
- Mansson, B.A., McGlade, J.M., 1993. Ecology, thermodynamics and H.T. Odum's conjectures, *Oecologia*, vol. 93(4), pp. 582–596.
- Meillaud, F., Gay, J.B., Brown, M.T., 2005. Evaluation of a building using the emergy method, *Solar Energy*, vol. 79(2), pp. 204–212.
- Odum, H.T., 1983. In: *Systems Ecology*, Wiley, New York, 644pp.
- Odum, H.T., 1996. *Environmental accounting: emergy and environmental decision making*, John Wiley and Sons, New York.

- Odum, H.T., Brown, M.T., Brandt-Williams, S.L., 2000. Folio#1, Introduction and Global Budget. Handbook of Emergy Evaluation. Center for Environmental Policy, Environmental Engineering Sciences, University of Florida, Gainesville.
- Odum, H.T., 2000. Folio #2: Emergy of Global Processes. Handbook of Emergy Evaluation, Center for Environmental Policy, Environmental Engineering Sciences, University of Florida, Gainesville, 28 pp.
- Paoli, C., Vassallo, P., Fabiano, M., 2008. Solar power: An approach to transformity evaluation, *Ecological Engineering*, vol. 34(3), pp. 191-206.
- Pizzigallo, A.C., Granai, C., Borsa, S., 2008. The joint use of LCA and emergy evaluation for the analysis of two Italian wine farms, *Environ. Manage.*, vol. 86(2), pp. 396-406.
- Pulselli, R.M., Simoncini, E., Ridolfi, R., Bastianoni, S., 2008. Specific emergy of cement and concrete: An energy-based appraisal of building materials and their transport, *Ecological Indicators*, vol. 8(5), pp. 647-656.
- Spath, P., Man, M., 2001. Life Cycle Assessment of Hydrogen Production via Natural Gas Steam Reforming, National Renewable Energy Laboratory (NREL), U.S.A.
- Spreng, D.T., 1988. Net-Energy Analysis and the Energy Requirements of Energy Systems. Praeger Publishers, New York, 289 pp.
- Ulgiati, S., 2001. A comprehensive energy and economic assessment of biofuels: when “green” is not enough, *Critical Reviews in Plant Sciences* vol. 20, pp. 71-106.
- Ulgiati, S., Brown, M.T., 2002. Quantifying the environmental support for dilution and abatement of process emissions: the case of electricity production, *Clean. Prod.*, vol. 10(4), pp. 335-348.
- Ulgiati, S., Raugei, M., Bargigli, S., 2004. Dotting the I’s and Crossing the T’s of Emergy Synthesis: Material Flows, Information and Memory Aspects, and Performance Indicators, Proceedings from the Third Biennial Emergy Evaluation Research Conference, Gainesville, Florida.
- Ulgiati, S., Lomas, P., Viglia, S., Zhang, P., Zucaro, A., 2010. Towards a database of unit emergy values, presentation, 6th Biennial Emergy Conference, Gainesville, Florida, USA.
- Yang, H., Li, Y.R., Shen, J.Z., Hu, S.Y., 2003. Evaluating waste treatment, recycle and reuse in industrial system: an application of the emergy approach, *Ecol. Modell.*, vol. 160(1-2), pp. 13-21.
- Yuang, F., Li, Q., 2008. A case study: evaluation of the value about recycling of construction and demolition wastes, *The Chinese Journal of Construction Economy*, pp. 97-100.

Chapter 3

- Amponsah, N.Y., Le Corre, O., 2010a. Critical review of the usage of transformity values in recent studies, presentation, *Emergy & Environmental Accounting: theories, applications and methodologies*, 6th Biennial Emergy Conference, Florida, USA (at press).
- Baral, A., Bakshi, B.R., 2010. Emergy evaluation using US economic input-output models with applications to life cycles of gasoline and corn ethanol, *ecological modelling*, vol. 221, pp. 1807-1818.
- Bastianoni, S., Porcelli, M., Pulselli, F. M., 2002. Emergy evaluation of composting municipal solid waste, Brebbia, C.A., Almorza, D., Sale, D., Popov, V. (Eds.), *waste management and the environment*, WIT Press, Southampton, pp. 575-583.
- Brown, M.T., Herendeen, R.A., 1996. Embodied energy analysis and emergy analysis: A comparative view, *Ecological Economics*, vol. 19(3), pp. 219- 235.
- Brown, M.T., Ulgiati, S., 1997. Emergy-based indices and ratios to evaluate sustainability: monitoring economies and technology toward environmentally sound innovation, *Ecological Engineering*, vol. 9(1-2), pp. 51-69.
- Brown, M.T., Buranakarn, V., 2003, Emergy indices and ratios for sustainable material cycles and recycle options, *Resources, Conservation and Recycling*, vol. 38(1), pp. 1-22.
- Brown, M.T., Cohen, M.J., 2008. Emergy and Network Analysis, In: Jorgensen, S., Fath, B. (Eds.), *Encyclopedia of Ecology*, Academic Press, Oxford, pp. 1229-1239.
- Buranakan, V., 1998. Evaluation of recycling and reuse of building materials using the emergy evaluation method, a Ph.D dissertation, Department of Architecture, University of Florida, Gainesville, FL.
- Dincer, I., Rosen, M.A., 2007: *Exergy analysis of renewable energy systems*, EXERGY, Environment and Sustainable Development, Ed. Elsevier, Chapter 10, pp. 163-228.
- Feng, X., Cao, K., 2007. The emergy analysis of multi-product systems, *ICE journal of process safety and environmental protection*, vol. 85(5), pp. 494-500.
- Herendeen, R.A., 2004. Energy analysis and EMERGY analysis – a comparison, *Ecological Modelling*, vol. 178(1-2), pp. 227-237.
- Ingwersen, W., 2010. Uncertainty characterization for emergy values, *Ecological Modelling*, vol. 221(3), pp. 445-452.
- Johnson, J., Reck, B.K., Wang, T., Graedel, T.E., 2008. The energy benefit of stainless steel recycling, *Energy Policy*, vol. 36(1), pp. 181-192.

- Lou, B., 2004. Emergy analysis in Waste disposal, *Journal of South China University of Technology (Natural Science Edition)*, vol. 32(9), pp. 63-66.
- Meillaud, F., Gay, J.B., Brown, M.T., 2005. Evaluation of a building using the emergy method, *Solar Energy*, vol. 79(2), pp. 204–212.
- Odum, H.T., 1996. *Environmental Accounting: Emergy and Environmental Decision Making*, Chichester Wiley, New York.
- Odum, H.T., Peterson, N., 1996. Simulation and evaluation with energy systems blocks, *Ecological Modelling*, vol. 93(1-3), pp. 155-173.
- Odum, H.T., 2000. Emergy evaluation of an OTEC electrical power system, *Energy*, vol. 25(4), pp. 389–393.
- Patten, B.C., 1995. Network integration of ecological extremal principles: exergy, emergy, power, ascendancy, and indirect effects, *Ecological Modelling*, vol. 79(1-3), pp. 75-84.
- Scienceman, D.M., 1987. Energy and Emergy, In: Pillet, G., Murota, T. (eds), *Environmental Economics*, pp. 257–276.
- Tilley, D.R., Brown, M.T., 2006. Dynamic emergy accounting for assessing the environmental benefits of subtropical wetland storm water management systems, *Ecological Modelling*, vol. 192(3-4), pp. 327-361.
- Ulgiati, S., Raugei, M., Bargigli, S., 2004. Dotted the I's and Crossing the T's of Emergy Synthesis: Material Flows, Information and Memory Aspects, and Performance Indicators, *Proceedings from the Third Biennial Emergy Evaluation Research Conference*, Gainesville, Florida.
- Ulgiati, S., Lomas, P., Viglia, S., Zhang, P, Zucaro, A., 2010. Towards a database of unit emergy values, presentation, 6th Biennial Emergy Conference, Gainesville, Florida, USA.
- Yang, H., Li Y., Shen J., Hu S., 2003. Evaluating waste treatment, recycle and reuse in industrial systems: an application of the emergy approach, *Ecological Modeling*, vol. 160(1-2), pp. 13-21.
- Zhang, S.Y., Godfrey, E., Kockelmann, W., Paradowska, A., Bull, M.J., Korsunsky, A.M., Abbey, B., Xu, P., Tomota, Y., Liljedahl, D., Zanellato, O., Fitzpatrick, M., Daymond, M.R., Toda, R.M., Holt, R.A., Kelleher, J., Siano, S., Santisteban, J., 2009. High-tech composites to ancient metals, *Materials Today*, vol. 12 (7-8), pp. 78-84.

Chapter 4

- Adalberth, K., 1997. Energy use during the life-cycle of single-unit dwellings: Examples, *Building and Environment*, vol. 32(4), pp. 321-329.
- Adalberth, K., Almgren, A., Peterson, E.H., 2001. Life-cycle assessment of four multi-family buildings. *International Journal of Low Energy and Sustainable Buildings*, vol. 2, pp. 1–21.
- ADEME, 2005, Website of the French Environment and Energy Management Agency: www2.ademe.fr (accessed on 15 March 2011).
- ADEME, 2011, Website of the French Environment and Energy Management Agency: www2.ademe.fr (accessed on 15 March 2011).
- Anderson, R., Christensen, C., Horowitz, S., 2006. Program Design Analysis using BEopt Building Energy Optimisation Software: Defining a Technology Pathway Leading to New Homes with Zero Peak Cooling Demand ACEEE, Summer Study Pacific Grove, California NREL/CP-550-39827.
- Arena, A.P., Rosa, C., 2003. Life cycle assessment of energy and environmental implications of the implementation of conservative technologies in school buildings in Mendoza-Argentina, *Building and Environment*, vol. 38(2), pp. 359–368.
- Asif, M., Muneer, T., Kelley, R., 2007. Life cycle assessment: A case study of a dwelling home in Scotland. *Building and Environment*, vol. 42(3), pp. 1391-1394.
- Bastianoni, S., Campbell, D., Susani, L., Tiezzi E., 2005. The solar transformity of oil and petroleum natural gas, *Ecological Modelling*, vol. 186(2), pp. 212–220.
- Berge, B., 2001. *The ecology of building materials*, Architectural Press, Great Britain.
- Bjork, B.C., Wix, J., 1991. *An introduction to STEP*, VTT (Technical research centre of Finland) and Wix McLelland Ltd., 47 pp.
- Brown, M.T., Arding, J.E., 1991. *Transformity Working Paper*, Center for Wetlands, University of Florida, FL.
- Brown, M.T., Buranakarn, V., 2003, Energy indices and ratios for sustainable material cycles and recycle options, *Resources, Conservation and Recycling*, vol. 38(1), pp. 1-22.
- Buranakarn, V., 1998. *Evaluation of recycling and reuse of building materials using the emergy analysis method*, Ph.D. Thesis submitted to the University of Florida, USA.

- Chen, T.Y, Burnett, J., Chau, C.K., 2001. Analysis of embodied energy use in the residential building of Hong Kong, *Energy*, vol. 26(4), pp. 323-340.
- Eriksen, E., Dan, Z., Jim, M., 2009. After the Avalanche, *Transmission and Distribution World*, March 1, http://tdworld.com/overhead_distribution/avalanche_pronetransmission-lines-0903/index2.html.
- Eurostat, 2000. Energy consumption in households, 2000 survey, European Commission.
- Fava, J. A., 2006. Will the next 10 years be as productive in advancing life cycle approaches as the last 15years? *International Journal LCA*, vol. 11(1), pp.6-8.
- Guggemos, A.A., Horvath, A., 2005. Comparison of environmental effects of steel- and concrete-framed buildings, *Journal of Infrastructure Systems*, vol. 11(2), pp. 93–101.
- Heijungs, R., Guinée, J., Huppes, G., Lankreijer, R., Udo de Haes, H., Wegener Sleeswijk, A., Ansems, A., Eggels, P., Duin, R., Goede, H., 1992. *Environmental Life Cycle Assessment of Products: Guide and Backgrounds*; CML, Leiden: Utrecht, The Netherlands.
- Huang, S., Hsu, W., 2003. Materials flow analysis and emergy evaluation of Taipei's urban construction, *Landscape and Urban Planning*, vol. 63(2), pp. 61-74.
- Hunkeler, D., Rebitzer, G., 2005. The Future of Life Cycle Assessment, *International Journal of Life Cycle Assessment*, vol. 10(5), pp. 305-308.
- ISO, 1997. Environmental management-life – cycle assessment-goal and scope definition and inventory analysis. International Organisation for Standardization.
- ISO, 2006. Environmental Management Life Cycle Assessment Requirements and Guidelines (ISO 14044), International Standards Organization: Brussels, Belgium.
- [IZUBA] Izuba énergies, <http://www.izuba.fr/equer.htm> (accessed 20 February 2011).
- Kennedy, C.A., 2002. A comparison of the sustainability of public and private transportation systems: study of the Greater Toronto Area, *Transportation*, vol. 29(2), pp. 459–493.
- Khasreen, M.M., Banfill, P.F.G., Menzies, G.F., 2009. Life-Cycle Assessment and the Environmental Impact of Buildings: A Review. *Sustainability*, vol. 1(3), pp. 674-701.
- Meillaud, F., Gay, J.B., Brown, M.T., 2005. Evaluation of a building using the emergy method, *Solar Energy*, vol. 79(2), pp. 204–212.

- Myer, A., Chaffee, C., 1997. Life cycle analysis for design of the Sydney Olympic stadium, *Renewable Energy*, vol. 10(2-3), pp. 169–172.
- Nässén, J., Holmberg, J., Wadeskog, A., Nyman, M., 2007. Direct and indirect energy use and carbon emissions in the production phase of buildings: an input-output analysis, *Energy*, vol. 32(9), pp. 1593-1602.
- Norman, J., MacLean, H.L., Kennedy, C.A., 2006. Comparing high and low residential density: life-cycle analysis of energy use and green house gas emissions, *Journal of Urban Planning and Development*, vol. 132(1), pp. 10–21.
- Odum, H.T., Odum, E.C., King, R., Richardson, R., 1987. *Ecology and Economy: Emergy Analysis and Public Policy in Texas. Energy System in Texas and The United States*, Policy Research Project Report Number 78, The Board of Regents, University of Texas, TX.
- Odum, H.T., 1996. *Environmental Accounting: Emergy and Environmental Decision Making*, Chichester Wiley, New York.
- Odum, H.T., Brown, M.T., Williams, S.B., 2000. *Handbook of Emergy Evaluation: A Compendium of Data for Emergy Computation Issued in a Series of Folios, Folio #1—Introduction and Global Budget*, Center for Environmental Policy, University of Florida, Gainesville, FL.
- Odum, H.T., 2002. Materials circulation, energy hierarchy, and building construction, In: Kibert, C.J., Sendzimir, J., Guy, G.B. (Eds.), *Construction Ecology: Nature as the basis for Green Buildings*, Spon Press, London, pp. 37-71.
- Ortiz, O., Castells, F., Sonnemann, G., 2009. Sustainability in the construction industry: A review of recent developments based on LCA, *Constr. Build Mater*, vol. 23(1), pp. 28-39.
- Peterson, E. H., 1997. Database and inventory tool for building components and buildings environmental parameters, SBI report 275, Danish Building Research Institute, Denmark.
- Peuportier, B., Kohler, N., Boonstra, C., Blanc-Sommereux, I., Hamadou, H., Pagani, R., Gobin, C., Kreider J., 1996. *European Methodology for the Evaluation of Environmental Impacts of Buildings*. Project REGENER, Final Report to European Commission DG 12, 450pp.
- Peuportier, B., 2001. Life cycle assessment applied to the comparative evaluation of single family houses in the French context, *Energy and Buildings*, vol. 33(5), pp. 443-450.
- Peuportier, B., Putzeys, K., Anerson, J., Anink, A., Hendriks, N., Kellenberger, D., Moetzl, H., Nibel, S., Vares, S., 2005. *Final Report of Work Package 2 of the PRESCO*

- Network, Inter-Comparison and Benchmarking of LCA-based Environmental Assessment and Design Tools, downloadable from <http://www.etn-presco.net>
- Polster, B., Peuportier, B., Sommereux, I.B., Pedregal, P.D., Gobin, C., Durand, E., 1996. Evaluation of the environmental quality of buildings towards a more environmentally conscious design, *Solar Energy*, vol. 57(3), pp. 219-230.
 - Pulselli, R.M., Simoncini, E., Pulselli, F.M., Bastianoni, S., 2007. Energy analysis of building manufacturing, maintenance and use: Em-building indices to evaluate housing sustainability, *Energy and buildings*, vol. 39(5), pp. 620-628.
 - REGENER final reports, C.E.C. DG XII contract no. RENA CT94- 0033, January 1997, 563 pp.
 - Saiz, S., Kennedy, C., Bass, B., Pressnail, K., 2006. Comparative life cycle assessment of standard and green roofs, *Environ Sci Technol*, vol. 40(13), pp. 4312-4316.
 - Scheuer, C., Keoleian, G.A., Reppe, P., 2003. Life cycle energy and environmental performance of a new university building: modelling challenges design implications, *Energy and Buildings*, vol. 35(10), pp. 1049-1064.
 - Scientific Applications International Corporation SAIC, 2006. Life Cycle Assessment: Principles and Practice, Environmental Protection Agency, Cincinnati, OH, USA.
 - Simoncini, E., 2006. Analisi energetica di un edificio: effetti ambientali dimateriali e tecniche della bioarchitettura, Degree Thesis, available at: Dept. of Chemical and Biosystems Sciences, University of Siena, Italy.
 - Thormark, C., 2002. A low energy building in a life cycle-its embodied energy, energy need for operation and recycling potential, *Building and Environment*, vol. 37(4), pp. 429-435.
 - Ulgiati, S., Brown, M.T., 1999. Energy accounting of human-dominated, large scale ecosystems, In Jorgensen and Kay (eds.), *Thermodynamics and Ecological modelling*, Lewis Publishers, Boca Raton, FL.
 - Yohanis, Y.G., Norton, B., 2002. Life-cycle operational and embodied energy for a generic single-storey office building in the UK., *Energy*, vol. 27(1), pp. 77-92.
 - Wargocki P., Wyon, D.P., 2007. The effects of outdoor air supply rate and supply air filter condition in classrooms on the performance of schoolwork by children, *HVAC&R Research*, vol.13(2), pp. 165-191.

Appendix A

The Emergy Concept

Definition A.1 – *The First Law of thermodynamics states that the total energy of any system and its surroundings is conserved – i.e. Energy is neither created nor destroyed, it changes from one form to another.*

Preliminary Concepts

Before introducing the emergy concept, it is important to recall some general energy concepts. The theoretical and conceptual basis for the emergy methodology is grounded in thermodynamics. According to the First Law of Thermodynamics, any system in a given condition or state contains a definite quantity of energy. When this system undergoes change, any gain or loss in its internal energy is equal to the loss or gain in the energy of the surrounding systems. In differential form, this is written as in Equation 2-1, without chemical reactions.

$$dU = \delta Q + \delta W \quad (2-1)$$

where the term U is internal energy, Q is heat and W is work (defined here as a useful energy transformation).

The symbol δ is employed to indicate that the term refers to an incremental amount of a quantity which is not a property. In contrast, dU denotes the incremental change of a property, internal energy. This is because, though we cannot measure the absolute values of either of these energy terms alone, we can and do measure their difference. Application of the First Law to a system or process is merely an accounting exercise. All the increases in the energy of the system due to all the non-thermal energy interactions are summed and this sum is the measure of the total work (available energies utilized in energy transformations) done on the system. The total energy increase due to thermal interactions is summed and this sum is the total heat absorbed by the system. This makes the accounting easier, as energy is either here or there. It does not go away.

Definition A.2 – *The second law of thermodynamics states that the entropy change of any system and its surroundings, considered together, resulting from any real process, is positive and approaches a limiting value of zero for any process that approaches irreversibility.*

The first law does not account for the observation that natural processes have a preferred direction of progress. For example, spontaneously, heat always flows to regions of lower temperature, never to regions of higher temperature without external work being performed on the system. The first law is completely symmetrical with respect to the initial and final states of an evolving system. In a refrigerator, heat flows from cold to hot, but only when forced by an external agent, a compressor. The second Law of Thermodynamics is behind the separate summing of work and heat. Basically, for every transformation of energy or material into another kind, some energy is lost from the system. Every system requires this kind of ‘payment’ in order to be productive.

$$dS = \frac{dQ_{rev}}{T} \quad (\text{Clausius, 1865}) \quad (2-2)$$

$$dS = dS_{system} + dS_{surroundings} \quad (2-3)$$

where δQ is the loss of the system's ability to do work in the form of dissipated heat;

T is the uniform temperature of the system; and

dS is the exact differential of entropy.

The second law is also known as the law of the dissipation or degradation of energy or the law of the increase in entropy (Gourgaud, 1997). Entropy (S) may be defined as a measure of the extent to which energy is degraded, dissipated, or diluted so that it becomes less able to do work. The energy contained in a system may be constant, but its utility diminishes with every increase in the entropy of the system. It is important to note here, that from the second law, it is the accumulative change in energy that takes place as a result of a change in the state of the system that is the crucial element underlying the theory of the *Emergy concept*.

Emergy Concept

Emergy is a concept conceived by Howard T. Odum, resulting from several decades of research on energy quality in ecosystems and human systems throughout the 1960's, '70's and '80's (Brown and Ulgiati, 2004). The logic behind Odum's concept of embodied energy or emergy is based on the logic behind the Second Law of Thermodynamics as stated in the previous section. This may also be known as the law of the dissipation or degradation of energy resulting in an increase in entropy. It is a measure of the recordable available energy of every process which has gone into the generation of a given product of nature or service in the economy.

Definition A.3 - *The term emergy was coined by David Scienceman, a visiting scholar from Australia working with H.T. Odum, and is a contraction of the phrase "embodied energy". It is a measure of not only the measurable energy currently contained in the product or service but also the totality of the available energies that have been consumed or degraded in each energy transformation that has contributed to the development of that product or service in its current form (Gourgaud, 1997).*

Though it was conceived in the ecological sciences, proponents claim it is applicable to all forms of systems, including natural systems, human systems, and the interface of natural and human systems (Brown and Ulgiati, 2004). Emergy is defined as "available solar energy used up directly and indirectly to make a service or product" (Odum, 1996, p.8). Brown and Ulgiati, 2004, state that emergy can be thought of as "energy memory" and is a way of including all inputs to a

system on a common basis. This common use of measure for energy is the solar emjoule, abbreviated seJ. Researchers from a number of disciplines use this approach to goods and services originating from natural and human systems. It has been applied to the examination of a number of different systems, including regional development, alternative energies, building efficiency, agricultural practices and natural environments (Giannetti, et al, 2006; Lei and Wang, 2008; Meillaud et al, 2005; Menegaki, 2008; Odum, 2000a; Pulselli, 2008; Rydberg and Haden, 2006; Tilley and Swank, 2003).

As stated previously, the First Law of thermodynamics states that energy entering a system is neither created nor destroyed. According to Gourgaud, 1997, energy flowing into a system is either stored within the system or leaves the system through the appropriate pathways. Although energy is conserved within a system, useful transformations (work) necessitate that the energy as it participates in these transformations changes its essential quality. As such, energies of different qualities are not additive. This distinction is a major breakthrough by the emergy concept from that of the traditional energy analysis, sometimes used in environmental accounting techniques as described in chapter 1 of this thesis, where energy of different types and qualities are deemed to be additive.

Mathematical Definition of Emergy

The concept of emergy is best understood by a clear understanding of exergy. Exergy as already defined, is the real proportion of the energy that can drive mechanical work. It could also be given as:

$$E_x = G + gz + \frac{1}{2}v^2 \quad (2-4)$$

where G is Gibbs free energy, and is the available chemical energy.

In thermodynamics, the Gibbs free energy is a thermodynamic potential which measures the useful work obtainable from an isothermal, isobaric thermodynamic system. Technically, the Gibbs free energy is the maximum amount of non-pV work which can be extracted from a closed system, and this maximum can be attained only in a completely reversible process. When a system evolves from a well-defined initial state to a well-defined final state, the Gibbs free energy 'G' equals the work exchanged by the system with its surroundings, less the work of the pressure forces, during a reversible transformation of the system from the same initial state to the same final state. Gibbs defined what he called the available energy of a body as: The greatest amount of mechanical work which can be obtained from a given quantity of a certain substance in a given initial state, without increasing its total volume or allowing heat to pass to or from external bodies, except such as at the close of the processes are left in their initial condition (Gibbs, 1873). The initial state of the body, according to Gibbs, is supposed to be such that the body can be made to pass from it to states of dissipated energy by reversible processes. The 'G' is referred to as Gibbs function or simply free energy. The Gibbs free energy is defined as:

$$G = U + PV + TS = \sum_{i=1} k\mu_i N_i \quad (2-5)$$

Exergy power, P_x , is the rate of change of exergy with time and given as:

$$P_x = \frac{dE_x}{dt} \quad (2-6)$$

Energy is then defined as the integral of the exergy power over time.

$$O(t) = O_{ref} + \int_{t_0}^{t_1} P_x dt \quad (2-7)$$

i.e. the fundamental energy of formation (O_{ref}) and the energy from a set time t_0 to a time t . However this is only true by the introduction of a transformity factor (τ) which considers the change of energy from one form to another which makes this not usable in its present form.

Transformity (τ)

The transformity (previous name transformation ratio, Scienceman, 1987) is the ratio obtained when the total energy used up to make a product is divided by the exergy remaining in the product. H.T. Odum defined transformity as the energy of one type required to make a unit of energy of another type (Odum, 1996). It has the dimension of energy/energy and measured in seJ/J. Transformity is a very important concept in Emery Evaluation. It is used as the name implies, to 'transform' a given energy unto energy by multiplying the energy by the transformity and hence, provides an energy quality factor (Brown and McClanahan, 1996). The transformity of a resource increases with more energy transformations contributing to the production of the resource because at each transformation, available energy is used up to produce a smaller amount of energy of another form. So, the emergy increases but the energy decreases that result in sharp increase in energy per unit energy, i.e. transformity (Hau and Bakshi, 2004).

According to Odum, the energy flows of the universe are organized in an energy transformation hierarchy and that the position in the energy hierarchy is measured with transformities (Odum and Peterson, 1996). According to Scienceman, the concept of transformity introduces a new basic dimension into physics. However there is ambiguity in the dimensional analysis of transformity as Bastianoni et al (2007) state that transformity is a dimensionless ratio.

In any useful energy transformation, many joules of low transformity (low quality) energy are required to produce a lesser quantity of higher transformity (higher quality) energy. The energy generated by the work of transformation constitutes a higher level in the series of transformations. The output of any one energy transformation contributes and converges energy to produce an even smaller output at the next higher level in an energy transformation chain (Figure 2.0, Odum, 1996).

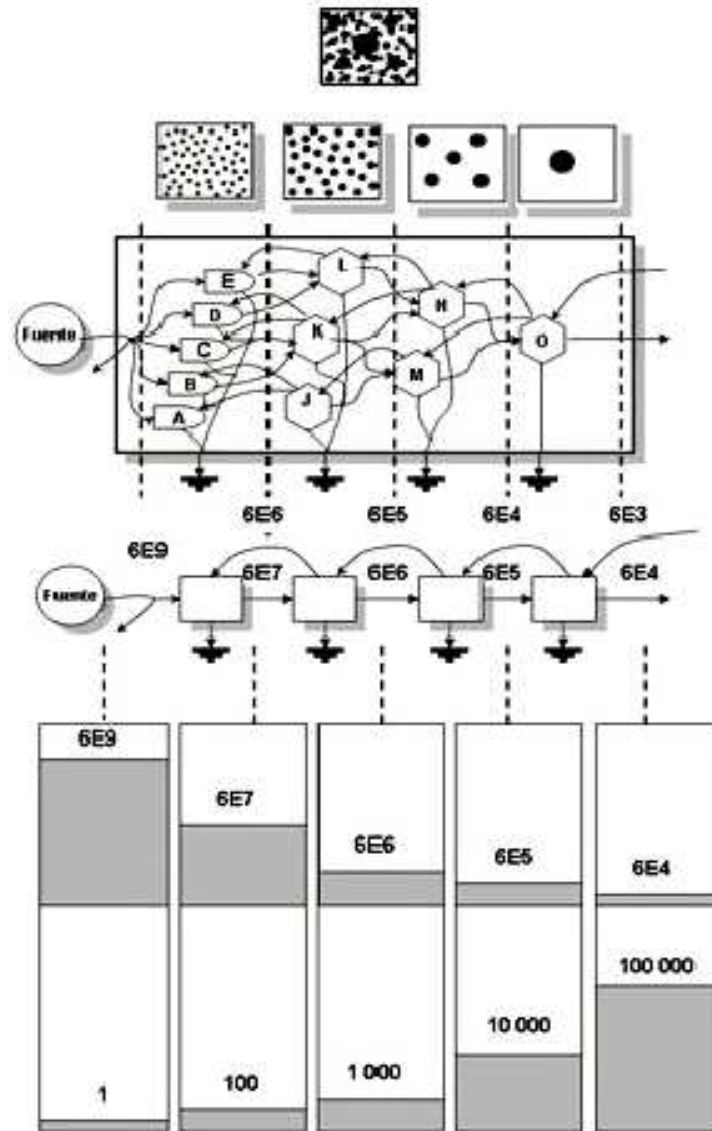

Figure 2.0: Energy transformation steps (Odum, 1996)

▪ **Definition as a ratio**

Like the efficiency ratio, transformity is quantitatively defined by a simple input-output ratio. However the transformity ratio is the inverse of efficiency and involves both indirect and direct energy flows rather than simply direct input-output energy ratio of energy efficiency. This is to say that it is defined as the ratio of energy input to energy output.

$$\tau = \frac{O(in)}{E(out)} \tag{2-8}$$

However, it was realized that the term 'energy output' refers to both the useful energy output and the non-useful energy output (Nag, 1984). But as Sciubba and Ulgiati observed, the notion of

transformity meant to capture the emergy invested per unit product, O , or useful output, E_x , (Sciubba and Ulgiati, 2005). The concept of transformity was therefore further specified as the ratio of input emergy dissipated (availability used up) to the unit output emergy. According to Jorgensen (2000), transformity is a strong indicator of the efficiency of the system.

$$\tau = \frac{O(in)}{E_x(out)} \quad (2-9)$$

Substituting the mathematical definition of emergy (2-7) in the above equation (2-9) gives:

$$O = \sum_i \tau_i E_{x_i} \quad (2-10)$$

▪ Calculation of Transformities

Transformities are usually calculated by analyzing the production process for a resource or a particular item. The transformity of a particular economic or ecological products and services is determined by analyzing the production processes of the economic and environmental subsystems. Then all energy inputs required for the production are documented and converted to solar emergy joule by multiplying by the appropriate transformity. Finally, to get the transformity of the product, all the solar emergy joules for the different steps in the production process are summed up and then divided by the available energy of the product (Brown and McClanahan, 1996). Transformities are usually available from other studies (e.g. Brown and Arding, 1991; Odum, 1996). Figure 2.1 shows how transformities are calculated by summing all the inputs to process, direct environmental inputs as well as purchased inputs, expressed in emergy (seJ), and then dividing this total emergy by the energy content of the product of the process.

The same item may have different transformities, depending on the process that resulted in the item. This may be due to the technology involved, the year of calculation and where the process took place (country, region).

The baseline for all transformity calculations is the total emergy input to the Earth. This is the sum of the emergy of the solar insolation, deep earth heat and tidal energy. These global emergy inputs are the driving force for all planetary activities. As mentioned previously, most of the case studies that use Emergy Evaluation rely on and use transformities previously calculated. Thus, the availability of this data often determines the ease with which emergy accounting studies can be performed (Hau and Bakshi, 2004). For an in-depth description of the methodologies used to derive the transformity coefficients for various natural and human processes, see Chapters 3 and 4 in Odum's *Environmental Accounting: Emergy and Environmental Decision Making*.

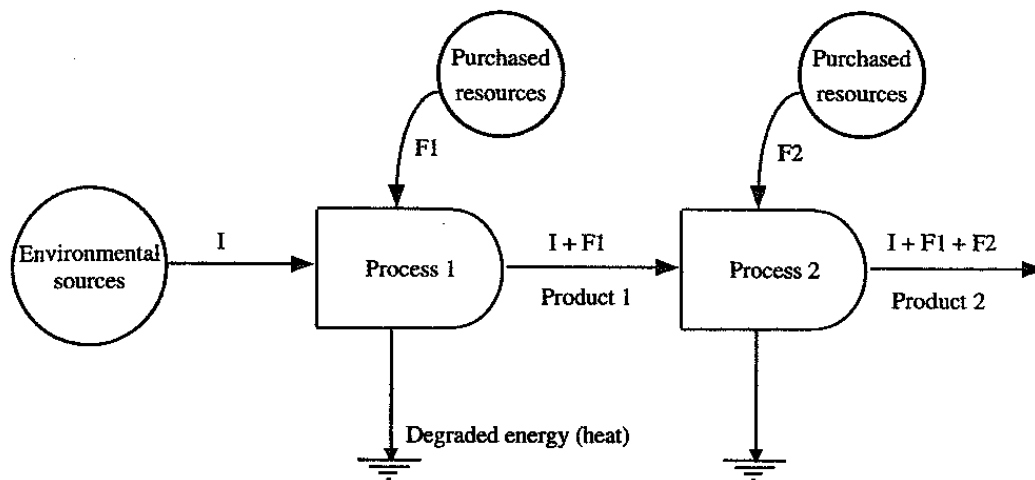

$$\text{Transformity of product 1} = \frac{\text{inputs } I + F1 \text{ in energy units}}{\text{output 1 in units of energy}}$$

$$\text{Transformity of product 2} = \frac{\text{inputs } I + F1 + F2 \text{ in energy units}}{\text{output 2 in units of energy}}$$

Figure A.1: Calculation of transformities (Lagerberg, 1999)

A range of transformities usually exist for a given product. The lower limit of the transformity range represents the most efficient approach to making the product. Odum (1996) maintains then that transformities for a given product can be used to compare production efficiencies among systems.

▪ Unit Energy Values (UEVs)

Unit Energy Values (UEVs) are based on the energy required to produce something. UEVs differ dependent upon whether the entity is better represented by an energy measure (joules) or a material measure (grams). According to Brown and Cohen, 2008, if the ratio compares energy inflow to unit energy outflow, that ratio is called a 'transformity'. If it compares energy inputs to unit material outflow, the ratio is the 'specific energy', similar to the specific heat associated with the mass of compound or element. UEVs are calculated by dividing the sum of all energy required by the units of product output. These values are computed based on the energy required to generate one unit of output from a process. Transformity and specific energy are the two types of UEVs considered in this thesis. However, there are several types of UEVs such as, Energy per unit money, which is the energy supporting the generation of one unit of economic product and energy per unit labor defined as the amount of energy supporting one unit of labor directly supplied to a process.

▪ Energy's relation with other thermodynamic quantities

There seems to be much confusion about the relationship between energy and other thermodynamic properties, such as energy, exergy, enthalpy, etc. The qualitative difference, as pointed out by Odum and coworkers, is that unlike energy, these thermodynamic quantities do not recognize the difference in quality of various energy sources. A common example is that 'a joule of sunlight is not equivalent to a joule of fossil fuel' in the sense that they cannot do the same kind of work (Brown et al., 1995). This leads to impressions that energy analysis is a very different approach from exergy analysis (Emblemsvag and Bras, 2001). Similarly, Ayres (2000) questions the need for energy as opposed to standard variables of thermodynamics, namely, enthalpy and exergy. There is also some confusion about the exact definition of available energy. It is certainly not Gibbs free energy because not all of it is available for work. Odum (1995) argues that neither is it exergy because "exergy is defined to include only energy flows of similar qualities that of mechanical work, while available energy as defined in energy analysis also considers important inflows, such as human services that require very large energy flows to maintain. On the other hand, Odum (2000b) and Campbell (2001) define available energy in energy analysis as exergy or energy with the potential to do work. Scrutiny of transformity calculations indicates that available energy as used in energy and exergy may indeed be equivalent. For example, for heat engines the available energy of the system is the same as exergy since it is obtained by multiplying its heat content or flow by the Carnot factor (Odum, 1996). The relationship of the transformities of fuels to their combustion efficiencies may be easily justified if available energy and exergy are equivalent. Odum uses the heat of combustion to determine available energy, which is shown to be close to exergy for fuels (Szargut et al., 1988). Moreover, the use of exergy justifies why dissipated heat carries no energy value. This lack of formal links between energy and other thermodynamics quantities is a significant cause of skepticism about energy among engineers. Some efforts have been made to connect energy with exergy (Ulgiati, 1999). Improved understanding of the relationship between energy and exergy is essential for constructive cross-fertilization between these areas. Such insight is essential for greater use of the data and concepts of energy analysis in evaluating the life cycle of engineering products and processes. A strong link between engineering thermodynamic concepts and energy helps proving that many criticisms of energy, such as its connection with economic value or the Maximum Empower Principle, are not relevant to using energy to capture the thermodynamic aspects of ecological goods and services. More importantly, it clears up much of the confusion regarding the relation of energy to other thermodynamic properties.

Overview of Energy Evaluation Procedure

Energy Evaluation of a given system is a mass and energy flow analysis where flows are transformed to energy using transformities. Energy evaluation allows comparison of energy flows of different forms. Energy Evaluation like other assessment methods is guided by the research or management questions of concern. It is based on universal principles of ecological energetics and uses the Energy Systems Language to describe natural systems.

▪ **Summary of energy analysis procedure**

There are five main steps required to complete an energy evaluation (Campbell et al., 2006).

- First, a detailed systems diagram is completed.
- The second step is to translate this knowledge into an aggregated diagram of the system addressing specific questions.
- Third, descriptions of the pathways in the aggregated diagram are transferred to energy analysis tables where the calculations needed to quantitatively evaluate these pathways are compiled.
- The fourth step in the method is to gather the raw data needed to complete the energy analysis tables along with the conversion factors (energy contents, transformities, etc.) needed to change the raw data into energy units.
- Finally, after the raw data has been converted into energy units, indices are calculated from subsets of the data

Overview System Diagrams

A system diagram is drawn first to put in perspective the system of interest, combine information about the system from various sources, and to organize data gathering efforts. The process of diagramming the system of interest in overview ensures that all driving energies and interactions are included. Since the diagram includes both the economy and environment of the system, it is like an impact diagram which shows all relevant interactions. Next, a second simplified (or aggregated) diagram, which retains the most important essence of the more complex version, is drawn. This final, aggregated diagram of the system of interest is used to construct a table of data requirements for the Energy analysis. Each pathway that crosses the system boundary is evaluated.

▪ **Language symbols for energy-energy systems from Odum**

The Energy Systems Language, also referred to as Energy Circuit Language and Generic Systems Symbols, was developed by the ecologist Howard T. Odum and colleagues in the 1950s during studies of Tropical Forests funded by the United States Atomic Energy Commission. They are used to compose energy flow diagrams in the field of systems ecology.



Energy circuit: A pathway whose flow is proportional to the quantity in the storage or source upstream.



Source: Outside source of energy delivering forces according to a program controlled from outside; a forcing function.

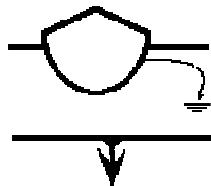

Tank: A compartment of energy storage within the system storing a quantity as the balance of inflows and outflows; a state variable.

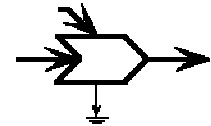

Heat sink: Dispersion of potential energy into heat that accompanies all real transformation processes and storages; loss of potential energy from further use by the system.

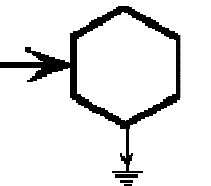

Interaction: Interactive intersection of two pathways coupled to produce an outflow in proportion to a function of both; control action of one flow on another; limiting factor action; work gate.

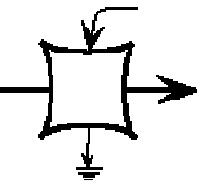

Consumer: Unit that transforms energy quality, stores it, and feeds it back autocatalytically to improve inflow.

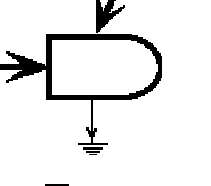

Switching action: A symbol that indicates one or more switching actions.

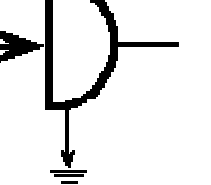

Producer: Unit that collects and transforms low-quality energy under control interactions of high-quality flows.

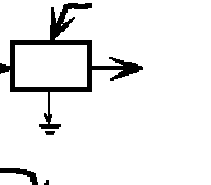

Self-limiting energy receiver: A unit that has a self-limiting output when input drives are high because there is a limiting constant quality of material reacting on a circular pathway within.

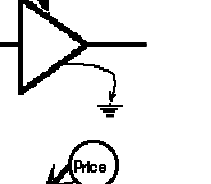

Box: Miscellaneous symbol to use for whatever unit or function is labeled.

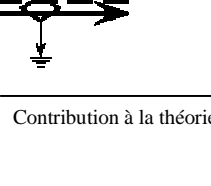

Constant-gain amplifier: A unit that delivers an output in proportion to the input I but is changed by a constant factor as long as the energy source S is sufficient.



Transaction: A unit that indicates a sale of goods or services (solid line) in exchange for payment of money (dashed line). Price is shown as an external source.

▪ **Emergy Algebra**

Rules of emergy evaluation

Since the definitions of emergy and transformity are based more on logic of memorization, than on conservation, algebra of emergy has been introduced (Brown and Herendeen, 1996). The rules of emergy evaluation are:

- all source emergy to a process is assigned to the processes output;
- by-products from a process have the total emergy assigned to each pathway;
- when a pathway splits, the emergy is assigned to each leg of the split based on its percentage of the total energy flow on the pathway;
- emergy cannot be counted twice within a system:
 - emergy in feedbacks cannot be double counted;
- By-products, when reunited, cannot be added to equal a sum greater than the source emergy from which they were derived.

Emergy allocation techniques

Figures A.2 (a) and A.2 (b) (Odum, 1996) indicate the energy, emergy and transformity relationships for the splitting of the flow via a pathway and a storage respectively. In by product branching, Figure A.2(c) (Odum, 1996), the flow in each resulting branch is of a different energy quality or transformity. By-product flow results from energy transformations. All by-product branches derived from an energy transformation carry the same emergy as the emergy on each pathway records the total input to the process. If these two pathways come together again in some other area of the system, they are not to be added as this would result in double counting (Gourgaud, 1997). A more detailed overview of the emergy allocation depicting the rules is discussed later in this chapter.

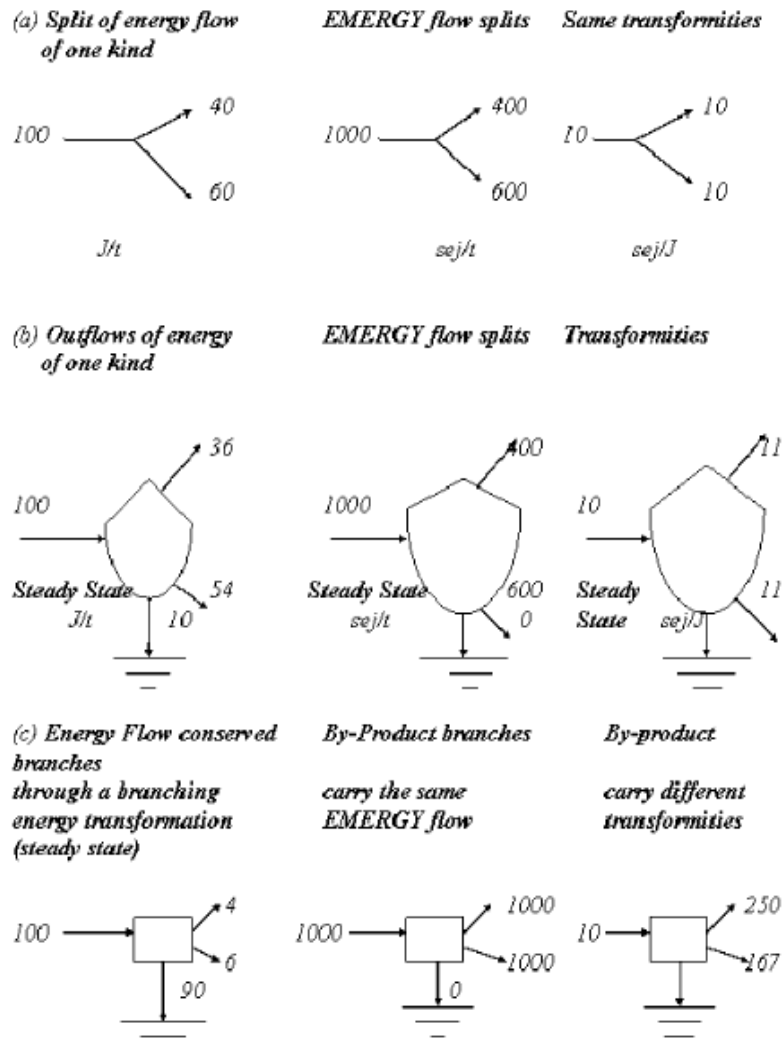

Figure A.2: (a) and (b) indicate the energy, emergy and transformity relationships for the splitting of the flow via a pathway and storage respectively. In by-product branching (c) the flow in each resulting branch is of a different energy quality or transformity (Odum, 1996)

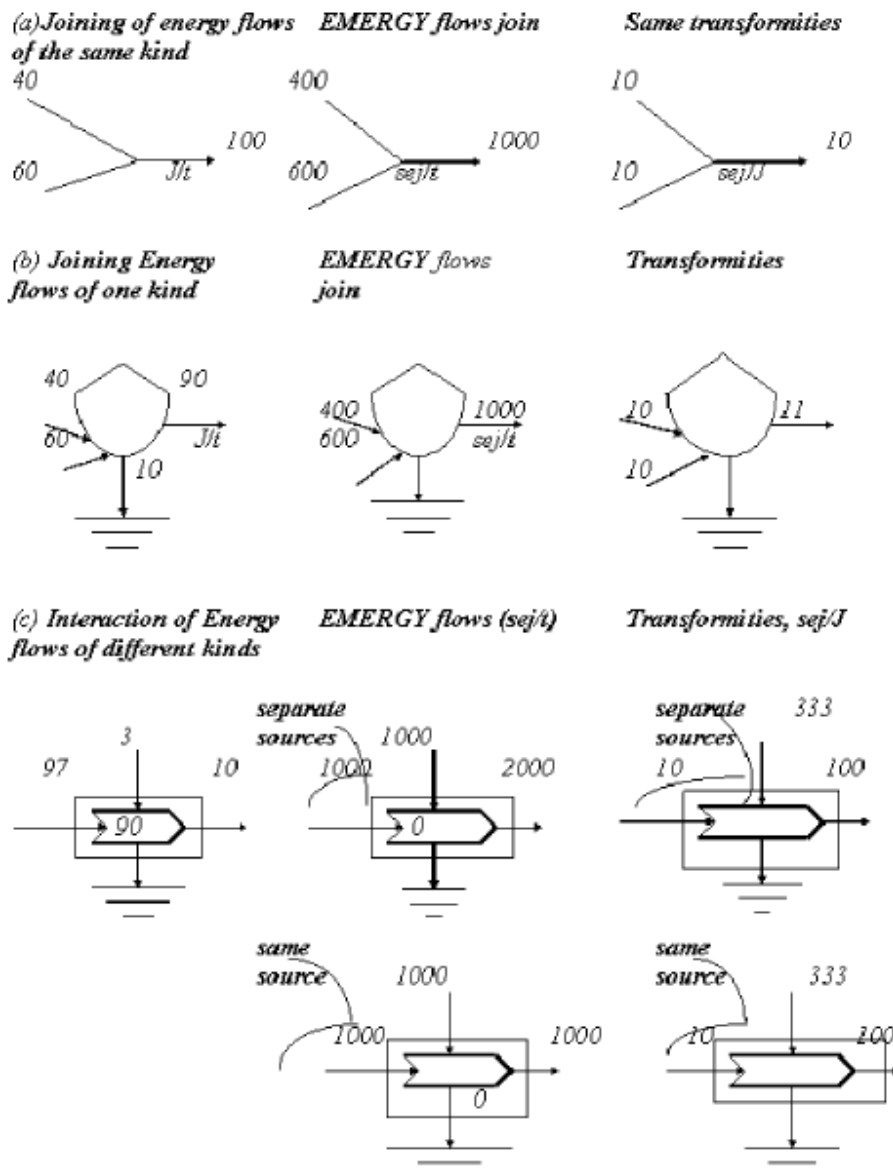

Figure A.3: Interactions of flows of the same kind (a) and (b); intersection of flows of different kinds, i.e. with different transformities (c) (Odum, 1996).

In figure A.3, interactions of flows of the same kind and different kinds are depicted. In figure A.3(c), there is an intersection of flows of different kinds, i.e. with different transformities. In this type of intersection, interactions occur in which both inputs are required for energy transformations resulting in one more output products. Most energy transformations involve the interaction of two or more inputs of different transformity.

Emergy Evaluation Tables

Emergy analysis of a system of interest is usually conducted at two scales. First, the system within which the system of interest is embedded is analyzed and indices necessary for evaluation and comparative purposes are generated. Second, the system of interest is analyzed. Both analyses are conducted using an Emergy Analysis Table organized with the following headings:

1	2	3	4	5	6
Note	Item	Raw Units	Transformity	Solar Emergy	Macro-economic \$

Each row in the table is an inflow or outflow pathway in the aggregated systems diagram; pathways are evaluated as fluxes in units per year. An explanation of each column in an Emergy Analysis Table is given next.

- Column 1: The line number and footnote number that contains sources and calculations for the item.
- Column 2: The item name that corresponds to the name of the pathway in the aggregated systems diagram.
- Column 3: The actual units of the flow usually evaluated as flux per year. Most often the units are energy (joules/year), but sometimes are given in grams/year or dollars/year.
- Column 4: Transformity of the item usually derived from previous studies.
- Column 5: Solar Emergy (seJ), which is the product of the raw units in Column 3 with the transformity in Column 4.
- Column 6: The result of dividing solar Emergy in Column 5 by the Emergy to money ratio (calculated independently) for the economy of the nation within which the system of interest is embedded.

Emergy Indices

Emergy evaluation classifies inputs into different categories – refer to fig. A.4 (i.e. local renewable, R, local non-renewable, N; and purchased, F). On the basis of these classes, some indicators can be computed in order to assess the sustainability of the use of resources. The environmental loading ratio (ELR) is the ratio of purchased (F) and non-renewable local emergy (N) to renewable environmental emergy (R). When a transformity or emergy content is assigned to a product, every input into the product can be measured in emergy terms, i.e. on a common basis. A measure of the real annual wealth of a nation is based on total annual emergy use.

Emergy availability to a nation and emergy use per person suggest a measure of the standard of living enjoyed by the population of that nation in a much more effective manner than that of fuel use per person or per capita income. This emergy-use index takes into account the different quality of input joules, by means of the transformities, and also includes renewable as well as non-renewable environmental resources, usually neglected in energy balances. In this context, standard of living refers to the availability of resources and goods and is a much more encompassing and effective measure of living standards than \$GDP/capita.

The emdollar refers to the total amount of money flow generated in the entire economy by a given amount of a particular emergy input. The emdollar is defined as the emergy input divided by the emergy/\$GDP ratio. A high emdollar value for a particular amount of emergy input contributes more to the economy. It has been proposed that the emdollar value of a resource could be used as a shadow price of the resource itself.

In trade analysis, the emergy exchange ratio (EER) is the ratio of emergy received for emergy delivered in a trade or sales transaction. A particular trade of one commodity for another can be expressed in emergy units. The nation receiving the higher emergy acquires a greater real value and as a consequence has its economy stimulated more than its trading partner. Unprocessed products tend to have high emergy exchange ratios for the importing nation when sold at market prices. Most technologically advanced nations exhibit a high emergy exchange ratio as they are not emergy self-sufficient. A high emergy exchange ratio contributes to the vitality of the economy of the importing nation which utilizes the unprocessed resources in its manufacturing sector making it capable of successfully competing with other nations in the overall balance of trade.

The emergy yield ratio (EYR) is the emergy of an output divided by the emergy of those inputs to the process that are fed back from the economy. "This ratio indicates whether a process is a primary energy source for the economy. Recently, the ratio for typical competitive sources of fuels has been about 6 to 1 (Lagerberg, 1999). Processes yielding less than this cannot be considered primary emergy sources. If the ratio is lower than unity, the process is not a positive source of net emergy; if the ratio is less than alternatives, less return be obtained per unit of emergy invested in comparison with alternatives. Less competitive emergy sources (i.e. having a lower net emergy yield ratio) may have a lower cost, due to local conditions: costs are affected by international markets and value of currencies, which may not reflect the physical reality of a misuse of the emergy invested in comparison with actually available alternatives. Sources less competitive may become competitive when the others approach scarcity or are used up." Odum (1995) has defined an emergy investment ratio in order to account for the contributions to the productive process from the environmental inputs.

The emergy investment ratio (EIR) is the purchased emergy feedback (F) from the economy (services and other resources) divided by the free emergy inflow from the environment (I). This ratio gives an indication of whether a process is as economical as a utilizer of an economy's investments when compared with alternatives and evaluates the emergy input from the economy required to develop a unit of environmental input. Prices may be low because of the high proportion of useful work which is provided free from the environment. Ulgiati et al (1994) state that if the ratio is low then the tendency is to increase the purchased inputs so as to process more output and more money. They claim that the tendency is towards optimum resource use.

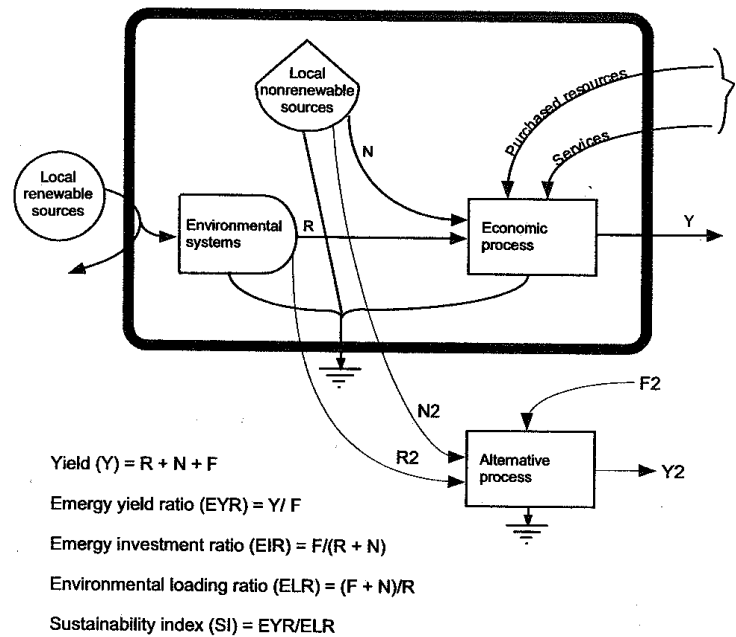

Figure A.4: Representation of typical energy indices (Lagerberg, 1999)

This ratio (EIR) is useful for the investigation of the economic viability of processes in the economy and is particularly relevant to the investigation of best alternate land use problems.

The environmental loading ratio (ELR) is the ratio of purchased and non-renewable indigenous energy to free environmental energy. A very high value for this ratio may be indicative that the pressure of economic activities to local environmental resources is excessive and resulting in environmental stress.

The empower density is defined as the energy flow per unit time and unit area and is a measure of spatial concentration of energy flow within a process or system. A high empower density can be found when energy use is large compared with available land area. The empower density is expected to be high for highly industrialized areas and for areas of intensive crop production.

The Sustainability Index (SI) which is a composite index tracking a diverse set of socioeconomic, environmental, and institutional indicators calculated for Italy in 1989 (Ulgiati et al., 1994) was $SI = 0.17$. This indicates a massive use of non-renewable energy, large imports of purchased energy and materials, and large environmental stress. In contrast, the value of the sustainability index for the village under study ($SI = 6.68$) is indicative that the eco-village economy is a model to pursue for a more sustainable development.

General Applications of Emergy Evaluation

The concept of Emergy Analysis has been widely accepted globally and its application has spanned such global problems as population carrying capacity, greenhouse emissions, material fluxes in conventional and renewable energy production systems, and sustainable patterns of development at local, regional, national and global scales.

Emergy research has led to the development of methods for quantifying environmental values, and their application to questions of energy policy and natural resource management throughout the world, helping developing nations understand their resource issues and to evaluate alternative solutions. It has addressed resource management questions in Thailand, Papua New Guinea, Mexico, Brazil, and Ecuador, the six countries of the “southern cone” of South America and most recently the Sahel region of northern Africa.

Emergy analysis was used to compare four technological options of soybean production in Brazil (Ortega et al., 2004): chemistry and machinery intensive; herbicide and no tillage; ecological traditional and modern organic enterprise. These were divided in two main categories, the biological models (organic and ecological farms) and the industrial models (green revolution chemical farms, using herbicide without tilling). The biological options showed better environmental, economical and social performance indicators. The classic emergy analysis, point out that the biological options are the better alternatives (Hau, 2002).

The emergy analysis was also used to evaluate the sustainability of a village which aims to be ecologically friendly. The choice of focusing on the use of local resources including agriculture and farm goods, photovoltaic panels, renewable heating and cooling systems, recycled water from constructed wetlands etc., aims to obtain a sustainable village.

Another study examined and evaluated, by using emergy analysis, the use of environmental resources for wastewater treatment in a Swedish town. The study included an evaluation of the amount of emergy associated with the production of wastewater. On the basis of the analysis, it was realized that the large amount of emergy that wastewater contains are in proportion to the amount of resources employed for wastewater treatment and the extensive effects on surrounding ecosystems of discharge of untreated wastewater. The use of local renewable natural resources in Swedish municipal wastewater treatment systems is negligible compared with the use of purchased inputs, processed largely with the support of fossil energy. A drastic shift of this order would demand that extensive land areas surrounding human settlements be (indirectly or directly) devoted to wastewater treatment. These areas are not accessible today. The analysis also indicated that resource requirements from the economy in the production of electricity by the digestion of sewage sludge is about two times the total resource use for generation of the average mix of electricity used in the town. As a result, if the only reason to digest the sludge were to produce electricity, it would be more resource-efficient to purchase the electricity on the Swedish distribution net (Bjorklund et al., 2001).

Appendix A [References]:

- Ayres, R.U., 2000. Commentary on the utility of the ecological footprint concept, *Ecological Economics*, vol. 32(3), pp. 347-349.
- Bastianoni, S., Facchini, A., Susani, L., Tiezzi, E., 2007. Emergy as a function of exergy, *Energy*, vol. 32(7), pp. 1158-1162.
- Bjorklund, J., Geber, U., Rydberg, T., 2001. Emergy analysis of municipal wastewater treatment and generation of electricity by digestion of sewage sludge, *Resources, Conservation & Recycling*, vol. 31(4), pp. 293-316.
- Brown, M.T., Arding, J., 1991. In: *Transformity Working Paper*, Center for Wetlands, University of Florida, Gainesville, USA.
- Brown, M.T., Odum, H.T., Murphy, R.C., Christianson, R.A., Doherty, S.J., McClanahan, T.R., Tennenbaum, S.E., 1995. Title. In: C.A.S. Hall, *Maximum Power - The Ideas and Applications of H.T. Odum*, University Press of Colorado, Niwot, 393 pp.
- Brown, M.T., McClanahan, T., 1996. Emergy Analysis Perspectives of Thailand and Mekong River Dam Proposals, *Ecological Modelling*, vol. 91(1-3), pp. 105-130.
- Brown, M.T., Herendeen, R.A., 1996. Embodied energy analysis and emergy analysis: A comparative view, *Ecological Economics*, vol. 19(3), pp. 219- 235.
- Brown, M.T., Ulgiati, S., 2004. Emergy Analysis and Environmental Accounting, In: Editor-in-chief: Cleveland, J., *encyclopedia of Energy*, Elsevier, New York, pp. 329-354.
- Brown, M.T., Cohen, M.J., 2008. Emergy and Network Analysis, In: Jorgensen, S., Fath, B. (Eds.), *Encyclopedia of Ecology*, Academic Press, Oxford, pp. 1229-1239.
- Campbell, D.E., 2001. Proposal for including what is valuable to ecosystems in environmental assessments. *Environ. Sci. Technol.*, vol. 35(14), pp. 2867–2873.
- Campbell, D.E., Lu, Z., Li, H., 2006. Emergy synthesis of an agro-forest restoration system in lower subtropical China. *Ecological Engineering*, vol. 27(3), pp. 175-192.
- Clausius, R., 1865. *The Mechanical Theory of Heat – with its Applications to the Steam Engine and to Physical Properties of Bodies*. London: John van Voorst, 1 Paternoster Row, MDCCCLXVII.
- Emblemvag, J., Bras, B., 2001. *Activity-Based Cost and Environmental Management, A Different Approach to ISO 14000 Compliance*, Kluwer Academic Publishers, Boston, 317pp.

- Giannetti, B.F., Barrella, F.A., Almeida, C.M., 2006. A combined tool for environmental scientists and decision makers: ternary diagrams and emergy accounting, *Journal of Cleaner Production*, vol. 14(2), pp. 201-210.
- Gibbs, J.W., 1873. A Method of Geometrical Representation of the Thermodynamic Properties of Substances by Means of Surfaces, *Transactions of the Connecticut Academy of Arts and Sciences*, vol. 2, pp. 382-404.
- Gourgaud, S., 1997. The use of the emergy theory of value in environmental accounting, website of Shirley Gourgaud and Darryl Seto: <http://sego.id.au>, date accessed: 16 January, 2011.
- Hau, J.L., 2002, Integrating life cycle assessment, Exergy and Emergy analysis, MSc. Thesis presented to the Department of Chemical Engineering, The Ohio State University.
- Hau, J.L., Bakshi, B.R., 2004. Promise and Problems of Emergy Analysis, *Ecological Modelling*, vol. 178(1-2), pp. 215-225.
- Jorgensen, S.E., 2000. *Thermodynamics and Ecological Modelling*, CRC Press.
- Lagerberg, C., 1999. Emergy analysis of the resource use in greenhouse crop production and of the resource basis of the Swedish economy. Doctoral thesis presented to the Swedish University of Agricultural Sciences.
- Lei, K., Wang, Z., 2008. Emergy synthesis of tourism-based urban ecosystem. *Journal of Environmental Management*, vol. 88(4), pp. 831-844.
- Meillaud, F., Gay, J.B., Brown, M.T., 2005. Evaluation of a building using the emergy method, *Solar Energy*, vol. 79(2), pp. 204–212.
- Menegaki, A., 2008. Valuation for renewable energy: A comparative review, *Renewable and Sustainable Energy Reviews*, vol. 12(9), pp. 2422–2437.
- Nag, P.K., 1984. *Engineering Thermodynamics*, Tata McGraw-Hill Publishing Company.
- Odum, H.T., 1995. Self organization and maximum power in *Maximum Power*, Ed. by C.A.S. Hall, University Press of Colorado, Niwot, pp. 311-364.
- Odum, H.T., 1996. *Environmental accounting: emergy and environmental decision making*, John Wiley and Sons, New York.
- Odum, H.T., Peterson, N., 1996. Simulation and evaluation with energy systems blocks, *Ecological Modelling*, vol. 93(1-3), pp. 155-173.

- Odum, H.T., 2000a. Folio #2: Emergy of Global Processes, Handbook of Emergy Evaluation, Center for Environmental Policy, Environmental Engineering Sciences, University of Florida, Gainesville.
- Odum, H.T., 2000b. Emergy evaluation of an OTEC electrical power system. *Energy*, vol. 25(4), pp. 389–393.
- Ortega, E., Cavalett, O., Bonifácio, R., Watanab, M., 2004. In Ortega, E. & Ulgiati, S. (editors): Proceedings of IV Biennial International Workshop on Advances in Energy Studies, Unicamp, Campinas, SP, Brazil, pp. 285-299.
- Pulselli, R.M., Simoncini, E., Ridolfi, R., Bastianoni, S., 2008. Specific emergy of cement and concrete: An energy-based appraisal of building materials and their transport, *Ecological Indicators*, vol. 8(5), pp. 647-656.
- Rydberg, T., Haden, A.C., 2006. Emergy evaluations of Denmark and Danish agriculture: Assessing the influence of changing resource availability on the organization of agriculture and society, *Agriculture, Ecosystems & Environment*, vol. 117(2-3), pp. 145-158.
- Scienceman, D.M., 1987. Energy and Emergy, In G. Pillet and T. Murota (eds), *Environmental Economics: The Analysis of a Major Interface*. Geneva: R. Leimgruber. pp. 257–276.
- Sciubba, E., Ulgiati, S., 2005. Emergy and exergy analyses: complementary methods or irreducible ideological options? *Energy*, vol. 30(10), pp. 1953-1988.
- Szargut, J., Morris, D.R., Steward, F.R., 1988. *Exergy Analysis of Thermal, Chemical and Metallurgical Processes*, Hemisphere Pubs., New York, 332 pp.
- Tilley, D.R., Swank, W.T., 2003. Emergy-based environmental systems assessment of a multi-purpose temperate mixed-forest watershed of the southern Appalachian Mountains, USA, *Journal of Environmental Management*, vol. 69(3), pp. 213–227.
- Ulgiati, S., Odum, H.T., Bastianoni, S., 1994. Emergy Use, Environmental Loading and Sustainability: An Emergy Analysis of Italy, *Ecological Modelling*, vol. 73(3-4), pp. 215-268.
- Ulgiati, S., 1999. Energy, Emergy and Embodied Exergy: Diverging or Converging Approaches, Proceedings of the First Biennial Emergy Analysis Conference, Gainesville, Florida.

Appendix B

Supplementary Results

Results of impact on EYR of building for recycled concrete usage

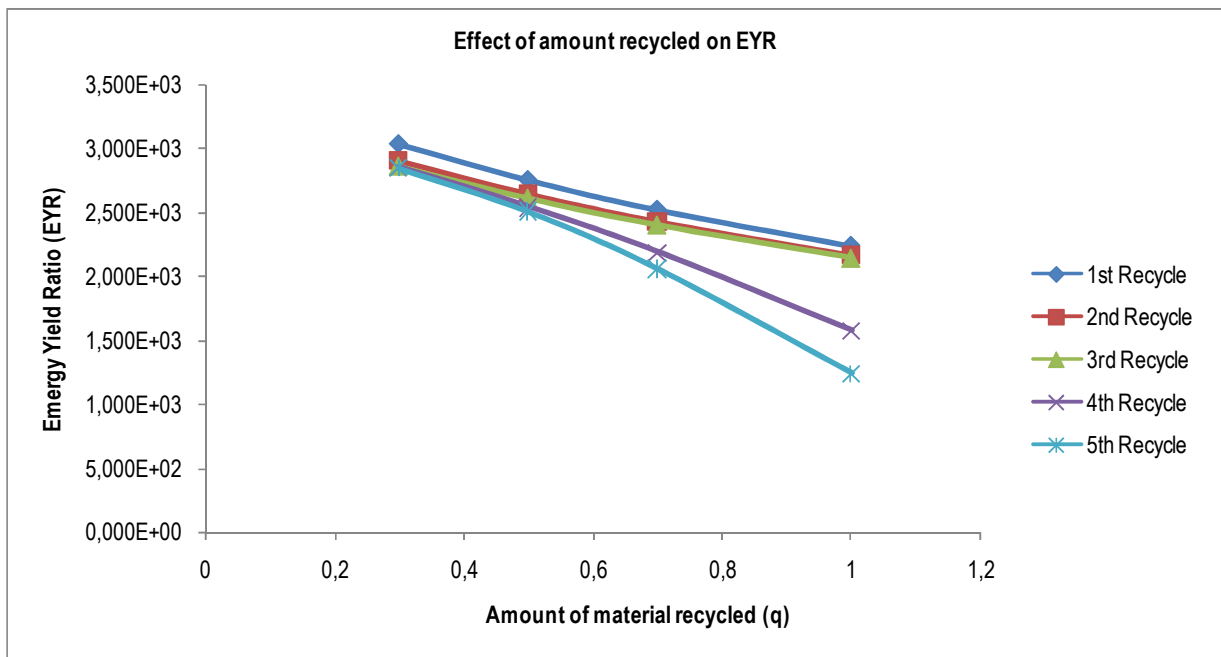
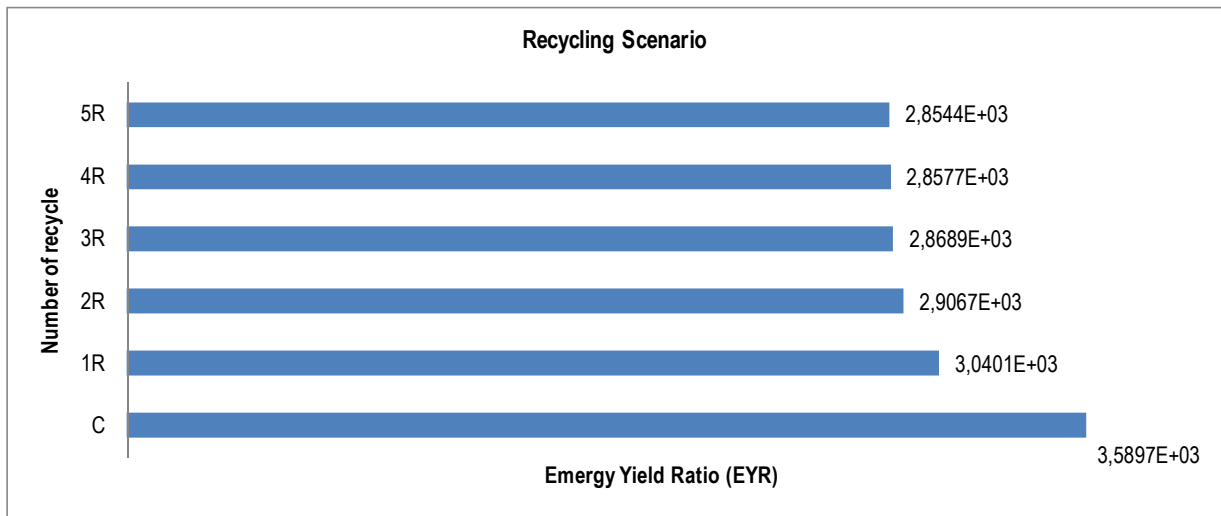

Results of impact on EYR of building for recycled aluminium usage

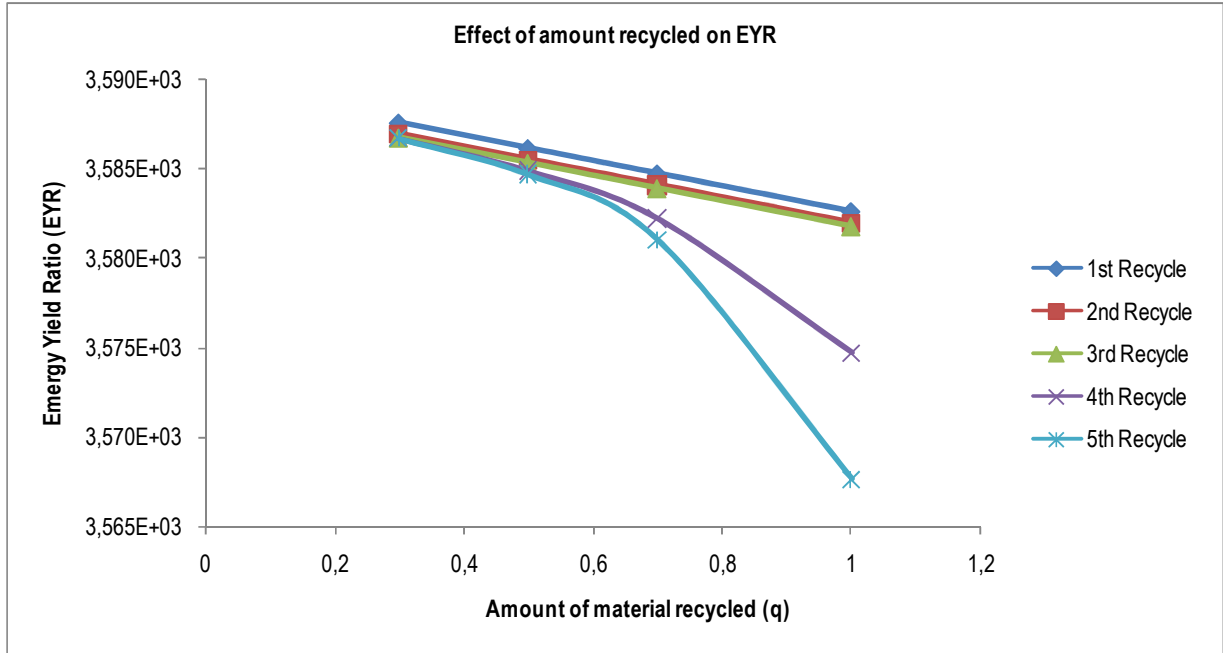
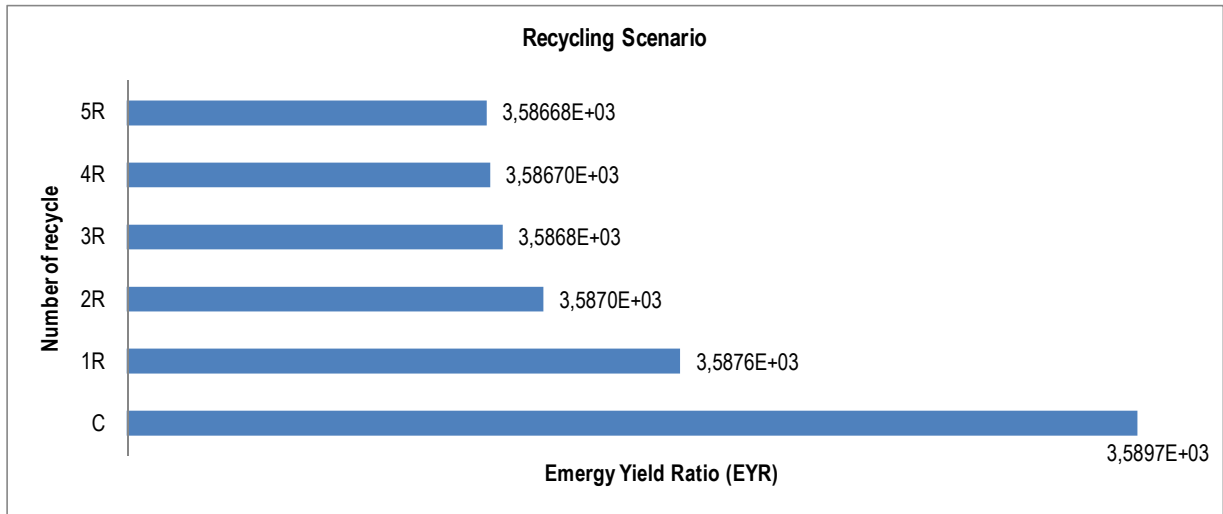

Results of impact on EYR of building for recycled glass usage

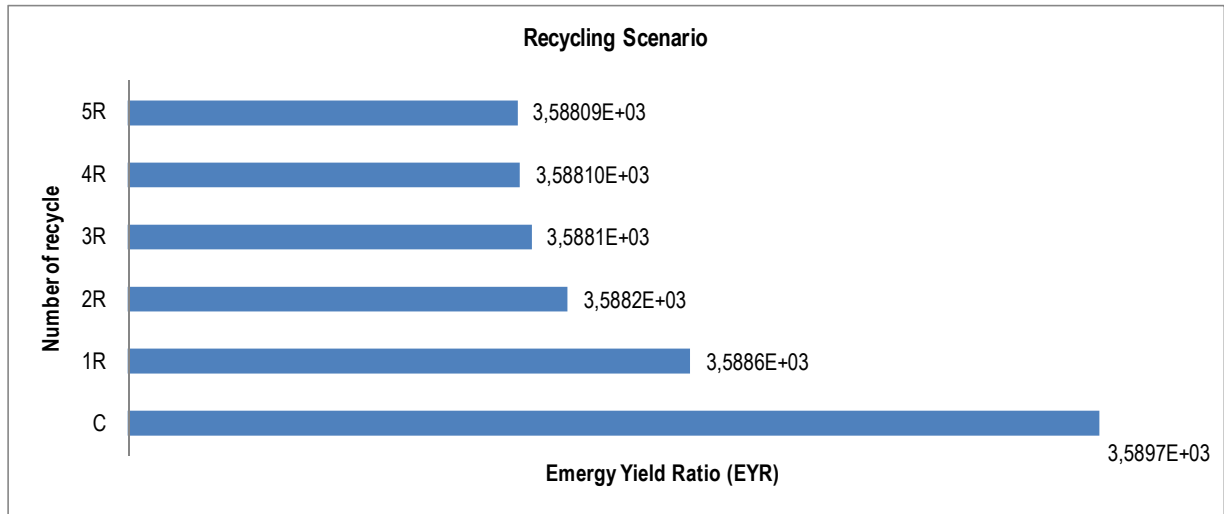

Appendix C

The walls, floor and roof composition can be described as well as the glazing type. In a first step, the same composition is given for all external walls, other compositions for all internal walls, all floors and all ceilings, but this can be changed in a second step (e.g. the composition of the south facade may be different compared to other walls). The wall compositions and glazing types can be chosen in a library, and the user can define specific components by giving the list of materials and thickness.

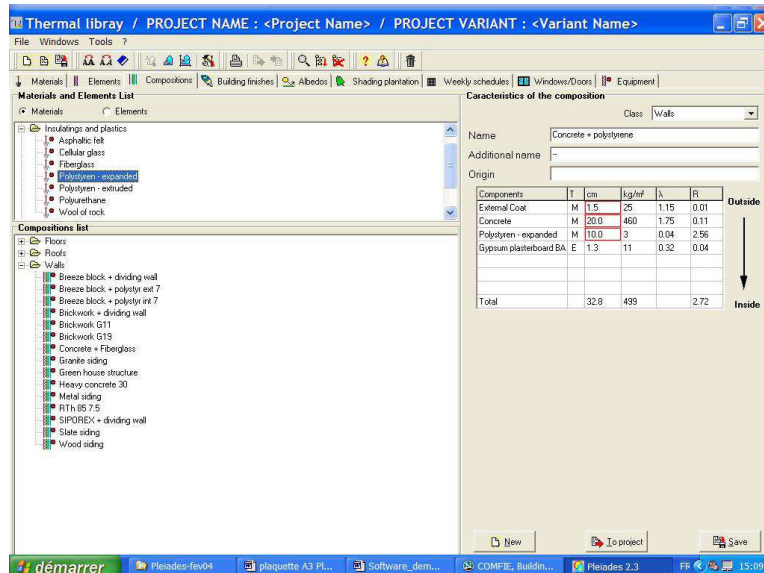

The materials can also be chosen in a library of defined by the user; the following characteristics have to be provided: density, thermal conductivity and specific heat.

The properties of windows and doors are available in a library as well or can be input by the user: heat loss coefficient U of the glass and frame, solar factor g of the glass and proportion of glass.

Some solar protection can be added in a second step (movable shading like roller blinds or shutters, vegetal shading with a monthly value of solar transmission, architectural shading like overhangs etc.).

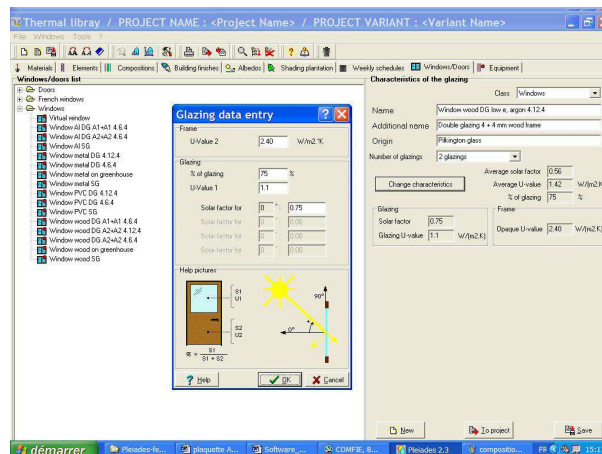

Other parameters

The description using ALCYONE can be refined e.g. by modifying the composition of one or several walls, the type of one or several windows, thermal bridges, adding shading devices on a window etc.

A shading element can be defined near a window, e.g. an overhang. A graph (cf. next picture) shows the monthly values of solar radiation with shading (yellow area) and without (green area). This allows different geometries to be compared in order to maximize winter gains and to minimize summer gains. The shading effect can be simulated according to the season and the hour of the day (animation, see the lower right part of the next picture).

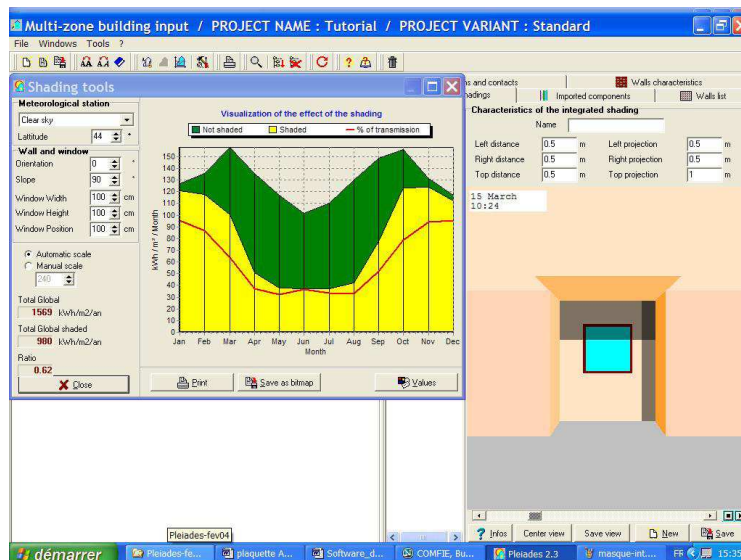

Shading from other buildings, trees, hills etc. can also be defined.

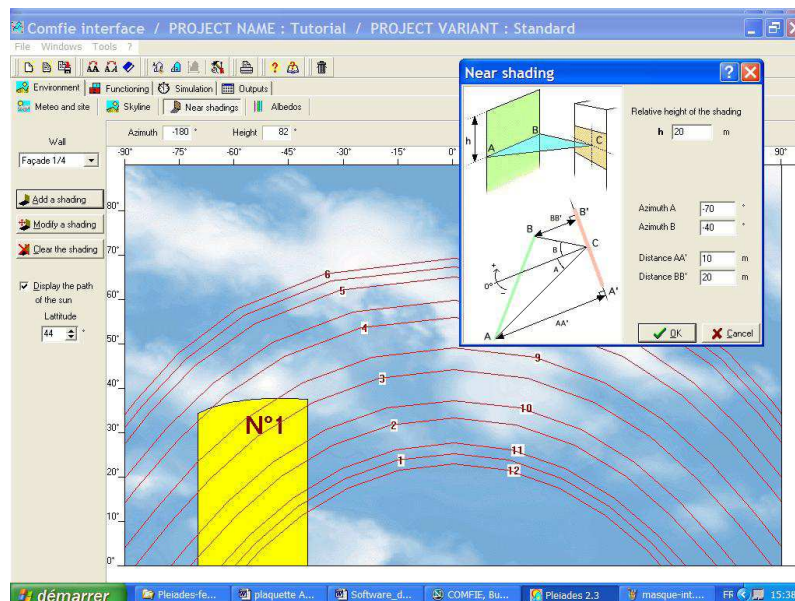

Climatic data can be chosen in a list of meteorological locations, and files can be constituted by the user including hourly values of external temperature, global and diffuse horizontal radiation during one typical year.

The use of each zone (e.g. living room, bedrooms) is characterized by different parameters that can vary each day of the week and each hour : the thermostat set point, internal gains, number of occupants, ventilation (e.g. to study passive cooling using night ventilation). Such a set of parameters constitutes a scenario that can be chosen in a library (e.g. typical dwelling) or defined by the user.

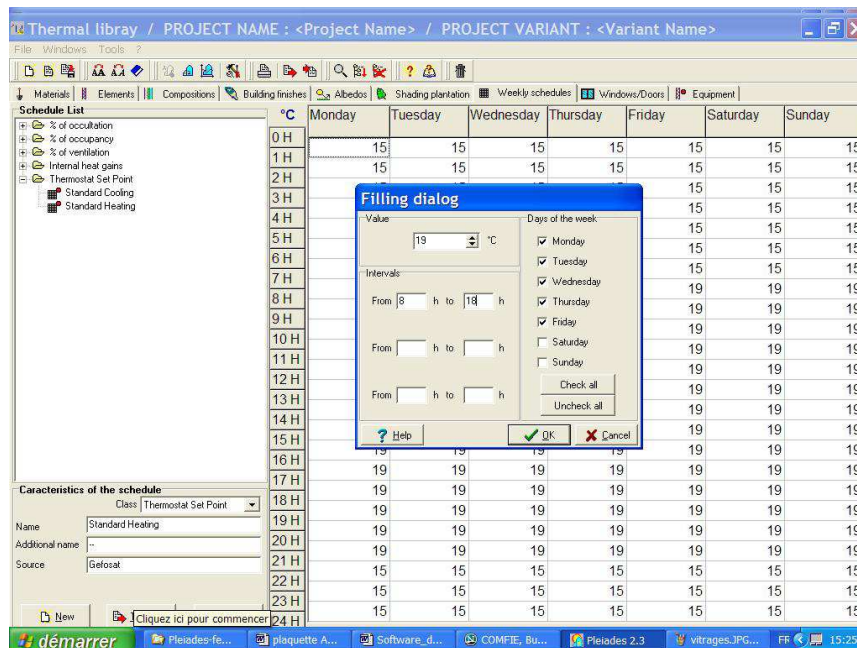

Other parameters can be defined: e.g. optical properties of surfaces, wind exposure, preheating of ventilation air, equipment and control, internal ventilation between zones etc.

The simulation time step is usually one hour to evaluate the heating demand and ¼ h to evaluate the cooling load or thermal comfort in summer and mid season.

Output

Heating load and energy saving

A simulation summary table gives the heating and cooling load, minimum, mean and maximum temperature in each zone. Different renovation measures can be compared. For instance, the following graph shows the heating load of an apartment building, expressed in kWh/m², in terms of the insulation thickness in walls and other parameters (glazing type, ventilation).

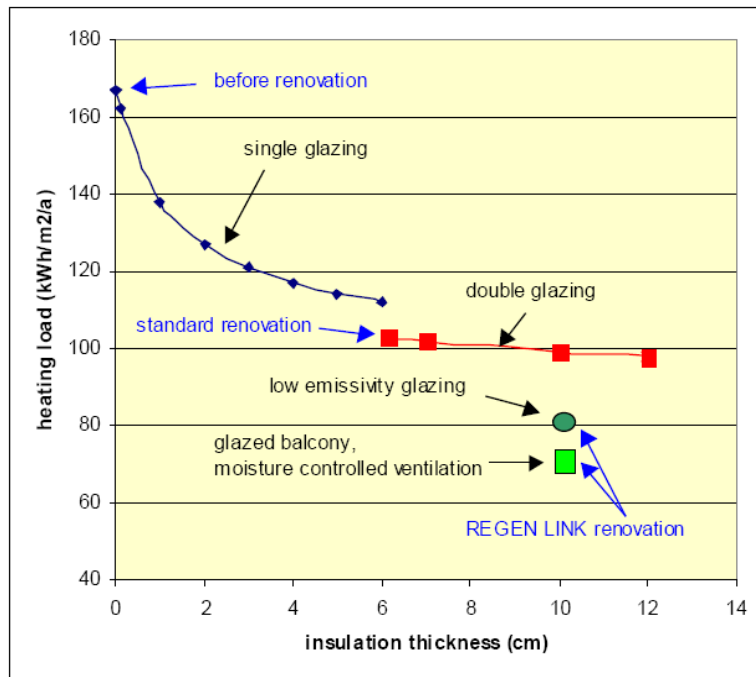

The heating load of the building before renovation is around 170 kWh/m². Implementing 6 cm insulation on the walls and replacing single glazing by double glazing reduces this load to around 100 kWh/m² (standard renovation). Adding 4 cm more insulation and using low emissivity glazing leads to 80 kWh/m² heating load, which can be further reduced thanks to a glazed balconies and moisture controlled ventilation (“Regen Link renovation”).

Thermal comfort and passive cooling

Temperature profiles can be obtained by choosing a period and zones to be displayed, see next graph.

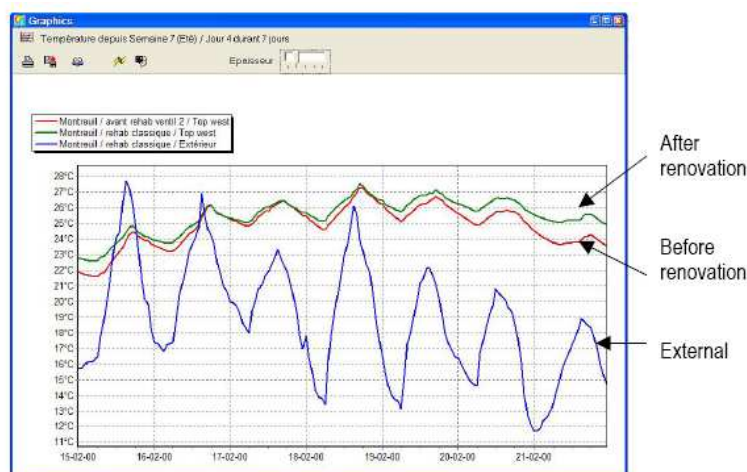

Histograms are convenient to assess globally the thermal comfort during a period: for each temperature T, such a graph shows the number of hours during which the zone temperature is T +/- 0.5°C.

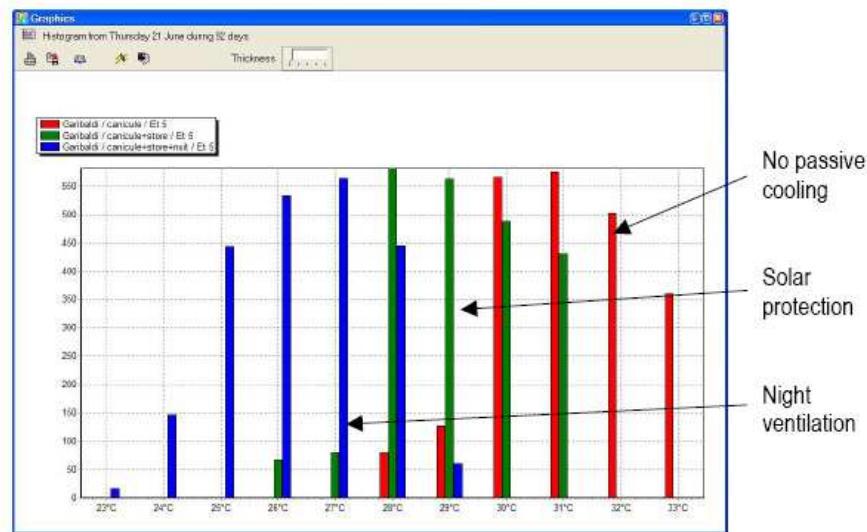

In the example graph above, the temperature rises above 30°C during around 2000 hours in a year without any passive cooling measure. The duration of the overheating period can be seen when solar protection is implemented (around 1000 hours above 30°C) and with night ventilation (temperature always lower than 30°C).

Sensitivity studies

Some parametric variations can be launched, e.g. choosing a composition (e.g. external wall), a material (e.g. insulation), giving the minimum thickness (e.g. 0 cm), maximum (e.g. 20) and step (e.g. 1 cm), 20 simulations are launched and the results can be compared on a graph.

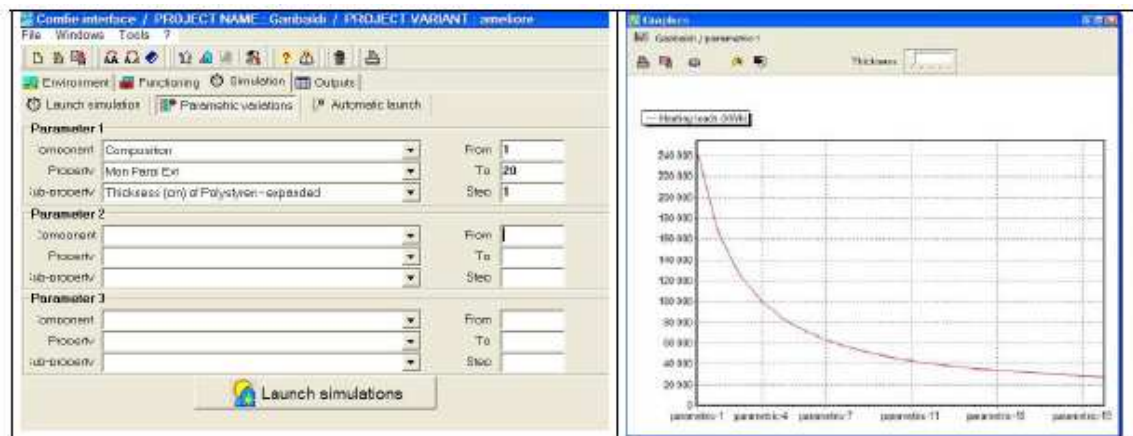

More information about the software and a free demonstration version can be downloaded from: www.izuba.fr (IZUBA)

Appendix D

The Calculation of emergy indices without recycling:

Local renewable sources (R)	= Note 1 + Note 2 = (6,19E + 11 + 2,95E + 10) = 6,49E + 11 seJ
Local nonrenewable sources (N)	= Sum (Note 3 to Note 65) = 7,0E + 16 seJ
Purchased resources and services (F)	= Sum (Note 66 to Note 70) = (1,96E + 13 + 1,78E + 11 + 1,28E + 10 + 2,19E + 09 + 1,82E + 09) = 1,98E + 13 seJ
Yield emergy flow (Y)	= Local renewable sources + Local nonrenewable sources + Purchased resources and services = 6,49E + 11 + 7,0E + 16 + 1,98E + 13 = 7,11E + 16 seJ
Economic Indices	
Emergy Yield Ratio (EYR)	= (Y/F) = 7,11E + 16 seJ ÷ 1,98E + 13 seJ = 3,59E + 03
Emergy Loading Ratio (ELR)	= (F+N)/R = (1,98E + 13 + 7,0E + 16) ÷ 6,49E + 11 = 1,08E + 05
Emergy Investment Ratio (EIR)	= F/(N+R) = 1,98E + 13 ÷ (7,0E + 16 + 6,49E + 11) = 2.83E - 04

The Calculation of emergy indices for the recycling option:

30% (q) of bricks recycled:

Additional emergy for recycling (O_c) = 1,81E+12 seJ (computed from Buranakarn, 1998)

$$O_c = O_{c_1} + O_{c_2} + O_{c_3} \quad (\text{subscripts: 1-purchased inputs; 2-renewable inputs; 3- nonrenewable inputs})$$

Initial emergy without recycling (O_i): $O_i = O_{i_1} + O_{i_2} + O_{i_3}$

Correction factor (ψ) can be defined for different number of times of recycle i.e. ψ_1 (1st recycle); ψ_2 (2nd recycle etc):

$$\psi_1: q = 0.30$$

$$\psi_2: q+q^2 = 0.39$$

$$\psi_3: q+q^2+q^3 = 0.417$$

$$\psi_4: q+q^2+q^3+q^4 = 0.425$$

$$\psi_5: q+q^2+q^3+q^4+q^5=0.427$$

$$\text{Emergy Yield ratio: } EYR_g = \frac{(O_{i_{1,2,3}} + \psi O_{c_{1,2,3}})}{(O_{i_1} + \psi O_{c_1})}$$

EYR _{1st}	3,5604E+03
EYR _{2nd}	3,5517E+03
EYR _{3rd}	3,5491E+03
EYR _{4th}	3,5483E+03
EYR _{5th}	3,5481E+03

With similar basis as above,

30% (q) of plastic recycled: $O_c = 4,52E+10$ seJ (computed from Buranakarn, 1998)

EYR _{1st}	3,5853E+03
EYR _{2nd}	3,5839E+03
EYR _{3rd}	3,5835E+03
EYR _{4th}	3,58340E+03
EYR _{5th}	3,58336E+03

30% (q) of concrete recycled: $O_c = 6,56E+12$ seJ (computed from Buranakarn, 1998)

EYR _{1st}	3,04E+03
EYR _{2nd}	2,91E+03
EYR _{3rd}	2,87E+03
EYR _{4th}	2,86E+03
EYR _{5th}	2,85E+03

Nana Ya Amponsah

Contribution à la théorie de l'éMergie: application au recyclage (Contribution to the emergy theory – application to recycling)

Résumé

Le développement continu d'outils pour mesurer le développement durable a conduit à la théorie éMergétique. L'éMergie d'une ressource ou d'un produit est définie en convertissant toutes les ressources (matières premières) et les entrées d'énergie sous la forme de leurs équivalents énergétiques solaires (solar energy unit seJ), cf Odum (1996, 2000).

L'objectif principal de cette thèse est d'adapter la méthode d'analyse éMergétique aux pratiques de recyclage industriel.

La principale contribution scientifique de cette étude peut être résumée comme suit : contribution à la théorie éMergétique en temps discret appliquée au recyclage. Sous certaines hypothèses, l'émergie d'un produit recyclé peut être exprimée sous la forme d'une série géométrique. L'éMergie d'un produit se détériorant, il existe un prix éMergétique au recyclage et une analogie avec l'énoncé de Carnot peut être faite. En conséquence, un nouveau «facteur» est introduit, ce dernier peut être inclus dans les tables d'évaluation éMergétique, pour tenir compte des accroissements de transformité dû aux recyclages multiples.

Enfin, l'approche développée est appliquée avec succès à l'utilisation de matériaux de recycle dans un bâtiment basse énergie.

Mots clés

Emergie, recyclage, déchets, transformité, durabilité

Abstract

The continuous development of tools to measure sustainability led to the eMergy theory. The Emergy of a resource or product is defined by converting all resource (raw materials) and energy inputs in the form of solar energy equivalents (solar energy unit, seJ), cf Odum (1996, 2000).

The main objective of this thesis is to adapt the method of emergy evaluation to industrial recycling practices.

The principal scientific contribution from the study can be summarized as : contribution to the eMergy theory in discrete time applied to recycling. Under certain assumptions, the emergy of a recycled product can be expressed in the form of a geometric series. If the emergy of a product deteriorates, there is a cost to the emergy of recycling with similarities to the Carnot principle. As a result, a 'factor' is introduced which could be included on emergy evaluation tables to reflect increases in transformity due to multiple recycling.

Finally, the developed approach is successfully applied to the use of recycle materials in a Low Energy Building.

Key Words

Emergy, recycle, wastes, transformity, sustainability