



HAL
open science

**Ecologie évolutive d'un genre d'acarien hématophage :
approche phylogénétique des délimitations
interspécifiques et caractérisation comparative des
populations de cinq espèces du genre *Dermanyssus*
(Acari: Mesostigmata)**

Roy Lise

► **To cite this version:**

Roy Lise. Ecologie évolutive d'un genre d'acarien hématophage : approche phylogénétique des délimitations interspécifiques et caractérisation comparative des populations de cinq espèces du genre *Dermanyssus* (Acari: Mesostigmata). Evolution [q-bio.PE]. INAPG (AgroParisTech), 2009. Français. NNT: AGPT N°0040 . tel-00661327

HAL Id: tel-00661327

<https://theses.hal.science/tel-00661327>

Submitted on 19 Jan 2012

HAL is a multi-disciplinary open access archive for the deposit and dissemination of scientific research documents, whether they are published or not. The documents may come from teaching and research institutions in France or abroad, or from public or private research centers.

L'archive ouverte pluridisciplinaire **HAL**, est destinée au dépôt et à la diffusion de documents scientifiques de niveau recherche, publiés ou non, émanant des établissements d'enseignement et de recherche français ou étrangers, des laboratoires publics ou privés.

THÈSE

pour obtenir le grade de

Docteur

de

**l'Institut des Sciences et Industries du Vivant et de l'Environnement
(Agro Paris Tech)**

Spécialité : Biologie de l'Evolution et Ecologie

*présentée et soutenue publiquement
par*

ROY Lise

le 11 septembre 2009

ÉCOLOGIE ÉVOLUTIVE D'UN GENRE D'ACARIEN HEMATOPHAGE :

**APPROCHE PHYLOGÉNÉTIQUE DES DÉLIMITATIONS INTERSPÉCIFIQUES ET CARACTÉRISATION
COMPARATIVE DES POPULATIONS DE CINQ ESPÈCES DU GENRE DERMANYSSUS (ACARI :
MESOSTIGMATA)**

Directeur de thèse : Claude Marie CHAUVE

Codirecteur de thèse : Thierry BURONFOSSE

*Travail réalisé : Ecole Nationale Vétérinaire de Lyon, Laboratoire de Parasitologie et Maladies
parasitaires, F-69280 Marcy-L'Etoile*

Devant le jury :

M. Jacques GUILLOT, PR, Ecole Nationale Vétérinaire de Maisons-Alfort (ENVA).....Président
M. Mark MARAUN, PD, J.F. Blumenbach Institute of Zoology and Anthropology.....Rapporteur
Mme Maria NAVAJAS, DR, Institut National de la Recherche Agronomique (INRA)..... Rapporteur
M. Roland ALLEMAND, CR, Centre national de la recherche scientifique (CNRS).....Examineur
M. Thierry BOURGOIN, PR, Muséum National d'Histoire Naturelle (MNHN)..... Examineur
M. Thierry BURONFOSSE, MC, Ecole Nationale Vétérinaire de Lyon (ENVL)..... Examineur
Mme Claude Marie CHAUVE, PR, Ecole Nationale Vétérinaire de Lyon (ENVL)..... Examineur

Résumé

Les acariens microprédateurs du genre *Dermanyssus* (espèces du groupe *gallinae*), inféodés aux oiseaux, représentent un modèle pour l'étude d'association lâche particulièrement intéressant : ces arthropodes aptères font partie intégrante du microécosystème du nid (repas de sang aussi rapide que celui du moustique) et leurs hôtes sont ailés. En outre, *D. gallinae* est une espèce d'importance économique, ce qui rend possible des comparaisons entre colonisation de milieux anthropisés et sauvages.

Au début de l'étude, les espèces du groupe *gallinae* sont très mal délimitées. Les caractères morphologiques utilisés sont variables au sein de l'espèce, voire de la population, très chevauchants entre espèces. Afin de mieux comprendre les exigences écologiques du développement de *D. gallinae* et d'appréhender ses voies de dissémination, une investigation comparative basée sur des séquences d'ADN entre espèces du groupe *gallinae* a été adoptée.

Un cheminement d'ordre taxinomique a permis de poser les bases nécessaires. Ensuite, l'exploration de certaines caractéristiques écologiques du groupe *gallinae* en relation avec sa phylogénie (spécificité d'hôte, flexibilité évolutive) a été menée à bien.

Une espèce a été décrite, *D. apodis*, une lignée de *D. gallinae* constitue aussi une probable espèce inédite et *D. longipes* regroupe deux entités. Des différences écologiques marquées entre *D. gallinae* et les autres espèces semblent résulter non seulement de l'activité humaine, mais aussi de caractéristiques intrinsèques. Aujourd'hui, le rôle des flux commerciaux dans la dispersion de *D. gallinae* en élevage de pondeuses s'avère primordial, au moins en France, celui des oiseaux sauvages presque nul.

Mots-clés

Système hôte-parasite, microprédateur, phylogénie, espèce, population, microhabitat, *Dermanyssus*, mésostigmate, acarien

Evolutionary ecology of a hematophagous mite genus: Phylogeny-based approach for interspecific delineations and comparative characterization of populations in five species of the genus *Dermanyssus* (Acari: Mesostigmata)

Abstract

Micropredator species of *Dermanyssus* (Moss'*gallinae*-group), which parasitize birds, represent an interesting model for the study of loose associations. Thus, these unwinged arthropods do not stay on host (blood meal as quick as mosquito's), are part of the nest's microecosystem and their hosts are winged. Moreover, micropredator *Dermanyssus* include at least one species of economic importance in fowl farms, *D. gallinae* (the Poultry Red Mite), which enables the comparison between species restricted to wild avifauna and synanthropic species.

At the beginning of the study, micropredator species are not clearly delimited. Most of species specific morphological characters are variable within species, in some cases within population, and are overlapping between species. In the aim to investigate the ecological needs for proliferation in *D. gallinae* and its ways for dispersal, a DNA-based comparative analysis involving this species and its close relatives has been performed. The first section consists of the clearing of the taxonomy and species delineations. In the second section, ecological and intrinsic data (host specificity, flexibility) are compared between species of the *gallinae*-group.

One species has been described (*D. apodis*), one lineage within *D. gallinae* seems to represent a cryptic species and *D. longipes* currently groups two different entities. Important ecological differences between *D. gallinae* and other species seem to result not only from human activities, but also from intrinsic characteristics. Currently, the role of trade flows in *D. gallinae*'s spread in layer farms appears to be essential, at least in France, as opposed to the role of wild birds (nearly nul).

Key words

Host-parasite system, micropredator, phylogeny, species, population, microhabitat, *Dermanyssus*, Mesostigmata, Acari

Remerciements

Je tiens à remercier du fond du cœur mes deux directeurs de thèse, à qui je dois, c'est certain, beaucoup plus qu'il n'est commun de devoir à ses directeurs de thèse.

Merci à Claude Chauve, pour le soutien et la confiance qu'elle m'a admirablement prodigués tout au long de cette thèse. Je ne sais comment exprimer ma reconnaissance et mon respect pour son courage et sa loyauté remarquables.

Merci à Thierry Buronfosse, pour le soutien, la confiance et la patience dont il m'a fait bénéficier au cours de cette thèse ! Nos continuelles oppositions, contradictions et confrontations ont sûrement été la clé du présent travail. Plus qu'un encadrant, c'est un collègue, voire un ami, que je crois avoir trouvé en lui, qui m'a soutenue et aidée au-delà de toute espérance. Et il a réussi à former une « prof. de Lettres » à la biologie moléculaire !

J'aimerais que cette thèse puisse constituer un remerciement suffisant à l'appui si solide, si bénéfique et sans cesse renouvelé dont ils ont tous deux fait preuve.

J'adresse mes vifs remerciements à Maria Navajas et Mark Maraun pour avoir accepté d'endosser l'important rôle de rapporteur.

Je remercie cordialement Roland Allemand, Thierry Bourgoïn et Jacques Guillot pour avoir accepté de prendre part au jury de cette thèse. Je remercie aussi les deux premiers pour leur suivi dans le cadre du comité de pilotage.

Merci à l'ensemble de mes collègues de travail, passés ou présents, en particulier mes collègues de laboratoire qui travaillent ou ont travaillé sur *Dermanyssus* : Claire Valiente Moro, Sophie Desloire, Marie-Thérèse Poirel. Une pensée émue à Marie-Claude Reynaud.

Merci à mes valeureux stagiaires, qui ont subi mon obsession du genre *Dermanyssus* au long de stages de durée variable, ont, pour la plupart, fourni un travail particulièrement satisfaisant et ont ainsi pleinement participé au travail de recherche que voici : Robin Bellon, Sandrine Bonnet, Jean Filippi, Mathieu Galès, Mehdi Gharbi, Nina Guichard, Guillaume Lallemand, Sophie Merlin, Sabrina El Quartiti, Anthony Piron, Marie Rigaux.

Merci à l'ensemble des personnes qui ont contribué à l'obtention des indispensables échantillons biologiques : Olivier et Nathalie Chovet, le Centre de Soins aux Oiseaux Sauvages du Lyonnais, notamment Pascal Tavernier, Mathilde, l'Ecopôle du Forez, notamment François Boléat, Claire Brucy, Pascal, ..., la Réserve du Romelëare, le Centre de Recherche sur la Biologie et les Populations d'Oiseaux, notamment Gérard Gory, Olivier Caparros, Laurent Brucy, Laurent Carrier, Nicolas Vincent-Martin, Yves Beauvallet, Olivier Dehorter, Franck Salmon, Rolf Wahl, J. Girard-Claudon, ... En particulier, merci à Olivier Caparros pour m'avoir accueillie au cours de ses passionnantes séances de baguage d'oiseaux sauvages, et m'avoir instruite quant à la biologie et les traits d'histoire de vie de ces animaux fascinants.

Merci à l'Association Ornithologique Rhodanienne, en particulier M. André Marchal et M. Marc Serre, pour m'avoir permis d'obtenir des échantillons provenant d'élevages de petits oiseaux de compagnie et/ou de compétition. J'adresse également mes sincères remerciements à M. Jean-Jacques Sage, président du Club Français du Montauban et M. S. Calabro, président de l'Amicale Ornithologique Becs Crochus Centre Est.

Merci à Christine Basset pour avoir pris le temps de m'accompagner et m'avoir ainsi si souvent permis d'entrer dans tous ces élevages de volailles en Bresse, pour sa sympathie et sa bonne volonté permanentes. Je remercie également le Dr Patrick Chabrol, Jérôme Arnal, ... , pour leur aide aux prélèvements dans les élevages de pondeuses.

Merci à Sophie Lubac pour son aide dans la collecte d'acariens provenant d'élevages de volailles et les informations concernant la filière pondeuse. Son implication, son soutien et son dynamisme ont fortement contribué à une bonne partie de l'étude.

Merci au PEP Avicole (Pôle d'Expérimentation et de Progrès, Région Rhône-Alpes) pour l'appui financier sans lequel l'étude, entamée au cours de cette thèse et prolongée au-delà, des voies de dissémination de l'acarien utilisant les outils de la génétique des populations n'aurait pas pu voir le jour.

Merci à Ashley P.G. Dowling pour sa remarquable participation aux travaux de phylogénie inclus dans cette thèse. Son ouverture d'esprit, sa réactivité et son enthousiasme ont accompagné et soutenu très efficacement l'élaboration de ce travail.

Merci à Jean-Charles Bouvier et Claire Lavigne pour leur précieuse et sympathique collaboration. En espérant qu'elle puisse être prolongée au-delà de ce travail de thèse.

Merci à Maurice Sabelis et Iza Lesna pour leur précieuse collaboration et pour m'avoir fait connaître leur passion de l'écologie des acariens.

Merci à l'ensemble de l'équipe de l'EURAAC pour son soutien précieux et l'invitation au congrès de l'été 2008 à Montpellier.

Merci à Joao Sollari Lopes pour ce début de collaboration prometteur dans le domaine de la génétique des populations.

Sommaire

<i>Résumé</i>	1
<i>Mots-clés</i>	1
<i>Abstract</i>	2
<i>Key words</i>	2
<i>Remerciements</i>	3
<i>Sommaire</i>	5
<i>Liste des publications constituant la thèse</i>	8
<i>Table des figures</i>	9
<i>Table des tables</i>	12
1 Avant-propos	14
1.1 Ecologie évolutive et démarche cladiste	14
1.2 Systèmes hôtes-parasites	15
a - Cas des ectoparasites	15
b - Microprédation et faible spécificité d'hôte, en lien avec l'essaimage	16
c - Difficultés dans l'appréhension des associations lâches	17
d - Intérêt de l'étude de systèmes microprédateur aptère / macroproie	18
1.3 Modèles microprédateur aptère / oiseau	19
2 Introduction	21
2.1 Contexte : le genre <i>Dermanyssus</i> et le groupe <i>gallinae</i>	21
a - Une espèce d'importance économique dans un genre méconnu	23
b - Impact direct sur l'hôte	24
c - Distribution	25
2.1.c.1 Spectre d'hôte	25
2.1.c.2 Répartition géographique	25
d - Reproduction	25
e - Particularités de la biologie des espèces du genre <i>Dermanyssus</i> en lien avec les difficultés de traitement rencontrées en élevage	28
2.1.e.1 Variabilité du temps de génération	28
2.1.e.2 Etroite relation avec le microenvironnement (nid, litière)	30
2.2 Problématique	31
2.3 Objectifs	33
2.4 Aperçu sommaire de l'étude : un débroussaillage en deux étapes	33
a - Structure du texte	33
b - Première étape (§4) : clarification de l'identité spécifique	33
c - Seconde étape (§5) : exploration écologique	34
3 Grandes lignes de la méthodologie adoptée	35
3.1 Matériel biologique : stratégie d'échantillonnage pour une représentation d'habitats variés	35
3.2 Marqueurs développés : utilisation concomitante de données morphologiques et moléculaires	35

3.3	Outils de la phylogénie et de la génétique des populations	36
4	<i>Taxinomie dans le genre Dermanyssus</i>	38
4.1	Synthèse historique : publication I	38
a -	Présentation	38
4.1.a.1	Objectifs	39
4.1.a.2	Principaux résultats	39
b -	Remarques sur la publication I	39
4.1.b.1	Nombre d'espèce augmenté (2008 et 2009)	39
c -	Publication I	40
d -	Erratum attachant à la publication I	52
II		
4.2	Evaluation des caractères morphologiques discriminants entre espèces : publication 53	
a -	Présentation	53
4.2.a.1	Objectifs	53
4.2.a.2	Matériel et méthodes	53
4.2.a.3	Principaux résultats	53
b -	Remarques sur la publication II	54
4.2.b.1	Des caractères réhabilités <i>a posteriori</i>	54
c -	Publication II	55
4.3	Délimitation des espèces par une approche complémentaire (« total evidence approach »): publication III	65
a -	Présentation	65
4.3.a.1	Objectifs	65
4.3.a.2	Matériel et méthodes	65
4.3.a.3	Principaux résultats	66
b -	Remarques sur la publication III	66
4.3.b.1	<i>D. longipes</i> : deux lignées différentes ?	66
4.3.b.2	Un marqueur moléculaire abandonné : EF1- α	67
4.3.b.3	<i>Liponyssoides</i> : genre introuvable ?	67
c -	Publication III	69
5	<i>Ecologie comparée des cinq espèces françaises du genre Dermanyssus</i>	94
5.1	Spécificité d'hôte chez cinq espèces du genre Dermanyssus : publication IV	94
a -	Présentation	94
5.1.a.1	Objectifs	94
5.1.a.2	Matériel et méthodes	94
5.1.a.3	Principaux résultats	94
b -	Remarques sur la publication IV	96
5.1.b.1	Données complémentaires sur la spécificité d'hôte chez <i>D. hirundinis</i> en France	96
c -	Publication IV	97
5.2	Diversité génétique et flux de populations chez quelques espèces du groupe gallinae : publication V	125
a -	Présentation	125
5.2.a.1	Objectifs	125
5.2.a.2	Matériel et méthodes	126
5.2.a.3	Principaux résultats	126
b -	Publication V (soumise)	131
5.3	Arthropodofaune de nids d'oiseaux en agroécosystème et implication des Dermanyssoidea hématophages : publication VI	211
a -	Présentation	211
5.3.a.1	Objectifs	211
5.3.a.2	Matériel et méthodes	212
5.3.a.3	Principaux résultats	212
b -	Publication VI (soumise)	214

6	<i>Discussion</i>	239
6.1	Relations phylogénétiques	239
	a - Des lacunes	239
	b - Topologies bifides ou en escalier ?	239
6.2	Etat de la taxinomie du genre <i>Dermanyssus</i>	240
6.3	Deux marqueurs complémentaires pour l'exploration intraspécifique	241
6.4	Patterns écologiques révélés	242
	a - Spécificité d'hôte	242
	6.4.a.1 Paramètres écologiques	242
	6.4.a.2 Paramètres intrinsèques	243
	b - Transition sauvage-synanthrope : hybridation et radiation chez <i>D. gallinae</i>	244
	c - Structure de populations	245
6.5	Du caractère invasif de <i>D. gallinae</i> et d'une espèce peut-être concurrente	246
7	<i>Conclusions et perspectives</i>	248
7.1	Conclusions sommaires	248
	a - Nouveautés taxinomiques	248
	b - Nouveautés écologiques	248
7.2	Perspectives	250
	a - Exploration des flux de populations au sein de l'espèce <i>D. gallinae</i>	250
	b - Espèces cryptiques	250
	c - Analyse moléculaire et morphologique de l'ensemble du genre <i>Dermanyssus</i>	250
	d - Cophylogénèse au niveau population	251
	e - Investigation de la situation symétrique entre <i>D. gallinae</i> et <i>O. sylviarum</i> en France et aux Etats-Unis	251
	f - Comparaison des valeurs de polymorphisme de séquences d'ADN nucléaires et mitochondriales entre espèces de microprédateurs aptères	251
8	<i>Lexique</i>	252
9	<i>Références bibliographiques</i>	252
10	<i>Annexes</i>	259
10.1	Annexe 1 : aperçu de la classification des Mesostigmata selon Hallan 2005	259
10.2	Annexe 2 : publications connexes	254
	a - Généralités sur <i>D. gallinae</i> et les problèmes engendrés en élevage	254
	b - Chimiorésistance vis-à-vis d'organophosphorés chez <i>D. gallinae</i>	294
	c - Participation à une publication sur une problématique de lutte biologique contre <i>D. gallinae</i>	295
10.3	Annexe 3 : numéros d'accès des séquences obtenues d'EF1-alpha et amorces correspondantes	296

Liste des publications constituant la thèse

La présente thèse repose sur les six articles dont voici les références. Chacune des publications apparaît, dans le document, isolée par un intercalaire de couleur.

Publication I : Roy L., Chauve C. M. (2007) Historical review of the genus *Dermanyssus* (Acari: Mesostigmata: Dermanyssidae). *Parasite* 14:87-100 (pp. 34-48 du présent document)

Publication II : Roy L., Chauve C. M. (*in press*) The genus *Dermanyssus* Dugès, 1834 (Acari : Mesostigmata : Dermanyssidae): species definition. Proceeding of the International Congress of Acarology, Amsterdam, August 2006, (*publication prévue dans Experimental and Applied Acarology*). (pp. 55-64)

Publication III : Roy L., Dowling A.P.G., Chauve C.M. and Buronfosse T. (2009) Delimiting species boundaries within *Dermanyssus* Dugès, 1834 (Acari: Mesostigmata) using a total evidence approach. *Molecular Phylogenetics and Evolution* 50:3:446-470 (pp. 69-93)

Publication IV : Roy L., Dowling, A.P.G., Chauve, C.M. Lesna I., Sabelis M.W. and Buronfosse, T. (2009) Molecular phylogenetic assessment of host range in five *Dermanyssus* species. *Experimental and Applied Acarology* 48: 115-142 (pp. 97-124)

Publication V : Roy L., Lopes J.S., Dowling A.P.G., Chauve C.M., Buronfosse T. (*soumis*). *Dermanyssus gallinae* (Acari: Mesostigmata) possesses characteristics of an invasive species, compared to four other *Dermanyssus* species. (*soumission le 17 juin 09 à Molecular Biology and Evolution*) (pp. 131-210)

Publication VI : Roy L., Bouvier J.C., Lavigne C., Galès M., Chauve C.M., Buronfosse T. (*soumis*) Arthropodofauna in bird nests as an indicator for agricultural practices' impact in pear and apple orchards. (*soumission le 26 juin 09 à Ecological indicators*) (pp. 214-241)

Table des figures

Corps du texte

Figure 1. Aperçu de la classification et de la composition du genre <i>Dermanyssus</i> au début de l'étude, selon Moss (1978).	21
Figure 2. Cycle de vie des espèces du groupe <i>gallinae</i>	23
Figure 3. Caractères permettant la séparation des stades/sexes chez <i>D. gallinae</i>	26-27
Figure 4. Agrégat de <i>D. gallinae</i> amassés au fond d'un angle de sachet plastique, en pleine lumière.	30
Figure 5. Chaetotaxie des pattes chez les acariens mésostigmates.	54
Figure 6. Reconstruction phylogénétique avec indication d'hôte et de milieu d'échantillonnage intégrant 73 isolats du groupe <i>gallinae</i> sur la base de la mt-Co1.....	95
Figure 7. Topologie finale retenue (consensus strict).....	128
Figure 8. Aperçu de la composition du genre <i>Dermanyssus</i> à l'issue de la présente étude.....	241

Publication I (les numéros de page renvoient à la numérotation de l'article lui-même)

Figure 1. Distribution map of non-gallinae species of <i>Dermanyssus</i>	88
Figure 2. Mouth parts of <i>D. gallinae</i>	89

Publication II

Figure 1. Dorsal shield of 10 from 20 randomly selected adult females of a cultured in lab population of <i>D. gallinae</i>	61
Figure 2. Relative length of peritrema according to position of coxae.	62
Figure 3. Peritrema (scanning electron microscope) in <i>D. gallinae</i>	63

Publication III (les numéros de page renvoient à la numérotation de l'article lui-même)

Figure 1. Strict consensus tree of 12 most parsimonious trees (L = 129, CI = 0.4264, RI = 0.6085) using matrix of 46 morphological characters.....451

Figure 2. Molecular combined analysis using 1570 bp from cytochrome oxidase subunit I, rRNA 16S and rRNA 18S-28S, including ITS1, 5.8S and ITS2.453

Figure 3. Total evidence analyses using 46 morphological characters and 1570 bp from cytochrome oxidase subunit I, rRNA 16S and rRNA 18S-28S, including ITS1, 5.8S and ITS 2.....454

Figure 4. Distribution of percentages of pairwise divergence among populations of the eight OTUs used in molecular analyses.....455

Figure 5. Bayesian analysis of the COI matrix, excluding 3rd positions of codons.455

Figure 6. *D. apodis n. sp.*.....459

Publication IV (les numéros de page renvoient à la numérotation de l'article lui-même)

Figure 1. Percentage of occurrence of *Dermanyssus* in nests of the five bird groups under test.126

Figure 2. Maximum Parsimony analysis (mt-Co1).128

Figure 3. Bayesian analysis (mt-Co1).129

Publication V

Figure 1. Overview of the distribution of variable elements along the studied Tropomyosin sequence (mutation points and insertion/deletion sites).....206

Figure 2. Haplotypes distribution according to the six ecological categories206

Figure 3. Amount of “pure synapomorphies”207

Figure 4. Haplotypic phylogenies obtained with mt-Co1 and Tropomyosin sequences.....207-210

Figure 5. Most supported topologies for the population genetics analysis using ABC methods.....210

Publication VI

Figure 1. Distribution of arthropod-rich, arthropod-poor and arthropod-free nests according to control conditions.....	236
Figure 2. Percentage of occurrence of arthropoda groups as defined in material and methods.	236
Figure 3. Average number of arthropodan groups in arthropod-rich or arthropod-poor nests.....	237
Figure 4. Number of nests containing one or several species belonging to the two hematophagous mite families isolated in present study according to control management.	237
Figure 5. Phylogenetic topology involving individuals of <i>D. gallinae</i> and <i>O. sylviarum</i> isolated in the framework of present study (sampled JBO _n), along with some individuals obtained from different environments and places.	238

Table des tables

Publication I (les numéros de page renvoient à la numérotation de l'article lui-même)

Table 1. Species included or previously included in <i>Dermanyssus</i> listed in chronological order with their present position/status.....	90-91
Table 2. List of species currently included in <i>Dermanyssus</i> and their known host species.....	93-95

Publication II

Table 1. Host diversity for <i>Dermanyssus</i> species (from literature data).	60
---	----

Publication III (les numéros de page renvoient à la numérotation de l'article lui-même)

Table 1. Taxonomic sampling and EMBL accession numbers for each sequence.....	449
Table 2. Primer sequences and key parameters for PCR conditions.	450
Table 3. Bootstrap (%) and relative Bremer support for monophyly of species with several populations and other groups in the three single genes analyses (maximum parsimony and bayesian).	456

Publication IV (les numéros de page renvoient à la numérotation de l'article lui-même)

Table 1. Description of restricted study areas (cf. § Matériel and Methods).	118-119
Table 2. Primer sequences.....	120
Table 3. Some data on development of 3 <i>Dermanyssus</i> species on canaries, obtained from long-time bioassays (referred to in text as comp1 and comp2).	121
Table 4. Engorgment and development of 3 <i>Dermanyssus</i> species compared using three host species and short-time bioassays (referred to in text as comp3 to comp7).	123-124
Table 5. Number of nests analysed per bird family and occurrence of genus <i>Dermanyssus</i> based and on present field data and on literature.	125

Publication V

Table 1. Primer sequences.....	166
Table 2. Evaluation of the three-times rule for species and other entities of <i>Dermanyssus</i> under test.....	166
Table 3. Pairwise Fst estimates between <i>D. gallinae</i> focused isolates and between specific datasets, corresponding P values and associated Nm for both nuclear and mitochondrial loci.....	167
Table 4. Computer simulations of coalescent process (DnaSP v5) given the number of segregating sites S, assuming an intermediate level of recombination R=10 for Tropomyosin amplicon and no recombination for COI amplicon (confidence interval =95%).....	168
Table 5. Estimates of modes and 95% credible intervals for the considered demographic parameter for the <i>D. gallinae</i> groups with different host types (case I, popABC).....	169
Table 6. Estimates of modes and 95% credible intervals for the considered demographic parameter for the <i>D. gallinae</i> populations in different geographical locations (case II, popABC).	169
Table 7. Estimates of modes and 95% credible intervals for the considered demographic parameter for the <i>Dermanyssus</i> species (case III, popABC).	170
Table 8. Genotypic and heterozygosity variability in focused isolates for Tropomyosin exon n, intron n and exon n+1.	170

Publication VI

Table 1. Species detected in the four focused recurrent primary groups.	235
Table 2. Number of species within Coleoptera and Mesostigmata in arthropod-rich and arthropod-poor nests sampled in 2007.	235

1 Avant-propos

1.1 *Écologie évolutive et démarche cladiste*

L'écologie évolutive, s'étend dans le champ de deux disciplines, la biologie évolutive et l'écologie. Elle étudie à la fois les influences historiques et contemporaines sur les patrons de variabilité observés et ce à tous les niveaux, depuis l'individu jusqu'aux communautés d'espèces ou grands groupes taxinomiques. Par excellence transdisciplinaire, elle fait usage d'outils variés, associe modélisations mathématiques de problèmes biologiques et approche expérimentale et représente une approche intégrée des interactions entre les gènes, les individus, les populations et l'environnement. S'attachant à prendre en compte les contingences historiques pour tester des hypothèses adaptatives, elle vise à apporter des éléments clés pour une meilleure compréhension de l'importance des processus à l'origine des patrons de variabilité observés à différents niveaux dans les systèmes biologiques.

La cladistique (du grec *klados*, branche) mettant à profit les analyses phylogénétiques pour l'appréhension de patrons écologiques, est une des facettes de l'écologie évolutive moderne. Reconstruire une histoire des relations phylogénétiques sur la base de données morphologiques, moléculaires, biochimiques, etc. permet, *a posteriori*, d'établir le scénario évolutif de tel ou tel aspect plus ou moins intimement lié aux taxa cibles. Quelle que soit la nature des caractères utilisés, le recours aux algorithmes phylogénétiques, qu'ils reposent sur le critère du maximum de parcimonie, du maximum de vraisemblance ou utilisent les méthodes bayésiennes, permet une appréhension raisonnée, et la plus objective possible, des relations évolutives entre lesdits taxa, indépendamment du questionnement initial. Ainsi, *a posteriori*, au vu des topologies retenues par ces méthodes objectives, des motifs évolutifs peuvent émerger, après un travail de mise en relation d'informations extérieures à l'arborescence avec les relations figurées par les branches à différents niveaux dans l'arbre retenu.

Ces informations peuvent être des caractères intrinsèques des taxa mêmes, tels des caractères morphologiques, des mutations sur une séquence d'ADN donnée, des traits d'histoire de vie. Dans ce cas, on établit un scénario évolutif desdits taxa. Par exemple, l'observation de l'arbre retenu avec examen des états de certains caractères morphologiques aux différents nœuds de l'arbre permet d'observer leur évolution depuis l'ancêtre commun (racine), jusqu'aux taxa étudiés (feuilles), en passant par les ancêtres communs internes (nœuds).

Des informations plus indirectement liées aux taxa cibles peuvent être corrélées aux arbres obtenus, telles le type d'habitat, la localisation géographique, etc. Des corrélations entre information historique et constat écologique contemporain plus ou moins attendues se dessinent. Les taxa groupés dans un clade donné peuvent s'avérer inféodés à un type d'habitat commun, différent de celui des autres clades, et signer un fait évolutif de nature écologique particulier. Ou encore, une absence de corrélation peut être mise à jour.

La démarche se déroule en deux étapes majeures : (1) la collecte et le traitement phylogénétique des données, (2) la mise en relation des données obtenues sur la base d'une matrice rigide avec des données différentes, plus ou moins dispersées. La première étape, à visée fondamentalement objective, est gérée par des algorithmes. La seconde étape, en revanche, n'est pas automatisable, tout au moins pas complètement. Elle repose sur la capacité à mettre en lien, en réseau, des informations éparses, qu'*a priori* rien ne lie nécessairement, et des topologies phylogénétiques. Convergence, réversion, dérivation successive d'états multiples apparaissent grâce à l'examen de la disposition des informations disponibles en fonction des clades sur

l'arborescence retenue. L'effort d'interconnexion entre les données écologiques, géographiques ou comportementales et l'histoire mise à jour par les relations de parenté permet la révélation de patrons de variabilité.

1.2 Systèmes hôtes-parasites

L'histoire d'associations biologiques peut être observée de cette manière, telles des associations proie-prédateur, hôte-parasite, hôte-symbiote, ... Les systèmes hôte-parasite en particulier constituent des modèles d'étude de l'écologie évolutive exemplaires. En effet, l'association plus ou moins étroite entre le parasite et son hôte, induisant des contraintes évolutives importantes, offre un vaste terrain pour l'étude des phénomènes adaptatifs. La conjonction de particularités intrinsèques de l'hôte comme du parasite et des caractéristiques écologiques de l'hôte (habitat, habitudes) et du parasite permet à ce système d'exploitation de durer. Ainsi Morand et Sorci (1988) ont-ils démontré, en comparant des nématodes parasites avec des nématodes libres, que, dans la plupart des cas, pour les parasites, l'évolution des traits d'histoire de vie est directement dépendante de caractéristiques de l'hôte.

a - Cas des ectoparasites

Les ectoparasites en particulier offrent une diversité dans le degré d'association avec l'hôte tout à fait remarquable (spécificité d'hôte, relations avec environnement de l'hôte). Certains sont aussi intimement liés à leur hôte que la plupart des endoparasites, montrant un haut niveau de spécialisation (ex. les poux mallophages parasitant des rongeurs du genre *Geomys* ; Page et Hafner 1996). D'autres, moins spécifiques, manifestent des liens un peu plus lâches (ex. les puces du genre *Pulex*, parasitant des mammifères aussi divers que l'homme, le renard, le blaireau, le hérisson...). Les degrés de spécificité sont variables entre groupes de haut niveau taxinomique, mais aussi parfois entre espèces proches (Desdevises *et al.* 2002, Price *et al.* 2003).

Les habitudes et traits d'histoire de vie sont ainsi très divers parmi les ectoparasites, certains accomplissant toutes les étapes de leur développement directement sur l'hôte, d'autres passant certains de leurs stades sur l'hôte, les autres dans l'environnement. Les poux mallophages, ectoparasites d'oiseaux ou de mammifères, les trématodes monogènes, ectoparasites de poissons, sont des exemples d'ectoparasites au développement complet sur l'hôte. Chez la plupart des puces (Siphonaptera : Pulicidae, Ceratophyllidae), en revanche, le stade adulte demeure sur l'hôte, mais les œufs sont généralement pondus dans le milieu extérieur où les larves et nymphes se développent ensuite. Les femelles adultes des puces chiques (Siphonaptera : Tungidae) pondent directement sur l'hôte, mais les œufs tombent au sol.

Chez certains arthropodes hématophages, des liens très lâches avec l'hôte et des habitudes alimentaires non strictement parasites tout au long du cycle de vie les rendent difficilement qualifiables de parasites. Chez les moustiques, par exemple, les femelles adultes sont hématophages, tandis que les mâles et les stades juvéniles ont des habitudes complètement différentes (se nourrissant respectivement de nectar et autres liquides sucrés, et de microorganismes aquatiques). Ces femelles adultes sont des microprédateurs, prédateurs qui ne prélèvent qu'une petite portion de tissu de leur hôte. Les arthropodes hématophages pourraient ainsi être classés soit parmi les ectoparasites typiques, soit parmi les microprédateurs.

Une telle distinction doit-elle être associée à la constance de leur statut de consommateur tout au long leur vie (hématophage/non hématophage) ou à la proportion de leur cycle passée directement sur l'hôte ? Quoi qu'il en soit, comme chaque fois que l'on cherche à classer quelque chose dans des catégories, des cas limites viennent brouiller les frontières. Les puces, dont les œufs, larves et nymphes se développent dans l'environnement, évoquent fortement des

microprédateurs, mais elles demeurent sur l'hôte au stade adulte. Les punaises de lit tendraient à être classées parmi les microprédateurs, car elles ne requièrent pas plus de temps que les femelles de moustique pour prélever leur repas de sang, et, elles aussi, quittent leur hôte immédiatement après, mais tous leurs stades sont hématophages. Et il en est de même pour les dermanysse ou poux rouges des poules (Acari : Mesostigmata : *Dermanyssus*), ainsi que pour les tiques molles (Acari : Ixodida : Argasidae). Ectoparasites typiques ou microprédateurs ?

Une réflexion quant à ces catégories présente un intérêt non négligeable pour l'interprétation écologique des histoires évolutives d'ectoparasites. Mais plutôt qu'à une durée de contact, donnée continue et par trop relative, Kuris et Lafferty (2000) attribuent une importance au nombre d'individus hôtes parasités/prédats par stade chez le parasite. En effet, dans le cadre d'une réflexion quant aux catégories de consommateurs en général, ils mettent en avant la corrélation entre le degré d'association avec l'hôte et l'attachement de l'individu parasite à l'individu hôte. Cet attachement à l'individu hôte/proie est en quelque sorte inversement proportionnel au nombre d'individus ponctionnés par un seul parasite à un stade donné. Les femelles adultes du moustique, par exemple, peuvent piquer plusieurs individus hôtes différents, et ne demeurent pas attachées à un seul. Cela les rapproche des prédateurs, qui se nourrissent successivement de différentes proies. Si l'on compare des arthropodes hématophages, les microprédateurs sont par excellence plus indépendants que les ectoparasites typiques vis-à-vis de leur hôte et beaucoup plus impliqués dans les environnements extérieurs à l'hôte.

b - Microprédation et faible spécificité d'hôte, en lien avec l'essaimage

L'indifférence augmentée du microprédateur quant à l'identité individuelle de sa macroproie oriente par excellence ce type de consommateur vers un plus large spectre d'hôtes. Price (1975) démontre l'extrême réduction du spectre des espèces consommées chez les insectes parasites (tant végétaux qu'animaux) si l'on compare aux insectes prédateurs. Intermédiaire entre l'ectoparasite typique et le prédateur, le microprédateur hématophage est indifférent ou presque à l'individu qu'il ponctionne, et ainsi plus à même de changer d'espèce d'hôte que l'ectoparasite typique. Et sa mobilité propre tend par conséquent à jouer un rôle dans l'ampleur du spectre de ses hôtes. Chez les parasites typiques, les transferts d'hôte à hôte au sein de la même espèce sont fréquents (contagion). Certes, certains cycles parasitaires impliquent des hôtes intermédiaires (cycles hétéroxènes, ex. la grande douve *Fasciola hepatica*), mais, si ces hôtes peuvent être très distants phylogénétiquement entre eux (ex. mammifère – mollusque dans le cas de la grande douve), ils appartiennent à un système écologique fermé. Dans les systèmes microprédateur - macroproie, les frontières écologiques sont par excellence plus ténues.

La définition des microprédateurs par Kuris et Lafferty (2000) s'applique là encore non seulement aux consommateurs se nourrissant de tissus animaux, mais aussi aux consommateurs se nourrissant de tissus végétaux. Chez de nombreux pucerons, un cycle complexe alterne générations à reproduction parthénogénétique aptères avec générations à reproduction sexuée aptes à essaimer (sur un individu de la même espèce de plante hôte ou d'une autre espèce), des générations parthénogénétiques pouvant aussi être ailées et participer à l'essaimage chez certaines espèces. Chez *Myzus persicae* par exemple, un puceron d'une génération parthénogénétique aptère, demeurant sur une seule et même plante hôte (individu) ponctionne les liquides d'un seul individu tout au long de sa vie et se comporte en parasite typique. Les individus ailés (virginipares ou sexupares) sont voués à l'essaimage et présentent les caractéristiques des microprédateurs. Ce sont ces microprédateurs qui permettent la dissémination des populations.

Chez les hématophages, les femelles adultes ont en général besoin de repas de sang pour la maturation de leurs œufs (Prasad 1987). Ce qui semble différencier en premier lieu la femelle adulte microprédatrice des moustiques (Diptera : Culicidae) par exemple de celle d'ectoparasites

typiques, comme les poux anoploures (« poux piqueurs » ; ex. *Pediculus hominis*), c'est la capacité pour un individu donné à prélever indifféremment des repas sanguins successifs chez plusieurs hôtes différents pour la réalisation des cycles gonotrophiques*. Là aussi, les mœurs microprédatrices s'accompagnent d'une capacité de dissémination augmentée, de colonisation d'aires géographiques nouvelles, mais aussi d'hôtes différents.

Certains microprédateurs hématophages sont aptères et sont, de ce fait, beaucoup moins mobiles. Ainsi la femelle adulte de la punaise de lit ponctionne-t-elle aussi le sang de différents individus, mais, non ailée, elle demeure confinée dans un périmètre plus restreint. Son spectre d'hôtes demeure cependant assez large (*Cimex lectularius* homme, rongeurs, chiroptères, oiseaux). Or on sait qu'elle peut être transportée entre autres par les personnes avec leurs effets personnels (vêtements, valises, ...) (Reinhardt & Siva-Jothy 2007).

Les tiques dures semblent représenter un cas particulier, s'attachant solidement à l'hôte pour la réalisation d'un seul long repas, mais se laissant tomber pour pondre ensuite dans l'environnement. La femelle adulte de la plupart des tiques dures ne fait qu'un seul repas de sang, mais l'ampleur du prélèvement semble contrebalancer l'absence d'itération (Prasad 1987). Le repas, d'une durée moyenne de 43 jours chez *Ixodes scapularis* par exemple (Troughton et Levin 2007) induit une extension du corps de l'acarien de plus de 100 fois son volume initial et permet l'accomplissement de sa ponte unique. Un repas interrompu peut très difficilement être continué sur un autre individu hôte, même de la même espèce. D'une manière générale, un repas de sang interrompu quel que soit le stade chez les tiques est difficilement repris et mène souvent à la mort (ex. chez *Dermacentor variabilis* ; Amin et Sonenshine 1969). Le caractère unique du repas de sang chez la femelle adulte rend la distinction microprédateur/ectoparasite malaisée suivant la définition de Kuris et Lafferty (2000). Toutefois, son implication dans l'environnement la rapproche des microprédateurs. Quant à la plupart des puces (Siphonaptera : Ctenocephalidae, ...), aptères par nature, et bien que le stade adulte demeure souvent longtemps sur l'hôte, pouvant aller jusqu'à se fixer solidement (Tungidae), elles présentent une biologie relativement proche de celle des moustiques. En effet, les larves ne sont pas hématophages (saprophages) et le développement complet de l'individu se déroule dans l'environnement.

c - Difficultés dans l'appréhension des associations lâches

Les couples hôte-parasite typique, hôte-endosymbiote, par l'étroitesse de leur association, impliquent par excellence des contraintes adaptatives telles qu'ils représentent souvent des cas d'école et que des règles très strictes peuvent en être tirées (ex. le cas des gauphres à poches du genre *Geomys* et de leurs poux mallophages ; Page et Hafner 1996). La spécificité d'hôte chez ces organismes est par conséquent très élevée en général, intégrant de fréquents événements de coévolution dans l'histoire de leur association. A tel point, d'ailleurs, que certains auteurs en viennent à considérer la phylogénie des uns comme patron pour reconstruire celle de autres (ex. Verneau *et al.* 2002).

Mais, dans les cas d'associations plus lâches, telle celle du microprédateur avec ses macroproies, au spectre d'hôtes par excellence élargi, et dans lesquelles le rôle de l'environnement extérieur à l'hôte est important, la régularité des processus adaptatifs et des patrons de variabilité a des chances d'apparaître bouleversée. Non seulement la complexité des interactions au sein de systèmes de ce type rend leur investigation déconcertante, mais encore les outils développés pour les reconstructions cophylogénétiques sont d'utilisation délicate dans le cadre de systèmes lâches. La réconciliation d'arbres de parasites associés à des hôtes multiples demeure par excellence malaisée. C'est d'ailleurs sans doute ce qui prévaut au conflit Dowling vs Page et Charleston (Dowling 2002, Page et Charleston 2002, Brooks *et al.* 2004) quant aux modèles les plus appropriés pour l'exploration de la cophylogénèse entre un parasite et son hôte. Le premier,

spécialiste des Dermanyssoidea, vaste groupe d'acariens principalement prédateurs, dont plusieurs lignées indépendantes semblent avoir évolué vers le parasitisme hématophage, de type principalement microprédateur, malgré quelques exceptions (Dowling 2006a, b), ne peut s'accommoder des mêmes outils que les seconds, spécialistes d'insectes parasites typiques (poux mallophages). Pour Page et Charleston, la réconciliation entre l'arbre des hôtes et l'arbre des parasites se doit de favoriser le plus grand nombre d'événements de coévolution. Pour Dowling, le critère du maximum de coévolution tendant à induire beaucoup de bruit dans une analyse intégrant des acariens aux mœurs plutôt prédatrices - et par conséquent plus opportunistes que les ectoparasites typiques - pose problème. Les événements les plus récurrents sont en effet probablement les transferts d'un hôte/proie à un autre, événements très difficiles à gérer s'ils ne se limitent pas à apparaître occasionnellement. Banks et Paterton (2005), explorant les difficultés d'investigation des systèmes hôte-parasite en cas d'hôtes multiples, remarquent que la plupart des études de cophylogénèse entre taxon hôte et taxon parasite traitent de parasites très spécifiques, arguant de la difficulté des reconstructions cophylogénétiques entre hôte et parasite à hôtes multiples.

d - Intérêt de l'étude de systèmes microprédateur aptère / macroproie

L'étude d'associations entre consommateurs au spectre large et leur cible est pourtant d'un grand intérêt, puisqu'elle permet l'appréhension de processus adaptatifs complexes entre paramètres biotiques et abiotiques extrêmement divers. Le degré de mobilité intrinsèque du microprédateur vient contraindre son attachement à l'environnement de l'hôte. Les systèmes microprédateur aptères / macroproies fournissent un matériel d'étude particulièrement intéressant, car intermédiaires entre systèmes hôte / ectoparasites typiques et systèmes prédateurs / proies : l'impact de l'environnement est probablement plus important que chez l'ectoparasite typique, mais des contraintes locales (microenvironnementales) peuvent jouer un rôle et contraindre l'association si l'on compare avec les microprédateurs ailés.

La nature isolée des populations de parasites typiques fait que la dispersion est, si ce n'est très réduite, au moins étroitement corrélée à celle de l'hôte (ex. Blouin *et al.* 1995). La structuration spatiale des populations de microprédateurs, ou tout au moins des arthropodes hématophages accomplissant leur développement dans l'environnement, est potentiellement très différente de celle des parasites typiques. Et elle est nécessairement très différente entre un arthropode ailé et un arthropode aptère. La capacité intrinsèque de dispersion d'un microprédateur ailé peut être très importante. Gorrochotegui-Escalante *et al.* (2000) montrent par exemple un isolement à partir de distances de 90-250 kilomètres chez le moustique *Aedes aegypti*. Les microprédateurs aptères tels les punaises de lit s'éloignent de l'hôte à la différence des ectoparasites typiques (séjournant à quelques mètres de distance de l'hôte), mais leur capacité de dispersion intrinsèque est nécessairement très réduite comparée aux insectes ailés. Ce sont précisément ces deux compétences combinées qui permettent à la police scientifique d'utiliser le sang contenu dans les punaises de lit comme indice dans certaines enquêtes judiciaires (Szalanski *et al.* 2006).

Les populations d'ectoparasites typiques tendent vers une structuration spatiale concordant avec celle de l'hôte, alors que celle des microprédateurs ailés est marquée par des caractéristiques macroenvironnementales (climat, paysage) (ex : Paupy *et al.* 2005). Qu'en est-il de microprédateurs à mobilité plus réduite ? Inaptes à couvrir des distances importantes par leurs propres moyens, et *a priori* moins enclins à voyager sur l'hôte, ils pourraient être paradoxalement les moins mobiles des trois catégories. Ils présentent d'ailleurs souvent une capacité de résistance au jeûne élevée, leur permettant de survivre dans un environnement déserté et d'attendre le retour

ou la venue d'une macroproie (jusqu'à 9 mois chez *D. gallinae*, selon Nordenfors *et al.* 1999, six à douze mois chez *Cimex lectularius* selon Koehler *et al.* 2008). Les puces et les tiques dures, dont la station sur l'hôte est relativement élevée constituent des modèles intermédiaires entre ectoparasites typiques et microprédateurs aptères. En effet, les jours voire semaines nécessaires au gorgement complet des femelles adultes dans le genre *Ixodes*, la station sur l'hôte des puces adultes du genre *Ctenocephalides* par exemple augmente sensiblement la probabilité du transport par l'hôte au cours d'un de ses déplacements. Ces espèces sont aussi douées de capacité importante de résistance au jeûne, à différents stades de leur développement. Les systèmes microprédateur aptère – macroproie représentent des modèles fondamentalement différents des systèmes ectoparasite typique / hôte et des systèmes microprédateur ailé / macroproie. Leur implication dans le microécosystème de l'environnement de l'hôte en fait des modèles de grand intérêt pour l'exploration des interactions au sein d'une association *a priori* relativement lâche entre les deux organismes, mais potentiellement étroite entre le microprédateur et le microécosystème de l'environnement de la macroproie.

Combes (2000) définit deux filtres génétiques primordiaux. Ces deux filtres représentent les caractéristiques impliquées (1) dans la rencontre entre parasite et hôte potentiel, (2) dans la compatibilité post-rencontre (nécessaire à la durabilité du système). L'étude de processus liés aux relations de descendance au sein d'un taxon microprédateur aptère et des contraintes évolutives afférentes au microécosystème du nid laisse envisager une meilleure compréhension de phénomènes adaptatifs complexes, à une échelle dépassant celle du seul hôte. Les deux filtres de Combes sont, chez les microprédateurs aptères, en prise avec des paramètres plus distants de l'hôte que chez l'ectoparasite typique. Complémentaire d'études portant sur des ectoparasites plus typiques, elle pourrait apporter de précieuses indications quant au rôle de paramètres abiotiques, ou à celui de la composition des communautés d'organismes très apparentés au parasite (arthropodes). C'est ainsi, par exemple, que *Cimex lectularius*, la punaise de lit la plus connue, semble avoir échappé à un goulot d'étranglement génétique, qui caractérise pourtant des parasites typiques, plus exposés aux pesticides dans les années 1940-50 aux Etats-Unis, selon Szalanski *et al.* (2008).

1.3 Modèles microprédateur aptère / oiseau

A l'instar des punaises de lit, les femelles adultes de plusieurs espèces du genre *Dermanyssus* (Acari : Mesostigmata) sont microprédatrices. Principalement inféodés aux oiseaux, ces acariens constituent un intéressant modèle d'association microprédateur/macroproie. En effet, composante importante de l'arthropodofaune des nids d'oiseaux, ils sont souvent recensés dans ces îlots aux communautés d'arthropodes souvent riches et variables en fonction de l'espèce d'oiseau (Zeman and Jurík 1981, Burt *et al.* 1991, Fend'a and Schniererová 2004, Nosek and Lichard 1962, Fain and Galloway 1993, Majka *et al.* 2006, Merkl *et al.* 2004...). En outre, le caractère ailé de l'hôte, ses habitudes migratrices éventuelles pourraient contribuer à la dissémination plus large du microprédateur aptère, en cas d'utilisation de l'hôte comme véhicule.

A l'heure actuelle, peu d'études ont porté sur la spécificité d'hôte et les voies de dissémination des populations de microprédateurs aptères inféodés à des hôtes ailés. La principale est celle menée par McCoy et coll. depuis plusieurs années sur les populations d'*I. uriae*, tique dure parasitant des oiseaux. McCoy (2001) et McCoy *et al.* (2003) ont montré l'impact de la biologie de l'hôte sur la différenciation entre populations chez cette tique d'oiseaux. Le modèle de cette étude étant une tique dure, c'est-à-dire aux habitudes hématophages strictes, quel que soit le stade, comme les espèces du genre *Dermanyssus*, mais dont la durée de la station sur l'hôte est nettement accrue, il est possible que l'impact des mouvements de l'hôte soit plus important que chez la plupart des dermanysse. Par ailleurs, l'environnement strictement naturel des hôtes de ces

tiques dans l'étude sus-citée (oiseaux marins, nichant dans des aires strictement naturelles) ne permet pas d'incriminer quelque action humaine que ce soit. Cela permet une analyse de la structuration des populations d'un microprédateur aptère inféodé à un hôte ailé hors de toute action humaine. L'omniprésence du genre *Dermanyssus* dans l'avifaune sauvage, ainsi que l'existence au sein des espèces du genre *Dermanyssus* d'au moins une espèce d'importance économique en font un modèle complémentaire fort intéressant. Il permet en effet l'investigation comparative de populations de microprédateurs aptères inféodés à des hôtes ailés en milieu sauvage et anthropisé. Cela laisse espérer non seulement des éclairages quant aux contraintes présidant à l'évolution d'associations relativement lâches, mais encore une meilleure compréhension de l'impact de l'activité humaine sur des associations plus ou moins liées à l'homme.

2 Introduction

La classification des oiseaux suivie ici est celle de Peterson (2007).

2.1 Contexte : le genre *Dermanyssus* et le groupe *gallinae*

Le genre *Dermanyssus* Dugès, 1834 (Acari: Mesostigmata: Dermanyssoidea: Dermanyssidae – cf. Annexe 1) regroupe des espèces hématophages ectoparasites d'oiseaux. Il est au début de la présente étude composé de 23 espèces décrites et a été divisé en deux sous-genres renfermant trois groupes par Moss (1968, 1978 ; cf. Fig. 1) : le sous-genre *Dermanyssus* scindé en 2 groupes (groupe *gallinae* -14 espèces - et groupe *hirsutus* – 4 espèces) et le sous-genre *Microdermanyssus* (5 espèces).

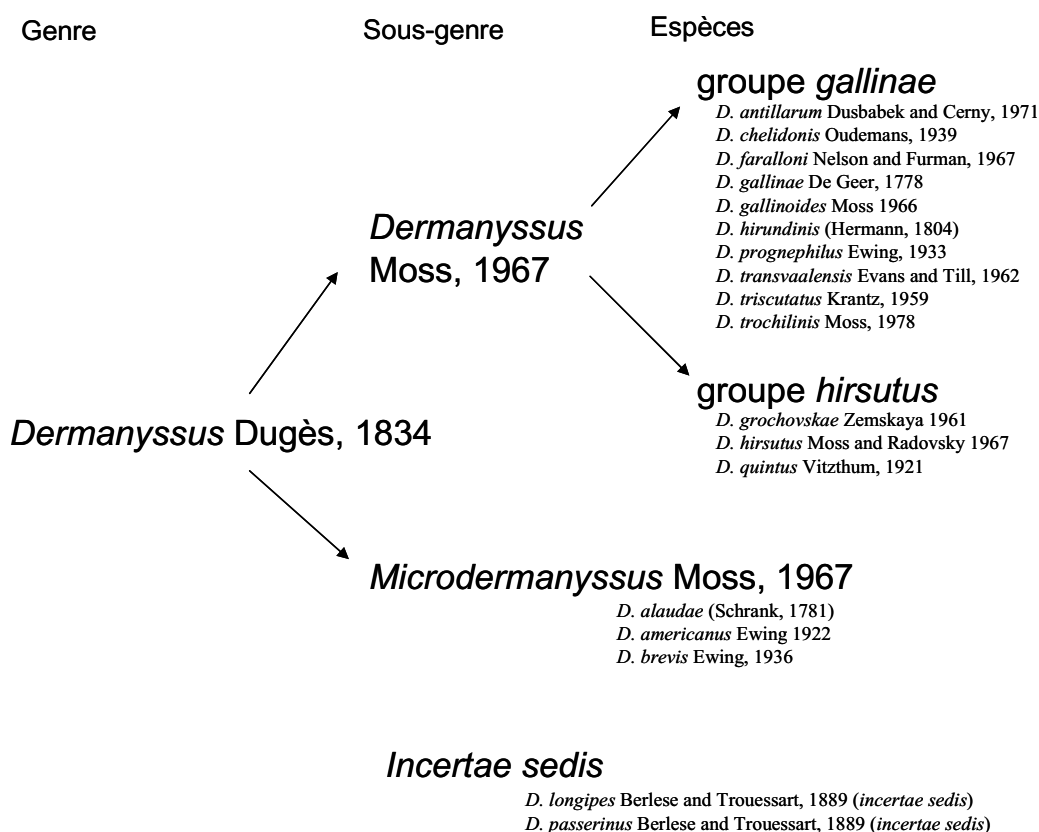

Figure 1. Aperçu de la classification et de la composition du genre *Dermanyssus* au début de l'étude, selon Moss (1978).

Les espèces du groupe *gallinae* sont douées d'une réelle capacité de gorgement – avec extension importante des organes digestifs et de l'opisthosome*¹ - qui leur permet de prélever en quelques minutes un repas de sang suffisant pour accomplir une métamorphose ou une ponte, selon le stade concerné (Radovsky 1994). Leur cycle de vie comporte cinq stades (cf. Fig. 2) : oeuf, larve, protonympe, deutonympe et adulte. Seuls les trois derniers ont besoin de se nourrir de sang, les protonymphes et deutonymphes pour accomplir leur métamorphose (un repas chacune

¹ La définition des mots suivis d'un astérisque (*) est consultable dans le lexique, en fin de document (p. 255).

seulement), les femelles adultes avant chaque ponte pour la maturation de leurs œufs (cycles gonotrophiques*). La biologie des autres espèces (groupe *hirsutus* du sous-genre *Dermanyssus* et sous-genre *Microdermanyssus*) a été peu étudiée. Toutefois, plusieurs éléments de la littérature laissent penser que les **espèces du groupe *hirsutus***, dont la morphologie est plus adaptée à l'agrippement qu'à la course (pattes massives et courtes), tout au moins certaines d'entre elles, ont des habitudes plus caractéristiques des parasites typiques, tels les poux, par exemple, qui passent leur vie sur l'hôte. Ainsi, *D. grochovskae* et *D. quintus* demeurent sur l'hôte, pondent directement dans ses plumes et ne présentent pas à proprement parler de capacité de gorgement. Leurs repas sont de faible ampleur et répétés au cours d'un même stade nymphal (Moss 1978). Les espèces du sous-genre *Microdermanyssus* présentent peut-être une biologie intermédiaire, nidicole durant la période de nidification de l'hôte, stationnant sur l'hôte durant les périodes hivernales : Zemaskaya (1968) et Zemskaya et Iliencko (1958) signalent la présence en nombre bien plus important d'individus appartenant à *D. americanus*, accompagnés d'œufs, sur l'hôte en hiver qu'au cours de la nidification. Zemskaya (1971) estime, sur la base d'observations portant sur deux espèces du groupe *hirsutus*, deux du groupe *gallinae* et une du sous-genre *Microdermanyssus* qu'une transition depuis le mode de vie nidicole vers le mode parasite permanent (parasite typique) est manifeste dans le genre *Dermanyssus*. Toutefois ce qui permet d'orienter le sens d'évolution (du groupe *gallinae* vers les autres groupes) n'apparaît pas clairement, aucune analyse phylogénétique ne venant étayer ce sens.

En bref, au sein du genre *Dermanyssus*, **les espèces du groupe *gallinae*** ont un mode de vie relativement déconcertant si l'on compare à celui de la majorité des parasites connus et aux deux autres groupes du même genre. A vrai dire, si l'on considère les femelles adultes au moins dans le groupe *gallinae*, elles se comportent **davantage en microprédateurs qu'en parasites typiques** : ponctionnant du sang avant chaque ponte à plusieurs reprises au cours de leur vie, elles ne se nourrissent pas nécessairement sur le même individu, à l'instar des femelles adultes de moustiques ou des punaises des lits. Cela correspond aux caractéristiques des microprédateurs, partagées par les moustiques, les punaises hématophages, et d'autres animaux zoologiquement très différents comme les sangsues, si l'on se réfère aux catégories des consommateurs de Kuris et Lafferty (2000).



Figure 2. Cycle de vie des espèces du groupe *gallinae*.

a - Une espèce d'importance économique dans un genre méconnu

D. gallinae, improprement nommé communément pou rouge des poules, est connu pour ses **dégâts majeurs en élevage de poules pondeuses**, entraînant d'importantes pertes économiques. Cette espèce **sévit dans les élevages principalement en Europe** et induit problèmes sanitaires et pertes financières (cf. plus-bas § 2.1b -). Sa prévalence est forte en Europe : environ 80% des élevages sont infestés en France. Elle est en outre croissante en Amérique du Sud (Tucci *et al.* 2008). Les élevages d'Amérique du Nord semblent en être exempts, ou presque, pour l'heure (B. Mullens, comm. pers., Phillis *et al.* 1976). Dans cette région du monde, une espèce appartenant à une famille apparentée semble occuper cette niche : *Ornithonyssus sylviarum* (Canestrini and Fanzago, 1877) (Dermanysoidea: Macronyssidae) (Axtell and Arends 1990, Mullens *et al.* 2001). Mais le mode de vie de cette espèce est plus proche de l'ectoparasite typique que du microprédateur, car, tout au moins chez les volailles d'élevages (Mullens *et al.* 2001) et chez les canaris (observation personnelle), les individus passent le plus clair de leur temps sur l'hôte et pondent directement dans le plumage. Cela suggère qu'en fait les deux espèces d'importance économique occupent deux niches chevauchantes, si ce n'est différentes.

D'une manière générale, peu d'études ont porté sur le genre *Dermanyssus*, tant sur le plan taxinomique qu'écologique. Or les déprédations non négligeables causées par au moins l'une des espèces qui le composent, ainsi que les difficultés de traitement associées suscitent aujourd'hui une certaine **mobilisation dans les institutions et universités touchant aux sciences vétérinaires en Europe**. Ainsi, de nombreux essais à visée appliquée sur l'espèce *D. gallinae* sont publiés régulièrement et connaissent un essor notoire depuis 2005 : 1-3 publications par an avec quelques rares pics à 4, 5 ou 6 jusqu'à 2004, puis 6 en 2005, 6 en 2006, 12 en 2007, 16 en 2008, 21 en 2009 (PubMed (NCBI), mot-clé "*Dermanyssus*"). Ces publications portent pour la plupart sur des essais de sensibilité à diverses molécules de synthèse et huiles essentielles (ex: Beugnet *et al.* 1997, Todisco *et al.* 2008). Certaines traitent aussi de contraintes environnementales liées au cycle de vie

(Nordenfors *et al.* 1999, Tucci *et al.* 2008), de travaux immunologiques à visée vaccinale (Nisbet *et al.* 2006, Wright *et al.* 2009), ainsi que du rôle vecteur vis-à-vis de pathogènes (Valiente Moro *et al.* 2005, 2007). Enfin, une équipe danoise travaille sur les stimuli présidant aux déplacements de l'acarien (Kilpinen 2001, 2005).

Mais aucune étude n'a clairement défini préalablement l'espèce cible. Malgré les dégâts engendrés en élevage avicole par *D. gallinae*, la **classification du genre *Dermanyssus* au niveau spécifique** est restée **très confuse**. Alors que sa description date de 1833, ce n'est qu'à partir des années 1960 que quelques auteurs ont commencé à réviser le genre. Une discussion constructive entre Krantz et Sheals sous forme d'articles (1959-1962) commença à clarifier la définition du genre, tout au moins vis-à-vis des autres genres apparentés. Evans et Till publièrent en 1962 la première révision complète du genre au niveau spécifique. Moss commença en 1967 un travail d'investigation des relations entre les espèces au sein du genre mettant à profit une approche phénétique. Son travail apporta de précieux éléments, avec des subdivisions internes (sous-genres *Microdermanyssus* et *Dermanyssus*, ce dernier incluant les groupes *gallinae* et *hirsutus*), mais demeura inachevé, sa dernière publication (Moss 1978) concluant davantage sur des expectatives (une étude annoncée comme en cours) que des clarifications. Moss (1978) insista aussi beaucoup sur l'extrême variabilité des caractères morphologiques au sein d'une même population et mit vivement en garde les utilisateurs de sa clé dichotomique contre les risques importants d'erreur. Enfin, avant la présente étude, le genre n'avait fait l'objet d'aucune reconstruction phylogénétique prenant en compte des caractères moléculaires. La délimitation interspécifique demeure donc peu claire, en particulier dans le groupe *gallinae sensu Moss* (1978).

b - Impact direct sur l'hôte

L'impact de *D. gallinae* sur son hôte **dans les élevages de volaille**, est relativement important. Il induit le déclassement des œufs tachés par les acariens écrasés (cf. Annexe 2a) et est potentiellement capable de transmettre des agents pathogènes : protozoaires (Lainson 1960), bactéries et/ou virus pathogènes (Valiente Moro *et al.* 2005, 2007, 2009). En outre, perturbant le sommeil des poules, il génère du stress, qui se traduit entre autres par une baisse du rendement (augmentation de la consommation d'aliment non accompagnée d'une augmentation de la production), une détérioration du plumage par augmentation du lissage des plumes (Kilpinen 1999, Kilpinen *et al.* 2005). Lors d'infestations massives, une chute de la ponte, une perte de poids et une augmentation de la mortalité peuvent apparaître rapidement (Kilpinen *et al.* 2005). A plus long terme, une modification des valeurs de certains paramètres sanguins a pu être notée dans certains cas, témoignant probablement d'une anémie régénérative (Kirkwood 1967, Keçeci *et al.* 2004). Au laboratoire, nous avons pu constater à plusieurs reprises la mort en une nuit par exsanguination de jeunes poulets (âgés de 3 à 15 jours) placés au contact d'aggrégats importants de *D. gallinae*. Dans la **faune sauvage**, Clayton et Tompkins (1994, 1995) ont montré qu'une prolifération de *D. gallinae* pouvait induire une réduction notable du temps de couvain des œufs et avoir un effet délétère important sur le succès de la reproduction du pigeon biset (*Columbia livia*: Columbidae).

Seules deux autres espèces de *Dermanyssus* ont fait l'objet d'études traitant de leur impact sur l'hôte : Moss et Camin (1970) ont démontré que les nids d'hirondelle noire (*Progne subis*: Hirundinidae) parasités par *D. prognephilus* produisaient des **poussins moins lourds** que les nids non parasités. En revanche, **l'impact de *D. hirundinis*** sur le troglodyte familial (*Troglodytes aedon*: Certhiidae) **n'a pas encore pu être clairement mis en évidence** (Johnson et Albrecht, 1993; Pacejka *et al.* 1996, 1998). Il semblerait que l'impact de *D. hirundinis*, tout au moins chez le troglodyte familial, soit moins flagrant que celui de *D. gallinae* chez la poule et chez le pigeon biset ou que celui de *D. prognephilus* chez l'hirondelle noire.

c - Distribution

2.1.c.1 Spectre d'hôte

La **spécificité d'hôte** des espèces du genre *Dermanyssus* était, au début du présent travail, **réputée très faible** dans la majorité des espèces. Notamment, plus de 40 espèces d'oiseaux réparties dans 8 ordres différents ont pu être recensées comme hôtes pour la seule espèce *D. hirundinis* (Hermann, 1804) et plus de 30 espèces d'oiseaux réparties dans 6 ordres différents pour *D. gallinae* (De Geer, 1778). *D. prognepphilus* Ewing, 1933 était répertorié chez 2 familles de Passériformes et 1 de Piciformes. Seules certaines espèces telles *D. quintus* Vitzthum, 1921, *D. hirsutus* Moss & Radovsky, 1967, *D. alaudae* (Schrank, 1781), étaient connues pour ne parasiter qu'une seule famille d'oiseau (respectivement Picidae, Picidae, Alaudidae). Pour d'autres, rencontrées trop rarement jusqu'à présent, l'ampleur du spectre d'hôtes est très difficile à évaluer (*D. wutaiensis* Gu et Ting, 1992 et *D. brevivulus* Gu et Ting, 1992, de *D. grochovskae* Zenskaya, 1961, *D. antillarum* Dusbabek & Cerny, 1971, *D. trochilinis* Moss, 1978, *D. rwandae* Fain, 1993, *D. nipponensis* Uchikawa et Kitaoka, 1981, ...).

2.1.c.2 Répartition géographique

Outre une large répartition dans la taxinomie des oiseaux, plusieurs espèces du genre *Dermanyssus*, aussi bien dans le groupe *hirsutus* que dans le groupe *gallinae* présentent aussi une **large répartition géographique**. *D. quintus* est recensé en Europe (Vitzthum, 1921), en Russie (Zenskaya 1971), en Amérique du Nord (Moss *et al.* 1970). *D. hirundinis* est abondamment signalée dans différents pays d'Europe (Zeman et Jurík 1981, Fend'a et Schniererová 2004, 2005, Evans et Till 1966, ...) et en Amérique du Nord (Moss *et al.* 1970, ...). ***D. gallinae*, seule espèce du genre *Dermanyssus* connue pour parasiter les volailles domestiques**, est cosmopolite, recensé aussi bien dans le Nouveau Monde que dans l'Ancien monde, aussi bien dans la faune sauvage (FS) qu'en élevage (E) : **Amérique du Nord** : Moss *et al.* 1970 (FS), **Amérique du Sud** : Tucci *et al.* 2008 (E), **Europe** : Rép. Tchèque, Zeman et Jurík 1981 (FS), Slovaquie, Fend'a et Schniererová 2004, 2005 (FS), Royaume Uni, Guy *et al.* 2004 (E), Royaume Uni, Italie, Pays-Bas, ... Sparagano *et al.* 2009 (E), **Afrique** (Maroc, Sahibi et Rhalem 2007; Egypte, El Kady *et al.* 1995 (E)), **Asie** (Israël, Rosen *et al.* 2002 (E, FS), Turquie, Kececi *et al.* 2004 (E)), Chine (Gu et Ting 1992), Japon (Uchikawa et Takahashi 1985 (FS)). Certaines espèces sont notées dans une seule localité/région, mais il s'agit dans la plupart des cas d'espèces rencontrées ponctuellement (1-3 collectes en tout, dans la même région, à la même période). C'est le cas de *D. wutaiensis* et *D. brevivulus* (Chine), *D. antillarum* (Cuba), *D. trochilinis* (Pérou), *D. rwandae* (Rwanda), *D. nipponensis* (Japon). Dans la plupart de ces cas, l'endémisme est peu probable, l'aire de répartition demeurant obscure par manque de données. *D. grochovskae*, décrit en Russie a aussi été rencontré au Japon (Uchikawa et Takahashi 1985). *D. carpathicus* Zeman, 1979, jusqu'alors noté uniquement en République Tchèque, le pays type, a d'ailleurs été isolée à de nombreuses reprises dans des nids collectés en France dans la présente étude. *D. americanus* Ewing, 1923 est peut-être réellement inféodé à l'Amérique du Nord (Ewing 1923, Phillis 1972).

d - Reproduction

Le mode de reproduction est dans le genre *Dermanyssus* difficile à explorer, du fait (1°) de son hématophagie stricte avec nécessité de piquer à travers une membrane et de stimuli alimentaires encore mal maîtrisés et (2°) de la faible différenciation morphologique entre les stades / sexes hors préparation microscopique, c'est-à-dire sur individus vivants.

1°) Les difficultés de la nutrition *in vitro* rendent les explorations individuelles très difficiles, un individu pouvant très difficilement être amené au stade adulte avec conservation

assurée de la virginité, afin de tester la parthénogenèse et de réaliser des accouplements contrôlés. Pour l'heure, les essais de gorgement individuels *in vitro* comme *in vivo* n'ont pas encore permis le développement d'un individu isolé jusqu'au stade adulte et ne permettent actuellement que le développement de groupes d'individus (ex : Valiente Moro 2007, McDevitt *et al.* 2006, expérience personnelle).

2°) En outre, le sexage d'individus vivants est très difficile, même à la loupe binoculaire, les caractères sexuels n'apparaissant clairement qu'après préparation microscopique (orifice spermatique et spermadactyle chez le mâle adulte, rabat de l'ovipore chez la femelle adulte, notamment). Un éclairage très rasant à un fort grossissement à la loupe binoculaire peut permettre la séparation de stades et sexes par observation des plaques ventrales et dorsales chez les plus grosses espèces, comme *D. gallinae*, mais la vivacité de ces acariens rend l'opération très délicate sur individus vivants. En outre, si cette méthode permet sans trop d'échec la distinction entre mâles et femelles (plaques ventrales et dorsales beaucoup plus développées chez le mâle ; fig. 3), la discrimination entre femelles adultes et deutonymphes demeure très délicate. En effet, les plaques dorsales étant identiques, il faut réussir à percevoir le rabat de l'ovipore propre à la femelle adulte (plaque ventrale entière chez la deutonymphe, scindée en la très mince plaque sternale à l'avant et la plaque épigynale à l'arrière, séparées par le rabat fripé de l'ovipore chez la femelle adulte ; fig. 3). C'est pourquoi peu d'études expérimentales ont été menées sur cet aspect.

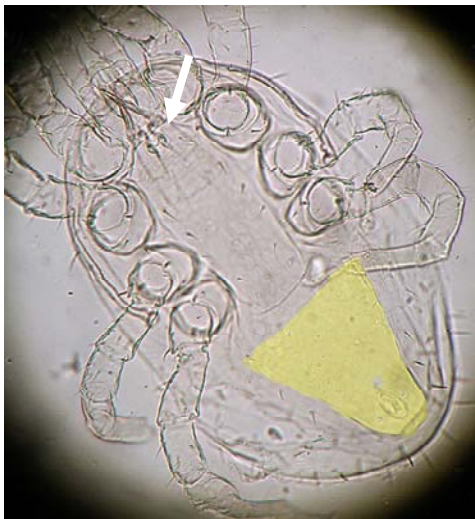

A.

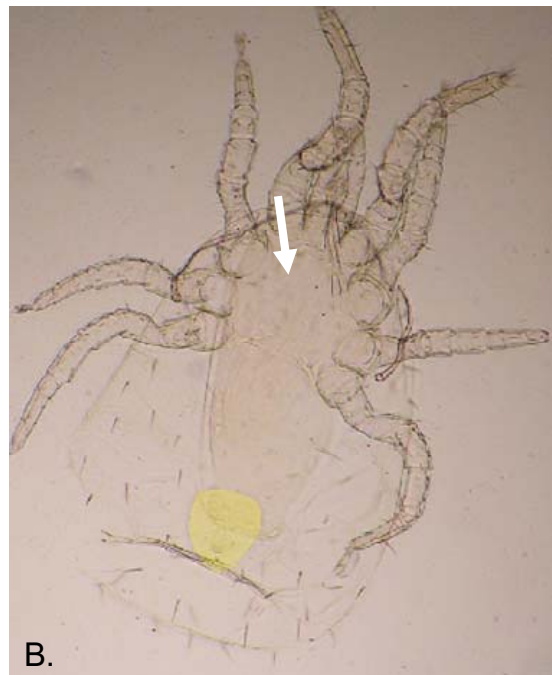

B.

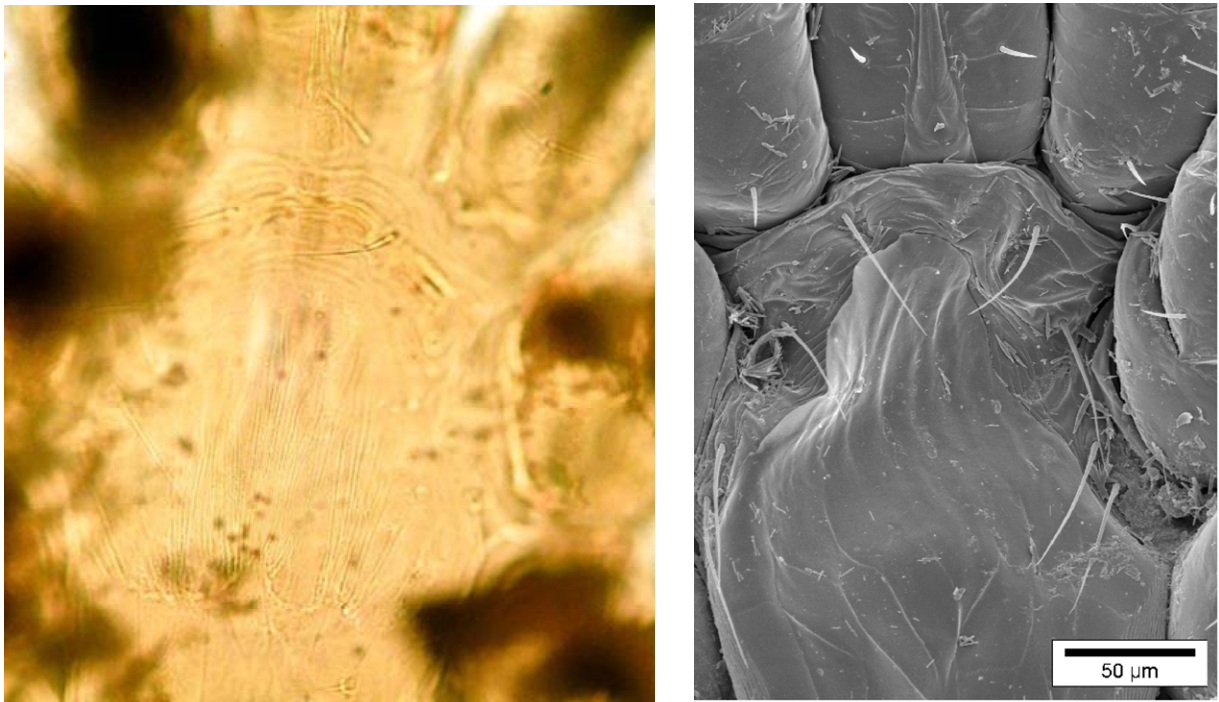

C.

Figure 3. Caractères permettant la séparation des stades/sexes chez *D. gallinae*. A. Caractères sexuels primaires et secondaires d'un mâle adulte visibles en microscopie photonique. La flèche blanche désigne l'orifice spermatique du mâle. Les contours de la plaque anale, surlignée en jaune, peuvent être aperçus à la loupe binoculaire, avec un éclairage rasant. B. Caractère sexuel secondaire d'une femelle adulte. La flèche blanche indique l'emplacement de l'ovipore (cf. D). Surlignage en jaune : plaque anale, cf. ci-dessus. C. Caractère sexuel primaire d'une femelle adulte vu en microscopie photonique (à gauche) et électronique à balayage (à droite) : rabat de l'ovipore.

Les principaux auteurs qui ont étudié la reproduction chez *Dermanyssus* (et apparentés) sont Oliver et Hutcheson (Oliver 1966, 1977, Hutcheson et Oliver 1988). Ils ont développé un sexage relativement efficace par observation au « microscope à dissection » des plaques ventrales sur des individus maintenus dans des tubes en verre (difficulté n°1 ci-dessus). Ils ne décrivent pas avec beaucoup de précision ce qu'ils observent², mais on peut penser que pour le discernement entre deutonymphe et femelle adulte, outre l'observation des plaques, ils renaient simplement le critère taille (femelles = les plus grosses). Ils ont en outre partiellement résolu la difficulté n° 2 ci-dessus en partant du principe que les deutonymphes séparées du reste de la population testée juste après le repas préalable à la mue imaginale n'avaient pas pu être fécondées. Ils procédaient au nourrissage des acariens en groupe sur jeunes poulets. En bref, il ressort des études d'Oliver et Hutcheson que chez *D. gallinae* (1) les œufs qui donneront naissance à des mâles sont non fécondés et haploïdes, (2) que les œufs qui donneront naissance à des femelles sont fécondés et diploïdes, (3) que l'accouplement (pas la fécondation) et le gorgement (jusqu'à un point minimum critique) sont des préalables nécessaires à l'oviposition, (4) qu'un seul accouplement suffit pour

² Par exemple, selon Hutcheson & Oliver (1988) « The sex of unfed adults was determined detecting presence or absence of the female genital plate as viewed through a 19 by 48-mm glass vial with a dissecting microscope ». On peut supposer que la « plaque génitale » observée est en fait le rabat membraneux de l'ovipore, la plaque épigyniale étant similaire à la plaque ventrale des deutonymphes. Mais il s'agit sans doute en fait des individus les plus gros, présélectionnés sur leur taille, sur lesquels il recherchait la plaque épigyniale de la femelle, par opposition à la plaque holoventrale du mâle. Toutefois, les mâles, naturellement plus petits que les femelles, peuvent ressembler aux deutonymphes.

féconder les œufs femelles de toutes les pontes d'une seule femelle, (5) mais que les œufs fécondés le sont rapidement après l'accouplement, et demeurent stockés tels quels. Ainsi, apparemment, les spermatozoïdes eux-mêmes ne sont pas stockés comme chez de nombreux arthropodes équipés de spermathèques (ex. cigales), ceux qui n'ont pas fécondé d'œuf disparaissant en quelques jours (>50j in Oliver 1966, <2j in Hutcheson et Oliver 1988). Dans le genre *Dermanyssus*, Oliver et coll ont réalisé des expérimentations sur la reproduction chez *D. gallinae* seulement. Ils ont toutefois aussi vérifié l'haplodiploïdie chez *D. prognephilus*.

Il apparaît donc, selon Oliver et Hutcheson, que *D. gallinae* est arrhénotoque*. Même si l'accouplement est nécessaire à l'induction de l'oviposition, il s'agit là de pseudogamie, les œufs mâles demeurant non fécondés.

La question de la pseudoarrhénotoquie* (nommée aussi para-haploïdie), toutefois, a été soulevée par Dotson (1982). Cette petite étude menée dans le cadre d'un mémoire de master n'a pas permis de mettre en évidence de pseudoarrhénotoquie. Elle a par ailleurs fait apparaître une augmentation constante du nombre d'œufs au fil des cycles gonotrophiques*. Oliver (1966) avait noté une augmentation jusqu'au 6^{ème} cycle, mais une décroissance aux 7^{ème} et 8^{ème}. Dotson (1982) relève aussi une évolution du sexe ratio au fil des pontes (premières pontes seulement mâles, dernières seulement femelles, intermédiaires mixtes), mais cela n'a pas été vérifié ni confirmé par une publication.

Quant à la supposée pseudoarrhénotoquie, l'inférence phylogénétique de Cruickschank et Thomas (1999) sur la base de l'ADNr 28S, visant à appréhender l'évolution de la ploïdie au sein des *Dermanyssina* sur la base de 10 taxa spécifiques tend à confirmer aussi le statut arrhénotoque expérimentalement déjà mis en évidence par Oliver et Hutcheson et non invalidé par Dotson (1982).

Le sexe chez *D. gallinae* semble donc simplement déterminé par la fécondation ou non de l'œuf, comme chez de nombreux autres arthropodes, tels les abeilles. Cela est en outre probablement le cas chez les autres espèces du genre, puisque les autres espèces testées de diverses familles de *Dermanyssina* se sont avérées arrhénotoques aussi (Oliver 1966, 1977).

Enfin, la fécondité individuelle de l'acarien, si l'on compare à d'autres acariens (voire à d'autres arthropodes) déprédateurs, est relativement faible. Une femelle adulte peut réaliser jusqu'à 8 cycles gonotrophiques* (Wood 1917) au cours de sa vie, durant lesquels elle peut pondre 1 à 8 œufs, pour un total moyen de 23 œufs (Oliver 1966) vs plusieurs milliers à plusieurs dizaines de milliers d'œufs par femelle chez certaines tiques (une seule ponte par femelle), 82 à 439 œufs par femelle chez *Cimex rotundatus* (Dunn 1924) ou 60 à 200 œufs par ponte chez les moustiques (Anderson & Harrington 2009).

e - Particularités de la biologie des espèces du genre *Dermanyssus* en lien avec les difficultés de traitement rencontrées en élevage

2.1.e.1 Variabilité du temps de génération

Malgré sa faible fécondité, *D. gallinae* parvient à **envahir rapidement des élevages** de manière plus ou moins délétère. La rapidité du cycle vient contrecarrer la taille réduite des pontes. En effet, en conditions optimales de température, hygrométrie et disponibilité d'hôte (généralement réalisées dans les élevages de volailles), **l'acarien peut accomplir une génération complète d'œuf à œuf en une semaine**. Nordenfors & Hoglund (2000) ont montré entre autres qu'une fois l'acarien détecté dans un élevage (méthode de piégeage standardisé), il lui fallait en moyenne 5 mois pour atteindre un niveau de population à l'équilibre, envahissant la totalité de l'élevage en Suède. Ce délai de plusieurs mois entre le début de l'infestation et le pic de

prolifération est l'une des raisons de la quasi-absence de problèmes engendrés par ledit pou rouge en élevages industriels de chair (bandes* de quelques semaines, entre 2 vides* sanitaires). Mais une fois l'équilibre atteint, et même un peu avant (à partir d'une infestation moyenne de 150000 à 200000 acariens par poule), l'impact sur les poules peut devenir important, allant jusqu'à perte de poids, anémie, voire augmentation significative de la mortalité (Kilpinen *et al.* 2005). Meyer-Kühling *et al.* (2007) ont aussi noté une augmentation de 400% en 42 jours d'une population de *D. gallinae* dans un bâtiment témoin (exempt de traitement) d'un élevage de poules en Allemagne.

Le temps de génération est donc rapide en conditions d'élevage. **Entre deux bandes et dans la faune sauvage**, toutefois, des **pauses** plus ou moins longues sont à signaler. En effet, en l'absence de tout hôte, *D. gallinae* peut survivre assez longtemps. Mais son développement complet (larve à adulte) requérant absolument 2 (chez le mâle) à 10 (chez la femelle réalisant le maximum de cycles gonotrophiques*) repas de sang par individu (selon le sexe, cf. Annexe 2a), la survie en condition de jeûne n'est marquée par aucune génération. Sa **résistance au jeûne est importante** et varie en fonction de la température et de l'hygrométrie relative. Des expérimentations de laboratoire ont mesuré cette capacité à survivre dans des conditions adverses (Wood 1917, Nordenfors *et al.* 1999). Protonymphes et deutonymphes, mâles adultes et femelles non encore gorgés peuvent survivre sans nourriture durant plusieurs mois (jusqu'à 9 mois pour certains individus selon Nordenfors 1999). La longévité des femelles adultes semble raccourcie une fois pris le premier repas de sang pour la maturation des œufs selon Wood (1917). Toutefois, les femelles qui se nourrissent et pondent sans interruption sembleraient vivre plus longtemps que celles qui, après un premier cycle gonotrophique*, se trouvent privées de nourriture et ne peuvent pas enchaîner un deuxième cycle.

Dans la faune sauvage, Moss (1978) relève une capacité à survivre en l'absence d'hôte (l'hirondelle noire, *Progne subis*), durant la saison froide, jusqu'à 7 mois 1/2 chez *D. prognephilus*. Pacejka et Thompson (1996) ont mené des expérimentations de terrain et montré que *D. hirundinis* aussi est capable d'hiverner, dans les vieux nids de troglodyte familial de la saison précédente. Cela signifie que chez cette espèce aussi, certains individus survivent plus de 8 mois sans nourriture (et dans des conditions de températures très variables). Phillis (1972) montra en outre que les populations (indifférenciées) de *D. hirundinis* et *D. americanus* dans des nids de moineau domestique (*Passer domesticus*: Passeridae) étaient coordonnées avec le cycle court de l'oiseau (couvaision des œufs : 13-14 jours ; élevage des poussins : 17 jours selon <http://www.oiseaux.net/>) : les populations de ces deux espèces amplifieraient assez rapidement durant la période de pré-niché, alors que le mâle construit le nid, ainsi que pendant la couvaision des œufs. Mais surtout, l'amplification deviendrait extrême durant le nourrissage des poussins, pour s'amortir rapidement et amorcer une décroissance rapide peu après le départ des oiseaux. Burt *et al.* (1991), sur trois autres espèces de passériformes (l'hirondelle des arbres *Tachycineta bicolor* : Hirundinidae, le troglodyte familial *Troglodytes aedon* : Certhiidae, et le merlebleu de l'Est, *Sialia sialis* : Muscicapidae), mettent en évidence une dynamique comparable et soulignent **l'extrême petitesse de la population fondatrice** chez *D. hirundinis*. L'accélération de la croissance leur semble corrélée avec l'apparition des fourreaux des plumes chez les petits, dont ils supposent que les papilles, fortement irriguées, permettraient aux acariens de trouver des repas abondants et aisés.

Une **grande flexibilité dans le temps de génération**, ainsi qu'une **adaptation au cycle de l'hôte** permettent ainsi aux espèces sauvages de développer des populations importantes, malgré la durée réduite de disponibilité de l'hôte au cours de l'année, comparée à celle des poules en condition d'élevage.

Aucune étude n'ayant porté précisément sur la biologie des **espèces du groupe *hirsutus* et du sous-genre *Microdermanyssus***, nous n'avons pas d'information quant à leur résistance au jeûne. Toutefois, le mode de vie de *D. grochovskae* et *D. quintus* (cf. supra) ne laisse pas présager une nécessité de survie sur de longues périodes en l'absence d'hôte, puisqu'elles le suivent durant l'hiver (Zemskaya 1971). Il n'est pas improbable que la résistance au jeûne chez ces espèces qui ne se gorgent pas à proprement parler, mais réalisent de petits repas répétés et pondent sur l'hôte, soit réduite comparée à celles du groupe *gallinae*. La longévité d'*O. sylviarum*, aux habitudes apparemment similaires aux espèces du groupe *hirsutus* et du sous-genre *Microdermanyssus*, est nettement réduite comparée à celle de *D. gallinae*. En effet, les essais de Kirkwood (1963), comparant la longévité de ces deux parasites de volailles dans un poulailler vide, ont obtenu des individus de *D. gallinae* vivant après 8 mois, alors que chez *O. sylviarum*, les derniers vivants ont été notés durant la troisième semaine.

2.1.e.2 **Etroite relation avec le microenvironnement (nid, litière)**

En outre, les habitudes particulières de *D. gallinae*, parasite aux mœurs de moustique aptère, ou plutôt de punaise des lits, en font un ennemi redoutable de l'éleveur. Ne demeurant que peu de temps sur l'hôte, le temps d'un rapide repas seulement, il se retranche rapidement dans des interstices étroits, nombreux dans les structures d'élevages. Dans la faune sauvage, les acariens du groupe *gallinae* sont très nettement plus nombreux dans les nids que sur l'hôte directement, à la différence du groupe *hirsutus*, où ils sont plus nombreux sur l'hôte en permanence chez *D. hirsutus* et *D. grochovskae*, et durant l'hiver chez *D. americanus* (Moss 1978, Zemskaya 1968). Les **habitudes nidicoles** des acariens du groupe *gallinae* sont **doublées d'un thigmotactisme*** certain, qui les pousse manifestement à s'agglutiner avec leurs congénères dans des espaces très étroits. Cette tendance est particulièrement visible lorsque l'on enferme un prélèvement de litière contenant des acariens du genre *Dermanyssus* dans un sachet hermétique en matière plastique transparente: après quelques heures, la majorité des acariens se trouve réunie au fond des angles du sachet (observation personnelle; cf. Fig. 4). Ainsi, peut-être davantage stimulés par ce thigmotactisme que par leur célèbre lucifugie, ils s'amassent en pleine lumière dans la zone où les points de contacts avec le plastique sont les plus nombreux.



Figure 4. Agrégat de *D. gallinae* amassés au fond d'un angle de sachet plastique, en pleine lumière.

A l'instar de la punaise des lits *Cimex lectularius* dans les habitations humaines, l'acararien dans les élevages est **par conséquent très difficile à atteindre avec les molécules acaricides existantes**. Traiter l'oiseau est inutile, les traitements de l'environnement souvent insuffisants du fait de ses habitudes nidicoles avec propension à s'immiscer dans des espaces protégés. Et l'acararien, abrité, n'est en général détecté qu'une fois sa population largement développée au sein du bâtiment. La détection précoce des infestations à *D. gallinae*, comme celles à *Cimex lectularius*, est très difficile. A tel point que pour cette dernière, des méthodes développées aux Etats-Unis pour des établissements recevant du public utilisent des chiens détecteurs de punaise des lits (Koehler *et al.* 2008), ces punaises émettant des substances odorantes. Les chiens permettent ainsi de détecter les infestations débutantes, avant même que les clients ne s'en aperçoivent à leurs dépens.

A ces difficultés d'ordre comportemental s'ajoutent d'importantes entraves d'ordre réglementaire, liées aux limites maximales de résidus (LMR), en particulier dans les œufs. Les LMR, déterminées par le règlement européen 2377/90/CEE³, rendent le traitement des élevages de pondeuses particulièrement délicat. Au début de cette étude, aucun traitement n'était autorisé durant la bande*, d'une durée d'un an dans cette filière. Seules quelques molécules (organophosphorés* et pyréthriinoïdes) étaient autorisées pendant le vide sanitaire*. C'est l'une des principales raisons pour lesquelles les pondeuses sont les volailles les plus affectées par cet acararien. En 2007, un produit à base de phoxime (organophosphoré*) a obtenu son autorisation de mise sur le marché. Il demeure aujourd'hui le seul produit composé de molécule de synthèse autorisé durant la bande en élevage de pondeuse standard en France. Dans un but alternatif, l'équipe d'I. Lesna (Université d'Amsterdam) travaille en collaboration avec la société Koppert Biological Systems à la mise en œuvre d'une démarche biologique impliquant un acararien auxiliaire (cf. Annexe 2b). Cette approche est aussi à l'étude dans l'équipe finlandaise de Tuovinen (2008). Les habitudes de chasse active à l'affût des espèces retenues (Mesostigmata : Laelapidae) en font des auxiliaires prometteurs, premier moyen de lutte susceptible d'agir sur les acarariens agrégés dans les interstices abrités sus-décrits. Des cycles lumineux mimant des photopériodes très courtes (4h/2h par exemple) semblent aussi participer au contrôle de l'acararien (Sokół *et al.* 2008).

2.2 Problématique

Préalablement à toute étude d'ordre écologique portant sur un taxon spécifique, une caractérisation précise de ce qu'il représente - c'est-à-dire une délimitation entre les populations qui le composent et celles qui composent les taxa apparentés - constitue une étape indispensable. Dans le cas de *D. gallinae*, cet aspect demeure, au début de l'étude, complètement irrésolu. Par ailleurs, si certains éléments précis de la biologie de *D. gallinae* ont été appréhendés, son écologie et la dynamique de ses populations demeurent très obscures, en particulier les voies de dissémination de ses populations.

De nombreuses questions demeurent en suspens parmi les parties prenantes de la filière avicole. L'intensité et la ténacité de l'infestation dans certains élevages paraissent souvent inexplicables. Souvent, d'autres élevages, dans des conditions apparemment similaires, maintiennent un niveau de population acceptable. Les cas d'élevages à double bâtiment mitoyen dans lesquels un seul bâtiment est infesté de manière récurrente, l'autre demeurant à peu près exempt de pou rouge (observation personnelle), aussi laisse perplexe. En outre, dans les cas d'élevage en plein air, les éleveurs et les vétérinaires se demandent souvent si les oiseaux sauvages

³ Un nouveau règlement sera applicable d'ici peu: le règlement (CE) no 470/2009 du Parlement européen et du Conseil du 6 mai 2009 abrogeant le règlement (CEE) no 2377/90.

ne sont pas la source de l'infestation (Eckert *et al.* 2005, Hoffmann 1987). En effet, certains passereaux (moineaux, mésanges, ...) viennent parfois picorer aux côtés des poules. Une transmission des acariens par l'avifaune sauvage peut sembler improbable si l'on prend en considération les habitudes nidicoles du pou rouge. En revanche, le large spectre d'hôtes des espèces du groupe *gallinae* établi dans la littérature n'est pas sans renforcer cette suspicion. Enfin, le rôle des échanges commerciaux - en particulier l'introduction potentielle de l'acarien par les poulettes entrant dans un bâtiment pour former une nouvelle bande de pondeuses - restent méconnus.

Ces énigmes sont fortement compliquées par la faiblesse des informations taxinomiques fournies par la morphologie hautement variable au sein des populations dans le groupe qui englobe *D. gallinae*. Les seules espèces réputées spécifiques à une famille (cf. supra) appartiennent au groupe *hirsutus* (*D. quintus*, *D. hirsutus*) ou au sous-genre *Microdermanyssus* (*D. alaudae*), qui sont nettement plus caractérisées morphologiquement que celles du groupe *gallinae*. Evans et Till (1962) ont suggéré la présence de nombreuses erreurs dans les inventaires, la faible caractérisation morphologique poussant certains auteurs à assigner systématiquement le nom *D. gallinae* à tout individu lui ressemblant. Moss (1978) insiste sur les citations hautement suspectes dans la littérature du fait de l'occurrence de nombreuses espèces morphologiquement similaires.

⇒ *Une spécificité d'hôte plus importante doit-elle être attendue d'espèces mal délimitées entre elles dans le groupe gallinae ? Avons-nous vraiment affaire à une seule espèce, D. gallinae, dans tous les élevages de pondeuses ? Et le groupe gallinae est-il composé d'un nombre d'espèces décrites qui surpasse le nombre des entités réellement isolées sur le plan reproducteur ? Ou bien, à l'inverse, les entités présentes en élevages appartiennent-elles à plusieurs espèces différentes, mal distinguées sur la base morphologique, seule disponible jusqu'alors ? Dans tous les cas, la réflexion et les stratégies de lutte contre ce ravageur aux importantes conséquences économiques sont fortement dépendantes de son identité précise.*

En outre, aucune étude précise concernant les modes de dissémination des espèces du genre *Dermanyssus* n'est disponible au début du présent travail. Les observations de Valera *et al.* (2003) à partir de nids d'oiseaux d'une colonie mixte suggèrent la possibilité de transfert d'une espèce d'hôte à l'autre en cas de partage du lieu de nidification. Ces auteurs, en effet, notant un passage du diptère *Carnus hemapterus* (Carnidae) des guêpiers (*Merops apiaster*) aux moineaux soulciers (*Petronia petronia*) se contentent d'envisager une transmission similaire pour les mésostigmatés hématophages aussi rencontrés (*D. gallinae* et *O. bursa*). Clayton et Tompkins (1994) considéraient la transmission de *D. gallinae* comme horizontale, au moins chez le pigeon, s'appuyant principalement sur le fait que l'acarien ne demeure pas sur l'hôte et sur les observations suivantes : les nids construits à proximité des nids infestés le devenaient aussi assez rapidement et des acariens avaient été vus courant sur les murs entre certains nids.

⇒ *Les acariens du groupe gallinae transitent-ils par le biais des oiseaux ? Si oui, sont-ils capables de passer d'un oiseau à l'autre par simple côtoiement, en picorant sur le même terrain, ou bien un contact plus important est-il requis ? Sont-ils capables de passer d'une espèce d'hôte à l'autre et de se développer normalement ? Une fois introduit dans un nid ou dans un élevage, qu'est-ce qui préside à leur installation et à l'amplification de leurs populations ?*

2.3 Objectifs

Les objectifs de la présente étude visent à obtenir des informations quant aux voies de dissémination de l'espèce *D. gallinae* et aux exigences écologiques de son développement en vue, à plus long terme, de formuler des préconisations à l'intention des éleveurs.

Pour cela, une approche large, tant au niveau taxinomique que méthodologique a été adoptée.

En effet, préalablement à l'exploration écologique, la caractérisation précise de la ou des espèce(s) d'importance économique s'impose, et, par conséquent, une exploration élargie au-delà des espèces du groupe *gallinae* dans le genre *Dermanyssus* en vue de la délimitation précise de la ou des entités concernées. Par ailleurs, une fois l'identité spécifique de l' (des) acarien(s) d'importance économique clarifiée, sa spécificité d'hôte et les flux de ses populations entre volailles domestiques et oiseaux sauvages sont à fouiller si l'on veut obtenir quelques éléments d'explication aux difficultés pratiques évoquées plus haut. Pour ce faire, une appréhension comparative de la ou des espèces d'importance économique avec des espèces proches tant phylogénétiquement qu'écologiquement a été envisagée, au moyen des outils de la cladistique. Morand *et al.* (2002) souligne la possibilité offerte par les études phylogénétiques d'analyser des patterns et de tester des hypothèses adaptatives, en optimisant sur les topologies obtenues des informations d'ordre écologique. Dans cet esprit, une observation globale et comparative de topologies phylogénétiques impliquant diverses populations du groupe *gallinae* pourrait permettre d'obtenir un recul suffisant pour comprendre les mouvements des populations et certaines exigences propres aux entités posant problème en élevage.

2.4 Aperçu sommaire de l'étude : un débroussaillage en deux étapes

a - Structure du texte

Le corps du texte qui suit est structuré de manière à permettre au lecteur de suivre l'évolution de l'étude représentée par six publications, avec ses rebondissements et ses réorientations successives. Le §3 présente les grandes lignes de la méthodologie adoptée tout au long de l'étude. Le travail de recherche se présente ici comme une enquête dont l'étape liminaire (§4) est primordiale et sert de base pour les étapes suivantes (§5). La recherche bibliographique préalable, traditionnellement à part, est intégrée à la première partie du corps (§4, publication I), suivie de deux publications. Cet ensemble représente la longue démarche de taxinomiste pour le "débroussaillage" initial de la classification du genre *Dermanyssus*. La seconde partie (§5) réunit des publications contrastées aussi, mais dont la ligne conductrice est la mise à profit des résultats du "débroussaillage" pour l'exploration de certains aspects de l'écologie de cinq espèces ciblées *a posteriori* du genre *Dermanyssus*.

Pour chaque publication, une présentation du contenu est sommairement développée, suivie d'éventuelles remarques visant en général à replacer certains éléments - dépassés déjà - dans le contexte actuel ou à souligner un ou des liens avec d'autres parties de la thèse.

b - Première étape (§4) : clarification de l'identité spécifique

Au début de la présente étude, le genre *Dermanyssus* apparaissait déjà clairement défini en tant que genre par rapport aux autres genres, si l'on faisait abstraction du genre *Liponyssoides* (cf. § 4.3b -). En revanche, la définition des entités spécifiques en son sein semblait fortement lacunaire (Publication I: Roy & Chauve 2007, revue). Les caractères morphologiques discriminants, traditionnellement utilisés au niveau spécifique ou à des niveaux taxinomiques supérieurs, sont dans ce genre pour la plupart fortement variables au niveau intraspécifique, voire

individuel (asymétries bilatérales), et les états de nombre d'entre eux sont chevauchants (Publication II : Roy & Chauve *in press*). Cela apparaissait particulièrement marqué chez les espèces du groupe *gallinae*. En effet, les espèces du groupe *hirsutus*, ainsi que celles du sous-genre *Microdermanyssus* sont porteuses de caractères morphologiques marqués (soies modifiées, aires sclérifiées plus ou moins élargies (plaque dorsale notamment), sculptées parfois de pores à la forme caractéristique) et permettant souvent la discrimination interspécifique. En revanche, les espèces du groupe *gallinae* – représentant 60% des espèces du genre *Dermanyssus* – sont faiblement sclérifiées dans l'ensemble et ne sont pas caractérisables par des éléments morphologiques nettement modifiés. Seules apparaissent accessibles des différences subtiles dans l'agencement d'éléments dont l'observation a été standardisée pour la caractérisation de nombreux groupes d'acariens libres, à des niveaux taxinomiques variés. Mais ces différences ne semblaient pas suffisantes pour séparer les espèces dans le genre *Dermanyssus*.

Afin d'obtenir une représentation précise de l'identité de l'espèce (ou des espèces) infestant les élevages, il est nécessaire d'appréhender l'ensemble du groupe d'espèces qui la (les) contiennent et d'y rechercher tout d'abord les limites interspécifiques. Par conséquent, il apparaissait, au début de l'étude, primordial de clarifier la délimitation entre les espèces du genre *Dermanyssus*, et en particulier entre les espèces du groupe *gallinae*, avant toute étude d'ordre écologique. Pour cela, une approche phylogénétique basée à la fois sur des caractères morphologiques et moléculaires a été choisie (Publication III Roy *et al.* 2009a).

c - Seconde étape (§5): exploration écologique

Une fois les espèces clairement définies, au moins dans le groupe *gallinae*, une estimation fiable du spectre d'hôtes a été rendue possible par un échantillonnage important dans l'avifaune sauvage ainsi qu'en élevages, et l'utilisation élargie d'un des marqueurs moléculaires retenus, la mt-Co1. Une reconstruction phylogénétique d'un nombre accru de populations des espèces testées moléculairement a permis de dégager certains patterns écologiques (Publication IV Roy *et al.* 2009b). Ensuite, une exploration des flux de populations a pu être entamée par une approche généalogique basée sur des haplotypes (phylogéographie), complétée par des tests de génétique des populations, grâce à l'utilisation élargie de la mt-Co1 et au développement d'un nouveau marqueur nucléaire variable intraspécifiquement. L'exploration intraspécifique basée sur ces deux loci indépendants a été réalisée de manière à comparer polymorphisme et flux de populations entre plusieurs espèces du groupe *gallinae*, dont *D. gallinae* (Publication V Roy *et al.*, in prep). Enfin, l'influence de certaines composantes du microenvironnement (nid, litière) ont été partiellement étudiées en mettant à profit le terrain d'étude de JC Bouvier (INRA-Avignon). Des nids de mésanges (*Parus sp.*) ont été collectés et analysés de manière à obtenir une représentation de leur arthropodofaune en fonction de quatre modalités (nature, vergers contrôlés biologiquement, vergers contrôlés chimiquement, vergers contrôlés de façon raisonnée) et à situer l'implication du genre *Dermanyssus* parmi les communautés recensées (Publication VI, Roy *et al.*, in prep). Le fil conducteur méthodologique est l'utilisation des outils de la phylogénie pour l'investigation à tous les niveaux des espèces du groupe *gallinae*.

3 Grandes lignes de la méthodologie adoptée

3.1 **Matériel biologique : stratégie d'échantillonnage pour une représentation d'habitats variés**

Afin d'obtenir une représentation la plus complète possible des entités du genre *Dermanyssus*, un effort d'échantillonnage a été orienté vers différents groupes d'oiseaux, différentes origines géographiques (principalement France, mais aussi quelques échantillons transeuropéens, et nord américains) et différents types d'environnement (élevages de volailles de consommation et d'ornement, faune sauvage *in natura*, en ville, en agroécosystème).

Pour ce faire, un réseau de vétérinaires en lien avec des élevages de volailles déjà développé à l'ENVL (Claude M. Chauve) a été mis à profit pour les prélèvements en élevage de volaille de consommation (prélèvements directs d'acariens, échantillons de litière). Pour les élevages d'ornement, des prospections auprès d'animaleries et d'associations d'éleveurs de petits oiseaux (Association Ornithologique Rhodanienne, Amicale Ornithologique Becs Crochus Centre Est (AOBC)) ont permis d'obtenir d'autres échantillons de litière.

Quant à la faune sauvage, un réseau d'ornithologistes, principalement composé de bagueurs diplômés du CRBPO (Centre de Recherche sur la Biologie et les Populations d'oiseaux, Muséum National d'Histoire naturelle, 75 Paris) et d'acteurs de réserves naturelles (Ecopôle du Forez, 42, Réserve naturelle nationale des étangs du Romelaëre, Pas-de-Calais) a été développé au cours de la thèse et a permis l'obtention d'un grand nombre de nids (ou fragments de nids) d'espèces très diverses, réparties dans la France, *in natura* et en ville. L'implication du CSOL (Centre de Soins aux Oiseaux Sauvages du Lyonnais, Francheville), la participation à des séances de baguage d'oiseaux sauvages sous la responsabilité d'O. Caparros (CRBPO) et la participation à une journée de chasse à l'alouette avec J. Berruyer (Fédération Départementale des Chasseurs du Rhône) ont permis l'exploration de la présence sur des hôtes hors nid d'acariens du genre *Dermanyssus*. Des collaborateurs du CRBPO ont aussi fortement contribué à cet aspect de l'étude au cours de leurs séances respectives de baguage. Enfin, une collaboration fructueuse avec JC Bouvier (INRA-Avignon) a fourni un important échantillon de nids d'oiseaux sauvages nichant dans des agroécosystèmes de vergers de fruitiers aux caractéristiques variées.

3.2 **Marqueurs développés : utilisation concomitante de données morphologiques et moléculaires**

Les marqueurs développés au cours de la thèse sont de deux ordres : morphologiques et moléculaires. Les **données morphologiques** sont toutes des **caractères discrets**, codés en 2 à 3 états, conformément aux aptitudes antérieurement développées dans le cadre d'une étude sur des insectes hémiptères (Roy *et al.* 2007). Aucun caractère continu n'a été testé ici. Le codage des caractères discrets retenus dans une matrice phylogénétique n'est utilisé que dans la première partie (délimitation interspécifique). Leur utilisation dans la seconde partie est limitée au diagnostic.

Les **marqueurs moléculaires** reposent sur le **séquençage** et l'**alignement** de portions d'ADN génomique. En vue d'accéder à des informations complémentaires et indépendantes, des gènes du **génom cytoplasmique** et du **génom nucléaire** ont été ciblés dans le même temps.

Pour la première partie de l'étude, des marqueurs couramment utilisés dans les études phylogénétiques portant sur des arthropodes, dont certains acariens (Navajas et Fenton 2000, Cruickshank 2002), ont été ciblés. Les marqueurs retenus sont situés sur deux gènes mitochondriaux (ARNr 16S, mt-Co1) et deux gènes nucléaires (**fin de l'ARNr 18S- début de l'ARNr 28S - incluant les ITS1 et 2 -, elongation factor 1- α**) ont été développés. Une seule

séquence du génome d'une espèce de *Dermanyssus* était disponible dans la banque de gène internationale (GenBank, EMBL) au début de l'étude. Il s'agissait d'une portion de l'ARNr 16S d'*D. gallinae*, utilisée par Black et Piesman (1994) comme outgroup dans une analyse des interrelations entre tiques (Acari : Ixodida). Pour ce gène, le séquençage a été obtenu par design direct d'amorces sur la séquence disponible, puis, au fil de l'étude par conception de nouvelles amorces sur les aires apparaissant conservées par alignement des premières séquences obtenues. Pour les trois autres, les amorces ont été conçues sur la base d'alignements des séquences orthologues d'autres arthropodes, disponibles sur la banque de gènes. Les trois premiers ont finalement participé à la délimitation interspécifique (publication III, p. 69 sqq.), mais le quatrième (EF1- α) a dû être abandonné, du fait d'anomalies (cf. 4.3b -).

Pour la seconde partie de l'étude, la portion de mt-Co1, non seulement porteuse de signatures spécifiques nettes, mais aussi d'une diversité intraspécifique très informative au niveau population, a été largement mise à profit. Aucun des marqueurs nucléaires développés pour la première partie n'ayant, en revanche, fourni d'information intraspécifique suffisante, un cinquième marqueur a été développé. L'utilisation d'au moins deux loci indépendants apparaissait en effet primordial pour l'exploration des flux de populations. Le marqueur nucléaire sélectionné alors consiste en deux petites portions d'exons du gène codant pour la **Tropomyosine**, et de l'intron qu'ils encadrent. L'ADNc complet de la Tropomyosine de *D. gallinae* a été publié par Nisbet *et al.* (2006) dans le cadre d'une étude immunologique. La fragmentation en de multiples portions de cette séquence et le criblage sur notre souche de laboratoire SK de ce gène au moyen d'amorces conçues à chacune des extrémités des fragments définis a donné lieu à l'isolement de l'amplicon retenu, à forte composante intronique. A notre connaissance, aucune analyse phylogénétique, ni de génétique des populations, n'a été menée sur la base de cette région chez des arthropodes. A la différence des reconstructions phylogénétiques de la première partie de l'étude, utilisant des régions classiquement analysées dans ce type d'étude, il s'agit ici d'une expérience originale.

3.3 Outils de la phylogénie et de la génétique des populations

Les séquences obtenues ont été alignées au moyen de logiciels divers (ClustalW, MAFFT, Muscle) et dans certains cas, les alignements ont été affinés à la main (Seaview). Les matrices ainsi obtenues ont été analysées au moyen de logiciels de phylogénie, suivant différents critères. Le maximum de parcimonie avec PAUP 4.0 et TNT, ainsi que le maximum de vraisemblance avec PhyML et Phylo_win, ont été exploités directement au cours de la thèse. Grâce à la collaboration d'APG Dowling (Université de Fayetteville, Arkansas, USA), des analyses bayésiennes ont été réalisées avec le logiciel MrBayes, qui réalise une simulation technique nommée Markov chain Monte Carlo (MCMC) pour obtenir une approximation des probabilités postérieures des topologies.

Les réseaux d'haplotypes, ainsi que certains outils de la génétique des populations ont été abordés en fin de thèse, dans le cadre de la seconde partie. Les outils statistiques de la génétique des populations, basés sur l'estimation de la neutralité (Nei 1987) de l'évolution trahie par les différences rencontrées dans les séquences analysées, analysent le polymorphisme de manière "statique" (à un instant t), par comparaison entre isolats, indépendamment de leur histoire. De fait, ils ne permettent pas (1) d'intégrer à l'analyse les nombreux isolats dont un petit nombre seulement d'individus avaient été séquencés pour la première partie de l'étude (statistiquement insuffisants), (2) de prendre en compte l'histoire évolutive des isolats, ce qui s'accorde difficilement avec l'esprit de l'étude dans son ensemble.

Afin de réduire au moins partiellement cette frustration, des méthodes complémentaires ont été recherchées pour la publication V (p. 131 sqq.). Le logiciel Network a été mis à profit dans l'analyse des réseaux d'haplotypes. L'approche de type NCPA (Nested Clade Phylogeographic

Analysis), initiée par Templeton (Templeton *et al.* 1995, Templeton 1998), a été tout d'abord envisagée. Mais de solides arguments récemment développés contre cette approche ont découragé cette initiative (Panchal et Beaumont 2007, Petit 2007). Très attractive pour une personne habituée aux informations historiques de la cladistique et rebutée par l'aspect "monodimension" des approches statistiques, cette méthode a longtemps séduit, se présentant comme la possibilité inespérée de mettre en évidence des structures de populations en prenant en compte, précisément, leur histoire. Les simples réseaux d'haplotypes permettaient bien sûr une telle approche, mais, multidimensionnels à l'extrême par excellence au sein de l'espèce (>>>3D), les relations entre entités étant typiquement réticulées du fait des flux de gène, la définition de la topologie à retenir demeurait très obscure et la robustesse des relations restait inestimée. Templeton et coll ont travaillé à l'objectivation d'une démarche d'analyse de réseaux d'haplotypes (« nichage » graduel des clades en partant des extrémités de la topologie), suivie d'un examen statistique de la structuration des isolats testés en fonction de paramètres géographiques (ou autres) connus. Mais, si l'estimation des structures est soutenue par un volet statistique, il n'en demeure pas moins que le support de l'analyse repose sur un réseau multidimensionnel, dont la (les) topologie(s) retenue(s) l'est (le sont) sur une base obscure, plutôt subjective. Un échange fructueux avec M. Panchal (Université de Reading, Royaume Uni) a conduit au choix de méthodes plus modernes, et surtout plus objectives. M. Panchal a développé et mis au point durant sa thèse une automatisation informatique de la NCPA (demandant jusqu'alors l'utilisation successive de plusieurs logiciels indépendants) (Panchal 2007). Cette automatisation, permettant de tester un plus grand nombre de modèles, a confirmé des doutes déjà plusieurs fois formulés quant à l'efficacité de la méthode : de nombreux faux-positifs sont générés par la NCPA, induisant des conclusions fortes sur des structurations de population en fait artéfactuelles. En remplacement des analyses basées sur des réseaux d'haplotypes, M. Panchal recommande des analyses basées sur des modèles, dont l'efficacité est bien sûr encore à tester, mais dont l'objectivité apparaît nettement plus importante.

Ainsi, une collaboration amorcée avec JS Lopes (Université de Reading, Royaume Uni) vise à tester les données mt-Co1 et Tropomyosine avec le logiciel PopABC. Basé sur une investigation bayésienne de la génétique des populations, ce logiciel développé par JS Lopes utilise la simulation technique Markov chain Monte Carlo (MCMC) pour l'approximation des probabilités postérieures dans le cadre de l'analyse de la démographie des populations (Lopes et Beaumont 2008). Des fourchettes quant à des paramètres démographiques concernant les populations à tester sont proposées *a priori* (priors) et définis de manière large. Les différents branchements possibles entre les populations prédéfinies constituent les modèles dont on teste la probabilité. Les structures sont retenues *a posteriori*, leur robustesse étant évaluée par les probabilités postérieures bayésiennes. Par ailleurs, une évaluation des groupements de populations a été réalisée grâce au logiciel Structure 2 et des tests statistiques classiques de génétique des populations ont été réalisés à l'aide de DnaSP v5 et Arlequin 3.11.

4 Taxinomie dans le genre *Dermanyssus*

4.1 Synthèse historique : publication I

a - Présentation

Dans la nomenclature zoologique, il n'est pas rare de rencontrer des étymologies trompeuses *a priori*, notamment chez les acariens. Le principe du taxon type, du nom duquel découlent les noms des taxa de niveaux supérieurs, entraîne dans certains cas d'apparentes incongruités entre dénomination et habitudes écologiques de l'organisme considéré. Il suffit que le représentant du groupe concerné découvert – et donc décrit – le premier soit nommé sur la base de caractéristiques qui lui sont propres pour que la nomenclature d'ordre ou de super-familles soit jalonnée des dénominations déconcertantes. En effet, il s'avère parfois *a posteriori*, au moment de la description d'autres taxa, découverts ultérieurement, que lesdites caractéristiques ne soient pas communes à l'ensemble des taxa du groupe considéré. Le genre *Dermanyssus*, du grec « derma », peau, et « nussein », piquer, désigne à l'évidence un acarien hématophage bien davantage qu'un prédateur ou un détritivore. Or la cohorte des *Dermanyssina* (cf. Annexe 1), dont il représente le genre type, si elle regroupe des parasites hématophages, est originellement et majoritairement constituée de prédateurs, d'après des analyses phylogénétiques (Dowling 2006a, b) ou sur la base d'observations évolutives (Radovski 1969). Les premiers fossiles de *Dermanyssina*, datant de l'Eocène (Witalinski 2000), sont aussi des prédateurs, ce qui va aussi dans ce sens. La superfamille des *Parasitoidea*, dont le genre *Parasitus* est le genre type, ne regroupe pas des parasites mais des prédateurs. De même, les *Dermanyssoidea* ne regroupent pas seulement des ectoparasites piqueurs.

Toutefois, la famille des *Dermanyssidae*, à l'inverse des *Parasitidae* qui ne comptent aucun parasite (Lesna et Sabelis, communication personnelle), ne regroupe aujourd'hui que des ectoparasites hématophages. Cette famille a en revanche longtemps regroupé des acariens aux habitudes diverses et est caractérisée par une histoire chaotique. Elle a tout d'abord représenté la famille la plus importante (en nombre d'espèces incluses) des *Dermanyssoidea*. Evans & Till (1966) comptaient dans les *Dermanyssidae* 15 sous-familles contenant de nombreux hématophages, mais pas seulement. Les *Laelapinae*, qui représentent la plus grande sous-famille, demeuraient principalement composée de prédateurs. La famille des *Dermanyssidae* s'est vu réduire drastiquement à deux genres en 1966 par Radovski : *Dermanyssus* et *Liponyssoides*. Vidée de cette pléthore de genres, elle apparaît minuscule maintenant, comparée aux familles apparentées, qui ne sont autres que les sous-familles qui la constituaient, sans les *Dermanyssinae*. Mais les arguments de Radovski, basés sur une analyse évolutive, si ce n'est phylogénétique, sont solides, puisqu'ils ont permis, enfin, une délimitation claire des *Dermanyssidae* par rapport aux autres familles. Aucun autre genre que *Dermanyssus* et *Liponyssoides* n'a été intégré depuis lors dans cette famille. Les *Macronyssidae*, en revanche, contiennent aujourd'hui 26 genres, les *Laelapidae* 144, les *Haemogamasidae* 7, les *Hirstionyssidae* 5, ... (selon Hallan 2005).

Parallèlement, le genre *Dermanyssus* a contenu au moins 60 espèces différentes. Dugès l'a décrit en 1834 sur la base de *D. gallinae*, l'espèce-type et le problème pour rouge des volailles. Il lui a alors associé 4 autres espèces, dont une, *D. convolvuli* (littéralement « du liseron ») représente probablement une espèce non hématophage et prédatrice d'acariformes phytophages. Il est probable que *D. gallinae* représentait alors déjà depuis longtemps un problème important dans les élevages, puisqu'il a été décrit précocement (en 1778, dans le genre *Acarus*, genre type des acariens) par rapport à des *Dermanyssoidea* prédateurs, comme certains *Laelapidae*, *Ascidae* ou

Macrochelidae. Lesdits prédateurs, de taille comparable au pou rouge pourtant, mais nettement moins gênants, attirent de fait beaucoup moins l'attention. Ainsi les déprédations produites par le pou rouge sont-elles probablement la cause de l'omniprésence du radical *dermanyss-* dans la nomenclature d'un groupe au cours de l'évolution duquel les parasites piqueurs ne sont apparus que sporadiquement (Dowling 2006a).

4.1.a.1 Objectifs

L'objectif principal de la revue historique était de faire le point sur la composition taxinomique du genre *Dermanyssus* au niveau spécifique, l'état des délimitations interspécifiques et sa caractérisation au niveau générique en 2006. Pour cela, un examen précis de l'histoire de sa taxinomie depuis sa description et des caractérisations morphologiques utilisées dans la littérature a été envisagé. Dans un but pratique, un aperçu de la répartition géographique et des spectres d'hôte a été intégré à l'article.

4.1.a.2 Principaux résultats

Au moment de la revue, *Dermanyssus* ne regroupait plus que 23 espèces. Une discussion entre Krantz et Sheals, ainsi que la révision du genre par Evans et Till en 1962 ont contribué à clarifier la définition du genre par rapport aux autres genres de *Dermanysoidea*. Cette dernière constitue la première révision complète du genre *Dermanyssus*, plus d'un siècle après sa description, et a drastiquement réduit le nombre d'espèces en son sein (14 espèces). Elle fut complétée ensuite par les travaux de Moss (1967, 1968, 1978 : 18 espèces), qui introduisit des subdivisions et participa à la définition des espèces au sein du genre. Mais Moss mit en évidence en 1978, avec l'introduction dans son analyse de nouvelles espèces, le caractère inapproprié d'une partie de ses subdivisions. Malheureusement, il ne publia jamais la nouvelle étude annoncée. Plusieurs auteurs ont dénoncé, au fil du temps, l'extrême variabilité intraspécifique de certains des caractères morphologiques proposés pour la définition des espèces et le diagnostic.

En outre, la claire délimitation entre *Dermanyssus* et *Liponyssoides* n'est pas apparue si tranchée que Moss ne le suggèrait en 1967. Là aussi, Moss annonçait une révision du genre *Liponyssoides*, qu'il ne publia jamais. Les deux genres de la famille des *Dermanyssidae* se différencient nettement des autres genres de *Dermanysoidea* par la structure particulière de leurs chélicères, fortement modifiée par l'adaptation à l'hématophagie (et de manière différente d'autres *Dermanysoidea* hématophages tels les *Macronyssidae*), la texture souple des cornicules et la pointe sur les tarsi III et IV chez le mâle. En revanche, la distinction *Dermanyssus* / *Liponyssoides*, principalement basée sur la forme de la plaque sternale ainsi que certains éléments de chaetotaxie, tous fortement polymorphes au sein de populations, et même des individus, demeurait (et demeure) peu nette.

Une répartition mondiale et une distribution par espèce d'hôte recensée, sur la base des données de la littérature, ont aussi été fournies.

b - Remarques sur la publication I

4.1.b.1 Nombre d'espèce augmenté (2008 et 2009)

Au moment de la publication I, 23 espèces étaient incluses dans le genre *Dermanyssus*. Aujourd'hui, 25 espèces sont à prendre en compte : l'Américain W. Knee a décrit *D. diphyes* en 2008 et nous avons nous-mêmes décrit *D. apodis* en 2009 (Publication III, p. 69 sqq.).

HISTORICAL REVIEW OF THE GENUS *DERMANYSSUS* DUGÈS, 1834 (ACARI: MESOSTIGMATA: DERMANYSSIDAE)

ROY L.* & CHAUVE C.M.*

Summary:

A synthetic review of the historical systematics of *Dermanyssus* Dugès, 1834 (Acari: Mesostigmata: Dermanyssidae) is provided. The classification at the specific level in this early genus has not really been clarified during more than a century despite its economic impact, and the history of the genus is complex and includes various stages. Moreover, *Dermanyssus* currently includes 23 species, whereas the last review took only 18 species into account. Changes in the species status and position in the genus *Dermanyssus* from 1834 until today are presented. The evolution of the generic definition is explored and compared with other genera of the group. How the discrimination between the different species evolved in the genus is also examined. Some difficulties in the specific definitions are discussed. A current diagnosis of the genus *Dermanyssus* is given. A table of the species included in this genus since its first description along with their respective current positions, a list of the currently included species in *Dermanyssus* with their hosts, and a world map presenting their geographic distribution are provided.

KEY WORDS : Acari, Mesostigmata, Gamasida, *Dermanyssus*, historical review, systematics.

Résumé : REVUE HISTORIQUE DU GENRE *DERMANYSSUS* (ACARI : MESOSTIGMATA : DERMANYSSIDAE)

La systématique historique de *Dermanyssus* Dugès, 1834 (Acari : Mesostigmata : Dermanyssidae) est révisée de manière synthétique. La classification au niveau spécifique de ce vieux genre n'a pas été véritablement clarifiée durant plus d'un siècle malgré son impact économique, si bien que son histoire est quelque peu complexe et présente diverses étapes. En outre, le genre *Dermanyssus* englobe à l'heure actuelle 23 espèces, tandis que la dernière révision prenait seulement 18 espèces en compte. Les changements de statut et de position des espèces dans le genre *Dermanyssus* depuis 1834 jusqu'à présent sont présentés. Le processus d'évolution de la définition du genre est exploré par comparaison avec d'autres genres du groupe. La manière dont la discrimination entre les différentes espèces a évolué est aussi considérée. Certaines difficultés dans la définition spécifique sont discutées. Une description diagnostique actualisée du genre *Dermanyssus* est fournie. Un tableau des espèces qui ont été incluses dans le genre depuis sa création avec leur position respective, une liste des espèces actuelles du genre *Dermanyssus* avec leurs hôtes, ainsi qu'une carte de leur distribution mondiale sont fournis.

MOTS CLÉS : Acari, Mesostigmata, Gamasida, *Dermanyssus*, revue historique, systématique.

INTRODUCTION

The genus *Dermanyssus* Dugès, 1834 (Acari: Mesostigmata: Dermanyssidae) includes hematophagous mite species which are ectoparasites of birds. *Dermanyssus* is the type genus of a family whose name has represented various groups all along 19th century, with more or less internal splitting. Dermanyssidae Kolenati, 1859 included first mites with diverse habits, some of them being obligatory ectoparasites and others free-living or facultative ectoparasites. Berlese (1892) separated the former and the last group in two different families: Dermanyssidae and Laelapidae respectively. Then numerous steps occurred, Dermanyssidae status alternating from subfamily-group name to family-

group name, including only obligatory ectoparasites. Radovsky (1966, 1967) separated this group into the two following families, depending on some morphological and biological characters: Macronyssidae Oudemans, 1936 and Dermanyssidae. Really Dermanyssidae appear phylogenetically closer to free-living Laelapids than to Macronyssidae. Consequently, Moss (1968, 1978) considered only the two following genera to be included in Dermanyssidae: *Dermanyssus* and *Liponyssoides*. In this paper, we follow this last classification.

Along with *Liponyssoides*, *Dermanyssus* possesses some morphological mainly located in the mouthparts adaptations to hematophagous habits. Adult females, protonymphs and deutonymphs possess conspicuously thin and elongated chelicerae, with a second segment adapted to hematophagy. Faces of opposed second segments are medially concave, so that they may form a tube by joining together through which blood is withdrawn. Chelae are conspicuously reduced, even if digits can be seen with a scanning electron microscope (cf. Fig. 2; Radovsky, 1969; Phillis, 2006). Male cheli-

* Laboratoire de Parasitologie et Maladies Parasitaires, École Nationale Vétérinaire de Lyon, 1, avenue Bourgelat, 69280 Marcy-L'Étoile, France.

Correspondence: Lise Roy.

Tel.: 00 33 4 78 87 25 74 – Fax: 00 33 4 78 87 25 77.

E-mail : l.roy@vet-lyon.fr

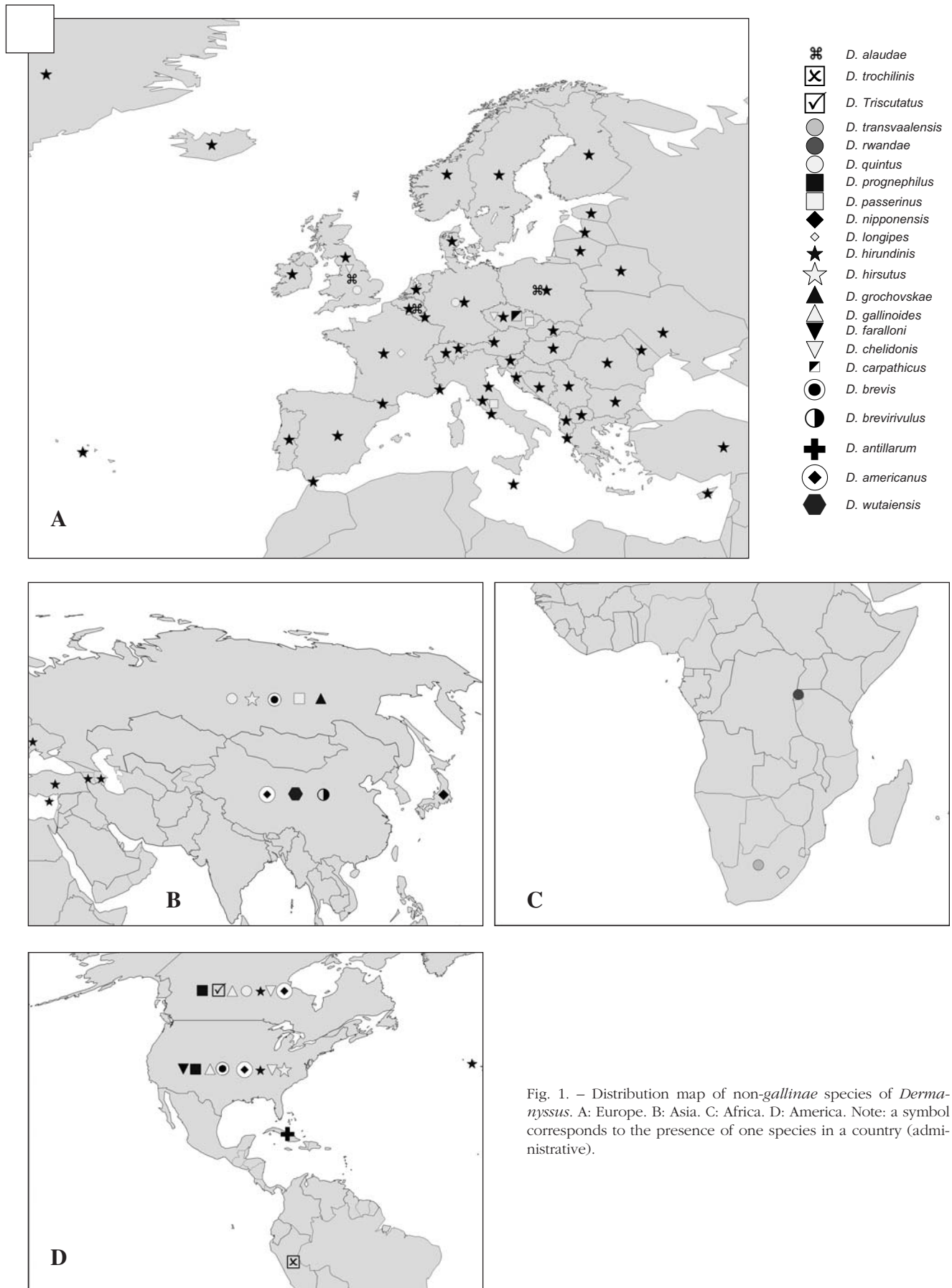

Fig. 1. – Distribution map of non-gallinae species of *Dermanysus*. A: Europe. B: Asia. C: Africa. D: America. Note: a symbol corresponds to the presence of one species in a country (administrative).

cerae are broader and male chelae are enlarged, with a long spermadactyl.

The poultry red mite *D. gallinae* (De Geer, 1778) is very common in layer houses in Europe. The economic impact of this parasite is quite important and may take many forms, including the following: downgraded eggs, decreased egg production, anaemia, possible death from exsanguination. The poultry red mite can also transmit diseases such as avian spirocheatosis, fowl cholera, salmonellosis, etc. Despite such economic importance, the classification of this genus at species level has been in a state of confusion for many years. About 40-50 years ago, some authors began working precisely on the genus *Dermanyssus*. According to some of them, *D. gallinae* may not be the only *Dermanyssus* parasitising laying hens. Consequently, some other closely related species might often have been confused with this species. A rather low host-specificity and a rather wide geographic distribution of *Dermanyssus* species contribute to obscure the issue.

Most species of this genus are not very host specific: for instance, more than 30 bird species are potential hosts for *D. gallinae* (Zemskaya, 1971) and 40 bird species (belonging to eight different orders) for *D. birundinis* (Hermann, 1804) (Moss *et al.*, 1970; Moss, 1978; Fend'a & Schniererová, 2004; Fend'a, unpublished data). Most of the *Dermanyssus* species are nidicolous. Although some of them can be found frequently on the host and can deposit their eggs on its feathers (*D. grochovskae* Zemskaya, 1961, *D. quintus* Vitzthum, 1921 and *D. americanus* Ewing, 1922), most of them climb onto their host only to get a meal and then go back to their hiding-place in the host nest or roost. Moreover,

many species of *Dermanyssus* are distributed on more than one continent (Fig. 1). The history of *Dermanyssus* is very complicated and has never been extensively examined. Moreover, this early genus currently includes 23 species, whereas the last review of the genus took only 18 species into account. For both these reasons and in order to get a clear view of the genus before reviewing it, it seemed necessary to examine it cursorily from its description until the present and to check the current species included in it. In order to get a view of the generic history, the text will be broken down as follows: changes in the species status and position in the genus *Dermanyssus* from 1834 until today are presented first, then the generic definition and its evolution are explored. Afterwards, the species definitions and their difficulties will be examined. Finally, concerning the genus as is currently defined, a list of the currently included species in *Dermanyssus* is provided. Abbreviations: Setal terminology follows Lindquist & Evans, 1965 for the dorsum and Evans, 1963 for the legs.

CHANGES IN THE STATUS AND THE POSITION OF SPECIES IN THE GENUS *DERMANYSSUS* FROM 1834 UNTIL TODAY

Dugès described the genus *Dermanyssus* in 1834, in which he included five new species: *D. avium* Dugès, 1834, *D. vespertilionis* Dugès, 1834, *D. convolvuli* Dugès, 1834, *D. oribatis* Dugès, 1834, and *D. hominis* Dugès, 1834. The type-species *D. gallinae* (De Geer, 1778) was described by De Geer in the

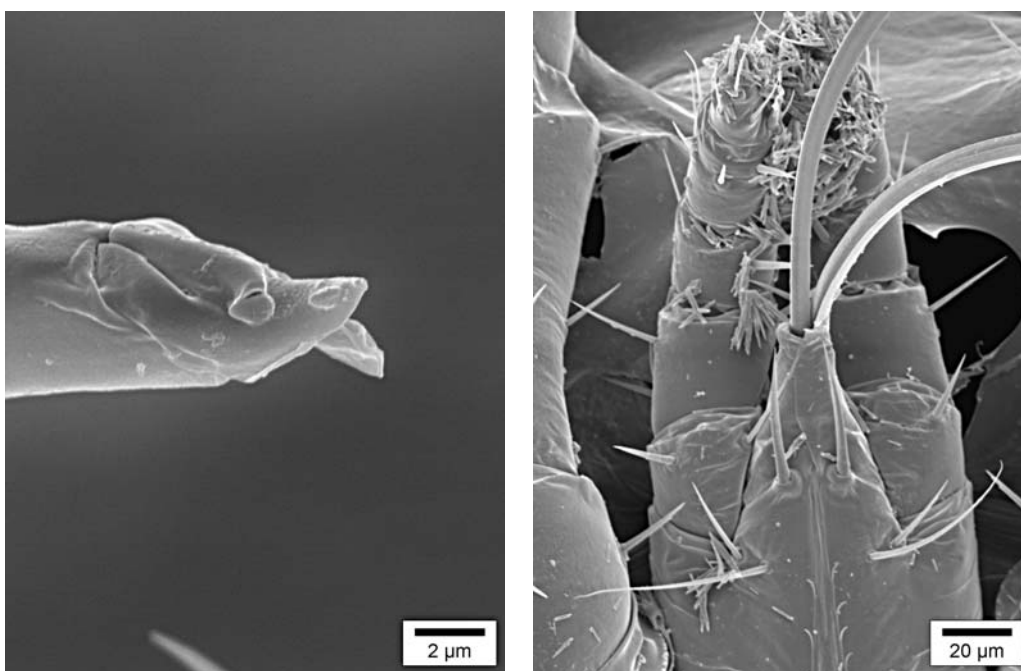

Fig. 2. – *Left*: characteristically reduced chela in *D. gallinae*. *Right*: second segments of chelicerae medially concave in *D. gallinae* (electron scanning microscope).

genus *Acarus*. In 1834, Dugès named it *D. avium*, and considered *A. gallinae*, although senior, synonymous with *D. avium*. *D. gallinae* was later reinstated as the senior synonym (Koch, 1836). *D. vespertilionis* has been suppressed by the International Commission of Zoological Nomenclature (ICZN) under the plenary powers for the principle of priority, but not for homonymy (Melville & Smith, 1987). About *D. oribatis* and *D. convo-*

lvuli, Dugès only noted for each: species name, followed by a comma and the personal latin pronoun *nobis*. Without any description and as species names suggest host associations far from the common ones, birds, in *Dermanyssus*, *D. oribatis* and *D. convolvuli* might be deemed *nomina dubia*. In any case, they cannot be included in *Dermanyssidae sensu* Radovsky (1966). *D. hominis* seems to have been omitted by all

	Species included or previously included in <i>Dermanyssus</i>	Current position	Comments
1778	* <i>D. gallinae</i> (De Geer, 1778) * <i>D. alaudae</i> (Schrank, 1781)	<u>Dermanyssidae</u> <i>Dermanyssus</i> <u>Dermanyssidae</u> <i>Dermanyssus</i>	In 1781, Schrank named <i>alaudae</i> the seventh species he described in 1776.
	* <i>D. birundinis</i> (Hermann, 1804) <i>D. truncatus</i> (Olfers, 1816) <i>D. hominis</i> (Dugès, 1834)	<u>Dermanyssidae</u> <i>Dermanyssus</i> synonymy > <i>D. alaudae</i> synonymy > <i>D. gallinae</i>	Bory de Saint Vincent described this species in 1823 and more completely in 1828 without any name nor systematic position within the Acari group. Dugès placed it in genus <i>Dermanyssus</i> and named it in 1834.
	<i>D. avium</i> Dugès, 1834 <i>D. vespertilionis</i> Dugès, 1834	synonymy > <i>D. gallinae</i> suppressed	ICZN direction 66: suppressed under the plenary powers for the principle of priority, but not for homonymy.
	<i>D. convolvuli</i> Dugès, 1834 <i>D. oribatis</i> Dugès, 1834 <i>D. musculi</i> Koch, 1836	? ? Macronyssidae <i>Steatonyssus</i>	This species has complicated history. Oudemans (1936) considered it junior synonym of <i>A. musculi</i> Schrank, which he placed in genus <i>Steatonyssus</i> (homonymy and synonymy in the same time). Evans and Till (1966:278-279) suggested that <i>S. musculi</i> Schrank could be a junior synonym of <i>Ornithonyssus bacoti</i> Hirst, 1913.
	<i>D. arcuatus</i> Koch, 1839 <i>D. carnifex</i> Koch, 1839	Hirstionyssidae <i>Echinonyssus</i> Hirstionyssidae <i>Echinonyssus</i>	Tenorio (1984) treats this species as <i>nomen dubium</i> .
	<i>D. coriaceus</i> Koch, 1839 <i>D. lanius</i> Koch, 1839 <i>D. noctulae</i> Koch, 1839 <i>D. murinus</i> Lucas, 1840 <i>D. avium</i> Wagner, 1841 <i>D. pipistrellae</i> Koch, 1841 <i>D. lacertarum</i> (Contarini, 1843) <i>D. natricis</i> Gervais, 1844 <i>D. musculi</i> Johnston, 1849	synonymy > <i>D. arcuatus</i> synonymy > <i>D. carnifex</i> synonymy > <i>D. arcuatus</i> Macronyssidae <i>Steatonyssus</i> synonymy > <i>D. murinus</i> synonymy > <i>D. arcuatus</i> ? Macronyssidae <i>Ophionyssus</i> Hirstionyssidae <i>Echinonyssus</i>	A complicated history. Seems to be conspecific to <i>D. musculi</i> Koch which is conspecific to <i>A. musculi</i> Shrank.
	<i>D. flavus</i> Kolenati, 1857 <i>D. glutinosus</i> Kolenati, 1857 <i>D. granulosis</i> Kolenati, 1857 <i>D. ambulans</i> Thorell, 1872 <i>D. richiardii</i> Canestrini & Fanzago, 1877 <i>D. sylviarum</i> Canestrini & Fanzago, 1877 <i>D. birundinis</i> Berlese, 1889	Macronyssidae <i>Macronyssus</i> synonymy > <i>M. granulosis</i> Macronyssidae <i>Macronyssus</i> Haemogamasidae <i>Haemogamasus</i> ? Macronyssidae <i>Ornithonyssus</i> homonymy > nomen novum: <i>D. chelidonis</i>	
	* <i>D. longipes</i> Berlese & Trouessart, 1889 * <i>D. passerinus</i> Berlese & Trouessart, 1889	Dermanyssidae <i>Dermanyssus</i> Dermanyssidae <i>Dermanyssus</i>	<i>nomen dubium</i> . <i>species inquirenda</i> .
1889			

Table I (to be continued).

	Species included or previously included in <i>Dermanyssus</i>	Current position	Comments
1902	<i>D. albatrus</i> Oudemans, 1902	synonymy > <i>D. arcuatus</i>	
	<i>D. aegyptius</i> Hirst, 1913	Dermanyssidae <i>Liponyssoides</i>	
	<i>D. muris</i> Hirst, 1913	Dermanyssidae <i>Liponyssoides</i>	
	<i>D. sanguineus</i> Hirst, 1914	Dermanyssidae <i>Liponyssoides</i>	
	* <i>D. quintus</i> Vitzthum, 1921	Dermanyssidae <i>Dermanyssus</i>	
	* <i>D. americanus</i> Ewing, 1922	Dermanyssidae <i>Dermanyssus</i>	
	<i>D. oti</i> Ewing, 1925	synonymy > <i>D. americanus</i>	
	<i>D. evotomydis</i> Ewing, 1933	synonymy > <i>D. gallinae</i>	
	* <i>D. prognepbilus</i> Ewing, 1933	Dermanyssidae <i>Dermanyssus</i>	
	<i>D. brasiliensis</i> Fonseca, 1935	Dermanyssidae <i>Liponyssoides</i>	
	* <i>D. brevis</i> Ewing, 1936	Dermanyssidae <i>Dermanyssus</i>	
	<i>D. scutatus</i> Ewing, 1936	homonymy > <i>nomen novum</i> : <i>D. hirsutus</i>	
	* <i>D. chelidonis</i> Oudemans, 1939	Dermanyssidae <i>Dermanyssus</i>	This species has been described in 1889 by Berlese as <i>D. hirundinis</i> . Because of homonymy, Oudemans renamed it in 1939.
	* <i>D. triscutatus</i> Krantz, 1959	Dermanyssidae <i>Dermanyssus</i>	
	* <i>D. grochovskae</i> Zemskaia, 1961	Dermanyssidae <i>Dermanyssus</i>	
	* <i>D. transvaalensis</i> Evans & Till, 1962	Dermanyssidae <i>Dermanyssus</i>	
	<i>D. intermedius</i> Evans & Till, 1964	Dermanyssidae <i>Liponyssoides</i>	
	* <i>D. gallinoides</i> Moss, 1966	Dermanyssidae <i>Dermanyssus</i>	
	* <i>D. faralloni</i> Nelson & Furman, 1967	Dermanyssidae <i>Dermanyssus</i>	
	* <i>D. hirsutus</i> Moss & Radovsky, 1967	Dermanyssidae <i>Dermanyssus</i>	
	* <i>D. antillarum</i> Dusbabek & Cerny, 1971	Dermanyssidae <i>Dermanyssus</i>	
	* <i>D. trochilinis</i> Moss, 1978	Dermanyssidae <i>Dermanyssus</i>	
	* <i>D. carpathicus</i> Zeman, 1979	Dermanyssidae <i>Dermanyssus</i>	
	* <i>D. nipponensis</i> Uchikawa & Kitaoka, 1981	Dermanyssidae <i>Dermanyssus</i>	
	* <i>D. brevirivulus</i> Gu & Ting, 1992	Dermanyssidae <i>Dermanyssus</i>	
	* <i>D. wutaiensis</i> Gu & Ting, 1992	Dermanyssidae <i>Dermanyssus</i>	
1993	* <i>D. rwandae</i> Fain, 1993	Dermanyssidae <i>Dermanyssus</i>	

Table I. – Species included or previously included in *Dermanyssus* listed in chronological order with their present position/status. Species names preceded by * are here included in *Dermanyssus*.

reviewers of *Dermanyssus* until today (cf. § *Species whose nomenclatural status is not clear*). To sum up, only one of the five initially included species has been considered in the subsequent studies.

After these descriptions, many species were created in *Dermanyssus* by other authors. We list 57 species which are included or have been included in the genus (Table I). 32 species are changed in status or position: ten species have been synonymized with other *Dermanyssus* species. Two species receive *nomina nova* because they are deemed junior homonyms. One was suppressed under the plenary powers (cf. above). 16 species are now included in some other groups: five in the other genus of Dermanyssidae *Liponyssoides*, seven in several genera of the family Macronyssidae, three in the family Hirstionyssidae, one in the family Haemogamasidae. Four are *incertae sedis* or *species inquirenda* (cf. § *Species whose nomenclatural status is not clear*). Finally, one species is suggested here being synonymized (*D. hominis*). As a result, 23 species are included in *Dermanyssus*.

Strandtmann & Wharton (1958) listed ten species in *Dermanyssus*: *D. gallinae*, *D. hirundinis*, *D. quintus*, *D. americanus*, *D. oti* Ewing, 1925, *D. evotomydis* Ewing, 1933, *D. prognepbilus* Ewing, 1933, *D. brevis*

Ewing, 1936, *D. scutatus* Ewing, 1936, *D. chelidonis* Oudemans, 1939.

Evans & Till (1962) recognized 14 species, two of which, overlooked by Strandtmann & Wharton (1958), were considered doubtful but not to be invalidated (*D. passerinus* Berlese & Trouessart, 1889 and *D. longipes* Berlese & Trouessart, 1889). Two others had been described after 1958 (*D. triscutatus* Krantz, 1959 and *D. grochovskae*), one was a new species (*D. transvaalensis* Evans & Till, 1962). Another one, which had been considered synonymous with *D. gallinae* by Oudemans, was restored (*D. alaudae* (Schrank, 1781)). From the ten listed species in Strandtmann and Wharton 1958, two were synonymized (*D. oti* with *D. americanus* and *D. evotomydis* with *D. gallinae*).

Moss (1968) also included 14 species in *Dermanyssus*, but not exactly the same as Evans & Till (1962). The differences were: the newly named *D. hirsutus* Moss & Radovsky, 1967 (= *D. scutatus*, *praecoc.*), the recently described *D. gallinoides* Moss, 1966 and *D. faralloni* Nelson & Furman, 1967 (in a footnote, because this species had been described as Moss's paper went to press), and the omission of *D. passerinus* and *D. longipes*. In 1978, Moss added four species: *D. antillarum* Dusbabek & Cerny, 1971, *D. trochilinis* Moss, 1978,

D. passerinus and *D. longipes*, the last two being considered *incertae sedis* and not included in the key for identification. Thus, in the last review of genus *Dermanyssus*, only 18 species were included.

The five species which have been described after Moss's last review are: *D. brevirivulus* Gu & Ting, 1992, *D. carpathicus* Zeman, 1979, *D. nipponensis* Uchikawa & Kitaoka, 1981, *D. rwandae* Fain, 1993, *D. wutaensis* Gu & Ting, 1992.

EVOLUTION OF THE GENUS DEFINITION COMPARED WITH THE OTHER GENERA OF THE GROUP

This early genus definition follows a somewhat complex evolution, and it is necessary to explore its history throughout the literature in order to understand it. Dugès (1834) described the genus *Dermanyssus* as follows: "*Palporum articulus 5^{us} minimus; labium acutum; mandibulae maribus chelatae, ungue longissimo, feminis ensiformes; corpus molle; pedes antici longiore; coxae contiguae. Larvae hexapodae, adultis vix dissimiles*". Such a morphological description appears today extremely general and fits most current mesostigmates. About a century later, in 1923 and in 1936, Ewing provided short surveys of this genus in North America. The first one, included in a review of North American dermanyssids, listed only two species, and the second survey, being a compact summation, included several recently described species.

In 1958, Strandtmann and Wharton, in a large opus reviewing the classification of the mesostigmates parasitic on vertebrates, pointed out the serious need of revision of the genus *Dermanyssus*: "The genus is in need of revision. It is doubtful that all the species listed below really are specific entities" (Strandtmann & Wharton, 1958, p. 122).

From then on, three steps can be distinguished, on the whole, which lead to the current and stabilized description. Many other genera have been created, which are more or less closely related to *Dermanyssus*.

First, two of these genera are very closely related to *Dermanyssus*: *Allodermanyssus* Ewing, 1923 and *Liponyssoides* Hirst, 1913. The exploration of both these genera compared with *Dermanyssus* helped the definition to become more precise. Krantz (1959) and Sheals (1962) took part in the evolution of the genus definition, discussing the relationships among the three closely related genera. According to both the authors, *Allodermanyssus* was not valid anymore. But Krantz considered *Allodermanyssus* synonymous with *Dermanyssus*, whereas Sheals considered *Allodermanyssus* synonymous with *Liponyssoides*. This discordance induced a

deeper investigation of the description of *Dermanyssus*. Krantz described the first *Dermanyssus* species having a divided dorsal shield in the adult stage: *D. triscutatus* (dorsal shield short, several metanotal scutella present). He also pointed out the fact that the discrimination between *Allodermanyssus* and *Dermanyssus* based on the character incomplete/complete dorsal shield in the adult stage is not correct anymore. But he neglected to consider the genus *Liponyssoides*. Sheals examined the three genera together. In order to explain the new synonymy he established between *Allodermanyssus* and *Liponyssoides*, he provided some arguments concerning the ontogeny (one seta less on the femur and one less on the palp genu in the adult stage in *Dermanyssus*).

Another apparently important argument concerned the chaetotaxy of the dorsal shield and applied, according to Sheals, not only to Dermanyssinae but also to MacroNyssinae (today MacroNyssidae; cf. infra): he considered the presence/absence of seta *j*₃ a character related to the host group in both taxa (present in all parasites of mammalian and absent in all parasites of birds). However, it should be noted that the more recently described species *D. trochilinis* is an exception to such a hypothesis: it is parasitic on birds and doesn't lack *j*₃. Moreover, genus *Ornithonyssus* (MacroNyssidae) lacks *j*₃ and includes species which are parasitic on mammals (e.g. *O. bacoti* on rodents). In short, Sheals was wrong in this last hypothesis.

Secondly, Evans & Till (1962) stabilized *Dermanyssus* description: they wrote the first worldwide monograph on the genus *Dermanyssus*. Many generic characters were based on the ontogeny and the chaetotaxy of shields and legs.

Finally, Radovsky (1966, 1967) established MacroNyssinae (Mesostigmata: Dermanyssidae) as the macroNyssid family. This status change is very important. From then on, dermanyssids species *i.e.* *Dermanyssus* spp. and *Liponyssoides* spp., are to be distinguished from macroNyssids in having the 2nd segment of the chelicerae elongate and very slender (the 1st one is elongate, and differently conformed, in MacroNyssids), the chelae reduced (edentate, but each digit visible with an optic microscope in MacroNyssids) and a deutonymphal stage which needs a blood meal in order to accomplish its moulting (deutonymphs moult without feeding, as do larvae, in macroNyssids).

CURRENT DIAGNOSIS OF DERMANYSSIDAE

Dermanyssids are characterized among Dermanyssoidae by the following characters:

- Adult females

Gnathosoma-*chelicerae*: distal segment (= 2nd) of the female chelicerae conspicuously elongated and slender,

<i>Dermanyssus</i> species	Host species	
<i>D. alaudae</i> (Schrank, 1781)	<i>Alauda arvensis</i> <i>Lullula arborea</i>	<i>Alauda</i> : Alaudidae: Passeriformes <i>Alauda</i> : Alaudidae: Passeriformes
<i>D. americanus</i> Ewing, 1922	<i>Carpodacus lexicanus</i> <i>Emberiza cioides</i> <i>Otus asio</i> <i>Passer domesticus</i> <i>P. montanus</i> <i>Serinus canaries</i> <i>Sitta</i> sp.	<i>Carpodacus</i> : Fringilloidea: Passeriformes <i>Emberiza</i> : Fringillidae: Passeriformes <i>Otus</i> : Strigidae: Strigiformes <i>Passer</i> : Passeridae: Passeriformes <i>Passer</i> : Passeridae: Passeriformes <i>Serinus</i> : Fringillidae: Passeriformes <i>Sitta</i> : Sittidae: Passeriformes
<i>D. antillarum</i> Dusbabek & Cerny, 1971	<i>Mimus polyglottos orpheus</i> <i>Passer domesticus</i> <i>Accipiter striatus fringilloides</i> <i>Tachornis phoenicobia</i>	<i>Mimus</i> : Sturnidae: Passeriformes <i>Passer</i> : Passeridae: Passeriformes <i>Accipiter</i> : Accipitridae: Ciconiiformes <i>Tachornis</i> : Apodidae: Apodiformes
<i>D. brevivulus</i> Gu & Ting, 1992	<i>Galerida cristata leautungensis</i>	<i>Galerida</i> : Alaudidae: Passeriformes
<i>D. brevis</i> Ewing, 1936	<i>Alauda arvensis</i> <i>Eremophila alpestris</i>	<i>Alauda</i> : Alaudidae: Passeriformes <i>Eremophila</i> : Alaudidae: Passeriformes
<i>D. carpathicus</i> Zeman, 1979	<i>Phoenicurus phoenicurus</i> <i>Parus major</i>	<i>Phoenicurus</i> : Muscicapidae: Passeriformes <i>Parus</i> : Paridae: Passeriformes
<i>D. chelidonis</i> Oudemans, 1939	<i>Carduelis carduelis</i> <i>Delichon urbica</i> <i>Hirundo rustica</i> <i>Parus coeruleus</i> <i>Riparia riparia</i> <i>Ptyonoprogne rupestris</i>	<i>Carduelis</i> : Fringillidae: Passeriformes <i>Delichon</i> : Hirundinidae: Passeriformes <i>Hirundo</i> : Hirundinidae: Passeriformes <i>Parus</i> : Paridae: Passeriformes <i>Riparia</i> : Hirundinidae: Passeriformes <i>Ptyonoprogne</i> = <i>Hirundo</i> : Hirundinidae: Passeriformes
<i>D. faralloni</i> Nelson & Furman, 1967	<i>Oceanodroma homochroa</i> <i>Cepphus columba</i> <i>Ptychoramphus aleutica</i>	<i>Oceanodroma</i> : Hydrobatidae: Ciconiiformes <i>Cepphus</i> : Alcidae: Ciconiiformes <i>Ptychoramphus</i> : Alcidae: Ciconiiformes
<i>D. gallinae</i> (De Geer, 1778)	<i>Acrocephalus arundinaceus</i> <i>Aegolius funereus</i> <i>Carduelis carduelis</i> <i>Carduelis spinus</i> <i>Columba livia</i> <i>Delichon urbica</i> <i>Emberiza citrinella</i> <i>Eritbacus rubecula</i> <i>Ficedula albicollis</i> <i>Ficedula hypoleuca</i> <i>Hirundo rustica</i> <i>Jynx torquilla</i> <i>Merops apiaster</i> <i>Parus major</i> <i>P. ater</i> <i>Passer domesticus</i> <i>P. montanus</i> <i>Phoenicurus phoenicurus</i> <i>Remiz pendulinus</i> <i>Riparia riparia</i> <i>Serinus canarius</i> <i>Sitta europaea</i> <i>Sturnus vulgaris</i>	<i>Acrocephalus</i> : Sylviidae: Passeriformes <i>Aegolius</i> : Strigidae: Strigiformes <i>Carduelis</i> : Fringillidae: Passeriformes <i>Carduelis</i> : Fringillidae: Passeriformes <i>Columba</i> : Columbidae: Columbiformes <i>Delichon</i> : Hirundinidae: Passeriformes <i>Emberiza</i> : Fringillidae: Passeriformes <i>Eritbacus</i> : Muscicapidae: Passeriformes <i>Ficedula</i> : Muscicapidae: Passeriformes <i>Ficedula</i> : Muscicapidae: Passeriformes <i>Hirundo</i> : Hirundinidae: Passeriformes <i>Jynx</i> : Picidae: Piciformes <i>Merops</i> : Meropidae: Coraciiformes <i>Parus</i> : Paridae: Passeriformes <i>Parus</i> : Paridae: Passeriformes <i>Passer</i> : Passeridae: Passeriformes <i>Passer</i> : Passeridae: Passeriformes <i>Phoenicurus</i> : Muscicapidae: Passeriformes <i>Remiz</i> : Paridae: Passeriformes <i>Riparia</i> : Hirundinidae: Passeriformes <i>Serinus</i> : Fringillidae: Passeriformes <i>Sitta</i> : Sittidae: Passeriformes <i>Sturnus</i> : Sturnidae: Passeriformes
	Other wild birds and numerous species of domestic fowl, etc. Sometimes on mammalian species (insectivora, rodents, man)	Galliformes, Anseriformes
<i>D. gallinoides</i> Moss, 1966	<i>Asyndesmus lewis</i> <i>Colaptes cafer</i> (= <i>C. auratus</i>) <i>Dendrocopos pubescens</i> <i>Dryocopus pileatus</i> <i>Sphyrapicus varius</i>	<i>Asyndesmus</i> = <i>Melanerpes</i> : Picidae: Piciformes <i>Colaptes</i> : Picidae: Piciformes <i>Dendrocopos</i> : Picidae: Piciformes <i>Dryocopus</i> : Picidae: Piciformes <i>Sphyrapicus</i> : Picidae: Piciformes

Table II (to be continued).

<i>Dermanyssus</i> species	Host species	
<i>D. grochovskae</i> Zemskaia, 1961	<i>Nucifraga caryocatactes</i>	<i>Nucifraga</i> : Corvidae: Passeriformes
	<i>Dendrocopos leucotos</i>	<i>Dendrocopos</i> : Picidae: Piciformes
	<i>D. major</i>	<i>Dendrocopos</i> : Picidae: Piciformes
	<i>Picus awokera awokera</i>	<i>Picus</i> : Picidae: Piciformes
<i>D. hirsutus</i> Moss & Radovsky, 1967	<i>Colaptes cafer</i> (= <i>C. auratus</i>)	<i>Colaptes</i> : Picidae: Piciformes
<i>D. birundinis</i> (Hermann, 1804)	<i>Acrocephalus arundinaceus</i>	<i>Acrocephalus</i> : Sylviidae: Passeriformes
	<i>A. palustris</i>	<i>Acrocephalus</i> : Sylviidae: Passeriformes
	<i>A. scirpaceus</i>	<i>Acrocephalus</i> : Sylviidae: Passeriformes
	<i>Anthus arboreus</i>	<i>Anthus</i> : Motacillidae: Passeriformes
	<i>Apus affinis</i>	<i>Apus</i> : Apodidae: Apodiformes
	<i>Aquila pomarina</i>	<i>Aquila</i> : Accipitridae: Passeriformes
	<i>Anser anser</i>	<i>Anser</i> : Anatidae: Anseriformes
	<i>Aythya fuligula</i>	<i>Aythya</i> : Anatidae: Anseriformes
	<i>A. ferina</i>	<i>Aythya</i> : Anatidae: Anseriformes
	<i>Chaetura pelagica</i>	<i>Chaetura</i> : Apodidae: Apodiformes
	<i>Columba livia</i>	<i>Columba</i> : Columbidae: Columbiformes
	<i>Delichon urbica</i>	<i>Delichon</i> : Hirundinidae: Passeriformes
	<i>Dendrocopos pubescens</i>	<i>Dendrocopos</i> : Picidae: Piciformes
	<i>Ficedula albicollis</i>	<i>Ficedula</i> : Muscicapidae: Passeriformes
	<i>Hirundo rustica</i>	<i>Hirundo</i> : Hirundinidae: Passeriformes
	<i>H. urbica</i>	<i>Hirundo</i> : Hirundinidae: Passeriformes
	<i>Iridoprocne bicolor</i>	<i>Iridoprocne</i> = <i>Tachynecita</i> : Hirundinidae: Passeriformes
	<i>Lanius minor</i>	<i>Lanius</i> : Laniidae: Passeriformes
	<i>L. collurio</i>	<i>Lanius</i> : Laniidae: Passeriformes
	<i>Luscinia megarhynchos</i>	<i>Luscinia</i> : Muscicapidae: Passeriformes
	<i>Merops apiaster</i>	<i>Merops</i> : Meropidae: Coraciiformes
	<i>Micropus affinis</i>	<i>Micropus</i> = <i>Apus</i> : Apodidae: Apodiformes
	<i>Parus caeruleus</i>	<i>Parus</i> : Paridae: Passeriformes
	<i>P. major</i>	<i>Parus</i> : Paridae: Passeriformes
	<i>P. palustris</i>	<i>Parus</i> : Paridae: Passeriformes
	<i>Passer montanus</i>	<i>Passer</i> : Passeridae: Passeriformes
	<i>P. domesticus</i>	<i>Passer</i> : Passeridae: Passeriformes
	<i>Petrochelidon pyrrhonota</i>	<i>Petrochelidon</i> : Hirundinidae: Passeriformes
	<i>Phoenicurus ochruros</i>	<i>Phoenicurus</i> : Muscicapidae: Passeriformes
	<i>Remiz pendulinus</i>	<i>Remiz</i> : Paridae: Passeriformes
	<i>Riparia riparia</i>	<i>Riparia</i> : Hirundinidae: Passeriformes
	<i>Sitta europaea</i>	<i>Sitta</i> : Sittidae: Passeriformes
	<i>Strix aluco</i>	<i>Strix</i> : Strigidae: Strigiformes
<i>Sturnus vulgaris</i>	<i>Sturnus</i> : Sturnidae: Sturniformes	
<i>Taeniopygia guttata castanotis</i>	<i>Taeniopygia</i> : Passeridae: Passeriformes	
<i>Troglodytes aedon</i>	<i>Troglodytes</i> : Certhiidae: Passeriformes	
<i>T. troglodytes</i>	<i>Troglodytes</i> : Certhiidae: Passeriformes	
<i>Turdus torquatus</i>	<i>Turdus</i> : Muscicapidae: Passeriformes	
<i>Vireo olivaceus</i>	<i>Vireo</i> : Vireonidae: Passeriformes	
	Sometimes on mammalian species (insectivora, rodents)	
<i>D. longipes</i> Berlese & Trouessart, 1889 (<i>incertae sedis</i>)	<i>Passer domesticus</i>	<i>Passer</i> : Passeridae: Passeriformes
<i>D. nipponensis</i> Uchikawa & Kitaoka, 1981	<i>Picus awokera awokera</i>	<i>Picus</i> : Picidae: Piciformes
<i>D. passerinus</i> Berlese & Trouessart, 1889 (<i>incertae sedis</i>)	<i>Emberiza cirtus</i>	<i>Emberiza</i> : Fringillidae: Passeriformes
	<i>Ficedula albicollis</i>	<i>Ficedula</i> : Muscicapidae: Passeriformes
	<i>Jynx torquilla</i>	<i>Jynx</i> : Picidae: Piciformes
	<i>Parus major</i>	<i>Parus</i> : Paridae: Passeriformes
	<i>Passer italiae</i>	<i>Passer</i> : Passeridae: Passeriformes
	<i>Sturnus vulgaris</i>	<i>Sturnus</i> : Sturnidae: Sturniformes
<i>D. prognebilus</i> Ewing, 1933	<i>Progne subis subis</i>	<i>Progne</i> : Hirundinidae: Passeriformes
	<i>Colaptes cafer</i> (= <i>C. auratus</i>)	<i>Colaptes</i> : Picidae: Piciformes
	<i>Dendrocopos pubescens</i>	<i>Dendrocopos</i> : Picidae: Piciformes
	<i>Melanerpes erythrocephalus</i>	<i>Melanerpes</i> : Picidae: Piciformes
	<i>Molothrus ater</i>	<i>Molothrus</i> : Fringillidae: Passeriformes
	<i>Sialia sialis</i>	<i>Sialia</i> : Muscicapidae: Passeriformes

Table II (to be continued).

<i>Dermanyssus</i> species	Host species	
<i>D. quintus</i> Vitzthum, 1921	<i>Dendrocopos major</i>	<i>Dendrocopos</i> : Picidae: Piciformes
	<i>D. pubescens</i>	<i>Dendrocopos</i> : Picidae: Piciformes
	<i>Dryobates leucotes</i>	<i>Dendrocopos</i> : Picidae: Piciformes
	<i>D. major</i>	<i>Dendrocopos</i> : Picidae: Piciformes
	<i>Picoides pubescens</i>	<i>Picoides</i> : Picidae: Piciformes
	<i>P. tridactylus</i>	<i>Picoides</i> : Picidae: Piciformes
	<i>Picus viridis</i>	<i>Picus</i> : Picidae: Piciformes
<i>D. rwandae</i> Fain, 1993	<i>Apus affinis</i>	<i>Apus</i> : Apodidae: Apodiformes
<i>D. transvaalensis</i> Evans & Till, 1962	<i>Hirundo spilodera</i>	<i>Hirundo</i> : Hirundinidae: Passeriformes
	<i>Petrochelidon spilodera</i>	<i>Petrochelidon</i> : Hirundinidae: Passeriformes
<i>D. triscutatus</i> Krantz, 1959	<i>Hirundo</i> sp.	<i>Hirundo</i> : Hirundinidae: Passeriformes
	<i>Petrochelidon pyrrhonota</i>	<i>Petrochelidon</i> : Hirundinidae: Passeriformes
<i>D. trochilinis</i> Moss 1978	Trochilidae	Trochilidae: Apodiformes
<i>D. wutaiensis</i> Gu & Ting, 1992	<i>Passer montanus</i>	<i>Passer</i> : Passeridae: Passeriformes

Table II. – List of species currently included in *Dermanyssus* and their known host species, established with the help of following references: Berlese & Trouessart (1889), Bory de Saint-Vincent (1828), Dusbabek & Cerny (1971), Evans & Till (1962), Evans & Till (1964), Ewing (1922, 1933), Fain (1993), Fend'a & Schniererová (2004), De Geer (1778), Gu & Ting (1992), Haitlinger (1987), Hermann (1804), Krantz (1959), Moss (1966), Moss (1978), Moss (1970), Nelson & Furman (1967), Nosek & Lichard (1962), Schrank (1776), Uchikawa & Kitaoka (1981), Uchikawa & Takahashi (1985), Vitzthum (1921), Zeman (1979), Zeman & Jurík (1981), Zemskaya (1971), Fend'a (2006, unpublished data) and collection data from Pr. A. Fain. Taxonomic bird data follow Peterson's website.

with chelae strongly reduced (Fig. 2); *cornicules* membranous, flexible (not acute as in free-living mesostigmate species) and convergent; *Podosoma-legs*: coxae without spurs.

• Adult males differ from adult females mainly in having more extensive sclerotization both ventrally and dorsally (holoventral shield in most cases, larger dorsal shield, including more dorsal setae than in female) and modified chelicerae (less elongated and much broader than in female, chelae with a long spermadactyl on the movable digit). The tarsi of legs III and IV bear a tooth-like protuberance. Moreover, the genital orifice is conspicuous and presternally situated.

KEY FOR *DERMANYSSID* GENERA

Few characters remain currently available for diagnosis between *Dermanyssus* and *Liponyssoides*. Hirst (1913) described *Liponyssoides* as a subgenus of *Dermanyssus* mainly based on a weak difference in the proportion of capitulum. Moss (1967) stated other clear differences between them based on sternal shield shape and chaetotaxy of dorsal shield, sternal shield and legs. But the three species *L. intermedius*, *D. trochilinis* and partially *D. antillarum* appear as yet intermediate between both genera with chaetotaxy. As a result, only following elements can be used for diagnosis of the two genera.

Sternal shield roughly crescent-shaped; usually parasitic on birds.....*Dermanyssus*

Sternal shield roughly hexagonal; parasitic on rodents.....*Liponyssoides*

SPECIES SPECIFIC CHARACTERS WITHIN THE GENUS

TRADITIONAL SYSTEMATICS

Here will be dealt with characters which have been used as arguments for species description, not with diagnostic characters. For all the following characters, only adult females are to be considered.

Most of specific-level discriminant characters are based on chaetotaxy of the legs and dorsal shield and on the relative length of peritremes against the position from terminating over coxae IV to over coxae III-I.

Few other morphological characters are used. A marked difference of the dorsal setae length is very conspicuous between central setae on dorsal shield (*J4-J6* + "*J*" series except *J5*) and the other setae, which are situated all around (*J5*, "*z-Z*" series, "*r-R*" series, "*s*" series), in the seven following species: *D. alaudae*, *D. brevis*, *D. brevirivulus*, *D. hirsutus*, *D. grochovskae*, *D. quintus*, *D. rwandae*. In these species, the central seta length is near one-quarter the length of the peripheral ones, whereas they are all subequal in the other *Dermanyssus* species.

A character concerning dorsal shield development is found only in five species: mesonotal scutella are present only in *D. americanus*, *D. antillarum*, *D. transvaalensis*, *D. triscutatus* and *D. wutaiensis*. The nature of these platelets seems to correspond to the primary dorsal plates, which don't become coalesced as they

do in other *Dermatonyssus* species in the adult stage. The dorsal shield is more strongly reduced in *D. triscutatus* and *D. antillarum* than in the three other species: from the "J" series, only *I* is on the shield in *D. triscutatus* and in *D. antillarum*, whereas at least *I* and *I/2* are on the shield in *D. americanus*, *D. transvaalensis* and *D. uitaiensis*. Moreover, the dorsal scutella are proportionally quite smaller in these three latter species than in the two former.

Three very conspicuous characters are found each in a single species and concern particular opisthoveentral setae:

- a ventral neotrichy in form of a cluster of elongate, simple setae laterad of the anal shield is present only in *D. birsuttus*;
- a U-shaped row of very large and deeply rooted setae on the opisthogaster is present only in *D. quintus*;
- several distally inflated setae situated posteriorly on the idiosoma are present only in *D. antillarum*.

No other *Dermatonyssus* species possess such species specific, apomorphic characters.

Additionally, in *D. quintus*, the wider than long anal plate is another species specific character. Nevertheless, apart from these characters, it should be noted that the leg and dorsal shield chaetotaxy provides most of the characters traditionally used for species discrimination in the genus *Dermatonyssus*. The reliability of some of them seems to be doubtful. Evans & Till (1962) emphasized with several remarks many intraspecific variations, concerning the chaetotaxy: "The chaetotaxy of the venter of the opisthosoma shows considerable intraspecific variation" (p. 277). "The chaetotaxy of the various segments [of the legs] is considerably more variable, both inter- and intra-specifically, than in the free living and facultative parasitic Laelaptidae" (p. 278). Moss (1968) also noticed that characters of the leg chaetotaxy usually seemed to be the most variable.

Other than the chaetotactic characters of the legs and dorsal shield, the other traditionally most used character is the relative length of the peritreme. However the states of this character don't provide any defined limit. The extension of the peritreme varies continuously from coxa IV to coxa III to coxa IV to coxa I without a sharp gap from one species to another in the genus *Dermatonyssus* and with intraspecific variations. Indeed, from Moss (1978) the following data can be extracted, in increasing order: the peritreme extends from the coxa IV "to middle of coxa III" in *D. transvaalensis* and *D. chelidontis*, "not as far as anterior margin of coxa III" in *D. alaudae* and *D. brevis*, "to or past anterior margin of coxa III" in *D. americanus*, "past anterior margin of coxa III" in *D. triscutatus*, "to middle of coxa II" in *D. birsuttus*, "to middle or anterior margin of coxa II" in *D. gallinae* and *D. gallinoides*, "to anterior margin of coxa II" in *D. grochowskiae* and *D. birundinis*, "to middle of coxa I" in *D. prognephibilus*, "past

posterior margin or to middle of coxa I" in *D. trochilini* and extends "anterior of base of coxa I" in *D. faralloni*. Although the character states seem to overlap each other, it takes part in several new species arguments. For instance, the first of the two characters which are cited by Uchikawa as a distinctive property in *D. nipponensis* is the remarkable length of the peritreme. Its length is also the first of the five characteristics used by Nelson and Furman in order to distinguish *D. faralloni* from the *a priori* most closely related species *D. birundinis*. Moreover, Oudemans (1939) cited this character as the main difference distinguishing *D. chelidontis* from *D. birundinis* and *D. gallinae*. It would be of interest to investigate the reliability of such a character as an argument for species description.

In short, many of the main traditionally used species specific characters are problematic. Chaetotactic characters of legs and dorsal shield are variable intraspecifically and the peritreme relative length doesn't seem to provide states of characters that are precise enough.

AN ATTEMPT WITH NUMERIC TOOLS

Moss tried to use more objective tools than the traditional systematics in order to explore the relationships between the *Dermatonyssus* species: in 1967, he published a work on some numeric taxonomy theories (phenetics), in which he used the genus *Dermatonyssus* as a model. He complained about the difficulties of finding characters in this genus and considered this to be due to a reduction and loss of structures correlated with parasitism. As a result, he selected quantitative characters, which are much easier to find than qualitative ones. His analysis resulted in two subdivisions of the genus: two subgenera, *Dermatonyssus* and *Microdermatonyssus*, are to be distinguished from one another by the setation of genu II (two al setae, one *av* and one *pv* setae in *Dermatonyssus* (*Dermatonyssus*), one *al* setae, one *av* and *pv* setae in *Dermatonyssus* (*Microdermatonyssus*)) and by the size of the unengorged female's body. Subgenus *Dermatonyssus* included *D. chelidontis*, *D. gallinae*, *D. gallinoides*, *D. grochowskiae*, *D. birsuttus*, *D. birundinis*, *D. prognephibilus*, *D. quintus*, *D. transvaalensis* and *D. triscutatus*. Subgenus *Microdermatonyssus* included *D. alaudae*, *D. americanus* and *D. brevis*. Moreover, two species-groups were separated in the subgenus *Dermatonyssus*: the *birsuttus*-group, with, among other discriminant characters, the seta *alI* of palp genu spiniform, and the *gallinae*-group, with the seta *alI* of palp genu spatulate. The *birsuttus*-group included *D. grochowskiae*, *D. birsuttus* and *D. quintus*, whereas the *gallinae*-group included *D. chelidontis*, *D. gallinae*, *D. gallinoides*, *D. birundinis*, *D. prognephibilus*, *D. transvaalensis* and *D. triscutatus*. Moss used these new subdivisions in his 1968 and 1978 keys. The 1978 article was somewhat more developed than the

one from 1968 and took three new species into account (*D. antillarum*, *D. trochilini* and *D. faralloni*). It provided a variety of information on the genus *Dermatonyssus* (hosts, phylogenetic results from Moss (1967), remarks on the high variability of some characters,...). The status of the two subgenera and the two species-groups is re-examined with the changes induced by the three new species. Actually, the introduction of *D. antillarum* and *D. trochilini* into Moss' phenetic analysis introduced some problems with the subdivisions. Nevertheless, Moss decided to continue to recognize the two subgenera and the two species-groups temporarily because he was expecting some additional elements from a new study he was preparing at that time. Unfortunately, this study was never published. As well as these doubts about the interrelationships of species in the genus *Dermatonyssus*, Moss warned in 1978 that any person who wanted to attempt identification with his key to remain careful because of the considerable variation within species: "The most useful setae for identification are those in the "J" series of the dorsum. [...] Leg setae are also useful in species identification, but tend to be more variable within species than dorsal setae. [...] Variation within species is considerable. One is advised to consider several characters from several individuals of a sample when attempting an identification. A recent example of such variation is described below for *D. gallinoides*. Most key couplets list several alternative features in view of this problem." (Moss, 1978:633-634). Moss also invalidated one of the discriminant characters for *D. gallinoides*: "Dorsal shield scaling has been a reliable feature until recently for the separation of *D. gallinoides* and *D. gallinae*. Two specimens just provided by N. Wilson have predominantly scaled teeth in one case and completely scaled teeth in the other, but otherwise key to *D. gallinoides*" (Moss, 1978:634).

SPECIES WHOSE NOMENCLATURE STATUS IS NOT CLEAR

About *D. hominis*, Dugès wrote as follows: "*D. hominis*; sorte d'acarie, Bory St-Vincent". Bory de Saint-Vincent described it in 1823, in a memoir which was read during a regular meeting of the French "Académie des Sciences". He did not attribute any name and any systematic position within the Acari group to this species. Latreille and Savigny were designated to judge such a position, but did not do so (*cf.* Académie des Sciences, 1823-1828). Mites of this species were found infesting the body of a woman. The description of this species and its illustration by Bory de Saint-Vincent (1828) appear very similar to *D. gallinae*. This last species has been reported from humans several times (Beck, 1999; Cremer & Morrien, 1962; Holz J., 1954; Pampiglione *et al.*, 2001). Moreover, there is no type material available and the drawing of Bory de Saint-Vincent is not suffi-

cient to morphologically identify this species. As a result *D. hominis* should be synonymized with *D. gallinae*. Two species are considered *incertae sedis*: *D. passerinus* Berlese & Trouessart, 1889 and *D. longipes* Berlese & Trouessart, 1889. Evans & Till (1962) considered them *incertae sedis* because of the inadequate descriptions and the damaged type material in the Berlese collection. In Moss (1978), a part of the discussion refers to both of these species, in order to begin to solve this problem. In short, Zemskaya suggested that *D. passerinus* should be conspecific with *D. americanus* (which should be then a junior synonym), but did not demonstrate this. Moss adds an argument: both hosts of these species seem to be conspecific too, according to an ornithologist. Moreover, according to Moss, it is most likely that *D. passerinus* and *D. longipes* are conspecific. The type of *D. longipes* is too opaque to confirm such a hypothesis.

However, as the type of *D. longipes* (No. 52-47) is almost opaque and essentially unusable according to Moss and as this species has not been cited for a long time, it could be more appropriate to establish it as a *nomen dubium* instead of *incertae sedis*. Indeed, the systematic position within *Dermatonyssus* does not appear to be doubtful, compared to its precise identity, which is doubtful.

As for *D. passerinus*, the type specimens are partially opaque and some papers include it in some acarofaunal lists (Nosek & Lichard, 1962; Zemskaya, 1971; Zeman & Jurik, 1981). So, the problem is more important with this species, which we suggest be considered *species inquirenda*.

D. lacertarium and *D. richiardii* are also problematic species. *D. richiardii* had been collected on two different species of insect, the hymenopteran *Xylocopa violaceus* and the lepidopteran *Gossus ligniperda* (Canestrini & Fanzago, 1877), which are not common hosts for the *Dermatonyssus*. As for *D. lacertarium*, it was transferred from genus *Ricinus* by Canestrini (1877) in the same paper, with the only following sentence: "Due specie vi sono citate come nuove, il *Ricinus lacertarium*, e *Lacanus penetrans*; il primo sembra un *Dermatonyssus*, il secondo è una forma larvale". From that date, we did not find any more information on these two species. Maybe they should be established as *nomen dubium*. In any case, given the information cited above, they can not be included in the genus *Dermatonyssus* anymore.

CONCLUSION AND PERSPECTIVES

The systematics of *Dermatonyssus* is not completely clear as yet. Its history is complex. *Dermatonyssus* seems to be well defined today, but species within the genus remain less clearly defined. Moreover,

not only was the last work on *Dermanyssus* not completely carried out, but also five new species have been described since this last review (Moss, 1978). The reliability of numerous traditional characters needs to be re-examined.

Today, 23 species are included in this genus, two of which are really doubtful. The status of *D. longipes* and *D. passerinus* is to be re-examined. *D. americanus* might be a junior synonym of *D. passerinus*. *D. hominis* is a synonym of likely *D. gallinae*. Some other early species might likely be synonymized too. The reliability of the five species described after Moss (1978), needs to be checked and they have to be integrated in a review of the entire genus.

For these reasons, it appears necessary to review the genus *Dermanyssus* at the specific level, which we plan to do, with the help of cladistic tools. Two major questions need to be answered. First, the correct definition of genus, even if it seems to be right using traditional tools, has to be checked by testing the monophyly of the group. Secondly, the a priori most problematic question of the species definitions within the genus should be explored, and maybe some species should be synonymized. Finally, as morphological characters seem to be insufficient, it seems necessary to add molecular characters to the phylogenetic analysis.

ACKNOWLEDGEMENTS

We are grateful for the help and advice of P. Fend'a (Faculty of Natural Sciences, Comenius University, Bratislava, Slovak Republic), R. Nannelli (Istituto Sperimentale per la Zoologia Agraria, Firenze, Italia), J. Hallan (Texas A & M University, College Station, Texas), O. Bain and I. Roy (Muséum National d'Histoire Naturelle, Paris, France), H. Ferrière (Université Paris I-Sorbonne, Paris, France), V. Marengo (Muséum d'Histoire naturelle, Lyon, France) and to Pr. F.J. Radovsky and an anonymous reviewer for constructive reviewing and valuable suggestions.

REFERENCES

- ACADÉMIE DES SCIENCES. Comptes-rendus hebdomadaires des séances de l'Académie des sciences, Paris, 1820-1835, 77-110.
- BECK W. Farm animals as disease vectors of parasitic epizoonoses and zoophilic dermatophytes and their importance in dermatology. *Hautarzt*, 1999, 50 (9), 621-628.
- BERLESE A. Acari, myriopoda et scorpiones hucusque in Italia reperta. *Pataviai - F. Salmin.*, 1889, fasc. 53.
- BERLESE A. & TROUËSSART E. Diagnoses d'acariens nouveaux ou peu connus. *Bulletin de la Bibliothèque Scientifique de l'Ouest 2^e année*, 1889, 2^e partie (9), 121-143.
- BORY DE SAINT-VINCENT J.-B.G.M. Note sur une espèce d'Acariade qui vit sur le corps humain. *FERUSSAC, Bulletin des Sciences Naturelles*, 1824, II, 305-306.
- BORY DE SAINT-VINCENT J.-B.G.M. Sur un nouveau genre d'Ascaridiens sorti du corps d'une femme. *Audouin et al. Annales des Sciences Naturelles*, 1828, XV, 125-131.
- CANESTRINI & FANZAGO INTORNO AGLI ACARI ITALIANI. *Atti del Regio Istituto veneto di scienze lettere ed arti*, 1877, IV (5:1-4), 57-58.
- CONTARINI N. Cataloghi degli uccelli e degli insetti delle provincie di Padova e Venezia, Ed. Bassano, 1843.
- CREMER G. & MORRIEN J.J. *Dermanyssus scabies* in man. *Ned Tijdschr Geneesk.*, 1962, 17 (106), 520-523.
- DUGÈS A.L. Recherches sur l'ordre des Acariens en général et la famille des Trombidiés en particulier. *Annales des sciences naturelles. Zoologie*, 1834, 2 (1), 5-46, pl. 1.
- DUSBABEK F. & CERNY V. Two mesostigmatic mites (Acarina: Macronyssidae and Dermanyssidae) associated with Cuban birds. *Folia parasitologica*, 1971, 18, 55-61.
- EVANS G.O. Observations on the chaetotaxy of the legs in the free-living Gamasina (Acari: Mesostigmata) *Bulletin of the British Museum (Natural History) Zoology*, 1963, 10, 277-303.
- EVANS G.O. Observations on the ontogenetic development of the chaetotaxy of the tarsi of legs II-IV in the Mesostigmata (Acari). Proceedings of the II International Congress of Acarology (1967), 1969, 195-200.
- EVANS G.O. & TILL W.M. The Genus *Dermanyssus* De Geer (Acari: Mesostigmata). *Annals and magazine of Natural History*, 1962, 13 (5), 273-293.
- EVANS G.O. & TILL W.M. A new species of *Dermanyssus* and a redescription of *Steatonyssus superans* Zemskaaya (Acari: Mesostigmata). *Acarologia*, 1964, 6 (4), 624-631.
- EVANS G.O. & TILL W.M. Studies on the British Dermanyssidae (Acari: Mesostigmata). Part I. External morphology. *Bulletin of the British Museum (Natural History) Zoology*, 1965, 13, 249-294.
- EVANS G.O. & TILL W.M. Studies on the British Dermanyssidae (Acari: Mesostigmata). Part II. Classification. *Bulletin of the British Museum (Natural History) Zoology*, 1966, 14, 109-370.
- EWING H.E. *Dermanyssus americanus*, new species. *Proceedings of the United States National Museum*, 1922, 62 (13), 24-26, pl. 2.
- EWING H.E. The dermanyssid mites of North America. *Proceedings of the United States National Museum*, 1923, 62, 1-26, pls 1, 2.
- EWING H.E. *Dermanyssus prognepbilus*, new species. *Proceedings of the United States National Museum*, 1933, 82 (30), 12.
- EWING H.E. A short synopsis of the North America species of the mite genus *Dermanyssus*. *Proceedings of the Entomological Society of Washington*, 1936, 38, 47-54.
- FAIN A. A new species of the genus *Dermanyssus* De Geer, 1778 (Acari: Dermanyssidae) from the nest of a bird *Apus affinis* in Rwanda. *Bulletin & Annales de la Société royale d'entomologie de Belgique*, 1993, 129, 163-168.

- FEND'A P. & SCHNIEREROVÁ E. Mites (Acarina: Mesostigmata) in the nest of *Acrocephalus* spp. and in neighbouring reeds. *Biologia, Bratislava*, 2004, 59 (Suppl. 15), 41-47.
- GEER CH. de. Mémoires pour servir à l'histoire des insectes, 1778, VII, 111-112.
- GU Y.M. & TING Q.Y. New species and new records of *Dermanyssus* from China (Acari: Dermanyssidae) *Acta Zootaxonomica Sinica*, 1992, 17(1), 32-36 (abstract in English, text in Chinese).
- HÄITLINGER R. *Dermanyssus alaudae* (Schrank, 1781) and other mites (Acari: Dermanyssidae, Macronyssidae, Haemogamasiade, Hirstionyssidae, trombiculidae, Erythraeidae) collected from birds in Poland. *Wiadomos Parazytologiczne*, 1987, 33 (2), 233-245 (in Polish).
- HERMANN J. Mémoire aptérologique. Levrault (ed.), Strasbourg, 1804.
- HIRST S. On three new species of Gamasid mites found on rats. *Bulletin of entomological research*, 1913, 4, 119-124.
- HOLZ J. *Dermanyssus avium* an occasional parasite in man. *Arztl Wochensh. Jan*, 1954, 2, 9 (1), 16.
- HUGHES T.E. Mites or the Acari. Athlone Press, University of London, 1959.
- ICZN. International code of zoological nomenclature, 4th ed, London, 1999.
- KOCH C.L. Deutschlands crustaceen, myriapoden und arachniden. Ein Beitrag zur deutschen Fauna, Dr. Herrich-Schäffer, 1836, 4, 14.
- KOLENATI F.A. Beiträge zur kenntniss des arachniden. *Sitzungsberichte der Kaiserlichen Akademie der Wissenschaften*, 1859, 35, 155-190, 8 tab.
- KRANTZ G.W. New synonymy in the Dermanyssidae Kolenati, 1859, with a description of a new species of *Dermanyssus* (Acarina, Dermanyssidae). *Proceedings of the Entomological Society of Washington*, 1959, 61, 174-178.
- LINDQUIST E.E. & EVANS G.O. Taxonomic concepts in the Ascidae, with a modified setal nomenclature for the idiosoma of the Gamasina (Acarina: Mesostigmata). *Memoirs of the Entomological Society of Canada*, 1965, 47, 1-64.
- MELVILLE R.V. & SMITH J.D.D. Official lists and indexes of names and works in zoology. International Trust for Zoological Nomenclature, London, 1987.
- MOSS W.W. *Dermanyssus gallinoides* n. sp. (Mesostigmata: Laelapoidea: Dermanyssidae), an acarine parasite of woodpeckers in Western North America. *The Canadian Entomologist*, 1966, 98, 635-638.
- MOSS W.W. The biological and systematic relationships of the martin mite, *Dermanyssus prognepbilus* Ewing (Acari: Mesostigmata: Dermanyssidae). Ph. D. dissertation, The University of Kansas, Lawrence, 1966.
- MOSS W.W. Some new analytic and graphic approaches to numerical taxonomy, with an example from the Dermanyssidae (Acari). *Systematic zoology*, 1967, 16, 177-207.
- MOSS W.W. An illustrated key to the species of the Acarine genus *Dermanyssus* (Mesostigmata: Laelapoidea: Dermanyssidae). *Journal of Medical Entomology*, 1968, (1), 67-84.
- MOSS W.W. The mite genus *Dermanyssus*: a survey, with description of *Dermanyssus trochilinus* n. sp., and a revised key to the species (Acari: Mesostigmata: Dermanyssidae). *Journal of Medical Entomology*, 1978, 14 (6), 627-640.
- MOSS W.W. & RADOVSKY F.J. *Dermanyssus hirsutus*, a new name for *Dermanyssus scutatus* Ewing (Acari: Mesostigmata: Dermanyssidae). *Journal of the Kansas Entomological Society*, 1967, 40, 277.
- MOSS W.W., MITCHELL C.J. & JOHNSTON D.E. New north american host and distribution records for the mite genus *Dermanyssus* (Acari: Mesostigmata: Dermanyssidae). *Journal of Medical Entomology*, 1970, 7, 589-593.
- NELSON B.C. & FURMAN D.P. A new species of *Dermanyssus* from marine birds, with observations on its biology (Acarina: Dermanyssidae). *Acarologia*, 1967, 9, 330-337.
- NOSEK J. & LICHARD M. Beitrag zur kenntniss der vogelnest-fauna. *Entomologické problémy (Bratislava)*, 1962, 2, 29-51.
- OUDEMANS A.C. Kritisch historisch overzicht der acarologie. Tweede gedeelte, 1759-1804. *Tijdschrift voor entomologie*, 1929, 72 (suppl.), 99.
- OUDEMANS A.C. Kritisch historisch overzicht der acarologie. Derde gedeelte, 1805-1850. Vols A-G. Leiden, E.J. Brill, 1936-1937.
- OUDEMANS A.C. Neue funde auf dem gebiete der systematik und der nomenklatur der Acari, V. *Zoologische Anzeiger*, 1939, 126 (11-12), 303-309.
- PAMPIGLIONE S., PAMPIGLIONE G., PAGANI M., RIVASI F. Persistent scalp infestation by *Dermanyssus gallinae* in an Emilian country-woman. *Parassitologia*, 2001, 43 (3), 113-115.
- PETERSON A.P. <http://www.zoonomen.net/avtax/frame.html>, Version 7.07 (2007.02.04).
- PHILLIS III W.A. Ultrastructure of the chelicerae of *Dermanyssus prognepbilus* Ewing (Acari: Dermanyssidae). *International Journal of Acarology*, 2006, 32 (1), 85-91.
- RADOVSKY F.J. Revision of the Macronyssid and Laelapid mites of bats: outline of classification with descriptions of new genera and new type species. *Journal of Medical Entomology*, 1966, 3(1), 93-99.
- RADOVSKY F.J. The Macronyssidae and Laelapidae (Acarina: Mesostigmata) parasitic on bats. *University of California Publications in Entomology*, 1967, 46, 1-288.
- RADOVSKY F.J. Adaptative radiation in the parasitic Mesostigmata. *Acarologia*, 1969, 11, 450-483.
- SHEALS G.J. The status of the genera *Dermanyssus*, *Allodermanyssus* and *Liponyssoides*. Proceeding of the XIth International Congress of Entomology, Vienna, 1962, 2, 473-476.
- SCHRANK F. von P. Beyträge zur naturgeschichte. Siebente Art, Augsburg, 1776, p. 11.
- SCHRANK F. von P. Enumeratio insectorum austriae indigenorum. *Augustae Vindelicorum: vid. Eberhardi Klett et Frank*, 1781.
- STRANDTMANN R.W. & WHARTON G.W. A manual of mesostigmatid mites parasitic on vertebrates. Institute of Acarology, Contribution No 4. University of Maryland, College Park, Maryland, 1958.
- TENORIO J.M. Catalog of the world *Echinonyssus* (= *Hirstionyssus*) (Acari: Laelapidae). *International journal of entomology*, 1984, 26 (3), 260-281.

- UCHIKAWA K. & KITAKA S. *Dermanyssus nipponensis* sp. nov. taken from Japanese green woodpecker indigenous to Japan (Acari: Mesostigmata) *National Institute of Animal Health Quarterly*, 1981, 21 (2), 80-82.
- UCHIKAWA K. & TAKAHASHI M. Contribution to mites of the genus *Dermanyssus* De Geer distributed in Japan (Acarina, Mesostigmata) *Japanese Journal of Sanitary Zoology*, 1985, 36 (3), 233-237.
- VITZTHUM H.G. Acarologische Beobachtungen. 4 Reihe. *Archiv für Naturgeschichte*, 1921, 864 (10), 1-69.
- VOIS A.G., LEIDEN E.J. Brill, 1956-1957.
- ZEMAN P. *Dermanyssus carpaticus* sp. n. (Acarina: Dermanyssidae), a new bird parasite from Czechoslovakia. *Folia Parasitologica (Praha)*, 1979, 26, 173-178.
- ZEMAN P. & JUREK M. A contribution to the knowledge of fauna and ecology of gamasoid mites in cavity nests of birds in Czechoslovakia. *Folia Parasitologica (Praha)*, 1981, 28, 265-271.
- ZEMSKAYA A.A. A New species of bird mites, *Dermanyssus grochotskiae* Zemskaaya sp. n. *Zoologicheskij Zhurnal*, 1961, 40, 134-136.
- ZEMSKAYA A.A. Mites of the family Dermanyssidae Kolenati, 1859, of the USSR fauna. *Meditsinskaja Parazitologija i Parazitarnye bolezni*, 1971, 40, 709-717 (in Russian).

Reçu le 15 novembre 2006
 Accepté le 12 mars 2007

- FONDATI A. Efficacy of daily oral ivermectin in the treatment of 10 cases of generalized demodicosis in adult dogs. *Veterinary Dermatology*, 1996, 7, 99-104.
- HILLIER A. & DESH C.E. Large-bodied *Demodex* mite infestation in four dogs. *Journal of American Veterinary Medical Association* 2002, 220, 623-627.
- MEDLEAU L., RISTIC Z. & MCCALVEEN D.R. Daily ivermectin for treatment of generalized demodicosis in dogs. *Veterinary Dermatology*, 1996, 7, 209-212.
- MOZOS E., PEREZ J., DAY M.J., LUCENA R. & GINEL P.J. Leishmaniosis and generalized demodicosis in three dogs: a clinicopathological and immunohistochemical study. *Journal of Comparative Pathology* 1999, 120, 257-268.
- PURVIS A.C. Immunosuppression in *Babesia microti* infections. *Parasitology*, 1977, 75, 197-205.
- SARIDOMICHELAKIS M., KOUTINAS A., PAPADOGIANNAKIS E., PAPAZACHARIADOU M., LIAPI M. & TRAKAS D. Adult-onset demodicosis in two dogs due to *Demodex canis* and a short-tailed demodectic mite. *Journal of Small Animal Practice*, 1999, 40, 529-532.
- TARELLO W. Cutaneous lesions in dogs with *Dirofilaria (Noch-itella) repens* infestation and concurrent tick-borne transmitted diseases. *Veterinary Dermatology*, 2002, 13, 267-274.
- TARELLO W. Concurrent cutaneous lesions in dogs with *Babesia gibsoni* infection in Italy. *Revue de Médecine Vétérinaire*, 2003a, 154, 281-287.
- TARELLO W. Canine granulocytic ehrlichiosis (CGE) in Italy. *Acta Veterinaria Hungarica*, 2003b, 51, 73-90.

Reçu le 15 juin 2007
 Accepté le 20 septembre 2007

Erratum

ROY L. & CHAUVE C.M. Historical review of the genus *Dermanyssus* Dugès, 1834 (Acari: Mesostigmata: Dermanyssidae). *Parasite*, 2007, 14 (2), 87-100.

The authors wish to correct an error in the published manuscript. On page 97, column 2, line 16, a confusion between two species names (*D. passerinus* and *D. birundinis*) has been found. The sentence should read: "Moreover, according to Moss, it is most likely that *D. longipes* and *D. birundinis* are conspecific." Authors apologize to readers for this mistake.

4.2 Evaluation des caractères morphologiques discriminants entre espèces : publication II

a - Présentation

La déconcertante variabilité des caractères morphologiques disponibles pour l'appréhension du genre *Dermanyssus* au niveau spécifique a été plusieurs fois soulignée. Les analyses pourtant très approfondies de Moss (1967, 1968, 1978) ont au moins partiellement échoué dans la clarification des délimitations interspécifiques.

4.2.a.1 Objectifs

Les objectifs consistaient ici à vérifier expérimentalement les assertions antérieures concernant l'extrême variabilité intraspécifique des caractères utilisés jusqu'alors et évaluer l'utilité de chacun en vue d'une exploration phylogénétique.

4.2.a.2 Matériel et méthodes

Pour ce faire, les caractères traditionnellement utilisés pour la discrimination interspécifique dans le genre *Dermanyssus* ont été observés, notés, dessinés chez différents individus appartenant à quelques populations de *D. gallinae*. Des informations complémentaires ont été tirées de types et paratypes d'autres espèces du genre, réparties dans les trois divisions de Moss.

4.2.a.3 Principaux résultats

Les principaux caractères morphologiques utilisés comme caractères diagnostiques chez les Mesostigmata, et en particulier chez les Dermanyssina, se situent dans la chaetotaxie des pattes, celle de la plaque dorsale et d'autres parties de l'idiosome et la longueur relative des péritrèmes par rapport à la position des coxae. D'une manière générale, de nombreux auteurs ont remarqué que la plupart des caractères étaient, pour des raisons non évidentes, beaucoup moins stables chez les acariens parasites que chez leurs parents libres dans ce groupe. En particulier, une étude a mis en évidence la variabilité accrue chez les Mesostigmata parasites de la chaetotaxie des pédipalpes (Evans 1963) par rapport aux Mesostigmata libres. Ainsi l'analyse de la chaetotaxie des pattes chez les acariens (cf. Fig. 5) repose-t-elle sur le nombre et la position de soies sur des portions définies dans la surface de chacun des segments, de forme plus ou moins cylindrique ou conique (*ad*, antéro-latérale, *pv* postéro-ventrale, ...). Or, très souvent, l'aire d'implantation de soies homologues chez *Dermanyssus* est apparue très élargie par comparaison aux Mesostigmata libres, et s'est montrée chevauchante avec les aires limitrophes. De fait, il s'avère souvent très difficile de décider à laquelle des portions appartiennent les soies observées. Sans même parler des soies absentes ou supplémentaires au sein d'une population de la même espèce, voire au sein d'un seul individu.

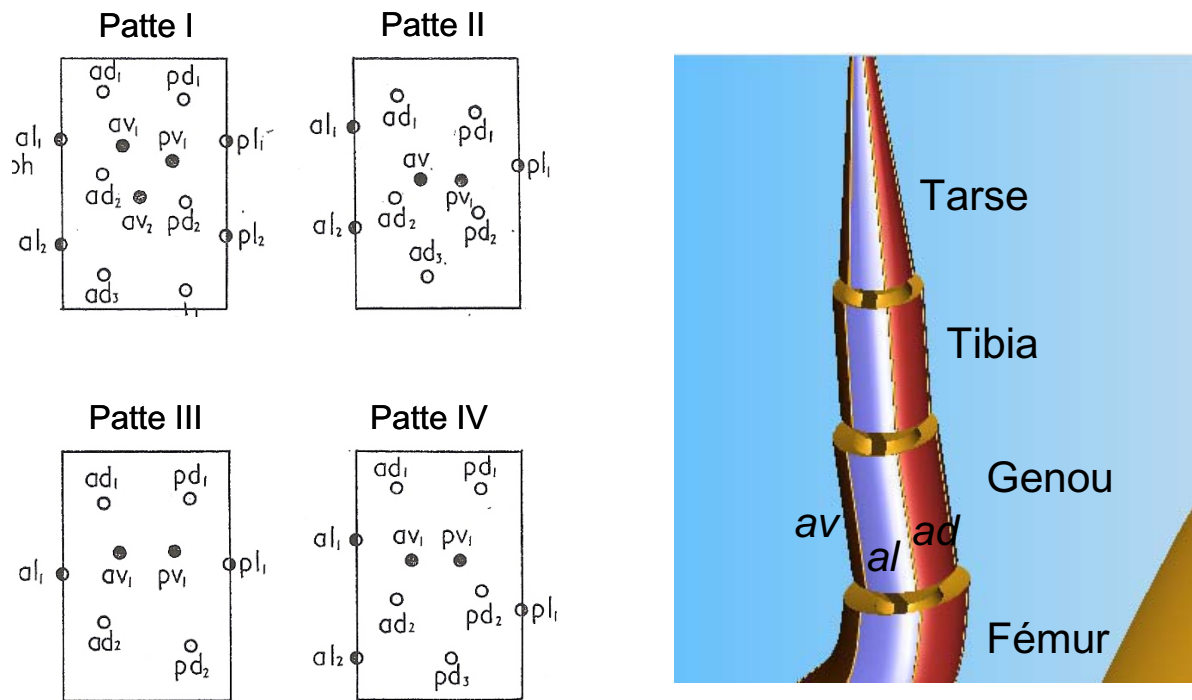

Figure 5. Chaetotaxie des pattes chez les acariens méso-stigmatés. *A gauche*, notation de la chaetotaxie des pattes chez les acariens méso-stigmatés d'après Evans (1963). Exemple de la représentation diagrammatique de la chaetotaxie du genou des pattes I à IV chez les deutonymphes et adultes de *Pergamasus*. *a*=antéro- *p*=postéro-, *d*=dorsal, *v*=ventral, ex. zone *ad*= zone antéro-dorsale. *A droite*, représentation en 3 dimensions d'une patte stylisée d'acarien méso-stigmaté avec surlignage coloré des différentes zones à observer. Les limites de ces zones sont virtuelles et s'avèrent extrêmement floues dans le genre *Dermanyssus*, les bases des soies trouvant souvent leur implantation à la limite de la zone, voire à l'extérieur, empiétant sur la zone voisine, de manière asymétrique sur un seul et même individu.

L'article suivant démontre que la variabilité des caractères traditionnels, jusqu'alors seulement évoqués à propos de *Dermanyssus* (Moss 1978), est extrême et rend leur utilisation dans le cadre d'une reconstruction phylogénétique très délicate. La mise en évidence de chevauchement de nombreux états entre espèces dans le genre, de variations importantes au sein d'une unique population de *D. gallinae*, ainsi que la récurrence d'asymétries bilatérales sont des arguments de poids en faveur de la recherche de caractères « nouveaux », non décrits jusqu'alors, ou peu utilisés.

b - Remarques sur la publication II

4.2.b.1 Des caractères réhabilités *a posteriori*

Parmi les caractères dénoncés comme douteux dans la publication II, plusieurs ont été testés au cours de la phase *a posteriori* de la publication III (p. 456-457 et 461). Pour une majorité des caractères testés concernant la chaetotaxie des pattes en particulier, l'instabilité est confirmée. Toutefois, certains en ressortent réhabilités.

Proceedings of the XIth International Congress of Acarology, Amsterdam, August 2006

The genus *Dermanyssus* Dugès, 1834 (Acari : Mesostigmata : Dermanyssidae): species definition

Running title: Species definition within *Dermanyssus*

L. Roy* and C. Chauve

Laboratoire de Parasitologie et Maladies Parasitaires, Ecole Nationale Vétérinaire de Lyon

1 avenue Bourgelat, 69280 MARCY-L'ETOILE, France, Email: l.roy@vet-lyon.fr, Tel 00 33 4 78 87 25 74, Fax 00 33 4 78 87 25 77

Abstract

The genus *Dermanyssus* Dugès, 1834 (Acari: Mesostigmata: Dermanyssidae) includes species of hematophagous mites that are ectoparasites of birds. The definition of this genus took a long time to get firmly established. Major changes in genus definition involving not only the establishment of synonymies, but also many changes in systematic position have been reviewed, based on literature data, by Roy and Chauve (2007). However, the species definition is currently not yet clear. Host specificity and geographic distribution of *Dermanyssus* species are reviewed. Some morphological characters posing problems in species identification are discussed.

Key-words: Acari, Mesostigmata, *Dermanyssus*, morphological characters, systematics

Introduction

The genus *Dermanyssus* Dugès, 1834 (Acari: Mesostigmata: Dermanyssidae) includes hematophagous mite species that are ectoparasites of birds. One of the species in this genus, *D. gallinae* (De Geer, 1778), the Red Fowl Mite, is economically important in the poultry industry. The damage consists of downgraded eggs, decreased egg production, anaemia and even mortality due to exsanguination. *D. gallinae* can also transmit diseases, such as avian spirochaetosis, fowl cholera and salmonellosis (Valiente Moro *et al.* 2005). Although the genus harbours species of economic importance, the classification of species in this genus has been in a state of confusion. The main characters discriminating Dermanyssidae from other families in the Dermanyssoidea are located on the chelicerae. Dermanyssidae have a strongly elongated 2nd segment of the chelicerae and they have much reduced chelae, a morphological feature that seems to be correlated to a hematophagous life style (see Phillis 2006, for more details). Macronyssidae, another family in the Dermanyssoidea, also includes obligatory hematophagous species which possess chelicerae modified but in a different way. Here, elongation is less important and concerns the first article, rather than the second as in Dermanyssidae and the chelae are not really atrophied as in the Dermanyssidae. The current Family Dermanyssidae includes only two genera: *Dermanyssus* and *Liponyssoides*. The main morphological differences between those two genera are to be found on genu IV (*ad* with 2 setae in *Dermanyssus* / 3 setae in *Liponyssoides*) and on the sternal shield (roughly crescent-shaped with 1 or 2 pairs of setae in *Dermanyssus* / roughly hexagonal with 3 pairs of setae in *Liponyssoides*). The host range differs

widely between the two genera. Whereas *Dermanyssus* includes bird parasites, *Liponyssoides* includes species mainly parasitic on rodents.

Only Evans and Till (1962) and Moss (1967, 1968, 1978) provided comprehensive systematic reviews of genus *Dermanyssus* at the species level. Although the genus seems to be well defined today, this does not hold for the species within this genus (Roy and Chauve 2007). At least 57 species have been included in *Dermanyssus*, whereas currently there are 23 species (Roy and Chauve 2007).

Here, we provide an overview of the current characterisation of species within the genus *Dermanyssus*. Firstly, we review the host specificity and geographic distribution of *Dermanyssus* species, based on the data published to date. Secondly, we examine the reliability of traditional species-specific characters.

Geographic distribution of *Dermanyssus* species

Concerning the geographical distribution of *Dermanyssus* species, *D. gallinae* is the most frequently collected species and it seems to be found all around the world. Some other *Dermanyssus* species are also cosmopolitan (see distribution map in Roy and Chauve 2007). Examples are *D. hirundinis*, *D. brevis* and *D. quintus* which have been reported from both American and Eurasian continents and are thus not restricted to the New or Old World. Some other *Dermanyssus* species stem from a single and recent record, such as *D. antillarum* Dusbabek & Cerny, 1971 (Cuba), *D. nipponensis* Uchikawa & Kitaoka, 1981 (Japan) and *D. rwandae* Fain, 1993 (Rwanda). Clearly, there are not enough data on these species to make any inference on their distribution.

Host specificity

Dermanyssus species are ectoparasites of birds. However, most species do not show host specificity, and some species have even been noted parasitizing mammals, such as man or rodents, in absence of birds as hosts.

Up to 30 bird species, distributed in twelve different families of birds and in eight different orders, are known to be parasitized by *D. gallinae* (Roy and Chauve 2007). Also, *D. hirundinis* has a rather broad host spectrum since it has 40 bird species as hosts out of 18 families and 9 orders of birds (bird classification from Peterson 2007). There may be a few species that are host-specific. Examples are *D. alaudae*, *D. quintus*, *D. brevis* and *D. triscutatus* each of which have been found on birds belonging to a single family. The most recently described *Dermanyssus* species might be host-specific too (Table 2), but there are not enough data available to prove that this is not a simple byproduct of limited sampling.

The question of the reliability of species specific characters

Traditional systematics

Most of the species-level discriminating characters are based on leg and dorsal chaetotaxy, and relative length of the peritreme against coxal position. Concerning leg chaetotaxy, some authors (Evans and Till 1962, Moss 1978) cautioned that there is great intraspecific variation. As for dorsal chaetotaxy and relative peritreme length, characters also seem to be very polymorphic (Roy, pers. obs.).

a - Major characters: dorsal shield chaetotaxy and relative length of peritreme

An example of the dorsal shield chaetotaxy from a single population of *D. gallinae* is shown in Figure 1. Focusing on the *j* line allows observing some important variation in the dorsal chaetotaxy. Dispositions of setae J3, J4 and J5 are shown (two nearly parallel longitudinal lines in *c* or a hexagone in *f* and *i*). Several cases of bilateral asymmetries in setation are found, not only with

some asymmetrical dispositions (*e*, *j*), but also with a case of unpaired seta J3/J4 (*d* with only one of them on the right side). Note that such frequent asymmetries have been pointed out by Evans and Till (1962). Moreover, there are major differences in the shape of the dorsal shields of mites shown in Figure 1. The shape of the dorsal shield is important for evaluating some chaetotactic characters: variation in position of *j1*, i.e. on or off shield, seems to be due to shield contour variations. Arrows in Figure 1 show different positions of *j1*, which is always on-shield in *D. gallinae*, but off-shield in *D. gallinoides* according to Moss (1978). Allred (1970) pointed out a similar case in two species of *Ornithonyssus* (Mesostigmata: Macronyssidae), which are also hematophagous parasites. In these species, the great degree of intraspecific variation in shape and chaetotaxy of the sternal plate imposes major difficulties for species discrimination.

The peritreme is associated with the respiratory organ. It is a groove extending anteriorly from the stigma, which is located near coxa IV. Using a scanning electron microscope, two sclerotized lips can be seen along the groove (Figure 3). The relative length of the peritreme from coxa IV to coxa III-I is considered to be a taxonomic character discriminating between *Dermanyssus* species, but there are numerous character states and they overlap each another (Roy, pers. obs.; data from Moss 1978). The extension of the peritreme varies continuously from coxa IV to coxa III up to coxa I without a distinct gap throughout the genus *Dermanyssus* as well as within species of this genus. There are more than 7 possible positions (Figure 2): peritreme extending to anterior margin of coxa III, and to posterior, middle or anterior margin of coxae II and I, and a various intermediate positions can be observed (Roy, pers. obs.).

Moreover, clearing specimens for slide-mounting and observation with an optical microscope may destroy attachment of the peritreme, so that the soft groove may change length and position, moving inside the podosoma (Figure 4 illustrates it with a case of asymmetric length). However, the clearing procedure is necessary for unambiguous identification of hematophagous mites.

Phenotypic plasticity concerning these frequently used characters and overlapping character states make them very difficult to be encoded for cladistic exploration.

b - Other characters

Apart from the major characters dealt with previously, some other types of character have been used for species identification. Two characters concerning the dorsal side allow the characterization of two small groups of species and each seems to provide a rather distinct gap between their two states:

- Dorsal setae show marked or no difference in length between "central setae" and "peripheral setae" (central setae = *j4-j6* + J-serie except J5; peripheral setae = J5, z-serie, Z-serie, r-serie, R-serie, s-serie). "Central setae" are markedly shorter than "peripheral setae" in 7 species (*D. alaudae*, *D. brevis*, *D. brevirivulus*, *D. hirsutus*, *D. grochovskae*, *D. quintus*, *D. rwandae*).
- Mesonotal scutella are present or not. They are present in 5 species (*D. americanus*, *D. antillarum*, *D. transvaalensis*, *D. triscutatus* and *D. wutaiensis*).

Each of the following three characters defines a single species:

- Ventral neotrichy in the form of a cluster of elongate, simple setae, lateral of the anal shield, is present only in *D. hirsutus*.
- Several inflated setae situated posteriorly on the idiosoma are found only in *D. antillarum*.
- A U-shaped row of very hard and deeply rooted setae on the opisthosomal ventral side is present only in *D. quintus*. In addition, several chitinous apophyses on coxae III and IV and some clawlike setae on trochanters and coxae III and IV, as well as an anal shield, more broad than long, constitute a set of unique characters for *D. quintus*.

A new character

Moss (1967), who studied the relationships between species within the genus *Dermanyssus* using phenetic tools, selected mostly morphometric characters in absence of clearly definable morphological characters - a feature he assumed to be an adaptation to the parasitic life style. In addition, he described a character not noted before, i.e. the shape of seta *all* of palp genu (distally expanded *vs* spike-like).

Based on his analysis, two subgenera were distinguished, but, in 1978, the addition of three new species blurred these subdivisions. No more exploration of interrelationships between *Dermanyssus* species have been published thereafter.

Discussion on species definition

The most frequently invoked characters are problematic: (1) leg chaetotaxy provides characters which are quite variable intraspecifically according to different authors, (2) dorsal shield chaetotaxy provides characters which are very variable at least in *D. gallinae* (which differs from *D. hirundinis* only by the number of setae pairs on dorsal shield according to Evans & Till 1962) and (3) relative length of the peritreme is not as clearly defined as required for species characterization within the genus *Dermanyssus*. Five additional characters seem to be reliable, but characterize only few species. Moss revealed a new not morphometric and apparently intraspecifically steady character (shape of seta *all* of palp genu).

Most of the purely morphological characters are too polymorphic intraspecifically and their number is not high enough, since there are few left that are reliable enough. Species within the genus *Dermanyssus* are not sufficiently clearly defined so that it is hard to separate them from each based on morphological characters alone.

Thus, species-specific characters, i.e. characters used to define new species, do not seem to be stable enough. Moreover, most of these species seem to provide low host specificity and are geographically widely distributed. For all these reasons there is doubt about the validity of several species within the genus *Dermanyssus*.

Conclusion and perspectives

In conclusion, the genus *Dermanyssus* includes species which are morphologically not clearly defined and therefore not unambiguously distinguished from each other. This is largely due to high phenotypic plasticity in many of traditional species-specific characters. Moreover, not only the last-published review on the genus *Dermanyssus* was unachieved, but also five new species have been described since this last review.

As a result, the genus is in need of revision, which we plan to do with the help of cladistic tools. Two major questions are to be answered: first, the correct definition of genus, even if it seems to be right with traditional tools, has to be checked by testing the monophyly of the group. Secondly, the *a priori* most problematic question on the species definition inside genus has to be solved.

Finally, as morphological characters seem to be insufficient, it is necessary to add molecular characters to the phylogenetic analysis of the genus *Dermanyssus*.

Acknowledgements

We are grateful for the help, advices, loans of type and non-type material, etc. of Baker A.S. and Beccaloni J. (The Natural History Museum, London, UK), Huber B. (Zoologisches Forschungsinstitut und Museum A. Koenig, Bonn, Germany), Bain O. and Judson M. (Muséum National d'Histoire Naturelle, Paris, France), Lindquist E.E., Beaulieu F. and King Wan Wu

(Agriculture & Agri-Food Canada, Ottawa, Canada), Klompen H. (Ohio State University, Museum of Biological Diversity, Columbus, USA), Ochoa R. (Systematic Entomology Laboratory, USDA, Beltsville, USA), O'Connor B.M. (Museum of Zoology, University of Michigan, Ann Arbor, USA), Dowling A.P.G. (University of Kentucky, Lexington, USA), Kilpinen O. (Danish Institute of Agricultural Sciences, Lyngby, Denmark), Knee W. (University of Alberta, Edmonton, Canada), Nannelli R. (Istituto Sperimentale per la Zoologia Agraria, Firenze, Italia), Hallan J. (Texas A&M University, College Station, Texas), Marengo V. (Muséum d'Histoire Naturelle, Lyon, France).

References

- Allred DM (1970) – Dermanyssid mites of New Guinea. *J. Med. Entomol.* 7:242-246
- Berlese A, Trouessart E (1889) Diagnoses d'acariens nouveaux ou peu connus. *Bull Biblioth Sci Ouest* 2^e année, 2^e partie (9) :121-143
- Canestrini, Fanzago (1877) Intorno agli acari italiani. *Atti R Ist veneto sci lett arti IV :5 :1-4 ;57-58*
- Contarini N (1843) Cataloghi degli uccelli e degli insetti delle provincie di Padova e Venezia. Tipografia Baseggio edit, Bassano
- Dugès AL (1834). Recherches sur l'ordre des Acariens en général et la famille des Trombidiés en particulier. *Ann sci nat, Zool* (2)1: 5-46 pl. 1.
- Dusbabek F, Cerny V (1971) Two mesostigmatic mites (Acarina: Macronyssidae and Dermanyssidae) associated with Cuban birds. *Folia parasitol* 18:55-61
- Evans GO (1963) Observations on the chaetotaxy of the legs in the free-living Gamasina (Acari: Mesostigmata). *Bull Br Mus Nat Hist, Zool* 10:277-303
- Evans GO (1969) Observations on the ontogenetic development of the chaetotaxy of the tarsi of legs II-IV in the Mesostigmata (Acari). In Evans GO (ed) *Proceedings of the II International Congress of Acarology, Budapest, 1967* :195-200
- Evans GO, Till WM (1962) The Genus *Dermanyssus* De Geer (Acari : Mesostigmata). *Bull Am Mus Nat Hist* 13(5):273-293
- Evans GO, Till WM (1964) A New Species of *Dermanyssus* and a redescription of *Steatonyssus superans* Zenskaya (Acari : Mesostigmata). *Acarologia*, 6(4):624-631
- Evans GO, Till WM (1965) Studies on the British Dermanyssidae (Acari: Mesostigmata). Part I. External morphology. *Bull Br Mus Nat Hist, Zool* 13:249-294
- Evans GO, Till WM (1966) Studies on the British Dermanyssidae (Acari: Mesostigmata). Part II. Classification. *Bull Br Mus Nat Hist, Zool* 14:109-370
- Ewing HE (1923). The dermanyssid mites of North America. *Proc US Natl Mus* 62: 1-26
- Ewing HE (1936) A short synopsis of the North America species of the mite genus *Dermanyssus*. *Proc Entomol Soc Wash* 38:47-54
- Fain A (1993) A new species of the genus *Dermanyssus* DE GEER, 1778 (Acari: Dermanyssidae) from the nest of a bird *Apus affinis* in Rwanda. *Bull ann Soc r entomolog Belg* 129:163-168
- Gu YM, Ting QY (1992) New species and new records of *Dermanyssus* from China (Acari: Dermanyssidae) *Dongwu fenlei xuebao (Acta zootaxonomica Sinica)*17(1): 32-36
- Hirst S (1913). On three new species of Gamasid mites found on rats. *Bull entomol res* 4: 119-124
- Krantz GW (1959) New synonymy in the Dermanyssidae Kolenati, 1859, with a description of a new species of *Dermanyssus* (Acarina, Dermanyssidae). *Proc Entomol Soc Wash* 61:174-178
- Lindquist EE, Evans GO (1965) Taxonomic concepts in the Ascidae, with a modified setal nomenclature for the idiosoma of the Gamasina (Acarina: Mesostigmata). *Mem Entomol Soc Can* 47:1-64
- Melville RV, Smith JDD (1987) Official lists and indexes of names and works in zoology. International Trust for Zoological Nomenclature, London, p. 308

- Moss WW (1966) *Dermanyssus gallinoides* n. sp. (Mesostigmata: Laelapoidea: Dermanyssidae), an Acarine Parasite of Woodpeckers in Western North America. *The Canadian Entomologist* 98:635-638
- Moss WW (1967) Some new analytic and graphic approaches to numerical taxonomy, with an example from the Dermanyssidae (Acari). *Syst zool* 16:177-207
- Moss WW (1968) An Illustrated Key to the Species of the Acarine Genus *Dermanyssus* (Mesostigmata: Laelapoidea: Dermanyssidae). *J Med Ent* 1:67-84
- Moss WW (1978) The mite genus *Dermanyssus* : a survey, with description of *Dermanyssus trochilinis*, n. sp., and a revised key to the species (Acari: Mesostigmata: Dermanyssidae). *J Med Ent* 14(6):627-640
- Moss WW, Radovsky FJ (1967) *Dermanyssus hirsutus*, a new name for *Dermanyssus scutatus* Ewing (Acari: Mesostigmata: Dermanyssidae). *J Kans Entomol Soc* 40:277
- Moss WW, Mitchell CJ and Johnston DE (1970) New North American host and distribution records for the mite genus *Dermanyssus* (Acari: Mesostigmata: Dermanyssidae). *J Med Ent* 7:589-593
- Nelson BC, Furman DP (1967) A new species of *Dermanyssus* from marine birds, with observations on its biology (Acarina: Dermanyssidae). *Acarologia* 9:330-337
- Peterson A.P. <http://www.zoonomen.net/avtax/frame.html> Version 7.07 (2007.02.04)
- Radovsky FJ (1966) Revision of the Macronyssid and Laelapid mites of bats : outline of classification with descriptions of new genera and new type *species*. *J Med Ent* 3(1):93-99
- Roy L, Chauve CM. (2007) Historical review of the genus *Dermanyssus* Dugès, 1834 (Acari: Mesostigmata: Dermanyssidae). *Parasite*. 14(2):87-100
- Sheals GJ (1962) The status of the genera *Dermanyssus*, *Allodermanyssus* et *Liponyssoides*. In: *Proceedings of the XIth International Congress of Entomology, Vienna, 1960* 2:473-476
- Strandtmann RW, Wharton GW (1958) *A manual of mesostigmatid mites parasitic on vertebrates*. Institute of Acarology, Contribution No. 4, University of Maryland, College Park, Maryland.
- Uchikawa K, Kitaoka S (1981) *Dermanyssus nipponensis* sp. nov. taken from Japanese green woodpecker indigenous to Japan (Acari: Mesostigmata) *Natl Inst Anim Health Q* 21(2):80-2
- Uchikawa K, Takahashi M (1985) Contribution to mites of the genus *Dermanyssus* De Geer distributed in Japan (Acarina, Mesostigmata) *Eisei Dobutsu (Jap J Sanit Zool)* 36:3:233-237
- Valiente Moro, .C, Chauve C and Zenner L (2005) Vectorial role of some dermanyssoid mites (Acari, Mesostigmata, Dermanyssidae) *Parasite* 12(2):99-109
- Valiente Moro C, Chauve C, Zenner L.(2007) Experimental infection of *Salmonella Enteritidis* by the poultry red mite, *Dermanyssus gallinae*. *Vet Parasitol.* 146(3-4):329-36
- Zeman P (1979). *Dermanyssus carpathicus* sp. n. (Acarina : Dermanyssidae), a new bird parasite from Czechoslovakia. *Folia Parasitol* 26:173-178
- Zemskaya, A.A. 1971. [Mites of the family Dermanyssidae Kolenati, 1859, of the U.S.S.R. fauna]. *Med. parazitol. parazit. bolezni* 40: 709-717

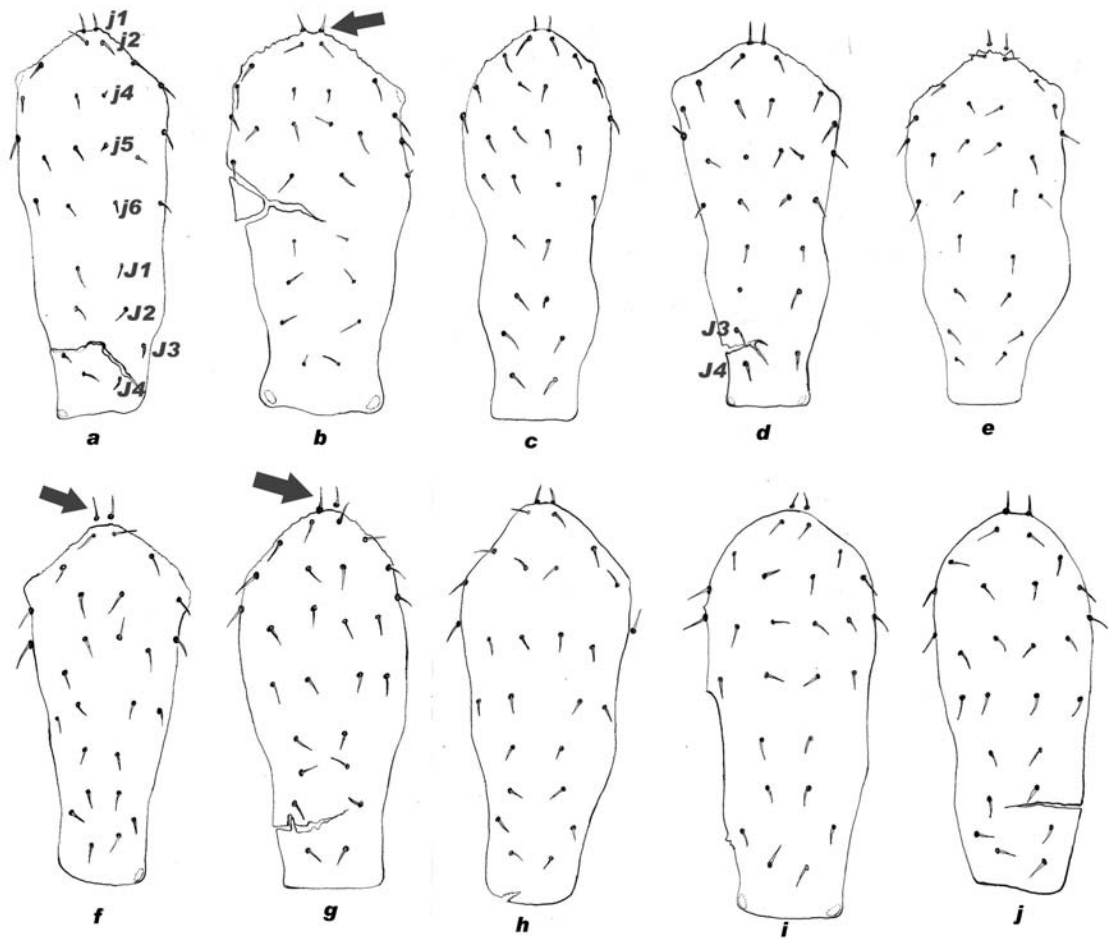

Figure 1
 Dorsal shield of 10 from 20 randomly selected adult females of a cultured in lab population of *D. gallinae*. Setal terminology follows Lindquist and Evans (1965).

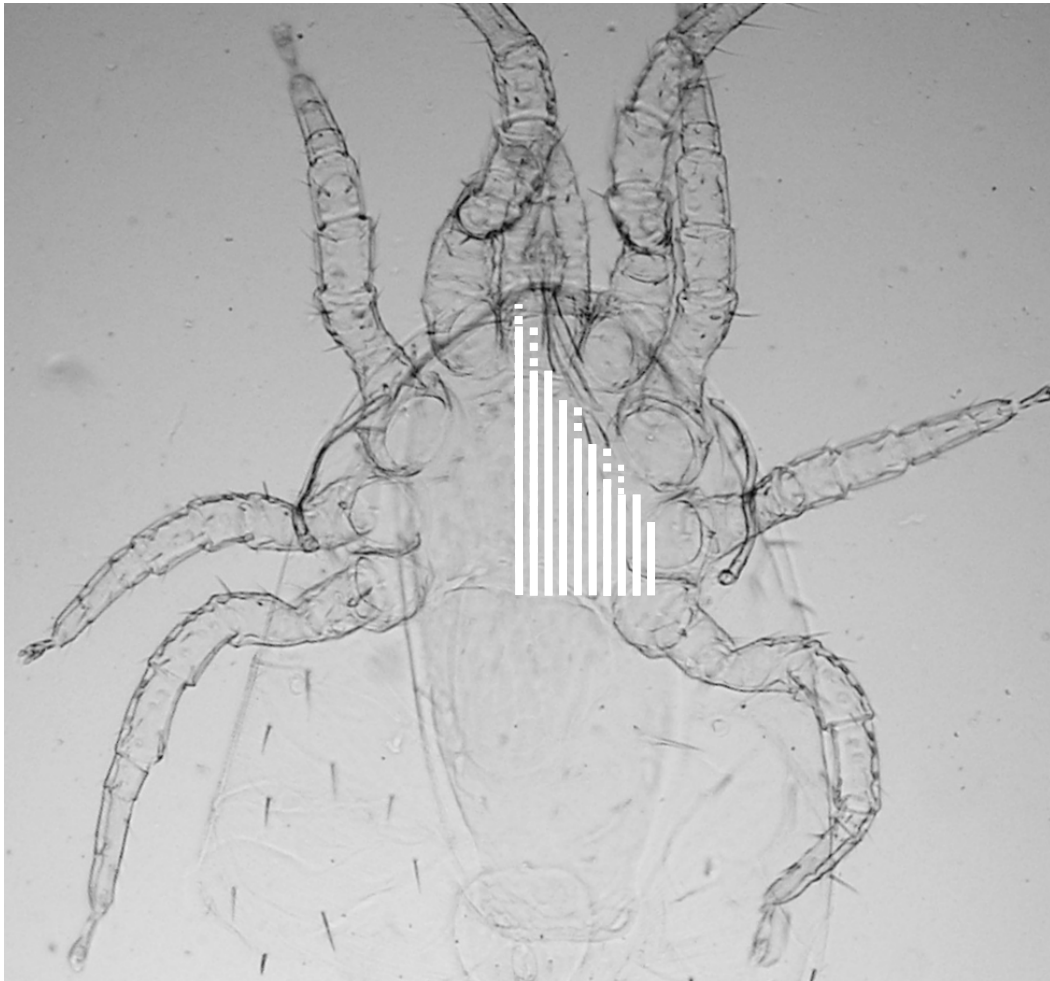

Figure 2

Relative length of peritrema according to position of coxae. Each bar from left to right corresponds to length of peritrema in following species:

D. faralloni

D. trochilinis

D. prognephilus *D. grochovskae* and *D. hirundinis*

D. gallinae and *D. gallinoides*

D. hirsutus

D. triscutatus

D. americanus

D. alaudae and *D. brevis*

D. transvaalensis and *D. chelidonis*

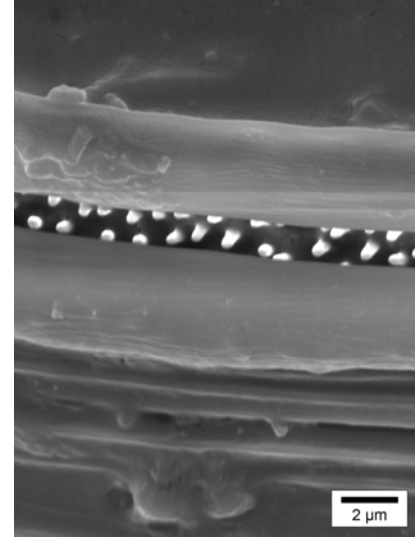
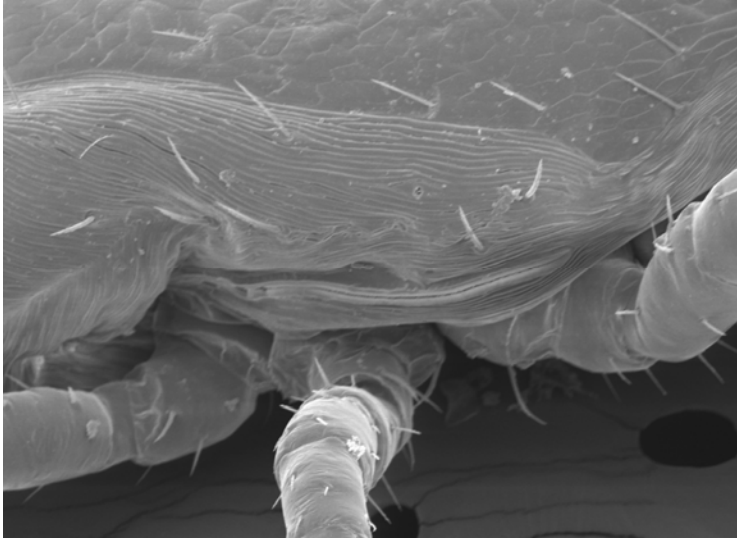

Figure 3
Peritreme (scanning electron microscope) in *D. gallinae*

		bird order																							
		bird family																							
		D. gallinae	D. alaudae	D. hirundinis	D. longipes	D. passerinus	D. quintus	D. americanus	D. prognephillus	D. brevis	D. chelidonis	D. triscutatus	D. grochoyskae	D. transvaalensis	D. gallinoides	D. faralloni	D. hirsutus	D. antillarum	D. trochilinis	D. carpathicus	D. nipponensis	D. brevirovullus	D. wutaicensis	D. rwandae	
P a s s e r i f o r m e s	Fringillidae																								
	Passeridae																								
	Sittidae																								
	Alaudidae																								
	Muscicapidae																								
	Paridae																								
	Hirundinidae																								
	Corvidae																								
	Certhiidae																								
	Laniidae																								
	Motacillidae																								
	Sylviidae																								
	Vireonidae																								
	Sturniformes	Sturnidae																							
	Piciformes	Picidae																							
Strigiformes	Strigidae																								
Apodiformes	Apodidae																								
	Trochilidae																								
Ciconiiformes	Accipitridae																								
	Alcidae																								
Coraciiformes	Hydrobatidae																								
	Meropidae																								
Columbiforme	Columbidae																								
Anseriformes	Anatidae																								
Galliformes	Phasianidae																								

Table 1

Host diversity for *Dermanyssus* species (from literature data). Species are in chronological order from left to right. Avian taxonomic groups were checked on <http://www.zoonomen.net/avtax/frame.html>.

4.3 Délimitation des espèces par une approche complémentaire (« total evidence approach »): publication III

a - Présentation

L'extrême instabilité des caractères morphologiques traditionnels et le chevauchement interspécifique de leurs états, détaillés dans la publication II, laissent prévoir des mises en synonymie nombreuses à l'issue de la révision envisagée. Mais il faut vérifier l'absence d'isolement reproducteur entre les entités potentiellement synonymes. Les reconstructions phylogénétiques incluant plusieurs isolats par entité testée et portant sur des loci indépendants (mitochondriaux et nucléaires) offrent la possibilité de vérifier l'isolement reproducteur des entités spécifiques. La description de caractères morphologiques non décrits jusqu'à présent, ainsi que le recodage de certains des traditionnels permettraient en outre une exploration du genre *Dermanyssus* confrontant caractères moléculaires à caractères morphologiques.

4.3.a.1 Objectifs

La troisième publication visait à clarifier les délimitations interspécifique dans le genre *Dermanyssus*, avec un focus sur le groupe *gallinae* en mettant à profit des techniques moléculaires, ainsi que de nouveaux caractères morphologiques (nouvellement décrits ou codés différemment).

4.3.a.2 Matériel et méthodes

Suivant les recommandations de Samadi et Barberousse (2006), une approche *a priori/a posteriori* a été adoptée pour atteindre une délimitation stable des espèces. C'est-à-dire que l'alpha taxinomie, classification au niveau spécifique telle qu'elle est admise au moment de l'étude, doit être testée par des moyens indépendants, de manière à pouvoir se tourner vers elle *a posteriori* et confirmer/infirmer ses différentes composantes. Les moyens choisis pour le test de l'alpha taxinomie dans le genre *Dermanyssus* étaient une analyse phylogénétique comparative (matrice combinée *vs* matrice gène par gène, méthode Bayésienne *vs* maximum de parcimonie), impliquant à la fois caractères morphologiques et moléculaires, et à la fois gènes mitochondriaux et gènes nucléaires.

L'intégration nouvelle de données moléculaires permettait d'espérer un tant soit peu de clarification dans ce genre à la morphologie apparemment peu informative. La confrontation de gènes nucléaires et mitochondriaux visait à détecter les éventuels flux de gènes entre entités supposées spécifiques (et ainsi remettre en question leur statut).

Quant aux caractères morphologiques, beaucoup des traditionnels paraissant impossibles à coder, nous avons recherché des caractères « nouveaux », utilisé un caractère peu utilisé, décrit par Moss (1968, K4, forme de la soie- *all*) et recodé certains des anciens (ex : K9, longueur relative du péritrème). Une matrice de 46 caractères a ainsi pu être construite. Le travail de notation morphologique a été réalisé, outre sur les types (ADN indisponible), sur des individus dont les séquences d'ADN des régions ciblées ont pu être obtenues, de manière à ménager la possibilité du retour *a posteriori* sur la morphologie des individus testés, et, ainsi, sur l'alpha taxinomie.

4.3.a.3 Principaux résultats

La réunion des types de 20 espèces parmi les 23 décrites au début de l'étude permet de décrire quelques rares caractères nouveaux (K6, K7, K26, K27, K31, K39, K40, K43), qui se présentaient pour la plupart comme discriminants entre groupe *gallinae* et groupe *hirsutus* (sous-genre *Dermanyssus*), et entre groupe *gallinae* et *Microdermanyssus*. Pratiquement aucun des caractères « nouveaux » ne semblaient permettre une distinction au sein du groupe *gallinae*. L'analyse phylogénétique de cette presque totalité des espèces du genre aboutit à un clade résolu pour les espèces hors groupe *gallinae*, tandis qu'une simple polytomie représente les relations des espèces du groupe *gallinae* entre elles et avec les autres.

L'analyse morphologique et moléculaire d'un échantillon de six de ces espèces, prélevées sur le terrain (ADN disponible), permet de mettre en évidence de flagrantes limites interspécifiques. Plusieurs populations ont pu être intégrées pour chacune des espèces testées (sauf deux, les deux seules hors groupe *gallinae*). Contre toute attente, des espèces *a priori* indiscernables entre elles laissèrent apparaître une nette isolation reproductrice.

Le retour *a posteriori* sur l'ensemble des cuticules préparées pour l'observation microscopique et dont des séquences d'ADN ont pu être intégrées aux analyses permet de découvrir, parmi la multitude de caractères chaetotactiques variables intraspécifiquement, quelques portions de segments de pattes porteuses de soies à l'implantation régulière. Ainsi, *D. hirundinis* et *D. longipes*, dont les caractéristiques morphologiques semblaient trop incertaines, sont bel et bien des entités distinctes. Et *D. apodis*, une espèce nouvelle, fut révélée. La caractérisation moléculaire dans ces trois cas est confirmée par de subtils – mais à peu près stables – caractères morphologiques. Enfin, deux lignées basales de *D. gallinae* (L1 et L2) peuvent sembler isolées aussi. Mais s'il s'agit d'espèces à part entière, alors elles sont cryptiques, aucun élément morphologique discriminant n'ayant pu être mis en évidence.

b - Remarques sur la publication III

4.3.b.1 *D. longipes* : deux lignées différentes ?

Les séquences d'ITS des deux populations testées de *D. longipes* (PAS et ENVLO83) présentent trois différences nucléotidiques l'une par rapport à l'autre, alors que les autres espèces ne présentent pour ainsi dire pas de mutations intraspécifiques (seulement 1 différence entre certains isolats de *D. gallinae* sur 1 site dans l'ITS1). L'isolat PAS provient d'un nid de moineau friquet (*Passer montanus*), et ENVL083 d'un nid de mésange charbonnière (*Parus major*). Or, ultérieurement, le séquençage d'une portion de gène codant pour la Tropomyosine (incluant un intron) a permis de relever des différences très importantes entre ces deux populations (publication V, p. 131 sqq.). En outre, un nouvel isolat provenant d'un nid de moineau friquet et un autre d'un nid de mésange charbonnière présentent exactement les mêmes différences respectives. Cela suggère deux lignées ou espèces différentes, inféodées chacune à un hôte différent, mais les prélèvements proviennent respectivement du même site, ce qui rend l'interprétation hasardeuse pour l'instant (différence liée à la localisation géographique ?). Toutefois, nous avons signalé dans la publication III comme caractéristique de *D. longipes* une séquence d'ITS attribuée par erreur à *D. gallinae* par Brännstörms *et al.* (2008). Or il s'agit de la séquence exacte de nos populations collectées sur mésange charbonnière. La séquence de Brännstörms *et al.* provient de plusieurs populations échantillonnées dans des nids de rousserolles (*Acrocephalus sp*) et de gobe-mouches (*Ficedula sp*) collectés en Suède. Nous n'avons malheureusement pas pu obtenir d'ADN de ces acariens afin d'en isoler la

Tropomyosine. Mais cela suggère que nous avons affaire là à la même lignée ou espèce que nos populations PAS et JBO108 (publication V) et que la localisation géographique est indépendante de la différence de trois nucléotides notée sur la séquence d'ITS. Enfin, les caractères morphologiques subtils notés sur les quelques individus de *D. longipes* intégrés à la publication IV se sont avérés, au vu des nouveaux échantillons, fortement instables entre isolats.

4.3.b.2 Un marqueur moléculaire abandonné : EF1- α

Par ailleurs, au cours de la recherche et de la mise au point des marqueurs moléculaires pour cette partie de l'étude, nous avons isolé 25 séquences d'une région du gène codant pour l'elongation factor 1- α (EF1- α). Ces séquences correspondent aux isolats suivants: 14 isolats de *D. gallinae*, 2 de *D. carpathicus*, 3 de *D. apodis*, 2 de *D. hirundinis*, 1 de *D. longipes* (PAS) et 3 isolats d'outgroups. Nous avons finalement renoncé à l'utiliser dans le cadre de la reconstruction phylogénétique du genre *Dermanyssus* du fait d'une anomalie probablement témoin de paralogie : des individus appartenant à *Ornithonyssus sylviarum* (Macronyssidae) présentaient la même séquence, exactement, que *D. gallinae*. L'essai a été effectué à plusieurs reprises, à plusieurs mois d'intervalles, sur des extraits d'ADN d'individus d'*O. sylviarum* de deux provenances différentes (Bouches-du-Rhône, Rhône) et réalisés indépendamment, afin d'éliminer le motif de contamination. Ce marqueur nucléaire, s'il ne présentait pas une variabilité très élevée dans le genre *Dermanyssus*, était porteur tout de même d'un certain nombre de mutations ponctuelles entre espèces : 2 % de divergence entre *D. gallinae* et *D. apodis*, 3-4 % de divergence entre *D. gallinae* et *D. carpathicus*, 3 % entre *D. apodis* et *D. carpathicus*, 4 % de divergence entre *D. apodis* et *D. hirundinis*...Mais l'un des outgroups – distant de surcroît (*O. sylviarum*) – apparaît espèce sœur de *D. gallinae*, en position distale au sein du groupe *gallinae* dans les topologies obtenues. Avec *D. longipes* PAS, *O. sylviarum* présente exactement la même séquence que la plupart des *D. gallinae* (1 % de divergence entre isolats testés de *D. gallinae*). Trop contradictoire avec l'ensemble des autres données moléculaires et inconciliable avec les éléments morphologiques séparant clairement Macronyssidae de Dermanyssidae, cette information a été considérée comme inadéquate et mise de côté. Des cas de paralogie dans ce gène chez des arthropodes ont été notés à plusieurs reprises déjà (Djernaes & Damgaard, 2006). S'agit-il d'un cas de double copie avec disparition de l'une des deux chez certains taxa ? Pour l'heure, 25 séquences d'EF1- α obtenues avec les amorces DgEF1-Fn DgEF1-R, AcEF1-F et AcEF1-R sont disponibles dans la banque de gène internationale (numéros d'accès EMBL et séquences des amorces disponibles en Annexe 3).

4.3.b.3 *Liponyssoides* : genre introuvable ?

Enfin, le genre *Liponyssoides*, seul autre genre avec *Dermanyssus* dans la famille des Dermanyssidae, n'a pas pu être intégré à la reconstruction phylogénétique de l'ensemble du genre, faute d'individu. Ce genre comprend actuellement 11 espèces, inféodées en général à des rongeurs et/ou des chiroptères, parfois à des oiseaux. Aucun des types demandés auprès d'institutions supposées les posséder n'a pu être obtenu. Trois des institutions susceptibles de posséder des types (holotypes ou paratypes) de *Liponyssoides*, le British Museum (Londres), Agriculture & Agrifood Canada (Ottawa), National Museum of Natural History (Washington) ont été contactées en vain : aucune trace des types, pas même de leur entrée en collection n'a pu être retrouvée, ni même de matériel non-type. Un examen des collections d'acaréens du MNHN (Muséum National d'Histoire Naturelle, Paris ; M. Judson) n'a permis de trouver aucun individu de ce genre (type ou non type). Aucun des acarologistes contactés n'a pu fournir d'individu (liste des courriels d'acarologistes du British Muséum (NHM), J. Deunff, spécialisé dans la phylogénie des Rhinonyssidae, mésostigmatés

parasites de chiroptères). En outre, nos efforts pour en isoler à partir de deux séries de prélèvements de terrain ont tous été vains : > 100 tubes contenant des acariens prélevés sur rongeur en Afrique, mis à disposition par Violaine Nicolas (MNHN) ont été examinés en vain (tous les spécimens étaient des Laelapidae (Mesostigmata) ; des photographies réalisées par Josyane Lips à partir d'échantillons de guano de chauves-souris de l'île de Vanuatu ont été visionnées en vain (absence de mésostigmate hématophage). Ashley P.G. Dowling a reçu une seule fois, en août 2007, en provenance d'Iran, un unique acarien prélevé sur rongeur, qui semblait correspondre à la description de *Liponyssoides muris*. Malheureusement, l'individu a été perdu au cours d'un déménagement.

Moss (1978) ayant annoncé une révision du genre *Liponyssoides* en collaboration avec Strandtmann et Camin, il était possible que les types soient présents dans ses collections. Or Hans Klompen, (Museum of Biological Diversity, Columbus, Etats-Unis), qui, suite à l'acquisition par son institution de l'intégralité de la collection de Moss, y a eu accès, a pu retrouver certains types de *Dermanyssus*, qu'il m'a transmis, mais n'a trouvé aucune trace de *Liponyssoides*. Peut-être certains de ces types sont-ils dans des collections des collègues de Moss, Strandtmann ou Camin, décédés aujourd'hui.

En bref, les espèces du genre *Liponyssoides* sont probablement peu fréquentes, ou très localisées et le mystère des types disparus reste entier.



ELSEVIER

Contents lists available at ScienceDirect

Molecular Phylogenetics and Evolution

journal homepage: www.elsevier.com/locate/ympev

Delimiting species boundaries within *Dermanyssus* Dugès, 1834 (Acari: Dermanyssidae) using a total evidence approach

L. Roy^{a,*}, A.P.G. Dowling^b, C.M. Chauve^a, T. Buronfosse^a

^a Université de Lyon, Ecole Nationale Vétérinaire de Lyon, Laboratoire de Parasitologie et maladies parasitaires, 69280 Marcy l'Etoile, France

^b University of Arkansas, Department of Entomology, Fayetteville, Arkansas, USA

ARTICLE INFO

Article history:

Received 25 February 2008

Revised 12 September 2008

Accepted 14 November 2008

Available online 27 November 2008

Keywords:

Dermanyssus

Acari

Mesostigmata

Species boundaries

Phylogeny

Evolution

Taxonomy

ABSTRACT

The genus *Dermanyssus* is currently composed of 24 hematophagous mite species and includes the Poultry Red Mite, *Dermanyssus gallinae*, a serious pest in poultry houses. Morphologically, *Dermanyssus* species fall into two groups corresponding to Moss' *gallinae*-group and to *hirsutus*-group + *Microdermanyssus*. Species of the *gallinae*-group exhibit high levels of morphological variability, and are nearly impossible to distinguish. Species of the second group display consistent characters and host associations and are easily distinguishable. Species of the *gallinae*-group tend to be the major problems in poultry houses and it is unknown whether *D. gallinae* is the only pest, or if there are numerous cryptic species present in the system.

Twenty species of *Dermanyssus* were tested phylogenetically based on 46 morphological characters. A subset of species, mainly of the *gallinae*-group, represented each by several populations, was sequenced for two mitochondrial and one nuclear gene regions. This allowed testing their specific status and their interrelationships based and on morphological and molecular characters. The molecular data was analysed separately and in combination with morphological characters. As expected, morphology did a poor job resolving relationships.

Molecular data proved more informative. The resulting phylogenetic hypotheses brought some information about interrelationships among species of the *gallinae*-group showing a split into two main clades. The invasion of human managed environments seems to occur only in taxa within one of the two clades. The host spectrum seems to get enlarged in more derived taxa in the same clade. A delineation of six species within the *gallinae*-group is provided. Additionally, a key for morphological identification of these species is provided. *D. gallinae* appears to be the only pest in poultry houses, but is composed of several different and more or less strongly isolated lineages. A new species found from the black swift is described.

© 2008 Elsevier Inc. All rights reserved.

1. Introduction

Genus *Dermanyssus* Dugès 1834 is currently composed of 24 hematophagous mite species, primarily parasitic on birds (Roy and Chauve, 2007; Knee, 2008).¹ The Poultry Red Mite, *Dermanyssus gallinae* (De Geer, 1778), is a serious pest in poultry houses, and other *Dermanyssus* species have been shown to affect wild birds, such as *Dermanyssus prognepphilus* Ewing, 1933 on Purple martin chicks (Moss and Camin, 1970) and *Dermanyssus hirundinis* (Hermann, 1804) on the offspring of House Wrens (Johnson and Albrecht, 1993; Pacejka et al., 1996, 1998). Additionally, Clayton and Tompkins (1995) showed that *D. gallinae* can induce adult Rock Doves *Columba livia* Gmelin, 1789 to spend less time incubating their eggs.

No complete taxonomic review of the genus has been completed since 1978 (Moss, 18 species), and six species have been de-

scribed since that date: *Dermanyssus carpathicus* Zeman, 1979, *Dermanyssus nipponensis* Uchikawa and Kitaoka, 1981, *D. brevirivulus* Gu and Ting, 1992, *D. wutaiensis* Gu and Ting, 1992, *Dermanyssus rwandae* Fain, 1993 and *Dermanyssus diphyes* Knee, 2008. *Dermanyssus* is clearly defined compared to other genera due to its roughly crescent-shaped and particularly short sternal shield and characteristic chelicerae. Chelicerae possess strongly reduced chelae and a strongly elongate, flattened and medially concave second segment, which forms something like a gutter and allows the two chelicerae, once joined together, to form a tube through which blood is sucked up (Phillis, 2006). On the other hand, species limits are not clearly defined and morphological characters traditionally used for diagnosis are highly variable within a single population (Roy and Chauve, 2006) and even the same individual (bilateral asymmetries). Consequently, some species other than *D. gallinae* may infest farms, which, if confirmed, may have serious consequences on control strategies.

In order to better define species limits, elucidate *Dermanyssus* phylogeny, and develop molecular tools for applied use, we have conducted a phylogenetic study of a part of the genus. The dataset

* Corresponding author. Fax: 33 478872577.

E-mail address: l.roy@vet-lyon.fr (L. Roy).

¹ *Dermanyssus diphyes* Knee, 2008 was published during paper revision, and therefore has not been included in present study.

includes morphological characters, several of which have never been examined for any study on *Dermanyssus* species relationships, and molecular data from ITS1 and 2 (plus some few bases of flanking regions of 18S and 28S rRNA,² and including 5.8S rRNA), 16S rRNA, and coding gene for Cytochrome oxidase subunit I (COI).

Dermanyssus species morphologically fall into two groups; those possessing a soft body adapted for sporadic and large engorgement with reduced shielding and slender legs (14 species) and those possessing a compact, more heavily sclerotized body with shorter, stouter legs (9 species). Species possessing the soft-body type are the most common and most of them are nearly indistinguishable from each other; they constitute the *gallinae*-group: *Dermanyssus antillarum* Dusbábek and Černý, 1971, *D. carpathicus* Zeman, 1979, *Dermanyssus chelidonis* Oudemans, 1939, *Dermanyssus farallonii* Nelson and Furman, 1967, *D. gallinae*, *Dermanyssus gallinoides* Moss, 1966, *D. hirundinis*, *Dermanyssus longipes* (Berlese and Trouessart, 1889) (*nomen dubium*), *D. nipponensis* Uchikawa and Kitaoka, 1981, *D. prognephilus*, *Dermanyssus transvaalensis* Evans and Till, 1962, *Dermanyssus triscutatus* Krantz, 1959, *Dermanyssus trochilinis* Moss, 1978, *D. wutaiensis* Gu & Ting, 1992. Several of these species have very large host ranges, in particular *D. hirundinis* and *D. gallinae*, which have been collected from numerous bird species, distributed across eight to nine orders (Roy and Chauve, 2007).

Dermanyssus species possessing the second body type correspond to Moss' subgenus *Microdermanyssus* (*Dermanyssus alaudae* (Schränk, 1781), *Dermanyssus americanus* Ewing 1922, *D. brevirivulus* Gu & Ting, 1992, *Dermanyssus brevis* Ewing, 1936, *Dermanyssus grochovskae* Zemskaya, 1961, *Dermanyssus hirsutus*, *Dermanyssus passerinus* Berlese and Trouessart, 1889, *Dermanyssus quintus* Vitzthum, 1921 and *D. rwandae* Fain, 1993) and members of his *hirsutus*-group (*D. hirsutus* Moss and Radovsky 1967, *D. grochovskae* and *D. quintus*). All except *D. quintus* display a strong asymmetry in setae length between those situated centrally on the dorsal shield and those located on the perimeter. Several species possess conspicuous and distinctive morphological characters, such as a paired sclerotized porelike-structures on dorsum in *D. alaudae*, *D. americanus* and *D. brevis* (Moss' subgenus *Microdermanyssus*), a U-shaped row of large and deeply rooted setae on the opisthogaster in *D. quintus*, and ventral neotrichy in the form of a cluster of elongate, simple setae laterad of the anal shield in *D. hirsutus*. These species are more clearly distinguishable if compared to one another than species of the *gallinae*-group on the basis of morphology.

Moreover, available data on these species suggest they are more host specific than the *gallinae*-group, typically parasitizing a single bird family (Picidae for *D. quintus* and *D. hirsutus*, Alaudidae for *D. alaudae*). However, *D. grochovskae* occurs on two bird orders, Piciformes and Passeriformes, and some of these species have been found only once (*D. brevis*, *D. brevirivulus*), so the extent of their host specificity is unknown.

Morphological differences between *gallinae*- and *hirsutus*-groups have been suggested by Moss to be correlated to life-style. Most *Dermanyssus* species are known to be nidicolous, climbing onto the host only to obtain a meal before returning to their hiding-place in the host nest or roost. However, some species frequently remain on the host for extended periods of time and can deposit their eggs on its feathers. These species possess a morphology more adapted to clinging onto the host rather than to running around on it (e.g. *D. grochovskae* and *D. quintus*) (Moss, 1978).

Dermanyssus gallinae (*gallinae*-group) is of economic and veterinary importance and it possesses highly polymorphic morpholog-

ical characters. Sclerotized areas, usually bearing most of the phylogenetically informative characters, are strongly reduced in these species and are often asymmetric on a single individual. The dorsal shield also displays irregularities, including contours that are asymmetric in an individual in almost all species of the *gallinae*-group and asymmetric setal patterns including numbers and position. Additionally, leg chaetotaxy is highly variable intraspecifically (Evans and Till, 1962; Moss, 1978), a characteristic common among mites that have formed parasitic associations (Evans, 1963).

Such phenotypic variability not only makes species identification difficult within a genus (Evans and Till, 1962; Moss, 1978), it also produces major problems for accurately coding morphological characters in a phylogenetic framework. Overall, this variability has led to confusion regarding species limits and evolution within *Dermanyssus* and until this study, molecular characters have not been consulted.

The aim of the present study is to explore relationships between *Dermanyssus* species using a phylogenetic framework based on morphological characters and between some species of the *gallinae*-group using and morphological and molecular characters. From obtained results, we plan (1) determining whether the *gallinae*-group includes distinct species or simply variants of populations, (2) estimating whether the *gallinae*-group body type is primitive or derived and examine its adaptive significance and (3) evaluating host specificity of field collected species.

2. Material and methods

In the aim of processing in a standardized manner, only adult female mites have been used in this study. Adult females have been selected as this is the only stage/sex described for all species. Adult males are less often found. Moreover, discriminant morphological characters appear to be mainly found in females.

2.1. Methodology for delineation of species boundaries

Primary hypotheses of alpha-taxonomy have been tested following Samadi and Barberousse (2006) recommendations for helping in species delimitation. Our objective was to identify reproductively isolated groups of organisms that warrant classification as distinct species by using phylogenetic tools. For such a purpose, successive validations of morphological characterization with correlation to molecular information have been processed in order to test primary hypotheses provided by α -taxonomy.

For testing primary hypotheses, two main actions have been carried out. First, a comprehensive analysis of *Dermanyssus* phylogeny at the species level based on reference material has been carried out, allowing us to obtain a set of discrete characters usable for phylogenetic exploration. Second, partial exploration of *Dermanyssus* phylogeny involving various populations of several field collected species, based on previously coded morphological characters and on molecular data. Several successive steps including comparisons between individual morphology and corresponding sequences was followed by phylogenetic analyses. Finally, some of the traditional species specific characters have been compared to the obtained phylogenetic hypotheses in order to assess their actual utility (*a posteriori* feedback).

2.2. Morphological study

2.2.1. Taxon sampling

In the present study, *Dermanyssus* is represented by 20 of the currently recognized 24 species and one unidentified taxon (Appendix A). Type specimens of *D. passerinus*, *D. brevirivulus* and *D. wutaiensis* were unavailable for examination (specimen dam-

² Abbreviations used: 16S, rRNA 16S; bp, base pairs; BPP, Bayesian posterior probabilities; COI, cytochrome oxidase subunit I; ITS, rRNA 18S (partial sequence), internal transcribed spacer 1 (ITS1), 5.8S, internal transcribed spacer 2 (ITS2), 28S (partial sequence); Kx, morphological character n°x; MP, maximum parsimony; OTU, operational taxonomic unit; RSE, reference specific entities.

aged for *D. passerinus* and institution housing types for *D. brevirivulus* and *D. wutaiensis* was unresponsive), and we did not find any other reference specimens for these species. The type specimen of *D. longipes* was also damaged but we were able to collect specimens in the field from the type locality near Avignon (France) as well as examine specimens in a Slovak collection (Fend'a, P., Comenius University). *D. diphyes* has been described during revision of present paper. Three species have been included as outgroups: *Ornithonyssus bacoti* (Hirst, 1913) (Mesostigmata: Dermanssoidea: Macronyssidae), *Haemogamasus hirsutus* Berlese, 1889 (Mesostigmata: Dermanssoidea: Haemogamasidae), *Androlaelaps casalis* (Berlese, 1887) (Mesostigmata: Dermanssoidea: Laelapidae) and *Typhlodromus pyri* Scheuten, 1857 (Mesostigmata: Ascoidea: Phytoseiidae). The family Dermanssoidea also includes *Liponyssoides*, but unfortunately no specimens were available for morphological or molecular study, despite efforts of the authors (several collections in which some types of *Liponyssoides* sp should have been deposited have been contacted, without any success). This has forced us to only include distant outgroups of *Dermanssus*.

2.2.2. Character sampling

Forty six morphological characters are included in the matrix (Appendix B and C). Due to very high variation (at the population level) of traditional chaetotactic characters (Roy and Chauve, 2006), stringent coding of such characters appeared impossible in many cases. Therefore, we strongly reduced our reliance on such characters (only five traditional characters in present study), and completely omitted leg chaetotaxy. We selected and coded 31 additional morphological characters and ten morphometric characters.

- Five characters focus on chaetotaxy (K13, 14, 21, 34 and 35) of anal and dorsal shields including the soft integument.
- Twenty one characters describe diverse parts of the body with five morphological characters describing soft integument (K10, 11, 18, 20 and 41), five describing shields (anal and dorsal shields; K8, 23, 24, 25 and 36), two describing peritreme (K9 and 42), one describing the palps (K1), five describing internal organs (K5, 6, 7, 19 and 45), two describing chelicerae (K32 and 33) and one describing corniculae (K46).
- Ten characters focus on the shape of some setae located on dorsal shield, hypostome, legs, palps and soft integument of opisthosoma (K4, 12, 15, 16, 17, 29, 30, 31, 43, and 44).
- Ten characters use relative morphometry, six of which describe dorsal, sternal, epigynial and anal shields (K2, 3, 22, 28, 37 and 38) and four of which describe the legs (K26, 27, 39 and 40).

2.2.3. Phylogenetic analysis based on morphological data

For the phylogenetic analysis, all characters were treated as unordered and unweighted. A heuristic analysis was performed under the parsimony criterion using PAUP[®] 4.0b10 (Swofford, 2001) with TBR branch swapping and 10,000 random additions saving all most parsimonious trees. Heuristic searches in TNT (Goloboff et al., 2008) were used to obtain relative Bremer (Goloboff and Farris, 2001) and bootstrap support values. TNT searches recovered the same topology and tree length as PAUP, but calculation of support values is much more efficient in TNT.

2.3. Molecular exploration

2.3.1. Biological material

Dermanssus specimens were collected from November 2005 to May 2008, mainly in France (some in USA), using two sampling methods due to the different lifestyles found within the genus.

Most samples come directly from wild bird nests, which have been treated following the method of De Lillo (2001) with slight modifications. Overall, 327 nests were analyzed from 37 different bird species distributed across eight different orders. Bird taxonomy follows Peterson (2007). Due to their diversity and ubiquity, passeriforms were the most represented host group, accounting for 248 nests, with most nests distributed across four families (202 nests): Hirundinidae (46 nests), *Parus* sp. (Paridae; 120 nests), Alaudidae (14 nests), *Passer* sp. (Passeridae; 22 nests). The remaining 46 passeriform nests were from 12 different species (less than ten nests/group). One species of apodiform is strongly present here (*Apus apus* L., 1758, Apodidae; 52 nests). Other nest samples examined were from the following bird groups: Columbiformes (13 nests), Ciconiiformes (six nests), Strigiformes (three nests), Anseriformes (two nests), Gruiformes (one nest), Piciformes (two nests).

Additional collections of living mites have been made directly from birds captured during bird-banding and/or bird care activities. This provided specimens from an additional species representing a ninth order: *Coracias garrulus* L., 1758 (Coraciiformes: Coraciidae). Three complementary populations have been obtained from other sampling activities (*D. hirsutus*ADhirs, *D. quintus*ADqui, *D. hirundinis*ADhirun).

2.3.2. Taxon sampling

Due to requirements of preserved specimens for DNA studies, our molecular dataset includes only those *Dermanssus* species collected freshly into ethanol (or simply dried) by the authors or collaborators. Due to these constraints, very few *Microdermanssus* + *hirsutus*-group have been included in this part of study: no *Microdermanssus* and only two species of the Moss' *hirsutus*-group (*D. quintus* and *D. hirsutus*) have been collected. On the opposite, significant sampling of the *gallinae*-group has been included in the molecular dataset: four known and one unknown species of *gallinae*-group are included. Because of the noted lack of discriminating characters found within the *gallinae*-group, several specimens were sampled from separate populations resulting in the inclusion of 45 *gallinae*-group OTUs in the combined molecular matrix, 29 of which are included in the total evidence analyses.

Only three of the four outgroups used in the morphological analysis (*O. bacoti*, *A. casalis*, and *T. pyri*) were available fresh for molecular examination. Although efforts were made to collect specimens of *Liponyssoides*, all attempts were unsuccessful.

2.3.3. Four different a priori morphs on field collected species

The key problems lie in the separation of the species of *gallinae*-group due to variable characters within species and a general lack of discriminating characteristics across species. Therefore, a first and rough examination of material led to delimitation of four a priori morphogroups. Only species of *gallinae*-group are dealt with here, as members of the "*Microdermanssus* + *hirsutus*-group" are easily defined. Initial examination focused on numerous populations across Europe and resulted in separation into the following four morphogroups based upon preliminary successive comparisons of sequences and morphological data: DG-morph (type population SK (Table 1)—*al1* of palp genu lanceolate, sternal shield with a deep central concave neckline, dorsal shield narrower than podosoma), GO-morph (type population GO1—*al1* of palp genu lanceolate, sternal shield without a sharp postero-medial neckline, dorsal shield as wide as podosoma, anterior pair of setae in hypostomal parallelogram larger than in *D. gallinae*), RQ-morph (type population RQ—*al1* of palp genu spine-like) and DL-morph (type population PAS—similar to DG-morph, but with a slightly different anal shield, proportionally longer and slightly more angular—cf. above).

The following populations were sequenced during this study however, not all were included in the final combined analyses, typically because of missing data (Table 1).

Table 1

Taxonomic sampling and EMBL accession numbers for each sequence. Each record corresponds to one mite population belonging to a single species sampled from a single nest or a single bird. Locality and host information are also provided.

Species	<i>a priori morph</i>	Pop code	Accession No.			Country, French department	Host	Context	
			18S–28S rRNA	16S rRNA	mt-COI				
<i>D. carpathicus</i>	RQ-morph	RQ	AM903316	AM921903	AM921876	France, 42	<i>Phoenicurus phoenicurus</i> (Passeriform)	Nest, near a human house, alt ca. 1500 m	
	RQ-morph	5.	AM903314	AM921901	AM921873	France, 42	<i>Parus major</i> (Passeriform)	Nest box	
	RQ-morph	<i>Veol</i>			AM921871	France, 69	<i>Parus major</i> (Passeriform)	Nest box	
	RQ-morph	<i>Parm</i>	AM903315			France, 69	<i>Parus major</i> (Passeriform)	Nest box	
	RQ-morph	<i>JBO59</i>	AM930882	AM921902	AM921870	France, 84	<i>Parus major</i> (Passeriform)	Nest box in an apple orchard	
	RQ-morph	<i>LC10A</i>			FM179367		<i>Parus major</i> (Passeriform)	Nest	
	RQ-morph	<i>LR20A</i>			FM179368		<i>Parus sp.</i> (Passeriform)	Nest	
	RQ-morph	<i>JMC10</i>	AM943018		AM943021	France, 62	<i>Parus major</i> (Passeriform)	Nest	
	<i>D. gallinae</i>	DG-morph	SK	AM903303	AM921887	AM921856	Denmark	<i>Gallus gallus</i> (Galliform)	Layer farm
		DG-morph	SB			AM921858	France, 69	<i>Gallus gallus</i> (Galliform)	Little amateur hen house
Special lineage one (L1).	DG-morph	Chab	AM931074	AM921886	AM921857	France, 01	<i>Gallus gallus</i> (Galliform)	Layer farm	
	DG-morph	Fa1	AM931072	AM921884	AM921853	Norway	<i>Gallus gallus</i> (Galliform)	Layer farm	
	DG-morph	Fa2	AM931071	AM921883	AM921852	Norway	<i>Gallus gallus</i> (Galliform)	Layer farm	
	DG-morph	PO1	AM903302		AM921854	Poland	<i>Gallus gallus</i> (Galliform)	Layer farm	
	DG-morph	PO2		AM921914	AM921855	Poland	<i>Gallus gallus</i> (Galliform)	layer farm	
	DG-morph	DR	AM931073	AM921885		Spain	<i>Fringillidae</i> (Passeriform)	Cage	
	DG-morph	ROL1	AM903304	AM921910	AM921864	France, 13	<i>Coracias garrulus</i> (Coraciiform)	On adult birds	
	DG-morph	ROL2	AM903305	AM921911	AM921865	France, 13	<i>Coracias garrulus</i> (Coraciiform)	On young birds at nest	
	DG-morph	Woodp	AM903301	AM921890	AM921863	France, 69	<i>Dendrocopos major</i> (Piciform)	On wild adult female bird	
	DG-morph	CANIT	AM903308	AM921909	AM921877	Italy	<i>Serinus canarius</i> (Fringillidae: Passeriform)	Breeding facility	
	DG-morph	LB07			AM921866	France, 18	<i>Delichon urbica</i> (Passeriform)	Nest	
	DG-morph	LB18	AM930889	AM921908	AM921867	France, 18	<i>Delichon urbica</i> (Passeriform)	Nest	
	DG-morph	JBO51	AM930885		AM921879	France, 84	<i>Parus major</i> (Passeriform)	Nest box in an apple orchard	
	DG-morph	Percnobis	AM943020			France, 07	<i>Neophron percnopterus</i> (Ciconiiform)	Nest	
	DG-morph	LC*	AM903306	AM921891	AM921859	France, 26	<i>Columba livia</i> (Columbiform)	Breeding facility, rural country	
	DG-morph	COL*	AM903307	AM921892	AM921875	France, 69	<i>Columba livia</i> (Columbiform)	On adult bird	
	DG-morph	PI*	FM179378	FM179375	AM921860	France, 13	<i>Columba livia</i> (Columbiform)	City center, coming from nest inside a flat	
	DG-morph	GO8*		AM921893		France, 30	<i>Apus apus</i> (Apodiform)	Nest	
	DG-morph	JGC1*			AM921861	France, 26	<i>Tyto alba</i> (Strigiform)	Nest	
	<i>D. hirsutus</i>	<i>hirsutus</i> -group	ADhirs	AM931077	AM921912	AM921878	USA, MI	<i>Colaptes cafer</i> (Piciform)	On bird
<i>D. hirundinis</i>	DG-morph	HR	AM903300	AM921888	AM921872	France, 69	<i>Hirundo rustica</i> (Passeriform)	Nest	
	DG-morph	OC	AM903312	AM921889	AM921862	France, 38	<i>Delichon urbica</i> (Passeriform)	On young birds at nest	
	DG-morph	ADhirun	AM931076	AM921913	AM921881	USA, MI	<i>Tachycineta bicolor</i> (Passeriform)	On bird	
	DG-morph	HIR1	FM179379		FM179366	France, 85	<i>Hirundo rustica</i> (Passeriform)	Nest	
	DG-morph	CHOV	AM943019		FM179369	France, 72	<i>Hirundo rustica</i> (Passeriform)	Nest in a barn	
<i>D. longipes</i>	DG-morph	PAS	AM903310	AM921904	AM921869	France, 84	<i>Passer montanus</i> (Passeriform)	Nest	
	DG-morph	ENVL08-3	FM179377	FM179374	FM179365	France, 69	<i>Parus sp.</i> (Passeriform)	Nest box	
<i>D. quintus</i>	<i>hirsutus</i> -group	ADqui	AM931075		AM921882	USA, MI	<i>Picoides villosus</i> (Piciform)	On bird	
<i>D. apodis</i>	GO-morph	MAR	AM945880	AM921899	AM921880	France, 69	<i>Apus apus</i> (Apodiform)	On young bird fallen from nest	
	GO-morph	<i>G01</i>	AM903299	AM921894		France, 30	<i>Apus apus</i> (Apodiform)	Nest	
	GO-morph	<i>G010</i>		AM921895		France, 30	<i>Apus apus</i> (Apodiform)	Nest	
	GO-morph	<i>G012</i>	AM903309			France, 30	<i>Apus apus</i> (Apodiform)	Nest	
	GO-morph	<i>G015</i>	AM903313	AM921896		France, 30	<i>Apus apus</i> (Apodiform)	On young birds at nest	
	GO-morph	<i>G016</i>	AM903313			France, 30	<i>Apus apus</i> (Apodiform)	On young birds at nest	
	GO-morph	<i>G026</i>		AM921900		France, 30	<i>Apus apus</i> (Apodiform)	Nest	
	GO-morph	<i>G036</i>			FM179371	France, 30	<i>Apus apus</i> (Apodiform)	Nest	
	GO-morph	<i>G044</i>		AM921898		France, 30	<i>Apus apus</i> (Apodiform)	Nest	
	GO-morph	<i>G046</i>		AM921897		France, 30	<i>Apus apus</i> (Apodiform)	Nest	
	GO-morph	<i>G054</i>	AM930888		AM921874	France, 30	<i>Apus apus</i> (Apodiform)	Nest	
GO-morph	<i>G058a</i>			FM179370	France, 30	<i>Apus apus</i> (Apodiform)	Nest		
<i>O. bacoti</i>	outgroup	Ob	AM903318	AM921905	FM179677	?	Rodents	From a lab strain in MNHN (O. Bain, Lab of Parasitology)	
<i>A. casalis</i>	outgroup	ACA	AM903317	AM921907	AM921868	France, 69	—	Breeding facility	
<i>T. pyri</i>	outgroup	TPYR	FM179376	FM179373	FM179364	?	—	From a lab strain in Supagro, Montpellier (S. Kreiter)	

gallinae-group: GO-morph, 11 populations; DG-morph, 25 populations; RQ-morph, 7 populations; DL-morph, 2 populations.

2.3.3.1. *D. longipes*. *Dermanyssus longipes* was deemed *nomen dubium* due to damaged type material and absence of additional records since description. One population has been isolated with the DL-morph and assigned to *D. longipes*, due to two morphological characteristics and to geographic locality. The anal plate is slightly more elongated and subrectangular and the dorsal shield has a subapical shrinkage and ends with a rounded apex. Of course it was considered that this might simply be another polymorphic character, but many specimens from the same nest (*Passer montanus*, South of France) and other from *P. domesticus*, in Slovakia, provided exactly the same characteristics. Repetition of these anal plate characters not only within a single population, but also in a geographically distant second population led us to conclude this is a reliable morphological difference from other specimens with the DG-morph. Moreover, this population has been collected near the same locality (20 km) and from the same host genus as *D. longipes* type material (Berlese and Trouessart, 1889).

2.3.4. Character sampling

Three gene regions have been selected for sequencing; two mitochondrial markers (COI and 16S) and one nuclear marker (ITS). The molecular dataset includes a total of 1524 bp for each taxon (cf. accession numbers in Table 1) and sequence data was aligned using MAFFT (Katoh et al., 2005) with the L-INS-i iterative refinement option on the MAFFT server at <http://align.bmr.kyushu-u.ac.jp/mafft/online/server/>. MAFFT with the L-INS-i option has shown to be the most accurate and consistent method for sequences (Wilm et al., 2006; Carroll et al., 2007).

2.3.5. Amplification and sequencing of DNA

2.3.5.1. Morphological preparation and DNA extraction. DNA was extracted from individual mites by cutting the cuticle at two points on the opisthosoma and pushing most of the internal elements out. This was done with a sterile pipet tip in the appropriate commercial buffer containing proteinase K (Qiagen) and digestion was performed at 70 °C for 19–30 h. The cuticle was separated from the DNA mixture and mounted as a voucher and for microscopic observation. Specimens slide mounted directly from alcohol having not

undergone DNA extraction were compared to these vouchers to determine the usefulness of the DNA voucher cuticles. The proteinase K digestion did not appear to have any adverse effects on the cuticle and all characteristics necessary for morphological examination remained intact. DNA was extracted following procedures in the Qiagen QIAamp DNA Mini Kit. When possible (most cases), two to three separate specimens from each tested population were extracted and sequenced.

2.3.5.2. DNA amplification and sequencing. PCRs were separately performed in order to amplify two mitochondrial gene regions (part of COI gene and of 16S) and one nuclear region (fragment 18S-ITS1-5.8S-ITS2) in either a Biometra TGradient or a MWG AG Biotech Primus 96plus thermal cycler in typical buffer containing 2 µl of template DNA, 2.5 U of Taq polymerase, 10 nmol of dNTPs, 20 pmol of each primer and a variable volume of 50 mM MgCl₂ depending of the target gene in accordance to Table 2 in a final volume of 50 µl. After an initial denaturation step (95 °C) for 10 min, followed by 40 cycles of: 20 s at 95 °C (denaturation), 30 s at the annealing temperature specified for each primer set (Table 2), and 90 s at 72 °C (extension). A final extension step was carried out for 10 min at 72 °C. Several primers have been designed for amplification in various species and are provided in Table 2.

Negative and positive controls were run with each round of amplification. PCR products were checked by electrophoresis in a 1% agarose gel. Depending on the brightness of the band either additional PCRs were run on the original template or reamplifications of the original PCR product were performed. PCR reamplifications using same primers were assessed on 1 µl of product and PCR conditions were as follows: initial denaturation at 95 °C for 3 min followed by 20 cycles of: 20 s at 95 °C, 45 s at specified annealing temperature (Table 2), and 2 min at 72 °C. A final extension step was carried out for 45 min at 60 °C. In both cases, a total of four reactions were run for each taxon sample and the resulting amplifications were pooled in order to obtain enough DNA for sequencing. The four PCR tubes from each sample were pooled together, submitted for electrophoresis in a 1% agarose gel, and PCR products were excised from the gel and purified using the Macherey-Nagel Nucleospin Extract-II kit. Purified PCR products were sequenced by Genoscreen (France, Lille) using a 96-capillary sequencer ABI3730XL.

Table 2
Primer sequences and key parameters for PCR conditions.

Gene	Primer name	Primer sequence	Primer annealing T° (°C)	MgCl ₂ (mM)	Comments
ITS-forward	DgITS-F	5'-AGAGGAAGTAAAAGTCGTAACAAGG-3'	48	3	
	RhITS-F*	5'-AGAGGAAGTAAAAGTCGTAACAAG-3'			
	DgITS-R	5'-CCTTAGTAATATGCTTAAATTCAGG-3'			
ITS-reverse	RhITS-R*	5'-ATATGCCTTAAATTCAGGGGG-3'			Amplicon including only 44 bp 28S Amplicon including only 37 bp 28S Amplicon including more than 600 bp 28S
	AmITS-R2	5'-GTTAGACTCCTGGTCCGTGTTCA-3'			
mt-COI-forward	COF1	5'-ATCGGAGGATTCGGAAACTG-3'	52.5	3.3	Works well with special lineage one Specific to <i>D. carpathicus</i> , <i>D. longipes</i> and <i>D. hirundinis</i>
	COF1bis	5'-CTGCACCTGACATGGCTTCCCAC-3'			
	CO1F4	5'-CACCTGACATGGCTTCCCACGAT-3'			
	CO1LCF	5'-GAAAGAGGAGCAGGCACTGG-3'			
	CO1RQF1	5'-GAAAGAGGAACAGGAACAGG-3'			
mt-COI-reverse	RQ-COI-R	5'-CCAGTAATACCTCCAATTGTAAT-3'			Works well with special lineage one Works well with <i>D. apodis</i>
	COIDpro-R	5'-GTTGGGATTGCAATAAT-3'			
	COIGOR	5'-GTTGGAATTGCAATAAT-3'			
	ObCOIF-rev	5'-GTGGGAATHGCAATAAT-3'			
16S-forward	Rh16S**	5'-GCTCAATGATTTTTTAAATTGCTG-3'	54	3.3	
	Dg16SF	5'-TGGGTGCTAAGAGAATGGATG-3'			
16S-reverse	Rh16S**	5'-CCGGTCTGAAGTCAAGATCATG-3'			
	Dg16SR	5'-CCGGTCTGAAGTCAAGATCAAG-3'			

* Primer sequence from De Rojas et al. (2002).

** Primer sequence from De Rojas et al. (2001).

2.3.6. Phylogenetic analyses based on combined morphological and molecular data

Phylogenetic analyses with Maximum Parsimony (MP) were run for the total evidence analysis, a combined molecular only analysis, and individual analyses of morphology and the separate gene regions. Heuristic searches were carried out in PAUP* 4.0b10 (Swofford, 2001) with TBR branch swapping and 10,000 random additions saving all most parsimonious trees. Heuristic searches in TNT (Goloboff et al., 2008) were used to obtain relative Bremer (Goloboff and Farris, 2001) and bootstrap support values.

For Bayesian analyses the total evidence data set (morphology and molecules), the combined molecular only data set, and the individual genes were all run using MrBayes (Huelsenbeck and Ronquist, 2001; Ronquist and Huelsenbeck, 2003). MrBayes differs from other programs in allowing partitions within the data set to implement different models of evolution, presumably allowing for a more realistic analysis of the data. Models of evolution were applied to individual molecular partitions and determined for each gene by MrModeltest (Nylander, 2004) for Bayesian analyses. In the total evidence Bayesian analysis, the following models were applied to each partition: (1) Morphology used the standard discrete model (appropriate for likelihood approximations of morphological datasets; Lewis, 2001) and assumed gamma-shaped rate variation; (2) ITS used GTR + *i* (proportion of invariable sites without a gamma distribution); (3) COI used GTR + Γ + *i*; and 4) 16S used GTR + Γ . Each of the models for the molecular partitions was determined in MrModeltest using Akaike information criterion (Akaike, 1974). Parameters within each model were not specified (or fixed) and MrBayes was left to estimate these independently for each partition from the data during analysis. All analyses in MrBayes included two independent runs, each consisting of four chains and 5,000,000 generations. Appropriate burnins were determined based on stationarity being reached through the use of Tracer v1.4 (Rambaut and Drummond, 2007).

Two other Bayesian runs were completed in order to test the effects of 3rd position change in the COI analysis as well as missing data in the molecular only analysis. In many analyses involving COI, the majority of change or divergence between taxa or populations is found in the highly variable 3rd position. Results based solely on 3rd position change are often criticized and considered based upon random data. This analysis excluded 3rd positions from the COI single gene analysis to determine if any presently supported groups would still exist in the final tree. The analysis was run with all the same parameters as previous Bayesian runs and an appropriate model determined by MrModeltest.

The primary reason for using a subset of taxa in the combined analyses was to eliminate a large amount of missing data that would have to be incorporated in order to include every population sequenced for at least one gene region. In order to test whether these missing data would have had an impact on the final analyses, all taxa sequenced for at least one region were included in a final "all-taxa" molecular only dataset. The Bayesian analysis was run under the same parameters as the other molecular only combined analysis.

3. Results

3.1. Comprehensive phylogenetic reconstruction based on morphology alone

The MP heuristic analysis of 25 taxa and 46 morphological characters resulted in 12 most parsimonious trees ($L = 129$, $CI = 0.4264$, $RI = 0.6085$) and the strict consensus is represented in Fig. 1. The monophyly of tested species of *Dermanyssus* is supported by a very short sternal shield (K3), a strongly atrophied third cheliceral segment (K32), a strongly elongate and foliate second cheliceral segment (K33) and membranous cornicules (K46).

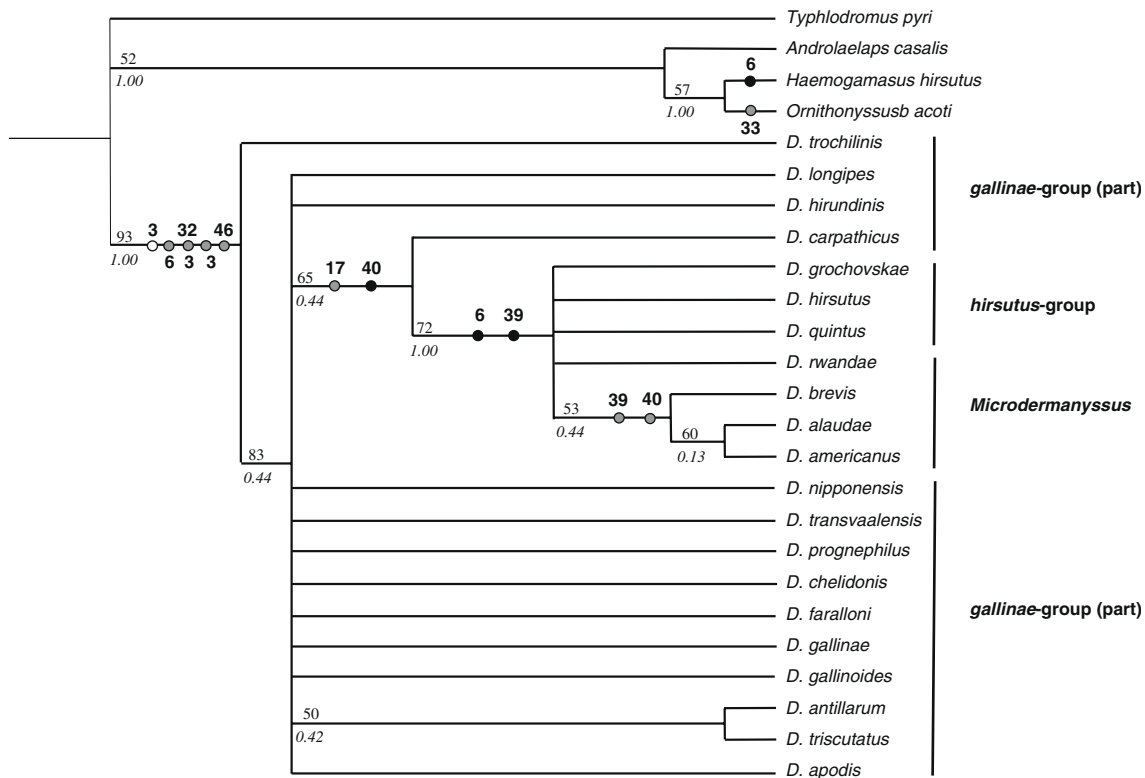

Fig. 1. Strict consensus tree of 12 most parsimonious trees ($L = 129$, $CI = 0.4264$, $RI = 0.6085$) using matrix of 46 morphological characters. The numbers below nodes refer to the relative Bremer support and numbers above refer to bootstrap percentages from 1000 replicates. Additionally, mapping of the main morphological synapomorphies is figured by white (character state 0), grey (character state 1) and black (character state 2) dots, labeled with corresponding character number.

Within *Dermanyssus*, *D. trochilinis* is a sister to all other *Dermanyssus* species, although support at this node is moderate (0.44 relative Bremer, 83% bootstrap). The remaining species share a strongly unresolved basal node and the clade grouping *Microdermanyssus* and the *hirsutus*-group is the only group with any kind of relative Bremer support and includes eight species (*D. alaudae*, *D. americanus*, *D. brevis*, *D. grochovskae*, *D. hirsutus*, *D. quintus*, *D. rwandae*). Monophyly of the group is supported within *Dermanyssus* by one apomorphy: the proportions of tibia I (K39, with an evolution in distal OTUs in *D. alaudae* + *D. americanus*). Moreover, the character state 2 in K6 (shape of the principal pore on the post-stigmatic element) is an apomorphy of this group within *Dermanyssus*, but there is a homoplasy with one outgroup (*H. hirsutus* shares same character state in K6). Note that the *hirsutus*-group does not appear to be monophyletic here, the interrelationships between the three species keep unresolved. It should be interesting to test the monophyly of this group using molecular data in a further study. *D. carpathicus*, one of the *gallinae*-group species, appears as sister group of above clade (0.44 relative Bremer; 65% bootstrap). Two synapomorphies support this new clade: character state 1 in K17 (relative length of setae on dorsal side of femur I) and 2 in K40 (proportions of genu I), with an evolution in distal OTUs in *Microdermanyssus*, (transition to the third state 1). As for other species, interrelationships in the *gallinae*-group keep unresolved (forming a large polytomy), except for the sister group relationship of *D. antillarum* and *D. triscutatus* (0.42 relative Bremer; 50% bootstrap).

3.2. Combined analyses on the subset of field collected species

Molecular information has been obtained from one to three genes in 46 different populations (Table 1). Obtained topologies are shown in Figs. 2A and 3A. Distribution of pairwise divergence among tested populations in the three tested genes is provided in Fig. 4.

3.2.1. Combined molecular matrix

The MP heuristic analysis of 34 taxa and 1524 characters (643 bp of ITS, 540 bp of COI, 341 bp of 16S) resulted in 576 most parsimonious trees ($L = 1357$ CI = 0.6478 RI = 0.7641). A strict consensus (Fig. 2A) resulted in two main clades within *Dermanyssus*. The first groups most of the DG-morph populations (clade B) with fairly strong support (0.77 relative Bremer; 98% bootstrap). Within this clade, several internal clades are strongly supported. Of them, two successive sister clades (F and E) group strongly together three and two populations respectively (1.0 relative Bremer and 100% bootstrap scores) and distinctively from the other DG-morphs and each other. The second clade groups populations with RQ-morph, DL-morph and the remaining DG-morph (clade I) although with very little support at the basal nodes. The individual morphs are monophyletic group with good support, including RQ-morph (J, 0.55 relative Bremer; 100% bootstrap), DL-morph (N, 0.90 relative Bremer; 100% bootstrap), and the remaining DG-morphs (L, 0.45 relative Bremer; 98% bootstrap). The remaining groups are basally unresolved and show no affinities to either of the previously mentioned clades. This includes the *hirsutus*-group (*D. hirsutus* and *D. quintus*) which is entirely unresolved and the populations with GO-morph, which form a monophyletic group with strong support (1.0 relative Bremer; 100% bootstrap) but with relationships to other *Dermanyssus* unresolved.

In the Bayesian analysis different models of evolution were implemented for each partition (gene region) in the molecular dataset and resulted in a more resolved tree than the MP run, although many characteristics of the two analyses are similar. The topology obtained from MrBayes (Fig. 2B) is almost completely resolved and results also in two major clades of *Dermanyssus*.

The clade G contains the RQ-morph, DL-morph, some of the populations with DG-morph, and unlike the MP analysis, the populations with GO-morph and the *hirsutus*-group are basally resolved and showing affinities to this first clade. Each of the morphs found in this large clade represents a monophyletic group of populations. Within this clade, the populations with GO-morphs are most basal and strongly supported (1.0 Bayesian Posterior Probabilities (BPP)), followed by the *hirsutus*-group (0.74 BPP), the RQ-morphs (1.0 BPP), then the populations with DL-morph (1.0 BPP), and finally a clade of DG-morphs (1.0 BPP). The other main clade (B) consists of the remaining populations with DG-morph and shows little sequence variation across the clade. This clade, like in the MP analysis, is very poorly supported (0.55 BPP) indicating the basal relationships within this clade are questionable. All other relationships within the clade B corroborate the results of the MP analysis.

The results of the “all-taxa” matrix represented in Appendix E show that the same groups are resolved, albeit with more members, and for all intents and purposes provides the same topology as the previously run molecular-only combined analysis. The large amount of missing data apparently had no effect on the final results, and in fact because the same major groups emerged, would indicate how strongly the individual genes converge on the same hypothesis.

3.2.2. Total evidence matrix

The MP heuristic analysis of 34 taxa and 1570 characters (46 morphological K, 643 bp of ITS, 540 bp of COI, 341 bp of 16S) resulted in 288 most parsimonious trees ($L = 1426$ CI = 0.6452 RI = 0.7634). Strict consensus (Fig. 3A) resulted in a hypothesis identical to the molecular only result.

The Bayesian analysis once again resulted in a well resolved tree (Fig. 3B) very similar to the molecular only tree (Fig. 2B). One major difference is the placement of the *hirsutus*-group. In the molecular only tree, the *hirsutus*-group was sister to the RQ-morph + DL-morph + DG-morph clade (clade H in Fig. 2B), whereas in the total evidence results, the *hirsutus*-group is sister to the RQ-morph clade and overall (clade I' in Fig. 3B), support values are much higher. All other groupings remain the same between the two results.

Removing 3rd positions from the COI analysis produced a less resolved phylogenetic hypothesis (Fig. 5) than the full COI analysis, as expected. However, the following major groups were still recovered: GO-morph (1.0 BPP), RQ-morph (1.0 BPP), RQ + DL-morphs group (0.76 BPP), GO + DG + *hirsutus* + DL + RQ-morphs group (0.82 BPP), and two DG-morph subgroups from the main DG-morph clade typically recovered (*COL* + *JGC* + *LC* + *PI*, corresponding to clade F: 0.88 BPP and *JBO51* + *LB07* + *LB18*, corresponding to clade E: 0.95 BPP). These results indicate that while major change is present in the 3rd position, informative change (information) still exists in the more slowly evolving 1st and 2nd positions.

3.3. Single gene analyses

COI: The MP heuristic analysis of 41 taxa and 540 characters of COI resulted in 36 most parsimonious trees ($L = 699$ CI = 0.5622 RI = 0.8216). The strict consensus resulted in a similar topology to the results of the combined analyses, although more unresolved. Most notably is the lack of resolution between the DL-morph and the DG-morphs, normally resolved in the combined analyses.

The Bayesian results for COI are more resolved than the MP results and the only difference between the COI results and the combined results is the separation of *D. hirsutus* and *D. quintus*.

16S: The MP heuristic analysis of 34 taxa and 341 bp of 16S resulted in 28 most parsimonious trees ($L = 309$ CI = 0.6796 RI = 0.8467). The strict consensus resulted in a similar result to the combined analyses, although slightly less resolved. Unlike the COI analysis, relationships of RQ-, DL- and part of DG-morphs are

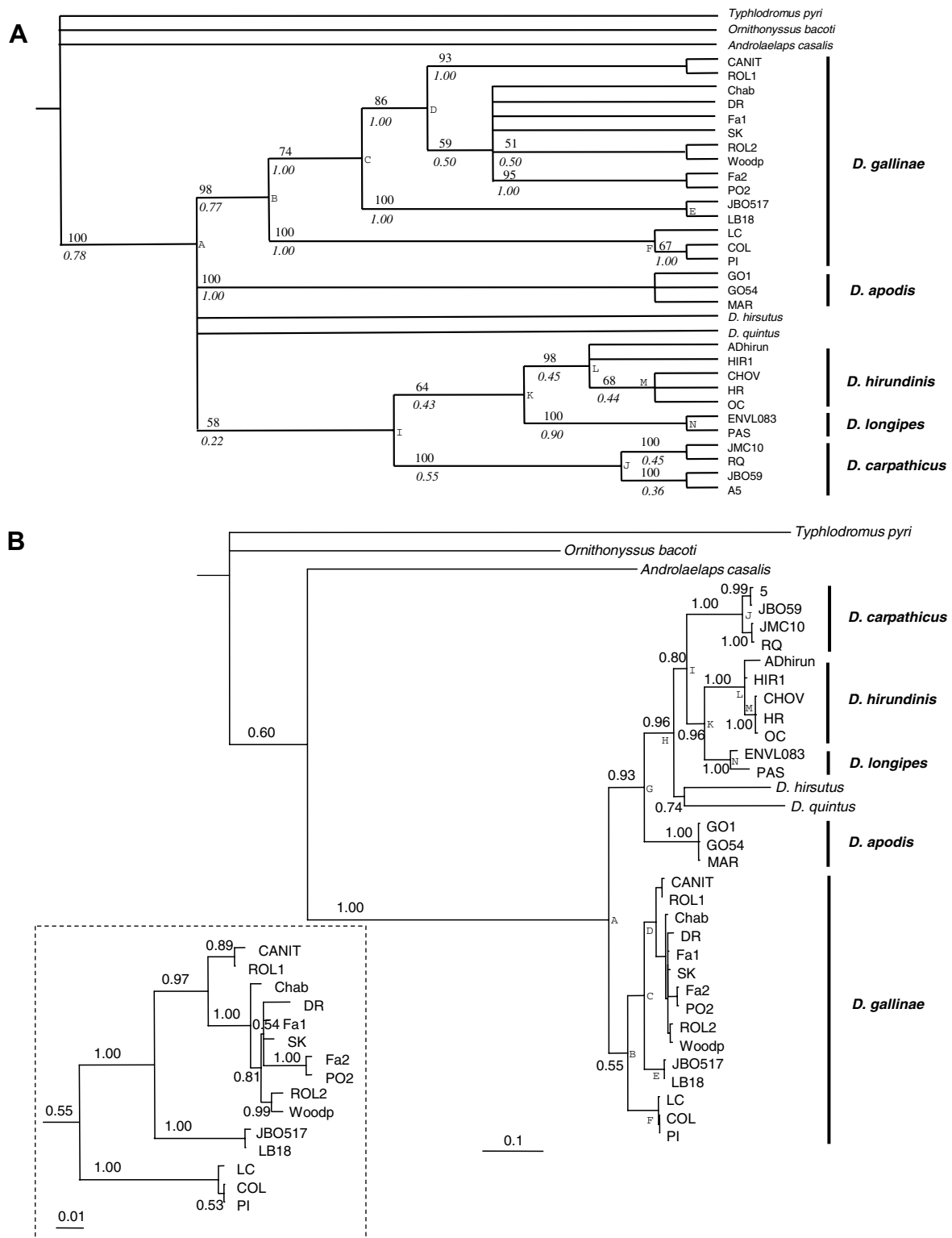

Fig. 2. Molecular combined analysis using 1570 bp from cytochrome oxidase subunit I, rRNA 16S and rRNA 18S–28S, including ITS1, 5.8S and ITS2. (A) Maximum parsimony criterion, PAUP 4.0. Strict consensus of 576 most parsimonious trees ($L = 1357$ CI = 0.6478 RI = 0.7641). The numbers below nodes refer to the relative Bremer support and numbers above refer to bootstrap percentages from 1000 replicates. (B) Bayesian analysis from 5,000,000 generations using partitioned data and independent models of evolution for each partition. Numbers on nodes refer to Bayesian posterior probabilities.

resolved, but with RQ-morph grouped with part of DG-morph, and with DL-morph as a sister group (different than results found in the combined analyses). Finally, interrelationships within the second main clade are less resolved than in previous analyses. Bayesian results are basically identical to the MP results, showing the same relationships.

ITS: The MP heuristic analysis of 35 taxa and 643 bp from ITS resulted in 1000 most parsimonious trees ($L = 413$ CI = 0.8184 RI = 0.7706). The strict consensus resulted in a conspicuously less resolved topology than in the combined analyses. The monophyly of populations with RQ-morph appears strongly supported (1.0 relative Bremer; 92% bootstrap) however no other relationships are

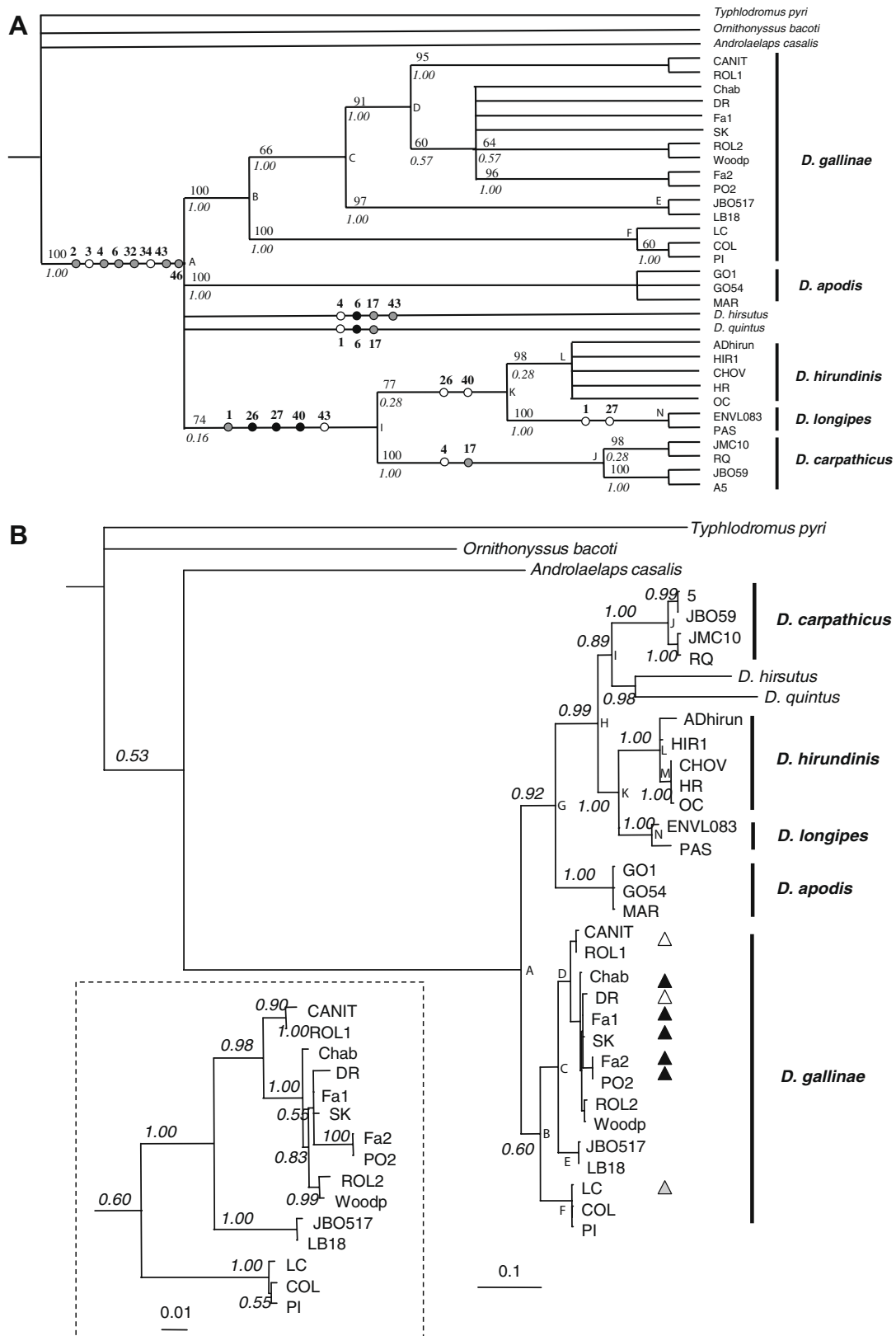

Fig. 3. Total evidence analyses using 46 morphological characters and 1570 bp from cytochrome oxidase subunit I, rRNA 16S and rRNA 18S–28S, including ITS1, 5.8S and ITS 2. (A) Maximum parsimony criterion, PAUP 4.0. Strict consensus of 288 most parsimonious trees ($L = 1426$ CI = 0.6452 RI = 0.7634). The numbers below nodes refer to the relative Bremer support and numbers above refer to bootstrap percentages from 1000 replicates. Additionally, mapping of the main morphological synapomorphies is figured by white (character state 0), grey (character state 1) and black (character state 2) dots, labeled with corresponding character number. (B) Bayesian analysis from 5,000,000 generations using partitioned data and independent models of evolution for each partition. Numbers on nodes refer to Bayesian posterior probabilities. Moreover, triangular signs indicate populations found in a human-shaped environment, internal color corresponding to different bird groups (grey triangle, pigeons breeding facilities, white triangle, fringillids breeding facilities, black triangle, layer hen houses).

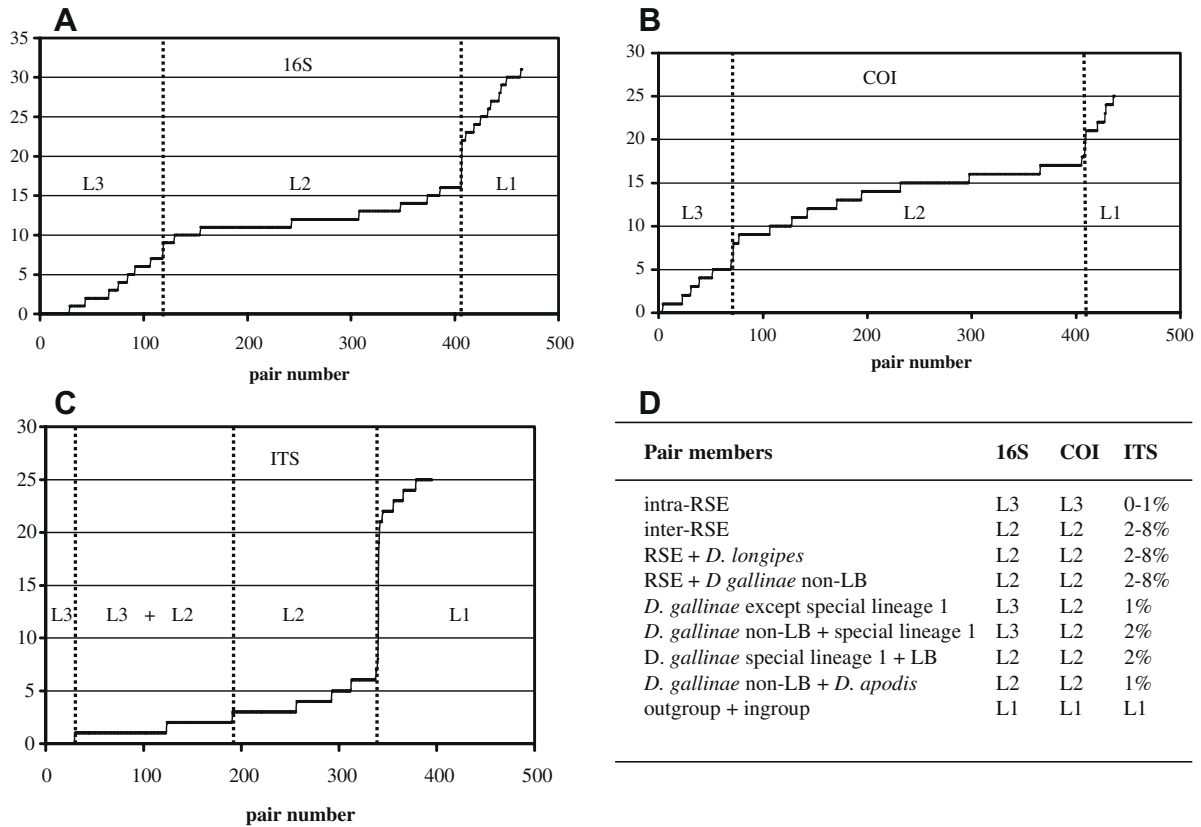

Fig. 4. Distribution of percentages of pairwise divergence among populations of the eight OTUs used in molecular analyses. RSE = reference specific entities (cf. discussion, § species), ie *D. carpathicus*, *D. hirsutus*, *D. quintus*. L1, L2, L3 = hierarchical levels 1, 2, 3 noted on trees are discussed in the text.

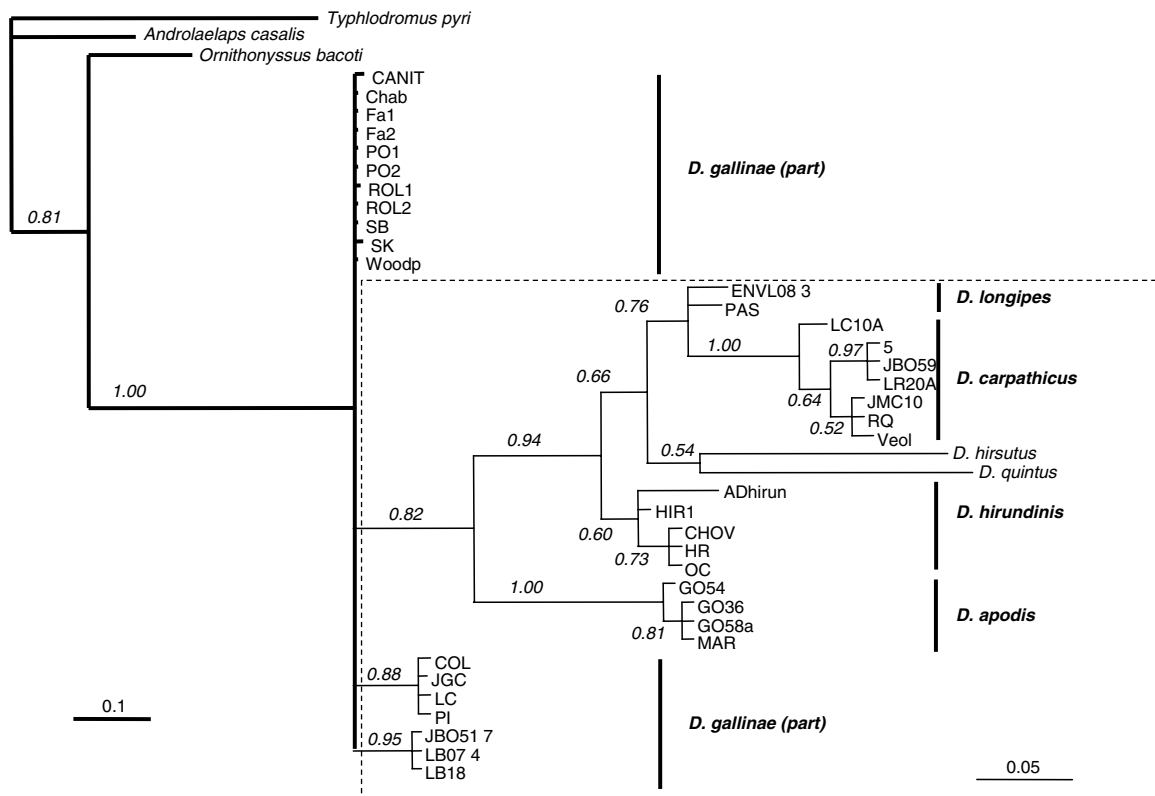

Fig. 5. Bayesian analysis of the COI matrix, excluding 3rd positions of codons.

discernable. Bayesian analysis provided a slightly more resolved result including a weakly supported clade of DG- and DL-morphs as in other results and a strongly supported clade of RQ-morph. Additionally, the DG-morph clade F forms a strongly supported monophyletic group.

As individual units, none of the gene regions show high resolving power or large amounts of useful phylogenetic data. However, as a combined unit the resolving power greatly increases and understandable relationships emerge, thus reinforcing the utility of total evidence approaches.

3.4. Species boundaries

In all three single gene analyses, as in the total evidence and combined analyses, the same populations typically group together, and it's the more internal nodes where disagreements are found. Mitochondrial gene analyses resolve rather similarly to each other, with less resolution intra-morph in 16S than in COI-based topologies. The ITS-based topology is less resolved, but still recovers the RQ-morph group.

On the whole, phylogenetic analyses of the total evidence and molecular-only matrices, recovered a monophyletic grouping of the different expected species of the *gallinae*-group with strong support values (bootstrap values from 98 to 100% in all analyses; Table 3). One interesting result, however, was the consistent splitting of the DG-morphs into two clades. In the analyses, the GO-morph reveals an isolated entity along with the following species level delineations:

- Populations with DL-morph (ENVL08, PAS) group together with 1.0 BPP in Bayesian and 1.0 relative Bremer and 100% bootstrap, in MP combined analyses and correspond to *D. longipes*.
- Populations with RQ-morph (RQ, 5, JBO59, JMC10) group together with 1.0 BPP in Bayesian and 1.0 relative Bremer and 100% bootstrap, in MP combined analyses and correspond to *D. carpathicus*.

Population with DG-morph split into two different clades, corresponding to at least two species. These four populations (ADhi, Hir1, HR, OC) group together with 1.0 BPP in Bayesian and 0.28 relative Bremer and 98% bootstrap, in MP combined analyses and correspond to *D. hirundinis*. These fifteen populations (COL, LC, PI,

CANIT, Chab, DR, Fa1, Fa2, JBO51-7, LB18, PO2, ROL1, ROL2, SK, Woodp) group together with 0.60 BPP in Bayesian and 1.0 relative Bremer and 100% bootstrap, in MP combined analyses and correspond to *D. gallinae*.

Populations with GO-morph (GO1, GO54, MAR) group together with 1.0 BPP in Bayesian and 1.0 relative Bremer and 100% bootstrap in MP combined analyses and correspond to *D. apodis* n. sp. described below.

Moreover, observations on the distribution of pairwise divergences between populations in mitochondrial genes allowed detection of three main levels of hierarchy represented in the trees (Fig. 4), which partially corroborate above cladistic delineations. Separation between level 1 (20-25% in COI, 22-31% in 16S and 19-25% in ITS) corresponds to separation between the ingroup and outgroup and level 2 (8-18% in COI, 9-16% in 16S and 0-8% in ITS) to separation between species (RSE, see below). Level 3 (0-6% in COI and 0-7% in 16S) is internal within ingroup (i.e. concerns differences within species). In the nuclear gene, level 3 does not generate a conspicuous gap and part of levels 2 and 3 are overlapping each other (1-2% pairwise divergence).

On the other hand, non-*hirundinis* populations with DG-morph do not clearly group together with strong support values, except for some subsets of populations. Populations of clade F appear clearly grouped together in the three single gene analyses and separated from other *D. gallinae* populations in the ITS analysis (sister group and to *D. gallinae* and to the GO-morph group). Other *D. gallinae*, together with this subset, form a monophyletic clade with the GO-morph clade in ITS single gene analyses, but with very weak bootstrap support (Table 3). Moreover, the populations of clade E in Figs. 2 and 3 form a strongly supported clade in COI analysis, but group in a weakly supported clade and together with the population CANIT in ITS single gene analysis (Table 3).

3.5. A posteriori observation of some traditional characters

Observation of traditional descriptive characters from the retained cuticles of sequenced individuals confirmed the strong variability of most of these traits. Closer examination in reference to phylogeny does indicate that some subtle characters do exist that may be useful for species distinction (cf. diagnostic characters in the key for identification below §4.5). Here are results on a posteriori tested characters.

Table 3
Support values for monophyly of species with several populations and other groups in the three single genes analyses (Maximum parsimony and bayesian) Nm = Not monophyletic.

a priori morphs	Group	16S		COI			ITS			
		BA		BA		BA		MP		
		Number of tested populations	Bayesian posterior probabilities	Number of tested populations	Bayesian posterior probabilities	Number of tested populations	Bayesian posterior probabilities	Branch support for monophyly (% bootstrap/rel. Bremer's)	Branch support for monophyly (% bootstrap/rel. Bremer's)	
DG-morph	<i>D. gallinae</i> except lineage 1(L1)	11	0.58	43/0.25	14	0.58	NM	12	NM	NM
DG-morph	<i>D. hirundinis</i>	3	1.00	100/1.00	5	1.00	98/1.00	5	NM	NM
RQ-morph	<i>D. carpathicus</i>	3	0.97	96/1.00	7	1.00	100/0.78	4	1.00	92/1.00
DG-morph	<i>D. gallinae</i> special lineage 1(L1)	4	0.99	100/0.93	4	1.00	100/1.00	3	1.00	69/1.00
GO-morph	<i>D. apodis</i>	7	1.00	99/1.00	4	1.00	100/1.00	3	NM	NM
DG-morph	(<i>D. gallinae</i> LB; JBO51)= clade E	1	—	—	3	1.00	100/1.00	1	—	—
DG-morph	(<i>D. hirundinis</i> ; <i>D. longipes</i>)	5	NM	NM	7	0.92	NM	7	0.99	NM
DG-morph	<i>D. gallinae</i>	15	0.81	89/0.88	18	0.73	86/0.90	15	NM	NM
DG+GO-morph	(<i>D. gallinae</i> ; <i>D. apodis</i>)	22	NM	NM	22	NM	NM	18	0.87	39/0.29
	Genus <i>Dermanyssus</i>	30	0.89	67/0.80	36	1.00	89/0.92	29	1.00	100/1.00

3.5.1. Dorsal shield chaetotaxy

The dorsal shield has very rough and irregular contours in many specimens, and *j1* and *s1* are sometimes situated on the shield and other times off the shield. Several specimens have been found with identical DNA sequences but variable position of such setae.

This is especially conspicuous in *D. gallinae* where 21% of sequenced individuals had *j1* clearly off shield, 16% clearly on, 53% along the edge and 11% exhibited clear asymmetry (off on one side, on on the other side). In the clade B, 67% of sequenced individuals had *j1* along the edge of the shield and 33% with clear asymmetry. In other species, the number of sequenced individuals is lesser, so fewer variations have been noted. However, below is an overview of noted variations:

- In *D. carpathicus*, 57% of sequenced individuals had *j1* off and 43% with clear asymmetry.
- In populations GOn and MAR, which slightly differ morphologically and strongly group together, 67% of sequenced individuals had *j1* off shield and 33% with clear asymmetry.

In some species, such as, *D. hirundinis* and *D. longipes*, 100% of sequenced individuals had *j1* off the shield without variation.

Moreover, variations in the total number of setae present on the dorsal shield have been noted in every species: 21–25 setae in *D. hirundinis*, 17–24 setae in *D. carpathicus*, 21–30 setae in *D. gallinae*, 20–25 setae in *D. longipes*, 25–29 setae in populations GOn and MAR.

3.5.2. Leg chaetotaxy

Leg chaetotaxy is highly variable in parasitic mite species (Evans, 1963), and especially within *Dermanyssus* (cf. Evans and Till, 1962; Moss, 1968). Within *Dermanyssus*, we found intraspecific and intra-individual variation across many species. In order to determine if there are any evolutionary tendencies or patterns in leg chaetotaxy, we mapped these characters onto the molecular phylogenetic hypothesis. Because of high mobility of setae on the legs, traditionally annotated setae *ad*, *pd*, *av* and *pv* have been condensed down to ventral (*v*) and dorsal (*d*) notation. We also noted anterior lateral (*al*) and posterior lateral (*pl*) setae on each taxon. It was not possible to compare sides with each other in all individuals due to occasional problems in cuticular treatment during DNA extraction or mounting (cf. Material and methods above).

Dermanyssus gallinae proved to be the most variable of all species with individual asymmetry (number of setae differing from one side to the other) observed in 50% of sequenced individuals (on femur I *v*, in genu I and II *d*, *v* and *pl* and in genu IV *d* and *pl*). In symmetrical individuals, intraspecific variation was found to be very high. Variation in the number of setae in homologous area between individuals has been noted on femur I *v* in 18% of sequenced individuals, in 11% on femur I *pl*, in 19% on genu II and III *v*, in 6% on genu IV *d* and *v*. This variation is found not only between populations, but also within single populations. Clearly leg chaetotaxy is not a phylogenetically informative character and appears amazingly plastic during the development of *D. gallinae*.

In other sequenced species of the *gallinae*-group, asymmetries (number of setae differing from one side to the other) were noted in 50% or more for sequenced individuals of *D. hirundinis* (mainly ventral faces of femur I, genu I, II and IV, and *al* and dorsal face in genu II). Additionally, variation between individuals of *D. hirundinis* was found in 14% of sequenced individuals on genu III *al* and in 50% on genu II *v*, genu III *d*, and genu IV *d*.

3.5.3. Pronotal scutella

Moss (1966) identifies the pronotal scutella as the anterior portion of the dorsal shield not rounded, but with two somewhat acute and laterally pointed angles, suggestive of shoulders. He

states that this condition is present in some species and absent in some others, indicating its utility in species identification. However, upon investigation, we found several cases where individuals found in the same aggregation exhibited body types with and without these shoulders or pronotal scutella. Additionally, when tested genetically with the three gene regions used in this study, all produced identical sequences. Moss observed that the “prominent shoulders” of *D. gallinae* were formed “by the fusion of the dorsal shield with the platelet” (Moss, 1966). These platelets in fact seem to be present in most species (K41), but can be fused or unfused to the dorsal shield within a single population of one species. Furthermore, many cases of bilateral asymmetry were discovered in this study, especially in *D. carpathicus* (25% of sequenced individuals) and in *D. gallinae* (9.5%).

4. Discussion

On the whole, the morphology-based analysis does not provide adequate information to determine species delineation nor phylogenetic relationships within the *gallinae*-group. Additionally, this analysis only brings some information about possible relationships within *Microdermanyssus* + *hirsutus*-group (cf. below). On the other hand, analyses including molecular data, either with MP or Bayesian, provide valuable information regarding delineation of some species and species' relationships (cf. below). All converge on similar results, with more or less resolution. The least resolved topologies result from ITS single gene analyses (MP, Bayesian) indicating that most of the resolving power is found in the mitochondrial genes. Total evidence and combined molecular only datasets offer much more resolution in the *gallinae*-group than the morphological.

The present study took into account mitochondrial and nuclear genes. As it has previously been observed at similar levels (Moore, 1995; Springer et al., 2001; Shaw, 2002), our results suggest that the tested nuclear gene (ITS) has less resolving power than the tested mitochondrial genes in recovering relationships within *Dermanyssus*. Therefore, our species delineation and evaluation of relationships are mainly based on mitochondrial data. It is recognized that this could be misleading for inferring species phylogenies due to the haploid character of mitochondrial origin, however, single gene analyses do not produce results highly contradictory to the total evidence and combined analyses.

4.1. Species

While the combined dataset does provide some interesting information about the *gallinae*-group phylogeny, the main purpose of incorporating molecules that tend to sort out closely related species, or even distinct populations, was to determine if the *gallinae*-group actually constitute a number of morphologically similar species or if they represent one homogenous population of *D. gallinae*. This is important in terms of dealing with pest species of domestic birds, which to this point have been continuously identified as *D. gallinae*.

4.1.1. Distribution of multi-population a priori morphs

In order to reveal species boundaries within morphologically similar entities, it is important to include several geographically distant populations in phylogenetic analyses (Monaghan et al., 2005). In the present study, several geographically distant populations (from various places in France) from the four *a priori* morphs have been tested in combined analyses (three genes and morphology, three genes only) and in single gene analyses (Appendix D) of both mitochondrial and nuclear sequences (GO-morph: 10 populations; DG-morph: 45 populations; RQ-morph: 5 populations). Populations of GO-morph and RQ-morph are, respectively, grouped

together in strongly supported clades (Table 3 and Figs. 2 and 3), whereas DG-morph is clearly separated in two distinct clades: populations HR, OC, CHOV, HIR1 and ADhirun in the clade L (Figs. 2 and 3), and the other DG-morphs (Table 1) in the clade B (Figs. 2 and 3).

4.1.2. *D. carpathicus*, *D. hirsutus* and *D. quintus*, clearly characterized described species, as reference specific entities

Three species appeared clearly characterized early in the study: *D. carpathicus* (sharp pairwise divergence with other entities, very little divergence between geographically distant populations within the species, phylogenetically grouped together with strong support in all analyses (Table 3), slight morphological differences but clear divergence); *D. hirsutus* (pairwise divergence with other entities, sharp morphological divergence); and *D. quintus* (pairwise divergence with other entities, sharp morphological divergence). Of course, respective monophylies of *D. quintus* and *D. hirsutus* have not been tested, due to lack of additional populations, but their DNA sequences are very divergent from each other and other populations and morphological characterization is obvious. For all these reasons, these three specific entities will be used in the present study as references for species status and are referred to as reference specific entities (RSE) in order to have a comparison of the distribution of pairwise divergence percentages (Fig. 4). Pairwise divergences located in hierarchical level 2 in Fig. 4 correspond to interspecific divergence.

4.1.3. *D. hirundinis* and *D. longipes*

Populations of *D. hirundinis* also form distinct clades separate from other *Dermanyssus* displaying large genetic divergence and some diagnostic morphological characters have been noted in the a posteriori feedback described in Section 4.3. *D. longipes* is a sister to *D. hirundinis* populations in all analyses, and this group as a whole is distinct from other *Dermanyssus*. There is a slight exception in 16S single gene Bayesian analysis, where it appears sister to a clade including *D. carpathicus* and *D. hirundinis*. These results provide confidence that *D. hirundinis* is a unique species. Moreover, as tested populations of *D. longipes* not only group together in all topologies and are separate from *D. hirundinis* in 16S gene analysis, but also it is 11.2% (16S) and 9.4% (COI) different from *D. hirundinis*AD, it is apparent that it also represents a good species concept. Additionally, slight morphological differences between *D. longipes* and all other *Dermanyssus* species have been noted. The anal plate is slightly more elongated (relative measures) and more or less subrectangular and the dorsal shield has a subapical shrinkage and ends with a quite rounded apex. In most cases, monophyly of tested populations in phylogenetic analyses supported not only by this amount of genetic divergence, but also by a few morphological characters typically constitute unique species status. It would be interesting to include more than two populations of this species in the future in order to firmly fix the specific status.

4.1.4. Non-hirundinis populations with DG-morph

The results from the analysis of the combined dataset indicate that what had been identified by the authors as *D. gallinae* is not as clear and does in fact group into several different lineages. These populations do not group together in a strongly supported clade in single gene analyses either (Table 3). Moreover, pairwise divergence between them is in some cases in level 2 and in some others in level 1.

Populations LB18, JBO51 (clade E in Figs. 2 and 3) and LB07-4 resolve monophyletic in single gene COI analysis (94% bootstrap), but not in ITS analysis, where LB18 and JBO51 branch with population *D. gallinae* CANIT (Table 3). This incongruence between mitochondrial and nuclear genes suggests that, even if these entities are partially isolated from each other, there is some gene flow between them and *D. gallinae* populations. This implies that it has to be deemed belonging to *D. gallinae*. Additionally, ITS sequences in

these populations are almost identical to that of other *D. gallinae* populations, except for one site (common to CANIT).

On the other hand, populations of the clade F (Figs. 2 and 3) appear morphologically identical to *D. gallinae* populations, but resolve monophyletic in all analyses. They are divergent from other *D. gallinae* in all analyses, and may represent a cryptic species. Thus single gene analyses resulted in similar topologies, and grouped these populations in strongly supported clades both in mitochondrial and nuclear genes (Table 3), with identical ITS sequences between each other and differing by 2% from *D. gallinae* populations. There is likely no gene flow between populations COL, LC, PI, GO8 and JGC1 (from various environments, with geographical distances between them from about 100 to 300 km) and other tested populations of *D. gallinae*, but since there are no clear diagnostic morphological characters, these populations may at best represent recent speciation or cryptic species. As Heethoff et al. (2007) concluded when studying potentially cryptic species of the oribatid mite *Platynothrus peltifer* Koch, 1839, we have decided to make no decision regarding species status until more biological information is obtained. Thus, as recommended by DeSalle et al. (2005), it is necessary to get corroboration for more than one line of evidence for delineation of a new taxon. Here, DNA is the only line of evidence. In the case of a cryptic species, as no morphological clues are available (even subtle as in some species of *Tectocepheus* in Laumann et al., 2007), some geographical or ecological data is necessary to corroborate the DNA evidence. Future studies will try and obtain additional samples from pigeons of various geographical origins and various types of environment (breeding facilities, urban nests), as an ecological common trait seems to be the host group (cf. below). In present paper, this entity will be referred to as *D. gallinae* special lineage one.

4.1.5. Does population Woodp belong to *D. gallinoides*?

Moss (1966) described *D. gallinoides* as follows: (1) no prominent shoulders (anterior part of the dorsal shield not rounded, but with two somewhat acute and laterally pointed angles, suggestive of shoulders), (2) small platelet on the soft integument on each side of the dorsal shield, (3) dorsal shield scaling smooth, (4) *j1* and *s1* off the dorsal shield (*D. gallinae*: *j1* always and *s1* generally on the dorsal shield), (5) epigynial pores off the shield, (6) tibia IV *pl* with 2 setae (instead of one in *D. gallinae*), (7) genu II *pl*, III *al* and IV *al* with two setae (opposed to only one seta in *D. prognepphilus*), (8) peritreme extending only to the middle or anterior margin of coxa II rather than to the middle of coxa I (different from *D. prognepphilus*). Upon examination of numerous populations of *D. gallinae* and now recognizing the great amounts of variability in many of these characters, the sixth argument appears to be the only valid one. In terms of host associations, *D. gallinoides*, has been found on several different species of Picidae, a group not normally associated with *D. gallinae*. We collected one specimen originally identified as *D. gallinae* (labelled Woodp population) from an adult female *Dendrocopos major* (Picidae) that exhibits several characteristics resembling *D. gallinoides*.

The shape of dorsal shield fits arguments one and two depending on the observed side (bilateral asymmetry) and position of *j1* is asymmetric (one side on, the other side off shield, 4th argument). Of course, depending on which side of the body you look at, these character states either direct you to *D. gallinoides* or *D. gallinae*. Tibia IV *pl* only has one seta, like in *D. gallinae*, but femur I *pl* only possesses one seta (instead of two in all other *D. gallinae*). Genetically, population Woodp falls within the other *D. gallinae* specimens indicating even more variation within that species, and if this does in fact represent what has been called *D. gallinoides*, it suggests that this should be synonymised with *D. gallinae*. However, many more specimens would be necessary to make this decision.

4.1.6. *D. apodis* n. sp

Strongly supported monophyly of populations GOn and MAR along with several subtle morphological characters separate these populations from other species of the *gallinae*-group. These populations constitute an entity which appears to be of specific status and which we describe here under the name *D. apodis*.

Female (holotype) (Fig. 6A–B):

Gnathosoma. Length of setae: anterior pair of hypostomal setae 37 μ m long (range with 5 paratypes 31–39 μ m), central pair 57 μ m

long (47–65 μ m), lateral pair 26 μ m long (24–31 μ m), posterior pair 26 μ m (26–28 μ m). Capitulum 96 μ m (96–137 μ m) long (from its basis to apex of palp coxae), 151 μ m (143–166 μ m) wide basally and 117 μ m (104–130 μ m) wide distally, (*i.e.* between lateral margins of palp coxae' apex).

Setae *al1* of palp genu lanceolate. Anterior hypostomal setae pair wider than other gnathosomal setae.

Idiosoma. 840 μ m (735–1050 μ m) long and 494 μ m (420–693 μ m) wide. *Dorsum*: dorsal shield length 714 μ m (646–

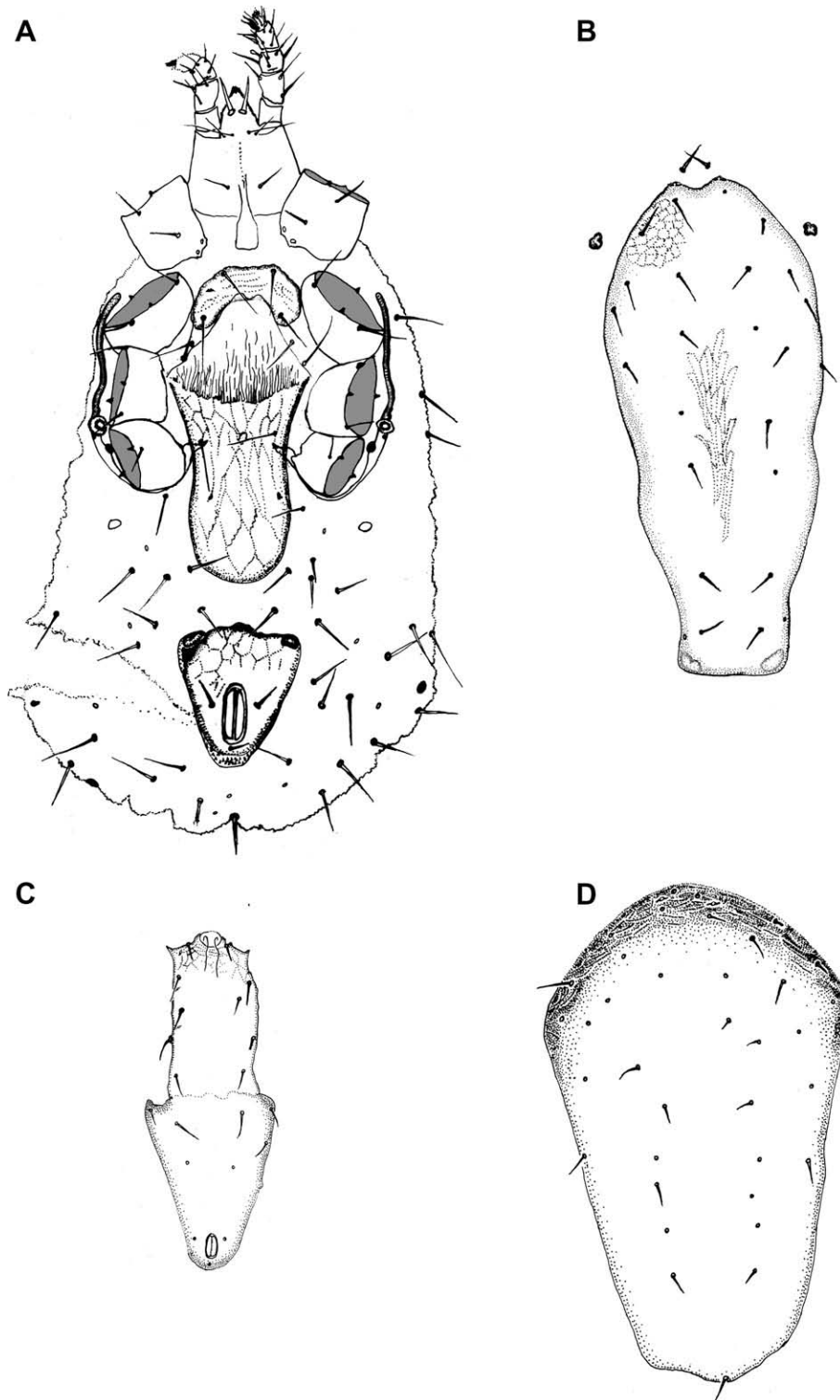

Fig. 6. *D. apodis* n. sp. (A) Venter of an adult female (holotype). (B) Dorsal shield of an adult female (holotype). (C) Venter of an adult male. (D) Dorsal shield of an adult male.

798 µm), width 286 µm (262–291 µm) at midlevel. Its anterior margin with a concave slit between the two anterior pores. These pores are often anteriorly located and separated from the shield. (Fig. 6B). Relative length of dorsal shield more than twice the podosoma area bounded by coxae (367 µm, 4 par. 346–451 µm) in length. Relative width of dorsal shield almost as wide as the podosoma area bounded by coxae, with lateral margin running across each coxa. Shape of ultrastructural network on dorsal shield slightly differing on anterior part and on middle and posterior part: grooves delimiting rather short areas (about as wide as long) in anterior part and longer areas around the middle of dorsal shield, which seem to converge toward posterior part via longitudinal axis. No major difference of length between central/peripheral setae of dorsal shield (series *j4-6* and *z5/j2*, *z2*, *z4* and *s4*). Pronotal scutella present, separated from dorsal shield. *Venter* (Fig. 6A). Sternal shield 18 µm (18–29 µm) long and 148 µm (122–171 µm) wide. Genito-ventral shield 254 µm (234–260 µm) long and 140 µm (119–140 µm) wide at midlevel. Oviporal flap 130 µm (109–169 µm) long. Anal shield 153 µm (148–174 µm) long and 148 µm (137–156 µm) wide, with anterior margin's outline very irregular. *Post-stigmatic trachea* (which extends posteriorly from stigmata): principal pore large (ca. 3 × setae base), a hole surrounded by a large raised chitinous ring, forming something like a neck.

Legs. Tibia I 99 µm long (94–101 µm) and 60 µm wide (52–65 µm). Tibia II 78 µm (73–75 µm) long and 52 µm wide (48–60 µm). Genu I 99 µm long (94–99 µm) and 73 µm wide (62–75 µm). Genu II 80 µm long (75–78 µm) and 68 µm wide (57–70 µm). Chaetotaxy of legs: Genu I 2–5/3–2; Genu II 2–4/2–2; Genu III 2–4/1–2; Genu IV 2–4/1–1. Variations in paratypes (6 examined): Genu I: one paratype 2–3/3–2 and two with a bilateral asymmetry on ventral face. Genu II: two paratypes with a bilateral asymmetry on ventral face. Genu III: one paratype with a bilateral asymmetry on ventral face, two not determined (legs III lost). Genu IV: one paratype 1–4/1–0, another with a bilateral asymmetry on ventral face.

Nucleic acids. Several amplicons from the three tested genes have been sequenced for different populations of *D. apodis* (accession numbers in Table 1: holotype belongs to population G054 and paratype females to populations G01, G015, G016, G046, G059, MAR). All obtained ITS and 16S sequences were exactly the same. Only two bases were different between sequences of COI obtained from the holotype population (holotype individuals and another individual found from the same swift nest) and the paratype population MAR (0.3% divergence).

Male (paratype) (Fig. 6C and D)

Gnathosoma. Length of setae: anterior pair of hypostomal setae 26 µm long (18 µm in a second male paratype), central pair 47 µm long (31 µm), lateral pair 33 µm long (not visible in second paratype), posterior pair 14 µm (13 µm). Capitulum 75 µm (75 µm) long (from its basis to apex of palp coxae), 127 µm (98 µm) wide basally and 109 µm (91 µm) wide distally, (i.e. between lateral margins of palp coxae' apex). Spermatodactyl 96 µm long.

Setae *al1* of palp genu lanceolate. Anterior hypostomal setae pair not wider than other gnathosomal setae; note: thinner anterior hypostomal setae in male than in female appears to be a sexual dimorphism present also in *D. gallinae*.

Idiosoma. 746 µm (693 µm) long and 525 µm (451 µm) wide. *Dorsum:* dorsal shield (Fig. 6D) length 651 µm (599 µm), width 316 µm (260 µm) at midlevel. Podosoma area bounded by coxae 340 µm (315 µm) in length. *Venter* (Fig. 6C). Sternigenitoanal shield 578 µm (536 µm) long and 187 µm (176 µm) wide. The genital orifice is located on the anterior margin of the sternigenitoanal shield. *Post-stigmatic trachea* as in adult female.

Remarks. Populations of *D. apodis* constitute a distal clade with strong bootstrap values in all combined analyses and in mitochondrial single gene analyses (Table 3, Figs. 2, 3 and 5, Appendix D).

Moreover, branch lengths are much more important between this entity and others than within the cluster (Monaghan et al., 2005), which highlights the unique status of this particular hierarchy in the tree (idem in *D. carpathicus* and *D. hirundinis*).

Among the 24 species of *Dermanyssus* described so far, only three species have been recorded from some Apodiformes: *D. hirundinis* (on swifts, family Apodidae), *D. rwandae* (on swifts, family Apodidae) and *D. trochilinis* (on hummingbirds, family Trochilidae).

Closely related to *D. gallinae* (and especially the subset of populations COL, JGC1, PI, LC), *D. apodis* morphologically differs from it mainly by the concave slit between the two anterior pores of dorsal shield (continuously rounded convex margin in *D. gallinae*). Moreover, the pronotal scutella are not fused to dorsal shield (usually fused in *D. gallinae*) and the anterior pair of hypostomal setae is slightly wider than in *D. gallinae*. It also clearly differs from *D. hirundinis* by the concave slit between the two anterior pores of dorsal shield (continuously rounded convex margin in *D. hirundinis*) and by some elements of leg chaetotaxy (*pl* of genu II and III with 2 setae in *D. apodis*, 1 in *D. hirundinis*). It also clearly differs from *D. trochilinis* by the concave slit between the two anterior pores of dorsal shield (continuously rounded convex margin in *D. trochilinis*), by the relative width of setae of anterior hypostomal pair (about as wide as other hypostomal setae) and by the absence of pronotal scutella.

Etymology. The species name is derived from the specific name of host and is the genitive form of the word.

Material examined.

- Individuals ex nests and adult birds of *A. apus* (Apodiformes: Apodidae), Nîmes, France (Gard), June–July 2007:

Holotype female (one individual of population G054, (n° MNHN Ac1111a, cf. Table 1). Seven paratype adult females from following populations: G01 (n° MNHN Ac1112), G015 (n° MNHN Ac1113b), G046 (n° MNHN Ac1116a and n° MNHN Ac1111b), G054 (n° MNHN Ac1111b), G059 (n° MNHN Ac1117a and n° MNHN Ac1117b); 2 paratype deutonymphs: G015 (n° MNHN Ac1113a), G016 (n° MNHN Ac1113c); 2 paratype adult males: G044 (n° MNHN Ac1115), G059 (n° MNHN Ac1117c).

Nest samples from which these mites have been isolated and samples directly caught from birds in this locality have kindly been provided by G. Gory (Muséum d'Histoire naturelle de Nîmes and Centre de Recherche sur la Biologie et les Populations d'Oiseaux).

- Individuals ex a young individual of *A. apus*, Francheville, France (Rhône), July 17th, 2007:

3 paratype adult females from population MAR (n° MNHN Ac1114a, n° MNHN Ac1114b, n° MNHN Ac1114c).

G. Lallemand sampled these mites during care activity in the Centre de Soins aux Oiseaux Sauvages du Lyonnais.

The holotype and paratype series are deposited in the Museum National d'Histoire Naturelle, Paris, France.

4.2. Different rates of evolution

The amount of genetic differentiation within and between species varied depending on the gene, however, we did not find any evidence of intrapopulation variation among any of the gene regions sampled. The nuclear marker (ITS region) provided few but sharp variations between each species, with the majority of variation found in ITS1 and 5.8S and almost no difference in ITS2. This is contrary to findings concerning most other mites that have been sampled (Navajas and Fenton, 2000; Cruickshank, 2002), but similar to patterns found in *Tetranychus* species (Navajas et al.,

1998). Resulting *Dermanyssus* sequences were easy to align and displayed several differences useful for molecular identification at the species level. Differences clearly characterize our respective populations of *D. carpathicus*, *D. hirundinis*, *D. longipes*, *D. hirsutus*, *D. quintus*, *D. apodis* and clearly separate these species from each another. Anyway, some few differences also separate some of the *D. gallinae* (especially the special lineage one L1) and *D. longipes* populations.

The mitochondrial markers (COI and 16S rRNA) show much higher levels of genetic differentiation between species than ITS (hierarchical level 2; Fig. 4), and exhibit small amounts of change between populations of a given specific entity (hierarchical level 1 of pairwise divergence in 16S and COI, Fig. 4). Additionally, some populations with identical ITS sequences exhibit several differences in their 16S sequences (Fig. 4). COI is by far the most variable of the three genes tested and provides many changes between populations. Pairwise divergence percentages between several populations of *D. gallinae* collected from European layer houses show that this marker is likely appropriate for phylogeographic investigation concerning economically important species. Gene sequences of COI revealed it to be a pertinent marker for phylogeographic exploration at a low taxonomic level (between closely related species or even populations of the same species) and although it is a protein coding gene, pairwise divergence appears often sufficient, if not excessive in some organisms (DeSalle et al., 2005), for obtaining valuable phylogeographic information, even in some parthenogenetic species (Heethoff et al., 2007).

4.3. Feedback on primary hypothesis: a diagnostic key for identification of the *gallinae*-group species from France

As stated previously, many characters traditionally used for species identification have shown to be highly variable even within single individuals of the various species of the *gallinae*-group. To date, there are no clear elements available for determining whether these differences are real phenotypic plasticity or only pure variations, because the impact of environmental influence on these variations is very difficult to estimate. Thus, it appears that some confusion may have occurred in some of the previous records likely due to these variations. A very recent example is found in Brännström et al. (2008), who found differences in ITS1 between some *D. gallinae* from layer farms and some *D. gallinae* from wild avifauna. Conspicuously, the ITS1 sequence found from wild birds corresponds to our *D. longipes*.

Most of these characters are no longer useful for distinguishing species, however, in light of the phylogenetic results and closer examination of characters, the following key has been generated for use in discriminating several species of the *gallinae*-group. Thus, among leg chaetotactic characters, it turned out that lateral sides of some leg articles have very few intraspecific variations, in contrast to most of other sides.

1. *al1* seta of palp genu spine-like, two setae on femur I *d* longer than the three others, *pl* of genu II and III usually each with one seta, pronotal scutella fused or not to dorsal shield (often asymmetric arrangement), anal plate D-shaped, anterior part of dorsal shield more or less convex. *D. carpathicus*

1'. *al1* seta of palp genu lanceolate, setae on femur I *d* without any conspicuous difference of length, other characters diverse. 2

2. *pl* of genu II and III usually each with one seta, anal plate D-shaped or elongate and more or less subrectangular, pronotal scutella usually unfused to dorsal shield and far from it, anterior part of dorsal shield more or less convex. 3

2'. *pl* of genu II and III usually each with two setae, anal plate D-shaped, other characters diverse. 4

3. Anal plate D-shaped, dorsal shield without any conspicuous subapical shrinkage. *D. hirundinis*

3'. Anal plate more elongate and more or less subrectangular, usually dorsal shield with a subapical shrinkage and ending with a quite rounded apex. *D. longipes*

4. Pronotal scutella usually separated from dorsal shield and far from it, anterior part of dorsal shield more or less concave, forming a neckline between the two anterior pores, anterior pores usually far from dorsal shield. *D. apodis*

4'. Pronotal scutella in most cases touching dorsal shield, anterior part of dorsal shield more or less convex. *D. gallinae*, including the special lineage one.

4.4. Phylogenetic relationships between species

Within *Dermanyssidae*, *Liponyssoides* possesses similar cheliceral and cornicular characters, but has a hexagonal-shaped sternal shield. Most species of *Liponyssoides* are also found on mammals instead of birds and it is unknown whether they are a sister group to *Dermanyssus* or originate from within the genus. Unfortunately, no specimens were available for inclusion in this study.

The results of the morphological analysis indicate that only two internal nodes provide a strong relative Bremer support (1.00). First, *D. trochilinis* is sister to the rest of tested *Dermanyssus* species. Secondly, the group *Microdermanyssus* + *hirsutus*-group appears monophyletic. Within the group *Microdermanyssus* + *hirsutus*-group, the relationships of the three species *D. quintus*, *D. hirsutus* and *D. grochovskae*, which correspond to Moss' (1968) *hirsutus*-group in the subgenus *Dermanyssus*, are unresolved. Three of the four remaining species correspond to Moss' *Microdermanyssus* and *D. rwandae* is sister to these three. This species is one of the more recently described species, and has never been included in a generic review of the group. Present results suggest it may be a member of the subgenus *Microdermanyssus*. *D. carpathicus*, also described after Moss' last review, is resolved as a sister group to the *Microdermanyssus* + *hirsutus*-group clade, but with rather weak support values. Our current morphological results coincide with Moss' idealized phylogeny with the exception of the *hirsutus*-group placement, which clearly falls out within Moss' *Microdermanyssus*. The subgenus *Dermanyssus* appears to be paraphyletic.

The total evidence and combined molecular only datasets offer much more resolution in the *gallinae*-group than the morphological analysis. These species appear more differentiated than expected on the single basis of morphology. Whereas the morphology-only topology results in a comb of *gallinae*-group species, with only *Microdermanyssus* + *hirsutus*-group forming a supported clade based on relative Bremer support, the combined tree shows a *gallinae*-group split into two different clades, one of them involving *D. carpathicus*, *D. longipes* and *D. hirundinis* (clade I), the second one a complex of *D. gallinae* lineages (clade B). The position of *D. apodis* is unresolved in the MP analyses, but is sister to the *hirsutus*-group + *D. carpathicus* + *D. longipes* + *D. hirundinis* (clade G) in the Bayesian analysis. As for the only two tested species of *hirsutus*-group, their mutual position is not strongly supported in these analyses. According to Bayesian analysis, they would be considered close to the clade I. This would be rather congruent with morphological topology, with *D. carpathicus* in a sister position to the *hirsutus*-group. But this is not supported by MP analysis.

4.5. Host specificity

Molecular results strongly confirm very low host specificity among *D. gallinae*, which has been previously suggested (Zemskaya, 1971; Nosek and Lichard, 1962; Zeman and Jurík, 1981; Fenďa and Schniererová, 2004). Populations of this species were

collected in this study from eight different orders of birds (Passeriformes, Coraciiformes, Piciformes, Galliformes, Ciconiiformes, Columbiformes, Apodiformes, Strigiformes), including domestic and wild birds. This leads to the conclusion that parasite transfer between wild bird fauna and domestic fowl is not out of the question. Additionally, within it, the special lineage one appears also rather unspecific, having also been collected from three different orders of birds (Columbiformes, Apodiformes, Strigiformes, Table 1).

On the other hand, many species appear more host specific, at least in France, such as *D. hirundinis* (found only on Hirundinidae) and *D. carpathicus* (found only in nests of two genera, *Parus* and *Phoenicurus*) and *D. longipes* (found in nests of two genera, *Parus* and *Passer*). Additionally, *D. apodis* was collected many times from two different places in France (ca 300 km apart), from more than 50 nests of *A. apus* and numerous individuals caught for banding. This is the only host species it is known from for the moment.

Some of these results contradict the published literature. *D. hirundinis* has been recorded from roughly 40 different bird species, in 9 bird orders (for review, Roy and Chauve, 2007): Passeriformes (19 previously recorded genera), Anseriformes, Apodiformes, Sturniformes, Strigiformes, Coraciiformes, Ciconiiformes, Columbiformes, Piciformes. In the present study, representatives from six of the above bird orders have been tested, but individuals belonging to *D. hirundinis* have been found in only three species of Hirundinidae (Passeriformes; *Delichon urbica* and *Hirundo rustica* in France, and *Tachycineta bicolor* in the USA), which is the type host family. Moreover, it was present in 25% of analyzed hirundinid nests in France. This suggests that *D. hirundinis* is more specific in France than expected from published data. As no faunistic inventory of *Dermanyssus* species in France was available today, it is likely that “dermanyssofauna” (and host specificity) differs in Europe and in the USA.

4.6. Evolutionary hypothesis for tested species of *Dermanyssus*

Tested species of *Dermanyssus* split into two clades in the total evidence (B and G in Figs. 2B and 3B) and molecular-only analyses. No clear evolutionary hypothesis can be drawn on the basis of morphology from this topology. Thus, several characters change their state at the basis of the clade grouping tested species of *Dermanyssus*, but all reverse in one clade or another more distally (K1, K17, K26, K27, K40, K43). These homoplasies obscure a clear view of morphological evolution. If we consider some ecological traits, some clues can be found.

No strict comparison with outgroups can be done, due to the different ways of life: *A. casalis* and *T. pyri* are predatory mites (and even *A. casalis* is not able to be occasionally parasitic; Lesna and Sabelis, pers. comm.). Only *O. bacoti* is a parasite, but is from an unrelated family of mites.

All strongly supported lineages here involve species found on a narrow host spectrum, except for the clade of *D. gallinae*. Even within this clade, an evolution of host spectrum seems to be visible, although host spectrum is not to be considered phylogenetically. Indeed, observation of obtained topologies in correlation with our bird data did not allow considering that there are any coevolution events (*A. Cibois*, pers. comm.). This suggests that this genus includes species with opportunistic habits. But phylogeny can be correlated to some ecological traits, difficult to clearly define, but inducing variations in adaptability to environment (farms vs *natura*, transferability from one to another bird species, etc.). *D. hirundinis* has been found in three species of Hirundinidae (*D. urbica*, *H. rustica*, *T. bicolor*). *D. carpathicus* was found in two different passeriform genera distributed in two different bird families (*Phoenicurus* and *Parus*, respectively, Muscicapidae and Paridae), as is the distribution found in the literature (Zeman, 1979). *D. longipes* has been found in two genera of Passeriformes distributed in

two different bird families as well (*Passer* and *Parus*, respectively Passeridae and Paridae), the first being the genus of the type host. *D. apodis* has been found only on one species *A. apus*. All these species have been found only in wild avifauna.

As for lineages in the *D. gallinae* clade (B), not only have several of them been found in “human managed environment” (cf. Fig. 3B), but also several lineages group populations from disparate bird species (cf. above). Especially, the clade D that groups together populations from layer farms, canary breeding facilities, wild European Roller, and a Woodpecker with strong support values (internal clades not supported). Moreover, the clade E includes populations found only in wild avifauna (*D. urbica*, Hirundinidae and *P. major*, Paridae).

Finally, special lineage one, the more basal lineage of *D. gallinae*, has been found in pigeon breeding facilities, also in pigeon nests in town, but never in layer farms. This lineage does not appear absolutely specific, as it has been isolated from two other bird groups, *in natura* (a owl and a swift; cf. Table 1). But in these two cases, mites were not necessary infesting the inhabitant of nest (a single mite in each case, isolated dead and dried from the two nests). Pigeon are known to be concurrent with swift concerning nesting place, especially into a town, which could explain the presence of the single specimen G08.

In short, host specificity may appear higher at the basis of the *gallinae* clade, with special lineage one (clade F) mainly on pigeons, with the intermediate clade E only found in wild passeriforms, and finally with remaining distal populations isolated from disparate bird groups. And synanthropicity appears to be proper to this clade B, the second one, clade G in Fig. 3B, being only found in wild avifauna. Intermediate ecological characteristics can maybe be seen in *D. apodis* and in some cases *D. gallinae* special lineage one, both having urban hosts (swift and pigeons).

4.7. Conclusion

The morphology-based phylogenetic hypothesis presented herein involves 20 of the 24 currently recognized species and a new species. The monophyly of *Dermanyssus* could not be tested due to the lack of *Liponyssoides* specimens and no assessment of relationships between the *Microdermanyssus* + *hirsutus*-group and the *gallinae*-group has been possible. Anyway relationships of species of the *gallinae*-group within the genus are robustly examined. These results suggest that *Microdermanyssus* + *hirsutus*-group contains species which are clearly distinguishable from one another solely on the basis of morphology, whereas the remaining species (*gallinae*-group) are sometimes indistinguishable from one another. Molecular data obtained from several populations of the *gallinae*-group indicates that many of these indiscernible species are clearly distinct species: *D. gallinae* and *D. hirundinis* are molecularly clearly divergent species, and *D. gallinae* contains several lineages. *D. carpathicus* is also a valid species, it is present in France and, by mapping morphological characters onto the molecular phylogeny, it appears there are two diagnostic characters (K4 and K17) for the species (Fig. 3A). A special lineage constituted by the subset of populations COL, JGC1, PI, LC may be a cryptic species closely related to *D. gallinae*. *D. apodis* is a new species to be linked to the *gallinae*-group, found on the black swift *A. apus*.

Based upon the way the tested populations of the *gallinae*-group sorted out, host specificity of *D. gallinae* appears very low, found on domestic birds as well as several orders of wild birds. On the other hand, *D. hirundinis* and *D. carpathicus* appear much more host specific, only found on a restricted set of hosts, at least in France. *D. apodis* has been found very often on *A. apus*, and only on this species in France. The fauna of *Dermanyssus* seems to strongly differ between USA and Europe.

Finally, two different clades were revealed within tested species of the *gallinae*-group, one of which seems to develop synanthropicity and proliferative capacity, with most derived OTUs present in hen farms. This also seems to be correlated with an adaptation to a wider host spectrum, populations with similar sequences being found on various bird orders in distal position in the *gallinae* clade on molecular tree.

Acknowledgments

We are grateful for their loan of reference material, sampling of fresh material, help, and advice to Baker A.S. and Beccaloni J., (Natural History Museum, London, UK), Huber B. (Zoologisches Forschungsinstitut and Museum A. Koenig, Bonn, Germany), Judson M. and Bain O. (Muséum National d'Histoire Naturelle, Paris, France), Beaulieu F., King Wan Wu and Lindquist E.E. (Agriculture & Agri-Food Canada, Ottawa, Canada), Klompen H. (Ohio State University, Museum of Biological Diversity, Columbus, USA), Ochoa R. (Systematic Entomology Laboratory, USDA, Beltsville, USA), Klimov P.B. and Oconnor B.M. (Museum of Zoology, University of Michigan, Ann Arbor, USA), Wauthy G. and Peeters M. (Institut Royal des Sciences Naturelles de Belgique, Brussel, Belgium), Kilpinen O. (Danish Institute of Agricultural Sciences, Lyngby, Denmark), Kreiter S. (Supagro, Montpellier, France), Knee W. (University of Alberta, Edmonton, Canada), Zeman P. (Institute of Parasitology, Ceske Budejovice, Czech Republic), Nannelli R.

(Istituto Sperimentale per la Zoologia Agraria, Firenze, Italia), Hallan J. (Texas A&M University, College Station, USA), Makarova O. (Severtsov Institute of Ecology and Evolution, Russian Academy of Sciences, Moscow, Russia), Dusbábek, F. (Academy of Sciences of the Czech Republic, Ceske Budejovice, Czech Republic), van Nieukerken E.J. (National Museum of Natural History Naturalis, Leiden, The Netherlands), Sabelis, M. and Lesna, I. (University of Amsterdam, IBED, Amsterdam, The Netherlands), Takahashi, M. (Kawagoe Sogo Senior High School, Kawagoe City, Japan), Ono Hirotsugu (National Science Museum, Tokyo, Japan), Paoletti B. (University of Teramo, Teramo, Italy), Fend'a P. (Comenius University, Slovakia), Heuch P.A. and Gjevre A.G. (National Veterinary Institute of Norway, Oslo, Norway), Cencek T. (Państwowy Instytut Weterynaryjny, Puławy, Poland), De Rojas M. (Universidad de Sevilla, Sevilla, Spain), Chabrol P. (veterinary office, Bourg-en-Bresse, France), Duret L. (Université Lyon 1, Lyon, France), Gory G. (Museum d'Histoire naturelle, Nîmes, France), Caparros O., Brucy L., Carrier L., Bouvier J.C., Vincent-Martin N., Beauvallet Y., and Dehorter O. (Centre de Recherche sur la Biologie et les Populations d'Oiseaux, Muséum National d'Histoire naturelle, Paris, France), Tavernier P. (Centre de Soins aux Oiseaux sauvages du Lyonnais, Francheville, France), Veau F. (CORA Ardèche, France), Bonnet S. and Guichard N. (LEGTA Saint-Genis-Laval, France), Lallemand G. (Lycée des Mandailles, Châteauneuf-de-Galaure, France), Rigaux M. (IUT A, Université Lyon1, France). We also thank three anonymous reviewers for valuable comments, which greatly improved the manuscript.

Appendix A

List of taxa examined for morphological analysis. Note: Indicated individuals correspond to specimens considered here as references. Other specimens of the same species may have been examined. T = type material; NT = non-type material.

Species	Loan from	Specimens' status
<i>Dermanyssus alaudae</i> (Schrank, 1781)	British museum of natural history (London, UK; neotype) and Belgian royal institute of natural sciences (Brussel, Belgium; NT, A. Fain's collection)	T + NT
<i>Dermanyssus americanus</i> (Ewing, 1922)	British museum of natural history (London, UK; NT) and National museum of natural history (Washington, DC, USA)(T)	T + NT
<i>Dermanyssus antillarum</i> (Dusbábek and Černý, 1971)	Institute of parasitology (Ceske Budejovice, Czech Republic)	T
<i>Dermanyssus brevis</i> (Ewing, 1936)	National museum of natural history (Washington, DC, USA)	T
<i>Dermanyssus carpathicus</i> (Zeman, 1979)	Institute of parasitology (Ceske Budejovice, Czech Republic)and P. Zeman (Czech Republic), specimens from several field collections of <i>Parus major</i> and <i>Phoenicurus phoenicurus</i> in France	T + NT
<i>Dermanyssus chelidonis</i> Oudemans, 1939	British museum of natural history (London, UK;), and Agriculture and Agri-food Canada (Ottawa, Canada)	NT
<i>Dermanyssus faralloni</i> Nelson and Furman, 1967	National museum of natural History (Washington, DC, USA)	T
<i>Dermanyssus gallinae</i> (De Geer, 1778)	British museum of natural history (London, UK; neotype)—Museum Koenig (Bonn; Germany; NT)—Muséum National d'Histoire naturelle (Paris, France; NT)—field samples	T + NT
<i>Dermanyssus gallinoides</i> Moss, 1966	Agriculture and Agri-Food Canada (Ottawa, Canada)	T
<i>Dermanyssus grochovskae</i> Zemskaya, 1961	Severtsov institute of ecology and evolution, Russian academy of sciences, (Moscow, Russia; NT, but specimens identified by A. Zemskaya herself)	NT
<i>Dermanyssus hirsutus</i> Moss and Radovsky, 1967	National museum of natural history (Washington, DC, USA; T)	T
<i>Dermanyssus hirundinis</i> (Hermann, 1804)	British museum of natural history (Bonn, Germany;neotype), Koenig museum (London, UK;NT), Belgian royal institute of natural sciences (Brussel, Belgium;NT, Fain's collection), National museum of natural history Naturalis. (Leiden, The Netherlands; coll. Oudemans, NT, nr P.4632)	T + NT
<i>Dermanyssus nipponensis</i> Uchikawa and Kitaoka, 1981	National science museum of Tokyo (Tokyo, Japan; TNSMT-Ac 12495)	T
<i>Dermanyssus prognephilus</i> Ewing, 1933	British museum of natural history (London, UK;NT), National museum of natural history (Washington, D.C., USA) (T, AL000244) and Ohio State University (Columbus, USA;NT)	T + NT

Appendix A (continued)

Species	Loan from	Specimens' status
<i>Dermanyssus quintus</i> Vitzthum, 1921	Agriculture and agri-food Canada (Ottawa, Canada; T), Museum of Zoology, University of Michigan (Ann Arbor, USA; NT), W. Knee (NI),	NT
<i>Dermanyssus rwandae</i> Fain, 1993	Belgian royal institute of natural sciences (Brussel, Belgium;T)	T
<i>Dermanyssus transvaalensis</i> Evans and Till, 1962	British museum of natural history (London, Uk;T)	T
<i>Dermanyssus triscutatus</i> Krantz, 1959	National museum of natural history (Washington, D.C., USA;T) and agriculture and agri-food Canada (Ottawa, Canada, NT)	T + NT
<i>Dermanyssus trochilinis</i> Moss, 1978	National museum of natural history (Washington, D.C., USA; T)	T
<i>Dermanyssus longipes</i> (Berlese and Trouessart, 1889)	Slovak national museum in Bratislava (Bratislava, Slovakia; 2 slides labelled <i>D. passerinus</i> , from specimens collected from prof. Milan Mrciak) from <i>Passer domesticus</i> (NT) and specimens collected from a nest of <i>Passer montanus</i> near Avignon (France; NT)	NT
<i>Dermanyssus apodis</i> n. sp.	Specimens from several field collections from <i>A. apus</i> in France by G. Gory and G. Lallemand (T+NT)	
<i>Haemogamasus hirsutus</i> Berlese, 1889	MNHN (3D7, 3E1-3E4, 3E6, 3E10)	NT
<i>Ornithonyssus bacoti</i> (Hirst, 1913)	Specimens from a live lab strain in MNHN (O. Bain)	NT
<i>Androlaelaps casalis</i> (Berlese, 1887)	Specimens from several field collections in France	NT
<i>Typhlodromus pyri</i> Scheuten, 1857	Specimens from mite culture in the lab of S. Kreiter (Supagro, Montpellier)	

Appendix B

List of morphological characters and states used in the analysis.

The main source of the following characters was either direct observations or the following publications: Moss (1966, 1968, 1978) and Evans and Till (1962).

1. Lateral contours of palp coxae in ventral view-0-Straight-1-Convex.

2. Sternal shield shape: relative location of points c and d, with c medially located on anterior margin of sternal shield and d laterally located on anterior margin of sternal shield-0-c at the same level as d (anterior margin rather straight)-1-c located above the line between both points d (anterior margin quite curved).

3. Sternal shield shape: ratio e/a with e = width at the largest point and a = central height-0-e/a>3-1-e/a ≤ 2.

4. Shape of seta al1 of palp genu-0-spine-like-1-lanceolate.

5. Shape of post-stigmatic trachea (a tube extending posteriorly from each stigmat)-0-one curved tube, around coxa IV-1-in two separate pieces.

6. Principal pore on post-stigmatic trachea (a pore located on post-stigmatic trachea, which extends posteriorly from stigmata):-0-absent-1-present, large (ca. 3× setae base), a hole usually surrounded by a large raised chitinous ring (something like a neck)-2-present, small (diameter smaller than setae bases) and simple (without any neck).

7. Intermediate pore on post-stigmatic trachea (a small pore located between principal pore and stigmata, close to stigmata):-0-absent-1-present.

8. Ultrastructure of dorsal shield-0-grooves absent-1-grooves present.

9. Relative length of peritreme-0- <2 × diameter of stigmat-1->4 × diameter of stigmat.

The traditional character (peritreme length in relation with the coxa it reaches) is a character which appeared to us not to be reliable in any case as such, because of its own nature(see below K9 in K definitions). It is something soft, and superficial. It forms a narrow groove inserted in the integument along the podosoma. The position and length of this element vary from one to another mite from the same strain and traditionally used character states constitute a continuum, which suggest this is not valuable species specific character within *Dermanyssus*. Any-

way, there exists very short peritremes in some species (type specimens), which appear really different than others (*D. chelidonis*, *D. alaudae*, *D. rwandae*...), being almost atrophied. Between this state of characters and all others, a gap is visible. That is the reason why we encoded it differently, with only two characters states (short, ie less than twice the diameter of stigmat and long, ie more than 4 times the diameter of stigmat).

10. Humeral paired simple pores as large as setae bases, on dorsal shield-0-absent-1-present.

11. Humeral paired large pores, about 4 times larger than setae bases and containing a central conical prominence (on or off dorsal shield)-0-absent-1-present.

12. Apico-opisthosomal setae width-0-similar with shape and width to other setae-1-much wider and more massive.

13. Apico-opisthosomal setae arrangement-0-in a jumble-1-regularly aligned.

14. Ventro-opisthosomal setae, located on areas laterad to anal shield-0-“classical” number-1-neotrichy.

15. Dorsal setae: comparison between central/peripheral setae of dorsal shield (series j4-6 and z5 / j2, z2, z4 and s4)-0-no major difference-1-length of central setae less than 1/3 length of peripheral setae.

16. Relative length of setae on dorsal side of genu I-0-all quite the same length-1-One apical and one basal setae much longer than others (> length of genu).

17. Relative length of setae on dorsal side of femur I-0-all quite the same length-1-Two apical setae much longer than others (> length of genu).

18. Mesonotal scutella (are considered here only sclerotized areas which detour more than 3 grooves of soft integument)-0-absent-1-present.

19. Ampoula near internal margin of coxa IV-0-fuzzy outlines and sharp apex (as if it was some crumpled membrane)-1-roughly rounded, quite sclerotized.

20. Ultrastructure of leg segments' cuticule-0-smooth-1-embossed with large circles (about 2-3 on each side of segments longitudinally).

21. Third seta on anal shield-0-absent-1-present.

22. Proportions of anal shield-0-as wide as long, apically rounded, D-shaped-1-wider than long, with lateral angles more

or less prominent-2-D-shaped, close to state 0, but longer than wide and apically subrectangular.

23. *Central longitudinal pillar within anal opening*-0-present-1-absent.

24. *Relative location of anal opening on shield*-0-anterior-1-posterior.

25. *Relative location of the largest part of anal shield*-0-anterior-1-central.

26. *Proportions of tibia II*-0-longer than wide-1-wider than large-2-as long as wide.

27. *Proportions of genu II*-0-longer than wide-1-wider than large-2-as long as wide.

28. *Morphometric comparison of oviporal flap (OF) and epigynial shield (ES): ratio length of OF/total length OF + ES*-0- $\leq 1/3$ -1-ca. = $1/2$.

29. *pv seta of palp trochanter*-0-present, as narrow as next setae-1-present, massive compared to next setae (large base, appears full)-2-absent.

30. *al seta of trochanter I*-0-present, as narrow as next setae-1-present, massive compared to next setae (large base, appears full)-2-absent.

31. *Anterior pair of setae within hypostomal parallelogram*-0-empty-1-filled with a clear substance.

32. *Chelae*-0-Mobile digit clearly distinguishable with an optical microscope-1-Mobile digit reduced, undistinguishable with an optical microscope.

33. *Shape of 2nd cheliceral segment section*-0-as wide as or wider than palp genu-1-narrower than palp genu.

34. *j3*-0-absent-1-present.

35. *J3 and J4*-0-off shield-1-J3 and J4 on shield-2-J3 on and J4 off or on limit.

36. *Dorsal shield*-0-Rounded, apical contours fuzzy-1-Posteriorly subtruncate, with two rounded “angles”.

37. *Relative length of dorsal shield according to podosoma*-0-same length-1-Dorsal shield much longer than podosoma (extending posteriorly, far behind coxae IV).

38. *Relative width of dorsal shield according to podosoma*-0-same width-1-Dorsal shield less wide than podosoma (lateral margin of dorsal shield not running across each coxa).

39. *Proportions of tibia I*-0-longer than wide-1-wider than large-2-as long as wide.

40. *Proportions of genu I*-0-longer than wide-1-wider than large-2-as long as wide.

41. *Pronotal scutella* (sticky or not to dorsal shield, usually raspberry-shaped with 3–4 “berries”)-0-present-1-Pronotal scutella absent.

42. *Shape of stigmata*-0-roughly rounded-1-dewdrop shaped.

43. *Relative width of anterior setae in hypostomal parallelogram according to al setae of palp femur*-0-base of anterior setae (basal part of seta, not the pit receiving base of seta) quite as wide as base of palp setae-1-3× or more.

44. *Outlines and shape of epigynial shield*-0-Irregular contours, with a rather tapering apex-1-Sharp contours, with a rounded apex, following a rounded narrowing.

45. *Ampoula near internal margin of coxa IV*-0-Conspicuously visible, with a narrowing at the base-1-Non clearly discernible or simply a filiform element, such as a slight extension of poststigmatic trachea.

46. *Cornicules*-0-Heavily sclerotized-1-Membranous.

Appendix C

Matrix of 24 taxa and 46 morphological characters used in the analysis.

Taxon/Node	111111111222222222333333333344444444	1234567890123456789012345678901234567890123456
D apodis	010101?1100000000011011000000110111000101001	
D longipes	010101111000000000112110000?00110111100100001	
D alaudae	11000200001000111000111111100011010101000001	
D americanus	110002?010000000110012110111000110?11011100001	
D antillarum	0100?10?1001000001??10110020001110001100111001	
D brevis	0100020?00100010110000111221000110111022000001	
D carpathicus	1100010110000000100110110220000110111102100011	
D chelidonis	010101011000000000110110000000110111100?010?1	
D farallonii	1101010110000000001?10110020000110111100001001	
D gallinae	010101011000000000110110000000110111100101001	
D gallinoides	110101111000000000110110000000110111100101001	
D grochovskae	110002011100011110111110221000110101022001101	
D hirsutus	1100020011000111101110010220000110101022100011	
D hirundinis	110101111000000000110110020000110111000100011	
D nipponensis	010101011000000000112110221000110111000101001	
D prognephilus	010101011000000000110110000000110111000101011	
D quintus	01010201101111010111110220110110111022001011	
D rwandae	000002010010001010?11110221001110101122001011	
D transvaalensis	010101110000000000110110021200110201000100001	
D triscutatus	110101011000000010110110000000110000100101011	
D trochilinis	100101011100000000?1211000000011110100000001	
Haemogamasus hir	0011020110000?000011000002001000-?0100000?10	
Ornithonyssus ba	001?000110000100001010000000001110110000010	
Androlaelaps cas	00111?1110100000001101000000000110100000110	
Typhlodromus pyr	001010011000000000-0121100002000011-1000100200	

Appendix D

Single gene analyses (COI, 16S, ITS) using MP and Bayesian analyses.

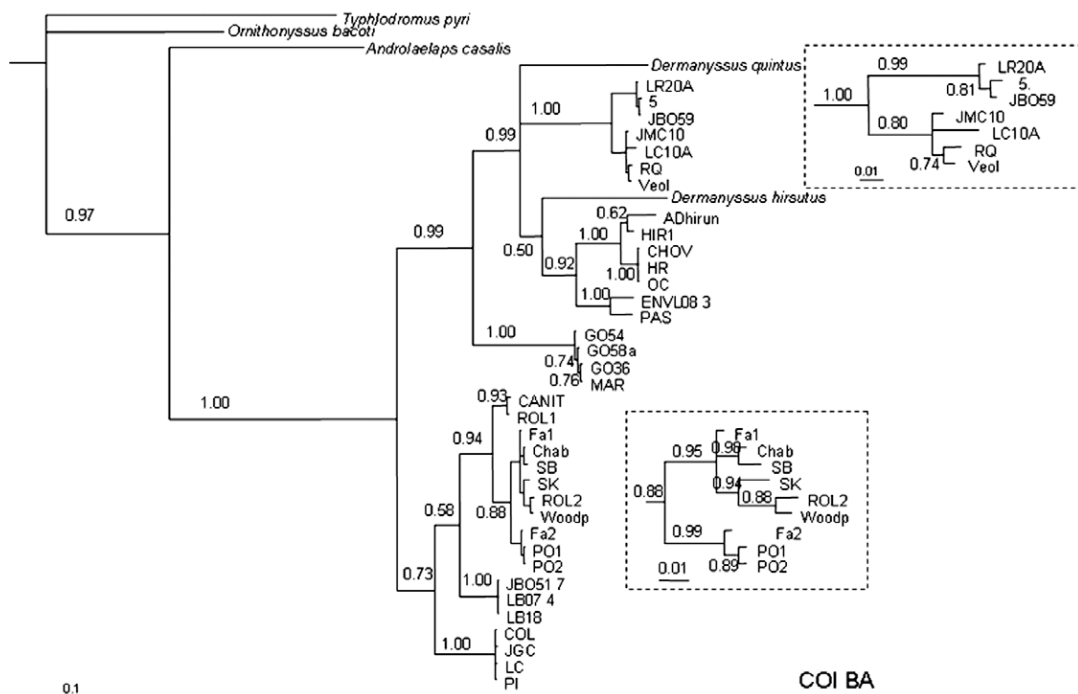
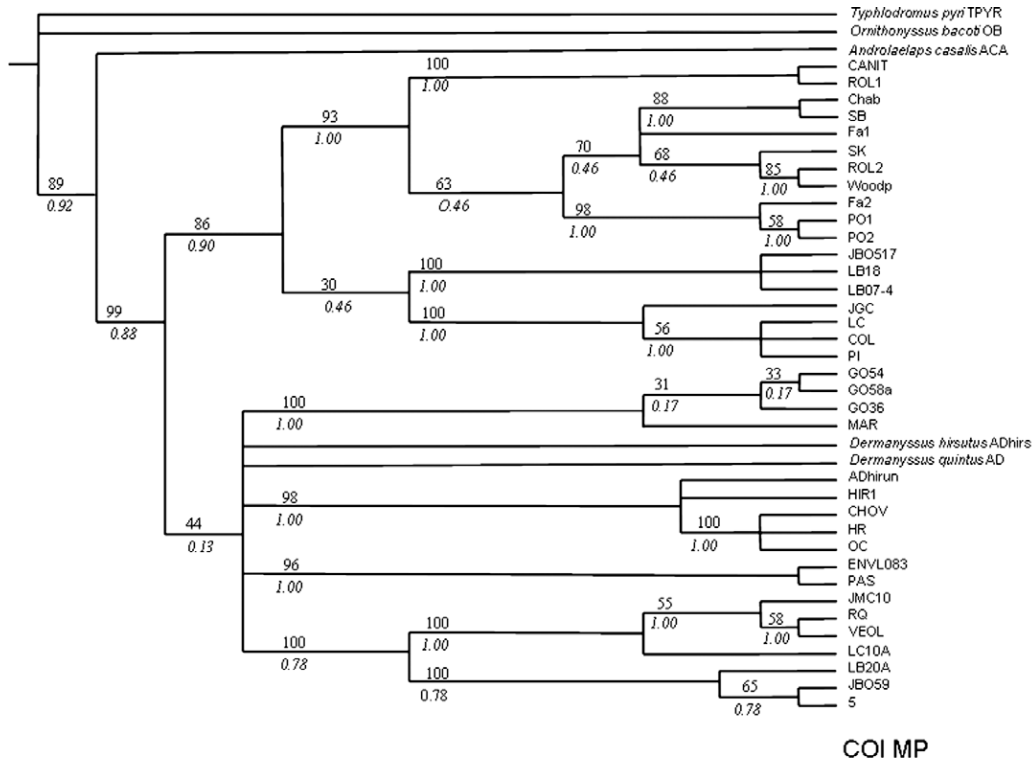

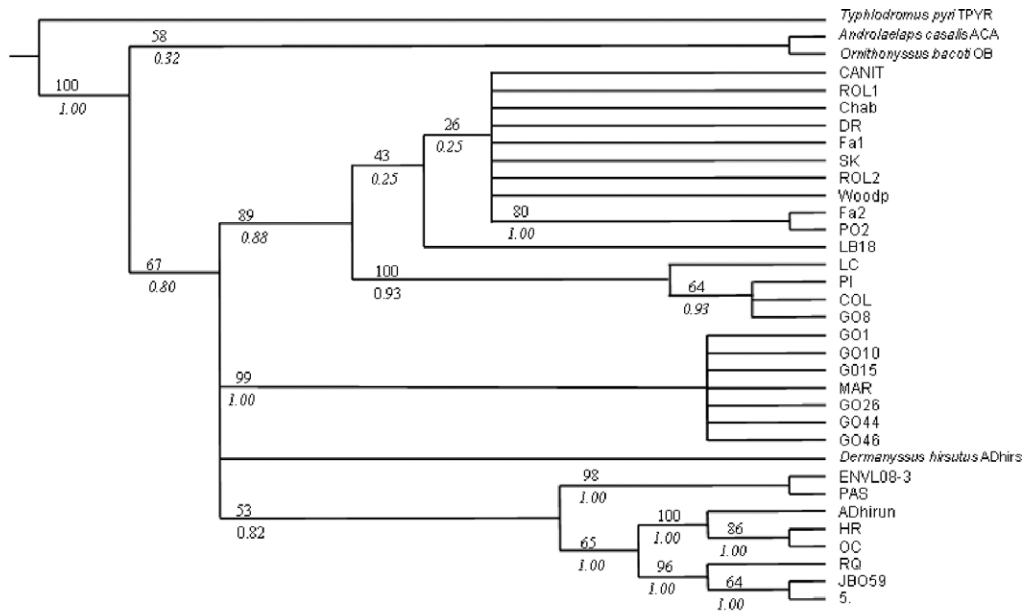

16S MP

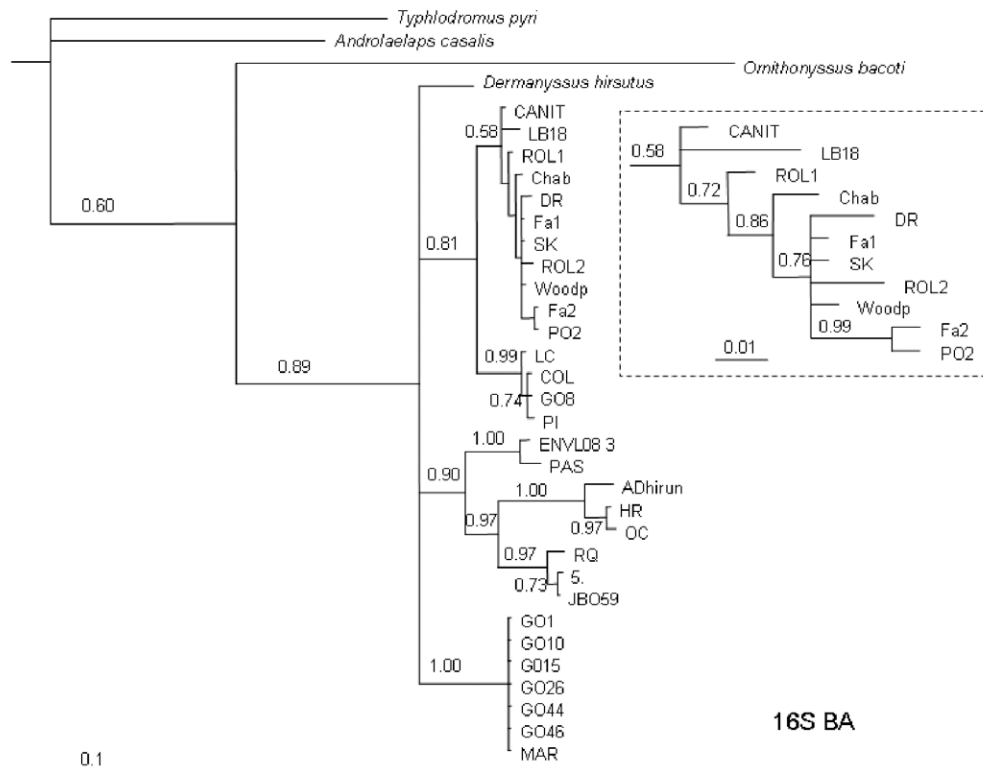

16S BA

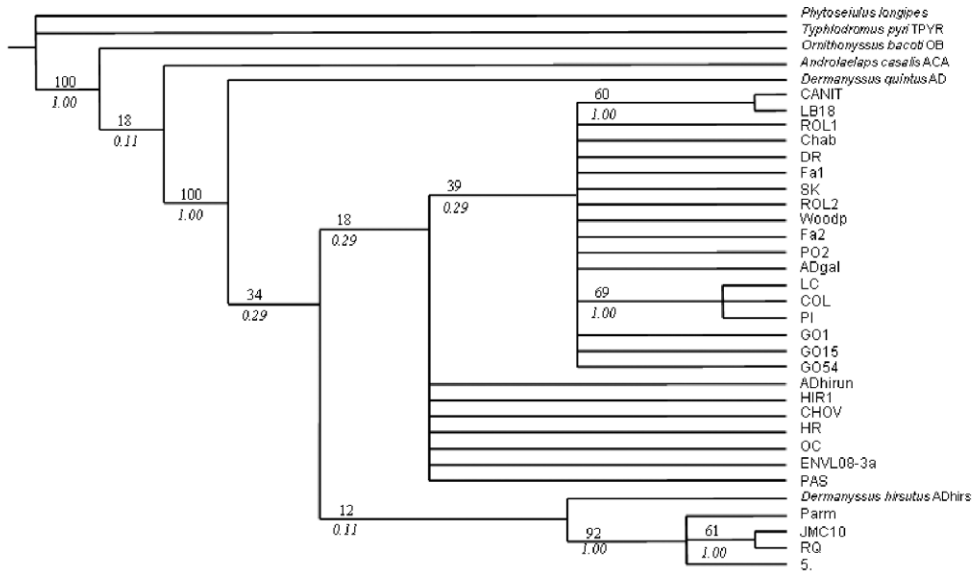

ITS MP

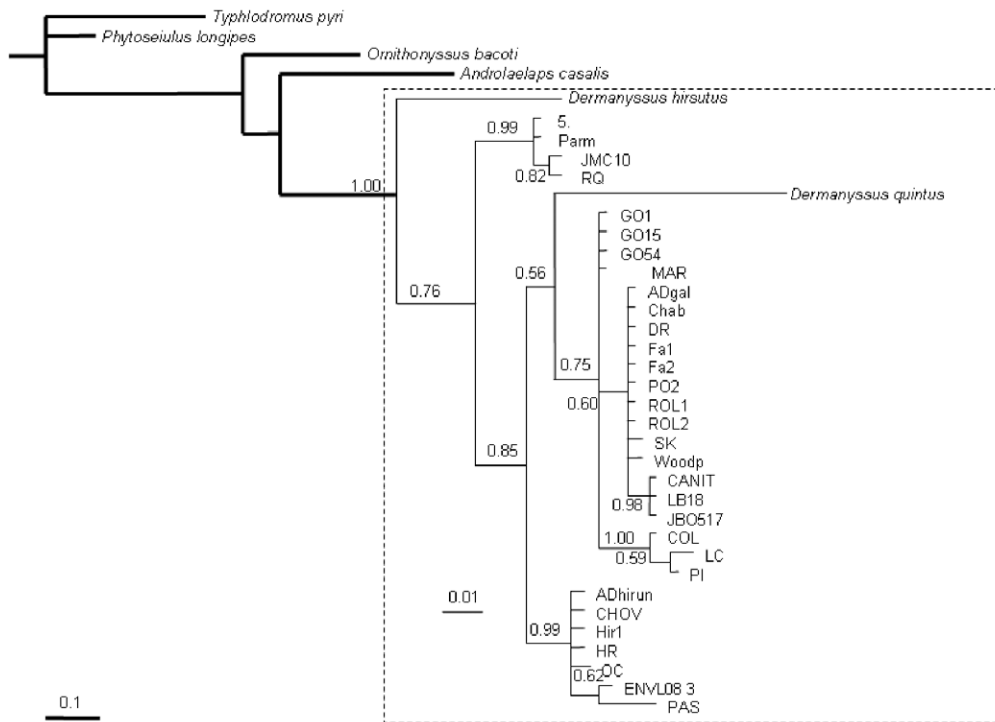

ITS BA

0.1

Appendix E

Results of the molecular “all-taxa” matrix, involving all tested taxa, including those with only one gene sequenced. Bayesian analysis from 5,000,000 generations using partitioned data and independent models of evolution for each partition. Numbers on nodes refer to Bayesian posterior probabilities.

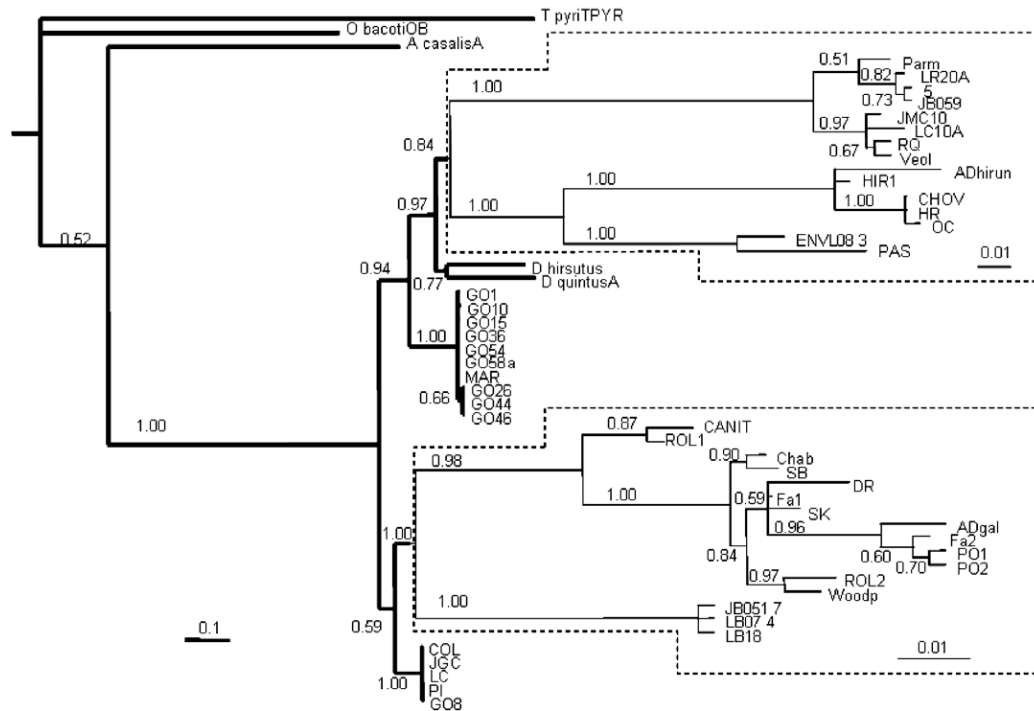

References

Akaike, H., 1974. A new look at the statistical model identification. *IEEE Transactions on Automatic Control* 19, 716–723.

Berlese, A., Trouessart, E., 1889. Diagnoses d'acariens nouveaux ou peu connus. *Bulletin de la Bibl. Sci. de l'Ouest* 2^e année, 2^e partie 9, 121–143.

Brännström, S., Morrison, D.A., Mattsson, J.G., Chirico, J., 2008. Genetic differences in internal transcribed spacer 1 between *Dermanyssus gallinae* from wild birds and domestic chickens. *Med. Vet. Entomol.* 22, 152–155.

Carroll, H., Beckstead, W., O'Connor, T., Ebbert, M., Clement, M., Snell, Q., McClellan, D., 2007. DNA reference alignment benchmarks based on tertiary structure of encoded proteins. *Bioinformatics* 23, 2648–2649.

Clayton, D.H., Tompkins, D.M., 1995. Comparative effects of mites and lice on the reproductive success of Rock Doves (*Columba livia*). *Parasitology* 110, 195–206.

Cruickshank, R.H., 2002. Molecular markers for the phylogenetics of mites and ticks. *Syst. Appl. Acarol.* 7, 3–14.

De Lillo, E., 2001. A modified method for Eriophyoid mite extraction (Acari: Eriophyoidea). *Internat. J. Acarol.* 27, 67–70.

De Rojas, M., Mora, M.D., Ubeda, J.M., Cutillas, C., Navajas, M., Guevara, D.C., 2001. Phylogenetic Relationships in Rhinonyssid mites (Acari: Mesostigmata) Based on Mitochondrial 16S rDNA sequences. *Exp. Appl. Acarol.* 25, 957–967.

De Rojas, M., Mora, M.D., Ubeda, J.M., Cutillas, C., Navajas, M., Guevara, D.C., 2002. Phylogenetic Relationships in Rhinonyssid mites (Acari: Mesostigmata) Based on ribosomal DNA sequences: insights for the discrimination of closely related species. *Parasitol. Res.* 88, 675–681.

DeSalle, R., Egan, M.G., Siddall, M., 2005. The unholy trinity: taxonomy, species delimitation and DNA barcoding. *Philos. Trans. R. Soc. Biol. Sci.* 360, 1905–1916.

Evans, G.O., 1963. Some observations on the chaetotaxy of the pedipalps in the Mesostigmata (Acari). *Ann. Mag. Nat. Hist.* 13, 513–527.

Evans, G.O., Till, W.M., 1962. The Genus *Dermanyssus* De Geer (Acari: Mesostigmata). *Ann. Mag. Nat. Hist.* 13, 273–293.

Fenda, P., Schniererová, E., 2004. Mites (Acarina: Mesostigmata) in the nest of *Acrocephalus* spp. and in neighbouring reeds. *Biologia* 59, 41–47.

Goloboff, P.A., Farris, J.S., 2001. Methods for quick consensus estimation. *Cladistics* 17, S26–S34.

Goloboff, P.A., Farris, J.S., Nixon, K., 2008. TNT: Tree Analysis Using New Technology. Willi Hennig society ed. Available from: <<http://www.cladistics.org/tnt.html>>.

Heethoff, M., Domes, K., Laumann, M., Maraun, M., Norton, R.A., Scheu, S., 2007. High genetic divergences indicate ancient separation of parthenogenetic

lineages of the oribatid mite *Platynothrus peltifer* (Acari, Oribatida). *J. Evol. Biol.* 20, 392–402.

Huelsenbeck, J.P., Ronquist, F., 2001. MRBAYES: Bayesian inference of phylogeny. *Bioinformatics* 17, 754–755.

Johnson, L.S., Albrecht, D.J., 1993. Effects of haematophagous ectoparasites on nestling House Wrens *Troglodytes aedon*: who pays the cost of parasitism? *Oikos* 66, 255–262.

Katoh, K., Kuma, K., Toh, H., Miyata, T., 2005. MAFFT version 5: improvement in accuracy of multiple sequence alignment. *Nucleic Acids Res.* 32, 511–518.

Knee, W., 2008. Five new species of Rhinonyssidae (Mesostigmata) and one new species of *Dermanyssus* (Mesostigmata: Dermanyssidae) from birds of Alberta and Manitoba, Canada. *J. Parasitol.* 94, 348–374.

Laumann, M., Norton, R.A., Weigmann, G., Scheu, S., Maraun, M., Heethoff, M., 2007. Speciation in the parthenogenetic oribatid mite genus *Tectocepheus* (Acari, Oribatida) as indicated by molecular phylogeny. *Pedobiologia* 51, 111–122.

Lewis, P.O., 2001. A likelihood approach to estimating phylogeny from discrete morphological character data. *Syst. Biol.* 50, 913–925.

Monaghan, M.T., Balke, M., Gregory, T.R., Vogler, A.P., 2005. DNA-based species delineation in tropical beetles using mitochondrial and nuclear markers. *Philos. Trans. R. Soc. B* 360, 1925–1933.

Moore, W.S., 1995. Inferring phylogenies from mtDNA variation: mitochondrial-gene trees versus nuclear-gene trees. *Evolution* 49, 718–726.

Moss, W.W., 1966. *Dermanyssus gallinoides* n. sp. (Mesostigmata: Laelapoidea: Dermanyssidae) an Acarine Parasite of Woodpeckers in Western North America. *Can. Entomol.* 98, 635–638.

Moss, W.W., 1968. An Illustrated Key to the Species of the Acarine Genus *Dermanyssus* (Mesostigmata: Laelapoidea: Dermanyssidae). *J. Med. Entomol.* 1, 67–84.

Moss, W.W., 1978. The mite genus *Dermanyssus*: a survey, with description of *Dermanyssus trochilinis*, n. sp., and a revised key to the species (Acari: Mesostigmata: Dermanyssidae). *J. Med. Entomol.* 14, 627–640.

Moss, W.W., Camin, J.H., 1970. Nest parasitism, productivity and clutch size in Purple Martins. *Science* 168, 1000–1003.

Navajas, M., Fenton, B., 2000. The application of molecular markers in the study of diversity in Acarology: a review. *Exp. Appl. Acarol.* 24, 751–774.

Navajas, M., Lagnel, J., Gutierrez, J., Boursot, P., 1998. Species-wide homogeneity of nuclear ribosomal ITS2 sequences in the spider mite *Tetranychus urticae* contrasts with extensive mitochondrial COI polymorphism. *Heredity* 80, 742–752.

- Nosek, J., Lichard, M., 1962. Beitrag zur Kenntnis der Vogelnestfauna. *Entomologické problémy (Bratislava)* 2, 29–51.
- Nylander, J.A.A., 2004. MrModeltest v2. Program distributed by the author. Evolutionary Biology Centre, Uppsala University.
- Pacejka, A.J., Santana, E., Harper, R.G., Thompson, C.F., 1996. House Wrens Troglodytes aedon and nest-dwelling ectoparasites: mite population growth and feeding patterns. *J. Avian Biol.* 27, 273–278.
- Pacejka, J., Gratton, C.M., Thompson, C.F., 1998. Do potentially virulent mites affect house wren reproductive success?—Troglodytes aedon. *Ecology* 5, 79.
- Peterson, A. Version 8.07 (2007.08.25). 'Zoonomen Nomenclatural data' Available from: <<http://www.zoonomen.net/avtax/frame.html>>.
- Phillis III, W.A., 2006. Ultrastructure of the chelicerae of *Dermanyssus prognepphilus* Ewing (Acari: Dermanyssidae). *Int. J. Acarol.* 32, 85–91.
- Rambaut A., Drummond A.J., 2007. Tracer v1.4, Available from <<http://beast.bio.ed.ac.uk/Tracer>>.
- Ronquist, F., Huelsenbeck, J.P., 2003. MRBAYES 3: Bayesian phylogenetic inference under mixed models. *Bioinformatics* 19, 1572–1574.
- Roy, L., Chauve, C.M., 2006. The genus *Dermanyssus* Dugès, 1834 (Acari: Mesostigmata: Dermanyssidae): species definition. In: Proceedings of the XIIth International Congress of Acarology, Amsterdam.
- Roy, L., Chauve, C.M., 2007. Historical review of the genus *Dermanyssus* Dugès, 1834 (Acari: Mesostigmata: Dermanyssidae). *Parasite* 14, 87–100.
- Samadi, S., Barberousse, A., 2006. The tree, the network, and the species. *Biol. J. Linn. Soc.* 89, 509–521.
- Shaw, K.L., 2002. Conflict between nuclear and mitochondrial DNA phylogenies of a recent species radiation: what mt DNA reveals and conceals about modes of speciation in Hawaiian crickets. *Proc. Natl. Acad. Sci. USA* 99, 16122–16127.
- Springer, M.S., DeBry, R.W., Douady, C., Amrine, H.M., Madsen, O., de Jong, W.W., Stanhope, M.J., 2001. Mitochondrial versus nuclear gene sequences in deep-level mammalian phylogeny reconstruction. *Mol. Biol. Evol.* 18, 132–143.
- Swofford, D.L., 2001. PAUP—Phylogenetic Analysis Using Parsimony (and other methods). Version 4.0B 10. (Computer software and manual). Sunderland, Massachusetts: Sinauer Associates.
- Wilm, A., Mainz, I., Steger, G., 2006. An enhanced RNA alignment benchmark for sequence alignment programs. *Algorithm Mol. Biol.* 1, 1–11.
- Zeman, P., 1979. *Dermanyssus carpathicus* sp. n. (Acarina: Dermanyssidae), a new bird parasite from Czechoslovakia. *Folia Parasitol.* 26, 173–178.
- Zeman, P., Jurík, M., 1981. A contribution to the knowledge of fauna and ecology of gamasoid mites in cavity nests of birds in Czechoslovakia. *Folia Parasitol.* 28, 265–271.
- Zemskaya, A.A., 1971. Mites of the family Dermanyssidae Kolenati, 1859, of the U.S.S.R. fauna. *Medicinskã parazitologiã i parazitarnye bolezni* 40, 709–717.

5 Ecologie comparée des cinq espèces françaises du genre *Dermanyssus*

Cinq espèces ont été rencontrées au cours de la présente étude dans les nids d'oiseaux collectés en France, ou directement sur des oiseaux capturés en France : *D. gallinae*, *D. carpathicus*, *D. longipes*, *D. hirundinis*, *D. apodis*. Chacune de ces espèces a été rencontrée de manière récurrente dans les échantillons analysés et indépendamment de la provenance géographique.

5.1 Spécificité d'hôte chez cinq espèces du genre *Dermanyssus* : publication IV

a - Présentation

Une fois les espèces redéfinies dans le groupe *gallinae*, le problème de la spécificité d'hôte peut enfin être abordé. Les espèces du groupe *gallinae* sont-elles vraiment toutes très généralistes ? Ou bien leur morphologie floue a-t-elle réellement introduit des erreurs dans l'inventaire, comme le craignait Moss (1978) ?

5.1.a.1 Objectifs

L'objectif principal de la quatrième publication était d'obtenir un aperçu solide de la répartition des espèces du groupe *gallinae* communes en France en fonction des groupes d'oiseaux et d'en tirer des patrons de variabilité éventuels en lien avec les informations d'ordre pratique et écologique liées à nos échantillons.

5.1.a.2 Matériel et méthodes

Une estimation du spectre d'hôtes par espèce a été réalisée, par le biais d'un échantillonnage large et d'une identification systématique des acariens du genre *Dermanyssus* isolés, au niveau spécifique.

L'utilisation sur un nombre accru d'isolats de l'un des marqueurs moléculaires utilisés pour la redéfinition des espèces (mt-Co1) a permis d'établir un scénario de l'évolution du spectre d'hôtes au sein des espèces testées sur la base d'une reconstruction phylogénétique. Un complément d'information a été recueilli par le biais de petites expérimentations en laboratoire (transfert artificiel d'un hôte à l'autre et suivi du développement individuel). Cela a contribué à mettre en évidence certains patterns évolutifs quant à l'écologie de cinq espèces communes en France.

Quelques essais de transfert d'un hôte à l'autre au laboratoire, ainsi que des observations à partir d'informations de terrain, ont permis d'approfondir quelque peu la réflexion sur les patterns écologiques révélés.

5.1.a.3 Principaux résultats

- (1) Les espèces du groupe *gallinae* ainsi que les deux espèces testées du groupe *hirsutus* se différencient en deux clades principaux sur la base de la mt-Co1. L'un de ces deux clades réunit des espèces rencontrées dans l'avifaune sauvage exclusivement, le second, constitué des différentes lignées composant *D. gallinae*, partagé entre avifaune sauvage et élevages (synanthropie). Ces deux clades montrent par ailleurs deux niveaux de spécificité d'hôte (les spécialistes ne parasitent que l'avifaune sauvage – cf. Fig. 6).

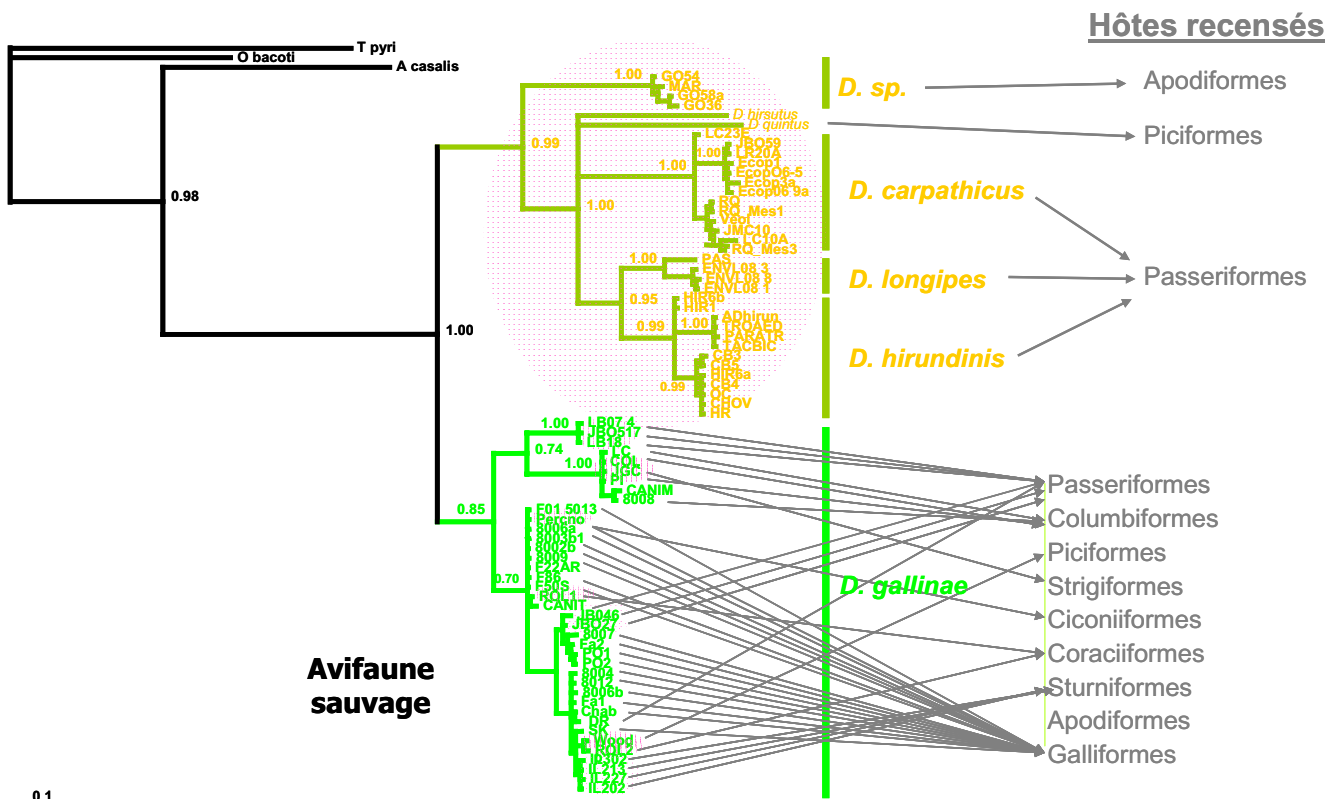

Figure 6. Reconstruction phylogénétique avec indication d'hôte et de milieu d'échantillonnage intégrant 73 isolats du groupe *gallinae* sur la base d'une région de la mt-Co1, analyse bayésienne, MrBayes v3.1.2, modèle d'évolution GTR+ Γ +i pour 5 000 000 générations.

- (2) Le spectre d'hôtes est fortement dépendant des habitudes de l'oiseau hôte, avec transfert possible d'un hôte principal à un autre en cas de partage de l'emplacement du nid chez certains oiseaux (cas des oiseaux vivant en colonies et nichant dans - ou reconstruisant un nid par-dessus - des nids de la colonie, mais pas nécessairement le même chaque année).
- (3) L'écosystème du nid (ou de la litière) semble comporter des paramètres essentiels au succès de l'adaptation de l'acarien et du développement de ses populations : la composition de l'arthropodofaune du nid (différentes guildes, telles celle des prédateurs, celle des détritivores, celle des parasites, en proportion variable et à la diversité variable en fonction de l'espèce d'oiseau, du site de nidification, ...), des facteurs physico-chimiques (température, hygrométrie, taux atmosphérique d'ammoniac...), les habitudes hygiéniques de l'oiseaux (rejet ou non des sacs fécaux des poussins hors du nid, ...), la disponibilité de l'hôte (tout au long de l'année, ou seulement durant la période de nidification), la présence de pesticides ou non, etc. sont autant de paramètres qui peuvent avoir une influence sur le développement des microprédateurs. Or ils sont par excellence très différents entre habitats sauvages et habitats anthropisés comme le sont les élevages. Le complexe de lignées composant *D. gallinae*

apparaît fortement opposé à l'ensemble des autres. Il semble intrinsèquement adapté aux conditions d'élevage.

- (4) L'oiseau est peut-être l'unique vecteur du microprédateur. Mais il n'est pas exclu que certains insectes volants puissent contribuer à la dissémination de l'acarien. Quoi qu'il en soit, il semblerait que l'acarien soit peu enclin à parcourir par lui-même des distances de plus de 2 mètres pour atteindre un hôte potentiel, même en cas de pénurie.
- (5) Les échanges entre volaille domestique et avifaune sauvage ne paraissent pas impossibles, mais ne sont pas encore prouvés.

b - Remarques sur la publication IV

5.1.b.1 Données complémentaires sur la spécificité d'hôte chez *D. hirundinis* en France

D. hirundinis (13 isolats testés) s'est avéré spécifique aux Hirundinidae en France (10 isolats), alors que les 3 isolats provenant d'un même site des Etats-Unis ont été isolés chez trois familles différentes de Passériformes (dont les Hirundinidae). Outre la divergence génétique des séquences provenant de France et de celles provenant des Etats-Unis, l'explication de cette différence de spécificité développée dans la publication IV repose sur la différence d'écologie entre les espèces d'Hirundinidae concernées (l'hirondelle des arbres aux Etats-Unis est cavernicole et partage volontiers les nichoirs avec les deux autres familles recensées). Or, en France, si aucune des deux espèces d'Hirundinidae testées ne niche jamais dans des nichoirs, certains Passériformes d'autres familles profitent souvent de nids d'hirondelles déjà construits pour élever leur progéniture. Le moineau domestique (*Passer domesticus*) et le troglodyte mignon (*Troglodytes troglodytes*) sont coutumiers du fait. Jusqu'à la publication IV, aucun acarien appartenant à *D. hirundinis* n'avait pu être isolé de nids de ces espèces, mais peu de ces nids avaient pu être testés. Depuis lors, un nid de troglodyte mignon a permis d'isoler 3 individus morts (LC083a, b, c) appartenant à notre lignée française de *D. hirundinis*. S'agit-il simplement d'individus de la saison précédente, qui se seraient en fait développés sur hirondelle ou ces individus ont-ils réellement parasité le troglodyte ? De plus, un individu mâle adulte (MG1) apparenté ou appartenant à *D. hirundinis* sur la base de sa séquence d'ARNr 16S (94-96% identité) et de sa séquence de mt-Co1 (96-99% identité) a été isolé dans la litière d'un jeune moineau vivant trouvé errant et hébergé dans une maison (probablement tombé du nid). Une question du même ordre que ci-dessus se pose. Toutefois, le fait qu'il s'agisse d'un mâle – sexe qui ne se nourrit pas au stade adulte et très rarement rencontré sur l'hôte - laisse supposer qu'il est arrivé à un stade inférieur (deutonymphe) et a réalisé sa métamorphose dans la litière, après un repas de sang pris sur l'oiseau. Ces nouveautés sont discutées dans la publication V (p. 214). Cela confirmerait le fait que *D. hirundinis* n'est pas fondamentalement inféodé aux hirundinidae, mais qu'il ne peut être transféré à un autre oiseau que par partage direct du nid. Il est probable que les acariens de cette espèce ne transitent que très rarement sur l'hôte (ou sur un quelconque insecte), demeurent longtemps dans le matériau du nid et parasitent tout oiseau venant s'installer et séjourner dans ce même nid. Le mâle ci-dessus a d'ailleurs probablement été emporté par hasard par l'oiseau s'envolant au moment précis du repas. Toutefois, la faible prévalence apparente de *D. hirundinis* chez les moineaux, sur la base de nos échantillons de nids de moineaux du genre *Passer*, suggère que la durabilité du système n'est pas optimale entre cette espèce de *Dermanyssus* et ce genre d'oiseau.

Exp Appl Acarol (2009) 48:115–142
DOI 10.1007/s10493-008-9231-1

Molecular phylogenetic assessment of host range in five *Dermanyssus* species

L. Roy · A. P. G. Dowling · C. M. Chauve · I. Lesna · M. W. Sabelis ·
T. Buronfosse

Received: 10 October 2008 / Accepted: 16 December 2008 / Published online: 22 January 2009
© Springer Science+Business Media B.V. 2009

Abstract Given that 14 out of the 25 currently described species of *Dermanyssus* Dugès, 1834, are morphologically very close to each another, misidentifications may occur and are suspected in at least some records. One of these 14 species is the red fowl mite, *D. gallinae* (De Geer, 1778), a blood parasite of wild birds, but also a pest in the poultry industry. Using molecular phylogenetic tools we aimed to answer two questions concerning host specificity and synanthropicity: (1) is *D. gallinae* the only species infesting European layer farms?, and (2) can populations of *D. gallinae* move from wild to domestic birds and vice versa? Mitochondrial cytochrome oxidase I gene sequences were obtained from 73 *Dermanyssus* populations collected from nests of wild European birds and from poultry farms and these were analyzed using maximum parsimony and Bayesian inference. Mapping of the observed host range on the obtained topology and correlation with behavioural observations revealed that (1) host range is strongly dependent on some ecological parameters (e.g. nest hygiene, exposure to pesticides and predators), that (2) out of five species under test, synanthropic populations were found only in lineages of *D. gallinae*, and that (3) at least some haplotypes found in wild birds were very close to those found in association with domestic birds.

Keywords *Dermanyssus* · Bird parasite · mt-COI · Host range · Synanthropicity · Host transfer

L. Roy (✉) · C. M. Chauve · T. Buronfosse
Université de Lyon, Ecole Nationale Vétérinaire de Lyon,
Laboratoire de Parasitologie, Marcy l'Etoile, France
e-mail: l.roy@vet-lyon.fr

A. P. G. Dowling
Department of Entomology, University of Arkansas, Fayetteville, AR, USA

I. Lesna · M. W. Sabelis
University of Amsterdam, IBED, Amsterdam, The Netherlands

Introduction

Dermanyssus gallinae (De Geer, 1778) is a nidicolous mite that is well known as a pest in poultry farms. Apart from this species, there are 24 other species that are currently included in the genus *Dermanyssus* Dugès 1834 (Roy and Chauve 2007; Knee 2008; Roy et al. 2008), but 14 of these species are morphologically very similar to *D. gallinae*, known as the poultry red mite. This may lead to identification problems and molecular tools are needed to answer questions concerning host specificity and synanthropicity: is *D. gallinae* the only species infesting European farms? Can populations of *D. gallinae* from wild birds and those from domestic birds undergo genetic exchange?

Host–parasite relationships, and especially host specificity, are hard to define in many mite groups, because they are often opportunistic, and they may have multiple hosts during post-embryonic development. For example, the ticks have been divided into 6 different categories according to the relative width of their host range and according to the mono- or polyxenity during development (Hoogstraal and Aeschlimann 1982). A similar situation exists with respect to species in the genus *Dermanyssus*. Although these species seem to complete their whole life cycle on a single bird species, the amplitude of their host range varies between two groups of species. According to previous records, only a few species appeared to be specialists in a single bird family within *Dermanyssus*, such as *D. alaudae* (Schrank, 1781) (Alaudidae only), *D. quintus* Vitzthum 1921 and *D. hirsutus* Moss and Radovsky 1967 (Picidae only) (Roy and Chauve 2007). On the other hand, most of the species in the Moss' *gallinae*-group, are known for having a very large host spectrum, involving a variety of bird families, widely distributed in bird phylogeny. *D. gallinae* and *D. hirundinis* (Hermann, 1804) have been recorded in the literature, respectively, from 8 to 9 different bird orders, some of which are phylogenetically very distant. For instance, *D. gallinae* can develop in some Galliformes as well as in some Passeriformes, the former being basally and the latter distally situated in the large clade of Neognathae according to the phylogenetic reconstruction of birds proposed by Livezey and Zusi (2007). Not to mention several mammalian recorded parasitized species. However, interpretation of data available to date is blurred by misidentifications resulting from confusion on morphological discrimination and host specificity is likely to slightly differ in some species in the *gallinae*-group (Roy et al. 2008).

In France, 5 species are commonly found in wild avifauna, which all belong to Moss' *gallinae*-group (Roy et al. 2008). *D. gallinae*, the Chicken Red Mite, seems to be the only species encountered in farms and breeding facilities. Present in more than 80% in layer farms in Europe, it is an important pest, inducing sanitary problems and financial losses.

As *D. gallinae* is a haematophagous mite, a pest in poultry industry and potentially a vector of some pathogens (Valiente Moro et al. 2005, 2007), it is of practical interest to assess if there are genetic exchanges between populations hosted by wild avifauna and domestic fowl. The aim of the work described in this article is to assess host specificity and host range in five *Dermanyssus* species by using molecular tools of phylogenetic analysis. An inventory of *Dermanyssus* species collected from wild and domestic birds in France and the Netherlands is provided as a first step towards a more comprehensive analysis. Moreover, the exploration of host specificity using phylogenetic tools will be complemented by some bioassays.

Materials and methods

Field sampling

For birds that re-use the nest, part of the nests was collected after the birds had left the nest. Otherwise whole nests were collected. Most of wild birds' nests were collected in France, and a few were collected in The Netherlands and in the USA. In addition, hundreds of wild birds have been directly examined in France. Moreover, some mite populations were collected from layer hen farms (from France, Norway, Denmark, Poland, Belgium) and facilities for breeding canaries, pigeons and chickens (France, Italy, Spain). A list of DNA-tested mite populations is provided in the Appendix. A population corresponds to a group of *Dermanyssus* mites found from a single nest (or a single building in a farm or breeding facility). Note that there was never more than 1 species of *Dermanyssus* per nest.

Note: We used the bird classification according to Peterson (2008), except for the blue tit, which we referred to as *Parus caeruleus* instead of *Cyanistes caeruleus* (L, 1758), in order to match common use in bird banders.

Restricted study areas

In addition, ten special areas with a rather small diameter (<3 km) allowed us testing several different nests used by a single bird community. These restricted study areas are described in Table 1 and indicated by the following acronyms: CB, Ecop, ENVL, HIR, JBO, LB, MOL, RQ in France, IL in The Netherlands, BMOC in the USA.

Nests' analysis

Nests were analysed using a method described by De Lillo (2001) except that no sodium hypochlorite was added to the water solution to wash the stack of sieves and that the sieves had a somewhat different mesh width (top to bottom: 2500, 1400, 180, 100 μm).

Molecular analysis

DNA was extracted from individual mites following a protocol that preserves an intact cuticle for voucher preparation and microscopic observation. Of each sampled population, 2 or 3 mite individuals have been sequenced. A 700–800 bp amplicon of mt-COI gene was isolated by PCR, depending on primer pairs used (i.e. on concerned species, cf. Table 2 and Appendix for EMBL database accession numbers), and then sequenced. PCRs was performed in either a Biometra TGradient or a MWG AG Biotech Primus 96 plus thermal cycler in typical buffer containing 2 μl of template DNA, 2.5 units of Taq polymerase, 10 nmol of dNTPs, 20 pmol of each primer and 3.4 mM MgCl_2 . After an initial denaturation step (95°C) for 10 min, followed by 40 cycles of 20 s at 95°C (denaturation), 30 s at 52°C (hybridization), and 90 s at 72°C (extension). A final extension step was carried out for 10 min at 72°C. Several primers designed for amplification of DNA from various species are listed in Table 2 and were chosen to perform PCRs under the same conditions.

Negative and positive controls were run with each round of amplification. PCR products were checked by electrophoresis in a 1% agarose gel. Depending on the brightness of the band either additional PCRs were run on the original template or reamplifications of the

Table 1 Description of restricted study areas (cf. “Materials and methods”)

Site acronym	Location	Site characteristics	Host	Number of nests tested	Number of nests with <i>Dermatophytosis</i>	Remarks
ENVL	France, 69	10 nestboxes occupied by great tits or blue tits on the Campus of the National Veterinary School of Lyon from 2007 to 2008	<i>Parus</i> sp. (Paridae)	11	6	<i>D. longipes</i> in 1 nest of 6 tested in 2007; <i>D. longipes</i> in 3 nests of 5 tested in 2008
Ecop	France, 42	Natural protected area Ecopole with several dozens of nestboxes, sampled in autumn 2005, summer 2006 and winter 2008	<i>Parus major</i> (Paridae), <i>Phoenicurus ochruros</i> (Musciicapidae)	15	7	<i>D. carpathicus</i> found only from <i>Parus</i> sp.—In 2006 and 2008.
RQ	France, 42	House, small garage with small hen house and girder with a redstart nest and two tit nests in a natural protected area at c. 950 m altitude (sampled in 2006, 2007 and 2008)	<i>Parus major</i> (Paridae), <i>Phoenicurus ochruros</i> (Musciicapidae)	5	5	<i>D. carpathicus</i> abundant in redstart nest in 2006, 2007 and 2008. Also found in a tit nest sampled in 2006. <i>D. gallinae</i> in hen house (Pop. 8004)
MOL	France, 69	A small farm housing sheep, calves, rabbits, dogs and cats, and chickens in four layer hen houses, and with wood girders, housing many swallow nests	<i>Hirundo rustica</i> (Hirundinidae)	3	0	Only one specimen of <i>D. gallinae</i> (Pop. 8005) collected from hen house in spring-summer 2008 (several liters of litter analyzed)
HIR	France, 85	House with 4 swallow nests in three different rooms	<i>Hirundo rustica</i> (Hirundinidae)	6	5	<i>D. hirundinis</i> collected in 2 successive years (before nesting in winter 2007, after nesting in spring 2008)
CB	France, 01	Small old farm housing calves, cats and also free-range chickens according to the production procedure called “AOC Poulets de Bresse”, and many swallow nests	<i>Hirundo rustica</i> (Hirundinidae)	8	3	Spring-summer 2008. <i>D. hirundinis</i> present in swallow nests. Many <i>D. gallinae</i> in wooden chicken cages (Pop. 8012)

Table 1 continued

Site acronym	Location	Site characteristics	Host	Number of nests tested	Number of nests with <i>Dermomyssus</i>	Remarks
JBO	France, 13	15 plots (maintained with chemical, organic or alternative methods) of apple/pear orchards with one nestbox with great tits every 50 meters in each row of trees	<i>Parus major</i> (Paridae)	62	5	Summer 2007. One, three and no nests with <i>D. gallinae</i> in resp. alternative control plot (Pop. JBO27), organic plot (Pop. JBO51, JBO46, JBO56) and chemical control plot. One nest with <i>D. carpathicus</i> in organic plot (Pop. JBO59).
IL	The Netherlands, Groningen	33 nestboxes occupied by European starlings (populations IL213, IL227, IL302, IL202)	<i>Sturnus vulgaris</i> (Sturnidae)	33	32	Summer 2007. <i>D. gallinae</i> abundant in many nests.
BMOC	USA, Michigan	4 nests with different birds from the campus of a school in Michigan	<i>Tachycineta bicolor</i> (Hirundinidae), <i>Parus atricapillus</i> (Paridae), <i>Troglodytes aedon</i> (Certhiidae)	4	3	Autumn 2007. <i>D. hirundinis</i> rather abundant.
LB	France, 45	Several swallow nests from a goat farm	<i>Delichon urbica</i> , <i>Hirundo rustica</i> (Hirundinidae)	10	9	Summer 2006 and 2007. <i>D. gallinae</i> present in some nests, <i>D. hirundinis</i> in some others.

Table 2 Primer sequences

Primer sense	Primer name	Sequence 5'-3'
Forward	CO1RQF1	GAAAGAGGAACAGGAACAGG
	CO1LCF	GAAAGAGGAGCAGGCACTGG
	COF1bis	CTGCACCTGACATGGCTTTCCAC
	CO1F4	CACCTGACATGGCTTTCCACGAT
	RhipiCOIF	CGAATAAATAATATAAGATTTTGA
	SKPOFa2diagF1	CTTTTATAGATCTTTAATTGAAA
Reverse	COIGOR	GTTGGAATtGCAATAAT
	RQ-COI-R	CCAGTAATACCTCCAATTGTAAAT
	ObCOIF-rev	GTGGGAATHGCAATAAT
	TyphloCOIR	GCTAATCAAGAAAAATTTTAAT

Primer pairs used in present study for the amplification of mt-COI according to species indicated into brackets: CO1RQF1 + RQ-COI-R (*D. carpathicus*, *D. hirundinis*, *D. longipes*), SKPOFa2diagF1 + RQCOIR, CO1F4 + RQCOIR, COF1bis + RQ-COI-R, COF1bis + ObCOIF-rev, CO1LCF + RQ-COI-R (*D. gallinae*), RhipiCOIF + TyphloCOIR (outgroups), CO1LCF + COIGOR (*D. apodis*)

original PCR product were performed. PCR products were sequenced by Genoscreen (France, Lille) using a 96-capillary sequencer ABI3730XL.

Phylogenetic reconstruction

Sequence data was aligned using MAFFT (Katoh et al. 2005) with the L-INS-i iterative refinement option on the MAFFT server at <http://align.bmr.kyushu-u.ac.jp/mafft/online/server/>. MAFFT with the L-INS-i option has shown to be the most accurate and consistent method for the alignment of sequences (Wilm et al. 2006; Carroll et al. 2007).

The alignment of 558 bp from cytochrome oxidase I (mt-COI) was analysed under several optimality criteria: (1) Parsimony using PAUP* 4.0b10 (Swofford 2001) to build tree(s) with TBR branch swapping and 10,000 random additions saving all most parsimonious trees, (2) Bayesian inference using the computer program MrBayes v3.1.2 (Huelsenbeck and Ronquist 2001; Ronquist and Huelsenbeck 2003) with the GTR + Γ -i model of evolution chosen in the computer program MrModeltest (Nylander 2004) that was run for 5,000,000 generations. Burnin was determined based on stationarity being reached. The clade notation taxon⁺ indicates the clade including the taxon at its base and all subsequent taxa included in the same clade (De Souza Amorim 1982).

Bioassays

In order to get some data complementary to phylogenetic information, some bio-assays were performed. Eight different bioassays have been performed in order to compare the behaviour of four *Dermanyssus* species. Note that most of these bioassays are rather tentative (method not completely validated), provide limited information, and are often not mutually comparable. However, some of the data obtained add interesting elements to the discussion.

The first two (comp1 and 2) involved a permanent or intermittent contact of mites with one canary, during a period of several weeks (cf. Table 3). A single canary was placed in a plastic box, provided with several apertures on the bottom and sides covered with a filter tissue for aeration, and with an eating and a drinking trough that can be filled from the exterior of the box. This enclosure was placed into a large bowl filled with water and a drop

Table 3 Some data on development of 3 *Dermatophagoides* species on canaries, obtained from long-time bioassays (referred to in text as comp1 and comp2)

Bio-assay	Host	Mite species	Mite population	Total number of mites tested	Duration of mite-bird contact	Total number of living mites collected	
comp1 (permanent contact)	a	Canary	<i>D. gallinae</i>	SK	20	98 days	205
	b	Canary	<i>D. longipes</i>	PAS	40	98 days	0
	c	Canary	<i>D. longipes</i>	PAS	>200 (nest residu)	>100 days	12
comp2 (intermittent contact: during 12 h every 2 weeks, all along 1 year)	Canary	<i>D. carpathicus</i> + <i>D. gallinae</i>	RQ + SK + Fa1	>200 (nest residu + mites)	ca. 24 days	>1000 <i>D.gal.</i> ; 8 <i>D.car.</i>	

Bioassay comp1 is split into three lines (a, b and c), which correspond to three boxes, each containing one canary, and which have been handled simultaneously and in the same conditions. Information about populations is to be found in the appendix. Mite population's codes correspond to population codes in Appendix

of tension-active agent. Water and food were added regularly and the canary was allowed to move, feed and drink ad libitum. Mites introduced into the enclosure cannot escape and no mites from outside can get in. Moreover, the escape of mites from the enclosure into the surrounding water was regularly checked, which represents less than 10% of final count. At the end of the period, the litter and plastic box were rinsed and treated following the method of De Lillo (2001). Mites were observed and counted using a stereoscopic magnifying glass.

The 5 other bioassays (comp3 to 8) consisted of short periods of contact between the mites and bird (several hours at a time) in glass containers (cf. Table 4). One small bird (canary, hen chick, duck chick) was placed within the container, which was placed into a bowl filled with water and a drop of tension-active agent. Next, mites were added (an aggregate consisting of an unknown number of individuals, or—in some cases—of a known number of individuals) and the whole device was kept in darkness (incubator at 25°C). In case of known number of handled mite individuals, mites were collected at lab using a vacuum pump and 10 µL filter tips (tips' filters are permeable to air, but retain mites). Tips were closed with some parafilm for storage and broken just before being introduced in the glass container with the canary at the beginning of the bioassay. After several hours, birds were removed, devices were examined and engorged mites were isolated in ELISA microplates, covered with extended parafilm (one small cut above each well, insertion of a single mite using a fine wet brush, obturation of cuts using a small piece of extended parafilm). Cues that provide information on developmental progress (exuvia, eggs) were recorded using a stereoscopic magnifying glass at d + 4 and noted down as follows: 1 exuvia (protonymph, deutonymph) or 1 laying (1 to several eggs) (adult female) in a well indicates that the isolated individual has developed.

Results

Inventory of *Dermanyssus* species from wild and domestic bird

Overall, 27 bird species distributed across nine different bird orders were examined. Among wild avifauna, 334 nests of wild birds, representing 25 bird species, distributed across seven bird orders and 31 families, have been analysed (Table 5). Note that the goal here is not to get an overview of prevalence and that this study is not an epidemiological one. Here, we report the results of our explorations on host specificity, based on simple records on a batch of samples obtained from various bird species and places. That is the reason why even some bird groups with only few nests examined are noted. Anyway, the focus will be on bird groups with a significant number of samples analysed (Fig. 1).

Moreover, hundreds of wild birds have been examined including Picidae, Alaudidae, Coraciidae, Paridae (adding one more bird species to our study: *Coracias garrulus* L., 1758).

Additionally, several dozens of mites have been collected from layer hen farms (hence one more species included in our study: *Gallus gallus* L., 1758) and some breeding facilities (chicken, pigeons, canaries, included in Fringillidae in Table 5).

Dermanyssus was present in nests of 10 wild bird families (Table 5). Moreover, one additional bird family parasitized by *Dermanyssus* was found by direct on-host sampling (during bird banding and bird care activities): *C. garrulus* (Coraciidae: Coraciiform) (Populations ROL1 and ROL2 in Appendix).

Overall, in France and in the Netherlands, 5 species of *Dermanyssus* have been isolated from nests and birds: *D. gallinae* including a special lineage, which may represent a cryptic

Table 4 Engorgment and development of 3 *Dermatysus* species compared using three host species and short-time bioassays (referred to in text as comp3 to comp8)

Assay	Host	Mite species	Mite population	Total number of mites tested	Duration of contact mite-bird (hours:minutes)	Number of engorged mites collected	% of live mites that were engorged upon collection	Total number of mites recovered (including those not engorged and submerged into water)	Number of development cues (d + 4)	% of mites having developed at d + 4 (mites engorged and collected alive)	Number of individuals dead after d + 0	Remarks
comp3	Duck chick	<i>D. gallinae</i>	SK	unknown	12:00	120	–	NE	120	100	NE	
comp4	Canary	<i>D. carpathicus</i>	RQ	unknown	04:40	3	–	NE	0	0	3	All mites were dead when collected
comp5	b	Canary	<i>D. gallinae</i>	8,010	04:40	51	–	NE	27	53	1	
	c	Canary	<i>D. hirundinis</i>	HIR5	04:40	45	–	NE	15	33	1	
	a	Hen chick	<i>D. carpathicus</i>	RQ	06:30	0	0	0	0	–	0	
comp6	b	Hen chick	<i>D. gallinae</i>	8,010	06:30	83	54	97	49	59	7	
	c	Canary	<i>D. carpathicus</i>	RQ	06:30	0	0	0	0	–	0	
	a	Canary	<i>D. gallinae</i>	8,010	11:45	29	19	86	24	83	2	
comp7	b	Hen chick	<i>D. gallinae</i>	8,010	11:45	60	39	90	46	77	4	
	c	Hen chick	<i>D. gallinae</i>	8,010	11:45	30	19	61	10	33	14	
	a	Canary	<i>D. gallinae</i>	8,010	05:00	31	20	78	22	71	0	
comp8	b	Canary	<i>D. gallinae</i>	8,010	05:00	22	14	70	10	45	3	
	c	Hen chick	<i>D. gallinae</i>	8,010	05:00	10	6	80	4	40	3	At least 77 individuals (NI) remaining within the filter tip, likely due to diarrhea produced by chick

Table 4 continued

Assay	Host	Mite species	Mite population	Total number of mites tested	Duration of contact mite-bird (hours:minutes)	Number of mites engaged upon collection	% of live mites that were engaged upon collection	Total number of mites recovered (including those not engaged and submerged into water)	Number of development cues (d + 4)	% of mites having developed at d + 4 (mites engaged and collected alive)	Number of individuals dead after d + 0	Remarks
d	Hen chick	<i>D. gallinae</i>	8,010	154	05:00	48	31	147	27	56	2	At least 77 individuals (N1) remaining within the filter tip, likely due to diarrhea produced by chick
comp8	a Canary	<i>D. carpathictus</i>	RQ	>150	12:00	8	<5%	33	–	–	–	The 8 engaged individuals found dead in liquid canary's droppings.
	b Canary	<i>D. gallinae</i>	8,010	>150	12:00	82	<55%	95	–	–	–	

Subdivisions in comp4 to comp8 (a, b, c, d) correspond to the different glass containers involved in the bioassay, containing each one small bird, and which have been handled simultaneously and in the same conditions. Recorded development cues are exuviae and eggs. Information about populations is to be found in the appendix

NE not estimated

Table 5 Number of nests analysed per bird family and occurrence of genus *Dermomyssus* based and on present field data and on literature

Bird order	Bird family	Nests analysed in present study	Mite populations from farms or breeding facilities	Wild bird individuals on which mite populations have been directly found	<i>D. alaudae</i>	<i>D. apodis</i>	<i>D. americanus</i>	<i>D. antillarum</i>	<i>D. breviventris</i>	<i>D. carpathicus</i>	<i>D. chelidoni</i>	<i>D. fjavalloni</i>	<i>D. gallinae</i>	<i>D. gallinoides</i>	<i>D. grochovskae</i>	<i>D. hirsutus</i>	<i>D. hrvatinus</i>	<i>D. longipes</i>	<i>D. nipponensis</i>	<i>D. passerinus</i>	<i>D. prognephtus</i>	<i>D. quinus</i>	<i>D. rwanadae</i>	<i>D. transvaalensis</i>	<i>D. triscutatus</i>	<i>D. trochilinus</i>	<i>D. wlatensis</i>	
Apodiform	Apodidae	52		7		F	L	L														L						
Ciconiiform	Trochilidae																									L		
	Accipitridae	3											F															
	Falconidae	1																										
	Alcidae	2										L																
	Ardeidae	1																										
	Ciconiidae	1																										
	Columbiform	Hydrobatidae																										
		Columbidae	9	2	1								L	L														
	Coccyiform	Coccyidae			2																							
		Meropidae												F														
Galliform	Phasianidae		18																									
	Gruidae	1																										
Gruiform	Alaudidae	14																										
	Passeriform	1																										
Passeriform	Certhidae	1																										
	Cincidae	1																										
	Corvidae	1																										
	Fringillidae	4																										
	Hirundinidae	39		3																								
	Laniidae																											
	Motacillidae																											
	Muscicapidae	23																										
	Paridae	124																										
	Passeridae	30																										
	Sittidae																											
	Sylviidae	1																										
	Vireonidae																											
	Piciform	Picidae	1		1																							
	Strigiform	Strigidae	2																									
Tyrionidae		1																										
Sturniform	Sturnidae	33																										

Source of literature references: Roy and Chauve (2007) for a review including 23 *Dermomyssus* species, Kneč (2008) for *D. diphyes*, Roy et al. (2008) for *D. apodis* and some data concerning *D. longipes*. Taxonomy of birds is according to Peterson website
L data from literature only, *F* data from our field work only, *M* mixed data from literature and from our field work

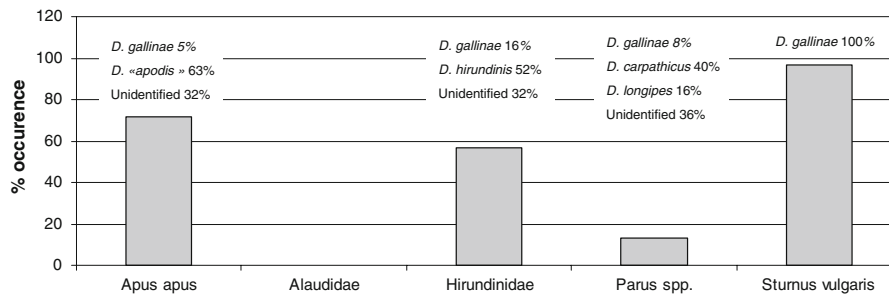

Fig. 1 Percentage of occurrence of *Dermanyssus* in nests of the five bird groups under test. Above each column the percentage of identified species among *Dermanyssus* individuals is given

species (here referred to as L1), *D. hirundinis*, *D. carpathicus* (Zeman 1979), *D. longipes* (Berlese and Trouessart 1889) and *D. apodis* Roy et al. 2008).

The number of nests analysed per bird group varied considerably, but a substantial number of nests were available in five bird groups and these represented together *ca.* 80% of all nests analysed. These groups are scrutinized below.

Apus apus, the black swift

Of the 52 nests analysed, 79% contained *Dermanyssus* individuals. Of these *Dermanyssus*, 32% were not identifiable at the species level because of their poor preservation condition. Of the remainder, 63% was identified as *D. apodis* and 5% as *D. gallinae*. In addition to *Dermanyssus* spp. collected from nest material, 18 individuals belonging to *D. apodis* were collected directly from the host (on several bird individuals), seven of which were on chicks in the nest and 11 on adults or on a fledged young (found far from nest).

Sturnus vulgaris, the European starling

Only one of the 33 nests analysed did not harbour any *Dermanyssus* individuals. Of the 32 others, four populations have been sequenced (mt-COI), which all appeared to belong to *D. gallinae*. Moreover, haplotypes found in these populations appeared to be very close to each other.

Parus major and *P. caeruleus*, the great tit and the blue tit

On the whole, 120 nests have been tested in the two species of tits, 62 of which originated from apple and pear orchards.

Of all these nests, 21% contained some *Dermanyssus* individuals, but in orchards, 8% provided some *Dermanyssus* individuals, versus 34.5% *in natura*. Moreover, almost all individuals collected from orchards were identified as *D. gallinae*, whereas mites from nests sampled *in natura* were identified as *D. carpathicus* or *D. longipes*. Moreover, several hundreds of bird individuals have been examined, without finding any individual of *Dermanyssus* spp.

Alaudidae, the larks

Nests of three species of Alaudidae have been examined, one of these species studied most extensively was *Melanocorypha calandra* L., 1766. No *Dermanyssus* were found in any of the nests.

Moreover, no more *Dermanyssus* have been found on any of the hundreds of bird individuals (mainly *Alauda arvensis* L. 1758) examined from two different regions in France around 800 km apart (Drôme, department 26, Pas de Calais, department 62). In particular, 50 individuals caught by a hunter in Drôme were closely examined, then submerged in water and analysed using the De Lillo's method, but there was no recovery of any *Dermanyssus* individual.

Hirundinidae, the swallows

Nests were obtained from two species of hirundinids: *Delichon urbicum* L., 1758 and *Hirundo rustica* L., 1758. Of the 42 nests analysed, 58% provided *Dermanyssus* individuals (mostly *D. hirundinis*). Moreover, the guild of bird parasites appeared to be more diverse, with several groups in addition to *Dermanyssus*, such as fleas (Insecta: Siphonaptera), chewing lice (Insecta: Mallophaga) and an individual belonging to *Myonyssus* sp. (Mesostigmata: Laelapidae).

Phylogenetic analysis

The data matrix consisted of 558 characters from a coding region of cytochrome oxidase subunit 1 (COI), of which 216 were parsimony-informative. The 78 included taxa, corresponding to mite populations, include 3 distant outgroups, 2 species of the *hirsutus*-group, and 73 populations of *gallinae*-group (groups classified according to Moss (1978)). Note that different haplotypes within a single population was detected in only two populations (RQ-Mes and 8006, 2 haplotypes of a single species detected in each), which come, respectively, from one nest and one farm. Parsimony analysis recovers 1000 most parsimonious trees ($L = 775$, $CI = 0.5316$, $RI = 0.8879$, Fig. 2), with 55 distinct haplotypes of *Dermanyssus* (53 of *gallinae*-group). Bayesian analysis resulted in a topology similar to MP, slightly more resolved concerning internal relations of the *D. apodis*⁺ clade (Fig. 3).

The same groupings appear in analyses using a subset of taxa and a combined matrix concatenating a region of rRNA 16S, a region from rRNA 18S to 28S, including ITS1, 5.8S and ITS2, as well as the COI region (Roy et al. 2008).

Populations sharing haplotypes

Populations, as defined above, come from different nests or different farms or breeding facilities, from different places. Most of mites obtained come from France (cf. Fig. 4 in Appendix), some additional samples come from Belgium, Denmark, The Netherlands, Spain, Italy, Norway, Poland and the USA (cf. Appendix). Each population is at least 3 km apart from each another, except in the cases of restricted study areas (Table 1) in which some nests stood several hundreds meters apart from each other.

Some haplotypes are to be noticed, as these were found in several populations of *D. hirundinis* and *D. gallinae* from single restricted study areas. For example, a single haplotype occurred in populations from areas BMOC, CB and IL, (except in two populations, which had haplotypes differing in only one (IL 227) or two (CB3) nucleotide

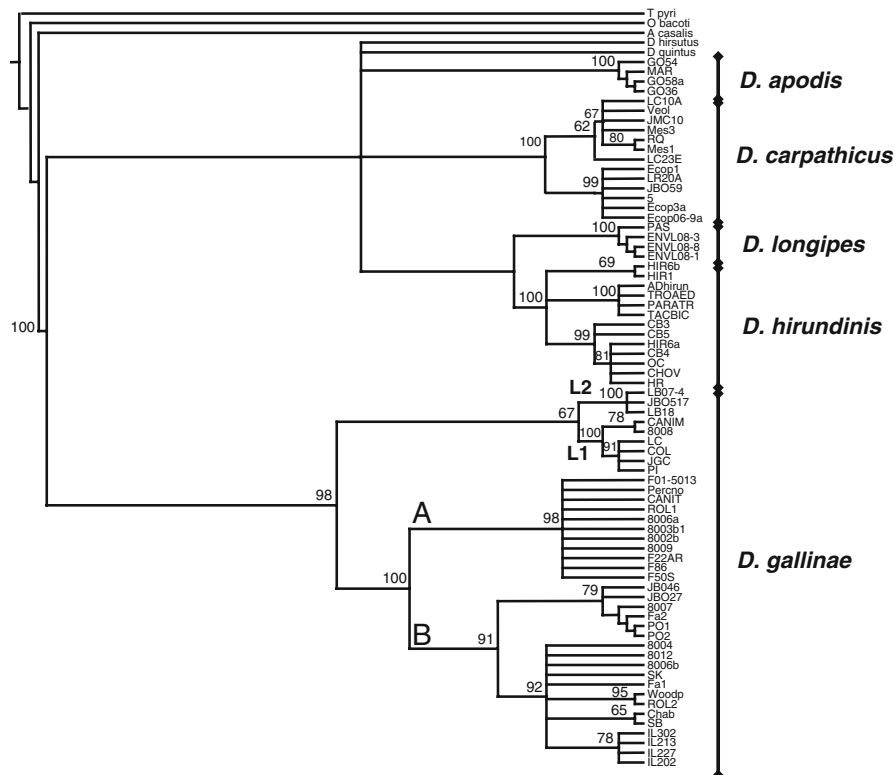

Fig. 2 Maximum Parsimony analysis. PAUP 4.0. Strict consensus of 1000 most parsimonious trees. Description of these 1,000 trees: $L = 775$, $CI = 0.5316$, $RI = 0.8879$. Numbers at nodes refer to bootstrap percentages for 1,000 replicates. Two lineages discussed in text are labeled L1 and L2. Two clades discussed in text are labeled A and B

substitutions). On the contrary, populations of *D. carpathicus* and *D. longipes* from single restricted study areas provided similar but slightly different haplotypes, as observed for populations from areas RQ, Ecop, ENVL. This suggests that populations' intermingling occurs, but the extent differs from species to species. The existence of single haplotypes in some restricted study areas suggests a single source. Possibly, starlings from restricted study area IL and swallows from CB have been infested by only one population of *D. gallinae* and *D. hirundinis*, respectively, whereas several infestation events may have occurred in areas RQ, Ecop and ENVL, with *D. carpathicus* and *D. longipes*.

Within the *D. gallinae* clade, 9 different populations from various geographic origins in France share a single haplotype (layer hen farms: 8009, 8002b, 8003b1, 8006a, F01-5013, F50S, F86, F22AR; wild bird: Percno; cf. Fig. 3). This group is labelled A in Figs. 2 and 3.

Observed host range

Comparison between literature and field data

Table 5 provides an overview of the distribution of *Dermanyssus* species across bird hosts using published literature data (based on morphological diagnosis of mites) and our field

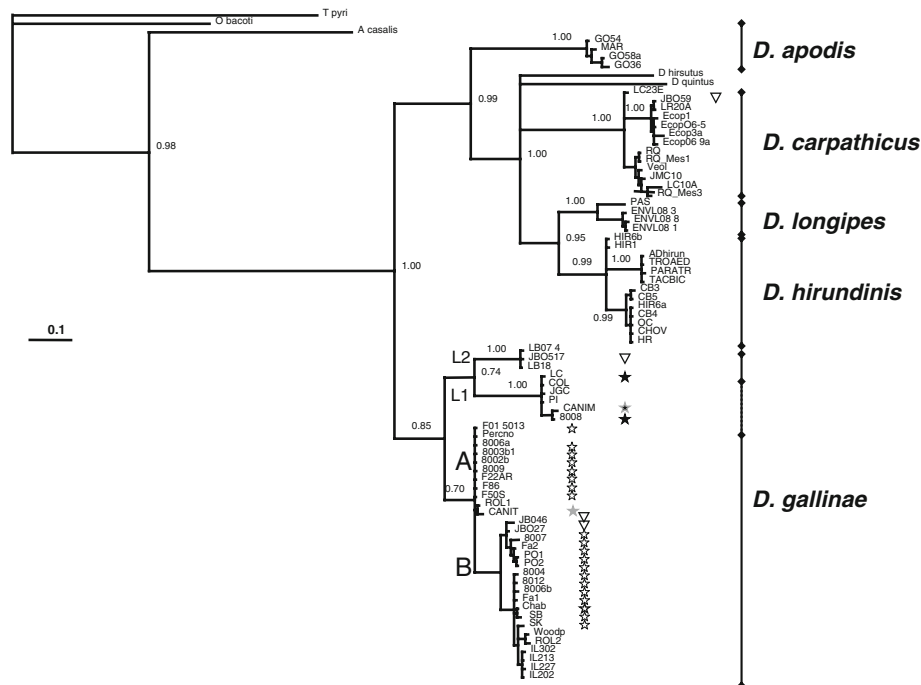

Fig. 3 Bayesian analysis. MrBayes v3.1.2, GTR + Γ +i model of evolution for 5×10^6 generations. Numbers at nodes refer to Bayesian Posterior Probabilities. Additional symbols indicate the type of anthropogenic ecosystem: “★” pigeons breeding facilities, “★” canary breeding facilities, “☆” layer hen or chicken houses, “▽” apple/pear orchards. Populations without any of these symbols have been collected in natura. Two lineages discussed in text are labeled L1 and L2. One clade discussed in text is labeled B. Group A corresponds to clade A in Fig. 2, and groups together populations sharing the same haplotype

data (based and on morphological and molecular diagnosis of mites). It includes data on 111 bird species (two of which undetermined: *Parus* sp. and *Passer* sp.), distributed over 9 bird orders and 31 bird families. Of these 111 species, data on 69 bird species were derived from the literature only, data on 17 bird species stemmed from literature and our field data and data on 25 bird species originated only from our field samples, which included rather variable numbers of nests per bird species.

Twenty-five mite species are currently included in the genus *Dermanyssus*. Of these 25 species, five have been found in our field samples (*D. carpathicus*, *D. gallinae*, *D. hirundinis*, *D. longipes*, *D. apodis*).

D. carpathicus was found in association with four passeriform bird species of two different genera [*P. major* and *P. caeruleus*, *Phoenicurus phoenicurus* (L., 1758) and *Ph. ochrurus* (Gmelin, 1774)]. These host genera were known from the literature.

D. gallinae was found in various, distant bird groups. It was previously recorded from 25 bird species, 4 of which were in our field samples [*G. gallus*, *Serinus canaria* (L., 1758), *P. major*, *S. vulgaris*]. Our field data also provided records of three bird species [*Dendrocopos major* (L., 1758), *Neophron percnopterus* (L., 1758) and *C. garrulus*] that are new as hosts of *D. gallinae*.

D. hirundinis was found exclusively and frequently (at least 30%) in nests of two species of Hirundinidae, the type host family in France. Since it was previously recorded from almost 40 different bird species distributed in nine different bird orders, we would

have expected a wider host range. Recently, some individuals from the restricted study area BMOC (Table 1) were found not only in nests of swallows (Hirundinidae), but also in nests of tits (Paridae) and wrens (Certhiidae) in the USA (cf. “[Host switches via nest sharing of host birds](#)”).

D. longipes has been found in a nest of *Passer montanus* and in several nests of *Parus* sp. Its type host was *Passer domesticus* (L., 1758). Moreover, some mites found by Brännström et al. (2008) from several species of Muscicapidae (Passeriforms) provided an ITS sequence similar to that obtained from our populations of *D. longipes* (Roy et al. 2008).

Host transfer of populations from four Dermanyssus species

To assess the ability of four *Dermanyssus* species to feed on hosts other than ones they are associated with, bioassays were carried out. These bioassays were not repeated or standardized enough to be dealt with statistically. At best they may give a hint as to the ability to feed and develop on the new host (cf. Tables 2, 3).

D. gallinae A strain of *D. gallinae* named SK and cultured on hens for the last ten years was, transferred to ducks and canaries, where they readily fed and successfully reproduced. Another population of *D. gallinae* (8010) also showed such an ability to feed on canaries under laboratory conditions, immediately after having been collected from a layer hen farm (after a starvation period of 4 days). This population shares the haplotype of group A (cf. above), *ie* provides a haplotype very common in French layer farms.

D. longipes and *D. carpathicus* *D. longipes* and *D. carpathicus* did not reveal an ability to feed on a new host to the extent observed for *D. gallinae*. *D. longipes* was unable to develop on a canary in the laboratory (long time bioassay). A population of *D. carpathicus* caught from a nest of *P. ochruros* (Gmelin 1774) appeared to maintain itself during about one year on a canary, since brilliant red individuals were regularly noticed. However, short time bioassays with canaries as the new host suggested a very different behaviour in *D. carpathicus* than in *D. gallinae*. In the former species, most individuals released were not recovered and there were only a few engorged mites observed, whereas in the latter species, simultaneously under similar conditions, most individuals were found aggregated and engorged.

D. hirundinis Although tested only once in bioassays, *D. hirundinis* did not seem to be different from *D. gallinae* in its ability to feed and develop on canaries as a host.

Discussion

Two main clades appear in the species of *Dermanyssus* tested here. One clade includes *D. carpathicus*, *D. hirundinis*, *D. longipes*, and *D. apodis*. The second clade includes the various lineages of *D. gallinae*. Within the *D. gallinae* clade, two lineages are strongly separated from the others.

D. gallinae: several lineages, some more specialized than others

The two lineages that stand out as strongly isolated from each other and from the other lineages, form a sister group to all other *D. gallinae*. All analyses provided strong support

for the monophyly of populations of L1 (Fig. 3) that were collected mainly from pigeons (domestic pigeons from breeding facilities and a nest sampled in a town) and stem from distant geographic areas. The monophyly of lineage L2 also receives strong support from the analyses shown in Figs. 2 and 4, but is not so strongly supported in other single gene analyses (Roy et al. 2008). Populations in this lineage were only found three times in wild Passeriformes.

The sister group of the clade L1 + L2 groups together populations found in industrial layer hen farms and some other populations (67% bootstrap in MP, 0.74 Bayesian Posterior Probabilities in Bayesian analysis). Within this clade, two major groupings become manifest, that are also found in wild avifauna: one grouping concerns *D. gallinae* populations in hen farms, in nests of *N. percnopterus* and on *C. garrulus* (group A, Figs. 2, 4) and the other grouping concerns *D. gallinae* populations in hen farms and in nests of *S. vulgaris*, *P. major* and *D. major* and on *C. garrulus* (clade B, cf. Figs. 2, 4). All populations in group A except ROL1 and CANIT provided the same haplotype, even though these populations are of quite different geographic origin (cf. Appendix). In clade B, approximately one haplotype per population is present, but in some cases there were haplotypes with very small differences: for instance the haplotype of PO1 and PO2 (layer hens from Poland) is very close to that of Fa1 (layer hens from Norway), differing by a single nucleotide substitution.

Assessments on host specificity using observed host range and ecological observations

The clade *D. apodis*⁺ had a much narrower host range than *D. gallinae*: only Passeriformes represent hosts for *D. carpathicus*, *D. longipes* and *D. hirundinis*, Piciformes for the *hirsutus*-group and Apodiformes in the basal *D. apodis*, whereas *D. gallinae* was isolated in eight different bird orders.

Host spectrum enlarging within the most synanthropic clade (D. gallinae)

L1 and L2 appear to be more specific than their sister clade. L1 was mainly found in association with pigeons and L2 with bird species of two different passeriform families. For L1, there were only two records from other bird groups, but these could well be cases of mites that do not actually infest these birds: one dead and dried individual was found in a nest of a predatory bird [*Tyto alba* (Scopoli 1769)] and another single individual was found dead in a nest of black swifts sampled in the town of Nîmes. Since in the town environment pigeons and swifts tend to compete for nesting places, the latter individual may have stemmed from a pigeon host. For these reasons, L1 could be specific to pigeons. L2 was never found in farms or other anthropogenic environments, whereas L1 was found in facilities for pigeon breeding.

The remainder of the *D. gallinae* populations showed very little divergence in mt-Co1 (only 19 haplotypes among 30 populations, pairwise divergence percentage 1–6%, vs. 8–12% between these populations and L1 or L2), were mainly collected from hens (Galliformes), but also from completely different bird groups (Coraciiformes, Piciformes, Passeriformes, Ciconiiformes). Moreover, some lab bioassays succeeded in feeding mites of different *D. gallinae* populations, freshly caught from hen farms, on canaries and on duck chicks and these mites showed a rate of development similar to that on their original host (Tables 2, 3). These *D. gallinae* populations seem to quickly adapt to new hosts and the large clade to which these populations belong was found exclusively in layer hen farms.

Host switches via nest sharing of host birds

The cases where haplotypes were found to be restricted to certain areas (sometimes with several successive samples, year after year; Table 1) require scrutiny because they may help to get insight into a possible mode of dissemination of *Dermanyssus* mites. For example, 2 sites with *D. carpathicus*, one with *D. longipes*, two with *D. hirundinis* and one with *D. gallinae* led us to suggest (1) that a single species was present in association with 1 (or 2) bird species in most areas that had a diameter compatible with the home range of birds under consideration, and (2) that mixing of mite populations occurs in restricted study areas in all *Dermanyssus* species under test. Thus, often a single haplotype was found per restricted study area, or haplotypes differing by only a few nucleotide substitutions. In 2 nests, however, two different populations were noted in the same *Dermanyssus* species (HIR6a and HIR6b both belonging to *D. hirundinis*, RQ-mes1 and RQ-mes3 both belonging to *D. carpathicus*). The concerned bird species (tits in genus *Parus*, starlings, swallows) are known to spend all time in a restricted area throughout the year and to rebuild their nest upon an older one, either their own or that of another (Caparros, Bouvier, Personal communication). Thus, there is ample opportunity for the *Dermanyssus* mites to switch from one host to another in case their hosts share nesting places, as suggested by Valera et al. (2003).

Contact between nest and bird seems to be absolutely necessary. This mode of dissemination via nest sharing is supported by our results in that different host ranges were noted in *D. hirundinis* between France (populations HIR6a, HIR6b, HIR1, CB3, CB4, CB5, OC, CHOV, HR) and the USA (populations ADhirun, TROAED, PARATR, TAC-BIC) (cf. Figs. 2, 3, and appendix for host affiliation). Indeed, this species has been isolated exclusively from *H. rustica* and *D. urbicum* (Hirundinidae) in France, whereas it was found from three different passeriform families in the USA (Hirundinidae, Certhiidae, Paridae). But the American hirundinid species tested is not present in France (*Tachycineta bicolor* (Vieillot 1808)) and its ecology strongly differs from the 2 tested French species: *T. bicolor* or the Tree Swallow is a cavity nesting bird and often uses nestboxes in the USA, as do the two other American host species (*Poecile atricapillus* L., 1766, the Black-Capped Chickadee and *Troglodytes aedon* Vieillot, 1809, the House Wren). These three bird species are often found sharing the same nestboxes in the USA (O. Dehorter, Personal communication), whereas none of the two tested French hirundinid species are found sharing nestboxes in France.

This opportunistic behaviour of *D. hirundinis* is also observed in our bioassays. Individuals of *D. hirundinis* directly sampled from a fresh nest of *H. rustica* did not show differences with individuals of *D. gallinae* in engorgement and development on canaries as hosts. The apparent host specificity observed in France is therefore likely the result of ecological and/or geographic factors. Alternatively, there may be genetic differences between the French and American populations tested, as indicated by small differences in COI sequences.

Evidence strongly suggests that dissemination of mites happens in cases of nest sharing between congeners and different species. The ability to switch from one host to another at a distance of several meters seems to be greatly reduced at least in some of these species. As indicated by scrutiny of the population in the restricted area CB (Table 1), some *D. gallinae* may rather starve for several weeks to a few months, than to venture bridging the distance to new hosts only metres away. For example, in absence of chicken, *D. gallinae* individuals present in large numbers in chicken cages do not appear to move to nests of swallows nearby. In these swallow nests, only *D. hirundinis* was found!

The nest seems to be a reservoir and the bird host could be the carrier. Note that all *Dermanyssus* individuals directly collected on flying birds in the present study (cf. Appendix) were adult females. Is this a stage adapted to dissemination by phoresy? Note also that, Flechtmann and Baggio (1993) reported one case of *D. gallinae* phoretic on a beetle, and the isolated individuals were adult females.

Synanthropicity and nest microenvironment

The micro-environmental conditions of farms and breeding facilities are likely to differ from those in wild bird nests. For example, these anthropogenic environments harbour large numbers of bird individuals in a small area, provide relatively regular temperatures and humidity, are usually exposed to some pesticides and provide hosts during most of the year (layer hen houses are usually bird-free for less than 2 months per year). On the contrary, in wild bird environments, even in cases of bird colonies, the number of bird individuals and the area they occupy is much smaller than in farms, and temperature and humidity are much more variable during the year and even during the day, than in farms. Also, pesticide products are typically absent (except in the case of orchards in restricted study area JBO) and the host is available only during a limited period, i.e. the breeding period of their host in spring-summer, and sometimes winter nights (implying absence of bird host for several months in autumn and summer).

The two main clades in the *Dermanyssus* species tested exhibit conspicuous adaptations to their microenvironments. Clade *D. apodis*⁺ was never found in any farm or breeding facility, but clade *D. gallinae* was present in poultry farms (layer hens, chickens) or breeding facilities for canaries, other Fringillidae and pigeons, where they usually proliferate. Moreover, the latter clade was found in agroecosystems such as orchards. Taken together, it can be concluded that the clade *D. gallinae* is unique in harbouring synanthropic populations (Fig. 3).

Role of the ecosystem in the nest environment

The nest provides a specific environment shaped by various organisms together forming a micro-ecosystem. First and foremost are the birds occupying the nest. They bring nest-building material and release waste products, but they may also remove them. So nest building and nest hygiene may be determinants of the nest as a biotope for *Dermanyssus* spp. In wild birds, *D. gallinae* was found proliferating only in pigeon nests (L1) and starling nests (restricted study area IL), which are birds that allow droppings from chicks to dry within the nest. Moreover, *D. gallinae* is commonly found in layer hen farms where hen droppings accumulate around the flock and numerous *D. gallinae* individuals are often found aggregating under dried droppings. In contrast, *D. hirsutus*, *D. quintus*, *D. carpathicus*, *D. longipes* and *D. hirundinis*, in clade *D. apodis*⁺, were never found in such nests and seem to proliferate only in passeriform or piciform nests which are regularly cleaned by the parental birds. One may wonder how the presence of bird droppings affects species of clade *D. apodis*⁺ relative to *D. gallinae*.

Another factor affecting the proliferation of *Dermanyssus* spp. could be the presence or absence of pesticide products. Results from nests of restricted study area JBO suggest that *D. gallinae* is better adapted to an orchard agroecosystem than *D. carpathicus*: the latter was found *in natura* (either in natural nest or in nestbox) in 15% of the *Parus*

nests sampled in France, whereas only once in fruit orchards (62 nests; i.e. 1,6%). However, *D. gallinae* was found in tit nests only when the nests were located in orchards (Fig. 1).

Finally, various other organisms inhabit nests, these are mostly insects and mites and represent different feeding guilds: bird parasites, predators, microbivores and scavengers. It is interesting to observe that tree-nesting birds generally suffer from attack by *Dermanyssus* spp. and that the breeding success of individual birds strongly depends on the presence of predatory mites that attack *Dermanyssus* spp. (Lesna et al. 2009). The only ground nesting group extensively analysed here are the larks (Alaudidae) and these bird species appear to stand out as the only ones that had no *Dermanyssus* individuals in their nests (Fig. 1). As a rule, these nests contained many species of predatory arthropods (data not shown) and the presence of various predators was inversely proportional to the presence of *D. gallinae*. The case of restricted study area MOL is a good illustration of it, with only one *D. gallinae* individual found among several cubic meters of litter sampled, but several species of predators present in considerable numbers.

Perspectives

To understand the distribution of *Dermanyssus* spp. and lineages over bird species as hosts, co-phylogenetic analysis is of fundamental importance (especially with respect to *D. carpathicus*, *D. hirundinis*, *D. longipes*, *D. apodis* and their bird hosts). However, the presence of a *Dermanyssus* species in the nest of a bird species depends on several ecological factors that may dramatically alter the potential host range. These include bird-related factors, such as nest material selection, nest hygiene, competition for nest sites and nest sharing, but also the presence of various guilds of nidicolous arthropods, including predators of *Dermanyssus* spp. and flying insects that may act as vectors for dissemination of *Dermanyssus* spp., being wingless and therefore less mobile. Given that anthropogenic environments, such as poultry farms, offer an environment that is widely different from that of wild birds, it is to be expected that *Dermanyssus* spp. (especially *D. gallinae*) undergo strong selection to adapt to this environment (e.g. by developing pesticide resistance). It is the extent to which these adaptations are decisive for survival in the anthropogenic environment and the extent to which they affect survival in the natural environment, which will determine how much exchange there will be between *Dermanyssus* from wild and domestic birds. Elucidating these adaptations will therefore be an important task for future research.

Acknowledgments Authors would like to warmly thank for help, sampling, advices: O. Bain (Muséum National d'Histoire naturelle (MNHN), Paris, France), Y. Beauvallet (Centre de Recherche sur la Biologie et les Populations d'Oiseaux (CRBPO), MNHN, Paris, France), S. Bonnet (LEGTA, Saint-Genis Laval, France), J. C. Bouvier (INRA unite PSH, Avignon, France), L. Brucy (CRBPO, MNHN, Paris, France), O. Caparros (CRBPO, MNHN, Paris, France), L. Carrier (CRBPO, MNHN, Paris, France), F. Humbert (CRBPO, MNHN, Paris, France), T. Cencek, (Państwowy Instytut Weterynaryjny, Puławy, Poland) M. De Rojas (Universidad de Sevilla, Sevilla, Spain), P. Chabrol (veterinary office, Bourg-en-Bresse, France), J. M. Chavatte (MNHN, Paris, France), O. Dehorter (CRBPO, MNHN, Paris, France), J. Delaporte (Bayer Animal HealthCare, Saint-Ave, France), A. G. Gjevre (National Veterinary Institute of Norway, Oslo, Norway), G. Gory (Museum d'Histoire naturelle, Nîmes, France), N. Guichard (LEGTA, Saint-Genis Laval, France), P. A. Heuch (National Veterinary Institute of Norway, Oslo, Norway), G. Inizan (Bayer Animal HealthCare, Saint-Ave, France), O. Kilpinen (Danish Institute of Agricultural Sciences, Lyngby, Denmark), S. Kreiter (Supagro, Montpellier, France), G. Lallemand (Lycée des Mandailles, Châteauneuf de Galaure, France), B. M. O'Connor (Museum of Zoology, University of Michigan, Ann Arbor, USA), B. Paoletti

(University of Teramo, Teramo, Italy), M. Rigaux (IUT A, Université Lyon1, Villeurbanne, France), P. Tavernier (Centre de Soins aux Oiseaux sauvages du Lyonnais, Francheville, France), F. Veau (CORA Ardèche, France), Vincent-Martin N. (CRBPO, MNHN, Paris, France), J. Witters (Institute for Agricultural and Fisheries Research, Mellebeke, Belgium).

Glossary

Mono-/polyxeny Condition of host specificity for a parasite species that needs a single host species/several host species for completion of its development.

Synanthropic Ecologically associated with humans.

Appendix

See Fig. 4 and Table 6.

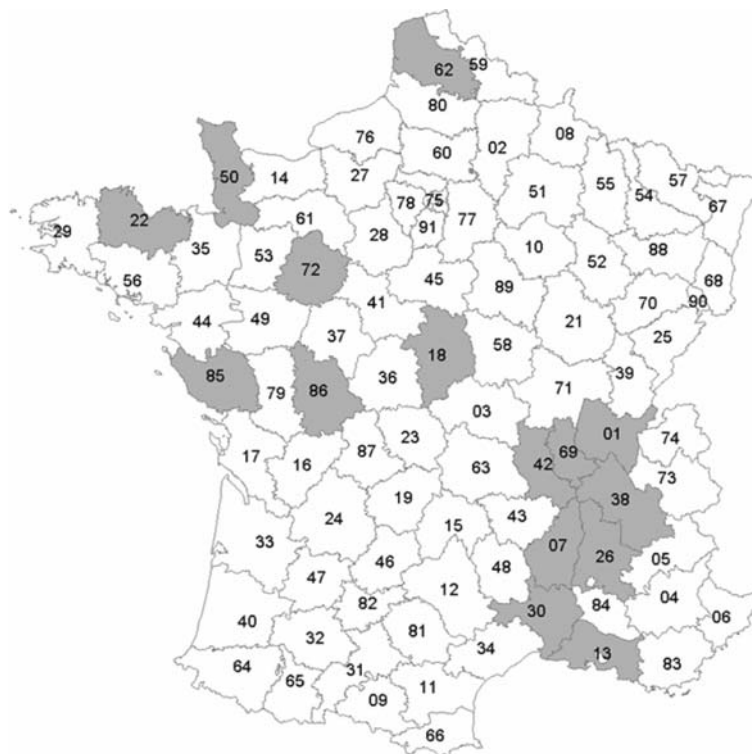

Fig. 4 Location of French departments. In grey are highlighted French departments in which *Dermanyssus* individuals have been found during field sampling in the present study (2005–2007)

Table 6 List of DNA-tested mite populations, including accession numbers

Pop ^c code	Species of mite	18S-28S rRNA	16S rRNA	COI	Country (State, French 'department')	Restricted study area	Sampling year (restricted study areas)	Host	Context
8002	<i>D. gallinae</i>			FM208713	France, 26			<i>Gallus gallus</i> (Galliform)	Layer farm
8003	<i>D. gallinae</i>			FM208733	France, 38			<i>Gallus gallus</i> (Galliform)	Layer farm
8004	<i>D. gallinae</i>			FM208722	France, 69			<i>Gallus gallus</i> (Galliform)	Little amateur hen house
8005	<i>D. gallinae</i>			FM208737				<i>Gallus gallus</i> (Galliform)	Little layer and chicken farm
8006	<i>D. gallinae</i>			FM208725 and FM208732	France, 01			<i>Gallus gallus</i> (Galliform)	Layer farm
8007	<i>D. gallinae</i>			FM208717	Belgium			<i>Gallus gallus</i> (Galliform)	Layer farm
8008	<i>D. gallinae</i>			FM208712	France, 69			<i>Columba livia</i> (Columbiform)	Breeding facilities for bird competitions
8009	<i>D. gallinae</i>			FM208724	France, 69			<i>Gallus gallus</i> (Galliform)	Layer farm
8012	<i>D. gallinae</i>			FM208739	France, 01	CB	2008 (summer)	<i>Gallus gallus</i> (Galliform)	Cages with chickens
8010	<i>D. gallinae</i>			FM881897	France, 26			<i>Gallus gallus</i> (Galliform)	Layer farm
ACA	<i>A. casalis</i>	AM903317	AM921907	AM921868	France, 69			-	Breeding facility
ADhirs	<i>D. hirsutus</i>	AM931077	AM921912	AM921878	USA, MI			<i>Colaptes cafer</i> (Piciform)	On bird
ADhirun	<i>D. hirundinis</i>	AM931076	AM921913	AM921881	USA, MI	BMOC	?	<i>Tachycineta bicolor</i> (Passeriform)	On bird
ADqui	<i>D. quintus</i>		AM931075	AM921882	USA, MI			<i>Picoides villosus</i> (Piciform)	On bird
CANIM	<i>D. gallinae</i>			FM208734	France, 69			(Pet shop with various bird species very close to each other)	Just caught from a cage with canaries and quails; many other bird species in cages next to them (including Psittaciforms, ...)
CANIT	<i>D. gallinae</i>	AM903308	AM921909	AM921877	Italy			<i>Serinus canarius</i> (Fringillidae: Passeriform)	Breeding facility

Table 6 continued

Pop ^s code	Species of mite	18S-28S rRNA	16S rRNA	COI	Country (State, French 'department')	Restricted study area	Sampling year (restricted study areas)	Host	Context
CB3	<i>D. hirundinis</i>			FM208726	France, 01	CB	2008 (summer)	<i>Hirundo rustica</i> (Passeriform)	Nest in farm building
CB4	<i>D. hirundinis</i>			FM208727	France, 01	CB	2008 (summer)	<i>Hirundo rustica</i> (Passeriform)	Nest in farm building
CB5	<i>D. hirundinis</i>			FM208728	France, 01	CB	2008 (summer)	<i>Hirundo rustica</i> (Passeriform)	Nest in farm building
Chab	<i>D. gallinae</i>	AM931074	AM921886	AM921857	France, 01			<i>Gallus gallus</i> (Galliform)	Layer farm
CHOV	<i>D. hirundinis</i>	AM943019		FMI79369	France, 72			<i>Hirundo rustica</i> (Passeriform)	Nest in a barn
COL*	<i>D. gallinae</i>	AM903307	AM921892	AM921875	France, 69			<i>Columba livia</i> (Columbiform)	On adult bird
DR	<i>D. gallinae</i>	AM931073	AM921885		Spain			<i>Fringillidae</i> (Passeriform)	Cage
Ecop1	<i>D. carpaticus</i>			FM208731	France, 42	Ecop	2008 (winter)	<i>Parus</i> sp. (Passeriform)	Nest box
Ecop3	<i>D. carpaticus</i>			FM208729	France, 42	Ecop	2008 (winter)	<i>Parus</i> sp. (Passeriform)	Nest box
Ecop06-5	<i>D. carpaticus</i>	AM903314	AM921901	AM921873	France, 42	Ecop	2006 (summer)	<i>Parus major</i> (Passeriform)	Nest box
Ecop06-9	<i>D. carpaticus</i>			FM208730	France, 42	Ecop	2007 (summer)	<i>Parus caeruleus</i>	Nest box
ENVL07-07	<i>D. longipes</i>				France, 69	ENVL	2007 (summer)	<i>Parus</i> sp. (Passeriform)	Nest box
ENVL08-1	<i>D. longipes</i>			FM208744	France, 69	ENVL	2008 (summer)		
ENVL08-3	<i>D. longipes</i>	FMI79377	FMI79374	FM179365	France, 69	ENVL	2008 (summer)	<i>Parus</i> sp. (Passeriform)	Nest box
ENVL08-7	<i>D. longipes</i>				France, 69	ENVL	2008 (summer)	<i>Parus</i> sp. (Passeriform)	Nest box
ENVL08-8	<i>D. longipes</i>			FM208743	France, 69	ENVL	2008 (summer)	<i>Parus</i> sp. (Passeriform)	Nest box
F01-5013	<i>D. gallinae</i>			FM208721	France, 01			<i>Gallus gallus</i> (Galliform)	Layer farm (free range)
F22AR	<i>D. gallinae</i>			FM208720	France, 22			<i>Gallus gallus</i> (Galliform)	Layer farm
F50S	<i>D. gallinae</i>			FM208719	France, 50			<i>Gallus gallus</i> (Galliform)	Layer farm
F86	<i>D. gallinae</i>			FM208718	France, 86			<i>Gallus gallus</i> (Galliform)	Layer farm
Fa1	<i>D. gallinae</i>	AM931072	AM921884	AM921853	Norway			<i>Gallus gallus</i> (Galliform)	Layer farm
Fa2	<i>D. gallinae</i>	AM931071	AM921883	AM921852	Norway			<i>Gallus gallus</i> (Galliform)	Layer farm (organic)

Table 6 continued

Pop ^c code	Species of mite	18S-28S rRNA	16S rRNA	COI	Country (State, French 'department')	Restricted study area	Sampling year (restricted study areas)	Host	Context
GO1	<i>D. apodis</i>	AM903299	AM921894		France, 30			<i>Apus apus</i> (Apodiform)	Nest
GO10	<i>D. apodis</i>		AM921895		France, 30			<i>Apus apus</i> (Apodiform)	Nest
GO12	<i>D. apodis</i>	AM903309			France, 30			<i>Apus apus</i> (Apodiform)	Nest
GO15	<i>D. apodis</i>	AM903313	AM921896		France, 30			<i>Apus apus</i> (Apodiform)	On young birds at nest
GO16	<i>D. apodis</i>	AM903313			France, 30			<i>Apus apus</i> (Apodiform)	On young birds at nest
GO26	<i>D. apodis</i>		AM921900		France, 30			<i>Apus apus</i> (Apodiform)	Nest
GO36	<i>D. apodis</i>			FMI79371	France, 30			<i>Apus apus</i> (Apodiform)	Nest
GO44	<i>D. apodis</i>		AM921898		France, 30			<i>Apus apus</i> (Apodiform)	Nest
GO46	<i>D. apodis</i>		AM921897		France, 30			<i>Apus apus</i> (Apodiform)	Nest
GO54	<i>D. apodis</i>	AM930888		AM921874	France, 30			<i>Apus apus</i> (Apodiform)	Nest
GO58a	<i>D. apodis</i>			FMI79370	France, 30			<i>Apus apus</i> (Apodiform)	Nest
GO8*	<i>D. gallinae</i>		AM921893		France, 30			<i>Apus apus</i> (Apodiform)	Nest
HIR1	<i>D. hirundinis</i>	FMI79379		FMI79366	France, 85	HIR	2008 (winter)	<i>Hirundo rustica</i> (Passeriform)	Nest
HIR2	<i>D. hirundinis</i>				France, 85	HIR	2008 (winter)	<i>Hirundo rustica</i> (Passeriform)	Nest
HIR5	<i>D. hirundinis</i>				France, 85	HIR	2008 (spring)	<i>Hirundo rustica</i> (Passeriform)	Nest
HIR6	<i>D. hirundinis</i>				France, 85	HIR	2008 (spring)	<i>Hirundo rustica</i> (Passeriform)	Nest
HR	<i>D. hirundinis</i>	AM903300	AM921888	AM921872	France, 69			<i>Hirundo rustica</i> (Passeriform)	Nest in farm building
IL302	<i>D. gallinae</i>			FM207495	The Netherlands	IL	2007	<i>Sturnus vulgaris</i> (Passeriform)	Nest box
IL213	<i>D. gallinae</i>	FM207490	FM207492	FM207499	The Netherlands	IL	2007	<i>Sturnus vulgaris</i> (Passeriform)	Nest box
IL227	<i>D. gallinae</i>	FM207491	FM207494	FM207496	The Netherlands	IL	2007	<i>Sturnus vulgaris</i> (Passeriform)	Nest box

Table 6 continued

Pop ^s code	Species of mite	18S-28S rRNA	16S rRNA	COI	Country (State, French 'department')	Restricted study area	Sampling year (restricted study areas)	Host	Context
IL202	<i>D. gallinae</i>			FM207497 and FM207498	The Netherlands	IL	2007	<i>Sturnus vulgaris</i> (Passeriform)	Nest box
JBO27	<i>D. gallinae</i>			FM208716	France, 13			<i>Parus major</i> (Passeriform)	Nest box in an apple orchard
JBO46	<i>D. gallinae</i>			FM208736	France, 13			<i>Parus major</i> (Passeriform)	Nest box in an apple orchard
JBO517	<i>D. gallinae</i>	AM930885		AM921879	France, 13			<i>Parus major</i> (Passeriform)	Nest box in an apple orchard
JBO59	<i>D. carpathicus</i>	AM930882	AM921902	AM921870	France, 13			<i>Parus major</i> (Passeriform)	Nest box in an apple orchard
JMC10	<i>D. carpathicus</i>	AM943018		AM943021	France, 62			<i>Parus major</i> (Passeriform)	Nest
LB074	<i>D. gallinae</i>			AM921866	France, 18	LB	2006-2007	<i>Delichon urbica</i> (Passeriform)	Nest
LB18	<i>D. gallinae</i>	AM930889	AM921908	AM921867	France, 18	LB	2006-2007	<i>Delichon urbica</i> (Passeriform)	Nest
LC	<i>D. gallinae</i>	AM903306	AM921891	AM921859	France, 26			<i>Columbus livia</i> (Columbiform)	Breeding facility, rural country
LC23	<i>D. carpathicus</i>			FM208735 and FM881898	France, 26			<i>Parus major</i> (Passeriform)	Nest
LC10A	<i>D. carpathicus</i>			FM179367				<i>Parus major</i> (Passeriform)	Nest
LR20A	<i>D. carpathicus</i>			FM179368				<i>Parus</i> sp. (Passeriform)	Nest
MAR	<i>D. apodis</i>	AM945880	AM921899	AM921880	France, 69			<i>Apus apus</i> (Apodiform)	On young bird fallen from nest
Ob	<i>O. bacoti</i>	AM903318	AM921905	FM179677	?			<i>rodents</i>	From a lab strain in MNHN (O. Bain, Lab of Parasitology)
OC	<i>D. hirundinis</i>	AM903312	AM921889	AM921862	France, 38			<i>Delichon urbica</i> (Passeriform)	On young birds at nest

Table 6 continued

Pop ^c code	Species of mite	18S-28S rRNA	16S rRNA	COI	Country (State, French 'department')	Restricted study area	Sampling year (restricted study areas)	Host	Context
PARATR	<i>D. hirundinis</i>			FM208746	USA, MI	BMOC	2007 (autumn)	<i>Parus atricapillus</i> (Passeriform)	Nest box ?
Parm	<i>D. carpathicus</i>	AM903315			France, 69			<i>Parus major</i> (Passeriform)	Nest box
PAS	<i>D. longipes</i>	AM903310	AM921904	AM921869	France, 13			<i>Passer montanus</i> (Passeriform)	Nest
Percnobis	<i>D. gallinae</i>	AM943020		FM208738	France, 07			<i>Neophron percnopterus</i> (Ciconiiform)	Nest
PJ*	<i>D. gallinae</i>	FM179378	FM179375	AM921860	France, 13			<i>Columbus livia</i> (Columbiform)	From nest inside a flat in city center
PO1	<i>D. gallinae</i>	AM903302		AM921854	Poland			<i>Gallus gallus</i> (Galliform)	Layer farm
PO2	<i>D. gallinae</i>		AM921914	AM921855	Poland			<i>Gallus gallus</i> (Galliform)	Layer farm
ROL1	<i>D. gallinae</i>	AM903304	AM921910	AM921864	France, 13			<i>Coracias garrulus</i> (Coraciiform)	On adult birds
ROL2	<i>D. gallinae</i>	AM903305	AM921911	AM921865	France, 13			<i>Coracias garrulus</i> (Coraciiform)	On young birds at nest
RQ	<i>D. carpathicus</i>	AM903316	AM921903	AM921876	France, 42	RQ	2006 (summer)	<i>Phoenicurus phoenicurus</i> (Passeriform)	Nest, near a house at altitude of ca. 1000 m
RQ-Mes	<i>D. carpathicus</i>			FM208715, FM208714 and FM208723	France, 42	RQ	2006 (summer)	<i>Parus</i> sp. (Passeriform)	Nest, in the wall of a house, alt ca. 1000 m
SB	<i>D. gallinae</i>			AM921858	France, 69			<i>Gallus gallus</i> (Galliform)	Small, amateur hen house
SK	<i>D. gallinae</i>	AM903303	AM921887	AM921856	Denmark			<i>Gallus gallus</i> (Galliform)	Layer farm
TACBIC	<i>D. hirundinis</i>			FM208745	USA, MI	BMOC	2007 (autumn)	<i>Tachycineta bicolor</i> (Passeriform)	Nest box
TROAED	<i>D. hirundinis</i>			FM208747	USA, MI	BMOC	2007 (autumn)	<i>Troglodytes aedon</i> (Passeriform)	Nest box

Table 6 continued

Pop ^s code	Species of mite	18S-28S rRNA	16S rRNA	COI	Country (State, French 'department')	Restricted study area	Sampling year (restricted study areas)	Host	Context
TPYR	<i>T. pyri</i>	FMI179376	FMI179373	FMI179364	France			–	From a lab strain in Supagro, Montpellier (S. Kreiter)
Veol	<i>D. carpathicus</i>			AM921871	France, 69			<i>Parus major</i> (Passeriform)	Nest box
Woodp	<i>D. gallinae</i>	AM903301	AM921890	AM921863	France, 69			<i>Dendrocopos major</i> (Piciform)	On wild adult female bird

Each population corresponds to a group of *Dermamyssus* mites from a single nest (or a single building in a farm or breeding facility). There was never more than 1 species of *Dermamyssus* per nest

References

- Brännström S, Morrison DA, Mattsson JG, Chirico J (2008) Genetic differences in internal transcribed spacer 1 between *Dermanyssus gallinae* from wild birds and domestic chickens. *Med Vet Entomol* 22(2):152–155. doi:10.1111/j.1365-2915.2008.00722.x
- Carroll H, Beckstead W, OConnor T, Ebbert M, Clement M, Snell Q, McClellan D (2007) DNA reference alignment benchmarks based on tertiary structure of encoded proteins. *Bioinformatics* 23(19):2648–2649. doi:10.1093/bioinformatics/btm389
- De Lillo E (2001) A modified method for Eriophyoid mite extraction (Acari: Eriophyoidea). *Int J Acarol* 27(1):67–70
- De Souza Amorim D (1982) Classificação por sequenciamento: uma proposta para a denominação dos ramos retardados. *Rev Bras Zool* 11:1–9
- Flechtmann HW, Baggio D (1993) On Phoresy of hematophagous ectoparasitic acari (Parasitiformes: Ixodidae and Dermanyssidae) on Coleoptera observed in Brazil. *Int J Acarol* 19(2):195–196
- Hoogstraal H, Aeschlimann A (1982) Tick host specificity. *Mitteilungen des Schweizerischen entomologischen Gesellschaft* 55:5–32
- Huelsenbeck JP, Ronquist F (2001) MRBAYES: Bayesian inference of phylogeny. *Bioinformatics* 17: 754–755. doi:10.1093/bioinformatics/17.8.754
- Knee W (2008) Five new species of Rhinonyssidae (Mesostigmata) and one new species of *Dermanyssus* (Mesostigmata: Dermanyssidae) from birds of Alberta and Manitoba, Canada. *J Parasitol* 94:348–374. doi:10.1645/GE-1358.1
- Lesna I, Wolfs P, Faraji F, Roy L, Komdeur J, Maurice W, Sabelis (2009) Candidate predators for biological control of the poultry red mite *Dermanyssus gallinae*. *Exp Appl Acarol*. doi:10.1007/s10493-009-9239-1
- Livezey BC, Zusi RL (2007) Higher order phylogeny of modern birds (Theropoda, Aves: Neornithes) based on comparative anatomy II. Analysis and discussion. *Zool J Linn Soc* 149:1–95. doi:10.1111/j.1096-3642.2006.00293.x
- Moss WW (1978) The mite genus *Dermanyssus*: a survey, with description of *Dermanyssus trochilinis*, n. sp., and a revised key to the species (Acari: Mesostigmata: Dermanyssidae). *J Med Ent* 14(6):627–640
- Nylander JAA (2004) MrModeltest v2. Program distributed by the author. Evolutionary Biology Centre, Uppsala University
- Peterson AP (2008) <http://www.zoobank.net/avtax/frame.html>, Version 7.07 (2008.07.30)
- Ronquist F, Huelsenbeck JP (2003) MRBAYES 3: Bayesian phylogenetic inference under mixed models. *Bioinformatics* 19:1572–1574. doi:10.1093/bioinformatics/btg180
- Roy L, Chauve CM (2007) Historical review of the genus *Dermanyssus* Dugès, 1834 (Acari: Mesostigmata: Dermanyssidae). *Parasite* 14(2):87–100
- Roy L, Dowling APG, Chauve CM, Buronfosse T (2008) Delimiting species boundaries within *Dermanyssus* Dugès, 1834 (Acari: Mesostigmata) using a total evidence approach. *Mol Phylogenet Evol*. doi:10.1016/j.ympev.2008.11.012
- Swofford DL (2001) PAUP*-Phylogenetic Analysis Using Parsimony (*and other methods). Version 4.0B 10. [Computer software and manual]. Sinauer Associates, Sunderland, Massachusetts
- Valera F, Casas-Crivillé A, Hoi H (2003) Interspecific Parasite exchange in a mixed colony of birds. *J Parasitol* 89(2):245–250
- Valiente Moro C, Chauve C, Zenner L (2005) Vectorial role of some dermanyssoid mites (Acari, Mesostigmata, Dermanyssoidea). *Parasite* 12(2):99–109
- Valiente Moro C, Fravallo P, Amelot M, Chauve C, Zenner L, Salvat G (2007) Colonization and invasion in chicks experimentally infected with *Dermanyssus gallinae* contaminated by *Salmonella enteritidis*. *Avian Pathol* 36(4):307–311. doi:10.1080/03079450701460484
- Wilm A, Mainz I, Steger G (2006) An enhanced RNA alignment benchmark for sequence alignment programs. *Algorithms Mol Biol* 1(19):1–11

5.2 Diversité génétique et flux de populations chez quelques espèces du groupe gallinae : publication V

a - Présentation

De concert avec divers paramètres écologiques, des caractéristiques intrinsèques président à l'adaptabilité des organismes à de nouveaux environnements. Ainsi, dans un taxon donné, tant animal que végétal ou fongique, certaines entités peuvent posséder une plus grande capacité à coloniser un habitat différent de l'habitat (ou des habitats) usuel(s) que d'autres. C'est ainsi que, sous l'effet de modifications induites par l'homme (transformation des écosystèmes, échanges à de grandes échelles géographiques, ...), certains organismes révèlent un potentiel invasif important, alors que des entités apparentées demeurent confinées dans leur environnement originel. Des organismes tels l'algue *Caulerpa taxifolia* ou la grenouille-taureau *Rana catesbeiana* importées volontairement ou par accident envahissent de ce fait brutalement des aires géographiques qui en étaient exemptes, aux dépens des espèces autochtones des écosystèmes concernés, alors que d'autres organismes importés n'ont pas réussi à s'adapter au nouvel environnement. Selon Williamson (1996), qui distingue quatre étapes dans le phénomène invasif (importation, introduction, établissement, développement nuisible, *ie* invasion), env. 0,1% des espèces importées deviennent invasives. Les systèmes hôte-parasite, modèles de prédilection pour l'étude des phénomènes adaptatifs, offrent de nombreux exemples de diversité dans les aptitudes adaptatives. En effet, là encore, certaines entités parasites étroitement apparentées diffèrent par le niveau de leur spécificité d'hôte, conséquence de caractéristiques écologiques et comportementales de l'hôte, mais aussi de particularités intrinsèques du parasite.

La biologie microprédatrice et nidicole des espèces du groupe *gallinae* en font des parasites particulièrement dépendants de l'écosystème du nid et *a priori* faiblement liés à l'hôte lui-même. Pourtant, une spécificité plus élevée que prévu a pu être notée chez les espèces rustiques dans la publication IV. Cela contraste en outre fortement avec le caractère généraliste de *D. gallinae*. Certains traits de l'écologie des oiseaux hôtes, influant sur les possibilités de transfert d'une espèce d'hôte à l'autre et sur la composition du microécosystème du nid, sont bien sûr en lien avec ces différences de spécificité. Mais cela ne semble pas expliquer complètement l'ampleur des différences dans les spectres d'hôte observés et le spectre des types d'habitats colonisés (en particulier, sauvages vs anthropisés).

5.2.a.1 Objectifs

Les objectifs de la publication V se répartissaient en 2 groupes :

- (1) Evaluer l'utilité d'un marqueur nucléaire nouvellement développé (Tropomyosin exon n, intron n and exon n+1) pour l'exploration phylogénétique des relations inter- et intraspécifiques dans le groupe *gallinae* et comparer les résultats obtenus à ceux de la publication III.
- (2) Répondre aux questions suivantes au niveau spécifique :
 - a) Les lignées généralistes de *D. gallinae* représentent-elles en fait des espèces cryptiques (potentiellement aussi spécifiques que les espèces « rustiques ») ?
 - b) Est-ce que les généralistes possèdent une plus grande flexibilité évolutive que les spécialistes dans le groupe *gallinae* ?

c) Quel sont les rôles respectifs des flux commerciaux et des échanges entre oiseaux sauvages et volaille domestique dans la dissémination des populations de *D. gallinae*?

5.2.a.2 Matériel et méthodes

Une combinaison d'analyses généalogiques basées sur des haplotypes (comparaison des arbres de gènes, méthode ABC d'investigation de l'histoire démographique des populations basée sur un modèle de type IM, Isolation with Migration), de tests basés sur la théorie de la coalescence et de tests statistiques du polymorphisme génotypique a été mise en œuvre. Des portions de deux loci indépendants – la mt-Co1 (mitochondriale) et la Tropomyosine (nucléaire, portion majoritairement intronique) – d'isolats d'origines géographiques et écologiques différentes ont constitué les matrices de travail. Pour les analyses phylogénétiques, les haplotypes de tous les isolats séquencés ont été inclus quel que soit le nombre d'individus séquencés par isolat. Pour les autres analyses, seuls des isolats dont un nombre relativement important d'individus ont été séquencés (18-24 individus par isolat) ont été pris en compte afin d'être à même d'évaluer la diversité intra-isolat, nécessaire à l'estimation de la diversité interpopulation. Ainsi un isolat de *D. apodis* et cinq de *D. gallinae* (un sauvage, un maintenu en laboratoire depuis 12 ans, trois prélevés dans des élevages de pondeuses et un dans un élevage de pigeons) ont pu être intégrés aux tests statistiques. En outre, un « pseudo-isolat » constitué d'une vingtaine d'individus provenant de nids d'hirondelles rustiques collectés en plusieurs endroits en France, appartenant à *D. hirundinis* a apporté un complément d'information statistique.

Une mise en relation récurrente des résultats obtenus avec des traits d'histoire de vie déjà connus ou nouvellement observés a participé à l'interprétation des données obtenues par les différentes analyses.

L'intégration d'isolats de *D. gallinae* ainsi que de quatre autres espèces françaises a permis la comparaison de variations intraspécifiques entre espèces proches tant sur le plan phylogénétique qu'écologique.

5.2.a.3 Principaux résultats

Les séquences isolées des deux gènes (mt-Co1 et Tropomyosine) ont montré des polymorphismes comparables entre eux en fonction des espèces. La diversité haplotypique entre isolats de *D. gallinae* et isolats de *D. apodis* et *D. hirundinis* prélevés *in natura* s'est avérée significativement plus élevée chez la première espèce dans les deux gènes. Le nombre d'haplotypes et la diversité haplotypique au sein des isolats correspondaient bien aux valeurs attendues suivant les lois de la coalescence.

Les arbres de gènes mitochondriaux et nucléaires ont montré une incongruence quant au point d'enracinement par les outgroups, mais les groupements spécifiques sont identiques et l'ordre des branchements entre les différentes espèces comparable. Une résolution beaucoup plus importante des relations interspécifiques qu'avec les ITS (Publication III) a été notée avec la Tropomyosine. Les événements de recombinaison semblent relativement peu nombreux sur la portion analysée. Plusieurs sites à insertion/délétion jalonnent la séquence. L'information phylogénétique qu'ils apportent a semblé indéniable (congruence des topologies obtenues en maximum de parcimonie avec gaps exclus (CI=0,80 RI=0,93) et avec une matrice codant les insertions/délétions seules (CI=0,72 RI=0,94)). Ils sont en outre marqués par une variation intraspécifique.

Une polyphylie est apparue dans l'arbre des séquences de Tropomyosine chez *D. longipes* (2 lignées indépendantes). Des informations contenues par les séquences d'ITS obtenues dans le cadre

de la publication III corrélées à deux séquences publiées en 2008 par Brännstöm *et al.* ont confirmé la présence d'une espèce cryptique.

L'inclusion de *D. hirsutus* dans l'analyse a permis d'éliminer une irrésolution notée dans la publication III quant à la position de cette espèce (séparée, quoique sans support, de *D. quintus* sur la base des ITS, nucléaires, et non des marqueurs mitochondriaux). Le polymorphisme très faible des ITS explique sans doute cette irrésolution. La reconstruction basée sur la Tropomyosine a confirmé sa position proche de *D. apodis*, avec des valeurs de supports significatives. Cela est venu renforcer l'invalidation de la division groupe *gallinae* / groupe *hirsutus* de Moss évoquée dans la publication III. Le groupe *hirsutus* s'embranchement manifestement, aussi bien sur la base des séquences mitochondriales que nucléaires, au beau milieu du groupe *gallinae*.

La Tropomyosine permet une résolution plus importante des relations interspécifiques que l'ensemble des autres gènes testés avec un taux d'homoplasies réduit (CI=0,8238, RI=0,9320 avec les gaps considérés comme 5^{ème} état ; CI=0,8023, RI=0,9263 gaps exclus). La topologie retenue (Fig. 7), suivant le critère du maximum de parcimonie (gaps considérés comme un 5^{ème} état), dessine une organisation proche de celle suggérée par la mt-Co1, mais le clade des espèces « rustiques » (clade A mitochondrial) se révèle paraphylétique. Toutefois, aucune contradiction dans l'ordre de branchement des entités spécifiques n'a été détectée. Le clade (*D. gallinae* + *D. apodis*) constitue l'entité distale, la plus dérivée.

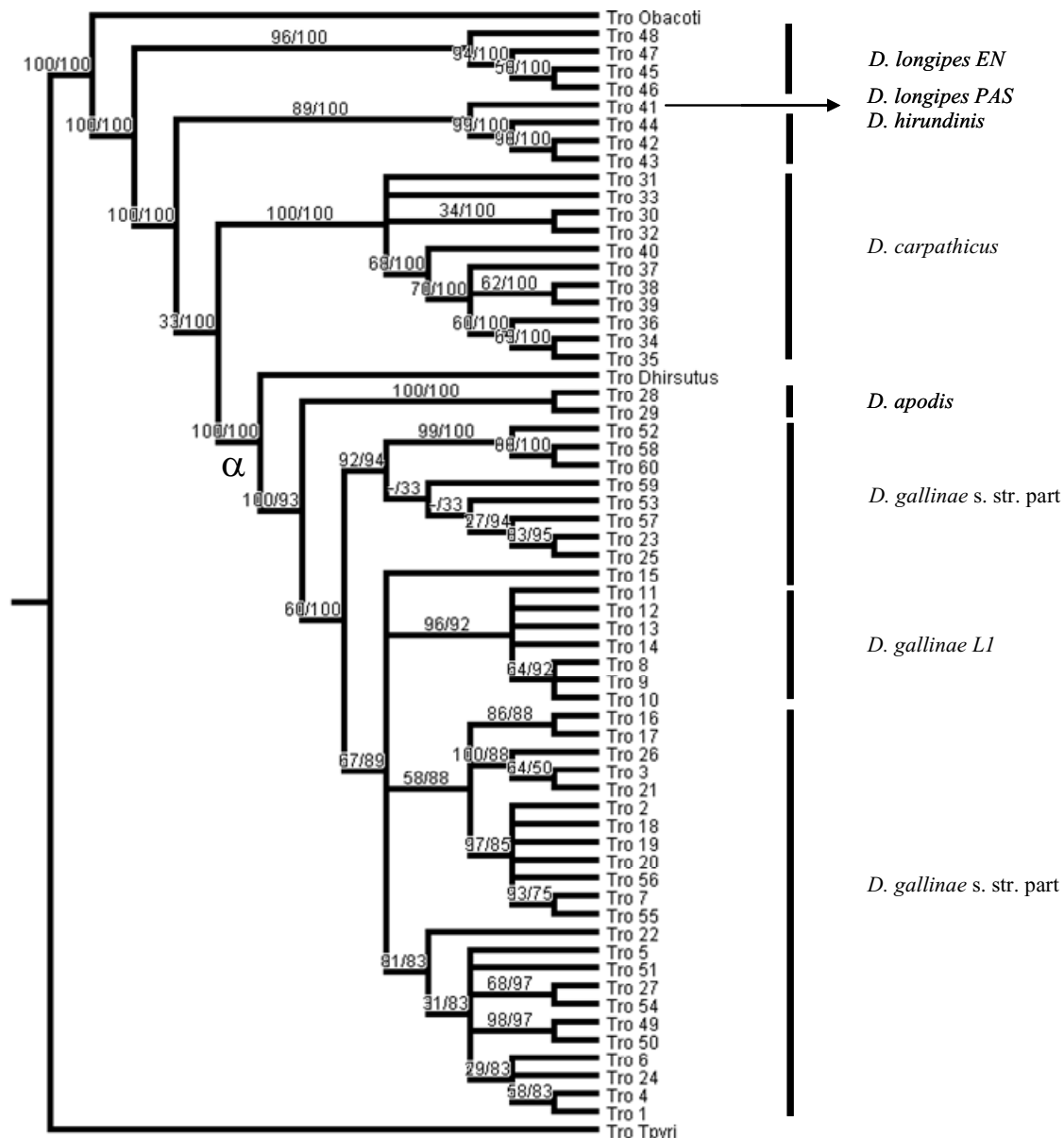

Figure 7. Topologie finale retenue (consensus strict). Tropomyosine, maximum de parcimonie (PAUP 4.0), gaps traités comme un 5^{ème} état. Consensus strict de 264 arbres équiparcimonieux, L=1288, CI=0,8238, RI=0,9320. Les numéros aux nœuds représentent, dans l'ordre, les valeurs de bootstrap obtenues après 1000 répliquats / les indices de Bremer relatifs.

Par ailleurs, les données de polymorphisme intra-isolat, de différenciation inter-isolat et les topologies phylogénétiques ont convergé vers la mise en évidence d'une radiation suivie d'hybridations qui semble avoir eu lieu peu de temps après la spéciation entre *D. gallinae* et *D. apodis*, dans la lignée *D. gallinae*. Dans la faune sauvage, le polymorphisme intra-isolat très élevé et la différenciation relativement faible entre isolats sur la base des séquences théoriquement moins dérivées de Tropomyosine (nucléaire) contrastent avec le polymorphisme intra-isolat réduit et la forte différenciation entre isolats de la mt-Co1 (mitochondriale). Les analyses utilisant la méthode ABC ont aussi permis de mettre en évidence des flux de gènes anciens plus importants que les contemporains. Les différences théoriques du taux de mutation de ces deux loci, corrélées à la taille

efficace de la population N_e des génomes mitochondriaux et nucléaires, ont permis d'interpréter l'image générée par la mt-Co1 comme plus récente que celle résultant de l'analyse des séquences de Tropomyosine. L'homogénéité relative des séquences de mt-Co1 témoigne d'une différenciation récente des isolats les uns par rapport aux autres. L'hétérogénéité importante des séquences de Tropomyosine témoigne d'un brassage ancien de populations longtemps isolées entre elles. Cela a suggéré une hybridation entre plusieurs espèces naissantes, antérieure à l'isolement signalé par la mt-Co1. La persistance plus ou moins marquée de deux lignées (L1, L3) au sein de ce complexe entre les deux loci, la multiplicité des lignées mitochondriales contenant des séquences de Tropomyosine très divergentes et la mise en évidence par la méthode ABC de flux de gène ancien plus important que les modernes soutiennent l'hypothèse d'une radiation ancienne, avortée ultérieurement par des hybridations multiples. Les hybridations postérieures à la radiation sont très probablement la conséquence de l'homogénéisation des milieux par l'action humaine. D'une manière générale, en brisant des frontières écologiques, celle-ci peut aboutir à la mise en contact de lignées récemment séparées, dont l'isolement reproducteur est encore réversible (Seehausen *et al.* 2007). Des événements d'hybridation non seulement interrompent le processus de spéciation en cours, mais encore, en produisant de nouvelles combinaisons de gènes, qui plus est dans un environnement brutalement altéré, la sélection naturelle intervient et une accélération du processus évolutif tend à en résulter.

Les populations au sein de *D. gallinae* sont apparues en outre très différemment structurées entre faune sauvage et élevage. Alors que l'isolat sauvage de références IL offre des valeurs de polymorphisme équilibrées, des déséquilibres importants dans les élevages sont mises à jour dans les valeurs de polymorphisme (valeurs observées significativement inférieures aux valeurs attendues).

Plus précisément, des déséquilibres importants sont constatés chez tous les élevages sur la base de la Tropomyosine, mais seulement chez certains d'entre eux sur la base de la mt-Co1 (nombre d'haplotypes et diversité haplotypique très inférieurs aux valeurs estimées).

Toutes les populations d'élevages semblent avoir subi un événement fondateur ancien, dont la marque est importante sur les caractéristiques du polymorphisme des séquences de Tropomyosine, si l'on compare les isolats d'élevages et les isolats sauvages. Elles semblent en outre avoir une origine commune (poules pondeuses de France, du Danemark, de Belgique, de Pologne, poulets de Bresse).

L'information associée aux déséquilibres du polymorphisme relevés dans l'analyse des séquences de mt-Co1 est un peu plus délicate à manipuler. En effet, l'image plus récente dessinée par cette séquence mitochondriale souligne des différences d'un autre ordre. L'isolat sauvage de référence offre une diversité mitochondriale très réduite (4 sites ségrégeants, 5 haplotypes), contrastant fort avec sa diversité nucléaire (37 sites ségrégeants, 19 haplotypes). Cela suggère que le génome mitochondrial de la population dont il est le représentant a eu le temps, depuis l'hybridation consécutive à la radiation évoquée ci-dessus, de dériver suffisamment pour retrouver un équilibre naturel en se développant à l'écart d'autres populations. Si l'on considère cet isolat comme le représentant de l'état « naturel » du génome de *D. gallinae*, les déséquilibres relevés ici dans les élevages, semblent représenter plutôt le signe de la mise en contact récente de populations longtemps isolées, plutôt que la marque d'une sélection brutale et passée d'un petit nombre d'individus. Or SK, représentant de la seule population dont nous connaissons l'histoire depuis 12 ans (élevage en laboratoire), manifeste un équilibre similaire à celui constaté chez IL sur la base de la mt-Co1, à la différence des autres isolats provenant directement d'élevages de poule. Le confinement au laboratoire de cet isolat s'oppose à l'effet de l'introduction de populations différentes. Il est donc

apparu donc évident que les isolats testés prélevés dans des élevages de poules françaises ont subi des mélanges récents de populations qui ont évolué assez longtemps séparément pour avoir développé des haplotypes de mt-Co1 très divergents. Paradoxalement, l'haplotype Co 1, extrêmement récurrent dans les isolats d'élevage de poules françaises dont un petit nombre seulement d'individus a été séquencé, mais absent des élevages d'autre pays et des autres types d'élevage, vient corroborer cette interprétation : les moyens de transports motorisés utilisés au sein de la filière pouleuse, tout au moins en France, participent pour une grande part à la dissémination de l'acarien. Même si l'on ne sait pas exactement quel est (ou quels sont) les vecteur(s) de ces arthropodes pour transiter entre l'élevage et le véhicule motorisé (cartons, cages, charriots, poules, techniciens, ...), la forte décorrélation entre distances géographiques et caractérisation mitochondriale est un argument de poids en faveur du rôle primordial des mouvements commerciaux.

L'espèce *D. gallinae* se présente comme un complexe de lignées en ébullition, qui ont évolué séparément les unes des autres, puis se sont hybridées entre elles dans le passé. A l'heure actuelle, des mixages incessants sont en outre réalisés par l'action des transports commerciaux, rendant encore possible de nouvelles hybridations. D'une manière générale, une évolution accélérée et une flexibilité bien supérieure caractérisent l'espèce généraliste *D. gallinae* si l'on compare à ses sœurs spécialistes. Ces particularités intrinsèques associées à de nombreuses preuves d'une adaptabilité remarquable et couronnée de succès (spectre d'hôtes large, synanthropie, expansion en cours constatée dans certaines zones du monde) clament le caractère fondamentalement apte à l'invasion de cette espèce. Le tableau réunit la plupart des caractéristiques recensées par Lee (2002), propres à ces rares espèces capables de passer toute les étapes de l'invasion décrites par Williamson (1996) : importation, introduction, établissement, développement nuisible. Et ce n'est pas un hasard si ce parasite généraliste se présente comme une entité dérivée dans un groupe de parasites dont l'état plésiomorphe de la spécificité d'hôte est l'état spécialiste. Une fois encore, le caractère spécialiste pour un parasite n'est pas un cul de sac évolutif (Desdevises *et al.* 2002) et l'augmentation de la spécificité d'hôte n'est pas nécessairement un progrès.

Au sein de *D. gallinae*, la lignée L1 semble bien isolée des autres sur le plan reproducteur, quoique la divergence demeure encore très faible sur la base de la Tropomyosine. Elle pourrait représenter une espèce cryptique, mais il n'est pas certain que l'isolement ne soit pas réversible. *D. longipes* contient une espèce cryptique, déjà bien divergente sur la base de la Tropomyosine.

***Dermanyssus gallinae* (Acari: Mesostigmata) possesses characteristics of an invasive species, compared to four other *Dermanyssus* species**

Roy L.*, Lopes J.S.**, Dowling A.P.G.***, Chauve C.M.*, Buronfosse T.*

* Université de Lyon, Ecole Nationale Vétérinaire de Lyon, Laboratoire de Parasitologie, Marcy-L'Etoile, France

** School of Biological Sciences, University of Reading, Reading, United Kingdom

*** Department of Entomology, University of Arkansas, Fayetteville, USA

Corresponding author: Lise Roy, Ecole Nationale Veterinaire de Lyon, 1 avenue Bourgelat, 69280, Marcy l'Etoile, France. Tel: 334 78 87 25 25; Fax: 334 78 87 25 77; l.roy@vet-lyon.fr

Running head: *D. gallinae*, invasive species

Abstract

Some organisms may rapidly adapt to new conditions, whereas their close relatives may not, due to both various ecological parameters and intrinsic characteristics. Genetic traits allow some plant or animal species to become successfully invasive when an opportunity arises and host specificity within host-parasite systems is governed by similar rules. The Poultry Red Mite, *Dermanyssus gallinae*, is a common and harmful pest in layer farms. It is the only species of *Dermanyssus* present in farms and the least host specific species within this genus of bird ectoparasites.

The aim of the study was to clarify the phylogenetic relationships of *D. gallinae* with four close relatives present in France and to test whether any conspicuous differences exist in the intraspecific molecular polymorphism between these species.

A region of mitochondrial gene coding for cytochrome oxidase I and a region of the nuclear coding gene of Tropomyosin including an intronic part were tested using phylogenetic and population genetics tools.

The phylogenetic relationships revealed a derived clade of *D. gallinae*+*D. apodis* preceded by *D. carpathicus* and the most basal species *D. hirundinis* and *D. longipes*. Apparently, within *D. gallinae*, radiations have occurred a few times after the split between *D. apodis* and *D. gallinae* and subsequent interbreedings between nascent species interrupted most of these speciation events. A comparison of genetic data between wild isolates of *D. gallinae*, *D. apodis* and *D. hirundinis* shows a significant difference of haplotype number and diversity, the former having far more variable sequences than the two latter in both loci under test.

Within *D. gallinae*, population structure clearly separates parasites from wild and domestic birds and there appears to be very little migration between the two host groups. Moreover, at least one ancient founder event is detectable in isolates from European layer farms. Recent migrations between French isolates show an important role of trade flow in the dissemination of *D. gallinae* between French layer farms.

Present ecological and farm information along with obtained results led to several insights in favor of *D. gallinae* as a typical invasive species.

Key words

D. gallinae, phylogeny, population, invasive species, *Dermanyssus*

Summary

<i>Abstract</i>	131
<i>Key words</i>	131
<i>Summary</i>	132
<i>Introduction</i>	133
<i>Material and methods</i>	135
Biological material	135
Whole dataset	135
“Focused isolates”	135
Farm 8006: exploration of mite movements within a farm building	136
DNA extraction, amplification and sequencing	136
Analyses	136
Matrices	136
Phylogenetics	137
Haplotype networks	137
Population genetics	137
<i>Results</i>	141
Sequence data and haplotype characteristics	141
COI	141
Tropomyosin	141
Haplotype diversity and networks	142
Consistency between mitochondrial and n analyses	143
Phylogenetic congruence at the interspecific level	144
ABC results	145
Genetic relationships within and between populations	146
Haplotype within focused isolates of <i>D. gallinae</i> and other species diversity and heterozygosity	146
Interpopulation diversity and gene flow	147
<i>Discussion</i>	148
Phylogenetic considerations: a prolongation to Roy et al. (2009a)	148
Relationships of <i>D. apodis</i> with other species of the genus <i>Dermanyssus</i>	148
Position of <i>D. hirsutus</i>	149
Derivation of <i>D. gallinae</i> : radiation and subsequent hybridizations	149
<i>D. longipes</i>	151
Intraspecific levels	152
Population structure	153
Range of mite’s mobility	156
Genetic variability according to the mite species	158
<i>Conclusion</i>	160
<i>Acknowledgments</i>	161

Introduction

Along with various ecological parameters, some intrinsic characteristics underlie the potential for organisms to adapt to a new environment. Within a given zoological or botanical group of species, some entities may possess a greater ability to colonize a new habitat than others. This is the case for invasive species, whose close relative may not always be able to invade as diverse habitats. Lee (2002) established that invasive organisms are characterized by diverse characteristics, related to the genetic architecture of the species, which allows the species to rapidly adapt to a new environment when the opportunity presents itself.

In a similar way, in host-parasite systems, the host range may be dictated partly by extrinsic ecological parameters and partly by intrinsic characteristics. Combes (2000) defined two filters genetically controlling parasite-host systems: (1) the genes or gene combinations involved in the encounter between the infective stages and potential hosts and (2) the genes or gene combinations implied in the post-encounter compatibility, i.e. the "durability" of the system. Thus, the host range may vary from one parasite species to another closely related one partly due to the physical possibilities of switching to various hosts (ecological parameters) and partly due to intrinsic characteristics allowing the parasite to rapidly adapt to a new host (*ie.* to a new environment). Generalist and specialist species in the Trematoda genus *Lamellodiscus* not only tend to respectively group together in phylogenetic topologies (Desdevises et al. 2002), but also generalist species have a much more important genetic (and morphological) diversity than specialists (Kaci-Chaouch et al. 2008). Authors of the latter article show that such a difference is rather an indicator of an intrinsically different genetic architecture allowing more variable species to adapt to a wider range of hosts/environments, than a consequence of the genetic isolation of the specialists. Finally, authors of the former paper also showed that specialists were not "dead-ends" as usually believed. Generalists in *Lamellodiscus* appear as derived ("more evolved") species.

In contrast to typical parasites, micropredators provide more distant relationships with their individual hosts, as they sample food only as needed and typically do not continually stay on the host. Population structures in mosquitoes – whose adult females are micropredators - are mainly dependent on factors that are unrelated to their prey (macroenvironment), such as rainfall and opened water containers (Paupy et al. 2005), and reproductive isolation by geographical distance is very reduced (Gorrochotegui-Escalante et al. 2000).

Following Kuris and Lafferty (2000), *Dermanyssus* species in the *gallinae*-group fall into the micropredator category, not in the typical parasite category since adult females feed successively on different host individuals like mosquitoes or bed bugs. Thus, within *Dermanyssus*, Moss (1978) highlights two different ways of life. Species in the *hirsutus*-group live almost permanently on a host, regularly taking small blood meals, which do not result in a conspicuously distended opisthosoma, and laying eggs among feathers as opposed to the nidicolous species of the *gallinae*-group. Many experiments performed on *D. gallinae* De Geer, 1778 (Wood 1917, Reynaud et al. 1997, Nordenfors et al. 1999) have shown that most of their time is spent within various crevices present around the bird and that only a short amount of time is needed to obtain a blood meal (1/2h-1h1/2 in *D. gallinae*). Life-cycle in the *gallinae*-group is as follows: egg is laid in the environment, larva moults into protonymph without feeding, protonymph and deutonymph each need one blood meal to moult into the subsequent stage (deutonymph and adult, respectively). In these species each blood meal is sizeable, resulting in engorgement and massive expansion of the opisthosoma (Radovsky 1994). During the adult stage, the male does not feed and the female needs only one blood meal per gonotrophic cycle (one egg laying session each and typically eight gonotrophic cycles per individual). Overall, feeding habits in adult females and several life history traits are strikingly comparable to micropredator bed bugs, much more than to

mosquitoes whose young stage ecology and winged condition represent important differences with *Dermanyssus*.

Micropredator species within genus *Dermanyssus* were until recently considered to have a very broad host range. However, unexpectedly, some of the micropredator *Dermanyssus* species turned out to be more specific than previously believed (Roy et al. 2009b). As they are not winged, it is likely that these species are more dependent on the prey's microenvironment, even if not necessarily on the host individual, and therefore constitute an intermediate case between winged micropredators and typical parasites for the purpose of studying characteristics associated with parasite dispersal.

Dermanyssus gallinae is the only species of the genus currently infesting European poultry farms, mainly in layer farms, whereas four additional closely related species are commonly found in wild bird nests (Roy et al. 2009b). In these layer farms, *D. gallinae* causes problems such as downgraded eggs, stress, anaemia, and increased mortality, and is therefore a pest of great economic importance. This species has also been shown to inducing problems in wild avifauna (ex. pigeons, Clayton and Tompkins 1994, 1995). Other species encountered in wild avifauna in France are *D. hirundinis* Hermann, 1804; *D. longipes* Berlese and Trouessart, 1889; *D. carpathicus* Zeman, 1979 and *D. apodis* Roy, Dowling, Chauve and Buronfosse, 2009 (all in the Moss' *gallinae*-group). Of these species, only the former's impact on hosts has been studied and that was in the United States (Johnson and Albrecht, 1993; Pacejkaa et al. 1996, 1998). None of these studies resulted in an observed impact even though mite population growth was conspicuous.

Within Moss' *gallinae*-group, Roy et al. (2009a,b), highlighted a strong opposition between two main clades, one of them consisting of *D. gallinae* haplotypes and potentially cryptic species ("synanthropic clade" or clade B in Roy et al. 2009), the second one grouping *D. hirundinis*, *D. longipes*, *D. carpathicus* and *D. apodis* ("tough clade" or clade A in Roy et al. 2009 due to their presence only in wild avifauna).. This opposition seemed to be correlated with a few ecological traits, and especially with the level of host specificity. The five species of *Dermanyssus* examined in Roy et al. (2009b) tend to group together, based on COI, according to their respective level of host specificity, the latter clade grouping specialist species, the former a diversity of generalist lineages. Such a distribution of host specificity levels had already been noted in the fish parasite genus *Lamellodiscus* (Trematoda: Monogenea), composed of typical parasites (Desdevises et al. 2002). And yet, these two parasitic taxa possess very divergent habits, the mites acting as micropredators and the trematodes as a more typical ectoparasite. As unwinged micropredators, *Dermanyssus* species are likely to be tightly bordered on the hosts' microenvironment, and so may have an intermediate behaviour between typical ectoparasites and mobile micropredators. Although members of the *gallinae*-group are nidicolous, Roy et al. (2009b) established that the bird host was also a vector of the mites, but that prolonged contact with the new nest seemed necessary for invasion by the mite.

This study has the following two objectives:

- (1) Assess the utility of a newly developed and original nuclear marker (Tropomyosin exon n, intron n and exon n+1) for the exploration of interrelationships between and within species belonging to *Dermanyssus* and comparing these results to previous studies (Roy et al. 2009a,b)
- (2) Address the following questions at an intraspecific level:
 - a) Are the generalist *Dermanyssus* lineages effectively composed of cryptic species (potentially making them as specialized as the "tough species")
 - b) Do generalists have more evolutionary flexibility than specialists?
 - c) What are the respective roles of commercial movement and potential exchange between wild and domestic birds in the dissemination of *D. gallinae* populations?

In order to sufficiently address both objectives, a combination of haplotype-based phylogenetic and genealogical approaches, tests based on coalescent theory, and statistical analyses of haplotype frequencies and diversity were conducted. Data from two independent loci, COI (mitochondrial) and Tropomyosin (nuclear) from isolates of various geographical, ecological and host origins were utilized in this study. The first objective will be dealt with by comparing obtained results from Tropomyosin with previous results utilizing COI, 16S, and ITS (Roy et al. 2009a, b). The second objective will be dealt with by the means of intraspecific considerations and of a recurrent linkage with previously known life history traits and newly observed ones. The inclusion of isolates of *D. gallinae* along with isolates of the four other French species will allow the comparison of obtained information on genetic diversity in the focused species and closely related species. Thus, these species are phylogenetically, but also ecologically close to *D. gallinae*, as all species tested are hematophagous ectoparasites and have nidicolous habits.

Material and methods

Biological material

The location, host species, mite species and other information linked with sampled mites are listed in Appendix 1. Mite isolates have been sampled from farms or from wild bird nests as described in Roy et al. (2009b). The distribution of samples is rather large and diverse within France, and includes a few samples from other European countries (ex. The Netherlands, Belgium, Poland, USA) (Appendix 1). Nests were analyzed using a method described by De Lillo (2001) except that no sodium hypochlorite was added to the water solution to wash the stack of sieves and that the sieves had a somewhat different mesh width (top to bottom: 2500 μm , 1400 μm , 180 μm , 100 μm).

Whole dataset

One isolate corresponds to mites of a single *Dermanyssus* species, isolated from an individual nest or from a group of nests closely located to each other in a bird colony (wild avifauna) or from a single building (farms). From each population, 1-5 individuals have been separately sequenced.

“Focused isolates”

From six of these populations (1 *D. apodis*, 4 *D. gallinae s. str.*, 1 *D. gallinae* special lineage L1 ; see Roy et al. 2009a), 18-24 individuals have been separately sequenced, in order to get an overview of the intrapopulation variation: 4 populations in *D. gallinae* (SK, 8006B1, 8020, IL), 1 in *D. apodis* (GO). Moreover, 21 individuals belonging to *D. hirundinis* collected from barn swallows distributed around France were included in the analyses. Due to conspicuously weak variability in both genes tested, it is handled here as a pseudo isolate among focused isolates. These seven groups will be referred to as “focused isolates” and used specifically for population genetics analyses.

The 4 isolates of *D. gallinae s. str.* were selected as follows: 3 farm populations and 1 wild population. Isolate SK was sampled in a Danish layer farm in 1997 and, since then, it has been cultured in lab by O. Kilpinen (Lyngby, Denmark), 8020 and 8006 directly come from two different layer farms (NW and Center of France, respectively) and IL was isolated in nests of a colony of European starlings nesting in a group of nest boxes installed and maintained by J. Komdeur near Groningen (The Netherlands). The L1 focused isolate was sampled in an amateur pigeon breeding facility in France (9001).

Farm 8006: exploration of mite movements within a farm building

Finally, 16 individuals randomly selected from a mixed aggregate of mites sampled from six different points in a single building (B5) in farm 8006 (see Appendix 1) were sequenced for COI. The obtained haplotype data were compared with COI obtained from a single point in a neighbouring building on same farm (focused isolate 8006B1).

DNA extraction, amplification and sequencing

DNA was extracted from individual adult females following a protocol that preserves an intact cuticle for voucher preparation and microscopic observation. Only females were sequenced in order to get maternal and paternal information from nuclear Tropomyosin as *D. gallinae* has been shown to be haplodiploid and reproduce through arrhenotokous parthenogenesis (Oliver 1966; Hutcheson and Oliver 1988).

From most individuals a 700-800 bp amplicon of COI (total length dependent on primer pair used) and a 600-700 bp amplicon of Tropomyosin were separately isolated by PCR, and then sequenced. PCR was performed in either a Biometra TGradient or a MWG AG Biotech Primus 96plus thermal cycler in a solution containing 2 µl of template DNA, 2.5 units of Taq polymerase, 10 nmol of dNTPs, 20 pmol of each primer and 3.4 mM (COI) or 1.4 mM (Tropomyosin) MgCl₂. After an initial denaturation step (95°C) for 10 minutes, 40 cycles of 20s at 95°C (denaturation), 30s at 52°C for COI or 56°C for Tropomyosin (hybridization), and 90s at 72°C (extension). A final extension step was carried out for 10 minutes at 72°C. Several primers designed for amplification of both DNA regions from various species are listed in Table 1 and were chosen to perform PCR under the same conditions for each of the two loci.

Negative and positive controls were run with each round of amplification. PCR products were checked by electrophoresis in a 1% agarose gel. PCR products were sequenced by Genoscreen (France, Lille) using a 96-capillary sequencer ABI3730XL.

For sequencing PCR primers were used and in some instances, in cases of Tropomyosin heterozygosity, internal primers were designed and used to effectively separate and sequence both alleles.

Analyses

Matrices

DNA alignments were performed using MUSCLE 3.7. Without refinement, MUSCLE has been shown to achieve accuracy statistically indistinguishable from T-Coffee and MAFFT, but overall is the fastest of the tested methods for large numbers of sequences (Edgar 2004). Seaview 4.0 (Galtier et al. 1996) was used for DNA alignment handling and seven different matrices were generated of four different types:

- Isolate DNA matrices are complete alignments of all obtained DNA sequences (one matrix per locus) (alignment ISOL_COI = the matrix containing all mt-CoI haplotypes; ISOL_TRO1 = a first Tropomyosin alignment including alleles from 82 mite individuals which serves as the reference for molecular characterization (cf. §Sequence data and haplotype characteristics), ISOL_TRO2 = the definitive Tropomyosin alignment containing all obtained Tropomyosin alleles).
- Haplotype matrices are alignments of haplotypes as individualized using DNAsp v5 (Rozas and Rozas 1995; Librado and Rozas 2009) (one matrix per locus)
- A matrix of encoded In/Del has been elaborated by encoding as discrete characters the presence/ absence and, when present, polymorphism of inserts at points where gaps are noted in the alignment of the whole Tropomyosin sequences dataset. This

insertions/deletions have been there encoded as if they were morphological or biochemical characters; see Appendix 2.

- An Arlequin matrix of Tropomyosin genotypes and a matrix of COI haplotypes for each focused isolate and each species

Phylogenetics

Each of the haplotype matrices and the matrix of encoded In/Del have been processed in phylogenetic analyses, including data on all isolates belonging to the five targeted *Dermanyssus* species. One individual of *D. hirsutus* and two outgroups were also included.

Analyses

For analyses using the maximum parsimony (MP) criterion, individual molecular datasets were run using PAUP 4.0. For DNA alignments of Tropomyosin, gaps were successively treated as missing and as a fifth state.

For Bayesian analyses the Tropomyosin data set was run using MrBayes (Huelsenbeck and Ronquist 2001; Ronquist and Huelsenbeck 2003). A model of evolution was applied to the dataset as determined for each gene by MrModeltest (Nylander 2004) for Bayesian analyses. Analysis of Tropomyosin used the GTR+ Γ +i model, which was determined in MrModeltest using Akaike information criterion (Akaike 1974). Parameters within the model were not specified (or fixed) and MrBayes was left to estimate these independently from the data during analysis. Analyses in MrBayes included two independent runs, each consisting of four chains and 5,000,000 generations. Appropriate burnins were determined based on stationarity being reached through the use of Tracer v1.4 (Rambaut and Drummond 2007).

Some coalescence ratios inferred from obtained topologies are presented in Table 2.

Haplotype networks

In order to roughly represent interrelationships between and frequencies of haplotypes within *D. gallinae* and to take into account the potentially reticulate characteristics of these *a priori* intraspecific interrelationships, parsimony networks of haplotypes in this entity were produced using Network 4.510 (Bandelt et al. 1999) using the median-joining network algorithm and with a post-processing MP analysis.

Population genetics

The aim of using population genetics tools to analyse the data was to recover demographic parameters such as ancient and modern population sizes, values of gene flow and time of divergence between the populations. Both inter- and intraspecific analyses were performed. The latter were performed solely within the *D. gallinae* specie since this group was by far the best sampled one. These analysis were conducted on isolates from various habitats with two different group divisions: ecological categories (French layer farms, Non French layer farms, Wild birds, Non hen farms); by isolate (corresponding to geographical categories : Netherlands, Denmark, France SE, France NW, France Center).

Finally a third study involving interspecific relations was performed. Although still not very widespread, the use of population genetics tools in phylogenetics studies has been steadily increasing (Miller et al. 2005; Hamilton et al. 2005). Population genetics analysis using Approximate Bayesian Computation (Beaumont et al. 2002) has been shown to be particularly useful in interspecies inferences, namely in colonization situations (Pascual et al. 2007), in speciation due to geographic expansion (Ferran et al. in submission), allopatric speciation (Hickerson et al. 2006) or in presence of several expansion events as in the humans out-of-Africa model (Fagundes et al. 2007). Advantages of using population genetics tools

come from the use of well sampled populations to estimate demographic parameters mostly disregarded by phylogenetic approaches. This last study involved mites belonging to the three best sampled populations each from a different species (*D. gallinae*, *D. apodis*, *D. hirundinis*). The test was performed on individuals from bird nests only. In these analyses, farm and other human managed habitat have been excluded as only *D. gallinae* is present in such conditions (Roy et al. 2009b).

In all the three studies an Isolation with Migration (IM) model was presupposed. This population model assumes the existence of ancient populations with constant sizes that splits originating two other populations in a single instantaneous event. After this splitting there is the possibility of gene flow between the newly formed populations or between themselves and other existent populations (Wakeley, 1996). This model was chosen because it allows for the study of the branching history of the population tree while permitting to study patterns of gene flow between the assumed groups.

ABC methods

Likelihoods for IM models can only be computed for relatively simple scenarios containing few parameters (Hey and Nielsen, 2007). In fact, likelihood functions can be practically impossible to solve analytically when dealing with complex demographic scenarios (Marjoram et al, 2009). Since ABC methods facilitate the comparison of alternative models marginal to the parameter values without the need for calculating likelihoods (Beaumont et al, 2002), their use to solve phylogeographic related problems has become of great interest (Hickerson et al., 2006; Fagundes et al, 2007; Legras et al. 2007).

The standard ABC approach involves two steps (Beaumont et al, 2002): a rejection step and a regression adjustment and weighting step. The rejection step consists of accepting simulations whose summary statistics are close enough to the values of summary statistics computed from the observed dataset. To assess this closeness, a Euclidian distance is computed between the entire set of normalized summary statistics and the normalized summary statistics calculated from the data. A set of values of the parameters is accepted when its Euclidian distance is within a certain percentage of the closest points to the studied data as in the study by Beaumont (2008). The second step is a local linear regression adjustment that attempts to model the relationship between the parameter values and the summary statistics. We assume that in the vicinity of the target summary statistics the relation between parameters and summary statistics is close to linear. This is the reason why the linear regression is performed only for the accepted set of values of the parameters. The regression adjustment has been shown to allow for a better characterization of the space problem since more points can be accepted (Estoup et al, 2004). Also in this step, each accepted set of parameter values is given a weight between zero and one that declines quadratically until a defined distance from the studied data set as used by Hickerson and co-workers (2006).

To reduce heteroscedasticity in the regression, all demographic parameter values were transformed on a log scale. The transformed values of the parameters were adjusted one at a time using a general linear regression on the accepted points. Adjusted values were then back-transformed taking the exponential for all parameters, to express posterior densities on a normal scale (Beaumont et al, 2002; Estoup et al, 2004). The use of a transformation has also the advantage of minimizing the appearance of values outside the prior ranges after performing the linear-regression correction. Previous studies have indicated that under particular circumstances the logistic and related transformations can lead to biases in the posterior densities estimated in the vicinity of the prior boundaries (Ferran et al, in submission). To avoid this problem we choose a log transformation which still allows for points at the lower boundary to be retained within the support of the model. By using this

transformation some points are adjusted by the regression to be outside the upper boundary. These points were then discarded, a procedure that has been shown to give better estimation (Ferran et al, in submission).

A standard backward coalescent process was implemented (Hudson, 1990; Nordborg, 2003) to simulate genetic data. This data are obtained by adding mutations under an infinite sites model for sequence data (Kimura, 1969). Hamilton and co-workers (2005) suggest running several hundreds of thousands to millions of simulations, depending on the complexity of the underlying model. In our simulations 5,000,000 values of the summary statistics sets were generated and a tolerance $\delta = 0.001$ was used to give 5,000 points from which parameters were estimated. When performing model-choice between the suggested different scenarios either 5,000,000 or 10,000,000 points were simulated and a value for the tolerance δ was used in order to obtain the same 5,000 closest points. We used the mode of the posterior distributions as a point estimate of the parameter. The credible intervals were calculated around the mode, following previous studies by Hamilton et al. (2005) and Beaumont (2008).

A program developed by Lopes and co-workers was used to simulate genetic data in an IM model for any number of modern populations (Lopes et al, in submission). The regression step was performed in the version 2.5.0 of the package R (Ihaka and Gentleman, 1996). A script developed by Beaumont was used to perform the step (makepd.r, www.rubic.rdg.ac.uk/~mab/). For all the posterior density estimation from the adjusted sample of parameter values we used the locfit function (Loader, 1996).

Comparison of scenarios using approximate Bayesian computation

Two analysis regarding population structure of *D. gallinae* were performed using an ABC method. The first one concerned the ecological context (host types, **case I**) being the groups divided in: 1) French layer farms; 2) Non-French layer farms; 3) French non-hen layer farms; and 4) wild birds. The second study reflected geographical locations and was composed of 5 groups corresponding to true populations (**case II**): 1) 8006 – in the centre of France; 2) 8020 in the Northwest of France; 3) IL in Netherlands; 4) JBO in the Southeast of France; and 5) SK in Denmark. In both cases, in order to estimate the branching history of the groups, an IM model was assumed. The first study was composed by the listed 4 groups, which corresponds to 18 possible branching histories (Stone and Repka, 1998). However a first approach was performed to assess the presence or absence of migration in all the 18 possible topologies, this led then to a 36 models comparison. The second study involved 5 populations, which correspond to 180 possible topologies (Stone and Repka, 1998). Instead of analysing the 180 single categories the topologies were first grouped in 30 clusters according to the order of the populations branching scheme (see Appendix 3). After this first approach the model choice was performed on the branching histories from the most supported clusters.

A third analyse concerning a inter-species situation was performed. Three populations belonging to different species were considered (**case III**): 1) IL – *D. gallinae*; 2) GO – *D. apodis*; and 3) *D. hirundinis*. This analysis aimed to disentangle the branching history of the 3 species. Absence of gene flow between the species was assumed.

The model-selection steps were performed before estimating the final demographic historic parameters, which were done conditional to the most likely scenarios, i.e. the ones with a higher Bayesian probability. In all of the comparisons the prior probability of each scenario was set to be the same (i.e. uniform prior distribution). The posterior probability of each model was estimated by performing the rejection-step followed by a logistic regression (Beaumont, 2008).

Beaumont (2008) indicated that it is possible to sample the model indicator (i.e. $\{1, 2, \dots, m\}$) for “m” models (M_1, M_2, \dots, M_m) from a prior and treat this as a categorical random variable, X , in the ABC simulations. We can then apply a categorical regression to estimate $P(X=x_1|S=s')$, where $x = 1, 2, \dots, m$ is the indicator for model M_x and s' is the vector of the summary statistics that summarize our observed data. A scheme of weighting was also employed, with weights coming from the same Epanechnikov kernel, as in the standard regression procedure. The regression-step was performed using Beaumont’s R script *calmod* (<http://www.rubic.rdg.ac.uk/~mab>), which needs the VGAM package Yee and Wild, 1996). This procedure has been shown to substantially improve previous methods to select among different models using ABC (Fagundes, 2007; Beaumont, 2008).

Prior distributions of parameters

The priors for the demographic parameters were chosen according to information available from the literature. In the absence of information broad priors were used so that all the realistic scenarios could be taken in account (Appendix 4). Mutation rates both for COI and Tropomyosin were treated as a nuisance parameter. Therefore, a broad prior was used for the loci mutation rates to account for the uncertainty on the estimates. When considering both loci at the same time the variation in mutation rate between them was accounted for by using large prior containing the ranges of values of the priors of the two loci taken separately. In a coalescent method the time is measured typically by generations. For this reasons the choice of generation times was important to translate divergence times in terms of years. The duration of the mites’ lifecycle is highly dependable on the presence or absence of hosts. This can vary from 9-15 generations per year in the wild to around 36-60 generations per year in farms, where hosts are fairly available. However, because we are working with values of time typically on the order of hundreds of thousands of years, whereas the domestication of hens as began at the most 8,000 years ago (Siegel et al., 1992; Yamashita et al., 1994), we assumed an average of 12 generations per year. Furthermore, the domestication of hens in Europe should have happen much later than in its place of origin (West and Zhou, 1988).

Choice of summary statistics

The summary statistics were chosen according to their success in previous ABC studies (Beaumont, 2008). Three summary statistics were then calculated for each sampled deme: number of haplotypes, h ; number of segregating sites, S ; and the average number of pairwise differences, π . These were computed for each of the populations taken individually and for each of the pairs of populations pooled together. Hence, the Euclidian distances were computed from a total of 30 normalized summary statistics in the first case with 4 groups and 45 normalized summary statistics in the second case with 5 populations considered.

Statistical analysis of haplotype frequencies and diversity

Statistical analyses were performed between and within species and between and within the 6 focused isolates. They were performed using the isolate DNA matrices of COI haplotype sequences and individual Tropomyosin alleles (phased alleles in heterozygous individuals and duplicated homozygous sequences, in such a way that sequences represent the diploid state of chromosomes).

Polymorphism in haplotype sequences (COI haplotypes and separated Tropomyosin alleles) within and among the seven “focused isolates” was examined (gaps excluded and as the fifth state in Tropomyosin) and migration rates were estimated using DnaSP v5 (Rozas and Rozas 1997). We estimated the number of segregating sites (S), the average number of nucleotide differences (k), the nucleotide diversity (π_1), and the nucleotide diversity with Jukes and Cantor correction (π_2). Pairwise genetic distances were computed using Fst (Hudson et al.

1992) and statistical significance assessed after 1000 permutations in all cases using Arlequin 3.1 (Excoffier et al. 2005). Effective migration rates (Nm) were estimated from F_{st} and compared with results obtained *via* popABC.

Additionally, in order to obtain an overview of observed polymorphism significance, simulations were performed using the coalescent process tool in DnaSP v5. Based on the coalescent process for a neutral infinite-sites model and assuming a large constant population size (Hudson 1990), allowed us to obtain empirical distributions for two of the above observed parameters with the confidence limit for a 95% interval from the number of segregating sites (S). This way, the expected number of haplotypes (h) and the expected haplotype diversity (H_d) were compared to corresponding observed data.

Results

Sequence data and haplotype characteristics

A 543 bp piece of COI from 211 individuals and a 615-694 bp piece of Tropomyosin from the same individuals was included into the analyses. The COI amplicon was also obtained in 41 additional individuals and the Tropomyosin amplicon in 16 other individuals.

COI

The COI gene fragment corresponds to the positions 403-945 of the *Varroa destructor* COI gene and 135-315 of the *V. destructor* protein (Navajas et al. 2002) and is that used in Roy et al. (2009a and b). All sequences were free of stop codons and amino acids that have been noted highly conserved in insects (Lunt et al. 1996) were equal in all sequences. Based on Lunt et al. (1996), the analysed part of the protein comprised 181 amino acids with two complete and one partial external loops, two complete internal loops and four complete and one partial membrane spanning helices. The alignment was unambiguous and free of gaps.

Tropomyosin

The nuclear Tropomyosin gene fragment involved in the whole analysis corresponds to 10 bp of exon n, a 585-664 bp intron n and 15 bp of exon n+1. Intron n is located between positions 551 and 552 of coding gene in *Boophilus microplus*, based on the complete CDS published in GenBank by C. Johnson (AF124514) and between positions 490 and 491 of the CDS sequence of *D. gallinae* published by Nisbet et al. 2006 (AM167555). In order to check the homology of aligned introns, larger Tropomyosin fragments from 1-2 individuals of four *Dermanyssus* species were first sequenced (individuals GO593, MAR1, 8004b, RQ18, JBO49DL2; see species and EMBL accession number in Appendix 1). This way, five sequences, including a 62-115 bp portion of exon n, the focused intron and a 53-80 bp portion of exon n+1 were aligned. This allowed confirmation of homology. Additionally, an alignment was performed with the above sequences after the intron was removed. The portions of coding region provided in the present study was exactly the same as the corresponding part in the *D. gallinae* CDS sequence in extended sequences of individuals of *D. gallinae*, *D. carpathicus* and *D. longipes*. In the sequences of the two individuals of *D. apodis*, a single nucleotide polymorphism in exon n and 1 in exon n+1 was noted (“C” instead of “T” at position 489 (exon n) and at position 498 (exon n+1) of Nisbet et al.’s CDS). As for the translated amino acids sequences, they were free of stop codons and identical in all six *Dermanyssus* sequences and very close to *B. microplus* (differing by only 3 amino acids).

Within the introns, more than 50 sites involve insertions/deletions, but in many cases a fixed series of 3-5 bp (and even up to 15 bp) is inserted/deleted, resulting in inserted/deleted 35 bp-portions in the whole dataset of *gallinae*-group individuals (see Appendix 2). One region

involves some microsatellite motifs, whose number is strongly varying between species, between populations and within populations. Sites with insertions/deletions have been recorded based on alignment ISOL_TRO1 (available on request from LR) and their distribution all along the region under test is located only on intron n and is rather regular when the five focused species are included (Fig. 1). Anyway, the first hundred and the last hundred base pairs are free of insertions/deletions. When considering only populations of the species of economic interest, *D. gallinae*, 12 regions with insertions/deletions are observed (noted A, B1, B2, C1, C2, D, E, F, G, H, I, J). Region J is the site with varying number of microsatellite motif repetitions (mainly TGA). The inserted/deleted bp series in region G is polymorphic (CAGT /GAGC). The ten remaining inserted/deleted series have been noted as monomorphic in the present study.

Note that inserted/deleted sites are found mainly in addition in *D. gallinae* and *D. apodis* (and in subtraction in *D. longipes*, *D. hirundinis*, *D. carpathicus*). As a result, sequences of *D. apodis* and *D. gallinae* populations are longer than in *D. longipes*, *D. hirundinis*, *D. carpathicus* (670-695 bp vs 615-652 bp).

Haplotype diversity and networks

(Appendix 1 for all species and fig. 2 for *D. gallinae*)

Fifty-five different COI haplotypes were isolated from the five species of *Dermanyssus* tested (three in *D. longipes*, three in *D. hirundinis*, six in *D. carpathicus*, four in *D. apodis*, 35 in *D. gallinae*). Sixty-one different Tropomyosin alleles were isolated from the five species (five in *D. longipes*, two in *D. hirundinis*, seven in *D. carpathicus*, two in *D. apodis*, 36 in *D. gallinae*).

Pure synapomorphies, representing unique signs respectively common to all populations of a given entity (segregating sites, In/Del) were noted based on alignment ISOL_TRO1 and are shown in Fig. 3.

Haplotype networks were calculated, using the Median-Joining algorithm, based on the whole data sets of COI and Tropomyosin sequences, including all sequenced individuals of the *D. gallinae* complex from every sampled isolate, and an outgroup. With $\epsilon = 0$, a treelike topology was obtained in both loci, without any loop between distant haplotypes, suggesting there was no important bias (such as recombination or recurrent mutation) (Bandelt et al 1999). The obtained haplotype networks are shown in fig. 2, with different colours/textures according to the six following categories: wild birds vs birds from farms (ex. French layers, other European layers, amateur layer, chickens, pet birds). The figure presents topologies obtained with epsilon = 10, in which numerous hypothetical haplotypes (corresponding to unsampled haplotypes) are present and form loops with close haplotypes in most cases.

Only five Tropomyosin haplotypes have been sampled from different ecological categories (Tro_1, Tro_2, Tro_3, Tro_8 and Tro_11), other Tropomyosin and the whole COI haplotypes are restricted respectively to a single category.

Isolates of L1 are grouped together in the networks for both loci, and their cluster is much more distant from the *D. gallinae* populations in COI-based than in Tropomyosin-based topology. This lineage emerges among other populations of *D. gallinae*.

Isolates from wild avifauna provide a variety of haplotypes, as opposed to domestic fowl in Tropomyosin (25 different haplotypes in wild birds vs 14 in fowls). In contrast, COI revealed less haplotypes in wild avifauna than in domestic fowls (14 different haplotypes vs 22 in fowls). Based on the Tropomyosin network, wild haplotypes are dispersed all over the network. Additionally, four different points of initial contamination are revealed in hen farms. Of these five points, only four appear as derived (Tro_3+21, Tro_17+16) and the two others are basal to some haplotypes from wild avifauna (Tro_1, Tro_2).

Consistency between mitochondrial and *n* analyses

Based on COI, several strongly characterized lineages have already been revealed within *D. gallinae* (Roy et al. 2009a and b). Of them, two provided apparently strong divergence, suggestive of reproductive isolation and were named L1 and L2 in Roy et al. (2009a).

Moreover, in the present study, one COI haplotype is revealed to be conspicuously recurrent in French layer farms Co_1. Indeed, 12 of the 13 French farms under test possess this haplotype (8002, 8003, 8006, 8009, 8010, 8011, 8018, 8019, 8020, F29, F38, F56) (Fig. 2 and Appendix 1). In the whole dataset, 28 of 29 individuals under test in both COI and Tropomyosin containing this haplotype also contain Tropomyosin allele Tro_1, Tro_2 or Tro_3.

Furthermore, one particular lineage is revealed by Tropomyosin-based analyses: lineage L3 groups together populations from wild avifauna only (Tro 23, 25, 52, 53, 57, 58, 59, 60). Individuals containing these alleles possess COI haplotypes which group together in both BA and MP analyses, but also include four haplotypes found from a Danish layer farm (Co 11, 12, 13, 14). These populations are strongly characterised by insertion/deletion events (Fig. 4C, insertions/deletions only), but also by mutations (Fig. 4B, gaps as missing data). In any case, these correspondences within *D. gallinae* between mitochondrial and nuclear topologies, although dominant, were not recovered in all individuals, as expected at the intraspecific level (Fig. 4A).

Comparison mt-/nDNA analyses

Because cytoplasmic DNA in most organisms is effectively haploid and maternally inherited, they have a genetically effective population size approximately four times smaller than that of nuclear loci (Birky et al. 1989). Therefore, evolution in mt-DNA is usually faster than in nuclear DNA. Due to differences in the effective population size between mitochondrial and nuclear DNA evolution, the monophyly of alleles is expected to appear more quickly in mt-DNA than in nuclear DNA (Palumbi et al. 2001). In the present case, the ratio is reduced to three times due to the haplodiploidy of *D. gallinae*. Thus, this species has been shown to be haplodiploid with diploid females evolving from fertilized eggs (Oliver et al. 1966; Hutcheson et al. 1988). As these authors also observed similar haplodiploidy in a closely related family (Macronyssidae), we assume here that other *Dermanysus* species reproduce the same way.

Although the three-times rule of Palumbi et al. (2001) is not applicable as such due to the haplodiploid condition, the simple comparison of the external branch length / internal branch length in mitochondrial monophyletic groups and of corresponding monophylies allows determining that Tropomyosin is already deeply structured (Table 2). In the COI gene tree, branch lengths between clades are much longer than intraspecific branch lengths in the “tough species”, but not in the “*gallinae* complex” (Roy et al. 2009b). All entities with a ration > 2 recovered monophyly in the nuclear topology. On the other hand, none of entities with a ratio $< 1,5$ recovered monophyly in the nuclear topology, except *D. gallinae*.

Except for L1 (ration 7.3) and Lmt1 (ratio 90), only few nuclear loci were expected to be monophyletic among the lineages within *D. gallinae* (1.5% for Lmt2 and Lmt3). Topologies obtained from Tropomyosin confirmed that lineages of *D. gallinae* drawn from COI were only rarely recovered, except for L1, but with very low divergence (2 segregating sites). The three other major lineages, including Lmt1, were not recovered.

The ABC analysis assumed a no migration model at the interspecific level (case III) and led to migration models intraspecifically (case I, II), which is consistent with phylogenetic topologies.

Statistic population genetic tests revealed much more differentiated populations in COI than in Tropomyosin (Table 3), exactly as it might have been expected due to the reduced effective population size in mitochondrial DNA and as it was suggested by haplotype networks: F_{st} values based on Tropomyosin were sharply higher in interspecific pairs (0.74-0.98) than in intraspecific non L1 *D. gallinae* pairs (0.00-0.32). As for the special lineage L1 of *D. gallinae*, obtained F_{st} values in pairs involving this lineage along with a typical *D. gallinae* isolate were intermediate (0.44-0.65). In contrast, F_{st} values based on COI were roughly similar between each of the pairs under test (0.77-0.99), except for pairs of *D. gallinae* focused isolates involving the individuals of farm 8006B5 sampled in six different points of building B5 (see above ; F_{st} 0.40-0.58).

Phylogenetic congruence at the interspecific level

First, in Tropomyosin, the numbers of pure synapomorphies (representing unique signs respectively common to all populations of a given entity, as opposed to the whole remaining dataset) are by far the most important in *D. apodis* and *D. carpathicus* (52, 49, fig. 3). Other specific entities group with no more than ten pure synapomorphies (Fig. 3).

In present haplotype trees (Fig. 4), the biclade topoplogy described by Roy et al. (2009b) based on mitochondrial DNA, opposing the group of tough species (*D. carpathicus*+*D. longipes*+*D. hirundinis*+*D. apodis*+*hirsutus*-group) to the *gallinae* complex is not supported anymore by Tropomyosin-based topologies. The group of tough species (clade A in Roy et al. 2009b) is revealed to be paraphyletic. Thus, this results in a large basal polytomy (or in an unsupported basal grade) based on gap as missing data analyses (either MP or BA), with *D. hirundinis* and *D. longipes* ENVL as independent haplotypes, haplotypes for *D. longipes* PAS and *D. carpathicus* accordingly grouped and a three species clade α : (*D. hirsutus* (*D. apodis* + *D. gallinae*)). Here, *D. apodis* is a sister to the complex of *D. gallinae* lineages. When considering gap as the fifth state (only MP), the topology appears much more resolved, with strong support values, forming rather like a grade. Tough species of the *gallinae* group are successively distributed at the basis of clade α : (*D. longipes* EN (*D. longipes* PAS(*D. hirundinis*(*D. carpathicus*(clade α))))). A similar topology, although less resolved, is revealed by using a matrix of encoded insertions and deletions (Fig. 4C).

As in Roy et al. (2009a), the relationships of *D. apodis* with other species are not the same in mitochondrial and nuclear analyses. Based on COI, it groups as a sister to (*D. longipes*+*D. hirundinis*+*D. hirsutus*+*D. carpathicus*). Based on the nuclear Tropomyosin, it appears grouped together with *D. gallinae* with strong support (100% bootstrap and 93-100%, rel. Bremer index in MP, 0.91 in BA Fig. 4D). Moreover, the number of pure synapomorphies in Tropomyosin opposing the entity (*D. apodis*+*D. gallinae*) to the other three species of the *gallinae* group is rather important (55, fig. 3). Finally, three ecological observations corroborate such a phylogenetic relation: (1) living mite individuals within *D. apodis* appear visually as active as *D. gallinae* at room temperature when stimulated by slightly breathing on them (in contrast to *D. carpathicus* individuals, which tend to stand motionless, even under breathing stimulations), (2) mite prevalence and density within nests of colony-living birds (swiflets for *D. apodis*, starlings for *D. gallinae*) was similar (up to 79% prevalence of *D. apodis* in GO population, with > 500 mites in many nests; up to 95% prevalence of *D. gallinae* in IL population with > 500 mites in many nests – other species around 30-40% prevalence in RSA), (2) both are proliferating in nests of birds exempt of hygiene against chick droppings (no removal of chick droppings as in tits, redstarts, etc.).

As a result, of the five species under test, *D. apodis* revealed to be the closest species to *D. gallinae*. Therefore, "focused isolates" for statistical analyses include one *D. apodis* population, in order to compare population haplotype diversity between these

phylogenetically and ecologically close species. The pseudo focused isolate DhirF, on the other hand, represents a more distant species (*D. hirundinis*).

D. longipes seems to be composed of two different lineages. Isolates from *Passer montanus* (JBO180 and PAS, Appendix 1) provide a single haplotype in mitochondrial as well as in nuclear topologies, whereas populations ENVL083 and ENVL088 possess 2-4 haplotypes per locus. Phylogenetic analyses revealed that these haplotypes group respectively together and independently from each other in Tropomyosin analyses, whereas only COI topologies present these two lineages as monophyletic (Table 2 and fig. 4). As a result, lineages of *D. hirundinis* and *D. longipes*, which appear to be closely related to each other, form a polytomy in Tropomyosin analyses. Members in this complex, which is basal to the whole *Dermanyssus* species set under test, remain ungrouped in gap as missing data analyses (both MP and BA). Moreover, the observed number of haplotypes (h) and haplotype diversity (Hd) are much lower than expected according to the coalescence calculation based on the number of segregating sites S within *D. longipes* (Table 4).

Isolates of the special lineage L1 (Roy et al. 2009a) group together in both mitochondrial and nuclear analyses (both MP and BA). However, they do not group in an exactly congruent manner with both loci, as this lineage appears as a sister to the remaining *D. gallinae* populations in mt-DNA-based topologies, whereas it arises from within the *D. gallinae* complex in nuclear DNA-based topologies. They diverge by 10-13 % from other *D. gallinae* lineages in COI (1-2 % between each another within L1) and by only two mutational differences (no particular insertions/deletions) from some other *D. gallinae* isolates in Tropomyosin. They are more differentiated in Tropomyosin from *D. gallinae* focused isolates (9001 vs *D. gallinae s. str.* Fst 0.44-0.65; Table 3) than they are between each other (Fst 0.00-0.32), but not as much as from other species (Fst 0.97 with *D. apodis*).

As for the special lineage L2 (Roy et al. 2009a), individuals of isolate LB18 (the only isolate of L2 sequenced with both COI and Tropomyosin), that were characterised by strongly divergent mitochondrial haplotypes, did not reveal any particular Tropomyosin allele. They share an allele that is very frequent in hen farms (Tro_1; fig. 2B). Anyway, only two different individuals belonging to a single isolate have been sequenced in this lineage. Therefore, the monophyly of L2 using the nuclear gene has not been tested in present study. Note that the particular COI haplotypes found in L2 seem to be very scarce, as they were isolated *in natura* in three different nests only through the whole study published in Roy et al. (2009a and b) and the present one.

ABC results

The aim of the first analysis of the *D. gallinae* groups divided by host types is to assess presence or absence of migration. The results show a clear presence of migration irrespectible of the branching tree history between the groups (Fig. 5A, Table 5, Appendix 4A). The presence of migration in IM models can lead to poor inferences of divergence times between populations (Beaumont, 2008). This situation was observed in this analysis with the posterior distributions for times (Table 5) being very close to the chosen prior distributions (Appendix 4A). Nevertheless the analysis strongly supports one topology against all the other. The branching history (((French layer farms, Non-hen farms), Wild birds), Non-French layer farms) has a probability value of 90% (Appendix 4A). Although the posterior distributions for migration rates are quite wide, having large 95% credible intervals, there is a notourious difference between ancient migrations and migrations observed in the modern groups, in

particular the gene flow in ancient times seems to be substantially higher than the ones at the present.

The second analysis refers to well defined *D. gallinae* populations. Each one of these populations is associated with a different geographical location: IL (Netherlands), JBO (France South-East), 8020 (France North-West), 8006 (France Center), SK (Denmark). In a first approach we try to identify the inherent branching tree history between the populations. Since there are 180 possible topologies in a tree with 5 populations, we grouped them in 30 clusters according to their branching scheme (Appendix 3). The analysis was then carried out firstly in these clusters. The results show that clusters D, Q and U have a cumulative probability of being the true underlined topology of nearly 95% (Appendix 4B). We then considered only the topologies represented in those clusters and run a model-choice analysis. The most supported topology by the data is ((8006, IL) ((8020, SK), JBO)) with a probability of 72% (Table 6, Fig. 5B). Despite the high probability value the referred topology is far from having a strong consensus. In fact, analysis carried out with COI and Tropomyosin data taken separately fail to support the same topology (Results not shown). It is not a surprise then that the posterior distributions of divergence times are very wide and close to the assumed prior distributions. Still, a common result between the analysis carried out with the whole data set and with one locus at the time is to indicate the presence of migration in all the ancient populations. Most of the 95% credible intervals of the migration rates, though, include 0 (Table 6).

The final ABC analyse concerns time divergences between the species *D. gallinae*, *D. hirundis* and *D. apodis*. This analysis supported strongly the division of *D. apodis* firstly at around 3.6 Mya followed by a more recent division between *D. hirundis* and *D. gallinae*. Once again there was no consensus between the trees obtained using the locus information separately, namely using the Tropomyosin data, and the tree obtained using the whole data set. Such results are quite interesting, suggesting the existence of genomic related pressures conditioning differently both loci. The posterior distribution of the more recent divergence time is not very informative, having a posterior distribution close to the chosen prior. The posterior distributions for effective population sizes, however, are quite sharp. They point to values between 30,000 and 90,000 with the 95% credible interval not going much higher than 100,000. We should be aware nevertheless that these values refer to the effective population size and not the census size.

Genetic relationships within and between populations

Haplotype within focused isolates of *D. gallinae* and other species diversity and heterozygosity

The average number of differences K in COI haplotypes for “focused isolates” (Table 4) is the most diverse in *D. gallinae* population from farm 8020 (K=4.3) and 8006B1 (K=3.6). In contrast, in *D. gallinae* isolates SK (from farm, but cultured in lab since >10 years) and IL and in *D. apodis* isolate GO, almost no within population diversity was noted (K=0.3, 1.1, 0.4 respectively). *Dermanyssus hirundinis* pseudo isolate DhirF shows a higher K (K=4.6), similar to the K of 8006B1. But it is important to keep in mind that this group of individuals was sampled from across France, as opposed to the five other focused isolates. Moreover, sample 8006B5 (six points in a single building in the same farm as 8006B1) provides the highest K (14.7).

In contrast, the average number of differences K in Tropomyosin haplotypes for “focused isolates” is completely null in *D. hirundinis* pseudo isolate DhirF, whereas K is important in farm *D. gallinae* isolates under test (13.9-17.3), and by far the most diverse in IL (32.5). *Dermanyssus apodis* isolate GO is the only population with relatively comparable diversity

between mitochondrial (0.4) and nuclear (4.6) genes. The intraspecific variation within *D. apodis* is not clearly estimable based on present dataset, as only one isolate was sequenced from a substantial number of individuals (South France). Anyway, the only other isolate involved here of *D. apodis* (MAR, Center France) provided the same haplotypes in both loci. Moreover, three individuals from Corsica provided a COI diverging by only 3-4 nucleotides from GO and MAR (*ie* 0.5-0.7 %; acc. no FN398146), not included in present analyses). These are sizeable insights of the low variability within *D. apodis*, which appears to be independent of geographical location.

The observed number of haplotypes (h) in both loci (Table 4) is similar to the expected one calculated based on coalescent process from the number of segregating sites S in wild groups except *D. longipes* and *D. hirundinis* (*D. gallinae* focused isolate IL, *D. apodis* GO, *D. carpathicus*) with high P values. In contrast, farm isolates show expected h values much higher than the observed ones (*D. gallinae* focused isolate 8006B1, 8020, P values <0.002). Farm focused isolate SK is somewhat special, as it shows much higher expected Tropomyosin h than observed, but an almost equal h in COI. French isolates of *D. hirundinis* did not provide any segregating sites in Tropomyosin.

The haplotype diversity Hd follows a similar scheme except that expected value in COI is a little bit higher than the observed one in *D. apodis* GO and that observed and expected values are similar in the farm isolate 8006B5 (whereas, as in other farm isolates, observed h value remains much lower than expected).

Observed heterozygosity along with the number of Tropomyosin alleles per population are shown in Table 8. An increasing gradient in the number of alleles present in each of the “Focused isolates” is noticeable from SK to 8006B1, with 8020 as an intermediate. The wild isolate IL provides by far the most important number of alleles. The observed heterozygosity and allele combinations showed some more or less important departure from the Hardy-Weinberg equilibrium in focused isolates. Due to the known haplodiploidy by arrhenotokous parthenogenesis (Oliver 1966; Hutcheson and Oliver 1988) within at least *D. gallinae*, and likely within the whole *gallinae* group, the allelic distribution is very likely to be strongly unbalanced (male haploid, female diploid). All the more, the sex ratio in most samples appeared to be unbalanced as well (more females than male). Not to mention various other parameters susceptible to induce a deviation from the Hardy-Weinberg disequilibrium such as inbreeding, this knowledge led us to consider the departure to be expectable and, as a result, to not consider alleles as independent for testing the significance of population differentiation. Therefore, permutation tests of Fst estimates based on Tropomyosin used the genotype as the randomisation unit instead of the allele.

Interpopulation diversity and gene flow

As already sensed by observing the haplotype networks, based on COI haplotypes (Table 3), Fst values indicate a strong differentiation between pairs of isolates within *D. gallinae* in all focused isolates pairs (0.70-0.92). An intermediate differentiation between pairs involving 8006B5 (0.40-0.58) and a stronger differentiation in pairs involving L1 (0.94-0.98) are to be noticed. In contrast, Fst values based on Tropomyosin alleles show very weak differentiation in pairs involving any layer farm focused isolates (0.00-0.11) and weak but somewhat higher in pairs involving the wild isolate IL (0.26-0.32). As for L1, pairs involving individuals in this lineage (9001) show a higher differentiation (0.44-0.65). Estimated migration rates Nm calculated from these Fst values are the highest between farm isolates independently of their geographical location (SK vs 8020: ∞, SK vs 8006B1: 4.19) and reduced between farm and wild isolates (based on Tropomyosin) and almost null in pairs involving L1 (both loci) (Tropomyosin: 0.26-0.64, COI: 0.009-0.031). Furthermore, the ABC analysis also suggest

important gene flow both by considering different groups according to the host types and by considering the different geographically located populations.

Discussion

Phylogenetic considerations: a prolongation to Roy et al. (2009a)

Considering species boundaries within *Dermanyssus* (Roy et al. 2009), *i.e.* branching points, roughly, a congruence between species and an incongruence within species can be noticed. Moreover, coalescence ratios and subsequent predicted percent of monophyly in nuclear topologies inferred from the mitochondrial topology are roughly consistent with observed nuclear topologies. Finally, the absence of detectable gene flow between species is accompanied by visible gene flow within species, as most of lineages drawn from mitochondrial COI are not recovered in Tropomyosin topologies, as pairwise F_{st} values based on Tropomyosin are much higher between species than between populations and as popABC runs led to migration models when processed on intraspecific divisions. All that suggests that both independent loci under test are reliable for investigation of species in the *gallinae* group within *Dermanyssus* at the inter- and intraspecific levels.

Relationships of *D. apodis* with other species of the genus *Dermanyssus*

The relationships between *D. apodis* and other species appear slightly different in mitochondrial and nuclear topologies. The species tree is often not identical to the gene tree (Nichols 2001), due to several potential causes. Reduced effective population size (N_e) in mitochondrial DNA compared to nuclear DNA often causes a higher mutation rate in mitochondrial DNA resulting in less resolved internal relationship in mitochondrial topologies than in nuclear topologies. As a result, in mitochondrial gene trees, the most recurrent bias is due to homoplasy, and inconsistencies in nuclear gene trees are due to the stochastic effects of lineage sorting (McCracken et al. 2005). Additionally, interspecific hybridization in some cases may induce reticulation.

In Roy et al. (2009a), a slight incongruence was already visible between mitochondrial and nuclear topologies, but the nuclear gene region used in this study was not variable enough to establish it firmly: in the present study, *D. apodis* appears definitely as a basal taxon to all others in mitochondrial analyses (as a sister to all other tough species or clade A) or as a sister to the distal *gallinae* complex in nuclear analyses.

The choice of the more appropriate gene tree for relationships between species requires some attention. Some authors considered more appropriate mitochondrial markers for inferring phylogenies at the specific level (Moore 1995 and 1996; Michaux et al. 2002) but they were dealing with organisms with smaller number of generations per year (birds, rodents; *D. gallinae in natura*, around 15 gen/y, in farms, >200 gen/y), and thus with likely reduced mutation rates in both mitochondrial and nuclear genomes. McCracken et al. (2005) recommended a balanced and reasoning approach, taking into account both advantages and flaws due to different effective population size N_e and considering first whether independent gene trees are adequately resolved and then whether those trees are congruent with the species history.

In present topologies, no contradiction with branching point nor in branching order may suggest any introgressive hybridization between the five specific entities under test. The only disagreement concerns outgroup rooting, which acts either among the whole species under test, leading to a biclade topology in mitochondrial trees, or at the base of the *Dermanyssus* clade, with a scale-shaped topology and members of the *hirundinis* group basally distributed to *D. gallinae* in nuclear topologies. Of course, some incomplete lineage sorting events might be responsible of such different gene trees. Anyway, almost no support is provided for basal

nodes in the mitochondrial biclade topology whereas supports for basal scale are superior in the nuclear topology (MP, BA). And Tropomyosin seems to be almost exempt of homoplasies, according to consistency and retention indices for MP topologies ((CI=0.8238, RI=0.9320 with gaps as the 5th state; CI=0.8023, RI=0.9263 with gaps excluded). Not to mention the fact that the strict biclade topology is not recovered in mitochondrial MP consensus tree, in which members of the *hirundinis* group form a basal polytomy, suggestive of the scale-like nuclear tree. For these reasons and as resolution is much higher with present intronic nuclear gene region than with ITS, but not contradictory (Roy et al 2009a), the Tropomyosin topologies are considered the most accurate representative of the *gallinae* group species tree.

Suggestion that *D. apodis* might be intermediate between the clade of tough and synanthropic mites was evoked in Roy et al. (2009a) based on some ecological and phylogenetic observations. This is confirmed here by Tropomyosin analyses. *Dermanyssus apodis* is parasitizing swifts, which are commonly living in towns, appears in Tropomyosin topologies as intermediate between species living *in natura* and more synanthropic lineages of the species of economic importance. *Dermanyssus gallinae* L1 is the only other city nesting taxon in present study, as it lives within pigeon nests, common nesting-sites concurrent of swifts (Nature Midi-Pyrénées 2001).

From the ABC inter-specific analysis with *D. apodis*, *D. gallinae* and *D. hirundis*, *D. apodis* seems to take the roll as basal clade with poor support, though. The divergence between this and the other two species seems to be placed around 3.6 Mya. Again discordance has been observed between the analysis with mitochondrial DNA and the Tropomyosin data.

Position of *D. hirsutus*

The respective positions of *D. hirsutus* and *D. quintus* (Moss' *hirsutus*-group) remained unresolved in Roy et al. (2009a). Unfortunately, we were unable to obtain *D. quintus* Tropomyosin sequence. Anyway, the position of *D. hirsutus* in our Tropomyosin-based topologies is similar to the position obtained in ITS for *D. quintus*. And yet, this was very different from the position of *D. hirsutus* in the same study. In Roy et al. 2009a, the position of these two species of Moss' *hirsutus*-group remained unclear precisely due to the surprising basal position of *D. hirsutus* in ITS only topologies. Effectively, this position was not supported by any node value: it appeared separated from *D. quintus* in BA, and closer to *D. quintus* in MP analysis, but with absolutely no support (basal nodes BPP 0.75, 0.85, 0.56 in BA, % bootstrap/Bremer relative index 34/0.29, 12/0.11 in MP), although with numerous and conspicuous morphological characters in common. Present Tropomyosin-based analyses seem to resolve these interrelationships. And so, the inconsistency of the opposition *gallinae*-group vs *hirsutus*-group evoked by Roy et al. (2009a) is confirmed here and Moss' *hirsutus*-group is definitely arising from within the *gallinae*-group.

Derivation of *D. gallinae*: radiation and subsequent hybridizations

The grade-like MP Tropomyosin topology suggests a more derived state in *D. gallinae* than in the other taxa. But the BA topology does not exhibit longer distances for this species. This analysis does take insertions/deletions into account, although the congruence of gap only topology with others (Fig. 4C, gap only, encoded following appendix 2) strongly suggests that these parts of Tropomyosin sequences contain important and consistent phylogenetic information. A similar topology was already suggested based on ITS sequences by Roy et al. (2009a), but the low amount of DNA divergence in this sequence did not provide strong support.

This grade-like structure also indicates once more, as showed in *Lamellodiscus* by Desdevises et al. (2002), that the specialist condition does not appear as a “dead-end”. *Dermanyssus gallinae*, the generalist species, is, if not the more derived species, at least one of the more distal ones with *D. apodis*, whereas basal positions are occupied by specialist species.

The monophyly of this entity is not doubtful here as it is recovered in all topologies, but this is not supported by many synapomorphies and branch lengths are amazingly short compared to other species such as *D. apodis*, *D. carpathicus*, *D. hirsutus* in both loci (Fig. 4B, F). This induced a low predicted percent of nuclear loci recovering this monophyly (15%, table 2), suggesting that the date of this coalescence occurred much later than coalescences for other species. But the distance of the coalescent node for *D. gallinae* to the common ancestor with the closest species (considering that the right arrangement is recovered by nuclear topologies) is also the shortest. Either the two loci under test in *D. apodis*, *D. hirsutus* and *D. carpathicus* have evolved faster than in *D. gallinae*, or the apparent low rate of evolution within the latter is rather an artifact due to multiple radiations and recurrent interbreeding. The latter alternative appears much more credible as:

- (1) The significantly highest number of nuclear segregating sites within *D. gallinae* isolates (12-37 with gaps as missing and 49-117 with gaps as the fifth state, see Table 4, Tropomyosin) as opposed to isolates or even pseudo isolates in others species (respectively *D. apodis*: 4 and 9, French *D. hirundinis*: 0 and 0, grouped French and American isolates of *D. hirundinis*: 8 and 10, *D. carpathicus*: 11 and 16) is suggestive of the assemblage of formerly highly divergent haplotypes,
- (2) The two lineages L1 and L3 are more or less completely isolated from other lineages within *D. gallinae*, and both are arising from within the species.
- (3) The presence of an important ancient gene flow is indicated by the ABC analysis (Table 5-6). Also, in these studies the topologies turned out to be hard to recover, which is usually caused by population structures more complex than the IM model assumed.

The weak coalescence ratios, as well as the very small number of "pure synapomorphies" in *D. gallinae* as compared to other species seem to result from one or several radiations close to the date of speciation between *D. gallinae* and *D. apodis*, in the former's lineage (hence the very short branch length). The "focused isolate" of *D. apodis* is the only species providing any deviation between observed and expected number of haplotypes in Tropomyosin using the coalescent process in DnaSP (haplotype diversity seems to be well balanced), whereas it shows no deviation in COI. In the same time, the branch length from the closest dichotomy is the longest either in COI or in Tropomyosin Bayesian inferences. This suggests there might have been some hybridization between divergent lineages within *D. apodis*, which would have resulted in an accelerated evolution. A similar event might have occurred within its close relative *D. gallinae*. Seehausen et al (2004) showed that interspecific hybridizations might induce adaptive radiations. And yet, given obtained nuclear topologies, a radiation seems to have occurred soon after the speciation between this species and *D. gallinae*, but subsequent hybridizations between radiate lineages in the process of speciation appear to have stopped speciation in most cases as often reported (Seehausen 2007). This resulted in an apparently reduced rate of evolution (short branch lengths), which may be explained by the successive reintroduction of ancestral polymorphisms. Some remainders of these successive hybridization events and of the adaptive radiation may be found in L1 and L3. Lineage L3 is likely a decaying old lineage, which shows much gene flow and was sampled in a multi lineage area (starling nests...).

On the other hand lineage L1 (Roy et al 2009a, b) seems to clearly represent an entity in the process of speciation. That might be due to interbreeding secondarily associated with a breakdown of the linkage disequilibrium (Seehausen 2007), which might be a consequence of ecological modifications encountered in this lineage since there is evidence that hybridization facilitates major ecological transitions (Rogers and Bernatchez 2007). This hypothesis is

supported by the long branch length in COI, along with Tropomyosin branching. According to obtained phylogenetic topologies, the reproductive isolation of the lineage L1 appears to be confirmed by the similar grouping in both nuclear and mitochondrial analyses, but the position of their Tropomyosin haplotypes in phylogenetic topologies is not as a sister to the remaining *D. gallinae* lineages. Moreover, retained model in popABC (case I: ecological categories) also shows, based on COI, an insertion of L1 within *D. gallinae* (Fig. 5; Non hen farms). On the whole, clues in favour of a branching of L1 among typical *D. gallinae* lineages rather than basal to all them grouped together are numerous. This supports the radiation hypothesis. The number of “pure synapomorphies” is very low and pairwise F_{st} values comparing L1 to *D. gallinae* focused isolates are lower (0.44-0.65) than F_{st} values against the closest species *D. apodis* (0.97), but higher than F_{st} values between *D. gallinae* focused isolates (0.00-0.32) (table 3). This is an incipient speciation in process, confirming the postulate of a species complex evoked by Roy et al (2009b). The cryptic characteristic of this nascent species is consistent with this hypothesis. Usually, in cryptic species, speciation has occurred very early, with no time enough to get marked in morphological characters. Moreover, it has been mainly found in pigeons (appendix 1), which makes it a specialist as seems to be the ancestral condition within the *gallinae* group.

Finally, the above described radiation and subsequent hybridization events could be correlated with the multiple origin of domesticated chickens evidenced by Liu et al (2006). Following these authors, not a single initial strain of the wild red jungle has been first domesticated and not in a single asian area. The nine strongly divergent clades they detected in hens suggest different origins from so distant regions as Yunnan, South and Southwest China ... Different lineages might have mixed together long before chicken domestication for an undetermined reason, which would have resulted in an adaptive radiation. A subsequent hybridization might have followed...

In sum, the generalist and synanthropic *D. gallinae* seems to be a species composed of hybridized species. The lineage complex composing *D. gallinae* is very likely to be a case in point of such man-induced outcomes. Hybridization is more known to enhance adaptation to new environmental conditions in some plants (Schweitzer et al 2002; Rieseberg et al 2003) than in animals. However, several recent studies recently highlighted similar phenomena in some animals (Schwenk et al 2008). Arnold (2004) recorded a variety of animal cases of yield increase in farm animals and development and virulence increase crop pests and disease vectors due to natural hybridizations. This "anthropocentric" review clearly evidenced the recurrent phenomenon of increased adaptability subsequent to interspecific hybridization, in some human-shaped environments. Similar yield increase is visible within species, by hybridization between differentiated populations. For instance, Edmands et al (2005) conducted experiments in some arthropods, which resulted in similar conclusions. Finally, Seehausen et al (2007) explored the correlation between human-induced homogenization of environment and loss of biodiversity and highlighted the numerous cases of speciation reversals following hybridization between young species, between which prezygotic reproductive barriers are not yet fixed. Loss of environment heterogeneity often results from man activity, and in turn results in the contact of previously either geographically (species issued from allopatric speciation) or ecologically (species issued from sympatric speciation) separated.

D. longipes

Splitting within *D. hirundinis* and *D. longipes* is re-estimated with rather three reproductively isolated lineages present rather than two, with our *D. longipes* to be divided into two divergent lineages: PAS and ENVL08 (sampled in two different host genera). The strong

difference between much lower observed h and H_d (table 4) values than expected in *D. longipes* (as opposed to other tough species) reflects important divergence within this group, which is unlikely due to a bottleneck, but likely to a natural separation by reproductive isolation. This was already suggested by a few mutations on the ITS sequence (acc. no FM179377 and AM903310; Roy et al. 2009a), but due to the overall very small number of differences within this sequence in *Dermanyssus*, the divergence was not conspicuous enough. Based on the newly developed nuclear gene marker Tropomyosin, the divergence is clearly confirmed. It is likely that lineages PAS and ENVL08 constitute two cryptic species. A problem is the fact that isolates of both lineages come respectively from the same locality, located ca 250 km apart from each other. Although no comparable level of divergence has been noted between geographically separated isolates within other *Dermanyssus* species under test, the potential effect of isolation by distance is questionable. Anyway one sequence in Brännström et al. (2008) provides us with a proof that the observed divergence between the two *D. longipes* lineages is not solely a geographical characteristic. Thus, these authors published two ITS sequences thought to be from *D. gallinae*, one from farms' populations, the other one from wild bird nests' populations. The latter isolates revealed to belong to *D. longipes* (Roy et al. 2009a), and possess exactly the same ITS sequence as isolates ENVL083 and ENVL088, sampled from great and blue tit nests. The corresponding sequence in Brännström et al. (2008) was from mites isolated from nests of flycatchers and warblers sampled in Sweden. No sharp specific morphological differences have been evidenced based on our cuticle vouchers between both lineages PAS and ENVL08. These data are in favour of two cryptic species within current *D. longipes*. The first one has been sampled from the Eurasian Tree Sparrow *Passer montanus* near Avignon (France), whereas the second lineage was found in Tits (*Parus spp*) near Lyon (France), flycatchers (*Ficedula spp*) and warblers (*Acrocephalus spp*) in Sweden. The former has been sampled from the type host genus (*Passer*) and the type host region, leading to considerate it is the name bearing lineage. The latter will have to be described soon, once additional material has been obtained from both lineages, in order to have a clearer overview of their respective morphology.

Intraspecific levels

The contrast between Tropomyosin which provides haplotypes sampled from various categories of habitat and COI with single category haplotypes was not unexpected in so differently transmitted loci (Fig. 2A). Thus, due to the biparental transmission of nuclear genes as opposed to the maternal origin of mitochondrial genes, it is likely that the Tropomyosin-based overview corresponds to a much more ancient state (three-fold effective population size if compared to COI) (cf. above). The difference in the evolution fastness between mtDNA and nDNA could have allowed populations to differentiate based on their mtDNA, and not yet on nDNA in case of isolation subsequent to above described hybridisation events.

As in many species and due to the above explained difference in nuclear and mitochondrial mutation rates, mitochondrial haplotypes appear monomorphic or with a few nucleotide differences in wild "focused isolates" (GO, IL) or other wild isolates (JBO, ROL). *D. apodis* and *D. hirundinis* may represent additional references of wild isolates. Of course, they provide much less variable haplotypes in both loci than *D. gallinae*. But the French population of *D. hirundinis* DhirF is not a "true" isolate (a single bird host species, but France-wide sampling), and yet, no diversity in Tropomyosin ($h=1$) vs moderate diversity in COI, higher than in true wild "focused isolates" *D. gallinae* IL ($S=4$, $h=5$) and *D. apodis* GO ($S=3$, $h=4$) from wild birds, was noted ($S=15$, $h=4$) (see Table 4). In contrast, the congruence between both loci in *D. apodis* true isolate GO (2 haplotypes in each locus) confirms the

effective faster evolution of COI in species under test, and so its enhanced power for characterizing populations from each another.

Population structure

Within *D. gallinae*, populations seem differently structured depending on the ecological context, especially opposing wild and domestic isolates. The ABC analyses, assuming an IM model, for the case with different host types [farms vs wild birds – farms including amateur hen houses, diverse types of industrial farms (see Fig. 5A, Table 5 and Appendix 4A)] generates a strongly supported topology affirming the existence of fairly defined populations (Table 5), although their interrelationships are not clearly resolved. Polymorphism analyses (Fst) also converge to support a structure where wild and farm isolates are at least partly isolated from each another. Gene flow is visible among farm isolates at least based on Tropomyosin (Fst). The ABC analysis also supports the presence of gene flow (Appendix 4A), in particular ancient migrations (Table 5).

Regarding the division in geographic locations (Fig.6B, Table 6, Appendix 4B), the structure is weakly recovered using the ABC method suggesting no real geographical structure. The lack of consensus between mtDNA and nDNA studies (Results not shown) might have led to different degrees of differentiation been reached according to the examined locus. A differentiation seems to be already sensible from Tropomyosin sequences at a large scale (involving different isolates of various geographical origins), in different environments. At a smaller geographical scale (at the isolate level, consisting of mites from nests of a single bird colony or a single farm building ; see §Whole dataset), no structure is revealed by Tropomyosin sequences, whereas COI seems to have already enough derived to give their own characters to mites living in the same small area, *ie* to reveal their monophyly as described by Palumbi et al (2001). In the same manner, the high number of COI haplotypes in the whole *D. gallinae* species (35) and their diversity (up to 9 % divergence excluding L1, up to 12 % including L1) contrasts with their homogenization within the wild isolate IL (S=3) and the lab isolate SK (S=4). And more interestingly, no geography-linked structure is evidenced, although isolates from very distant locations have been included.

History of exchanges between wild and domestic birds

Initial(s) contamination(s) has (have) necessarily occurred from wild birds as poultry breeding is a man-made condition. According to the network of COI haplotypes (Fig. 2), in L1, the basal position of haplotype from wild pigeons to farm pigeons suggests that we sampled by chance both ancestral and derived haplotypes in this case.

In hen farm haplotypes, no similar observation can be done. And yet, given the diversity in both loci across the species *D. gallinae*, and especially among and between wild isolates, it is likely that we were unable to enough largely sample to get a representation of ancestral populations. Several insights seem to confirm that present samples omitted populations close to the common ancestor in wild birds and that the closest one here is from farm. Based on Tropomyosin, it appears that some alleles that are omnipresent in farms (French as well as from other European origins) are also encountered in wild avifauna (Tro_1, Tro_2, Tro_3, Tro_16, Tr_17). This would be consistent with the necessarily wild initial origin of first contaminations in farms. The aim of the ABC analysis concerning host types of *D. gallinae* was to desintangle this underlined topology. However, given the wide 95% credible intervals for divergence times and migration rates the recover of the branching historie is far from consensual.

Moreover, more than 14 other alleles that are predominant in wild avifauna (found in the Dutch focused isolate IL, and in additional wild isolates from France; appendix 1) have not been encountered in farms (ex. Tro_27, Tro_50, Tro_51; appendix 1). This also suggests that shared haplotypes between wild and farm isolates more likely result from more or less recent exchanges of mites between wild and domestic birds, and that exchanges are from fowl to wild birds. Additionally, the total absence of COI haplotypes shared between wild and domestic bird isolates reveals that no very recent exchange between wild and domestic birds has occurred (Fig. 2). The farm haplotype Co_1 is basal to a very close haplotype sampled (a single mutated site), from a wild bird (Co_23), suggesting there might have been some relatively recent transfer from farms to wild avifauna, but if so, very uncommon since only a single individual case is present in the dataset. This uncommon transfer should have occurred at least after 6000BC (domestication of hen in China according to West and Zhou 1988), but more likely after 3000BC (first dispersion events of domesticated chickens in Europe, *ibid.*), which is not contradictory with the single mutated site. No other closely related haplotypes revealed any other exchanges between wild and domestic bird in non L1 *D. gallinae* populations. Finally, only one isolate from wild avifauna provided exactly the haplotype Co_1 (isolate Percno, in Roy et al. 2009b). This case should not suggest a possibility of fowl contamination by wild bird, but may simply result from an accidental transfer since concerned bird was *Neophron percnopterus*, a protected bird of prey that was cared for by some ornithologist societies (LPO) and precisely allowed to feed on dead hens directly collected from farms in the sampling area (France, Ardèche).

Founder event in farms and intra fowl industry mite dissemination

A very different population structure is revealed within *D. gallinae* isolates sampled in wild avifauna and isolates sampled in farms. The isolate IL taken as a feral reference provides balanced polymorphism values according to coalescent simulations using DnaSP, whereas important deviations between observed and expected values are revealed in farm isolates (observed values significantly lower to expected values). More in details, important deviations are visible based on Tropomyosin sequences in all layer farm focused isolates, whereas deviations characterize all layer farm focused isolates except SK based on COI sequences.

On the whole, the possible interpretation for such departures leads to an alternative: the strongly reduced number of haplotypes and values of haplotype diversity may result from a bottlenecked population followed by an expansion (founder event) or simply give evidence of a recent admixing of long separated populations.

Due to the fundamental difference in the mutation rate between both loci, it is assumed that Tropomyosin witnesses much older events than do COI. And yet, all farm populations seem to have undergone a common ancient event. In contrast, only French farm isolates appear to have been subjected to some more recent event, since the polymorphism of COI sequences within the Danish farm isolate SK looks like well balanced.

The fact that all farm isolates show a similar deviation, with a strongly reduced number of haplotypes compared to their respective expected values and to the feral reference IL based on the number of segregating sites is strongly suggestive of a founder event consecutive to farming practices (use of pesticides...).

And it is likely that similar founder events are to be found in chicken French farms, as well as in non French layer farms, but not enough individuals/isolates have been sequenced to establish it with any statistical significance. Both isolates from chicken farms (8012 and BER)

group together based on COI haplotypes (Co_7 and C_15, relatively close to each other; fig. 2). Additionally, they share same Tropomyosin haplotypes as samples from French layer farms and from other European layer farms, suggesting that the former founder event has occurred before the separation of this population from French layer farms' population. Moreover, demographic information obtained using case I and both loci could help leading to this interpretation. Indeed, the N_e of wild category (453000) along with internal nodes ancestral N_e (217000 and 264000) appear to be much larger than in layer farms especially in French farms (Non French farms: 24000; French farms: 2000), although the 95% credible interval expressed by quantile values are quite wide (Table 7).

The more recent picture which is drawn from COI sequences seems to be correlated to a very different event. Thus, the feral reference isolate IL shows a mitochondrial diversity very reduced (4 segregating sites, 5 haplotypes) if compared to its own nuclear diversity (37 segregating sites, 19 haplotypes). This suggests that the mitochondrial genome of the population it represents had time enough, since above described hybridization events, to derive and differentiate from each others and so recover a natural polymorphism balance. When considering this isolate as the representative of the "natural" state of *D. gallinae* mitochondrial and nuclear gene diversity, deviations noted here in farm isolates give evidence much more likely of very recent, if not contemporaneous, intermingling of separated populations than of bottlenecked populations. Indeed, the isolate SK is the only population of which pesticide exposition and isolation history is known since 12 years (cultured in laboratory, without any pesticide treatment and strictly confined). And yet, it shows a balanced polymorphism comparable to the isolate IL's based on mitochondrial sequences, in contrast to field sampled farm isolates. The laboratory confinement of isolate SK keeps it from getting mixed with other layer farm populations. As SK was sampled from not a organically controlled layer farm, a potential pesticide-induced bottleneck explaining the deviation within directly field sampled isolates would have occurred less than 12 year ago or SK would have been able to enough derivate to get homogenized COI sequenced. A duration of 12 years spent within farms or laboratory for populations of *D. gallinae* might have allowed *ca* 400 generations to get completed, as mites in this species have shown being able to perform one individual complete development (from egg laid to egg laying) within 6-11 days in farm conditions (Tucci et al 2008) and as fowls are almost always available in layer farms (flock duration = 12 months, empty period between two flocks = no more than 2 months). Clearly, up to 5-6% divergence is not possible to get reached within 400 generations. Therefore, it seems impossible to correlate the COI deviations with a farming practice founder effect. Finally, mitochondrial information here gives strong evidence of recent or contemporaneous population exchanges and intermingling within French layer industry. Trade flows apparently play an important role in the dissemination of populations of *D. gallinae* at least within the French industry network.

And the clearly uncorrelated geographical distances and mitochondrial characterization within French layer farm isolates, although wild isolates highlighted the natural isolation mark of COI sequences, are an additional clue in favour of this interpretation. For instance, the conspicuously recurrent haplotype Co 1 (along with close derived Co_5 and Co_10) in layer farms was encountered France-wide and in various types of industrial layer farms (see Appendix 1). As a result, motorized vehicles are obviously responsible of mite exchanges between farms, although we do not exactly know in details which precise vector(s) is (are) used by mites for transferring from farm to vehicle (boxes, cages, hens, men...).

Farm 8006 confirms the potential role of pullets as vectors for poultry red mites between farms: the multi-origins of pullets is to be correlated to the much lower haplotype diversity

Hd as expected whereas the average number of differences K is the highest (Table 4) in sample 8006B5. With the apparent contradiction of a low Hd vs the highest K (14.7), this isolate is a case in hand of the very recent admixing of separated lineages within French layer industry. The layer farmer of 8006 is provided with young hens for layer flocks by more than 10 different hen breeders (one per flock, 10 different buildings with an overlapping turnover of flocks) distributed France wide. Sample 8006B5 is representative of the whole mite population of a farm building that is successively introduced to newly entering pullets from a diversity of hen breeding facilities.

Range of mite's mobility

Among the many possible ways of dissemination, human activity has been evoked above on a large geographical scale (France, Europe) or, on a smaller scale, between nests separated by several hundred meters (isolate IL). But at still smaller scales, within a farm building or at the nest level, within a precise site and excluding transport by another organism, almost no knowledge is currently available. Concerning the self movement of mites on a smaller defined volume, Roy et al. (2009b) reported an amazing case. In a barn housing chicken cages together with barn swallow nests, lots of *D. gallinae* individuals were found within and around chicken cages, some *D. hirundinis* individuals in swallow nests, but no cases of cross contamination. Especially, swallow nests were absolutely exempt of any *D. gallinae* individual, although located only two meters above chicken cages. The chicken farming schedule along with swallow chicks examination allowed deducing that *D. gallinae* mites were present at the beginning of swallow nesting in two nests and in the absence of chickens. The complete absence of even dead *D. gallinae* mites in hirundinid nests was surprising, as mites in this species are (1) quick and nimble runners (Clayton and Thompkins 1994, LR pers. observation), (2) able to switch instantaneously from galliform to passeriform birds and easily develop (Roy et al. 2009b), (3) have been recorded – at least LB18 (appendix 1) – in swallow nests. Moreover, since then, authors noted a second similar case (isolate TB08, appendix 1)). This might be due, more than to motion ability, to the ability of detecting host presence. Kilpinen (2001) has shown that temperature variations are one of the main stimuli allowing *D. gallinae* mites to find its host. This author evidenced that a gradient of temperature as subtle as 0.005°C/s is effective in activating *D. gallinae* mites. Other stimuli detected by this species are CO₂ and vibrations (Kilpinen 2005). Additionally, some bird skin compounds may act as kairomones stimulating feeding behaviour (Zeman 1988). But experiments in these studies were performed in areas much more restricted than any barn. Thus, mites belonging to *D. gallinae* are known to be highly sensitive to some physico-chemical stimuli, but we do not know exactly within which range of distance, and as a result, cannot assess whether, in the present case in hand, mites in the vicinity of empty chicken cages did or did not detect swallow individuals only two meters away.

Additionally, the sampling strategy in farm 8006 is bringing more insight into the reduced movement of *D. gallinae*. Indeed, in this free-range farm, COI sequence copies isolated from mites randomly selected from 6 different points within a single building (8006B5, points located 6-10 meters apart from each another) revealed significantly more diversity than in the corresponding single point samples 8006B1 (radius *ca* 30 cm). This strongly suggests that mites do not move a lot within layer buildings, subpopulations keeping roughly unmixed within a building. Although *D. gallinae* mites are physically able to run actively and go from one neighbor nest box to another as noted by Clayton and Tompkins (1994), they do not do so necessarily very often. The omnipresence of hens in a farm building during flock likely justifies the fact that mites do not need to move, although hens are moving themselves. Farm 8006 is not a cage farm, but a free range farm and sampling points were located at the connexion between roosts. As micropredators, mite individuals do not need to feed

successively on a single host individual. The roost connexions were, as usually, full of mite aggregates, which did not need to move due to the recurrent availability of host in these areas. Mullens et al. (2001) evidenced in the distantly related species *O. sylviarum* a gradual contamination of hen cages from one neighbor to another. Infestations increased first on the nearest hens and were detected on more distant hens only after mites had increased to moderate-to-high populations on closer hens. Of course, *O. sylviarum* possesses differences habits (staying and laying eggs on host) and life history (deutonymph does not feed), but its hematophagous habits are comparable to *D. gallinae*'s. And yet, a similar scheme is suggested by Clayton and Tompkins (1994) in *D. gallinae* following an experiment on pigeons involving a batch of nest boxes. Apparently, *D. gallinae* mites are unlikely to run from one nest to another above several meters distance (a range to be defined by some field/lab experiments). Above this undefined distance, it seems that a carrier is needed for mite dispersal (bird, man, trolley, etc.).

D. hirundinis is likely to disperse the same way. In Roy et al. (2009b), this species appeared to be specific to hirundinids in France (ten isolates), whereas the three isolates coming from the same site in the USA were isolated from nests of three different families of Passeriformes: tits (Paridae), wrens (Certhiidae) and swallows (Hirundinidae). Over the marked genetic divergence between American and French isolates, the different host specificity was explained by fundamental ecological differences between American hirundinids (Tree Swallow, *Tachycineta bicolor*) and French hirundinids (Barn Swallow, *Hirundo rustica*, and Common House Martin, *Delichon urbica*). The former is a cavity nesting bird, whereas the latter are birds that build their own nests. Therefore, the American Tree Swallow is commonly sharing nestboxes with House Wrens or with Tits, in contrast to French mason swallows, which never nest in wren or tit nest boxes. This explains the absence of *D. hirundinis* from the numerous tit nests analysed in previous and present study (around 200). Anyway, the House Sparrow (*Passer domesticus*) as well as the Wren (*Troglodytes troglodytes*) are known to reuse old nests of Barn Swallows. And yet, since then, three dead individuals have been isolated from wren nest (isolate LC083; appendix 1), belonging to the French lineages (haplotypes Co_?? and Tro_44). The question here is, are they individuals from the previous season, which would have developed on swallows and would not have parasitized wrens? Another clue in favor of a host spectrum directly correlated with nest-sharing and carriage by the bird host is the individual MG1 (appendix 1): an adult male isolated from litter of a young House Sparrow which had been taken in after falling from the nest. So far, only 16S and COI amplicons have been obtained (respectively 94-96% and 96-99% identity with other French individuals).

Both these elements suggest that *D. hirundinis* may switch from one host to another in case of nest sharing (from one year to another), as does *D. gallinae*. This confirms what Roy et al. (2009b) partly evidenced by performing some lab bioassays (some *D. hirundinis* individuals sampled from a swallow nest fed on canaries and normally developed). As a result, the observed reduced host spectrum in French *D. hirundinis* does not seem to be due to intrinsic factors, but much more likely to ecological factors, linked to bird host habits, as do American lineages in the same species. The filter one in Combes (2000) may be similar in *D. gallinae* and *D. hirundinis*.

Nevertheless, at least the French lineage possesses adaptability to a new habitat (Combes' filter 2) different than in *D. gallinae*. Thus, although found on a House Sparrow, it has never been found in tit nests (a significant number of tit nests analysed), nor in any other bird under test. And yet, the House Sparrow is not only known to reuse swallow nests (Weisheit and Creighton 1989, but also to use nestboxes made for cavity-nesting birds). If *D. hirundinis* is

able to feed on another passeriform species than the initial host and subsequently develop in case of bird nesting within the initial host nest, it does not seem to be able to develop in a – even slightly - different habitat. Is the difference in nest arthropodofauna the cause? Are the components of the nest a cause (earth vs herbs)? It is not unlikely that once transferred to a Sparrow nest by the bird, the mite does not find any appropriate conditions for its development (no species of *Dermanyssus* detected in 12 nests of House Sparrow sampled in France analyzed and three nests containing *D. longipes* lineage PAS out of 17 nests of Eurasian Tree Sparrow analyzed).

And interestingly, Clayton and Tompkins (1994) deduced from their experiments involving *D. gallinae* along with some Mallophaga on pigeons and comparing their differential virulence that the virulence of ectoparasites is proportional to the amount of horizontal transmission. Ectoparasites which are able to disperse independently of hosts are extremely virulent, in contrast to those which are dependent on the direct contact with the host, which are not virulent. And yet, the impact of *D. gallinae* and *D. prognephilus* in wild avifauna has been shown with rather strong statistical significance (Clayton and Tompkins 1994; Moss and Camin 1970), whereas none of three studies on *D. hirundinis* (USA) has been able to evidence any impact on wrens (Johnson and Albrecht, 1993; Pacejkaa *et al.* 1996, 1998). Is this one additional clue in favor of the absolute need of nest sharing for transfer in *D. hirundinis*? Even if *D. gallinae* seems to disperse the same way, its apparently increased flexibility (generalist condition) makes its transfer less insecure than *D. hirundinis*', making it less dependent on its host. Note that phylogenetically close *D. gallinae* and *D. apodis* share a nimble mobility as well as high levels of prevalence within some nests in colonies, in contrast to *D. carpathicus* (pers. obs.). And yet, only these two species of the five under test were found directly on the host in previous studies (Roy *et al.* 2009b), and always as adult females, which might represent the stage/sex appropriate to dissemination (Roy *et al.* 2009b). Maybe these species are simply more able to cling to their host by being more nimble than the others?

Genetic variability according to the mite species

Present study provides several clues for assessment of a potential invasive character in *D. gallinae*. Lee (2002) established that successful invasive species in many cases:

- possess either increased additive genetic variance (AGV) or increased epistatic genetic variance if compared to other species under test.
- are favored by hybridization, along with multiple introduction events. Several invasive plants got established through multiple introductions, followed by hybridizations, which allowed the organisms to benefit from new AGV or new epistasis (joint effect of different loci).
- are accompanied by rapid speciation. Indeed, invasions constituting frequently rapid evolutionary events, rapid speciation following invasions could occur through neutral and selective processes (Lee, 2002).

Several clues in favor of the presence of a particular genetic architecture in *D. gallinae* are available in present data.

Different genetic diversities

D. gallinae provides a much higher genetic diversity than the four other species under test (S, h, Hd, K, table 4). The higher genetic diversity of *D. gallinae* suggests this species may possess either increased additive genetic variance (AGV) or increased epistatic genetic variance if compared to other species under test. This is one of the characteristics in the genetic architecture of many invasive species (Lee 2002). Of course, the genetic architecture

was not strictly observed in present study, as our simple haplotype-based approach does not allow distinguishing between genetic drift and natural selection. Anyway, as suggested by Lee (2002), genetic diversity may be an indicator of genetic variance.

Differences are intrinsic

Apparently, an important intermingling involving a large number of a diversity of haplotypes in *D. gallinae* is noticeable within a colony of starlings (population IL, 19 Tropomyosin haplotypes). But this does not seem to be solely correlated to the bird's ecology, as we noted the exact contrary in *D. apodis* from a colony of swiftlets (two Tropomyosin haplotypes) and in *D. hirundinis* from 7 separated French colonies of barn swallows (one Tropomyosin haplotype). Thus starlings, swiftlets and swallows are used to reusing nests of other pairs in the same colony from one year to another (O. Caparros, CRBPO, MNHN, pers. comm.). This could suggest that *D. gallinae* is able to move from one nest to another by the mean of the bird host (see above). But the ability of *D. apodis* to get transferred by the mean of birds has also been shown by several adult females directly sampled on (flying) hosts (Roy et al. 2009a, b). The conspicuous stability of both genes under test in *D. apodis* and *D. hirundinis* strongly contrasts with their variability in *D. gallinae* and suggests that these species are intrinsically very different. The variability within *D. carpathicus* and *D. longipes* is difficult to be estimated due to the too weak number of sequenced individuals/isolates.

Incipient speciations and hybridization within *D. gallinae*

Radiate nascent species apparently have inter-hybridized, which stopped the speciation process, as shown above. The subsequent diversity of alleles found in wild avifauna, as opposed to the very low number of alleles found in close species could have alleviated loss of AGV during founder events detected in the present study, and have generated novel genotypes, more adapted to their farm environment.

Invasions constituting frequently rapid evolutionary events and rapid speciation following invasions could occur through neutral and selective processes (Lee 2002). And yet, several incipient speciations seem to have occurred within *D. gallinae*, one maybe being definitive (L1), some others having been aborted (hybridization; e.g. lineage L3). *D. gallinae* revealed here to be a species complex in evolution: the high variability of mitochondrial and nuclear haplotypes is correlated in one case with reproductive isolation according to phylogenetic analyses (L1) and in other cases, strongly divergent Tropomyosin alleles are mixed in single isolates with homogenous COI sequences, suggesting a relatively ancient intermingling between long separated nuclear alleles. Some entities have likely been in the process of speciation (ex/ L3), but most of these incipient speciations were not definitive. The L1 lineage is an example of a youngest species which is maybe in the process of becoming definitely isolated, but maybe it is still able to reproduce with other lineages of *D. gallinae* in case of opportunity.

Some more recent events, linked with the modern commercial exchanges and other man-made environmental defragmentations currently allows some more recently isolated lineages (possibly nascent species) to remix with others and once more enrich the genetic diversity in this species. The very recent admixing of populations in farm isolates revealed by polymorphism analyses in COI at least predicts potential new hybridizations.

Increase of genetic diversity in *D. gallinae* has already proved being successful in increasing adaptability to a new environment

Several insights into invasive characteristics in *D. gallinae* allowing this species to be a generalist have been revealed here. But also several data confirm that *D. gallinae* has already proved to be successful in adapting to a wide range of new environments.

Desdevises et al (2002a) have shown that generalist species tend to group together in the phylogeny of genus *Lamellodiscus* (Trematoda: Monogenea), suggesting that the level of host specificity is related to some intrinsic characteristics. In the same point of view, Kaci-Chaouch et al (2008) has shown that genetic and morphometric variability within *Lamellodiscus* was correlated to the level of host specificity. These authors, after having demonstrated that increased variability in generalists was not a consequence of the large host range (natural selection in various habitats), conclude that, in *Lamellodiscus*, successful host switching is more likely to occur in parasite species exhibiting more intraspecific variability. As a result, the genetic architecture is different between generalist and specialist species within a given parasite taxon. And yet, within *Dermanyssus* less genetically variable (h, Hd, K) species are effectively more specific: *D. apodis* is only known from genus *Apus* and *D. hirundinis* is encountered in France almost exclusively on hirundinids and seems not to be able to quickly adapt to different bird nests (see above), in contrast to *D. gallinae* which has been noted in birds belonging to nine different orders and having very diverse habits (Roy et al 2009b). *D. longipes* PAS seems to be restricted to the genus *Passer* (Berlese and Trouessart 1889, previous studies of authors). Looking like intermediate species, *D. longipes* ENVL08 and *D. carpathicus* are known from two different bird families (Paridae and Muscicapidae), both in Passeriformes, but datasets in the present study are not sufficient to establish any correlation between the level of host specificity and the degree of genetic variability. The mono-haplotype characteristic of populations PAS and JBO108 in both loci under test contrasts with the two and four haplotypes found respectively in COI and Tropomyosin in populations ENVL083 and ENVL088.

Of the five species of the *Dermanyssus* under test here, only one is a true generalist, which does not allow consistent tests that phylogenetic groupings are correlated with the level of specificity as found in other groups by Desdevises et al (2002). Anyway, the strongly divergent variability noted in both loci within *D. gallinae* contrasting with related species strongly suggests that a different genetic structure has allowed this species to successfully colonize the recorded diversity of hosts, possessing a diversity of habits (nest hygiene...), and in a variety of habitats (*in natura*, cities, farms...).

Moreover, *D. gallinae* is increasingly troubling layer farms in Europe (Sparagano et al 2009), at least partly due to important restrictions in the Maximal Residue Limits in the eggs (less acaricide products are allowed to be used during layer flocks, which are around one year long). On the other hand, Tucci et al (2008) suggest that *D. gallinae* is in the process of largely colonizing layer farms in Brazil. *Ornithonyssus bursa* was predominant in Brazilian hen farms around 1938-39 and this tendency was established inverted in favor of *D. gallinae* in 1997 (Tucci 1997). Moreover, the recurrent presence of *D. gallinae* in various bird groups noted in France by Roy et al (2009b), along with its spread in human-shaped environments, highlights the remarkable adaptive flexibility in this pest species.

Conclusion

The utility of the intron n in Tropomyosin has been evidenced for inter- and intraspecific explorations within *Dermanyssus*. The split into *hirsutus* group and *gallinae* group in *Dermanyssus* does not seem to be convenient anymore, as *D. hirsutus* is branching from within the *gallinae* group.

Within *D. gallinae*, several successive founder events seem to have occurred all along the fowl farming history. One bottleneck, likely due to pesticides and other farming practices, seems to have occurred formerly. More recently, some important admixing between long isolated populations are conspicuous in layer farm isolates. Commercial exchanges play an

important role in the dissemination of populations of the Poultry Red Mite *D. gallinae*, at least within the layer industry in France. Exchanges of mites between domestic and wild birds seem to occur very rarely to date (almost never).

The genetic variability of *D. gallinae* in wild habitats is significantly higher than in other species, seemingly a consequence of an ancient radiation and of multiple hybridizations. The generalist *D. gallinae* seems to possess intrinsic characters of an invasive species, in contrast to the other four species, and showed the ability to colonize a variety of hosts, in very various habitats, successfully.

Cophylogenetic analyses would be interesting in order to establish more precisely the patterns of host switching and coevolution within *Dermanyssus*. Field experiments and population genetic analysis involving a larger amount of "focused isolates", in collaboration with the layer industry, are needed in order to establish the precise carrier(s) for mite dispersal in the framework of commercial exchanges. Also, the range of distance on which *D. gallinae* is able to move by itself (without the help of any other organism or vehicle) remains to be clearly estimated.

Supplementary material

Appendix 1. Sampling and EMBL information for the populations under test in the present study

Appendix 2. Information about the matrix of encoded In/Del (Tropomyosin)

Appendix 3. ABC analysis of case II. 30 clusters of the 180 branching tree histories when considering 5 populations cladograms

Appendix 4. Prior distribution and Bayesian probabilities of different scenarios in the three studies using an ABC method

Acknowledgments

We want to warmly thank S. Lubac (Institut Technique de l'Aviculture, Lyon, France), F. Boléat et coll. (Ecopôle du Forez, France), O. Kilpinen (Danish Institute of Agricultural Sciences, Lyngby, Denmark), MW Sabelis and I Lesna (IBED, University of Amsterdam, The Netherlands), Damien and Marion Buronfosse for having provided precious mite samples. Many thanks to E. Vila (Maison de l'Orient et de la Méditerranée, Lyon, France) for valuable information about the history of hen domestication.

Finally, LR would like to offer her most sincere thanks for their technical participation to S. Bonnet and N. Guichard N. (LEGTA Saint-Genis-Laval, France), M. Rigaux (IUT A, Université Lyon1, France), S. Merlin (Lycée Jean-Baptiste de la Salle, Lyon, France), S. El Ouartiti (IUT GBGE, Université Jean Monnet, Saint-Etienne, France), G. Lallemand (Lycée des Mandailles, Châteauneuf de Galaure, France).

This work was supported by the PEP (Pôle d'Experimentation et de Progrès) Avicole of the Région Rhône-Alpes (France).

Literature cited

- Arnold, M. 2004. Natural hybridization and the evolution of domesticated, pest and disease organisms. *Mol Ecol* 13:997-1007.
- Bandelt, H.J., P. Forster, A. and Röhl. 1999. Median-joining networks for inferring intraspecific phylogenies. *Mol Biol Evol* 16:37-48.
- Beaumont, M.A., W. Zhang, and D. J. Balding. 2002. Approximate Bayesian computation in population genetics. *Genetics* 162:2025-2035.

- Beaumont, M. A. 2008. Joint determination of topology, divergence time, and immigration in population trees. In: Simulations, Genetics, and Human Prehistory. Edited by Matsumura S, Forster P, Renfrew C. Cambridge: McDonald Institute for Archaeological Research. p. 135-154.
- Berlese, A. and E. Trouessart. Diagnoses d'acariens nouveaux ou peu connus. 1889. Bull Bib Sci Ouest 2e année, 2e partie 9:121-143
- Birky C. W., P. Fuerst, and T. Maruyama. 1989. Organelle gene diversity under migration, mutation and drift: equilibrium expectations, approach to equilibrium, effects of heteroplasmic cells, and comparison to nuclear genes. Genetics 121:613-627.
- Brännström, S., D. A. Morrison, J. G. Mattsson, and J. Chirico. 2008. Genetic differences in internal transcribed spacer 1 between *Dermanyssus gallinae* from wild birds and domestic chickens. Med Vet Entomol 22:152-155.
- Clayton, D. H., and D. M. Tompkins. 1994. Ectoparasite virulence is linked to mode of transmission. Proc Biol Sci 256:211-217.
- Clayton D. H., and D. M. Tompkins. 1995. Comparative effects of mites and lice on the reproductive success of Rock Doves (*Columba livia*). Parasitology 110:195-206.
- Combes C. 2000. Parasites, hosts, questions. In: Poulin R, Morand S, Skorping A, editors. Evolutionary Biology of Host-Parasite Relationships: Theory Meets Reality. Elsevier Science B.V. p. 1-8.
- Desdevises Y., S. Morand, and P. Legendre. 2002. Evolution and determinants of host specificity in the genus *Lamellodiscus* (Monogenea). Zool J of the Linnean Soc 77:431-443.
- De Geer, C. 1778. Mémoires pour servir à l'histoire des insectes. VII:111-112.
- Edgar, R. C. 2004. MUSCLE: multiple sequence alignment with high accuracy and high throughput. Nucleic Acids Res 32:1792-1797.
- Edmands S., H. V. Feaman, J. S. Harrison, and C. C. Tommermann. 2005. Genetic consequences of many generations of hybridization between divergent Copepod populations. J Hered 96:114-123.
- Edwards S. V., L. Liu, and D. K. Pearl. 2007. High-resolution species trees without concatenation. Proc Nat Am Soc 104:5936-5941.
- Estoup, A., M. A. Beaumont, F. Sennedot, C. Moritz, and J. M. Cornuet. 2004. Genetic analysis of complex demographic scenarios: spatially expanding populations of the cane toad, *Bufo marinus*. Evolution 58:2021-2036.
- Excoffier, L., G. Laval, and S. Schneider. 2005. Arlequin ver. 3.0: An integrated software package for population genetics data analysis. Evol Bioinform Online 1:47-50.
- Fagundes N., N. Ray, M. A. Beaumont, S. Neuenschwander, and F. M. Salzano. 2007. Statistical evaluation of alternative models of human evolution. Proc Nat Am Soc 104:17614-17619.
- Galtier, N., M. Gouy, and C. Gautier. 1996. SeaView and Phylo_win, two graphic tools for sequence alignment and molecular phylogeny. Comput Appl Biosci 12:543-548.
- Gorrochotegui-Escalante, N., M. L. De Lourdes Munoz, I. Fernandez-Salas, B. J. Beaty, and W. C. Black 4th. 2000. Genetic isolation by distance among *Aedes aegypti* populations along the northeastern coast of Mexico. Am J Trop Med Hyg 62:200-209.
- Hamilton, G., M. Currat, N. Ray, G. Heckel, M. Beaumont, and L. Excoffier. 2005. Bayesian estimation of recent migration rates after a spatial expansion. Genetics 170:409-417
- Hare, M. P. 2001. Prospects for nuclear gene phylogeography. Trends Ecol Evol. 16:700-706.
- Hey, J., and R. Nielsen. 2007. Integration within the Felsenstein equation for improved Markov chain Monte Carlo methods in population genetics. Proc Nat Am Soc 104:2785-2790.
- Hickerson, M., E. Stahl, and H. A. Lessios. 2006. Test for simultaneous divergence using approximate bayesian computation. Evolution. 60:2435-2453.
- Hudson, R. R. 1990. Gene genealogies and the coalescent process. Oxf Surv Evol Biol 7:1-44.
- Hudson, R. R., M. Slatkin, and W. P. Maddison. 1992. Estimation of levels of gene flow from DNA sequence data. Genetics 132:583-589.
- Huelsenbeck, J.P., and F. Ronquist. 2001. MrBayes: Bayesian Inference for Phylogenetic Trees. Bioinformatics 17:754-755.
- Hutcheson, H. J., and J. H. Oliver Jr. 1988. Spermiogenesis and reproductive biology of *Dermanyssus gallinae* (De Geer) (Parasitiformes: Dermanyssidae). J Med Entomol 25:321-330.
- Ihaka, R., and R. Gentleman. 1996. A language for data analysis and graphics. J Comput. Graph. Stat 5:299-314.

- Johnson, L. S., and D. J. Albrecht. 1993. Effects of haematophagous ectoparasites on nestling House Wrens, *Troglodytes aedon*: who pays the cost of parasitism? *Oikos* 66:255-262.
- Kaci-Chaouch, T., O. Verneau, and Y. Desdevises. 2008. Host specificity is linked to intraspecific variability in the genus *Lamellodiscus* (Monogenea). *Parasitology* 1-8.
- Kimura, M. 1969. The number of heterozygous nucleotide sites maintained in a finite population due to steady flux of mutations. *Genetics* 61:893-903.
- Kimura, M., T. Ohta. 1978. Stepwise mutation model and distribution of allelic frequencies in a finite population. *Proc Nat Am Soc* 75:2868-2872.
- Kilpinen, O. 2001. Activation of the poultry red mite, *Dermanyssus gallinae* (Acari: Dermanyssidae), by increasing temperatures. *Exp Appl Acarol* 25:859-867.
- Kilpinen, O. 2005. How to obtain a bloodmeal without being eaten by a host: the case of poultry red mite, *Dermanyssus gallinae*. *Physiol Entomol* 30:232-240.
- Klompen, H., M. Lekveishvili, and W. C. Black. 2007. Phylogeny of Parasitiform mites (Acari) based on rRNA. *Mol Phyl Evol* 43:936-951.
- Kuris, A. M., and K. D. Lafferty. 2000. Parasite-host modelling meets reality: adaptive peaks and their ecological attributes. In: Poulin R., S. Morand, and A. Skorping, editors. *Evolutionary Biology of Host-Parasite Relationships: Theory Meets Reality*, Elsevier Science BV p. 9-26.
- Lee, C. E. 2002. Evolutionary genetics of invasive species. *Trends Ecol Evol* 17:386-391.
- Legras, J., D. Merdinoglu, J. M. Cornuet, and F. Karst. 2007. Bread, beer and wine: *Saccharomyces cerevisiae* diversity reflects human history. *Mol ecol* 16:2091-2102.
- Librado, P., and J. Rozas. 2009. DnaSP v5: A software for comprehensive analysis of DNA polymorphism data. *Bioinformatics* 25: 1451-1452.
- Liu, L., D. K. Pearl, R. T. Brumfield, and S. V. Edwards. 2008. Estimating species trees using multiple-allele DNA sequence data. *Evolution* 62:2080-2091.
- Liu, Y. P., G. S. Wu, Y. G. Yao, Y. W. Miao, G. Luikart, M. Baig, A. Beja-Pereira, Z. L. Ding, M. G. Palanichamy, and Y. P. Zhang. 2006. Multiple maternal origins of chickens: Out of the Asian Jungles? *Mol Phyl Evol* 38:12-19.
- Loader, C. R. 1996. Local Likelihood Density Estimation. *Annals of Statistics* 24:1602-1618.
- Lunt, D. H., D. X. Zhang, J. M. Szymura, and G. M. Hewitt. 1996. The insect cytochrome oxidase I gene: evolutionary patterns and conserved primers for phylogenetic studies. *Insect Mol Biol* 5:153-165.
- Marjoram, P., J. Molitor, V. Plagnol, and S. Tavaré. 2009. Markov chain Monte Carlo without likelihoods. *Proc Nat Am Soc* 100:15324-15328.
- Mallet, J. 2005. Hybridization as an invasion of the genome. *Trends Ecol Evol* 20:229-237.
- McCracken, K., and M. Sorenson. 2005. Is homoplasy or lineage sorting the source of incongruent mtDNA and nuclear gene trees in the stiff-tailed ducks (*Nomonyx-oxyura*)? *Syst Biol* 54:35-55.
- Michaux, J. R., P. Chevret, M. G. Filippucci, and M. Macholan. 2002. Phylogeny of the genus *Apodemus* with a special emphasis on the subgenus *Sylvaemus* using the nuclear IRBP gene and two mitochondrial markers: cytochrome b and 12SrRNA. *Mol Phyl Evol* 23:123-136.
- Miller, N., A. Estoup, S. Toepfer, D. Bourguet, L. Lapchin, S. Derridj, K. S. Kim, P. Reynaud, L. Furlan, and T. Guillemaud. 2005. Multiple Transatlantic Introductions of the Western Corn Rootworm. *Science* 310, 992.
- Moore, W. S. 1995. Inferring phylogenies from the mt-DNA variation: mitochondrial-gene trees versus nuclear-gene trees. *Evolution* 49:718-726.
- Moss, W. W., and J. H. Camin. 1970. Nest parasitism, productivity, and clutch size in Purple Martins. *Science* 168:1000-1003.
- Mullens, B. A., N. C. Hinkle, L. J. Robinson, and C. E. Szijj. 2001. Dispersal of Northern Fowl Mites, *Ornithonyssus sylviarum*, Among Hens in an Experimental Poultry House. *J appl Poult Res* 10:60-64.
- Nature Midi-Pyrénées (association). 2001. Etude et prospection du Martinet Pâle *Apus pallidus* en Midi-Pyrénées.
<http://www.premiumwanadoo.com/naturemp/6Proteger/Etudes/RapportMartinetPale2.pdf>. 2009.

- Navajas, M., Y. Le Conte, M. Solignac, S. Cros-Arteil, and J. M. Cornuet. 2002. The complete sequence of the mitochondrial genome of the honeybee ectoparasite mite *Varroa destructor* (Acari: Mesostigmata) *Mol Biol Evol* 19: 2313-2317.
- Nichols, S. 2000. Gene trees and species trees are not the same. *Trends Ecol Evol* 16:358-364.
- Nisbet, A. J., J. F. Huntley, A. McKellar, N. Sparks, and R. McDevitt. 2006. A house dust mite allergen homologue from poultry red mite *Dermanyssus gallinae* (De Geer). *Parasite Immunol* 28:401-405.
- Nordborg, M. 2003. Coalescent theory. In *Handbook of Statistical Genetics*. 2nd edition. Edited by Edited by Balding, D.J., M. Bishop, and C. Cannings. Chichester: Wiley p. 602-635.
- Nordenfors, H., J. Höglund, and A. Ugglå. 1999. Effects of temperature and humidity on oviposition, molting, and longevity of *Dermanyssus gallinae* (Acari: Dermanyssidae). *J Med Entomol* 36:68-72.
- Nylander, J. A. A. 2004. MrModeltest v2. Program distributed by the author. Evolutionary Biology Centre, Uppsala University.
- Oliver, J. H. Jr. 1966. Notes on Reproductive Behavior in the Dermanyssidae. *J Med Entomol* 3:29-35.
- Pacejka, A. J., and C. F. Thompson. 1996. Does removal of old nests from nestboxes by researchers affect mite populations in subsequent nests of House Wrens? *J Field Ornithol* 67:558-564.
- Pacejka, J., C. M. Gratton, and C. F. Thompson. 1998. Do potentially virulent mites affect house wren reproductive success? – *Troglodytes aedon*. *Ecology* 5:79.
- Palumbi, S. R., F. Cipriano, and M. P. Hare. 2001. Predicting nuclear gene coalescence from mitochondrial data: The three-times rule. *Evolution* 55:859-868.
- Pascual, M., M. Chapuis, F. Mestres, J. Balanya, and R. Huey. 2007. Introduction history of *Drosophila subobscura* in the New World: a microsatellite-based survey using ABC methods. *Mol ecol* 16:3069-3083.
- Radovsky, F. J. 1994. The Evolution of Parasitism and the Distribution of Some Dermanyssoid Mites (Mesostigmata) on Vertebrate Hosts. In *Mites Ecological and Evolutionary Analyses of Life-History Patterns*, ed. MA Houck, USA
- Reynaud, M. C., C. M. Chauve, and F. Beugnet. 1997. *Dermanyssus gallinae* (De Geer, 1778): Reproduction expérimentale du cycle et essai de traitement par la moxidectine et l'ivermectine. *Rev Med Vet* 148:433-438.
- Rieseberg, L. H., O. Raymond, D. M. Rosenthal, Z. Lai, K. Livingstone, T. Nakazato, J. L. Durphy, A; E. Schwarzbach, L. A. Donovan, and C. Lexer. 2003. Major ecological transitions in wild sunflowers facilitated by hybridization. *Science* 301:1211-1216.
- Rogers, S. M., and L. Bernatchez. 2007. The genetic architecture of ecological speciation and the association with signatures of selection in natural lake whitefish (*Coregonus* sp. Salmonidae) species pairs. *Mol Biol Evol* 24:1423-1438.
- Ronquist, F., and J. P. Huelsenbeck. 2003. MRBAYES 3: Bayesian phylogenetic inference under mixed models. *Bioinformatics*. 19:1572-1574.
- Roy, L., A. P. G. Dowling, C. M. Chauve, and T. Buronfosse. 2009a. Delimiting species boundaries within *Dermanyssus* Dugès, 1834 (Acari:Dermanyssidae) using a total evidence approach. *Mol Phyl Evol* 50:446-470.
- Roy, L., A. P. G. Dowling, C. M. Chauve, I. Lesna, M. W. Sabelis, and T. Buronfosse. 2009b. Molecular phylogenetic assessment of host range in five *Dermanyssus* species. *Exp Appl Acarol in press*
- Rozas, J., and R. Rozas. 1995. DnaSP, DNA sequence polymorphism: an interactive program for estimating Population Genetics parameters from DNA sequence data. *Comput Applic Biosci* 11:621-625.
- Schwenk, K., N. Brede, and B. Streit. 2008. Extent, processes and evolutionary impact of interspecific hybridization in animals. *Phil. Trans. R. Soc B* 363:2805-2811.
- Schweitzer, J. A., G. D. Martinsen, and T. G. Whitham. 2002. Cottonwood hybrids gain fitness traits of both parents: a mechanism for their long-term persistence? *Am J Bot* 89:981-990.
- Seehausen, O. 2004. Hybridization and adaptive radiation. *Trends Ecol Evol* 19:198-207.
- Seehausen, O, G. Takimoto, D. Roy, and J. Jokela. 2007. Speciation reversal and biodiversity dynamics with hybridization in changing environments. *Mol Ecol* 17:30-44.

- Siegel, P. B., A. Haberfeld, T. K. Mukherjee, L. C. Stallard, H. L. Marks, N. B. Anthony, and E. A. Dunnington. 1992. Jungle fowl–domestic fowl relationships: a use of DNA fingerprinting. *World's Poult. Sci J* 48:147–155.
- Sparagano, O., A. Pavličević, T. Murano, A. Camarda, H. Sahibi, O. Kilpinen, M. Mul, R. van Emous, S. le Bouquin, K. Hoel, and M. Cafiero. 2009. Prevalence and key figures for the poultry red mite. *Dermanyssus gallinae* infections in poultry farm systems. *Exp Appl Acarol* 48:3-10.
- Stone, J., and J. Repka. 1998. Using a Nonrecursive Formula to Determine Cladogram Probabilities. *Syst Biol* 47:617–624.
- Storz, J. F., and M. A. Beaumont. 2002. Testing for genetic evidence of population expansion and contraction: an empirical analysis of microsatellite DNA variation using a hierarchical Bayesian model. *Evolution* 56:154-166.
- Tucci, E. C. 1997. A laboratory method for the rearing of *Dermanyssus gallinae* (De Geer, 1778) (Acari, Dermanyssidae). *Arq Inst Biol São Paulo* 64:1-4.
- Tucci, E. C., A. P. Prado, and R. P. Araújo. 2008. Development of *Dermanyssus gallinae* (Acari: Dermanyssidae) at different temperatures. *Vet Parasitol* 155:127-132.
- Wakeley, J. 1996. The variance of pairwise nucleotide differences in two populations with migration. *Theor Popul Biol* 49:39-57.
- Weisheit, A. S., and P. D. Creighton. 1989. Interference by House Sparrows in nesting activities of Barn Swallows. *J Field Ornithol* 60:323-328.
- West, B., and B. X. Zhou. 1988. Did Chickens Go North ? New evidence for domestication. *J Archaeol Sci* 15:515-533.
- Witalinski, W. 2000. *Aclerogamasus stenocornis* sp. n., a fossil mite from the Baltic amber (Acari: Gamasida: Parasitidae). *Genus* 11:619-626.
- Wood, H. P. 1917. The chicken mite: its life history and habits. United States Department of Agriculture, Washington, DC., Bull 553:1-14.
- Yamashita, H., S. Okamoto, Y. Maeda, and T. Hashiguchi. 1994. Genetic relationships among domestic and jungle fowls revealed by DNA fingerprinting analysis. *Jpn Poult Sci* 31:335–344.
- Yee, T., and C. Wild. 1996. Vector generalized additive models. *J. R. Stat Soc, B.* 58:481-493.
- Zeman, P. 1988. Surface skin lipids of birds - a proper host kairomone and feeding inducer in the poultry red mite, *Dermanyssus gallinae*. *Exp Appl Acarol* 5:163-173.

Tables

Primer name	Sequence	Gene portion
SKPO-F	5' CTTTTTAGATCTTTAATTGAAA 3'	COI
RQ-COI-R	5' CCAGTAATACCTCCAATTGTAAAT 3'	COI
T5bis-F	5' TCGAGCACAGGAACATCACTG 3'	Tropomyosin
T5bis-R	5' AGTCTCGGCACGGTCTTCA 3'	Tropomyosin

Table 1. Primer sequences.

	Mt external branch length	Mt internal branch length	Coalescence ratio	Nuclear monophyly support (Bayesian Posterior Probabilities)	Nuclear monophyly support (Bootstrap / Bremer values on MP topologies) gap=5th state	Nuclear monophyly support (Bootstrap / Bremer values on MP topologies) gap=missing
<i>D. gallinae</i>	0.09	0.08	1	0.95	60/100	60/100
<i>D. apodis</i>	0.121	0.00	36	1.00	100/100	100/100
<i>D. carpathicus</i>	0.116	0.02	5	1.00	100/100	100/100
<i>D. hirundinis</i>	0.043	0.02	2	0.59	99/100	nm
<i>D. longipes</i>	0.043	0.03	1	nm	nm	nm
<i>D. gallinae</i> L1	0.073	0.01	8	0.97	96/92	96/100
<i>D. gallinae</i> except L1	0.026	0.06	0	nm	nm	nm
<i>D. gallinae</i> Lmt1	0.9	0.01	90	nm	nm	nm
<i>D. gallinae</i> Lmt2	0.01	0.03571	0.3	nm	nm	nm
<i>D. gallinae</i> Lmt3	0.01	0.03125	0.3	nm	nm	nm
<i>D. gallinae</i> + <i>D. apodis</i>	nm	nm	-	0.91	100/93	100/100
<i>D. hirundinis</i> + <i>D. carpathicus</i> + <i>D. longipes</i> + <i>D. hirsutus</i>	0.175	0.42	0.4	nm	nm	nm
<i>D. gallinae</i> + <i>D. apodis</i> + <i>D. hirsutus</i> (clade α)	nm	nm	-	0.88	100/100	100/100

Table 2. Evaluation of the three-times rule for species and other entities of *Dermanyssus* under test. nm = not monophyletic

	Tropomyosin			mt-Co1		
	Fst	P value	Nm (from Fst)	Fst	P value	Nm (from Fst)
<i>D. gallinae</i> All Wild vs <i>D. apodis</i>	0.73835	<0.0001	0.17631	0.82812	<0.0001	0.10378
<i>D. gallinae</i> All Wild vs <i>D. hirundinis</i> DhirF	0.81934	<0.0001	0.12074	0.80102	<0.0001	0.12421
<i>D. gallinae</i> All Wild vs <i>D. carpathicus</i>	0.84537	<0.0001	0.09192	0.78628	<0.0001	0.13591
<i>D. carpathicus</i> vs <i>D. apodis</i> GO	0.96972	<0.0001	0.01561	0.92393	<0.0001	0.04117
<i>D. hirundinis</i> DhirF vs <i>D. apodis</i> GO	0.97856	<0.0001	0.01096	0.96457	<0.0001	0.01836
8020 vs 8006B5				0.39878	<0.0001	0.75381
8020 vs 8006B1	0.09610	0.0039	4.7027	0.83984	<0.0001	0.09535
8020 vs SK	-0.00335	0.41699	∞	0.91934	<0.0001	0.04387
8020 vs IL	0.19807	<0.0001	2.0243	0.89575	<0.0001	0.05819
SK vs 8006B5				0.58486	<0.0001	0.35490
SK vs 8006B1	0.10665	0.00098	4.1882	0.76838	<0.0001	0.15072
IL vs 8006B5				0.52019	<0.0001	0.46119
IL vs 8006B1	0.32236	<0.0001	1.0510	0.69884	<0.0001	0.21547
SK vs IL	0.25762	<0.0001	1.4409	0.87909	<0.0001	0.06877
9001 vs IL	0.43939	<0.0001	0.63793	0.97479	<0.0001	0.01293
9001 vs SK	0.65114	<0.0001	0.26789	0.98236	<0.0001	0.00898
9001 vs 8020	0.58870	<0.0001	0.34933	0.94154	<0.0001	0.03104
9001 vs 8006B1	0.65452	<0.0001	0.26392	0.95529	<0.0001	0.02340
<i>D. gallinae</i> L1 9001 vs <i>D. apodis</i> GO	0.96793	<0.0001	0.01657	0.98604	<0.0001	0.00708

Table 3. Pairwise Fst estimates between *D. gallinae* focused isolates and between specific datasets, corresponding P values and associated Nm for both nuclear and mitochondrial loci. For Tropomyosin, permutation tests of Fst estimates used the genotype as the randomization unit instead of the allele.

isolate/population	Tropomyosin										mt-Co1										
	Number of segregating sites, S (obs).	Number of segregating sites, S (obs).	Number of haplotypes, h (obs)	h (expected)	P(h<=h obs)	Number of haplotypes, h (gap as a fifth state)(obs).	Haplotype diversity, Hd (obs).	Hd (expected)	P(Hd<=Hd obs)	Average number of differences, K (obs).	Average number of differences, K (gap as a fifth state)(obs).	Number of segregating sites, S.	Number of haplotypes, h.	h (expected)	P(h<=h obs)	Haplotype diversity, Hd (obs).	Hd (expected)	P(Hd<=Hd obs)	Average number of differences, K.		
<i>D. gallinae</i> 8006B1	44	17	49	5	14.56	<0.0001	5	0.69767	0.8774	0.020	5.12051	14.73573	24	33	3	12.289	<0.0001	0.16304	0.90748	<0.0001	3.59058
<i>D. gallinae</i> 8020	40	18	50	5	14.58	<0.0001	5	0.65641	0.88805	0.003	5.52179	16.94231	19	21	3	9.347	0.002	0.44444	0.86594	0.001	4.25731
<i>D. gallinae</i> SK	44	14	41	3	13.08	<0.0001	3	0.54017	0.85677	0.002	4.60042	14.46195	24	3	4	3.57	1.00	0.30797	0.51839	0.107	0.32609
<i>D. gallinae</i> IL	40	37	116	18	19.63	0.329	18	0.94103	0.93624	0.488	9.56154	31.88077	20	4	5	4.13	1.00	0.74211	0.58455	0.895	1.05789
<i>D. gallinae</i> L1 9001	48	0	0	1	-	-	1	0.00000	-	-	0.00000	0.00000	24	8	2	6.284	0.004	0.22826	0.72339	0.003	1.82609
<i>D. gallinae</i> 8006B5	40	4	9	2	5.20	<0.0001	2	0.50128	0.58449	0.268	2.00513	4.51154	20	3	4	3.524	1.00	0.28421	0.52435	0.081	0.38947
<i>D. apodis</i> GO	34	0	0	1	-	-	1	0.00000	-	-	0.00000	0.00000	21	15	4	8.335	0.020	0.53333	0.82551	0.010	4.59048
<i>D. hirundinis</i> DhirF	38	8	10	3	8.74	<0.0001	3,00	0.19772	0.77086	<0.0001	1.40683	1.79374	19	29	3	10.681	<0.0001	0.50292	0.89884	0.001	8.94737
<i>D. hirundinis</i> FR+USA	16	21	56	5	8.75	0.041	5,0	0.73333	0.879	0.037	10.46667	28.8	8	25	3	6.175	0.017	0.71429	0.91721	0.013	14.14286
<i>D. longipes</i>	26	11	16	10	9.819	0.657	11,0	0.86462	0.84488	0.567	3.44308	5.17231	16	36	9	10.403	0.299	0.81667	0.92184	0.044	13.84167
<i>D. carpathicus</i>	194	28	60	14	27.667	<0.0001	14,0	0.70124	0.89674	0.007	5.84573	16.71428	122	84	22	35.587	0.007	0.83796	0.94216	0.003	18.79461
<i>D. gallinae</i> All Farms	60	56	137	27	27.163	0.546	29,0	0.95028	0.94833	0.437	10.8209	30.69605	33	85	14	20.538	0.027	0.90909	0.95553	0.047	23.45265

Table 4. Computer simulations of coalescent process (DnaSP v5) given the number of segregating sites S, assuming an intermediate level of recombination R=10 for Tropomyosin amplicon and no recombination for COI amplicon (confidence interval =95%).

Parameters	Description	Mode	0.95	
Ne1	Population size in French layer farms	2000	0	8000
Ne2	Population size in non-French layer farms	24000	0	42000
Ne3	Population size in French non-hen layer farms	79000	0	200000
Ne4	Population size in Wild birds	453000	82000	500000
NeA1	First ancestral population size	217000	0	337000
NeA2	Second ancestral population size	264000	29000	500000
NeA3	Third ancestral population size	43000	0	68000
m1	Migration in French layer farms	0	0	0.0094
m2	Migration in non-French layer farms	0.0032	0	0.0056
m3	Migration in French non-hen layer farms	0	0	0.0057
m4	Migration in Wild Birds	0.0002	0	0.0005
mA1	Migration in first ancestral population	0.0100	0.0006	0.0100
mA2	Migration in second ancestral population	0.0026	0	0.0043
t1	First splitting time	0	0	280000
t2	Second splitting time	590000	70000	1110000
t3	Third splitting time	1270000	470000	1590000

Table 5. Estimates of modes and 95% credible intervals for the considered demographic parameter for the *D. gallinae* groups with different host types (case I, popABC).

Parameters	Description	Mode	0.95	
Ne1	8006 population size	0	0	421000
Ne2	8020 population size	0	0	33000
Ne3	IL population size	0	0	464000
Ne4	JBO population size	500000	277000	500000
Ne5	SK population size	0	0	31000
NeA1	First ancestral population size	500000	38000	500000
NeA2	Second ancestral population size	168000	0	248000
NeA3	Third ancestral population size	0	0	474000
NeA4	Fourth ancestral population size	122000	0	192000
m1	Migration in 8006	0	0	0.0022
m2	Migration in 8020	0.0020	0	0.0035
m3	Migration in IL	0	0	0.0016
m4	Migration in JBO	0.0070	0.0006	0.0097
m5	Migration in SK	0.0014	0	0.0025
mA1	Migration in first ancestral population	0.0019	0	0.0047
mA2	Migration in second ancestral population	0.0040	0	0.0069
mA3	Migration in third ancestral population	0.0032	0	0.0055
t1	First splitting time	0	0	860000
t2	Second splitting time	1020000	130000	2390000
t3	Third splitting time	2490000	750000	2500000
t4	Fourth splitting time	2500000	1130000	2500000

Table 6. Estimates of modes and 95% credible intervals for the considered demographic parameter for the *D. gallinae* populations in different geographical locations (case II, popABC).

Parameters	Description	Mode	0.95	
Ne1	<i>D. apodis</i> population size	34000	0	93000
Ne2	<i>D. gallinae</i> population size	93000	67000	106000
Ne3	<i>D. hirundinis</i> population size	31000	0	95000
NeA1	First ancestral population size	68000	0	98000
NeA2	Second ancestral population size	68000	0	100000
t1	First splitting time	0	0	5070000
t2	Second splitting time	3680000	420000	8690000

Table 7. Estimates of modes and 95% credible intervals for the considered demographic parameter for the *Dermanyssus* species (case III, popABC).

	n	n_a	G	$H_{(obs)}$	H_{WE} P(SE)
SK	44	3	4	0.41	0.11555 (0.00108)
8020	40	4	7	0.65	0.41775 (0.00149)
8006	44	5	8	0.86	0.02825 (0.00052)
IL	36	18	18	0.88	0.13373 (0.00041)
GO	40	2	3	0.14	0.00374 (0.00018)
DhirF	36	1	1	-	-
9001	48	1	1	-	-

Table 8. Genotypic and heterozygosity variability in focused isolates for Tropomyosin exon n , intron n and exon $n+1$. n refers to the number of sequences under test, n_a to the allele number, G to the genotype number, $H_{(obs)}$ to the observed percentage of heterozygosity.

Figures Legends

Fig. 1. Overview of the distribution of variable elements along the studied Tropomyosin sequence (mutation points and insertion/deletion sites).

Fig. 2. Haplotypes distribution according to the six ecological categories as defined in § Material and Methods. Network 4.5.1.0, epsilon=10, post-processing MP processed (shortest trees), 187 individuals of *D. gallinae* sequenced in both COI and Tropomyosin and additional individuals sequenced only in one of these loci (total: 228 individuals for COI and 203 for Tropomyosin). A. Haplotype network for COI. H_n reads Co_n in the text. B. Haplotype network for Tropomyosin. H_n reads Tro_n in the text. The size of circle is proportional to the number of individuals sharing this haplotype for COI and to the number of alleles representing this haplotype in Tropomyosin. The small squares correspond to missing intermediate haplotypes. The length of lines is proportional to the number of mutated positions.

Fig. 3. Amount of “pure synapomorphies” (*i.e.* synapomorphies strictly characterizing observed entity as opposed to all other) found in diverse entities of various taxonomic levels on targeted Tropomyosin sequences, based on Roy *et al.* (2009a)'s species boundaries and the individuals under test in present study.

Fig. 4. Haplotypic topologies obtained with COI and Tropomyosin sequences. A, B, C and D. Tropomyosin based topologies. A, B and C. Maximum parsimony criterion, PAUP4.0. A. Gaps treated as a fifth state. Strict consensus of 264 most parsimonious trees (L=1288 CI=0.8238 RI=0.9320). Dots indicate alleles which have been isolated from individuals which group within the three mt lineages tested in Table 2: grey triangles, Lmt1; white squares, Lmt2; black circles, Lmt3. Gaps treated as missing data. Strict consensus of 1000 most parsimonious trees (L=607 CI=0.8023 RI=0.9263). C. Gaps alone, encoded following appendix. Strict consensus of 1000 most parsimonious trees (L=80 CI=0.7250 RI=0.9450). D. Bayesian analysis with gaps as missing data...E and F. COI based topologies. E. Maximum parsimony criterion, PAUP4.0. Strict consensus of the 434 most parsimonious trees (L=749 CI=0.5340 RI=0.8452). F. Bayesian analysis

Figure 5. Most supported topologies for the population genetics analysis using ABC methods. A. *D. gallinae* groups with different host types (case I). B *D. gallinae* populations with different geographic locations (case II). C. *Dermanyssus* species (case III).

Appendix 1. Sampling and EMBL information for the populations under test in present study.

Both tropomyosin accession numbers are given in the two right columns in case of heterozygosity, in the first one in case of homozygosity (HOM. in the last column in such a case).

<i>Dermomyssus</i> species	Host	Context	Country	Departement (France)	Isolate	Individual	COI haplotype	COI accession numbers	Tropomyosin haplotypes	Tropomyosin accession numbers		
<i>A. casalis</i>			France		ACA	ACA	Co_Acasalis	AM921868				
<i>D. apodis</i>	Swift	on bird -bird care activity	France	69	MAR	mar 1	Co_52	AM921880	Tro_29	+ Tro_29	FM897372	HOM.
<i>D. apodis</i>	Swift	on bird -bird care activity	France	69	MAR	mar 2	Co_52	AM921880	Tro_29	+ Tro_29	FN257768	HOM.
<i>D. apodis</i>	Swift	bird nest - inside a building, in a town	France	30	GO102	GO102a	Co_53	xxxxxxx	Tro_28	+ Tro_29	id. FM897373	id. FN257763
<i>D. apodis</i>	Swift	bird nest - inside a building, in a town	France	30	GO108	GO108c			Tro_28	+ Tro_28	id. FM897373	HOM.
<i>D. apodis</i>	Swift	bird nest - inside a building, in a town	France	30	GO111	GO111			Tro_28	+ Tro_28	id. FM897373	HOM.
<i>D. apodis</i>	Swift	bird nest - inside a building, in a town	France	30	GO40	GO40b			Tro_28	+ Tro_28	id. FM897373	HOM.
<i>D. apodis</i>	Swift	bird nest - inside a building, in a town	France	30	GO54	GO542	Co_54	AM921874	Tro_28	+ Tro_29	id. FM897373	id. FN257763

D. apodis	Swift	bird nest - inside a building, in a town bird nest - inside a building, in a town	France	30	GO54	GO543	Co_54	id. AM921874	Tro_28	+	Tro_28	id. FM897373	id. FM897373
D. apodis	Swift	bird nest - inside a building, in a town bird nest - inside a building, in a town	France	30	GO54	GO54b	Co_54	id. AM921874	Tro_28	+	Tro_28	id. FM897373	id. FM897373
D. apodis	Swift	bird nest - inside a building, in a town bird nest - inside a building, in a town	France	30	GO54	GO54c	Co_54	id. AM921874	Tro_28	+	Tro_28	id. FM897373	id. FM897373
D. apodis	Swift	bird nest - inside a building, in a town bird nest - inside a building, in a town	France	30	GO58	GO58a	Co_54	FM179370	Tro_29	+	Tro_29	id. FN257763	HOM.
D. apodis	Swift	bird nest - inside a building, in a town bird nest - inside a building, in a town	France	30	GO59	GO591	Co_54	xxxxxxxxxx	Tro_29	+	Tro_29	FN257763	FN257764
D. apodis	Swift	bird nest - inside a building, in a town bird nest - inside a building, in a town	France	30	GO59	GO592	Co_54	xxxxxxxxxx	Tro_28	+	Tro_29	id. FM897373	FN257763
D. apodis	Swift	bird nest - inside a building, in a town bird nest - inside a building, in a town	France	30	GO59	GO593	Co_54	xxxxxxxxxx	Tro_28	+	Tro_28	FM897373	HOM.
D. apodis	Swift	bird nest - inside a building, in a town bird nest - inside a building, in a town	France	30	GO63	GO63a	Co_54	xxxxxxxxxx		+			
D. apodis	Swift	bird nest - inside a building, in a town bird nest - inside a building, in a town	France	30	GO64	GO64a	Co_54	xxxxxxxxxx		+			
D. apodis	Swift	bird nest - inside a building, in a town bird nest - inside a building, in a town	France	30	GO69	GO69a	Co_54	xxxxxxxxxx	Tro_29	+	Tro_29	id. FN257763	id. FN257763

D. gallinae	Layer hen	layer farm - on ground	France	1	8006B1	8006B1M2a	Co_4	xxxxxxxxxx	Tro_3	+ Tro_1	id.	FN257812	id.	FN257872
D. gallinae	Layer hen	layer farm - on ground	France	1	8006B1	8006B1M2b	Co_4	xxxxxxxxxx						
D. gallinae	Layer hen	layer farm - on ground	France	1	8006B1	8006B1M2c	Co_1	xxxxxxxxxx	Tro_17	+ Tro_1	xxxxxxxxxx	FN257872	id.	FN257872
D. gallinae	Layer hen	layer farm - on ground	France	1	8006B1	8006B1M2d	Co_4	xxxxxxxxxx	Tro_2	+ Tro_3	id.	FN257781	id.	FN257812
D. gallinae	Layer hen	layer farm - on ground	France	1	8006B1	8006B1M2e	Co_4	xxxxxxxxxx	Tro_16	+ Tro_2	id.	FN257813	id.	FN257781
D. gallinae	Layer hen	layer farm - on ground	France	1	8006B1	8006B1M2f	Co_4	xxxxxxxxxx	Tro_17	+ Tro_2	xxxxxxxxxx	FN257781	id.	FN257781
D. gallinae	Layer hen	layer farm - on ground	France	1	8006B1	8006B1M2g	Co_4	xxxxxxxxxx	Tro_2	+ Tro_1	id.	FN257781	id.	FN257872
D. gallinae	Layer hen	layer farm - on ground	France	1	8006B1	8006B1M2h	Co_4	xxxxxxxxxx	Tro_17	+ Tro_2	xxxxxxxxxx	FN257781	id.	FN257781
D. gallinae	Layer hen	layer farm - on ground	France	1	8006B1	8006B1M2i	Co_4	xxxxxxxxxx	Tro_2	+ Tro_3	id.	FN257781	id.	FN257812
D. gallinae	Layer hen	layer farm - on ground	France	1	8006B1	8006B1M2j	Co_4	xxxxxxxxxx	Tro_2	+ Tro_3	id.	FN257781	id.	FN257812
D. gallinae	Layer hen	layer farm - on ground	France	1	8006B1	8006B1M2k	Co_2	xxxxxxxxxx	Tro_2	+ Tro_2	id.	FN257781	id.	FN257781
D. gallinae	Layer hen	layer farm - on ground	France	1	8006B1	8006B1M2l	Co_4	xxxxxxxxxx	Tro_2	+ Tro_2	id.	FN257781	id.	FN257781
D. gallinae	Layer hen	layer farm - on ground	France	1	8006B5	8006d	Co_4	xxxxxxxxxx						
D. gallinae	Layer hen	layer farm - on ground	France	1	8006B5	8006e	Co_1	xxxxxxxxxx						
D. gallinae	Layer hen	layer farm - on ground	France	1	8006B5	8006f	Co_3	xxxxxxxxxx						
D. gallinae	Layer hen	layer farm - on ground	France	1	8006B5	8006g	Co_1	xxxxxxxxxx						
D. gallinae	Layer hen	layer farm - on ground	France	1	8006B5	8006i	Co_4	xxxxxxxxxx						

D. gallinae	Layer hen	layer farm - on ground	France	1	8006B5	8006j	Co_5	xxxxxxxxxx	Tr0_2	+ Tr0_2	FN257773	HOM.
D. gallinae	Layer hen	layer farm - on ground	France	1	8006B5	8006k	Co_3	xxxxxxxxxx				
D. gallinae	Layer hen	layer farm - on ground	France	1	8006B5	8006l	Co_4	xxxxxxxxxx				
D. gallinae	Layer hen	layer farm - on ground	France	1	8006B5	8006m	Co_4	xxxxxxxxxx				
D. gallinae	Layer hen	layer farm - on ground	France	1	8006B5	8006n	Co_4	xxxxxxxxxx				
D. gallinae	Layer hen	layer farm - on ground	France	1	8006B5	8006p	Co_5	xxxxxxxxxx				
D. gallinae	Layer hen	layer farm - on ground	France	1	8006B5	8006q	Co_3	xxxxxxxxxx				
D. gallinae	Layer hen	layer farm - on ground	France	1	8006B5	8006r	Co_1	xxxxxxxxxx				
D. gallinae	Layer hen	layer farm - on ground	France	1	8006B5	8006s	Co_1	xxxxxxxxxx				
D. gallinae	Layer hen	layer farm - on ground	France	1	8006B5	8006t	Co_5	xxxxxxxxxx				
D. gallinae	Layer hen	layer farm - on ground	Belgium		8007	8007a	Co_6	FM208717	Tr0_3	+ Tr0_21	FN257820	FN257821
D. gallinae	Layer hen	layer farm - on ground	Belgium		8007	8007b	Co_6	id. FM208717	Tr0_3	+ Tr0_3	FN257815	HOM.
D. gallinae	Pigeon	facility - aviary breeding pigeon		69	8008	8008g	Co_34	FM208712	Tr0_8	+ Tr0_10	FN257787	FN257788
D. gallinae	Pigeon	facility - aviary breeding pigeon		69	8008	8008h	Co_34	id. FM208712	Tr0_8	+ Tr0_10	FN257789	FN257790
D. gallinae	Pigeon	facility - aviary breeding pigeon		69	8008	8008i	Co_34	id. FM208712	Tr0_8	+ Tr0_10	FN257791	FN257792
D. gallinae	Layer hen	layer farm -	France	69	8009	8009a	Co_1	FM208724	Tr0_20	Tr0_2	FN257774	FN257775

D. gallinae	Layer hen	layer farm	France	49	8020	8020i	Co_1	xxxxxxxx	Tro_2	+	Tro_1	+	Tro_10	id.	FN257781	id.	FN257872
D. gallinae	Layer hen	layer farm	France	49	8020	8020j	Co_9	xxxxxxxx	Tro_2	+	Tro_2	+	Tro_10	id.	FN257781	id.	FN257872
D. gallinae	Layer hen	layer farm	France	49	8020	8020k	Co_1	xxxxxxxx	Tro_2	+	Tro_1	+	Tro_10	id.	FN257781	id.	FN257872
D. gallinae	Layer hen	layer farm	France	49	8020	8020l	Co_1	xxxxxxxx	Tro_1	+	Tro_1	+	Tro_10	id.	FN257872	id.	FN257874
D. gallinae	Layer hen	layer farm	France	49	8020	8020m	Co_10	xxxxxxxx	Tro_3	+	Tro_2	+	Tro_10	id.	FN257873	id.	FN257874
D. gallinae	Layer hen	layer farm	France	49	8020	8020n	Co_1	xxxxxxxx	Tro_2	+	Tro_2	+	Tro_10	id.	FN257781	id.	HOM.
D. gallinae	Layer hen	layer farm	France	49	8020	8020o	Co_10	xxxxxxxx	Tro_2	+	Tro_1	+	Tro_10	id.	FN257781	id.	FN257872
D. gallinae	Layer hen	layer farm	France	49	8020	8020p	Co_1	xxxxxxxx	Tro_3	+	Tro_1	+	Tro_10	id.	FN257812	id.	FN257872
D. gallinae	Layer hen	layer farm	France	49	8020	8020q	Co_1	xxxxxxxx	Tro_2	+	Tro_1	+	Tro_10	id.	FN257781	id.	FN257872
D. gallinae	Layer hen	layer farm	France	49	8020	8020r	Co_1	xxxxxxxx	Tro_1	+	Tro_1	+	Tro_10	id.	FN257872	id.	HOM.
D. gallinae	Layer hen	layer farm	France	49	8020	8020s	Co_1	xxxxxxxx	Tro_1	+	Tro_1	+	Tro_10	id.	FN257812	id.	FN257781
D. gallinae	Layer hen	layer farm	France	49	8020	8020t	Co_1	xxxxxxxx	Tro_3	+	Tro_2	+	Tro_10	id.	FN257872	id.	FN257781
D. gallinae	Layer hen	layer farm	France	49	8020	8020u	Co_10	xxxxxxxx	Tro_1	+	Tro_2	+	Tro_10	id.	FN257872	id.	FN257781
D. gallinae	Layer hen	layer farm	France	49	8022	8022a	Co_1	xxxxxxxx	Tro_3	+	Tro_2	+	Tro_10	id.	FN257812	id.	FN257781
D. gallinae	Pigeon	pigeon breeding facility - aviary	France	69	9001	9001a	Co_35	AM921875	Tro_10	+	Tro_10	+	Tro_10	id.	FN257788	id.	HOM.
D. gallinae	Pigeon	pigeon breeding facility - aviary	France	69	9001	9001b	Co_34	FM208712	Tro_10	+	Tro_10	+	Tro_10	id.	FN257788	id.	HOM.
D. gallinae	Pigeon	pigeon breeding facility - aviary	France	69	9001	9001c	Co_34	FM208712	Tro_10	+	Tro_10	+	Tro_10	id.	FN257788	id.	HOM.

D. gallinae	Pigeon	pigeon breeding facility - aviary pigeon	69	9001	9001d	Co_34	id. FM208712	Tro_10	+	Tro_10	id. FN257788	HOM.
D. gallinae	Pigeon	breeding facility - aviary pigeon	69	9001	9001e	Co_34	id. FM208712	Tro_10	+	Tro_10	id. FN257788	HOM.
D. gallinae	Pigeon	breeding facility - aviary pigeon	69	9001	9001f	Co_34	id. FM208712	Tro_10	+	Tro_10	id. FN257788	HOM.
D. gallinae	Pigeon	breeding facility - aviary pigeon	69	9001	9001g	Co_34	id. FM208712	Tro_10	+	Tro_10	id. FN257788	HOM.
D. gallinae	Pigeon	breeding facility - aviary pigeon	69	9001	9001h	Co_34	id. FM208712	Tro_10	+	Tro_10	id. FN257788	HOM.
D. gallinae	Pigeon	breeding facility - aviary pigeon	69	9001	9001i	Co_34	id. FM208712	Tro_10	+	Tro_10	id. FN257788	HOM.
D. gallinae	Pigeon	breeding facility - aviary pigeon	69	9001	9001j	Co_35	id. AM921875	Tro_10	+	Tro_10	id. FN257788	HOM.
D. gallinae	Pigeon	breeding facility - aviary pigeon	69	9001	9001k	Co_34	id. FM208712	Tro_10	+	Tro_10	id. FN257788	HOM.
D. gallinae	Pigeon	breeding facility - aviary pigeon	69	9001	9001l	Co_34	id. FM208712	Tro_10	+	Tro_10	id. FN257788	HOM.
D. gallinae	Pigeon	breeding facility - aviary pigeon	69	9001	9001m	Co_34	id. FM208712	Tro_10	+	Tro_10	id. FN257788	HOM.
D. gallinae	Pigeon	breeding facility - aviary pigeon	69	9001	9001n	Co_34	id. FM208712	Tro_10	+	Tro_10	id. FN257788	HOM.
D. gallinae	Pigeon	breeding facility - aviary pigeon	69	9001	9001o	Co_34	id. FM208712	Tro_10	+	Tro_10	id. FN257788	HOM.
D. gallinae	Pigeon	breeding facility - aviary pigeon	69	9001	9001p	Co_35	id. AM921875	Tro_10	+	Tro_10	id. FN257788	HOM.

D. gallinae	Pigeon	pigeon breeding facility - aviary pigeon	69	9001	9001q	Co_34	id. FM208712	Tro_10	+ Tro_10	id. FN257788	HOM.
D. gallinae	Pigeon	breeding facility - aviary pigeon	69	9001	9001r	Co_34	id. FM208712	Tro_10	+ Tro_10	id. FN257788	HOM.
D. gallinae	Pigeon	breeding facility - aviary pigeon	69	9001	9001s	Co_34	id. FM208712	Tro_10	+ Tro_10	id. FN257788	HOM.
D. gallinae	Pigeon	breeding facility - aviary pigeon	69	9001	9001t	Co_34	id. FM208712	Tro_10	+ Tro_10	id. FN257788	HOM.
D. gallinae	Pigeon	breeding facility - aviary pigeon	69	9001	9001u	Co_34	id. FM208712	Tro_10	+ Tro_10	id. FN257788	HOM.
D. gallinae	Pigeon	breeding facility - aviary pigeon	69	9001	9001v	Co_34	id. FM208712	Tro_10	+ Tro_10	id. FN257788	HOM.
D. gallinae	Pigeon	breeding facility - aviary pigeon	69	9001	9001w	Co_34	id. FM208712	Tro_10	+ Tro_10	id. FN257788	HOM.
D. gallinae	Pigeon	breeding facility - aviary chicken farm - Bresse	69	9001	9001x	Co_34	id. FM208712	Tro_10	+ Tro_10	id. FN257788	HOM.
D. gallinae	Layer hen	(epinettes) chicken farm - Bresse	1	BER	BER1	Co_15	xxxxxxxxxx	Tro_1	+ Tro_3	FN257877	FN257878
D. gallinae	Layer hen	(epinettes) chicken farm - Bresse	1	BER	BER2	Co_15	xxxxxxxxxx	Tro_2	+ Tro_3	id. FN257781	id. FN257812
D. gallinae	Layer hen	(epinettes)	1	BER	BER3	Co_15	xxxxxxxxxx	Tro_1	+ Tro_3	id. FN257872	id. FN257812
D. gallinae	Various pet birds	bird pet shop	69	CANIM	CANIM	Co_34	FM208734	Tro_9	+ Tro_8	FN257799	FN257800
D. gallinae	Layer hen	layer farm	1	Chab	Chab3	Co_16	xxxxxxxxxx	Tro_2	+ Tro_2	FN257806	HOM.
D. gallinae	Layer hen	layer farm	1	Chab	Chab4	Co_17	xxxxxxxxxx	Tro_2	+ Tro_2	FN257807	HOM.

D. gallinae	Layer hen	layer farm on bird - care	France	1	Chab	Chab5	Co_16	xxxxxxx	Tro_2	+	Tro_2	FN257808	HOM.
D. gallinae	Pigeon	activity on bird - care	France	69	COL	COL1	Co_35	AM921875	Tro_8	+	Tro_8	FN257803	HOM.
D. gallinae	Pigeon	activity layer farm -	France	69	COL	COL3	Co_35	AM921875	Tro_11	+	Tro_12	FN257804	FN257805
D. gallinae	Layer hen	cages layer farm -	France	29	F29	F29b	Co_1	xxxxxxx	Tro_2	+	Tro_2	FN257784	HOM.
D. gallinae	Layer hen	cages layer farm -	France	38	F38	F38_6002	Co_1	xxxxxxx	Tro_4	+	Tro_1	FN257809	FN257810
D. gallinae	Layer hen	cages	France	56	F56	F56b	Co_1	xxxxxxx	Tro_1	+	Tro_1	FN257872	HOM.
D. gallinae	European starling	bird nest - nest	Netherlands		IL202	IL202A	Co_27	xxxxxxx	Tro_27	+	Tro_1	FN257902	FN257903
D. gallinae	European starling	bird nest - nest	Netherlands		IL202	IL202C	Co_28	xxxxxxx	Tro_23	+	Tro_23	FN257826	HOM.
D. gallinae	European starling	bird nest - nest	Netherlands		IL202	IL202D	Co_28	xxxxxxx	Tro_23	+	Tro_22	FN257883	FN257884
D. gallinae	European starling	bird nest - nest	Netherlands		IL202	IL202m	Co_28	xxxxxxx					
D. gallinae	European starling	bird nest - nest	Netherlands		IL202	IL202n	Co_27	xxxxxxx					
D. gallinae	European starling	bird nest - nest	Netherlands		IL202	IL202o	Co_28	xxxxxxx	Tro_1	+	Tro_5	FN257885	FN257886
D. gallinae	European starling	bird nest - nest	Netherlands		IL202	IL202p	Co_28	xxxxxxx	Tro_51	+	Tro_52	xxxxxxx	xxxxxxx
D. gallinae	European starling	bird nest - nest	Netherlands		IL202	IL202q	Co_26	xxxxxxx	Tro_53	+	Tro_53	xxxxxxx	HOM.
D. gallinae	European starling	bird nest - nest	Netherlands		IL213	IL2131			Tro_49	+	Tro_27	FN257910	FN257911
D. gallinae	European starling	bird nest - nest	Netherlands		IL213	IL2132	Co_27	FM207499	Tro_50	+	Tro_22	FN257881	FN257882
D. gallinae	European starling	bird nest - nest	Netherlands		IL213	IL2133	Co_27	FM207499	Tro_50	+	Tro_27	FN257906	FN257907
D. gallinae	European starling	bird nest - nest	Netherlands		IL227	IL2272	Co_26	FM207496	Tro_27	+	Tro_27	FN257895	HOM.
D. gallinae	European starling	bird nest - nest	Netherlands		IL227	IL2273	Co_26	FM207496	Tro_6	+	Tro_7	FN257896	FN257897
D. gallinae	European starling	bird nest - nest	Netherlands		IL302	IL302A	Co_27	xxxxxxx					

	starting box	bird nest - nest																		
D. gallinae	European starling	bird nest - nest	Netherlands	IL302	IL302B	Co_29	xxxxxxx													
D. gallinae	European starling	bird nest - nest	Netherlands	IL302	IL302e			Tro_5	+	Tro_6										
D. gallinae	European starling	bird nest - nest	Netherlands	IL302	IL302f	Co_30	xxxxxxx	Tro_1	+	Tro_54										
D. gallinae	European starling	bird nest - nest	Netherlands	IL302	IL302h	Co_26	xxxxxxx	Tro_49	+	Tro_55										
D. gallinae	European starling	bird nest - nest	Netherlands	IL302	IL302m	Co_26	xxxxxxx	Tro_6	+	Tro_7										
D. gallinae	European starling	bird nest - nest	Netherlands	IL302	IL302n	Co_26	xxxxxxx	Tro_27	+	Tro_2										
D. gallinae	European starling	bird nest - nest	Netherlands	IL302	IL302o	Co_27	xxxxxxx	Tro_7	+	Tro_27										
D. gallinae	European starling	bird nest - nest	Netherlands	IL302	IL302p	Co_27	xxxxxxx	Tro_6	+	Tro_24										
D. gallinae	European starling	bird nest - nest	Netherlands	IL302	IL302q	Co_27	xxxxxxx	Tro_56	+	Tro_57										
D. gallinae	Tit	bird nest - nest	France	JBO46	JBO46i	Co_31	FM208736 id.	Tro_26	+	Tro_3										
D. gallinae	Tit	bird nest - nest	France	JBO46	JBO464	Co_31	FM208736	Tro_26	+	Tro_26										
D. gallinae	Tit	bird nest - nest	France	JBO75	JBO75a	Co_32	xxxxxxx													
D. gallinae	Tit	bird nest - nest	France	JBO75	JBO75b	Co_32	xxxxxxx	Tro_3	+	Tro_60										
D. gallinae	Tit	bird nest - nest	France	JBO75	JBO75c	Co_32	xxxxxxx	Tro_59	+	Tro_3										
D. gallinae	Tit	bird nest - nest	France	JBO90	JBO90a	Co_32	xxxxxxx													
D. gallinae	Tit	bird nest - nest	France	JBO90	JBO90b	Co_32	xxxxxxx													
D. gallinae	Tit	bird nest - nest	France	JBO90	JBO90c	Co_32	xxxxxxx													
D. gallinae	House martin	bird nest - from barn	France	LB18	LB181	Co_21	xxxxxxx AM921867	Tro_1	+	Tro_1										
D. gallinae	House martin	bird nest - from barn	France	LB18	LB183	Co_22		Tro_1	+	Tro_1										

D. gallinae	Pigeon	pigeon breeding facility - aviary pigeon	France	26	LC	LC1	Co_36	AM921859	Tro_13	+	Tro_11	FN257797	FN257798
D. gallinae	Pigeon	breeding facility - aviary	France	26	LC	LC4	Co_36	id. AM921859	Tro_11	+	Tro_11	FN257793	HOM.
D. gallinae	Pigeon	bird nest - in town	France	13	P1	P11	Co_35	AM921860	Tro_11	+	Tro_11	FN257794	HOM.
D. gallinae	Pigeon	bird nest - in town	France	13	P1	P12	Co_35	id. AM921860	Tro_14	+	Tro_11	FN257795	FN257796
D. gallinae	Layer hen	layer farm	Poland		PO1	PO1b	Co_18	xxxxxxx	Tro_3	+	Tro_3	FN257818	HOM.
D. gallinae	Layer hen	layer farm	Poland		PO2	PO2A	Co_18	xxxxxxx	Tro_3	+	Tro_3	FN257819	HOM.
D. gallinae	Layer hen	layer farm	Poland		PO2	PO2B	Co_19	xxxxxxx	Tro_2	+	Tro_1	FN257875	FN257876
D. gallinae	Roller	on bird - nest box	France	13	ROL1	ROL12		xxxxxxx	Tro_15	+	Tro_2	xxxxxxx	FN257781
D. gallinae	Roller	on bird - nest box	France	13	ROL1	ROL15	Co_23	AM921864		+			id.
D. gallinae	Roller	on bird - nest box	France	13	ROL1	ROL16			Tro_15	+	Tro_1	xxxxxxx	FN257872
D. gallinae	Roller	on bird - nest box	France	13	ROL2	ROL23	Co_24	AM921865					id.
D. gallinae	Roller	on bird - nest box	France	13	ROL2	ROL25			Tro_15	+	Tro_3	xxxxxxx	FN257812
D. gallinae	Roller	on bird - nest box	France	13	ROL2	ROL26	Co_25	xxxxxxx	Tro_58	+	Tro_15	FN257914	FN257915
D. gallinae	Layer hen	amateur layer house lab strain	France	69	SB	SB1	Co_20	AM921858	Tro_2	+	Tro_2	FN257766	HOM.
D. gallinae	Layer hen	(original isolate from a layer farm)	Denmark		SK	SK_Fa17	Co_11	xxxxxxx					

D. hirundinis	Barn swallow	bird nest - from barn	France	1	CB5	CB5e	Co_38	id. FM208728	Tro_44	+	Tro_44	FN257840	HOM.
D. hirundinis	Barn swallow	bird nest - from barn	France	72	CHOV	CHOV1	Co_38	FM179369	Tro_44	+	Tro_44	FN257841	HOM.
D. hirundinis	Barn swallow	bird nest - from barn	France	72	CHOV	CHOV2	Co_38	id. FM179369	Tro_44	+	Tro_44	FN257842	HOM.
D. hirundinis	Barn swallow	bird nest - from barn	France	85	HIR1	HIR1A	Co_39	FM179366	Tro_44	+	Tro_44	FN257843	HOM.
D. hirundinis	Barn swallow	bird nest - from barn	France	85	HIR1	HIR1B	Co_39	id. FM179366	Tro_44	+	Tro_44	FN257844	HOM.
D. hirundinis	Barn swallow	bird nest - from barn	France	85	HIR6	HIR6a	Co_38	xxxxxxxxxx	Tro_44	+	Tro_44	FN257845	HOM.
D. hirundinis	Barn swallow	bird nest - from barn	France	85	HIR6	HIR6b	Co_39	xxxxxxxxxx	Tro_44	+	Tro_44	FN257849	HOM.
D. hirundinis	Barn swallow	bird nest - from barn	France	85	HIR6	HIR6c	Co_39	xxxxxxxxxx	Tro_44	+	Tro_44	FN257848	HOM.
D. hirundinis	Barn swallow	bird nest - from barn	France	18	LB18c	LB18c	Co_39	xxxxxxxxxx	Tro_44	+	Tro_44	id. FN257846	HOM.
D. hirundinis	Barn swallow	bird nest - building roof	France	38	OC	OC5	Co_38	AM921862	Tro_44	+	Tro_44	FN257846	HOM.
D. hirundinis	Barn swallow	bird nest - building roof	France	38	OC	OC6	Co_38	id. AM921862	Tro_44	+	Tro_44	FN257847	HOM.
D. hirundinis	Tit Barn	layer farm bird nest - from barn	USA		PARATR	PARATR8	Co_37	FM208746	Tro_43	+	Tro_42	FN257851	FN257852
D. hirundinis	Barn swallow	bird nest - from barn	France	69	TB081	TB082	Co_38	xxxxxxxxxx	Tro_44				
D. hirundinis	Barn swallow	bird nest - from barn	France	69	TB081	TB083	Co_38	xxxxxxxxxx	Tro_44				
D. hirundinis	Barn swallow	bird nest - from barn	France	69	TB081	TB084	Co_38	xxxxxxxxxx	Tro_44	+	Tro_44	FN257879	HOM.
D. hirundinis	Barn swallow	bird nest - from barn	France	69	TB081	TB085	Co_38	xxxxxxxxxx	Tro_44	+	Tro_44	FN257880	HOM.
D. hirundinis	Barn swallow	bird nest - from barn	France	69	TB085	TB085e	Co_56	xxxxxxxxxx	Tro_44	+	Tro_44	FN257846	HOM.
D. hirundinis	Barn swallow	bird nest - from barn	France	69	TB085	TB085g	Co_56	xxxxxxxxxx	Tro_44	+	Tro_44	id. FN257846	HOM.
D. hirundinis	Troglodyte	bird nest	USA		TROAED	TROAED2	Co_37	FM208747	Tro_42	+	Tro_42	FN257853	HOM.

D. longipes	Tit	bird nest - nest box	France	69	ENVL083	ENVL083a	Co_40	FM179365 id.	Tro_48	+	Tro_48	FN257854	HOM.
D. longipes	Tit	bird nest - nest box	France	69	ENVL083	ENVL083b	Co_40	FM179365	Tro_47	+	Tro_47	FN257855	HOM.
D. longipes	Tit	bird nest - nest box	France	69	ENVL088	ENVL088a	Co_41	FM208743 id.	Tro_46	+	Tro_46	FN257856	HOM.
D. longipes	Tit	bird nest - nest box	France	69	ENVL088	ENVL088b	Co_41	FM208743	Tro_45	+	Tro_45	FN257857	HOM.
D. longipes	Sparrow	bird nest - nest box	France	13	JBO108	JBO108a	Co_42	xxxxxxxxxx	Tro_41	+	Tro_41	FN257837	HOM.
D. longipes	Sparrow	bird nest - nest box	France	13	JBO49	JBO495	Co_42	AM921869 id.	Tro_41	+	Tro_41	FN257858	HOM.
D. longipes	Sparrow	bird nest - nest box	France	13	JBO49	JBO49DL2	Co_42	AM921869 id.	Tro_41	+	Tro_41	FM897376	HOM.
D. longipes	Sparrow	bird nest - nest box	France	13	JBO49	JBO49DL3	Co_42	AM921869 id.	Tro_41	+	Tro_41	FN257860	HOM.
D. quintus	Sparrow	bird nest - nest box	USA		ADqui	ADqui	Co_Dquintus	AM921882					
O. bacoti	lab strain	lab strain	France	75	Ob	Ob	Co_Obacoti	FM179677	Tro_Obacoti	+	Tro_Obacoti	FN257767	HOM.
T. pyri	lab strain	lab strain	France	34	T_pyri	T_pyri	Co_Tpyri	FM179364	Tro_Tpyri	+	Tro_Tpyri	xxxxxxx	HOM.

Appendix 2. Information about the matrix of encoded In/Del (Tropomyosin)

List of discrete characters encoded from insertions/deletions recorded along the Tropomyosin sequence

On the whole dataset, 12 different regions with insertions/deletions variable intraspecifically have been identified based on all Tropomyosin gene copies obtained from individuals belonging to *D. gallinae* (named using the first letters of alphabet, followed in some cases by a number). Additionally, insertions/deletions which were not potentially discriminant between populations of *D. gallinae* were named using ID (In/Del) followed by a number.

Character name	Presence of intraspecific variation according to presence/absence of the considered insert	Position of insert (based on alignment ISOL-TR01)	Character state	Code	Character state concerned	species of Dermanyssus	Comments
ID1		37	c absent	1 0	<i>D. carpathicus</i> <i>all others</i>		
ID2		106-108	ttc gtc	2 1	<i>D. gallinae</i> <i>D. apodis</i>		
A	x	130-132	absent gtg absent	0 1 0	<i>D. carpathicus</i> , <i>D. hirundinis</i> , <i>D. longipes</i> <i>D. gallinae</i> <i>D. gallinae</i> , <i>D. apodis</i> , <i>D. carpathicus</i> , <i>D. hirundinis</i> , <i>D. longipes</i>		
ID3	x	170	g absent	1 0	<i>D. longipes</i> (population ENVL08) <i>D. gallinae</i> , <i>D. apodis</i> , <i>D. carpathicus</i> , <i>D. hirundinis</i> , <i>D. longipes</i>		
B1	x	179-184	ttgtct g tag	1 0 2	<i>D. gallinae</i> <i>D. gallinae</i> , <i>D. apodis</i> , <i>D. hirundinis</i> , <i>D. longipes</i> <i>D. carpathicus</i>		
B2	x	195-199	cttgg tttt cttta tttgg tttg	1 2 3 4 5	<i>D. gallinae</i> , <i>D. apodis</i> <i>D. gallinae</i> <i>D. gallinae</i> <i>D. carpathicus</i> , <i>D. hirundinis</i> , <i>D. longipes</i> <i>D. gallinae</i>		

ID4	x	220-223	absent	0	<i>D. gallinae</i>
			aaag	1	<i>D. hirundinis</i> , <i>D. longipes</i> (+ 1 <i>D. gallinae</i> individual 8018)
ID5		228-229	aaaa	2	<i>D. carpathicus</i>
			gaag	3	<i>D. gallinae</i> , <i>D. apodis</i>
			absent	0	<i>D. longipes</i> (population ENVL08)
			tt	1	<i>D. carpathicus</i>
ID6-C1 complex	x	230-254	absent	0	<i>D. gallinae</i> , <i>D. apodis</i> , <i>D. hirundinis</i> , <i>D. longipes</i>
			absent	0	<i>D. longipes</i> (population ENVL08)
ID7-C2 complex	x	258-267	c/tggttgaaccgaa	2	<i>D. carpathicus</i> , <i>D. hirundinis</i> , <i>D. longipes</i>
			/gtttgaatt		
			tggttgaaccgaaaa	3	<i>D. apodis</i>
			agtttag		
			tggc/tg/tgaaccg	3	<i>D. gallinae</i>
			gaaaat/ag/tgaa		
			tgccgtgaa	1	<i>D. gallinae</i>
			a/citttaaaa	2	<i>D. gallinae</i>
			atttttta	2	<i>D. gallinae</i>
			absent	0	<i>D. gallinae</i>
ID8	x	273	atgtttaaaa	2	<i>D. apodis</i>
			gtttttaaa	2	<i>D. longipes</i> (population ENVL08)
			gttttaaa	1	<i>D. longipes</i> (population ENVL08)
			gtttttaaaa	2	<i>D. hirundinis</i> , <i>D. longipes</i>
			gttttaaatt	2	<i>D. carpathicus</i>
			c	1	<i>D. carpathicus</i>
			absent	0	<i>D. gallinae</i> , <i>D. apodis</i> , <i>D. carpathicus</i> , <i>D. hirundinis</i> , <i>D. longipes</i>
			cta	2	<i>D. gallinae</i> , <i>D. apodis</i>
			cca	1	<i>D. gallinae</i>
			absent	0	<i>D. carpathicus</i> , <i>D. hirundinis</i> , <i>D. longipes</i>
ID9		286-288	ttc	1	<i>D. hirundinis</i>
			absent	0	<i>D. gallinae</i> , <i>D. apodis</i> , <i>D. carpathicus</i> , <i>D. longipes</i>
ID10		297-299	absent	0	

numerous
nucleotide
mutations

D	x	318-322	tagta	1	<i>D. gallinae, D. apodis, D. carpathicus, D. hirundinis, D. longipes</i>
			absent	0	<i>D. gallinae</i>
			cgctcga	1	<i>D. gallinae, D. apodis, D. hirundinis, D. longipes</i>
E	x	347-353	tgctcga	2	<i>D. carpathicus</i>
			absent	0	<i>D. gallinae</i>
ID11		354-355	aa	1	<i>D. gallinae, D. carpathicus, D. hirundinis, D. longipes</i>
			ga	2	<i>D. apodis</i>
			absent	0	<i>D. longipes (population ENVL08)</i>
ID12		377-380	atac	2	<i>D. apodis</i>
			a	1	<i>D. gallinae, D. carpathicus</i>
			absent	0	<i>D. hirundinis, D. longipes</i>
			attggacc	1	<i>D. gallinae, D. apodis</i>
F	x	398-408	attggact	5	<i>D. longipes</i>
			atcggat	2	<i>D. carpathicus</i>
			attggaccgac	4	<i>D. hirundinis</i>
			attggaecgc	3	<i>D. longipes</i>
			absent	0	<i>D. gallinae</i>
ID13	x	415-416	cc	1	<i>D. gallinae, D. apodis, D. carpathicus, D. hirundinis, D. longipes</i>
			c	2	<i>D. hirundinis</i>
			absent	0	<i>D. carpathicus</i>
G	x	422-425	gtca	1	<i>D. gallinae, D. apodis, D. carpathicus, D. hirundinis, D. longipes</i>
			gccca	2	<i>D. gallinae</i>
			gtcc	3	<i>D. gallinae</i>
			gcct	4	<i>D. gallinae</i>
			absent	0	<i>D. gallinae</i>
H	x	426-433	ggcggc	1	<i>D. gallinae</i>
			ggcggctc	2	<i>D. apodis</i>
			absent	0	<i>D. gallinae, D. carpathicus, D. hirundinis, D. longipes</i>
ID14	x	445-449	tgaag	1	<i>D. carpathicus</i>
			tgaaa	2	<i>D. carpathicus</i>
			c	3	<i>D. gallinae (one individual)</i>
			absent	0	<i>D. gallinae, D. apodis, D. hirundinis, D. longipes</i>

ID15	453-455	ctg absent	1 0	<i>D. gallinae</i> , <i>D. apodis</i> <i>D. carpathicus</i> , <i>D. hirundinis</i> , <i>D. longipes</i>	
ID16	464-467	agct absent	1 0	<i>D. apodis</i> <i>D. gallinae</i> , <i>D. carpathicus</i> , <i>D. hirundinis</i> , <i>D. longipes</i>	
ID17	483	g	1	<i>D. gallinae</i> , <i>D. apodis</i> , <i>D. carpathicus</i> , <i>D. hirundinis</i> , <i>D. longipes</i>	
ID18	506-508	absent atg absent	0 1 0	<i>D. hirundinis</i> <i>D. gallinae</i> , <i>D. apodis</i> <i>D. carpathicus</i> , <i>D. hirundinis</i> , <i>D. longipes</i>	
J	564-582	TGAX2	1	<i>D. gallinae</i>	TGC instead of TGA in some cases
		TGAX3	2	<i>D. gallinae</i>	TGC instead of TGA in some cases
		TGAX4	3	<i>D. gallinae</i>	TGC instead of TGA in some cases
		TGAX5	4	<i>D. gallinae</i>	TGC instead of TGA in some cases
		TGAX6	5	<i>D. gallinae</i>	TGC instead of TGA in some cases
		TGAX3+ CGGA	6	<i>D. apodis</i>	
ID19	599-601	absent tcg	0 1	<i>D. carpathicus</i> , <i>D. hirundinis</i> , <i>D. longipes</i> <i>D. gallinae</i> , <i>D. apodis</i>	
ID20	636	absent g	0 1	<i>D. carpathicus</i> , <i>D. hirundinis</i> , <i>D. longipes</i> <i>D. gallinae</i>	
ID21	639-340	absent tg cg	1 1 2	<i>D. apodis</i> , <i>D. carpathicus</i> , <i>D. hirundinis</i> , <i>D. longipes</i> <i>D. gallinae</i> , <i>D. apodis</i> , <i>D. longipes</i> <i>D. hirundinis</i>	
ID22	684	absent a	0 1	<i>D. carpathicus</i> <i>D. gallinae</i>	

ID23	688-690	absent gca absent	0 1 0	<i>D. gallinae</i> , <i>D. apodis</i> , <i>D. carpathicus</i> , <i>D. hirundinis</i> , <i>D. longipes</i> <i>D. gallinae</i> , <i>D. apodis</i> <i>D. carpathicus</i> , <i>D. hirundinis</i> , <i>D. longipes</i>
------	---------	-------------------------	-------------	---

Matrix of encoded In/Del

Character n°	11111111112222222222223333
Haplotype n°	123456789012345678901234567890123
Tro_1	010011103201011111110101011411101
Tro_2	010001103201011111011101011311101
Tro_3	010011103201011111011101011311101
Tro_4	010011103201011111111101011411101
Tro_5	01101110320101111111101011411101
Tro_6	01101110320101111111101011411101
Tro_7	010000103201011111011101011311101
Tro_8	010011103201011111111101011311101
Tro_9	01001110320101111111101011311101
Tro_10	01001110320101111111101011311101
Tro_11	01001110320101111111101011311101
Tro_12	01001110320101111111101011311101
Tro_13	01001110320101111111101011311101
Tro_14	01001110320101111111101011311101
Tro_15	01001110320101111111101011311101
Tro_16	01001110320101111111101011211101
Tro_17	01001110320101111111101011311101
Tro_18	01000110320101111111101011311101
Tro_19	01000110320101111111101011311101
Tro_20	01000110320101111111101011311101
Tro_21	0100111032010111111101011311101
Tro_22	01101110320101011111101011311101
Tro_23	01000110320100111112001011211101
Tro_24	01101110320101111111101011411101
Tro_25	01000110320100111112001011211101
Tro_26	0100111032010111110101011311101
Tro_27	01101110120101111111101011511101
Tro_28	020001103211011212111301111610101
Tro_29	020001103211011212111201111610101
Tro_30	100021112200012101111010010000000
Tro_31	100021112200012101111010010000000

Tro_32 100021112200012101111010010000000
Tro_33 100021112200012101111010010000000
Tro_34 100021112200012101111010010000000
Tro_35 100021112200012101111010010000000
Tro_36 100021112200012101111010010000000
Tro_37 100021112200012101111010010000000
Tro_38 100021112200012101111010010000000
Tro_39 100021112200012101111010010000000
Tro_40 100021112200012101101010010000000
Tro_41 000001102220011110113000010000100
Tro_42 000001102220111110121000010000200
Tro_43 000001102220111110121000010000200
Tro_44 00000110222011111011100000000200
Tro_45 000101000120011010111000010000100
Tro_46 000101000120011010111000010000100
Tro_47 000101000120011010111000010000100
Tro_48 000101000220011010111000010000100
Tro_49 01101110320101111111101011411101
Tro_50 01101110320101111111101011411101
Tro_51 01101110320101111111101011411101
Tro_52 011011103201001111112001011111101
Tro_53 010001103201001111114001011111101
Tro_54 01101110320101111111101011511101
Tro_55 010000103201011111011101011311101
Tro_56 010001103001011111011101011311101
Tro_57 010000103201001111112001011211101
Tro_58 011011103201001111112001011111101
Tro_59 010011103201001111112001011211111
Tro_60 011011103201001111112031011111101
Tro_D_hirsutus 100001102221011110111300011100101
Tro_T_pyri 000131?0002001011000000000100????
Tro_O_bacoti 100031?0040002111??1?01001000????

Appendix 3. ABC analysis of case II. 30 clusters of the 180 branching tree histories when considering 5 populations cladograms.

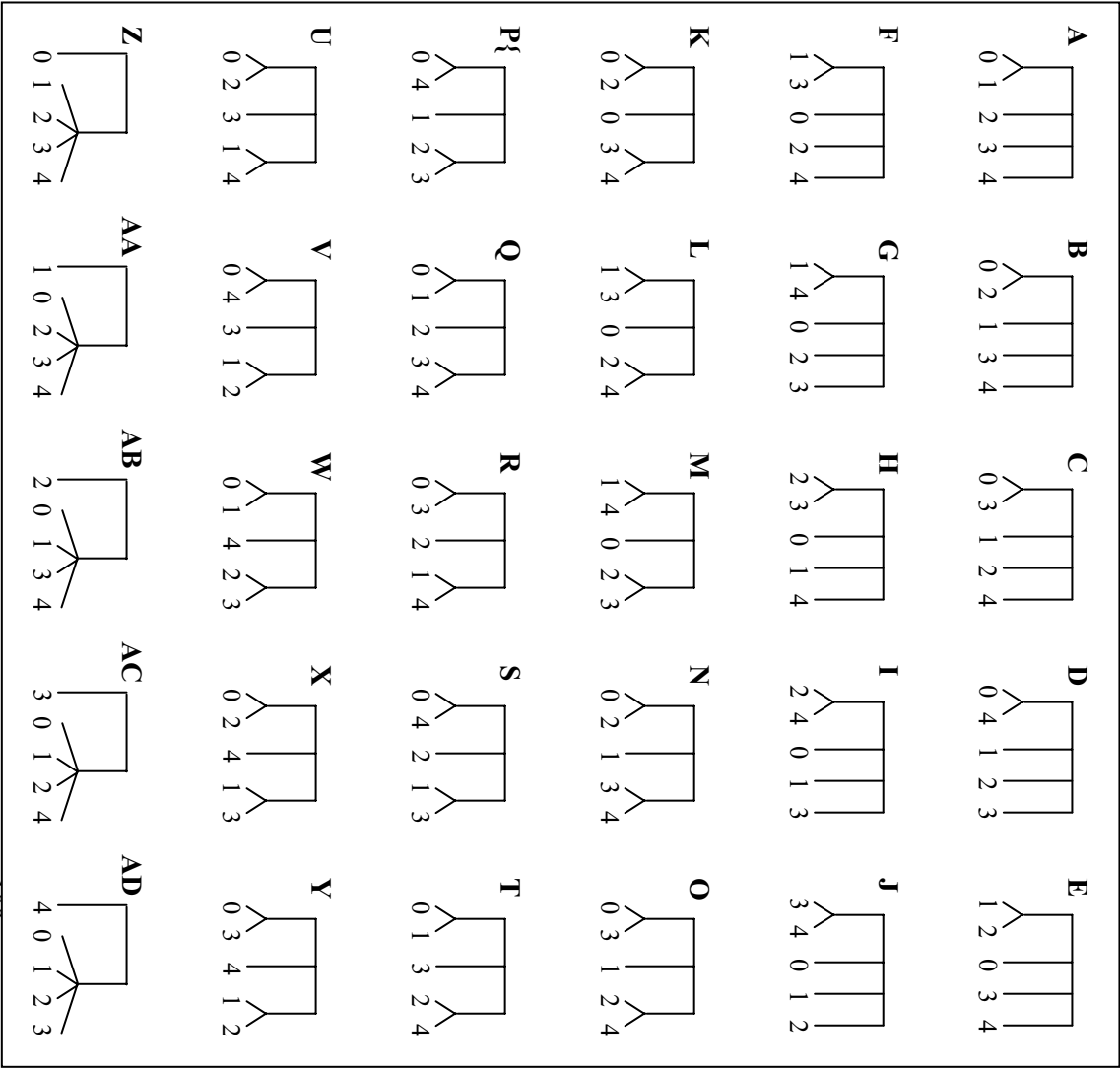

Appendix 4. Prior distribution and Bayesian probabilities of different scenarios in the three studies using an ABC method.

A. Case I (intraspecific, *D. gallinae*, host type). B. Case II (intraspecific, *D. gallinae*, individual isolates, with diverse geographical locations). C. Case III (interspecific, *D. gallinae*, *D. hirundinis*, *D. apodis*).

A. Case I (intraspecific, *D. gallinae*, host type)

Prior distributions used for the intra-specific population genetics analyses of *D. gallinae*.

Symbol	description	Prior distribution
Demographic parameters		
Ne	Population sizes	Uniform(0, 500000)
t	Splitting times	Uniform(0, 2.5Mya)
m	Migration rates	Uniform(0, 0.01)
Mutations parameters		
<input type="checkbox"/> COI	mutation rate for COI locus	Lognormal(-5.00, 0.06)
<input type="checkbox"/> Troppo	mutation rate for Troposymmin locus	Lognormal(-5.68, 0.15)]
<input type="checkbox"/> both	mutation rate for both locus	Normal(6.92E-6, 2.95E-6)

Bayesian probabilities of different scenarios regarding presence or absence of migration between *D. gallinae* groups with different host types.

<u>topologies</u>	both loci
1 migration	3.6%
2 migration	3.6%
3 migration	3.7%
4 migration	4.0%
5 migration	4.4%
6 migration	3.5%
7 migration	4.0%
8 migration	3.4%
9 migration	3.8%
10 migration	4.0%
11 migration	3.6%

12	migration	3.9%
13	migration	3.8%
14	migration	3.8%
15	migration	3.3%
16	migration	3.7%
17	migration	3.6%
18	migration	3.6%
19	no migration	2.2%
20	no migration	2.1%
21	no migration	2.1%
22	no migration	2.7%
23	no migration	1.9%
24	no migration	2.0%
25	no migration	1.8%
26	no migration	1.9%
27	no migration	1.8%
28	no migration	1.8%
29	no migration	1.1%
30	no migration	1.5%
31	no migration	1.9%

	migration	
	no migration	
32	migration	1.8%
	no migration	
33	migration	1.5%
	no migration	
34	migration	1.4%
	no migration	
35	migration	1.5%
	no migration	
36	migration	1.9%

Bayesian probabilities of different scenarios regarding population branching tree histories between *D. gallinae* groups with different host types.

topologies	both loci
1	0%
2	0%
3	0%
4	0%
5	90%
6	0%
7	0%
8	0%
9	0%
10	0%
11	0%
12	0%
13	0%
14	0%
15	0%
16	0%
17	0%
18	9%

B. Case II (intraspecific, *D. gallinae*, individual isolates, with diverse geographical locations).

Bayesian probabilities of different clusters of population branching tree histories between *D. gallinae* populations with different geographical location.

Clusters	both loci
A	0%
B	4%
C	1%
D	16%
E	0%
F	0%
G	0%
H	0%
I	0%
J	0%
K	0%
L	0%
M	0%
N	0%
O	0%
P	0%
Q	44%
R	0%
S	0%
T	0%
U	34%
V	0%
W	0%
X	0%
Y	0%

Z	0%
AA	0%
AB	0%
AC	0%
AD	0%

Bayesian probabilities of different population branching tree histories from the most supported clusters between *D. gallinae* populations with different geographical location.

topologies	both
19	0.00
22	0.00
25	0.02
27	0.00
28	0.00
46	0.00
55	0.00
56	0.01
60	0.00
63	0.00
64	0.24
73	0.00
130	0.00
133	0.00
137	0.00
141	0.72
157	0.00
164	0.00

C. Case III (interspecific, *D. gallinae*, *D. hirsutinis*, *D. apodis*)

Prior distributions used for the inter-specific population genetics analyses of *Dermatophyssus*.

Symbol	description	Prior distribution
--------	-------------	--------------------

Demographic parameters		
Ne	Population sizes	Uniform(0, 500000)
t	Splitting times	Uniform(0, 10Mya)
m	Migration rates	No migration considered
Mutations parameters		
<input type="checkbox"/> COI	mutation rate for COI locus	Lognormal(-5.00, 0.06)
<input type="checkbox"/> Topo	mutation rate for Toposymmin locus	Lognormal(-5.68, 0.15)]
<input type="checkbox"/> both	mutation rate for both locus	Normal(6.92E-6, 2.95E-6)

Bayesian probabilities of different scenarios regarding population branching tree histories between different *Dermomyssus* species.

topologies	both loci
1	35%
2	10%
3	54%

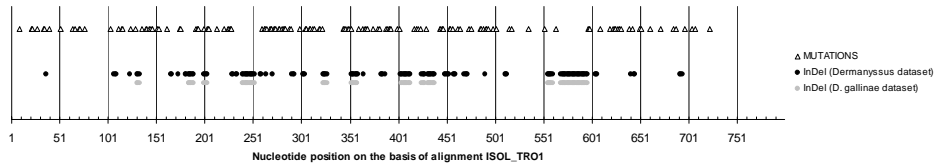

Figure 1

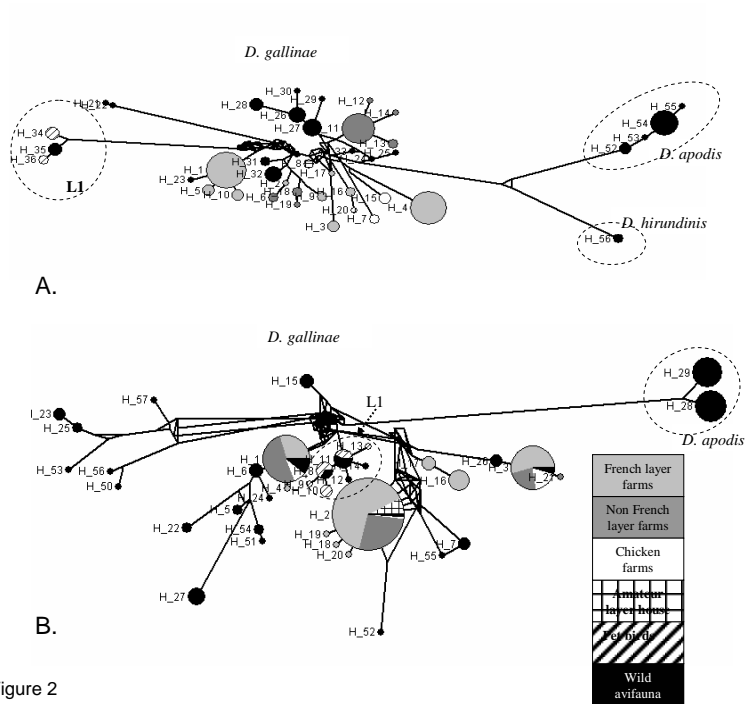

Figure 2

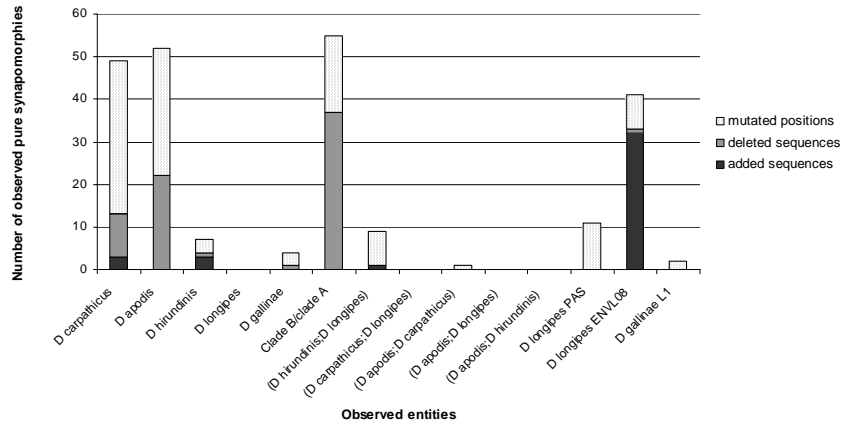

Figure 3

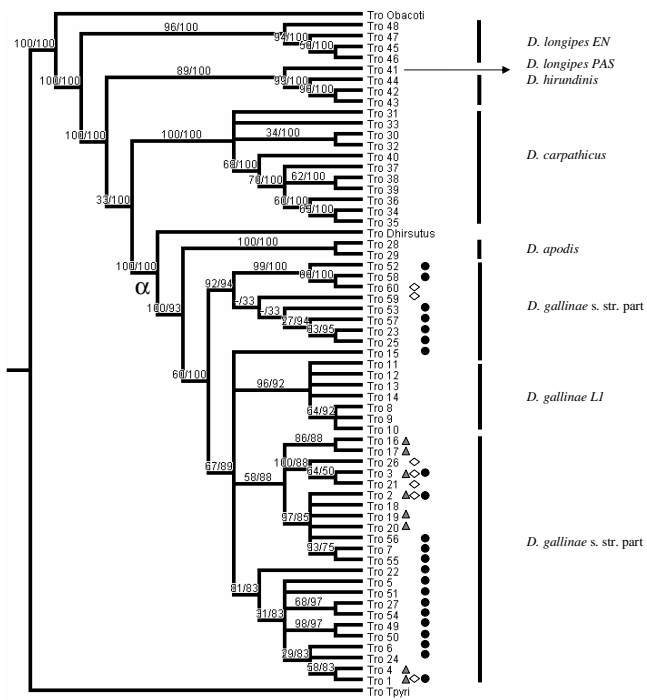

Figure 4
A.

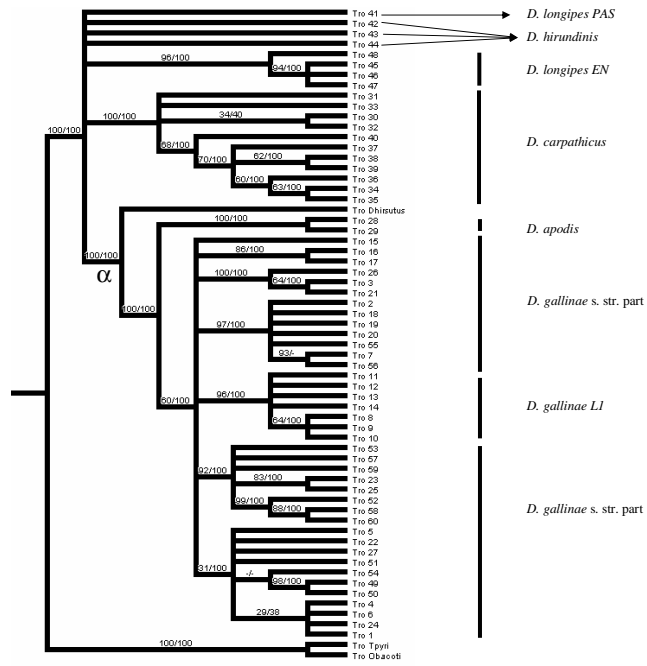

Figure 4
B.

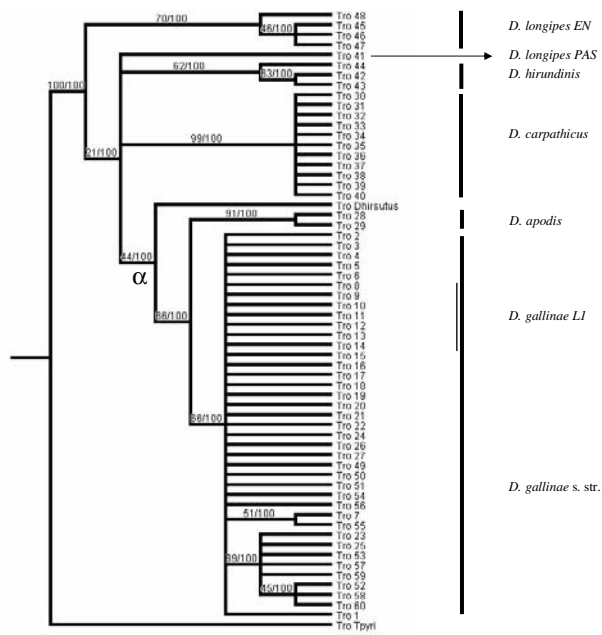
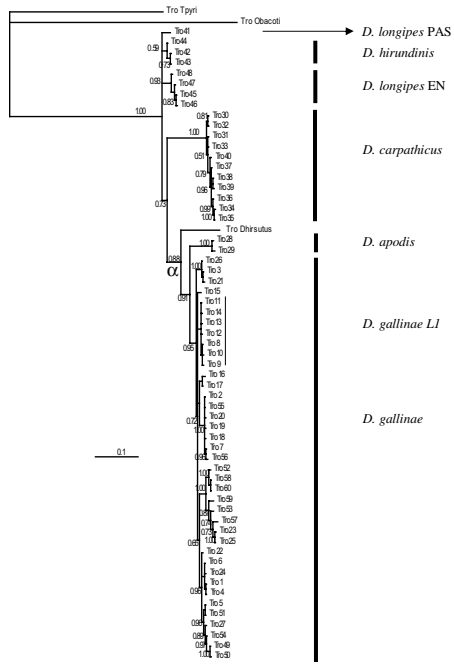
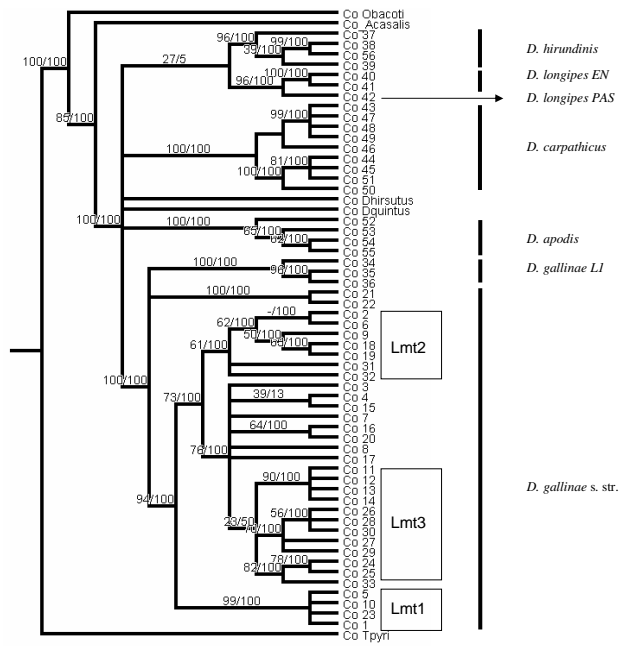

Figure 4
C.

Figure 4
D.



E.



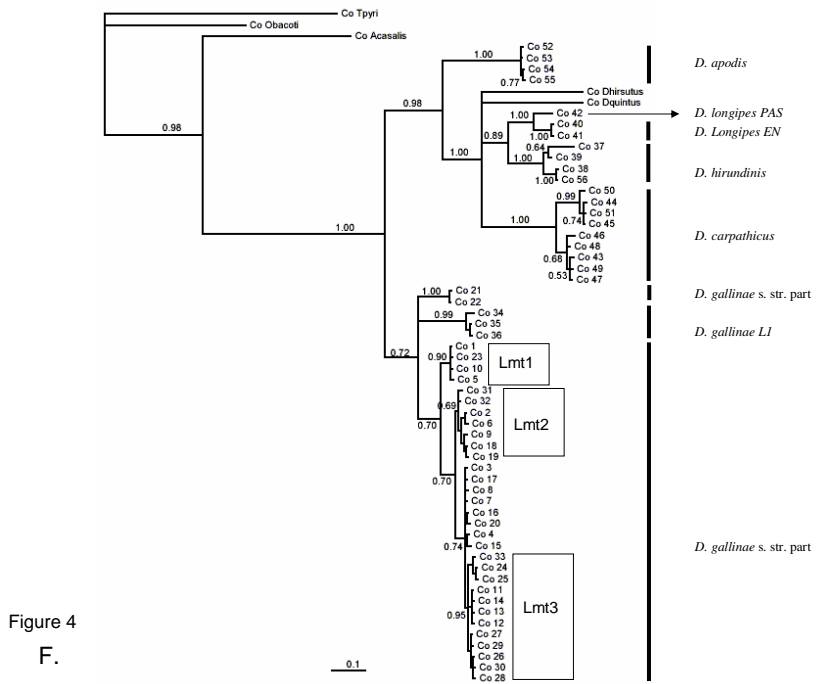

Figure 4
F.

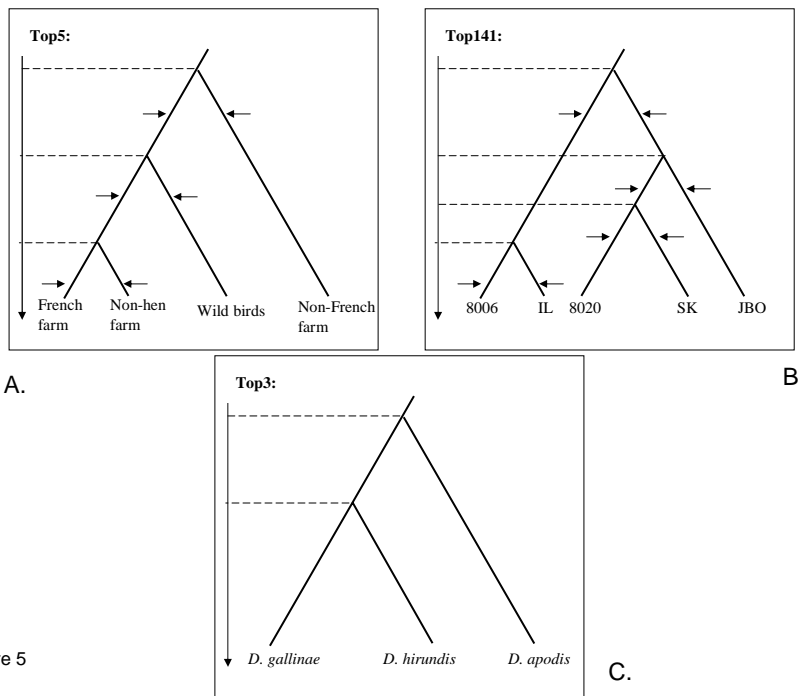

Figure 5

5.3 Arthropodofaune de nids d'oiseaux en agroécosystème et implication des *Dermanyssosidea* hématophages : publication VI

a - Présentation

Après des études mettant à profit des outils phylogénétiques et de génétique des populations, certains éléments de l'écologie des espèces françaises du groupe *gallinae* ont été partiellement clarifiés. Ou plutôt, certaines questions plus précises ont pu être formulées, sur la base d'indices évolutifs. En particulier, les éléments qui président à l'adaptation accrue de *D. gallinae* aux habitats modifiés par l'homme tels les élevages, comparé aux autres espèces de *Dermanyssus*, demeurent pour l'heure très hypothétiques (cf. éléments des résultats 3 de la publication IV, énumérés dans le § 5.1.a.3). Parmi ces hypothèses est évoqué le rôle de la composition des communautés d'arthropodes peuplant les nids d'oiseaux.

Les agroécosystèmes sont en général caractérisés par une altération de la faune, si l'on compare avec la plupart des écosystèmes naturels. La biodiversité dans divers groupes zoologiques est souvent modifiée, en particulier chez les arthropodes et les oiseaux. En outre, la prise en compte de la préservation de l'environnement et le souci d'une agriculture durable nécessitent de limiter au maximum l'utilisation de produits phytosanitaires. Ainsi plusieurs types d'agroécosystèmes sont-ils générés par la diversification des méthodes de lutte. J.C. Bouvier (INRA Avignon) compare ainsi depuis plusieurs années nichées et couvées d'oiseaux obtenues dans des nichoirs placés dans des parcelles soumises à trois types différents de modes de lutte contre les arthropodes prédateurs des fruitiers considérés : conventionnel, biologique, intégré. Des nids de mésange prélevés *in natura* viennent compléter l'étude.

Les nids d'oiseaux constituant par excellence des îlots, leur arthropodofaune est tout à fait particulière et riche. En effet, de par leur isolement naturel et la présence du vertébré, ces îlots offrent une biodiversité souvent remarquable *in natura* : un microécosystème plus ou moins équilibré se crée, impliquant un guildes de détritivores et saprophages souvent riche, se nourrissant sur les déchets produits/introduits par le vertébré, ainsi qu'une guildes de prédateurs tout à fait intéressante, se nourrissant des ectoparasites apportés par le vertébré et des détritivores et saprophages sus-cités. L'isolement caractéristique de ce type d'habitat entraîne un certain degré de spécialisation chez ces arthropodes, certains parmi l'une ou l'autre des trois guildes principales (détritivores/saprophages, prédateurs, parasites) étant strictement inféodés aux nids d'oiseaux.

Afin d'obtenir un aperçu du microécosystème de cet acarien chez des oiseaux particulièrement communs et de détecter une éventuelle corrélation entre arthropode prédateur et présence de *D. gallinae*, entre pesticides et présence de *D. gallinae*, nous avons engagé, en collaboration avec l'INRA d'Avignon, un étude comparative de l'arthropodofaune de nids d'oiseaux en agroécosystèmes de vergers.

5.3.a.1 Objectifs

Les objectifs étaient scindés en deux axes : L'arthropodofaune particulière des îlots constitués par les nids d'oiseaux dans les agroécosystèmes est-elle aussi affectée par les pratiques agricoles, malgré leur isolement ? Comment sont affectés les mésostigmatés hématophages inféodés aux oiseaux dans les agroécosystèmes de verger ?

5.3.a.2 Matériel et méthodes

L'étude est venue s'intégrer à une étude déjà très avancée, menée par J.C. Bouvier, sur la biodiversité de l'avifaune dans ce type de milieu et les impacts des pratiques agricoles sur divers paramètres afférents aux oiseaux (biodiversité, fitness, ...). Elle reposait sur la comparaison de cette faune particulière observée dans trois grands types de vergers de fruitiers (fruits à pépins) (ainsi qu'*in natura*) : lutte biologique, lutte chimique et lutte intégrée. L'arthropodofaune a été appréhendée sous trois volets plus ou moins approfondis : (1) la simple présence ou non d'arthropodes dans les nids analysés d'une manière standardisée, (2) la diversité des arthropodes isolés, (3) la nature de certains ectoparasites hématophages (Acari : Mesostigmata) parmi ces arthropodes. Les résultats présentés ici sont issus des deux années d'échantillonnage (2007 et 2008). Des tests statistiques ont évalué le degré de significativité des différences observées dans les trois volets.

5.3.a.3 Principaux résultats

Le ratio du nombre de nids ayant permis de détecter des arthropodes par rapport au nombre de nids « vides » (volet n°1) s'est avéré significativement marqué par les pratiques de lutte : les nids « vides » étaient nettement plus nombreux en verger conventionnel. En revanche, les résultats des volets n°2 et 3 ont mis en évidence des tendances, mais n'ont pas montré, pour la plupart, de significativité notoire, sans doute du fait de la trop faible occurrence des différents groupes d'arthropodes pour l'obtention de données statistiquement fiables.

La comparaison de la biodiversité relevée entre nids de vergers et nids prélevés *in natura* a suggéré une variation en accord avec les résultats d'Ives *et al.* (2000). Ces auteurs ont démontré que la richesse en espèce augmente la stabilité au niveau de la communauté dans la mesure où ladite communauté fournit des espèces qui ont des chances d'être tolérantes à différentes fluctuations environnementales, et ainsi sont complémentaires des autres. Ici, les acariformes détritivores étaient faiblement diversifiés et leur nombre a semblé influencé par les pratiques agricoles, alors que les ectoparasites considérés comportent des espèces qui ont été démontrées comme très différentes en terme de tolérance aux environnements modifiés par l'homme et leur nombre se trouve ne pas être affecté. En revanche, les psocoptères détritivores se sont avérés représentés par une seule espèce, *Liposcelis bostrychophila* Badonnel, 1931, apparemment non influencée par les modalités de lutte. Mais il s'agit précisément d'une espèce qui a fait la preuve d'une capacité d'adaptation remarquable dans des environnements modelés par l'homme, développant rapidement des résistances croisées multiples. Quant au genre *Dermanyssus*, *D. gallinae* s'est montré une fois de plus différent des autres en terme de tolérance à des pratiques humaines, puisqu'il a été isolé dans les vergers et non *in natura* chez les mésanges du genre *Parus*. En l'occurrence, le seul point commun apparent entre verger et élevage semble être les actions de contrôle des arthropodes (et de manière corrélée, la présence réduite de prédateurs). Toutefois, *D. gallinae* n'était présent qu'en verger biologique ou intégré, jamais en verger conventionnel. Il semblerait peu tolérant aux traitements rencontrés dans les vergers conventionnels. Un acarien d'une autre famille, *O. sylviarum* (Macronyssidae) a semblé, par ailleurs, présenter un spectre de tolérance plus large encore puisqu'il était aussi présent en verger conventionnel, et de manière récurrente.

Notons enfin qu'*O. sylviarum*, fréquemment rencontré dans les nids d'oiseaux testés, demeure aujourd'hui absent des élevages de pondeuses en France. Cette espèce est un ravageur notoire en pondeuses aux Etats-Unis. A l'inverse, *D. gallinae*, le pou rouge des volailles, présent *in natura* dans les deux continents, est un ravageur notoire en France, pas aux Etats-Unis. Par ailleurs, *D. gallinae* bien que présent dans 80% des élevages de pondeuses n'a jamais été recensé dans les nids de mésange charbonnière prélevés *in natura*. Une analyse comparative de la génétique des populations

de chacune des deux espèces en France et aux USA (en élevages comme *in natura*) pourrait apporter d'intéressantes informations quant à l'impact différentiel des pratiques d'élevages des deux pays.

Arthropodofauna in bird nests as an indicator for agricultural practices' impact in pear and apple orchards

Roy L.*, Bouvier J.C.**, Lavigne C.**, Galès M.**, Chauve C.M.* and Buronfosse T.*

l.roy@vet-lyon.fr * Université de Lyon - Ecole Nationale Vétérinaire de Lyon – Laboratoire de Parasitologie – 1 av. Bourgelat – 69280 MARCY L'ETOILE - FRANCE

**INRA - Unité PSH - Site Agroparc – 84914 AVIGNON Cédex 9 - FRANCE

Abstract

Man-induced environmental alterations may be particularly important in agroecosystems. Recent changes in agriculture in the interest of the sustainable development may have an impact on these alterations. The aim of present study is to estimate whether the particular arthropodofauna of bird nests in agroecosystems is affected by three types of agricultural practices (organic, conventional and integrated control) in an orchard agroecosystem and how bird parasites respond to the management practices.

The amount and diversity of arthropodan communities developping in bird nests in the context of pear and apple orchards was evaluated using standardized nest boxes. A few additional samples from natural habitats have also been analyzed and obtained results compared.

A comparison of observed nest arthropodofauna according to the pest control methods allowed detecting some strong impact of synthetic pesticides on non target arthropoda which are enclosed within the island ecosystem of nest. Thus, statistically more arthropod-free nests were recorded in conventional (chemically controlled) orchards than in integrated and still more than in organic orchards. Due to the weak number of occurrences, results on arthropod biodiversity were not as significant as the simple notation of presence/absence. Nevertheless, following tendencies were evidenced: 1) coleoptera were more numerous and more diverse *in natura* vs in orchards, even considering only organic orchards. 2) some opportunistic arthropods which were encountered are also pests for human in stored food or farms, either in the guild of saprophagous/detritivorous arthropods, or in the guild of ectoparasites. And yet, some of them did not show any clear sensitivity to chemical control methods, as they were recurrently found in conventional orchards. This was not unexpected as these arthropods have already shown an enhanced flexibility.

Finally, among these less sensitive and commonly pest arthropods, *Ornithonyssus sylviarum*, the Northern Fowl Mite was recorded. It is remarkable that *O. sylviarum* is so commonly encountered in bird nests under test, yet absent from French layer farms, whereas it is a serious pest in layer farms in the USA. The opposite applies to *Dermanyssus gallinae*, the Poultry Red Mite, an important layer pest in Europe. This suggests that different farming practices between both continents might explain the paradox of the omnipresence of both species in wild avifauna and a selective presence in layer farms.

Key words

arthropodofauna, bird nest, ectoparasite, *Ornithonyssus*, *Dermanyssus*

1.	<i>Introduction</i>	215
2.	<i>Material and methods</i>	216
2.1.	Sampled orchard nests	216
2.1.1.	The study areas	216
2.1.2.	Nest boxes and birds	217
2.1.3.	Natural environments	217
2.1.4.	Nests analysis	217
2.1.5.	Presence/absence notation	217
2.1.6.	Arthropoda identifications	217
3.	<i>Results</i>	218
3.1.	Presence/absence of arthropoda	218
3.2.	Diversity of arthropoda	219
4.	<i>Discussion</i>	221
4.1.	Presence/absence of arthropoda	221
4.2.	Diversity of arthropoda	221
4.2.1.	Ecological role of isolated taxa within nests' arthropoda communities	221
4.2.2.	<i>Natura</i> vs orchard nests	223
4.2.3.	Hematophagous Mesostigmata	225
5.	<i>Conclusion</i>	225
6.	<i>Acknowledgments</i>	226
7.	<i>References</i>	226
8.	<i>Legends</i>	229
9.	<i>Appendix 1. Host and location information for tit nests sampled in natura.</i>	230
10.	<i>Appendix 2. Mite species, sample location and EMBL accession numbers for sequenced samples</i>	231

1. Introduction

Agroecosystems are usually characterized by a fauna that is different from most of natural ecosystems. Biodiversity in various zoological groups is often altered, especially in arthropods and birds. Nevertheless, the need of preservation of environment and practicing sustainable agriculture requires maximum restriction of phytosanitary products' use. Thus, several types of agroecosystems have been generated by the diversification of control methods.

Numerous studies have been carried out on the impact of development and/or phytosanitary treatments in agroecosystems on abundance or diversity of the entomofauna *sensu lato* [1, 2, 3, 4, 5]. Nevertheless, most of these studies focus on crops auxiliary arthropods.

On the other hand, the bird diversity in orchards changes with the pest control method according to several studies [6, 7, 8]. And yet, bird nests constitute islands par excellence, in which a particular and rich arthropodofauna is to be found. Indeed, due to their natural isolation and to the presence of a vertebrate, these islands are provided with an often amazing diversity of insects and arachnids *in natura* [9, 10, 11, 12, 13, 14, 15]: a rich microecosystem

is created in many bird nests. It involves a large guild of detritivorous or saprophagous arthropods, which feed on droppings and/or wastes produced/introduced by the bird inhabitant. As well a guild of predator insects and arachnids is often present, which feeds on ectoparasites (carried by the vertebrate host) and/or on detritivorous or saprophagous arthropods cited above. The particular isolation of such habitats may result in more or less nest-specialized arthropods in each guild. As a result, some of them, in any of these three guilds are strictly confined to bird nests. Parasites are usually at least specialized on birds in general, if not on the bird species under consideration. But even in detritivorous/saprophagous and predator guilds, some arthropods are specific to bird nests. Moreover, the regulating action of some of these arthropods may play a role in the control of parasite development. Thus, the proliferation of some ectoparasites in farms might be a side effect of farming practices.

The aim of present study was to address following questions: is the particular arthropodofauna of bird nests from nest boxes in agroecosystems also affected by agricultural practices ? How are bird parasites affected by the management practices in an orchard agroecosystem ?

In the present study, the arthropodofauna of nest boxes sampled in three different types of apples and pear orchards were sampled and compared. These three types were defined by the control methods used against crop pests: orchards with organic control, chemical control or integrated control. An additional dataset was obtained from nests of birds sampled *in natura*.

2. Material and methods

2.1. *Sampled orchard nests*

2.1.1. The study areas

The study area is located in southeastern France in the Avignon region (43°96' N, 4°82' E). Studied orchards were commercial apple and pear orchards located on privately owned farms. Among the orchards followed, 5 were conducted under organic, 5 under conventional and 5 under Integrated Pest Management (IPM) strategies for each fruit species. In organic orchards, the use of synthetic chemicals (both fertilisers and pesticides) is excluded according to the commission regulation (European Community 473/2002) that amended the council regulation (European Economic Community 2092/91). Conventional orchards were managed using synthetic chemical pesticides only according to the 1997 French national charter of apple production. The IPM orchards were conventional orchards using mating disruption against *Cydia pomonella*, the main insect pest. These orchards displayed a similar pattern of a cultivated area restricted to one hectare inside a larger orchard unit and is surrounded by single-rowed hedgerows used for protection against the north prevailing wind. All studied apple orchards were surrounded only by orchards conducted under a similar protection strategy. Orchards had also been chosen for their similar pattern in terms of local and landscape features that might influence bird communities. We tested this similarity prior to analyses, and checked in particular that organic, integrated and conventional orchards did not differ in that respect to avoid confounding effects ($p > 0.1801$).

In 2008, in each fruit tree species, the analysis has been conducted in 5 organically controlled orchards, 5 conventionally controlled orchards and 5 controlled using IPM methods. A reduced sampling campaign was also carried out in 2007, with only apple orchards tested.

2.1.2. Nest boxes and birds

Arthropodan communities in bird nests were collected in nest boxes. The nest boxes were the Schwegler 1B type. Each orchard had five nest boxes installed on 1 ha at least two years before the present study. Each nest box was located on an apple tree 2.5 m from the ground, 30 m from its nearest neighbor, and 20 m from surrounding hedgerows. Entrances of all nest boxes faced southeast to avoid both the north prevailing wind and the south prevailing rain.

Birds occupying nest boxes were in most cases great tits (*Parus major*). In a few nest boxes, blue tits (*Parus caeruleus*) (1%) or Eurasian Tree Sparrows (*Passer montanus*) (9%) nestlings were found.

Every nest in occupied nest boxes was systematically collected after the young had fledged. Complete nests were removed from the nest box and then stored in a closed plastic bag.

2.1.3. Natural environments

Additionally, in order to get an insight into the arthropodofauna to be expected under natural conditions, 21 nests of tits (*Parus* sp) from nest boxes installed *in natura* in diverse regions in France (mainly Center or South-eastern France) were sampled in 2007 and analysed using same methods as explained above. Location information is available in Appendix 1.

2.1.4. Nests analysis

Arthropoda were isolated from nests following the method described in de Lillo (2001) slightly modified (see Roy et al. 2009b). This method is based on the immersion of the nest in a fixed quantity of water and subsequent filtration using stacked sieves. Next, the obtained filtrate is reimmersed and observed using a stereoscopic magnifying glass. Prior to immersion, a macroscopic observation of the dry sample was systematically done in order to detect larger arthropoda, which might be lost during the filtrate analysis. As compared to Berlese funnel method used in Burt et al (2001), de Lillo's method allows detecting both living and dead arthropoda.

The arthropodofauna is explored following two different points of view: (1) the simple presence or absence of any arthropod in nests under test is noted, (2) isolated arthropods are identified. This study uses some nest boxes which have been installed in the framework of a study dealing with the impact of agricultural practices on avifauna in agroecosystems.

2.1.5. Presence/absence notation

The detection of arthropods led to the following classification of nests:

Arthropod-free nest: a nest from which no arthropod has been isolated.

Arthropod-poor nest: a nest from which only 1 or 2 individuals belonging to a single primary group (as defined below, in the Results section) have been isolated.

Arthropod-rich nest: a nest from which more than 1 primary group or more than 2 individuals of a single primary group have been isolated.

In order to get an overview of the number of individuals per primary group and per nest, a rough estimation was noted.

2.1.6. Arthropoda identifications

The identification of arthropoda has been performed in two successive stages:

(1) A rough identification at a high taxonomic level such as order or family was first performed by using a stereoscopic magnifying glass (2007 and 2008).

(2) A species identification was then performed in recurrent taxa, described below (see § Results) (all taxa in 2008, only Coleoptera and Hematophagous Mesostigmata in 2007). Mites:

Mesostigmata were identified by LR, acariforms by F. Faraji. Insects: Psocoptera were identified by Z. Kucerova, Coleoptera by R. Allemand.

Note: around 2% of isolated arthropods kept undetermined due to bad condition or to inappropriate stage (larval/nymphal stage in some holometabolous insects or in some mites). As for Psocoptera, a sample of isolated insects only has been identified at the specific level (27 individuals, distributed in 6 organic, 5 integrated, 4 conventional orchard nests).

DNA sequencing of some gene portions was performed in hematophagous Mesostigmata following Roy et al. (2009a, b) in order to check specific identity and get some additional population characteristics. In this framework, some mites belonging to *Ornithonyssus sylviarum* (Canestrini and Fanzago, 1877) (Mesostigmata: Macronyssidae) sampled in layer farms in the USA were kindly provided by Dr. Bradley Mullens and this enabled comparing pest populations with populations from wild bird nests in this species. Phylogenetic analyses were run using Phylo_win 2.0 [16] with the maximum-likelihood (ML) method. All trees were built with 500 bootstrap replicates.

1.1. Statistical tests

We tested whether the proportion of empty nests differed among years (qualitative, two levels) and crop protection treatments (qualitative, three levels: organic, integrated and conventional) using a logistic regression (proc GENMOD, SAS 9.01, SAS Institute, Cary, NC, USA) on the binary variable describing whether nests were free of arthropods or not and a logit link function. As nests within orchards are not statistically independent, we introduced a random orchard level in the model. We also tested if the proportion of empty nests differed between nests situated in Organic orchards and *in natura* in 2007 using logistic regression on the same binary data.

We then compared the average number of primary groups in each nest containing arthropoda (arthropod-rich or arthropod-poor) among years (qualitative, two levels) and crop protection treatments (qualitative, three levels: organic, integrated and conventional) using a generalized linear model assuming a Poisson distribution of the numbers of taxa and a log link function (proc GENMOD, SAS 9.01). As above, we introduced a random orchard level in the model to account for dependence among nests within orchards. We similarly tested if the average number of primary groups differed between nest in Organic orchards and *in natura* in 2007.

Finally, we tested whether the occurrence of detritivorous Acariforms, Psocoptera and Siphonaptera (fleas) differed between nests situated in Organic orchards and *in natura* in 2007 also using logistic regression (proc GENMOD, SAS 9.01) on the binary data describing presence or absence of each group in each nest.

In cases where a year effect was significant, analyses were performed using the same independent variables for each study year.

3. Results

3.1. *Presence/absence of arthropoda*

The ratio between arthropod-free /arthropod-rich nests (calculated as a percentage of sampled nests in each year) is similar in both years ($P=0.5982$) (Fig. 1). In contrast, control methods have a significant impact on this ratio ($P=0.0085$). An increasing gradient of the number of arthropod-free nests from organic orchards to conventional orchards is conspicuous and

statistically significant ($P=0.0028$, organic vs conventional). Nests sampled *in natura* provided about as many arthropod-free and arthropod-poor nests as nests from Organic orchards ($P=0.5450$).

3.2. Diversity of arthropoda

The occurrence of arthropoda is presented in Fig. 2 distributed in primary groups as defined below. Primary groups represent a consensus between ecological and taxonomical knowledge related to first-glance available morphological characteristics (first stage of identification). Mites were divided into four main groups: hematophagous Mesostigmata, non hematophagous Mesostigmata (predators belonging to Dermanyssoidea, Ascoidea or Eviphidoidea), detritivorous Acariforms (Astigmata), predator Acariforms (Prostigmata: Cheyletoidea). An additional arachnid group was Aranea (spiders). Most insects were first identified at the order level, with only one division within Hymenoptera: Formicoidea (ants) and parasitoid microhymenopteran was distinguished from each another. Finally, the terrestrial crustacean order Isopoda was sometimes noted.

The occurrence of most of arthropodan groups being occasional (if not accidental), the species identification was performed only in repeatedly recovered groups. By far, the best represented groups in orchard nests ($\geq 20\%$ occurrence in both years 2007 and 2008) were hematophagous Mesostigmata (Acari), detritivorous/saprophagous Acariforms (Acari) and Psocoptera (Insecta, detritivorous/saprophagous) (Fig. 2). In *natura* nests, the same groups were repeatedly found, but in addition the following groups: Aranea, Diptera, Coleoptera. As Coleoptera from birds nests may be rather diverse, belong to various guilds, and, in many cases, are more or less nest specific [15, 17], an identification at the species level of adult individuals was also performed in this group (in samples of 2007 and of 2008). A list of species found within these four recurrent primary groups is given in Table 1.

The main noticeable difference concerning taxa between the two years in orchard nests is the occurrence of spiders (31% in 2007, <3% in 2008). The presence/absence of such large arthropodans is likely strongly correlated to the role of nest boxes as shelters from extreme, but transient climatic conditions. Other arthropodan primary groups were represented in accordance to what had been noticed in previous study [18, 19]. A second difference between 2007 and 2008 orchard nests is to be noted in the number of different groups (based on our above described classification) in Organic orchard nests (Fig. 3): the average number of different primary groups in each nest containing arthropoda (arthropod-rich or arthropod-poor) is greater in organic orchards than in integrated and conventional orchards in 2007 ($P=0.0139$), not in 2008 ($P=0.0871$). In 2008, a roughly similar number of groups in the three orchard types has been noted. Nests from natural environments that have been sampled the same year, during similar periods, provide significantly more arthropod groups than orchards ($P=0.0032$), but this is not significant if only Organic orchards are compared to *natura* ($P=0.1469$). When considering the specific level in the only two orders of arthropoda identified specifically in both *natura* and orchards (Coleoptera and Mesostigmata), *natura* nests contain more coleopteran species than Organic orchards and a similar number of hematophagous Mesostigmata, in the dataset as a whole as well as *per* nest (cf. Table 2).

Seven species were recurrently collected from orchard nests under test, four of which are hematophagous mesostigmatic mites (*D. gallinae* (De Geer, 1778), *D. carpathicus* Zeman, 1979, *D. longipes* Berlese and Trouessart, 1889, *O. sylviarum*, *Ornithonyssus* sp (see Table 1), two of which are the detritivorous prostigmatic mites *Hirstia chelidonis* Hull, 1931 and *Tyrophagus longior* (Gervais, 1844), the last one being the well know stored-food pest

psocopteran insect species *Liposcelis bostrychophila* Badonnel, 1931 (Table 1). Ten different species of Coleoptera, belonging to four different families, were isolated, eight of which from nests sampled *in natura* (Table 1). Individuals which were at a larval stage were not identified at the species level. Unfortunately, individuals collected from orchards were mainly larvae (in most cases, a single larva isolated per nest), which we did not identify at the species level, but they all looked like dermestid larvae.

Additionally, some other arthropoda have been isolated anecdotically: a diversity of insects, some Isopoda (woodlice) and one Ixodida (ticks), especially in *natura* nests.

The guild of parasites in nests under test in the present study is rather similar in *natura* and orchard nests, and not so diverse at the order level. It is almost restricted to Mesostigmata (Acari: Parasitiformes) in the present study except for one orchard nest with Mallophaga in samples of 2008, three orchard nests and three *natura* nests with fleas in samples of 2007 (Insecta: Siphonaptera) and one *natura* nest with one hard tick individual (Ixodida).

Among the hematophagous Mesostigmata, five species have been collected. In orchard nests of both years, three species of *Dermanyssus* (Dermanyssidae) and two species of *Ornithonyssus* (Macronyssidae) have been isolated: *D. carpathicus*, *D. gallinae*, *D. longipes*, *O. sylviarum*, *Ornithonyssus* sp (see Table 1). Mites belonging to both families have been isolated in 16 % orchard nests under test, 24 % *natura* nests in 2007 and 27 % orchard nests under test in 2008. Of these five species, the following three ones were isolated from both *natura* and orchard nests: *D. carpathicus*, *D. longipes*, *O. sylviarum*. *D. gallinae* and *Ornithonyssus* sp were only found in orchard nests.

In orchards, the three species of genus *Dermanyssus* were isolated in organic and integrated orchards only, whereas species of genus *Ornithonyssus* were found in the three types of orchards (Fig. 4). Note that most of individuals of the genus *Ornithonyssus* belong to *O. sylviarum* (87.5%). The second detected species of this genus was recorded very occasionally (two nests in Organic orchards in 2008). *O. sylviarum* and each of the 3 species of genus *Dermanyssus* were encountered regularly in non-arthropod-free nests in the present study.

Of these five species, two are of economic importance in fowl farms, and especially in layer farms: *O. sylviarum*, in the USA, and *D. gallinae*, in the Old World. The DNA sequencing of some mitochondrial regions showed that isolates of *O. sylviarum* from French bird nests under test in present study were not only conspecific to but also very close to an American poultry pest isolate (OSBM ; see Appendix 2 and Fig. 5). Based on an rRNA 16S region isolated following Roy et al [20], isolates sampled in French orchards and isolate OSBM were diverging by 2-3% from each other, and by 1-2 % from an isolate sampled from African Gold Breasted Starlings (*Cosmopsarus regius*) (accession number AY185362) [21]. Based on an mt-Co1 coding region (Fig. 5), OSBM and isolates sampled in French orchards were diverging by 4% from each other and isolates from orchards were diverging by 1% from two additional French isolates sampled in nests of Montagu's Harrier, *Circus pygargus* (Linnaeus, 1758) located in a wheat field (FS5 and FS6). Moreover, all French individuals group together as a sister group to the American isolate (OSBM) according to Maximum Likelihood phylogenetic reconstruction, with much shorter branch length between each other, than between their common clade and the close relative *O. bacoti* (Fig. 5).

On the whole, except for bird ectoparasites, the diversity of arthropoda seems to be slightly higher in *natura* than in orchards, even organic only. Especially, the species diversity of Coleopteran individuals isolated in *natura* nests appears greater than in orchard nests (cf. above) and the occurrence percentage of detritivorous Acariforms is higher in *natura* nests than in orchards (P=0.0172). In contrast, the occurrence percentage of Psocoptera is similar (P=0.2414). Several more rarely encountered taxa have also shown a more frequent

occurrence *in natura* than in orchards: Siphonaptera (fleas) appeared more often *in natura* nests, but this had no clear statistical support ($P=0.0924$), due to the too weak overall amount of occurrences, and Isopoda (woodlice) were found in 12% *natura* nests and absent in orchard nest.

4. Discussion

4.1. Presence/absence of arthropoda

The significant increasing in the ratio of arthropod-free /-poor /-rich nests across the three control methods strongly shows that chemical control has an impact on many non-target arthropoda, which are normally found in bird nests. These differences may not be due to landscape characteristics, as all orchards under test have been shown being similar from a landscape point of view by PCA analyses. It was previously shown by Bouvier et al (2005) that the orchard control methods had a strong impact on orchard avifauna diversity. In contrast, previous studies which reported some differences in soil arthropodofauna of some agroecosystems mainly highlighted the strong impact of landscape and concluded that control methods did not clearly influence the number nor the diversity of arthropods they tested [3, 22]. But both studies dealt with larger and much more mobile insect communities (beetles and butterflies). These arthropods are able to move from one place to another often and very quickly and are not restricted to small island microecosystems as are arthropod communities found in bird nests. The important isolation of nests in nest boxes is not even sufficient however to prevent a strong impact of agricultural practices. Bird nests' arthropod communities are restricted to a fixed place, and may therefore show more precisely the impact of the different control methods on local atmospheric quality than do mobile terrestrial insects.

4.2. Diversity of arthropoda

The biodiversity of arthropodofauna in orchard nests under test was not as informative as did the ternary approach (arthropod-free /-poor /-rich nests) concerning the difference between the three control methods in orchards. The different guilds were very less diversified: recurrent detritivorous arthropoda were restricted to two mite and one insect species, predators were almost absent, parasites were mainly represented by five hematophagous mesostigmata species (see Table 1). Even if there are some trends, none is strongly supported (not enough arthropod-rich nests, not enough individuals within arthropod-rich nests). Nevertheless, among these weakly supported trends, some differences can be noticed concerning hematophagous mesostigmatic mites according to control methods (cf. below). In contrast, nests sampled *in natura* seem to contain more different taxa than orchard nests at least at the species level within Coleoptera. This suggests that even organic methods might have an impact on the biodiversity of arthropodan communities in bird nests. Anyway, nests in *natura* are not abundant enough, have not been sampled in exactly the same region, nor in comparable environment, so that a firm conclusion cannot be drawn about it.

4.2.1. Ecological role of isolated taxa within nests' arthropoda communities

In the present study, bird nests' arthropodan taxa may be split into 4 different categories according to the assumed ecological role in nests. Higher taxa and corresponding ecological habits are roughly similar to what Burt et al [10] found in nest boxes occupied by the Tree Swallow (*Tachycineta bicolor*: Passeriformes: Hirundinidae), the house wren (*Troglodytes aedon*: Passeriformes: Certhiidae), the eastern bluebird (*Sialia sialis*: Passeriformes: Muscicapidae) in North America and to what Krištofik et al [23, 24] found in nests of two

shrikes (*Lanius collurio*, *L. minor*: Passeriformes: Laniidae) and the bearded tit (*Panurus biarmicus*: Passeriformes: Sylviidae) in Europe. Some differences may be noticed.

(1) The occurrence of some arthropoda within bird nests is accidental, due to the tree environment: large saprophagous such as Dermaptera (earwigs) and Isopoda (woodlice) were sometimes isolated, likely due to the shelter role of nest boxes; phytophagous Thysanoptera (thrips) and Hemiptera such as aphids were likely introduced into nests by chance; *Embidopsocus enderleini* is a psocopteran species found under bark of trees (a single specimen in a single nest); the occurrence of Collembola may be correlated to the large presence of moss in tit nests; the floricolous beetle species *Potosia oblonga* (Scarabaeidae) was represented by a likely freshly emerged adult (larvae living within tree cavities); two adult individuals of *Nalassus dryadophilus* (Tenebrionidae) also emerged from tree-living larvae (larvae living under bark trees in this species). Similarly, herbivorous flat bark beetles (Coleoptera: Silvanidae) were noted in many nests by Burt et al [10].

(2) Some others may, by chance, have found a convenient habitat within nest (adapted to the life within nests, but not specialists). Indeed, larvae of microlepidopteran moths (related to stored-food moths) were found in a few nests likely due to the presence of food substances omitted by chicks. The much more recurrent mite *H. chelidonis* (and some more rarely encountered *T. longior*), as well as the insect *L. bostrychophila* might have found a similar opportunity. These species are not proper to bird nests, but are likely better adapted to such an environment. Formicoidea (ants) are often found in bird nests [10, 25] and some interactions between ants and tits have precisely been shown [26]. Parasitoid microhymenoptera, already recorded in other bird nests by Burt et al [10], can parasitize either lepidoptera larvae or other arthropoda present in the nest. Flies (not parasitic Brachycera Diptera) can find food in droppings and chicks' food. Several species of detritivorous Coleoptera were isolated in *natura* nests. *Attagenus unicolor* (Dermestidae) is an unspecific detritivorous insect which can feed on various wastes generated by chicks, *Anthrenus pimpinellae*, *Dermestes undulatus*, (Dermestidae) and *Alphitobius diaperinus* (Tenebrionidae) are feeding on animal substances, which are largely available in insectivorous bird nests (dead insects brought by adult birds but omitted by chicks or dead chicks' corpse). *Cryptophagus sp* (Cryptophagidae) is a mycetophagous beetle, already noted in some bird nests [27].

These species are not nest specialists and several of them represent common pests in human environments, such as stored food (*L. bostrychophila*, *T. longior*), fowl farms (*A. diaperinus*) and natural history collections (*A. unicolor*, *A. pimpinellae*). The presence of *A. diaperinus* in bird nests has been noted in abundance and in various bird groups [17, 15] and so does *L. bostrychophila* [28].

(3) Two more or less nest specialist predators were isolated (specialized in bird nest ecosystems): *Gnathoncus buyssoni* (Histeridae) is a nidicolous predator of sapro-necrophagous larvae and *Carcinops 14 striatus* (= *pumilio*) (Histeridae) is an often nidicolous predator of sapro-necrophagous larvae. These species or some congeners are commonly found in raptor nests [14, 15]. They have each been isolated once, the former *in natura*, the latter in an orchard. The presence of the predator of sapro-necrophagous larvae confirms the family identity of the few dermestid-like larvae isolated from orchard nests, and suggests that one or more of above detritivorous dermestid species are present in orchard nests, but in a much lesser amount than *in natura*.

(4) As for the occurrence of some common bird ectoparasites (specialized in birds), hematophagous Mesostigmata are largely predominant, whereas Mallophaga (shewing lice) and Siphonaptera (fleas) only occur sparsely and rarely. This difference may be correlated to the respective habits of these parasites. Hematophagous Mesostigmata are nidicolous micropredators. In contrast, Mallophaga are spending their complete life on host. Nevertheless, Burt et al [10] found around six Mallophaga individuals per nest. But their

study was performed in a different continent (North America) and on different bird species. This may suggest that the prevalence of these parasites is different in these bird species. Krištofik et al [24, 26] did not notice any Mallophaga individuals in shrikes and bearded tits' nests. As Mallophaga are usually host specific, it is possible that no mallophagan species are used to parasite *Parus* species.

On the other hand, eggs and nymphs, and sometimes adults of Siphonaptera are to be found within nest, which might have been expected more often in nests under test. *In natura* Burt et al [10] did not notice any Siphonaptera, whereas Krištofik et al [24, 26] isolated many. This may likely be explained by the divergence in the method for nest analysis more than by the bird species. Indeed, Burt et al [10] used the Berlese funnel method for extracting arthropoda from collected nests, which requires isolated arthropods to be alive. De Lillo's method used in present study allows detecting not only living arthropods, but also dead ones. Maybe this could explain the absence of fleas in Burt et al's study.

Predators are commonly less numerous than detritivorous/saprophagous and parasites in most ecosystems. Nevertheless, the presence of predators seems to be rather reduced in all tit nests under test if compared to nests of other wild birds. Several different predator Mesostigmata were recurrently isolated in starling nests (Ascidae, Laelapidae, Macrochelidae, Parasitidae,...[29]). Pseudoscorpions are occasionally but regularly found in nests of the barn swallow *Hirundo rustica* Linnaeus, 1758 (LR pers. observation) or in the bearded tit *Panurus biarmicus* (Linnaeus, 1758) [24], and regularly in shrikes' nests (Krištofik et al 2002), among others. And Kristofik et al [24] noted the presence of predator beetles in almost 1/3 nests in *P. biarmicus*. In present study, only two nests were noted with one predator mesostigmatic mite in each in 2007, one in 2008 and zero in *natura* nests in 2007. Some rare Cheyletoidea, along with some ants and a few Coleoptera may play this role on different types of prey. This is finally more in accordance with the fauna of predators noted in Burt et al [10], which is not unexpected as birds under test are all cavity-nesting birds, as opposed to barn swallows, shrikes and bearded tits.

4.2.2. *Natura* vs orchard nests

Although only 21 *natura* nests have been analyzed and although these samples come from slightly different geographical areas, making results not easily comparable, some elements strongly suggest that diversity within arthropod-rich nests in agroecosystems (whether it is inorganic, integrated or conventional orchard) is not as rich as *in natura*.

Not only detritivorous Acariforms were more frequent and numerous *in natura* than in orchard nests, but also Siphonaptera, Isopoda and Thysanoptera have been more often (if not only) noted *in natura* than in orchards. The absence of phytophagous Thysanoptera in orchards may be explained by different tree substrates, but not that of saprophagous Isopoda. This strongly suggests an impact of agroecosystem conditions on these latter arthropods' development.

This difference in arthropod diversity and amount between *natura* and orchard nests is also supported by the specific identity of Coleoptera. Some more or less specific coleopteran insects have been isolated from *natura* and orchard nests, in a greater number in each nest *in natura* (3 to >20 per nest) than in orchards (1 to 2). Even compared with Organic orchards, nests sampled *in natura* are more species rich. This is not exactly in accordance with avian data [6]. These authors demonstrated in the orchards under test that the bird diversity were similar in Organic orchards and *in natura*. This difference between arthropod and bird diversity is effectively very consistent with the control management, as pests against which organic substances (mineral oil, granulosis virus, sexual pheromones) are used are arthropods,

not birds. Especially, granulosis virus and sulfur might have a strong impact on non target arthropods living within nests.

In contrast, parasitic nidicolous mite species' occurrence is similar in the whole dataset (Table 2). This suggests two possibilities: (1) either mesostigmatic hematophagous mites better tolerate agroecosystem conditions than other encountered taxa, or (2) the increased presence of potentially predator taxa such as ants *in natura* results in a regulation of these parasite populations, as suggested by Lambrechts et al [26].

The first possibility is not unlikely to occur at least with *O. sylviarum* as it has already shown being able to develop resistance to inhibitors of acetylcholinesterase in the USA [30]. Indeed, populations in this species are regularly exposed to organophosphates (Ravap EC) or carbamates (sevin-80s) in North American poultry farms, not only by spraying, but also in some cases by digging [31, Rubinoff I, pers. comm.]. And yet, it is also exposed to various pesticides in French pet birds breeding facilities, including carbamates and organophosphates [Association Ornithologique Rhodanienne, pers. comm.], which may have resulted in a selection of resistant populations in France too. This may explain its presence in the three control conditions under test (plus *in natura*). As for *D. gallinae*, it is regularly exposed to organophosphates and other pesticides (such as amitraze, for instance) in European farms (legally during the empty period, but also illegally during flocks), but the hypothesis of selected populations here is not so consistent, as it was found only in integrated and organic orchards, along with the unselected feral *D. carpathicus* species. Anyway, the presence of *D. gallinae* in orchards and its absence *in natura* nests may be due to concomitant enhanced tolerance to neutral pesticide substances (as encountered in organic farms also, such as sulphur) and reduction of predator presence (second possibility). Lesna et al [29] showed significant negative relationships between the mite predator *Androlaelaps casalis* and *D. gallinae* densities in some starling nest boxes.

But in any case, populations of *Dermanyssus* in tit nests *in natura* are restricted to *D. carpathicus* and *D. longipes*, whereas in orchards, *D. gallinae* is also regularly found. Here is an illustration of results of Ives et al [32], who demonstrated that species richness increases community-level stability by insuring that some species in a community are tolerant to different environmental fluctuations. Among recurrent arthropoda in bird nests, the occurrence of a less species-rich group (detritivorous / saprophagous mites – one largely dominant species: *H. chelidonis*) is more affected by agricultural practices in general, than are more species-rich nidicolous parasites. And yet, two of these species (*D. gallinae* and *O. sylviarum*) are known tolerating different environmental conditions than the three others.

On the other hand, the psocopteran order is composed of almost a single species, *L. bostrychophila* (the second psocopteran species having been found only once and being known to live under tree bark) and is not as affected by agricultural practices as do detritivorous Prostigmata. But *L. bostrychophila* is a parthenogenetic species and possesses an amazing flexibility, which allows it rapidly getting more tolerant to a variety of conditions. It can easily become resistant to organophosphates and carbamate [33, 34] and proved to adapt to hypoxia and hypercarbia [35]. It showed even some adaptation against entomopathogenic fungi [36] and is not so sensitive to a bacterium-derived insecticide, which is efficient against other insect pests [37]. Cross resistance between very different parameters (hypoxia, hypercarbia, organophosphates,...) have been evidenced by Wei et al [38], so that the last mean found to control this species is the use of an antibiotic in order to kill an endosymbiotic bacteria and so slightly reduce the pest's fitness [39]. The occurrence of this species indifferently in all orchard conditions might be due to its extreme flexibility, allowing it to adapt, alone, to all conditions under test.

4.2.3. Hematophagous Mesostigmata

The five species of hematophagous Mesostigmata recorded in the present study belong to two distant families within Dermanysoidea (Dermanyssidae and Macronyssidae). They correspond to species encountered *in natura* on similar hosts [19, 20]. Of them, only *O. sylviarum* was noted in conventional orchards, and it was repeatedly found in such conditions. This species is a pest in layer farms in USA [40, 41]. *D. gallinae*, the equivalent pest in European layer farms [42, 43], has only been encountered in organic or integrated orchards. Note that *O. sylviarum* is currently a pest in North American layer farms, but not in French layer farms, contrarily to what was published by Bruneau et al [44]. Roy et al [19, 20, 45] sampled mites the same way in same regions in more than 40 layer farms and always found *D. gallinae* alone.

Not only present mt-Co1 phylogenetic analysis show that the American isolate OSBM, the African isolate [21] and isolates in present study are conspecific (Fig. 5), but also 16S RNA sequences suggest that French field isolates are not more distant from American than from African isolates (acc. no AY185362). This is in favour of a close relationship between population from layer farms (American isolate OSBM) and from wild avifauna (French and African samples). A similarly close relationship between poultry and wild populations of *D. gallinae* is visible in [19] (isolates *D. gallinae* JBO).

At least in farms, these two species do not have same habits. *O. sylviarum* not only stays long on host, but also lays on it, so that a direct examination of the bird allows detecting a large number of mites in farms [41, LR pers. observation]. In contrast, *D. gallinae* has exclusively nidicolous habits, has a fast blood meal, about as fast as do mosquitoes or more appropriately as do bed bugs, and once the meal is completed, the mite quickly goes back to its hiding-place [46]. Eggs are laid in hiding-places, never on bird [47]. Does this result in less sensitive *O. sylviarum* than *D. gallinae* to some pesticides, since *D. gallinae* is more difficult to reach with sprayed pesticides? Such an impact could explain the difference noted in present study between these two taxa. Anyway, this difference is not well supported by statistical tests, apparently due to the too weak number of samples containing Mesostigmata (and more generally samples containing any arthropoda). Nevertheless, *O. sylviarum* was also detected in abundance in wild avifauna by authors in three nests of *Circus pygargus* (Montagu's Harrier) sampled in wheat meadows, which are chemically controlled and where no *D. gallinae* was found.

On the other hand, never *D. gallinae* has been noted by authors before in great tits' nests (*Parus major*) [19]. It has been isolated in present study in 2007 as well as in 2008 orchard nests. This species has been shown to be much more synanthropic than tougher *D. carpathicus* and *D. longipes* and is likely to resist less to predators' activity [19, 20]. And yet, ants seem to be less present in orchards nests than *in natura*. Even organic control methods may have an impact on such auxiliaries arthropoda, whereas *D. gallinae* and *O. sylviarum* seem to be more tolerant, especially the latter.

5. Conclusion

In conclusion, the presence/absence of any arthropod in bird nests is a reliable indicator of some agricultural practices' impact in orchards. A marked contrast between the two terminal agroecosystem modalities and an intermediate characterisation of integrated control orchards were observed using the presence/absence of arthropoda approach.

The diversity within arthropodan communities does not provide as sharp information as did the simple presence / absence notation. Nevertheless, two main elements seem to arise from our diversity data set: (1) among hematophagous mesostigmata species, not all seem to tolerate chemical methods in orchard nests, (2) the diversity of arthropoda communities is likely to be more important in *natura* nests.

Finally, it is remarkable that *O. sylviarum* is so commonly encountered in bird nests under test, yet absent from French layer farms, whereas it is a serious pest in layer farms in the USA. The opposite applies to *D. gallinae*, the layer pest in Europe. This suggests that different farming practices between both continents might explain the paradox of the omnipresence of both species in wild avifauna and a selective presence in layer farms.

6. Acknowledgments

Authors want to warmly thank Z. Kucerova (Crop Research Institute, Prague, Czech Republic), R. Allemand (Université Lyon 1, Villeurbanne, France) and F. Faraji (MITOX Consultants, Amsterdam, The Netherlands) for insect or mite identifications, M. Sabelis and I. lesna (IBED, University of Amsterdam, Amsterdam, The Netherlands) for valuable comments, B. Mullens (University of California, Riverside, USA), F. Salmon (Centre de Recherche sur la Biologie et les populations d'Oiseaux, Paris, France), A. Marchal and ? (Association Ornithologique Rhodanienne, Lyon, France), S. Calabro (Association Ornithologique Becs Crochus Centre Est, Relevant, France), I. Rubinoff (Hy-Line International, Dallas Center, USA) for useful samples and information.

Finally, LR would like to offer her most sincere thanks for his technical participation to G. Lallemand (LEGTA des Mandailles, Chateauneuf-de-Galaure, France).

7. References

- [1] P. Duelli, M.K. Obrist, D.R. Schmatz, Biodiversity evaluation in agricultural landscapes: above-ground insects, *Agriculture, Agric. ecosyst. environ.* 74 (1999) 33-64.
- [2] N.C. Elliot, R.W. Kieckhefer, J.H. Lee, B.W. French, Influence of within-field and landscape factors on aphid predator populations in wheat, *Landsc. ecol.* 14 (1998) 239-252.
- [3] T. Purtauf, I. Roschewitz, J. Dauber, C. Thies, T. Tschardt, V. Wolters, Landscape context of organic and conventional farms : influences on carabid beetle diversity, *Agric. ecosyst. environ.* 108 (2005) 165-174.
- [4] A.C. Weibull, J. Bengtsson, E. Nohlgren, Species composition in agroecosystems : the effect of landscape, habitat, and farm management, *Basic appl. ecol.* 4 (2003) 349-361.
- [5] A. MacLeod, S. Wratten, N. Sotherton, M. B. Thomas, 'Beetle banks' as refuges for beneficial arthropods in farmland: long-term changes in predator communities and habitat, *Agric. for. entomol.* 6 (2004) 147-154.
- [6] J.C. Bouvier, J.F. Toubon, T. Boivin, B. Sauphanor, Effects of apple orchard management strategies on the great tit (*Parus major*) in south-eastern France, *Envir. Toxicol. Chem.* 24 (2005) 2846-2852.
- [7] E. Padoa-Schioppa, M. Baietto, R. Massa, L. Bottoni, Bird communities as bioindicators: The focal species concept in agricultural landscapes, *Ecological indicators*, 6 (2006) 83-93.
- [8] J. Cabral, A. Rocha, M. Santos, A. Crespi, A stochastic dynamic methodology to facilitate handling simple passerine indicators in the scope of the agri-environmental measures, *Ecological indicators*, 17 (2007) 34-37.
- [9] P. Zeman, M. Jurik, A contribution to the knowledge of fauna and ecology of gamasoid mites in cavity nests of birds in Czechoslovakia, *Folia Parasitologia* 28 (1981) 265-271.
- [10] E. H. Burt Jr., W. Chow, G.A. Babbitt, Occurrence and demography of mites of Tree Swallow, House Wren, and Eastern Bluebird nests, in : J. E. Loye and M. Zuk, editors. *Bird-parasite interactions: ecology, evolution, and behaviour*, Oxford University Press, Oxford, UK, 1991, pp. 104-122.
- [11] P. Fend'a, E. Schniererová, Mites (Acarina: Mesostigmata) in the nest of *Acrocephalus* spp. and in neighbouring reeds, *Biologia*, 59 (2004) 41-47.

- [12] J. Nosek, M. Lichard, Beitrag zur Kenntnis der Vogelnestfauna, Entomol. probl. 2 (1962) 29-51.
- [13] A. Fain, T.D. Galloway, Mites (Acari) from nests of sea birds in New Zealand. II. Mesostigmata and Astigmata, Bull. - Inst. r. sci. nat. Belg., Entomol. 63 (1993) 95-111.
- [14] C.G. Majka, J. Klimaszewski, R.F. Lauff, New Coleoptera records from owl nests in Nova Scotia, Canada, Zootaxa 1194 (2006) 33-47.
- [15] O. Merkl, J. Bagyura, L. Rózsa, Insects inhabiting Saker (*Falco cherrug*) nests in Hungary, Ornithologica 14 (2004) 1-4.
- [16] N. Galtier, M. Gouy, C. Gautier, SEAVIEW and PHYLO_WIN: two graphic tools for sequence alignment and molecular phylogeny, CABIOS 12 (1996) 543-548.
- [17] Z. Šustek, J. Krištofik, Beetles (Coleoptera) in deserted nests of *Phoenicurus ochruros*, *Parus caeruleus*, *Parus major*, *Sitta europaea* and *Sturnus vulgaris*, Entom. carpath. 14 (2002) 64-69.
- [18] L. Roy, C.M. Chauve, G. Lallemand, T. Buronfosse, Implication du genre *Dermanyssus* dans l'arthropodofaune des nids d'oiseaux sauvages, Congrès de la Société Française de Parasitologie, Nice, 2007, 13-14th december.
- [19] L. Roy, A.P.G. Dowling, C.M. Chauve, I. Lesna, M.W. Sabelis, T. Buronfosse, Molecular phylogenetic assessment of host range in five *Dermanyssus* species, Exp. Appl. Acarol. 48 (2009) 115-142.
- [20] L. Roy, A.P.G. Dowling, C.M. Chauve, T. Buronfosse, Delimiting species boundaries within *Dermanyssus* Dugès, 1834 (Acari: Dermanyssidae) using a total evidence approach, Mol. Phylogenet. Evol. 50 (2009) 446-470.
- [21] M.D. Schrenzel, G.A. Maalouf, L.L. Keener and P.M. Gaffney, Molecular characterization of malarial parasites in captive passerine birds, j. parasitol. 89 (2003) 1025-1033.
- [22] I. Roschewitz, M. Hücker, T. Tschardt, T. Carsten, The influence of landscape context and farming practices on parasitism of cereal aphids, Agric. ecosyst. environ. 108 (2005) 218-227.
- [23] J. Krištofik, Z. Šustek, P. Mašán, Arthropods (Pseudoscorpionida, Acari, Coleoptera, Siphonaptera) in the nest of red-backed shrike (*Lanius collurio*) and lesser grey shrike (*Lanius minor*), Biologia 57 (2002) 603-613.
- [24] J. Krištofik, P. Mašán, Z. Šustek, Arthropods (Pseudoscorpionida, Acarina, Coleoptera, Siphonaptera) in nests of the bearded tit (*Panurus biarmicus*), Biologia 62 (2007) 749-755.
- [25] D.C. Duffy. Ants, ticks, and nesting seabirds: dynamic interactions, in: J. E. Loye and M. Zuk, editors, Bird-parasite interactions: ecology, evolution, and behaviour, Oxford University Press, Oxford, UK, 1991, pp. 242-257.
- [26] M.M. Lambrechts, B. Schatz, P. Bourgault, Interactions between ants and breeding Paridae in two distinct Corsican oak habitats, Folia Zool. 57 (2008) 264-268.
- [27] Z. Šustek, D. Hornyčová, The Beetles (Coleoptera) in the nests of *Delichon urbica* in Slovakia, Acta Rer. natur. Mus. nat. slov. 29 (1983) 119-134.
- [28] C. Lienhard, Psocoptères euro-méditerranéens, Faune de France, Fédération Française des Sociétés de Sciences naturelles, 1998, 83.
- [29] I. Lesna, P. Wolfs, F. Faraji, L. Roy, J. Komdeur, M.W. Sabelis, Candidate predators for biological control of the poultry red mite *Dermanyssus gallinae*, Exp. Appl. Acarol. 48 (2009) 63-80.
- [30] B.A. Mullens, R.K. Velten, N.C. Hinkle, D.R. Kuney, C.E. Szijj, Acaricide resistance in northern fowl mite (*Ornithonyssus sylviarum*) populations on caged layer operations in Southern California. Poult. sci. 83 (2004) 365-374.
- [31] B.A. Mullens, J.P. Owen, D.R. Kuney, C.E. Szijj, K.A. Klingler, Temporal changes in distribution, prevalence and intensity of northern fowl mite (*Ornithonyssus sylviarum*)

parasitism in commercial caged laying hens, with a comprehensive economic analysis of parasite impact, *Veterinary Parasitology* 160 (2009) 116-133.

[32] A.R. Ives, J.L. Klug, K. Gross, Stability and species richness in complex communities, *Ecol. lett.* 3 (2000) 399-411.

[33] M.K. Nayak, P.J. Collins, R.A. Kopittke, Residual toxicities and persistence of organophosphorus insecticides mixed with carbaryl as structural treatments against three liposcelidid psocid species (Psocoptera: Liposcelididae) infesting stored grain, *J. Stored Prod. Res.* 39 (2003) 343-353.

[34] Chaia Yu-Xin, Liua Guo-Ying, Wang Jin-Jun, Toxicological and biochemical characterizations of AChE in *Liposcelis bostrychophila* Badonnel (Psocoptera: Liposcelididae), *Pestic. biochem. physiol.* 88 (2007) 197-202.

[35] Wang Jinjun, Zhao Zhimo, Li Lungshu, Some Biochemical Aspects of resistance to controlled atmosphere in *Liposcelis bostrychophila* Badonnel (Psocoptera: Liposcelididae). *Insect sci.* 6 (2009) 178-186.

[36] J.C.Lord, R.W. Howard, A proposed role for the cuticular fatty amides of *Liposcelis bostrychophila* (Psocoptera: Liposcelidae) in preventing adhesion of dry-conidia entomopathogenic fungi. *Mycopathologia* 158 (2004) 211-217.

[37] M.K. Nayak, G.J. Daghli, V.S. Byrne, Effectiveness of spinosad as a grain protectant against resistant beetle and psocid pests of stored grain in Australia, *J. Stored Prod. Res.* 41 (2005) 455-467.

[38] Wei Ding, ZhiMo Zhao, JinJun Wang, HuiYing Tao, YongQiang Zhang, The relationship between resistance to controlled atmosphere and insecticides of *Liposcelis bostrychophila* Badonnel (Psocoptera: Liposcelididae), *Agric. sci. China*

[39] Wang Jinjun, Dong Peng, Xiao Li-Sha, and Dou Wei, Effects of Removal of Cardinium Infection on Fitness of the Stored-Product Pest *Liposcelis bostrychophila* (Psocoptera: Liposcelididae), *J. econ. entomol.* 101(2008):1711-1717.

[40] R.C. Axtell, J.J. Arends, Ecology and Management of arthropod pests of poultry, *Ann. Rev. Entomol.* 35 (1990) 101-126.

[41] B.A. Mullens, N.C. Hinkle, L. J. Robinson, C.E. Szijj, Dispersal of Northern Fowl Mites, *Ornithonyssus sylviarum*, Among Hens in an Experimental Poultry House, *J. appl. poult. res.* 10 (2001) 60-64.

[42] JH Guy, M Khajavi, MM Hlalel, O. Sparagano, Red mite (*Dermanyssus gallinae*) prevalence in laying units in Northern England, *Br. poult. sci.* 45 (2004) 15-16.

[43] O. Sparagano, A. Pavličević, T. Murano, A. Camarda, H. Sahibi, O. Kilpinen, M. Mul, R van Emous, S. le Bouquin, K. Hoel, M. Cafiero, Prevalence and key figures for the poultry red mite. *Dermanyssus gallinae* infections in poultry farm systems, *Exp. Appl. Acarol.* 48 (2009) 3-10.

[44] A. Bruneau, A. Dernburg, C. Chauve, L. Zenner, First report of the northern fowl mite *Ornithonyssus sylviarum* in France, *Vet. record.* 150 (2002) 413-414.

[45] L. Roy, C.M. Chauve, J. Delaporte, G. Inizan, T. Buronfosse, Exploration of the susceptibility of AChE from the Poultry Red Mite *Dermanyssus gallinae* (Acari: Mesostigmata) to organophosphates in field isolates from France, *Exp. Appl. Acarol.* 48 (2009) 19-30.

[46] H.P. Wood, The chicken mite : its life history and habits. United States Department of Agriculture, Washington, DC., *Bull.* 553 (1917) 1-14.

[47] W.W. Moss, The mite genus *Dermanyssus*: a survey, with description of *Dermanyssus trochilinis*, n. sp., and a revised key to the species (Acari: Mesostigmata: Dermanyssidae), *J Med Ent* 14 (1978) 627-640.

8. Legends

Tables

Table 1. Species detected in the four focused recurrent primary groups. ? represent larvae potentially belonging to corresponding species. * Rare, ** Common, yet never abundant, *** common and sometimes abundant

Table 2. Number of species within Coleoptera and Mesostigmata in arthropod-rich and arthropod-poor nests sampled in 2007.

Figure

Figure 1. Distribution of arthropod-rich, arthropod-poor and arthropod-free nests according to control conditions. Three types of orchard: AB = organic, Int. = integrated and Chem. = conventional. Nests from *natura* have been sampled in not human-shaped environments.

Figure 2. Percentage of occurrence of arthropoda groups as defined in material and methods. A black star indicates a group identified at the specific level.

Figure 3. Average number of arthropodan groups in arthropod-rich or arthropod-poor nests

Figure 4. Number of nests containing one or several species belonging to the 2 hematophagous mite families isolated in present study according to control management. No nest from nature has been sampled in 2008.

Figure 5. Phylogenetic topology involving individuals of *D. gallinae* and *O. sylviarum* isolated in the framework of present study (sampled JBO_n), along with some individuals obtained from different environments and places. Maximum Likelihood, Phylo_win. Numbers at nodes represent bootstrap values for 500 replicates.

9. Appendix 1. Host and location information for tit nests sampled *in natura*.

Nest	Bird species	French departement
LC 7	Parus caeruleus	Drôme
LBO7-1	Parus major	Loiret
LBO7-2	Parus major	Loiret
LC10	Parus major	Drôme
LC4	Parus major	Drôme
LC6	Parus major	Drôme
MA1	Parus major	Rhône
MA2	Parus major	Rhône
N4	Parus major	Rhône
N5	Parus major	Rhône
N6	Parus major	Rhône
N7	Parus major	Rhône
OC2	Parus major	Rhône
JGC3	Parus sp.	Drôme
JGC4	Parus sp.	Drôme
JGC5	Parus sp.	Drôme
N1	Parus sp.	Rhône
N2	Parus sp.	Rhône
N3	Parus sp.	Rhône
N9	Parus sp.	Rhône
NO18	Parus sp.	Loire

10. Appendix 2. Mite species, sample location and EMBL accession numbers for sequenced samples

Dermanyssus species	Host	Country	French department	Context	Environment	Individual	16S	
							COI accession numbers	rRNA accession numbers
D. apodis	Swift	France	Gard	bird nest - inside a building, in a town	Colony inside town	GO54c	id. AM921874	
D. carpathicus	Tit	France	Rhône	box	Nature reserve	Ecop3a	FM208729	
D. carpathicus	Tit	France	Bouches-du-Rhône	bird nest - nest	Organic orchard	JB0133f	xxxxxxxxxx	
D. carpathicus	Tit	France	Bouches-du-Rhône	bird nest - nest	Organic orchard	JB0134d	xxxxxxxxxx	
D. carpathicus	Tit	France	Bouches-du-Rhône	bird nest - nest	Organic orchard	JB0134f	xxxxxxxxxx	
D. carpathicus	Tit	France	Bouches-du-Rhône	bird nest - nest	Organic orchard	JB0135a	xxxxxxxxxx	
D. carpathicus	Tit	France	Bouches-du-Rhône	bird nest - nest	Organic orchard	JB0135B	xxxxxxxxxx	
D. carpathicus	Tit	France	Bouches-du-Rhône	bird nest - nest	Organic orchard	JB0135f	xxxxxxxxxx	
D. carpathicus	Tit	France	Bouches-du-Rhône	bird nest - nest	integrated orchard	JB083b	xxxxxxxxxx	
D. carpathicus	Tit	France	Pas-de-Calais	bird nest - nest	Individual garden	JMC10A	AM943021	

D. gallinae	House martin	France	Ain8	bird nest - from barn	Barn conventional layer farm	LB183	AM921867
D. gallinae	Layer hen	Poland	Bouches-du-Rhône	layer farm	layer farm	PO2A	xxxxxxxxxx
D. gallinae	Roller	France	du-Rhône	on bird - nest box	Natura	ROL23	AM921865
D. gallinae	Roller	France	Bouches-du-Rhône	on bird - nest box	Natura	ROL26	xxxxxxxxxx
D. gallinae	Layer hen	Denmark		lab strain	Lab strain	SK0815	xxxxxxxxxx
D. gallinae	Layer hen	Denmark		farm) layer farm	layer farm	SK0815	xxxxxxxxxx
D. gallinae	Layer hen	Denmark		lab strain	Lab strain	SK0818	xxxxxxxxxx
D. gallinae	Pic	France	Rhône	(original isolate sampled in a layer conventional farm)	layer conventional farm	SK0818	xxxxxxxxxx
D. hirundinis	Tit	USA		on bird - banding	Natura	Woodp	AM921863
D. longipes	Tit	France	Rhône	bird nest - nest box	Natura	Woodp	AM921863
D. longipes	Tit	France	Rhône	bird nest - nest box	Natura	Woodp	AM921863
D. longipes	Tit	France	Rhône	bird nest - nest box	Natura	Woodp	AM921863
D. longipes	Tit	France	Rhône	bird nest - nest box	Natura	Woodp	AM921863
D. longipes	Tit	France	Rhône	bird nest - nest box	Natura	Woodp	AM921863
D. longipes	Tit	France	Rhône	bird nest - nest box	Natura	Woodp	AM921863
D. longipes	Sparrow	France	Bouches-du-Rhône	bird nest - nest box	Organic orchard	JBO108a	xxxxxxxxxx
D. longipes	Sparrow	France	Bouches-du-Rhône	bird nest - nest box	Organic orchard	JBO108a	xxxxxxxxxx
D. longipes	Sparrow	France	Bouches-du-Rhône	bird nest - nest box	Organic orchard	JBO495	AM921869
O. sylviarum	Tit	France	du-Rhône	bird nest - nest box	conventional orchard	JBO78c	xxxxxxxxxx

<i>O. sylviarum</i>	Tit	France	Bouches-du-Rhône	bird box	nest	Organic orchard	JB074a	xxxxxxxxxx	
<i>O. sylviarum</i>	Tit	France	Bouches-du-Rhône	bird box	nest	Organic orchard	JB0100b	xxxxxxxxxx	
<i>O. sylviarum</i>	Tit	France	Ain4	bird box	nest	Organic orchard	JB0122	xxxxxxxxxx	
<i>O. sylviarum</i>	Canary	France	Isère	cage - litter		Amateur bird breeding facility	Rh1b	xxxxxxxxxx	
<i>O. sylviarum</i>	Canary	France	Isère	cage - litter		Amateur bird breeding facility	Rh1d	xxxxxxxxxx	
<i>O. sylviarum</i>	Montagu's Harrier	France	Vendée	bird wheatfield	nest	conventional wheatfield	FS5a	xxxxxxxxxx	
<i>O. sylviarum</i>	Montagu's Harrier	France	Vendée	bird wheatfield	nest	conventional wheatfield	FS5b	xxxxxxxxxx	
<i>O. sylviarum</i>	Montagu's Harrier	France	Vendée	bird wheatfield	nest	conventional wheatfield	FS5c	xxxxxxxxxx	
<i>O. sylviarum</i>	Montagu's Harrier	France	Vendée	bird wheatfield	nest	conventional wheatfield	FS6a	xxxxxxxxxx	
<i>O. sylviarum</i>	Harrier	France	Vendée	bird wheatfield	nest	conventional wheatfield	FS6a	xxxxxxxxxx	
<i>O. sylviarum</i>	Layer hen	USA		layer farm		layer farm	OSBM	xxxxxxxxxx	xxxxxxxxxx
<i>O. bacoti</i>	Rodent	France		outgroup strain	- lab		OBAC		xxxxxxxxxx
<i>T. pyri</i>		France	Hérault	outgroup strain	- lab		T_pyri	FM179364	
<i>A. casalis</i>		France	Rhône	outgroup nest	- bird		ACA	AM921868	xxxxxxxxxx

Tables

Table 1.

Primary group	Species / family	Environment % occurrence - * abundance within nest							
		Organic orchards		Integrated orchards		Conventional orchards	natural		
Acari									
hematophagous Mesostigmata	<i>D. gallinae</i> (Dermanyssidae)	6,6	**	3,6	**	0,0		0,0	-
	<i>D. carpathicus</i> (Dermanyssidae)	11,5	**	5,4	**	0,0		9,5	**
	<i>D. longipes</i> (Dermanyssidae)	6,6	**	0,0		0,0		9,5	**
	<i>Ornithonyssus sylviarum</i> (Macronyssidae)	11,5	**	7,1	**	14,6	**	4,8	**
	<i>Ornithonyssus</i> sp (Macronyssidae)	1,6	*	1,8	*	0,0		0,0	-
	Remark : this species is very similar to, but slightly differs from <i>O. bacoti</i> (Hirst, 1913), according to Micherdziński (1980) and compared to individuals of <i>O. bacoti</i> of a lab strain in MNHN								
detritivorous Acariforms	<i>Hirstia chelidonis</i> (Astigmata : Pyroglyphidae)	30,8	***	21,1	***	2,1	**		
	<i>Tyrophagus longior</i> (Astigmata : Acaridae)	0,0		2,6	*	4,2	*		
Insecta									
Psocoptera	<i>Liposcelis bostrychophila</i> (Liposcelididae)	59,0	***	31,6	**	11,4	*		
	<i>Embiodopsocus enderleini</i> (Liposcelididae)	0,0		2,6	*	0,0			
Coleoptera	<i>Attagenus unicolor</i> (Dermestidae)	?		?		?		4,8	*
	<i>Anthrenus pimpinellae</i> (Dermestidae)	?		?		?		9,5	***
	<i>Dermestes undulatus</i> (Dermestidae)	?		?		?		4,8	**
	<i>Cryptophagus</i> sp (Cryptophagidae)	0,0		0,0		0,0		4,8	*
	<i>Alphitobius diaperinus</i> (Tenebrionidae)	0,0		0,0		0,0		4,8	*
	<i>Nalassus dryadophilus</i> (Tenebrionidae)	0,0		0,0		0,0		4,8	*
	<i>Gnathoncus buyssoni</i> (Histeridae)	0,0		0,0		0,0		4,8	*
	<i>Carcinops 14 striatus</i> (= <i>pumilio</i>) (Histeridae)	2,6	*	0,0		0,0		4,8	*
	<i>Potosia oblonga</i> (Scarabaeidae)	0,0		2,6	*	0,0		0,0	-

Table 2.

	No of species (n=no of nests under test)		Average number of species per nest	
	in natura (n=19)	orchards (n=43)	in natura	orchards
Coleoptera	7	2	1.6	1.0
Mesostigmata	3	5	1.0	1.1

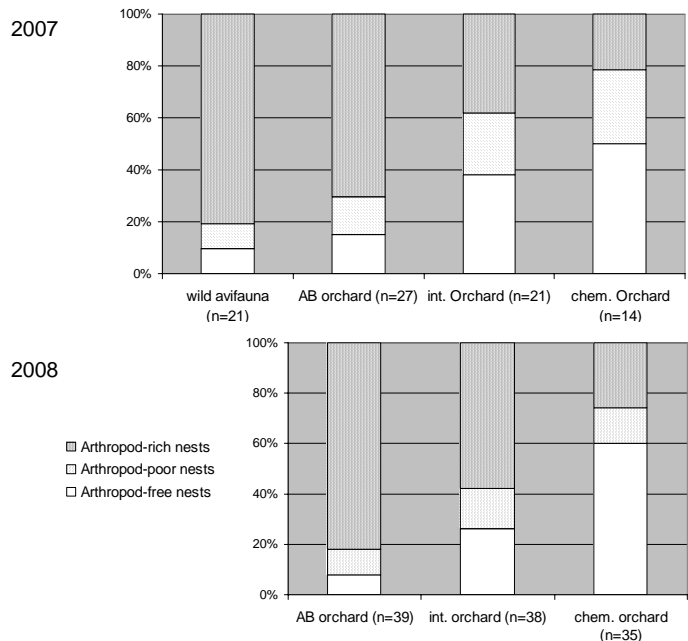

Figure 1

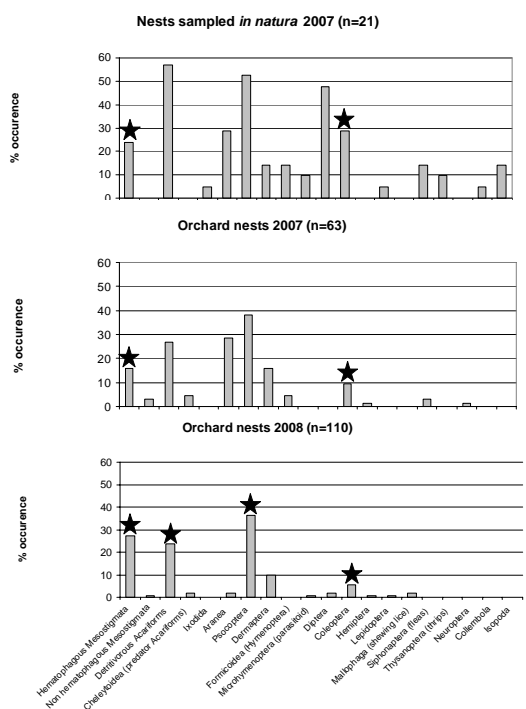

Figure 2

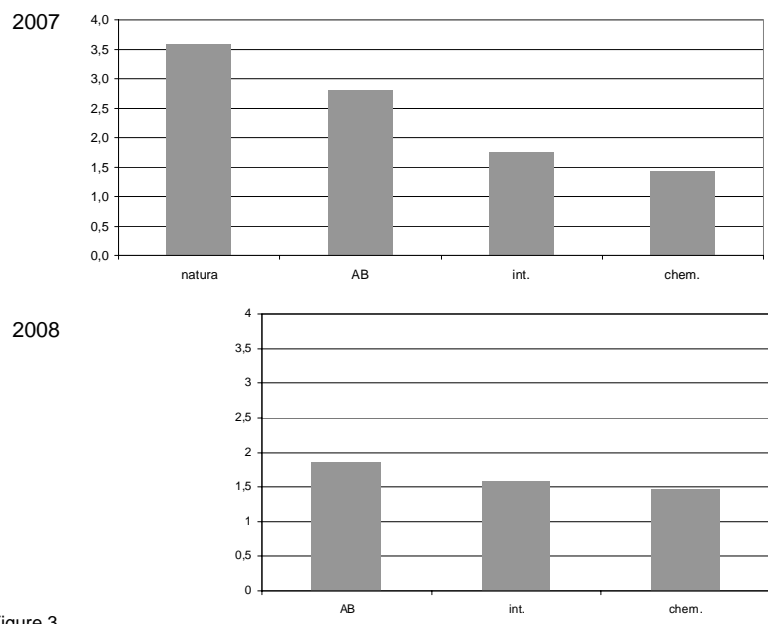

Figure 3

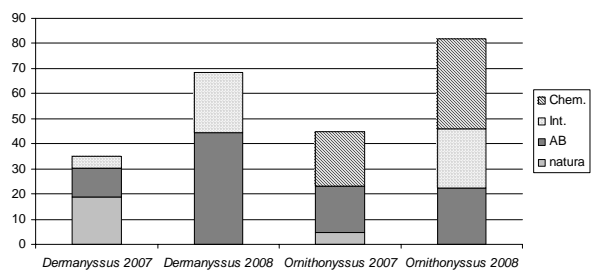

Figure 4

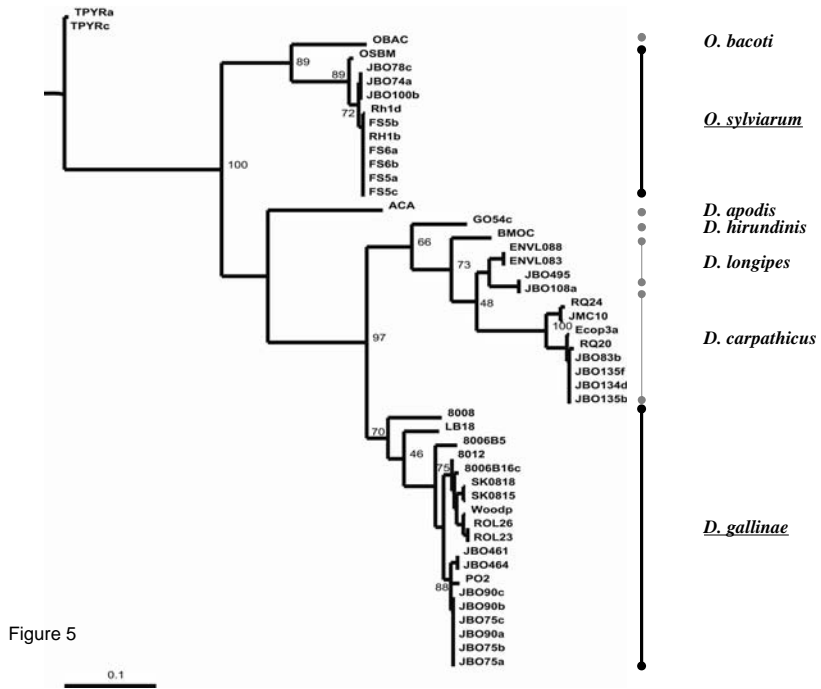

Figure 5

0.1

6 Discussion

6.1 Relations phylogénétiques

a - Des lacunes

Le genre *Liponyssoides* demeure un mystère, puisque nous n'avons pu obtenir aucun type et n'avons jamais pu en isoler un seul individu sur le terrain (cf. § 4.3.b.3 p. 67). La famille des Dermanyssidae n'englobant que *Dermanyssus* et *Liponyssoides* (cf. Annexe 1), il en résulte que seuls des outgroups distants ont pu être intégrés aux analyses phylogénétiques (familles des Macronyssidae, Laelapidae, Phytoseiidae ; cf. Annexe 1). Certes, ces outgroups permettent un enracinement sans ambiguïté des populations testées du genre *Dermanyssus*. Mais la monophylie du genre *Dermanyssus* vis-à-vis de son plus proche parent demeure à tester. Il n'est pas certain que la séparation entre les espèces des deux genres soit une séparation naturelle.

Au sein de *Dermanyssus*, seul le sous-genre *Dermanyssus* a pu être testé par l'approche « exhaustive » (morphologie + marqueurs moléculaires), dont seulement 2 espèces du groupe *hirsutus*. Il apparaît toutefois assez clair que les subdivisions dans le sous-genre *Dermanyssus* ne correspondent pas à deux groupes monophylétiques, comme le considérait Moss. *D. hirsutus* et *D. quintus* s'embranchent au beau milieu des espèces du groupe *gallinae* sur la base des quatre marqueurs moléculaires développés. En outre, le sous-genre *Microdermanyssus*, sur la base de l'analyse morphologique de l'ensemble du genre (Publication III), semble apparenté à *D. hirsutus* et *D. quintus*. Cela suggère aussi l'invalidité de la subdivision en deux sous-genres, mais demeure à vérifier.

b - Topologies bifides ou en escalier ?

D'une manière générale, les relations distales des populations testées au long de la présente étude sont bien résolues sur la base de chacun des deux gènes mitochondriaux, présentent des supports importants suivant les deux critères utilisés (maximum de parcimonie - MP, méthode bayésienne -BA), tandis que les relations plus basales (internes) demeurent irrésolues sur la base de l'ARNr 16S et au moins en partie faiblement soutenues sur la base de la mt-Co1. Les entités spécifiques apparaissent ainsi bien délimitées, mais leurs relations mutuelles ne sont pas claires sur la base mitochondriale. Cela s'accorde bien avec la transmission clonale du génome mitochondrial, résultant en une taille efficace de la population N_e réduite au tiers comparé au génome nucléaire. La vitesse d'évolution des gènes mitochondriaux est par conséquent plus importante.

Les marqueurs nucléaires se comportent très différemment des marqueurs mitochondriaux, mais aussi entre eux. Les reconstructions phylogénétiques obtenues sur la base des ITS1 et 2 demeurent fortement irrésolues, tant distalement que basalement (Publication III). Toutefois, une structure en escalier apparaît sur cette base, même si faiblement soutenue. Sur la base de l'EF1-alpha, une anomalie de type paralogie rend le marqueur inutilisable en l'état, puisque des outgroups se voient intégrés au beau milieu de *Dermanyssus* (cf. § 4.3.b.2). Enfin, l'amplicon de Tropomyosine, intégrant deux courtes portions d'exon et une portion plus conséquente d'intron offre une résolution importante aussi bien dans les relations internes que distales (Publication V). Les entités spécifiques clairement délimitées sur la base mitochondriale correspondent toutes aux clades monospécifiques des topologies obtenues sur la base de la Tropomyosine, exceptée *D. longipes* qui se révèle polyphylétique (cf. plus bas). Les relations basales aussi sont bien résolues, les indices de cohérence (CI) et de rétention (RI) obtenus en MP indiquent un taux d'homoplasie plutôt bas.

Deux clades se dessinent dans les analyses phylogénétiques basées sur la mt-Co1 (Publication IV et V ; cf. Fig. 6), regroupant pour l'un *D. hirundinis*, *D. longipes* et *D. carpathicus* (clade A ou groupe *hirundinis*), pour l'autre les diverses lignées de *D. gallinae* (clade B, publications III, IV, V). En revanche, sur la base de la Tropomyosine (publication V), la topologie retenue, ie celle obtenue en MP, avec les gaps considérés comme un 5^{ème} état, présente les relations interspécifiques entre les 5 espèces testées et avec *D. hirsutus* comme graduelles plutôt que bifides (Publication V ; cf. Fig. 7): le clade A observé sur la base mitochondriale apparaît paraphylétique. Mais l'ordre de leur branchement mutuel n'est pas remis en cause. *D. hirundinis* et les deux lignées de *D. longipes* occupent les positions les plus basales. *D. carpathicus* représente ensuite le groupe frère de l'ensemble des restants, suivi de *D. hirsutus*. Enfin, *D. apodis* et les différentes lignées de *D. gallinae* constituent les 2 entités sœurs en position distale dans la topologie.

Les relations de *D. apodis* avec l'ensemble des autres espèces demeuraient incertaines dans les topologies mitochondriales (supports de nœuds faibles), quoique dans tous les cas à la base de l'un ou l'autre des clades principaux (A ou B, cf. Publication IV). Elles s'avèrent finalement plutôt en faveur d'une relation étroite avec les lignées de *D. gallinae* sur la base du dernier marqueur nucléaire développé (Tropomyosine, Publication V). Non seulement les supports pour cette topologie sont satisfaisants, mais encore de nombreuses études font état d'une faiblesse des marqueurs mitochondriaux dans la résolution des relations internes. Cela nous pousse à choisir les topologies basées sur la Tropomyosine en ce qui concerne les relations de *D. apodis* avec les autres espèces. Dans tous les cas, *D. apodis* se présente à l'interface entre représentants du clade A et du clade B mitochondriaux et possède des caractères écologiques que l'on peut considérer comme intermédiaires entre les deux clades (cf. ci-dessous § Patterns écologiques révélés).

Enfin, la position interne de *D. hirsutus*, seul représentant du groupe *hirsutus* de Moss, dans nos topologies basées sur la Tropomyosine (publication V) vient confirmer l'invalidité de la division opposant groupe *gallinae* à groupe *hirsutus*, déjà pressentie sur la base des ITS (publication III).

Les deux marqueurs retenus pour l'exploration intraspécifique sont aussi les marqueurs qui offrent la meilleure résolution des relations à tous les niveaux.

6.2 **Etat de la taxinomie du genre *Dermanyssus***

Le groupe *gallinae sensu Moss* s'est révélé beaucoup plus riche en espèces que nous ne l'avions supposé au début de l'étude. En effet, *D. hirundinis* et *D. longipes*, qui *a priori* paraissaient indiscernables de *D. gallinae*, se sont révélés clairement isolés des autres espèces, dont *D. gallinae*, sur le plan reproducteur. *D. longipes*, longtemps considéré *incertae sedis*, puis transféré *nomen dubium* dans la publication I, a finalement affirmé son existence, à la suite de prélèvements dans la région type, dans la publication III. En outre, une seconde espèce, indiscernable morphologiquement de *D. hirundinis* et de *D. longipes*, a été considéré comme appartenant à cette dernière espèce dans la publication III et déclarée espèce cryptique à décrire dans la publication V (lignée ENV). *D. carpathicus* a confirmé aussi son statut spécifique, comme pouvait le laisser attendre les quelques caractères discriminants notés *a priori*. Une espèce nouvelle a été décrite : *D. apodis*. Enfin, *D. gallinae* s'avère constitué d'une diversité de lignées, dont l'une semble être, en fait, une espèce cryptique, divergeant encore faiblement des autres (la lignée L1). Enfin, les subdivisions de Moss ont été remises en cause (cf. Fig. 8).

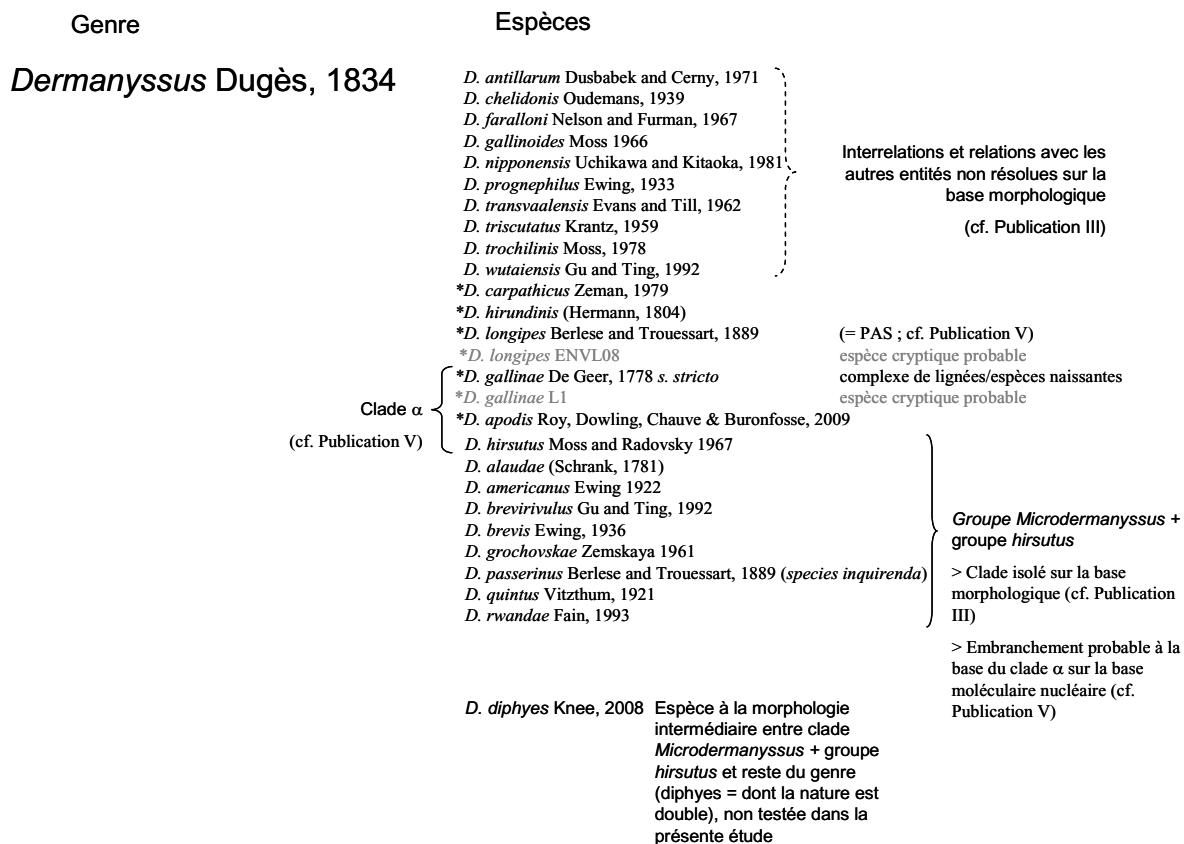

Figure 8. Aperçu de la composition du genre *Dermanyssus* à l'issue de la présente étude. Cette représentation fait écho à celle de la Fig. 1, p. 21. * espèces testées, appartenant à la faune commune en France.

6.3 Deux marqueurs complémentaires pour l'exploration intraspécifique

Les gènes retenus pour l'exploration intraspécifique, la mt-Co1 et la Tropomyosine, sont aussi ceux qui aboutissent aux relations interspécifiques les mieux résolues (Publication V). Le degré de divergence entre populations au sein du genre *Dermanyssus* (*D. gallinae* au moins) est comparable entre ces deux gènes, pourtant situés dans des génomes dont la taille efficace de la population théorique est différente, et par conséquent dont la rapidité d'évolution diffère aussi. Le caractère fonctionnel de la portion majoritairement intronique de la Tropomyosine ayant des chances d'être très réduit comparé à celui des autres marqueurs testés, il n'est pas étonnant (1) qu'elle offre une image claire des relations phylogénétiques (faible taux de convergence probable), (2) qu'elle soit porteuse d'une information intraspécifique plus importante que les autres marqueurs nucléaires. En effet, s'il est vrai que la taille efficace de la population N_e est trois fois supérieure à celle des gènes mitochondriaux, l'effet de la sélection naturelle est quant à lui presque inexistant, la dérive génétique laisse probablement seule sa marque. Dans la mt-Co1, à l'inverse, celle-ci agit plus rapidement, de par la réduction de N_e , mais elle est contrainte par le rôle fonctionnel des différentes bases du codon. La théorie neutraliste de l'évolution moléculaire (Kimura 1968) explique partiellement l'équivalence constatée des divergences entre séquences de mt-Co1 et séquences de l'intron n de la Tropomyosine. Kimura défend en effet l'hypothèse qu'une grande majorité des polymorphismes génétiques moléculaires résulte de l'évolution par dérive génétique d'allèles mutants sélectivement neutres. La

vitesse d'évolution de la mt-Co1 aux multiples positions contraintes par la fonctionnalité du codon, elle bénéficie d'une taille réduite de la Ne. A l'inverse, la réduction comparative de la vitesse d'évolution de l'intron n de la Tropomyosine est légèrement contrecarrée par sa nature non codante, donc plus à même d'être touchée par la dérive génétique. Cela n'est d'ailleurs pas le cas des ARN ribosomiques testés dans cette étude (séquence 18S-28S, incluant ITS1, 5,8S et ITS2), qui offrent en l'occurrence un très faible pourcentage de divergence dans le genre *Dermanyssus*. Cela n'explique toutefois pas une telle similitude des pourcentages de divergence entre un gène mitochondrial et un gène nucléaire au sein des populations de l'espèce *D. gallinae*. La mise en évidence d'une radiation suivie d'hybridations multiples par des analyses combinant phylogénie et génétique des populations ont permis d'expliquer cela (cf. plus bas).

6.4 Patterns écologiques révélés

a - Spécificité d'hôte

La spécificité d'hôte dans le genre *Dermanyssus*, comme on peut s'y attendre dans un système macroproie / microprédateur plus encore que dans un système hôte / ectoparasite typique, apparaît régie en grande partie par des paramètres écologiques. Toutefois, des caractéristiques intrinsèques du parasite jouent aussi un rôle important.

6.4.a.1 Paramètres écologiques

Les habitudes de l'oiseau hôte influent fortement sur le spectre d'hôtes, puisque les transferts d'une espèce d'hôte à l'autre ont été révélés possibles en cas de partage du nid, c'est-à-dire réutilisation d'une saison sur l'autre. Ainsi *D. hirundinis* se montre-t-il en France cantonné aux Hirundinidae (*Delichon urbica*, *Hirundo rustica*), mais est aussi présent chez le moineau domestique (*Passer domesticus*) et le troglodyte mignon (*Troglodytes troglodytes*), les deux espèces d'oiseaux qui sont précisément connues pour réutiliser les nids de l'hirondelle rustique *H. rustica*. Le parallèle avec le spectre d'hôtes constaté aux Etats-Unis chez cette même espèce est emblématique : l'un des Hirundinidae parasités dans cette région du Monde (l'hirondelle des arbres, *Tachycineta bicolor*) étant cavernicole et habitué à faire usage de nichoirs fréquemment utilisés par le troglodyte familier *T. aedon* et la mésange à tête noire *Parus atricapillus*, *D. hirundinis* a pu être isolé chez ces trois espèces d'hôte. Or *T. bicolor* est absente du continent européen et aucune des mésanges testées en France ne réutilisent le nid des hirundinidae français. L'absence de *D. hirundinis* chez nos mésanges françaises du genre *Parus*, pourtant largement testées au cours de cette étude, confirme encore la nécessité de partage du nid pour le transfert d'un hôte à l'autre. Et cette possibilité est aussi soutenue par quelques essais de transfert artificiel au laboratoire de *D. hirundinis* sur canari. *D. gallinae*, *D. carpathicus* et *D. longipes* ont montré leur aptitude au transfert dans des conditions similaires. Cela s'accorde avec la capacité à survivre en l'absence d'hôte durant les mois d'absence *in natura* déjà démontrée chez *D. gallinae* et *D. hirundinis* (cf. §2.1.e.1).

La capacité à transiter d'un nid à l'autre semble quant à elle fortement et rapidement limitée par la distance. Deux cas de nids d'hirondelles contenant des individus appartenant à *D. hirundinis*, construits à proximité de poules fortement parasitées par des populations de *D. gallinae*, soulignent une mobilité ou une capacité à détecter un hôte à distance réduites chez ces acariens. En effet, des cas d'espèces de ces microprédateurs cantonnées à leur hôte respectif, même en cas d'absence de leur hôte propre, ont mis en évidence cette faible mobilité ou aptitude à localiser un hôte.

6.4.a.2 Paramètres intrinsèques

Un transfert sur un hôte nouveau semble possible chez ces espèces en cas d'opportunité dans un rayon d'action très réduit. Toutefois, une fois transféré artificiellement en conditions de laboratoire, *D. carpathicus* a montré à plusieurs reprises être incapable de se développer sur poule et l'installation de populations de la lignée PAS de *D. longipes* et de *D. apodis* sur canari a échoué (absence d'amplification de la population après plusieurs mois, mort de l'ensemble des individus). Certes, ces observations au laboratoire n'ont été faites pour la plupart qu'en dehors d'expérimentations strictement standardisées et planifiées. Elles manquent par conséquent de répétabilité et ne sont pas statistiquement exploitables. Toutefois, cela oriente la réflexion vers les caractéristiques intrinsèques qui président à la spécificité d'hôte dans le genre *Dermanyssus*.

Des points communs et des différences entre les cinq espèces testées sont directement en relation avec les deux filtres génétiques définis par Combes (2000). Ces deux filtres représentent respectivement les caractéristiques impliquées (1) dans la rencontre entre parasite et hôte potentiel, (2) dans la compatibilité post-rencontre (nécessaire à la durabilité du système). En effet, parmi les cinq espèces explorées sur le plan écologique au cours de la présente étude, les points communs semblent relever du filtre 1, l'oiseau paraissant toujours être un vecteur à la condition *sine qua non* que le nid soit partagé (d'une saison sur l'autre, ou d'une couvée à l'autre), jamais de proche en proche. Des différences importantes en revanche relèvent du filtre 2. En effet, l'adaptabilité à des microécosystèmes plus diversifiés semble caractériser les lignées synanthropes et généralistes de *D. gallinae*, alors que les espèces basales ainsi que *D. apodis* (clade A mitochondrial), beaucoup plus spécialisées, sont confinées aux nids d'oiseaux sauvages, et apparemment aux oiseaux habitués à soigner au moins un peu l'hygiène du nid. Il n'est d'ailleurs pas inintéressant de noter que les différentes lignées de *D. gallinae* ont été recensées chez des oiseaux aux habitudes très diverses, mais ses populations étaient relativement faibles en nombre chez la plupart des oiseaux sauvages intégrés à l'analyse, si l'on compare aux explosions de population relevées couramment en conditions d'élevage. Les seuls cas de populations importantes dans l'avifaune sauvage, accompagnées d'ailleurs d'une prévalence très élevée, ont toutefois été remarqués chez l'étourneau d'Europe (*Sturnus vulgaris*), grâce à la colonie suivie et entretenue par le biais de plus de 30 nichoirs par l'ornithologiste J. Komdeur à Groningen (Pays-Bas). Or, parmi les espèces testées d'oiseaux ayant permis d'isoler des individus du genre *Dermanyssus* au cours de l'étude, l'étourneau d'Europe est de loin le plus ignorant des règles hygiéniques qui consistent à débarrasser le nid des fientes des poussins. La prolifération de *D. gallinae* en présence de fientes accumulées contraste avec le développement des autres espèces dans des nids « nettoyés ». *D. apodis*, cependant, espèce à l'écologie intermédiaire, parasite les martinets, dont les habitudes hygiéniques sont moindres que chez la plupart des autres espèces testées (mésanges, par exemple). En effet, les martinets communs adultes ingèrent les fientes des poussins durant une partie de la période de nidification, mais n'en évacuent pas (Dell'Omo *et al.* 1998).

La nature de l'interaction entre fientes accumulées et sélection d'espèces du genre *Dermanyssus* est difficile à expliciter à ce stade de l'étude. Au laboratoire, *D. carpathicus* a montré des difficultés à se développer sur un canari à demeure, autorisé à déposer des fientes fraîches en permanence. L'entretien des souches de cette espèce nécessite le maintien du canari dans une cage séparée, son introduction dans le terrarium contenant les acariens n'ayant lieu qu'une nuit par semaine. Ainsi, les fientes s'accumulent en faible quantité et ont le temps de sécher. Les souches de *D. gallinae*, au contraire, se développent très bien dans une cage avec un canari à demeure. De nombreuses explications peuvent être envisagées, dont celles impliquant les possibles altérations de l'atmosphère induites par la présence de fientes en grande quantité : la composition de l'air, très

probablement affectée par ce paramètre, joue-t-elle un rôle direct sur le développement des parasites ? Des compétitions entre les espèces du genre *Dermanyssus* s'ajoutent-elles à une gêne plus ou moins importante engendrée par l'altération de l'atmosphère ambiante ? Celle-ci s'oppose-t-elle à l'installation de prédateurs ou de microorganismes entomopathogènes auxquels les lignées de *D. gallinae* seraient plus sensibles que les autres ? Ou encore le dégagement de certains gaz (ammoniac par exemple) pourrait-il entraver les éventuelles interactions par des phéromones entre acariens dans certaines espèces (confusion sexuelle, par exemple) ? Bien d'autres paramètres physico-chimiques ou mécaniques liés à l'accumulation de fientes non envisagés ici peuvent avoir un impact inattendu.

Enfin, Clayton et Tompkins (1994) montrent que la virulence des ectoparasites est proportionnelle à la quantité de transmission horizontale. Suivant leur théorie, les ectoparasites capables de transmission indépendante sont extrêmement virulents alors que ceux qui dépendent du contact direct avec l'hôte ne sont pas virulents. Mais ils comparent des ectoparasites très différents entre eux tant phylogénétiquement qu'écologiquement (*D. gallinae* et poux mallophages). Si l'on considère les espèces du genre *Dermanyssus* étudiées ici, on s'aperçoit que la règle de Clayton et Tompkins (1994) trouve son application dans la mesure où l'on précise quelque peu la notion de transmission. En effet, si la virulence de *D. gallinae* et de *D. prognepphilus* a pu être démontrée, celle de *D. hirundinis* n'est pas évidente (cf. 2.1b -). Apparemment, le filtre 1, celui de la transmission, n'est pas différent entre les espèces testées du genre *Dermanyssus*. Mais le filtre 2 semble très différent. Il est probable que, si *D. hirundinis* peut transiter d'une hôte à l'autre en cas de partage de nid, sa compatibilité avec l'hôte soit beaucoup plus hasardeuse que celle des deux espèces ci-dessus. La théorie de Clayton et Tompkins semblerait donc bien s'appliquer au sein du genre *Dermanyssus*, entre espèces beaucoup plus comparables entre elles que leurs modèles. Mais il faudrait préciser que l'on doit considérer la quantité de transmission horizontale réussie (ou dont le succès est probable), c'est-à-dire sous l'angle à la fois du filtre 1 (transmission) et du filtre 2 (compatibilité post-transmission). L'apparente faiblesse de la virulence de *D. hirundinis* pourrait être corrélée à sa faible capacité à s'adapter en cas de transfert sur un nouvel hôte, même si cela ne lui est pas absolument impossible.

b - Transition sauvage-synanthrope : hybridation et radiation chez *D. gallinae*

Sur la base de l'ensemble des analyses phylogénétiques, *D. apodis* se positionne comme une espèce intermédiaire entre les lignées synanthropes de *D. gallinae* (clade B mitochondrial ; cf. Publication IV) et les espèces typiquement rustiques que sont *D. hirundinis*, *D. longipes*, *D. carpathicus*, *D. quintus* et *D. hirsutus* (clade A mitochondrial, base de l'escalier de la topologie nucléaire). L'ancêtre commun étant par excellence adapté à l'avifaune sauvage, *D. apodis*, inféodée aux martinets, pourrait être le témoin d'une transition écologique vers la synanthropie du clade *D. gallinae*, puisque ses hôtes de prédilection fondent très souvent leurs colonies en ville, dans des milieux fortement anthropisés, même s'ils demeurent dans des micro-écosystèmes d'oiseaux sauvages (nids). En outre, la lignée L1, dont les populations présentent un isolement reproducteur relativement avancé, parmi les autres lignées interhybridées de *D. gallinae*, parasite principalement les pigeons bisets, concurrents habituels des martinets quant aux sites de nidification (Nature Midi-Pyrénées, 2001). Cela semble confirmer ce statut transitoire dans l'évolution de l'écologie des espèces du groupe *gallinae* et, par là-même, le caractère intrinsèque de l'adaptabilité des lignées de *D. gallinae* aux milieux anthropisés.

Par ailleurs, plusieurs éléments sont en faveur d'une radiation ancienne au sein de *Dermanyssus*, qui pourrait être la conséquence d'activités humaines. Seehausen *et al.* (2004, 2007) ont montré qu'une radiation peut être une conséquence adaptative d'hybridations entre espèces naissantes, et que l'homogénéisation des milieux par l'action humaine (implantation de cultures, d'élevages, constructions diverses, ...) peut en être la cause. Ces auteurs démontrent la défragmentation des milieux par le fait de l'homme peut engendrer une perte de la biodiversité : en effet, certaines barrières écologiques se voient brisées et des lignées récemment isolées les unes des autres sur le plan reproducteur (*ie* des espèces naissantes) peuvent se retrouver en contact. Ces entités spécifiques en formation n'ont souvent pas encore développé d'incompatibilité pré- ou post-zygotique, et peuvent s'hybrider avec succès. Cela non seulement interrompt les événements de spéciation en cours, mais encore, en produisant de nouvelles combinaisons de gènes, qui plus est dans un environnement brutalement altéré, la sélection naturelle intervient et une accélération du processus évolutif tend à en résulter. Cette accélération peut, selon Seehausen *et al.* (2004), donner lieu à des spéciations multiples et concomitantes (radiation).

Or ce sont précisément les lignées de l'espèce synanthrope qui trahissent une radiation (Publication V). Et les événements de spéciations de cette radiation semblent avoir déjà largement avorté, puisque une forte réticulation entre isolats est manifeste et que de nombreux isolats – et individus – partagent des séquences de Tropomyosine très divergentes. Et les séquences mitochondriales, au taux de mutation par nature plus élevé sur une période donnée, bien que contraintes par le caractère fonctionnel des codons (mt-Co1) ou de la structure secondaire de l'ARN codé (16S), dénoncent une différenciation déjà bien avancée, tout au moins dans les isolats sauvages. Enfin, la méthode ABC (Publication V) met à jour davantage de flux de gène ancien que de flux de gène récent. Des hybridations multiples semblent donc avoir là encore suivi de près la radiation, sans doute rendues possibles par les mouvements humains, dont l'échelle et la fréquence dépasse de loin les mouvements des autres espèces (échanges internationaux, voire transcontinentaux). Malheureusement, l'importance des flux de gène rend la datation des divergences très difficiles, voire impossible, suivant la méthode ABC (cf. Publication V). La concordance entre action humaine et radiation, action humaine et hybridations demeure donc seulement supposée.

Enfin, preuve de plus de cette succession ancienne radiation-hybridations, deux lignées non basales montrent encore un certain isolement reproducteur : isolement partiel de la lignée nommée L3 dans la publication V et isolement apparemment complet de la lignée spéciale L1 (publication III, V). La lignée L1 est étroitement liée au pigeon. La monophylie des isolats testés chez cette lignée est visible dans toutes les topologies (sauf avec la matrice des insertions/délétions de la Tropomyosine seule et sur la base des ITS). Sur la base des tests statistiques de différenciation (Fst) appliqués aux séquences de mt-Co1 et de Tropomyosine, l'isolat 9001 de la lignée spéciale L1 (Publication V) se montre moins différencié des autres isolats de *D. gallinae* que de ceux de *D. apodis* et *D. hirundinis*, mais davantage de chacun des autres isolats de *D. gallinae* que ces isolats ne le sont entre eux.

c - Structure de populations

La structuration des populations au sein de *D. gallinae* apparaît en outre très différente entre faune sauvage et élevage. Les analyses utilisées ici ont porté uniquement sur un nombre réduit d'isolats largement explorés (plus de 20 individus séquencés par isolat). En effet, l'isolat sauvage de référence IL montre une équivalence entre valeurs attendues et valeurs observées de la diversité des séquences (nombre d'haplotypes et diversité haplotypique en fonction du nombre de séquences testées dans l'isolat et du nombre de sites ségrégeants). Les isolats de *D. gallinae* prélevés dans des élevages, en revanche, révèlent des déséquilibres importants entre diversité attendue et diversité

observée dans les deux gènes (nombre d'haplotype et diversité haplotypique très inférieurs aux valeurs estimées).

Cela peut témoigner soit événements fondateurs, soit d'une simple mise en contact récente de populations isolées les unes des autres. Le premier cas est commun chez les espèces déprédatrices en général, aussi bien phytophages qu'hématophages ou envahissant les denrées stockées, dont l'homme cherche à contrôler les populations par divers moyens (pesticides naturels ou de synthèse, organismes auxiliaires, ...). Une réduction brutale de la taille de la population par l'application de ces moyens réduit fortement la diversité génétique (goulot d'étranglement) et, sélectionnant aléatoirement les génotypes, induit un déséquilibre des rapports de diversité haplotypique. Après une phase de développement à partir de ce nombre réduit d'individus, la population peut retrouver sa taille originale, mais est marquée génétiquement. Quant au second cas possible, le mélange récent de populations isolées, l'action de l'homme peut là aussi en être la cause directe : les échanges commerciaux au sein des filières d'élevages sont tout à fait susceptibles d'initier accidentellement un contact entre des populations d'acariens établies dans des élevages distants, depuis longtemps, par le transfert des animaux et du matériel d'élevage.

Le déséquilibre très significatif dans les élevages ne s'explique sans doute pas de la même manière pour les deux gènes, dont les vitesses d'évolution sont très différentes par nature, et par conséquent, témoins d'événements très décalés dans le temps. Le déséquilibre des valeurs pour les séquences de Tropomyosine, qui offrent une image relativement ancienne, important au sein des isolats de tous les élevages de poules testés, s'accorde aisément avec un goulot d'étranglement concomitant avec la domestication des volailles ou la mise en place de pratiques de lutte dans les élevages. En effet, tous les isolats provenant d'élevage de poules présentent cette caractéristique. L'isolat 9001, en provenance d'un élevage de pigeon, représentant de la lignée spéciale L1, possède un seul haplotype de Tropomyosine, ce qui exclut toute interprétation quant au caractère prévisible ou non de cette faible diversité. Il n'en demeure pas moins qu'il est susceptible de représenter l'état "naturel" des lignées originelles de *D. gallinae*, c'est-à-dire une séquence de Tropomyosine très stable, comme chez les autres espèces testées dans le genre *Dermanyssus*.

En revanche, le déséquilibre dans la diversité des haplotypes de mt-Co1 n'est pas relevé dans tous les élevages de poules avec le même degré de significativité : l'isolat SK, prélevé au Danemark il y a 12 ans et confiné en laboratoire depuis, ne présente pas de déséquilibre significatif entre valeurs observées et valeurs attendues. Il porte en outre la marque d'un isolement évident par rapport aux isolats provenant directement d'élevages français. Une alternative se présente comme suit : soit les isolats français ont vécu un second événement fondateur, très postérieur au premier, soit le déséquilibre des isolats français rend compte d'un simple mélange de population par les échanges commerciaux. Le confinement de SK l'aurait soustrait à l'effet du contrôle des parasites ou de l'introduction de populations au matériel génétique très différent. Etant donnée l'ampleur de la divergence entre séquences de mt-Co1 isolées dans les élevages de poules, si l'on compare à SK, le mélange de populations isolées semble nettement la plus plausible des interprétations. Le rôle des flux commerciaux semble donc important dans la dissémination des acariens au sein de la filière poule française.

6.5 Du caractère invasif de *D. gallinae* et d'une espèce peut-être concurrente

D. gallinae présente de nombreuses particularités qui l'opposent aux autres (synanthropie, variabilité génétique et morphologique accrue, faiblesse de la spécificité d'hôte ...) et en font un candidat redoutable pour l'invasion des milieux avicoles (cf. Publication V). D'une manière générale,

les analyses utilisant chacune des deux portions de gène utilisées révèlent de fortes différences entre *D. gallinae* et les autres espèces testées, tout au moins *D. apodis* et *D. hirundinis*. La diversité des haplotypes, tant en nombre qu'en degré de divergence y est très nettement plus élevée que chez les autres. Cela peut être le signe d'une architecture génétique différente entre l'entité *D. gallinae* et les autres membres du genre *Dermanyssus* testés, et par conséquent de potentielle variance génétique additive et/ou épistasie augmentées (Lee 2002). Les hybridations décrites plus haut ont pu contribuer à construire ces caractéristiques. L'espèce *D. gallinae* se présente comme un complexe de lignées en effervescence, s'isolant les unes des autres, amorçant des spéciations qui sont ensuite interrompues par des hybridations incessantes, le tout marquant une évolution accélérée et une flexibilité bien supérieure à ses sœurs spécialistes. Ces particularités intrinsèques associées à de nombreuses preuves d'une adaptabilité remarquable et couronnées de succès (spectre d'hôtes large, synanthropie, expansion en cours constatée dans certaines zones du monde) clament le caractère fondamentalement apte à l'invasion de cette espèce. Le tableau réunit la plupart des caractéristiques recensées par Lee (2002), propres à ces rares espèces capables de réussir toutes les étapes de l'invasion décrites par Williamson (1996) : importation, introduction, établissement, développement nuisible. Et ce n'est pas un hasard si ce micropredateur généraliste se présente comme une entité dérivée dans un groupe de micropredateurs dont l'état plésiomorphe de la spécificité d'hôte est l'état spécialiste. Une fois encore, le caractère spécialiste pour un parasite n'est pas un cul de sac évolutif (Desdevises *et al.* 2002) et l'augmentation de la spécificité d'hôte n'est pas nécessairement un progrès. Curieusement, d'ailleurs, un motif comparable semble émerger d'une reconstruction phylogénétique proposée par Reinhardt et Siva-Jothy (2007) sur la base de caractères morphologiques et de traits d'histoire de vie, pour les Cimicidae : les punaises de cette famille, micropredatrices aptères comme *Dermanyssus*, montrent un spectre d'hôtes variable, quoique en général relativement restreint. Comme chez *Dermanyssus*, les entités basales dans la reconstruction de ces auteurs, tels les Primiciminae et les Latrociminae, montrent un spectre d'hôtes étroit. Et comme chez *Dermanyssus*, quelques espèces dont les synanthropes (genre *Cimex*, incluant les punaises de lit), en position distale, semblent être aptes à transiter d'un hôte à l'autre relativement aisément (chiroptères, homme, oiseaux).

D. gallinae n'est toutefois pas adaptable à tous les environnements, puisqu'on le rencontre rarement dans les nids d'oiseaux aux habitudes hygiéniques développées (éjection des sacs fécaux des poussins hors du nid par les mésanges, par exemple ; cf. plus haut). Cependant, cette différence de tolérance vis-à-vis de l'accumulation des fientes fraîches n'est probablement pas la cause unique de l'absence de *D. gallinae* des nids de mésanges *in natura* puisqu'il est présent dans les nids de mésanges en verger biologique et intégré (Publication VI). Il est aussi probable que d'autres arthropodes, dont de potentiels prédateurs de *D. gallinae* soient gênés par l'accumulation de fientes (et/ou par certains traitements utilisés en verger biologique et intégré). En outre, *D. gallinae* paraît absent des nids d'oiseaux en agroécosystème de verger conventionnel (*i.e.* traités chimiquement). En revanche, une espèce potentiellement concurrente serait à explorer plus avant : *O. sylviarum*. Très présente dans l'avifaune sauvage en France - davantage même que *D. gallinae* selon nos résultats - cette espèce semble en outre relativement peu sensible à certains traitements phytosanitaires réalisés dans les vergers conventionnels (cf. Publication VI, pp. 214 sqq.). Or cette espèce a déjà montré son aptitude à s'adapter à certaines molécules de synthèses telles des organophosphorés et carbamates (Mullens *et al.* 2004).

Par ailleurs, certains indicateurs d'une émergence en cours de cette espèce de Macronyssidae en conditions d'élevages commencent à apparaître en France : isolement d'individus dans un élevage amateur de canaris (Rhône) et dans un élevage de faisans (Vendée), témoignages d'autres éleveurs de canaris et de faisans du Rhône évoquant fortement l'infestation à Macronyssidae (« pou rouges » visibles sur l'hôte), et ce, apparemment depuis deux ou trois années. Les échantillonnages réalisés au

cours de la présente thèse dans plusieurs dizaines d'élevages de poules de France de types variés (au sol/en cages, conventionnels/biologiques) ont permis de détecter uniquement des acariens appartenant à *D. gallinae*. L'annonce de la présence d'*O. sylviarum* dans des élevages de poules français des mêmes régions par Bruneau *et al.* (2002) semble curieuse. Quoiqu'il en soit, les résultats de la présente thèse soulignent qu'aujourd'hui seul *D. gallinae* pose des problèmes en élevage de poules françaises.

La présente étude a mis en évidence la flexibilité remarquable de *D. gallinae*, mais n'a pas travaillé sur celle d'*O. sylviarum*. Or à l'heure actuelle, les deux espèces distantes entre elles phylogénétiquement présentent des répartitions écologiques symétriques si l'on considère les États-Unis et l'Europe. Occupant des niches chevauchantes, si ce n'est similaires, elles sont présentes dans les faunes sauvages nord-américaine et française et absente la première des élevages de poules nord-américaines, la seconde des élevages de poules françaises. Cela est-il dû à de grandes différences dans les moyens de production (et par conséquent dans l'écologie des microécosystèmes concernés) ? Ou des invasions de l'un et/ou de l'autre dans les élevages des régions opposées sont-elles en cours chez ces espèces ? Quelques récents témoignages d'élevages de volailles d'Europe du Nord contaminés par *O. sylviarum* (Chirico, communication personnelle) laissent penser que cette espèce est en cours d'expansion dans ces milieux dans l'Ancien Monde. Les changements climatiques y sont-ils pour quelque chose ?

7 Conclusions et perspectives

7.1 Conclusions sommaires

La première partie de thèse retrace un cheminement d'ordre taxinomique et a permis de poser les bases nécessaires à la seconde partie, ainsi qu'à toute étude d'ordre écologique d'espèces du genre *Dermanyssus* communes dans l'avifaune française au moins. De ce long préalable ont émergé plusieurs informations nouvelles, et certaines des connaissances antérieures ont pu être confirmées et précisées.

La base taxinomique qui en résulte a permis (1) d'obtenir un inventaire des espèces de *Dermanyssus* présentes en France, (2) de commencer à explorer certaines caractéristiques écologiques du groupe *gallinae* en relation avec sa phylogénie (spécificité d'hôte, flexibilité évolutive).

a - Nouveautés taxinomiques

Un aperçu synoptique des remaniements taxinomiques est présenté dans la Figure 8 (p. 241), à comparer avec l'aperçu initial de la Figure 1 (p. 21). Contrairement à notre première hypothèse, aucune espèce n'a pu être mise en synonymie. Seule *D. gallinoides* semble représenter un synonyme junior de *D. gallinae*, mais l'échantillonnage sur Picidae (sa famille d'hôtes type) est insuffisant pour l'affirmer avec certitude. Les autres espèces sont nettement isolées les unes des autres. En outre, une espèce a été décrite consécutivement au travail de délimitation des espèces (*D. apodis*), une lignée de *D. gallinae* constitue aussi sans doute une espèce inédite, quoique le caractère définitif de son isolement reproducteur reste à vérifier, et *D. longipes* regroupe manifestement deux entités spécifiques différentes. La diversité du genre *Dermanyssus* est apparemment plutôt sous-estimée à l'heure actuelle que surestimée, comme nous le pensions au début de l'étude.

b - Nouveautés écologiques

Sur la base taxinomique obtenue, le simple inventaire des espèces du genre *Dermanyssus* dans des échantillons provenant de l'avifaune sauvage (principalement française) a révélé une étroitesse

inattendue du spectre d'hôtes chez certaines espèces. Parmi les deux espèces réputées les moins spécifiques du groupe, *D. hirundinis* s'avère parasiter un spectre d'hôtes nettement réduit, au moins en France (une seule famille, celle des Hirundinidae), alors que *D. gallinae* confirme sa faible spécificité. Quant à notre nouvelle espèce *D. apodis*, elle semble bien être inféodée aux martinets (genre *Apus*). La clarification taxinomique était donc bien nécessaire à un réajustement de l'appréhension de la spécificité d'hôte dans ce genre. Comme McCoy *et al.* (2003) l'on montré au sein de l'espèce *I. uriae*, la biologie de l'oiseau hôte semble jouer un rôle important dans la dispersion des populations d'acariens. Tout nidicole qu'il soit, et si rapide que soit son repas (cf. § Avant-propos), le microprédateur du genre *Dermanyssus* semble bien profiter des déplacements de son hôte ailé pour se déplacer, de la même manière que la tique *I. uriae*. Les espèces microprédatrices du genre *Dermanyssus* ne demeurent pas longtemps sur l'hôte pour la prise du repas, mais il semblerait qu'un essaimage « volontaire » puisse avoir lieu par l'intermédiaire des femelles adultes : il est noté dans la publication III que les quelques individus prélevés directement sur un hôte hors du nid au cours de la présente étude étaient presque systématiquement des femelles. Un constat similaire a été établi par plusieurs auteurs chez des Cimicidae (Reinhardt et Siva-Jothy 2007). Par ailleurs, le rôle des flux commerciaux dans la dispersion des populations de *D. gallinae* en élevage de pondeuses s'avère primordial, suggérant une capacité à voyager par l'intermédiaire d'objets divers, comme cela a déjà été noté par Reinhardt et Siva-Jothy chez les punaises de lit (2007). Enfin, un autre parallèle peut être établi avec les Cimicidae (incluant les punaises de lit), dont les habitudes plésiomorphes semblent plutôt être une spécificité d'hôte relativement élevée (Reinhardt et Siva-Jothy 2007).

Des différentes analyses phylogénétiques menées au cours de la présente thèse, il ressort en outre une forte opposition entre *D. gallinae* et les 4 autres espèces françaises testées : (1) *D. gallinae* manifeste une synanthropie marquée, à l'opposé des autres espèces françaises, beaucoup plus rustiques, (2) *D. gallinae* est largement généraliste, tandis que les autres espèces françaises sont spécifiques (à des niveaux variés), (3) *D. gallinae* présente une flexibilité et un potentiel évolutifs très accrus, comparé aux autres espèces.

Or ces différences semblent résulter non seulement de l'activité humaine et de ses retombées environnementales, mais aussi, pour une grande part, de caractéristiques intrinsèques. *D. gallinae*, complexe d'espèces en ébullition et en position distale dans les topologies nucléaires, apparaît fondamentalement équipé pour une invasion des milieux avicoles. Composée de lignées qui ont rapidement divergé les unes des autres et se sont hybridées entre elles, l'architecture génétique de cette espèce la rend sans doute fortement apte à s'adapter rapidement à des modifications dans les conditions écologiques dans lesquelles elle vit. La phylogénie proposée par Reinhardt et Siva-Jothy (2007) présente les espèces de Cimicidae infestant l'homme (*Cimex lectularius* et *C. hemipterus*) comme en position distale (avec d'autres). Un motif comparable est-il envisageable chez cet hémiptère aux mœurs très proches (microprédateur aptère, cf. § Avant-propos), et en pleine réémergence dans divers pays, par exemple aux Etats-Unis (Szalanski *et al.* 2008), en Corée (Lee *et al.* 2008) ? Toutefois, un comportement fréquent d'accouplement interspécifique entre les deux espèces citées ci-dessus, apparemment très proches, a prouvé être délétère par l'absence d'hybridation qui en est issue (œufs stériles) (Newberry 2008). Les fréquentes hybridations démontrées chez *D. gallinae* ne sont peut-être pas possibles chez les espèces du genre *Cimex*.

Par ailleurs, une espèce de Macronyssidae, *O. sylviarum*, l'équivalent nord américain de *D. gallinae* en élevage de pondeuses, représente peut-être une concurrence non négligeable. D'autant que les analyses de nids réalisés au cours de la présente thèse ont permis de révéler une situation symétrique en Europe et aux Etats-Unis : *D. gallinae* est présent en condition sauvage comme en élevage de pondeuse en France, seulement (ou presque) en condition sauvage aux Etats-Unis, et *vice*

versa pour *O. sylviarum*. Mais cette dernière espèce a déjà été signalée en élevage de pondeuses en Europe du Nord, et est actuellement rencontrée dans des élevages très différents en France (faisans, canaris).

7.2 Perspectives

Comme souvent à l'issue d'un travail de recherche, si quelques éléments de réponse à certaines questions ont pu être formulées, bien davantage de questions nouvelles ont été soulevées. Nombreuses sont les perspectives de recherche qui peuvent découler de la présente étude, et nombreuses aussi sans doute les questions à « trouver ». Voici les principales :

a - Exploration des flux de populations au sein de l'espèce *D. gallinae*

Une analyse utilisant les outils de la génétique des populations intégrant un plus grand nombre d'isolats massivement séquencés que la publication V a été entamée, et vise à clarifier les voies de dissémination entre populations infestantes en élevages de pondeuses en Europe, voire à l'échelle mondiale. Une publication devrait en émerger, dans le prolongement de l'exploration intraspécifique esquissée dans la publication V.

Ce travail en cours de réalisation est financé par le Pôle d'Expérimentation et de Progrès (PEP) avicole de la Région Rhône-Alpes, et mené en collaboration avec l'Institut Technique de l'AViculture (ITAVI) (Sophie Lubac).

b - Espèces cryptiques

Le statut spécifique de la lignée L1 (*D. gallinae*) et des deux lignées regroupées dans *D. longipes* est à confirmer, et le cas échéant, deux espèces cryptiques sont à décrire. Pour cela, des analyses, morphologiques et moléculaires sont nécessaires, de même, si possible que des essais de croisement au laboratoire.

c - Analyse moléculaire et morphologique de l'ensemble du genre *Dermanyssus*

Une analyse complète (morphologie et marqueurs moléculaires) impliquant un plus grand nombre des espèces actuellement décrites permettrait de peaufiner certaines délimitations interspécifiques non explorées ici au sein du genre *Dermanyssus*, en particulier chez les espèces que Moss classait dans le groupe *hirsutus* du sous-genre *Dermanyssus* et dans le sous-genre *Microdermanyssus*. Selon notre analyse impliquant 20 des espèces actuellement décrites, ces deux groupes n'en formeraient qu'un. Toutefois, l'inclusion de caractères moléculaires ayant montré une efficacité plus importante pour la résolution des relations intragénériques parmi les espèces testées, il serait intéressant de voir s'ils confirment la monophylie du groupe *hirsutus* de Moss, ainsi que leur insertion parmi les espèces du groupe *gallinae sensu* Moss (1978).

En outre, l'intégration d'une ou deux espèces du genre *Liponyssoides* permettrait de tester réellement le monophylie du genre *Dermanyssus*.

Par ailleurs, une investigation plus poussée de la région de l'EF1- α séquencée au cours de l'étape liminaire (cf. § Remarques sur la publication III pp.) pourrait permettre de comprendre le problème rencontré. S'agit-il de paralogie, avec une double copie dont une ou l'autre éteinte chez certaines espèces ? Un séquençage massif d'un plus grand nombre de populations et leur analyse phylogénétique suivie d'une réconciliation des arbres de gène avec les arbres d'espèces tels que nous les avons fixés dans la présente étude pourrait faire émerger une explication à l'incongruence

rencontrée (Page & Charleston 1997) et apporter un complément d'information quant aux relations phylogénétiques dans le groupe *gallinae*.

d - Cophylogenèse au niveau population

Enfin, la spécificité d'hôte s'est avérée plus importante que l'on ne le pensait auparavant. Des facteurs écologiques semblent jouer un rôle important dans le transfert d'un hôte à l'autre, mais des caractéristiques intrinsèques sont aussi très impliquées. La forte opposition entre les habitats permettant la prolifération des lignées de *D. gallinae* et ceux hébergeant les autres espèces françaises ainsi que le rôle vecteur de l'oiseau mis en évidence dans la publication IV témoignent des premiers. Les caractéristiques évolutives particulières mises à jour chez *D. gallinae* par comparaison avec *D. hirundinis* et *D. apodis* dans la publication V signent les secondes. Ces éléments ne sont toutefois que les témoins de particularités dans la relation hôte-parasite chez ces espèces du groupe *gallinae* qui demeurent au moins partiellement inconnues. Une approche cophylogénétique au niveau population tant pour les acariens que pour leurs oiseaux hôtes, associée à des bioessais sur le terrain, permettrait une appréhension approfondie de ces aspects.

Dans cet esprit, deux projets ont été soumis à l'Agence Nationale de la Recherche (ANR), mais n'ont pas été retenus. Leur mise en œuvre pourrait aboutir à une meilleure compréhension de ce qui préside à la dissémination et au développement des populations des espèces du groupe *gallinae* :

Avipred - « Spécificité d'hôte chez un ectoparasite nidicole : association hôte-parasite chez quelques espèces microprédatrices de *Dermanyssus* » – ANR Blanc édition 2009

Phylopred – « Spécificité d'hôte chez un ectoparasite nidicole : cophylogénie hôte-parasite chez quelques espèces microprédatrices de *Dermanyssus* » – ANR Jeunes Chercheuses et Jeunes Chercheurs édition 2009

e - Investigation de la situation symétrique entre *D. gallinae* et *O. sylviarum* en France et aux Etats-Unis

Une exploration utilisant les outils de la phylogénie et de la génétique des populations visant à comparer un nombre important d'isolats des deux espèces provenant des deux pays, et des deux grands types d'environnements (sauvage, élevage) pourrait permettre, en collaboration avec la filière avicole, de détecter des raisons écologiques liées aux pratiques d'élevages des deux pays dans le déséquilibre constaté entre les deux espèces et/ou de mettre en évidence une expansion actuelle de l'une ou des deux espèces dans les zones respectivement non colonisées. Cela pourrait aboutir à terme à des préconisations à l'attention des éleveurs et/ou des fabricants de structure d'élevage en vue d'une prophylaxie améliorée. Cela est en outre susceptible d'offrir un aperçu de certains effets non envisagés actuellement dans les élevages de volaille des changements globaux.

f - Comparaison des valeurs de polymorphisme de séquences d'ADN nucléaires et mitochondriales entre espèces de microprédateurs aptères

Il serait intéressant de voir si le motif de la diversité haplotypique augmentée, et éventuellement des hybridations multiples, chez l'espèce synanthrope et généraliste *D. gallinae*, contrastant avec les données des autres espèces du genre se répète chez des espèces aux mœurs similaires : explorer ainsi *O. sylviarum* vs autres Macronyssidae, *C. lectularius* et *C. hemipterus* vs autres Cimicidae pourrait permettre d'appréhender ce qui préside au développement de ces espèces microprédatrices synanthropes, et peut-être d'assouplir et affiner des règles trop rigides que l'on risquerait de tirer du cas *Dermanyssus*.

8 Lexique

arrhénotoque (parthénogénèse) (grec *arrhên*, mâle, et *tokos*, action d'enfanter, de mettre bas) : cas de la reproduction haplodiploïde fréquente chez certains arthropodes, dont les hyménoptères sociaux, où les œufs non fécondés donnent naissance aux mâles (haploïdes, issus de parthénogénèse) et les œufs fécondés donnent naissance aux femelles (diploïdes, issues de reproduction sexuée).

bande (contexte : élevage) : ensemble des volailles maintenues en commun dans un type d'élevage entre leur entrée et leur réforme (retrait de l'élevage et abattage). Pour les pondeuses, l'entrée de la bande se fait aux alentours de 18 semaines (âge de début de maturité pour la ponte) et la réforme, en conditions normales, correspond à la fin de la période optimale/rentable de ponte et a lieu environ un an plus tard.

gonotrophique (grec *gonos*, semence génitale, et *trophê*, action de nourrir) : un cycle gonotrophique désigne la succession recherche de l'hôte-repas de sang-maturation des œufs-oviposition caractérisant chaque ponte chez les femelles d'arthropodes hématophages.

haplodiploïdie : cas des différents types de reproduction où les mâles sont haploïdes et les femelles diploïdes (selon Cruickshank et Thomas 1999).

opisthosome (grec *opisthe*, ensuite, derrière, *soma*, corps) : partie du corps des acariens située à l'arrière des dernières paires de pattes. Equivalent de l'abdomen des insectes et Aranea (araignées, scorpions, ...), l'opisthosome ne présente pas la séparation nette par rapport à la partie antérieure que l'on observe entre l'abdomen et le thorax chez les premiers, entre l'abdomen et le céphalothorax chez les seconds.

organophosphoré : groupe de molécules à action neurotoxique visant l'acétylcholinestérase, médiateur chimique impliqué dans la transmission de l'influx nerveux. De nombreux organophosphorés sont utilisés comme insecticides ou acaricides en agriculture aussi bien végétale qu'animale.

pseudoarrhénotoque (cf. arrhénotoque) : cas particulier de l'haplodiploïdie* où les mâles sont issus d'œufs fécondés, mais à un stade ou un autre de l'embryogenèse desquels, l'élimination d'une moitié du génome, aboutit *a posteriori* à un état haploïde.

vide sanitaire (contexte : élevage) : d'une durée d'env. 2 mois (souvent réduit à 3 semaines), le vide sanitaire est réalisé entre 2 bandes. En l'absence des volailles, un certain nombre de mesures à visée sanitaires sont appliquées (nettoyage, désinfection, désinsectisation).

thigmotactisme (grec *thigein*, toucher et *taxis*, arrangement) : immobilisation provoquée par le contact d'un corps solide, tendance à rechercher le contact de surfaces dures avec son corps. Le thigmotactisme amène certains animaux à se regrouper dans des espaces réduits.

9 Références bibliographiques

- Amin OM, Sonenshine DE. 1969. Development of the American Dog Tick, *Dermacentor variabilis*, Following Partial Feeding by Immatures. *Annals of the Entomological Society of America*, 63(1):128-133.
- Anderson RR and Harrington LC. 07/04/2009. MOSQUITO BIOLOGY for the HOMEOWNER. <http://www.entomology.cornell.edu/MedEnt/MosquitoFS/MosquitoFS.html>
- Axtell RC, Arends JJ. 1990. Ecology and Management of arthropod pests of poultry. *Annual review of entomology* 35:101-126.
- Banks JC, Paterson AM. 2005. Multi-host parasite species in cophylogenetic studies. *International Journal for Parasitology*. 35(7):741-746

- Burt EH Jr, W Chow, and GA Babbitt. 1991. Occurrence and demography of mites of Tree Swallow, House Wren, and Eastern Bluebird nests. Pages 104-122 in J. E. Loye and M. Zuk, editors. Bird-parasite interactions: ecology, evolution, and behaviour. Oxford University Press, Oxford, UK.
- Clayton, D. H., and D. M. Tompkins. 1994. Ectoparasite virulence is linked to mode of transmission. *Proceedings of the Royal Society of London* 256:211-217.
- Clayton, D. H., and D. M. Tompkins. 1995. Comparative effects of mites and lice on the reproductive success of Rock Doves (*Columba livia*). *Parasitology* 110:195-206.
- Cruickshank, R.H., 2002. Molecular markers for the phylogenetics of mites and ticks. *Systematic and Applied Acarology* 7:3-14.
- Cruickshank RH et Thomas RH. 1999. Evolution of Haplodiploidy in Dermanyssine mites (Acari: Mesostigmata). *Evolution* 53(6):1796-1803.
- Dell'Omo G, Alleva E, Carere C. 1998. Parental recycling of nestling faeces in the common swift. *Animal Behaviour* 56(3):631-637
- Desdevises Y, Morand S and Legendre P. 2002. Evolution and determinants of host specificity in the genus *Lamellodiscus* (Monogenea). *Zoological Journal of the Linnean Society* 77(4):431-443.
- Djernaes M. and Damgaard J. 2006. Exon-intron structure, Paralogy and Sequenced Regions of Elongation Factor-1 alpha in Hexapoda. *Arthropod Systematic and Phylogeny* 64(1):45-52.
- Dotson E. 1982. The question of para-haploidy or haplodiploidy in the chicken mite, *Dermanyssus gallinae*. M.S., Georgia Southern College, Statesboro. M.S. Thesis.
- Dowling APG. 2006a. Systematics, genomics, and the evolution of parasitism within Dermanyssoidea (Mesostigmata). XIIth International Congress of Acarology, Amsterdam, 21-26 août 2006.
- Dowling APG. 2006b. Mesostigmatid mites as parasites of small mammals: Systematics, ecology, and the evolution of parasitic associations. In Morand, Krasnov, and Poulin (eds). *Micromammals and macroparasites : From evolutionary ecology to management*. Springer-Verlag, Tokyo.
- Dunn LH. 1924. Life history of the Tropical Bed Bug, *Cimex rotundatus*, in Panama. *The American journal of tropical medicine and hygiene* S1-4(1):77-83.
- el Kady GA, Shoukry A, Ragheb DA, el Said AM, Habib KS, Morsy TA. 1995. Mites (acari) infesting commensal rats in Suez Canal zone, Egypt. *Journal of the Egyptian Society of Parasitology* 25(2):417-25.
- Evans GO., 1963. Some observations on the chaetotaxy of the pedipalps in the Mesostigmata (Acari). *Annals & magazine of natural history* 13, 513-527.
- Evans GO and WM Till. 1966. Studies on the British Dermanyssidae (Acari: Mesostigmata). Part II. Classification. *Bulletin of the British Museum (Natural History) Zoology* 14:109-370
- Ewing, HE. 1923. The dermanyssid mites of North America. *Proceedings of the United States National Museum* 62: 1-26 pls 1, 2.
- Fain A, Galloway TD. 1993. Mites (Acari) from nests of sea birds in New Zealand. Ii. Mesostigmata and Astigmata. *Bulletin De L'Institut Royal Des Sciences Naturelles De Belgique, Entomologie* 63, p. 95-111
- Fend'a P, E Schniererová. 2004. Mites (Acarina: Mesostigmata) in the nests of *Acrocephalus* spp. and in neighbouring reeds. *Biologia (Bratislava)* 59: 41-47.
- Fend'a P, E Schniererová. 2005. Mites (Acarina, Gamasida) in littoral zone of Jakubov fishponds (Slovakia), p. 9-14. In: Tajovský, K., Schlaghamerský, J., Pižl, V. (eds), *Contributions to Soil Zoology in Central Europe I*, Institute of Soil Biology Academy of Sciences of the Czech Republic, České Budějovice.
- Gorochotegui-Escalante N, De Lourdes Munoz M, Fernandez-Salas I, Beaty BJ and Black IV WC. 2000. Genetic isolation by distance among *Aedes aegypti* populations along the northeastern coast of Mexico. *The American journal of tropical medicine and hygiene* 62(2):200-209.

- Gu YM, Ting QY. 1992. New species and new records of *Dermanyssus* from China (Acari: Dermanyssidae). *Acta Zootaxonomica Sinica* 17:1:32-36.
- Guy JH ; Khajavi M ; Hlalel MM ; Sparagano 2004. Red mite (*Dermanyssus gallinae*) prevalence in laying units in Northern England. *British Poultry Science* 45:15-16
- Hallan J. 2005. <http://insects.tamu.edu/research/collection/hallan/Acari/Family/Mesostigmata1.htm>. 04/07/2009.
- Hirst S. 1913. On three new species of Gamasid mites found on rats. *Bulletin of entomological research* 4: 119-124.
- Hoffmann G. 1987. Vogelmilbe als Lästlinge, Krankheitserzeuger und Vektoren bei Mensch und Nutztier. *Deutsche Tierärztliche Wochenschrift* 95:7-10.
- Hutcheson HJ et Oliver JH Jr. 1988. Spermiogenesis and Reproductive Biology of *Dermanyssus gallinae* (De Geer) (Parasitiformes: Dermanyssidae). *Journal of Medical Entomology* 25:5:321-330.
- Izri A. 2001. Les poux : diagnostic, nuisance et rôle vectoriel. *Revue Française des Laboratoires* 338:37-40.
- Ives AR, Klug JL and Gross K. 2000. Stability and species richness in complex communities. *Ecology letters* 3:399-411.
- Johnson, L. S., and D. J. Albrecht. 1993. Effects of haematophagous ectoparasites on nestling House Wrens, *Troglodytes aedon*: who pays the cost of parasitism? *Oikos* 66:255-262.
- Keçeci T, Handemir E, Orhan G (2004) The Effect of *Dermanyssus gallinae* Infestation on Hematological Values and Body Weights of Cocks. *Trkiye Parazitoloji Dergisi* 28:192-196.
- Kilpinen O. 1999. Problems caused by the chicken mite, *Dermanyssus gallinae*, in the Danish egg production. *Cost 833 Agriculture, 2. Annual Workshop, Cluj, Roumanie*, pp. 61-65.
- Kilpinen O. 2001. Activation of the poultry red mite *Dermanyssus gallinae* (Acari : Dermanyssidae) by increasing temperatures. *Experimental and Applied Acarology* 25:859-867.
- Kilpinen O. 2005. How to obtain a bloodmeal without being eaten by a host: the case of poultry red mite *Dermanyssus gallinae* *Physiological Entomology* 30:232-240
- Kilpinen O, Roepstorff A, Permin A, Nørgaard-Nielsen G, Lawson LG & Simonsen HB. 2005. Influence of *Dermanyssus gallinae* and *Ascaridia galli* infections on behaviour and health of laying hens (*Gallus gallus domesticus*). *British Poultry Science* 46 (1), 26-34.
- Kirkwood AC. 1967. Anaemia in poultry infested with the red mite *Dermanyssus gallinae*. *Veterinary Record* 29;80(17):514-6.
- Kirkwood AC. 1963. Longevity of the Mite *Dermanyssus gallinae* and *Liponyssus sylviarum*. *Experimental Parasitology* 14:358-366.
- Koehler PG, Pereira RM, Pfiester M, and Hertz J. 2008. Bed Bugs and Blood-Sucking Conenose. ENY-227 (IG083), one of a series of the Entomology and Nematology Department, Florida Cooperative Extension Service, Institute of Food and Agricultural Sciences, University of Florida.
- Kuris AM and Lafferty KD 2000. Parasite-host modelling meets reality: adaptive peaks and their ecological attributes. In: *Evolutionary Biology of Host-Parasite Relationships: Theory Meets Reality*, Ed. Poulin R., Morand S. and Skorping A. Elsevier Science B.V. pp. 9-26.
- Lainson R. 1960. The Transmission of *Lankesterella* (= *Atoxoplasma*) in Birds by the Mite *Dermanyssus gallinae*. *Journal of Eukaryotic Microbiology* 7(4):321-322.
- Lee CE. 2002. Evolutionary genetics of invasive species. *Trends in Ecology and Evolution* 17(8):386-391
- Lee IY, Ree HI, An SJ, Linton JA, Yong TS. 2008. Reemergence of the bedbug *Cimex lectularius* in Seoul, Korea. *Korean Journal of Parasitology* 46:269-71.
- Lopes J, Beaumont M. 2008. Approximate Bayesian Computation - Studying demographic parameters. *Mathematics and Informatics in Evolution and Phylogeny*, Montpellier 10-12 juin.

- Majka CG, Klimaszewski J and Lauff RF. 2006. New Coleoptera records from owl nests in Nova Scotia, Canada. *Zootaxa* 1194:33-47.
- McCoy. 2001. Conséquence de la dispersion dans les systèmes hôtes-parasites : dynamique des populations, structure génétique, et adaptation locale chez un parasite d'oiseaux marins, la tique *Ixodes uriae*. Thèse nouveau doctorat.
- McCoy KD, Boulinier T, Tirard C, Michalakis Y. 2003. Host-dependent genetic structure of parasite populations: differential dispersal of seabird tick host races. *Evolution* 57(2):288-296.
- McDevitt R, Nisbet AJ, Huntley JF. 2006. Ability of a proteinase inhibitor mixture to kill poultry red mite, *Dermanyssus gallinae* in an *in vitro* feeding system. *Veterinary Parasitology* 5:141(3-4):380-5.
- Merkl O., Bagyura J. and Rózsa L. 2004. Insects inhabiting Saker (*Falco cherrug*) nests in Hungary. *Ornis Hungarica* 14:1-4.
- Meyer-Kühling B, Pfister K, Müller-Lindloff J, Heine J. 2007. Field efficacy of phoxim 50% (ByeMite®) against the poultry red mite *Dermanyssus gallinae* in battery cages stocked with laying hens. *Veterinary Parasitology*, 147(-4):289-296.
- Morand S., Sorcib G. 1988. Determinants of Life-history Evolution in Nematodes. *Parasitology Today* 14(5):193-196.
- Morand S, Simkova A, Matejusová I, Plaisance L, Verneau O et Desdevises Y. 2002. Investigating patterns may reveal processes: evolutionary ecology of ectoparasitic monogeneans. *International Journal of Parasitology* 32:111-119.
- Moss WW. 1967. Some new analytic and graphic approaches to numerical taxonomy, with an example from the Dermanyssidae (Acari). *Systematic zoology* 16:177-207.
- Moss WW. 1968. An Illustrated Key to the Species of the Acarine Genus *Dermanyssus* (Mesostigmata: Laelapoidea: Dermanyssidae). *Journal of Medical Entomology* 1:67-84.
- Moss WW. 1978. The mite genus *Dermanyssus*: a survey, with description of *Dermanyssus trochilinis*, n. sp., and a revised key to the species (Acari: Mesostigmata: Dermanyssidae). *Journal of Medical Entomology* 14(6):627-640.
- Moss WW, Mitchell CJ, Johnston DE. 1970. New North American host and distribution records for the mite genus *Dermanyssus* (Acari: Mesostigmata: Dermanyssidae). *Journal of Medical Entomology* 7:589-593.
- Moss, WW, Camin JH. 1970. Nest parasitism, productivity, and clutch size in Purple Martins. *Science* 168:1000-1003.
- Mullens BA, Hinkle NC, Robinson LJ, Szijj CE. 2001. Dispersal of Northern Fowl Mites, *Ornithonyssus sylviarum*, Among Hens in an Experimental Poultry House. *Journal of applied poultry research* 10: 60-64.
- Mullens B.A., Velten R.K., Hinkle N.C., Kuney D.R., Szijj C.E. 2004. Acaricide resistance in northern fowl mite (*Ornithonyssus sylviarum*) populations on caged layer operations in Southern California. *Poultry Science* 83:365-374
- Nature Midi-Pyrénées (association). 2001. Etude et prospection du Martinet Pâle *Apus pallidus* en Midi-Pyrénées.
<http://www.premiumwanadoo.com/naturemp/6Proteger/Etudes/RapportMartinetPale2.pdf>
- Navajas M, Fenton B. 2000. The application of molecular markers in the study of diversity in Acarology: a review. *Experimental and Applied Acarology* 24:751-774.
- Nei M. 1987. *Molecular Evolutionary Genetics*. Columbia University Press.
- Newberry K. 2008. The effects on domestic infestations of *Cimex lectularius* bedbugs of interspecific mating with *C. hemipterus*. *Medical and Veterinary Entomology* 3(4):407-414.

- Nisbet AJ, Huntley JF, MacKellar A, Sparks N, McDevitt R. 2006. A house dust mite allergen homologue from poultry red mite *Dermanyssus gallinae* (De Geer). *Parasite Immunology* 28:401-405.
- Nordenfors H, Höglund J, Uggla A. 1999. Effects of Temperature and humidity on oviposition, molting, and longevity of *Dermanyssus gallinae* (Acari : Dermanyssidae). *Journal of Medical Entomology* 36:68-72
- Nordenfors H, Hoglund J. 2000. Long term dynamics of *Dermanyssus gallinae* in relation to mite control measures in aviary systems for layers. *British Poultry Science* 41(5):533-540
- Nosek J, Lichard M. 1962. Beitrag zur Kenntnis der Vogelneftauna. *Entomologické problémy (Bratislava)* 2:29-51
- Oliver JH Jr. 1977. Cytogenetics of mites and ticks. *Annual Review of Entomology* 22:407-29
- Oliver JH Jr. 1966. Notes on Reproductive Behavior in the Dermanyssidae. *Journal of Medical Entomology* 3:1:29-35
- Pacejka AJ, Thompson CF. 1996. Does removal of old nests from nestboxes by researchers affect mite populations in subsequent nests of House Wrens? *Journal of Field Ornithology* 67:558-564.
- Pacejka J, Gratton CM, Thompson CF. 1998. Do potentially virulent mites affect house wren reproductive success? – *Troglodytes aedon*. *Ecology* 5:79.
- Page RDM, Hafner MS. 1996. Molecular phylogenies and host–parasite cospeciation: gophers and lice as a model system. In: P.H. Harvey, A.J. Leigh-Brown, J. Maynard Smith and S. Nee, Editors, *New Uses for New Phylogenies*, Oxford University Press, Oxford (1996), pp. 255–270.
- Page RD, Charleston MA. 1997. From gene to organismal phylogeny: reconciled trees and the gene tree/species tree problem. *Molecular Phylogenetics and Evolution* 7(2):231-40.
- Panchal M. 2007. The automation of Nested Clade Phylogeographic Analysis. *Bioinformatics* 23(4):509-510.
- Panchal M, Beaumont MA. 2007. The automation and evaluation of nested clade phylogeographic analysis. *Evolution* 61(6):1466-80.
- Peterson, A. Version 8.07. 25/08/2007. ‘Zoonomen Nomenclatural data’ <http://www.zoonomen.net/avtax/frame.html>.
- Petit RJ. 2007. The coup de grâce for the nested clade phylogeographic analysis? *Molecular Ecology* 17(2):516-518.
- Phillis W. 1972. Seasonal abundance of *Dermanyssus hirundinis* and *D. americanus* (Mesostigmata: Dermanyssidae) in nests of the House Sparrow. *Journal of Medical Entomology* 9:111-112
- Phillis WA, Cromroy HL, Denmark HA. 1976. New Host and distribution records for the mite genera *Dermanyssus*, *Ornithonyssus* and *Pellonyssus* (Acari: Mesostigmata: Laelapoidea) in Florida). *The Florida Entomologist* 59:1:89-92.
- Prasad RS. 1987. Nutrition and reproduction in haematophagous arthropods. *Proceedings of the Indian Academy of Sciences (Animal Sciences)* 96(3):253-273.
- Price PW. 1975. *Insect ecology*. J. Wiley, New York.
- Price RD, Hellenthal RA, Palma RL. 2003. World checklist of chewing lice with host associations and keys to families and genera. In: R.D. Price, R.A. Hellenthal, R.L. Palma, K.P. Johnson and D.H. Clayton, Editors, *The Chewing Lice. World checklist and Biological Overview*, Illinois Natural History Survey Special Publication 24:1–448.
- Radovsky F.J. 1966. Revision of the Macronyssid and Laelapid mites of bats: outline of classification with descriptions of new genera and new type species. *Journal of Medical Entomology* 3(1):93-99
- Radovsky FJ. 1969. Adaptive radiation in parasitic Mesostigmata. *Acarologia* 11:450-483.

- Radovsky FJ. 1994. The Evolution of Parasitism and the Distribution of Some Dermanyssoid Mites (Mesostigmata) on Vertebrate Hosts. In *Mites Ecological and Evolutionary Analyses of Life-History Patterns*, ed. MA Houck, USA.
- Reinhardt K, Siva-Jothy MT. 2007. Biology of the Bed Bugs (Cimicidae). *Annual Review of Entomology* 52:351-74.
- Rosen S, Yeruham I, Braverman Y. 2002. Dermatitis in humans associated with the mites *Pyemotes tritici*, *Dermanyssus gallinae*, *Ornithonyssus bacoti* and *Androlaelaps casalis* in Israel. *Medical and Veterinary Entomology* 16:4:442-444.
- Rosen S, Hadani A, Shoham D. 1985. Parasitic mites (Acarina, Arachnoidea) in wild birds trapped in poultry farms in Israel. *Acarologia* 26:79-85.
- Roy L, Guilbert E, Bourgoin T. 2007. Phylogenetic patterns of mimicry strategies in Darnini (Insecta: Hemiptera: Membracidae). *Annales de la Société Entomologique de France*, 43(3) : 273-288.
- Sahibi H, Rhalem A. 2007. *Dermanyssus gallinae*: Acarien particulièrement agressif et négligé à tort au Maroc. 1er Colloque International d'Acarologie et d'Entomologie Médicales, Rabat, 02-03 novembre 2007.
- Sokół R, Szkamelski A, Barski D. 2008. Influence of light and darkness on the behaviour of *Dermanyssus gallinae* on layer farms. *Pol J Vet Sci.* 11(1):71-3.
- Sparagano O, Pavličević A, Murano T, Camarda A, Sahibi H, Kilpinen O, Mul M, van Emous R, le Bouquin S, Hoel K, Cafiero M. 2009. Prevalence and key figures for the poultry red mite. *Dermanyssus gallinae* infections in poultry farm systems. *Experimental and Applied Acarology* 48:1:3-10
- Strandtmann RW, Wharton GW. 1958. A manual of mesostigmatid mites parasitic on vertebrates Institute of Acarology, Contribution No. 4, University of Maryland, College Park, Maryland.
- Szalanski AL, Austin JW, McKern JA, Steelman CD, Miller DM, Gold RE. 2006. Isolation and Characterization of Human DNA From Bed Bug, *Cimex lectularius* L. (Hemiptera : Cimicidae) Blood meals. *Journal of Agricultural and Urban Entomology* 23(3):189-194.
- Szalanski AL, Austin JW, McKern JA, Steelman CD, Gold RE. 2008. Mitochondrial and Ribosomal Internal Transcribed Spacer 1 Diversity of *Cimex lectularius* (Hemiptera: Cimicidae). *Journal of Medical Entomology* 45(2):229-236.
- Templeton AR. 1998. Nested clade analyses of phylogeographic data: testing hypotheses about gene flow and population history. *Molecular Ecology* 7:399-412.
- Templeton AR, Routman E, Phillips CA. 1995. Separating population structure from population history: a cladistic analysis of the geographical distribution of mitochondrial-DNA haplotype in the Tiger Salamander *Ambystoma tigrinum*. *Genetics* 140:767-782.
- Todisco G, Paoletti B, Giammarino A, Manera M, Sparagano OA, Iorio R, Giannella B, Robbe D. 2008. Comparing therapeutic efficacy between ivermectin, selamectin, and moxidectin in canaries during natural infection with *Dermanyssus gallinae*. *Annals of the New York Academy of Sciences* 1149:365-7.
- Troughton DR, Levin LR. 2007. Life Cycles of Seven Ixodid Tick Species (Acari: Ixodida) under Standardized Laboratory Conditions. *Journal of Medical entomology* 44(5):732-740.
- Tuovinen T. 2008. Predatory arthropods as biocontrol agents of *Dermanyssus gallinae*? In *BSP Spring, Trypanosomiasis/Leishmaniasis & Malaria Meetings*. March 30th-April 2nd 2008. (poster).
- Uchikawa K, Takahashi M. 1985. Contribution to mites of the genus *Dermanyssus* De Geer distributed in Japan (Acarina, Mesostigmata) *Japanese Journal of Sanitary Zoology* 36:3:233-237.
- Valera F, Casas-Crivillé, Hoi H. 2003. Interspecific Parasite exchange in a mixed colony of birds. *Journal of Parasitology* 89(2):245-250.

- Valiente Moro C, Chauve C, Zenner L. 2005. Vectorial role of some dermanyssoid mites (Acari, Mesostigmata, Dermanysoidea). *Parasite* 12(2): 99-109.
- Valiente Moro, C., Fravallo, P., Amelot, M., Chauve, C., Zenner, L., Salvat, G. 2007. Colonization and invasion in chicks experimentally infected with *Dermanyssus gallinae* contaminated by *Salmonella enteritidis*. *Avian Pathol.* 36(4): 307-311.
- Valiente Moro C., De Luna C.J., Tod A., Guy J.H., Sparagano O.A.E., Zenner L. 2009. The poultry red mite (*Dermanyssus gallinae*): a potential vector of pathogenic agents. *Experimental and Applied Acarology* 48 :93-104.
- Verneau O, Bentz S, Sinappah ND, du Preez L., Whittington I, Combes C. 2002. A View of early vertebrate evolution inferred from the phylogeny of polystome parasites (Monogenea: Polystomatidae). *Proceedings of the Royal Society of London* 269:535-543.
- Vitzthum H.G. 1921. Acarologische Beobachtungen. 4 Riehe. *Archiv für Naturgeschichte* 86A(10):1-69
- Williamson M. 1996. *Biological invasions*. New York : Chapman & Hall.
- Witalinski W. 2000. *Aclerogamasus stenocornis* sp. n., a fossil mite from the Baltic amber (Acari: Gamasida: Parasitidae). *Genus* 11:619-662.
- Wood HP. 1917. The chicken mite: its life history and habits. United States Department of Agriculture, Washington, DC Bulletin 553:1-14.
- Wright HW, Bartley K, Nisbet AJ, McDevitt RM, Sparks NHC, Brocklehurst S, Huntley JF. 2009. The testing of antibodies raised against poultry red mite antigens in an in vitro feeding assay; preliminary screen for vaccine candidates. *Experimental and Applied Acarology* 48:81-91.
- Zeman P, Jurík M. 1981. A contribution to the knowledge of fauna and ecology of gamasoid mites in cavity nests of birds in Czechoslovakia. *Folia Parasitologica (Prague)* 28: 265-271.
- Zemskaya AA. 1968. [Sparrow mite *Dermanyssus passerinus* Berlese and Trouessart.] *Medicinskâ parazitologiâ i parazitarnye bolezni* 37:313-319 (en Russe).
- Zemskaya AA. 1971. [Mites of the family Dermanyssidae Kolenati, 1859, of the U.S.S.R. fauna]. *Medicinskâ parazitologiâ i parazitarnye bolezni* 40: 709-717 (en Russe).
- Zemskaya AA et Iliencko AI. 1958. [Blood-feeding mites on house and field sparrows in Moscow and environs.] *Medicinskâ parazitologiâ i parazitarnye bolezni* 27:475-481 (en Russe).

10 Annexes

10.1 Annexe 1 : aperçu de la classification des Mesostigmata selon Hallan 2005

**Ordre
Mesostigmata**

Sous-ordre Heatherellina

Famille Heatherellidae

Sous-ordre Sejina

Super-Famille Sejoidea

Famille Sejidae

Sous-ordre Arctacarina

Super-Famille Arctacaroidea

Famille Arctacaridae

Sous-ordre Microgyniina

Super-Famille Microgynioidea

Famille Nothogynidae

Famille Microgyniidae

Sous-ordre Epicriina

Super-Famille Epicrioidea

Famille Epicriidae

Famille Dwigubskyiidae

Famille Coprozerconidae

Famille Zerconidae

Sous-ordre Uropodina

Super-Famille Uropodoidea

Famille Protodinychidae

Famille Thinozerconidae

Famille Polyaspididae

Famille Trachytidae

Famille Dithinozerconidae

Famille Nenteriidae

Famille Trematuridae

Famille Macrodingyidae

Famille Trigonuropodidae

Famille Urodinychidae

Famille Dinychidae

Famille Uroactinidae

Famille Circocyllibamidae

Famille Deraiphoridae

Famille

Discourellidae

Famille

Uropodidae

Famille

Metagynuridae

Famille

Oplitidae

Famille

Trachyuropodidae

Sous-ordre Diarthrophallina

Super-Famille Diarthrophalloidea

Famille Diarthrophallidae

Sous-ordre Cercomegistina

Super-Famille Cercomegistoidea

Famille Cercomegistidae

Famille Saltiseiidae

Famille Asternoseiidae

Famille Davacaridae

Famille Seiodidae

Famille Pyrosejidae

Sous-ordre Antennophorina

Super-Famille Aenicteguioidea

Famille Aenicteguidae

Famille Messoracaridae

Famille Physalozzerconidae

Famille Ptochacaridae

Super-Famille Antennophoroidea

Famille Antennophoridae

Super-Famille Celaenopsoidea

Famille Neotenogyniidae

Famille Celaenopsidae

Famille Costacaridae

Famille Schizogyniidae

Famille Megacelaenopsidae

Famille Triplogyniidae

Famille Meinertulidae

Famille Diplogyniidae

Famille Euzerconidae

Super-Famille Fedrizzioidea

Famille Fedrizzidae

Famille Klinckowstroemiidae

Famille Promegistidae

Famille Paramegistidae

Super-Famille Megisthanoidea

Famille Hoplomegistidae

Famille Megisthanidae
Super-Famille Parantennuloidea
 Famille Parantennulidae
 Famille Philodanidae
Sous-ordre Parasitina
Super-Famille Parasitoidea
 Famille Parasitidae
Sous-ordre Dermanyssina
Super-Famille Rhodacaroidea
 Famille Rhodacaroideaincertae
 Famille Ologamasidae
 Famille Euryparasitidae
 Famille Rhodacaridae
 Famille Digamasellidae
 Famille Laelaptonyssidae
 Famille Panteniphididae
Super-Famille Veigaiioidea
 Famille Veigaiidae
Super-Famille Eviphidoidea
 Famille Macrochelidae
 Famille Parholaspididae
 Famille Pachylaelapidae
 Famille Megalolaelapidae
 Famille Eviphididae
Super-Famille Ascoidea
 Famille Ascidae
 Famille Phytoseiidae
 Famille Otopheidomenidae

Famille Halolaelapidae
 Famille Ameroseiidae
 Famille Podocinidae
Super-Famille Dermanysoidea
 Famille Trichoaspididae
 Famille Larvamimidae
 Famille Leptolaelapidae
 Famille Varroidae
 Famille Laelapidae
 Famille Haemogamasidae
 Famille Pneumophionyssidae
Famille Dermanyssidae
 Famille Hirstionyssidae
 Famille Hystrichyonyssidae
 Famille Macronyssidae
 Famille Rhinonyssidae
 Famille Spinturnicidae
 Famille Spelaeorhynchidae
 Famille Halarachnidae
 Famille Raillietiidae
 Famille Entonyssidae
 Famille Ixodorhynchidae
 Famille Omentolaelapidae
 Famille Dasyponyssidae
 Famille Manitherionyssidae
Sous-ordre Heterozerconina
 Famille Heterozerconidae
 Famille Discozerconidae

DERMANYSSUS GALLINAE, ECTOPARASITE DES VOLAILLES

Pou rouge : diagnostic et lutte contre l'infestation

***Dermanyssus gallinae* est un parasite redouté en élevage de poudeuses. Cet acarien discret est un vecteur expérimental de salmonelles. Les traitements sont limités par l'absence de médicament avec une LMR définie dans les œufs.**

Les étapes essentielles

Étape 1 : identifier les contextes d'infestation

- Chez divers oiseaux (peuvent aussi piquer des mammifères en l'absence d'oiseaux).
- Surtout chez les poules poudeuses. Présent aussi en élevage amateur.
- Se cache dans des abris variés de l'environnement.
- Baisse de production, déclassement des œufs, voire mortalité. Rôle vectoriel.

Étape 2 : reconnaître le parasite

- Diagnose en élevage de volailles en France, à l'examen microscopique x 40 à x 400 de femelles adultes ébouillantées : examiner les chélicères, pas la couleur, pour distinguer *D. gallinae* des autres acariens.

Étape 3 : traiter

- L'animal : non autorisé et insuffisant.
- Son environnement : autorisé pendant le vide sanitaire en poudeuse, nettoyage, puis organophosphorés, certaines pyréthriinoïdes, avec beaucoup d'eau. En présence des volailles, aucune LMR pour les œufs.

par Lise Roy*,

Claire Valiente Moro*
et Claude Chauve*

* Laboratoire de parasitologie
de l'ENV Lyon,
UMR Inra-ENVL 958,
1, avenue Bourgelat,
69280 Marcy-l'Étoile

Dermanyssus *gallinae* (the red fowl mite, actuellement dans la famille des Dermanyssidés, voir le TABLEAU complémentaire "Place de *D. gallinae* parmi les acariens" sur Planète-vet) est un acarien hématophage parasite des oiseaux et résistant au jeûne. La répartition des poux rouges est particulière à chaque élevage. Elle doit donc être clairement identifiée afin de mettre en place des moyens de lutte efficaces. Le pou rouge ne doit pas être confondu avec d'autres espèces rencontrées en élevage de volailles en France.

● Première étape : identifier les contextes d'infestation

1. Aire de répartition

D. gallinae est présent en Europe, alors qu'*Ornithonyssus sylviarum*, une espèce apparentée, sévit plutôt en Europe du Nord et en Amérique du Nord. Cette dernière espèce a été signalée en France il y a quelques années [3], mais n'a pas été retrouvée depuis.

2. Espèces atteintes

Le pou rouge est capable de parasiter un grand nombre d'oiseaux (plus de trente espèces recensées). En l'absence de volatiles, il peut aussi piquer des mammifères, notamment les chevaux et des rongeurs, ainsi que l'homme. Il peut alors provoquer une gêne chez le personnel, liée à des irritations cutanées et à une éventuelle allergie à l'acarien. Le problème majeur posé par *D. gallinae* ne se situe toutefois pas dans les maisons de particuliers comme cela a été suggéré, mais en aviculture [2].

3. Types d'élevages infestés

À peu près maîtrisé dans les élevages de volailles de chair, parfois présent chez les reproducteurs, le pou rouge pose surtout un problème en élevage de poules poudeuses car la bande est maintenue en production plus longtemps et les traitements sont limités par les directives européennes sur les limites maximales de résidus (LMR) dans les œufs. Il trouve des conditions de développement optimales dans les élevages avicoles actuels : en cage comme



PHOTO 1. Agrégat de *D. gallinae* fraîchement gorgés sous un amas de fientes séchées, accumulées sur le seuil d'une trappe de sortie (élevage de poules poudeuses en plein air).

Cliché : L. Roy

au sol chez les poudeuses. L'acarien est également rencontré dans les élevages "amateurs", même si les infestations massives sont rares. En effet, les conditions sont favorables à l'hébergement d'arthropodes prédateurs des poux et la densité des volailles au mètre carré est moindre.

4. Facteurs favorisant le maintien du pou

Les poux rouges se logent dans des abris variés et souvent difficiles d'accès, notamment pour les substances acaricides éventuellement utilisées : sous des fientes sèches, dans des amas de plumes ou de duvet, dans les fissures des murs, dans les interstices situés entre divers constituants des structures d'élevage, notamment les petits éléments métalliques ou en matière plastique qui servent à unir les barreaux des cages en batterie, des perchoirs, pondoirs et/ou caillebotis au sol, etc. (PHOTO 1). La distribution de l'acarien est en outre variable d'un élevage, voire d'un bâtiment à l'autre. En l'absence de tout hôte, *D. gallinae* peut survivre plusieurs mois. Sa résistance au jeûne est fonction de son stade de développement, mais aussi de la température et de l'hygrométrie relative. Les protonymphes et

les deutonymphes, les mâles adultes et les femelles non encore gorgées peuvent survivre sans nourriture pendant plusieurs mois (huit ou neuf mois pour les deutonymphes selon certains auteurs). La prise du premier repas de sang nécessaire à la maturation des œufs raccourcit la longévité des femelles. Toutefois, celles qui se nourrissent et pondent sans interruption semblent vivre plus longtemps que celles qui, après un premier cycle gonotrophique (voir la FIGURE "Cycle parasitaire de *D. gallinae*"), se trouvent privées de nourriture et ne peuvent pas enchaîner un deuxième cycle.

5. Impact en élevage de volailles

Cet ectoparasite qui ponctionne le sang des poules peut provoquer des pertes économiques non négligeables. Source de stress et d'irritations cutanées, il perturbe les oiseaux. Il engendre du picage et une détérioration du plumage, une augmentation de la consommation de nourriture par les volailles, accompagnés parfois d'une chute de la ponte. Les œufs sont déclassés en raison des taches de sang dues à des poux écrasés sur la coquille (jusqu'à 5 % d'œufs déclassés sur l'ensemble de la production d'une bande). Lors d'infestation massive, qui survient rapidement en l'absence d'intervention, le nombre d'érythrocytes et la concentration en hémoglobine peuvent diminuer. L'interprétation de cette anémie n'est cependant pas facile et les variations dans la composition sanguine demeurent souvent peu significatives. La mortalité par exsanguination constatée au laboratoire est difficile à évaluer sur le terrain. Comme les tiques, cet acarien est en outre susceptible de transmettre des maladies entre volailles en raison de son comportement hématophage (voir l'ENCADRÉ "Rôle vectoriel potentiel du pou rouge des volailles").

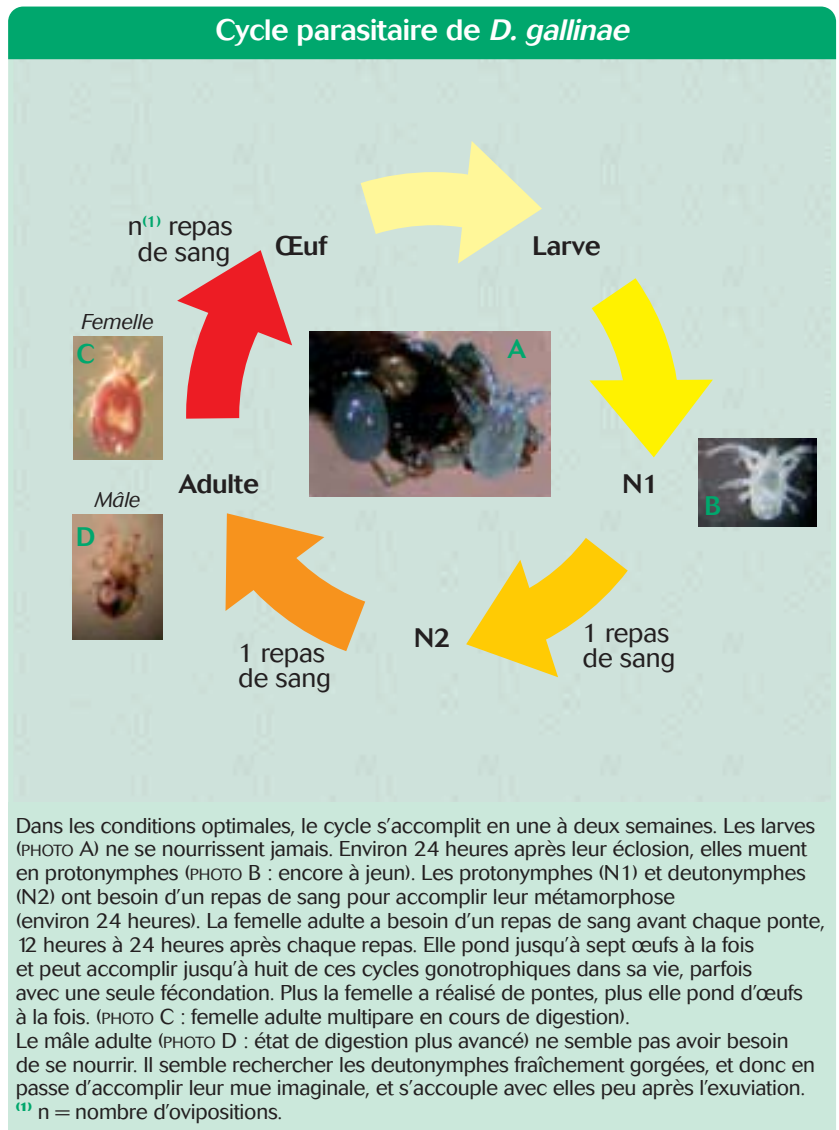

Clichés : L.Roy

Rôle vectoriel potentiel du pou rouge des volailles

- **Au même titre que les tiques**, l'implication de cet acarien hématophage dans la transmission vectorielle de plusieurs maladies a été suspectée (voir l'ENCADRÉ complémentaire "Anthropodes vecteurs définitions", sur Planete-veb). Les travaux sont encore peu nombreux sur ce sujet et, lorsqu'ils existent, ils sont souvent limités. Le rôle du parasite est donc certainement sous-estimé dans l'apparition, le maintien et la propagation des certaines infections.
- **Pour les salmonelles** (zoonose), le rôle de vecteur biologique expérimental du pou rouge a été récemment démontré par notre équipe. Des transmissions transovarienne et transstadiale des salmonelles ont en outre été observées. Si le rôle de vecteur naturel était confirmé par l'isolement de salmonelles à partir de prélèvements du terrain, *D. gallinae* pourrait être un facteur favorisant la persistance des infections à salmonelles pendant le vide sanitaire. Des bactéries ont été isolées à partir d'acariens prélevés sur le terrain, mais un plus grand nombre de cas serait nécessaire pour conclure au rôle de vecteur naturel de *D. gallinae*.
- **Les genres *Listeria* et *Pasteurella***, autres agents de zoonose, ont été isolés sur des poux rouges, mais le rôle vecteur n'a pas encore été étudié pour ces bactéries. *D. gallinae* serait un vecteur occasionnel de spirochètes (élimination de ces bactéries

dans les matières fécales), sans en être pour autant un réservoir naturel. Il serait vecteur potentiel et réservoir avéré d'*Erysipelothrix rhusiopathiae*, bactérie responsable du rouget du porc (une zoonose). Il a aussi été expérimentalement démontré que *D. gallinae* peut être contaminé en se nourrissant sur des animaux infectés par *Coxiella burnetii*, agent de la fièvre Q (une zoonose). Actuellement, dans la superfamille des Dermanssoidea, seule *Liponyssoides sanguineus*, espèce appartenant aux Dermanssidés, est reconnue comme le vecteur principal d'un agent pathogène (*Rickettsia akari*).

- **Des virus animaux**, dont ceux de la variole aviaire et de la maladie de Newcastle, sont parfois trouvés associés à *D. gallinae*. Ainsi, le rôle de vecteur biologique a été établi pour les virus des encéphalites équine de l'Est et de l'Ouest. Un rôle de vecteur mécanique vis-à-vis du virus de l'encéphalite équine vénézuélienne a également été associé. Les virus de l'encéphalite de Saint-Louis et des encéphalites à tiques ont été isolés sur ces acariens, sans que leur rôle vecteur ou celui de réservoir aient été démontrés. Ces virus équins sévissent en Amérique, mais *D. gallinae* pourrait porter des virus présents en Europe, comme celui de la maladie de Marek qui affecte les volailles.

Deuxième étape : reconnaître le parasite

1. Modalités pratiques de diagnostic simplifiée

L'examen microscopique de femelles adultes aux grossissements x 40 à x 400, en considérant en particulier les chélicères, permet de faire la distinction entre les différents acariens dont la présence

est possible en élevage de volailles en France (voir l'ENCADRÉ "Définitions" et l'ENCADRÉ complémentaire "Distinction entre le mâle et la femelle" sur Planète-vet). Une grille de diagnose peut être utilisée avec des acariens de taille moyenne à grande (au minimum 0,5 à 1 mm de long) (voir l'ENCADRÉ "Diagnose de *D. gallinae*"). En deçà, le parasite appartient à un autre groupe ou bien il s'agit d'un stade inapproprié à la diagnose. Il convient d'examiner plusieurs individus.

Diagnose de *D. gallinae*

Acarien femelle adulte de 0,5 à 1 mm
au microscope optique, grossissements x 40 à x 400, issu d'un élevage de volailles en France

- ▶ Coxae (= bases des pattes) distinctes formant chacune 1 article à part entière
- ▶ Coxae plus ou moins contiguës, occupant les deux tiers antérieurs du corps



- ▶ Coxae réduites à d'étroites plaques chitineuses sillonnant la cuticule ventrale
- ▶ Généralement, coxae en deux groupes distincts : paires I et II situées vers l'avant, nettement séparées des paires III et IV, situées à l'arrière

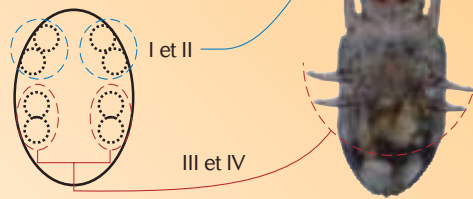

Il ne s'agit pas d'un parasitiforme

- ▶ Articles des chélicères porteurs des pinces plus minces que les pédipalpes et très allongés (dépassant souvent de beaucoup la longueur de ceux-ci)
- ▶ Pinces réduites

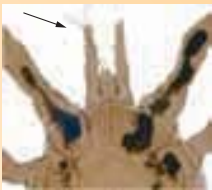

- ▶ Articles des chélicères porteurs des pinces (→) aussi épais (→) voire plus épais que les pédipalpes (→) et ne dépassant pas la longueur des pédipalpes
- ▶ Pinces très nettes, dentées



L'acarien appartient probablement à l'une des familles suivantes : Laelapidé, Haemogamasidé, Parasitidé, Macrochélidé.

- ▶ Corps dur (se brisant à la pression) aux contours arrondis très nets
- ▶ Pinces visibles



- ▶ Corps mou aux contours peu définis
- ▶ Pinces visibles ou non



- ▶ Pinces atrophiées, non visibles au microscope optique



Il s'agit d'un *Dermanyssidé*, et très probablement de *D. gallinae*

- ▶ Pinces visibles, fines et non dentées



Il s'agit d'un *Macronyssidé*

Il s'agit d'un Uropodoidea



La couleur du parasite ne présente aucun intérêt pour la diagnose, car la cuticule de nombreux acariens, dont celle de *D. gallinae*, est transparente et laisse apparaître les organes et les liquides internes. L'acarien n'est donc rouge que lorsqu'il vient de prendre un repas de sang.

Avant l'examen, il convient de tuer les acariens dans de l'eau bouillante pour favoriser le déploiement des chélicères (souvent rétractés, surtout chez les Macroxyssidés et les Dermanyssidés). Une décoloration avec de la potasse à 10 % (chauffée au bain-marie pendant quinze minutes) ou à l'acide lactique (à température ambiante, pendant un à trois jours) facilite l'observation. Pour rendre la décoloration plus efficace, il est possible de percer préalablement chaque individu vers l'arrière du corps à l'aide d'une aiguille fine, à la loupe binoculaire.

Schématiquement, hormis dans les familles des Macroxyssidés, des Dermanyssidés et dans la superfamille des Uropodoidea, les chélicères des femelles adultes sont massives (articles épais, non filiformes) et munies de pinces, ou *chelae*, nettes et extrêmement chitinisées (forme "ancestrale", (voir l'ENCADRÉ "Adaptation des chélicères à l'hématophagie"). Les femelles adultes des Macroxyssidés, hématophages obligatoires, ainsi que des Uropodoidea, présentent des chélicères fortement allongées et aux *chelae*, réduites mais nettement dessinées. Chez les Dermanyssidés, hématophages obligatoires, l'allongement est également marqué et les *chelae*, sont atrophiées, indistinctes au microscope optique, même à fort grossissement (chélicères des femelles adultes filiformes, semblables à des cheveux).

Ces éléments de diagnose succincts suffisent à infirmer ou à confirmer une infestation à *D. gallinae* dans un élevage de poules pondeuses en France, mais en aucun cas pour les autres espèces d'acariens. Quelque 700 espèces sont incluses dans la famille des Laelapidés, plus de 100 dans celle des Macroxyssidés, une soixantaine chez les Haemogamasidés... Les familles d'acariens potentiellement présentes en élevage ne sont pas toutes citées ici.

2. Risque de confusion avec d'autres acariens

Dans les élevages de pondeuses en France, *D. gallinae* est pratiquement la seule espèce infestante. La distinction entre *D. gallinae* et les autres espèces du genre *Dermanyssus* (*D. hirundinis*, *D. gallinoides*, etc.) est difficile. Cependant, ce sont plutôt des parasites des oiseaux sauvages, rarement observés dans les élevages (et systématiquement associés à des quantités massives de *D. gallinae*). Certains parasites de rongeurs du genre *Liponyssoides* spp., ressemblant au pou rouge et appartenant aussi à la famille des Dermanyssidés, peuvent aussi être rencontrés, mais ils sont rares.

Les autres espèces d'acariens parasites potentiellement présents dans les élevages appartiennent à d'autres familles. Les caractères discriminants sont donc plus accessibles. Ils sont soit parasites d'autres espèces que les volailles (souris notamment, potentiellement présentes dans les bâtiments), soit parasites non obligatoires et incapables de provoquer des dégâts compara-

Adaptation des chélicères à l'hématophagie

► **À gauche**, les chélicères d'une femelle appartenant à une espèce non parasite apparentée aux Dermanyssidés donnent une idée de l'état ancestral, avec ses *chelae* ou pinces nettement développées (microscope optique).

► **Au centre**, les chélicères d'une femelle de *D. gallinae* se présentent comme de fins cheveux au microscope optique.

► **À droite**, une vue ventrale au microscope électronique à balayage des pièces buccales d'une femelle de *D. gallinae* permet de mieux comprendre leur conformation : les chélicères amincies et modifiées en gouttières peuvent se réunir pour former un sorte de tuyau. À leur base, un fourreau permet leur rétraction.

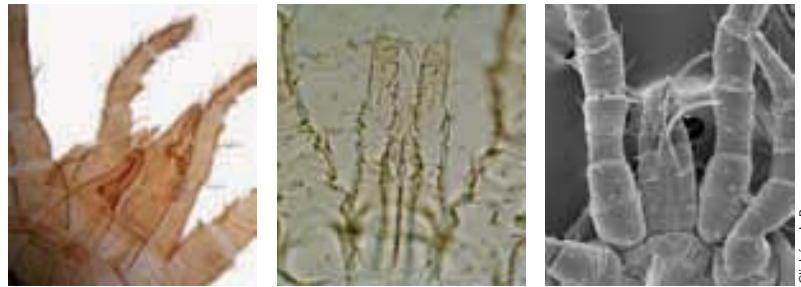

Clichés : L. Roy

Définitions

► **Parasitifforme** : l'une des deux grandes divisions du groupe des acariens, englobant entre autres les Méso-stigmatés tels *D. gallinae*, *Ornithonyssus* spp., *Varroa* spp. et les Méta-stigmatés ou Ixodida, c'est-à-dire les tiques. L'autre division est celle des acariformes.

► **Coxa** : article basal des pattes. Les pattes des acariens sont constituées de six articles : *coxa*, trochanter, fémur, genou, tibia, tarse (depuis la base jusqu'à l'extrémité).

► **Chélicères** : appendices buccaux pairs des acariens, constitués de deux articles, le second portant une pince ou *chela*. Rétractiles chez certaines espèces.

► **Pédipalpes** : appendices buccaux pairs, semblables à de courtes pattes et encadrant les chélicères.

bles à ceux engendrés par *D. gallinae*. Ainsi, *Ornithonyssus bacoti* (Macroxyssidé) est un ectoparasite hématophage inféodé aux rongeurs. *Androlaelaps casalis* (Laelapidé) est un prédateur d'autres arthropodes et un parasite hématophage seulement occasionnel (signalé en colonies importantes dans un élevage de dindes auquel il n'infligeait aucun dommage). Des Haemogamasidés, dont certaines espèces parasitent les rongeurs, peuvent aussi être rencontrés dans les élevages. Des espèces de la superfamille des Uropodoidea, saprophages et/ou prédatrices, sont fréquemment présentes dans les élevages au sol, ainsi que chez les éleveurs "amateurs". *Leiodinychus krameri* (Dinychidé), couramment rencontré dans la poussière des greniers à foin, est parfois présent dans les poulaillers. Signalé comme un parasite occasionnel (par Neveu-Lemaire en 1938), il n'est généralement à l'origine d'aucun problème. De nombreuses espèces de Laelapidés sont exclusivement prédatrices et incapables de parasiter la volaille (*Hypoaspis* spp., par exemple). D'autres familles de prédateurs sont souvent présentes, par exemple des Macrochelidés, des Parasitidés. Les espèces de cette

Un TABLEAU complémentaire "Place de *D. gallinae* parmi les acariens" et un ENCADRÉ complémentaire "Distinction entre le mâle et la femelle" sont consultables sur le site



www.planete-vet.com
Rubrique **bibliographie** ►►



(1) Index phytosanitaire de l'association de coordination technique agricole Acta 2006.

Bibliographie

- 1 - Beugnet F, Chauve C, Gauthey M, et coll. Resistance of the red poultry mite to pyrethroids in France. *Vet. Rec.* 1997;140:577-579.
- 2 - Bertrand, M. Note d'information sur un espèce particulièrement agressive d'Acarien : *Dermanyssus gallinae* (De Geer, 1778). *Insectes.* 1998;111:21-23.
- 3 - Bruneau, A., Dernburg, A., Chauve, C. et coll. First report of the northern fowl mite *Ornithonyssus sylviarum* in France. *Vet. Rec.* 2002;150:413-414.
- 4 - Chauve C. The poultry red mite *Dermanyssus gallinae* (De Geer, 1778): current situation and future prospects for control. *Vet. Parasitol.* 1998;79:239-245.
- 5 - Cosoroaba I. Observation d'invasions massives par *Dermanyssus gallinae* (De Geer 1778), chez les poules élevées en batterie en Roumanie. *Revue Méd. Vét.* 2001;152:1:89-96.
- 6 - Evans GO et Till WM. Studies on the British *Dermanyssidae* (Acari: Mesostigmata). Part I. External morphology. *Bull. Br. Mus. (Nat. Hist.) Zool.* 1965; 13:249-294
- 7 - Kirkwood A. Longevity of the Mites *Dermanyssus gallinae* and *Liponyssus sylviarum*. *Exp. Parasitol.* 1963;14:358-366.
- 8 - Moss WW. The mite genus *Dermanyssus* : a survey, with description of *Dermanyssus trochilinis*, n. sp., and a revised key to the species (Acari: Mesostigmata: *Dermanyssidae*). *J. Med. Entomol.* 1978;14(6):627-640
- 9 - Neveu-Lemaire. *Traité d'entomologie médicale et vétérinaire.* Ed. Vigot, Paris. 1938;1339pp.
- 10 - Nordenfors H. Epidemiology and control of the poultry red mite, *Dermanyssus gallinae*. Thèse de doctorat, Swedish University of Agricultural Sciences, Uppsala. 2000;43pp.Vappendix.
- 11 - Reynaud MC, Chauve C, Beugnet F. *Dermanyssus gallinae* (De Geer, 1778) : reproduction expérimentale du cycle et essai de traitement par la moxidectine et l'ivermectine. *Rev. Méd. Vét. Toulouse.* 1997;148 :433-438.
- 12 - Valiente-Moro C, Chauve C et Zenner L. Vectorial Role of Some *Dermanyssoid* Mites (Acari, Mesostigmata, *Dermanyssoidea*). *Parasite* 2005;12:99-109.
- 13 - Wood HP. The chicken mite: its life history and habits. United States Department of Agriculture, Washington, DC, *Bull.* 1917;553: 1-14.
- 14 - Zeman P, Železný J. The Susceptibility of the Poultry Red Mite, *Dermanyssus gallinae* (De Geer, 1778), to some acaricides under laboratory conditions. *Exp. Appl. Acarol.* 1985;1:17-22.

dernière famille, contrairement à ce que semble indiquer leur nom, ne sont pas parasites ou seulement parasites occasionnels.

Troisième étape : traiter

La lutte contre *D. gallinae* se heurte à deux obstacles majeurs : sa biologie particulière et les limitations réglementaires.

1. Traiter l'animal n'est pas suffisant

Les traitements appliqués directement sur les poules sont superflus car *D. gallinae* est un ectoparasite nidicole. À la différence de *O. sylviarum*, le pou rouge ne séjourne pas longtemps sur son hôte. Le parasite ne grimpe sur l'oiseau que pour prendre un repas de sang, principalement la nuit, pendant une demi-heure à une heure et demie. Une fois le sang prélevé, il retourne dans un abri : la litière, les anfractuosités des murs, etc. Ce sont les lieux où il séjourne qu'il faut traiter pour le détruire. La lutte doit être instaurée précocement car le cycle du pou rouge peut être extrêmement rapide si un hôte est disponible et que la température et l'hygrométrie sont adéquates, comme c'est le cas dans les élevages de poules pondeuses. Un œuf du pou rouge peut alors évoluer pour devenir une femelle prête à pondre en une à deux semaines seulement.

2. Substances utilisables dans l'environnement

► Pendant le vide sanitaire

Plusieurs acaricides au sens large peuvent être appliqués lors du vide sanitaire (molécules chimiques, mais aussi silice, extraits de plantes, etc.). L'utilisation des acaricides de synthèse en élevage de pondeuses n'est autorisée qu'entre deux bandes. Les principales molécules chimiques indiquées dans ce cadre sont des organophosphorés (Actogard®, Alfacron®). D'autres molécules destinées à lutter contre les arthropodes (certains pyrèthrinoïdes préconisés contre les mouches⁽¹⁾) sont aussi applicables. Il convient d'associer à ces traitements un dépoussiérage et un nettoyage efficace et minutieux afin d'éliminer le maximum d'acariens. Diluer les matières actives dans de grandes quantités d'eau à pulvériser en augmente l'efficacité. Il est ainsi recommandé d'imbiber au maximum les structures.

► En présence de volailles

En présence de volailles, aucun médicament *stricto sensu* n'est autorisé car il n'existe pas à ce jour de spécialité avec AMM disposant d'une LMR déterminée pour les œufs. Toutefois, d'autres produits qui n'ont pas le statut de médicament, à base de soufre, de silice, d'huiles essentielles et/ou de pyrèthre naturel, sont employés, principalement en élevage de plein air. Certains biocides utilisables en présence de poules peuvent être légalement appliqués. Il s'agit de produits de traitement des bâtiments et des structures, et non des poules, généralement à large spectre d'action, qui ne détruisent pas uniquement le pou rouge, mais aussi d'autres agents pathogènes tels que

les bactéries, les champignons, etc. L'efficacité de tous ces produits est difficile à évaluer car ils n'ont pas fait l'objet d'une étude précise et officielle, et les avis en provenance du terrain sont disparates, parfois contradictoires. Certaines différences d'efficacité constatées par les éleveurs et les autres acteurs de la filière sont parfois dues à des variations dans les protocoles d'application des produits. La rigueur du protocole d'application et une connaissance exhaustive de la répartition du parasite au sein de l'élevage semblent être les clés d'une lutte efficace. *D. gallinae* s'abrite souvent en petits groupes dans des interstices particulièrement étroits, à tel point qu'il est parfois difficile d'envisager que des poux rouges peuvent s'y loger. Il convient donc de ne pas se limiter à traiter les zones où sont réunis les agrégats les plus visibles.

3. Émergence d'une chimiorésistance ?

Les éleveurs se heurtent parfois à une diminution de l'efficacité des produits utilisés, qui peut être due à un défaut d'application. L'apparition de phénomènes de résistance à certaines molécules acaricides est aussi possible. Au laboratoire, des différences de sensibilité à certaines molécules acaricides ont été mises en évidence, aux pyrèthrinoïdes notamment [1]. Des résistances marquées contre le DDT avait aussi été suspectées. Elles semblent de faible intensité vis-à-vis de quelques organophosphorés [14], sur des populations de poux rouges provenant d'élevages soumis à des pressions insecticides variables. Les travaux sur ce sujet demeurent peu nombreux et, en l'absence de souche sensible de référence, aucune véritable résistance n'a pu être démontrée.

4. Moyens complémentaires de lutte

Un programme lumineux par cycles courts (quatre heures de lumière/deux heures d'obscurité) aide à lutter contre *D. gallinae*. La prolifération des acariens est probablement limitée par la perturbation de leurs repas. D'autres moyens complémentaires de lutte pourraient être développés : phéromones répulsives, auxiliaires de lutte (acariens prédateurs, micro-organismes entomopathogènes), etc. Ces voies de recherche n'ont cependant pas encore abouti à des applications sur le terrain.

Il reste aussi beaucoup d'études à mener pour mieux appréhender le rôle vecteur de ce parasite, et notamment vis-à-vis de certains agents pathogènes impliqués en santé publique. En effet, la résistance au jeûne du pou rouge des volailles, son comportement nidicole, son éventuelle chimiorésistance, ainsi que sa répartition ubiquitaire en font une source potentielle de dissémination d'agents pathogènes qui pourrait favoriser le maintien de zones d'endémie. ■

Congrès et internet

- Lubac S, Dernburg A, Bon G et coll. Problématique et pratique d'élevage en poules pondeuses dans le sud-est de la France contre les nuisibles : poux rouges et mouches. *Proc. 5^e Journées de la recherche avicole*, Tours, 26-27 mars 2003:101-104.
- <http://insects.tamu.edu/research/collection/hallan/acari/OReportHi.htm>

La durée de prescription du carprofène est limitée par l'AMM

- Une erreur s'est glissée dans l'article "Gestion médicamenteuse de la douleur cancéreuse" de Roxane Steux, paru dans le n° 266 du *Point Vétérinaire*, page 56 : le carprofène ne possède pas d'AMM sans limitation de durée de prescription, cette dernière étant limitée à cinq jours dans le RCP. Il fallait donc lire : « - choisir un AINS avec AMM sans limitation de durée de prescription, possédant une bonne tolérance gastrique. L'AINS est alors administré en continu sur de longues périodes (exemple : méloxicam) ».

Figure "Diagnose de *D. gallinae*"

- Dans l'article "Pou rouge : diagnostic et lutte contre l'infestation" de Lise Roy et coll., publié dans le n° 266 du *Point Vétérinaire*, la figure "Diagnose de *D. gallinae*" contient deux erreurs. Nous reproduisons donc cette figure corrigée.

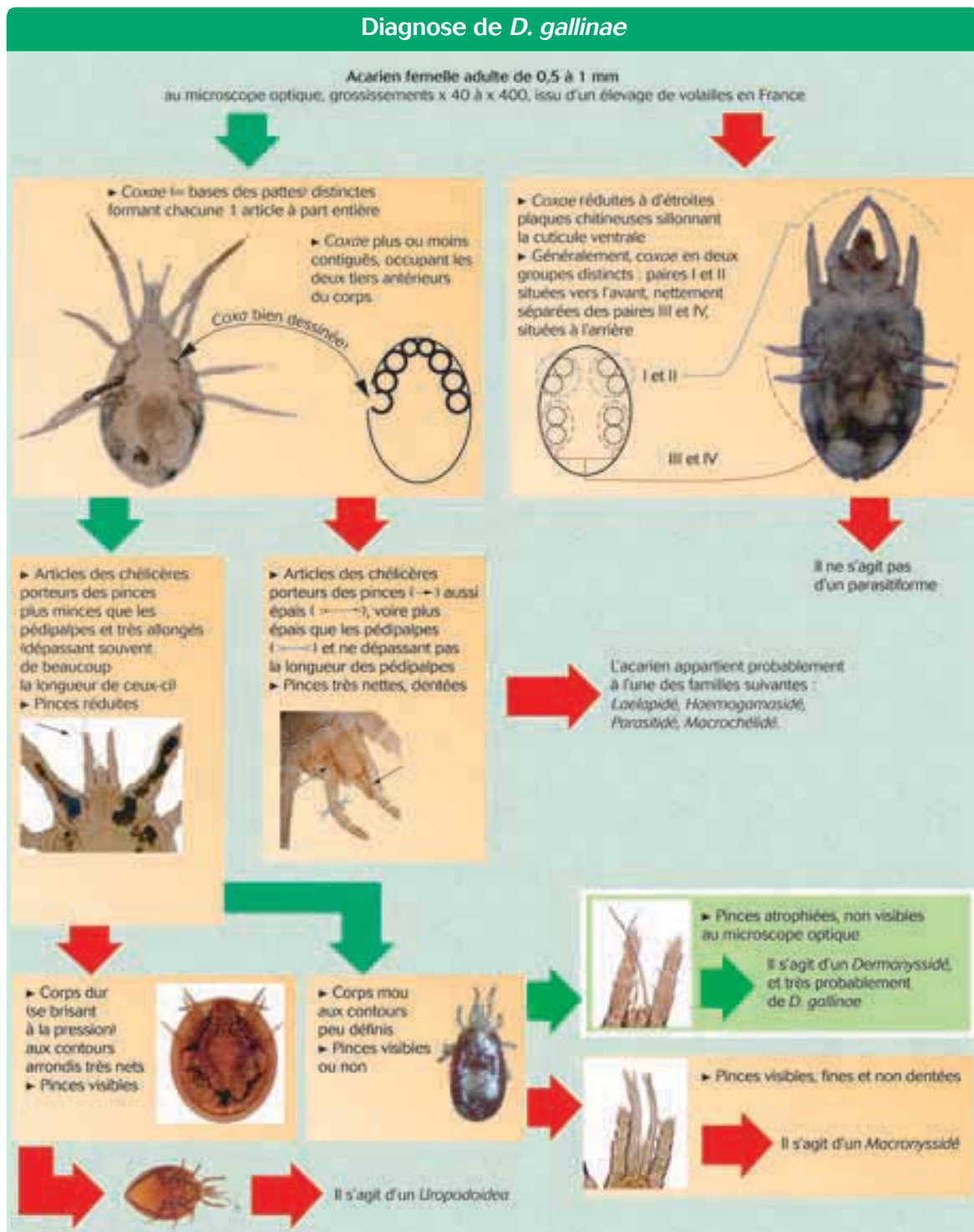

Exploration of the susceptibility of AChE from the poultry red mite *Dermanyssus gallinae* (Acari: Mesostigmata) to organophosphates in field isolates from France

Lise Roy · Claude Chauve · Jean Delaporte · Gilbert Inizan · Thierry Buronfosse

Received: 10 October 2008 / Accepted: 23 January 2009 / Published online: 13 February 2009
© Springer Science+Business Media B.V. 2009

Abstract The red fowl mite *Dermanyssus gallinae* (De Geer, 1778) is a hematophagous mite species, which is very commonly found in layer facilities in Europe. The economic and animal health impact of this parasite is quite important. In laying hen houses, organophosphates are almost the only legally usable chemicals. Detecting a target resistance can be useful in order to limit the emergence of resistant populations. The acetylcholinesterase (AChE) activity and the enzyme sensitivity to paraoxon was investigated in 39 field samples and compared to a susceptible reference strain (SSK). Insensitivity factor values (expressed as IC₅₀ ratio) obtained from field isolates compared to SSK revealed some polymorphism but not exceeding a 6-fold difference. The kinetic characteristics of AChE from some field samples showed some difference in K_M values for acetylthiocholine and inhibition kinetics performed with diethyl paraoxon exhibited a 5.5-fold difference in the bimolecular rate constant in one field isolate. Taken together, these data suggested that differences in AChE susceptibility to organophosphates may exist in *D. gallinae* but no resistant population was found.

Keywords *Dermanyssus gallinae* · Inhibition of acetylcholinesterase · Paraoxon · Field isolates · Organophosphate resistance

Introduction

Dermanyssus gallinae (De Geer, 1778) or the poultry red mite is a cosmopolitan hematophagous mite, parasitic on birds. Five life stages are known for this species (egg, larva, protonymph, deutonymph, adult), two of which need a blood meal for performing

L. Roy (✉) · C. Chauve · T. Buronfosse
Ecole Nationale Vétérinaire de Lyon, Laboratoire de parasitologie, Université de Lyon,
69280 Marcy-L'Etoile, France
e-mail: l.roy@vet-lyon.fr

J. Delaporte · G. Inizan
Bayer Healthcare Animal Health, Bayer Pharma S.A.S, 10A, rue Joseph Le Brix,
BP 40011, 56891 Saint-Ave Cedex, France

metamorphosis (protonymph, deutonymph; Wood 1917). Adult females need blood meals for egg maturation. The economic impact of this parasite is quite important with more or less serious direct damages, such as anemia (Kirkwood 1967; Keçeci et al. 2004), possible death from exsanguination, decreased egg production, but also possible transmission of certain bacterial or viral diseases (avian spirocheatosis, fowl cholera, salmonellosis, etc.) (Valiente Moro et al. 2005, 2007). Moreover, some well visible blood spots on egg shells induce a heavy financial loss with downgraded eggs. It is especially injurious in layer houses in Europe and, today, controlling the spread of these mites is an economic challenge. Because of the Maximum Residue Limits in eggs, only few products are allowed for the control of *D. gallinae* in Europe.

Insects and other arthropods have developed different mechanisms to escape to a selective pressure imposed by the use of the same insecticide. One of the adaptive mechanisms, which confer resistance to organophosphates (OPs) and carbamate pesticides, is allowed by a modification of the acetylcholinesterase (AChE), the insecticide target protein (Fournier and Mutero 1994). AChE catalyses the hydrolysis of the neurotransmitter, acetylcholine, thereby ending transmission of nerve impulses at the synapses of cholinergic neurones. The inhibition of this enzyme leads to paralysis and death of arthropods. Conversely, AChEs that are not inhibited by OPs and carbamates confer resistance to these pesticides. In resistant arthropods, a structural change of AChE preserves it from being inhibited by the OPs. This structure modification has been shown in more than 33 insect and acari species (Fournier and Mutero 1994). For instance: some crop pests such as spider mites (Stumpf et al. 2001; Tsagkarakou et al. 2002) or codling moth (Reuveny and Cohen 2004), some stored-food pests such as Psocidae (Wang et al. 2004), some potential diseases vectors such as mosquitoes (Weill et al. 2003), some ticks (Stone et al. 1976; Baxter et al. 1999; Pruett 2002), etc. The molecular basis of this resistance has been characterized for some insects (Zhu et al. 1996; Newcomb et al. 1997; Nabeshima et al. 2004) and ticks (Xu et al. 2003) and is associated with specific mutations in the *ace* genes. Single or multiple amino acid substitutions confer distinct catalytic properties to the mutated protein leading to a decreased sensitivity of AChE to inhibition by OPs insecticides.

This phenomenon has been developed following extensive and prolonged use of these insecticide compounds. Because the frequency of *D. gallinae* infestations is currently increasing and that large populations can be established rapidly under favorable conditions, farmers, worried by economic losses, use chemical acaricide treatments at least in the empty chicken houses (Chauve 1998). All these factors are therefore prerequisite to expect that a resistant strain may be favored if a benefit mutation point in the *D. gallinae* AChE gene arises. High levels of resistance in *D. gallinae* have been reported for DDT and permethrin resistant mites was suspected to be involved as the main reason for the failure to control some *D. gallinae* populations (Zeman and Zelezny 1985; Nordenfors et al. 2001).

In French laying hen houses, almost only OP compounds can be legally used, and, until recently, only between flocks. Previously, no ectoparasiticide was allowed to be used during flocks except some products composed of vegetal extracts, inert substances and some detergents, with mechanical actions. The lack of efficacy of these compounds compared to cholinesterase inhibitors incited egg farmers to use these chemicals as soon as the poultry red mites represented a major problem in aviary systems. As a result, many populations of European mites might have been repeatedly exposed to OPs. The fast development potential of *D. gallinae* in layer houses conditions and the applications of OPs, legally done between flocks and sometimes illegally during flocks, to maintain

the mite populations below economic thresholds are factors that may have facilitate the emergence of insecticide resistance in this species. Since 2007, an OP ectoparasiticide, phoxim, which can assure a 0-day withholding period for eggs, was approved by EMEA to be used, in Europe, to treat a *D. gallinae* infestation in poultry houses stocked with egg-laying hens (Keïta et al. 2006). Thus, one can suppose that as a new OP-based product is going to be used during flocks, poultry red mites will be exposed constantly, forward favoring the emergence of resistant populations. The aim of the present study, which was conducted before the commercial authorization for using phoxim, was to use a biochemical assays for monitoring AChE in mites coming from different layer houses from different French counties in order to investigate the possible existence of resistant strains.

Materials and methods

Mites

Fourty different populations of mites were used in this study. A putative susceptible reference strain called Standard Strain Kilpinen (SSK) was kindly provided by Dr Ole Kilpinen (Lyngby, Denmark). This strain has been cultured in laboratory conditions since 1997 and has not been exposed to OPs since at least that date.

The 39 other mite populations were collected in 39 independent layer houses from various counties in France. All isolates were maintained alive separately in the laboratory for few days (less than 6 days) allowing the emergence of a sufficient number of protonymphs to perform the biochemical assay. Thus, as mites were directly coming from farms, most of protonymphs were engorged. In order to get enough living and unengorged protonymphs, females were allowed laying their eggs and eggs hatching by placing each strain at room temperature in an open box. Each box was placed into a large bowl filled with water (with a drop of a tension-active agent) so that mites cannot escape and that inter-isolate contamination is avoided.

To standardize the biochemical assay as a potential diagnostic test and to avoid expected interferences due to blood meal in adults or in deutonymphs, only unengorged protonymphs were ground and AChE extracted. Typically, 200 protonymphs were placed into a 1.5 ml microcentrifuge tube and killed by freezing (-20°C for 2 h). Samples were ground in ice in the same tube containing 1.4 ml of a 10 mM pH 7.5 Tris-HCl buffer, 5.84% (m/v) NaCl, 0.4% Triton X-100 and 25 mM EDTA using a Potter's device. AChE was extracted for 20 min at 4°C and extracted AChE was harvested in the supernatant following centrifugation at 14,000g for 10 min at 4°C . These extracts were immediately used for measuring AChE activity.

AChE assays

Basic principle

AChE activity of protonymph extracts was measured with a modification of the Ellman assay based on the enzymatic hydrolysis of acetylthiocholine iodide, ASCh, (Ellman et al. 1961). Reactions were conducted in 96-well microplates (Maxisorp, Nunc, France). Typical AChE activity of protonymph extract was assayed on 100 μl of extract mixed with 100 μl of buffering solution containing Tris-HCl 0.5 mM pH 8.0, 1.6 mM of 5-5'-dithio-bis

(2-nitro-benzoic acid) (DTNB, Sigma chemicals) and ASCh 1 mM. The change of absorbance at 410 nm was measured every 4 min for 40 min at 25°C on a Dynex microplates reader. Each assay was performed in duplicate. The spontaneous ASCh hydrolysis was corrected to the signal obtained from each well by subtracting the change of absorbance occurring in wells where protonymph extracts were omitted.

Preliminary assays for the validation of the test

Because assays on the susceptibility of AChE have never been done on *D. gallinae*, some parameters were first checked for the validation of tests. The linearity of the reaction with time and with the enzyme amount has been explored by measuring the enzymatic activity on extracts containing various numbers of protonymphs (from 50 to 400 protonymphs) in the same amount of lysis buffer.

The stability of protonymph AChE to freezing was evaluated over a 3 months period using several aliquots of protonymphs conserved at -20°C . These aliquots were regularly extracted and their AChE activity measured between day 1 and 90.

Moreover, AChE activity was measured exclusively on this stage because other stages (deutonymphs or adults) may contain some residual esterase activities coming from the host's blood. However, few assays were conducted on AChE extracted from adults after 2 weeks of starvation. Measured activities were roughly in the same order of magnitude than those observed with protonymph extracts but interassay variations appeared to be important (results not shown), suggesting a possible interaction of remaining blood enzyme activities as soon as mites have had a blood meal.

In order to verify that the change in the absorbance at 410 nm of protonymph extracts was dependent of AChE activity, inhibition studies were assayed. The thermal inactivation of the enzymatic activity was evaluated by measuring the residual activity of the extract after an incubation for 10 min at 50°C of the protonymph extracts. The ability of the carbamate eserine sulphate to inhibit the change in the absorbance was also evaluated by measuring the activity in the presence of 0.5 mM of eserine.

Exploration of kinetic parameters of extracted AChE

The kinetic parameters K_M and V_{\max} of AChE extracts from the SSK strain and four isolates from field were determined with 12 different concentrations of ASCh ranging from 10 μM to 5 mM of final concentration. The AChE activity was converted to picomoles of ASCh hydrolyzed per min and per protonymph using $1.36 \cdot 10^4 \text{ M}^{-1} \text{ cm}^{-1}$ as molar extinction coefficient. Kinetic constants K_M and V_{\max} were obtained by linear regression after fitting a Lineweaver-Burk double-reciprocal plot of the Michaelis-Menten function.

OP inhibitory assay

To investigate whether the AChE activity, extracted from protonymphs sampled in different laying farms, was susceptible to OP inhibition, inhibition kinetics were analyzed with the OP inhibitor diethyl paraoxon which is the form of the insecticide that irreversibly inhibits AChE. The organophosphate diethyl paraoxon [*O,O*-diethyl-*O*-(4-nitrophenyl) phosphate] was purchased from Riedel-de Haen, Seelze, Germany and was used in inhibitory assays as an AChE specific inhibitor.

Progressive inhibition of AChE activity by OP over time

A progressive inhibition of AChE activity over time was performed in the AChE extract from the SSK strain and three additional field samples (number 6002, 6005 and 22S84). The inhibitory action of diethyl paraoxon on AChE extracts from these samples was also analyzed by calculating the bimolecular rate constant, k_i , using the Aldridge method (1950). Briefly, residual AChE activity was measured as stated above for standard AChE assay except that supernatant extract was incubated with different concentrations of diethyl paraoxon (2.0×10^{-7} M, 1.0×10^{-7} M, 5.0×10^{-8} M) for various times (0, 6, 12, 19 and 30 min) prior the addition of the substrate reagent. In each assay, blank controls were done with wells without protonymph extract, in order to subtract non enzymatic hydrolysis of ASCh. The logarithm of the residual activity was plotted against the preincubation time and the bimolecular rate constant, k_i , was extracted by linear regression by dividing the slope by the inhibitor concentration in accordance with Aldridge (1950).

Screening of 39 field populations

In order to explore potential variations in the susceptibility to OP inhibition of AChE extracted from protonymphs sampled in different laying farms, inhibition of AChE for each 39 field samples was measured in the presence of 1 mM ASCh by three concentrations of inhibitor and without any preincubation time. Paraoxon concentrations used were 8.0×10^{-7} M, 2.0×10^{-7} and 5.0×10^{-8} . These concentrations were selected to inhibit between 20 and 80% of the residual AChE activity in SSK strain without any delay between the addition of diethyl paraoxon and the addition of the substrate reagent. Each sample was analyzed in two separate assays. In each duplicate, a reaction without the inhibitor was included as a control. An OP inhibitory assay in duplicate of the SSK strain was also systematically included in each plate. All the assay conditions were the same as that used for kinetics assays. The inhibitory data were analyzed by plotting residual activities with the inhibitor concentration. Inhibitory concentration 50% (IC_{50}) value of each field sample was evaluated by linear regression and the ratio of this IC_{50} value with that obtained with the SSK strain in the same plate was calculated.

Statistical analysis

Kinetic parameters were compared using a non-parametric Kruskal–Wallis test.

Results

Validation of AChE extraction

The AChE activity was measured from an extract of protonymphs from the SSK strain in the supernatant and in the pellet after suspending the disrupted protonymph fragments in 100 μ l of the lysis buffer. Variations in the change of absorbance obtained when incubations were performed with the pellet were not significantly higher than the spontaneous hydrolysis of ASCh, suggesting that no AChE activity remained present in the non-extracted fraction (results not shown). The AChE activity was linear with incubation time up to 40 min and with the amount of protonymphs extracted up to 200 protonymphs per 1.4 ml of lysis buffer (Fig. 1a). Above this quantity, the activity plateaued probably due to

Fig. 1 Kinetic properties of acetylcholinesterase extracted from N1 stage from *Dermanyssus gallinae*. **a** Acetylcholinesterase activity of *D. gallinae* extracted from different quantities of protonymphs. Each data point represents the velocity of thiocholine production from acetylthiocholine calculated as the OD (410 nm) changes after 5, 10 or 15 min incubation time in the presence of the substrate (1 mM). **b** Hydrolysis of acetylthiocholine as a function of incubation time when AChE extracted from 200 protonymphs is used. **c** Acetylcholinesterase activity in the presence or absence of eserine (0.5 mM) or when extracts containing acetylcholinesterase have been incubated 10 min at 50°C prior the introduction of the substrate. OD (410 nm) was measured after 40 min of incubation. Bars represent mean \pm SD

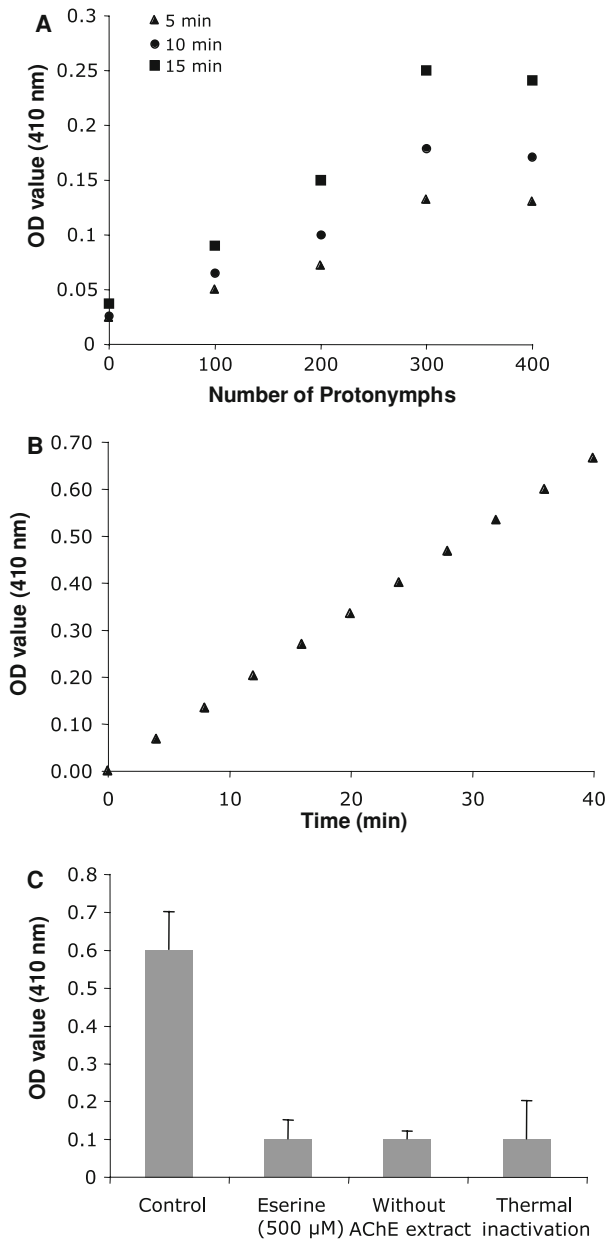

competitive reactions. For this reason, all assays were further performed using 200 protonymphs per extraction. The OD curve was linear with incubation time at least up to 40 min (Fig. 1b).

The catalytic activity mediated by the protonymph extract was totally inhibited by thermal pretreatment at 50°C for 10 min or by incubation with 0.5 mM eserine sulphate, a carbamate compound that specifically inhibits AChE (Fig. 1c).

Further, AChE stability to freezing was checked over a 90-days period. No significant loss of AChE activity was observed in protonymphs that had been stored at -20°C for up to 3 months before extraction (data not shown). Thus, this microtiter plate assay using *D. gallinae* protonymphs was proved to be suitable for measuring AChE activity and performing inhibition studies.

Kinetic parameters of AChE in *Dermanyssus gallinae*

The catalytic properties of *D. gallinae* AChE extracts have been characterized in five different strains coming from a laboratory source (SSK) or from field samples. Kinetics of the AChE extracts using ASCh as artificial substrate followed Michaelis–Menten kinetics. Kinetic parameters of the AChE extracts are shown in Table 1. Despite apparent differences in K_M values between isolates under test, there was no significant difference. Nevertheless, a lower V_{\max} value was obtained with AChE extracts from SSK and 6001 ($P = 0.004$) compared to the other field samples.

The AChE inhibition kinetics obtained with the reference strain SSK and three field samples (numbers 6002–6005–22S84) were further characterized for their sensitivity to diethyl paraoxon. The progressive inhibition of AChE curves followed a pseudo first order kinetics (Fig. 3). The apparent bimolecular rate constants (k_i) for AChE inhibition were extracted for each of these samples and values are given in Table 2. The k_i values for the 6005 and 22S84 field samples were in the same range of magnitude than that obtained with AChE extracted from SSK strain whereas the bimolecular rate constant for 6002 strain was significantly different ($P < 0.01$) from the sensitive reference strain (Table 2). The lower k_i

Table 1 K_M and V_{\max} values of AChE extracted from *Dermanyssus gallinae* protonymphs coming from SSK strain and from different field samples

Strain/field isolates	V_{\max} ($\text{pmol}^{-1} \text{min}^{-1}$ protonymph)	K_M (μM)
SSK ($n = 8$)	62.1 ± 8.7	36.4 ± 9.5
22S84 ($n = 6$)	106.5 ± 9.6	54.8 ± 18.5
35S72 ($n = 3$)	87.0 ± 4.1	44.7 ± 12.0
6001 ($n = 3$)	57.2 ± 1.1	38.7 ± 9.0
Berthet ($n = 3$)	105.0 ± 9.9	52.7 ± 7.6

Values are expressed as mean \pm SD, numbers in parentheses represent number of independent determinations

Table 2 Bimolecular rate constants (k_i) for AChE extracts inhibition by paraoxon in SSK strain and 3 field samples

Strain/field isolates	Bimolecular rate constant ($\text{M}^{-1} \text{min}^{-1}$)	Insensitivity factor
SSK ($n = 8$)	$2.5 \times 10^5 \pm 1.3 \times 10^5$	
22S84 ($n = 6$)	$9.8 \times 10^4 \pm 1.3 \times 10^4$	2.5
6005 ($n = 6$)	$1.7 \times 10^5 \pm 0.5 \times 10^5$	1.4
6002 ($n = 12$)	$4.4 \times 10^4 \pm 2.2 \times 10^4$	5.5

Insensitivity factor is expressed as the ratio of bimolecular rate constants k_i SSK/ k_i field sample

k_i values are expressed as the mean of several independent assays using at least two different diethyl paraoxon concentrations each. Number of independent assays is represented as ($n=$)

value observed for the 6002 sample led to a 5.5-fold difference in the AChE insensitivity of this isolate toward paraoxon compared to AChE sensitivity in SSK strain. This was associated with two to sixfold increase of the time required to obtain 50% of AChE inhibition compared to SSK strain depending on the inhibitor concentration.

AChE inhibition screening

IC₅₀ values obtained from the SSK strain were $1.52 \times 10^{-7} \pm 0.18$ M. IC₅₀ values obtained from field samples ranged between 1.29×10^{-7} and 1.47×10^{-6} M. The insensitivity factor, calculated as a ratio between IC₅₀ values obtained from field samples with that with the SSK strain, both obtained during a single assay, are represented in Fig. 2. The 39 field samples harbored a range in the IC₅₀ ratio compared to that of SSK strain between 1 and 6. Over the 39 analyzed samples, none provided a IC₅₀ ratio over 10.

Discussion

Validation of the tests

The results reported in the present study showed that the selected method is convenient and sensitive enough to detect subtle changes in AChE activities between field populations. AChE activity was linear up to 200 protonymphs per replicate and 40 min of incubation (Fig. 1a, b). Hydrolysis of ASCh appears to be catalytically mediated by AChE because of a strong decrease in activity when protonymphs extracts were incubated with 500 μM eserine or after thermal inactivation (Fig. 1c).

Kinetics

The kinetic properties of *D. gallinae* AChE in the reference strain SSK for ASCh were characterized and michaelian parameters were compared to those obtained from field samples. K_M values were comparable to that obtained from mites such as *Tetranychus urticae* Koch (Tsagkarakou et al. 2002). It has been reported that incubations performed with Triton X-100 may significantly affect the kinetic constant K_M exhibiting a competitive

Fig. 2 Acetylcholinesterase inhibition studies of 39 field-collected samples. IC₅₀ for acetylcholinesterase inhibition by diethyl paraoxon were determined according to “Material and methods”. Each data point represents the ratio of IC₅₀ value of the corresponding field-collected sample divided by IC₅₀ value of the sensitive reference strain (SSK) obtained in the same assay

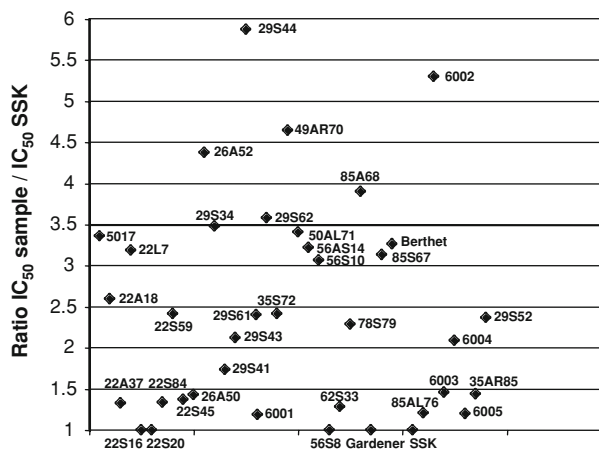

inhibition (Chen et al. 2001; Rosenfeld et al. 2001). Nevertheless, we were unable to investigate the kinetic properties of the native enzyme because of a lack of efficiency in solubilizing AChE enzyme when the detergent was omitted from the lysis buffer.

All tested field samples exhibited similar K_M values and different V_{max} values (some field isolates with increased V_{max} values). It has been reported that insensitive AChE in *Boophilus microplus* exhibited a reduced K_M value relative to the susceptible enzyme associated with a corresponding lower V_{max} (Nolan and Schnitzerling 1975). Smissaert found similar results in *T. urticae* sensitive and resistant strains (Smissaert 1964). Conversely in the latter species, lower K_M values in AChE sensitive strain associated with similar V_{max} values as compared to resistant strains were reported (Stumpf et al. 2001). These modifications in kinetics parameters were considered to be the consequence of structural changes in the enzyme and are the biochemical support of the severe fitness cost that has been observed in most populations with insensitive AChE that expressed a reduction of AChE activity in synapses (Lenormand et al. 1999). In our study, the reference SSK strain and the field sample (6001) exhibited a significant lower V_{max} value compared to the other samples. Although low AChE activity is a characteristic of a resistant phenotype (Lee and Bantham 1966), none of AChE inhibition studies conducted with extracts from these two populations exhibited specific characteristics of a resistant strain (Fig. 2; Table 2). Interestingly, comparisons of the kinetic parameter V_{max} between the different populations clearly showed that polymorphism in AChE expression exists among isolates of *D. gallinae* under test. Whether it can be supposed that a strain which has been maintained in laboratory culture for several years without any acaricide treatment may led to produce an homogenous population with low intrinsic AChE activity, it is surprising to detect a field-collected population harboring the same low specific activity without any apparent disadvantage.

As AChE inhibition by diethyl paraoxon follows a first-order kinetic, the bimolecular rate constant was determined for SSK and three field isolates as this parameter appears to be a much better index than the usual—but less time and mites consuming— IC_{50} (Aldridge and Davison 1952). The k_i values obtained in *D. gallinae* were comparable to those described in *T. urticae* (Tsagkarakou et al. 2002), but differences between *D. gallinae* isolates remained small compared to those observed between sensitive and experimentally selected OP resistant strain of *T. urticae* (k_i differences of 39-fold in Tsagkarakou et al. 2002). Indeed, kinetic analysis of the interaction of AChE from these three different field isolates (22S84-6005-6002) with diethyl paraoxon revealed a maximum difference between the k_i values of ~ 5 – 6 in the favor of the 6002 isolate (Table 2; Fig. 3) and was associated with a higher IC_{50} value (Fig. 2). The kinetics of AChE clearly showed that the enzyme, in this isolate, was different than those measured in other *D. gallinae* isolates. Nevertheless, whether both the lower k_i value and the higher IC_{50} value evoked target site insensitivity, it is worth to note that the insensitivity factor, obtained in the 6002 isolate, remained low compared to factors observed in experimentally confirmed AChE-resistant strains in other related mites (Tsagkarakou et al. 2002). The decrease in k_i value in this particular isolate should probably be interpreted as a probable decrease in AChE affinity to diethyl paraoxon even if a modification of the phosphorylation rate should not be excluded as it was shown in OP resistant *B. microplus* (Pruett 2002). In this species, the bimolecular rate constant was most affected by a slower rate of enzyme phosphorylation. At last, kinetic studies of AChE in field samples of *D. gallinae* exhibited a moderate heterogeneity in these activities that may be associated with different sensitivities to OP. The biological significance of this polymorphism and its potential impact on the control of the Poultry Red Mite in farms remains to be evaluated. In order to get an overview of this polymorphism prevalence, 39 populations from field isolates were screened and their IC_{50} measured.

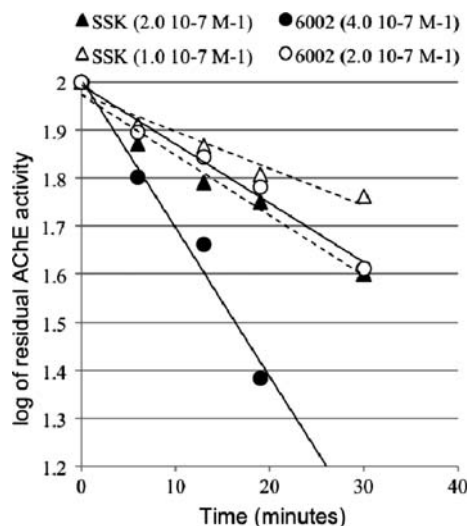

Fig. 3 Graph representative of the evolution of residual AChE activity from isolate 6002 and strain SSK with different incubation times and two different diethyl paraoxon concentrations. Isolate 6002 and strain SSK have been incubated with two different sets of concentrations of diethyl paraoxon (SSK: 2.0×10^{-7} and 1.0×10^{-7} M $^{-1}$; 6002: 4.0×10^{-7} and 2.0×10^{-7} M $^{-1}$). As inhibition is stopped by the introduction of substrate ASCh, the difference of incubation time generates different levels of inhibition with a single OP concentration. The apparent bimolecular rate k_i was extracted from the regression of each slope

Screening of 39 field populations

Around 10% of populations under test exhibited a maximum 6-fold difference in the inhibitory effect of diethyl paraoxon compared to SSK strain (Fig. 2) whereas a 100-fold difference in the inhibitory effect of diethyl paraoxon is classically observed in tetranychid pest species (Stumpf et al. 2001) even if lower insensitivity factors have sometimes been reported for other OP compounds such as dichlorvos (ratios ranged between 25 and 38, Zahavi and Tahori 1970). Insensitivity factors from these 39 isolates were not as high as compared to other acarid proved to be resistant. Indeed, even if AChE OP-insensitivity is defined by a slower rate of AChE inhibition in the resistant phenotype and that the insensitivity factor can vary depending on the species under test or the inhibitor compound used, insensitivity factors (IC_{50} ratios between a population under test and SSK from a single assay) obtained in our results appear too low to consider any field-collected population as resistant.

However, results of this study clearly showed that AChE from field-collected populations of *D. gallinae* exhibited different susceptibilities to diethyl paraoxon. But no target resistance has been detected in isolates under test.

Conclusion

This study provides the basis for the development of diagnostic tools that can be used for management of possible AChE resistance in *D. gallinae* against OPs and carbamates insecticides. A screening on 39 field samples has revealed moderate differences in AChE sensitivity to paraoxon between field populations but AChE insensitivity to OPs has been

considered to be too weak in comparison with analyses on other Arthropoda in literature. Thus, in spite of the existence of selection pressure, no important AChE insensitivity has occurred in *D. gallinae*. But, our results clearly show that isolates which were sampled in independent farms revealed distinct inhibition kinetics suggesting the existence of AChE polymorphism in *D. gallinae*. Additionally, it would be interested to test whether the polymorphism detected in field isolates in present study is selectable under laboratory conditions under elevated OP pressure.

Acknowledgments We are grateful for having provided SSK strain to O. Kilpinen and N. Hansen (Danish Institute of Agricultural Sciences, Denmark) and for their help and advices to A. Micoud, C. Brazier and C. Mottet (Service Régional de la Protection des Végétaux, France). We also want to thank Mehdi Gharbi (IUT, Villeurbanne, France), Jennifer Lanneau (IUT, Villeurbanne, France) and Coralie Pulido (LGTA, Saint-Genis Laval, France) for their technical help.

References

- Aldridge WN (1950) Some properties of specific cholinesterase with particular reference to the mechanism of inhibition by diethyl *p*-nitrophenyl triphosphate (E605) and analogues. *Biochem J* 46:451–460
- Aldridge WN, Davison AN (1952) The inhibition of erythrocyte cholinesterase by tri-esters of phosphoric acid. *Biochem J* 52:62–70
- Baxter GD, Green P et al (1999) Detecting resistance to organophosphates and carbamates in the cattle tick *Boophilus microplus*, with a propoxur-based biochemical test. *Exp Appl Acarol* 23:907–914. doi:10.1023/A:1006364816302
- Chauve C (1998) The poultry red mite *Dermanyssus gallinae* (De Geer, 1778): current situation and future prospects for control. *Vet Parasitol* 79:239–245. doi:10.1016/S0304-4017(98)00167-8
- Chen Z, Newcomb R, Forbes E et al (2001) The acetylcholinesterase gene and organophosphorus resistance in the Australian sheep blowfly, *Lucilia cuprina*. *Insect Biochem Mol Biol* 31:805–816. doi:10.1016/S0965-1748(00)00186-7
- Ellman GL, Courtney KD et al (1961) A new, rapid colorimetric determination of acetylcholinesterase activity. *Biochem Pharmacol* 7:88–95. doi:10.1016/0006-2952(61)90145-9
- Fournier D, Mutero A (1994) Modification of the acetylcholinesterase as a mechanism of resistance to insecticides. *Comp Biochem Physiol* 108C:19–31
- Keçeci T, Handemir E, Orhan G (2004) The effect of *Dermanyssus gallinae* infestation on hematological values and body weights of cocks. *Turkiye Parazitoloj Derg* 28:192–196
- Keïta A, Pagot E, Pommier P et al (2006) Efficacy of phoxim 50% E.C. (ByeMite) for treatment of *Dermanyssus gallinae* in laying hens under field conditions. *Rev Med Vet* 157:590–594
- Kirkwood AC (1967) Anaemia in poultry infested with the red mite *Dermanyssus gallinae*. *Vet Rec* 80(17):514–516
- Lee RM, Bantam P (1966) The activity and organophosphate inhibition of cholinesterase from susceptible and resistant ticks (Acari). *Entomol Exp Appl* 9:13–24. doi:10.1007/BF00341156
- Lenormand T, Bourguet D, Guillemaud T et al (1999) Tracking the evolution of insecticide resistance in the mosquito *Culex pipiens*. *Nature* 400:861–864. doi:10.1038/23685
- Nabeshima T, Mori A, Kozaki T et al (2004) An amino acid substitution attributable to insecticide-insensitivity of acetylcholinesterase in a Japanese encephalitis vector mosquito, *Culex tritaeniorhynchus*. *Biochem Biophys Res Commun* 313:794–801. doi:10.1016/j.bbrc.2003.11.141
- Newcomb RD, Campbell PM, Russel RJ et al (1997) cDNA cloning, Baculovirus-expression and kinetic properties of the esterase, E3, involved in organophosphorus resistance in *Lucilia cuprina*. *Insect Biochem Mol Biol* 27:15–25. doi:10.1016/S0965-1748(96)00065-3
- Nolan J, Schnitzerling HJ (1975) Characterisation of acetylcholinesterases of acaricide resistant and susceptible strains of the cattle tick *Boophilus microplus*. I. Extraction of the critical component and comparison with enzyme from other sources. *Pest Biochem Physiol* 5:178–188
- Nordenfors H, Höglund J, Tauson R et al (2001) Effect of permethrin impregnated plastic strips on *Dermanyssus gallinae* in loose-housing systems for laying hens. *Vet Parasitol* 102:121–131. doi:10.1016/S0304-4017(01)00528-3
- Pruett JH (2002) Comparative inhibition kinetics for acetylcholinesterases extracted from organophosphate resistant and susceptible strains of *Boophilus microplus* (Acari:Ixodidae). *J Econ Entomol* 95:1239–1244

- Reuveny H, Cohen E (2004) Evaluation of mechanisms of azinphos-methyl resistance in the codling moth *Cydia pomonella* (L.). *Insect Biochem Physiol* 57:92–100. doi:[10.1002/arch.20016](https://doi.org/10.1002/arch.20016)
- Rosenfeld C, Kousba A, Sultatos LG (2001) Interactions of rat brain acetylcholinesterase with the detergent Triton X-100 and the organophosphate paraoxon. *Toxicol Sci* 63:208–213. doi:[10.1093/toxsci/63.2.208](https://doi.org/10.1093/toxsci/63.2.208)
- Smissaert HR (1964) Cholinesterase inhibition in spider mites susceptible and resistant to organophosphates. *Science* 143:129–134. doi:[10.1126/science.143.3602.129](https://doi.org/10.1126/science.143.3602.129)
- Stone BF, Nolan J, Schuntner CA (1976) Biochemical genetics of resistance to organophosphorus acaricides in three strains of the cattle tick, *Boophilus microplus*. *Aust J Biol Sci* 29:265–279
- Stumpf N, Zebitz C, Kraus W et al (2001) Resistance to organophosphates and biochemical genotyping of acetylcholinesterases in *Tetranychus urticae* (Acari: Tetranychidae). *Pestic Biochem Physiol* 69:131–142. doi:[10.1006/pest.2000.2516](https://doi.org/10.1006/pest.2000.2516)
- Tsakarakou A, Pasteur N, Cuany A et al (2002) Mechanisms of resistance to organophosphates in *Tetranychus urticae* (Acari: Tetranychidae) from Greece. *Insect Biochem Mol Biol* 32:417–424. doi:[10.1016/S0965-1748\(01\)00118-7](https://doi.org/10.1016/S0965-1748(01)00118-7)
- Valiente Moro C, Chauve C, Zenner L (2005) Vectorial role of some dermanysoid mites (Acari, Mesostigmata, Dermanyssoidea). *Parasite* 12:99–109
- Valiente Moro C, Fravallo P, Amelot M et al (2007) Colonization and invasion in chicks experimentally infected with *Dermanyssus gallinae* contaminated by *Salmonella enteritidis*. *Avian Pathol* 36:307–311. doi:[10.1080/03079450701460484](https://doi.org/10.1080/03079450701460484)
- Wang JJ, Cheng WX et al (2004) The effect of the insecticide dichlorvos on esterase extracted from the psocids, *Liposcelis bostrychophila* and *L. entomophila*. *J Insect Sci* 4:23–27
- Weill M, Lutfalla G, Mogensen K et al (2003) Comparative genomics: Insecticide resistance in mosquito vectors. *Nature* 423:136–137. doi:[10.1038/423136b](https://doi.org/10.1038/423136b)
- Wood HP (1917) The chicken mite: its life history and habits United States Department of Agriculture, Washington, DC. *Bull* 553:1–14
- Xu G, Fang QQ, Keirans JE et al (2003) Cloning and sequencing of putative acetylcholinesterase cDNAs from the American dog tick, *Dermacentor variabilis*, and the brown dog tick, *Rhipicephalus sanguineus* (Acar : Ixodidae). *J Med Ent* 40:890–896
- Zahavi M, Tahori AS (1970) Sensitivity of acetylcholinesterase in spider mites to organophosphorous compounds. *Biochem Pharmacol* 19:219–225. doi:[10.1016/0006-2952\(70\)90342-4](https://doi.org/10.1016/0006-2952(70)90342-4)
- Zeman P, Železný J (1985) The susceptibility of the poultry red mite, *Dermanyssus gallinae* (De Geer, 1778), to some acaricides under laboratory conditions. *Exp Appl Acarol* 1:17–22. doi:[10.1007/F01262196](https://doi.org/10.1007/F01262196)
- Zhu KY, Lee SH, Clark JM (1996) A point mutation of acetylcholinesterase associated with azinphos-methyl resistance and reduced fitness in colorado potato beetle. *Pestic Biochem Physiol* 55:100–108. doi:[10.1006/pest.1996.0039](https://doi.org/10.1006/pest.1996.0039)

Candidate predators for biological control of the poultry red mite *Dermanyssus gallinae*

Izabela Lesna · Peter Wolfs · Farid Faraji · Lise Roy ·
Jan Komdeur · Maurice W. Sabelis

Received: 10 October 2008 / Accepted: 8 January 2009 / Published online: 30 January 2009
© Springer Science+Business Media B.V. 2009

Abstract The poultry red mite, *Dermanyssus gallinae*, is currently a significant pest in the poultry industry in Europe. Biological control by the introduction of predatory mites is one of the various options for controlling poultry red mites. Here, we present the first results of an attempt to identify potential predators by surveying the mite fauna of European starling (*Sturnus vulgaris*) nests, by assessing their ability to feed on poultry red mites and by testing for their inability to extract blood from bird hosts, i.e., newly hatched, young starlings and chickens. Two genuine predators of poultry red mites are identified: *Hypoaspis aculeifer* and *Androlaelaps casalis*. A review of the literature shows that some authors suspected the latter species to parasitize on the blood of birds and mammals, but they did not provide experimental evidence for these feeding habits and/or overlooked published evidence showing the reverse. We advocate careful analysis of the trophic structure of arthropods inhabiting bird nests as a basis for identifying candidate predators for control of poultry red mites.

Keywords Biological control · Ectoparasite · Poultry red mite · *Dermanyssus gallinae* · Predatory mites · *Androlaelaps casalis* · *Hypoaspis aculeifer* · European starling · *Sturnus vulgaris* · Chicken · *Gallus gallus* · Trophic structure · Bird nest · Poultry house

I. Lesna · M. W. Sabelis
Section Population Biology, Institute for Biodiversity and Ecosystem Dynamics,
University of Amsterdam, Kruislaan 320, 1098 SM Amsterdam, The Netherlands

I. Lesna (✉) · P. Wolfs · J. Komdeur
Animal Ecology Group, Centre for Ecology and Evolution, University of Groningen,
P.O. Box 14, 9750 AA Haren, The Netherlands
e-mail: lesna@science.uva.nl; i.k.lesna@rug.nl

F. Faraji
MITOX Trial Management BV, P.O. box 92260, 1090 AG Amsterdam, The Netherlands

L. Roy
Laboratoire de Parasitologie et Maladies Parasitaires, Ecole Nationale Vétérinaire de Lyon,
Marcy l'Etoile, France

Introduction

The poultry red mite, *Dermanyssus gallinae* (De Geer) (Acari: Dermanyssidae), is a blood-sucking ectoparasite in nests of birds and small mammals. It is of economic importance as a worldwide pest in the poultry industry (Axtell and Arends 1990). This holds especially for 'laying hen' houses because the period of egg laying and breeding of domesticated chickens (*Gallus gallus*) is long (Maurer et al. 1993; Emous et al. 2005) relative to the time required for poultry red mites to double their population size (5.9 days at 25°C; Maurer and Baumgärtner 1992, 1994). In the Netherlands, outbreaks occurred infrequently in the past (mainly during summer), but now these occur throughout the year and in virtually all 'laying hen' (but also 'broiler breeder', 'rearing hen' and 'parent stock') houses. This increased incidence may be due to modern farming systems (e.g., constant climate) and perhaps also due to pesticide resistance arising from intensive chemical control. In addition, more strict allowance regulations have limited the number of pesticides available for control. As eggs are produced for human consumption, pesticides have to meet strict standards for food safety: (1) no residuals and (2) rapid breakdown into non-harmful components. Selection of effective chemicals is further complicated by the demand that pesticides should not harm bird health or bird welfare. Exposure of chickens to chemical sprays is hard to avoid, even though poultry red mites do not stay on their host permanently. This is because poultry red mites spend most of their time in the vicinity of the chicken and then they hide in crevices and other narrow places in the farm structure, where they are hard to target by pesticide sprays. The currently admitted pesticides do not suffice to eradicate poultry red mites.

Damage due to poultry red mites involves anaemia, increase in death risks and food demands, reduced time available for resting, decrease in disease resistance and egg-laying, and reduced egg quality (downgraded eggs due to egg shell with blood spots arising from squashed poultry red mites) (Emous et al. 2005). Based on a recent inquiry among farmers, the total costs from damage and control measures to the whole egg industry in The Netherlands are estimated to be 11 million Euros per year (Emous et al. 2005). This underestimates real costs because poultry red mites may vector disease agents of poultry (Valiente Moro et al. 2005, 2007) and they are a source of allergens causing dermatological problems to farmers and veterinarians (Rosen et al. 2002; Beck 1999).

Because current control methods are not sufficiently effective (Emous et al. 2005), we aimed to develop new methods of poultry red mite control by the use of their natural enemies, in particular predatory mites. This approach was pioneered by Buffoni et al. (1995, 1997) and Maurer and Hertzberg (2001). They reported the spontaneous occurrence of the predatory mite *Cheyletus eruditus* (Schrank) in the litter of poultry houses in Switzerland (for similar findings in Egypt, Mexico and UK, see: Abo-Taka 1996; Quintero and Acevedo 1984; Brady 1970a, b) and observed this mite feeding on juvenile poultry red mites. Releases of this predatory mite in poultry houses turned out not to yield control of poultry red mites, however. We pursued another approach to develop biological control methods by identifying predators of poultry red mites in their natural habitat. We analysed the food web structure of bird nests that have natural infestations of *D. gallinae*. Inventories of arthropods inhabiting bird nests have revealed a community structure involving bird parasites, microbivores and predators that may feed on them (e.g., Philips and Dindal 1979; Philips et al. 1989; Putatunda et al. 1989; Gupta and Paul 1989; Burt et al. 1991; Lundqvist 1995; Kristofik et al. 1996; Philips 2000). Feeding at more than one trophic level (omnivory) may also be possible, but has not yet been shown for mites inhabiting bird nests. Some of the species are found exclusively in nests (nidicolous species), others are opportunistic visitors (e.g.,

edaphic species) and yet others (plant-dwelling species) end up in nests via plant material birds use for nest construction, and perhaps also via the green material birds use for courtship, for chemical control of ectoparasites or as a drug to boost their immune response (Clark 1991; Brouwer and Komdeur 2004; Gwinner and Berger 2005; Veiga et al. 2006). For the arthropods inhabiting a nest to establish a system with more trophic levels will require time. Hence, elaborate micro-ecosystems of arthropods are more likely to occur in association with birds that re-use nesting sites, such as European starlings (*Sturnus vulgaris* Linnaeus 1758). Our approach was therefore (1) to identify the mites inhabiting poultry houses and nests of European starlings, (2) to identify potential predators based on the literature and based on their numerical associations with *D. gallinae*, (3) to assess their predatory activity with respect to the blood parasite *D. gallinae* and microbivores, such as astigmatic mites, and finally (4) to test whether these candidate predators can switch to blood feeding on starlings and chicken in absence of prey (in which case they are omnivores because they feed at more than one trophic level).

Materials and methods

Mite inventory of poultry houses

Surveys of the mite fauna inhabiting four poultry farms in the provinces Brabant and Limburg (The Netherlands) were made every 2 weeks in the period from October 2007 to July 2008. Per sampling date and poultry house 20 samples were taken by Nordenfors traps, i.e., traps made of 3 mm thick, 140 × 100 cm, corrugated cardboard (Nordenfors and Chirico 2001). These traps were placed in laying nests and on perches, poles and walls. In addition, a variable number of samples from poultry house litter and from conspicuous *D. gallinae* aggregations were taken. Samples were inspected first under a binocular microscope and any mite suspected to be different from *D. gallinae* was collected in vials with alcohol, mounted in modified Hoyer's medium (Faraji and Bakker 2008) on a microscope slide and then identified. If available, at least 10 voucher specimens per species were maintained for later inspection.

Estimates of abundance were classified as rare (1–5 individuals/sample), common and never abundant (5–100/sample), common and sometimes abundant (>100/sample).

Mite inventory of starling nests

A total of 106 nest boxes, at least 6 m apart and 2.5 m above ground, were at our disposal at Vosbergen estate (Eelde-Paterswolde, The Netherlands). Because starlings re-use nest boxes and the mite fauna may become more diverse with time, the occupation of the nest boxes by breeding starlings was recorded in 2006 and the presence of old nest material was assessed in March 2007. A total of 29 nest boxes were occupied by starlings in April 2007, 14 of which had also been occupied in 2006. A large proportion of old nest material (from 2006 or earlier) was collected from each of all 29 nest boxes to assess the arthropod fauna. Nest boxes were not cleaned, however, to allow a significant proportion of the mite fauna to hide in grooves, cracks and crevices in the nest box. Within a week after fledging of the young starlings in June 2007, nest material was collected from the nest boxes. After transferring samples from the old (March 2007) and new (June 2007) nest material to Berlese funnels, the mites were collected in vials with alcohol over a period of 3–4 days, mounted in modified Hoyer's medium (Faraji and Bakker 2008) on microscope slides and then identified. If available, at least ten voucher specimens per species were maintained for later inspection.

Species-specific densities per nest were estimated and subsequently classified in the following ranges: 0–1; 2–10; 11–100; 101–1,000; 1,001–10,000; 10,001–100,000 individuals per nest. For statistical analyses these ranges were arbitrarily transformed into single discrete numbers, representing categorical densities: 1; 5; 50; 500; 5,000; 50,000.

Statistical analysis of mite–mite associations

Categorical densities were incorporated in statistical analyses as \log_{10} transformed (categorical) variables. The statistical analysis was part of a more comprehensive multilevel modelling approach (MLwiN 2.10 beta 5 package; Rabash et al. 2008), with three hierarchical levels involving nest-box-group, nest box and nestling. A stepwise backward elimination was performed manually by removing the least significant independent fixed variable from the model.

As part of this modelling exercise, relationships of ‘putative predator’ densities (individuals per nest) were tested using a model with the variables occupancy history of nest box (occupied in 2006 or not) and *D. gallinae* density (individuals per nest) as well as three variables describing the state of the starlings occupying the nest box (brood size, hatching date, female quality; for definitions see Brouwer and Komdeur 2004). Since the emphasis in this article is on the inter-relationships between nest-inhabiting mites, we refrain here from describing the starling-related variables and discussing the results ensuing. This will be published elsewhere (P. Wolfs et al., in prep.).

Predation tests

Based on the nest inventory and the analysis of mite–mite associations, predatory activity was assessed for adult females of *Androlaelaps casalis* (Berlese). For reasons of comparison, we chose females of *Hypoaspis aculeifer* (Canestrini) because (1) it was occasionally found in starling nests, (2) it was observed to feed on *D. gallinae* (I. Lesna, pers. obs.) and (3) it was reared in our laboratory since 1991 (Lesna et al. 1995), and therefore readily available. Both *A. casalis* (obtained from starling nests in 2007) and *H. aculeifer* (obtained from lily fields in 1991) were cultured on a diet of *Tyrophagus putrescentiae* (Schrank), which in turn was reared on dry yeast flakes (22°C, 70% RH). One week before the predation test the cultures of both species of predatory mites were provided with ample prey to satiate the predators. Females nearing oviposition (i.e., showing a full grown terminal oocyte in their opisthosoma) were taken from the culture and transferred to vials (3 cm diameter, 4 cm high) with a moistened bottom of plaster of Paris mixed with charcoal. The vials had ten individuals of *D. gallinae* (mobile juveniles and adults). After transfer, the vials were tightly closed by a lid with an opening sealed with mite-proof gauze and placed in a climate room at 22°C, 70% RH and total darkness. After 24 h, numbers of live and dead *D. gallinae* were counted and all individuals were replaced by fresh ones to achieve the same starting density for a second day of the predation test. The predation experiments were replicated simultaneously in ten vials for each species and each day. Control experiments with vials containing *D. gallinae* alone were also carried out. Student *t*-tests for comparison of means were applied to detect differences in predation between the two species and between the 2 days of the experiment.

Apart from the predation assessment over two consecutive days we also made direct observations of more than 100 predation events and together with Prof. Urs Wyss (University of Kiel, Germany) we recorded part of these by the aid of a video-equipped binocular microscope. Stills of the video-records are included in this article (Figs. 3, 4).

Haematophagy tests

To test whether mites shown to have a capacity to prey upon *D. gallinae* also have a capacity to extract blood directly from the host of *D. gallinae*, we carried out two experiments one with starling and another with chicken. Three-day-old starlings and ten-day-old chickens were used to offer a bird stage most vulnerable to haematophagy (due to their thin skin and hence more accessible blood vessels). Moreover, given their less dense feather cover it was easier to observe bite marks, as well as mites especially on the starling host.

The experiments with young starlings were carried out in a brood incubator at 32–34°C (total darkness), installed at the field station in Vosbergen estate. Due to the proximity of the field station to the starling-occupied nest boxes, we were able to minimize the time between brood removal and their introduction into the incubator, as well as their reintroduction into their original nest. The young starlings were away from their nest no longer than 2.5 h. The experiments were carried out for 2 h during mid-day (13:00–15:00) to ensure that the young starlings had been fed by their parents before the experiment and that they would be fed by their parents before night. The young starlings were introduced each into a separate container (300 ml, 6 cm diameter) closed by a lid with a hole sealed with mite-proof gauze. Pieces of filter paper were provided on the bottom of the vial as a means to absorb moisture and to accommodate the young birds. Per container, 20 female mites of either *A. casalis*, *H. aculeifer* or *D. gallinae* were released that had been deprived of food for at least 3 days prior to the experiment. These three treatments were replicated five times and all replicates were carried out simultaneously. Bite marks on the young starling, gut colouration of the mites (as a bloodmeal indicator) and the presence of mites on and off the bird were checked just before and immediately after the 2 h experiment.

The experiments with young chickens were carried out from 18:00 to 12:00 next day in a climate room at $26 \pm 2^\circ\text{C}$ (darkness from 19:00 to 10:00 next day), at the experimental Farm Laverdonk (Heeswijk, The Netherlands). The experiment was carried out mostly during the night because *D. gallinae* is most active at night when the young chickens are sleeping. The young chickens were brought in cages with food and water in the climate room, the day before the experiment. At the start of the experiment the chickens were introduced each into a separate container (3 l volume, 17 cm diameter) closed by a lid with a hole sealed with mite-proof gauze and they had no access to food and water during the time spent in the container. Pieces of soft cardboard (from egg baskets) were provided on the bottom of the container as a means to absorb moisture and to accommodate the young birds. Per container 20 mites, nymphs and females of either *A. casalis*, *H. aculeifer* or *D. gallinae*, were released that had been deprived of food for at least 3 days prior to the experiment. These three treatments were replicated ten times. Bite marks on the young chickens, gut colouration of the mites and the presence of mites on and off the chickens were checked before and after the 18 h experiment.

Results

Mite inventory of poultry houses and starling nests

During summer time, the densities of the poultry red mite, *D. gallinae*, increased dramatically (up to 60.000 mobile stages per Nordenfors trap) with the time the laying hen flocks stayed in the poultry house (I. Lesna, pers. obs.). In individual starling nests, densities of *D. gallinae* could increase from a few individuals appearing at the time young starlings

hatch to more than 30.000 at the end of the starling's breeding period (I. Lesna, pers. obs.). As argued in the [Appendix](#), populations of *D. gallinae* from starling nests and poultry houses are conspecific. Blood-feeding mites other than *D. gallinae* were not found in poultry houses and starling nests, except for a few individuals of *Ornithonyssus sylviarum* (Canestrini and Fanzago) in a single starling nest (Roy et al. 2009).

Astigmatic mites varied in abundance largely depending on the presence of certain plant-derived materials, such as straw (collected from farmland nearby) and seeds in starling nests as well as chicken-feed in poultry houses. The species composition in starling nests was more diverse than in poultry houses (Table 1). Whereas three species of glycyphagid and histiostomatid species prevailed in starling nests, it was almost exclusively, the acarid mite, *Tyrophagus putrescentiae* (Schrank), that was found in poultry houses. The astigmatic mites are all thought to be microbivores and may serve as the main or alternative prey for various predatory mites.

Table 1 List of Acari found in association with starling nests (estate Vosbergen, Eelde-Paterswolde, Groningen) and in litter of poultry houses (Brabant, Limburg, The Netherlands)

Order Family	Species	Starling Nest	Poultry House
Mesostigmata			
Ascidae	<i>Blattisocius keegani</i> Fox	–	***
	<i>Proctolaelaps pygmaeus</i> (Müller)	–	*
	<i>Proctolaelaps</i> sp. ^a	*	–
	<i>Zerconopsis remiger</i> (Kramer)	***	–
	<i>Dermanyssus gallinae</i> (De Geer) ^b	****	****
Digamasellidae	<i>Dendrolaelaps fallax</i> (Leitner)	*	–
Laelapidae	<i>Androlaelaps casalis</i> (Berlese)	***	**
	<i>Hypoaspis aculeifer</i> (Canestrini)	*	–
Macrochelidae	<i>Macrocheles ancyleus</i> Krauss	*	–
Macronyssidae	<i>Ornithonyssus sylviarum</i> (Canestrini and Fanzago)	*	–
Parasitidae	<i>Parasitellus fucorum</i> De Geer ^c	*	–
Polyaspididae	<i>Uroseius acuminatus</i> (Koch)	–	*
Prostigmata			
Cheyletidae	<i>Cheyletus eruditus</i> (Schrank)	**	**
Tydeidae	<i>Lorryia reticulata</i> (Oudemans)	*	–
Astigmata			
Acaridae	<i>Aleuroglyphus ovatus</i> (Troupeau)	*	–
	<i>Tyrophagus putrescentiae</i> (Schrank)	–	**
	<i>Tyrophagus longior</i> (Gervais)	*	–
	<i>Sancassania</i> sp.	–	*
	<i>Glycyphagus domesticus</i> (De Geer)	**	–
Glycyphagidae	<i>Lepidoglyphus destructor</i> (Schrank)	**	–
	<i>Myianoetus</i> sp. ^d	**	–
Histiostomatidae	<i>Dermatophagoides evansi</i> Fain, Hughes and Johnston	–	*
Pyroglyphidae	<i>Saprogllyphus</i> sp. ^d	*	–

* Rare, ** common, yet never abundant, *** common and sometimes abundant, **** very abundant. Mounted voucher specimens are available on request to I. Lesna or F. Faraji

^a Possibly new species, currently being described (F. Faraji)

^b Conspecific specimens from starling nests and poultry houses (L. Roy)

^c A single nymph positively identified

^d Unidentified species

Prostigmatic mites were represented almost exclusively by *Cheyletus eruditus* in both starling nests and poultry houses (Table 1). This species is known to be a predator of different species of astigmatic mites and can probably feed on *D. gallinae* (Maurer and Hertzberg 2001). We also noted dark-red coloured individuals collected from poultry houses where *D. gallinae* was very abundant. In starling nests, *C. eruditus* tended to be somewhat more abundant when there were more astigmatic mites, but the available data did not allow statistical analyses to test this claim.

After nestlings had fledged in June 2007, starling nests harboured mesostigmatic mites (other than *D. gallinae*) that were represented most frequently by *Androlaelaps casalis* and *Zerconopsis remiger* (Kramer) (Table 1). The latter species was absent in nest boxes before the start of the breeding season (March 2007), but *A. casalis* was then found frequently and abundantly in old nest material in ca. 80% of the nest boxes that had been occupied by starlings in 2006 (as opposed to ca. 30% in nest boxes that had not been occupied in the 2006). In some of the poultry houses sampled, *A. casalis* was also found in considerable numbers, *Z. remiger* was absent and *Blattisocius keegani* Fox was relatively the most abundant species (Table 1). Each of these four species can feed on astigmatic mites, such as *Acarus siro* (Linnaeus) and *T. putrescentiae* (I. Lesna, pers. obs.). Their potential to interfere with *D. gallinae* is further explored below. Strikingly, the mesostigmatic genera harbouring generalist predators, such as *Hypoaspis* spp., *Macrocheles* spp. and *Parasitus* spp., were rarely found in starling nests as well as in poultry houses.

Mite–mite associations

Based on visual inspection of scatter diagrams of the data obtained directly after the starling nestlings had fledged, we detected the following tendencies: densities of *A. casalis* and *Z. remiger* were relatively high when *D. gallinae* density was low, whereas densities of *A. casalis* and *Z. remiger* were low, when *D. gallinae* density was high. Because—just before nest building (March 2007)—*A. casalis* was more likely to be found in nest boxes that had nest material from 2006 (whereas then *Z. remiger* was absent), we further explored the negative relation between *A. casalis* and *D. gallinae* densities by taking the history of nest-box occupancy into account. Post-fledging densities of *A. casalis* in starling nests in June 2007 were significantly higher in nest boxes that had been occupied, than in nests that had no starling nest in 2006 (Fig. 1; Wald test $P = 0.013$). Post-fledging densities of *D. gallinae* were not significantly different between nest boxes that had been occupied in 2006 and those that had not been occupied in 2006 (Fig. 1; Wald test $P = 0.333$). Most strikingly, postfledging densities of *A. casalis* and *D. gallinae* in June 2007 showed a significant negative relationship in nest boxes that had a starling nest in 2006 (Fig. 2; Wald test $P < 0.001$), whereas there was no significant relationship in nest boxes that had not been occupied in 2006 (Fig. 2; Wald test $P = 0.414$).

This negative relationship requires an interpretation. It points at some form of interference between *A. casalis* and *D. gallinae*. Hence, one would expect variation in numbers among nests to be more reduced under conditions where the two interacting mite species are more likely to co-occur from the start of the starling's breeding period (provided that mite immigration rates are low compared to mite growth rates in the nest). These conditions may apply to nest boxes occupied by starlings in the previous year for the following reasons: (1) in these nests *A. casalis* is more likely to be present at the start of the starling's breeding period, and (2) the growth rates of *A. casalis* and *D. gallinae* are similar and most likely high (relative to migration into the nests). We hypothesize that these conditions prompted the significant negative relationship in nest boxes occupied in 2006 as well as the absence of such a relationship in nest boxes unoccupied in 2006.

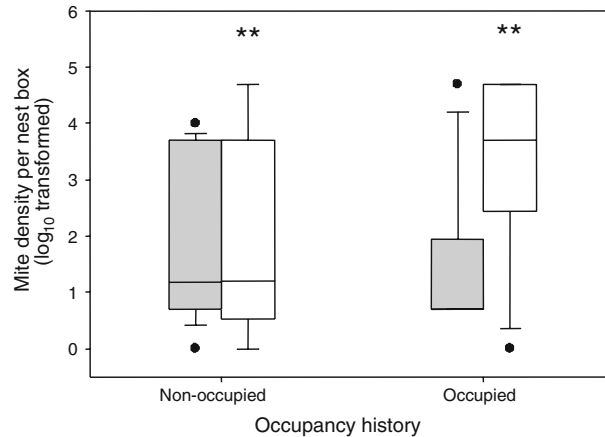

Fig. 1 Mite densities in nest boxes with different occupancy history. Grey bars represent *Dermanyssus gallinae* densities and white bars represent *Androlaelaps casalis* densities. Data for these densities were separated according to nest occupancy history; nest boxes which were not occupied ($n = 15$ for *D. gallinae*; $n = 14$ for *A. casalis*) and were occupied ($n = 14$ for both) by starlings in the previous breeding season (2006). The boxes in the figure represent the interquartile range, with the line within being the median. The error bars represent the 10–90th quartile range. Dots (●) represent data points interpreted as outliers. Note that the median (= 0.70) of *D. gallinae* in nest boxes occupied in the previous year coincides with the 10th quartile range. Significant differences between *A. casalis* densities from the N · O. category and those from the O. category are indicated by ** above the data ranges (Wald test; slope is equal to 1.235 with SE = 0.498 and is significantly different from zero at $P = 0.013$). Differences between *D. gallinae* densities from the two categories were not significant (Wald test; slope is equal to -0.519 with SE = 0.936 and is not significantly different from zero at $P = 0.333$)

The observed negative relationship between *A. casalis* and *D. gallinae* densities may arise from two distinct mechanisms: (1) competition for the same food resource (bird blood), (2) predation of one mite species on the other, or (3) a combination of competition and predation. To distinguish between these mechanisms, the most simple, first approach is to test whether *A. casalis* can feed on *D. gallinae* and whether it can extract blood from its bird host. The results of these predation and haematophagy tests are given below.

Predation tests

Predation tests were carried out with two species of mesostigmatic mites, one commonly found in starling nests and poultry houses, i.e., *A. casalis*, and one rarely found in these environments, i.e., *H. aculeifer*. Out of ten replicate experiments one female of *H. aculeifer* could not be retrieved after the second day (hence 9 replicates remained). For *A. casalis* two females could not be retrieved after the first day (hence 8 replicates remained). Control experiments with only *D. gallinae* did not show any *D. gallinae* mortality during the 2 days and are therefore left out of further analysis. The results of the experiments with putative predators of *D. gallinae* (Table 2) showed that the number of dead *D. gallinae* did not differ between day 1 and 2 of the experiment for *H. aculeifer* (t -test; $P = 0.35$) and for *A. casalis* (t -test; $P = 0.23$), but revealed significant differences between *H. aculeifer* and *A. casalis* treatments on day 1 ($P = 0.0012$) and day 2 ($P = 0.02$): the number of dead prey under exposure of *H. aculeifer* females was 1.8–2.1 times higher than that under exposure of *A. casalis* females. Oviposition was observed in several replicates, on both days for *H. aculeifer* and *A. casalis*. We refrained from quantifying oviposition because *A. casalis* and

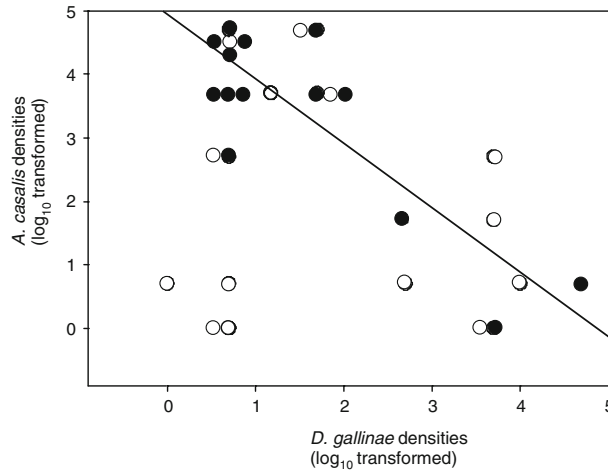

Fig. 2 Densities of *Androlaelaps casalis* plotted against *Dermanyssus gallinae*. Data for these densities were separated according to nest box occupancy history; nest boxes that were occupied (●) ($n = 14$) and were not occupied (○) ($n = 14$) in the previous breeding season (2006). The continuous line with negative slope represents the significant relationship between *A. casalis* densities (\log_{10} transformed) and *D. gallinae* densities (\log_{10} transformed) in nest boxes that were occupied in 2006 (Wald test; slope is equal to -1.016 with $SE = 0.169$ and is significantly different from zero at $P < 0.001$). For nests that were not occupied in 2006 the slope of the regression was not significantly different from zero (Wald test; slope is equal to -0.210 with $SE = 0.257$ and is not significantly different from zero at the 5% level since $P = 0.414$)

Table 2 Assessment of the rate of predation on poultry red mites (juveniles and adults) by females of two species of mesostigmatic mites during two consecutive days, following their rearing on a diet of astigmatic mites (*Tyrophagus putrescentiae*)

Species	Number of red mites killed per day							
	Day 1				Day 2			
	Mean	SD	Range	n	Mean	SD	Range	n
<i>Hypoaspis aculeifer</i>	5.5 ax	1.7	3–8	10	6.4 ax	2.5	3–10	9
<i>Androlaelaps casalis</i>	2.6 ay	1.3	1–4	8	3.6 ay	1.8	1–6	8

Climate room conditions were 22°C, 70% RH and total darkness; n = number of replicates; SD = Standard Deviation. Significant differences between means of two samples according to Student t -tests are indicated by different letters following the mean (between days: a, b ; between species: x, y)

H. aculeifer have a strong tendency to hide eggs in small holes in the layer of plaster of Paris, and there were indications for egg retention in *A. casalis* females, a phenomenon known to occur in mesostigmatic mites under unfavourable conditions and reported for *A. casalis* by McKinley (1963).

Direct observations of attacks on *D. gallinae* individuals and ingestion of their body fluids were obtained for *H. aculeifer* (Fig. 3) and *A. casalis* (Fig. 4) during prey mortality assessments in the above tests and in more than 100 other predation tests. Attacks were observed on eggs and all mobile stages of *D. gallinae*. Large nymphs and adults were most frequently pierced at their flanks just behind the gnathosoma. Adults of *D. gallinae* were not sucked dry by the predatory mites. Instead they were only partially consumed. However, they were invariably leaking body fluids through the wound, were immobilized and



Fig. 3 Adult female of *Hypoaspis aculeifer* feeding on a nymph of the poultry red mite. Note that the gut of *H. aculeifer* is visible through the integument and starts to become dark-coloured (red-brown). Still from a video record made by Urs Wyss and Izabela Lesna. (Color figure online)



Fig. 4 Adult female of *Androlaelaps casalis* after feeding on a poultry red mite nymph, which causes their gut—visible through the integument—to turn red-brown (dark-coloured in this picture). Still from a video record made by Urs Wyss and Izabela Lesna. (Color figure online)

ultimately died. Due to the transparency of their integuments, body fluids were seen to move from the victim into the gut of *H. aculeifer* and *A. casalis* females, thereby causing the gut to assume a red-brownish colour (Figs. 3, 4). Such a change in gut colour does not occur when they fed on eggs or on unfed individuals of *D. gallinae*.

Haematophagy tests

Tests with starved *A. casalis* showed no evidence for haematophagy during 2 h of exposure to hatchlings of starlings at 32–34°C (Table 3). None of the mites were found on the host, none of them exhibited gut colouration (as in Fig. 4) and the host had no bite marks. In

Table 3 Replicated ($n = 5$) experiments to test whether starved females of two mite species feed on the blood of starling hatchlings (3 days after hatching)

Mite species	Replicate number	Number recovered	% with coloured gut
<i>Dermanyssus gallinae</i>	1	17	53
	2	12	58
	3	17	59
	4	19	68
	5	17	82
<i>Androlaelaps casalis</i>	1	17	0
	2	16	0
	3	17	0
	4	18	0
	5	15	0

Shown are the number of mites recovered after 2 h from the 20 individuals initially released per container and the percentage of these recovered mites with a red-brown coloured gut. Brood incubator conditions were 32–34°C, RH >50% and no daylight

contrast, tests involving *D. gallinae* yielded ca. 10% of the mites on host, 50–80% of the mites with red-brown coloured guts (indicating a fresh bloodmeal) and some hosts with bite marks (Table 3). Unfortunately, *H. aculeifer* did not survive the conditions of this experiment. Separate trials showed that temperatures above 30°C are detrimental to survival of *H. aculeifer*. For this reason the haematophagy tests with young chicken were carried out at a lower, yet bird-friendly temperature ($26 \pm 2^\circ\text{C}$). These tests (Table 4) showed that both *H. aculeifer* and *A. casalis* females cannot obtain blood during 18 h of exposure to young chicken. In contrast, 50–90% of the *D. gallinae* that were recovered had red-coloured guts. Possibly, because the light had been switched on 2 h before collecting the mites from the containers, none of the *D. gallinae* mites were found on the hosts. Bite marks on the young chicken were noted in only few cases, but they were not easy to observe because 10-day-old chicken possess already a more dense feather cover.

Not all of the 20 mites released per container were recovered at the end of the experiments. In the tests with starling hatchlings 12–19 *D. gallinae* and 15–19 *A. casalis* were recovered. The missing individuals are most likely present in or under the starling's droppings, where part of them may have gone unnoticed. Escape during inspection and hiding on the host is quite unlikely for these experiments. In the tests with young chickens relatively more mites (especially *D. gallinae* and *A. casalis*) were missing for a variety of reasons, the most likely of which was that they were hiding in the cardboard structure and chicken faeces on the bottom of the containers. Probably due to the relatively larger size of *H. aculeifer* retrieval of released mites was less of a problem (10–18 mites recovered, as opposed to 4–14 for the other 2 species).

Discussion

Our approach was to explore species of putative *D. gallinae* predators that occur in association with *D. gallinae* in bird (starling) nests under natural conditions, and those that occur spontaneously in poultry farms in which *D. gallinae* is a pest. Two species, one laelapid (Mesostigmata) and one cheyletid (Prostigmata), were found more or less frequently in large numbers in both environments: *Androlaelaps casalis* and *Cheyletus eruditus* (Table 1). Two other species, both ascids (Mesostigmata), were found in only one of the

Table 4 Replicated ($n = 10$) experiments to test whether starved females of three mite species feed on the blood of young chicken (10 days since hatching)

Mite species	Replicate number	Number recovered	% with coloured gut
<i>Dermanyssus gallinae</i>	1	11	91
	2	12	50
	3	4	25
	4	7	86
	5	10	70
	6	11	73
	7	12	75
	8	10	80
	9	10	60
	10	8	62
<i>Hypoaspis aculeifer</i>	1	18	0
	2	17	0
	3	10	0
	4	15	0
	5	13	0
	6	14	0
	7	12	0
	8	11	0
	9	14	0
	10	18	0
<i>Androlaelaps casalis</i>	1	12	0
	2	14	0
	3	11	0
	4	6	0
	5	15	0
	6	8	0
	7	8	0
	8	14	0
	9	11	0
	10	6	0

Shown are the number of mites recovered after 18 h from the 20 individuals initially released per container and the percentage of these recovered mites with a red-brown coloured gut. Climate room conditions were 26°C, RH >50% and 15 h of darkness

two environments and then sometimes in large numbers: *Zerconopsis remiger* in starling nests and *Blattisocius keegani* in poultry farms (Table 1). Strikingly, another laelapid species, *Hypoaspis miles* (Berlese) (probably *Stratiolaelaps scimitus* (Womersley); F. Faraji, pers. obs. 2008), currently used to control *D. gallinae* and other blood feeding mites (e.g., the snake mite, *Ophionyssus natricis* (Gervais)) on pet animals, such as canaries, pigeons and reptiles (J. Evers, REFONA BV, pers. comm. 2008), was never found spontaneously in starling nests as well as in poultry farms. Only a few individuals of yet another laelapid species, *Hypoaspis aculeifer*, were found at the end of the breeding season in two starling nests at Vosbergen estate (Eelde-Paterswolde, The Netherlands). This raises the question whether the putative *D. gallinae* predators found in association with *D. gallinae* in bird nests under natural conditions offer perspectives for control of *D. gallinae* and how they compare to *H. miles*, currently used in practice for control of *D. gallinae* on pet animals but not (yet) in poultry farms. This question needs to be answered in future experiments in cages and poultry farms. Below, we discuss the arguments as to why the two *Hypoaspis* species and one of the four species of putative *D. gallinae* predators from starling nests, *A. casalis*, represent candidate predators for biocontrol of *D. gallinae* in poultry houses.

The laelapid mites, *H. miles* and *H. aculeifer*, are mainly ground-dwelling predators and they are occasionally reported to occur in nests of birds in low to very low numbers (e.g., Gwiazdowicz et al. 1999; Kristofik et al. 2003; Fenda and Lengyel 2007). Yet, they seem to be somewhat more numerous in nests of ground-nesting birds, such as European bee-eaters

and sand martins (Kristofik et al. 1996). We found *H. aculeifer* in nest boxes with starling nests but then only very late in the breeding season and in very low numbers, even when *D. gallinae* infestations emerged early in the breeding season. All these observations do not lend support to the hypothesis that *H. miles* and *H. aculeifer* have a strong association with bird nests, let alone with *D. gallinae* infestations. The observations are more consistent with the hypothesis that they inhabit soil litter and visit bird nests. Testing whether *H. miles* and *H. aculeifer* in the soil litter exhibit an aggregative response to the density of *D. gallinae* in nests of ground-nesting birds, has not yet been done, but it seems a feasible and informative experiment to do.

Both *H. miles* and *H. aculeifer* may well be opportunistic generalist predators of *D. gallinae* under natural conditions. We found strong evidence for *H. aculeifer* females attacking and feeding on all stages of *D. gallinae* (Table 2; Fig. 3). In fact, starved females of *H. aculeifer* are voracious predators once released in Petri dishes with *D. gallinae* and they resume oviposition within a day (I. Lesna, pers. obs.). Also, *H. miles* has proven to be a voracious predator of *D. gallinae* and has proven to reproduce on an exclusive diet of *D. gallinae* (Tuovinen 2008; J. Evers, pers. comm. 2008). For reasons unclear to us, *H. miles* and *H. aculeifer* have never been considered to be omnivores that feed on *D. gallinae* as well as the blood from the host of *D. gallinae*. Clearly, the mouthparts of these species exhibit none of the adaptations known for true blood-feeding acarines. Our blood-feed tests with *H. aculeifer* and young chicken also did not provide any evidence for feeding on blood of the chicken, even when in a stage where it is most vulnerable to blood-feeding ectoparasites (Table 4). We therefore conclude that *H. aculeifer* and probably also *H. miles* are true predators and candidate agents for biocontrol of *D. gallinae* in poultry houses. The only cautionary remark is that *H. aculeifer* (in contrast to *A. casalis*) cannot survive at 32–34°C in the brood incubator where we carried our blood-feed tests on young hatchlings of European starlings and that such temperatures do occur on hot summer days in Dutch poultry houses (N. Harteveld, pers. comm. 2008).

The laelapid mite, *A. casalis*, has been reported as a frequent and sometimes abundant inhabitant of the nests from a wide variety of bird species: white storks (Bloszyk et al. 2005), white-tailed sea-eagles (Fenda and Lengyel 2007), owls (Kristofik et al. 2003; Gwiazdowicz 2003), eagles, harriers, buzzards, kites, ospreys, falcons (Gwiazdowicz 2003), house wrens (Pacejka and Thompson 1996; Pacejka et al. 1998), woodpeckers (Pung et al. 2000), European bee-eaters (Kristofik et al. 1996), reed warblers (Kristofik et al. 2001) and European starlings (this article). Hence, its common name is ‘the cosmopolitan nest mite’. It has also been found in poultry houses in the UK, Egypt and The Netherlands in considerable numbers (McKinley 1963; Brady 1970a, b; El-Kammah and Oyoum 2007; this article).

Its trophic position in the food web of organisms in bird nests has been unclear. McKinley (1963) observed *A. casalis* feeding on droplets of human blood, but is of the opinion that *A. casalis* cannot penetrate mammalian or avian skin and can therefore not be a blood parasite, a view shared by Hughes (1976) and Tenquist and Charleston (2001). Indeed, the structure of its gnathosoma and in particular its chelicerae are very different from other blood-sucking mesostigmatic mites, such as Dermanyssidae (*Dermanyssus gallinae*; McKinley 1963; Roy and Chauve 2007), Macronyssidae (*Ornithonyssus sylviarum*; Evans 1957) and Rhinonyssidae (*Sternostoma tracheacolum* Lawrence; Evans 1957). Other authors assume that *A. casalis* is a (facultative) blood parasite (Men 1959; Radovsky 1985, 1994; Kristofik et al. 1996; Pacejka and Thompson 1996; Pacejka et al. 1996, 1998; Pung et al. 2000; Phillips 2000; Rosen et al. 2002; Svana et al. 2006; Fenda and Lengyel 2007; for review, see Proctor and Owens 2000). However, despite the presence of *A. casalis* in bird nests in relatively high numbers negative effects on brood performance have not been

found in the house wren (Pacejka and Thompson 1996; Pacejka et al. 1998) and in the red-cockaded woodpecker (Pung et al. 2000). This may indicate that blood parasitism is not the predominant mode of feeding in *A. casalis*, or it may even be absent altogether. Some authors consider the possibility that *A. casalis* is a predator of small arthropods (including mites) in addition to being a blood parasite (Pacejka and Thompson 1996; Pacejka et al. 1996; Kristofik et al. 1996). Using a statistical method called path analysis, Pacejka et al. (1998) found a positive, direct effect of the numbers of *Dermanyssus hirundinis* (Hermann) on the numbers of *A. casalis*. Referring to Pacejka et al. (1998), Proctor and Owens (2000) hypothesize *A. casalis* to be a predator of blood-feeding mites and therefore a potential mutualist to the nesting bird. Pacejka et al. (1998) did not consider the effects of arthropods other than blood feeding mites and overlooked the possibility that *A. casalis* might be a predator of non-parasitic mites as well as young, vulnerable stages of parasitic and non-parasitic insects in bird nests. For example, *A. casalis* can feed on several astigmatic mite species (McKinley 1963) and has been considered as a biocontrol agent of astigmatic mites that are pests in stored products (Barker 1968). Various species of astigmatic mites in stored products are also found in bird nests, where they are probably feeding on fungi. Clearly, the trophic relations of *A. casalis* with other nest-dwelling arthropods and with the bird are in need of a causal experimental analysis.

In this article we provide quantitative evidence supporting the hypothesis that *A. casalis* is a predator of the poultry red mite (*D. gallinae*) (Table 2; Fig. 4) and of astigmatic mites living in nests (*Glycyphagus domesticus* (De Geer), *Lepidoglyphus destructor* (Schrank)) and in poultry houses (*Tyrophagus putrescentiae*). We also show quantitatively that *A. casalis* could not extract blood from young chicken and young starlings (Tables 3, 4), i.e., from birds in a life stage where they are most accessible and vulnerable to acarine blood parasites. These results are largely in agreement with the qualitative observations reported by McKinley (1963). This author also observed starved *A. casalis* feeding on astigmatic mites and poultry red mites and found no evidence (based on mite gut colouration or bite marks on host skin) for feeding on chicken, laboratory mice and men (even when the human skin was treated with fine sandpaper to improve access to blood vessels). Thus, given its numerical abundance in starling nests, its inverse association with *D. gallinae* in starling nests, its spontaneous occurrence in poultry houses infested with *D. gallinae*, its ability to complete its life cycle on a diet of *D. gallinae* and its inability to acquire blood directly from a bird (even when in its most vulnerable stage), we conclude that *A. casalis* is a true predator. This conclusion should challenge ornithologists to revise their views on how to judge (and perhaps how birds judge) the risk of ectoparasitism in a nest and their views on why birds re-use old nesting sites or old nest material (e.g., Mazgajski (2007) considers old nest material of European starlings only as a source of ectoparasites). Moreover, it points at a new candidate agent for the control of *D. gallinae* in poultry houses.

Apart from *H. miles*, *H. aculeifer* and *A. casalis*, there may well be several other candidate predators for biocontrol of *D. gallinae*. Our inventory of mites in starling nests and poultry farms in The Netherlands yielded species that may act as predators of *D. gallinae*, like *C. eruditus*, *Z. remiger* and *B. keegani*. Also, our attempt to review the literature on mites in bird nests appeared to provide several nidicolous species, such as *Hypoaspis lubrica* Voigts and Oudemans (Brady 1970a, b; Gwiazdowicz et al. 1999). However, none of these species have been actually tested for their ability to feed on *D. gallinae*, nor for their (in-)ability to feed on the blood of their hosts. Some of these species have been observed to feed on free blood (e.g., *H. lubrica* feeding on free blood of mice; Li and Meng 1992), but as shown for the case of *A. casalis* feeding on free blood is not sufficient evidence to infer haematophagy (McKinley 1963; this article).

As much as we realize that our conclusions on the exclusive predatory life style of *A. casalis* and *H. aculeifer* may not hold under all conditions (e.g., other bird species), we caution against uncritical citing and unconfirmed inferences on feeding life styles of nidicolous arthropods (e.g., Pacejka et al. 1998; Xing-Yuan et al. 2007). Bird nests may not only harbour ectoparasites and fungivores but also predators of one or even both of these trophic guilds. Indeed, the arthropods in nests are part of a multitrophic system.

Acknowledgments We (IL, MWS) thank René Heijnen (CeHaVe, Veghel, The Netherlands) and Karel Bolckmans (Koppert BV, Berkel en Rodenrijs, The Netherlands) for stimulating us to work on biological control of poultry red mites. Thea Fiks-Niekerk, Monique Mul and Rick van Emous (Animal Sciences group, Wageningen University, Lelystad, The Netherlands) were instrumental in providing information on pest status of poultry red mites and current practice of poultry management. Sampling of the mite fauna of poultry houses (4 farms in the province of Brabant and Limburg, The Netherlands) was enabled with much help of Nico Hartevelde (Koppert BV, Berkel en Rodenrijs, The Netherlands) and Sieds van der Schaaf (Protekta, Gemert, The Netherlands). Ria Wiltenburg and Marnix van de Wetering (CeHaVe, Veghel, The Netherlands) are thanked for their help in realizing the required WOD licence (Wet op de Dierproeven) for tests on blood feeding by mites on young chicken, experiments that were carried out at the research farm ‘Laverdonk’ (CeHaVe, Heeswijk, The Netherlands). Two M.Sc. students of the University of Groningen, Judith J. Westveer and Linda M. van Zomeren, are thanked for their help with tests on blood feeding by mites on young starlings, experiments that were carried out at Vosbergen estate (Paterswolde, The Netherlands) under WOD licences held by Prof. Jan Komdeur (University of Groningen, Haren, The Netherlands). Tuomi Tuovinen (MTT-Agrifood Research, Jokioinen, Finland) and John Evers (REFONA BV, Westerbork, The Netherlands) are thanked for sharing insights on the use of *Hypoaspis miles* for poultry red mite control. Prof. Urs Wyss (University of Kiel, Germany) is thanked for his skills, patience and help to make video-records of mite behaviour. The work presented in this article was enabled by financial support from the Netherlands Academy of Sciences (KNAW, Amsterdam, The Netherlands), the Dutch Ministry of Agriculture, Nature and Food Quality (LNV, Expertise Center, Bennekom, The Netherlands) and the Product Boards for Livestock, Meat and Eggs (PVE, Zoetermeer, The Netherlands).

Appendix

To test for conspecificity of *Dermanyssus* samples from starling nests and those from poultry farms, three gene regions were sequenced and aligned with homologous sequences from populations of various origins and diverse *Dermanyssus* species: (1) a fragment of 18S–28S rRNA, including internal transcribed spacer 1 (ITS1), 5.8S rRNA and ITS2 (nuclear gene region) (2) 16S rRNA (mitochondrial gene region), and (3) mt-COI (a mitochondrial protein-coding region of cytochrome oxidase subunit I). Populations collected in The Netherlands are labelled by an acronym (IL) referring to the first author of this article, followed by the number of the starling’s nest box at Vosbergen estate (Eelde-Paterswolde, The Netherlands). The EMBL Accession numbers are provided below to enable citation of database entries.

Gene region	Population	EMBL accession number
ITS	IL213	FM207490
ITS	IL227	FM207491
16S rRNA	IL213	FM207492
16S rRNA	IL227	FM207494
mt-COI	IL302	FM207495
mt-COI	IL227	FM207496
mt-COI	IL202A	FM207497
mt-COI	IL202C	FM207498
mt-COI	IL213	FM207499

On the basis of mt-COI, Roy et al. (2009) show that four populations (IL302, IL227, IL202, IL213) sampled from starling nests belong to *D. gallinae*. Roy et al. (2008) show that the species delineation apparent from the mt-COI tree is confirmed by other analyses, which include all three gene regions (two mitochondrial and one nuclear). Because the samples from starling populations branch within the most distal *D. gallinae* clade (and neither in a sister clade, nor at the basis of the large *D. gallinae* clade), we infer that they are conspecific. Most likely, all 29 populations from starling-occupied nest boxes at Vosbergen estate in 2007 are conspecific, because Roy et al. (2009) found strong evidence for single or very similar haplotypes of *Dermanyssus* per bird host and geographical location.

Finally, Roy et al. (2009) show that in contrast to others the clade *D. gallinae* groups together all populations represented in poultry farms (layer hens) or breeding facilities for canaries, other Fringillidae and pigeons. Thus, the clade *D. gallinae* harbours synanthropic, as well as bird-associated populations.

References

- Abo-Taka SM (1996) Mites inhabiting poultry farms in Egypt. In: Mitchell R, Horn DJ, Needham GR, Welburn WC (eds) Acarology IX, proceedings, vol 1. Ohio Biological Survey, Columbus, pp 97–99
- Axtell RC, Arends JJ (1990) Ecology and management of arthropods pests of poultry. *Annu Rev Entomol* 35:101–126. doi:10.1146/annurev.en.35.010190.000533
- Barker PS (1968) Bionomics of *Androlaelaps casalis* (Berlese) (Acarina: Laelapidae), a predator of mite pests of stored cereals. *Can J Zool* 46:1099–1102. doi:10.1139/z68-157
- Beck W (1999) Farm animals as disease vectors of parasitic epizoonoses and zoophilic dermatophytes and their importance in dermatology. *Hautarzt* 50:621–628. doi:10.1007/s001050050971
- Bloszyk J, Gwiazdowicz DJ, Bajerlein D, Halliday RB (2005) Nests of the white stork *Ciconia ciconia* (L.) as a habitat for mesostigmatic mites (Acari, Mesostigmata). *Acta Parasitol* 50(2):171–175
- Brady J (1970a) The mites of poultry litter: observations on the bionomics of common species, with a species list for England and Wales. *J Appl Ecol* 7:331–348. doi:10.2307/2401384
- Brady J (1970b) Litter mites and their effects on poultry. *Worlds Poult Sci J* 26:658–668. doi:10.1079/WPS19700022
- Brouwer L, Komdeur J (2004) Green nesting material has a function in mate attraction in the European starling. *Anim Behav* 67:539–548. doi:10.1016/j.anbehav.2003.07.005
- Buffoni G, Di Cola G, Baumgärtner J, Maurer V (1995) A mathematical model for trophic interactions in an acarine predator–prey system. *J Biol Syst* 3:303–312. doi:10.1142/S0218339095000289
- Buffoni G, Di Cola G, Baumgärtner J, Maurer V (1997) The local dynamics of acarine predator–prey (*Cheyletus eruditus*–*Dermanyssus gallinae*) populations: identification of a lumped parameter model. *Mitt Schweiz Entomol Ges* 70:345–359
- Burt EH Jr, Chow W, Babitt GA (1991) Occurrence and demography of mites of tree swallow, house wren, and eastern bluebird boxes. In: Loye JE, Zuk M (eds) Bird–parasite interactions: ecology, evolution and behaviour. Oxford University Press, Oxford, pp 104–122 (ornithology Series)
- Clark L (1991) The nest-protection hypothesis: the adaptive use of plant secondary compounds by European starlings. In: Loye JE, Zuk M (eds) Bird–parasite interactions: ecology, evolution and behaviour. Oxford University Press, Oxford, pp 205–221 (ornithology Series)
- El-Kammah KM, Oyoun LMI (2007) Taxonomic records of mite species associated with animal and poultry farms in the Nile Delta, valley and N. Sinai Egypt. In: Morales-Malacara JB, Behan-Pelletier V, Uecker-mann E, Perez-T, Estrada-Venegas EG, Badii M (eds) Acarology XI, proceedings of the international congress, pp 223–232
- Emous RA, Fiks-Van Niekerk TGCM, Mul MF (2005) Enquete vogelmijten op leghennenbedrijven: € 11.000.000 schade voor de sector. *Pluimveehouderij* 35(22 januari):8–9
- Evans GO (1957) An introduction to the British Mesostigmata (Acarina) with keys to families and genera. *Zool J Linn Soc* 43:203–259. doi:10.1111/j.1096-3642.1957.tb01552.x
- Faraji F, Bakker FM (2008) A modified method for clearing, staining and mounting plant-inhabiting mites. *Eur J Entomol* 105:793–795
- Fenda P, Lengyel J (2007) Rostoce (Acarina: Mesostigmata) v hniezdach orliaka morskeho (*Haliaeetus albicilla*) na Slovensku. *Entomofauna carpathica* 19:48–50

- Gupta SK, Paul K (1989) Nest-associated acarines of birds in India. In: Channabasavanna GP, Viraktamath CA (eds) Progress in acarology, vol 2. EJ Brill, Leiden, The Netherlands, pp 315–321
- Gwiazdowicz DJ (2003) Mites (Acari: Mesostigmata) occurring in the nests of birds of prey (Falconiformes) and owls (Strigiformes). *Acarina* 11:235–239
- Gwiazdowicz DJ, Mizera T, Skorupski M (1999) Mites from greater spotted eagle nests. *J Raptor Res* 33:257–260
- Gwinner H, Berger S (2005) European starlings: nestling condition, parasites and green nest material during the breeding season. *J Ornithol* 146:365–371. doi:10.1007/s10336-005-0012-x
- Hughes AM (1976) The Mites of stored food and houses. Second Edition, Ministry of Agriculture, Fisheries and Food, Technical Bulletin 9:1–400
- Kristoffik J, Masan P, Sustek Z (1996) Ectoparasites of bee-eater (*Merops apiaster*) and arthropods in its nests. *Biologia* 51:557–570
- Kristoffik J, Masan P, Sustek Z (2001) Mites (Acari), beetles (Coleoptera) and fleas (Siphonaptera) in the nests of great reed warbler (*Acrocephalus arundinaceus*) and reed warbler (*A. scirpaceus*). *Biologia* 56:525–536
- Kristoffik J, Masan P, Sustek Z, Kloubec B (2003) Arthropods (Pseudoscorpionida, Acari, Coleoptera, Siphonaptera) in nests of the Tengmalm's owl, *Aegolius funereus*. *Biologia* 58:231–240
- Lesna I, Sabelis MW, Bolland HR, Conijn CGM (1995) Candidate natural enemies for control of *Rhizoglyphus robini* Claparède (Acari: Astigmata) in lily bulbs: exploration in the field and preselection in the laboratory. *Exp Appl Acarol* 19:655–669. doi:10.1007/BF00145254
- Li G, Meng Y (1992) Investigation in sucking mice free blood habit of *Hypoaspis lubrica*. *Chin J Vector Biol Control* 3:9–12 (in Chinese)
- Lundqvist L (1995) Ectoparasitic mites in the nest of starlings (*Sturnus vulgaris*); do they play a role in the sexual selection of the birds? In: Kropczynska D, Boczek J, Tomczyk A (eds) The Acari: physiological and ecological aspects of Acari-host relationships. Oficyna Dabor, Warszawa, Poland, pp 545–548
- Maurer V, Baumgärtner J (1992) Temperature influence on life table statistics of the chicken mite *Dermanyssus gallinae* (Acari: Dermanyssidae). *Exp Appl Acarol* 15:27–40. doi:10.1007/BF01193965
- Maurer V, Baumgärtner J (1994) A population model for *Dermanyssus gallinae* (Acari, Dermanyssidae). *Exp Appl Acarol* 18:409–422. doi:10.1007/BF00051523
- Maurer V, Hertzberg H (2001) Ökologische legehennenhaltung. Was tun gegen die kleinen Vampire? DGS-Magazin. Woche 40:49–52
- Maurer V, Baumgärtner J, Bieri M, Fölsch DW (1993) The occurrence of the chicken mite *Dermanyssus gallinae* (Acari: Dermanyssidae) in Swiss poultry houses. *Mitt Schweiz Entomol Ges* 66:87–97
- Mazgajski TD (2007) Effect of old nest material in nest boxes on ectoparasite abundance and reproductive output in the European starling *Sturnus vulgaris* (L.). *Pol J Ecol* 55:377–385
- McKinley DJ (1963) The morphology and biology of *Haemolaelaps casalis* Berlese (Acarina: Mesostigmata). *Ann Mag Nat Hist* 13(6):65–76
- Men YT (1959) Concerning the feeding of the mite *Haemolaelaps casalis* (Gamasoidea, Parasitiformes). *Medskaya Parazitol* 28:603–609 (in Russian)
- Nordenfors H, Chirico J (2001) Evaluation of a Sampling Trap for *Dermanyssus gallinae* (Acari: Dermanyssidae). *J Econ Entomol* 94:1617–1621
- Pacejka AJ, Thompson CF (1996) Does removal of old nests from nest boxes by researchers affect mite populations in subsequent nests of house wrens? *J Field Ornithol* 67:558–564
- Pacejka AJ, Santana E, Harper RJ, Thompson CF (1996) House wrens *Troglodytes aedon* and nest-dwelling ectoparasites: mite population growth and feeding patterns. *J Avian Biol* 27:273–278. doi:10.2307/3677258
- Pacejka AJ, Gratton CM, Thompson CF (1998) Do potentially virulent mites affect house wren (*Troglodytes aedon*) reproductive success? *Ecology* 79:1797–1806
- Philips JR (2000) Review and checklist of the parasitic mites (Acarina) of the Falconiformes and Strigiformes. *J Raptor Res* 34:210–231
- Philips JR, Dindal DL (1979) The acarine community of nests of birds of prey. In: Rodriguez JG (ed) Recent advances of acarology, vol 1. Academic Press, New York, pp 559–562
- Philips JR, Poole A, Holt D (1989) Nest mites of ospreys and short-eared owls in Massachusetts salt marshes, USA. In: Channabasavanna GP, Viraktamath CA (eds) Progress in acarology, vol 2. EJ Brill, Leiden, The Netherlands, pp 305–307
- Proctor H, Owens I (2000) Mites and birds: diversity, parasitism and coevolution. *Trends Ecol Evol* 15:358–364. doi:10.1016/S0169-5347(00)01924-8
- Pung OJ, Carlile LD, Whitlock J, Vives SP, Durden LA, Spadgenske E (2000) Survey and host fitness effects of red-cockaded woodpecker blood parasites and nest cavity arthropods. *J Parasitol* 86:506–510

- Putatunda BN, Gupta SK, Singh J (1989) Acarine associates of birds in West Bengal, India. In: Channabasavanna GP, Viraktamath CA (eds) Progress in acarology, vol 2. EJ Brill, Leiden, The Netherlands, pp 309–313
- Quintero MT, Acevedo AC (1984) Studies on deep litter mites in poultry farms in Mexico. In: Griffiths DA, Bowman CE (eds) Acarology VI, vol 1. Ellis Horwood Ltd, Chichester, pp 629–634
- Rabash J, Browne W, Healy M, Cameron B, Charlton C (2008) “MLwiN v2.10 beta 5” Centre of Multilevel Modelling. University of Bristol, UK
- Radovsky FJ (1985) Evolution of mammalian mesostigmatid mites. In: Kim KC (ed) Coevolution of parasitic arthropods and mammals. Wiley, New York, pp 441–504
- Radovsky FJ (1994) The evolution of parasitism and the distribution of some dermanyssoid mites (Mesostigmata) on vertebrate hosts. In: Houck MA (ed) Mites: ecological and evolutionary analysis of life history patterns. Chapman and Hall, New York, pp 186–217
- Rosen S, Yeraham I, Braverman Y (2002) Dermatitis in humans associated with the mites *Pyemotes tritici*, *Dermanyssus gallinae*, *Ornithonyssus bacoti* and *Androlaelaps casalis* in Israel. Med Vet Entomol 16:442–444. doi:10.1046/j.1365-2915.2002.00386.x
- Roy L, Chauve CM (2007) Historical review of the genus *Dermanyssus* Dugès (Acari: Mesostigmata: Dermanyssoidea). Parasite 14:87–100
- Roy L, Dowling APG, Chauve CM, Buronfosse T (2008) Delimiting species boundaries within *Dermanyssus* Dugès, 1834 (Acari: Mesostigmata) using a total evidence approach. Mol Phylogenet Evol (in press). doi:10.1016/j.ympev.2008.11.012
- Roy L, Dowling APG, Chauve CM, Lesna I, Sabelis MW, Buronfosse T (2009) Molecular phylogenetic assessment of host range in *Dermanyssus* species. Exp Appl Acarol. doi:10.1007/s10493-008-9231-1
- Svana M, Fenda P, Orszaghova Z (2006) Rostoce (Acarina: Mesostigmata) v hniezdach vtakov jz Slovenska. Folia faunistica Slovaca 11:39–42
- Tenquist JD, Charleston WAG (2001) A revision of the annotated checklist of ectoparasites of terrestrial mammals in New Zealand. J R Soc N Z 31:481–542
- Tuovinen T (2008) Predatory arthropods as biocontrol agents of *Dermanyssus gallinae*? In: BSP Spring, trypanosomiasis/leishmaniasis & malaria meetings. Newcastle, UK, March 30–April 2. Abstract booklet: 170
- Valiente Moro C, Chauve C, Zenner L (2005) Vectorial role of some dermanyssoid mites (Acari, Mesostigmata, Dermanyssoidea). Parasite 12:99–109
- Valiente Moro C, Chauve C, Zenner L (2007) Experimental infection of *Salmonella Enteritidis* by the poultry red mite, *Dermanyssus gallinae*. Vet Parasitol 146:329–336. doi:10.1016/j.vetpar.2007.02.024
- Veiga JP, Polo V, Vinuela J (2006) Nest green plants as a male status signal and courtship display in the spotless starling. Ethology 112:196–204. doi:10.1111/j.1439-0310.2006.01148.x
- Xing-Yuan M, Xian-Guo G, Wen-Ge D, Ai-Qin N, Ti-Jun Q, Dian W (2007) Ectoparasites of Chevrier 's field mouse, *Apodemus chevrieri*, in a focus of plague in Southwest China. Med Vet Entomol 21:297–300

10.3 Annexe 3 : numéros d'accès des séquences obtenues d'EF1-alpha et amorces correspondantes

Espèce	Isolat	Numéro d'accès EMBL
<i>Androlaelaps casalis</i>	2.4	AM930875
<i>Androlaelaps casalis</i>	ACA	AM930874
<i>Dermanyssus apodis</i>	GO15	AM930867
<i>Dermanyssus apodis</i>	GO16	AM930866
<i>Dermanyssus apodis</i>	MAR	AM930870
<i>Dermanyssus carpathicus</i>	5	AM930871
<i>Dermanyssus carpathicus</i>	RQ	AM930872
<i>Dermanyssus gallinae</i>	CANIT	AM930877
<i>Dermanyssus gallinae</i>	Chab	AM930857
<i>Dermanyssus gallinae</i>	DR	AM930856
<i>Dermanyssus gallinae</i>	Fa1	AM930855
<i>Dermanyssus gallinae</i>	GO12	AM930865
<i>Dermanyssus gallinae</i>	GO26	AM930869
<i>Dermanyssus gallinae</i>	GO44	AM930868
<i>Dermanyssus gallinae</i>	LB	AM930876
<i>Dermanyssus gallinae</i>	PO1	AM930861
<i>Dermanyssus gallinae</i>	SK	AM930858
<i>Dermanyssus gallinae</i>	Woodp	AM930862
<i>Dermanyssus gallinae</i> (L1)	COL	AM930854
<i>Dermanyssus gallinae</i> (L1)	GO8	AM930864
<i>Dermanyssus gallinae</i> (L1)	LC	AM930863
<i>Dermanyssus hirundinis</i>	HR	AM930859
<i>Dermanyssus hirundinis</i>	OC	AM930860
<i>Dermanyssus longipes</i>	PAS	AM930873
<i>Ornithonyssus sylviarum</i>	JBO10 ⁵	AM930881

Amorces pour l'obtention des séquences d'EF1-alpha :

DgEF1-F	5' TGGGCAAGGGCTCCTTCAAGTA 3'
DgEF1-R	5' TCGCACTTCTCCTTAATCTCCTTGAA 3'
AcEF1-F	5' CTGTGGAAGTTCGAGACGCC 3'
AcEF1-R	5' CTCGTGGTGCATTTTCGACCGACTTC 3'

Le couple DgEF1-F + DgEF1-R génère un amplicon d'env. 1000 pb, généralement faiblement amplifié. Le couple AcEF1-F + AcEF1-R génère un amplicon un peu plus court (env. 900 pb), la réaction de PCR est en général beaucoup plus performante (intensité de la bande et succès du séquençage nettement accrus).

⁵ Même séquence exactement que PM (3 individus à chaque fois), un autre isolat d'*O. sylviarum*, et que *D. gallinae* (lignes précédentes). Provenances des isolats d'*O. sylviarum* : PM, Vaulx-en-Velin, Rhône, France ; JBO10, Mollégès, Bouches-du-Rhône, France.