

Université de Paris 1 Panthéon-Sorbonne
UFR 03 Histoire de l'Art et Archéologie – École doctorale d'Archéologie

**Acquisition des ressources animales, alimentation carnée
et distinction sociale en Anjou de la fin du X^e au début du XII^e siècle.
Étude archéozoologique du site de Montsoreau (Maine-et-Loire).**

ANNEXES

Thèse présentée et soutenue publiquement pour obtenir le grade de
Docteur de l'Université Paris 1 Panthéon-Sorbonne
en Archéologie Environnementale, spécialité Archéozoologie

par Aurélia Borvon

Sous la direction de Joëlle Burnouf,
Professeure à l'Université Paris 1 Panthéon-Sorbonne

le 26 janvier 2012

Jury :

Mme Joëlle Burnouf , Professeure, Université Paris 1 Panthéon-Sorbonne UMR 7041 ArScAn - Archéologies Environnementales	directrice
M. Claude Guintard , Maître de Conférences, École Nationale Vétérinaire de Nantes-ONIRIS	tuteur
Mme Marie-Christine Marinval , PRAG, Dr., Université Paris 1 Panthéon-Sorbonne UMR 7041 ArScAn - Archéologies Environnementales	tuteur
M. Louis Chaix , Professeur émérite, Université de Genève, Muséum d'Histoire Naturelle de Genève	rapporteur
M. Luc Bourgeois , Maître de Conférences, HdR, Université de Poitiers Centre d'Études Supérieures de Civilisation Médiévale, UMR 6223	examineur
M. Bruno Chanet , Dr., HdR, Muséum National d'Histoire Naturelle, Équipe "Phylogénie", UMR 7138 CNRS-IRD-MNHN-P6, département Systématique et Évolution	rapporteur
M. Daniel Prigent , Dr., Archéologue conservateur en chef du patrimoine, Service Archéologique Départemental de Maine-et-Loire	examineur

ANNEXES

Annexe 1 : Montsoreau, diagrammes et coupes stratigraphiques.

Annexe 2 : convention interne ENVN-Oniris : Centre de Soins de la Faune Sauvage - Service d'Anatomie Comparée.

Annexe 3 : vestiges fauniques par US/Str. et par phase chronologique.

Annexe 4 : enregistrement des éruptions et des usures dentaires des Suidés.

Annexe 5 : ostéométrie des Mammifères.

Annexe 6 : ostéométrie des Oiseaux.

Annexe 7 : ostéométrie des « poissons ».

Annexe 1.1 (suite) : Montsoreau, diagramme stratigraphique, rempart sud (documentation SADML ; secteurs de fouilles : chap.2, fig. 2.4).

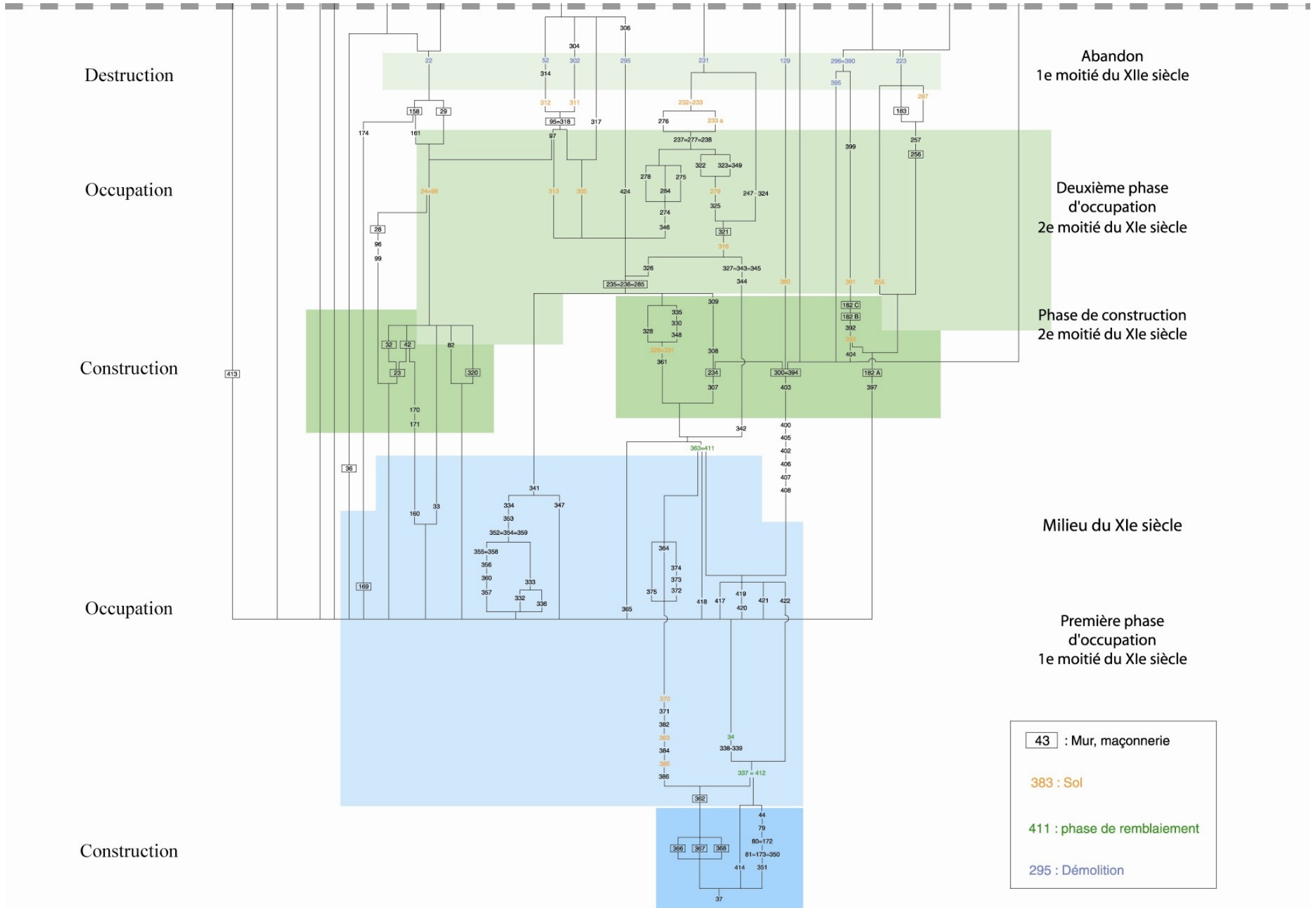

Annexe 1.2 : Montsoreau, diagramme stratigraphique, cour sud (documentation SADML ; secteurs de fouilles : chap.2, fig. 2.4).

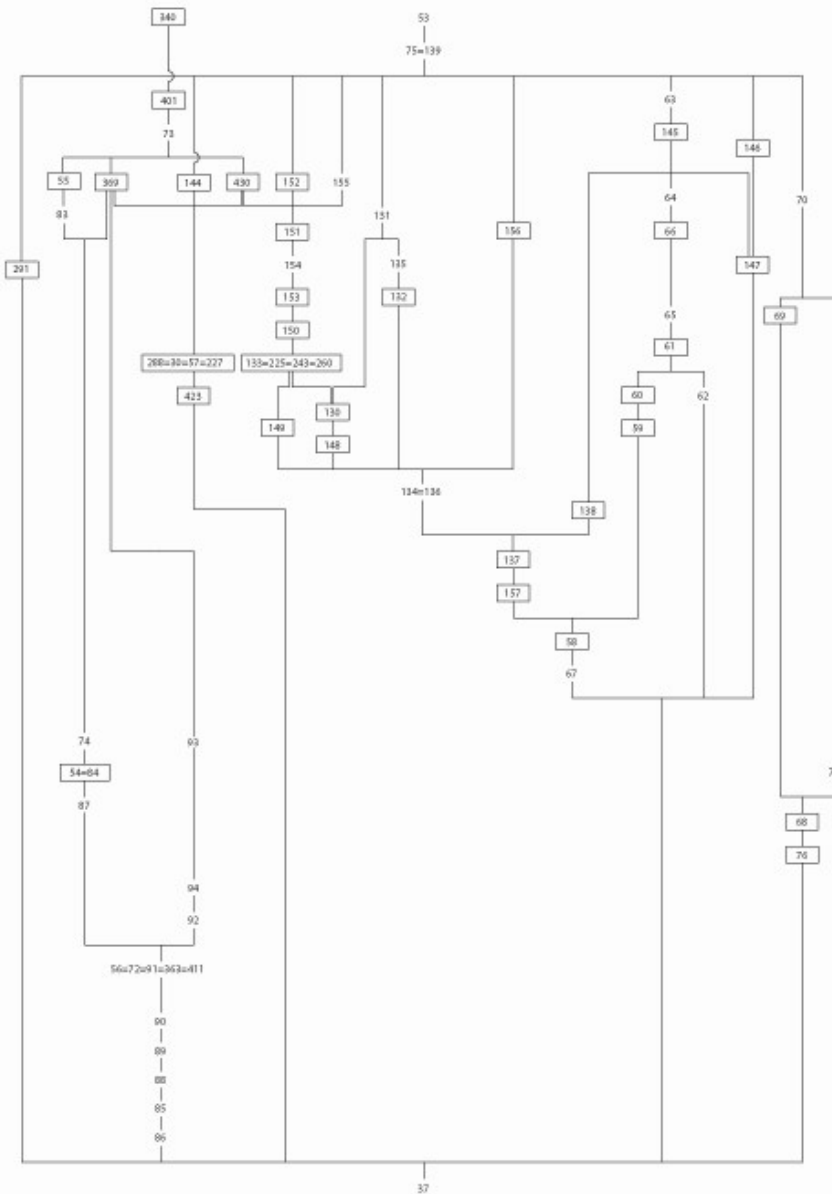

Annexe 1.3 : Montsoreau, diagramme stratigraphique, châtelet (documentation SADML ; secteurs de fouilles : chap.2, fig. 2.4).

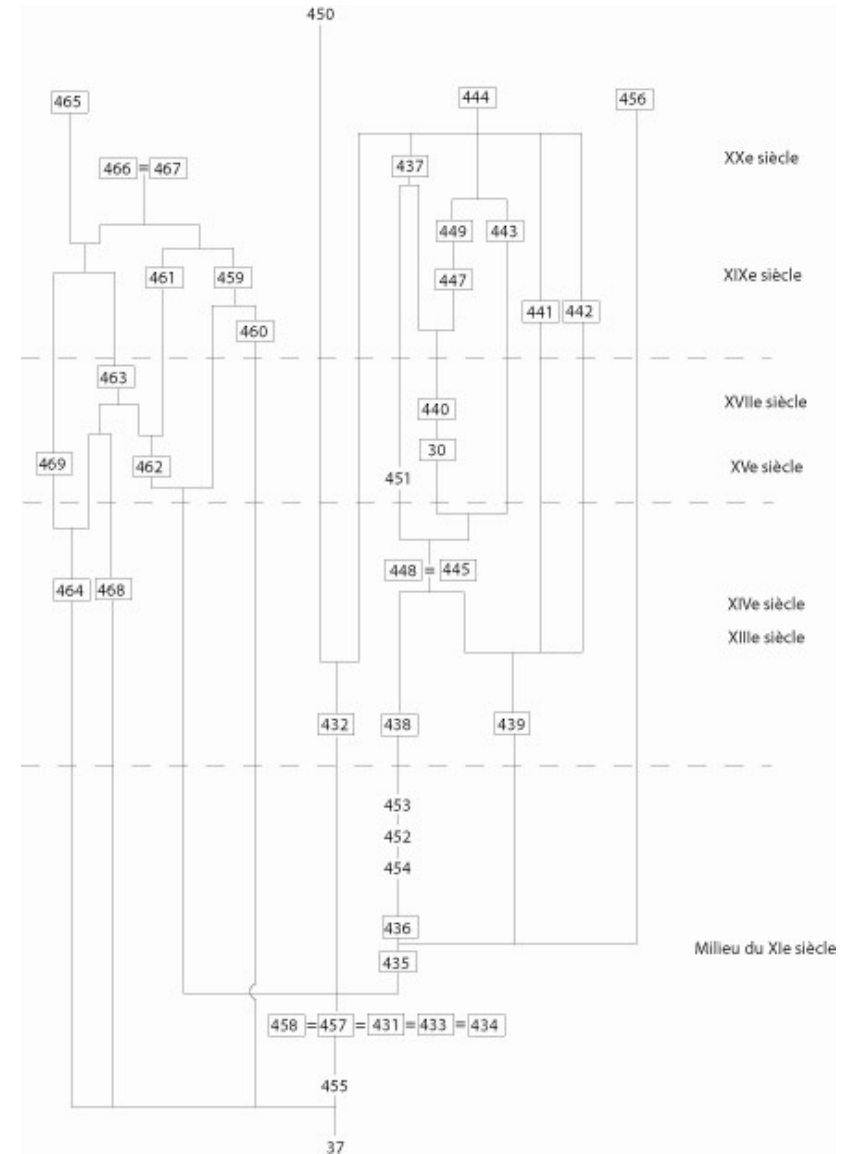

**Annexe 1.4 : Montsoreau, coupes stratigraphiques (documentation SADML ;
localisation des coupes : chap.2, fig. 2.6).**

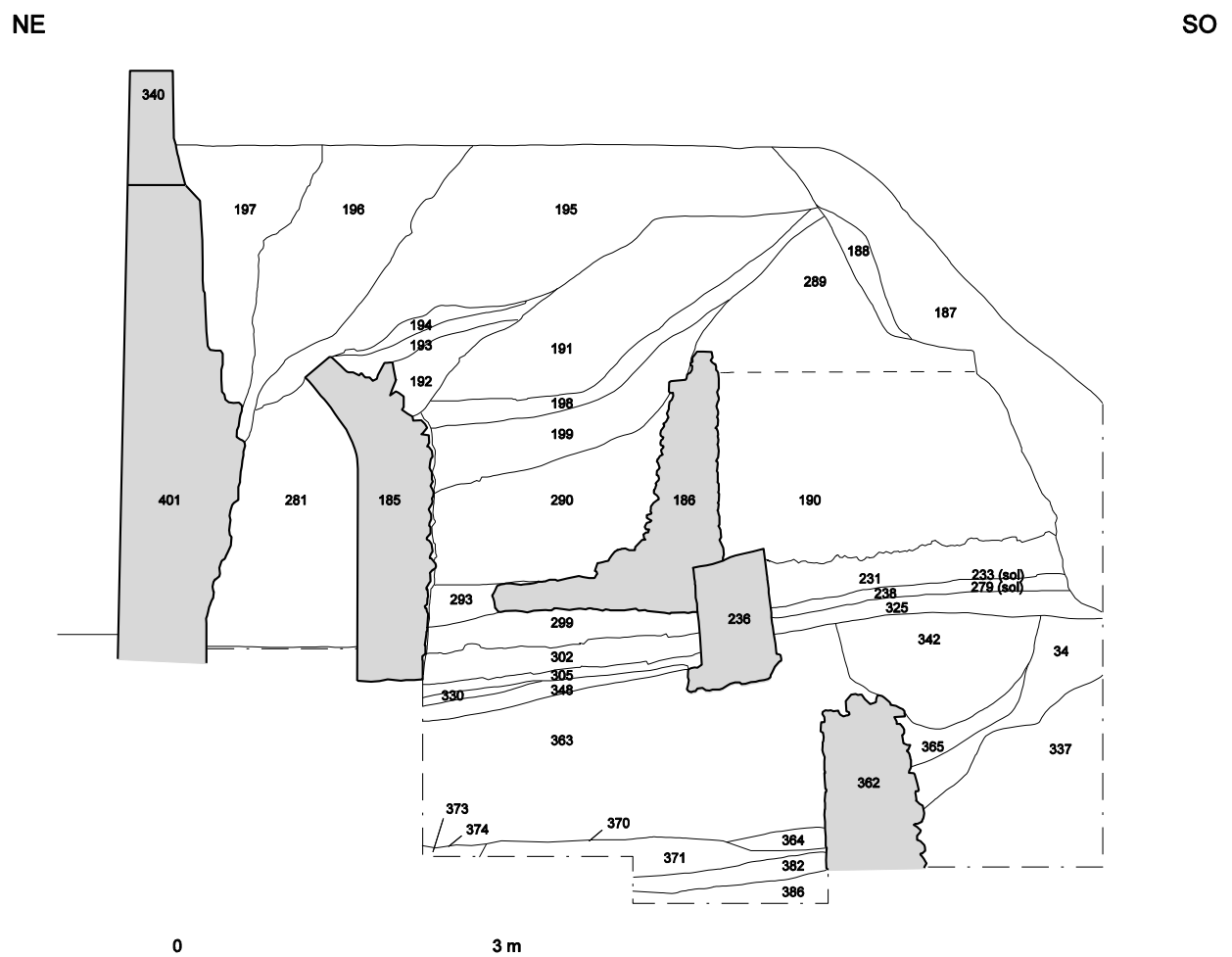

Annexe 2 : convention interne ENVN-Oniris : Centre de Soins de la Faune Sauvage - Service d'Anatomie Comparée.

Annexe 2.1 :

CONVENTION INTERNE

ENTRE LE CENTRE VETERINAIRE DE LA FAUNE SAUVAGE ET DES ECOSYSTEMES

ET L'UNITE D'ANATOMIE DES ANIMAUX DOMESTIQUES-ETHNOZOOTECHE

ECOLE NATIONALE VETERINAIRE DE NANTES

1 – Désignation des contractants

La présente convention est établie

Entre

LE CENTRE VETERINAIRE DE LA FAUNE SAUVAGE ET DES ECOSYSTEMES DE L'ECOLE NATIONALE VETERINAIRE DE NANTES (CVFSE/ENVN)

Atlanpole – La Chantrerie – BP40706 – 44307 Nantes cedex 03

Représenté par Madame Monique L'Hostis, directrice du centre et/ou Monsieur Olivier Lambert, responsable du centre, capacitaires du CVFSE

ci-après désigné par le « CVFSE »

Et

L'UNITE D'ANATOMIE DES ANIMAUX DOMESTIQUES – ETHNOZOOTECHE DE L'ECOLE NATIONALE VETERINAIRE DE NANTES

Atlanpole – La Chantrerie – BP40706 – 44307 Nantes cedex 03

Représentée par Monsieur Claude Guintard, enseignant chercheur et/ou Monsieur Eric Betti, enseignant chercheur

ci-après désigné par « l'Unité d'Anatomie »

2 - Objet de la convention interne

Utilisation par l'Unité d'Anatomie de spécimens d'animaux morts ou de prélèvements de spécimens d'animaux morts en provenance du CVFSE pour la réalisation d'études scientifiques en particulier dans les cadres de travaux de thèses vétérinaires ou universitaires.

3 – Cadre réglementaire

Vu le titre 1^{er} du livre IV – protection de la faune et de la flore – du code de l'environnement ;

Vu l'arrêté ministériel du 11 septembre 1992 relatif aux règles générales de fonctionnement et aux caractéristiques des installations des établissements qui pratiquent des soins sur les animaux de la faune sauvage ;

Vu la décision du ministre de l'environnement du 06 novembre 1995 accordant le certificat de capacité à Madame Monique L'Hostis ;

Vu la décision du préfet de Loire-Atlantique du 20 décembre 2007 accordant à Monsieur Olivier Lambert le certificat de capacité ;

Vu les arrêtés préfectoraux n°97/PE/31 du 14 mars 1997 et n°2008/BE/008 du 21 janvier 2008, autorisant le Directeur de l'Ecole Nationale Vétérinaire de Nantes à ouvrir le CVFSE ;

Vu l'article 6 de l'arrêté préfectoral n°2008/BE/008 ;

« les cadavres d'animaux sauvages issus du CVFSE peuvent être utilisés dans les laboratoires de l'Ecole Nationale Vétérinaire de Nantes pour la réalisation d'études scientifiques ».

Considérant ceci :

A/ une photocopie de l'arrêté préfectoral n°2008/BE/008 du 21 janvier 2008 devra obligatoirement être mise en annexes de chaque rapport issu de ces études scientifiques (thèses vétérinaires, universitaires, ...) ;

B/ dans la partie « cadre de l'étude » de chaque étude, le texte suivant devra être inséré : « les animaux utilisés sont soumis aux lois de protection de la nature donc à une réglementation et une législation strictes, que nous nous sommes appliqués à respecter rigoureusement lors cette étude. Vu l'arrêté préfectoral n°2008/BE/008 du 21 janvier 2008 (annexe n°...), nous avons pu utiliser les cadavres d'animaux décédés au CVFSE/ENVN » ;

C/ pour chaque étude, le CVFSE sera soit dans les auteurs soit dans les remerciements en fonction de son implication ;

D/ pour chaque étude, une fiche (cf annexe 1) sera remplie par les deux parties.

4 – Spécifications

Les spécimens ou les prélèvements d'animaux morts seront collectés au CVFSE par Olivier Lambert. En fonction de la capacité de stockage de ces échantillons, Olivier Lambert préviendra en temps voulu l'Unité d'Anatomie pour leur récupération et leur transfert vers les laboratoires de l'Unité d'Anatomie. Aucun spécimen ou prélèvement d'animal mort ne pourra sortir du CVFSE vers l'Unité d'Anatomie sans l'autorisation préalable d'Olivier Lambert.

Les spécimens ou les prélèvements d'animaux morts seront préparés pour la réalisation des études dans les laboratoires de l'Unité d'Anatomie et par les étudiants concernés.

Une liste en double exemplaire (une pour le CVFSE et une pour l'Unité d'Anatomie) des animaux issus du CVFSE et utilisés devra être tenue à jour pour chaque étude : elle mentionnera le titre (provisoire ou définitif) de l'étude, le ou les étudiants concernés, l'espèce et le n° d'entrée de chaque animal utilisé (modèle cf annexe 2).

5 – Durée de la convention

La présente convention démarre dès sa signature et se poursuit jusqu'à la réalisation du rapport final de l'étude. Elle peut être annulée par une des deux structures en cas de non respect des consignes énoncées ci-dessus.

A Nantes, le 11.11.2007

Pour l'Unité d'Anatomie

L'enseignant chercheur

Claude Guintard



L'étudiant : Aurélia Borvon



A Nantes, le 11.05.07

Pour le CVFSE

Le capacitair

Olivier Lambert



ANNEXE 1 :

TITRE DE L'ETUDE :

Etude archéozoologique du site de Montsoreau (Maine-et-Loire, XIe siècle)

DEMANDEUR

Nom : Guintard

Prénom : Claude

Structure : ENVN

Laboratoire : Anatomie Comparée

Fonction : enseignant chercheur

UTILISATEUR

Nom : Borvon

Prénom : Aurélia

Coordonnées (tél, mail, ...) :

0240054663

aureliageronimo@aol.com

Cadre scolaire ou universitaire (thèse, exercice, M1, M2, doctorat, ...) :

Thèse de doctorat

ARGUMENTAIRE DE L'ETUDE :

Préparation d'une collection de référence ostéologique en vue de déterminer des spécimens archéologiques

OBJECTIFS PRINCIPAL ET OPERATIONNELS :

Diagnose (anatomie comparée) des espèces présentes sur les sites archéologiques

PROTOCOLE (matériel nécessaire, descriptif, ...) ET CALENDRIER :

Préparation des squelettes

2007-2012

Cette étude donnera lieu à la rédaction :

- d'un mémoire
- d'une thèse d'exercice
- d'une thèse de doctorat universitaire
- d'un (ou plusieurs) article scientifique

X

L'auteur devra mentionner le CVFSE en tant que :

- auteur
- remerciements

X

A Nantes, le 11.1X.2007

Pour l'Unité d'Anatomie

L'enseignant chercheur

Claude Guintard



L'étudiant

Aurélia Borvon



A Nantes, le 11.05.07

Pour le CVFSE

Le capacitaire

Olivier Lambert





PREFECTURE DE LA LOIRE-ATLANTIQUE

DIRECTION DE L'AMENAGEMENT
ET DE L'ENVIRONNEMENT
Bureau de l'Environnement
2008/BE/008

Nantes, le 21 JAN. 2008

**LE PREFET DE LA REGION PAYS-DE-LA-LOIRE
PREFET DE LA LOIRE-ATLANTIQUE
Officier de la légion d'honneur
Commandeur de l'ordre national du mérite**

VU le titre 1^{er} du livre IV - protection de la faune et de la flore - du code de l'environnement notamment les articles L413-2 à L413-5, R413-8 à R 413-9 et R413-22;

VU l'arrêté ministériel du 11 septembre 1992 relatif aux règles générales de fonctionnement et aux caractéristiques des installations des établissements qui pratiquent des soins sur les animaux de la faune sauvage;

VU la décision du ministre de l'environnement du 6 novembre 1995 accordant le certificat de capacité à Madame Monique L'HOSTIS en tant que responsable d'élevage d'animaux d'espèces non domestiques pour le centre de soins de la faune sauvage de l'école nationale vétérinaire de Nantes;

VU la décision du préfet de la Loire-Atlantique en date du 20 décembre 2007 accordant à Monsieur Olivier LAMBERT à titre définitif le certificat de capacité pour l'élevage de mammifères, oiseaux, reptiles et amphibiens de la faune européenne;

VU l'arrêté préfectoral n°97/PE/31 du 14 mars 1997 autorisant l'ouverture d'un centre de soins pour les animaux sauvages de la faune européenne situé dans l'enceinte de l'école nationale vétérinaire de Nantes;

VU la demande en date du 09 juillet 2007 déposée par Monsieur le directeur de l'école nationale vétérinaire de Nantes pour obtenir l'ouverture de l'établissement "centre vétérinaire de la faune sauvage de l'école nationale vétérinaire de Nantes" dans de nouveaux locaux, situés parc de la Chantrerie à Nantes;

Considérant le transfert du centre de soins de la faune sauvage de l'école nationale vétérinaire dans de nouveaux locaux situés dans le parc de la Chantrerie à compter du mois de novembre 2007;

SUR la proposition du secrétaire général de la préfecture de Loire-Atlantique;

ARRETE

Article 1^{er} : Le directeur de l'école nationale vétérinaire de Nantes est autorisé à ouvrir le centre vétérinaire de la faune sauvage et des écosystèmes situé à l'adresse suivante : route de Gachet – site Atlanpole-la Chantrerie – BP 40706 – 44307 NANTES cedex 03

Article 2 : L'ensemble des dispositions fixées par l'arrêté ministériel du 11 septembre 1992 *relatif aux règles générales de fonctionnement et aux caractéristiques des installations des établissements qui pratiquent des soins sur les animaux de la faune sauvage* doit être respecté.

Article 3 : Le centre est autorisé à accueillir des mammifères, des oiseaux, des reptiles et des amphibiens de la faune sauvage européenne.

Le nombre moyen d'animaux sera de 50 spécimens ; le nombre maximum de 150 spécimens. Ce nombre s'entend en dehors des périodes de crises écologiques majeures durant lesquelles ce nombre pourra être exceptionnellement dépassé sans toutefois compromettre la santé des personnes travaillant dans la structure.

Le nombre maximum d'animaux pourra être augmenté à concurrence de l'agrandissement des installations.

Article 4 : L'établissement sera implanté et installé conformément aux plans joints au dossier.

Toute transformation dans l'état des lieux et toute modification de l'installation dans sa partie technique et de son mode d'utilisation doivent être portés à la connaissance du préfet avant leur réalisation.

Article 5 : organisation générale

Tout changement de responsable des animaux doit faire l'objet d'une déclaration auprès des services préfectoraux dans le mois qui suit la prise en charge de l'établissement.

Un organigramme fonctionnel et hiérarchique sera tenu à la disposition des agents de l'administration en charge du contrôle.

La liste des titulaires de certificats de capacité sera tenue à la disposition des agents de l'administration en charge du contrôle.

L'exploitant élabore et fait respecter un règlement de service dont les caractéristiques figurent dans l'arrêté ministériel du 11 septembre 1992.

Article 6: dispositions particulières

6.1 - Etudes scientifiques, activités pédagogiques et de développement.

Du fait de sa situation au sein de l'école nationale vétérinaire de Nantes, établissement public à caractère administratif d'enseignement et de recherche, le centre est autorisé à développer les actions suivantes :

- information des particuliers qui viennent apporter des animaux ;
- réalisation d'outils pédagogiques pour les scolaires ;
- conférences, expositions, opérations de découverte ;
- accueil d'étudiants de l'école nationale vétérinaire de Nantes, de vétérinaires praticiens ainsi que d'étudiants d'autres structures (France et Etranger) ;
- recherche et développement.

Cependant, les bâtiments et volières du centre où sont hospitalisés les animaux ne sont pas ouverts au public.

6.2 - Devenir des cadavres.

Les cadavres des animaux issus du centre vétérinaire de la faune sauvage et des écosystèmes peuvent être utilisés :

-dans les laboratoires de l'école nationale vétérinaire de Nantes et dans le cadre de conventions passées avec d'autres organismes de recherche, pour la réalisation d'études scientifiques ou leur naturalisation ;

-pour les travaux pratiques organisés pour les étudiants de l'école nationale vétérinaire de Nantes.

In fine, tous les cadavres qui ne sont pas conservés sont déposés dans des boîtes inviolables et envoyés vers une usine de traitement autorisée afin d'y être incinérés.

6.3- Autorisations relatives aux espèces protégées.

Sous réserve de l'envoi à Monsieur le préfet de la Loire-Atlantique d'un rapport annuel d'activité comportant en particulier l'inventaire des animaux reçus, soignés et relâchés, les autorisations suivantes sont accordées sans limitation de durée au centre vétérinaire de la faune sauvage et des écosystèmes:

- autorisation de capturer ;
- autorisation de transporter ;
- autorisation de relâcher ;
- autorisation d'utiliser ;
- autorisation de naturaliser

les espèces figurant sur les listes établies pour l'application des articles L 411-1 et L 411-2 du code de l'environnement (espèces protégées) sur l'ensemble du territoire métropolitain.

Article 7: autres dispositions réglementaires

Le présent arrêté ne dispense pas le responsable de l'établissement de l'application de la réglementation relative au commerce et à la protection des animaux de la faune sauvage.

En aucun cas, ni en aucune époque, ces conditions ne pourront faire obstacle à l'application des dispositions édictées par le livre II du code du travail et des décrets réglementaires pris en exécution dudit livre dans l'intérêt de l'hygiène et de la sécurité des travailleurs, ni être opposées aux mesures qui pourraient être régulièrement ordonnées dans ce but.

Article 8: L'arrêté préfectoral n°97/PE/31 du 14 mars 1997 autorisant l'ouverture d'un centre de soins pour les animaux sauvages de la faune européenne situé dans l'enceinte de l'école nationale vétérinaire de Nantes est abrogé.

Article 9: Le secrétaire général de la préfecture de la Loire-Atlantique, le maire de NANTES, le directeur départemental des services vétérinaires, le chef du service départemental de l'office national de la chasse et de la faune sauvage sont chargés chacun en ce qui le concerne, de l'exécution du présent arrêté qui sera notifié à M. le directeur de l'école nationale vétérinaire de Nantes par lettre recommandée avec accusé réception.

Le PREFET

Pour le Préfet,
le Secrétaire Général,

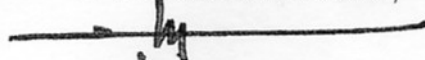

Fabien SUDRY

Annexe 3 : vestiges fauniques par US/Str. et par phase chronologique.

Les valeurs soulignées sont estimées ; NR : Nombre de Restes, MR : Masse des Restes en grammes.

Annexe 3.1 : première moitié du XI^e siècle.

33

		NR	NR	NR	MR	MR	MR
		"à vue"	tamissage	total	"à vue"	tamissage	total
Mammifères							
Bœuf	<i>Bos taurus</i>	165		165	3203.4		3203.4
Caprinés		167	4	171	889.4	3.6	893.0
Porc	<i>Sus scrofa f. domesticus</i>	658	46	704	3502.3	15.3	3517.6
Sanglier	<i>Sus scrofa scrofa</i>	1		1	17.1		17.1
Cerf	<i>Cervus elaphus</i>	2		2	61.0		61.0
Chevreuil	<i>Caprolus capreolus</i>	3		3	33.3		33.3
Lièvre	<i>Lepus europaeus</i>	5	1	6	11.8	1.6	13.4
Campagnol agreste	<i>Microtus agrestis</i>		6	6		0.12	0.12
Rat noir	<i>Rattus rattus</i>	18	1	19	7.6	0.07	7.67
Souris domestique	<i>Mus musculus</i>		1	1		0.06	0.06
Homme	<i>Homo sapiens</i>	1		1	0.4		0.4
	total déterminés	1020	59	1079	7726.3	20.75	7747.05
	indéterminés	1789	<u>8440</u>	<u>10229</u>	2800.0	165.46	2965.46
Total Mammifères		2809	<u>8499</u>	11308	10526.3	186.21	10712.51
Oiseaux							
Oie cendrée	<i>Anser anser</i>	11	2	13	28.2	1.3	29.5
Anatidés "Canards"		16	3	19	15.4	1.1	16.5
Poule domestique	<i>Gallus gallus</i>	196	61	257	285.8	22.0	307.8
Perdrix	<i>Alectoris / Perdix</i>		1	1		0.2	0.2
Oedicnème criard	<i>Burhinus oediconemus</i>	1		1	1		1.0
Bécasse des bois	<i>Scolopax rusticola</i>		1	1		0.2	0.2
Pygargue à queue blanche	<i>Haliaeetus albicilla</i>	2		2	9.2		9.2
petits passereaux			18	18		0.2	0.2
	total déterminés	226	86	312	339.6	25.0	364.6
	indéterminés	104	385	489	37	8.3	45.3
Total Oiseaux		330	471	801	376.6	33.25	409.9
coquilles d'œufs			6	6		0.02	0.02
"poissons"							
Cyprinidés		7	906	913	0.75	7.71	8.46
Brochet	<i>Esox lucius</i>	3	13	16	0.82	0.35	1.17
Cobitidés (Loches)			8	8		0.03	0.03
Anguille	<i>Anguilla anguilla</i>		128	128		0.75	0.75
Flet	<i>Platichthys flesus</i>	1	19	20	0.27	0.55	0.82
Grande Alose	<i>Alosa alosa</i>	1	6	7	0.24	0.19	0.43
Esturgeon	<i>Acipenser sturio</i>	1		1	13.25		13.25
Mulet	<i>Liza ramada</i>		18	18		1.00	1.00
	total déterminés	13	1098	1111	15.33	10.58	25.91
	indéterminés	15	<u>1437</u>	<u>1452</u>	0.9	7.07	7.97
Total "poissons"		28	<u>2535</u>	2563	16.23	17.65	33.88
écailles			504	504		0.56	0.56
Lissamphibiens							
Crapaud commun	<i>Bufo bufo</i>	1		1			
	indéterminés		1	1			
total Lissamphibiens		1	1	2			
Squamates							
Lacertidés (Lézards)			1	1			
restes de Vertébrés							
			+	+			
Mollusques							
Helicidés	<i>Cornu aspersum</i>	1	9	10			
Pomatidés	<i>Pomatias elegans</i>		2	2			
Lymnaeidés	<i>Radix balthica</i>		1	1			
Mytilidés	<i>Mytilus edulis</i>		1	1			
	total déterminés	1	13	14			
	indéterminés		3	3			
Total Mollusques		1	16	17			

34

Mammifères	NR	MR
Caprinés	1	4.4
Porc <i>Sus scrofa f. domesticus</i>	7	39.6
total déterminés	8	44.0
indéterminés	3	13.9
Total Mammifères	11	57.9

44

Mammifères	NR "à vue"	NR tamisage	NR total	MR "à vue"	MR tamisage	MR total
Bœuf <i>Bos taurus</i>						
Caprinés	85	68	153	221.2	23.2	244.4
Porc <i>Sus scrofa f. domesticus</i>	29	23	52	65.3	4.85	70.2
Léporidés		2	2		0.2	0.2
total déterminés	114	93	207	286.5	28.25	314.75
indéterminés	44	4192	4236	42.1	155.75	197.85
Total Mammifères	158	4285	4443	328.6	184	512.6
Oiseaux						
Poule domestique <i>Gallus gallus</i>	2	31	33	0.6	2.75	3.35
Caille des blés <i>Coturnix coturnix</i>		22	22		1.0	1.0
total déterminés	2	53	55	0.6	3.8	4.4
indéterminés	3	159	162	0.3	1.2	1.5
Total Oiseaux	5	212	217	0.9	4.95	5.81
coquilles d'œufs		1800	1800		9.3	9.3
"poissons"						
Cyprinidés	1	233	234	0.1	3.47	3.57
Brochet <i>Esox lucius</i>	1	10	11	0.11	0.27	0.38
Anguille <i>Anguilla anguilla</i>	3	1083	1086	0.2	4.34	4.54
Flet <i>Platichthys flesus</i>		8	8		0.067	0.07
Grande Alose <i>Alosa alosa</i>	4	24	28	0.55	0.95	1.50
total déterminés	9	1358	1367	0.96	9.092	10.05
indéterminés		4574	4574		15.21	15.21
Total "poissons"	9	5932	5941	0.96	24.302	25.26
écailles		33618	33618		54.0	54.0
Lissamphibiens						
"Grenouilles vertes" <i>Pelophylax sp.</i>		1	1			
Ranidés	1	4	5			
indéterminés		3	3			
total Lissamphibiens	1	8	9			
restes de Vertébrés						
		+	+			
Mollusques						
Agriolimacidae <i>Deroceras reticulatum ?</i>		1	1			
Endodontidés <i>Discus rotundatus</i>		1	1			
Hygromiidés <i>Trichia sp.</i>		1	1			
Hygromiidés <i>Candidula intersecta</i>		1	1			
Hygromiidés <i>Ceruella sp.</i>		1	1			
Helicidés <i>Cornu aspersum</i>		5	5			
Pomatiidés <i>Pomatias elegans</i>		33	33			
Vallonidés <i>Vallonia costata</i>		10	10			
Hydrobiidés <i>Bythinia sp.</i>		1	1			
Lymnaeidés <i>Radix sp.</i>		1	1			
Planorbidés <i>Gyraulus albus</i>		1	1			
total déterminés		56	56			
indéterminés		238	238			
Total Mollusques		294	294			

160

Mammifères		NR	MR
Bœuf	<i>Bos taurus</i>	35	1052.1
Caprinés		6	22.3
Porc	<i>Sus scrofa f. domesticus</i>	21	125.3
Lièvre	<i>Lepus europaeus</i>	1	1.1
	total déterminés	63	1200.8
	indéterminés	49	159.4
Total Mammifères		112	1360.2
Oiseaux			
Oie cendrée	<i>Anser anser</i>	1	5.5
Poule domestique	<i>Gallus gallus</i>	4	4.2
Bécasse des bois	<i>Scolopax rusticola</i>	1	0.2
Total Oiseaux		6	9.9
"poissons"			
	indéterminés	1	0.15
total "poissons"		1	0.15

332

Mammifères		NR	MR
Bœuf	<i>Bos taurus</i>	2	58.7
	indéterminés	1	3.4
Total Mammifères		3	62.1

334 / 354 / 359

Mammifères		NR "à vue"	NR tamisage	NR total	MR "à vue"	MR tamisage	MR total
Bœuf	<i>Bos taurus</i>	277		277	11042.1		11042.1
Caprinés		135	2	137	1085.3	0.2	1085.5
Porc	<i>Sus scrofa f. domesticus</i>	449	9	458	4336.1	6.6	4342.7
Sanglier	<i>Sus scrofa scrofa</i>	7		7	147.3		147.3
Cerf	<i>Cervus elaphus</i>	4		4	92.1		92.1
Chevreuril	<i>Caprolus capreolus</i>	2		2	60.8		60.8
Lièvre	<i>Lepus europaeus</i>	2		2	9.4		9.4
Équidés	<i>Equus sp.</i>	18		18	598.8		598.8
Rat noir	<i>Rattus rattus</i>		1	1		0.05	0.05
	total déterminés	894	12	906	17371.91	6.8	17378.71
	indéterminés	724	418	1142	3622.1	9.007	3631.107
Total Mammifères		1618	430	2048	20994	16	21009.8
Oiseaux							
Oie cendrée	<i>Anser anser</i>	11		11	29.0		29.0
Anatidés "Canards"		5		5	12.7		12.7
Poule domestique	<i>Gallus gallus</i>	10	5	15	14.1	3.2	17.3
Perdrix grise	<i>Perdix perdix</i>	1		1	0.6		0.6
Perdrix	<i>Alectoris / Perdix</i>	1		1	0.2		0.2
Paon	<i>Pavo cristatus</i>	1		1	6.8		6.8
Pigeons	<i>Columba sp.</i>	2		2	1.9		1.9
petits passereaux			6	6		0.03	0.03
	total déterminés	31	11	42	65.3	3.18	68.48
	indéterminés	3	87	90	2.6	0.8	3.4
Total Oiseaux		34	98	132	67.9	3.98	71.88
"poissons"							
Cyprinidés			307	307		0.80	0.80
Brochet	<i>Esox lucius</i>		15	15		0.10	0.10
Perche	<i>Perca fluviatilis</i>		1	1		0.01	0.01
Chabot	<i>Cottus gobio</i>		13	13		0.03	0.025
Cobitidés (Loches)			24	24		0.06	0.06
Gasterostéidés (Épinoche/Épinochette)			3	3		0.01	0.01
Anguille	<i>Anguilla anguilla</i>		153	153		0.67	0.67
Flet	<i>Platichthys flesus</i>		3	3		0.15	0.15
Esturgeon	<i>Acipenser sturio</i>	3		3	41.59		41.59
	total déterminés	3	519	522	41.59	1.81	43.40
	indéterminés		<u>1147</u>	<u>1147</u>		1.98	1.98
Total "poissons"		3	1666	1669	41.59	3.79	45.38
écailles			36	36		0.01	0.01
restes de Vertébrés			+	+			
Mollusques							
Pomatiidés	<i>Pomatias elegans</i>		6	6			
Total Mollusques			6	6			

336

Mammifères		NR	MR
Bœuf	<i>Bos taurus</i>	1	8.4
Porc	<i>Sus scrofa f. domesticus</i>	1	12.2
	total déterminés	2	20.6
	indéterminés	1	3.6
Total Mammifères		3	24.2

338

Mammifères		NR	MR
Caprinés		1	4.6
Porc	<i>Sus scrofa f. domesticus</i>	3	25.5
Total Mammifères		4	30.1

339

Mammifères		NR	MR
Bœuf	<i>Bos taurus</i>	3	234.4
Caprinés		5	47.7
Porc	<i>Sus scrofa f. domesticus</i>	1	3.6
Total Mammifères		9	285.7

341

Mammifères		NR	MR
Bœuf	<i>Bos taurus</i>	14	250.4
Caprinés		7	44.5
Porc	<i>Sus scrofa f. domesticus</i>	26	151.5
Chat	<i>Felis catus</i>	2	2.6
	total déterminés	49	449.0
	indéterminés	44	71.3
Total Mammifères		93	520.3
Oiseaux			
Oie cendrée	<i>Anser anser</i>	1	2.2
Poule domestique	<i>Gallus gallus</i>	3	3.7
Total Oiseaux		4	5.9

364

Mammifères		NR	MR
Bœuf	<i>Bos taurus</i>	5	90.3
Porc	<i>Sus scrofa f. domesticus</i>	8	108.5
	total déterminés	13	198.8
	indéterminés	2	5.1
Total Mammifères		15	203.9

371

Mammifères		NR	MR
Bœuf	<i>Bos taurus</i>	105	4725.8
Caprinés		35	230.3
Porc	<i>Sus scrofa f. domesticus</i>	98	1199.5
Cerf	<i>Cervus elaphus</i>	5	255.1
Lièvre	<i>Lepus europaeus</i>	2	1.1
Équidés	<i>Equus sp.</i>	1	61.8
	total déterminés	246	6473.6
	indéterminés	88	271.8
Total Mammifères		334	6745.4
Oiseaux			
Oie cendrée	<i>Anser anser</i>	2	3.9
Anatidés "Canards"		4	4.0
Poule domestique	<i>Gallus gallus</i>	9	18.5
	total déterminés	15	26.4
	indéterminés	13	2.9
Total Oiseaux		28	29.3
"poissons"			
Flet	<i>Platichthys flesus</i>	1	0.28

		NR	NR	NR	MR	MR	MR
		"à vue"	tamissage	total	"à vue"	tamissage	total
Mammifères							
Bœuf	<i>Bos taurus</i>	10	1	11	254.5	2.0	256.5
Caprinés		9	8	17	40.4	8.6	49.0
Porc	<i>Sus scrofa f. domesticus</i>	35	21	56	297.6	24.35	322.0
Cerf	<i>Cervus elaphus</i>	1		1	14.5		14.5
Lapin	<i>Oryctolagus cuniculus</i>						
Lièvre	<i>Lepus europaeus</i>		1	1		2.5	2.5
Chat	<i>Felis catus</i>	1		1	0.9		0.9
	total déterminés	56	31	87	607.9	37.45	645.35
	indéterminés	27	<u>1869</u>	<u>1896</u>	57.8	110.73	168.53
Total Mammifères		83	<u>1900</u>	<u>1983</u>	665.7	148.18	813.88
Oiseaux							
Oie cendrée	<i>Anser anser</i>	2		2	2.4		2.4
Anatidés "Canards"		4	15	19	2.4	2.4	4.8
Poule domestique	<i>Gallus gallus</i>	10	11	21	12.7	3.9	16.6
Vanneau huppé	<i>Vanellus vanellus</i>		2	2		0.3	0.3
Bécassine des marais	<i>Gallinago gallinago</i>		4	4		0.7	0.7
Bécasse des bois	<i>Scolopax rusticola</i>	2	1	3	0.2	0.5	0.7
Pigeons	<i>Columba sp.</i>		1	1		0.2	0.2
petits passereaux			10	10		0.06	0.06
	total déterminés	18	44	62	17.7	8.06	25.76
	indéterminés	10	<u>2170</u>	<u>2180</u>	2.2	22.1	24.3
Total Oiseaux		28	<u>2214</u>	<u>2242</u>	19.9	30.16	50.06
coquilles d'œufs			<u>1346</u>	<u>1346</u>		4.2	4.2
"poissons"							
Cyprinidés		6	801	807	1.49	6.18	7.67
Brochet	<i>Esox lucius</i>		5	5		0.08	0.08
Cobitidés (Loches)			5	5		0.025	0.03
Anguille	<i>Anguilla anguilla</i>		47	47		0.225	0.23
Flet	<i>Platichthys flesus</i>		74	74		1.585	1.59
Grande Alose	<i>Alosa alosa</i>		3	3		0.04	0.04
Alose feinte	<i>Alosa fallax</i>		9	9		0.12	0.12
Mulet	<i>Liza ramada</i>		1	1		0.12	0.12
Hareng	<i>Cuplea harengus</i>		8	8		0.09	0.09
	total déterminés	6	953	959	1.49	8.465	9.955
	indéterminés	3	<u>9464</u>	<u>9467</u>	0.8	16.83	17.63
Total "poissons"		9	<u>10417</u>	<u>10426</u>	2.29	25.29	27.58
écailles			<u>5080</u>	<u>5080</u>		2.54	2.54
restes de Vertébrés			+	+			
Lissamphibiens							
Ranidés			1	1			
Mollusques							
Clausiliidés	<i>Balea perversa</i>		1	1			
Helicidés	<i>Cornu aspersum</i>		13	13			
Pomatiidés	<i>Pomatias elegans</i>		211	211			
Vallonidés	<i>Vallonia costata</i>		7	7			
Vallonidés	<i>Vallonia excentrica</i>		2	2			
Vallonidés	<i>Vallonia pulchella</i>		3	3			
Vallonidés	<i>Vallonia sp.</i>		10	10			
Planorbidés	<i>Anisus spirorbis</i>		1	1			
	total déterminés		248	248			
	indéterminés		621	621			
Total Mollusques			869	869			

382

Mammifères		NR "à vue"	NR tamisage	NR total	MR "à vue"	MR tamisage	MR total
Bœuf	<i>Bos taurus</i>	7		7	245.7		245.7
Caprinés		6		6	73.1		73.1
Porc	<i>Sus scrofa f. domesticus</i>	6		6	72.6		72.6
	total déterminés	19	0	19	391.4	0	391.4
	indéterminés	1	232	233	1.5	5.0	6.5
Total Mammifères		20	232	252	392.9	5	397.9
Oiseaux							
Anatidés "Canards"			1	1		0.7	0.7
petits passereaux			17	17		0.14	0.14
	total déterminés	0	18	18	0	0.84	0.84
	indéterminés	3	52	55	0.1	0.1	0.2
Total Oiseaux		3	70	73	0.1	0.94	1.04
coquilles d'œufs			995	995		2.0	2.0
"poissons"							
Cyprinidés			13	13		0.06	0.06
Anguille	<i>Anguilla anguilla</i>		2	2		0.01	0.01
	total déterminés		15	15		0.07	0.07
	indéterminés		94	94		0.25	0.25
Total "poissons"			109	109		0.32	0.32
écailles			205	205		0.13	0.13
restes de Vertébrés			+	+			
Lissamphibiens							
Crapauds	<i>Bufo sp.</i>		1	1			
Mollusques							
Hélicidés			3	3			
Pomatiidés	<i>Pomatias elegans</i>		48	48			
Pupillidés	<i>Pupilla muscorum</i>		1	1			
Vallonidés	<i>Vallonia costata</i>		1	1			
Lymnaeidés	<i>Radix balthica</i>		1	1			
Planorbidés	<i>Anisus spirorbis</i>		1	1			
	total déterminés		55	55			
	indéterminés		188	188			
Total Mollusques			243	243			

384

Mammifères		NR	MR
Bœuf	<i>Bos taurus</i>	3	202.1
Caprinés		3	38.7
Porc	<i>Sus scrofa f. domesticus</i>	3	69.6
	total déterminés	9	310.4
	indéterminés	3	7.5
Total Mammifères		12	317.9

417

Mammifères		NR	MR
Bœuf	<i>Bos taurus</i>	1	18.6
Caprinés		1	2.7
Porc	<i>Sus scrofa f. domesticus</i>	1	38.9
Rat noir	<i>Rattus rattus</i>	1	0.24
	total déterminés	4	60.4
	indéterminés	2	1.6
Total Mammifères		6	62.04

419

Mammifères		NR	MR
Bœuf	<i>Bos taurus</i>	76	2601.0
Caprinés		98	527.8
Porc	<i>Sus scrofa f. domesticus</i>	306	1841.6
Cerf	<i>Cervus elaphus</i>	5	205.3
Lièvre	<i>Lepus europaeus</i>	6	3.0
Léporidés		1	0.1
Rat noir	<i>Rattus rattus</i>	33	11.0
Homme	<i>Homo sapiens</i>	4	1.8
	total déterminés	529	5191.6
	indéterminés	575	725.1
Total Mammifères		1104	5916.7
Oiseaux			
Oie cendrée	<i>Anser anser</i>	5	9.6
Anatidés "Canards"		1	1.4
Poule domestique	<i>Gallus gallus</i>	47	34.8
	total déterminés	53	45.8
	indéterminés	56	15.7
Total Oiseaux		109	61.5
"poissons"			
Cyprinidés		1	0.03
Brochet	<i>Esox lucius</i>	4	1.09
Flet	<i>Platichthys flesus</i>	1	0.2
Esturgeon	<i>Acipenser sturio</i>	4	14.14
	total déterminés	10	15.46
	indéterminés	3	0.21
total "poissons"		13	15.67

418

		NR	NR	NR	MR	MR	MR
		"à vue"	tamissage	total	"à vue"	tamissage	total
Mammifères							
Bœuf	<i>Bos taurus</i>	35		35	808.6		808.6
Caprinés		115	29	144	735.9	33.3	769.2
Porc	<i>Sus scrofa f. domesticus</i>	268	20	288	1678.1	23.8	1701.9
Sanglier	<i>Sus scrofa scrofa</i>	4		4	81.8		81.8
Chevreuil	<i>Caprolus capreolus</i>	1		1	18.1		18.1
Lièvre	<i>Lepus europaeus</i>	2	14	16	9.9	7.7	17.6
Musaraigne	<i>Crocidura leucodon/russula</i>		3	3		0.02	0.02
Rat noir	<i>Rattus rattus</i>	20	5	25	10.0	0.11	10.1
Souris domestique	<i>Mus musculus</i>		1	1		0.01	0.01
Muridés			4	4		0.09	0.09
total déterminés		445	76	521	3342.4	65	3407.5
indéterminés		595	1033	1628	583.5	36.61	620.11
Total Mammifères		1040	1109	2149	3925.9	101.68	4027.58
Oiseaux							
Oie cendrée	<i>Anser anser</i>	39	7	46	102.0	2.5	104.5
Anatidés "Canards"		15	6	21	14.7	1.1	15.8
Poule domestique	<i>Gallus gallus</i>	134	25	159	201.3	3.9	205.2
Bécassine des marais	<i>Gallinago gallinago</i>		1	1		0.2	0.2
Bécasse des bois	<i>Scolopax rusticola</i>	2	2	4	1.6	0.3	1.9
Butor étoilé	<i>Botaurus stellaris</i>	1		1	1.1		1.1
Pigeons	<i>Columba sp.</i>	2		2	0.8		0.8
petits passereaux		1	25	26	0.05	0.32	0.37
total déterminés		194	66	260	321.55	8.32	329.87
indéterminés		75	543	618	16.7	9.1	25.8
Total Oiseaux		269	609	878	338.25	17.42	355.67
coquilles d'œufs			1310	1310		12.1	12.1
"poissons"							
Cyprinidés		18	1670	1688	4.52	20.62	25.14
Brochet	<i>Esox lucius</i>	10	211	221	6.68	7.68	14.36
Perche	<i>Perca fluviatilis</i>	6	19	25	1.79	1.72	3.51
Ombre	<i>Thymallus thymallus</i>		2	2		0.01	0.01
Anguille	<i>Anguilla anguilla</i>		64	64		0.75	0.75
Flet	<i>Platichthys flesus</i>		3	3		0.33	0.33
Grande Alose	<i>Alosa alosa</i>	1	9	10	0.07	0.35	0.42
Hareng	<i>Cuplea harengus</i>		3	3		0.02	0.02
total déterminés		35	1981	2016	13.06	31.48	44.54
indéterminés		11	3492	3503	1.1	15.99	17.09
Total "poissons"		46	5473	5519	14.16	47.47	61.63
écailles			2216	2216		1.59	1.59
restes de Vertébrés				+			+
Mollusques							
Endodontidés	<i>Discus rotundatus</i>		1	1			
Hygromiidés	<i>Trichia hispida</i>		1	1			
Hygromiidés	<i>Candidula intersecta</i>		3	3			
Hygromiidés	<i>Helicella sp.</i>		1	1			
Helicidés	<i>Cornu aspersum</i>	3	2	5			
Pomatiidés	<i>Pomatias elegans</i>		1	1			
Pomatiidés	<i>Pomatias sp.</i>		16	16			
Vallonidés	<i>Vallonia sp.</i>		1	1			
Lymnaeidés	<i>Radix conf. balthica</i>		2	2			
Unionidés			1	1			
total déterminés		3	29	32			
indéterminés			57	57			
Total Mollusques		3	86	89			

420

		NR	MR
Mammifères			
Bœuf	<i>Bos taurus</i>	1	39.0
Caprinés		1	3.4
Porc	<i>Sus scrofa f. domesticus</i>	4	18.9
Rat noir	<i>Rattus rattus</i>	1	0.6
total déterminés		7	61.9
indéterminés		1	1.5
Total Mammifères		8	63.4
Oiseaux			
Poule domestique	<i>Gallus gallus</i>	1	1.8
Total Oiseaux		1	1.8

		NR	NR	NR	MR	MR	MR
		"à vue"	tamissage	total	"à vue"	tamissage	total
Mammifères							
Bœuf	<i>Bos taurus</i>	20		20	885.6		885.6
Caprinés		29	2	31	206.5	3.2	209.7
Porc	<i>Sus scrofa f. domesticus</i>	47	6	53	288.3	2.8	291.1
Sanglier	<i>Sus scrofa scrofa</i>	1		1	32.7		32.7
Cerf	<i>Cervus elaphus</i>	1		1	45.5		45.5
Léporidés			1	1		0.1	0.1
Rat noir	<i>Rattus rattus</i>		1	1		0.06	0.06
total déterminés		98	10	108	1458.6	6.12	1464.7
indéterminés		152	174	326	109.0	8.1	117.1
Total Mammifères		250	184	434	1567.6	14.2	1581.8
Oiseaux							
Oie cendrée	<i>Anser anser</i>	4		4	3.4		3.4
Anatidés "Canards"			1	1		0.8	0.8
Poule domestique	<i>Gallus gallus</i>	16	4	20	22.1	2.1	24.2
total déterminés		20	5	25	25.5	2.9	28.4
indéterminés		10	58	68	5.2	1.5	6.7
Total Oiseaux		30	63	93	30.7	4.4	35.1
coquilles d'œufs			20	20		0.2	0.2
"poissons"							
Cyprinidés		3	21	24	1.5	0.61	2.11
Brochet	<i>Esox lucius</i>		4	4		0.1	0.1
Anguille	<i>Anguilla anguilla</i>		9	9		0.12	0.12
Flet	<i>Platichthys flesus</i>		3	3		0.04	0.04
Grande Alose	<i>Alosa alosa</i>		1	1		0.05	0.05
total déterminés		3	38	41	1.5	0.92	2.42
indéterminés		7	93	100	0.3	0.83	1.13
Total "poissons"		10	131	141	1.8	1.75	3.55
écailles			51	51		0.83	0.83
Lissamphibiens							
Crapauds	<i>Bufo sp.</i>	1	1	2			
"Grenouilles vertes"	<i>Pelophylax sp.</i>		2	2			
	indéterminés		1	1			
Total Lissamphibiens		1	4	5			
Squamates							
Lézard vert	<i>Lacerta bilineata.</i>		1	1			
Mollusques							
Clausiliidés	<i>Clausilia bidentata ?</i>		1	1			
Hygromiidés	<i>Candidula sp.</i>		1	1			
Helicidés	<i>Cornu aspersum</i>		2	2			
Hélicidés			4	4			
Pomatiidés	<i>Pomatias elegans</i>		15	15			
Zonitidés	<i>Oxychilus sp.</i>		1	1			
Total Mollusques			24	24			

Annexe 3.2 : remplissage 36 du puits 472 (XI^e siècle).

		NR	NR	NR	MR	MR	MR
		"à vue"	tamissage	total	"à vue"	tamissage	total
Mammifères							
Boeuf	<i>Bos taurus</i>	10		10	213.3		213.3
Caprinés		58		58	214.0		214
Porc	<i>Sus scrofa f. domesticus</i>	98	15	113	629.4	4.5	633.9
Lapin	<i>Oryctolagus cuniculus</i>	1	1	2	1.5	1.0	2.5
Lièvre	<i>Lepus europaeus</i>	22	10	32	28.5	6.3	34.8
Léporidés		7	13	20	2.4	1.5	3.9
Équidés	<i>Equus sp.</i>	1		1	6.6		6.6
Arvicolidés			1	1		0.13	0.13
Homme	<i>Homo sapiens</i>	1		1	4.0		4.0
total déterminés		198	40	238	1099.67	13.43	1113.1
indéterminés		287	<u>2686</u>	<u>2973</u>	539.6	39.08	578.7
Total Mammifères		485	<u>2726</u>	3211	1639.27	52.51	1691.8
Oiseaux							
Oie cendrée	<i>Anser anser</i>	32	5	37	73.2	2.5	75.7
Anatidés "Canards"		22	6	28	23.5	1.6	25.1
Poule domestique	<i>Gallus gallus</i>	151	47	198	180.6	17.7	198.2
Perdrix grise	<i>Perdix perdix</i>		1	1		0.2	0.2
Paon	<i>Pavo cristatus</i>	1		1	1.9		1.9
Courlis cendré	<i>Numenius arquata</i>	2		2	3.3		3.3
Bécasse des bois	<i>Scolopax rusticola</i>	1		1	0.3		0.3
Héron cendré	<i>Ardea cinerea</i>	2		2	8.9		8.9
Spatule blanche	<i>Platalea leucorodia</i>	3		3	5.2		5.2
Pigeons	<i>Columba sp.</i>	1		1	1.4		1.4
petits passereaux			40	40		0.3	0.3
total déterminés		215	99	314	298.3	22.3	320.5
indéterminés		146	274	420	34.7	11.8	46.5
Total Oiseaux		361	373	734	333.0	34.1	367.0
coquilles d'œufs			<u>1367</u>	<u>1367</u>		6.0	6.0
"poissons"							
Cyprinidés		2	1134	1136	0.29	3.66	3.95
Brochet	<i>Esox lucius</i>	6	80	86	4.42	2.56	6.98
Perche	<i>Perca fluviatilis</i>		20	20		0.60	0.60
Ombre	<i>Thymallus thymallus</i>		3	3		0.02	0.02
Chabot	<i>Cottus gobio</i>		34	34		0.12	0.12
Cobitidés (Loches)			190	190		0.32	0.32
Gasterostéidés (Epinoche/Epinochette)			7	7		0.02	0.02
Anguille	<i>Anguilla anguilla</i>		225	225		1.30	1.30
Flet	<i>Platichthys flesus</i>		4	4		0.20	0.20
Hareng	<i>Cuplea harengus</i>		1	1		0.01	0.01
Salmonidés	<i>Salmo sp.</i>		5	5		0.04	0.04
total déterminés		8	1703	1711	4.71	8.84	13.55
indéterminés		8	<u>5222</u>	<u>5230</u>	0.12	9.89	10.01
Total "poissons"		16	<u>6925</u>	6941	4.83	18.73	23.56
écailles			471	471		0.38	0.38
Lissamphibiens							
Crapaud commun	<i>Bufo bufo</i>		4	4			
Crapaud calamite	<i>Bufo calamita</i>		1	1			
Crapaud	<i>Bufo sp.</i>		1	1			
"Grenouilles vertes"	<i>Pelophylax sp.</i>		1	1			
total déterminés			7	7			
indéterminés			2	2			
Total Lissamphibiens			9	9			
restes de Vertébrés			+	+			
Mollusques							
Hygromiidés	<i>Candidula intersecta</i>		1	1			
Helicidés	<i>Cornu aspersum</i>	10	140	150			
Hélicidés			1	1			
Pomatiidés	<i>Pomatiás elegans</i>		10	10			
Pupillidés	<i>Pupilla muscorum</i>		1	1			
Vallonidés	<i>Vallonia costata</i>		2	2			
Vallonidés	<i>Vallonia sp.</i>		1	1			
Hydrobiidés	<i>Bythinia sp.</i>		1	1			
Neritidés	<i>Theodoxus fluviatilis</i>		1	1			
Unionidés			1	1			
total déterminés		10	159	169			
indéterminés			221	221			
Total Mollusques		10	380	390			
Euarthropodes							
Diptères (pupes et larves)			<u>1780</u>	<u>1780</u>			
Coléoptères (larves)			27	27			
Cloportes			169	169			
Total Euarthropodes			<u>1976</u>	1976			

Annexe 3.3 : milieu du XI^e siècle.

85

Mammifères		NR	MR
Bœuf	<i>Bos taurus</i>	26	1121.4
Caprinés		17	223.3
Porc	<i>Sus scrofa f. domesticus</i>	17	227.5
Cerf	<i>Cervus elaphus</i>	2	52.5
total déterminés		62	1625
indéterminés		7	27.8
Total Mammifères		69	1653
Oiseaux			
Oie cendrée	<i>Anser anser</i>	1	2.3
Anatidés "Canards"		1	0.6
Total Oiseaux		2	2.9

90 - 91

Mammifères		NR	MR
Bœuf	<i>Bos taurus</i>	2	93.3
Porc	<i>Sus scrofa f. domesticus</i>	2	33.2
Total Mammifères		4	126.5

342

Mammifères		NR	MR
Bœuf	<i>Bos taurus</i>	11	451.3
Porc	<i>Sus scrofa f. domesticus</i>	9	105.0
total déterminés		20	556.3
indéterminés		6	15.5
Total Mammifères		26	571.8
Oiseaux			
Anatidés "Canards"		1	0.7

363 - 411

Mammifères		NR	MR
Bœuf	<i>Bos taurus</i>	219	7497.4
Caprinés		84	581.5
Porc	<i>Sus scrofa f. domesticus</i>	322	2699.2
Sanglier	<i>Sus scrofa scrofa</i>	5	136.4
Cerf	<i>Cervus elaphus</i>	5	254.5
Chevreuril	<i>Caprolus capreolus</i>	5	84.0
Lièvre	<i>Lepus europaeus</i>	2	3.2
Équidés	<i>Equus sp.</i>	41	1311.6
Rat noir	<i>Rattus rattus</i>	5	1.4
total déterminés		688	12569.2
indéterminés		353	1021.4
Total Mammifères		1041	13590.6
Oiseaux			
Oie cendrée	<i>Anser anser</i>	17	24.6
Anatidés "Canards"		12	11.1
Poule domestique	<i>Gallus gallus</i>	15	24.7
total déterminés		44	60.4
indéterminés		5	1.7
Total Oiseaux		49	62.05
"poissons"			
Esturgeon	<i>Acipenser sturio</i>	1	1.3
Total "poissons"		1	1.3

400

Mammifères		NR	MR
Bœuf	<i>Bos taurus</i>	30	709.5
Caprinés		39	236.4
Porc	<i>Sus scrofa f. domesticus</i>	141	908.3
Chevreuril	<i>Caprolus capreolus</i>	2	13.4
Lièvre	<i>Lepus europaeus</i>	1	3.6
Renard	<i>Vulpes vulpes</i>	1	7.0
total déterminés		214	1878.2
indéterminés		102	158.8
Total Mammifères		316	2037.0
Oiseaux			
Oie cendrée	<i>Anser anser</i>	1	1.0
Anatidés "Canards"		3	6.0
Poule domestique	<i>Gallus gallus</i>	9	16.4
Corneille noire (Corbeau freux)	<i>Corvus corone ?</i>	1	0.9
total déterminés		14	24.3
indéterminés		4	2.0
Total Oiseaux		18	26.3
"poissons"			
Cyprinidés		3	0.91
Esturgeon	<i>Acipenser sturio</i>	1	0.54
Total "poissons"		4	1.45

402

Mammifères		NR	MR
Bœuf	<i>Bos taurus</i>	25	1051.8
Caprinés		4	27.3
Porc	<i>Sus scrofa f. domesticus</i>	15	173.3
Lièvre	<i>Lepus europaeus</i>	1	2.2
total déterminés		45	1254.6
indéterminés		12	12.7
Total Mammifères		57	1267.3
Oiseaux			
Grue cendrée	<i>Grus grus</i>	1	10.1

405

Mammifères		NR	MR
Bœuf	<i>Bos taurus</i>	8	268.3
Caprinés		5	56.9
Porc	<i>Sus scrofa f. domesticus</i>	22	248.2
Cerf	<i>Cervus elaphus</i>	1	54.8
total déterminés		36	628.2
indéterminés		8	31.8
Total Mammifères		44	660.0
"poissons"			
Grande Alose	<i>Alosa alosa</i>	1	0.14
Esturgeon	<i>Acipenser sturio</i>	1	2.83
Total "poissons"		2	2.97

407

Mammifères		NR	MR
Bœuf	<i>Bos taurus</i>	2	30.8
Porc	<i>Sus scrofa f. domesticus</i>	3	13.4
total déterminés		5	44.2
indéterminés		2	8.6
Total Mammifères		7	52.8

Annexe 3.4 : seconde moitié du XI^e siècle.

22

Mammifères		NR	MR
Bœuf	<i>Bos taurus</i>	1	12.1
Caprinés		1	4.9
Porc	<i>Sus scrofa f. domesticus</i>	4	95.3
Cerf	<i>Cervus elaphus</i>	1	102.9
total déterminés		7	215.2
indéterminés		1	12.1
Total Mammifères		8	227.3

23

Mammifères		NR	MR
Porc	<i>Sus scrofa f. domesticus</i>	1	1.5
total déterminés		1	1.5
indéterminés		1	1.2
Total Mammifères		2	2.7
Oiseaux			
Poule domestique	<i>Gallus gallus</i>	1	1.7

24 - 98

Mammifères		NR	MR
Bœuf	<i>Bos taurus</i>	13	319.0
Caprinés		5	34.9
Porc	<i>Sus scrofa f. domesticus</i>	34	260.4
Équidés	<i>Equus sp.</i>	2	27.0
total déterminés		54	641.3
indéterminés		28	81.5
Total Mammifères		82	722.8
Oiseaux			
Oie cendrée	<i>Anser anser</i>	1	0.8
Poule domestique	<i>Gallus gallus</i>	3	2.1
total déterminés		4	2.9
indéterminés		1	2.3
Total Oiseaux		5	5.2
Mollusques			
Helicidés	<i>Cornu aspersum</i>	1	

42

Mammifères		NR	MR
Bœuf	<i>Bos taurus</i>	3	41.5
Caprinés		4	32.8
Porc	<i>Sus scrofa f. domesticus</i>	5	23.7
total déterminés		12	98.0
indéterminés		16	17.5
Total Mammifères		28	115.5
Oiseaux			
Poule domestique	<i>Gallus gallus</i>	1	2.0

52

Mammifères		NR	MR
Bœuf	<i>Bos taurus</i>	1	32.4
Équidés	<i>Equus sp.</i>	1	5.7
Total Mammifères		2	38.1

96

Mammifères		NR	MR
Bœuf	<i>Bos taurus</i>	2	62.5
Porc	<i>Sus scrofa f. domesticus</i>	4	32.2
total déterminés		6	94.7
indéterminés		7	29.2
Total Mammifères		13	123.9
Oiseaux			
Anatidés "Canards"		1	1.1

161

Mammifères		NR	MR
Bœuf	<i>Bos taurus</i>	8	254.2
Caprinés		2	4.7
Porc	<i>Sus scrofa f. domesticus</i>	12	116
total déterminés		22	374.9
indéterminés		10	38.7
Total Mammifères		32	413.6
Oiseaux			
Poule domestique	<i>Gallus gallus</i>	2	2.2

170

Mammifères		NR	MR
Bœuf	<i>Bos taurus</i>	15	482.7
Caprinés		14	85.4
Porc	<i>Sus scrofa f. domesticus</i>	42	339.1
Lièvre	<i>Lepus europaeus</i>	3	3.9
Chat	<i>Felis cattus</i>	1	1.7
Rat noir	<i>Rattus rattus</i>	1	0.42
total déterminés		76	913.2
indéterminés		34	54.3
Total Mammifères		110	967.52
Oiseaux			
Poule domestique	<i>Gallus gallus</i>	3	3.2
total déterminés		3	3.2
indéterminés		4	0.7
Total Oiseaux		7	3.9

171

Mammifères		NR	MR
Bœuf	<i>Bos taurus</i>	1	23.9
Porc	<i>Sus scrofa f. domesticus</i>	3	38.3
Rat noir	<i>Rattus rattus</i>	2	0.8
total déterminés		6	63.0
indéterminés		3	10.1
Total Mammifères		9	73.1

223

Mammifères		NR	MR
Porc	<i>Sus scrofa f. domesticus</i>	2	35.8

182

Mammifères		NR	MR
Bœuf	<i>Bos taurus</i>	1	18.2
Caprinés		1	1.6
Porc	<i>Sus scrofa f. domesticus</i>	3	17.5
total déterminés		5	37.3
indéterminés		4	11.9
Total Mammifères		9	49.2

213

Mollusques		NR
Unionidés		1

231

		NR	NR	NR	MR	MR	MR
		"à vue"	tamissage	total	"à vue"	tamissage	total
Mammifères							
Bœuf	<i>Bos taurus</i>	5		5	220.9		220.9
Caprinés		7		7	37.7		37.7
Porc	<i>Sus scrofa f. domesticus</i>	27	1	28	141.6	0.1	141.7
Cerf	<i>Cervus elaphus</i>	3		3	42.0		42.0
	total déterminés	42	1	43	442.2	0.1	442.3
	indéterminés	42	199	241	36.35	4.68	40.23
Total Mammifères		84	200	284	478.55	4.78	482.53
Oiseaux							
Oie cendrée	<i>Anser anser</i>	6		6	9.1		9.1
Anatidés "Canards"		1		1	1.8		1.8
Poule domestique	<i>Gallus gallus</i>	9		9	5.5		5.5
petits passereaux			3	3		0.02	0.02
	total déterminés	16	3	19	16.4	0.02	16.42
	indéterminés	3	25	28	1.2	1.9	3.1
Total Oiseaux		19	28	47	17.6	1.92	19.52
coquilles d'œufs			46	46		0.1	0.1
"poissons"							
Cyprinidés			13	13		0.075	0.075
Brochet	<i>Esox lucius</i>		1	1		0.005	0.005
Anguille	<i>Anguilla anguilla</i>		4	4		0.04	0.04
	total déterminés		18	18		0.12	0.12
	indéterminés		47	47		0.22	0.22
Total "poissons"			65	65		0.34	0.34
écailles			110	110		0.1	0.1
Lissamphibien indéterminé			1	1			
restes de Vertébrés			+	+			
Mollusques							
Clausiliidés	<i>Clausilia bidentata</i>		1	1			
Enidés	<i>Merdigera obscura</i>		1	1			
Endodontidés	<i>Discus rotundatus</i>		1	1			
Ferussaciidés	<i>Ceciliooides acicula</i>		3	3			
Hygromiidés	<i>Trichia sp.</i>		2	2			
Hygromiidés	<i>Candidula intersecta</i>		14	14			
Hygromiidés	<i>Candidula sp.</i>		1	1			
Helicidés	<i>Cornu aspersum</i>		18	18			
Pomatiidés	<i>Pomatias elegans</i>		1	1			
Pomatiidés	<i>Pomatias sp.</i>		84	84			
Pupillidés	<i>Lauria cylindracea</i>		3	3			
Pupillidés	<i>Pupilla sp.</i>		1	1			
Vallonidés	<i>Vallonia costata</i>		19	19			
Vallonidés	<i>Vallonia pulchella</i>		4	4			
Zonitidés	<i>Vitraea cristallina</i>		7	7			
	total déterminés		160	160			
	indéterminés		241	241			
Total Mollusques			401	401			

232

		NR	MR
Mammifères			
Bœuf	<i>Bos taurus</i>	2	17.2
Caprinés		11	44.1
Porc	<i>Sus scrofa f. domesticus</i>	55	103.4
Lièvre	<i>Lepus europaeus</i>	1	0.4
Mulot	<i>Apodemus sp.</i>	1	0.09
	total déterminés	70	165.2
	indéterminés	39	38.7
Total Mammifères		109	203.9
Oiseaux			
Oie cendrée	<i>Anser anser</i>	19	31.2
Anatidés "Canards"		4	5.4
Poule domestique	<i>Gallus gallus</i>	15	15.1
Butor étoilé	<i>Botaurus stellaris</i>	2	2.0
	total déterminés	40	53.7
	indéterminés	9	4.6
Total Oiseaux		49	58.3

233

		NR	MR
Mammifères			
Bœuf	<i>Bos taurus</i>	2	27.6
Caprinés		4	20.4
Porc	<i>Sus scrofa f. domesticus</i>	16	101.4
Cerf	<i>Cervus elaphus</i>	1	38.1
Chevreuil	<i>Caprolus capreolus</i>	3	12.2
	total déterminés	26	199.7
	indéterminés	17	47.4
Total Mammifères		43	247.1
Oiseaux			
Oie cendrée	<i>Anser anser</i>	3	5.4
Anatidés "Canards"		1	1.1
Poule domestique	<i>Gallus gallus</i>	2	1.7
Total Oiseaux		6	8.2

237

Mammifères		NR	MR
Bœuf	<i>Bos taurus</i>	36	365.7
Caprinés		72	336.4
Porc	<i>Sus scrofa f. domesticus</i>	186	538.1
Lièvre	<i>Lepus europaeus</i>	6	3.7
Léporidés		3	0.2
total déterminés		303	1244.1
indéterminés		303	365.3
Total Mammifères		606	1609.4
Oiseaux			
Oie cendrée	<i>Anser anser</i>	31	76.2
Anatidés "Canards"		11	9.3
Poule domestique	<i>Gallus gallus</i>	36	49.3
Butor étoilé	<i>Botaurus stellaris</i>	3	4.2
petits passereaux		1	0.005
total déterminés		82	139.005
indéterminés		24	5.4
Total Oiseaux		106	144.405
"poissons"			
Cyprinidés		3	0.81
Brochet	<i>Esox lucius</i>	8	2.25
Perche	<i>Perca fluviatilis</i>	2	0.33
Grande Alose	<i>Alosa alosa</i>	1	0.11
total déterminés		14	3.5
indéterminés		3	0.15
Total "poissons"		17	3.65

238

Mammifères		NR	MR
Bœuf	<i>Bos taurus</i>	23	833.9
Caprinés		5	45.6
Porc	<i>Sus scrofa f. domesticus</i>	52	442.7
Cerf	<i>Cervus elaphus</i>	4	126.9
total déterminés		84	1449.1
indéterminés		38	93.5
Total Mammifères		122	1542.6
Oiseaux			
Oie cendrée	<i>Anser anser</i>	1	2.9
Anatidés "Canards"		3	1.9
Poule domestique	<i>Gallus gallus</i>	2	0.7
total déterminés		6	5.5
indéterminés		1	0.3
Total Oiseaux		7	5.8

278

Mammifères		NR "à vue"	NR tamisage	NR total	MR "à vue"	MR tamisage	MR total
Bœuf	<i>Bos taurus</i>	1		1	2.2		2.2
Caprinés		4	1	5	6.6	0.3	6.9
Porc	<i>Sus scrofa f. domesticus</i>	7	7	14	7.8	3.0	10.8
Muridés			1	1		0.03	0.03
total déterminés		12	9	21	16.6	3.33	19.93
indéterminés		12	104	116	14.2	11.89	26.09
Total Mammifères		24	113	137	30.8	15.22	46.02
Oiseaux							
Oie cendrée	<i>Anser anser</i>	1		1	0.4		0.4
Poule domestique	<i>Gallus gallus</i>	1		1	0.2		0.2
petits passereaux		3	26	29	0.07	0.19	0.26
total déterminés		5	26	31	0.67	0.19	0.86
indéterminés		6	41	47	0.9	1.5	2.4
Total Oiseaux		11	67	78	1.57	1.69	3.26
coquilles d'œufs			2222	2222		11.8	11.8
"poissons"							
Cyprinidés		6	240	246	0.23	2.25	2.48
Brochet	<i>Esox lucius</i>		17	17		0.17	0.17
Perche	<i>Perca fluviatilis</i>		1	1		0.01	0.01
Ombre	<i>Thymallus thymallus</i>		1	1		0.01	0.01
Chabot	<i>Cottus gobio</i>		1	1		0.01	0.005
Cobitidés (Loches)			1	1		0.01	0.01
Anguille	<i>Anguilla anguilla</i>		25	25		0.26	0.26
Grande Alose	<i>Alosa alosa</i>		4	4		0.35	0.35
Hareng	<i>Cuplea harengus</i>		1	1		0.01	0.01
total déterminés		6	291	297	0.23	3.06	3.29
indéterminés		4	599	603	0.11	3.13	3.24
Total "poissons"		10	890	900	0.34	6.19	6.53
écailles			1545	1545		1.4	1.4
Lissamphibiens							
"Grenouilles rousses"	<i>Rana sp.</i>		1	1			
restes de Vertébrés							
			+	+			
Mollusques							
Hygromiidés	<i>Candidula sp.</i>		2	2			
Helicidés	<i>Cornu aspersum</i>		19	19			
Hélicidés			2	2			
Pomatiidés	<i>Pomatias sp.</i>		27	27			
Vallonidés	<i>Vallonia costata</i>		1	1			
total déterminés			51	51			
indéterminés			29	29			
Total Mollusques			80	80			

		NR	NR	NR	MR	MR	MR
		"à vue"	tamissage	total	"à vue"	tri	total
Mammifères							
Bœuf	<i>Bos taurus</i>	32	1	33	361.1	5.9	367.0
Caprinés		172	53	225	460.1	18.1	478.2
Porc	<i>Sus scrofa f. domesticus</i>	297	122	419	1009.9	38.00	1047.9
Lapin	<i>Oryctolagus cuniculus</i>	1		1	1.4		1.4
Lièvre	<i>Lepus europaeus</i>	4	19	23	6.2	7.1	13.3
Musaraigne musette	<i>Crocidura russula</i>		1	1		0.03	0.03
Campagnol agreste	<i>Microtus agrestis</i>		2	2		0.1	0.1
Rat noir	<i>Rattus rattus</i>		4	4		0.12	0.12
Souris domestique	<i>Mus musculus</i>		4	4		0.02	0.02
Muridés			5	5		0.05	0.05
total déterminés		506	211	717	1838.7	69.42	1908.12
indéterminés		681	<u>8523</u>	<u>9204</u>	786.6	362.14	1148.74
Total Mammifères		1187	8734	9921	2625.3	431.56	3056.86
Oiseaux							
Oie cendrée	<i>Anser anser</i>	73	26	99	97.5	6.3	103.8
Anatidés "Canards"		26	13	39	21.7	3.3	25.0
Poule domestique	<i>Gallus gallus</i>	106	114	220	64.1	12.1	76.1
Perdrix	<i>Alectoris / Perdix</i>		1	1		0.4	0.4
Caille des blés	<i>Coturnix coturnix</i>		1	1		0.1	0.1
Chevalier guignette	<i>Actitis hypoleucos</i>		1	1		0.09	0.09
Butor étoilé	<i>Botaurus stellaris</i>	3	1	4	3.8	0.4	4.2
Pigeons	<i>Columba sp.</i>	1	1	2	1.5	0.3	1.8
petits passereaux		5	440	445	0.3	4.71	5.01
total déterminés		214	598	812	188.85	27.65	216.5
indéterminés		64	<u>2746</u>	<u>2810</u>	28.0	89.4	117.4
Total Oiseaux		278	3344	3622	216.85	117.05	333.9
coquilles d'œufs			<u>28996</u>	<u>28996</u>		260.1	260.1
"poissons"							
Cyprinidés		10	3651	3661	1.44	29.23	30.67
Brochet	<i>Esox lucius</i>	19	810	829	12.59	22.61	35.20
Perche	<i>Perca fluviatilis</i>	1	75	76	0.2	3.47	3.67
Ombre	<i>Thymallus thymallus</i>		277	277		2.44	2.44
Chabot	<i>Cottus gobio</i>		9	9		0.045	0.045
Cobitidés (Loches)			13	13		0.035	0.035
Gasterostéidés (Épinoche/Épinochette)			5	5		0.01	0.01
Anguille	<i>Anguilla anguilla</i>	2	399	401	0.5	3.655	4.16
Flet	<i>Platichthys flesus</i>	7	58	65	1.39	2.22	3.61
Grande Alose	<i>Alosa alosa</i>	7	120	127	1.3	8.945	10.25
Mulet	<i>Liza ramada</i>	1	4	5	0.14	0.11	0.25
Hareng	<i>Cuplea harengus</i>		4	4		0.04	0.04
total déterminés		47	5425	5472	17.56	72.81	90.37
indéterminés		20	<u>17545</u>	<u>17565</u>	2.3	102.19	104.49
Total "poissons"		67	22970	23037	19.86	175	194.86
écailles			<u>31894</u>	<u>31894</u>		45.62	45.62
Lissamphibiens							
"Grenouilles rousses"	<i>Rana sp.</i>	3	17	20			
Grenouille agile	<i>Rana dalmatina</i>			1			
Total Lissamphibiens		3	17	21			
restes de Vertébrés							
			+	+			
Mollusques							
Agriolimacids	<i>Deroceras sp.</i>		1	1			
Endodontidés	<i>Discus rotundatus</i>		1	1			
Hygromiidés	<i>Candidula intersepta</i>		8	8			
Helicidés	<i>Cornu aspersum</i>		21	21			
Pomatidés	<i>Pomatias elegans</i>		30	30			
Vallonidés	<i>Vallonia costata</i>		2	2			
Zonitidés	<i>Oxychilus draparnaudi</i>		2	2			
Zonitidés	<i>Oxychilus sp.</i>		1	1			
Hydrobiidés	<i>Bithynia tentaculata</i>		1	1			
Lymnaeidés	<i>Radix balthica</i>		1	1			
Lymnaeidés	<i>Radix cf auricularia</i>		2	2			
Valvatidés	<i>Valvata piscinalis</i>		5	5			
total déterminés			75	75			
indéterminés			203	203			
Total Mollusques			278	278			

279

Mammifères		NR	MR
Bœuf	<i>Bos taurus</i>	18	698.8
Caprinés		13	63.3
Porc	<i>Sus scrofa f. domesticus</i>	18	170.3
Cerf	<i>Cervus elaphus</i>	2	86.5
Chevreuril	<i>Caprolus capreolus</i>	2	31.9
Équidés	<i>Equus sp.</i>	1	23.5
Chien	<i>Canis familiaris</i>	1	8.7
Rat noir	<i>Rattus rattus</i>	2	0.8
total déterminés		57	1083.8
indéterminés		11	21.7
Total Mammifères		68	1105.5
Oiseaux			
Anatidés "Canards"		1	0.3
Poule domestique	<i>Gallus gallus</i>	1	2.9
Total Oiseaux		2	3.2

296

Mammifères		NR	MR
Bœuf	<i>Bos taurus</i>	3	188.8
total déterminés		3	188.8
indéterminés		1	11.0
Total Mammifères		4	199.8

308

Mammifères		NR	MR
Bœuf	<i>Bos taurus</i>	29	673.1
Caprinés		7	90
Porc	<i>Sus scrofa f. domesticus</i>	51	326.3
Sanglier	<i>Sus scrofa scrofa</i>	1	26.2
Cerf	<i>Cervus elaphus</i>	2	98.9
Chevreuril	<i>Caprolus capreolus</i>	1	5.0
Équidés	<i>Equus sp.</i>		
total déterminés		91	1219.5
indéterminés		57	126.6
Total Mammifères		148	1346.1
Oiseaux			
Oie cendrée	<i>Anser anser</i>	2	2.5
Anatidés "Canards"		3	1.6
Poule domestique	<i>Gallus gallus</i>	12	8.8
petits passereaux		1	0.12
total déterminés		18	13.02
indéterminés		7	1.3
Total Oiseaux		25	14.32
Mollusques			
Helicidés	<i>Cornu aspersum</i>	4	

314

Mammifères		NR	MR
Bœuf	<i>Bos taurus</i>	1	14.3
Porc	<i>Sus scrofa f. domesticus</i>	5	36.6
Équidés	<i>Equus sp.</i>	1	197.1
total déterminés		7	248.0
indéterminés		3	13.2
Total Mammifères		10	261.2

317

Mammifères		NR	MR
Bœuf	<i>Bos taurus</i>	1	45.2
Porc	<i>Sus scrofa f. domesticus</i>	2	51.8
total déterminés		3	97.0
indéterminés		2	2.0
Total Mammifères		5	99.0
Oiseaux			
Oie cendrée	<i>Anser anser</i>	1	0.9
Poule domestique	<i>Gallus gallus</i>	1	1.5
Total Oiseaux		2	2.4

295

Mammifères		NR	MR
Bœuf	<i>Bos taurus</i>	1	19.2
Porc	<i>Sus scrofa f. domesticus</i>	1	3.6
total déterminés		2	22.8
indéterminés		1	2.7
Total Mammifères		3	25.5

300

Mammifères		NR	MR
Bœuf	<i>Bos taurus</i>	1	20.7
Porc	<i>Sus scrofa f. domesticus</i>	4	58.4
Chevreuril	<i>Caprolus capreolus</i>	1	20.4
total déterminés		6	99.5
indéterminés		1	3.0
Total Mammifères		7	102.5

302

Mammifères		NR	MR
Bœuf	<i>Bos taurus</i>	3	147.4
Porc	<i>Sus scrofa f. domesticus</i>	2	40.1
total déterminés		5	187.5
indéterminés		1	9.0
Total Mammifères		6	196.5
Mollusques			
Valvatidés	<i>Valvata piscinalis</i>	1	

311

Mammifères		NR	MR
Bœuf	<i>Bos taurus</i>	4	145.5
Caprinés		2	41.6
Porc	<i>Sus scrofa f. domesticus</i>	19	181.7
total déterminés		25	368.8
indéterminés		3	35.6
Total Mammifères		28	404.4
Oiseaux			
Oie cendrée	<i>Anser anser</i>	3	7.2

312

Mammifères		NR	MR
Bœuf	<i>Bos taurus</i>	5	145.5
Caprinés		1	15.4
Porc	<i>Sus scrofa f. domesticus</i>	5	142.2
Total Mammifères		11	303.1

316

Mammifères		NR	MR
Bœuf	<i>Bos taurus</i>	8	268.1
Caprinés		1	7.0
Porc	<i>Sus scrofa f. domesticus</i>	9	70.7
Sanglier	<i>Sus scrofa scrofa</i>	1	4.5
Cerf	<i>Cervus elaphus</i>	1	29.1
total déterminés		20	379.4
indéterminés		5	13.9
Total Mammifères		25	393.3
Oiseaux			
Anatidés "Canards"		1	0.5

322

Mammifères		NR	MR
Bœuf	<i>Bos taurus</i>	1	75.3
Caprinés		2	20.1
Porc	<i>Sus scrofa f. domesticus</i>	6	11.9
Cerf	<i>Cervus elaphus</i>	1	9.2
total déterminés		10	116.5
indéterminés		6	6.7
Total Mammifères		16	123.2

325

Mammifères		NR	MR
Bœuf	<i>Bos taurus</i>	1	4.9
Caprinés		3	37.1
Porc	<i>Sus scrofa f. domesticus</i>	14	68.1
Lièvre	<i>Lepus europaeus</i>	1	3.6
total déterminés		19	113.7
indéterminés		14	51.6
Total Mammifères		33	165.3
Oiseaux			
Anatidés "Canards"		1	0.2
Poule domestique	<i>Gallus gallus</i>	1	1.4
Total Oiseaux		2	1.6

326

Mammifères		NR	MR
Bœuf	<i>Bos taurus</i>	2	119.8
Caprinés		2	29.6
Porc	<i>Sus scrofa f. domesticus</i>	4	78.3
total déterminés		8	227.7
indéterminés		2	8.6
Total Mammifères		10	236.3

328

Mammifères		NR	MR
Bœuf	<i>Bos taurus</i>	5	99.8
Porc	<i>Sus scrofa f. domesticus</i>	4	33.7
Chevreuril	<i>Caprolus capreolus</i>	1	17.2
Total Mammifères		10	150.7
Oiseaux			
Tourterelle des bois	<i>Streptopelia turtur</i>	1	0.4

346

Mammifères		NR	MR
Bœuf	<i>Bos taurus</i>	2	284.4
Porc	<i>Sus scrofa f. domesticus</i>	7	134.0
total déterminés		9	418.4
indéterminés		4	11.2
Total Mammifères		13	429.6

361

Mammifères		NR	MR
Bœuf	<i>Bos taurus</i>	4	60.3
Caprinés		2	26.7
Porc	<i>Sus scrofa f. domesticus</i>	4	32.1
total déterminés		10	119.1
indéterminés		4	7.0
Total Mammifères		14	126.1

323 - 349

Mammifères		NR	MR
Bœuf	<i>Bos taurus</i>	8	522.9
Caprinés		9	42
Porc	<i>Sus scrofa f. domesticus</i>	16	89.2
Sanglier	<i>Sus scrofa scrofa</i>	1	42.5
Lièvre	<i>Lepus europaeus</i>	5	8.6
total déterminés		39	705.2
indéterminés		24	59.6
Total Mammifères		63	764.8
Oiseaux			
Anatidés "Canards"		1	0.3
Pigeons	<i>Columba sp.</i>	1	0.3
Total Oiseaux		2	0.6
"poissons"			
Esturgeon	<i>Acipenser sturio</i>	1	4.15

327 - 343

Mammifères		NR	MR
Bœuf	<i>Bos taurus</i>	12	338.7
Caprinés		6	26.9
Porc	<i>Sus scrofa f. domesticus</i>	9	106.7
Sanglier	<i>Sus scrofa scrofa</i>	1	23.3
Cerf	<i>Cervus elaphus</i>	1	22.3
Chevreuril	<i>Caprolus capreolus</i>	1	5.4
Équidés	<i>Equus sp.</i>	1	54.4
total déterminés		31	577.7
indéterminés		19	33.0
Total Mammifères		50	610.7
Oiseaux			
Anatidés "Canards"		1	0.4
Total Oiseaux		1	0.4
Mollusques			
Helicidés	<i>Cornu aspersum</i>	1	

330

Mammifères		NR	MR
Bœuf	<i>Bos taurus</i>	1	21
Porc	<i>Sus scrofa f. domesticus</i>	1	6.9
total déterminés		2	27.9
indéterminés		7	20.7
Total Mammifères		9	48.6

348

Mammifères		NR	MR
Bœuf	<i>Bos taurus</i>	5	159.4
Caprinés		4	33.6
Porc	<i>Sus scrofa f. domesticus</i>	13	94.5
Cerf	<i>Cervus elaphus</i>	2	73.3
Chevreuril	<i>Caprolus capreolus</i>	1	11.0
Lièvre	<i>Lepus europaeus</i>	1	2.3
total déterminés		26	374.1
indéterminés		11	54.4
Total Mammifères		37	428.5
Oiseaux			
Oie cendrée	<i>Anser anser</i>	1	1.9
Poule domestique	<i>Gallus gallus</i>	1	0.8
Total Oiseaux		2	2.7

		NR	NR	NR	MR	MR	MR
		"à vue"	tamisa	total	"à vue"	tamisa	total
Mammifères							
Bœuf	<i>Bos taurus</i>	23	5	28	717.0	1.2	718.2
Caprinés		33	2	35	214.6	1.1	215.7
Porc	<i>Sus scrofa f. domesticus</i>	111	17	128	711.7	3.6	715.3
Cerf	<i>Cervus elaphus</i>	4		4	67.6		67.6
Chevreuril	<i>Caprolus capreolus</i>	1		1	11.5		11.5
Lièvre	<i>Lepus europaeus</i>	1		1	1.3		1.3
Léporidés			1	1		0.2	0.2
Musaraigne musette	<i>Crocidura russula</i>		4	4		0.09	0.09
Rat noir	<i>Rattus rattus</i>		3	3		0.1	0.1
Rat des moissons	<i>Micromys minutus</i>		5	5		0.02	0.02
	total déterminés	173	37	210	1723.7	6.3	1730.0
	indéterminés	116	449	565	302.0	52.2	354.2
Total Mammifères		289	486	775	2025.7	58.5	2084.2
Oiseaux							
Oie cendrée	<i>Anser anser</i>	5		5	8.8		8.8
Anatidés "Canards"		3		3	4.0		4
Poule domestique	<i>Gallus gallus</i>	10	9	19	11.4	1.7	13.1
Perdrix rouge	<i>Alectoris rufa</i>	1		1	0.8		0.8
Cigogne blanche	<i>Ciconia ciconia ?</i>		1	1		4.1	4.1
Pigeons	<i>Columba sp.</i>		1	1		0.2	0.2
petits passereaux			30	30		0.24	0.24
	total déterminés	19	41	60	25	6.24	31.24
	indéterminés	7	122	129	1.5	2.4	3.9
Total Oiseaux		26	163	189	26.5	8.64	35.14
coquilles d'œufs			3015	3015		12.6	12.6
"poissons"							
Cyprinidés		14	1039	1053	6.21	15.19	21.40
Brochet	<i>Esox lucius</i>	2	126	128	0.58	1.67	2.25
Perche	<i>Perca fluviatilis</i>		12	12		0.18	0.18
Ombre	<i>Thymallus thymallus</i>		1	1		0.01	0.01
Chabot	<i>Cottus gobio</i>		1	1		0.01	0.005
Anguille	<i>Anguilla anguilla</i>	1	281	282	0.05	2.47	2.52
Flet	<i>Platichthys flesus</i>		13	13		0.17	0.17
Grande Alose	<i>Alosa alosa</i>	2	20	22	0.23	0.66	0.89
Hareng	<i>Cuplea harengus</i>		1	1		0.01	0.01
	total déterminés	19	1494	1513	7.07	20.36	27.43
	indéterminés	9	5964	5973	0.21	38.8	39.0
Total "poissons"		28	7458	7486	7.28	59.2	66.43
écailles			9047	9047		14.2	14.2
Lissamphibiens							
"Grenouilles vertes"	<i>Pelophylax sp.</i>		8	8			
restes de Vertébrés							
			+	+			
Mollusques							
Agriolimacés	<i>Deroceras reticulatum ?</i>		1	1			
Clausiliidés	<i>Balea perversa</i>		5	5			
Endodontidés	<i>Discus rotundatus</i>		4	4			
Hygromiidés	<i>Trichia hispida</i>		7	7			
Hygromiidés	<i>Candidula intersecta</i>		4	4			
Helicidés	<i>Cornu aspersum</i>		49	49			
Hélicidés			1	1			
Pomatiidés	<i>Pomatias sp.</i>		100	100			
Pupillidés	<i>Lauria cylindracea</i>		2	2			
Vallonidés	<i>Vallonia costata</i>		3	3			
Vallonidés	<i>Vallonia excentrica</i>		3	3			
Vallonidés	<i>Vallonia sp.</i>		1	1			
Zonitidés	<i>Vitraea cristallina</i>		1	1			
Hydrobiidés	<i>Bithynia tentaculata</i>		1	1			
Hydrobiidés	<i>Bythinia sp.</i>		1	1			
Lymnaeidés	<i>Radix sp.</i>		9	9			
Planorbidés	<i>Anisus spirorbis</i>		5	5			
Valvatidés	<i>Valvata piscinalis</i>		1	1			
Sphaeriidés	<i>Pisidium subtruncatum</i>		2	2			
Sphaeriidés			1	1			
Mytilidés	<i>Mytilus edulis</i>		1	1			
	total déterminés		202	202			
	indéterminés		515	515			
Total Mollusques			717	717			

393

Mammifères		NR	MR
Bœuf	<i>Bos taurus</i>	4	129.0
Caprinés		4	25.2
Porc	<i>Sus scrofa f. domesticus</i>	9	39.0
total déterminés		17	193.2
indéterminés		5	6.1
Total Mammifères		22	199.3

404

Mammifères		NR	MR
Bœuf	<i>Bos taurus</i>	1	28.1
Porc	<i>Sus scrofa f. domesticus</i>	1	9.8
total déterminés		2	37.9
indéterminés		1	2.9
Total Mammifères		3	40.8
Oiseaux			
Anatidés "Canards"		1	1.0
Total Oiseaux		1	1

452

Mammifères		NR	MR
Bœuf	<i>Bos taurus</i>	1	22.2
Caprinés		2	8.9
Porc	<i>Sus scrofa f. domesticus</i>	5	38.7
total déterminés		8	69.8
indéterminés		4	7.2
Total Mammifères		12	77.0
Oiseaux indéterminés			
		1	0.2

397

Mammifères		NR	MR
Bœuf	<i>Bos taurus</i>	13	290.1
Caprinés		46	284.4
Porc	<i>Sus scrofa f. domesticus</i>	82	595.1
total déterminés		141	1169.6
indéterminés		60	126.2
Total Mammifères		201	1295.8
Oiseaux			
Oie cendrée	<i>Anser anser</i>	2	2
indéterminés		1	0.4
Total Oiseaux		3	2.4

436

Mammifères		NR	MR
Porc	<i>Sus scrofa f. domesticus</i>	2	18.3
indéterminés		1	1.1
Total Mammifères		3	19.4

453

Mammifères		NR	MR
Caprinés		1	1.7
Porc	<i>Sus scrofa f. domesticus</i>	2	22.7
total déterminés		3	24.4
indéterminés		2	1.2
Total Mammifères		5	25.6

Annexe 3.5 : XII^e - XIV^e siècles.

26

Mammifères		NR	MR
Bœuf	<i>Bos taurus</i>	2	181.3
Porc	<i>Sus scrofa f. domesticus</i>	7	44.4
Total Mammifères		9	225.7

286 - 299

Mammifères		NR	MR
Bœuf	<i>Bos taurus</i>	15	320.1
Caprinés		5	23.6
Porc	<i>Sus scrofa f. domesticus</i>	15	104.0
Cerf	<i>Cervus elaphus</i>	1	40.5
total déterminés		36	488.2
indéterminés		21	30.7
Total Mammifères		57	518.9
Oiseaux			
Oie cendrée	<i>Anser anser</i>	3	9.0
Anatidés "Canards"		1	0.6
Poule domestique	<i>Gallus gallus</i>	2	1.7
Bécasse des bois	<i>Scolopax rusticola</i>	1	0.2
Total Oiseaux		7	11.5

71 (XII-XIII)

		NR	NR	NR	MR	MR	MR
		"à vue"	tamissage	total	"à vue"	tamissage	total
Mammifères							
Bœuf	<i>Bos taurus</i>	4		4	25.6		25.6
Caprinés		15		15	61.4		61.4
Porc	<i>Sus scrofa f. domesticus</i>	36	1	37	146.1	0.6	146.7
Chat	<i>Felis catus</i>	29	11	40	50.8	1.4	52.1
Campagnol agreste	<i>Microtus agrestis</i>		1	1		0.01	0.01
	total déterminés	84	13	97	283.85	1.96	285.81
	indéterminés	42	235	277	41.4	13.47	54.87
Total Mammifères		126	248	374	325.25	15.43	340.68
Oiseaux							
Oie cendrée	<i>Anser anser</i>	4		4	6.3		6.3
Anatidés "Canards"		1	1	2	0.5	0.3	0.8
Poule domestique	<i>Gallus gallus</i>	13	8	21	12.9	2.2	15.1
Epervier d'Europe	<i>Accipiter nisus</i>		3	3		1.2	1.2
petits passereaux			5	5		0.04	0.04
	total déterminés	18	17	35	19.7	3.74	23.44
	indéterminés	10	129	139	3.8	2.4	6.2
Total Oiseaux		28	146	174	23.5	6.14	29.64
coquilles d'œufs			1559	1559		8.7	8.7
"poissons"							
Cyprinidés		1	150	151	0.15	1.226	1.376
Brochet	<i>Esox lucius</i>		17	17		1.57	1.57
Perche	<i>Perca fluviatilis</i>		1	1		0.25	0.25
Anguille	<i>Anguilla anguilla</i>		35	35		0.29	0.29
Flet	<i>Platichthys flesus</i>		1	1		0.19	0.19
Grande Alose	<i>Alosa alosa</i>	6	5	11	1.76	0.42	2.18
Hareng	<i>Cuplea harengus</i>		1	1		0.03	0.03
	total déterminés	7	210	217	1.91	3.98	5.89
	indéterminés	8	453	461	0.09	2.17	2.26
Total "poissons"		15	663	678	2	6.14	8.14
écailles			3674	3674		2.57	2.57
Lissamphibiens							
"Grenouilles rousses"	<i>Rana sp.</i>		4	4			
Squamates							
Lacertidés	lézards		1	1			
restes de Vertébrés							
			+	+			
Euarthropodes							
Cloportes			2	2			
Mollusques							
Clausiliidés	<i>Balea perversa</i>		2	2			
Hygromiidés	<i>Trichia sp.</i>		4	4			
Hygromiidés	<i>Candidula sp.</i>		1	1			
Helicidés	<i>Cornu aspersum</i>	1	19	20			
Hélicidés			1	1			
Pomatiidés	<i>Pomatias elegans</i>		17	17			
Pupillidés	<i>Lauria cylindracea</i>		6	6			
Pupillidés	<i>Pupilla muscorum</i>		1	1			
Vallonidés	<i>Vallonia pulchella</i>		3	3			
Vallonidés	<i>Vallonia sp.</i>		1	1			
Zonitidés	<i>Oxychilus cellarius</i>		1	1			
Zonitidés	<i>Oxychilus sp.</i>		19	19			
Endodontidés	<i>Discus rotundatus</i>		7	7			
Planorbidés	<i>Anisus spirorbis</i>		1	1			
Succineidés	<i>Succinea putris</i>		1	1			
Unionidés	<i>Unio sp.</i>	3		3			
	total déterminés	4	84	88			
	indéterminés	4	120	120			
Total Mollusques		4	204	208			

304

Mammifères	NR "à vue"	NR tamisage	NR total	MR "à vue"	MR tamisage	MR total
Caprinés	4	1	5	11.9	0.5	12.4
Porc <i>Sus scrofa f. domesticus</i>	3		3	2.5		2.5
total déterminés	7	1	8	14.4	0.5	14.9
indéterminés	8	87	95	11.1	1.9	13.0
Total Mammifères	15	88	103	25.5	2.4	27.9
coquilles d'œufs		146	146		0.3	0.3
"poissons"						
Cyprinidés	1	1	2	0.19	0.005	0.195
Grande Alose <i>Alosa alosa</i>		1	1		0.050	0.050
total déterminés	1	2	3	0.19	0.055	0.245
indéterminés		4	4		0.015	0.015
Total "poissons"	1	6	7	0.19	0.07	0.26
écailles		28	28		0.02	0.02
Mollusques						
Hygromiidés <i>Trichia sp.</i>		1	1			
Hygromiidés <i>Candidula sp.</i>		1	1			
Vallonidés <i>Vallonia costata</i>		12	12			
total déterminés		14	14			
indéterminés		195	195			
Total Mollusques		209	209			

306

Mammifères	NR	MR
Bœuf <i>Bos taurus</i>	2	40.5
Caprinés	13	27.1
Porc <i>Sus scrofa f. domesticus</i>	5	9.3
Cerf <i>Cervus elaphus</i>	1	9.2
Lièvre <i>Lepus europaeus</i>	1	0.5
total déterminés	22	86.6
indéterminés	12	12.6
Total Mammifères	34	99.2
Oiseaux		
Anatidés "Canards"	2	0.9
Poule domestique <i>Gallus gallus</i>	6	4.8
total déterminés	8	5.7
indéterminés	13	1.1
Total Oiseaux	21	6.8
"poissons"		
Cyprinidés	1	0.07
Total "poissons"	1	0.07

310

Mammifères	NR	MR
Bœuf <i>Bos taurus</i>	1	7.5
Caprinés	1	7.8
Porc <i>Sus scrofa f. domesticus</i>	1	13.4
total déterminés	3	28.7
indéterminés	1	4.0
Total Mammifères	4	32.7

Annexe 3.6 : XV^e - XX^e siècles.

451

XV^e

Mammifères	NR	MR
Porc <i>Sus scrofa f. domesticus</i>	1	9.5
indéterminés	1	1.4
Total Mammifères	2	10.9

10

XV^e-XVI^e

Mammifères	NR	MR
Bœuf <i>Bos taurus</i>	1	9.5
Caprinés	4	11.4
Porc <i>Sus scrofa f. domesticus</i>	9	34.8
Total Mammifères	14	55.7
Oiseaux		
Poule domestique <i>Gallus gallus</i>	1	1.3
"poissons"		
Brochet <i>Esox lucius</i>	1	0.83

		NR	NR	NR	MR	MR	MR
		"à vue"	tamissage	total	"à vue"	tamissage	total
Mammifères							
Bœuf	<i>Bos taurus</i>	18		18	535.3		535.3
Caprinés		14	2	16	90.1	0.8	90.9
Porc	<i>Sus scrofa f. domesticus</i>	15	8	23	209.4	0.7	210.1
Chien	<i>Canis familiaris</i>	2	3	5	1.0	0.7	1.7
Rat noir	<i>Rattus rattus</i>	3	121	124	2.08	5.14	7.22
Souris domestique	<i>Mus musculus</i>		2	2		0.04	0.04
Muridés			10	10		0.16	0.16
	total déterminés	52	146	198	837.88	7.54	845.42
	indéterminés	19	938	957	38.6	24.7	63.3
Total Mammifères		71	1084	1155	876.48	32.24	908.72
Oiseaux							
Oie cendrée	<i>Anser anser</i>	9	9	18	20.4	2.1	22.5
Anatidés "Canards"			1	1		0.1	0.1
Poule domestique	<i>Gallus gallus</i>	22	18	40	25.0	3.0	28.0
Perdrix rouge	<i>Alectoris rufa</i>		1	1		0.3	0.3
petits passereaux			8	8		0.12	0.12
	total déterminés	31	37	68	45.4	5.62	51.02
	indéterminés	18	308	326	3.1	10.1	13.2
Total Oiseaux		49	345	394	48.5	15.72	64.22
coquilles d'œufs			337	337		2.1	2.1
"poissons"							
Cyprinidés		4	303	307	3.03	1.96	4.99
Brochet	<i>Esox lucius</i>	3	31	34		0.63	0.63
Cobitidés (Loches)			4	4		0.02	0.015
Gasterostéidés (Epinoche/Epinochette)			4	4		0.01	0.01
Anguille	<i>Anguilla anguilla</i>		56	56		0.30	0.30
Mulet	<i>Liza ramada</i>	1	1	2	1.8	0.13	1.93
Hareng	<i>Cuplea harengus</i>		3	3		0.02	0.02
	total déterminés	8	402	410	4.83	3.06	7.89
	indéterminés	6	584	590	0.1	2.27	2.37
Total "poissons"		14	986	1000	4.93	5.33	10.26
écailles			5519	5519		6.03	6.03
Lissamphibien indéterminés			3	3			
Squamates							
Lacertidés	lézards		1	1			
restes de Vertébrés			+	+			
Euarthropodes							
Diptères (pupes et larves)			20	20			
Cloportes			742	742			
Total Euarthropodes			762	762			
Mollusques							
Clausiliidés	<i>Balea perversa</i>		6	6			
Clausiliidés	<i>Clausilia sp.</i>		2	2			
Ferussaciidés	<i>Cecilioides acicula</i>		3	3			
Hygromiidés	<i>Candidula intersecta</i>		13	13			
Helicidés	<i>Cornu aspersum</i>	3	55	58			
Hélicidés			12	12			
Pomatidés	<i>Pomatias elegans</i>		2	2			
Pomatidés	<i>Pomatias sp.</i>		47	47			
Pupillidés	<i>Pupilla muscorum</i>		5	5			
Pupillidés	<i>Pupilla sp.</i>		2	2			
Vallonidés	<i>Vallonia costata</i>		8	8			
Vallonidés	<i>Vallonia pulchella</i>		1	1			
Zonitidés	<i>Oxychilus sp.</i>		1	1			
Endodontidés	<i>Discus rotundatus</i>		1	1			
	total déterminés	3	158	161			
	indéterminés		269	269			
Total Mollusques		3	427	430			

162		XV ^e -XVI ^e	
Mammifères		NR	MR
Porc	<i>Sus scrofa f. domesticus</i>	1	12.7

168		XV ^e -XVI ^e	
Mammifères		NR	MR
Bœuf	<i>Bos taurus</i>	1	93.6

190		XV ^e -XVI ^e	
Mammifères		NR	MR
Caprinés		1	4.6
Porc	<i>Sus scrofa f. domesticus</i>	1	8.2
Total Mammifères		2	12.8

213		XV ^e -XVI ^e	
Mammifères		NR	MR
Porc	<i>Sus scrofa f. domesticus</i>	1	0.1
	indéterminés	3	3.6
Total Mammifères		4	3.7
Mollusques			
Unionidés		1	

429		XV ^e -XVI ^e	
Mammifères		NR	MR
	indéterminés	1	3.6

220		XVI ^e -XVII ^e	
Mammifères		NR	MR
Bœuf	<i>Bos taurus</i>	4	164.9
Caprinés		2	25.5
Porc	<i>Sus scrofa f. domesticus</i>	2	41.7
Sanglier	<i>Sus scrofa scrofa</i>	2	24.6
	total déterminés	10	256.7
	indéterminés	2	3.9
Total Mammifères		12	260.6
"poissons"			
Brochet	<i>Esox lucius</i>	2	0.48

7		XVII ^e -XVIII ^e	
Mammifères		NR	MR
Bœuf	<i>Bos taurus</i>	23	327.6
Caprinés		7	41.8
Porc	<i>Sus scrofa f. domesticus</i>	11	61.4
Sanglier	<i>Sus scrofa scrofa</i>	1	3.5
Équidés	<i>Equus sp.</i>	1	30.1
	total déterminés	43	464.4
	indéterminés	35	84.8
Total Mammifères		78	549.2
Oiseaux			
Poule domestique	<i>Gallus gallus</i>	3	2.3
Mollusques			
Mytilidés	<i>Mytilus edulis</i>	1	
Ostreidés	<i>Ostrea edulis</i>	2	
Total Mollusques		3	

167		XV ^e -XVI ^e	
Mammifères		NR	MR
Bœuf	<i>Bos taurus</i>	3	193.0
Porc	<i>Sus scrofa f. domesticus</i>	5	113.8
	total déterminés	8	306.8
	indéterminés	1	5.0
Total Mammifères		9	311.8

210		XV ^e -XVI ^e	
Mammifères		NR	MR
Bœuf	<i>Bos taurus</i>	10	567.4
Caprinés		11	146.9
Porc	<i>Sus scrofa f. domesticus</i>	8	186.1
	total déterminés	29	900.4
	indéterminés	2	7.3
Total Mammifères		31	907.7

315		XV ^e -XVI ^e	
Mammifères		NR	MR
Bœuf	<i>Bos taurus</i>	2	106.3
	indéterminés	1	5.3
Total Mammifères		3	111.6

175		XVI ^e -XVIII ^e	
Mammifères		NR	MR
Bœuf	<i>Bos taurus</i>	3	71.1
Caprinés		2	7.4
Porc	<i>Sus scrofa f. domesticus</i>	1	7.9
	total déterminés	6	86.4
	indéterminés	1	1.4
Total Mammifères		7	87.8
Mollusques			
Ostreidés	<i>Ostrea edulis</i>	1	

8		XVII ^e -XVIII ^e	
Mammifères		NR	MR
Bœuf	<i>Bos taurus</i>	1	15.0
Caprinés		2	14.0
	total déterminés	3	29.0
	indéterminés	2	11.1
Total Mammifères		5	40.1
Mollusques			
Ostreidés	<i>Ostrea edulis</i>	1	

21		XVII ^e -XVIII ^e	
Mammifères		NR	MR
Porc	<i>Sus scrofa f. domesticus</i>	1	6.1
Oiseaux			
Poule domestique	<i>Gallus gallus</i>	1	0.1

39		XVII ^e -XVIII ^e	
Mammifères		NR	MR
Bœuf	<i>Bos taurus</i>	8	277.7
Caprinés		8	86.0
Porc	<i>Sus scrofa f. domesticus</i>	4	38.4
Lièvre	<i>Lepus europaeus</i>	1	1.2
	total déterminés	21	403.3
	indéterminés	8	26.9
Total Mammifères		29	430.2
Oiseaux			
Oie cendrée	<i>Anser anser</i>	1	1.2
Poule domestique	<i>Gallus gallus</i>	3	2.8
	total déterminés	4	4
	indéterminés	1	0.1
Total Oiseaux		5	4.1
Mollusques			
Ostreidés	<i>Ostrea edulis</i>	2	

45		XVII ^e -XVIII ^e	
Mammifères		NR	MR
Bœuf	<i>Bos taurus</i>	9	484.3
Caprinés		3	35.9
Cerf	<i>Cervus elaphus</i>	1	20.9
Total Mammifères		13	541.1

78		XVII ^e -XVIII ^e	
Mammifères		NR	MR
Bœuf	<i>Bos taurus</i>	2	104.9
Caprinés		2	17.4
Total Mammifères		4	122.3

185		XVII ^e -XVIII ^e	
Mammifères		NR	MR
Bœuf	<i>Bos taurus</i>	2	7.0
Porc	<i>Sus scrofa f. domesticus</i>	1	1.7
Total Mammifères		3	8.7
Mollusques			
Unionidés		1	

222		XVII ^e -XIX ^e	
Mammifères		NR	MR
Bœuf	<i>Bos taurus</i>	1	56.2

222		XVII ^e -XIX ^e	
Mammifères		NR	MR
Bœuf	<i>Bos taurus</i>	1	56.2

381		XVII ^e -XIX ^e	
Mammifères		NR	NR
Porc	<i>Sus scrofa f. domesticus</i>	3	13.3
	indéterminés	1	3.6
Total Mammifères		4	16.9

377		XVIII ^e -XIX ^e	
Mammifères	NR	NR	
indéterminés	1	2.4	

65		XIX ^e	
Mammifères	NR	NR	
Caprinés	1	5.6	

40		XVII ^e -XVIII ^e	
Mammifères		NR	MR
Bœuf	<i>Bos taurus</i>	15	750.1
Caprinés		15	220.1
Porc	<i>Sus scrofa f. domesticus</i>	3	24.4
Sanglier	<i>Sus scrofa scrofa</i>	1	46.2
Âne	<i>Equus asinus</i>	88	1363.4
	total déterminés	122	2404.2
	indéterminés	19	36.5
Total Mammifères		141	2440.7
Oiseaux			
Poule domestique	<i>Gallus gallus</i>	1	0.9
Mollusques			
Zonitidés	<i>Oxychilus sp.</i>	1	

47		XVII ^e -XVIII ^e	
Mammifères		NR	MR
Bœuf	<i>Bos taurus</i>	29	647.3
Caprinés		32	241.5
Porc	<i>Sus scrofa f. domesticus</i>	14	89.0
Sanglier	<i>Sus scrofa scrofa</i>	1	27.1
Lièvre	<i>Lepus europaeus</i>	1	2.4
	total déterminés	77	1007.3
	indéterminés	19	32.2
Total Mammifères		96	1039.5
Oiseaux			
Oie cendrée	<i>Anser anser</i>	1	5.3
Poule domestique	<i>Gallus gallus</i>	4	2.6
	total déterminés	5	7.9
	indéterminés	4	2.6
Total Oiseaux		9	10.5
"poissons"			
Cyprinidés		2	1.15
Mollusques			
Hélicidés		1	
Ostreidés	<i>Ostrea edulis</i>	5	
Total Mollusques		6	

389		XVII ^e -XIX ^e	
Mammifères		NR	NR
Bœuf	<i>Bos taurus</i>	4	60.8
Porc	<i>Sus scrofa f. domesticus</i>	5	36.8
Total Mammifères		9	97.6

209		XVIII ^e -XX ^e	
Mammifères		NR	NR
Bœuf	<i>Bos taurus</i>	11	183.3
Caprinés		20	127.8
Porc	<i>Sus scrofa f. domesticus</i>	7	69.2
	total déterminés	38	380.3
	indéterminés	11	31.2
Total Mammifères		49	411.5
Mollusques			
Ostreidés	<i>Ostrea edulis</i>	1	

13		XIX ^e -XX ^e	
Mammifères		NR	NR
Bœuf	<i>Bos taurus</i>	1	49.3

Annexe 4 : enregistrement des éruptions et des usures dentaires des Suidés.

Avec : D : côté droit / G : côté gauche

ND : nombre de dents

mdble : mandibule

mx : maxillaire et/ou incisif

'-' : alvéole sans dent

KC : dent cassée

X : absence d'emplacement pour la pm1 (considérée comme une dent de lait à éruption tardive, Barone 1997)

Les dents déciduales sont indiquées par des lettres minuscules, les dents définitives par des lettres majuscules. Ces dernières sont en gras dans les tableaux.

Pour les **pm4/P4, M1, M2, M3**, les stades d'éruption et d'usure dentaires sont enregistrés suivant la codification proposée par A. Grant (1982 ; adapté ici pour les pm4 et M supérieures), par ordre croissant d'usure avec les lettres a, b, c, etc., et pour les éruptions :

C : l'os présente une perforation,

V : la dent est visible dans la crypte mais ne dépasse pas l'os,

E : la dent traverse l'os,

½ : la dent est à moitié sortie,

U : la dent est presque à la table.

Pour **toutes les autres dents**, les abréviations employées sont les suivantes :

b.d. : bourgeon dentaire

érupt° : dent en éruption

table : dent à la table, pas d'usure

'+' : dent définitive sortie

Groupes d'âge et indication d'âge possible :

I : 0-6 mois

II : 6-12 mois

III : 12-18 mois

IV : 18-24 mois

V : plus de 24 mois

Annexe 4.1 : le Porc *Sus scrofa f. domesticus*, dents inférieures.

XIA

groupe d'âge	US/Str.	mdble / dent isolée	D/G	ND	i1 I1	i2 I2	i3 I3	c C	pm1	pm2 P2	pm3 P3	pm4 P4	M1	M2	M3
I	334	mdble	G	2						-	pm	pm : c			
I	418	mdble	G	5		i	-			pm	pm	pm : c		E	
I	334	mdble	G	5			i (b.d.)	c (b. d.)	pm (b.d.)	pm	pm	pm : e			
I	334	mdble	G	3							pm	pm : d		E	
I	334	mdble	G	4						pm	pm	pm : d		E	
I	418	mdble	D	4						pm	pm	pm : b/c		C/V	
I	418	mdble	D	2				c		pm érupt°					
I	334	mdble	D	5	i					pm	pm	pm : d		E	
I	334	mdble	D	6	i	i		-		pm	pm	pm : f		1/2	
I	359	mdble	D	2							pm	pm : e			
I	334	isolée	D	1		i									
I	334	isolée	D	1										b. d.	
I	418	isolée	D	1		i				pm					
I	419	isolée	D	1		i									
I	421	isolée	D	1										b. d.	
I	418	isolée	G	3	i					2 pm					
I	371	isolée	G	1	i										

groupe d'âge	US/Str.	mdble / dent isolée	D/G	ND	i1 I1	i2 I2	i3 I3	c C	pm1	pm2 P2	pm3 P3	pm4 P4	M1	M2	M3
II	419	mdble	G	5		i					pm	pm : e	b	V	
II	418	mdble	G	1									-	C	
II	33	mdble	G	4						pm	pm	pm : k	c		
II	33	mdble	G	2									b	C	
II	33	mdble	G	2							pm KC	pm : g			
II	419	mdble	G	1									-	C	
II	371	mdble	G	3								pm : k	c	V	
II	371	mdble	G	2		i	érupt°	-	-						
II	34	mdble	G	4								pm : e + b.d.	b	C	
II	334	mdble	G	2		i			X	table					
II	33	mdble	D	2					-	pm	pm				
II	334	mdble	D	3							pm	pm : g	a		
II	419	mdble	D	5					érupt°	pm	pm	pm : f	c		
II	419	mdble	D	3					-	pm	pm	pm : f			
II	33	mdble	D	1									a		
II	33	mdble	D	1									b		
II	371	mdble	D	3							pm KC	pm : h	c		
II	334	mdble	D	1									c		
II	347	mdble	D	5						pm	pm	pm : f	c	V	
II	334	mdble	D	1									d		
II	419	mdble	D	1										E	
II	334	mdble	D	3							pm	pm : k	d		
II	419	mdble	D	1					érupt°						
II	33	mdble	D	6					dbt usure	pm	pm	pm : k	d	E	
II	33	mdble	D	6				érupt°	-	pm	pm	pm : l	e	E	
II	33	mdble	D	1							pm				
II	160	isolée	D	1	i										
II	334	isolée	D	1							pm				
II	418	isolée	D	2	2 i										
II	419	isolée	D	3	i						b.d.		a		
II	33	isolée	D	1				érupt°							
II	347	isolée	D	1									b		
II	371	isolée	D	1				érupt°							
II	33	isolée	G	3	2 i						pm				
II	418	isolée	G	2	i				table						
II	371	isolée	G	1				table							
II	334	isolée	G	2								pm : f	c		
II	419	isolée	G	2								pm : h	d (KC)		
II	33	isolée	G	1										U	
II	419	isolée	G	1								b.d.			
III	354	mdble	D	6	table	i (KC) + I (b.d.)		mâle	KC	érupt°					
III	33	mdble	D	5				mâle KC	X	-	table	érupt°	f	b	-
III	418	mdble	D	5				- : femelle		KC	érupt°	a	g	c	-
III	419	mdble	D	3								E	e	b	-
III	33	isolée	D	3	2 i1					érupt°					
III	33	isolée	G	3	érupt°						érupt°	E			
III	341	isolée	G	1				mâle ?							
II - III	33	isolée	D	2		2 i2									
II - III	334	isolée	D	1		i2									
II - III	371	isolée	D	1		i2									
II - III	419	isolée	D	2		2 i2									
II - III	418	isolée	G	1		i2									
II - III	419	isolée	G	2		2 i2									
II - III	34	isolée	G	1		i2									
IV	334	mdble	G	8		érupt°		mâle	pm1	-	table	b	j	e	E
IV	371	mdble	G	3						-	-	-	g	d	V
IV	419	mdble	G	3								-	f	d	V
IV	419	mdble	G	6					-	érupt°	table	b	g	d	V
IV	33	mdble	G	2										d	E
IV	334	mdble	G	3									h	f	1/2
IV	371	mdble	D	6		érupt°		femelle	-	-	-	a	h	d	V
IV	419	mdble	D	4				mâle	-	-	-	b	e	c	-
IV	334	mdble	D	3							+	c	g		
IV	33	mdble	D	4				- : mâle	pm1	+	+	c			
IV	33	mdble	D	2									g	b	-
IV	334	mdble	D	5							+	c	f	c	V
IV	359	mdble	D	2	+	table									
IV	419	mdble	D	2	+	érupt°									
IV	371	mdble	D	3									g	KC	KC
IV	418	mdble	D	1							+				
IV	33	isolée	D	2	+			mâle							

groupe d'âge	US/Str.	mdble / dent isolée	D/G	ND	i1 I1	i2 I2	i3 I3	c C	pm1	pm2 P2	pm3 P3	pm4 P4	M1	M2	M3
IV	334	isolée	D	2		+		mâle							
IV	354	isolée	D	1				mâle							
IV	419	isolée	D	3		+		mâle							a
IV	371	isolée	D	1		+									
IV	33	isolée	G	2		érupt°		mâle							
IV	419	isolée	G	1				mâle							
IV	371	isolée	G	1				mâle							
III - IV	334	isolée	D	2				2 mâles							
III - IV	384	isolée	G	1				mâle							
III - IV	33	isolée	G	1				mâle							
V	371	mdble	G	8				mâle	pm1	+	+	e	k	h	d
V	334	mdble	G	2							-	d	k		
V	371	mdble	G	5		+		femelle	pm1	+	KC				
V	384	mdble	G (+D)	3	D+G KC	KC									
V	359	mdble	G	2	+			mâle	pm1						
V	334	mdble	D	7				femelle	-	+	+	e	m	h	d
V	334	mdble	D	5				- : femelle			+	e	l	j	c
V	419	mdble	D	2										KC	e
V	33	mdble	D	2										g	e
V	371	mdble	D (+G)	4	D+G	+		femelle	X						
V	418	isolée	D	3	+			2 mâles							
V	371	isolée	D	1	+										
V	334	isolée	D	3	+	+		mâle							
V	33	isolée	D	3		2									k
V	338	isolée	D	2				2 mâles							
V	160	isolée	D	1				mâle							
V	334	isolée	G	3	+			mâle				d			
V	334	isolée	G	1				femelle							
V	418	isolée	G	2		+		mâle							
V	419	isolée	G	2				mâle	pm1						
V	33	isolée	G	1				mâle							
V	338	isolée	G	1	+										
V	421	isolée	G	1	+										
II - V	418	isolée	D	1			+								
II - V	418	isolée	G	1			+								
II - V	418	isolée	G	1					pm1						

XI

groupe d'âge	US/Str.	mdble / dent isolée	D/G	ND	i1 I1	i2 I2	i3 I3	c C	pm1	pm2 P2	pm3 P3	pm4 P4	M1	M2	M3
IV	36	mdble	D	3									g	c	V
IV	36	mdble	D	6	+	érupt°		femelle	X	-	+	b	g		
IV	36	mdble	D	7				femelle	pm1	+	+	e	h	e	

mil. XI

groupe d'âge	US/Str.	mdble / dent isolée	D/G	ND	i1 I1	i2 I2	i3 I3	c C	pm1	pm2 P2	pm3 P3	pm4 P4	M1	M2	M3
I	363	isolée	G	1		i									
I	363	mdble	D	7	i		b.d.		b.d.	pm	pm	pm : e	1/2		
II	411	mdble	D	2						-	pm	pm : f			
II	400+411	mdble	D	5	i + b.d.					pm KC	pm	pm : g			
II	411	mdble	D	4					X	pm	pm	pm KC+ b.d.			
II	411	mdble	D	5				érupt° KC	érupt°	-	pm	pm : g	b		
II	363	mdble	D	2					X	-	-	-	c	V	
II	405	mdble	D	5	b.d.				X	pm KC	-	pm : f	c	V	
II	405	mdble	D	6				érupt°	-	pm	pm	pm : l	c	(C)V	
II	411	mdble	D	6			b.d.		-	pm	pm	pm : k	b	(C)V	
II	85	mdble	D	2									d	V (E)	
II	400	isolée	D	1						b.d.					
II	411	isolée	D	2									b	V	
II	411	mdble	G	7	b.d.			b.d.	X	pm	pm	pm g	c	V	
II	411	mdble	G	3				érupt°			pm	-	c	-	
II	411	mdble	G	5				érupt°			pm	pm : j	d	1/2	
II	411	mdble	G	2									e	U	
II	411	mdble	G	1				érupt°	-						
II	363	mdble	G	1								-	e		
II	411	mdble	G	1								E			

groupe d'âge	US/Str.	mdble / dent isolée			i1	i2	i3	c	pm1	pm2	pm3	pm4	M1	M2	M3
		D/G	ND	i1	i2	i3	C	P2	P3	P4					
II	411	mdble	G (+D)	6	2i KC+2 b.d.	i	érupt°	b.d.	-						
II	411	isolée	G	3		i	érupt°			pm					
III	411	mdble	D+G	3	2 érupt°	b.d.		- : femelle	X						
III	400	mdble	G	2									-	b	C
III	411	mdble	G	3									- (pm)	e	b C
IV	400	mdble	G	1											E
IV	400	mdble	D	4					pm1	+	+				
IV	400	mdble	G	2						+	+				
IV	411	mdble	G	3										-	c -
IV	400	mdble	G (+D)	10	G + D KC	+		mâle	table	+	+			b	h e E
IV	411	isolée	G	2	+										E
IV	411	isolée	D	1			érupt°								
V	400	mdble	D	1											c
V	411	mdble	D	2										h	b/c
V	400	mdble	D	1			+	- : mâle	pm1						
V	411	mdble	D	3								KC		-	j c
V	411	isolée	D	3	2			mâle							
V	405	isolée	D	1			+								
V	363	isolée	D	1				mâle							
V	400	isolée	D	1				mâle							
V	400	isolée	D	1				mâle							
V	411/363	mdble	G	8	+	+	-	femelle	X	+	+			d	- j c
V	411	mdble	G	3										c	h f
V	411	mdble	G	4						+	+			e	m
V	411	mdble	G	9	KC	+	-	mâle	-	+	+			c	f e KC
V	411	mdble	G	3	+	+	-	mâle							
V	363	isolée	G	2				2 femelle							c
V	363	isolée	G	1				mâle							
V	411	isolée	G	4				3 mâles				f			
V	400	isolée	G	1				mâle							

XIB

groupe d'âge	US/Str.	mandibule dent isolée			i1	i2	i3	c	pm1	pm2	pm3	pm4	M1	M2	M3
		D/G	ND	i1	i2	i3	C	P1	P2	P3	P4				
I	161	mdble	D	3							-	pm : e	1/2	b.d.	
I	308	isolée	D	1								pm : d			
I	170	mdble	G	4								pm : c	V		
I	237	mdble	G	4	i				b.d.			pm : b	V		
I	392	mdble	G	2	i	table									
I	237	isolée	G	1	i										
I	276	isolée	G	1	i										
II	276	mdble	G	5					X	pm	pm	pm : f	a	c	
II	279	mdble	G	2								-	b	V	
II	238	mdble	G	4				érupt°			pm	pm : k	c		
II	317	mdble	G	5							pm	pm : j + b.d.	d	E	
II	276	isolée	G	3						2 pm	pm				
II	233	mdble	G	4						-	pm	pm : j	d	1/2	-
II	237	mdble	D	1					érupt°						
II	276	isolée	D	4	b.d.			2 érupt°							
II	238	isolée	D	1										c	
II - III	276	isolée	D	1											
II - III	361	isolée	D	1		i									
II - III	397	isolée	G	1		i									
II - III	232	isolée	G	1		i									
II - III	238	isolée	G	1		i									
II - V	392	isolée	G	1					pm1						
II - V	325	isolée	G	1			+								
II - V	325	isolée	D	1			+								
III	276	mdble	G	4								pm : m + b.d.	c	U	
III	98	mdble	G	3									e	b	C
III	238	mdble	G	5	+			mâle	-	pm + b.d.	érupt°	érupt°			
III	346	mdble	G	6				- : mâle	-	érupt°	table	table	f	b	V
III	279	isolée	G	1				mâle							
III - IV	343	isolée	G	1	+										
III - IV	232	isolée	G	1	+										
III - IV	276	mdble	D+G	2	2										
III	311	mdble	D	4				mâle	X	-	érupt°	-	e	a	-
III	323	isolée	D	1	table										

groupe d'âge	US/Str.	mandibule dent isolée	D/G	ND	i1 I1	i2 I2	i3 I3	c C	pm1 P1	pm2 P2	pm3 P3	pm4 P4	M1	M2	M3
III	311	isolée	D	1				mâle							
IV	237	mdble	G	4				mâle							
IV	311	mdble	G	5						-	+	b		h	
IV	452	mdble	D	3	+	+		- : mâle	+					f	c E
IV	276	isolée	G	1						+					
IV	325	isolée	D	1								c			
V	308	mdble	G	4		+		- : femelle	X	++	+++	f			
V	276	mdble	G	2							++	e			
V	392	mdble	G	3									KC	f	KC
V	392	mdble	G	1											d
V	308	mdble	G	0				- : femelle							
V	323	isolée	G	1		+									
V	308	isolée	G	1				mâle							
V	237/232	mdble	D	5		+		femelle	-	+	+	f			
V	453	mdble	D	4						+	+	d	k		
V	300	mdble	D	2										f	c
V	392	mdble	D	2										g	c
V	392	mdble	D	1											c
V	323	mdble	D	2										KC	KC
V	392	mdble	D	1											d
V	327	mdble	D	4								KC	m/n	j	f
V	392	isolée	D	1				mâle							
V	279	isolée	D	1	+										
V	170	isolée	D	1	+										
V	316	isolée	D	1	+										
V	325	isolée	D	1	+										
V	231	isolée	D	1			+								
V	453	isolée	D	1											a

post. XI

groupe d'âge	US/Str.	mandibule dent isolée	D/G	ND	i1 I1	i2 I2	i3 I3	c C	pm1 P1	pm2 P2	pm3 P3	pm4 P4	M1	M2	M3	datation
I	71	isolée	G	1									E			XII-XIII
II	167	isolée	G	1	i											XV-XVI
II	10	mdble	G	2									b	V		XV-XVI
III	31	mdble	D	2								-	d	a	-	XV-XVI
III	31	mdble	D	6				mâle	b.d.	pm		pm : k + b.d.	c			XV-XVI
V	167	mdble	G	4						KC		b	k	e	-	XV-XVI
V	210	isolée	G	1											f	XV-XVI
V	31	isolée	G	1	+											XV-XVI

Annexe 4.2 : le Porc *Sus scrofa f. domesticus*, dents supérieures.

XIA

groupe d'âge	US/Str.	mx / dent isolée	D/G	ND	i1 I1	i2 I2	i3 I3	c C	pm1 P1	pm2 P2	pm3 P3	pm4 P4	M1	M2	M3
I	359	mx	D	2							pm	pm : b/c	-		
I	334	mx	D	2					-	-	pm	pm : b	-		
I	418	mx	D	3						table	pm	pm : a/b	-		
I	418	mx	D	2							pm	pm : a			
I	33	mx	D	1				-	érupt°	-					
I	334	mx	D	4					-	pm	pm	pm : d	E		
I	418	mx	D	3							pm	pm : b/c	U		
I	334	mx	D	3							pm	pm : b/c	U		
I	33	isolée	D	1		i									
I	33	mx	G	1								-			V
I	382	mx	G	2							pm	pm : a			
II	418	mx	D	4				c	-	pm	pm	pm : j/k	a	b.d.	
II	334	mx	D	4				érupt°	-	pm	pm	pm : d/e	a	b.d.	
II	334	mx	D	3								pm : e + b.d.	b	C/V	
II	334	mx	D	2					-	pm	pm				
II	419	mx	D	2								pm : d	a	-	
II	33	mx	D	2									b	C/V	

groupe d'âge	US/Str.	mx / dent isolée	D/G	ND	i1 I1	i2 I2	i3 I3	c C	pm1 P1	pm2 P2	pm3 P3	pm4 P4	M1	M2	M3
II	419	mx	D	1							-	-	a		
II	419	mx	D	4						-	pm	pm : j	c	V/E	
II	33	mx	D	4						pm	pm	pm : ef	a		
II	33	isolée	D	1										½ / U	
I - III	418	isolée	D	1	i1										
I - III	421	isolée	D	1	i										
II	334	mx	G	6				-	pm	pm	pm	pm : j	b	V	
II	33	mx	G	6				érupt°	-	pm	pm	pm : e	b	V	
II	418	mx	G	6				érupt°	-	pm	pm	pm : k/l	b	V	
II	33	mx	G	4								pm : m/n + b.d.	e	1/2	
II	334	mx	G	4								pm : l + b.d.	d	U	
I - II	418	isolée	G	1	i										
I - II	33	isolée	G	1		i									
III	418	mx	D	6				- : femelle	-	b.d.	pm + b.d.	pm : l + b.d.	d/e	a/b	-
III	334	mx	D	3				mâle	pm1	-	table				
III	33	mx	D	1	érupt°	-	-								
III	359	isolée	D	1				femelle							
III	419	isolée	D	1										b	
III	334	mx	G	7				femelle	-	érupt°	table	table	f	b	V
III	418	mx	G	3								érupt°	e	b	
III	419	mx	G	3								érupt°	d/e	U/a	
III	334	mx	G	5				- : femelle	-	érupt°	table	table	ef	b	-
III	334	mx	G	3								+	ef	C/V	-
III	419	mx	G	1				mâle	-	-					
III	371	mx	G	1	table	-	-								
III	33	mx	G	1	érupt°	-	-								
III	33	mx	G	2	érupt°		érupt°								
III	334	isolée	G	1				femelle							
III	334	isolée	G	1				femelle							
IV	334	mx	D	5				- : femelle	-	-	+	+	j/k	~ e	V
IV	334	mx	D	4								+	g	c	E
IV	334	mx	D	3								+	f	b	-
IV	33	mx	D	2										b	(E) 1/2
IV	419	mx	D	4				mâle	X	-	table	table	j		
IV	334	mx	D	2	+	érupt°									
IV	334	isolée	D	1	érupt°										
IV	33	mx	G	4								table	e	a/b	V
IV	418	mx	G	2								+	e		
IV	371	mx	G	2								-	f/g	d?	-
IV	418	mx	G	4								+	f/k	d	
IV	384	mx	G	6				-	-	+	+	+	k/l	d/e	1/2
IV	364	mx	G	5						+	+	+	h/j	d	-
IV	418	mx	G	2	table	érupt°									
IV - V	44	insicif	G	1	KC	-									
IV - V	371	insicif	G	1	+	-									
IV - V	371	insicif	G	1	+	-									
IV - V	33	isolée	G	1	+										
IV - V	359	isolée	D	1	+										
IV - V	364	isolée	D	1	+										
V	334	mx	D	5							+	+	k/l	e	a/b
V	371	mx	D	2										k	c/d
V	418	mx	D	4								+	h/j	e	a/b
V	160	mx	D	1											d
V	334	isolée	D	2				mâle						f	
V	341	isolée	D	1				mâle							
V	334	mx	G	6				mâle	-	+	+	+	j	e	-
V	371	mx	G	3								+	j/k	e	
V	33	mx	G	7					+	+	+	+	l/m	j/k	d
V	347	mx	G	1								+			
V	334	mx	G	2				femelle	-	table	-				
V	334	mx	G	2				-	-	+	+				
V	418	isolée	G	1		+									
V	359	isolée	G	1				mâle							

mil. XI

groupe d'âge	US/Str.	mx / dent isolée	D/G	ND	i1 I1	i2 I2	i3 I3	c C	pm1 P1	pm2 P2	pm3 P3	pm4 P4	M1	M2	M3
I	411	mx	D	1				-	-	pm	-				
I	411	mx	G	2				-	-	pm	pm				
II	411	mx	D	4							pm + b.d.	pm : f/g	a/b		
II	363	mx	D	3							pm	pm : d	U/a		
II	342	mx	G	3				-	-	pm	pm	-	b/c	-	
II	400	mx	G	2					-	pm	pm				
II	400	isolée	G	1									d		
II	363	isolée	G	1					pm						
III	85	mx	D	3							-	1/2	e/f	a/b	
III	411	isolée	D	1			érupt°								
III	411+363	mx	G	3				mâle	-	pm	pm				
III	405	mx	G	8					-	pm + b.d.	b.d.	pm : n + b.d.	e	a	C
III	411	mx	G	2								-	d	a	-
III	411	mx	G	3								table	e/f	b	-
III	402	mx	G	2								-	d	a	-
III	411	mx	G	1	-		érupt°	-							
III	411	isolée	G	1				mâle							
IV	400	mx	D	5				- : mâle		P2*2	+	+	g/h		
IV	411	mx	D	2										e/f	U
IV	411	mx	D	2							-	+	j		
IV	400	mx	D	1	+	-									
IV	411	isolée	D	1				mâle							
IV	411	mx	G	2									g	b	-
IV	411	mx	G	1	table										
IV - V	411	isolée	D	1	+										
V	402	mx	D	7				- : femelle	pm1	+	+	+	m	f	b
V	400	mx	D	4								+	g/h	d/e	b
V	363	mx	D	2										k?	e
V	400	isolée	D	1	+										
V	400	mx	G	4								+	m	j/k	c/d
V	400	mx	G	2										d/e	b
V	411	mx	G	3				- : mâle	pm1	+	+				
V	405	mx	G	1				femelle	-	-					
V	411	isolée	G	1				femelle							
V	400	isolée	G	1				mâle							
V	411	isolée	G	1				mâle							
V	411	isolée	G	1											? +++
V	400	isolée	G	1	+										

XIB

groupe d'âge	US/Str.	mx / dent isolée	D/G	ND	i1 I1	i2 I2	i3 I3	c C	pm1 P1	pm2 P2	pm3 P3	pm4 P4	M1	M2	M3
I	170	mx	D	5				c + b.d.	-	pm	pm	pm4 : c/d	U		
I	278	isolée	D	1			i								
I	276	mx	G	7				b.d.	pm1	pm	pm	pm : d/e	U / 1/2	C	
I	276	isolée	G	1			I								
II	328	mx	D	4					-	pm	pm	pm : g	a		
II	276	mx	D	3							pm	pm : d	a		
II	311	isolée	D	1									b		
II	170	mx	D	2	I + b.d.										
II	170	mx	D	7				table	pm	pm	pm	pm : k	c	1/2	
II	276	isolée	D	1			i								
II	276	mx	G	4				- : c	pm	pm	pm	pm : m			
II	316	mx	G	3							pm	pm : j	a/b		
II	397	mx	G	3				table	pm	pm	-				
III	397	mx	D	2	érupt°		érupt°								
III	232	mx	D	3	i1 + érupt°	i									
III	231	mx	D	1				femelle	-	-					
III	232	isolée	D	1	+										
III	392	isolée	D	1			i								
III	233	mx	G	6				mâle	pm	pm	érupt°	érupt°	e/f	-	
III	231	mx	G	2								érupt°	e		
III	237	mx	G	1	table										
III	328	mx	G	2	-		i + b.d.								
IV	392	mx	D	2	+		érupt°								
IV	392	isolée	D	1	KC										
IV	392	mx	D	1										-	U/a

groupe d'âge	mx / dent				i1 I1	i2 I2	i3 I3	c C	pm1 P1	pm2 P2	pm3 P3	pm4 P4	M1	M2	M3
	US/Str.	isolée	D/G	ND											
IV	325	mx	G	3											
IV	361	mx	G	1				femelle	-		-	+	g	b	-
III-V	392	isolée	D	1			+								
V	231	mx	D	3									KC	e/f	b/c
V	392	mx	D	1	+										
V	392	isolée	D	1	+										
V	392	mx	D	2				mâle	pm1						
V	300	isolée	D	1				mâle							
V	233	isolée	D	1				femelle							
V	392	isolée	D	1				femelle							
V	325	mx	G	1											b/c
V	316	mx	G	1				mâle							
V	316	isolée	G	1				mâle							
V	343	mx	G	1				mâle							
V	161	isolée	G	1				mâle							
V	392	isolée	G	1				mâle							
V	238	isolée	G	1				femelle							
V	237	isolée	G	1				femelle							

post XI

groupe d'âge	mx / dent				i1 I1	c C	pm1	pm2 P2	pm3 P3	pm4 P4	M1	M2	M3	datation
	US/Str.	isolée	D/G	ND										
III	26	mx	G	1		femelle								XII-XIV
IV	286	mx	G	3					-	+	f	b	-	XII-XIV
V	286	mx	D	5		mâle	pm1 * 2	+	+	-				XII-XIV
V	286	isolée	D	1	+									XII-XIV
II	162	mx	G	2				-	+	a/b				XV-XVI
IV	31	mx	D	5			-	+	+	+	KC	KC (a/b prob)		XV-XVI
IV	190	mx	G	1								a/b		XV-XVI
V	210	mx	D	4						+	h/j	e	a/b	XV-XVI
V	167	mx	G	1									c/d	XV-XVI
IV	7	mx	G	1							e/f			XVII-XVIII
IV	209	mx	D	2								d	U/a	XVIII-XX

Annexe 4.3 : le Sanglier *Sus scrofa scrofa*.

groupe d'âge	phase	US/Str.	mdble/ mx	D/G	nd	C	pm1	P2	P3	P4	M1	M2	M3
V	mil XI	323	mdble	D	4	- : mâle	-	-	+	c	g	e	-
V	XIA	33	mx	G	4				+	+	m/n	e/f	

Annexe 5 : ostéométrie des Mammifères

d'après les recommandations de A. von den Driesch (1976). Quelques mesures complémentaires ont également été réalisées pour certains taxons. Le ou les auteurs sont alors mentionnés avant la présentation des mesures.

Toutes les mesures sont en millimètres. Les valeurs soulignées sont estimées. Avec :

- épiphysation (E) proximale (P) ou distale (D) : '-' = non commencée, '+' = terminée, lorsque l'état d'épiphysation est inconnu, rien n'est indiqué ;

- XI A : première moitié du XI^e siècle, mil XI : milieu du XI^e siècle, XI B : seconde moitié du XI^e siècle.

Annexe 5.1 : erreur sur la mesure.

Grande longueur d'un métacarpe (fosse 334, XIA), mesurée cinq fois par trois personnes différentes, à différents intervalles de temps.

1	184.8
2	182.58
3	183.78
4	184.32
5	184.25
6	184.12
7	184.67
8	183.34
9	183.06
10	184.45
11	184.37
12	184.62
13	184.79
14	184.39
15	184.4
n	15
moyenne	184.1
valeur minimale	182.6
valeur maximale	184.8
écart type	0.66
coefficient de variation	0.36

Annexe 5.2 : ostéométrie du Porc *Sus scrofa f. domesticus*.

Avec pour les tableaux concernant les dents :

- 'mdble' : mandibule, 'mx' : maxillaire et/ou incisif, 'KC' : dent cassée, '-' : alvéole sans dent ;
- mensurations des dents d'après S. Payne & G. Bull (1988) ; lorsque les mesures sont en italiques, cela signifie que la stade de dent est antérieur au stade 'a' de A. Grant (1982) ;
- pour la hauteur de la mandibule, elle est mesurée en face interne, entre la pm4/P4 et la M1. Elle équivaut à la mesure 16b de A. von den Driesch (1976) mais qui est mesurée quand la M3 est sortie (tabl. des mandibules).

mandibules														(mesure 16 face interne)		
phase	US	sexe	3	6	7	7a	8	9	9a	11	12	13	14	16a	16b	16c
XI A	334	femelle		114.2	106.4	94.3	59.4	46.6	33.7					36.8	35.9	41.3
XI A	334	femelle					62.6									
XI A	371	femelle		124.2	117.1	98.1	61.6	55.8	36.2							
XI A	371	femelle								40.2	59.0					
XI A	384	-									62.1					
mil XI	411	mâle		133.1	125.4	107.2	71.9	54.1	34.8	42.8						42.8
mil XI	411 + 363	femelle		119.2		97.4	63.5	pas de pm1	34.8	37.1						36.1
XI B	232 + 237	femelle						55.1	34.7	43.1						41.5
XI B	238	femelle						52.71	39.6	41.6	67.9					44.8
XI B	308	femelle									70.3					
XI B	308	femelle						pas de pm1	34.7	41.1	69.0					42.4
XI B	327	-	70.4				69.9					104.6	101	45.5		
XI B	453	-							36.8							

dents inférieures																				
phase	US/Str.	mâle / femelle		D/G	mdble/ isolée	hauteur mdble	pm4		stade Grant	M1			stade Grant	M2			stade Grant	M3		
		L	WP				L	WA		WP	L	WA		WP	L	WA		Grant		
XIA	334			G	mdble	14.3	20.2	8.8	c				-							
XIA	418			G	mdble	19.3	19.9	8.6	c				E							
XIA	334			G	mdble		18.4	8.5	e											
XIA	334			G	mdble	21.9	20.3	8.8	d				E							
XIA	334			G	mdble		18.7	8.2	d											
XIA	418			D	mdble	15.7	18.8	8.6	b/c				C/V							
XIA	334			D	mdble	16.4	18.8	8.1	d				E							
XIA	334			D	mdble	25.3	19.8	8.3	f				1/2							
XIA	359			D	mdble	22.4	20.0	8.7	e				-							
XIA	419			G	mdble	29.1	19.2	9.5	e	17.8	10.2	10.9	b				V			
XIA	33			G	mdble	28.9	18.9	8.3	k	17.3	9.5	10.7	c				-			
XIA	33			G	mdble					17.3	10.2	11.0	b							
XIA	33			G	mdble		18.3	8.3	g											
XIA	371			G	mdble			8.2	k	17.2	10.0	10.4	c							
XIA	34			G	mdble	26.2	19.9	9.4	e	18.3	10.1	11.0	b				C			
XIA	334			D	mdble		18.1	8.5	g	17.3	9.7	10.4	a							
XIA	419			D	mdble	<u>24.6</u>	18.6	8.5	f				-				-			
XIA	33			D	mdble					18.3	10.2	11.1	a							
XIA	33			D	mdble					17.3	10.1	10.4	b							
XIA	371			D	mdble		19.3	8.2	h	17.5	9.4	9.9	c							
XIA	334			D	mdble	30.5					9.4		c				V			
XIA	347			D	mdble	25.1	17.6	7.6	f	16.0	9.3	9.8	c				V			
XIA	334			D	mdble					16.9	9.7	10.1	d							
XIA	334			D	mdble		18.5	8.3	k	19.9	9.3	10.1	d							
XIA	33			D	mdble	29.2	18.5	9.0	k	17.7	10.5	11.1	d				E			
XIA	33			D	mdble	30.3	18.6	8.8	l	17.2	10.1	10.3	e				E			
XIA	334			G	isolée		18.0	8.3	f											
XIA	419			G	isolée		19.3	8.5	h											
XIA	334			G	isolée					17.1	9.8	10.2	c							
XIA	347			D	isolée					17.6	9.7	10.6	b							
XIA	419			D	isolée					17.4	9.8	10.1	a							
XIA	33	mâle		G	mdble	33.2				17.3	9.8	10.5	f		22.0	12.7	13.8	b	-	
XIA	418	femelle		G	mdble	36.4				17.5	10.2	11.4	g		21.5	12.1	13.8	c	-	
XIA	419			G	mdble	31.5				18.7	10.4	10.8	e		23.6	12.6	12.8	b	-	
XIA	33			G	isolée										<i>21.5</i>	<i>12.1</i>	<i>12.8</i>	<i>U</i>		
XIA	334	mâle		G	mdble	35.4				15.7	10.0	10.4	j		21.2	12.6	13.5	e	E	
XIA	371			G	mdble					16.7	10.0	10.5	g		20.6	12.9	13.8	d		
XIA	419			G	mdble	32.0					KC		f			KC	d		V	
XIA	419			G	mdble	32.0				16.7	10.1	11.4	g		21.5	12.8	13.6	d	V	
XIA	33			G	mdble										21.9	13.4	13.4	d		
XIA	334			G	mdble					16.4	9.8	10.7	h		21.6	13.1	13.2	f	32.9 15.2 1/2	
XIA	371	femelle		D	mdble	30.9				18.1	10.0	10.8	h		22.0	12.6	13.0	d	V	
XIA	419	mâle		D	mdble	35.9				17.1	10.5	11.8	e		23.6	13.3	14.6	c	-	
XIA	334			D	mdble					17.0	10.0	10.7	g							
XIA	33			D	mdble					17.1	9.4	10.2	g		19.2	11.6	12.0	b		
XIA	334			D	mdble					17.1	10.0	10.7	f		22.6	12.7	12.9	c		
XIA	371			D	mdble						10.7	11.9	g							
XIA	334			D	isolée														28.6 13.4 a	
XIA	371	mâle		G	mdble					13.4	9.7	10.1	k		18.3	12.4	12.8	h	31.1 14.8 d	
XIA	334			G	mdble					15.3	10.3	10.5	k							
XIA	334	femelle		D	mdble	35.9				13.4	8.9	10.2	m		17.2	11.9	13.0	h	29.4 15.0 d	
XIA	334	femelle		D	mdble					15.0	10.6	11.2	l		20.0	13.1	13.5	j	30.3 15.7 c	
XIA	419			D	mdble														28.6 e	
XIA	33			D	mdble										20.1	13.7	14.2	g	35.4 15.8 e	
mil XI	363			D	mdble	21.2	19.5	8.5	e				1/2							
mil XI	411			D	mdble		17.8	8.3	f											
mil XI	411			D	mdble	24.9	19.1	8.3	g	18.2	10.2	10.6	b					-		
mil XI	363			D	mdble	23.5				18.2	9.6	10.2	c					V		
mil XI	405			D	mdble	30.3	18.6	8.5	f	17.3	9.9	10.9	c					V		
mil XI	405			D	mdble	27.0	18.3	8.8	l	17.9	9.9	10.5	c					C/V		
mil XI	411			D	mdble	25.0	17.6	8.3	k	16.7	9.7	10.2	b					C/V		
mil XI	85			D	mdble					16.4	9.5	10.7	d							
mil XI	411			G	mdble	26.6	18.0	8.4	g	16.9	9.3	10.3	c					V		
mil XI	411			G	mdble	25.8				18.6	10.5	11.0	c					-		
mil XI	411	mâle ?		G	mdble	34.3	18.6	9.2	j	17.0	10.7	11.1	d					1/2		
mil XI	411			G	mdble	31.1				17.2	10.2	10.5	e					U		
mil XI	400			G	mdble										22.8	13.5	13.5	b		
mil XI	411			G	mdble					16.6	9.8	10.6	e		21.0	12.7	13.0	b		
mil XI	400			G	mdble														32.7 16.8 E	
mil XI	411			G	mdble										22.1	13.4	13.6	c		
mil XI	400	mâle		G	mdble					18.0	11.2	11.5	h		23.1	13.6	14.1	e		
mil XI	411			D	mdble										20.1	13.8	14.2	h	33.9 15.0 b/c	
mil XI	411			D	mdble										18.9	12.6	12.7	j	30.3 13.9 c	
mil XI	411+363	femelle		G	mdble	36.1									18.2	12.6	13.1	j	30.7 13.7 c	

dents inférieures																				
phase	US/Str.	mâle / femelle		D/G	mdble/ isolée	hauteur mdble	pm4		stade Grant	M1			stade Grant	M2			stade Grant	M3		
							L	WA		WP	L	WA		WP	L	WA		WP		
mil XI	411			G	mdble					16.3	10.6	11.5	h	22.3	13.3	13.9	f			
mil XI	411			G	mdble					14.0	10.4	11.2	m							
mil XI	411	mâle		G	mdble	42.8				16.3	10.5	10.8	f	22.4	13.1	13.8	e	34.0	16.2	KC
mil XI	363			G	isolée															c
XIB	161			D	mdble	21.9	20.4	8.7	e											
XIB	308			D	isolée		19.5	8.3	d											
XIB	170			G	mdble	15.8	19.6	8.5	c				V							
XIB	237			G	mdble		19.4	8.5	b	17.4	9.6	9.9	V							
XIB	276			G	mdble	22.8	20.5	9.4	f	18.3	9.8	10.7	a				C			
XIB	279			G	mdble	32.1				17.5	10.0	11.2	b				V			
XIB	238			G	mdble	30.1	17.9	8.1	k	17.5	9.8	10.4	c				-			
XIB	317			G	mdble	31.9	17.7	8.6	j	17.5	10.4	11.3	d				E			
XIB	233			G	mdble	31.5	18.5	8.7	j	17.3	10.1	10.7	d				1/2			
XIB	238			D	isolée					15.4	9.3	9.6	c							
XIB	276			G	mdble		17.8	8.3	m	17.6	9.2	10.2	c	21.4	11.3	12.3	U			
XIB	98			G	mdble					17.5	9.8	10.9	e	21.3	13.0	13.6	b			
XIB	346	mâle		G	mdble	37.6				17.5	10.5	11.6	f	21.7	13.9	13.9	b			V
XIB	311	mâle		D	mdble					16.8	10.2	10.6	e	20.7	12.6	12.9	a			
XIB	237	mâle		G	mdble					15.9	9.3	10.3	h							
XIB	311			G	mdble					17.2	10.4	10.9	f	22.0	13.4	13.8	c	33.8		E
XIB	392			G	mdble					21.2	12.4	12.7	f							
XIB	453			D	mdble					16.3	10.8	11.3	k							
XIB	300			D	mdble					21.1	12.6	12.7	f						14.8	c
XIB	392			D	mdble					20.2	13.5	14.3	g					34.8	15.7	c/d
XIB	327			D	mdble					16.2	11.3	12.6	m / n	19.6	14.2	14.3	j	35.2	16.9	f
XIB	453			D	isolée													35.4	15.4	a
XI	36			D	mdble					15.3	9.3	10.1	g	20.1	12.2	13.1	c			
XI	36	femelle		D	mdble					16.7	10.0	10.4	g							
XI	36	femelle		D	mdble	34.9				15.3	9.4	10.1	h	19.7	12.0	13.0	e			-
XII-XIII	71			G	mdble						9.8		E							
XV-XVI	10			G	mdble					17.3	9.4	10.6	b	21.8			V			
XV-XVI	31			D	mdble					18.9	10.5	11.0	d	22.4	12.0	13.2	a			
XV-XVI	31	mâle		D	mdble	37.9	17.1	7.8	k	17.2	9.7	10.4	c							
XV-XVI	167			G	mdble					16.5	10.5	11.0	k	21.5	13.4	13.7	e			
XV-XVI	210			G	isolée													33.7	14.9	f

maxillaires									
phase	US/Str.	D/G	sexe	25	27	27a	28	29	
XIA	334	G	mâle					45.0	
XIA	334	D					58.7		
XIA	418	D					65.4		
mil XI	400	D					67.0		
mil XI	400	G					62.0		
mil XI	402	D	femelle	109.4	101.4	95.3	61.0	40.5	
XV-XVI	210	G					64.2		

dents supérieures																				
phase	US/Str.	mâle / femelle		D/G	mx/ isolée	pm4		stade Grant	M1			stade Grant	M2			stade Grant	M3			
						L	WA		WP	L	WA		WP	L	WA		WP			
XIA	359			D	mx	15.6	11.3	11.0	b/c											
XIA	334			D	mx	14.0	10.8	10.0	b/c											
XIA	418			D	mx	14.6	11.5	10.7	a/b											
XIA	418			D	mx	14.0	10.8	10.0	a											
XIA	334			D	mx	14.5	10.8	10.9	d											
XIA	418			D	mx	14.2	10.5	10.6	b/c	17.2	13.6	12.9	U							
XIA	334			D	mx	15.1	10.9	11.4	b/c	18.4	13.7	13.0	U							
XIA	382			G	mx	14.8	10.3	10.2	a											
XIA	418			D	mx	13.9	10.6	10.2	j/k	17.3	13.3	12.7	a							
XIA	334			D	mx	14.2	10.2	10.9	d/e	17.8	12.7	12.5	a							
XIA	334			D	mx	15.0	10.7	10.3	e	18.3	13.2	13.1	b							
XIA	419			D	mx	14.8	11	11.2	d	18.4	14.0	13.3	a							
XIA	33			D	mx					17.0	13.0	13.2	b							
XIA	419			D	mx					18.4	-	12.7	a							
XIA	419			D	mx	13.6	10.7	10.0	j	16.5	11.9	12.5	c							
XIA	33			D	isolée									21.3	14.7	13.8	1/2 / U			
XIA	33			D	mx	14.2	11.0	10.6	e/f	18.8	12.6	12.9	a							
XIA	334			G	mx	14.0	11.2	11.8	j	18.7	13.6	13.9	b							
XIA	33	mâle ?		G	mx	14.3	10.8	10.7	e	17.4	13.0	13.2	b							
XIA	418	mâle ?		G	mx	13.9	10.4	10.8	k/l	17.9	13.8	13.4	b							
XIA	33			G	mx	11.8	10.7	10.1	m/n	17.5	13.5	13.2	e							

dents supérieures																			
phase	US/Str.	mâle / femelle	D/G	mx/ isolée	pm4 L	WA	WP	stade Grant	M1 L	WA	WP	stade Grant	M2 L	WA	WP	stade Grant	M3 L	WA	stade Grant
XIA	334		G	mx	13.0	11.2	11.4	l	17.2	14.1	14.5	d	20.1	16.5	15.6	U			
XIA	418	femelle	D	mx	14.2	10.9	10.4	l	17.3	13.1	13.4	e	21.7	15.9	15.3	b			
XIA	419		D	mx											15.4	b			
XIA	334	femelle	G	mx					16.8	12.7	13.0	f	20.8	15.9	14.2	b			
XIA	418		G	mx					18.2	13.3	13.1	e	22.0	16.4	16.3	b			
XIA	419		G	mx					16.7	12.7	12.9	d/e	19.1	13.4	13.2	U/a			
XIA	334	femelle	G	mx					18.1	13.4	13.5	ef	20.5	15.9	15.0	b			
XIA	334		G	mx					17.0	13.0	12.7	ef	20.0	15.1	14.0	c			
XIA	334	femelle	D	mx					16.4	13.4	13.2	j/k	20.1	15.0	14.3	env. e			
XIA	334		D	mx					17.4	13.6	13.4	g	20.9	15.9	15.2	c			
XIA	334		D	mx					17.4	14.1	13.4	f	20.8	16.2	15.6	b			
XIA	33		D	mx					19.1	15.1	14.3	b							
XIA	419	mâle	D	mx					16.7	14.2	13.6	j							
XIA	33		G	mx					18.1	14.3	14.8	e	22.3	17.6	16.7	a/b	30	16.9	V
XIA	418		G	mx						14.0		e							
XIA	371		G	mx					17.0	12.9	12.8	f/g	20.7	15.7		d?			
XIA	418		G	mx					15.5	13.8	13.4	l/k	20.8	16.6		d			
XIA	384		G	mx					15.7	13.7	13.5	k/l	20.9	16.8	16.4	d/e			
XIA	364		G	mx					17.1	14.2	14.2	h/j	22.3	17.5	17.1	d			
XIA	334		D	mx					14.9	12.6	12.8	k/l	20.4	15.2	15.4	e	27.3	16.3	a/b
XIA	371		D	mx									18.4	15.7	15.6	k	30.8	16.3	c/d
XIA	418		D	mx					17.9	14.8	14.9	h/j	23.4	18.5	17.9	e	28.1	17.6	a
XIA	160		D	mx													28.3		d
XIA	334		D	isolée									20.2	15.6	14.4	f			
XIA	334	mâle	G	mx					15.6	13.4	13.9	j	20.5	15.3	15.5	e			
XIA	371		G	mx					16.5	14.3	14.0	j/k	21.7	17.2	16.4	e			
XIA	33		G	mx					14.9	14.0	13.9	l/m	19.1	16.7	15.9	j/k			d
mil XI	411		D	mx	13.5	11.2	10.7	f/g	18.0	14.0	13.8	a/b							
mil XI	363		D	mx	14.0	10.5	10.7	d	16.7	12.8	13.1	U/a							
mil XI	342		G	mx					17.8	13.8	13.6	b/c							
mil XI	400		G	isolée					17.5	13.6	13.2	d							
mil XI	85		D	mx					17.2	13.9	13.7	ef	20.8	16.3	15.9	a/b			
mil XI	405		G	mx	11.5		10.6	n	17.0	13.4	13.1	e	20.3	15.0	13.8	a			
mil XI	411		G	mx					18.0	13.7	13.5	d	20.6	16.0	14.1	a			
mil XI	411		G	mx					16.7	13.2	13.3	ef	21.2	15.1	15.3	b			
mil XI	402		G	mx					17.9	13.3	13.1	d	20.9	15.8	15.4	a			
mil XI	400	mâle	D	mx					17.3			g/h							
mil XI	411		D	mx									20.7	14.6	14.1	ef	32.8	17.0	U
mil XI	411		D	mx					16.0	13.4	13.1	j							
mil XI	411		G	mx							13.2	g	20.3	16.2	15.5	b			
mil XI	402	femelle	D	mx					14.3	13.7	12.8	m	19.3	15.5	14.5	f	29.7	17.4	b
mil XI	400		D	mx					15.8	12.8	12.4	g/h	19.9	15.9	15.1	d/e	33.2	18.0	b
mil XI	363		D	mx										18.0		k?	33.2	18.7	e
mil XI	400		G	mx					13.1	12.2	13.3	m	18.6	15.1		j/k	31.0	17.5	c/d
mil XI	400		G	mx									21.4	15.1	14.7	d/e	28.9	18.0	b
mil XI	411		G	isolée													31.7	19.7	?
XIB	170		D	mx	14.4	11.0	10.9	c/d	17.2	13.5	13.6	U							
XIB	276		G	mx	15.1	11.0	11.0	d/e	18.6	13.5		U							
XIB	328		D	mx	13.9	11.5	10.8	g	17.6	13.8	13.5	a							
XIB	276		D	mx	14.3	10.7	10.5	d	16.8	12.4	12.4	a							
XIB	311		D	isolée					18.0	13.4	12.4	b							
XIB	170	mâle ?	G	mx	14.1	10.1	10.3	k	17.5	12.9	12.8	c	20.6			1/2			
XIB	276		G	mx	12.9	10.4	9.8	m											
XIB	316		G	mx	14.8	11.2	11.1	j	19.3	14.3	14.5	a/b							
XI B	233	mâle	G	mx					16.8	14.4	14.3	ef							
XI B	231		G	mx					18.0	14.2	13.6	e							
XIB	392		D	mx													32.3	17.7	U/a
XIB	325		G	mx					16.6	13.5	13.1	g	21.3	15.5	15.3	b			
XIB	231		D	mx									20.5		16.1	ef	33.0	19.8	b/c
XIB	325		G	mx													28.8	15.3	b/c
XII-XIV	286		G	mx					16.5	13.2	13.1	f	21.1	16.1	15.3	b			
XV-XVI	162		G	mx	12.6	10.6	9.9	k	17.3	12.7	12.9	a/b							
XV-XVI	31		D	mx											14.8	a/b			
XV-XVI	190		G	mx									21.4	15.2	15.1	a/b			
XV-XVI	210		G	mx					15.5	13.4	13.8	h/j	20.4	15.2	15.8	e	31.4	17.3	a/b
XV-XVI	167		G	mx													30.0	17.5	c/d
XVII-XVIII	7		G	mx					16.2	12.5	12.6	ef							
XVIII-XX	209		D	mx										16.5	16.8	d	35.8	19.0	U/a

scapula phase	US/Str.	centre coracoïdien					
		DHA	HS	SLC	GLP	BG	
XI A	33	+	149.0		22.2	34.7	25.7
XI A	33	+			21.6	35.8	24.3
XI A	33	+			22.3	32.6	25.0
XI A	33	+				34.4	25.3
XI A	33	+			19.3		21.7
XI A	33	-	147.6	146.0	19.0	30.0	19.9
XI A	33	-	113.1	109.6			
XI A	160				22.1		
XI A	334	+			19.3	32.0	22.0
XI A	334	+			24.5	33.6	21.5
XI A	334	+			25.2	39.8	29.2
XI A	334	+			21.4		
XI A	334	+			18.9	29.5	20.1
XI A	341				19.8		
XI A	359	-	67.8				
XI A	371	+			22.6		
XI A	371	+			21.4		23.3
XI A	371	-			19.9	29.6	18.6
XI A	382	+			18.8	30.6	21.0
XI A	418	-		114.6	17.2		18.7
XI A	419	+			22.4		
XI A	419				21.9		
XI A	419	-	103.1	98.8	16.3	23.8	15.5
mil XI	85	-			17.8	28.1	18.2
mil XI	90-91	+			22.7	35.3	24.8
mil XI	363	+			22.2	36.0	24.0
mil XI	363	+			18.0		21.0
mil XI	363	+			24.2	39.2	26.1
mil XI	405	-	94.8	94.5	13.8	21.7	16.3
mil XI	411	+	162.0		21.0	30.1	22.9
mil XI	411	+			24.7		30.9
mil XI	411	+			24.3		
mil XI	411	+			21.8	33.5	25.3
mil XI	411				23.1		
mil XI	411	-			17.7	27.4	19.3
XI B	24	+	180.8		23.9	36.9	26.0
XI B	98	+			22.1	34.8	25.2
XI B	238				22.5		
XI B	238	-	105.2		15.0		
XI B	276	+	174.0		21.7	33.5	25.2
XI B	276	+			20.7	35.2	28.0
XI B	276	+			23.9	37.2	26.9
XI B	276	+				33.5	25.5
XI B	276	+			22.7	34.9	25.7
XI B	276	-	96.1	94.9	13.9	22.2	15.9
XI B	311	+			24.6	36.8	26.0
XI B	312	+			22.6		
XI B	326	+	201.1		26.3	37.5	27.3
XI B	348	+			18.2	30.6	20.8
XI B	361	+			24.3		
XI B	397	+	181.6		23.6	34.2	23.1
XI B	404				21.0		
XV-XVI	210	+			22.7	34.0	23.6

humérus phase	US/Str.	EP	ED	GL	GLC	Bp	SD	Bd	BT
XI A	33		+				15.3	41.4	30.3
XI A	33		+					34.3	26.7
XI A	334		+				15.0	40.8	32.0
XI A	334		+					39.0	31.0
XI A	334	-	-	60					
XI A	347	-	+	140.1			13.6	35.8	26.8
XI A	371		+				13.1	36.7	27.5
XI A	418	-	+	136.3			13.2	33.5	28.8
XI A	418	-	-	98.5					
XI A	418	-	-	64.8					
XI A	418	-	-	118.8					
XI A	419	+	+		168.2	45.4	16.1	41.9	32.6
XI A	419		+					41.4	31.1
XI A	419	-	-	110.2					
mil XI	400		+					36.7	27.6
mil XI	400	-	-	81.7					
XI B	237	-	-	86.6					
XI B	237	-	-	63.5					
XI B	238		+				15.8	38.7	27.9
XI B	238		+					37.7	28.4
XI B	312		+					40.8	31.1
XI B	397		+				15.8	37.9	30.9
XI B	452		+					37.6	29.7

radius phase	US/Str.	EP	ED	GL	Bp	SD
XI A	33	+			26.1	15.5
XI A	33	+			28.0	17.6
XI A	33	+			27.9	
XI A	33	+			28.1	
XI A	33	+	-	117.5	28.8	15.5
XI A	33	+	-	134.2	27.8	16.4
XI A	33	-	-	65.7		
XI A	33	-	-	101.7		
XI A	334	+			32.4	19.5
XI A	334	+			28.3	18.5
XI A	334	-	-	45.9		
XI A	354	+			27.0	15.7
XI A	354	+			25.3	16.0
XI A	371	+			30.4	18.6
XI A	419	-	-	81.5		
XI A	421	+			28.3	
mil XI	85	+			27.2	17.0
mil XI	85	-	-	104.2		
mil XI	342	+			28.9	17.8
mil XI	363	+			29.6	17.0
mil XI	405	-	-	86.9		
mil XI	411	+			29.3	16.7
mil XI	411	-	-	78.0		
XI B	238	-	-	80.0		
XI B	276	-	-	98.0		
XI B	346	-	-	64		
XI B	392	+			28.4	
XVII-XVIII	40	+	-	169.8	33.4	21.1
XVII-XVIII	47	+			27.9	16.5
XVII-XIX	381	-	-	70.4		

ulna					
phase	US/Str.	EP	ED	GL	BPC
XI A	33	-			22.2
XI A	33	-			17.8
XI A	33	-			15.7
XI A	33	-			19.8
XI A	33	-			22.0
XI A	33	-			20.8
XI A	33	-			23.6
XI A	33	-			21.5
XI A	33	-			21.7
XI A	33	-			17.7
XI A	334	-			21.0
XI A	334	-			18.5
XI A	334	-			20.1
XI A	334	-			22.9
XI A	334	-			20.1
XI A	334	-			22.7
XI A	334	-			22.9
XI A	334	-	-	103.8	17.4
XI A	334	-	-		17.9
XI A	334	-	-	<u>55</u>	
XI A	354	-			20.6
XI A	354	-			19.8
XI A	347	-			18.7
XI A	371	-			23.1
XI A	371	-			20.8
XI A	371	-			19.5
XI A	418	-	-	106.1	18.1
XI A	419	-			18.5
XI A	419	-			18.6
XI A	421	-	-	139.9	19.8
XI A	421	-			21.8
mil XI	342	-			25.3
mil XI	363	-			20.0
mil XI	363	-			20.2
mil XI	363	-	-	92.4	17.1
mil XI	400	-	-	147.3	18.4
mil XI	400	-			18.2
mil XI	400	-			15.7
mil XI	411	-			18.0
XI B	237	-			19.2
XI B	276	-	-	132.1	19.1
XI B	276	-			20.6
XI B	276	-			17.8
XI B	300	-			23.4
XI B	348	-			22.5
XI B	392	-			21.2
XI B	397	-	-	94.8	15.5
XI B	397	-	-	144.5	21.7
XI B	436	-			21.6

fibula				
phase	US/Str.	EP	ED	GL
XI A	421	-	-	171.6
mil XI	400	-	-	143.3
XI B	237	-	-	118.7
XI	36	-	-	127.5
XII-XIII	71	-	-	124.1

coxal (il : crête iliaque, ca : centre acétabulaire, is : tubérosité ischiatique)									
phase	US/Str.	il	ca	is	LA	LAR	SB	SH	LFO
XI A	33		+		34.1	31.4	11.9	24.5	
XI A	334		+		33.5	30.6	13.1	23.1	
XI A	371		+		32.9	31.3			39.8
XI A	371		+				11.2	23.0	
XI A	419	-	+	-	36.9	33.9	13.7	25.1	
XI A	419	-	+	-	30.6	26.6	11.5	17.8	29.8
XI A	421		+		30.3	28.5			
mil XI	85		+		31.1	28.9	12.3	23.5	
mil XI	411		+		35.9	33.5	13.4	25.2	
XI B	22		+	-	34.0	30.0	12.8	27.3	
XI B	96		+		28.1	26.2	9.8		
XI B	170		+		35.9	31.5	10.7	22.8	
XI B	233		+		32.1	29.5	12.6	21.7	
XI B	279		+		<u>38</u>	<u>35</u>	14.4	25.8	
XI B	392		+		32.7	29.9	12.6	22.2	
XI B	397	-	+	-	34.8	30.4	12.0	24.0	41.6
XI	36		+	-	32.5	31.0			37.7

fémur							
phase	US/Str.	EP	ED	GL	Bp	Bd	SD
XI A	33	-	-	<u>134</u>			
XI A	334	+			58.4		
XI A	334	-	-	64.4			
XI A	418	-	+			43.5	15.6
XI A	418	-	-	126.0			
XI A	419	-	-	117.0			
XI B	276	-	-	117.0			
XI B	276	-	-	117.2			
XI B	343	-	-	<u>87</u>			
XI B	392	-	-	146.4			
XI B	397	-	-	120.4			
XI B	397	-	-	144.9			

tibia								
phase	US/Str.	EP	ED	GL	Bp	SD	Bd	Dd
XI A	33		+			18.8	28.9	24.8
XI A	33		+			19.0	28.5	24.5
XI A	33	-	-	133.4				
XI A	33	-	-	134.1				
XI A	334	+			46.8			
XI A	334		+			19.6	31.0	27.5
XI A	334	-	-	<u>120</u>				
XI A	334	-	-	63.7				
XI A	371	-	-	159.4				
XI A	418	-	+	176.7		17.5	28.1	25.5
XI A	418	-	-	120.9				
XI A	418	-	-	127.6				
XI A	419	-	-	167.8				
XI A	421	-	-	44.7				
mil XI	85		+			20.3	32.3	28.0
mil XI	363	-	-	164.2				
mil XI	411		+				30.2	29.2
mil XI	411	+			48.9			
mil XI	411	-	-	111.8				
XI B	238		+			20.7	30.7	25.7
XI B	238	-	-	94.0				
XI B	308	-	-	84.0				

MC IV							
phase	US/Str.	ED	GL	LeP	Bp	B	Bd
XI A	33				18.1		
XI A	33	-	57				
XI A	33	-	60.8		16.9		
XI A	33	-	59.2		17.1		
XI A	33	-	54.3		15.6		
XI A	33	-	46.9		13.3		
XI A	33	-	63.7		19.9		
XI A	334	+	72.0	69.8	17.3	12.8	15.2
XI A	334	-	63.3		17.2		
XI A	334				19.4		
XI A	347	-	66.4		18.1		
XI A	418	-	48.5		14.5		
XI A	419	+	69.7	69.1	14.0	11.0	15.9
XI A	419	-	61.0		13.7		
XI A	419	-	63.1		14.4		
XI A	419	-	69.9		15.5		
mil XI	85	-	65.7		14.6		
mil XI	400	+	74.0	70.9	18.3	15.8	18.4
mil XI	411	+	78.2	77.5	17.9	15.0	
mil XI	411	+	77.7	75.4	19.1	14.0	15.5
XI B	237	-	35.8		11.5		
XI B	237	-	50.4		12.7		
XI B	237	-	57.3		14.0		
XI B	276	-	42.5		12.9		
XI B	276				15.7		
XI B	276				14.6		
XI B	308	-	45		13.3		
XI B	314	-	50.1				
XI B	392	-	62.2		17.2		
XI B	397	+	77.5	73.4	15.8	14.3	16.8
XI B	397	-	48.2		13.0		
XII-XIII	71	-	52.1		13.6		
XV-XVI	31				18.3		

MC III							
phase	US/Str.	ED	GL	LeP	Bp	B	Bd
XI A	33				12.9		
XI A	33				15.3		
XI A	33	-	62.3		15.1		
XI A	33	-	47.7		12.0		
XI A	33	-	59.0		14.5		
XI A	33	-	59.2		16.6		
XI A	334	+	76.9	73.9	16.9	13.9	16.9
XI A	334	-	60.6		13.8		
XI A	418	-	55.8				
XI A	418	-	67.2		16.3		
XI A	418	-	43.8		12.0		
XI A	419	-	48.2				
XI A	419	-	66.3		14.3		
mil XI	402	-	68.6		15.8		
mil XI	411	-	69.2		15.4		
XI B	170	-	62.2		14.8		
XI B	170	-	66.5		15.5		
XI B	237	-	66.7		17.0		
XI B	237	-	55.1		14.6		
XI B	346	-	64.8		13.7		
XI B	392	+	73.5	70.1	14.2	11.7	15.8
XI B	392	-	60.3		14.1		
XI B	397	+	73.4	69.3	13.9	11.7	15.6
XI B	397	+	73.2	69.1	15.3	11.4	15.6
XI B	397	+	81.1	77.7	16.0	13.0	17.4
XI	36				10.9		

MC II			
phase	US/Str.	ED	GL
XI A	33	-	42.2
XI A	33	-	43.7
XI A	33	-	41.1
XI A	33	-	35.0
XI A	33	-	44.3
XI A	334	-	54.9
XI A	347	-	35.3
XI A	418	-	48.3
XI A	419	-	43.1
XI A	419	-	43.2
XI A	419	-	48.7
XI A	421	+	52.7
mil XI	411	+	56.4
XI B	233	+	52.1
XI B	237	-	26.5
XI B	279	-	49.8
XI B	393	-	46.4
XI	36	-	42.5
XII-XIII	71	-	37.5

MC V			
phase	US/Str.	ED	GL
XI A	33	-	44.1
XI A	33	-	44.8
XI A	33	-	32.5
XI A	33	-	30.7
XI A	33	-	25.8
XI A	33	-	40.7
XI A	33	-	33.5
XI A	33	-	32.3
XI A	33	-	33.9
XI A	418	+	51.2
XI A	418	+	57.3
XI A	419	+	52.1
XI A	419	+	51.8
XI A	419	-	50.5
XI A	419	-	50.0
XI B	231	-	36.3
XI B	232	-	51.3
XI B	237	-	42.8
XI B	276	-	39.4
XI B	276	-	33.7
XI B	276	-	47.0
XI B	311	-	37.0
XI B	392	-	42.8

MT III							
phase	US/Str.	ED	GL	LeP	Bp	B	Bd
XI A	33	-	58.2		14.1		
XI A	160	-	55.6		12.4		
XI A	334	+	77.9	77.6	13.7	10.8	13.6
XI A	334	-	74.6		15.5		
XI A	334	-	58.1		14.0		
XI A	371				16.0		
XI A	418	-	60.4		12.6		
XI A	419				15.7		
XI A	421	+	81.2	79.7	15.7	13.8	17.1
XI A	421	-	51.8		13.7		
mil XI	411				14.2		
XI B	170	-	63.8		14.6		
XI B	237	-	41.0		10.3		
XI B	276				14.3		
XI B	276	-	53.8				
XI B	308				17.4		
XI B	397	-	49.5		12.3		
XI B	452	-	59.0		14.0		
XI	36	-	56.6		12.5		
XI	36				15.1		
XI	36				14.2		
XV-XVI	210	-	76.4				

MT IV				
phase	US/Str.	ED	GL	Bp
XI A	33			13.7
XI A	33	-	52.3	13.8
XI A	33	-	56.8	12.9
XI A	160	-	59.2	13.8
XI A	342	-	81.6	15.7
XI A	418	-	64.5	14.3
XI A	418	-	53.7	12.1
XI A	419			14.1
XI A	419	-	72.0	15.6
mil XI	405	-	77.2	16.1
mil XI	411			17.7
XI B	96	-	76.5	15.8
XI B	232	-	66.8	15.1
XI B	232	-	66.3	13.2
XI B	237	-	58.0	13.4
XI B	237	-	55.9	11.9
XI B	238	-	55.6	12.5
XI B	276	-	75.2	15.5
XI B	276	-	54.1	11.2
XI B	276	-	50.0	
XI B	308	-	70.4	14.7
XI B	311	-	73.3	16.6
XI B	392	-	56.8	13.4

MT II			
phase	US/Str.	ED	GL
XI A	33	-	48.5
XI A	33	-	34.5
XI A	33	-	46.3
XI A	34	-	40.1
XI A	160	-	38.3
XI A	347	-	35.4
XI A	419	+	55.5
XI A	419	-	51.8
mil XI	405	-	45.0
XI B	98	+	59.1
XI B	276	-	39.3
XI B	276	-	45.9

MT V			
phase	US/Str.	ED	GL
XI A	33	-	42.7
XI A	33	-	42.8
XI A	33	-	46.8
XI A	33	-	33.9
XI A	364	-	45.3
XI A	418	-	52.5
XI A	418	-	57.0
XI A	418	-	51.4
XI A	418	-	55.4
XI A	419	-	53.4
XI A	419	-	56.6
XI B	98	+	62.6
XI B	232	-	51.2
XI B	237	-	42.3
XI B	276	-	50.8
XI B	276	-	44.5
XI B	276	-	42.7
XI B	279	-	56.7
XI B	308	-	32.1
XI B	397	-	56.8
XI	36	-	48.1

talus					
phase	US/Str.	GLI	GLm	DI	Dm
XI A	33	39.0	36.4	19.8	23.0
XI A	33	36.3	34.6	18.6	
XI A	33	38.3	36.7	19.2	20.5
XI A	33	39.1	36.5	19.4	22.5
XI A	33	40.4	37.6	20.4	24.7
XI A	33		24.8		
XI A	33	39.5	36.2		
XI A	33		34.3	19.0	
XI A	334	37.9	35.6	19.5	23.9
XI A	334	39.2	35.6	20.1	25.1
XI A	334	41.7	39.2	20.8	21.5
XI A	371	40.0	37.0	20.0	23.1
XI A	418		37.5		
XI A	418	38.4	36.7	19.4	20.5
XI A	418	40.2	37.1	19.6	24.0
XI A	418	41.4	38.5	20.8	23.9
XI B	231	41.3	37.7		
XI B	237	38.5	35.3	20.1	24.3
XI B	276	41.4	38.4	21.4	24.3
XI B	276	42.0	38.4	21.0	25.0
XI B	308	41.9	39.0	22.2	23.9
XI B	308	43.4	39.5	21.8	24.3
XI	36	39.5	35.8	20.1	24.9

juvénile ?

juvénile

juvénile

juvénile ?

calcanéum			
phase	US/Str.	EP	GL
XI A	33	-	36.7
XI A	33	-	48.0
XI A	334	+	79.6
XI A	334	-	65.2
XI A	334	-	64.6
XI A	334	-	78.8
XI A	354	-	69.7
XI A	359	-	59.9
XI A	371	-	57.0
XI A	418	+	75.3
XI A	418	-	36.7
XI A	418	-	73.2
XI A	418	-	69.6
XI A	418	-	52.8
XI A	421	-	78.5
mil XI	405	-	71.1
XI B	231	-	72.5
XI B	276	-	69.4
XI B	346	-	68.0
XI B	392	-	74.6
XI B	397	-	71.6
XI	36	-	66.0

phalange proximale						
phase	US/Str.	EP	GI(pe)	Bp	SD	Bd
XI A	33	+	34.3	16.2	12.5	15.2
XI A	33	+	36.7	17.3	14.5	15.4
XI A	33	+	34.9	16.5	13.7	15.4
XI A	33	-	28.6			
XI A	33	-	31.7			
XI A	33	-	29.2			
XI A	33	-	23.8			
XI A	33	-	28.0			
XI A	33	-	30.4			
XI A	33	-	26.9			
XI A	33	-	27.5			
XI A	33	-	25.3			
XI A	34	-	29.4			
XI A	334	+	39.5	18.0	13.5	15.9
XI A	334	+	39.8	15.9	12.4	14.5
XI A	334	+	35.9	15.2	13.3	15.0
XI A	341	+	37.2	16.4	12.9	15.2
XI A	359	+	33.5	16.8	13.0	15.1
XI A	359	+	40.4	15.9	12.9	14.1
XI A	359	+	39.3	15.8	12.6	14.4
XI A	359	+	39.2	15.5	12.3	14.0
XI A	359	+	39.1	15.5	11.9	13.8
XI A	359	-	29.6			
XI A	359	-	30.7			
XI A	359	-	33.5			
XI A	371	-	30.7			
XI A	418	+	34.7	16.1	13.4	14.3
XI A	418	+	39.1	16.1	12.7	15.2
XI A	418	+	37.3	15.9	12.2	14.1
XI A	418	+	36.2	16.4	12.3	15.4
XI A	418	-	30.0			
XI A	418	-	27.4			
XI A	419	+	35.0	16.5	12.7	15.2
XI A	419	+	34.2	15.7	12.5	14.2
XI A	419	+	37.5	15.9	12.3	14.1
XI A	419	+	37.9	15.1	11.4	14.1
XI A	419	+	39.5	15.2	12.0	13.5
XI A	419	+	39.5	15.3	12.4	14.7
XI A	419	+	33.7	16.1	13.1	15.8
XI A	419	+	35.1	17.5	13.6	15.1
XI A	419	-	26.8			
XI A	421	+	36.5	16.5	12.9	14.5
XI A	421	+	37.7	16.8	13.3	15.5
XI A	421	-	29.1			

phalange intermédiaire						
phase	US/Str.	EP	GL	Bp	SD	Bd
XI A	33	+	22.3	15.6	12.6	13.3
XI A	33	+	25.2	16.1	13.2	14.1
XI A	33	+	24.2	16.6	13.7	15.2
XI A	33	-	18.8			
XI A	33	-	17.0			
XI A	33	-	14.4			
XI A	418	+	23.0	14.5	12.4	12.4
XI A	418	+	23.1	15.2	13.3	12.7
XI A	418	+	23.8	15.1	12.6	12.9
XI A	418	+		14.0	12.0	
XI A	418	-	19.3			
XI A	418	-	16.9			
XI A	419	+	22.4	14.6	11.4	12.4
XI A	419	+	26.7	16.0	12.3	13.5
XI A	419	+	23.1	16.3	12.6	14.0
XI A	419	+	25.4	15.9	13.1	13.7
XI B	237	+	23.3	17.2	13.7	15.7
XI B	237	+	21.0	15.4	13.2	14.1
XI B	237	-	15.3			
XI B	238	-	16.8			
XI B	276	-	16.5			
XI B	276	-	20.2			
XI B	276	-	19.6			
XI B	276	-	20.2			
XI B	276	-	19.1			
XI B	276	-	19.2			
XI B	311	+	21.5	15.1	12.3	13.7

phalange proximale						
phase	US/Str.	EP	GI(pe)	Bp	SD	Bd
mil XI	400	+	37.6	15.5	12.7	13.4
mil XI	400	-	32.1			
mil XI	400	-	27.4			
mil XI	407	-	35.5			
mil XI	411	-	33.1			
mil XI	411	-	31.1			
XI B	231	-	28.7			
XI B	232	-	34.4			
XI B	233	+	34.8	17.4	12.5	15.1
XI B	237	+	36.8	16.4	12.9	15.7
XI B	237	-	27.5			
XI B	237	-	25.5			
XI B	237	-	28.4			
XI B	237	-	28.2			
XI B	237	-	22.4			
XI B	237	-	24.0			
XI B	278	-	32.0			
XI B	276	-	34.6			
XI B	276	-	32.3			
XI B	276	-	26.6			
XI B	276	-	33.0			
XI B	276	-	34.4			
XI B	279	+	41.6	16.3	12.6	15.5
XI B	311	-	30.9			
XI B	311	-	28.3			
XI B	392	+	36.6	15.8	13.4	14.7
XI B	392	+	43.1	15.9	12.6	16.1
XI B	397	+	35.8	18.7	14.4	17.3
XI B	397	-	32.8			
XI	36	+	41.2	17.4	13.6	16.3

phalange distale					
phase	US/Str.	DLS	Ld	MBS	
XI A	33	26.3	24.5	9.8	
XI A	33	28.0	27.0	10.9	
XI A	33	19.0	17.2	8.5	juvénile
XI A	33	24.7	22.5	9.3	
XI A	33	22.1			juvénile
XI A	347	22.6	20.3	9.1	juvénile
XI A	359	28.5	26.3	10.2	
XI A	418	28.1	27.2	11.4	
XI A	418	28.3	26.8	10.8	
XI A	418	28.6	27.7	12.0	
XI A	418	29.4	26.0	11.5	
XI A	418	21.5	18.6	8.5	juvénile
XI A	418	24.5	21.2	9.1	juvénile
XI A	419	28.7	27.7	11.5	
XI A	419	26.5	25.1	9.8	
mil XI	411	30.4	27.5	12.6	
XI B	24	30.4	27.4	10.9	
XI B	237	28.2	25.1	11.6	
XI B	276	26.3	24.5	9.9	adulte ?
XI B	276	26.1	24.8	9.2	adulte ?
XI B	276	25.8	23.4	9.7	adulte ?
XI B	276	26.5	25.2	9.1	adulte ?
XI B	276	20.7	18.4	8.6	juvénile
XI B	276	21.5	19.3	7.9	juvénile
XI B	278	26.3	24.2	9.4	
XI B	311	27.4	25.2	10.2	
XI B	343	30.9	29.8	13.4	
XI B	392	29.9	27.3	11.8	
XV-XVI	10	27.4	25.4	10.2	juvénile ?

Annexe 5.3 : ostéométrie des Caprinés, Mouton *Ovis aries* et Chèvre *Capra hircus* avec 'mf.' pour morphotype.

tête osseuse									
phase	US/Str.	espèce	27	29	30	31	40	41	42
XI A	371	Mouton				40.1			
XI A	419	mf. Mouton					120.0	45.0	28.5
mil XI	85	Mouton	42.5	20.1	15.5				
mil XI	411	mf. Mouton					130.0	47.0	29.4

maxillaire et dents supérieures					
phase	US/Str.	espèce	21	22	23
XI A	33	mf. Mouton	69.1	44.0	27.5
XI A	334	mf. Mouton	65.5	42.1	25.6

mandibule																
phase	US/Str.	espèce	3	5	6	7	8	9	10 B	10 L	11	12	13	15a	15b	15c
XV-XVI	210	Mouton	52	122	139	70.6	48.4	33.8	8.56	21.4	<u>37</u>	69.3	63.4	37.5	23	17.8

(mesure 15 face interne)

atlas								
phase	US/Str.	espèce	GB	GL	BFcr	BFcd	GLF	H
XI A	354	Mouton		46.7	46.4	41.0	41.9	34.2
XI A	419	Mouton	56.6	42.9	44.3	41.1	40.1	33.9
XI A	419	Mouton	<u>63</u>			43.0		36.7
XI B	276	Mouton		44.5			37.6	
XV-XVI	31	Mouton		43.7			38.3	
XV-XVI	210	Mouton			<u>42</u>	35.6	36.8	30.8
XVII-XVIII	45	Mouton			44.6		42.3	35.6

(à peine adulte, ligne de soudure encore visible)

axis - : épiphyse vertébrale non fusionnée ; LCDe mesuré sans l'épiphyse											
phase	US/Str.	espèce	LCDe	LAPa	BFcr	BPacd	BPtr	SBV	BFcd	H	
XI A	33	mf. Mouton	-		39.9			23.5			
XI A	334	Mouton	+	52.3	49.1	39.3	31.3	24.5	<u>25</u>	48.2	
XI A	334	Mouton	-	50.4		<u>40</u>		21.8	21.3		
XI A	354	Mouton	+			46.2		27.7	<u>26</u>		
XI A	382	Mouton	-	47.1	38.4	40.7	32.6	<u>38</u>	24.1	21.9	
mil XI	85	Mouton	-	<u>52</u>		43.2		29.3	<u>28</u>		
mil XI	400	Mouton	-	<u>47</u>		41.4		23.1			
mil XI	411	Mouton	+	50.8				23.2	20.8		
XI B	42	Mouton	-	<u>46</u>		<u>41</u>		24.4	<u>23</u>		
XI B	276	Mouton	-	48.0			38.7	20.4		<u>41</u>	
XI B	276	Mouton	-	45.5			36.0				
XI B	392	Mouton	-	51.1		39.5		21.3	22.5		
XI B	392	Mouton	-					24.3			
XI B	397	Mouton	-	45.1		38.8		<u>37</u>	22.1	20.7	

scapula													
phase	US/Str.	espèce	centre coracoïdien				HS	DHA	Ld	SLC	GLP	LG	BG
XI A	33	Mouton	+							28.7	23	19.3	
XI A	33	Mouton	+						21.8			19.6	
XI A	33	Mouton	+						20.7			21.1	
XI A	33	Mouton	+						19.5	32.2	26.3	20	
XI A	33	mf. Mouton	+						20.9				
XI A	33	-	-		64.1	69.6							
XI A	33	-	-		78.4	85.1							
XI A	334	Mouton	+						16.9	30.5	25.0	<u>20</u>	
XI A	334	Mouton	+						20.3		25.5	20.2	
XI A	334	Mouton	+							31.7	25.7	20.2	
XI A	334	Mouton	+								24.4	19.9	
XI A	334	mf. Chèvre	+									20.4	
XI A	339	mf. Mouton	+						20.2				
XI A	341	mf. Mouton	+						18.1				
XI A	347	Mouton	+						17.6	30.6		19.2	
XI A	347	-	-										
XI A	371	Mouton	+		73.9				18.8	32.6	25.4	19.9	
XI A	371	mf. Mouton	+						17.3		21.3	18.6	
XI A	418	Mouton	+		129.9	138.9	93.9	19.8	30.6		23.2	19.4	
XI A	418	Mouton	+		<u>129</u>	<u>135</u>	95.7	19.9				<u>19.1</u>	
XI A	418	Mouton	+			137.5		18.9	29.9	24.9		20.0	
XI A	418	mf. Mouton	+					18.4	31.5	23.9		19.7	
XI A	418	-	-		62.7	66.7							
XI A	418	-	-		70.9	74.7							

scapula		centre coracoïdien								
phase	US/Str.	espèce		HS	DHA	Ld	SLC	GLP	LG	BG
XI A	419	Mouton	+	128.4			18.9	31.0	24.4	19.9
XI A	419	Mouton	+				17.5	30.8	25.0	19.9
XI A	419	mf. Mouton	+				15.7	29.6	23.0	15.1
XI A	419	Mouton	+				16.4	30.8	23.7	19.2
XI A	419	-	-		73.4					
XI A	419	-	-	65.0	67.8					
XI A	421	Mouton	+				16.7	31.6	24.6	18.6
XI A	421	Mouton	+				17.8	30.9	24.5	18.1
XI A	421	mf. Mouton	+				15.8			
mil XI	363	mf. Mouton	+				18.0			
mil XI	400	mf. Mouton	+				17.3			
mil XI	402	Mouton	+				16.2	27.6	22.7	16.5
mil XI	411	Mouton	+				18.6	30.9	24.1	18.5
mil XI	411	mf. Mouton	+				14.7			17.8
mil XI	411	Mouton	+				17.5		24.7	18.1
XI B	237	Mouton	+	138.2	147.5	87	19.1	30.1	24.5	18.9
XI B	238	Mouton	+				16.7	30.1	24.0	17.9
XI B	276	Mouton	+				19.3			
XI B	276	-	-	67.8	70.9					
XI B	308	Mouton	+				15.7	29.3	23.4	18
XI B	397	Mouton	+	106.0	115.6	71.0	15.0	26.5	21.9	16.8
XI B	397	Mouton	+	105.5	101.5		14.5	26.0	21.9	17.1
XI B	452	Mouton	+				17.5	30.0	22.9	18.9
XI	36	Mouton	+				16.7	28.8	22.2	18.5
XI	36	-	-		68.3					
XII-XIII	71	Mouton	+		129.6		16.6	29.4	23.6	17.4
XII-XIV	310	mf. Mouton	+				19.2			
XV-XVI	10	-	-	68.0	72.2					
XVII-XVIII	47	mf. Mouton	+				16.8	28.2	22.0	18.1
XVIII-XX	209	mf. Mouton	+				16.1	30.8	24.2	19.1

humérus											
phase	US/Str.	espèce	EP	ED	GL	GLC	Bp	Dp	SD	Bd	BT
XI A	33	Mouton		+					12.5	26.7	24.0
XI A	33	Mouton		+					12.1	26.4	24.7
XI A	33	Mouton		+						25.6	24.0
XI A	33	Mouton		+						32.2	26.9
XI A	334	Mouton		+					14.4	29.6	28.1
XI A	334	Mouton		+						27.7	25.6
XI A	334	Mouton		+					12.1	27.0	25.4
XI A	334	Mouton		+						27.8	26.0
XI A	359	Mouton	-	+	102.3				13.5	26.8	25.5
XI A	371	Mouton		+						24.0	22.0
XI A	371	Chèvre		+						26.7	24.3
XI A	418	Mouton		+			35.0	37.3			
XI A	418	Mouton		+					11.5	25.9	24.4
XI A	419	Mouton		+						26.5	23.5
XI A	419	Mouton		+						30.0	26.6
XI A	419	-	-	-	106.0						
XI A	421	Mouton	-	+	98.4				12.6	27.8	26.3
XI A	421	Mouton		+					15.2	29.9	28.2
XI A	421	Mouton		+						28.4	26.1
XI A	421	Mouton		+					15.3	29.1	26.8
XI A	421	-	-	-	63						
mil XI	400	Mouton	+	+		111.6	36	39.0	13.7	27.5	24.7
mil XI	400	Mouton		+					14.3	30.2	27.8
mil XI	402	Mouton	-	+	106.9				12.7	28.9	-
mil XI	405	Mouton	-	+	130.0	116.1		39.3	13.0	28.3	26.3
mil XI	411	Mouton		+						29.4	26.7
mil XI	411	Mouton		+					12.8	28.2	26.4
mil XI	411	Mouton		+						29.7	28.4
mil XI	411	Mouton		+					13.3	26.2	24.2
XI B	237	Mouton		+			37	41.2	13.9		
XI B	279	Mouton		+					13.3	30.6	28.0
XI B	322	Mouton		+						29.2	27.1
XI B	323	Mouton		+						28.1	25.6
XI B	392	Mouton	-	+	113.2				13.2		26.4
XI B	397	-	-	-	124.1						
XII-XIV	306	-	-	-	52.0						
XVII-XVIII	8	Mouton		+						27.0	24.7
XVII-XVIII	39	Mouton		+					12.2	26.1	24.5
XVII-XVIII	40	Mouton		+					12.3	27.0	25.5
XVII-XVIII	40	Mouton	-	+						28.0	26.3
XVII-XVIII	47	Mouton		+						28.8	26

humérus											
phase	US/Str.	espèce	EP	ED	GL	GLC	Bp	Dp	SD	Bd	BT
XVII-XVIII	47	Mouton		+						26.7	24.8
XVIII-XX	209	Mouton		+						27.5	25.2
XVIII-XX	209	Mouton		+						26.0	23.6

ulna							
phase	US/Str.	espèce	EP	BPC	SDO	LO	
XI A	334	Mouton	-	19.5			
XI A	334	Mouton	-	19.0			
XI A	371	Mouton	-	16.5			
XI A	418	mf. Mouton	-	16.2			
XI A	418	Mouton	-	17.5			
mil XI	405	mf. Chèvre	-	18.0			
XI B	237	Mouton	+	19.2	20.4	38.4	
XI B	237	Mouton	-	18.5			
XI B	276	Mouton	+	19.1	21.7	39.3	
XI B	276	Mouton	+	17.9	21	38.5	
XI B	276	Mouton	-	17.5			
XI B	279	Mouton	-	16.5			
XI	36	Mouton	-	18.2			

radius											
phase	US/Str.	espèce	EP	ED	GL	Bp	BFp	SD	Bd	BFd	
XI A	33	Mouton	+			27.8	25.9				
XI A	44	Mouton		+					28.3	24.6	
XI A	44	Mouton		-					26.5	24.2	
XI A	44	Mouton		-					28.2	22.6	
XI A	334	Mouton	+			30.3	27.7	16.9			
XI A	334	Mouton	+			32.3	29.6	19.1			
XI A	334	Mouton	+			27.1	25.6				
XI A	347	Mouton	+			31.2	26.8	16.1			
XI A	371	-	-	-	69.0						
XI A	418	Mouton	+			31.7	27.7	18.3			
XI A	418	-	-	-	64.1						
XI A	418	-	-	-	62						
XI A	418	-	-	-	72.5						
XI A	419	Mouton	+	-	116.2	27.8	26.6	15.8			
XI A	419	Mouton	+			29.5	27.5	16.4			
XI A	419	Mouton		-					27.1	23.3	
XI A	421	Mouton	+	-	109.0	28.9	26.8	14.6			
XI A	421	Mouton	+	-	122.0	29.2	26.2	15.6			
mil XI	85	Mouton	+	+	144.4	31.3	27.8	16.9	26.2	23.4	
mil XI	411	Mouton	+			29.3	26.3	15.5			
mil XI	411	Mouton	+			28.3	25.3				
mil XI	411	Mouton	+			26.8	24.5	14.5			
XI B	24	-	-	-	62.7						
XI B	232	-	-	-	73.5						
XI B	237	Mouton	+	+	128.3	KC	KC	15.6	26.5	23.1	
XI B	237	Mouton	+			29.7	26.4				
XI B	237	Mouton		+				15.4	26.8	22.9	
XI B	237	Mouton		+				15.5	27.2	23.9	
XI B	237	-	-	-	74.3						
XI B	238	Mouton	+			30.8	27.0	17.6			
XI B	276	Mouton	+			29.7	26.7				
XI B	276	Mouton	+			31.9	28.8				
XI B	276	Mouton	+			29.6	26.5				
XI B	276	Mouton		-					27.1	24.2	
XI B	276	-	-	-	69.1						
XI B	276	-	-	-	74.8						
XI B	276	-	-	-	72.3						
XI B	276	-	-	-	70.3						
XI B	279	Mouton	+			28.4	26.8	14.3			
XI B	308	mf. Mouton	+	-	95.8	24.5	23.9	12.7			
XI B	397	Mouton	+	-	130.5	29.0	26.5	14.2			
XI B	397	Mouton	+	-	102.2	26.3	24.1	12.8			
XI	36	-	-	-	72.4						
XV-XVI	210	Mouton	+	-	129.8	27.8	25.6	16.4			
XVI-XVII	220	Mouton	+			32.9	29.3	16.5			
XVII-XVIII	40	Mouton	+			28.4	26.2	15.1			
XVII-XVIII	40	Mouton	+			28.4	25.7	15.1			
XVII-XVIII	47	Mouton	+			29.1	26.9	15.5			

métacarpe			
phase	US/Str.	ED	GL
XI A	33	-	64.66
XI A	359	-	105.39
XI A	419	-	90.48
XVII-XVIII	40	-	111.83

coxal (il : crête iliaque, ca : centre acétabulaire, is : tubérosité ischiatique)											
phase	US/Str.	espèce	sexe	il	ca	is	GL	LA	SH	SB	Lfo
XI A	33	mf. Mouton	mâle	-	+			28.6	17.1	11.8	
XI A	33	Mouton	mâle	-	+	-	156.4	27.5	13.5	9.4	
XI A	33	Mouton	mâle		+	-		28.2	15.7	9.8	34.2
XI A	33	mf. Mouton	mâle ?		+			26.1			
XI A	33	-	mâle ?		+			28.1			
XI A	334	Mouton	mâle		+	-		26.3			31.7
XI A	334	mf. Mouton	mâle		+			26.3			
XI A	334	mf. Mouton	mâle		+			28.1	15.4	9.2	
XI A	334	Mouton	mâle	-	+				13.6	8.5	
XI A	334	-	mâle ?		+			28.7			
XI A	334	mf. Mouton	mâle		+	-		30.1			
XI A	339	-	mâle ?		+			28.3			
XI A	359	mf. Mouton	mâle		+			24.5	13.9	8.7	
XI A	418	Mouton	femelle	-	+	+	169.7	26.8	12.9	8.5	31.0
XI A	418	Mouton	femelle	-	+	+	178.1	28.9	13.5	10.2	34.6
XI A	418	mf. Mouton	mâle		+			26.2	13.1	8.1	28.3
XI A	419	mf. Mouton	mâle ?		+				14.4	9.1	
XI A	419	-	mâle	-	+			25.6	12.5	7.9	
XI A	419	-	mâle ?		+			27.4			
mil XI	363	mf. Mouton	mâle ?		+				14.6	9.8	
mil XI	400	mf. Mouton	mâle ?		+			25.4			
XI B	231	-	mâle ?		+			<u>26.2</u>	13.6	9.7	
XI B	231	mf. Mouton	mâle ?	-	+			<u>24.6</u>	14	8.8	
XI B	276	Mouton	mâle	-	+	-	153.7	25.4	13.8	9.1	<u>31</u>
XI B	276	Mouton	mâle		+			31.0			
XI B	279	mf. Mouton	mâle ?		+			27.3			
XI B	392	mf. Mouton	mâle ?		+			24.7			
XI B	397	mf. Mouton	mâle		+			24.4	12.7	9.1	
XI B	397	mf. Mouton	mâle	-	+			25.9	13.0	9.1	
XI	36	Mouton	mâle	-	+	-	160	25.4	13.8	8.8	33.5
XV-XVI	31	Mouton	mâle		+	-		25.3	12.9	8.2	32.1
XVII-XVIII	47	mf. Mouton	mâle ?		+			28.2			
XVIII-XX	209	mf. Mouton	mâle ?		+						35.6

fémur									
phase	US/Str.	espèce	EP	ED	Bp	DC	SD	Bd	
XI A	44	Mouton	+		43.1	19.8	15.0		
XI A	418	Mouton	+		43.7	20.0			
XI A	418	Mouton		+				35.0	
XI A	418	-	-	-	74.6				
XI A	418	-	-	-	77.6				
XI A	418	-	-	-	94.5				
mil XI	405	Mouton		-				37.0	
XI B	237	Mouton	+			19.7			
XI B	237	Mouton		-				29.5	
XI B	237	-	-	-	97.3				
XI B	276	Mouton	+		44.1	19.6			
XI B	276	Mouton	+		42.0	18.6			
XI B	232+276	Mouton	-		41.2	18.8	14.5		
XI B	308	Mouton		-				36.4	
XI B	326	-	-	-	118				
XI B	397	-	-	-	122				
XI	36	-	-	-	85.5				

tibia										
phase	US/Str.	espèce	EP	ED	GL	Bp	SD	Bd	Dd	
XI A	33	mf. Mouton		+			13.5	25.2	19.9	
XI A	33	mf. Mouton		+			14.7	25.7	20.1	
XI A	33	mf. Mouton		+				24.8	18.8	
XI A	44	mf. Mouton		+			14.68	27.5	21.3	
XI A	44	mf. Mouton		+				25.3	20.7	
XI A	44	mf. Chèvre		+				26.1	20.0	
XI A	339	mf. Mouton		+			13.23	23.6	17.8	
XI A	347	mf. Mouton		+				25.2	19.8	
XI A	354	-	-	-	114.8					
XI A	359	-	-	-	94.3					

tibia									
phase	US/Str.	espèce	EP	ED	GL	Bp	SD	Bd	Dd
XI A	382	-	-	-	169.9				
XI A	418	mf. Mouton	-			40.2			
XI A	418	mf. Mouton		+			14.1	23.6	20.5
XI A	418	mf. Mouton		+			12.9	22.5	18.7
XI A	418	mf. Mouton		+			12.5	23.5	18.9
XI A	418	-	-	-	93.1				
XI A	418	-	-	-	182.4				
XI A	419	mf. Mouton		+				26.2	19.6
mil XI	85	mf. Mouton		+			12.9	24.4	19.8
mil XI	400	-	-	-	101.0				
XI B	237	Mouton	+			37.8			
XI B	237	Mouton	+			38.1			
XI B	237	mf. Mouton		+				23.1	18.6
XI B	237	mf. Mouton		+				25.6	19.1
XI B	237	-	-	-	99.8				
XI B	237	-	-	-	101.5				
XI B	276	-	-	-	103.3				
XI B	276	-	-	-	102.1				
XI B	325	-	-	-	150.8				
XI B	397	-	-	-	124				
XV-XVI	31	mf. Mouton		+			11.1	23.2	19.3
XVII-XVIII	39	mf. Mouton		+			12.8	25.2	18.8
XVII-XVIII	39	mf. Mouton		+			12.1	21.7	16.6
XVII-XVIII	40	mf. Mouton		+			12.9	23.0	19.5
XVII-XVIII	40	mf. Mouton	-	+	194.4		13.8	23.2	20.0
XVII-XVIII	47	mf. Mouton		+			12.8	23.5	18.5
XVII-XVIII	47	Mouton	+	+	177.0	34.2	11.8	20.7	16.8
XVII-XVIII	47	-	-	-	105.4				
XVIII-XX	209	mf. Mouton		+			14.5	23.6	19.3

patelle				
phase	US/Str.	espèce	GL	GB
XI A	44	mf. Mouton	27.4	19.5
XI A	418	mf. Mouton	27.1	17.2
XI B	237	mf. Mouton	26.5	18.0
XI B	276	mf. Mouton	27.3	18.6
XI B	276	mf. Mouton	27.1	18.3
XI B	343	mf. Mouton	25.7	-

talus							
phase	US/Str.	espèce	GLI	GLm	DI	Bd	
XI A	33		22.4				
XI A	44	Mouton	29.4	27.4	15.8	19.0	jeune
XI A	44	Mouton	28.4	26.6	15.3	17.9	
XI A	44	Mouton	29.5	27.3	16.5	19.5	
XI A	44	Mouton			15.2	18.7	
XI A	44	Mouton	29.3			19.3	
XI A	44	Mouton			14.8	17.7	à peine adulte
XI A	44	Mouton				18.6	
XI A	44	Mouton			15.4	19.2	
XI A	44	Mouton			16.6		
XI A	160		22.8				jeune
XI A	334	Mouton	27.8	25.7	15.2	18.4	
XI A	359	Mouton	25.6	24.0	14.2	16.6	
XI A	418		22.9				jeune
XI A	418		24.1				jeune
mil XI	402		24.0				jeune
mil XI	411	Mouton	28.1	-	15.6	18.7	
mil XI	411	Mouton	28.7	27.5	15.5	18.3	
XI B	237	Mouton	27.0	26.1	15.0	17.6	
XIB	237		24.2				jeune
XI B	276	Mouton	26.5	25.0	14.5	17.7	
XI B	276	mf. Mouton				19.2	
XIB	276		24.4				jeune
XIB	276		23.9				jeune
XI B	348	Mouton	32.2		17.8	20.1	
XI B	397	Mouton		26.2	-	18	
XVII-XVIII	47	Mouton	25.6	24.0	14.1	16.0	

calcanéum				
phase	US/Str.	espèce	E	GL
XI A	44	Mouton	+	54.1
XI A	44	Mouton	-	52.7
XI A	44	Mouton	-	51.8
XI A	160	Mouton	-	46.1
XI A	418	Mouton	-	51.8
XI A	419	-	-	38.8
XI A	419	Mouton	-	51.8
mil XI	411	Mouton	-	53.1
mil XI	411	Mouton	-	48.5
XI B	237	-	-	35.4
XI B	276	-	-	35
XI B	392	-	-	36.9
XI B	393	Mouton	-	50.2
XVII-XVIII	47	Mouton	-	47.4
XV-XVI	31	Mouton	+	50.8

naviculocuboïde			
phase	US/Str.	espèce	GB
XI A	44	Mouton	22.9
XI A	44	Mouton	23.8
XI A	44	Mouton	22.1
XI A	44	Mouton	20.8
XI A	44	Mouton	23.1
XI A	44	Mouton	24.1
XI A	44	Mouton	22.2
XI A	418	Mouton	22.0
mil XI	411	Mouton	22.1
mil XI	411	-	16.8

jeune

métatarse										
phase	US/Str.		ED	GL	Bp	Dp	SD	DD	Bd	Dd
XI A	334	-	-	64.0						
XI B	308	mf. Chèvre			21.9	19.9	14.8	11.9		
XI B	392	Mouton	+	122.5	19.7	19.4	10.9	9.2	23.8	15.2
mil XI	400	-	-	66.5						
mil XI	411	-	-	71.0						
XV-XVI	210	Mouton	+	124.3	17.5	17.5	10.2	9.1	22.2	14.1
XVII-XVIII	45	Mouton	+	123	16.3	17.7	10.7	8.9	20.8	-

phalange proximale							
phase	US/Str.	espèce	EP	Glpe	Bp	SD	Bd
XI A	33	Mouton	+	36.1	12.2	10.0	11.4
XI A	334	Mouton	+	35.0	12.2	9.6	10.4
XI A	418	-	-	25.1			
XI A	418	-	-	31.6			
XI A	419	Mouton	+	32.1	11.3	9.4	10.7
XI A	419	-	-	28.4			
XI B	393	Chèvre	+	32.1	11.8	9.1	10.9
XI B	397	-	-	20.4			

phalange moyenne							
phase	US/Str.	espèce	EP	GL	Bp	SD	Bd
XI A	418	Mouton	+	21.6	11.7	8.7	9.4

phalange distale					
phase	US/Str.	espèce	DLS	MBS	Ld
XI A	418	Mouton	24.5	5.5	19.1
XI	36	Mouton	24.4	5.3	19.1

Annexe 5.4 : ostéométrie du Bœuf *Bos taurus*

d'après C. Guintard (1998a) pour les mesures 'd' et 'e' des métapodes. Avec :

- M : mâle, F : femelle ;

- pour les phalanges, ant. : antérieures, post. : postérieures.

mandibule							
phase	US/Str.	7	8	9	15a	15b	15c
XI A	371	120.9	76.1	46.1	60.9	41.7	31.4

(mesure 15 face interne)

scapula						
phase	US/Str.	centre coracoïdien				
		+	SLC	GLP	LG	BG
XI A	160	+	45.7	63.1	54.0	45
XI A	334	+	42.2	56.7	46.8	39.0
XI A	334	+	43.2			47.2
XI A	334	+			58.4	50.8
XI A	334	+	50.5	67.0		
XI A	371	+	45.9			
XI A	418	+	46.4	64.7	51.5	42.8
mil XI	363	+	47.2	65.0	55.5	45.5
mil XI	363	+	38.9	58.2	47.8	40.4
mil XI	400		34.7			
mil XI	405	+	51.1	65.7	50.3	46.0
mil XI	411	+	41.3	66.5	54.8	44.2
XI B	276		36.2			

humérus							
phase	US/Str.	EP	ED	Dp	SD	Bd	BT
XI A	33	+		108.0			
XI A	334		+			72.0	66.0
XI A	371		+		35.9	80	74
XI A	371		+		34.8	82.8	75.7
mil XI	363		+		30.8	62.0	65.8
XI B	238		+		33.5	73.1	71
XI B	238		+			68.4	61.6
XI B	308		+			74.3	69.9
XVII-XVIII	39		+			74.2	67.1
XVII-XVIII	45		+			86.0	

radius										
phase	US/Str.	EP	ED	GL	Bp	BFp	SD	Bd	BFd	
XI A	33	+			81.4	73.8				
XI A	160		+	280			43.3	74.0	68.2	
XI A	334	+	+	275	74.3	69.4	35.1	63.9	56.2	
XI A	334	+	+	288	81.6	73.1	44.9	76.2	69.7	
XI A	334	+			69.6	65.4	29.5			
XI A	334		+					73.5	67	
XI A	339		+				44.0	75.6	68.9	
XI A	371	+	+	275.4	78.6	70.6	42.7	70.1	63.4	
XI A	371	+	+	255.2			33.3	60.5	54.3	
XI A	371	+			67.3	60.9				
XI A	371	+	-	207	69.0	62.4	33.1		70.6	67.9
XI A	371		-							
XI A	419	+			79.9	72.9				
mil XI	363	+				61.1	34.7			
mil XI	363		+				38.8	63.0	59.9	
mil XI	363	+			78.1	71.7	38.4			
mil XI	363	+			76.3	70.6				
mil XI	400		+					68.9	63.8	
mil XI	411	+			75.9	69.9	38.4			
XI B	98	+			71.3	67.2				
XI B	170		-					62.0	58.9	
XI B	346	+	+	264	77.5	72.2	44.3			

ulna			
phase	US/Str.	EP	BPC
XI A	334		44.1
XI A	334		41.7
XI A	334		44.4
XI A	334	-	45.3
XI A	334		46.8
XI A	419		47.1
mil XI	342		44.7
mil XI	363		42.6
mil XI	411		43.9
XI B	161		44.0
XI B	279		47.6

métacarpe												
phase	US/Str.	ED	GL	Bp	Dp	SD	DD	Bd	Dd	e	d	
XI A	334	-	153.2	47.2	29.0	25.0	16.4			16.3	24.9	
XI A	334	+	183.8	56.3	34.7	35.7	21.8	61.4	31.5	22.4	35.7	M
XI A	341	+	180.9	58.0	34.6	32.8	19.2	60.3	32.1	22.3	33.0	M
mil XI	85	-	160.4	49.6	31.2	27.5	18.3			19.7	27.4	
mil XI	342	+	179.2	48.6	29.1	23.8	17.6	49.0	26.7	18.7	23.9	F
XI B	276+237	-	150.3	44.4	26.4	24.1	16.7	17.1	24.6	17.1	24.6	
XI B	279	+	167.8	54.5	34.0	32.7	20.4	55.6	30.4	21.3	32.8	M
XVII-XVIII	45	+						61.1	32.3			

coxal					centre acétabulaire (ilium et ischium : non observable)		
phase	US/Str.	LA	SH	SB			
XI A	33	+	70.6				
XI A	334	+	71.6	46.3	16.4		
XI A	334	+	64.7				
XI A	334	+	70.5				
XI A	371	+	67				
XI A	419	+	66.9				
XI B	322	+	69.4				
XV-XVI	31	+	67.7				

fémur						
phase	US/Str.	EP	ED	Bp	SD	Bd
XI A	419		+			88.2
XI A	421	+		113.2	36.0	
XI B	279		+			81.5
XI B	392		+		30.4	86.9

métatarse												
phase	US/Str.	ED	GL	Bp	Dp	SD	DD	Bd	Dd	e	d	
XI A	33	-	166	43.9		24.8	22.75				25.9	
XI A	334	+				27.8	25.4	54.8	31.9			
mil XI	363	+	213	48.4	46.6	28.1	24.6	56.2	32.7	28.3	28.8	
XI B	170	-	171			20.5	19.5			20.0	21	
XI B	237	-		38.4	36.8	20.5						
XI B	308	+	209	45.5	42	23.4	22.7			23.5	26.0	
XV-XVI	31			43.4	40.8	21.9						
XV-XVI	167	+		47.6	44.0	26.9	24.4					
XVII-XVIII	7			44.4	41.0							
XVII-XVIII	40			52.9	49.8	29.6	28.2					

tibia								
phase	US/Str.	EP	ED	GL	Bp	SD	Bd	Dd
XI A	33		-				51.7	41.2
XI A	160	+	+	<u>350</u>	<u>94</u>		54.9	
XI A	334	+	+	315		37.3		
XI A	334		+			34.7	55.1	42.3
XI A	334	-	+	310		37.9	61.7	42.6
XI A	334		+				64.9	45.0
XI A	334		+			39.3	63.7	46.7
XI A	334		+				59.3	43.4
XI A	334		+			36.0	54.6	41.9
XI A	334		+				61.9	48.2
XI A	334		+				58.8	
XI A	347		+			31.4	51.8	40.3
XI A	347		+			32.5	52.2	
XI A	371		+			33.9	55.0	43.3
XI A	371		+			32.8	52.7	38.8
XI A	419		-				54.5	40.9
XI A	421		+				50.2	37.5
mil XI	85		+			30.9		<u>40</u>
mil XI	85		+				51.9	38.8
mil XI	85		-				60.3	44.4
mil XI	363	+	+	295		31.0	52.0	39.5
mil XI	363		+			37.2	58.7	45.3
mil XI	363	+	+	292		33.0	52.0	38.7
mil XI	400	-			83.6			
mil XI	402		+				58.9	41.4
mil XI	402		+				63.3	46.7
mil XI	402		+				59.4	46.3
mil XI	402		+				58.7	41.6
mil XI	411		+			37.9	<u>64</u>	46.0
mil XI	411		+			37.1	62.6	44.2
XI B	349		+			33.9	55.4	42.1
XI B	349		+				55.5	43.0
XII-XIV	286		+				52.1	40.6

naviculocuboïde			
phase	US/Str.	GB	
XI A	33	49.8	
XI A	33	52.3	
XI A	332	47.5	
XI A	334	50.2	
XI A	334	56.9	
XI A	334	52.3	
XI A	334	52.4	
XI A	341	49.9	
XI A	420	54.2	
mil XI	85	47.6	
mil XI	85	50.1	
mil XI	400	52.9	
mil XI	402	50.1	
mil XI	402	50.4	
mil XI	402	51.6	
mil XI	405	49.0	
mil XI	411	47.0	
mil XI	411	53.5	
mil XI	411	56.6	
mil XI	411	53.6	
XI B	161	49.7	
XI B	392	52.7	
XV-XVI	210	49.7	

calcaneum				
phase	US/Str.	EP	GL	
XIA	33	-	107.7	
XIA	33	-	103.3	
XIA	334	+	123.1	
XIA	334	+	124.9	
XIA	334	-	106.4	
XIA	334	-	113.0	
XIA	334	-	106.1	
XIA	334	-	98.8	
XIA	334	-	104.9	
XIA	334	-	107.7	
XIA	334	-	104.0	
XIA	371	+	123.3	
XIA	371	-	109.9	
XIA	371	-	<u>101</u>	
mil XI	342	+	124.0	
mil XI	363	+	129.0	
mil XI	363	-	97.0	
mil XI	400	+	111.8	
mil XI	400	-	107.2	
mil XI	402	+	125.9	
mil XI	402	+	125.0	
mil XI	402	+	117.2	
mil XI	411	-	110.1	
mil XI	411	-	110.6	
mil XI	411	-	<u>115</u>	
XI B	98	-	101.7	
XI B	296	+	128.1	
XI B	316	-	107.8	
XI B	392	-	99.7	
XI B	397	-	103.6	
XV-XVI	210	+	128.6	

talus						
phase	US/Str.	GLI	GLm	DI	Dm	Bd
XI A	33	61.2	56.0	34.5	33.5	37.2
XI A	334	65.6	59.6	36.8	36.8	41.7
XI A	334	60.9	53.6	32.6	32.4	37.4
XI A	334	61.0	56.6	33.8	35.6	39.0
XI A	334	57.7	52.2	30.5	31.0	35.1
XI A	334	60.0	55.6	33.7	34.8	35.9
XI A	334	56.5	53.2	32.1	32.7	36.6
XI A	334	64.7	59.0	35.4		43.0
XI A	334	62.0		34.4		
XI A	334		55.7		33.8	39.1
XI A	334	57.2		30.6		
XI A	334			32.0		
XI A	334	59.5	53.2	33.5	34.9	39.9
XI A	334		56.3		34.1	
XI A	371	61.4	57.1	34.1	32.9	37.4
XI A	371	60.0		33.0		
XI A	371	61.9	55.6	34.1	34.4	41.3
XI A	371	58.6	53.1	32.8	32.6	37.4
XI A	419	62.0	56.4	33.1	33.7	40.0
XI A	419	58.3	52.6	31.4	33.9	38.7
XI A	419	57.9			32.8	37.1
XI A	419	60.0	54.9	32.6	33.0	36.7
mil XI	402	59.9	54.5	34.4	34.8	39.5
mil XI	402	59.7	54.4	34.3	34.0	40.3
mil XI	402	65.3	61.1	34.7	35.5	38.5
mil XI	402	66.0	59.7	36.2	36.3	42.6
mil XI	402	62.9	56.3	35.3	35.3	40.8
mil XI	402	60.3	54.9	32.9	33.3	41.6
mil XI	411		58.8	36.5	37.1	42.3
mil XI	411	66.7	60.0			
XI B	170	59.7	56.5	34.1	34.6	38.7
XI B	231					37.9
XI B	237	62.0	55.3	33.3	32.1	38.4
XI B	276	53.8	50.0	28.7	31.8	33.7
XI B	302	66.2	61.7		36.1	40.4
XI B	392	61.2	55.0	34.5	34.0	38.2
XI B	392	60.9	54.8	33.8	33.6	37.6
XVII-XVIII	40					39.8
XVII-XIX	222	64.4	57.9	36.0	35.6	41.3

patelle			
phase	US/Str.	GL	GB
XI A	334	66.8	57.5
XI A	359	51.3	42.5
XI A	419	54.5	
mil XI	85	66.4	55.2
mil XI	363	61.0	52.7
XI B	327	62.8	52.2
XI	36	51.5	<u>42</u>
XVIII-XX	209	58.1	47.0

phalange proximale							
phase	US/Str.	EP	GLPe	Bp	SD	Bd	ant/post
XI A	334	+	52.7	27.7	22.7	26.7	ant
XI A	334	+	53.0	26.7	22.1	25.2	ant ?
XI A	334	-	49.5		20.5	27.3	ant ?
XI A	334	+	57.0	26.6	22.1	24.9	post
XI A	334	+	56.2	26.9	22.0	24.7	post ?
XI A	371	+	50.3	26.9	21.7	23.3	ant
XI A	371	+	57.2	22.9	19.1	22.3	post
XI A	419	+	54.0	30.4	25.0	27.2	ant
XI A	419	+	54.5	26.5	22.1	25.1	ant
XI A	419	+	52.7	25.3	21.2	24.1	ant ?
XI A	421	+	61.1	28.0	23.3	26.9	post
mil XI	363	+	52.0	29.2	23.9	26.2	ant
mil XI	411	+	51.4	25.9	23.8	24.3	ant ?
XI B	182	+	59.0	24.0	20.7	23.4	post
XI B	343	+	53.4	24.6	20.0	23.8	post
XI B	397	+	55.6	31.5	26.4	31.7	ant
XVI-XVII	220	+	63.0	26.2	21.4	25.1	post
XVII-XIX	389	+	58.8	27.9	23.7	25.5	post
XVII-XVIII	47	+	65.0	37.7	30.4	36.2	ant
XVIII-XX	209	+	62.6	32.7	27.8	33.7	ant

phalange intermédiaire							
phase	US/Str.	EP	GL	Bp	SD	Bd	ant/post
XI A	33	+	35.5	29.2	23.0	25.5	ant
XI A	33	+	37.4	27.1	20.4	22.4	post
XI A	33	+	36.5	24.3	18.7	19.8	post
XI A	334	+	35.2	26.5	21.7	22.5	ant
XI A	371	+	39.0	30.4	23.8	24.2	post ?
XI A	371	+	36.1	27.4	19.9	20.1	post
XI A	419	+	34.4	28.9	23.5	25.4	ant
XI A	419	+	34.6	29.0	24.7	25.2	ant
XI A	419	+	32.8	25.0	20.7	21.5	ant
mil XI	363	+	38.8	29.0	23.7	23.4	post ?
mil XI	411	+	35.3	27.8	21.3	22.8	ant
mil XI	411	+	30.7	23.9	18.3	20.4	ant
XII-XIV	286	+	36.9	28.3	23.0	22.7	ant
XV-XVI	31	+	34.4	22.4	17.7	19.3	post

phalange distale					
phase	US/Str.	DLS	Ld	MBS	ant/post
XI A	33	61.3	49.1	19.7	post
XI A	160	66.5	49.8	21.8	ant
XI A	334	75.4	56.7	26.3	post
XI A	334	59.0	47.9	20.9	post
XI A	371	54.1	44.2	18.2	ant
XI A	419	81.7	59.3	27.4	post
mil XI	411	70.1	52.3	21.6	ant
XI B	98	61.6		20.4	ant
XI B	279	78.8	60.7	26.4	ant
XI B	392	75.5	57.8	25.0	ant
XV-XVI	31	59	49	20.5	post

Annexe 5.5 : ostéométrie des Équidés, Cheval *Equus caballus*, Âne *E. asinus*, et leurs possibles hybrides

d'après V. Eisenmann (1980, 1981) pour les dents jugales ; d'après A. von den Driesch (1976) [lettres] et V. Eisenmann (1986) [chiffres] pour le squelette post-cranien. Dans le remblai 40, il s'agit d'un seul individu (Âne).

dents inférieures								
Âne (un seul individu)								
phase	US/Str.	dent	D/G	H	Lo	lo	LPF	LDB
XVII-XVIII	40	Pm2	D	32.2	25.1	12.5	12.3	12.5
XVII-XVIII	40	Pm2	G	34.9	25.9	13.0	12.7	13.1
XVII-XVIII	40	Pm3	D	44.2	24.3	14.0	11.7	16.3
XVII-XVIII	40	Pm3	G	44.1	24.5	14.1	11.9	16.4
XVII-XVIII	40	Pm4	D	54.3	23.5	14.3	10.8	15.5
XVII-XVIII	40	Pm4	G	53.3	24.1	14.3	10.8	15.6
XVII-XVIII	40	M1	D	47.4	21.9	12.7	8.0	12.8
XVII-XVIII	40	M1	G	46.5	21.1	12.9	7.9	12.7
XVII-XVIII	40	M2	D	53.0	22.0	12.4	9.7	12.7
XVII-XVIII	40	M2	G	50.5	21.5	12.5	9.6	12.4
XVII-XVIII	40	M3	G	55.5	25.6	11.9	11.1	12.4
Cheval (un seul individu)								
phase	US/Str.		D/G	H	Lo	lo	LPF	LDB
mil XI	363	Pm4	G	-	29.3	14.8	15.3	16.9
mil XI	363	M1	G	72.9	29.1	15.0	11.1	14.7
mil XI	363	M2	G	81.2	30.2	14.0	11.4	13.4
mil XI	363	M3	G	81.4	32.7	11.7	10.9	13.1
Cheval ?								
phase	US/Str.		D/G	H	Lo	lo	LPF	LDB
XVII-XVIII	7	M3	D	64.0	28.6	10.0	9.6	10.8

dents supérieures								
Âne (un seul individu)								
phase	US/Str.		D/G	H	Lo	lo	LP	
XVII-XVIII	40	Pm2	G	34.0	33.4	21.3	6.0	
XVII-XVIII	40	Pm3	D	41.2	25.7	23.1	8.1	
XVII-XVIII	40	Pm3	G	43.0	26.2	23.5	8.0	
XVII-XVIII	40	Pm4	D	48.8	23.2	23.0	9.4	
XVII-XVIII	40	Pm4	G	49.7	22.9	23.0	9.8	
XVII-XVIII	40	M1	D	39.1	21.1	22.6	8.3	
XVII-XVIII	40	M1	G	40.5	21.0	22.3	8.4	
XVII-XVIII	40	M2	D	41.8	21.6	21.6	9.0	
XVII-XVIII	40	M2	G	43.2	21.6	21.8	9.0	
XVII-XVIII	40	M3	D	38.9	20.5	19.0	10.0	
XVII-XVIII	40	M3	G	39.6	20.2	19.2	10.5	
Cheval (probablement un seul individu en 363)								
phase	US/Str.		D/G	H	Lo	lo	LP	
XIA	371	Pm3/4	D	58.1	28.8	28.4	12.4	
mil XI	363	M2	D	61.6	25.7	24.1	12.4	
mil XI	363	M2	G	61.7	25.6	23.9	12.2	
mil XI	363	M3	D	62.3	26.0	20.9	12.6	
Cheval/Mule ?								
phase	US/Str.		D/G	H	Lo	lo	LP	
mil XI	411	M1(2)	D	-	28.6	26.1	12.7	
mil XI	411	M3	D	85.0	28.0	21.5	12.4	
Équidés								
phase	US/Str.		D/G	H	Lo	lo	LP	
XI B	52	pm2	G	-	38.8	20.5	-	

scapula							
phase	US/Str.	centre coracoïdien	SLC	GLP	LG	BG	
		taxon	2	3	4	5	
XVII-XVIII	40	âne	+	42.2	62.3	41.6	33.5

humérus							
phase	US/Str.	taxon	EP	ED	Bd	BT	
					-	-	
					6	8	
XVII-XVIII	40	âne		+	54.5	53.0	25.0

radius													
phase	US/Str.	taxon	EP	ED	GL	LI	SD	-	Bd	BFd	-	-	-
					1	2	3	6	7	8	9	10	11
XI A	334	mule ?		+					85.1	65.6	39.8	29.2	15.7
XI A	334	âne		+			28.8	54.2	44.6	25.9	18.5	9.8	
XVII-XVIII	40	âne		+			28.3		46.7	26.8	18.2	11.0	
XVII-XVIII	40	âne	+	+	256	248.5	28.1	25.5		27.9	19.3		

métacarpe																		
phase	US/Str.	taxon	ED	GL	LI	(SD)	-	Bp	-	-	-	-	(Bd)	(Bd)	Dd	-	-	
				1	2	3	4	5	6	7	8	8'	9	10	11	12	13	14
XI A	334	mule ?						55.3		45.1	16.3		7.1					
XVII-XVIII	40	âne	+	170.8	167.3	24.2	19.4		24.7		11.0	6.5	4.2	33.0	32.5	25.4	20.6	23.6
XVII-XVIII	40	âne	+	170.5	165.9	23.9	19.5	38.0	25.0	31.1	11.1	6.5	3.8	31.3	30.9	24.5	20.4	22.9

métatarses																		
phase	US/Str.	taxon	ED	GL	LI	(SD)	-	Bp	Dp	-	-	-	(Bd)	(Bd)	Dd	-	-	GLI
				1	2	3	4	5	6	7	8	9	10	11	12	13	14	-
XI A	334	âne ?	+	207.1	201.3	24.0	21.7	35.4	29.6	30.9	9.5	5.0	32.8	32.4	26.1	19.9	22.0	202.2
XI B	314	cheval/mule	+	251.6	246.5	29.9	31.4	45.7	38.1	39.5	11.6	7.1	45.9	46.7	36.1	27.2	31.0	242.9

calcanéum										
phase	US/Str.	taxon	EP	GL	-	GB	-	-		
				1	2	3	4	5		
								6		
								7		
XI A	334	âne ?				36.8		36.0		
XVII-XVIII	40	âne	+	79.6	53.3	36.8	13.5	23.6	34.8	35.7

talus									
phase	US/Str.	taxon	(GH)	LmT	GB	-	BFd		
			1	2	3	4	5		
							6		
							7		
XVII-XVIII	40	âne	46.1	42.1	43.9	20.0	37.7	24.3	34.7

phalange proximale				GL	-	SD	Bp	Dp	Bd	-	-	-	-	-	-	BFd	
phase	US/Str.	taxon	EP	1	2	3	4	5	6	7	8	9	10	11	12	13	14
XI A	334	âne	+	61.4	55.7	21.8	35.1	25.7	30.7	37.3	34.8	55.6	45.5	45.1	10.3	11.6	28.0
mil XI	411	cheval	+	86.3	76.5	34.9	57.5	40.9	48.4	58.1	51.7	75.4	59.4	61.8	19.1	16.0	46.0
XVII-XVIII	40	âne	+	64.6	59.0	22.7	33.8	26.4	33.1	42.4	37.4	58.6	49.9	48.6	9.7	10.3	31.9
XVII-XVIII	40	âne	+	64.7	58.6	22.3	33.0	26.0	32.7	40.7	37.6	58.9	48.9	49.3	10.5	9.4	31.6

antérieure
antérieure

phalange moyenne				GL	-	SD	Bp	Dp	Bd	BFp
phase	US/Str.	taxon	EP	1	2	3	4	5	6	-
mil XI	363	cheval/mule	+	48.9	37.0	44.8	54.8	34.2	54.8	48.4
mil XI	411	cheval/mule	+	49.0	38.6	44.9	55.3	33.5	55.4	47.7
XI B	279	cheval/mule	+	48.1	38.1	-	51.6	32.3	-	44.9
XVII-XVIII	40	âne	+	33.6	23.8	30.7	35.3	21.8	33.9	33.1

antérieure

phalange distale				Ld	GL	HP	GB	LF	BF
phase	US/Str.	taxon	1	2	3	4	5	6	-
XI A	334	âne (?)	31.6	35.8	26.1	39.0	18.0	26.9	-

Annexe 5.6 : ostéométrie du Chat *Felis catus*.

Il s'agit d'un seul individu issu du comblement 71 du puits 68 (XII-XIII^e siècle).

humérus	EP	ED	GL	GLC	Bp	Dp	SD	Bd	BT
D	+	+	90.2	88.1	14.1	19.5	6.3	16.1	12.2

radius	EP	ED	GL	Bp	SD	Bd
G	+	+	85.6	7.4	5.0	11.3

ulna	EP	ED	GL	LO	DPA	SDO	BPC
G	+	+	101.9	10.6	10.6	8.8	8.1

coxaux		(il : crête iliaque, ca : centre acétabulaire, is : tubérosité ischiatique)								
		il	ca	is	GL	LA	LS	SH	SB	Lfo
D	+	+	+	+	70.3	10.5	-	10.2	4.0	17.6
G	+	+	+	+	70.4	10.3	26.2	10.0	4.1	17.7

sacrum	E	GL	PL	GB	BFcr	HFcr
	+	24.9	24.0	27.4	13.8	6.7

fémur	EP	ED	GL	Bp	DC	SD	Bd
D	+	+	98.8	18.6	8.4	7.2	16.2
G	+	+	99.6	18.9	8.5	7.2	16.4

tibia	EP	ED	GL	Bp	SD	Bd	Dd
D	+	+	101.2	17.3	6.3	13.3	8.2
G	+	+	101.5	17.3	-	13.4	8.3

calcaneum	EP	GL	GB
D	+	27.1	10.5
G	+	27.0	10.6

talus	GL
D	14.81

métacarpe G	ED	GL	Bd
2	+	26.1	4.3
3	+	29.6	4.6
4	+	27.8	4.0
5	+	23.6	3.9

métatarse D	ED	GL	Bd
2	+	41.1	4.4
3	+	45.4	5.2
4	+	46.2	4.8
5	+	45.3	4.2

phalange proximale	EP	GL
	+	11.7

Annexe 5.7 : ostéométrie du Cerf *Cervus elaphus*.

scapula		centre coracoïdien				
phase	US/Str.		SLC	GLP	LG	BG
XI A	371	+	37.1	57.9	43.0	39.9
mil XI	363	+	32.9	55.3	42.9	38.2
mil XI	411	+	33.2	57.8		41.5

humérus						
phase	US/Str.	EP	ED	SD	Bd	BT
XI A	371		+	25.0	52.3	47.2

radius							
phase	US/Str.	EP	ED	Bp	BFp	Bd	BFd
XI A	371		-			50.2	48.5
XI A	419	+		48.9	46.0		

ulna			
phase	US/Str.	EP	BPC
XI A	419		29.2

coxal						mâle
centre acétabulaire (ilium et ischium : non observables)						
phase	US/Str.	ca	LA	SH	SB	
XI A	419	+	49.1	30.7	17.0	
mil XI	363	+		35.0	14.9	
XI B	238	+	51	31.8	14.0	

tibia					
phase	US/Str.	EP	ED	Bd	Dd
XI A	33		+	48.6	41.0
XI A	421		+	46.7	36.7
XI B	238		+	45.0	37.0
XVII-XVIII	45		+	44.4	35.6

calcanéum			
phase	US/Str.	EP	GL
mil XI	405	+	115.9
XI B	233	+	105.5
XI B	348	+	106.2
XI B	343	-	92.8

talus						
phase	US/Str.	GLI	GLm	DI	Dm	Bd
mil XI	411	53.3	51.1	29.2	30.3	34.5
XI B	279	49.4	46.7	26.6	26.0	30.6
XI B	348	50.1	48.2	27.3	29.4	31.3
XI B	316	51.7	47.1	26.8	29.6	33.6
XII-XIV	299	56.8	52.3	31.6	31.5	36.5

naviculocuboïde		
phase	US/Str.	GB
XI A	419	37.9
XI B	238	37.7
XI B	392	43.9

métatarse			
phase	US/Str.	ED	Bp
XI B	308		33

phalange moyenne						
phase	US/Str.	EP	GL	Bp	SD	Bd
XI A	33	+	40.6	19.7	15.7	16.4
XI A	334	+	40.5	20.7	14.7	15.1

Annexe 5.8 : ostéométrie du Chevreuil *Capreolus capreolus*
d'après J.-D. Vigne (1988, en partie d'après Heintz 1970) pour le bois de massacre.

bois de massacre							
phase	US/Str.	S1	DAPb	DAPpé	DAPmeu	DTpé	DTmeu
XI A	334	93.2	29.6	18.6	37.3	16.8	35.0

scapula									
centre coracoïdien									
phase	US/Str.	HS	DHA	Ld	SLC	GLP	LG	BG	
XI A	418	+	130.0	135.8	86.3	17.2	26.6	20.9	20.0
mil XI	363	+	-	-	-	19.3	-	24	22.5
mil XI	411		-	-	-	18.0	-	-	-
XI B	343	+	-	-	-	16.5		22.1	20.3

radius					
phase	US/Str.	EP	ED	Bd	BFd
XI A	33		+	24.4	23.2
XI B	233		+	24.0	23.4

Bd avec ED ulna
Bd sans ED ulna

ulna						
phase	US/Str.	EP	DPA	SDO	BPC	LO
XI A	334	+	24.6	22.3	15.0	36.6
mil XI	411	+	26.6	21.1	15.0	36.5
XI B	308		25.8	-	16.5	-

scaphoïde (carpe)		
phase	US/Str.	GB
mil XI	400	17.9
XI B	233	17.5

tibia							
phase	US/Str.	EP	ED	Bd	Dd	SD	Bp
mil XI	411		+	27.8	21.3	17.2	
mil XI	411	+					43.3

métatarse						
phase	US/Str.	ED	Dp	Bp	SD	DD
XI B	279		20.6	18.3	11.3	10.8

calcanéum			
phase	US/Str.	EP	GL
XI B	348	+	64.1

Annexe 5.9 : ostéométrie du Sanglier *Sus scrofa scrofa*
(mêmes mesures et abréviations que pour le Porc).

phase	US/Str.	mdble/ mx	sexe	D/G	M1 L	WA	WP	stade Grant	M2 L	WA	WP	stade Grant	M3 L	WA	stade Grant	9	9a
mil XI	363	mdble		G									38.3	18.3	c		
XIB	323	mdble	mâle	D	17.8	11.7	12.4	g	23.8	14.5	14.4	e				67.1	43.8
XIA	33	mx		G	17.2	15.9	16.6	m/n	23.2	20.0	19.5	e/f					

scapula			
centre coracoïdien			
phase	US/Str.	SLC	BG
mil XI	411	+	30.9 28.3

talus				
phase	US/Str.	GLI	GLm	DI Dm
XI A	334	46.2	42.9	24.2 27.7

radius						
phase	US/Str.	EP	ED	SD	Bd	BFd
XI A	334		+	22.0	34.5	30.2

phalange proximale						
phase	US/Str.	EP	GLpe	Bp	SD	Bd
XI A	334	+	41.4	20.4	16.2	18.8

coxal			
centre acétabulaire (ilium et ischium : non observable)			
phase	US/Str.	LA	
mil XI	411	+	39.4

phalange distale			
phase	US/Str.	DLS	Ld MBS
XI B	316	40.1	38.7 17.7

Annexe 5.10 : ostéométrie du Lapin *Oryctolagus cuniculus*.

mandibule							
phase	US/Str.	1	2	3	4	5	5a
XI	36	55.4	15.5	32.2	17.1	34.7	33.9

fémur			
phase	US/Str.	ED	Bd
XI B	276	+	15.2

Annexe 5.13 : ostéométrie du Rat noir *Rattus rattus*.

tête osseuse (sans les mandibules)																			
phase	US/Str.	1	2	3	4	5	6	6 bis	7	8	9	10	11	12	14	15	16	17	19
XIA	33	43.2	42.1	39.7	22.6		12.0	5.2	16.0		8.3	11.7	7.1	9.0	11.9	15.1		22.1	4.2
XIA	33				21.9				15.7		7.7	11.7	8.2						4.2
XIA	33						12.2	6.7	16.5		7.9		7.1	9.4	12.6	14.8			3.9
XIA	33						13.5												
XIA	33						12.0		14.8		7.5		7.8			14.9			4.3
XIA	418	43.0	42.5	39.9	21.5		13.1	6.9	15.3		7.6	11.6	7.2	9.4	12.9	15.7	22.6	22.8	4.5
XIA	418				22.7		12.8	6.8	15.8		7.8	11.9	8.0		12.3	14.8			4.0
XIA	419	43.3	41.9	39.5	21.6	14.8	11.1	6.0	14.8	15.6	7.1	11.6	7.7	9.3	10.7	14.6	21.5		4.2
XIA	419										6.9								
XIA	419										7.2								
XIA	419								14.1										
XIA	419						12.5	6.3	15.2					9.7	12.1				
XIA	420										7.3								
XIA	420								11.7										
XV-XVI	31	42.6	42.5	39.8	23.4	14.9	12.0	5.5	12.3	17.3	7.4	12.0	7.6	9.6	11.9	14.4	21.0	22.0	5.0
XV-XVI	31										7.5								
XV-XVI	31													9.0					

mandibules							
phase	US/Str.	1	2	3	4	5	5 bis
XIA	33	22.3	6.8	12.5	5.2	10.2	11.5
XIA	33	25.7	7.9	14.0	5.6	13.4	
XIA	418	22.0	7.5	14.2	7.4	13.7	15.4
XIA	419	21.4	7.2	13.0	6.0	11.8	13.2
XIA	419	26.2	6.9	13.1	6.0	11.7	13.5
XIA	419	26.2	7.4	12.7	6.1	12.5	14.0
mil XI	411		7.3	12.3	5.3		
XV-XVI	31	25.7	7.5	14.6	7.2	12.7	14.1
XV-XVI	31	23.3	7.5	12.5	6.3	11.5	12.1
XV-XVI	31	25.6	7.7	14.4	7.3	12.8	13.9
XV-XVI	31		7.2	(M3 en éruption)			

coxaux (centre acétabulaire soudé)					
phase	US/Str.	LA	GL	LFo	SH
XIA	33	4.8	40.4		3.5
XIA	33	4.9			4.1
XIA	33	4.4			3.4
XIA	33	4.2			3.6
XIA	419	4.6	38.1	11.8	3.5
XIA	419	4.4	38.5	11.5	3.7
XIA	419	4.1	37.9	11.7	3.6
XIA	419	4.4	38.6	11.9	3.7
XIA	419	4.6	36.0		3.8
XIA	418	4.9	39.3	12.1	3.8
XIA	418	5.0	39.5	11.6	3.4
XIA	418	5.2	40.2		3.7
XIA	418	4.6	39.8	12.0	3.8
XI B	171	4.4	37.2	11.7	3.6
XI B	170	4.7	39.8	12.0	3.7
XI B	279	4.3	40.3		3.6
XV-XVI	31	3.9	37.3	11.2	3.2

fémur						
phase	US/Str.	EP	ED	GL	Bp	Bd
XIA	33	+	-	28.8	7.6	5.9
XIA	418	+	+	34.4	7.2	6.4
XIA	418	+	+	34.7	7.3	6.4
XIA	418	-	-	33.8	7.5	5.6
XIA	418	-	-	33.8	7.5	5.7
XIA	419	+	+	36.9	7.8	6.3
XIA	419	+	+	33.7	7.3	6.2
XIA	419	+	+	34.4	7.0	6.1
XIA	419	+	+	37.2	7.8	6.3
mil XI	411	+	+	36.0	7.2	6.8
XI B	279	-	+	36.1	10.1	6.4
XV-XVI	31	+	+	31.9	6.8	5.7

scapula (centres coracoïdiens soudés)					
phase	US/Str.	GL	SLC	GLP	BG
XIA	418	24.2	3.6	4.9	2.8
XIA	419	24.8	3.6	5.1	2.9
XV-XVI	31	21.5	2.8	4.4	2.5
XV-XVI	31	21.3	2.8	4.4	2.5

un seul individu probable

humérus						
phase	US/Str.	EP	ED	GL	Bp	Bd
XIA	418	-	+	26.6	4.3	6.6
XIA	419	-	+	25.7	4.3	5.9
mil XI	363	+	+	26.9	4.7	6.2
mil XI	411	+	+	28.0	5.7	6.5
XV-XVI	31	-	+	22.4	4.2	5.6

ulna					
phase	US/Str.	EP	ED	GL	LO
XIA	419	+	-	28.0	3.7
XV-XVI	31	+	-	25.6	3.2
XV-XVI	31	+	-	25.7	3.3

radius					
phase	US/Str.	EP	ED	GL	Bd
XV-XVI	31	+	-	21.6	2.4

tibia									
phase	US/Str.	EP	ED	GL	Bp	Bp avec fibula	Bd	Bd avec fibula	
XIA	33	-	+	39.7	5.5		4.2		
XIA	417	+	+				4.1	5.3	
XIA	418	+	+	38.5	6.7	7.8	3.8	5.2	
XIA	418	+	+				4.0	5.5	
XIA	418	+	+	38.8	6.7		3.8		
XIA	418	-	+	40.3	6.1		4.0		
XIA	419	+	+	39.0	6.9		3.7	5.1	
XIA	419	+	+	39.0	7.1	8.4	4.0	4.9	
XIA	419	-	+	39.9	6.9		3.8	5.4	
XIA	419	-	+	38.3	5.8		3.8	5.4	
mil XI	363	+	+	41.6		7.3	4.2		
XI B	171	-	+	37.2	6.1		3.6	5.4	
XV-XVI	31	-	+	35.6	5.6		3.8		

Annexe 6 : ostéométrie des Oiseaux

d'après les recommandations de A. von den Driesch (1976) : GL, Lm, ... et de C. Mourer-Chauviré (1975) : A, B, C, ... (cf. annexe 6.1 infra). Les mesures des carpométacarpes de passereaux (annexe 6.14 infra) sont celles proposées par T. Tomek & Z. Bochenski (2000) pour les Corvidés.

Toutes les mesures sont en millimètres. Les valeurs soulignées sont estimées. Avec : XIA : première moitié du XI^e siècle, mil XI : milieu du XI^e siècle, XIB : seconde moitié du XI^e siècle.

Annexe 6.1 : mesures réalisées sur les os d'Oiseaux d'après les recommandations de C. Mourer-Chauviré (1975), avec : 1, 4, 5, 6, 7, 8 : Foulque macroule *Fulica atra* ; 2, 3 : Grand Corbeau *Corvus corax*.

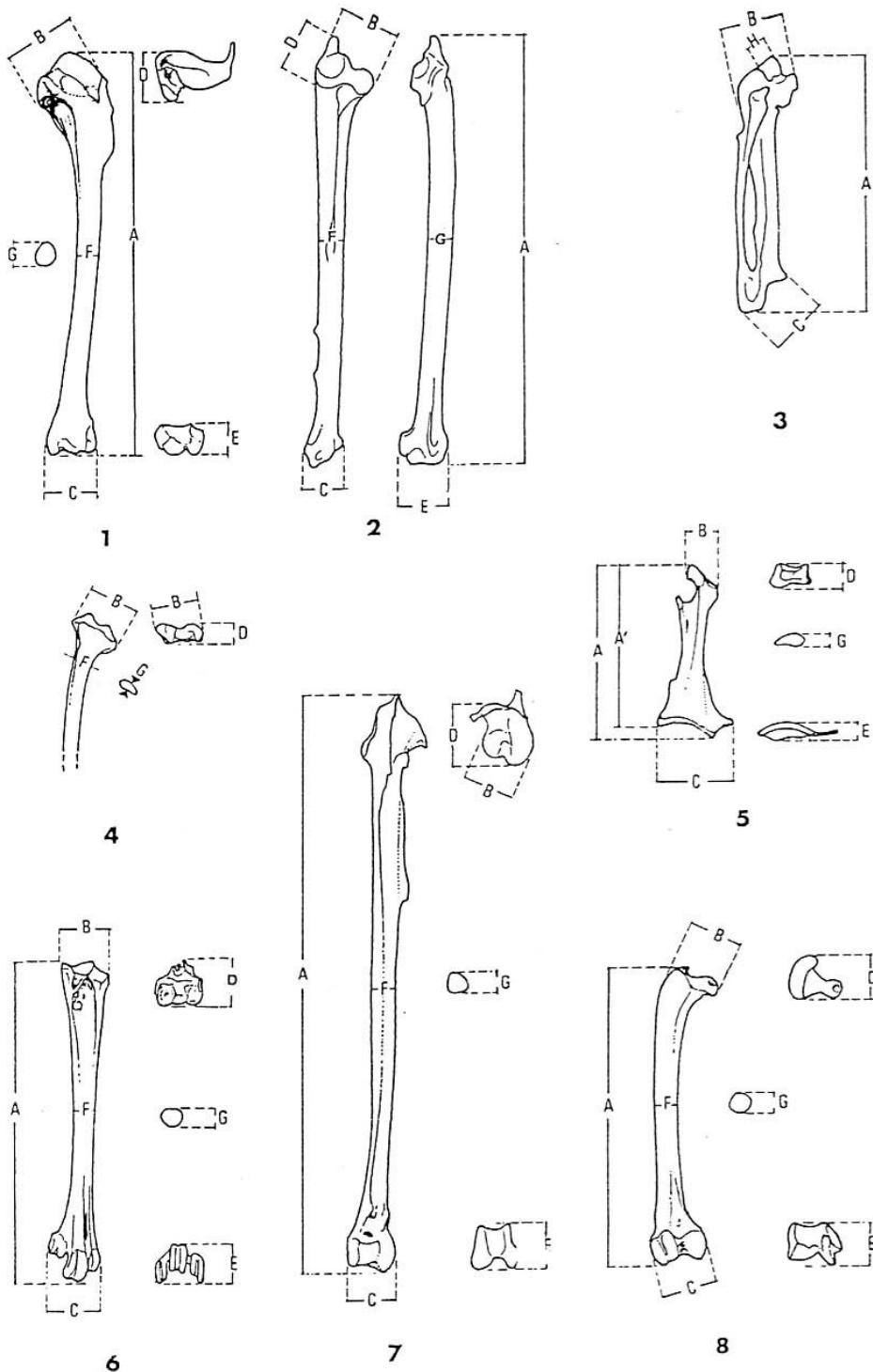

Annexe 6.2 : ostéométrie de la Poule *Gallus gallus*

avec indication de la présence d'un dépôt minéral de calcium, ou os médullaire, à l'intérieur des os longs des femelles en période de ponte par la notation suivante : dm- / dm+ / dm++ (dm- lorsque le dépôt calcaire n'est représenté que par une fine couche ; dm++ : diaphyses pratiquement complètement remplies d'os médullaire).

coracoïde adultes							
phase	US/Str.	GL A	Lm A'	Bb C	BF -	E	G
XIA	33	53.9	52.0	14.5	11.9	3.8	4.8
XIA	33	55.4	53.1	15.0	11.5	4.2	4.9
XIA	33			17.2	12.8	4.9	5.1
XIA	33	48.9					3.6
XIA	33			<u>12.4</u>	10.0	<u>3.6</u>	3.9
XIA	33	57.9	55.8		11.8		4.8
XIA	33	55.0	52.3		12.7	<u>4.7</u>	4.4
XIA	33	49.5	47.2	<u>12.5</u>	9.8	<u>4.2</u>	3.5
XIA	33	51.7	49.2	13.1	10.8	5.4	4.4
XIA	33	45.3	42.7	12.8	10.8	3.3	3.5
XIA	33	51.9	50.3		11.4		4.0
XIA	334	53.7	51.3	<u>14.3</u>	12.3	4.3	4.1
XIA	347	56.5	53.8		11.7		4.6
XIA	371	57.5	54.9		12.3	4.8	5.1
XIA	418	57.8	56.1	14.8	13.8	4.9	5.4
XIA	418	62.6	59.7	17.7	13.9	5.1	5.5
XIA	418	62.4	59.6	<u>16.0</u>	13.6	4.9	4.9
XIA	418	55.7	53.0	15.0	11.7	4.7	5.0
XIA	418	57.6	55.7	15.0	14.1	4.3	5.0
XIA	418	58.6	55.4	14.8	12.8	4.3	4.5
XIA	418	47.5	45.3	13.4	10.6	3.7	4.0
XIA	419	46.7	45.0	12.3	9.7	3.9	4.2
XIA	419	56.9	53.5	15.4	13.3	4.0	5.1
XIA	419						4.4
XIA	421	54.4	50.8	15.5	12.6	4.2	4.5
XIA	421			<u>12.3</u>	<u>10.2</u>	<u>3.4</u>	
mil XI	411	57.2	54.9	15.3	13.2	5.0	5.4
XIB	170	56.8	54.8	15.2	12.4	4.9	4.8
XIB	231	49.3	46.3	13.7	11.1	3.3	3.8
XIB	232	47.8	45.4	13.3	10.5	3.9	4.2
XIB	276	44.8	42.6	12.7	10.2	2.9	3.9
XIB	276	56.3	55.1		<u>11.0</u>		5.0
XIB	306	45.4	44.8				3.8
XI	36	51.7	49.3	13.5	11.6	4.2	4.5
XI	36	48.8	46.3	12.5	10.1	4.0	4.3
XI	36	50.1	47.9		9.5	4.4	4.4
XI	36	48.3	45.6	13.8	10.5	3.5	4.0
XI	36	<u>54.2</u>	<u>51.8</u>		12.4	4.5	<u>4.8</u>
XI	36			12.8	10.0	4.5	4.5
XVII-XVIII	7	55.0	53.2		10.0	<u>5.3</u>	4.2

coracoïde juvéniles		
phase	US/Str.	GL A
XIA	33	44.8
XIA	33	41.2
XIA	33	50.2
XIA	33	41.3
XIA	33	45.2
XIA	33	43.8
XIA	418	51.4
XIA	419	<u>42.0</u>
XI	36	48.1
XI	36	38.3
XI	36	34.1
XI	36	47.7
XI	36	45.6
XI	36	46.8
XI	36	40.9
XI	36	<u>38.2</u>
XII-XIII	71	34.6
XII-XIII	71	33.9
XV-XVI	31	33.5

dm++

dm++

scapula adultes						
phase	US/struct	GL A	Dic B	- D	- F	- G
XIA	33	61.1	10.2	4.6	4.9	2.3
XIA	33	58.8	10.6	5.4	4.7	2.5
XIA	33	72.7	12.0	6.4	6.5	3.0
XIA	33		12.2	5.5	6.3	3.5
XIA	33		12.4	6.0	6.0	3.3
XIA	33	69.0	11.8	6.3	5.9	3.4
XIA	33		10.6	5.3	5.0	2.9
XIA	33		12.2	6.2	5.9	3.5
XIA	33		13.1	6.6	6.5	3.7
XIA	347	74.6	12.5	6.0	5.5	3.1
XIA	418	79.3	13.4	7.0	6.4	3.2
XIA	418	75.3	12.7	6.5	5.8	3.4
XIA	418		13.0	6.2	5.6	3.0
XIA	418		13.8	6.8	6.7	3.6
XIA	418	59.9	11.0	5.5	3.1	3.1
XIA	418		10.6	5.6	5.2	2.9
XIA	419				3.3	5.7
XIA	421		14.8	7.6	7.1	4.1
XIA	421	64.5	11.0	6.1	5.2	2.8
XIA	421			5.2	5.3	2.8

adultes						
phase	US/struct	GL A	Dic B	- D	- F	- G
XIB	161		11.2	5.6	4.6	2.7
XIB	237		11.0	5.2	5.2	3.0
XIB	276	<u>64.0</u>	10.8	5.6	5.1	3.0
XIB	276				4.9	3.2
XIB	276		10.6	5.4	4.6	2.7
XIB	276		10.8	5.6	5.3	2.9
XI	36		11.6	5.4	4.7	3.7
XI	36		10.0	5.0	4.7	2.8
XI	36	64.5	10.8	5.1	5.1	3.0
XI	36	64.5	10.8	5.4	5.1	2.8
XI	36		11.4	5.8	5.1	2.9
XI	36		11.4	5.4	5.4	3.0

juvéniles		
phase	US/struct	GL A
XIA	33	61.8
XIA	36	49.4
XIA	36	58.4
XIB	231	51.9
XII-XIII	71	39.8
XV-XVI	31	44.3

humérus adultes		A	B	D	C	E	F	G
phase	US/Str.	GL	Bp	-	Bd	-	SC	-
XIA	33	71.3	19.6	9.5	15.0	8.9	7.9	6.8
XIA	33	62.0	16.4	8.1	13.5	7.4	6.1	4.8
XIA	33	58.9	16.1	7.6	12.5	7.2	6.2	4.5
XIA	33				15.1	7.8	6.9	5.7
XIA	33				15.0	8.7	6.8	5.4
XIA	33		18.8	9.4				
XIA	33		17.1	8.3				
XIA	33				15.9	8.7		
XIA	33	70.1	18.4	9.0	14.7	8.2	6.6	5.3
XIA	33	64.4	17.6	8.3	14.0	6.9	6.3	4.8
XIA	33	64.3	16.9	8.2	13.1	7.5	6.3	5.0
XIA	33				14.1	8.0	7.2	5.9
XIA	33						7.3	6.1
XIA	33					7.9	7.1	6.4
XIA	33				13.1	7.3		
XIA	33						7.1	6.6
XIA	33				15.8	8.2		
XIA	334	74.0	19.0	9.1	15.01	8.5	7.2	5.7
XIA	334				13.7	7.5	6.4	5.1
XIA	347	72.5	20.1	9.8	15.9	9.3	7.7	6.5
XIA	371		20.1	9.9			7.6	6.4
XIA	371				15.9	9.0		
XIA	418	69.8	19.1	9.4	13.7	8.2	6.9	5.5
XIA	418	69.3	19.7	9.2	15.2	8.8	7.5	6.1
XIA	418		20.6	9.9			7.3	6.2
XIA	418	62.7	16.3	8.1		7.2	6.1	4.6
XIA	418	76.2	20.0	10.0	15.6	8.9	8.1	6.9
XIA	418	<u>79.0</u>	20.6	10.4	15.6	9.2	7.4	6.5
XIA	421	85.6	23.7	11.7	18.3	10.3	8.6	7.7
XIA	421				13.5	7.2	6.3	4.9
mil XI	411		21.3	10.4				
mil XI	411				15.9	8.6	8.4	6.7
XIB	42						7.7	6.6
XIB	161	67.9					6.4	5.3
XIB	232	72.9	19.3	9.8	15.6	8.4	7.2	6.0
XIB	237	64.4	17.1	<u>8.0</u>	13.8	7.3	6.2	5.0
XIB	237						6.1	4.9
XIB	237	58.2	15.5	8.0	13.2	7.0	6.2	4.9
XIB	237	63.1	16.1	7.8	13.7	6.7	6.3	5.3
XIB	237	62.7	17.4	8.3	13.7	6.9	6.1	5.1
XIB	237	66.0	16.6	7.8	13.3	7.1	6.3	5.2
XIB	237		18.4	8.9				
XIB	237		16.9	7.9			6.6	5.3
XIB	237						6.7	5.3
XIB	276	73.1	19.4	9.2	15.0	8.2	7.4	6.0
XIB	276	74.2	20.0	9.5	15.6	8.8	7.8	6.2
XIB	276		18.4	8.4			6.7	5.4
XIB	276		21.6	10.0				
XIB	276				15.9	8.5		
XI	36	68.3	17.8	8.5	14.4	7.8	6.5	5.5
XI	36				13.9	7.5	6.2	5.2
XI	36						7.3	5.9
XI	36	74.4	20.8	10.1	17.2	8.4	7.3	6.6
XI	36	<u>67.4</u>	17.6	9.1			6.1	5.3
XI	36	68.5	17.8	8.6	14.6	7.7	6.3	5.5
XI	36	61.2	15.8	7.4	12.6	7.0	5.5	4.9
XI	36				14.1	7.6	6.5	5.4
XI	36				13.9	7.1	6.0	4.0
XI	36				14.0	7.7	6.5	5.3
XI	36						6.6	5.7
XI	36						7.3	5.7
XV-XVI	31	63.7		8.8	13.7	7.3	6.4	5.0

humérus juvéniles		A
phase	US/Str.	GL
XIA	33	60.5
XIA	33	58.0
XIA	347	62.6
XIA	418	60.7
XIB	237	49.1
XIB	276	49.9
XIB	306	64.0
XI	36	62.9
XI	36	60.8
XI	36	54.1
XI	36	51.7
XI	36	63.1
XV-XVI	31	44.1
XV-XVI	31	48.0

radius adultes				
phase	US/Str.	GL	Bd	SC
XIA	33	62.4	6.9	2.9
XIA	33		7.8	3.4
XIA	33	61.5	6.5	3.2
XIA	33	62.7	7.2	3.2
XIA	33	63.5	7.4	3.4
XIA	33	60.3	7.6	3.0
XIA	33	66.1	7.8	3.5
XIA	33	55.5	6.2	3.0
XIA	33		6.9	3.0
XIA	33		7.0	3.2
XIA	33	58.2	6.7	3.4
XIA	33	62.6	6.9	3.6
XIA	418	69.9	7.8	3.5
XIA	418	70.5	7.8	3.3
XIA	418	66.6	7.0	3.5
XIA	418	69.2	7.3	3.2
XIA	418	63.8	6.8	3.0
XIA	418		7.3	3.2

radius adultes				
phase	US/Str.	GL	Bd	SC
XIB	24	57.3	6.3	2.7
XIB	98	55.2	6.1	2.6
XIB	237	62.0	6.6	3.0
XIB	276	58.3	6.2	2.8
XIB	308			2.8
XIB	392		7.5	3.2
XI	36	55.3	6.1	2.7
XI	36	53.8	5.5	2.3
XI	36	56.9	5.9	2.7
XI	36		5.9	2.5
XI	36	56.4	6.2	2.9
XI	36	55.4	5.7	2.4
XII-XIII	71	50.3	5.8	2.6
XII-XIII	71	54.9	5.9	2.9
XVII-XVIII	47			3.1

radius juvéniles		
phase	US/Str.	GL
XIA	33	49.5
XIA	33	54.7
XIA	418	65.9
XIA	418	51.7
XI	36	57.1
XI	36	51.5
XI	36	51.8
XI	36	57.8
XII-XIV	306	54.8

ulna adultes								
phase	US/Str.	GL A	Bp B	Dip D	- C	Did E	SC F	- G
XIA	33	71.9	8.7	13.6	8.2	9.8	4.3	5.7
XIA	33	66.3	8.3	12.6	8.2	9.6	4.3	6.2
XIA	33	60.0	7.5	11.6	7.1	8.6	3.6	4.8
XIA	33	60.0	7.8	11.8	7.0	8.6	3.6	5.3
XIA	33	57.2	7.6	11.5	7.0	8.5	3.5	4.9
XIA	33				7.7	9.2	4.1	5.5
XIA	33	73.9	9.2	14.3	9.4	10.9	5.2	6.5
XIA	33	68.7	9.2	13.7	8.5	10.0	4.2	5.3
XIA	33	72.9	9.2	13.2	7.7	10.3	4.4	6.1
XIA	33	65.8	8.8	12.5	8.3	9.5	4.4	5.6
XIA	33	68.2	8.6	12.1	7.8	9.6	4.1	5.4
XIA	33						4.4	6.0
XIA	33				8.0	9.9	3.8	5.5
XIA	33				7.9	9.6	3.8	5.3
XIA	160						4.0	5.8
XIA	160				7.5	8.7	3.5	5.1
XIA	334				8.9	10.1	4.5	5.8
XIA	347		9.2	13.4			4.6	6.0
XIA	418	70.9	9.8	14.2	9.4	10.1	4.4	6.3
XIA	418	70.5	8.7	12.9	8.6	9.6	4.0	5.5
XIA	418						4.6	6.2
XIA	418				8.4	9.3	4.2	6.2
XIA	418	68.0	7.7		9.2	9.7	4.1	5.6
XIA	418	77.3	9.2	14.7	9.2	10.6	4.4	6.2
XIA	418				8.9	10.3	4.4	6.0
XIA	418	61.2	7.5	11.6	7.5	8.5	3.6	4.8
XIA	418	71.9			8.8	10.0	4.4	6.1
XIA	419				7.7	8.7	3.6	5.0
XIA	419						3.8	5.1
XIA	419						4.6	6.3
mil XI	400	71.3	8.9	13.4	9.0	10.2	4.2	6.2
mil XI	411	73.6			9.0	10.1	4.5	6.1
XIB	24	63.6	8.5	12.2	7.8	8.9	3.5	5.1
XIB	237	65.4	8.2	11.7	7.8	8.6	3.7	5.3
XIB	237		8.4				3.8	5.4
XIB	237						3.6	5.2
XIB	276	62.1	7.6	11.7	7.9	8.6	3.7	5.3
XIB	276		7.5	11.0				
XIB	276				7.5	8.7	3.6	5.2
XIB	276	63.9	8.5	11.7	7.8	9.0	4.1	5.4
XIB	276		8.0	12.1			4.0	5.0
XIB	286		7.1	10.9			3.8	4.8
XIB	306				7.4	8.5	3.9	4.9
XI	36	65.3	8.2	12.6	8.2	9.6	4.2	5.5
XI	36		8.0	11.7			4.0	5.4
XI	36	73.8	8.8	13.2	8.5	10.1	4.6	5.9
XI	36	65.9	7.9	12.2	8.8	9.4	4.2	5.7
XI	36	59.1	7.4	10.7	7.4	7.9	3.5	4.8
XI	36		7.6	10.7				
XII-XIII	71	62.4	8.0	11.7	7.4	8.7	3.6	4.9
XII-XIII	71		7.7	11.0			3.3	4.6
XV-XVI	31		7.4		7.0	8.3	3.7	5.1
XVII-XVIII	47				9.2	10.3		

ulna juvéniles		
phase	US/Str.	GL A
XIA	33	55.7
XIA	33	68.6
XIB	276	48.7
XIB	308	46.6
XI	36	59.7
XI	36	58.7
XI	36	60.6
XI	418	49.2
XI	418	57.7
XII-XIII	71	45.4
XVII-XVIII	39	45.4

va avec 347
va avec 334 (GL = 72.2)

dm-

dm++

dm+

dm-

dm-

carpométacarpe adultes				
phase	US/Str.	GL A	Bp B	Did C
XIA	33	36.5	11.6	7.1
XIA	33	36.4	11.3	7.1
XIA	33			6.9
XIA	418	38.2	11.6	7.2
XIA	418		11.8	
XIA	418	39.1	12.2	7.8
XIA	419	33.8	10.5	6.6

carpométacarpe adultes				
phase	US/Str.	GL A	Bp B	Did C
XIB	170	37.7	11.0	8.0
XIB	170	41.4	12.2	7.8
XIB	231	34.3	<u>10.0</u>	6.3
XIB	276	35.1	10.4	6.4
XIB	278			6.9
XIB	308		9.7	
XI	36	33.9	9.9	6.7
XI	36	32.8	10.0	6.0
XI	36			5.1
XI	36	36.5	10.6	7.3
XII-XIII	71	34.3	10.4	6.6

carpométacarpe juvéniles		
phase	US/Str.	GL A
XIA	33	37.5
XIA	418	32.6

tibiotalpe adultes									
phase	US/Str.	GL A	La -	- B	Dip -	Bd C	Dd E	SC F	- G
XIA	33	115.7	112.3	13.7	19.9	11.8	12.3	6.8	5.8
XIA	33	114.9	111.5	13.8	19.3	11.8	11.5	6.2	5.3
XIA	33	116.2	113.3	14.0	19.5	12.1	12.0	6.4	5.9
XIA	33		111.7	14.1		11.5	11.6	6.9	5.5
XIA	33				19.6	11.6	11.6	5.9	4.9
XIA	33			12.3	17.3			5.1	5.1
XIA	33			12.2	17.0				
XIA	33			12.4	19.1				
XIA	33					10.3	10.2	5.5	4.9
XIA	33					11.0	12.2		
XIA	33					10.5	10.6		
XIA	33	113.7	110.7	14.1	19.5	11.9	10.6	6.4	5.2
XIA	33	120.0	116.6	15.1	21.8	11.9	12.9	7.4	6.2
XIA	33		105.0	13.5		11.5	11.2	6.5	5.9
XIA	33	97.3	94.6	12.3	17.6	10.5	10.5	5.6	5.0
XIA	33			12.0	18.3				
XIA	33					11.8	12.0	6.4	5.6
XIA	33					10.7	10.9	5.6	4.6
XIA	33					10.9	10.7	5.2	4.8
XIA	334	98.8	94.8	11.6	18.9	11.1	10.9	6.4	5.3
XIA	334							5.7	5.0
XIA	347					10.5	10.5		
XIA	347					9.7	9.1		
XIA	371			14.2	21.5			7.0	5.7
XIA	371							6.9	5.8
XIA	418		123.1	14.8	22.3	12.2	13.5	7.0	6.0
XIA	418		<u>108.1</u>			11.4	11.3	6.8	6.6
XIA	418			14.4	20.1				
XIA	418	101.1	98.2	12.6	18.3	10.1	11.0	5.9	5.1
XIA	418							5.4	4.7
XIA	418		109.5			11.5	11.5	6.0	5.5
XIA	418					11.6	12.1		
XIA	418			11.6	16.2			5.1	4.8
XIA	419	<u>91.0</u>	88.2	11.1	16.9	9.4	9.7	5.2	5.3
XIA	419					11.2	11.9		
XIA	421	<u>116.0</u>	113.0	<u>14.0</u>	<u>20.5</u>	10.6	11.0	7.2	6.0
mil XI	411			15.0	21.7			6.9	6.2
XIB	237			13.4					
XIB	237					13.4	12.0	6.3	6.0
XIB	276					10.4	11.2	6.1	5.2
XIB	276					10.2	10.2		
XIB	276			11.9	17.0				
XIB	276							6.0	4.9
XIB	279					12.9	12.3		
XIB	308					11.3	12.1		
XIB	392							5.9	5.4
XI	36	98.4	95.6	12.2	18.2	10.3	10.5	5.7	5.0
XI	36			11.6	17.3				
XI	36					10.6	11.2	5.3	4.9
XI	36					10.5	11.2	5.4	4.9
XI	36	102.3	98.9	12.3	18.9	11.2	11.4	5.8	5.7
XI	36	96.1	93.0	12.2	16.8	9.7	10.8	5.1	4.9
XI	36			11.1	17.1				
XI	36					9.7	10.8	5.4	4.6
XII-XIII	71							6.0	5.0
XV-XVI	31							5.6	4.9
XVII-XVIII	39							6.0	5.0

tibiotalpe juvéniles		
phase	US/Str.	GL A
XIA	33	79.0
XIA	33	<u>85.0</u>
XIA	33	69.8
XIA	418	102.2
XIA	418	84.9
XIB	276	68.7
XI	36	69.1
XI	36	70.5
XV-XVI	31	67.6
XV-XVI	31	61.0
XV-XVI	31	61.0

dm-

dm+

dm-

dm+

dm+

dm-

dm++

dm+

dm-

tarsométatarse			e+	ergot présent						
			e-	ergot absent						
			e?	ergot cassé ?						
			p	protubérance						
			pas d'indication : inconnu							
adultes			GL	Bp	-	Bd	-	SC	-	
phase	US/Str.		A	B	D	C	E	F	G	
XIA	33	e+	77.7	13.3	11.9	13.3	9.8	6.9	5.0	
XIA	33	e+				13.6	10.1	6.8	4.9	
XIA	33	e-				13.0	9.1	6.3	4.3	
XIA	33	p						6.9	4.6	
XIA	160	e-	71.2	11.7	11.7	12.2	9.1	5.7	4.2	
XIA	341	p	79.4	13.4	12.9	13.0	9.8	6.3	4.4	
XIA	347	p		13.4	13.1			6.4	4.2	
XIA	418	e+	84.2	16.4	13.3	13.7	10.9	8.0	5.1	
XIA	418	e?	80.8	13.8	12.5	13.9	10.0	6.8	4.6	
XIA	418	e+	83.0	14.6	12.9	13.7	10.8	7.4	4.9	
XIA	418	p	82.5	13.6	12.6	13.9	10.4	7.1	5.0	
XIA	418	e-	66.6			12.6	9.3	6.3	4.2	
XIA	418	e+	68.7	12.9	11.9	12.5	9.5	6.3	4.3	
XIA	419	e-	70.2	13.2	11.3	12.9	11.1	6.3	4.4	
XIA	419	e-	70.2	11.5	10.4			5.6	4.2	
XIA	419	e-		12.6	11.3					
XIA	419	e-				13.9	10.2			
XIA	419	e-				12.9	10.0			
XIA	419	e-	67.6	10.9	10.7	11.6	8.9	5.6	4.4	
XIA	419	e-		11.8	10.3			5.7	4.0	
XIA	419	e-		12.5	11.0					
mil XI	400	e+	77.5	14.5	10.5	13.8	10.2	7.0	5.1	
mil XI	400	e+		20.5	16.7			8.8	6.3	
mil XI	400	e-				13.0	9.7			
mil XI	411	p	80.9	13.3	12.5	13.9	9.2	7.5	4.8	
mil XI	411	p	80.2	13.1	12.8	13.8	9.8	7.8	5.0	
mil XI	411	p						7.9	5.7	
XIB	232	e-	71.8	12.2	11.5	12.3	9.7	5.8	4.2	
XIB	232	e-		11.2	10.7			5.0	3.9	
XIB	232	e-	71.9	12.8	12.1	12.8	9.9	6.3	4.3	
XIB	237			13.4						
XIB	237	e-						5.7	3.6	
XIB	276	e-	66.1	11.9	10.6	12.3	9.4	5.9	4.2	
XIB	276			13.0	12.5			6.7	5.1	
XIB	276			12.1	11.4					
XIB	276	e-				11.3	9.3	5.4	4.0	
XIB	276					13.4				
XIB	276	e-	77.0	13.3	12.0	13.0	10.1	6.4	4.5	
XIB	276	e-	74.2	13.7	11.9	12.6	9.7	6.3	4.7	
XIB	276	e-	63.6	11.6	11.2			5.6	3.7	
XIB	276	e-						5.7	3.6	
XIB	276	e-						5.3	3.4	
XIB	276	e-	47.9	10.4		10.3	7.3	5.7	2.8	
XIB	276			10.0	9.5			5.6	2.7	
XIB	276					10.3	7.7			
XIB	325	e-	66.2	11.5	11.1	12.1	9.3	5.8	3.8	
XIB	392	e?		14.3	12.0			7.6	5.0	
XIB	392			13.3	12.2					
XI	36	e+	78.4	13.4	12.3	13.4	10.9	6.6	4.6	
XI	36	e+	78.0	13.2	12.3	13.4	10.8	6.7	4.8	
XI	36	e+	64.6	12.2	11.0	12.7	9.1	6.4	4.1	
XI	36	e-	69.1	12.1		11.6	8.8	5.6	4.3	
XI	36	e-	65.9	10.9	10.6	11.6	8.3	5.6	3.9	
XI	36	e-	65.2	12.2	10.8	11.6	8.7	5.5	4.2	
XI	36	e-	69.4	12.6	11.2	12.2	9.2	5.8	4.2	
XI	36	e-	71.2	12.1	11.2	13.0	9.5	6.3	4.1	
XI	36	e-	73.0	12.2	11.3	13.1	9.7	5.9	4.6	
XI	36	e-	59.3	11.8	11.0	12.4	9.0	5.8	4.1	
XI	36	e-		11.5	10.0			5.5	3.9	
XI	36	e-	64.8	11.7	11.0	11.6	8.6	5.6	4.3	
XI	36	e-	67.9	11.5	11.0	11.0	8.6	5.1	3.6	
XI	36	e-	69.3	13.3	11.1	12.1	8.6	5.9	4.7	
XI	36	e-	69.4	12.5	11.0	12.2	9.7	6.3	4.6	
XI	36	e-	59.8	11.5	10.6	11.3	8.8	5.5	3.9	
XI	36	e-				11.3	8.0	5.8	4.0	
XV-XVI	31	e-	68.3	12.1	11.4	11.6	9.7	5.5	4.0	
XV-XVI	31	e-	69.2	12.2	11.0	11.7	10.5	6.1	4.4	
XVII-XVIII	47	e-				10.8	8.5	5.0	3.6	

tarsométatarse			GL
juvéniles	US/Str.		A
phase			
XIA	33		49.1
XIA	33		46.8
XIA	33		48.9
XIA	33		49.0
XIA	371		60.8
XIA	418		73.3
XIA	418		72.3
XIA	418		66.0
XIA	418		58.7
XIA	418		71.8
XIA	419		50.9
XIA	419		40.2
mil XI	400		59.7
XIB	276		46.5
XIB	276		48.5
XIB	276		53.7
XIB	276		50.9
XIB	276		48.4
XI	36		50.0
XI	36		62.5
XI	36		52.0
XII-XIII	71		53.8
XII-XIII	71		51.84
XV-XVI	31		40.8
XV-XVI	31		28.1
XV-XVI	31		26.1
XV-XVI	31		27.0
XV-XVI	31		26.6
XV-XVI	31		25.4
XV-XVI	31		26.0

dm-
dm-
poussin
poussin
poussin
poussin
poussin
poussin

Annexe 6.3 : ostéométrie de l'Oie domestique *Anser anser* f. *domesticus*, sauf indication contraire : format *Anser anser anser* : Oie cendrée / *A. fabalis* : Oie des moissons ; format *A. albifrons* Oie rieuse.

coracoïde phase	US/Str.	GL A	Lm A'	Bb C	BF -	- E	- G
XIA	334						6.3
XIB	237	72.1	63.5	29.6	28.9	8.4	7.3
XIB	237	69.2	61.1	28.5	27.9	8.7	6.5
XIB	276	<u>70</u>	63.9	<u>29.8</u>		8.9	8.1
XIB	276						8.0
XIB	276			28.9	27.4	7.9	
XIB	276	<u>72.5</u>	<u>63</u>	30.6	29.3	8.8	7.9

scapula phase	US/Str.	Dic B	- D	- F	- G
XIB	276		6.1	9.0	4.6
mil XI	85	<u>20.1</u>	6.7	8.8	5.5

humérus phase	US/Str.	A GL	B Bp	D -	C Bd	E -	F SC	G -
XIA	33		<u>32.1</u>	16.5				
XIA	33						11.4	9.7
XIA	160		34.1	16.0				
XIA	334				<u>21.0</u>	13.2	11.5	10.0
XIA	334						11.1	9.5
XIA	418				23.7	13.9	11.5	10.3
XIA	418						11.2	10.4
mil XI	411						11.6	10.1
XIB	232				22.6	13.1		
XIB	232				25.9	15.5		
XIB	237						13.0	11.4
XIB	237						11.1	9.9
XIB	276	<u>171</u>			23.9	14.7	11.9	10.2
XIB	276						11.4	10.2
XVII-XVIII	47		33.1	15.2				

radius phase	US/Str.	GL	Bd	SC
XIA	33	147.1	10.8	<u>4.8</u>
XIA	33			<u>4.8</u>
XIA	418	<u>141</u>		5.9
XIA	418			6.0
XIA	418			6.0
XIB	237			6.1
XIB	276		10.5	
XIB	276			5.9
XIB	276			6.3
XIB	276		10.0	
XIB	276		9.9	
XIB	276			5.9
XIB	276			6.3
XIB	276			5.7
XIB	392			4.8

va avec 237
va avec 232

ulna phase	US/Str.	A GL	B Bp	D Dip	C -	E Did	F SC	G -
XIA	418		<u>16</u>	14.1				
XIA	418						8.8	8.7
mil XI	411						7.9	7.9
mil XI	363						8.3	8.3
XIB	231						7.8	7.7
XIB	231				12.5			
XIB	232				14.0	16.4	8.6	7.9
XIB	237	153.7	15.4	20.3	12.3	<u>15.3</u>	8.6	8.5
XIB	237				14.1	16.5	8.3	7.9
XIB	237						8.3	7.9
XIB	276	153.6	15.8	20.3	12.6	16.0	8.5	8.4
XIB	276				12.1	14.8	7.7	7.7
XIB	276		<u>16</u>	14.1			8.7	8.2
XIB	392						8.5	7.8
XIB	392				11.0	13.0		

A. anser anser / *A. fabalis* ? (insertions musculaires marquées)

A. anser anser / *A. fabalis* ? (insertions musculaires marquées)

domaine de variation d'*Anser albifrons* et insertions musculaires marquées

carpométacarpe phase	US/Str.	GL A	Bp B	Did C
XIA	418	84.0	19.6	10.4
XIA	418	94.5	21.8	11.8
XIA	418	91.1	20.3	10.9
XIA	418	85.4	19.3	10.9
XIA	418	92.0	21.6	10.8
XIA	418	91.0		
XIA	418		22.3	
mil XI	400			10.0
XIB	231	93.8	20.7	11.6
XIB	232		19.1	
XIB	233	93.2	<u>21.9</u>	11.4
XIB	233			11.1
XIB	237	87.2	20.4	11.5
XIB	237		20.0	
XIB	299	86.0	20.2	10.9
XIB	276			10.6
XIB	308			11.7
XIB	311			10.2

carpométacarpe phase	US/Str.	GL A	Bp B	Did C
XI	36	99.0	22.2	11.7
XI	36			10.7
XI	36	88.2	20.3	11.0
XI	36			<u>10</u>
XII-XIII	71	85.7	19.4	
XII-XIII	71			10.3
XV-XVI	31	88.7	20.9	10.9
XV-XVI	31	89.2	21.4	11.3
XV-XVI	31	94.5	juvénile	
XV-XVI	31	82.0	20.7	11.0

domaine de variation de *A. albifrons* (Bacher 1967)

phalange proximale du doigt principal de l'aile		
phase	US/Str.	GL
XIA	347	39.4
XIA	418	35.6
XIA	418	39.7
XIA	418	37.1
XIA	418	36.6
XIA	418	39.1
XIA	421	39.5
XIB	98	36.2
XIB	231	40.1
XIB	233	38.9
XIB	276	39.6
XIB	311	37.9
XI	36	38.0
XV-XVI	31	39.9
XV-XVI	31	36.0
XVII-XVIII	39	41.5

fémur		A	-	B	D	C	E	F	G
phase	US/Str.	GL	Lm	Bp	Dp	Bd	Dd	SC	-
XIB	232			19.5	<u>13.7</u>			8.1	7.7
XIB	232			21.9	15.2			8.0	8.4
XIB	237					20.1	15.9		
XIB	276	80.2	75.6	20.9	14.7	19.8	15.9	8.3	8.9
XIB	276	80.6	75.8	21.1	15.3	20.7	17.1	8.0	9.0
XIB	311	77.5	72.8	20.9	<u>14.9</u>	19.7	15.4	8.8	8.3
XI	36		72.3			18.8	15.6	7.5	7.9

tarsométatarse		GL	Bp	-	Bd	-	SC	-
phase	US/Str.	A	B	D	C	E	F	G
XIA	418		18.3	16.7			7.7	6.8
XIB	232		18.5	16..3			7.9	6.8
XIB	276	86.9	18.0	16.4	17.5	14.9	8.2	6.7
XIB	276	83.3	17.4		17.1	13.6	7.8	6.6
XI	36	85.4	17.8	16.7	19.4	14.4	7.9	6.6
XI	36	78.6						juvénile
XI	36	78.3						juvénile
XV-XVI	31	57.1						juvénile

tibiotarse		GL	La	-	Dip	Bd	Dd	SC	-
phase	US/Str.	A	-	B	-	C	E	F	G
XIA	33					14.1	13.6		
XIA	418	138.0	131.9	16.6	24.6	16.5	15.9	8.7	8.0
XIA	418			16.8	25.0				
XIA	419							8.1	5.9
XIB	232					17.0	16.4	8.6	7.7
XIB	232					16.5	16.3		
XIB	237		139.4	16.7		16.5	16.6	7.9	6.6
XIB	237	<u>145.5</u>	<u>140</u>	17.3	26.3	16.6	16.9	8.7	7.4
XIB	237			16.9	25.3				
XIB	276	147.1	142.3	17.1	<u>25</u>	17.0	16.9	9.1	7.7
XIB	276			<u>17</u>	25.1				

domaine de variation de *A. albifrons* (Bacher 1967)

Annexe 6.4 : ostéométrie des Canards

avec les espèces suivantes :

Anas platyrhynchos : Canard colvert

Anas acuta : Canard pilet

Anas clypeata : Canard souchet

Anas penelope : Canard siffleur

Anas strepera : Canard chipeau

Anas querquedula : Sarcelle d'été

Anas crecca : Sarcelle d'hiver

Aythya fuligula : Fuligule morillon

Bucephala clangula : Garrot à œil d'or

Mergus serrator : Harle huppé

Netta rufina : Nette rousse

Tadorna tadorna : Tadorne de Belon

Lorsque le genre *Anas* a été identifié, mais pas l'espèce, trois classes de taille : *Anas* f. colvert, *Anas* f. chipeau et *Anas* f. Sarcelle.

Lorsque le genre n'est pas identifié, classement par taille : taille 'Canard colvert', taille 'intermédiaire' et taille 'Sarcelle'.

coracoïde		GL	Lm	Bb	BF	-	-	
phase	US/Str.	A	A'	C	-	E	G	
XIA	33			21.7	20.6	3.8	3.5	<i>Anas strepera</i> ?
XIA	33	<u>52.6</u>	<u>49.6</u>		18.8	4.8	4.0	<i>Anas</i> f. colvert
XIA	33			20.5	18.8	3.7	3.2	<i>Anas</i> f. chipeau
XIA	418						3.9	<i>Anas</i> f. colvert
mil XI	411	57.4	53.4	<u>23</u>	<u>19</u>	<u>4.7</u>	3.9	<i>Mergus serrator</i> ?
mil XI	411				19.9	4.0	3.2	<i>Anas</i> f. chipeau
XIB	96	50.9	46.0		20.5	4.3	3.4	<i>Anas</i> f. chipeau
XIB	237	52.6	47.8	22.4	20.1	4.3	3.6	<i>Anas</i> f. colvert
XIB	237				20.8	4.8		<i>Anas</i> f. colvert
XIB	237	58.4	53.0	23.9	22.0	4.6	3.8	<i>Anas</i> f. colvert
XIB	276	55.1	50.5	21.7	20.3	4.6	3.5	<i>Anas</i> f. colvert
XIB	276		49.5				3.4	<i>Anas</i> f. colvert
XIB	276	54.2	48.9	<u>22</u>	20.9	4.0	3.6	<i>Anas</i> f. colvert
XIB	276	55.4	50.5		20.7	4.7	3.6	<i>Anas</i> f. colvert
XI	36	53.7	48.6	23.3	21.4	4.5	4.0	<i>Anas</i> f. colvert
XI	36	<u>34.3</u>	<u>31.6</u>				2.4	<i>Anas</i> f. sarcelle

scapula phase	US/Str.	Dic B	- D	- F	- G	
XIA	33	11.7	3.4	5.5	2.9	taille colvert
XIA	33	11.6	3.7	5.7	2.9	taille colvert
XIA	33	8.2	2.8	4.5	2.1	taille sarcelle
XIA	33	11.7	4.5	6.0	3.0	taille colvert
XIA	33	11.5	3.4	5.5	2.8	taille colvert
XIA	347	7.7	2.8	3.6	2.1	taille sarcelle
XIA	371	<u>12.0</u>	3.6	5.5	3.1	taille colvert
XIA	418	8.1	2.8	3.3	1.8	taille sarcelle
XIB	276	12.8	4.0	6.0	3.2	taille colvert
XIB	276	12.1	3.7	6.1	2.7	taille colvert
XIB	276	12.5	3.5	5.8	2.8	taille colvert
XIB	276	12.8	3.7	6.1	3.2	taille colvert
XI	36	9.4	3.1	5.0	2.4	taille intermédiaire
XI	36	7.0	2.1	3.6	1.8	taille sarcelle
XII-XIV	286			5.8	3.2	taille colvert
XII-XIV	306	10.2	3.2	4.1	2.5	taille intermédiaire

radius phase	US/Str.	GL	SC	Bd	
XIA	334	69.3	3.0	6.7	taille colvert
XIA	418		3.2		taille colvert
XIA	418	47.8	2.3	4.5	taille sarcelle
XIA	418	47.4	1.9	4.2	taille sarcelle
mil XI	411		3.1	<u>6.7</u>	taille colvert
XIB	237		3.1		taille colvert
XIB	238	75.6	6.5	2.9	taille colvert
XIB	238	47.7	4.4	2.1	taille sarcelle
XIB	308			2.1	taille sarcelle
XIB	323	49.6	4.5	2.1	taille sarcelle
XIB	343		6.6		taille colvert
XI	36	73.7	3.3	6.6	taille colvert
XI	36	68.5	2.9	6.6	taille colvert
XI	36	66.0	2.4	5.0	taille intermédiaire

humérus phase	US/Str.	A GL	B Bp	D -	C Bd	E -	F SC	G -	
XIA	33				9.9	5.7			Anas f. sarcelle
XIA	347				14.4	9.1			Anas f. colvert
XIA	347						4.8	4.0	Anas f. sarcelle
XIA	334	92.1	20.5	11.6	14.6	9.0	7.4	6.2	Anas f. colvert
XIA	334	92.3	21.6	10.1	14.5	8.5	7.7	6.8	Anas f. colvert
XIA	334				15.1	9.0	7.7	6.7	Anas f. colvert
XIA	418	88.4	20.7	11.5			7.1	5.8	Anas f. colvert
XIA	418				14.3	9.2	7.3	6.3	Anas f. colvert
XIA	419						6.4	5.6	Anas f. colvert
mil XI	400				15.1	8.7	7.2	6.2	Anas f. colvert
XIB	232		20.7	11.4			7.1	5.8	Anas f. colvert
XIB	232						7.5	6.2	Anas f. colvert
XIB	237		20.1	<u>11.7</u>			6.9	6.0	Anas f. colvert
XIB	276	93.3	20.5	<u>11.7</u>	14.5	8.7	7.3	6.3	Anas strepera ?
XIB	276		21.8	12.9			7.5	5.9	Anas f. colvert
XI	36				10.6	7.1	5.4	4.6	Anas clypeata
XI	36	56.7	12.3	7.3	8.5	5.2	4.1	3.7	Anas crecca
XI	36	87.9			14.2	8.4	6.8	6.6	Anas platyrhincos

ulna phase	US/Str.	GL A	Bp B	Dip D	- C	Did E	SC F	- G	
XIA	334						5.5	5.2	Anas f. colvert ?
XIA	347	<u>51</u>	6.5	<u>6.0</u>	5.5	7.1	3.3	3.8	Anas querquedula
XIA	347		8.8	8.1					Anas f. colvert
XIA	371		10.0		8.9	10.7	5.1	5.7	Anas platyrhincos
XIA	371						5.3	5.5	Anas f. colvert
XIA	418	<u>79</u>	10.0	<u>12.8</u>	8.9	10.3	5.3	5.4	Anas platyrhincos
XIA	418	<u>52</u>	6.7	<u>9.2</u>	5.8	7.2	3.4	3.9	Anas crecca
XIA	418						3.8	4.0	Anas f. sarcelle
XIA	418				8.8	10.3			Anas f. colvert
XIA	418						5.3	5.4	taille colvert
XIA	418						5.4	5.6	Anas f. colvert
XIA	418	<u>51.5</u>	6.3	<u>8.2</u>	5.7	6.9	3.4	3.6	Anas querquedula
mil XI	400		10.4				5.7	5.8	Anas f. colvert
mil XI	411		10.3		9.0	10.8	5.3	5.5	Anas platyrhincos
mil XI	411						5.7	5.9	Anas platyrhincos
mil XI	411		7.7				4.2	4.5	Bucephala clangula ?
XIB	276		9.1		8.0	<u>9.2</u>	5.1	5.4	Anas f. colvert
XIB	276				7.5	9.2			Anas f. colvert
XIB	316	<u>51</u>	6.5	<u>8</u>	5.5	6.9	3.1	3.8	Anas crecca
XIB	392				8.7	10.5	5.2	5.9	Anas f. colvert
XIB	404				9.1	10.6	5.7	5.7	Anas f. colvert
XI	36	79.5	8.6	12.3	8.7	9.9	5.2	5.3	Aythya fuligula ?
XI	36	<u>70.2</u>	6.7	9.7	6.5	8.1	4.0	4.5	Anas clypeata / penelope ?
XI	36	74.5	9.2	12.4	9.4	10.5	5.3	5.5	Anas f. colvert
XII-XIII	71		6.6		5.6	7.0	3.3	3.7	Anas crecca
XII-XIII	71				5.9	7.3	3.46	4.0	Anas f. sarcelle
XV-XVI	31		6.0	8.1					taille sarcelle

carpométacarpe phase	US/Str.	GL A	Bp B	Did C	
XIA	33	57.4	12.6	6.3	taille colvert
XIA	33			6.3	taille colvert
XIA	33	<u>60</u>		<u>6.7</u>	taille colvert
XIA	33	54.2		6.7	taille colvert
XIA	347	36.7	9.0	4.6	taille sarcelle
XIA	418	57.6	13.1	7.2	taille colvert
XIA	418	37.6	9.1	5.2	taille sarcelle
mil XI	400	55.5		6.6	taille colvert
mil XI	411			6.8	taille colvert
XIB	238	51.8	12.8	6.4	taille intermédiaire
XIB	279		9.7		taille sarcelle
XIB	392	58.1	13.2	6.9	taille colvert
XI	36	58.6	13.1	7.3	taille colvert
XI	36	58.9	13.2	7.1	taille colvert
XI	36	54.9	13.0	7.5	taille colvert
XI	36	54.1	13.4	7.2	taille colvert

phalange proximale du doigt principal de l'aile			
phase	US/Str.	GL	
XI	36	22.28	taille colvert

fémur phase	US/Str.	GL A	Lm -	Bp B	Dp D	Bd C	Dd E	SC F	- G	
XIA	33							4.1	5.4	<i>Anas platyrhynchos ?</i>
XIB	237	51.0	48.7	11.2	8.4	11.2	8.7	4.4	5.4	<i>Netta rufina ?</i>
XIB	237			<u>12</u>	8.6					<i>Anas platyrhynchos</i>
XIB	237					11.3				<i>Netta rufina ?</i>
XIB	308	53.3	50.2	12.0	8.7	11.6	8.7	4.0	5.2	<i>Anas platyrhynchos</i>

tibiotarse phase	US/Str.	La -	- B	Dip -	- D	Bd C	Dd E	SC F	- G	
XIA	33					9.1	9.2	4.3	3.7	<i>Tadorna tadorna ?</i>
XIA	347							4.0	3.4	<i>Anas acuta</i>
XIA	347					5.5	6.0			<i>Anas crecca ?</i>
mil XI	411							3.6	3.1	taille sarcelle
XIB	237	77.9	<u>9.2</u>	<u>13</u>	<u>10</u>	8.9	9.1	4.2	3.7	<i>Anas f. colvert</i>
XIB	276		8.6	12.7	9.7			4.5	3.8	<i>Anas f. colvert</i>
XIB	276					8.8	9.2			<i>Anas f. colvert</i>
XIB	276					8.7	9.2	4.5	3.8	<i>Anas f. colvert</i>
XIB	392							4.9	3.7	<i>Anas f. colvert</i>
XI	36		9.1	13.4				4.9	3.9	<i>Anas f. colvert</i>
XI	36						10.5	5.4	4.2	<i>Anas f. colvert</i>

tarsométatarse phase	US/Str.	GL A	Bp B	- D	Bd C	- E	SC F	- G	
XIA	347	<u>31</u>	5.9	5.7	5.8	4.5	2.4	2.6	<i>Anas crecca</i>
XIA	347				6.8	5.1			<i>Anas querquedula ?</i>
mil XI	342	47.1	9.8	9.6	9.8	7.5	4.5	3.9	<i>Anas platyrhynchos</i>
XIB	237	42.8	9.0	8.2	8.9	7.4	4.3	4.2	<i>Anas platyrhynchos</i>
XIB	276	46.9	10.0	8.8	8.9	7.7	4.8	4.2	<i>Anas platyrhynchos</i>
XIB	276	42.6	9.4	8.2	8.5	7.1	4.5	3.8	<i>Anas platyrhynchos</i>
XIB	276	41.2	9.2	8.2	8.4	7.7	4.1	3.7	<i>Anas platyrhynchos</i>
XIB	276				8.7	7.3			<i>Anas platyrhynchos</i>
XIB	276	45.5	10.4	9.1	9.6	7.9	4.6	4.3	<i>Anas platyrhynchos</i>
XI	36		8.0	7.8					<i>Anas penelope</i>

Annexe 6.5 : ostéométrie des Phasianidés (autres que la Poule).

- les Perdrix

avec : *Perdix perdix* : Perdrix grise et *Alectoris rufa* : Perdrix rouge

humérus phase	US/Str.	A GL	B Bp	D -	C Bd	E -	F SC	G -	
XI	36		11.9						<i>Perdix perdix</i>
XIA	334	46.8	13.3	5.8	9.6	5.5	4.6	3.5	<i>Perdix perdix</i>
XIB	276	<u>37</u>	juvénile						<i>Alectoris / Perdix</i>
XV-XVI	31				9.7	5.2	4.0	3.4	<i>Alectoris rufa</i>

ulna phase	US/Str.	Did E	SC F	- G	
XIA	33	5.5	2.5	3.2	<i>Alectoris / Perdix</i>

scapula phase	US/Str.	Dic B	- D	- F	- G	
XIA	334	8.7	3.5	3.4	2.0	<i>Perdix perdix ?</i>

fémur phase	US/Str.	GL A	Lm -	Bp B	Dp D	Bd C	Dd E	SC F	- G	
XIB	392	56.4	53.9	10.7	7.2	9.6	6.7	4.0	4.4	<i>Alectoris rufa</i>

- la Caille des blés *Coturnix coturnix* :

tarsométatarse phase	US/Str.	GL A	Bp B	- D	Bd C	- E	SC F	- G
XIA	44	26.4	4.6	4.5	4.9	3.9	2.3	1.7
XIA	44		5.0	4.9			2.3	1.8
XIA	44		5.2	4.7				
XIA	44				5.2	3.8		
XIA	44				5.3	3.8		
XIA	44	27.0	4.6	4.7	5.0	3.4	2.2	1.8
XIA	44	26.1	4.6	4.5		3.9	2.3	1.8
XIA	44	26.9	4.4	4.5			2.1	1.5
XIA	44		4.6	4.6				
XIA	44		5.2	4.5				

tibiotarse phase	US/Str.	Bd C	Dd E
XIA	44	4.6	4.5
XIA	44	4.5	4.6
XIA	44	4.3	4.6
XIA	44	4.6	4.5
XIA	44	4.4	4.2
XIA	44	4.3	4.4
XIA	44	4.1	4.4
XIA	44	4.6	4.6
XIB	276	4.5	4.4

- le Paon bleu *Pavo cristatus* :

ulna phase	US/Str.	A GL	B Bp	D Dip	C -	E Did	F SC	G -
XIA	334	124.6	14.9	19.8	13.1	16.2	7.1	9.0

radius phase	US/Str.	Bd C	SC -
XI	36	10.9	5.4

Annexe 6.6 : ostéométrie de la Grue cendrée *Grus grus* (Gruidés).

humérus phase	US/Str.	Bp B	D
mil XI	402	44.6	22

Annexe 6.7 : ostéométrie de l'Oedicnème criard *Burhinus oedicnemus* (Burhinidés).

tarsométatarse phase	US/Str.	GL A	Bp B	- D	Bd C	SC F	- G
XIA	33	75.1	9.1	7.9	8.6	3.6	4.0

Annexe 6.8 : ostéométrie du Vanneau huppé *Vanellus vanellus* (Charadriidés).

coracoïde phase	US/Str.	GL A	Lm A'	Bb C	BF -	- E	- G
XIA	347	24.2	22.9	-	7.9	3.1	2.5

tibiotarse phase	US/Str.	Bd C	Dd E
XIA	347	5.5	5.2

Annexe 6.9 : ostéométrie des Scolopacédés :

- le Courlis cendré *Numenius arquata* :

tibiotarse phase	US/Str.	Bd C	Dd E	SC F	- G
XI	36	9.3	8.7	4.7	3.4
XI	36	9.0	8.4	5.0	4.1

- la Bécassine des marais *Gallinago gallinago* :

humérus phase	US/Str.	Bd C	E	SC F	G
XIA	347	6.3	4.0	2.9	2.6
XIA	347	6.7	4.1	3.0	2.6
XIA	418			2.8	2.6

tarsométatarse phase	US/Str.	GL A	Bp B	D	Bd C	E	SC F	G
XIA	347	32.7	4.7	5.2	4.6	3.9	1.9	1.7

tibiotarse phase	US/Str.	Bd C	Dd E	SC F	G
XIA	347	4.4	4.1	2.1	2.2

- le Chevalier guignette *Actitis hypoleucos* :

humérus phase	US/Str.	C Bd	E	F SC	G
XIB	276	4.6	2.9	2.0	1.9

- la Bécasse des bois *Scolopax rusticola* :

coracoïde phase	US/Str.	GL A	Lm A'	Bb C	BF -	- E	- G
XI	36	30.8	28.8	12.7	7.8	3.2	2.4
XII-XIV	286	28.6	26.8		7.9	3.5	2.1

ulna phase	US/Str.	Bp B	Dip D	- C	Did E	SC F	- G
XIA	347	8.0	8.5			3.8	3.9
XIA	347			5.7	6.6		

humérus phase	US/Str.	GL A	Bp B	- D	Bd C	- E	SC F	- G
XIA	418	56.7	14.3	8.2			4.6	4.2
XIA	418				10.0	6.2	4.6	4.0
XIA	347				9.8	6.0		

radius phase	US/Str.	GL	Bd	SC
XIA	418			1.9
XIA	160	58.3	5.2	2.0

fémur phase	US/Str.	Dp D	SC F	- G
XIA	418	5.2	3.3	3.2

Annexe 6.10 : ostéométrie des Ardéidés :

- le Héron cendré *Ardea cinerea* :

humérus phase	US/Str.	Bp B	- D	SC F	- G
XI	36	27	16.2	10.2	9.1

phalange proximale du doigt principal de l'aile phase	US/Str.	GL
XI	36	34.8

- le Butor étoilé *Botaurus stellaris* :

coracoïde phase	US/Str.	GL A	Lm A'	Bb C	BF -	- E	- G
XIA	418				17.8		4.0
XIB	232						3.9
XIB	276	63.2	59.9	21	18.5	6.2	3.9

scapula phase	US/Str.	Dic B	- D	- F	- G
XIB	276	11.8	3.7	5.3	2.8
XIB	276	11.4	3.8	5.0	3.0

humérus phase	US/Str.	Bp B	- D	SC F	- G
XIB	276	21	12	7.3	6.5
XIB	232	21.5			

fémur phase	US/Str.	GL A	Lm -	Bp B	Dp D	Bd C	Dd E	SC F	- G
XIB	237	100.6	98.3	15.2	10.9	14.5	11.5	6.6	7.0
XIB	237					14.5	11.4	6.6	6.9

Annexe 6.11 : ostéométrie de la Spatule blanche *Platlea leucoradia* (Treskiornithidés)

scapula phase	US/Str.	Dic B	D
XI	36	14.8	4.5

coracoïde phase	US/Str.	Lm A'	- G
XI	36	56	6.6

carpométacarpe phase	US/Str.	GL A	Bp B	- H	Did C
XI	36	80.4	16.3	9.6	11.2

Annexe 6.12 : ostéométrie des Columbidae

avec : *Columba palumbus* : Pigeon ramier ou Palombe

C. livia : Pigeon biset

C. oenas : Pigeon colombin

Streptopelia turtur : Tourterelle des bois.

coracoïde phase	US/Str.	GL A	Lm A'	BF BF	- E	- G	
XIB	276	32.6	31.1	8.7	3.3	2.7	<i>Columba sp.</i> (juvénile)
XIB	323	35.7	34.7	8.8	3.0	2.7	<i>C. oenas / livia</i>

humérus phase	US/Str.	A GL	B Bp (Dip)	D -	C Bd	E -	F SC	G -	
XIA	334	55.8	19.1	10.8	10.8	7.8	6.6	4.9	<i>C. palumbus</i>
XIB	276	55.5	19.1	11.2	13.7	8.6	6.6	5.0	<i>C. palumbus</i>
XIB	328	35.1	12.9	8.3	6.4	5.5	4.1	3.0	<i>Streptopelia turtur</i>
XI	36	54.2	18.9	-	13.5	8.5	6.6	5.0	<i>C. palumbus</i>

radius phase	US/Str.	GL	Bd	SC	
XIA	347	46.7	4.5	2.0	<i>C. oenas / livia</i>

ulna phase	US/Str.	GL A	Bp B	Dip D	- C	Did E	SC F	- G	
XIA	418	51.3	6.8	9.0	5.6	6.7	3.3	4.0	<i>C. oenas / livia</i>
XIA	418	47.4	juvénile						<i>Columba sp.</i>
XIA	334	53.8	6.6	9.6	6.1	7.1	3.8	4.1	<i>C. oenas / livia</i>

tarsométatarse phase	US/Str.	GL A	Bp B	- D	Bd C	- E	SC F	- G	
XIB	392	30.0	7.2	6.3	-	4.0	3.0	2.5	<i>Columba sp.</i>

Annexe 6.13 : ostéométrie des Accipitridés :

- l'Épervier d'Europe *Accipiter nisus* :

ulna phase	US/Str.	GL A	Bp B	- D	Did C	SC E	- F	- G
XII-XIII	71	61.8	6.5	6.3	5.3	5.8	3.7	3.6

tibiotarse phase	US/Str.	GL A	La -	- B	Dip -	Bd C	Dd E	SC F	- G	
XII-XIII	71	61.9	60.7	5.9	7.4	6.0	4.4	3.5	2.6	mâle

tarsométatarse phase	US/Str.	GL A	Bp B	- D	Bd C	- E	SC F	- G	
XII-XIII	71	54.2	6.2	5.2	6.2	3.8	2.4	3.2	mâle

- le Pygargue à queue blanche *Haliaeetus albicilla* :

carpométacarpe phase	US/Str.	GL A	Bp B	Did C
XIA	33	122.4	27.3	17.7

phalange proximale du doigt principal de l'aile phase	US/Str.	GL
XIA	33	45.6

Annexe 6.14 : ostéométrie des petits passereaux

avec : mesures a, b, e, i pour les carpométacarpes d'après T. Tomek & Z. Bochenski (2000)

Alaudidé : famille des Alouettes, *Alauda arvensis* Alouette des champs

ou *Galerida cristata* Cochevis huppé

Passer domesticus : Moineau domestique

Fringilla coelebs : Pinson des arbres

Turdus / Sturnus : Merles - Grives / Étourneaux.

humérus phase	US/Str.	A GL	B Bp	D -	C Bd	E -	F SC	G -	
XIB	276	25.4	7.2	3.5	5.6	3.0	2.1	1.8	Alaudidé
XIB	276	-	7.6	3.9	-	-	2.5	2.2	Alaudidé
XI	36	-	7.1	3.3	-	-	-	-	Alaudidé
XIB	276	18.9	6.5	3.1	-	-	1.9	1.7	<i>Passer domesticus</i> (?)
XIB	276	18.9	6.3	3.1	4.8	2.7	1.9	1.7	<i>Passer domesticus</i> (?)
XIB	276	-	6.2	3.1	-	-	-	-	<i>Passer domesticus</i> (?)
XIB	276	19.2	6.0	3.1	4.6	2.6	1.8	1.5	<i>Fringilla coelebs</i> ?
XIB	276	-	6.0	3.1	-	-	1.8	1.6	<i>Fringilla coelebs</i> ?
XIB	276	-	6.0	-	-	-	-	-	<i>Fringilla coelebs</i> ?
XIB	276	19.3	-	-	4.9	2.8	1.8	1.5	<i>Fringilla coelebs</i> ?

carpométacarpe phase	US/Str.	GL a	L b	e	i	
XIA	382	18.5	17.0	4.2	3.8	Turdus/Sturnus
XIB	278	13.8	12.1	3.2	3.0	
XIB	278	-	-	3.5	-	
XIB	278	-	-	-	2.7	Alaudidé ?
XIB	278	-	-	-	3.0	
XIB	392	10.4	9.5	2.5	2.1	
XIB	276	18.4	16.9	4.2	3.7	
XIB	276	14.3	12.7	3.8	3.2	
XIB	276	13.1	11.6	3.3	3.0	
XIB	276	14.0	12.6	3.6	3.3	
XIB	276	12.8	11.4	3.0	-	
XIB	276	12.8	11.3	3.2	2.9	
XIB	276	-	-	-	3.2	
XIB	276	-	12.1	3.6	3.1	
XIB	276	-	-	3.2	-	
XIB	276	12.8	11.6	3.3	2.9	
XIB	276	12.7	11.3	3.4	3.1	
XIB	276	13.2	11.9	3.5	3.0	
XIB	276	13.3	12.0	3.4	-	
XIB	276	13.7	12.3	3.5	3.1	
XIB	276	13.9	12.4	3.3	3.1	
XIB	276	13.0	11.6	3.4	3.1	
XIB	276	14.4	12.9	3.6	3.1	
XIB	276	14.1	12.7	3.6	3.3	
XIB	276	13.3	11.8	3.5	3.2	
XIB	276	13.0	11.5	3.4	2.9	
XIB	276	13.2	12.0	3.4	3.1	
XIB	276	13.0	11.6	3.1	3.0	
XIB	276	12.9	11.4	3.3	3.0	
XIB	276	13.0	11.6	3.2	2.9	
XIB	276	13.2	11.6	3.4	3.1	
XIB	276	12.7	11.2	3.1	2.8	
XIB	276	11.6	10.3	2.9	2.7	
XIB	276	13.5	12.1	3.3	3.0	
XIB	276	12.9	11.5	3.3	2.9	
XIB	276	-	-	3.2	-	
XIB	276	-	-	3.1	-	
XIB	276	-	-	3.5	-	
XIB	276	-	-	3.4	-	
XIB	276	-	-	3.3	-	
XIB	276	-	-	-	3.2	
XIB	276	-	-	-	2.9	
XIB	276	-	-	-	3.1	
XIB	276	-	-	-	2.9	
XIB	276	-	-	-	3.0	
XIB	276	-	-	-	3.1	

carpométacarpe phase	US/Str.	GL a	L b	e	i
XIB	276	-	-	-	3.0
XIB	276	-	-	-	2.9
XIB	276	13.1	11.6	3.4	3.0
XIB	276	13.0	11.6	3.4	3.1
XIB	276	14.3	12.7	3.6	3.3
XIB	276	12.4	11.3	3.4	3.1
XIB	276	13.4	12.0	3.6	3.1
XIB	276	13.5	12.2	3.5	3.3
XIB	276	12.8	11.7	3.3	2.9
XIB	276	12.8	11.4	3.3	3.0
XIB	276	14.0	12.6	3.5	3.2
XIB	276	13.2	11.9	3.6	3.1
XIB	276	13.9	12.5	3.5	3.2
XIB	276	13.4	12.1	3.3	3.0
XIB	276	13.4	12.0	3.4	3.0
XIB	276	13.9	12.5	3.6	3.1
XIB	276	13.3	12.0	3.5	3.1
XIB	276	13.0	11.8	3.5	3.1
XIB	276	12.6	11.3	3.2	3.1
XIB	276	13.0	11.7	3.4	3.0
XIB	276	13.9	12.5	3.4	-
XIB	276	13.2	11.9	3.3	3.0
XIB	276	13.0	11.7	3.4	2.8
XIB	276	12.9	11.4	3.2	3.0
XIB	276	13.8	12.4	3.5	3.3
XIB	276	13.9	12.4	3.6	3.2
XIB	276	13.3	12.0	3.5	3.1
XIB	276	13.0	11.5	3.3	3.1
XIB	276	13.0	11.9	-	3.0
XIB	276	-	12.3	3.8	-
XIB	276	-	-	3.6	-
XIB	276	-	12.6	3.4	-
XIB	276	-	-	3.6	-
XIB	276	-	-	3.2	-
XIB	276	-	-	3.7	-
XIB	276	-	-	3.4	-
XIB	276	-	-	-	2.7
XIB	276	-	-	-	2.9
XIB	276	-	-	-	3.0
XIB	276	-	-	-	3.1
XIB	276	-	-	-	2.9
XIB	276	-	-	-	3.0
XIB	276	-	-	-	2.8

Annexe 7 : ostéométrie des « poissons ».

Les valeurs soulignées sont estimées. Avec : XIA : première moitié du XI^e siècle, mil XI : milieu du XI^e siècle, XIB : seconde moitié du XI^e siècle.

Annexe 7.1 : ostéométrie des Cyprinidés.

1) Cyprinidés de la collection de comparaison : hauteur (M1) et largeur (M2) de la face postérieure des basioccipitaux en millimètres, longueur totale (LT) en centimètres, et masse en grammes.

espèce	M1 (mm)	M2 (mm)	LT (cm)	masse (g)
Ablette	2.2	2.2	15.7	23.3
Ablette	1.2	1.8	9.2	6.1
Barbeau	7.1	8.3	46.0	820.1
Brème bordelière	3.6	3.7	22.7	150.5
Brème bordelière	4.1	4.3	23.5	206.7
Brème	4.0	4.2	24.0	201.0
Brème	8.5	8.9	50.7	1358.0
Brème	2.9	3.3	17.0	60.2
Brème	6.5	7.1	40.0	906.0
Brème	6.6	7.2	39.5	809.0
Brème	5.8	6.7	36.5	604.0
Brème	10.2	10.7	56.0	2160.0
Chevaine	7.0	7.8	38.2	758.2
Gardon	2.5	2.4	16.3	43.4
Gardon	3.5	3.6	22.0	151.0
Gardon	4.4	4.6	28.5	291.0
Rotengle	4.1	4.2	23.5	238.7
Tanche	4.3	4.8	25.3	298.3
Vairon	0.6	0.7	4.1	0.6

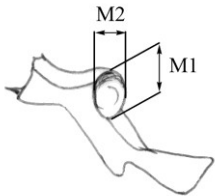

2) relation entre la hauteur de la face postérieure M1 en millimètre du basioccipital et la longueur totale LT en centimètres de Cyprinidés de la collection de référence : $LT = 5,5993 * M1 + 2,1947$, avec un coefficient de corrélation $r = 0,9827$.

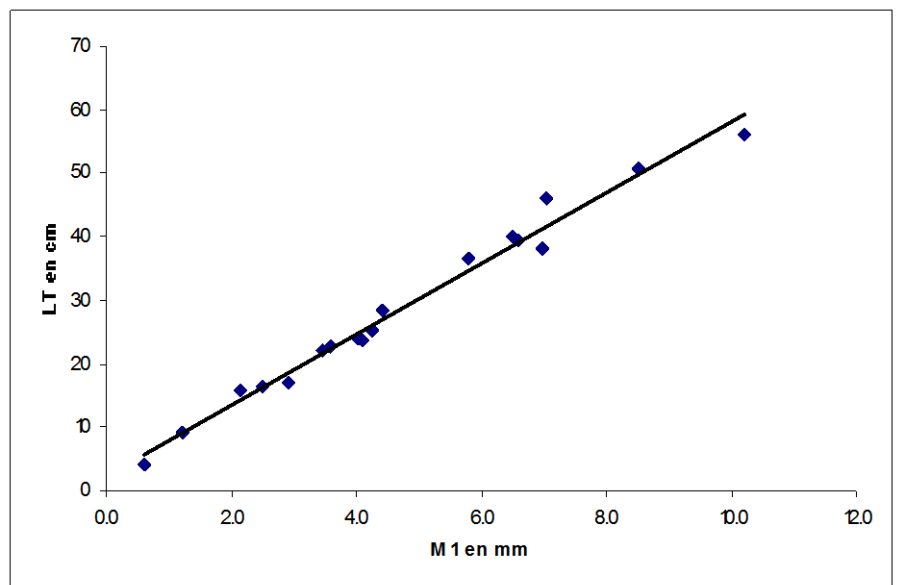

3) relation entre la longueur totale LT en centimètres et la masse M en grammes des Cyprinidés de la collection de référence : $P = 0,0069 * LT^{3,1705}$, avec un coefficient de corrélation $r = 0,9822$.

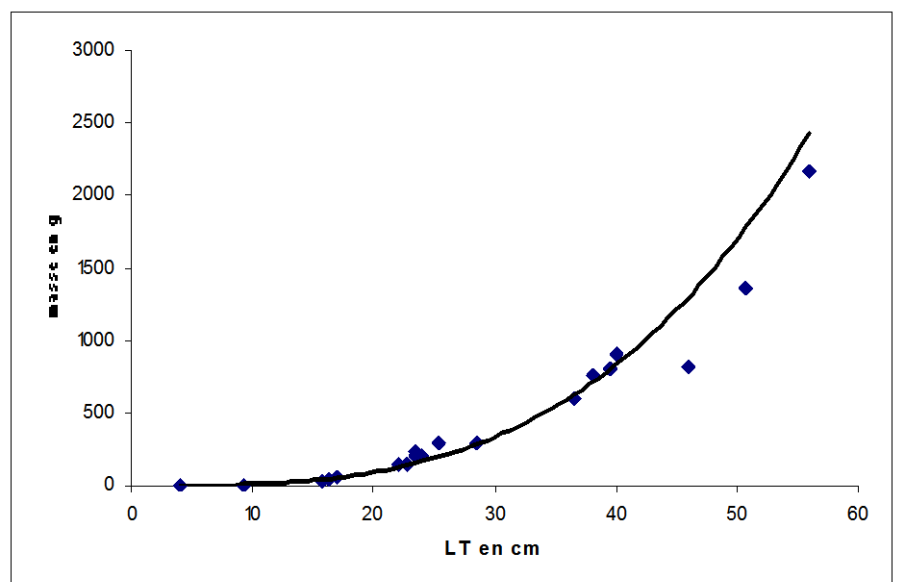

4) matériel archéologique : mesures M1 et M2 en millimètres des **basioccipitaux de Cyprinidés** de Montsoreau, avec estimation de leur longueur totale LT en centimètres, et de leur masse M en grammes, d'après les formules obtenues à partir des mensurations des individus de la collection de référence.

phase	US/Str.	espèce	M1 (mm)	M2 (mm)	LT (cm)	M (g)
XI A	33	Chevaine	2.8	3.4	18.0	66.1
XI A	33	Chevaine	2.3	3.1	14.9	36.5
XI A	33	Chevaine	2.2	2.5	14.5	33.2
XI A	33	Chevaine	1.3	1.8	9.2	7.8
XI A	33	Chevaine	1.7	1.8	11.8	17.3
XI A	33	Ablette	1.0	1.4	7.8	4.7
XI A	33	Ablette	0.9	1.2	7.2	3.7
XI A	33	Vairon	1.4	1.9	10.0	10.3
XI A	33	Vairon	1.5	1.8	10.5	12.0
XI A	33	Vairon	1.4	1.5	9.8	9.6
XI A	33	Vairon	1.0	1.3	7.5	4.1
XI A	33	Vairon	1.0	1.2	7.6	4.3
XI A	33	Vairon	1.5	1.4	10.6	12.2
XI A	33	Vairon	1.0	1.1	7.7	4.4
XI A	44	Vandoise ?	2.0	2.5	13.4	26.1
XI A	44	Vandoise ?	2.0	2.5	13.1	24.1
XI A	44	Chevaine	2.2	2.6	14.7	34.8
XI A	44	Chevaine	2.3	2.6	15.0	37.0
XI A	44	Ablette	1.2	1.5	8.7	6.7
XI A	44	Vairon	1.1	1.3	8.2	5.5
XI A	334	Vairon	1.2	1.3	8.9	7.1
XI A	334	Vairon	1.1	1.3	8.3	5.8
XI A	334	Cyp. Indét.	1.0	1.1	7.7	4.4
XI A	334	Cyp. Indét.	0.7	1.0	6.1	2.1
XI A	334	Cyp. Indét.	0.9	0.9	7.2	3.7
XI A	334	Cyp. Indét.	1.1	1.2	8.4	5.9
XI A	334	Cyp. Indét.	0.6	0.7	5.6	1.6
XI A	334	Cyp. Indét.	0.9	1.1	7.2	3.7
XI A	347	Chevaine	3.4	3.7	21.0	108.1
XI A	347	Chevaine	1.7	2.1	11.8	17.1
XI A	347	Vairon	1.2	1.3	8.9	7.1
XI A	347	Cyp. Indét.	2.9	3.2	18.4	70.8
XI A	347	Cyp. Indét.	0.8	1.0	6.7	2.8
XI A	347	Cyp. Indét.	0.6	0.7	5.5	1.5
XI A	418	Vandoise ?	2.7	3.4	17.1	56.3
XI A	418	Vandoise ?	2.8	3.3	17.6	61.1
XI A	418	Vandoise ?	2.7	3.5	17.0	55.1
XI A	418	Vandoise ?	2.7	3.3	17.2	56.9
XI A	418	Chevaine	2.2	2.7	14.6	33.6
XI A	418	Chevaine	1.5	1.8	10.3	11.2
XI A	418	Chevaine	2.0	2.6	13.6	27.1
XI A	418	Chevaine	6.0	7.2	35.9	586.0
XI A	418	Chevaine	2.5	2.9	16.0	45.4
XI A	418	Chevaine	2.1	2.8	13.9	28.9
XI A	421	Chevaine	2.6	3.0	17.0	54.5
XI	36	Brème bord.	1.3	1.6	9.5	8.6
XI	36	Vairon	1.5	1.6	10.6	12.4
XI	36	Vairon	1.6	1.7	11.1	14.2
XI	36	Ablette	1.2	1.5	8.9	7.1
XI	36	Ablette	0.9	1.1	7.2	3.7
XI	36	Ablette	1.0	1.3	7.6	4.2
XI	36	Ablette	0.8	1.2	6.6	2.7
XI	36	Ablette	1.2	1.2	8.6	6.4
XI	36	Ablette	0.9	1.0	7.1	3.5
XI	36	Cyp. Indét.	0.8	1.0	6.7	2.8
XI	36	Cyp. Indét.	0.6	0.8	5.6	1.6
XI	36	Cyp. Indét.	0.7	0.8	6.1	2.1
XI	36	Cyp. Indét.	0.8	0.8	6.6	2.8
XI	36	Cyp. Indét.	0.7	0.9	6.1	2.1
XI	36	Cyp. Indét.	0.8	0.9	6.5	2.6
XI	36	Cyp. Indét.	0.5	0.7	5.0	1.1
XI	36	Cyp. Indét.	0.7	0.8	6.1	2.1
XI	36	Cyp. Indét.	0.8	1.0	6.5	2.6
XI	36	Cyp. Indét.	0.8	0.9	6.7	2.8
XII-XIII	71	Gardon	1.9	2.1	12.7	21.9
XII-XIII	71	Ablette	1.0	1.3	7.9	4.8
XII-XIII	71	Cyp. Indét.	2.5	2.4	16.2	47.0
XII-XIII	71	Cyp. Indét.	1.6	1.5	10.9	13.5
XV-XVI	31	Cyp. Indét.	1.0	1.2	8.0	4.9
XV-XVI	31	Barbeau	11.0	12.0	63.8	3634.7

phase	US/Str.	espèce	M1 (mm)	M2 (mm)	LT (cm)	M (g)
XI B	276	Rotengle	1.9	2.0	12.6	21.2
XI B	276	Ablette	1.9	2.4	12.8	22.5
XI B	276	Ablette	1.6	2.1	10.9	13.3
XI B	276	Ablette	1.5	2.0	10.6	12.2
XI B	276	Ablette	1.7	2.0	11.8	17.3
XI B	276	Ablette	0.9	1.2	7.3	3.8
XI B	276	Ablette	2.0	2.4	13.3	25.4
XI B	276	Chevaine	2.9	3.4	18.5	71.5
XI B	276	Chevaine	3.8	4.6	23.6	154.6
XI B	276	Chevaine	3.4	4.2	21.3	111.8
XI B	276	Chevaine	2.6	2.9	16.8	53.4
XI B	276	Chevaine	2.6	2.9	16.6	51.2
XI B	276	Chevaine	2.2	2.4	14.5	33.2
XI B	276	Chevaine	3.3	3.7	20.5	100.1
XI B	276	Chevaine	2.1	2.2	13.8	28.2
XI B	276	Chevaine	2.5	2.7	16.1	45.9
XI B	276	Chevaine	2.5	2.8	16.2	47.0
XI B	276	Chevaine	2.4	2.8	15.8	43.4
XI B	276	Chevaine	2.1	2.3	13.8	28.2
XI B	276	Chevaine	2.4	2.8	15.7	43.0
XI B	276	Chevaine	2.7	3.0	17.5	59.8
XI B	276	Chevaine	3.2	3.5	20.3	95.8
XI B	276	Chevaine	2.6	3.1	16.5	49.6
XI B	276	Chevaine	2.9	3.8	18.4	70.1
XI B	276	Chevaine	2.6	3.3	16.8	53.4
XI B	276	Chevaine	2.8	3.4	18.1	66.8
XI B	276	Chevaine	2.0	2.8	13.1	24.1
XI B	276	Chevaine	2.9	3.4	18.3	69.4
XI B	276	Chevaine	1.8	2.2	12.1	18.7
XI B	276	Chevaine	3.0	3.3	18.7	74.3
XI B	276	Chevaine	2.3	2.3	15.1	37.4
XI B	276	Chevaine	1.7	2.0	11.4	15.6
XI B	276	Chevaine	1.8	2.3	12.0	18.4
XI B	276	Chevaine	2.2	2.6	14.6	33.6
XI B	276	Chevaine	0.8	1.2	6.4	2.5
XI B	276	Cyp. Indét.	2.4	2.8	15.4	40.1
XI B	276	Cyp. Indét.	3.2	3.4	19.9	90.9
XI B	276	Cyp. Indét.	3.3	3.5	20.7	101.8
XI B	276	Cyp. Indét.	0.8	1.2	6.8	3.1
XI B	276	Cyp. Indét.	1.8	1.9	12.0	18.1
XI B	276	Cyp. Indét.	0.7	0.9	6.1	2.1
XI B	276	Cyp. Indét.	1.5	1.7	10.8	13.1
XI B	276	Cyp. Indét.	0.7	0.9	6.1	2.1
XI B	276	Cyp. Indét.	1.0	1.2	8.0	5.1
XI B	278	Brème bord.	4.0	4.2	24.3	170.3
XI B	278	Chevaine	2.3	2.5	15.3	39.2
XI B	278	Chevaine	2.4	3.1	15.7	43.0
XI B	278	Chevaine	2.8	3.2	17.6	61.1
XI B	278	Chevaine	3.7	4.2	22.8	140.0
XI B	278	Chevaine	2.0	2.5	13.2	24.7
XI B	392	Tanche	1.0	1.3	7.6	4.3
XI B	392	Chevaine	5.5	6.3	32.7	436.2
XI B	392	Chevaine	2.7	3.5	17.5	60.5
XI B	392	Chevaine	2.7	3.0	17.5	59.8
XI B	392	Chevaine	2.1	2.7	13.8	28.2
XI B	392	Chevaine	1.9	2.2	12.7	21.9
XI B	392	Chevaine	1.1	1.6	8.2	5.4
XI B	392	Cyp. Indét.	2.1	2.3	13.9	29.3
XI B	392	Cyp. Indét.	1.1	1.3	8.3	5.8

5) matériel archéologique : mensurations (en millimètres) proposées dans la littérature pour estimer la longueur totale LT (en centimètres) des Cyprinidés identifiés spécifiquement (la plupart des auteurs proposent des formules avec un résultat en millimètres, résultat ici converti en centimètres).

Pour chaque espèce et chaque pièce squelettique mesurée, sont mentionnés :

- le ou les auteurs proposant la mesure ainsi que la date de la publication ;
- la formule du ou des mêmes auteurs permettant à partir de la mesure proposée de restituer la longueur totale (LT) du spécimen, et le coefficient de corrélation (r) associé à cette formule.

Brème commune *Abramis brama*

hyomandibulaire						
Radu 2003						
Lt = 4.5976 + 36.366 M1 r = 0.969						
Lt = -40.205 + 33.9432 M2 r = 0.956						
phase	US/Str.	D/G	M1	LT (M1)	M2	LT (M2)
XI A	418	G	4.8	17.9	6.3	17.4
XI A	421	G	4.0	15.1	5.4	14.4

dentaire				
Radu 2003				
LT = 72.474 + 89.1 M4 r = 0.968				
phase	US/Str.	D/G	M4	LT (M4)
XI A	418	G	1.4	19.3
XI B	276	D	1.1	17.3

maxillaire						
Libois & Hallet-Libois 1988						
LT = 75.866 E + 15.435 r = 0.983						
Radu 1998 (<i>in</i> Radu 2003)						
LT = 58.606 M3 - 8.4318 r = 0.95						
phase	US/Str.	D/G	E	LT E	M3	LT (M3)
XI B	276	D	2.4	19.8	3.4	19.1
XI B	278	D	2.0	16.9		

dents pharyngiennes				
Libois & Hallet-Libois 1988				
LT = 187.924 Ds + 15.463 r = 0.984				
phase	US/Str.	D/G	Ds	LT (Ds)
XI B	276	G	1.6	31.6

Goujon *Gobio gobio*

dents pharyngiennes									
Libois & Hallet-Libois 1988									
LT = 19.599 L - 3.692 r = 0.99									
Mann & Beaumont 1980									
Lt = -7.13 + 18.84 * tip r > 0.97									
Lt = -2.92 + 23.46 * gape r > 0.97									
phase	US/Str.	D/G	L	LT (L)	tip	LT (tip)	gape	LT (gape)	
XI A	33	D	9.5	18.2	9.2	16.6	6.1	13.9	
XI A	33	D	4.7	8.8	4.5	7.7	3.2	7.2	
XI A	33	D	3.6	6.8					
XI A	33	D	6.6	12.6	6.4	11.3	3.8	8.6	
XI A	33	G	4.5	8.4	4.4	7.6	3.6	8.2	
XI A	33	G	3.8	7.0	4.0	6.8	2.8	6.2	
XI A	33	G					2.4	5.3	
XI A	334	G	3.4	6.4	3.3	5.4	2.0	4.3	
XI A	334	D	3.0	5.5	2.7	4.4	1.8	3.9	
XI A	334	D	2.9	5.4	2.9	4.7	2.2	4.8	
XI A	334	D	3.2	6.0					
XI A	334	D	2.9	5.4	2.3	3.6	2.1	4.5	
XI A	347	D	4.3	8.0	3.9	6.6	3.0	6.8	
XI A	347	D	5.0	9.4	4.7	8.1	3.4	7.6	
XI B	276	G	4.0	7.5	3.6	6.0	2.3	5.1	
XI B	392	G	6.9	13.2	6.7	11.9	5.2	11.9	
XI	36	D	3.4	6.3	3.3	5.5	2.1	4.6	
XI	36	D	2.9	5.3	2.8	4.5	2.1	4.7	
XI	36	D	3.6	6.7	3.0	5.0	2.5	5.5	
XI	36	D	4.3	8.1			2.7	6.0	
XI	36	D					2.3	5.2	
XI	36	G	<u>7.3</u>	13.9			5.0	11.3	
XI	36	G	5.2	9.8	4.8	8.4	3.3	7.3	
XI	36	G	4.3	8.1					
XII-XIII	71	G					4.6	10.4	

dentaire

Libois & Hallet-Libois 1988

LT = 16.678 L + 6.255

r = 0.988

LT = 34.774 H - 1.742

r = 0.974

phase	US/Str.	D/G	L	LT (L)	H	LT (H)
XI B	276	D	<u>6</u>	10.6	2.8	9.6
XI A	33	G	4.5	8.1	2.7	9.1
XI A	33	G	4.2	7.5	2.7	9.2
XI A	36	G	<u>4.7</u>	8.5	2.2	7.3
XI A	36	G	<u>5</u>	9.0	2.7	9.2
XI A	36	D	3.4	6.3	2.2	7.5
XI A	36	D	3.6	6.6	1.9	6.4
XI A	36	D	4.9	8.8	2.6	8.9
XI A	36	D	3.4	6.3	1.8	6.1
XI A	36	G	5.6	10.0	3.8	13.0
XI A	36	G	5.3	9.5	3.2	11.0
XI A	36	G	4.8	8.5	3.3	11.3
XI A	36	G			3.1	10.6
XI A	36	G			2.0	6.6
XI A	36	G	3.2	6.0	1.8	6.1
XI A	334	D	3.6	6.6	2.0	6.8
XI A	334	D	<u>4.3</u>	7.8	2.3	7.8
XI A	334	D	<u>4.7</u>	8.5	2.4	8.2
XII-XIII	71	G	4.4	8.0	2.9	9.8

maxillairePrenda *et al.* 2002

Lt = 0.42 + 16.23 L

r = 0.976

phase	US/Str.	D/G	L	LT (L)
XI A	33	D	5.3	8.7
XI B	392	D	5.4	8.8
XI B	392	D	4.8	7.8
XI	36	D	4.4	7.2
XI	36	D	4.6	7.4
XI	36	G	5.6	9.1
XI	36	G	5.7	9.3
XI	36	D	6.0	9.7
XI	36	G	6.1	9.9
XI	36	G	5.8	9.4
XI	36	G	3.2	5.2

Chevaine *Leuciscus cephalus***dentaire**

LT = 15.965*L - 8.204

Miranda *et al.* 2005

r = 0.982

phase	US/Str.	D/G	L	LT (L)
XI	36	G	<u>9</u>	12.7
XI A	347	D	4.4	6.1
XI B	231	D	7.3	10.8

dents pharyngiennes

LT = 11.83*M1 - 1.474

Miranda *et al.* 2005

r = 0.994

phase	US/Str.	D/G	M1	LT (M1)
XI A	418	G	9.0	10.5
XI A	418	G	11.7	13.7
XI A	418	G	14.8	17.4
XI A	418	G	29.6	34.9
XI A	418	G	11.4	13.4
XI A	418	G	35.2	41.5
XI A	418	D	13.8	16.2
XI A	418	D	15.3	17.9
XI A	418	D	13.9	16.3
XI A	421	D	28.6	33.7
XI B	276	D	7.8	9.0
XI B	276	D	14.0	16.4
XI B	276	G	12.4	14.6
XI B	276	G	12.8	15.0
XI B	278	D	14.6	17.1

Gardon *Leuciscus rutilus***dents pharyngiennes**

Radu 2003

Lt = 14.11 * M1 + 24.673

r = 0.989

phase	US/Str.	D/G	M1	LT (M1)
XI B	276	G	8.57	14.6

Brème bordelière *Blicca bjoerkna***dents pharyngiennes**

Radu 2003

LT = 99.9 * M4 + 46.02

r = 0.95

phase	US/Str.	D/G	M4	LT (M4)
XII-XIII	71	D	1.7	21.9

dentaire

Radu 2003

Lt = 34.507 * M4 + 36.727

r = 0.74

phase	US/Str.	D/G	M4	LT (M4)
XI B	276	G	1.8	9.7

Ablette *Alburnus alburnus*

dentaire				
Libois & Hallet-Libois 1988				
LT = 18.066 L - 9.319 r = 0.992				
phase	US/Str.	D/G	L	LT (L)
XI A	44	G	5.8	9.5

maxillaire						
Libois & Hallet-Libois 1988						
LT = 19.294 L + 8.918 r = 0.975						
LT = 99.023 E + 24.684 r = 0.943						
phase	US/Str.	D/G	L	LT (L)	E	LT (E)
XI A	334	G	3.9	8.4		
XI B	276	D			0.93	11.7
XI	36	D			1.65	18.8
XV-XVI	31	D	4.3	9.2	0.8	9.9

Tanche *Tinca tinca*

dents pharyngiennes						
Libois & Hallet-Libois 1988						
LT = 81.172 Ds + 15.208 r = 0.983						
LT = 13.807 L - 5.002 r = 0.994						
phase	US/Str.	D/G	L	LT (L)	Ds	LT (Ds)
XI A	418	D	23.2	31.5	3.8	32.1
XI A	418	G	19.0	25.7	2.9	24.7
XI A	334	D	5.0	6.4	0.8	8.2
XI B	276	D	21.5	29.2	3.4	29.4
XI B	392	D	23.4	31.8	3.8	32.0
XI B	392	D	21.0	28.5	3.3	27.9
XI B	392	D	12.1	16.2	1.7	15.3
XI B	392	D			2.6	22.6
XI B	392	D			3.3	28.2
XI B	392	D			2.5	22.1
XI B	392	G			3.0	26.0
XI B	392	G			2.3	20.3

maxillaire						
Libois & Hallet-Libois 1988						
LT = 18.488 L - 4.946 r = 0.996						
LT = 85.649 E + 10.935 r = 0.989						
phase	US/Str.	D/G	L	LT (L)	E	LT (E)
XI B	392	D			3.0	27.0
XI B	392	D			3.3	29.7
XI B	392	G	13.7	24.8	2.7	24.2

dentaire						
Libois & Hallet-Libois 1988						
LT = 23.516 A - 10.928 r = 0.994						
LT = 85.237 C' + 1.976 r = 0.985						
phase	US/Str.	D/G	A	LT (A)	C'	LT (C')
XI A	347	D	4.3	8.9	1.0	8.5
XI B	276	G			3.3	28.6
XI B	392	D	10.0	22.5	2.6	22.2
XI B	392	D	8.5	18.8	1.9	16.6
XI B	392	D	11.2	25.2	3.1	26.5
XI B	392	D	9.5	21.2	2.2	18.9
XI B	392	D			2.1	18.1
XI B	392	D			3.0	25.3
XI B	392	G	11.9	26.8	2.8	24.1
XI B	392	G	10.8	24.2	3.1	26.4
XI B	392	G			2.2	18.5
XI	36	D	3.6	7.4	1.0	8.3

operculaire				
Bodker-Enghoff 1994b				
Lt=25.6707*Op1.1464 r = 0.9846				
phase	US/Str.	D/G	Op	LT (Op)
XI A	418	G	7.0	20.5
XI A	418	G	6.1	18.0
XI A	418	G	5.2	15.4
XI A	418	D	6.3	18.5
XI A	418	D	7.0	20.5
XI A	421	G	9.5	28.0
mil XI	400	D	6.4	18.7
mil XI	400	G	6.1	18.0
XI B	392	G	7.3	21.5
XI B	392	G	6.4	18.9
XI B	392	D	7.2	21.3
XI B	392	D	5.5	16.2
XI B	392	D	5.4	15.9
XI B	392	D	5.9	17.2
XI B	392	D	5.9	17.2
XII-XIV	304	D	7.2	21.0

Annexe 7.2 : ostéométrie du Brochet *Esox lucius*

avec pour chaque pièce squelettique mesurée :

- le ou les auteurs proposant la mesure ainsi que la date de la publication ;
- la formule du ou des mêmes auteurs permettant à partir de la mesure proposée de restituer la longueur totale (LT) du spécimen, et le coefficient de corrélation (r) associé à cette formule.

Les mesures des os sont en millimètres, les longueurs totales en centimètres. Les auteurs cités proposent des formules avec un résultat en millimètres, résultat ici converti en centimètres (sauf De Grossi Mazorin & Frezza (2000) qui expriment directement la longueur totale en centimètres).

operculaire				
Radu 1998 (in Radu 2003)				
Lt= - 44.634+97.76 * M2				
r = 0.98				
phase	US/Str.	D/G	M1	LT (M1)
XI B	276	D	7.9	72.8
XI B	276	D	4.7	41.5
XI B	276	D	3.8	32.7
XI B	276	D	2.6	20.5
XI B	276	D	2.5	20.1
XI B	276	D	2.8	23.2
XI B	276	D	2.3	18.3
XI B	276	D	3.3	27.8
XI B	276	D	3.7	31.7
XI B	276	D	7.3	66.5
XI B	276	D	2.8	22.9
XI B	276	D	5.3	47.3
XI B	276	D	4.1	35.2
XI B	276	D	3.8	32.7
XI B	276	D	2.6	21.3
XI B	276	D	2.6	20.8
XI B	276	D	2.9	23.6
XI B	276	G	4.4	38.6
XI B	276	G	4.1	35.7
XI B	276	G	2.8	22.7
XI B	276	G	3.8	32.9
XI B	276	G	3.8	32.8
XI B	276	G	3.2	26.9
XI B	276	G	2.6	21.0
XI B	276	G	3.0	24.8
XI B	392	D	5.1	45.0
XI	36	D	3.9	33.5

ectoptérygoïde				
Radu 1998 (in Radu 2003)				
Lt = 45.53+79.652 * M1				
r = 0.976				
phase	US/Str.	D/G	M1	LT (M1)
XI A	44	D	5.0	44.7
XI A	334	D	3.1	29.4
XI A	418	G	3.6	33.2
XI A	418	D	2.7	26.1
XI A	418	D	2.2	21.7
XI A	418	D	3.3	30.8
XI A	418	D	4.0	36.1
XI A	418	D	4.0	36.4
XI A	418	D	2.7	26.2
XI A	418	D	2.9	27.7
XI A	421	D	4.3	38.8
XI B	276	G	7.6	65.2
XI B	276	G	6.6	56.7
XI B	276	G	<u>7.3</u>	62.7
XI B	276	D	<u>2.7</u>	26.1
XI B	237	D	<u>5.7</u>	50.0
XI B	392	D	4.2	38.0
XI	36	G	3.3	30.4

hyomandibulaire				
Radu 1998 (in Radu 2003)				
Lt=19.168+84.558 * M1				
r = 0.976				
phase	US/Str.	D/G	M1	LT (M1)
XI A	418	D	3.4	30.7
XI A	418	G	3.1	27.8
XI B	276	G	4.1	36.2
XI B	276	G	4.5	40.0
XI B	276	G	3.3	29.8
XI B	276	D	3.9	34.9
XI B	276	D	4.3	38.3
XI	36	D	4.3	38.2
XVI-XVIII	220	G	5.4	47.2

articulaire				
De Grossi Mazorin & Frezza 2000				
Lt=9.6648*M3+6.6862				
r = 0.8855				
phase	US/Str.	D/G	mesure	LT (M3)
XI A	418	D	2.0	25.8
XI A	418	D	2.7	32.7
XI A	418	D	4.3	48.6
XI B	276	G	4.2	47.5
XI B	276	G	2.7	32.8
XI B	276	G	3.0	35.7
XI B	276	G	1.4	19.7
XI B	276	D	4.1	46.3
XI B	276	D	2.7	32.5
XI B	276	D	2.6	31.3
XI B	276	D	2.5	30.9
XI B	276	D	2.1	27.4
XI	36	G	6.3	67.9
XI	36	G	8.0	84.0

palatin				
Radu 1998 (in Radu 2003)				
Lt=10.861+44.346 M2				
r = 0.979				
phase	US/Str.	D/G	M2	LT (M2)
XI B	276	G	9.9	45.0
XI B	276	G	7.5	34.3
XI B	276	G	<u>5.4</u>	25.0
XI B	276	G	<u>6.0</u>	27.5
XI B	276	G	4.8	22.4
XI B	276	D	<u>9.5</u>	43.2
XI B	276	D	6.8	31.0
XI B	276	D	3.2	15.1
XI A	418	D	5.0	23.4
XI A	418	G	5.9	27.3
XI	36	G	6.8	31.4

cleithrum
De Grossi Mazorin & Frezza 2000
Lt = 4.8796 * M3 + 8.6633 r = 0.9415

phase	US/Str.	D/G	M3	LT (M3)
XI A	33	G	6.4	39.7
XI A	418	G	2.0	18.3
XI A	418	G	3.6	26.4
XI A	418	G	4.2	29.3
XI A	418	G	5.1	33.5
XI A	418	G	7.7	46.3
XI A	418	G	10.9	61.6
XI A	418	D	3.1	23.6
XI A	418	D	3.5	25.8
XI A	418	D	4.0	28.2
XI A	418	D	4.6	31.2
XI A	418	D	7.4	44.8
XI A	418	D	7.9	47.2
XI A	418	D	8.0	47.5
XI A	418	D	9.1	52.8
XI A	419	D	6.3	39.3
XI B	237	D	9.4	54.4
XI B	276	G	2.9	22.6
XI B	276	G	3.0	23.4
XI B	276	G	3.1	23.9
XI B	276	G	3.5	25.7
XI B	276	G	3.7	26.6
XI B	276	G	3.7	26.7
XI B	276	G	3.8	27.0
XI B	276	G	4.0	27.9
XI B	276	G	4.0	28.0
XI B	276	G	4.2	29.0
XI B	276	G	4.4	29.9
XI B	276	G	4.4	30.1
XI B	276	G	4.9	32.6
XI B	276	G	4.9	32.6
XI B	276	G	5.0	33.1
XI B	276	G	5.1	33.6
XI B	276	G	7.4	44.6
XI B	276	G	11.1	62.7
XI B	276	G	11.5	64.9
XI B	276	G	12.6	70.2
XI B	276	D	2.5	20.7
XI B	276	D	3.3	24.7
XI B	276	D	3.4	25.1
XI B	276	D	3.4	25.4
XI B	276	D	3.7	26.5
XI B	276	D	3.9	27.4
XI B	276	D	4.0	28.0
XI B	276	D	4.0	28.2
XI B	276	D	4.3	29.5
XI B	276	D	4.3	29.8
XI B	276	D	4.5	30.6
XI B	276	D	4.5	30.6
XI B	276	D	4.5	30.8
XI B	276	D	4.6	31.1
XI B	276	D	4.7	31.5
XI B	276	D	4.9	32.3
XI B	276	D	5.1	33.5
XI B	276	D	5.4	34.9
XI B	276	D	5.5	35.4
XI B	276	D	5.6	35.9
XI B	276	D	7.3	44.1
XI B	276	D	7.3	44.5
XI B	276	D	8.2	48.7
XI B	276	D	11.7	65.8
XI B	392	D	7.1	43.3
XI B	392	G	6.6	40.6
XI	36	G	10.5	60.0
XI	36	G	10.0	57.4
XII-XIII	71	D	5.3	34.6
XII-XIII	71	D	9.3	54.2

basioccipital
De Grossi Mazorin & Frezza 2000
Lt=5.4918*M4+4.8494 r = 0.961

phase	US	M4	LT (M4)
XI B	276	3.4	23.7

vomer
Radu 1998 (in Radu 2003)
Lt=23.539+51.225 * M2 r = 0.969

phase	US/Str.	M2	LT (M2)
XI A	418	5.8	32.1
XI B	276	14.5	76.6
XI B	276	7.3	39.7

parasphénoïde
Bodker-Enghoff 1994b
Lt=181.6086*(P)^{0.8921} r = 0.9806

phase	US/Str.	P	LT (P)
XI A	418	3.4	54.5
XI A	418	3.3	52.0
XI A	418	2.1	34.6
XI A	418	2.0	33.3
XI A	418	2.2	36.0
XI B	276	5.3	79.7
XI B	276	2.9	46.2
XI B	276	2.2	36.7
XI B	276	1.8	30.4
XI B	392	2.6	41.9

carré
De Grossi Mazorin & Frezza 2000
Lt=7.1668*X+8.955 r = 0.9246

phase	US/Str.	D/G	M3	LT (M3)
XI B	276	G	7.6	63.4
XI B	276	G	5.0	44.4
XI B	276	G	2.9	29.7
XI A	334	D	1.6	20.4
XI A	418	G	6.9	58.4
XV-XVI	10	G	8.9	73.0

dentaire
Bodker-Enghoff 1994b
Lt=119.3059 * (D)^{0.9048} r = 0.9947

phase	US/Str.	D/G	D	LT (D)
XI A	418	G	4.7	48.4
XI A	418	G	5.8	58.7
XI A	418	G	2.6	28.0
XI A	418	G	2.8	30.4
XI A	418	D	4.7	48.2
XI A	418	D	4.8	49.3
XI A	418	D	3.1	33.0
XI A	418	D	3.3	35.2
XI A	419	D	4.1	43.1
XI A	419	D	3.2	34.1
XI A	421	D	1.9	21.3
XI B	237	D	6.3	63.1
XI B	276	G	6.3	63.1
XI B	276	G	3.2	34.2
XI B	276	G	2.9	30.8
XI B	276	D	6.4	64.0
XI B	276	D	4.7	48.4
XI B	276	D	2.9	30.9
XI B	276	D	2.8	29.8
XI B	276	D	2.7	29.3
XI B	276	D	3.9	40.9
XI	36	G	4.8	49.3
XI	36	G	3.1	33.0

Annexe 7.3 : ostéométrie de la Perche *Perca fluviatilis*

avec pour chaque pièce squelettique mesurée :

- le ou les auteurs proposant la mesure ainsi que la date de la publication ;
- la formule du ou des mêmes auteurs permettant à partir de la mesure proposée de restituer la longueur totale (LT) du spécimen, et le coefficient de corrélation (r) associé à cette formule (pour Desse *et al.* 1987b, l'estimation de taille est réalisée directement par lecture graphique).

Les mesures des os sont en millimètres, les longueurs totales en centimètres. Les auteurs cités proposent des formules avec un résultat en millimètres, résultat ici converti en centimètres (sauf Brinkhuizen (1989) qui exprime directement la longueur totale en centimètres).

phase	US/Str.	os	D/G	auteur(s)	formule / graphique	r	mesure os (mm)	LT (cm)
XIB	276	basioccipital	-	Brinkhuizen 1989	$Lt = 89.668 M1 + 30.7941$	0.968	4.5	28.2
XIA	418	maxillaire	D	Desse <i>et al.</i> 1987b	graphique M2	> 0.94	7.0	28
XIB	276	maxillaire	G	Radu 2003	$Lt=44.932 M3 + 36.215$	0.9669	5.8	29.5
XIB	276	maxillaire	D	Radu 2003	$Lt=44.932 M3 + 36.215$	0.9669	3.1	17.6
XI	36	maxillaire	D	Radu 2003	$Lt=44.932 M3 + 36.215$	0.9669	2.6	15.2
XIB	276	carré	G	Radu 2003	$Lt= 72.219 M1 + 9.9915$	0.978	2.9	22.1
XIB	276	carré	G	Radu 2003	$Lt= 72.219 M1 + 9.9915$	0.978	3.7	27.6
XIA	418	articulaire	G	Desse <i>et al.</i> 1987b	graphique M1	> 0.94	27.3	32
				Desse <i>et al.</i> 1987b	graphique M2	> 0.94	13.5	33
				Desse <i>et al.</i> 1987b	graphique M4	> 0.94	5.3	33
XIB	276	articulaire	D	Desse <i>et al.</i> 1987b	graphique M2	> 0.94	11.4	28
				Desse <i>et al.</i> 1987b	graphique M4	> 0.94	4.1	28
XIB	276	dentaire	D	Desse <i>et al.</i> 1987b	graphique M4	> 0.94	3.4	27
				Radu 2003	$Lt=61.792 M2 + 17.184$	0.974	3.4	22.9
				Bodker-Enghoff 1994b	$Lt = 95.6287 * D0.853$	0.987	3.4	27.4
XIB	276	hyomandibulaire	D	Radu 2003	$Lt=30.275 M2 + 26.277$	0.981	6.9	23.5
XIA	418	préoperculaire	G	Libois <i>et al.</i> 1987	$LT = 7.742 L(os) + 15.368$	0.962	31.8	26.2
				Desse <i>et al.</i> 1987b	graphique M3	> 0.94	2.9	25
XIA	418	préoperculaire	D	Desse <i>et al.</i> 1987b	graphique M3	> 0.94	2.5	20
XIB	237	préoperculaire	G	Libois <i>et al.</i> 1987	$LT = 7.742 L(os) + 15.368$	0.962	30.8	25.4
				Desse <i>et al.</i> 1987b	graphique M3	> 0.94	2.8	25
XIB	276	préoperculaire	G	Desse <i>et al.</i> 1987b	graphique M3	> 0.94	2.9	25
XIB	276	préoperculaire	D	Desse <i>et al.</i> 1987b	graphique M3	> 0.94	1.4	15
XIA	418	operculaire	G	Desse <i>et al.</i> 1987b	graphique M1	> 0.94	25.1	30
				Desse <i>et al.</i> 1987b	graphique M2	> 0.94	25.3	30
				Desse <i>et al.</i> 1987b	graphique M3	> 0.94	3.4	32
XII-XIII	71	operculaire	D	Desse <i>et al.</i> 1987b	graphique M3	> 0.94	3.9	32
XIA	418	cleithrum	D	Bodker-Enghoff 1994b	$Lt = 38.7425 * C0.7671$	0.9805	16.3	33.0
XIA	418	cleithrum	G	Bodker-Enghoff 1994b	$Lt = 38.7425 * C0.7671$	0.9805	11.5	25.2
XIB	237	cleithrum	G	Bodker-Enghoff 1994b	$Lt = 38.7425 * C0.7671$	0.9805	15.0	30.9
XIB	276	cleithrum	D	Bodker-Enghoff 1994b	$Lt = 38.7425 * C0.7671$	0.9805	14.5	30.1
XIB	276	cleithrum	D	Bodker-Enghoff 1994b	$Lt = 38.7425 * C0.7671$	0.9805	8.9	20.7
XIB	276	cleithrum	G	Bodker-Enghoff 1994b	$Lt = 38.7425 * C0.7671$	0.9805	9.2	21.3
XIB	276	cleithrum	G	Bodker-Enghoff 1994b	$Lt = 38.7425 * C0.7671$	0.9805	8.4	19.8
XI	36	cleithrum	D	Bodker-Enghoff 1994b	$Lt = 38.7425 * C0.7671$	0.9805	11.7	25.6
XIA	418	basiptérygium	G	Brinkhuizen 1989	$LT=0.7236 * GL + 3.1908$	0.9936	41.5	33.2
XIA	418	basiptérygium	D	Brinkhuizen 1989	$LT=0.7236 * GL + 3.1908$	0.9936	35.0	28.5
XI	36	basiptérygium	D	Brinkhuizen 1989	$LT=0.7236 * GL + 3.1908$	0.9936	46.6	36.9
XI	36	basiptérygium	G	Brinkhuizen 1989	$LT=0.7236 * GL + 3.1908$	0.9936	9.0	9.7

Annexe 7.4 : ostéométrie de l'Anguille *Anguilla anguilla*

avec pour chaque pièce squelettique mesurée :

- le ou les auteurs proposant la mesure ainsi que la date de la publication ;
- la formule du ou des mêmes auteurs permettant à partir de la mesure proposée de restituer la longueur totale (LT) du spécimen, et le coefficient de corrélation (r) associé à cette formule.

Les mesures des os sont en millimètres, les longueurs totales en centimètres. Les auteurs cités proposent des formules avec un résultat en millimètres, résultats ici converti en centimètres.

articuloangulaire					phase									
Libois <i>et al.</i> 1987														
LT = 15.365 * D + 4.093					r = 0.98									
phase	US/Str.	D/G	D	LT (D)	phase	US/Str.	D/G	D	LT (D)	phase	US/Str.	D/G	D	LT (D)
XI A	44	D	2.5	42.5	XI A	44	G	2.4	41.4	XI B	276	D	1.3	23.8
XI A	44	D	1.1	21.0	XI A	44	G	1.5	26.4	XI B	276	D	2.8	46.8
XI A	44	D	1.6	29.1	XI A	44	G	1.3	24.7	XI B	276	D	1.3	23.5
XI A	44	D	1.5	26.8	XI A	44	G	1.6	28.5	XI B	276	D	1.4	24.8
XI A	44	D	1.3	23.6	XI A	44	G	1.4	25.1	XI B	276	D	1.4	25.0
XI A	44	D	1.2	22.7	XI A	44	G	1.5	26.4	XI B	276	D	1.2	23.1
XI A	44	D	2.6	44.5	XI A	44	G	1.3	24.4	XI B	276	G	1.3	23.3
XI A	44	D	1.3	23.8	XI A	44	G	1.5	26.7	XI B	276	G	2.0	34.7
XI A	44	D	1.4	25.0	XI A	44	G	1.1	20.7	XI B	276	G	1.9	33.1
XI A	44	D	0.8	16.7	XI A	44	G	1.2	22.7	XI B	276	G	2.6	44.0
XI A	44	D	1.0	19.5	XI A	44	G	1.5	27.3	XI B	276	G	2.8	47.6
XI A	44	D	1.1	20.4	XI A	44	G	1.0	19.8	XI B	276	G	1.3	24.5
XI A	44	D	1.2	21.9	XI A	44	G	1.1	21.0	XI B	276	G	1.3	24.2
XI A	44	D	1.0	19.2	XI A	44	G	1.3	24.4	XI B	392	D	2.4	41.1
XI A	44	D	1.0	19.3	XI A	44	G	1.1	21.3	XI B	392	D	2.0	35.0
XI A	44	D	1.5	27.6	XI A	44	G	1.4	25.0	XI B	392	D	1.5	27.4
XI A	44	D	1.7	29.4	XI A	44	G	1.0	19.0	XI B	392	D	1.3	24.1
XI A	44	D	1.3	23.3	XI A	44	G	1.1	21.5	XI B	392	D	1.8	31.9
XI A	44	D	1.1	21.6	XI A	44	G	1.4	24.8	XI B	392	D	1.6	28.8
XI A	44	D	1.4	25.5	XI A	44	G	1.1	20.4	XI B	392	D	2.1	35.7
XI A	44	D	1.3	24.1	XI A	44	G	1.1	21.6	XI B	392	D	1.3	23.3
XI A	44	D	1.1	20.4	XI A	44	G	1.1	20.2	XI B	392	G	2.0	34.4
XI A	44	D	1.2	22.4	XI A	44	G	1.0	19.2	XI B	392	G	1.7	29.4
XI A	44	D	1.6	28.8	XI A	347	G	1.5	26.8	XI B	392	G	1.3	23.8
XI A	44	D	1.2	21.9	XI A	421	D	2.2	37.9	XI B	392	G	1.1	21.0
XI A	44	D	1.0	19.3	XI A	421	G	2.1	36.4	XI B	392	G	1.2	22.5
XI A	44	D	1.3	23.3	XI B	231	G	1.4	25.6	XI B	392	G	1.7	30.2
										XI B	392	G	1.8	32.4
										XI B	392	G	1.5	27.1
										XI B	392	G	1.1	21.0
										XV-XVI	31	D	1.0	19.6

operculaire					phase									
Libois <i>et al.</i> 1987														
LT = 26.827 * D + 5.175					r = 0.98									
phase	US/Str.	D/G	D	LT (D)	phase	US/Str.	D/G	D	LT (D)	phase	US/Str.	D/G	D	LT (D)
XI A	347	G	1.2	36.3	XI A	44	D	1.0	31.7	XI A	44	G	1.6	48.1
XI A	421	G	1.9	56.1	XI A	44	D	0.9	30.4	XI A	44	G	1.5	45.7
XI B	276	D	1.6	48.1	XI A	44	D	1.1	33.9	XI A	44	G	1.0	31.7
XI B	276	D	1.0	31.2	XI A	44	D	0.9	30.1	XI A	44	G	0.9	28.8
XI B	276	D	0.9	28.5	XI A	44	D	1.0	31.2	XI A	44	G	0.9	29.3
XI B	276	D	1.1	34.4	XI A	44	D	0.8	27.4	XI A	44	G	0.8	27.2
XI B	276	D	1.0	32.5	XI A	44	D	1.9	57.0	XI A	44	G	0.7	25.0
XI B	276	D	1.0	30.7	XI A	44	D	0.9	29.9	XI A	44	G	0.8	26.1
XI B	276	D	1.0	32.3	XI A	44	D	1.0	30.7	XI A	44	G	1.0	30.9
XI B	276	D	0.9	29.3	XI A	44	D	1.0	32.5	XI A	44	G	0.7	23.7
XI B	276	G	0.9	28.8	XI A	44	D	1.0	32.3	XI A	44	G	1.0	31.7
XI B	276	G	1.9	56.7	XI A	44	D	0.8	25.8	XI A	44	G	0.9	29.6
XI B	276	G	1.3	39.0	XI A	44	D	0.9	28.5	XI A	44	G	0.8	25.3
XI B	276	G	0.8	26.1	XI A	44	D	0.6	19.9	XI A	44	G	0.6	21.5
XI B	276	G	0.9	28.5	XI A	44	D	0.8	26.9	XI A	44	G	1.6	49.2
XI B	392	D	1.9	55.9	XI A	44	D	0.7	22.9	XI A	44	G	0.9	30.1
XI B	392	G	1.7	50.0	XI A	44	D	1.0	32.8	XI A	44	G	0.9	28.2
XI B	392	G	2.0	59.6	XI A	44	D	0.8	27.7	XI A	44	G	0.9	29.6
XI B	392	G	0.9	28.5	XI A	44	D	1.1	35.0	XI A	44	G	0.9	29.6
XI B	392	G	1.1	33.3	XI A	44	D	0.7	25.0	XI A	44	G	0.7	24.2
XI	36	D	0.7	24.0	XI A	44	D	1.0	30.7	XI A	44	G	0.9	29.9
XI	36	D	0.8	26.6	XI A	44	D	0.8	27.2	XI A	44	G	1.0	31.2
XV-XVI	31	D	0.8	26.6	XI A	44	D	0.7	24.5	XI A	44	G	0.7	22.9
					XI A	44	D	1.0	33.1	XI A	44	G	1.1	34.7
										XI A	44	G	0.8	26.4
										XI A	44	G	0.9	29.6
										XI A	44	G	0.9	28.5
										XI A	44	G	0.7	23.1

cératohyal														
Bodker-Enghoff 1986														
LT = 345.2232 * W ^{0.7460}					r = 0.983									
phase	US/Str.	D/G	W	LT (W)	phase	US/Str.	D/G	W	LT (W)	phase	US/Str.	D/G	W	LT (W)
XI A	44	D	1.6	48.6	XI A	44	D	0.9	31.1	XI B	276	D	1.1	35.8
XI A	44	D	1.1	36.6	XI A	44	G	1.6	49.2	XI B	276	D	1.2	38.6
XI A	44	D	1.1	37.1	XI A	44	G	0.9	31.9	XI B	276	D	1.7	52.2
XI A	44	D	0.9	31.9	XI A	44	G	0.8	29.5	XI B	276	D	1.0	34.0
XI A	44	D	1.2	39.3	XI A	44	G	1.1	36.1	XI B	276	D	0.9	30.8
XI A	44	D	0.8	30.3	XI A	44	G	0.9	30.6	XI B	276	D	1.0	35.0
XI A	44	D	0.9	33.0	XI A	44	G	0.9	31.1	XI B	276	G	0.9	32.7
XI A	44	D	0.9	30.8	XI A	44	G	0.8	30.3	XI B	276	G	1.0	34.5
XI A	44	D	0.9	33.0	XI A	44	G	1.1	38.1	XI B	276	G	1.0	35.3
XI A	44	D	0.8	30.0	XI A	44	G	0.8	28.4	XI B	276	G	1.7	50.4
XI A	44	D	1.0	33.5	XI A	44	G	1.0	33.5	XI B	276	G	1.1	36.8
XI A	44	D	0.9	30.8	XI A	44	G	0.9	30.8	XI B	392	D	1.7	50.4
XI A	44	D	1.0	34.3	XI A	44	G	0.9	32.4	XI B	392	D	0.9	32.2
XI A	44	D	0.9	32.7	XI A	44	G	0.7	27.6	XI B	392	D	0.7	27.6
XI A	44	D	0.9	32.4	XI A	44	G	1.0	33.2	XI B	392	D	0.8	30.3
XI A	44	D	1.0	34.5	XI A	44	G	1.0	34.3	XI B	392	D	0.9	31.9
XI A	44	D	0.8	30.0	XI A	44	G	0.7	27.3	XI B	392	D	1.0	35.3
XI A	44	D	0.9	30.6	XI A	44	G	1.0	34.3	XI B	392	D	1.4	43.2
					XI A	44	G	0.6	24.7	XI B	392	D	0.7	26.5
					XI A	44	G	0.9	31.1	XI B	392	D	2.1	60.7
					XI A	44	G	0.9	30.8	XI B	392	D	1.2	39.8
					XI A	44	G	0.8	29.5	XI B	392	D	1.1	36.3
					XI A	44	G	0.7	27.6	XI B	392	G	0.8	30.3
					XI A	44	G	0.9	32.2	XI B	392	G	1.8	53.5
										XI B	392	G	1.4	43.7
										XI B	392	G	1.4	45.1
										XI B	392	G	1.9	55.7
										XI B	392	G	1.4	43.7
										XI B	392	G	1.1	37.3
										XI B	392	G	1.2	40.0
phase	US/Str.	D/G	W	LT (W)										
XI	36	G	1.2	38.3										
XV-XVI	31	D	0.9	31.9										
XV-XVI	31	D	0.9	31.6										

dentaire														
Bodker-Enghoff 1986														
LT = 279.2544 * W ^{0.8969}					r = 0.972									
phase	US/Str.	D/G	W	LT (W)	phase	US/Str.	D/G	W	LT (W)	phase	US/Str.	D/G	W	LT (W)
XI A	44	G	1.9	49.7	XI A	44	D	2.0	52.2	XI B	231	G	1.1	29.2
XI A	44	G	1.2	32.9	XI A	44	D	1.1	29.4	XI B	276	D	1.7	44.0
XI A	44	G	1.3	35.8	XI A	44	D	1.3	35.3	XI B	276	D	1.4	37.3
XI A	44	G	1.5	39.5	XI A	44	D	1.4	37.0	XI B	276	G	1.4	38.2
XI A	44	G	0.8	21.8	XI A	44	D	1.2	32.9	XI B	276	G	2.2	57.3
XI A	44	G	0.9	26.4	XI A	44	D	1.3	34.1	XI B	276	G	1.2	32.1
XI A	44	G	1.1	30.9	XI A	44	D	1.2	31.9	XI B	276	G	1.1	30.9
XI A	44	G	1.2	32.1	XI A	44	D	0.8	22.9	XI B	276	G	2.3	58.9
XI A	44	G	0.9	25.2	XI A	44	D	1.0	28.2	XI B	392	D	1.9	48.5
XI A	44	G	1.4	37.5	XI A	44	D	1.3	35.8	XI B	392	D	1.3	35.8
XI A	44	G	1.2	32.1	XI A	44	D	1.0	28.2	XI B	392	D	1.2	32.1
XI A	44	G	1.19	32.6	XI A	44	D	1.0	26.7	XI B	392	D	1.2	32.9
XI A	44	G	1.0	26.7	XI A	44	D	1.0	28.9	XI B	392	D	1.6	41.9
XI A	44	G	1.0	27.2	XI A	44	D	1.0	27.2	XI B	392	D	1.4	37.8
XI A	44	G	1.1	30.4	XI A	44	D	1.1	30.7	XI B	392	D	2.0	50.8
XI A	44	G	1.2	32.1	XI A	44	D	1.0	28.4	XI B	392	D	1.6	41.4
XI A	44	G	1.0	26.7	XI A	44	D	0.9	26.2	XI B	392	G	1.3	34.6
XI A	44	G	1.0	27.2	XI A	44	D	1.2	32.6	XI B	392	G	1.5	40.9
XI A	44	G	1.1	30.4	XI A	44	D	1.1	29.7	XI B	392	G	0.8	21.6
XI A	44	G	1.2	32.1	XI A	44	D	1.1	31.2	XI B	392	G	0.9	26.2
XI A	44	G	1.0	26.9	XI A	44	D	0.9	26.4	XI B	392	G	0.8	22.3
XI A	44	G	1.1	30.9	XI A	44	D	0.9	25.2	XI B	392	G	1.0	27.7
XI A	44	G	1.0	28.2	XI A	44	D	0.8	22.6	XI B	392	G	1.5	40.7
XI A	44	G	1.5	39.0	XI A	44	D	1.3	36.1	XI B	392	G	1.6	41.4
XI A	44	G	1.4	36.6	XI A	44	D	1.2	32.9	XI B	392	G	1.3	34.1
					XI A	44	D	1.2	32.9	XI B	392	G	1.3	35.3
										XI B	392	G	1.8	47.8
										XI B	392	G	1.2	31.7
										XI B	392	G	1.0	27.7
										XII-XIII	71	D	2.1	53.6

maxillaire					phase	US/Str.	D/G	D	LT (D)
Libois <i>et al.</i> 1987					XI A	44	D	0.9	27.8
LT = 26.814 * D + 4.439 r = 0.974					XI A	44	D	1.4	42.0
					XI A	44	D	1.4	40.6
phase	US/Str.	D/G	D	LT (D)	XI A	44	D	0.7	23.7
XI B	276	D	0.9	29.1	XI A	44	D	0.9	27.5
XI B	278	D	0.8	26.2	XI A	44	D	0.9	29.4
XI B	392	D	1.1	33.9	XI A	44	D	0.9	28.0
XI B	392	D	1.2	37.4	XI A	44	D	1.1	34.2
XI B	392	D	1.0	29.9	XI A	44	G	0.8	24.8
XI B	392	D	0.9	29.4	XI A	44	G	1.0	31.8
XI B	392	D	1.2	37.2	XI A	44	G	0.7	24.0
XI B	392	D	1.3	40.4	XI A	44	G	0.6	20.5
XI B	392	D	1.1	33.9	XI A	44	G	1.4	42.2
XI B	392	G	1.3	38.0	XI A	44	G	1.0	31.8
XI B	392	G	1.1	33.9	XI A	44	G	0.8	24.8
XI B	392	G	0.8	25.4	XI A	44	G	1.0	31.8
XI B	392	G	1.0	31.8	XI A	44	G	1.1	33.7
XI B	392	G	1.0	32.1	XI A	44	G	0.9	27.2
XI B	392	G	1.1	33.4	XI A	44	G	1.0	30.7
					XI A	44	G	1.1	32.6
					XI A	44	G	1.0	31.8
					XI A	44	G	1.4	42.5
					XI A	44	G	0.8	24.5
					XI A	44	G	0.6	21.6
					XI A	44	G	1.0	31.5

basioccipital			
Libois <i>et al.</i> 1987			
LT = 9.246 * L - 6.342 r = 0.989			
phase	US/Str.	L	LT (L)
XI A	44	6.1	49.8
XI A	44	3.3	23.8
XI A	44	3.3	24.5
XI A	44	2.7	18.3
XI A	44	2.6	17.8
XI A	44	4.0	30.5
XI A	44	3.8	29.2
XI A	44	2.7	18.6
XI A	44	3.2	22.8
XI A	44	3.9	29.3
XI A	44	3.6	26.9
XI A	44	3.4	25.2
XI A	44	3.5	25.8
XI A	44	4.2	32.0
XI A	44	3.8	28.3
XI A	44	3.0	21.6
XI A	44	4.3	33.2
XI A	44	3.7	27.6
XI A	44	3.0	21.7
XI A	44	5.4	43.5
XI A	44	3.7	27.6
XI A	44	2.9	20.5
XI A	44	3.5	26.3
XI A	44	2.9	20.4
XI A	44	4.2	32.9
XI A	44	2.9	20.0
XI A	44	3.7	27.9
XI A	44	3.6	27.1
XI A	44	3.0	21.7
XI A	44	3.7	27.5
XI A	44	3.0	21.7
XI A	44	3.8	28.8
XI A	44	3.4	24.9
XI B	276	3.3	24.4
XI B	392	3.6	26.9
XI B	392	3.5	26.0
XI B	392	2.9	20.8
XI B	392	4.1	31.8
XI B	392	3.6	26.8
XI B	392	4.2	32.5
XI B	392	3.5	26.3
XI B	392	3.9	29.4

cleithrum					phase	US/Str.	D/G	D	LT (D)
Libois <i>et al.</i> 1987					XI A	44	G	1.0	25.4
LT = 19.299 * D + 5.347 r = 0.981					XI A	44	G	2.3	50.3
phase	US/Str.	D/G	D	LT (D)	XI A	44	G	2.4	51.5
XI A	44	D	1.2	28.9	XI A	44	G	2.1	46.3
XI A	44	D	1.1	25.6	XI A	44	G	1.4	31.4
XI A	44	D	1.2	28.3	XI A	44	G	1.1	26.4
XI A	44	D	1.0	24.1	XI A	44	G	1.1	26.2
XI A	44	D	1.2	27.9	XI A	44	G	1.4	33.1
XI A	44	D	1.2	28.1	XI A	44	G	1.4	31.6
XI A	44	D	2.4	50.9	XI A	44	G	1.2	28.1
XI A	44	D	1.3	30.2	XI A	44	G	1.2	27.9
XI A	44	D	1.1	26.6	XI A	44	G	1.0	23.7
XI A	44	D	1.0	24.5	XI A	44	G	1.1	25.8
XI A	44	D	1.3	31.0	XI A	347	G	1.1	26.0
XI A	44	D	1.2	27.9	XI A	347	G	1.5	33.5
XI A	44	D	1.0	24.6	XI B	276	D	1.2	27.9
XI A	44	D	1.1	27.0	XI B	276	D	1.1	26.8
XI A	44	D	1.1	26.4	XI B	276	G	1.4	32.0
XI A	44	D	1.1	26.4	XI B	276	G	1.3	30.0
XI A	44	D	0.9	23.1	XI B	276	G	2.3	48.8
XI A	44	D	1.2	29.3	XI B	278	D	1.2	29.3
XI A	44	D	1.2	27.9	XI B	392	G	1.0	25.0
XI A	44	D	1.5	34.3	XI B	392	G	1.5	34.1
XI A	44	D	1.4	32.8	XI	36	D	1.4	31.6
XI A	44	D	0.9	22.1	XI	36	G	1.7	37.6
XI A	44	D	1.3	30.0	XV-XVI	31	G	1.1	26.0

première vertèbre			
Bodker-Enghoff 1986			
LT = 225.2683 * W ^{0.7832} r = 0.9781			
phase	US/Str.	W	LT (W)
XI A	44	2.3	42.5
XI A	44	1.4	29.6
XI A	44	1.5	30.6
XI A	44	1.5	30.1
XI A	44	1.8	35.2
XI A	347	1.7	34.1
XI B	276	2.8	50.0
XI B	276	2.8	49.7
XI B	276	1.7	34.1
XI B	276	1.7	34.4
XI B	392	3.1	54.4
XI B	392	1.4	28.8
XI B	392	1.4	29.6
XI B	392	2.1	39.5
XI B	392	1.6	32.6
XI B	392	1.8	35.2
XV-XVI	31	1.7	33.3

Annexe 7.5 : ostéométrie de la Loche, plus probablement la Loche franche *Barbatula barbatula* (cf. chap. 8, III, 1.1.5 pour les questions de détermination). Mesures de la hauteur (M1) et de la longueur (M2) en millimètres des hyomandibulaires (mesures définies par Morales & Rosenlund 1979).

phase	US/Str.	D/G	M1	M2
XI A	33	D	2.1	4.7
XI A	33	D	2.2	4.7
XI A	334	D	1.8	4.3
XI A	347	D	2.5	4.6
XI A	334	G	2.0	3.6
XI A	334	G	1.8	3.8
XI A	334	G	1.9	
XI B	276	D	2.4	4.1
XI B	276	D	2.6	4.3
XI B	276	D	2.0	3.4
XI B	276	D	1.8	3.1
XI B	278	D	1.9	3.3
XI B	276	G	1.9	4.1
XI B	276	G	2.7	
XI B	276	G	2.2	4.3
XI B	276	G	2.2	
XV-XVI	31	D	<u>2.8</u>	6.9
XV-XVI	31	G	2.5	

phase	US/Str.	D/G	M1	M2
XI	36	D	1.8	3.8
XI	36	D	1.5	3.1
XI	36	D	1.5	2.8
XI	36	D	1.9	3.2
XI	36	D	2.2	3.8
XI	36	D	1.6	2.6
XI	36	D	1.4	3.0
XI	36	D	1.8	3.1
XI	36	D	1.9	3.6
XI	36	D		4.1
XI	36	G		5.0
XI	36	G	2.3	4.4
XI	36	G	2.0	3.8
XI	36	G	1.9	4.3
XI	36	G	2.1	3.6
XI	36	G	1.9	3.0
XI	36	G	1.8	4.1
XI	36	G	1.8	3.3
XI	36	G	1.6	2.8
XI	36	G	2.4	4.7
XI	36	G		3.9
XI	36	G		2.9
XI	36	G	1.9	3.3
XI	36	G	1.8	3.0

Annexe 7.6 : estimation de la masse des « poissons » de Montsoreau à partir de leur longueur totale.

	référence	formule / estimation
espèces dulçaquicoles		
Cyprinidés	coll. réf. (n = 19) : annexe 7.1	$P = 0,0069 * LT^{3,1705}$ (r = 0,9822)
Brochet <i>Esox lucius</i>	Brinkhuizen 1989	$\ln P = 3.1938 * \ln(Lt) - 5.7075$ (r = 0.996)
Perche <i>Perca fluviatilis</i>	Brinkhuizen 1989	$\ln P = 3.273 * \ln Lt - 5.5298$ (r = 0.997)
Ombre <i>Thymallus thymallus</i>	Paquet 2002 (isométrique)	$P = Lt^{3,0912} * 0.0000047295$ (r = 0.988)
	Paquet 2002 (allométrique)	$P = Lt^{3,3276} * 0.0000031634$ (r = 0.971)
Chabot <i>Cottus gobio</i>	coll. réf., Persat 2001c	moins de 10 g / individu
Loche franche <i>Barbatula barbatula</i>	coll. réf.	moins de 10 g / individu
Gasterostéidés : Épinoche / Épinochette	Crivelli 2001 / Lafaille & Feunteun 2001a	quelques grammes
espèces migratrices		
Anguille <i>Anguilla anguilla</i>	Dorel 1986	$P = 0.003203 * L^{2.851363}$ (r = 0.99532)
Flet <i>Platichthys flesus</i>	Masson 1987	$P = 0.0093 * Lt^{3,066}$ (r = 0.999)
Grande Alose <i>Alosa alosa</i>	Baglinière & Sabatié 2001	1,46 kg / individu (en moyenne)
Alose feinte <i>Alosa fallax</i>	Baglinière & Sabatié 2001	0,66 kg / individu (en moyenne)
Esturgeon <i>Acipenser sturio</i>	Quéro & Vayne 2005	environ 40 kg à 2 m
Mulet <i>Liza ramada</i>	Desse <i>et al.</i> 1987b	lecture graphique
espèces marines		
Hareng <i>Cuplea harengus</i>	Quéro & Vayne 2005	environ 200 g à 30 cm
autre		
Salmonidés <i>Salmo sp.</i>	- tacon : Prouzet & Gaignon 1981 ; Prignon & Micha 1996 - truitelle : Prenda <i>et al.</i> 2002, Hajkova <i>et al.</i> 2003, Desse-Berset 1994a ; Baglinière & Maise 1990	entre 10 et 40 g à 10-15 cm