



HAL
open science

Modeling and simulation of wireless sensor networks

Wan Du

► **To cite this version:**

Wan Du. Modeling and simulation of wireless sensor networks. Other. Ecole Centrale de Lyon, 2011. English. NNT : 2011ECDL0026 . tel-00690466

HAL Id: tel-00690466

<https://theses.hal.science/tel-00690466>

Submitted on 23 Apr 2012

HAL is a multi-disciplinary open access archive for the deposit and dissemination of scientific research documents, whether they are published or not. The documents may come from teaching and research institutions in France or abroad, or from public or private research centers.

L'archive ouverte pluridisciplinaire **HAL**, est destinée au dépôt et à la diffusion de documents scientifiques de niveau recherche, publiés ou non, émanant des établissements d'enseignement et de recherche français ou étrangers, des laboratoires publics ou privés.

ÉCOLE CENTRALE DE LYON

ÉCOLE DOCTORALE Electronique, Electrotechnique, Automatique

Institut des Nanotechnologies de Lyon

Année : 2011

Thèse Numéro : 2011-26

Thèse

pour obtenir le grade de

DOCTEUR DE L'ÉCOLE CENTRALE DE LYON

Discipline : Electronique

présentée et soutenue par

Wan DU

le mercredi 14 septembre 2011

Modélisation et Simulation de Réseaux de Capteurs sans Fil

Thèse dirigée par Ian O'CONNOR

JURY :

Lionel TORRES	Professeur, Université Montpellier 2	Président
Hervé GUYENNET	Professeur, Université de Franche-Comté	Rapporteur
Cécile BELLEUDY	Maître de Conférences, Université de Nice-Sophia Antipolis	Rapporteur
Fabien MIEYEVILLE	Maître de Conférences, École Centrale de Lyon	Examineur
David NAVARRO	Maître de Conférences, École Centrale de Lyon	Examineur
Ian O'CONNOR	Professeur, École Centrale de Lyon	Examineur

To my parents and my sister

Acknowledgements

I would like to express my sincere appreciation to Prof. Ian O’connor, Dr. David Navarroc and Dr. Fabien Mieyeville for their supervision, guidance and support throughout my Ph.D. I am grateful to them for having shared so much of time and insight in our weekly discussions. I have learned a lot from them.

I would also like to thank the China Scholarship Council (CSC) for the financial support of my Ph.D studies. I am also thankful for the research facilities and support provided by the Lyon Institute of Nanotechnology and Ecole Centrale de Lyon. I am also grateful to the heterogeneous systems design group for providing travel support in order for me to publish and present my research in many international conferences.

I wish to thank my colleagues of the heterogeneous systems design group, including Junchen Liu who guided me for the work and life at Lyon when I first arrived in France, Felipe Frantz, Vijayaragavan Viswanathan, Mihai Galos, Kotb Jabeur, Lioua Labrak, Nataliya Yakymets, Zhenfu Feng and Nanhao Zhu who are always willing to share their knowledge with me and have made it such an interesting place to work over the past three years. I would also like to thank the two excellent engineers, Laurent Carrel and Raphaël Lopez, for their technical supports of my research. Moreover, I won’t forget the help from the secretaries, Ms. Patricia Dufaut and Ms. Nicole Durand, for their kindness, availability and good humor that ease my thesis life.

Finally, I wish to thank my family and friends. Without their love and support, I can never complete this thesis.

Résumé en français (Abstract in French)

Les évolutions des technologies du microsysteme électromécanique (MEMS) et de l'intégration à très grande échelle (VLSI) ont facilité le développement de capteurs intelligents et de microprocesseurs et transceivers radiofréquence à faible puissance, permettant l'essor des réseaux de capteurs sans fil (WSN: Wireless Sensor Networks) ces dernières années. Un nœud de réseau de capteurs est généralement équipé d'un ou plusieurs capteurs, une unité de calcul, une mémoire, une alimentation et d'une fréquence radio (RF) transceiver. Divers phénomènes peuvent être mesurés, tels que les sons, vibrations, humidité, pression ou température.

Les WSN ont été utilisés dans une large variété d'applications. Selon leurs fonctionnalités, les applications peuvent être essentiellement classées en deux catégories: les applications de surveillance et les applications de suivi. Diverses applications ont des exigences différentes; par exemple, une application industrielle en temps réel nécessite une latence faible de livraison de paquets, mais une autonomie d'une semaine est souvent suffisante. En revanche, un système de surveillance de l'environnement à distance devra avoir une durée de vie de plusieurs années avec un rapport cyclique faible. En raison de la petite taille et des exigences de faible coût des nœuds, les ressources de nœuds de capteurs telles que la capacité de traitement, le stockage et l'énergie, sont limitées.

Pour mettre en œuvre de nouvelles applications, les techniques de réseau devraient être étudiées afin de transmettre les données d'un nœud à un hôte qui peut être consulté par les utilisateurs. Les protocoles de communication des réseaux de capteurs peuvent être représentés en différentes couches, comme la couche d'application, de transport, de réseau, de liaison de données et de physique. Chaque couche a plusieurs tâches spécifiques et fournit des services à sa couche supérieure. Trois caractéristiques particulières rendent la conception de protocoles WSN différents des autres réseaux sans fil (par exemple informatiques). Un exemple est la source d'alimentation limitée qui nécessite des protocoles WSN dédiés à l'économie d'énergie. Le dernier est le déploiement à grande échelle. Dans

un réseau composé de centaines ou de milliers de nœuds de capteurs, l'hôte peut être situé hors de la portée de transmission de certains nœuds, ce qui nécessite la communication multi-sauts (multi-hop).

Pour répondre aux diverses exigences des applications WSN, les concepteurs ont besoin d'envisager un grand nombre de choix de conception au niveau du nœud (par exemple, la consommation d'énergie des composants matériels et la capacité de traitement) et de nombreux paramètres au niveau du protocole (par exemple, les algorithmes d'anti-collision et des méthodes de routage). Comparée aux mesures sur banc de test, la simulation est un moyen économique et rapide pour explorer de nombreuses solutions. La simulation est actuellement la méthode la plus largement adoptée pour analyser les réseaux de capteurs.

En raison de l'énergie limitée sur les nœuds de capteurs, et afin de prolonger la durée de vie du réseau, de nombreux efforts ont été effectués pour réduire la consommation d'énergie du matériel, du logiciel, du protocole de communication et de l'application. Par conséquent, il est nécessaire de prévoir avec précision la consommation d'énergie des WSN, qui exige des modèles détaillés du matériel et du logiciel (HW/SW) des nœuds de capteurs.

Beaucoup d'outils de simulation de WSN ont été développés en utilisant des méthodes différentes telles que la simulation générale du réseau, l'émulation du système d'exploitation (OS), la simulation d'instructions, et la simulation niveau système (SLDL). Cependant, la plupart d'entre eux sont mis en œuvre dans les langages de programmation génériques comme C++ et Java qui ne supportent pas directement la co-simulation de HW/SW. Seul un petit nombre de simulateurs conçus en SLDLs supportent la modélisation de la concurrence, de l'interruption et des primitives de synchronisation des systèmes embarqués. Par exemple, SystemC est une bibliothèque en C++ qui permet la conception d'un système matériel et logiciel. Il permet de modéliser le système embarqué à différents niveaux d'abstraction et permettent aux concepteurs de se concentrer sur les fonctionnalités du système en masquant les détails de communication et de calcul.

Par conséquent, afin de permettre la co-simulation matérielle / logicielle (HW/SW)

des nœuds et l'estimation précise de la consommation d'énergie des réseaux de capteurs, la faisabilité et les avantages de l'utilisation de SLDLs dans la modélisation et la conception de réseaux de capteurs sans fil doivent être étudiés. Un simulateur en SLDL pour les WSN devrait être validé par des mesures expérimentales et évalué en comparant avec les autres simulateurs existants de WSN.

Un simulateur de WSN en SystemC, nommée IDEA1 (hierarchical DEsign plATform for sensOr Networks Exploration) a été développé. IDEA1 permet l'évaluation rapide des performances d'un WSN au niveau système. Les résultats des simulations incluent le taux de livraison de paquets (PDR: Packet Delivery Rate), la latence de transmission et la consommation d'énergie. La principale caractéristique d'IDEA1 est la prédiction précise de la consommation d'énergie. Le modèle d'énergie mis en œuvre dans IDEA1 prend en compte les consommations de puissance de tous les modes opérationnels de chaque composant matériel et les transitions entre ces différents modes.

Plusieurs plateformes de WSN, telles que MICAz et MICA2, sont modélisées. La norme IEEE 802.15.4 est mise en œuvre. IEEE 802.15.4 a été largement utilisé dans les applications de WSN, car il est conçu pour les communications bas débit et pour les applications à faible consommation d'énergie en conformité avec les contraintes des WSN.

Quatre simulateurs de WSN en SystemC ont été développés, mais IDEA1 est le premier simulateur en SystemC de WSN qui a été validé avec des mesures expérimentales et évalué en comparant avec d'autres simulateurs. La validation des modèles de simulation est nécessaire pour obtenir une précision suffisante et connue. LA comparaison avec d'autres simulateurs peuvent évaluer les performances de IDEA1, principalement par rapport aux aspects réseau.

Les contributions principales de cette thèse sont les quatre parties suivantes:

- *Conception d'IDEA1*: C'est un environnement de conception et de simulation système pour les WSN. Il est développé en SystemC. L'architecture d'IDEA1 est modulaire, donc de nouveaux modules (composants) peuvent être facilement mis en œuvre et rajoutés. Beaucoup de paramètres au niveau système du nœud et au

niveau du réseau peuvent être configurés.

- *Validation et évaluation d'IDEA1*: Un banc d'essai de 9 nœuds de capteurs a été construit pour valider les résultats de simulation d'IDEA1. Les simulations d'IDEA1 ont également été comparées avec NS-2, le simulateur le plus utilisé dans le domaine des réseaux mobiles ad hoc (MANET). Les paramètres comparés sont la précision de la simulation, l'analyse de la consommation et la vitesse de la simulation.
- *Etude du réseau de capteurs IEEE 802.15.4*: La performance d'un réseau de capteurs IEEE 802.15.4 est étudié par IDEA1, y compris les taux de livraison de paquets, la latence moyenne, la consommation d'énergie par paquets et la consommation moyenne de puissance. De nombreux cas avec différentes configurations des paramètres du protocole sont simulés.
- *Etude d'une application industrielle*: Dans ce projet, un réseau de capteurs sans fil est déployé sur un véhicule pour mesurer les vibrations. Par la simulation d'IDEA1, certaines conceptions préliminaires basées sur des protocoles de communication et des plates-formes matérielles sont évaluées.

Cette thèse est organisée comme suit. Le chapitre 2 présente les réseaux de capteurs sans fil par rapport aux applications, aux plates-formes matérielles, aux protocoles de communication, à la modélisation et à la simulation. Une taxonomie des outils de simulation WSN est proposée. L'état de l'art des simulateurs existants de WSN est résumé selon le schéma de classification de la taxonomie. Le chapitre 3 décrit la conception d'IDEA1. L'architecture, la mise en œuvre du modèle de simulation, les sorties, la modélisation du réseau, et le modèle d'énergie sont expliqués en détail. Le chapitre 4 valide les résultats de la simulation et évalue la performance d'IDEA1. Les résultats de simulation d'IDEA1 sont comparés avec certaines mesures expérimentales sur un banc d'essai de 9 nœuds. Les performances d'IDEA1 ont également été comparés avec NS-2, le simulateur le plus largement utilisé dans la recherche sur les WSN. Le chapitre 5 utilise deux cas d'études pour montrer le flot de conception d'IDEA1. La performance du réseau

IEEE 802.15.4 du capteur est globalement évaluée. En outre, IDEA1 est également utilisé pour étudier une application industrielle dans lequel un réseau de capteur sans fil est déployé sur un véhicule pour mesurer les vibrations. Le chapitre 6 conclut cette thèse et décrit des perspectives intéressantes.

Chapitre 2 Introduction au Réseau de Capteur sans Fil

Les réseaux de capteurs sans fil (WSN) sont des réseaux ad hoc de nœuds aux ressources limitées qui sont déployés à différents endroits pour surveiller les conditions physiques ou environnementales, comme la température, la vibration et le mouvement. Ce sont des réseaux uniques en raison de ressources limitées (capacité de mémoire, de calcul et d'énergie). Comme les nœuds sont souvent conçus pour fonctionner sur des périodes de plusieurs mois ou années, l'énergie est la ressource la plus précieuse des nœuds. WSN ont été employés dans beaucoup d'applications, tels que la surveillance de l'environnement, les applications militaires et industrielles [1]. Différentes applications ont des exigences différentes sur le matériel de capteur et les protocoles du réseau. La modélisation et simulation ont été largement utilisées pour évaluer la performance des systèmes de WSN.

Dans la section 2.1, les applications de WSN sont introduites. Dans un passé récent, les WSNs ont trouvé leur place dans une grande variété d'applications. Comme dans le système de classification dans [2], les applications de WSN peuvent être essentiellement classées en deux catégories: les applications de surveillance et les applications de suivi. Dans les applications de surveillance, des réseaux de capteurs sont déployés dans un endroit pour surveiller les phénomènes. Dans les applications de suivi, un ou plusieurs nœuds de capteurs sont attachés à un objet cible et une infrastructure de réseau de capteurs est déployée afin de détecter le mouvement de cet objet ou suivre ses caractéristiques.

Dans la section 2.2, les plateformes matérielles actuelles disponibles sont étudiées. Un nœud est normalement composé d'un ou plusieurs capteurs, une unité de traitement, un transceiver radiofréquence(RF) et une ou plusieurs sources d'énergie. En plus de la mesure, un nœud a besoin pour traiter les données d'une unité de traitement,

de transmettre les informations à d'autres nœuds grâce à son transceiver RF, en consommant le moins d'énergie de la batterie.

Dans la section 2.3, l'architecture du réseau et les protocoles de communication sont analysés. La couche MAC (Medium Access Control) définit les procédures de l'accès au canal, afin d'éviter les corruptions de données et les collisions de paquets. Il assure la fiabilité de la transmission entre deux nœuds en utilisant certaines retransmissions, comme les accusés de réception (ACK). De plus, il détecte et corrige éventuellement les erreurs qui peuvent survenir dans la couche inférieure.

Dans la section 2.4, les systèmes d'exploitation de WSN sont étudiés. Beaucoup d'aspects essentiels de ces systèmes d'exploitation sont résumés, y compris les plateformes matérielles prises en charge, les langages de programmation, et la reprogrammation.

Dans la section 2.5, une taxonomie des simulateurs existants de WSN est proposée. Il partage les outils de simulation en quatre catégories selon leurs méthodes de modélisation. Basée sur le système de classification de la taxonomie, une analyse sur les outils existants de simulation est présentée. Basé sur l'analyse ci-dessus d'outils existants de simulation de WSN, nous pouvons constater que la plupart des simulateurs sont mis en œuvre dans les langages de programmation génériques comme C++ et Java qui ne supportent pas directement la co-simulation du matériel et du logiciel de nœud. Les simulateurs génériques de réseau se concentrent principalement sur l'étude des protocoles de communication. Les émulateurs du système exploitation et les ISS (*instruction set simulator*) peuvent accélérer la mise en œuvre du logiciel embarqué, mais elles impliquent beaucoup de détails au bas niveau qui ne sont pas forcément disponibles au stade de la conception. Les simulations à ce niveau ont normalement besoin d'une implémentation exécutable de l'application finale et les protocoles. Seul un petit nombre de simulateurs conçus dans SLDLs, tels que SystemC, peuvent fournir l'abstraction appropriée du système final, mais aussi avec assez d'information détaillée sur le matériel et les opérations du logiciel. En outre, la modélisation en SLDL est compatible avec le flot de conception

microélectrique.

SystemC fournit un support natif de modélisation simultanée, la hiérarchie structurelle, les interruptions et les primitives de synchronisation des systèmes embarqués [3]. Bénéficiant de la co-simulation de HW/SW, SystemC est plus approprié pour la modélisation et simulation de WSN. A l'heure actuelle, quatre simulateurs en SystemC de WSN [4, 5, 6, 7] ont été développés, mais aucun d'eux n'a été validé avec des mesures expérimentales ou évalués globalement en comparant avec d'autres simulateurs.

Pour résoudre cette limitation, un nouveau simulateur en SystemC de WSN nommée IDEA1 (plateforme de conception hiérarchique de réseaux de capteurs Exploration) a été développé. Un banc d'essai de 9 nœuds a été construit pour valider les résultats de simulation d'IDEA1. Les simulations d'IDEA1 ont également été comparés avec NS-2 qui est le simulateur le plus utilisé dans la recherche de WSN *mobile ad hoc* (MANET) [8].

Chapitre 3 Conception et Implémentation d'IDEA1

Dans ce chapitre, un nouveau simulateur de WSN, nommé IDEA1 (hierarchical DEsign pLATFORM for sensOr Networks Exploration), est présenté. Les nœuds sont modélisés en SystemC et leurs interconnexions en C++. SystemC est un langage de description niveau système qui est largement utilisé dans la conception du système sur puce, par conséquent, IDEA1 n'est pas seulement un simulateur, mais aussi un outil de conception de systèmes pour WSN. Avec un modèle du nœud de capteur, il est possible d'évaluer la performance du réseau. Quand les exigences du système final sont remplies, la mise en œuvre réelle de la conception du système peut commencer à partir de cette description. IDEA1 fournit aux concepteurs de systèmes des possibilités d'évaluer la performance du réseau avec de nouvelles architectures à un stade précoce, et il permet également aux concepteurs de simuler le protocole de communication sur des nouveaux nœuds, même si les plates-formes matérielles sont encore en développement.

La section 3.1 présente brièvement SystemC. SystemC est une bibliothèque en C++ pour la conception du matériel et du système. Il peut être utilisé par les concepteurs de systèmes complexes matériels et logiciels (HW/SW) [9]. Il supporte la co-design du

HW/SW à un niveau élevé d'abstraction. Cette évaluation de la performance primaire donne au concepteur une compréhension fondamentale du système final à un stade précoce du processus de conception.

La section 3.2 décrit l'architecture d'IDEA1. IDEA1 est un outil de simulation. Chaque composant est modélisé comme un module individuel en SystemC qui communique avec les autres via les canaux. Le noyau SystemC agit comme moteur de simulation. Il planifie l'exécution des processus et des mises à jour de l'état de tous les modules à chaque cycle de simulation. Tous les processus actifs sont invoqués au même moment, ce qui crée une illusion de simultanéité. Les nœuds de capteurs sont modélisés exactement comme leurs architectures. Les composants matériels d'un nœud de capteur comprennent généralement un microcontrôleur, un transceiver, plusieurs capteurs et une batterie. Chaque composante est modélisée comme un module individuel de SystemC. IDEA1 comprend une bibliothèque qui contient de nombreuses implémentations de plateformes matérielles existantes et de protocoles de communication. Il fournit également un environnement graphique pour permettre aux utilisateurs une configuration simple de la simulation et l'analyse des résultats.

La section 3.3 illustre la mise en œuvre d'IDEA1. Le microcontrôleur et le transceiver RF sont modélisés comme des machines d'états finis (FSM). La FSM du microcontrôleur est contrôlée par les interruptions générées par le transceiver et l'application. La transition de l'état de transceiver est déclenchée par trois types d'événements, y compris le protocole mis en œuvre, les commandes du microcontrôleur et les événements réseau. Le modèle de réseau relie chaque nœud, gère la topologie du réseau et mise en œuvre de la propagation des ondes radio. Le modèle de réseau établit un éventail de topologie à deux dimensions basé sur cette information et les modèles de propagation radio. Dans IDEA1, chaque état des composants matériels principaux dans un nœud de capteur est associé à une consommation de courant. La durée et la consommation instantanée de chaque transition entre deux états sont également identifiées. Pendant la simulation, les états de ces composants sont mis à jour en fonction de l'exécution des logiciels et des événements

du réseau.

La section 3.4 présente les résultats de la simulation. Il y a deux types de sortie de simulation dans IDEA1, y compris le log de simulation et le chronogramme des événements. Le log de simulation est utilisé pour déboguer les implémentations du modèle et montrer les comportements du réseau. Beaucoup de résultats statistiques des comportements du réseau sont donnés à la fin du log de simulation, y compris les aspects débit, latence de livraison de paquets, consommations de puissance et temps de simulation. Pendant que la simulation est en cours, les états de tous les composants matériels et les variables sont mises à jour en permanence et suivies dans un fichier (VCD), et peuvent être affichées graphiquement en utilisant des outils de visualisation de forme d'onde.

Dans ce chapitre, un nouveau simulateur WSN niveau système, nommé IDEA1, est présenté. Il est développé en SystemC et C++, ce qui rend la simulation compatible au flot de conception des systèmes embarqués. Il permet l'exploration de l'espace de conception à un stade précoce et permet une modélisation modulaire de nœuds de capteurs et d'applications de WSN. Beaucoup de plateformes matérielles ont été modélisées et la norme IEEE 802.15.4 a été mise en œuvre. Un modèle d'énergie a été proposé pour tous les modèles de composants d'IDEA1.

Chapitre 4 Validation et Evaluation d'IDEA1

Dans ce chapitre, les performances d'IDEA1 sont évaluées, en particulier sous deux aspects: la précision et le temps de simulation. Pour la validation de la précision, les résultats de simulation d'IDEA1 sont comparés avec des mesures sur un banc d'essai composé de 9 nœuds. La simulation d'IDEA1 est également comparée avec NS-2, le simulateur le plus largement utilisé dans la recherche des WSN, y compris les comparaisons des résultats de simulation et le temps de simulation.

La section 4.1 présente les paramètres utilisés pour évaluer les performances du réseau. Quatre indicateurs sont utilisés pour évaluer les performances du réseau dans les expériences et les comparaisons avec NS-2, dont le taux de délivrance des paquets (*PDR*), le temps de latence moyen (*AL*), la consommation d'énergie par paquet (*ECPkt*)

et la consommation électrique moyenne (*APC*).

La section 4.2 décrit le banc d'essai et montre la comparaison entre les mesures et les résultats de simulation. Un banc d'essai de 9 nœuds est construit. Deux types de mesures ont été effectués. L'une est la mesure des consommations de tous les modes de fonctionnement d'un nœud afin de calibrer le modèle d'énergie, qui sera utilisée dans la simulation d'IDEA1. L'autre est la mesure sur le banc d'essai du réseau de 9 nœuds. Ce réseau se compose de huit nœuds et un coordinateur. Les nœuds sentent l'environnement périodiquement. La fréquence de lecture est présentée comme le taux d'échantillonnage. L'application réalisée avec le banc d'essai a également été mis en œuvre dans IDEA1 avec la même configuration. Pour évaluer les performances du réseau avec des rapports cycliques différents, et la période d'échantillonnage est fixé à 10, 1, 0,1, 0,01 et 0,001 secondes respectivement. La déviation moyenne des quatre métriques (*PDR*, *AL*, *APC* et *ECPkt*) entre les simulations et les mesures est de 5,2%, 3,2%, 3,4% et 6,5% respectivement. Par conséquent, la déviation moyenne entre les simulations et les mesures est de 4,6% qui peut être accepté pour les simulations généraux au haut niveau.

La section 4.3 présente les résultats de simulation d'IDEA1 et de NS-2 sur un réseau utilisant IEEE 802.15.4. De nombreux cas avec différentes configurations (principalement *BO* et *SO*) et des taux d'échantillonnage ont été évalués. Des paramètres de l'algorithme CSMA-CA (par exemple, *macMinBE*, *macMaxCSMABackoffs*, *macMaxFrameRetries*, etc) sont définis avec les valeurs par défaut de la norme IEEE 802.15.4. Trois types de résultats de simulation sont comparés, y compris NS-2, IDEA1 avec la modélisation du matériel (IDEA1_ HW) et IDEA1 sans la modélisation du matériel (IDEA1_ NOHW). Dans la dernière simulation, tous les paramètres matériels sont mis à 0. Comme le modèle IEEE 802.15.4 de NS-2 ne considère pas le matériel, NS-2 et IDEA1_ NOHW sont au même niveau d'abstraction. La déviation moyenne entre les IDEA1_ HW et NS-2 est de 26,7%, et celui entre IDEA1_ NOHW et NS-2 est de 4,8%. Le premier est plus grand puisque l'information plus détaillée des opérations HW/SW a été considérée. La vitesse de simulation des IDEA1 est 2 fois plus rapide que NS-2.

Chapitre 5 Cas d'études

Après la validation expérimentale de la précision et l'évaluation des performances, IDEA1 est prêt à être utilisé dans des applications réelles. Il est d'abord utilisé pour fournir l'évaluation du réseau IEEE 802.15.4 étudié dans le dernier chapitre. Les performances d'IEEE 802.15.4 sont évaluées pour différents paramétrages. Enfin, IDEA1 est utilisé pour étudier une application industrielle. Par la simulation, certaines conceptions préliminaires basés sur les protocoles IEEE 802.15.4 et deux plates-formes matérielles différentes ont pu être évaluées. Les quatre paramètres utilisés dans le chapitre 4, y compris les *PDR*, *AL*, *ECPkt* et *APC*, sont évalués.

La section 5.1 propose une évaluation des performances du réseau IEEE 802.15.4 par NS-2 et IDEA1. Selon l'étude dans la section 4.3, lorsque le taux d'échantillonnage est petit, les nœuds dépensent trop d'énergie pour la recherche du paquet (tracking) beacon. Par conséquent, dans cette section, nous mettons en œuvre la même application, sans tracking. Jusqu'à présent, *BO* est réglé sur 0, 1 et 2 respectivement, et *SO* est mis à 0. Certaines autres configurations des paramètres du protocole et du mode non-beacon sont également évalués pour trouver le meilleur choix de l'algorithme et la configuration des paramètres pour des échantillonnages différents.

La section 5.2 étudie une application industrielle pour démontrer le flot de conception et de la convivialité d'IDEA1. Un réseau de capteurs et actionneurs sans fil est déployé sur une automobile pour mesurer et contrôler ses vibrations. La première tâche de notre travail est de concevoir le réseau de capteurs. Au début, certains concepts préliminaires basés sur plusieurs plates-formes matérielles et protocoles existantes doivent être examinées. Quatre algorithmes MAC sont mises en œuvre, y compris *IEEE 802.15.4 unslotted CSMA-CA*, *IEEE 802.15.4 slotted CSMA-CA*, *IEEE 802.15.4 GTS* et *TDMA GTS*. Deux plates-formes matérielles ont été utilisées, N@L et MICAz.

Les algorithmes de CSMA-CA ne sont pas appropriés pour cette application en raison du faible *PDRs*, qui est du au grand nombre de collisions. Le système se sature quand le taux d'échantillonnage est trop élevé. Le *PDR* de l'IEEE 802.15.4 GTS est grand,

mais la latence est également très grande. Pour l'algorithme TDMA GTS, le *PDR* peut atteindre 100%, mais ce réseau IEEE 802.15.4 ne peut pas répondre à l'exigence en temps réel de cette application. Bien que la latence moyenne des paquets peut atteindre 7,0 ms, le *sizePayload* est de 10 échantillons qui signifie que le premier échantillon de données doit attendre au moins 17 ms avant d'être reçu par le coordonnateur. Cette latence des données de capteurs est trop élevée pour générer un contrôle actif en temps réel. Par conséquent, nous avons conclu que la norme IEEE 802.15.4 ne peut pas répondre à l'exigence de cette application. Certains protocoles de communications à haute vitesse doivent être étudiés.

Chapitre 6 Conclusions et Perspectives

Cette thèse a étudié la modélisation et la simulation de réseaux de capteurs sans fil. Un nouveau simulateur WSN, nommé IDEA1, a été développé en SystemC.

Basé sur le support de la concurrence par SystemC, la hiérarchie structurelle, les interruptions et les primitives de synchronisation, IDEA1 permet la co-simulation du matériel et du logiciel des nœuds. En effet, les consommations d'énergie d'un nœud individuel de capteurs et du réseau peuvent être prédites avec précision. Le modèle d'énergie mis en œuvre dans IDEA1 prend en compte les consommations de puissance de tous les modes de fonctionnement de chaque composant matériel et les transitions entre les différents modes. Beaucoup de composants matériels, comme ceux composant les plateformes MICAz et MICA2, sont modélisés. La norme IEEE 802.15.4 a été mise en œuvre.

Premièrement, les résultats de simulation d'IDEA1 ont été comparés avec des mesures expérimentales sur un banc d'essai de 9 nœuds, sur les aspects de taux de livraison de paquets, latence moyenne, consommation d'énergie par paquets et consommation moyenne de puissance. La déviation moyenne entre les simulations d'IDEA1 et les mesures expérimentales est de 4,6% qui peut être accepté pour une simulation au niveau système. Les performances d'IDEA1 ont également été comparées avec NS-2, le simulateur réseau le plus largement utilisé dans la recherche de WSN. Bénéficiant de modèles matériels et

logiciels, IDEA1 fournit des informations plus détaillées sur les consommations d'énergie que NS-2. Si les informations de certaines opérations matérielles relatives ne sont pas prises en compte dans IDEA1, la déviation moyenne entre les simulations d'IDEA1 et de NS-2 est de 4,8% ce qui prouve qu'IDEA1 peut fournir la même précision avec NS-2. Toutefois, si les opérations matérielles relatives sont considérées dans la simulation d'IDEA1, la déviation moyenne entre les simulations d'IDEA1 et NS-2 est de 26,7%. La vitesse de simulation d'IDEA1 est 2 fois plus vite que NS-2.

Enfin, deux cas d'études ont été réalisés pour montrer la facilité d'utilisation et le flot de conception d'IDEA1. La performance du réseau IEEE 802.15.4 a été entièrement évaluée. Pour différentes charges de trafic, différents paramètres des protocoles sont simulés. En outre, une application temps réel de contrôle actif des vibrations a également été étudiée. Par les études de simulation d'IDEA1, le meilleur choix de protocole de communication basés sur MICAz ou N@L a été trouvé.

Les travaux de recherche mis en œuvre dans cette thèse ont montré des résultats intéressants. Toutefois, il y a beaucoup de recherches supplémentaires qui pourraient être menées.

- Pour renforcer la capacité d'IDEA1 dans la modélisation des systèmes réels de WSN, certains capteurs doivent être modélisés en SystemC.
- Le système d'exploitation est une partie importante du développement de logiciels pour le système de WSN, par conséquent IDEA1 sera plus complet si on peut modéliser le système d'exploitation. En outre, des modèles précis du logiciel, telles que la simulation de jeu d'instructions, peut être étudiée.
- La simulation du réseau IEEE 802.15.4 a montré que cette norme est plus efficace pour les applications à faible rapport cyclique. Donc, pour certaines applications à haute fréquence d'échantillonnage, les protocoles de communication haut débit doivent être étudiés.
- Les couches hautes, comme des couches réseau et transport, devraient être mises en

œuvre afin de permettre la simulation à grande échelle du réseau de capteurs.

- Les modèles de propagation radio dans la version actuelle d'IDEA1 ne contient que deux modèles typiques. Certains modèles de propagation plus précis et plus complexes doivent être mises en œuvre dans IDEA1.
- Le modèle de décharge de batterie dans la version actuelle d'IDEA1 est seulement un processus linéaire. Certains modèles plus précis doivent être étudiés.

Contents

Table of Contents	I
List of Figures	VIII
List of Tables	XIII
Chapter 1 : Introduction	1
1.1 Brief Introduction to Wireless Sensor Networks	3
1.2 Research Motivation	4
1.3 Research Contributions	5
1.4 Selected Publications	6
1.5 Thesis Structure	8
Chapter 2 : Wireless Sensor Networks	11
2.1 Application Scenarios	13
2.1.1 Monitoring Application Examples	14
2.1.2 Tracking Application Examples	16
2.1.3 Summary	17
2.2 Wireless Sensor Hardware Platforms	18
2.2.1 Architecture of wireless sensor node	18
2.2.2 Hardware platforms	20
2.3 Communication Protocols	20
2.3.1 Introduction to Protocol Stacks	22
2.3.2 Medium Access Control	24
2.3.2.1 Synchronous MAC Protocols	25
2.3.2.2 Asynchronous MAC Protocols	27
2.3.2.3 IEEE 802.15.4 MAC protocols	28
2.3.3 Data Aggregation and Routing	32
2.3.3.1 Network Topologies	33
2.3.3.2 Routing Protocol for Mesh Topology	34

2.3.3.3	Routing Protocol for Cluster Topology	35
2.4	Operating Systems	36
2.4.1	Characteristics of WSN Operating Systems	36
2.4.2	Summary of WSN Operating Systems	37
2.5	Modeling and Simulation	40
2.5.1	Requirements of WSN Modeling and Simulation	41
2.5.2	A Typical Model of WSN System	42
2.5.3	A Taxonomy of WSN Simulation Tools	43
2.5.4	A Survey of WSN Simulation Tools	45
2.5.4.1	Network Simulators with Node Models	45
2.5.4.2	Node Emulators with Network Models	49
2.5.4.3	Node System Simulator with Network Models	51
2.5.4.4	Network Simulators with Node Emulators	53
2.5.5	Summary	53
2.6	Conclusion	56
 Chapter 3 : Design and Implementation IDEA1		57
3.1	Modeling Wireless Sensor Networks with SystemC	59
3.1.1	Introduction to SystemC	59
3.1.1.1	Features of SystemC	60
3.1.1.2	SystemC Modeling Constructs	60
3.1.1.3	SystemC Simulation Kernel	61
3.1.2	Transaction Level Modeling	62
3.2	IDEA1 Framework	63
3.2.1	Architecture of IDEA1	63
3.2.2	Design Flow of IDEA1	65
3.2.3	Current Library	66
3.2.4	Graphical User Interface	71
3.2.5	IDEA1 Features	72

3.3	Simulation Model Implementations	74
3.3.1	Sensor Node Modeling	74
3.3.2	Microcontroller Model	75
3.3.2.1	Model of ATMEL ATmega128	80
3.3.2.2	Model of Microchip PIC16LF88	82
3.3.3	Transceiver Model	85
3.3.3.1	Transceiver Model of TI CC2420 and CC1000	86
3.3.3.2	Transceiver Model of Microchip MRF24J40	86
3.3.4	Network Modeling	89
3.3.4.1	Packet Transmission	90
3.3.4.2	Radio Propagation Model	90
3.3.5	Energy Model	91
3.4	Simulation Output	94
3.4.1	Simulation Log	94
3.4.2	Event Sequence Tracing	95
3.4.3	Sensor Data	97
3.5	Conclusion	98
 Chapter 4 : Performance Evaluation of IDEA1		99
4.1	Performance Metrics	101
4.2	Experimental Validation	102
4.2.1	Calibration of the Energy Model	102
4.2.2	A Testbed of Sensor Network	103
4.2.2.1	Testbed Establishment	103
4.2.2.2	Testbed Measurements and Simulation Results	107
4.3	Performance Comparison with NS-2	111
4.3.1	Simulation Model Implementation of NS-2 and IDEA1	112
4.3.2	Simulation Results of NS-2 and IDEA1	114
4.3.2.1	Packet Delivery Rate	115

4.3.2.2	Average Latency	116
4.3.2.3	Average Power Consumption	118
4.3.2.4	Energy Consumption per Packet	119
4.3.2.5	Summary	121
4.3.3	Simulation Time of NS-2 and IDEA1	121
4.3.4	Detailed Analysis of Power Consumptions by IDEA1	122
4.4	Conclusion	124
 Chapter 5 : Case Studies		127
5.1	Performance Evaluation of IEEE 802.15.4 Sensor Network	129
5.1.1	Slotted CSMA-CA with Fixed <i>SO</i> and Various <i>BO</i>	130
5.1.1.1	Packet Delivery Rate	130
5.1.1.2	Average Latency	131
5.1.1.3	Average Power Consumption	134
5.1.1.4	Energy Consumption per Packet	135
5.1.1.5	Summary	136
5.1.2	Slotted CSMA-CA with Equal <i>SO</i> and <i>BO</i>	137
5.1.3	Unslotted CSMA-CA	140
5.1.4	Summary	140
5.2	An Industrial Application	143
5.2.1	Introduction to the Industrial Application	144
5.2.2	Preliminary Study	145
5.2.3	Simulation Study	147
5.2.3.1	Comparisons of MAC algorithms	148
5.2.3.2	Comparisons of Hardware Platforms	149
5.2.3.3	Detailed Analysis of Energy Consumption	150
5.3	Conclusion	151
 Chapter 6 : Conclusions and Future Works		153

6.1	Summary of Work	155
6.2	Future Works	156
Appendix A : Modifications to the IEEE 802.15.4 NS-2 Model		161
Bibliography		166

List of Figures

1.1	Overall structure of thesis	9
2.1	A typical architecture of wireless sensor node	19
2.2	Protocol stack models: OSI Basic Reference Model [10], Zigbee stack [11] and the sensor network protocol stack proposed in [12]	22
2.3	S-MAC Frame Format [13][14]	25
2.4	IEEE 802.15.4 supported operation modes and algorithms	29
2.5	CSMA-CA algorithm of IEEE 802.15.4 [15]	30
2.6	The typical structure of a superframe [15]	31
2.7	Basic network topologies for wireless sensor network	33
2.8	A Typical Model of WSN System	43
3.1	Architecture of IDEA1	64
3.2	Design flow of IDEA1	66
3.3	N@L node prototype	69
3.4	Packet frame format of IEEE 802.15.4, redrawn from [15]	70
3.5	Graphical user interface of IDEA1: A network with 100 nodes is modeled in this example	72
3.6	A typical model of sensor nodes	74
3.7	A typical model of microcontroller	76
3.8	State machine for microcontroller of IEEE 802.15.4 MAC protocol	77
3.9	Algorithm for handling the concurrency of sensing and other operations	79
3.10	A typical model of transceiver	85
3.11	Model of MRF24J40 in non-beacon mode with CSMA-CA algorithm	87
3.12	Model of MRF24J40 in beacon mode with slotted CSMA-CA algorithm	88
3.13	Model of MRF24J40 in beacon mode with GTS algorithm	89
3.14	An example of simulation log	95
3.15	An example of event sequence tracing	96
3.16	Measured sensor data by N@L mote	97
4.1	Hardware measurement configuration	102

4.2	Testbed Measurement Configuration	104
4.3	A typical wave record of current consumption of nodes	106
4.4	Measured and simulated results of <i>PDR</i> and <i>AL</i>	108
4.5	Measured and simulated results <i>APC</i> and <i>ECPkt</i>	109
4.6	A typical transmission process when sample rate is small	110
4.7	Simulation Results of Packet Delivery Rate by NS-2 and IDEA1	116
4.8	Simulation Results of Latency by NS-2 and IDEA1	117
4.9	Simulation Results of Power Consumption by NS-2 and IDEA1	119
4.10	Simulation Results of Energy Consumption per Packet by NS-2 and IDEA1	120
4.11	Simulation time of NS-2 and IDEA1	122
4.12	Power consumptions of hardware components in different operating modes	123
4.13	Power consumptions of hardware components for different tasks	124
4.14	Power consumptions of microcontroller for different tasks	125
5.1	Packet delivery rate of slotted CSMA-CA with fixed <i>SO</i> and various <i>BO</i> .	130
5.2	Latency of slotted CSMA-CA with fixed <i>SO</i> and various <i>BO</i>	131
5.3	Power consumption of slotted CSMA-CA with fixed <i>SO</i> and various <i>BO</i> .	134
5.4	Energy consumption per packet of slotted CSMA-CA with fixed <i>SO</i> and various <i>BO</i>	136
5.5	Simulated results of <i>PDR</i> and <i>AL</i> with <i>SO</i> equal to <i>BO</i>	138
5.6	Simulated results of <i>APC</i> and <i>ECPkt</i> with <i>SO</i> equal to <i>BO</i>	139
5.7	Simulated results of <i>PDR</i> and <i>AL</i> with nonbeacon-enabled mode	141
5.8	simulation results of <i>APC</i> and <i>ECPkt</i> with nonbeacon-enabled mode	142
5.9	M@L wireless sensor and actuator network infrastructure	144
5.10	Superframe structure for the TDMA-based GTS algorithm	146
5.11	Data fame structure of M@L application	147
5.12	An energy breakdown at component level	150

List of Tables

2.1	Wireless sensor hardware platforms	21
2.2	Operating Systems for Wireless Sensor Networks	38
3.1	Input parameters of IDEA1 and their types	67
3.2	Output parameters of IDEA1 and their types	68
3.3	Current consumptions of MICAz mote [16][17]	93
3.4	Current consumptions of N@L mote [18][19]	93
4.1	Measured current consumptions of N@L motes (3.3 V VDD and 8 MHz clock frequency)	103
5.1	Simulation results of Of MICAz and N@L motes	148

Chapter 1 :

Introduction

1.1 Brief Introduction to Wireless Sensor Networks

With the advances in Micro-Electro-Mechanical Systems (MEMS) and Very-Large-Scale Integration (VLSI) technologies which have facilitated the development of smart sensors and compact low-power microprocessors and radio frequency transceivers, Wireless Sensor Networks (WSNs) have gained worldwide attention in recent years. A sensor node is typically equipped with one or more sensors, a processing unit, memory, a power supply and a Radio Frequency (RF) transceiver [2]. Sensors are devices that can measure a physical quantity and convert it into a signal which can be read by a processing unit. Various phenomena can be measured, such as sound, vibration, humidity, pressure and temperature.

WSNs have been used in a wide variety of applications. According to their functionalities, WSN applications can be mainly classified into two categories: monitoring applications and tracking applications [2]. Different applications have diverse requirements; for example, a real-time industrial application requires short packet delivery latency, but a lifetime of weeks is often enough. In contrast, a remote environment monitoring system prefers a long lifetime of years with a low duty cycle. Due to the small size and low cost requirements of sensor nodes, the resources of sensor nodes, such as processing capability, storage and energy supply are limited [12].

To enable and implement new applications, networking techniques should be investigated in order to transmit the sensor data to a host which can be accessed by users. The communication protocols of WSNs can be realized in different layers, such as application layer, transport layer, network layer, data link layer and physical layer. Each layer has several specific tasks and provides services to its upper layer. Three special features make the design of WSN protocols different from other wireless networks. One is the limited power supply that requires the WSN protocols should be energy efficient. Another one is self-organizing. Some applications need to randomly deploy sensor nodes, which require the sensor network protocols and algorithms possess the self-organizing

capabilities. The last one is the large scale deployments. In a network consisting of hundreds or thousands of sensor nodes, the host may be located outside of the transmission range of some sensor nodes, which necessitates the multi-hop communications.

To meet the diverse requirements of WSN application, designers need to consider a great number of node-level design choices (e.g., energy consumption of hardware components and processing capability) and many protocol-level parameters (e.g., anti-collision algorithms and routing approaches). Compared to testbed and analytical methods, simulation is a cheap and quick way to perform many experiments with different hardware prototypes and network settings [20]. Simulation is currently the most widely adopted method of analyzing WSNs [21].

1.2 Research Motivation

Due to the limited energy supply on sensor nodes, in order to extend the network lifetime, many efforts have been taken to reduce the energy consumptions of hardware, software, communication protocols and applications. Therefore, it is necessary to accurately predict the energy consumption of WSN, which requires detailed models of the hardware and software (HW/SW) of sensor nodes.

Many simulation tools for WSN have been developed by using different methodologies such as general purpose network simulation, Operating System (OS) emulation, instruction set simulation and System-Level Description Language (SLDL). However, most of them are implemented in general programming languages such as C++ and Java that do not support directly the HW/SW co-simulation. Only a few simulators designed in SLDLs provide native support to model concurrency, pipelining, structural hierarchy, interrupts and synchronization primitives of embedded systems [3]. As a SLDL, SystemC is a C++ class library for system and hardware design [9]. It can model the embedded system at different abstraction level and allow designers to focus on the system functionalities by hiding the unnecessary details of communication and computation.

Therefore, in order to enable the HW/SW co-simulation of sensor nodes and accurate energy consumption estimations of sensor networks, the feasibility and advantages of using SystemC or other SLDLs in the modeling and design of wireless sensor networks need to be investigated. The proposed SLDL-based WSN simulators should be validated by experimental measurements and evaluated by comparing with other existing WSN simulators.

1.3 Research Contributions

A novel SystemC-based WSN simulator named IDEA1 (hierarchical DEsign plAtform for sensOr Networks Exploration) is developed. IDEA1 allows rapid performance evaluation of WSN systems at system-level. The simulation results include packet delivery rate, transmission latency and power consumption. The key feature of IDEA1 is the accurate prediction of energy consumption of each sensor node and the whole network. The energy model implemented in IDEA1 takes into account the power consumptions of all operation modes of each hardware component and transitions between different modes.

Many commercial off-the-shelf (COTS) hardware components, such as MICAz and MICA2, are modeled. The IEEE 802.15.4 standard [15] is implemented. IEEE 802.15.4 has been widely used in WSN applications since it is designed for low data rate, short distance, and low power consumption applications in conformity with the constraints of WSN systems [22].

Although, four SystemC-based WSN simulators [4, 5, 6, 7] have been developed; however, IDEA1 is the first SystemC-based WSN simulator that has been validated with experimental measurements and evaluated by comparing with other simulators. Properly validating simulation models against the real-world implementation is necessary to mitigate many of the problems of simulation, such as package differences, incorrect parameter settings, and improper level of detail [23]. Comparison with other simulators can evaluate the performances of IDEA1 in aspects of simulation time, level of detail,

usability, etc.

The major contributions of this thesis are the following four parts:

- *Design of IDEA1:* It is a validated SystemC-based system-level design and simulation environment for WSN systems. The architecture of IDEA1 is well designed as a component-based framework so that new modules can be easily implemented and added. Many system parameters at both sensor node and network levels can be configured.
- *Validation and Evaluation of IDEA1:* A testbed of 9 sensor nodes has been built to validate the simulation results of IDEA1. The implementations of IDEA1 are refined many times so as to limit the average deviation between the IDEA1 simulations and the experimental measurements within an acceptable range. The simulations of IDEA1 have also been compared with NS-2, the most used simulator in Mobile Ad hoc NETWORK (MANET) research [8], in aspects of simulation accuracy, power consumption analysis and simulation speed.
- *Simulation study of IEEE 802.15.4 sensor networks:* The performance of IEEE 802.15.4 sensor network is studied by IDEA1, including packet delivery rate, average latency, energy consumption per packet and average power consumption. Many cases with different configurations of protocol parameters and network traffic loads are simulated.
- *Simulation study of a real vibration control application:* In this project, a wireless sensor and actuator network is deployed on a vehicle to measure and control vibrations. By the simulation of IDEA1, some preliminary designs based on different communication protocols and hardware platforms are evaluated.

1.4 Selected Publications

The research in this thesis has contributed to the following publications:

1. W. Du, F. Mieyeville, D. Navarro, and I. O'connor, "IDEA1: A Validated SystemC-based System-level Design and Simulation Environment for Wireless Sensor Networks," *EURASIP Journal on Wireless Communications and Networking*, to appear
 2. D. Navarro, W. Du, and F. Mieyeville, "System-level Graphical Simulations for Wireless Sensor Networks Design Space Exploration," *The Mediterranean Journal of Computers and Networks*, to appear
 3. W. Du, D. Navarro, F. Mieyeville, and I. O'connor, "IDEA1: A Validated System-level Simulator for Wireless Sensor Networks," *In Proc. the 8th IEEE International Conference on Mobile Ad-hoc and Sensor Systems (IEEE MASS 2011), the 4th International Workshop on Wireless Sensor, Actuator and Robot Networks (WiSARN-Fall)*, Valencia, Spain, 17-22 October, 2011. to appear
 4. F. Mieyeville, W. Du, and D. Navarro, "Wireless Sensor Networks for active control noise reduction in automotive domain," *the 14th International Symposium on Wireless Personal Multimedia Communications*, Brest, France, 3-6 October, 2011. to appear
 5. D. Navarro, F. Mieyeville, W. Du, M. Galos and I. O'connor, "Towards a Design Framework for Heterogeneous Wireless Sensor Networks," *In Proc. 1st International Symposium on Access Spaces (IEEE-ISAS 2011)*, Yokohama, Japan, 17-19 June 2011.
 6. W. Du, F. Mieyeville, and D. Navarro, "Modeling Energy Consumption of Wireless Sensor Network by SystemC," *In Proc. the 5th International Conference on Systems and Networks Communications (ICSNC 2010)*, IEEE Press, Nice, France, Aug. 22-27, 2010. (Best Paper)
 7. W. Du, D. Navarro, and F. Mieyeville, "A Simulation Study of IEEE 802.15.4 Sensor Networks in Industrial Applications by System-level Modeling," *In Proc. the 4th International Conference on Sensor Technologies and Applications (SENSORCOMM 2010)*, IEEE Press, Venice/Mestre, Italy. July 18-25, 2010.
 8. W. Du, F. Mieyeville, and D. Navarro, "IDEA1: A SystemC-based System-level Simulator for Wireless Sensor Networks," *In Proc. IEEE International Conferece on Wireless*
-

- Communications, Networking and Information Security (WCNIS2010)*, IEEE Press, Beijing, China. June 25-27, 2010.
9. D. Navarro, W. Du, F. Mieyeville, and F. Gaffiot, "A Complete System-level Behavioural Model for IEEE 802.15.4 Wireless Sensor Network Simulations" In Proc. the IEEE International Symposium on Circuits and Systems (ISCAS2010), IEEE Press, Paris, France. May 30-June 2, 2010.
 10. W. Du, D. Navarro, F. Mieyeville, and F. Gaffiot, "Towards a Taxonomy of Simulation Tools for Wireless Sensor Networks," *In Proc. the 3rd International ICST Conference on Simulation Tools and Techniques (SIMUTools 2010)*, ICST, Malaga, Spain. Mar. 15-19, 2010.
 11. F. Mieyeville, W. Du, D. Navarro, and O. Bareille, "Wireless Sensor Network for active vibration control," *In Proc. the 1st International Conference on Passives and Actives Mechanical Innovations in Analysis and Design of Mechanical Systems (IMPACT 2010)*, Djerba, Tunisia. Mar. 22-24, 2010.
 12. W. Du, D. Navarro, F. Mieyeville, and F. Gaffiot, "IDEA1: Un Simulateur au Niveau Système pour Réseaux de Capteurs sans Fil," *Journées Nationales du Réseau Doctoral en Microélectronique*, Montpellier, France, June 7-9, 2010
 13. W. Du, F. Mieyeville, D. Navarro, and F. Gaffiot, "Un Environnement de Simulation de Réseaux de Capteurs sans Fil," *Ecole d'hiver Francophone sur les Technologies de Conception des Systèmes embarqués Hétérogènes*, Chamonix - Mont Blanc, France, January 11-13, 2010.

1.5 Thesis Structure

The overall structure of this thesis is shown in Fig. 1.1

Chapter 2 introduces the wireless sensor networks with respect to applications, hardware platforms, communication protocols, modeling and simulations. A taxonomy

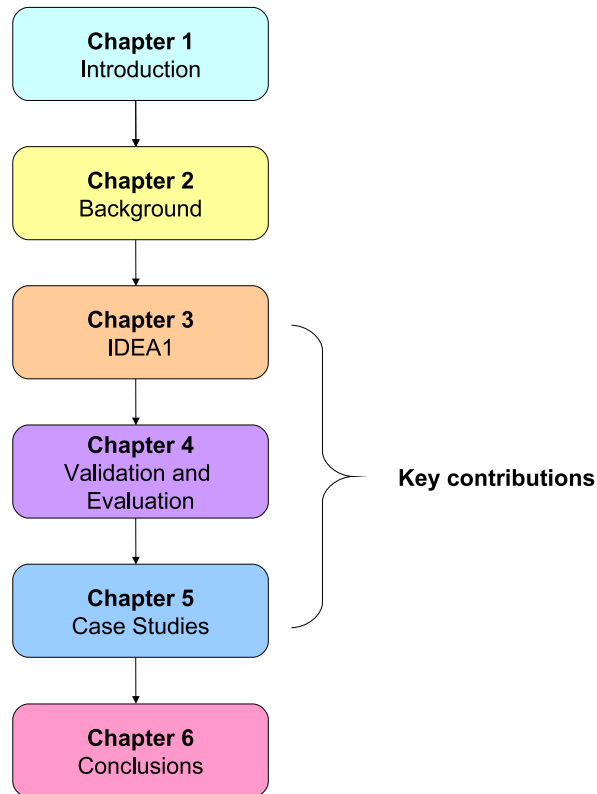

FIG. 1.1: Overall structure of thesis

of WSN simulation tools is proposed. A survey of the existing simulators for WSN is provided according to the classification scheme of the taxonomy.

Chapter 3 describes the design of IDEA1. The architecture and design frame, model implementation and simulation outputs will be explained in detail.

Chapter 4 validates the simulation results and evaluates the performance of IDEA1. The simulation results of IDEA1 are compared with some experimental measurements on a testbed of 9 nodes. The performances of IDEA1 have also been compared with NS-2, the most widely used simulator in WSN research.

Chapter 5 uses two case studies to show the usability and design flow of IDEA1. The performance of IEEE 802.15.4 sensor network is comprehensively evaluated by IDEA1. In addition, IDEA1 is also used to study a real-time industrial application in which a wireless sensor and actuator network is deployed on a vehicle to measure and control vibrations.

Chapter 6 concludes this thesis and outlines the activities of future research.

Appendix A lists the modifications we have made to the IEEE 802.15.4 NS-2 model [24] and [25] in release 2.34. It has been improved, since it was built complying with an earlier standard edition (IEEE 802.15.4 draft D18), which has been replaced by the latest revised release IEEE Std 802.15.4-2006 [15]. Moreover, some bugs are fixed and several new functions are added.

Chapter 2 :

Wireless Sensor Networks



Wireless sensor networks (WSN) are large-scale ad hoc networks of resource-constrained sensor nodes that are deployed at different locations and could cooperatively monitor the physical or environmental conditions, such as temperature, vibrations and motions. They are unique networks due to restricted resources (memory, energy, and processing ability). As nodes are often expected to operate over periods of many months or years and be self-powered, the energy is the most precious resource of the nodes. Considerable researches are being undertaken into the development of energy-efficient application, hardware, protocols and software. WSNs have been employed in a wide range of application domains, such as health-related deployments, environment monitoring, industry and military applications [1]. Different applications have different requirements on wireless sensor hardware and network protocols. Simulation methods have been widely used for evaluating the performance of WSN systems.

In this chapter, the background of WSN research is investigated. This chapter is organized as follows. Firstly, in section 2.1, the applications of WSN are introduced. Secondly, in section 2.2, the current commercially-available hardware platforms of wireless sensor nodes are investigated. Thirdly, in section 2.3, the network architecture and communication protocols, especially these of media access control and network layers, are analyzed. Fourthly, in section 2.4, the operating systems of WSN are studied. Fifthly, in section 2.5, a model of WSN system is provided. Based on this model, a taxonomy of the existing WSN simulators is proposed. It categorizes the existing simulation tools into four classes according to their modeling methodologies and their target applications. Based on the classification scheme of taxonomy, a survey of the existing simulation tools is presented. Finally, in section 2.6, this chapter is concluded.

2.1 Application Scenarios

In the recent past, wireless sensor networks have found their way into a wide variety of applications with vastly varying requirements and characteristics. As the classification

scheme in [2], according to their functionalities, WSN applications can be mainly classified into two categories: monitoring applications and tracking applications. In monitoring applications, sensor networks are deployed in a location to monitor the phenomena in this area. In tracking applications, one or more sensor nodes are attached to a targeted object and one infrastructure sensor network is deployed to detect the movement of this object or to estimate its location. In the following two subsections, some typical examples of these two kinds of applications are introduced.

2.1.1 Monitoring Application Examples

Macroscopic of Redwood [26] is a case study of a wireless sensor network that measures some environmental parameters (e.g., air temperature, relative humidity and photosynthetically active solar radiation) surrounding a 70-meter tall redwood tree, at a density of every 5 minutes in time and every 2 meters in space. The network captured a detailed picture of the complex spatial variation and temporal dynamics of the microclimate surrounding a coastal redwood tree. The collected data can be used to validate biological theories. The hardware platform used in this application is Mica2Dot, a repackaged Crossbow Mica2 mote [27].

The reliable clinical monitoring system [28] uses a wireless sensor network to measure the heart rate and blood oxygenation of patients. The network is composed of a base station, a set of relays, and sensor nodes attached to patients. The sensor data are collected to the base station by the wireless multihop communications among the relay nodes. The relay and patient nodes are based on Crossbow TelosB mote [29]. This system was deployed in a step-down cardiology unit over seven months involving forty one patients. It achieved high reliability in both network and sensing aspects. The fraction of packets delivered to the base station can attain 99.68% and 80.85% of these packets have valid pulse and oxygenation readings.

An industrial Predictive Maintenance (PdM) sensor network is deployed in [30] and

[31] to measure the vibrations and monitor the health status of equipments in a central utility support building at a semiconductor fabrication plant. The vibrations are measured by Wilcoxon model 786A sensors with Integrated Circuit Piezo (ICP) accelerometers. Two platforms are used: one based on Crossbow Mica2 Motes [27] and the second on Intel Motes [30]. Sensor nodes form clusters around gateway nodes which are within an 802.11 network providing high speed and highly-reliable backbone to relay sensor data to enterprise server. Six clusters are deployed. Each cluster included several nodes (up to 10 motes) and each mote had about 5 sensors attached. The motes wake up at regular intervals to capture and send data to their gateway node. The application lasted for 7 days. One data collection was performed to transmit 3000 vibration samples every hour. Time and frequency domain waveform analysis of vibration data can identify changes in amplitude and frequency patterns, suggesting repair or replacement.

Volcanic monitoring [32] extends the WSN applications to some environments that humanity is not able to reach. A network consists of 16 sensor nodes was deployed on Volcàn Reventador in northern Ecuador. Each sensor node is a T-mote sky device [33] equipped with a seismoacoustic sensor. Sensor nodes are placed approximately 200-400 m apart from each other. Nodes relay data via multi-hop routing to a gateway node that connected to a long-distance Free-Wave radio modem transmits the collected data to the base station. During network operation, each sensor node samples two or four channels of seismoacoustic data at 100 Hz. The data is stored in local flash memory. When an interesting event occurs, the node will route a message to the base station. During the 19-day deployment, the network captured 230 volcanic events and retrieved 61% data.

PinPtr [34] is an example of military application which uses a WSN based on Crossbow Mica2 Motes [27] running TinyOS [35] to locate snipers and the trajectory of bullets. The system consists of sensor nodes that measure the muzzle blast and measure the time of arrival (TOA) of acoustic shock waves. The sensor nodes form a multi-hop ad hoc network that can deliver the measured TOA to a base station (typically a laptop computer), where the sensor fusion algorithm calculates the shooter location with an accuracy within one

meter, and with a latency of less than two seconds.

The first three examples are normal monitoring applications that collect some environment parameters periodically and sent the sensor data to a host to help scientists to have a comprehensive and accurate control of environment. Volcanic monitoring and PinPtr are security monitoring applications that also sense the environment frequently, but the sensor nodes only transmit a data report when there is an interesting event occurs.

2.1.2 Tracking Application Examples

InTrack [36] is a cooperative tracking system that is able to locate a moving sensor node with high accuracy over large areas. The radio-interferometric ranging technique, q-range algorithm, proposed in [37], is used to calculate the location of target node. In this algorithms, the target node and a second transmitter from the infrastructure nodes transmit unmodulated high frequency sine waves at slightly different frequencies concurrently. Two other infrastructure nodes, referred to as measuring nodes, can capture the low beat frequency of the composite interference signal. The relative phase offset of these two measuring nodes depends only on the distances between the four nodes. The locations of the three infrastructure nodes are know; therefore, the location of target node can be calculated by the relative phase offset of the two infrastructure nodes. After obtaining the frequency and phase of the periodic interference signal, the two measuring nodes route all measured data to a PC server. The q-ranging algorithm is executed on the server and the location of the tracked node is computed. The system is tested in a football stadium using 12 Crossbow XSM motes [38]. The location errors can be limited into a small range, from 0.34 to 0.71 meter.

Sensor-network-based Vehicle Anti-Theft System (SVATS) [39] is a typical vehicle alarming and tracking system. Three networks are implemented to achieve the alarming and tracking tasks. The first one is formed by all sensors in vehicles parked in the same parking area. Each vehicle is equipped with a wireless sensor nodes powered by the

vehicle. Each node is monitored by its neighbors which can identify possible vehicle thefts by detecting unauthorized vehicle movement. When an abnormal phenomenon occurs, this network will report the problem to a base station which in turn automatically sends a warning message to the security officer. The second network is used to track the stolen vehicle on road. It is composed of the sensor node within the vehicle and several roadside wireless access points. The sensor node within the vehicle can detect its own unauthorized movement by using movement sensors or by measuring sensor signal of its neighbors, and hence report problems to the roadside wireless access points. The third network is used in case the sensor node within the vehicle, referred to as master sensor, is destroyed by the thief. Some more sensor nodes are deployed at several hidden places inside the vehicle to monitor the master sensor and to report vehicle theft when master sensor is destroyed.

2.1.3 Summary

Kay Romer et al. [40] use the dimensions in the design space to analyze the application. They divided the design space into twelve dimensions, such as deployment, mobility, lifetime, network topology, coverage, cost and size of nodes. Each dimension presents one aspect that may impact the hardware, software and network protocols design. For example, the topology affects many network characteristics such as latency, robustness, capacity and complexity of data routing and processing; the resource constraints of nodes limit the complexity of the software executed on sensor nodes.

Based on the above analysis of application, some requirements of WSN applications are summarized as follows.

- *Low cost*: Large sensor network deployments require the sensor nodes be designed as cheap as possible. In order to reduce the cost of nodes, the hardware should be simple; this brings a limited process capacity and energy support.
 - *Energy efficiency*: Depending on the application, the required lifetime of a sensor
-

network may range from some hours to several years. Since most of the existing nodes are powered by battery, the energy is the most precious resource of nodes. The software and the network protocol be energy-efficient.

- *Real-time*: in some applications, especially industrial applications, the collection of sensor data should be completed within a short time to ensure the usability of data.
- *Fault tolerant*: the network system should be robust against environment change and node failure (running out of energy, physical destruction, hardware and software issues etc).
- *Security*: in some applications, especially military applications, the access to the radio information should be strictly controlled, and unauthorized changes to the message shall be detected and prevented.
- *Reprogrammability*: the remotely reprogramming of sensor nodes is necessary to some applications where the physical touch of nodes is impossible.

2.2 Wireless Sensor Hardware Platforms

Wireless sensor nodes are the essential ingredient for a sensor network. Applications and communication protocols are implemented on them. In this section, we first present a typical architecture of wireless sensor node, and then introduce many commercially available sensor nodes.

2.2.1 Architecture of wireless sensor node

A wireless sensor node is normally composed of one or more sensors, a processing unit, a radio frequency (RF) transceiver and one or more power supplier. Despite of what they are measuring with sensors, a node needs to process the data by a processing unit, to transmit the information to other nodes through its RF transceiver and to take care of

how much energy is available in its battery [1]. A typical architecture of sensor node is presented in Fig. 2.1.

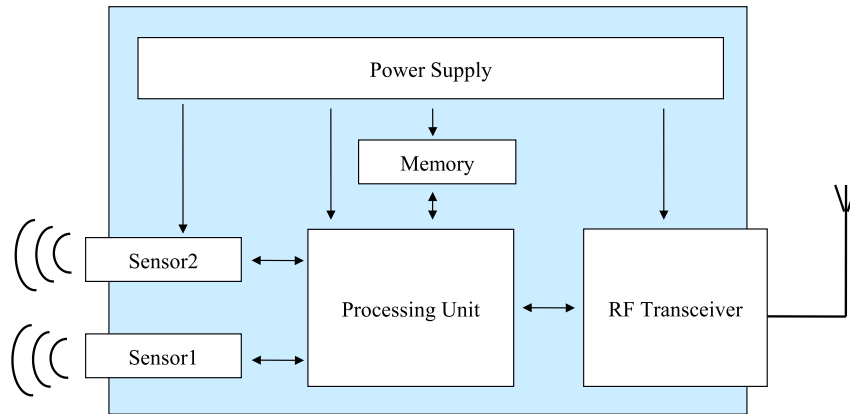

FIG. 2.1: A typical architecture of wireless sensor node

Due to the cost and size constraints of sensor nodes, replaceable or large energy resources is infeasible. The main challenge of the hardware design is to produce low cost and energy-efficient sensor nodes. Ultra-low power operation is one of the main design goals of sensor node hardware platforms [29].

Sensors used in WSN systems are devices that can measure a physical quantity and converts it into a signal which can be read by a processing unit. Various phenomena can be measured, such as sound, vibration, humidity, pressure and temperature. Because the limited power supply of wireless sensor nodes, the processing units are normally 8 or 16 bits low power microcontrollers. Benefiting from the high growth of large scale integrated circuit, current RF transceivers can provide more complete implementation of wireless communication, normally including full hardware support of low level protocols (e.g., physical layer) and partially support of high level protocols (e.g., media access control and network). Currently, frequencies used for WSN mainly include 315 MHz, 433 MHz, 868 MHz (Europe), 915 MHz (North America) and 2.45-GHz frequency band.

2.2.2 Hardware platforms

Many wireless sensor nodes have been developed by both academic organizations and commercial companies. Each node has its own capabilities and features such as power consumption, communication protocol support. An overview of commonly used sensor node hardware platforms is available in [41]. Some typical platforms have been summarized in Table 2.1.

Motes developed at the University of California, Berkeley and commercialized through Crossbow Technology Inc., such as MICA and Telos series, have been widely used through their flexible interfacing, small size and reasonable cost. A good background to the family of motes is given by Polastre et al. [29]. TelosB is a low-power MSP430-based platform. Imote2 is a high-bandwidth sensing platform featuring an enhanced processor and larger memory. BTnode features in two different RF transceivers in the same node, Bluetooth supported Zeevo ZV4002 and low power CC1000. It has also been used in many applications, such as the remotely monitor of the physiological signals of a patient [46].

2.3 Communication Protocols

A wireless sensor network consists of numerous sensor nodes that are usually scattered in a sensor field. Sensor nodes measure some environmental parameters and send the data to a sink. The sink is a node that is in charge of collecting the sensor data of nodes and sending the collected data to a base station through Internet or satellite networks. If the sink is located out of the propagation range of a sensor node, some other nodes are used to route the packet to its destination.

Communication protocols are fundamental to the research and design of WSN systems. In this section, the architecture of WSN protocol stack is investigated and a brief summary of existing protocols commonly used in each stack layer is presented. At the same time, two widely adapted standards (ZigBee [11], IEEE 802.15.4-2006 [15]) are introduced.

TAB. 2.1: *Wireless sensor hardware platforms*

Motes	MICA2 [27]	MICAz [42]	TelosB [43]	Imote2 [44]	BTnode [45]
<i>Microcontroller</i>					
Type	Atmega128L	ATmega128L	TI MSP430	Intel PXA271 XScale	ATmega128L
System Clock (MHz)	7.3728	7.3728	8	4 - 416	7.3728
Program memory (KB)	128	128	48	32000	128
RAM(KB)	4	4	10	32000	4
Sleep Current (μ A)	0.3	0.3	5.1	390 [44]	0.3
Active Current (mA)	9	9	1.8	31 [44]	9
<i>Transceiver</i>					
type	CC1000	CC2420	CC2420	CC2420	Zeevo ZV4002 & CC1000
protocol standard	n/a	IEEE 802.15.4	IEEE 802.15.4	Bluetooth	IEEE 802.15.4
frequency band	315, 433 or 868/916 MHz	2.4 GHz	2.4GHz	2.4GHz	2.4GHz & 315, 433 or 868/916 MHz
Data Rate (kbps)	38.4	250	250	250	n/a & 38.4
Modulation Type	FSK	O-QPSK	O-QPSK	O-QPSK	n/a & FSK
Sleep Current (μ A)	0.2	20	20	20	9900 (CPU on, radio off) [45]& 0.2
Idle Current (μ A)	n/a	426	426	426	n/a & n/a
Receive Current (mA)	7.4	18.8	18.8	18.8	102.3 (CPU on) [45]& 7.4
Transmit Current at 0dBm (mA)	10.4	17.4	17.4	17.4	102.3(CPU on) [45]& 10.4
<i>Node</i>					
Min Vin (V)	2.7	2.7	n/a	0.85	0.85 [45]
Remarks	first widely-used commercial mote	first IEEE 802.15.4 support mote	energy-efficient microcontroller	powerful processor	Bluetooth support

The values without references are from the data sheet of each component.
n/a refers to that this value can not be found in the relative data sheet.

2.3.1 Introduction to Protocol Stacks

The protocol stacks are developed to facilitate the implementation of protocols. Protocol stacks have been used for decades, providing a method of formally structuring the functionality of a networking through the use of multiple layers [47]. Each implementing distinct networking tasks and providing services to its upper layer [48]. By doing this, the details and complexity of the actual layer implementation is hidden from different layers. There are many protocol stack models have been proposed. The number, contents and function of layers differs between models. Fig. 2.2 presents three most widely adopted protocol stack models in WSN.

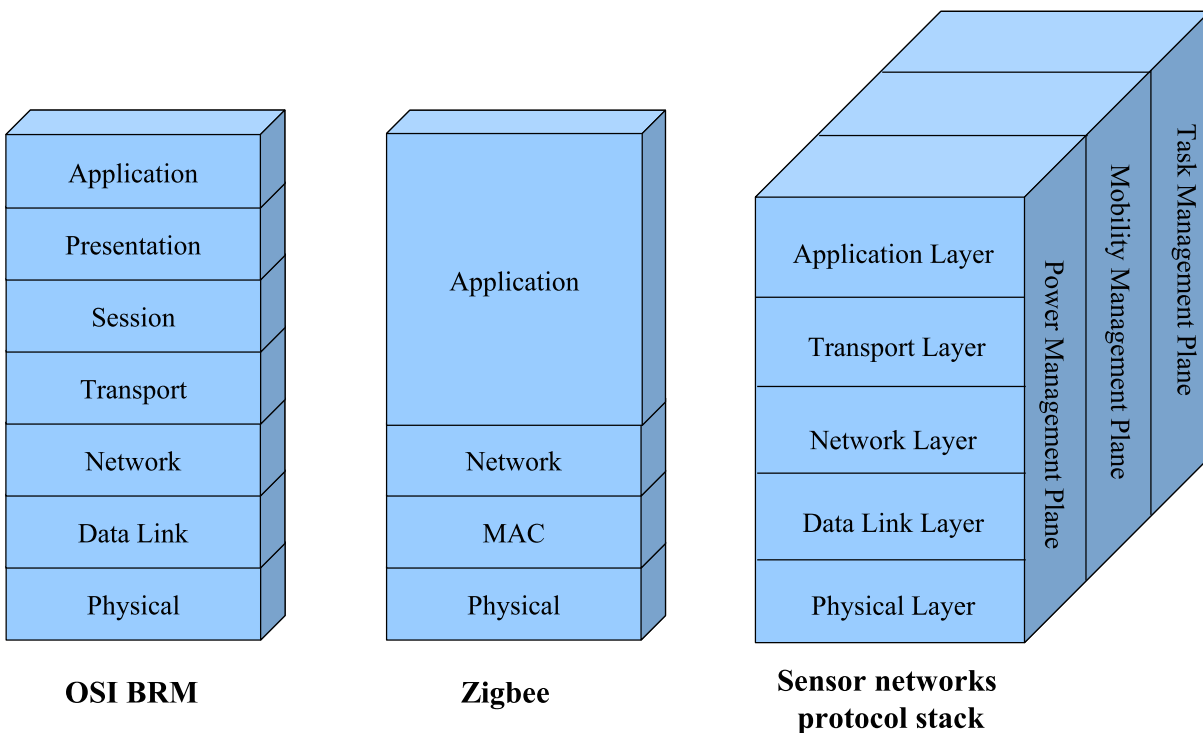

FIG. 2.2: Protocol stack models: OSI Basic Reference Model [10], Zigbee stack [11] and the sensor network protocol stack proposed in [12]

The Open Standards Interconnection Basic Reference Model (OSI BRM) [10] proposes a basic layered structure for communication protocols of general computer networks. In this model, a networking system is divided into 7 layers. Within each layer, one or more entities implement its functionality. Each entity interacts directly only with the layer immediately beneath it, and provides service to its upper layer. Protocols enable an

entity in one host to interact with a corresponding entity at the same layer in another host. Many other models for specific networks are developed based on OSI BRM model.

Zigbee [11] stack is a simplified OSI BRM model that is more suitable for Low-Rate Wireless Personal Area Networks (LR-WPANs). The ZigBee standard is published and maintained by ZigBee Alliance that provides the specifications of NWK layer and application layer and adopts the IEEE 802.15.4 standard [15] as the foundations of MAC and PHY layers. The functionality of different layers in ZigBee stack are described as follows.

- *Application layer* provides an interface between users and protocols. It receives the user data and uses the underlying network layer protocols to establish host-to-host connections. It also integrates other functionalities of presentation, session and transport layers, such as the reliability of transactions by employing end-to-end retries, the rejection of the duplicate messages and the segmentation of messages longer than the payload of a single network layer frame.
 - *Network (NWK) layer* is used to enable the configurations of a network (starting a network of coordinators, joining, rejoining and leaving a network of a device), implement different routing mechanisms to efficiently exchange data in the network and ensure both the authenticity and confidentiality of a transmission.
 - *Medium Access Control (MAC) layer* defines the procedures of the channel access in order to avoid data corruptions and packet collisions. It also specifies the frame format and performs data encapsulation and decapsulation for communication between devices [49]. It ensures the reliability of transmission between two nodes by using some retransmissions such as acknowledgment (ACK) messages. In addition, it detects and possibly corrects errors that may occur in the lower Layer.
 - *Physical (PHY) layer* defines the electrical and physical specifications for devices. It is a fundamental layer underlying the logical data structures. It performs character
-

encoding, transmission, reception and decoding. It provides carrier sense and collision detection services to MAC layer.

More specific features of WSN systems are considered in the sensor network protocol stack proposed in [12]. Besides the four layers in Zigbee stack, it also keeps the transport layer of the OSI BRM model. The transport layer provides end-to-end communication services, such as connection-oriented data stream support and flow control. In addition, the power, mobility, and task management planes are used by the sensor nodes to lower their overall power consumption, manage their movement and coordinate their tasks. The implementation and optimization of these services may happen at any layer and some cross layer designs need to be considered.

In the next two subsections, an overview of state-of-the-art MAC and NWK layers is presented.

2.3.2 Medium Access Control

Limited energy resources place strict limits on the design of communication protocols and applications for WSN. Most works on MAC protocols of WSN have focused on the energy-efficient medium access techniques since the transceiver consumes a significant amount of energy and the MAC protocol has the most direct control over its utilization [14]. By applying proper MAC protocols, the energy waste can be reduced. The main sources of energy waste in MAC layer are the follows [50].

- *Collisions*: When two packets arrive at a node at the same time, a collision occurs. The packets have to be discarded and a new retransmission may be needed.
 - *Idling listening*: In many MAC protocols such as IEEE 802.11, nodes have to listen to an idle channel for possible arriving packet. Many measurements have shown that idle listening consumes 50-100% of the energy required for receiving [13] [51].
-

If sensor nodes can be scheduled to turn on their receivers periodically for receiving packets, much energy will be saved.

- *Overhearing*: Nodes may receive some packets that are not intended to them.
- *Overhead of control packet*: Control packets are necessary for the management of protocol procedure, but their usage should be optimized as minimum.

The main motivation of the MAC protocols for WSN is to reduce the energy waste. As proposed in [14] [52], they can be divided into two categories: synchronous and asynchronous approaches. In this section, both the synchronous and asynchronous MAC protocols are introduced. For each kind of protocols, many representative protocols will be discussed. Finally, the IEEE 802.15.4 MAC protocols that combine the mechanisms of both synchronous and asynchronous protocols will be presented.

2.3.2.1 Synchronous MAC Protocols

In synchronous protocols, the transmissions of different nodes are organized in an order way to avoid collisions, such as Time Division Multiple Access (TDMA), and the time and energy wasted in idle listening are decreased by scheduling the time when nodes must be awake in order to communicate.

Sensor-MAC (S-MAC) [13][53] is a synchronous MAC protocol designed explicitly for WSN. It forms virtual clusters within a network by synchronizing the sleep schedules of neighboring sensor nodes. It schedules the operations of sensor nodes of a virtual cluster into a frame format, as shown in Fig. 2.3.

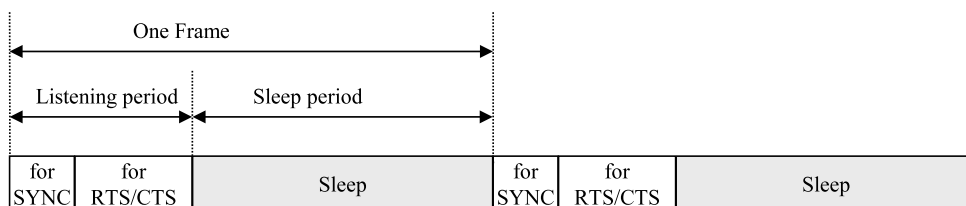

FIG. 2.3: S-MAC Frame Format [13][14]

The durations of listening and sleep periods are fixed according to different application scenarios. Sensor nodes periodically transmit SYNC messages which allow their neighbors to learn their schedules. The listening portion is divided into many time slots. To ensure only one sensor node sending the SYNC message during a frame, each node performs a carrier sense of random slots and starts sending SYNC message if it has not detected any transmission at the end of carrier sense. Before a transmission of data packet, sensor nodes use RTS (request to send) and CTS (clear to send) scheme to address the hidden terminal problems. The RTS packet contains the address of its receiver; thereby uninvolved sensor nodes can go to sleep mode after the RTS/CTS exchanging, which limits the overhearing problem. To avoid collisions, the same carrier sense procedure of sending SYNC message is applied to every transmission of RTS. In addition, every transmitted packet contains a duration field indicating how long the transmission will last. When a node receives a packet intended to other nodes, it knows how long it has to keep silent.

S-MAC provides better energy conserving properties comparing with IEEE 802.11 [13]. It also minimizes and distributes the energy drain of coordinating sensor nodes for communication evenly throughout the network. However, it has one limitation that the duty cycles of sensor nodes are fixed and can not be changed at run-time according to different traffic loads. Many improvements of S-MAC have been proposed in several protocols to address its limitations. DSMAC [54] and T-MAC [55] extend S-MAC by supporting dynamic duty cycles based on modifying the listening and sleep period lengths according to traffic and energy considerations. AC-MAC [56] uses queued messages in sensor nodes to introduce multiple data exchanges during one frame. SCP-MAC [57] reduces the duty cycle from 1-2% to 0.1% or even below by scheduled channel polling (SCP). Channel polling, also named as low-power listening (LPL), refers to the technique that allows sensor nodes to wake up very briefly to check channel activity without actually receiving data. It has been widely adopted in asynchronous MAC protocols such as WiseMAC [58] and B-MAC [59] which will be introduced in the next subsection.

The main advantages of synchronous MAC protocols are that a sensor node knows

the schedules of its neighbors so that it can start transmissions to their destinations efficiently. However, the cost of listening period is about ten times of that of polling a channel for activity, thus its overhead in lightly used networks is higher than LPL based approaches [57].

2.3.2.2 Asynchronous MAC Protocols

Asynchronous protocols attempt to reduce the probabilities of collision by using random access mechanisms, such as carrier sense multiple access (CSMA), which also allows sensor nodes to operate in distributed manner.

B-MAC (Berkeley MAC) [59] is a CSMA based asynchronous MAC protocol for low power wireless sensor networks. For sending a packet, it uses clear channel assessment (CCA) and CSMA backoff mechanism for channel arbitration. For receiving a packet, it adopts LPL for putting the receivers into sleep mode. With LPL, sensor nodes wakes up for checking the channel activities periodically. Every node operates according to its independent schedule. During a certain time, if activity is detected, it stays awake for the time required to receive the incoming packet. After reception, it returns to sleep. If no packet is received, a timeout forces the node back to sleep. To reliably receive data, a data packet should contain a preamble that is bigger than the interval of checking the channel so that the sensor node can detect its channel activity. For example, if the channel is checked every 100 ms, the preamble must be at least 100 ms. By using B-MAC protocol, the energy consumed by idle listening is minimized. However, long preamble increases the latency of data packet transmission and the power consumption of the sender and all nodes within its propagation range. In addition, the LPL approach suffers from the overhearing problem. The receivers who are not the target of the sender but located within its propagation range have to receive the long preamble and find out the packet is not intended for them at the end of preamble.

WiseMAC [58] uses the similar techniques and is developed almost at the same time as B-MAC. However, it reduces the length of preamble by having sensor nodes remember

the sampling offsets of their neighbors. Each ACK packet has an extra field indicating the time of next channel sampling so that the sender can start the transmission just before the receiver wakes up. Beside the reduction of energy consumption of long preamble listening, WiseMAC also limits the overhearing problem by the short preambles. The authors have also applied WiseMAC [60] to the downlink of infrastructure WSN. The access points that are linked with a backbone network using the WiseMAC protocol to transmit data packets. WiseMAC is not suitable for broadcasting communications, because sensor nodes are in different active/sleep schedules and the sender has to transmit a broadcasting packet many times during the active portions of different sensor nodes.

X-MAC [52] improves the performance of B-MAC by employing a series of short preambles that can reduce the time and energy waste caused by long preambles. X-MAC divide the long preamble of low power listening into many short preambles which contains a destination address field. Therefore, when non targeted nodes receive a short preamble, they can choose to go to sleep, which resolves the overhearing problem. Between two adjacent short preambles, there is a short pause that allows the receiver to send an short ACK packet back to the sender; thereby the sender can stop sending the preamble and start the data packet transmission. By using the short ACK mechanism, X-MA can achieve additional energy savings at both the sender and receiver, as well as a reduction in per-hop latency.

A key advantage of asynchronous MAC protocols is that it minimizes the overhead of listening time when there is no traffic. Moreover, the sender and receiver can be completely decoupled in their duty cycles. The distribution feature of this design removes the overhead introduced by synchronized schedules.

2.3.2.3 IEEE 802.15.4 MAC protocols

The IEEE 802.15.4 standard specifies the PHY and MAC layers that are the basis for many upper layer protocol standards (e.g., ZigBee [11] and MiWi [61]). It has been widely used in WSN application since it is designed for low data rate, short distance, and

low power consumption applications in conformity with WSN constraints. It provides both synchronous and asynchronous MAC protocols. In this section, a brief overview to IEEE 802.15.4 protocols is provided. More detailed description could be found in the standard documents [15].

IEEE 802.15.4 defines three types of logical devices, a Personal Area Network (PAN) coordinator, a coordinator and a device. The PAN coordinator is the primary controller of PAN, which initiates the network and operates often as a gateway to other networks. Coordinators collaborate with each other for executing data routing and network self-organization operations. Devices do not have data routing capability and can communicate only with coordinators.

The MAC layer controls access to the radio channel using a CSMA-CA mechanism. IEEE 802.15.4 MAC layer supports two operational modes: (1) the nonbeacon-enabled mode, where the MAC is ruled by non-slotted CSMA-CA; (2) the beacon-enabled mode, where beacons are periodically sent by the PAN coordinator to identify its PAN, to synchronize nodes, and to delimit a superframe during which all transmissions must occur. Fig. 2.4 shows all of the possible configurations.

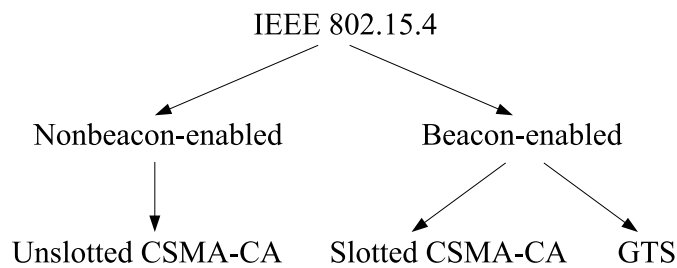

FIG. 2.4: *IEEE 802.15.4 supported operation modes and algorithms*

In nonbeacon-enabled mode, the unslotted CSMA-CA algorithm can be used. In beacon-enabled mode, there are two algorithms can be chosen, slotted CSMA/CA and guaranteed time slots (GTS). Figure 2.5 illustrates the steps of both slotted and unslotted CSMA-CA algorithms.

For the unslotted CSMA-CA algorithm, firstly, the number of backoff (NB) is initialized to 0. Then the algorithm starts counting down a random number of backoff

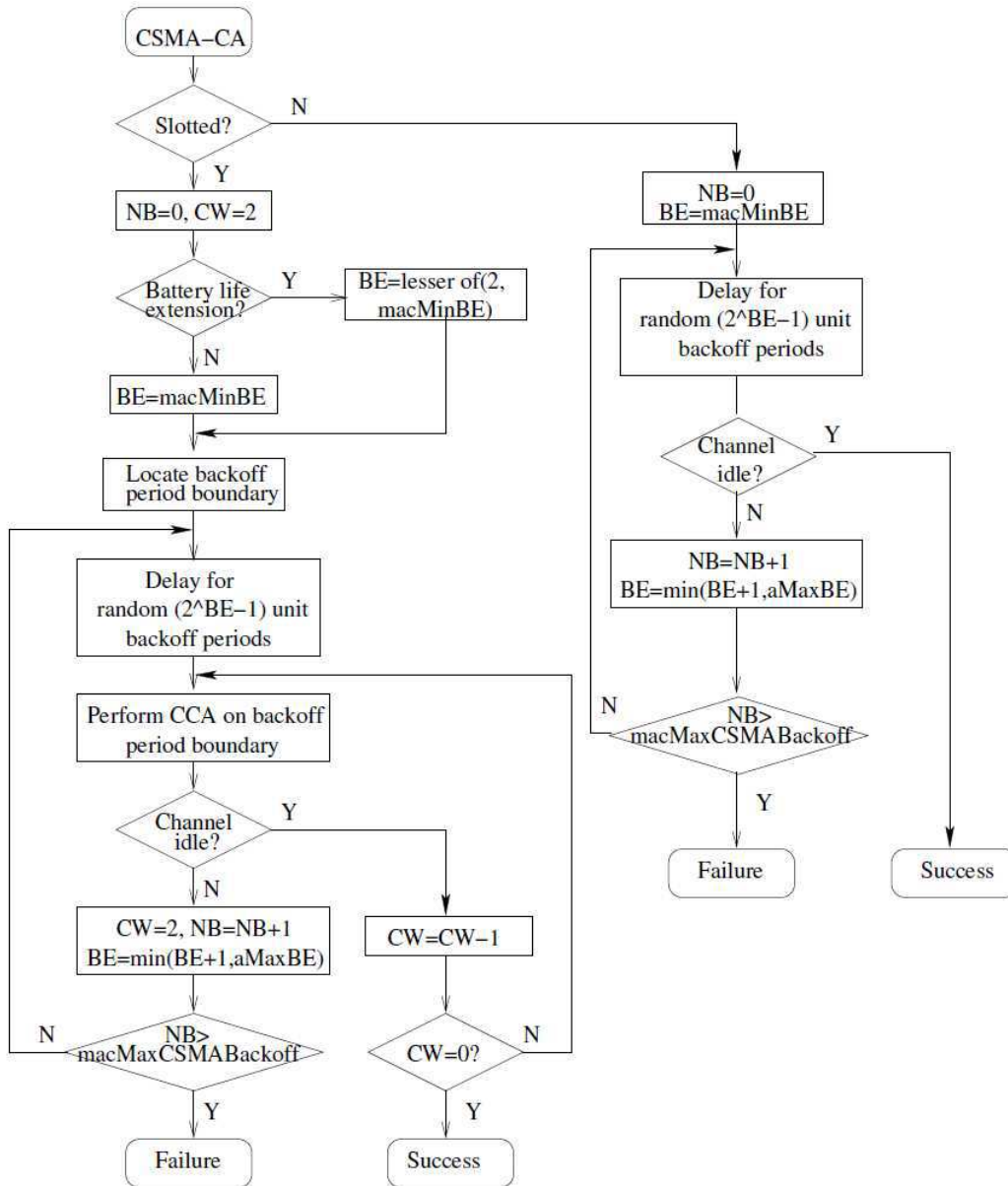

FIG. 2.5: CSMA-CA algorithm of IEEE 802.15.4 [15]

periods. A backoff period, called aUnitBackoffPeriod, is equal to 20 symbols. One symbol is the transmission time of 4 bits, which is $16 \mu\text{s}$ for a data rate of 250 kbps. When the timer expires, the algorithm performs channel assessment. If the channel is idle, the node starts transmitting; otherwise, NB is incremented. If NB does not reach the maximum number of backoff (macMaxCSMABackoff), the algorithm goes back to delay a random number of backoff periods again; otherwise, the channel access operation fails.

In slotted CSMA-CA algorithm, the operations of sensor nodes within a same PAN are

synchronized. The backoff period boundaries of every sensor node shall be aligned with a superframe slot boundaries of PAN coordinator. Additionally, all the transmissions should begin at the boundary of a backoff period. Different from unslotted CSMA-CA algorithm, unslotted CSMA-CA adopts a contention window (CW) size of 2, which requires sensor nodes to check the channel activity twice before claiming a free channel.

IEEE 802.15.4 supports beacon mode by the conception of superframe, as shown in Fig. 2.6. The beacon packets are transmitted periodically by the coordinator to synchronize the attached nodes and describe the superframe structure.

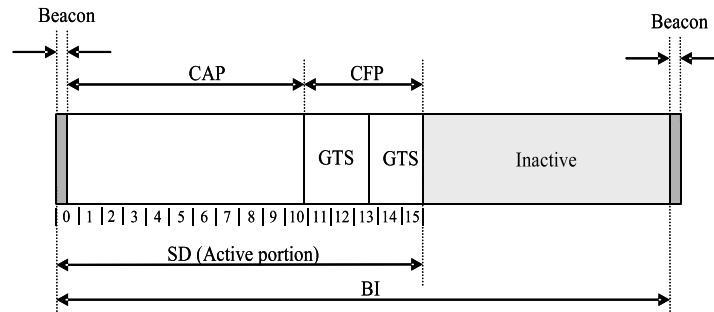

FIG. 2.6: *The typical structure of a superframe [15]*

Beacon Interval (BI) defines the superframe length, which includes an active period and, optionally, an inactive period. Superframe Duration (SD) presents the length of active period. BI and SD are determined by two parameters respectively, Beacon Order (BO) and Superframe Order (SO).

$$BI = aBaseSuperframeDuration \cdot 2^{BO}, 0 \leq BO \leq 14 \quad (2.1)$$

$$SD = aBaseSuperframeDuration \cdot 2^{SO}, 0 \leq SO \leq BO \leq 14 \quad (2.2)$$

The minimum duration of a superframe ($aBaseSuperframeDuration$) is fixed to 960 symbols corresponding to 15.36 ms, assuming 250 kbps in the 2.4 GHz frequency band. The active portion consists of two periods, namely contention access period (CAP) and contention free period (CFP). During CAP, nodes use the slotted CSMA-CA algorithm to access the channel. During CFP, many GTSs (up to 7) can be allocated, which allow

the node to operate on the channel that is dedicated exclusively to it.

In order to support applications with particular bandwidth and latency requirements, IEEE 802.15.4 offers the possibility of having a Contention Free Period (CFP) during a superframe. One CFP may include many guaranteed time slots (GTS), which allows a device to operate on the channel within a portion of the superframe that is dedicated (on the PAN) exclusively to that device. To ask a GTS usage, the node must send a GTS request command to the coordinator during CAP by using the slotted CSMA-CA algorithm. On receipt of this command, the coordinator sends an ACK. Then, the node keeps tracking the beacon frames for at most 4 superframes to verify which time slot is allocated. The information is located in the GTS descriptor field of the beacon packet. A minimum length of CAP with 440 symbols must be guaranteed in every superframe. After the GTS request is acknowledged by the coordinator, the node keeps tracking the beacon packet and sends data during its GTS slot.

The performances of four widely used MAC protocols, i.e., IEEE 802.11, TDMA, SMAC and IEEE 802.15.4, have been evaluated by NS-2 network simulator [62] in [63]. The results showed that IEEE 802.15.4 outperformed better than the other three protocols in terms of energy consumption and energy efficiency. However, it is not stable once the number of sensors nodes increases. On the other hand, the scalability of SMAC is much better.

2.3.3 Data Aggregation and Routing

In a narrow manner, data aggregation is the combination of data from different sources according to aggregation functions, e.g., duplicate suppression, minimum, maximum and average. For example, for an application measuring the average temperature of the whole network, the average function can be used at every overlapping node [64]. Another example is Directed Diffusion [65], which is a popular data aggregation paradigm for WSNs. In their experiments, a duplicate suppression function is used. Intermediate

nodes suppress duplicate location estimates.

Generally, data aggregation is defined as the process of aggregating data from multiple sensor nodes to provide fused information to the base station [66]; thus any routing protocols aggregating the data from multiple sensor nodes can be viewed as data aggregation algorithms. A more complete survey of routing protocols for WSN can be found in [67].

Network topologies can be used to facilitate the data aggregation process. In the following subsections, the basic topologies of sensor networks will be introduced and many typical routing protocols will be summarized according to different network topologies.

2.3.3.1 Network Topologies

Three basic topologies are illustrated in Fig. 2.7.

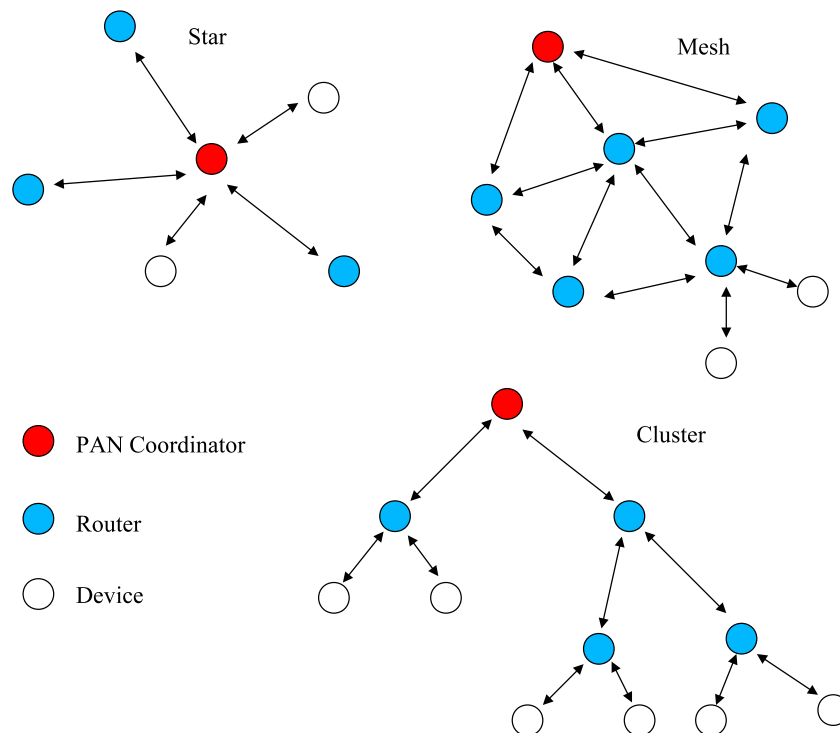

FIG. 2.7: Basic network topologies for wireless sensor network

These topologies in Fig. 2.7 are also the three topologies that the ZigBee standard [11] supports. In the star topology, every device transmits packets to the PAN coordinator

and direct transmissions between devices are not allowed. In order to extend the network coverage, multi-hop deployment is used in the mesh topology. Some routers are deployed between the PAN coordinator and the target sensor node. The routers are also normal devices, but besides sensing operations, they can also forward the packets from one sensor node to another. In the tree topology, a tree rooted at the PAN coordinator is created based on the parent-child relationships. The data of a device can be routed to the PAN coordinator through its parent node. A disadvantage of tree topology is that a failure of a router may cause a rupture of the whole route. The re-establishment of the topology may be energy consuming. Finally, in mesh topologies, direct transmissions between devices are allowed; therefore, one device can have more than one connection with other nodes and the reliability is enhanced. Mesh topology is suitable for some highly dynamic applications that require efficient self-configuration and large coverage. A disadvantage is the increased network latency due to the message relaying. The data aggregation techniques can be categorized according to the network topologies [66]: mesh and cluster topologies.

2.3.3.2 Routing Protocol for Mesh Topology

In mesh networks, each sensor node plays the same role. Data aggregation is accomplished by data-centric routing.

Flooding [68] is one classical mechanism to relay data in sensor networks. When a sensor node receives a data packet, it broadcasts this packet to all of its neighbors. This process continues until the packet arrives at the destination. A big drawback of flooding is overlap [67]. It is possible in flooding that more than two nodes sense the same region and send the same data to a coordinator.

To solve the overlap problem, a description of data should be advertised to neighbors before the transmission of real data. SPIN [69] solves this problem by data advertising. On receipt of a new packet, the router first informs its neighbors of this new sensor data. Those who are interested to this packet will retrieve the data by sending a request message.

Directed Diffusion (DD) [65] differs from SPIN in terms of the on demand data querying mechanism. In DD, the PAN coordinator queries the sensor nodes if a specific data is available.

The Ad hoc On Demand Distance Vector (AODV) routing algorithm [70] adapted in the ZigBee standard [11] is a reactive routing protocol designed for the mesh topology. Reactivity means that a connection is established only when it is needed. No predefined route needs to be maintained. When a sensor node wants to send data, it first broadcasts a request to its neighbors which will forward this message to theirs. Every node has to record the requesting node of each message. On receipt of a such message, if a node already has a route to the destination indicated in the message, it will send a message backwards through the reverse route to the requesting node which may receive several feedbacks of different routs. The requesting node will choose an efficient route according to some metrics, such as the least number of hops.

2.3.3.3 Routing Protocol for Cluster Topology

In cluster networks, hierarchical data aggregation is used. Data from different nodes are fused at routers, which reduces the number of messages transmitted to the PAN coordinator.

As a hierarchical data aggregation, Low Energy Adaptive Clustering Hierarchy (LEACH) [71] is a cluster-based protocol. It include two operations, cluster formation (the organization of network into clusters and the selection of cluster heads) and data transmission. Data is aggregated at the cluster head and sent to the PAN coordinator. To save energy, some signal processing functions may be applied by cluster head to compress the data into a single signal.

The ZigBee standard [11] also defines a routing protocol for cluster topology, named as Hierarchical routing (HERA). It is based on the MAC layer associations of IEEE 802.15.4 to perform the routing functionality. IEEE 802.15.4 MAC topology formation procedure

forms a network rooted by a PAN coordinator with some attached coordinators and devices through passive or active scan. With HERA, a sensor node sends data to its parent node and every router forwards data to its parent node until the PAN coordinator. On the other hand, the PAN coordinator-to-device communication uses an inverse route. For the device-to-device communication, packets are routed upward first to the PAN coordinator and then downward to the destination along the cluster tree. Because of the parent child relationship between nodes, synchronized communication is easy to implement. Each node only needs to maintain the synchronization with its parent coordinator. Therefore, the energy-efficient synchronized active and sleep schedule of all nodes, like the superframe based mechanism of beacon-enabled mode of IEEE 802.15.4, become possible. However, HERA suffers from the energy consuming re-association if a router fails.

2.4 Operating Systems

Due to the diversity of WSN applications and available sensor hardware platforms, an operating system is needed to facilitate users to develop complicated applications on WSN. The basic service of an operating system is to hide the low-level details of the sensor nodes by providing an easy-to-use high level interface.

2.4.1 Characteristics of WSN Operating Systems

An operating system of WSN system must provide these following basic services: hardware abstraction, task management, memory management, power management and peripheral management [72].

Besides easy programming, WSN OS has to meet other requirements exposed by the specific constraints of WSN, such as efficient execution, real-time and reprogramming. These special requirements are described as follows.

- *Efficient Execution*: Due to the limited resource (energy, memory and processing
-

capability) of sensor nodes, the WSN OSs should provide small footprint and efficient power utilization.

- *Real Time*: To provide native supports for real-time applications, the scheduler of WSN OSs assign a priority to each task and use this property to decide which task runs on the processor at a certain moment.
- *Reprogramming*: It refers to the service of changing the software or tasks of sensor nodes remotely. It is important for some large scale applications that are installed to some environments where humans are not able to attach easily [73]. Many operating systems support reprogramming directly, such as SOS [74] and Contiki [75].

2.4.2 Summary of WSN Operating Systems

Some important WSN OSs are analyzed in Table 2.2. Many essential aspects of these OSs have been summarized, including the supported hardware platforms, programming language, methods supporting concurrency, reprogramming and real time support.

Some of the operating systems are still under development and improvement, but some have been out of maintenance. However, they are studied in Table 2.2, because they have used several interesting techniques, which make them valuable as a reference. From Table 2.2, we can find that most of the operating systems support the MICA series motes designed by UC Berkeley. Benefiting from the widely spread, TinyOS have been extended to many sensor hardware platforms. Almost all the operating systems are based on C programming, except TinyOS providing its own programming language, nesC. It is an extension to C language designed to embody the structuring concepts and execution model of TinyOS [35].

Sensor nodes always need to handle multiple tasks, including analog to digital conversion of sensor signals, communication process, power management, etc. TinyOS is an event-based operating system. It provides an abstracted programming interface for sensor nodes in NesC. It handles the concurrency by asynchronous events and tasks.

TAB. 2.2: Operating Systems for Wireless Sensor Networks

OS	Maintenance	Hardware	Processing Unit	Language	Concurrency	Reprogramming	Real-time
TinyOS [35]	Yes	MICA, Telos, iMote2, etc.	ATMega128, MSP430, PIC, etc.	nesC	Event and Partial Thread	No	No
Mantis OS [76]	No	MICA2	ATMega128	C	Thread	No	No
SOS [74]	No	MICA2 and iMote2	ATMega128 and XScale PXA271	C	Event	Yes	No
Contiki [75]	Yes	MICA2 and Telos	ATMega128 and MSP430	C	Event and Thread	Yes	No
Nano-RK [77]	Yes	MicaZ and FireFly	ATMega128	C	Event	No	Yes
LiteOS [78]	Yes	MICAZ	ATMega128	C	Event and Thread	Yes	No
AmbientRT [79]	Yes	embedded devices with limited memory, processing and energy resources	MSP430	C	Thread	Yes	Yes

Users should define the event handlers. To ensure low task execution latency, individual tasks must be short; lengthy operations should be spread across multiple tasks. Unlike TinyOS, Mantis OS [76] is a thread-driven operating system. Thread can be viewed as a computational entity to accomplish an individual task. Mantis OS uses multithreading to handle the concurrency. The OS kernel maintains a thread table that holds the priority and other informations of treads. The threads are scheduled to be executed according to their priorities. LiteOS [78] is also a multi-threaded operating system that provides Unix-like abstractions for wireless sensor networks. A hierarchical file system and a wireless shell interface for user interaction using UNIX-like commands are provided.

TinyOS does not support the reprogramming directly, because a TinyOS system image is statically linked at compile time. Maté implements a virtual machine (VM) architecture that allows developers to build custom VMs on TinyOS. Reprogramming is one primary motivation for SOS [74]. It consists of dynamically-loaded modules and a common kernel. The kernel provides basic hardware abstractions and module loading functionality at run-time. Upon the kernel, modules are loaded to provide higher level functionality, such as applications. Modules can be inserted, updated, and removed from sensor nodes at run time.

Nano-RK [77] provide real-time execution of tasks by fixed-priority preemptive multitasking to ensure that the execution of each task is with a targeted deadline. Tasks proposed by processing unit, communication interface, as well as, sensor and actuator can specify their resource demands. The operating system provides timely, guaranteed and controlled access to CPU cycles and network packets. AmbientRT [79] is another real-time supported operating system for WSN. It uses EDF (Earliest deadline first) preemptive scheduling to guarantee the real-time execution of tasks. Unlike Nano-RK, the priorities of tasks do not have to be assigned in AmbientRT. It allows the assignment of priorities to tasks being done at run-time based on the timing properties of tasks, which enable a better processor utilization.

2.5 Modeling and Simulation

Three techniques have been used to evaluate the performances of WSN systems: analytical methods [80], physical testbeds [81] and simulations [82]. Many constraints imposed on sensor networks, such as limited resources, decentralized collaboration and fault tolerance, necessitate the use of complex algorithms that usually make analytical methods be impossible [83]. Additionally, although using the physical testbeds is direct, such studies also suffer some significant limitations, such as cost and scalability. It is costly and troublesome to establish a testbed for a network with thousands of nodes. However, simulation can provide a good approximation at lower cost and often in less time. For example, one application lasting 27.8 hours with a sensing interval of 10 seconds, the simulation time of NS-2 (open-source) is just 24 minutes. In addition, simulation also provides an easy-to-use debugging environment and a better insight of network behaviors. Therefore, simulation has become a common way to evaluate performances of WSN systems.

Lots of simulators for WSNs have been developed in the past few years. But different simulators may be designed to accomplish different target applications. For example, some are intended to simulate the performance of communication protocols and some may be designed to emulate the execution of the binary code. Therefore it is important to find out their similarities and differences. Based on an elaborate study of WSN simulations and the existing simulation tools, we proposed a classification scheme that categorizes the existing simulation tools into four classes. According to the taxonomy, a comprehensive study of the existing simulation tools for WSN will be made.

In this section, the modeling and simulation of WSN system are investigated. In section 2.5.1, the requirements of WSN simulations are summarized. In section 2.5.2, a typical model of WSN system is provided. In section 2.5.3, a taxonomy of existing WSN simulation tools is proposed. According to this taxonomy, the current WSN simulators are categorized into four classes. Finally, in section 2.5.4, a survey of existing WSN simulation

tools is presented.

2.5.1 Requirements of WSN Modeling and Simulation

By taking into account of the special characteristics of WSN systems and the requirements of different WSN design fields (e.g. communication protocol design, application design and node system design), we summarized the following six key requirements that are important to a WSN simulation framework:

- *Fidelity*: The main purpose of simulation is to model the real-world system faithfully and predict the system's behavior. For WSN, it requires accurate models of radio channels, physical environment and node system. Inaccurate simulation may lead to erroneous conclusions. For example, an ideal battery model usually treats the battery as a reservoir of energy from which the energy consumption can be subtracted. However, this is not accurate as a real battery that shows non-linear discharge behavior and recovery effects. It is proved that the accuracy of battery models can affect the route fluctuations and routing overheads [84].
 - *Scalability*: Because nodes are often deployed in large quantities in many WSN applications, the simulator should well support the scalability. The simulation time should be short.
 - *Energy aware*: Due to the limited power supply on sensor nodes, network designers need to obtain accurate power consumption and timing figures to tune their applications before the deployment in real environments [85]. Therefore, the simulator shall be able to accurately capture the energy consumption and timing information of HW/SW operations and radio communication.
 - *Extensibility*: It shall be easy to modify the existing modules or integrate some new ones. A careful structure with clean interfaces and high modularity allows the users to easily add or change functionality.
-

- *Heterogeneity Support*: Many recently deployed WSN systems are heterogeneous systems, incorporating a mixture of elements with widely varying capabilities [86]. Therefore, modeling different kinds of nodes and managing the interconnections among them are necessary in WSN simulations.
- *Easy to use*: A graphical user interface (GUI) can facilitate and speed the establishment of the network topology and the composition of basic modules. It can also allow the quick visualization of the simulation results. In addition, it supports to trace and debug the simulation at real time. Non-specialist users can get an easier control of the simulation by using GUI.

There is always a tradeoff between fidelity and scalability [82]. Better fidelity involves more complex and detailed modeling. However, the simulators need more time to deal with the additional detail. The simulation time may become intolerable if the number of nodes is very large in some WSN applications. Thus, the high level abstraction is sometimes more suitable for implementing the simulation with proper complexity and little running time, and their results are detailed enough to answer the design questions at an early stages of design flow. For example, at the beginning of a system design, the need to quickly explore a variety of alternatives is more important than a detailed result for a specific scenario. The challenge is to identify which level of detail does not affect answers to the design questions at hand.

2.5.2 A Typical Model of WSN System

WSN mainly involves three parts: node system, network and physical environment. A typical model of WSN system is presented in Figure 2.8.

In this model, the node system is composed of two parts: hardware and software. The hardware platform consists of processing unit, RF transceiver, sensor and battery. The software model includes operating system, protocol stack, application software implementation and so on. Nodes are connected to each other by the wireless network

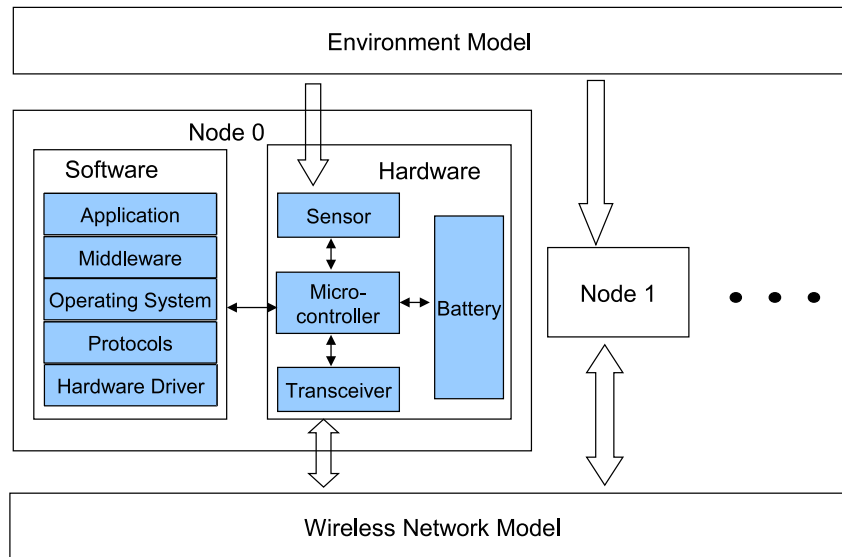

FIG. 2.8: A Typical Model of WSN System

model that holds the network topology and transfers packets among nodes. It also implements many radio frequency channel models. The environment model specifies how the physical parameters in the environment vary in both spatial and temporal sense.

2.5.3 A Taxonomy of WSN Simulation Tools

Environment modeling of WSNs is still at the beginning of development. A more detailed description of environment modeling can be found in [21]. Since only few simulators have addressed environment modeling well, our taxonomy will not treat it as a determinant. We mainly focus on the node system and network modeling.

Simulation has been used in both node system and protocol designs to help the designer easily evaluate their new designs. At the beginning, these two aspects are addressed by different people with different knowledge and tools. In the context of node system design, the aim is to design the nodes' hardware, to implement the software running on the hardware and to co-design the hardware and software (HW/SW) of a single node[87] [88]. The network performance of these nodes can not be simulated in this stage. In the context of protocol design, the tools model the protocols, manage the concurrency among different nodes, and simulate the throughput of the network. The protocol designers often

make simple assumptions to the behavior of hardware and software, but this may be not detailed enough for some applications. For example, timing information in instruction granularity shall be considered to the fast routing lookups [89]. In addition, it is better to compress the data by processing them in local CPU rather than transmitting the raw data to the destination node in some applications, since wireless communication is a major energy consumer during the system operation [90]. Simulations shall be able to help the designer find a balance between the wireless communication and the local processing. Therefore, WSN simulations require designers to integrate the node system and the network simulation together.

A common way to evaluate the WSN system is to add sensor node models to the network simulators (e.g. NS-2 [62] and OMNeT++ [91]). There are two kinds of node model: node models implemented by the network simulators and node emulators. The latter refers to the instruction level simulators of the nodes' microcontrollers or operating system emulators.

Besides adding node models to the network simulators, we can also model the network in the node system design tools (e.g. SCNSL [4]) or in the node emulator (e.g. Aurora [92]). Therefore, the existing efforts in WSN evaluation can be divided into four categories: network simulators with node models (NSNM), network simulators with node emulators (NSNE), node system simulator with network models (NSSNM) and node emulators with network models (NENM).

NSNM emphasizes more on discrete event scheduling, the radio medium, network modeling and perhaps the sleep duty cycles of the sensor node. Network modeling is the predominate object. Many node models implemented by NSNM are simple power and estimated timing profiles.

NSNE integrates the advantages of both the network simulators and node emulators. The network simulator provides the detailed network model. The node emulator gives accurate timing information of the software execution because they simulate the system performance with instruction cycle granularity. But the interconnection between the

network simulator and node emulator may take much time.

In NSSNM, the node system is often modeled by System-Level Description Languages (SLDL), such as SystemC [9]. NSSNM has a simulation kernel which supports modeling the concurrency and synchronization among different hardware components. SLDL can also model the software, which allows the HW/SW co-design and co-simulation. It models the node hardware in different abstraction level with different degrees of detail (e.g. system level, transaction level and register transfer level).

The node emulators of NENM can be divided into two different sets: instruction set simulators (ISS) for special microcontrollers and emulators designed to emulate the execution of the application code of an operating system (e.g. TinyOS [35], SOS [74] and Contiki [75]). They can provide high timing accuracy of software execution. The embedded software developed for physical platforms can be executed directly in the simulation framework with little or no modifications.

2.5.4 A Survey of WSN Simulation Tools

In this section, we will analyze the existing simulation tools according to classification scheme of the taxonomy presented in section 2.5.3. The existing simulation tools are divided to four classes. In each category, many simulators will be studied to demonstrate their common features.

2.5.4.1 Network Simulators with Node Models

Many general-purpose network simulators, such as NS-2 [62], OMNeT++ [91], OPNET [93], GloMoSim [48] and J-Sim [94], have been utilized in WSN simulations. Some extensions have been applied to them to introduce the WSN specific characteristics. Besides the extensions to general-purpose network simulators, some WSN-specific network simulators have also been developed.

NS-2 [62] is a discrete event, object-oriented, general purpose network simulator.

Simulations are written by C++ and OTcl (Object-oriented Tcl) languages. In general, C++ is used for implementing protocols and extending the NS-2 library. OTcl is used to create and control the simulation environment. Its extensibility has been a major contributor to its success, with protocol implementations being widely produced and developed by the research community. According to [8], it is the most used simulator in Mobile Ad hoc NETwork (MANET) research. Regarding WSN, it includes many ad-hoc and WSN specific protocols [82]. An IEEE 802.15.4 model is developed in [24]. However, NS-2 does not scale well in terms of memory usage and simulation time [95]. It also lacks detailed support to measure the energy utilization of different hardware, software, and firmware components of a WSN node [96]. SensorSim [97] is built on top of an NS-2 802.11 network model. It models the sensor node in two parts: software model (Function Model) and hardware model. The power models of different hardware components have been implemented. The state of the hardware model is changed based on the function that is carried out by the software model. Therefore, the power consumption of the whole network can be simulated. In addition, SensorSim can be interacted with real nodes. However, the CPU and sensor models have not been implemented. Furthermore, IEEE 802.11 is designed for high speed connectivity and not optimized for WSN.

OMNeT++ [91] is a component-based network simulator, with an Eclipse-based IDE and a graphical runtime environment. The IDE supports all stages of a simulation project: developing, building, configuring, running simulation models and analysing results. OMNeT++ consists of modules that communicate with message passing. Simple modules implement the atomic behavior of a model, e.g. a particular protocol. Multiple simple modules can be linked together and form a compound module. OMNeT++ provides the infrastructure to assemble simulations from these modules and configure them (NED language). OMNeT++ can be extended easily by interfaces for real-time simulation, emulation, parallel distributed simulation, SystemC integration and so on. As OMNeT++ is becoming more popular, many contributions have been added to it. The Mobility Framework (MF) [98] supports simulations of wireless and mobile networks

within OMNeT++. MF includes an 802.11 model. It can be seen as the first start point of the WSN modeling by OMNeT++. An IEEE 802.15.4 implementation by OMNeT++ can be found in [99]. PAWiS [96] [100] is an OMNeT++ based WSN simulator. Its architecture is similar to SensorSim. It can evaluate the power consumption of WSN systems with many levels of accuracy which can still be balanced with complexity. The model programmer has to insert special framework requests to the CPU module to simulate the execution time and power consumption. These requests include the estimated execution time of the firmware code on the CPU.

WSNet [101] is a modular-based event-driven high level wireless network simulator. It is composed of many blocks that model the properties of sensor nodes and radio medium. The sensor nodes model include the hardware and software abstraction and node behavior modeling (e.g., mobility). WSNet can be used to evaluate the high level design, such as traffic pattern, application dimensioning and protocol parameters tuning. It is one of the two simulators in Worldsens [101], an integrated environment for development and rapid prototyping of wireless sensor network applications. Worldsens also includes a low level simulator to enable the refinement of WSN application development. The cycle accurate simulator, WSim, will be introduced in the node emulator category, section 2.5.4.2.

SENSE [83] is another component-based simulator developed by C++. It models various network devices as a collection of components. Connections between each component are in the format of input and output ports. Packets are created, transmitted and received by components through the ports. Through its component-based model, SENSE can be extended easily. A new component can replace an old one if they have compatible interfaces; inheritance is not required. SENSE also supports the parallel simulation, which is provided as an option to the users.

GloMoSim [48] is a parallel simulator for WSNs. GloMoSim allows the users to select sequential or one of the 3 available parallel synchronization algorithms (null message protocol, conditional event protocol and accelerated null message protocol). Once a parallel algorithm is selected, the analyst can additionally indicate the mapping strategy

and number of processors. Taking advantage of parallel simulation, GloMoSim has been shown to scale to 10 000 nodes [102]. QualNet [103] is a commercial derivative of GloMoSim. It has extended GloMoSim to other networks, such as satellite, cellular and sensor networks. ZigBee protocol model is provided too.

Prowler [104] is an event-driven network simulator running in Matlab environment. Benefits gained from Matlab environment are easy prototyping of applications and GUI interface. Prowler is capable of simulating the radio transmission, propagation and the MAC-layer operation in ad hoc networks. The radio models are based on specific signal strength calculations combined with random errors. Prowler is well suited for protocol and algorithm development. However, it does not have sensor node energy modeling. NetTopo [105] is an integrated WSN-specific network simulator that provides the simulation of virtual WSN and the visualization of real testbeds. It also supports the interaction between the simulated WSN and real testbeds.

The main advantages of these simulators are that they usually have a rich library of the radio modules and protocol implementations. Many contributions to these tools are carried out ceaselessly. For example, the performances of NS-2 in the aspects of scalability and extensibility are improved by its successor, NS-3 [106]. It also simplified the model implementation by choosing C++ as the sole development language and the usage of Python scripting language can be optionally enable [107]. However, the network simulators are dedicated to model the network. It may be not the best way to model the node system since they are normally incapable to model the concurrency within the node and provide a direct path to HW/SW synthesis [4]. The energy consumption is usually based on some assumptions or estimations of the software execution, for example, the processor and RF transceiver of a sensor node have same operating state, but in fact the processor can be in sleep mode when the RF transceiver is listening to the channel and woken up by the RF transceiver when the latter receives a packet. As presented in [99], most of the energy models of simulations at network level are not complete. The problems are the following.

- Some energy models assume that the radio consumes the same power in idle listening as in receiving state and they are ignoring the energy consumption in sleeping state.
- Few simulation models take into account the transition energy cost for switching between the radio operational states.
- The energy consumption of the micro controller is frequently not considered, or the power profile is very simple (just active and inactive states).

2.5.4.2 Node Emulators with Network Models

Two kinds of node emulator, operating system emulator and instruction set simulator, are studied separately in this section. One special simulator providing the both features will be presented too.

TOSSIM [108] and PowerTOSSIM [85] are two emulators designed to emulate the execution of TinyOS [35]. Software development for WSN can be simplified by using these emulators. They permit developing algorithms, studying system behaviors and observing interactions among the nodes in a controlled environment. The application code of TinyOS can be compiled to the simulation framework by only replacing a few low-level TinyOS components that deal with hardware. TOSSIM can capture the behavior of the network of thousands of TinyOS nodes at bit granularity. TOSSIM allows developer to easily transition between running an application on motes and in the simulation environment. PowerTOSSIM is an extension to TOSSIM in evaluation of the power consumption. The main problem of such frameworks is that the user is constrained to a specific platform (typically MICA motes) and a single programming language (typically TinyOS/NesC) [100]. In addition, TOSSIM loses the fine-grained timing and interrupt properties of the code that can be important when the application runs on the hardware and interacts with other nodes [92].

AEMU [109] is an instruction-level cycle-accurate emulator for WSN written in C. It simulates programs of each individual node with accuracy down to the clock cycle. Its core

is an ISS. Along with support for the AVR processor, it also includes support for other peripheral devices on the MICA2 sensor node platform, such as the transceiver. ATEMU provides a GUI, called Xatdb, which provides users a complete system for debugging and monitoring the execution of their code. Avrora [92], written in Java, improves the performance of ATEMU in the scalability aspect. Avrora can scale to networks of up to 10000 nodes. Both ATEMU and Avrora provide a high behavioral and timing accuracy of the WSN programs. Moreover, they are both language and operating system independent. The main disadvantage of such frameworks is that they only support systems based on components that have already existed, e.g. memories and processors, like MICA motes. Unfortunately they do not cover systems containing new hardware blocks.

WSim is the low level simulator in Worldsens [101]. It is based on cycle accurate full platform simulation using microprocessor instruction driven timings. It provides many hardware block descriptions of components on the chip level. A sensor node platform can be built by describing the physical interconnection among these components. WSim can also handle real target binary code simulation and debugging. The time resolution can be at nanosecond level. By combining WSim and WSNet, Worldsens can provide a complete design flow of WSN application, from the high level design choices down to the target code implementation, debug and performance analysis.

F. Fummi et al. [110] have developed an energy-aware simulator by integrating an ISS of node's microcontroller and a functional SystemC model of the network module on SCNSL [4]. SCNSL is a networked embedded system simulator, which will be introduced in section 2.5.4.3. μ Csim is used as the ISS for the Intel 8051 microcontroller of the Texas Instruments CC2430F128 chip. Using ISS makes it possible to run the exact binary embedded software on the simulated hardware platform. The SystemC kernel is modified to communicate with the ISS through inter-process communication primitives (e.g. a socket or shared memory).

COOJA [111] is a Java-based simulator that provides both the operating system emulation and the instruction set emulation in a single framework. The Contiki operating

system [75] can be compiled to the simulation framework. It executes native code by making Java Native Interface (JNI) calls from the Java environment to a compiled Contiki system. MSPSim [112] is used as the instruction set simulator in the COOJA. MSPSim is also written in Java. It supports the Texas Instruments MSP430 microcontroller and includes some hardware peripherals such as sensor, communication ports, LEDs, and sound devices. Recently, the COOJAMSPSim platform [113] has been extended to support the TinyOS. The interoperability testing of nodes with different operating systems is realized.

The main advantage of using such tools is that the code used for emulation can also run on the real node, which reduces the effort to rewrite the code. In addition, they often provide detailed information about resource utilization. The main problems are that they are always constrained to specific hardware platforms or operating systems. Because much detail of cycle-accurate level is considered, they can not scale as well as the node system models at system level. Moreover, for new applications, it may take more time to develop the final executable code than to abstract the applications at the beginning of system design.

2.5.4.3 Node System Simulator with Network Models

Wireless SEnsor NEtwork Simulator (WISENES) [114] is developed in Specification and Description Language (SDL) [115], which is a high-level abstraction language widely-used in communication protocol design and can be converted to C code automatically. The key feature of WISENES is that its simulation models are reusable in the embedded software design for the final system. However, WISENES only contributes to the software implementation. SDL is unsuitable to model synchronous digital circuits because the SDL system behavior is defined as a network of extended finite state machines that communicate with each other using asynchronous signals [116]. On the other hand, SystemC provides native supports of HW/SW co-simulation.

Kashif Virk et al. [5] have developed a SystemC-based modeling framework for WSN.

It models the applications, real-time operating systems, sensors, processor, and transceiver at node level and signal propagations at network level. It is the first work using SystemC in WSN simulation, but the simulation result is simple. Only a MAC behavior (states of the sending and receiving tasks) waveform has been presented in [5].

ATLeS-SN (Arizona Transaction-Level Simulator for Sensor Network) [6] is a Transaction-Level Modeling (TLM) based sensor network simulation environment developed in SystemC. It models a sensor node in 3 components: application specification, network stack implementation and sensor system. The physical channel is modeled as a component. It provides an interface that can be called from sensor nodes. ATLeS-SN demonstrated the feasibility of using TLM for sensor network application, but no standard networking protocol has been implemented.

The SNOPS framework [7] is another TLM-based WSN simulator. A sensor node transmits or receives a data packet to or from an environment model by transaction exchanges. In [7], it is proved that the SNOPS framework requires 49.7% less simulation time than PAWiS [96].

SystemC Network Simulation Library (SCNSL) [4] is a networked embedded system simulator, written in SystemC and C++. It includes 3 modules: node (SystemC), node-proxy (SystemC) and network (C++). During the initialization of simulation, each node registers its information (e.g., location, TX power and RX sensitivity) at a network class which maintains the network topology and transmits packets to other nodes. The node-proxy is an interface between the network and nodes. By using Node-Proxy, nodes can be designed as pure SystemC modules so as to exploit all advantages of SystemC in HW/SW co-design and verification. SCNSL demonstrates a great perspective for system-level simulation of WSN system, but it still has some limitations such as node-level simulation without any specific hardware platform or energy model.

These simulators scale well since they usually model WSN at the system level. New hardware and software modules can be easily added to the existing library. However, the simulation results only can be used to the system level design.

2.5.4.4 Network Simulators with Node Emulators

Two main simulators have been developed in this category. Heemin Park et al. [117] have developed a unified network and node level simulation framework. They developed the Embedded Systems Power Simulator (ESyPS) by integrating sensor and radio modules into EMSIM [118]. EMSIM is an energy simulation framework for embedded systems featuring in StrongARM microprocessor and Linux OS. Then, they integrated the ESyPS with SensorSim [97]. The framework can explore the interactions between network level and node level.

Another example is sQualNet [119], which is a scalable and extensible sensor network simulation framework built on top of QualNet [103]. It uses QualNet as the network simulator and provides the emulation of the SOS operating system [74]. sQualNet allows using the QualNet's detailed models of channel, propagation, mobility, etc. The user also can use the rich protocol suite for other kinds of networks to model heterogeneous sensor networks. sQualNet introduces a sensor stack parallel to the networking stack and provides accurate simulation models for various layers in the sensor and networking stack.

These two simulators integrate the advantages of both the network simulators and node emulators. They provide accurate results about the energy consumption of the whole network. However, they are both constrained to particular hardware and operating system. Moreover, interactions between the network simulator and the node emulator have to be well maintained, which increases the simulation time and impacts the scalability.

2.5.5 Summary

Based on the above analysis of existing simulation tools for WSN, we can find that most of the simulators are implemented in general programming languages such as C++ and Java that do not support directly the hardware and software co-simulation of sensor nodes. The general network simulators mainly focus on the communication protocol abstraction. The OS emulators and ISS can accelerate the implementation of embedded

software, but they involve too much detail in low level that is not available at the early design stage. The simulations at this level normally need an executable implementation of final application and protocols. Only a few simulators designed in SLDLs, such as SystemC, can provide appropriate abstraction of final system but also with enough detailed information of hardware and software operations. In addition, SLDL modeling is compatible to a complete top-down design flow from the network level simulation to the real implementation of final systems.

SystemC provides native support to model concurrency, pipelining, structural hierarchy, interrupts and synchronization primitives of embedded systems [3]. Benefiting from HW/SW co-simulation, SystemC is more suitable for the WSN modeling. At present, four SystemC-based WSN simulators [4, 5, 6, 7] have been developed; however, none of them has been validated with experimental measurements or evaluated comprehensively by comparing with other simulators.

To resolve this limitation, a novel SystemC-based system-level WSN simulator named IDEA1 (hierarchical DEsign pLatform for sensOr Networks Exploration) is developed. A testbed of 9 nodes has been built to validate the simulation results of IDEA1. The simulations of IDEA1 have also been compared with NS-2 which is the most used simulator in Mobile Ad hoc NETWORK (MANET) research [8].

SystemC-based IDEA1 is not only a simulator, but also a system design environment for WSN. Having a sensor node model, it is possible to evaluate its network performance. Once the requirements of final system are met, the real implementation of HW/SW components can start from this description. Contrary to WISENES focusing on the high level software and protocol abstractions, IDEA1 is designed for the HW/SW co-simulation of WSN systems. Every hardware component is modeled as an individual module in IDEA1. By doing this, the concurrencies between different components and the energy consumptions of each component can be accurately captured. For example, the communications between microcontroller and RF transceiver and the current consumptions of each operation state of main hardware component are considered in

IDEA1 simulation.

IDEA1 provides node system designers with possibilities to evaluate the network performance of novel architectures at an early stage. It also allows communication protocol researchers to simulate their proposals on new sensor nodes even if the hardware platforms are still under development.

IDEA1 is based on the SCNSL library of alpha version. The network model of IDEA1 is inherited from SCNSL; however, many novel features have been developed, which are summarized as follows.

- Emphasizing modular design, but not like ATLeS-SN, IDEA1 model a sensor node exactly according to its hardware architecture. Each hardware component is modeled as an individual module in SystemC. Different components communicate with each other through channels, for example, Serial Peripheral Interface (SPI) communications between processor and transceiver. By doing this, the energy consumption of hardware components can be accurately evaluated. Many COTS processors and transceivers have been modeled in IDEA1, such as ATMEL ATmega128, Microchip PIC16LF88, TI CC2420 and Microchip MRF24J40.
 - The software, such as applications and protocols, are implemented in separated modules which can control the operations of processor. One of the most-used WSN communication protocols, the IEEE 802.15.4 standard, has been implemented.
 - An energy model has been developed to enable the accurate energy consumption prediction. It has been calibrated by some experimental measurements.
 - The simulation results (e.g., packet delivery rate, transmission latency and energy consumption) of IDEA1 have been validated with some measurements of a testbed consisting of 9 nodes.
 - The performances of IDEA1 have been compared with NS-2 in the aspects of simulation results and simulation time.
-

- A graphical user interface (GUI) has been developed to facilitate the system configuration, the observation of network topology, and the analysis of simulation results.

2.6 Conclusion

In this chapter, the background of wireless sensor network research was investigated, including the aspects of application, sensor network hardware platforms, network architectures, operating systems and simulations of wireless sensor networks. The particular requirements of the WSN simulation were studied. A typical WSN system model was presented. Based on these, a taxonomy of WSN simulations was proposed, and a survey of the existing simulation tools for WSN was made according to the taxonomy. Most of the significant existing simulation tools with relatively widespread uses have been studied. Based on the analysis of existing sensor network simulators, their advantages and limitations are summarized. In order to improve the fidelity and performance of WSN simulations, a new simulator based on SystemC is needed to be developed and validated.

Chapter 3 :
Design and Implementation IDEA1

In this chapter, a novel system-level WSN design and simulation environment, named as IDEA1 (hierarchical DEsign plAtform for sensOr Networks Exploration), is presented. Sensor nodes are modeled in SystemC and their interconnections are implemented in C++. SystemC is a system and hardware description language that is widely-used in embedded system design; therefore, SystemC-based IDEA1 is not only a simulator, but also a system design framework for WSN. Having a sensor node model, it is possible to evaluate its network performance. Once the requirements of final system are met, the real implementation of system design can start from this description. IDEA1 provides system designers with possibilities to evaluate the network performance of novel architectures at an early stage, and it also allows communication protocol designers to simulate their proposals on new sensor nodes even if the hardware platforms are still under development.

This chapter is organized as follows. First, section 3.1 briefly introduces SystemC and Transaction Level Modeling (TLM), and their usability in the field of WSN system modeling. Second, section 3.2 describes the framework of IDEA1. Third, section 3.3 illustrates the implementation of IDEA1. Then, section 3.4 presents the simulation output. Finally, section 3.5 concludes this chapter.

3.1 Modeling Wireless Sensor Networks with SystemC

3.1.1 Introduction to SystemC

SystemC is an C++ class library for system and hardware design. It can be used by designers and architects of complex system that is a aggregation of hardware and software (HW/SW) [9]. It is designed to meet the requirements of electronic system designers to improve overall productivity [120]. It provides real productivity gains by supporting both the hardware and software co-design at a high level of abstraction. This primary performance evaluation by SystemC gives the design team a fundamental understanding

of the final system at an early stage of the design process.

3.1.1.1 Features of SystemC

The main features of SystemC are listed as follows.

- *HW/SW co-design*: Since SystemC is based on C++ language, it naturally supports modeling the embedded software. On the other hand, to model hardware, it provides necessary constructs for timing and concurrency. Therefore, it is a language that can capture the behaviors of both the hardware and software components.
- *Support for multi-level abstraction*: With SystemC, we can model a system with different levels of abstraction in a same design. For example, a system-level design can be combined with a low-level model of a part of the system [121].
- *Efficiency*: Compared with the traditional hardware description language like VHDL and Verilog, SystemC model is able to achieve a speed ten times faster than a VHDL model at the same abstraction level [122].
- *Reusability*: SystemC enables the reuse of implemented models by structural hierarchical libraries of design units and some other powerful mechanisms benefited from C++, such as inheritance, templates and overloading. Great reusability increases the speed and decreases the complexity of system model design.

3.1.1.2 SystemC Modeling Constructs

The main modeling constructors of SystemC are presented as follows.

- *Modules*: Complex embedded systems are comprised by many independently components, including both the hardware and software components. In SystemC, components are modeled by SC_MODULE class, like the *entity* in VHDL and *module* in Verilog, which implements the algorithms and processes data. A module may contain many processes and ports.
-

- *Process*: Processes can be invoked when an event occurs. There are three kinds of processes, i.e., methods, thread and cthread. The method process is executed when an event occurs. Once the execution begins it cannot be suspended. It returns control to the simulation kernel after completing execution. Thus, the action executed in a method process is completed instantaneously at a simulation time point. To the contrary, the tread process can be suspended by calling a wait() function, and it will resume execution when an event occurs or the wait time passed. If a process is in wait state, it is treated as an inactive process. Cthread is a special kind of threads that is sensitive only to the clock signal. It is useful for hardware synthesis.
- *Ports and Signals*: Ports provide modules the interfaces to communicate with other modules. Ports of different modules are connected by signals which implement the transactions between two modules. Ports and Signals can be of any data type supported by SystemC.

3.1.1.3 SystemC Simulation Kernel

SystemC simulation can be divided in three distinct major phases, includes elaboration, simulation and postprocessing [120]. All the setting and control of these phases are implemented in a `sc_main` function, which is the start point of the SystemC simulation program. During the elaboration phase, all the modules are initialized; the relative ports are connected by signals. After elaboration, the simulation execution begins with a call of the `sc_start` function. The simulation kernel will update the values of all signals and invoke all the active processes at every simulation cycle. An active process goes into the suspended state after it completes its operation or reaches a wait statement. Once all the active processes are invoked, simulator time advances a simulation cycle. Because all the active processes are invoked at the same simulator time, it creates an illusion of concurrency. Finally, when the simulator time reaches the point that the application sets, the simulation stops and all the objects are deleted. A detailed and rigorous description

and semantics of the SystemC simulation kernel can be found in [123].

3.1.2 Transaction Level Modeling

TLM has become a widely-used abstraction method to simplify the early architecture exploration of embedded systems. It can speed up the system design and allow designers to focus on the system functionalities, since unnecessary details are hidden and may be added later. As Stuart Swan stated in [124], transaction level modeling is a modeling method that models the communications by using function calls. It integrates the hardware and software development and enables early system exploration and verification.

There are two kinds of components in TLM: communication and computation components. TLM separates the details of communication components from the computation components. Communication is modeled by channels, while transaction requests take place by calling interface functions of these channel models.

TLM also supports multi-level abstraction. As defined in [125], according to the time accuracy degree of communication and computation components, TLMs can be divided into 4 categories.

- *Component-assembly model*: In this model, the communication has no time information and computation time is approximate.
- *Bus-arbitration model*: In this model, both the communication and computation time are approximate.
- *Bus-functional model*: It contains time/cycle accurate communication and approximate-timed computation.
- *Cycle-accurate computation model*: It contains cycle accurate computation and approximate-timed communication.

By these hierarchical abstractions, TLM provides an efficient design process of complex

systems that allows designers to start with a high-level behavioral model and successively refine it until a final cycle-accurate implementation is reached.

3.2 IDEA1 Framework

IDEA1 is developed in SystemC and C++. The sensor node is modeled in SystemC and the interconnections among nodes are implemented in C++. IDEA1 includes a library that contains many implementations of existing hardware platforms and communication protocols. It also provides a graphical user interface to facilitate users to configure system, control simulation and analyze results. In this section, the architecture and design framework of IDEA1 are presented.

3.2.1 Architecture of IDEA1

IDEA1 is a component-based simulation framework. Every component is modeled as an individual SystemC module communicating with each other via channels. The architecture of IDEA1 is illustrated in Fig. 3.1.

The SystemC kernel acts as the simulation engine. It schedules the execution of processes and updates the state of all modules at every simulation cycle. All active processes are invoked orderly at the same simulator time, which creates an illusion of concurrency. SystemC provides us with a function, named wait, to set relative process to inactive state until a sensitive event occurs, which can improve the simulation speed.

The node system is a composite module comprising 2 parts, hardware and software. The sensor nodes are modeled exactly as their architectures. The hardware components of a sensor node generally include a processing unit, a RF transceiver, several sensors and a battery. Each component is modeled as an individual module of SystemC. The software model consists of protocol stack and application implementations. A more detailed explanation about the node system modeling will be presented in section 3.3.1.

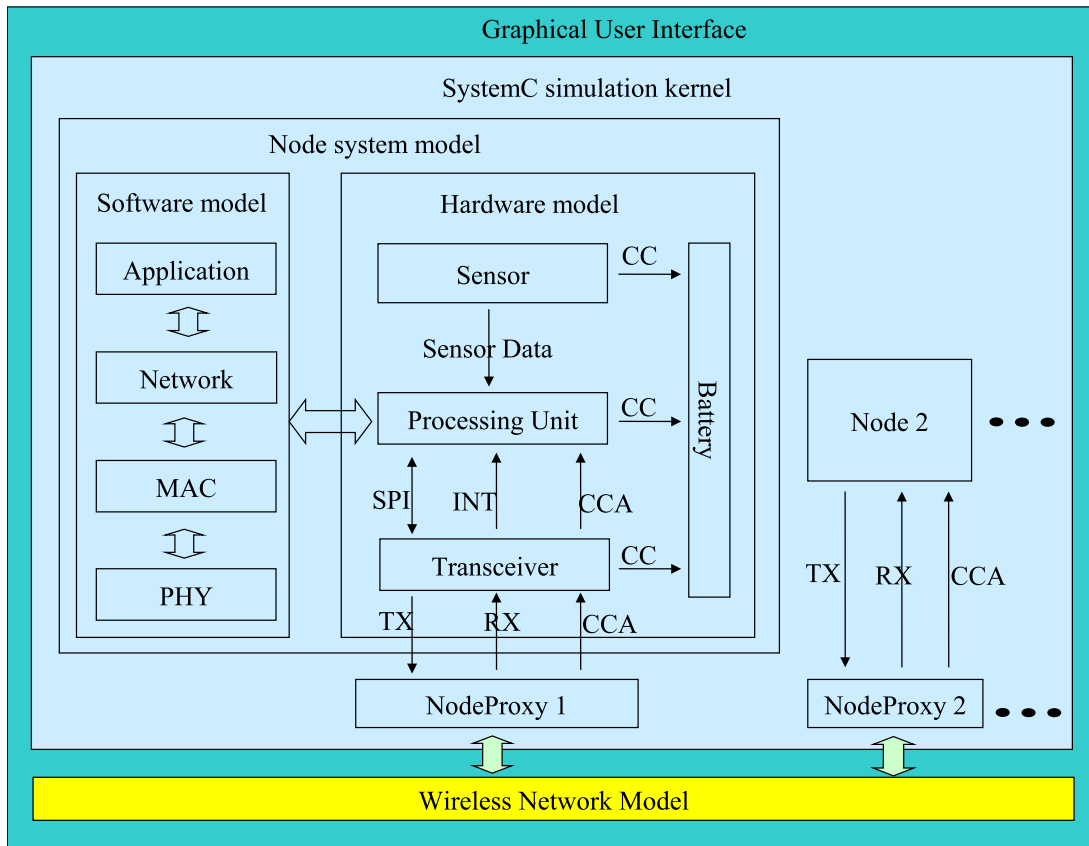

FIG. 3.1: Architecture of IDEA1

The network model of IDEA1 is inherited from SCNSL [4]. It is implemented as a pure C++ class. All nodes are connected to a same network object via their proxy modules. The network module manages the network topology, implements the radio propagation and verify the occurrence of collisions. At the initialization phase, every proxy registers its information in the network module such as position, TX power and RX sensitivity by calling a function of network class. During simulation, the network object reads the packet sent by nodes, calculates the distance between the source and its destination based on the parameters of relative nodes, and forwards the packet according to the radio propagation models. If two nodes in the radio range transmit at the same time, a collision will occur. The network class does not has the conception of time; therefore, a proxy module written in SystemC is used to enable the emulation of transmission delay by synchronizing the event with the SystemC kernel simulation cycles. By using Node-Proxy, nodes can be

designed as pure SystemC modules so as to exploit all advantages of SystemC in HW/SW co-design and verification. A more detailed description about the network modeling will be presented in section 3.3.4.

A GUI based on Qt platform [126] is developed to integrate all the parts, which can facilitate the system configuration, network topology visualization, simulation control and result analysis. Users can use graphical interface to configure the network system and analyze the simulation results. A more detailed introduction of the GUI will be provided in section 3.2.4.

3.2.2 Design Flow of IDEA1

The design flow of IDEA1 are summarized in Fig. 3.2. At the configuration stage of the simulation, user set the parameters of the targeted application in an eXtensible Markup Language (XML) file. After the configuration, the GUI can display the topology of the network before the execution of simulation. According to the topology, users can verify and modify their settings. When the executable simulation file start to run, it first read the input parameter file and set its relative variables. When the simulation finish, the results are provided in two forms: simulation log and event trace. The simulation log displays all important steps of network behaviors and the simulation results; and the event trace is recorded in a value change dump (VCD) file that tracks the state transitions of some selected modules and can be read by a waveform viewer. This design flow is a typical one that is supported by many other simulators, such as WISENES [114]. The particular feature of IDEA1 is the state tracing of every module and selected variables which can facilitate the verifications of model implementation.

Many parameters of different-levels can be configured by users, including node level, protocol level, application level, etc, as listed in Table 3.1. Application parameters describes the network compositions and application tasks. Network parameters defines the environment. The protocol can be tuned by setting the protocol parameters.

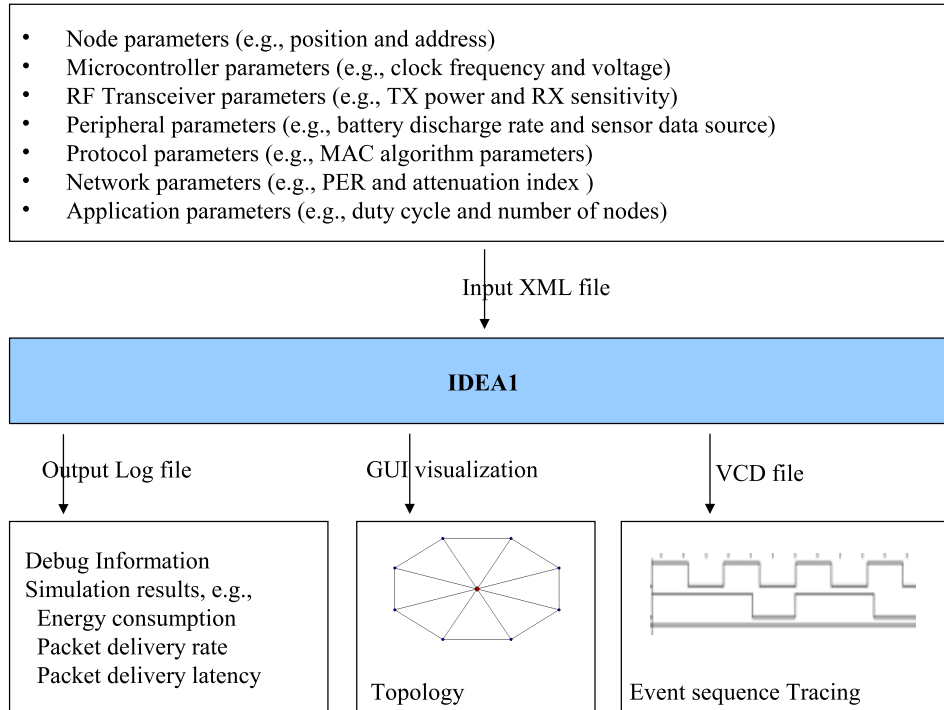

FIG. 3.2: *Design flow of IDEA1*

Node, microcontroller and transceiver parameters specify the capabilities of sensor node platforms and some behaviors of hardware components. Regarding to the implementation of simulation codes, these parameters are presented as variables which are defined as different types. For example, the data rate is stated as a float variable.

Table 3.2 presents the output results and their types. The output parameters are calculated after the simulation based on the statistics of network behaviors. They are displayed at the end of simulation log. All output parameters can be divided into four categories, i.e., packet delivery, latency, energy consumption and simulation time.

3.2.3 Current Library

Many commercial off-the-shelf (COTS) hardware platforms have been modeled, including MICA2, MICAz and N@L motes. Therefore, the microcontroller models include ATMEL ATmega128 and Microchip PIC16LF88; the RF transceiver models contain TI CC2420, TI CC1000 and Microchip MRF24J40.

TAB. 3.1: *Input parameters of IDEA1 and their types*

parameters	type (unit)	description
<i>application level</i>		
number of nodes	integer	
position of nodes	three-dimension integer array	
sensing interval	integer (μ s)	interval between two sensing
length of application	integer (s)	how long the application lasts
<i>network level</i>		
attenuation exponent	float	attenuation exponent used in radio propagation model
packet error rate	integer	packet error rate caused by channel interference
<i>protocol level</i>		
data rate	float(kbps)	
channel access algorithm	unsigned char	non-slotted CSMA-CA, slotted CSMA-CA or GTS
BO	integer	determining the length of superframe
SO	integer	determining the length of the active portion of a superframe
<i>node level</i>		
short address	2-byte integer array	short address of nodes
long address	8-byte integer array	long address of nodes
processing unit	unsigned char array	choose a microcontroller from the library for a node
transceiver	unsigned char array	choose a transceiver from the library for a node
<i>microcontroller level</i>		
clock frequency	integer array (Hz)	operating frequency
voltage	float array (V)	Vdd
ADC conversion time	float array (μ s)	the time for converting one sensor date.
SPI transmission time	float array (μ s)	the time for sending one byte to the transceiver.
data memory size	integer array (bytes)	available data memory
power model	float array (μ W)	power consumption of each operation model
<i>transceiver level</i>		
data rate	integer (bps)	data rate of transceiver
TX power	float array (dBm)	transmission power
RX sensitivity	float array (dBm)	receiving sensitivity
wake up time	integer array(μ s)	the time used to wake up from sleep mode
power model	float array (μ W)	power consumption of each operation model
<i>peripheral level</i>		
battery discharge rate	float array()	a factor impacting the lifetime of battery
initial energy	integer array(μ J)	initial energy reserve of battery
sensor data source	unsigned char	measured sensor data or random generated
power model	float array (μ W)	power consumption of each operation model

TAB. 3.2: *Outpt parameters of IDEAI and their types*

parameters	type	description
<i>packet delivery</i>		
throughput	float (bps)	average throughput of the network
packet delivery rate	float	packets successfully transmitted divided by packets transmitted
collisions	integer array	number of collision happened to a node
<i>latency</i>		
packet delivery latency	float (μ s)	average transmission latency
<i>energy consumption</i>		
energy consumption per node	float (μ J)	average energy consumption of a node
power consumption per node	float (μ W)	average power consumption of a node
power consumption per packet	float (μ W)	average power consumption for transmitting a packet
power consumption of microcontroller	float array (μ W)	power consumption of the microcontroller in a node
power consumption of microcontroller in active mode	float array (μ W)	
power consumption of microcontroller in sleep mode	float array (μ W)	
power consumption of transceiver	float array (μ W)	power consumption of the transceiver in a node
power consumption of transceiver in active mode	float array (μ W)	
power consumption of transceiver in sleep mode	float array (μ W)	
power consumption of SPI	float array (μ W)	power spent on SPI transmission between the microcontroller and transceiver of a node
power consumption of ADC	float array (μ W)	power spent on converting the sensor data of a node
network lifetime	float (s)	from the beginning to the first node died
<i>simulation time</i>		
simulation time	integer (s)	time used for running one simulation

Since the processing units of the existing generic sensor node platforms are mostly based on 8/16 bits microcontrollers [127], we mainly focus on some power-efficient microcontrollers. These hardware components can be assembled to construct some COTS hardware platforms (e.g., MICA2 [27] and MICAz [42]). As stated in section 2.1.2, MICA notes are commercially available products that have been used widely by researchers and developers. Microchip PIC16LF88 and MRF24J40 are the main part of the node developed in our laboratory, named N@L (Node@Lyon), which has been used to establish an experimental testbed for validating the simulation results of IDEA1. The N@L mote prototype is depicted in Fig. 3.3.

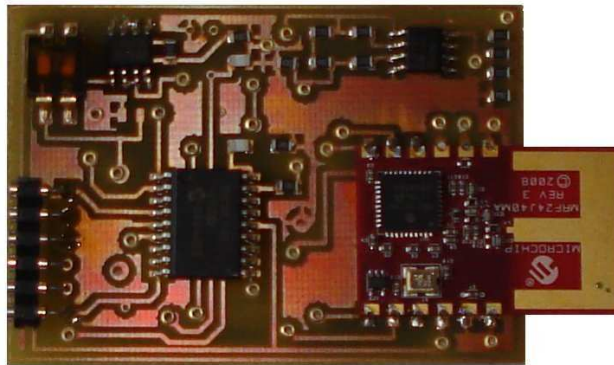

FIG. 3.3: *N@L node prototype*

It is powered by 2 AA batteries. The main feature of N@L mote is low power consumption. It is mainly composed of a PIC16LF88 microcontroller and a MRF24J40 transceiver. Its key feature is power efficient. The current consumption of active operation mode of PIC16LF88 is only 0.93-1.2mA [18]. Another feature is hardware support of IEEE 802.15.4 standard by MRF24J40.

The microcontroller communicates with the RF transceiver via a SPI bus. For transmission, the microcontroller needs to write a MAC header and sensor data to the TXFIFO of RF transceiver. MRF24J40 will automatically add a synchronization header, PHY header and Frame Check Sequence (FCS), and transmit the packet by using the IEEE 802.15.4 media access algorithms. After transmission, the RF transceiver will send the microcontroller an interrupt to report the transmission results. For receiving,

MRF24J40 calculates and verifies the cyclic redundancy check (CRC) automatically and sends an interrupt to the microcontroller to report a receipt of packet. If the packet requires an acknowledgment (ACK), MRF24J40 will send an ACK automatically. The microcontroller only needs to handle the sensing operation and read/write packets from/to the RF transceiver.

In the aspect of communication protocol, IEEE 802.15.4 has been implemented, including the three MAC algorithms (i.e., non-beacon non-slotted CSMA-CA, beacon-enabled slotted CSMA-CA and GTS algorithm). Low Rate Wireless Personal Area Network (LR-WPAN), especially IEEE 802.15.4, is intended to become an enabling technology for WSN [12][22] which stresses short range operation, low data rate, energy efficiency, and low cost.

At present, the packet frame format implemented in IDEA1 is mainly focusing on IEEE 802.15.4. The packet frame format defined in IEEE 802.15.4 standard is presented in Fig. 3.4.

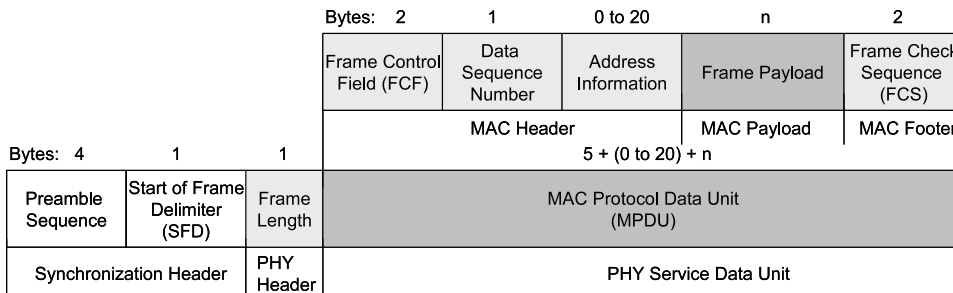

FIG. 3.4: Packet frame format of IEEE 802.15.4, redrawn from [15]

Preamble sequence is used for synchronizing messages. SFD can indicate the starting point of packet. A lot of information can be presented by the frame control field, such as packet type (e.g., data, command, beacon and ACK), security enabled, ACK request, etc. The frame check sequence is utilized for error detection and correction. The frame format is implemented as a packet structure in IDEA1. The transmissions between nodes are at packet-level in order to accelerate the simulation speed. However, the length of packet can be changed and the transmission time of packets is cycle accurate.

In recent years, many radio chips implement the communication protocols (specifications of PHY and MAC layers) by hardware; for instance, Texas Instrument (TI) CC2420 supports the IEEE 802.15.4 standard partially by hardware. Users of TI CC2420 must implement the CSMA-CA algorithms by software, such as backoff period waiting and beacon tracking. However, Microchip MRF24J40 implements the IEEE 802.15.4 completely in hardware. Users only need to load the packet frame to the TXFIFO buffer of the transceiver and trigger the transmission by sending a command from the microcontroller to transceiver, and then the transceiver will handle the transmission and report the transmission result to the microcontroller. A same function can be implemented by both hardware and software, which refers to the HW/SW partitioning problem. Due to the advantages of SystemC in HW/SW co-design and co-synthesis, we can model HW/SW at TLM level and easily handle HW/SW partitioning at lower level.

3.2.4 Graphical User Interface

The GUI is designed as a plug-in to the simulation environment so that the experienced designers can also write SystemC code directly to configure applications and control simulations. An example of IDEA1 graphical user interface is presented in Fig. 3.5.

The GUI presented in Fig. 3.5 consists of three major parts: system configuration table (top-left of the main window) managing all the system parameters that users can set the input parameters, network topology widget (top-right) showing the relative positions of all nodes and the radio connections among them, and a console (bottom) displaying the debug information and simulation log. The users first establish their WSN systems by configuring the system parameters in the system configuration table such as number of nodes, positions of nodes and protocol parameters. The connections between two nodes indicated by a solid line on the topology display window are calculated based on radio propagation models that considers many impact factor, such as positions of nodes, transmit power, receive sensitivity and attenuation factor. Then the simulation can be started by pressing the 'Run' button (light blue triangle) on the toolbar, which will trigger the execution of final

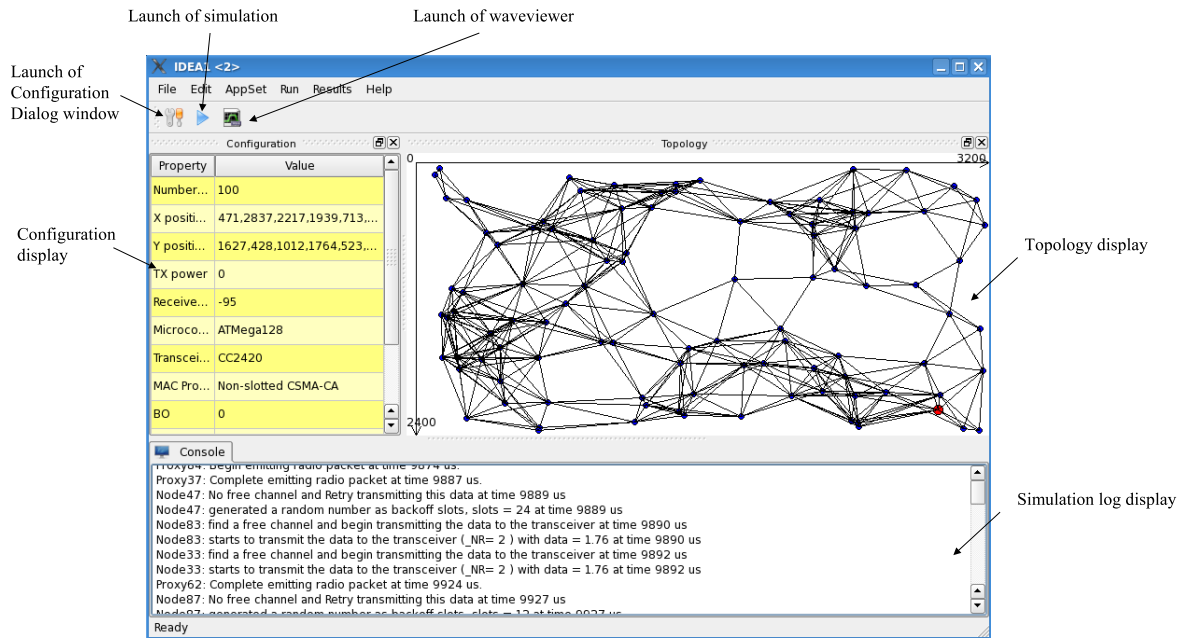

FIG. 3.5: Graphical user interface of IDEA1: A network with 100 nodes is modeled in this example

executable simulation program that will read the user setting recorded in an XML file during runtime. Finally, the simulation results are shown in the console window and the generated trace file, normally in Value Change Dump (VCD) format, can be viewed by any waveform-viewing tools.

3.2.5 IDEA1 Features

IDEA1 can quickly model the WSN system at system-level with the detailed parameters of hardware and software. As a simulator especially for WSN, it also has many other features that meet the requirements of the special characteristics of WSN. They are as follows.

- *Scalability:* The nodes are often deployed in large quantities in many WSN applications. When simulating these applications, the simulation time should not augment too much as the number of nodes increases. IDEA1 provides great scalability as a result of the system-level modeling and its efficient implementation

of SystemC code. It has been proved that the simulation speed of IDEA1 is 2 times faster than NS-2. A detailed analysis will be presented in section 4.3.3.

- *Energy aware:* IDEA1 can assess accurately the energy consumption of a single node and the lifetime of network. All the microcontroller and transceiver models in IDEA1's library are associated with an energy model based on some experimental measurements or values from datasheets. The energy models include not only the current consumptions of all the states, but also the current consumptions and timing information of the transitions between two states.
 - *Extensibility:* As an extensible simulator, it should be easy to modify the existing modules or add some new ones. The code of the existing modules in IDEA1 can be reused to develop new components by the users. In addition, IDEA1 is a component-based simulation environment, so new hardware or software modules can be easily integrated to the current library.
 - *Heterogeneity Support:* Many recently deployed WSN applications are heterogeneous systems, incorporating a mixture of elements with varying capabilities. In IDEA1, all the nodes are modeled by SystemC and they can be connected to the network model as long as they have the compatible interfaces with the network module.
 - *Compatibility to the embedded system design flow:* Node system design is always an important topic in the field of WSN. New node systems are modeled normally by SystemC at first. SystemC has become an emerging de-facto-standard for system-level modeling. Having a model of the system, it is possible to simulate and verify it. Once the model is correct, the real hardware can be synthesized starting from its description. Therefore, IDEA1 provides the node system designers the possibilities to evaluate the network performance of their new designs at an early stage. And it also allows the designers to simulate the proposed protocols on new hardware even if it has not been fabricated. The models developed for the simulation can also be
-

synthesized into lower-level designs.

- *Easy to use:* SystemC is very easy to learn if the users are familiar with C++ programming, since SystemC is a C++ library. In addition, the users can establish their system with the components in our library, so they do not have to write any code. The GUI also provides the users with some other useful functions to facilitate the control of simulation and the analysis of results.

3.3 Simulation Model Implementations

In this section, we explain the implementations of simulation models of IDEA1 in detail, including sensor node, microcontroller, transceiver, network and energy models.

3.3.1 Sensor Node Modeling

IDEA1 is a component-based simulator. Each hardware component is modeled as an individual module of SystemC. A typical model of sensor node is defined, as presented in Fig. 3.6.

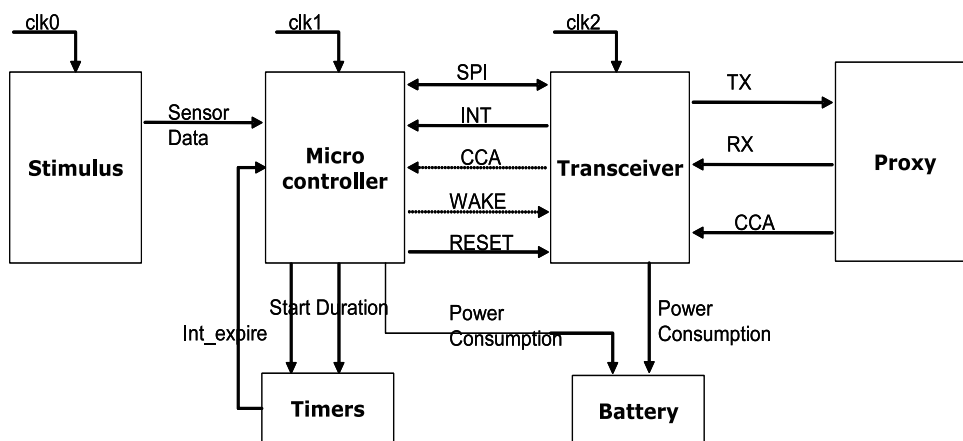

FIG. 3.6: A typical model of sensor nodes

For hardware modeling, sensor is simulated as a stimuli generator that is an interface specifying how the physical parameters in the environment vary in spatial and temporal

terms. The processing unit converts the analog signal from the sensor module into digital format by a built-in Analog to Digital Converter (ADC), processes the data and sends the packet to the RF transceiver via a Serial Peripheral Interface (SPI) bus which is a standard communication type between microcontroller and transceiver. The RF transceiver emits the packets in the network by different media access protocols. Some connections are used by the RF transceiver to report interrupts (INT) to the processing unit, such as a receipt of packet, Clear Channel Assessment (CCA), etc. The processing unit can also wake up or reset the RF transceiver by two connections relatively. The processing unit and RF transceiver are modeled as Finite State Machines (FSMs). During simulation, the state transition traces of each component are recorded. Each state of the hardware components is associated with a Current Consumption (CC) based on experimental measurements and their data sheets. The duration and current consumption of each transition between two states are also identified. Based on this information, the battery module calculates the energy consumption of each component and its residual capacity according to particular battery models (e.g., linear model, discharge rate dependent model and relaxation model [128]) during runtime.

3.3.2 Microcontroller Model

The microcontroller is modeled as a finite state machine, as presented in Fig. 3.7. The FSM of microcontroller is controlled by the interrupts generated by RF transceivers and the applications it implements. In the model presented in Fig. 3.7, the application is a typical one. The microcontroller wakes up periodically by a built-in timer in order to obtain a sensor data and try to transmit the data to its destination; in addition, it may be in IDLE state for waiting a RX interrupt from RF transceiver. When the microcontroller is in the SENSING state, it performs the sensing operation which is modeled by data generation in the sensor module and analog-to-digital conversion in the microcontroller. After conversion, it stores the sensor data in a buffer. It will go to either SLEEP or IDLE state depending on the application specifications if the data size is less than a certain

value (the payload field size of the protocol-defined packet); otherwise, it will go to TX state. In this state, the microcontroller send the sensor data to the RF transceiver via SPI when the size of sensor data is big enough to construct a packet frame. The transceiver will send the packet to its destination. The microcontroller quits the TX state until the transmission of the packet is finished, that is to say it receive a interrupt report of the transmission results from RF transceiver. After a transmission, the microcontroller may stay in TX state and transmit another packet, or it will go to SLEEP or IDLE state. When the microcontroller is in IDLE state, if a packet is received by RX transceiver, it will go to RX state for reading the packet via SPI by an interrupt from RF transceiver. If the packet is intended to other nodes, the microcontroller need to resend it to RF transceiver in order to forward it to its destination; otherwise, the microcontroller will go to SLEEP or IDLE state.

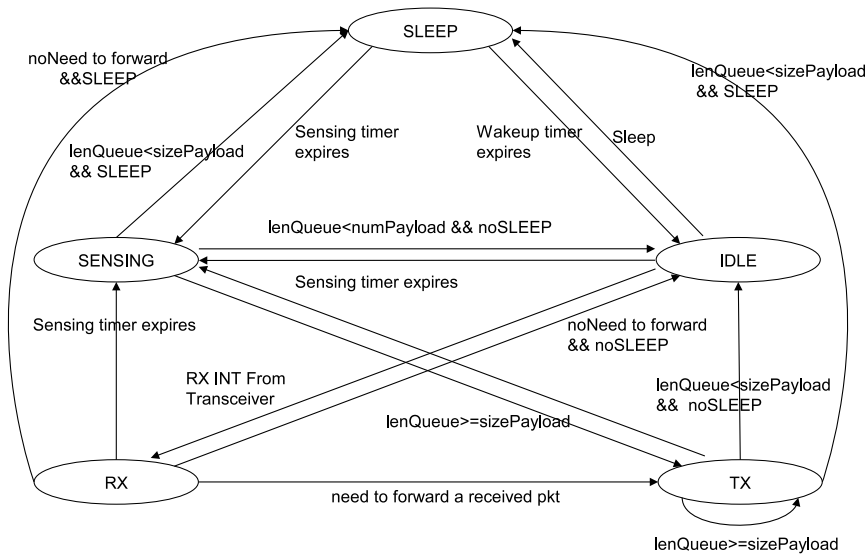

FIG. 3.7: A typical model of microcontroller

The microcontroller model presented in Fig. 3.7 is a typical one. Any specific microcontroller model can be developed based on this typical model. For specific microcontrollers, the current consumptions of each states and some timing parameters may need to be update; moreover, according to different RF transceivers, the RX and TX process may be different. It depends on the hardware implementations of communication protocols by the RF transceivers.

When the microcontroller is in TX state, the node (both microcontroller and RF transceiver) need to perform specific communication protocols in order to access the channel and avoid collisions of packet. The protocols can be implemented either by RF transceiver with hardware support or by microcontroller with software. In the latter case, the TX state of microcontroller will be divided into many sub-states. For example, if the IEEE 802.15.4 MAC protocols presented in section 2.3.2.3, the TX state will be replaced by the following sub-states, as presented in Fig. 3.8.



FIG. 3.8: State machine for microcontroller of IEEE 802.15.4 MAC protocol

In Fig. 3.8, it is an example of IEEE 802.15.4 slotted CSMA-CA algorithm. When entering to TX state, the microcontroller first backoff a random duration and check the channel. If the channel is free, it will start transmitting a packet. The backoff period boundaries should be aligned with the superframe slot boundaries and the microcontroller should ensure that the transceiver commences all of its transmissions on the boundary of a backoff period. One backoff period includes 20 symbols, corresponding to 320 μ s if

the data rate is 250kbps. For the unslotted CSMA-CA algorithm, there is no need to locate the backoff boundary and the clear channel assessment only need to be performed once. For the GTS algorithm, the algorithm is very simple, after the receipt of a beacon packet, the microcontroller wait until its slot to transmit without any backoff or CCA mechanisms.

The sensing operation has the first priority that can interrupt any task. If the sensing timer expires when a microcontroller is in other states except SENSING state, it will suspend ongoing task, start converting sensor data, and resume its old task after the sensing. If an interrupt from RF transceiver occurs when the microcontroller is in SENSING state, the interrupt will be recorded and handled after the sensing operation. In order to save energy, nodes should go to SLEEP mode as long as they have no data to send. However, the transition from SLEEP mode to ACTIVE mode of microcontroller takes some time, for example, PIC16LF88 spends 4 ms to wake up from sleep to INTOSC mode [18]. Sometimes, the interval between two consecutive sensing operations is less the transition time of microcontroller. We proposed an algorithm to handle the concurrency between the sensing and other operations, as presented in Fig. 3.9.

When the sensing timer expires, this algorithm will be invoked. If the sensing interval is less than or equal to the transition time, the nodes do not go to SLEEP mode and they set the sensing timer as the sensing interval; otherwise, they go to SLEEP mode after sensing if they do no need to send the data immediately and they set the sensing timer as a value that is the sensing interval minus the transition so that they have enough time to wake up before sensing. Nodes firstly set the timer for the next sensing operation. Secondly, they read the sensor data and wait a sensing operation duration. After sensing, the nodes store the sensor data in a buffer. If the previous state is not SLEEP, they will go to the previous state; otherwise, they will transmit a packet when the size of sensor data is bigger than the the payload field size of protocol-defined packet.

The transition from one state to another is controlled by the system configuration and network simulation. The microcontroller has to go to SENSING state whenever

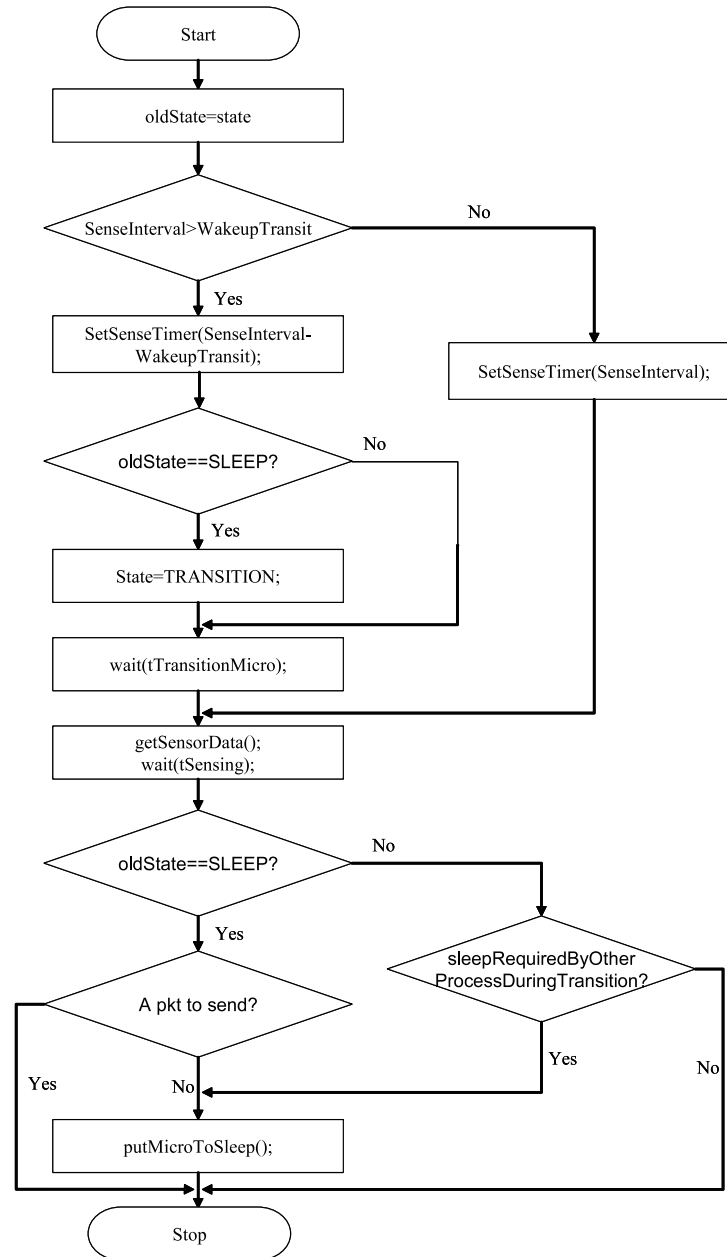

FIG. 3.9: Algorithm for handling the concurrency of sensing and other operations

the sensing timer expires, where the sample interval is an input parameter of system configuration. In addition; it will go to RX state when it receive an interrupt form RF transceiver, which is a result of network simulation. However, the time staying in SENSING and RX states is constant. They are determined by the software executions. In the SENSING state, the microcontroller performs the analog to digital conversion. In the RX state, it reading the RXFIFO of RF transceiver via SPI reading. The time of this operation depends on the SPI communications speed, the time of software configuration

of SPI hardware and the length of the packet. The time staying in TX state is determined by SPI writing and the packet transmission.

The embedded software running on microcontroller is divided into different tasks, such as analog to digital conversion and SPI communication. Before the simulations, the execution time of these tasks need to be inputted by users. The time for an analog to digital conversion or SPI communication is composed by two parts. One is the time to configure the ADC or SPI hardware by software, and the other is the conversion or communication duration of hardware.

The software execution time of each tasks can be obtained by their C or assembly codes. For some new architectures that are still under development, many execution time estimation methods for embedded systems can be applied in our model like the SystemC-based hybrid approach proposed in [129]. This approach combines the advantages of simulation-based and analytical approaches. In the first step, cycle-accurate static execution time analysis is applied at each basic block of a cross-compiled binary program using static processor models. After that, the determined timing information is back-annotated into SystemC for a fast simulation of all effects that can not be resolved statically.

At present, in the library of IDEA1, there are two microcontroller models, ATMEL ATMega128 and Microchip PIC16LF88. Some specifications of these two models will be introduced in the following two subsections.

3.3.2.1 Model of ATMEL ATMega128

In this section, the timing specifications of ADC and SPI tasks of ATMEL ATMega128 are introduced. The energy consumptions of each operation state will be presented in the energy model part, section 3.3.5.

According to the data sheet of ATMega128 [16], the ADC clock frequency should be fixed between 50 kHz and 200 kHz to get a maximum resolution; therefore, if the CPU

operation frequency is 7.3728MHz, the division factor of ADC prescaler should be set to 64 or 128 in order to get a 115.2 or 57.6 kHz ADC clock frequency; thus the conversion time to this two division factor is 217 μ s and 434 μ s. The smaller one is chosen as the value of this parameter in our simulations. The time taken by the microcontroller to configure and control the ADC hardware can be estimated by the assembly code of this task. It takes 12 clock cycles for the software ADC configuration; one analog to digital conversion is therefore 218.6 μ s.

If the SPI prescaler is set to 2 and the operating frequency of microcontroller is 7.3728 MHz, ATmega128 needs to spend 2.17 μ s to transmit one byte by SPI hardware. The configuration software execution time is calculated based on the C and assembly codes. The C code of SPI communication is presented in Listing. 3.1.

LISTING 3.1: *C code example for SPI communication of ATmega128*

```
FASTSPLSTROBE(int a)
{
    PORTB &= ~BM(CSN); //2 clock cycle
    SPDR = a; //1 clock cycle
    while (!(SPSR & BM(SPIF))); //waiting for the end of SPI communication.
    PORTB |= BM(CSN); //2 clock cycle
}
FASTSPLWRITE_FIFO(p, c)
{
    SPLENABLE(); //2 clock cycle
    SPDR = CC2420_TXFIFO; //1 clock cycle
    while (!(SPSR & BM(SPIF))); //waiting for the end of SPI communication.
    for (UINT8 spiCnt = 0; spiCnt < (c); spiCnt++) { //for loop, 18 clock
        cycle
        SPDR = ((BYTE*)(p))[spiCnt]; //1 clock cycle
        while (!(SPSR & BM(SPIF))); //waiting for the end of SPI communication.
    }
    SPL_DISABLE(); //2 clock cycle
}
```

```

BOOL basicRfSendPacket(BASIC_RF_TX_INFO *pRTI)
{
    // Write the packet to the TX FIFO
    FASTSPLWRITE_FIFO((BYTE*) &packet, frameLength);
    FASTSPLSTROBE(CC2420_STXON); //enable the transmission.
}

```

In this example, the RF transceiver is TI CC2420. It takes ATMega128 ($0.68 + 2.17$) μs to transmit one strobe command and $((0.68 + 2.17) + (2.577 + 2.17) * lengthFrame)$ μs to transmit a data frame with a length of $lengthFrame$ bytes. Unlike MRF24J40, it does not need to write the address of each byte when writing a frame of several bytes to CC2420. It only need to tell CC2420 that the frame is intended to TXFIFO and then send the frame continually. To transmit one packet, the microcontroller needs to send the data frame and a TX command to the transceiver. Therefore, ATMega128 needs $(2 * (0.68 + 2.17) + (2.577 + 2.17) * lengthFrame)$ μs to transmit a packet of $lengthFrame$ bytes to RF transceiver.

3.3.2.2 Model of Microchip PIC16LF88

In this section, the timing specifications of ADC and SPI tasks of Microchip PIC16LF88 are introduced.

An analog to digital conversion of PIC16LF88 takes $65.974\mu\text{s}$, including $54\mu\text{s}$ computation time (108 instruction cycles with 8MHz clock frequency) and $11.974\mu\text{s}$ acquisition time (Minimum Required Acquisition Time [18]). One instruction includes 4 oscillator cycles in PIC16LF88. The computation time includes the configuration of ADC hardware and read of ADC result. The C code used in this evaluation is presented in Listing. 3.2.

LISTING 3.2: C code example for analog to digital conversion of PIC16LF88

```

unsigned int ReadADC()
{

```

```

/* Initialising the ADC channel 0 */
TRISA0 = 0; //3 cycles
/* Analogue-RA0/RA1/RA3 Digital-RA2/RA5 */
ADCON1 = 0b10000100; //3 cycles
/* Selecting ADC channel */
ADCON0 = 0b00000001; // Enable ADC, 3 cycles
ADIE = 0; // Masking the interrupt, 3 cycles
ADIF = 0; // Resetting the ADC interrupt bit, 3 cycles
ADGO = 1; // Starting the ADC process, 1 cycles
while(!ADIF) continue; // Wait for conversion complete
volatile unsigned int ADC_VALUE;
ADC_VALUE = ADRESL; // Getting LSB of CCP1, 9 cycles
ADC_VALUE += (ADRESH << 8); // Getting HSB of CCP1, 60 cycles
return (ADC_VALUE); // Return the value of the ADC process, 9 cycles
}

```

The number of instruction cycle needed for each statement is also provided in Listing. 3.2. Before the start of conversion, the initialization of ADC channel and interrupt is performed. After conversion, the results is stored in a variable and returned. Note that, the while loop is waiting for the hardware conversion to be finished, which is not included in the computation time.

For the SPI communication of PIC16LF88, if the SPI prescaler is set to 4 and the operating frequency of microcontroller is 8 MHz, PIC16LF88 needs to spend 4 μ s to transmit one byte by SPI hardware. The configuration software execution time is calculated based on the C and assembly codes. The C code of SPI communication is presented in Listing. 3.3.

LISTING 3.3: C code example for SPI communication of PIC16LF88

```

void spiwrite_short(int8 address, int8 value)
{
    output_low(CS); //1 cycle
    spi_write(((address << 1) & 0b01111111) | 0x01); //8 cycles + SPI
        transmission time
}

```

```

    spi_write(value); //7 cycles + SPI transmission time
    output_high(CS); //1 cycle
}
void spiwrite_long(int16 address, int8 value)
{
    output_low(CS); //1 cycle
    spi_write(((address>>3)&0b01111111)|0x80); //22 cycles + SPI transmission
        time
    spi_write(((address<<5)&0b11100000)|0x10); //27 cycles + SPI transmission
        time
    spi_write(value); //7 cycles + SPI transmission time
    output_high(CS); //1 cycle
}
void basicRfSendPacket()
{
    spiwrite_long(TXNFIFO0,0x0A); //length of the frame payload
    spiwrite_long(TXNFIFO1,0b01100001); //frame control
    spiwrite_long(TXNFIFO2,0b10001000); //frame control
    spiwrite_long(TXNFIFO3,++nSequence); //sequence number
    spiwrite_long(TXNFIFO4,0x00); //Des address
    spiwrite_long(TXNFIFO5,0x00); //Des address
    spiwrite_long(TXNFIFO6,addNode0); //Src address
    spiwrite_long(TXNFIFO7,0x00); //Src address
    spiwrite_long(TXNFIFO8,0x11); //payload

    spiwrite_short(TXNCON,0x05); // trig data and ack required.
}

```

In this example, the RF transceiver is MRF24J40. It takes $(8.5 + 2 * 4) \mu\text{s}$ to write one byte to a register with short address of MRF24J40 RF transceiver and $(29 + 3 * 4) \mu\text{s}$ to write a register of long address. Therefore, PIC16LF88 needs $((8.5 + 2 * 4) + (29 + 3 * 4) * \text{lengthFrame}) \mu\text{s}$ to transmit a packet of *lengthFrame* bytes to RF transceiver, including *lengthFrame* writes of long address register to load the frame to the TXFIFO of

RF transceiver and one write of short address register (Transmit Normal FIFO Control Register of MRF24J40) to enable the transmission.

3.3.3 Transceiver Model

The state transition of RF transceiver is triggered by three types of events, including protocol implemented, microcontroller commands and network events. Different transceivers may have various protocols implemented. However, for microcontroller commands and network event, we have summarized some common events. Based on this, a universal model of transceivers is developed, as illustrated in Fig. 3.10.

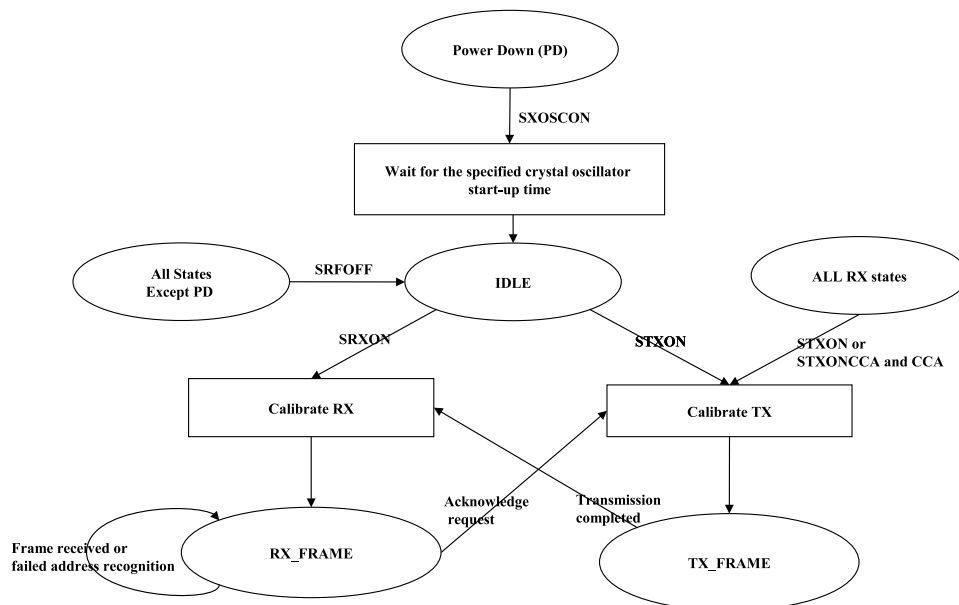

FIG. 3.10: A typical model of transceiver

The transceiver is woken up by a command of microcontroller and wait for a specified crystal oscillator start-up time to enter IDLE state. The transitions from IDLE state to RX_FRAME or TX_FRAME states are also triggered by commands of microcontroller. When a packet is received in RX_FRAME state, the transceiver may automatically go to TX_FRAME state to send back an acknowledgment if an ACK is required by the received packet.

For specific transceivers, some parameters need to be fixed, including the data

rate, data frame needed to transmit from microcontroller to transceiver and the SPI communication speed.

3.3.3.1 Transceiver Model of TI CC2420 and CC1000

TI CC2420 supports the IEEE 802.15.4 PHY layer with a 250 kbps data rate in the 2.4 GHz frequency band, but the maximum data rate of TI CC1000 is 76.8 kbps. TI CC2420 can add a preamble Sequence, start of frame delimiter and frame check sequence to the data frame automatically; however, for TI CC1000, the microcontroller needs to write these fields of packet to transceiver by SPI communication.

Because TI CC2420 and CC1000 do not implement any channel access algorithms with hardware, the models of these two transceivers are almost the same with that presented in Fig. 3.10. Two small changes have to be applied for CC1000. One is that CC1000 do not have IDLE state. It is woken up by the microcontroller and go directly to RX or TX states. The other is that CC1000 do not support automatic address check and ACK transmission.

3.3.3.2 Transceiver Model of Microchip MRF24J40

Since Microchip MRF24J40 provides hardware support of IEEE 802.15.4 MAC protocols, its models of finite state machine extend the typical model by adding some protocol based states and transitions of states. The three IEEE 802.15.4 media access algorithms has been modeled, including unslotted CSMA-CA, slotted CSMA-CA and guaranteed time slots (GTS). Therefore, three finite state machines of transceiver are developed according to these MAC algorithms.

According to the tasks of unslotted CSMA-CA algorithm, the RF transceiver has 7 states, as presented in Fig. 3.11.

The transceiver is set to sleep mode or woken up from sleep modes by commands of microcontroller. Like TI CC1000, there is no IDLE state in MRF24J40; therefore, the

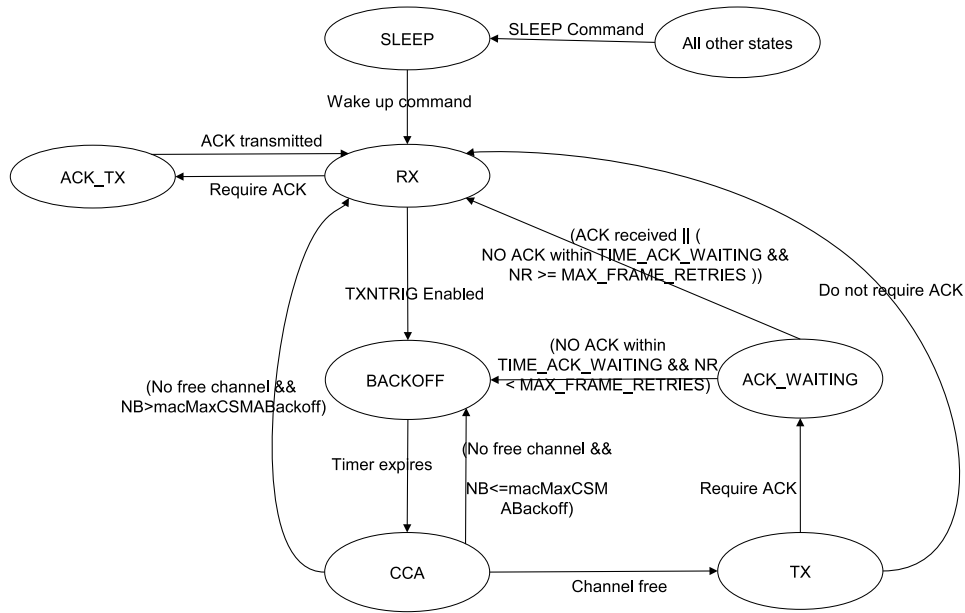

FIG. 3.11: Model of MRF24J40 in non-beacon mode with CSMA-CA algorithm

transceiver is woken up directly to RX mode. When a packet is received in RX mode, the transceiver will inform the microcontroller by an interrupt and automatically send back an ACK packet immediately if an ACK is required. If a transmission of packet is triggered by the microcontroller, the transceiver will use the unslotted CSMA-CA algorithm to transmit the packet. After the transmission of a packet, the RF transceiver waits a fixed duration for the transmission being acknowledged if the ACK request bit in the frame control field of the packet is set. The transmission is successful if the ACK is received in time. The transceiver will report the transmission results to the microcontroller and go to RX state. A transmission may fail after *macMaxCSMABackoff* times attempts of clear channel assessment or *macMaxFrameRetries* times failures of receiving an ACK packet. A failure of receiving an ACK packet may be caused by the collisions of either data packet or ACK packet. The microcontroller can set the RF transceiver to SLEEP mode from any state immediately by a command.

The process of slotted CMA-CA algorithm is similar to the unslotted algorithm except the backoff period boundaries of every node should be aligned with the superframe slot boundaries and the MAC sublayer should ensure that the PHY commences all of its transmissions on the boundary of a backoff period. The model of MRF24J40 with slotted

CSMA-CA algorithm is presented in the Fig. 3.12.

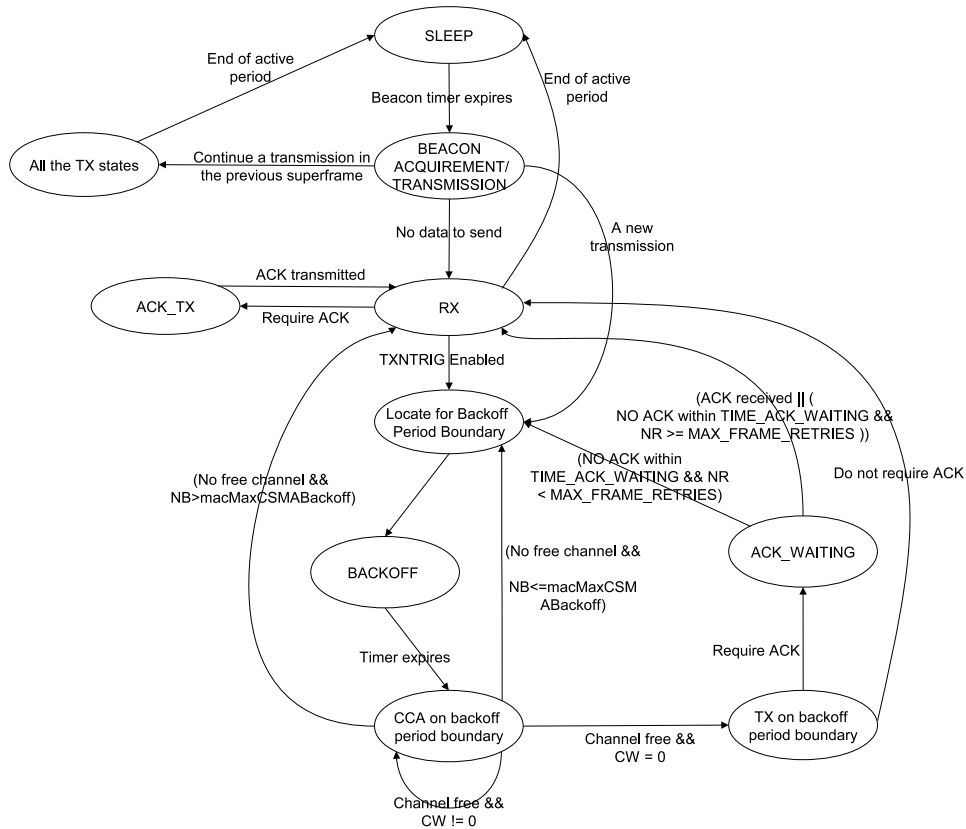

FIG. 3.12: Model of MRF24J40 in beacon mode with slotted CSMA-CA algorithm

If it is a coordinator, the BEACON ACQUIREMENT/TRANSMISSION state is to broadcast a beacon packet; for a device node, it is BEACON ACQUIREMENT. In order to send a packet, the transceiver should first receive a beacon packet to be synchronized with the coordinator. On a successful receipt of beacon packet, the node may go to RX state if it has no data to send, or it will start a new transmission by using slotted CSMA-CA algorithm. Before and after the random backoff, the transceiver should ensure that the remaining CSMA-CA operations can be undertaken before the end of the CAP. If the remaining number of backoff periods in the CAP is not enough for the random backoff, the transceiver will continue the backoff countdown and resume it at the start of the CAP in the next superframe. After the random backoff, if the remaining time is not enough for the transaction, including two CCAs, one transmission of data packet and one transmission of ACK packet, the transceiver will wait until the next superframe and perform a new random backoff delay again. Therefore, on receipt of a beacon packet, the

transceiver may go the backoff state to resume a transmission of the previous superframe.

To ask a GTS usage, the node must send a GTS request command to the coordinator during CAP by using the slotted CSMA-CA algorithm. On receipt of this command, the coordinator sends an ACK. Then, the node keeps tracking the beacon frames for at most 4 superframes to verify which time slot is allocated. The information is located in the GTS descriptor field of the beacon packet. A minimum length of CAP with 440 symbols must be guaranteed in every superframe. After the GTS request is acknowledged by the coordinator, the node keeps tracking the beacon packet and sends data during its GTS slot, as presented in Fig. 3.13.

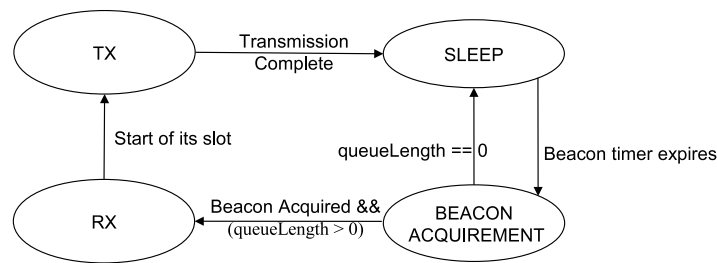

FIG. 3.13: Model of MRF24J40 in beacon mode with GTS algorithm

On a successful receipt of beacon packet, the transceiver may go back to SLEEP state if it has no data to send or it will wait until its GTS slot to transmit a packet. For the transmission of GTS algorithm, ACK is not required, because the channel is allocated exclusively to one node.

3.3.4 Network Modeling

The network model connects each node, manages the network topology and implemented the radio propagation. In this section, two questions will be answered.

- *Packet Transmission*: how a packet from one node can be transmitted to another node?
- *Radio propagation model*: what happens during the transmission?

3.3.4.1 Packet Transmission

In this section, the packet transmission process in IDEA1 is described. As stated in section 3.1.1, SystemC simulation executes in three distinct major phases, includes elaboration, simulation and postprocessing. During the elaboration phase, a network and several node objects are instantiated. Each nodeProxy object registers its information to the network object. The registered information includes its address, position, TX power and RX sensitivity. The network model establishes a two-dimension topology array based on this information and the radio propagation models. A detailed description of the implemented radio propagation models will be provided in section 3.3.4.2. As detailed in [4], the network object also contains a pointer array that points to each nodeProxy instance, which is used to send a packet to the relative nodes.

When the simulation runs, if a node, named as node A, wants to send a packet to a node B, it firstly calls a public function of the network class to calculate the transmission time of this packet. After waiting the transmission duration, the nodeProxy sends the packet to the network model. On receipt of this packet, the network model will send that packet immediately to all the nodes that are in the transmission range of the transmitter. By doing these, the transmission duration is modeled.

The network model also assign a counter to each node which is used to check the transmission validity with respect to collisions. The counter holds the numbers of active transmissions that can reach a relative nodes at a given time. If it is bigger than one, a collision occurs. When a node receives a packet, it check the destination address of that packet and accept it if the addresses match.

3.3.4.2 Radio Propagation Model

Radio propagation model is used to predict the received signal power of each packet. Every transceiver has a receiving sensitivity which is a threshold. If the power of a signal arrived at a transceiver is below the receiving sensitivity of this transceiver, it will not be able to

be successfully decoded. At present, two models have been implemented in IDEA1: the free space propagation model [130] and the ITU (International Telecommunication Union) indoor propagation model [131]. They present two typical working environments of WSN applications, i.e., indoor and outdoor scenarios. The users can choose a propagation model at the beginning of simulation by setting a system parameters. If these two models are not accurate enough for the specific applications of some users, they can add some more special radio propagation models in IDEA1.

The free space propagation model has the following form:

$$P_r(d) = \frac{P_t G_t G_r \gamma^2}{(4\pi)^2 d^2} \quad (3.1)$$

Where $P_r(d)$ presents the received power of a signal at the part of receiver which is located d meters away from the transmitter. P_t is the TX power of a signal at the part of transmitter. G_t and G_r are the antenna gains of the transmitter and the receiver respectively. γ is the wavelength.

The ITU indoor propagation model is formally expressed as:

$$L_{total} = 20 \times \log_{10} f + N \times \log_{10} d + L_f(n) - 28 \quad (3.2)$$

Where L_{total} is the total path loss. f is the transmission frequency and its unit is MHz. N is the distance power loss coefficient. L_f is the floor penetration loss factor and its unit is dB. Both the distance power loss coefficient and the floor penetration loss factor have been given some recommended values by IUT based on various measurement results which can be found in [131]. n is the number of floors between the transmitter and receiver.

3.3.5 Energy Model

Many energy models have been developed and implemented in the existing simulation tools for WSN. For example, a power model of different hardware components have

been included in SensorSim [97]. In this model, the power consumption of each hardware component is considered, but the CPU and sensor device models have not been implemented. A measured prototype power consumption model for Tampere University of Technology Wireless Sensor Network (TUTWSN) motes is provided in [132]. The power consumptions of TUTWSN mote in different operation modes (e.g., sleep, RX and TX) have been measured; however, the transition between two states has not been considered. An improved energy model [133] has been implemented in OMNeT++. In this model, both the the transition energy cost for switching between the radio operational states and the energy consumption of microcontroller have been considered. However, in the implementation of this model, the authors assume that the microcontroller follows the same sleeping schedule of the radio interface; nevertheless, the processor can be in sleep mode when the RF transceiver is listening to the channel and woken up by the latter when a packet is received. IDEA1 overcomes these limitations by component-based hardware models of sensor nodes which allow each components to operate independently.

In IDEA1, each state of the main hardware components in a sensor node is associated with a current load. The duration and current consumption of each transition between two states are also identified. During the simulation, the states of these components are updated according to software execution and network events. The energy consumed by node i can be calculated as follows.

$$\begin{aligned}
 E_i &= \sum_{j=0}^N \left(\sum_{k=0}^M E_{ijk} + \sum_{l=0}^O E_{ijl} \right) \\
 &= \sum_{j=0}^N \left(\sum_{k=0}^M V \cdot I_{ijk} \cdot t_{ijk} + \sum_{l=0}^O V \cdot I_{ijl} \cdot t_{ijl} \right)
 \end{aligned} \tag{3.3}$$

Where E_{ijk} presents the energy consumption of the k^{th} state of the j^{th} component of node i , and E_{ijl} presents the energy consumption of the l^{th} state transition of the j^{th} component of node i . The node has N components consuming energy. Each component has M states and O transitions. During the simulation, the state transition traces of each component are recorded; thus the time spent on different states and transitions, t_{ijk} and t_{ijl} , is known.

Based on this information, the battery module calculates the energy consumptions of each component as well as the network lifetime during runtime.

The current consumptions of different operation modes need to be calibrated by real measurements. A testbed has been established to calibrate the energy model and validate the simulation results. It will be described in section 4.2. In this chapter, the current consumptions of the main operation modes of the hardware components of MICAz and N@L motes are summarized according to the data sheets of their main hardware components [16][17][18][19], as presented in Table 3.3 and Table 3.4.

TAB. 3.3: *Current consumptions of MICAz mote [16][17]*

Microcontroller (ATMEL ATMega128)		Transceiver (TI CC2420)	
mode	current consumption (transition time)	mode	current consumption (transition time)
PowerDown	0.3 μ A	PowerDown	17 μ A
PowerSaving	8.9 μ A	IDLE	426 μ A
IDLE	4mA	RX	18.8mA
Active	9mA	TX(0dBm)	17.4mA
PowerSaving->Active	n/a	TX(-5dBm)	13.9mA
		TX(-10dBm)	11.2mA
		TX(-25dBm)	8.5mA
		PowerDown -> IDLE	426 μ A(1ms)
		IDLE -> RX	18.8mA(192 μ s)
		IDLE -> TX	6.7mA(192 μ s)

TAB. 3.4: *Current consumptions of N@L mote [18][19]*

Microcontroller (Microchip PIC16LF88)		Transceiver (Microchip MRF24J40)	
mode	current consumption (transition time)	mode	current consumption (transition time)
Sleep	0.01~8 μ A	Sleep	2 μ A
Active	0.93~1.2mA	RX	19mA
Sleep->Active	n/a(4mA)	TX	23mA
		SLEEP -> RX or TX	n/a(2ms)
		TX -> RX	n/a(192 μ s)
		RX -> TX	n/a(192 μ s)

In Table 3.3, the timing information and current consumptions of transitions from power saving states to Active state of the microcontroller have not been found in its data sheet. The minimum current consumption of MICAz motes is 17 μ A when the whole system is in sleep mode. The current consumption increases to 4 or 9 mA when the

microcontroller is woken up. It takes the transceiver 1 ms to wake up from power down state to IDLE state to wait for the crystal oscillator to be stable. When this mote is transmitting packets, its current consumption is 26.4 mA corresponding to 0 dBm TX power. The transceiver also needs 192 μ A to transit from IDLE to RX or TX states.

In Table 3.4, the current consumptions of the state transitions of N@L mote are not found in the data sheets of its microcontroller and transceiver. Both PIC16LF88 and MRF24J40 do not support an IDLE state. PIC16LF88 is a low power microcontroller. Its active current consumption is only 0.93~1.2 mA.

3.4 Simulation Output

There are three kinds of simulation output in IDEA1, including simulation log, event sequence tracing file and sensor data received by nodes.

3.4.1 Simulation Log

The simulation log is used to debug the model implementations and show the network behaviors. The designers can output debug information when an event occurs to verify whether this event is triggered with correct logic. An example is presented in Fig. 3.14.

In this example, we can observe a complete transmission process of the transceiver of node0. After one failed channel access, node1 delays a random number of backoff duration, and then successfully finds a free channel. On reception of the packet from Node0, the coordinator sends an acknowledgment back. After receiving the ACK packet, Node0 goes to SLEEP mode since it has no data to transmit. When the coordinator is sending an acknowledgment packet to Node0, the transceiver of node3 finds the channel is busy at 8448 μ s by CCA.

Many statistical results of network behaviors are attached at the end of simulation log, including aspects of throughput, packet delivery latency, power consumptions and

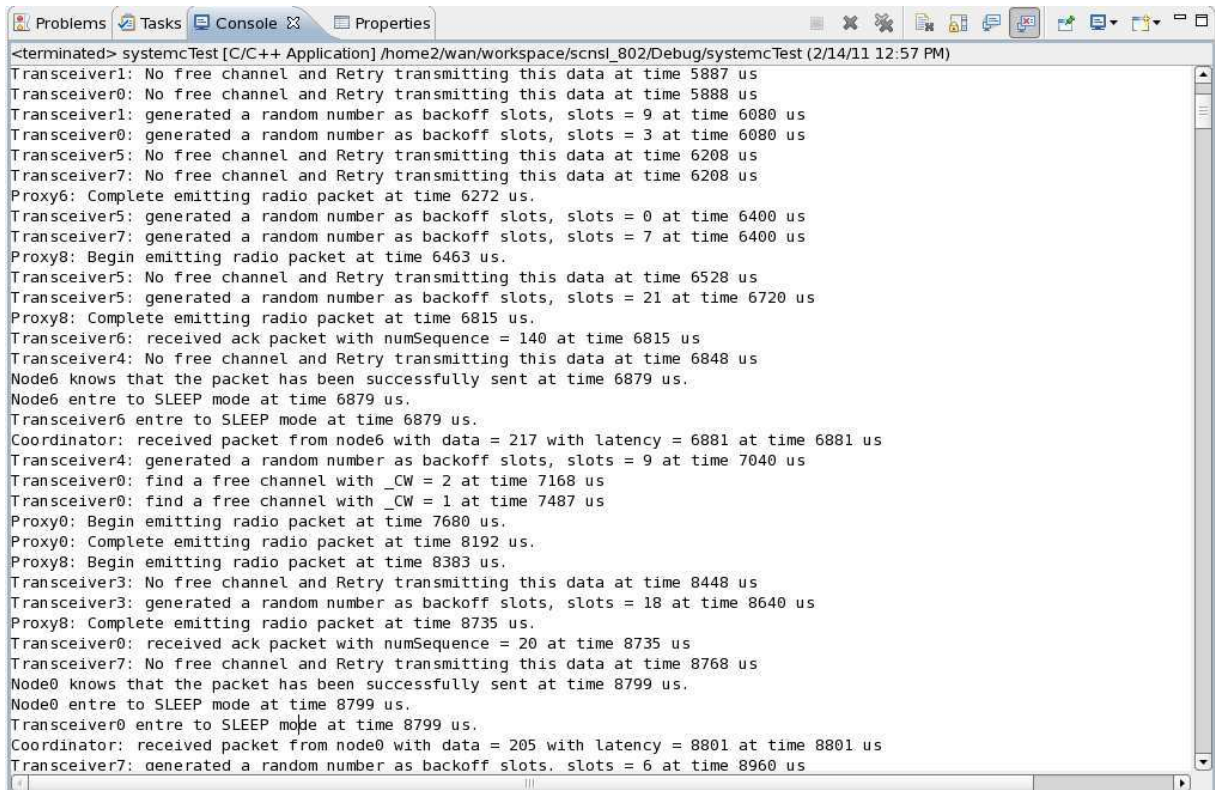

```

<terminated> systemcTest [C/C++ Application] /home2/wan/workspace/scns1_802/Debug/systemcTest (2/14/11 12:57 PM)
Transceiver1: No free channel and Retry transmitting this data at time 5887 us
Transceiver0: No free channel and Retry transmitting this data at time 5888 us
Transceiver1: generated a random number as backoff slots, slots = 9 at time 6080 us
Transceiver0: generated a random number as backoff slots, slots = 3 at time 6080 us
Transceiver5: No free channel and Retry transmitting this data at time 6208 us
Transceiver7: No free channel and Retry transmitting this data at time 6208 us
Proxy6: Complete emitting radio packet at time 6272 us.
Transceiver5: generated a random number as backoff slots, slots = 0 at time 6400 us
Transceiver7: generated a random number as backoff slots, slots = 7 at time 6400 us
Proxy8: Begin emitting radio packet at time 6463 us.
Transceiver5: No free channel and Retry transmitting this data at time 6528 us
Transceiver5: generated a random number as backoff slots, slots = 21 at time 6720 us
Proxy8: Complete emitting radio packet at time 6815 us.
Transceiver6: received ack packet with numSequence = 140 at time 6815 us
Transceiver4: No free channel and Retry transmitting this data at time 6848 us
Node6 knows that the packet has been successfully sent at time 6879 us.
Node6 entre to SLEEP mode at time 6879 us.
Transceiver6 entre to SLEEP mode at time 6879 us.
Coordinator: received packet from node6 with data = 217 with latency = 6881 at time 6881 us
Transceiver4: generated a random number as backoff slots, slots = 9 at time 7040 us
Transceiver0: find a free channel with _CW = 2 at time 7168 us
Transceiver0: find a free channel with _CW = 1 at time 7487 us
Proxy0: Begin emitting radio packet at time 7680 us.
Proxy0: Complete emitting radio packet at time 8192 us.
Proxy8: Begin emitting radio packet at time 8383 us.
Transceiver3: No free channel and Retry transmitting this data at time 8448 us
Transceiver3: generated a random number as backoff slots, slots = 18 at time 8640 us
Proxy8: Complete emitting radio packet at time 8735 us.
Transceiver0: received ack packet with numSequence = 20 at time 8735 us
Transceiver7: No free channel and Retry transmitting this data at time 8768 us
Node0 knows that the packet has been successfully sent at time 8799 us.
Node0 entre to SLEEP mode at time 8799 us.
Transceiver0 entre to SLEEP mode at time 8799 us.
Coordinator: received packet from node0 with data = 205 with latency = 8801 at time 8801 us
Transceiver7: generated a random number as backoff slots, slots = 6 at time 8960 us

```

FIG. 3.14: An example of simulation log

simulation time.

3.4.2 Event Sequence Tracing

During the simulation is running, the states of every hardware components and the variables are updated continually. SystemC provides users a `sc_trace` module to track signals and records the values of signals into a file in Value Change Dump (VCD) format, which can be displayed graphically by using waveform-viewing tools. The event sequence tracing is analyzed to verify and refine the model implementations. Fig. 3.15 presents an example of event sequence tracing.

A typical carrier sensing multiple access process is presented in this example. The states of microcontroller and transceiver are presented as numbers. The meaning of each state is also illustrated in Fig. 3.15. Node1 finds the channel being busy when node0 is emitting data to the channel; therefore it waits for a random number of backoff periods

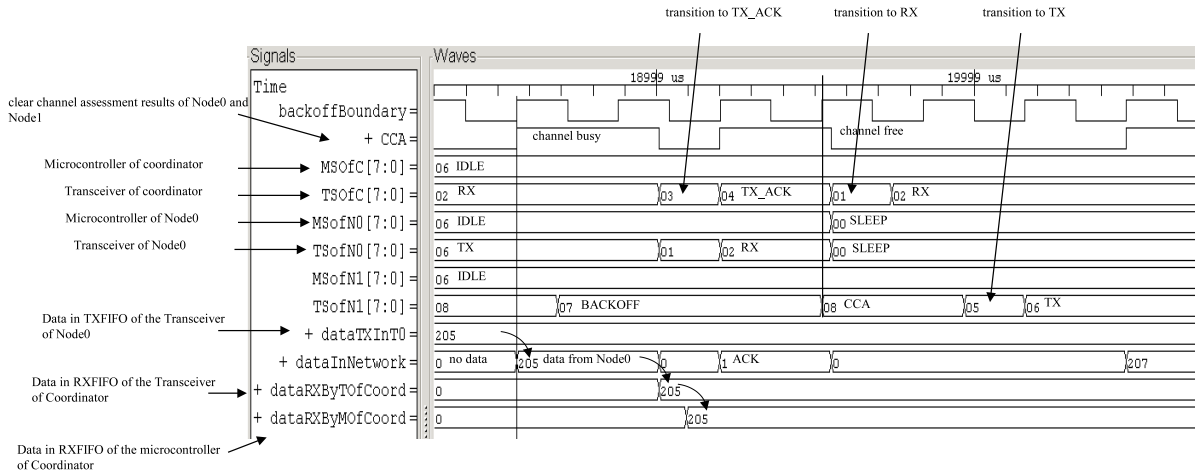

FIG. 3.15: An example of event sequence tracing

to retransmit the packet.

The packet transmission process among different hardware components and network is also presented. The packet with a value of 205 in Fig. 3.15 is transmitted from node0 to the network module and to the transceiver and microcontroller of the coordinator, as shown by the arrows.

Depending on the event sequence tracing, we can also verify the timing accuracy at cycle accurate level. For the slotted CSMA-CA algorithm, all the transmissions should be aligned with the backoff boundary. As indicated by two vertical lines in Fig. 3.15, the transmissions of node0 and node1 have started exactly at the beginning of a backoff boundary.

The event sequence trace method can provide more comprehensive informations than simulation log. Every state transition of interested variables is recorded in the VCD file; on the contrary, the simulation log only tracks the event where a print function is invoked. However, the simulation log is more flexible and readable; for example, the transmission results (e.g., failure or success) can be attached in the simulation log directly.

3.4.3 Sensor Data

At present, sensors are modeled as an individual module in IDEA1. The sensor module generates sensor data in two ways. One is random generation, and the other is read the real measured data in a data file. Some specific sensor chips will be modeled later. Fig. 3.16 presents an example of the measured sensor data.

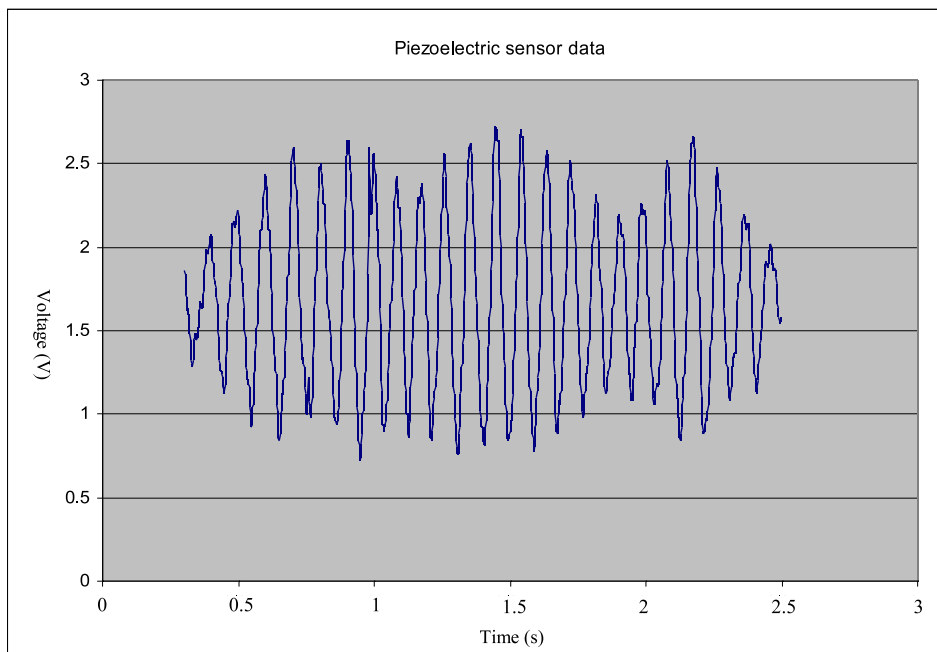

FIG. 3.16: Measured sensor data by N@L mote

The data is measured by one sensor of N@L mote, PZT PIC255 piezoelectric sensor, and a sensor amplifier circuit based on TLV2772 from Texas Instrument. During IDEA1 simulation, every node reads its data from its sensor data file and transmits the data to the coordinator by using some communication algorithms. After receiving the packets from nodes, the coordinator stores the sensor data to different files according to every node. These files can be compared with the original sensor data files to analyze the packet lost.

3.5 Conclusion

In this chapter, a novel system-level WSN simulator, named IDEA1, is presented. It is developed in SystemC and C++, which makes the simulation to be a part of the embedded system design. It enables the design space exploration at an early stage and supports a modular design pattern of sensor nodes and WSN applications. Many COTS hardware platforms have been modeled and the IEEE 802.15.4 standard has been implemented. An energy model has been implemented on all the hardware component models of IDEA1.

In next chapter, the performance of IDEA1 will be evaluated. The accuracy of the simulation results of IDEA1 will be validated by some real measurements of a testbed. The simulation results of IDEA1 will also be compared with NS-2, a widely-used simulator in WSN field. Other performances of IDEA1, like simulation speed and power consumption analysis, will also be evaluated.

Chapter 4 :
Performance Evaluation of IDEA1

In this chapter, the performance of IDEA1 is evaluated, especially in two aspects: accuracy and simulation time. For the accuracy validation, the simulation results of IDEA1 are compared with some measurements on a testbed composed of 9 nodes. The simulation of IDEA1 is also compared with NS-2, the most widely-used simulator in the research of WSN, including the comparisons of simulation results and simulation time.

This chapter is organized as follows. Section 4.1 introduces the metrics used to evaluate the network performances. Section 4.2 describes the testbed establishment and shows the comparisons between the testbed measurements and simulation results. Section 4.3 presents the simulation results of both IDEA1 and NS-2 to an IEEE 802.15.4 sensor networks. The differences between these two simulators are summarized. Finally, section 4.4 concludes this chapter.

4.1 Performance Metrics

Four metrics are used to evaluate the network performances in the testbed experiments and comparisons with NS-2. They are defined as follows.

- *Packet Delivery Rate (PDR)*: *PDR* is used to evaluate the network throughput. It is the ratio of the number of packets successfully received to the number of packets generated by nodes.
 - *Average Latency (AL)*: Latency of a packet is the duration from the generation of the last sensor data in the packet to the receipt of this packet by coordinator. *AL* is an average latency of all packets that successfully received by coordinator. If the packets only contain one sensor data, *AL* is also the average latency of sensor data; however, if several sensor data are transmit in one packet, the latency of a sensor data is *AL* plus the interval between this data to the last sensor data.
 - *Energy Consumption per Packet (ECPkt)*: *ECPkt* is the average energy consumed for successfully transmitting one packet.
-

- *Average Power Consumption (APC)*: APC is used to measure the average power consumption per node which is a basic parameter to predict the lifetime of a sensor node and the network.

4.2 Experimental Validation

To validate the accuracy of IDEA1 simulation, a testbed of 9 nodes is built. Two kinds of measurements have been done. One is the measurements of the current consumptions of every operation modes of an individual sensor node in order to calibrate the energy model, which will be used in the simulation of IDEA1. The other one is the measurements on the network testbed of 9 nodes.

4.2.1 Calibration of the Energy Model

Initially, the energy model needs to be calibrated by some experimental measurements. The current consumptions of every operation mode of hardware components are measured. Our measurement setup is illustrated in Fig. 4.1.

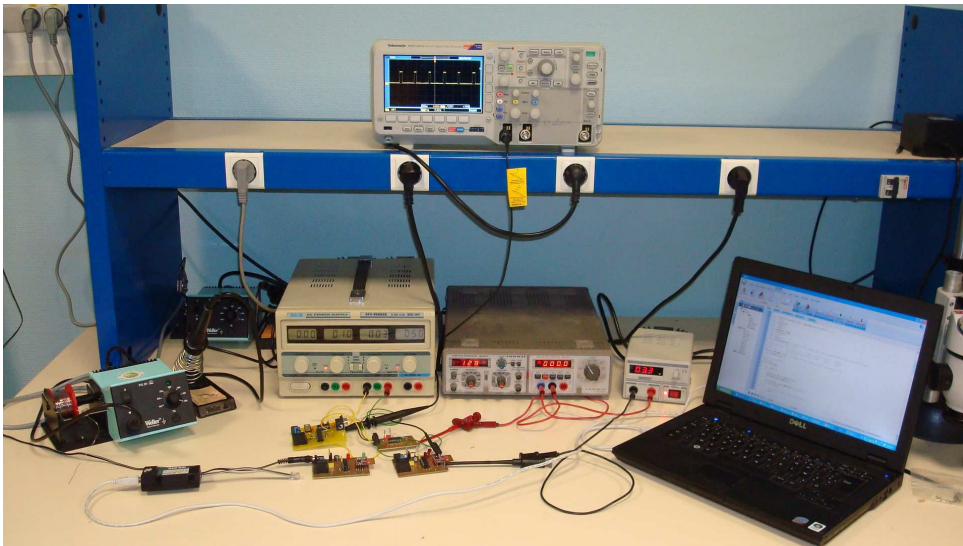

FIG. 4.1: *Hardware measurement configuration*

One resistor of $1\ \Omega$ was placed series with the power supply of a node (named as node0)

TAB. 4.1: *Measured current consumptions of N@L motes (3.3 V VDD and 8 MHz clock frequency)*

PIC16LF88 microcontroller		MRF24J40 RF transceiver	
active	1.386mA	sleep	17 μ A
sleep	7 μ A	RX	23.504mA
sleep->active	7 μ A/1.846ms	TX(0dBm)	23.961mA
		TX(-10dBm)	22.901mA
		TX(-20dBm)	22.631mA
		TX(-30dBm)	22.409mA
		sleep-> RX	6.7mA/720 μ s
		sleep->TX	6.7mA/720 μ s

in order to measure the current consumption of the node by the voltage across this resistor. The output of the voltage generator is adjusted to ensure that the node has a 3.3V power supply. An instrumentation amplifier [134] with a gain of 76 is used to amplify the voltage across the resistor. Tektronix *MSO2012* mixed signal oscilloscope [135] is used to track the output of this amplifier with the highest possible resolution. Tektronix *MSO2012* provides a 1 GS/s sample rate. By doing this, the energy consumption of node0 can be measured.

A set of micro-benchmarks have been developed to isolate the hardware consumption of microcontroller and transceiver in order to obtain the current consumptions of each operation mode. For the low current consumption of sleep mode, we use a digital multi-meter that can capture extremely small current. The current consumptions of N@L motes is listed in Table 4.1.

As shown in Table 4.1, both the microcontroller and transceiver need a period of time to wake up from the sleep mode. The current consumptions of the transitions between two states that are not available in data sheet are also measured.

4.2.2 A Testbed of Sensor Network

4.2.2.1 Testbed Establishment

A star topology testbed of 9 N@L motes is built, as illustrated in Fig. 4.2.

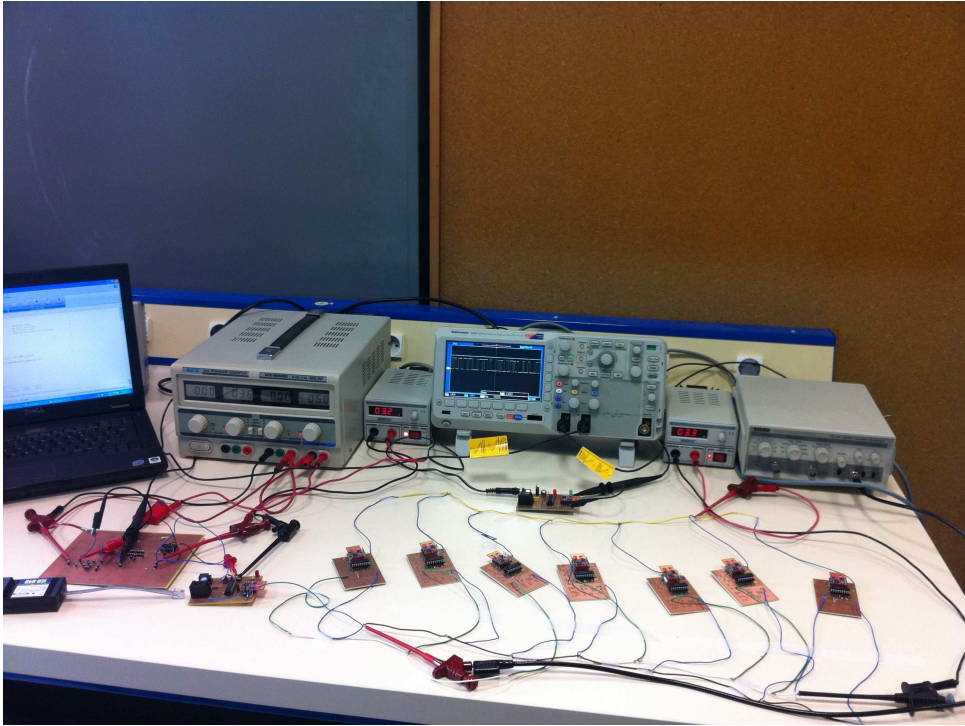

FIG. 4.2: *Testbed Measurement Configuration*

This network consists of eight nodes and one coordinator. The nodes read a sensor data (an integer of one byte generated randomly) periodically. The reading frequency is presented as sample rate. A sample rate is 10, which means that the node read the sensor data every 0.1 s. The nodes send the sensor data to the coordinator immediately after the data is read by using the IEEE 802.15.4 unslotted CSMA-CA algorithm. If the sensing timer expires when the nodes is transmitting a old sensor data, the microcontroller will store the new sensor data in a one-byte buffer. However, if the sensing timer expires when there is already a sensor data in the buffer waiting to be sent, the new sensor data will replace the old sensor data in the buffer to enable a short latency of sensor data.

The parameters of the unslotted CSMA-CA algorithm (e.g., *macMinBE*, *macMaxCSMABackoffs*, *macMaxFrameRetries*, etc.) are set as the default values defined in IEEE 802.15.4 standard [15]. The TX power of RF transceiver is set to 0 dBm. The nodes go to SLEEP mode after the transmission is finished. The transmission is successful if an acknowledgment (ACK) is received; otherwise, it fails after *macMaxCSMABackoffs* attempts of channel access failure or *macMaxFrameRetries* attempts of retrying to

transmit the packet. The nodes are woken up periodically by a built-in timer which uses an external oscillator in order to continue to increment asynchronous to the internal phase clocks. The timer will continue to run during the sleep period of the microcontroller. It can generate an interrupt on overflow that will wake up the microcontroller. In our testbed, the timer1 of Microchip PIC16LF88 with a clock of 32.768 kHz is used to provide this function.

Once the coordinator receives a packet from node0 with different sequence number, it will toggle one of its I/O pins that is connected with a led. The voltage transition trace of this led pin is also recorded by the oscilloscope in order to observe the latency of sensor data. It is the duration from the generation of this sensor data to the receipt of the packet by the coordinator. On the trace of oscilloscope, it is the duration from node0 is woken up to the toggle of the led pin of coordinator.

A successful transmission of packet is determined by two factors. One is that the coordinator successfully received the packet from node0, which is illustrated on the trace of oscilloscope as the led pin of coordinator is toggled before node0 goes to sleep mode. The other factor is that the data packet is successfully acknowledged by the coordinator, which can also be observed on the trace. The duration between the led pin of coordinator being toggled and node0 going to sleep mode is within an ACK packet transmission time added by an ACK packet processing time. An ACK frame comprises 11 bytes; the transmission time of an ACK packet is thus 352 μ s. An ACK packet processing time of node0 is 239 μ s, including the data sequence number checking and some settings of registers in order to set the transceiver to sleep mode. If the duration between the led pin of coordinator being toggled and node0 going to sleep mode is very big, it means that the first ACK packet is lost and nodes retransmitted the packet. In this case, only one packet is considered in the calculation of *PDR*. A typical wave record is presented in Fig. 4.3.

In this example, the sample interval is 100 ms. The blue wave presents the voltage across the 1 Ω resistor of node0 and the red wave refers to the transition trace of the led pin of coordinator. The rise edge of the blue wave is the transition from sleep to active of

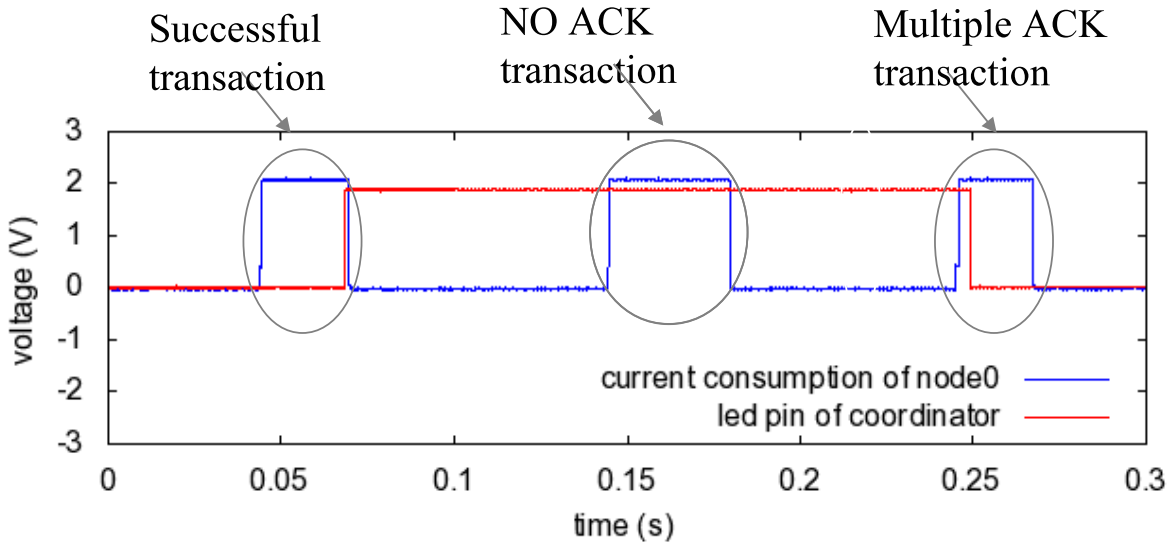

FIG. 4.3: A typical wave record of current consumption of nodes

the nodes and the fall edge is the transition from active to sleep. When the coordinator receives a packet from node0 with different sequence number, a switch of the red wave occurs. From Fig. 4.3, we can see that the sample interval (the duration between two rise edge of the blue wave is 100 ms). The pulse widths of the blue wave are different because the duration of every transaction is different. From Fig. 4.3, three typical network behaviors can also be observed.

- *Successful transmission*: Node0 is woke up by its timer1 and start transmitting a packet to the coordinator. On receipt of a packet from node0, the coordinator sends back an ACK packet to node0 and toggle its led pin. Once the transaction is acknowledged by the coordinator, node0 will turn off its transceiver and go to sleep mode.
- *No ACK*: Like the second sample transaction in Fig. 4.3, the coordinator did not receive any packet from node0, which may be caused by collisions with other nodes' transmission or channel access failures after *macMaxCSMABackoffs* attempts. Node0 reported an failure transmission of packet after *macMaxFrameRetries* attempts and went to sleep mode.

- *Multiple ACK*: As the third transaction in Fig. 4.3, the first ACK packet from the coordinator was not able to reach ndoe0 because of collisions or channel interference. Node0 retried to transmit the packet and succeeded. For the latency, the first toggle of the led pin of coordinator is considered. In addition, only one packet is calculated in *PDR*.

4.2.2.2 Testbed Measurements and Simulation Results

The measurement results includes the four metrics, i.e., *PDR*, *AL*, *APC* and *ECPkt*. The *ECPkt* and *APC* are measured by the current consumption trace of node0. *AL* and *PDR* can be observed by the output trace of the led pin of coordinator.

The application performed by the testbed has also been implemented in IDEA1 with the same configuration. To evaluate the performances of this network in different duty cycles, sample interval is set to 10, 1, 0.1, 0.01 and 0.001 s respectively. The duty cycles we have chosen can represent the main applications of WSN, from low rate sensing (0.1 Hz) to high speed rate (1 kHz). The low duty cycles are typical applications of WSN, such as environment monitoring [26]. The high speed rate may be required in many real-time automatic control applications [136]. The simulation and measurement results are presented in Fig. 4.4 and Fig. 4.5 .

When the sample rates are 100 or 1000 Hz, the latency results of experimental measurements are not available. The sample interval is too short that nodes sometimes can not finish one transmission before the next sensing operation. The nodes may start a new transmission immediately after a terminative one without going to sleep mode. In this case, for a switch of the I/O pin of coordinator, we can not determine when the sensor data is received by node0.

In Fig. 4.4 and Fig. 4.5, the average deviations for the four metrics (i.e., *PDR*, *AL*, *APC* and *ECPkt*) between IDEA1 simulations and testbed measurements are 5.2%, 3.2%, 3.4% and 6.5% respectively. Therefore, the average deviation between IDEA1 simulations and

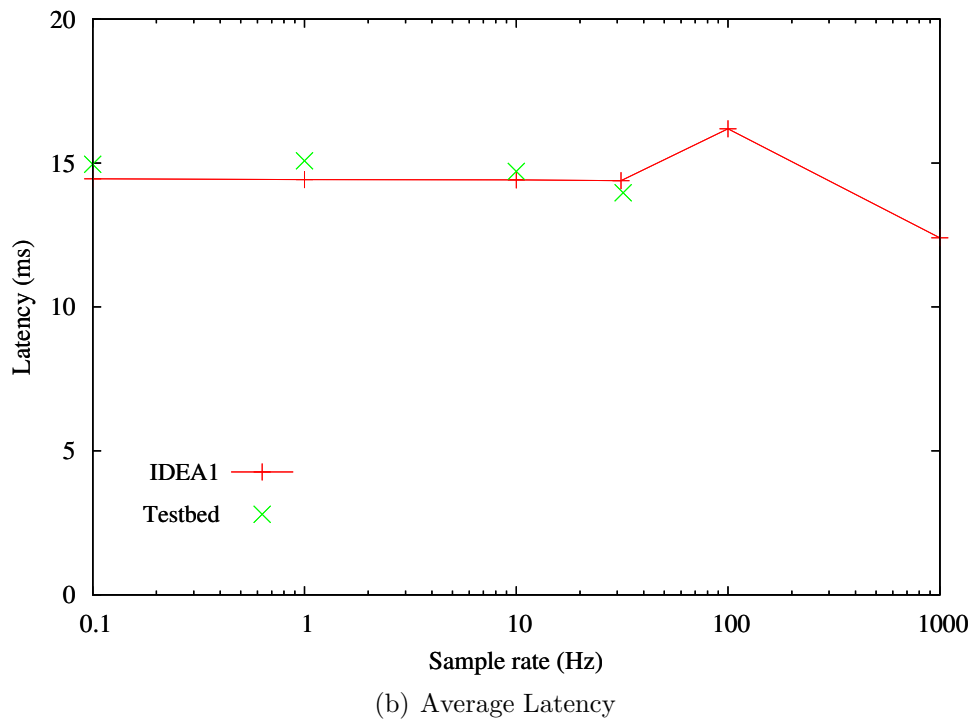
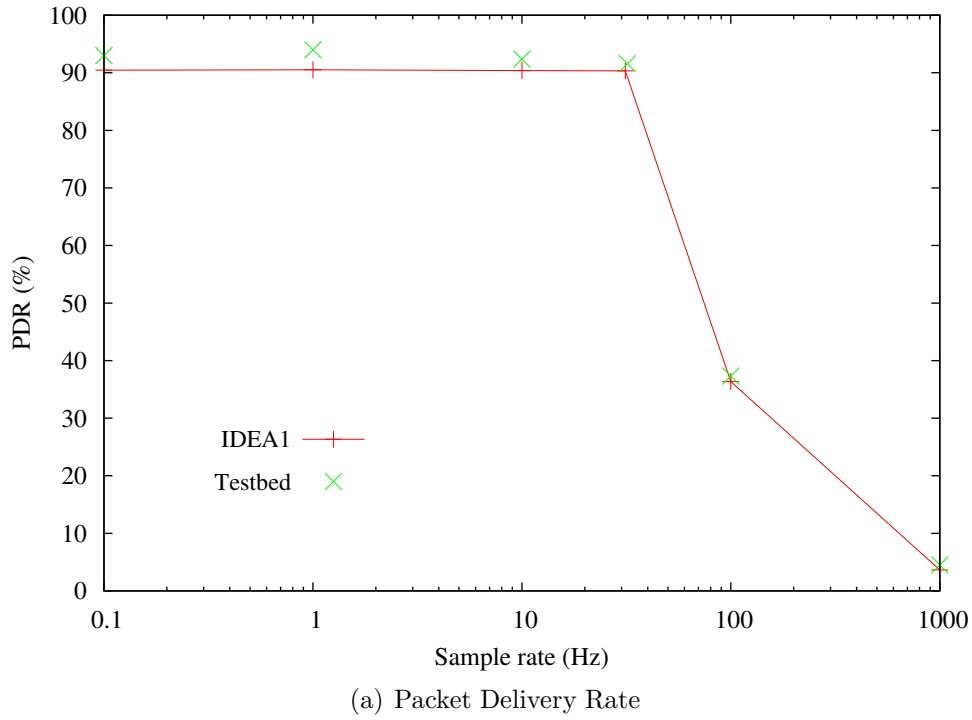
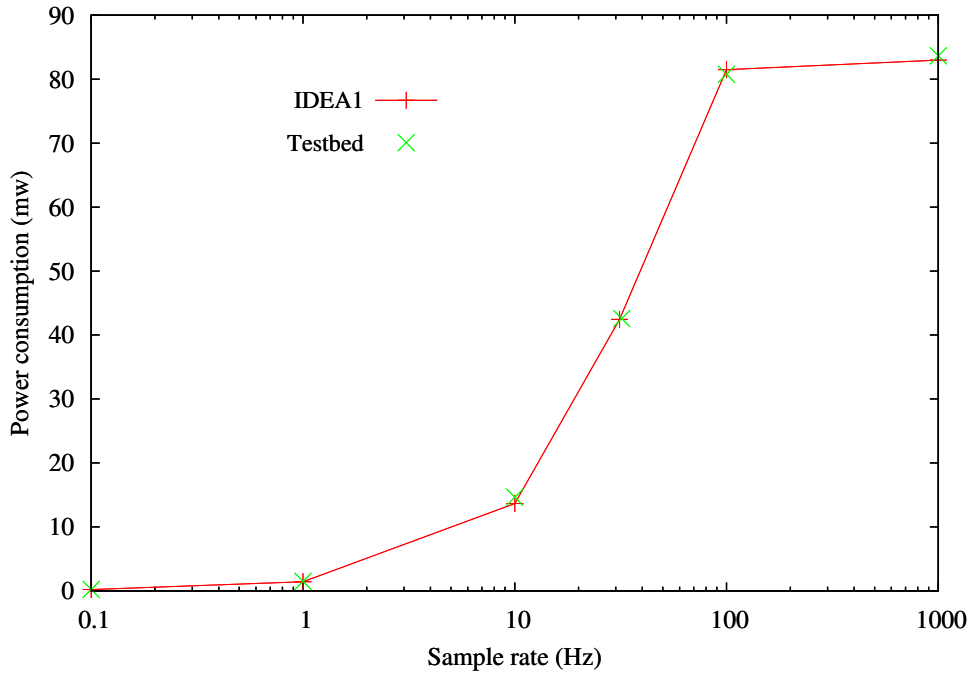

FIG. 4.4: Measured and simulated results of PDR and AL

testbed measurements is 4.6% which can be accepted for general high-level simulations.

With a small sample rate (0.1, 1, 10 and 31.25), the system is light loaded and every node can finish its transmission before a new sensor data arrives. Therefore, the



(a) Average Power Consumption

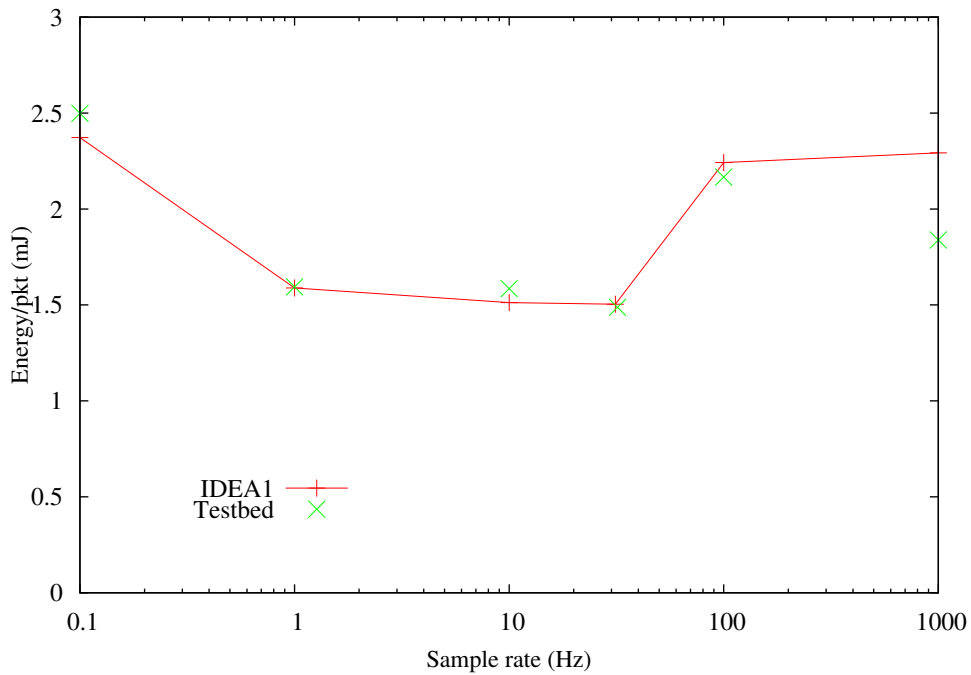

(b) Energy Consumption per Packet

FIG. 4.5: Measured and simulated results *APC* and *ECPkt*

average number of successful transmitted packets per sample interval is almost the same for different sample rates. The *PDRs* and *ALs* remain stable. The *ECPkt* of a bigger sample interval is larger, since it comprises longer period of sleep mode. The power

consumption augments due to the decrease of sleep period. The largest sample rate without transmission overlapping is 31.25 Hz. From the point view of network, a typical transmission process in these cases is presented in Fig. 4.6.

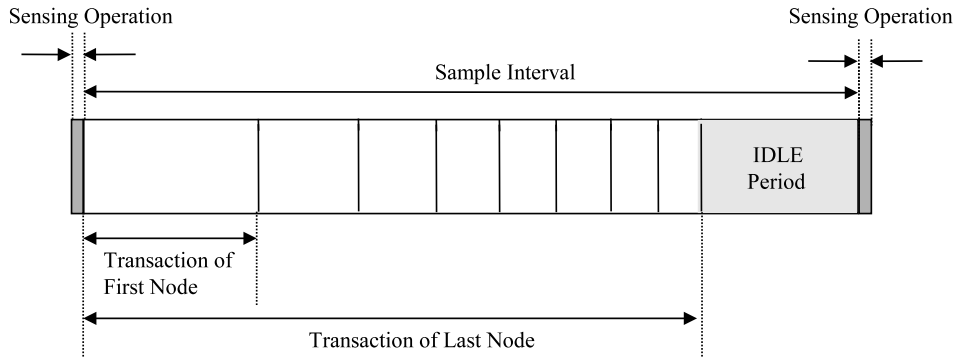

FIG. 4.6: A typical transmission process when sample rate is small

After reading a sensor data at the same time, the nodes start to transmit packets to the coordinator by using unslotted CSMA-CA algorithm. A node will go to sleep mode after its transmission finishes. As more and more nodes go to sleep mode, the network is light loaded. The rest nodes can easily find an idle channel with less competitions. After all the nodes finish their transactions, the network is IDLE. One transaction of a node is the duration from the beginning of the transmission to the receipt of ACK packet. The first node who finds the idle channel and is successfully acknowledged by the coordinator will achieve the shortest latency. When the next sensing operation occurs, the same process will be executed.

When the sample rates are 100 or 1000 Hz, the *PDRs* decrease and the other three metrics augment. In these cases, the number of collisions increase and less packets can be successfully received by the coordinator.

The available simulation results show that the latency increases when the sample rate is 100, because the system is partially saturated and the transmissions of two adjacent sample intervals overlap. There is no IDLE period in Fig. 4.6. Only a part of nodes can finish their transmissions before the next sample interval begins and others have to continue transmitting the old sensor data in the new sample interval. The new sensor

data is loaded to a one byte data buffer in microcontroller. It will be sent after the old transaction finishes. Thus, the transactions of the new sensor data is prolonged and the average latency increases.

The latency is short when the sample rate is 1 kHz. In this case, the system is completely saturated, the nodes always have one pending packet to send. When a node reads a new sensor data, if there is a data in the buffer, this unsent data will be discarded. The time for a sensor data staying in the buffer is less than the sample interval, 1 ms; thus the average latency is supposed to be smaller than the one of 100 Hz sample rate and a little larger than the one of small sample rates. However, The simulation results show that its average latency is smaller than the one of small sample rates. In this case, the network is always full of eight nodes for the competition of channel usage. The number of clear channel assessment failure is big and the nodes gives up transmitting one packet after *macMaxCSMABackoffs* failures. Thus, all the transactions in this case are short like the one of first node in Fig. 4.6.

4.3 Performance Comparison with NS-2

NS-2 [62] is a discrete event, object-oriented, general purpose network simulator. Its extensibility has been a major contributor to its success, with protocol implementations being widely produced and developed by the research community. According to [8], it is the most used simulator in Mobile Ad hoc NETWORK (MANET) research. Therefore, in this section, an application is studied by both NS-2 and IDEA1 with same configurations of system parameters. The simulation results and the performance of these two simulators are compared.

The same application in the section 4.2, a star topology network with eight nodes and one coordinator, is studied. The nodes are in beacon-enabled mode and utilize the slotted CSMA-CA algorithm to access channel.

The rest of this section is organized as follows. Section 4.3.1 introduces the NS-2

simulation and the modifications we have made to improve an existing IEEE 802.15.4 NS-2 model. The differences about the model implementation between NS-2 and IDEA1 are also summarized. Section 4.3.2 presents the simulations results of NS-2 and IDEA1. The deviations of the simulation results between NS-2 and IDEA1 are analyzed. Based on the simulation results, the network behavior is explained. Section 4.3.3 shows the comparison of simulation time between NS-2 and IDEA1. Finally, section 4.3.4 provides more detailed analysis of the power consumption at component-level.

4.3.1 Simulation Model Implementation of NS-2 and IDEA1

In NS-2, four schedulers with different data structures (i.e., linked-list, heap, calendar queue and real-time) are provided to maintain the event list which is ordered by the timestamps of events. The scheduler executes the earliest event in the list to completion and continue to execute the next event. One event performs some activities and possibly generate some new events. NS-2 simulations are written in two languages, C++ and OTcl (Object-oriented Tcl). In general, C++ code can be executed fast but it is inconvenient to change (need to be recompiled), making it suitable for protocol implementation. OTcl code runs much slower (interpreted) but can be changed easily, making it ideal for simulation configuration. Therefore, once the network system implementation is compiled as an executable file, many simulations of various configurations of system parameters can be executed by just modifying the OTcl script.

In IDEA1, all models are implemented in C++ in order to facilitate the model implementation process. However, as explained in section 3.2.2, all the system parameters are defined in an XML file and are read by the simulation program at the beginning of each simulation. Therefore, the change of system configuration can be done easily in IDEA1 by resetting the relative parameters and recompilation is not necessary.

The NS-2 model we used is based on an existing IEEE 802.15.4 NS-2 model in release 2.34 [24]. The extensions provided by [25] have also been added to this NS-2 model,

such as sleep mode and symbol period CCA duration implementation. The existing IEEE 802.15.4 NS-2 model has been modified significantly, since it was built complying with an earlier standard edition (IEEE 802.15.4 draft D18), which has been nowadays replaced by the latest revised release IEEE Std 802.15.4-2006. Totally, twenty two modifications have been implemented. A detailed description of these modifications can be found in Appendix A.

In IEEE 802.15.4 standard, there are two synchronization mechanisms in the beacon-enabled mode: beacon tracking and non beacon tracking (presented as noTracking mode in this thesis). If tracking is specified, the node shall attempt to acquire the beacon packet and keep track of it by regular and timely activation of its receiver. After the transmission, if it has no sensor data to send, it will go to sleep mode. If tracking is not specified, the node shall either attempt to acquire the beacon only once or terminate the tracking after the next beacon. The IEEE 802.15.4 NS-2 model [24] has only implemented the tracking mode; therefore, in section 4.3, the performance of the beacon-enabled mode with beacon tracking is evaluated by both NS-2 and IDEA1. The beacon-enabled mode without beacon tracking will be studied by IDEA1 in section 5.1.1.

The communication process in the modified IEEE 802.15.4 NS-2 model is described as follows. When the sensing operating timer expires, the Service-Specific Convergence Sublayer (SSCS) layer of the protocol stack in node sends a packet containing the new sensor data to Media Access Control (MAC) layer by calling the `mcps_data_request` function. The MAC layer will start the channel access process according to CSMA-CA algorithms. If an idle channel is found, the MAC layer will handle down the packet to Physical (PHY) layer which will transmit the packet to Channel module and decrement energy. On receipt of a packet, the Channel module will forward the packet to each node after a relative propagation delay. The PHY layer of the receiving nodes will be first indicated of a new packet receipt, and it will pass the packet to upper layer. The MAC layer will drop the packets not intended for it. It will also send back an ACK packet to the sender if ACK request is specified in the packet frame.

In IDEA1, the communication process is determined by the hardware architecture of sensor nodes. The implementations of protocol stacks are based on hardware platforms. For example, the specifications of both MAC and PHY layers of the IEEE 802.15.4 standard are implemented as hardware operations of RF transceiver of N@L motes; however, if MICAz motes are used, the MAC layer specifications are implemented as software operations of microcontroller since the transceiver of MICAz mote (TI CC2420) does not provide hardware support of the IEEE 802.15.4 MAC layer. By doing this, the timing and energy consumption behaviors of sensor networks can be modeled in detail. For instance, if MICAz mote is used, the data exchange between MAC and PHY layer is implemented by the SPI communication between microcontroller and transceiver.

The native support of hardware and software co-modeling embedded systems by SystemC, such as primitives to model the concurrency, interrupts, structural hierarchy and synchronization, enable us to easily model the HW/SW of sensor nodes within one environment. For example, the statical and dynamical sensitivity mechanisms offered by SystemC ensure that all the relative process can catch the event if an interrupt occurs. The process can decide to handle the event immediately or ignore it. In the implementation of IDEA1, if an relative interrupt occurs when the microcontroller is at SENSING state, it will be ignored; however, if a sensing interrupt occurs when the microcontroller is at other states, the microcontroller will stop what it is doing and handle the sensing interrupt immediately. It will resume its task when the sensing operation finishes.

4.3.2 Simulation Results of NS-2 and IDEA1

Many cases with various configurations of parameters (mainly *BO* and *SO*) and different sample rates have been studied. Other parameters of the CSMA-CA algorithms (e.g., *macMinBE*, *macMaxCSMABackoffs*, *macMaxFrameRetries*, etc.) are set to the values defined by default in the IEEE 802.15.4 standard. To investigate the impact of different combination *BO* and *SO*, *BO* is set to 3 values (0, 1 and 2) respectively and *SO* is set to 0 for all the simulations. Each simulation includes 10000 samples, for example, when

sample rate is 0.1, the application lasts 27.8 hours. Each case is simulated 100 times with different seeds for the generators of random backoff slot numbers.

Three types of simulation results are compared, including NS-2, IDEA1 with hardware modeling (denoted as IDEA1_HW) and IDEA1 without hardware modeling (IDEA1_NOHW). In the last simulation, all the timing parameters about the hardware operations are set to 0, including analog to digital conversion, SPI communication and transitions from sleep to active of microcontroller and transceiver; thus these operations do not consume any time or energy. Because the IEEE 802.15.4 NS-2 model does not consider the hardware operations, NS-2 and IDEA1_NOHW are at the same abstraction level. The hardware prototype used for this analysis is N@L motes and the energy model is calibrated according to the testbed measurements presented in section 4.2. The simulation results about the four metrics are presented in the following subsections.

4.3.2.1 Packet Delivery Rate

Fig. 4.7 shows the simulation results of *PDR*. The average deviation between IDEA1_HW and NS-2 is 2.7% and the average deviation between IDEA1_NOHW and NS-2 is 1.0%.

If component level hardware operations are not considered, the simulation results of IDEA1_NOHW and NS-2 is much similar since they are at the same level. The *PDRs* of IDEA1_HW are smaller than NS-2 model, which is caused by its detailed sensor node modeling, especially the impact of the sensing operations and SPI communication on the communication process when the sample rates are high. For example, when the sample rate is 1 kHz, during every sample interval (1 ms), the microcontroller has to spend 66 μ s to convert the sensor data. If this sensor need to be sent, the SPI communication also takes 386 μ s. However, these parameters are all set to 0 in IDEA1_NOHW and NS-2 simulations; thus they can transmit more packet than IDEA1_HW.

In the light traffic load area on the left side of Fig. 4.7, *PDR* remains stable as the sample rate increases. In these cases, the sample interval is long enough for every node

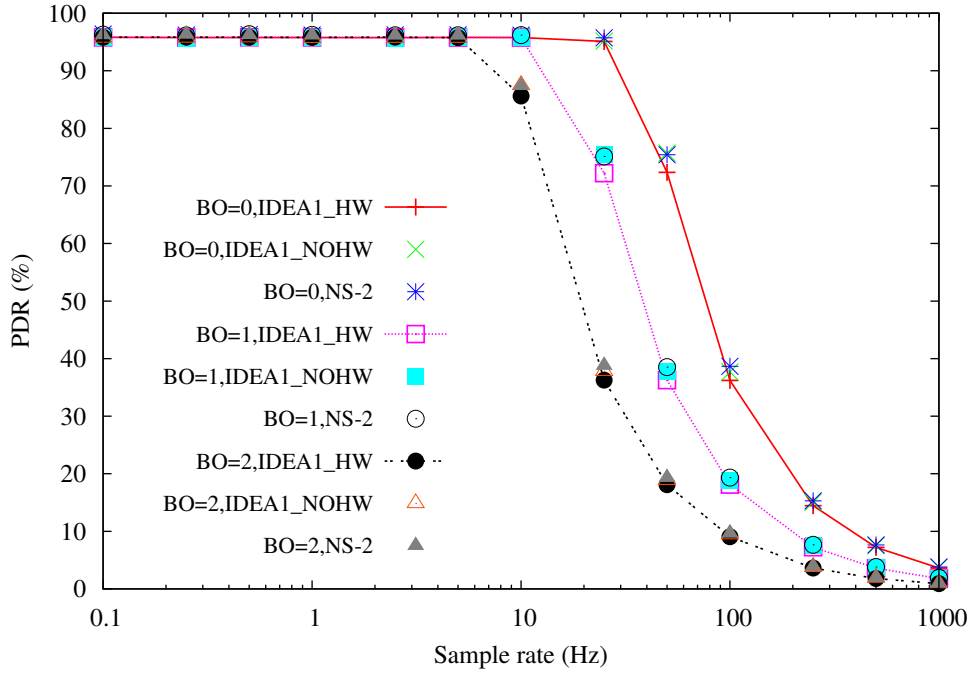

FIG. 4.7: Simulation Results of Packet Delivery Rate by NS-2 and IDEA1

to accomplish its transmission before the next sensor data is received. As the sample rate increases, the number of sensor data need to be sent per unit time augments and PDR begins to decrease due to the increase of packet collisions. PDR with bigger BO begins to decrease first, because SO is the same and a bigger BO means that one sample interval includes less number of active portions.

4.3.2.2 Average Latency

The results of latency are presented in Fig. 4.8. The average deviation IDEA1_HW and NS-2 is 8.9% and the average deviation IDEA1_NOHW and NS-2 is 2.6%.

The AL of a bigger BO is larger than a smaller BO, because SO is set to 0. If some nodes can not transmit their sensor data in one active portion of a superframe, they have to wait at least one inactive portion to resume their transmissions. A bigger BO causes a longer inactive portion for waiting. As the sample rate increases from 1 to 1000, the system goes through 3 different stages, including lightly loaded, heavily loaded and saturated.

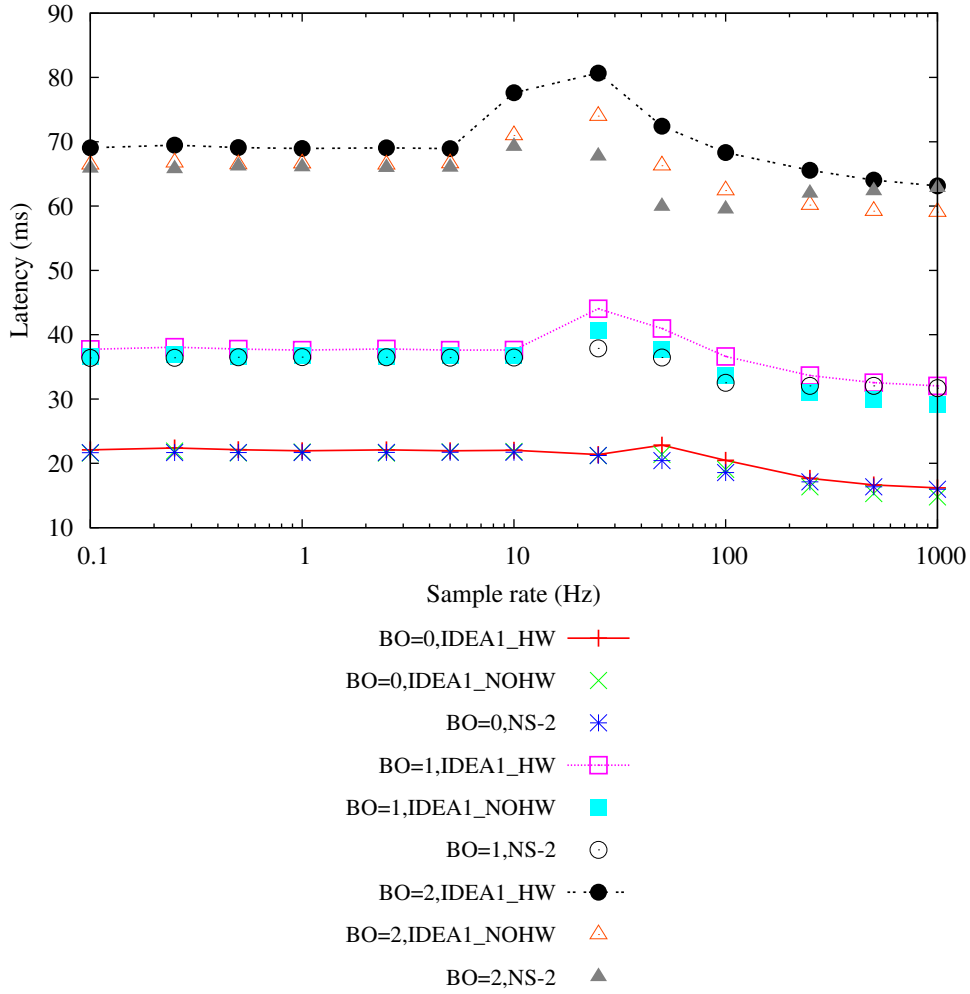

FIG. 4.8: *Simulation Results of Latency by NS-2 and IDEA1*

During the lightly loaded stage, AL remains stable because the transmissions between two adjacent sample intervals do not overlap; the network utilization statuses are almost the same for different sample intervals.

When the system is heavily loaded, it is transiting to be saturated. AL increases if $B0$ is not equal to $S0$; on the contrary, it decreases slightly if $B0$ is 0. In this transition period, some nodes can not complete their transmissions before the next sample interval begins and the last one or two nodes transmitting during the overlapping period of two sample intervals have to compete with other seven or six nodes for channel usage. If these last transmissions succeed, they will be longer than the case there were no overlapping between two sample intervals and AL will increase compared with the lightly loaded

stage; if they fail, they will not be considered in the calculation of latency and AL will decrease. In addition, the new sensor data of the last one or two nodes will be delayed for transmitting, which extends AL . For the case that BO is 0, there is no inactive portion during a superframe; thus the delay of new sensor data transmissions and the extension of old sensor data transmissions are smaller than the loss of failed transmissions of old sensor data, as a result, AL decreases. However when BO is 1 and 2, each superframe comprises an inactive portion, especially in case that BO is 2, the length of superframe is 61.44 ms which includes an inactive portion of 46.08 ms; thus the delay of new sensor data transmissions and the extension of old sensor data transmissions are larger than the loss of failed transmissions of old sensor data, as a result, AL increases.

As the sample rate continues to increase, the system becomes completely saturated. In these cases, all nodes always have pending sensor data to be sent and they compete for channel usage during the active portion of every superframe. If a node gets two new sensor data before the end of a transmission, only the last sensor data will be sent and first ones are discarded. The delay of new sensor data transmissions is small; therefore, AL decreases.

4.3.2.3 Average Power Consumption

Fig. 4.9 demonstrates the simulation results of APC . The average deviation IDEA1_HW and NS-2 is 45.8% and the average deviation IDEA1_NOHW and NS-2 is 7.2%.

As the sample rate increases, APC s augments, because more sensor data need to be sent. For a same sample rate, the power consumption of a smaller BO is larger than a bigger BO, since a smaller BO means more beacons received and shorter inactive portion of a superframe.

During the lightly loaded stage, APC s augments slowly. In these cases, most of the time, the nodes are in sleep mode. When the system is heavily loaded transiting to be saturated, sharp increase of APC s can be observed. During this period, the power

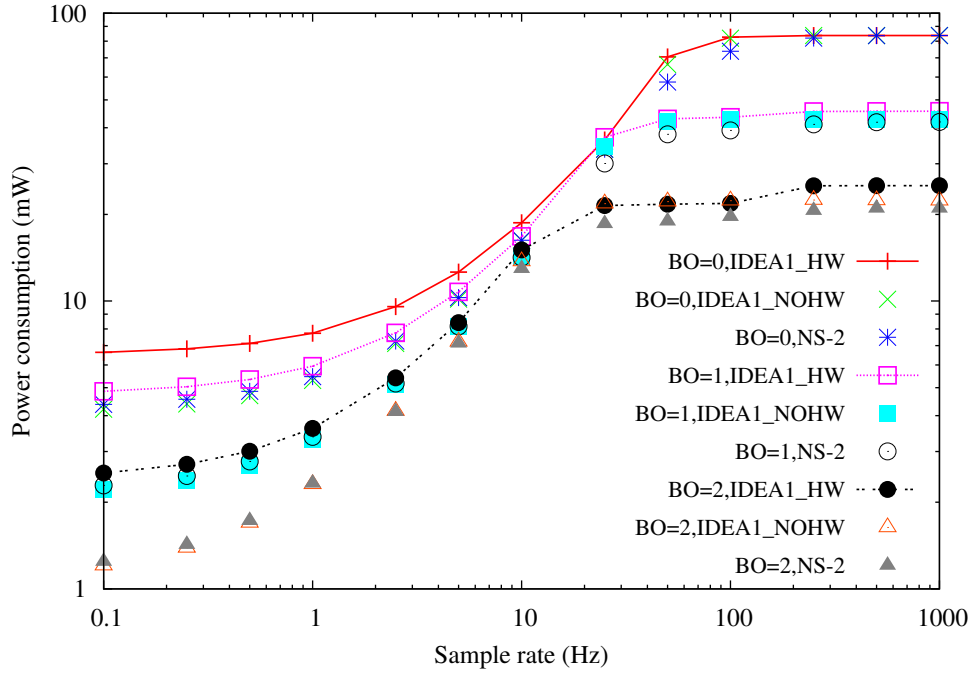

FIG. 4.9: Simulation Results of Power Consumption by NS-2 and IDEA1

consumptions of transmissions account for the main part of the whole power consumption. When the system becomes completely saturated, *APCs* become steady which are the largest power consumptions per node. The nodes are always in active mode during the active portion of a superframe. Because there is no inactive portion when BO is 0, its power consumptions are bigger than others.

4.3.2.4 Energy Consumption per Packet

Fig. 4.10 illustrates the simulation results of *ECPkt*. The average deviation IDEA1_HW and NS-2 is 49.3% and the average deviation IDEA1_NOHW and NS-2 is 8.3%.

During the lightly loaded stage, *ECPkt* decreases as the sample rate increases and the smallest BO consumes the most energy for a fixed sample rate. In these cases, the average number of packets transmitted during one sample interval is the same for different sample rates, which can be proved by the constant *PDRs* in Fig. 4.7; *ECPkt* is therefore less if the sample interval is shorter. For a fixed sample rate, a smaller BO consumes more energy since one sample interval includes more superframes and the nodes have to wake up to

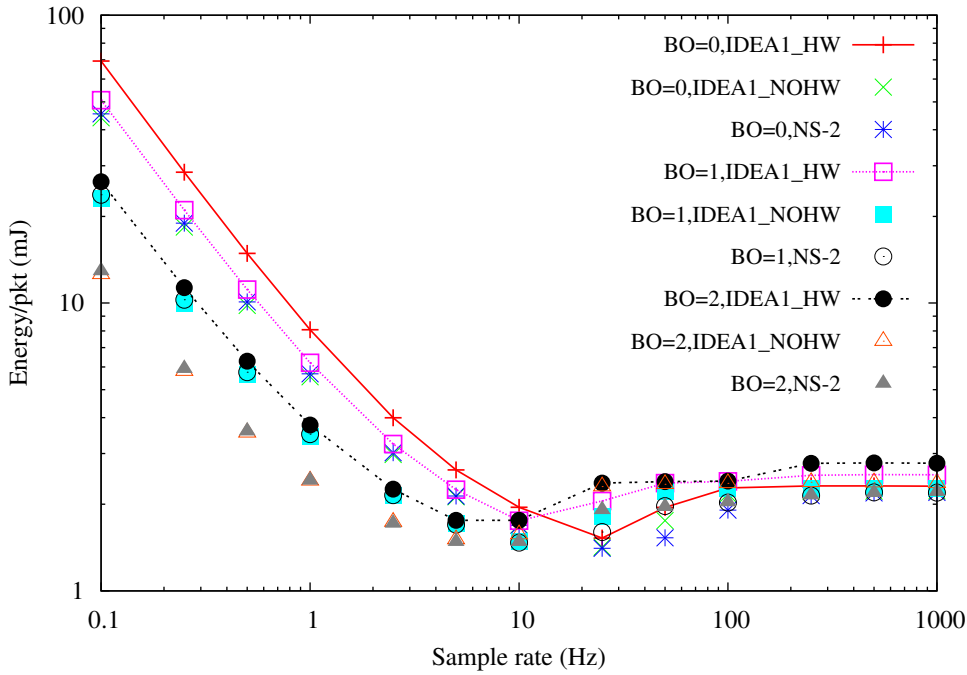

FIG. 4.10: *Simulation Results of Energy Consumption per Packet by NS-2 and IDEA1*

track the beacon packet at the beginning of each superframe.

The smallest $ECpkt$ occurs when PDR begins to decline, where the system begins to transit to be saturated. In this case, every node can accomplish its transmission before new sensor data arrives, but the interval between the last node turns to sleep and the next sensor data arrives is very short, so the nodes spend the least energy in sleep mode. As the sample rate continues to increase, the $ECpkt$ augments due to the transmission overlap of two sample intervals and the increase of collisions. The energy consumption per packet with bigger BO begins to increase first because the number of superframes per sample interval is less for a larger BO.

When the system is saturated, $ECpkt$ remains constant and the smallest BO consumes the least energy. In these cases, nodes are always having pending sensor data to send. The number of successfully transmitted packets per superframe is almost the same; therefore $ECpkt$ remains constant for the same BO. In addition, for a fixed sample rate, because one superframe includes a longer inactive portion if BO is larger, its $ECpkt$ is bigger.

4.3.2.5 Summary

Based on the simulation results in Fig 4.7, Fig 4.8, Fig 4.9 and Fig 4.10, the deviations of the simulation results between IDEA1_HW and NS-2 about the *PDR*, *AL*, *APC* and *ECPkt* are 2.7%, 8.9%, 45.8% and 49.3% respectively. The ones between IDEA1_NOHW and NS-2 are 1.0%, 2.6%, 7.2% and 8.3%. Therefore, the average deviation between IDEA1_HW and NS-2 is 26.7%, and the one between IDEA1_NOHW and NS-2 is 4.8%. The former is bigger since more detailed information of HW/SW operations have been considered. Especially when the sample rate is low, the deviations of *ECPkt* and *APC* results between IDEA1 and NS-2 are very large, because the SPI communications of microcontroller and transceiver account for a very great proportion of the power consumptions. For example, the SPI communication takes 42.4% of the power consumption of microcontroller when sample rate is 0.1. A more detailed power consumption analysis of each hardware component will be provided in section 4.3.4.

4.3.3 Simulation Time of NS-2 and IDEA1

For the simulations in section 4.3, the simulation speed of IDEA1 is about 2 times faster than NS-2. The simulation time of NS-2 and IDEA1 for the application with *BO* set to 2 is presented in Fig. 4.11.

The simulation of IDEA1 is IDEA1_NOHW, which is at the same abstraction level of the IEEE 802.15.4 NS-2 model. All the simulations are executed individually on a server with an Intel 2.66 GHz Xeon X3230 processor and a 4.6 GB memory. For the application lasting 27.8 hours with a sample rate of 0.1 Hz, the simulation time of IDEA1 and NS-2 are 7.35 and 24.0 minutes respectively. The high speed simulation of IDEA1 profits mainly from the efficient simulation kernel of SystemC and our optimized model implementation. SystemC provides a wait function which can set relative processes to inactive state until an interesting event occurs. In our model, this event interrupt mechanism is used in the while statement of FSM implementation. Instead of checking the states of microcontroller

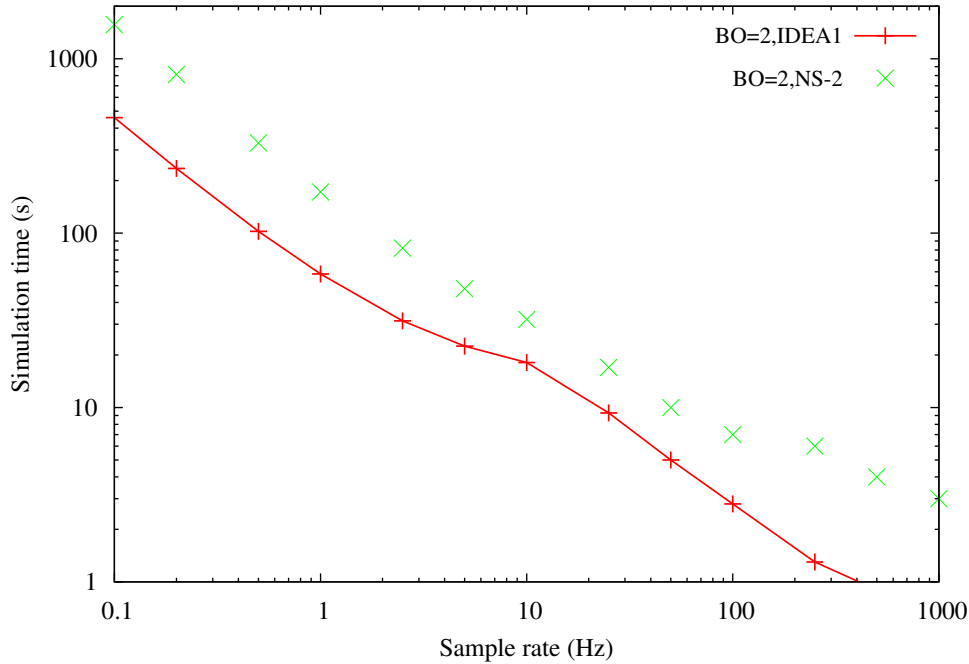

FIG. 4.11: *Simulation time of NS-2 and IDEA1*

and transceiver every simulation cycle, their FSMs are woken up only when an interesting event occurs, which can reduce the simulation time significantly.

4.3.4 Detailed Analysis of Power Consumptions by IDEA1

In previous sections, the fidelity of IDEA1 simulation have been proved by testbed measurements, and the performance of IDEA1 has been compared with NS-2. In this section, the detailed hardware modeling feature of IDEA1 is shown by a further analysis of this application in section 4.3.

The IEEE 802.15.4 NS-2 model is at node-level. A sensor node is modeled as a single module and no specific hardware component has been modeled. However, IDEA1 is at component-level, both the operations of individual hardware component and the communications among them are considered, such as SPI communication between microcontroller and transceiver and analog to digital conversion of sensor data. The power consumptions of hardware components in different operating modes can be investigated by IDEA1. In this section, a complete performance evaluation of IEEE 802.15.4 sensor

network is provided by IDEA1.

Compared to NS-2, IDEA1 can provide detailed informations about the energy consumptions of individual hardware components. The power consumptions of hardware components in different operating modes are also presented in Fig. 4.12.

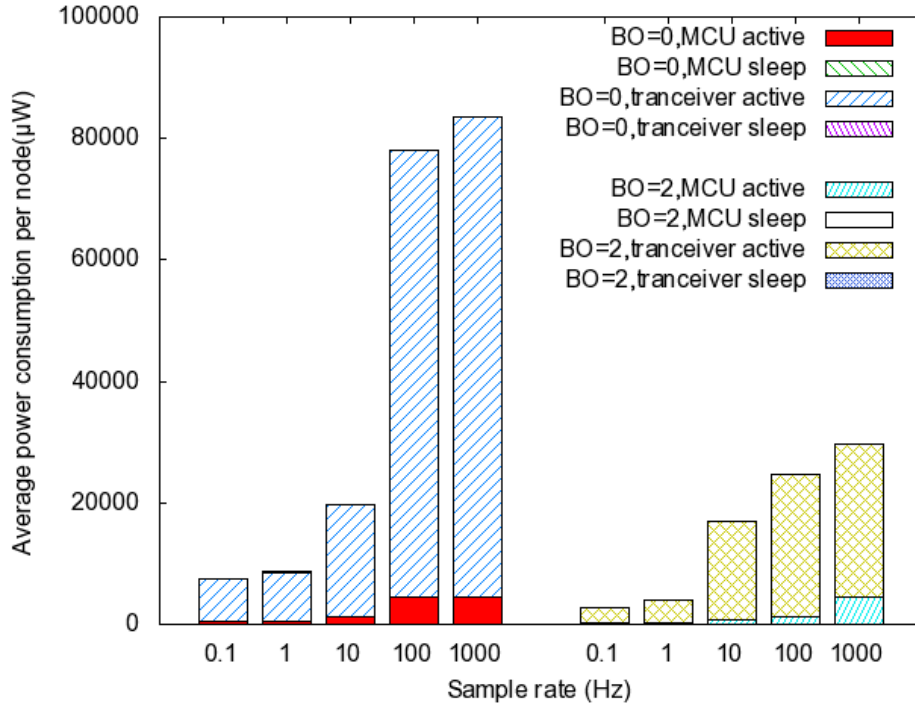

FIG. 4.12: Power consumptions of hardware components in different operating modes

From Fig. 4.12 we can see that the average power consumption per node is bigger when BO is 0 than BO is 2, because the nodes spend more energy for beacon tracking when BO is 0. For a fixed BO , the power consumption per node augments as the sample rate increases, since the nodes spend less time in sleep mode and more collision occurs. In addition, the transceiver consumes much more energy than the microcontroller and the energy consumed in the sleep mode is very little.

Fig. 4.13 presents the average power consumption of hardware components for different tasks. Tracking presents the power consumed by useless beacon tracking. On receipt of a beacon packet, if the node has no data to transmit, this beacon tracking is useless. Useful refers to the power consumption that the useless beacon tracking is subtracted.

From Fig. 4.13, we can see that the nodes spend too much energy for useless beacon

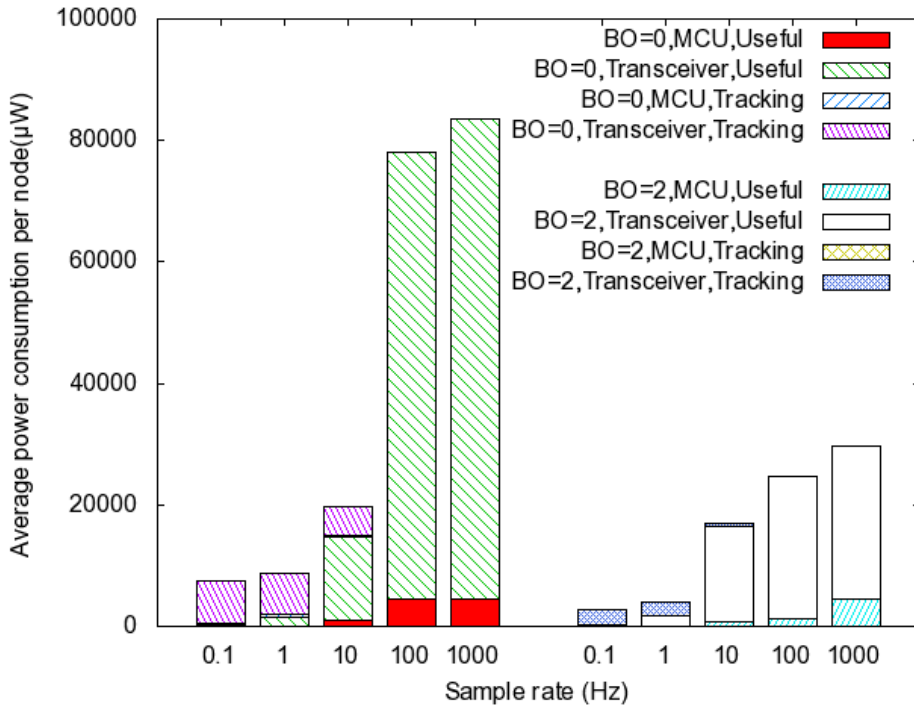

FIG. 4.13: *Power consumptions of hardware components for different tasks*

tracking when the sample rate is small. Besides the power consumptions of active and sleep operating mode, we can also divide the power consumption of microcontroller in active operating mode into more detailed parts, including analog to digital conversion, SPI communications with transceiver and processing. Fig. 4.14 illustrates the power consumption of microcontroller for different tasks.

The microcontroller spend most of its energy for processing data and executing codes, a part of its energy for SPI communication and a little energy for analog to digital conversion and in sleep mode. The consumption of SPI communication is too big to be ignored, especially when sample rate is small.

4.4 Conclusion

In this chapter, the accuracy of IDEA1 has first been validated by experimental testbed measurements. The average deviation between the simulation results of IDEA1 and the testbed measurements is 4.65%, which can be accepted for many high level simulations.

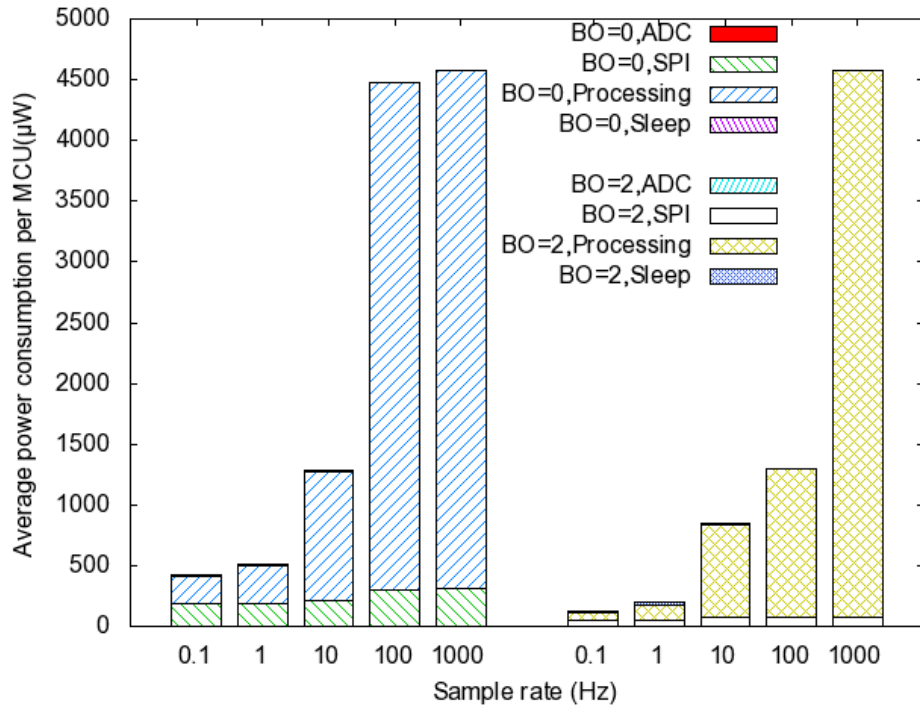

FIG. 4.14: Power consumptions of microcontroller for different tasks

Secondly, the performances of IDEA1 have also been compared with NS-2, the most widely used simulator in WSN research. Benefiting from the SystemC-based hardware and software co-simulation, IDEA1 can easily model the concurrency and interconnection within and among hardware components. It can provide more detailed informations about the energy consumptions than the IEEE 802.15.4 NS-2 model. Based on system-level modeling, the simulation speed of IDEA1 is 2 times faster than NS-2.

Chapter 5 :

Case Studies

After the experimental validation of accuracy and performance evaluation by comparing with other simulators, IDEA1 is ready to be used in real applications. It is firstly used to provide further performance evaluation of the IEEE 802.15.4 sensor network studied in last chapter. The performances of this IEEE 802.15.4 are evaluated for different parameter setting and traffic loads. Finally, IDEA1 is used to study a real industrial application in which a wireless sensor and actuator network is deployed on a vehicle to measure and control vibrations. By the simulation, some preliminary designs based on IEEE 802.15.4 protocols and two different hardware platforms are evaluated. The four metrics used in chapter 4, including *PDR*, *AL*, *ECPkt* and *APC*, are used.

This chapter is organized as follows. Section 5.1 offers a further comprehensive performance evaluation of the IEEE 802.15.4 sensor networks studied by NS-2 and IDEA1. Section 5.2 studies an industrial application to demonstrate the design flow and usability of IDEA1.

5.1 Performance Evaluation of IEEE 802.15.4 Sensor Network

A comprehensive evaluation of IEEE 802.15.4 sensor network is performed in this section. According to the study in section 4.3, when the sample rate is small, the nodes spend too much energy for beacon tracking without any data to send. Therefore, in this section, we will implement the same application without beacon tracking mechanism and evaluate the performance of this network. Until now, *BO* is set to 0, 1 and 2 respectively, and *SO* is set to 0. Some other configurations of protocol parameters are also evaluated to explore the maximum sample rate the IEEE 802.15.4 can support. All the simulations are implemented on IDEA1 with considerations of hardware operation. The hardware prototype used for this analysis is also N@L motes

The rest of this section is organized as follows. Section 5.1.1 evaluates the performance

of IEEE 802.15.4 networks in beacon-enabled mode without beacon tracking. Therefore, in section 5.1.2, the same simulations are re-executed with SO set to the same value with BO . Finally, in section 5.1.3 studies the IEEE 802.15.4 nonbeacon-enabled mode and summarizes the performance evaluation of IEEE 802.15.4 LR-WPAN for industrial applications.

5.1.1 Slotted CSMA-CA with Fixed SO and Various BO

In this section, the same application is implemented without beacon tracking mechanism and a further analysis of this application will be presented.

5.1.1.1 Packet Delivery Rate

The simulation results of packet delivery rate are presented in Fig. 5.1.

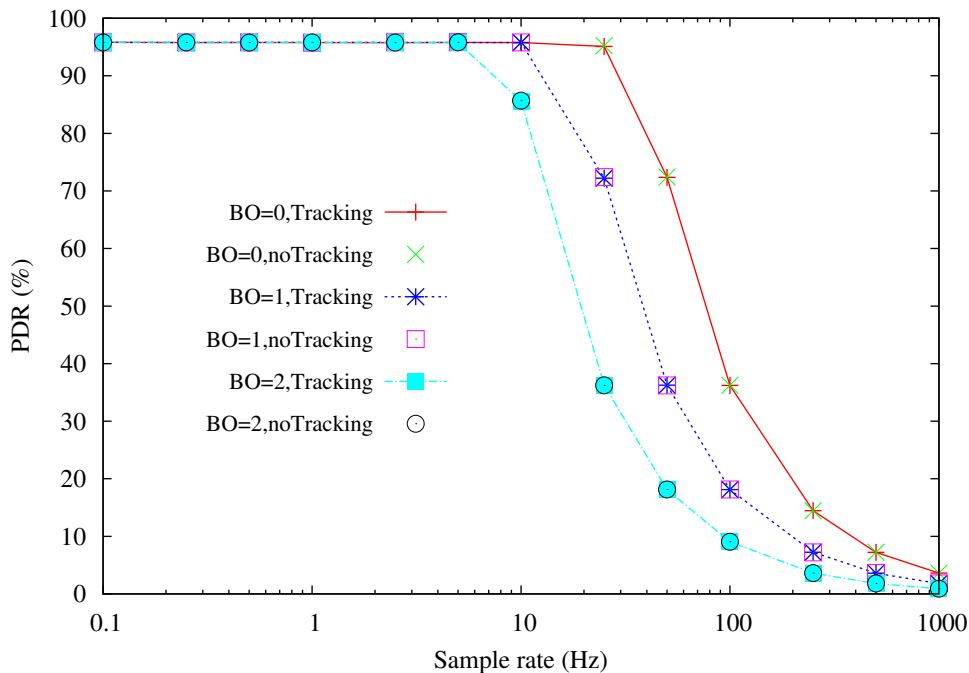

FIG. 5.1: Packet delivery rate of slotted CSMA-CA with fixed SO and various BO

In Fig. 5.1, Tracking presents the simulations of beacon tracking mechanism and noTracking refers to the simulations without beacon tracking mechanism. The average absolute deviation of PDR between the tracking and nottracking modes is less than 0.1%

which is the simulation error. The two modes should have the same PDR , since the only difference between them is whether to track the beacon during the period after a transmission and before a new sample cycle and the transmissions are not impacted.

5.1.1.2 Average Latency

Fig. 5.2 presents the results of latency. The average absolute deviation of AL between the tracking and notracking modes is 2.4%. The system with notracking mode also goes through 3 different stages, i.e., lightly loaded, heavily loaded and saturated. The tendency in change of latency of both modes are the same.

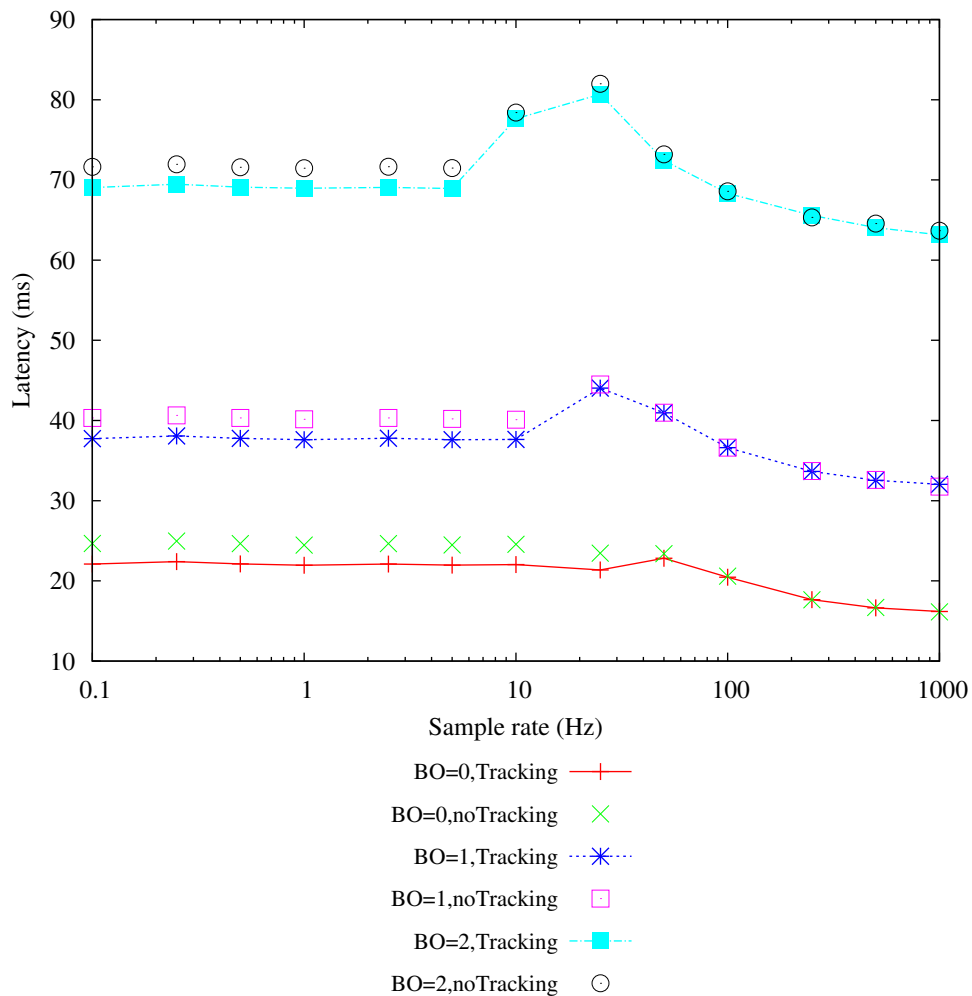

FIG. 5.2: Latency of slotted CSMA-CA with fixed SO and various BO

The AL s of notracking mode are a little bigger than those of the tracking mode, which

is caused by the timing cost of resynchronization. With notracking mode, nodes go to sleep mode after a transmission if they have no data to send. They wake up some time later and performs a new sensing operation. They need to be resynchronized with the coordinator if they want to send this new sensor data. The microcontroller wake up the transceiver to acquire a beacon packet. During the transition from sleep to active mode of transceiver, the coordinator may be transmitting a beacon packet. The nodes will miss this beacon packet and they have to listen the channel for almost one superframe duration to receive the next beacon. This resynchronization process can be observed in the example of simulation log presented in Listing. 5.1.

LISTING 5.1: *Log fragment of noTracking mode*

```

Node0: Begin to wake up to read sensor data at 8598154 us.
Node0: reads a new sensor data (Value,Time): 248,8.6 at 8600066 us.
Node0: start to wake up the transceiver at 8600066 us.
Transceiver8: starts transmitting the beacon at 8601600 us
Proxy8: Begin emitting radio packet at time 8601792 us.
Proxy8: Complete emitting radio packet at time 8602336 us.
Transceiver0: is woken up at 8602066 us
Node0: starts to transmit the data to the transceiver (_NR= 0 ) with data =
    248 at 8602066 us
Transceiver0: starts to track beacon with _state = 10 at 8602066 us
Transceiver0: receives a TX packet from microcontroller at 8602446 us.
Transceiver8: starts transmitting the beacon at 8663040 us
Proxy8: Begin emitting radio packet at time 8663232 us.
Proxy8: Complete emitting radio packet at time 8663776 us.
Transceiver0: receives a beacon packet and start to transmit the TX packet
    at 8663776 us
Transceiver0: generated a random number as backoff slots , slots = 3 at 8664
    ms

```

The example shown in Listing. 5.1, *BO* is set to 2, corresponding to 61.44 ms superframe. With the notracking mode, the nodes have to wake up their transceivers after reading a new sensor data; however, during the wakeup transition of transceiver, the

coordinator has transmitted a beacon packet at 860.16 ms. The nodes have to listen to the channel and receive a beacon packet after one superframe duration at 866.3776 ms. If the tracking mode is used, this resynchronization will not occur. The transceiver uses a built-in timer to count for the superframe length and wake up automatically before the transmission of beacon packet. The same scenario of the tracking mode is illustrated in Listing. 5.2.

LISTING 5.2: *Log fragment of tracking mode*

```

Node0: Begin to wake up to read sensor data at 8598154 us.
Transceiver0: Begin to wake up to track beacon at 8599600 us.
Node0: reads a new sensor data (Value,Time): 248,8.6 at 8600066 us.
Transceiver0: starts to track beacon with _state = 10 at 8601600 us
Node0: starts to transmit the data to the transceiver (_NR= 0 ) with data =
    248 at 8601600 us
Transceiver8: starts transmitting the beacon at 8601600 us
Proxy8: Begin emitting radio packet at time 8601792 us.
Transceiver0: receives a TX packet from microcontroller at 8601986 us.
Proxy8: Complete emitting radio packet at time 8602336 us.
Transceiver0: receives a beacon packet and start to transmit the TX packet
    at 8602336 us
Transceiver0: generated a random number as backoff slots , slots = 5 at
    8602560 us

```

The beacon packet at 860.16 ms was received by the synchronized transceivers which are woken up for tracking beacon automatically by a built-in timer. Therefore, the latency of notraking mode is larger than that of tracking mode.

Note that the timing cost of resynchronization of the notracking mode, compared to the tracking mode, only happens when a transmission of beacon packet occurs during the wakeup transition of transceiver. If there is no beacon packet transmission during the wakeup transition of transceiver, the latency results of notracking and tracking modes are the same. In this case, the difference between these two modes is power consumption. After reading a sensor data, the nodes of tracking mode can go to sleep again and

wake up before the transmission of beacon packet, because they know the information of superframe. However, the nodes of notracking mode have to listen the channel until a receipt of beacon packet.

5.1.1.3 Average Power Consumption

Fig. 5.3 demonstrates the simulation results of *APC*. Firstly, we analyze the change tendency of the power consumption of notracking mode. Finally, we compare the difference between the notracking and tracking mode.

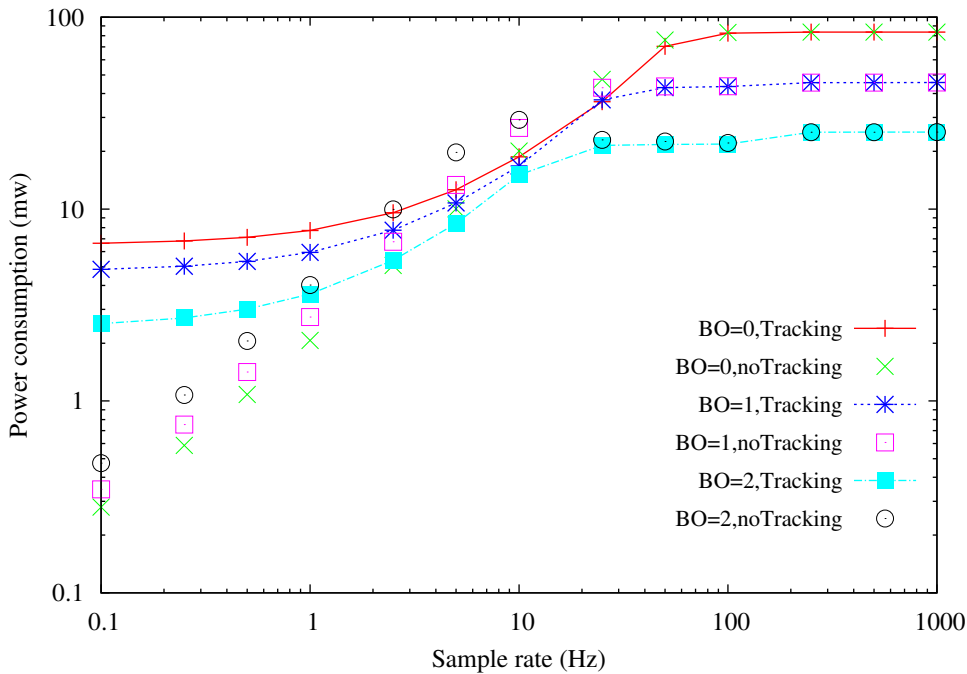

FIG. 5.3: Power consumption of slotted CSMA-CA with fixed *SO* and various *BO*

During the lightly loaded stage, the *APCs* of notracking mode increase as the sample rate augments. In these cases, the nodes go to sleep mode after the transmission and wake up when the next sample interval begins, so the energy spent during one sample interval for different sample rate are almost the same. The difference of energy consumption between two sample rates is the length of sleep mode. Therefore, the *APCs* increases as the sample interval decreases. In addition, the *APC* of a bigger *BO* is higher than that of a smaller *BO*, because the energy cost of resynchronization of notracking mode for a bigger *BO* is more heavy. In these cases, after reading a new sensor data, the

microcontroller turns on the transceiver to listen for a beacon. The listening period is the cost of resynchronization which can be observed in Listing. 5.1. The transceiver of Node0 is woken up at $8602066 \mu s$ which is $60974 \mu s$ before the beacon packet transmission. The transceiver has to listen to the channel during this time. The listening period may last long if the length of superframe is big. Finally, *APC* is tending towards stability when the system is saturated. The microcontroller keeps in active mode and the transceiver goes to sleep mode during the inactive portion of a superframe and turn to active when active portion begins.

The *APCs* of nottracking mode are smaller than tracking mode during the lightly loaded stage, because one sample interval consists of a lot of superframes and the tracking mode spends too much energy for useless beacon tracking. When the system is heavily loaded, the *APCs* of nottracking mode are much bigger than tracking mode. During this period, the cost of resynchronization of nottracking mode is much bigger than the useless beacon tracking of tracking mode since one sample interval consists of a few of superframes. When the system becomes completely saturated, the two modes have the same behaviors and the *APCs* become steady.

5.1.1.4 Energy Consumption per Packet

Fig. 5.4 illustrates the simulation results of *ECPkt*. During the lightly loaded stage, the *ECPkts* of nottracking mode remain constant, because the energy spent during one sample interval for different sample rate are almost the same and the numbers of successfully transmitted packet during one sample interval for different sample rates are same. While the system is heavily loaded, *ECPkt* begins to decrease because the cost of resynchronization declines. Finally, *ECPkt* is tending towards stability when the system is saturated.

When the sample rate is small (0.1, 0.25, 0.5, 1 and 2.5 for *BO* set to 1), the *ECPkts* of nottracking mode are smaller than the tracking mode, because the useless beacon tracking consumes much energy. At the end of lightly loaded stage and the entire

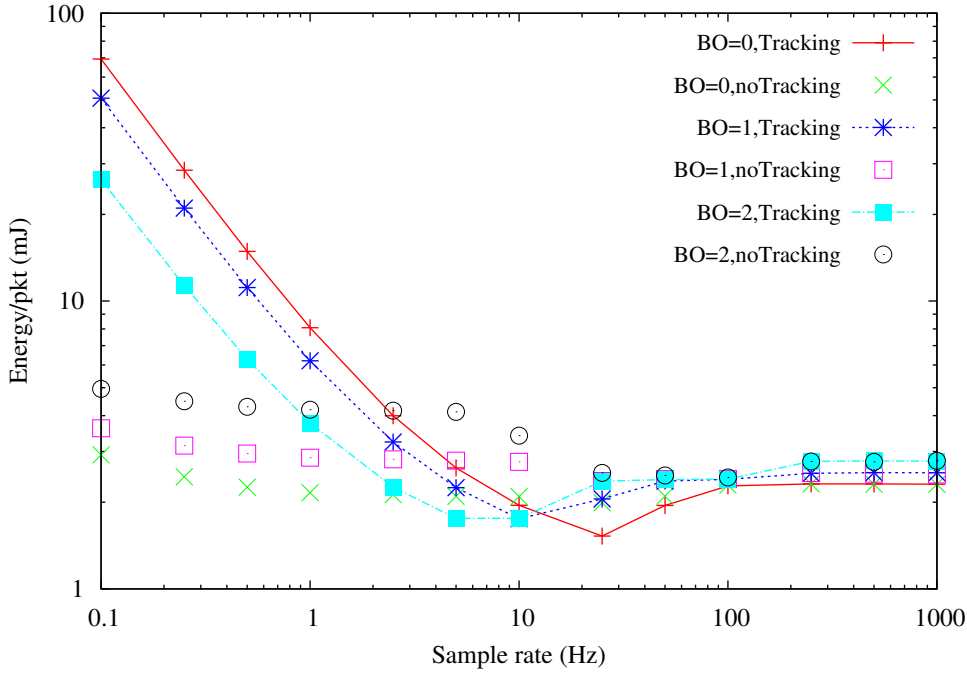

FIG. 5.4: Energy consumption per packet of slotted CSMA-CA with fixed SO and various BO

transition stage, the $ECPkts$ of notracking mode are bigger than the tracking mode, since the resynchronization of notracking mode consumes much energy. When the system is saturated, the $ECPkts$ of notracking and tracking mode are the same. In these cases, the system behaviors of the two modes are the same.

5.1.1.5 Summary

Based on the above analysis, we can find a best parameter setting for different sample rates. If the sample rate is small, the notracking mode with BO set to 0 consumes the least energy for transmitting one packet and provides the shortest AL with the best PDR . When the sample rate is 25, the tracking mode with BO set to 0 performs better than any other settings. If the sample rate is bigger than 25, for this application with 8 nodes and 1 coordinator, the performance of these two modes are the same. In this period, the contention-based CSMA-CA algorithm cannot guarantee a PDR bigger than 95% and BO should be set to 0 in order to provide biggest PDR with shortest AL and smallest $ECPkts$; however, these advantages are obtained by sustaining a big power consumption which results a short lifetime of sensor nodes and the network.

The beacon-enabled mode without beacon tracking and with SO set to 0 has successfully solved the useless beacon tracking problem. The $ECPkts$ and APCs become smaller when the sample rate is smaller. However, it still has a problem that the ALs of a bigger BO are much longer than a smaller BO , which is caused by the waiting in the inactive portion of a superframe because SO is set too small and some transmissions can not be finished in one superframe. Therefore, in next section, the same simulations in this section will be re-executed with SO set to the same value with BO .

5.1.2 Slotted CSMA-CA with Equal SO and BO

In the last section, SO is fixed to 0 and variable BO results different duty cycle in a superframe. In this section, the application is implemented by using the beacon-enabled slotted CSMA-CA algorithm without beacon tracking and with a SO that is equal to BO ; the inactive portion of the superframe is thus 0. The unfinished transmissions do not have to wait a long inactive portion for resuming. The simulation and measurement results are presented in Fig. 5.5 and Fig. 5.6.

In order to facilitate the comparisons, the simulation results of beacon-enabled mode without beacon tracking and with SO set 0 are also illustrated in Fig. 5.5 and Fig. 5.6. Two improvements have been obtained if SO is set to the same value with BO . They are presented as follows.

- *PDR*: *PDRs* with BO set to 1 and 2 are increased when the sample rate is bigger than the start point of the stage of transition to be saturated. Because SO is equal to BO , the nodes have more time to transmit the sensor data and the start point of the system heavily loaded is deferred.
- *AL*: Latency diminishes, since the inactive portion of a superframe is set to 0 and the nodes do not have to wait a long time for resume their transmissions in a new superframe. During the lightly loaded stage, the ALs of a bigger BO are larger than a smaller BO . In these cases, the nodes are in sleep mode if they have no sensor data

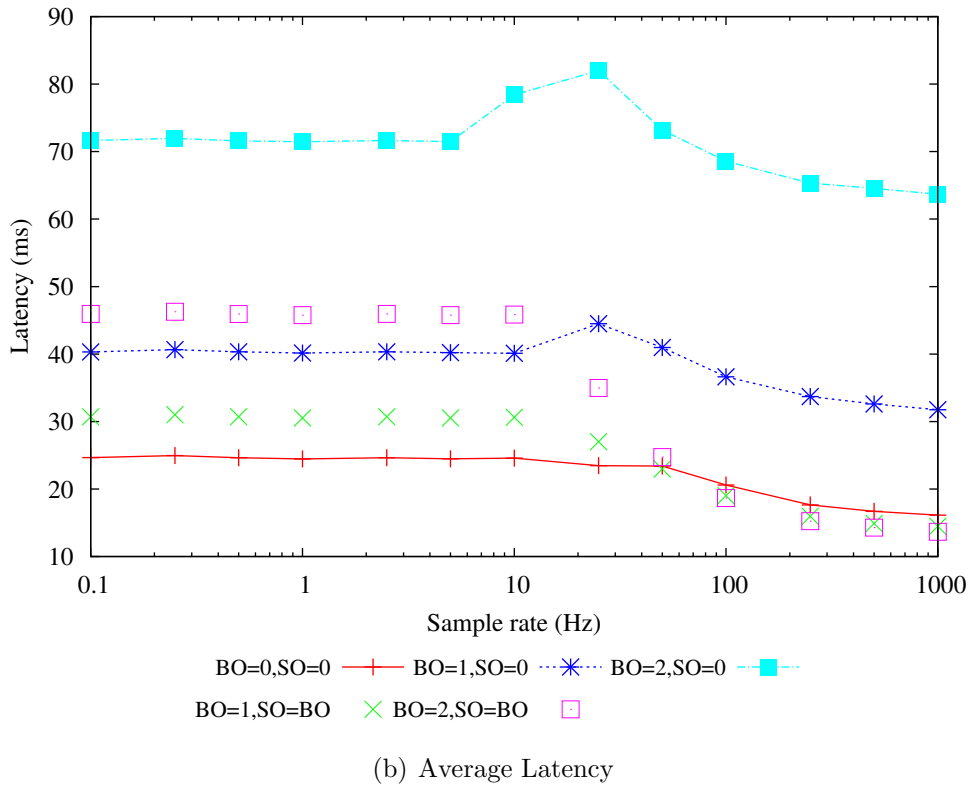
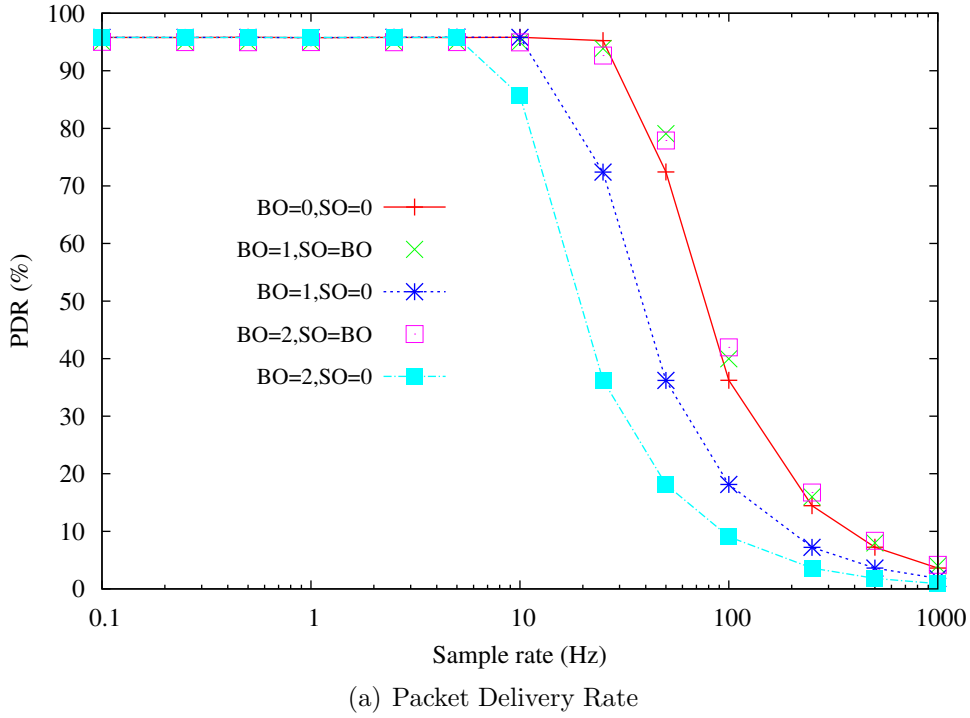

FIG. 5.5: Simulated results of PDR and AL with SO equal to BO

to be sent. They will be woken up by a built-in timer if they need to read a sensor data. In the beacon-enabled mode, the nodes can only transmit the new sensor

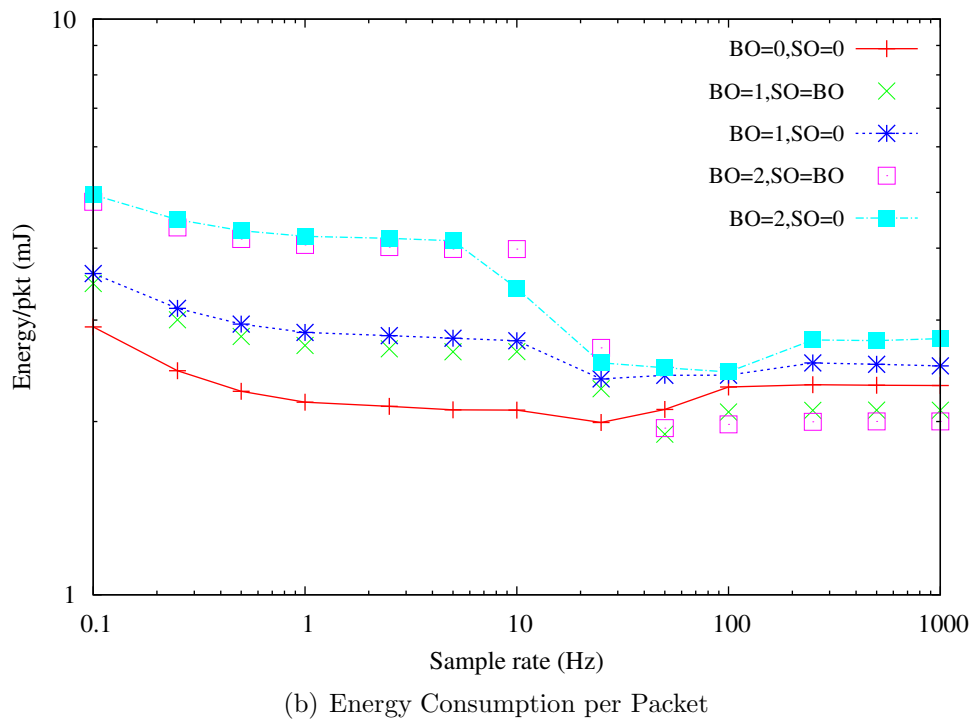
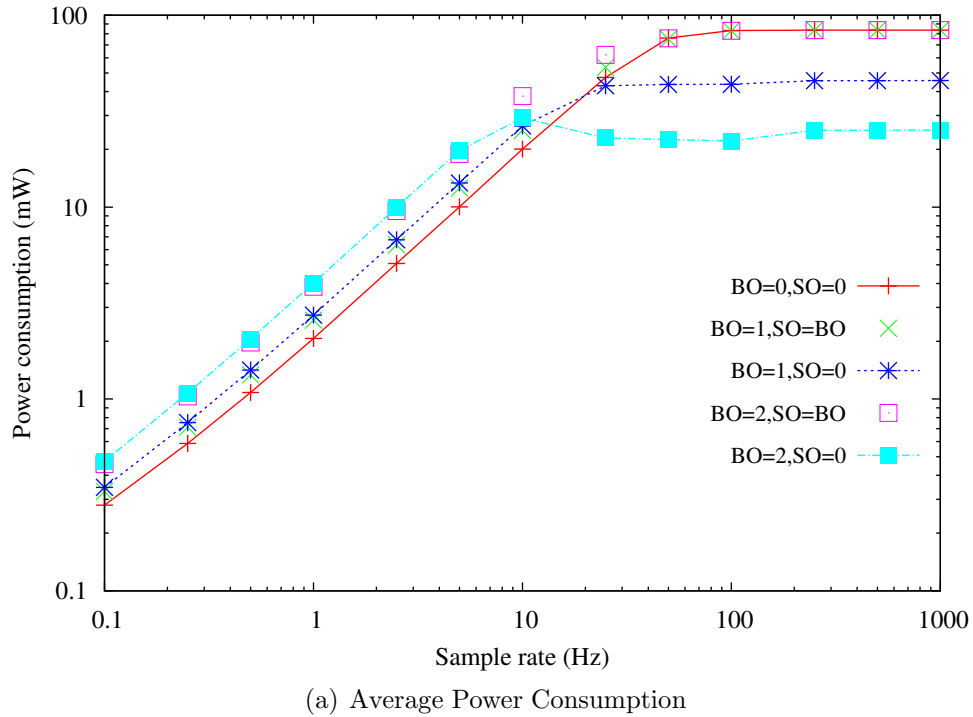

FIG. 5.6: Simulated results of APC and ECPkt with SO equal to BO

data after they successfully receive a beacon packet. We name this kind of delay of latency is the cost of resynchronization. A sensor data may wait for a longer time to be sent if BO is bigger. When the system is heavily loaded, the ALs become small.

As the system becomes completely saturated, the ALs of a bigger BO are shorter than a smaller BO as a result of less receiving of beacon.

5.1.3 Unslotted CSMA-CA

The cost of resynchronization is an intrinsic drawback of beacon-enabled mode; in this section, the performance of nonbeacon-enabled mode with unslotted CSMA-CA algorithm is thus evaluated. The simulation results are shown in Fig. 5.7 and Fig. 5.8.

The simulation results of beacon-enabled mode without beacon tracking and with SO set 0 are also illustrated in Fig. 5.7 and Fig. 5.8. Without the cost of resynchronization, the nonbeacon-enabled mode provides smaller ALs than beacon-enabled mode; in addition, the $ECPkts$ and APCs of nonbeacon-enabled mode are smaller if the system is not saturated. However, the $PDRs$ of nonbeacon-enabled mode are smaller than beacon-enabled mode. Because the transmissions of nonbeacon-enabled mode are not aligned with the backoff period boundary and CW is set to 0, the number of collisions is increased. When the system is saturated, the $ECPkts$ of nonbeacon-enabled mode are bigger due to its smaller $PDRs$.

5.1.4 Summary

Based on the above simulations and analysis, we can find the following conclusions.

- The nonbeacon-enabled mode can provide better performance in the aspects of latency and energy consumptions than beacon-enabled mode, but with a smaller PDR .
 - The beacon-enabled mode can offer a bigger PDR , but it has one intrinsic cost of resynchronization which increases the latency and power consumption.
 - If the sample rate is small and the system is lightly loaded, the nodes spend too much for many useless beacon receipts if tracking is specified; thus nottracking mode
-

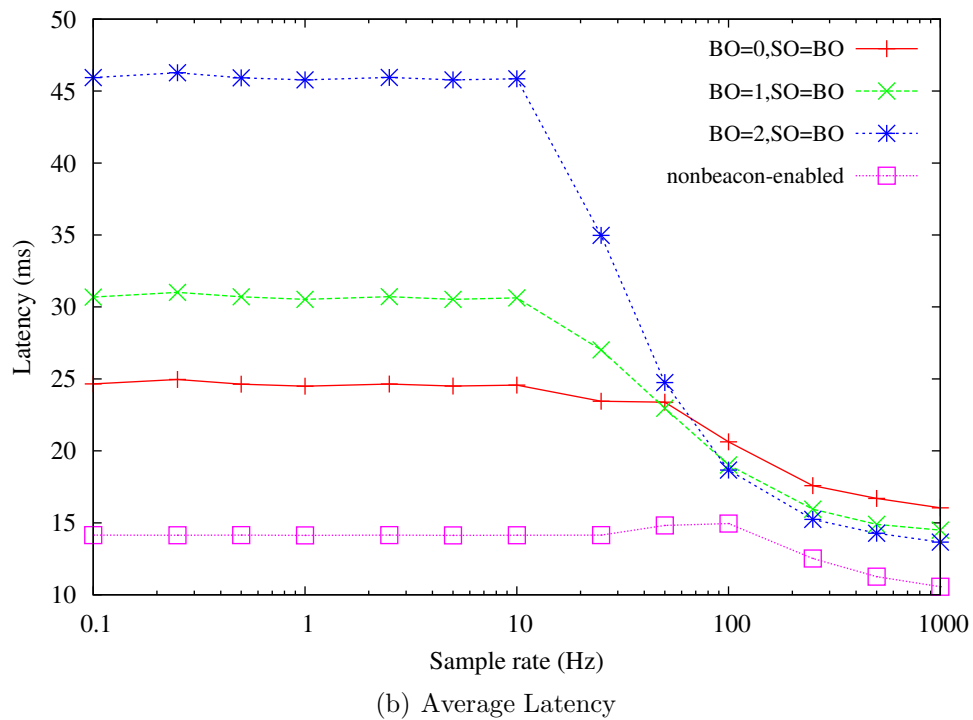
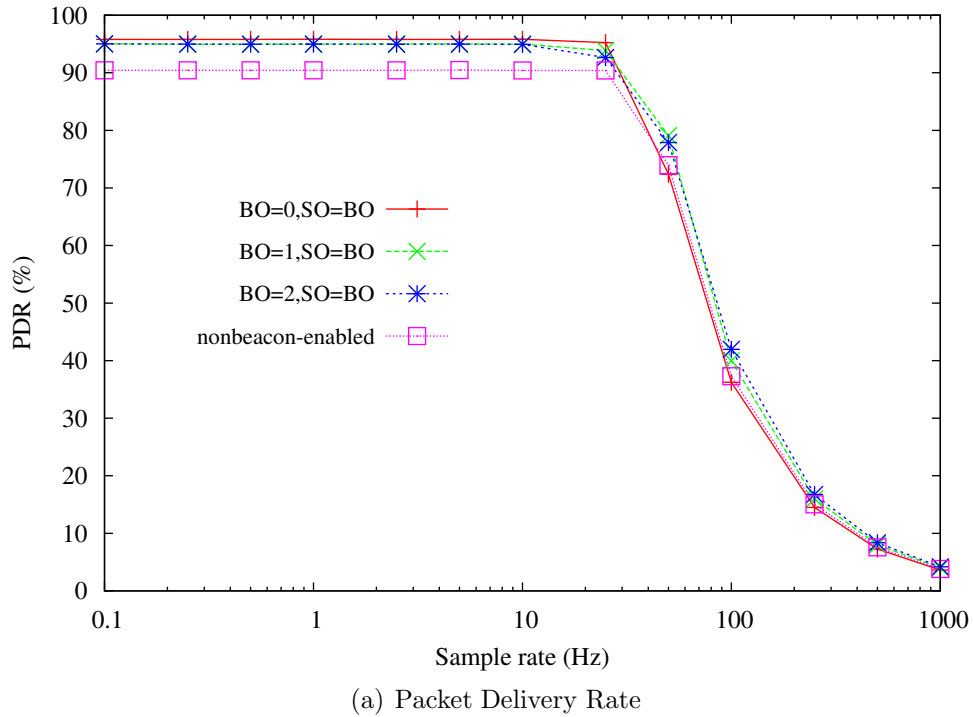
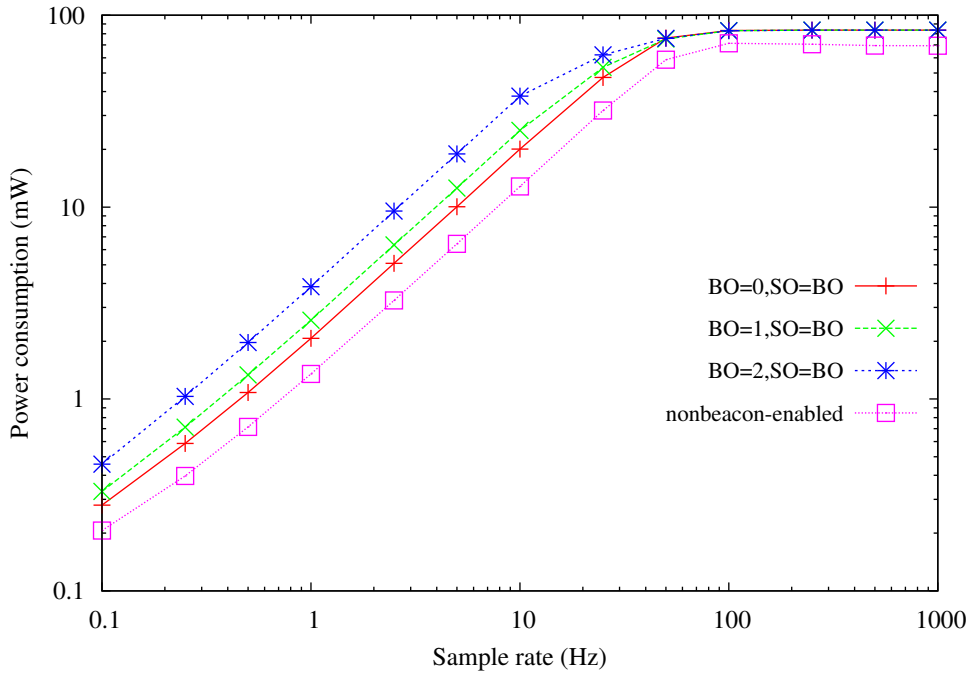
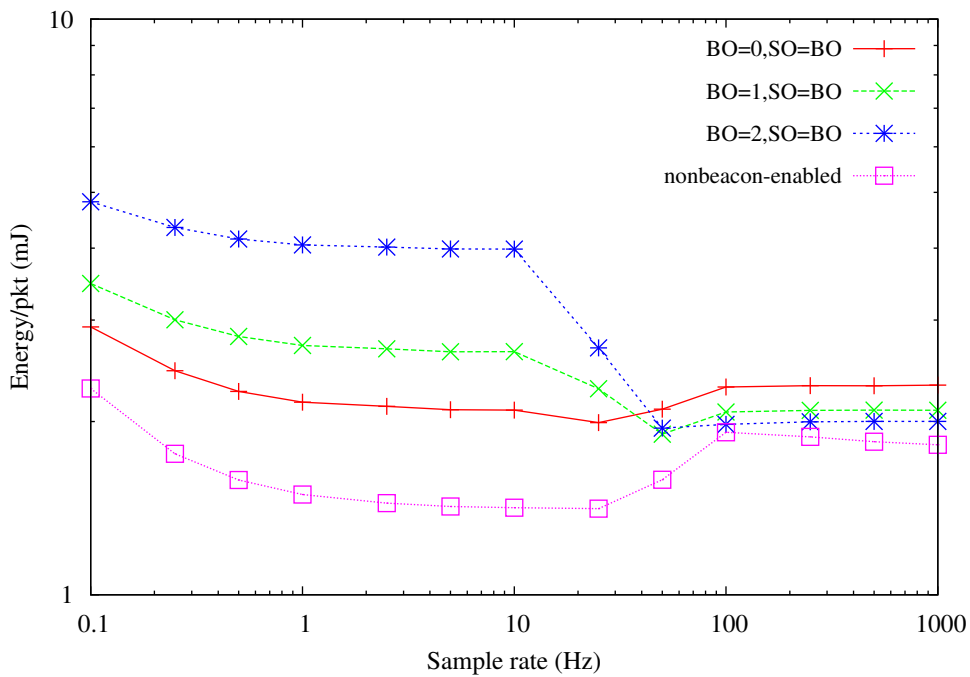

FIG. 5.7: Simulated results of PDR and AL with nonbeacon-enabled mode

should be used. In order to minimize the impact of the resynchronization cost, BO is set to 0.



(a) Average Power Consumption



(b) Energy Consumption per Packet

FIG. 5.8: simulation results of APC and ECPkt with nonbeacon-enabled mode

- During the period that the system is heavily loaded, if SO is set to the values of BO , the start point of the transition can be deferred. In addition, the beacon-enabled mode with beacon tracking can support a better $ECPkt$.

- When the system is completely saturated, the *PDRs* of the CSMA-CA algorithms are less than 50% and a bigger *BO* with *SO* set to its value can provide a better performance in the aspects of both latency and energy consumption.

5.2 An Industrial Application

In this section, IDEA1 is used to study an industrial application of WSN in vibration measurement in order to validate and demonstrate the usability of IDEA1 in the real project.

WSNs have recently received much attention in the industrial communications community [137]. An important class of applications is monitoring the equipment and machinery health, using for example vibration, heat or thermal sensors. Our group participated in a project, named Mechanic@Lyon (M@L) [136]. It is a project supported by Ingénierie@Lyon (I@L), an institute of Carnot Network. The objective of this project is to identify and integrate some new intelligent control technologies in automotive systems in order to improve the internal comfort (reduce the vibration and noise). A wireless sensor and actuator network is deployed on an automobile to measure and control its vibration.

The first task of our work is to design the sensor network from the network protocol to the hardware specifications of each component on a sensor node. At the beginning, some preliminary designs based on several existing hardware platforms and communication protocols need to be investigated at an early stage.

The rest of this section is organized as follows. Firstly, section 5.2.1 introduces the industrial application. Secondly, section 5.2.2 studies this application by analytical methods. Finally, section 5.2.3 presents the simulation results of IDEA1.

5.2.1 Introduction to the Industrial Application

The architecture of sensor and actuator network is shown in Fig. 5.9. This sensor network is composed of several nodes and a coordinator. The nodes measure periodically the vibrations of their given positions by a piezoelectric sensor and transmit the data to a coordinator which collects the sensor data of all nodes. A sample occupies one byte. The coordinator is connected to a host that analyzes the collected data and implements control algorithms by an actuator network. The main challenges of designing this sensor network are the high sample rate and real-time requirements. The node should read the sensor data with a sample rate exceeding kilohertz and send the data to the coordinator within a short latency.

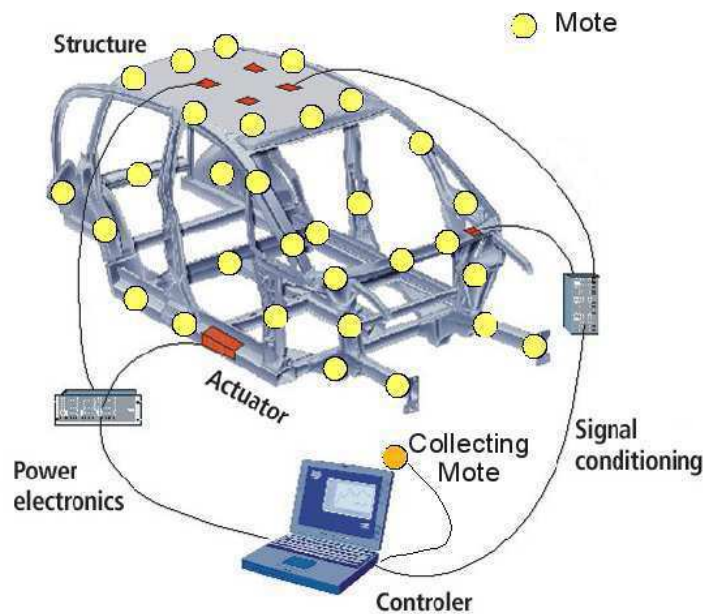

FIG. 5.9: *M@L wireless sensor and actuator network infrastructure*

At the early stage, some preliminary designs based on the existing hardware platforms and network protocols need to be evaluated. Four metrics, including *PDR*, *AL*, *ECPkt* and *APC*, are used to evaluate the network performance.

The performance of IEEE 802.15.4 [15] protocol is first evaluated since it has been widely used in the real time industrial automations [138]. In next section, some preliminary analysis are made in order to obtain a first understanding of this application.

In section 5.2.3, both the CSMA-CA and GTS algorithms are evaluated by simulations. Two sensor nodes that support the IEEE 802.15.4 standard, MICAz and N@L, are chosen as the hardware platforms. These two sensor platforms have been introduced in section 2.2.2 and section 3.2.3.

5.2.2 Preliminary Study

In this section, some preliminary analysis are provided based on some existing works on the performance analysis of the IEEE 802.15.4 standard. At first, the eight nodes deployed on the vehicle roof are modeled. The nodes and coordinator form a star topology, where all nodes can communicate with the coordinator directly. The nodes store the sample data temporarily in a data buffer and they will send the sensor data to the coordinator if the data in the buffer is more than *sizePayload* bytes. *sizePayload* is the payload field length of data packet.

As shown by the simulation results of IEEE 802.15.4 protocols in section 5.1, the *PDRs* of the CSMA-CA algorithms are very small when the sample rate is 1 kHz, because they are based on the random backoff mechanism and contention-based channel access. In addition, the mathematical analysis in [139] [140] proves that the unslotted and slotted CSMA-CA algorithms can not guarantee a 100% packet delivery rate and the channel access success probability decreases monotonically when the number of nodes is bigger than one, since the number of nodes competing for the channel increases.

As stated in section 2.3.2.3, the contention free guaranteed time slots algorithm is design to support applications with particular latency requirements. The studies made in [141] showed that the minimum latency of IEEE 802.15.4 GTS algorithm is 15.9 ms for any star network of any size, since the IEEE 802.15.4 standard requires a minimum length of CAP period that is 440 symbols (7.04 ms).

Besides the limited minimum latency of the IEEE 802.15.4 GTS algorithm, another constraint of this algorithm is that the maximum number of GTSs in a superframe is set

to 7. Since our application consists of 8 nodes, a TDMA-based GTS algorithm proposed in [138] is adopted. It is more suitable for industrial applications which require low packet delivery latency. It makes some modifications to the IEEE 802.15.4 GTS algorithm and these modifications can be easily implemented by software on the two hardware platforms we use. The contention access period (CAP) is set to 0. The contention free period (CFP) is divided into 8 equal parts, called node slot, which are allocated to nodes off-line. During its slot, the node wakes up if it has data to transmit. Transmissions do not require ACKs since they happen during GTSs without contention. The node tracks the beacon at the beginning of every superframe. It starts transmitting within its GTS that is allocated beforehand. The node is in SLEEP mode when it is not transmitting data or receiving beacon packets. The structure of this superframe is presented in Fig 5.10.

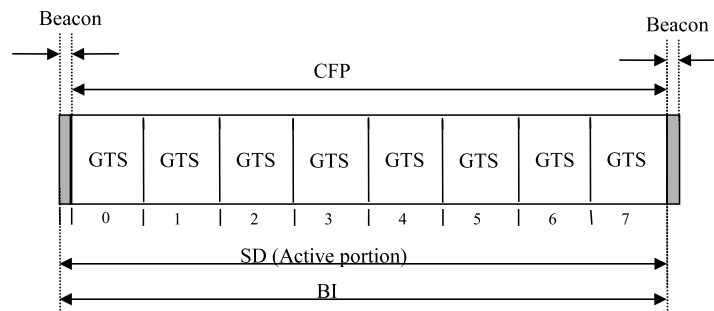

FIG. 5.10: *Superframe structure for the TDMA-based GTS algorithm*

The sample data is presented as a short integer type with one byte. The data frame format has been presented in Fig. 3.4. Because all the nodes can reach the coordinator directly and the number of nodes is 8, we use the short address with two bytes to identify the nodes and coordinator, and the data frame only includes one address, either the source address or the destination address. For a packet from a node to the coordinator, the value in the address field is the source address so that the coordinator can identify the packet is from which node; for a packet from the coordinator to the nodes, the destination address is loaded in the address field of the data frame so that the right node can receive this packet. In this context, the maximal size of payload field can attain 121 bytes, since the maximal value of the frame length field is 127 bytes. The frame length, frame control, sequence number and address fields occupy 6 bytes. The data frame structure is presented

in Fig. 5.11.

Bytes:1	2	1	2	n
Frame Length	Frame Control Field (FCF)	Data Sequence Number	Address Information	Frame Payload
PHY Header	MAC Header			MAC Payload

FIG. 5.11: *Data frame structure of M@L application*

This data frame is the data needed to be transmitted from the microcontroller to transceiver via SPI bus. The other fields, like preamble sequence, start of frame delimiter and frame check sequence, will be added by the transceiver automatically.

Because all the existing analysis focus on the IEEE 802.15.4 standard and they ignored the timing detail of the hardware and software implementations in real motes, we need to do some simulations by IDEA1 to take account into the hardware and software operations. In addition, the size of the payload field in data packet is adjusted to find out the shortest latency of best packet delivery rate. At the same time, the power consumptions of different hardware platforms are also investigated.

5.2.3 Simulation Study

In this section, the application is implemented in IDEA1 and analyzed. The goal is to evaluate whether the IEEE 802.15.4 sensor network based on these two platforms can successfully transmit all the sensor data within a short time. The energy models of MICAz and N@L motes used in this application are based on the measurements presented respectively in section 3.3.5 and section 4.2.1.

Four IEEE 802.15.4 MAC algorithms are implemented, including nonbeacon-enabled unslotted CSMA-CA, beacon-enabled slotted CSMA-CA, original GTS and TDMA-based GTS. Due to the constraints of the maximum GTS slots number of the IEEE 802.15.4 standard, the number of nodes in the simulation for this algorithm is set to 7. For each of the four algorithms, many cases with different configurations of parameters

(e.g., *sizePayload*, superframe length, *macMaxCSMABackoffs*, *macMaxFrameRetries*, etc.) have been simulated. Since the sample rate is constant, a small *sizePayload* results in more packets to be sent, causing more collisions and thus lower *PDR*. In contrast, a large *sizePayload* leads a longer time for transmitting a packet, which increases the possibilities of channel access failures and causes lower *PDR* too. The best *PDR*, hence, occurs in the case with a moderate *sizePayload*. However, *sizePayload* should be as short as possible. A smaller *sizePayload* means the first sensor data in the packet need to wait a shorter time to be sent. Here only the best result with the highest *PDR* (or lowest *AL* if two or more cases achieve the biggest *PDRs*) is presented. Each case includes 2500 samples and is simulated 100 times with different seeds of the random number generator of backoff periods. The simulation results of MICAz and N@L motes are provided in Table 5.1.

TAB. 5.1: *Simulation results of Of MICAz and N@L motes*

Algorithm	Unslotted CSMA-CA		Slotted CSMA-CA		IEEE802154 GTS		TDMA-based GTS	
	MICAz	N@L	MICAz	N@L	MICAz	N@L	MICAz	N@L
Hardware platform	MICAz	N@L	MICAz	N@L	MICAz	N@L	MICAz	N@L
<i>sizePayload</i> (byte)	30	30	30	30	30	15	10	19
<i>BO</i>	n/a	n/a	1	1	1	0	n/a	n/a
<i>BI</i> (μ s)	n/a	n/a	30720	30720	30720	15360	10000	19000
<i>PDR</i> (%)	36.5	54.4	39.7	67.4	97.4	97.4	100	100
<i>AL</i> (μ s)	11583	15841	22426	24250	53854	42777	6953	12508
<i>ECPkt</i> (μ J/pkt)	3811	1924	3784	1576	1283	1001	425	408
<i>APC</i> (μ W)	46693	35155	50397	35684	41071	64630	42300	21264
<i>APC of microcontroller</i> (μ W)	29916	4576	29916	4576	29915	4448	29928	4573
<i>APC of transceiver</i> (μ W)	16777	30579	20481	31108	11157	60182	12371	16691

5.2.3.1 Comparisons of MAC algorithms

The CSMA-CA algorithms are not appropriate for this industrial application due to the low *PDRs*, which is caused by the large number of collisions. The sample rate is too high that the system is overloaded.

For the original IEEE 802.15.4 GTS algorithm, because the packet is transmitted after the CAP portion (at least 7.04 ms), the *AL* is high. During one superframe of 30.72 ms, 30.72 sensing operations are performed, but only 30 sensor data can be sent in one packet; the *PDRs* can not therefore be 100%. This algorithm is implemented by software in MICAz and by hardware in N@L. For MICAz mote, after receiving a beacon packet,

the microcontroller can set the transceiver to sleep mode until its GTS slot; however for N@L mote, the transceiver performs automatically and stays in active mode during the CAP portion of a superframe. Therefore, the power consumption of this algorithm based on N@L motes is much bigger than that of MICAz motes.

For the TDMA-based GTS algorithm, the *PDRs* can attain 100%, which prove that the TDMA-based GTS algorithm can reliably transmit the sensor data to the coordinator. However, this IEEE 802.15.4 sensor network fails to meet the real-time requirement of this application. Although the average latency of packets can attain 7.0 ms, *sizePayload* is 10 samples which mean that the first sample data should wait 17 ms to be received by the coordinator. This latency of sensor data is too high to generate a real-time control action.

5.2.3.2 Comparisons of Hardware Platforms

The *PDRs* of N@L are bigger than MICAz, because the MAC algorithms are implemented in MRF24J40 by hardware and the sensing operation in PIC16LF88 has limited impact on the communication process. For N@L mote, the communication process in transceiver and the sensing operation (analog to digital conversion) in microcontroller can be performed at the same by these two hardware components; however, the microcontroller of MICAz mote has to stop its task immediately when the sensing timer expires.

The *ALs* of N@L is larger than MICAz, since for transmitting a same data frame the SPI communication between PIC16LF88 and MRF24J40 is longer than that between ATMEL ATMega128 and TI CC2420. In order to transmit one packet of several bytes from PIC16LF88 to MRF24J40, the address needs to be sent before each byte. However, ATMega128 only has to transmit one address for a whole packet.

Microchip PIC16LF88 is a power-efficient microcontroller. With a extra low power consumption microcontroller, the *APCs* of N@L is smaller than MICAz, although the power consumption of MRF24J40 is much higher than CC2420. CC2420 provides an IDLE state that is power saving. When it is not receiving or transmitting, it will be at

IDLE state. However, MRF24J40 does not support an IDLE state. Except transmitting, the transceiver is at RX state which is energy consuming.

5.2.3.3 Detailed Analysis of Energy Consumption

Besides the global results about the performances at network level presented in Table 5.1, some detailed analysis about the energy consumption at hardware component level are also provided, as presented in Fig. 5.12.

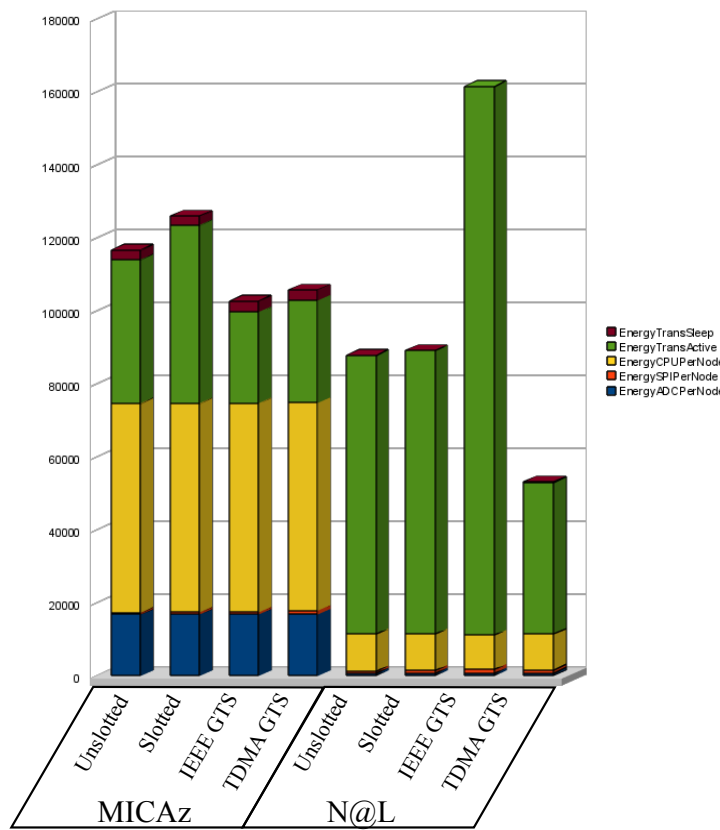

FIG. 5.12: An energy breakdown at component level

In Fig. 5.12, the energy consumption of a node is broken down into many small parts, including consumptions of microcontroller and transceiver. The main operations of microcontroller is composed of analog to digital conversion, SPI communication and data processing. For the transceiver, we have chosen to separate the energy consumption in two parts : consumption in active mode and consumption in sleeping mode.

From Fig. 5.12, we can find that the energy consumption of ATEMEga128 (yellow

part) is much more than that of PIC16LF88. The latter is more power-efficient. In addition, the analog to digital conversion of PIC16LF88 ($66\mu s$) is short than that of ATEmega128 ($219\mu s$). However, the transceiver of N@L mote, MRF24J40, is much more power consuming than that CC2420, the transceiver of MICAz mote. Compared with other algorithms and configurations, the energy consumption of MRF24J40 with the IEEE GTS algorithm is very large, because this algorithm is implemented by hardware and the transceiver stays on active after receiving a beacon packet until its GTS slot. On the contrary, more flexibility can be obtained by the software implementation of this algorithm on MICAz and the microcontroller can set the transceiver to sleep mode after the receipt of a beacon and wake it up before the allocated GTS slot.

5.3 Conclusion

In this chapter, IDEA1 has been used in two case studies to demonstrate its usability and design flow. First, the performance of IEEE 802.15.4 sensor network has been evaluated by IDEA1 simulations. The advantages and disadvantages of different algorithms with various parameter settings for different traffic loads have been summarized. Finally, IDEA1 has been used to design a real-time industrial application in which a wireless sensor and actuator network is deployed on a vehicle to measure and control vibrations. The best configurations of protocol parameters for various traffic loads based on different hardware platforms have been identified. By these two case studies, the usability of IDEA1 in real development of WSN systems has been demonstrated. IDEA1 can help the system designers to evaluate some primary designs with low timing and financial cost at an early stage of design flow. It is able to explore the design space by tuning the parameters of both sensor nodes and network protocols.

Chapter 6 :

Conclusions and Future Works

6.1 Summary of Work

This thesis has investigated the modeling and simulation of wireless sensor networks. A validated SystemC-based system-level design and simulation environment for WSN systems, named IDEA1, has been developed.

Based on the SystemC-based support of modeling concurrency, structural hierarchy, interrupts and synchronization primitives of embedded systems, IDEA1 enables the hardware and software co-simulation of wireless sensor networks. By doing this, the energy consumptions of an individual sensor node and the whole network can be accurately predicted. The energy model implemented in IDEA1 takes into account the power consumptions of all operation modes of each hardware component and transitions between different modes. IDEA1 implements a clock-based synchronization mechanism to provide performance evaluation with cycle accurate communication and approximate time computation. Many off-the-shelf hardware components, such as MICAz and MICA2, are modeled. The IEEE 802.15.4 standard is implemented.

Firstly, the simulation results of IDEA1 were compared with some experimental measurements on a testbed of 9 nodes in the aspects of packet delivery rate, average latency, energy consumption per packet and average power consumption. The average deviation between the IDEA1 simulations and the experimental measurements is 4.6% which can be accepted by general system-level simulations. The performances of IDEA1 have also been compared with NS-2, the most widely used simulator in WSN research. Benefiting from the SystemC-based hardware and software co-simulation, IDEA1 provides more detailed information about the energy consumptions than NS-2. If the timing information of some relative hardware operations are not considered in IDEA1, the average deviation between IDEA1 and NS-2 simulations is 4.8% which proves that IDEA1 can provide the same accuracy with NS-2. However, if the relative hardware operations are considered in the IDEA1 simulation, the average deviation between IDEA1 and NS-2 simulations is 26.7%. Especially when the sample rate is low, the deviations of

energy consumption results between IDEA1 and NS-2 are very large, because the SPI communications between microcontroller and transceiver and other hardware operations account for a very great proportion of the power consumptions. Based on system-level modeling, the simulation speed of IDEA1 is 2 times faster than NS-2.

Finally, two case studies have been performed to show the usability and design flow of IDEA1. The performance of IEEE 802.15.4 sensor network was comprehensively evaluated. For various traffic loads, diverse configurations of protocol parameters, including unslotted and slotted CSMA/CA algorithms and different superframe architectures are simulated. In addition, a real-time active vibration control application was also studied. By the simulation studies of IDEA1, the best choice of communication protocols based on MICA2 or N@L motes was found.

6.2 Future Works

The research work implemented for this thesis has successfully met the research motivations proposed in section 1.2. However, the investigated research area of modeling and simulation of wireless sensor networks has been highlighted as a diverse aspect of WSNs. There are many additional research that could be conducted to further this research.

- To enhance the capability of IDEA1 in modeling the real WSN systems, some typical sensor chips need to be modeled by SystemC.
 - Operating system is one important part of the software development for WSN system; therefore IDEA1 will be more powerful if it can provide operating system abstraction supports. In addition, more accurate software modeling techniques, such as instruction set simulation, will be investigated.
 - The simulation of IEEE 802.15.4 sensor networks showed that this standard is more efficient for low duty cycle applications; therefore, for some high sample rate
-

applications, more communication protocols, especially high data rate protocols, need to be investigated.

- The protocols of high layers, such as network and transport layers, should be implemented so as to enable the large scale sensor network simulation and design.
 - The radio propagation models in current version of IDEA1 only contains two typical application scenarios. Some more accurate and complex propagation models should be implemented in IDEA1.
 - The battery discharge model in current version of IDEA1 is only a linear one. Some more accurate models need to be investigated.
-

Appendix A :
Modifications to the IEEE 802.15.4
NS-2 Model

When comparing the performances of IDEA1 with NS-2, we utilized the IEEE 802.15.4 NS-2 model in release 2.34 [24] and [25]. The existing IEEE 802.15.4 NS-2 model has been modified, since it was built complying with an earlier standard edition (IEEE 802.15.4 draft D18), which has been nowadays replaced by the latest revised release IEEE Std 802.15.4-2006 [15]. In addition, some bugs have been fixed and several new functions have been added. The main modifications are listed as follows.

1. Add function "*sendData(IE3ADDR SrcAddr,IE3ADDR DstAddr,UINT_8 payloadLength,bool isUperlayer)*" in the `p802_15_4sscs` class. Users can call this function to send data to the MAC layer in the tcl script.
 2. Add function "*MCPS_DATA_confirm(UINT_8 msduHandle,MACenum status)*" in the `p802_15_4sscs` class. This function is used by the MAC layer to report the transmission results to the SSCS layer. On receipt of this report, the MAC layer can start next transmission.
 3. Add function "*MLME_BEACON_NOTIFY_indication(UINT_8 BSN,PAN_ELEMENT *PANDescriptor,UINT_8 PendAddrSpec,IE3ADDR *AddrList,UINT_8 sduLength,UINT_8 *sdu)*" in the `p802_15_4sscs` class. This function is used by the MAC layer to report the successful receipt of a beacon packet so that the SSCS layer knows when the CAP ends. During the inactive portion of the superframe, the "*sendData*" function can not be invoked.
 4. Disable "*if (!(mpib.macAutoRequest)|| (wph->MSDU_PayloadLen > 0))*" in the function "*recvBeacon(Packet *p)*" of `p802_15_4mac` to enable the SSCS layer to handle the beacon transmission event.
 5. Enable the first "*log(p->refcopy());*" in the "*recvData(Packet *p)*" function and disable the first "*log(msdu->refcopy());*" in the "*MCPS_DATA_indication*" function of `p802_15_4mac` so as to log a packet in the trace file immediately when the node receives the packet, but not after sending the ACK.
-

6. Change "*if(newtime > 0.0)*" to "*if(newtime > 0.0000000001)*" in "*locateBoundary(bool parent, double wtime)*" function of `p802_15_4mac`, because `newtime` is a double variable, when it is 0, in fact, it is a small value that is bigger than 0 and less than 0.0000000001.
 7. According to the IEEE 802.15.4 standard-2006, after backoff, if the CSMA algorithm can not proceed the following process in this CAP, it should wait to the next superframe and redo the backoff. Add "*start (false);*" in the "*newBeacon(char trx)*" function of `p802_15_4csmaca`.
 8. Add "*rxCmd = 0;*" in the "*if ((frmCtrl.frmType == defFrmCtrlType_MacCmd) && (wph->MSDU_CmdType == 0x01))*" statement of the "*recv(Packet *p, Handler *h)*" function of `p802_15_4mac` in order to solve the problem that some devices can not associate with the coordinator because the BSY drop packet. If the beacon timer expires when the coordinator is sending ACK for the CM4 command to a node, the coordinator has to send beacon immediately. In this case, the `rxCmd` packet should be cleared, so that when that a device sends a new CM4 command, the coordinator will not drop it by checking "*rxCmd!=0*".
 9. Change "*if ((rxCmd)|| (txBcnCmd))*" to "*if (rxCmd)*" in the "*recv(Packet *p, Handler *h)*" function of `p802_15_4mac` in order to solve the problem that some devices can not associate with the coordinator because the BSY drop packet. If the beacon timer expires when the coordinator is waiting an ACK for the CM2 command, the coordinator is forced to send beacon immediately. In this case, the `txBcnCmd` packet has not been cleared, so when nodes send a new CM4 command in the next superframe, the coordinator will drop it by checking "*txBcnCmd!=0*". With this modification and the last one, the BSY error becomes rare, but I can not remove it totally. It happens randomly to some simulations. Maybe there are still some cases I did not discover. To guarantee the correctness of my simulations only concerning the communication process after the association stage, I check the trace
-

file of every simulation. If there are some devices not successfully associated, I will redo that simulation.

10. Change `"delay = locateBoundary((p802_15_4macDA(txAck) == mpib.macCoordShortAddress),0.0);"` to `"delay = 0.0;"` in the `"PLME_SET_TRX_STATE_confirm(PHYenum status)"` function of `p802_15_4mac`. The transmission of an acknowledgment frame in the CAP period shall commence either *aTurnaroundTime* symbols after the reception of the last symbol of the data or MAC command frame or at a backoff slot boundary. I chose to use the first case.
11. Disable `"reset();"` in the `"newBeacon ()"` function of `p802_15_4csmaca`. In a new superframe, the CSMA-CA algorithm does not need to reset. It will continue the operation in the last superframe. For example, if NR is 2 in at the end of last superframe, at the beginning of new superframe, NR is still 2 and does not need to reset to 0.
12. Some modifications in `mcps_data_request()` of `p802_15_4mac.cc` to set the format of sending packet.
13. Replace the `"canProceed()"` function of `p802_15_4csmaca` by a modified function made by Ca Phan on ["http://mailman.isi.edu/pipermail/ns-developers/2007-July/003196.html"](http://mailman.isi.edu/pipermail/ns-developers/2007-July/003196.html). The reason is *"First, we can not use UINT_16 for t_bPeriods,t_CAP. Because the values of t_CAP (in abackoffperiodunit) will exceeds the maximum value of 16bits number for SO>=11. For instance, when SO=11, then t_CAP= 98304 (abackoffperiodunits) > 65535 (maximum value of 16bits). Hence, in this function, we have to use UINT_32 instead of UINT_16. Second, when this function calculates the bPeriodsLeft, an fundamental error occurs when the packet arrives in the off period. In this case, the bPeriodsLeft get a wrong value."*
14. Two further modifications have been implemented in the new modified `"canProceed()"` function of `p802_15_4csmaca`.

`t_bPeriods` sometimes is -1998362383. It is caused by `"t_CAP = (UINT_32)(tmpf / phy->getRate('s'));"`. Converting to end of CAP to an integer caused many errors.

With `"t_transacTime += phy->trxTime(txPkt); t_transacTime += mac->mpib.macAckWaitDuration / phy->getRate('s');"` , the txPkt time has been added to `t_transacTime`, but with `"macAckWaitDuration=phy->trxTime(txPkt)+phy->trxTime(ACKPkt);"` , the txPkt time is calculated again.

15. Add the modifications of Iyappan, who has added the sleep mode to nodes.
 16. Add sensing time information in the timestamp field of pkt so as to measure the average latency of sensor data.
 17. Add `macBeaconSOTimer` in `"p802_15_4mac"` class to set nodes to sleep after the active portion.
 18. Add `"status_=SLEEP;"` in the `"putNodeToSleep();"` function and `"status_=IDLE;"` in the `"wakeupNode(void)."` function of `Phy802_15_4`. The energy is updated during `channel_sleep_time_`. Maybe it is cause by the incompatibility between Iyappan's code (based on release 2.28) and release 2.34.
 19. Add `"#define NONBEACON"` in the `"p802_15_4phy.h"` file to set the network to Nonbeacon-enabled mode (do not check if it is during CAP of a superframe in `sendData` of `SSCS802_15_4` and do not `setWakeTimer` in `putNodeToSleep` of `p802_15_4phy`).
 20. Add `"mac->phy->putNodeToSleep();"` in the `"MCPS_DATA_confirm"` function of `SSCS802_15_4` to set nodes to sleep if the transmission finishes and no data to transmit. In addition, add `"mac->phy->wakeupNode();"` in the `"sendData"` function of `SSCS802_15_4` to wake nodes up if they are in SLEEP.
 21. Change `"node()->energy_model()->DecrSleepEnergy(NOW-channel_sleep_time_, P_sleep_);"` to `"node()->energy_model()->DecrSleepEnergy(NOW-`
-

update_energy_time_, P_sleep_);” in the *wakeupNode()* function of Phy802_15_4. The UpdateSleepEnergy() function is invoked every second if the sleep interval is bigger than 1s, so the DecrSleepEnergy function will decrease more energy, including the energy that has been decreased UpdateSleepEnergy().

22. Add *node()->energy_model()->DecrIdleEnergy(NOW-update_energy_time_, P_idle_);*” in the *putNodeToSleep* function of Phy802_15_4 to decrease the energy consumed from the last *update_energy_time_* to NOW.

Bibliography

- [1] D. Bri, M. Garcia, J. Lloret, and P. Dini, “Real deployments of wireless sensor networks,” *Proc. of the 3rd int. conf. on Sensor Technologies and Applications*, pp. 415–423, 2009.
 - [2] J. Yick, B. Mukherjee, and D. Ghosal, “Wireless sensor network survey,” *Computer Networks*, vol. 52, no. 12, pp. 2292 – 2330, 2008.
 - [3] G. Sachdeva, R. Dömer, and P. Chou, “System modeling: A case study on a wireless sensor network,” University of California, Irvine, Tech. Rep. CECS-TR-05-12, 2005.
 - [4] F. Fummi, D. Quaglia, and F. Stefanni, “A systemc-based framework for modeling and simulation of networked embedded systems,” in *Proc. of the Forum on Specification and Design Languages*, 2008, pp. 49–54.
 - [5] K. Virk, K. Hansen, and J. Madsen, “System-level modeling of wireless integrated sensor networks,” in *Proc. of the Int. Symposium on System-on-Chip*, 2005, pp. 179–182.
 - [6] J. Hiner, A. Shenoy, R. Lysecky, S. Lysecky, and A. G. Ross, “Transaction-level modeling for sensor networks using systemc,” in *Proc. of the 2010 IEEE int. conf. on Sensor Networks, Ubiquitous, and Trustworthy Computing*, ser. SUTC '10. Washington, DC, USA: IEEE Computer Society, 2010, pp. 197–204.
 - [7] M. Damm, J. Moreno, J. Haase, and C. Grimm, “Using transaction level modeling techniques for wireless sensor network simulation,” in *Proc. of the Conference on Design, Automation and Test in Europe*, ser. DATE '10, 2010, pp. 1047–1052.
 - [8] S. Kurkowski, T. Camp, and M. Colagrosso, “Manet simulation studies: the incredibles,” *SIGMOBILE Mob. Comput. Commun. Rev.*, vol. 9, pp. 50–61, October 2005.
 - [9] *IEEE Std 1666 - 2005 IEEE Standard SystemC Language Reference Manual*, Institute of Electrical and Electronics Engineers, 2006.
 - [10] *Information technology – Open Systems Interconnection – Basic Reference Model: The Basic Model*, Institute of Electrical and Electronics Engineers Std., 1994.
 - [11] *ZigBee specification - Document 053474r17*, ZigBee Alliance, 2007. [Online]. Available: <http://www.zigbee.org/>
-

-
- [12] I. F. Akyildiz, W. Su, Y. Sankarasubramaniam, and E. Cayirci, "Wireless sensor networks: a survey," *Computer Networks*, vol. 38, no. 4, pp. 393–422, 2002. [Online]. Available: <http://dblp.uni-trier.de/db/journals/cn/cn38.html#AkyildizSSC02>
- [13] W. Ye, J. Heidemann, and D. Estrin, "An energy-efficient mac protocol for wireless sensor networks," in *Proc. of the Joint Conference of the IEEE Computer and Communications Societies (InfoCom)*, USC/Information Sciences Institute. New York, NY, USA: IEEE, June 2002, pp. 1567–1576.
- [14] K. K. II and P. Mohapatra, "Medium access control in wireless sensor networks," *Computer Networks*, vol. 51, no. 4, pp. 961 – 994, 2007.
- [15] *IEEE Standard for Information technology- Telecommunications and information exchange between systems- Local and metropolitan area networks- Specific requirements Part 15.4: Wireless Medium Access Control (MAC) and Physical Layer (PHY) Specifications for Low-Rate Wireless Personal Area Networks (WPANs)*, Institute of Electrical and Electronics Engineers, 2006.
- [16] *ATMEL ATMega128 datasheet*, Atmel Corporation. [Online]. Available: www.atmel.com/atmel/acrobat/doc2467.pdf
- [17] *TI CC2420 datasheet*, Texas Instruments Incorporated. [Online]. Available: focus.ti.com/lit/ds/symlink/cc2420.pdf
- [18] *PICmicro Mid-Range MCU Family Reference Manual*, Microchip Technology Inc. [Online]. Available: ww1.microchip.com/downloads/en/devicedoc/33023a.pdf
- [19] *Microchip MRF24J40 Data Sheet*, Microchip Technology Inc. [Online]. Available: ww1.microchip.com/downloads/en/DeviceDoc/DS-39776b.pdf
- [20] G. P. Halkes and K. G. Langendoen, "Experimental evaluation of simulation abstractions for wireless sensor network mac protocols," *EURASIP J. Wirel. Commun. Netw.*, vol. 2010, pp. 24:1–24:2, April 2010.
- [21] G. V. Merrett, N. M. White, N. R. Harris, and B. M. Al-Hashimi, "Energy-aware simulation for wireless sensor networks," in *Proc. of the 6th Annual IEEE communications society conference on Sensor, Mesh and Ad Hoc Communications and Networks*, ser. SECON'09. Piscataway, NJ, USA: IEEE Press, 2009, pp. 64–71.
- [22] P. Baronti, P. Pillai, V. W. Chook, S. Chessa, A. Gotta, and Y. F. Hu, "Wireless sensor networks: A survey on the state of the art and the 802.15.4 and zigbee standards," *Computer Communications*, vol. 30, no. 7, pp. 1655 – 1695, 2007.
-

-
- [23] T. R. Andel and A. Yasinac, "On the credibility of manet simulations," *Computer*, vol. 39, pp. 48–54, July 2006.
- [24] J. Zheng and M. J. Lee, "Will IEEE 802.15.4 make ubiquitous networking a reality?: a discussion on a potential low power, low bit rate standard," *Communications Magazine, IEEE*, vol. 42, no. 6, pp. 140–146, Jun. 2004.
- [25] I. Ramachandran, A. K. Das, and S. Roy, "Analysis of the contention access period of ieee 802.15.4 mac," *ACM Trans. Sen. Netw.*, vol. 3, March 2007.
- [26] G. Tolle, J. Polastre, R. Szewczyk, D. Culler, N. Turner, K. Tu, S. Burgess, T. Dawson, P. Buonadonna, D. Gay, and W. Hong, "A macroscope in the redwoods," in *Proc. of the 3rd int. conf. on Embedded networked sensor systems*, ser. SenSys '05. New York, NY, USA: ACM, 2005, pp. 51–63.
- [27] *MICA2 Datasheet*, Crossbow Technology, Inc. [Online]. Available: www.xbow.com/Products/Product_pdf_files/Wireless_pdf/MICA2_Datasheet.pdf
- [28] O. Chipara, C. Lu, T. C. Bailey, and G.-C. Roman, "Reliable clinical monitoring using wireless sensor networks: experiences in a step-down hospital unit," in *Proc. of the 8th ACM Conference on Embedded Networked Sensor Systems*, ser. SenSys '10. New York, NY, USA: ACM, 2010, pp. 155–168.
- [29] J. Polastre, R. Szewczyk, and D. Culler, "Telos: enabling ultra-low power wireless research," in *Proc. of the 4th international symposium on Information processing in sensor networks*, ser. IPSN '05. Piscataway, NJ, USA: IEEE Press, 2005.
- [30] L. Nachman, R. Kling, R. Adler, J. Huang, and V. Hummel, "The intel mote platform: a bluetooth-based sensor network for industrial monitoring," in *Proc. of the 4th Int. Symposium on Information Processing in Sensor Networks*, 2005, pp. 437–442.
- [31] L. Krishnamurthy, R. Adler, P. Buonadonna, J. Chhabra, M. Flanigan, N. Kushalnagar, L. Nachman, and M. Yarvis, "Design and deployment of industrial sensor networks: experiences from a semiconductor plant and the north sea," in *Proc. of the 3rd int. conf. on Embedded networked sensor systems*, ser. SenSys '05. New York, NY, USA: ACM, 2005, pp. 64–75.
- [32] G. Werner-Allen, K. Lorincz, M. Welsh, O. Marcillo, J. Johnson, M. Ruiz, and J. Lees, "Deploying a Wireless Sensor Network on an Active Volcano," *IEEE Internet Computing*, vol. 10, no. 2, pp. 18–25, Mar. 2006.
-

-
- [33] *Tmote Sky Datasheet*, Moteiv Corporation. [Online]. Available: <http://sentilla.com/files/pdf/eol/tmote-sky-datasheet.pdf>
- [34] G. Simon, M. Maróti, A. Lédeczi, G. Balogh, B. Kusy, A. Nádas, G. Pap, J. Sallai, and K. Frampton, "Sensor network-based countersniper system," in *Proc. of the 2nd int. conf. on Embedded networked sensor systems*, ser. SenSys '04. New York, NY, USA: ACM, 2004, pp. 1–12.
- [35] J. Hill, R. Szewczyk, A. Woo, S. Hollar, D. Culler, and K. Pister, "System architecture directions for networked sensors," *ACM SIGPLAN Notices*, vol. 35, pp. 93–104, November 2000.
- [36] B. Kusy, G. Balogh, J. Sallai, A. Lédeczi, and M. Maróti, "Intrack: high precision tracking of mobile sensor nodes," in *Proc. of the 4th European conference on Wireless sensor networks*, ser. EWSN'07. Berlin, Heidelberg: Springer-Verlag, 2007, pp. 51–66.
- [37] M. Maróti, P. Völgyesi, S. Dóra, B. Kusy, A. Nádas, A. Lédeczi, G. Balogh, and K. Molnár, "Radio interferometric geolocation," in *Proc. of the 3rd int. conf. on Embedded networked sensor systems*, ser. SenSys '05. New York, NY, USA: ACM, 2005, pp. 1–12.
- [38] P. Dutta, M. Grimmer, A. Arora, S. Bibyk, and D. Culler, "Design of a wireless sensor network platform for detecting rare, random, and ephemeral events," in *Proc. of the 4th international symposium on Information processing in sensor networks*, ser. IPSN '05. Piscataway, NJ, USA: IEEE Press, 2005.
- [39] H. Song, S. Zhu, and G. Cao, "Svats: A sensor-network-based vehicle anti-theft system," in *Proc. of the 27th IEEE Conference on Computer Communications*, 2008, pp. 2128–2136.
- [40] K. Römer and F. Mattern, "The design space of wireless sensor networks," *IEEE Wireless Communications*, vol. 11, no. 6, pp. 54–61, December 2004.
- [41] "The sensor network museum project." [Online]. Available: <http://www.snm.ethz.ch/Main/HomePage>
- [42] *MICAz Datasheet*, Crossbow Technology, Inc. [Online]. Available: www.xbow.com/Products/Product_pdf_files/Wireless_pdf/MICAz_Datasheet.pdf
- [43] *TelosB Datasheet*, Crossbow Technology, Inc. [Online]. Available: www.willow.co.uk/TelosB_Datasheet.pdf
-

-
- [44] *Imote2 Hardware Reference Manual*, Crossbow Technology, Inc. [Online]. Available: www.xbow.com/Products/Product_pdf_files/Wireless_pdf/Imote2_Datasheet.pdf
- [45] *BTnode Platform*, ETH Zurich. [Online]. Available: <http://www.btnode.ethz.ch/>
- [46] Y. Zhang and H. Xiao, "Bluetooth-based sensor networks for remotely monitoring the physiological signals of a patient," *Trans. Info. Tech. Biomed.*, vol. 13, pp. 1040–1048, November 2009.
- [47] A. Tanenbaum, *Computer Networks*, 4th ed. Prentice Hall Professional Technical Reference, 2002.
- [48] X. Zeng, R. Bagrodia, and M. Gerla, "Glomosim: a library for parallel simulation of large-scale wireless networks," in *Proc. of the twelfth workshop on Parallel and distributed simulation*, ser. PADS '98. Washington, DC, USA: IEEE Computer Society, 1998, pp. 154–161.
- [49] J. F. Kurose and K. W. Ross, *Computer Networking: A Top-Down Approach*, 5th ed. USA: Addison-Wesley Publishing Company, 2009.
- [50] I. Demirkol, C. Ersoy, and F. Alagoz, "MAC protocols for wireless sensor networks: a survey," *Communications Magazine, IEEE*, vol. 44, no. 4, pp. 115–121, 2006.
- [51] E. Shih, P. Bahl, and M. J. Sinclair, "Wake on wireless: an event driven energy saving strategy for battery operated devices," in *Proc. of the 8th annual int. conf. on Mobile computing and networking*, ser. MobiCom '02. New York, NY, USA: ACM, 2002, pp. 160–171.
- [52] M. Buettner, G. V. Yee, E. Anderson, and R. Han, "X-mac: a short preamble mac protocol for duty-cycled wireless sensor networks," in *Proc. of the 4th int. conf. on Embedded networked sensor systems*, ser. SenSys '06. New York, NY, USA: ACM, 2006, pp. 307–320.
- [53] W. Ye, J. Heidemann, and D. Estrin, "Medium access control with coordinated adaptive sleeping for wireless sensor networks," *IEEE/ACM Trans. Netw.*, vol. 12, pp. 493–506, June 2004.
- [54] P. Lin, C. Qiao, and X. Wang, "Medium access control with a dynamic duty cycle for sensor networks," in *Proc. of the IEEE Wireless Communications and Networking Conference (WCNC)*, vol. 3, 2004, pp. 1534–1539 Vol.3.
- [55] T. van Dam and K. Langendoen, "An adaptive energy-efficient mac protocol for wireless sensor networks," in *Proc. of the 1st int. conf. on Embedded networked sensor systems*, ser. SenSys '03. New York, NY, USA: ACM, 2003, pp. 171–180.
-

- [56] J. Ai, J. Kong, and D. Turgut, "An adaptive coordinated medium access control for wireless sensor networks," in *Proc. of the IEEE Symposium on Computers and Communications*, vol. 1. Los Alamitos, CA, USA: IEEE Computer Society, 2004, pp. 214–219.
- [57] W. Ye, F. Silva, and J. Heidemann, "Ultra-low duty cycle mac with scheduled channel polling," in *Proc. of the 4th int. conf. on Embedded networked sensor systems*, ser. SenSys '06. New York, NY, USA: ACM, 2006, pp. 321–334.
- [58] A. El-Hoiydi and J.-D. Decotignie, "Wisemac: An ultra low power mac protocol for multi-hop wireless sensor networks," in *Algorithmic Aspects of Wireless Sensor Networks*, ser. Lecture Notes in Computer Science, S. Nikolettseas and J. Rolim, Eds. Springer Berlin / Heidelberg, 2004, vol. 3121, pp. 18–31, 10.1007/978-3-540-27820-7_4.
- [59] J. Polastre, J. Hill, and D. Culler, "Versatile low power media access for wireless sensor networks," in *Proc. of the 2nd int. conf. on Embedded networked sensor systems*, ser. SenSys '04. New York, NY, USA: ACM, 2004, pp. 95–107.
- [60] A. El-Hoiydi and J.-D. Decotignie, "Wisemac: an ultra low power mac protocol for the downlink of infrastructure wireless sensor networks," in *Proc. of the Ninth Int. Symposium on Computers and Communications 2004 Volume 2 (ISCC'04) - Volume 02*, ser. ISCC '04. Washington, DC, USA: IEEE Computer Society, 2004, pp. 244–251.
- [61] D. Flowers and Y. Yang, *AN1066 application note: MiWi Wireless Networking Protocol Stack*, Microchip Technology Inc., 2007. [Online]. Available: <http://ww1.microchip.com/\penalty\exhyphenpenaltydownloads/\penalty\exhyphenpenaltyAppNotes/\penalty\exhyphenpenaltyAN1066%20-%20MiWi%20App%20Note.pdf>
- [62] K. Fall and K. Varadhan, *The ns Manual (formerly ns Notes and Documentation)*, Jan. 2009. [Online]. Available: http://www.isi.edu/nsnam/ns/doc/ns_doc.pdf
- [63] N. R. H. Ioannis Mathioudakis, Neil M. White and G. V. Merrett, "Wireless sensor networks: A case study for energy efficient environmental monitoring," in *Proc. of Euroensors 2008*, Dresden, Germany, Sep. 2008.
- [64] M. Watfa, W. Daher, and H. Al Azar, "A sensor network data aggregation technique," *Int. Journal of Computer Theory and Engineering*, vol. 1, pp. 19–26, 2009.
-

-
- [65] C. Intanagonwiwat, R. Govindan, and D. Estrin, "Directed diffusion: a scalable and robust communication paradigm for sensor networks," in *Proc. of the 6th annual int. conf. on Mobile computing and networking*, ser. MobiCom '00. New York, NY, USA: ACM, 2000, pp. 56–67.
- [66] R. Rajagopalan and P. K. Varshney, "Data-aggregation techniques in sensor networks: A survey." *IEEE Communications Surveys and Tutorials*, vol. 8, pp. 48–63, 2006.
- [67] K. Akkaya and M. Younis, "A survey on routing protocols for wireless sensor networks," *Ad Hoc Networks*, vol. 3, no. 3, pp. 325 – 349, 2005.
- [68] S. M. Hedetniemi, S. T. Hedetniemi, and A. L. Liestman, "A survey of gossiping and broadcasting in communication networks," *Networks*, vol. 18, no. 4, pp. 319–349, 1988.
- [69] W. R. Heinzelman, J. Kulik, and H. Balakrishnan, "Adaptive protocols for information dissemination in wireless sensor networks," in *Proc. of the 5th annual ACM/IEEE int. conf. on Mobile computing and networking*, ser. MobiCom '99. New York, NY, USA: ACM, 1999, pp. 174–185.
- [70] I. D. Chakeres and E. M. Belding-Royer, "Aodv routing protocol implementation design," in *Proceedings of the 24th International Conference on Distributed Computing Systems Workshops - W7: EC (ICDCSW'04) - Volume 7*, ser. ICDCSW '04. Washington, DC, USA: IEEE Computer Society, 2004, pp. 698–703.
- [71] W. R. Heinzelman, A. Chandrakasan, and H. Balakrishnan, "Energy-efficient communication protocol for wireless microsensor networks," in *Proc. of the 33rd Hawaii int. conf. on System Sciences-Volume 8 - Volume 8*, ser. HICSS '00. Washington, DC, USA: IEEE Computer Society, 2000, pp. 8020–.
- [72] A. M. V. Reddy, A. P. Kumar, D. Janakiram, and G. A. Kumar, "Wireless sensor network operating systems: a survey," *Int. J. Sen. Netw.*, vol. 5, pp. 236–255, August 2009.
- [73] C. Hartung, R. Han, C. Seielstad, and S. Holbrook, "Firewxnet: A multi-tiered portable wireless system for monitoring weather conditions in wildland fire environments," in *Proc. of the 4 th int. conf. on Mobile Systems, Applications, and Services*. ACM Press, 2006, pp. 28–41.
- [74] C.-C. Han, R. Kumar, R. Shea, E. Kohler, and M. Srivastava, "A dynamic operating system for sensor nodes," in *Proc. of the 3rd int. conf. on Mobile systems*,
-

- applications, and services*, ser. MobiSys '05. New York, NY, USA: ACM, 2005, pp. 163–176.
- [75] A. Dunkels, B. Gronvall, and T. Voigt, “Contiki - a lightweight and flexible operating system for tiny networked sensors,” in *Proc. of the 29th Annual IEEE int. conf. on Local Computer Networks*, ser. LCN '04. Washington, DC, USA: IEEE Computer Society, 2004, pp. 455–462.
- [76] S. Bhatti, J. Carlson, H. Dai, J. Deng, J. Rose, A. Sheth, B. Shucker, C. Gruenwald, A. Torgerson, and R. Han, “Mantis os: an embedded multithreaded operating system for wireless micro sensor platforms,” *Mob. Netw. Appl.*, vol. 10, pp. 563–579, August 2005.
- [77] A. Eswaran, A. Rowe, and R. Rajkumar, “Nano-rk: An energy-aware resource-centric rtos for sensor networks,” in *Proceedings of the 26th IEEE International Real-Time Systems Symposium*. Washington, DC, USA: IEEE Computer Society, 2005, pp. 256–265.
- [78] Q. Cao, T. Abdelzaher, J. Stankovic, and T. He, “The liteos operating system: Towards unix-like abstractions for wireless sensor networks,” in *Proc. of the 7th int. conf. on Information processing in sensor networks*, ser. IPSN '08. Washington, DC, USA: IEEE Computer Society, 2008, pp. 233–244.
- [79] T. Hofmeijer, S. Dulman, P. Jansen, and P. Havinga, “Ambientrt - real time system software support for data centric sensor networks,” in *Proceedings of the 2004 Intelligent Sensors, Sensor Networks and Information Processing Conference*. IEEE Computer Society Press, 2004, pp. 61–66.
- [80] V. Prasad and S. Son, “Classification of analysis techniques for wireless sensor networks,” *the 4th int. conf. Networked Sensing Systems*, pp. 93–97, 2007.
- [81] V. Handziski, A. Köpke, A. Willig, and A. Wolisz, “Twist: a scalable and reconfigurable testbed for wireless indoor experiments with sensor networks,” in *Proc. of the 2nd international workshop on Multi-hop ad hoc networks: from theory to reality*, ser. REALMAN '06. New York, NY, USA: ACM, 2006, pp. 63–70.
- [82] E. Egea-López, J. Vales-Alonso, A. S. Martínez-Sala, P. Pavón-Marõio, and J. García-Haro, “Simulation tools for wireless sensor networks,” *Proc. of the Int. Symposium on Performance Evaluation of Computer and Telecommunication Systems*, 2005.
-

-
- [83] G. Chen, J. Branch, M. Pflug, L. Zhu, and B. Szymanski, "Sense: A wireless sensor network simulator," in *Advances in Pervasive Computing and Networking*, B. K. Szymanski and B. Yener, Eds. Springer US, 2005, pp. 249–267, 10.1007/0-387-23466-7_13.
- [84] M. Varshney and R. Bagrodia, "Detailed models for sensor network simulations and their impact on network performance," in *Proc. of the 7th ACM international symposium on Modeling, analysis and simulation of wireless and mobile systems*, ser. MSWiM '04. New York, NY, USA: ACM, 2004, pp. 70–77.
- [85] V. Shnayder, M. Hempstead, B.-r. Chen, G. W. Allen, and M. Welsh, "Simulating the power consumption of large-scale sensor network applications," in *Proc. of the 2nd int. conf. on Embedded networked sensor systems*, ser. SenSys '04. New York, NY, USA: ACM, 2004, pp. 188–200.
- [86] L. Girod, T. Stathopoulos, N. Ramanathan, J. Elson, D. Estrin, E. Osterweil, and T. Schoellhammer, "A system for simulation, emulation, and deployment of heterogeneous sensor networks," in *Proc. of the 2nd int. conf. on Embedded networked sensor systems*, ser. SenSys '04. New York, NY, USA: ACM, 2004, pp. 201–213.
- [87] F. Fummi, M. Loghi, G. Perbellini, and M. Poncino, "Systemic co-simulation for core-based embedded systems," *Design Automation for Embedded Systems*, vol. 11, pp. 141–166, 2007, 10.1007/s10617-007-9006-7.
- [88] L. Séméria and A. Ghosh, "Methodology for hardware/software co-verification in c/c++ (short paper)," in *Proc. of the 2000 Asia and South Pacific Design Automation Conference*, ser. ASP-DAC '00. New York, NY, USA: ACM, 2000, pp. 405–408.
- [89] M. Degermark, A. Brodnik, S. Carlsson, and S. Pink, "Small forwarding tables for fast routing lookups," in *Proc. of the ACM SIGCOMM '97 conference on Applications, technologies, architectures, and protocols for computer communication*, ser. SIGCOMM '97. New York, NY, USA: ACM, 1997, pp. 3–14.
- [90] V. Raghunathan, C. Schurgers, S. Park, and M. B. Srivastava, "Energy-aware wireless microsensor networks," *Signal Processing Magazine, IEEE*, vol. 19, no. 2, pp. 40–50, 2002.
- [91] A. Varga, "The omnet++ discrete event simulation system," *Proc. of the European Simulation Multiconference (ESM'2001)*, June 2001.
-

-
- [92] B. L. Titzer, D. K. Lee, and J. Palsberg, "Avrora: scalable sensor network simulation with precise timing," in *Proc. of the 4th international symposium on Information processing in sensor networks*, ser. IPSN '05. Piscataway, NJ, USA: IEEE Press, 2005.
- [93] "Opnet," OPNET Technologies, Inc., 2006. [Online]. Available: <http://www.opnet.com/>
- [94] A. Sobeih, W.-P. Chen, J. C. Hou, L.-C. Kung, N. Li, H. Lim, H.-Y. Tyan, and H. Zhang, "J-sim: A simulation environment for wireless sensor networks," in *Proc. of the 38th annual Symposium on Simulation*, ser. ANSS '05. Washington, DC, USA: IEEE Computer Society, 2005, pp. 175–187.
- [95] V. Naoumov and T. Gross, "Simulation of large ad hoc networks," in *Proc. of the 6th ACM international workshop on Modeling analysis and simulation of wireless and mobile systems*, ser. MSWIM '03. New York, NY, USA: ACM, 2003, pp. 50–57.
- [96] J. Glaser, D. Weber, S. A. Madani, and S. Mahlknecht, "Power aware simulation framework for wireless sensor networks and nodes," *EURASIP J. Embedded Syst.*, vol. 2008, pp. 3:1–3:16, January 2008.
- [97] S. Park, A. Savvides, and M. B. Srivastava, "Sensorsim: a simulation framework for sensor networks," in *Proc. of the 3rd ACM international workshop on Modeling, analysis and simulation of wireless and mobile systems*, ser. MSWIM '00. New York, NY, USA: ACM, 2000, pp. 104–111.
- [98] W. Drytkiewicz, S. Sroka, V. Handziski, A. Koepke, and H. Karl, "A mobility framework for omnet++," in *Proc. of the 3rd Int. OMNeT++ Workshop*, 2003.
- [99] F. Chen, N. Wang, R. German, and F. Dressler, "Performance evaluation of ieee 802.15.4 lr-wpan for industrial applications," in *In 5th IEEE/IFIP Conference on Wireless On demand Network Systems and Services (IEEE/IFIP WONS 2008)*. IEEE, 2008, pp. 89–96.
- [100] D. Weber, J. Glaser, and S. Mahlknecht, "Discrete event simulation framework for power aware wireless sensor networks," in *Proc. of the 5th int. conf. on Industrial Informatics*, 2007, pp. 335–340.
- [101] G. Chelius, A. Fraboulet, and E. Fleury, "Worldsens: development and prototyping tools for application specific wireless sensors networks," in *Proc. of the International Conference on Information Processing in Sensor Networks*, Boston, USA, 2007, pp. 176–185.
-

-
- [102] M. Takai, R. Bagrodia, K. Tang, and M. Gerla, "Efficient wireless network simulations with detailed propagation models," *Wirel. Netw.*, vol. 7, pp. 297–305, May 2001.
- [103] *QualNet*, Scalable Network Technologies. [Online]. Available: <http://www.scalable-networks.com>
- [104] G. Simon, P. Volgyesi, M. Maroti, and A. Ledeczi, "Simulation-based optimization of communication protocols for large-scale wireless sensor networks," in *2003 IEEE Aerospace Conference*, Big Sky, MT, March 2003.
- [105] L. Shu, C. Wu, Y. Zhang, J. Chen, L. Wang, and M. Hauswirth, "Nettopo: beyond simulator and visualizer for wireless sensor networks," *SIGBED Rev.*, vol. 5, pp. 2:1–2:8, October 2008.
- [106] E. Weingärtner, H. Vom Lehn, and K. Wehrle, "A performance comparison of recent network simulators," in *Proc. of the 2009 IEEE int. conf. on Communications*, ser. ICC'09. Piscataway, NJ, USA: IEEE Press, 2009, pp. 1287–1291.
- [107] J. L. Font, P. Iñigo, M. Domínguez, J. L. Sevillano, and C. Amaya, "Analysis of source code metrics from ns-2 and ns-3 network simulators," *Simulation Modelling Practice and Theory*, vol. 19, no. 5, pp. 1330–1346, 2011.
- [108] P. Levis, N. Lee, M. Welsh, and D. Culler, "Tossim: accurate and scalable simulation of entire tinyos applications," in *Proc. of the 1st int. conf. on Embedded networked sensor systems*, ser. SenSys '03. New York, NY, USA: ACM, 2003, pp. 126–137.
- [109] J. Polley, D. Blazakis, J. McGee, D. Rusk, and J. S. Baras, "ATEMU: a fine-grained sensor network simulator," in *Sensor and Ad Hoc Communications and Networks, 2004. IEEE SECON 2004. 2004 First Annual IEEE Communications Society Conference on*, Oct. 2004, pp. 145–152.
- [110] F. Fummi, G. Perbellini, D. Quaglia, and A. Acquaviva, "Flexible energy-aware simulation of heterogeneous wireless sensor networks," in *Proc. of the Conference on Design, Automation and Test in Europe*, ser. DATE '09. 3001 Leuven, Belgium, Belgium: European Design and Automation Association, 2009, pp. 1638–1643.
- [111] F. Österlind, A. Dunkels, J. Eriksson, N. Finne, and T. Voigt, "Cross-level sensor network simulation with cooja," in *Proc. of the First IEEE Int. Workshop on Practical Issues in Building Sensor Network Applications (SenseApp '06)*, Tampa, Florida, USA, Nov. 2006.
-

-
- [112] J. Eriksson, A. Dunkels, N. Finne, F. Österlind, T. Voigt, and N. Tsiftes, “Demo abstract: Mspsim - an extensible simulator for msp430-equipped sensor boards.” in *Proc. of the 5th European Conference on Wireless Sensor Networks*, 2006.
- [113] J. Eriksson, F. Österlind, N. Finne, N. Tsiftes, A. Dunkels, T. Voigt, R. Sauter, and P. J. Marrón, “Cooja/mspsim: interoperability testing for wireless sensor networks,” in *Proc. of the 2nd int. conf. on Simulation Tools and Techniques*, ser. Simutools '09. ICST, Brussels, Belgium, Belgium: ICST (Institute for Computer Sciences, Social-Informatics and Telecommunications Engineering), 2009, pp. 27:1–27:7.
- [114] M. Kuorilehto, M. Hännikäinen, and T. D. Hämäläinen, “Rapid design and evaluation framework for wireless sensor networks,” *Ad Hoc Netw.*, vol. 6, pp. 909–935, August 2008.
- [115] “Sdl forum society homepage.” [Online]. Available: <http://www.sdl-forum.org/>
- [116] M. Haroud and A. Biere, “Hw accelerated ultra wide band mac protocol using sdl and systemc,” in *Proc. of the 10th int. conf. on Architectural support for programming languages and operating systems*, ser. ASPLOS-X. New York, NY, USA: ACM, 2002, pp. 85–95.
- [117] H. Park, W. Liao, K. H. Tam, M. B. Srivastava, and L. He, “A unified network and node level simulation framework for wireless sensor networks,” in *Proc. of the 2009 IEEE int. conf. on Communications*, 2003.
- [118] T. K. Tan, A. Raghunathan, and N. K. Jha, “Emsim: An energy simulation framework for an embedded operating system,” in *Proc. of the IEEE Int. Symposium on Circuits and Systems*, 2002, pp. 70–77.
- [119] M. Varshney, D. Xu, M. Srivastava, and R. Bagrodia, “squalnet: An accurate and scalable evaluation framework for sensor networks,” in *Proc. of the int. conf. on Information Processing in Sensor Networks*, 2007.
- [120] D. C. Black and J. Donovan, *SystemC: From the Ground Up*. Secaucus, NJ, USA: Springer-Verlag New York, Inc., 2005.
- [121] T. Grotker, *System Design with SystemC*. Norwell, MA, USA: Kluwer Academic Publishers, 2002.
- [122] E. Aboulhamid, “New hardware/software design methodologies,” in *The 13th ICM International Conference on Microelectronics*. IEEE, 2001, pp. 3–5.
-

-
- [123] J. Ruf, D. Hoffmann, J. Gerlach, T. Kropf, W. Rosenstiehl, and W. Mueller, "The simulation semantics of systemc," in *Proceedings of the conference on Design, automation and test in Europe*, ser. DATE '01. Piscataway, NJ, USA: IEEE Press, 2001, pp. 64–70. [Online]. Available: <http://portal.acm.org/citation.cfm?id=367072.367091>
- [124] S. Stuart, "A tutorial introduction to the systemc tlm standard," 2006.
- [125] L. Cai and D. Gajski, "Transaction level modeling: an overview," in *CODES+ISSS '03: Proc. of the 1st IEEE/ACM/IFIP international conference on Hardware/software codesign and system synthesis*. New York, NY, USA: ACM, 2003, pp. 19–24.
- [126] *Qt - A cross-platform application and UI framework*. [Online]. Available: <http://qt.nokia.com/>
- [127] J. Hill, M. Horton, R. Kling, and L. Krishnamurthy, "The platforms enabling wireless sensor networks," *Commun. ACM*, vol. 47, pp. 41–46, June 2004.
- [128] A. Savvides, S. Park, and M. B. Srivastava, "On modeling networks of wireless microsensors," in *Proceedings of the 2001 ACM SIGMETRICS international conference on Measurement and modeling of computer systems*, ser. SIGMETRICS '01. New York, NY, USA: ACM, 2001, pp. 318–319. [Online]. Available: <http://doi.acm.org/10.1145/378420.378808>
- [129] J. Schnerr, O. Bringmann, M. Krause, A. Viehl, and W. Rosentiel, "Systemc-based performance analysis of embedded systems," *Model-Based Design of Heterogeneous Embedded Systems*, pp. 27–55, 2010.
- [130] J.-P. M. Linmartz, *Wireless Communication*. P.O. Box 37208, 1030 AE Amsterdam: Baltzer Science Publishers,, 1996.
- [131] "Propagation data and prediction methods for the planning of indoor radiocomm. systems and radio local area networks in the frequency range 900 mhz to 100 ghz," 1999.
- [132] M. Kohvakka, J. Suhonen, M. Kuorilehto, V. Kaseva, M. Hännikäinen, and T. D. Hämäläinen, "Energy-efficient neighbor discovery protocol for mobile wireless sensor networks," *Ad Hoc Networks*, vol. 7, no. 1, pp. 24 – 41, 2009.
- [133] F. Chen, I. Dietrich, R. German, and F. Dressler, "An Energy Model for Simulation Studies of Wireless Sensor Networks using OMNeT++," *Praxis der*
-

- Informationsverarbeitung und Kommunikation (PIK)*, vol. 32, no. 2, pp. 133–138, June 2009.
- [134] *LT1014 amplifier*, Linear Technology. [Online]. Available: <http://cds.linear.com/docs/Datasheet/10134fd.pdf>
- [135] *Tektronix MSO2012 mixed signal oscilloscope*, Tektronix. [Online]. Available: <http://www.tek.com/>
- [136] F. Mieleveville, W. Du, D. Navarro, and O. Bareille, “Wireless Sensor Network for active vibration control,” in *Proceedings of the 1st International Conference on Passives and Actives Mechanical Innovations in Analysis and Design of Mechanical Systems (IMPACT 2010)*, Mar. 2010.
- [137] A. Willig, “Recent and emerging topics in wireless industrial communications,” *IEEE Transactions on Industrial Informatics*, vol. 4, no. 2, pp. 102–124, 2008.
- [138] F. Chen, T. Talanis, R. German, and F. Dressler, “Real-time enabled IEEE 802.15.4 sensor networks in industrial automation,” in *2009 IEEE Int. Symposium on Industrial Embedded Systems*. IEEE, Jul. 2009, pp. 136–139.
- [139] C. Buratti, “Performance analysis of ieee 802.15.4 beacon-enabled mode,” *IEEE Transactions on Vehicular Technology*, 2010.
- [140] N. I. Dopico, C. Gil-Soriano, I. Arrazola, and S. Zazo, “Analysis of ieee 802.15.4 throughput in beaconless mode on micaz under tinys 2,” in *Proc. of the 72th IEEE Vehicular Technology Conference, VTC Fall, 2010*, pp. 1–5.
- [141] T. ElBatt, C. Saraydar, M. Ames, and T. Talty, “Potential for intra-vehicle wireless automotive sensor networks,” in *Proc. of IEEE Sarnoff Symposium, 2006*, pp. 1–4.
-

Modélisation et Simulation de Réseaux de Capteurs sans Fil

Résumé:

Cette thèse traite de la modélisation et la simulation de réseaux de capteurs sans fil afin de fournir des estimations précises de consommations d'énergie. Un cadre de conception et de simulation basé sur SystemC au niveau système est proposé, nommé IDEA1. Elle permet l'exploration de l'espace de conception de réseaux de capteurs à un stade amont. Les résultats de simulation comprennent le taux de livraison de paquets, la latence de transmission et les consommations d'énergie. Sur un banc d'essai comportant 9 nœuds, la différence moyen entre les IDEA1 simulations et les mesures expérimentales est 4.6 %. Les performances d'IDEA1 sont comparées avec un autre simulateur largement utilisé, NS-2. Avec la co-simulation matérielle et logicielle, IDEA1 peut apporter des modèles plus détaillés de nœuds de capteurs. Pour fournir les résultats de la simulation au même niveau d'abstraction, IDEA1 réalise les simulations deux fois plus vite que NS-2. Enfin, deux études de cas sont accomplies pour valider le flot de conception d'IDEA1. La performance de l'IEEE 802.15.4 est globalement évaluée pour diverses charges de trafic et configurations de paramètres de protocole. Une application de contrôle actif des vibrations est également étudiée. Les simulations d'IDEA1 trouvent le meilleur choix de protocoles de communication.

Mots clés: réseaux de capteurs sans fil, co-simulation de matériel et logiciel, SystemC, validation expérimentale, l'évaluation des performances, MAC protocole.

Modeling and Simulation of Wireless Sensor Networks

Abstract:

This thesis deals with the modeling and simulation of wireless sensor networks in order to provide more accurate prediction of energy consumptions. A SystemC-based system level design and simulation framework is proposed, named as IDEA1. It enables the design space exploration of sensor networks at an early stage. The simulation results include packet delivery rate, transmission latency and energy consumptions. A testbed consisting of 9 nodes is built to validate the simulation results of IDEA1. The average deviation between the IDEA1 simulations and the experimental measurements is 4.6%. The performances of IDEA1 are compared with a widely-used WSN simulator, NS-2. With the hardware and software co-simulation, IDEA1 can provide more detailed models of sensor nodes. For offering the simulation results at same abstraction level, IDEA1 only uses one third of the simulation time of NS-2. Finally, two case studies are performed to validate design flow of IDEA1. The performance of IEEE 802.15.4 sensor networks is comprehensively evaluated for various traffic loads and configurations of protocol parameters. In addition, a real-time active vibration control application is also studied. By the simulation of IDEA1, the best choice of communication protocols and hardware platforms is found.

Key words: wireless sensor networks, hardware and software co-simulation, SystemC, experimental validation, performance evaluation, MAC protocol.