



**HAL**  
open science

# On the use of hierarchical modulation for resource allocation in OFDMA-based networks

Anis Jdidi

► **To cite this version:**

Anis Jdidi. On the use of hierarchical modulation for resource allocation in OFDMA-based networks. Economics and Finance. Institut National des Télécommunications, 2011. English. NNT : 2011TELE0024 . tel-00698488

**HAL Id: tel-00698488**

**<https://theses.hal.science/tel-00698488v1>**

Submitted on 16 May 2012

**HAL** is a multi-disciplinary open access archive for the deposit and dissemination of scientific research documents, whether they are published or not. The documents may come from teaching and research institutions in France or abroad, or from public or private research centers.

L'archive ouverte pluridisciplinaire **HAL**, est destinée au dépôt et à la diffusion de documents scientifiques de niveau recherche, publiés ou non, émanant des établissements d'enseignement et de recherche français ou étrangers, des laboratoires publics ou privés.



Ecole Doctorale EDITE

**Thèse présentée pour l'obtention du diplôme de  
DOCTEUR de Télécom & Management SudParis**

*Doctorat délivré conjointement par  
Télécom & Management SudParis et l'Université Pierre et Marie Curie - Paris 6*

**Spécialité :  
Télécommunications**

**Par :  
Anis Jdidi**

**On the use of hierarchical modulation for resource allocation in OFDMA-  
based networks**

**Soutenue le 03-11-2011, devant le jury composé de :**

<b>M. Guy Pujolle</b>	<b>Président</b>	<b>Université Pierre et Marie Curie, France</b>
<b>M. Farouk Kamoun</b>	<b>Rapporteur</b>	<b>Ecole Nationale des Sciences de l'Informatique, Tunisie</b>
<b>M. Fabio Martignon</b>	<b>Rapporteur</b>	<b>Université Paris-Sud 11, France</b>
<b>M. Eitan Altman</b>	<b>Examineur</b>	<b>INRIA Sophia Antipolis, France</b>
<b>Mme. Berna Sayrac</b>	<b>Examinatrice</b>	<b>Orange Labs, Issy-Les-Moulineaux, France</b>
<b>M. Tijani Chahed</b>	<b>Directeur de thèse</b>	<b>Telecom SudParis, France</b>

**Thèse n° 2011TELE0024**

# Contents

<b>1</b>	<b>Introduction</b>	<b>7</b>
1.1	Contributions . . . . .	9
1.2	Thesis organization . . . . .	10
<b>2</b>	<b>Related works and problem statement</b>	<b>12</b>
2.1	OFDMA system . . . . .	12
2.2	Hierarchical Modulation . . . . .	16
2.2.1	Principle . . . . .	16
2.2.2	Related works . . . . .	19
2.3	Adopted approach . . . . .	23
2.3.1	Flow-level study . . . . .	23
2.3.2	Related works at the flow-level . . . . .	25
2.4	Conclusion . . . . .	26
<b>3</b>	<b>Flow-level modeling of hierarchical modulation in OFDMA-based networks</b>	<b>27</b>
3.1	System and model . . . . .	27
3.1.1	Processor sharing analysis . . . . .	28
3.1.2	Performance metrics . . . . .	29
3.2	Adding HM . . . . .	30
3.2.1	Algorithm . . . . .	30
3.2.2	Markovian analysis . . . . .	31
3.2.3	Approximate PS analysis . . . . .	32
3.3	Numerical analysis and simulations . . . . .	33
3.3.1	Simulator description . . . . .	33

3.3.2	Model validation and performance evaluation . . . . .	34
3.3.3	Extensions . . . . .	39
3.4	Conclusion . . . . .	41
<b>4</b>	<b>On the use of hierarchical modulation with proportional fairness</b>	<b>43</b>
4.1	Proportional fairness . . . . .	44
4.2	Flow-level modeling of PF . . . . .	45
4.2.1	Related works . . . . .	45
4.2.2	Modeling throughput under PF . . . . .	46
4.2.3	With HM . . . . .	49
4.3	Model validation and performance evaluation . . . . .	49
4.3.1	Model validation . . . . .	49
4.3.2	Comparison with RR and max-min . . . . .	51
4.4	Conclusion . . . . .	54
<b>5</b>	<b>Joint use of hierarchical modulation with cooperative relaying</b>	<b>56</b>
5.1	Relay-based system . . . . .	57
5.2	Use of HM with cooperative relaying . . . . .	58
5.2.1	Motivations . . . . .	58
5.2.2	Related works . . . . .	58
5.3	Proposal: HM and link adaptive relaying . . . . .	59
5.4	Flow-level modeling . . . . .	63
5.4.1	Using classical relaying . . . . .	64
5.4.2	Using HM-based link adaptive relaying . . . . .	65
5.5	Proposal for enhancement . . . . .	66
5.6	Model validation and performance evaluation . . . . .	67
5.7	Conclusion . . . . .	73
<b>6</b>	<b>Non-cooperative relaying with hierarchical modulation</b>	<b>75</b>
6.1	Proposal: joint use of HM and non-cooperative relaying . . . . .	75
6.2	Flow-level modeling . . . . .	77
6.3	Model validation and performance evaluation . . . . .	79
6.4	Conclusion . . . . .	82



# Acknowledgments

I would like to express my gratitude to my supervisor Prof. Tijani CHAHED. I thank him for giving me the opportunity to work under his direction, for encouraging me and believing in my capacities. I thank him for every advice and comment. I doubt that I will ever be able to convey my appreciation fully, but I owe him my eternal gratitude.

I would like to thank Mr. Hichem BESBES, Professor in SUP'COM-Tunisia, and Mr. Salah Eddine ELAYOUBI, Research Engineer in Orange Labs, for their help and their advices.

I would like to thank Mr. Guy PUJOLLE for the honor he bestowed upon in accepting to preside the defence committee. I thank the reviewers Mr. Farouk KAMOUM and Mr. Fabio MARTIGNON for their effort, time and the valuable comments that enabled me to improve the content of the manuscript. I thank the examiners Mr. Eitan ALTMAN and Mrs. Berna SAYRAC for their interest, involvement and time.

I would also like to thank my parents, and all my family for their encouragements and their support.

I dedicate also this work to all my friends.

Finally, I thank every person who helped me during this thesis.

# Abstract

We investigate, in this thesis, the use of Hierarchical Modulation (HM), a physical layer technique that enables to exploit multiuser diversity, for resource allocation in OFDMA-based systems, so as to improve the system capacity.

HM allows the sharing of the resources, namely subcarriers and power, between users of different radio conditions by sending an additional stream to a user with good radio conditions on a subcarrier that was initially allocated to carry an original stream to a user with lower radio conditions. And this, without affecting the original user's rate nor the total amount of power assigned to the shared subcarrier.

Our study will be carried out at the flow-level, for a dynamic configuration where users come to the system at random times and leave it after a finite time duration corresponding to the completion of their services. This enables us to evaluate the system performance in terms of system-level metrics, such as mean transfer time and blocking probability, which are meaningful both to the user and to the network operator/provider.

We, first, focus on the flow-level modeling of the use of HM in an OFDMA-based cell, where resources are shared between users of different classes based on time division multiplexing, and quantify the gains achieved both individually and globally. We also propose and evaluate two novel extensions to the use of HM in such a setting and show the larger gains they permit.

We, second, study the use of HM with proportional fairness, an algorithm which belongs to the so-called  $\alpha$ -fair allocation strategies and which is known to achieve a good trade-off between efficiency and fairness among those

strategies. We evaluate the system performance and show that, with HM, a simple round robin mechanism achieves larger gains at an appreciably lower implementation complexity cost.

We, third, study the use of HM in relay-based OFDMA systems, considering both cooperative and non-cooperative relaying schemes. In the cooperative case, we propose a scheduling scheme which uses jointly HM and relaying to enable the relay to produce a more robust copy of the original signal. We also make use of link adaptation between the relay and the destination in order to minimize the cost of the resources needed for relaying. We propose an enhancement that takes advantage of the good radio conditions of users who are close to the base station to send them an additional stream using HM.

For the non-cooperative case, we propose a joint use of HM and relaying in the case where the relay is not needed for the successful decoding of the signal at the destination. Without HM, the use of relays in this case would be both inefficient and useless. With HM, users, both individually and globally, achieve a better performance, in terms of mean transfer times and blocking probabilities.



# Chapter 1

## Introduction

The increasing demand for high data rates resulting from the explosion of the use of mobile Internet is driving an unprecedented need for the optimization of the use of the scarce and expensive wireless resources. In this context, several access techniques such as Time, Frequency and Code Division Multiple Access (TDMA, FDMA and CDMA, respectively), have been proposed; the resulting capacity is nevertheless below the user demand. To answer those needs, multi-carrier Orthogonal Frequency Division Multiplexing (OFDM) has been adopted for IEEE 802.16d WiMAX [1] and IEEE 802.11 WiFi [2] networks, as well as in Digital Video Broadcasting (DVB) systems such as DVB-Terrestrial (DVB-T) [3], Satellite Handheld (DVB-SH) and Satellite 2 (DVB-S2) standards [4][5]. In an OFDM-based system, the total bandwidth is divided into narrow subcarriers, offering parallel lower rates. This, in turn, allows to mitigate the problem of channel selectivity and yields an improvement of the overall system capacity.

In order to ensure a scalable and flexible resource allocation among users, in particular in the case of high mobility, Orthogonal Frequency Division Multiple Access (OFDMA) was adopted for IEEE 802.16e WiMAX [6] as well as the downlink of 4G Long Term Evolution (LTE) [7] and LTE Advanced systems [8]. OFDMA is, as its name indicates, a multiple access technique that inherits OFDM's characteristics, where the orthogonal subcarriers can be shared by several users in the same time slot. This allows to take advantage of multi-user diversity, by using Adaptive Modulation

and Coding (AMC) [9] which assigns different modulation-coding pairs to users experiencing different radio conditions so as to increase each user's throughput, and hence the overall system capacity.

In order to allocate the resources (subcarriers and power) among users, many algorithms were proposed in OFDMA-based systems; most of them are based on the notion of orthogonality between users. Indeed, if a subcarrier is allocated to a specific user in a given time slot, no other user will be permitted to transmit at the same time on this subcarrier, so as to avoid signal degradation due to interference. This is also the case for TDMA, FDMA and CDMA techniques, where access to resources is guaranteed by the orthogonality in time, frequency or codes, respectively.

A surprising result found by Cover in 1972 [10] and known as *writing on dirty paper* states that the addition of a sequence in the channel known only to the transmitter does not change the capacity of the link. This means that it is possible to access the link on a *non-orthogonal* basis by allowing users to share the same subcarrier based on multiuser diversity; and this, without degrading the capacity seen by each individual user of the sequence [11][12]. This technique was termed Hierarchical Modulation (HM) and is also known as superposition coding or yet embedded constellations. And it is the main focus of our present dissertation.

Specifically, using HM, an additional stream is sent to a user with good radio conditions on a subcarrier that was initially allocated to carry an original stream to a user with bad radio conditions. Based on its good radio conditions, the user (with good radio conditions) is able to decode the two streams: using successive interference cancellation [13][14], this user can filter out the other user's signal and decode successfully his own signal. The user with lower radio conditions is able to decode his original stream only because of the low amount of power allocated to the user with good radio conditions. Indeed, using HM, a small amount of the power allocated to the basic stream will be allocated to the additional one, without affecting the original stream's rate.

And hence, HM allows to increase the spectral efficiency by exploiting the multiuser diversity, yielding a higher overall system capacity. And this, without any extra power cost.

In the literature, most of the works that consider the use of HM focus solely on the physical layer performance, notably in terms of the bit error rate. And this for a static user scenario, i.e., with a fixed number of users in the system, each with an infinite service duration. This configuration however does not reflect the real system behavior where the number of users is dynamic, i.e., the users come to the system at random time epochs and leave it after a finite duration, corresponding to the completion of their services.

The study of the system at the flow-level, as opposed to the packet level, for a dynamic user configuration, enables us to investigate the realistic relationship between capacity and demand and to quantify several system-level performance metrics, such as mean transfer times and blocking rates, which are meaningful both to the user and the network operator/provider [15]. This Erlangian approach is at the basis of our present work.

## 1.1 Contributions

Our contributions in this thesis are:

- Flow-level modeling of the use of HM in an OFDMA-based cell, based on time division multiplexing scheduling, for a dynamic user configuration. We quantify several performance metrics, mean transfer time and blocking probability, and investigate the gain achieved using HM, for several user class distributions in the system. The term class refers to the user's radio conditions in our case.
- Proposal of two extensions/enhancements to classical HM wherein first, users of lower radio conditions are also superposed on subcarriers initially allocated to users with better radio conditions and second, allowing users of any class to be superposed on users of the same class as well.
- Investigation of the use of HM with proportional fairness [16][17], an algorithm known to achieve a good trade-off between efficiency and fairness among all so-called  $\alpha$ -fair allocation strategies. We show, through comparisons with round robin and max-min fairness, that

this is no longer the case when using HM; rather, simple round robin achieves higher gain at appreciably lower complexity cost.

- Study of HM in relay-based OFDMA systems. We consider the joint use of HM with relaying in two cases: cooperative and non-cooperative relaying schemes. In the cooperative case, we propose a scheduling scheme that uses jointly HM and relaying to enable the relay to produce a more robust copy of the original signal. We make use, also, of link adaptation between the relay and the destination in order to minimize the cost of the resources needed for relaying.
- A proposal, in the context of joint HM and cooperative relaying, that takes advantage of the good radio conditions of users who are close to the base station to send them an additional stream using HM.
- In the non-cooperative case, study of the gain achieved by the joint use of HM and relaying in the case where the relay is not needed for the successful decoding of the signal by the destination. Without HM, the use of relays would be both inefficient and useless in this case. With HM, gains for all classes of users can be achieved.

## 1.2 Thesis organization

The remainder of the manuscript is composed of seven chapters.

In the next chapter, we introduce HM operation and describe most works found in the literature pertaining to the use of HM for resource allocation in OFDMA-based networks. We also introduce flow-level modeling and its interest for modeling and evaluation of system performance.

In the third chapter, we investigate the use of HM with a round robin scheduler, and quantify the gains thus achieved for several scenarios of user class distributions within the system.

In the fourth chapter, we consider the use of HM with proportional fairness and show that simple round robin achieves larger gains along with lower implementation complexity. Comparisons with max-min are also provided.

In the fifth and sixth chapters, we study the joint use of HM with relaying, both cooperative (in the fifth chapter) and non-cooperative (sixth

chapter).

The last chapter contains the conclusion and future work perspectives.

## Chapter 2

# Related works and problem statement

In this chapter, we, first, describe OFDMA and the way resources are allocated therein. We, then, detail the principle of HM along with the power and bits allocation. We, next, describe the works that propose the use of HM in wireless networks in general and in OFDM/OFDMA networks in particular. We also focus on the definition of the flow-level modeling approach and its interest for the evaluation of system performance. We, eventually, describe the related works that consider the flow-level dynamics.

### 2.1 OFDMA system

OFDMA is, as its name indicates, an access and multiplexing technique based on OFDM multicarrier which allows to divide the total bandwidth into several smaller, orthogonal subcarriers.

The total number of subcarriers is divided into three types, as shown in Figure 2.1: pilot subcarriers used for channel estimation measurements, data subcarriers, used to carry information bits, and guard subcarriers, used to guarantee space between data subcarriers.

An OFDM-based system uses the Inverse Fast Fourier Transform (IFFT) upon transmission and FFT upon reception and introduces a cyclic prefix to combat the time dispersion of the channel and to avoid the Inter-Carrier

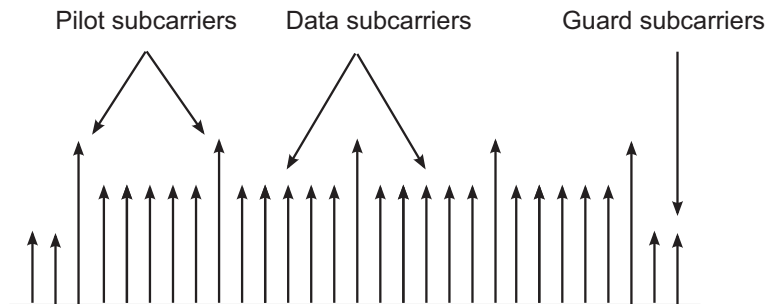

Figure 2.1: Subcarrier types

Interference (ICI) at the receiver. Inter-Symbol Interference (ISI) caused by time-dispersion of a multipath channel can be neglected if the time dispersion of the channel (measured by its delay spread) is much shorter than the length of one transmitted symbol. For this, a guard interval between two consecutive sub-channels is introduced [9].

The time slot duration is divided into two parts: the first part is used to transmit/receive data and the second part, called cyclic prefix period, contains a portion of the data information that the first part contains, and this allows to overcome the ICI.

By doing so, OFDM allows to avoid the complex use of channel equalization needed to mitigate the frequency selective fading channels and enables thus to offer parallel rates on narrow flat fading subcarriers leading to a high spectral efficiency.

Moreover, the use of Adaptive Modulation and Coding (AMC) allows to further enhance the overall system throughput [9]. Indeed, the use of a single modulation size does not enable users to exploit the channel gain fluctuations in the system. Using AMC, the transmission rates (equivalently, modulation sizes) will be chosen based on the instantaneous radio channel gain: a higher signal constellation for a higher channel gain and a more robust modulation for a lower gain, as shown in Figure 2.2, where radio conditions are shown to depend solely on the path loss, i.e., the distance between the user and the base station.

Let us consider that the total bandwidth is divided into  $N$  orthogonal subcarriers and that the time resource is divided into time slots. Let us

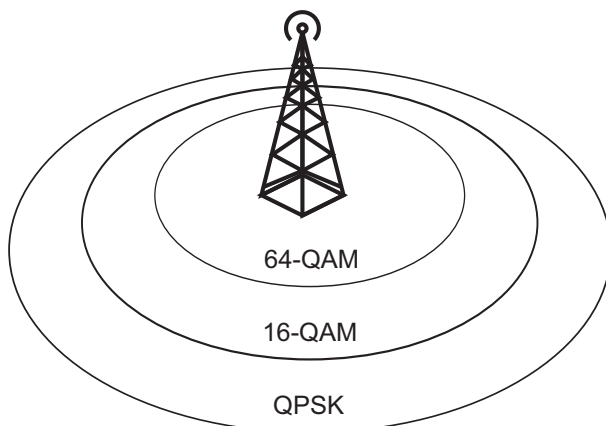

Figure 2.2: AMC

denote by  $SNR_{s,n}$  the Signal to Noise Ratio (SNR) experienced by a given user  $s$  on subcarrier  $n, n = 1, \dots, N$ . It is given by:

$$\frac{p_{s,n}|h_{s,n}|^2}{\sigma_{s,n}^2} \quad (2.1)$$

where  $p_{s,n}$  is the transmission power of user  $s$  on subcarrier  $n$ ,  $p_{s,n}$  is its channel gain and  $\sigma_{s,n}$  is the variance of the Additive White Gaussian Noise (AWGN) with zero mean.

Based on the Shannon formula, the number of bits  $b_{s,n}$  that this user can transmit is related to its SNR by [9]:

$$b_{s,n} = \log_2 \left( 1 + \frac{SNR_{s,n}}{\Gamma} \right) \quad (2.2)$$

$\Gamma$  is the SNR-gap which is used to ensure some Quality of Service (QoS) for an uncoded Quadrature Amplitude Modulation (QAM) system and is given by [9]:

$$\Gamma = \frac{1}{3} \left[ \mathcal{Q}^{-1} \left( \frac{P_e}{4} \right) \right]^2, \Gamma \geq 1$$

where  $\mathcal{Q}^{-1}(\cdot)$  is the inverse standard Marcum Q-function and  $P_e$  is the target Bit Error Rate (BER).

OFDMA, and owing to the joint use of OFDM and Frequency Division Multiple Access (FDMA), allows to mitigate OFDM limitations such as lack of both flexibility and scalability. Indeed, resource allocation in an OFDM-based system is not flexible enough. For example, a user might need only one



part of the assigned subcarriers to finish transmission/reception and, in this case, the other part of these subcarriers will not be used because no other user can share them with him. Also, in the case where the user presents low channel gains on some of the subcarriers, OFDM does not allow to exploit the multiuser diversity and allocate these subcarriers to other users who have better channel gains than him.

We illustrate, in Figure 2.3, an OFDMA-based system where subcarrier allocation is done in the time-frequency domain: a flow may share a subcarrier with other users. For instance, users 2, 3, 4 and 5 occupy each one subcarrier half of the time while user 1 occupies one subcarrier all the time.

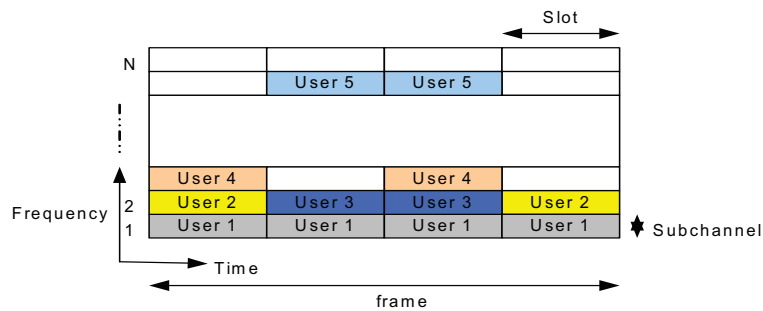

Figure 2.3: Time-frequency resource allocation in OFDMA

Due to the scalability and flexibility of its resource allocation, OFDMA is thus more suitable for highly mobile communications (higher channel variations) compared to the multicarrier modulation OFDM.

In order to allocate the resources among users, many algorithms were proposed in OFDMA-based systems, making use of orthogonality between users. Indeed, as indicated previously, if a subcarrier is allocated to a specific user in a given time slot, no other user will be permitted to transmit at the same time on this subcarrier in order to avoid signal degradation due to interference.

With HM, it is however possible to relax the orthogonality imperative between users when allocating resources; the same subcarrier can be shared among two or more users by taking advantage of multiuser diversity in the system, as described next.

## 2.2 Hierarchical Modulation

### 2.2.1 Principle

Let us consider, without loss of generality, a system with two users: user  $k^*$  with good radio conditions and user  $k$  with worse ones.

Using HM, the Base Station (BS) will be able to send an additional data stream to user  $k^*$  on a subcarrier that was initially allocated to carry a basic information stream to user  $k$ . This will be done without affecting the rate of user  $k$  and, also, without increasing the total allocated power to the shared subcarrier. This yields, in turn, an increase in the resource utilization and hence the overall system throughput.

Let us consider, again without loss of generality, that using AMC, user  $k^*$  is assigned 16-QAM constellations (Figure 2.4, right) and that user  $k$  is assigned 4-QAM constellation (Figure 2.4, left). HM makes it possible for the BS to send over one subcarrier the combination of the two signals using 64-QAM constellation, as shown in Figure 2.5.

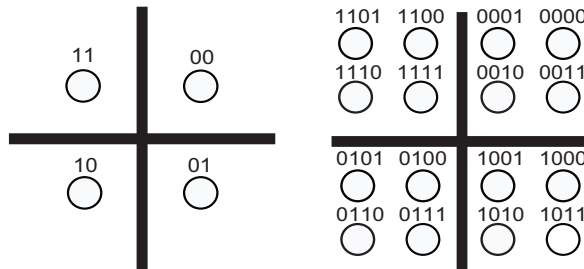

Figure 2.4: 4-QAM (left) and 16-QAM (right)

HM is a non-uniformly spaced signal points and offers thus different levels of protection to the bits in the same symbol according to their priorities [12]. In our case, each symbol in the resulting constellation will be composed of 6 bits where the two most significant bits - to the left - represent the basic information sent to the basic user of lower radio conditions (also termed the first level of hierarchy) and the other 4 bits represent the additional information sent to the user with better radio conditions (the second level of hierarchy). Higher priority is then given to the first level whereas the second level is of lower priority.

Let us define by  $D$  the modulation parameter that indicates the degree

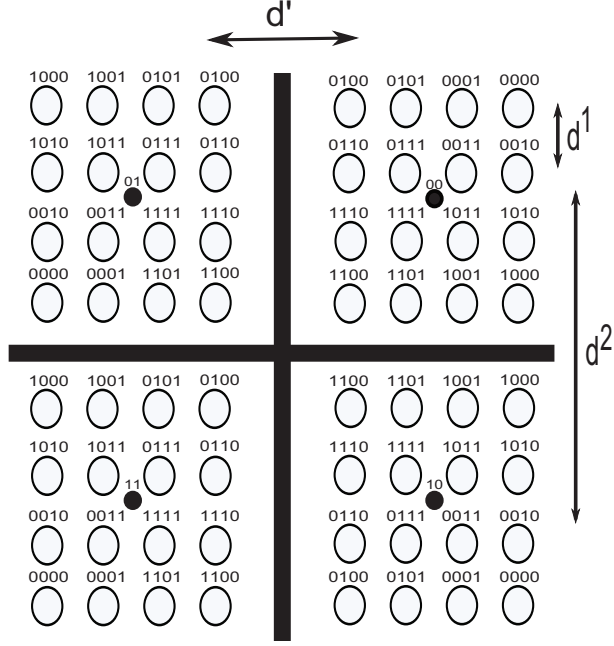

Figure 2.5: Hierarchical constellation

of protection of each stream. It is defined by:

$$D = \frac{d^1}{d'} \quad (2.3)$$

where

- $d^1$  is the minimum distance between the flextious symbol in the constellation of user  $k^*$ , on subcarrier  $n$  (please refer to Figure 2.5), given by:

$$\sqrt{\frac{6\Gamma(\sigma_{k^*,n})^2}{(h_{k^*,n})^2}} \quad (2.4)$$

- $d'$  is given by:

$$\sqrt{\frac{6\Gamma(\sigma_{k,n})^2}{(h_{k,n})^2}} \quad (2.5)$$

In our case,  $d^2$ , is the minimum distance between the flextious symbol in the constellation of user  $k$ , on subcarrier  $n$ , and is given by:

$$d^2 = d' + \left(\frac{\sqrt{M}}{2} - 1\right)d^1 \quad (2.6)$$

where  $M$  denotes the total constellation size of the hierarchical signal.

$D$  varies between 0 and 1: if  $D = 0$ , the total transmitted signal is a 4-QAM constellation whereas if  $D = 1$ , it is a 16-QAM constellation.

In general, we denote by  $L/M$ -QAM the constellation that results from the use of HM where  $L$  ( $L = 2^{2l}$ ) and  $M$  ( $M = 2^{2m}$ ) are the constellation sizes for, respectively, the first and second levels of hierarchy. In our case,  $2l$  bits are sent to user  $k$  and  $2(m - l)$  bits are sent to user  $k^*$ .

Let us denote by  $p_n$  the amount of power allocated initially to subcarrier  $n$ . For the square constellation  $4/M$ -QAM, in order to ensure a decoding without errors, the amounts of power allocated to the two users, on the shared subcarrier  $n$ , are given by [18][19]:

$$\begin{aligned} p_{k^*,n}^{HM} &= \frac{d_{k^*,n}^1 (2^{b_{k^*,n}^{HM}} - 1)}{6} \\ p_{k,n}^{HM} &= \frac{d_{k,n}^2 (2^{b_{k,n}^{HM}} - 1)}{6} \end{aligned} \quad (2.7)$$

where  $p_{k^*,n}^{HM} + p_{k,n}^{HM} \leq p_n$  and  $b_{k^*,n}^{HM}$  and  $b_{k,n}^{HM}$  correspond, respectively, to the transmitted bits for user  $k^*$  and user  $k$ .

At the reception, user  $k^*$  is able to decode its own signal because the composed HM signal it receives is clear as this user enjoys good radio conditions; the constellation of user  $k$  appears as a single point inside its own constellation (please refer to Figure 2.5) and it can thus easily filter it out before decoding its own signal using Successive Interference Cancellation (SIC) [13][14]. The number of bits decoded by user  $k^*$  is given by:

$$b_{k^*,n}^{HM} = \log_2 \left( 1 + \frac{p_{k^*,n}^{HM} |h_{k^*,n}|^2}{\Gamma(\sigma_{k^*,n})^2} \right) \quad (2.8)$$

To the user  $k$  of bad radio conditions, the constellation of user  $k^*$  will appear as (Gaussian) noise which it can also filter out before decoding its own signal [13] and this is because of the lower amount of power allocated to user  $k^*$ . The number of bits decoded by user  $k$  is given by:

$$b_{k,n}^{HM} = \log_2 \left( 1 + \frac{p_{k,n}^{HM} |h_{k,n}|^2}{\Gamma((\sigma_{k,n})^2 + p_{k^*,n}^{HM} |h_{k,n}|^2)} \right) \quad (2.9)$$

And hence the possibility for HM to transmit simultaneously to the two users on the same subcarrier without degrading the capacity of the

link, albeit with some extra complexity cost both at the transmitter and the receiver sides. Indeed, in comparison to the orthogonal case, the transmitter implements now a new loop in which it determines the user to superpose on the subcarrier allocated initially to the first user. This loop requires extra computation. On the receiver side, HM requires a SIC module to be used for decoding. This also requires additional computation and memory and induces some extra delay.

### 2.2.2 Related works

In the literature, most of the works that studied the use of HM focused on the lower layer performance and targeted issues related to rate maximization, power allocation as well as BER performance. Some works studied the issue of scheduling using HM but they focused only on a static user scenario where the number of users in the system is assumed to be fixed.

We now review these works and classify them according to different uses of HM, namely subcarrier and power optimization, improving BER performance, coding and decoding as well as scheduling.

#### HM and subcarrier and power optimization

Many works investigated the problem of subcarrier and power allocations using HM.

In [20], the authors optimized the joint channel and power allocation among users according to their radio channel conditions in an embedded scheme.

In [19], the authors proposed a low-complexity, time-scalable algorithm, which allows for an efficient allocation of radio resources in terms of subcarriers and power, according to their individual QoS requirements in an OFDMA system.

In [21], the authors optimized the effective capacity, a useful metric to characterize the system throughput with statistical delay constrained QoS guarantees. They considered the delay and the loss rate requirements in multicast transmission and proposed an optimal pre-drop strategy and power/rate allocation jointly with HM in order to enhance the system per-

formance.

In [22], the authors proposed three schemes to optimize the use of HM, in an OFDM system, in order to enhance the overall achieved rate, maximize the spectral efficiency and minimize the Peak-to-Average-Power Ratio (PAPR) and thus optimize the power allocation.

In [23], the authors proposed a low complexity symbol and bit allocation algorithm using HM for video transmission over wireless channels.

In [24], the authors optimized the use of HM for scalable multimedia transmission over selective channels by combining it with convolutional encoding for a single user scheme in order to improve the BER of two different video streams with two different priorities. For a two-user scheme, they considered the joint use of HM with the video codec in the spatial domain in order to enhance the perceivable quality of the (scalable) video transmission.

In [25], the authors proposed a cross-layer optimization of unequal protected layered video over HM.

In [26], the authors investigated an adaptive transmission technique by using the feedback of the Channel State Information (CSI) in resource allocation (time, power and bandwidth) for continuous real-time transmission with different levels of error protection.

### **HM and BER performance**

Other works studied and analyzed the physical layer performance that results from the use of HM, especially in terms of BER.

In [27], [28] and [29], the authors proposed approximate BER expressions for embedded 4/16 and 4/64-QAM constellations.

In [18], the authors derived a generic closed-form expression for the BER of 4/M-QAM family where a 4-QAM constellation is embedded into an 4/M-QAM constellations. They also proposed a generic expression to evaluate the BER of the square and non square 4/M-QAM constellations.

In [30], the authors proposed a novel scheme to use HM with rotate constellations signals and interleaving in order to improve the system efficiency in terms of BER.

In [31], the authors proposed a multilevel unequal error protection sys-

tem using multiplexed hierarchical modulation for progressive transmission over mobile radio channels. They also focused on the use of asymmetric hierarchical QAM constellations which allows to reduce the PAPR without performance loss.

### **Coding and decoding with HM**

Some works studied the coding and decoding techniques using HM.

In [14], the authors proposed a dirty paper HM-based coding scheme that enhances the performance of coding/decoding using SIC without extra computation or memory requirements at the receiver.

In [32], the authors proposed a coherent detection for terrestrial digital multimedia broadcasting using HM in order to overcome the SNR degradation and the man-made noise.

In [33], the authors investigated a peak-power-limited HM QAM system based on clipping and proposed an efficient iterative coded system in order to combat clipping which allows to ensure a better tradeoff between PAPR and system performance.

In [34], the authors proposed an enhanced HM with ICI and inter-layer interference cancellation for OFDM systems. They proposed to improve the quality of the additional signal sent over the second level of hierarchy which suffers from noise and interference because of the low proportion of power that is allocated to it.

In [35], the authors proposed a multi-level coding algorithm for multimedia transmission based on unequal error protection.

In [36], the authors used HM to ensure a scalable modulation scheme that ensures different service priority levels in multimedia transmission.

### **HM and scheduling**

Yet some works studied the issue of scheduling in the presence of HM.

In [37], the authors studied a two best-user opportunistic scheduling algorithm based on the use of HM. They proposed to serve the two best users in terms of radio conditions using the same subcarrier in order to maximize the overall spectral efficiency.

In [38], the authors studied the performance of the above mentioned work in the case where the users have different average link gains. They also proposed a hybrid, two-user opportunistic scheme that selects the first user based on the largest channel gain and the second user based on the ratio of its (good) radio condition over the average channel gain of all the users. They showed that this last scheme enhances the fairness among the users compared to the first scheme proposed in [37] and that it allows to increase the spectral efficiency compared to the proportional fairness algorithm.

In [39], the authors analyzed the queuing delay as well as buffer distribution of the packets stored at the base station buffer for the downlink transmission of their two-user opportunistic scheduling proposed in [37].

In [40], the authors investigated the issue of resource allocation in a simple HM scheme. They described an algorithm that takes into consideration the buffer occupancy in resource allocation in an OFDMA system. They proposed to send, whenever possible, an additional stream to a user who has better radio conditions compared to the first user chosen based on his buffer occupancy.

In [41], the authors described new multi-user schedulers under superposed transmissions in the downlink, for the two cases of proportional fair and weighted sum-rate algorithms. They studied the user pairing criteria based on SNR and the user priority for the two above-mentioned algorithms.

In [42], the authors proposed a resource allocation algorithm in an OFDM system where users are divided into two groups: one with good radio conditions and one with bad radio conditions. They proposed, first, to choose the user with the smallest rate, and tried, then, to superpose on its best sub-carriers (with the highest channel gains), a user with good radio conditions.

In [43], the authors used HM in a downlink TDMA system. They also divided the users into two groups based on their radio conditions: they proposed to randomly select a pair of users belonging to the center set and the edge set and used HM in order to increase the average throughput of the system.

In [44], the authors investigated the use of HM in an OFDM-based system. They considered also two types of users and applied HM each time the BS had to serve a user with bad radio conditions. They showed, using



simulations, a large gain when using HM.

## 2.3 Adopted approach

In the previous works, system performance analysis was carried out at the packet level, for a static user configuration, and focused solely on the physical layer performance [45][46][47].

In general, the static system configuration allows to determine the feasible throughput that can be achieved by each user in the system as well as the so-called rate-region [48][49]. This, however, does not reflect the real behavior of the system, nor does it allow to determine the Erlangian system capacity [15][50].

This is the rationale for our present work where we propose to study the performance of HM, at the flow level, for a realistic, dynamic user setting [51][52][53].

We, next, describe the principle of the flow-level dynamic approach as well as its related works.

### 2.3.1 Flow-level study

Let us assume, without loss of generality, a dynamic system, where (data) users arrive to the system following a Poisson process of intensity  $\lambda$  and leave it after the completion of their file transfers. In a wireless network setting, users can be classified into  $J$  groups, or classes, based for instance on their radio channel conditions.

Let us denote by  $S$  the system state which corresponds to the number of active users (flows) per class in the cell.  $S$  is given by:

$$S = (s^1, \dots, s^J)$$

where, again,  $J$  is the total number of classes.

We denote by  $R$  all the vectors  $R = (R^1, \dots, R^J)$  that correspond to the feasible rates that each flow of class  $j$ ,  $j = 1, \dots, J$ , can achieve.

In such a system, the feasible rate for the  $j$ th class user is given by  $\frac{R^j}{s^j}$ . If the number of users  $s^j$  continues to grow, the feasible rate  $\frac{R^j}{s^j}$  will tend to zero. Also, if the resource allocation scheme does not ensure some kind of

fairness, in terms of access to the resources, some users can monopolize the resources which yields an increased service time for the other users in the system causing starvation and instability.

In the literature, one resource allocation strategy which received much attention is the optimization strategy based on the maximization of a utility function  $U$  under some given constraints, introduced by Kelly et al. in [17].

The utility function to maximize is of the form:

$$\max \sum_j^J s^j U\left(\frac{R^j}{s^j}\right)$$

subject to  $R = (R^1, \dots, R^J) \in \mathbf{R}$  where  $\mathbf{R}$  is a compact set of  $\mathbf{R}_+^J$  denoting the so-called rate region, i.e., the set of all vectors representing the achievable throughput  $R$  for which the system is stable [54].

A large class of resource allocation strategies are obtained based on the so-called  $\alpha$ -fair strategies for which the utility function takes the following form [50][55][56]:

$$\begin{cases} U_\alpha(Z^j) = (Z^j)^{1-\alpha}/(1-\alpha) & \text{if } \alpha > 0, \alpha \neq 1 \\ U_\alpha(Z^j) = \log(Z^j) & \text{if } \alpha = 1 \end{cases} \quad (2.10)$$

The parameter  $\alpha$  reflects the degree of fairness of the allocation [57]. If  $\alpha \rightarrow 0$ , this corresponds to system throughput maximization, with an unfair resource allocation among users. The case of  $\alpha \rightarrow \infty$  corresponds to the most fair allocation algorithm known by the max-min fairness, albeit a low overall system throughput [58]. For the case of  $\alpha = 1$ ,  $U(\cdot) = \log(\cdot)$  and the allocation is termed proportional fairness.

Let us further assume that users transmit files with exponentially distributed sizes of mean  $E[F]$ . The traffic load  $\rho^j$  of users of class  $j$  is given by:  $\rho^j = \lambda^j E[F]$  where  $\lambda^j$  is the mean intensity of the Poisson arrivals of users of class  $j$ .

We denote by the stability region the different vectors  $\rho = (\rho^1, \dots, \rho^J)$  such that the network is stable, i.e. the number of flows remains finite even for a high traffic intensity.

Using a centralized resource allocation decision, any  $\alpha$ -fair allocation algorithm, with  $\alpha > 0$ , achieves maximal system stability and, in this case,

the rate region  $\mathbf{R}$  is convex and the stability region coincides with the rate region [57].

For non-convex and/or time-varying rate regions, the choice of the utility function is crucial to ensure maximum stability and, in this case, the stability region of  $\alpha$ -fair allocation strategies depends on  $\alpha$ : maximum stability is obtained for  $\alpha \rightarrow 0$  and minimum stability for  $\alpha \rightarrow \infty$  [57].

### 2.3.2 Related works at the flow-level

For performance evaluation, at the flow-level, authors in [15] and [59] proposed to use a Processor Sharing (PS) model where the total system throughput is dependent to the number of users in the system. The PS model, also studied in [60] and [61], is known for its insensitivity property: the stationary distribution of the users in the cell is insensitive to their services times, i.e., insensitive to the flow size distribution, which may be quite complex, for instance heavy-tailed [15].

In [59], the authors focused on the flow-level performance evaluation of the proportional fairness algorithm and in [15], the authors generalized the performance evaluation to other scheduling algorithms such as fair time allocation as well as the proportional fair algorithm for the two cases of slow and fast fading, with and without admission control.

In [62], the authors compared the performance of the opportunistic algorithm (based on maximum SNR) and the proportional fairness algorithm to the scored-based algorithm.

In [63] and [64], the authors studied the impact of mobility on the flow-level performance in single and multiple CDMA cells.

In [57] and [65], the authors characterized the system stability under flow-level dynamics for convex and non-convex rate regions, respectively.

In [48] and [50], the authors analyzed the case of time-varying rate regions and showed that, using  $\alpha$ -fair allocation, the stability region is sensitive to  $\alpha$  in contrast to the convex rate region case. This is also the case for non-convex rate regions.

Further to what is indicated above, in [15], the authors studied two cases of admission control: a first one based on the number of users in the system

and a second one based on a minimum rate per active user in the system. They showed that simple admission control based on the number of users is sufficient and is very important in order to overcome system saturation.

As of OFDM/OFDMA networks, in [66], the authors investigated the flow-level performance of an OFDM-based system and focus on two cases: OFDM-TDMA and OFDMA with opportunistic scheduling. In [67], the authors proposed modeling of streaming and elastic flows integration in OFDMA-based IEEE802.16 WiMAX.

These works, however, focused solely on the case of strict orthogonality between users for resource allocation. To the best of our knowledge, no works studied the flow-level performance of a non-orthogonal allocation strategy, such as HM. And this is the aim of our work.

## **2.4 Conclusion**

In this chapter, we, first, gave an overview on OFDMA-based systems and the way resources are allocated among users in such a system using AMC. We, also, described the principle of HM, in terms of power and bit allocation, as well as its related works. In the last part, we focused on the flow-level modeling for a dynamic user configuration and its interest for the evaluation of a realistic network performance. In the next chapter, we investigate the flow-level modeling of HM in OFDMA-based networks.

## Chapter 3

# Flow-level modeling of hierarchical modulation in OFDMA-based networks

We consider, in this chapter, the performance of an OFDMA system using HM for a Time Division Multiplexing (TDM) Round Robin (RR) scheduler, at the flow-level, where data users come to the system at Poisson distributed arrival times and leave it after a finite duration corresponding to the completion of a file transfer. We specifically model and quantify, both analytically and via simulations, the gain achieved using HM and its variation with the user class distribution in the system. We also propose two extensions to the basic HM algorithm: a first one in which a user with bad radio conditions is also superposed on one with better radio conditions and a second one in which a user of one type is further superposed on a user of the same type as well.

### 3.1 System and model

We consider a downlink single OFDMA cell where the Base Station (BS) coordinates the resource allocation among all users in the cell. Let the total bandwidth be denoted by  $W$ . It is partitioned into  $N$  OFDM subcarriers. We assume that users are divided into  $J$  groups or types based on their

channel radio conditions as shown in Figure 3.1, assuming path loss only.

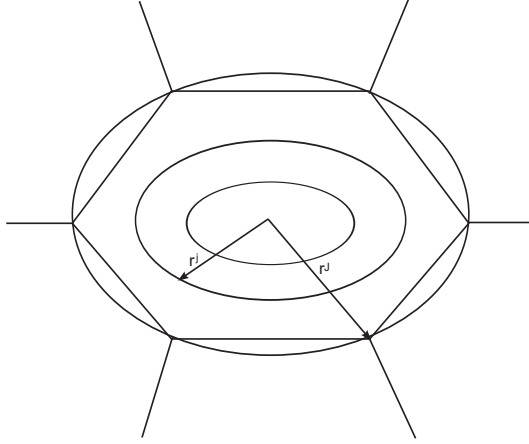

Figure 3.1: Regions

Users of class  $j$  are granted  $N^j(\mathbf{s})$  subcarriers for a (finite) mean time duration  $T^j$ .  $\mathbf{s}$  is a vector with entry  $j$  representing the number  $s^j$  of users in group  $j$ ,  $j = 1, \dots, J$ .

The service duration  $T$  depends on the quantity of resources the users get which, in turn, depends on the number of users  $\mathbf{s}$  that are simultaneously in progress in the system as well as how well they can take advantage of the resources they are granted, i.e., their radio conditions.

As indicated previously, let us assume that users are served on a TDM basis, using RR scheduling [15], which ensures fairness in time among all users in the system.

### 3.1.1 Processor sharing analysis

Let us consider that users arrive to the system following a Poisson process with mean intensity  $\lambda$ . The number of users in the system can be modeled as a Continuous Time Markov Chain (CTMC) with state vector  $\mathbf{s}$ , again, denoting the number of users  $s^j$  in each region of the system,  $j = 1, \dots, J$ . This model is completely described by a Processor Sharing (PS) queue with  $S = \sum_j s^j$  being the total number of users in the system.

We also apply an admission control scheme on the maximal number of users  $s_{max}$  that can be admitted to the system. This would guarantee every

admitted user some minimal number of subcarriers  $n_{min}$  equal to  $\frac{N}{s_{max}}$  which would in turn guarantee some minimal throughput for each user admitted to the system.

Let us denote by  $\bar{\rho}$  the total load of the cell and by  $\bar{\rho}^j$  the load corresponding to region  $j$ ,  $j = 1, \dots, J$ . We have:

$$\bar{\rho} = \sum_{j=1}^J \bar{\rho}^j \quad (3.1)$$

The steady-state probabilities are given by [15]:

$$\pi(x) = \frac{\bar{\rho}^x}{1 + \bar{\rho} + \dots + \bar{\rho}^{s_{max}}} \quad (3.2)$$

for  $0 \leq x \leq s_{max}$ , where:  $\bar{\rho}^j = \rho^j / c^j$ ;  $\rho^j = \rho \pi((r^j)^2 - (r^{j-1})^2)$ ;  $\rho = \lambda E[F]$ ,  $r^j$  is the radius of region  $j$ ,  $E[F]$  is the mean file size and  $c^j$  is the rate that a user  $s$  of type  $j$  can achieve if he is alone in the system, given by:

$$c^j = \sum_{n=1}^N \frac{W}{N} \log_2 \left( 1 + \frac{p_{s,n}^j |h_{s,n}^j|^2}{\Gamma(\sigma_{s,n}^j)^2} \right) \quad (3.3)$$

where,  $p_{s,n}^j$  is the transmit power of user  $s$  of type  $j$  on subcarrier  $n$ ,  $h_{s,n}^j$  is its channel gain which includes the effects of path loss and shadowing and  $\sigma_{s,n}^j$  is the variance of the Additive White Gaussian Noise (AWGN) with zero mean.

### 3.1.2 Performance metrics

In view of Eqn. (3.2), the mean transfer time  $T^j$  with a user in region  $j$  for a file of mean size  $E[F]$  is given by:

$$T^j = E[F] \frac{1 - (s_{max} + 1)\bar{\rho}^{s_{max}} + s_{max}\bar{\rho}^{(s_{max}+1)}}{c^j(1 - \bar{\rho})(1 - \bar{\rho}^{s_{max}})} \quad (3.4)$$

and the mean transfer time  $T$  in all the cell is given by:

$$T = \frac{\sum_{j=1}^J T^j \lambda^j}{\sum_{j=1}^J \lambda^j} \quad (3.5)$$

where  $\lambda^j$  is the mean arrival intensity to region  $j$ .

The blocking probability  $B$  of a new flow, based on our admission control algorithm, is given by:

$$B = \frac{\bar{\rho}^{s_{max}}}{1 + \bar{\rho} + \dots + \bar{\rho}^{s_{max}}} \quad (3.6)$$

## 3.2 Adding HM

We now combine HM with the afore-mentioned RR resource allocation algorithm.

### 3.2.1 Algorithm

Let us consider, without loss of generality, that users are divided into two classes or types: the first type represents users of good radio conditions and the second one represents users with bad radio conditions.

There are actually different ways of implementing HM as described in the previous chapter. In our work, when a user  $k$  of type 2 (bad radio conditions) is served, based on RR, we search for a user  $k^*$  of type 1 (good radio conditions) so as to superpose it on the same subcarrier allocated initially to user  $k$ .

HM can be implemented as follows. For user  $s$  to be served by the scheduler, on the RR basis in our case, for each subcarrier  $n$ ,

- Calculate  $b_{s,n}^j$  using Eqn. (2.2) given in Chapter 2. This step indicates the number of bits achieved by user  $s$  on subcarrier  $n$  for the initial power level  $p_n$
- If user  $s$  is of type 2 and if  $b_{s,n}^2 = 2$  bits,  $k \leftarrow s$
- Determine user  $k^*$  of type 1 such that

$$k^* \leftarrow \arg \max_{s \in s^1, s \neq k} h_{s,n}^1$$

- Re-calculate for both users  $k$  and  $k^*$  their powers  $p_{k,n}^{2,HM}$  and  $p_{k^*,n}^{1,HM}$  using Eqn. (2.7), given in Chapter 2, and their  $b_{k,n}^{2,HM}$  and  $b_{k^*,n}^{1,HM}$  using Eqn. (2.8) and Eqn. (2.9), given also in Chapter 2
- If  $b_{k^*,n}^{1,HM}$  is equal to 4 bits for user  $k^*$  (of type 1) and  $b_{k,n}^{2,HM}$  is equal to 2 bits for user  $k$  (of type 2) and if  $p_{k,n}^{2,HM} + p_{k^*,n}^{1,HM} < p_n$  where  $p_n$  is the power initially allocated to subcarrier  $n$ , HM can effectively take place. This constraint on the powers ensures that the power required by the two users does not exceed the total power on the shared subcarrier



### 3.2.2 Markovian analysis

With HM, the previously mentioned PS analysis does not hold because the resource sharing depends not only on the total number of users in the cell, but also on the exact number of users of type 1 and type 2. Indeed, users of type 1 will take advantage of HM only if there are users of type 2 in the cell. The state of the system is thus described by  $(s^1, s^2)$  where  $s^j$  is the number of users of type  $j$ ,  $j = 1, 2$ , and the exact analysis needs the solving of the CTMC mentioned in Section 3.1.1. This requires the construction of the infinitesimal generator matrix  $Q$  of the CTMC and the resolution of the system of equations  $\pi Q = 0$  and  $\pi.e = 1$ , where  $\pi$  is the steady-state probability vector and  $e$  is a vector of ones of appropriate dimension. Elements of matrix  $Q$  describe the transitions between states of the system that correspond to the following:

- Arrivals of calls of type 1 or 2, with rates  $\lambda\pi(r^1)^2$  and  $\lambda\pi((r^2)^2 - (r^1)^2)$ , respectively.  $r^j$ ,  $j = 1, 2$ , is the radius of region  $j$  in the cell.
- Departures of users of type 1. These users profit from their throughput  $c^1$ , in a RR way, and thus each user of type 1 obtains a throughput  $\frac{c^1}{s^1+s^2}$ . They will be also given extra throughput by HM each time a user of type 2 is scheduled; this happens on average  $\frac{s^2}{s^1+s^2}$  of the time and produces a throughput equal to  $\sum_{n=1}^N \frac{W}{N} \log_2(1 + \frac{p_{k^*,n}^{1,HM} |h_{k^*,n}^1|^2}{\Gamma(\sigma_{k^*,n}^1)^2})$  as given by Eqn. (3.3), shared by all users of type 1. Here we denote by  $p_{k^*,n}^{1,HM}$  the power for user of region 1 obtained from Equation (2.7). The resulting additional user throughput due to HM is thus given by:  $\frac{1}{s^1} \frac{s^2}{s^1+s^2} \sum_{n=1}^N \frac{W}{N} \log_2(1 + \frac{p_{k^*,n}^{1,HM} |h_{k^*,n}^1|^2}{\Gamma(\sigma_{k^*,n}^1)^2})$ , giving the total type 1 user throughput:

$$t_1(s^1, s^2) = \frac{1}{s^1 + s^2} [c_1 + \frac{s^2}{s^1} \sum_{n=1}^N \frac{W}{N} \log_2(1 + \frac{p_{k^*,n}^{1,HM} |h_{k^*,n}^1|^2}{\Gamma(\sigma_{k^*,n}^1)^2})] \quad (3.7)$$

The departure rate for users of type 1 is thus equal to  $s^1 \frac{t_1(s^1, s^2)}{E[F]}$

- Departures of users of type 2, with rate  $\frac{s^2}{s^1+s^2} \frac{c^2}{E[F]}$

The numerical resolution of this system of equations gives the above-mentioned performance measures: mean global and individual throughputs and the blocking probability.

### 3.2.3 Approximate PS analysis

Equation (3.7) suggests that the behavior of the system is as if users of type 1 have a peak throughput equal to:

$$c^1 + \frac{s^2}{s^1} \sum_{n=1}^N \frac{W}{N} \log_2 \left( 1 + \frac{p_{k^*,n}^{1,HM} |h_{k^*,n}^1|^2}{\Gamma(\sigma_{k^*,n}^1)^2} \right)$$

The peak throughput of users of type 2 does not change and is equal to  $c^2$  as given by Eqn. (3.3). We can thus approximate the performance of the system using the Processor Sharing model by changing the rate  $c^1$  of users of type 1 to a new total rate which is the sum of the initial rate  $c^1$ , as given by Eqn. (3.3), plus the new rate  $c^{1,HM}$  obtained from HM. Formally,

$$c^{1,HM} = \sum_{n=1}^N \frac{W}{N} \log_2 \left( 1 + \frac{p_{k^*,n}^{1,HM} |h_{k^*,n}^1|^2}{\Gamma(\sigma_{k^*,n}^1)^2} \right) Pr(s^1 > 0, s^2 > 0) \frac{s^2}{s^1} \quad (3.8)$$

where  $s^j$  is the mean number of users of type  $j$  present in the cell which we approximate by  $\frac{\bar{\rho}^j}{1-\bar{\rho}}$ , which is actually the expression for the case without admission control. The accuracy of this expression will be validated, in the next section, through simulations.

The first term of the right hand side of Equation (3.8) gives the throughput that is achieved by type 1 users on a subcarrier allocated originally to a type 2 user. This is conditioned by the fact that HM effectively takes place which is ensured by the probability  $Pr(s^1 > 0, s^2 > 0)$  that there are users of both types in the system. We approximate it through the following expression:

$$\pi(s^1, s^2) = \frac{(s^1 + s^2)!}{s^1! s^2!} (\bar{\rho}^1)^{s^1} (\bar{\rho}^2)^{s^2} (1 - \bar{\rho})$$

which is, again, the stationary distribution of the number of users of each type for a system with no admission control. Here too, our numerical results, shown in the next section, show the validity of this approximation.

The last term  $\frac{s^2}{s^1}$  gives the average number of type 2 users on which extra streams for type 1 users are superposed through HM and is also equal to  $\bar{\rho}^2 / \bar{\rho}^1$ .

### 3.3 Numerical analysis and simulations

We, now, validate our model and show the performance of the system, with and without HM, through numerical as well as simulation results.

#### 3.3.1 Simulator description

For the simulation results, we have developed a new simulator for a down-link OFDMA-based system that implements detailed features of the channel, slow and fast fading, as well as complete HM operation, in terms of constellations and powers.

For the channel model, we have used a multi-path IEEE802.16 Model E channel, which corresponds to a typical office environment for Non Line-of-Sight (NLOS) conditions with an exponential decay power profile [68] [69].

Table 3.1 shows the parameters used in our simulations.

Carrier frequency	3.5 GHz
System channel bandwidth	1.25 MHz
FFT	128
OFDMA symbol duration	102,9 $\mu$ s
Noise	-160dbm/Hz
$\Gamma$	8.8 dB

Table 3.1: System parameters

Note that  $\Gamma = 8.8dB$  ensures a probability of error equal to  $10^{-6}$ . We suppose that the BS has a perfect knowledge on the Chanel State Information (CSI) on each subcarrier for each user.

Again, the number of bits that a user  $s$  can transmit on subcarrier  $n$  is given by:

$$b_{s,n} = \log_2\left(1 + \frac{p_{s,n}|h_{s,n}|^2}{\Gamma(\sigma_{s,n})^2}\right) \quad (3.9)$$

where  $h_{s,n}$  and  $p_{s,n}$  are, again, its channel gain and allocated power on subcarrier  $n$ . We suppose that the noise is AWGN with zero mean and

variance  $\sigma^2 = N_0 \frac{W}{N}$ .  $W$  is the total available bandwidth and  $N_0$  is the noise power spectral density.

We consider in our case that the total amount of power  $p_{tot}$  is uniformly distributed among all the subcarriers. And so, the amount of power  $p_n$  allocated to each subcarrier  $n$  is given by:  $p_n = \frac{1}{N} p_{tot}$ .

We, also, implement, as indicated previously, an admission control scheme based on a maximal number  $s_{max}$  of users in the system;  $s_{max}$  is obtained by setting a minimal threshold  $n_{min}$  on the number of subcarriers per user. In our simulations, we used  $s_{max} = 10$  users, which is obtained by setting  $n_{min}$  to 12 subcarriers, for a total of 128 subcarriers.

We denote by  $\bar{h}_s$  the average channel response that a user  $s$  can achieve over all  $N$  subcarriers. It is obtained by:

$$\bar{h}_s = \frac{1}{N} \sum_{n=1}^N h_{s,n} \quad (3.10)$$

The different classes  $j, j = 1, \dots, J$ , can now be constructed by grouping different mean channel responses  $\bar{h}_s$  into a finite set of values. For simplicity, we assume that, based on their radio conditions, users are divided into two groups ( $J = 2$ ): users of type 1 with good radio conditions ( $j = 1$ ), to which Adaptive Modulation and Coding (AMC) assigns 16-QAM constellation, and users of type 2 with lower radio conditions ( $j = 2$ ) to which AMC assigns 4-QAM constellation.

We, eventually, assume that the file size is exponentially distributed with mean 40 Kbits.

### 3.3.2 Model validation and performance evaluation

Figures 3.2, 3.3 and 3.4 show the mean transfer time for all the users in the system, users of type 1 and users of type 2, respectively, as a function of increasing offered traffic (in bps). The offered traffic is obtained by multiplying the mean arrival rates  $\lambda$  by the mean file size. The values of the offered traffic that we have chosen correspond to a system utilization (load) ranging from 0.1 to 0.8, i.e., from lightly to heavy-loaded system. The curves correspond to the theoretical models we have developed above and which

we term PS for Processor Sharing and Markovian for the exact analysis, as well as Monte Carlo simulations, with and without HM.

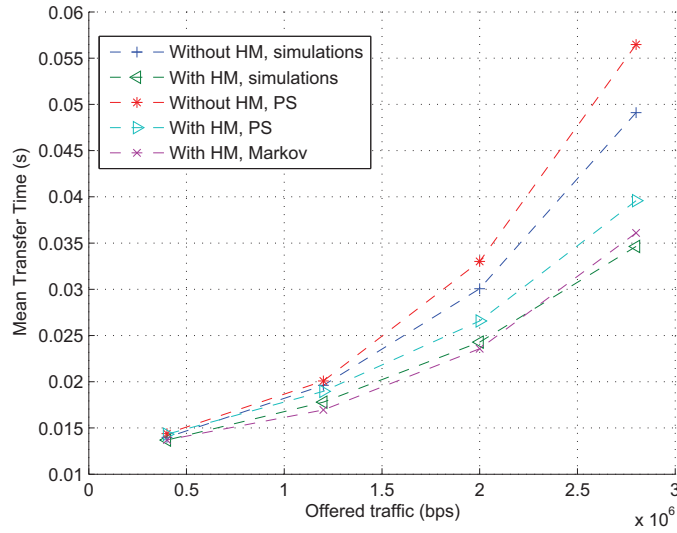

Figure 3.2: Mean transfer time - all users

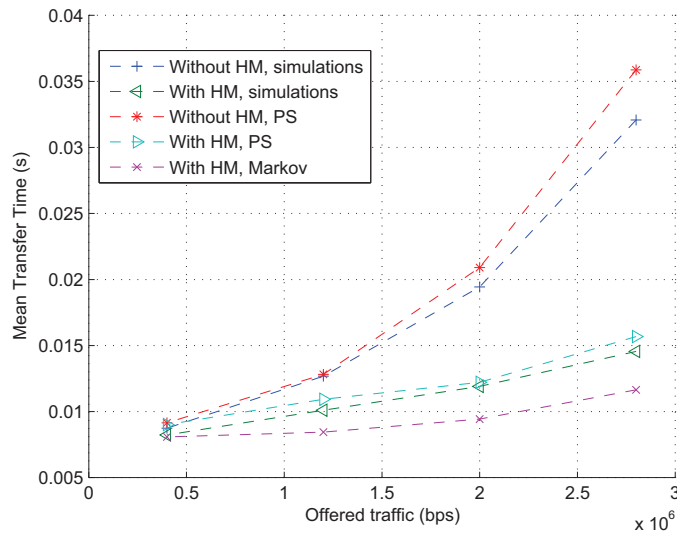

Figure 3.3: Mean transfer time - users of type 1

We, first, observe in all these cases that the mean transfer times are, trivially, increasing with increasing load.

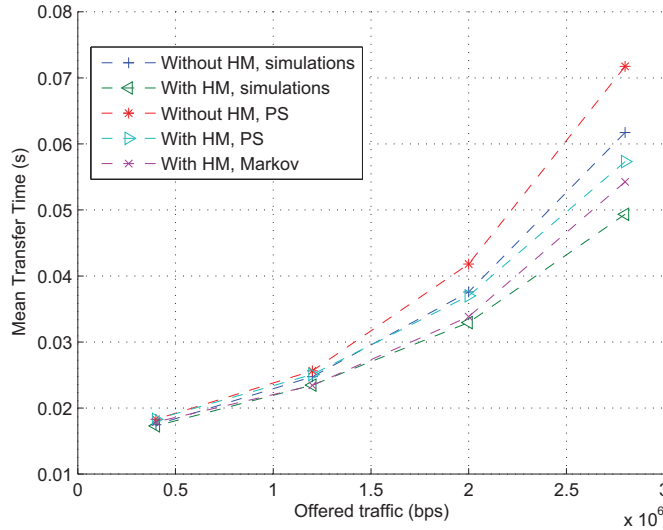

Figure 3.4: Mean transfer time - users of type 2

We, second, observe the quite good match between theory and simulations. The differences between the theoretical and simulation curves can be explained by the fact that our simulator implements fast fading as well as detailed operation of HM in terms of powers and channel gains, whereas the theoretical models assume slow fading only and constant channel gains, averaged for each region of the cell. We note, also, the good match between the Markovian analysis and the PS approximation in the case of HM.

We, third, observe that there is a gain in using HM and it is even larger as the system becomes more loaded, as in this case more users of type 2 will be used to superpose additional streams for users of type 1. The gain is, as expected, more to the advantage of users of type 1 (Figure 3.3) but it does exist for users of type 2 also (Figure 3.4). This is due to the fact that, when users of type 1 get an additional rate, they will be able to finish their services earlier and thus free the resources that will be used by users of type 2, leading to an additional gain for the latter as well.

We now investigate to which extent this gain (in terms of mean transfer times) is dependent on the proportion of users of each type. We consider three scenarios:

- Scenario 1: 25% of the users are of type 1 and 75% of the users are of type 2;
- Scenario 2: 50% of the users are of type 1 and 50% of the users are of type 2;
- Scenario 3: 75% of the users are of type 1 and 25% of the users are of type 2.

Figures 3.5, 3.6 and 3.7 show the gains achieved by using HM for the three scenarios for all users, for users of type 1 and for users of type 2, respectively.

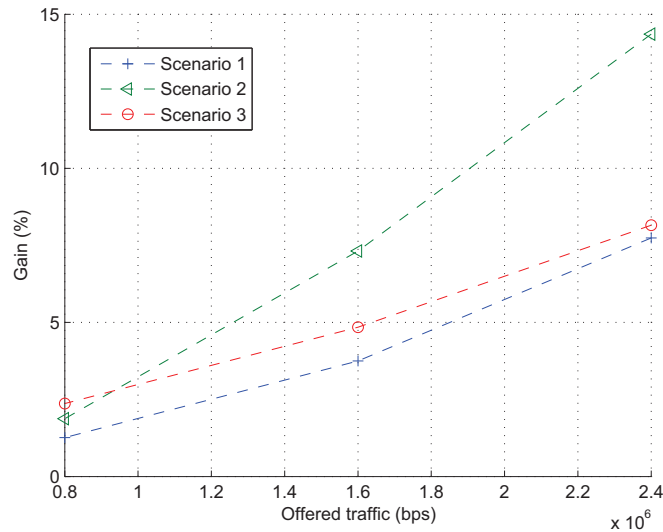

Figure 3.5: Gain for all users

We observe that with respect to all users in the system considered at once (Figure 3.5), scenario 2 achieves the highest gain because: i. when there are more users of type 1 (scenario 3), the amount of individual gain achieved by these users is high (Figure 3.6) but overall, as their number is small, the total gain is limited, and ii. when the number of users of type 2 is higher (scenario 1), the gain is limited as the number of users of type 1 that can take advantage of their cooperation is limited and hence the gain that would in turn come back to them is limited too (Figure 3.7).

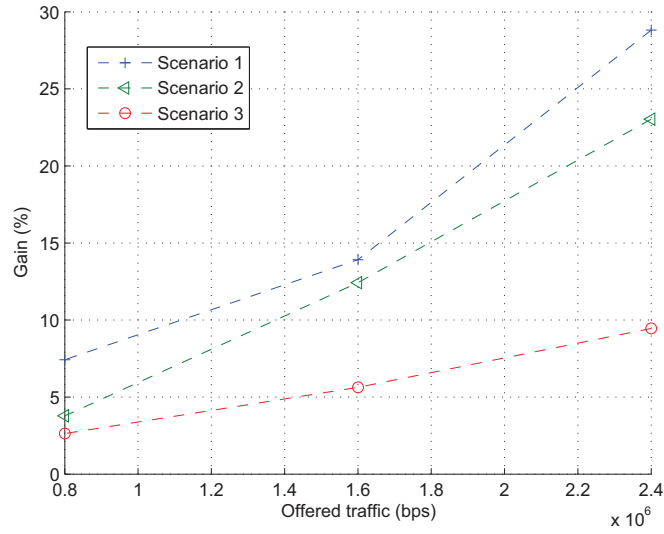

Figure 3.6: Gain for users of type 1

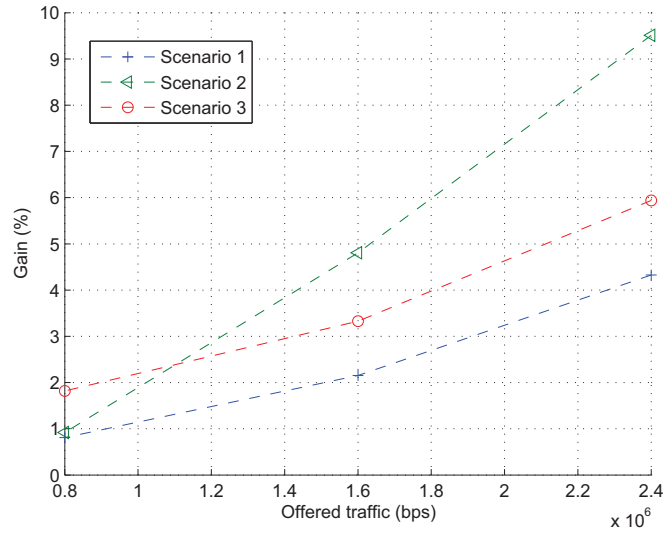

Figure 3.7: Gain for users of type 2

Figure 3.8 represents the maximum capacity of the cell obtained by the calculation of the following harmonic mean:

$$\frac{\sum_{j=1}^J \lambda^j}{\sum_{j=1}^J \frac{\lambda^j}{c^j}}$$



where  $\lambda^j$  is the mean arrival rate of users of type  $j$  in the system and  $c^j$  is their service rate, with and without HM.

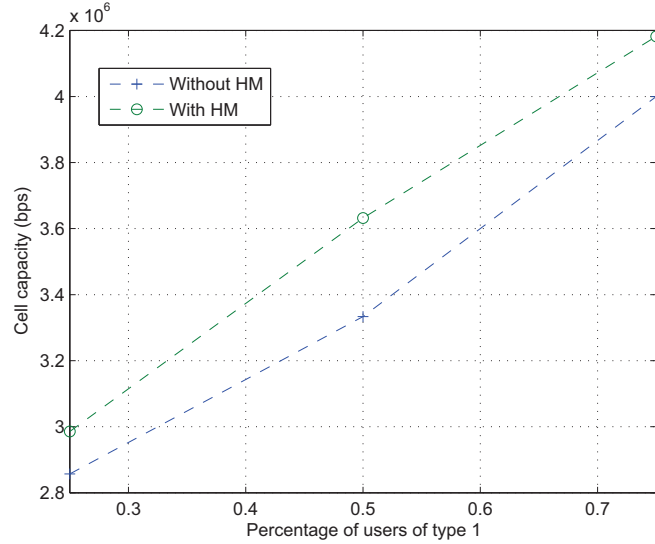

Figure 3.8: Maximal traffic that can be carried by the cell

We observe, in accordance with our previous results, that the maximum increase with HM takes place when the percentage of users of each type is equal to 50%.

### 3.3.3 Extensions

We now turn to investigate two extensions that we propose to the previously studied HM algorithm which we denote, hereafter, by classical HM.

The first extension we propose is one that allows further users of type 2 to be superposed on subcarriers allocated primarily to users of type 1. Specifically, in this case, the same resulting 4/64-QAM constellation as in the classical case will be used, which means that 2 additional bits will be sent to a user of type 2 on each subcarrier initially allocated to a user of type 1.

The second extension is one that allows further users of one type: 1 or 2, to be superposed, along the same algorithm, on subcarriers originally allocated to users of the same type. In this case, both 4/16 and 4/64-QAM

constellations will be obtained: the former refers to the case when two extra bits are sent for a user of type 2 superposed on a subcarrier for yet another user, of type 1 or 2, and the latter is as the first extension above.

Figures 3.9, 3.10 and 3.11 show, respectively, the gains (in terms of mean transfer times) for all the users in the system as well as those of type 1 and those of type 2, for the cases of classical HM and our two proposals versus the case with no HM at all. Recall that our first proposal (corresponding to legend Proposal I) allows, further to classical HM, users of type 2 to be superposed on users of type 1. As of our second proposal (legend Proposal II), it allows, further, users of one type, 1 and 2, to be superposed on users of the same type.

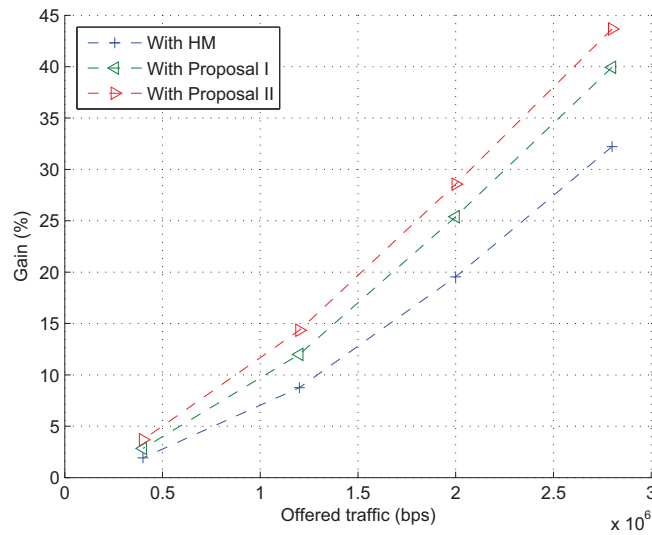

Figure 3.9: Gain for all users

We observe that for the first extension, there is indeed a gain, and it now profits more to users of type 2 compared to the case with a simple use of HM. This is due to the fact, users of type 2 will get an additional rate every time a user of type 1 is served. As of the second extension, we observe that our proposal enables to further enhance the achieved gain for the two types of users.

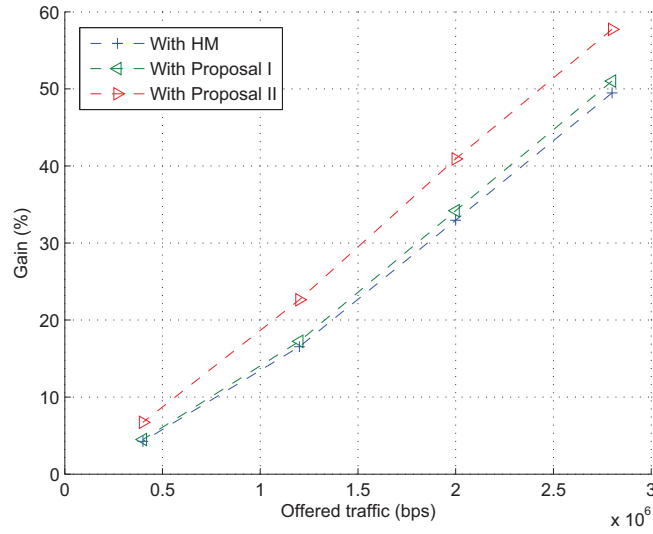

Figure 3.10: Gain for users of type 1

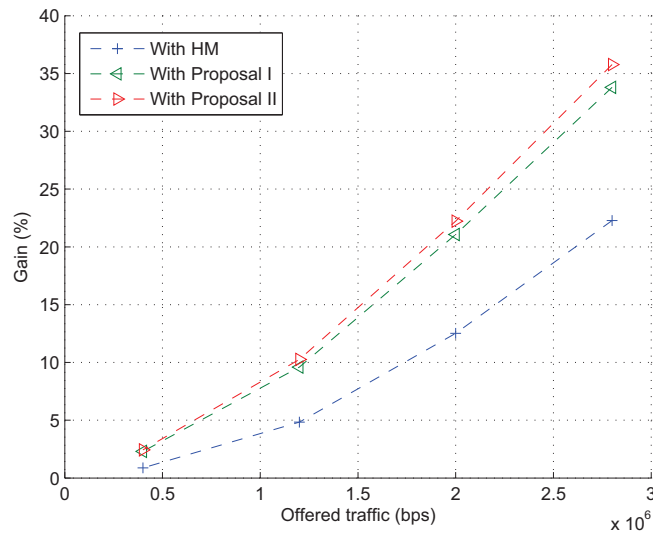

Figure 3.11: Gain for users of type 2

### 3.4 Conclusion

We considered, in this chapter, the flow-level modeling of HM, a physical layer technique wherein additional streams for users of good radio conditions are superposed on the same subcarriers allocated initially to users with lower

radio conditions, by means of constellation embedding. We quantified, under TDM, the gain obtained by such a technique, at the individual and global levels, and showed how the gain varies with the proportion of users of each type: the optimum being for the case where both types of users are of equal proportions. We eventually extended HM to the case where users with bad radio conditions are also superposed on those with better ones as well as to the case where users of one type can also be superposed on those of their own type as well, and showed that the gain is even larger in these cases.

In the next chapter, we focus on the use of HM with proportional fairness, an algorithm known to exploit opportunistically multiuser diversity in order to increase the overall system capacity without sacrificing fairness among users.

## Chapter 4

# On the use of hierarchical modulation with proportional fairness

We investigated in the previous chapter the use of Hierarchical Modulation (HM) with Round Robin (RR) which serves users in a cyclic manner on a time basis. RR achieves fairness in terms of time but does not take into consideration the users diversity, in terms of radio conditions, which may lead to a poor utilization of the resources and hence a poor overall system throughput.

In this chapter, we focus on the use of HM with Proportional Fairness (PF) in OFDMA-based networks. PF is an algorithm that belongs to the so-called  $\alpha$ -fair allocation strategies, known to achieve a good trade-off between efficiency and fairness among these  $\alpha$ -fair policies, by an opportunistic allocation of resources to users with good radio conditions, without sacrificing fairness towards the other users of the system who have worse radio conditions.

We, specifically, model the system performance, obtained by jointly using PF with HM, for a dynamic user setting. We, also, evaluate the system performance, notably in terms of mean transfer times and blocking probabilities, under PF in the presence of HM and see whether it still is the optimal strategy in the sense of  $\alpha$ -fair allocation strategies.

## 4.1 Proportional fairness

PF is, as already stated, an algorithm which belongs to the so-called  $\alpha$ -fair allocation strategies and which is known to achieve a good trade-off between efficiency and fairness. It corresponds to a utility maximization allocation that maximizes the sum of the logarithms of the rates. It is such that any increase in the rate allocation for a user results in a decrease in the overall throughput of the system [70][71].

Moreover, PF is known to be the only utility maximizing allocation that is homothetic<sup>1</sup> which simplifies the analysis of some networks [58].

PF is an opportunistic algorithm that makes it possible to exploit the user diversity: it allocates resources primarily to users with good radio conditions because they would be able to take full advantage of these resources and finish their data transfers quickly. Resources can then be given to the other users of the system, with worse radio conditions. Of course, some fairness should be guaranteed in order for the users with good radio conditions not to cause the starvation of the others.

Formally, let  $c_s[u]$  and  $Z_s[u]$  denote, respectively, the instantaneous rate for user  $s$ ,  $s = 1, \dots, S$ , in time slot  $u$ , and its average throughput until time slot  $u$ ;  $S$  being the total number of users in the system.

Based on the weighted alpha rule proposed in [72] and [73], user  $s^*$  who would be served by PF is the user who maximizes the following weighted ratio:

$$w_s \frac{c_s[u]}{(Z_s[u])^\alpha} \quad (4.1)$$

where  $w_s$  is the weighted parameter for user  $s$  and  $\alpha$  is, again, the parameter that determines the trade-off between efficiency and fairness for the  $\alpha$ -fair policies, as seen in Chapter 2.

In our work, we suppose that all users have the same weight  $w_s = 1$ . Considering the PF case ( $\alpha = 1$ ), the average throughput  $Z_s[u]$  is updated according to the following set of equations [16][73]:

---

<sup>1</sup>A resource allocation is said to be homothetic if changing the resources available for a given class by some factor changes the bit rate allocated to this class by the same factor [58].

$$Z_s[u] = \begin{cases} (1 - \frac{1}{t_c})Z_s[u-1] + \frac{1}{t_c}c_s[u-1] & \text{if } s = s^* \\ (1 - \frac{1}{t_c})Z_s[u-1] & \text{if } s \neq s^* \end{cases} \quad (4.2)$$

where  $t_c$  is a low pass filter that allows to update  $Z_s[u]$  every  $t_c$  time slots [45].

The system performance depends, thus, on the parameter  $t_c$ . For a low value of  $t_c$  ( $t_c \rightarrow 0$ ), the scheduler behaves like RR since it neglects the users's radio conditions when allocating the resources [74]. On the contrary, with a high value of  $t_c$ , the scheduler behaves as max SNR algorithm [74]. In this case, users with bad radio conditions will wait longer until a possible improvement in their radio conditions, but not for an infinite time. The larger the value of  $t_c$ , the larger the delay for the users.

## 4.2 Flow-level modeling of PF

We now model the system, at the flow level, under PF, without and with HM.

We specifically make use of the same Processor Sharing (PS) model described in Chapter 3, along with the same performance metrics, namely mean transfer times and blocking probabilities. What now differs is the expression for the throughput achieved under PF. Before deriving it, let us first start with a literature review on major implementations, and consequent throughput expressions, under PF.

### 4.2.1 Related works

In the literature, different expressions for the throughput obtained under PF result from the use of different metrics in choosing the user to which the resources are allocated.

In [15], the authors consider the SNR metric and allocate the resources to the user whose SNR is maximal. This approximation corresponds in fact to the ideal case where all users experience symmetric fading conditions [75].

In [76], the authors make, again, use of the SNR in selecting the user to serve. The calculation of the throughput follows two models: a first one

where the feasible rate is considered to be a linear function of the SNR and a second one in which the relationship is logarithmic, as is the case of the Shannon formula.

In [77], the authors make use of the ratio of the instantaneous SNR to the average SNR to select the user to be served. The calculations make, again, use of a linear and logarithmic expressions, but this time using the previously mentioned ratio of the SNRs.

As of the rate estimation, the use of the Gaussian approximation has been shown in [78] and [79] to model very accurately the feasible rate in the cases of Raleigh and Rician fadings. The linear and the logarithmic models are simple and mathematically attractive but they are known to over-estimate the feasible rate and hence the gain achieved by PF compared to a simple time division multiplexing scheme [78][80].

In [81], the authors make use of this Gaussian approximation and show that the gain is much lower than in the linear case but only symmetric channels have been considered. In [80], the same approach is used, but this time, for asymmetric channels. Using simulations, the expression of the gain has been modified to match different fadings: Raleigh and Rician.

As of the use of PF with HM, the authors in [38] make use of PF to determine the user who will receive the additional stream. The first user to be served is the one who maximizes the SNR whereas the second user is the one who maximizes the ratio of the instantaneous SNR to the average SNR, as in [77].

In our work, we assume that resources are initially allocated to users based on PF. If the selected user has a low SNR, we, then, use HM to superpose, if possible, a user with higher SNR on the same subcarrier.

#### 4.2.2 Modeling throughput under PF

We, now, derive the achievable throughput in the case of PF under a dynamic user setting, considering a Gaussian approximation.

We will make use of the ratio given by Eqn. (4.1) to choose the user to whom the resources will be allocated. The average rate  $Z_s[u]$  is updated using Eqn. (4.2).



Denoting by  $I_s^j[u]$  the index that indicates if user  $s$  of type  $j$  is served or not in time slot  $u$ , we have:

$$I_s^j[u] = \begin{cases} 1 & \text{if user } s \text{ of type } j \text{ is served in time slot } u \\ 0 & \text{otherwise} \end{cases}$$

Using the Gaussian approximation, the instantaneous data rate  $c_s^j$  of the  $s^{\text{th}}$  user of type  $j$  is characterized by its mean  $E[c_s^j]$  and standard deviation  $\sigma_{c_s^j}^2$ , given, respectively, by:

$$E[c_s^j] = \int_{-\infty}^{\infty} \log(1 + xSNR_s^j) \exp^{-x} dx \quad (4.3)$$

$$\sigma_{c_s^j}^2 = \int_{-\infty}^{\infty} \log(1 + xSNR_s^j)^2 \exp^{-x} dx - (E[c_s^j])^2 \quad (4.4)$$

The mean achieved throughput  $\bar{c}_s^j$  of user  $s$  of type  $j$  is given by:

$$\begin{aligned} \bar{c}_s^j &= E[I_s^j[u] = 1 \times c_s^j[u]] \\ &= Pr(I_s^j[u] = 1) \int_{-\infty}^{\infty} x f_{c_s^j}(x | I_s^j[u] = 1) dx \\ &= \int_{-\infty}^{\infty} x f_{c_s^j}(x) Pr(I_s^j[u] = 1 | c_s^j[u] = x) dx \end{aligned} \quad (4.5)$$

where  $f_{c_s^j}(\cdot)$  is the probability density function of the instantaneous throughput of user  $s$  of type  $j$  and  $Pr(I_s^j[u] = 1 | c_s^j[u] = x)$  is the conditional probability that user  $s$  of type  $j$  is served in time slot  $u$  with instantaneous rate  $c_s^j$ .

Considering all the classes, the mean throughput  $\bar{c}_s$  of a user in the cell is given by:

$$\bar{c}_s = \sum_{j=1}^J \int_{-\infty}^{\infty} Pr(j) x f_{c_s^j}(x) Pr(I_s^j[u] = 1 | c_s^j[u] = x) dx$$

where  $Pr(j)$ ,  $j = 1, \dots, J$ , is the probability that a user of type  $j$  is indeed served and is given by:

$$\frac{s^j}{\sum_{j=1}^J s^j} \quad (4.6)$$

where  $s^j$  is the number of users of type  $j$  in the system.

Using the PF metric given by Eqn. (4.1), we have:

$$\begin{aligned}
Pr(I_s^j[u] = 1 | c_s^j[u] = x) &= Pr(\forall v \neq s, \frac{c_v^j[u]}{c_s^j[u]} < \frac{x}{c_s^j[u]}) \\
&= \prod_{v=1, v \neq s}^{s^j} F_{c_s^j}(\frac{x}{c_s^j[u]} \overline{c_v^j[u]})
\end{aligned} \tag{4.7}$$

where  $F_{c_s^j}(\cdot)$  is the cumulative distribution function of the instantaneous throughput of user  $s$  of type  $j$ . For  $u$  large and using the Gaussian approximation [81], we obtain:

$$\prod_{v=1, v \neq s}^{s^j} F_{c_s^j}(\frac{x}{c_s^j[u]} \overline{c_v^j[u]}) = \prod_{v=1, v \neq s}^{s^j} F_{c_s^j}(\frac{E[c_v^j]}{E[c_s^j]}(E[c_s^j] + x\sigma_{c_s^j})) \tag{4.8}$$

Based on the fact that, statistically, users of the same type have all the same feasible rates, we have:

$$\begin{aligned}
\overline{c_s} &= \sum_{j=1}^J \int_{-\infty}^{\infty} Pr(j)(E[c_s^j] + x\sigma_{c_s^j}) \frac{\exp^{-\frac{x^2}{2}}}{\sqrt{(2\pi)}} (F_{(0,1)}(x))^{s^j-1} dx \\
&= \sum_{j=1}^J \int_{-\infty}^{\infty} Pr(j) (\frac{E[c_s^j]}{s^j} + \sigma_{c_s^j} x \frac{\exp^{-\frac{x^2}{2}}}{\sqrt{(2\pi)}}) (F_{(0,1)}(x))^{s^j-1} dx
\end{aligned} \tag{4.9}$$

where  $F_{(0,1)}(\cdot)$  is the zero mean, unit variance, standard Normal distribution function.

In Eqn. (4.9),  $\frac{E[c_s^j]}{s^j}$  corresponds to the rate that a user  $s$  of type  $j$  would achieve using a fair time allocation such as RR. The gain achieved with PF with respect to RR is then given by:

$$G = 1 + \frac{\sum_{j=1}^J Pr(j) \int_{-\infty}^{\infty} \sigma_{c_s^j} x \exp^{-\frac{x^2}{2}} (F_{(0,1)}(x))^{s^j-1} dx}{\sum_{j=1}^J Pr(j) \frac{E[c_s^j]}{s^j}} \tag{4.10}$$

Please note that, in this expression, the number of users  $s^j$  in each class  $j$  is taken as the average number of users obtained under RR.

And so, in the case of PF without HM, the rate achieved by user  $s$  of type  $j$  is given by:

$$c^j = G \sum_{n=1}^N \frac{W}{N} \log_2 \left( 1 + \frac{SNR_{s,n}^j}{\Gamma} \right) \quad (4.11)$$

where  $G$  is the gain with respect to RR, given by Eqn. (4.10), and  $\sum_{n=1}^N \frac{W}{N} \log_2 \left( 1 + \frac{SNR_{s,n}^j}{\Gamma} \right)$  is the rate achieved under RR as well. Recall that  $W$  is the total bandwidth and  $SNR_{s,n}^j$  is the SNR experienced by user  $s$  of type  $j$  on sub-carrier  $n$  and which is given by Eqn. (2.1) in Chapter 2.

### 4.2.3 With HM

Using HM, user  $k^*$  of type 1 will get an additional throughput  $c_{add}$  each time a user of type 2 is scheduled (by PF). It is given by:

$$c_{add} = \sum_{n=1}^N \frac{W}{N} \log_2 \left( 1 + \frac{P_{k^*,n}^{1,HM} |h_{k^*,n}^1|^2}{\Gamma(\sigma_{k^*,n}^1)^2} \right) \quad (4.12)$$

The peak rate  $c^1$  of user  $k^*$  is now given by:

$$c^{1,HM} = c^1 + c_{add} \times Pr(s^1 \geq 1, s^2 \geq 1)$$

where  $c^1$  is given by Eqn. (4.11) and  $Pr(s^1 \geq 1, s^2 \geq 1)$  is the probability of having at least one user of each type in the system so that HM effectively takes place.

## 4.3 Model validation and performance evaluation

In order to validate our analytical model and to evaluate the system performance, we have used our simulator that we described in the previous chapter, considering the same parameters and assumptions.

### 4.3.1 Model validation

We, first, validate our analytical model by plotting the various performance metrics obtained numerically against the ones obtained through simulations.

Figure 4.1 shows the mean transfer time, for all the users in the system, as a function of increased load, for the case of PF, with and without HM.

We observe a quite good match between the curves obtained through the analytical model versus simulations, as well as the gain achieved by HM.

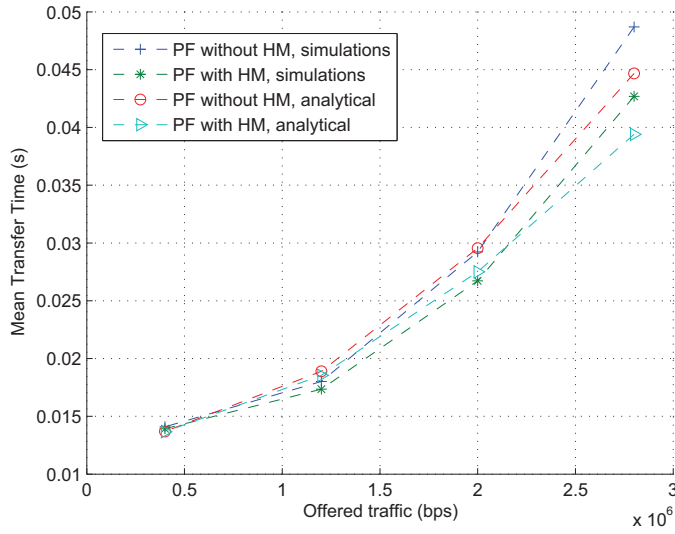

Figure 4.1: Mean transfer time - all users

This gain is biased towards users of type 1, as shown in Figure 4.2, which is expected because these users are the ones that are superposed using HM on users of type 2. The latter achieve less gain, as illustrated in Figure 4.3.

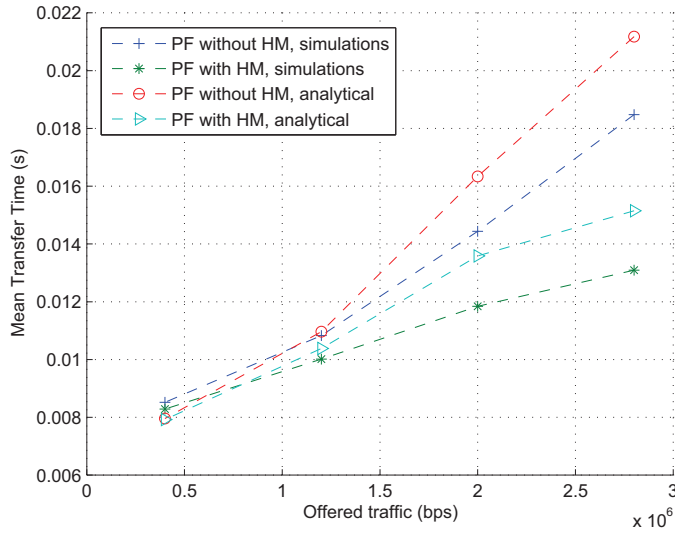

Figure 4.2: Mean transfer time - users of type 1

Figure 4.4 shows the blocking probability, resulting from our admission

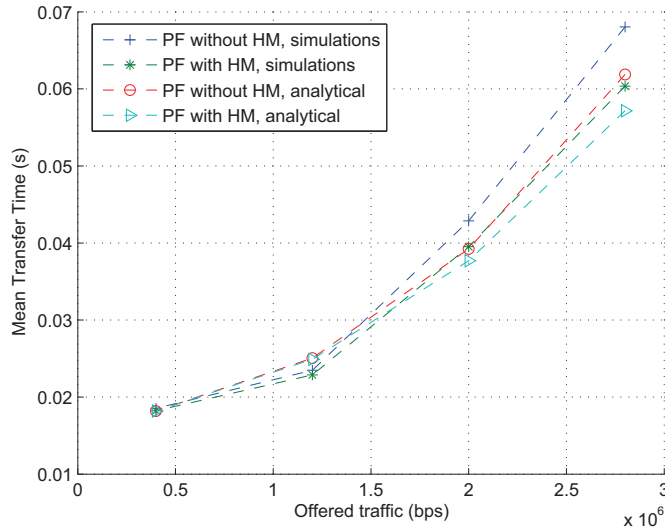

Figure 4.3: Mean transfer time - users of type 2

control algorithm that we described in Chapter 3. With HM, blocking is smaller than without HM, due to the fact that with HM, users of type 1 enjoy more resources and hence leave the system earlier, which in turn leaves more resources to users of type 2. Overall, the system empties more quickly, and the admission opportunities increase.

### 4.3.2 Comparison with RR and max-min

We now compare the performance of PF with respect to RR and max-min, with and without HM.

Figure 4.5 shows the mean transfer time for all the users in the system, as a function of increased load, for the cases of PF, RR and max-min, without and with HM.

Without HM, we observe that PF performs slightly better than RR and max-min, as it obtains a higher throughput, or equivalently, a lower mean transfer time. The reason for the better performance of PF is the opportunistic exploitation of user diversity in terms of radio conditions. The fact that the difference is not very large is due to the fact that PF actually exploits fast fading which is less significant compared to slow fading, especially

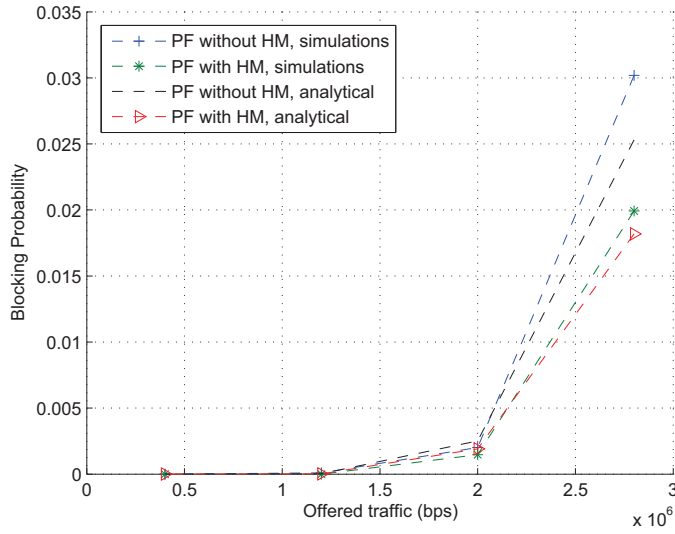

Figure 4.4: Blocking probability - all users

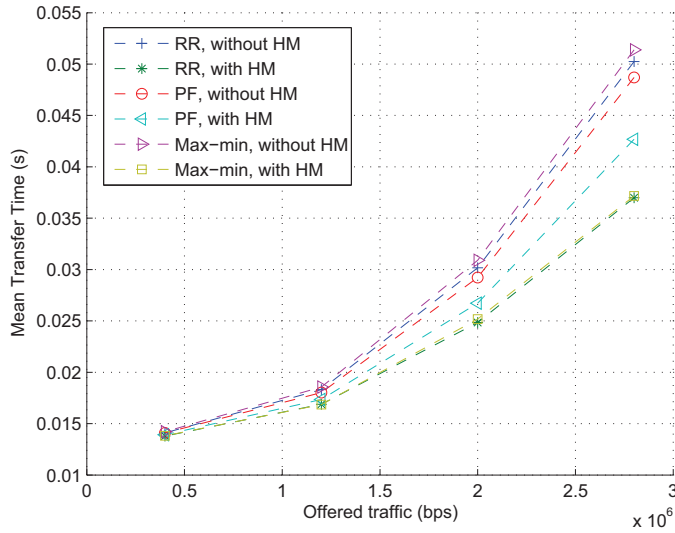

Figure 4.5: Mean transfer time - all users

when the number of users in the system is not very large [15].

As of RR versus max-min, the former outperforms slightly the latter, as max-min allocates more resources, in terms of time slots, to the users with worse radio conditions.

With HM, we observe that the performance of PF, RR and max-min improves, obtaining lower mean transfer times (equivalently, higher throughputs). The improvement is more significant for both RR and max-min, especially max-min. This can be explained by the fact that with RR and max-min, users of type 2, on which we superpose additional streams for users of type 1, are served for relatively longer times than in the case of PF and hence, they can ensure more HM opportunities for users of type 1 and so, a higher gain for these users. The latter would thus leave the system sooner and account for a higher overall system performance. Max-min achieves a slightly larger gain than RR because, with max-min, users of type 2 are allocated more time slots than users of type 1, and hence the opportunities to perform HM are even more frequent.

These observations are in accordance with the individual performances of the users of both types, as shown in Figures 4.6 and 4.7 for users of types 1 and 2, respectively.

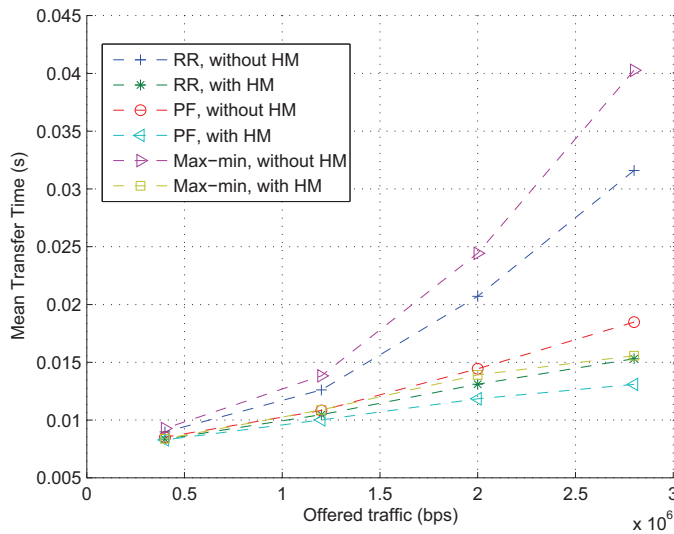

Figure 4.6: Mean transfer time - users of type 1

In effect, we observe in these figures that users of type 1 are, of course, better off using PF, without and with HM, as, in this case, the scheduler grants them with larger transmission opportunities compared to users of type 2. In the case of HM however, they do not gain, relatively, much in

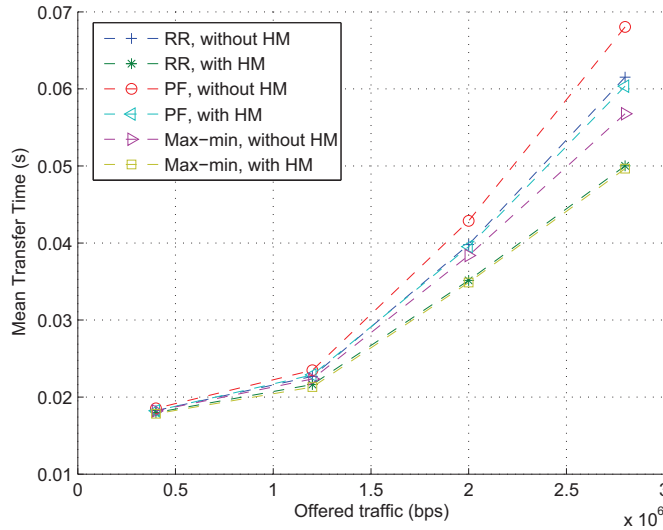

Figure 4.7: Mean transfer time - users of type 2

the case of PF as, again, they monopolize the scheduler for longer periods of time compared to users of type 2. Users of type 2 show a better performance using max-min and RR, without and with HM.

Figure 4.8 shows the blocking probability in the six cases: PF, RR and max-min, with and without HM. Here too, without HM, the blocking probability is slightly better for the case of PF than RR and max-min; the trend is, again, inverted in the case of HM where RR and max-min outperform PF.

In conclusion, in the case of HM, RR and max-min achieve a better performance than PF, in terms of transfer times and blocking rates. With a simpler implementation in the case of the cyclic scheduler RR.

## 4.4 Conclusion

We considered, in this chapter, the joint use of HM with PF. We modeled the system performance under PF, and quantified the gains achieved by adding HM, in terms of mean transfer times and blocking probabilities. We compared the gains achieved under PF versus RR, as well as max-min, a fair scheduler in terms of the throughput achieved by the different users in



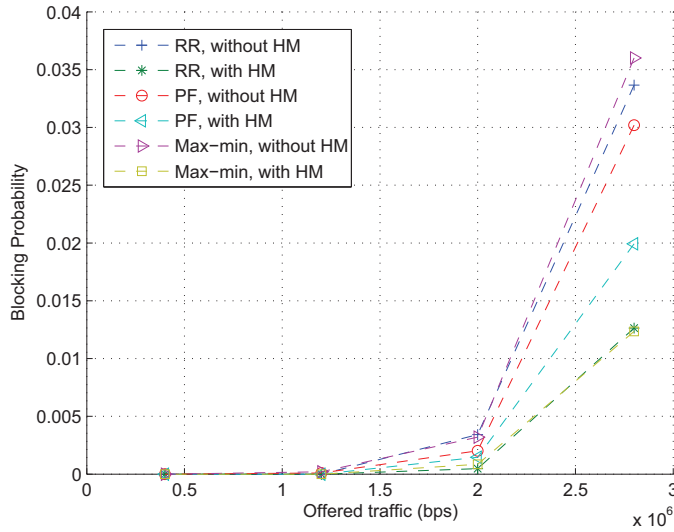

Figure 4.8: Blocking probability - all users

the system.

Without HM, PF performs slightly better than RR and max-min. With HM, however, our results show a better performance for RR and max-min which is explained by the fact that in the case of PF, users of type 2, on which we superpose additional streams for users of type 1, have less transmission opportunities and thus less superposition opportunities as well. The argument in favor of RR is further comforted by the fact that its implementation is simpler than that of PF and max-min.

## Chapter 5

# Joint use of hierarchical modulation with cooperative relaying

In cooperative relaying, the Base Station (BS) broadcasts a signal to the destination, the Relay Station (RS) overhears it and forwards, it in a next time slot, to the destination. The latter combines the two received copies of the signal in order to reconstruct the original one.

We consider, in this chapter, the joint use of Hierarchical Modulation (HM) and cooperative relaying, in OFDMA-based networks, in order to send additional information to the RS so as to enable it to reconstruct a more robust copy of the original signal. We, also, adapt the transmission from the RS to the destination by taking advantage of the typically good radio conditions between them so as to reduce the cost of additional resources needed by relaying and hence improve the overall system capacity.

We model, and validate against simulations, such a system and resource allocation schemes at the flow-level, and quantify the gains thus achieved, in terms of throughput and blocking probability. We, eventually, propose an enhancement to the afore mentioned scheme in order to further enhance the overall system throughput.

## 5.1 Relay-based system

In order to improve the system performance in terms of capacity and/or coverage, relays have been proposed to OFDMA-based systems [82][83]. In such a system, the RS relays information from the BS to the Subscriber Station (SS), i.e., user, who suffers from poor radio conditions in its direct link with the BS. This allows the SS to take advantage of the spatial diversity gain without using multiple antennas.

There exists two different relay modes: a transparent mode and a non-transparent mode. The transparent mode, shown in Figure 5.1, is used to increase the system capacity by increasing the throughput experienced by the SS, while the non-transparent mode, shown in Figure 5.2, is proposed to mitigate coverage holes and enhance, thus, the system coverage.

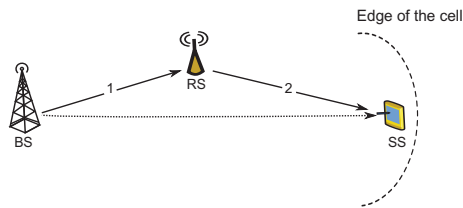

Figure 5.1: Transparent mode

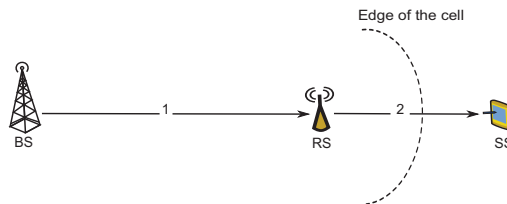

Figure 5.2: Non transparent mode

In order to relay information to the destination, the RS typically uses one of two relaying techniques: Amplify and Forward (AF) or Decode and Forward (DF) [84]. AF is a simple scheme where the RS only amplifies the amplitude of the received signal from the BS and then forwards it to the destination. One of the major drawbacks of this technique is the amplification of noise. With DF, the RS first decodes the signal overheard from the BS and then re-encodes it and transmits it to the destination. Apart from

the extra cost and delay resulting from the decoding and encoding steps, DF may be inefficient if the RS is not able to successfully decode the received signal from the BS.

## 5.2 Use of HM with cooperative relaying

We consider, in this chapter, a transparent cooperative relaying scheme, wherein the SS combines the two signals received from the direct BS-SS and indirect BS-RS-SS links so as to reconstruct a robust copy of the original signal.

### 5.2.1 Motivations

HM, as described previously, allows to send an additional data stream to a user with good radio conditions on a subcarrier initially allocated to a user with worse radio conditions. And so, combining HM with relaying, the idea is to use the fact that the RS enjoys typically better radio conditions with the BS compared to the destination to send additional information to the RS on the same subcarrier that was initially allocated to the destination. The RS, as it enjoys good radio conditions, would be able to decode the two signals: the primary one sent to the destination and the additional information sent to it, and to generate a more robust copy of the initial signal compared to the case of classical relaying where the RS will use only the overheard signal to decode and encode a new copy of the initial signal. This can be very useful in the case of DF where the RS may not be able to successfully decode the overheard signal.

### 5.2.2 Related works

Other works studied the use of HM in cooperative relaying systems.

In [85] and [86], the authors proposed to send additional information using HM via the indirect link in order to improve the Bit Error Rate (BER) at reception.

In [84], and [87], the authors proposed to optimize the use of HM in order to also minimize the BER at the destination.

In [88], the authors studied the use of HM in the case of a multiple relay scheme.

And in [89], the authors investigated the case of cooperative transmit diversity based on the use of HM in the case of two sources that communicate directly with one destination.

These works, again, focused solely on the physical layer, notably on the BER improvement, and did not address the issues related to capacity, along with the gains achieved, at the flow-level, for a dynamic user setting. And this is the focus of our present work.

Moreover, these works did not consider the problem of the additional resources needed for relaying, and which we propose to combat using link adaptation. In [90], the authors did indeed adapt the transmission of the relay to the radio conditions of the RS-SS link, but their work did not make use of cooperative relaying in the sense that the destination does not combine two copies of information, one from the direct link and one from the indirect one, in order to reconstruct the original signal. In [91], the authors developed a multiuser cooperative scheme where HM is used between two destinations; the RS decodes the two overheard signals, without additional information, and relays them to the destinations using HM also.

### 5.3 Proposal: HM and link adaptive relaying

We now detail the operation of HM and link adaptive relaying.

We suppose that the BS has knowledge of the Channel State Information (CSI) of all links: BS-RSs, BS-SSs and RSs-SSs. We denote, respectively, by  $SNR_k$ ,  $SNR_{sr}$  and  $SNR_{rd}$ , the SNRs of the BS-SS, BS-RS and RS-SS links as shown in Figure 5.3. Index  $k$  stands for a given user of type 2 who cannot decode his information bits on the direct link (BS-SS).

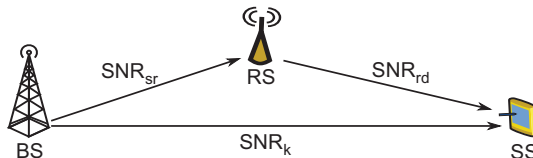

Figure 5.3: relaying mode

In classical cooperative relaying using DF, the BS broadcasts a  $M$ -QAM signal  $A$  to a user  $k$  with bad radio conditions, the RS overhears it, decodes it, encodes a new copy  $\bar{A}$  and forwards it in the next time slot to this given user  $k$ .

We suppose that the destination uses a simple Maximal Ratio Combining (MRC) combiner in order to decode its signal. In this case, and using DF-based relaying, the SNR achieved by user  $k$  after the two steps described above is given by:

$$\overline{SNR}_k = \min((SNR_k + SNR_{coop}), SNR_{sr}) \quad (5.1)$$

where  $SNR_{coop}$  is equal to  $SNR_{rd}$  if  $SNR_k < SNR_{rd}$ . Note that if  $SNR_k > SNR_{sr}$ , relaying is useless and  $\overline{SNR}_k = SNR_k$ .

Let us denote by  $BER_{coop}$  the BER achieved over the indirect link (BS-RS-SS). It is given by:

$$BER_{coop} = 1 - (1 - BER_{sr})(1 - BER_{rd}) \quad (5.2)$$

where  $BER_{sr}$  and  $BER_{rd}$  stand, respectively, for the BER of the BS-RS and RS-SS links.

$BER_k$  of user  $k$  for an  $M$ -QAM system over an Additive White Gaussian Noise (AWGN) channel is related to its  $SNR_k$  through the following equation [92]:

$$BER_k = 0.2 \exp\left(-\frac{3SNR_k}{2(M-1)}\right) \quad (5.3)$$

Based on Eqns. (5.1), (5.2) and (5.3), we see that the quality of decoding at the destination depends, notably, on the quality of the signal decoded and encoded at the RS (depends notably on  $SNR_{sr}$  and  $SNR_{rd}$ ). If the overheard signal cannot be decoded correctly by the RS, the encoded copy,  $\bar{A}$ , will also be corrupted, and hence relaying will be inefficient. And so, in order to improve the decoding at the RS, we propose the use of HM.

Using HM, the BS will be able to send two different signals, which we term  $A$  and  $B$ , to the SS and RS, by adapting the transmission to each entity. Signal  $A$  is the original signal sent to the SS and signal  $B$  is the additional information sent to the RS. In this case, the RS, owing to its good radio conditions, will be able to decode the two signals  $A$  and  $B$  while the SS will be able to receive only signal  $A$ .

Please note that  $B$  can be a simple copy of the initial signal  $A$  or control information that allows to ensure the success of decoding at the RS, as considered in [85]. The latter case corresponds to a coded cooperation scheme, with distributed channel coding [93], and allows to ensure better error protection.

We suppose in what follows, for simplicity, that signal  $B$  contains a second copy of the original signal  $A$ . This results in a spatial diversity gain at the RS. Using MRC, the RS will now be able to decode the original signal with an SNR equal to  $SNR_k + SNR_{sr}$ . Since the BER is inversely proportional to the received SNR (Eqn. (5.3)), and because of the higher received SNR ( $SNR_k + SNR_{sr} > SNR_k$ ), the RS will thus be able to decode and encode a more robust signal  $\bar{A}$  with a lower BER. This, in turn, will ensure a decoding without error at the destination as well.

Moreover, using classical relaying, the RS relays the signal to the destination using the same rate (same constellation size  $M$ ) as that of the overheard signal, which is typically low because of the worst radio conditions of the direct link (BS-SS). The RS-SS link is, however, typically of good radio conditions, and may support higher bit rates. We thus propose to take advantage of this fact and to forward the relayed signal  $\bar{A}$  at a higher bit rate, or equivalently, in a lower number of time slots than classically needed, assuming, for instance, Time Division Multiplexing (TDM) scheduling.

Formally, if  $BER_{rd} \leq 10^{-2}$ , Eqn. (5.3) can be inverted and yields the maximum constellation size  $M'$  that the RS can use for a given  $SNR_{rd}$  and pre-fixed target  $BER_{rd}$  as [92]:

$$\log_2(M') = \log_2\left(1 + \frac{3SNR_{rd}}{2K_0}\right)$$

where  $K_0 = -\ln(5BER_{rd})$ . Since the RS-SS link presents good radio conditions (higher  $SNR_{rd}$ ), the RS is thus able to use a higher constellation size  $M'$  to serve the destination without affecting the target BER ( $BER_{rd}$  in this case). This, in turn, yields a higher spectral efficiency by increasing the signal rate on the RS-SS link.

In our work, we take one time slot as our smallest time unit. In this case, we shall assign, using TDM,  $\beta = \frac{\log_2(M')}{\log_2(M)}$  consecutive time slots to each user to be served ( $\beta > 1$ ) so that the RS to SS relaying operation is

done using one time slot. In this one time slot, the RS actually relays  $\beta$  different (robust) signals to the target destination.

**Example**

In order to illustrate our proposal, let us assume, without loss of generality, that users with bad radio conditions are assigned 4-QAM constellations for their direct link with the BS and that the BS-RS and RS-SS links allow the use of 16-QAM constellations.

In classical relaying, the RS overhears the original signal  $A_1$  using 4-QAM, in a first time slot, and generates a signal  $\bar{A}_1$  to the SS using 4-QAM also. This second signal, which can or cannot be decoded-encoded successfully at the RS, will be sent to the SS in a second time slot using the same constellation size as that of the overheard signal, 4-QAM in this case. At the SS as well, it may or may not be decoded successfully.

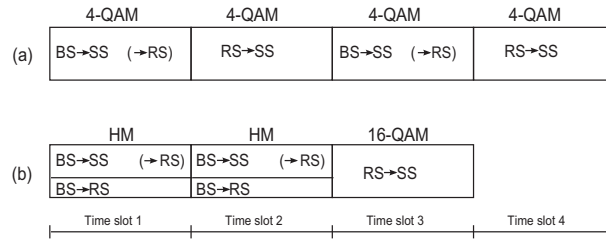

Figure 5.4: (a) classical relaying, (b) using HM-based link adaptive relaying

Using HM and link adaptive relaying, we now allow each user to be served for  $\beta = 2$  time slots. In each time slot, the RS will receive additional information for every signal from the BS using HM, it will decode the original signal  $A_1$  and the additional information  $B_1$  and encode a more robust copy  $\bar{A}_1^R$  of this signal. It then relays the 2 robust copies of the two different signals received in the previous two time slots to the destination using a higher bit rate, as allowed by the 16-QAM constellation. This corresponds to one time slot for the relaying of the two robust signals (see Figure 5.4(b)), as opposed to the case of classical relaying where two time slots are needed to relay two different signals (not even robust copies) to the destination, as shown in Figure 5.4(a). This gain in time slots improves the overall system capacity as will be quantified next.



## 5.4 Flow-level modeling

We, now, model both the classical relaying scheme and the HM-based link adaptive relaying scheme.

We, again, consider the same Processor Sharing (PS) model described in Chapter 3.

There too, let users in the system be divided, without loss of generality, into two types: users of type 1 who enjoy good radio conditions and who are able to decode successfully their signals, and users of type 2, who present worse radio conditions and may not be able to decode successfully their signals through the direct link (BS-SS) only.

Let  $I$  denote the number of RSs that are, now, added to the plain OFDMA architecture in order to assist users who cannot decode successfully their signals on the direct link.

Let  $P^R$  denote the probability that the user to be served does indeed require the help of an RS to be able to successfully decode the original signal.

Let us further denote by  $P$  the probability that the user who needs the assistance of an RS is indeed covered by an RS. This probability depends on the number and the position of RSs in the cell.  $P$  is given by:

$$P = \min\left(\frac{I}{I_{threshold}}, 1\right)$$

where  $I_{threshold}$  denotes the minimum number of RSs in the cell in order to cover it all, and hence potentially be able to assist any user who needs relaying.

In order to determine  $I_{threshold}$ , we assume that the cell is represented by a disc with, say, two regions corresponding to users with good radio conditions (inner region) and those with worse ones (outer region). RSs are placed at the edge of the first region as shown in Figure 5.5. Assuming that the areas covered by RSs are tangent to each other, we obtain:

$$I_{threshold} = \frac{\pi}{\Phi}$$

where  $\Phi$  is equal to  $\cos^{-1}\left(1 - \frac{(r^2 - r^1)^2}{2(r^1)^2}\right)$  and  $r^j$  denotes the radius of region  $j$ ,  $j = 1, 2$ .

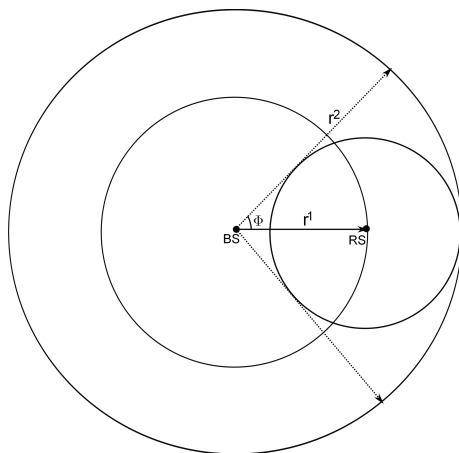

Figure 5.5: RS placement

#### 5.4.1 Using classical relaying

In the case where the destination can decode successfully the signal sent by the BS ( $P^R = 0$ ), the transmission from the BS to the SS takes only one time slot through the direct link. And so, the capacities  $c^1$  and  $c^2$  of users of both types, 1 and 2, respectively, given by Eqn. (3.3) in Chapter 3, are unchanged.

In the case, however, where the destination cannot decode successfully the signal sent by the BS ( $P^R = 1$ ), the transmission takes two time slots: one through the direct link and another one through the indirect one; and, in the case of cooperative relaying, the user combines the two received signals in order to decode his own information.

Considering TDM scheduling, time slots are classified into three possibilities: one time slot to serve a user of type 1, one time slot to serve a user of type 2 if  $P^R = 0$  and 2 time slots to serve the same user if  $P^R = 1$ . And so, given  $P$  and  $P^R$ , users of type 2 get a rate equal to  $((1 - P^R) + PP^R)c^2$  for  $\frac{s^2((1 - P^R) + PP^R)}{s^1 + (1 - P^R)s^2 + 2P^R s^2}$  of the time where  $s^j$ ,  $j = 1, 2$ , denotes the mean number of users of each type in the system, and which we approximate as before by  $\frac{\bar{\rho}^j}{1 - \rho}$  which, again, corresponds to the case with no admission control.

Without the need for relaying (successful decoding on the direct link), users of type 2 get a rate equal to  $c^2$  for  $\frac{s^2}{s^1 + s^2}$  of the time.

Consequently, the capacity  $c^2$  of users of type 2 changes, and the capacity

given by Eqn. (3.3) in Chapter 3 will now be multiplied by the following term:

$$\frac{(s^1 + s^2)((1 - P^R) + PP^R)}{s^1 + (1 - P^R)s^2 + 2P^R s^2}$$

The change in  $c^2$  will, in turn, impact the performance of users of type 1 as they will now have one time slot less every time the transmission to users of type 2 uses a relay. Users of type 1 obtain a rate equal to  $c^1$  for  $\frac{s^1}{s^1 + (1 - P^R)s^2 + 2P^R s^2}$  of the time. On the other hand, without the need for relaying, they obtain a rate equal to  $c^1$  for  $\frac{s^1}{s^1 + s^2}$  of the time.

Consequently, the capacity for users of type 1, given by Eqn. (3.3) in Chapter 3 under TDM will now be multiplied by:

$$\frac{s^1 + s^2}{s^1 + (1 - P^R)s^2 + 2P^R s^2}$$

#### 5.4.2 Using HM-based link adaptive relaying

Considering the HM-based adaptive relaying scheme described previously, the TDM scheduling will also be altered due to the need for resources for relaying. As mentioned previously, the use of a resource allocation that is adapted to the radio conditions of the RS-SS link allows us to save some resources (in terms of time slots and power) compared to the classical relaying scheme and, in this case, during only one time slot, the RS forwards  $\beta$  different signals to the destination instead of only one signal. Recall that  $\beta$  is an integer equal to  $\frac{c^R}{c^2}$ , where  $c^R$  is the throughput achieved at the RS-SS link and  $c^2$  is the capacity of users of type 2. Recall also that the ratio  $\frac{c^R}{c^2}$  is equal to the ratio  $\frac{\log_2(M')}{\log_2(M)}$  where  $M$  and  $M'$  stand for the constellation size without and with the use of link adaptation in the RS-SS link, respectively.

Here too, time slots can be divided into 3 possibilities:  $\beta$  time slots to serve a user of type 2 if  $P^R = 0$ ,  $\beta + 1$  time slots to serve a user of type 2 if  $P^R = 1$  and  $\beta$  time slots to serve a user of type 1. And so, users of type 2 will get a rate equal to  $(\beta PP^R + \beta(1 - P^R))c^2$  for  $\frac{s^2((1 - P^R) + PP^R)}{\beta s^1 + \beta(1 - P^R)s^2 + (\beta + 1)P^R s^2}$  of the time where  $s^j$ ,  $j = 1, 2$ , denotes, again, the mean number of users of each type in the system.

Hence, using HM-based link adaptive relaying, the capacity for users of

type 2,  $c^2$ , given by Eqn. (3.3) in Chapter 3, will now be multiplied by:

$$\frac{\beta P P^R + \beta(1 - P^R)}{\beta s^1 + \beta(1 - P^R)s^2 + (\beta + 1)P^R s^2}(s^1 + s^2)$$

As of users of type 1, their capacity  $c^1$ , given by Eqn. (3.3) in Chapter 3, will now be multiplied by a new term given by:

$$\frac{\beta(s^1 + s^2)}{\beta s^1 + \beta(1 - P^R)s^2 + (\beta + 1)P^R s^2}$$

## 5.5 Proposal for enhancement

We propose, now, to take advantage of the good radio conditions of users who are close to the BS to send them a new additional stream using HM.

So far, the HM-based adaptive relaying scheme did send the additional information to the RS using a low modulation rate (4-QAM in our example above). The BS-RS link is, however, typically of good radio conditions, which allows the use of a higher modulation rate, for instance 16-QAM, to transmit the second level of hierarchy in the HM operation.

In this case, the second level of hierarchy of the HM operation can be used to transmit, in addition to the additional information  $B$  sent to the RS and meant to the user with bad radio conditions (type 2), a new extra signal  $C$  to a user with good radio conditions (type 1), as shown in Figure 5.6.

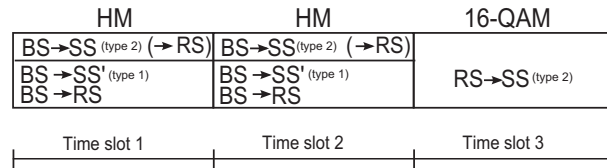

Figure 5.6: Enhanced HM-based adaptive relaying scheme

This can be achieved by sharing the number of subcarriers  $N$  equally between the two signals in this second level of hierarchy. And so, over the two time slots ( $\beta = 2$ ), a user of type 1 will now receive an additional rate equal to

$$\beta c^{add1} \tag{5.4}$$

where  $c^{add1}$  is given by:

$$c^{add1} = \sum_{n=1}^{N/2} \frac{W}{N} \log_2 \left( 1 + \frac{p_{k^*,n}^1 |h_{k^*,n}^1|^2}{\Gamma(\sigma_{k^*,n}^1)^2} \right) \quad (5.5)$$

where  $p_{k^*,n}^1$  denotes the amount of power given by Eqn. (2.7) in Chapter 2.

The capacity of a user of type 2 remains unchanged compared to the case of HM-based link adaptive relaying, whereas the rate that a user of type 1 can achieve will vary. In fact, considering TDM, the time is again divided into three parts:  $\beta$  time slots to serve a user of type 2 if  $P^R = 0$  with rate equal to  $c^2$ ,  $\beta + 1$  time slots to serve a user of type 2 with rate equal to  $\beta c^2$  and users of type 1 with rate equal to  $\beta c^{add1}$  if  $P^R = 1$  and  $\beta$  time slots to serve a user of type 1 with rate equal to  $c^1$ .

Users of type 1 will, now, be served with a rate equal to  $\beta c^1 + \beta c^{add1}$  for  $\frac{s^1 \beta (1 + \frac{c^{add1}}{c^1} P^R)}{\beta s^1 + \beta (1 - P^R) s^2 + (\beta + 1) P^R s^2}$  of the time. Consequently, the capacity for users of type 1, given by Eqn. (3.3) in Chapter 3, will now be multiplied by:

$$\frac{(s^1 + s^2) \beta (1 + \frac{c^{add1}}{c^1} P^R)}{\beta s^1 + \beta (1 - P^R) s^2 + (\beta + 1) P^R s^2}$$

where  $c^{add1}$  is the additional rate that a user of type 1 can achieve in each of the  $\beta$  time slots that are allocated to user of type 2 given by Eqn. (5.5).

## 5.6 Model validation and performance evaluation

We, now, validate our analytical model, investigate the flow-level performance of the HM-based link adaptive relaying scheme, in terms of mean transfer times and blocking rates, and quantify the gains achieved using the enhancement we further propose to this scheme.

Note that the physical layer performance, in terms of BER, is beyond the scope of our work.

In our simulations, we make use of our simulator described in Chapter 3, with the same system parameters.

We assume, however, that users of type 2 need RS assistance (i.e.,  $P^R = 1$ ) and that we have a sufficient number of RSs in the cell to cover these users (i.e.,  $P = 1$ ). We also assume that the BS and RS use, respectively,

4-QAM and 16-QAM signal modulation to serve users of type 2. Users of type 1 use 16-QAM signal modulation. Based on TDM, each user will be served for  $\beta = 2$  time slots in each cycle.

Figures 5.7, 5.8 and 5.9 show the mean transfer time for all users in the system, users of type 1 and users of type 2, respectively, as a function of an increasing offered traffic. The curves show both analytical and simulation results for the cases of the HM-based link adaptive relaying scheme versus classical relaying.

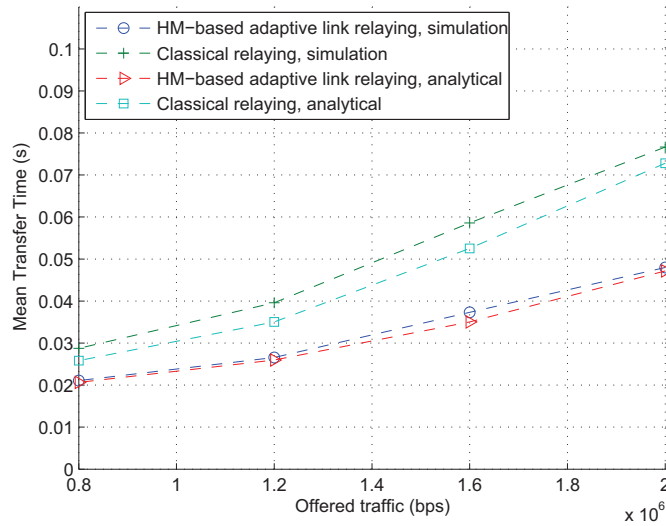

Figure 5.7: Mean transfer time - all users

We observe, first, a good match between the analytical model and the simulation results for the two schemes.

We observe, second, that the HM-based link adaptive relaying scheme allows a gain, in terms of mean transfer times, for users of both types, as compared to the classical relaying scheme. This is due to the use of HM and also to the use of the resource allocation strategy that adapts the modulation scheme to the radio conditions on the RS-SS link. Indeed, in this case, relays use less resources, in terms of time, to assist users with worse radio conditions; the resources thus freed will be used by other users in the system to finish their services earlier which allows to increase the overall system capacity.

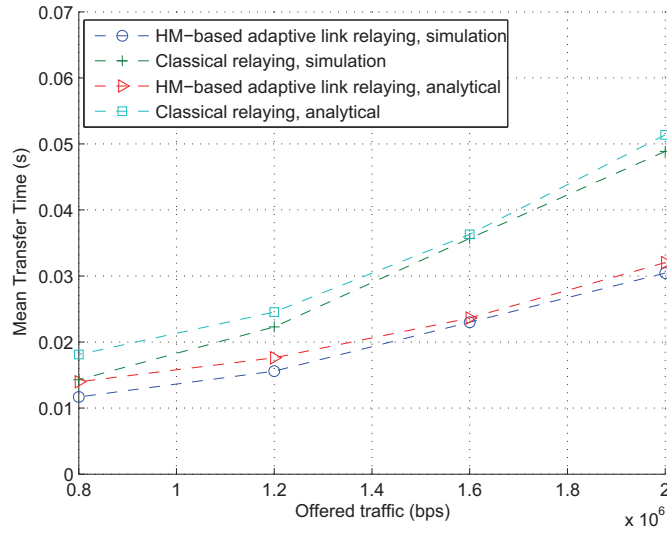

Figure 5.8: Mean transfer time - users of type 1

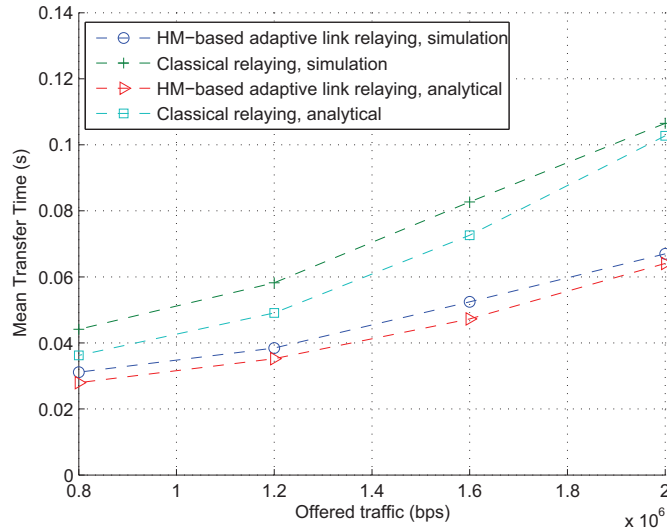

Figure 5.9: Mean transfer time - users of type 2

We observe, third, that the gain is larger as the system becomes more loaded, and this, again, for all users. This is due to multiuser diversity.

Figure 5.10 shows the blocking probability for the two schemes. Here too, the blocking probability is better for the HM-based link adaptive relaying

scheme, which means a higher admission rate, because, again, users of both types finish their service earlier and hence leave more room to yet other users to be admitted to the system.

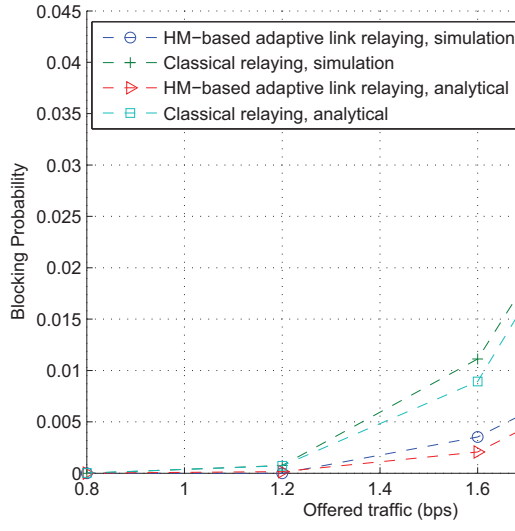

Figure 5.10: Blocking probability - all users

We, now, turn to the impact of the number of RSs on the performance of our relay-based system. Indeed, in the previous figures, we assumed that the number of RSs was large enough so as to assist all users with bad radio conditions (i.e.,  $P = 1$ ). In a real case,  $P$  can be less than 1. We show, in Figures 5.11 and 5.12, the load in the system (given by Eqn. (3.1) in Chapter 3) as well as the blocking rate as a function of the number of RSs, both for classical relaying and HM-based adaptive link relaying respectively.

We observe that both measures decrease when the number of relays increases. This is due to the additional resources that users with bad radio conditions can get using relaying, with a clear advantage to the case of HM and adaptive link relaying over the classical one.

We, eventually, investigate the performance of the proposed enhancement as compared to the HM-based adaptive relaying scheme. We show in Figures 5.13, 5.14 and 5.15 the mean transfer time for all the users in the system, as well as for users of type 1 and users of type 2, respectively. We observe that the enhanced scheme achieves the lowest mean transfer time,



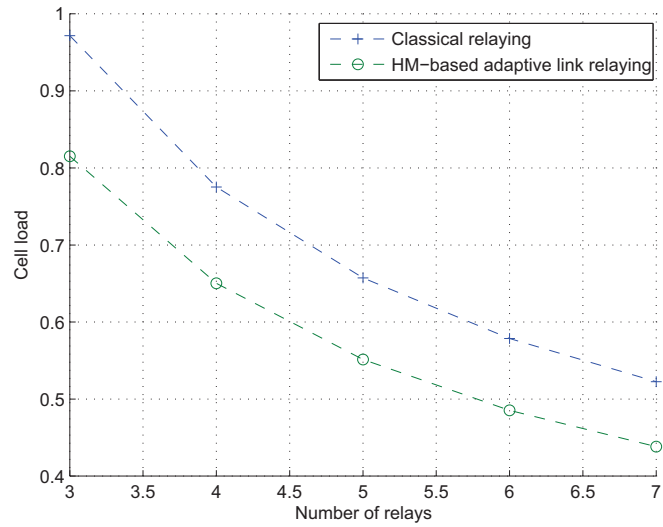

Figure 5.11: Load of the cell

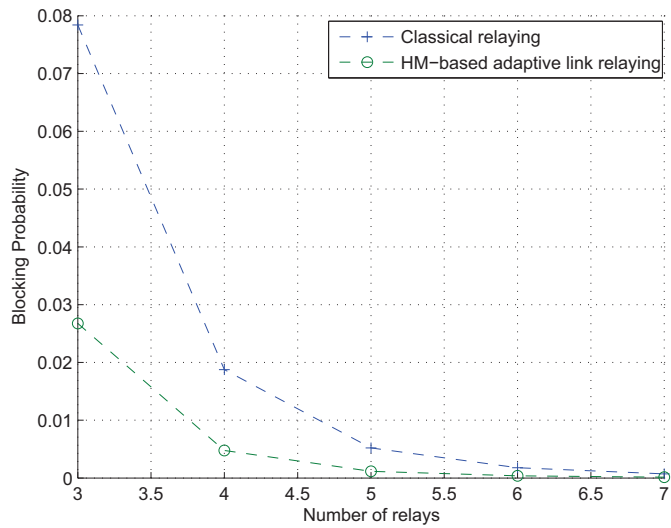

Figure 5.12: Blocking probability

and this is due to the additional throughput received by users of good radio conditions who will now finish their service earlier (Figure 5.14) and free resources to the other users in the system (Figure 5.15).

The same result holds for the blocking rate also, as shown in Figure 5.16,

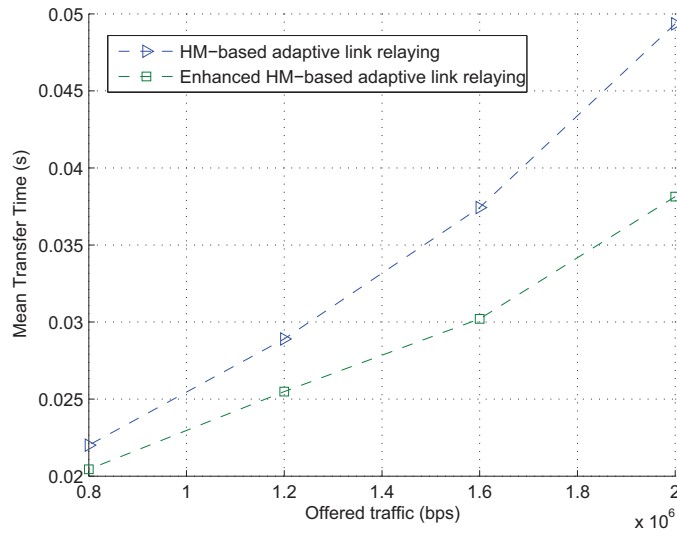

Figure 5.13: Mean transfer time - all users

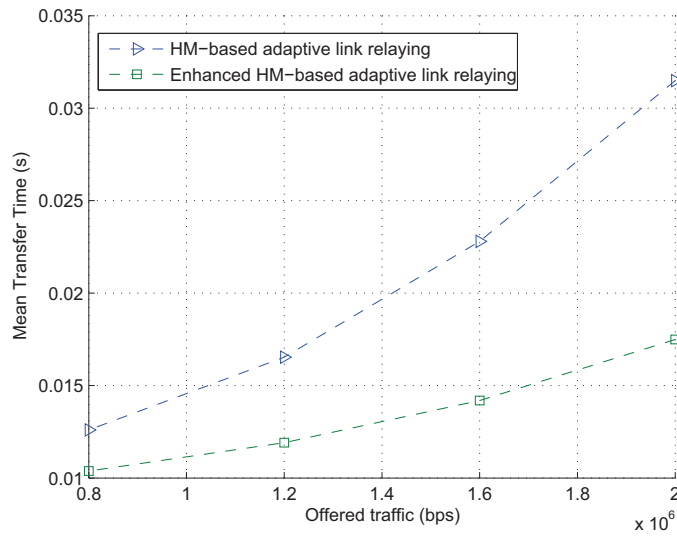

Figure 5.14: Mean transfer time - users of type 1

for the same reasons detailed above for the case of HM-based relaying over the classical scheme.

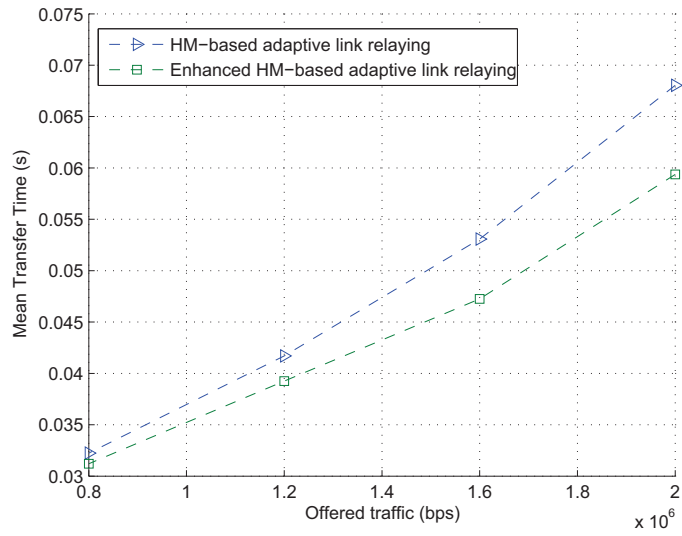

Figure 5.15: Mean transfer time - users of type 2

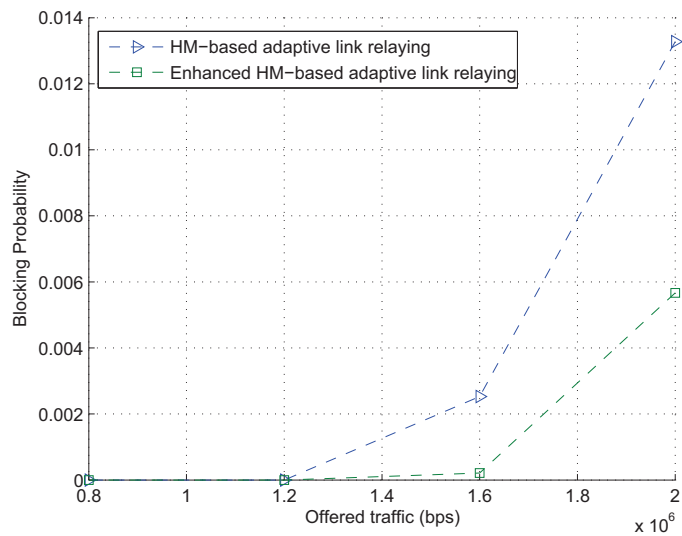

Figure 5.16: Blocking probability - all users

## 5.7 Conclusion

We considered, in this chapter, the joint use of HM with cooperative relaying in OFDMA-based systems.

We, specifically, made use of HM to reconstruct a more robust signal at

the RS owing to the sending of an additional information from the BS to the RS. We, further, proposed the use of link adaptation between the RS and SS in order to reduce the cost of additional resources needed for relaying and hence improve the overall system capacity.

Our numerical results enabled us to validate our analytical model and to quantify the gains obtained by such a joint use of HM and adaptive relaying, in terms of mean transfer times and blocking rates, as compared to the classical relaying scheme.

We also proposed an enhancement to the HM-based adaptive relaying scheme which takes advantage of the good radio conditions of the BS-RS link so as to send extra information to other users in the cell using higher modulation rate. This, in turn, allows to further increase the overall system capacity.

In the next chapter, we turn to the case where relays are present in the system but users do not need them to decode their direct signals. As such, relaying could be both useless and inefficient. Unless HM is used.

## Chapter 6

# Non-cooperative relaying with hierarchical modulation

Relay Stations (RS) are generally used to convey information to users who are unable to decode the direct signal from the Base Station (BS) successfully. In the case where the users are able to successfully decode the direct signal without the help of relays, the use of the latter can only decrease their performance because they will consume, uselessly, additional resources. If, however, Hierarchical Modulation (HM) is jointly used, the overall performance of the relay-based system can be enhanced even if the users are able to decode the direct signal successfully, without the need for relays. This is the rationale behind this chapter where we study the joint use of HM and relaying, with a focus on the non-cooperative case in which the destination either decodes the direct signal or the indirect one, and does not combine two copies of the signal (direct and indirect) to produce the original one.

### 6.1 Proposal: joint use of HM and non-cooperative relaying

In the literature, the works that study the use of HM in a relay-based system assume a cooperative setting, as described in the previous chapter, wherein the RS relays the same or additional information to the Subscriber Station (SS) as the one sent directly from the BS to the SS; the latter cannot decode

successfully the signal received through the direct link (BS-SS), but will need to combine both copies of the signal, direct and indirect (BS-RS-SS), to reconstruct the original one.

Our aim in this chapter is to propose a new algorithm in which we account also for the case of non-cooperative relaying in conjunction with HM, in order to enhance the system performance for a downlink OFDMA cell with a single BS.

We consider the same system described in the previous chapter. We assume, again, by reference to Figure 6.1, that users with good radio conditions, typically belonging to the inner region, can decode successfully the signal sent directly from the BS, whereas users belonging to the outer region may or may not do so. In the case of non-successful decoding, a relay, whenever available, will be used to relay the information from the BS to the SS in the outer region.

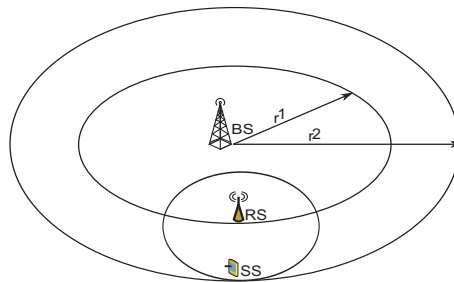

Figure 6.1: OFDMA system

We suppose that the BS has knowledge of the Channel State Information (CSI) of all links: BS-RSs, BS-SSs and RSs-SSs.

Again, let  $P^R$  and  $P$  denote, respectively, the probability that the user to be served does indeed require the help of an RS to be able to successfully decode the original signal and the probability that the user who needs the assistance of an RS is indeed covered by an RS.

As indicated previously, in the case the SS (of type 2) is unable to successfully decode the signal sent directly from the BS ( $P^R = 1$ ), the BS transmits, in a first step, a signal to the RS, and the latter forwards the received signal to the SS in a second step. And so, the SS will receive two copies of the same signal after two steps, which it combines in a cooperative

manner.

In the case the direct link between the BS and SS of both types is good enough for the SS to successfully decode the signal ( $P^R = 0$ ), we propose the following scheme:

1. In a first step, using HM, the BS sends the sum of two different signals: one to the RS using 16-QAM constellation (owing to its good radio conditions) and one to the SS of type 2 using 4-QAM constellation, as shown in Figure 6.2 (First step). The resulting signal is a 64-QAM constellation (as shown in Figure 2.5 in Chapter 2). At the reception and as described in Chapter 2, each entity (RS and SS) uses its own decoding technique to extract its signal.
2. In a second step, based on the fact that the RS presents, typically, good radio conditions with the SS of type 2, the RS transmits the received signal to this SS using 16-QAM constellation, as shown in Figure 6.2 (Second step).

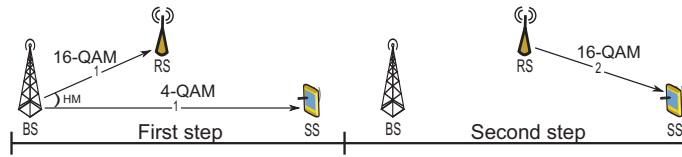

Figure 6.2: Hierarchical modulation-based relay scheme

## 6.2 Flow-level modeling

We now model our proposal which accounts for both cooperative and non-cooperative relaying using, again, the same Processor Sharing (PS) model described in Chapter 3. Only the rates  $c^j$ ,  $j = 1, 2$ , of users of type  $j$ ,  $j = 1, 2$ , will vary in this case.

The classical Time Division Multiplexing (TDM) scheduling, shown in Figure 6.3(a), will now be altered as shown in Figure 6.3(b). The latter illustrates two cases for a user of type 2:

- $P^R = 1$ , the user of type 2 cannot decode the direct signal from the BS (time slot designated by  $\times$ ), it combines, in the next time slot,

the two received copies from the BS and the RS so as to decode the original signal with capacity  $c^2$ .

- $P^R = 0$ , the user of type 2 decodes successfully the direct signal in the first time slot with capacity  $c^2$ , as given in Chapter 3 by Eqn. (3.3), and, thanks to HM, it receives from the RS an extra signal in the next time slot with capacity  $c^R$  given by:

$$c^R = \sum_{n=1}^N \frac{W}{N} \log_2 \left( 1 + \frac{p_n^R |h_n^R|^2}{\Gamma(\sigma_n^R)^2} \right) \quad (6.1)$$

where  $p_n^R$ ,  $h_n^R$  and  $\sigma_n^R$ , denote, respectively, the power, channel gain and variance of the AWGN with zero mean of the RS on subcarrier  $n$ .

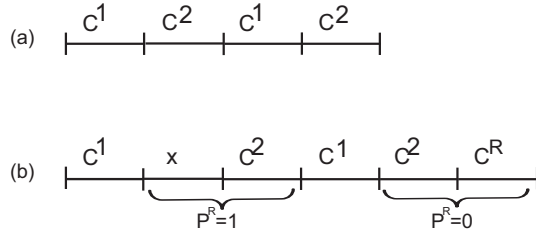

Figure 6.3: (a) Classical TDM scheme and (b) HM-based relaying scheme

In both cases, the capacities  $c^j$ ,  $j=1,2$ , given by Eqn. (3.3) for the two types of users, will change because of the resources that the RS will get.

Given  $P$  and  $P^R$ , a user of type 2 obtains a rate equal to  $PP^R c^2$  in the case of a cooperative scheme ( $P^R = 1$ ) and equal to  $(1+\alpha P)(1-P^R)c^2$  in our case of non-cooperative relaying ( $P^R = 0$ ).  $\alpha$  is an integer equal to  $\frac{c^R}{c^2}$  and  $c^R$  is as given by Eqn. (6.1). Considering TDM (as shown in Figure 6.3(b)), users of type 2 can achieve a rate equal to  $c^2$  for  $\frac{s^2(PP^R+(1+\alpha P)(1-P^R))}{s^1+2(1-P^R)s^2+2P^R s^2}$  of the time where  $s^j$  is the mean number of users of type  $j$  present in the cell approximated again by  $\frac{\bar{\rho}^j}{1-\bar{\rho}}$ .

Due to the fact that in simple TDM (as shown in Figure 6.3(a)), users of type 2 get a rate equal to  $c^2$  for  $\frac{s^2}{s^1+s^2}$  of the time, the capacity for users of type 2, given by Eqn. (3.3), will now be multiplied by:

$$\frac{PP^R + (1 + \alpha P)(1 - P^R)}{s^1 + 2(1 - P^R)s^2 + 2P^R s^2} (s^1 + s^2) \quad (6.2)$$



The use of relaying impacts also the performance of users of type 1 as they will now have one time slot less every time the transmission to user of type 2 uses a relay. Users of type 1 obtain a rate equal to  $c^1$  for  $\frac{s^1}{s^1 + 2(1 - P^R)s^2 + 2P^R s^2}$  of the time. Consequently, the capacity for users of type 1, given by Eqn. (3.3), will now be multiplied by:

$$\frac{s^1 + s^2}{s^1 + 2(1 - P^R)s^2 + 2P^R s^2} \quad (6.3)$$

### 6.3 Model validation and performance evaluation

We, now, validate our analytical model and investigate the performance of the HM-based non-cooperative relaying scheme. For this, we use the same simulator, for the downlink OFDMA system, described in Chapter 3.

In order to assess the performance of the HM-based relay scheme which applies in the case of successful decoding of the signal from the direct link by users of type 2, we take  $P^R = 0$  (this case corresponds to non-cooperative relaying). We also assume that  $P = 1$  which means that relays are deployed in sufficient number to assist users of type 2.

Figures 6.4 and 6.5 show the mean transfer time and the blocking probability for all users in the system, respectively, as a function of an increasing offered traffic. The curves show both analytical and simulation results for the case of the HM-based relaying scheme. We observe a good match between the analytical and simulation curves, which validates our model.

We next show in Figures 6.6, 6.7 and 6.8 the mean transfer time for all users in the system, users of type 1 only and users of type 2 only, respectively, as a function of an increasing offered traffic. We plot three curves corresponding to three cases: i. HM-based relaying scheme, ii. plain TDM scheme with HM but without the use of relays, in which case users of type 1 receive an additional throughput whenever users of type 2 are served (and which we investigated in Chapter 3) and iii. plain TDM scheme without HM and without relays. Recall that we consider that users of type 2 can successfully decode the direct signal from the BS ( $P^R = 0$ ), and so, we do not plot the case with relaying when we do not make use of HM, which is, as stated previously, both useless and inefficient.

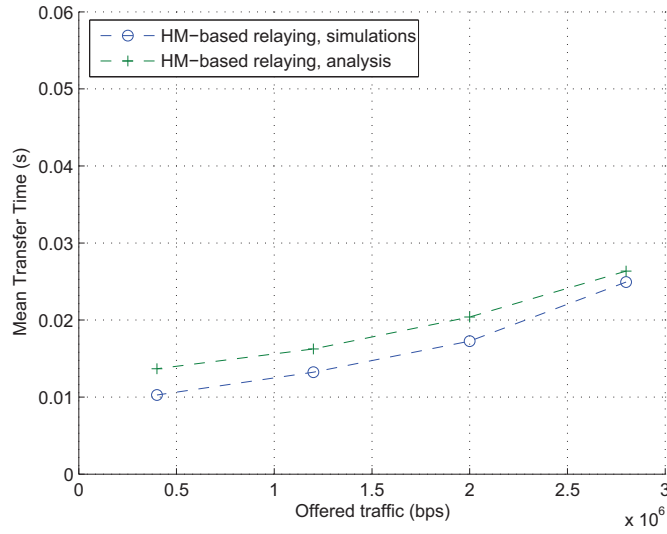

Figure 6.4: Mean transfer time - all users

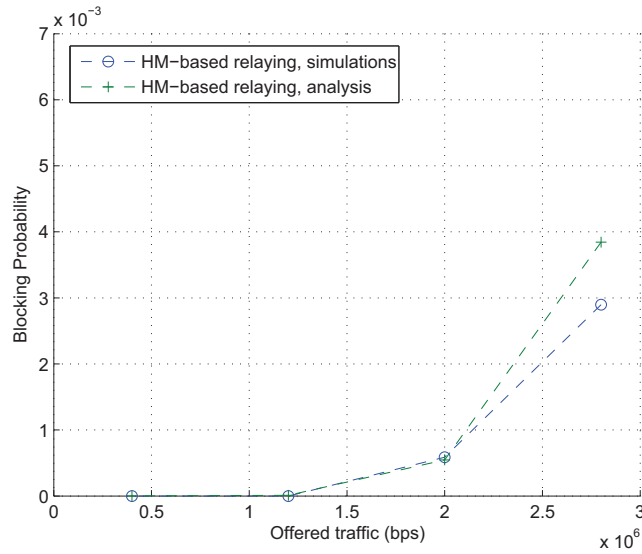

Figure 6.5: Blocking probability - all users

We observe in Figure 6.6 that the HM-based relaying scheme achieves a better performance than the other two schemes, in terms of mean transfer time, due to the additional throughput obtained by users of type 2. The latter achieve indeed a large gain, as shown in Figure 6.8. As of users of

type 1 (good radio conditions), they achieve the best performance in the case of classical HM, as shown in Figure 6.7, as in this case, they will be superposed on subcarriers initially allocated to users of type 2, and hence receive maximal additional throughput. This implies that assisting users of type 2, using jointly HM and relaying, is more beneficial to the global system than assisting users of type 1 through the use of HM. This is due to the fact that the overall system performance depends more heavily on the performance of users with bad radio conditions (type 2).

We eventually observe that the gain is larger as the system becomes more loaded. This is due, again, to multiuser diversity.

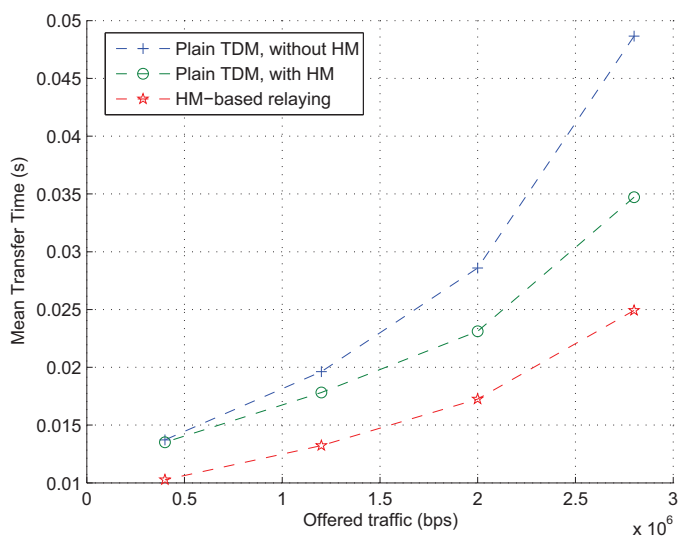

Figure 6.6: Mean transfer time - all users

Figure 6.9 shows the blocking probability as a function of the offered traffic for the three above-mentioned cases. Here too, the blocking probability is lower for the HM-based relay scheme, which means a higher admission rate. This improvement results from the fact the mean transfer time is lower in this case, which means that the system empties faster than in the other two cases.

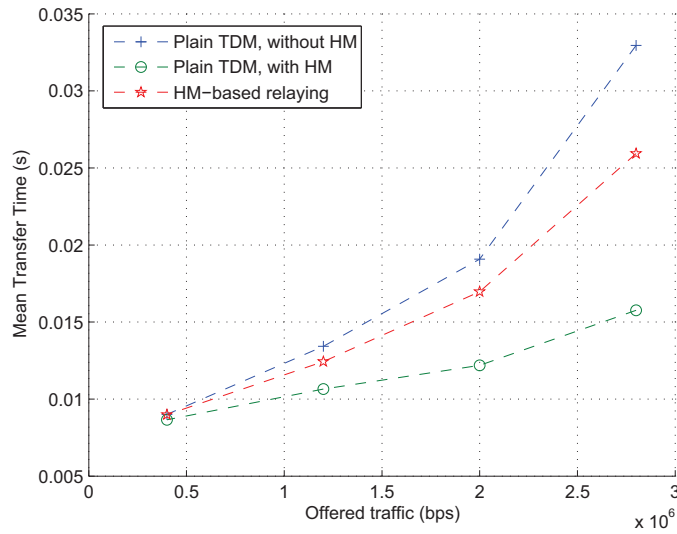

Figure 6.7: Mean transfer time - users of type 1

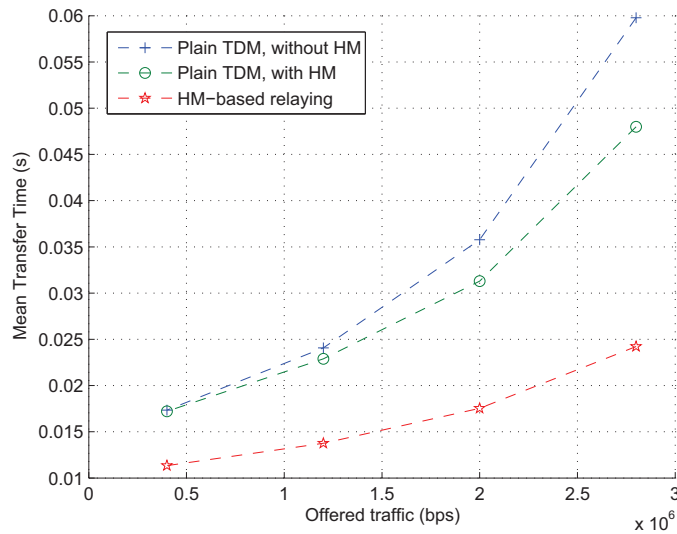

Figure 6.8: Mean transfer time - users of type 2

## 6.4 Conclusion

We considered, in this chapter, the use of HM in a non-cooperative relay-based OFDMA system. This scheme allows users with worse radio conditions to obtain an additional rate via the indirect link BS-RS-SS, in addition to the direct link BS-SS.

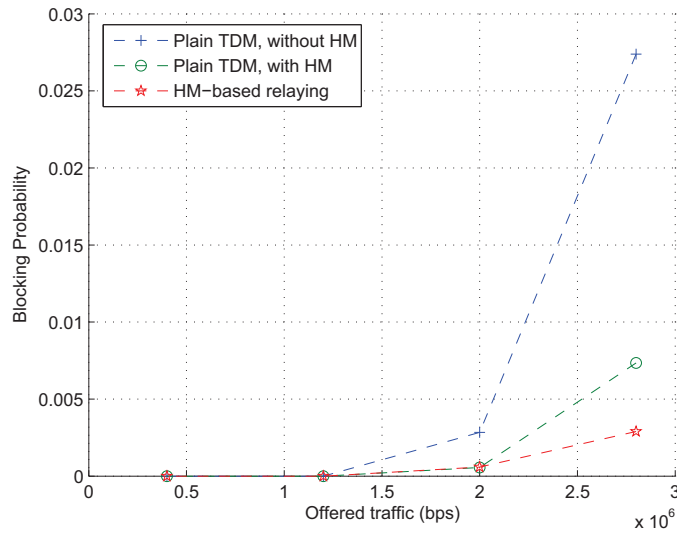

Figure 6.9: Blocking probability - all users

tion to the one obtained through the direct one BS-SS. We modeled such a system, validated our model against simulations and quantified the gains obtained by the joint HM-relay scheme, at the individual and global levels, as compared to plain TDM, with and without using HM.

## Chapter 7

# Conclusion

We investigated, in this work, the use of Hierarchical Modulation (HM) in an OFDMA-based networks, with and without relays. HM is an old technique which was introduced in digital broadcast systems in order to increase the spectral efficiency by exploiting the multiuser diversity, without any extra power cost. It allows to send an additional stream to a user, with good radio conditions, on a subcarrier that was initially allocated to carry a basic stream to a user with worse radio conditions. A small amount of power allocated to the first stream will be allocated to the additional one, without affecting the rate of the first one.

We carried out our study at the flow-level for a dynamic user configuration where users come to the system at random time epochs and leave it after a finite service duration, corresponding in our case to the completion of their file transfers. This reflects a realistic behavior of such systems, as opposed to a static user scenario, as is the case of most works on HM found in the literature. Moreover, this flow-level study enabled us to quantify system level performance metrics, such as mean transfer times and blocking probabilities, as opposed to more common lower layer ones.

In the first chapter, we described the principle of HM and classified the major works pertaining to it in the literature. We also formally defined the flow-level approach and reported on its related works.

In the second chapter, we considered the flow-level modeling of HM, for a Time Division Multiplexing (TDM) Round Robin (RR) scheduler. We

specifically modeled and quantified, both analytically and via simulations, the gain thus achieved and its variation according to the user class distribution in the system. We showed that users with good radio conditions will get an additional throughput that will allow them to finish their service earlier. This, in turn, allows users with lower radio conditions to enjoy more resources yielding to a higher spectral efficiency and hence an increase in the overall system capacity. We, also, studied the impact of the user distribution in the cell and showed that the maximum gain is obtained when both types of users present in the system are of equal proportions.

We eventually extended the use of HM to the case where users with bad radio conditions are also superposed on those with good radio conditions as well as to the case where users of one type can also be superposed on those of their own type as well, and showed that the gain is even larger in these cases, especially the second one.

In the third chapter, we investigated the HM-based system performance under Proportional Fairness (PF), a scheduling algorithm of the so-called  $\alpha$ -fair strategies. PF is an opportunistic algorithm which allocates resources to users with good radio conditions, without sacrificing fairness towards the other users of the system. It achieves a good trade-off between efficiency and fairness among all  $\alpha$ -fair strategies, which are themselves proven to achieve maximal system stability.

We modeled such a system and compared the gain achieved under PF versus RR as well as Max-min, a fair scheduler in terms of the throughput achieved by all users in the system. We showed that, in the presence of HM, a simple cyclic service, such as RR, yields a better performance than PF, along with less complex implementation.

In the last two chapters, we considered the use of HM in relay-based OFDMA networks. We investigated in the fifth chapter the use of HM in a cooperative relaying scheme where a Relay Station (RS) is required to serve users with bad radio conditions. We, first, made use of HM in order to send additional information to the RS so as to enable it to reconstruct a more robust copy of the original signal, and, second, adapted the transmission from the RS to the destination by taking advantage of the typically good radio conditions between them so as to reduce the cost, in terms of additional

resources, needed by relaying and hence improve the overall system capacity.

We also proposed an enhancement to the proposed HM-based adaptive relaying scheme which takes advantage of the good radio conditions of users who are close to the base station so as to allow them to receive an additional throughput. This, in turn, allows to further increase the overall system capacity.

In the sixth chapter, we considered the use of HM with non-cooperative relaying, where the RS is not useful as such, i.e., users are able to decode successfully their original signals sent from the base station. We have shown that using HM, the use of relays turns out to be beneficial at the individual and global levels, as compared to classical TDM scheme (without need for relaying) or yet the classical TDM scheme using HM.

In the future, we shall focus on the following perspectives:

- Consider the use of HM in a Multiple-Input Multiple-Output (MIMO) system.
- Study the impact of imperfect CSI, due to propagation delays, speed or yet estimation errors, on system performance.
- Investigate the impact of the low pass filter  $t_c$  on system performance in the case of the use of HM with PF.
- Consider the buffer constraint in resource allocation in the case of  $\alpha$ -fair allocation strategies with HM.
- Propose a resource allocation scheme wherein instead of allocating, initially, the resources based on a given algorithm and, then, search for a possible user to share the subcarrier, using HM, with the designated user, one can incorporate the possible use of HM in the first initial decision of the scheduler as well.
- Characterize the system stability and fairness in the case of using HM with  $\alpha$ -fair allocation strategies.
- Investigate the impact of the number and position of relays on system performance.



- Investigate the problem of power allocation when using HM and relays.
- Consider the use of HM with multi-relays scheme in order to further improve the overall system throughput.

# Bibliography

- [1] “IEEE P802.16d, IEEE Standard for Local and Metropolitan Area Networks, Part 16: Air Interface for Fixed Broadband Wireless Access Systems”, Oct. 2004.
- [2] “IEEE 802.11: Wireless LAN Medium Access Control (MAC) and Physical Layer (PHY) Specifications”, 2007 revision, IEEE-SA. 12 Jun. 2007.
- [3] “ETSI Standard: EN 300 744 V1.5.1, Digital Video Broadcasting (DVB); Framing structure, channel coding and modulation for digital terrestrial television”, 2001.
- [4] H. Mric, J. Lacan, C. Amiot-Bazile, F. Arnal and M-L. Boucheret, “Generic Approach for Hierarchical Modulation Performance Analysis: Application to DVB-SH”, CoRR, 2011.
- [5] H. Mric, J. Lacan, C. Amiot-Bazile, F. Arnal and M-L. Boucheret, “Generic Approach for Hierarchical Modulation Performance Analysis: Application to DVB-SH and DVB-S2 CoRR abs/1103.1742”, 2011.
- [6] “IEEE P802.16e, IEEE Standard for Local and Metropolitan Area Networks, Part 16: Air Interface for Fixed and Mobile Broadband Wireless Access Systems”, P802.16Rev2/D2, Dec. 2007.
- [7] “3GPP, 3GPP TS 36.201 V8.0.0, Evolved Universal Terrestrial Radio Access (E-UTRA); Long Term Evolution (LTE) physical layer; General description (Release 8)”, Sept. 2009.
- [8] “3GPP TR 36.912, Feasibility study for Further Advancements for E-UTRA (LTE-Advanced)”, v9.3.0., Jun. 2010.

- [9] T. S. Rappaport, “Wireless communications principles and practice”, in 4G Wireless communication systems series, pp. 100-150, 1996.
- [10] T. Cover, “Broadcast Channels”, IEEE Trans. on Information Theory, IT-18:2–14, Jan. 1972.
- [11] M. Costa, “Writing on dirty paper”, IEEE Trans. on Information Theory, 29: 439-441, May 1983.
- [12] Md. J. Hossain, M.-S. Alouini and V. K. Bhargava, “Multi-User Opportunistic Scheduling using Power Controlled Hierarchical Constellations”, IEEE Trans. Wireless Commun, vol. 6, pp. 1581-1586, May 2007.
- [13] D. Tse and P. Viswanath, “Fundamentals of Wireless Communication”, Cambridge University Press, May 2005.
- [14] B. Liu and H. Liu, “DPC-based Hierarchical Broadcasting: Design and Implementation”, IEEE Transactions on Vehicular Technology, Vol. 57, Nov. 2008.
- [15] T. Bonald and A. Proutiere, “Wireless downlink data channels: user performance and cell dimensioning”, in Proceedings of the 9th annual international conference on Mobile computing and networking, ACM Press: San Diego, CA, USA p. 339-352, 2003.
- [16] P. Viswanath, D. Tse and R. Laroia, “Opportunistic Beamforming using Dumb Antennas”, IEEE Trans. on Information Theory, vol. 48(6), Jun. 2002.
- [17] F. Kelly, A. Maulloo and D. Tan, “Rate Control for Communication Networks: Shadow Prices, Proportional Fairness and Stability”, Journal of Operations Research Society, vol. 49, no. 3, pp. 237–252, 1998.
- [18] P. K. Vitthaladevuni and M.-S. Alouini, “BER Computation of 4/M-QAM Hierarchical Constellations”, IEEE Trans. On Broadcasting, Vol. 47, No. 3, pp. 228-239, Sept. 2001.

- [19] S. Pietrzyk and G. J. M. Janssen, "Subcarrier and Power Allocation for QoS-aware OFDMA Systems Using Embedded Modulation", ICC'2004, Paris, Jun. 2004.
- [20] L. M. C. Hoo, J. Tellado and J. M. Cioi, "Multiuser loading algorithms for multicarrier systems with embedded constellations", in IEEE ICC'2000, vol. 2, New Orleans, Jun. 2000.
- [21] Q. Du and X. Zhang, "Effective Capacity of Superposition Coding Based Mobile Multicast in Wireless Networks", in Proc. ICC, pp.1-5, 2009.
- [22] S. Wang, S. Kwon, and B. K. Yi, "On enhancing hierarchical modulation", in Proceedings of the IEEE International Symposium on Broadband Multimedia Systems and Broadcasting (BMSB '08), pp. 1-6, Apr. 2008.
- [23] Y. C. Chang, S. W. Lee and R. Komiya, "A low complexity hierarchical QAM symbol bits allocation algorithm for unequal error protection of wireless video transmission", IEEE Transaction on Consumer Electronics, Vol. 55, No.3, Aug. 2009.
- [24] Y. Liu and C. Heneghan, "Optimization of Hierarchical Modulation for Use of Scalable Media", EURASIP Journal on Advances in Signal Processing, vol. 2010.
- [25] D. Pradas, A. Bouabdallah, J. Lacan, M. A. Vazquez Castro, and M. Bousquet, "Cross-layer optimization of unequal protected layered video over hierarchical modulation", in Proceedings of the IEEE Global Telecommunications Conference (GLOBECOM '09), pp. 1-6, 2009.
- [26] Y. H. Tahir, C. K. Ng, N. K. Noordin, B. M. Ali and S. Khatun, "Adaptive real time wireless data transmission using superposition coding with feedback of channel state information", Scientific Research and Essays Vol. 5(22), pp 3490-3498, Nov. 2010.

- [27] J. Lu, K. B. Letaief, J. C.-I. Chuang, and M. L. Liou, "M-PSK and M-QAM ber computation using signal-space concepts", *IEEE Trans. Commun.*, vol. COM-47, pp. 181-184, Feb. 1999.
- [28] M. Morimoto, H. Harada, M. Okada, and S. Komaki, "A study on power assignment of hierarchical modulation schemes for digital broadcasting", *IEICE Trans. Commun.*, vol. E77-B, Dec. 1994.
- [29] M. Morimoto, M. Okada, and S. Komaki, "A hierarchical image transmission system in a fading channel", in *Proc. IEEE Int. Conf. Univ. Personal Comm. (ICUPC'95)*, pp. 769-772, Oct. 1995.
- [30] S. Jo, J. Choi and J. Seo, "An Advanced Hierarchical Modulation with Rotated Constellation", *ICACT'10*, Gangwon-Do, Korea, Feb. 2010.
- [31] S.-H. Chang, M. Rim, P.C. Cosman and L.B. Milstein, "Optimal Multiplexed Hierarchical Modulation for Unequal Error Protection of Progressive Bitstreams", *IEEE Globecom '09*, Honolulu, HI, 2009.
- [32] J.-H. Kim, J.-B. Lee, H.-N. Kim, H. Lim, and J.S. Lim, "Coherent Detection for T-DMB Receiver in Hierarchical Modulation Mode", *IEEE Trans. Consum. Electron.*, vol. 53, no. 2, pp. 294-299, May 2007.
- [33] J. Tong and L. Ping, "Iterative decoding of superposition coding", in *4th International Symposium on Turbo Codes and Related Topics*, Munich, Germany, Apr. 2006.
- [34] R.-T. Juang, K.-Y. Lin, P. Ting, H.-P. Lin, and D.-B. Lin, "Enhanced Hierarchical Modulation with Interference Cancellation for OFDM Systems", *Proceedings of The 20th Personal, Indoor and Mobile Radio Communications Symposium 2009 (PIMRC 2009)*, Tokyo, Japan, Sept. 2009.
- [35] N. von Deetzen and W. Henkel, "Unequal error protection multilevel codes and hierarchical modulation for multimedia transmission", *Information Theory*, 2008, *ISIT 2008*, *IEEE International Symposium on*, pp. s2237 - 2241, Jul. 2008.

- [36] L. Cai, Y. Luo, S. Xiang, and J. Pan., “Scalable modulation for wireless broadcast”, Technical report, Univ. of Victoria, Dec. 2009.
- [37] Md. J. Hossain, M.-S. Alouini, and V. K. Bhargava, “Rate adaptive hierarchical modulation-assisted two-user opportunistic scheduling”, in Proc. of the IEEE Global Telecommun. Conf. (Globecom’05), pp. 1267-1272, St. Louis, MO, Nov. 2005. Also accepted for publication in the IEEE Trans. Wireless Commun., Nov. 2006.
- [38] Md. J. Hossain, M.-S Alouini and V. K. Bhargava, “Two-user opportunistic scheduling using hierarchical modulations in wireless networks with heterogenous average link gains”, IEEE Transactions on Communications 58(3): 880-889, 2010.
- [39] Hossain, Md. J., M.-S. Alouini, and V. K. Bhargava, “Queuing delay and buffer distribution of two-user opportunistic scheduling schemes in wireless networks”, pp. 3694 - 3700, ICC’08, 2008.
- [40] S. Najeh and H. Besbes, “A Simple Superposition Coding Scheme for Optimizing Resource Allocation in Downlink OFDMA Systems”, Wireless Personal Communications, Jan. 2010.
- [41] A. Agustin de Dios, J. Vidal and O. Muoz Medina, “Performance of downlink schedulers with superposed or orthogonal transmissions”, ICC 2010, Cape town.
- [42] C. Huppert, B. Stender and A. Hof, “Resource Allocation for OFDM Broadcast Channels Allowing User-Wise Coding”, 3rd International Symposium on Wireless Communication Systems, Valencia, Spain, Sept. 2006.
- [43] B. Li, Z. Ruan, X. Zhang, Y. Chang and D. Yang, “Throughput Analysis of TDMA System Forward Link with Superposition Coding for Location-Based Sets of Users”, WCNC’2008. pp.2502-2506, 2008.
- [44] P. Vizi, S. Vanka, S. Srinivasa, M. Haenggi, and Z. Gong, “Scheduling using Superposition Coding: Design and Software Radio Implementation”, in IEEE Radio Wireless Week, (Phoenix, AZ), Jan. 2011.

- [45] A. Jalali, R. Padovani and B. Pankaj, “Data throughput of CDMA-HDR a high efficiency-high data rate personal communication wireless system”, in: Proc. IEEE VTC Spring, 2000.
- [46] M. Andrews, K. Kumaran, K. Ramanan, A. L. Stolyar, R. Vijayakumar, and P. Whiting, “Scheduling in a queueing system with asynchronously varying service rates”, *Probability in the Engineering and Informational Sciences*, 18:191-217, 2004.
- [47] R. Agrawal, A. Bedekar, R.J. La and V. Subramanian., “Class and channel condition based weighted proportional fair scheduler”, in: *Teletraffic Engineering in the Internet Era*, Proc. ITC-17, Salvador da Bahia, eds. J.M. de Souza, N.L.S. da Fonseca, E.A. de Souza e Silva (North-Holland, Amsterdam), 553-565, 2001.
- [48] J. Liu, A. Proutiere, Y. Yi, M. Chiang and H. V. Poor, “Stability, fairness, and performance: A flow-level study on nonconvex and time-varying rate regions”, *IEEE Trans. Inf. Theory.*, vol. 55, no. 8, pp. 3437 - 3456, 2009.
- [49] N. Hegde and A. Proutiere, “Packet and Flow Level Performance of Wireless Multihop Data Networks”, *GLOBECOM 2006*.
- [50] J. Liu, A. Proutiere, Y. Yi, M. Chiang and H.V. Poor, “Flow-level stability of data networks with non-convex and time-varying rate regions”, in Proc. *SIGMETRICS*, pp.239-250, 2007.
- [51] S. C. Borst, “User-level performance of channel-aware scheduling algorithms in wireless data networks”, in Proc. *IEEE INFOCOM*, 2003.
- [52] T. Bonald, S. C. Borst, and A. Proutiere, “How mobility impacts the flow-level performance of wireless data system”, in Proc. *IEEE INFOCOM*, 2004.
- [53] R. Prakash and V. V. Veeravalli, “Centralized wireless data networks with user arrivals and departures”, *IEEE Trans. Inform. Theory*, vol. 53, no. 2, pp. 693-713, 2007.

- [54] F. P. Kelly, “Charging and rate control for elastic traffic”, *European Transactions on Telecommunications*, 8:33–37, 1997.
- [55] T. Lan, D. Kao, M. Chiang, and A. Sabharwal, “An axiomatic theory of fairness in network resource allocation”, in *Proceedings of IEEE INFOCOM*, San Diego, CA, pp. 1-9, Mar. 2010.
- [56] E. Altman, K. Avrachenkov and A. Garnaev, “Generalized Alpha-Fair Resource Allocation in Wireless Networks”, in *Proc. of 47th IEEE Conference on Decision and Control*, Cancun, Mexico, Dec. 2008.
- [57] T. Bonald and A. Proutire, “Flow-level stability of utility-based allocations for non-convex rate regions”, in *Proc. 40th Conf. Information Sciences and Systems*, Princeton, NJ, pp. 327-332, Mar. 2006.
- [58] T. Bonald, L. Massoulié, A. Proutiere and J. Virtamo, “A queueing analysis of max-min fairness, proportional fairness and balanced fairness”, *Queueing Systems*, 2006.
- [59] S. C. Borst, “User-level performance of channel-aware scheduling algorithms in wireless data networks”, in *Proc. IEEE INFOCOM*, 2003.
- [60] R.F. Serfozo, “Introduction to Stochastic Networks”, Springer Verlag, 1999.
- [61] F. Kelly, “Reversibility and Stochastic Networks”, Wiley and Sons, 1979.
- [62] T. Bonald, “Flow-level performance analysis of some opportunistic scheduling algorithms”, *European transactions on telecommunications*, pp. 65-75, 2005.
- [63] T. Bonald, S. Borst, and A. Proutiere, “How mobility impacts the flowlevel performance of wireless data networks”, in *Proc. IEEE Infocom*, Hong Kong, pp. 1872-1881, Jun. 2004.
- [64] S. Borst, A. Proutire and N. Hedge, “Capacity of wireless data networks with intra- and inter-cell mobility”, in *Proceedings of IEEE INFOCOM 2006* 1058-1069. Barcelona, Spain, 2006.



- [65] T. Bonald, L. Massoulié, A. Proutiere and J. Virtamo, “A queueing analysis of max-min fairness, proportional fairness and balanced fairness”, *Queueing systems*, 2006.
- [66] L. Lei, C. Lin, J. Cai, and X. Shen, “Flow level performance of opportunistic OFDM-TDMA and OFDMA networks”, *IEEE Trans. Wireless Communications*, vol. 7, no. 12, pp. 5461-5472, Dec. 2008.
- [67] C. Tarhini and T. Chahed, “Modeling of streaming and elastic flows integration in OFDMA-based IEEE802.16 WiMAX”, *Computer Communications* 30(18): 3644-3651, 2007.
- [68] Z. Shen, J. G. Andrews and B. L. Evans, “Adaptative resource allocation in multiuser OFDM system with proportional rate constraints”, *IEEE Trans. Wireless Commun.*, vol. 4, no .6, pp. 2726-2737, Nov. 2005.
- [69] M. Ibnkahla Ed., “Signal Processing for Mobile Communications Handbook”, CRC Press, 872 pages, 2004.
- [70] Q. Zhu, “A trade-off study between efficiency and fairness in communication networks”, *INFOCOM. IEEE Conference on Computer Communications Workshops 2008. Phoenix, AZ 2008*, pp. 1-3.
- [71] H. Kim and Y. Han, “A proportional fair scheduling for multicarrier transmission systems”, *IEEE Commun. Lett.*, vol. 9, pp. 210-212, Mar. 2005.
- [72] F. Sun, J. Liu, P. Lan, H. Xu and Y. Li, “A Suboptimal User Selection Algorithm for Wireless Broadcast Channels”, *ChinaCom2008-Signal Processing for Communications Symposium*, 2008.
- [73] A. Sang, X. Wang, M. Madihian, and R. D. Gitlin, “Downlink scheduling schemes in cellular packet data systems of multiple-input multiple-output antennas”, in *Proc. IEEE GLOBECOM, Dallas, TX, Nov. 2004*.
- [74] V. Vukadinovic and G. Karlsson, “Video Streaming in 3.5G: On Throughput-Delay Performance of Proportional Fair Scheduling”, *Proc. IEEE Int. Symp. Modeling, Analysis, and Simulation of Computer and Telecommunication Systems (MASCOTS), Monterey, CA, Sept. 2006*.

- [75] T. Bonald, “A score-based opportunistic scheduler for fading radio channels”, Proc. European Wireless, 2004.
- [76] D. Avidor, S. Mukherjee, J. Ling and C. Papadias, “On Some Properties of the Proportional Fair Scheduling Policy”, in Proc. IEEE PIMRC, New Jersey, Sept. 2004.
- [77] J-G. Choi and S. Bahk, “Cell-Throughput Analysis of the Proportional Fair Scheduler in the Single-Cell Environment”, IEEE Trans. Veh. Technol., vol. 56, no. 2, pp. 766-778, Mar. 2007.
- [78] H. A. Suraweera, J. T. Y. Ho, T. Sivaumaran and J. Armstrong, “An Approximated Gaussian Analysis and Results on the Capacity Distribution for MIMO-OFDM”, in Proc. IEEE PIMRC, Melbourne, Sept. 2005.
- [79] P. J. Smith and M. Shafi, “On a Gaussian Approximation to the Capacity of Wireless MIMO Systems”, in Proc. IEEE ICC, New York, Apr. 2002.
- [80] E. Liu and Kin K. Leung, “Fair Resource Allocation under Rayleigh and/or Rician Fading Environments”, IEEE PIMRC 2008, Cannes, Sept. 2008.
- [81] E. Liu and Kin K. Leung, “Proportional Fair Scheduling: Analytical Insight under Rayleigh Fading Environment”, in Proc. IEEE WCNC, Las Vegas, 2008.
- [82] “IEEE Baseline document v4 for draft standard, Part 16: Air Interface for Fixed and Mobile Broadband Wireless Access Systems, Multihop Relay Specification”, Jun. 2008.
- [83] “3GPP TR 36.814 V9.0.0, Further advancements for E-UTRA physical layer aspects”, Mar. 2010.
- [84] H. X. Nguyen, H. H. Nguyen and T. Le-Ngoc, “Signal Transmission with Unequal Error Protection in Wireless Relay Networks”, IEEE Transactions on Vehicular Technology, vol. 59, pp. 2166-2178, Jun. 2010.

- [85] C. Hausl and J. Hagenauer, "Relay communication with hierarchical modulation", *IEEE Commun. Lett.*, vol. 11, no. 1, pp. 64-66, Jan. 2007.
- [86] L. Zheng, K. Wang and Wang W., "Performance Analysis of Coded Cooperation with Hierarchical Modulation", *Communications*, 2008. ICC'08. IEEE International Conference on, pp. 4978-4982, 2008.
- [87] M.-K. Chang and S.-Y. Lee, "Performance Analysis of Cooperative Communication System with Hierarchical Modulation over Rayleigh Fading Channel", *IEEE Transactions on Wireless Communications*, volume 8, pages 2848-2852, Jun. 2009.
- [88] S. Jeong-Chul, K. Jee-Hoon, S. Jin-Hyuk and S. HyoungKyu, "New Transmission Scheme with Hierarchical Modulation in Dual-hop Wireless Relaying Systems", *ATNAC*, Nov. 2009.
- [89] E. G. Larsson and B. R. Vojcic, "Cooperative transmit diversity based on superposition modulation", *IEEE Comm. Lett.*, vol. 9, No. 9, Sept. 2005.
- [90] P. Popovski and E. de Carvalho, "Improving the Rates in Wireless Relay Systems through Superposition Coding", *IEEE Trans. Wireless Communications*, Dec. 2008.
- [91] R. J. Whang, H. Liu and E. K. Hong, "Multiuser Cooperative Relay Communication Employing Hierarchical Modulation", *VTC Spring*, Taipei, May 2010.
- [92] T. Nechiporenko, K. T. Phan, C. Tellambura, and Ha H. Nguyen, "Performance Analysis of Adaptive M-QAM for Rayleigh Fading Cooperative Systems", in *Proc. IEEE International Conference on Communications (ICC)*, May 2008.
- [93] T. E. Hunter and A. Nosratinia, "Diversity through coded cooperation", *IEEE Trans. Wireless Commun.*, vol. 5, no. 2, pp. 283-289, Feb. 2006.

# Publications

## Journals

A. Jdidi and T. Chahed, “Flow-level performance of proportional fairness with hierarchical modulation in OFDMA-based networks”, *Computer Networks* 55(8): 1784-1793, 2011.

A. Jdidi, T. Chahed, S-E. Elayoubi and H. Besbes, “Modeling the flow-level performance of hierarchical modulation in OFDMA-based networks”, *Telecommunication Systems*, vol. 51, Issue 1, September 2012 (on-line December 2010).

## Conferences

A. Jdidi and T. Chahed, “Joint use of hierarchical modulation and relays in OFDMA networks”, *VTC Fall 2011*, San Francisco, September 2011.

A. Jdidi and T. Chahed, “Impact of hierarchical modulation on proportional fair in OFDMA-based networks”, pp. 1-6, *ComNet’2010*, Tozeur, Nov. 2010, (Best Paper Award).

A. Jdidi, T. Chahed, S-E. Elayoubi and H. Besbes, “On hierarchical modulation to increase flow-level capacity in OFDMA-based networks”, pp. 1-6, *ICC’2010*, Cape Town, May 2010.

## Résumé de la thèse en français

# Table des matières

<b>1</b>	<b>Introduction</b>	<b>4</b>
<b>2</b>	<b>Modélisation au niveau flux de l'utilisation de la modulation hiérarchique dans un système OFDMA</b>	<b>6</b>
2.1	Système . . . . .	6
2.1.1	Analyse du modèle "Processor Sharing" . . . . .	7
2.1.2	Les métriques de performances . . . . .	8
2.2	Utilisation de la MH . . . . .	8
2.3	Evaluation des performances . . . . .	9
2.3.1	Extensions . . . . .	10
2.4	Conclusion . . . . .	11
<b>3</b>	<b>Utilisation de la modulation hiérarchique avec l'algorithme proportional fairness</b>	<b>13</b>
3.1	Proportional fairness . . . . .	13
3.2	Modélisation au niveau flux . . . . .	14
3.2.1	PF sans utilisation de la MH . . . . .	14
3.2.2	PF avec utilisation de la MH . . . . .	15
3.3	Evaluation des performances . . . . .	15
3.3.1	Validation de l'étude analytique . . . . .	15
3.3.2	Comparison avec RR et max-min . . . . .	18
3.4	Conclusion . . . . .	18
<b>4</b>	<b>Utilisation de la modulation hiérarchique dans un cas de relayage coopératif</b>	<b>20</b>

4.1	Utilisation de la modulation hiérarchique et de l'adaptation de lien en relaying . . . . .	21
4.2	Modélisation au niveau flux . . . . .	21
4.2.1	Cas classique de relaying . . . . .	22
4.2.2	Cas d'utilisation de la MH et d'adaptation du lien . . . . .	22
4.3	Proposition d'amélioration de performances . . . . .	23
4.4	Evaluation des performances . . . . .	23
4.5	Conclusion . . . . .	25
<b>5</b>	<b>Utilisation de la modulation hiérarchique dans le cas du relaying non-coopératif</b>	<b>27</b>
5.1	Utilisation de la modulation hiérarchique . . . . .	27
5.2	Modélisation au niveau flux . . . . .	28
5.3	Conclusion . . . . .	30
<b>6</b>	<b>Conclusion</b>	<b>32</b>

# Chapitre 1

## Introduction

L'évolution pertinente des technologies et la modification radicale des demandes et des exigences des clients ont abouti à une croissance des services de communication sans fil. Plusieurs techniques d'accès se basant sur un multiplexage temporel, fréquentiel et par code ont été proposées. Parmi ces techniques, nous citons l'Orthogonal Frequency Division Multiplexing (OFDM) qui a été défini pour les réseaux à haut débit.

Dans un système OFDM, la bande de fréquence est divisée en des multiples sous-porteuses. Les utilisateurs présents dans le système se partagent ces sous-porteuses pour échanger les données avec la station de base.

Plusieurs techniques d'accès basées sur l'OFDM ont été proposées en vue de partager la bande entre les utilisateurs. Orthogonal Frequency Division Multiple Access (OFDMA) représente une de ces techniques, elle permet de gérer le spectre d'une manière plus efficace en tirant profit de la diversité d'utilisateurs, grâce à laquelle une mauvaise sous-porteuse pour un utilisateur est susceptible d'être bonne pour un autre.

La plupart des algorithmes d'allocation des ressources proposés dans la littérature respectent une orthogonalité parfaite lors de l'allocation : une sous-porteuse est allouée à un seul utilisateur et aucun autre utilisateur ne pourra l'utiliser en même temps.

Cependant un résultat très important a été démontré par Costa en précisant que la capacité d'un canal à Bruit Blanc Additif Gaussien (BBAG) ne varie pas si nous envoyons sur le même canal une information adjacente.



Des schémas simples de codage/décodage sont présents dans la littérature dans le cas d'une diffusion de deux types d'informations sur le même canal sans perte de données. Le codage superposé est aussi appelé modulation hiérarchique (MH) ou aussi modulation non uniforme.

Nous proposons dans cette thèse d'exploiter la MH en vue d'améliorer d'avantage la capacité du système en tirant profit de la diversité d'utilisateurs. MH permet, dans ce cas, de transmettre un flux supplémentaire à un utilisateur de bonnes conditions radio sur une sous-porteuse initialement allouée à un utilisateur de mauvaises conditions radio.

Dans la littérature, la plupart des travaux qui se sont intéressés à l'utilisation de la MH se sont concentrés seulement sur les performances en termes de couche basse avec un nombre fixe d'utilisateurs dans le système correspondant à une configuration statique. Toutefois, cette configuration ne reflète pas la dynamique du nombre d'utilisateurs dans un tel système, où les utilisateurs arrivent selon une loi aléatoire et partent après avoir fini leurs services.

Dans cette thèse, nous exposons l'étude des performances de l'utilisation de la modulation hiérarchique avec des configurations dynamiques d'utilisateurs correspondant à une étude au niveau flux. Cela nous permet d'évaluer les performances en termes de nouvelles métriques à savoir le temps moyen de transfert et la probabilité de blocage qui sont importants pour l'utilisateur et pour l'opérateur.

## Chapitre 2

# Modélisation au niveau flux de l'utilisation de la modulation hiérarchique dans un système OFDMA

Dans ce chapitre, nous étudions les performances de l'utilisation de la modulation hiérarchique (MH) dans un système OFDMA. Les ressources sont initialement allouées aux utilisateurs en utilisant l'algorithme Round Robin. Notre étude sera faite au niveau flux, pour une configuration dynamique des utilisateurs.

### 2.1 Système

Nous considérons la voie descendante d'un système OFDMA avec une bande passante  $W$  divisée en  $N$  sous-porteuses. Nous supposons que les utilisateurs présents dans la cellule sont divisés en  $J$  groupes selon leurs conditions radio comme indiqué par la figure 2.1.

Chaque classe d'utilisateurs  $j$ ,  $j = 1, \dots, J$ , utilise  $N^j(\mathbf{s})$  sous-porteuses pour un temps moyen de transfert  $T^j$ .  $\mathbf{s}$  représente un vecteur mentionnant le nombre d'utilisateurs  $s^j$  de type  $j$ ,  $j = 1, \dots, J$ .

Le temps de service  $T$  depend de la quantité de ressources allouée aux

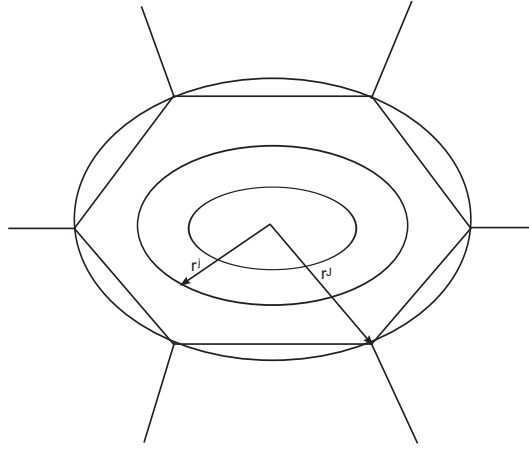

FIGURE 2.1 – Les différentes régions

utilisateurs qui dépend à son tour du nombre d'utilisateurs présents dans le système ainsi que de la manière dont ces derniers vont en profiter.

### 2.1.1 Analyse du modèle "Processor Sharing"

Nous considérons que les utilisateurs arrivent au système selon une loi de Poisson de moyenne  $\lambda$ . Le nombre d'utilisateur dans le système est modélisé en utilisant une chaîne de markov à temps continue avec un vecteur  $\mathbf{s}$  mentionnant le nombre d'utilisateurs de chaque type. Ce modèle peut être décrit par une file "Processor Sharing" (PS) avec  $S$  utilisateurs dans le système.  $S = \sum_j s^j$ .

Un algorithme de contrôle d'admission, basé sur le nombre maximal d'utilisateurs admis, est utilisé. Seulement  $s_{max}$  utilisateurs seront acceptés afin de garantir à chaque utilisateur un nombre minimum de sous-porteuses  $n_{min}$  égal à  $\frac{N}{s_{max}}$ .

Notons par  $\bar{\rho}$  la charge totale du système et par  $\bar{\rho}^j$  la charge correspondante à la région  $j$ ,  $j = 1, \dots, J$ . On a :

$$\bar{\rho} = \sum_{j=1}^J \bar{\rho}^j \quad (2.1)$$

La distribution des utilisateurs dans le système est donnée par :

$$\pi(x) = \frac{\bar{\rho}^x}{1 + \bar{\rho} + \dots + \bar{\rho}^{s_{max}}} \quad (2.2)$$

pour  $0 \leq x \leq s_{max}$ .

$\bar{\rho}^j = \rho^j / c^j$ ;  $\rho^j = \rho\pi((r^j)^2 - (r^{j-1})^2)$ ;  $\rho = \lambda E[F]$ ,  $r^j$  est le rayon de la région  $j$ ,  $E[F]$  est la taille moyenne du fichier et  $c^j$  est le débit maximal qu'un utilisateur  $s$  de type  $j$  peut obtenir en utilisant toutes les ressources disponibles, donné par la formule suivante :

$$c^j = \sum_{n=1}^N \frac{W}{N} \log_2 \left( 1 + \frac{p_{s,n}^j |h_{s,n}^j|^2}{\Gamma(\sigma_{s,n}^j)^2} \right) \quad (2.3)$$

où  $p_{s,n}^j$  est le montant de puissance alloué à l'utilisateur  $s$  de type  $j$  sur la sous-porteuse  $n$ ,  $h_{s,n}^j$  est le gain du canal radio et  $\sigma_{s,n}^j$  représente la variance du bruit.

### 2.1.2 Les métriques de performances

En considérant l'équation Eqn. (2.2), le temps moyen de transfert  $T^j$  pour un utilisateur de type  $j$  avec un fichier de taille moyenne  $E[F]$  est donné par :

$$T^j = E[F] \frac{1 - (s_{max} + 1)\bar{\rho}^{s_{max}} + s_{max}\bar{\rho}^{(s_{max}+1)}}{c^j(1 - \bar{\rho})(1 - \bar{\rho}^{s_{max}})} \quad (2.4)$$

Le temps moyen de transfert global  $T$  est obtenu par :

$$T = \frac{\sum_{j=1}^J T^j \lambda^j}{\sum_{j=1}^J \lambda^j} \quad (2.5)$$

La probabilité de blocage  $B$  pour un nouvel utilisateur, basée sur notre schéma de contrôle d'admission décrit précédemment, est donnée par :

$$B = \frac{\bar{\rho}^{s_{max}}}{1 + \bar{\rho} + \dots + \bar{\rho}^{s_{max}}} \quad (2.6)$$

## 2.2 Utilisation de la MH

Nous considérons que les utilisateurs dans le système sont divisés en deux groupes : le premier groupe correspond aux utilisateurs proches de la station de base et qui présentent de bonnes conditions radio et le deuxième groupe correspond aux utilisateurs lointains ayant de mauvaises conditions radio.

Après avoir allouer les  $N$  sous-porteuses en se basant sur l'algorithme Round Robin, nous procédons à une deuxième allocation qui vise à trouver éventuellement un utilisateur de bonnes conditions radio pour partager chaque sous-canal déjà attribué à un utilisateur lointain. Tout cela doit se faire sans toutefois augmenter le montant total de puissance alloué à la sous-porteuse à partager ni diminuer le débit de l'utilisateur lointain.

Dans ce cas, les utilisateurs de type 1 vont recevoir un débit supplémentaire  $c^{1,HM}$  obtenu par :

$$c^{1,HM} = \sum_{n=1}^N \frac{W}{N} \log_2 \left( 1 + \frac{p_{k^*,n}^{1,HM} |h_{k^*,n}^1|^2}{\Gamma(\sigma_{k^*,n}^1)^2} \right) Pr(s^1 > 0, s^2 > 0) \frac{s^2}{s^1} \quad (2.7)$$

où  $s^j$  est le nombre moyen d'utilisateur de type  $j$  présents dans la cellule approximé par  $\frac{\bar{\rho}^j}{1-\bar{\rho}}$ .

La probabilité  $Pr(s^1 > 0, s^2 > 0)$  représente le fait d'avoir au moins un utilisateur de type 1 et un utilisateur de type 2, condition nécessaire pour appliquer la modulation hiérarchique. Elle est approximée par l'expression suivante :

$$\pi(s^1, s^2) = \frac{(s^1 + s^2)!}{s^1!s^2!} (\bar{\rho}^1)^{s^1} (\bar{\rho}^2)^{s^2} (1 - \bar{\rho})$$

## 2.3 Evaluation des performances

La figure 2.2 représente le temps moyen de transfert global dans le system en fonction du trafic offert. Les valeurs du trafic offert correspondent à des charges de l'ordre de 0.1 à 0.8. Les courbes correspondent aux résultats théoriques (notés par PS), résultats de simulations ainsi que la solution exacte (noté par markovian) avec et sans utilisation de la MH.

Nous remarquons que les courbes des résultats de simulations et des résultats théoriques se suivent ce qui nous permet de valider notre étude analytique.

Nous observons aussi que l'utilisation de la MH permet d'augmenter le débit total de la cellule. Le gain, ainsi obtenu, augmente en fonction de la charge du système et ceci est due à l'exploitation de la diversité d'utilisateurs.

Nous étudions maintenant la variation du gain obtenu en utilisant la MH en fonction de la distribution des utilisateurs dans le système. Nous

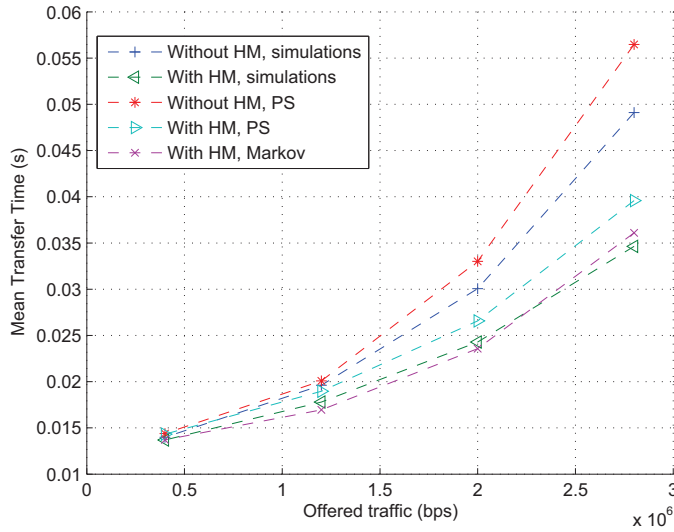

FIGURE 2.2 – Temps moyen de transfert global

représentons dans la figure 2.3 la variation du gain résultant de l'utilisation de la MH pour trois scénarios différents :

- Scénario 1 : 25% des utilisateurs sont de type 1 et 75% des utilisateurs sont de type 2 ;
- Scénario 2 : 50% des utilisateurs sont de type 1 et 50% des utilisateurs sont de type 2 ;
- Scénario 3 : 75% des utilisateurs sont de type 1 et 25% des utilisateurs sont de type 2.

Nous observons que le gain est plus important dans le deuxième scénario. En effet, dans le cas où on a plus d'utilisateurs de type 1 on a moins d'utilisateurs de type 2 et donc moins de possibilité d'appliquer la MH et dans le cas où on a plus d'utilisateurs de type 2 le gain obtenu ainsi n'est pas si important puisque on n'a pas un nombre suffisant d'utilisateurs de type 1 à aider.

### 2.3.1 Extensions

Nous proposons dans ce paragraphe deux extensions permettant d'améliorer d'avantage le débit total en utilisant la MH.

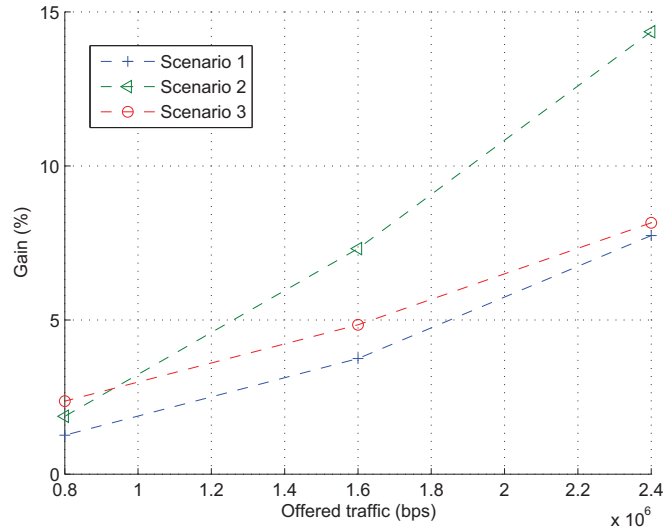

FIGURE 2.3 – Gain obtenu

Dans la première extension, à chaque fois où un utilisateur proche de la station de base (de type 1) est servi, nous proposons de chercher le meilleur utilisateur lointain pour partager la même sous-porteuse. Nous utilisons toujours la modulation 4/64-HQAM.

La seconde extension permet de généraliser l'utilisation de la MH. Nous cherchons pour chaque utilisateur, de type 1 ou 2, un utilisateur de type 1 ou de type 2 pour partager les mêmes ressources en utilisant des modulations 4/16-HQAM et 4/64-HQAM.

La figure 2.4 représente le gain obtenu pour les deux extensions par rapport au cas classique d'utilisation de la MH. La deuxième extension permet d'améliorer d'avantage le débit total par rapport à la première extension. Cette première proposition permet à son tour d'avoir un débit plus important par rapport au cas classique d'utilisation de la MH.

## 2.4 Conclusion

Dans ce premier chapitre, nous avons modélisé, au niveau flux, l'utilisation de la modulation hiérarchique dans les systèmes OFDMA. En considérant que les ressources sont initialement allouées avec l'algorithme Round

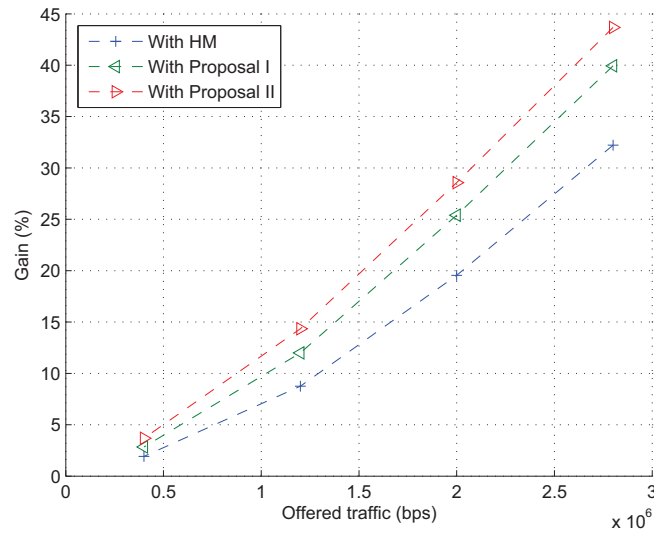

FIGURE 2.4 – Gain Obtenu

Robin, nous avons évalué le gain obtenu et proposé deux extensions permettant d'améliorer d'avantage le débit total du système.

Dans le prochain chapitre nous nous intéresserons au cas de l'utilisation de la modulation hiérarchique avec l'algorithme proportional fairness toujours en considérant une configuration dynamique d'utilisateurs dans le système.



## Chapitre 3

# Utilisation de la modulation hiérarchique avec l’algorithme proportional fairness

Dans le chapitre précédent nous avons étudié l’utilisation de la modulation hiérarchique avec l’algorithme Round Robin. Cet algorithme permet d’avoir une équité en termes d’accès au ressources mais ne permet pas d’exploiter la diversité d’utilisateurs dans le système causant une faible efficacité spectrale. Dans ce chapitre nous nous intéressons à l’utilisation de la modulation hiérarchique avec l’algorithme proportional fairness, un algorithme de la famille  $\alpha$ -fair algorithmes qui permet d’exploiter la diversité d’utilisateurs en allouant d’une façon opportuniste les ressources disponibles sans toutefois sacrifier l’équité entre utilisateurs.

### 3.1 Proportional fairness

Proportional fairness (PF) est un algorithme qui permet d’assurer un bon compromis entre efficacité et équité entre les utilisateurs.

Nous notons par  $c_s[u]$  and  $Z_s[u]$ , respectivement, le débit instantané de l’utilisateur  $s$ ,  $s = 1, \dots, S$  et son débit moyen obtenu jusqu’au time slot  $u$  ;

$S$  représente le nombre maximal d'utilisateur dans le système.

En se basant sur la règle "weighted alpha", l'utilisateur  $s^*$  à servir, est celui qui maximise le rapport suivant :

$$w_s \frac{c_s[u]}{(Z_s[u])^\alpha} \quad (3.1)$$

où  $w_s$  est un paramètre de pondération pour l'utilisateur  $s$  et  $\alpha$  représente le paramètre qui définit l'équité lors de l'allocation des ressources.

Dans notre travail, nous considérons que tous les utilisateurs ont le même poids ( $w_s = 1$ ). Dans le cas du PF ( $\alpha = 1$ ), le débit moyen  $Z_s[u]$  est mis à jour selon les equations suivantes :

$$Z_s[u] = \begin{cases} (1 - \frac{1}{t_c})Z_s[u-1] + \frac{1}{t_c}c_s[u-1] & \text{si } s = s^* \\ (1 - \frac{1}{t_c})Z_s[u-1] & \text{si } s \neq s^* \end{cases} \quad (3.2)$$

$t_c$  représente un filtre qui indique le nombre de time slots après lesquels  $Z_s[u]$  est mis à jour.

## 3.2 Modélisation au niveau flux

Dans ce paragraphe nous proposons la modélisation au niveau flux de l'allocation des ressources en utilisant PF avec et sans utilisation de la Modulation Hiérarchique (MH). Pour cela, nous utiliserons le modèle Processor Sharing (PS) décrit dans le chapitre précédent.

### 3.2.1 PF sans utilisation de la MH

Le débit qu'un utilisateur  $s$  de type  $j$  peut obtenir est donné par :

$$c^j = G \sum_{n=1}^N \frac{W}{N} \log_2 \left( 1 + \frac{SNR_{s,n}^j}{\Gamma} \right) \quad (3.3)$$

$G$  est le gain obtenu dans le cas de l'utilisation de l'algorithme PF par rapport au cas du Round Robin, il est donné par :

$$G = 1 + \frac{\sum_{j=1}^J Pr(j) \int_{-\infty}^{\infty} \sigma_{c_s^j} x \exp^{-\frac{x^2}{2}} (F_{(0,1)}(x))^{s^j-1} dx}{\sum_{j=1}^J Pr(j) \frac{E[c_s^j]}{s^j}} \quad (3.4)$$

$\sum_{n=1}^N \frac{W}{N} \log_2(1 + \frac{SNR_{s,n}^j}{\Gamma})$  est le débit obtenu avec Round Robin. Rappelons que  $W$  représente la bande passante et que  $SNR_{s,n}^j$  représente le SNR de l'utilisateur  $s$  de type  $j$  sur la sous-porteuse  $n$ .

$s^j$  représente le nombre moyen d'utilisateurs de type  $j$  dans le système.

### 3.2.2 PF avec utilisation de la MH

En utilisant la MH, les utilisateurs de type 1 vont recevoir un débit supplémentaire  $c_{add}$  à chaque fois où un utilisateur de type 2 est servi. Ce débit est donné par :

$$c_{add} = \sum_{n=1}^N \frac{W}{N} \log_2 \left( 1 + \frac{p_{k^*,n}^{1,HM} |h_{k^*,n}^1|^2}{\Gamma(\sigma_{k^*,n}^1)^2} \right) \quad (3.5)$$

Le débit maximal qu'un utilisateur de type 1 peut obtenir dans ce cas est donné par :

$$c^{1,HM} = c^1 + c_{add} \times Pr(s^1 \geq 1, s^2 \geq 1)$$

où  $c^1$  est le débit obtenu dans le cas sans utilisation de la MH et  $Pr(s^1 \geq 1, s^2 \geq 1)$  est la probabilité d'avoir au moins un utilisateur de chaque type.

## 3.3 Evaluation des performances

Nous allons maintenant valider notre étude théorique par des simulations. Nous nous intéresserons aussi au gain obtenu dans le cas de PF, en utilisant la MH, par rapport aux deux algorithmes : Round Robin et max-min.

### 3.3.1 Validation de l'étude analytique

La figure 3.1 représente la variation du temps moyen de transfert pour tous les utilisateurs en fonction du trafic offert avec et sans utilisation de la MH.

Nous observons que les résultats de simulations valident les résultats obtenus analytiquement. Nous remarquons aussi un gain obtenu en utilisant la MH. Ce gain est obtenu pour les deux types d'utilisateurs. Ceux de type

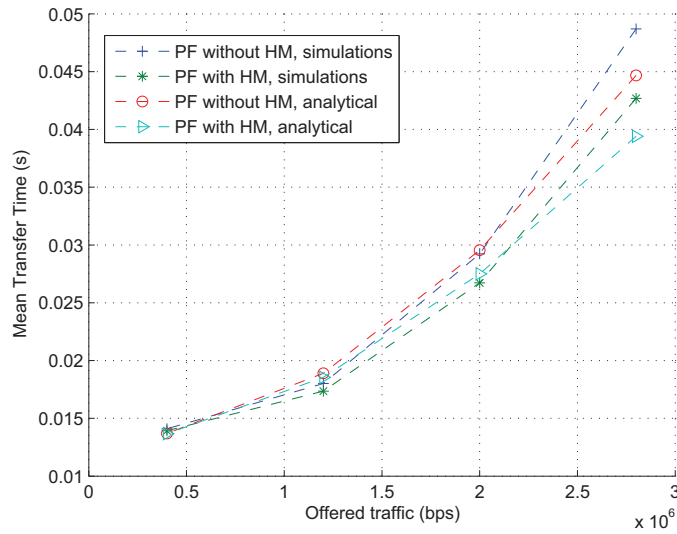

FIGURE 3.1 – Temps moyen de transfert global

1 vont bénéficier directement d'un débit supplémentaire à chaque fois où un utilisateur de type 2 est servi et vont donc quitter le système rapidement (voir figure 3.2). Ceci permet aux utilisateurs de type 2 de profiter d'avantages des ressources libérées (voir figure 3.3).

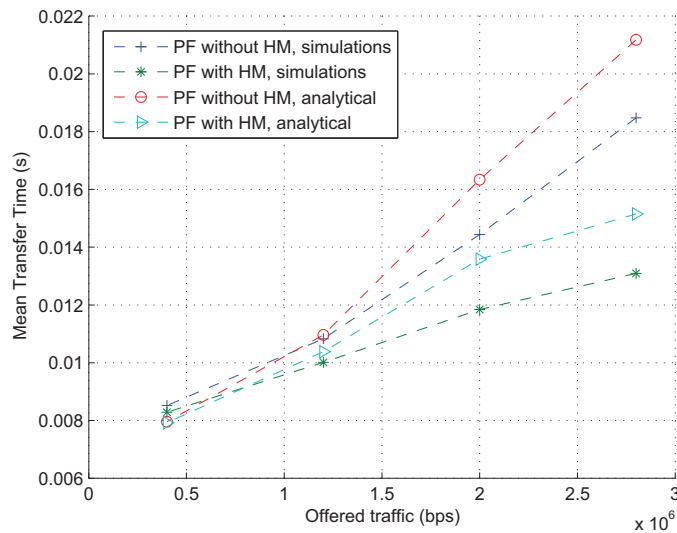

FIGURE 3.2 – Temps moyen de transfert - utilisateurs de type 1

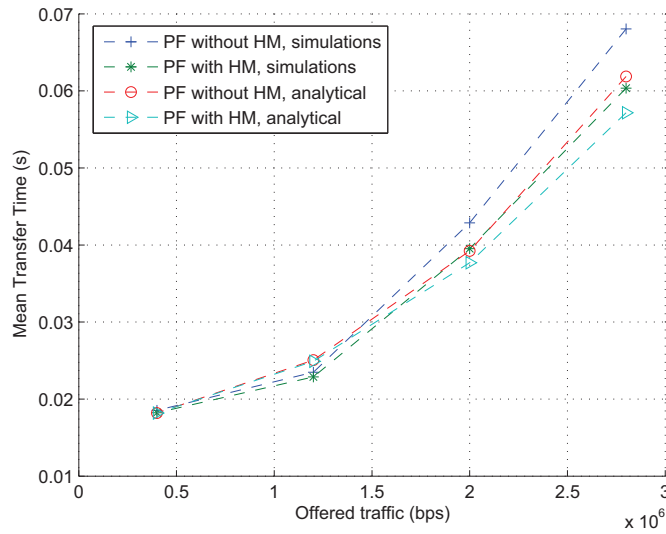

FIGURE 3.3 – Temps moyen de transfert - utilisateurs de type 2

La figure 3.4 illustre la variation de la probabilité de blocage résultante du schéma de contrôle d'admission décrit dans le chapitre précédent.

nous remarquons que l'utilisation de la MH permet de diminuer la probabilité de blocage permettant ainsi d'augmenter la capacité totale du système.

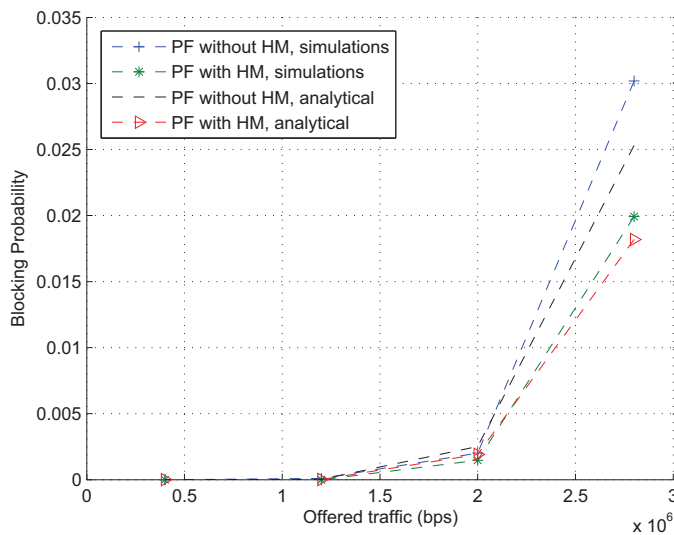

FIGURE 3.4 – Probabilité de blocage

### 3.3.2 Comparison avec RR et max-min

Nous allons maintenant comparer les performances de l'utilisation de la MH avec PF par rapport aux deux algorithmes : Round Robin et max-min.

La figure 3.5 illustre la variation du temps moyen de transfert en fonction du trafic offert pour les 3 algorithmes, avec et sans utilisation de la MH.

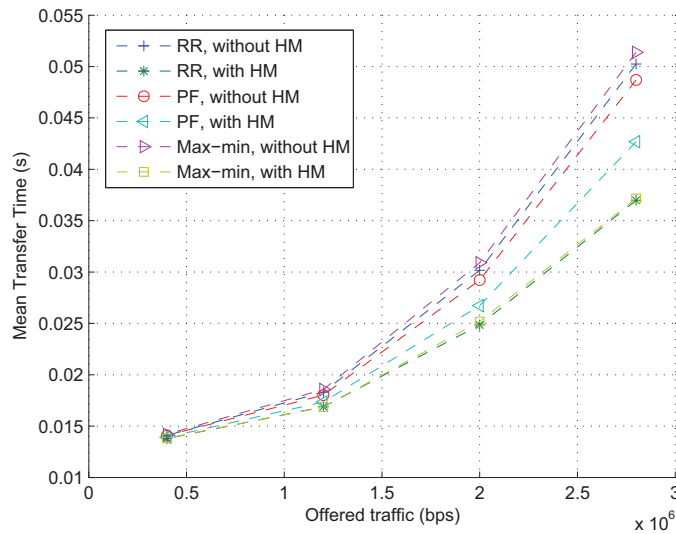

FIGURE 3.5 – Temps moyen de transfert global

Sans utilisation de la MH, nous remarquons que PF permet de minimiser le temps moyen de transfert par rapport aux deux autres algorithmes. Toutefois avec la MH, la tendance est inversée. En effet, avec Round Robin, les utilisateurs de type 2 ont beaucoup plus d'opportunités d'être servis par rapport au PF.

Les mêmes résultats sont observés pour la probabilité de blocage comme il est illustré dans la figure 3.6.

## 3.4 Conclusion

Dans ce chapitre nous avons modélisé au niveau flux l'utilisation de la modulation hiérarchique avec l'algorithme proportional fairness. Nous avons tout d'abord validé notre modèle analytique par des simulations. Ensuite

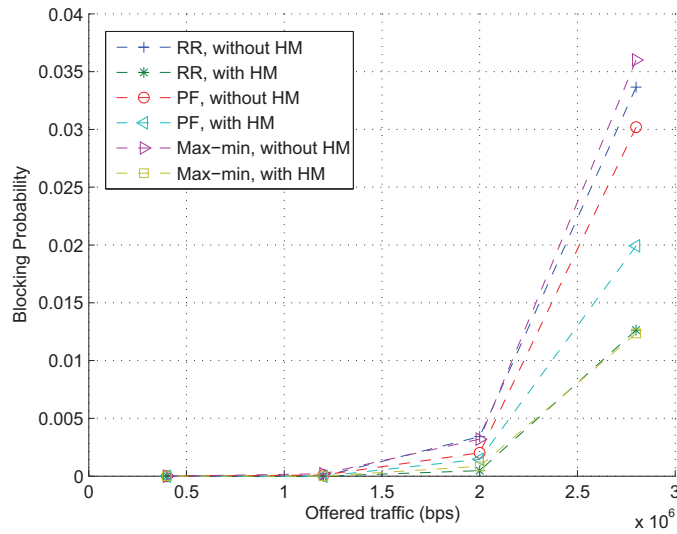

FIGURE 3.6 – Probabilité de blocage

nous avons quantifié le gain obtenu avec utilisation de la modulation hiérarchique. Enfin nous avons comparé les performances de l'utilisation de la modulation hiérarchique avec proportional fairness par rapport aux deux algorithmes : Round Robin et max-min. Sans modulation hiérarchique, proportional fairness permet de minimiser le temps moyen de transfert et la tendance s'inverse en utilisant la modulation hiérarchique.

## Chapitre 4

# Utilisation de la modulation hiérarchique dans un cas de relayage coopératif

Dans ce chapitre nous nous intéresserons au cas de l'utilisation de la modulation hiérarchique dans un système OFDMA avec relayage coopératif. Un relais est utilisé pour assister un utilisateur de mauvaises conditions radio et qui ne peut pas décoder correctement le signal transmis par la station de base. Dans ce cas, la destination va recevoir deux copies du même signal qu'il va combiner afin de décoder son propre signal.

Dans ce chapitre, nous allons exploiter la modulation hiérarchique afin de transmettre un signal additionnel au relais en vue de décoder une version plus robuste du signal original. Ce signal va être ensuite relayé à la destination. Nous proposons aussi d'adapter la modulation utilisée sur le lien relais-destination afin de diminuer le coût des ressources additionnelles utilisées lors du relayage.

Nous allons modéliser et valider avec des simulations notre système au niveau flux. De plus, nous allons proposer une extension permettant d'améliorer le débit total.



## 4.1 Utilisation de la modulation hiérarchique et de l'adaptation de lien en relayage

Nous supposons que la Station de Base (SB) a toutes les informations sur les SNRs de tous les liens : SB-relais, SB-SSs and relais-SSs.

Dans le cas classique du relayage cooperative, le relais est capable de recevoir le signal émis par la SB vers la destination. Nous proposons maintenant grâce à l'utilisation de la Modulation Hiérarchique (MH) de transmettre un signal supplémentaire au relais. Le relais dans ce cas, est capable de décoder les deux signaux, ce qui va lui permettre de décoder une copie plus robuste.

Ce dernier signal va être transmis par la suite à la destination, lui permettant ainsi de décoder à son tour un signal plus robuste.

Nous allons maintenant nous intéresser à l'adaptation du débit transmis vers la destination sur le lien relais-destination. Nous proposons donc d'utiliser une modulation plus efficace permettant d'augmenter le débit. Notons que généralement le relais utilise la même modulation que celle utilisée sur le lien SB-destination. La constellation utilisée est moins efficace (en termes d'efficacité spectrale) à cause des mauvaises conditions radio du lien SB-destination. Notons par  $M$  la constellation utilisée sur le lien SB-destination et par  $M'$  la constellation maximale que nous pouvons utiliser sur le lien relais-destination.

En utilisant une modulation adaptative au niveau du lien relais-destination, le coût des ressources additionnelles est diminué. Considérant un schéma d'accès temporel, on propose d'allouer pour chaque utilisateur  $\beta = \frac{\log_2(M')}{\log_2(M)}$  time slots. Dans ce cas, le relais va utiliser 1 seul time slot pour relayer  $\beta$  signaux robustes à la destination.

## 4.2 Modélisation au niveau flux

Nous proposons maintenant de modéliser notre système au niveau flux. Nous utiliserons le même modèle Processor Sharing (PS) décrit dans le premier chapitre.

Nous considérons que les utilisateurs sont divisés en deux groupes : des utilisateurs de type 1 proches de la station de base et des utilisateurs de

type 2 lointains de la station de base.

Nous supposons que les utilisateurs lointains peuvent ne pas décoder correctement les signaux émis par la SB. Nous supposons aussi que  $I$  relais sont introduits dans la cellule.

Notons par  $P^R$  la probabilité que l'utilisateur à servir a besoin d'être assisté par un relais et par  $P$  la probabilité d'être sous couverture d'un relais.

#### 4.2.1 Cas classique de relayage

Dans le cas d'un système de coopération classique le débit  $c^2$  des utilisateurs de type 2, donné par Eqn. (2.3), est maintenant multiplié par :

$$\frac{(s^1 + s^2)((1 - P^R) + PP^R)}{s^1 + (1 - P^R)s^2 + 2P^R s^2}$$

Ce changement de débit des utilisateurs de type 2 cause à son tour un changement du débit des utilisateurs de type 1. Le débit  $c^1$ , donné par Eqn. (2.3), est maintenant multiplié par :

$$\frac{s^1 + s^2}{s^1 + (1 - P^R)s^2 + 2P^R s^2}$$

#### 4.2.2 Cas d'utilisation de la MH et d'adaptation du lien

En utilisant la MH et l'adaptation de lien, les débits des deux types d'utilisateurs vont changer. Le débit  $c^2$  des utilisateurs de type 2, donné par Eqn. (2.3), est maintenant multiplié par :

$$\frac{\beta PP^R + \beta(1 - P^R)}{\beta s^1 + \beta(1 - P^R)s^2 + (\beta + 1)P^R s^2}(s^1 + s^2)$$

Le débit  $c^1$  des utilisateurs de type 1, donné par Eqn. (2.3), est maintenant multiplié par :

$$\frac{\beta(s^1 + s^2)}{\beta s^1 + \beta(1 - P^R)s^2 + (\beta + 1)P^R s^2}$$

### 4.3 Proposition d'amélioration de performances

Nous proposons maintenant une extension permettant d'améliorer d'avantage le débit total du système. Nous proposons d'exploiter les bonnes conditions radio des utilisateurs de type 1 pour leur envoyer un débit supplémentaire. Dans ce cas, en utilisant la MH, la SB va pouvoir transmettre un signal additionnel vers le relais et un autre signal vers un utilisateur de bonnes conditions radio comme le montre la figure 4.1.

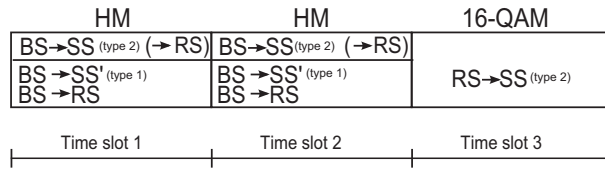

FIGURE 4.1 – Utilisation de la MH et de l'adaption de lien

A chaque fois où un utilisateur de type 2 est servi, les utilisateurs de type 1 recevront un débit supplémentaire donné par :

$$c^{add1} = \sum_{n=1}^{N/2} \frac{W}{N} \log_2 \left( 1 + \frac{p_{k^*,n} |h_{k^*,n}|^2}{\Gamma(\sigma_{k^*,n})^2} \right)$$

Le débit total des utilisateurs de type 1, donné par Eqn. (2.3), est maintenant multiplié par :

$$\frac{(s^1 + s^2)\beta(1 + \frac{c^{add1}}{c^1}PR)}{\beta s^1 + \beta(1 - PR)s^2 + (\beta + 1)PRs^2}$$

### 4.4 Evaluation des performances

Nous proposons maintenant de valider notre modélisation analytique et de quantifier le gain ainsi obtenu. Nous considérons que les utilisateurs de type 1 utilisent la modulation 16-QAM et que les utilisateurs de type 2 utilisent la modulation 4-QAM. Ces derniers peuvent ou pas décoder correctement leurs signaux transmis par la SB. Nous supposons aussi que nous avons un nombre suffisant de relais pour pouvoir assister tous les utilisateurs de type 2.

La figure 4.2 illustre la variation du temps moyen de transfert en fonction du trafic offert.

Les courbes représentent les résultats théoriques et les résultats de simulations pour le cas de relayage classique et pour le cas d'utilisation de la MH et d'adaptation de lien.

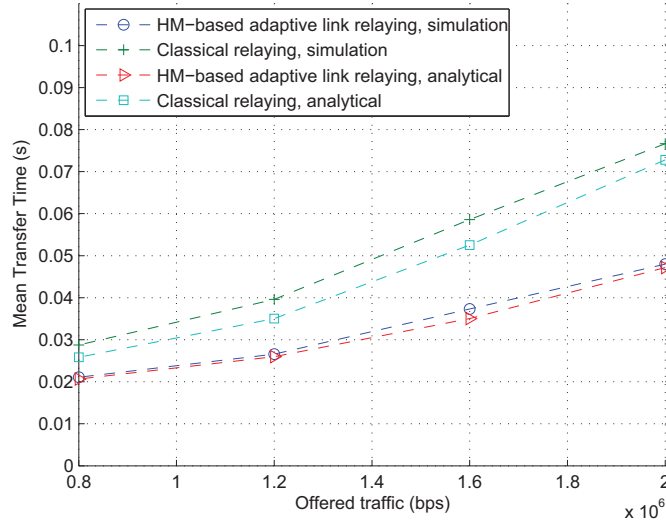

FIGURE 4.2 – Temps moyen de transfert global

Nous remarquons que les résultats de simulations permettent de valider nos résultats analytiques.

Nous observons aussi un gain obtenu par notre proposition par rapport au cas classique. La figure 4.3 montre la variation de la probabilité de blocage pour les deux cas mentionnés précédemment. Notre proposition permet aussi de diminuer la probabilité de blocage permettant ainsi d'améliorer d'avantage la capacité totale du système.

Les figures 4.4 et 4.5 illustrent la variation du temps moyen de transfert et le taux de blocage en fonction du trafic offert pour les deux algorithmes : utilisation de la MH et d'adaptation de lien et notre extension.

Nous remarquons que notre extension permet d'améliorer les performances par rapport au cas d'utilisation de la MH et d'adaptation de lien.

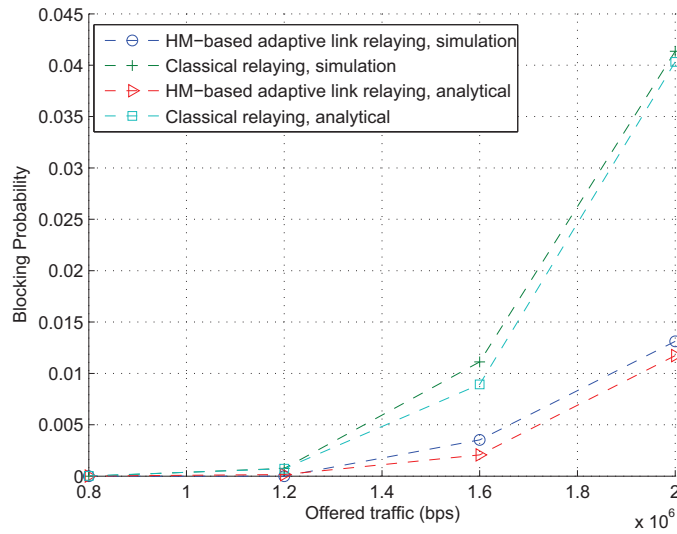

FIGURE 4.3 – Probabilité de blocage

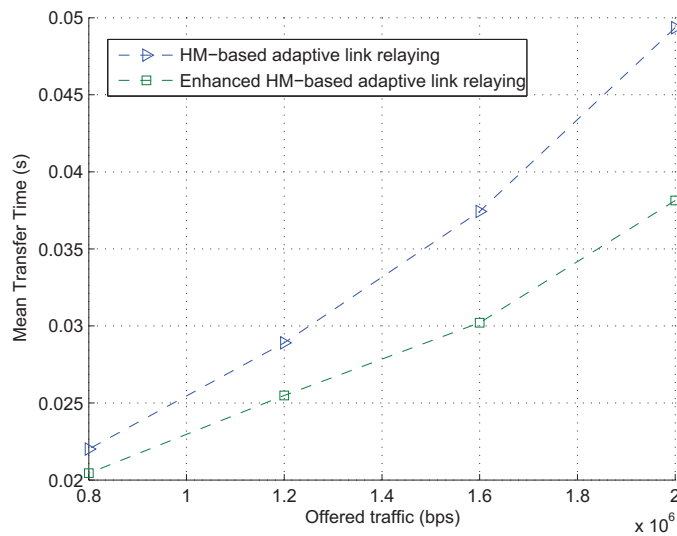

FIGURE 4.4 – Temps moyen de transfert global

## 4.5 Conclusion

Dans ce chapitre nous avons modélisé au niveau flux l'utilisation de la modulation hiérarchique dans un système OFDMA avec relais. Nous nous sommes intéressés au cas du relayage coopératif où les utilisateurs de mau-

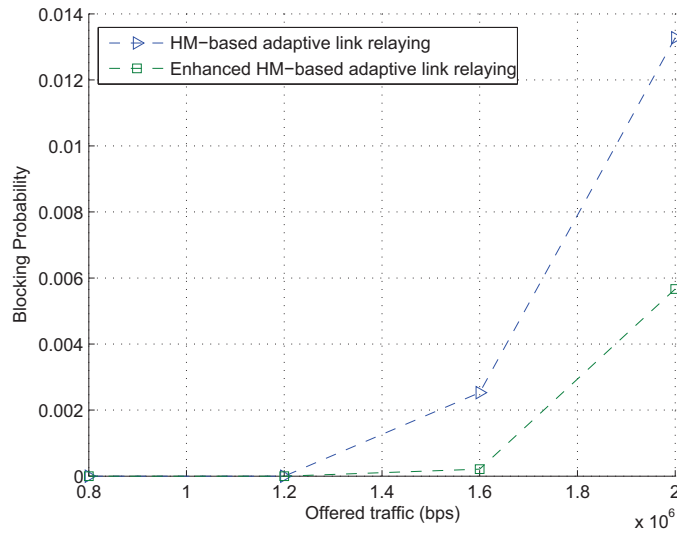

FIGURE 4.5 – Probabilité de blocage

vaises conditions radio ont besoin des relais pour pouvoir décoder leurs propres signaux.

Nous avons montré que l'utilisation de la modulation hiérarchique et l'adaptation de la modulation sur le lien relais-destination permettent d'améliorer le débit total du système par rapport au cas de coopération classique.

Nous avons aussi proposé une extension permettant de transmettre un débit supplémentaire aux utilisateurs de type 1 en exploitant leurs bonnes conditions radio. Cela permet d'améliorer les performances du système en termes de débit total et de probabilité de blocage.

## Chapitre 5

# Utilisation de la modulation hiérarchique dans le cas du relayage non-coopératif

Dans ce chapitre nous proposons d'exploiter la modulation hiérarchique dans le cas d'un system où les relais ne sont pas utilisés pour assister les utilisateurs lointains afin de décoder leurs propres signaux émis par la station de base.

Nous évaluons les performances de notre système au niveau flux en termes de temps moyen de transfert et de probabilité de blocage.

### 5.1 Utilisation de la modulation hiérarchique

Généralement les relais sont utilisés pour assister les utilisateurs de mauvaises conditions radio afin qu'ils puissent décoder sans erreur leurs propres signaux envoyés par la station de base. Nous proposons, dans le cas ou les utilisateurs peuvent décoder leurs signaux en provenance de la station de base d'utiliser la Modulation Hiérarchique (MH) afin d'améliorer le débit total. Le schéma proposé est le suivant :

1. Dans la première étape nous proposons de transmettre deux signaux : un pour la destination et un pour le relais. Ceci est possible grâce à l'utilisation de la MH.

2. Dans la deuxième étape nous proposons de transmettre l'information reçue par le relais à son utilisateur (nous considérons dans notre cas le même utilisateur choisi dans la première étape).

La figure suivante résume notre proposition.

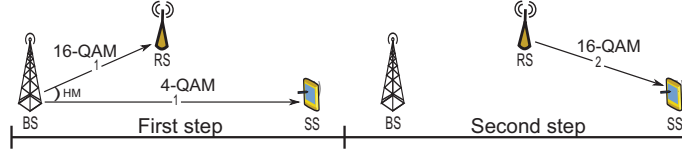

FIGURE 5.1 – Utilisation de la MH

## 5.2 Modélisation au niveau flux

Nous allons maintenant modéliser notre système au niveau flux tout en considérant une configuration dynamique des utilisateurs. Pour cela, nous utiliserons le même système Processor Sharing décrit dans le premier chapitre.

Nous considérons aussi les mêmes probabilités  $P$  et  $P^R$  décrites dans le chapitre précédent.

Le débit des utilisateurs de type 2, donné par Eqn. (2.3), est maintenant multiplié par :

$$\frac{PP^R + (1 + \alpha P)(1 - P^R)}{s^1 + 2(1 - P^R)s^2 + 2P^R s^2} (s^1 + s^2) \quad (5.1)$$

Le débit des utilisateurs de type 1, donné par Eqn. (2.3), est maintenant multiplié par :

$$\frac{s^1 + s^2}{s^1 + 2(1 - P^R)s^2 + 2P^R s^2} \quad (5.2)$$

Nous supposons que tous les utilisateurs de type 2 sont capable de décoder leurs propres signaux sans assistance des relais.

Les deux figures 5.2 et 5.3 illustrent la variation du temps moyen de transfert ainsi que le taux de blocage en fonction du trafic offert.

Nous remarquons que les deux courbes se suivent ce qui nous permet de valider notre modèle analytique.

Nous représentons sur les deux figures 5.4 et 5.5 la variation du temps moyen de transfert et la probabilité de blocage pour 3 cas : notre schéma



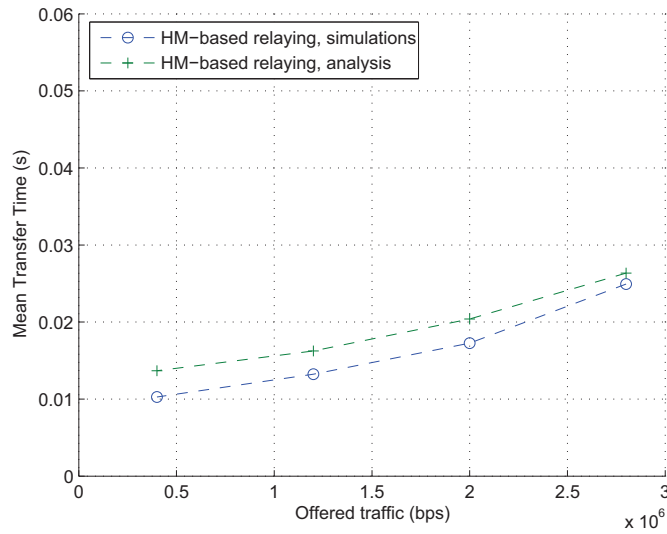

FIGURE 5.2 – Temps moyen de transfert global

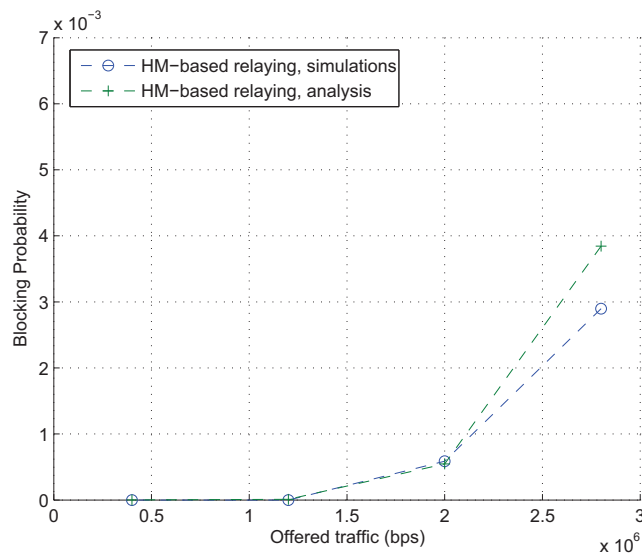

FIGURE 5.3 – Probabilité de blocage

d'utilisation de MH avec les relais, cas du Round Robin sans utilisation de la MH et le cas du Round Robin avec MH.

Nous observons que notre proposition permet de diminuer le temps moyen de transfert et le taux de blocage par rapport aux deux autres algorithmes.

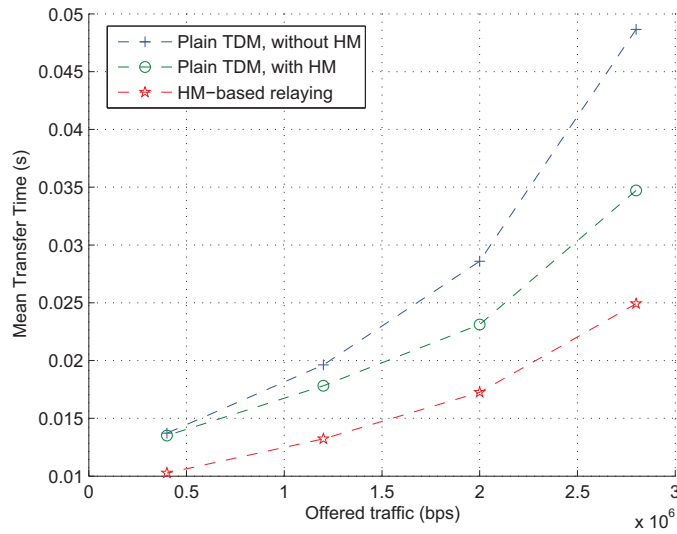

FIGURE 5.4 – Temps moyen de transfert global

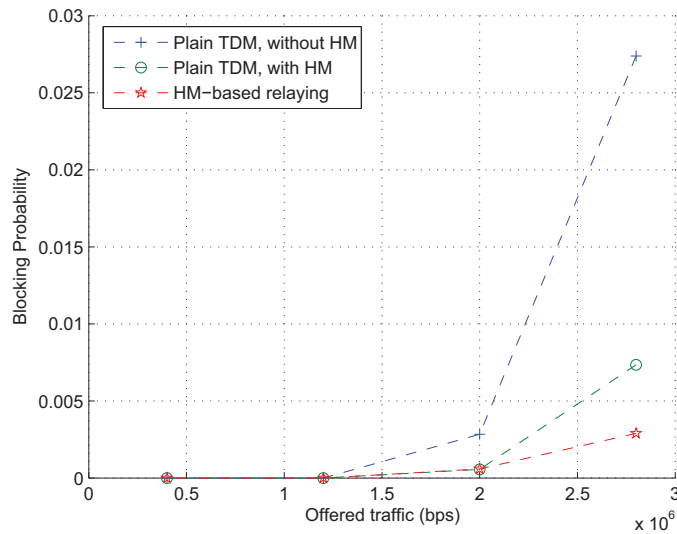

FIGURE 5.5 – Probabilité de blocage

### 5.3 Conclusion

Nous avons considéré dans ce chapitre l'utilisation de la modulation hiérarchique dans un système OFDMA avec relais où les utilisateurs sont capables de décoder correctement leurs signaux transmis par la station de

base. Nous avons proposé d'utiliser la modulation hiérarchique afin de transmettre un signal supplémentaire aux utilisateurs de mauvaises conditions radio. Nous avons modélisé au niveau flux notre proposition, et nous avons quantifié le gain obtenu par rapport aux deux cas : Round Robin avec et sans utilisation de la modulation hiérarchique.

## Chapitre 6

# Conclusion

Nous avons proposé dans ce travail d'exploiter la modulation hiérarchique dans les systèmes OFDMA. Nous avons, tout d'abord, commencé par utiliser la modulation hiérarchique dans le cas où les ressources sont initialement allouées avec l'algorithme Round Robin. Nous avons modélisé et quantifié le gain ainsi obtenu. Nous avons aussi proposé deux extensions permettant d'améliorer le débit total du système. Nous avons ensuite étudié l'impact de l'utilisation de la modulation hiérarchique sur le proportional fairness. Nous avons modélisé notre système au niveau flux et nous avons comparé les performances obtenues aux deux algorithmes Round Robin et max-min. Nous avons montré que l'algorithme Round Robin permet d'avoir de bonnes performances par rapport au proportional fairness dans le cas d'utilisation de la modulation hiérarchique.

Dans la deuxième partie de la thèse, nous avons considéré l'utilisation de la modulation hiérarchique dans un système OFDMA avec relais. Nous avons étudié deux modes de relayage : un mode coopératif et un mode non-coopératif. Dans le cas coopératif, nous avons proposé d'utiliser la modulation hiérarchique afin d'envoyer un signal supplémentaire à la station relais pour lui permettre d'encoder un signal plus robuste par rapport au signal encodé dans le cas du relayage coopératif classique. Nous avons aussi proposé d'adapter le débit utilisé sur le lien relais-destination en utilisant une modulation plus efficace et nous avons montré que ceci permet de diminuer les coûts des ressources utilisées pour le relayage.

Dans le cas non-coopératif, nous avons utilisé la modulation hiérarchique afin de transmettre un signal supplémentaire aux les utilisateurs de mauvaises conditions radio. Nous avons modélisé au niveau flux notre proposition et nous l'avons comparée aux deux algorithmes : Round Robin sans utilisation de la modulation hiérarchique et Round Robin avec utilisation de la modulation hiérarchique. Nous avons montré, dans ce cas, que notre proposition permet d'avoir de meilleures performances par rapport aux deux autres algorithmes.