



HAL
open science

Energy management of a hybrid electric vehicle: an approach based on type-2 fuzzy logic

Javier Solano

► **To cite this version:**

Javier Solano. Energy management of a hybrid electric vehicle: an approach based on type-2 fuzzy logic. Electric power. Université de Franche-Comté, 2012. English. NNT: . tel-00699896

HAL Id: tel-00699896

<https://theses.hal.science/tel-00699896>

Submitted on 21 May 2012

HAL is a multi-disciplinary open access archive for the deposit and dissemination of scientific research documents, whether they are published or not. The documents may come from teaching and research institutions in France or abroad, or from public or private research centers.

L'archive ouverte pluridisciplinaire **HAL**, est destinée au dépôt et à la diffusion de documents scientifiques de niveau recherche, publiés ou non, émanant des établissements d'enseignement et de recherche français ou étrangers, des laboratoires publics ou privés.

THESE

présentée pour obtenir le grade de

Docteur de l'Université de Franche-Comté
École Doctorale : Sciences pour l'Ingénieur et Microtechniques
Spécialité : Sciences pour l'Ingénieur

Par

Javier SOLANO MARTÍNEZ

Ingénieur, Universidad Industrial de Santander, Bucaramanga, Colombie
M.Sc., Université de Franche-Comté Belfort, France

**Modélisation et supervision des flux énergétiques à bord d'un
véhicule hybride lourd : approche par logique floue de type-2**

**Energy management of a hybrid electric vehicle:
an approach based on type-2 fuzzy logic**

Soutenue le 8 février 2012 devant le jury composé de :

M. Bernard DAVAT	Président du jury	Université de Lorraine
M. Hamid GUALOUS	Rapporteur	Université de Caen Basse-Normandie
M. Benoît ROBYNS	Rapporteur	Ecole des Hautes Etudes d'Ingénieur, Lille
M. Michel AMIET	Examineur	Direction Générale de l'Armement, DGA
M. Bob JOHN	Examineur	De Montfort University, Royaume-Uni
M. Joeri VAN MIERLO	Examineur	Vrije Universiteit, Belgique
M. Daniel HISSEL	Directeur de la thèse	Université de Franche-Comté
Mme. Marie-Cécile PERA	Co-directrice de la thèse	Université de Franche-Comté
M. Samuel HIBON	Membre invité	ALSTOM Transport

Acknowledgments

I am very grateful with Bernard Davat, for being the chair of my thesis committee. Benoît Robyns and Hamid Gualous for their review of the manuscript and the suggestions they made to improve it. Joeri Van Mierlo, Robert John, Michel Amiet and Samuel Hibon examiners of the Ph.D for their participation and their interesting questions during my thesis defence.

I would like to thank my advisors Daniel Hissel and Marie-Cécile Péra, for their constant personal and professional support and guidance throughout this thesis. I am very grateful with them, not only for their advice but also for trusting in my work. It has been a pleasure and a privilege working with them.

I must also acknowledge Christophe Espanet, professor of the University of Franche-Comté, and principal advisor during my M.Sc. He is not only a great researcher but also is an exceptional person who I truly admire.

Thanks goes to the staff of Femto-ST Laboratory. Thanks to Fabien Harel and Jérôme Mulot, who help me to evaluate and to improve my research (and also my abilities in babyfoot). Thanks to Karine Diez who help me with the experimental setup at FC Lab. Thanks to Isabelle Christen and Laurence Mary for their help in the quotidian.

Thanks also goes to the partners of the ECCE project, Michel Amiet, head of engineering with the DGA (French Army), for giving me the opportunity to work in this interesting project. Thanks to Ivan Rodel and the staff of PANHARD, HELION and CIRTEM for their kindness.

I am grateful with Robert John, Simon Coupland, Stephen Matthews, David Elizondo and all the members of the CCI. I have really enjoyed working and sharing with them during the summer 2010. I am grateful to the SPIM doctoral school of the University of Franche-Comté, for the financial support to realise this part of my research at Leicester in United Kingdom.

I am grateful with all the experts who kindly accept to participate in the survey to design the fuel cell system fuzzy logic controller: Rochdi Trigui, (IFSTTAR Institute, France), Christopher Romaus (University of Paderborn, Germany), Ricardo Pinto (University of Porto, Portugal). Daniel Bienaime, Daniel Hissel and Marie-Cécile Péra, (Université de Franche-Comté), Vicente Azuedo (Fundación para el Desarrollo del Hidrógeno, Aragon, Spain), Yuan Chen (Harbin University, China), Harry Luque (PSA, Peugeot Citroën, France) and Loïc Boulon (Université de Quebec à Trois-Rivières, Canada).

I also acknowledge Samuel Hibon who gives me the opportunity to continue my research as a postdoctoral researcher at Alstom Transport (and also for the time he allows me to prepare my Ph.D. dissertation). I am convinced that ecodriving and optimal control is a really interesting continuation of my research.

I would like to thanks my friends and colleagues, at Belfort Daniel, Joseba, François, Charly, Vincent, Jérôme, Raissa, Minh, Destiny, Nathalie, Serge... My friends at Leicester Stephen, Ben, Zoey, John and Rikka, Luis... my fellows at Belfort Andres and Victoria, Jorge, Mario, Andrés, William, Akamitl, Adriana, Carlos, Tata, Julian...

Finally, I am grateful with my family and with Elvira who support me through it all

I may never find all the answers

I may never understand why

I may never prove what I know to be true

but I know that I still have to try

Jhon Petrucci - Dream Theater

Résumé

Le transport des personnes et des marchandises représente plus de 25% de la consommation d'énergie et est l'une des principales sources de pollution dans le monde. Plusieurs efforts doivent être faits pour réduire la dépendance du pétrole, la consommation d'énergie et l'impact environnemental des systèmes de transport. Dans cette perspective, la Direction Générale de l'Armement a soutenu la conception et la réalisation du banc d'Evaluation de Composantes de la Chaîne Electrique (ECCE). Il s'agit d'un laboratoire mobile qui permet d'évaluer dans des conditions d'utilisation réelles, les différentes composantes énergétiques utilisées dans les véhicules électriques.

Les travaux de cette Thèse de Doctorat s'inscrivent dans le contexte du projet ECCE. Le principal objectif est de concevoir, d'implanter et de valider expérimentalement un système temps réel de gestion d'énergie pour véhicule électrique hybride. L'architecture énergétique retenue pour cette étude comporte un banc de batteries au plomb, un système pile à combustible et un banc de supercondensateurs.

Nous proposons un système de gestion d'énergie qui permet de prendre en compte l'expertise de plusieurs spécialistes sur ces sujets. La conception du système de gestion d'énergie est ainsi réalisée en utilisant une enquête conçue pour extraire la connaissance des experts du domaine (10 experts de différentes affiliations). La logique floue de type 2 permet d'intégrer de l'incertitude dans les réponses et ainsi de considérer simultanément les différents avis des experts.

Ce travail présente dans une première partie l'étude des modèles des sources énergétiques et de la structure de commande du véhicule. Cette structure est basée sur la Représentation Energétique Macroscopique (REM). Des résultats de simulation et de validation expérimentale d'une méthodologie pour paramétrer le modèle équivalent des supercondensateurs sont également présentés.

La deuxième partie est consacrée à l'étude des systèmes logique floue de type 2. Ces systèmes sont étudiés et présentés en utilisant un exemple numérique. En complément des travaux menés sur l'implantation logicielle de la logique floue de type 2, une application a été conçue, implantée et validée expérimentalement : il s'agit du contrôle de la tension de sortie d'un hacheur dévolteur. L'objectif principal de cette application était de permettre une pré-validation de l'application de la logique floue de type 2 dans le cas d'applications industrielles.

Finalement, le système de gestion d'énergie proposé a été validé successivement par des simulations, des essais statiques expérimentaux, des essais de roulage en mode d'opération normale et en mode d'opération dégradée. Nous avons mis en évidence que la logique floue de type 2 est particulièrement bien adaptée pour des applications temps réel dans le domaine du génie électrique.

Mots clés

- Véhicules électriques hybrides
- Gestion d'énergie
- Logique floue de type 2
- Traitement de l'incertitude
- Modélisation de l'expertise humaine
- Piles à combustible, supercondensateurs, batteries
- Simulation, validation expérimentale
- Représentation énergétique macroscopique, structure de commande

Contents

Introduction	1
1 Background and Motivation	5
1.1 Research overview	5
1.1.1 FEMTO-ST Laboratory	6
1.1.2 ENERGY research department	6
1.1.3 SHPAC research group	6
1.1.3.1 Former related research	6
1.1.4 Centre for Computational Intelligence (CCI)	7
1.2 ECCE test bed hybrid electrical vehicle	7
1.3 Hybrid electrical vehicles	9
1.3.1 HEV classification	10
1.3.2 HEV energy sources	10
1.3.2.1 Hybridisation of sources	11
1.4 HEV Energy management	11
1.4.1 Off-line strategies	12
1.4.1.1 Dynamic programming	12
1.4.1.2 Frequency-based energy management strategies	13
1.4.2 On-line strategies	13
1.4.2.1 DC voltage regulation	14
1.4.2.2 Predictive energy management	14
1.4.2.3 Global position based energy management systems	14
1.4.2.4 Stochastic dynamic programming	15
1.4.2.5 State-of-charge regulation	15
1.4.2.6 Acceleration based strategy	15
1.4.3 Fuzzy logic based strategies	15
1.4.3.1 Fuzzy system output : absolute output reference	16
1.4.3.2 Fuzzy output: variation on the absolute output reference	17
1.4.3.3 Fuzzy logic controllers design	17
1.5 Energetic Macroscopic Representation based control	18
1.5.1 Energetic Macroscopic representation	18
1.5.2 Maximal control structure	19

1.5.3	Practical control structure	19
1.5.4	Control Strategy	20
1.5.5	Related works	20
1.6	Soft computing and type-2 fuzzy logic	22
1.6.1	Fuzzy logic	22
1.6.2	Type-2 fuzzy logic	23
1.7	Chapter conclusion	23
2	ECCE energy sources: modelling and control	25
2.1	Batteries and DC bus	26
2.1.1	Modelling and parameter identification	27
2.1.1.1	State-of-charge	28
2.1.2	Representation and control structure	29
2.2	Ultracapacitor system	30
2.2.1	Modelling	31
2.2.2	Parameter identification	32
2.2.2.1	Experimental measurements	32
2.2.2.2	Minimisation function constraints and parameters	33
2.2.2.3	Minimisation function: iterative procedure	34
2.2.2.4	Experimental validation	35
2.2.3	State-of-charge	36
2.2.4	Representation and control structure	37
2.3	Fuel cell system	37
2.3.1	Motor-compressor group	39
2.3.2	Gas supply	40
2.3.2.1	Fuel cell stack	40
2.3.3	Power Electronics	42
2.3.4	Fuel cell system	42
2.3.5	Maximal control structure	42
2.3.6	Practical control structure	42
2.3.6.1	MCS Simplifications	44
2.3.6.2	Estimated Variables	44
2.3.6.3	Motor-compressor group	45
2.3.6.4	Complete PCS	45
2.4	Flywheel system	45
2.4.1	Representation	48
2.4.1.1	Mechanical part	48
2.4.1.2	Electrical part	49
2.4.1.3	Flywheel system	49
2.5	Traction chain and ancillaries	49
2.5.1	Modelling of the traction chain	50

CONTENTS

2.6	ECCE representation and control structure	51
2.7	Chapter conclusion	54
3	Type-2 fuzzy logic control of a DC/DC buck converter	55
3.1	Fuzzy logic control and uncertainty	56
3.1.1	Uncertainty	56
3.2	Rule-base	57
3.3	Membership functions	57
3.3.1	Interval type-2 membership functions	58
3.3.2	Membership functions creation	59
3.3.3	Centroid of an interval type-2 fuzzy membership function	59
3.3.3.1	Karnik-Mendel algorithm	61
3.4	Fuzzifier	62
3.4.1	Fuzzifier example	63
3.5	Inference Engine	64
3.5.1	Inference Engine example	64
3.6	Output Processor	65
3.6.1	Type-reducer	65
3.6.2	Defuzzificator	66
3.6.3	Output Processor example	66
3.7	Buck converter voltage controller	67
3.7.1	Overview	67
3.7.2	Input	68
3.7.3	Input normalisation	68
3.7.4	Fuzzy logic controller	68
3.7.5	Fuzzy logic controller output denormalisation	68
3.7.6	Controller Output - Duty cycle	68
3.7.7	Fuzzy logic controller	68
3.8	Fuzzy logic system design	69
3.8.1	Rule-base design	69
3.8.2	Input membership functions design	69
3.8.2.1	Parameters	70
3.8.3	Output membership functions design	72
3.8.4	Fuzzy logic control surfaces	72
3.9	Fuzzy controller evaluation and validation	73
3.9.1	Evaluation of the controller	74
3.9.2	Validation results	74
3.10	Chapter conclusion	75

4	ECCE energy management strategy based on type-2 fuzzy logic	79
4.1	Global energy management strategy	80
4.1.1	Global energy management strategy objectives	80
4.1.2	Global energy management strategy inputs	80
4.1.3	Global energy management strategy outputs	81
4.1.4	Local energy management strategies overview	81
4.2	Batteries energy management strategy	82
4.2.1	Batteries local EMS parameters	82
4.2.2	Batteries additional power (state-of-charge control)	83
4.2.3	Batteries additional power correction (voltage limitations)	83
4.3	UCS energy management strategy	84
4.3.1	UCS management strategy parameters	84
4.3.2	UCS reference power	85
4.3.3	UCS power reference dynamic limitation	86
4.3.4	UCS reference power static limitation	86
4.4	FCS energy management strategy	87
4.4.1	Fuel cell system energy management parameters	87
4.4.2	Fuzzy logic controller inputs	88
4.4.3	Input normalisation	88
4.4.4	UC SOC dynamic reference (UC SOC control)	88
4.4.5	Fuzzy logic controller design	89
4.4.5.1	Fuzzy rules	89
4.4.5.2	Fuzzy membership functions	90
4.4.5.3	Fuzzy logic controller - example	90
4.4.6	Fuzzy logic controller output	95
4.4.7	Integration of the local EMS into the global strategy	96
4.5	Degraded operation strategies	96
4.5.1	Degraded operation without FCS	97
4.5.2	Degraded operation without UCS	97
4.6	Simulation validation	97
4.6.1	Simulation parameters	98
4.6.2	Simulation results	98
4.7	Experimental validation	100
4.7.1	Static validation	100
4.7.1.1	Experimental setup	100
4.7.1.2	Static validation parameters	103
4.7.1.3	Static validation results - global EMS	103
4.7.1.4	Static validation results - UCS local EMS	105
4.7.1.5	Static validation results - FCS local EMS	105
4.7.2	Driving validation	106
4.7.2.1	Driving validation parameters	107

CONTENTS

4.7.2.2	Nominal operation conditions results	107
4.7.2.3	Degraded operation without UCS	109
4.7.2.4	Degraded operation without FCS	109
4.8	Chapter conclusion	110
Conclusion		113
A	Interval type-2 fuzzy logic system software implementation	117
A.1	Membership functions creation	117
A.2	Fuzzy sets creation	118
A.2.1	Fuzzy sets implementation using Matlab	118
A.3	Centroid of a type-2 fuzzy MF	118
A.3.1	Centroid computation using Matlab	118
A.3.1.1	Left point of the centroid: KMA	119
A.3.2	Centroid example	119
A.4	Fuzzifier	119
A.4.1	Fuzzifier implementation using Matlab	121
A.5	Inference engine	121
A.5.1	Inference engine implementation using Matlab	122
A.6	Output processor	122
A.6.1	Output processor implementation using Matlab	122
A.6.1.1	Left point of the type-reductor: KMA	123
A.7	Fuzzy logic control software implementation	124
A.7.1	Software implementation - Validation	124
A.7.2	Matlab graphic user interfaces - Fuel cell fuzzy logic controller	124
A.7.2.1	Matlab graphic user interface	124
B	Survey-based fuzzy logic system for ECCE energy management	127
B.1	Energy management survey	127
B.1.1	Energy management survey sample	127
B.2	Survey processing	132
B.2.1	Fuzzy sets design (membership functions)	132
B.2.1.1	Trapezoidal membership functions definition	132
B.2.1.2	Triangular membership functions definition	133
B.2.1.3	Membership functions - Results	133
B.2.1.4	Membership functions - Centroids	133
B.2.2	Fuzzy rules design	134
B.2.2.1	Fuzzy rules design - Exemple	134
B.2.3	Fuzzy logic control surface	134
Bibliographie		153

List of Tables

1.1	FEMTO-ST Energy department related research	7
1.2	Basic EMR elements	20
1.3	Complementary EMR elements I	21
1.4	Complementary EMR elements II	22
1.5	Some type-2 fuzzy logic-based applications	24
2.1	ECCE batteries parameters	27
2.2	ECCE ultracapacitor system parameters	31
2.3	UC parameters (single bank)	35
2.4	UC parameters (both banks)	35
2.5	ECCE fuel cell system parameters	39
2.6	Fuel cell system control - required measurements	46
2.7	ECCE flywheel system parameters	47
2.8	ECCE vehicle simulation parameters	51
3.1	Weighted averages of the 4 interval type-1 MF	61
3.2	Centroids of the fuzzy MFs for ΔP	62
3.3	Fuzzy rules	64
3.4	Fuzzy controller rules	70
3.5	Buck converter - Simulation and Experimental parameters	73
3.6	Type-2 fuzzy logic controller - Simulation and Experimental parameters	74
3.7	Validation results - IAE	75
4.1	Global objectives of the EMS and it compatibility with the sources	82
4.2	Batteries local energy management strategy parameters	83
4.3	Ultracapacitor system local energy management strategy parameters	85
4.4	Fuel cell system local energy management strategy parameters	88
4.5	Processed survey results: Fuzzy Rules	91
4.6	Fuzzy Rules MFs: Interval bounds	92
4.7	Simulation parameters	99
4.8	Experimental static validation EMS parameters	103
4.9	Experimental validation EMS parameters	107

A.1 Centroids of the fuzzy MFs for ΔP 120

B.1 Processed survey results: ΔP Linguistic labels 132

B.2 Processed survey results: ΔSOC Linguistic labels 132

List of Figures

1.1	ECCE test bed	7
1.2	ECCE test bench construction	8
1.3	ECCE test bench construction (electrical machines)	8
1.4	ECCE Phase 1	9
1.5	ECCE Phase 2 - configuration 1	9
1.6	ECCE Phase 2 - configuration 2	9
1.7	ECCE Phase 2 - configuration 3	9
1.8	ECCE history	9
1.9	HEV series architecture	10
1.10	HEV parallel architecture	10
1.11	HEV series-parallel architecture	10
1.12	Ragone plot including ECCE energy sources	11
1.13	NEDC driving cycle	12
1.14	French CO ₂ label for new vehicles	12
1.15	Frequency approaches for energy management	13
1.16	Traffic prediction controller for energy management	14
1.17	Fuzzy logic controllers used in HEV energy management	16
1.18	Fuzzy logic controllers used in HEV energy management II	17
1.19	EMR-based control methodology	19
2.1	Lead-acid batteries schematic diagram and construction	26
2.2	Lead-acid batteries implemented in ECCE	27
2.3	Ceraolo's lead-acid batteries model	28
2.4	Batteries and DC bus EMR	29
2.5	Batteries and DC bus EMR	29
2.6	UC schematic and electrode active layer pore representation	30
2.7	SAFT ultracapacitors implemented in ECCE	31
2.8	Different ultracapacitor models	32
2.9	Retained UC equivalent circuit model	32
2.10	UC equivalent circuit parameters identification flowchart	34
2.11	UC equivalent circuit parameter identification - Simulink application	34
2.12	UC equivalent circuit parameter identification - Validation results I	35

2.13 UC equivalent circuit parameter identification - Validation results II	36
2.14 Ultracapacitor system EMR and control structure	37
2.15 Fuel cell stack schematic and system multi-domain aspects	38
2.16 Fuel cell system implemented in ECCE	39
2.17 Motocompressor group EMR	40
2.18 Stack gaz supply EMR	41
2.19 Fuel cell stack EMR	41
2.20 Fuel cell system DC/DC power converter EMR	42
2.21 Fuel Cell system EMR	43
2.22 Fuel Cell system MCS	43
2.23 Fuel Cell system gaz supplies PCS	44
2.24 Air motocompressor group PCS	45
2.25 Fuel cell system practical control structure	46
2.26 Flywheel system implemented in ECCE	47
2.27 ECCE flwheel system homopolar synchronous machine	47
2.28 Flywheel system - Mechanical part EMR	48
2.29 Flywheel system - Electrical part EMR	49
2.30 Flywheel system implemented in ECCE	49
2.31 Road-vehicle free body diagram	50
2.32 ECCE Energetic Macroscopic Representation	52
2.33 ECCE Maximal Control Structure	53
2.34 ECCE Practical Control Structure	53
3.1 Sources of uncertainty	56
3.2 Type-1 fuzzy logic systems architecture	57
3.3 Type-2 fuzzy logic systems architecture	57
3.4 Singleton fuzzy logic membership function	58
3.5 Interval type-1 fuzzy logic membership function	58
3.6 Type-1 fuzzy logic membership function	58
3.7 Interval type-2 fuzzy logic membership function	58
3.8 General type-2 fuzzy logic membership function	58
3.9 Interval type-2 fuzzy logic primary and secondary MFs	59
3.10 Trapezoidal membership functions example	59
3.11 Triangular membership function example	59
3.12 An interval type-2 MF discretised into p interval type-1 MFs	60
3.13 Interval type-2 MF discretised into 4 interval type-1 MFs	60
3.14 KMA flow-chart to compute the left point of the centroid	62
3.15 Membership Functions for input x_1	63
3.16 Membership Functions for input x_2	63
3.17 Fuzzifier example I	63
3.18 Fuzzifier example II	64

LIST OF FIGURES

3.19	Inference-engine: firing degree for Rule 2 (product inference)	64
3.20	Inference-engine: Firing degrees for all the activated rules	65
3.21	The inference engine	65
3.22	KMA flow-chart to compute the right point of the type-reduced set	66
3.23	The output processor example	66
3.24	The output processor	66
3.25	Buck converter	67
3.26	DC/DC buck output voltage controller	67
3.27	DC/DC power converter voltage controller	69
3.28	Step 1: Definition of the type-1 fuzzy membership functions	70
3.29	Step 2: Definition of the type-2 fuzzy membership functions	71
3.30	Type-1 fuzzy membership functions ($U=0\%$) to represent e and de	71
3.31	Type-2 fuzzy membership functions ($U=20\%$) to represent e and de	71
3.32	Type-2 fuzzy membership functions ($U=50\%$) to represent e and de	72
3.33	Singleton membership functions	72
3.34	Type-2 fuzzy logic control surfaces $U=0\%$, $U=20\%$ and $U=50\%$	72
3.35	DC/DC converter experimental setup	73
3.36	Simulation results	76
3.37	Experimental results	77
4.1	Global EMS as implemented in Matlab Simulink	81
4.2	Batteries state-of-charge control strategy	84
4.3	Batteries additional power correction	84
4.4	Batteries local energy management strategy	85
4.5	UCS reference power dynamic limitation	86
4.6	Ultracapacitor local energy management strategy	87
4.7	UC state-of-charge dynamical reference	89
4.8	Interval type-2 fuzzy membership functions to represent ΔP	93
4.9	Interval type-2 fuzzy membership functions to represent ΔSOC	94
4.10	FCS energy management: type-2 fuzzy logic normalised control surface	95
4.11	Fuel cell system local energy management strategy	96
4.12	Global EMS as implemented in Matlab Simulink - detail	96
4.13	Degraded operation strategy - FCS failure	97
4.14	Degraded operation strategy - UCS failure	98
4.15	EMS simulations results - Normalised driving cycle	101
4.16	EMS simulations results - Real driving cycle	102
4.17	Static validation schema (left) - experimental setup (right)	103
4.18	Experimental results - Static validation I - Global Strategy	104
4.19	Experimental results - Static validation II - UCS local strategy	106
4.20	Experimental results - Static validation III - FCS local strategy	106
4.21	ECCE test bed driving validation at PANHARD	107

4.22 Experimental results - Drive validation I	108
4.23 Experimental results - Drive validation II	109
4.24 Experimental results - Drive validation III	110
4.25 Experimental results - Drive validation IV	110
A.1 KMA flow-chart to compute the right point of the centroid	120
A.2 A type-2 membership functions and its centroid	120
A.3 Fuzzification flow-chart	121
A.4 Inference-engine flow-chart	122
A.5 KMA flow-chart to compute the left point of the type-reduced set	123
A.6 Matlab application to compute the fuzzy logic surface	125
A.7 Type-1 and type-2 fuzzy maps, and their difference	125
B.1 HEV Fuzzy Energy Management Survey - Page 1/4	128
B.2 HEV Fuzzy Energy Management Survey - Page 2/4	129
B.3 HEV Fuzzy Energy Management Survey - Page 3/4	130
B.4 HEV Fuzzy Energy Management Survey - Page 4/4	131
B.5 Centroids of the interval type-2 fuzzy MFs representing ΔP	134
B.6 Rule 5 membership function	134

Introduction

One of the effects of the globalisation of our society is that people travel more covering longer distances, live far from their work place and consume goods from all around the world. Therefore, it is no coincidence that the transport of people and goods represents more than 25% of the energy consumption and is one of the principal sources of pollution worldwide. Several efforts must be done to reduce the oil dependence, the energy consumption and the environmental impact of transport systems.

In this perspective, the French Army (DGA) has designed and constructed the Electrical Chain Components Evaluation vehicle (ECCE). It is a mobile laboratory to evaluate under real conditions the electric components of Hybrid Electrical Vehicles (HEVs) that reduce the energy consumption and the pollution emission of conventional vehicles. ECCE permits evaluating different energy sources such as batteries, fuel cells, internal combustion engines, ultracapacitors or flywheels.

The ECCE project, nowadays in a second phase¹ is developed in joint cooperation with the FEMTO-ST laboratory of the University of Franche-Comté and two industrial partners, HELION and PANHARD General Defense. It aims to study the implementation, control and energy management of different hybrid sources.

As a research developed along the second phase of the ECCE project, the principal objective of this thesis is to design, to implement and to evaluate an energy management supervision system in the ECCE HEV. This thesis proposes an original energy management strategy based on expert knowledge and type-2 fuzzy logic. The design of the fuzzy logic controller is done by using knowledge engineering. This technique allows extracting knowledge from several experts using surveys. The consideration of type-2 fuzzy logic systems enables modelling the uncertainty in the answers of the experts.

This thesis presents a second application of type-2 fuzzy logic: the voltage regulation of a DC/DC power converter. The principal motivation for developing this application is that it is easier to implement in laboratory at a relatively low cost and it permits a viability evaluation of type-2 fuzzy logic before an implementation in the ECCE mobile laboratory. This is useful because one of the main challenges of this thesis is to reduce the time to

¹The first phase of the ECCE project is explained in Chapter 1

experimentally validate the energy management system. This is required to respect the time schedule constraints and to reduce the costs associated to gather the partners of the project at PANHARD locations in Saint-Germain Laval.

This thesis is structured in four chapters in the main body and two chapters in the appendix organised as follows:

Chapter 1 presents the research background and related state of the art.

Firstly, this chapter introduces the context of the research and presents the ECCE research project. Then, it introduces the hybrid electrical vehicles and presents a literature review about the techniques and methodologies used in their energy management, at the meantime it exposes the motivations to prefer fuzzy logic to perform the energy management in ECCE HEV. After that, the chapter presents the Energetic Macroscopic Representation (EMR) technique used to represent the vehicle and to identify its control structure. Finally, the chapter introduces the motivations to consider using type-2 fuzzy logic in engineering applications and particularly the energy management of the ECCE HEV. Finally, it presents a literature review about former applications based on type-2 fuzzy logic systems.

Chapter 2 is devoted to study the energy sources evaluated on the ECCE mobile laboratory, to wit: lead-acid batteries, a fuel cell system and an ultracapacitor system.

For each of the sources available in ECCE mobile laboratory, this chapter studies their characteristics, their modelling, their EMR and their control structure. The knowledge and understanding of the advantages and drawbacks of each of the sources is fundamental to study their implementation and to define their energy management strategies. Modelling and parameter identification is useful to simulate the vehicle and its energy management, a compulsory step before performing any experimental implementation. The EMR is useful to identify the measurements and estimations, and to define a practical control structure of the vehicle.

This chapter also presents an original procedure to identify the equivalent electric circuit of an ultracapacitor. This approach is experimentally implemented and validated.

Chapter 3 introduces type-2 fuzzy logic sets and systems. It also presents the first application of type-2 fuzzy logic control developed in this research: the voltage regulation of a DC/DC buck power converter.

After presenting the concept of uncertainty and type-2 fuzzy logic systems, this chapter introduces in detail the interval type-2 fuzzy logic systems (IT2-FLS) considered in this research. The chapter explains by using numerical examples the subsystems of an IT2-FLS (i.e. the fuzzy sets creator, the fuzzifier, the inference engine and the output processor). A toolbox is developed to implement IT2-FLS, however it is presented in Appendix A.

To introduce the applications of type-2 fuzzy logic, this chapter presents a fuzzy logic system used to control the output voltage of a buck converter. A classical structure of fuzzy logic controller is implemented to compare the performance of type-2 and type-1 fuzzy logic systems. The validation of the voltage controller is performed by simulation and by experimentation.

Chapter 4 is devoted to the design, implementation and validation by simulation and experimentation of the energy management system considered in the ECCE HEV.

This chapter presents the definition and the global Energy Management Strategy (EMS) implemented in the ECCE vehicle. This EMS considers the advantages and drawbacks of the different sources as explained in Chapter 2. As each source is independently controlled, the global EMS is divided in local EMSs for each of the sources. The local EMS for the fuel cell system is based on a survey-based type-2 logic system. To facilitate the lecture of this chapter, the design of this IT2-FLS is presented in Appendix B.

The proposed EMS is validated by simulations and by experimentation. The simulations are based on the EMR model of the vehicle developed in Chapter 2. Experimentally, the EMS is evaluated in two steps. Firstly, by connecting a variable resistance to the DC bus of the vehicle, secondly, by driving the vehicle in a driving cycle.

Appendix A presents the software developed to create the type-2 fuzzy logic control surfaces.

This software is used to map off-line the interval type-2 fuzzy logic systems used in Chapters 3 and 4. The software is presented by using flowcharts and structured programming. This appendix also proposes a toolbox to implement interval-type-2 fuzzy logic systems in Matlab. As an advantage, regarding other toolboxes presented in literature, our code does not require the use of the Matlab fuzzy logic toolbox.

Appendix B presents the design of fuzzy logic system used in Chapter 4.

The type-2 fuzzy logic system used in ECCE energy management system is designed by using human knowledge. An energy management survey was conducted among experts in hybrid electrical vehicles, the survey allows extracting expertise in the form of IF-THEN rules. The survey was mainly performed among the participants of the IEEE Vehicle Power and Propulsion Conference, September 2010 in Lille, France.

Chapter 1

Background and Motivation

This chapter presents the research background and related state of the art.

The research presented in this dissertation focuses on the study of energy management of Hybrid Electrical Vehicles (HEV) and type-2 fuzzy logic. After introducing the context of the research, this chapter presents and compares the techniques and methodologies used in HEV representation, modelling and energy management. This is done to identify the most adapted techniques to be used in next stages of the research. Finally, type-2 fuzzy logic is presented as a well adapted technique to perform energy management in HEV.

This chapter is organised as follows: Section 1.1 presents the research group where the research is performed. The ECCE vehicle is presented in Section 1.2. Section 1.3 introduces some basic concepts of Hybrid Electrical Vehicles (HEV) and their energy sources. A literature review about HEV energy management techniques is presented in Section 1.4. Section 1.5 presents the Energetic Macroscopic Representation (EMR), formalism used to study multiphysical systems as HEV. Section 1.6 presents soft computing and introduces the type-2 fuzzy logic. Finally, Section 1.7 presents the conclusions of the chapter.

1.1 Research overview

This research was performed in the Hybrid systems and fuel cell systems (SHPAC) research group (*Systèmes hybrides et systèmes PAC*), ENERGY research department of the FEMTO-ST Laboratory, Belfort, France. A part of this research was conducted as joint cooperation with the Centre for Computational Intelligence (CCI), De Montfort University at Leicester, United Kingdom.

The research was supported by the University of Franche-Comté under the ECCE-2 contract with the French Army General Direction (DGA). The training at the CCI was partially financed by the Doctoral School of Engineering Sciences and Microtechniques (SPIM) of the University of Franche-Comté.

1.1.1 FEMTO-ST Laboratory

FEMTO-ST (Franche-Comté Electronique Mécanique Thermique et Optique - Sciences et Technologies) is a joint research unit which is affiliated with the French Centre of Scientific Research (CNRS), the University of Franche-Comté (UFC), the National School of Mechanical Engineering and Microtechnology (ENSMM), and the Belfort-Montbéliard University of Technology (UTBM).

FEMTO-ST is organised according to the 6 following research departments: Automatic control & Micro-Mechatronic Systems department (AS2M), Energy department, Applied Mechanics department, Micro Nano department (MN2S), Optics department and Time Frequency department.

1.1.2 ENERGY research department

The ENERGY department of FEMTO-ST is involved in applied research, mainly around the following four axes:

1. Thermal flows and complex fluids
2. Unconventional thermal and electrical machines
3. Fuel cell systems
4. Hybrid energy systems (and hybrid electrical vehicles)

ENERGY department is located in the north of the Franche-Comté region and many of the research developed in this department is performed in cooperation with regional industrial partners as Alstom or PSA (Peugeot-Citroën group) among others.

1.1.3 SHPAC research group

The scientific aim of the SHPAC research group is around a systematic approach of multiphysics systems such as fuel cell systems or hybrid electrical vehicles. The group looks forward to develop original modelling approaches, real-time and less-expensive diagnostic and control systems. The aim of the research presented in this dissertation is clearly identified with the objectives of the SHPAC research group (multiphysics systems modelling and control, electrical vehicles and energy sources).

1.1.3.1 Former related research

The research developed in this project is the natural continuation of the line of research and development realised at ENERGY department from the last years. From the study of fuel cell systems control structure to optimisation of electrical machines used in electrical vehicles, a list of a few exemplary publications related with this research and developed in FEMTO-ST are listed in Table [1.1](#)

Table 1.1: FEMTO-ST Energy department related research

Domain	Application	References
HEV design, energy management & control	ECCE test bench	[Pusc02], [Espa06], [El K06], [Jeuv09], [Mulo10]
	Hybrid helicopters	[Asen11], [Bien11a], [Bien11b]
	Military and heavy-duty vehicles	[Wu09], [Wu10],[Boul10a]
	Railway vehicles	[Soug10], [Baer11a], [Baer11b]
	Urban vehicles	[Gran07], [Gran08], [Mai09], [Mai10], [Louk10]
Energy sources	Batteries	[Narj08]
	Source hybridisation	[Agbl11]
	Ultracapacitors	[Bien09], [Louk10], [Devi11]
	Stirling motor	[Sari08], [Gay10], [Gay11b]
Fuel cell systems	Diagnosis	[Hern06], [Narj08], [Wast10], [Yous11a], [Yous11b]
	PEMFCS modelling and control	[Chre08], [Jemi04], [Hiss08], [Laff08], [Boul10b], [Cuen11]
	SOFC modelling and control	[Chna08], [Gay11a], [Wang11]
	Ancillaries	[Teki04], [Duba06], [Sari08], [Chre10], [Bech10]

1.1.4 Centre for Computational Intelligence (CCI)

The CCI develops fundamental theoretical and practical solutions to real world problems using a variety of computational intelligence paradigms. Research carried out within the centre is conducted by three main teams of researchers: bio-health informatics, fuzzy logic, and intelligent mobile robots and creative computing. The Fuzzy Logic Group is interested in uncertainty models, including fuzzy sets and particularly in type-2 fuzzy logic.

1.2 ECCE test bed hybrid electrical vehicle

The Electrical Chain Components Evaluation vehicle (ECCE) is a research project supported by the French Army General Direction (DGA), (*Direction Générale de l'Armement*). This mobile laboratory is used for researches under real conditions on technological solutions for hybrid electrical vehicles. The ECCE vehicle, which was driven for the first time on 2003, is presented in Figure 1.1.



Figure 1.1: ECCE test bed

ECCE is a HEV specifically designed for real-world evaluation of electrical components such as electrical machines, power converters, energy sources or energy management systems. Its traction chain is composed by four independently controlled electrical machines which drive the vehicle (acting as motors) or recuperate the braking energy (acting as generators). To design different hybrid configurations, ECCE modular vehicle can be equipped with various energy sources such as Fuel Cell Systems (FCS), Internal Combustion Engines (ICE), Ultracapacitors (UCS), batteries and/or Flywheel Systems (FWS).

Phase I of ECCE project (1997-2005) was devoted to design, construction and evaluation of the vehicle (See Figures 1.2 and 1.3). This phase focused on the configuration shown in Figure 1.4, the study of energy management of the traction chain [Pusc02] and the energy sources [Diop04], and the evaluation of the batteries, vehicle electrical safety [El K06] and electrical machines [Espa06].



Figure 1.2: ECCE test bench construction



Figure 1.3: ECCE test bench construction (electrical machines)

Phase II of ECCE project (2008-2012) focuses on the integration, control and management of different energy sources available for transport applications (FCS, UCS, batteries, ICE and FWS). The Phase II of the ECCE project is managed by the University of Franche-Comté and counts with the participation of the following industrial partners: 1) Panhard General Defense (Saint Germain-Laval, Loire, France) supplier of military vehicles in charge of the mechanical integration and the flywheel system development and 2) Helion Hydrogen Power (Aix-en-Provence, France) subsidiary of Areva group, supplier of the FCS.

Figures 1.5, 1.6 and 1.7 presents the different hybrid configurations evaluated on phase II of ECCE (this dissertation focuses on the study of the second configuration). Figure 1.8 presents a time-line which resumes some of the research developed in ECCE mobile laboratory.

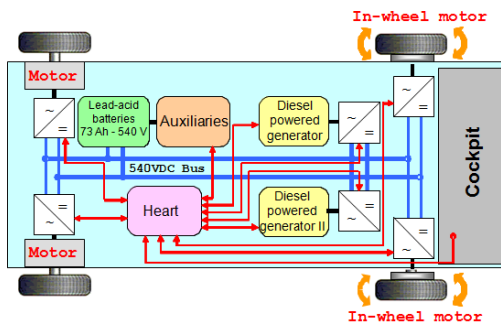

Figure 1.4: ECCE Phase 1

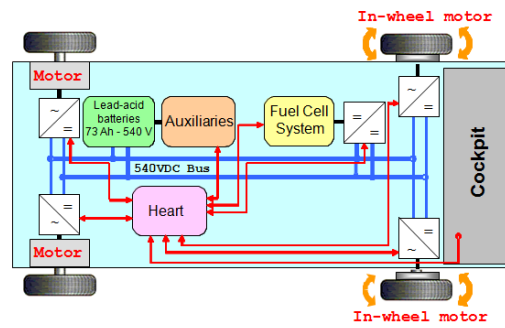

Figure 1.5: ECCE Phase 2 - configuration 1

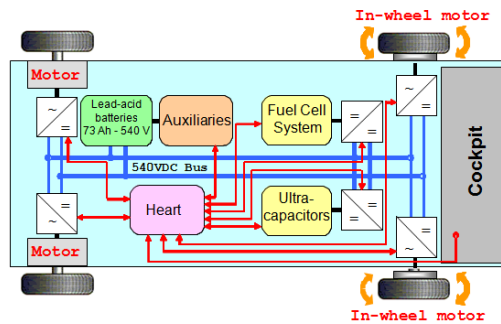

Figure 1.6: ECCE Phase 2 - configuration 2

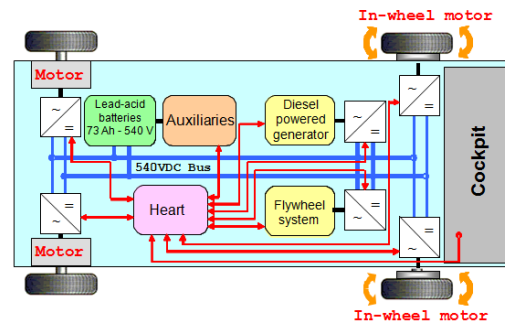

Figure 1.7: ECCE Phase 2 - configuration 3

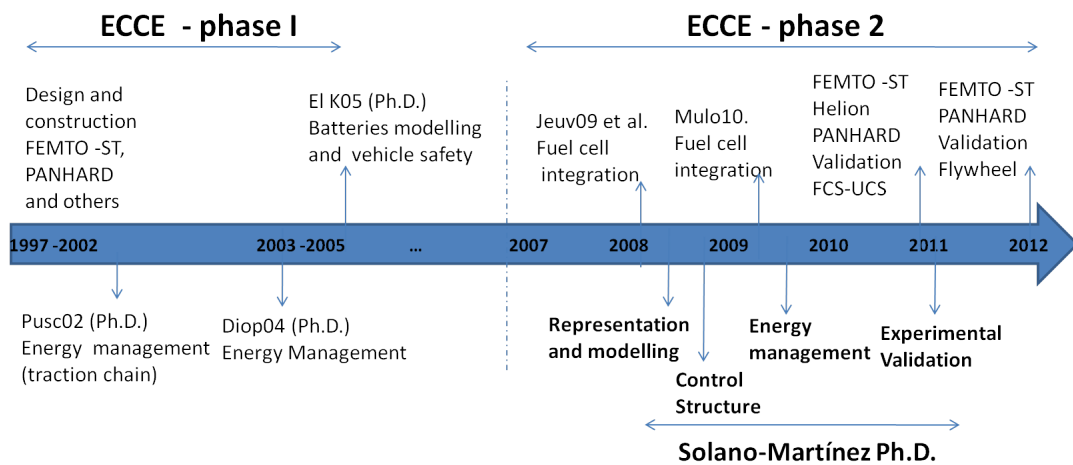

Figure 1.8: ECCE history

1.3 Hybrid electrical vehicles

Vehicle applications require a power supply with high autonomy and output power, fast dynamic response and, if possible, energy recovery and fast to recharge. However, it is not easy to find an energy source which fulfils all these requirements by itself (at a reasonable cost). Hybrid Electrical Vehicles (HEV) combine two or more energy sources (at least one electrical) to benefit from their different characteristics improving autonomy, reversibility and dynamic response. However, hybridisation imposes new technical difficulties such as energy management.

1.3.1 HEV classification

HEV are generally classified according to their powertrain architecture in series, parallel and series-parallel [Magg00, Chan07, Cera08]:

- **Series HEV:** all traction power is converted from electricity. The balance of energy is done in terms of electrical power, generally in a DC bus as is the case in ECCE. In HEV that includes an ICE, the ICE is not mechanically coupled to the powertrain as in conventional vehicles and instead it is used to drive an electrical generator which supplies energy to the DC bus. ECCE is a series HEV and the balance of power is done in a DC bus. The series architecture is presented in Figure 1.9.
- **Parallel HEV:** the electrical machines and the ICE are both coupled to the powertrain using mechanical transmissions. As a consequence, the balance of power is done in terms of mechanical power. This architecture is presented in Figure 1.10
- **Series-parallel or combined HEV:** this architecture is a combination between series and parallel, here the ICE could be used either to drive the powertrain or to supply energy to the DC bus. This architecture is illustrated in Figure 1.11.

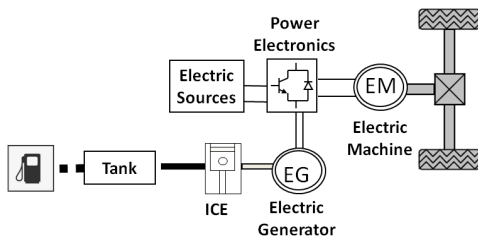

Figure 1.9: HEV series architecture

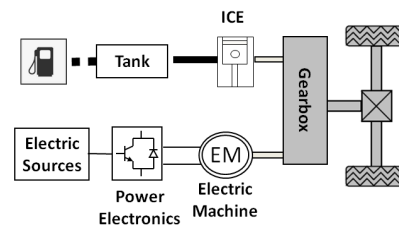

Figure 1.10: HEV parallel architecture

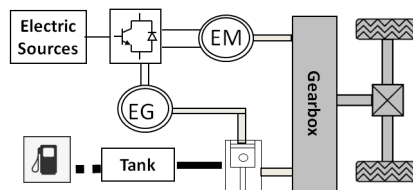

Figure 1.11: HEV series-parallel architecture

1.3.2 HEV energy sources

Hybrid vehicles can be equipped with a variety of power and energy sources such as batteries, Fuel Cell Systems (FCS), Internal Combustion Engines (ICE), Ultracapacitor Systems (UCS) or Flywheel Systems (FWS). These sources have different characteristics and functions and are classified according to the way they get the electrical energy:

Energy Conversion Sources (ECS): take chemical energy from a fuel e.g. diesel (ICE) or hydrogen (FCS) and convert it into electrical energy. They provide the whole amount of energy required to propel the vehicle. They are not reversible i.e. they can supply electrical energy but they cannot receive it.

Energy Storage Sources (ESS): take electrical energy from the ECS and when they are charged, provide energy to the system. Generally, the mean energy provided by an ESS tends to zero, however in plug-in electrical vehicles the ESS take the energy from an external electrical source and provide the whole amount of energy required by the vehicle.

Chapter 2 of this dissertation is devoted to the study of the energy sources used in ECCE.

1.3.2.1 Hybridisation of sources

Hybridisation of sources consists of combining two or more energy sources to benefit from their different characteristics (reversibility, autonomy, dynamic answer). Ragone diagram [Rago68] in Figure 1.12 compares the energy sources regarding their specific energy (the ability to supply energy for relative long periods of time) and specific power (the ability to supply high amounts of power in short periods of time as required in acceleration). It can be inferred from this chart that in a UCS-FCS hybrid source, the UCS allows fast dynamics and the FCS allows an extended autonomy (e.g. [Pala07, Ferr08, Eren09, Thou09, Caux10]). On the contrary, UCS and FWS present similar characteristics and there could be fewer advantages in integrating both in the same HEV.

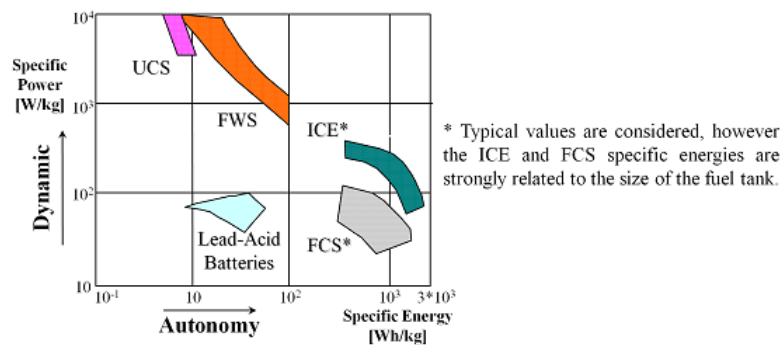

Figure 1.12: Ragone plot [Rago68] including ECCE hybrid electric vehicle energy sources

1.4 HEV Energy management

Unlike conventional vehicles where only the ICE supplies the whole amount of energy, hybrid vehicles have multiple energy sources to fulfil the energy supply. The new challenge of energy management consists in proposing a power distribution between the different sources to meet the demand whilst meeting design requirements such as comfort or minimising energy consumption or pollutant emissions. Energy Management is realised using several different techniques classified in two groups: a first group that requires previous knowledge of the driving cycle and a second group that only use real-time information.

1.4.1 Off-line strategies

Off-line methods use efficient techniques (genetic algorithms, dynamic programming, swarm particle optimisation) to minimise the energy consumption or polluting emission in pre-established driving cycles. These techniques are appropriate when the driving cycle is relatively easy to know in advance like in rail-road applications [Akli08] or public transport applications [Xu09].

Normalised driving cycles aim to represent real driving conditions and are used to assess the performance or to homologate vehicles. Among these driving cycles, the Normalised European Driving Cycle (NEDC) illustrated in Figure 1.13 is performed to measure the pollution emission and to grant CO₂ labels: high pollution emissions are punished with a tax or low emissions are rewarded with a reduction in the price of new vehicles. The French CO₂ label (*éco-bonus/malus*) is illustrated in Figure 1.14. Off-line techniques are here used to minimise these emissions and then to obtain a reduction on the price (or the tax) and to attract more clients.

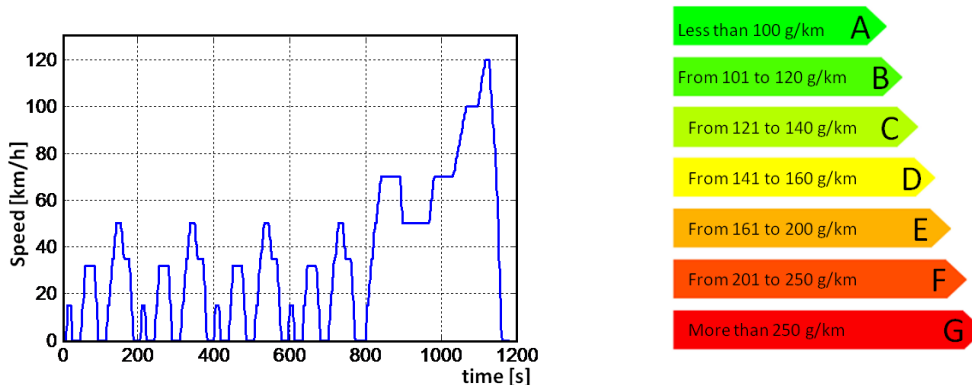

Figure 1.13: NEDC driving cycle



Figure 1.14: French CO₂ label for new vehicles

The main drawback of this approach is that the consumption is optimised only for a particular vehicle in particular conditions which will probably never be repeated in real use (e.g. in NEDC cycle the acceleration from 0 to 50 *km/h* takes more than 20 *s* !) and the vehicle will perform less than claimed. Among this group, dynamic programming and frequency-based management strategies are now presented:

1.4.1.1 Dynamic programming

Dynamic Programming (DP) is a technique used to find optimal solutions to non-linear and constrained problems using recursive equations. This technique has been presented to minimise fuel and emissions in HEVs [Lin04, Pere06, Vino10]. Some drawbacks of this technique are that DP is difficult to implement [Pere06], and is not suitable in complex models [Lin04].

1.4.1.2 Frequency-based energy management strategies

Chapoulie [Chap99] proposed to filtrate the power profile using a Fourier frequency analysis (FFT). The power distribution is based on the characteristics of the sources and on a filtering frequency: the energy sources with high specific energy supply the low frequency harmonics, the energy sources with high specific power supply the high frequency harmonics.

Akli [Akli08] presents a frequency-based strategy for energy management in a locomotive including an internal combustion engine, a flywheel system and batteries. The internal combustion engine works at a constant point, the FWS supplies the high frequency and the batteries supply the low frequency power. A schema for this frequency approach energy management is shown in Figure 1.15.

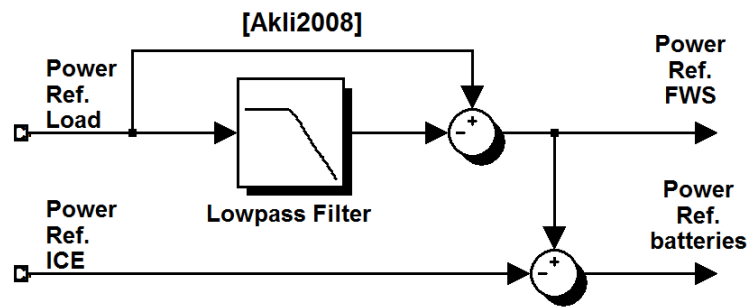

Figure 1.15: Frequency approach for energy management [Akli08]

A similar strategy presented in [Cera08] considers the propulsion power as the addition of a mean power and a ripple power (this could be done only for predetermined cycles). The mean power is supplied by the ECS and the ripple power is supplied by the ESS.

1.4.2 On-line strategies

The second group of energy management strategies does not require information about the future. These strategies only consider real-time information (speed or acceleration of the vehicle; power, voltage, current or state-of-charge of the energy sources or loads). These techniques are generally based on rules which enable on-line optimisation.

Real-drive conditions are highly random depending on the traffic, type of road, the driver style (see [Lin06, Murp09, Dosh10, Ryu10]) or the weather conditions. Moreover, in military application the driving cycle is not known a priori and pollution emission reduction is not a priority. On-line techniques, without previous knowledge of future drive conditions, appears to be more adequate to perform energy management in road vehicles and particularly in military applications.

The drawback of these techniques is that they propose a solution which is not necessarily the optimal. Among on-line techniques, DC voltage or state-of-charge regulation and fuzzy logic energy management strategies are now presented:

1.4.2.1 DC voltage regulation

Energy management strategies based on DC voltage regulation focus on the management of transient power peaks and regenerative braking by regulating the DC voltage using the energy stored in the energy storage sources (UCS, FWS or batteries). This technique exploits the fast dynamic responses of the ESS to reinforce the relatively slow FCS dynamics. More detailed studies on these strategies are presented in [Paym08] and [Thou09].

1.4.2.2 Predictive energy management

The energy to propel the HEV is optimised within a predicted driving cycle. This requires information or hypotheses formulation about the future. However, this information is generally limited and does not consider different driving strategies or conditions leading to unpredictable modifications from the original driving cycle.

A real-time predictive strategy to reduce fuel consumption using global optimisation has been presented by Kermani *et al.* [Kerm08]. This approach does not require predicting the temporal evolution of the driving conditions, contrary, previous values are used within a predictive control scheme.

An off-line predictive strategy for a FCS-battery HEV has been developed and evaluated by Bubna *et al.* [Bubn10]. This EMS aims to minimise the hydrogen consumption. They conclude that inaccurate predictions may lead to higher fuel consumptions than non-predictive strategies.

1.4.2.3 Global position based energy management systems

In real-world applications, the position information and the driving cycle can be partially predicted using Global Position Systems (GPS) or information transmitted for surrounding vehicles (e.g. [Haji07], [Joha07] or [Ambu09]). Hajimiri *et al.* [Haji07] presented a predictive EMS based on fuzzy logic. The controller, presented in Figure 1.16, control the charge and discharge of the battery.

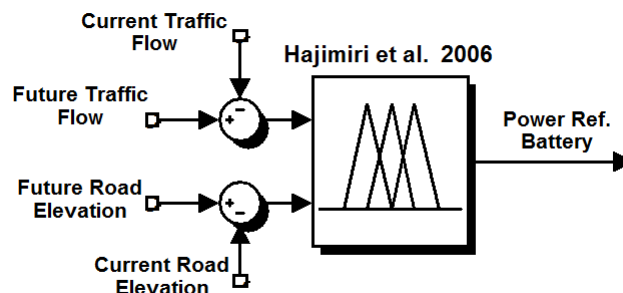

Figure 1.16: Traffic prediction controller for energy management [Haji07]

1.4.2.4 Stochastic dynamic programming

The EMS presented on [Joha07], [Li08] and [Roma10] uses collected records to predict the future (only on a short horizon). They constantly optimise the fuel consumption for these short periods of time. This technique is based on the Markov property i.e. it does not rely upon prior knowledge of future driving conditions but only upon the current system operation.

1.4.2.5 State-of-charge regulation

The State-of-Charge (SOC) is an indicator of the energy stored in the energy storage sources. A high SOC indicates available energy but less capacity to recover energy and a low SOC suggests low energy but more capacity for recovery. The SOC must be maintained within a pre-established range to avoid operation under extremes of charge.

The energy management of a FCS-UCS-batteries hybrid source using a strategy based on maintaining the state-of-charge on both the UCS and the batteries is presented in [Pala07]. Won *et al.* [Won05] studied the optimal torque distribution between an internal combustion engine and an electrical motor supplied by lead-acid batteries in a parallel architecture.

Most of the works in literature propose to maintain the UC state-of-charge between static or fuzzy bounds [Pala07], [Ferr08], [Caux10] or [Ryu10]. However, some authors propose to define dynamic references for the SOC based on the speed of the vehicle. At low speeds the electrical energy stored in the UC has to be high enough to permit the acceleration, at high speeds the UC must be discharged enough to enable regenerative braking e.g. [Schi05], [Fagg99] or [Kohl09].

1.4.2.6 Acceleration based strategy

Allègre [Allg10], presents an original approach to energy management using the acceleration of the vehicle, an UCS-batteries microbus. This is one of the first works (also does this dissertation) which develops an EMS based on the characteristics of the sources and not on normalised driving conditions. In her particular application, UCS has less Joule losses (considering its internal resistance) and is most efficient than batteries. The strategy privilege the UCS to supply the peaks of power (i.e. the power to accelerate the vehicle and the power in regenerative braking), and the batteries supply the mean energy.

1.4.3 Fuzzy logic based strategies

Fuzzy logic controllers are widely used to perform energy management in hybrid electric vehicles. These controllers does not require complex mathematical models as required in classic control and it has been demonstrated that this kind of controllers works in real-world applications. Fuzzy logic is presented in detail on Section 1.6.1.

As a general rule, the fuzzy controller output is a power reference for the energy conversion source (FCS is here considered). This output is calculated to supply the power to propel the vehicle while maintaining the battery and/or UC state-of-charge between pre-determined bounds (e.g.[Teki07, Ferr08, Gao08, Eren09, Li09a, Li09b, Caux10, Ryu10]). In this dissertation the fuzzy logic controllers are classified based on their output:

1.4.3.1 Fuzzy system output : absolute output reference

The output of the fuzzy logic controller is the absolute reference power of the FCS (i.e. output in W, kW). The computation of the reference value does not consider the previous value of the FCS output power. The principal drawback is that the reference can vary much faster than the real output and this can originate stability problems.

Caux *et al.* [Caux10] presented a fuzzy logic controller for energy management in a UCS-FCS HEV hybrid source where the inputs are the UCS SOC and the demand power. Li *et al.* [Li09a] and Li *et al.* [Li09b] present a similar controller for a FCS-battery HEV. However, in [Li09b] an estimation of the battery SOC is used as a third input.

Gao *et al.* [Gao08] presented an EMS for a FCS-UCS-battery hybrid source. This strategy uses a three-input two-output fuzzy logic controller to maintain the battery and ultracapacitor state-of-charge.

Eren *et al.* [Eren09] presented a fuzzy logic controller for a FCS-UCS hybrid source. In this strategy the load reference power is filtered using a wavelet transform and only the low frequency power is used as input in the fuzzy logic controller. Figure 1.17 illustrate the fuzzy controllers which has an absolute output reference.

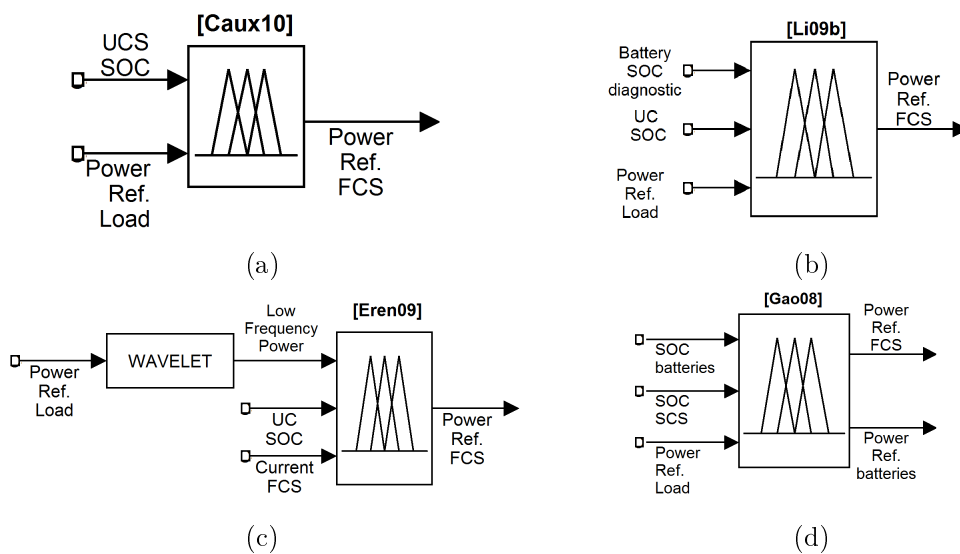

Figure 1.17: Fuzzy logic controllers used in hybrid electrical vehicles energy management (a) [Caux10], (b) [Li09b], (c) [Eren09], (d) [Gao08]

1.4.3.2 Fuzzy output: variation on the absolute output reference

The output of the fuzzy logic controller is a relative change in the reference of the FCS output power (i.e. output in W/s, kW/s). The definition of the absolute reference power requires then integrating the output value. This is an easy way to handle the problem of the fuel cell system slow dynamics: it avoids reference difficult (or even impossible) to follow by the real system. These controllers consider the dynamic of the FCS as well as its previous output value.

Ferreira *et al.* [Ferr08] study the energy management in a FCS-UCS-battery HEV. It proposes a three-input two-output fuzzy logic controller with rule-base that changes with the drive condition (acceleration, hilly roads).

Ryu *et al.* [Ryu10] presented an energy management strategy based on driving mode recognition using a fuzzy logic controller for a FCS-battery HEV. It is interesting to highlight that the structure of the proposed fuzzy logic controller is very similar to those used in power electronics where dynamic is a very important issue [Hiss98, Lin05, Elma09]. Figure 1.18 illustrate the fuzzy controllers which its output is a variation on the absolute reference.

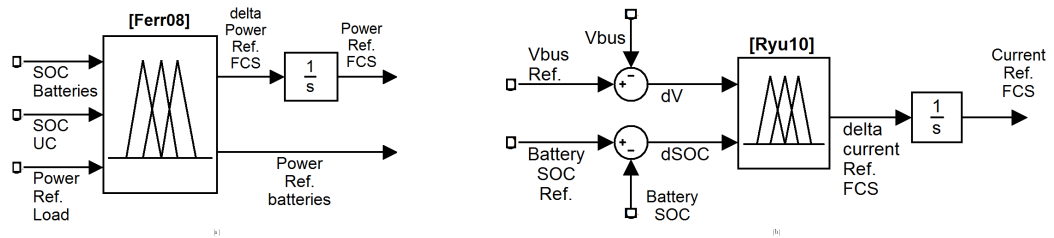

Figure 1.18: Fuzzy logic controllers used in HEV energy management:
 (a) [Ferr08], (b) [Ryu10]

To improve the performance of fuzzy logic controllers, fuzzy logic is frequently combined with another technique (hybridisation). A fuzzy logic-wavelet and a fuzzy logic-predictive EMS are presented respectively in [Eren09] and [Haji07]. A technique to optimise the fuzzy logic systems using dynamical programming is studied in [Caux10].

1.4.3.3 Fuzzy logic controllers design

Fuzzy logic controllers are generally designed either using human experience or data from the system:

The use of data from the system permits designing the fuzzy sets and rules using optimisation techniques as simulated annealing or genetic algorithms [Mart09], [Alma10], [Caux10], [Onie11]. These optimisations are performed for specific drive cycles in specific vehicles. However, nothing guarantees that the calculated set of parameters is still appropriate in different vehicles or in variable drive conditions. Additionally, accurate models to represent the vehicle and to calculate the fuzzy system parameters are required.

As an alternative to design the fuzzy systems the use of human experience can be considered. Survey-based fuzzy logic systems permit to combine the knowledge from different experts to design the MFs [Mend01], [Lian02], [Auep02], [Chri09]. However, different experts will define different FLS with different MFs and different rules [Mend01]. Type-2 fuzzy systems permit to combine the knowledge from the different experts handling the uncertainty associated with the meaning of the words. A survey-based type-2 fuzzy logic system has been developed to perform FCS energy management in ECCE and is presented in detail in Appendix B.

1.5 Energetic Macroscopic Representation based control

The study of the control of multiphysics complex systems requires defining an adapted tool. Boulon [Boul09] has studied different approaches to study energy management in HEV: Bond graphs [Payn61], VEHLIB software [Trig04], power flow diagrams [Geit09] or **Energetic Macroscopic Representation (EMR)** [Bous03] among others. As a conclusion of this work developed at FEMTO-ST, the EMR is the most adapted technique to analyse the energy management problem in HEV.

The EMR is a synthetic graphic tool for the systematic analysis of all interactions between the elements (subsystems) of a multi-physics system. This technique was developed in the Laboratory of Electrical Engineering and Power Electronics (L2EP), University of Lille, France, to facilitate the study of electromechanical systems as electrical machines or HEV [Bous03]. After different works realised in FEMTO-ST this formalism was actualised to enable an easier extension to other physical fields (thermal, thermodynamics) as demonstrated in the works around Fuel-Cell Systems (See Table 1.1).

The EMR formalism has several advantages: representation of multiphysics systems, systematic deduction of control structures, and the implementation can be easily performed under common commercial software environments, such as Matlab Simulink. EMR based-control is generally developed in the following 4 steps as illustrated in Figure 1.19:

1. Organisation of the model according to EMR rules
2. Analysis of the EMR and inversion-based control
3. Simplifications and estimations
4. Development of control strategies

1.5.1 Step 1: Energetic Macroscopic representation (EMR)

The model of the system is organised according to EMR rules [Bous03]. The EMR uses pictograms which are interconnected using exchange variables (arrows), following the action-reaction principle and respecting the integral causality. The product of action and

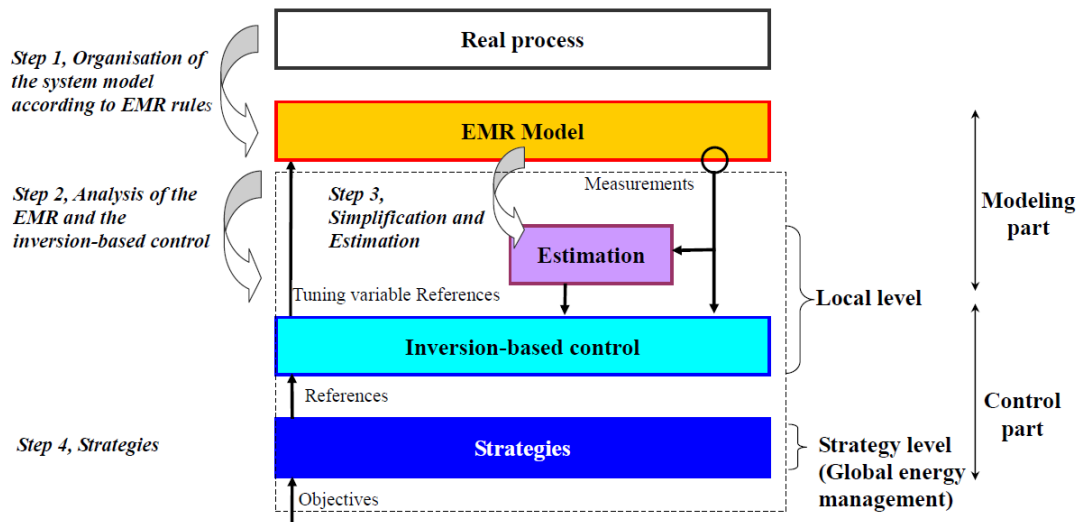

Figure 1.19: EMR-based control methodology. Adapted from [Chen10]

reaction variables between two elements leads to the instantaneous power exchanged. Basically, EMR uses different pictograms to represent:

- **Energy sources** The terminal elements which supplies or receive energy such as batteries or electric loads
- **Energy conversions** The elements which converts different nature energy as electromechanical conversion in electrical machines and the elements which converts same nature energy as electrical transformers
- **Energy accumulators** The elements which store energy such as inductors or mechanical shafts
- **Energy distributions** The coupling elements for energy distribution as DC bus or mechanical differentials

1.5.2 Step 2: Maximal control structure (MCS)

The MCS considers all the theoretical calculations and measurements required by the EMR. Although these calculations are not always technically or financially feasible; this step is necessary to understand how to adapt the structure to achieve a practical, less expensive and perhaps a more realistic structure. To deduce the MCS, the different control objectives have to be identified. Then the EMR blocks are inverted regardless of practical issues: the conversion blocks are directly inverted and the accumulation blocks are inverted using controllers in order to respect physical causality.

1.5.3 Step 3: Practical control structure

The PCS is the final step in the EMR based methodology to find the control structure of a given system. It allows a technically and financially viable control system. The

PCS could require modifications of the MCS using simplification hypotheses. To go from the MCS to the PCS the measurements that are physically or economically infeasible are suppressed. Obviously, they can sometimes also be replaced by so-called software sensors (in automation, these could be also called observers or estimators).

The basic and some complementary pictograms in EMR formalism are illustrated in Tables 1.2, 1.3 and 1.4.

Table 1.2: Basic EMR elements - physical elements

Element	EMR Pictogram (model)	MCS Pictogram (control)	Example
Source			Batteries, Ultracapacitors, loads...
Accumulation			Capacitance, Inductance, Mechanical shaft,
Monophysical Conversion			DC/DC converter Transformer Speed reductor
Multiphysical Conversion			Electrical machine

1.5.4 Step 4: Global control strategy

The last step is to define the control strategy regarding the global control objectives and the practical control structure.

The objectives of the energy management in ECCE are presented in Chapter 2. As energy management of this HEV is one of the principal objectives of this Ph.D. dissertation, this step is widely discussed on Chapter 4.

1.5.5 Related works

More details about EMR can be found on the following dissertations realised on L2EP or FEMTO-ST: The HDR¹ of Pr. Alain Bouscayrol (L2EP) which presents the fundamentals

¹A qualification required for supervising PhD students in France

Table 1.3: Complementary EMR elements - coupling and selectors

Element	EMR Pictogram (model)	MCS Pictogram (control)	Example
Monophysical Coupling			DC bus Gearbox
Multiphysical Coupling			Air compressor (head) Fuel cell stack
Model selector			Clutch

of EMR [Bous03], the Ph.D. of Mr. W. Lhomme (L2EP) which develops EMR-based control structures for different HEVs [Lhom07], the Ph.D of Ms. D. Chrenko (FEMTO-ST) devoted to fuel cell systems [Chre08], the Ph.D of Mr. L. Boulon (FEMTO-ST - L2EP) which study the EMR of energy sources [Boul09], the Ph.D of Ms K. Chen (L2EP - FEMTO-ST) about EMR of powertrains of HEV [Chen10] and the Ph.D of Ms. A-L. Allègre (L2EP) devoted to the study of sizing and energy management of the sources in HEV [Allg10].

While this research was conducted, 4 more Ph.D students at FEMTO-ST were working around EMR: Mr. K-S. Agbli (FEMTO-ST - University of Abidjan) [Agbl11] for stationary hybrid sources (Fuel Cell - photovoltaic systems), Mr D. Bienaimé (FEMTO-ST - Eurocopter) for hybrid helicopter control and energy management [Bien11b], Mr. C. Gay (FEMTO-ST) for cogeneration of high temperature fuel-cell and Stirling motor [Gay11b] and Mr. J. Baert (FEMTO-ST - Alstom Transport) for energy management in hybrid locomotives [Baer11a].

Table 1.4: Complementary EMR elements - measurement, estimators and control

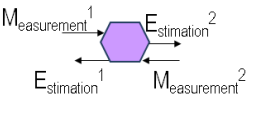
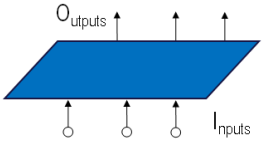
Element	EMR Pictogram	Example
Measurement		Sensors
Estimator or model		Compressor cartography (torque vs speed)
Control		Energy Management Strategy

1.6 Soft computing and type-2 fuzzy logic

Soft computing techniques study real-world problems difficult to model and which solutions cannot be precisely accurate (such as energy management in hybrid electrical vehicles). The objective of this branch of computer science is to find almost-exact solutions to complex problems; as a consequence, soft computing is characterised for its imprecision and uncertainty.

The three principal branches of soft computing are fuzzy logic [Zade65], probabilistic reasoning [Pear88] and neurocomputing (neural networks) [Hayk94]. Other examples are wavelet theory [Youn93], fractals and chaos theory [Peit04], and Bayesian networks [Heck08]. All of these techniques are widely used not only in engineering but also in other disciplines such as medicine [Yard09] or even in humanities [Leon10].

1.6.1 Fuzzy logic

In the last 20 years "Fuzzy Logic Inside" products has become very popular worldwide, however fuzzy logic is not such a new concept; L. Zadeh, an electrical engineer, introduced the theoretical concepts of Fuzzy Logic almost fifty years ago in 1965 [Zade65]. This technique does not require complex mathematical models as used in classic control and it has been widely demonstrated that it works in industrial applications since 1974 when Mamdani presents a fuzzy controller for a steam engine [Mamd74].

FEMTO-ST previous experience working with fuzzy-logic in domains such as fuzzy control of electrical converters and machines [Hiss98]², energy management [Pusc04], [Teki07], [Caux10]³ or diagnosis [Hiss07], presents evidence that fuzzy logic is a very powerful tool in electrical engineering applications. The natural continuation of the works developed at ENERGY department of FEMTO-ST takes this research to consider the study of type-2

²Ph.D performed at National Polytechnic Institute of Toulouse (INPT) by Mr. D. Hissel now with FEMTO-ST

³Joint cooperation with the INPT

fuzzy logic systems, which appears to be more performing than classical fuzzy logic as it shown in next subsection.

1.6.2 Type-2 fuzzy logic

The concept of Type-2 Fuzzy Logic Sets was also introduced by Lofti Zadeh in 1975 [Zade75]. Nevertheless, the first type-2 logic system was developed and presented only 23 years later by N. Karnik and J. Mendel [Karn98]. As J. Mendel defines, type-2 is an expanded and richer fuzzy logic which enables to better handle the uncertainty [Mend01]. The strength of type-2 fuzzy logic is that it takes us one more step toward the goal of "Computing with Words" or the use of computers to represent human perception [John07].

Type-2 Fuzzy Logic (T2-FL) is a relatively new field of research and there are less authors working on it than on Type-1 Fuzzy Logic (T1-FL). Anyway, in last years T2-FL has begun to interest researchers around the world, the number of publications increases at a high rate⁴. Most of the authors working in T2 FSs consider that T2-FL can outperform their counterpart because they can model complex processes and T2-FL controllers are usually more robust and better able to eliminate oscillations than their counterpart T1-FLS. Table 1.5 presents a short list of different published applications based on T2-FL.

This dissertation presents the first works about T2-FL performed at FEMTO-ST. The first natural objective was to understand, to learn how to use and implement this technique, this is presented on Chapter 3 and on the Appendix. Two different applications based on T2-FL will be presented in this dissertation: the control of a DC/DC converter on Chapter 3 and the energy management of a hybrid electric vehicle on Chapter 4.

1.7 Chapter conclusion

The energy management study of a hybrid electrical vehicle is here considered. It is a heavy-duty mobile laboratory designed to evaluate under real conditions different electric components. This complex application requires the definition of appropriate tools:

- Energetic Macroscopic Representation is identified as the most appropriate formalism to represent and modelling the vehicle and its energy sources. This is a natural choice taking in account the know-how of the laboratory
- Considering the characteristics of the vehicle (difficult to model and without previous knowledge of the driving cycles), on-line techniques are retained to perform the energy management
- Type-2 fuzzy logic has been selected as a technique to perform the energy management. This is a new direction in research performed at FEMTO-ST

⁴J. Mendel website <http://sipi.usc.edu/mendel> presents a complete list of references about T2-FL

Table 1.5: Some type-2 fuzzy logic-based applications

Domain	Application	References
Automobile & transport	Controller for vehicle active suspensions	[Cao08]
	Fuel consumption prediction	[Zhou09]
	Real-time speed control of diesel engines	[Lync05], [Lync06]
	Traffic management & forecasting	[Li06], [Lima07], [Bala10]
	Vehicle classification	[Wu07]
	Route choice	[Shaf10]
Electrical engineering	Electrical machines control	[Bark08], [Bark11], [Kaya11]
	Fault current analysis	[Rome07]
	Power electronics	[Lin05], [Bark08]
	Power system stabiliser	[Roba08]
	Transformer diagnostics	[Flor08]
	Photovoltaic array modelling	[Jafa10], [Fada10]
Industrial & control	Hardware implementation	[Melg07], [Coup08]
	Liquid-level control	[Wu04]
	Plant monitoring and diagnostics	[Cast04], [Tan06]
	Quality control	[Meli07]
	Robotics	[Coup03], [Hagr04], [Figu05], [Birk09], [Mart09]
	Steel desulphurisation	[Celi08]
	Temperature estimation	[Gupt07], [Mend10]
	Vibration and pressure estimation	[Homa01], [Pare06]
Marketing & decision support	Human resource selection	[Doct08]
	Management studies	[Auep02]
	Risk estimation	[Kaur04], [Reha05], [Pras05]
	Stock Market Analysis	[Huar05], [Bagu06], [Faze09]
	Supply chain modelling	[Mill10]
	Urban water management	[Makr03]
Medical	Diagnosis	[Inno01], [Inno02], [Di L05], [Bart09], [Faze09]
	Radiology	[John97], [Ozen03]
	Treatment	[John01], [Lee10]
Software	Connection admission	[Lian02]
	Global position systems	[Fish07]
	Image processing	[Bust07], [Hwan07], [El B08], [Jeon09], [Mend09]
	Signal processing	[Karn99], [Cast04]
	Speech recognition	[Zeng06]
	Weather forecasting	[Li06], [Shah11]

Chapter 2

ECCE energy sources: modelling and control

This chapter is devoted to study the energy sources available on ECCE vehicle.

The knowledge and understanding of the advantages and drawbacks of the different energy sources is fundamental to study their implementation in Hybrid Electrical Vehicles (HEV). ECCE HEV permits the real-world evaluation of the following energy sources: batteries, fuel cell systems, ultracapacitor systems, internal combustion engines and flywheel systems. This chapter presents the characteristics, modelling, representation and control structure of these energy sources.

Simulation is a necessary step before performing any experimental implementation of energy sources. It aims to define their control structure or their energy management. It requires to develop theoretical models and to experimentally identify their parameters. ECCE energy sources' models are based on those given in literature. Their control structures are developed using Energetic Macroscopic Representation (EMR) technique. Most of this part of the research is based on previous research work developed in FEMTO-ST laboratory:

- Lead-acid batteries model and parameter identification done by El Kadri [El K06].
- Ultracapacitor experimental setup developed by Bienaimé and Harel [Bien09]
- Air compressor model and parameter identification adapted from the works of Tekin [Teki04] and Genre-Grandpierre [Genr08] respectively.
- Fuel cell parameters identification from the work presented by Hissel *et al.* [Hiss08]
- Fuel cell system model and control structure developed by Boulon [Boul09].

As it can be seen, an additional motivation for using the EMR approach is its ability to use directly previous research works and to enable the capitalisation of the research developments preliminary obtained in the laboratory.

This chapter is organised as follows: Section 2.1 is devoted to the batteries. Ultracapacitors and fuel cell systems are studied in Sections 2.2 and 2.3 respectively. Flywheel systems are introduced in Section 2.4. Section 2.5 presents the traction chain and ancillaries modelling. The integration of the different energy sources in ECCE is presented in Section 2.6. Finally, Section 2.7 presents the conclusions and outlooks.

2.1 Batteries and DC bus

Batteries are electrochemical accumulators that store chemical energy which can be converted into electrical energy and as it is a bidirectional source, electrical energy can be converted into chemical energy. Because of their specific energy and power, reversibility and relatively low cost (regarding other technologies), batteries are one of the most attractive sources to be used in electrical and hybrid electrical vehicles. However they still require deep research on issues as fabrication, security or recycling. Batteries technologies are commonly based on metals as lead and more recently lithium or nickel, however, at the time ECCE HEV was designed and constructed, lead-acid was the most common technology (and the most interesting regarding the price) in batteries and then retained (also see [Holm03, Larm03, El K06]).

Lead-acid batteries are composed of two electrodes in an electrolyte: a lead (Pb) plate and a lead dioxide (PbO_2) plate suspended in sulphuric acid (H_2SO_4) as illustrated in Figure 2.1. When an electric load is connected through their terminals (discharge), the electrodes reacts with the sulphuric acid, this reaction releases electrons (electrical current) and produces lead sulphate in the electrodes ($PbSO_4$) and water (H_2O) in the electrolyte. The reversible reaction requires a supply of electrical energy (recharge). This operation principle is similar but the reactions are obviously not the same in other kind of batteries.

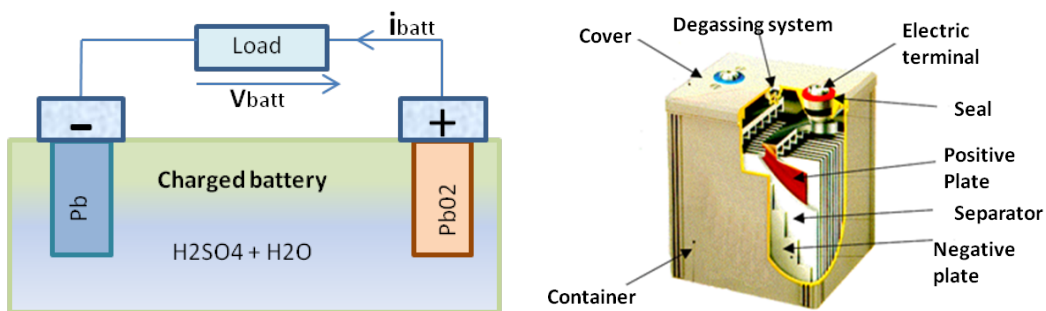

Figure 2.1: Lead-acid batteries schematic diagram (left) and construction [Hawk05] (right)

Lead-acid batteries have many drawbacks and seem quite far from the state-of-art: their efficiency, specific energy and power are much lower than lithium-based or nickel-based batteries. Nevertheless, batteries in general are still an intermediate technology regarding its specific power and energy: it can be observed from Ragone plot in Figure

1.12 that batteries present less specific power than ultracapacitors or flywheels and less specific energy than fuel cells. For this reason battery energy management solutions do not vary much with their different technologies.

ECCE test bench is equipped with a bank of 46 valve-regulated lead-acid batteries in series connection. As the 12V batteries are directly connected to the DC bus, the nominal voltage of the DC bus is 552V. Table 2.1 resumes the parameters of the lead acid batteries and Figure 2.2 illustrates the batteries implemented in ECCE.

Table 2.1: ECCE batteries parameters

Description	Value
Fabricant	Hawker
Technology	Lead-acid
Elements in series	46 (12[V])
Nominal voltage	552 [V]
Capacity	72 [Ah]



Figure 2.2: Lead-acid batteries implemented in ECCE

2.1.1 Modelling and parameter identification

The retained batteries model is the one presented by Ceraolo [Cera00]. The batteries are represented by an equivalent electric circuit composed by electrical elements that not only depends on the instantaneous values but also on its charge-discharge history which is not always available (as is the case in ECCE). The experimental parameter identification is presented in [El K06], a former Ph.D. research about ECCE. Ceraolo model is illustrated in Figure 2.3.

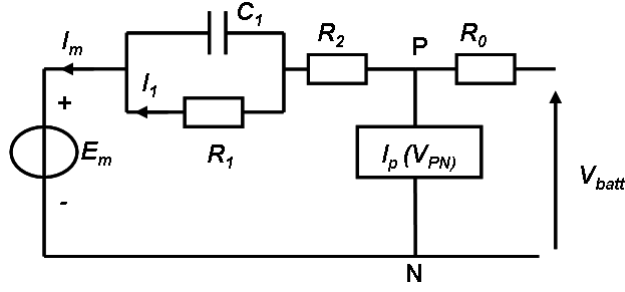

Figure 2.3: Ceraolo's lead-acid batteries model [Cera00]

2.1.1.1 State-of-charge

The state-of-charge (SOC) is a dimensionless quantity defined as the ratio between the residual capacity $Q_{residual}$ and rated capacity $Q_{nominal}$ of the energy storage source as defined in Equation 2.1. The SOC is an indicator of how many energy is available to supply or can be recovered and its estimation is fundamental for energy management. In batteries, the SOC depends on multiple factors as current, discharge history, age, self-discharge or ambient temperature. For this reason, SOC estimation in batteries is a very difficult task.

$$SOC = \frac{Q_{residual}}{Q_{nominal}} \quad (2.1)$$

When theoretical models are used to estimate the SOC, the results are based on estimated parameters and/or simplification hypotheses. Ceraolo SOC model strongly depends on the batteries' history. Different approaches to estimate SOC value have been presented [Pill01, Ng09, Urba09, Yan10].

In ECCE, the Coulomb counting method (also known as current integration method) is retained to estimate the SOC: the batteries open circuit voltage (OCV) is measured at the start-up of the vehicle to estimate the initial SOC (Q_0) using information from the manufacturer [Hawk05]. Then the battery current is integrated to estimate the amount of charge supplied (or recovered considering an efficiency η) by the batteries. This method is formally presented in Equation 2.2.

$$SOC_{batteries} \approx \frac{Q_0(OCV) + \eta \int i_{batt} dt}{Q_{rated}} \quad (2.2)$$

The principal drawbacks of this simplified approach are: 1) imprecise measurements of the current induce accumulating errors, 2) the losses during charging and discharging are difficult to estimate and 3) it does not takes into account the effect of aging and the decrease on the releasable capacity. Nevertheless, the interest of this method lies in their simplicity and flexibility (it could be easily enhanced by considering the losses or the aging effects) [Ng09], [Pill01].

2.1.2 Representation and control structure

In ECCE the batteries are directly connected to the DC bus. Then direct control of this source is not possible and the DC bus voltage value is imposed by the batteries. As a consequence, any source or load connected to the DC bus (fuel cell, flywheel system and/or ultracapacitor systems, traction chain and ancillaries) acts as current source (i_{sx}).

Figure 2.4 illustrates the equivalent circuit of this configuration. Here, the batteries impose the voltage to the sources and the sources impose the current to the batteries respecting physical causality and Kirchoff's laws (Equations 2.3).

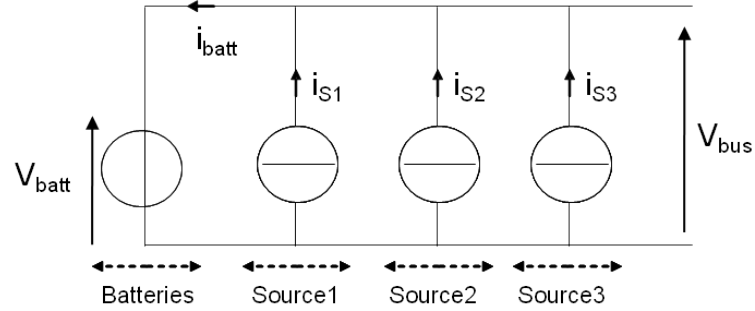

Figure 2.4: Batteries and DC bus EMR

$$\begin{aligned} i_{batt} &= i_{S1} + i_{S2} + i_{S3} \\ V_{bus} &= V_{batt} \end{aligned} \quad (2.3)$$

In Energetic Macroscopic Representation (EMR) formalism, batteries are represented using a source element and the DC bus is represented using a mono-physical coupling element. The different current sources coupled to the DC bus are represented by source elements (see EMR synoptic in Tables 1.2, 1.3 and 1.4). Figure 2.5 presents the EMR of the batteries, the DC bus and three generic current sources. In Section 2.5 these generic sources are replaced by their respective EMR.

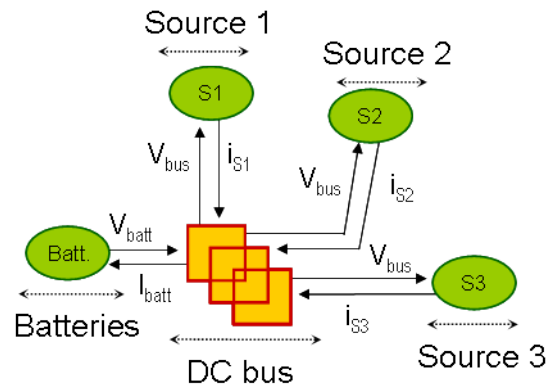

Figure 2.5: Batteries and DC bus EMR

2.2 Ultracapacitor system

Ultracapacitors (also known as electric double-layer capacitors or supercapacitors) are electrochemical sources that store electrical energy that can be directly used without conversion and so with high efficiency. This source has a very high specific power but a low specific energy. Ultracapacitors (UC) are widely considered in transport applications because of this high specific power and also because of this high efficiency.

As batteries, ultracapacitors are composed of two electrodes immersed in an electrolyte. The electrodes are made of activated carbon and recovered by a dielectric, the electrolyte could be aqueous such acids (H_2SO_4) or alkalis (KOH) or non-aqueous such as propylene carbonate or acetonitrile [Pand06]. UC profits from the double-layer capacitance principle: this enables to highly increase the capacitance by reducing the distance between the electrodes d and increasing the active electrodes surface S (see Equation 2.4). Figure 2.6 presents the UC schematics as well as the representation of a pore in a carbon electrode active layer.

$$C = \epsilon \frac{S}{d} \quad (2.4)$$

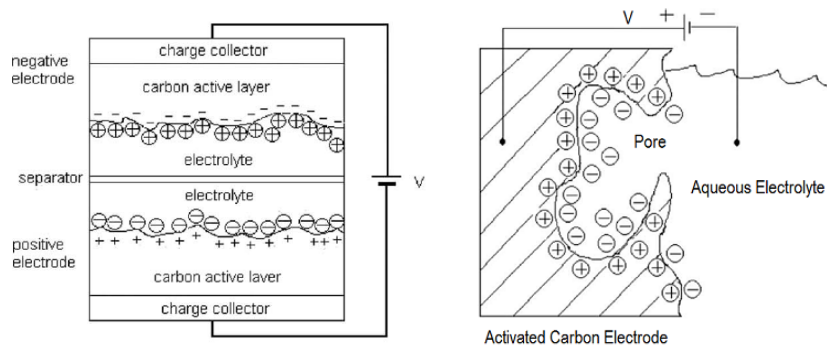

Figure 2.6: UC schematic (left) and electrode active layer pore representation (right) [Sign09]

The capacitance value of UC is several orders higher than in conventional electrical capacitors (e.g. the ultracapacitors used in ECCE presents a capacitance of $3500F$). However the use of an electrolyte to increase the capacitance has also its consequence: the maximal voltage in UC is highly reduced (limited to about $2.5V$). To increase the terminal voltage, UC are connected in series, this originates a voltage imbalance due to the mismatch in the characteristics of the different UC and thus a balance circuit has to be designed to do this connection.

ECCE is equipped with 2 ultracapacitor banks; each bank is composed of 18 modules of 6 UC. All the 216 UC are connected in series. The UC was developed by SAFT (Bordeaux, France) and its voltage balancing system was developed by SAFT in cooperation with the GREEN research laboratory (Nancy, France) [Desp03]. The UCS is composed by the two UC banks and the power electronic device to boost the voltage and to permit the connection

to the ECCE DC bus. The DC/DC converter has been specially developed for ECCE by the CIRTEM society (Toulouse, France).

In the following, UC is used to refer the ultracapacitors exclusively, Ultracapacitor system (UCS) will refer to the UC and the power converter. Figure 2.7 shows the UC implemented in ECCE test bench and Table 2.2 resumes the UCS characteristics.



Figure 2.7: SAFT ultracapacitors implemented in ECCE

Table 2.2: ECCE ultracapacitor system parameters

Description	Value
UC Fabricant	SAFT
DC/DC Converter supplier	CIRTEM
UC in series	216 (2.5 [V] - 3500 [F])
UC Rated current	600 [A]
DC/DC converter rated current	200 [A]
UC Rated voltage - capacitance	540 [V] - 16 [F]

2.2.1 Modelling

Zubieta *et al.* [Zubi00] observed that electrochemical ultracapacitors behave quite similar to electrical capacitors but they also observed a new phenomenon: an internal charge redistribution. They proposed to model the UC with an equivalent electric circuit composed by passive components. This model presents a principal branch representing the energy accumulation, and multiple secondary branches to represent the charge redistribution and the self-discharge. This UC equivalent circuit is represented in Figure 2.8.

Rafik *et al.* [Rafi07] proposed to improve Zubieta model by considering the frequency and temperature effect in the UC. The equivalent circuit is illustrated in Figure 2.8. Parameter identification in this approach is relatively complicated as studied by Bienaimé in his Master internship at FEMTO-ST [Bien09].

In HEV applications the UC operates at relatively low electrical frequencies, moreover in ECCE a cooling system regulates the temperature in the UCS. For these reasons, frequency and temperature variations are not considered and the model of Zubieta is retained.

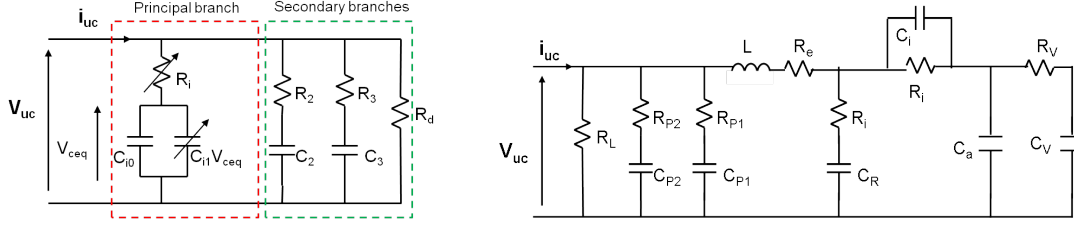

Figure 2.8: Different ultracapacitor models: Zubieta [Zubi00] (left), Rafik [Rafi07] (right)

However, this model uses multiple secondary branches which can be represented by only one Thévenin-equivalent branch (low frequencies hypotheses).

The principal branch represents the internal resistance R_i , and the energy accumulation by considering a constant capacitor C_{i0} and a non-linear capacitor $C_{i1} V_{ceq}$ (please note that C_{i1} is presented in [F/V]). The secondary branch represents the charge redistribution by considering a constant capacitor C_2 and the self-discharge by considering a resistance R_2 . The retained equivalent circuit is illustrated in Figure 2.9.

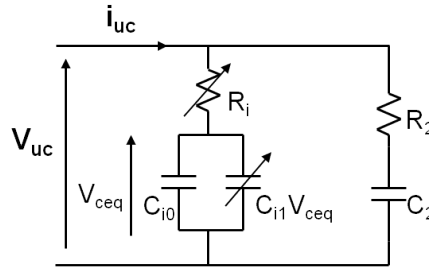

Figure 2.9: Retained UC equivalent circuit model

2.2.2 Parameter identification

Zubieta [Zubi00], proposed a procedure to find the parameters of the UC equivalent circuit. A predetermined current (a step of current as presented on Figure 2.12) is imposed to the UC, then the output voltage is analysed to find the parameters. However, the current used in this approach does not represent real operation conditions.

In this work, a novel approach to automatically find the parameters of the UC's equivalent circuit is proposed. The procedure is resumed in two steps: 1) to impose a non-predetermined current to the UC (e.g. HEV's UC current in normal operation as illustrated in Figure 2.13) and 2) to analyse the output voltage.

2.2.2.1 Experimental measurements

Experimentally a variable current is imposed to the UC. The objective is to measure the voltage variation regarding the variation of the current. The experimental data (time, current i_{exp} and voltage V_{exp}) is used to find the parameters using an iterative procedure:

2.2.2.2 Minimisation function: constraints and initialisation parameters

Multivariable function minimisation is used to find a set of parameters (R_i , C_{i0} , C_{i1} , C_2 and R_2) which represent the behaviour of the UC. The set of values has to respect physical conditions (mathematical constraints of the variables) as: 1) all the parameters must be positive 2) the capacitances cannot be greater than the nominal capacitance (supplier data sheet values). These physical conditions are presented as mathematical constraints:

$$R_i, C_{i0}, C_{i1}, C_2, R_2 > 0 \quad (2.5)$$

$$C_{i0}, C_{i1}, C_2 < C_{nominal} \quad (2.6)$$

The iterative procedure requires the definition of a set of parameters which can ‘reasonably’ represent the physical values. This set of initialisation values is used in the first iteration and define the way the algorithm will converge (or not). The choice of these values is then fundamental for the convergence of the solution. The following assumptions and initialisation values are retained:

1. The value of the capacitance in the main branch is near from the value of the nominal capacitance. It can be assumed (from typical values in literature such as [Zubi00], [Gual07], [Raf07] or [Bien09]) that the total capacitance is equally distributed between the two capacitances of the branch:

$$C_{i0}(0) = \frac{C_{rated}}{2} \quad (2.7)$$

$$C_{i1}(0) = \frac{C_{rated}}{2 V_{rated}} \quad (2.8)$$

2. The value of the capacitance of the secondary branch is expected to be much lower than the capacitance of the first branch. The secondary branch capacitance is defined as a fraction of the first branch capacitance (based on typical results in literature, C_2 is not far from 10% of C_{i0}):

$$C_2(0) = \frac{C_{i0}}{10} \quad (2.9)$$

3. The value of the main branch resistance is expected to be the nominal value of the internal resistance, the secondary branch resistance is expected to be much bigger than the primary and typically their ratio is not far from 20:

$$R_i(0) = R_{rated} \quad (2.10)$$

$$R_2(0) = 20 R_{rated} \quad (2.11)$$

2.2.2.3 Minimisation function: iterative procedure

The last step of parameter identification consists into an iterative procedure based on the simulation of the UC response to i_{exp} (the current experimentally imposed to the real UC). The simulated V_{sim} and experimental V_{exp} difference is compared (mean square). The parameters R_i , C_{i0} , C_{i1} , C_2 and R_2 which minimises this difference are retained.

An application has been developed in Matlab and Matlab Simulink to automatically find the parameters. The application is based on the *fmincon*¹ function. The iterative procedure is illustrated in Figure 2.10. The application developed in Matlab Simulink is illustrated in Figure 2.11.

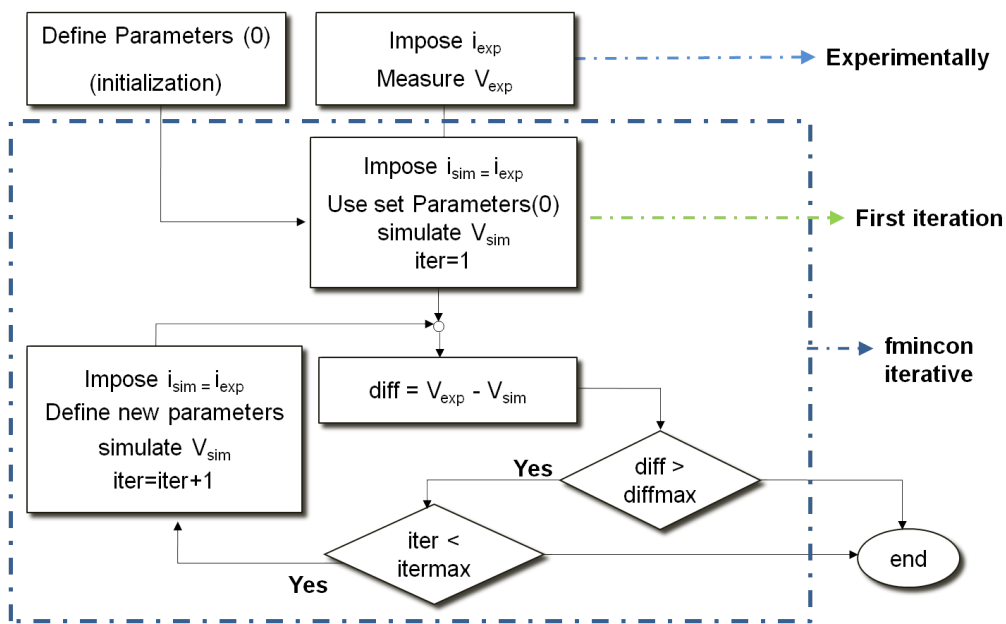

Figure 2.10: UC equivalent circuit parameters identification flowchart

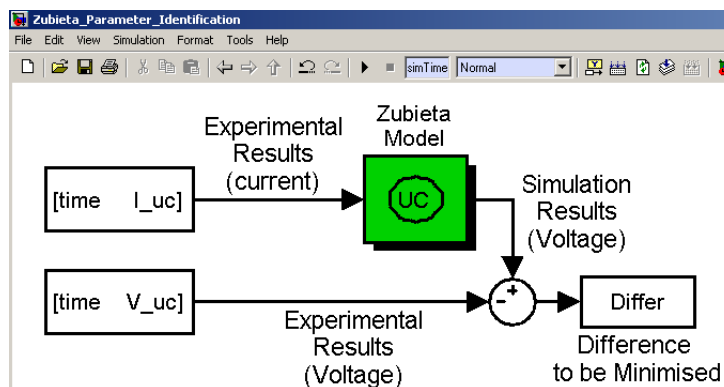

Figure 2.11: UC equivalent circuit parameter identification - Simulink application

¹This function find minimum of constrained nonlinear multivariable function and is explained in detail at <http://www.mathworks.com/help/toolbox/optim/ug/fmincon.html> (Mathworks website)

2.2.2.4 Experimental validation

To validate the proposed procedure, experimental evaluations were performed. The first evaluation is realised in the Laboratory under controlled conditions as proposed by Zubieta. The second evaluation is performed with the UC implemented in the ECCE mobile laboratory. As the UC are used to drive the vehicle, this is an evaluation under real-utilisation.

Figure 2.12 presents the obtained results for the predetermined current (only one UC bank). Figure 2.13 presents the obtained results for the real current profile (both UC banks). These results are considered satisfactory for simulation applications. Tables 2.3 and 2.4 present the values for the parameters of the equivalent UC circuit model in each case.

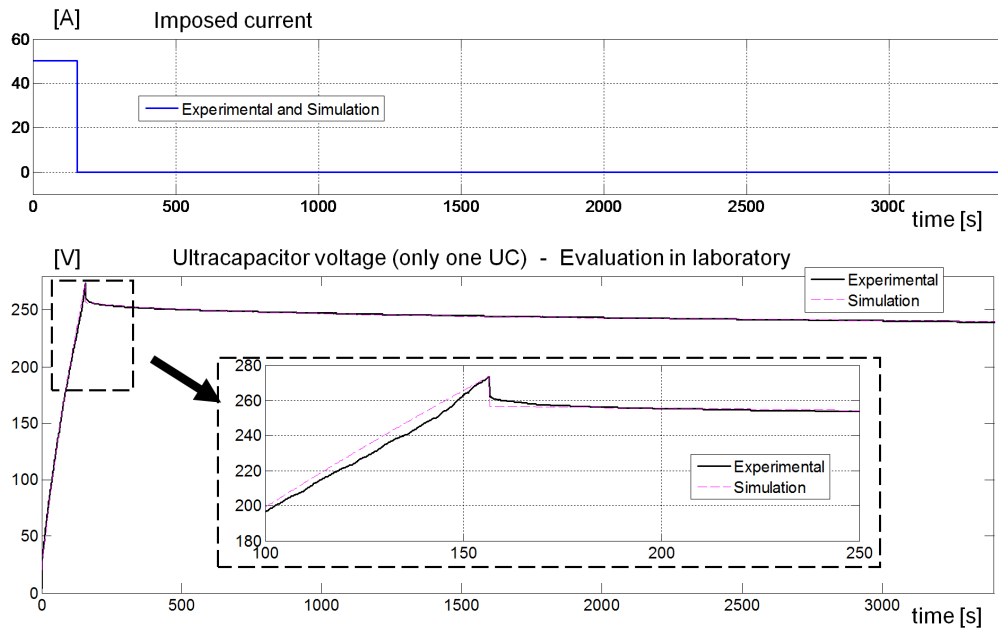

Figure 2.12: UC equivalent circuit parameter identification - Validation results I

Table 2.3: UC parameters (single bank)

Parameter	Value
C_{rated}	32 [F]
C_{i0}	19.77 [F]
C_{i1}	77.5 [mF/V]
C_2	0.9 [F]
R_i	337 [m Ω]
R_2	8.1 [Ω]

Table 2.4: UC parameters (both banks)

Parameter	Value
C_{rated}	16 [F]
C_{i0}	11.36 [F]
C_{i1}	7.8 [mF/V]
C_2	0.09 [F]
R_i	602 [m Ω]
R_2	13.53 [Ω]

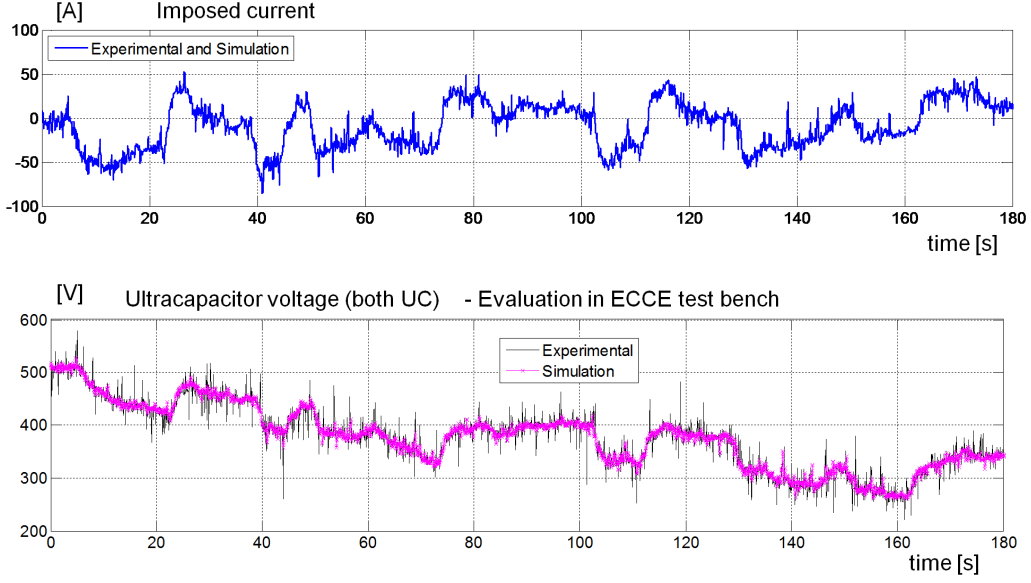

Figure 2.13: UC equivalent circuit parameter identification - Validation results II

2.2.3 State-of-charge

The charge in an ultracapacitor is directly related to its terminal voltage; as a consequence UC SOC estimation is a much easier task than in batteries. Equation 2.12 presents one method to estimate it using the values of the UC voltage [Alle09]. However, this approach has two significant problems: 1) it does not consider the voltage drop in the internal UC resistance and 2) this estimation is represented by a discontinuous function (the voltage in a UC is discontinuous because of its internal resistance), while the SOC is by definition continuous (law of conservation of energy).

$$UC_{SOC} \approx \frac{V_{uc}}{V_{rated}} \quad (2.12)$$

In this dissertation, an improved method to estimate the UC SOC is proposed. It is based on two hypotheses:

1. All the charge in the UC is stored in the principal branch of the circuit which has a much higher capacitance than the secondary
2. All the current in the UC flows through the principal branch which presents a much lower impedance than the secondary

The estimation of the SOC considers the ohmic drop voltage in the internal resistance of the UC (the voltage in the capacitor is by definition continuous). The UC SOC is estimated using the equivalent circuit parameters, the current and voltage values as proposed in Equation 2.13. Here the numerator represents the stored charge in the first branch (see Figure 2.9); the denominator represents the UC charge at rated voltage.

$$UC_{SOC} \approx \frac{V_{ceq}^2 (C_{i0} + C_{i1} V_{ceq})}{V_{rated}^2 (C_{i0} + C_{i1} V_{rated})} \quad (2.13)$$

where

$$V_{ceq} = V_{uc} - i_{uc} R_i \quad (2.14)$$

2.2.4 Representation and control structure

In ECCE, the UCS acts as a current source supplying (or receiving) current to (from) the DC bus, its voltage is imposed by the batteries. The UC are represented using a source element, the power converter is represented as an ideal conversion element and an accumulation element is used to represent the converter equivalent impedance.

The UCS EMR presents only one control input (the power converter duty-cycle). The control objective is identified as the power delivered by this source (as the voltage is imposed, then a current controller is implemented).

The Maximal Control Structure (MCS) of the UCS is obtained from direct inversion of the EMR. As the considered MCS only requires voltage and current measurements, the Practical Control Structure (PCS) in this case remains the MCS without any change. Figure 2.14 presents the EMR and control structure (MCS and PCS) of the UCS, this figure also illustrates how the MCS blocks look inside (the study of the controllers is not considered in this thesis).

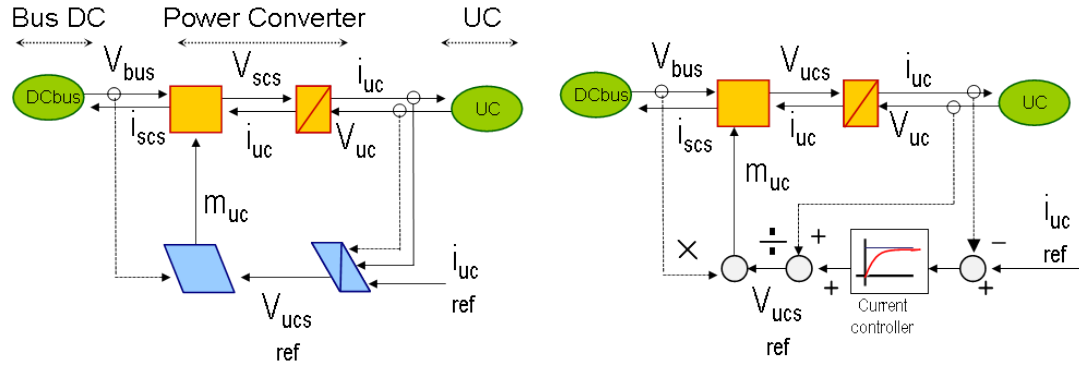

Figure 2.14: UCS EMR and control structure: MCS and PCS (left) detail (right)

2.3 Fuel cell system

The Fuel cell system (FCS) is a multi-physical source that converts hydrogen (and oxygen) into electrical energy (and heat and water), its reverse process is the electrolysis of water. It becomes a more and more interesting and promising energy source to fight against oil-dependence in automotive industry and stationary power plants [Pera07]. However, as it is not classically a reversible source, the fuel cell cannot be considered alone for electrical vehicles (EV) unless electrical energy cannot be recovered during braking. UC or batteries have then to be associated.

The fuel cell is an electrochemical source composed by two electrodes separated by an electrolyte (as batteries and ultracapacitors!). The electrodes are recovered with a catalyst which enables the chemical reactions. The type of electrolyte defines the operation and temperature: low temperature fuel cells as the Proton Exchange Membrane Fuel Cell (PEMFC) work at about 70°C , high temperature fuel cells as the Solid Oxide Fuel Cell (SOFC) operate at temperatures about 800°C .

The operation of low temperature fuel cell requires several ancillaries (compressor, humidifier, power converter), for this reason the efficiency of the FCS is highly reduced regarding the fuel cell stack itself. Moreover, the dynamic response of the FCS is highly limited by the gas supply and then the fuel cell system is very constrained to supply high frequency power (time constants in gas flow are much higher than in electrical). Figure 2.15 presents the fuel cell stack basic working principle and the FCS schematic.

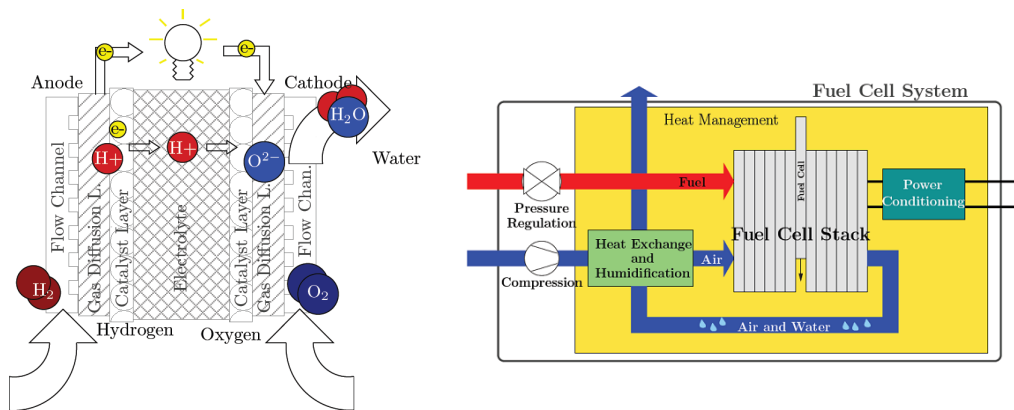

Figure 2.15: Fuel cell stack schematic (left) FCS multidomain aspects (right) [Chre08]

ECCE test bench is equipped with an 80 [kW] PEMFC stack. The FCS was developed by HELION, (Aix-en-Provence, France), for the SPACT-80 project which aimed to develop FCS suitable for high power transport applications: the LHyDIE hybrid locomotive [Aki08] and the ECCE hybrid vehicle. It is the most powerful FCS developed in France for transportation applications and is illustrated in Figure 2.16, their characteristics are resumed in Table 2.5.

A rigorous study of the fuel cell system modelling and representation with control purposes has been developed in the Ph.D. dissertation realised by Mr. Loïc Boulon in the FEMTO-ST laboratory [Boul09]. To facilitate the study of the fuel cell system, the retained FCS model is divided in four parts: the motor-compressor group to compress the air, the hydrogen and oxygen supply channels, the fuel cell stack itself and the DC/DC power converter.



Figure 2.16: Fuel cell system implemented in ECCE

Table 2.5: ECCE fuel cell system parameters

Description	Value
Supplier	HELION (Areva)
Elements in series	2*110
Maximal gross power	80 [kW]
Maximal voltage	190 [V]
Power rate change	5 [A/s]

2.3.1 Motor-compressor group

The air supplied to the stack is compressed using a motor-compressor group: a rotary screw compressor coupled to a Permanent Magnet Synchronous Machine (PMSM). The compressor model was developed in the Ph.D. dissertation realised by Tekin [Teki04]. The retained PMSM model is that presented by Meibody [Meib00]. The air compressor and PMSM parameter identification is presented in [Genr08].

The EMR of the PMSM has been presented by Bouscayrol *et al.* [Bous05]. The electrical machine is represented by two accumulation elements representing the inductance of the electrical side and the shaft in the mechanical side. The electromechanical conversion is represented by a multi-physics conversion element.

In EMR formalism, the compression head is represented by a multi physics domain coupling device. For both fluid sides, the air input pressure P_{in} and the fuel cell stack pressure P_{O_2} are imposed to the compressor and the volume flows $q_{V_{in}}$ and $q_{V_{out}}$ are considered as outputs. On the mechanical side, the input is the rotation speed of the motor and the output is the mechanical torque T_{comp} applied to the shaft [Boul10c].

Figure 2.17 presents the EMR of the motor-compressor group including the power converter represented by a mono-physical conversion element. This representation highlights the fact that in the ECCE test bench, the energy required by the motor-compressor group is directly supplied from the DC bus.

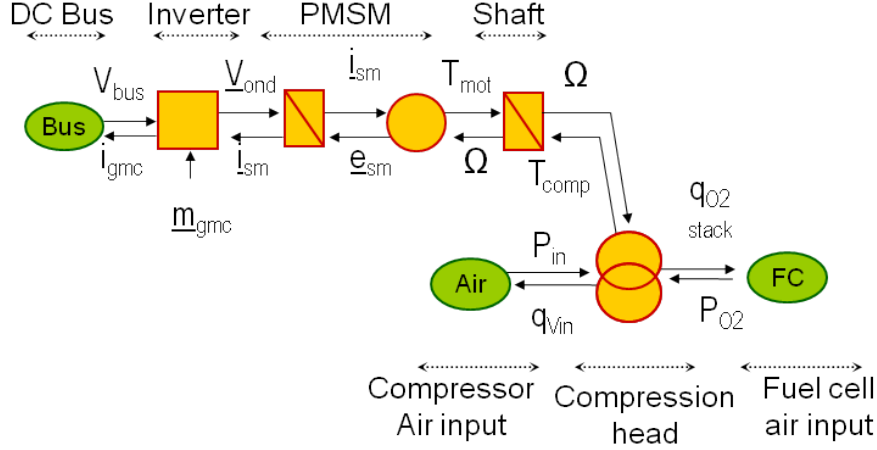

Figure 2.17: Motocompressor group EMR

2.3.2 Gas supply

In the considered model of the FCS, the hydrogen is fed to the fuel cell stack by a tank which is supposed to be perfectly controlled, the oxygen is fed by the air compressor presented in previous subsection. Figure 2.18 presents the EMR of the gas supply, this is used for both the O_2 and the H_2 gas supply. The monophysical conversion blocks represents the input and output pressure drops in the circuit gas between the tank (or compressor) and the electrodes of the stack. The accumulation block represents the hydraulic capacitance of the circuit.

Regarding the original EMR ([Boul10c]), two normalisation blocks are included to normalise the gas flow. The total flow input of the stack q_{stack} is divided in the number of cells of the stack N_{cell} and in the surface of the cell S . This is equivalent to supply a single cell with a surface of $1cm^2$. Normalisation blocks 1 and 2 are defined by Equations 2.15 and 2.16 respectively. The gas supply EMR is represented in Figure 2.18, here the index x represent the gas (this EMR is valid in the anode and in the cathode).

$$q_{xcell} = \frac{q_{xstack}}{N_{cell} S} \quad (2.15)$$

$$q_{xoutstack} = q_{xoutcell} N_{cell} S \quad (2.16)$$

2.3.2.1 Fuel cell stack

The fuel cell model presented in [Boul09] is retained in this thesis (stack and gas supply). The EMR of the FCS stack is based on that presented in [Boul09]. However, to simplify the study, it has been slightly modified by using normalisation blocks to perform normalised simulations.

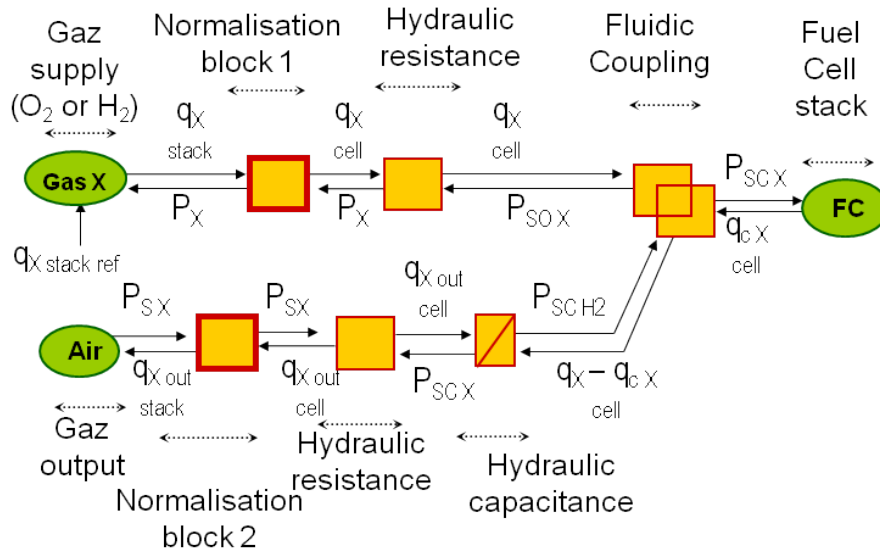

Figure 2.18: Stack gas supply EMR (O_2 and H_2)

Figure 2.19 presents the EMR of the fuel cell stack. The thermodynamics potential block includes the reversible cell potential plus the voltage drop at the considered pressure and temperature (multi-physical coupling block). Finally a normalisation block is used to work with normalised current densities A/cm^2 . The current is normalised by the surface of the cell (Equation 2.17), and the output voltage is denormalised using the number of cells (Equation 2.18).

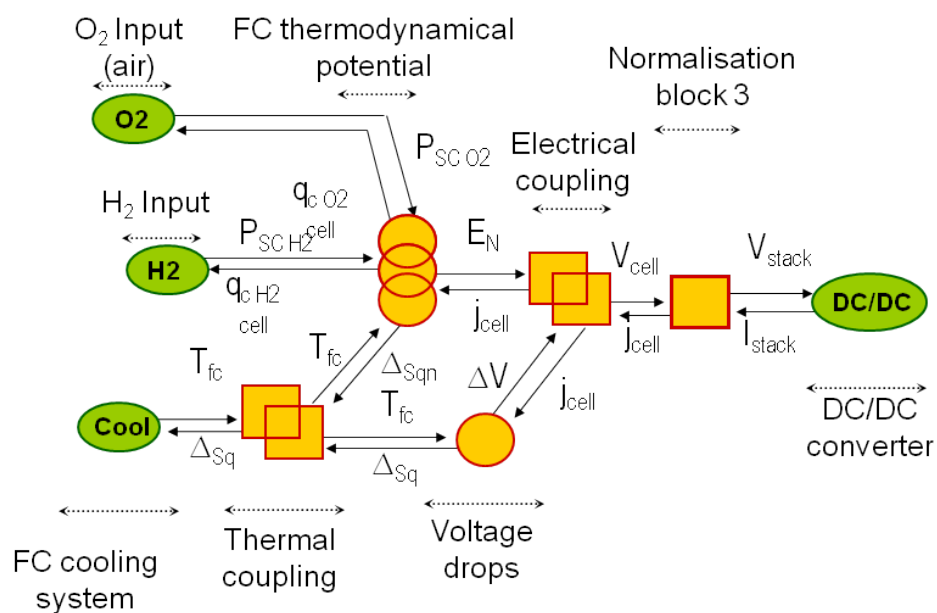

Figure 2.19: Fuel cell stack EMR

$$j_{cell} = \frac{j_{stack}}{N_{cell} S} \quad (2.17)$$

$$V_{stack} = V_{cell} N_{cell} \quad (2.18)$$

2.3.3 Power Electronics

A DC/DC boost converter is used to couple the fuel cell to the DC bus. The power converter is modelled as an ideal DC/DC converter represented by a conversion block and its electrical impedance represented by an accumulation block. The EMR of the power converter presented in Figure 2.20.

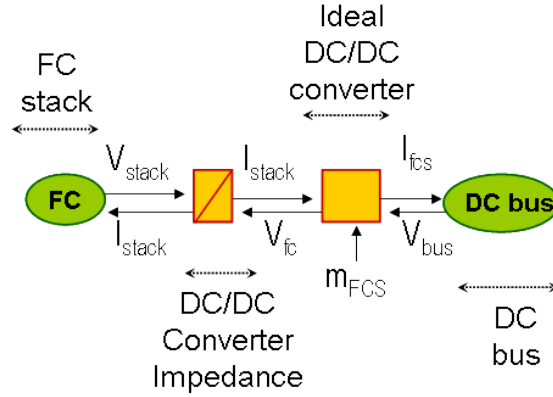

Figure 2.20: Fuel cell system DC/DC power converter EMR

2.3.4 Fuel cell system

Figure 2.21 presents the proposed EMR to represent the whole fuel cell system.

2.3.5 Maximal control structure

Two control objectives are identified in the FCS: the delivered power and the stack voltage. As batteries impose the DC voltage, the power of the FCS is managed by controlling its current via the duty cycle of the DC/DC converter (m_{FCS} in Figure 2.21). The stack voltage is controlled by controlling the air and hydrogen supply (m_{GMC} and $q_{H_2, stack, ref}$ in Figure 2.21). The MCS of the FCS is done by direct inversion of the EMR blocks as shown in Figure 2.22. This figure also highlights the considered control chains.

2.3.6 Practical control structure

The control of the FCS power output has no constraints (only requires current and voltage measurements), this control structure could be directly implemented without modifications. However, the structure to control the fuel cell stack voltage is highly constrained and has to be simplified:

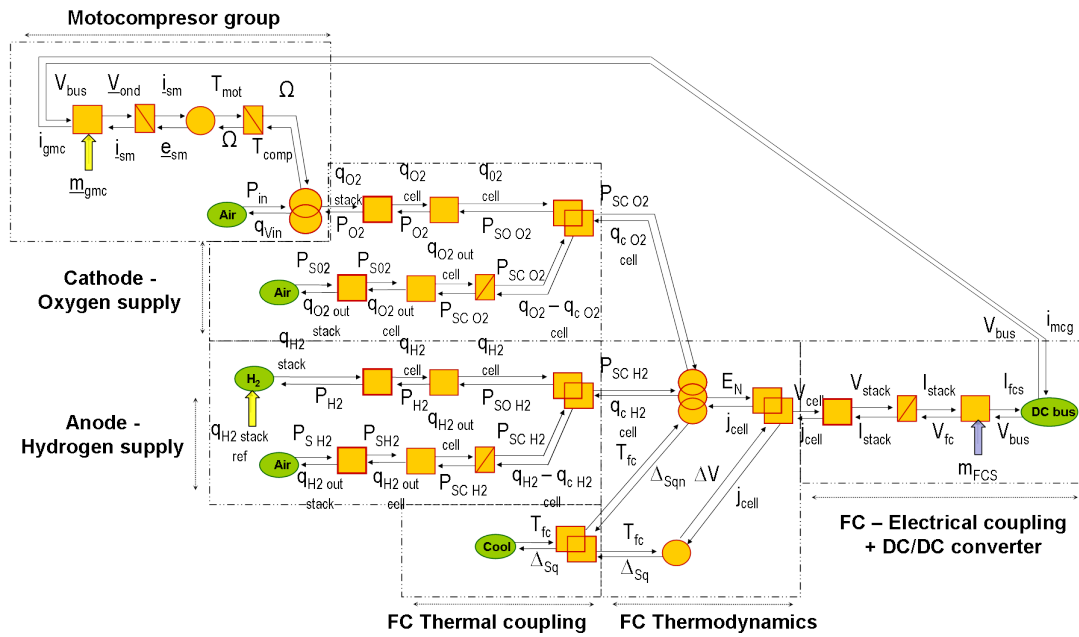

Figure 2.21: Fuel Cell system EMR

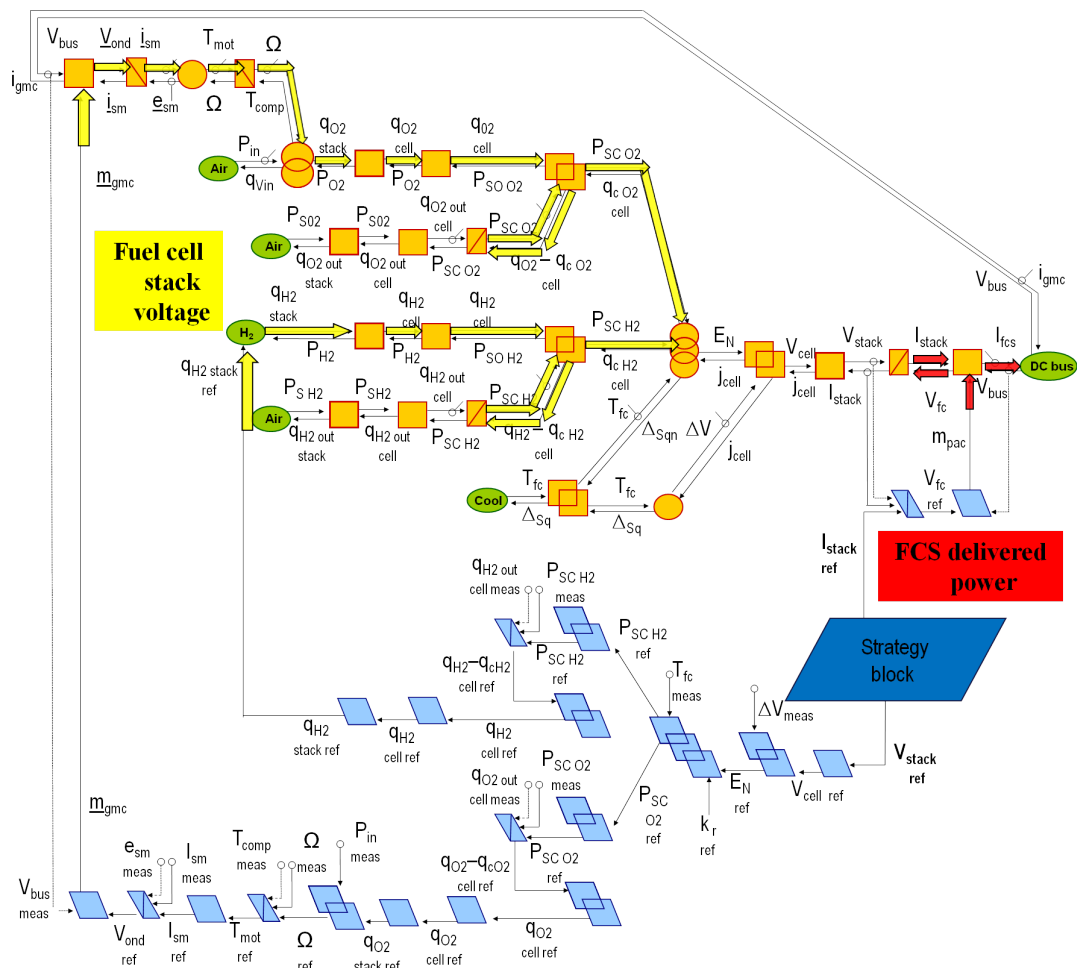

Figure 2.22: Fuel Cell system MCS

Based on the MCS approach, the FCS control requires the sixteen measurements listed in Table 2.6). Among them, there are non physical measurements such as the electromotive force (EMF), the hydrogen and oxygen catalytic partial pressures and the fuel cell overpotentials. There are also relatively expensive measurements (air and hydrogen output flows, and PMSM torque). Therefore, it could be interesting to consider only the other physical quantities to establish a Practical Control Structure of the hybrid electrical vehicle.

2.3.6.1 MCS Simplifications

A simplification of the MCS is made on the basis that the time delay of the gas in the supply channels can be neglected. This hypothesis is justified because the time constants of the gas flow can be neglected regarding the (relatively slow-) energetic demand on the DC bus and also linked to the fact that the UCS guarantees the DC bus power fastest dynamics. As a consequence of this simplification, the references of the gas flows are defined without considering the gas delay in the supply channels. This is represented in Figure 2.23.

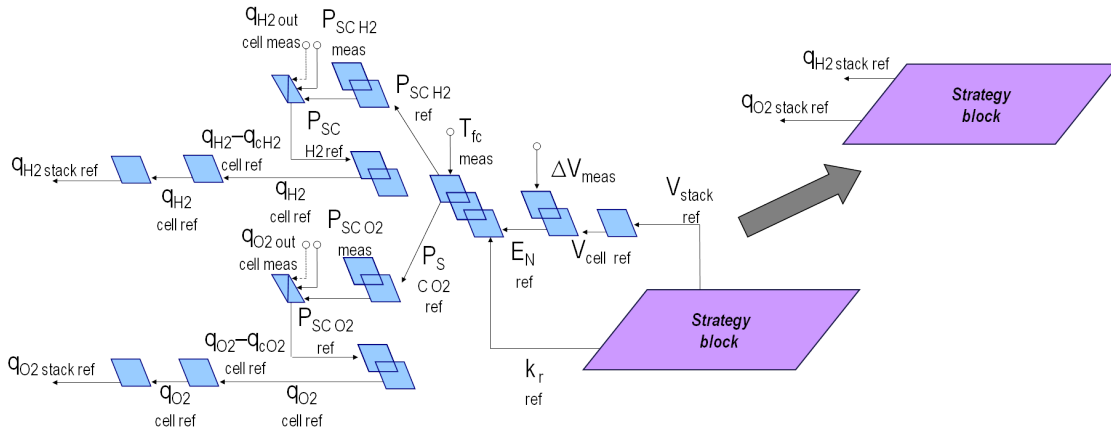

Figure 2.23: From a complicated MCS to a feasible PCS - Fuel Cell system gas supplies

2.3.6.2 Estimated Variables

For the non measurable physical quantities it is important to estimate those that permit inverting the control chain. The estimators in the open loop control are:

1. Compressor torque. The compressor head torque is estimated from the rotor speed using mappings [Genr08].
2. PMSM EMF. This electromotive force is estimated using the measured PMSM current and speed.
3. Air compressor input air pressure. The input pressure is considered as the standard atmospheric pressure. Thus, no estimator is considered at this level.

2.3.6.3 Motor-compressor group

The PCS of the motor compressor group can be developed from its MCS, considering the simplifications and estimations: the torque is estimated using a cartography (speed - torque). The EMF is estimated using the PMSM equations presented by Meibody [Meib00]. The motor-compressor group PCS is presented in Figure 2.24.

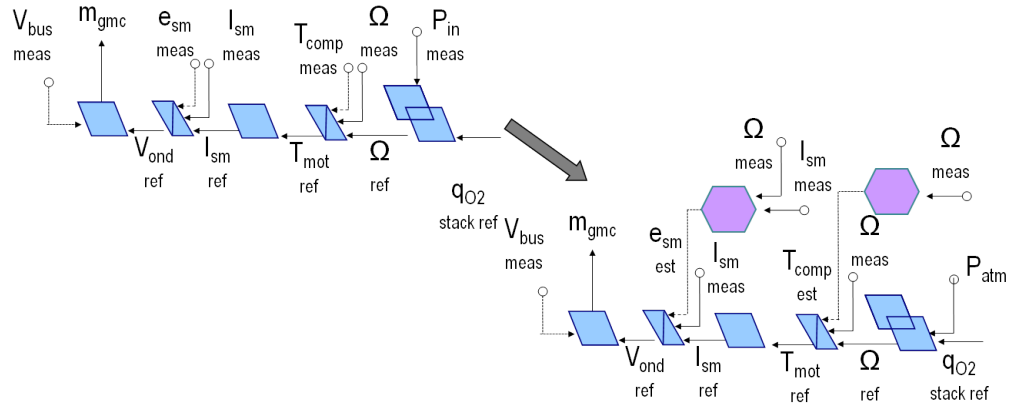

Figure 2.24: From an expensive MCS to an affordable PCS - Air motocompressor group

2.3.6.4 Complete PCS

To summarise the transformation from the MCS to the PCS, the first step was to identify the constraints, after that, simplifications were applied and the non-feasible measurements were estimated. Based on the MCS, the control of the FCS requires 16 measurements; based on the PCS it requires only 7 measurements. Seven measurements were avoided using simplification hypotheses and two measurements are now estimated. Table 2.6 summarises all the requested measurements for each control structure and Figure 2.25 presents the complete PCS.

2.4 Flywheel system

The kinetic energy E_k stored in a mass rotating at angular speed of ω with a moment of inertia J is defined by Equation 2.19.

$$E_k = \frac{1}{2} J \omega^2 \quad (2.19)$$

Flywheel systems (FWS) are electromechanical devices that store kinetic energy using a flywheel coupled to a high speed electric machine (10000-40000 [rpm]). Because of its extended lifetime and reliability, a flywheel system appear to be an attractive source to be used in HEV and mainly in high power-energy applications as railroad electric traction [Beno02, Holm03, Soug10].

Table 2.6: Fuel cell system control - required measurements

Element - Physical quantity	MCS	Simplified	Estimated	PCS
Motocompressor - Speed	x			x
Motocompressor - Torque	x		x	
Motocompressor - Air input pressure	x	x		
PMSM - EMF	x		x	
Fuel Cell stack - H2 output flow	x	x		
Fuel Cell stack - O2 output flow	x	x		
Fuel Cell stack - O2 Catalytic Pressure	x	x		
Fuel Cell stack - H2 Catalytic Pressure	x	x		
Fuel Cell stack - Temperature	x	x		
Fuel Cell stack - Overpotentials	x	x		
DC Bus - Voltage	x			x
Fuel Cell stack - Output Voltage	x			x
Fuel Cell stack - Output Current	x			x
Motocompressor group - DC current	x			x
Fuel Cell System - Output Current	x			x
PMSM AC Current	x			x

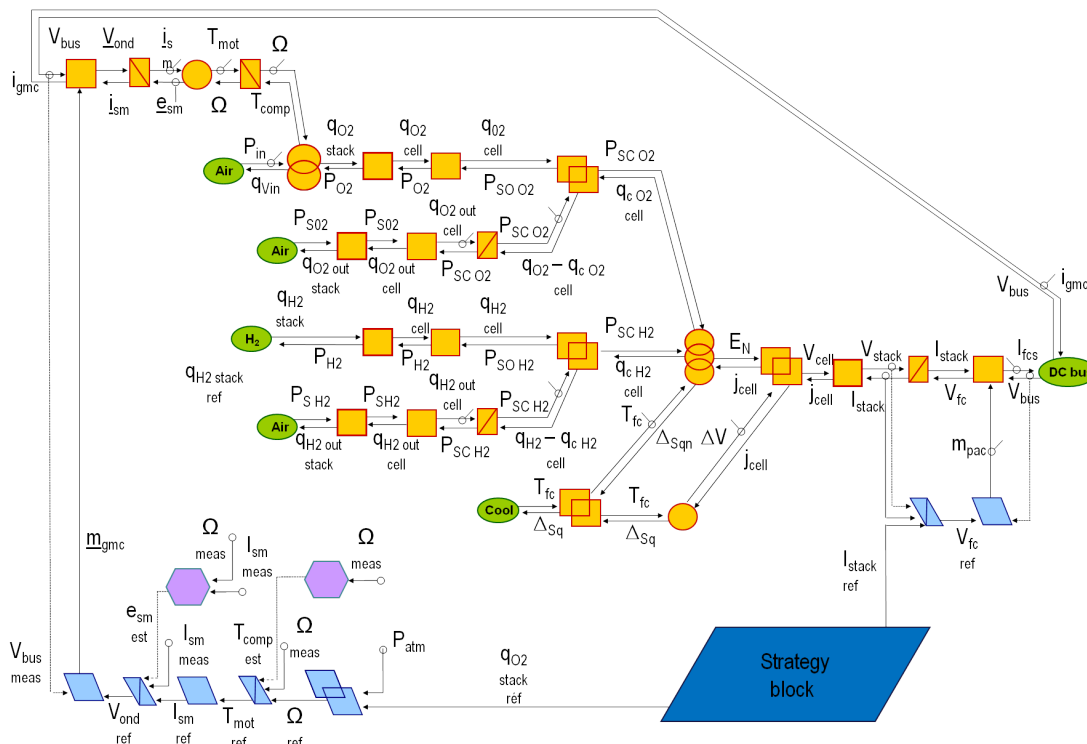

Figure 2.25: Fuel cell system practical control structure

Table 2.7: ECCE flywheel system parameters

Description	Value
FWS nominal power	50 [kW]
Flywheel maximal speed	40000 [rpm]
Power autonomy	100 [kW] - 10 [s]
Speed reducer ratio	10

The ECCE test bench will be equipped in the last stage of the project with a flywheel system. This FWS delivers a continuous power of 50 [kW] @ 40000 [rpm] and an over-charge of 100 [kW] for 10 [s]. The FWS integrates an Internal Combustion Engine (ICE), a mechanical transmission and two flywheels coupled electrical machines. To limit the gyroscopic effect, the flywheels are counter-rotating implemented and rotate at the same speed. The flywheel system is illustrated in Figure 2.26 and its characteristics are resumed in Table 2.7. Figure 2.27 shows the electrical machine developed by THALES AES company (Chatou, France) [Mart05].

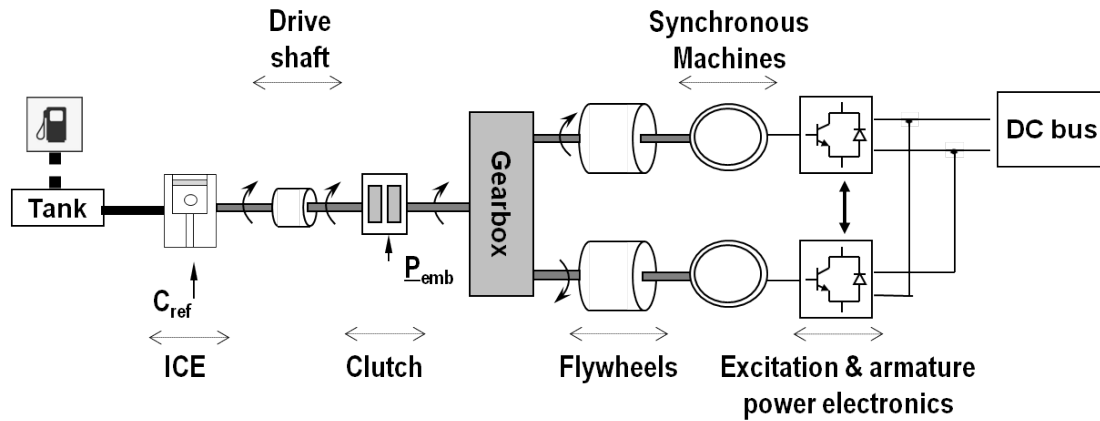

Figure 2.26: Flywheel system implemented in ECCE

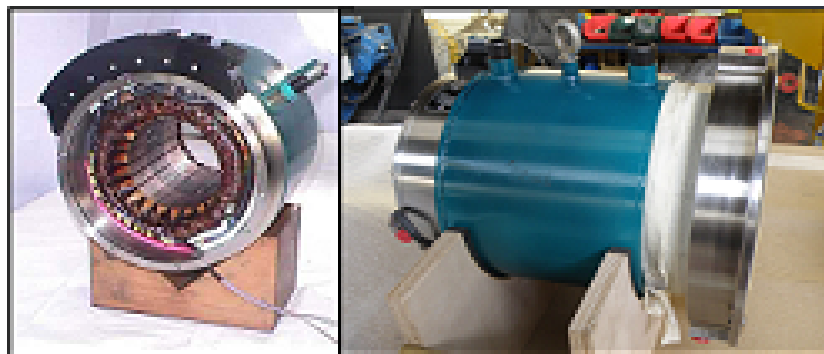

Figure 2.27: ECCE flywheel system homopolar synchronous machine [Mart05]

Designing and constructing a very-high speed system is a challenge in various aspects:

Flywheel components have to be highly optimised to support high mechanical speeds and electrical switching frequencies. The flywheel system containment must guarantee the security of the vehicle and its passengers. The losses (such as friction) has to be minimised to avoid self-discharge.

In FWS the rotational speed is used to estimate the SOC (Equation 2.20). Usually, in FWS, the minimal operational speed is 50% of the rated speed and then only 75% of the rated energy is available (as in UC see Subsection 2.2.3).

$$FWS_{SOC} \approx \frac{\omega_{fw}^2}{\omega_{fwmax}^2} \quad (2.20)$$

2.4.1 Representation

Neither the modelling nor the control of this source is considered in this thesis, however an energetic macroscopic representation is proposed. To facilitate the EMR study, the FWS is divided in an electric and a mechanical part.

2.4.1.1 Mechanical part

The mechanical part includes the ICE, the transmission and the flywheels. The ICE is modelled with a cartography (torque, speed, fuel consumption) [El K06] and represented by a source element [Boul09]. The clutch is represented with the two-states (locked and slipping) EMR presented by Lhomme *et al.* [Lhom08].

The flywheels and the shaft of the diesel motor are represented using energy accumulation elements: 1) when the clutch is locked, the flywheel system speed is directly dependent to the diesel motor speed an only one accumulation element is considered, when the clutch is slipping, the speed of the flywheel is independent from the motor speed and then two accumulation elements are considered. This is presented in Figure 2.28

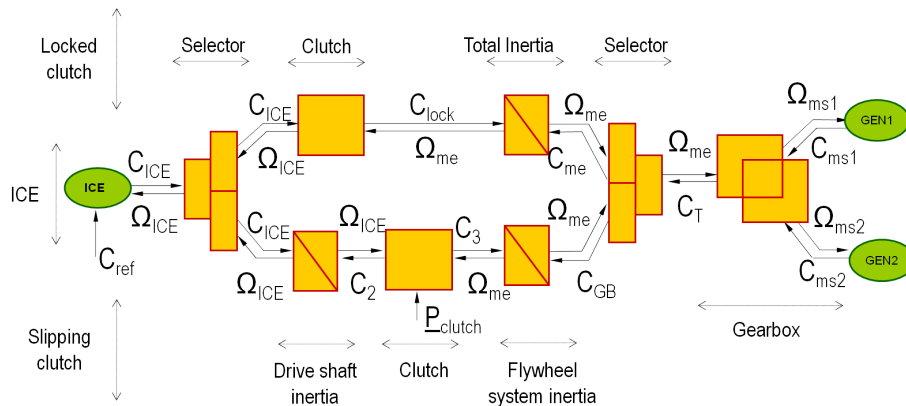

Figure 2.28: Flywheel system - Mechanical part EMR

2.4.1.2 Electrical part

The electrical part includes the synchronous machine with independent excitation and the power converter. This is presented in Figure 2.29

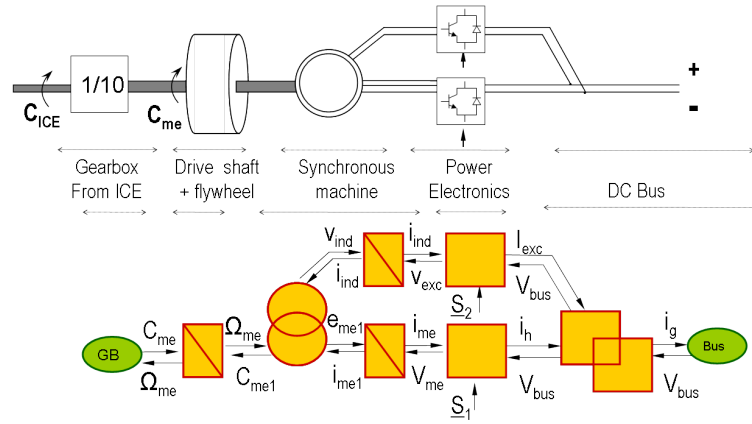

Figure 2.29: Flywheel system - Electrical part EMR

2.4.1.3 Flywheel system

The flywheel system EMR is presented in Figure 2.30

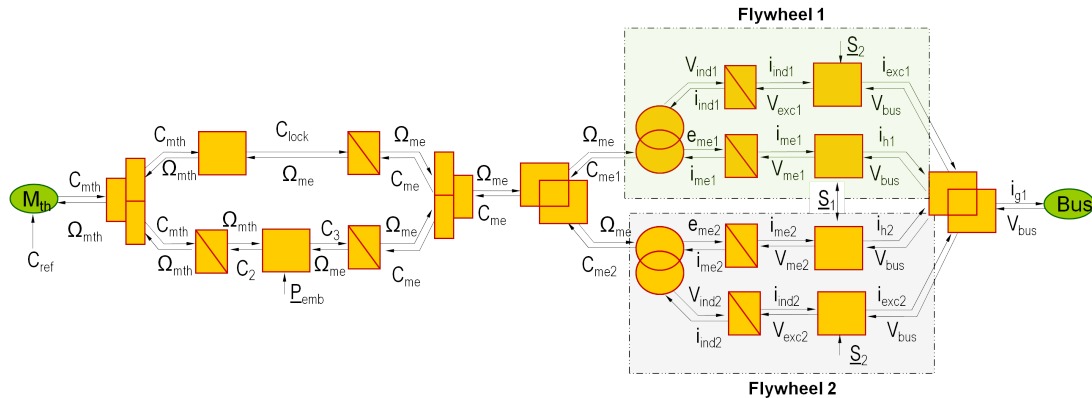

Figure 2.30: Flywheel system implemented in ECCE

2.5 Traction chain and ancillaries

The ECCE traction chain is very difficult to model: different motors, converters and mechanical transmissions technologies are implemented in each wheel. A simplified model-representation is then considered. The traction chain is represented by a current source which represents the equivalent power consumption supplied by the DC bus.

The ancillaries consumption (pumps, lights, power steering...) is also difficult to estimate and for facility in this work, it is considered as a constant current source (i_{aux}).

2.5.1 Modelling of the traction chain

The traction chain power consumption is estimated using classical dynamic equations as presented by Larminie [Larm03]. To estimate the force to drive a vehicle the following forces are considered:

- The force to accelerate the vehicle is proportional to its mass m and the magnitude of the acceleration defined as the time derivative of the velocity v . This force which became negative in braking is defined by Equation 2.21.

$$F_a = m a = m \frac{dv}{dt} \quad (2.21)$$

- The hill climbing force needed to drive the vehicle in a road with a slope angle of Θ is defined by Equation 2.22. Here, g represents the acceleration due to gravity.

$$F_{hc} = m g \sin \Theta \quad (2.22)$$

- The rolling resistance force due to the friction between the tyre and the road is nearly independent of the velocity and considered as a constant. A friction coefficient μ_{rr} which depends on the road and tyre parameters permits to estimate this force which is always opposed to the motion and is defined in Equation 2.23.

$$F_{rr} = \mu_{rr} m g \quad (2.23)$$

- The aerodynamic drag force is the friction due to the air resistance which opposes to the movement of the vehicle and is defined by Equation 2.24. Here S represents the frontal surface and C_d a shape constant of the vehicle and ρ the air density.

$$F_{ad} = \frac{1}{2} \rho S C_d v^2 \quad (2.24)$$

Finally, the traction force to drive a vehicle (F_{tr}) on a sloped road is calculated using Newton's second law of motion as defined in Equation 2.25. A free body diagram representing the different forces acting in the vehicle dynamics is presented in Figure 2.31.

$$F_{tr} = F_a + F_{rr} + F_{hc} + F_{ad} \quad (2.25)$$

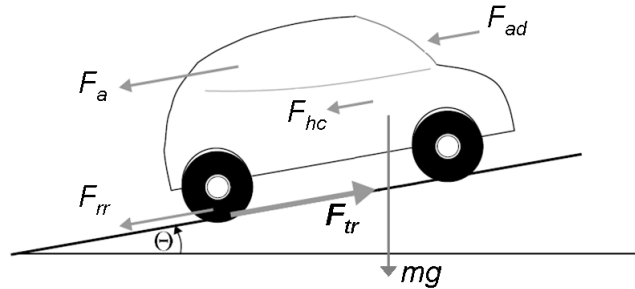

Figure 2.31: Road-vehicle free body diagram. Adapted from [Larm03]

The mechanical power to drive the vehicle now can be computed as the traction force and the velocity are known. This quantity is computed using Equation 2.26.

$$P_{mec} = F_{tr} v \quad (2.26)$$

The electrical power to drive the vehicle supplied by the DC bus $P_{el \text{ sup}}$ is estimated in considering a global efficiency η ($0 < \eta < 1$). This efficiency represents the losses in the mechanical transmission, power electronics and electrical machines. The electrical power to drive the vehicle is then higher than the mechanical and is presented in Equation 2.27.

$$P_{el \text{ sup}} = P_{mec}/\eta \quad (2.27)$$

Obviously, this relation changes in regenerative braking and the recovered electrical power is lowest than the mechanical. It is presented in Equation 2.28.

$$P_{el \text{ rec}} = P_{mec} \eta \quad (2.28)$$

Finally the current of the current source is calculated from the voltage in the DC bus. (Equation 2.29)

$$i_{trac} = \frac{P_{el}}{V_{bus}} \quad (2.29)$$

Table 2.8 presents the values used for modelling in simulation the ECCE test bench. The choice of the parameters to model the friction coefficient and the shape factor is based on typical values presented in [Larm03].

Table 2.8: ECCE vehicle simulation parameters

Description	Value
Mass	12000 [kg]
Friction coefficient	0.015
Frontal surface	8 [m^2]
Shape constant	0.4

2.6 ECCE representation and control structure

The EMR of the batteries and DC Bus presented in Figure 2.5 is modified to include the different sources (FCS and UCS) and loads (fuel cell air compressor, ancillaries and traction chain). To complete the EMR of the vehicle, the pictograms representing these sources are replaced by their developed EMRs. This is shown in Figure 2.32. This figure also highlights the control chain for three control objectives explained in previous subsections.

Finally, the maximal and practical control structures of the vehicle are shown in Figures 2.33 and 2.34.

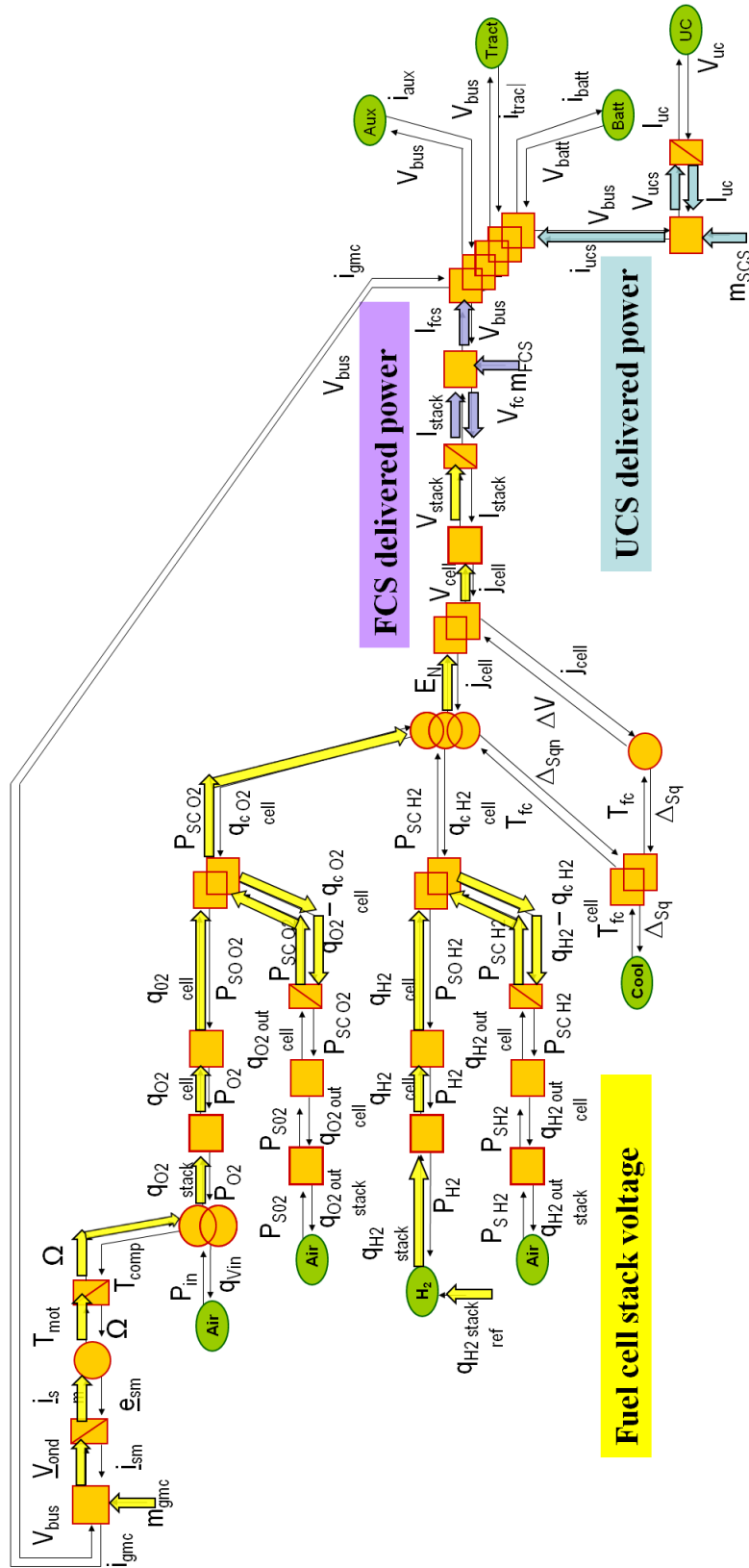

Figure 2.32: ECCE Energetic Macroscopic Representation

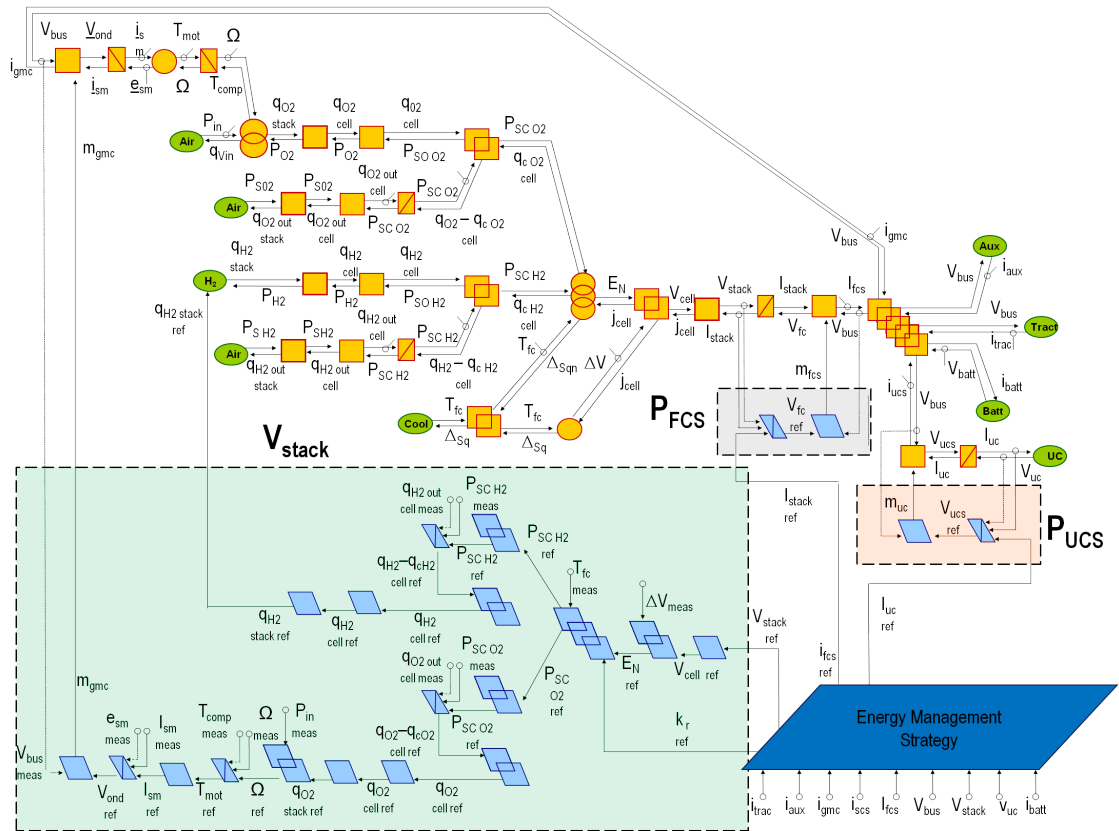

Figure 2.33: ECCE Maximal Control Structure

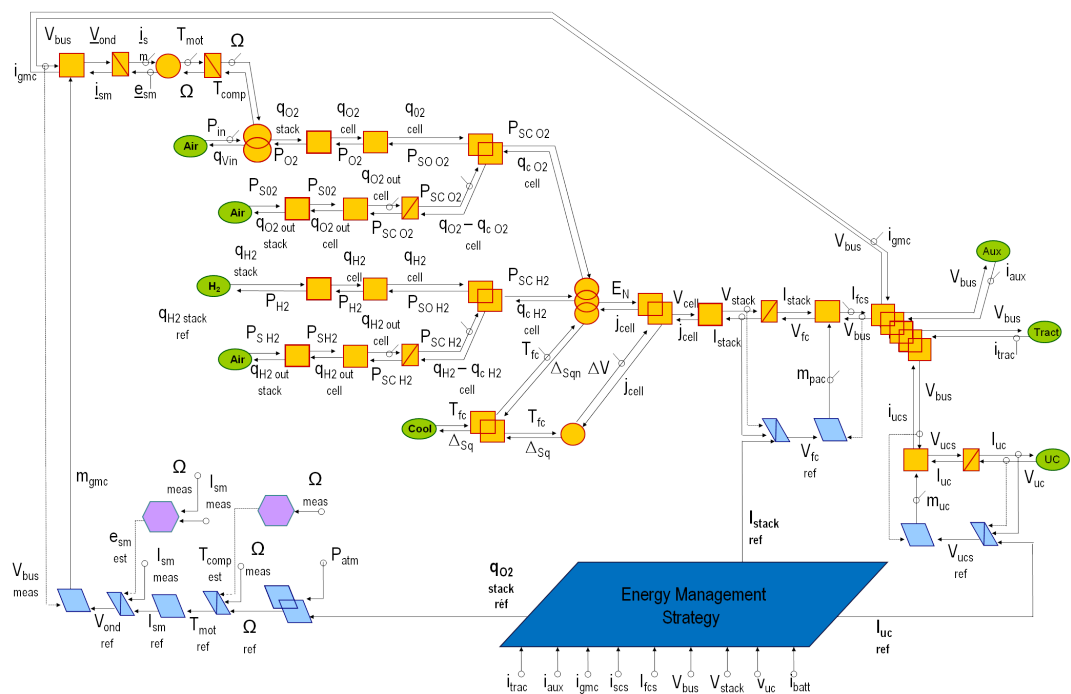

Figure 2.34: ECCE Practical Control Structure

2.7 Chapter conclusion

The energy sources of ECCE multi-physical multi-source were studied regarding their advantages and drawbacks. This is useful to define how each source can be used in the energy distribution of the vehicle.

An ultracapacitor circuit model (simplification of Zubieta model [Zubi00]) for hybrid electrical vehicle simulation and the procedure to identify its parameters is proposed. This is the first contribution presented in this thesis. The circuit model and parameter identification was experimentally validated in laboratory and in a real hybrid electric vehicle: the ECCE test bed. The UC model is well adapted to be used in HEV simulation.

EMR is selected as a tool to represent the vehicle and its sources, it permits the identification of the control structure and enables using directly previous research performed in FEMTO-ST laboratory. The control structure of a configuration of ECCE including batteries, ultracapacitor system and fuel cell system is developed and presented (the flywheel system will be studied later in ECCE project).

Considering the energy management in ECCE it can be concluded that:

- Lead-acid batteries used in ECCE are not adequate to be used as a principal energy source anymore. This is due to the facts that 1) this source presents the lowest efficiency and cyclability of the available sources and 2) technically the voltage variation of the ECCE DC bus is very restrained (i.e. voltage variations out of pre-established limits will cause malfunctioning in the FCS or UCS power converters). The considered energy management strategy must aim to minimise the use of the batteries.
- Fuel cell system presents the highest specific energy of the considered sources, however the dynamic of this source (linked to the ancillaries dynamic) is limited and then it is difficult to use the FCS to supply high dynamic power. In ECCE the energy management strategy should aim to use this source in low frequencies to extend its lifetime. As this is the only energy conversion source, this source must regulate the state-of-charge of the remaining energy sources.
- Regarding its cyclability, efficiency and dynamical response, the ultracapacitor system is clearly the most interesting power source to be used in ECCE. The energy management in ECCE must privilege the use of this source. However, as its specific energy is not high enough, then other sources (particularly the FCS) have to regulate its state-of-charge.

Chapter 3

Type-2 fuzzy logic control of a DC/DC buck converter

This chapter aims to introduce type-2 fuzzy logic as a powerful tool in electrical engineering.

In the second part of this thesis, two applications of type-2 fuzzy logic control are presented. The first application is the output voltage regulation of a DC/DC buck power converter, presented in this chapter. The second application is the energy management of the ECCE mobile laboratory presented in Chapter 4.

This chapter introduces the type-2 fuzzy systems and their different subsystems. At the meantime, numerical examples are presented to facilitate their understanding. Then, a fuzzy logic controller is developed to perform the output voltage regulation of a DC/DC buck power converter. As Type-1 Fuzzy Logic (T1-FL) controllers are well known in this application, the objective is to consider type-2 fuzzy logic (T2-FL) controllers. The voltage controller is implemented, evaluated and compared (using one T1-FL and T2-FL systems) by simulation and by experimentation.

The principal motivations for developing this application, is that it is easy to implement in laboratory at a relatively low cost. It permits a viability evaluation of type-2 fuzzy logic in actual applications before an implementation in the ECCE mobile laboratory.

This chapter is organised as follows: Section 3.1 of this chapter introduces some motivations for using T2-FL instead of T1-FL control systems. Sections 3.2 to 3.6 are devoted to present the type-2 fuzzy systems' architectures as well as their differences and similarities with type-1 fuzzy logic systems. Section 3.7 is devoted to the design of the voltage controller. Section 3.8 presents the design of the different fuzzy systems used in the voltage controller. Section 3.9 presents and discuss the validation results. Finally, Section 3.10 presents the conclusions of the chapter.

Complementary to this chapter, the software implementation of T2-FL systems is presented in Appendix A.

3.1 Fuzzy logic control and uncertainty

From an electrical engineering point of view, fuzzy logic allows using linguistic labels and human knowledge 1) to represent or model physical process and 2) to design their control systems. Fuzzy control has been used in different applications such as voltage control in power converters or speed control in electric machines .

Driving a bicycle illustrates the concept of fuzzy control: people does not need to measure the speed or the acceleration to be able to control the speed while driving in safe conditions. Human brain process linguistic labels as slow, fast, near or far and performs control actions as accelerate or brake.

3.1.1 Uncertainty

Uncertainty is involved with any situation with some lack of information: *it may be incomplete, imprecise, fragmentary, not fully reliable, vague, contradictory or deficient in some other way* [Klir95]¹. Different authors define and classify different types of uncertainty. The classification proposed by Pr. B. Ioos fits to describe uncertainty in electrical engineering [Ioos09]. This classification is illustrated in Figure 3.1.

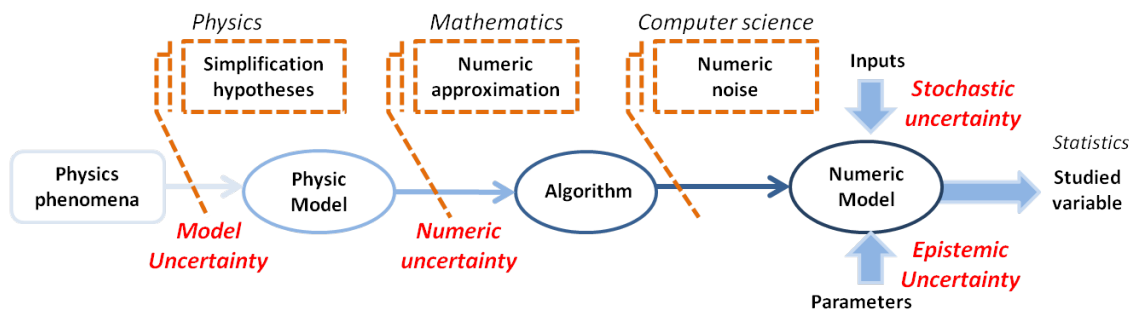

Figure 3.1: Sources of uncertainty - Adapted from [Ioos09]

Uncertainty is also present in fuzzy logic systems as explained by Pr. J. Mendel [Mend01]:

- Uncertainty about the meaning of the words that are used in the rules
- Uncertainty about the consequence that is used in a rule
- Uncertainty about the measurements that activate the fuzzy logic systems
- Uncertainty about the data used to tune the fuzzy logic system parameters

Type-1 fuzzy sets as used in T1-FL does not represent the uncertainty. This is the reason why Zadeh proposed to represent this uncertainty by using type-2 fuzzy sets [Zade75]. Type-2 fuzzy sets and systems are slightly different from those used in classical fuzzy logic as presented in Figure 3.2. Next sections presents these differences by introducing the subsystems of a T2-FL system as presented on Figure 3.3.

¹This reference presents, in Chapter 9, a very interesting discussion about uncertainty

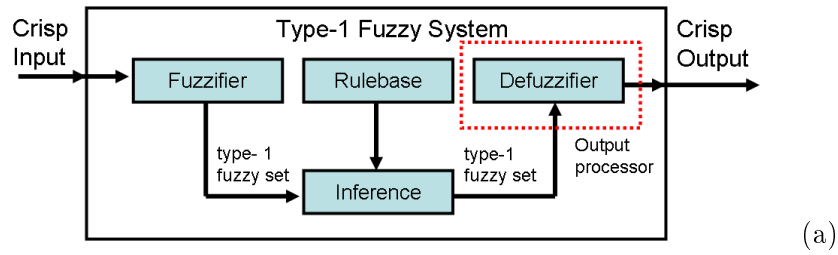

Figure 3.2: Type-1 fuzzy logic systems architecture - Adapted from [Mend01]

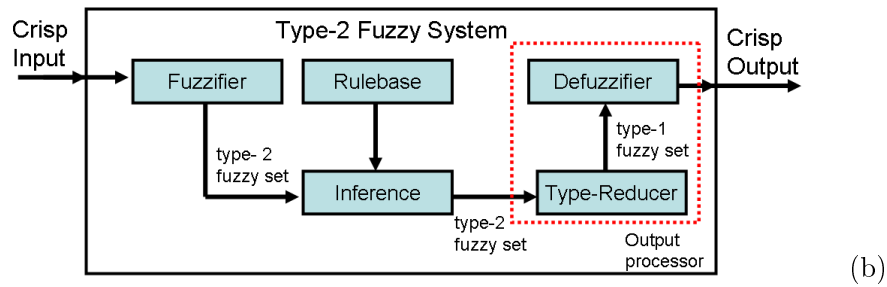

Figure 3.3: Type-2 fuzzy logic systems architecture - Adapted from [Mend01]

3.2 Rule-base

The rule base allows representation of human knowledge by using linguistic labels. A classical fuzzy rule presents the same structure as below:

IF (some conditions are verified) **THEN** (do something) **ELSE** (do something different)

Generally, the fuzzy rules are organised using tables which objective is to represent all the different combinations among the inputs of the system. The structure of the rule-base does not vary between type-1 and type-2 fuzzy logic.

3.3 Membership functions

Membership functions (MFs) enable establishing a relationship between numerical values and linguistic labels. Type-1 fuzzy MFs (T1-MF) are two dimensional and represent the membership degree μ for a variable x . Type-2 fuzzy MFs (T2-MF) are three dimensional: they consider an uncertainty U of the membership degree. T1-MFs are a particular case of T2-MFs where the uncertainty value is 0. Membership functions are classified as:

- Singleton MFs, if μ value is 0 but in a single point of the domain μ value is 1.
- Interval type-1 MFs, if μ value is 0 except in the interval defined by its left and right bounds $[l_b, r_b]$ where $\mu=1$ if $l_b < x < r_b$
- Type-1 MFs if μ is a crisp value which vary between 0 and 1
- Type-2 MFs if μ is represented by a secondary degree MF $\mu_{\tilde{A}}$

Type-2 MFs are classified in:

1. Interval type-2 MFs if $\mu_{\tilde{A}}(\mu, x)$ is an interval type-1 MF
2. General type-2 MFs if $\mu_{\tilde{A}}(\mu, x)$ is a type-1 MF

Figures 3.4, 3.5, 3.6, 3.7 and 3.8 respectively illustrates singleton, interval, type-1, interval type-2 and general type-2 membership functions.

3.3.1 Interval type-2 membership functions

Interval type-2 fuzzy membership functions are easy to implement and then have been used in almost all the works about type-2 fuzzy logic (See Table 1.5). For simplicity reasons, interval type-2 membership function has been also selected for this research.

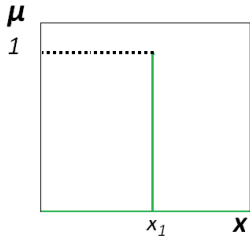

Figure 3.4: Singleton MF

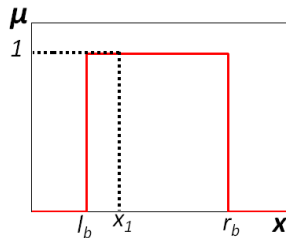

Figure 3.5: Interval type-1 MF

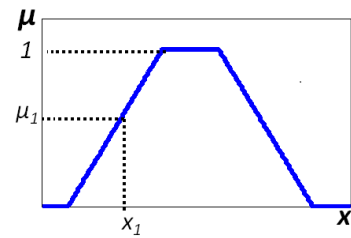

Figure 3.6: Type-1 MF

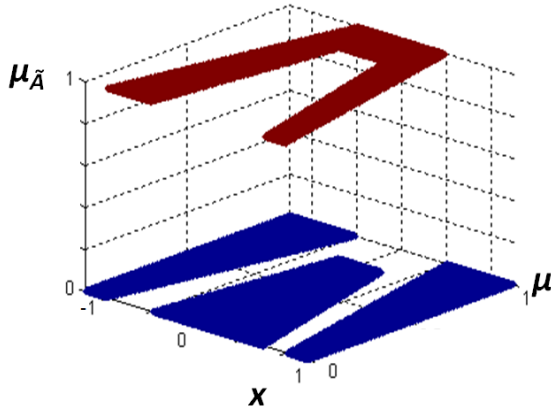

Figure 3.7: Interval type-2 MF

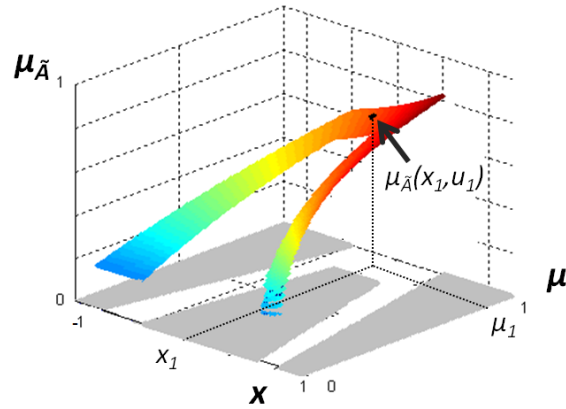

Figure 3.8: General type-2 MF

Interval type-2 fuzzy membership functions can be created from two type-1 MFs. An Upper Membership Function (UMF) which represents the maximum value and a Lower Membership Function (LMF) which represents the minimum value of μ for each x . The uncertainty U is represented by the area between the UMF and the LMF. This region is called Footprint of Uncertainty (FOU) and is illustrated in Figure 3.9.

Type-1 MFs are a particular case of T2-MFs which does not consider the uncertainty, the same MF represents both the UMF and the LMF and the area of the FOU is zero.

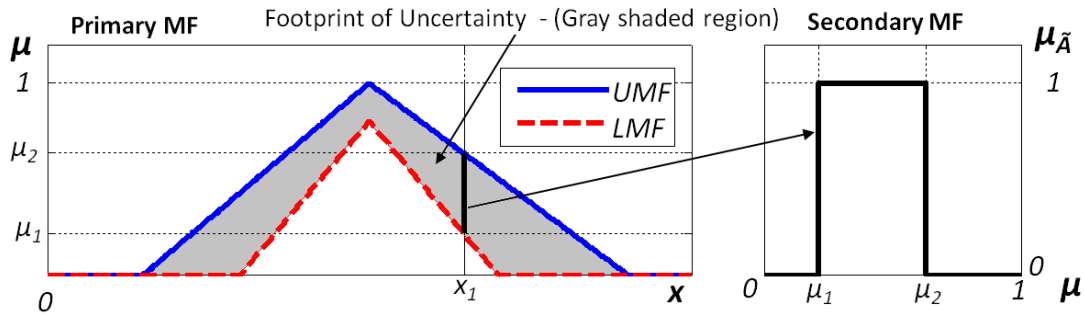

Figure 3.9: Interval type-2 fuzzy logic primary and secondary MFs

3.3.2 Membership functions creation

Triangular and trapezoidal membership functions retained in this work are defined using 4 linear functions, completely described by 5 points (a, b, c, d and e) as defined in Equations 3.1, 3.2 and 3.3, and illustrated in Figure 3.10. Triangular MFs are a particular case of trapezoidal MFs where $b=c$ as illustrated in Figure 3.11.

$$Trapezoid(x, a, b, c, d, e) = \max(0, \min(y_1, y_2, e)) \quad (3.1)$$

$$y_1(x, a, b, c) = e \frac{x - a}{b - a} \quad (3.2)$$

$$y_2(x, c, d, e) = e \frac{d - x}{d - c} \quad (3.3)$$

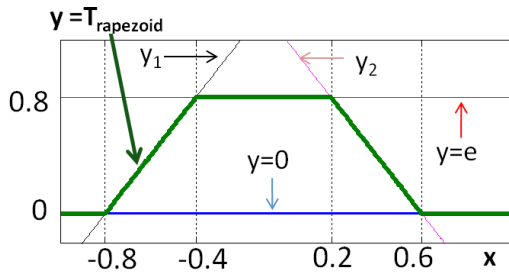

Figure 3.10: Trapezoidal MF example
 $a = -0.8, b = -0.4, c = 0.2, d = 0.6, e = 0.8$

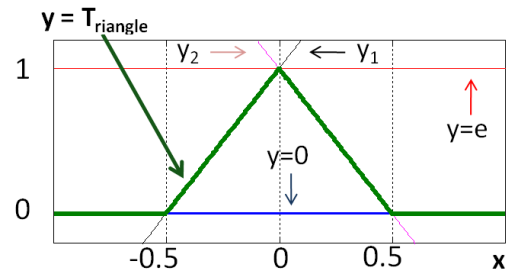

Figure 3.11: Triangular MF example
 $a = -0.5, b = c = 0, d = 0.5, e = 1$

3.3.3 Centroid of an interval type-2 fuzzy membership function

An interval type-2 membership function (IT2-MF), can be approximately represented for a set of p interval type 1 membership functions (IT1-MFs) located at the points x_i and with upper and lower bounds $\mu_{UMF}(i)$ and $\mu_{LMF}(i)$ as illustrated on Figure 3.12. The centroid of the IT2-MF is then computed as the centroid of the p IT1-MFs. Obviously the exactitude of the computation depends on the value of p . The exact centroid is found when $p \rightarrow \infty$.

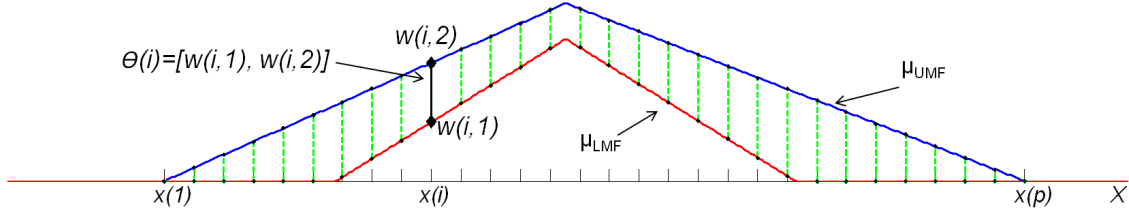

Figure 3.12: An interval type-2 MF discretised into p interval type-1 MFs

The centroid of a type-1-MF discretised in p points is located at $x = c$. This point is defined by Equation 3.4

$$c = \frac{\sum_{i=1}^p \mu(x_i) \cdot x_i}{\sum_{i=1}^p \mu(x_i)} \quad (3.4)$$

Similarly, the centroid of an interval type-2 MF discretised in p intervals is located at the interval $[c_l, c_r]$, defined by Equation 3.5

$$[c_l, c_r] = \left[\frac{\sum_{i=1}^p \mu^*(x_i) \cdot x_i}{\sum_{i=1}^p \mu^*(x_i)}, \frac{\sum_{i=1}^p \mu^{**}(x_i) \cdot x_i}{\sum_{i=1}^p \mu^{**}(x_i)} \right] \quad (3.5)$$

Where $\mu^*(x_i)$ (and $\mu^{**}(x_i)$) are either $\mu_{UMF}(x_i)$ or $\mu_{LMF}(x_i)$, the values which minimise (maximise) the weighted average in Equation 3.4 [Mend01]. To exemplify this, the centroid of the IT2-MF in Figure 3.13 (discretised in 4 IT1-MFs) is presented.

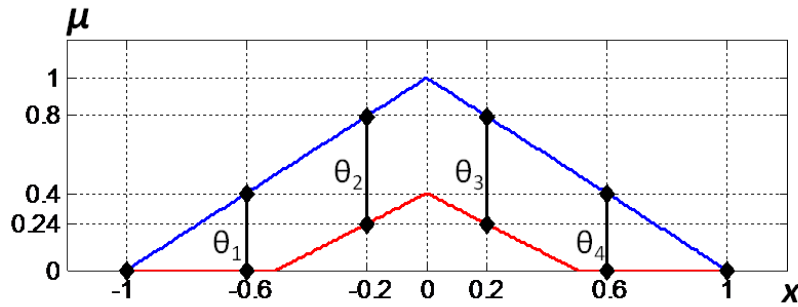

Figure 3.13: Interval type-2 MF discretised into 4 interval type-1 MF
 UMF=Trapezoid($x, -1, 0, 0, 1, 1$), LMF=Trapezoid($x, -0.5, 0, 0, 0.5, 0.4$)

The IT2-MF is discretised into the following 4 IT1-MFs:

1. $\Theta_1 = [0, 0.4]$ at $x_1 = -0.6$
2. $\Theta_2 = [0.24, 0.8]$ at $x_2 = -0.2$
3. $\Theta_3 = [0.24, 0.8]$ at $x_3 = 0.2$
4. $\Theta_4 = [0, 0.4]$ at $x_4 = 0.6$

Table 3.1 summarises all the possible weighted averages defined in Equation 3.4. As there are 4 (p) IT1-MFs and two bounds for MF, there are 16 (2^p) weighted averages.

Table 3.1: Weighted averages of the 4 interval type-1 MF

x_1	x_2	x_3	x_4	$\mu(x_1)$	$\mu(x_2)$	$\mu(x_3)$	$\mu(x_4)$	$\frac{\sum_{i=1}^4 \mu(x_i) \cdot x_i}{\sum_{i=1}^4 \mu(x_i)}$
-0.6	-0.2	0.2	0.6	0	0.24	0.24	0	0.0000
-0.6	-0.2	0.2	0.6	0	0.24	0.24	0.4	0.2727
-0.6	-0.2	0.2	0.6	0	0.24	0.8	0	0.1077
-0.6	-0.2	0.2	0.6	0	0.24	0.8	0.4	0.2444
-0.6	-0.2	0.2	0.6	0	0.8	0.24	0	-0.1077
-0.6	-0.2	0.2	0.6	0	0.8	0.24	0.4	0.0889
-0.6	-0.2	0.2	0.6	0	0.8	0.8	0	0.0000
-0.6	-0.2	0.2	0.6	0	0.8	0.8	0.4	0.1200
-0.6	-0.2	0.2	0.6	0.4	0.24	0.24	0	-0.2727
-0.6	-0.2	0.2	0.6	0.4	0.24	0.24	0.4	0.0000
-0.6	-0.2	0.2	0.6	0.4	0.24	0.8	0	-0.0889
-0.6	-0.2	0.2	0.6	0.4	0.24	0.8	0.4	0.0609
-0.6	-0.2	0.2	0.6	0.4	0.8	0.24	0	-0.2444
-0.6	-0.2	0.2	0.6	0.4	0.8	0.24	0.4	-0.0609
-0.6	-0.2	0.2	0.6	0.4	0.8	0.8	0	-0.1200
-0.6	-0.2	0.2	0.6	0.4	0.8	0.8	0.4	0.0000

It can be noticed that the values which minimise and maximise the weighted averages are respectively $[c_l, c_r] = [-0.2727, 0.2727]$. This is an approximation for the centroid of the IT2-MF.

3.3.3.1 Karnik-Mendel algorithm

When the value of p is incremented to find better approximations of the centroid, the number of weighed averages increase exponentially, and the computing time is then prohibitive. Karnik and Mendel proposed an iterative algorithm to find the bounds c_l and c_r which reduces the number of iterations to find the solutions (one weighted average for iteration). The Karnik-Mendel algorithm is explained in detail in [Karn01].

The centroid of the IT2-MF shown in Figure 3.13 is computed using the KMA. Table 3.2 presents the results of the centroid when different values of discretisation p are considered. The table presents the number of iterations to find the value of the centroid. As it can be noticed, the KMA permits finding the centroid while using a large discretisation and considerably reducing the computation time.

Table 3.2: Centroids of the fuzzy MFs for ΔP

Discretisation p	Centroid	KMA Iterations	2^p iterations
4	[-0.2727 0.2727]	7	16
8	[-0.2861 0.2861]	7	256
16	[-0.2885 0.2885]	7	65536
64	[-0.2908 0.2908]	9	$1.84 \cdot 10^{19}$
256	[-0.2910 0.2910]	9	$1.158 \cdot 10^{77}$
2048	[-0.2910 0.2910]	11	$2^p > 1.8 \cdot 10^{308}$

Figure 3.14 shows the flowchart which describes the Karnik-Mendel algorithm when it is used to compute the right point of the centroid of a type-2 fuzzy MF. The algorithm used to compute the left point is very similar and is presented on Appendix A.

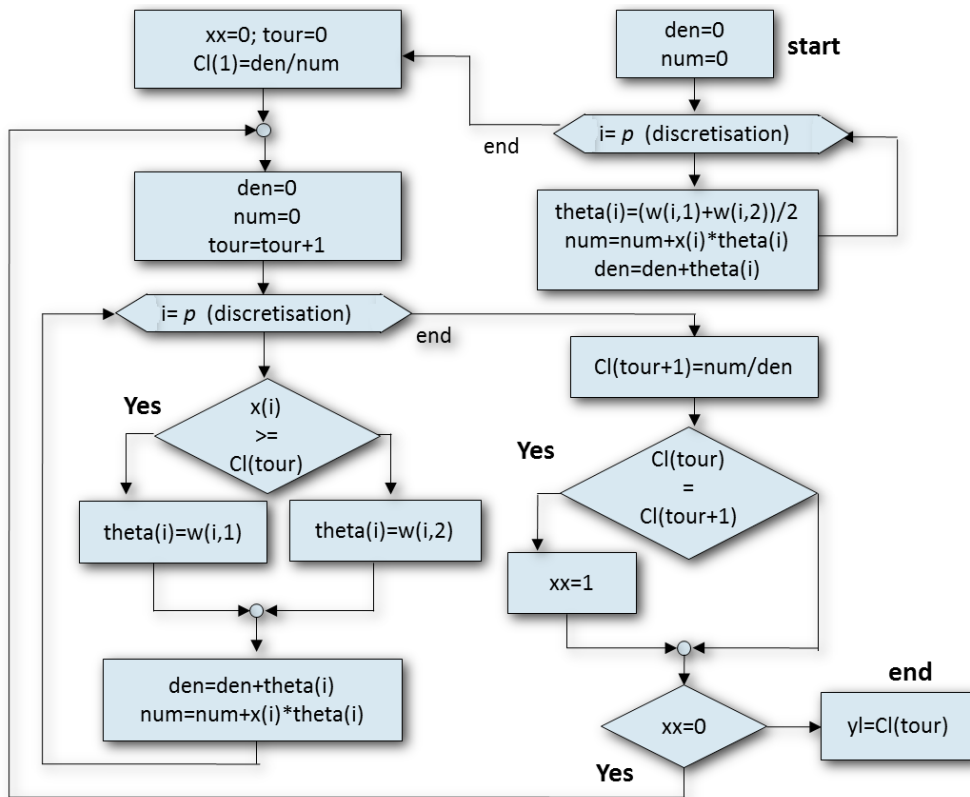

Figure 3.14: KMA flow-chart to compute the left point of the centroid

3.4 Fuzzifier

The fuzzifier maps a crisp input $(x_1, x_2 \dots x_n)$ into the interval type-2 membership functions to produce a set of interval type-1 fuzzy sets. The number of sets depends on the number of inputs and the number of membership functions.

3.4.1 Fuzzifier example

In order to illustrate the methodology to implement the fuzzifier and all the subsystems of an interval type-2 fuzzy system, a numerical example is presented: the whole process to compute a crisp output from a crisp input is considered step by step (fuzzification, inference, type-reduction and defuzzification).

The example consists into finding the output of the interval type-2 fuzzy logic system² whose MFs are presented in Figures 3.15 and 3.16 and rule base is presented in Table 3.3. A crisp input of $(x_1, x_2) = (-0.6, -0.32)$ is considered.

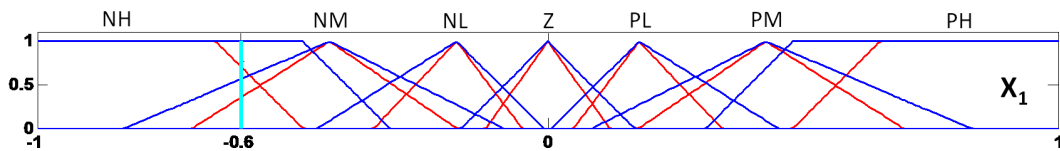

Figure 3.15: Membership Functions for input x_1

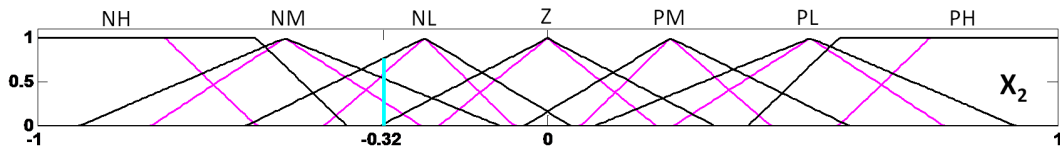

Figure 3.16: Membership Functions for input x_2

The first step is to fuzzify the input into the MFs. It can be viewed in Figures 3.15 and 3.16 that the first input is fuzzified in two MFs (NH and NM) and the second input is fuzzified into three MFs (NM, NL and Z). This is illustrated in Figure 3.17 and summarised in Figure 3.18.

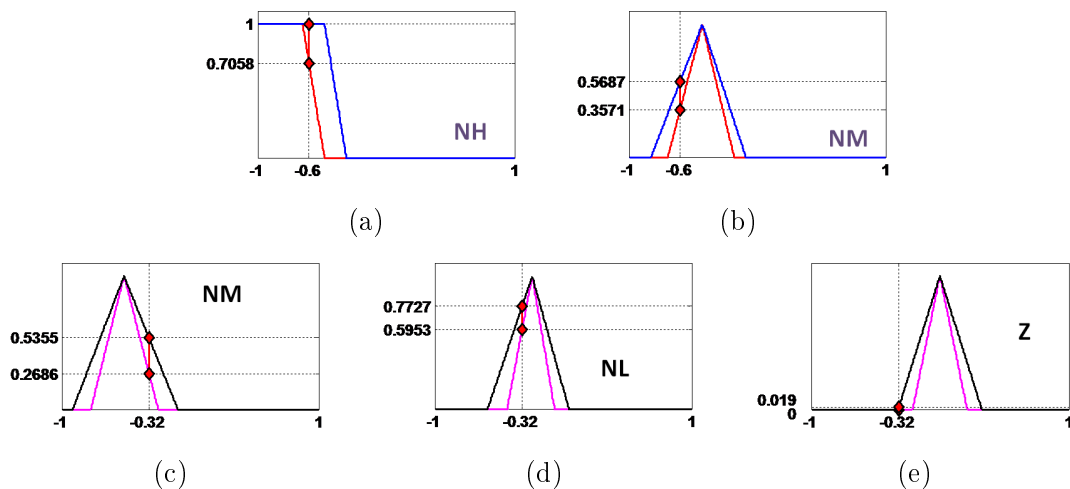

Figure 3.17: Non-null fuzzified sets for x_1 (a) and (b), and x_2 (c), (d) and (e)

²This fuzzy system is explained in detail on Chapter 4, here the interest is on the numerical values of their MFs and rules

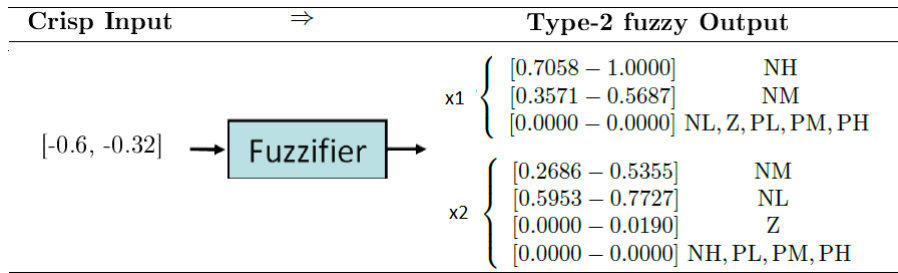

Figure 3.18: The fuzzifier: maps crisp inputs into type-2 fuzzy sets outputs

Table 3.3: Fuzzy rules

Rule	If x_1 is	And x_2 is	Then Out is
2	NH	NM	[-0.7814, -0.6971]
3	NH	NL	[-0.6904, -0.6090]
4	NH	Z	[-0.5387, -0.4662]
9	NM	NM	[-0.5691, -0.4915]
10	NM	NL	[-0.4983, -0.4100]
11	NM	Z	[-0.4080, -0.3416]

3.5 Inference Engine

The inference engine maps the set of interval type-1 fuzzy MFs into the MFs used to represent the rules. The output is a set of type-2 fuzzy MFs. The number of MFs is equal to the number of active (or fired) rules.

3.5.1 Inference Engine example

Continuing with the example, there are 6 activated rules (2 and 3 activated MFs for input 1 and 2 respectively). Table 3.3 summarises the 6 activated rules, in this example, the rules are represented by interval type-1 MFs. (See complete list of rules on Tables 4.5 and 4.6). Figure 3.19 illustrates the inference engine for Rule 2. Here, Z represents the rule MF and W its firing value. The six type-2 fuzzy sets (one for each activated rule) are shown in Figure 3.20. Figure 3.21 summarises the results of the inference engine.

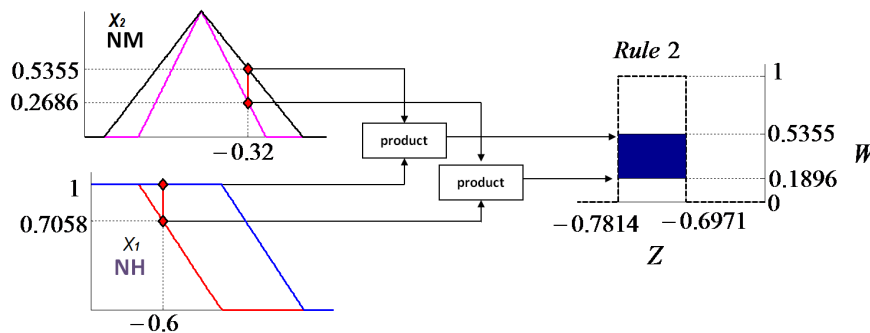

Figure 3.19: Inference-engine: firing degree for Rule 2 (product inference)

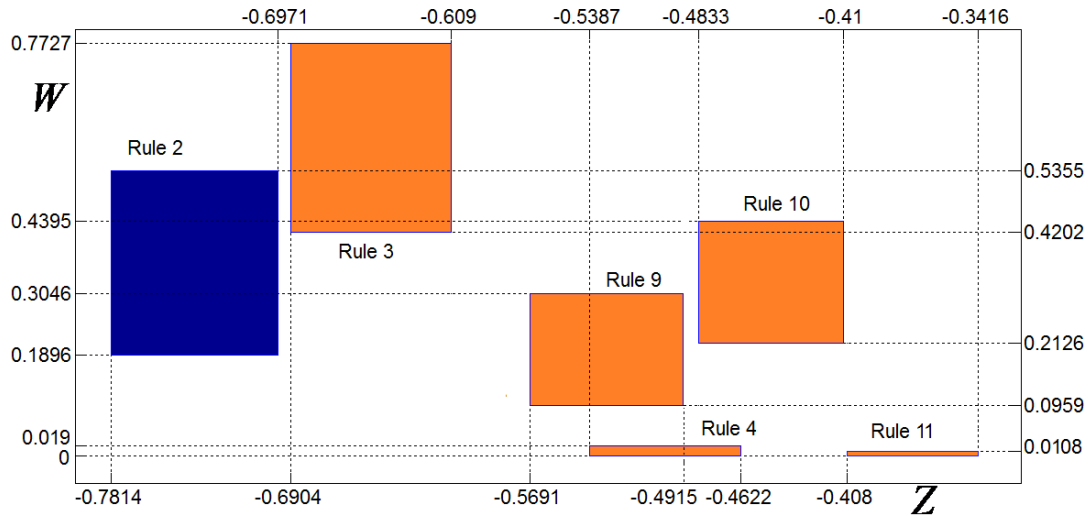

Figure 3.20: Inference-engine: Firing degrees for all the activated rules

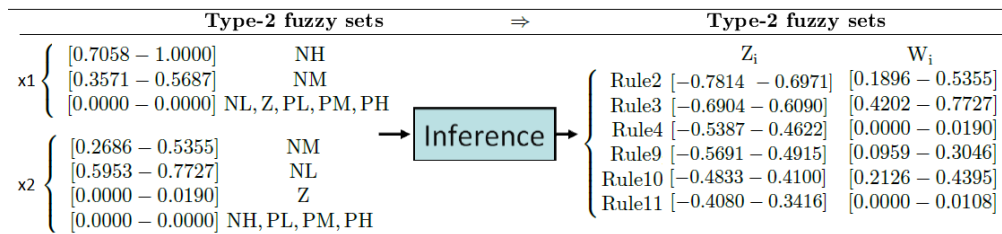

Figure 3.21: The Inference engine: maps type-2 fuzzy sets inputs into type-2 fuzzy sets outputs

3.6 Output Processor

The output processor combines the type-2 fuzzy sets (one for each activated rule) to obtain the crisp output of the fuzzy logic system. The output processor is the principal difference between T1-FL and T2-FL systems. However, the output processor of a T2-FL system can be used in T1-FL systems (not vice versa). The type-2 output processor is divided into the type-reducer and the defuzzificator.

3.6.1 Type-reducer

The type-reducer combines type-2 fuzzy sets into an interval type-1 fuzzy MF called the type-reduced set. The number of input fuzzy sets corresponds to the number of activated rules. There is only one output, the type-reduced fuzzy MF. This MF is computed by using the Karnik-Mendel algorithm. The input to the algorithm are the sets W_i and Z_i which are the output of the inference engine. Figure 3.22 shows the flowchart which describes the Karnik-Mendel algorithm when it is used to compute the right point of the type-reduced set. The algorithm used to compute the left point is presented on Appendix A.

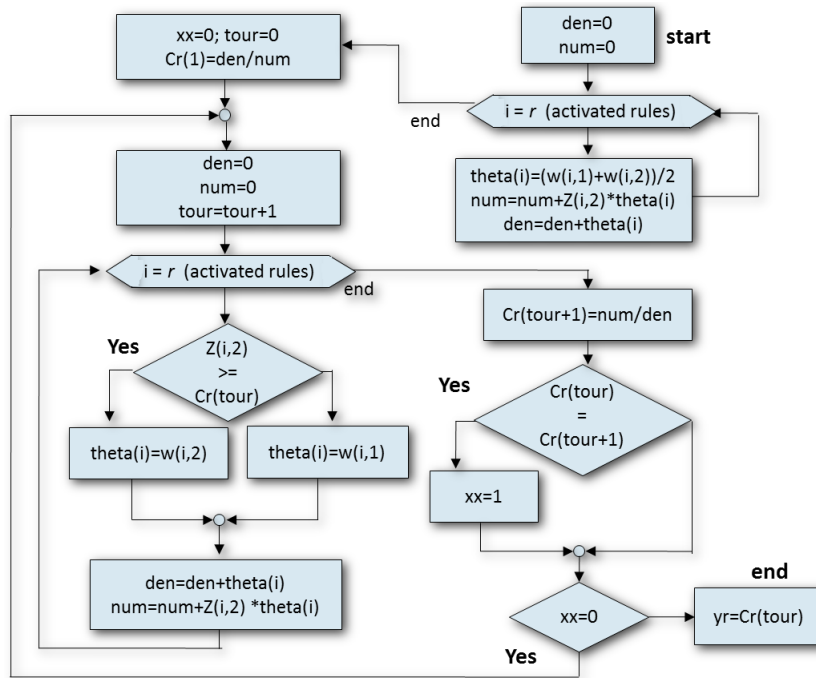

Figure 3.22: KMA flow-chart to compute the right point of the type-reduced set

3.6.2 Defuzzificator

The defuzzificator transforms the type-reduced fuzzy set into a crisp output. It is the simplest subsystem, the crisp output value is computed as the average of the bounds of the type-reduced set.

3.6.3 Output Processor example

The Karnik-Mendel algorithm is applied to combine the fuzzy sets in Figure 3.20. The output processor results are shown in Figure 3.23 and summarised in Figure 3.24.

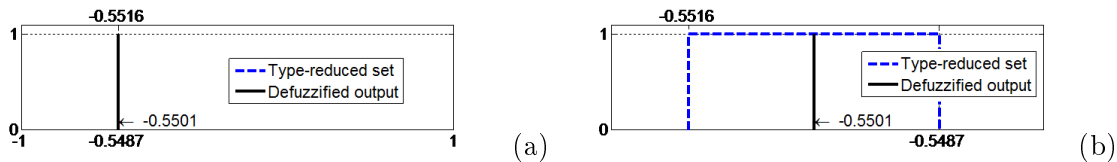

Figure 3.23: The output processor example (a), detail (b)

Type-2 fuzzy sets input	⇒	Type-1 fuzzy set output	⇒	Crisp output
Z_i W_i Rule2 [-0.7814 - 0.6971] [0.1896 - 0.5355] Rule3 [-0.6904 - 0.6090] [0.4202 - 0.7727] Rule4 [-0.5387 - 0.4622] [0.0000 - 0.0190] Rule9 [-0.5691 - 0.4915] [0.0959 - 0.3046] Rule10 [-0.4833 - 0.4100] [0.2126 - 0.4395] Rule11 [-0.4080 - 0.3416] [0.0000 - 0.0108]	⇒	Type-reducer ⇒ [-0.5516, -0.5487]	⇒	Defuzzifier ⇒ 0.5501

Figure 3.24: The output processor: combines type-2 fuzzy sets into a crisp output

3.7 Buck converter voltage controller

A DC/DC buck converter is an electrical device used to couple a DC voltage source to a load, while controlling the quantity of energy supplied by the former by reducing the voltage. The buck converter structure as presented on Figure 3.25 allows transit of energy from the source to the load but not vice versa.

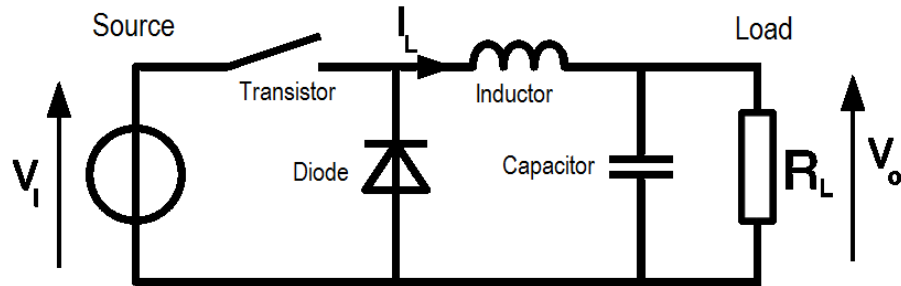

Figure 3.25: Buck converter

The output voltage of the buck converter depends on different parameters and operation conditions as: the input voltage, the duty cycle, the switching frequency and, the inductance, capacitance and load values. Generally, the switching frequency, the inductance and the capacitance values are constant. The input voltage can be also considered as constant or non controlled. As the load is imposed, the output voltage is controlled by controlling the duty cycle.

3.7.1 Overview

The voltage controller requires one single input which is the error signal between the reference and the measured voltage (V_{ref} and V_0). The output of the controller is the duty cycle of the converter (δ_c). The controller computes an output for a sample time denoted k . The sampling period T_{ech} is constant. The PWM is performed at a constant switching frequency f_{sw} .

The objective is to evaluate different fuzzy logic systems (one T1-FL and two T2-FL systems) using the same controller structure as shown in Figure 3.26.

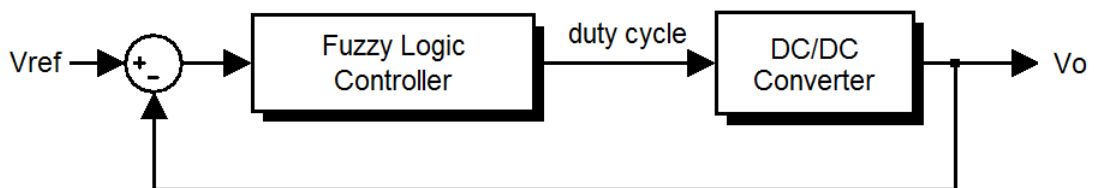

Figure 3.26: DC/DC buck output voltage controller

3.7.2 Input

The error between the reference and measured voltage is defined in Equation 3.6.

$$e(k) = V_{ref}(k) - V_0(k) \quad (3.6)$$

The error variation is also considered and is defined in Equation 3.7 .

$$de(k) = e(k) - e(k - 1) \quad (3.7)$$

3.7.3 Input normalisation

The fuzzy logic controller handles normalised inputs (domain [-1, 1]) as defined in Equations 3.8 and 3.9. Generally, the value of e_n is fixed and de_n is used as an optimisation parameter.

$$e^*(k) = \max \left(-1, \min \left(\frac{e(k)}{e_n}, 1 \right) \right) \quad (3.8)$$

$$de^*(k) = \max \left(-1, \min \left(\frac{de(k)}{de_n}, 1 \right) \right) \quad (3.9)$$

3.7.4 Fuzzy logic controller

A FL controller defines the relative change in the duty cycle as defined in Equation 3.10. The design of the fuzzy logic systems is presented in next section.

$$\Delta\delta_c(k)^* = f(e^*(k), de^*(k)) \quad (3.10)$$

3.7.5 Fuzzy logic controller output denormalisation

The output of the fuzzy controller is denormalised using a denormalisation factor g_m to obtain the relative change in the duty cycle as defined by Equation 3.11. The denormalisation factor g_m is generally used as an optimisation variable.

$$\Delta\delta(k) = \Delta\delta(k)^* g_m \quad (3.11)$$

3.7.6 Controller Output - Duty cycle

Finally, the relative change is integrated to find the duty cycle of the converter by using an integrator as defined by Equation 3.12.

$$\delta(k) = \max(0, \min(1, \delta(k - 1) + \Delta\delta(k) T_{ech})) \quad (3.12)$$

3.7.7 Fuzzy logic controller

Figure 3.27 presents the voltage converter explained in this section.

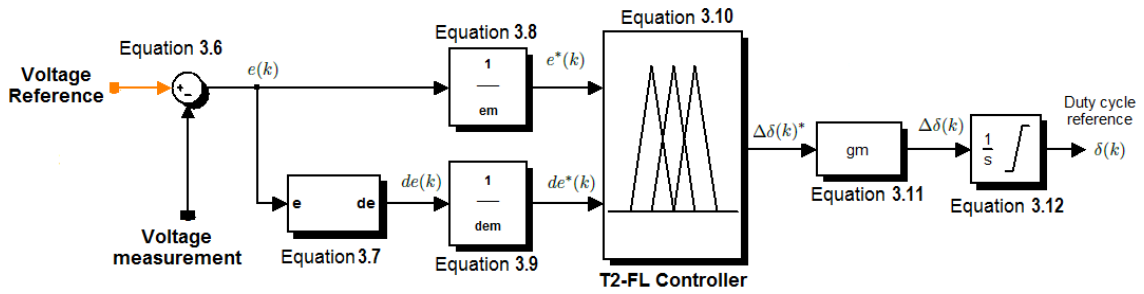

Figure 3.27: DC/DC power converter voltage controller

3.8 Fuzzy logic system design

Three different FL systems have been developed to perform the voltage regulation of the buck converter. The difference between the FL systems is their uncertainty U . The first FL has an uncertainty of 0% (T1-FL), the second and the third consider an uncertainty of 20% and 50% respectively (IT2-FL). The design of the type-1 fuzzy membership functions is based on the approach presented in [Hiss98]. We propose an approach to consider the uncertainty by using interval type-2 membership functions.

The objective of this work is to study the viability of the use of type-2 fuzzy logic in real applications, and thus the optimisation of the fuzzy logic system is not considered. Nevertheless, different levels of uncertainty in the membership functions are considered. This choice permits to evaluate and compare type-2 and type-1 fuzzy controllers under very similar conditions.

The input and output membership functions are defined as classically done in this real-time application: triangular membership functions for the two input fuzzy sets and singleton membership functions for the output fuzzy set.

3.8.1 Rule-based design

Table 3.4 presents the considered classical anti-diagonal rule base. The seven linguistic labels are: (Negative High (NH), Negative Low (NL), Negative Very Low (NVL), Zero (Z), Positive Very Low (NVL), Positive Low (PL) and Positive High (PH))

3.8.2 Input membership functions design

The two input fuzzy sets (for e and de) are composed of seven membership functions. The MFs are symmetric around the zero axis and are defined in two steps by using only three parameters:

1. Seven type-1 membership functions (Uncertainty = 0%) are defined by two parameters as illustrated in Figure 3.28.
 - The MF Z has its peak at $x = 0$ and its right base at $x = pvl_x$

Table 3.4: Fuzzy controller rules

		$\Delta\delta$					
$e \downarrow de \rightarrow$	NH	NL	NVL	Z	PVL	PL	PH
NH	NH	NH	NH	NL	NL	NVL	Z
NL	NH	NH	NL	NL	NVL	Z	PVL
NVL	NH	NL	NL	NVL	Z	PVL	PL
Z	NL	NL	NVL	Z	PVL	PL	PL
PVL	NL	NVL	Z	PVL	PL	PL	PH
PL	NVL	Z	PVL	PL	PL	PH	PH
PH	Z	PVL	PL	PL	PH	PH	PH

- The MF PVL has its left base at $x = 0$, its peak at $x = pvl_x$ and its right base at $x = pl_x$
- The MF PL has its left base at $x = pvl_x$, its peak at $x = pl_x$ and its right base at $x = 1$
- The MF PH has its left base at $x = pl_x$, its peak at $x = 1$

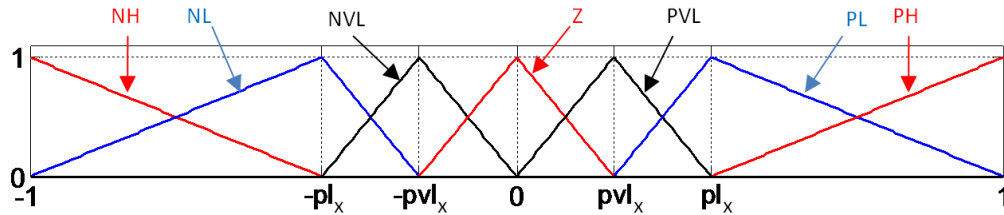

Figure 3.28: Step 1: Definition of the type-1 fuzzy membership functions
MFs linguistic labels in uppercase and its parameters in Lowercase

2. The uncertainty U in the membership functions is the third considered parameter. Each type-1 membership function is modified as illustrated in Figure 3.29. Here, three different uncertainties were chosen: 0%, 20% and 50%.

3.8.2.1 Parameters

The choice of the parameters (pl_x and pvl_x) defining the fuzzy sets is based on previous works about fuzzy control of power converters [Hiss98]:

- To guarantee a fast convergence of the controller, the parameters pl_e and pvl_e which define the error (e) membership functions are relatively close to zero. Values of $pl_e = 0.15$ and $pvl_e = 0.3$ are retained.
- To reduce the noise amplification of the controller, the parameters pl_{de} and pvl_{de} which define the error differential (de) membership functions are relatively close to one. Values of $pl_e = 0.4$ and $pvl_e = 0.7$ are retained.

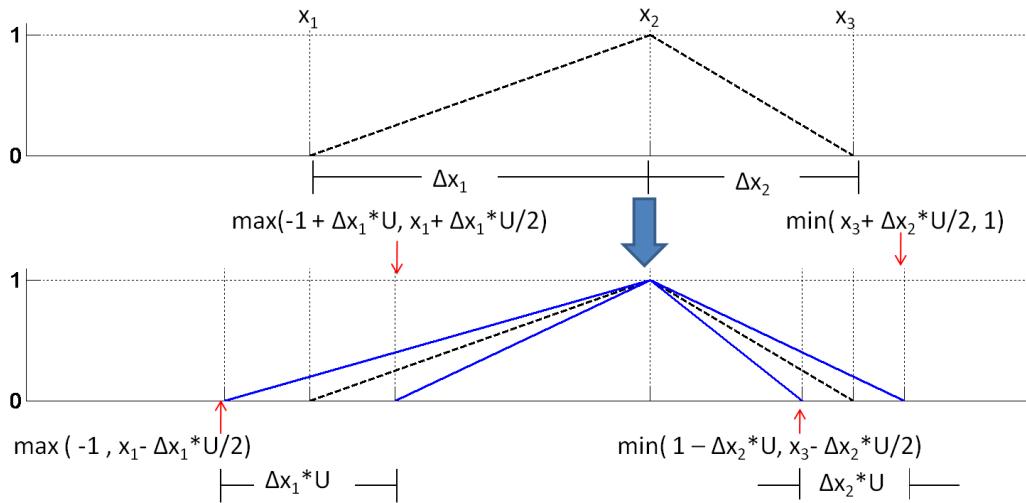

Figure 3.29: Step 2: Definition of the type-2 fuzzy membership functions

The selection of the values is obviously subjective but at least it permits to have a set of parameters to evaluate and compare the considered type-2 fuzzy logic controllers. Figures 3.30, 3.31 and 3.32 illustrate the fuzzy sets for uncertainty values of 0%, 20% and 50% respectively.

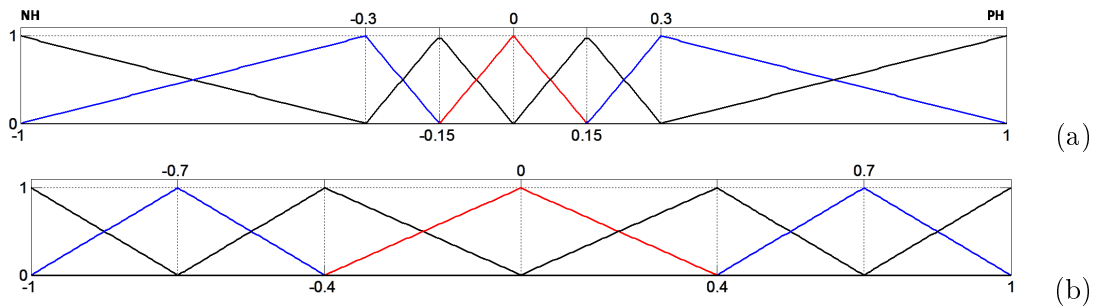

Figure 3.30: Type-1 fuzzy membership functions ($U=0\%$) to represent e (a) and de (b)

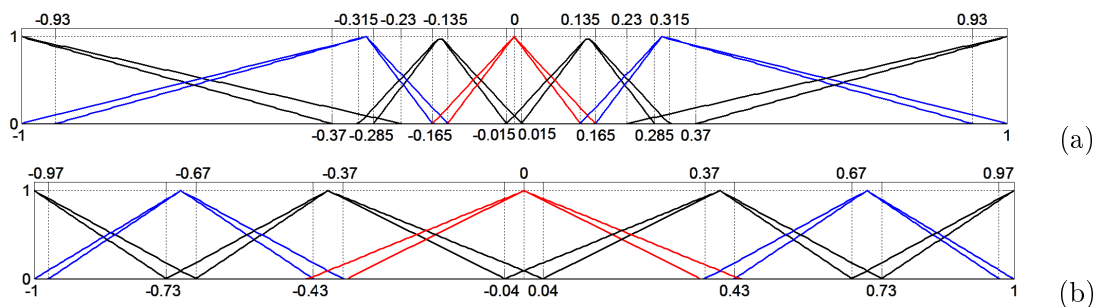

Figure 3.31: Type-2 fuzzy membership functions ($U=20\%$) to represent e (a) and de (b)

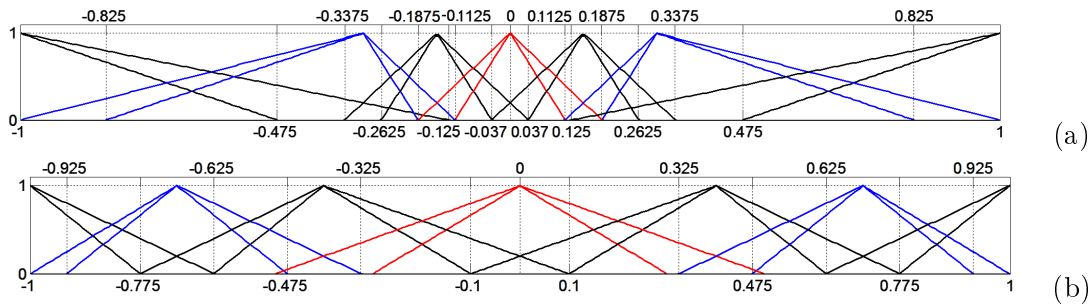

Figure 3.32: Type-2 fuzzy membership functions ($U=50\%$) to represent e (a) and de (b)

3.8.3 Output membership functions design

For simplicity reasons, the output fuzzy set is composed by singleton membership functions (not interval type-1 as in the example presented in precedent sections). The singletons are uniformly distributed around the domain of the fuzzy sets as illustrated in Figure 3.33

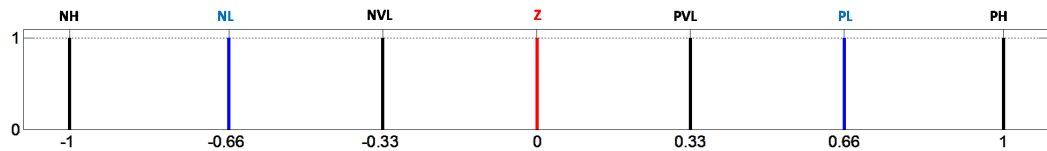

Figure 3.33: Singleton membership functions

3.8.4 Fuzzy logic control surfaces

The fuzzy logic system is completely defined by its membership functions and fuzzy rules. The three normalised control surfaces defined by Equation 3.10 are mapped off-line and presented on Figure 3.34.

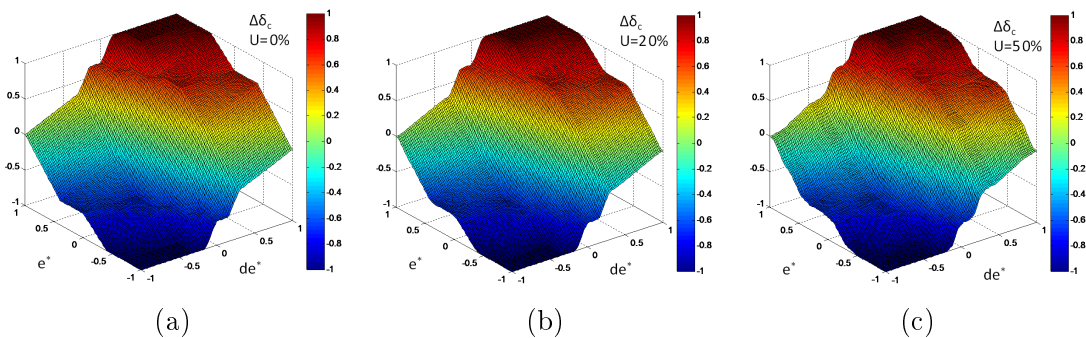

Figure 3.34: Type-2 fuzzy logic control surfaces $U=0\%$ (a), $U=20\%$ (b), $U=50\%$ (c)

3.9 Fuzzy controller evaluation and validation

The proposed voltage controller is evaluated by two methods: by computer simulations and experimentally.

1. **Simulation setup:** The fuzzy controller and the buck converter are implemented in Matlab Simulink using the Power Systems toolbox .
2. **Experimental setup:** The fuzzy controller is implemented in Matlab Simulink and uploaded to a dSPACE programmable controller which generates the signal to drive the MOSFET transistors. The experimental setup is illustrated in Figure 3.35.

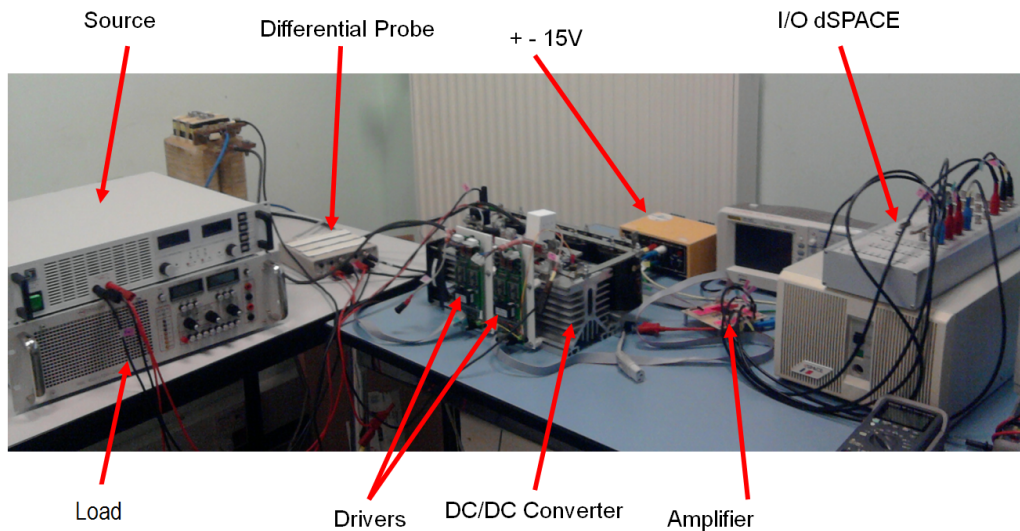

Figure 3.35: Experimental setup

Tables 3.5 and 3.6 resume the parameters used in the validation of the voltage controller.

Table 3.5: Buck converter - Simulation and Experimental parameters

Description	Parameter	Value
Series Inductance	L	1 [mH]
Parallel Capacitance	C	1 [mF]
Fixed load resistance	R_0	120[Ω]
Switchable load resistance	R_{ch}	36 [Ω]
PWM Switching frequency	f_{sw}	15 [kHz]
Input voltage	V_i	10.4 [V]
Reference output voltage	V_{ref}	5 [V]

Table 3.6: Type-2 fuzzy logic controller - Simulation and Experimental parameters

Description	Parameter	Value
Processor sampling time	T_{ech}	100 [μs]
Error normalisation	e_n	3 [V]
Error differential normalisation	de_n	5 [V]
Denormalisation factor	g_m	0.004

3.9.1 Evaluation of the controller

The evaluation of the controller response is performed by imposing an initial condition and three different operation conditions:

1. **Initialisation:** The output voltage reference is initially fixed at 2.8 [V]
2. **Start up:** At $t = 0$ [s] the voltage reference changes to 5[V]. The load is constant during this period (27.69 Ω).
3. **Load regulation (-):** At $t = 1$ [s] The switchable load resistance is switched off. (Load resistance from 27.69 Ω to 120 Ω)
4. **Load regulation (+):** At $t = 1.5$ [s] The switchable load resistance is switched on again. (Load resistance from 120 Ω to 27.69 Ω)

To compare the three fuzzy controllers, the Integral Absolute Error (IAE) criterion is retained. IAE is defined in Equation 3.13:

$$IAE_{\Delta V} = \int_0^t |V_{ref}(t) - V_0(t)| dt. \quad (3.13)$$

3.9.2 Validation results

Simulation and experimental results are resumed in Table 3.7 and illustrated in Figures 3.36 and 3.37. The voltage regulation is performed as expected but the results are not in agreement with simulation (in simulation the best results were found with an uncertainty of 0.5, in experimental the best results were found with an uncertainty of 0.2). The difference between simulation and experimentation results could be explained by the fact that in simulation we do not model the noise, which is always present in experimentation.

It is nevertheless demonstrated that type-2 fuzzy logic controllers can be used to control the voltage of buck converters. However, it is not possible (yet) to affirm that type-2 fuzzy logic controllers are better performing than type-1 fuzzy logic controllers. This is not unexpected, as we do not consider optimisation of the fuzzy controllers.

Table 3.7: Validation results - IAE (Best result light background, worst result dark background)

	Simulation	Experimental
Type-1 fuzzy logic U=0%	0.2194	0.2086
Type-2 fuzzy logic U=20%	0.2201	0.2059
Type-2 fuzzy logic U=50%	0.2166	0.2581

3.10 Chapter conclusion

In this chapter we introduce type-2 fuzzy logic and explain each of their subsystem by using numerical examples. The voltage control of a DC/DC buck converter, one of the classical applications of fuzzy control in electrical engineering, was presented, developed and validated using type-2 fuzzy logic. An original method to generate the IT2 fuzzy sets is proposed.

Simulation and experimental results suggest that T2-FL can be used in this particular application. However, it is too early to affirm that T2-FL controllers are better than T1-FL controllers. Future research at FEMTO-ST will be focused on the study of the tuning and optimisation of the parameters of type-2 fuzzy logic systems. The results obtained are an additional motivation to use type-2 fuzzy control in other applications such as energy management in hybrid electrical vehicles.

The software considered to implement IT2-FL systems is given in Appendix A. It is based on flowcharts and structured programming and does not require the use of the Matlab Fuzzy Logic Toolbox.

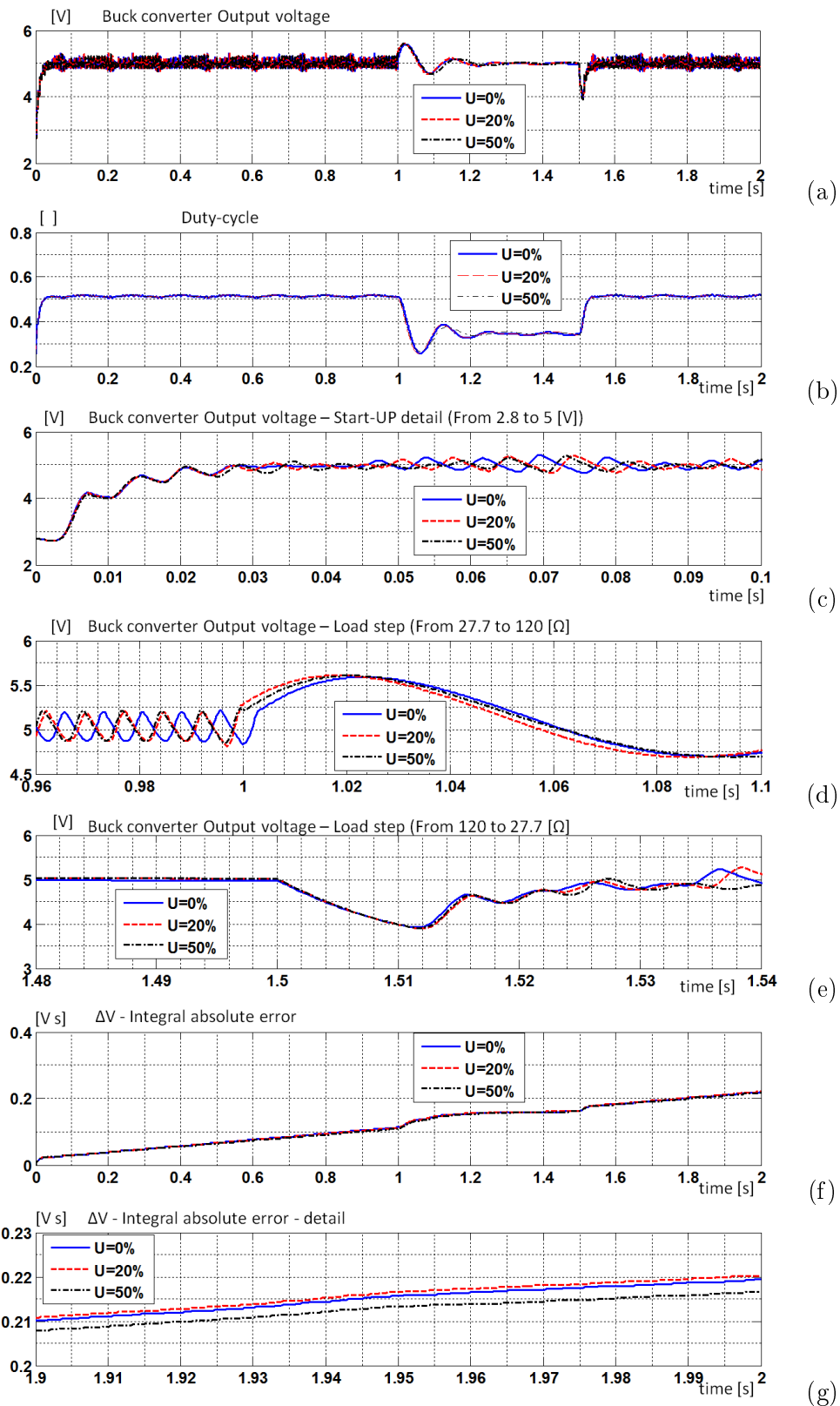

Figure 3.36: Simulation results - Output voltage(a), duty cycle (b) output voltage details (c), (d) and (e), IAE (f), IAE detail (g)

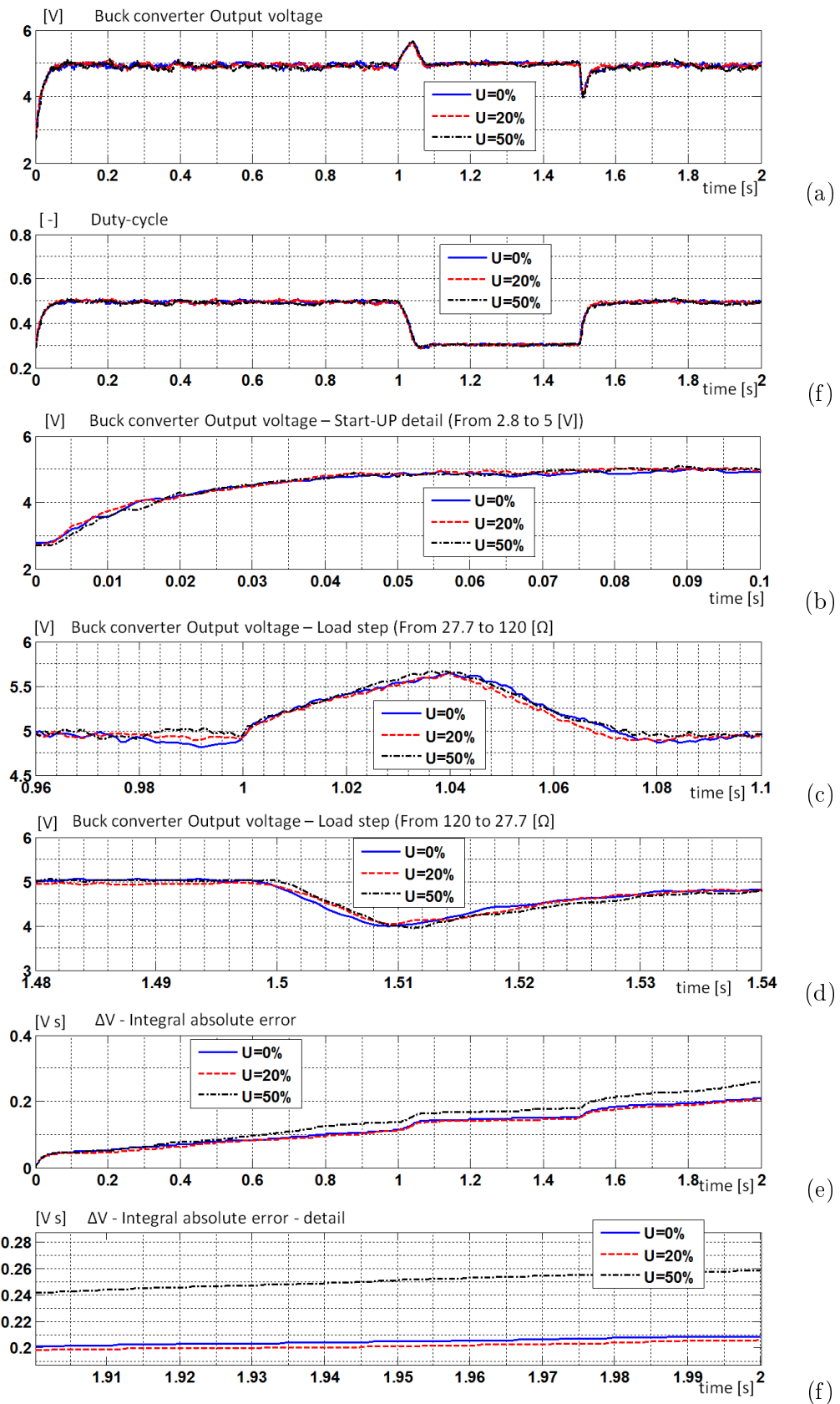

Figure 3.37: Experimental results - Output voltage(a), duty cycle (b) output voltage details (c), (d) and (e), IAE (f), IAE detail (g)

Chapter 4

ECCE energy management strategy based on type-2 fuzzy logic

This chapter presents the energy management strategy implemented in the ECCE test bench

The second application of type-2 fuzzy logic presented in this research is the Energy Management Strategy (EMS) of a Hybrid Electrical Vehicle (HEV). A real scale application is presented here: the ECCE HEV with its predetermined architecture, constraints and specifications (as presented in Section 1.2). The hybrid source implemented in the vehicle is composed by a battery bank, an Ultracapacitor System (UCS) and a Fuel Cell System (FCS).

This EMS is performed at two control levels. The first control level, namely the local EMS, is realised in real time for each source. The second control level, that is the global EMS, is insured at the system level to coordinate the power flow of each subsystem. The local EMS is defined to control the sources while the global EMS is defined to supervise the whole system.

A type-2 fuzzy logic controller is used to perform the local management of the FCS. The design of the fuzzy logic controller is done by using knowledge engineering technique. This technique allows extracting knowledge from experts using surveys. The consideration of type-2 fuzzy logic membership functions enables modelling the uncertainty in the answers of the experts.

The definition and global solution of the energy management problem are presented in Section 4.1. Local management strategies for batteries, UCS and FCS are introduced in Sections 4.2, 4.3 and 4.4 respectively. Energy management in degraded configurations of ECCE is analysed in Section 4.5. Energy management strategy validation by simulation and experimentation are respectively presented in Sections 4.6 and 4.7. Finally, Section 4.8 presents the conclusions and outlooks of this chapter. The design of the type-2 fuzzy logic system (membership functions and fuzzy rules) is presented in detail in Appendix B.

4.1 Global energy management strategy

In ECCE HEV, finding the UCS, FCS and batteries power references to supply the vehicle power consumption (motor drives and ancillaries) seems to be the natural objective of the energy management strategy (EMS) as defined by Equation 4.1. However, as the batteries are directly connected to the DC bus (see Figure 1.4), the power flow of this source cannot be directly controlled. The EMS is thus, in this case, limited to finding the UCS and FCS power references.

$$P_{motor\ drives} + P_{ancillary} = P_{reference} = P_{FCS} + P_{batt} + P_{UCS} \quad (4.1)$$

We choose to develop an energy management strategy based on the power. The power distribution in ECCE can be directly transformed into a current distribution because all the sources are connected to the same DC bus. This is useful in experimental validation where the references to the real control systems are in terms of current and not in power.

4.1.1 Global energy management strategy objectives

The first step to design the EMS is to define a global EMS regarding the characteristics and constraints of both the vehicle and the hybrid source. The second control level of the EMS is defined without considering the energy sources separately. The global objectives of the EMS are listed by priority order:

- To maximise the durability of the power sources.
- To guarantee the general power balance and to recover the maximal amount of braking energy. (Equation 4.1 changes if mechanical braking is applied).
- Currents, states-of-charge, powers and/or voltages (and change rates) must remain within predetermined and constrained limits
- To minimise the battery (DC bus) voltage variation and to minimise the use of this source because it is less efficient and presents a lower durability than the UCS.
- In steady state, the power is totally provided by the fuel cell system (fast and easy to recharge). It's also the only real 'energy' source on the vehicle.
- The UCS ensures the dynamic answer and guarantee enough energy to accelerate the vehicle and enough capacity to recover energy.
- The EMS enables degraded operation (i.e. failure of any of the power sources).

4.1.2 Global energy management strategy inputs

The EMS is realised without knowledge of future driving conditions. It only uses real-time information to compute the output power references:

- **Reference power:** The power to drive the motors depends on the speed of the vehicle and on the accelerator and brake pedals positions. The auxiliary power depends on the ancillary implemented on-board (for example compressors or pumps).
- **Fuel cell power:** the value of the output power of the FCS (measured after power electronics, because this is the net contribution of the FCS to the power sharing).
- **Batteries SOC:** estimated batteries state-of-charge.(See Subsection 2.1.1.1).
- **UC SOC:** estimated ultracapacitor state-of-charge. (See Subsection 2.2.3).
- **UC voltage:** measured voltage at the ultracapacitor bank (before power electronics).
- **DC bus voltage:** measured voltage of batteries.
- **Vehicle speed:** measured vehicle speed.

4.1.3 Global energy management strategy outputs

The EMS has the following two outputs:

- **UCS output reference power:** the power (or the current) supplied by the UCS.
- **FCS output reference power:** the power (or the current) supplied by the FCS.

The battery power reference could be also enumerated as an intermediate output, however the power of this source is here not directly controlled. Figure 4.1 illustrates the EMS as implemented in Matlab Simulink.

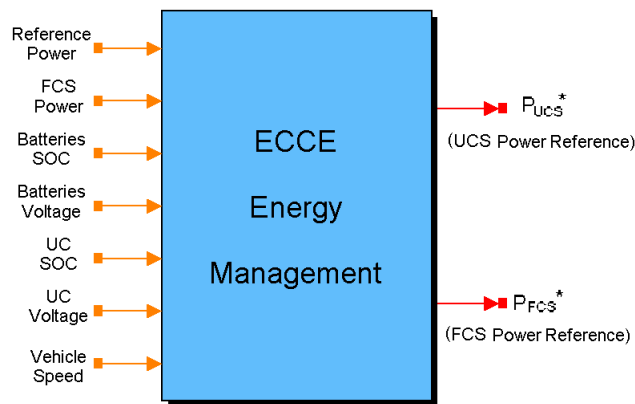

Figure 4.1: Global EMS as implemented in Matlab Simulink

4.1.4 Local energy management strategies overview

As the control of the sources is independently realised, the next step is to identify local objectives for each source EMS (first level control). This is done by comparing the characteristics of the sources with the global EMS objectives as presented in Table 4.1.

Table 4.1: Global objectives of the EMS and its compatibility with the sources

Objective	FCS	UCS	Batteries
To supply energy to the charge	+ +	- -	+
To maximise the energy recovered in braking	- -	+ +	+
To minimise the DC bus voltage variation	+	++	-
To regulate the UC and batteries SOC	+ +	- -	-
To supply high dynamic power	-	+ +	+

By using table 4.1 it can be defined that: the UCS supplies the dynamic power required by the load and is considered to recovery braking. The FCS ensures the autonomy of the vehicle, and regulate the state of charge of the storage sources. The battery power flows are minimised to reduce the voltage variations on the DC bus and also to increase the durability of the battery.

4.2 Batteries energy management strategy

A challenge in ECCE EMS is that batteries are directly connected to the DC bus and cannot be directly controlled (a power converter could be considered as a more expensive solution). The proposed solution to handle this problem is to indirectly manage the battery using the remaining sources (FCS and UCS). A state-of-charge control is implemented, this control is based on that presented by Candusso et al. [Cand01].

4.2.1 Batteries local EMS parameters

Two groups of parameters are identified for the batteries EMS: imposed parameters that depends on the specifications of the vehicle and/or the batteries and strategy parameters that can be used for optimisation:

- As imposed parameters the EMS considers: the DC bus nominal voltage, the maximal and the minimal voltage values, not only for the batteries but also for all the devices connected to the DC bus (such as the UCS or FCS power converters or the ancillary).
- The second group of parameters considers limitations in the state-of-charge and in the power supplied by the battery. The limitation in power is done to indirectly limit the rise (drop) of the DC bus voltage in charge (discharge) of the battery; this power can be estimated using the value of the internal resistance of the battery.

The battery EMS presented on this section requires the definition of the parameters enumerated in Table 4.2.

Table 4.2: Batteries local energy management strategy parameters

Parameter	Description	Type
V_{busref}	DC bus voltage reference	Specifications parameter
$V_{battmin}$	Batteries maximal voltage	Specifications parameter
$V_{battmax}$	Batteries minimal voltage	Specifications parameter
$SOC_{batthigh}$	Batteries maximal state-of-charge	Strategy parameter
$SOC_{battlow}$	Batteries minimal state-of-charge	Strategy parameter
$dP_{battmax}$	Batteries maximal charge-discharge power	Strategy parameter

4.2.2 Batteries additional power (state-of-charge control)

As the EMS only deals with the FCS and the UCS, Equation 4.1 could be redefined to make appear the battery power in the load side. The combined FCS & UCS source power reference ($P_{UCS\&FCS}^*$) is calculated as the addition of the reference power and an additional power to control the batteries SOC ($dP_{batteries}$). This is defined in Equation 4.2.

$$P_{UCS\&FCS}^* = P_{reference} + dP_{batteries} \quad (4.2)$$

If the battery state-of-charge is greater than their reference value, $dP_{batteries}$ becomes negative, i.e. the FCS & UCS combined source supplies less energy and then the battery supplies that difference. The batteries discharge until meeting the SOC reference. The additional power $dP_{batteries}$ is computed using Equations 4.3 and 4.4. This is illustrated in Figure 4.2. A maximal value of $dP_{battmax}$ is selected to avoid over or under voltages due to the energy management.

$$dP_{batteries}^* = dP_{battmax} \alpha_{SOC_{batt}} \quad (4.3)$$

where

$$\alpha_{SOC_{batt}} = \min \left(1, \max \left(-1, \left(\frac{SOC_{batt_{high}} + SOC_{batt_{low}} - SOC_{batt}}{2} \right) \right) \right) \quad (4.4)$$

4.2.3 Batteries additional power correction (voltage limitations)

The batteries SOC control as described in Equation 4.3, could bring the voltage out of the considered limits (e.g. battery recharge simultaneously with recuperative braking would cause an overvoltage). To avoid this situation, a correction of the additional power is applied. If batteries voltage approaches the maximal (minimal) limits then a charge (discharge) limitation is applied. These limitations are described by Equations 4.5 and 4.6 and are illustrated in Figure 4.3.

$$dP_{batteries} = (dP_{batteries}^*) \alpha_{V_{batt}} \quad (4.5)$$

where

$$\alpha_{V_{batt}} = \begin{cases} \min \left(1, \max \left(0, \left(\frac{V_{bus_ref} - V_{batt}}{V_{bus_ref} - V_{batt_max}} \right) \right) \right) & \text{if } dP_{batteries}^* > 0 \\ \min \left(1, \max \left(0, \left(\frac{V_{batt} - V_{batt_min}}{V_{bus_ref} - V_{batt_min}} \right) \right) \right) & \text{if } dP_{batteries}^* < 0 \end{cases} \quad (4.6)$$

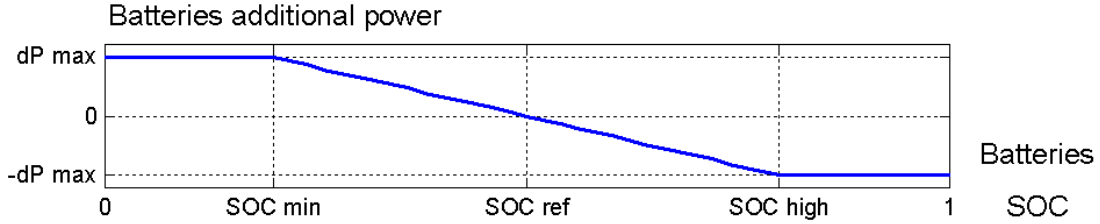

Figure 4.2: Batteries state-of-charge control strategy

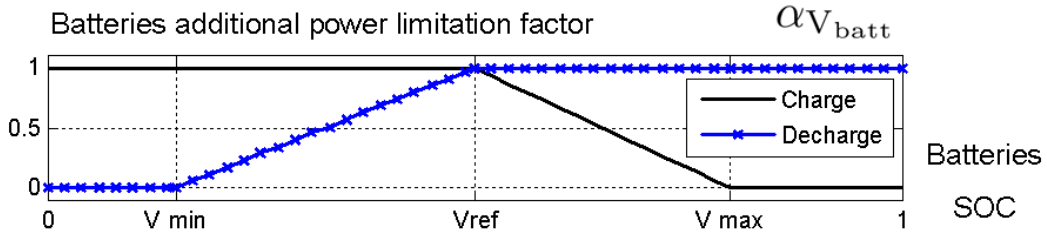

Figure 4.3: Batteries additional power correction - $\alpha_{V_{batt}}$

As the batteries are directly connected to the DC bus, at any change in the DC bus power the battery will be the first source to act. This is the reason why the real contribution of this source can be different from the reference (mainly in transient), as constated in simulation and experimental validation. The batteries EMS is illustrated in Figure 4.4.

4.3 UCS energy management strategy

The UCS is the most efficient source in ECCE, it allows also the recovery braking and a high dynamic reponse, but it has a low specific energy. As the FCS is limited to handle fast power dynamics, and the batteries power is aimed to be minimised, the UCS assures the dynamic in the whole power supply system. The global EMS considers a control of the UC SOC; however, this is indirectly done by the FCS (see Subsection 4.4.4).

4.3.1 UCS management strategy parameters

The local EMS of the UCS is defined by using specification and strategy parameters:

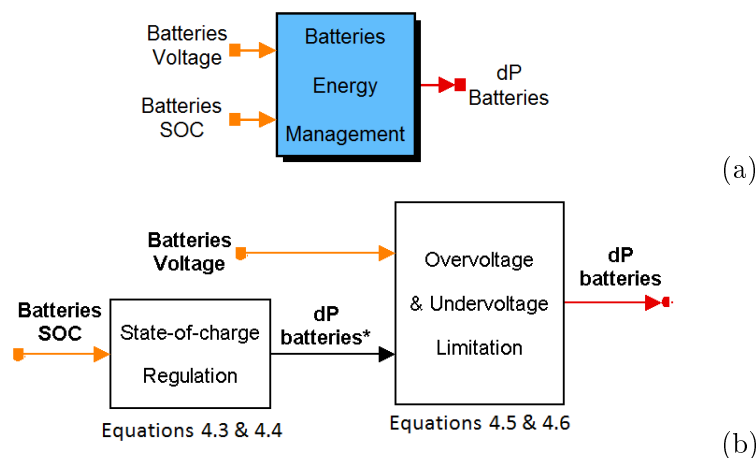

Figure 4.4: Batteries local energy management strategy. (a) global view, (b) detail

- As imposed parameters the EMS considers: limitations in current in the UC as well as in the UCS (both sides of the power converter). A limitation in UC voltage indirectly done by limiting the UC SOC (maximum SOC).
- As strategy parameters the EMS considers: A high and a low SOC levels are considered to trigger charge and discharge limitations respectively. A limitation on the discharge (minimum SOC) to avoid operation in low efficiency regions [Gual07].

The UCS EMS requires the definition of the parameters in Table 4.3:

Table 4.3: Ultracapacitor system local energy management strategy parameters

Parameter	Description	Type
i_{UCSmax}	UCS maximal current (discharge)	Specifications parameter
i_{UCSmin}	UCS minimal current (charge)	Specifications parameter
i_{UCmax}	UC maximal current (discharge)	Specifications parameter
i_{UCmin}	UC minimal current (charge)	Specifications parameter
SOC_{ucmax}	UC maximal state-of-charge	Specifications parameter
SOC_{ucmin}	UC minimal state-of-charge	Strategy parameter
SOC_{uchigh}	UC charge limitation threshold	Strategy parameter
SOC_{uclo}	UC discharge limitation threshold	Strategy parameter

4.3.2 UCS reference power

The reference power of this source (P_{UCS}^{**}) is computed as the difference between the FCS & UCS combined source power reference (Equation 4.2) and the measured FCS power. This is defined in Equation 4.7.

$$P_{UCS}^{***} = P_{UCS\&FCS}^* - P_{FCS} \quad (4.7)$$

4.3.3 UCS power reference dynamic limitation

A limitation factor is considered to limit the charge or discharge in this source. Equations 4.8 and 4.9 define the limitation factor illustrated in Figure 4.5.

$$P_{UCS}^{**} = P_{UCS}^{***} \alpha_{SOC_{UC}} \quad (4.8)$$

where

$$\alpha_{SOC_{UC}} = \begin{cases} \min \left(1, \max \left(0, \left(\frac{SOC_{UC_{max}} - SOC_{UC}}{SOC_{UC_{max}} - SOC_{UC_{high}}} \right) \right) \right) & \text{if } P_{UCS}^{***} > 0 \\ \min \left(1, \max \left(0, \left(\frac{SOC_{UC} - SOC_{UC_{min}}}{SOC_{UC_{low}} - SOC_{UC_{min}}} \right) \right) \right) & \text{if } P_{UCS}^{***} < 0 \end{cases} \quad (4.9)$$

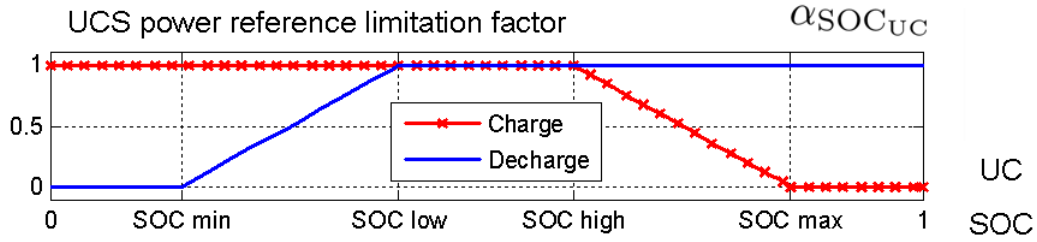

Figure 4.5: UCS reference power dynamic limitation

4.3.4 UCS reference power static limitation

Maximal values in current in the UCS (and in the UC) are considered. The current in the UCS and in the UC are computed using the value of the power P_{UCS}^{**} and Equations 4.10a (UCS) and Equation 4.10b (UC). The latter adds the converter losses when a cartography is available (losses vs output power $P_{losses}(P_{UCS}^{**})$).

$$i_{UCS}^{**} = \frac{P_{UCS}^{**}}{V_{batt}} \quad (4.10a)$$

$$i_{UC}^{**} = \frac{P_{UCS}^{**} + P_{losses}(P_{UCS}^{**})}{V_{UC}} \quad (4.10b)$$

The limitation in the magnitude of the current is applied as defined in Equations 4.11a (UCS) and 4.11b (UC).

$$i_{UCS}^* = \min(i_{UCS_{max}}, \max(i_{UCS}^{**}, i_{UCS_{min}})) \quad (4.11a)$$

$$i_{UC}^* = \min(i_{UC_{max}}, \max(i_{UC}^{**}, i_{UC_{min}})) \quad (4.11b)$$

This reference in current can be directly used (e.g. as in experimental validation on Section 4.7). The UCS power references is defined in Equation 4.12. The reference in the power must respect the two limitations in current.

$$P_{UCS}^* = \min(i_{UCS}^* V_{batt}, i_{UC}^* V_{UC}) \quad (4.12)$$

The local UCS energy management system is shown in Figure 4.6.

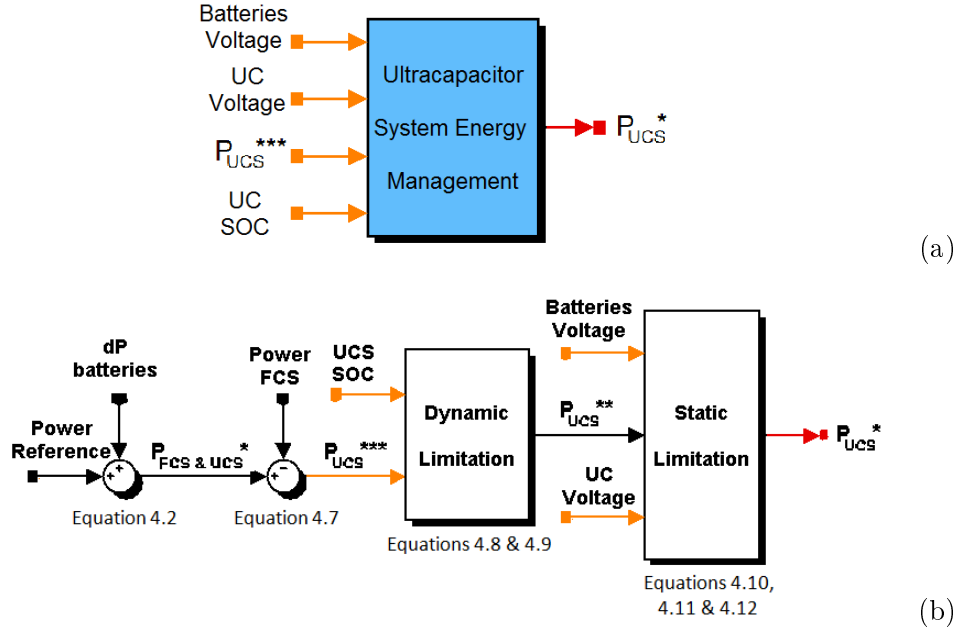

Figure 4.6: Ultracapacitor local energy management strategy. (a) global view, (b) detail

4.4 FCS energy management strategy

The FCS supplies the whole amount of energy in ECCE. As a consequence, the FCS must control the batteries and UC states-of-charge. The EMS must consider the fact that FCS has limitations to handle high dynamics. Fuzzy logic is selected to manage the FCS. The design of the fuzzy logic controller is done by using knowledge engineering, a technique that allows extracting information from experts using surveys [Mend01].

4.4.1 Fuel cell system energy management parameters

The FCS EMS specification parameters are: the maximum and minimum output power (minimum power to avoid works in low efficiency regions). The dynamic of the fuel cell system is considered by limiting the rate of power variation. The maximum speed of the vehicle is considered to control the UC SOC.

The FCS EMS strategy parameters are related with the UC SOC control: the UC SOC reference at maximum speed (when the kinetic energy accumulated in the vehicle is maximal) and the UC SOC reference at speed zero (when the kinetic energy accumulated in the vehicle is zero). The FCS system EMS presented on this section requires the definition of parameters in Table 4.4.

Table 4.4: Fuel cell system local energy management strategy parameters

Parameter	Description	Type
$P_{fcs_{max}}$	FCS maximal power	Specifications parameter
$P_{fcs_{min}}$	FCS minimal power	Specifications parameter
$dP_{fcs_{max}}$	FCS maximal power rate change	Specifications parameter
$speed_{max}$	Vehicle maximal speed	Specifications parameter
$SOC_{UCref_{max}}$	UC SOC reference at maximal speed	Strategy parameter
$SOC_{UCref_{min}}$	UC SOC reference at speed zero	Strategy parameter

4.4.2 Fuzzy logic controller inputs

The FCS supplies the propulsion power in steady state, this is the reason why the first input of the fuzzy logic controller is the difference between the FCS & UCS combined source reference power (Equation 4.2) and the measured FCS power (Equation 4.13). The FCS also controls the UC SOC, for this reason the second input of the fuzzy controller is the difference between the UCS state-of-charge and its dynamical reference presented in next section (Equation 4.14).

$$\Delta P^* = P_{UCS\&FCS}^* - P_{FCS} \quad (4.13)$$

$$\Delta SOC^* = UC_{SOC_{ref}} - UC_{SOC} \quad (4.14)$$

4.4.3 Input normalisation

The fuzzy logic controller handle normalised inputs (domain [-1, 1]) as defined in Equations 4.15, 4.16 and 4.17.

$$\Delta P = \frac{\Delta P^*}{P_{FCS_{max}}} \quad (4.15)$$

$$\Delta SOC = \frac{\Delta SOC^*}{SOC_{UCref_{max}} - SOC_{UCref_{min}}} \quad (4.16)$$

$$speed^* = \frac{speed}{speed_{max}} \quad (4.17)$$

4.4.4 UC SOC dynamic reference (UC SOC control)

Different authors propose to define dynamical references for the UC SOC (See Subsection 1.4.2.5). We propose to use a reference which depends on the speed of the vehicle:

- When the vehicle is stopped there is no possibility to recover braking energy in the UCS. A low state-of-charge means less available energy to accelerate. The reference

for the UC SOC is "charged" (this is a parameter of the strategy and does not imply that the UCS is completely charged).

- If the vehicle is at maximal speed, no further acceleration will be required and braking is the next state, a high UC SOC will limit the recovery of braking energy. The reference for the UC state-of-charge is "discharged" (again this is a parameter of the strategy and does not imply that the UC is completely discharged).

The proposed relation between the UC SOC dynamic reference and the vehicle speed is defined in Equation 4.18 and is illustrated in Figure 4.7.

$$UC_{SOCref} = SOC_{UC_{ref_{max}}} - speed * (SOC_{UC_{ref_{max}}} - SOC_{UC_{ref_{min}}}) \quad (4.18)$$

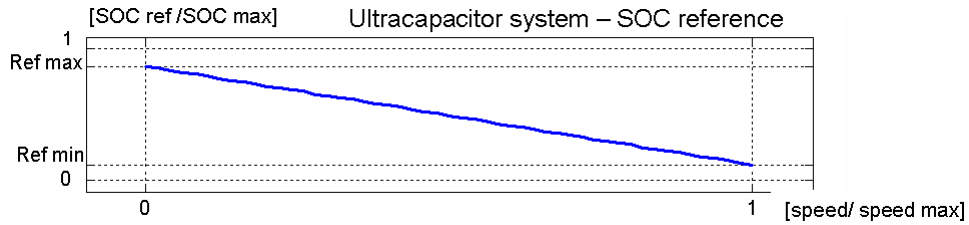

Figure 4.7: UC state-of-charge dynamical reference

4.4.5 Fuzzy logic controller design

A type-2 fuzzy logic system is used to perform the FCS energy management. The fuzzy logic controller maps two crisp inputs into a one crisp output as in Equation 4.19.

$$\Delta P_{FCS} = f(\Delta P, \Delta SOC) \quad (4.19)$$

An energy management survey was conducted among 10 experts in hybrid electrical vehicles worldwide. The experts were asked to define fuzzy rules and fuzzy intervals by using specified linguistic labels. The answers were used to create the fuzzy logic system (survey-based fuzzy logic system). The use of type-2 fuzzy logic membership functions permits to consider and reduce the effect of the uncertainty in the answers of the experts. The methodology and results of the survey are presented in Appendix B.

4.4.5.1 Fuzzy rules

The inputs of the fuzzy system (ΔP and ΔSOC) are represented by seven linguistic labels: Negative High (NH), Negative Medium (NM), Negative Low (NL), Zero (Z), Positive Low (PL), Positive Medium (PM) and Positive High (PH).

The output of the fuzzy system (ΔP_{FCS}) is represented by seven linguistic labels: High Decrease (DH), Medium Decrease (DM), Low Decrease (DL), Hold (H), Low Increase (IL), Medium Increase (IM) and High Increase (IH).

The experts were asked to define the 49 (7·7) rules of the fuzzy logic system by using the specified linguistic labels. The rules as defined by the experts are summarised in Table 4.5. These answers are used to define the rules of the fuzzy system, as explained in Appendix B. The rules are summarised in Table 4.6.

4.4.5.2 Fuzzy membership functions

The input MFs have been selected to be triangular for the labels NM, NL, Z, PL and PM and trapezoidal for the labels NH and PH. The MFs are selected to be symmetrical around the zero axis. The MFs that represent ΔP are presented in Figure 4.8. The MFs that represent ΔSOC are shown in Figure 4.9.

4.4.5.3 Fuzzy logic controller - example

In Chapter 3, a numerical example was presented to illustrate how the fuzzy logic system compute an output from a determined input. The analysis of the numerical example is now presented to explain how the T2-FL controller works.

$$\text{If } [\Delta P, \Delta SOC] = [-0.6, -0.32] \text{ then } \Delta P_{FCS} = -0.5501.$$

This relationship could be explained using the linguistic labels as:

If the ultracapacitors are relatively overcharged (60% of rated charge)
and
If the fuel cell system provides more power than required (32% of rated power)
then
Decrease the power of the fuel cell (at 55% of maximal decrease rate)

Based on the operation conditions, this is a logical output: if the fuel cell is supplying more power than required and additionally the ultracapacitors are overcharged, then it is necessary to rapidly decrease the power supplied by the fuel cell.

Table 4.5: Processed survey results: Fuzzy Rules

Rule	If ΔP is	And ΔSOC is	Then ΔP_{FCS} is						
			DH	DM	DL	H	IL	IM	IH
1	NH	NH	10	0	0	0	0	0	0
2	NH	NM	10	0	0	0	0	0	0
3	NH	NL	7	3	0	0	0	0	0
4	NH	Z	2	8	0	0	0	0	0
5	NH	PL	0	6	3	1	0	0	0
6	NH	PM	1	1	6	1	1	0	0
7	NH	PH	1	1	1	5	2	0	0
8	NM	NH	9	1	0	0	0	0	0
9	NM	NM	3	7	0	0	0	0	0
10	NM	NL	1	8	1	0	0	0	0
11	NM	Z	1	5	4	0	0	0	0
12	NM	PL	0	0	8	1	1	0	0
13	NM	PM	0	1	2	6	1	0	0
14	NM	PH	1	1	0	2	6	0	0
15	NL	NH	3	7	0	0	0	0	0
16	NL	NM	1	7	2	0	0	0	0
17	NL	NL	0	1	9	0	0	0	0
18	NL	Z	0	0	8	2	0	0	0
19	NL	PL	0	0	1	8	1	0	0
20	NL	PM	0	0	1	3	6	0	0
21	NL	PH	0	0	1	1	4	4	0
22	Z	NH	0	7	3	0	0	0	0
23	Z	NM	0	2	8	0	0	0	0
24	Z	NL	0	0	6	4	0	0	0
25	Z	Z	0	0	0	10	0	0	0
26	Z	PL	0	0	0	4	6	0	0
27	Z	PM	0	0	0	0	7	3	0
28	Z	PH	0	0	0	0	2	8	0
29	PL	NH	0	4	4	1	1	0	0
30	PL	NM	0	1	4	3	2	0	0
31	PL	NL	0	1	0	6	3	0	0
32	PL	Z	0	0	0	2	8	0	0
33	PL	PL	0	0	0	0	8	2	0
34	PL	PM	0	0	0	0	2	8	0
35	PL	PH	0	0	0	0	0	7	3
36	PM	NH	0	1	4	3	0	2	0
37	PM	NM	0	1	0	5	2	2	0
38	PM	NL	0	0	1	1	5	3	0
39	PM	Z	0	0	0	0	4	6	0
40	PM	PL	0	0	0	0	1	9	0
41	PM	PM	0	0	0	0	0	7	3
42	PM	PH	0	0	0	0	0	1	9
43	PH	NH	0	0	2	4	2	1	1
44	PH	NM	0	0	1	1	4	3	1
45	PH	NL	0	0	1	0	2	6	1
46	PH	Z	0	0	0	0	0	8	2
47	PH	PL	0	0	0	0	1	3	6
48	PH	PM	0	0	0	0	0	0	10
49	PH	PH	0	0	0	0	0	0	10

Table 4.6: Fuzzy Rules MFs: Interval bounds

$\Delta SOC \downarrow \Delta P \rightarrow$	ΔP_{FCs}							
	NH	NM	NL	Z	PL	PM	PH	
NH	[-0,7814,-0,6971]	[-0,7511, -0,6678]	[-0,5691, -0,4915]	[-0,4028, -0,3351]	[-0,2661, -0,2073]	[-0,0628, -0,0101]	[0,0933, 0,1427]	
NM	[-0,7814, -0,6971]	[-0,5691, -0,4915]	[-0,4582, -0,3872]	[-0,2773, -0,2211]	[-0,1084, -0,0603]	[0,06, 0,1087]	[0,2366, 0,2965]	
NL	[-0,6904, -0,609]	[-0,4833, -0,41]	[-0,2522, -0,1983]	[-0,1427, -0,0989]	[-0,0048, 0,0374]	[0,1845, 0,241]	[0,3242, 0,3929]	
Z	[-0,5387, -0,4622]	[-0,408, -0,3416]	[-0,1849, -0,1372]	[-0,016, 0,016]	[0,1372, 0,1849]	[0,3123, 0,3777]	[0,4622, 0,5387]	
PL	[-0,3566, -0,2931]	[-0,1657, -0,1161]	[-0,018, 0,018]	[0,0989, 0,1427]	[0,2211, 0,2773]	[0,3806, 0,453]	[0,5569, 0,635]	
PM	[-0,2463, -0,1911]	[-0,0853, -0,0431]	[0,0778, 0,1235]	[0,2439, 0,3024]	[0,3579, 0,4279]	[0,4915, 0,5691]	[0,6971, 0,7814]	
PH	[-0,1216, -0,0742]	[-0,0238, 0,0294]	[0,2073, 0,2661]	[0,3579, 0,4279]	[0,4915, 0,5691]	[0,6678, 0,7511]	[0,6971, 0,7814]	

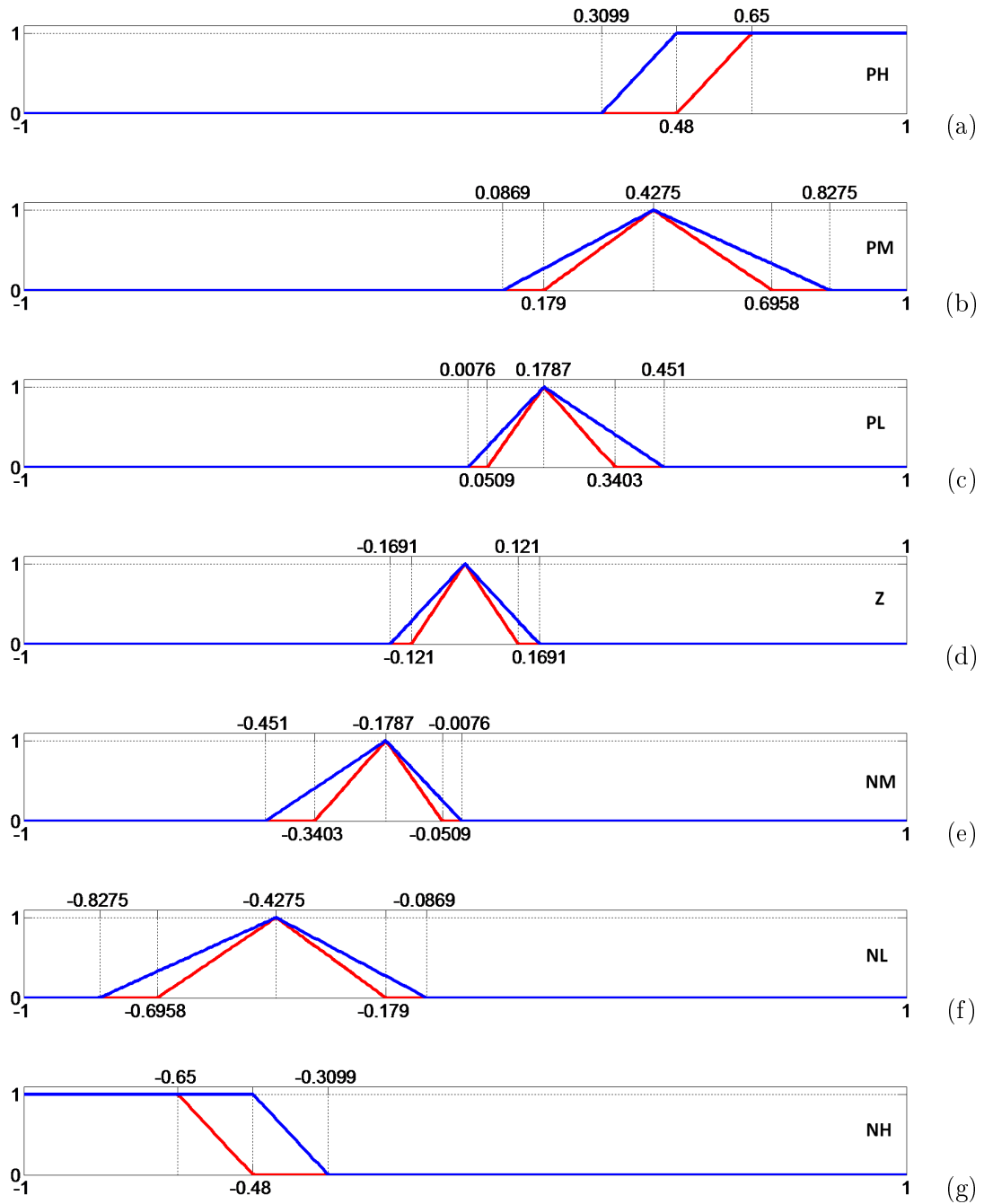

Figure 4.8: Interval type-2 fuzzy membership functions to represent e :
 PH (a), PM (b), PL (c), Z (d), NL (e), NM (f), NH (g)

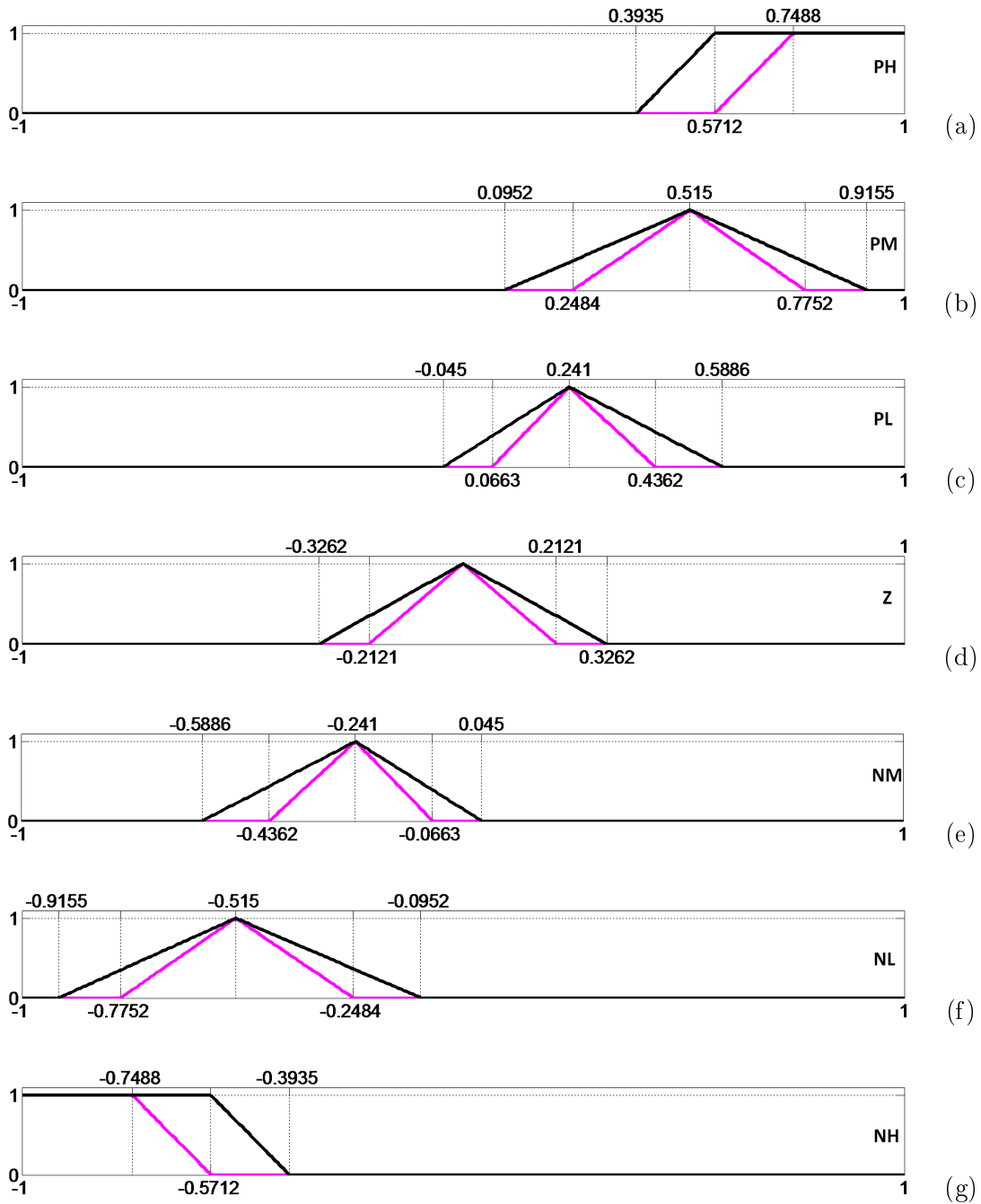

Figure 4.9: Interval type-2 fuzzy membership functions to represent ΔSOC : PH (a), PM (b), PL (c), Z (d), NL (e), NM (f), NH (g)

The T2-FLC normalised control surface defined by Equation 4.19 is mapped off-line and is presented on Figure 4.10.

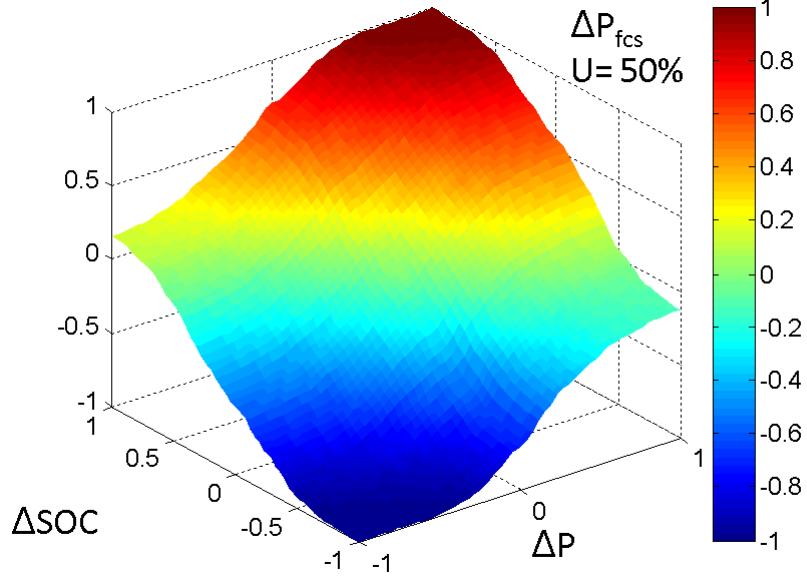

Figure 4.10: FCS energy management: type-2 fuzzy logic normalised control surface

4.4.6 Fuzzy logic controller output

The fuzzy controller output (a relative change in the FCS output power reference) is denormalised (domain $[-1, 1]$), using Equation 4.20.

The denormalised output is the rate of change in the FCS output power. This operation implicitly filters the reference power by considering the dynamical limitation of the FCS $dP_{FCS_{max}}$.

$$\Delta P_{FCS}^* = \Delta P_{FCS} dP_{FCS_{max}} \quad (4.20)$$

The rate change is integrated to find the FCS power reference. To limit the output a limited integral is considered: the integration action is turned off when upper or lower limits are reached (Equation 4.21).

$$P_{FCS}^* = \int_{\text{limited}} \Delta P_{FCS}^* dt \quad (4.21)$$

Finally, the whole local FCS EMS is presented in Figure 4.11.

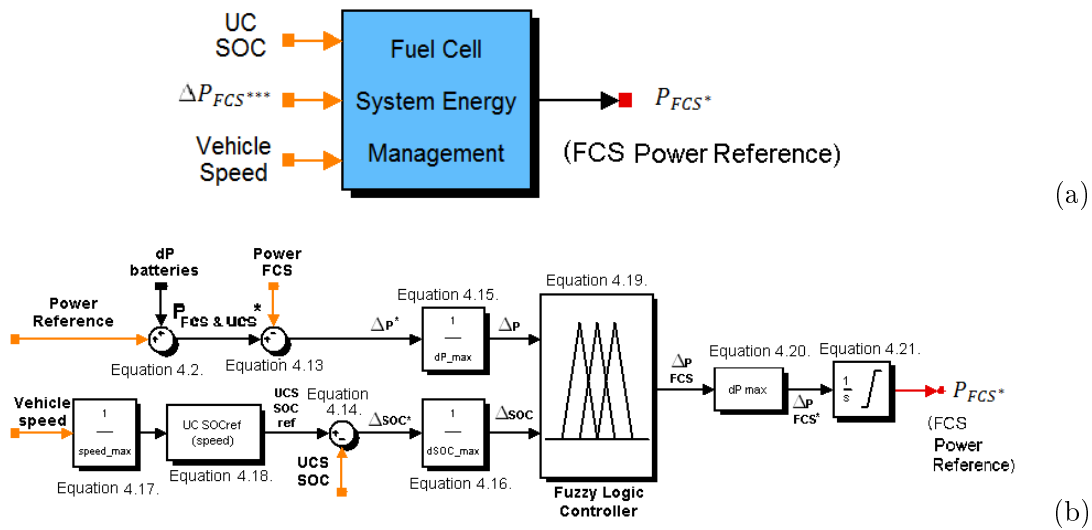

Figure 4.11: Fuel cell system local energy management strategy. (a) global view, (b) detail

4.4.7 Integration of the local EMS into the global strategy

Now that all the local strategies are defined, the final step is their integration on a global strategy as illustrated on Figure 4.12

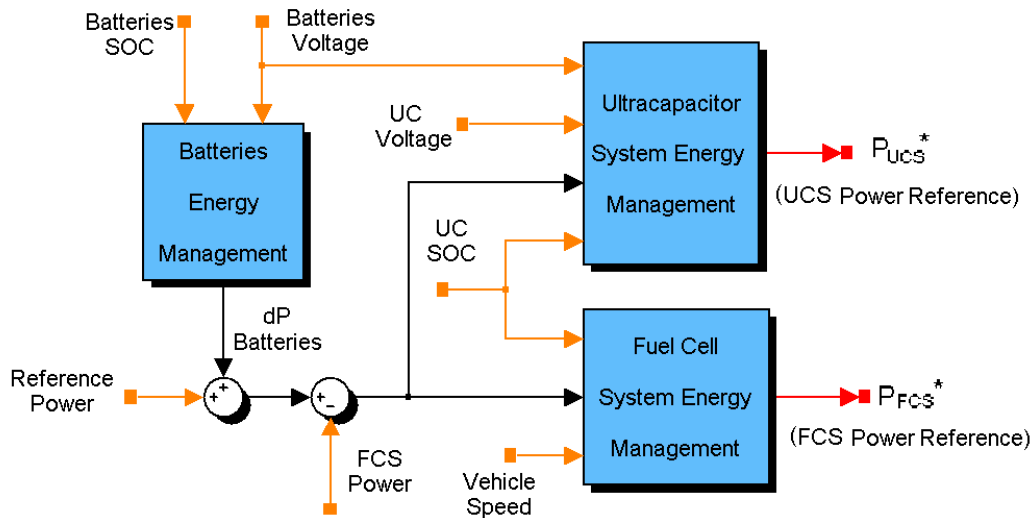

Figure 4.12: Global EMS as implemented in Matlab Simulink - detail

4.5 Degraded operation strategies

The EMS must enable degraded operation if any of the sources fails (Subsection 4.1.1). As the vehicle is not operational without batteries because they impose the DC bus voltage, degraded operations are only considered for FCS or UCS failure. It is important to highlight that the objective is not to develop a whole new EMS but to alter the already developed EMS with slight modifications.

4.5.1 Degraded operation without FCS

The first case considered is a fault in the FCS. Here, ECCE operates as a plug-in vehicle (i.e. the batteries provide the whole amount of energy until discharge) and as a consequence the SOC control in batteries is not possible anymore. Nevertheless, the UC SOC could be still controlled via the batteries. The proposed solution is to use the batteries to supply the power that the FCS cannot supply. As the batteries are directly connected and their power cannot be directly controlled, this is done by modifying the UCS input power reference.

The EMS that permits degraded operation without FCS is graphically presented in Figure 4.13. The blocks used in this strategy are the same used on normal operation (as presented on Figure 4.12), however, the way the blocks are interconnected is not the same.

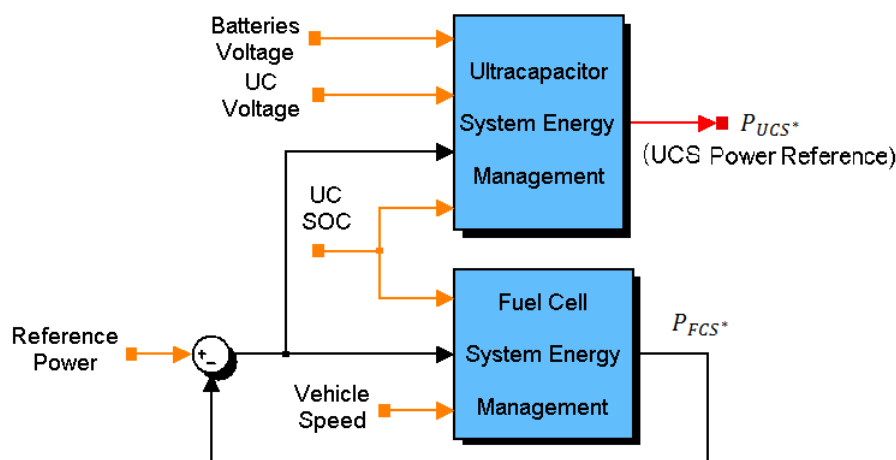

Figure 4.13: Degraded operation strategy - FCS failure

4.5.2 Degraded operation without UCS

The second case considered is a fault in the UCS. In this case, the control of batteries SOC is possible, however the UC SOC control is obviously not necessary anymore. The proposed solution is to use the same fuzzy logic controller than in precedent section. However, as the UC SOC control is not required, the input ΔSOC is imposed to be zero. This is equivalent to say that the second objective is already achieved and then the only FCS objective is to supply the whole amount of energy. The modified EMS for the FCS is illustrated in Figure 4.14(a). The EMS for this degraded operation is graphically presented in Figure 4.14(b).

4.6 Simulation validation

The proposed EMS is evaluated by computer simulations. The energetic macroscopic representation and the energy management strategy are implemented in Matlab Simulink™ (See Sections 2.3 and Section 4.1). The EMS is evaluated by considering FLC uncertainties of 50% and 0% (type-1 fuzzy logic). The simulation results are very similar (power

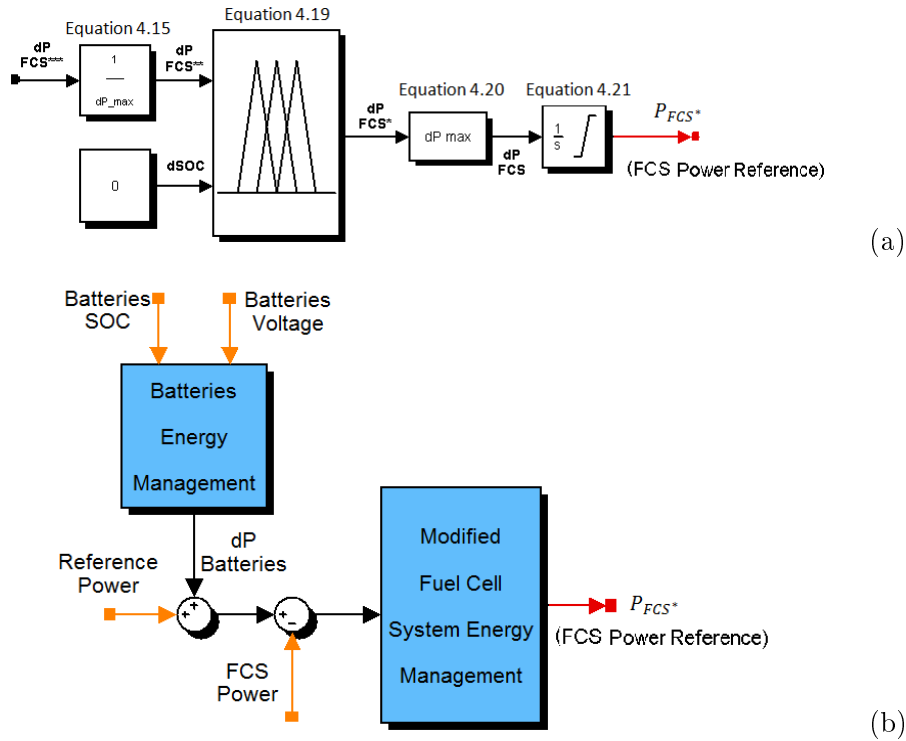

Figure 4.14: Degraded operation strategy - UCS failure (a) Modified FCS EMS, (b) Global view

distribution, states-of-charge). The FCS dynamic is very slow regarding the other power sources and the difference among the power distribution obtained with the two FLC is very reduced. For this reason, only simulations with 50% uncertainty are presented.

Simulations are performed for a normalised cycle and for a real driving cycle:

- Normalised cycle A Normalised European Driving Cycle (NEDC) is here considered (See Figure 1.13). However, only the urban semi-cycle is retained because the maximal speed of the 14 ton vehicle is less than 50[km/h].
- Real drive cycle This is a representative drive cycle of the ECCE vehicle measured in real test drive circuit. This cycle represents with better accuracy the operation of the vehicle (speed and energy consumption).

4.6.1 Simulation parameters

Simulations are performed using the parameters in Table 4.7. The choice of these parameters is based on the technical specifications of the vehicle and its sources.

4.6.2 Simulation results

Figures 4.15 and 4.16 presents the simulation results for the normalised and the real driving cycle respectively. In the EMS as described in Equation 4.1, the power supplied by a source is positive as well as the power consumption in the load side.

Table 4.7: Simulation parameters

Parameter (references)	Value
FCS maximal power	15000[W]
FCS minimal power	5000[W]
FCS maximal power rate change	2500[W/s]
SC SOC reference at maximal speed	0.25
SC SOC reference at speed zero	0.97
Vehicle maximal speed	50[km/h]
UC maximal state-of-charge	0.97
UC charge limitation threshold	0.9
UC minimal state-of-charge	0.25
UC discharge limitation threshold	0.3
UCS maximal current (discharge)	400 [A]
UCS minimal current (charge)	-400 [A]
Batteries maximal state-of-charge	0.91
Batteries minimal state-of-charge	0.89
Batteries maximal charge-discharge power	5000 [W]
Batteries voltage range	500-600[V]
Batteries reference voltage	540 [V]

- **Vehicle speed:** Figures 4.15(a) and 4.16(a) show the considered drive cycles. A recharge period for the SC and batteries is considered at the end of each cycle (the final SOC meets the initial). This recharge period permits to objectively compare the fuel consumption (here all the energy was supplied by the FCS H_2).
- **Reference Power:** the reference power is evaluated at the dc bus, and includes the power of the electrical traction motors and all the ancillary of the vehicle (pumps, compressors). In NEDC, it is calculated in Matlab Simulink using the vehicle model. In the real drive cycle the power was measured at the DC bus (it includes the motor drives and ancillaries consumption).
- **Battery power:** as expected, the battery is the first element which acts when any change in the reference is applied. The battery output power remains almost constant during low variations of the speed. In acceleration or braking a rise in the contribution of the battery is observed.
- **Ultracapacitor system power:** The UCS supplies most of the dynamic response even if there is a delay (associated to the current controller) between the reference power and the ultracapacitor response.
- **Fuel cell system power:** the FCS supplies the mean energy and controls the UC and batteries SOC. The output power presents a low frequency evolution (the fuzzy

logic system acts as a low-pass filter because of the consideration of the maximal power rate change ($dP_{fcs_{max}}$). Finally, when the vehicle is stopped, the fuel cell power increases to charge the ultracapacitor system and the batteries.

- **Battery voltage:** the battery voltage varies with the battery output power, but stays in assigned limits.
- **Battery state-of-charge:** the battery state-of-charge does not varies much and stay in the assigned limits. In the NEDC cycle the minimal batteries SOC reference was 0.9.
- **Ultracapacitor state-of-charge:** the ultracapacitor system state-of-charge stay in the assigned limits. It also varies inversely with the vehicle speed.

As simulation results are in agreement with expectations the next step is now to validate the EMS in real conditions.

4.7 Experimental validation

This section presents the implementation and validation of the EMS developed in the previous sections. The experimental conditions are quite different from those in simulation and particularly regarding the control of the energy sources. In ECCE, the FCS and the UCS are controlled by their own control system (provided by their suppliers) and the control structure proposed in Section 2.6 cannot be directly experimentally validated.

The energy management system (software & hardware) is implemented using a dSPACE AutoBox programmable controller. This system generates current references for the UCS and FCS as required by their control systems. ECCE control software (start-up, security, EMS...) is implemented in Matlab Simulink and then uploaded to the dSPACE (the Simulink blocks are the same than used in simulation).

The experimental validation was performed in two steps: firstly, static validation (i.e. without moving the vehicle) and secondly, driving validation.

4.7.1 Static validation

Static evaluation presents very interesting characteristics to evaluate the EMS: the experimentation is easy to control (and to stop if any problem occurs) and the load power consumption can be easily imposed and controlled.

4.7.1.1 Experimental setup

A variable resistive load (adjustable power resistor) is directly connected to the DC bus as illustrated in Figure 4.17. The nominal value of the load is $100kW@500V$ (in steps of $5kW$). Figure 4.17 illustrates the experimental setup.

Experimental validation

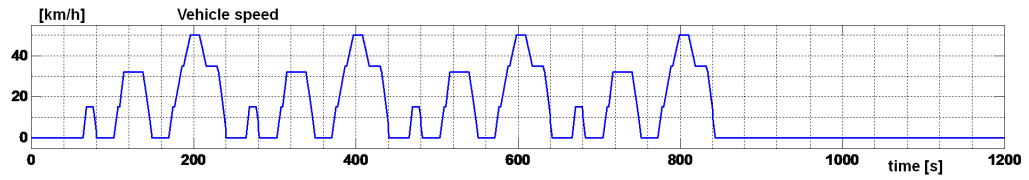

(a)

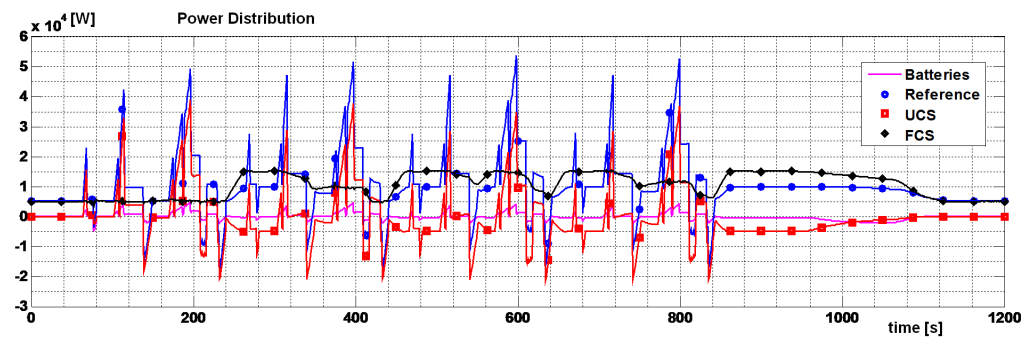

(b)

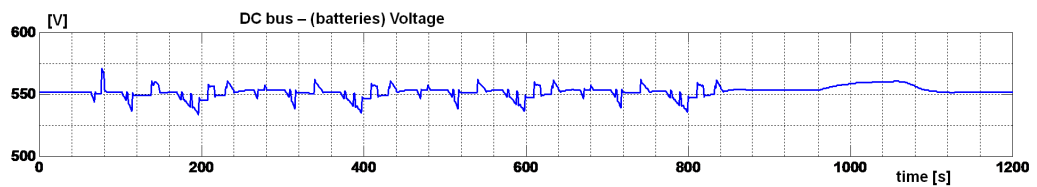

(c)

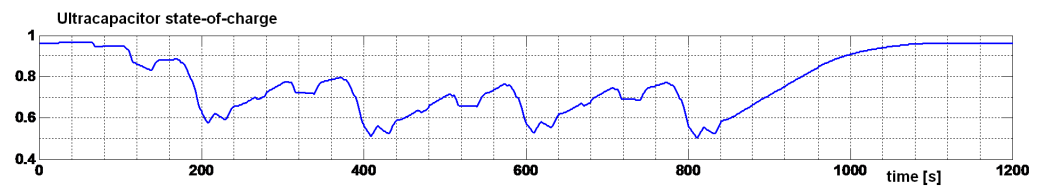

(d)

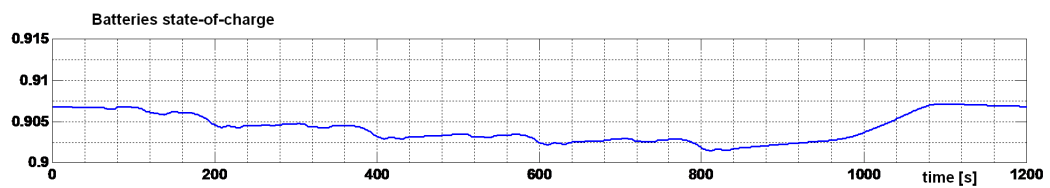

(e)

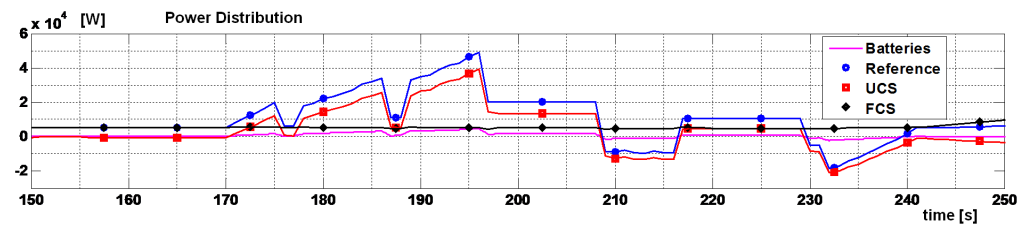

(f)

Figure 4.15: EMS simulations results - NEDC driving cycle
Vehicle speed (a), Power distribution (b), DC bus voltage (c), UC SOC (d),
Batteries SOC (e), Power distribution detail (f)

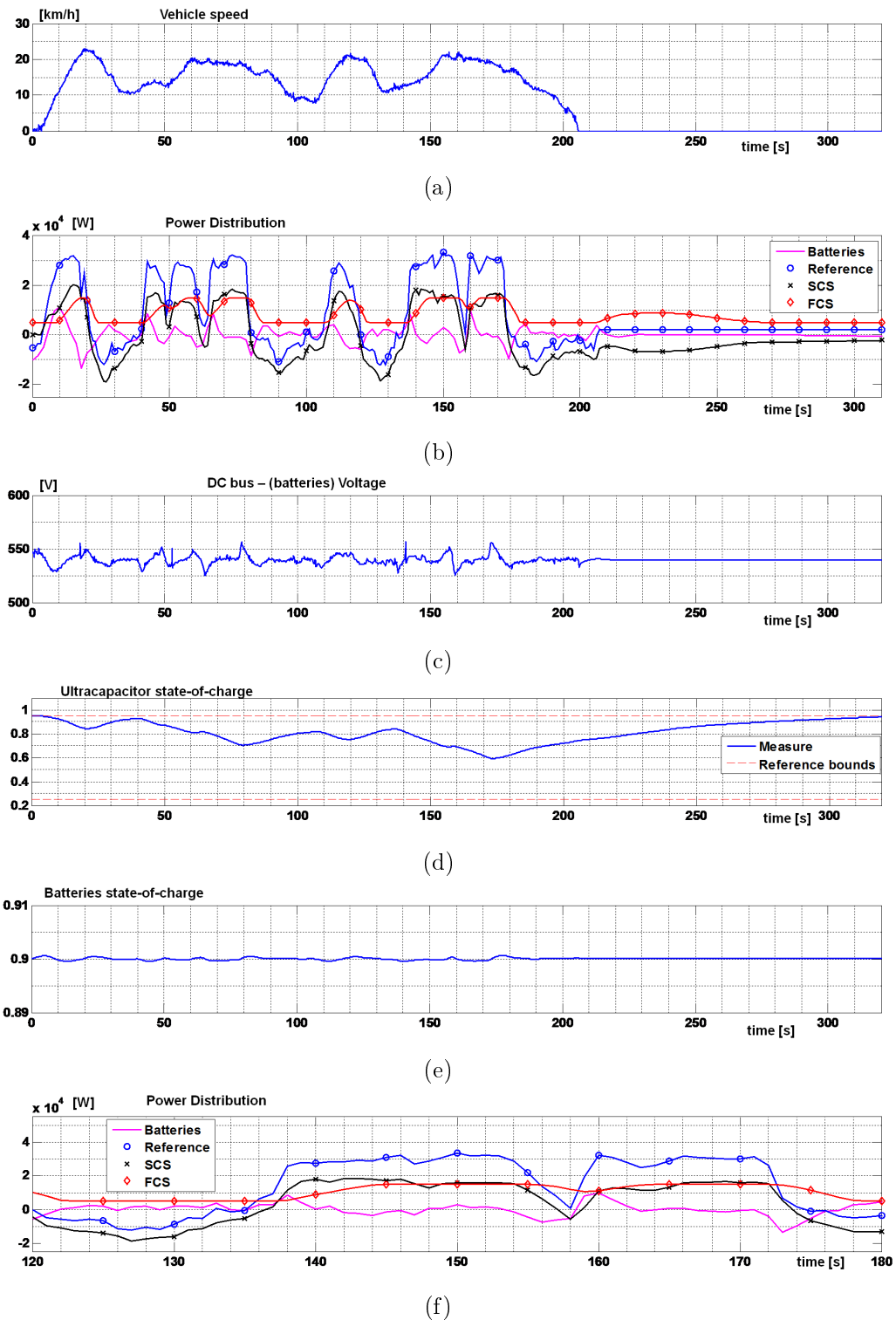

Figure 4.16: EMS simulations results - Real driving cycle
 Vehicle speed (a), Power distribution (b), DC bus voltage (c), UC SOC (d),
 Batteries SOC (e), Power distribution detail (f)

Experimental validation

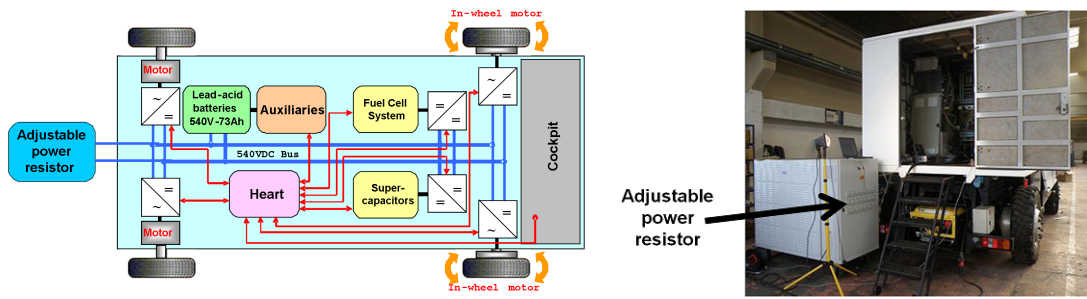

Figure 4.17: Static validation schema (left) - experimental setup (right)

4.7.1.2 Static validation parameters

The EMS is uploaded into the dSPACE Autobox using the parameters given in Table 4.8. As the dynamic control of the UC SOC based on the speed is not possible, the reference value for the UC SOC control is then imposed by the software. The batteries SOC control is not considered. Here, it is important to highlight that the objective is to evaluate the different local strategies. For this reason, the reference in the UC SOC is very low (an undesirable condition). In real operation a high SOC must be considered.

Table 4.8: Experimental static validation EMS parameters

Parameter (references)	Value
FCS maximal current	40[A]
FCS minimal current	4 [A]
FCS maximal current rate change	40[A/s]
UC SOC reference	0.5
UC maximal state-of-charge	0.85
UC charge limitation threshold	0.8
UC minimal state-of-charge	0.25
UC discharge limitation threshold	0.3
UCS maximal current (charge & discharge)	200 [A]
UC maximal current (charge & discharge)	400 [A]

4.7.1.3 Static validation results - global EMS

The first evaluation performed consist into imposing different variations of the charge and analysing the global power distribution between the different sources. The principal interest of performing this test is the fact than the the load can change from zero to the nominal value much faster than in driving conditions.

Figure 4.18 presents the results of the first evaluation: a load reference increasing or decreasing in variable steps (from 5[kW] to 75[kW]). The figure presents the power distribution between the different sources, the current in FCS and UCS and the DC bus voltage.

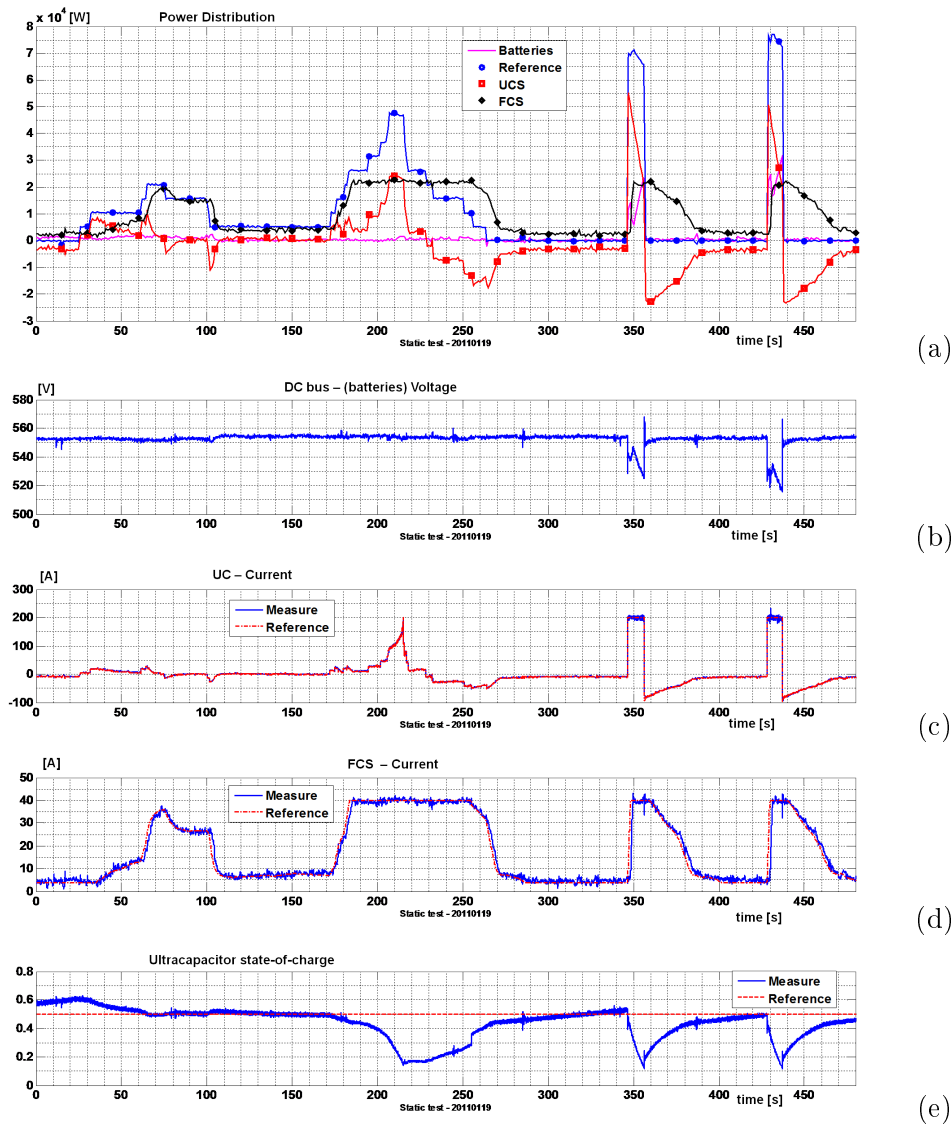

Figure 4.18: Experimental results - Static validation I - Global Strategy
 Power distribution (a), DC bus voltage (b), UC current (c), FCS current(d), UC SOC (e)

- The FCS power regulates the UC state-of-charge and has relatively low frequencies.
- Maximum and minimum limitation values of FCS current are validated as well as the maximum value of the UCS current.
- The output currents of the sources follow their references.
- The UCS supplies the transient power to the load (high dynamics) and enables energy recovery (in this case from the FCS).
- The power contribution as well as the voltage variation of the batteries is highly minimised. The batteries reinforces the UCS when required (e.g. from time 345 to

355 [s] or from 425 to 438 [s] when a high load is applied and the UCS current reaches its maximum value.

4.7.1.4 Static validation results - UCS local EMS

The second evaluation performed consist into 1) verifying the operation of the overcharge and discharge limits in the UC as defined in Section 4.3 and 2) verifying the operation of the UC SOC control by the FCS as defined in Section 4.4.

Figure 4.19(a) illustrates the evaluation of the power reference dynamic limitation for the UCS. To evaluate this limitation two different tests are performed:

1. The load resistor power was selected to be higher than the maximal output power of the FCS, then the UCS power reference is always positive (P_{UCS}^{***} in Equation 4.7). It can be observed (from time 170 to 210 [s]) that the UC SOC remains in the predetermined limits (discharge protection validation). As a consequence, the batteries discharge while supplying the charge consumed by the resistor.
2. The load resistor is switched off, the FCS is manually operated in order to supply a maximal power. It can be observed (from time 600 to 800 [s]) that the UC SOC remains in the predetermined limits (overcharge protection). The batteries charge in this operation conditions.

Figure 4.19(b) illustrates the evaluation of the UC SOC control. The dynamic reference is temporarily modified to study how the UC SOC follows the reference. It is important to highlight that the speed of the UC SOC controller can vary drastically regarding the operating conditions:

- The UC can be relatively fast discharged when the requested load power is high or relatively fast charged when the requested load power is low.
- If the requested load power is low or null, the discharge is only possible by charging the batteries. This operation is however very limited by the EMS (limits in DC bus voltage, limits in FCS minimal current, limits in battery power). This is the operation mode illustrated in Figure 4.19(b).
- If the load power is high (higher than the FCS nominal power), the charge is only possible by discharging the batteries. This operation is also very limited by the EMS.

4.7.1.5 Static validation results - FCS local EMS

The third evaluation consists into verifying the operation of the limits in maximal current rate change of the FCS. The evaluation consists into applying a high load when the FCS power is low and the UC relatively discharged. The FCS EMS imposes a maximal variation of the reference power to supply the power and to recharge the UC.

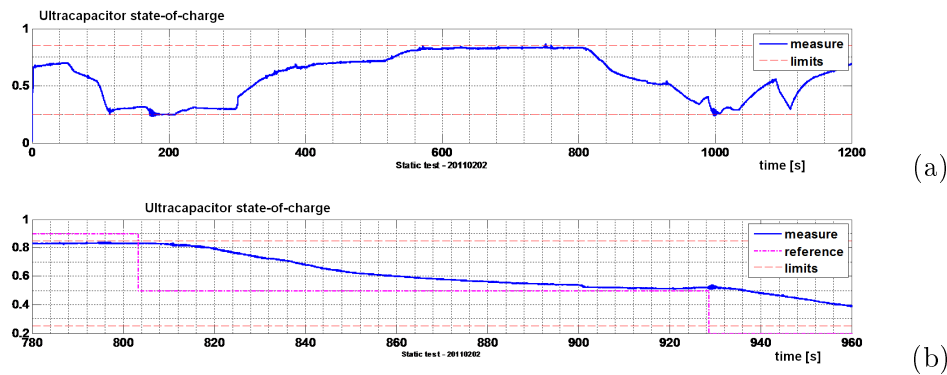

Figure 4.19: Experimental results - Static validation II - UCS local strategy
UC SOC (a), UC SOC detail (b)

Figure 4.20 shows that when the power load is applied, the FCS power increases at a maximum rate until the FCS reaches the limit in maximal power as defined in Equations 4.20 and 4.21).

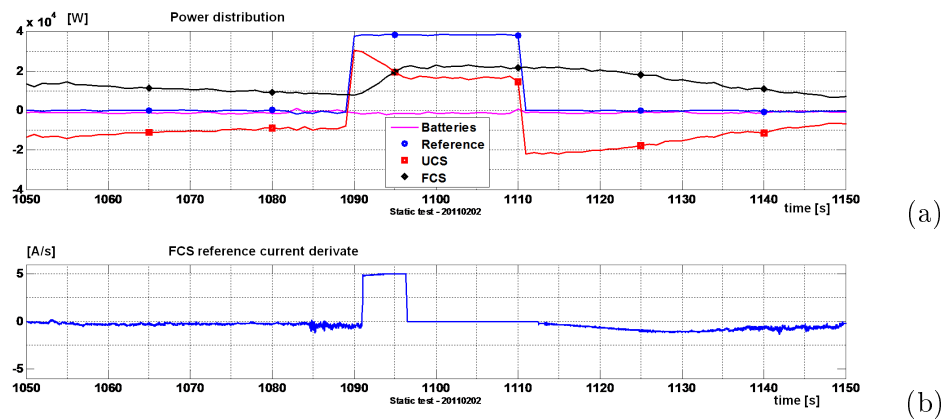

Figure 4.20: Experimental results - Static validation III - FCS local strategy
Power distribution (a), FCS current reference variation - Fuzzy logic controller output (b)

4.7.2 Driving validation

Driving validation is performed on a drive circuit located in PANHARD at Saint-Germain Laval, Loire, France. The evaluation of the EMS is performed to analyse its operation in the vehicle under real-world situations. The EMS was evaluated by considering uncertainties of 50% and 0% (type-1 fuzzy logic). The experimental results are similar (power distribution, states-of-charge variation) but very difficult to compare objectively. This is because in real experimentation, it is almost impossible to repeat exactly the same conditions (initial states-of-charge, speed profile...). For this reason, only the 50% uncertainty results are presented.



Figure 4.21: ECCE EMS driving validation at PANHARD (Saint-Germain Laval)

4.7.2.1 Driving validation parameters

The EMS is uploaded into the dSPACE Autobox using the parameters given in Table 4.9.

Table 4.9: Experimental validation EMS parameters

Parameter (references)	Value
FCS minimal-maximal current	4-40[A]
FCS maximal current rate change	40[A/s]
UC SOC reference	0.5
UC maximal state-of-charge	0.85
UC charge limitation threshold	0.8
UC minimal state-of-charge	0.25
UC discharge limitation threshold	0.3
UCS maximal current (charge & discharge)	200 [A]
UC maximal current (charge & discharge)	400 [A]
Batteries minimal-maximal state-of-charge	0.64-0.88
Batteries maximal charge-discharge power	5000 [W]
Batteries minimal-maximal voltage	500-600[V]
Batteries reference voltage	540 [V]

4.7.2.2 Nominal operation conditions with UCS-FCS and batteries results

Figures 4.22 and 4.23 present experimental results. They are satisfactory and in agreement with the simulation results. The objectives of the EMS as defined in Section 4.1.1 are fulfilled. Figure 4.22 presents the power distribution between the energy sources. Figure 4.23 additionally presents the speed, the UC and battery SOC and the DC bus voltage.

- **Vehicle speed:** it is limited to low values in order to limit the load power. When higher speeds were considered, the UC discharges fast and the FCS output was not enough to propel the vehicle and the batteries SOC drops fast as the DC bus voltage.

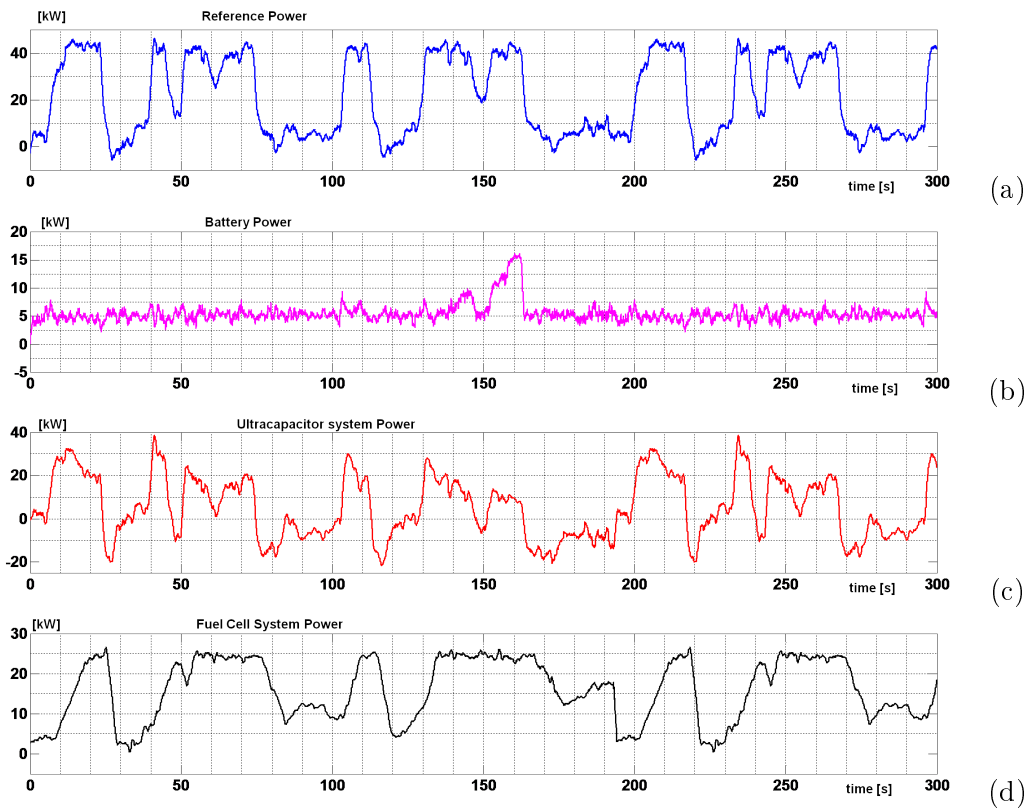

Figure 4.22: Experimental results - Drive validation I
 Reference (a), Batterie power (b), UCS power (c), FCS power (d)

- **Reference Power:** The amount of available braking energy was lower than expected because the driving circuit was very constrained in terms of slope and curves. Moreover, when driving in negative slopes (where the energy is expected to be recovered) the circuit is very curved and the energy is used to supply the power steering.
- **Battery power:** The battery output power remains almost constant, except when the UC are relatively discharged and the battery reinforces it.
- **Ultracapacitor system power:** The UCS supplies most of the dynamic power solicitations.
- **Fuel cell system power:** the FCS supplies the mean energy and controls the UC and batteries SOC. The output power remains into determined limits.
- **Battery voltage:** the battery voltage varies with the battery output power, but stays in assigned limits.
- **Battery state-of-charge:** The battery SOC control is verified: a contribution of $5kW$ is observed almost all the time because the SOC is higher than the reference.
- **Ultracapacitor state-of-charge:** The UC SOC control is verified: at low speeds the UC is charged by the FCS, at high speeds the UC discharges.

Experimental validation

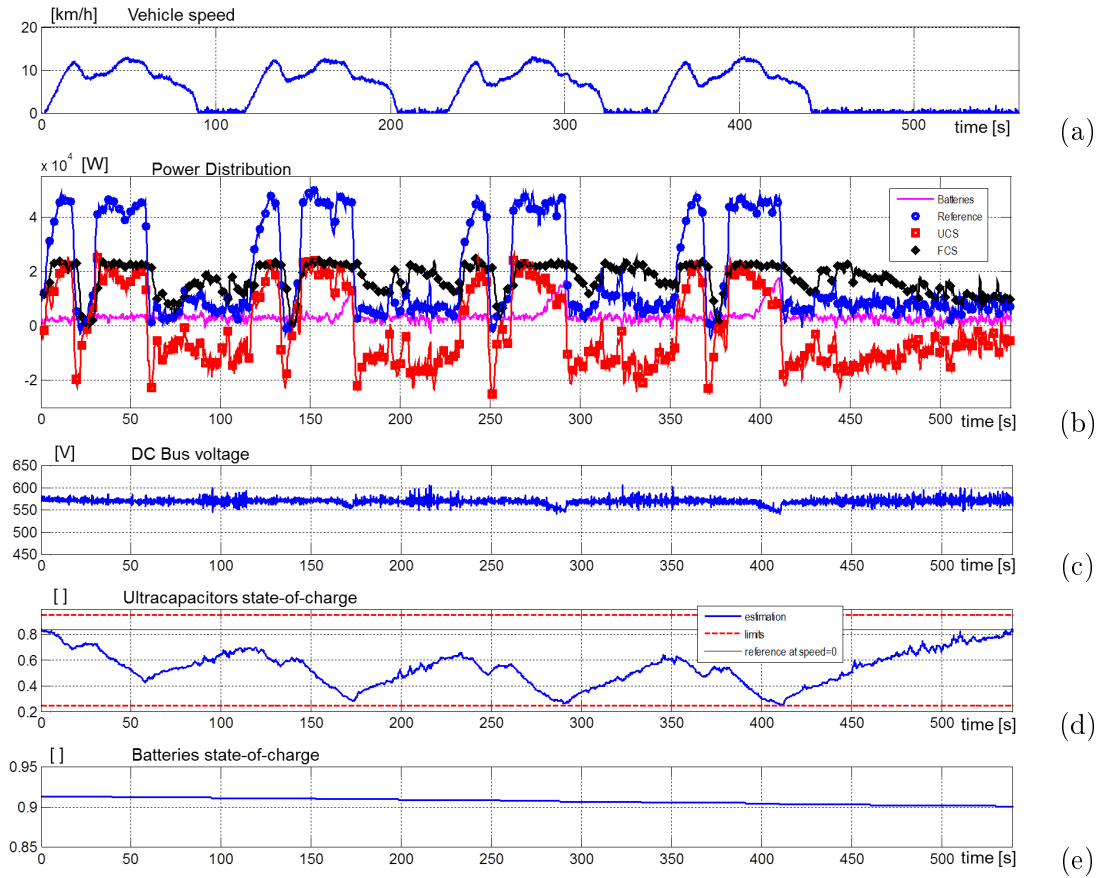

Figure 4.23: Experimental results - Drive validation II
Speed (a), Power sharing (b), DC bus voltage (c), UC SOC (d), battery SOC (e)

4.7.2.3 Degraded operation without UCS

Experimental results are presented in Figure 4.24. To emulate the UCS fail, the output of this element is imposed to be zero. Additionally, the EMS is modified as explained in Subsection 4.5.2 and shown in Figure 4.14. In this degraded operation the batteries supply the dynamic response and the the output voltage is not stable as in the configuration including the UCS. The batteries SOC is nevertheless controlled by the FCS.

4.7.2.4 Degraded operation without FCS

To emulate the FCS fail, the output of this element is imposed to be zero. The strategy is modified as explained in Subsection 4.5.1 and shown in Figure 4.13. Experimental results are presented in Figure 4.25. In this configuration the UCS supplies the dynamic response and the output voltage variation is much lower than in the degraded configuration without UCS (this element minimises the DC bus voltage variation). The batteries controls the UC SOC, however, the batteries SOC cannot be controlled and then a progressive decrease in the batteries voltage can be noticed.

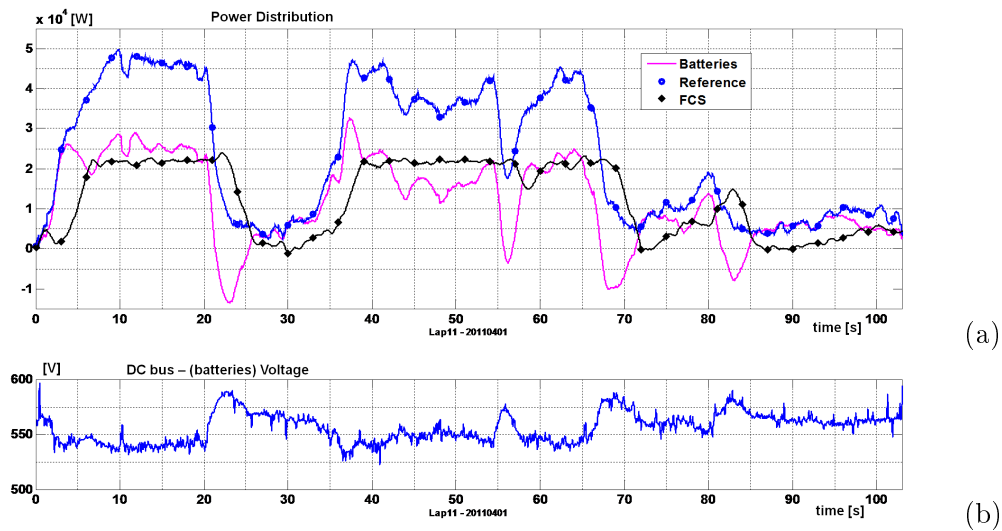

Figure 4.24: Experimental results - Drive validation III (Whitout the UCS)
Power distribution (a), DC bus voltage (b)

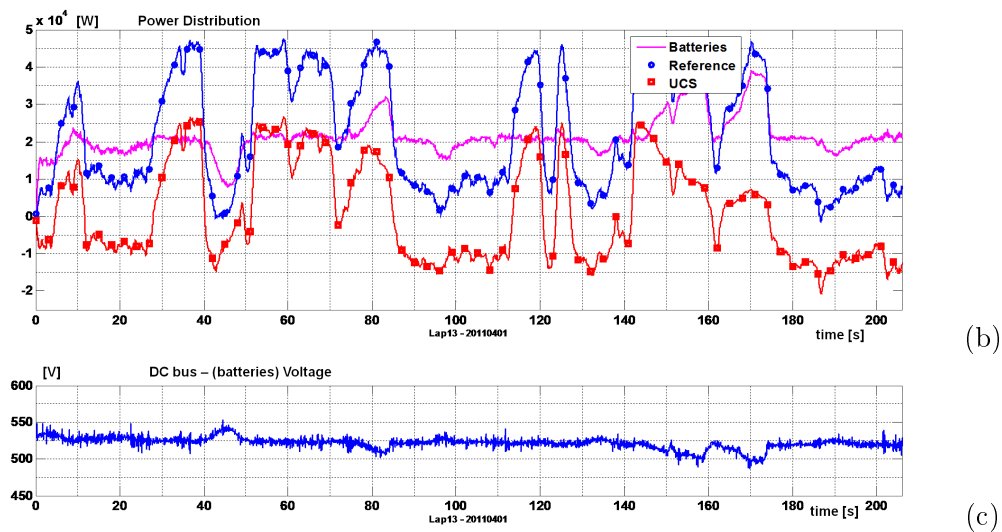

Figure 4.25: Experimental results - Drive validation IV (Without the FCS)
Power distribution (a), DC bus voltage (b)

4.8 Chapter conclusion

A novel energy management strategy (EMS) was presented in this chapter. It is based on the embedded energy sources characteristics without any previous knowledge of driving conditions (only real-time information is used). The principal contribution is the use of type-2 fuzzy logic systems and human expertise in energy management of hybrid sources:

- As far as we know, it is the first industrial application of type-2 fuzzy logic in France and the first experimental validation of an energy management system on a hybrid electrical vehicle using 1) type-2 fuzzy logic and 2) using experience of multiple experts

- It is an application for a military application but it could be used in civil applications (the parameters of the energy management strategy depends only on the characteristics of the sources and not on the vehicle)
- In this EMS the priority source is the UCS because it is the most performing source in terms of efficiency, power and dynamic response. Moreover, the bounds of operation are not limited as classically in the literature, the strategy considers the vehicle speed to find a dynamic reference for the UC SOC.
- The strategy permits an easy operation in degraded mode, using only one software application. Additionally the fuzzy logic controller structure is used either to find a power reference (simulation) or to find a current reference (experimentation). The EMS structure itself does not change.

Not all the ideas to improve the energy management strategy were neither evaluated on ECCE vehicle nor presented in this dissertation. Further research are identified:

- To redefine the dynamical references of the state-of-charge of UC and batteries regarding the road slope and/or the traffic (e.g. using GPS information).
- The ECCE test bench operation is very constrained in terms of voltage variation. Moreover, the batteries used on this vehicle (lead-acid) are relatively inefficient and also presents a relatively low durability . For these reasons the use of batteries in ECCE is minimised. However, if different batteries were considered (such as lithium or nickel-based), it could be interesting to redefine the batteries EMS.
- When the energy management survey was presented to the experts, not all the information about the vehicle constraints (confidentiality reasons) nor the whole management strategy were presented (not before publication) and not all the ECCE constraints were clearly identified (before experimental validation). It could be interesting to conduct a new survey presenting more information about the vehicle.
- The investigation of adaptive energy management strategy with driving style recognition.

Conclusion

This thesis presents a research work developed around two axes in electrical engineering: energy management in hybrid electrical vehicles and type-2 fuzzy logic controllers.

This work takes part of the research developed in FEMTO-ST Laboratory about the modelling and control of multi-physics systems. It is a natural continuation of previous research developed in subjects such as Energetic Macroscopic Representation (EMR), modelling and control of electrical sources or type-1 fuzzy logic controllers. In the same perspective, this thesis aims to present a contribution to the research developed in FEMTO-ST Laboratory around energy management in Hybrid Electrical Vehicles (HEV) and type-2 fuzzy logic control.

Overview

The research presented in this thesis is realised in the framework of the ECCE project. ECCE is a hybrid electrical vehicle that can be used as a mobile laboratory. Here, the interest is to develop and to evaluate an energy management system for a hybrid source composed by a bank of batteries, an Ultracapacitor System (UCS) and a Fuel Cell System (FCS).

EMR formalism is selected to represent the ECCE HEV and to identify its Practical Control Structure (PCS). The modelling and the parameter identification of the batteries and the FCS have been developed in previous research at FEMTO-ST Laboratory. This thesis propose a new procedure to identify the equivalent electrical parameters of the UCS. This procedure is experimentally validated.

As previous knowledge of the driving cycles is not considered, on-line techniques are identified as the most adapted to perform the energy management in ECCE. The proposed Energy Management Strategy (EMS) only considers real-time information such as electrical power, current or voltage, the state of charge of the storage sources or the speed of the vehicle. The EMS is developing considering the advantages and drawbacks of each of the sources. The batteries are directly connected to the DC bus and then their power is indirectly controlled by the FCS and UCS. The UCS is the most efficient source and then is considered as the priority source to supply the power. A fuzzy logic controller is selected to perform the local energy management of the FCS.

As (again) previous knowledge of the driving cycles is not considered, human expertise is used to design the Fuzzy Logic Controller (FLC) which control the FCS. A fuzzy logic system is designed from human experience, it permits using human knowledge to define the fuzzy rules and membership functions of the fuzzy system. The energy management survey was performed among experts in energy management of HEV. Type-2 fuzzy logic controllers (T2-FLC) are retained because they consider the uncertainty in the answers and the fact that different experts think differently and define different rules.

A toolbox is developed in Matlab to map T2-FLC into control surfaces (interval type-2 fuzzy logic controllers are considered in this thesis). The control surface and the EMS are implemented in Matlab Simulink and computer simulations are performed using the EMR and the PCS of the vehicle. Simulation results show an EMS which fulfills all the imposed requirements. This is interpreted as satisfactory enough to continue with the experimental validation.

A secondary application is considered to experimentally validate the T2-FLC before its implementation in the real vehicle. A T2-FLC is used to control the voltage in a DC/DC power converter. The principal motivation to perform this intermediary validation is its relatively easy implementation and economical experimental setup. Moreover, the evaluation of this T2-FLC is done under controlled conditions in Laboratory. The T2-FLC is developed, implemented and experimentally validated with satisfactory results. This secondary validation of T2-FLC is considered (together with the simulation results) as strong motivation to continue to the last stage of the project: the implementation of the T2-FLC in the ECCE energy management system.

Finally, experimental validation of the energy management system is performed in the ECCE mobile laboratory. As expected in simulation, we observe an energy management system which fulfils the control objectives. The experimental results (the voltage controller and the energy management system) can be seen as strong evidence that T2-FLC are well adapted for use in electrical engineering applications. However, as the research presented in this thesis does not consider optimisation of the fuzzy controllers, it does not present enough evidence to affirm that T2-FLC are better performing than T1-FLC. Nevertheless, thanks to the proposed survey and the use of type-2 FLC, the knowledge of different experts among the world can easily be integrated into one single fuzzy controller.

Research summary

Chapter 1 introduces the research group, the context and motivations of the ECCE project and to present the background of the thesis: hybrid electrical vehicles, energy management techniques, and type-2 fuzzy logic.

Chapter 2 describes the different sources used in the vehicle: from their EMR it develops their practical control structure (PCS) by considering the technical and economical

Conclusion

constraints. It also introduces the modelling and parameter identification of the sources.

Chapter 3 introduces type-2 fuzzy logic systems (FLS) and presents in detail the interval type-2 fuzzy logic systems retained in this research. This chapter presents the first experimental validation of T2-FLC control, the output voltage control in a buck converter.

Chapter 4 presents the design, implementation and validation by simulation and experimentation of the ECCE energy management system.

Appendix A presents the software developed to map interval-type-2 fuzzy systems into control surfaces. Appendix B presents the energy management survey performed to design the IT2-FLC implemented in ECCE.

Chapters 3 and 4 present two applications of type-2 fuzzy logic in electrical engineering. These applications present very different scenarios to evaluate type-2 fuzzy logic controllers:

The output voltage T2-FLC presented in Chapter 3 requires a relatively easy to implement and economical experimental setup. Their evaluation is done under controlled conditions in Laboratory. The control of the DC/DC converter is exclusively performed by the T2-FLC. This application is well adapted to evaluate different fuzzy logic systems and even is useful to study optimisation as a perspective of future research.

The energy management application presented on Chapter 4 requires a very complex and very expensive experimental setup. Evaluation of this application is done under restrained and less controllable conditions (real-drive conditions). The EMS response not only depends on the T2-FLC but also on the control systems of the other sources implemented in the vehicle. Experimental evaluation of the FLS is much more complicated and optimisation is prohibitive for the moment.

Research contributions

As contributions of this thesis we list:

An ultracapacitor circuit model for hybrid electrical vehicle simulation and the procedure to identify its parameters is proposed. The circuit model and parameter identification was experimentally validated in laboratory and in a real hybrid electric vehicle.

A software to implement interval type-2 fuzzy logic systems is proposed. This software is based on flowcharts and structured programming and does not require the use of the Matlab Fuzzy Logic Toolbox as the software proposed by other authors.

A novel energy management strategy (EMS) was presented in this thesis. The EMS is based on the embedded energy sources characteristics without any previous knowledge of driving conditions. It considers the vehicle speed to find a dynamic reference for the UC SOC. The strategy permits operation in degraded mode i.e. failure of one of the sources.

The principal contribution is the use of type-2 fuzzy logic systems and human expertise in energy management in HEV.

The research developed in this thesis has been presented in national ([Sola09d], [Sola11a]¹) and international conferences ([Sola09a], [Sola10b], [Mulo11], [Sola12a]), in scientific journals with lecture committee ([Sola12d], [Sola11c], [Sola12b]² and [Sola12c]), as a part of a research contract, in deliverable technical reports ([Sola09c], [Sola09b], [Sola10a] and [Sola11b]).

Research outlooks

As perspectives of this thesis it can be identified:

In the subject of energy management, it could be interesting to redefine the dynamical references of the state-of-charge of the UC and the batteries by considering the road slope and/or forecasting of the traffic (e.g. using GPS information). It is considered to alter the proposed EMS and use it in the different configurations of the ECCE HEV (including flywheel systems or internal combustion engines). The strategies in degraded configurations must be improved. It could be also interesting to consider energy management of hybrid sources where the load profile can be partially known in advance (such as in stationary applications or in railroad transport).

In the field of type-2 fuzzy logic control, non-optimised interval T2-FL membership functions were retained in this thesis. Further research at FEMTO-ST will consider different topics such as the implementation of general type-2 FLC, the influence of the uncertainty in the operation and in the stability of the control systems, the definition of the parameters of the T2-FLC. Finally, it is interesting to study the optimisation of the type-2 fuzzy logic controllers.

¹Conférence jeunes chercheurs en génie électrique JCGE 2011 - Best paper award - Industrial innovation

²Prix A'doc de la jeune recherche en Franche-Comté - Award of the *Prix A'doc* - Open competition for young researchers of the region of Franche-Comté

Appendix A

Interval type-2 fuzzy logic system software implementation

This appendix presents the software to implement interval type-2 fuzzy logic systems

This software is used to map interval type-2 fuzzy logic systems from their membership functions and their fuzzy rules as presented in Appendix B. The application (i.e. the program) is structured into the following subprograms: the membership function and the fuzzy sets creators, the fuzzifier, the inference engine, the type-reducer and the defuzzifier. Each subprogram is presented and explained using examples.

To facilitate the implementation in any computational language, the subprograms are developed using flowcharts and structured programming (Matlab code is also presented). Complementary approaches to implement type-2 fuzzy systems using Matlab can be found in [Mend01]¹, [Cast08] or [Ozek08].

A.1 Membership functions creation

The first subprogram is used to create triangular and trapezoidal membership functions. The domain of the fuzzy sets is $x = [-1, 1]$

%Definition of the domaine for the normalised fuzzy set discretised into p points

```
Xd=linspace(-1, 1, p)
```

%Function to create linear membership functions

```
function [Trapezoid] = Trapezoid(Xd, a, b, c, d, e)
```

```
for k=1:length(Xd)
```

```
    Trapezoid(k)=max(0, min([e*(Xd(k)-a)/(b-a), e, e*(d-Xd(k))/(d-c)]));
```

```
end
```

¹Software available as freeware at <http://sipi.usc.edu/mendel/software/>

A.2 Fuzzy sets creation

This subprogram is used to create the fuzzy sets of the fuzzy system. It requires the previous definition of the parameters which define all the membership functions.

- The inputs of the subprogram are: the domain of the set x , and the parameters that define the MFs
- The output of the subprogram is a fuzzy set of $2 \cdot n$ MFs for each input. Here, n represents the number of MFs per input and the factor 2 allows considering that each interval type-2 MF is defined by one UMF and one LMF.

A.2.1 Fuzzy sets implementation using Matlab

```

for i=1:inputs %Number of inputs
    for j=1:MFs(i) %Number of membership functions of input i
        for k=1:2 %k=1:LMF, k=2:UMF
            MF(i, j, k, :)=Trapezoid(Xd, a(i, j, k), b(i, j, k), c(i, j, k), d(i, j, k), e(i, j, k));
        end
    end
end
end

```

A.3 Centroid of a type-2 fuzzy MF

This subprogram computes the centroid of an interval type-2 fuzzy MF discretised into p interval type-1 MFs, as illustrated on Figure 3.12. This is computed by using the Karnik-Mendel algorithm. The KMA used to compute the left point of the centroid is shown in Figure 3.14, the algorithm to compute the right point is shown in Figure A.1.

A.3.1 Centroid computation using Matlab

```

centroid=0;
for i=1:inputs;
    for j=1:MF;
        for k=1:p;
            x1=Xd(k);
            w1=MF(i,j,1,k); w2=MF(i,j,2,k);
            W(i,k,:)=[w1,w2]; Z(i,k,:)=[x1,x1];
        end
        km %Calls Karnik-Mendel Algorithm (KMA).
        centroid(k,:)=[y1,yr];
    end
end

```

A.3.1.1 Left point of the centroid: KMA

```
xx=0;
tour=0;
while xx==0
    den=0;
    num=0;
    tour=tour+1;
    for i=1:p
        if x(i) > Cl(tour); %Or Cr(tour) to compute the righth point
            theta(i)=W(i,1); %Or W(i,2) to compute the righth point
        else
            theta(i)=W(i,2); %Or W(i,1) to compute the righth point
        end
        num=num+x(i)*theta(i);
        den=den+theta(i);
    end
    Cl(tour+1)=num/den;%Or Cr(tour+1) to compute the righth point
    if Cl(tour)==Cl(tour+1);%Or Cr(tour) and Cr(tour+1) to compute the righth point
        xx=1;
    end
end
yl=Cl(tour);%Or yr and Cr(tour) to compute the righth point
```

A.3.2 Centroid example

Figure A.2 shows an example of the centroid of a type-2 MF using and a discretisation of $p = 501$ points.

Table A.1 presents the result of the KMA for the fuzzy membership functions presented in Figure 4.8, when different discretisations are considered.

A.4 Fuzzifier

The fuzzifier converts a crisp input into type-2 fuzzy sets. The same fuzzifier used in type-1 fuzzy MFs is used in interval type-2 fuzzy MFs. However, fuzzification is performed two times (one for the UMF and one for the LMF).

Figure A.3 shows the flowchart of the fuzzifier which allows an easy implementation in any computer language.

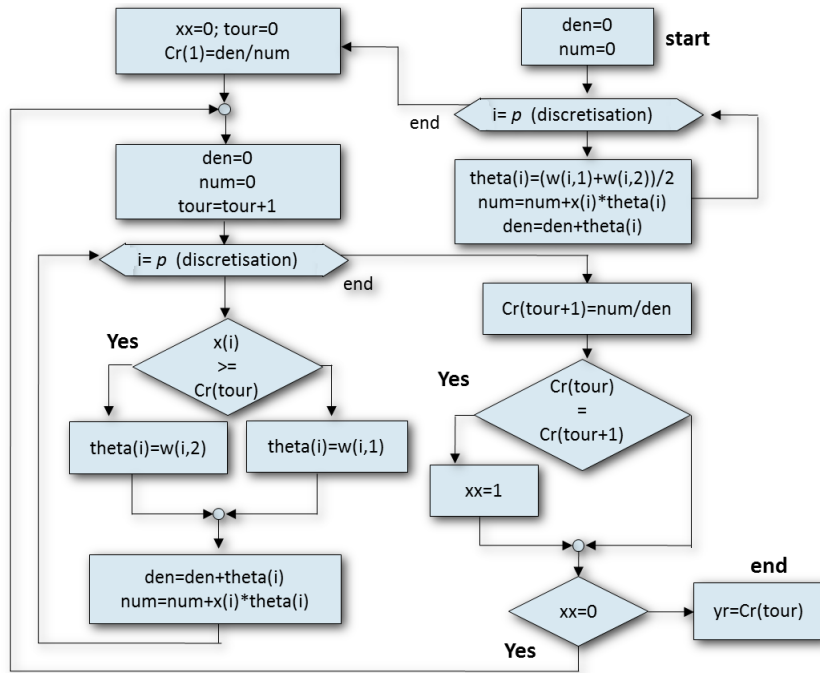

Figure A.1: KMA flow-chart to compute the right point of the centroid

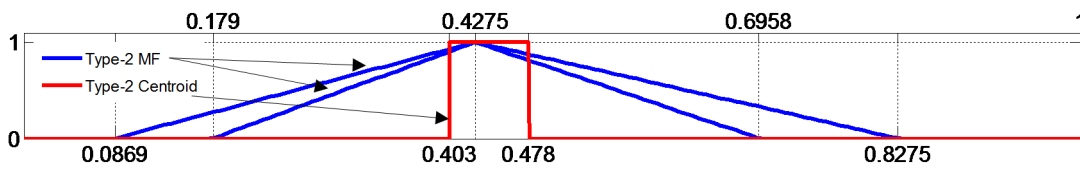

Figure A.2: A type-2 membership functions and its centroid

Table A.1: Centroids of the fuzzy MFs for ΔP

p	Z	PL	PM	PH
21	[-0.0148 0.0148]	[0.1825 0.2273]	[0.4013 0.4782]	[0.7216 0.8049]
51	[-0.0168 0.0168]	[0.1760 0.2273]	[0.4037 0.4780]	[0.7051 0.7903]
101	[-0.0163 0.0163]	[0.1753 0.2270]	[0.4034 0.4782]	[0.7004 0.7849]
201	[-0.0160 0.0160]	[0.1755 0.2271]	[0.4034 0.4781]	[0.6980 0.7823]
501	[-0.0160 0.0160]	[0.1756 0.2271]	[0.4034 0.4781]	[0.6965 0.7807]
1001	[-0.0160 0.0160]	[0.1756 0.2271]	[0.4034 0.4781]	[0.6960 0.7802]
10001	[-0.0160 0.0160]	[0.1756 0.2271]	[0.4034 0.4781]	[0.6955 0.7798]
20001	[-0.0160 0.0160]	[0.1756 0.2271]	[0.4034 0.4781]	[0.6955 0.7798]

A.4.1 Fuzzifier implementation using Matlab

```

for i=1:inputs
    for k=1:MFs(i)
        mu(i,k,1)=LMF(input(i),k,i);
        mu(i,k,2)=UMF(input(i),k,i);
    end
end
end

```

With the following functions:

```

function [LMF] = LMF(x,k,i)
av(1,:)=MF(i,k,2,:);
LMF=interp1(Xd,av,x);%Linear interpolation

```

```

function [UMF] = UMF(x,k,i)
av(1,:)=MF(i,k,1,:);
UMF=interp1(Xd,av,x);%Linear interpolation

```

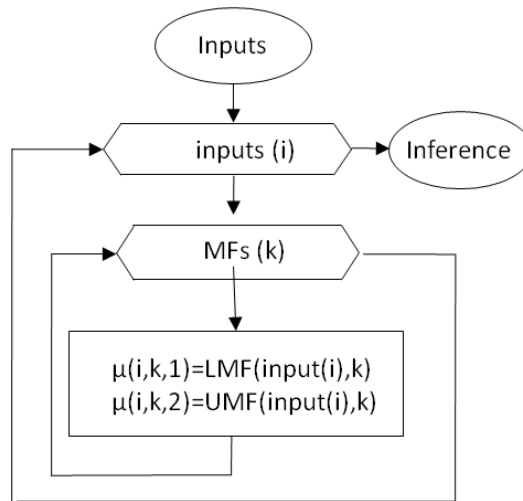

Figure A.3: Fuzzification flow-chart

A.5 Inference engine

The inference engine maps type-2 fuzzy sets into type-2 fuzzy sets. The same inference engine used in type-1 fuzzy logic is used for interval type-2 fuzzy logic.

Figure A.4 shows the flowchart which describes the inference engine. Two loops are used one for each input to create a vector containing the firing degree for each rule.

A.5.1 Inference engine implementation using Matlab

```

for i=1:MFs(1)
    for k=1:MFs(2)
        f(i,k,1)=mu(1,i,1)*mu(2,k,1);
        f(i,k,2)=mu(1,i,2)*mu(2,k,2);
    end
end

```

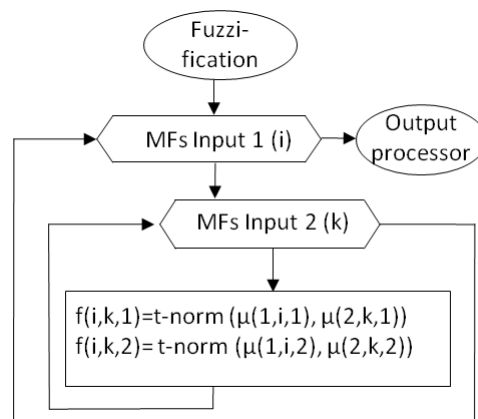

Figure A.4: Inference-engine flow-chart

A.6 Output processor

The output processor combines type-2 fuzzy sets to obtain the crisp output of the fuzzy logic system. It is the principal difference between T1-FL and T2-FL systems. However, the output processor of a T2-FL system can be used in T1-FL systems (not vice versa).

A.6.1 Output processor implementation using Matlab

```

Rules=0;
for i=1:MFs(1)
    for k=1:MFs(2)
        if f(i,k,1)~0||f(i,k,2)~0
            Rules=Rules+1;
            W(Rules,:)=f(i,k,1),f(i,k,2)];
            Z(Rules,:)=Y(i,k,1),Y(i,k,2)]; %Y contains the values of the fuzzy rules as in Table 4.6
        end
    end
end km %Calls Karnik-Mendel subprogram
centroid=[yl,yr];output=(yl + yr)/2; %Defuzzification

```

A.6.1.1 Left point of the type-reductor: KMA

```

xx=0;tour=0;
while xx==0
    den=0; num=0; tour=tour+1;
    for i=1:Rule %Or the value of discretisation p of the MF in Type-2 MF centroid calcul
        if Z(i,1) > Cr(tour); %Or Z(i,2) to compute the righth point
            theta(i)=W(i,1); %Or W(i,2) to compute the righth point
        else
            theta(i)=W(i,2); %Or W(i,1) to compute the righth point
        end
        num=num+Z(i,1)*theta(i); %Or Z(i,2) to compute the righth point
        den=den+theta(i);
    end
    Cr(tour+1)=num/den;
    if Cr(tour)==Cr(tour+1);
        xx=1;
    end
end
yr=Cr(tour);

```

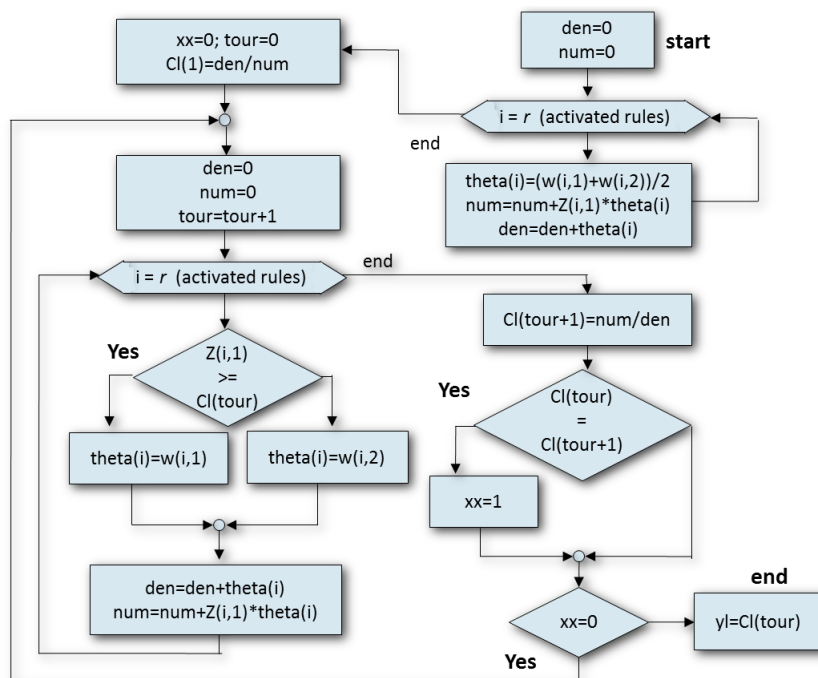

Figure A.5: KMA flow-chart to compute the left point of the type-reduced set

A.7 Fuzzy logic control software implementation

Type-2 fuzzy logic defuzzification is well known as the bottleneck in type-2 fuzzy systems. The computational cost of this subsystem is related with the difficulty to implement a real-time type-2 fuzzy controller. Here, we choose not to implement a real-time fuzzy controller but to do off-line mapping of the system as also proposed by [Matt97].

A.7.1 Software implementation - Validation

To validate the software implementation two different evaluations are performed:

1. The interval type-2 fuzzy logic systems presented in [Mend01] and [Lian02] present all the parameters which completely define the fuzzy logic systems. These fuzzy system are implemented in our application. The input-output results of our application meets those in the publications.
2. Fuzzy logic systems with identical membership functions and rules are created in the Matlab fuzzy toolbox and in our application. Both fuzzy logic systems are mapped and it difference is computed. The same results are obtained in the Matlab toolbox and in our application. This evaluation also validates that our application can be used either to create type-2 or type-1 fuzzy logic systems. Obviously, the uncertainty is selected to be zero (the matlab toolbox only enable work with type-1 fuzzy systems).

A.7.2 Matlab graphic user interfaces - Fuel cell fuzzy logic controller

Applications in Matlab has been developed to automatically map a fuzzy logic controller surface from their fuzzy membership functions and rules parameters (e.g. the results of the survey as presented in Appendix B).

The application requires:

1. The number of points to create the MFs (resolution)
2. The uncertainty in the MFs
3. The output map discretisation or grid size (an small grid size improves the resolution of the map, but could cause problems in memory of the controller)

A.7.2.1 Matlab graphic user interfaces - Fuel cell fuzzy logic controller

Figure A.6 presents the graphical user interface developed in Matlab to map the FLSs used in the ECCE energy management (see Chapter 4. and Appendix B.). The fuzzy systems are mapped onto a 3D control surfaces. Here, a grid of 51*51 points is selected to have a homogeneous surface that can be easily handled by the dSPACE in terms of memory.

As a complementary exemple of the application, Figure A.7 illustrates the difference between the type-2 and the type-1 FLS designed from the survey.

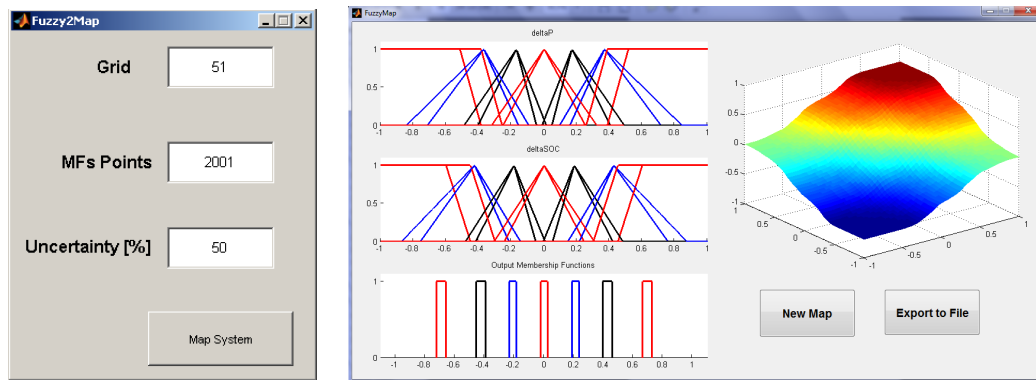

Figure A.6: Matlab application to compute the fuzzy logic surface

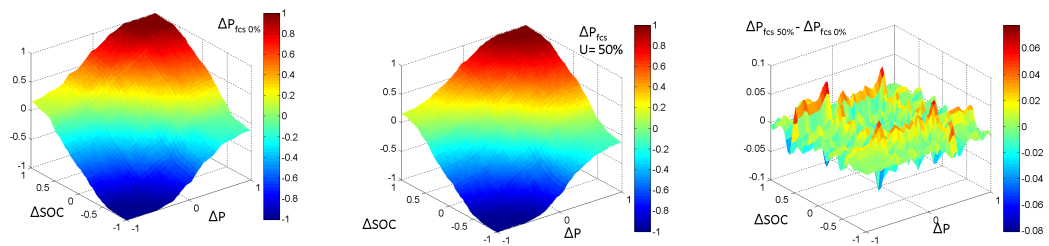

Figure A.7: Type-1 (left) type-2 (medium) fuzzy maps and their differences (right)

Appendix B

Survey-based fuzzy logic system for ECCE energy management

This appendix presents the design of the type-2 fuzzy logic controller used in Chapter IV

A type-2 fuzzy logic controller is used to perform the energy management in the ECCE hybrid electric vehicle. The controller is used to define a reference for the power delivered by the fuel cell system. The design of the fuzzy system (rules and membership functions) is done using the knowledge-mining (or knowledge engineering) technique proposed by Mendel [Mend01]. This technique, based on surveys, allows extracting information from experts in the form of IF-THEN rules.

B.1 Energy management survey

An energy management survey was conducted among 10 experts in hybrid electrical vehicles worldwide. The survey was mainly performed among the participants of the IEEE Vehicle Power and Propulsion Conference, September 2010 in Lille, France. The participants of this survey are affiliated with: the University of Franche-Comte, the French Network on Hybrid Electric Vehicles (MEGEVH) and the French Institute for Transport and Safety Research (IFSTTAR) in France, the Foundation for the Development of New Hydrogen Technologies in Spain, the University of Porto in Portugal, the University of Harbin in China, the PSA Peugeot Citroën group in France, the University of Paderborn in Germany and the University of Trois-Rivières in Canada. The survey was designed at the Centre for Computational Intelligence at Leicester, UK.

B.1.1 Energy management survey sample

The experts were asked to answer a fuzzy energy management survey divided in three sections. Each section presented examples to explain how to answer the questionnaire. Figures B.1, B.2, B.3 and B.4 present a sample of the survey as presented to the experts.



HEV Fuzzy Energy Management Survey

My name is Javier Solano and I am a Ph.D. student at Femto Laboratory - University of Franche Comte in Belfort, France. My current research focuses on the use of human expert knowledge in energy management of Hybrid Electrical Vehicles (HEVs). This is a joint project between the Femto Laboratory and the Centre for Computational Intelligence at De Montfort University in Leicester, UK.

As an expert in HEVs you have been selected to participate in this survey that aims to design a Fuzzy Logic System (FLS) for energy management in a HEV. All the information you provide will be treated confidentially and you will be notified of the results of this research as soon as possible. If you have any question or comment please feel free to contact me at:

Email: jsolanom@univ-fcomte.fr
 Address: FC LAB Belfort, 90000 France
 Tel: +33 3 84 58 36 25

Section I. Contact details

Name _____
 Affiliation _____
 Email _____

Section II. Expert knowledge

Section II aim to extract expert knowledge to design the energy management system for the HEV shown in Figure 1.

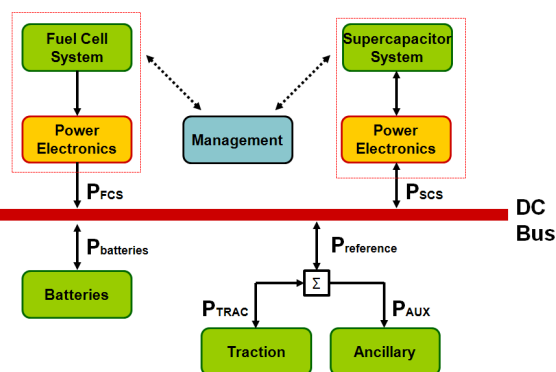

Figure 1. Energy configuration of the Vehicle

The objectives of the management strategy for this HEV are:

- In steady state the reference power is provided by the Fuel Cell System (FCS)
- In transitory the Supercapacitor System (SCS) reinforces the FCS
- The battery regulates the bus voltage and reinforces the SCS if required
- The SCS State of Charge(SOC) is maintained at optimal levels



A fuzzy controller is used to find the FCS output power. Figure 2 presents the fuzzy logic controller, and Table 1 explains its inputs and outputs.

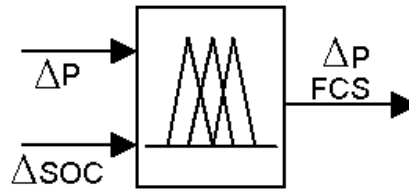

Figure 2. Fuzzy logic controller

	Definition	Description
ΔP	$\Delta P(t) = P_{ref}(t) - P_{FCS}(t)$	P_{ref} is the reference power and P_{FCS} is the actual FCS power
ΔSOC	$\Delta SOC(t) = SOC_{ref}(t) - SOC(t)$	SOC_{ref} is the reference value and SOC is the actual value in the SCS
ΔP_{FCS}	$\Delta P_{FCS}(t) = f(\Delta P(t), \Delta SOC(t))$	ΔP_{FCS} is an increment in P_{FCS}

Table 1. FLS input–output description

Section II.1 Linguistic label localisation

The purpose of this part of the survey is to locate linguistic labels to determine intervals. This information will be used to construct the fuzzy sets. The following example demonstrates how to complete this section.

Example 1:

Table 2 summarises the assigned values to four linguistic labels representing the speed of a vehicle with maximum speed of 150 (km/h). Obviously these values could be different for different people.

Speed (km/h)	Start	End
Zero to Very Slow	0	20
Slow	15	50
Medium	35	85
Fast	70	150

Table 2. Linguistic labels to describe speed

It can be inferred from Table 2 that the person completing this table thinks that:

- A slow speed is between 15 and 50 (km/h)
- A speed of 40 (km/h) could be considered slow as well as medium



Question 1. Power of the Fuel Cell System

Please use your own experience, thoughts and preferences to complete Table 3 using percentage values of the FCS nominal power to represent ΔP as defined in Table 1.

ΔP	Start	End
Almost Zero	0 %	
Low		
Medium		
High		100 %

Table 3. Linguistic labels to describe ΔP

Question 2. State of Charge of the Supercapacitor System

Please use your own experience, thoughts and preferences to complete Table 4 using percentage of the maximal SOC to represent ΔSOC in the SCS as defined in Table 1.

ΔSOC	Start	End
Almost Zero	0 %	
Low		
Medium		
High		100 %

Table 4. Linguistic labels to describe ΔSOC

Section II.2 Rules definition

The FLS presented on Figure 3 and described in Table 1 takes the inputs and processes them to produce outputs using the fuzzy rules and the linguistic labels in Table 5. These rules are summarized in Table 6.

$\Delta P - \Delta SOC$		ΔP_{FCS}	
Linguistic Label	Abbreviation	Linguistic Label	Abbreviation
Negative High	NH	High Decrease in output power	DH
Negative Medium	NM	Medium Decrease in output power	DM
Negative Low	NL	Low Decrease in output power	DL
Zero	Z	Hold the output power	H
Positive Low	PL	Low Increase in output power	IL
Positive Medium	PM	Medium Increase in output power	IM
Positive High	PH	High Increase in output power	IH

Table 5. Linguistic labels to locate the speed

Figure B.3: HEV Fuzzy Energy Management Survey - Page 3/4



The following examples demonstrate how to complete this section. However, they are only examples. Please feel free to modify your answers.

Example 2: If ΔP is NH and ΔSOC is NH then ΔP_{FCS} is _____?

- The FCS system supplies more power than required and the SCS are relatively overcharged.
- It is necessary to rapidly decrease the FCS output power:

If ΔSOC is NH and ΔP is NH then ΔP_{FCS} is DH

Example 3: If ΔP is Z and ΔSOC is Z then ΔP_{FCS} is _____?

The actual values meet the reference
 It is necessary to hold the output power in the FCS
 If ΔSOC is Z and ΔP is Z then ΔP_{FCS} is H

Question 3. Fuzzy rules definition

Please use your own experience, thoughts and preferences to complete Table 6 using the linguistic labels in Table 5.

Please remember!

- A positive ΔSOC is less charge than required.
- A negative ΔP is more power than required.

		ΔP_{FCS}						
$\Delta SOC \downarrow$	$\Delta P \rightarrow$	NH	NM	NL	Z	PL	PM	PH
NH								
NM								
NL								
Z								
PL								
PM								
PH								

Table 6. Fuzzy rules

This is the end of the survey. Thank you very much

B.2 Survey processing

The processed results of the survey are used to define the fuzzy sets (two inputs, seven MFs per input) and the forty-nine rules (one MF per rule):

Tables B.1 and B.2 present the processed results for Questions 1 and 2 of the survey (mean values and standard deviation of the answers). This information is used to define the parameters required to create the membership functions for the inputs of the fuzzy system. Table 4.5 presents the processed results for Question 3 of the survey (summarises the rules defined by the experts). This information is used to define the 49 fuzzy rules.

Table B.1: Processed survey results: ΔP Linguistic labels

Range label	Mean		Std. deviation	
	start (a)	end (b)	start (σ_a)	end (σ_b)
Zero	0,00	9,70	0,00	4,81
Low	7,25	28,50	4,33	11,07
Medium	22,50	63,00	9,20	13,17
High	56,50	100,00	17,00	0,00

Table B.2: Processed survey results: ΔSOC Linguistic labels

Range label	Mean		Std. deviation	
	start (a)	end (b)	start (σ_a)	end (σ_b)
Zero	0,00	15,50	0,00	11,41
Low	12,20	36,00	11,13	15,24
Medium	32,50	70,50	15,32	14,03
High	66,00	100,00	17,76	0,00

B.2.1 Fuzzy sets design (membership functions)

As generally done in literature, the MFs has been selected to be triangular for the labels Negative Medium (NM), Negative Low (NL), Zero (Z), Positive Low (PL) and Positive Medium (PM) and trapezoidal for the labels Negative High (NH) and Positive High (PH). The MFs are selected to be symmetrical around zero, (i.e. NL, NM and NH MFs are completely defined by the PL, PM and PH MFs respectively).

B.2.1.1 Trapezoidal membership functions definition (NH, PH)

The MFs are defined using the following relations ([Mend01] in Section 10.12.):

- The upper trapezoids (UMF) are defined for the breakpoints:
 $(a - (1 + \rho)\sigma_a, 0)$, $(a - \rho\sigma_a, 1)$, $(b + \rho\sigma_b, 1)$ and $(b + (1 + \rho)\sigma_b, 0)$.
- The lower trapezoids (LMF) are defined for the following breakpoints:
 $(a - (1 - \rho)\sigma_a, 0)$, $(a + \rho\sigma_a, 1)$, $(b - \rho\sigma_b, 1)$ and $(b + (1 - \rho)\sigma_b, 0)$.

The creation of type-2 MFs (with $\rho = 0.5$) for the label ΔP PH is presented as example:

1. The results of the survey are summarised in Table B.1:
 $a = 0.565, b = 1, \sigma_a = 0.17, \sigma_b = 0.$
2. The breakpoints of the upper triangle are located at:
 $a - (1 + \rho)\sigma_a = 0.3099, a - \rho \sigma_a = 0.48, b + \rho \sigma_b = 1$ and $b + (1 + \rho)\sigma_b = 1.$
3. The breakpoints of the lower triangle are located at:
 $a - (1 - \rho)\sigma_a = 0.48, a + \rho \sigma_a = 0.65, b - \rho \sigma_b = 1$ and $b + (1 - \rho)\sigma_b = 1.$

The MFs representing ΔP PH are shown in Figure 4.8(a).

The MFs representing ΔP NH, illustrated in Figure 4.8(g), are constructed using the negative values of the breakpoints of the MF ΔP PH.

B.2.1.2 Triangular membership functions definition (NM, NL, Z, PL, PM)

- The upper triangles (UMF) are defined for the breakpoints:
 $(a - (1 + \rho)\sigma_a, 0), ((a + b)/2, 1)$ and $(b + (1 + \rho)\sigma_b, 0).$
- The lower triangles (LMF) are defined for the breakpoints:
 $(a + (1 + \rho)\sigma_a, 0), ((a + b)/2, 1)$ and $(b - (1 + \rho)\sigma_b, 0).$

The creation of type-2 MFs (with $\rho = 0.5$) for the label ΔP PM is presented as example:

1. The results of the survey are summarised in Table B.1:
 $a = 0.225, b = 0.63, \sigma_a = 0.092, \sigma_b = 0.137.$
2. The breakpoints of the upper triangle are located at:
 $a - (1 + \rho)\sigma_a = 0.0869, (a + b)/2 = 0.4275$ and $b + (1 + \rho)\sigma_b = 0.8275.$
3. The breakpoints of the lower triangle are located at:
 $a - (1 - \rho)\sigma_a = 0.1790, (a + b)/2 = 0.4275$ and $b + (1 - \rho)\sigma_b = 0.6958.$

The MFs representing ΔP PM are shown in Figure 4.8(b).

The MFs representing ΔP NM, illustrated in Figure 4.8(f), are constructed using the negative values of the breakpoints of the MF ΔP PM.

B.2.1.3 Membership functions - Results

The MFs that represent ΔP are presented in Figure 4.8. The MFs that represents ΔSOC are shown in Figure 4.9.

B.2.1.4 Membership functions - Centroids

The centroids of the MFs ΔP are calculated using the Karnik-Mendel algorithm. They are associated to the label ΔP_{FCS} or the desired change in the fuel cell power, as illustrated in Figure B.5.

As defined in the survey, the linguistic labels are: High Decrease (DH), Medium Decrease (DM), Low Decrease (DL), Hold (H), Low Increase (IL), Medium Increase (IM) and High Increase (IH).

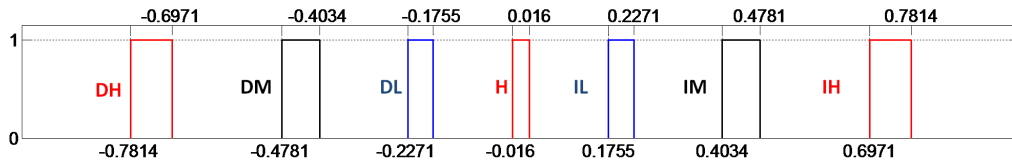

Figure B.5: Centroids of the interval type-2 fuzzy MFs representing ΔP

B.2.2 Fuzzy rules design

The survey asked the experts to associate labels to each rule as summarised in Table 4.5. Each of these labels is now associated with a MF: ΔP_{FCS} as presented on Figure B.5.

As different experts defined different rules, an ‘average’ rule is retained. Each rule is then associated with a MF which is the average of the MFs defined by the experts.

B.2.2.1 Fuzzy rules design - Exemple

To explain how the procedure works, the creation of the MF for the rule 5 is explained:

‘If ΔP is NH and ΔSOC is PL then do’ six experts preferred a medium decrease, three a low decrease and one expert preferred to hold the FCS power as summarised in Table 4.5. The average centroid is calculated:

$$C_{avg}^5 = \frac{6[-0.4781, -0.4034] + 3[-0.2271, -0.1755] + [-0.0160, 0.0160]}{10} = [-0.3566, -0.2931]$$

The MFs which represents the fuzzy rule 5 is illustrated in Figure B.6.

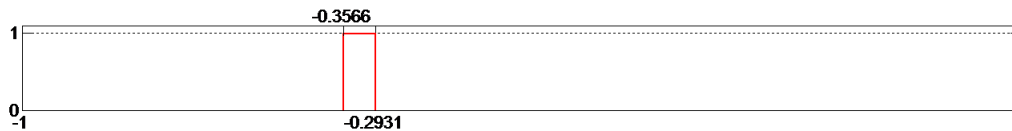

Figure B.6: Rule 5: If ΔP is NH and ΔSOC is PL then ΔP_{FCS} is $[-0.3566, -0.2931]$

Table 4.6 resumes the parameters that define the MFs used to represent the 49 rules.

B.2.3 Fuzzy logic control surface

The fuzzy logic system is completely defined by its membership functions and fuzzy rules. An uncertainty value of $p = 0.5$ is retained as a first approach. Figure 4.10 shows the fuzzy logic surface representing the fuzzy logic controller designed from the survey.

Bibliography

- [Agbl11] K. Agbli, M. Péra, D. Hissel, O. Rallières, C. Turpin, and I. Doumbia. “Multiphysics simulation of a PEM electrolyser: Energetic Macroscopic Representation approach”. *International Journal of Hydrogen Energy*, Vol. 36, No. 2, pp. 1382 – 1398, 2011. The 3rd Annual Korea-USA Joint Symposium on Hydrogen & Fuel Cell Technologies.
- [Akli08] C. A. Akli. *Conception systémique d’une locomotive hybride de démonstration et d’investigations en énergétique LHyDIE développée par la SNCF*. PhD thesis, Institut National Polytechnique de Toulouse, 2008.
- [Alle09] A. Allegre, A. Bouscayrol, and R. Trigui. “Influence of control strategies on battery/supercapacitor hybrid energy storage systems for traction applications”. In: *Vehicle Power and Propulsion Conference, 2009. VPPC’09. IEEE*, pp. 213–220, IEEE, 2009.
- [Allg10] A. Allègre. *Gestion du stockage mixte de l’énergie pour véhicule hybride électrique*. PhD thesis, Université de Sciences et Technologies de Lille, 2010.
- [Alma10] M. Almaraashi, R. John, S. Coupland, and A. Hopgood. “Time series forecasting using a TSK fuzzy system tuned with simulated annealing”. In: *Fuzzy Systems (FUZZ), 2010 IEEE International Conference on*, pp. 1–6, IEEE, 2010.
- [Ambu09] D. Ambuhl and L. Guzzella. “Predictive reference signal generator for hybrid electric vehicles”. *Vehicular Technology, IEEE Transactions on*, Vol. 58, No. 9, pp. 4730–4740, 2009.
- [Asen11] J. Asensio. “Modélisation et simulation d’un ”starter-generator” fonctionnant sur un bus de tension continue multisource pour application hélicoptère”. *Jeunes Chercheurs en Génie Electrique JCGE 2011*, Vol. 1, pp. 1–8, Belfort, 2011.
- [Auep02] S. Auephanwiriyaikul, A. Adrian, and J. Keller. “Type-2 fuzzy set analysis in management surveys”. In: *Proc. FUZZ-IEEE Conf*, pp. 1321–1325, 2002.
- [Baer11a] J. Baert, S. Jemei, D. Chamagne, D. Hissel, and S. Hibon. “Sizing of a hybrid locomotive”. In: *Vehicle Power and Propulsion Conference, 2011. VPPC’11. IEEE*, 2011.

- [Baer11b] J. Baert, J. Pouget, D. Hissel, and M.-C. Péra. “Energetic Macroscopic Representation of a Hybrid Railway Powertrain”. In: *Vehicle Power and Propulsion Conference, 2011. VPPC’11. IEEE*, 2011.
- [Bagu06] P. Baguley, T. Page, V. Koliza, and P. Maropoulos. “Time to market prediction using type-2 fuzzy sets”. *Journal of Manufacturing Technology Management*, Vol. 17, No. 4, pp. 513–520, 2006.
- [Bala10] P. Balaji and D. Srinivasan. “Type-2 fuzzy logic based urban traffic management”. *Engineering Applications of Artificial Intelligence*, Vol. 24, p. 11, 2010.
- [Bark08] S. Barkati, E. Berkouk, and M. Boucherit. “Application of type-2 fuzzy logic controller to an induction motor drive with seven-level diode-clamped inverter and controlled infeed”. *Electrical Engineering (Archiv fur Elektrotechnik)*, Vol. 90, No. 5, pp. 347–359, 2008.
- [Bark11] B. Barkat, H. Nouri, and A. Tlemcani. “Non-interacting Adaptive Control of PMSM Using Interval Type-2 Fuzzy Logic Systems”. *Fuzzy Systems, IEEE Transactions on*, Vol. To be published, No. 99, pp. 1–1, 2011.
- [Bart09] Ł. Bartczuk and D. Rutkowska. “Medical diagnosis with type-2 fuzzy decision trees”. *Computers in Medical Activity*, Vol. 1, pp. 11–21, 2009.
- [Bech10] M. Becherif and D. Hissel. “MPPT of a PEMFC based on air supply control of the motocompressor group”. *International Journal of Hydrogen Energy*, Vol. 35, No. 22, pp. 12521–12530, 2010.
- [Beno02] J. Beno, R. Thompson, and R. Hebner. “Flywheel batteries for vehicles”. In: *Autonomous Underwater Vehicles, 2002. Proceedings of the 2002 Workshop on*, pp. 99–101, IEEE, 2002.
- [Bien09] D. Bienaime. *Modélisation et caractérisation expérimentale de supercondensateurs dédiés à des applications transports*. Master’s thesis, Université de Lille 1, 2009.
- [Bien11a] D. Bienaime. “Etude d’un réseau de bord d’un hélicoptère basée sur la Représentation Energétique Macroscopique”. *Jeunes Chercheurs en Génie Electrique JCGE2011*, Vol. 1, pp. 1–8, Belfort, 2011.
- [Bien11b] D. Bienaime, N. Devillers, M. Péra, F. Gustin, A. Berthon, and M. Hopdjanian. “Energetic macroscopic representation of an electric network embedded in a helicopter”. In: *Vehicle Power and Propulsion Conference, 2011. VPPC’11. IEEE*, 2011.
- [Birk09] P. Birkin and J. Garibaldi. “A comparison of Type-1 and Type-2 fuzzy controllers in a micro-robot context”. In: *Fuzzy Systems, 2009. FUZZ-IEEE 2009. IEEE International Conference on*, pp. 1857–1862, IEEE, 2009.

Bibliography

- [Boul09] L. Boulon. *Modélisation multiphysique des éléments de stockage et de conversion d'énergie pour les véhicules électriques hybrides. Approche systémique pour la gestion d'énergie*. PhD thesis, Université de Franche Comté, 2009.
- [Boul10a] L. Boulon, D. Hissel, A. Bouscayrol, O. Pape, and M. Pera. "Simulation Model of a Military HEV With a Highly Redundant Architecture". *Vehicular Technology, IEEE Transactions on*, Vol. 59, No. 6, pp. 2654–2663, 2010.
- [Boul10b] L. Boulon, D. Hissel, A. Bouscayrol, and M. Pera. "From Modeling to Control of a PEM Fuel Cell Using Energetic Macroscopic Representation". *Industrial Electronics, IEEE Transactions on*, Vol. 57, No. 6, pp. 1882–1891, 2010.
- [Boul10c] L. Boulon, M. Péra, P. Delarue, A. Bouscayrol, and D. Hissel. "Causal fuel cell system model suitable for transportation simulation applications". *Journal of Fuel Cell Science and Technology*, Vol. 7, p. 011010, 2010.
- [Bous03] A. Bouscayrol. "Formalismes de représentation et de commande des systèmes électromécaniques multimachines multiconvertisseurs". *HDR de l'Université de Sciences et Technologies de Lille*, p. 200, 2003.
- [Bous05] A. Bouscayrol, P. Delarue, and X. Guillaud. "Power strategies for maximum control structure of a wind energy conversion system with a synchronous machine". *Renewable energy*, Vol. 30, No. 15, pp. 2273–2288, 2005.
- [Bubn10] P. Bubna, D. Brunner, S. Advani, and A. Prasad. "Prediction-based optimal power management in a fuel cell/battery plug-in hybrid vehicle". *Journal of Power Sources*, Vol. 195, pp. 6699–6708, 2010.
- [Bust07] H. Bustince, E. Barrenechea, M. Pagola, and R. Orduna. "Construction of interval type 2 fuzzy images to represent images in grayscale. False edges". In: *Fuzzy Systems Conference, 2007. FUZZ-IEEE 2007. IEEE International*, pp. 1–6, IEEE, 2007.
- [Cand01] D. Candusso, E. Rullière, and E. Toutain. "A fuel cell hybrid power source for a small electric vehicle". *Rev Energ. Ren.: Power Engineering*, Vol. 1, No. 1, pp. 85–92, 2001.
- [Cao08] J. Cao, H. Liu, P. Li, and D. Brown. "Adaptive fuzzy logic controller for vehicle active suspensions with interval type-2 fuzzy membership functions". In: *Fuzzy Systems, 2008. FUZZ-IEEE 2008. (IEEE World Congress on Computational Intelligence). IEEE International Conference on*, pp. 83–89, IEEE, 2008.
- [Cast04] O. Castillo and P. Melin. "A new approach for plant monitoring using type-2 fuzzy logic and fractal theory". *International Journal of General Systems*, Vol. 33, No. 2, pp. 305–319, 2004.

- [Cast08] O. Castillo, P. Melin, and J. Castro. “Computational intelligence software for interval type-2 fuzzy logic”. *Computer Applications in Engineering Education*, Vol. 1, p. 1, 2008.
- [Caux10] S. Caux, W. Hankache, M. Fadel, and D. Hissel. “On-line fuzzy energy management for hybrid fuel cell systems”. *International Journal of Hydrogen Energy*, Vol. 35, No. 5, pp. 2134–2143, 2010.
- [Celi08] A. Celikyilmaz, B. Turksen, *et al.* “Enhanced fuzzy system models with improved fuzzy clustering algorithm”. *Fuzzy Systems, IEEE Transactions on*, Vol. 16, No. 3, pp. 779–794, 2008.
- [Cera00] M. Ceraolo. “New dynamical models of lead-acid batteries”. *Power Systems, IEEE Transactions on*, Vol. 15, No. 4, pp. 1184–1190, 2000.
- [Cera08] M. Ceraolo, A. di Donato, and G. Franceschi. “A general approach to energy optimization of hybrid electric vehicles”. *Vehicular Technology, IEEE Transactions on*, Vol. 57, No. 3, pp. 1433–1441, 2008.
- [Chan07] C. Chan. “The state of the art of electric, hybrid, and fuel cell vehicles”. *Proceedings of the IEEE*, Vol. 95, No. 4, pp. 704–718, 2007.
- [Chap99] P. Chapoulie. *Modélisation systémique pour la conception de véhicules électriques multi-sources Application aux véhicules équipés de générateurs photovoltaïques ou de supercondensateurs*. PhD thesis, Institut National Polytechnique de Toulouse, 1999.
- [Chen10] K. Chen. *Common energetic macroscopic representation and unified control structure for different hybrid electrical vehicles*. PhD thesis, Université de sciences et technologies de Lille, Université de Franche-Comté, 2010.
- [Chna08] M. Chnani. *Modélisation macroscopique de piles PEFC et SOFC pour l'étude de leur couplage*. PhD thesis, Université de Franche-Comté - Université de Technologie de Belfort-Montbelliard, 2008.
- [Chre08] D. Chrenko. *Energetic Macroscopic Representation Modeling and Control of a Low Temperature Fuel Cell System Fed by Hydrocarbons*. PhD thesis, Université de Franche-Comté, 2008.
- [Chre10] D. Chrenko, S. Lecoq, E. Herail, D. Hissel, and M. Péra. “Static and dynamic modeling of a diesel fed fuel cell power supply”. *International Journal of Hydrogen Energy*, Vol. 35, No. 3, pp. 1377–1389, 2010.
- [Chri09] W. Christian and H. Hagrais. “Novel methods for the design of general type-2 fuzzy sets based on device characteristics and linguistic labels surveys”. In: *IFSA/EUSFLAT*, pp. 1–8, IEEE, 2009.

Bibliography

- [Coup03] S. Coupland. "Type-2 fuzzy control of a mobile Robot". *Centre for Computational Intelligence De Montfort University, UK*, Vol. 1, p. 25, 2003.
- [Coup08] S. Coupland, J. Wheeler, and M. Gongora. "A generalised type-2 fuzzy logic system embedded board and integrated development environment". In: *Fuzzy Systems, 2008. FUZZ-IEEE 2008. (IEEE World Congress on Computational Intelligence)*. *IEEE International Conference on*, pp. 681–687, IEEE, 2008.
- [Cuen11] F. Cuenot, P. Baucour, M.-C. Pera, and D. Hissel. "Calcul parallèle pour la pile à combustible". In: *Réunion GDR PACS, 6-9 juin 2011, Nantes, France*, 2011.
- [Desp03] P. Desprez, G. Barrailh, P. Lavaur, M. Bariand, C. Jehoulet, S. Ra "el, and B. Davat. "SAFT Supercapacitors cells and batteries". *Proc. EPE'03*, Vol. 1, pp. 1–8, 2003.
- [Devi11] N. Devillers, S. Jemei, D. Bienaime, M.-C. Péra, and F. Gustin. "Characterization for supercapacitor modelling". *Submitted to IEEE Transactions on Industrial Electronics*, Vol. x, p. xx, 2011.
- [Di L05] L. Di Lascio, A. Gisolfi, and A. Nappi. "Medical differential diagnosis through type-2 fuzzy sets". In: *Fuzzy Systems, 2005. FUZZ'05. The 14th IEEE International Conference on*, pp. 371–376, IEEE, 2005.
- [Diop04] D. Diop. *Contribution a la gestion de l'énergie d'un véhicule hybride serie*. PhD thesis, Université de Franche-Comté, 2004.
- [Doct08] F. Doctor, H. Hagrais, D. Roberts, and V. Callaghan. "A type-2 fuzzy based system for handling the uncertainties in group decisions for ranking job applicants within human resources systems". In: *Fuzzy Systems, 2008. FUZZ-IEEE 2008. (IEEE World Congress on Computational Intelligence)*. *IEEE International Conference on*, pp. 481–488, IEEE, 2008.
- [Dosh10] A. Doshi and M. Trivedi. "Examining the Impact of Driving Style on the Predictability and Responsiveness of the Driver: Real-world and Simulator Analysis". In: *2010 IEEE Intelligent Vehicles Symposium University of California, San Diego, CA, USA June 21-24, 2010*, pp. 1–6, IEEE, 2010.
- [Duba06] F. Dubas. *Conception d'un moteur rapide à aimants permanents pour l'entraînement de compresseurs de piles combustible*. PhD thesis, Université de Franche-Comté, Belfort, France., 2006.
- [El B08] F. El Baf, T. Bouwmans, and B. Vachon. "Type-2 fuzzy mixture of Gaussians model: application to background modeling". *Advances in Visual Computing*, Vol. 1, pp. 772–781, 2008.

- [El K06] K. El Kadri. *Contribution a la conception d'un générateur hybride d'énergie électrique pour véhicule: modélisation, simulation, dimensionnement*. PhD thesis, Université de technologie de Belfort-Montbéliard, 2006.
- [Elma09] C. Elmas, O. Deperlioglu, and H. Sayan. "Adaptive fuzzy logic controller for DC-DC converters". *Expert Systems with Applications*, Vol. 36, No. 2, pp. 1540–1548, 2009.
- [Eren09] Y. Eren, O. Erdinc, H. Gorgun, M. Uzunoglu, and B. Vural. "A fuzzy logic based supervisory controller for an FC/UC hybrid vehicular power system". *International Journal of Hydrogen Energy*, Vol. 34, No. 20, pp. 8681–8694, 2009.
- [Espa06] C. Espanet, J. Kauffmann, and R. Bernard. "Comparison of Two In-Wheel Permanent Magnet Motors for Military Applications". In: *Vehicle Power and Propulsion Conference, 2006. VPPC'06.*, pp. 1–6, IEEE, 2006.
- [Fada10] M. Fadali, S. Jafarzadeh, and A. Nafeh. "Fuzzy TSK approximation using type-2 fuzzy logic systems and its application to modeling a photovoltaic array". In: *American Control Conference (ACC), 2010*, pp. 6454–6459, IEEE, 2010.
- [Fagg99] E. Faggioli, P. Rena, V. Danel, X. Andrieu, R. Mallant, and H. Kahlen. "Supercapacitors for the energy management of electric vehicles". *Journal of Power Sources*, Vol. 84, No. 2, pp. 261–269, 1999.
- [Faze09] M. Fazel Zarandi, M. Zarinbal, and M. Izadi. "Systematic image processing for diagnosing brain tumors: A Type-II fuzzy expert system approach". *Applied Soft Computing*, Vol. 1, p. 1, 2009.
- [Ferr08] A. Ferreira, J. Pomilio, G. Spiazzi, and L. de Araujo Silva. "Energy management fuzzy logic supervisory for electric vehicle power supplies system". *IEEE Transactions on Power Electronics*, Vol. 23, No. 1, pp. 107–115, 2008.
- [Figu05] J. Figueroa, J. Posada, J. Soriano, M. Melgarejo, and S. Rojas. "A type-2 fuzzy controller for tracking mobile objects in the context of robotic soccer games". In: *Fuzzy Systems, 2005. FUZZ'05. The 14th IEEE International Conference on*, pp. 359–364, IEEE, 2005.
- [Fish07] P. Fisher. "What is Where? Type-2 Fuzzy Sets for Geographical Information". *Computational Intelligence Magazine, IEEE*, Vol. 2, No. 1, pp. 9–14, 2007.
- [Flor08] W. Flores, E. Mombello, J. Jardini, and G. Ratta. "A novel algorithm for the diagnostics of power transformers using type-2 fuzzy logic systems". In: *Transmission and Distribution Conference and Exposition, 2008. T&D # x00026; D. IEEE/PES*, pp. 1–5, IEEE, 2008.

Bibliography

- [Gao08] D. Gao, Z. Jin, and Q. Lu. “Energy management strategy based on fuzzy logic for a fuel cell hybrid bus”. *Journal of Power Sources*, Vol. 185, No. 1, pp. 311–317, 2008.
- [Gay10] C. Gay, D. Hissel, F. Lanzetta, M. Pera, and M. Feidt. “Energetic Macroscopic Representation of a Solid Oxide Fuel Cell for Stirling Engine combined cycle in high-efficient powertrains”. In: *IEEE Vehicle Power and Propulsion Conference (VPPC)*, pp. 1–8, IEEE, 2010.
- [Gay11a] D. Gay, D. Hissel, F. Lanzetta, M.-C. Péra, and M. Feidt. “Energetic Macroscopic Representation of a solid Oxide Fuel Cell (SOFC) for Stirling Engine (SE) combined Cycle”. In: *Fundamentals and Developments of Fuel Cells Conference, Grenoble, 2011*, 2011.
- [Gay11b] D. Gay, F. Lanzetta, D. Hissel, and M. Feidt. “Représentation Energétique Macroscopique (REM) d’un moteur Stirling en vue d’une hybridation thermique”. In: *Congrès Annuel de la Société Française de Thermique (SFT 2011), Perpignan : France*, 2011.
- [Geit09] G. Geitner and W. Hofmann. “Teaching power flow oriented modelling of dynamic systems - Basics”. In: *Power Electronics and Applications, 2009. EPE’09. 13th European Conference on*, pp. 1–10, IEEE, 2009.
- [Genr08] R. Genre-Grandpierre. *Alimentation en air d’une pile à combustible : Conception du système, caractérisation, modélisation*. Master’s thesis, Conservatoire National des Arts et Métiers, Centre régional Franche-Comté, 2008.
- [Gran07] J. Grandvullemin, D. Chamagne, R. Glises, C. Tiraby, and F. Degrange. “Thermal modelling of enclosed cables in automotive applications”. In: *Vehicle Power and Propulsion Conference, 2007. VPPC 2007. IEEE*, pp. 730–735, IEEE, 2007.
- [Gran08] J. Grandvullemin, D. Chamagne, C. Tiraby, and R. Glises. “Ampacity of power bus bars for Hybrid-Electric or Electric Vehicles”. In: *Vehicle Power and Propulsion Conference, 2008. VPPC’08. IEEE*, pp. 1–6, IEEE, 2008.
- [Gual07] H. Gualous and R. Gallay. “Applications des supercondensateurs”. *Techniques de l’ingénieur. Génie électrique*, Vol. 5, No. D3335, p. 12, 2007.
- [Gupt07] R. Gupta, U. Pareek, and I. Kar. “Soft computation of turbine inlet temperature of gas turbine power plant using type-2 fuzzy logic systems”. In: *Fuzzy Systems Conference, 2007. FUZZ-IEEE 2007. IEEE International*, pp. 1–6, IEEE, 2007.
- [Hagr04] H. Hagrass. “A hierarchical type-2 fuzzy logic control architecture for autonomous mobile robots”. *Fuzzy Systems, IEEE Transactions on*, Vol. 12, No. 4, pp. 524–539, 2004.

- [Haji07] M. Hajimiri and F. Salmasi. “A fuzzy energy management strategy for series hybrid electric vehicle with predictive control and durability extension of the battery”. In: *Electric and Hybrid Vehicles, 2006. ICEHV'06. IEEE Conference on*, pp. 1–5, IEEE, 2007.
- [Hawk05] E. Hawker. *Hawker Powerbloc dry séries XP : guide d'exploitation*. February 2005.
- [Hayk94] S. Haykin. *Neural networks: a comprehensive foundation*. Prentice Hall PTR Upper Saddle River, NJ, USA, 1994.
- [Heck08] D. Heckerman. “A tutorial on learning with Bayesian networks”. *Innovations in Bayesian Networks*, Vol. 1, pp. 33–82, 2008.
- [Hern06] A. I. Hernandez. *Diagnostic d'une pile à combustible de type PEFC*. PhD thesis, Université de Technologie de Belfort Montbelliard, 2006.
- [Hiss07] D. Hissel, D. Candusso, and F. Harel. “Fuzzy-clustering durability diagnosis of polymer electrolyte fuel cells dedicated to transportation applications”. *Vehicle Technology, IEEE Transactions on*, Vol. 56, No. 5, pp. 2414–2420, 2007.
- [Hiss08] D. Hissel, M. PERA, A. Bouscayrol, and D. Chrenko. “Représentation énergétique macroscopique d'une pile à combustible”. *Revue internationale de génie électrique*, Vol. 11, No. 4-5, pp. 603–623, 2008.
- [Hiss98] D. Hissel. *Contribution à la commande de dispositifs électrotechniques par logique floue Procédures de réglage sur site par plans d'expériences et méthodologie Taguchi Application à un hacheur dévolteur et à une machine synchrone*. PhD thesis, Institut National Polytechnique de Toulouse, N° d'ordre 1483., 1998.
- [Holm03] S. Holm. *Modelling and optimisation of a permanent magnet machine in a flywheel*. PhD thesis, Technische Universiteit Delft, 2003.
- [Homa01] A. Homaifar, Y. Shen, and B. Stack. “Vibration control of plate structures using PZT actuators and type II fuzzy logic”. In: *American Control Conference, 2001. Proceedings of the 2001*, pp. 1575–1580, IEEE, 2001.
- [Huar05] K. Huarng and H. Yu. “A type 2 fuzzy time series model for stock index forecasting”. *Physica A: Statistical Mechanics and its Applications*, Vol. 353, pp. 445–462, 2005.
- [Hwan07] C. Hwang and F. Rhee. “Uncertain fuzzy clustering: interval type-2 fuzzy approach to c-means”. *Fuzzy Systems, IEEE Transactions on*, Vol. 15, No. 1, pp. 107–120, 2007.

Bibliography

- [Inno01] P. Innocent, R. John, I. Belton, and D. Finlay. “Type 2 fuzzy representations of lung scans to predict pulmonary emboli”. In: *IFSA World Congress and 20th NAFIPS International Conference, 2001. Joint 9th*, pp. 1902–1907, IEEE, 2001.
- [Inno02] P. Innocent and R. John. “Type-2 fuzzy diagnosis”. In: *Fuzzy Systems, 2002. FUZZ-IEEE’02. Proceedings of the 2002 IEEE International Conference on*, pp. 1326–1330, IEEE, 2002.
- [Ioos09] B. Iooss. “Contributions au traitement des incertitudes en modélisation numérique”. *Mémoire d’HDR, Université Toulouse III*, Vol. 1, p. 1, 2009.
- [Jafa10] S. Jafarzadeh, M. Fadali, M. Etezadi-Amoli, and A. Nafeh. “Type 1 and type 2 fuzzy TSK modeling of solar radiation for PV power generation”. In: *North American Power Symposium (NAPS), 2010*, pp. 1–5, sept. 2010.
- [Jemi04] S. Jemèi. *Modélisation d’une pile à combustible de type PEM par réseaux de neurones*. PhD thesis, Université de Franche-Comté et Université de Technologie de Belfort-Montbelliard, n° d’ordre 14, 2004., 2004.
- [Jeon09] G. Jeon, M. Anisetti, V. Bellandi, E. Damiani, and J. Jeong. “Designing of a type-2 fuzzy logic filter for improving edge-preserving restoration of interlaced-to-progressive conversion”. *Information Sciences*, Vol. 179, No. 13, pp. 2194–2207, 2009.
- [Jeu09] J. Jevvrey, F. Harel, S. Begot, D. Hissel, I. Rodel, V. Faure, and S. Boblet. “Fuel cell system integration on a heavy-duty vehicle and development of a control strategy with real time simulation”. In: *Vehicle Power and Propulsion Conference, 2009. VPPC’09. IEEE*, pp. 704–710, IEEE, 2009.
- [Joha07] L. Johannesson, M. Asbogard, and B. Egardt. “Assessing the potential of predictive control for hybrid vehicle powertrains using stochastic dynamic programming”. *Intelligent Transportation Systems, IEEE Transactions on*, Vol. 8, No. 1, pp. 71–83, 2007.
- [John01] R. John and S. Lake. “Type-2 fuzzy sets for modelling nursing intuition”. In: *IFSA World Congress and 20th NAFIPS International Conference, 2001. Joint 9th*, pp. 1920–1925, IEEE, 2001.
- [John07] R. John and S. Coupland. “Type-2 fuzzy logic: A historical view”. *IEEE Computational Intelligence Magazine*, Vol. 2, No. 1, pp. 57–62, 2007.
- [John97] R. John, P. Innocent, and M. Barnes. “Type 2 fuzzy sets and neuro-fuzzy clustering of radiographic tibia images”. In: *Fuzzy Systems Proceedings, 1998. IEEE World Congress on Computational Intelligence., The 1998 IEEE International Conference on*, pp. 1373–1376, IEEE, 1997.

-
- [Karn01] N. Karnik and J. Mendel. “Centroid of a type-2 fuzzy set”. *Information Sciences*, Vol. 132, No. 1, pp. 195–220, 2001.
- [Karn98] N. Karnik and J. Mendel. “Introduction to type-2 fuzzy logic systems”. In: *Fuzzy Systems Proceedings, 1998. IEEE World Congress on Computational Intelligence.*, pp. 915 –920 vol.2, may. 1998.
- [Karn99] N. Karnik and J. Mendel. “Applications of type-2 fuzzy logic systems: Handling the uncertainty associated with surveys”. In: *Fuzzy Systems Conference Proceedings, 1999. FUZZ-IEEE’99. 1999 IEEE International*, pp. 1546–1551, IEEE, 1999.
- [Kaur04] D. Kaur and D. Wilson. “Trust evaluation within a type-2 fuzzy logic framework”. In: *Fuzzy Systems, 2004. Proceedings. 2004 IEEE International Conference on*, pp. 203–207, IEEE, 2004.
- [Kaya11] E. Kayacan, Y. Oniz, A. Aras, O. Kaynak, and R. Abiyev. “A Servo System Control with Time-varying and Nonlinear Load Conditions Using Type-2 TSK Fuzzy Neural System”. *Applied Soft Computing*, Vol. To be published, p. 10, 2011.
- [Kerm08] S. Kermani, S. Delprat, R. Trigui, and T. Guerra. “Predictive energy management of hybrid vehicle”. In: *Vehicle Power and Propulsion Conference, 2008. VPPC’08. IEEE*, pp. 1–6, IEEE, 2008.
- [Klir95] G. Klir and B. Yuan. *Fuzzy sets and fuzzy logic: theory and applications*. Prentice Hall PTR Upper Saddle River, NJ, USA, 1995.
- [Kohl09] T. Kohler, D. Buecherl, and H. Herzog. “Investigation of control strategies for hybrid energy storage systems in hybrid electric vehicles”. In: *Vehicle Power and Propulsion Conference, 2009. VPPC’09. IEEE*, pp. 1687–1693, IEEE, 2009.
- [Laff08] E. Laffly. *Modelisation d’une Pile a Combustible de Type PEMFC Integrant les Phenomenes de Vieillessement*. PhD thesis, Université de Franche Comté, 2008.
- [Larm03] J. Larminie, J. Lowry, and I. NetLibrary. *Electric vehicle technology explained*. Wiley Online Library, 2003.
- [Lee10] C. Lee, M. Wang, and H. Hagraas. “A type-2 fuzzy ontology and its application to personal diabetic-diet recommendation”. *Fuzzy Systems, IEEE Transactions on*, Vol. 18, No. 2, pp. 374–395, 2010.
- [Leon10] T. Leon and V. Liern. “Obtaining the Compatibility between Musicians Using Soft Computing”. *Information Processing and Management of Uncertainty in Knowledge-Based Systems. Applications*, Vol. 1, pp. 75–84, 2010.

Bibliography

- [Lhom07] W. Lhomme. *Gestion d'énergie de véhicules électriques hybrides basée sur la représentation énergétique macroscopique*. PhD thesis, Université des Sciences et Technologies de Lille, 2007.
- [Lhom08] W. Lhomme, R. Trigui, P. Delarue, B. Jeanneret, A. Bouscayrol, and F. Badin. "Switched causal modeling of transmission with clutch in hybrid electric vehicles". *Vehicular Technology, IEEE Transactions on*, Vol. 57, No. 4, pp. 2081–2088, 2008.
- [Li06] L. Li, W. Lin, and H. Liu. "Type-2 fuzzy logic approach for short-term traffic forecasting". *IEE Proc. Intell. Transp. Syst*, Vol. 153, No. 1, pp. 33–40, 2006.
- [Li08] W. Li, G. Xu, Z. Wang, and Y. Xu. "Dynamic energy management for hybrid electric vehicle based on approximate dynamic programming". In: *Intelligent Control and Automation, 2008. WCICA 2008. 7th World Congress on*, pp. 7864–7869, IEEE, 2008.
- [Li09a] C. Li and G. Liu. "Optimal fuzzy power control and management of fuel cell/battery hybrid vehicles". *Journal of Power Sources*, Vol. 192, No. 2, pp. 525–533, 2009.
- [Li09b] X. Li, L. Xu, J. Hua, X. Lin, J. Li, and M. Ouyang. "Power management strategy for vehicular-applied hybrid fuel cell/battery power system". *Journal of Power Sources*, Vol. 191, No. 2, pp. 542–549, 2009.
- [Lian02] Q. Liang, N. Karnik, and J. Mendel. "Connection admission control in ATM networks using survey-based type-2 fuzzy logic systems". *Systems, Man, and Cybernetics, Part C: Applications and Reviews, IEEE Transactions on*, Vol. 30, No. 3, pp. 329–339, 2002.
- [Lima07] M. Lima. *A lógica fuzzy do tipo 2 e um estudo de caso aplicado ao controle de tráfego aéreo*. Master's thesis, Universidade Federal da Bahia, Brasil, 2007.
- [Lin04] C. Lin, H. Peng, J. Grizzle, and J. Kang. "Power management strategy for a parallel hybrid electric truck". *Control Systems Technology, IEEE Transactions on*, Vol. 11, No. 6, pp. 839–849, 2004.
- [Lin05] P. Lin, C. Hsu, and T. Lee. "Type-2 fuzzy logic controller design for buck DC-DC converters". In: *Fuzzy Systems, 2005. FUZZ'05. The 14th IEEE International Conference on*, pp. 365–370, IEEE, 2005.
- [Lin06] C. Lin, S. Liang, W. Chao, L. Ko, C. Chao, Y. Chen, and T. Huang. "Driving Style Classification by Analyzing EEG Responses to Unexpected Obstacle Dodging Tasks". In: *Systems, Man and Cybernetics, 2006. SMC'06. IEEE International Conference on*, pp. 4916–4919, IEEE, 2006.

- [Louk10] D. Loukakou, H. Gualous, Y. Cheng, C. Espanet, and F. Dubas. “Sizing and experimental characterization of ultra-capacitors for small urban hybrid electric vehicle”. In: *Vehicle Power and Propulsion Conference (VPPC), 2010 IEEE*, pp. 1–7, IEEE, 2010.
- [Lync05] C. Lynch, H. Hagrass, and V. Callaghan. “Embedded type-2 FLC for real-time speed control of marine and traction diesel engines”. In: *Fuzzy Systems, 2005. FUZZ'05. The 14th IEEE International Conference on*, pp. 347–352, IEEE, 2005.
- [Lync06] C. Lynch, H. Hagrass, and V. Callaghan. “Using uncertainty bounds in the design of an embedded real-time type-2 neuro-fuzzy speed controller for marine diesel engines”. In: *Fuzzy Systems, 2006 IEEE International Conference on*, pp. 1446–1453, IEEE, 2006.
- [Magg00] G. Maggetto and J. Van Mierlo. “Electric and electric hybrid vehicle technology: a survey”. In: *Electric, Hybrid and Fuel Cell Vehicles (Ref. No. 2000/050), IEE Seminar*, pp. 1–1, IET, 2000.
- [Mai09] H. Mai, F. Dubas, D. Chamagne, and C. Espanet. “Optimal design of a surface mounted permanent magnet in-wheel motor for an urban hybrid vehicle”. In: *Vehicle Power and Propulsion Conference, 2009. VPPC'09. IEEE*, pp. 481–485, IEEE, 2009.
- [Mai10] H. Mai, R. Bernard, P. Bigot, F. Dubas, D. Chamagne, and C. Espanet. “Consideration of radial magnetic forces in brushless DC motors”. In: *Electrical Machines and Systems (ICEMS), 2010 International Conference on*, pp. 1–6, IEEE, 2010.
- [Makr03] C. Makropoulos and D. Butler. “Fuzzy logic spatial decision support system for urban water management”. *Journal of water resources planning and management*, Vol. 129, p. 69, 2003.
- [Mamd74] E. Mamdani *et al.* “Application of fuzzy algorithms for control of simple dynamic plant”. *Proc. Iee*, Vol. 121, No. 12, pp. 1585–1588, 1974.
- [Mart05] M. Martinez and J. Midy. “Alternateur inertielle à surcharge élevée pour véhicule électrique de combat”. *J3eA*, Vol. 4, No. HORS SÉRIE 1, pp. 8–8, 2005.
- [Mart09] R. Martínez, O. Castillo, and L. T. Aguilar. “Optimization of interval type-2 fuzzy logic controllers for a perturbed autonomous wheeled mobile robot using genetic algorithms”. *Information Sciences*, Vol. 179, No. 13, pp. 2158 – 2174, 2009. Special Section on High Order Fuzzy Sets.
- [Matt97] P. Mattavelli, L. Rossetto, G. Spiazzi, and P. Tenti. “General-purpose fuzzy controller for DC-DC converters”. *Power Electronics, IEEE Transactions on*, Vol. 12, No. 1, pp. 79–86, 1997.

Bibliography

- [Meib00] F. Meibody. *Machines synchrones à aimants permanents alimentées par onduleurs de tension : Modélisation, commande et segmentation de puissance*. PhD thesis, Institut National Polytechnique de Lorraine, 2000.
- [Melg07] M. Melgarejo and C. Pena-Reyes. “Implementing Interval Type-2 Fuzzy Processors [Developmental Tools]”. *Computational Intelligence Magazine, IEEE*, Vol. 2, No. 1, pp. 63–71, 2007.
- [Meli07] P. Melin and O. Castillo. “An intelligent hybrid approach for industrial quality control combining neural networks, fuzzy logic and fractal theory”. *Information Sciences*, Vol. 177, No. 7, pp. 1543–1557, 2007.
- [Mend01] J. Mendel. *Uncertain rule-based fuzzy logic systems: introduction and new directions. 2001*. Prentice-Hall, Upper Saddle River, NJ, 2001.
- [Mend09] O. Mendoza, P. Melín, and O. Castillo. “Interval type-2 fuzzy logic and modular neural networks for face recognition applications”. *Applied Soft Computing*, Vol. 9, No. 4, pp. 1377–1387, 2009.
- [Mend10] G. Méndez, L. Leduc-Lezama, R. Colas, G. Murillo-Pérez, J. Ramírez-Cuellar, and J. López. “Application of Interval Type-2 Fuzzy Logic Systems for Control of the Coiling Entry Temperature in a Hot Strip Mill”. *Hybrid Artificial Intelligence Systems*, Vol. 1, pp. 352–359, 2010.
- [Mill10] S. Miller and R. John. “An interval type-2 fuzzy multiple echelon supply chain model”. *Knowledge-Based Systems*, Vol. 23, No. 4, pp. 363–368, 2010.
- [Mulo10] J. Mulot, F. Harel, S. Begot, D. Hissel, I. Rodel, S. Boblet, and M. Amiet. “Fuel cell system integration into a heavy-duty hybrid vehicle: preliminary experimental results”. In: *Vehicle Power and Propulsion Conference (VPPC), 2010 IEEE*, pp. 1–5, IEEE, 2010.
- [Mulo11] J. Mulot, J. Solano Martinez, F. Harel, D. Hissel, M. Péra, I. Rodel, J. Duclos, S. Boblet, and M. Amiet. “Implementation of a battery/fuel cell/ultracapacitor configuration into a heavy-duty vehicle (ECCE)”. In: *Les Rencontres Scientifiques d’IFP Energies nouvelles - International Scientific Conference on hybrid and electric vehicles - RHEVE 2011*, p. 11, 2011.
- [Murp09] Y. Murphey, R. Milton, and L. Kiliaris. “Driver’s style classification using jerk analysis”. In: *Computational Intelligence in Vehicles and Vehicular Systems, 2009. CIVVS’09. IEEE Workshop on*, pp. 23–28, IEEE, 2009.
- [Narj08] A. Narjiss. *Diagnostic Non-Intrusif d’une Pile à Combustible PEMFC Grâce au Convertisseur Statique*. PhD thesis, Université de Franche-Comté, 2008.

- [Ng09] K. Ng, C. Moo, Y. Chen, and Y. Hsieh. “Enhanced coulomb counting method for estimating state-of-charge and state-of-health of lithium-ion batteries”. *Applied Energy*, Vol. 86, No. 9, pp. 1506–1511, 2009.
- [Onie11] E. Onieva, J. Naranjo, V. Milanés, J. Alonso, R. García, and J. Pérez. “Automatic lateral control for unmanned vehicles via genetic algorithms”. *Applied Soft Computing*, Vol. 11, No. 1, pp. 1303 – 1309, 2011.
- [Ozek08] M. Ozek and Z. Akpolat. “A software tool: Type-2 fuzzy logic toolbox”. *Computer Applications in Engineering Education*, Vol. 16, No. 2, pp. 137–146, 2008.
- [Ozen03] T. Ozen and J. Garibaldi. “Investigating adaptation in type-2 fuzzy logic systems applied to umbilical acid-base assessment”. In: *Proceedings of 2003 European Symposium on Intelligent Technologies (EUNITE 2003), Oulu, Finland*, pp. 289–294, 2003.
- [Pala07] V. Paladini, T. Donato, A. de Risi, and D. Laforgia. “Super-capacitors fuel-cell hybrid electric vehicle optimization and control strategy development”. *Energy conversion and management*, Vol. 48, No. 11, pp. 3001–3008, 2007.
- [Pand06] A. Pandolfo and A. Hollenkamp. “Carbon properties and their role in supercapacitors”. *Journal of power sources*, Vol. 157, No. 1, pp. 11–27, 2006.
- [Pare06] U. Pareek and I. Kar. “Estimating compressor discharge pressure of gas turbine power plant using type-2 fuzzy logic systems”. In: *Fuzzy Systems, 2006 IEEE International Conference on*, pp. 649–654, IEEE, 2006.
- [Paym08] A. Payman, S. Pierfederici, and F. Meibody-Tabar. “Energy control of supercapacitor/fuel cell hybrid power source”. *Energy Conversion and Management*, Vol. 49, No. 6, pp. 1637–1644, 2008.
- [Payn61] H. Paynter. *Analysis and design of engineering systems*. MIT press, 1961.
- [Pear88] J. Pearl. *Probabilistic reasoning in intelligent systems: networks of plausible inference*. Morgan Kaufmann, 1988.
- [Peit04] H. Peitgen, H. Jurgens, and D. Saupe. *Chaos and fractals: new frontiers of science*. Springer Verlag, 2004.
- [Pera07] M. Pera, D. Candusso, D. Hissel, and J. Kauffmann. “Power generation by fuel cells”. *Industrial Electronics Magazine, IEEE*, Vol. 1, No. 3, pp. 28–37, 2007.
- [Pere06] L. Pérez, G. Bossio, D. Moitre, and G. García. “Optimization of power management in an hybrid electric vehicle using dynamic programming”. *Mathematics and Computers in Simulation*, Vol. 73, No. 1-4, pp. 244–254, 2006.

Bibliography

- [Pill01] S. Piller, M. Perrin, and A. Jossen. “Methods for state-of-charge determination and their applications”. *Journal of Power Sources*, Vol. 96, No. 1, pp. 113–120, 2001.
- [Pras05] W. Prassl, J. Peden, and K. Wong. “A process-knowledge management approach for assessment and mitigation of drilling risks”. *Journal of Petroleum Science and Engineering*, Vol. 49, No. 3-4, pp. 142–161, 2005.
- [Pusc02] R. Pusca, Y. Ait-Amirat, A. Berthon, and J. Kauffmann. “Modeling and simulation of a traction control algorithm for an electric vehicle with four separate wheel drives”. In: *Vehicular Technology Conference, 2002. Proceedings. VTC 2002-Fall. 2002 IEEE 56th*, pp. 1671–1675, IEEE, 2002.
- [Pusc04] R. Pusca, Y. Amirat, and A. Berthon. “Fuzzy logic speed estimator to drive a four electric wheels truck”. In: *Power Electronics and Motion Control Conference, 2004. IPEMC 2004. The 4th International*, pp. 1448–1453, IEEE, 2004.
- [Rafi07] F. Rafik, H. Gualous, R. Gallay, A. Crausaz, and A. Berthon. “Frequency, thermal and voltage supercapacitor characterization and modeling”. *Journal of power sources*, Vol. 165, No. 2, pp. 928–934, 2007.
- [Rago68] D. Ragone. *Review of battery systems for electrically powered vehicles*. Society of Automotive Engineers, 1968.
- [Reha05] M. Rehak, M. Pechoucek, P. Benda, and L. Foltyn. “Trust in coalition environment: Fuzzy number approach”. In: *Proceedings of The 4th International Joint Conference on Autonomous Agents and Multi Agent Systems-Workshop Trust in Agent Societies*, pp. 119–131, Citeseer, 2005.
- [Roba08] I. Robandi and B. Kharisma. “Design of interval type-2 fuzzy logic based power system stabilizer”. In: *Proc. of world academy of science engineering and technology*, pp. 2070–3740, 2008.
- [Roma10] C. Romaus, K. Gathmann, and J. Bocker. “Optimal energy management for a hybrid energy storage system for electric vehicles based on Stochastic Dynamic Programming”. In: *Vehicle Power and Propulsion Conference (VPPC), 2010 IEEE*, pp. 1–6, IEEE, 2010.
- [Rome07] J. Romero and A. Vargas. “Calculating functions of interval type-2 fuzzy numbers for fault current analysis”. *Fuzzy Systems, IEEE Transactions on*, Vol. 15, No. 1, pp. 31–40, 2007.
- [Ryu10] J. Ryu, Y. Park, and M. Sunwoo. “Electric powertrain modeling of a fuel cell hybrid electric vehicle and development of a power distribution algorithm based on driving mode recognition”. *Journal of Power Sources*, Vol. 195, No. 17, pp. 5735 – 5748, 2010.

- [Sari08] A. Sari, C. Espanet, and D. Hissel. “Particle swarm optimization applied to the co-design of a fuel cell air circuit”. *Journal of Power Sources*, Vol. 179, No. 1, pp. 121–131, 2008.
- [Schi05] J. Schiffer, O. Bohlen, R. De Doncker, D. Sauer, and K. Ahn. “Optimized energy management for fuelcell-supercap hybrid electric vehicles”. In: *Vehicle Power and Propulsion, 2005 IEEE Conference*, pp. 341–348, IEEE, 2005.
- [Shaf10] Y. Shafahi, A. Masouleh, and M. Masouleh. “Type-II fuzzy route choice modeling”. In: *Fuzzy Information Processing Society (NAFIPS), 2010 Annual Meeting of the North American*, pp. 1–5, IEEE, 2010.
- [Shah11] A. Shahi, R. Atan, and M. Sulaiman. “Decision making for uncertain data in dynamic environment using hybrid method”. In: *Control and Automation, 2009. ICCA 2009. IEEE International Conference on*, pp. 398–403, IEEE, 2011.
- [Sign09] R. Signorelli, D. Ku, J. Kassakian, and J. Schindall. “Electrochemical Double-Layer Capacitors Using Carbon Nanotube Electrode Structures”. *Proceedings of the IEEE*, Vol. 97, No. 11, pp. 1837–1847, 2009.
- [Sola09a] J. Solano Martínez, L. Boulon, D. Hissel, M. Pera, and M. Amiet. “Energetic macroscopic representation of a multiple architecture heavy duty hybrid vehicle”. In: *Vehicle Power and Propulsion Conference, 2009. VPPC’09. IEEE*, pp. 1322–1329, IEEE, 2009.
- [Sola09b] J. Solano Martínez, D. Hissel, and M. Pera. “Développement d’un modèle énergétique du banc ECCE”. Tech. Rep., FEMTO-ST, DGA, 2009.
- [Sola09c] J. Solano Martínez, D. Hissel, and M. Pera. “Etude théorique du pilotage énergétique du banc ECCE et recherche des paramètres pertinents”. Tech. Rep., FEMTO-ST, DGA, 2009.
- [Sola09d] J. Solano Martínez, D. Hissel, M. Pera, and M. Amiet. “Représentation Énergétique Macroscopique d’un véhicule hybride lourd d’architecture modulable”. *Conférence Électrotechnique du Futur (EF’2009)*, Vol. 1, pp. 1–9, 2009.
- [Sola10a] J. Solano Martínez, D. Hissel, and M. Pera. “Type-2 fuzzy logic sets and systems, Bibliographic report”. Tech. Rep., FEMTO-ST, 2010.
- [Sola10b] J. Solano Martínez, D. Hissel, M. Pera, and M. Amiet. “Practical Control Structure of a Heavy Duty Hybrid Electric Vehicle”. In: *Vehicle Power and Propulsion Conference, 2010. VPPC’10. IEEE*, pp. 1322–1329, IEEE, 2010.
- [Sola11a] J. Solano Martínez. “Gestion d’énergie d’un véhicule électrique hybride basée sur la logique floue d’ordre 2”. *Jeunes Chercheurs en Génie Electrique, Belfort, JCGE2011*, Vol. 1, pp. 1–9, 2011.

Bibliography

- [Sola11b] J. Solano Martínez, D. Hissel, and M. Pera. “Stratégie de gestion d’énergie du banc ECCE”. Tech. Rep., FEMTO-ST, DGA, 2011.
- [Sola11c] J. Solano Martínez, D. Hissel, M. Pera, and M. Amiet. “Practical Control Structure and Energy Management of a Test Bed Hybrid Electric Vehicle”. *Vehicular Technology, IEEE Transactions on*, Vol. 60 Issue:9 Nov., No. 99, pp. 4139 – 4152, 2011.
- [Sola12a] J. Solano-Martínez, D. Hissel, and M. Péra. “Type-2 fuzzy logic control of a DC/DC buck converter”. In: *Power Plant and Power Systems Control symposium 2012, Toulouse, Submitted*, 2012.
- [Sola12b] J. Solano Martínez. “Gestion d’énergie d’un véhicule hybride : approche par l’intelligence artificielle”. *Prix A’Doc de la jeune recherche en Franche-Comté 2012*, Vol. 0, p. 16, 2012.
- [Sola12c] J. Solano Martínez, D. Hissel, and M. Pera. “Experimental validation of a type-2 fuzzy logic controller for energy management in hybrid electrical vehicles”. *Fuzzy Systems, IEEE Transactions on*, Vol. xx, No. xx, p. xx, submitted in April 2012.
- [Sola12d] J. Solano Martínez, R. I. John, D. Hissel, and M.-C. Péra. “A survey-based type-2 fuzzy logic system for energy management in hybrid electrical vehicles”. *Information Sciences*, Vol. 190, No. 0, pp. 192 – 207, 2012.
- [Soug10] M. Sough, D. Depernet, F. Dubas, B. Boualem, and C. Espanet. “PMSM and inverter sizing compromise applied to flywheel for railway application”. In: *Vehicle Power and Propulsion Conference (VPPC), 2010 IEEE*, pp. 1 –5, sept. 2010.
- [Tan06] W. Tan *et al.* “A simplified type-2 fuzzy logic controller for real-time control”. *ISA transactions*, Vol. 45, No. 4, pp. 503–516, 2006.
- [Teki04] M. Tekin. *Contribution à l’optimisation énergétique d’un système pile à combustible embarqué*. PhD thesis, Université de Franche Comté, 2004.
- [Teki07] M. Tekin, D. Hissel, M. Pera, and J. Kauffmann. “Energy-management strategy for embedded fuel-cell systems using fuzzy logic”. *Industrial Electronics, IEEE Transactions on*, Vol. 54, No. 1, pp. 595–603, 2007.
- [Thou09] P. Thounthong, S. Raël, and B. Davat. “Energy management of fuel cell/battery/supercapacitor hybrid power source for vehicle applications”. *Journal of Power Sources*, Vol. 193, No. 1, pp. 376–385, 2009.
- [Trig04] R. Trigui, B. Jeanneret, and F. Badin. “Systemic modelling of hybrid vehicles in order to predict dynamic performance and energy consumption Building the

- VEHLIB library of models”. *RTS-Recherche Transports Securite*, Vol. 1, No. 83, pp. 129–150, 2004.
- [Urba09] M. Urbain. *Modélisation électrique et énergétique des accumulateurs lithium-ion. Estimation en ligne du SOC et du SOH*. PhD thesis, tut National Polytechnique de Lorraine, 2009.
- [Vino10] E. Vinot, R. Trigui, and B. Jeanneret. “Optimal management of electric vehicles with a hybrid storage system”. In: *Vehicle Power and Propulsion Conference (VPPC), 2010 IEEE*, pp. 1–6, IEEE, 2010.
- [Wang11] K. Wang, D. Hissel, M. Péra, N. Steiner, D. Marra, M. Sorrentino, C. Pianese, M. Monteverde, P. Cardone, and J. Saarinen. “A Review on solid oxide fuel cell models”. *International Journal of Hydrogen Energy*, Vol. 36, No. 12, pp. 7212 – 7228, 2011.
- [Wast10] S. Wasterlain. *Approches expérimentales et analyse probabiliste pour le diagnostic de piles a combustible de type PEM*. PhD thesis, Université de Franche-Comté, 2010.
- [Won05] J. Won, R. Langari, and M. Ehsani. “An energy management and charge sustaining strategy for a parallel hybrid vehicle with CVT”. *Control Systems Technology, IEEE Transactions on*, Vol. 13, No. 2, pp. 313–320, 2005.
- [Wu04] D. Wu and W. Tan. “A type-2 fuzzy logic controller for the liquid-level process”. In: *Fuzzy Systems, 2004. Proceedings. 2004 IEEE International Conference on*, pp. 953–958, IEEE, 2004.
- [Wu07] H. Wu and J. Mendel. “Classification of battlefield ground vehicles using acoustic features and fuzzy logic rule-based classifiers”. *Fuzzy Systems, IEEE Transactions on*, Vol. 15, No. 1, pp. 56–72, 2007.
- [Wu09] Z. Wu, D. Depernet, C. Kieffer, F. Dubas, D. Hissel, and C. Espanet. “Electrical motor design for hybrid heavy-duty electrical powertrain”. In: *Vehicle Power and Propulsion Conference, 2009. VPPC’09. IEEE*, pp. 486–493, IEEE, 2009.
- [Wu10] Z. Wu, D. Depernet, and C. Espanet. “Optimal design of electrical drive and power converter for hybrid electric powertrain”. In: *Vehicle Power and Propulsion Conference (VPPC), 2010 IEEE*, pp. 1–8, IEEE, 2010.
- [Xu09] L. Xu, J. Li, J. Hua, X. Li, and M. Ouyang. “Optimal vehicle control strategy of a fuel cell/battery hybrid city bus”. *International Journal of Hydrogen Energy*, Vol. 34, No. 17, pp. 7323–7333, 2009.
- [Yan10] J. Yan, G. Xu, H. Qian, and Y. Xu. “Robust State of Charge Estimation for Hybrid Electric Vehicles: Framework and Algorithms”. *Energies*, Vol. 3, No. 10, pp. 1654–1672, 2010.

Bibliography

- [Yard09] A. Yardimci. “Soft computing in medicine”. *Applied Soft Computing*, Vol. 9, No. 3, pp. 1029–1043, 2009.
- [Youn93] R. Young. *Wavelet theory and its applications*. Springer, 1993.
- [Yous11a] N. Yousfi Steiner, D. Hissel, P. Moçotéguy, and D. Candusso. “Diagnosis of polymer electrolyte fuel cells failure modes (flooding & drying out) by neural networks modeling”. *International Journal of Hydrogen Energy*, Vol. 36, No. 4, pp. 3067 – 3075, 2011.
- [Yous11b] N. Yousfi Steiner, P. Moçotéguy, D. Hissel, D. Candusso, A. Di Filippi, D. Marra, C. Pianese, M. Sorrentino, R. Silva, N. Ayadi, and M. Zahid. “Application of fault tree analysis to fuel cell diagnosis”. In: *Fundamentals and Developments of Fuel Cells Conference, Grenoble, 2011*, 2011.
- [Zade65] L. Zadeh. “Fuzzy sets*^o”. *Information and control*, Vol. 8, No. 3, pp. 338–353, 1965.
- [Zade75] L. Zadeh. “The concept of a linguistic variable and its application to approximate reasoning–I* 1”. *Information sciences*, Vol. 8, No. 3, pp. 199–249, 1975.
- [Zeng06] J. Zeng and Z. Liu. “Type-2 fuzzy hidden Markov models and their application to speech recognition”. *Fuzzy Systems, IEEE Transactions on*, Vol. 14, No. 3, pp. 454–467, 2006.
- [Zhou09] S. Zhou, J. Garibaldi, R. John, and F. Chiclana. “On constructing parsimonious type-2 fuzzy logic systems via influential rule selection”. *Fuzzy Systems, IEEE Transactions on*, Vol. 17, No. 3, pp. 654–667, 2009.
- [Zubi00] L. Zubieta and R. Bonert. “Characterization of double-layer capacitors for power electronics applications”. *Industry Applications, IEEE Transactions on*, Vol. 36, No. 1, pp. 199–205, 2000.