



HAL
open science

Evaluation et amélioration du comportement à long terme d'élastomères pour une application isolateur électrique

Namrata Singh Tomer

► **To cite this version:**

Namrata Singh Tomer. Evaluation et amélioration du comportement à long terme d'élastomères pour une application isolateur électrique. Matériaux. Université Blaise Pascal - Clermont-Ferrand II, 2006. Français. NNT : 2006CLF21683 . tel-00703290

HAL Id: tel-00703290

<https://theses.hal.science/tel-00703290>

Submitted on 1 Jun 2012

HAL is a multi-disciplinary open access archive for the deposit and dissemination of scientific research documents, whether they are published or not. The documents may come from teaching and research institutions in France or abroad, or from public or private research centers.

L'archive ouverte pluridisciplinaire **HAL**, est destinée au dépôt et à la diffusion de documents scientifiques de niveau recherche, publiés ou non, émanant des établissements d'enseignement et de recherche français ou étrangers, des laboratoires publics ou privés.

Numéro d'Ordre : D.U. 1683

UNIVERSITE BLAISE PASCAL

(U.F.R. de recherche scientifique et technique)

ECOLE DOCTORALE DES SCIENCES FONDAMENTALES

N° : 495

THESE

Présentée pour obtenir le grade de

DOCTEUR D'UNIVERSITE

(Spécialité : Chimie physique)

Par

Namrata Singh TOMER

Master of Science-INDE

Evaluation et amélioration du comportement à long terme d'élastomères pour une application isolateur électrique

Soutenue publiquement le 20 Octobre 2006, devant la commission d'examen

Rapporteurs: Jean-Jacques ROBIN – Professeur POLYTECH Montpellier II (Président)
Alain DUFRESNE – Professeur INP Grenoble/EFPG

Examineurs : Jacques LACOSTE – Directeur ENSCCF / LPMM
Bruno FAYOLLE – MC ENSAM Paris
Florence DELOR-JESTIN – MC ENSCCF / LPMM

Invités : Emmanuel BROCARD – SEDIVER
Guy THEVENET – SEDIVER
Gilbert WEILL – IFCPAR / Institut C.Sadron Strasbourg

*Dedicated to my parents
&
Rahul*

ACKNOWLEDGMENTS

This work has been performed in Laboratoire de Photochimie Moleculaire et Macromoleculaire (UMR-CNRS-Universite Blaise Pascal, Clermont-Ferrand) under the direction of Prof. Jean-Luc Gardette and later Dr. Claire Richard. I would like to express my gratitude towards them for accepting me as student in their laboratory.

I would sincerely like to thank my PhD supervisors Prof. Jacques Lacoste and Dr. Florence Delor Jestin for providing me with their invaluable guidance. They were always there to encourage and motivate me. They have been great mentors and guides and it has been an honor to work under their guidance.

I would like to sincerely thank Prof. Jean-Jacques Robin, Prof. Alain Dufresne and Dr. Bruno Foyolle for their valuable comments which helped in improving the manuscript and for being jury members .

I would like to acknowledge the financial support of Indo-French Centre for the Promotion of Advanced Research (IFCPAR) for the thesis.

I would like to thank G. Thevenet and E. Brocard from Sediver, France for the helpful suggestions and explanations. I am deeply indebted to Eric Tomasella and Joël Cellier for their help in performing the plasma experiments. Many thanks to the all the members of the laboratory and CNEP particularly Lawrence Frezet and Christine Cluzel for their help. I am grateful to Franck Jouandon, Thierry Encinas and Cécile Esparcieux from ENSCCF for their assistance with all types of technical problems.

I would like to thank my friends Fatima, Ecaterina, Anne, Pierre, Branislav, Freddy, Harout, Laurent, Michal, Rajiv, Sylvain, Hana, Denis and the list goes on..... for helping me get through the difficult times, and for all the emotional support, entertainment, and caring they provided.

Last but not the least I would like to thank my parents, Rahul, Anshu and Sonu for the enormous support, patience and love they gave me.

TABLE OF CONTENT

Section	Page
GENERAL INTRODUCTION	3
CHAPTER 1 : BIBLIOGRAPHIC STUDY	
1. General properties of Silicone	13
1.1. Effect of substituent groups in polysiloxanes	14
1.2. Synthesis of siloxanes	15
1.3. Cross-linking of siloxanes	16
1.4. Role of fillers in polydimethylsiloxanes	18
1.5. Effect of different types of degradation on PDMS	
1.5.1. Photo-degradation	20
1.5.2. Thermal Degradation	22
1.5.3. Ozone ageing	23
1.5.4. Plasma ageing	24
1.5.5. Acid Pollution	25
2. General properties of EPDM	26
2.1. EPDM used as an insulator	27
2.2. Synthesis of EPDM	28
2.3. Degradation of EPDM	29
2.3.1. Photo and thermal degradation	31
2.3.2. Acid degradation	33
2.3.4. Plasma treatment	34
2.3.3. Ozone degradation	34
2.3.4. Effect of stabilizers on degradation	34
CHAPTER II : MATERIALS AND EXPERIMENTAL TECHNIQUES	
1.1. Historical Development	39
1.2. Structure of insulators	40
1.3. Materials used for study	
1.3.1. Crude Silicones	42
1.3.2. Cross-linked Silicone	42
1.3.3. Cross-linked EPDM	45
1.4. Techniques used for accelerated ageing	47

1.5. Techniques used for characterisation	49
1.5.1 HATR-FTIR spectroscopy	49
1.5.2. Differential Scanning Calorimetry (DSC)	50
1.5.3. Photo-DSC	53
1.5.4. Thermogravimetric analysis (TGA) coupled with FTIR	53
1.5.5. Densimetry	54
1.5.6. Hardness measurements	54
1.5.7. Permeability to water-vapour	54
1.5.8. Size Exclusion Chromatography (SEC)	54
1.5.9. Contact angle measurements	55
1.5.10. Resistivity measurements	56
1.5.11. Conductivity measurements	56
1.5.12. Chemical methods	57

CHAPTER III : STUDY OF UNCROSS-LINKED POLYSILOXANES

1. Introduction	63
2. Oxidation, chain scission and cross-linking studies of polysiloxanes upon ageings	65
3. Comparision of thermal properties and crystallization behaviour of polysiloxanes	78
4. Conclusion	94

CHAPTER IV : STUDY OF CROSS-LINKED PDMS AND EPDM

1. Introduction	101
2. Characterization of polydimethylsiloxane rubber upon photochemical, thermal, salt-fogs ageings and exposure to acid vapours	103
3. Cross-linking assessment after accelerated ageings of ethylenepropylene diene monomer rubber	118
4. Comparision of EPDM and Silicone durability	132
5. Conclusion	137

**CHAPTER V : COMPARISON OF NATURAL AND ARTIFICIAL
AGEINGS OF SILICONE**

STUDY OF NEW STABILIZED FORMULATION

1. Introduction	143
2. Comparison of natural and artificial ageings on silicone polymer composites	145
3. Polydimethyl siloxane modified by hydrotalcite/ATH filler: Effect of stabilizers on degradation	157
4. Conclusion	170
GENERAL CONCLUSION	172
REFERENCES	178
LIST OF ABBREVIATIONS	183
RESUME	184

General Introduction

Introduction Générale

Les élastomères ont de nombreuses applications dans différents secteurs de l'industrie (automobile, bâtiment, électrique, électroménager...) en raison de leurs propriétés mécaniques particulières. Ces matériaux sont le plus souvent des élastomères diéniques, des élastomères thermoplastiques, mais également des polysiloxanes. Un matériau est reconnu comme un élastomère s'il est souple (de faible rigidité) à température ambiante, hautement déformable et résiliant; il est susceptible de retrouver sa géométrie initiale après les sollicitations répétées ou non, en restituant l'énergie qui lui a été fournie. Un élastomère est un polymère généralement amorphe avec une température de transition vitreuse basse, de masse molaire élevée. Sa température d'utilisation après réticulation et sa température de mise en œuvre sont très supérieures à sa température de transition vitreuse. Son comportement à long terme en conditions d'usage est souvent un point critique. Il doit être systématiquement examiné avant la mise sur le marché de tout matériau.

Différentes approches permettent d'établir des critères d'évaluation du vieillissement du matériau polymère. La première approche consiste à déterminer l'évolution de critères macroscopiques tels que les propriétés mécaniques, électriques ou l'aspect. La seconde approche envisage une étude à l'échelle moléculaire pour déterminer l'évolution chimique des matériaux à faible taux d'avancement et établir les causes du vieillissement. Ce type d'étude est largement développé au sein du Laboratoire de Photochimie Moléculaire et Macromoléculaire et se base en particulier sur des techniques analytiques telles que la spectroscopie infra-rouge et l'analyse thermique couplée à la thermoporosimétrie. Notre étude abordera ces deux approches afin de comparer les évolutions chimiques et physiques des élastomères soumis à un vieillissement.

Dans le cas de l'application isolateur électrique en matériaux composites, nous avons un jonc central en époxy fortement chargé en fibres de verre et une enveloppe (ou ailette) en élastomère qui va nous intéresser particulièrement. Ce revêtement est soumis à des agressions multiples quand il est en conditions d'usage. Ces agressions dépendent du climat et du site d'installation (bord de mer, environnement pétrochimique...).

Nous sommes intéressés à la compréhension de son comportement à long terme afin d'améliorer la stabilisation des formulations et de pouvoir choisir les matériaux les plus pertinents. Quatre formulations industrielles à base de polydiméthylsiloxane (PDMS) ou d'Éthylène Propylène Diène Monomère (EPDM) sont étudiées. Nous comparons l'évolution des propriétés des

différentes compositions afin de mettre en évidence l'influence des constituants et celle de la matrice polymère sur le vieillissement. La stabilité thermique et photochimique reconnue des polysiloxanes, souvent décrite dans la littérature, constitue un atout pour cette catégorie d'élastomère. Cependant les formulations à base silicone exposées à des environnements sévères se dégradent en quelques années et ne répondent plus au cahier des charges. Une étude plus fondamentale sur les polysiloxanes non réticulés, non chargés est également proposée. Elle permet de mieux appréhender le comportement en vieillissement des silicones par rapport aux réactions de réticulation en particulier et d'étudier les relations structure-propriétés.

En raison des agressions multiples que peut subir l'isolateur, nous avons envisagé plusieurs vieillissements artificiels :

- photochimique
- thermique
- électrique
- brouillard salin
- vapeur acide (sulfurique ou nitrique)
- ozone
- plasma oxydant.

Ces vieillissements sont réalisés séparément dans un premier temps afin de connaître les points critiques pour chaque matériau. Des essais de vieillissements combinés (l'un après l'autre) sont finalement proposés dans le but de simuler une exposition représentative d'une dégradation en milieu extérieur.

Différents outils analytiques sont retenus pour l'étude. Dans le cas des élastomères crus (non chargés, non réticulés), les techniques sont les suivantes :

- la spectroscopie infra-rouge en réflexion
- la densimétrie
- la photo-DSC (irradiation photochimique couplée à l'analyse thermique différentielle)
- la TG-IR (analyse thermogravimétrique couplée à la spectroscopie infra-rouge)
- la chromatographie d'exclusion stérique

Les techniques utilisées pour les formulations réticulées sont :

- la spectroscopie infra-rouge en réflexion
- la DSC-Thermoporosimétrie (analyse thermique différentielle couplée avec la thermoporosimétrie)

- la TG-IR (analyse thermogravimétrique couplée à la spectroscopie infra-rouge)
- les mesures de dureté
- les mesures électriques
- la goniométrie et les mesures d'angles de contact
- les mesures de perméabilité à la vapeur d'eau

Le vieillissement se traduit par une modification chimique résultant de réactions d'oxydation, de réticulation et/ou des coupures de chaînes. Il convient d'avoir plusieurs analyses complémentaires pour caractériser ces phénomènes. La spectroscopie infra-rouge apporte classiquement une information sur le niveau d'oxydation et la nature des produits formés. L'analyse thermique (DSC) couplée à la thermoporosimétrie est une technique récemment mise en place au laboratoire. Elle permet de déterminer la taille et la distribution des mailles du réseau polymère. Elle constitue une nouvelle approche de la réticulation des élastomères.

Suite à cette étude nous pourrions retenir le meilleur outil pour caractériser rapidement la période d'induction avant dégradation et la modification d'une propriété. Cet outil devrait permettre d'évaluer les performances de nouvelles formulations.

Le travail présenté comprendra cinq parties. Après avoir précisé les propriétés spécifiques des élastomères, nous rappellerons dans une partie bibliographique les principaux résultats acquis dans les études de vieillissement de polysiloxanes et d'EPDM. La deuxième partie concernera les matériaux et techniques expérimentales, utilisés au cours de l'étude. Dans la troisième partie nous aborderons l'étude fondamentale du vieillissement des polysiloxanes non réticulés, non chargés (avec deux publications). La quatrième partie sera consacrée aux élastomères formulés silicone et EPDM (avec deux publications). Finalement nous décrirons dans la cinquième partie une comparaison des vieillissements artificiel et naturel susceptibles d'intervenir sur nos matériaux en conditions d'usage (une publication), puis l'étude de nouvelles formulations stabilisées (une publication) et une proposition de formulation améliorée.

Remarque : Le travail présenté est dans le cadre d'un contrat de recherche franco-indien associant le LPMM (Clermont-Ferrand), le National Chemical Laboratory division Polymer (Pune) et la Société Sediver (Saint-Yorre). Parallèlement à cette thèse réalisée au LPMM, deux autres doctorants travaillent en Inde sur la synthèse de nouveaux agents de formulation dont certains seront testés à la fin de ce travail.

Pour tenir compte de contraintes liées à ce type de contrat de recherche géré par un organisme franco-indien localisé à New Delhi (Centre Franco-Indien pour la Promotion de la Recherche

Avancée, CEFIPRA), le manuscrit est rédigé en anglais. L'introduction générale et la conclusion générale, les introductions et conclusions de chapitres 3, 4 et 5 sont rédigées dans les deux langues. Le texte contient six publications soumises ou acceptées. Ce type de présentation entraîne quelques répétitions au niveau de la bibliographie et de la description des techniques analytiques et nous nous en excusons auprès du lecteur. Par contre la défense orale de la thèse se fera en français.

Le sujet a une finalité Recherche et Développement, il s'est focalisé sur le cas concret de deux types d'élastomères utilisés dans le domaine de l'isolation électrique moderne et a été réalisé en étroite collaboration avec la société Sediver l'un des leaders mondial du domaine.

General Introduction

Elastomers have special mechanical properties and have found their way in different industrial applications like automobiles, construction and electronics. These materials can be either dienic elastomers, thermoplastic elastomers or polysiloxanes. A material is termed as an elastomer if it is flexible (has low rigidity) at ambient temperature and resilient. It should be susceptible to recover its initial geometry after repeated stress by restoring the energy which was provided to it initially. An elastomer is a generally amorphous polymer with a low glass transition temperature, having high molecular weight. Its processing and use temperature after cross-linking are superior than its glass transition temperature. Their long term behaviour is not well understood and should be systematically examined before using them for large scale commercial applications.

Different approaches are used to study the ageing of polymeric materials. The first approach is the determination of macroscopic criteria like mechanical, or electrical properties. The second approach considers the chemical evolution of materials at molecular scale to establish the causes of their degradation. This type of study is well developed in Laboratory of Photochemistry Molecular and Macromolecular and is particularly based on infra red spectroscopy and thermal analysis coupled with thermoporosimetry. We have used the techniques described above to study the physical and chemical evolution of aged materials.

We have focused on composite electric insulator material for this study. These insulators typically consists of a central rod made of epoxy and fiber glass enclosed in an envelope/housing of elastomer which is the part we are interested in studying. The housing material is subjected to multiple aggressive environments during its service life. The aggressive environments depend on the climate and the installation site (proximity to the coast or petrochemical environment).

This research deals with the study of long term behavior of these insulators, and will help in improving the stability of the formulation and the choice of material for improving their service life. Four industrial formulations having bases of polydimethylsiloxane (PDMS) or ethylene propylene diene are studied. We have compared the evolution of properties of the different components of the formulations, this helped us to identify the influence of the polymer matrix and the different components on its ageing. According to literature studies the polysiloxanes have an advantage due to their photo and thermal stability. However, the formulations having a

silicone base when exposed to severe environmental conditions degrade in a few years and no longer possess the required initial properties.

We have carried out a fundamental study on uncross-linked polysiloxanes without fillers. It helps us to better understand the ageing behavior of silicones compared to the cross-linking and to study the structure property relationships.

Due to the multiple aggressive environments that the insulators experienced we have considered various artificial ageings:

- Photochemical
- Thermal
- Electrical ageing
- Salt-fog
- Acid vapour (sulphuric or nitric acid)
- Ozone
- Oxidizing plasma

These agings have been carried out separately, initially to understand the critical points for each material. The tests of combined ageings (consecutively) have been proposed in the end, aiming to simulate an exposure which can be representative to exterior degradation.

Different analytical techniques have been used for this research. The following techniques have been used for analyzing the crude (uncross-linked, unfilled) elastomer:

- Infra-red reflexion spectroscopy
- Densimetry
- Photo-DSC (Photo-irradiation coupled with Differential Scanning Calorimetry)
- TGA-IR (Thermogravimetric analysis coupled with infra-red spectroscopy)
- Size exclusion chromatography

The techniques used for cross-linked formulations are:

- Infra-red reflexion spectroscopy
- DSC- Thermoporosimetry (Differential Scanning Calorimetry coupled with thermoporosimetry)
- TGA-IR (Thermogravimetric analysis coupled with infra-red spectroscopy)
- Hardness measurements

- Electrical measurements
- Contact angle measurements
- Water vapour permeability

The ageing takes place by chemical modifications of the insulator resulting in oxidation reactions, cross-linking and/or chain scission. It is appropriate to have many complementary analysis for characterizing these phenonemons. The infra-red spectroscopy gives classical information on the oxidation and the oxidation products formed. The thermal analysis (DSC) coupled with thermoporosimetry is a new technique for polymers. It gives the pore size distribution of polymer network giving a new view of the cross-linking of elastomers.

Due to this study we can rapidly characterize the period of induction before degradation and modification of the properties. This tool can be used to evaluate the performance of new formulations.

The work presented here consists of 5 chapters. We have presented the literature available on the study of ageing of polysiloxane and EPDM in the first chapter. The second chapter consists of materials and experimental techniques used for our study. In the third chapter the fundamental studies on the uncross-linked and unfilled polysiloxanes have been presented (it has two publications). The fourth chapter consists of the studies done on the cross-linked formulations (it has two publications). Finally the fifth chapter consists of the comparison of natural and artificial ageing (one publication), studies on new stabilized formulations (one publication) and a proposed improved formulation.

Remarks: The work presented here is in the framework of an Indo-French research contract between LPMM (Clermont-Ferrand), Polymer Division of National Chemical Laboratory (Pune) and the company Sediver (Saint-Yorre). Simultaneously to this thesis carried out in LPMM, two doctoral students work worked in India on the synthesis of new stablizing agents, a few of which are studied towards the end of this thesis.

Taking into account the constraints of this type of research contract financed by the Indo French Centre for the Promotion of Advanced Research (IFCPAR) the manuscript is written in english (the general introduction and general conclusion is written in the 2 languages) and it contains 6 papers submitted/ accepted for publication. Due to this type of format of the manuscript there are some repetitions in the literature study and the experimental techniques for which be would like be to excused by the readers. The defense of the dissertation will be done in French.

The subject has an aim of Research and Development, it is focussed on concrete case of two types of elastomers used in the field of modern electric insulation and was carried out in close collaboration with the company Sediver one of the leaders in this field worldwide.

CHAPTER I

Bibliographic Study

1. General properties of Silicone

Silicone polymers are semi-inorganic materials which are industrially very important due to their outstanding chemical and physical properties and have many diverse applications. The silicon atom lies below carbon in the periodic table with similar electronic configuration, however, the larger atomic radius of silicon makes the silicon-silicon bond much less energetic. Due to this reason silanes ($\text{Si}_n\text{H}_{2n+2}$) are much less stable than alkanes. The opposite is true for silicon-oxygen bonds that are more stronger than carbon-oxygen bonds. Polysiloxanes have recurring Si-O linkages in the backbones. The nature of the free bond on the silicon is used to classify them into two major families: oils and resins on the basis of structure and the physical properties of the end products obtained.

Oils: The long linear macromolecules (fluid at room temperature) where a Si-C bond is created, are known as oils as they behave like vegetable or mineral oils. Polydimethylsiloxane (PDMS) is the most commonly used oil having a general formula:

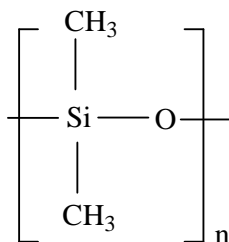

The chemical reactivity of PDMS depends on the reactivity of the end groups. If we use $\text{Si}(\text{CH}_3)_3$ as end groups then a non reactive oil is obtained. To obtain a reactive oil, usually silanol function is used as it is easiest to attach.

Resins: When one or two Si-C bonds are replaced by Si-O bonds then a silicone resin is obtained:

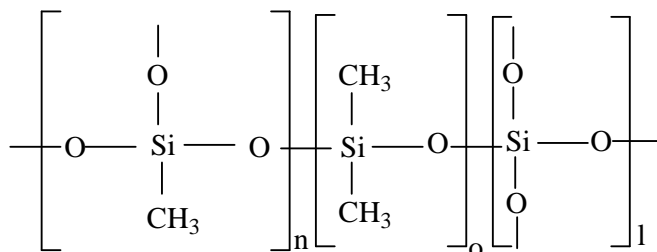

The oxygen atoms in the skeletal backbone do not have any groups attached to them hence polysiloxanes have a skeletal bond angle of 143° which is more open than the usual

tetrahedral bond angle of 109.5°C. This also results in low energy barrier for the rotation of the silicon oxygen bond, which in turn gives polysiloxane chains the ability to rearrange themselves with a small amount of external energy. Polysiloxanes are highly permeable as compared to other solid polymers due to these low barrier to molecular motion. There is a difference in bond strengths, bond lengths and ionic nature for silicon and carbon compounds. The average bond energies for silicon and carbon bonds are listed in Table 1. It is apparent that bonds of silicon to oxygen, nitrogen and the halogens are stronger than the corresponding bonds with carbon. The silicon-oxygen bond is much stronger than the carbon oxygen bond and is partially responsible for the high thermal stability of polysiloxanes. Pauling has estimated relative electro negativities of silicon 1.8, carbon 2.5 and oxygen 3.5. Due to this, the partial ionic character of silicon-oxygen bond is 30-51% while that of the carbon-oxygen is 20-22% resulting in the high Si-O bond stability.

Bond	Energy KJ/mole	Bond	Energy
Si-Si	221	C-C	343
Si-C	326	C-Si	326
Si-O	443	C-O	356
Si-H	318	C-H	413
Si-N	335	C-N	304
Si-F	565	C-F	485
Si-Cl	381	C-Cl	339
Si-Br	310	C-Br	285
Si-I	235	C-I	213

Table 1: Bond energies (KJ/mole)

1.1. Effect of substituent groups in polysiloxanes

The substituent group bonded to the silicon atom is the most important factor for determining the properties of the polysiloxanes. They can have different types of groups attached from single hydrogen atoms to all sizes of alkyl and polymeric functionalities. Generally, if the silicon atom on the backbone is asymmetrically functionalized, the dielectric constants and the dipole moments of these materials increases. Similarly substituent properties such as solubility, stability, polarity, surface energy are transferred to resultant polysiloxanes if

larger or more substituents are present. Polydimethylsiloxane is the most commonly used polysiloxane. Polydimethylsiloxanes have a low glass transition temperature (-123°C) due to the segmental mobility, high free volume and low intermolecular forces. The regular chain structure makes PDMS a crystalline polymer and the absence of carbon carbon single bond increases their overall stability. The substituent groups attached on the silicon atom also affect the crystallization behaviour. Polydimethylsiloxane crystallizes rapidly without super cooling at -54°C, however, if the methyl groups are substituted by a small number of bulky phenyl groups, the regularity of the polymer molecule is interrupted and thus crystallization is retarded. Polysiloxanes containing phenyl groups are the next most commonly used polysiloxane. The phenyl substituents are more stable and resistant to oxidation than aliphatic substituents as their bulky nature shields the polysiloxane backbone more closely. As the phenyl content increases, the mobility of the polysiloxane is degraded by steric effects as well as strong intermolecular interactions resulting in higher glass transition temperature. The use of higher alkyl silicones is restricted due to the lack of thermal and oxidative stability which makes their properties less of polysiloxane chains and more of hydrocarbons, however they have outstanding water repellent properties. Fluorosilicones containing some quantity of fluorinated or perfluorinated substituents are sometimes used to decrease surface energy and frictional coefficients of the materials. These siloxanes have highest dielectric constants due to the asymmetric substitution in these materials as it is difficult to make symmetrically substituted fluorosilicones. They also show enhanced thermal stability compared to PDMS as the C-F bonds are more stable than C-H bonds. Finally, of all the silicones they tend to be chemically most inert.

1.2. Synthesis of siloxanes

Silicon is the second most abundant element found on the earth's crust, mostly found as silicates in rocks and as silica in sand. These minerals can be treated with chlorine to produce silicon tetrachloride which can be purified and reduced to form powdered silicon:

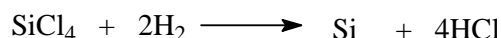

The powdered silicon is reacted with methylchloride to produce dimethyldichlorosilane:

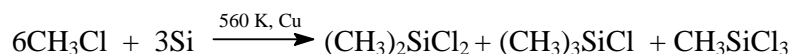

Oligomeric dimethylsiloxane is produced from the hydrolysis of dimethyl-dichlorosilane followed by condensation reaction:

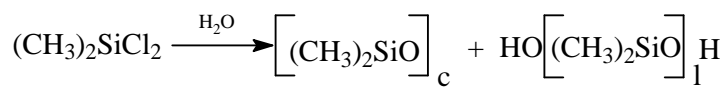

This reaction yields a mixture of cyclic(c) and linear (l) dimethylsiloxane oligomers which are used to produce high molar weight polydimethylsiloxane.

1.3. Cross-linking of siloxanes

There are three classes of reaction which are widely used to cross-link siloxanes in commercial applications:

- Peroxide induced free radical reactions
- Condensation reactions
- Hydrosilylation addition reactions

The peroxide induced free radical reaction depends on the availability of reactive groups which are readily susceptible to radical attack and form bonds with other polymer chains through radical coupling to effect the cross-linking and so does not add any additional organic character. There are two categories of peroxide used to achieve this cross linking: the vinyl specific catalysts which work only in the presence of vinyl groups and the non specific catalysts, typically aryloxy peroxides which do not need vinyl groups to effect cross-linking. This type of cross-linking is also known as High Temperature Vulcanization (HTV) as cross-linking takes place through decomposition of peroxides at temperatures above 100°C depending typically, on the peroxide. The peroxides decompose into free radicals which react with unsaturated bonds by abstraction of hydrogen atoms. The free radicals then recombine and form cross-links between the siloxane chains (Scheme 1.1.). Peroxides are effective regardless of the molecular weight of the siloxanes in use, and can generate polysiloxanes with molecular weights on the order of one million. The residual volatile decomposition products within the cross-linked siloxane rubbers are generally removed by a post-curing step (storage at elevated temperature for a few hours).

The next type of curing process is condensation or Room Temperature Vulcanization (RTV). This type of reaction relies on the ability of some organic groups such as alkoxy or acyloxy, attached to silicon to react with water to produce silanol groups which can further react with the starting materials or another silanol group to produce siloxane cross-link.(Scheme 1.2) As the reactive groups are usually found only at chain ends in low concentration, this type of curing process cannot be used to obtain polymers of greater than 150,000 molecular weight. However, it has an advantage of producing polymer networks with narrow crosslink density

distribution. Usually, a polyfunctional cross-linker is required possessing either Si-OH or Si-OR groups along with a catalyst in order to cause sufficient hydrolysis and condensation to occur.

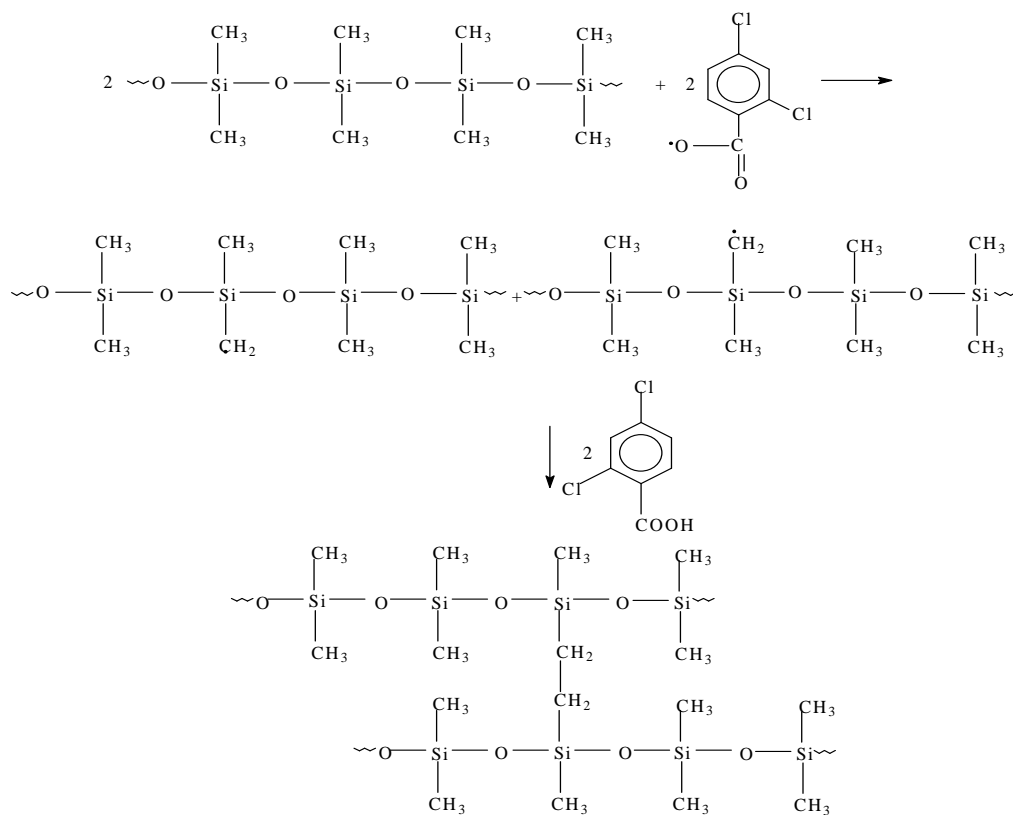

Scheme 1.1: Reactions taking place in peroxide induced cross-linking of silicones

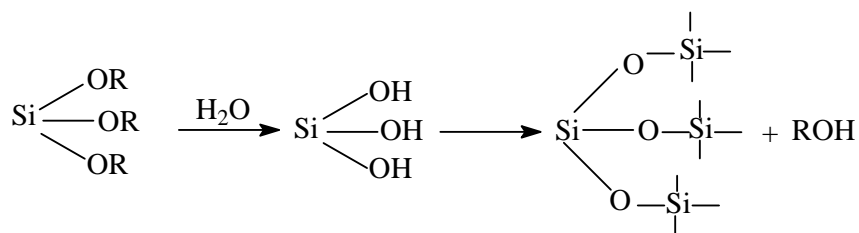

Scheme 1.2: Reactions taking place in Condensation cross-linking of silicones

The hydrosilylation addition reactions are the most modern form of polysiloxane cross-linking. This technique uses the hydrosilylation reaction *i.e.* the reaction between Si-H group and a vinyl group, to form a Si-CH₂-CH₂-Si and Si-CH(CH₃)-Si (low) linkages catalysed by a noble metal typically Pt.

There are no additional by products formed, hence it is one of the cleanest methods of cross-linking and least prone to side reactions. An added advantage of this technology is that it can be easily emulsified and applied as water based coating and this has established it in the area of coated papers used for food release. Disadvantage of this technique include the sometimes excessive speed of the reaction, which must be moderated [1].

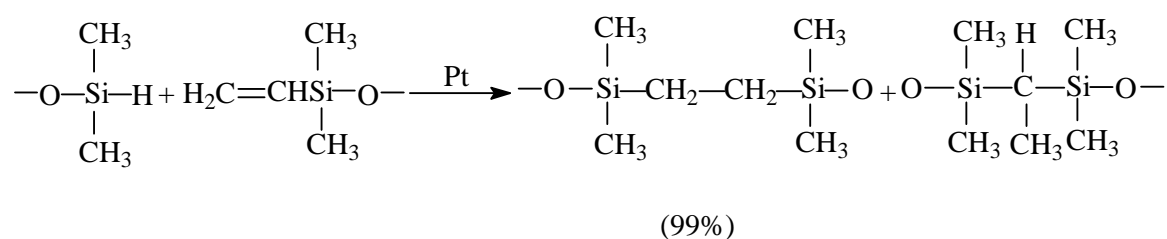

1.4. Role of fillers in polydimethylsiloxanes

Cross-linked polydimethylsiloxane matrix produced as a result of any of the above processes is an inherently weak material. This weakness results from the absence of any strong intermolecular forces in the polydimethylsiloxane polymer. To produce acceptable commercial materials, it is necessary to reinforce the cross-linked matrix with inorganic fillers and the choice of the fillers is critical for realizing the ultimate physical properties of the cross-linked matrix. Thus, unlike many organic materials, control over the degree of cross-linking is not always the most important factor in defining the physical properties of the final silicone material. Fillers such as barium titanate, contribute to increasing the relative permittivity of silicone composites used as housing material for outdoor insulators as they reduce significantly the surface stresses. Antimony doped zinc oxide contribute to electrical conductivity thereby preventing partial discharge, corona discharge or dry band arcing on the surface of the insulation and thereby enhancing the pollution performance [2]. Fillers such as mica and ferric oxide are also found to improve the thermal stability of silicones by delaying the onset temperature of degradation. The residual yield is lower than silicone in case of ferric oxide while higher in case of mica [3].

Fumed silica is the most important filler used for reinforcing silicone rubber. The polymer filler interactions are very strong and are responsible for the improvement of mechanical properties of silica filled silicone rubber. Due to these interactions, there is adsorption of polymer molecules on the filler surface and formation of bound rubbers which consists of polymer molecules resisting extraction by a good solvent at room temperature. The quantity of bound polymer is very high for silica filled silicone rubber due to the formation of more bonds between silica and silicone rubber. The adsorption of polydimethylsiloxane on silica

particles occurs due to hydrogen bonding between silanol (SiOH) groups of the silica surface which is proton donor and oxygen atoms of polydimethylsiloxane which is proton acceptor. Sohoni *et al.* [4] have seen that presence of small amounts of silica increases the thermal degradation temperature of hydroxyl terminated PDMS while if the amount of silica is increased the degradation temperature decreases before leveling off. The acidic SiOH groups on the surface of silica can themselves cause chain cleavage. Thus, at low concentrations of silica, most of the SiOH groups on the surface of silica are used in binding the polymer chain ends. As the concentration of silica is increased, the number of SiOH group exceeds the number of PDMS chain ends hence, the excess groups on the filler can cause chain cleavage. They have also observed that in-situ precipitated silica increases the degradation temperature more than fumed silica. Sometimes the surface of silica is treated with silicone oils or oligomers to increase the stability of filler dispersion.

Aluminium trihydrate (ATH) is also a very commonly used filler for PDMS due to its flame retarding properties. When it is heated above 200°C, it decomposes endothermically to give aluminium oxide and water:

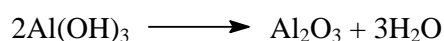

This endothermic decomposition consumes 300kJ/mol of formed Al_2O_3 due to which there is lowering of surface temperature, hence thermal degradation and thermal oxidation of the polymer is avoided. The results presented by Kumagai *et al.* [5] can be used to explain this as they showed by TGA-MS analysis that ATH besides cooling the surface also inhibited surface oxidation. They also showed in the same analysis that smallest cyclic dimethylsiloxane oligomers were formed at lower temperature when ATH was included. The decomposition product Al_2O_3 forms a flame protective thermally insulating surface layer which can be a very useful property in some applications. Along with the flame retarding properties, ATH and its decomposition products are capable of improving the thermal stability of PDMS [6,7]. The influence of the content of ATH is also important in the formulations. Kim *et al.* [8] have found in salt fog test of RTV coatings that 200 phr showed a higher electrical activity at the initial phase of the test compared to the less filled formulations (0 and 100 phr). They attributed this to a higher surface roughness of the 200 phr one compared to the less filled systems. At later stages, the test showed an increased performance with increasing filler content, due to the increased erosion resistance brought about by the ATH. Zhang *et al.* [9] have found that the thermal stability of conductive silicone filled with conductive carbon black has better stability than that of silicone rubber filled with the same amount of silica.

1.5. Effect of different types of degradation on PDMS

1.5.1. Photo-degradation

Polydimethylsiloxanes are very resistant to UV light in the near UV region (300-400nm). Delman *et al.* [10] have shown that cross-links and hydroxyl groups were formed on PDMS upon irradiation below 300nm. On exposure to Xenon arc lamp ($\lambda=281\text{nm}$), SiCH_2Si linkages were formed while exposure to mercury vapor lamp ($\lambda=185$ to 436 nm) lead to the formation of silanol groups (SiOH) and $\text{SiCH}_2\text{CH}_2\text{Si}$ linkages. The energy corresponding to Xenon arc lamp is 426 KJ/mol while that of Mercury vapour lamp is $276\text{-}648\text{ KJ/mol}$. Due to the high energy emitted by mercury vapour lamp, there is excitation of oxygen molecules which interacted with active Si radicals formed by peroxide decomposition to produce Si-OH. Another possible result of excitation of oxygen molecule is the electro-negativities of the elements involved. The strongly electro positive Si atom will react more readily with the strong electronegative oxygen atom than with the less electro negative carbon atom. The active Si radical will react forming Si-O-Si linkages. The $\text{SiCH}_2\text{CH}_2\text{Si}$ linkages were formed as the result of secondary reactions. The various reactions taking place on UV exposure are shown below in Scheme 1.3.

a)

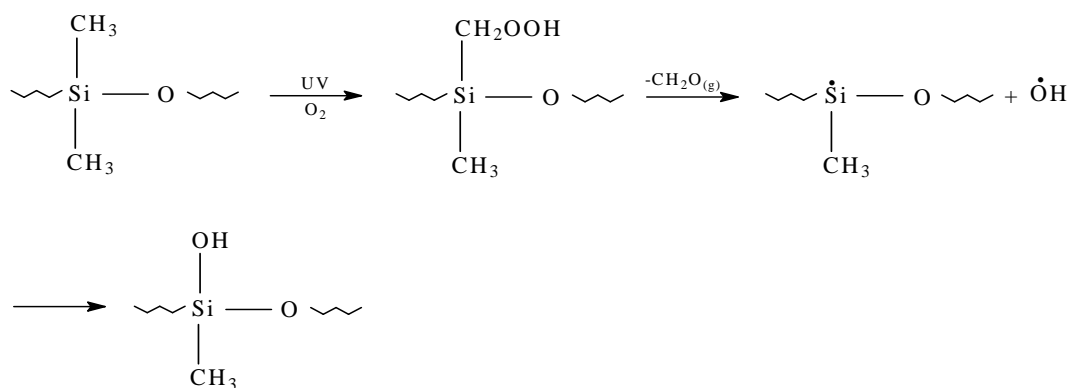

b)

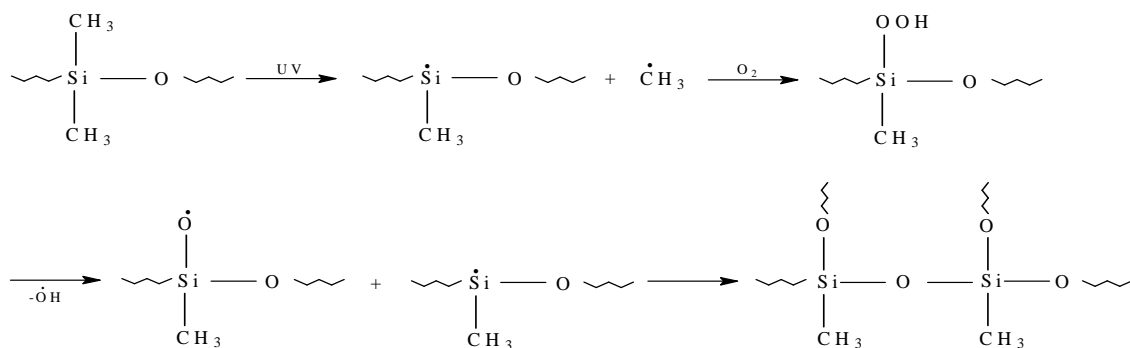

c)

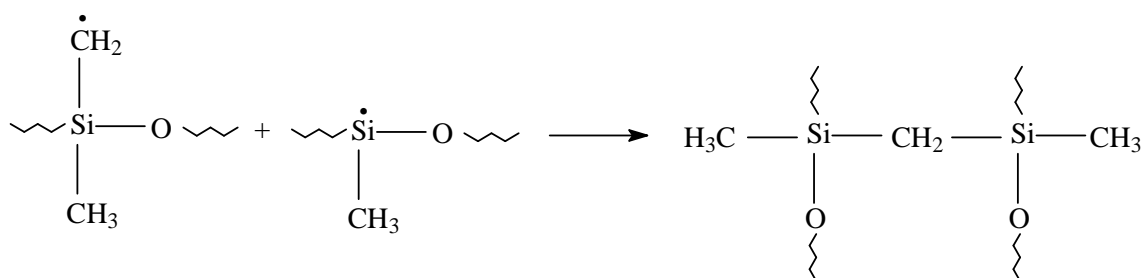

d)

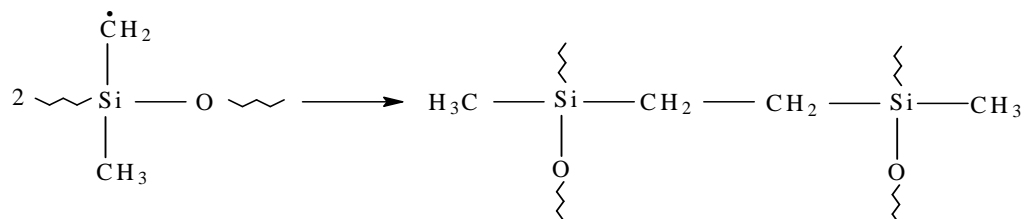

Scheme 1.3: Mechanisms of Photo-degradation of silicone (below 300 nm)

Photochemical behavior of PDMS oils at wavelengths longer than 300 nm is examined by Israeli *et al.* [11-14]. They have used PDMS with different contents of hydride SiH, vinyl (in the polymer chain or at the end of the chain), dimethylene $-\text{CH}_2\text{CH}_2-$, methine $-\text{CHCH}_3-$, MePh and PH_2 groups. In the case of SiH silicone, the hydroperoxides are primarily formed and result from the radical attack on the Si-H bonds. These unstable hydroperoxides are mostly transformed into silanols. SiH-PDMS is rather unstable in comparison with PDMS. The behaviour of SiH-PDMS weakly depends on the SiH content but strongly on the position of the SiH group. When the SiH groups are located at the end of the chain, the oxidation rate is fairly high, probably because of the easy accessibility of the reactive groups. In the case of vinyl PDMS, the oxidation rates (appearance and consumption of photoproducts) are lower than those observed in the case of SiH-PDMS. Chain scission and direct oxidation of the vinyl group lead to a very complex mixture of photoproducts, as revealed by gas chromatography and mass spectroscopy. Scission of the Si-vinyl bond seems to be the main reaction [11]. PDMS containing dimethylene and methine groups, formed by hydrosilylation reactions has a similar oxidation rate to that of vinyl-PDMS. The main photo-oxidation process is the hydroperoxidation of the dimethylene groups and the photo scission of hydroperoxide groups into β -silylated carboxylic acid and silanol groups. Photo-ageing studies on cured PDMS using peroxide crosslinkers with wavelengths longer than 300nm, have showed similar stability

towards oxidation for 6000 hrs. They have however, showed a tendency to cross-link upon ageing which was detected using DSC thermoporosimetry technique [15].

1.5.2. Thermal Degradation:

Detailed information on the thermal degradation of linear PDMS has then been obtained by studying the products resulting from exposing the polymers to a variety of conditions that lead to depolymerization [1]. N.Grassie *et al.* [16] have reported the thermal stability of PDMS upto 300°C under vacuum. The volatile products of thermal degradation were a continuous mixture of cyclic oligomers from trimer upwards. The replacement of terminal hydroxyl by trimethyl silyl structures (end blocking) results in the considerable increase in stability but no change in the distribution products. In the absence of ionic impurities, hydroxyl terminated chains decompose mainly by backbiting, but at higher temperature even random chain scission takes place, whereas methyl terminated ones decompose only by random chain scission. The incorporation of methyl-phenyl siloxane or diphenyl siloxane as a copolymer with PDMS has been shown to increase the onset temperature of degradation to nearly 400°C [17]. Deshpande and Rezac [18] have shown that the decomposition products of vinyl terminated PDMS under inert atmosphere thermal degradation at 364°C were principally the cyclic oligomers hexamethyltrisiloxane and octamethyltetrasiloxane. The degradation of polydimethyl diphenylsiloxane resulted in the same conditions in the evolution of benzene in the initial stages of the reaction [18]. A kinetic study was proposed on the same materials by thermogravimetric analysis from 300°C to 925°C [19]. Thermal degradation of PDMS have also been studied by Camino *et al.* [20,21]. Thermal oxidative degradation in the presence of air gives results much different from the decomposition in nitrogen. Kinetic treatment shows that PDMS thermal volatilisation, as rate of heating increases, becomes dominated by the rate of diffusion and evaporation of oligomers produced on its decomposition [20]. The products of the thermal degradation are essentially determined by the temperature and the heating rate [21]. Model PDMS subjected to thermal weathering at 200°C (in air circulating oven) were characterized by size exclusion chromatography [22]. Loss of average molecular weight and broadening of molecular weight distributions was observed. The thermal degradation seems to proceed by a mechanism where chain scission predominates at the beginning. When thermal ageing takes place in an oxygen containing atmosphere, the removal of methyl groups followed by formation of siloxane cross-links will dominate over the depolymerization process and may finally lead to the formation of silica like structure. Some reactions taking place on thermal ageing are shown in Scheme 1.4.

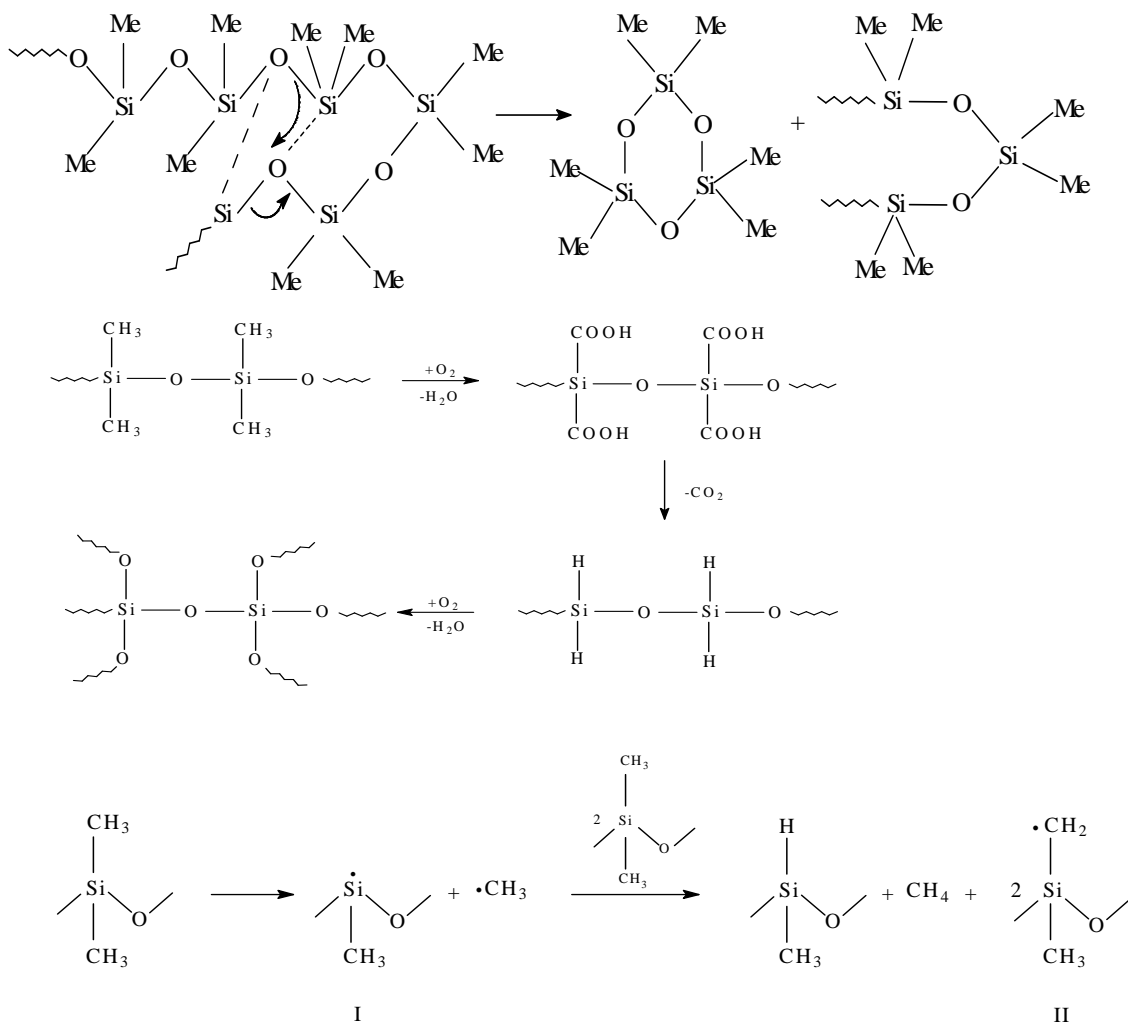

Scheme 1.4: Mechanisms of thermal ageing of silicone

1.5.3. Ozone ageing:

Ozone is an active oxidizing agent, generated in-situ from atmospheric oxygen by exposure to 185 nm UV light. Ozone can also be easily produced by high-voltage electrical arc. The passage of a high voltage, alternating electric discharge through a gas stream containing oxygen results in the breakdown of the molecular oxygen, to atomic oxygen. Some of the atoms of oxygen thus liberated can reform into ozone, while others recombine again to form oxygen:

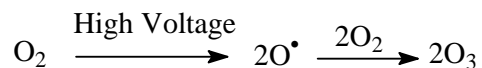

There is subsequent photo-dissociation of ozone into molecular oxygen and atomic oxygen upon exposure to 254 nm light. The latter species react with the polymer to form free radicals

and activated species that eventually remove organic portions of the polymer in the form of carbon dioxide, water and volatile organic compounds. In general the ozone resistance of silicone rubber is good as they do not contain unsaturated functional groups but at higher concentration of ozone, degradation is expected as for all polymers. Keshavaraj *et al.* [23] noticed discoloration, softening and formation of cracks on the surface of silicone rubber upon ozone ageing. There is a formation of a thin layer of SiO₂ on the surface of PDMS on increasing UV/ozone exposure [24-26]. The surface roughness of the layer was found to be dependent on the filler size/content in the exposed material. PDMS containing homogeneously dispersed filler exhibited decreased surface roughness when the oxidized surface region collapsed into a very smooth SiO₂ layer, while the PDMS containing heterogeneously aggregated filler showed the opposite behavior [26]. XPS measurements on the surface of the treated PDMS shows that 90% of the methyl side groups are converted to hydroxyl and bridging oxygen species. Ozone has also been used for the chemical modification of PDMS to generate reactive hydroxyl groups on its surface which can be used for photolithographic micropatterning [27].

1.5.4. Plasma ageing

Plasma treatment provides manifold possibilities to refine a polymer surface as it is possible to change the parameters like gas flow, power, pressure and treatment time. Depending on the gas composition and plasma conditions, ions, electrons, radicals are formed and UV radiation results in etching, activation or cross-linking of the polymers. The main effects of plasma treatment are:

- Formation of a glassy SiO_x surface layer.
- Increase in oxygen content in the surface by formation of SiO_x, hydroxyl and carbonyl groups.
- Degradation of network structure results in the formation of mainly low molar mass cyclic and medium to high molar weight linear PDMS.

Plasma treatment increases the water wettability of siloxanes due to surface hydroxyl formation probably silanol. On exposure to air, these treated surfaces gradually lose wettability. The hydrophobic recovery progressively ensues upon cessation of treatment with marked changes being evident after 24 hours and virtually complete recovery within one week. There is a debate about the mechanism of this recovery as most researchers believe it is due to migration of low molecular weight, untreated chains from the bulk to the surface (diffusion mechanism). Another mechanism is known as the reorientation mechanism in which there is reorientation of untreated methyl groups back into the surface replacing plasma produced surface hydrophilic

groups [1]. The first experiments on the hydroxylation of polydimethylsiloxane surfaces by oxidizing plasmas were carried out by Hollahan *et al.* [28]. They have observed by FTIR spectroscopy that on oxygen plasma treatment there is a high density of –OH groups formation on the surface of PDMS predominantly associated with SiCH₂OH and SiCH₂OOH. When plasma treatment was performed using nitrogen gas there was a broad absorption for Si-O linkage indicating cross-linking. Toth *et al.* [29] showed that PDMS surfaces exposed to oxygen plasma were oxidized, a decrease in surface carbon content and a increase in oxygen content was observed by XPS. Curve resolution of Si 2p XPS peak showed that inorganic silicon was present in the exposed surface samples. In the presence of oxygen the first reactions yield peroxides and hydroperoxides which react to form unstable silyl ketones. These readily decompose into scission products such as carboxylic acids and silanol groups. Silanol groups undergo condensation reactions leading to formation of Si-O-Si cross-links [29-32].

1.5.5. Acid Pollution

It has been observed that independent of presence of environmental pollutants, brittle fracture of the composite insulators is caused by nitric acid which is formed during corona discharge [33]. Acid can also be formed inside an insulator if moisture and internal corona discharges are present. Depending on the amount of moisture, voltage and the location within the insulator, the acid concentration can vary with time. Some reactions stimulated by corona discharges are as follows [34] in Scheme 1.5.

The changes in properties of silicone rubber after acid rain exposure were mainly due to removal of ATH filler from the surface [33-36]. Koo *et al.* [35] have studied the effect of sulphuric and nitric acid solutions on silicone insulator rubbers at different pH values. They observed that surface degradation consistently increased with decreasing pH for sulphuric acid while for nitric acid there is a critical value between pH 2.5-1.5 during which there was serious degradation. The contact angle increased with increase in acidity for both the acids. When RTV silicone insulator rubber was exposed to nitric acid, sulphuric acid and oxalic acid for one week with pH 2 and 4, only a slight reduction in the hydrophobicity was found and the tracking and erosion resistances were not affected [37].

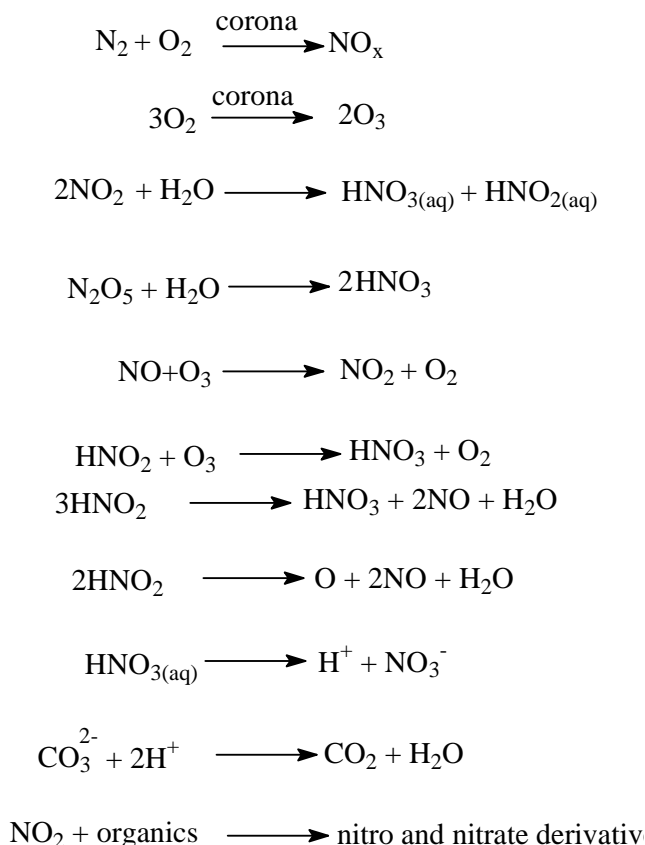

Scheme 1.5: Reactions taking place following corona discharges in atmosphere

2. General properties of EPDM

Ethylene-propylene rubbers and elastomers (also called EPDM and EPR) continue to be one of the most widely used and fastest growing synthetic rubbers having both speciality and general-purpose applications. Versatility in polymer design and performance has resulted in broad usage in automotive weather-stripping and seals, glass-run channel, radiator, garden and appliance hose, tubing, belts, electrical insulation, roofing membrane, rubber mechanical goods, plastic impact modification, thermoplastic vulcanizates and motor oil additive applications. Ethylene-propylene rubbers are valuable for their excellent resistance to heat, oxidation, ozone and weather ageing due to their stable, saturated polymer backbone structure. Properly pigmented black and non-black compounds are color stable. As non-polar elastomers, they have good electrical resistivity, as well as resistance to polar solvents, such as water, acids, alkalies, phosphate esters and many ketones and alcohols. Amorphous or low crystalline grades have excellent low temperature flexibility with glass transition points approx. at -60°C . Heat aging

resistance up to 130°C can be obtained with properly selected sulfur acceleration systems and heat resistance at 160°C can be obtained with peroxide cured compounds. Compression set resistance is good, particularly at high temperatures, if sulfur donor or peroxide cure systems are used. These polymers respond well to high filler and plasticizer loading, providing economical compounds. They can develop high tensile and tear properties, excellent abrasion resistance, as well as improved oil swell resistance and flame retardance. The general structure of EPDM is:

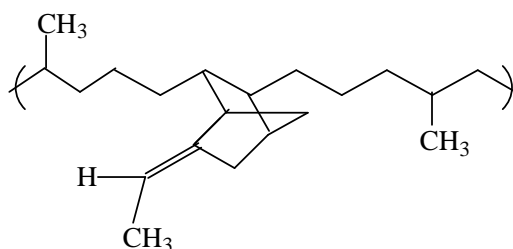

Advantages of EPDM are:

- Light weight
- Impact and vandalism resistance
- High pollution resistance
- Low profile - makes them less environmentally obtrusive
- A wide range of substrates and end fittings
- Many direct replacement products to obviate the need to re-tension lines after replacement of traditional insulators.

2.1. EPDM used as an insulator

EPDM has been used since 1960 in composite forms for outdoor insulator. It has some advantages over the traditional porcelain or glass in that they are very strong and do not shatter. EPDM is also much lighter and they having low dielectric loss. Recently, many electric utilities have begun converting to composite insulators which consist of a central rod made of fibre reinforced plastic and an outer weathershed made of EPDM. Composite insulators are less costly, lighter weight, and they have excellent hydrophobic capability. This combination makes them ideal for service in polluted areas.

	Porcelain , Ceramic or Glass insulators	EPDM Polymer Insulator
Hydrophobic recovery	No	No
Light weight	No	Yes
Contamination resistant	No	Yes
Leakage current control	No	Yes
Resists weather	Yes	Yes
Lower cost installation/breakage	No	Yes
Resists UV	Yes	Varies

Table 2: Comparison of Insulators

When selecting the insulator, there are choices that encompass both material properties and design. There is an ever-increasing interest in power industry worldwide. The elastomer materials used for the housing of composite insulator, usually EPDM and silicone rubber, differ from ceramic materials in that their surface properties may be altered significantly with age. This effect is particularly noticeable for EPDM materials, which unlike silicone rubber do not typically remain hydrophobic but deteriorate, becoming hydrophilic after ~ 2 to ~ 8 years service [38]. Surface deterioration has been found to affect electrical performance and in severe cases can result in the pollution performance becoming less than that of equivalent porcelain and glass.

2.2. Synthesis of EPDM

The EPDM available from industry are mostly based on 2-ethylidene bi-cyclo [2.2.1] hept-5-ene (ENB) [39]. For both technical and economical reasons, these monomers are incorporated in the E/P chains only in very low limited proportions (2-5 mol %). In most technical processes for the production of EPDM rubber, vanadium-based catalyst systems, such as VOCl_3 or $\text{VO}(\text{OR})_3$, co-catalyzed by alkylaluminum chloride in the presence of organic halogen promoters have been currently employed.

A typical laboratory scale preparation is carried out as follows: the polymerizations are carried out in a 2-L glass reactor (Buchi) using toluene as a solvent. The diene, the co-catalyst and the required amount of the catalyst were introduced in this order into the reactor containing

toluene (1 L) under positive pressure of a mixture of ethylene and propylene. The temperature was maintained at 313 K, under a continuous flow of ethylene and propylene, for 60 min. The reaction was then quenched by the addition of ethanol (at room temperature). The polymer was collected, washed with ethanol (1 L) and vacuum-dried at room temperature for several hours.

2.3. Degradation of EPDM

EPDM is quite weather resistant, however, it also has some detrimental aspects: having relatively weak chemical bonds which are easily broken, by high energy photons for example, and it may thus degrade due to UV radiation, heat and surface contamination induced leakage currents. Nevertheless, polymeric material is now widely used because of its overall advantages over porcelain or glass. However, the relatively short history of the use of composites in these applications means that their degradation properties are not well known, and being organic materials, they will degrade more quickly than porcelain or glass. Polymeric insulators are relatively easily scored and torn (birds can cause very substantial damage) and such damage reduces their performance and may expose the fiber glass core. In humid conditions, water can then penetrate to the fiber. Discharges that may lead to breakdown can then occur. This is exacerbated by the presence of pollutants.

Degradation of EPDM insulators typically occurs as loss of hydrophobicity followed by surface cracking and / or loss of surface polymer exposing underlying filler, producing a power surface known as chalking or flouing [40]. The physical changing with ageing observed in hydrocarbon polymers such as EPDM usually is associated with oxidation of the polymer [41]. A polymeric insulator subjected to high voltages, suffers the well known degradation by tracking [42,43]. It is believed that tracking arises as a result of two major contributions: pure thermal decomposition with eventual pyrolysis, and polymer damage by electron bombardment.

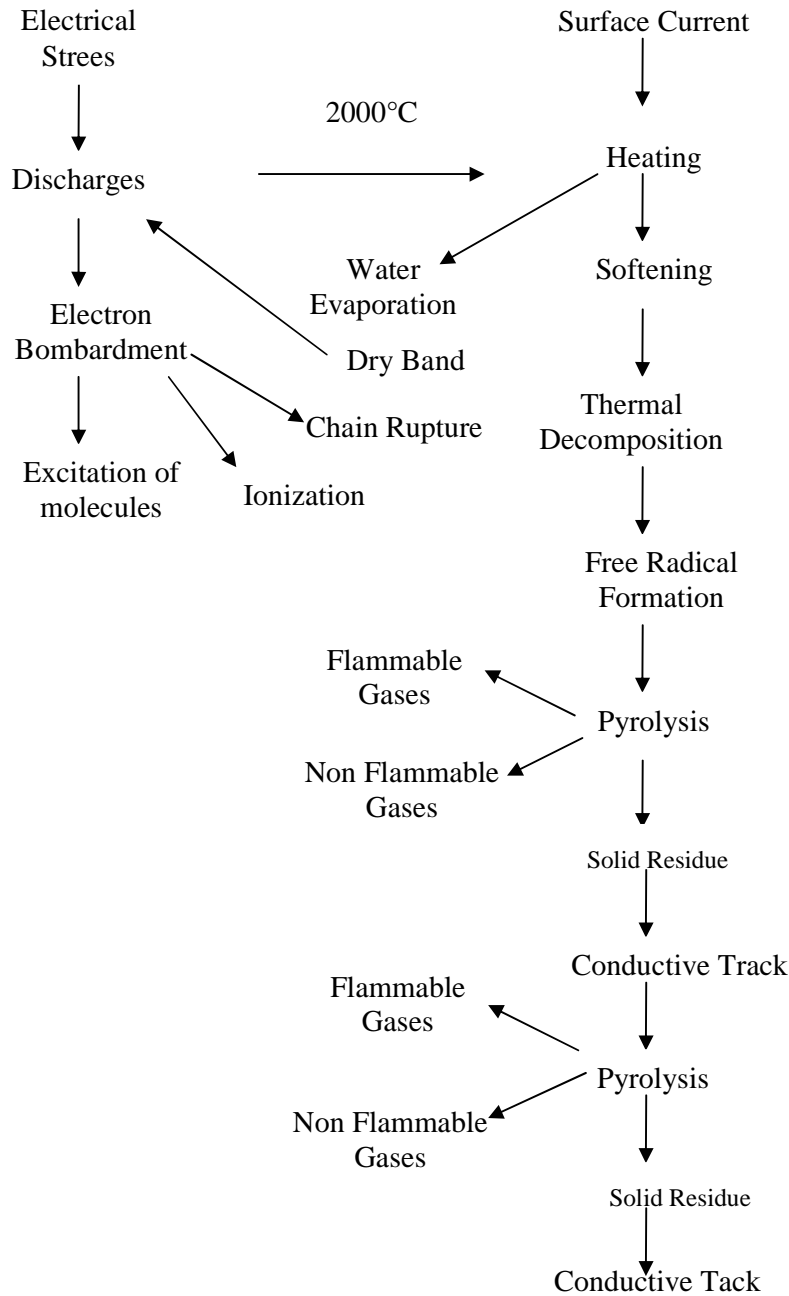

Scheme 2: Mechanism of polymer combustion

A high electric stress can be interface between conductor and polymeric insulator, due to the presence of non-uniform fields. This stress leads to local discharges with corona effects, even when the voltage difference between electrodes is not enough to cause complete flash-over. The effect of these discharges is polymer degradation with formation of a black track on the surface. The exact chemical mechanism of tracking degradation is not well defined, although there is some evidence concerning the formation of tracking residue [42]. However, pyrolysis

seems to have a major role in tracking process, which can be described, taking in account available information on mechanism of polymer combustion [44, 45] (Scheme 2).

Ethylene-propylene-diene monomer (EPDM) rubber, based on 5-ethylidene 2-norbornene (ENB) is well known to be very sensitive to oxidation [46, 47] compared with ethylene-propylene rubber (EPR). Conversely, EPDM is more stable than conventional elastomers (butadiene, isoprene rubber). The sensitivity of the ENB site is very useful for subsequent crosslinking by peroxide or sulfur. The ENB is present in low content (maximum 5%) and mainly responsible for oxidation. It is generally accepted that photo or thermo-oxidations starts on the ENB moiety and eventually reaches the ethylene-propylene units. Studies of oxidized raw EPDM have been reported in several papers [47-48]. The synthesis and the photooxidative properties of hydroperoxides, resulting from the EPDM oxidation, have been reported elsewhere [48].

2.3.1. Photo and thermal degradation

The relative instability of polyolefins to ageing is mainly due to the possibility of abstracting hydrogen atoms from the polymer chain. Such a reaction is quite difficult in the case of pure hydrocarbons but is made easier in the case of polymers because of the presence of by-products (catalyst residues, hydroperoxides from the processing etc.) [49]. The resulting macroalkyl radicals react quickly with oxygen leading to the formation of peroxy radicals, which finally convert into hydroperoxides by a second hydrogen abstraction (Scheme 3). Because of their instabilities, these thermal and photochemical hydroperoxides do not accumulate in the matrix but are decomposed into more stable products, such as ketones (also unstable in the case of photo-oxidation), carboxylic acids and alcohols. A stationary state in hydroperoxide concentration may arise when the formation rate is equal to the decomposition rate [50]. Thus, hydroperoxides are key products of the oxidation of most polymers and knowledge of their decomposition is of great interest for understanding the oxidation mechanisms. However, it is quite difficult to study the specific decomposition of hydroperoxides in an oxidized polymer as their concentrations are often low and they are always in the presence of other oxidation products. An interesting case is given by EPDM the ENB group is known to be a sensitive site for oxidations [47,51-53] probably because of the presence of hydrogen atoms in α positions of the double bond. In the case of photolysis, primary reactions are not strongly dependent on temperature and it is possible to follow the reaction by recording radical growth by ESR spectroscopy at low temperature [54,55].

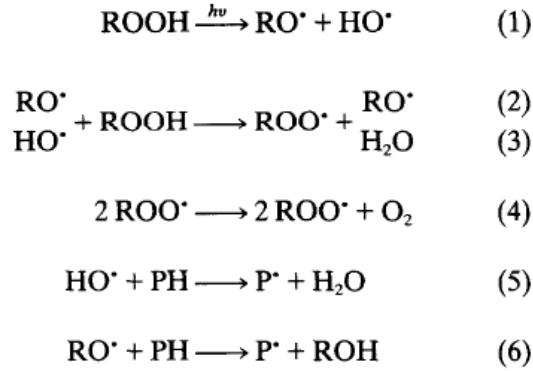

Scheme 3: Peroxides formation during degradation

The thermo-oxidation of EPDM was performed at 100°C. During the initial hours of oxidation (until 50 hrs), the decrease of a band at 1680 cm⁻¹ was observed and then the formation of an absorption band at 1715 cm⁻¹ with two shoulders at 1735 and 1775 cm⁻¹. We recognized the evolution observed on raw EPDM [48], characteristic of oxidation of ethylene-propylene units. For longer oxidation times, the IR results were different. The absorption band at 1715 cm⁻¹ decreased, while a band centered at 1580 cm⁻¹ increased. This effect is characteristic of the presence of zinc oxide in formulations [56]. Carboxylic acids are converted into zinc carboxylates absorbing at 1580 cm⁻¹. The carboxylates are then the main oxidation products. The carboxylate formation showed an induction period of a few hours, this effect was associated with acid formation before carboxylate conversion. The quantity of detected oxidized products on the surface of pristine EPDM is almost equivalent as the concentration determined for EPDM with ZnO. Zinc oxide does not seem to have catalytic effect on oxidation. The formation of a wide band between 3100 cm⁻¹ and 3600 cm⁻¹ has also been observed on unfilled EPDM in ATR-IR spectra. This band was due to the presence of several functional groups such as alcohols, hydroperoxides and carboxylic acids. The decrease of the double bonds at 808 cm⁻¹ characteristic of ethylidene norbornene can also be seen on cross-linked material. It is not very significant compared to pristine EPDM because of the small quantity of double bonds after cross-linking.

The EPDM formulation with carbon black has then been studied during thermal oxidation. After thermo-oxidation at 100°C an induction period of 300 hrs was determined by ATR-IR spectroscopy. After that time the formation of carbonylated products were visible with new bands at 1580 cm⁻¹, 1650 cm⁻¹ and 1715 cm⁻¹. The carboxylates are predominant on the material surface. A SF₄ treatment on a thermo-oxidized cross-linked material allowed the

characterization of acids and salts (1715 cm^{-1} and 1580 cm^{-1}) and converted the acids and carboxylates into acid fluorides at 1840 cm^{-1} . After 1500 h in oven, the oxidation rate measured on the sample surface did not increase. Several phenomena could explain this oxidation plateau. At this time of degradation, the material surface was very hard, so the contact between the ATR-crystal and elastomer was less satisfactory. Cross-linking reactions also happened during ageing. Gas permeability (N_2 , O_2 and CO_2) measurements allowed indirectly to underline these reactions. During thermo-oxidation at 150°C the chemical evolution of EPDM-carbon black presented the same changes in IR spectra. An induction period of 150 hrs was observed. However, the formation of zinc carboxylates was not dominant. This is different in the case of thermo-oxidation at 100°C . The ATR-IR analysis showed the positive influence of carbon black on thermo-oxidation of filled cross-linked EPDM. Its presence increased the duration of the induction period. Phenolic residues present on the surface of carbon black could explain this stabilising effect at 100 and 150°C . The hydroxylated and carbonylated oxidation products on filled EPDM seemed to be similar to the degradation products on unfilled EPDM. However, stoichiometry differences were observed on IR spectra. The carboxylates were dominant at 100°C . This phenomenon is probably associated with the quantity of thermo- products; the quantity is less important at that temperature.

The photo-oxidation of EPDM filled with carbon black has been studied. After an induction period of 15 hrs, the formation of hydroxylated and carbonylated products were rapid. The development of the four maxima at 1775 cm^{-1} , 1715 cm^{-1} , 1660 cm^{-1} and 1590 cm^{-1} was visible in the carbonyl region. Carboxylate formation was dominant in that case. In the deformation vibrations region, we have noted the reduction of bands characteristic from calcium carbonate (1425 cm^{-1} and 875 cm^{-1}) present on samples surface. A wide band was detected at around 1100 cm^{-1} . A wide absorption developed from 3300 to 3600 cm^{-1} . The carbon black has a positive influence on photo-oxidation of vulcanized elastomers. For important concentration of carbon black, a thermal coalescence phenomenon was observed [57].

2.3.2. Acid degradation

The chemical degradation of accelerated sulphur cured EPDM in aqueous acidic solution has been monitored for different periods of time. The results revealed the formation of several oxygenated species on the surface as a consequence of the acid attack. Furthermore, the cross-link sites of the exposed rubber samples are also found vulnerable to hydrolytic attack as evidenced by the decrease in cross-link density. The results [58] indicate that the chemical

degradation proceeds mainly via hydrolysis of cross-links but upon prolonged exposure. Aqueous acid induced chemical degradation of peroxide cured EPDM in the presence of triallylcyanurate (TAC) as coagent has been studied for different periods of time. The primary process of degradation is hydrolytic attack on the cross-link sites, which is manifested by a decrease in cross-link density. Importantly, the coagent used in this study is shown to enhance the chemical degradation through the formation of weaker sites for hydrolysis [59].

2.3.4. Plasma treatment

Plasma interacts in a numerous ways with polymer surface. At severe conditions, polymer surface is subjected to etching effects leading to polymer degradation. Plasma treatments have been used to reduce the friction coefficient of EPDM rubber due to cross-linking of the surface layer [60].

2.3.3. Ozone degradation

It is well known that ozone attack causes a reduction of molecular weight in polymer due to loss of C=C bonds and generates carbonyl, products and ozonides. EPDM has a good resistance to ozone due to extremely low content of unsaturation. After ozone degradation of EPDM it was observed there was an increase in the carbonyl group vibrations at 1720 cm^{-1} however, there is no change in the hydroxyl group between $3300\text{-}3500\text{ cm}^{-1}$ which are correlated to them. There are no major C-C bonds which are broken after the ozone attack but new low intensity bands appear at 1380 cm^{-1} indicating that ozonide formation takes place [61,62].

2.3.4. Effect of stabilizers on degradation

The addition of a phenolic antioxidant and hindered amine stabilizer (HAS) was not effective in the case of sulphur vulcanized EPDM. This behavior has been attributed to antagonisms between HAS and sulfur derivatives. These derivatives could interact with hydroperoxides; the formation of nitroxyl radicals (from HAS) would then be delayed [63]. The sulfur derivatives could give sulfur acids which could form a salt with HAS; HAS are then less active [64]. So researchers have focused on the synthesis of polymeric HAS, the high molecular weight stabilizers. The polymeric stabilizers, made by copolymerization of a monomer bearing HAS group with styrene and/or acrylate having high polarity, are less effective in hydrophobic polymers like polyethylene and polypropylene probably because of the poor dispersion. So, there is a demand for polymeric stabilizers containing HAS moieties, which can be fairly dispersed in the polymer and do not easily migrate to solvents. Wilen *et al.* [64] reported the

copolymerization of 4-(hex-5-enyl) 2,2,6,6-tetramethyl piperidine with polypropylene by using a heterogeneous catalyst. Several long chain HAS monomers with poly(propylene) and also a long chain HAS monomer were copolymerized with ethylene by using metallocene catalyst system. The efficient stabilizer should exhibit better miscibility, compatibility and less migration from polymer matrix to the solvent. It will be worthwhile to synthesize a polymeric stabilizer with appreciable molecular weight and better compatibility so that it can disperse well through out the matrix to show better performance.

With a proper material development and product design, they can offer high performance with desired service life. Developing of a polymeric material formulation is a complex optimizing process with a number of additives and fillers combined with the base polymer. Additives include antioxidants, plasticizers, pigments, curing agents, catalysts, flame-retardants, UV stabilizers, racking and erosion resistors, such as alumina trihydrate ($\text{Al}_2\text{O}_3 \cdot 3\text{H}_2\text{O}$: ATH), silica, processing aids and other compounds, depending on the specific product formulation [65]. In many cases, the additives and fillers are up to 80% by weight, and both collectively and individually determine the overall performance [65,66].

CHAPTER II

Materials and Experimental Techniques

1. Introduction of high voltage electric insulators

Electrical insulators are a very important component of electric power distribution systems and transmission lines. In the early days, insulators were made of ceramic and glass materials. Polymer insulators have been in use since 1963, over the course of time they have been improved by making improvements to their design and manufacturing processes, and are in abundant use these days. One of their major advantages is their low surface energy which helps them in maintaining a good hydrophobic surface property in the presence of wet conditions such as fog, dew, and rain. Their other advantages include:

- 1) Light weight which results in a more economic design of towers and also enables the upgrading of the voltage capacity of existing towers without any change in their dimensions. The light weight of the composite also permits an increase in the clearance distance between the conductor to ground and an increase in the phase to phase distance in order to reduce the electric and magnetic fields which are becoming a growing concern to some members of the general public. The light weight of the composite insulators also obviates the need to use heavy cranes for their handling and installation and this saves on the cost.
- 2) A higher mechanical strength to weight ratio which enables the construction of longer spans of towers.
- 3) Line post insulators are less prone to serious damages from vandalism such as gunshots which cause the ceramic insulators to shatter and drop the conductor to the ground.
- 4) They give much better performance in outdoor services in the presence of heavy pollution and withstand better voltage than porcelain and glass insulators.
- 5) Due to their easy installation, labour costs are saved.
- 6) The use of composite insulators reduces the maintenance costs such as insulator washing which is often required for ceramic and glass insulators in heavily contaminated environment.

1.1. Historical Development

The first polymers used for electrical insulators were bisphenol and cycloaliphatic epoxy resins. Introduced commercially in the mid 1940s, bisphenol epoxy resins were the first polymers used for electrical insulators, and are still used to make electrical insulators for indoor and outdoor applications. Cycloaliphatic epoxies (CE) were introduced in 1957. They are superior to bisphenol because of their greater resistance to carbon formation. However, the first commercial CE insulators failed shortly after installation in the outdoor environments. Since then, new CE formations have been resulted in the improved electrical performance. In the early

1960s, distribution class CE insulators were first sold commercially in the U.S. under the name GEPOL. These units failed due to surface damage and puncture. CE was used later in experimental 500 kV station breaker bushings, and in 115 kV bushings in the 1970s, and for suspension insulators by Transmission Development Limited (TDL) of England. The TDL suspension insulators used slant sheds to provide natural washing of contamination. From the mid 1960s on, CE insulators were tested at up to 400 kV service voltage as suspension / strain insulators and cross-arm in the United Kingdom. For various reasons, including poor cold temperature performance and insufficient weight reduction, CE did not gain acceptance in the US for outdoor high voltage suspension insulators but today, CE is widely used in indoor and even semi-enclosed power systems.

In the 1960s, an insulator having porcelain sheds supported by an epoxy resin fibre-glass rod, was developed. It was not widely used because of further developments in lighter-weight polymeric insulating materials. Polymeric outdoor insulators for transmission lines were developed as early as 1964 in Germany, and by other manufacturers in England, France, Italy, and the U.S. In Germany, units for field-testing were provided in 1967. In the late 1960s and early 1970s, manufactures introduced the first generation of commercial polymeric transmission line insulators. A large number of utilities started to experiment with the first generation composite insulators manufactured before the mid 1980s. The early experience was disappointing. Utilities initially installed these insulators in short sections of lines and at trouble spots, mostly for experimentation and data gathering. As a consequence of reported failures some manufacturers stopped producing high voltage units and others started an intensive research effort, which led to the second generation of composite transmission line insulators. These improved units have tracking free sheds, better corona resistance [67-70].

1.2. Structure of insulators

An example of a composite insulator (line insulator type) is shown in Figure 1a and its structure in Figure1b. The basic design for a composite insulator consists of three components and the design of each must be optimized to yield satisfactory electrical and mechanical performance over the lifetime of the insulators. The core or center of the insulator system is prepared from glass fiber reinforced polymer. This is reinforced with either polyester, vinyl ester or epoxy resin to provide the mechanical strength. Epoxy is the most widely used material for the rod. The metal end fittings are typically forged steel, ductile cast iron, malleable iron or aluminium and are selected for mechanical strength and resist corrosion. Their shape is important to limit the production of corona discharges which causes the polymeric material to

become brittle and may crack, leading to failure of the insulator by moisture ingress into the fiber-glass rod. The glass fiber reinforced plastics are very strong and are excellent insulators but they are not suitable for hostile outdoor environment hence, a polymeric housing is needed to protect the sensitive core from moisture, pollution and electrical discharges and they also provide the required leakage distance. The presence of dirt and moisture in combination with electrical stress, causes the material to degrade by tracking and erosion. Rubbers are used instead of ordinary plastics for housing material as they are flexible to follow the changes in dimension caused by temperature or mechanical load changes of the component, it covers. The housing material is made with a wide range of materials and formulations like silicone rubber, ethylene propylene diene rubber, ethylene vinyl acetate polymers (EVA) and cycloaliphatic and aromatic epoxy resins. Sometimes, blends of EPDM and silicone rubber are used to provide better mechanical properties such as stiffness of EPDM and excellent hydrophobic characteristics of silicone rubber. For low voltage indoor and outdoor applications, additionally high density polyethylene, polytetrafluoroethylene, polyurethane, polyolefin elastomers and other materials are employed. In the compounding of housing materials, fillers are added to enhance the resistance to tracking and erosion as well as to provide improved mechanical performance in tensile strength, abrasion resistance, tear strength, modulus and to reduce flammability. Typical fillers used are aluminium trihydrate or hydrated alumina and silica.

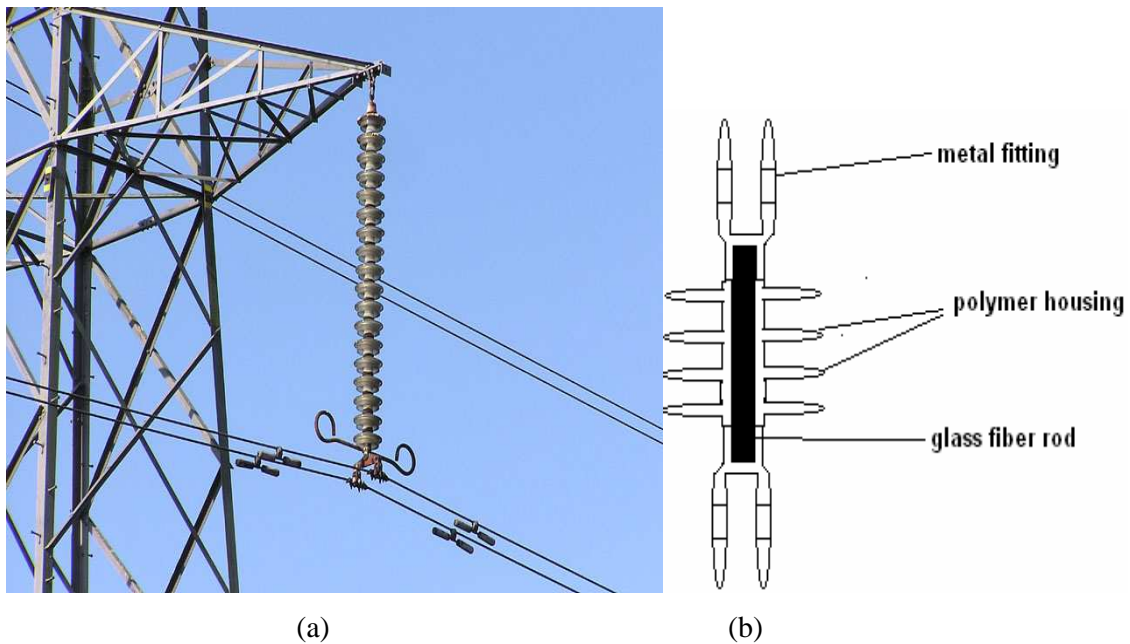

Figure 1 (a) Line insulators installed at electric power station (b) Structure of composite insulator

However, there are a few disadvantages of composite polymeric insulators:

- They are subjected to chemical changes of the surface due to weathering and from dry band arcing.
- They might suffer from erosion and tracking which might ultimately lead to their failure.
- It is difficult to evaluate the life expectancy of the insulators and faulty insulators are difficult to detect.

1.3 Materials used for study

1.3.1. Crude Silicones

In order to understand the ageing of the industrial formulations we have studied the ageing of different crude unfilled silicones having different terminations and different substituents attached to silicone and different molecular weights. All the crude materials were supplied by Sp² (Scientific Polymer Products) USA. The materials were used without any further purification for all the analysis. The details of the polysiloxanes used are given in Table 1.1.

Polymer	Catalog Number	Terminal group	Mw (g/mol)	Density (g/cc)	Reference
PDMS	145		115 000	0.976 (25°C)	S1
PDMS	807	dihydroxy	110 000	0.975 (20°C)	S2
PDMS	870	dihydroxy	90 000	0.98	S3
PDMS	808	acetoxo	36 000	0.98	S4
PDMS	809	methyldiacetoxo	36 000	1	S5
PMOS	798		11 000	0.886	S6
PMTS	799		9 400	0.89	S7

Table 1.1: Analytical data for polysiloxanes

1.3.2. Cross-linked Silicone

Silicone rubber (HTV) is polydimethylsiloxane and was provided by SEDIVER, France. The filled cross-linked PDMS consists of:

- curing agent 2,5 dimethyl 2,5di(t-butylperoxy) hexane
(CH₃)₃C-O-O-C(CH₃)₂-CH₂-CH₂-(CH₃)₂C-O-O-C(CH₃)₃ (DHBP) (approximately 0.4 parts)

-silica (approximately 23 parts)

-aluminium trihydrate (approximately 80 parts) as a flame retardant.

The curing time for compression moulding at 170°C was 12 minutes corresponding to the usual optimal curing conditions. Sheets having thickness of 2 mm or 6 mm were prepared for ageing and characterization. We have studied 3 different formulations of cross-linked PDMS having different percentage and types of treatments on the surface of ATH fillers.

We have presented in Figure 2.1 the typical ATR-IR spectra for filled silicone and attributed the different absorptions observed in Table 1.2.

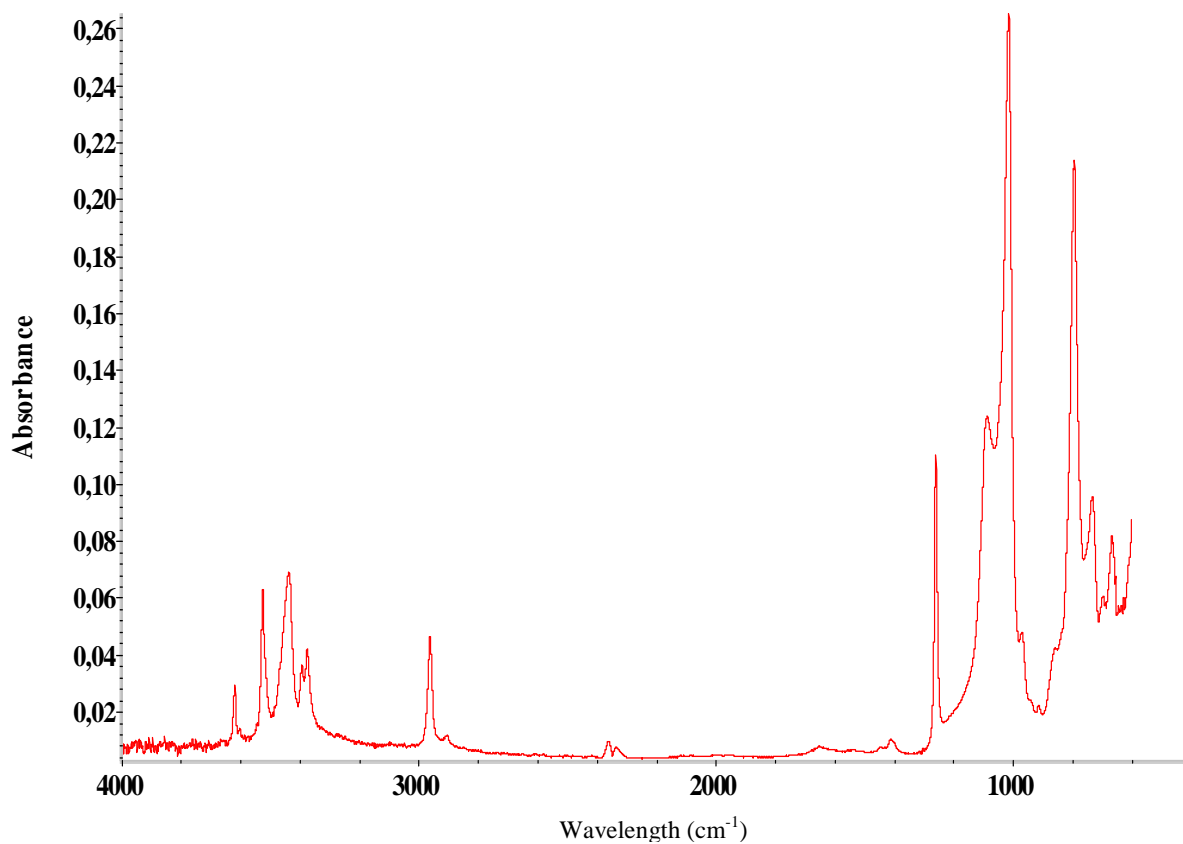

Figure 2.1 : ATR-IR spectra of filled silicone

Wavenumber (cm ⁻¹)	Tentative assignment
3615, 3524, 3432, 3375	ν OH of Al(OH) ₃
2960	ν CH in CH ₃
1646	ν C=C
1408	Not assigned
1256	ν CH in Si-CH ₃
1090	Si-O-Si
1010	Si-O-Si, Al-O
795	Si-O-C, Al-O
730	Al-O
665	Al-O

Table 1.2 : Main absorption observed for unaged filled uncross-linked PDMS then assignments of IR bands (ν = stretching vibration)

All the industrial samples were thermally stable up to 300°C under oxygen atmosphere and as can be seen in Figure 2.2. the weight loss takes place in three steps. Between 250°C and 300°C there is a small weight loss due to dehydration of Al(OH)₃. The decomposition of PDMS is then observed in two steps.

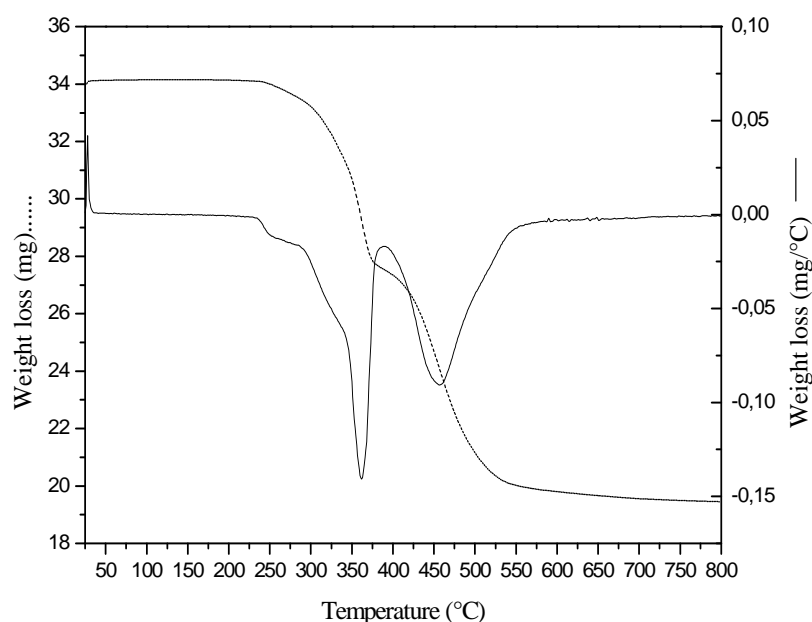

Figure 2.2 : TGA for unaged Silicone

The DSC thermogram of Silicone shows that is a semi-crystalline polymer with a crystallisation at -83° C, glass transition at -124° C and 2 peaks for fusion -35° C and 45° C.

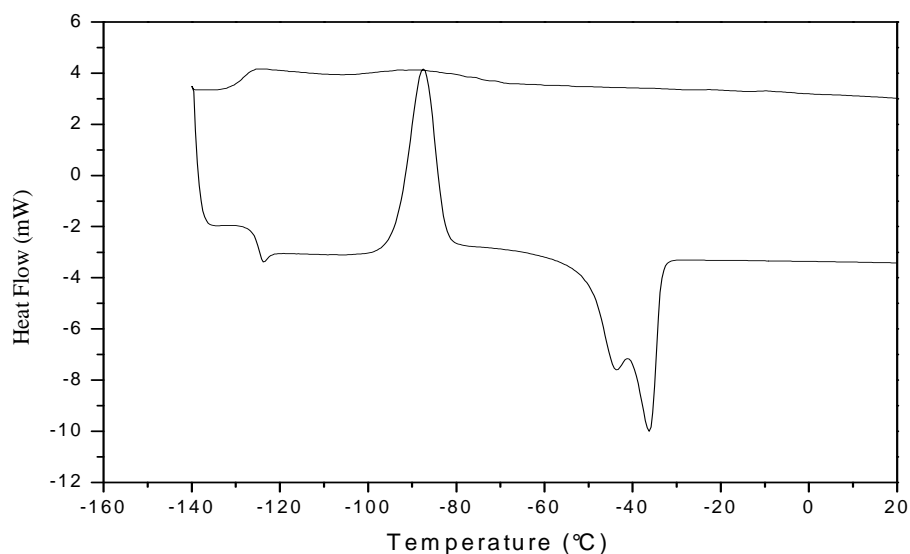

Figure 2.3 : DSC Thermogramme of Silicone

1.3.3. Cross-linked EPDM

The cross-linked filled EPDM we used for our studies was supplied by Sediver, France. It is composed of aluminium trihydrate (ATH) as filler, plasticizers, a peroxide, and an agent for stabilization. The curing time for compression moulding at 170°C was 12 minutes corresponding to the usual optimal curing conditions. Sheets having thickness of 2 mm or 6 mm were prepared for ageing and characterization. The composition is given in Table 1.3.

Composition	Quantity
EPDM	100 parts
Plasticizer	40 parts
Alumina Trihydrate	240 parts
Additives	5 parts
Dicumyl Peroxide	6 parts

Table 1.3: Composition of filled cross-linked EPDM

We have presented in Figure 2.4 the typical ATR-IR spectra for filled EPDM and attributed the different absorptions observed in Table 1.4.

The TGA analysis shows that the industrial formulations of EPDM are stable upto 250°C in oxygen atmosphere (figure 2.5). In the beginning of the decomposition we can see that

dehydration of $\text{Al}(\text{OH})_3$ takes place at 250°C which is followed by the decomposition of the main polymer backbone.

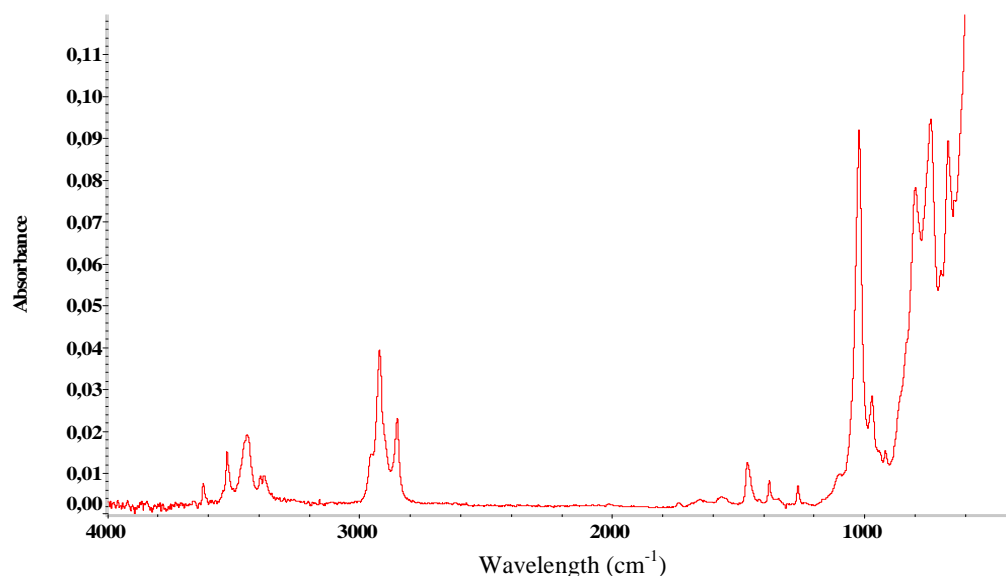

Figure 2.4 : ATR-IR spectra of filled EPDM

Wavenumber (cm^{-1})	Tentative assignment
3615, 3524, 3432, 3375	ν OH of $\text{Al}(\text{OH})_3$
2920, 2848	ν CH_3 symmetric and asymmetric (PE)
1457	δ CH_3
1376	δ CH_3
1259	δ CH
1016	Al-O
791	Al-O
728	Al-O
665	Al-O

Table 1.4 : Main absorption observed for unaged filled uncross-linked EPDM and assignments of IR bands (ν = stretching vibration; δ = in-plane deformation)

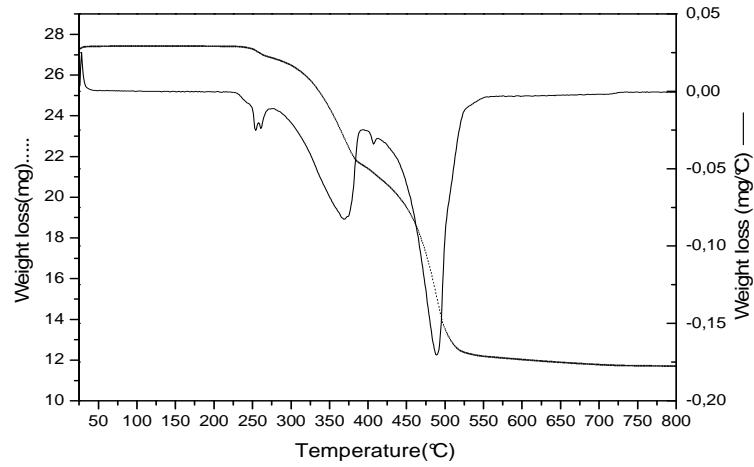

Figure 2.5: TGA thermogramme of EPDM

The DSC analysis showed that EPDM we used is amorphous as it is not having any crystallisation and fusion. It has a glass transition temperature of -60°C (figure 2.6).

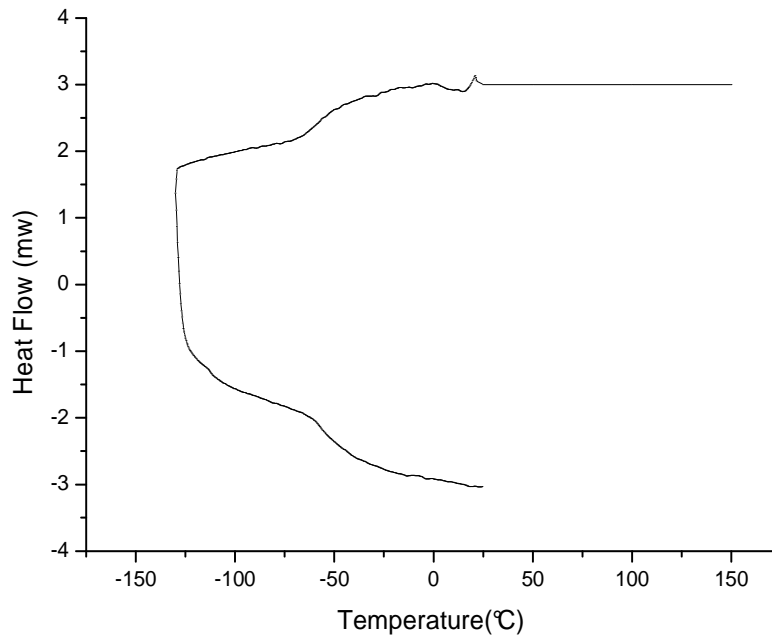

Figure 2.6 : DSC Thermogramme of EPDM

1.4. Techniques used for accelerated ageing

An accelerated photoageing is carried out using the irradiation device (SEPAP 12/24-ATLAS) which has been described previously [14,15]. The source used for light generation are

4 medium pressure mercury vapour lamps (Mazda MA 400W). They are covered with an envelope of borosilicate glass to emit radiations between 290 and 450 nm. Samples are rotated in a carousel at a constant distance (20 cm) from the sources. The temperature is controlled by the microprocessor which regulates the air input and the heaters. The air flow produced by two fans guarantees a homogenous temperature distribution on the sample surface. The Pt (Platinum) temperature sensor measures the temperature on the surface of the sample. The values are within a range of + 45°C to +80°C, with a $\pm 2^\circ\text{C}$ accuracy. The rate of acceleration for ageing in SEPAP 12/24 is 8 times under these condition for polypropylene compared to natural ageing in Clermont-Ferrand. The industrial samples were cut in smaller rectangular sheets and attached directly to the carousel. The irradiation was carried out at 60°C in SEPAP chamber (figure 2.7). Polysiloxane oils were irradiated in small glass tubes at the same temperature.



Figure 2.7: Photo-ageing device

We used an aerated oven (MEMMERT) for thermal exposure. The industrial formulations were aged at 100°C, while the crude materials were aged at 60°C and 100°C.

The salt-fog test usually used for metallic materials (H. Kohler – HK 320) was used for ageing of the industrial formulations. The test was carried out with the concentration of NaCl (5% weight) and the temperature of 35°C.

We used “laboratory desiccators” to carry out polluted ageing, such as nitric acid vapours or sulphuric acid vapours at room temperature. Samples were placed in small trays and acid solution (68% nitric acid or 95% sulphuric acid) at the bottom.

Plasma treatment was carried out in an Alcatel SCM 450 unit equipped with 13.56 MHz radio-frequency generator. The treatments were performed at a pressure of 1.33×10^{-2} mbar and 2.56×10^{-2} mbar with a mixture of argon, nitrogen and oxygen and power varying from 400W to 550W. The disk on which the samples were exposed to the plasma in the unit was rotated in order to obtain a uniform exposure to the specimens.

The ozone ageing was performed in ‘Laboratoire de recherches et de controle du caoutchouc et des plastiques (LRCCP)’ in Vitry sur Seine, France. The industrial formulations were aged for 8 weeks at 200ppm concentration and $(23 \pm 2)^\circ\text{C}$ without stress.

Natural ageings were performed near petrochemical sites in Texas or Saudi Arabia for 6 years. Laboratory electrical ageing were performed at 20 Kilo volts for 5 years.

1.5. Techniques used for characterisation

1.5.1 HATR-FTIR spectroscopy

The chemical changes upon irradiation were followed by Attenuated Total Reflection infrared (ATR-IR - Nicolet Impact 400 and Thunderdome accessory with germanium crystal). This spectroscopy is used for analysis of the top 2-3 micrometres surface of materials. It is also suitable for characterization of materials which are either too thick, flexible coloured or too strong absorbing to be analyzed by transmission spectroscopy.



Principle of the HATR technique

For the ATR-IR spectroscopy, the infrared radiation is passed through an infrared transmitting crystal with a high refractive index, allowing the radiation to reflect within the ATR element several times (except for thunderdome as it has only a single reflection). The sampling surface is pressed into intimate optical contact with the top surface of the crystal having high refractive index such as ZnSe or Ge. The IR radiation from the spectrometer enters the crystal. It then reflects through the crystal and penetrating “into” the sample a finite amount with each reflection along the top surface via the so-called “evanescent” wave. At the output end of the crystal, the beam is directed out of the crystal and back into the normal beam path of the spectrometer. To obtain internal reflectance, the angle of incidence must exceed the so-called ‘critical’ angle. This angle is a function of the real parts of the refractive index of both the sample and the ATR crystal:

$$\theta_c = \sin^{-1} (n_2/n_1)$$

Where n_2 is the refractive index of the sample and n_1 is the refractive index of the crystal. The evanescent wave decays into the sample exponentially with distance from the surface of the crystal over a distance on the order of microns. The depth of penetration of the evanescent wave d is defined as the distance from the crystal-sample interface where the intensity of the evanescent decays to $1/e$ (37%) of its original value. It can be given by:

$$d = \lambda / \{ 2\pi n_1 [\sin^2 \theta - (n_2/n_1)^2]^{1/2} \}$$

Where l is the wavelength of the IR radiation. For instance, if the ZnSe crystal ($n_1=2.4$) is used, the penetration depth for a sample with the refractive index of 1.5 at 1000cm^{-1} is estimated to be $2.0\mu\text{m}$ when the angle of incidence is 45° . The depth of penetration and the total number of reflections along the crystal can be controlled either by varying the angle of incidence or by selection of crystals. Different crystals have different refractive index of the crystal material. It is worthy noting that different crystals are applied to different transmission range (*ca.* ZnSe for $20,000\sim 650\text{cm}^{-1}$, Ge for $5,500\sim 800\text{cm}^{-1}$).

1.5.2. Differential Scanning Calorimetry (DSC)

DSC is a thermoanalytical technique in which the difference in the amount of heat required to increase the temperature of a sample and reference are measured as a function of temperature. Both the sample and reference are maintained at the same temperature throughout the experiment. The basic principle underlying this technique is that, when the sample undergoes

a physical transformation such as phase transitions, more (or less) heat will need to flow to it than the reference to maintain both at the same temperature. Whether more or less heat must flow to the sample depends on whether the process is exothermic or endothermic. For example, as a solid sample melts to a liquid it will require more heat flowing to the sample to increase its temperature at the same rate as the reference. This is due to the absorption of heat by the sample as it undergoes the endothermic phase transition from solid to liquid. Likewise, as the sample undergoes exothermic processes (such as crystallization) less heat is required to raise the sample temperature. By observing the difference in heat flow between the sample and reference, differential scanning calorimeters are able to measure the amount of energy absorbed or released during such transitions. DSC may also be used to observe more phase changes, such as glass transitions (Figure 2.8).

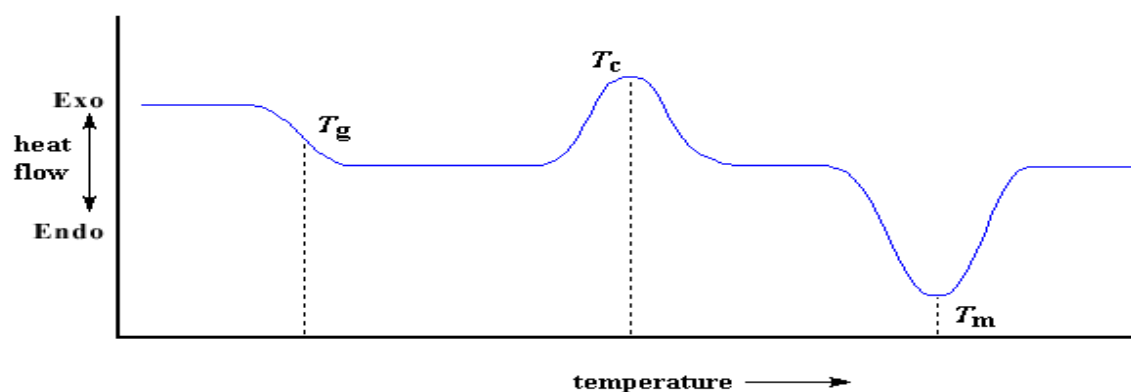

Figure 2.8: A schematic DSC curve demonstrating the appearance of several common features taking place in a polymer: T_g -Glass transition temperature, T_c -Crystallisation temperature, T_m -Melting temperature

The evolution of cross-linking is followed by DSC-thermoporosimetry a technique recently developed in our laboratory (LPMM). It is a calorimetric technique used for the visualization of the material texture by studying the phase transition (crystallization, melting or other change of state) undergone by the swelling solvent (cyclohexane) trapped in the polymeric network. The transition temperature of this confined solvent depends on the characterisation of the surrounding polymeric swollen network. The thermoporosimetry has essentially been applied to rigid porous substrates. It is assumed that a polymeric gel is equivalent to a three dimensional network of adjacent cells that is called mesh. The solvent swells the crosslinked polymer until equilibrium state is reached. It yields to a swollen gel where the solvent is present under two

environments : the confined solvent which is trapped inside the gel and the part of solvent which remains out and represents the excess (free solvent). The free solvent behaves like a pure solvent in term of phase transitions. On the other hand the confined solvent undergoes the phase transitions at different temperatures depending on the characteristics of surrounding polymeric network and especially depending on the size of the network mesh. The difference in the transition temperature ΔT between free and confined solvent can be related to the size of the mesh for elastomers. Differential Scanning Calorimetry can be used to measure ΔT precisely. Calibration have been done for obtaining useful thermodynamical data from the solid to solid cyclohexane transition [89]. The following empirical relationships have been established :

$$R(\text{\AA}) = 16.93 + 125.43 * \exp\left(-\frac{1/\Delta T + 0.0756}{0.0205}\right) \text{ with } -55 \leq \Delta T \leq 0^\circ\text{C for cyclohexane (1)}$$

$$\frac{dV}{dR} = K \frac{y^*(\Delta T)^2}{Wa * \exp\left(-\frac{1/\Delta T + 0.0756}{0.0205}\right)} \quad (2)$$

$$Wa(J / g) = 0.0203 * (\Delta T)^2 + 2.6034 * \Delta T + 82.199 \text{ with } 0 > \Delta T > -55^\circ\text{C (3)}$$

where $R(\text{\AA})$ is the distance between cross links in the swollen gel, expressed in *Angstrom* and $\Delta T = T - T_0$, the temperature depression of the swelling solvent determined from the thermal DCS curve with $T_0 = -88.63^\circ\text{C}$ for cyclohexane.

V is the volume of the solvent concerned by the thermal transition and contained in network cells, R is the distance between cross links, K is a proportionality coefficient that depends on both the DSC instrument and the swelling solvent, y is the DSC thermal curve ordinate and Wa the apparent energy of the solid-solid transition. DSC programme method used is -88°C to :

-106°C at $0.7^\circ\text{C}/\text{min}$ to see the crystalline solid-solid transition. A cryogenic microtome LEICA Jung Supercut LN20 was used at -50°C to cut the 2 mm sheets into small slices of $180 \mu\text{m}$ thick.

The DSC analyses have been carried out in two calorimeters :

- Mettler Toledo DSC822 equipped with two systems of cooling : an intracooler which permits cooling upto -65°C or another system using liquid nitrogen cooling upto -150°C .
- Mettler Toledo DSC30 using liquid nitrogen for cooling.

The calorimeters are controlled using STARE software and are calibrated with Indium (156°C), Zinc (420°C) and heptane (-92°C).

1.5.3. Photo-DSC

In Photo-DSC system the light beam provokes the photodegradation of the polymeric material while the DSC is used to measure the thermal consequences. A Mettler Toledo DSC822e apparatus, equipped with an Intracooler and a liquid nitrogen cooling was used. A Hamamatsu light generator equipped with a 'Lightningcure LC6' source (Xe/Hg, 'medium pressure') was affixed to the DSC device as represented in Figure 2.9. The light generator is servocontrolled by the DSC software (STARE) which permits a choice of both the light intensity from 0 to 324 mW/cm² and the duration of the irradiation. Two identical fiber bundles supply the irradiation light both to sample and reference DSC pans. The source is filtered by sapphire disks to deliver radiations of wavelengths longer than 300 nm. In this technique we can control the atmosphere used for carrying out the ageing. We have carried out all the experiments under air atmosphere.

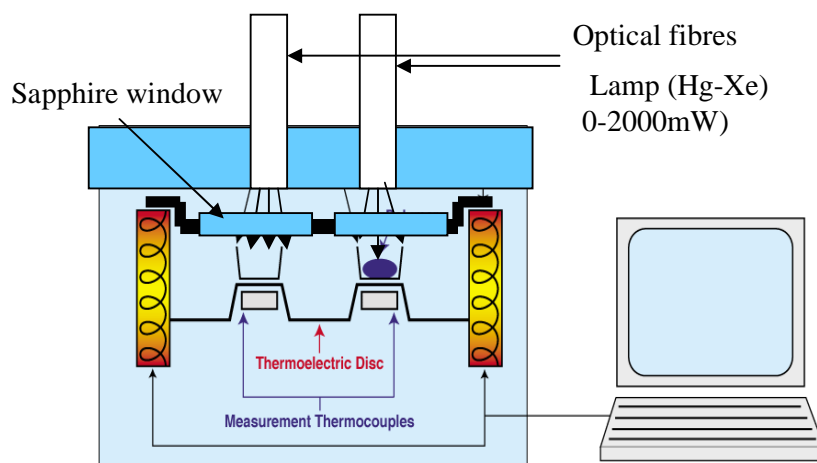

Figure 2.9 : Schematic representation of Photo-DSC

1.5.4. Thermogravimetric analysis (TGA) coupled with FTIR

TGA is a type of analysis performed on samples to determine changes in weight in relation to change in temperature. A derivative weight loss curve depicts the temperature at which weight loss is more apparent. We have used Mettler Toledo TGA/SDTA851 – Nicolet Nexus. The gases coming from TGA are transferred to a heating tube in a gas cell and characterized by FTIR spectroscopy. The temperature method was a dynamic segment from 25 to 800°C at 10°C/minute under oxygen or nitrogen (40ml/min). The IR spectra were recorded

every minute throughout the thermogravimetric program using the series option of OMNIC software.

1.5.5. Densimetry

The soluble fraction of crude polysiloxanes has been characterised by densimetry. Density measurements were done with an accurate vibrating densimeter tube (Anton Paar DMA 58). Solutions of crude silicone rubber formulation (before and after irradiation) were prepared in cyclohexane with the same ratio mass of polymer/solvent volume and hermetically sealed for 48 hours (material amount 0.165g in 5 ml of cyclohexane). After this equilibrium period two millilitres solution was taken from the liquid phase which represents the sol fraction and injected in the tube using a syringe. The accuracy of the instrument is $\pm 0.00001 \text{ g/cm}^3$. Air and water have been used for its calibration.

1.5.6. Hardness measurements

The hardness test measures the depth of an indentation in the material created by a given force. The depth is dependent on the hardness of the material, its viscoelastic properties and the duration of the test. We have done the tests with a Zwick Werk (NR 83195) – Shore A (weight 1 kg) system on 6mm thick polymer sheets before and after ageing. An average value of ten measurements on each sample was calculated.

1.5.7. Permeability to water-vapour

The instrument used to carry out the characterization is Mocon Permatran W3-33 with IR detection. The coefficients for transmission of water-vapour for films are determined according to ASTM F 1249 at 38°C and 90% relative humidity. The results are expressed in $\text{g/m}^2/24 \text{ hours}$. The surface analysed was 50cm^2 .

1.5.8. Size Exclusion Chromatography (SEC)

SEC is a high performance liquid chromatography technique used for the separation of components based on their molecular size in solution. (hydrodynamic volume) SEC separates the sample into its discrete components and determines its molecular weight distribution (M_w weight average molecular weight and M_n number average molecular weight). The solution of the polymer to be analyzed is introduced at the top of the column and then is eluted with a non solvent. The polymer molecules diffuse through the column at rates depending on their molecular size. As they emerge from the bottom of the column they are detected by a differential

refractometer or UV detector from which a molecular size distribution curve is plotted. The instrument we have used is of Viscotek having universal calibration. The detectors are refractive index detector (Viscotek VE 3580) and viscosimeter detector (Viscotek TriSec Model 270). The column is made of cross-linked PMMA with a flow rate of 1 ml per minute. The solvent used is HPLC grade Toluene.

1.5.9. Contact angle measurements

Contact angle is a quantitative measure of the wetting of a solid by a liquid. It is the angle formed by a liquid at the three phase boundary where a liquid, gas and solid intersect. Low values of contact angle indicate the liquid spread or wets well, while high value indicates poor wetting. It is more than 90° it is said to be non wetting. A zero contact angle represents complete wetting. We have used the the CAM unit (KSV instruments, France) having a firewire camera with telecentric optics and 55mm focus length. Distilled water has been used as the liquid for both EPDM and silicone. The set up of the instruments is shown in figure. 2.10.

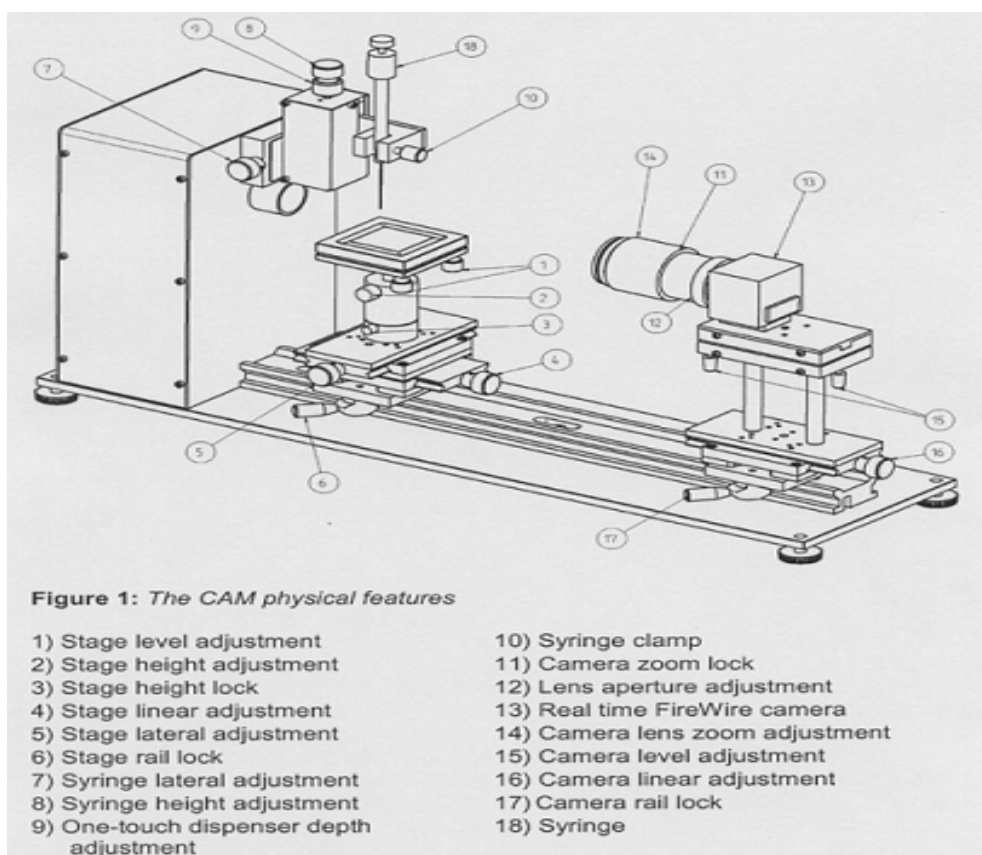

Figure 2.10 : Schematic representation of CAM Instrument

1.5.10. Resistivity measurements

Insulating materials are used in general to isolate components of an electrical system from each other and from the earth; solid insulating materials may also provide mechanical support. For these purposes it is generally desirable to have the insulation resistance as high as possible, consistent with acceptable mechanical, chemical and heat resisting properties. Surface resistance changes very rapidly with humidity while volume resistance changes slowly, although the final changes may be greater. The resistivity measurements have been performed in Sediver, St. Yorre, France. We have used the Keithley 6517 Hi-R Test model which can measure surface resistivity from 10^3 to 10^{17} ohms and volume resistivity from 10^3 to 10^{18} ohm-cm. Initial voltage used is 1000 volts. We have used the industrial formulations having 2 mm thickness for these tests. The samples were cut in circles having 8 cm diameter.

1.5.11. Conductivity measurements

The conductivity measurements have also been carried out in Sediver, St. Yorre, France. These measures are performed with a Schering bridge, and based on capacity measure and capacitor dielectric loss.

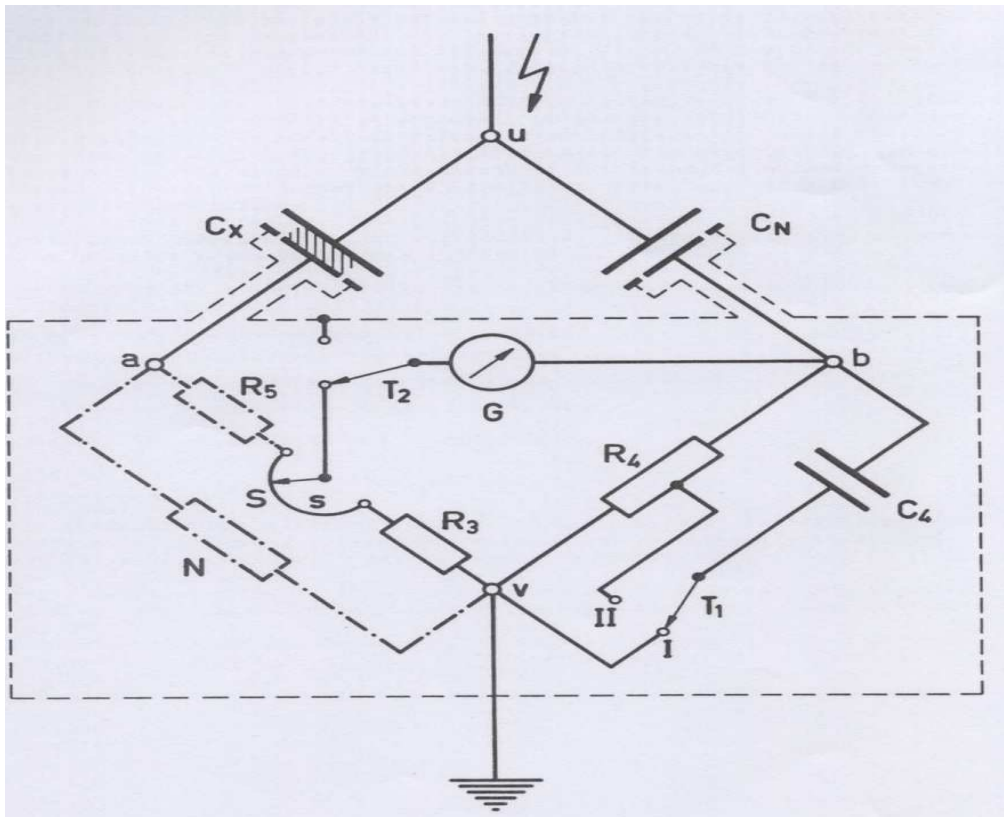

Figure 2.11 : Circuit diagram of Schering Bridge

We modify the R_4 , C_4 , and R_3 value until the galvanometer is at 0 in the Schering bridge.

Finally, $\tan \delta$ has been calculated using the formula below:

$$\tan \delta = \Pi \times R_4 \times C_4$$

We have used the industrial formulations having 2 mm thickness for these tests. The samples were cut in circles having 8 cm diameter.

1.5.12. Chemical methods

A number of chemical methods are used for identification of hydroxyl and carbonyl groups by FTIR spectroscopy. We analyse the samples before and after the chemical treatment to observe the new bands appearing and the old bands disappearing after the treatment to understand the transformations taking place.

Treatment by SF_4

The samples were exposed to SF_4 (sulphur tetrafluoride) (Fluka) gas at room temperature in Teflon reactor. The gas is allowed to pass in the reactor for 2-3 minutes and then it is sealed off for 15 mins to 2 hrs depending on the samples to allow the reaction to proceed. Carboxylic acids are known to react with SF_4 to give acyl fluorides (RCOF). The acyl fluorides are characterised by a distinct IR absorption band in the range 1810–1845 cm^{-1} the frequency of the maximum of this band is related to the structure of the acid. The SF_4 reaction gives a total disappearance of hydroxyl absorption (alcohols, hydroperoxides).

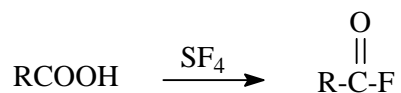

Treatment by NH_3

This treatment is also carried out in the same manner as SF_4 but the sealing times for it is 15-24 hours. The ammonia reacts with carboxylic acids, acid chlorides and esters to give the corresponding ammonium salts and amides by the following reactions.

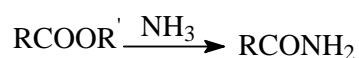
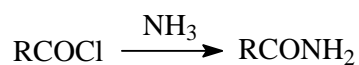
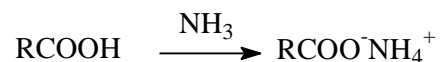

Results and Discussions

CHAPTER III

Study of Uncross-linked Polysiloxanes

CHAPITRE 3

INTRODUCTION

Le sujet de la thèse porte essentiellement sur des formulations complexes à base de polysiloxanes ou d'EPDM. Toutefois il nous a semblé opportun, après la réalisation de la bibliographie sur ces élastomères largement décrite dans le chapitre 1, de compléter l'étude par une approche plus fondamentale sur les polysiloxanes non réticulés et non chargés. Ce travail permettra de mieux appréhender le comportement en vieillissement des silicones par rapport aux réactions de réticulation en particulier. La connaissance des mécanismes de dégradation présente un intérêt fondamental et un intérêt pratique. En effet on peut espérer améliorer la stabilisation du matériau par intervention sur les différentes étapes de l'évolution chimique. Sept polysiloxanes (PDMS, polydimethyl siloxane – PMOS, polymethyl octadecyl siloxane – PMTS, polymethyl tetradecyl siloxane) ont été retenus pour l'étude. Les terminaisons sont différentes et nous avons une gamme de masses molaires (M_w) de 9400 à 115 000 g/mol. Le tableau récapitulatif des caractéristiques des matériaux est donné dans le chapitre 2 et dans les deux publications.

Ce chapitre donne lieu à deux publications inclus dans le texte. L'article "*Oxidation, chain scission and cross-linking studies of polysiloxanes upon ageings*" a été soumis à *European Polymer Journal* en octobre 2006. Cette première publication donne une analyse détaillée de l'évolution chimique, grâce à la spectroscopie infra-rouge avec accessoire ATR. L'étude des mesures de densité et de l'évolution de la masse molaire (GPC) fournit une approche complémentaire pour suivre le vieillissement de l'élastomère. Les vieillissements photochimique et thermique sont comparés.

L'article suivant "*Comparision of thermal properties and crystallization behaviour of polysiloxanes*" a été proposé à *European Polymer Journal* en août 2006. La comparaison des propriétés thermiques et de la structure chimique est étudiée par analyses thermiques (DSC et ATG-IRTF). L'utilisation de la photo-DSC permet en particulier de suivre l'évolution de la cristallisation pendant le photovieillissement. L'effet de la réticulation et des coupures de chaînes est finalement examiné mais avec des techniques complémentaire de celles utilisées dans l'article précédent.

CHAPTER 3

INTRODUCTION

The subject of this thesis primarily deals with complex formulations having polysiloxanes or EPDM as base materials. However after carrying out the literature study on these elastomers which has been documented in chapter 1, we felt it was necessary to supplement this study with a more fundamental approach on the uncross-linked and unfilled polysiloxanes. This work will make it possible to better understand the ageing behavior of silicones particularly the cross-linking reactions. The knowledge of the mechanisms of degradation is of fundamental and practical interests. Indeed one can hope to improve stabilization of the material by intervening in the various stages of the chemical evolution. Seven polysiloxanes (PDMS, polydimethyl siloxane -PMOS, polymethyl octadecyl siloxane - PMTS, polymethyl tetradecyl siloxane) are used for the study. They have different terminations and have a range of molar masses (M_w) from 9400 to 115 000 g/mol. The table of the materials characteristics is given in Chapter 2 and in the two publications in this chapter.

This chapter is in the form of two publications. The article "*Oxidation, chain scission and cross-linking studies of polysiloxanes upon ageings*" has been submitted to *European Polymer Journal* in October 2006. This first publication gives a detailed analysis of the chemical evolution, with the infra-red spectroscopy having ATR accessory. The study of measurements of density and the evolution of the molar mass (SEC) provide a complementary approach to follow the ageing of elastomer. Photochemical and thermal ageings are compared.

The next article "*Comparison of thermal properties and crystallization behaviour of polysiloxanes*" has been submitted to *European Polymer Journal* in August 2006. The comparison of the thermal properties and the chemical structure is studied by thermal analyses (DSC and ATG-FTIR). The use of photo-DSC makes it possible in particular to follow the evolution of crystallization during photoageing. The effect of the cross-linking and the chain scission is finally examined but using the techniques complementary to the ones in the previous article.

Publication – I

Oxidation, chain scission and cross-linking studies of polysiloxanes upon ageings

Abstract

Several polysiloxanes (polydimethyl, polymethyloctadecyl or polymethyltetradecyl-siloxane) were studied by FTIR spectroscopy, densimetry and gel permeation chromatography. Different types of ageings such as thermal ageing (60°C and 100°C), photo-ageing (SEPA) and acid vapour ageing were performed and compared. Oxidation, chain scission and cross-linking were estimated after ageings. The presence of pendant carbon chain in the backbone makes it susceptible to oxidation. The stability of the polysiloxanes without pendant carbon chain towards oxidation is confirmed after the various ageings. The difference of induction period for thermal exposure at 100°C and photo-ageing is quite surprising for oxidation of polymethyloctadecyl (or tetradecyl) siloxane. Cross-linking levels are dependant on the type of ageing.

N. S. Tomer, F. Delor-Jestin, L. Frezet and J. Lacoste

1 INTRODUCTION

Polysiloxanes are often used as protective coatings for a variety of specialized applications. The resistance at high temperatures to oxidation of the silicone backbone surpasses that of most dienic elastomers. However degradative processes appear when used for long term in outdoor conditions hence, it is important to identify the principal factors involved, so that degradation prevention can be applied.

The photochemical behaviour of polydimethylsiloxane (PDMS) oil has been examined previously [1-4]. Y. Israeli *et al.* have focussed in particular on the photoreactivity of the main substituent groups used in the silicone field. Photo-oxidations of PDMS oil with various content of hydride SiH, vinyl (in the polymer chain or at the end of the chain), dimethylene $-\text{CH}_2-\text{CH}_2-$, methine $-\text{CHCH}_3-$, MePh and Ph₂ groups have been studied. In the case of SiH-silicone, hydroperoxides are primarily formed and result from radical attack on the Si-H bonds. These unstable hydroperoxides are transformed essentially into silanols. SiH-PDMS is rather unstable in comparison with PDMS. The behaviour of SiH-PDMS depends weakly on the SiH content but strongly on the position on the SiH group. When SiH groups are located at the end of the chain, the oxidation rate is fairly high probably because of good accessibility of the reactive groups [1]. In the case of vinyl-PDMS the oxidation rates are lower than those observed in the case of SiH-PDMS [2]. Chain scission and direct oxidation of the vinyl group lead to a very complex mixture of photoproducts. The scission of Si-vinyl bond seems to be the main reaction. PDMS formed by hydrosilylation reactions containing dimethylene and methine groups [2] have similar oxidation rates of vinyl-PDMS. Thermal stability up to 200-250°C can be further improved by the substitution of methyl groups by phenyl groups [4]. The estimation of cross-linking of crude

silicone (*i.e.* without cross-linking agent) upon photoageing was also investigated with techniques such as densimetry and hardness measurements [5]. The stability towards oxidation was confirmed and unexpected facility to cross-link upon ageing was detected.

N.Grassie *et al.* have reported on the thermal stability of PDMS to 300°C under vacuum [6]. The incorporation of methyl-phenyl siloxane or diphenyl siloxane as a copolymer with PDMS has been shown to increase the onset temperature of degradation to nearly 400°C [7]. G. Deshpande and M.E. Rezac have shown that the decomposition products of vinyl terminated PDMS after inert atmosphere thermal degradation at 364°C were principally the cyclic oligomers hexamethyltrisiloxane and octamethyltetrasiloxane. The degradation of polydimethyldiphenylsiloxane resulted in the same conditions in the evolution of benzene in the initial stages of the reaction [8]. A kinetic study was proposed on the same materials by thermogravimetric analysis from 300°C to 925°C [9]. Thermal degradation of PDMS have also been studied by G. Camino *et al.*[10,11]. Thermal oxidative degradation in the presence of air gives results much different from the decomposition in nitrogen. Kinetic treatment shows that PDMS thermal volatilization, as rate of heating increases, becomes dominated by rate of diffusion and evaporation of oligomers produced on its decomposition [10]. The products of the thermal degradation are essentially determined by the temperature and the heating rate [11]. Gel Permeation Chromatography separates the molecules based on their hydrodynamic volumes eluting large molecules from the column before the smaller ones. The increase in molecular weight upon γ - radiolysis of polydimethylsiloxane has been reported by Hill *et al* [12]. They observed that the total yields for cross linking predominates over those for scission at all temperatures for radiolysis under vacuum. When radiolysis was carried out in air at 303K cross-linking was predominant but the nett yield of cross-linking was much less than that observed for radiolysis under vacuum. Howard Thomas *et al.* have studied the molecular weight and molecular weight distribution changes taking place during isothermal depolymerization of PDMS [13]. The residue left upon thermal depolymerization had lower molecular weight due to formation of cyclic dimethylsiloxanes and a broader molecular weight distribution as compared to the initial material. Hydroxy end blocked PDMS upon isothermal investigation below the depolymerization temperature have shown an increase in molecular weight due to intermolecular condensation of terminal hydroxy groups leading to cross-linking. Similar studies on molecular weight changes in model linear PDMS at 200°C in air were minimal upto 310 hours of oxidation, while a significant increase in M_w was measured after 1760 hours [14].

We have focussed our study on crude PDMS (without silica and any additives, uncross-linked) to have a better understanding of the long term behaviour of the resin and correlations between physical properties, chemical structure and ageing. Competitive ways of degradation such as oxidation, cross-linking and chain scission will be discussed to have a better understanding of the degradation mechanism.

2 EXPERIMENTAL

2-1- Materials

All polysiloxanes used for this study were provided by SP² (Scientific Polymer Products). The differences and the initial characterization of seven polysiloxanes are shown in Table 1. Most of samples are PDMS hydroxy or acetoxy terminated. Molecular weights (M_w) were in the range between 9 400 and 115 000 g/mol. Two samples PMOS (polymethyloctadecylsiloxane) and PMTS (polymethyltetradecylsiloxane) were chosen for their specific chemical structure.

Polymer	Terminal group	Mw (g/mol)	Density (g/ml)	Reference
PDMS		115 000	0.976 (25°C)	S1
PDMS	dihydroxy	110 000	0.975 (20°C)	S2
PDMS	dihydroxy	90 000	0.98	S3
PDMS	acetoxy	36 000	0.98	S4
PDMS	methyldiacetoxy	36 000	1	S5
PMOS		11 000	0.886	S6
PMTS		9 400	0.89	S7

Table 1 : Analytical data for the used polysiloxanes, given by Sp².

2-2- Ageings

An accelerated photoageing is carried out using the irradiation device (SEPAP 12/24-ATLAS) which has been described previously [15]. The system is characterised by the source, medium pressure Hg lamps filtered with borosilicate envelope ($\lambda > 300$ nm) and by careful control of the temperature with a thermocouple in close contact with one of the samples. Samples are rotated at a constant distance (20 cm) from the sources. The samples were irradiated at 60°C in a SEPAP chamber equipped with four lamps. Polysiloxanes were mainly liquids and irradiated in small glass tubes. We used an aerated oven (MEMMERT) for thermal exposure at 60°C or 100°C. We finally used dessicators to carry out polluted ageings, such as nitric acid vapours or sulphuric

acid vapours at room temperature. Sulphuric acid (95%), nitric acid (68%) were products purchased from Prolabo (VWR).

2-3- Analytical tools

The chemical changes upon irradiation were followed by FTIR-ATR (Attenuated Total Reflectance) spectroscopy with a Nicolet Impact 400 system. A Thunderdome accessory with germanium crystal was used. We analyze the surface of polysiloxanes upto a few micrometers.

The soluble fraction of crude silicone has been characterised by densimetry. Density measurements were done with an accurate vibrating densimeter tube (Anton Paar DMA 58, accuracy better than 0.00001 g/cm^3). Solutions of crude silicone rubber formulation (before and after irradiation) were prepared in cyclohexane with the same ratio mass of polymer/ solvent volume and hermetically sealed during 48 hours (material amount 0.165g in 5 ml of cyclohexane). After this equilibrium period two milliliters solution was taken from the liquid phase which represents the sol fraction and analysed at 20°C .

Size exclusion Chromatography measurements were carried out using a Viscotek instrument having universal calibration. Two types of detectors were used a viscosimetric detector and a refractive index detector. The mobile phase used was HPLC grade toluene with a flow rate of 1 ml/min and separation was achieved using a GMHxl column. The calibration curve was obtained using polystyrene standards. Solutions were filtered through $0.2\mu\text{m}$ filters before being injected into the column.

A number of chemical methods are used for identification of hydroxyl and carbonyl groups (oxidation products) by FTIR spectroscopy. We analyse the samples before and after the chemical treatment to observe the new bands appearing and the old bands disappearing after the treatment to understand the transformations taking place. The samples were exposed to SF_4 (sulphur tetrafluoride) (Fluka) gas at room temperature in Teflon reactor. The gas is allowed to pass in the reactor for 2-3 minutes and then it is sealed off for 2 hrs to allow the reaction to proceed. Carboxylic acids are known to react with SF_4 to give acyl fluorides (RCOF). The acyl fluorides are characterised by a distinct IR absorption band in the range 1810–1845 cm^{-1} . The NH_3 treatment is also carried out in the same manner as SF_4 but the sealing times for it is 15-24 hours. The ammonia reacts with carboxylic acids, acid chlorides and esters to give the corresponding ammonium salts and amides.

3 RESULTS AND DISCUSSION

3-1- FTIR spectroscopy results

FTIR-ATR spectroscopy was used to compare polysiloxanes and to detect their resistance towards oxidation. The different spectra obtained upon accelerated artificial photo-ageing or thermal ageing are quite similar to the initial spectrum (for unaged sample) even for long time exposure till 10,000 hours in oven or irradiation device (figure 1). No significant oxidative products can be detected for samples S1, S2, S3, S4 and S5, which are PDMS.

The spectra of PMOS (S6) et PMTS (S7) are quite different. The presence of aliphatic carbon chain is clearly detected with new bands at 2960, 2830 and 1470 cm^{-1} .

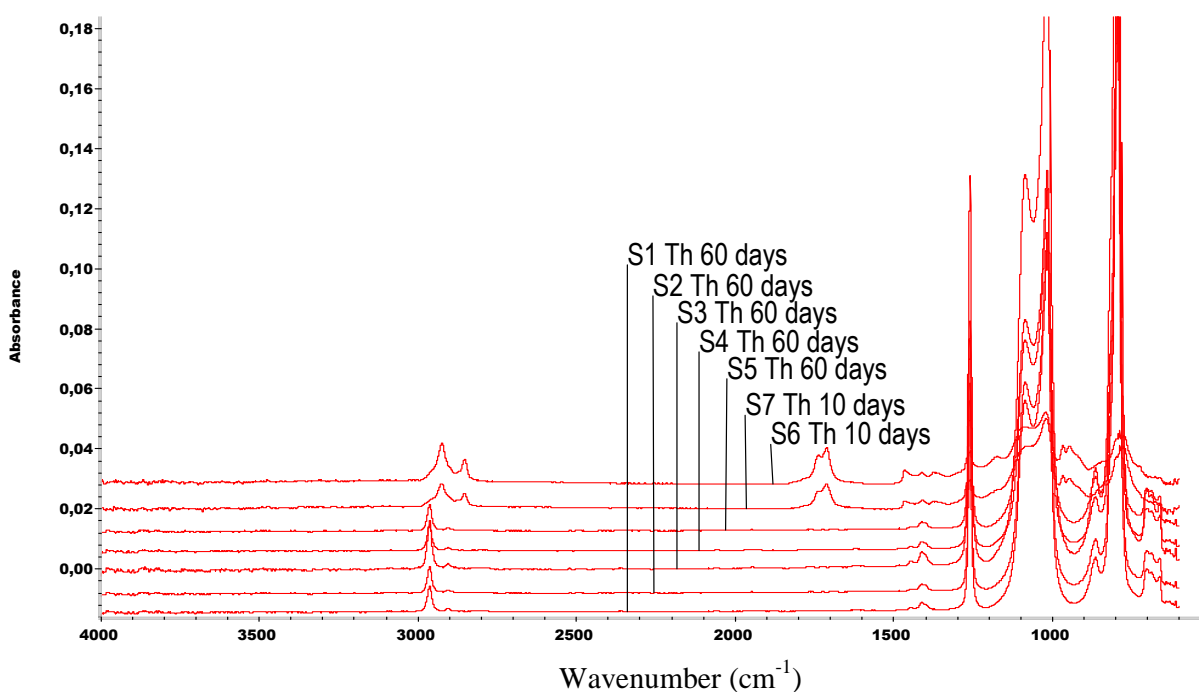

Figure 1: FTIR-ATR spectra for the seven references (S1-S7) after thermal ageing at 100°C

Oxidation products for S6 and S7 in the carbonyl absorption area were detected after thermal or photochemical ageing. Figures 2A and 2B give the detailed results for S6 and S7. The two samples showed very similar IR changes which can be summarized as follows: the formation of two distinct absorption bands at 1710 and 1735 cm^{-1} , which could be mainly assigned to carboxylic acid and ketones. This kind of oxidation is usual with hydrocarbon chain. The chemical structure of S6 and S7 allows to have a specific behaviour towards ageing and specific properties. The pendant carbon chain on these polysiloxanes reacted like a polyethylene. A comparison of thermo-oxidation kinetics (figure 2C) gives an induction period for S6 and S7 45

hours and 75 hours respectively at 100°C. No oxidation is detected for upto 400 hours after low temperature thermal ageing (60°C) and also after photo-ageing (SEPAP) for both S6 and S7. The difference of induction period for thermal exposure at 100°C and photo-ageing is quite surprising as compared with other polymers (polyethylene, polypropylene...).

It has been already shown that the crude PDMS (S3) was not oxidized after photochemical [1-4] thermal ageing or acid treatment (nitric or sulphuric) [16].

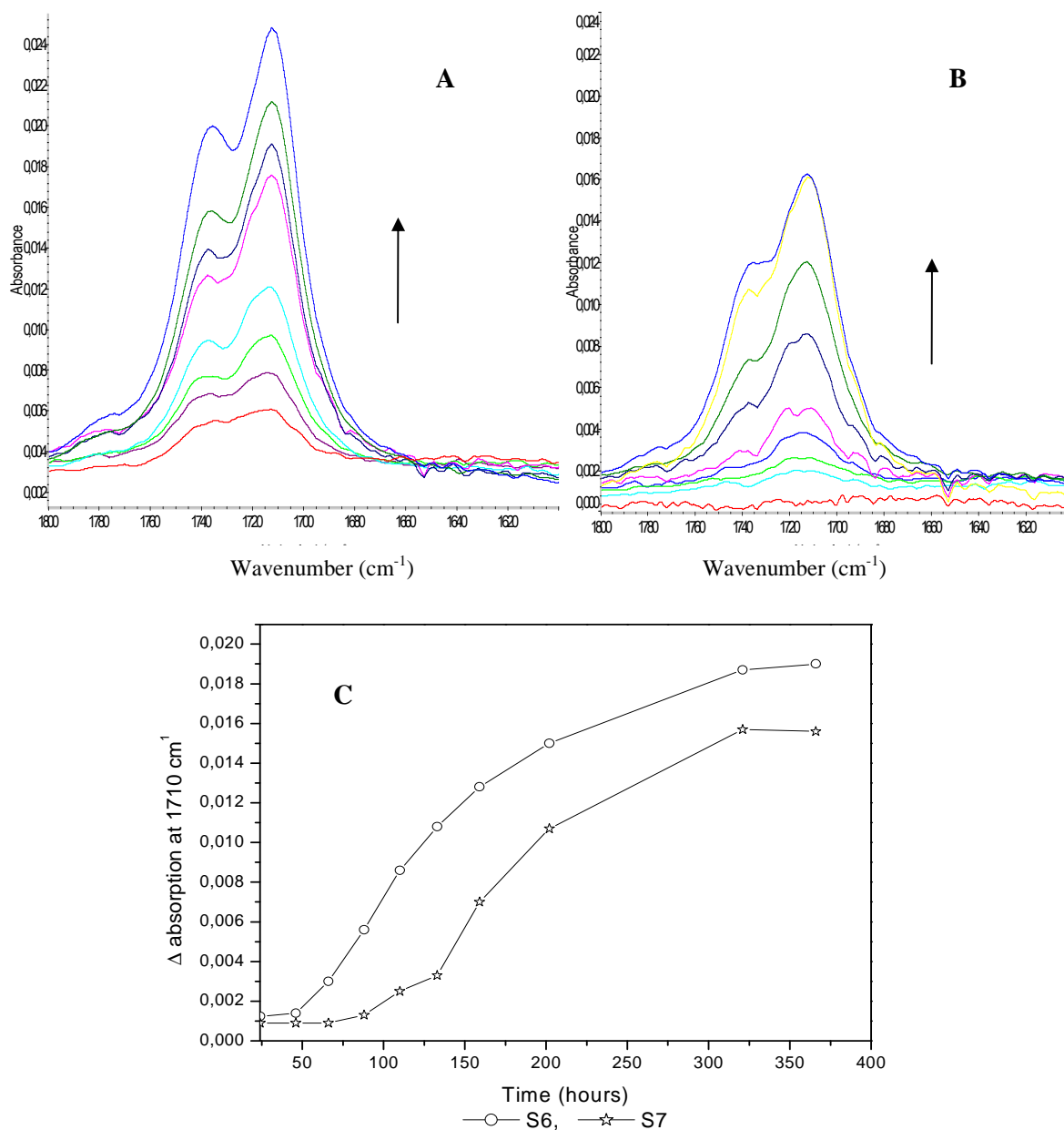

Figure 2: FTIR-ATR spectra upon thermo-oxidation at 100°C ; A- Carbonyl absorption area for S6; B- Carbonyl absorption area for S7 (times: T=0, 50 hrs, 100 hrs, 150 hrs, 200 hrs, 250 hrs, 300 hrs, 350 hrs)

We checked that the results were identical for S1, S2, S4 and S5. This means that the terminal chain (hydroxy, acetoxy or methylacetoxy) on PDMS does not affect the ability to oxidize. The behaviour of S6 and S7 was again different under nitric acid vapours. Figure 3 shows the specific results for S6. The appearance of several bands at 1540 and 1650 cm^{-1} is clearly detected and due to nitration products. There is no oxidation after sulphuric acid vapour exposure. Vapour pressure of nitric acid is 8 mm of Hg at 20°C while the vapour pressure of sulphuric acid is 1 mm of Hg at 145°C only. This difference of vapour pressure is probably the reason for the samples reacting easily with nitric acid, as compared with sulphuric acid.

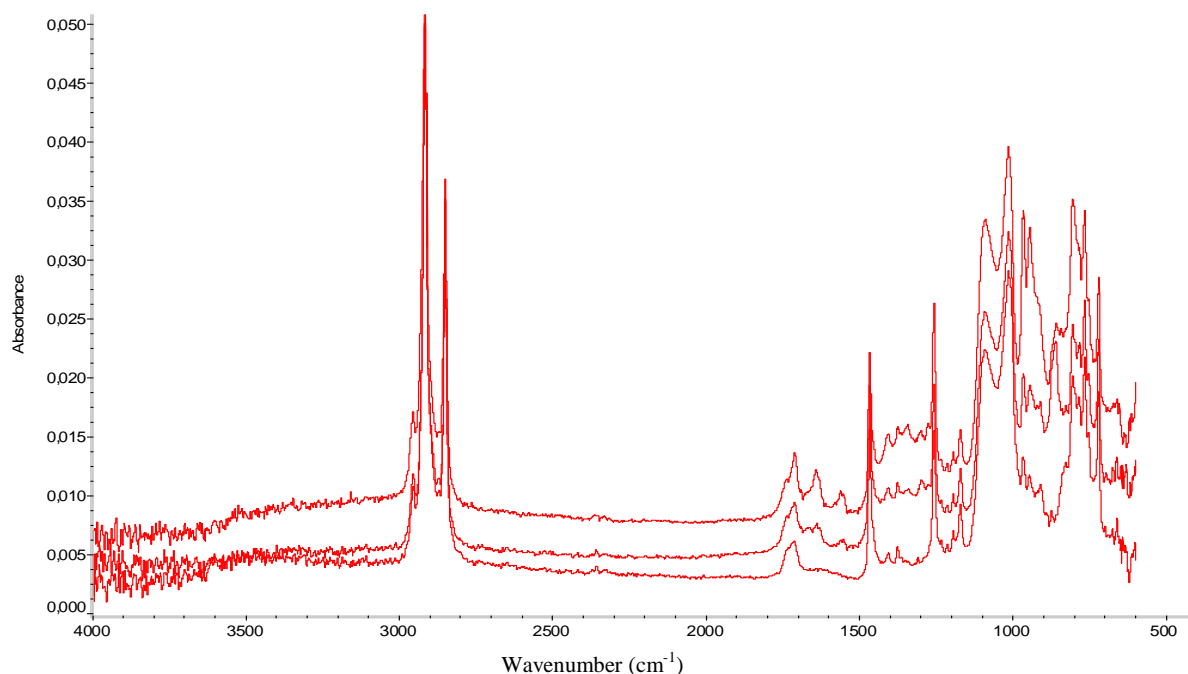

Figure 3 : FTIR-ATR spectra upon nitric acid treatment for S6 (PMOS)

3-2- Chemical treatments

SF_4 treatment was carried out on aged samples. It allows to detect specific oxidation products on aged samples S6 and S7. Acids (1710 cm^{-1}) were formed upon thermal-ageing and nitric acid treatment as shown on figures 4A and 4B and were transformed in acid fluorides (1840 cm^{-1}) with SF_4 . The same results were observed for S7. The polluted ageing with nitric acid vapours for samples S6 and S7 gave oxidation (acids) and nitration products. NH_3 treatment (fig. 4B) allowed also to determine the presence of acids.

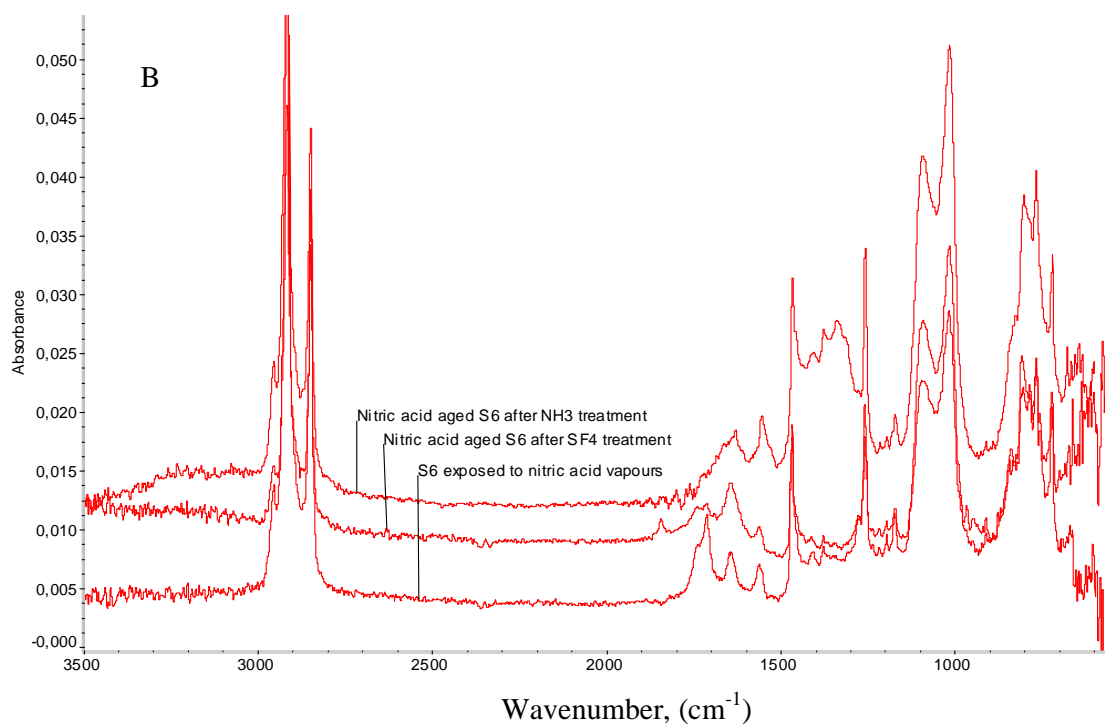
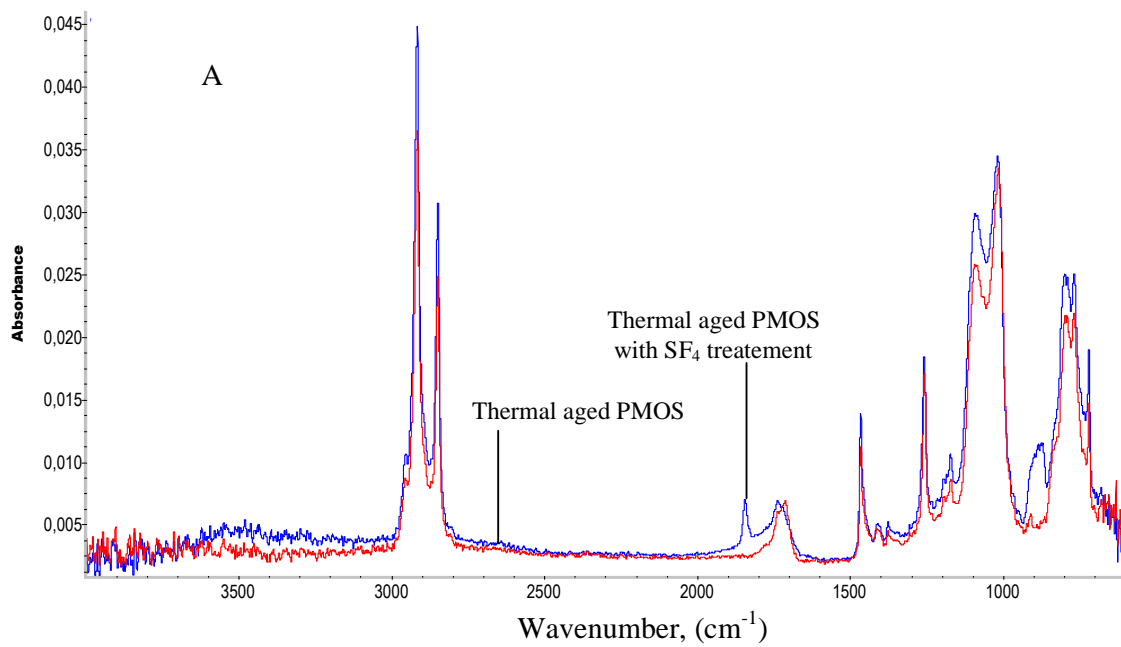

Figure 4: FTIR spectra A - SF₄ treatment on sample S6 (thermo-aged); B- SF₄ and NH₃ treatments on sample S6 (after nitric acid ageing).

3-3- Density measurements

The densimetry was then used to follow the eventual gel formation. The crude polymer is at the beginning completely soluble in cyclohexane, density is then maximum before irradiation. After

a few hours of irradiation we observed the formation of a gel insoluble in cyclohexane. By measuring the density loss of the soluble part in cyclohexane we can follow the branching of silicone formulation particularly before the gel point. Reproducible measurements were made in each case. Figure 5A represents the estimation of density for S3 after photochemical, thermal ageing and acid treatment. The three curves obtained are rather similar and show a rapid decrease of density during the first hours of exposure. Similar results were observed for all PDMS. But no significant decrease of density was observed for S6 and S7 upon irradiation in comparison to other samples (fig. 5B). This proves that hydroxy or acetoxy terminated PDMS are quickly cross-linked by ageing (in absence of curing agent such as peroxide). During the first hours of irradiation a gel fraction is observed, a network has been formed. The chains included in the network gave a gel fraction insoluble in cyclohexane. The density of the soluble part decreased as a consequence. After longer times (20 hours), we can observe a small increase of density, attributed to chain scissions, before reaching a stationary state. No induction period is seen for this cross-linking reactions.

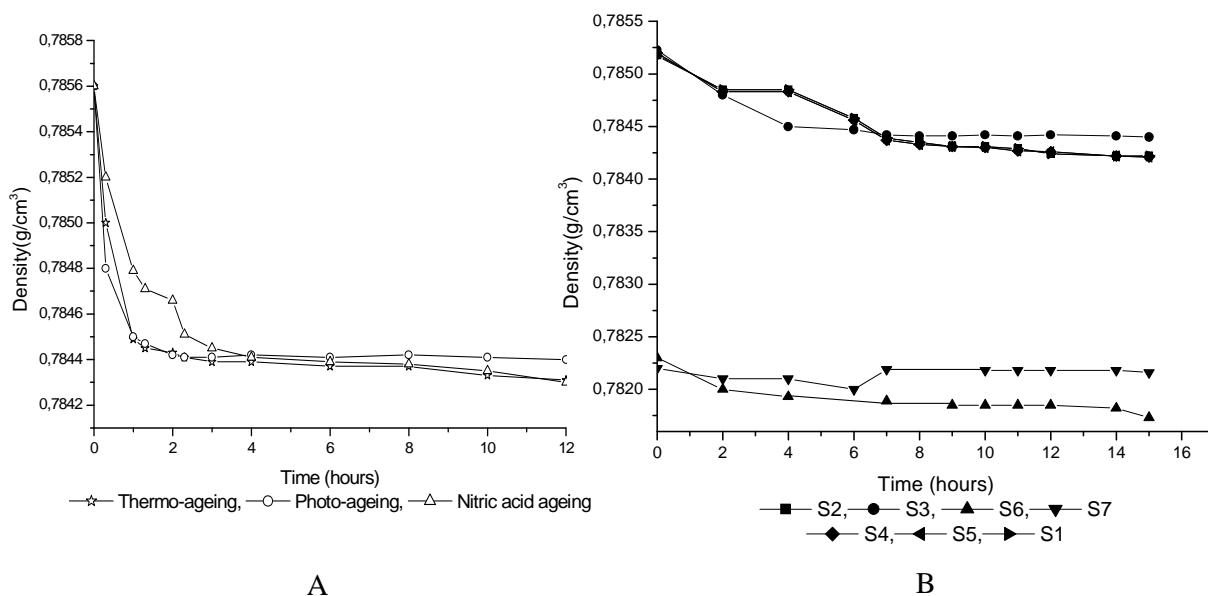

Figure 5: Densimetry results with cyclohexane ($\rho = 0.77858 \text{ g/ml}$); A- Comparison of photochemical (SEPAP), thermal ageings (60°C) and nitric acid treatment for S3; B- Comparison of all the samples after thermal ageing.

3-4- SEC results

For all the samples the changes in the molecular weight after various types of ageings was analysed by SEC. All the references showed an increase in molecular weight (weight average molecular weight M_w and number average molecular weight M_n) after photo-ageing and nitric acid vapour exposure after a few hours of exposure. The increase in molecular weight was very

rapid and almost double for the PDMS samples (Fig 6A, 6B). However there is no important change in the molecular weight of soluble part after thermal ageing at 60°C or 100°C for 20 to 75 hours. It means that the behaviour of PDMS is different under thermal or photochemical ageing. We observed that the areas of SEC peaks were increased during ageings for the same sample concentration. It means that chain scission mainly operated after 20 hours. Chain scission are favoured upon thermal ageing, in comparison with photo-ageing. The increase in molecular weight of soluble parts indicates that photo-ageing and nitric acid vapour exposure leads both to cross-linking and chain scission of the polymer.

We can also see that the hydroxy and acetoxy terminal groups almost have a similar effect for cross-linking reactions. The changes in molecular weight for S7 and S8 were not significant because of the initial low molecular weight. This kind of experiments only analyse the soluble fraction (like for densimetry) hence it is possible that a weak part of the strongly cross-linked material could be left on the filter and hence not analysed. To have a better understanding of the cross-linking level DSC was used in another paper [18].

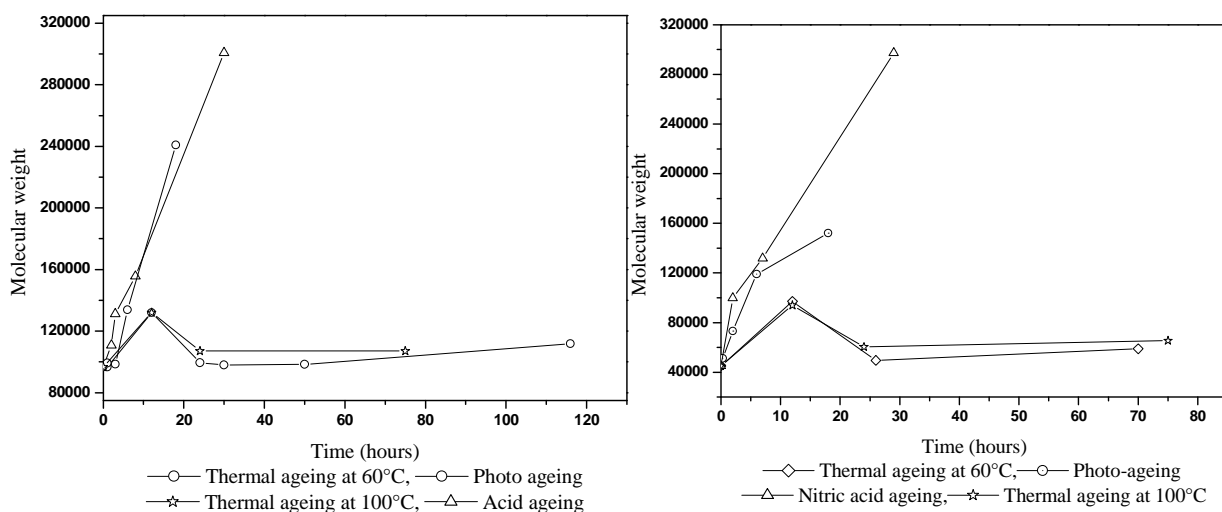

Figure 6: GPC results using toluene as solvent; A-Comparison of changes in molecular weight upon various ageing for S2; B-Comparison of changes in molecular weight upon various ageing for S4.

Conclusion

We can conclude that the main backbone substitution and terminal groups play an important role in the properties of polysiloxanes. We have summarized all the results in Table 2. It allows us to give structure-property relationships. Percentage crystallinity was determined by DSC [18]. Cross-linking is favoured in amorphous part of materials. S4 and S5 presented a decrease in

cristallinity upon ageing. After GPC experiments we can suggest that this phenomenon can be correlated to a higher cross-linking level for S4 and S5, compared to S1, S2 and S3.

The presence of carbon chain in the backbone makes it susceptible to oxidation. The stability of the polysiloxanes without carbon chain towards oxidation is confirmed after the various ageings. The five PDMS show almost similar behaviour upon ageing showing only cross-linking and chain scission reactions. With densimetry we showed that cross-linking reactions took place during the first four hours of ageing. With GPC we observed that the long term behaviour of PDMS is rather different upon thermal and photochemical ageings after 20 hours. Thermal ageing favoured mainly chain scission. Photo-ageing induced both chain scission and cross-linking reactions.

The behaviour of classical dienic elastomers is quite different as they have competitive schemes for degradation oxidation/cross-linking operating simultaneously. In the case of polysiloxanes we only have one way either cross-linking, or oxidation. An opposite behaviour is found for the samples S6 and S7, which presented a mechanism with oxidation. It means that cross-linking appears preferentially with methyl groups on PMOS and PMTS and PDMS (see scheme 1). Different experiments by Nuclear Magnetic Resonance (proton and carbon 13) were carried out to analyze the evolution of bridges during ageing, but were unsuccessful probably because of the very low content of CH₂-CH₂ bridges.

Ref	Mw (g/mol)	Chemical structure	Initial Cristallinity	Oxydation	Cross-linking
S1	115 000	PDMS	Approx. 10 %	No	Yes
S2	110 000	PDMS - hydroxy	15 %	No	Yes
S3	90 000	PDMS - hydroxy	20 %	No	Yes
S4	36 000	PDMS - diacetoxy	55 %	No	Yes
S5	36 000	PDMS - methylacetoxy	55 %	No	Yes
S6	11 000	PMOS	Amorphous	Yes	No
S7	9 400	PMTS	Semi-crystalline	Yes	No

Table 2 : Structure-property relationships

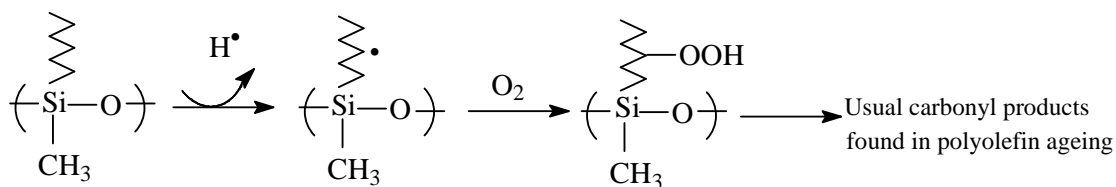

or

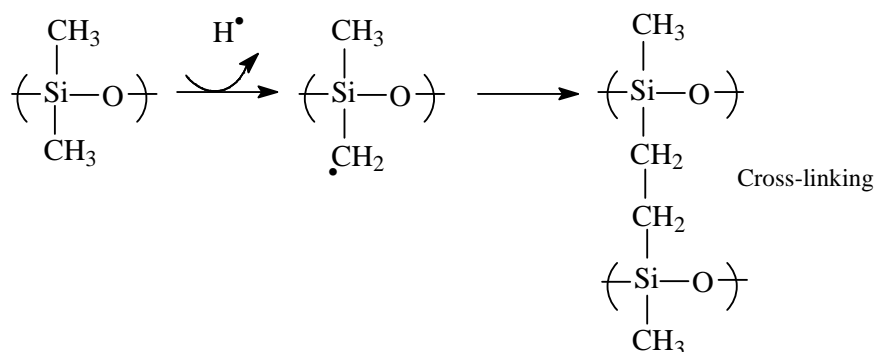

Scheme 1 Proposed mechanism of oxidation and chain scission and PDMS mainly taking place by cross-linking and is independent of the terminal group.

References

- [1] Israëli Y., Philippart JL., Cavezzan J., Lacoste J. and Lemaire J.; Polym Degrad Stab; 36;179-185; 1992.
- [2] Israëli Y., Cavezzan J., and Lacoste J.; Polym Degrad Stab; 37; 201-208; 1992.
- [3] Israëli Y., Lacoste J., Cavezzan J. and Lemaire J. Polym Degrad Stab; 42; 267-279; 1993.
- [4] Israëli Y., Lacoste J., Cavezzan J. and Lemaire J.; Polym Degrad Stab; 47; 357-362; 1995.
- [5] Virlogeux F., Bianchini D., Delor-Jestin F., Baba M and Lacoste J.; Polymer International; 53; 163-168; 2004.
- [6] Grassie N., Francey KF., Macfarlane IG.; Polym Degrad Stab; 2; 67-83; 1980.
- [7] Yilgol I., Yilgol E. Polymer Bulletin; 40; 525-532; 1998.
- [8] Deshpande G. and Rezac ME.; Polym Degrad Stab; 74; 363-370; 2001.
- [9] Deshpande G. and Rezac ME.; Polym Degrad Stab; 76; 17-24; 2002.
- [10] Camino G., Lomakin SM., Lazzari M. Polymer; 42; 2395-2402; 2001.
- [11] Camino G., Lomakin SM., Lazzari M.; Polymer; 43; 2011-2015; 2002.
- [12] Hill JTD., Preston ML., Salisbury DJ., Whittaker AK.; Radiation Physics and Chem; 62; 11-17; 2001.
- [13] Howard Thomas T and Kendrick TC. Journal of Polym Sci Part A-2; 7; 537-549; 1969.

- [14] Valles E., Sarmoria C., Villar M., Lazzari M., Chiantore O.; *Polym Degrad Stab*; 69; 67-71; 2000.
- [15] Penot G., Arnaud R and Lemaire J.; *Die Angew Makromol Chem*; 30; 493-499; 1992.
- [16] Delor-Jestin F., Tomer N., Singh RP and Lacoste J.; *e-Polymers*; 13; 1-13; 2006.
- [17] Aranguren MI.; *Polymer*; 39; 4897-4903; 1998.
- [18] Tomer NS., Delor-Jestin F and Lacoste J.; Submitted to *Polymer* in August 2006.

Publication – II

Comparison of thermal properties and crystallization behaviour of polysiloxanes

Abstract

The comparison between physical properties and chemical structure of several polysiloxanes (polydimethylsiloxane with different terminal group, polymethyloctadecylsiloxane and polymethyltetradecylsiloxane) was studied. Using the thermogravimetric technique (TGA) we could differentiate the thermal stability of the polysiloxanes in presence of oxygen, nitrogen and after ageing. TGA coupled with IR spectroscopy allowed us to distinguish volatile products resulting from decomposition. Photo-DSC was also used to study the effect of photo-ageing on the crystallization of the polysiloxanes. The resulting cross-linking or chain scissions are also investigated.

N. S. Tomer, F. Delor-Jestin, and J. Lacoste

1 INTRODUCTION

The stability of polysiloxanes at high temperature and its resistance to oxidation due to the higher bonding energy of the Si-O siloxane bond is well known. They can retain their elasticity and mechanical properties over a wide range of temperature. These properties have led polysiloxanes to be used for a wide range of industrial applications.

Detailed information on the thermal degradation of linear polydimethylsiloxane (PDMS) has then been obtained by studying the products resulting from exposing the polymers to a variety of conditions that lead to depolymerization [1]. The siloxane bond is the only bond involved in the depolymerisation process, while in the degradation process in oxygen, all the bonds are typically involved. N. Grassie *et al.* have reported on the thermal stability of PDMS to 300°C under vacuum [2]. The incorporation of methyl-phenyl siloxane or diphenyl siloxane as a copolymer with PDMS has been shown to increase the onset temperature of degradation to nearly 400°C [3]. G. Deshpande and M. E. Rezac have shown that the decomposition products of vinyl terminated PDMS after inert atmosphere thermal degradation at 364°C were principally the cyclic oligomers hexamethyltrisiloxane and octamethyltetrasiloxane. The degradation of polydimethyldiphenylsiloxane in the same conditions resulted in the evolution of benzene in the initial stages of the reaction [4]. A kinetic study was proposed on the same material by thermogravimetric analysis from 300°C to 925°C [5]. Thermal degradation of PDMS have also been studied by G. Camino *et al.*[6,7]. Thermal oxidative degradation in the presence of air gives results much different from the decomposition in nitrogen. Kinetic treatment shows that PDMS thermal volatilization, as rate of heating increases becomes dominated by rate of diffusion and evaporation of oligomers produced on its decomposition [6]. The products of the thermal degradation are dependant on two parameters: the temperature and the heating rate [7].

Model PDMS subjected to thermal weathering at 200°C (in air circulating oven) were characterized by gel permeation chromatography [8]. Loss of average molecular weight and broadening of molecular weight distributions was observed. The thermal degradation seems to proceed by a mechanism where chain scission predominates at the beginning, contrary to what is seen in γ -irradiation of PDMS.

Y. Israeli *et al.* have examined the photochemical behaviour of polydimethylsiloxane (PDMS) [9-12]. Photo-oxidations of PDMS oils with various content of hydride SiH, vinyl (in the polymer chain or at the end of the chain), dimethylene $-\text{CH}_2-\text{CH}_2-$, methine $-\text{CHCH}_3-$, MePh and Ph₂ groups have been studied. The evaluation of cross-linking of silicone upon photoageing was also investigated with techniques such as densimetry and hardness measurements [13]. The stability towards oxidation was confirmed and unexpected facility to cross-link upon ageing was detected.

There are very few papers in the literature for the properties of crude polysiloxanes (without silica and any additives, uncross-linked). We have focussed our study on several crude polysiloxanes (polydimethylsiloxane with different terminal group, polymethyloctadecylsiloxane and polymethyltetradecylsiloxane) to have a better understanding of structure-property relationships. We have compared the thermal properties of the different polysiloxanes and the volatile products emitted during thermal degradation. We have given new results on the long term behaviour of these specific elastomers. By using photo-DSC (Differential Scanning Calorimetry) a new technique which allows to measure *in-situ* the changes in thermal transitions taking place upon photo-ageing in DSC furnace, we report on the crystallization behaviour of polysiloxanes.

2 EXPERIMENTAL

2-1- Materials

All polysiloxanes used for this study were provided by Sp² (Scientific Polymer Products, USA). The differences and the initial characterization of seven polysiloxanes are shown in Table 1. Most of samples are PDMS ($-(\text{CH}_3)_2\text{SiO}-$) hydroxy or acetoxy terminated. Molecular weights (M_w) were in the range between 9 400 and 115 000 g/mol. Two samples PMOS (polymethyloctadecylsiloxane, $-(\text{CH}_3)(\text{C}_{18}\text{H}_{37})\text{SiO}-$) and PMTS (polymethyltetradecylsiloxane, $-(\text{CH}_3)(\text{C}_{14}\text{H}_{29})\text{SiO}-$) were chosen for their specific chemical structure. Nitric acid (68%) was product purchased from Prolabo (VWR).

Polymer	Reference	Catalog Number	Terminal group	Mw (g/mol)	Density (g/cc)
PDMS	S1	145		115 000	0.976 (25°C)
PDMS	S2	807	dihydroxy	110 000	0.975 (20°C)
PDMS	S3	870	dihydroxy	90 000	0.98
PDMS	S4	808	acetoxo	36 000	0.98
PDMS	S5	809	methyldiacetoxo	36 000	1
PMOS	S6	798		11 000	0.886
PMTS	S7	799		9 400	0.89

Table 1 : Analytical data for the used polysiloxanes, given by Sp².

2-2- Ageings

An accelerated photoageing is used. The irradiation device (SEPAP 12-24) has been described previously [14]. The system is characterised by the source, medium pressure Hg lamps filtered with borosilicate envelope ($\lambda > 300$ nm) and by careful control of the temperature with a thermocouple in close contact with one of the samples. Samples are rotated at a constant distance (20 cm) from the sources. The samples were irradiated at 60°C in a SEPAP chamber equipped with four lamps. Polysiloxanes were irradiated in small glass tubes. The photo-DSC system was also used for direct *in-situ* irradiation (see 2-3). We used an aerated oven (MEMMERT) for thermal exposure at 100°C or 60°C. We finally used laboratory dessicator to carry out polluted ageing with nitric acid vapours at room temperature.

2-3- Analytical tools

TGA-FTIR (Mettler Toledo TGA/SDTA851 – Nicolet Nexus) was used to study the thermal stability of the materials. The gases coming from TGA are transferred through a heating tube in a gas cell and characterized by FTIR spectroscopy. The temperature programme was a dynamic segment from 25° to 700°C at the rate of 20°C/minute under oxygen or nitrogen (40ml/min). The IR experiments were done every minute during the entire thermogravimetric program.

Photo-DSC was then used to characterize the evolution of crystallinity during ageing. A Mettler Toledo DSC822 apparatus, equipped with an Intracooler and a liquid nitrogen cooling set was used. It allows working between 500°C and -150°C with a scanning temperature rate from 0.1°C/h to 50°C/min. Indium (156.61°C), zinc (419.58°C) and heptane (-90.61°C) were used to calibrate this apparatus. A Hamamatsu light generator equipped with a “Lightningcure LC6” source (Xe/Hg, “medium pressure”) was affixed to the DSC device [15]. The light generator is

servo-controlled by the DSC software (STARe) which permits a choice of both the light intensity from 0 to 324 mW/cm² and the duration of the irradiation. Two identical fiber bundles supply the irradiation light both to sample and reference DSC pans. The source is filtered by sapphire disks to deliver wavelenghts longer than 300 nm, which is representative of outdoor ageing. The different intensities tested were: 16, 31, 68 and 146 mW/cm².

The enthalpies of fusion ΔH_{th} reported in the literature for crystalline linear PDMS are in the range 30-36 J.g⁻¹ [1].

3 RESULTS AND DISCUSSION

3-1- TGA-FTIR results

The thermal stability of polysiloxanes has been assessed in oxygen atmosphere and in nitrogen atmosphere. In Table 2 we have summarized the TGA results for all the polysiloxanes.

Reference	Under oxygen		Under Nitrogen	
	Temperature of onset of degradation(°C)	Total weight loss % (average value +/- 2%)	Temperature of onset of degradation(°C)	Total weight loss % (average value +/- 2%)
S1	340	51%	400	93%
S2	340	42%	400	85%
S3	340	45%	400	85%
S4	350	82%	410	96%
S5	300	42%	390	93%
S6	220	88%	230	95%
S7	220	81%	230	90%

Table 2 : Total weight loss after TGA of polysiloxanes (before ageing)

We observed that the thermal stabilities of samples S1, S2 and S3 were identical as their temperature for onset of degradation and total weight loss were similar. In oxygen atmosphere degradation takes place in one step due to decomposition of Si-O-Si backbone (figure 1A).

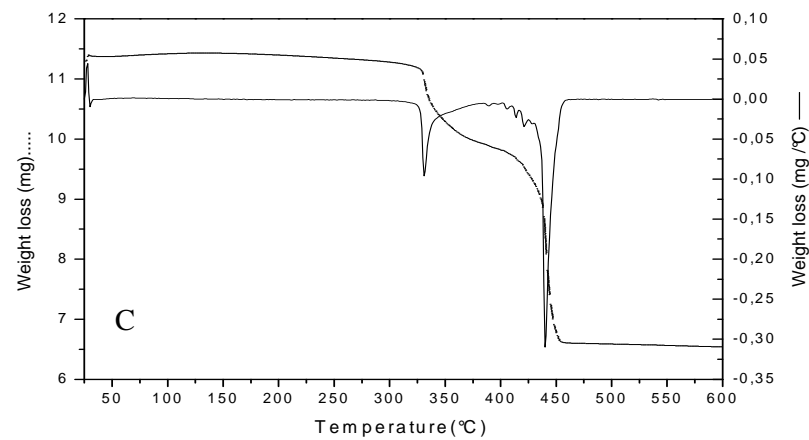
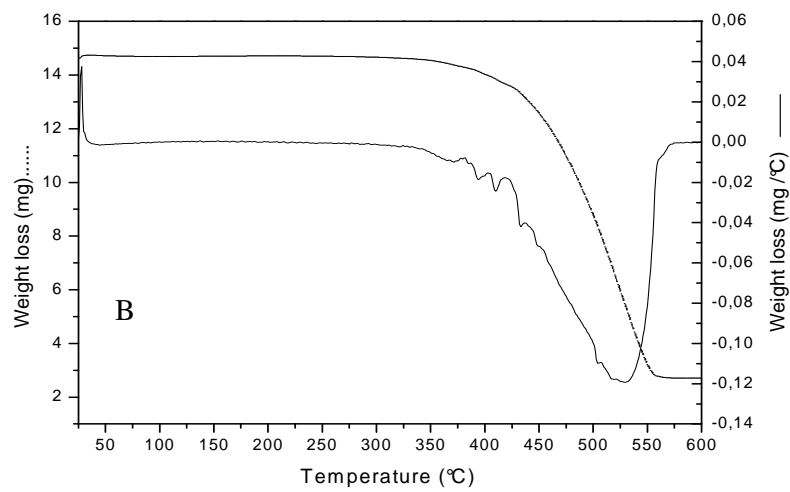
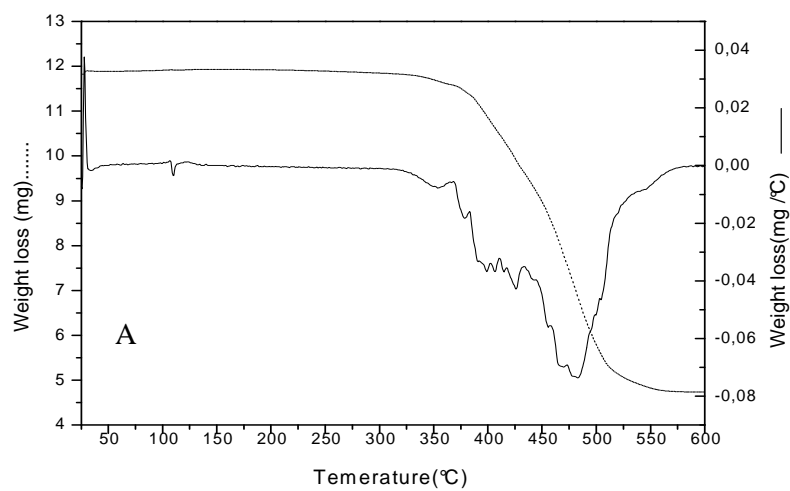

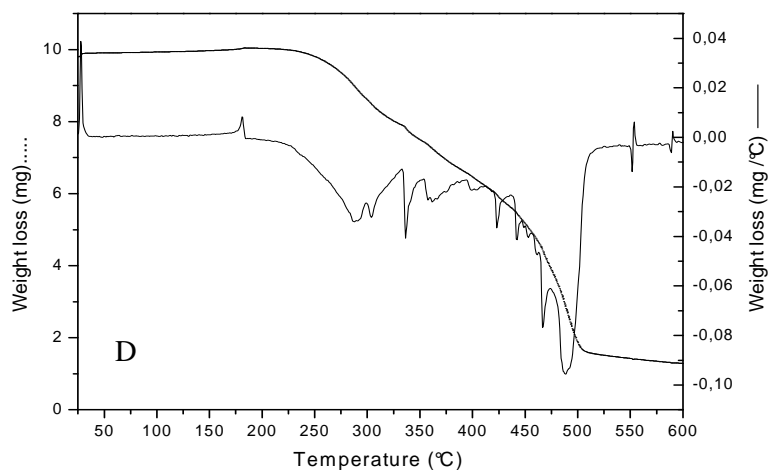

Figure 1: TGA curves under oxygen A-S2 (PDMS hydroxyl terminated); B-S4 (PDMS acetoxy terminated); C-S5 (PDMS methyldiacetoxy terminated); D-S6 (PMOS)

The volatile products emitted during the course of degradation were monitored after every one minute interval using FTIR spectroscopy. Below 340°C water and carbon dioxide are observed by FTIR while above this temperature methane and oligomers of polysiloxanes passed (figure 2).

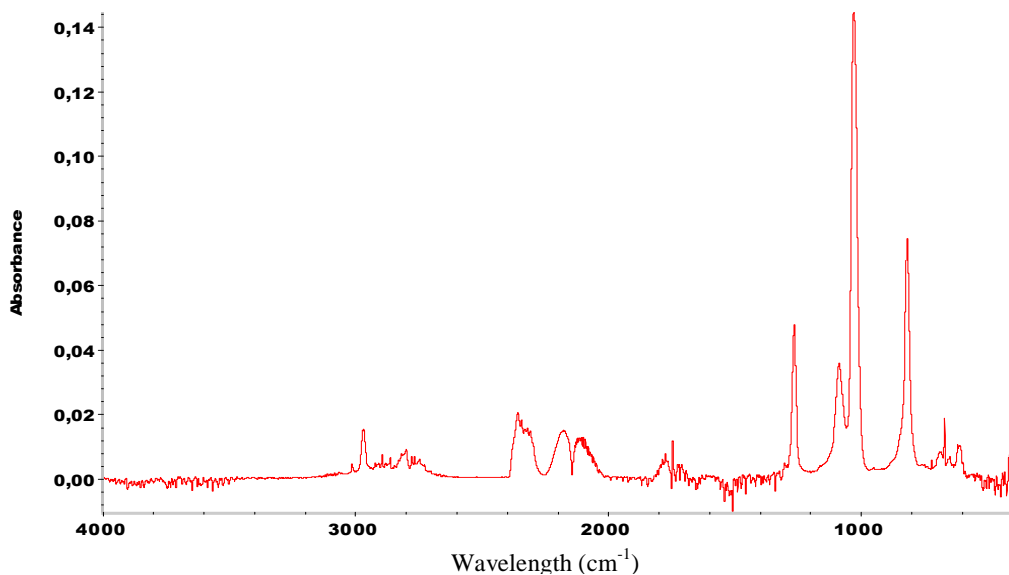

Figure 2: IR spectrum of volatile products after TGA of S2 above 340°C

At higher temperatures silicon atom in polydimethylsiloxane uses its vacant 3d orbitals to form energetically favorable transition states leading to formation of cyclic oligomers and shortening of chains [1]. The weight loss of S1, S2 and S3 was lower in oxygen atmosphere due to

formation of products which are thermally stable at higher temperature. The thermal stabilities of reference S4 and S5 having similar terminations were not identical (figures 1B, 1C). Reference S4 having acetoxy termination was the most stable PDMS while reference S5 having methyldiacetoxy termination was the weakest PDMS. The weight loss for reference S4 was more than S5 in oxygen atmosphere indicating that the product formed on its decomposition was thermally unstable. The thermal decomposition of reference S4 takes place in one step while that of S5 takes place in two steps this indicates that the mechanisms of their decompositions are different. The FTIR analysis of volatile products of reference S5 showed acetaldehyde as a major product below 330°C due to which there is a decrease in its thermal stability. Figure 3A gives the evolution of volatile products upon time, figure 3B gives the IR result after 25 minutes and figure 3C precises the assignment of products. Thereafter oligomers of siloxanes were emitted as in other PDMS. In case of reference S4 acetaldehyde is emitted at higher temperatures. This shows that the terminal groups have a very important effect on the thermal stabilities of PDMS.

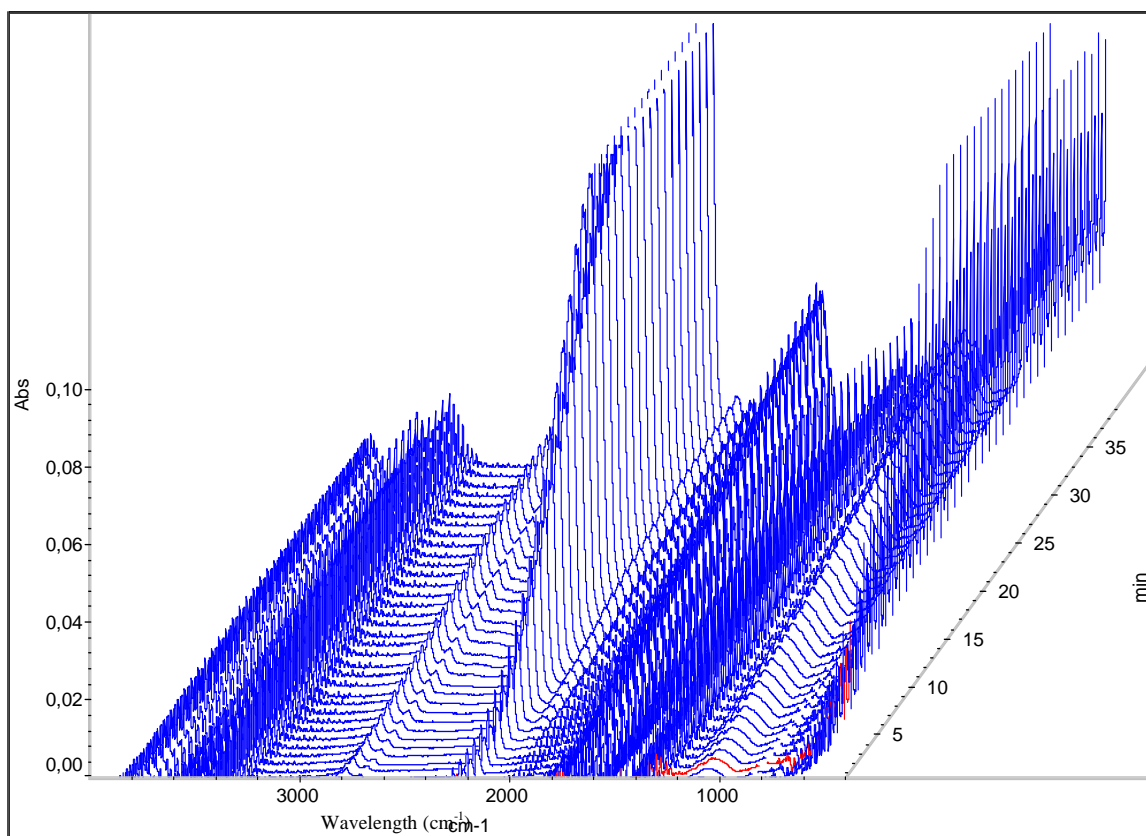

Figure 3 A: Waterfall spectra of volatile products for S5 between 23-330°C (every minute)

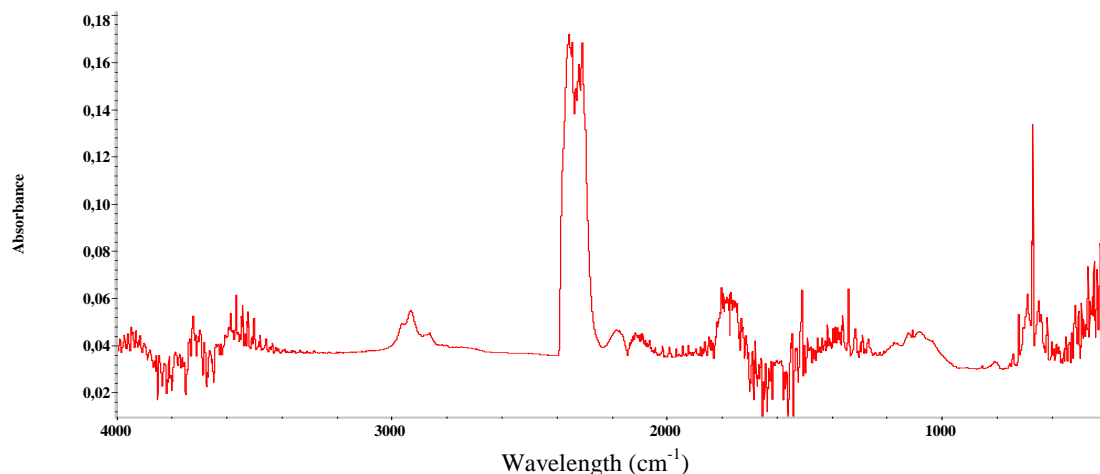

Figure 3B: IR spectrum of volatile products after TGA of S5 after 25 minutes

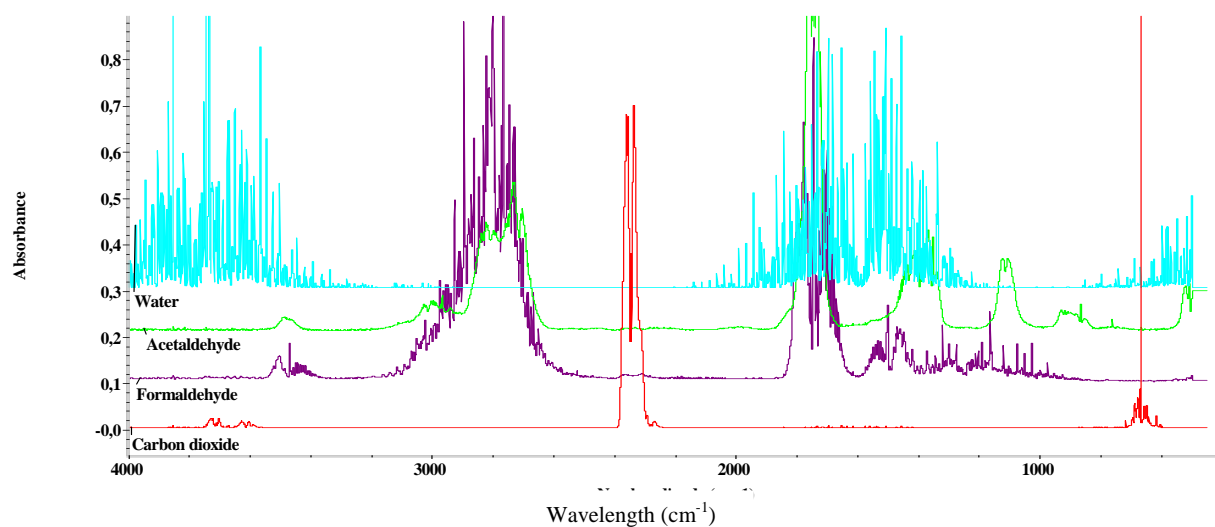

Figure 3C: Library data for the identification of products in previous spectrum

Reference S6 and S7 are the thermally weakest polysiloxanes as their decomposition began at 220°C (figure 1D). This is due to replacement of CH₃ group by an alkane chain on the Si in the main chain. Reference S6 having a longer alkane chain showed more weight loss in presence of oxygen than S7 having a shorter alkane chain. The FTIR spectra of the emitted products of both references S6 and S7 were similar. The IR spectra of S6 (figure 4) shows the presence of carbon dioxide, water, siloxane oligomers and hydrocarbons.

The thermal stability of polysiloxanes increases when they have a methyl substitution on silicone. Oxygen catalyses the onset of degradation for all the polysiloxanes while a delay in onset temperature of degradation in presence of nitrogen is observed. However the products formed in nitrogen were thermally unstable hence they have more weight loss. The degradation

in presence of oxygen started at 365°C for both the samples S2 and S3 while in the presence of nitrogen it was 450°C (figure 5A). The degradation of S6 started at 225°C in presence of oxygen and at 250°C in presence of nitrogen (figure 5B). The formation of silica was favoured in the case of thermal decomposition under oxygen, specially for PDMS S1, S2, S3 and S5.

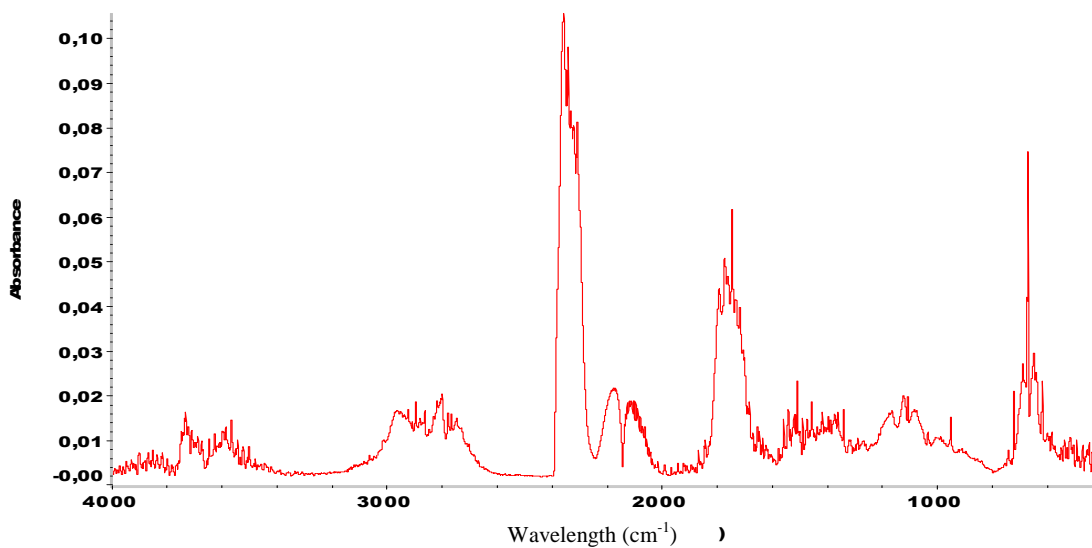
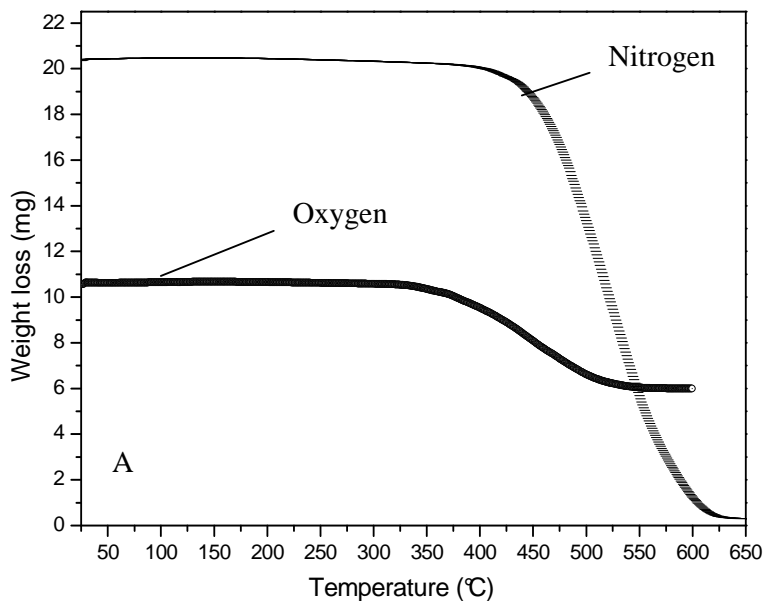

Figure 4: IR spectrum of volatile products after TGA of S6 above 340°C



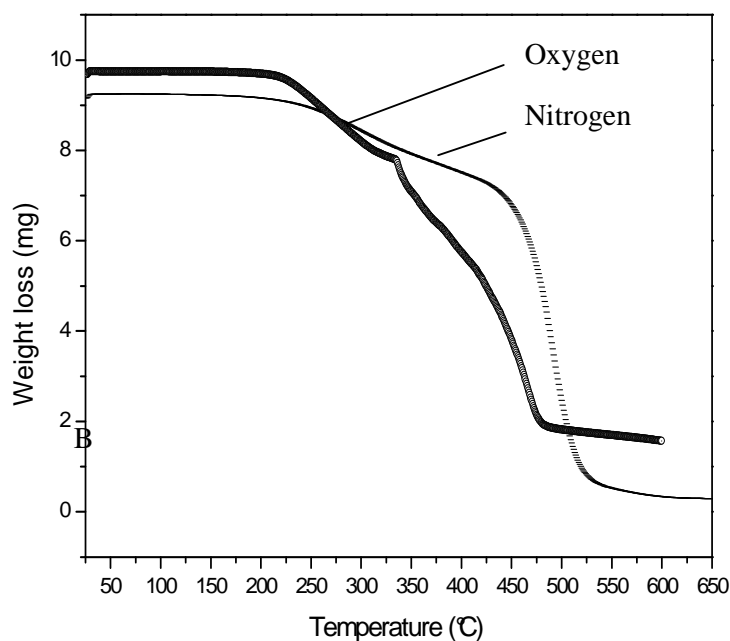

Figure 5: Comparison of TGA curves under nitrogen or oxygen; A-S3 ; B-S6

Complementary TGA experiments under oxygen were carried out after thermal ageing at 100°C or nitric acid treatment. The aged samples of the polysiloxanes gave similar curves as initial samples. The temperature of onset of degradation was 325°C after previous ageing, instead of 340°C for unaged S2 (see Table 3). There was a decrease in the weight loss after ageing. We can suggest that aged samples were more cross-linked, hence the decomposition was not favoured.

Reference	Temperature of onset of degradation (°C)	Total weight loss after thermal ageing (%)	Temperature of onset of degradation (°C)	Total weight loss after nitric acid ageing (%)
S1	327	47%	328	45%
S2	325	37%	325	34%
S3	328	41%	327	38%
S4	335	75%	334	73%
S5	290	38%	291	35%
S6	215	82%	214	79%
S7	215	77%	214	74%

Table 3 : Total weight loss after TGA of polysiloxanes after thermal ageing at 100°C or nitric acid treatment for 5 days.

3-2- DSC and photo-DSC results

Crystallinity was estimated for each sample with DSC curves. The value of the enthalpy of fusion $\Delta H_{th} = 37.4 \text{ J/g}$ for crystalline linear PDMS was used [16]. Figure 6 shows the DSC thermograms obtained for unirradiated S2 and S3. They show an exothermic peak, two endothermic peaks and a glass transition. The glass transition appears around $-123 \text{ }^\circ\text{C}$ for both the samples, thus it does not depend on the molecular weight. However the recrystallisation appears at a slightly lower temperature for S3 (-73°C) which has lower molecular weight than S2 (-70°C). This is in agreement with results published earlier [16], the location of the cold crystallization peak (after fast cooling) depends on molecular weight and appears at lower temperature for shorter chains of PDMS. Multiple endothermic peaks are typically exhibited in the measured DSC thermograms of a variety of polymeric materials. Three possible causes of this phenomenon could be given: differences in crystallite size distribution, melting-recrystallization of the original crystallites and their subsequent melting and different crystalline forms of the polymer [1]. In DSC studies of PDMS model networks however, only one crystalline melting peak was observed suggesting that the junction points inhibit the melting-recrystallization of the original crystallites and that is therefore the likely source of the double endothermic peak. This is also consistent with the fact that only one type of crystal structure has been reported for linear PDMS.

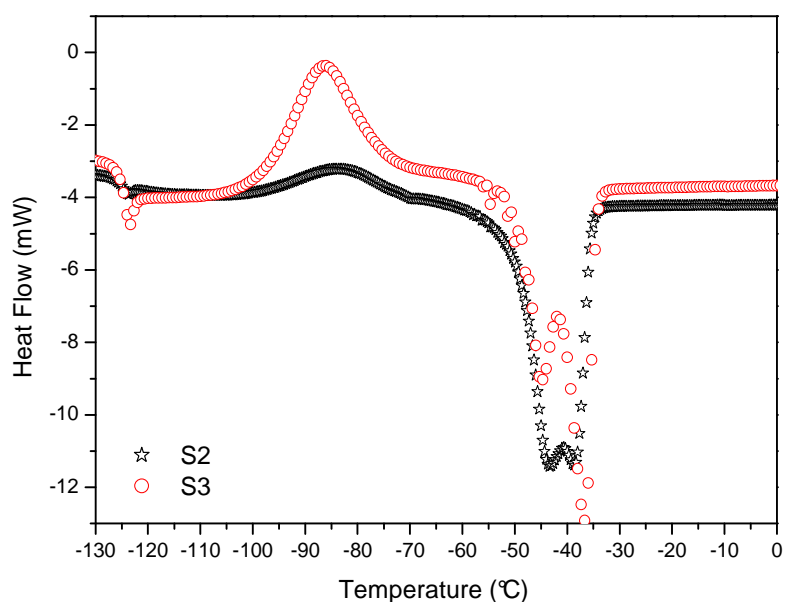

Figure 6: DSC thermograms of S2 and S3

The crystallinity is measured using the formula:

$$\alpha = \Delta H_f / \Delta H_{f100\%}$$

where α is crystallinity, ΔH_f is measured melting enthalpy, $\Delta H_{f100\%}$ is the value for 100 percent crystalline sample ($\Delta H_{th} = 37.4$ J/g).

The crystallinity of S1, S2 and S3, samples with higher molecular weight was between 10% and 20%. S4 and S5 were more crystalline (approx. 50-60%). Our results were logical as compared to results published [16]. The ratio of the cold crystallization peak decreases with decreasing molecular weight. Shorter chains have larger mobility and thus they can form more crystals and in large proportion than higher molecular weight PDMS. S6 was amorphous while S7 was semi-crystalline. The crystallinity ratio could not be determined for S7 because the value of reference enthalpy was not found in literature. The recrystallisation onset temperature was quite different (12°C) from other samples, due to the specific chemical structure and the low molecular weight.

We used photo-DSC to follow the changes in the peaks of crystallisation of PDMS upon irradiation. All the irradiations were performed at 60°C, and we used 4 different intensities for it. We also carried out DSC experiments after photo-ageing in SEPAP and thermal exposure in oven for comparison. Figure 7A shows the DSC curves at 31 mW/cm² for S2. We noticed an increase in the surface area of the recrystallisation peak and its shift towards lower temperature upon irradiation (between -70°C and -95°C).

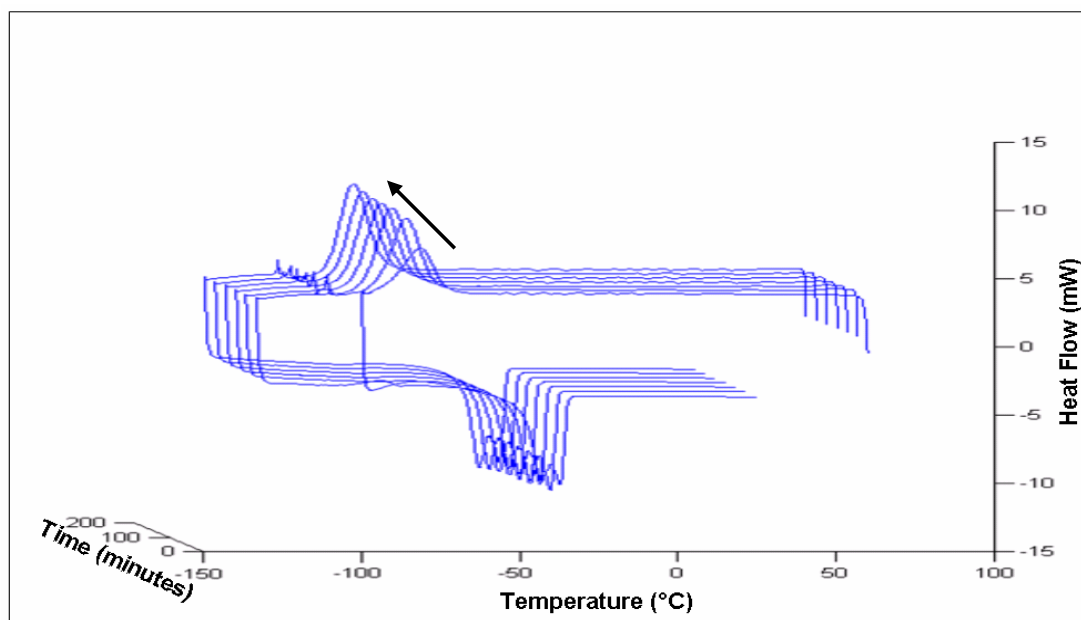

Figure 7 A: Photo-DSC thermograms after irradiation at 31 mW/cm² at 60°C ($\lambda > 300$ nm) (initial, 30, 60, 90, 120, 150 and 180 min); for S2

In figure 7B we have shown the DSC curve of S3 at the same intensity and cooling rate. We noticed similar phenomena for the recrystallisation peak. The cold crystallisation peak (always observed with S3) decreases gradually with irradiation for 30 minutes and then starts increasing and shifts towards lower temperature. There is no change in the endothermic peak of S3 after irradiation. The crystallisation temperature is affected by irradiation, this reflects the growth rates and nucleation of the crystallites. The recrystallisation onset temperature for S3 was -74°C initially, but it changed to it was -102°C after 180 min of irradiation. The decrease in the temperature of crystallisation with irradiation indicates there is cross-linking or chain scission. The crystallisation behaviour of polydimethylsiloxane depends on the molecular weight and the chemical structure. There is a rapid increase (S1, S2 and S3) or decrease (S4 and S5) in the crystallinity percentage upon irradiation. The samples S4 and S5 which are 55% crystalline presented a decrease of crystallinity upon ageings, and the recrystallisation temperature shifted towards lower temperature (from -68°C to -80°C at 31 mW/cm^2 for S5).

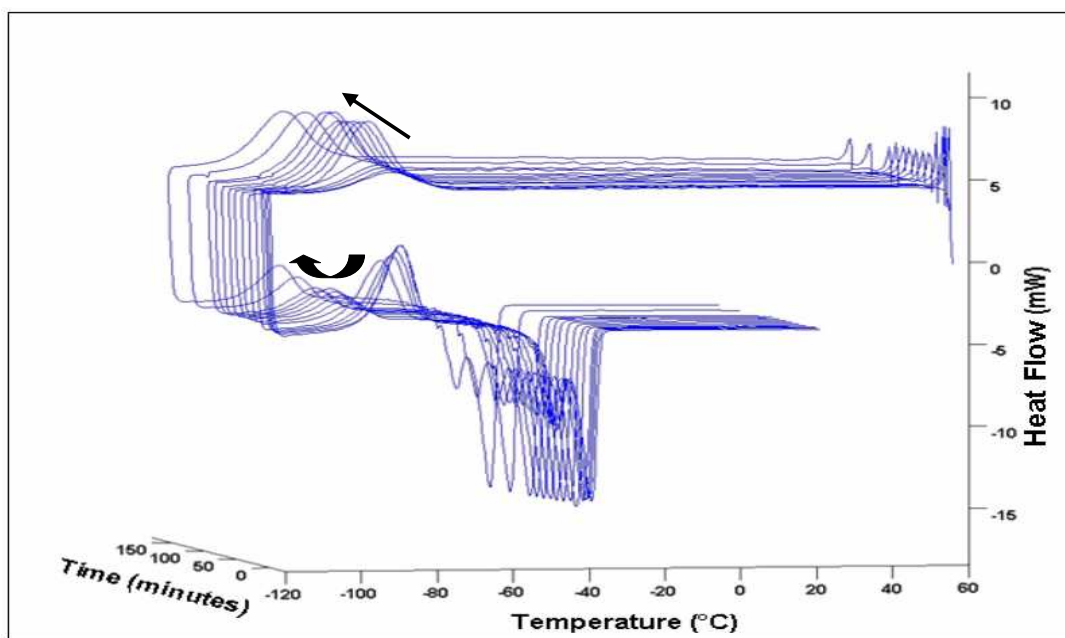

Figure 7 B: Photo-DSC thermograms after irradiation at 31 mW/cm^2 at 60°C ($\lambda > 300\text{nm}$) (initial, 30, 60, 90, 120, 150 and 180 min); for S3

In figure 8 we have compared the changes in crystallisation at different intensities for S3. We have observed that change in crystallinity by thermal ageing is negligible at 60°C hence all the crystallinity changes are due to the photo-ageing phenomena. There is an acceleration of crystallinity change with increase in the intensity of light in photo-DSC device. The observed

evolution with the intensity 146 mW/cm^2 was drastic compared to irradiation in SEPAP or the other intensities (16 to 76 mW/cm^2). Similar results were obtained for S2 and S1 (almost same crystallinity and molecular weights). S4 and S5 presented an opposite behaviour in terms of crystallinity change upon ageing (fig 7 C).

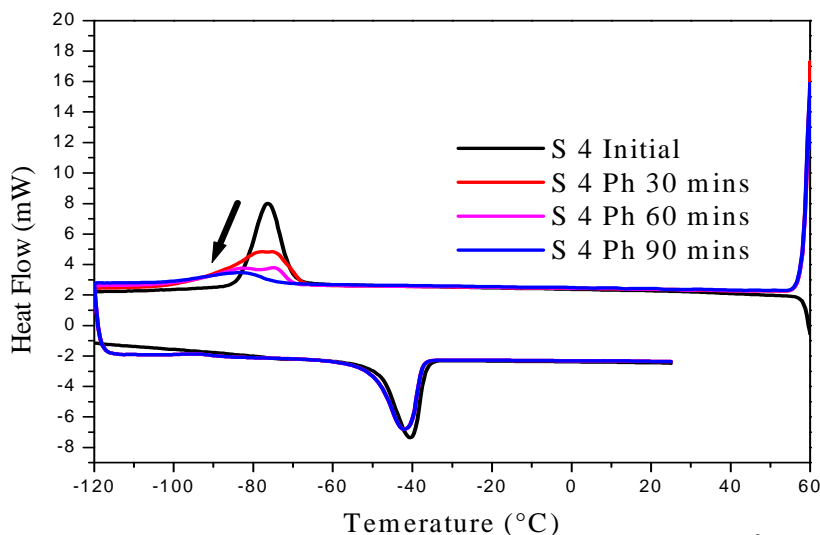

Figure 7 C: Photo-DSC thermograms after irradiation at 31 mW/cm^2 at 60°C ($\lambda > 300\text{nm}$) (initial, 30, 60, 90 mins); for S 5

Crystallinity yield after 180 min of irradiation was around 15%. Cross-linked chains can not be very active in the formation of crystallites. When the crystallinity increases upon ageing it means that the degradation of polysiloxanes proceeds mainly by chain scission.

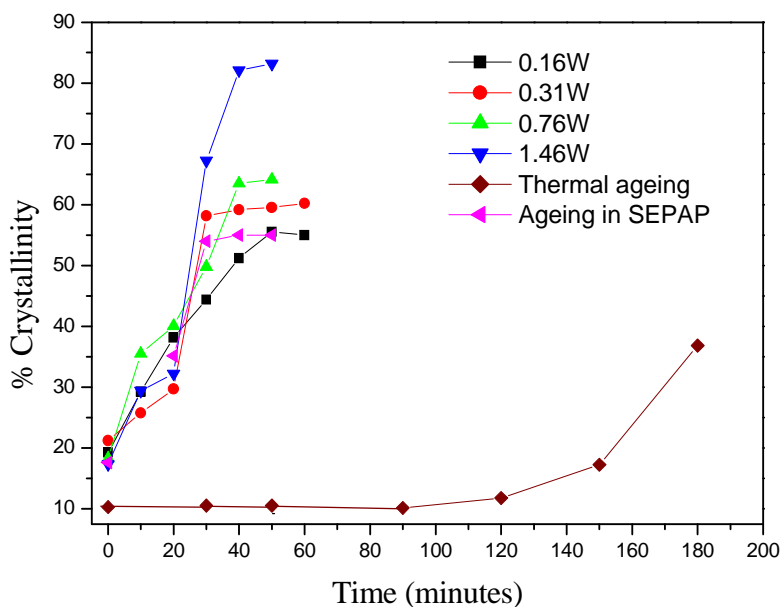

Figure 8 : Comparison of changes in crystallinity with different ageings for S3 (irradiation by photo-DSC, SEPAP, thermal ageing at 60°C)

Conclusion

The crystallisation behaviour of polydimethylsiloxane depends on the molecular weight and the chemical structure. There is a rapid increase (S1, S2 and S3) or decrease (S4 and S5) in the crystallinity with photo-ageing. Chain scission operates mainly when the crystallinity increases. We have summarized all the results in Table 4. It allows us to give structure-property relationships. The decrease in the temperature of crystallisation with irradiation indicates there is cross-linking or chain scission. The thermal stability of polysiloxanes increases when they have a methyl substitution on silicone compared to higher alkane group. The stability towards oxidation of the polysiloxanes without long carbon chain in the backbone was confirmed after the various ageings [17]. The volatile products passing at low temperatures were carbon dioxide and water for all the polysiloxanes. At higher temperature oligomers of silicone were detected for S1,S2,S3 with an addition of acetaldehyde for S4, S5 and hydrocarbons for S6, S7. The five PDMS are almost similar for crystallinity yield and thermal behaviour upon ageing. The competitive scheme for degradation oxidation/cross-linking operates simultaneously in the case of dienic elastomers. In the case of polysiloxanes we only have one major way either cross-linking, or oxidation. The five first samples showed only cross-linking or chain scission reactions. A opposite behaviour is found for the samples S6 and S7, which presented a mechanism with oxidation.

Ref	Mw (g/mol)	Chemical structure	Initial Crystallinity	Recrystallisation onset temperature
S1	115 000	PDMS	Approx. 10 %	-82°C
S2	110 000	PDMS - hydroxy	15 %	-70°C
S3	90 000	PDMS - hydroxy	20 %	-73°C
S4	36 000	PDMS - acetoxy	55 %	-68°C
S5	36 000	PDMS - methyl diacetoxy	55 %	-68°C
S6	11 000	PMOS	Amorphous	-
S7	9 400	PMTS	Semi-crystalline	12°C

Table 4 : Structure-thermal property-crystallinity relationships

References

1. Clarson SJ., Semlyen JA.; Siloxane polymers; Ellis Horwood–PTR Prentice Hall; 216-240; 1993.
2. Grassie N., Francey KF., Macfarlane IG.; Polym Degrad and Stab; 2; 67-83; 1980.
3. Yilgol I., Yilgol E., Polym Bulletin; 40; 525-532; 1998.
4. Deshpande G., Rezac ME.; Polym Degrad and Stab; 74; 363-370; 2001.
5. Deshpande G., Rezac ME., Polym Degrad and Stab; 76; 17-24; 2002.
6. Camino G., Lomakin SM., Lazzari M.; Polymer; 42; 2395-2402; 2001.
7. Camino G., Lomakin SM., Lazzari M.; Polymer; 43; 2011-2015; 2002.
8. Valles E., Sarmoria C., Villar M., Lazzari M., Chiantore O.; Polym Degrad and Stab; 69; 67-71; 2000.
9. Israëli Y., Philippart JL., Cavezzan J., Lacoste J., Lemaire J.; Polym Degrad and Stab; 36; 179-185; 1992.
10. Israëli Y., Cavezzan J., Lacoste J.; Polym Degrad and Stab; 37; 201-208; 1992.
11. Israëli Y., Lacoste J., Cavezzan J., Lemaire J.; Polym Degrad and Stab; 42; 267-279; 1993.
12. Israëli Y., Lacoste J., Cavezzan J., Lemaire J.; Polym Degrad and Stab; 47; 357-362; 1995.
13. Virlogeux F., Bianchini D., Delor Jestin F., Baba M., Lacoste J.; Polym International; 53; 163-168; 2004.
14. Penot G., Arnaud R., Lemaire J.; Die Angew Makromol Chem; 30; 493-499; 1992.
15. Morel M., Lacoste J., Baba M.; Polymer; 46; 9274-9282; 2005.
16. Aranguren MI.; Polymer; 39; 4897-4903; 1998.
17. Tomer NS., Delor- Jestin F., Frezet L., Lacoste, J.; Submitted to Polym. Degrad and Stab.

CHAPTER 3

CONCLUSION

Sept polysiloxanes [PDMS, polydimethyl siloxane (5 échantillons différents par leur masse molaire et leur groupe terminal) – PMOS, polymethyl octadecyl siloxane – PMTS, polymethyl tetradecyl siloxane] ont été caractérisés au cours de vieillissements photochimique, thermique ou sous vapeur acide.

Le premier article “*Oxidation, chain scission and cross-linking studies of polysiloxanes upon ageings*” donne une analyse détaillée de l’évolution chimique, grâce à la spectroscopie infra-rouge avec accessoire ATR. L’étude des mesures de densité et de l’évolution de la masse molaire (SEC) fournit une approche complémentaire pour suivre le vieillissement de l’élastomère. Une approche des mécanismes de dégradation est proposée. L’étude a mis en évidence l’influence de la structure chimique des polysiloxanes sur le vieillissement. Les cinq PDMS ne s’oxydent pas mais se dégradent en donnant lieu à des réactions de réticulation et de scissions de chaînes, en l’absence d’agent de réticulation et avec un taux de vinyl résiduel très faible (<1% d’après l’analyse RMN). On a cependant noté des différences entre les mesures de densité (qui suivent la diminution de solubilité du polymère due à la réticulation) et de SEC (qui suit l’évolution des masses molaires dans la partie soluble). La détermination des ponts issus de la réticulation a été envisagée par une analyse RMN, cependant les résultats ont été infructueux, les spectres des élastomères vieillis étant identiques à celui du matériau initial. Cela signifie que les niveaux de réticulation observés restent faibles, de l’ordre de quelques pourcents. Les PDMS ne réagissent pas sous vapeur acide. En revanche les deux références PMOS et PMTS se sont dégradées. Les matériaux PMOS et PMTS se comportent différemment en raison de la présence d’une chaîne carbonée pendante. Leur oxydation ressemble à celle d’un polyéthylène. Des produits résultant d’une oxydation et d’une nitration sont clairement détectés en analyse infra-rouge.

L’article suivant “*Comparison of thermal properties and crystallization behaviour of polysiloxanes*” donne une comparaison des propriétés thermiques et de la structure chimique par analyses thermiques (DSC et ATG-IRTF). L’utilisation de la photo-DSC permet en particulier de suivre l’évolution de la cristallisation pendant le photo-vieillissement. Les résultats en terme de réticulation et de coupures de chaînes ont également été examinés. Les deux articles apportent donc une approche complémentaire sur la dégradation de polysiloxanes crus.

Les niveaux de réticulation observés dépendent de la structure chimique, du vieillissement et du taux de cristallinité initial. Les PDMS présentent un taux de réticulation supérieur à celui de PMOS et PMTS sous vieillissement, ce qui confirme les conclusions de l'article. Le vieillissement thermique favorise une réticulation plus importante à terme que la photo-oxydation. Finalement nous avons vérifié que les réactions de réticulation étaient favorisées dans les zones amorphes (et dans les matériaux initialement plus cristallins, pour lesquels la cristallinité diminue au cours du vieillissement).

CHAPTER 3

CONCLUSION

Seven polysiloxanes [PDMS, polydimethyl siloxane (5 different types having different molecular weight and terminal groups) - PMOS, polymethyl octadecyl siloxane - PMTS, polymethyl tetradecyl siloxane] were characterized during photochemical, thermal or under acid vapour ageings.

The article "*Oxidation, chain scission and cross-linking studies of polysiloxanes upon ageings*" gives a detailed analysis of the chemical evolution, using the infra-red spectroscopy with ATR accessory. The study of density measurements and the evolution of the molar mass (GPC) provides a complementary approach to follow the ageing of elastomer. An approach to determine the mechanisms of degradation is proposed. The study highlights the influence of the chemical structure of the polysiloxanes on ageing. Five PDMS do not oxidize but are degraded by cross-linking and chain scissions reactions, in the absence of cross-linking agent and with a very low rate of vinyl residual (<1% determined by NMR spectroscopy). We have observed some differences between the density measurements (which follows the reduction in the solubility of the polymer due to cross-linking) and SEC (which analyses the evolution of the molar mass of the soluble part of the polymer). The determination of the bridges resulting from the cross-linking was considered with NMR analysis, however the results were unfruitful, as the spectra of the aged elastomers were identical to that of initial material. This may be due to the reason that the levels of cross-linking observed remain low, about a few percent. The PDMS do not react under acid vapour while the two references PMOS and PMTS were degraded. The materials PMOS and PMTS behave differently because of the presence of a pendant carbon chain in the backbone. Their oxidation resembles that of polyethylene. Products resulting from oxidation and nitration are clearly detected in infra-red analysis.

The next article "*Comparison of thermal properties and crystallization behaviour of polysiloxanes*" gives a comparison of the thermal properties and chemical structure by thermal analyses (DSC and TGA-FTIR). The use of photo-DSC makes it possible particularly to follow the evolution of crystallization during photo ageing. The results of the cross-linking and chain scission are examined.

The two articles hence show a complementary approach on the degradation of polysiloxanes. The levels of cross-linking observed depend on the chemical structure, the ageing and the initial rate of crystallinity. The PDMS show a rate of cross-linking higher than that of

PMOS and PMTS upon ageing. This confirms the conclusion of the article. Thermal ageing support a more important cross-linking in long term than the photo-oxidation. Finally we checked that the reactions of cross-linking were favoured in the amorphous zones (and in materials initially more crystalline, for which crystallinity decreases during ageing).

CHAPTER IV

Study of Cross-linked PDMS and EPDM

CHAPITRE 4

INTRODUCTION

La stabilité thermique et photochimique reconnue des polysiloxanes, souvent décrite dans la littérature, constitue un atout pour cette catégorie d'élastomère. Cependant les formulations pour isolateurs à base silicone exposées à des environnements sévères se dégradent en quelques années et ne répondent plus au cahier des charges. Quatre formulations industrielles à base de polysiloxane ou d'Ethylène Propylène Diène Monomère (EPDM) sont étudiées. Il s'agit de matériaux chargés et réticulés. Dans ce chapitre, nous comparons l'évolution des propriétés des différentes compositions afin de mettre en évidence l'influence des constituants et celle de la matrice polymère sur le vieillissement, avec différentes techniques analytiques et au cours de vieillissements artificiels variés.

La composition des formulations à l'étude est donnée dans le chapitre 2 et dans les publications. Trois formulations à base PDMS sont caractérisées. Elles diffèrent en raison d'un traitement silane sur la charge $\text{Al}(\text{OH})_3$. Une seule formulation EPDM a été étudiée.

Ce chapitre donne lieu à deux publications incluses dans la thèse. L'article "*Characterization of polydimethylsiloxane rubber upon photochemical, thermal, salt-fogs ageings and exposure to acid vapours*" a été accepté en novembre 2005 dans *e-Polymers*. Cette troisième publication donne une analyse détaillée de l'évolution chimique par spectroscopie IR-ATR, une évolution de la dureté, des changements au niveau de la densité de réticulation grâce à la technique de DSC couplée à la thermoporosimétrie et finalement une comparaison de la stabilité thermique en fonction des vieillissements envisagés (photochimique, thermique, brouillard salin et vapeur acide).

L'article suivant "*Cross-linking assessment after accelerated ageings of ethylene propylene diene monomer rubber*" a été accepté dans *Polymer Degradation and Stability* en octobre 2006. Il s'agit de caractériser l'évolution de la formulation à base d'EPDM au cours de différents vieillissements. A la suite, une comparaison de la durabilité des différents matériaux est proposée avant la conclusion. Des résultats complémentaires ne figurant pas dans les deux précédentes publications sont alors donnés.

CHAPTER 4

INTRODUCTION

Thermal and photochemical stability of polysiloxanes are well known in literature and are considered as an asset for this category of elastomer. However the formulations of insulators having a silicone base when exposed to severe environments are degraded in a few years and no longer possess the desired initial properties. Four industrial formulations containing polysiloxanes or Ethylene Propylene Diene Monomer (EPDM) are studied. They are filled and cross-linked materials. In this chapter, we compare the evolution of the properties of the various compositions in order to understand the influence of the components and that of the polymeric matrix on ageing, with various analytical techniques and upon different artificial ageings. The details of the formulations studied have been given in chapter 2 and in the two publications in this chapter. Three formulations having PDMS base have been characterised. They differ as a silane treatment on the $\text{Al}(\text{OH})_3$ filler has been carried out for one of them. Only one formulation of EPDM has been studied.

This chapter is in the form to two publications. The article "*Characterization of polydimethylsiloxane rubber upon photochemical, thermal, salt-fogs ageings and exposure to acid vapours*" was accepted in November 2005 in *e-Polymers*. This third publication gives a detailed analysis of the chemical evolution by FTIR-ATR spectroscopy, an evolution of hardness, changes in cross-linking densities calculated with DSC coupled with the thermoporosimetry and lastly a comparison of thermal stability upon the various ageings (photochemical, thermal, salt fog and acid vapour).

The next article "*Cross-linking assessment after accelerated ageings of ethylene propylene diene monomer rubber*" was accepted in *Polymer Degradation and Stability* in October 2006. We have characterised the evolution of the formulations having a base of EPDM during various ageings.



Characterization of polydimethylsiloxane rubber upon photochemical, thermal, salt-fog ageings and exposure to acid vapours

F. Delor-Jestin^{1*}, *N. S. Tomer*¹, *R.P. Singh*² and *J. Lacoste*¹

¹ Ecole Nationale Supérieure de Chimie de Clermont-Ferrand
Laboratoire de Photochimie Moléculaire et Macromoléculaire - UMR CNRS 6505 –
Ensemble Universitaire des Cézeaux - 63177 Aubière Cedex – France;
florence.jestin@univ-bpclermont.fr

² National Chemical Laboratory – Polymer Chemistry Division - Dr. Homi Bhabha
Road, Pune - 411 008- India

(Received :2 November, 2005; published: 8 May 2006)

Abstract: The changes in the chemical structure and the physical properties of a filled cross-linked polydimethylsiloxane rubber were monitored as a function of various ageing factors. The variables included photochemical, thermal, salt-fog ageings and exposure to acid vapours. Unaged and aged samples were studied by IR spectroscopy, hardness measurements, Differential Scanning Calorimetry (DSC) and thermogravimetric analysis (TGA) coupled with IR spectroscopy. No significant oxidation was detected after all ageings, except for nitric acid treatment. The presence of aluminium trihydrate was clearly identified as responsible for the observed chemical changes. Then an important vulnerability of this filled silicone rubber towards the cross-linking reactions provoked by usual ageings was also detected. The DSC-thermoporosimetry measurements of the mesh size distribution gave a comparison of cross-linking densities for each ageing. The complementary analysis with TGA-IR allowed us to differentiate the thermal stability of the formulation after various ageings and to acquire new knowledge about thermal decomposition.

Introduction

Polysiloxanes are widely used as protective surface coatings for a variety of specialized applications. The long term behaviour of cross-linked polysiloxanes is often very satisfactory. Compared with usual dienic elastomers, silicone rubber has outstanding heat resistance and a low chemical reactivity. However, it is important to recognise and identify the principal factors involved in rubber ageing so that degradation prevention can be applied. Knowledge of the amount of change that can be tolerated over the life of a material helps towards the determination of the lifetime expectancy.

Literature about polydimethylsiloxane (PDMS) ageing essentially concerns the unfilled uncross-linked polymer. The photochemical behaviour of polydimethylsiloxane (PDMS) oil has been examined previously [1-4]. Y. Israeli *et al.* have focussed in particular on the photoreactivity of the main substituent groups used in the silicone field. The other studies deal with the thermal behaviour of polysiloxanes. N. Grassie *et al.* have reported on the thermal stability of PDMS to 300°C under vacuum [5]. Thermal degradation of PDMS has also been studied by G. Camino *et al.*[6,7]. Thermal oxidative degradation in the presence of air gives results much different from the decomposition in nitrogen. Kinetic treatment shows that PDMS thermal volatilization as rate of heating increases, and becomes dominated by rate of diffusion and evaporation of oligomers produced on its decomposition [6]. The products of the thermal degradation are essentially determined by the temperature and the heating rate [7]. The evaluation of cross-linking after photo-ageing of silicone rubber has been proposed by using calorimetric analysis (Differential Scanning Calorimetry–DSC) and densimetry. No significant oxidation was detected, but competitive ways such as cross-linking and chain scission were clearly identified [8].

Most studies on filled cross-linked silicone rubber gave results on hydrophobicity changes after corona discharge and plasma treatment [9-13]. One of the major drawbacks with siloxanes is hydrolysis, which leads to low molecular weight cyclic fragments in the rubber network. A mechanism has been proposed by M. Zeldin *et al.* [9]. The hydrophobic character or the water repellancy of PDMS is due to the close packing of the methyl groups, which under usual conditions point outward from the surface. Reorientation of the main chain, a change in the surface roughness, the deposition of contaminants on the surface, or surface oxidation can play a major role in the change from a hydrophobic to a hydrophilic state on PDMS surface [10]. MJ. Owen *et al.* have summarized the plausible mechanisms for hydrophobicity recovery after exposure to corona or plasma [13]. Migration of low molar mass species is undoubtedly the process that most researchers in the field believe as the dominant mechanism for hydrophobicity recovery. Outdoor expositions of silicone rubber have also been carried out and analysed by X-ray photoelectron spectroscopy (XPS) to understand the water repellency [14-16]. Another paper is a review about the recent performance experience of silicone composite insulators in outdoor service [17]. The ageing of silicone started with the loss of hydrophobicity, then a depolymerisation was also reported using gas chromatography-mass spectrometry [18]. The degradation is indicated by permanent

changes such as increase in depolymerisation and changes in the surface physical structure brought about by an increase in the degree of crystallization of the polymer and the conglomeration of small particles into larger ones. Recent papers concerned the effect of antioxidants on the surface oxidation of cross-linked PDMS after air-plasma treatment [19]. Degradation at 180-200°C in air of PDMS rubber was studied by chemiluminescence [20]. Ageing is due to small fragments and catalyst solvents rather than the main siloxane network. Storage of siloxane rubbers in a closed inert atmosphere results in softening of the material. Thermal ageing studies on room-temperature rubbers and compression set experiments were also proposed to give the lifetime prediction [21]. Kinetics of the thermal degradation and thermal stability of conductive silicone rubber (unfilled, filled with carbon black or silica) have been studied by J. Zhang *et al.* [22]. The thermal stability of carbon black rubber was the best, compared to unfilled or silica elastomer.

We focussed our study on filled cross-linked PDMS and used different analytical technics such as IR spectroscopy, hardness measurements, DSC to evaluate the polymer long term behaviour upon usual ageings and specific acidic treatments. The new DSC-thermoporosimetry technique was first used upon photoageing of PDMS [8]. In this work we present new DSC-thermoporosimetry results for the estimation of the cross-linking level after various ageings. We will compare the competitive ways of degradation such as oxidation, post cross-linking and chain scission for each ageing.

Results and discussion

Study with FTIR spectroscopy

First we analyzed the ATR-IR spectrum of the unaged cross-linked filled polydimethylsiloxane (Table 1, figure 1) [27]. The specific bands attributed to PDMS are localised at 2960, 1256, 1090, 1030 and 795 cm^{-1} . The main bands of the flame retardant are found at 3615, 3524, 3430 and 3375 cm^{-1} due to hydroxyl bonds. The presence of silica is not significative for this analysis, the Si-O band from inorganic filler will be overlayed with the Si-O band of PDMS. The presence of the crosslinks due to peroxide is not detected because of the small quantity of curing agent. The other spectra (figure 1) were obtained after UV irradiation, thermal exposure, salt-fog test, nitric acid treatment and sulphuric acid treatment. The spectra obtained by photochemical, thermal, salt-fog or sulphuric acid ageings were identical with the initial spectrum of unaged material, for various times of exposure. These results confirmed

the silicone stability towards oxidation. The evolution of any oxidation products (carbonyl and hydroxyl) was not significant, even after 10.000 hours of accelerated photo-ageing or thermal exposure. The repeated cycle in salt-fog test was not a degradative test for the silicone material. The polymer was not damaged by sulphuric acid vapour even after two weeks of exposure. On the other hand the exposure under nitric acid vapours was very aggressive for silicone rubber. The quick formation of three bands in the region $1700-1300\text{ cm}^{-1}$ was observed after a few hours of this acid ageing. These bands are the nitrate bands, resulting from the decomposition of $\text{Al}(\text{OH})_3$. The intensity of the hydroxyl vibration ($3600-3400\text{ cm}^{-1}$) is decreasing after 24 or 64 hours under acid exposure.

Tab. 1. Main absorption observed for unaged filled uncross-linked PDMS then assignments of IR bands (ν = stretching vibration; δ = in-plane deformation)

Wavenumber (cm^{-1})	Tentative assignment
3615, 3524, 3432, 3375	ν OH of $\text{Al}(\text{OH})_3$
2960 (median intensity)	ν CH in CH_3
1646 (weak)	ν C=C
1408 (weak)	Not assigned
1256 (strong)	ν CH in Si- CH_3
1090 (strong)	Si-O-Si
1030 (strong)	Si-O-Si
795 (strong)	Si-O-C
730 (weak)	Not assigned
665 (weak)	Not assigned

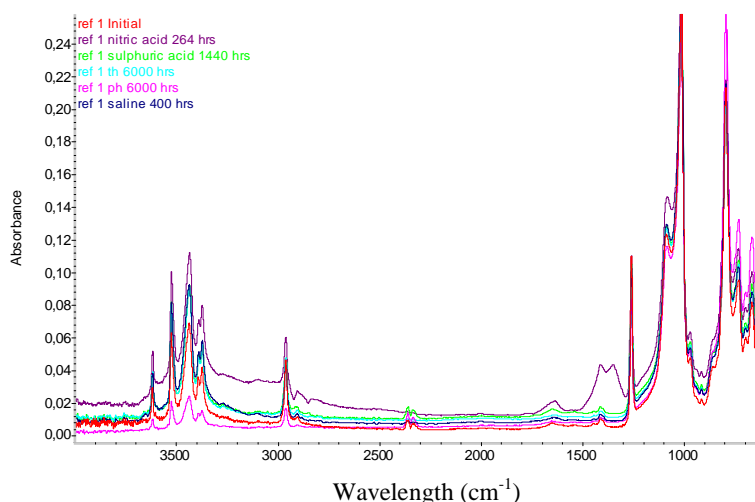

Fig. 1. FTIR-ATR spectra of silicone rubber before and after ageings
 Curve a – Unaged sample; b – 6000 hours after photochemical ageing; c – 6000 hours after thermal ageing; d – 400 hours after salt-fog test; e – 264 hours under nitric acid vapours; f – 1400 hours under sulphuric acid vapours.

We also studied the crude PDMS (unfilled uncross-linked silicone, reference 870) and showed that no oxidation is detected after photochemical, thermal, sulfuric acid or nitric acid treatment (figure 2). This proves that the silicone matrix is not affected by acid vapours in the absence of additives and fillers. The direct acidic treatment on aluminium trihydrate powder confirmed the results on filled polysiloxane (figure 3). The formation of aluminium nitrate is clearly detected in this case.

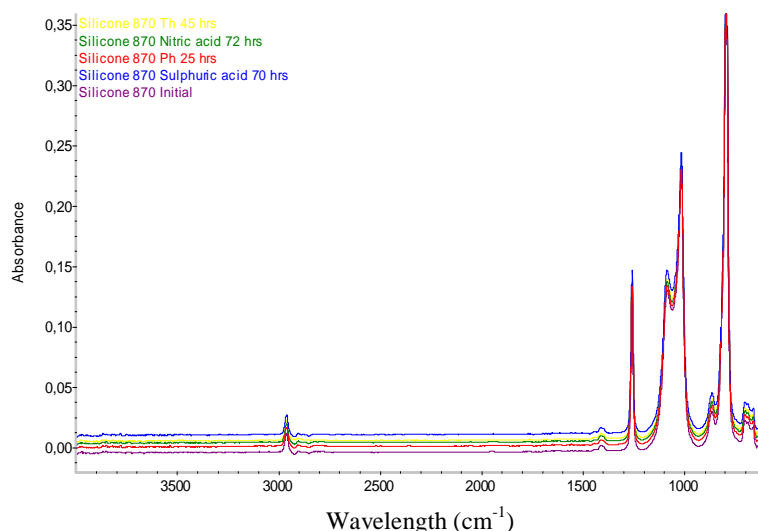

Fig.2. FTIR-ATR spectra of crude polysiloxane before and after ageings

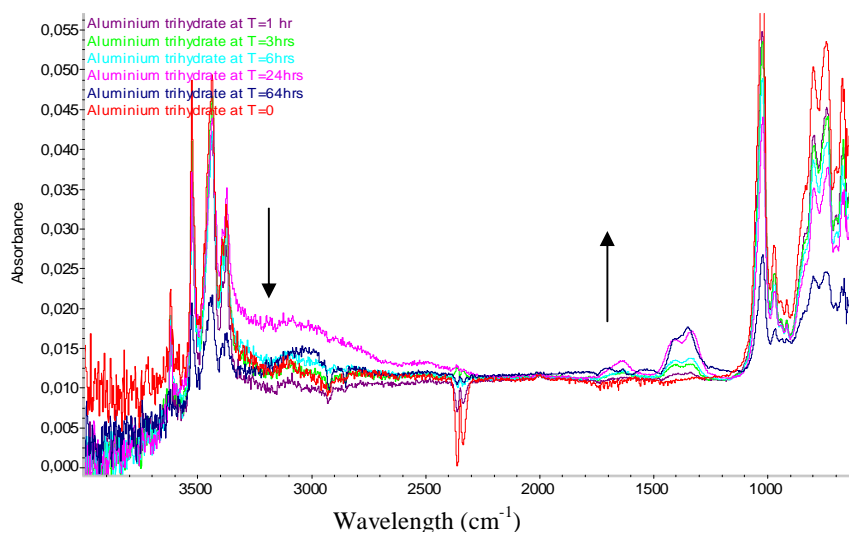

Fig. 3. Nitric acid treatment on aluminium trihydrate powder characterized by FTIR Spectroscopy

Hardness measurements

The hardness measurements are given in figure 4. Hardness measurements on the initial material gave an average value of 70.0 (+/- 2.1) Shore A. During ageings the samples became harder on their surface layers. The surface is harder because the polymer chains cannot explore different configurations during constraint and are less flexible, hence the material is more cross-linked. The hardness values quickly increased after acidic treatments without induction period. After photo- or thermo-ageing an induction period of around 500 hours was detected, then the hardness is increasing till a stabilized value 87.1 (+/- 1.4) Shore A. The evolution towards hardness is accelerated after polluted ageings with acidic vapours. The evolution of the fire retardant with HNO_3 is supposed to enhance the hardness of the rubber. The evolution with H_2SO_4 is more surprising because we could not detect any change on IR spectra. The results also show that post cross-linking reactions occur upon usual ageings such as UV and thermal exposures.

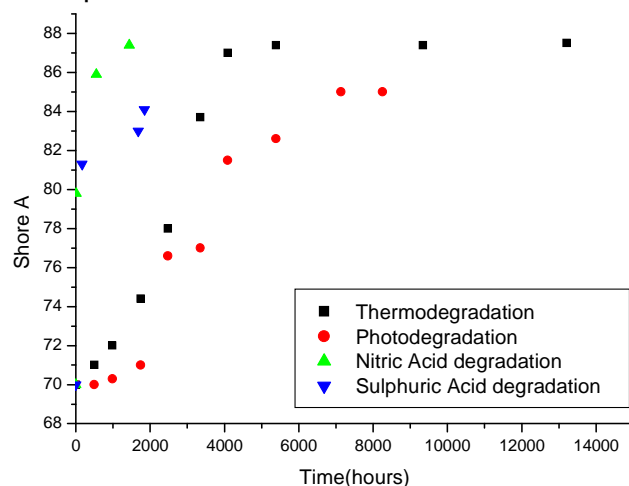

Fig. 4. Hardness measurements after different ageings

DSC-thermoporosimetry results

To estimate the cross-linking densities and to explain other structural changes upon degradation, DSC-thermoporosimetry measurements were carried out. This application of DSC has already been validated for dienic elastomers and silicone rubber [9]. The initial material (unaged sample) shows a distribution of mesh sizes with two peaks (figure 5). Different cuts (180 μm thick slices) from the surface of the rubber sheet have been characterized. We can underline that most meshes have a radius (distance between cross-links) around 200 \AA , the other mesh size is around 700 \AA .

After photochemical or thermal ageings (figure 6) we obtain different distributions. After short exposures (< 1000 hours, figure 6A) we always get two peaks. The first one gives a radius around 200 Å, the second peak is shifted to 400 Å. This means that post cross-linking reactions are first detected. The cross-linking density is therefore affected by usual ageing. For longer time (1,000-5,000 hours) we can notice with figure 6B that only one peak is observed at 550 Å after thermal ageing. Chain scissions mainly occurred and gave such repetitive results. The same behaviour is confirmed after 10,000 hours.

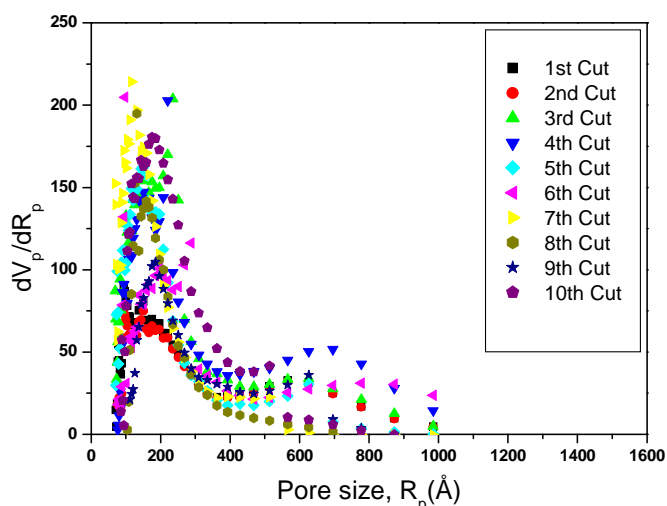

Fig. 5. Cross-linking profile obtained by DSC-thermoporosimetry on unaged sample surface (radius or pore size R_p , distribution dV/dR).

In the case of photo-ageing (figure 6C) we also get one peak around 1,200 Å after 2,000 hours. The photo-degradation process leads to a number of chain scissions. After 5,000 hours, new cross-linking reactions on the rubber surface can be detected (figure 6D). The observed distribution curve gives one peak at 700 Å. With hardness measurements, we do not observe such differences between photochemical and thermal ageings. DSC-thermoporosimetry is a more sensitive technique.

After acidic treatment such as HNO_3 the estimation of post cross-linking is done for short time of exposure (figure 6E). It was not possible to do the measurements for very hard samples (aged more than 3 hours). The distribution is narrower and the average radius value is 900 Å. Chain scission reactions are the main path of material degradation, simultaneously with the decomposition of the fire retardant at the polymer surface.

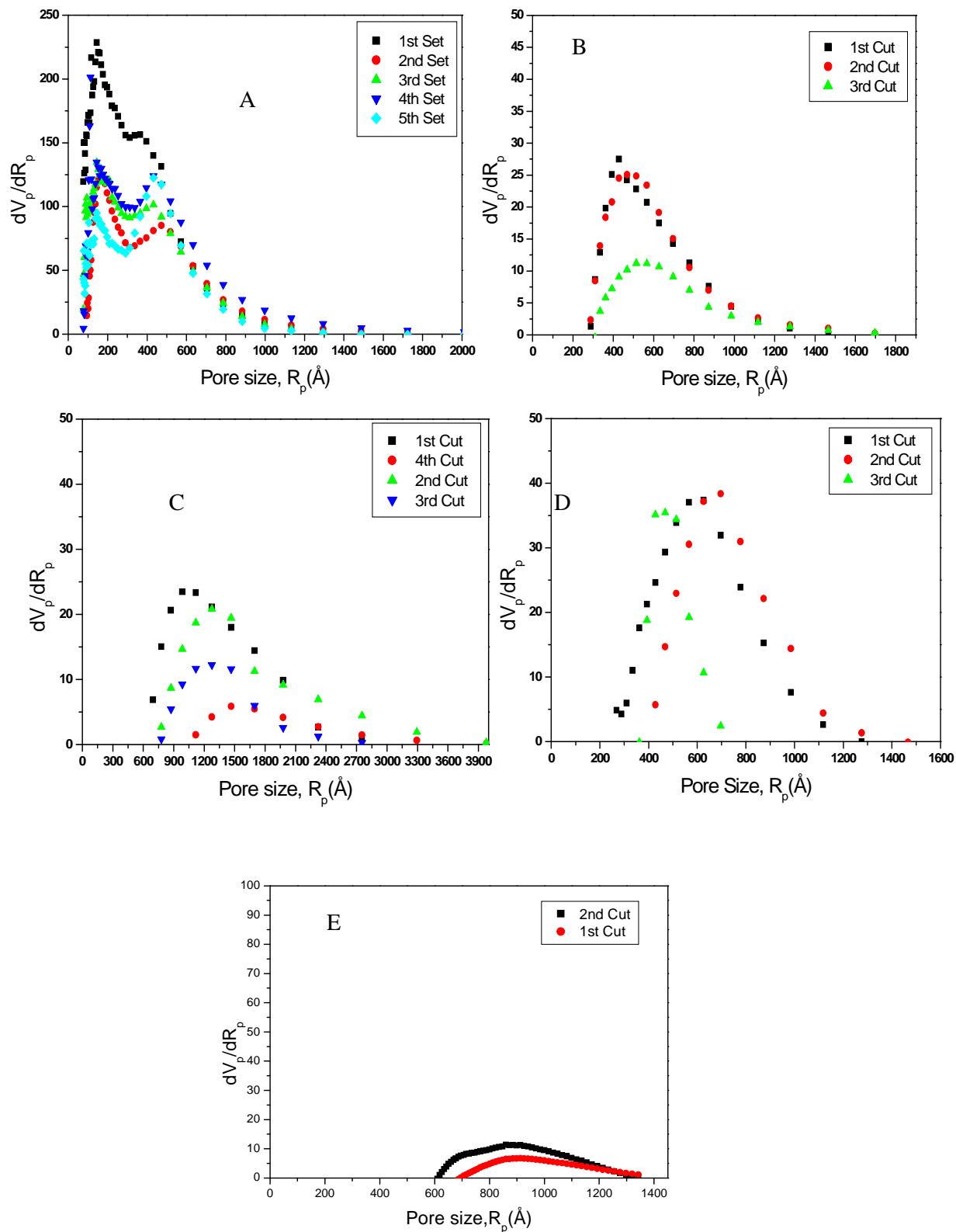

Fig. 6. Cross-linking profile obtained by DSC-thermoporosimetry on aged sample surface; A- 907 hours in oven; B- 4000 hours in oven; C- 2000 hrs in photochemical device; D- 7000 hours in photochemical device; E- Nitric acid treatment 1 hour.

TGA-FTIR results

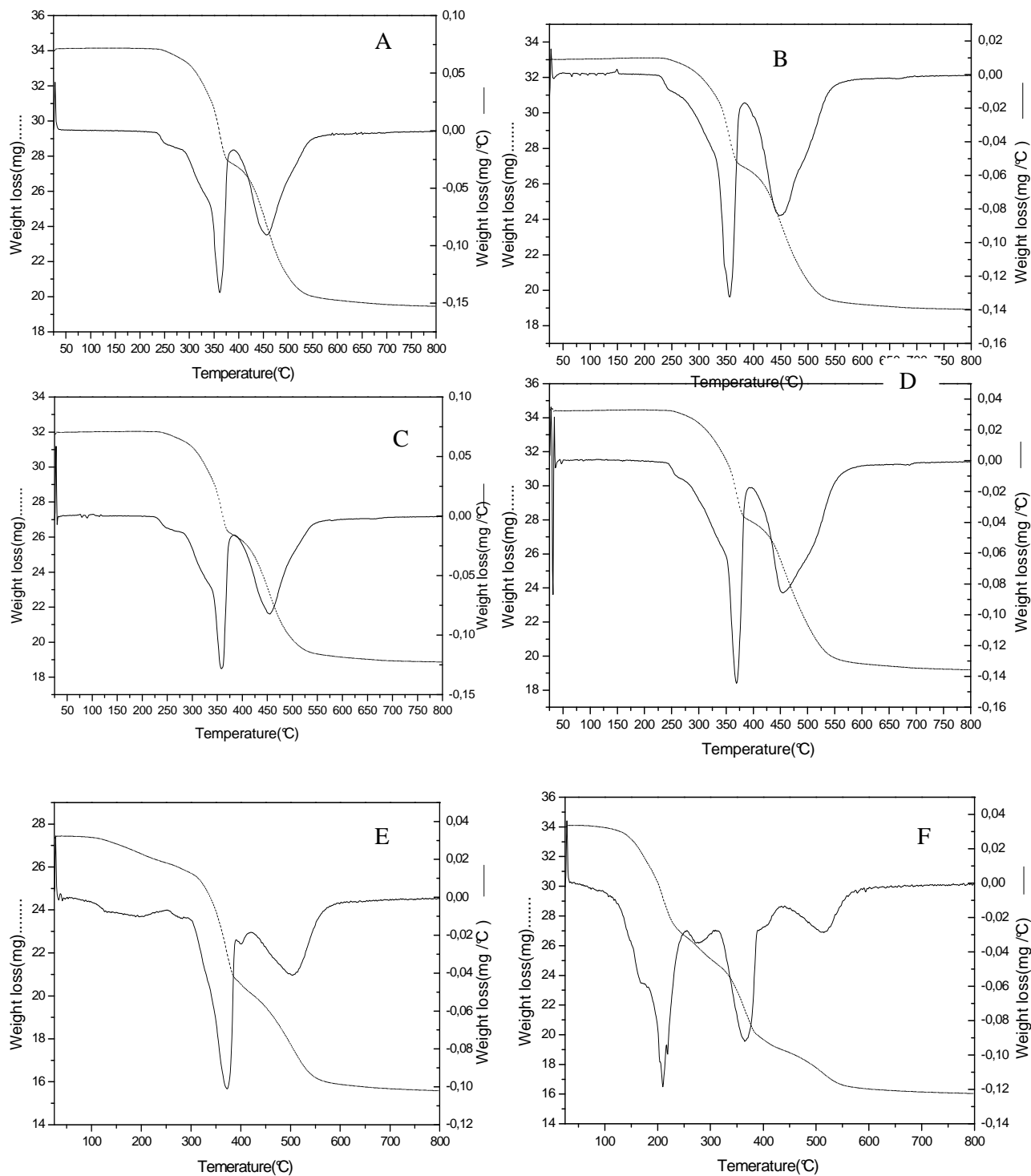

Fig. 7. TGA of silicone rubber before and after ageings (weight loss and derivate curves); A– Unaged sample; B– 10 000 hours in photochemical device; C– 10 000 hours in oven; D–260 hours under sulfuric acid treatment; E– 48 hours under nitric acid treatment; F– 2 months under nitric acid treatment.

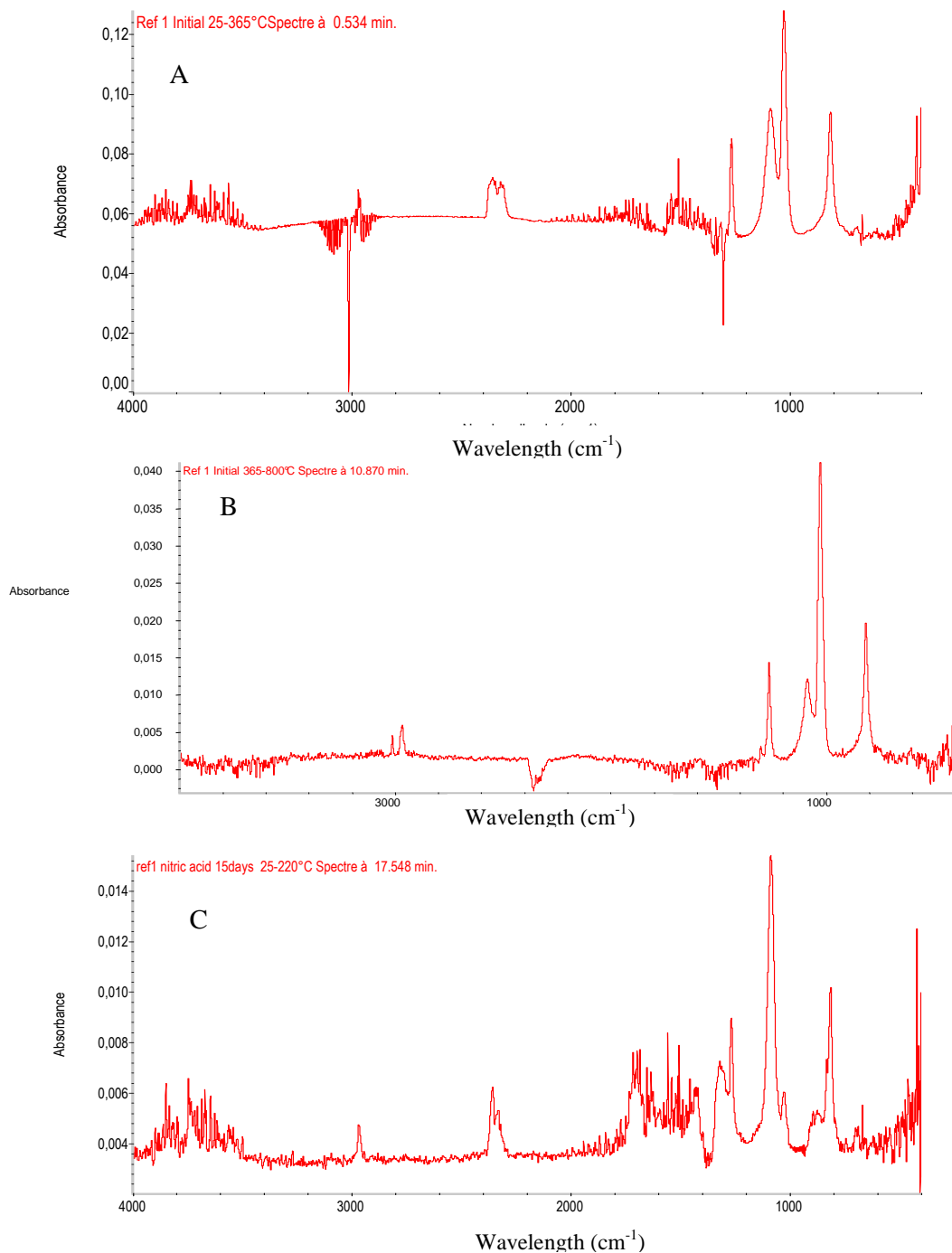

Fig. 8. FTIR results on gaz coming from TGA

A– First part (360°C) for unaged sample; B– Second part (450°C) for unaged material;
 C– New bands for the sample under nitric acid treatment (15 days).

The TGA curves obtained after a thermal decomposition from 20°C to 800°C by 10°C/min under oxygen allowed us to compare the thermal stability of silicone rubber

after various ageings (figure 7). The curve 7A with the weight loss shows the decomposition of unaged filled cross-linked sample, which starts at 250°C, due to $\text{Al}(\text{OH})_3$ deshydration. We can mainly notice two peaks (derivative curve) with two stages of decomposition (endset temperatures 360 and 450°C). We get the same results after different times under photochemical, thermal ageings and exposure to sulphuric acid vapours (curves B, C and D). It means that post cross-linking or chain scission occurred upon ageing and detected with other techniques, does not affect the thermal stability of silicone material. The first IR spectra of the gas coming from the degradation show main bands attributed to H_2O and CO_2 . Then new bands of siloxane oligomers at 1260, 1090, 1030, and 790 cm^{-1} are detected (figures 8A and B). The two peaks at 360°C and 450°C show the presence of several siloxane oligomers. The presence of H_2O and CO_2 decreases upon the degradation after 360°C is also noticed for the last part of decomposition. Its assignment was not successful. The thermal oxidative decomposition after nitric acid treatment is quite different and depends on the time of exposure. After 48 hours in HNO_3 vapours the weight loss starts at 150°C (figure 7E). This means that the thermal stability of the formulation is weaker compared to other ageings. The main peak on derivative curve gives an endset temperature at 360°C. We underline also the presence of a peak around 500°C. After 7 days the weight loss for the first peak at 150-200°C increases (figure 7F). The second peak intensity at 360°C decreases. We can always observe the peak at 500°C. The IR spectra allow to detect the presence of H_2O and CO_2 and new siloxane oligomers bands (figure 8C). A new band at 1380 cm^{-1} of strong intensity is also noticed for the last part of decomposition. Its assignment was not successful.

Conclusion

This work confirms the stability towards oxidation upon accelerated ageings of filled cross-linked silicone rubber. Changes in the IR spectra could not be detected even after 10000 hours in UV device or oven. The presence of aluminium trihydrate in the formulation is clearly identified to be a problem in terms of long term behaviour after nitric acid treatment. Post cross-linking and chain scission reactions are revealed by hardness measurements and DSC-thermoporosimetry after usual ageings (photochemical, thermal) and exposures to acidic vapours. The main path of degradation (chain scission or cross-linking) depends on the ageing. To avoid this degradation process stabilizers should be tested in such formulation. TGA-FTIR results

allow us to compare the thermal stability of silicone rubber after various ageings. The thermal decomposition of samples after nitric acid treatment is quite different from the degradation obtained for unaged material or other aged rubbers.

The studied formulation gives satisfactory results towards usual ageings (an induction period is identified). In the case of polluted ageing (with HNO₃) we need to do some improvements by adding specific stabilizer or removing the actual fire retardant. In this paper we have also tried to highlight the choice of techniques and the complementary nature of each.

Experimental part

Materials

Silicone rubber (HTV – High Temperature Vulcanized) is polydimethylsiloxane kindly provided by SEDIVER, France. The composition of the filled cross-linked PDMS is given in Table 2. The presence of silica can be noticed. The curing agent is 2,5 dimethyl 2,5 di(t-butylperoxy) hexane (DHBP).

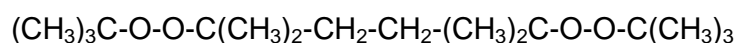

The formulation contains a flame retardant which is aluminium trihydrate. Thick 2 mm sheets were prepared for the ageing and the characterization. The curing time by compression moulding at 170°C was 12 minutes; this time corresponds to the usual optimal curing conditions. Sulphuric acid (95%), nitric acid (68%) and sodium chloride were products coming from Prolabo (VWR). We also used a crude hydroxy terminated PDMS coming from Scientific Polymer Products (Sp²). This sample is reference 870 with a molecular weight of 90,000 g/mol (GPC).

Tab. 2. Composition of filled cross-linked PDMS

Composition	Quantity
PDMS	100 parts
Silica	23 parts
Alumina Trihydrate	80 parts
DHBP	0.4 part

Ageings

Five types of ageing were tested for comparison. An accelerated classical photoageing was performed directly on the silicone rubber sheets. The irradiation device (SEPAP 12-24) has been described previously [23]. The system is characterised by the source, medium pressure Hg lamps filtered with borosilicate envelope ($\lambda > 300$ nm) and by

careful control of the temperature with a thermocouple in close contact with one of the samples. Samples are rotated at a constant distance (20 cm) from the sources. The samples were irradiated at 60°C in a SEPAP chamber equipped with four lamps.

We used an aerated oven (MEMMERT) for thermal exposure at 100°C. The other ageing was salt-fog test usually used for metallic materials (H. KOHLER – HK 320). The conditions of this test were the concentration of NaCl (5% weight) and the temperature at 35°C. We finally used dessicators to carry out polluted ageings, such as nitric acid vapours or sulphuric acid vapours at room temperature.

Analytical tools

The chemical changes upon irradiation were followed by FTIR-ATR spectroscopy (Attenuated Total Reflectance - Nicolet Impact 400 and Thunderdome accessory with germanium crystal). With this reflection analysis we can operate on thick sheets (for example cross-linked and coloured polymers). We analyse the material surface upto a few micrometers.

Hardness measurements were done with a Zwick Werk (NR 83195) – Shore A (weight 1 kg) system on polymer sheets before and after ageings. Ten measurements were made and an average value was then given.

The evolution of cross-linking is followed by DSC-thermoporosimetry. It is a calorimetrical technique used for the visualization of the material texture by studying the phase transition (crystallization, melting or other change of state) undergone by the swelling solvent (cyclohexane) trapped in the polymeric network. The transition temperature of this confined solvent depends on the characterisation of the surrounding polymeric swollen network. The thermoporosimetry has essentially been applied to rigid porous substrates [24, 25]. The theoretical basis was established by Brun *et al.* [24]. It is assumed that a polymeric gel is equivalent to a three dimensional network of adjacent cells that is called mesh. The solvent swells the crosslinked polymer until equilibrium state is reached. It yields to a swollen gel where the solvent is present under two environments : the confined solvent which is trapped inside the gel and the part of solvent which remains out and represents the excess (free solvent). The free solvent behaves like a pure solvent in term of phase transitions. On the other hand the confined solvent undergoes the phase transitions at different temperatures depending on the characteristics of surrounding polymeric network and especially depending on the size of the network mesh. The difference in the transition temperature ΔT between free and confined solvent can be related to the size of the mesh for elastomers. Differential

Scanning Calorimetry can be used to measure ΔT precisely. Calibration have been done for obtaining useful thermodynamical data from the solid to solid cyclohexane transition [26]. The following empirical relationships have been established :

$$R(A) = 16.93 + 125.43 * \exp\left(-\frac{1/\Delta T + 0.0756}{0.0205}\right) \text{ with } -55 \leq \Delta T \leq 0^\circ C \text{ for cyclohexane (1)}$$

$$\frac{dV}{dR} = K \frac{y * (\Delta T)^2}{Wa * \exp\left(-\frac{1/\Delta T + 0.0756}{0.0205}\right)} \quad (2)$$

$$Wa(J / g) = 0.0203 * (\Delta T)^2 + 2.6034 * \Delta T + 82.199 \text{ with } 0 > \Delta T > -55^\circ C \quad (3)$$

where $R(\text{\AA})$ is the distance between cross-links in the swollen gel, expressed in *Angstrom* and $\Delta T = T - T_0$, the temperature depression of the swelling solvent determined from the thermal DCS curve with $T_0 = -88.63^\circ C$ for cyclohexane.

V is the volume of the solvent concerned by the thermal transition and contained in network cells, R is the distance between cross-links, K is a proportionality coefficient that depends on both the DSC instrument and the swelling solvent, y is the DSC thermal curve ordinate and Wa the apparent energy of the solid-solid transition. DSC instrument is a METTLER TOLEDO DSC 30 used from $-88^\circ C$ to $-106^\circ C$ at $0.7^\circ C/\text{min}$ to see the crystalline solid-solid transition. A cryogenic microtome LEICA Jung Supercut LN20 was used at $-50^\circ C$ to cut the 2 mm sheets into small slices of $180 \mu\text{m}$ thick.

Other results were obtained with a coupled equipment TGA-FTIR (METTLER TOLEDO TGA/SDTA851 – NICOLET Nexus). Gas coming from TGA is transferred with a heating tube in a gas cell and characterized by FTIR. The temperature method was a dynamic segment from 20 to $800^\circ C$ by $10^\circ C/\text{minute}$ under oxygen ($40\text{ml}/\text{min}$). The IR experiments were done every minute during all the thermogravimetric program.

Acknowledgements: This work has been supported by the Indo-French Centre for the Promotion of Advanced Research (IFCPAR) through project 7104. Thanks to E. Brocard and G. Thevenet from SEDIVER, France for their advices.

References

- [1] Israëlî Y, Philippart JL, Cavezzan J, Lacoste J and Lemaire J.; *Polym. Degrad. Stab.* **1992**, 36, 179-185
- [2] Israëlî Y, Cavezzan J and Lacoste J.; *Polym. Degrad. Stab.* **1992**, 37, 201-208

- [3] Israël Y, Lacoste J, Cavezzan J and Lemaire J.; *Polym Degrad Stab* **1993**, 42, 267-279
- [4] Israeli Y, Lacoste J, Cavezzan J and Lemaire J.; *Polym Degrad Stab* **1995**; 47: 357-362
- [5] Grassie N, Francey KF, Macfarlane IG.; *Polym Degrad Stab* **1980**, 2, 67-83
- [6] Camino G, Lomakin SM, Lazzari M.; *Polymer* **2001**, 42, 2395-2402
- [7] Camino G, Lomakin SM, Lazzari M.; *Polymer* **2002**, 43, 2011-2015
- [8] Virlogeux F, Bianchini D, Delor-Jestin F, Baba M and Lacoste J.; *Polymer International* **2004**, 53,163-168
- [9] Zeldin M, Qian BR and Choi SJ.; *J. Polym. Sci. - Polym. Chem. Ed.* **1983**, 21, 1361-1369
- [10] Hillborg H, Sandeli M, Gedde UW.; *Polymer* **2001**; 42, 7349-7362
- [11] Hillborg H and Gedde UW.; *IEEE Transactions on Dielectrics and Electr Insulation*; **Oct 1999** 6 (5), 703-717
- [12] Smith PJ, Owen MJ, Holm PH and Toskey GA.; *IEEE CEIDP 1992*; Annual report – Surface studies of corona-treated silicone.
- [13] Owen MJ, Gentle TM, Orbeck T and Williams DE. Dynamic wettability of hydrophobic polymers, *Polymer Surface Dynamics*, Ed JD Andrade - Plenum Press **1988**
- [14] Vlastos AE and Gubanski SM.; *IEEE Transactions on Power Delivery* April **1991**, 6(2), 888-900
- [15] Sorqvist T and Vlastos AE.; *IEEE Transactions on Power Delivery* April **1997**, 12(2), 1041-1047
- [16] Kim SH, Cherney EA, Hackam R and Rutherford KG.; *IEEE Transactions on Dielectrics and Electrical Insulation* Feb **1994**, 1(1), 106-123
- [17] Hackam R.; *IEEE Transactions on Power Delivery*; October **1999**, 6(5), 557-585
- [18] Homma H, Mirley CL, Ronzello J and Boggs SA.; *IEEE Transactions on Power Delivery* October **2000**, 15(4), 1298-1303
- [19] Fateh-Alavi K., Gallstedt M., Gedde UW.; *Polym. Degrad. Stab.* **2001**, 74: 49-57
- [20] Chaudhry AN, Billingham NC.; *Polym. Degrad. Stab.* **2001**, 73, 505-510
- [21] Patel M and Skinner AR.; *Polym. Degrad. Stab.* **2001**, 73, 399-402
- [22] Zhang J, Feng S and Ma Q.; *J. Applied Polym. Science* **2003**, 89, 1548-1554
- [23] Penot G, Arnaud R, Lemaire J.; *Die Angew. Makromol. Chem.* **1992**, 30, 493-499
- [24] Quinson JF, Astier M and Brun M.; *Applied catalysis* **1987**, 30, 123-127
- [25] Liu J, Gan LM, Chew CH and Teo WK.; *Langmuir* **1997**, 13, 6421-6425
- [26] Baba M., Nedellec JM., Gardette JL., Lacoste J.; *Journal of non-crystalline solids* Jan **2003**, 31(3), 228-238
- [27] Socrates G.; *IR and Raman characteristics group frequencies 3rd Edition* Wiley **2001**, 244

Cross-linking assessment after accelerated ageings of ethylene propylene diene monomer rubber

Abstract: The ageing of filled and cross-linked ethylene propylene diene elastomer (EPDM) is studied under accelerated UV irradiation ($\lambda \geq 290$ nm) at 60°C, thermal ageing at 100°C and in nitric acid vapours for different time intervals. Hardness measurements are given. DSC-thermoporosimetry was used to estimate the mesh size distribution and cross-linking densities for each ageing. The development of new functional groups was monitored by ATR spectroscopy. An increase in oxidation with exposure time after the different types of ageing was observed. The thermal stability of EPDM was assessed by TGA and evolved volatile gases were identified using FTIR spectroscopy.

N.S.Tomer, F. Delor-Jestin, R.P. Singh and J. Lacoste

1 INTRODUCTION

Polymer materials such as Ethylene propylene diene monomer (EPDM) have been used for outdoor use since many years. They have advantages of light weight, good vandalism resistance and better contamination performance. However polymeric materials are prone to chemical changes. These changes may adversely affect the reliability and long term performance of the materials used for outdoor use thus limiting their service life. A comparison of the results from different artificial accelerated ageings such as thermal, photochemical and acid pollution may provide a guide line for degradation prevention of these materials and thus help in increasing its life time.

Pure EPDM should not in principle be degraded by UV light of wavelength >290 nm, as UV is not absorbed by C-C or C-H bonds and hence cannot cause direct cleavage of the polymer backbone or saturated diene crosslinks. However, experience shows that EPDM is degraded by UV, and this has been attributed to the presence of impurities at the time of manufacture which are able to absorb UV light and thereby initiate the degradation process [1]. The typical degradation scheme thought responsible for oxidation of polyolefinic polymer proceeds as follows: UV is absorbed by chromophoric impurities present at the time of manufacture, which degrade to produce free radicals. The free radicals attack the polymer backbone in the presence of oxygen and cause bond scission, introducing further UV absorbing impurities such as peroxides and carbonyl into the polymer. When oxygen is not readily available such as in the bulk, the free radicals can initiate cross-linking between the polymer chains. Sources of initiating

impurities are carbonyl and peroxides produced during processing at high temperatures, or from polymerization process such as catalyst residues.

It has been observed that materials undergoing chain scission produce surface cracking [2]. Chain scission may continue to such an extent that polymer is lost exposing the underlying filler material, creating a chalky appearance, and increasing surface wettability. The horizontal attenuated total reflectance (HATR) accessory equipped with a germanium crystal has been used previously for the analysis of photo and thermal oxidations of EPDM [3]. Generally oxidation (thermal or photo-induced) of EPDM starts by production of hydroperoxides and at later stages unsaturated and saturated carboxylic acids, ketones and alcohols are formed [4]. It has been observed that independent of the presence of environmental pollutants, brittle fracture of suspension composite insulators is caused by nitric acid formed through corona discharges [5] hence, we have studied the effect of nitric acid pollution on our material.

In this paper we have focussed our study on filled cross-linked EPDM using different analytical techniques such as TGA coupled with FTIR spectroscopy, hardness measurements, ATR, DSC to evaluate the polymer long term behaviour upon different types of ageings. We present DSC-thermoporosimetry results for the estimation of cross-linking level after photochemical and thermal ageing. We will compare the competitive ways of degradation such as oxidation, post cross-linking and chain scission for each ageing.

2 EXPERIMENTAL

2-1 Materials:

The cross-linked filled EPDM we used for our studies was supplied by Sediver, France. It contains aluminium trihydrate (ATH) as filler, plasticizers, a peroxide, and an agent for stabilization. Nitric acid (68%) was bought from Prolabo (VWR). The composition is given in Table 1.

Composition	Quantity
EPDM	100 parts
Plasticizer	40 parts
Aluminium Trihydrate	240 parts
Additives	5 parts
Dicumyl Peroxide	6 parts

Table 1: Composition of filled cross-linked EPDM

2-2- Ageings:

Three types of ageing were tested for comparison. Firstly we used the classical accelerated photochemical ageing. Sheets of EPDM were used directly for irradiation and most of analysis. The irradiation device (SEPAP 12-24) has been described previously [6]. The system is characterised by the source, medium pressure Hg lamps filtered with borosilicate envelope ($\lambda > 300$ nm) and by careful control of the temperature with a thermocouple in close contact with one of the samples. Samples are rotated at a constant distance (20 cm) from the sources. The samples were irradiated at 60°C in a SEPAP chamber equipped with four lamps. For the next type of ageing we used an aerated oven (MEMMERT) for thermal exposure at 100°C. Lastly we used “laboratory dessicators” to carry out ageing by nitric acid vapours at room temperature.

2-3- Analytical tools

The chemical changes upon irradiation were followed by ATR-FTIR spectroscopy (Attenuated Total Reflectance-Nicolet Impact 400 and Thunderdome accessory with germanium crystal). With this analysis we can operate on thick sheets (for example cross-linked and coloured polymers). We analyse the material surface on a few micrometers.

Hardness measurements were done with a Zwick Werk (NR 83195) – Shore A (weight 1 kg) system on polymer sheets before and after ageings. Ten measurements were made and an average value was then given.

The evolution of cross-linking is followed by DSC-thermoporosimetry. It is a calorimetric technique used for the visualization of the material texture by studying the phase transition (crystallization, melting or other change of state) undergone by the swelling solvent (cyclohexane) trapped in the polymeric network. The transition temperature of this confined solvent depends on the characterisation of the surrounding polymeric swollen network. The thermoporosimetry has essentially been applied to rigid porous substrates [7, 8]. The theoretical basis was established by Brun and co-workers [7]. It is assumed that a polymeric gel is equivalent to a three dimensional network of adjacent cells that will be called mesh. The solvent swells the crosslinked polymer until equilibrium state is reached. It yields to a swollen gel where the solvent is present under two environments: the confined solvent which is trapped inside the gel and the part of solvent which remains out and represents the excess (free solvent). The free solvent behaves like a pure solvent in term of phase transitions. On the other hand the confined solvent undergoes the phase transitions at different temperatures depending on the characteristics of surrounding polymeric network and especially depending on the size of the network mesh.

The difference in the transition temperature ΔT between free and confined solvent can be related to the size of the mesh for elastomers. Differential Scanning Calorimetry can be used to measure ΔT precisely. Calibrations have been done for obtaining useful thermodynamical data from the solid to solid cyclohexane transition [9]. The following empirical relationships have been established:

$$R(\text{\AA}) = 16.93 + 125.43 * \exp\left(-\frac{1/\Delta T + 0.0756}{0.0205}\right) \text{ with } -55 \leq \Delta T \leq 0^\circ\text{C for cyclohexane (1)}$$

$$\frac{dV}{dR} = K \frac{y * (\Delta T)^2}{Wa * \exp\left(-\frac{1/\Delta T + 0.0756}{0.0205}\right)} \quad (2)$$

$$Wa(\text{J/g}) = 0.0203 * (\Delta T)^2 + 2.6034 * \Delta T + 82.199 \text{ with } 0 > \Delta T > -55^\circ\text{C (3)}$$

Where R (\AA) is the distance between cross links in the swollen gel, expressed in Angstrom and $\Delta T = T - T_0$, the temperature depression of the swelling solvent determined from the thermal DCS curve with $T_0 = -88.63^\circ\text{C}$ for cyclohexane. V is the volume of the solvent concerned by the thermal transition and contained in network cells, R is the distance between cross links, K is a proportionality coefficient that depends on both the DSC instrument and the swelling solvent, y is the DSC thermal curve ordinate and Wa the apparent energy of the solid-solid transition. DSC instrument is a Mettler Toledo DSC 30 used from -88°C to -106°C at $0.7^\circ\text{C}/\text{min}$ to see the crystalline solid-solid transition. A cryogenic microtome LEICA Jung Super cut LN20 was used at -50°C to cut the 2 mm sheets into small slices of $180\ \mu\text{m}$ thick.

The last technique used was thermogravimetric analysis (TGA) coupled with FTIR. The equipment is TGA-FTIR (Mettler Toledo TGA/SDT A851 – Nicolet Nexus). The gases coming from TGA are transferred with a heating tube in a gas cell and characterized by FTIR. The temperature method was a dynamic segment from 25 to 800°C at $20^\circ\text{C}/\text{minute}$ under oxygen ($40\text{ml}/\text{min}$). The IR experiments were done every minute during the entire thermogravimetric program.

3 RESULTS AND DISCUSSION

3-1- Hardness measurements:

The hardness measurement results are given in figure 1. Hardness measurements on the initial material gave an average value of 72.0 (+/- 2.1) Shore A. During ageing the samples became harder on their surface layers. After photochemical and thermal ageing the evolution of hardness values was quite weak for the first 500 hours. Photochemical ageing shows an average stable value of 80 Shore A (+/- 2.1) after about 2000 hours of irradiation, while thermal ageing shows an average stable value of 78 Shore A (+/- 2.1) after 2500 hours of exposure. The surface is harder because the polymer chains cannot explore different configurations during constraint and are less flexible, hence the material is more cross-linked. The hardness values quickly increased after acid vapour exposure without any induction period and gave a value of 86 Shore A (+/- 1.9) after 800 hours of exposure. This specific evolution in acid vapour maybe due to the presence of ATH. Aluminium nitrate is created and detected with IR spectroscopy in the presence of ATH and nitric acid (see 3-3). The evolution towards hardness is more accelerated after photo ageing as compared to thermal ageing. The results show that post cross-linking reactions occur upon usual ageing such as UV and thermal exposures.

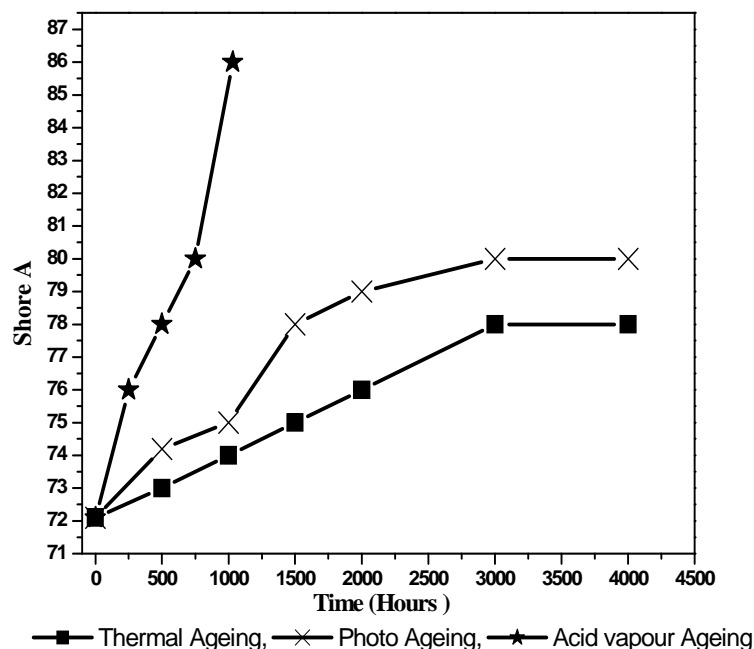

Figure 1: Hardness measurements after different ageings

3-2 DSC-thermoporosimetry results:

The samples were cut into 180 μm thick slices the top surface layer was used for characterization for thermoporosimetry. Fig 2 shows the DSC curves for EPDM samples swollen in cyclohexane for 48 hours after photo ageing. For each sample two peaks are observed, the first larger peak indicates the transition for the free excess solvent and the second smaller peak towards the lower temperature indicates the confined cyclohexane inside the polymer. The peak of the confined solvent shifts towards the lower temperature upon irradiation. This behaviour indicates that the size of the pore is reducing upon ageing hence the solvent is taking a longer time for crystallization. We have seen a similar shift towards lower temperature of the confined solvent with samples swollen after thermal ageing.

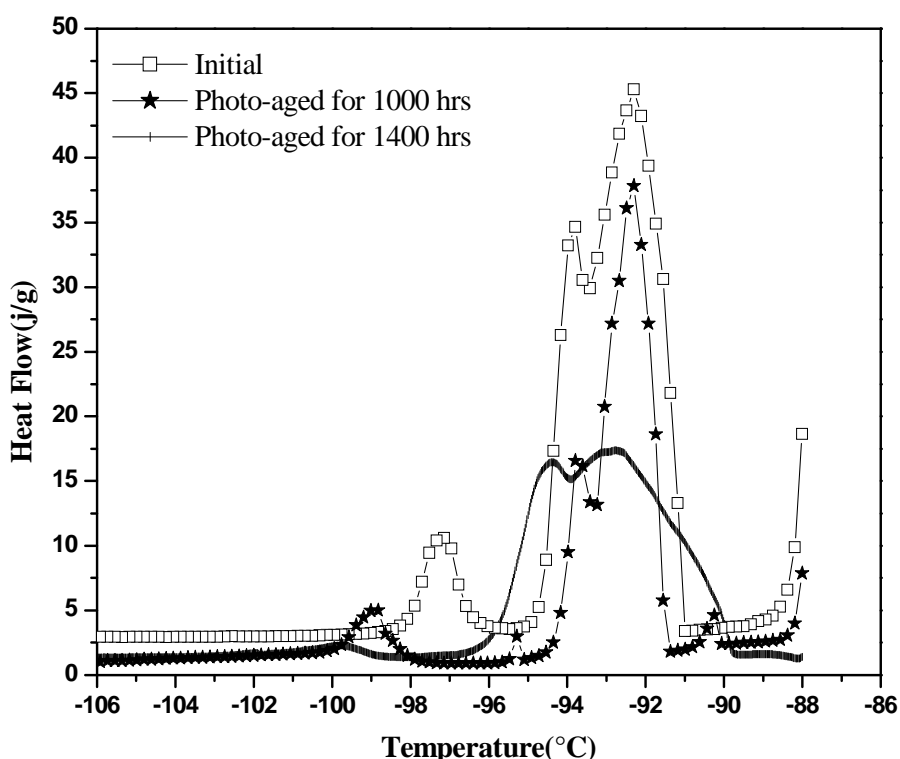

Figure 2: DSC curves for cyclohexane confined in the crosslinked EPDM samples after photo-ageing in SEPAP for different time intervals

To estimate the cross-linking densities and to explain other structural changes upon degradation, DSC-thermoporosimetry measurements were carried out. We can see in fig 3 and 4 the initial unaged material (already peroxide cross-linked) has a mesh size distribution with a pore radius

around 400 Å. If we consider the average distance between 2 carbon atoms (1.54 Å), molar mass between cross-links will be around 12,000 g/mol.

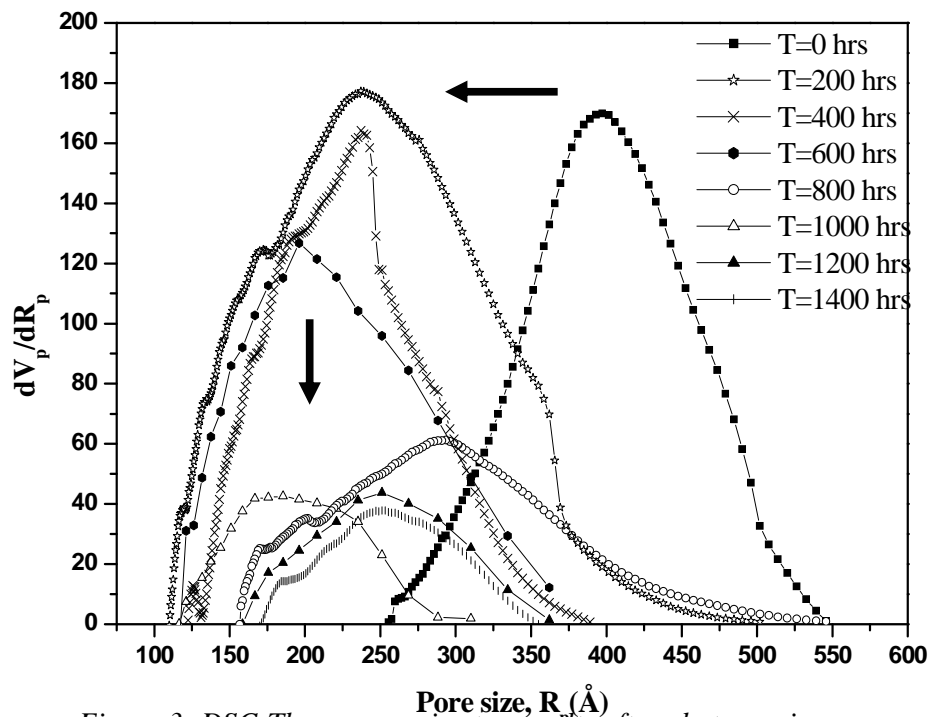

Figure 3: DSC-Thermoporosimetry results after photo-aging

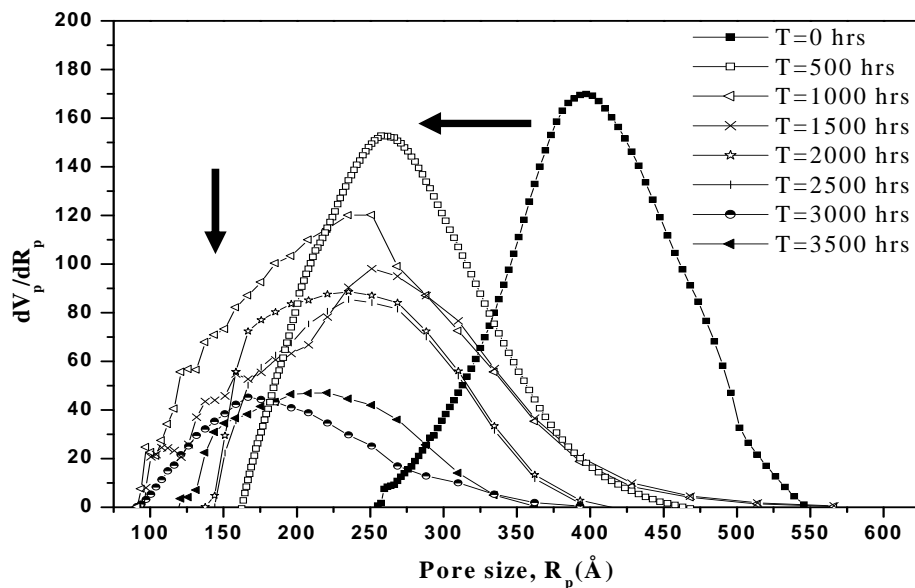

Figure 4: DSC-Thermoporosimetry results after thermal aging

After photochemical and thermal ageings we obtained different distributions. There is a decrease in pore size distribution with an increase in the irradiation time, we can also see that the pore size radius is shifted towards 250Å. This indicates there is cross-linking leading to a decrease in the widths of the meshes. Hence we can conclude that post cross-linking brings about densification of the network and a reduction in its pore size distribution. It was not possible to carry out thermoporosimetry for photo-aged samples after 1500 hrs of irradiation as the surface was hard and cracks started appearing on the surface. The reduction in the pore size distribution for the photo-aged samples was more rapid than the thermal aged samples.

3-3 ATR-IR results:

The ATR-IR spectrum was used to study the oxidation of the EPDM after the different types of ageing. The main bands seen in the initial unaged EPDM spectrum have been attributed in Table 2.

Wavenumber (cm ⁻¹)	Tentative assignment
3615, 3524, 3432, 3375	Al(OH) ₃
2920, 2848	CH ₃ symmetric and asymmetric (PE)
1457	CH ₃
1376	CH ₃
1259	CH
1016	Al-O
791	Al-O
728	Al-O
665	Al-O

Table 2: Main absorption observed for unaged filled uncross-linked EPDM and assignments of IR bands.

Figure 5 shows the ATR-IR spectra at initial time and after different times of photo-degradation at 60°C. The carbonyl region (1850 cm⁻¹ – 1550 cm⁻¹) showed several overlapping bands corresponding to carboxylic acid, ketone, ester and lactones. We noticed that oxidation of EPDM initiates after 24 hours of photo-irradiation. The carbonyl group generation increases with exposure time. There is a reduction in the intensity of the bands at 2920 cm⁻¹ and 2850 cm⁻¹ the asymmetric and symmetric stretching vibrations of methyl and methylene respectively, present in EPDM backbone. After 1300 hrs of exposure to light, cracks are developed on the surface of the sheets and the material becomes white in colour. There is a reduction in the intensity of the hydroxyl bands of the ATH after photo-ageing.

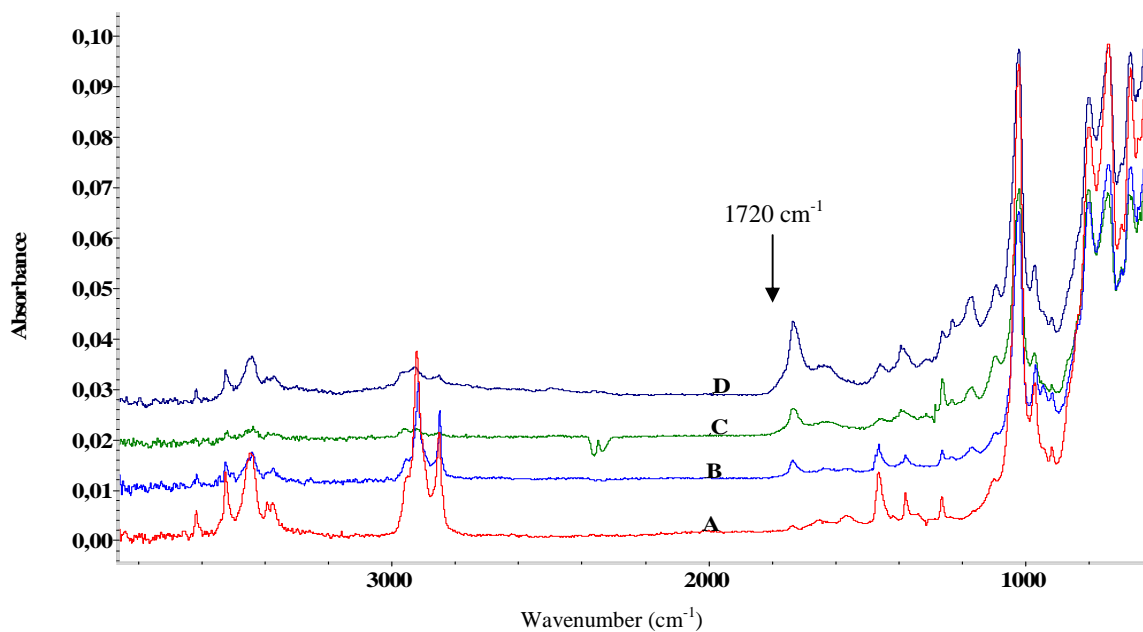

Figure 5: FTIR spectra of EPDM after photo-aging at 60°C (A=Initial, B = 24 hrs, C= 108 hrs, D= 600 hrs)

Similar changes were obtained in ATR-IR spectra after thermal ageing at 100°C (Figure 6) but the period of induction (500 hours) was more as compared to photo-aging (24 hours). There is no change in colour and cracking of surface of EPDM on thermal ageing for upto 5000 hours.

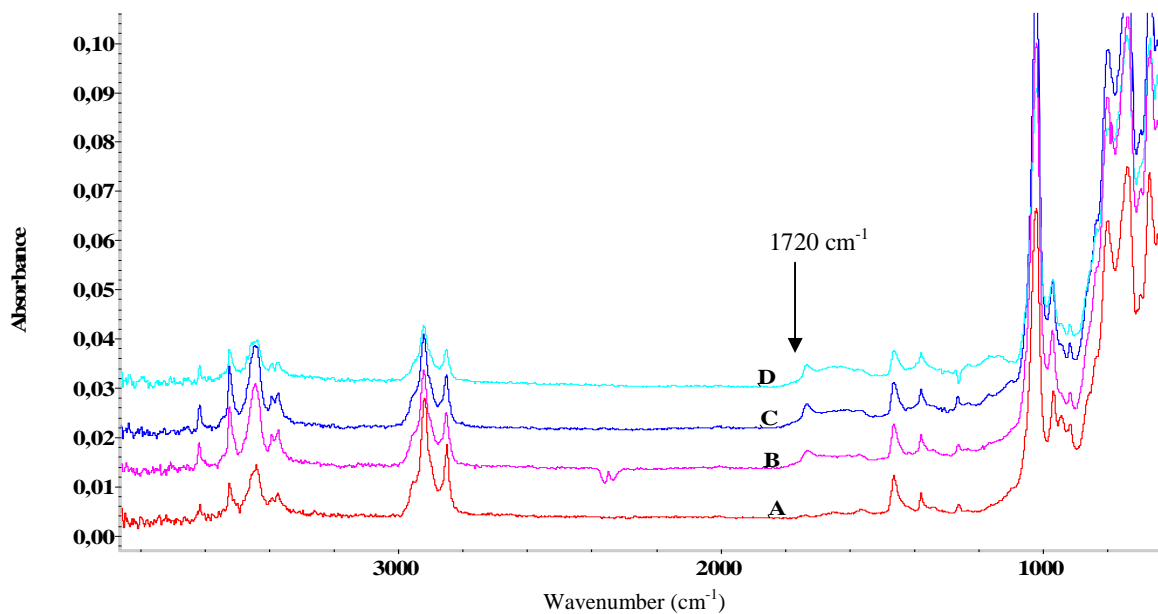

Figure 6: EPDM after thermal ageing at 100°C in oven (A= Initial, B= 1 hr, C = 3 hr and D= 24 hrs)

In Figure 7 the results of nitric acid exposure on EPDM are shown. The exposure of nitric acid vapours was very aggressive for EPDM rubber. The quick formation of the bands in the region 1700-1270 cm^{-1} were observed after few hours of this acid exposure. The filler $[\text{Al}(\text{OH})_3]$ of EPDM upon exposure to nitric acid vapour, reacts with its vapours and is transformed into nitrate $[\text{Al}(\text{NO}_3)_3]$. This reaction was previously described for polysiloxane filled with ATH [10].

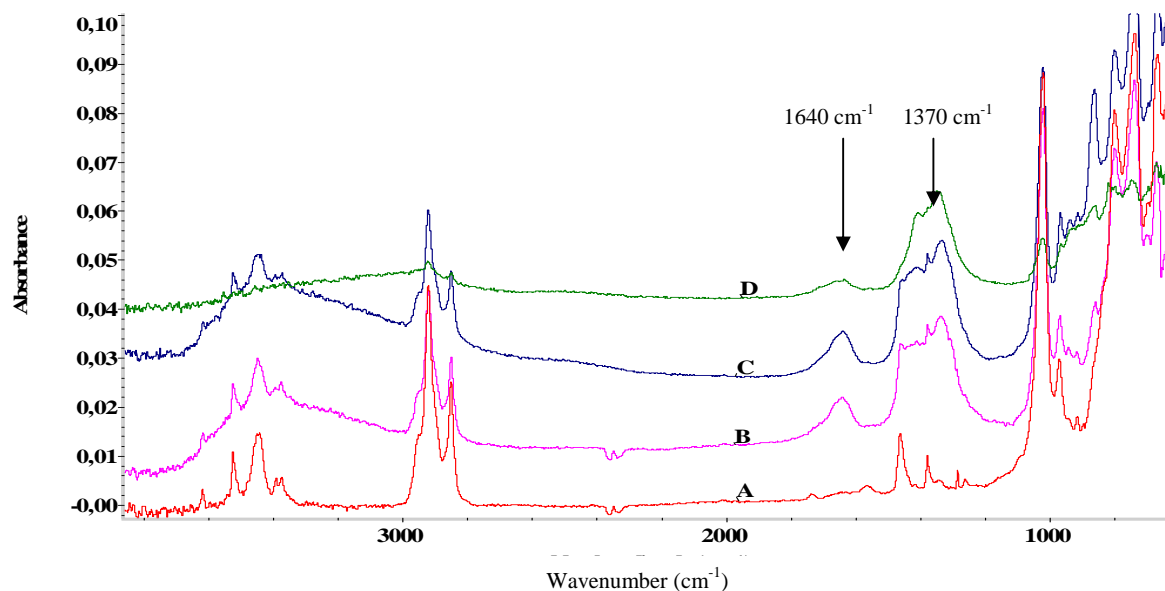

Figure 7: EPDM after nitric acid vapours exposure (A= Initial, B= 10 hr, C = 24 hr and D= 48 hrs)

3-4 TGA-FTIR:

The thermal stability of EPDM was assessed by TGA. The samples were heated from 25°C to 800°C at the rate of 20°C/min having a constant flow of oxygen gas. We observed the thermal degradation of EPDM occurs between 320°C and 500°C almost completely. From the derivative thermogravimetric curve we found the temperatures for maximum weight loss were 350°C and 475°C (Figure 8). There is a small amount of weight lost at 250°C due to the dehydration of the ATH filler used. There is no change in the thermal stability of EPDM after photo-ageing and thermal ageing for 5000 hours (Figure 9). However after nitric acid vapour exposure for 170 hrs there is a drastic change in the thermal stability of the material as the decomposition starts at 150°C. From the derivative of the thermogravimetric curve it is seen that maximum weight loss takes place at 150°C (Figure 10). This weight loss is perhaps due to decomposition of the filler ATH, hence the properties of the filler are strongly affected by the nitric acid vapours.

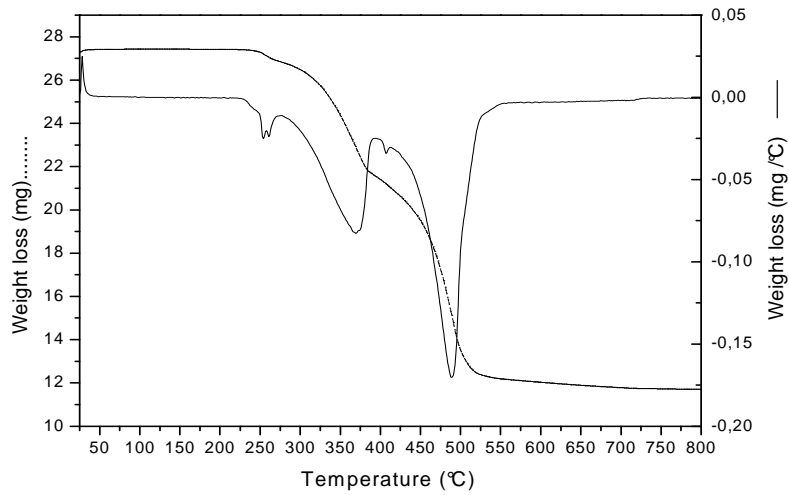

Figure 8: Figure 8: TGA and DTG results for initial EPDM under oxygen.

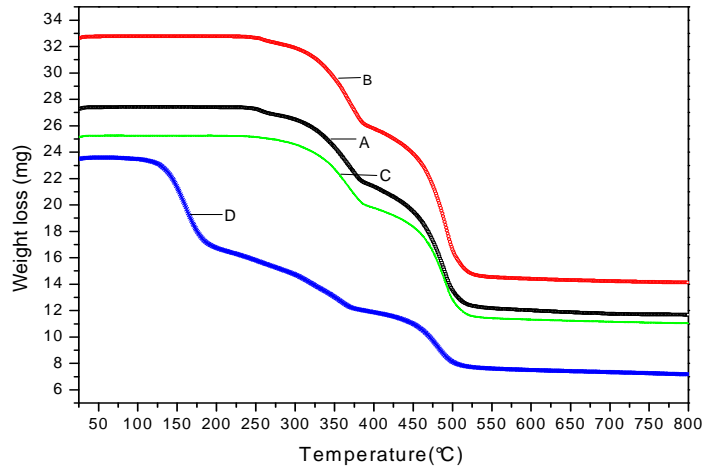

Figure 9: TGA results for EPDM (A= Initial, B= Thermal aged sample for 5000 hrs, C = Photo-aged sample for 5000 hrs, D= Nitric acid vapour aged sample for 170 hrs)

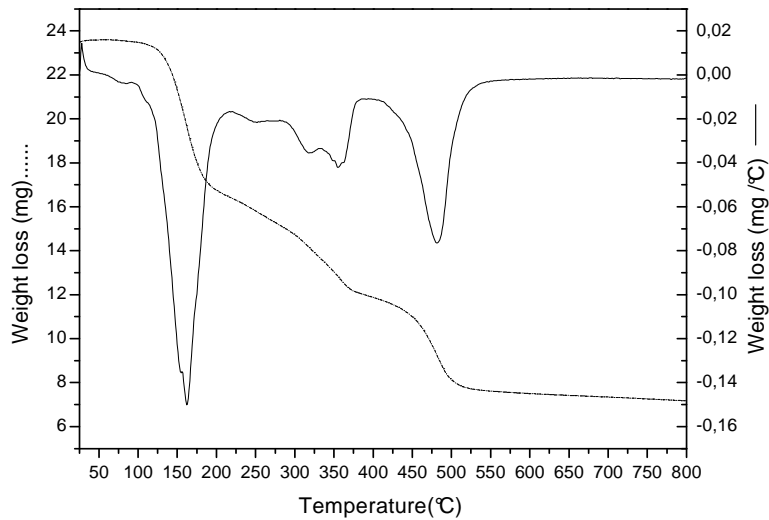

Figure 10: TGA and DTG results for Nitric acid vapour aged EPDM for 170 hrs

The gaseous products emitted from TGA are transferred through a heating tube in a gas cell and characterized by FTIR at an interval of one minute. During 25°C – 320°C the products passing were carbon dioxide and water due to the dehydration of ATH and combustion of small molecules (Figure 11).

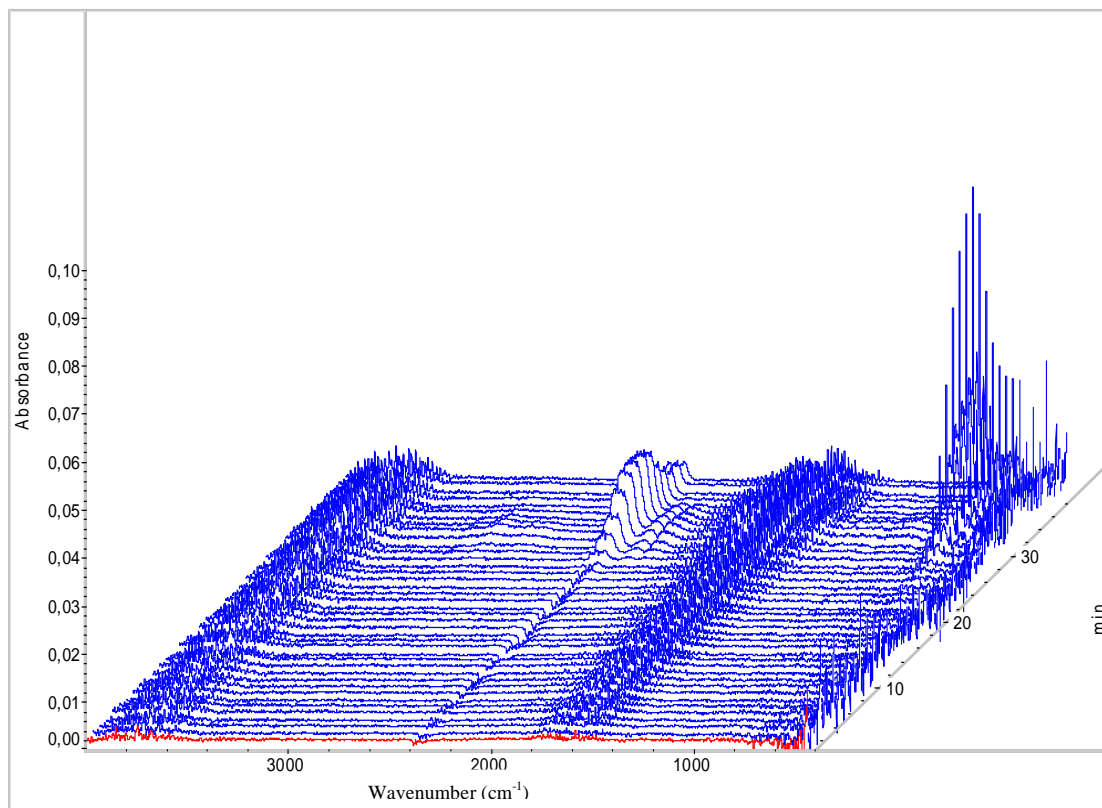

Figure 11: FTIR spectra of volatile products emitted during thermal degradation of EPDM (25°C-320°C at 1 min interval)

After 320°C there is an increase in the amount of carbon dioxide released (Figure 12). Cross-linking and chain scission reactions are occurring due to decomposition of the main chain. There is a mixture of gases passing after 320°C. The main products identified are carbon dioxide, water, carbon monoxide, methane, and ethane. The emission of these gases has been confirmed by gas chromatography during tracking degradation and pyrolysis of EPDM [11].

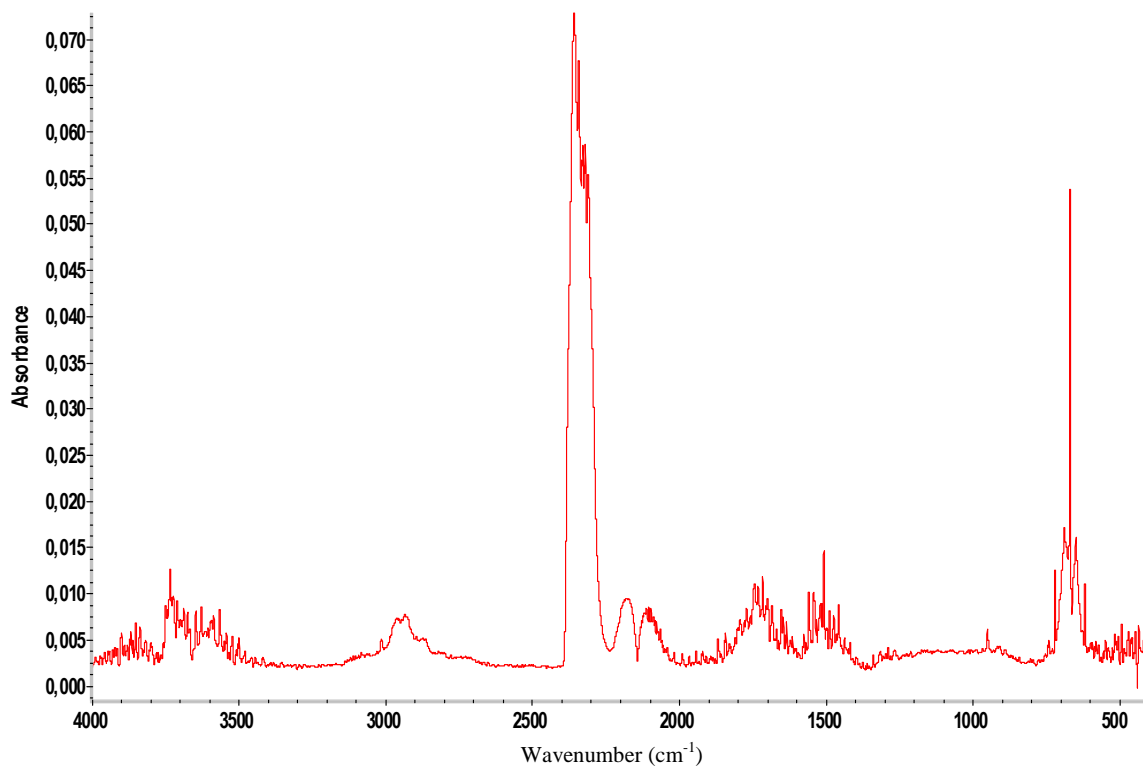

Figure 12: FTIR spectra of volatile products emitted during thermal degradation of EPDM at 450°C

Conclusion

The exposure of nitric acid vapours was very aggressive for filled/cross-linked EPDM rubber. The hardness values quickly increased after acid vapour exposure without any induction period. EPDM formulation was found to be more sensitive to accelerated photo-ageing as compared to thermal ageing at 100°C. From the thermoporosimetry results we can conclude that the cross-linking brings about densification of the network and a reduction in its pore size distribution. The reduction in the pore size distribution for the photo-aged samples was more rapid than the thermal aged samples. Cross-linking and oxidation reactions were predominant upon photo-ageing.

References

- [1] Dueck ER., Juliano VF., Guzzo MG., and DePaoli MA.; *Polym. Degrad. and Stab.*; 28; 235-248 ; 1990.
- [2] George GA.; *Materials Forum*; 19; 145-161; 1995.
- [3] Delor F., Barrois-Oudin N., Duteurtre X., Cardinet C., Lemaire J., and Lacoste J.; *Polym. Degrad. and Stab.*; 62; 395-401; 1998.

- [4] Delor F., Teissedre G., Baba M., and Lacoste J.; Polym. Degrad. and Stab.; 60 ; 321-331; 1998
- [5] Chughtai A., Smith D., and Kumosa M.; Composite Sci. Tech.; 58; 1641-1647; 1998.
- [6] Penot G., Arnaud R. and Lemaire J.; Die Angew. Makromol. Chem., 30; 493-499; 1992.
- [7] Quinson JF., Astier M., and Brun M.; Applied catalysis; 30; 123-127; 1987.
- [8] Liu J., Gan LM., Chew CH and Teo WK.; Langmuir; 13; 6421-25; 1997.
- [9] Baba M., Nedelec JM., Gardette JL., Lacoste J.; Journal of non-crystalline solids; 31; 3; 228-238; 2003.
- [10] Delor-Jestin, F.; Tomer, N.; Lacoste, J. e-Polymers, 2006, 013.
- [11] Nunes SP., Da costa RA., Barbosa SP., Almeida GR and Galembeck F., IEEE Trans. Electrical Insul.; 24; 1; 99-195; 1989.

Comparison of EPDM and Silicone Durability

Insulators materials fabricated from EPDM and silicone are normally qualified for outdoor use. However in the long term test (electrical ageing) silicone rubber composite insulator kept its good performance, while the performance of EPDM rubber deteriorated. The bonding energy of Si-O bond 443 KJ/mole is higher than that of C-C bond which is 356 KJ/mole for the in EPDM. This is one of the reasons for silicone having higher resistance to long term ageing as compared to EPDM. After lengthy exposure to intense discharges, silica (SiO_2) which is similar to glass and non conducting is produced on the surface of silicone rubber while on EPDM carbon is produced. Studies using X Ray Photoelectron spectroscopy (XPS) on silicone insulator rubber and EPDM rubber at $130\text{kV}_{\text{rms}}$ (phase to ground) in agricultural areas, showed that the content of carbon decreased and of oxygen increased on the surface of EPDM compared to the bulk, while in silicone rubber changes in these elements were not significant [84]. After outdoor exposure the evolution of composite insulators were different. In polluted areas the silicone insulators were drastically deteriorated while EPDM were good.

We observed no significant oxidation on the surface of PDMS rubber for 10,000 hrs of accelerated ageing (photochemical or thermal) by ATR-FTIR spectroscopy, but EPDM was sensitive to oxidation. The surface of silicone rubber was smooth after 10,000 hrs of ageing whereas cracks started to appear on EPDM surface after 1300 hrs of photo-ageing. The mechanism of degradation for silicone and EPDM upon photochemical or thermal ageing is quite different. The changes in pore size distribution measured by thermoporosimetry showed more rapid changes taking place for EPDM than silicone rubber. Post cross-linking appeared for both formulations. In our case the evolution upon classical artificial ageings is more significant for EPDM than for silicone.

After acid treatment we showed that the four samples were drastically deteriorated. EPDM was however more resistant than PDMS. A difference was observed for the three polysiloxanes. When the filler $\text{Al}(\text{OH})_3$ is treated with silane the behaviour towards nitric acid treatment is a little more satisfactory. The replacement of $\text{Al}(\text{OH})_3$ by $\text{Mg}(\text{OH})_2$ was investigated but was unsuccessful as the reaction kinetics under nitric acid vapour were the same for both of them.

The changes in hardness (Shore A) and thermal stability (TGA) for both the elastomers were comparable after photo, thermal and nitric acid ageing. Figure 1 shows the comparison of the four samples with hardness measurement after photochemical ageing in SEPAP. The

evolution of Reference 3 is lower, due to the specific treatment on filler. The evolution of hardness for EPDM is also weak.

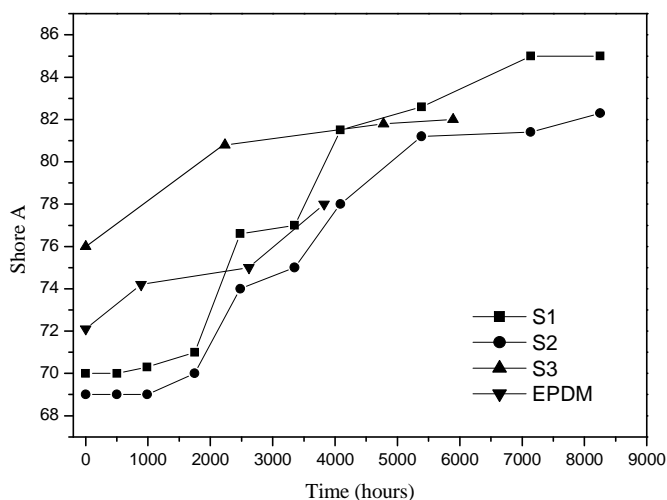

Figure2: Hardness measurement for silicones (Ref1, 2 and 3) and EPDM

Another artificial ageing was tested with ozone (This will be discussed in more detail in chapter 5 for polysiloxanes). There is an increase in the hardness of silicone rubber upon ozone ageing while there is no change in the hardness for EPDM. In Figure 2 we have shown the changes in the ATR-FTIR spectra upon ozone ageing at 200 ppm for 8 weeks. For the silicone rubber we observed formation of a new peak at 1650 cm^{-1} and decrease in the peak at 2958 cm^{-1} upon ageing. The band at 1650 cm^{-1} is not attributed. In the spectra of EPDM we observed formation of a 2 broad shoulders between 1300 cm^{-1} to 1800 cm^{-1} due to carbonyl products. There is a reduction in the intensity of the bands at 2920 cm^{-1} and 2850 cm^{-1} the asymmetric and symmetric stretching vibrations of methyl and methylene respectively, present in EPDM backbone upon ozone ageing. The reaction of ozone with double bonds is well known [60,61]. A specific reaction of ozone with additives of EPDM formulation explained the observed yellowing.

First results are presented after oxidized plasma treatment. These experiments were carried out in Laboratoire des Matériaux Inorganiques, UBP, Clermont-Ferrand. In Figure 3 we have shown the changes taking place upon plasma treatment in EPDM. The experimental conditions for plasma treatment of Silicone and EPDM are listed in Table 1.

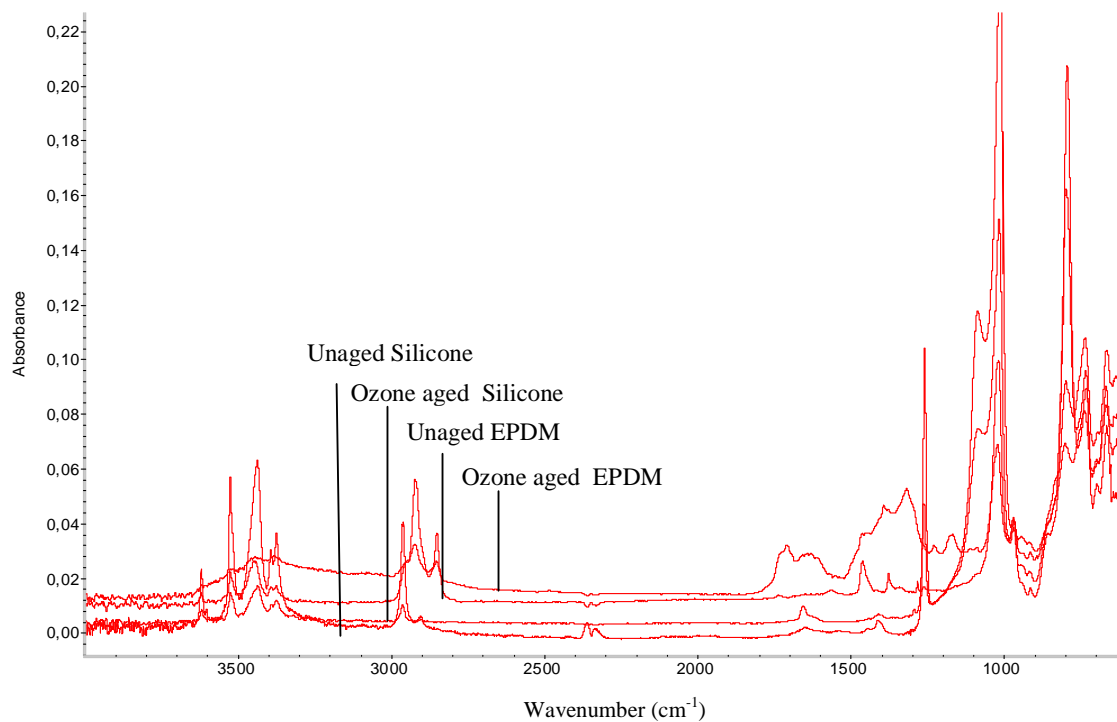

Figure 2: ATR-FTIR spectra after ozone ageing of silicone and EPDM

Expt. No.	Power(W)	Gas used	Pressure (mbar)	Time for treatment (mins)
1	450+ 350	Argon(20%) Oxygen(22%)	1.33×10^{-2}	20+25
2	400	Air	1.33×10^{-2}	45
3	400	Nitrogen(23%) Oxygen (20%) Argon (47%)	2.55×10^{-2}	130
4	400	Nitrogen(23%) Oxygen (20%) Argon (47%)	2.55×10^{-2}	255

Table 1: Experimental conditions for plasma treatment

The changes on the surface of EPDM in the ATR-FTIR spectra start to appear in experiment 1. As treatment time increases the absorption in the carbonyl region increases accompanied by a decrease in the absorption of the bands 2914 cm^{-1} and 2850 cm^{-1} the asymmetric and symmetric stretching vibrations of methyl and methylene respectively. The bands of the ATH filler are absent on the plasma treated EPDM.

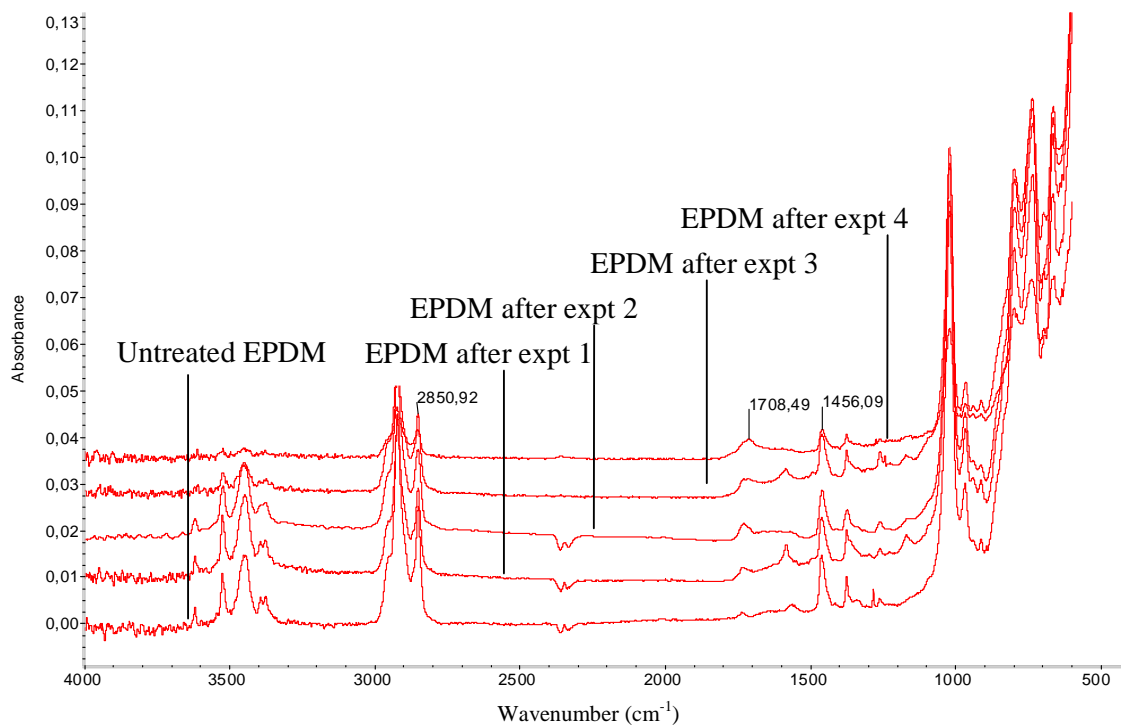

Figure 3: ATR-FTIR spectra of plasma treated EPDM

Plasma treatment for Silicone rubber showed a small evolution between 1400 and 1650 cm⁻¹ (figure 4). There is a decrease in the intensity of C-H stretching of the CH₃ group and the bands of ATH filler are absent on the treated samples.

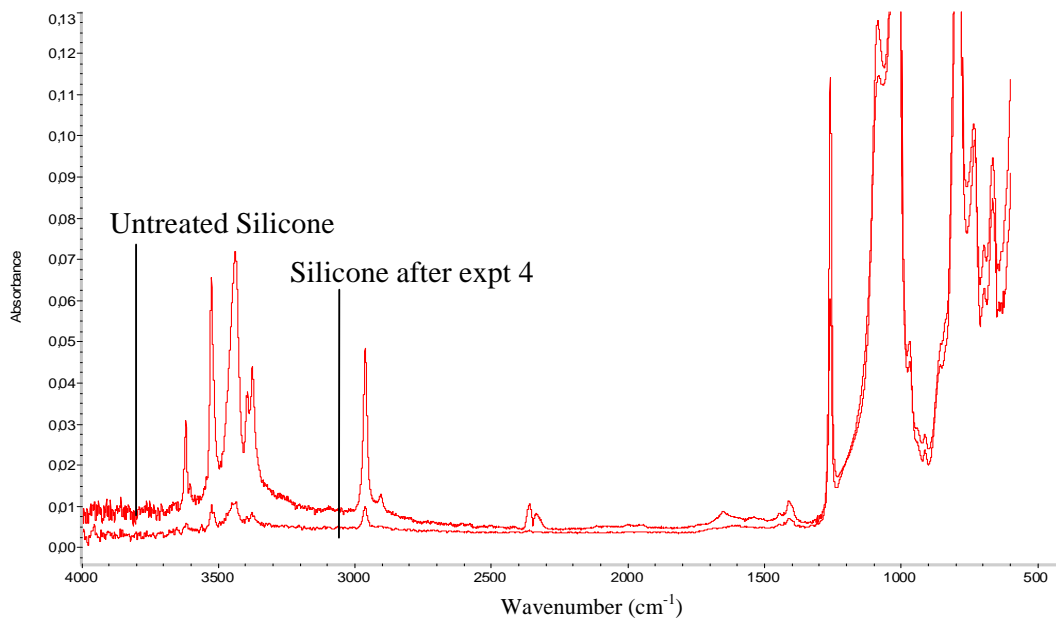

Figure 4: ATR-FTIR spectra of plasma aged Silicone

Silicone rubber has higher repellency than EPDM especially when aged. In silicone rubber there is migration of low molecular weight silicone from the bulk to the surface upon ageing making the surface hydrophobic [83]. On the other hand ageing of EPDM leads surface oxidation through chain scission. This creates polar groups and radicals on the surface making it hydrophilic. The use of plasma treatment was done for comparison with natural ageing later (in chapter 5).

The change in hydrophobicity was evaluated by measuring the contact angle between water drops and the surface of the modified samples using contact angle measurement instrument. The initial contact angle for Silicone was 110°, after thermal ageing at 100° for 5000 hrs it changed to 105° while after plasma experiment 4 it changed to 102°.

In table 2 we have then compared the permeability to water vapour of Silicone and EPDM after photo, thermal and nitric acid ageing. It is seen clearly that EPDM offers better protection to water permeation than silicone. The change in permeation after the various ageings was more in silicone as compared to EPDM. Hence in long term use EPDM will provide better protection to permeability of water to the core of the insulator and help in maintaining the useful properties.

References	Thickness (mm)	Water vapour 100% HR	Water vapour 90% HR
Unaged silicone	2.30	9.62	8.66
Unaged EPDM	2.16	0.49	0.44
Photo-aged silicone (1500 hrs)	2.16	6.39	5.75
Photo-aged EPDM (1500 hrs)	2.17	0.50	0.45
Thermal aged silicone (3000 hrs)	2.16	6.80	6.12
Thermal aged EPDM (3000 hrs)	2.23	0.41	0.37
Nitric acid vapour ageing (2 hrs)	2.30	9.55	8.60
Nitric acid vapour ageing (2 hrs)	2.16	0.55	0.50

Table 2: Coefficients of transmission of water vapour expressed in g/m²/24h

CHAPITRE 4

CONCLUSION

L'étude de formulations industrielles à base de polysiloxane ou d'Éthylène Propylène Diène Monomère (EPDM) a mis en évidence l'influence de différents paramètres sur le vieillissement. Nous avons comparé l'évolution des propriétés des différentes compositions afin de mettre en évidence l'influence des constituants et celle de la matrice polymère.

L'article "*Characterization of polydimethylsiloxane rubber upon photochemical, thermal, salt-fogs ageings and exposure to acid vapours*" a été accepté en novembre 2005 dans e-Polymers. Cette troisième publication donne une analyse détaillée de l'évolution chimique par spectroscopie IR-ATR, une évolution de la dureté, des changements au niveau de la densité de réticulation grâce à la technique de DSC couplée à la thermoporosimétrie et finalement une comparaison de la stabilité thermique en fonction des vieillissements envisagés (photochimique, thermique, brouillard salin et vapeur acide).

Les formulations à base PDMS sont peu sensibles aux vieillissements usuels (thermique et photochimique). Aucune oxydation n'est détectée après 10 000 heures d'exposition. Une sur-réticulation est cependant à noter. L'évolution sous brouillard salin est négligeable. En revanche ces matériaux sont très réactifs vis-à-vis de vapeurs d'acide nitrique. Une étude approfondie a montré que la défaillance du matériau est liée en particulier à la présence de trihydrate d'aluminium. Cette charge réagit avec les vapeurs d'acide nitrique. Une importante sur-réticulation est observée en parallèle. La réaction avec les vapeurs d'acide sulfurique est plus faible essentiellement en raison d'une tension de vapeur beaucoup plus basse.

L'article suivant "*Cross-linking assessment after accelerated ageings of ethylene propylene diene monomer rubber*" donne une caractérisation de l'évolution de la formulation à base d'EPDM au cours de différents vieillissements. La technique de DSC-thermoporosimétrie est largement utilisée pour mettre en évidence les réactions de réticulation. La formulation à base d'EPDM présente à la fois une oxydation classique d'élastomère diénique et une sur-réticulation, au cours des vieillissements photochimique et thermique. L'influence de la charge $\text{Al}(\text{OH})_3$ est une nouvelle fois signalée lors du vieillissement pollué sous acide nitrique.

La comparaison du comportement à long terme des quatre matériaux est donnée par la suite. Trois formulations à base PDMS sont caractérisées. Elles diffèrent en raison d'un traitement silane sur la charge $\text{Al}(\text{OH})_3$. La référence avec charge traitée se comporte mieux sous vieillissement acide. La formulation EPDM évolue plus rapidement lors des vieillissements classiques. En revanche son comportement sous vieillissement pollué est plus satisfaisant que celui des silicones. Les essais en vieillissement sous ozone montrent une évolution très spécifique pour tous les matériaux. Les essais préliminaires réalisés sous traitement plasma ont pour but d'être comparés à un vieillissement électrique sous oxygène.

CHAPTER 4

CONCLUSION

The study of industrial formulations containing polysiloxane or Ethylene Propylene Monomer Diene (EPDM) has shown the influence of various parameters on ageing. We have compared the evolution of the properties of the different compositions in order to understand the influence of the components and that of the polymeric matrix on the ageing.

The article "*Characterization of polydimethylsiloxane rubber upon photochemical, thermal, salt-fogs ageings and exposure to acid vapours*" was accepted in November 2005 in *e-Polymers*. This third publication gives a detailed analysis of the chemical evolution by ATR-IR spectroscopy, an evolution of hardness, changes on the level of the cross-link density calculated using thermoporosimetry couple with DSC and finally a comparison of thermal stability upon the various ageing (photochemical, thermal, salt fog and acid vapour). The formulations having a base of PDMS are not very sensitive to usual ageings (thermal and photochemical). No oxidation is detected after 10,000 hours of exposure a post cross-linking is however detected. The evolution under salt fog is negligible. On the other hand these materials are very reactive to nitric acid fumes. A thorough study showed that the failure of material is in particular related to the presence of aluminium trihydrate. This filler reacts with the nitric acid fumes. An important post cross-linking is observed simultaneously. The reaction with the sulphuric acid fumes is weaker primarily because its vapour tension is much lower.

The next article "*Cross-linking assessment after accelerated ageings of ethylene propylene diene monomer rubber*" gives a characterization of the evolution of the formulation based on EPDM during various types of ageings. The technique of DSC-thermoporosimetry is largely used to understand the cross-linking reactions. The formulation based on EPDM present at the same time a traditional oxidation of the dienic elastomer and a post cross-linking, during photochemical and thermal ageings. The influence of the $\text{Al}(\text{OH})_3$ filler is noticed once again at the time of the polluted ageing under nitric acid.

The comparison of the long-term behavior of four materials is given thereafter. Three formulations having a base of PDMS are characterized. They differ due to a silane treatment on the $\text{Al}(\text{OH})_3$ filler. The reference with treated filler has better protection against under acid

ageing. The formulation of EPDM evolves more quickly at the time of traditional ageings. On the other hand its behavior under polluted ageing is more satisfactory than that of silicones. The tests under ozone show a very specific evolution for all materials. The purpose of the preliminary tests carried out under plasma treatment are to be compare with electric ageing under oxygen.

CHAPTER V

*Comparision of Natural and Artificial
Ageings of Silicone*

Study of New Stabilized Formulation

CHAPITRE 5

INTRODUCTION

Après avoir mis en évidence l'évolution des propriétés des formulations à base PDMS ou EPDM et déterminer les points critiques pour améliorer leur durabilité, nous avons comparé les matériaux sous vieillissements artificiels et les expositions en conditions d'usage :

- sous arc électrique en laboratoire,
- avec un environnement pétrochimique et/ou bord de mer, lieux Texas ou Arabie Saoudite.

La réalisation de vieillissements artificiels multiples sur un même échantillon a été examinée également. Il convient de retenir le ou les vieillissements artificiels représentatifs de ce qui se passe sur les isolateurs en extérieur. Les matériaux défectueux utilisés pendant 6 ans en environnement spécifique présentent une augmentation de la dureté et une couche de silice en surface pouvant atteindre 200 microns d'épaisseur. Nous cherchons à expliquer ces évolutions et à y remédier.

Ce chapitre apporte deux publications. L'article 5 : "*Comparison of natural and artificial ageings on silicone polymer composites*" va être proposé dans *Journal of Applied Polymer Science*. Cette cinquième publication donne une comparaison de tous les vieillissements envisagés afin de déterminer le ou les vieillissements représentatifs des expositions en extérieur. Les techniques analytiques de spectroscopie IRTF, d'ATG, des mesures de dureté, de perméabilité et des mesures électriques sont envisagées. Nous pouvons finalement choisir une technique pour qualifier rapidement du point de vue du comportement à long terme différentes formulations à base d'élastomère.

La sur-réticulation des polysiloxanes induit une modification de la dureté en surface du matériau. Pour pallier à cette évolution des mélanges PDMS-stabilisants proposés par NCL (Pune) sont caractérisés et évalués au niveau d'un traitement sous vapeur d'acide nitrique ou d'un vieillissement photochimique. La charge $\text{Al}(\text{OH})_3$ est un point critique sous exposition de vapeurs d'acide. Son remplacement est envisagé. Une proposition de formulation à base PDMS plus résistante sous vieillissement pollué sera testée. L'article 6 "*Polydimethylsiloxane modified by hydrotalcite/ATH filler : Effect of stabilizers on degradation*" est finalement proposé pour donner l'évolution des nouvelles formulations réalisées avec NCL.

CHAPTER 5

INTRODUCTION

After having highlighted the evolution of the properties of the formulations having PDMS base or EPDM and finding the critical points for a better durability, we compared materials after artificial ageings and the ageings in use conditions:

- under electric arc,
- with a petrochemical environment and/or sea shore, places like Texas or Saudi Arabia.

Multiple ageings on the same sample were also examined. It is advisable to retain the artificial ageings similar those the insulators experience outside. The materials used for 6 years in specific environment present an increase in hardness and a 200 micron thick layer of silica on the surface. We are trying to explain these evolutions and find methods to reduce them.

This chapter is in the form of two publications. The article “*Comparison of natural and artificial ageings on silicone polymer composites*” will be submitted to *Journal of Applied Polymer Science*. This fifth publication gives a comparison of all ageings performed in order to determine ageings representative to the outside exposures. The analytical techniques such as FTIR spectroscopy, TGA, measurements of hardness, permeability and electrical measurements are considered. We finally choose the techniques which can quickly analyze the long term behavior of the various elastomer based formulations.

The post-cross-linking of polysiloxanes lead to the modification of the surface hardness of the material. To reduce this evolution stabilized-PDMS mixtures prepared in NCL (Pune) are characterized and evaluated after treatment under nitric acid fumes or upon photochemical ageing. The Al(OH)₃ filler behaves critically under nitric acid vapour exposure. Hence, its replacement is considered. A formulation having PDMS base is proposed and tested which is more resistant under polluted ageing. Article 6 “*Polydimethylsiloxane modified by hydrotalcite/ATH filler : Effect of stabilizers on degradation*” is finally proposed to give the evolution of the new formulations prepared in NCL.

Publication V

Comparison of natural and artificial ageings on silicone polymer composites

Abstract

The changes in properties of silicone elastomers exposed to ozone, salt fog, photo, thermal, nitric acid and electrical ageings has been carried out to yield valuable information for long term outdoor applications. Samples aged for 5 years in natural environment and electrical ageing in laboratory have also been compared. The elastomers have shown a good stability to the different ageings but an important vulnerability of the filler towards nitric acid vapour exposure was detected. Post cross-linking and chain scission are observed after ageings.

1 INTRODUCTION

Polysiloxanes are widely used as protective surface coatings for specialized applications such as composite isolators. Silicone rubber has outstanding heat resistance and low chemical reactivity, compared with usual dienic elastomers. However, it is important to recognise and identify the principal factors involved in rubber ageing so that degradation prevention can be applied. Knowledge of changes that can be tolerated over the life of a material helps towards the determination of the lifetime expectancy.

Literature about polydimethylsiloxane (PDMS) ageing often concerns the unfilled uncross-linked polymer. The photochemical behaviour of polydimethylsiloxane (PDMS) oil has been examined previously [1-4]. Y. Israeli *et al.* have focussed in particular on the photoreactivity of the main substituent groups used in the silicone field. A recent paper gives relationships between chemical structure and physical properties upon photochemical or thermal ageing or under acidic vapours [5]. The other studies deal with the thermal behaviour of polysiloxanes. N. Grassie *et al.* have reported on the thermal stability of PDMS to 300°C under vacuum [6]. Thermal degradation of PDMS with air or nitrogen has also been studied by G. Camino *et al.* [7,8]. The products of the thermal degradation are essentially determined by the temperature and the heating rate [8]. The evaluation of cross-linking after photo-ageing of silicone rubber has been proposed by using calorimetric analysis (Differential Scanning Calorimetry–DSC) and densimetry. No significant oxidation was detected, but competitive ways such as cross-linking and chain scission were clearly identified upon UV irradiation [9].

Most studies on filled cross-linked silicone rubber gave results on hydrophobicity changes after corona discharge and plasma treatment [10-14]. One of the major drawbacks with siloxanes is hydrolysis under acid vapours, which leads to the build up low molecular weight cyclic fragments in the rubber network. A mechanism has been proposed by M. Zeldin *et al.* [10]. The hydrophobic character or the water repellancy of PDMS is due to the close packing of

the methyl groups, which under usual conditions point outward from the surface. Reorientation of the main chain, a change in the surface roughness, the deposition of contaminants on the surface, or surface oxidation can play a major role in the change from a hydrophobic to a hydrophilic state on PDMS surface [11]. MJ. Owen *et al.* have summarized the plausible mechanisms for hydrophobicity recovery after exposure to corona or plasma [14]. Migration of low molar mass species is undoubtedly the process that most researchers in the field believe as the dominant mechanism for hydrophobicity recovery. Outdoor exposures of silicone rubber have also been carried out and analysed by X-ray photoelectron spectroscopy (XPS) to understand the water repellency [15-17]. Another paper is a review about the recent performance experience of silicone composite insulators in outdoor service [18]. The ageing of silicone started with the loss of hydrophobicity, then a depolymerisation was also reported using gas chromatography-mass spectrometry [19]. The degradation is indicated by permanent changes such as increase in depolymerisation and changes in the surface physical structure brought about by an increase in the degree of crystallization of the polymer and the conglomeration of small particles into larger ones. Recent papers concerned the effect of antioxidants on the surface oxidation of crosslinked PDMS after air-plasma treatment [20]. Degradation at 180-200°C in air of PDMS rubber was studied by chemiluminescence [21]. Storage of siloxane rubbers in a closed inert atmosphere results in softening of the material. Thermal ageing studies on room-temperature rubbers and compression set experiments were also proposed to give the lifetime prediction [22]. Kinetics of the thermal degradation and thermal stability of conductive silicone rubber (unfilled, filled with carbon black or silica) have been studied by J. Zhang *et al.* [23]. The thermal stability of carbon black rubber was the best, compared to unfilled or silica elastomer. There is an increasing interest in the degradation of polymer material used in outdoor applications in acid rain as it is one of the most severe environmental contaminants. Koo *et al.* observed when silicone rubber is aged in acid rain surface aging takes place [24]. In case of high acidity of nitric acid solution the electrical characteristic of the sample surface is noticeably changed leading to decrease in cross-link density and chain scission of base resin. The critical value of pH for this surface degradation is between 1.5 to 2.5. However, in case of sulphuric acid solutions the degree of the surface degradation consistently increased. They also noticed that only surface ageing takes place and hydrophobicity and tracking resistance of the silicone rubber are well retained regardless of the acidity of the solution for both the cases. In another study it was observed that silicone rubber on acid ageing has a scission of the Si-CH₃ bond whereas the Si-O-Si bond remains intact [25]. When exposed to UV light and ozone PDMS underwent chain scission involving both main backbone and side groups accompanied by formation of

hydrophilic groups on the surface [26]. Oldfield *et al.* have studied the long term natural ageing of various types of silicone elastomers exposed in Australia to different types of climatic conditions for 20 years. They observed that best performance was shown by iron oxide pigmented high temperature vulcanized PDMS. Room temperature vulcanized PDMS showed low mechanical properties initially but were very resistant to weathering later [27].

We focussed our study on filled cross-linked PDMS and used different analytical techniques such as IR spectroscopy, hardness measurements, TGA, electrical measurements and permeability measurements to evaluate the polymer long term behaviour upon usual ageings and specific acidic treatments. In this work we present complementary analytical approach to compare natural and artificial ageings in the case of electrical insulators. We will compare the competitive ways of degradation such as oxidation, post cross-linking and chain scission for each ageing.

2 EXPERIMENTAL

2-1- Materials

Silicone rubber (HTV – High Temperature Vulcanized) is polydimethylsiloxane kindly provided by SEDIVER, France. The composition of the filled cross-linked PDMS is given in Table 1.

Composition	Quantity
PDMS	100 parts
Silica	23 parts
Alumina Trihydrate	80 parts
DHBP	0.4 part

Table 1: Composition of filled cross-linked PDMS

The presence of silica can be noticed. The curing agent is : 2,5 dimethyl 2,5 di(t-butylperoxy) hexane (DHBP).

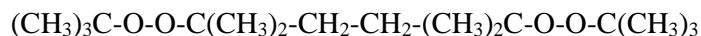

The formulation contains a flame retardancy which is aluminium trihydrate. Thick 2 mm sheets were prepared for the ageing and the characterization. The curing time by compression moulding at 170°C was 12 minutes; this time corresponds to the usual optimal curing conditions. Sulphuric acid (67 %), nitric acid (concentration 67%) and sodium chloride were products from Prolabo (VWR).

2-2- Ageings

Sheets of silicone rubber were used directly for irradiation and most of analysis. An accelerated photoageing is used. The irradiation device (SEPAP 12-24) has been described previously [28]. The system is characterised by the source, medium pressure Hg lamps filtered with borosilicate envelope ($\lambda > 300$ nm) and by careful control of the temperature with a thermocouple in close contact with one of the samples. Samples are rotated at a constant distance (20 cm) from the sources. The samples were irradiated at 60°C in a SEPAP chamber equipped with four lamps.

Then we used an aerated oven (MEMMERT) for thermal exposure at 100°C. The other ageing was salt-fog test usually used for metallic materials (H. Kohler – HK 320). The conditions of this test were the concentration of NaCl (5% weight) and the temperature at 35°C. We used “laboratory dessicators” to carry out polluted ageings, such as nitric acid vapours or sulphuric acid vapours at room temperature.

The ozone ageing were performed in ‘Laboratoire de recherches et de contrôle du caoutchouc et des plastiques (LRCCP)’ in Vitry sur Seine, France. The formulations were aged for 8 weeks at 200 -ppm concentration and $(23 \pm 2)^\circ\text{C}$ without stress.

Natural ageings were performed near petrochemical sites in Texas or Saudi Arabia for 6 years.

Laboratory electrical ageing were performed at 20 Kilo volts for 5 years.

2-3- Analytical tools

The chemical changes upon irradiation were followed by FTIR-ATR spectroscopy (Attenuated Total Reflectance - Nicolet Impact 400 and Thunderdome accessory with germanium crystal). With this reflection analysis we can operate on thick sheets (for example cross-linked and coloured polymers). We analyse the material surface on a few micrometers.

Hardness measurements were done with a Zwick Werk (NR 83195) – Shore A (weight 1 kg) system on polymer sheets before and after ageings. Ten measurements were made and an average value was then given.

The thermogravimetric analysis were carried out using TGA-FTIR (METTLER TOLEDO TGA/SDTA851 – NICOLET Nexus).

Permeability to water-vapour is carried out using Mocon Permatran W3-33 with IR detection. The coefficients for transmission of water-vapour for films are determined according to ASTM F 1249 at 38°C and 90% relative humidity. The results are expressed in $\text{g/m}^2/24$ hours. The surface analysed was 5 cm^2

The conductivity and resistivity measurements have been performed in Sediver, St. Yorre, France. We have used the Keithley 6517 Hi-R Test model which can measure surface resistivity from 10^3 to 10^{17} Ohms and volume resistivity from 10^3 to 10^{18} Ohm-cm. The conductivity measurements have been performed with a Schering bridge, and based on capacity measure and capacitor dielectric loss. We modify the R_4 , C_4 , and R_3 value until the galvanometer is at 0 in the Schering bridge (See Chapter 2).

Finally, $\text{Tan } \delta$ has been calculated using the formula below:

$$\text{Tan } \delta = \Pi \times R_4 \times C_4$$

3 RESULTS AND DISCUSSION:

ATR-IR spectroscopy:

In figure 1 we have shown the ATR spectra of the filled silicone before and after ozone ageing. The main absorptions observed in the spectra are shown in Table 2. We have noticed the formation of a new peak at 1655 cm^{-1} after the ozone ageing. There is decrease in the intensity of the $\text{Al}(\text{OH}_3)$ after the ageing indicating that the filler is strongly affected by ozone. The peak at 1655 cm^{-1} also appears for the cross-linked silicone which is not filled with $\text{Al}(\text{OH}_3)$, thus it is formed due to the reaction of the silicone with ozone. There is a decrease in the intensity of the peak of CH_3 (2960 cm^{-1}) which is present on the main backbone of PDMS after the ozone treatment.

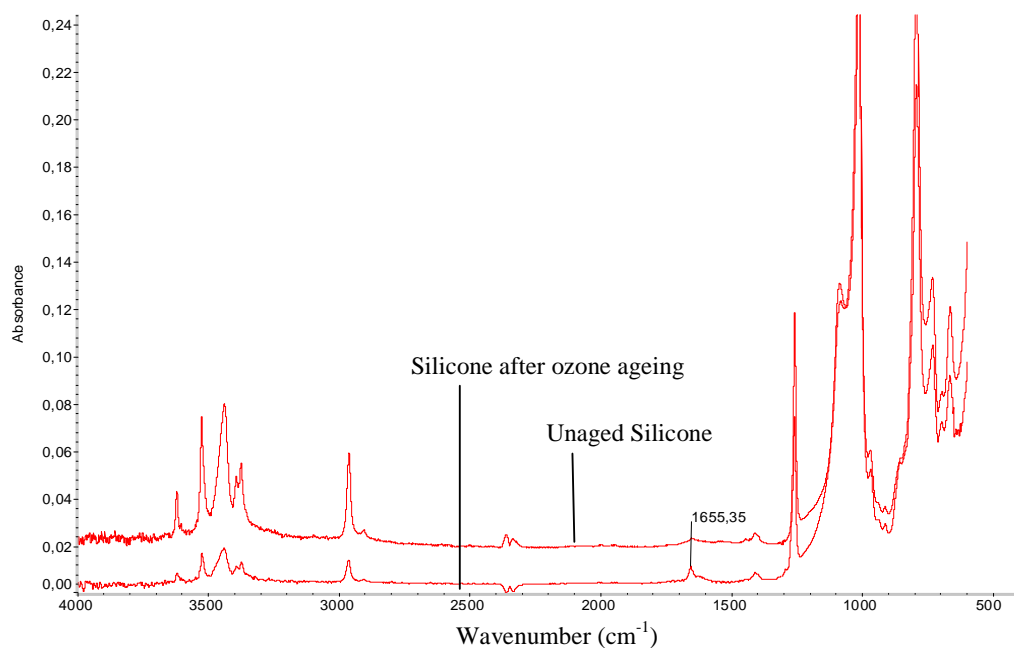

Figure 1: FTIR-ATR spectra for unaged and ozone aged silicone.

Wavenumber (cm ⁻¹)	Tentative assignment
3615, 3524, 3432, 3375	ν OH of Al(OH) ₃
2960	ν CH in CH ₃
1646	ν C=C
1408	Not assigned
1256	ν CH in Si-CH ₃
1090	Si-O-Si
1010	Si-O-Si, Al-O
795	Si-O-C, Al-O
730	Al-O
665	Al-O

Table 2: Main absorption observed for unaged filled cross-linked PDMS and assignments of IR bands (ν = stretching vibration; δ = in-plane deformation)

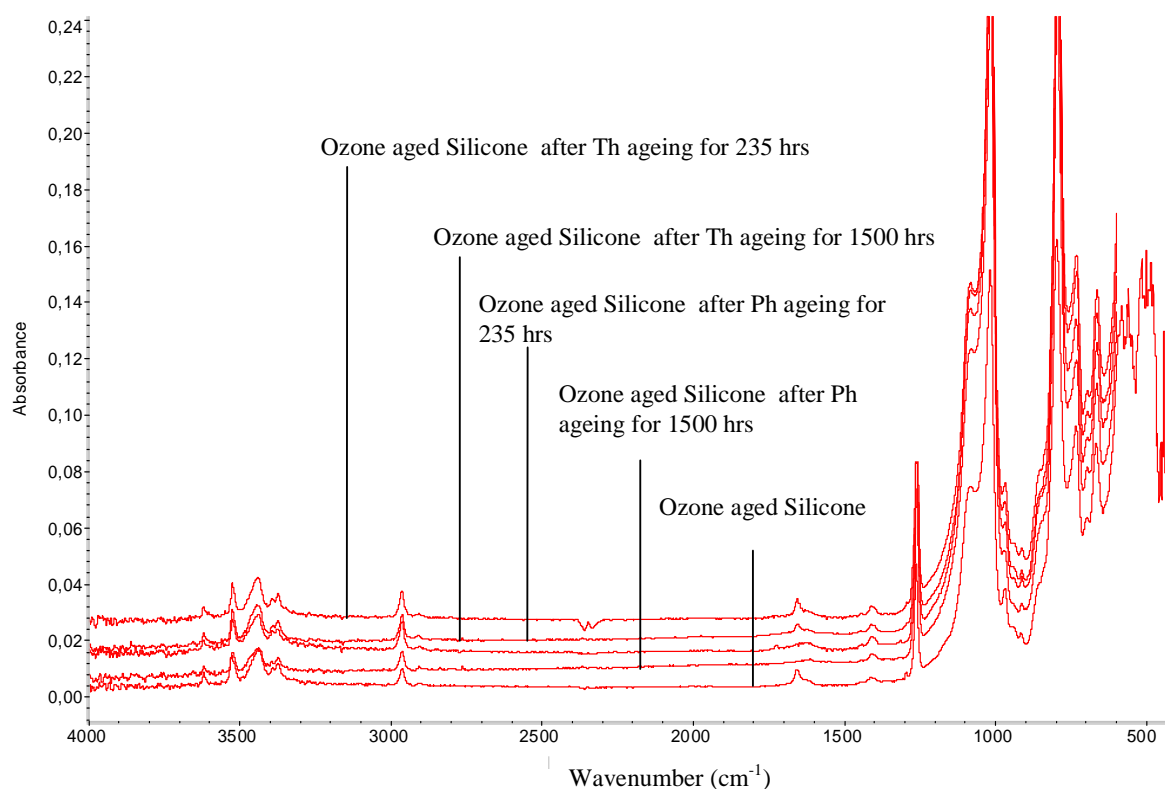

Figure 2: FTIR-ATR spectra of silicone after mixed ageing.

Fig. 2 compares the ATR spectra after mixed ageing. The ozone aged samples were further kept for photo-ageing at 60°C and thermal ageing at 80°C. We observed the intensity of the peak at 1655 cm⁻¹ decreased. The peak disappears after 1500 hours of photo ageing. The decrease in the intensity of the peak after thermal ageing was slower.

In Figure 3 we have compared the silicone aged electrically for 5 years in laboratory and aged naturally at petrochemical site.

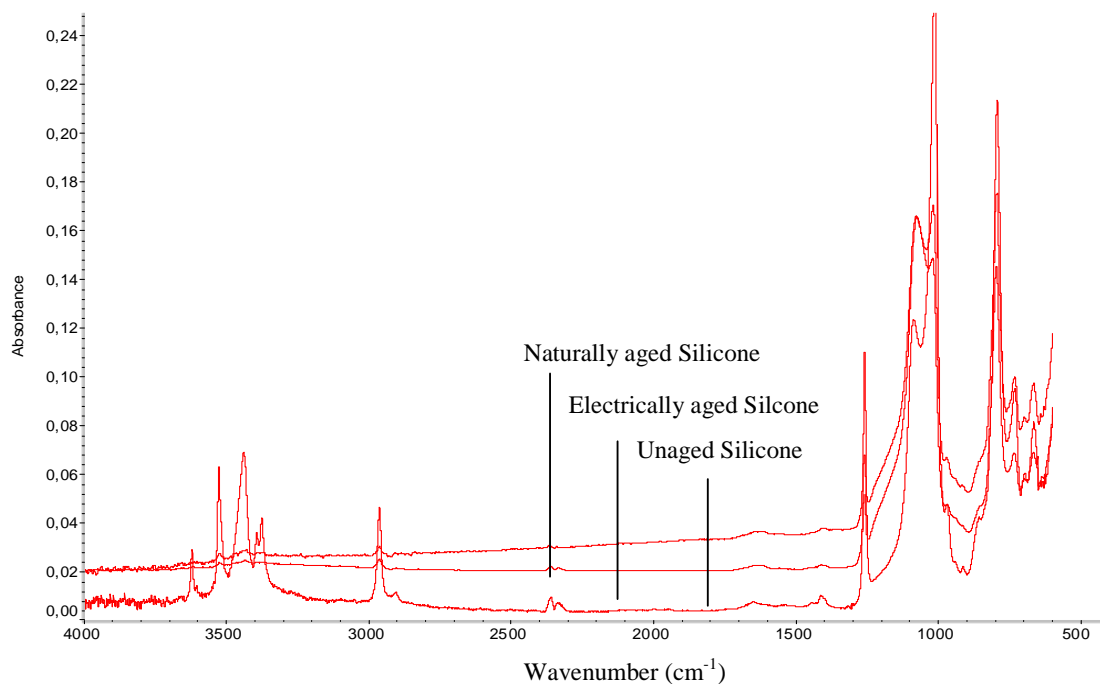

Figure 3: FTIR-ATR spectra of naturally aged and laboratory aged silicone for 5 years.

In both the samples we have observed the formation of a thin layer of SiO₂ on the surface (fig 4). There is decrease in the content of CH₃ groups (2960 cm⁻¹) present on the surface after both the ageing. During ageing chain scission and cross-linking reactions are taking place on the surface of the material. SiO₂ is formed due to the condensation reactions of the silanol groups [29,30]. After photo, thermal and salt fog ageings no drastic degradation was observed [31].

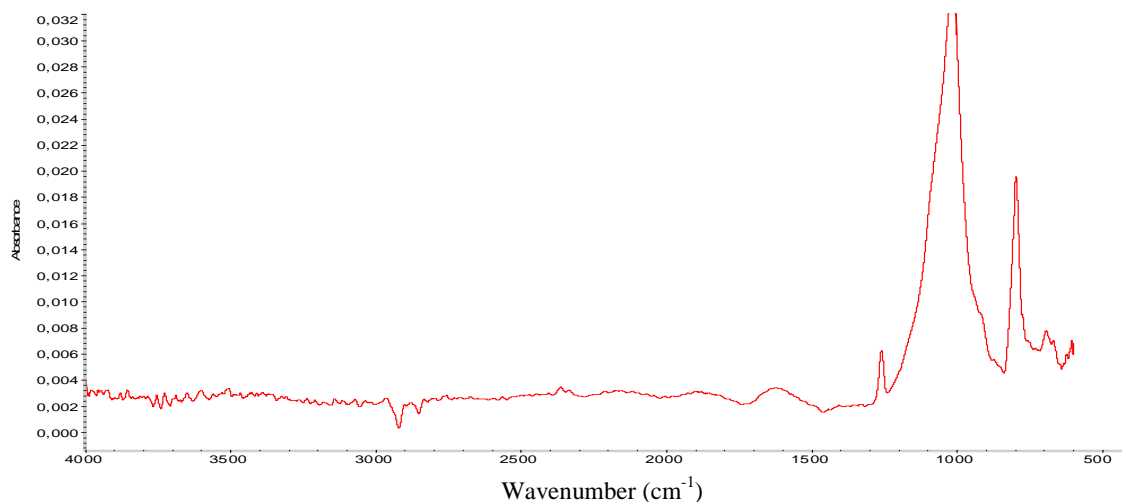

Figure 4: FTIR-ATR spectra of the powder on the surface of naturally aged and laboratory aged silicone for 5 years identified as silica (SiO₂)

Hardness measurements:

We have already shown that after photo-ageing, thermal ageing and nitric acid vapour ageing the samples become harder on the surface and there is an increase in the hardness values [31]. New measurements were made for ozone exposition. The hardness results on the initial unaged material gave an average value of 86 Shore A (+/- 2.1) for the cross-linked silicone filled with $\text{Al}(\text{OH})_3$ while the cross-linked silicone without $\text{Al}(\text{OH})_3$ gave an average value of 57 Shore A (+/- 2.1). Similarly there is an increase in the hardness values after ozone ageing for the $\text{Al}(\text{OH})_3$ filled silicone as the hardness increases to 92 Shore A (+/- 2.1). There is no increase in the hardness of the silicone not filled with $\text{Al}(\text{OH})_3$ after ozone ageing it remained to 57 Shore A (+/- 2.1). This indicates that increase in hardness is enhanced due to the filler present in the formulations. Hence we can conclude that post cross-linking reactions are taking upon ozone exposure resulting in a increase in hardness. Similarly long term aged samples aged naturally and electrically were very hard and brittle.

TGA results:

The thermogravimetric analysis has been used to compare the thermal stability of the silicone after the various types of ageing. The samples have been heated from 25°C - 800°C at the rate of $20^\circ\text{C}/\text{min}$ under 40 ml flow rate of oxygen. Figure 6 shows the weight loss of the samples after ozone ageing, natural ageing, electrical ageing in laboratory and unaged material. We observed that there is no change in the thermal stability after the different types of ageing.

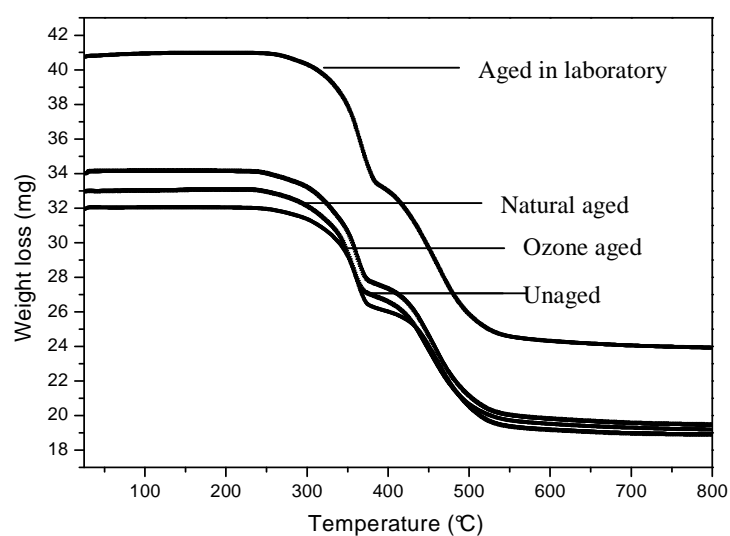

Figure 5: TGA results after various ageings.

The weight loss starts at 250°C due to the dehydration of $\text{Al}(\text{OH})_3$ followed by the decomposition of the main Si-O-Si backbone.

Electrical measurements:

There is not much change in the conductivity of silicone after thermal ageing at 100°C, photo-ageing at 60°C and salt fog ageing but there is a rapid increase in the conductivity within one hour of nitric acid vapour exposure and it not possible to carry out the conductivity of the samples aged for longer time duration.

On the contrary the surface resistivity of the silicones decreases upon nitric acid exposure. The initial resistivity is $1 \times 10^{14} \Omega \cdot \text{cm}$ but upon nitric acid exposure it decreases to $1 \times 10^8 \Omega \cdot \text{cm}$

This change of conductivity and resistivity is due to exposure of the $\text{Al}(\text{OH})_3$ particles on the surface and due to the acid ageing.

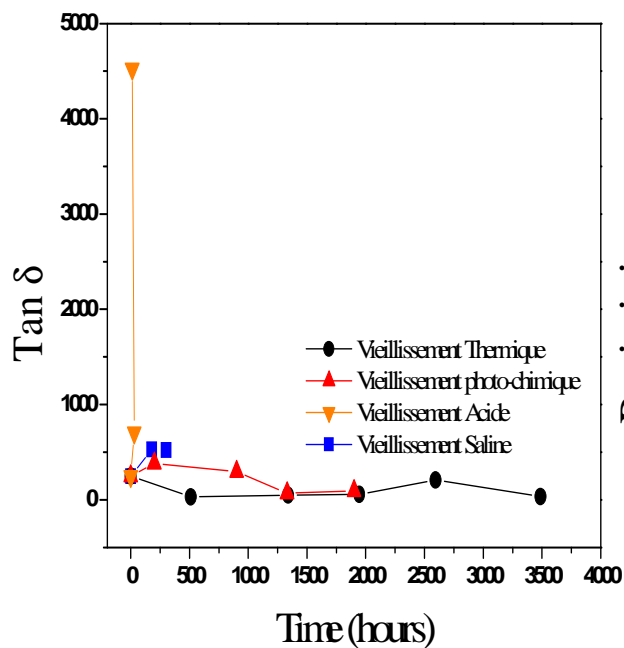

Figure 6

Figure 6: Conductivity results after various ageings.

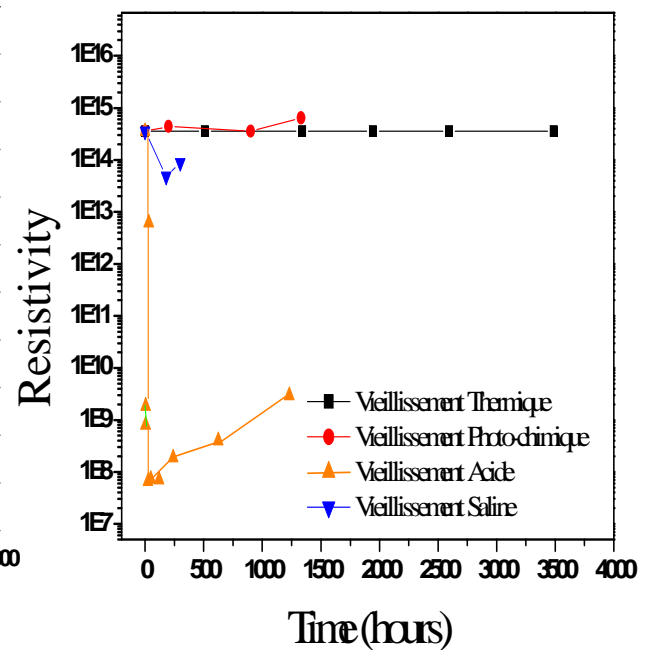

Figure 7

Figure 7: Resistivity results after various ageings

Permeability measurements:

The silicone housing is used as a protective layer for the epoxy- fiber glass composite hence water permeability upon ageing is an important property as it will result in deterioration of its use properties (electrical properties..). In table 3 we have shown the results obtained for

permeability to water vapour for the unaged, photo aged, thermal aged (100°C) and nitric acid vapour aged silicone. There is a decrease in the permeability after photo-ageing as well as thermal ageing and is more for photo-aged silicones. This is perhaps due to chain scission reactions taking place upon ageing leading to decomposition of the chains. There is no change in the permeability to water vapour after 2 hours of ageing nitric acid vapours. This indicates that there is a competition between cross-linking and chain scission during this time period. Chain scission reactions are more significant in nitric acid vapours as compared the thermal and photo ageing. It was not possible to carry out the tests for silicone aged for more than 5 hours under nitric acid vapours.

References	Thickness (mm)	Water vapour 100% HR	Water vapour 90% HR
Unaged silicone	2.30	9.62	8.66
Photo-aged silicone (1500 hrs)	2.16	6.39	5.75
Thermal aged silicone (3000 hrs)	2.16	6.80	6.12
Nitric acid vapour silicone (2 hrs)	2.30	9.55	8.60

Table 3: Coefficients of transmission of water vapour expressed in g/m²/24h

Conclusion:

We compared the chemical evolution of cross-linked, filled PDMS formulations upon various ageings with ATR spectroscopy. The material was not very susceptible to usual ageings (photochemical and thermal). The ozone aged samples gave specific results but this type of ageing is not experienced much by insulators. The samples aged for long term at natural sites and electrically aged samples in laboratory showed the formation of silica layer and were brittle however, there is no change in their thermal stability and no oxidation. Nitric acid treatment maybe a good test to verify the stability of the material in polluted environment. Hence tests representative to natural ageing are electrical ageing and acid ageing.

References

- [1] Israëli Y., Philippart JL., Cavezzan J., Lacoste J., Lemaire J.; Polym. Degrad. Stab.; 36 ; 179-185 ; 1992.
- [2] Israëli Y., Cavezzan J., Lacoste J.; Polym. Degrad. Stab.; 37; 201-208;1992.

- [3] Israëli Y., Lacoste J., Cavezzan J., Lemaire J.; *Polym Degrad Stab.*; 42; 267-279; 1993.
- [4] Israeli Y., Lacoste J., Cavezzan J., Lemaire J.; *Polym Degrad Stab.*; 47 ; 357-362; 1995.
- [5] Tomer R. N. S., Delor Jestin F., and Lacoste J.; *Submitted Polym Degrad Stab*; 2005.
- [6] Grassie, N., Francey KF.,; Macfarlane IG.; *Polym Degrad and Stab.*; 2; 67-83;1980.
- [7] Camino G., Lomakin SM., Lazzari M.; *Polymer*; 42; 2395-2402; 2001.
- [8] Camino G., Lomakin SM., Lazzari M.; *Polymer*; 43; 2011-2015; 2002.
- [9] Virlogeux F., Bianchini D., Delor-Jestin F., Baba M., Lacoste J.; *Polymer International*; 53; 163-168; 2004.
- [10] Zeldin M., Qian BR. and Choi SJ. ; *J. Polym. Sci.; Polym. Chem. Ed.*; 21 ;1361-1369; 1983.
- [11] Hillborg H., Sanelin M., Gedde U.W., *Polymer* 42 ;7349-7362; 2001.
- [12] Hillborg H., and Gedde U.W., *IEEE Transactions on Dielectrics and Electrical Insulation*, 6; 5; 703-717; 1999.
- [13] Smith P.J., Owen M.J.; *IEEE CEIDP Annual Report*; 1992.
- [14] Owen MJ., Gentle TM., Orbeck T., Williams DE.; *Polymer Surface Dynamics*, Ed JD Andrade - Plenum Press 1988.
- [15] Vlastos A.E., Gubanski S.M.; *IEEE Trans. On Power Delivery*; 6; 2; 888-900; Apr. 1991.
- [16] Sorqvist T., Vlastos AE.; *IEEE Trans. Power Delivery.*; 12.;2.; 1041-1047.;1997.
- [17] Kim SH., Cherney EA., Hackam R., Rutherford KG.; *IEEE Trans on Dielectrics and Electrical Insulation.*; 1.;1.;106-123.; 1994.
- [18] Hackam R. ; *IEEE Trans. Dielec. and Elec. Insul.*; 6.;5.;557-585.;1999.
- [19] Homma H., Mirley CL., Ronzello J., Boggs SA.; *IEEE Transactions on Power Delivery.*; 15.;4.; 1298-1303.; 2000.
- [20] Fateh-Alavi K., Gallstedt M., Gedde UW.; *Polym. Degrad. Stab.*; 74.; 49-57.; 2001.
- [21] Chaudhry AN., Billingham NC.; *Polym. Degrad. Stab.*; 73.; 505-510.; 2001.
- [22] Patel M.; Skinner AR.; *Polym. Degrad. Stab.*; 73.; 399-402.; 2001.
- [23] Zhang J., Feng S., Ma Q.; *J. Applied Polym. Science*; 89; 1548-1554; 2003.
- [24] Koo JY, Kim IT, and Park WK., *IEEE Annual Report CEIDP*; 370-373; 1997.
- [25] Wang X, Kumagai S and Yoshimura N.; *IEEE Trans. Dielec and Elec. Ins.*; 5; 6; 909-916; 1998.
- [26] Efimenko K, Wallace WE, Genzer J.; *Journal of Colloid Interface Science*; 254; 306-315; 2002.
- [27] Oldfield, Symes T; *Polymer Testing*; 15; 115-128; 1996.
- [28] Penot G., Arnaud R. and Lemaire J.; *Die Angew. Makromol. Chem.*, 30; 493-499; 1992.

[29] Toth A., Bertoti I., Blazlo M., Banhegyi G., Bognar A., Szaplanczay P.; J.Appl. Polym. Sci; 52; 1293-1307; 1994.

[30] Morra M., Occhiello E., Morola R., Garassi F., Humphrey P., Johnson D.; J.Colloid Inter Sci; 137; 11-24; 1990.

[31] Delor-Jestin F, N.S.Tomer NS, Singh RP and Lacoste J.; E-Polymers., 013 ; 2006.

Publication -VI

Polydimethyl siloxane modified by hydrotalcite/ATH filler: Effect of stabilizers on degradation

Abstract: Polydimethylsiloxane (PDMS) was modified by filling silica and aluminium trihydrate (ATH) or hydrotalcite into its matrix and the influence of commercial stabilizers was estimated during nitric acid vapour exposure, photo-oxidative and thermal degradation. In-situ photoageing of filled PDMS was performed by Photo-DSC and its effect on crystallization was monitored. ATR-FTIR spectroscopy was used to evaluate the evolution of oxidation of filled PDMS. Thermogravimetric analysis was used to determine the thermal stability of the formulations. Silanox was observed to be the best stabilizer for filled PDMS. The use of hydrotalcite seems to be very efficient as an anti-acid for the formulations.

1. Introduction:

Polysiloxanes are often used as protective coatings for a variety of specialized applications. Compared to usual dienic elastomers, silicone rubber have outstanding thermal, photo and high energy radiation resistance, however it is important to recognise and identify the degradation products in order to impart a better resistance against oxidative degradation of polydimethylsiloxane (PDMS) through the addition of suitable fillers and stabilizers.

The reaction of PDMS with oxygen leads to cross-linking *via* siloxane bonds and formation of oxygen rich silica like layer on the surface upon air plasma and corona discharge [1]. This layer is brittle and prone to cracking upon elongation. Cyclic oligomers are also formed upon oxidative crosslinking leading to loss of hydrophobicity. It is well known that stabilizers are used in polymers to make them resistant to oxidative degradation, but there are very few publications on the stabilization of PDMS rubbers. Fateh Alavi *et al.* have reported that higher doses of air plasma was required for the formation of silica like surface on PDMS in the presence of stabilizers [2]. The time required to form silica like layer on corona exposure showed a linear increase with increasing stabilizer concentration [3], Tinuvin 770 showed highest efficiency and Irganox 1076 showed lowest efficiency. Tinuvin 770 and Irganox 565 can be used to protect PDMS against thermal oxidation at elevated temperatures [4]. Fateh Alavi *et al.* concluded that hindered amine stabilizers or stabilizers combining chain-breaking and hydro peroxide decomposing functions improved protection against air plasma and corona discharges for PDMS.

The photochemical behaviour of polydimethylsiloxane (PDMS) oil has been examined previously [5-8]. J. Y. Israeli *et al.* have focussed in particular on the photoreactivity of the main

substituent groups used in the silicones. N. Grassie *et al.* have worked on the thermal stability of PDMS to 300°C under vacuum [9].

The changes in the chemical structure and the physical properties of a filled cross-linked PDMS rubber were monitored as a function of various ageing factors such as photochemical, thermal, salt-fog ageing and exposure to acid vapours [10]. Aluminium trihydrate was found to be responsible for the chemical changes taking place in presence of nitric acid vapours, hence we have replaced it by hydrotalcite filler because they are known to be used as acid neutralizers for polyolefins [11]. We also found post cross-linking taking place on photo and thermal degradation therefore we have used antioxidants for its prevention. Photo-DSC technique was used to study the effect of photo-ageing on the crystallization of the crude polysiloxanes [12]. In this study we have attempted to design stabilizer system to extend the life cycle of PDMS. We have compared stability of silica filled PDMS having additionally two more types of fillers ATH or hydrotalcite and 7 different commercially available stabilizers keeping the filler concentration constant.

2. EXPERIMENTAL:

2-1-Materials:

Polydimethylsiloxane Mw 90,000 was purchased from Ms Scientific Polymers USA. The seven commercial stabilizers BHT, Tinuvin 770, Irganox 1010, Irganox 1076, Irgafos PEPQ, Uvasil and Silanox were obtained through the courtesy of Ms Ciba Geigy India Pvt Ltd., Mumbai India. The other chemicals e.g. NaOH, MgCl₂·6H₂O, AlCl₃·6H₂O, H₂SO₄(95%), HNO₃(68%), Na₂CO₃ and aluminium trihydrate were Merck products.

The formulation contains PDMS, 10% Silica, 20% ATH/ Hydrotalcite, and 0.5% stabilizer.

Synthesis of Hydrotalcite (acid killer synthesized in NCL, Pune, India):

For the synthesis of hydrotalcite (a Mg/Al double-layered hydroxide) of formula (Scheme 1): $[Mg_3Al(OH)_8]^+[0.5CO_3^-.mH_2O]^-$, an aqueous solution (250ml) containing Mg(NO₃)₂·6H₂O and Al(NO₃)₃·9H₂O with a ratio of Mg / Al (3:1) was slowly added to a second solution (250ml) of NaOH (0.675 mol) and NaNO₃ (0.2 mol) under vigorous stirring at 65°C. The addition took nearly 2 hrs. The precipitate formed was filtered and washed thoroughly with 500 ml deionised water (at least until the pH of the filtrate was 7) and freeze dried and then aged for 20 hrs at 20°C in their mother liquor and then filtered, washed and dried. The samples were hydrothermally treated using microwave heating (8 hrs with a step-wise increase in temperature

from 120°C up to 180°C and a corresponding pressure of 2-10 bar). The crystalline phases were determined by X-ray diffraction [13].

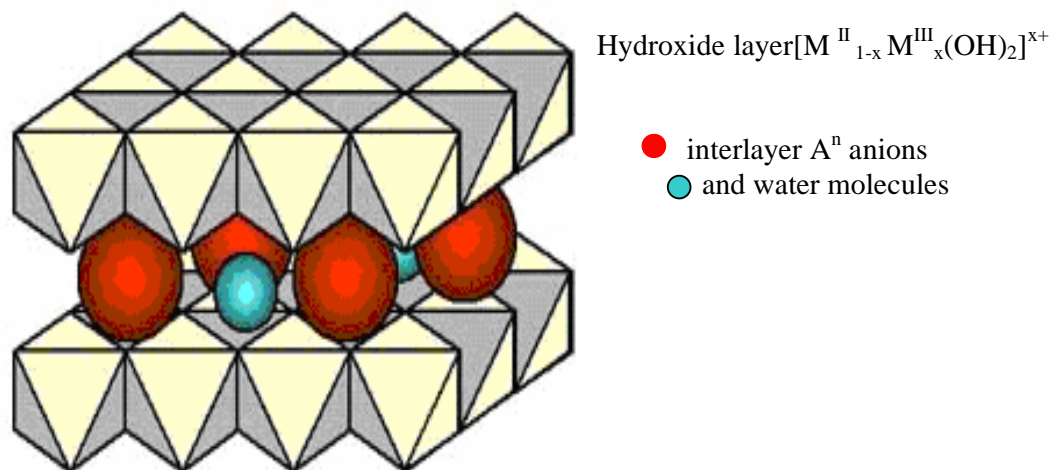

Scheme 1: Layered crystal structure of hydrotalcite compounds.

2-2-Ageings:

The photo-DSC system was used for direct *in-situ* photo irradiation for DSC experiments.

An accelerated photoageing is carried out using the irradiation device (SEPAP 12/24-ATLAS).

The system is characterised by the source, medium pressure Hg lamps filtered with borosilicate envelope ($\lambda > 300$ nm) and by careful control of the temperature with a thermocouple in close contact with one of the samples. Samples are rotated at a constant distance (20 cm) from the sources. The samples were irradiated at 60°C in a SEPAP chamber equipped with four lamps. The formulations were irradiated in small glass tubes. We used an aerated oven (MEMMERT) for thermal exposure. A “laboratory desiccator” was used to carry out nitric acid vapour ageing.

2-3- Analytical tools:

The chemical changes upon irradiation were followed by ATR-FTIR (Attenuated Total Reflectance) spectroscopy with a Nicolet Impact 400 system. A Thunderdome accessory with germanium crystal was used. We analysed the surface of PDMS upto a few micrometers.

Photo-DSC was used to characterize the evolution of crystallinity during ageing. A Mettler Toledo DSC822 apparatus, equipped with an Intracooler and a liquid nitrogen cooling set was used. It allows working between 500°C and -150°C with a scanning temperature rate from 0.1°C/h to 50°C/min. Indium (156.61°C), zinc (419.58°C) and heptane (-90.61°C) were used to calibrate this apparatus. A Hamamatsu light generator equipped with a “Lightningcure

LC6” source (Xe/Hg, “medium pressure”) was affixed to the DSC device. The light generator is servo-controlled by the DSC software (STARe) which permits a choice of both the light intensity from 0 to 324 mW/cm² and the duration of the irradiation. Two identical fibre bundles supply the irradiation light both to sample and reference DSC pans. The source is filtered by sapphire disks to deliver wavelengths longer than 300 nm, which is representative of outdoor ageing. The intensity used for photo-ageing is 51 mW/cm².

Thermo-gravimetric analysis (Mettler Toledo TGA/SDTA851–Nicolet Nexus) is used to measure weight changes vs temperature. The sample is heated from 25°C to 800°C at a constant rise of temperature(20°C/minute) under oxygen or nitrogen(40ml/min). Approximately 10-15 mg of sample was used for each analysis.

3. Results and discussion:

3-1- DSC and photo-DSC results:

Polydimethylsiloxane is a semi crystalline polymer exhibiting an ordered part surrounded by an amorphous matrix. Chain scission and cross-linking phenomena occur as a consequence of photo-ageing resulting in changes in crystallization temperature and enthalpy of crystallization. The changes in temperature of crystallisation and peaks of crystallisation of PDMS upon addition silica and ATH/Hydrotalcite was studied. We observed that there is change in the temperature of crystallisation between filled and unfilled PDMS. The temperature of crystallisation for unfilled PDMS is in an average around -90°C (Fig.1) while that of filled PDMS is around -75°C to -80°C.

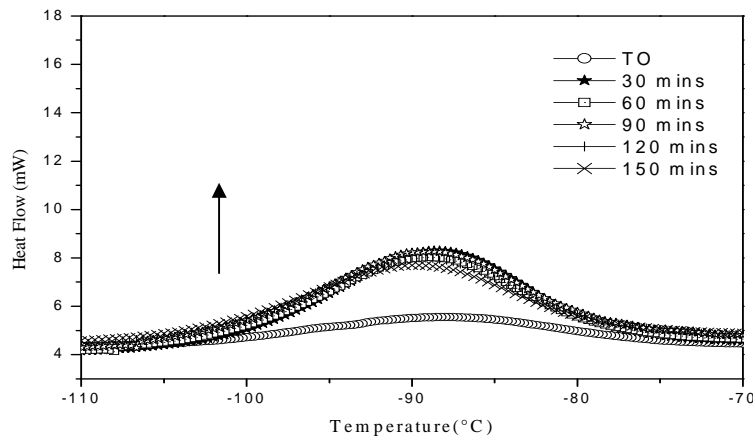

Figure 1: Photo DSC curve of unfilled PDMS at 51 mW/cm² after different times of photo- irradiation.

This change in temperature of crystallisation is due to the adsorption of the fillers on the PDMS chains. The fillers act as nucleating agents for the PDMS-silica matrix and thereby commence the process of crystallisation earlier than that of unfilled PDMS. Photo-DSC results for the unfilled PDMS showed there is an increase in the peak of crystallisation and its shift towards lower temperature, after 30 minutes of irradiation. However, Photo-DSC experiments for filled PDMS showed decrease in peak of crystallization after irradiation due to lowering of the size of spherulite dimensions, perhaps due to increase of cross-linking reactions. The changes in the peak of crystallisation depended upon the filler and the antioxidant present. Hydrotalcite filled PDMS with Irganox 1010, Irganox 1076 and Silanox FZ16 (Fig.2) antioxidants showed better photo stability than BHT, Tinuvin 770, Irgafos PEPQ antioxidants as there is no change in the peak of crystallization for 5 hours of irradiation. ATH filled PDMS showed best photo stability in the presence of Silanox antioxidant while for the other stabilizers there is a change in the crystallisation after 1 hour of irradiation (Fig.3).

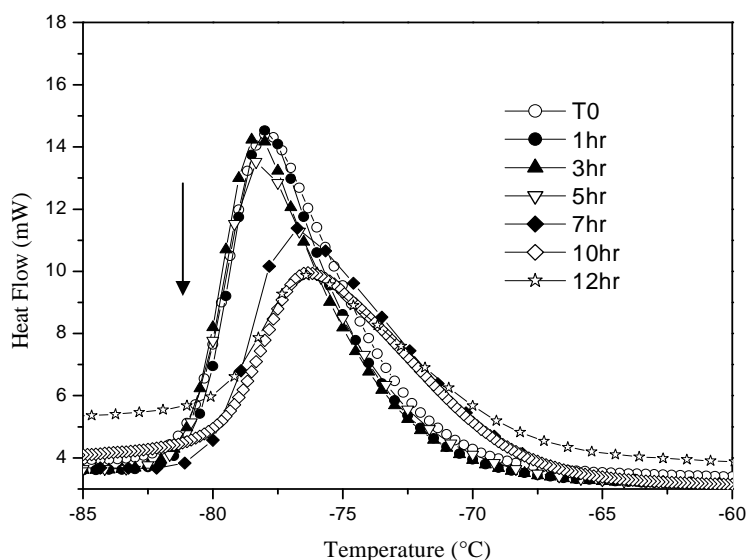

Figure 2: Photo DSC curve of hydrotalcite filled PDMS at 51 mW/cm² with Silanox stabilizers after different times of photo-irradiation.

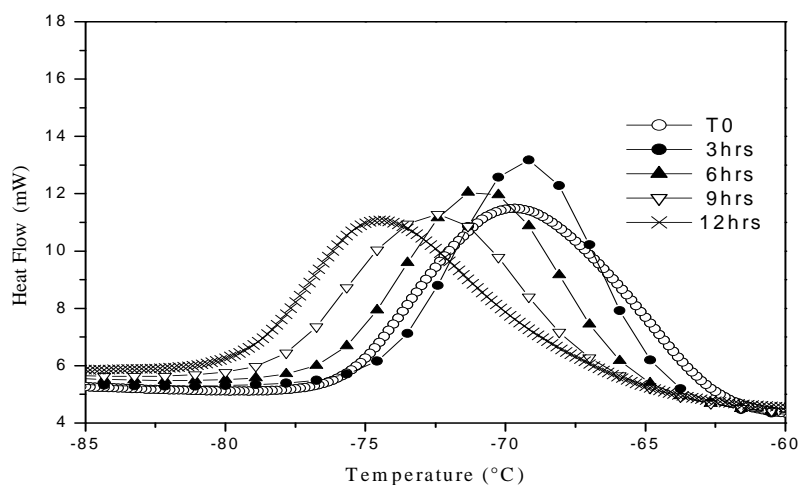

Figure 3: Photo DSC curve of ATH filled PDMS at 51 mW/cm^2 with Silanox stabilizers after different times of photo-irradiation.

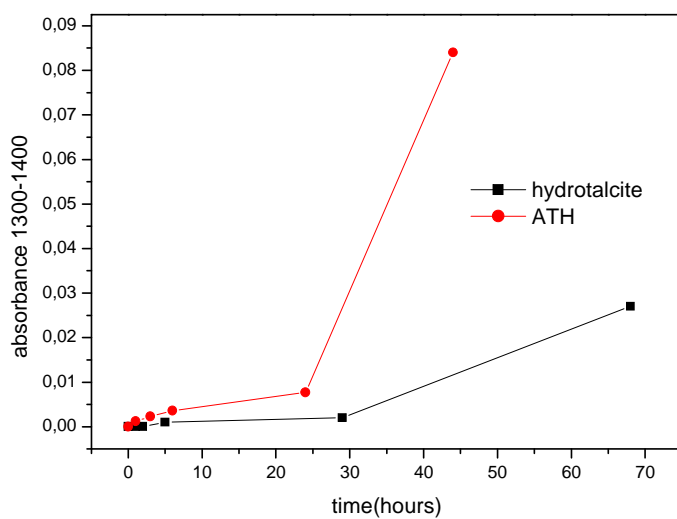

Figure 4: Comparison of ATH and hydrotalcite after nitric acid vapours using ATR-FTIR spectroscopy

3-2- ATR Spectroscopy results:

ATR-IR spectroscopy was used to detect the resistance towards oxidation of the filled PDMS. The different spectra obtained upon accelerated artificial photo-ageing and thermal ageing are similar to the initial spectrum for unaged sample even for long time exposure. No significant oxidative products can be detected for the samples. Unfilled PDMS does not oxidize upon nitric acid vapours but ATH filled PDMS showed formation of aluminium nitrate after a

few hours of exposure [10]. We have compared the effect of nitric acid vapours on hydrotalcite and ATH filler (Fig.4). It is clear that hydrotalcite is more resistant to nitric acid vapours in comparison to ATH. The IR spectra of ATH filled PDMS with all antioxidants showed the formation of nitrates after 1 or 2 hours of exposure, but the hydrotalcite filled PDMS showed an induction period of 5 hours (Fig.5,6).

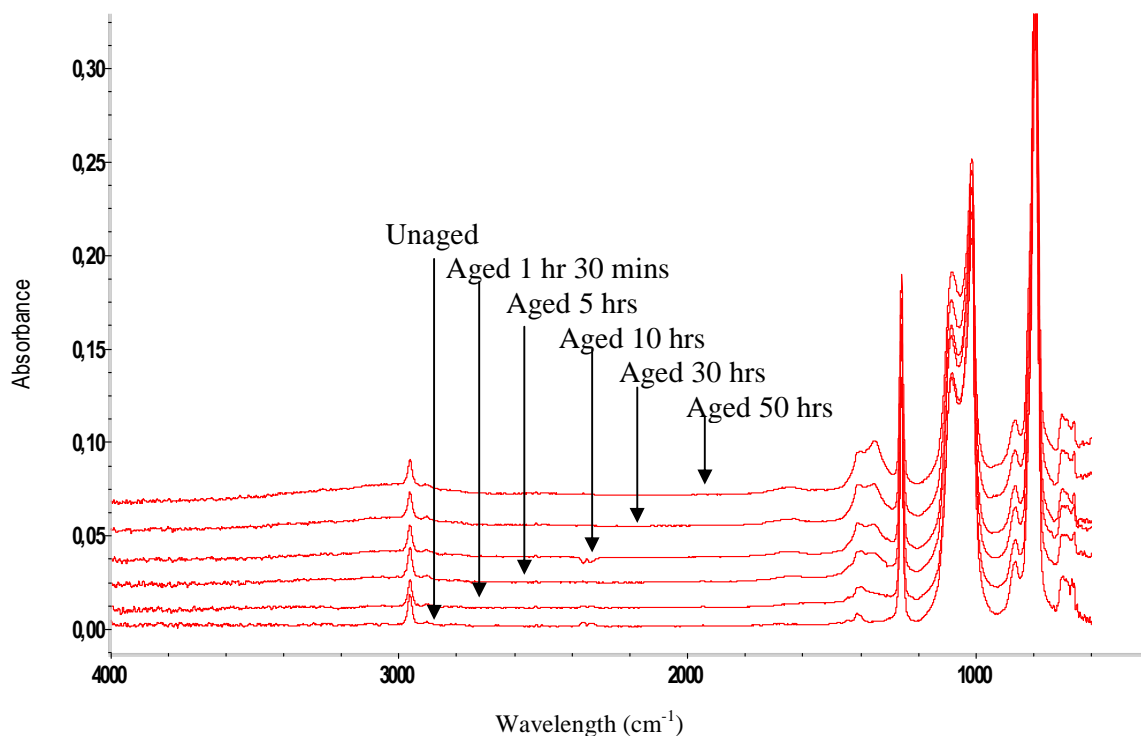

Figure 5: ATR-FTIR spectra of ATH filled PDMS with Silanox stabilizers exposed to nitric acid vapours.

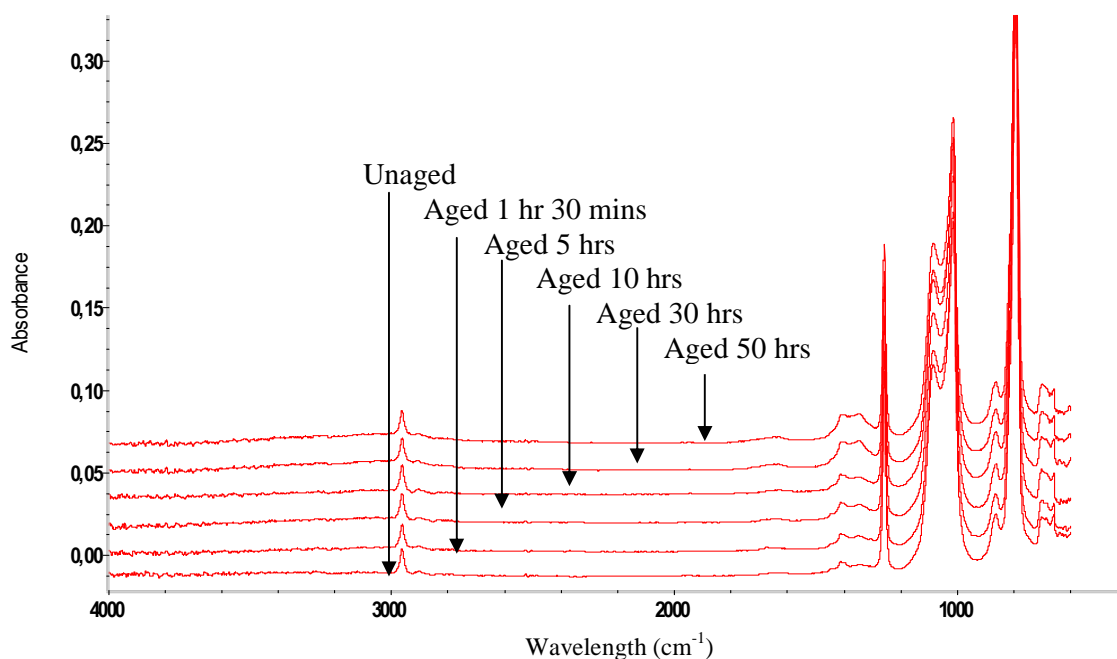

Figure 6: ATR-FTIR spectra of hydrotalcite filled PDMS with Silanox stabilizers exposed to nitric acid vapours.

3-3-Thermogravimetric Analysis Results:

The efficiency of the fillers and stabilizers to retard the thermal degradation of PDMS was assessed by thermogravimetric analysis. All the samples were thermally stable upto 350°C as the change in weight was very less. There are two stages for decomposition for both ATH and hydrotalcite filled PDMS. The rates of thermal degradation increased rapidly henceforth as the temperature increases until the maximum rates are reached and it is over at 600°C. The hydrotalcite filled PDMS having Irganox 1010, Silanox FZ16 are thermally stable almost upto 400°C (Fig.7, 8). The weight loss of hydrotalcite filled PDMS with BHT was least in comparison with other antioxidants. In general hydrotalcite filled PDMS showed better thermal stability than ATH filled PDMS. The total weight loss of the hydrotalcite filled PDMS was less than the ATH filled PDMS (Table 1). The thermal stability of all the samples was more in nitrogen atmosphere than oxygen atmosphere.

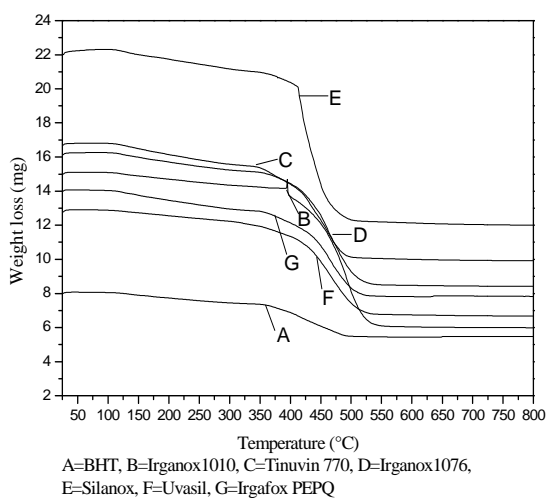

Figure 7

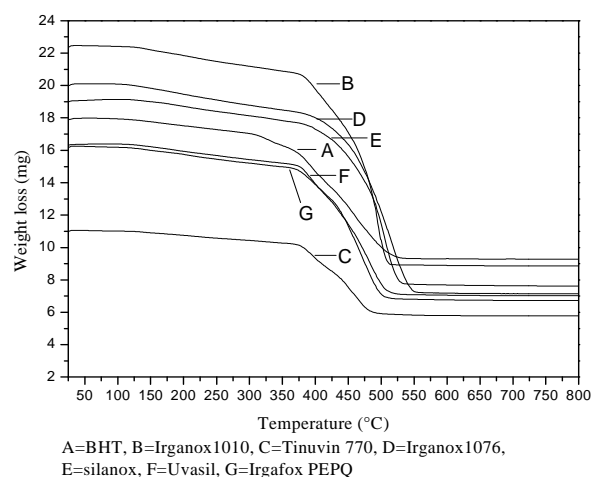

Figure 8

Figure 7: TGA curves of hydrotalcite filled PDMS with different stabilizers under oxygen atmosphere.

Figure 8: TGA curves of ATH filled PDMS with different stabilizers under oxygen atmosphere.

Sample	Hydrotalcite Total wt. Loss (%)	ATH Total wt. loss (%)
A	33	59
B	59	61
C	41	48
D	48	57
E	46	48
F	48	60
G	45	64

Table 1: Comparison of TGA weight loss of hydrotalcite/ATH filled PDMS with different stabilizers under oxygen atmosphere(A=BHT, B=Irganox 1010, C=Tinuvin 770, D=Irganox 1076, E=Silanox, F=Uvasil, G=Irgafos PEPQ)

The thermal stability of the filled PDMS after nitric acid vapour exposure was reduced as the weight loss starts after 150°C (Fig. 9,10). The decomposition takes place in several stages. There is no difference in the thermal stability of ATH filled PDMS and hydrotalcite filled PDMS after nitric acid vapour exposure neither is there any difference in the total weight loss (Table II).

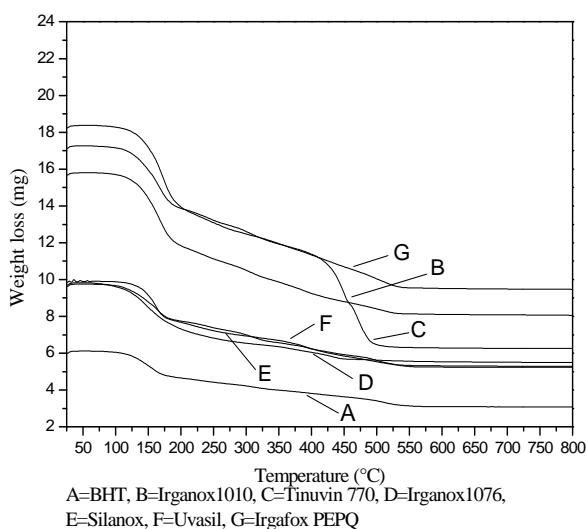

Figure 9

Figure 9: TGA curves of hydrotalcite filled PDMS with different stabilizers after nitric acid vapour exposure for 4 days under oxygen atmosphere.

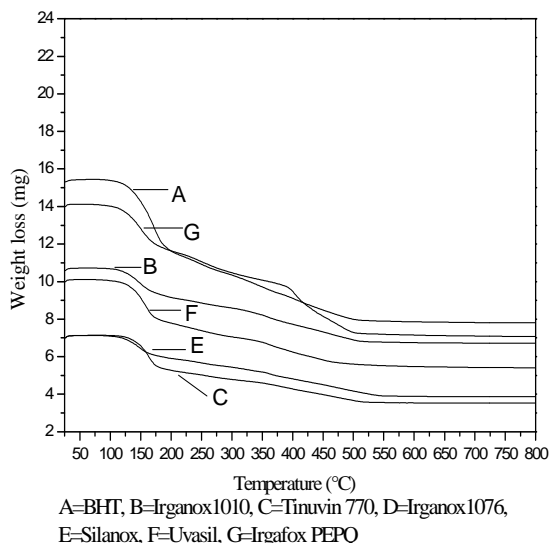

Figure 10

Figure 10: TGA curves of ATH filled PDMS with different stabilizers after nitric acid vapour exposure for 4 days under oxygen atmosphere.

Sample	Hydrotalcite Total wt. loss (%)	ATH Total wt. loss (%)
A	49	49
B	48	47
C	62	61
D	42	45
E	45	46
F	47	45
G	50	49

Table 2: Comparison of TGA weight loss of hydrotalcite/ATH filled PDMS with different stabilizers after nitric acid vapour exposure under oxygen atmosphere(A=BHT, B=Irganox 1010, C= Tinuvin 770, D=Irganox 1076, E=Silanox, F=Uvasil, G=Irgafos PEPQ).

The results of this study show that the degradation is retarded by the incorporation of stabilizers in PDMS. The chain breaking antioxidants Silanox, Irganox 1010, Irganox 1076 showed optimum performance to protect PDMS from ageing. Tinuvin 770 and phosphite based

antioxidants (Irgafos PEPQ) are known to act hydroperoxide decomposer and are converted into phosphates. They act as chain terminating antioxidants by scavenging peroxy and alkoxy radicals. The combination of HAS (Tinuvin 770) and phosphates phenolic based antioxidants did not show any synergistic effect. BHT did not show good performance due to its low molecular weight. It is also relatively volatile antioxidant hence at high temperature it is physically lost rapidly. Irganox is an effective antioxidant as it is having tertiary butyl group in both the ortho positions leading to steric enhancement of antioxidant activity, due to which the derived phenoxy radical reduces the rate of chain transfer reactions. Silanox is an effective stabilizer due to its miscibility with PDMS.

Conclusion:

All the stabilizers enhance the stability of PDMS satisfactorily but the chain breaking hindered phenolic antioxidants exhibited improved stabilization wherein silanox showed the best stabilization due to its miscibility with PDMS. Hydrotalcite is a better filler than ATH for improving the resistance of PDMS against nitric acid vapours. The temperature of crystallization of filled PDMS is lower than unfilled PDMS. The crystallization behaviour of photo-aged filled PDMS depends upon the antioxidants. There is no change in the crystallization peak of hydrotalcite filled PDMS (induction period) in the presence of Silanox and Irganox antioxidants for 5 hours under photo irradiation.

Stabilizers Used

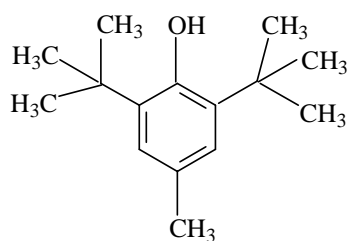

BHT

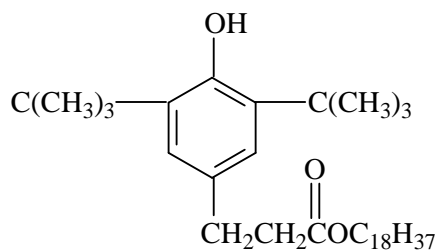

Irganox 1076

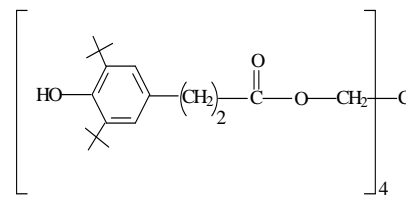

Irganox 1010

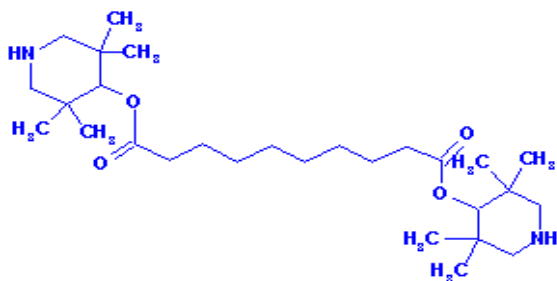

Tinuvin 770

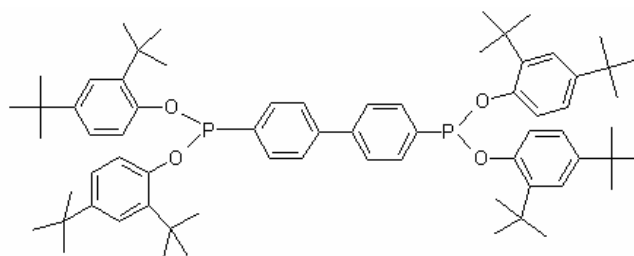

Irgafos PEPQ

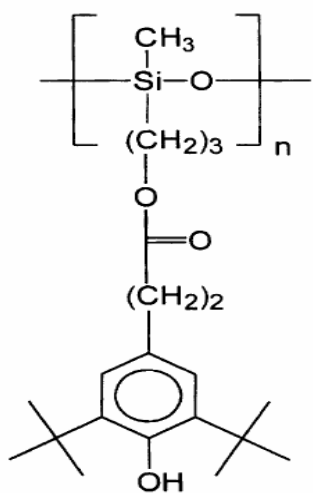

Silanox

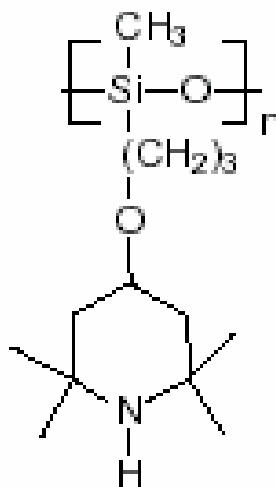

Uvasil 299

References

- [1] Hillborg H., Ankner JF., Gedde UW., Smith GD., Yasuda HK., Wikstrom K.; *Polymer*; 41; 6851-6863; 2000.
- [2] Fateh Alavi K., Gallstedt M., Gedde UW.; *Polym Degrad and stab*; 74; 49-57; 2004.
- [3] Fateh Alavi K., Gedde UW.; *Polym Degrad and Stability*; 84; 469-474; 2004.
- [4] Fateh Alavi K., Nunez ME., Karlsson S., Gedde UW.; *Polym Degrad and stability*; 78; 17-25; 2002.
- [5] Israëli Y., Philippart JL., Cavezzan J., Lacoste J and Lemaire J.; *Polym. Degrad Stab.*; 36; 179-185; 1992.
- [6] Israëli Y., Cavezzan J and Lacoste J.; *Polym Degrad. Stab.*; 37; 201-208; 1992.
- [7] Israëli Y., Lacoste J., Cavezzan J and Lemaire J.; *Polym Degrad Stab*; 42; 267-279; 1993.
- [8] Israeli Y., Lacoste J., Cavezzan J and Lemaire J.; *Polym Degrad Stab*; 47; 357-362; 1995.
- [9] Grassie N., Francey KF., Macfarlane IG.; *Polym Degrad Stab.*; 2; 67-83; 1980.
- [10] Delor-Jestin F., Tomer NS., Singh RP and Lacoste J.; *e- polymers*; 013; 2006.
- [11] Patel SH., Xanthos M., and Greci J.; *Journal of vinyl and additive tech*; vol 1; 201- 205; 1995.
- [12] Tomer NS., Delor-Jestin F., and J. Lacoste communicated.
- [13] Mohmel I., Kurzwaski I., Uecker D., Muller D., and W.Gebner.; *Cryst. Res. Technol.*; 37; 359; 2002.

CHAPITRE 5

CONCLUSION

Le chapitre 5 réunit tous les résultats de recherche appliquée pour l'étude. L'article "*Comparision of natural and artificial ageings on silicone polymer composites*" donne une comparaison de tous les vieillissements envisagés afin de déterminer le ou les vieillissements représentatifs des expositions en extérieur. Le traitement sous vapeur d'acide nitrique permet d'évaluer les formulations prévues en extérieur sous vieillissement spécifique. Un vieillissement électrique en laboratoire est également intéressant. Le choix d'un traitement sous vapeur d'acide nitrique n'est pas surprenant. La formation de ces vapeurs est courante en présence d'un arc électrique sur site spécifique. Ce traitement est un point critique dans le choix des matériaux utilisés en environnement pollué. Les autres vieillissements (photochimique, thermique, ozone ou plasma oxydant) sont moins pertinents pour notre application isolateur. Il est toujours délicat de reproduire la couche de silice obtenue sur la surface des matériaux, sans utiliser des conditions extrêmes de vieillissement. Le vieillissement naturel des matériaux sur site moins pollué reste très satisfaisant.

Nous pouvons finalement choisir deux techniques pour qualifier du point de vue du comportement à long terme différentes formulations à base d'élastomère: l'ATG et la DSC. L'analyse thermogravimétrique permettra de comparer rapidement la stabilité thermique des formulations après vieillissement électrique ou traitement acide. Une étude en DSC-thermoporosimétrie donnera une comparaison du niveau de sur-réticulation après vieillissement.

Dans le deuxième article "*Polydimethyl siloxane modified by hydrotalcite/ATH filler: Effect of stabilizers on degradation*" nous notons une réduction de l'évolution des mélanges PDMS-stabilisants proposés par NCL (Pune) au cours d'un traitement sous vapeur d'acide nitrique ou d'un vieillissement photochimique. Le mélange PDMS-Silanox présente une période d'induction lors des vieillissements et semble le plus satisfaisant pour améliorer la durabilité. La charge $\text{Al}(\text{OH})_3$ est un point critique sous exposition de vapeurs d'acide. Son remplacement par un hydrotalcite a été concluant pour les essais en laboratoire.

CHAPTER 5

CONCLUSION

Chapter 5 combines together the results of the research done in this the study. The article "*Comparision of natural and artificial ageings on silicone polymer composite*" gives a comparision of all ageings performed in order to determine ageings best representing the outdoor exposures. The treatment under nitric acid vapour makes it possible to evaluate the formulations in environment similar to outdoor specific ageing. An electrical ageing in laboratory was interesting. The treatment under nitric acid vapour is used as the formation of these vapours is common in the presence of an electric arc on specific sites. This treatment is important in selection of materials used in polluted environments. Other ageings (photochemical, thermal, ozone or oxidizing plasma) are less relevant for our insulator application. It was not possible to reproduce the silica layer on the surface of the materials without using extreme ageing conditions. The natural ageing of the materials in less polluted sites is satisfactory.

We finally chose two techniques to verify the long term behavior of various elastomer formulations: TGA and DSC. The thermogravimetric analysis makes it possible to quickly compare the thermal stability of the formulations after electric ageing or acid treatment. The DSC-thermoporosimetry gives a comparison of the level of post-cross-linking after ageing.

In the second article: "*Polydimethyl siloxane modified by hydrotalcite/ATH filler: Effect of stabilizers on degradation*" we noticed a reduction in the evolution of stabilized-PDMS mixtures prepared in NCL (Pune) after treatment under nitric acid vapour or photochemical ageing. The PDMS-Silnox mixture present a satisfactory period of induction upon ageings and seem to improve the stability. The $\text{Al}(\text{OH})_3$ filler performs weakly under acid vapour exposure. Its replacement by a hydrotalcite was done for the laboratory tests and the first results were satisfactory.

CONCLUSION GENERALE

Cette thèse comporte une partie plus fondamentale et une approche appliquée. Le travail réalisé sur les élastomères a permis dans un premier temps, de préciser les voies de dégradation majoritaires pour des polysiloxanes non réticulés et soumis à un vieillissement photochimique ou thermique. Ces résultats ont été obtenus grâce à au couplage de la spectroscopie IR avec des réactions de dérivation spécifique (SF_4 , NH_3). Les techniques d'analyses thermiques (photo-DSC et ATG-IR) se sont avérées également très utiles. Le vieillissement des PDMS conduit à une réticulation et des coupures de chaîne. Dans le cas de PMOS et PMTS, la voie de dégradation principale est la formation de produits d'oxydation. Les niveaux de réticulation observés dépendent de la structure chimique, du vieillissement et du taux de cristallinité initial. Le vieillissement thermique favorise une réticulation plus importante à terme que la photo-oxydation. Finalement nous avons vérifié que les réactions de réticulation étaient favorisées dans les zones amorphes (et dans les matériaux initialement plus cristallins, pour lesquels la cristallinité diminue au cours du vieillissement).

Nous avons pu caractériser des formulations complexes à base de polysiloxanes et d'EPDM avec des outils analytiques adaptés comme la spectroscopie IR en réflexion et la DSC-thermoporosimétrie. Les formulations à base PDMS sont peu sensibles aux vieillissements usuels (thermique et photochimique). Aucune oxydation n'est détectée après 10 000 heures d'exposition. Une sur-réticulation est cependant à noter. L'évolution sous brouillard salin est négligeable. En revanche ces matériaux sont très réactifs vis-à-vis de vapeurs d'acide nitrique. Une étude approfondie a montré que la défaillance du matériau est liée en particulier à la présence de trihydrate d'aluminium. Cette charge réagit avec les vapeurs d'acide nitrique. Une importante sur-réticulation est observée en parallèle lors de ce traitement. L'influence de la matrice élastomère, des différentes charges et des additifs sur le comportement à long terme a été minutieusement examinée. Sur le plan des mécanismes chimiques qui gouvernent la dégradation la formation de nitrate d'aluminium est bien sûr la réaction la plus évidente.

La formulation à base d'EPDM présente à la fois une oxydation classique d'élastomère diénique et une sur-réticulation, au cours des vieillissements photochimique et thermique. L'influence de la charge $\text{Al}(\text{OH})_3$ est une nouvelle fois mise en évidence lors du vieillissement pollué sous acide nitrique. La comparaison du comportement à long terme des quatre matériaux

à l'étude (3 PDMS, 1 EPDM) a été proposée. La référence PDMS avec charge traitée se comporte mieux sous vieillissement acide. La formulation EPDM évolue plus rapidement lors des vieillissements classiques. En revanche son comportement sous vieillissement pollué est plus satisfaisant que celui des silicones. Les essais en vieillissement sous ozone montrent une évolution très spécifique pour tous les matériaux.

Les évolutions physiques et chimiques des formulations à base de PDMS ont été comparées en fonction des différents vieillissements artificiels envisagés et des vieillissement en conditions d'usage (vieillissement électrique en laboratoire et retour de ligne sur site spécifique). Nous avons cherché à déterminer les vieillissements accélérés représentatifs des expositions en extérieur. Le traitement sous vapeur d'acide nitrique permet d'évaluer les formulations prévues en extérieur sous vieillissement pollué. Un vieillissement électrique en laboratoire est également intéressant.

Nous avons également retenu deux techniques pour qualifier du point de vue du comportement à long terme de différentes formulations à base d'élastomère: l'ATG et la DSC. Des mesures complémentaires de dureté en surface, de perméabilité à la vapeur d'eau, et des mesures électriques permettent de mieux appréhender l'évolution des matériaux soumis à un vieillissement.

Des mélanges PDMS-stabilisants proposés par NCL (Pune) ont été finalement évalués au niveau d'un traitement sous vapeur d'acide nitrique ou d'un vieillissement photochimique. Le mélange PDMS-Silanox semble le plus satisfaisant pour améliorer la durabilité et retarder les réactions de réticulation. La charge $\text{Al}(\text{OH})_3$ est un point critique sous exposition de vapeurs d'acide. Son remplacement par un hydrotalcite a été concluant pour les essais en laboratoire.

Cette thèse qui se proposait d'examiner le problème de la durabilité d'un matériau à structure complexe (polymère réticulé/ charges/ agent stabilisant) a finalement permis de caractériser le vieillissement du matériau soumis artificiellement à plusieurs types de sollicitations (photo et thermo-oxidations, vieillissement chimique, électrique, sous plasma ou ozone). Il ressort que les points critiques qui ont été révélés concernent l'association d'un charge d'alumine trihydratée avec des vapeurs d'acide nitrique pouvant provenir de l'interaction du champs électrique avec l'azote de l'air. Cette interaction semble très exacerbée dans le cas de matériaux à base de PDMS sans doute en raison de leur grande perméabilité

notablement plus importante que celle de l'EPDM. La formulation peut alors atteindre un état de dégradation très avancée avec formation de silice et fissuration. Une des conséquences de la thèse est donc d'identifier une piste sérieuse pour améliorer la durabilité des formulations à base d'EPDM et des travaux en cours (confidentiels) concernent naturellement l'optimisation de la nature de la charge et des agents de stabilisation à introduire, ce qui constitue une première perspective.

Les coupures de chaînes et les réticulations que subissent les polymères supports (PDMS, EPDM) sont vraisemblablement des réactions radicalaires mais l'accélération de ces réactions par la neutralisation de la charge, si elle est confirmée, reste à expliquer. La réaction de réticulation des silicones est sans doute due à une recombinaison de radicaux SiCH_2 cependant la visualisation des ponts diméthylènes n'a pas été possible par RMN sans doute en raison de leur trop faible concentration. Une autre perspective intéressante de ce travail pourrait donc être de renforcer la sensibilité de la technique RMN par l'utilisation de PDMS marqués ^{13}C (sur le méthyle).

GENERAL CONCLUSION

The work done in this thesis can be divided into two parts: a fundamental study of uncross-linked unfilled elastomers and a second part on applied study of cross-linked filled elastomers. The study on elastomers allowed us to initially, specify the major pathways of degradation for uncross-linked polysiloxanes subjected to photochemical or thermal ageing. These results were obtained by coupling of the IR spectroscopy with reactions of specific chemical reactions (SF_4 , NH_3). The techniques of thermal analyses (photo-DSC and TGA-IR) also proved very useful. The degradation of polysiloxanes leads to cross-linking and chain scission. In case of PMOS and PMTS, the principal pathway of degradation is by formation of oxidation products. The levels of cross-linking observed depended on the chemical structure, the ageing and the initial crystallinity. Thermal ageing results in a more important cross-linking than photo-oxidation in the long term. Finally we checked that the reactions of cross-linking were favoured in the amorphous zones (and in materials initially more crystalline, for which crystallinity decreases during ageing).

Next, we have characterized complex formulations of polysiloxanes and EPDM with analytical tools like the IR spectroscopy in reflexion and DSC-thermoporosimetry. The formulations having PDMS base are not very sensitive to usual ageings (thermal and photochemical). No oxidation is detected after 10000 hours of exposure. A post cross-linking is however observed. The evolution under salt fog ageing is negligible. On the other hand these materials are very reactive with nitric acid vapours. A thorough study showed that the failure of material is in particular related to the presence of aluminium trihydrate. This filler reacts with the nitric acid vapours. The chemical mechanism which control degradation is aluminium nitrate formation. An important post cross-linking is also observed after this treatment. The influence of the matrix of the elastomer, the various fillers and the additives on the long-term behavior was thoroughly examined.

The EPDM formulation presents a traditional oxidation of the dienic elastomer and a post-cross-linking, during photochemical and thermal ageings. The influence of the $\text{Al}(\text{OH})_3$ filler was once again responsible for the ageing under nitric acid. The comparison of the long-term behavior of four materials studied (3 PDMS, 1 EPDM) was proposed. The PDMS reference with treated filler showed better performance under acid ageing. EPDM formulation evolves

more quickly at the time of traditional ageings. On the other hand its behavior under polluted ageing is more satisfactory than that of silicones. Under ozone ageing the formulations show a very specific evolution.

Lastly, the physical and chemical evolutions of the PDMS formulations are compared according to various artificial ageings and ageings in use conditions (electric ageing in laboratory and field aged samples). We tried to determine accelerated ageings similar to outdoor exposures. The treatment under nitric acid vapour makes it possible to evaluate the formulations similar to polluted ageing. An electric ageing in laboratory is also interesting. The performance under acid vapour is a critical point for choosing materials used in polluted environment. Other ageings (photochemical, thermal, ozone or oxidizing plasma) are less relevant for our insulator application. However, the simulation of natural ageing was difficult.

We used two techniques: TGA and DSC to understand the long term behaviour of the various elastomer formulations. Complementary measurements of surface hardness, permeability to water vapour, and electrical measurements make it possible to better understand the evolution of the materials subjected to ageing.

Stabilized-PDMS mixtures prepared by NCL (Pune) were finally evaluated for performance under nitric acid vapour or photochemical ageing. The PDMS-Silanox mixture seems most satisfactory to improve durability and to delay the cross-linking reactions. The $\text{Al}(\text{OH})_3$ filler was replaced by hydrotalcite which has better stability to acid vapours.

In this thesis work we have proposed to examine the problem of durability of material with complex structure (cross-linked polymer/ filled/ stabilized) and have characterized their ageing by subjecting them to several types of artificial stress (photo and thermo-oxidations, chemical ageing, electric ageing, under plasma or ozone). It was found that the crucial point related to the association of $\text{Al}(\text{OH})_3$ filler with nitric acid vapours formed from the interaction of electric fields with nitrogen of the air. This interaction undoubtedly seems very important in the case of materials containing PDMS because of their greater permeability notably more important in comparison to that of EPDM. The formulation can reach a very advanced state of degradation with formation of silica powder on the surface and fissuration. One of the goals of the thesis is thus to identify a serious pathway to improve the durability of the formulations

based on EPDM/PDMS and the work in progress (confidential) naturally relate to optimization of the nature of filler and the stabilizing agents added.

The chain scissions and cross-linking which the polymers (PDMS, EPDM) undergo are probably radicalar reactions but the acceleration of these reactions by neutralization of the filler, is not yet confirmed and has to be explained. The cross-linking reaction of silicones are undoubtedly due to recombination of SiCH₂ radicals, however the formation of the dimethylenes bridges was not detected by NMR spectroscopy because their concentration is very weak. Another interesting perspective for this work could thus be to use of NMR technique to study PDMS marked with ¹³C (on methyl).

References

- [1] Clarson S.J., Semlyen J.A.; Siloxane polymers; Ellis Horwood–PTR Prentice Hall; 216-240; 1993.
- [2] E.A. Cherney.; IEEE Trans. on dielec. and elec. Ins.; 12; 6;1108-1114; 2005.
- [3] Hanu L.G., Simon G.P., Cheng Y.B.; Polym Degrad Stab; 91; 1373-1379; 2006.
- [4] G.B. Sohoni., J.E.Mark.; Journal of applied polymer science; 45; 1763-1775; 1992.
- [5] Kumagai S., Yoshimura N.; IEEE Trans; Dielectrics Elect. Ins.; 8; 203-211; 2001.
- [6] Kuncera M., Lanikova J.; J. Polym. Sci; 54; 375-384; 1961.
- [7] Kuncera M., Lanikova J., Jelinek M.; J. Polym. Sci; 53; 301-310; 1961.
- [8] Kuncera M., Lanikova J.; J. Polym. Sci; 59; 79-85; 1962.
- [9] Zhang J., Feng S., Ma Q.; J. Applied Polym. Science; 89; 1548-1554; 2003.
- [10] Delman A.D., Landy M., Simms.B.B.; Journal of applied polymer science; 7; 3375-3386; 1969.
- [11] Israëli Y., Philippart JL., Cavezzan J., Lacoste J., Lemaire J.; Polym. Degrad. Stab.; 36 ; 179-185 ; 1992.
- [12] Israëli Y., Cavezzan J., Lacoste J.; Polym. Degrad. Stab.; 37; 201-208;1992.
- [13] Israëli Y., Lacoste J., Cavezzan J., Lemaire J.; Polym Degrad Stab.; 42; 267-279; 1993.
- [14] Israeli Y., Lacoste J., Cavezzan J., Lemaire J.; Polym Degrad Stab.; 47 ; 357-362; 1995.
- [15] Virlogeux F., Bianchini D., Delor-Jestin F., Baba M., Lacoste J.; Polymer International; 53; 163-168; 2004.
- [16] Grassie, N., Francey KF.,; Macfarlane IG.; Polym Degrad and Stab.; 2; 67-83;1980.
- [17] Yilgol I., Yilgol E.; Polym Bulletin; 40; 525-532; 1998.
- [18] Deshpande G., Rezac ME.; Polym Degrad and Stab; 74; 363-370; 2001.
- [19] Deshpande G., Rezac ME.; Polym Degrad and Stab;76; 17-24; 2002.
- [20] Camino G., Lomakin SM., Lazzari M.; Polymer; 42; 2395-2402; 2001.
- [21] Camino G., Lomakin SM., Lazzari M.; Polymer; 43; 2011-2015; 2002.
- [22] Valles E.,; Sarmoria C.; Villar M., Lazzari M., Chiantore O.,; Polym Degrad and Stab; 69; 67-71; 2000.
- [23] Keshavaraj R., Tock RW.; Adv in Polym. Tech.;13;149-156; 1994.
- [24] Mirley C.L., Koberstein., Langmuir.; 11; 1049-1052.
- [25] Ouyang M., Yuan C., Muisener R.J., Boulares A., Koberstein J.T.; Chem. Mater; 12; 1591-1596; 2000.
- [26] Olah A., Hillborg H., Vancso J.; Applied Surface Science; 239; 410-423; 2005.

- [27] Diaz-Quijada GA., Wayner DDM.; Langmuir; 20; 9607-9611; 2004.
- [28] Hollohan R., Carlson G.L.; J.Appl Polym. Sci; 14; 2499-2508; 1970.
- [29] Toth A., Bertoti I., Blazlo M., Banhegyi G., Bognar A., Szaplanczay P.; J.Appl. Polym. Sci; 52; 1293-1307; 1994.
- [30] Smith P.J., Owen M.J.; IEEE CEIDP Annual Report; 1992.
- [31] Morra M., Occhiello E., Morola R., Garassi F., Humphrey P., Johnson D.; J.Colloid Inter Sci; 137; 11-24; 1990.
- [32] Hillborg H., Ankner J.F., Gedde U.W., Smith G.D., Yasuda H.K., Wikstrom K.; Polymer; 41; 6851-6863; 2000.
- [33] Chughtai AR., Smith DM., Kumosa M.S.; Composite Sci and Tech; 58; 1641-1647; 1998.
- [34] Finlayson P., Pitts B.J., Jr JN.; Atmospheric Chemistry: Fundamentals and Experimental Techniques, Wiley New York; Ch.8; 1986.
- [35] Koo JY., Kim IT., Park WK.; IEEE Annual Report CEIDP; 370-373; 1997.
- [36] Wang X., Kumagai S., Yoshimura N.; IEEE Trans on Dielec and Elec Ins; 5; 909-916; 1998.
- [37] Montesinos J., Gorur RS., Goudie J.; IEEE-CEIDP; 39-42; 1998.
- [38] Gubanski S.M., Vlastos A.E.; IEEE Trans. On Power Delivery; 5; 3; 1527-1533; 1990.
- [39] Strate, G. V., Mark H. F., Bikales N. M., Overberger C. G., Koschwitz J. J.; In Encyclopedia of Polymer Science and Engineering Eds Wiley New York; 522; 1973.
- [40] Vlastos A.E., Gubanski S.M.; IEEE Trans. On Power Delivery; 6; 2; 888-900; 1991.
- [41] George G.A.; Materials Forum; 19; 145-161; 1995.
- [42] Billings M.J., Smith A., Wilkins R.; IEEE Trans. Electr. Insul; 2; 131-137; 1967.
- [43] Tanaka T., Naito K., Kitagawa J.; IEEE Trans. Electr. Insul.; 13; 184-193; 1978.
- [44] Akita K.; Aspects of Degradation and Stabilization of Polymers, ed. H.H.G. Jellinek, Elsevier, Amsterdam; 1978.
- [45] Troitzsch J.; Plastics Flammability Handbook, Hanser, Munchen; 1983.
- [46] Geuskens G., Kabamba M.S.; Polym Degrad Stab.; 4; 69-76; 1982.
- [47] Coiffier F., Arnaud R., Lemaire J.; Macromol Chem.; 185; 1095-1104; 1984.
- [48] Delor F., Teissedre G., Baba M., Lacoste J.; Polym Degrad Stab.; 60;321-331; 1998.
- [49] Carlsson J.D., Wiles D.M.; J. Macromol. Sci. Rev. Macromol. Chem.; C14; 65; 1976.
- [50] Lacoste J., Carlsson D.J.; J. Polym. Sci. Polym.Chem. Ed.; 30; 493; 1992.
- [51] Allen N.S., Mekellar J.F.; Macromol. Chem.; 179; 2103; 1978.
- [52] Maecker N.L., Priddy D.B.; J. Appl. Polym. Sci.; 42; 21-33; 1991.
- [53] Scoponi M., Pradella F., Carassiti V.I.; Macromol. Chem. Phys; 195; 985-997; 1994.

- [54] Teissede G., Pilichowski J.F., Lacoste J.; Polym. Degrad. Stab.; 45; 145-153; 1994.
- [55] Singh R.P., Mani R., Sivaram S., Lacoste J., Lamaire J.; Polymer; 35; 1382-1385; 1994.
- [56] Delor F., Lacoste J., Lemaire J., Oudin N.B., Cardinet C.; Polym Degrad Stab.; 53; 361-369; 1996.
- [57] Arnaud R., Lemaire J., Quemer J., Roche G.; Eur. Polym. J.; 12; 499-504; 1976.
- [58] Mitra S., Ghanbari-Siahkali A., Kingshott P., Rehmeier HK., Abildgaard H., Almdal K Polm Degrad Stab.; 91; 69-80; 2006.
- [59] Mitra S., Ghanbari-Siahkali A., Kingshott P., Rehmeier HK., Abildgaard H., Almdal K; Polm Degrad Stab.; 91; 81-93; 2006.
- [60] Hegemann D., Brunner H., Oehr C.; Nucl. Instr. And Meth. In Phys. Res. B; 208; 281-286; 2003.
- [61] Giurginca M., Zaharescu T., Meghea A.; Poly. Degrad. and Stab.; 50; 45-48; 1995.
- [62] Rakovsky S., Zaikov.; J. of Applied Polymer Science; 91; 2048-2057; 2004.
- [63] Kikkawa K., Nakahara Y., Ohkatsu Y.; Polym Degrad Stab.; 13; 237; 1987.
- [64] Wilen C. E., Auer M., Nasman J.H.; J.Poly.Sci., Polym.Chem.Ed.; 114; 9679; 1992.
- [65] Sundhar S., Bernstorff A., Goch W., Linson D., Huntsman L.; Intl. Symposium on Electrical Insulation; 1992.
- [66] Mackevich J., Shah M.; IEEE Electrical Insulation Magazine; 13; 3; 1997.
- [67] Kikuchi T., Nishimura S., Nagao M., Izumi K., Kubota Y., Sakota M.; IEEE Trans. on dielec. and elec. Insul.; 6;5;548-556.; 1999.
- [68] Hackam R .; IEEE Trans. Dielec. and Elec. Insul.; 6.;5.;557-585.;1999.
- [69] Hall F.; IEEE Trans. Power Delivery.; 8.;1.;376-385.
- [70] Scheider HM., Hall HF., Karady G., Rendowen J.; IEEE Trans. Dielec. and Elec. Insul.; 4.;4.; 2214-2221.; 1989.
- [71] (P1-12) Hill JTD, Preston ML, Salisbury DJ, Whittaker AK.; Radiation Physics and Chem.; 62.; 11-17.; 2001.
- [72] (P1-13) Howard Thomas T., Kendrick TC.; Journal of Polym. Sci, Part A-2.; 7.; 537-549.; 1969.
- [73] (P1-14) Valles E., Sarmoria C., Villar. M., Lazzari M., Chiantore O.; Polym Degrad Stab; 69.; 67-71.; 2000.
- [74] (P1-15) Penot G.; Arnaud R.; Lemaire J.; Die Angew Macromol Chem.; 30.; 493-499.; 1992.
- [75] (P1-16) Aranguren MI.; Polymer.; 39.; 4897-4903.; 1998.
- [76] (P2-15) Morel M.; Lacoste J.; Baba M.; Polymer.; 46.; 9274-9282.; 2005.

- [77] (P3-9) Zeldin M., Qian BR., Choi SJ.; J. Polym. Sci.- Polym. Chem.; 21.; 1361-1369.; 1983.
- [78] (P3-10) Hillborg H., Sandeli M., Gedde UW.; Polymer .; 42.; 7349-7362.; 2001.
- [79] (P3-11) Hillborg H.; Gedde UW.; IEEE Transactions on Dielectrics and Electr Insulation.; 6.;5.; 703-717.; 1999.
- [80] (P3-13) Owen MJ., Gentle TM., Orbeck T., Williams DE.; Polymer Surface Dynamics, Ed JD Andrade - Plenum Press 1988.
- [81] (P3-15) Sorqvist T., Vlastos AE.; IEEE Trans. Power Delivery.; 12.;2.; 1041-1047.;1997.
- [82] (P3-16) Kim SH., Cherney EA., Hackam R., Rutherford KG.; IEEE Trans on Dielectrics and Electrical Insulation.; 1.;1.;106-123.; 1994.
- [83](P3-18) Homma H., Mirley CL., Ronzello J., Boggs SA.; IEEE Transactions on Power Delivery.; 15.;4.; 1298-1303.; 2000.
- [84] (P3-19) Fateh-Alavi K., Gallstedt M., Gedde UW.; Polym. Degrad. Stab.; 74.; 49-57.; 2001.
- [85] (P3-20) Chaudhry AN., Billingham NC.; Polym. Degrad. Stab.; 73.; 505-510.; 2001.
- [86] (P3-21) Patel M.; Skinner AR.; Polym. Degrad. Stab.; 73.; 399-402.; 2001.
- [87] (P3-24) Quinson JF., Astier M.; Brun M.; Applied catalysis.; 30;123-127; 1987.
- [88] (P3-25) Liu J., Gan LM., Chew CH., Teo WK.; Langmuir.; 13; 6421-6425; 1997.
- [89] (P3-26) Baba M., Nedellec JM., Gardette JL., Lacoste J.; Journal of non-crystalline solids.; 31; 3; 228-238; 2003.
- [90] (P3-27) Socrates G.; IR and Raman characteristics group frequencies 3rd Edition Wiley.; 244.; 2001.
- [91] (P4-1) Dueck ER ., Juliano VF ., Guzzo MG ., and DePaoli M.A.; Polym. Degrad. and Stab.; 28; 235-248 ; 1990.
- [92] (P4-3) Delor F., Barrois-Oudin N., Duteurtre X., Cardinet C., Lemaire J., and Lacoste J.; Polym. Degrad. and Stab.; 62; 395-401; 1998.
- [93] (P4-4) Delor F., Teissedre G., Baba M., and Lacoste J.; Polym. Degrad. and Stab.; 60 ; 321-331; 1998
- [94] (P4-11) Nunes SP., Da costa RA., Barbosa SP., Almeida GR and Galembeck F., IEEE Trans. Electrical Insul.; 24; 1; 99-195; 1989.
- [95] (P5-26) Efimenko K., Wallace WE., Genzer J.; Journal of Colloid Interface Science.; 254; 306-315; 2002.
- [96] (P5-27) Oldfield ST., Polym. Testing; 15; 115-128; 1996.
- [97] (P6-3) Fateh Alavi K., Gedde UW., Polym Degrad and Stability; 84; 469-474; 2004.

[98] (P5-4) Fateh Alavi K., Nunez ME., Karlsson S., Gedde UW., Polym Degrad and stability; 78; 17-25; 2002.

[99] (P5-11) Patel SH., Xanthos M., Greci J., Journal of vinyl and additive tech; vol 1; 201-205; 1995.

[100] (P5-13) Mohmel S, Kurzawski I, Uecker D, Muller D and Gebner W, Cryst. Res. Technol., 37, 359, 2002.

List of Abbreviations

ATH:	Aluminium Trihydrate
ATR-FTIR:	Attenuated Total Reflection- Fourier Transform Infrared spectroscopy
CE:	Cycloaliphatic Epoxies
DSC:	Differential Scanning Calorimetry
EPDM:	Ethylene Propylene Diene Monomer
ENB:	5-ethylidene-2-norbornene
ENSCCF:	L'Ecole Nationale Supérieure de Chimie de Clermont-Ferrand
EVA	Ethylene Vinyl Acetate
SEC:	Size Exclusion Chromatography
HAS:	Hindered Amine Stabilizer
HTV:	High Temperature Vulcanized
LMI :	Laboratoire des Matériaux Inorganiques
LPMM:	Laboratoire de Photochimie Moléculaire et Macromoléculaire
PDMS:	Polydimethylsiloxane
PMOS :	Polymethyloctadecylsiloxane
PMTS :	Polymethyltetradecylsiloxane
RTV:	Room Temperature Vulcanized
SEPAP:	System d'étude de photo-vieillessement accéléré des polymères (Accelerated Photo-Irradiation system)
T _g :	Glass transition temperature
TGA:	Thermogravimetric Analysis
UV:	Ultra-violet
XPS	X Ray Photoelectron spectroscopy

RESUME

Ce travail de thèse traite de l'étude du comportement à long terme de revêtements élastomères utilisés pour la protection de jonc central en époxy et fibres de verre pour l'isolateur électrique. Quatre formulations industrielles à base de polydiméthylsiloxane (PDMS) ou d'Éthylène Propylène Diène Monomère (EPDM) sont étudiées.

Nous comparons l'évolution des propriétés des différentes compositions afin de mettre en évidence l'influence des constituants et celle de la matrice polymère sur le vieillissement. La charge de trihydrate d'aluminium a été identifiée comme étant le point critique de la formulation en présence des vapeurs d'acide nitrique.

Les formulations à base PDMS sont peu sensibles aux vieillissements usuels (thermique et photochimique). Aucune oxydation n'est détectée après 10 000 heures d'exposition. La formulation à base d'EPDM présente à la fois une oxydation classique d'élastomère diénique, et des réactions de réticulation au cours des vieillissements photochimique et thermique. La technique de DSC-thermoporosimétrie est largement utilisée pour mettre en évidence les réactions de réticulation. Elle permet de déterminer la taille et la distribution des mailles du réseau polymère. Elle constitue une nouvelle approche de la réticulation des élastomères. Suite à cette étude nous pourrions retenir le meilleur outil pour caractériser rapidement la période d'induction avant dégradation et modification d'une propriété. Une importante sur-réticulation, au cours des vieillissements photochimique et thermique est observée pour les formulations siloxanes et EPDM.

Une étude plus fondamentale sur les polysiloxanes non réticulés, non chargés est également proposée. Elle permet de mieux appréhender le comportement en vieillissement des silicones par rapport aux réactions de réticulation en particulier et d'étudier les relations structure-propriétés. Les PDMS ne s'oxydent pas mais se dégradent en donnant lieu à des réactions de réticulation et de scissions de chaînes au cours des vieillissements photochimique, ou thermique. Ils ne réagissent pas sous vapeur acide nitrique. En revanche les polysiloxanes avec une chaîne carbonée pendante s'oxydent et donnent lieu à des réactions de réticulation et de scissions de chaînes au cours de vieillissements photochimique, et thermique et se dégradent sous vapeur acide nitrique.

Enfin, nous avons testé des nouvelles formulations stabilisées en présence de vapeurs acide nitrique et en vieillissement photochimique.

Mot clés : Polysiloxane, EPDM, vieillissement photo-chimique, vieillissement thermique, vieillissement sous vapeur d'acide, spectroscopie ATR-IRTF, DSC-thermoporosimétrie, ATG.

ABSTRACT

This research deals with the study of long term behavior of elastomer housings used for the protection of the central epoxy and fiber glass composite rod of the electric insulators. Four types of industrial formulations having bases of polydimethylsiloxane (PDMS) or ethylene propylene diene (EPDM) are studied.

The formulations were subjected to various types of ageings in order to simulate an exposure similar to natural degradation which the insulator experiences during its service life time. We have compared the evolution of properties of the different components of the formulations, to help us in identifying the influence of the polymer matrix and the different components on its aging. The $\text{Al}(\text{OH})_3$ filler was identified as the weakest component of the formulations in presence of nitric acid vapour.

The formulations having a base of PDMS are not very sensitive to usual ageings (thermal and photochemical). No oxidation is detected after 10,000 hours of exposure. The formulation based on EPDM present at the same time a traditional oxidation of the dienic elastomer during photochemical and thermal ageings and the reactions of cross-linking. We have used the thermoporosimetry technique to calculate the pore size distribution of the polymer network giving us a new view about the cross-linking of the elastomers. Using this study we can rapidly characterize the period of induction before degradation and modification of the properties, an important post cross-linking is detected upon ageing for the EPDM and Siloxane formulations.

We have carried out a fundamental study on uncross-linked polysiloxanes without fillers. It helps us to better understand the ageing behavior of silicones compared to the cross-linking and to study the structure property relationships. Polydimethylsiloxane do not oxidize but are degraded by cross-linking and chain scissions reactions upon thermal and photo-ageing. They are stable in presence of nitric acid vapours. However, polysiloxanes having a carbon chain in the backbone undergo oxidation, cross-linking and chain scission reactions upon thermal and photo-ageing. They are also degraded by nitric acid vapours.

Lastly, we have tested new stabilized formulations in presence of nitric acid vapours and photochemical ageing.

Key words: Polysiloxanes, EPDM, photo ageing, thermal ageing, acid ageing, ATR-FTIR spectroscopy, DSC-thermoporosimetry, TGA

