



HAL
open science

Perishable items Inventory Mnagement and the Use of Time Temperature Integrators Technology

Chaaben Kouki

► **To cite this version:**

Chaaben Kouki. Perishable items Inventory Mnagement and the Use of Time Temperature Integrators Technology. Other. Ecole Centrale Paris, 2010. English. NNT : 2010ECAP0043 . tel-00711476

HAL Id: tel-00711476

<https://theses.hal.science/tel-00711476>

Submitted on 25 Jun 2012

HAL is a multi-disciplinary open access archive for the deposit and dissemination of scientific research documents, whether they are published or not. The documents may come from teaching and research institutions in France or abroad, or from public or private research centers.

L'archive ouverte pluridisciplinaire **HAL**, est destinée au dépôt et à la diffusion de documents scientifiques de niveau recherche, publiés ou non, émanant des établissements d'enseignement et de recherche français ou étrangers, des laboratoires publics ou privés.



**ÉCOLE CENTRALE DES ARTS
ET MANUFACTURES
« ÉCOLE CENTRALE PARIS »**

THÈSE
présentée par
Chaaben KOUKI

pour l'obtention du

GRADE DE DOCTEUR

Spécialité : Génie Industriel

Laboratoire d'accueil : Laboratoire Génie Industriel

**SUJET : Perishable Items Inventory Management and the Use of
Time Temperature Integrators Technology**

soutenue le : xx/12/2010 à l'Ecole Centrale Paris

devant un jury composé de :

Michel Gourgand : Professeur, LIMOS, Campus Scientifique des Cézeaux

Jean-Claude Hennet : Directeur de Recherche, CNRS-LSIS, Marseille

Maria Di Mascolo : Maître de Conférences, CNRS / Laboratoire G-SCOP, INPG-Grenoble

Yves Dallery : Professeur, Laboratoire Génie Industriel, Ecole Centrale Paris

Evren Sahin : Maître de Conférences, Laboratoire Génie Industriel, Ecole Centrale Paris

Zied Jemai : Maître de Conférences, Laboratoire Génie Industriel, Ecole Centrale Paris

Abstract. One of the implicit assumptions made in research related to inventory control is to keep products indefinitely in inventory to meet future demand. However, such an assumption is not true for a large wide of products characterized by a limited lifetime. The economic impact of managing such products led to substantial work in perishable inventory control literature. Investigations developed so far underline the complexity of modeling perishable inventory. Moreover, the dependency of the lifetime to temperature conditions in which products are handled adds more complexity since the lifetime of products stemming from the same order may vary from product to another. In this context, the ability of Time Temperature Integrators to capture the effects of temperature variations on products' lifetime, offers an opportunity to reduce spoilage and therefore ensure product's freshness and safety.

The general aim of this thesis is to model perishable inventory systems. Particularly, three different problem areas are considered. The first one concerns perishable inventory with fixed lifetime, often referred as Fixed Life Perishability Problem, where an approximate (r, Q) inventory policy is developed. This model relaxes some assumptions made in previous related works. The second problem considered is a (T, S) perishable inventory system with random lifetime. Results of this model contribute to the development of a theoretical background for perishable inventory systems which are based on Markov renewal process approach. The third area incorporates the impact of temperature variations on products' lifetime throughout inventory systems that use TTIs technology. More general settings regarding the demand and the lifetime distributions are considered throughout simulation analysis. The economic relevance stemming from the deployment of this technology is therefore quantified.

Keywords : Perishable items, Time-Temperature Integrators, Continuous review, Periodic review, Markov Process, Simulation

Résumé. L'une des hypothèses implicites faites dans la recherche liée à la gestion des stocks est de maintenir les produits indéfiniment pour satisfaire la demande future. Toutefois, cette hypothèse n'est pas vraie pour les produits caractérisés par une durée de vie limitée. L'impact économique de la gestion de tels produits a conduit à d'importants travaux de recherche. Les investigations développées jusqu'ici ont souligné la complexité de modéliser les stocks de produits périssables. En plus, la dépendance de la durée de la vie à la température à laquelle les produits sont maintenus crée un challenge majeur en terme de modélisation puisque la durée de vie des produits provenant d'une même commande peut varier d'un produit à un autre. La capacité des nouvelles technologies de contrôle de fraîcheur telles que les intégrateurs temps - température de capturer les effets des variations de la température sur la durée de vie offre une opportunité de réduire les pertes et donc d'assurer la fraîcheur des produits vendus.

L'objectif général de cette thèse est de modéliser des politiques de gestion de stock des produits périssables. En premier lieu, nous nous intéressons à la politique (r, Q) où les produits ont une durée de vie constante. Le modèle que nous proposons relaxe certaines hypothèses formulées dans les précédents travaux. La deuxième politique considérée est la politiques (T, S) où les produits ont une durée de vie aléatoire. Enfin, nous étudions l'impact des nouvelles technologies de control de fraîcheur des produits périssables sur la gestion des stocks. Nous nous intéressons à la pertinence économique découlant du déploiement des intégrateurs temps températures dans la gestion des stocks.

Mots clefs : Produits périssables, Intégrateurs Temps-Température, Revue continue, Revue périodique, Processus de Markov, Simulation

To my family

Acknowledgements

I am very pleased to begin this manuscript by thanking all the persons who have contributed in the achievement of this doctoral work.

First, I would like to thank... (to be continued)

Contents

List of Figures	vi
List of Tables	viii
Introduction	1
0.1 Problem statement and research questions	1
0.2 Scope of the dissertation and structure of the content	2
1 Challenges on Modeling Perishability in Inventory Management Systems	5
1.1 Introduction	5
1.2 Challenges of perishability on inventory management	7
1.3 Perishable inventory management without TTIs	8
1.4 Perishable inventory management with TTIs	11
1.4.1 TTI type 1 technology	11
1.4.2 TTI type 2 technology	14
1.4.3 Benefits of using TTI technologies	14
1.4.4 Limitations of cold chain monitoring systems based on TTIs	16
1.5 Basic notions of inventory management	17
1.6 Basic inventory management policies	20
1.6.1 The (r, Q) policy	20
1.6.2 The (T, S) policy	21
1.6.3 Optimization	21
1.7 Context	23
1.8 Conclusion	25

2	Literature Review of Single Item Single Stage Perishable Inventory Management Systems	27
2.1	Introduction	27
2.2	Issuing policies of perishable inventory management	28
2.3	Perishable inventory control with fixed lifetime	29
2.3.1	Perishable inventory based on dynamic programming approach	29
2.3.2	Queuing-based perishable inventory models	33
2.3.3	Perishable inventory systems based on regenerative processes tool	35
2.3.4	Perishable inventory based on mathematical modeling	38
2.4	Perishable inventory control with stochastic lifetime	41
2.4.1	Perishable inventory systems with exponential lifetime	43
2.4.2	Perishable inventory systems with general distribution lifetime	44
2.5	Conclusion	45
3	An (r, Q) Inventory Control with Fixed Lifetime and Lead time	49
3.1	Introduction	49
3.2	A continuous review (r, Q) model subject to perishability	51
3.2.1	Expected outdating quantity	54
3.2.2	Expected backlogged quantity	56
3.2.3	Expected inventory level per unit time	57
3.2.4	The expected average total cost	60
3.3	Evaluation of the performance	62
3.3.0.1	Model validation based on a simulation study	64
3.3.0.2	Comparison with the simulation model and Chiu's model	66
3.4	Consideration of the undershoot in an (r, Q) perishable inventory	69
3.4.1	Model description	72
3.4.2	Expected inventory level per unit time	74
3.4.3	The expected average total cost	76
3.5	Evaluation of the performance of the proposed model with undershoots	77
3.5.1	Comparison with the simulation model	77
3.5.2	Comparison 1: $TC_2(r_2, Q_2)$ vs. $TC_c(r_c, Q_c)$	80
3.5.2.1	Comparison 2: i.e. $TC_2(r_2, Q_2)$ vs. $TC_2(r_c, Q_c)$	80

3.6	Conclusion	82
4	Impact of Random Lifetime in Periodic Review Perishable Inventory Systems	87
4.1	Introduction	87
4.2	The (T,S) model with full lost sales	89
4.2.1	Transition probabilities	89
4.2.2	Steady state probability	92
4.2.3	Expected operating costs	93
4.3	The (T,S) model with full backorders	94
4.3.1	Transition probabilities	94
4.3.2	Steady state probabilities	96
4.3.3	Expected operating costs	97
4.4	Optimization	98
4.5	Numerical analysis	102
4.5.1	Comparison with inventory model when perishability is ignored .	103
4.5.2	Comparison with the inventory model with deterministic lifetime	105
4.6	Conclusion	106
5	Impact of TTIs on Perishable Inventory Management	111
5.1	Introduction	111
5.2	General framework	112
5.3	Comparison between a TTI-based (r, Q) inventory control model to an (r, Q) inventory control model with fixed lifetime	116
5.3.1	The technology is affixed to the whole order Q	117
5.3.1.1	The TTI type 1 is affixed to the whole order Q	117
5.3.1.2	Validation by simulation experiment	119
5.3.1.3	The TTI type 2 is affixed to the whole order Q	123
5.3.1.4	Evaluation of the performance when the technology is affixed to the whole order Q	124
5.3.2	The technology is affixed to each product in the batch Q	125
5.3.2.1	Sensitivity analysis with regard to the purchase cost C .	126

CONTENTS

5.3.2.2	Sensitivity analysis with regard to the mean of the demand	126
5.3.2.3	Sensitivity analysis with regard to the variance of the lifetime	127
5.4	Comparison between TTI-based (T, S) inventory control to a (T, S) in- ventory control with fixed lifetime	129
5.4.1	Results and discussion	130
5.4.2	Impact of the issuing policy on inventory management	131
5.4.3	Sensitivity analysis regarding the cost of the TTI tag	132
5.4.3.1	Comparison between the performance of the technology in an (r, Q) and in a (T, S) policy	138
5.5	Conclusion	140
6	Conclusions and Perspectives	141
	Bibliography	145

List of Figures

1.1	Example of effective lifetime distribution	9
1.2	Sharing the product's lifetime between supply chain actors	11
1.3	Example of TTI type 1-Vitsab	12
1.4	Example of TTI type 1-Cryolog	12
1.5	Example of TTI type 1-Ciba and FreshPoint	13
1.6	Example of TTI type 1-FreshPoint	13
1.7	Example of TTI type 2	15
1.8	Inventory depletion under an (r, Q) ordering policy	21
1.9	Inventory depletion under an (T, S) ordering policy	22
1.10	The supply chain we base our research work on	25
3.1	An (r, Q) inventory policy for perishable products	52
3.2	Cases which they are not considered by our model	53
3.3	Behavior of the inventory where perishability does not occur during L	58
3.4	Behavior of the inventory where perishability occurs during L	59
3.5	Convexity of the total expected cost for a fixed value of r (fixed parameters : Poisson demand with mean $D = 10$, $C = 5$, $P = 20$, $K = 50$, $W = 5$, $H = 1$, $L = 1$, $m = 3$)	61
3.6	Convexity of the total expected cost for a fixed value of Q (fixed parameters : Poisson demand with mean $D = 10$, $C = 5$, $P = 20$, $K = 100$, $W = 5$, $H = 1$, $L = 1$, $m = 3$)	62
3.7	Convexity of the total expected cost for a fixed value of r (fixed parameters : Normal demand with mean $D = 10$, $Variance = 10$, $C = 5$, $P = 20$, $K = 50$, $W = 5$, $H = 1$, $L = 1$, $m = 3$)	62

LIST OF FIGURES

3.8	Convexity of the total expected cost for a fixed value of Q (fixed parameters : Normal demand with mean $D = 10$, $Variance = 10$, $C = 5$, $P = 20$, $K = 100$, $W = 5$, $H = 1$, $L = 1$, $m = 3$)	63
3.9	An (r, Q) inventory policy for perishable items	72
3.10	Expected inventory level	74
3.11	Variation of the total expected cost (fixed parameters : Normal demand $N(10, 3)$, $C = 5$, $P = 20$, $K = 150$, $W = 5$, $H = 1$, $L = 1$, $m = 3$)	76
3.12	Percentage difference $TC\%$ with respect to K	81
3.13	Percentage difference $TC\%$ with respect to P	82
4.1	Periodic review inventory policy for perishable products	89
4.2	Transition probabilities	92
4.3	Periodic review inventory policy for perishable products	95
4.4	Convexity of the total operating cost for with full lost sales (fixed parameters : $\lambda=10$, $C = 5$, $b = 40$, $K = 100$, $W = 5$, $H = 1$, $L = 1$)	98
4.5	Convexity of the total operating cost for with full backorders (fixed parameters : $\lambda=10$, $C = 5$, $b = 20$, $K = 100$, $W = 5$, $H = 1$, $L = 1$)	99
4.6	Total cost for a given S (fixed parameters : $\lambda=10$, $C = 5$, $b = 40$, $K = 50$, $W = 5$, $H = 1$, $L = 1$, $S = 25$)	101
5.1	Types of models we consider in this chapter	113
5.2	General framework of our study	114
5.3	Effective lifetime (ELT) of each item at order arrival	114
5.4	Different types of comparison	125
5.5	Effective lifetime distribution, mean =6, variance= 0.50	134
5.6	Effective lifetime distribution, mean =6, variance= 0.95	134
5.7	Effective lifetime distribution, mean =6, variance= 3	134

List of Tables

2.1	Costs assumptions of perishable inventory management based on dynamic programming approach	31
2.2	A summary of perishable inventory management based on dynamic programming approach	32
2.3	A summary of Queuing-based perishable inventory models	34
2.4	Costs assumptions of perishable inventory systems based on regenerative processes tool	36
2.5	A summary of perishable inventory systems based on regenerative processes tool	37
2.6	A summary of perishable inventory based on mathematical modeling . .	40
2.7	Costs assumptions of perishable inventory based on mathematical modeling	40
2.8	Costs assumptions of perishable inventory control with stochastic lifetime	41
2.9	A summary of perishable inventory control with stochastic lifetime	42
3.1	Comparison of the proposed model with the simulation one for $L = 1$. .	67
3.2	Comparison of the proposed model with the simulation one for $L = 2$. .	68
3.3	Comparison of the proposed model with the simulation one for a normal demand distribution	69
3.4	Comparison with Chiu's model and simulation for $L = 1$	70
3.5	Comparison with Chiu's model and simulation for $L = 2$	71
3.6	Comparison of the proposed model with the simulation one	79
3.7	Comparison of the proposed model with classical (r, Q) for normal demand distribution with $cv = 0.2$	83

LIST OF TABLES

3.8	Comparison of the proposed model with classical (r, Q) for normal demand distribution with $cv = 0.1$	84
3.9	Variation of the expected total cost with m	85
4.1	Comparison of the proposed model with the classical (T, S) policy: case of full lost sales	107
4.2	Comparison of the proposed model with the classical (T, S) policy: case of full backorders	108
4.3	Comparison of the proposed model with simulation: case of full lost sales	109
4.4	Comparison of the proposed model with simulation: case of full backorders	110
5.1	Performance of the (r, Q) inventory with TTI type 1 for $L=1$	121
5.2	Performance of the (r, Q) inventory with TTI type 1 for $L=2$	122
5.3	Performance of TTI technologies when it is affixed to the order Q	124
5.4	Performance of TTI technologies for $C = 5$	126
5.5	Performance of TTI technologies for $C = 10$	127
5.6	Performance of TTI technologies for different mean of demand	127
5.7	Performance of TTI technologies with the variability of the lifetime distribution	128
5.8	Comparison between Scenarios 1, 2 and 3 for a shelf life with variance =0.5	135
5.9	Comparison between Scenarios 1, 2 and 3 for a shelf life with variance =0.95	136
5.10	Comparison between Scenarios 1, 2 and 3 for a shelf life with variance =3	137
5.11	Performance of TTI technologies with fixed TTI cost	138
5.12	Comparison between Model 2 and Model 3	139
5.13	Performance of TTI technologies with the variability of the lifetime distribution	139

Introduction

0.1 Problem statement and research questions

Perishable items represent one of most important sources of revenue in grocery industry. The 2005 National Supermarket Shrink Survey (NSSS, 2005) reported that perishables account for more than 54% of total store sales which constitute more than \$200billion and approximately 57% of total store shrink. Further, perishables become the main operating key to achieve and sustain competitive advantages. Accordingly, suppliers are subject to offer more brands with higher quality while keeping their availability. Even if such an objective seems to be realizable, perishables, characterized by finite lifetime, create a serious challenge. Roberti (2005) reported that roughly 10% of all perishable goods (fresh products and other food products) goes to waste before consumers purchase it. The \$1.7 billion U.S. apple industry is estimated to lose \$300 million annually due to spoilage (Webb, 2006). Thus, suppliers are faced to an important dilemma: offering to customers what they want so that they can achieve a higher customer service level or reducing losses by decreasing quantities on shelves which leads to frequent stock outs. Clearly, the ability to satisfy customer while reducing losses needs the application of good inventory management principles. Such figures are also available from other industries, for instance, in 2006, almost 4.6% (1276000 out of 27833000 processed/Produced units) of platelet units that were collected in the United States were outdated without being transfused (AABB, 2007). Thus, losing a platelet unit due to expiration is a huge financial burden for blood centers. Another challenge for blood centers is the limited pool of platelet donors.

In addition to this problem, perishable products' lifetime is sensitive to storage conditions such as temperature and humidity. Typical examples of such products are chilled and

frozen foods, pharmaceutical and biological products such as blood. Perishables must therefore be maintained in an appropriate level of temperature and for a limited period of time to preserve their freshness. Recently, a technology called Time Temperature Integrator technology (TTIs) has been developed. This technology is able to evaluate the effective shelf life of perishables by recording time temperature history. Although the potential wide benefits that such a technology can offer, most of suppliers are still not totally convinced of its impact on reducing spoilage (Ketzenberg & Bloemhof, 2008). Among reasons of that are the limited knowledge and diffusion of TTIs and the lack of analysis that aim at quantifying the benefits of using such a technology.

In this context, this thesis has contributions in two areas : perishable inventory management and the benefit of using TTIs on inventory management. More specifically, this thesis deals with inventory control of perishable items and addresses the value that TTI scan bring to perishable inventory management. Our goal to answer the following relevant questions:

- 1) What are the main existing works developed in perishable inventory management?
- 2) How can a tradeoff be found between customer satisfaction and spoilage reduction?
- 3) What is the impact of perishability on inventory management?
- 4) At which cost level, the deployment of TTIs is cost effective?

0.2 Scope of the dissertation and structure of the content

In order to achieve our goals, this dissertation will firstly outline the impact of perishability on inventory management, concentrate on better understanding TTIs technologies and sketch the major benefits of using TTIs in supply chains. Secondly, we will provide a comprehensive literature review related to our research topic which enables us to distinguish two research streams. The first one is perishable inventory systems with fixed lifetime and the second one is perishable inventory with stochastic lifetime. For both categories, we will point out the complexity of modeling inventories of perishable items. Thirdly, based on our literature review, we will propose an inventory model for single perishable item with constant lifetime. Therefore, throughout numerical investigations,

0.2. Scope of the dissertation and structure of the content

we will respond to the first three questions mentioned above. After, we address the problem of perishable inventory with stochastic lifetime and propose an exact solution of an inventory model for a single item having a random lifetime under specific conditions. The exact ordering policy we propose will enable us to investigate the impact of randomness on inventory management. Finally, we will consider the application of TTI technologies in inventory systems. We will show that TTIs can effectively improve inventory management however, this improvement depends on several system parameters such as the cost of TTI devices, product purchasing cost, demand distribution, effective shelf live distribution, etc. More specifically, the content of each chapter of this thesis is as follows:

Chapter 1: This chapter aims first of all at emphasizing the challenges introduced by perishability on inventory management in one hand. On the other hand, it provides a basic understanding of TTIs technologies and presents the qualitative impacts of such technologies on supply chains. We note here that we consider two types of TTIs: the first one provides a binary information about a product's freshness and the second one gives an information on the remaining shelf life of a product. In the last section, we introduce the basic concepts related to inventory management which the following chapters are based on.

Chapter 2: This chapter reviews the literature of inventory management subject to perishability and emphasizes challenges introduced by the aging of such items. We distinguish two classes of modeling: perishable inventory with fixed and constant lifetime and perishable inventory with stochastic lifetime. For each class, we mainly explain the complexity to keep track products having different ages on hand and give the major findings. Finally, we explain how we contribute in literature and provide the main motivations behind different models we propose.

Chapter 3: Based on our literature review of modeling perishable inventory presented in the Chapter 2, we firstly propose a perishable inventory control model under a continuous review policy for a single item that is assumed to have a constant lifetime. For this model, we derive approximate expressions of the key operating characteristics of the inventory system (such as the expected quantity of perished products, the expected shortage and the expected inventory level) and obtain a closed form long run average cost under constant lead time. We then assess the effectiveness of approximations we

made by a simulation model implemented in the Arena software. Secondly, we extend this model to the case the undershoots of the reorder point is considered. As for the first model, the operating costs are formulated and its effectiveness is assessed by simulation study. For both models, numerical analysis are conducted to illustrate their economic advantages.

Chapter 4: This chapter considers a periodic review inventory system for perishable items with random lifetime. We investigate two cases: the first one is the case where excess demand is completely lost and the second one deals with full backorder. Demands arrive according to a Poisson process. The lifetime of each item is exponentially distributed. The procurement lead time is constant. We model the behavior of this inventory system as a Markov process which we can characterize the stationary regime. This model allows us to get some insights on the impact of the parameters on the overall system performance in terms of costs or profit.

Chapter 5: This chapter investigates the benefits of using TTIs on inventory management. We formulate and derive the operating costs of an inventory system with TTIs technologies. We next explore the benefits of such technology and determine whether or not the deployment of TTIs is cost effective. To do so, we compare two inventory models based on information we have on product's lifetime. The first one deals with items with fixed lifetime (without technology), the second use a TTI type 1 technology which enables to monitor products' freshness and alerts when products are no longer fresh. The third model considers the deployment of TTI type 2 technology which gives information on products' remaining shelf lives.

Chapter 6: This chapter is dedicated to the general conclusions of this work and some propositions for future research such as multi-echelon, multi-items perishable inventory systems and dynamic pricing decisions.

Chapter 1

Challenges on Modeling Perishability in Inventory Management Systems

1.1 Introduction

Successful inventory control is recognized today's as the key to maintain competitive market conditions. Although inventory is considered as a waste, the traditional motivation behind holding products is to ensure compliance with customer demand and to guard against uncertainties arising in demand fluctuations and delivery lead times. Benefits obtained from quantity discounts, economies of scale and shipment consolidation are among other reasons to keep products in stock. Certainly, an effective inventory management requires maintaining economical quantity while keeping the ability to carry out customer demand. However, the trade off between customer satisfaction and maintaining economical quantity is rather a proven challenge regarding demand fluctuation and costs induced by shortage.

In addition to this trade off, one of the implicit assumptions made in research related to inventory is that products can be stored indefinitely to meet future demand. Such an assumption is not appropriate for a large wide of commodities which are subject to obsolescence, deterioration and perishability. Drugs, foodstuff, fruits, vegetables, photographic films, radioactive substances, gasoline, etc are typical examples of such

Challenges on Modeling Perishability in Inventory Management Systems

commodities. Within this range of products [Goyal & Giri \(2001\)](#) distinguish:

Obsolete items: which refer to items that lose their value through time because of the rapid changes in technology or the introduction of a new product by a competitor. This situation corresponds to the case where all items remaining in inventory become simultaneously unusable and not reordered at the end of the planning horizon. Style goods for example, must be sharply reduced in price or otherwise disposed off after the season is over. Therefore, obsolete inventory is managed as non perishable one but for a finite planning horizon. Obvious examples of items subject to obsolescence are products in industries with high rates of technical innovation, such as computers. Also, products in markets with frequent shifts in consumer tastes fit this pattern, including books, records, and perfumes.

Deteriorating items: which refer to items that lose their utility or their marginal value throughout time but can be reordered at the end of their planning horizon. Deteriorating items are not tied up to shelf lives; their impact on inventory management is usually modeled as a proportional decrease in terms of its utility or physical quantity. Among the range of such products, one may find gasoline and radioactive products, etc.

Perishable items: in contrast to deteriorating item, the perishable one may not lose its value or utility over time. Under such category, one may find foodstuff and pharmaceuticals. The consideration of perishability on inventory management is usually modeled by associating shelf lives (deterministic or stochastic) to items.

Hereafter, we will consider perishable items. An excellent literature review of inventory models with deteriorating items can be found in the papers of [Raafat \(1991\)](#) and [Goyal & Giri \(2001\)](#).

The limited lifetime of perishable products contribute greatly to the complexity of their management. The major challenge, however, stems from the dependency of the remaining lifetime and environmental factors such as temperature. Due to these factors, shipments leaving the producers with an initial lifetime may arrive at the retailer with different age categories. These factors are often difficult to assess by merely visual or tactile inspections. Perceptible changes in color and quality mostly become apparent only at the end of product's life. Therefore human-sense-based examinations are hardly able to aid decision making with respect to the use of products. While the human senses have only a limited capability to assess the intrinsic product properties, modern sen-

1.2. Challenges of perishability on inventory management

sensor technologies such as Time Temperature Integrators (TTIs) can help to provide the required information regarding product's freshness. Such devices enable to track environmental parameters such as temperature of individual product. This allows problems in the supply chain to be identified more rapidly and to predict more precisely the actual product's lifetime. However, the value that such a technology can bring to inventory management of perishable products is not totally clear.

This chapter is organized as follows: we first outline the major challenges induced by perishability on inventory management. Then, we focus on understanding perishable inventory management without TTIs (Section 1.3) and the functionality of TTIs, their benefits as well as their limitations in cold chain applications (Section 1.4). In Sections (1.5) and (1.6), we give a brief description of notions that are usually used in inventory management and define the basic ordering policies in the context of non perishable items which are often used to control the perishable one. Finally, we introduce the context of our research (Section 1.7).

1.2 Challenges of perishability on inventory management

Modeling perishable inventory is mainly stimulated by the economic impact of perishability. In the grocery and pharmaceutical industry, expiration is responsible of 19% and 31% of total unsaleable respectively (Joint Industry Unsaleables Benchmark Survey, 2003). Furthermore, Lystad *et al.* (2006) reported that about \$30 billion are lost due to perishability in US grocery industry. In the European grocery sector, products that are not purchased before their sell-by date are estimated to cause yearly costs of billions of dollars (ECR Europe, 2001). Another investigation in Nordic retail sector (Karkkainen, 2003), reported that the spoilage costs of perishables are up to 10 percent of total sales. Although this powerful motivation, incorporating the feature of perishability in inventory management is rather complex issue. Even if the tradeoff between customer satisfaction and cost minimization could be handled through appropriate control rules, the limited lifetime of products makes such rules unsuccessful. The main reason of that is the difficulty to track the different ages of items in stock. The matching policy (which

correspond to the way that the inventory is depleted) is another reason for which inventory management policies that are suitable for non perishables becomes less appropriate for perishables. When items have infinite lifetime, depleting inventory according to any matching policy does not affect the overall performance of the ordering policy. However, for perishables, it is better to deplete inventory according to the lowest shelf life value first out since this matching policy can help to cut down the amount of expired items. Moreover, the demand process may change over time, probably due to customer who, faced to a perishable product, could adopt different behavior. He may substitute item with reduced lifetime by another if he estimates that the remaining shelf life of product in question cannot guarantee its safety. Alternatively, the customer may choose to leave the store if he does not find what he needs. Such behaviors are analyzed in investigations such as [van Woensel *et al.* \(2007\)](#) who conducted a survey to study consumer behavior with regards to out of stock situation of bread category in supermarkets. They find that around 84% buy another type of bread in the same store while 10% of consumers decide to buy their bread in another store and 6% decide to buy later. [Tsiros & Heilman \(2005\)](#) investigate the effect of expiration dates on the purchasing behavior of grocery store customers. They find that consumers check the expiration dates more frequently if their perceived risk (of spoilage or health issues) is greater. They also determine that consumers' willingness to purchase decreases as the expiration date gets close for all the products in this study.

1.3 Perishable inventory management without TTIs

Perishable products are sensitive to temperature conditions in which they are handled and require special storage conditions in order to preserve their freshness. The variation of temperature arises when items move throughout supply chain actors (manufacturing, transportation, distribution stages). The freshness of perishable products is tracked by their lifetime. Once an item reaches its lifetime, it is considered to be lost (no longer safe for use). In practice, the lifetime is determined by keeping the product in a pre-specified level of temperature and observing throughout a specified duration the growth of microbial development under this condition. The time before the microbial development reaches a certain rate, by which the product is considered unsafe for use, determines its

1.3. Perishable inventory management without TTIs

expected lifetime. If the product is maintained in appropriate temperature conditions, this lifetime is expected to be experienced by the product in the supply chain. However, it may happen that the product is maintained in higher temperature levels than what is recommended. Such situations may arise when products move from the blast freezer to the cold store, from the factory cold store to the truck, from the truck to the supermarket, from the supermarket cold store to the shelves or from the shelves to the consumer's home. Frequent or prolonged door opening in vehicles during distribution or freezer failures are among other causes of temperature variations. In order to take into account such situations where temperature conditions are not respected, manufacturers are taking a large margin of precaution when determining products' lifetimes. This product's lifetime is then used as a basis for the determination of the use by date information that will be printed on product's packaging.

To illustrate how the use by date is determined in practice, Figure (1.1) shows an example of the distribution of a fresh product's effective lifetime. The expiry date printed on

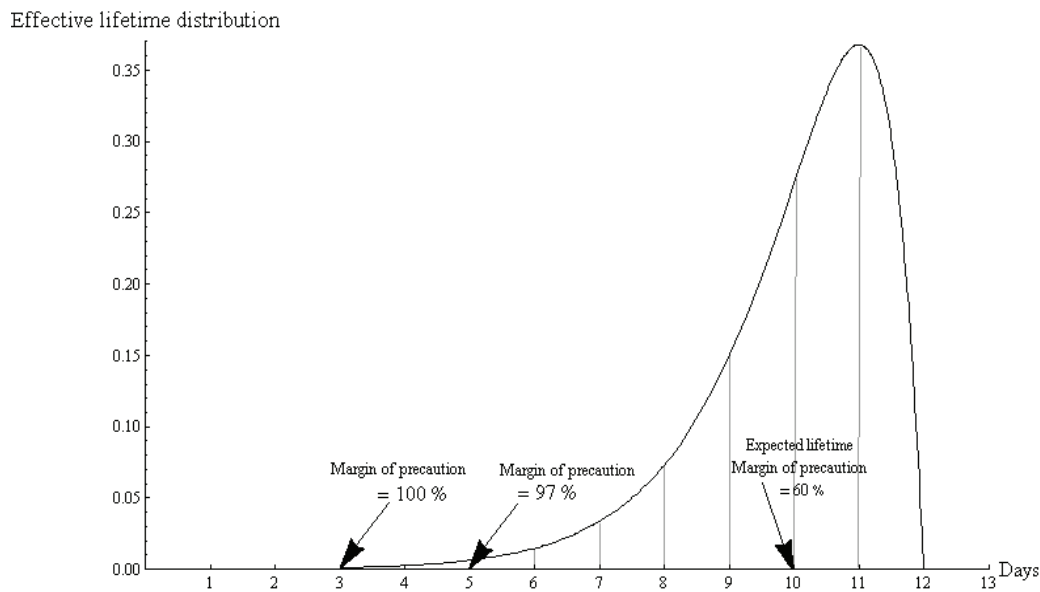

Figure 1.1: Example of effective lifetime distribution

a product's packaging (i.e. the use by date) is based on the margin of precaution that a manufacturer want to take. As seen from Figure (1.1), the expected product's lifetime is equal to 10 days. Manufacturers could fix the use by date to $d + 10$ days (d being the date of production) in order to sell products within this lifetime (i.e. 10 days). However,

Challenges on Modeling Perishability in Inventory Management Systems

all products would not be usable up to 10 days depending on conditions in which they are maintained. By affixing a sell by date of 10 days, manufacturers take therefore a risk of having (and probably selling) products that will perish before 10 days, the probability of this event being 0.4 in the example on Figure (1.1). In order to avoid this risk, manufacturers must increase the safety margin taken in the determination of the sell by date. If the margin of precaution is set to 97% for instance, then the product's lifetime can be set to 5 days. Again, by choosing a lifetime equal to 5 days, there exists a risk of selling an unsafe product. Therefore, in order to avoid selling unsafe products, most of manufacturers take a safety margin equal to 100%. As a consequence, the use by date is fixed to the minimum realization of the effective lifetime. In our example, 100% of safety margin (i.e, the use by date is equal to 3 days) guarantees that the product is safe for use.

Once the “use by date” is determined, it is dispatched between supply chain actors to guide their stock rotation. In Figure (1.2), we represent an example of a supply chain with 3 actors (manufacture, distribution center and store) including the final consumer. The product in this supply chain is perishable with a use by date of m' units of time. Each actor can maintain the product in stock up to a certain threshold of m_0 , m_1 , m_2 and m_3 . Once the corresponding threshold is reached for the manufacture, the distribution center, the store or the final consumer, the product in question should be disposed off. m_0 , m_1 , m_2 and m_3 are already negotiated throughout contracting between supply chain actors.

The intention of the use by date is to ensure consumer safety, provide a guide to retailers when to remove stock from sale, and provide a guide to consumers about the freshness and quality of the product. This requirement is applied to both locally made and imported products. The “use by date” is an indication by the manufacturer of the length of time that a product can be kept under specified storage condition before it starts to noticeably deteriorate, i.e., perishable but still usable. It also used to indicate when products become unfit for consumption and may present a safety risk, and therefore should be discarded. Enhancing such quality and safety of products, requires controlled temperatures and humidity levels, proper stock rotation practices (first in-first out policy) and proper home storage conditions. However, managing perishable inventory with fixed lifetime does not afford the opportunity to sell products that are still usable after

1.4. Perishable inventory management with TTIs

their expiration dates. Therefore, it is worthwhile to have a technology that can provide information about the shelf life in the situation where temperature variations occur and contribute to improve inventory management.

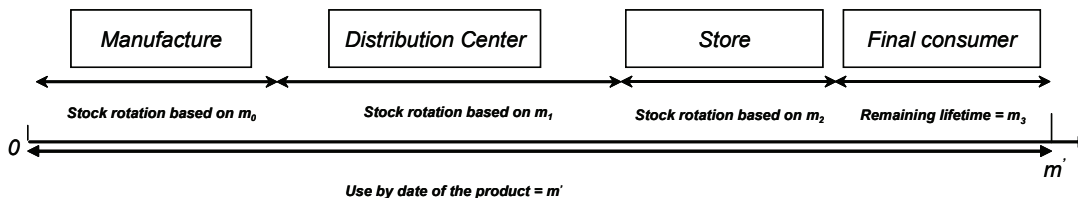

Figure 1.2: Sharing the product's lifetime between supply chain actors

1.4 Perishable inventory management with TTIs

Manufacturers, distributors and retailers have a common objective to ensure that the product they sell to consumers has been stored and transported correctly in order to guarantee freshness and safety. In addition, the food industry destroys billions of dollars each year as a result of temperature related perishable shrink, much of which can be avoided by more appropriate inventory management. Emerging intelligent technology such as Time Temperature Integrators (TTIs) can help manufacturers, distributors and retailers to easily recognize potentially spoiled products and better managing their inventories.

Broadly, the TTI technologies fall into two types: TTI type 1 and type 2.

1.4.1 TTI type 1 technology

TTI type 1 technology is a sensor that simulates in real time the biological quality of products and provides binary information regarding the freshness by changing color irreversibly once a pre-specified level of microbial rate is reached. This technology is used with the use by date label affixed to product's packaging. The use by date is necessary because of the legislative rules and provides information for the FIFO issuing. Products are removed from the stock either when the TTI changes color or when the use by date is reached whichever occurs first. *CheckPoint* and *eO* devices represented in Figures (1.3) and (1.4) commercialized by Vitsab and Cryolog companies respectively,

Challenges on Modeling Perishability in Inventory Management Systems

are among examples of TTI type 1. A large number of commercial TTI prototypes have been developed, and their principles of operation/function, as reported in [Taoukis & Labuza \(2003\)](#), is based on (i) molecular diffusion, e.g., the 3M MonitorMark and Freshness Check indicators [by 3M Co., St. Paul, MN]; (ii) polymerization reactions, e.g., the Lifelines Fresh-Check and Freshness Monitor indicators [by Lifelines Inc., Morris Plains, NJ]; (iii) enzymatic changes (decreases in pH via controlled enzymatic hydrolysis of a lipid substrate, leading to a color change in the indicator, e.g., the Vitsab TTI [by Vitsab A.B., Malmö, Sweden]); and (iv) microbial changes (the acidification of the TTI medium by selected lactic acid bacteria, which induces a color change in the indicator, e.g., the Cryolog TTIs [Cryolog S.A., Nantes, France]. This technology can be parameterized to

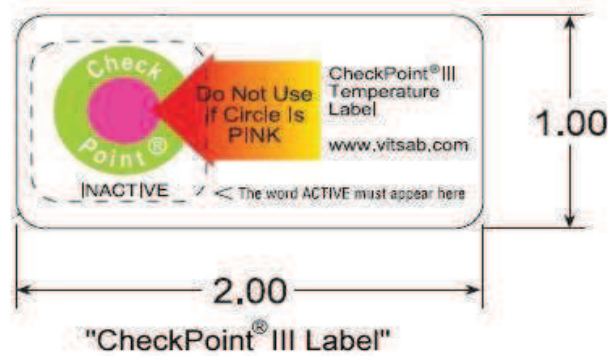

Figure 1.3: Example of TTI type 1-Vitsab



Figure 1.4: Example of TTI type 1-Cryolog

a specific microbial rate with high accuracy. The second version of TTI type 1 is the one that can be parameterized to several levels of microbial rates rather than single level as previously discussed.

Among other examples of TTI type 1, one may find *OnVuTM* tags provided by Ciba and

1.4. Perishable inventory management with TTIs

FreshPoint companies (see Figure (1.5)) which are able to provide information about the shelf life by changing color twice. We find also other types that could provide

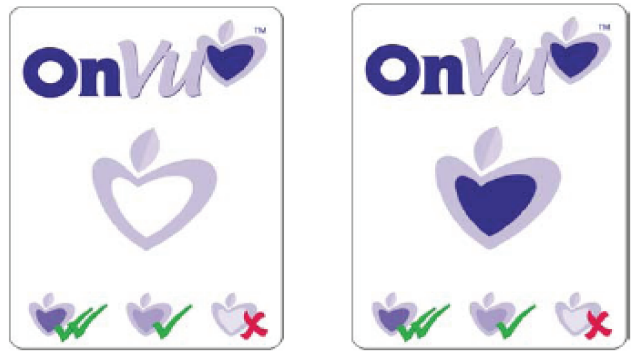

Figure 1.5: Example of TTI type 1-Ciba and FreshPoint



Figure 1.6: Example of TTI type 1-FreshPoint

time/temperature dependant rate, thereby revealing a visual signal that indicates the end of the product's shelf life (e.g. coolVu tag from FreshPoint company, cf. Figure 1.6). Thus, this type of TTI can serve as dynamic or active shelf-life labeling instead of, or complementary to the use by date labeling. This type of TTI would assure the consumer that the product was properly handled and would thus indicate remaining shelf-life based on the actual time and temperature conditions. A disadvantage of such tags instead of tags providing binary information, is that the transition color with time could confuse consumer (who would like to purchase the freshest items among the available products on the shelves) over whether the end point had been reached or not.

Generally, TTI type 1 technologies are flexible in size and design and can be printed directly on the package throughout adhesive labels which are amenable to existing product's packaging systems. They could be applied on item, carton or pallet level and are

suitable for all perishable products.

This technology could be applied at any location in the supply chain. As a consequence, TTI type 1 provides an opportunity to manage inventory for only one supply chain actor, multi actors (e.g. from manufacturers until the store shelves) or for the whole supply chain including the final consumers. This is, once a TTI type 1 is attached to products as they are packaged, it immediately begins to indicate the freshness level of products until the time of perishing. This allows consumers to ensure that the products they are purchasing are both fresh and safe.

According to [Smolander *et al.* \(1999\)](#) LifeLines' TTIs can be found on a variety of products in national U.S. supermarkets. eatZi's Market and Bakery (in US) uses the labels on its entire line of prepared meats, Trader Joe's (in US) uses them on its packaged fresh meats. The Fresh-Check labels are currently being used in European supermarkets, including Monoprix in France, Continente in Spain and Sainsbury in the United Kingdom. The U.S. Army also uses this technology for monitoring its Meals Ready-to-Eat rations by attaching TTI labels to each carton of product.

1.4.2 TTI type 2 technology

This sensor is coupled with an RFID (Radio Frequency Identification) tag. It provides information on items' remaining shelf lives. The TTI type 2 captures the timing temperature variations that affect the freshness of products by an RF (Radio Frequency) reader. Once the time-temperature history is known, then the shelf life is predicted based on microbiological models. The *VarioSens* label (see [Figure \(1.7\)](#)) of KSW microtec company is an example of TTI type 2. We note that TTI type 2 is used without the use by date label. This technology is actually less used in practice than TTI type 1.

1.4.3 Benefits of using TTI technologies

Common benefits of using TTI technologies:

- TTIs can extend the lifetime of products by reducing the safety margin that producers take in order to determine the products' use by date. Hence, products that are perished before their use by date with a low margin of precaution can be detected by TTI devices



Figure 1.7: Example of TTI type 2

and be discarded from the inventory. Since with TTI type 1, a used by date label is affixed to the product's packaging, this date is greater than the date label chosen when the technology is not used. This benefit will be analyzed in this the last chapter.

- TTIs can reduce the cost associated with the outdated quantity and the stock outs. For TTI type 1, when decreasing the margin level, the amount of outdated products decreases and, as a consequence, the frequency of stock outs decreases also. This leads to increased sales and profits. For example, according to [Scott & Butler \(2006\)](#), the French supermarket chain Monoprix uses Fresh-Check indicators (commercialized by indicators Lifelines Inc., Morris Plains, NJ) to nearly 200 of their products over the last 15 years. One of the major motivation of deploying TTI type 1, is to give Monoprix a competitive advantage since they are only applied to Monoprix products that are sold alongside competitive brands and products. When a TTI type 2 technology is used the cost associated with the outdated quantity and the stock outs can be reduced by first selling products having the least shelf life left. Using a least shelf life first out strategy based on cold chain RFID data, a distributor for example can direct shipments to specific stores, or stores group, in the most advantageous location. Indeed, products that only have one or two days left while the lead time for shipping to some stores is three days, then products with the shortest lifetime are shipped to the nearest store whereas those with the longest shelf life to the farthest one.
- TTIs can detect weaknesses regarding temperature abuse in the distribution network so that decisions can be made to correct temperature to maintain products properly.
- The extent of markdown and the stock rotation could be also improved based on the

color changes or the remaining shelf life rather than the fixed shelf life information.

Benefits of using TTI type 2:

- Ability to store real-time environmental data (including temperature) and transmit this information in near real-time, allowing corrective actions to be taken before products are irrevocably damaged. For example, Manor monitors supermarket freezers and refrigerators in order to decrease shrinkage due to food spoilage and to have a faster response to equipment failures. Unilever tracks ice cream temperatures from manufacture to retail shelves in order to ensure quality assurance throughout the cold chain (Estrada-Flores & Tanner, 2008).
- Potential benefits at a retail level, such as an increase in sales, shrinkage reduction, labor cost reduction and improved transparency in the supply chain. Ballantine tracks fresh fruit shipments from packing house to retail shelves in order to possess a competitive advantage. Wal-Mart stores, and more recently Carrefour and Metro have adopted (and asked suppliers to adopt) digital-tagging technologies, including RFID. Nevertheless, at this stage Wal-Mart has not required temperature tracking of perishable goods (Estrada-Flores & Tanner, 2008).
- Benefits in delivery and logistics level: DHL uses RFID to track shipments of temperature sensitive goods. Through the uptake of RFID, DHL aims to increase its competitive advantage and to improve its customers' confidence in its quality assurance systems (Estrada-Flores & Tanner, 2008).

1.4.4 Limitations of cold chain monitoring systems based on TTIs

- *Sensor placement:* Surface placement of the indicators (affixed to the product or to pallets) for ease of readability means that they react to changes in the surrounding temperature, which are normally more extreme than those occurring in the product. The relationship between the surface temperature and the product temperature varies from product to product, depending on the packaging material, physical properties of the product, head space, etc. Hence, adjustment of the indicator results to represent the exact condition of the product is difficult.
- *Cost of implementation:* The “cost” of TTIs technology has been cited frequently by

1.5. Basic notions of inventory management

companies as a reason for deploying it. For TTI type 1, the cost of a single tag can be significant relative to the value of some products when used on consumer packs. In addition, the, personnel salaries and personnel training required to use such technology could be a major factor to restrain its deployment. For TTI type 2, the cost of readers, processing and supporting information technology hardware and software, personnel salaries and personnel training could be a determining factor of deploying it. Besides these costs, tangible benefits of monitoring temperature during the distribution of perishables, advantages of RFID monitoring to supply chain players remains open questions.

- *Legislative rules:* Potential conflict between TTI indications and the mandatory expiry dates required in some countries may occur. Until TTIs are certified as a method used to indicate the lifetime, controlling authorities and legislation will continue to use expiry date markings. Hence, the use of TTIs cannot completely eliminate ordinary lifetime calculations.

- *Accuracy:* For most cold chain applications, a TTI accuracy of $\pm 0.5^\circ\text{C}$ or better is expected (Estrada-Flores & Tanner, 2008). However, mass production of TTIs requires a calibration method that is simple and inexpensive, yet reliable enough to ensure the desired accuracy in all active tags manufactured. Unlike conventional RFID tags, cold chain devices require precise adjustment before being placed into service. Tags that are not properly calibrated will deliver incorrect and potentially misleading remaining shelf lives.

1.5 Basic notions of inventory management

The fundamental question of inventory control is to answer the following questions: How much to order? When order should be placed? Answering such questions depends on the stock situation and different factors and assumptions under consideration. When talking about the stock situation, it is natural to think of the physical stock on hand. But an ordering decision can not be based only on the stock on hand. We must also include the outstanding orders that have not yet arrived. In addition, we have to know how the system reacts to excess demand (that is, demand that cannot be filled immediately from the stock). The two common assumptions are that excess demand is either back-ordered (held over to be satisfied at the future time) or lost (generally satisfied from outside the

system). Other possibilities include partial back-ordering (part of the demand is back-ordered and part of the demand is lost) or customer impatience (if the customer's order is not filled within fixed amount of time, he cancels). The vast majority of inventory models assume full back-ordering or full lost sales of excess demand (Nahmias, 2001). The decision of ordering or not is based on the inventory position defined as follows in the backorder case:

$$\text{Inventory position} = \text{stock on hand} + \text{outstanding orders} - \text{backorders}.$$

Naturally, in the lost sales case, the inventory position does not include backorders

Production/Inventory settings

Demand pattern: The demand pattern is the most significant factor that determines the complexity of modeling. The demand is characterized by two parameters: the time between successive demands, also called the inter-arrival time and the demand size. Generally, these two parameters are random variables following some probability distributions. For examples, the inter-arrival follows an exponential distribution and the demand size is one at a time or the inter-arrival is constant and the demand size follows a geometric or a general distribution. Sometimes, the demand may be deterministic in time. This means that both inter-arrival time and demand size are constant.

Replenishment lead time: The replenishment delivery time is defined as the time that elapses from the instant an order is placed until it arrives. It is not only the transit time from an external supplier or the production time in case of an internal order. It also includes, for example, order preparation time, transit time for the order, administrative time at the supplier, and time for inspection after receiving the order. It can be instantaneous, fixed or stochastic.

Type of review policy: In some inventory systems the current inventory position is known at all times and the decision of ordering or not is taken by checking the inventory position continuously. We refer to this case as continuous review. An alternative to continuous review is to consider the inventory position only at certain given points in time. In general, the intervals between these reviews are constant and we talk about periodic review.

Relevant costs: Inventory management is based on cost minimization or profit maximization as criterion of performance. Typically, inventory costs consist of four categories (Silver *et al.*, 1998):

1.5. Basic notions of inventory management

- *The inventory holding cost:* This cost represents the sum of all costs that are proportional to the amount of inventory physically on hand at any point in time. It includes for example the opportunity cost of the money invested, taxes and expenses of running a warehouse. In the most of settings, the holding cost is charged per unit of product per unit of time basis.

- *The ordering cost or the setup cost:* This cost is associated with a replenishment and has two components: a fixed and a variable component. The fixed cost is independent of the size of the order. It includes costs for order forms, authorization, receiving, and handling of invoices from the supplier. In production, the fixed cost includes administrative costs associated with the handling of orders and all other costs in connection with transportation and material handling, interrupted production, etc.

For the variable component it included generally the cost of loading and unloading truck, expense associated with inspection of orders (counting the number of received items, quality control, etc) and fuel cost.

- *The purchasing cost:* is the cost proportional to the order size and incurs on per unit basis. It can depend, via quantity discounts, on the size of the replenishment. The most popular types of quantity discounts are: all-units and incremental. In both case there are one or more breakpoints defining changes in the unit cost. for all-units, the discount is applied to ALL of the units in the order while for the incremental, the discount is applied only to the additional units beyond the breakpoint.

- *The Penalty / shortage/ stock out cost:* occurs when customer demand cannot be filled immediately. Customer may choose to wait while his order is backlogged, but he could also choose some other supplier. If the customer order is backlogged, there are often extra costs for administration, price discounts for late deliveries, material handling, and transportation. If the sale is lost, the contribution of the sale is also lost. In any case, it usually means a loss of good will that may affect the sales in the long run. Among the more common measures of the penalty cost, there are (see [Silver et al. \(1998\)](#)):

-) The penalty cost per stockout occasion: here, it is assumed that the only cost associated with a stockout is a fixed value independent of the magnitude or the duration of the stockout.

-) The penalty cost per unit short: here the penalty cost is charged per unit basis. That is, each time a demand occurs that cannot be satisfied immediately, a penalty cost is

incurred independent of how long it takes to eventually fill the demand.

-) The penalty cost per unit short per unit time: in this case, the penalty cost is charged not only on per unit of product basis, but also on per unit of time basis. This approach is appropriate when the time of the back order is important; for example if a back order results in stopping a production line because of the unavailability of a part.

Most of these costs are difficult to estimate. Therefore, it is very common to replace them by a suitable service constraint which would be somewhat simpler than finding the penalty cost in many practical situations.

1.6 Basic inventory management policies

It is not our attention to deeply cover the topic of inventory management in this section. Several books exist in this context ([Silver *et al.*, 1998](#); [Zipkin, 2000](#)). We provide in this section a brief description of ordering systems related to our research topic. We choose in this section to describe the most widely practiced control policies for single-stage, single-item inventory systems which we called the basic policies, i.e., the (r, Q) and (T, S) policies, since they are typically used in the case of perishable inventory management.

1.6.1 The (r, Q) policy

An inventory controlled by an (r, Q) review system, means that an order of size $Q > 0$, is placed whenever the inventory position drops to the reorder point r . $Q > 0$ only if the ordering cost is positive. The demand size can be one unit at a time or may arrives in batch. When the demand is one unit at a time, orders are triggered exactly when the reorder point is reached. For a batch of demand size, order are triggered when the inventory position is equal or below the reorder point r . In addition, orders may arrive instantaneously or after a replenishment lead time generally denoted by L which can be deterministic or stochastic. The inventory depletion under this control rule is represented in Figure (1.8).

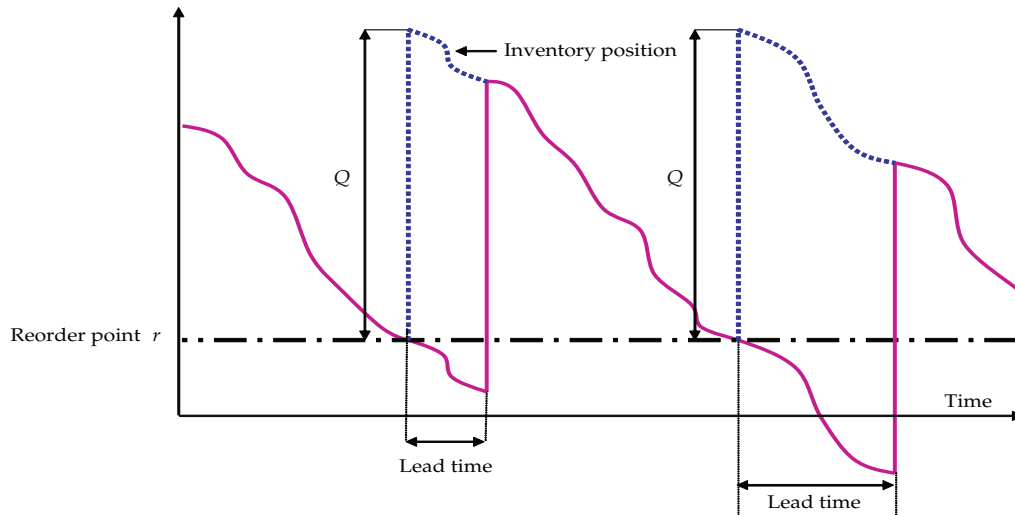

Figure 1.8: Inventory depletion under an (r, Q) ordering policy

1.6.2 The (T, S) policy

An inventory controlled by a (T, S) review system, means that the inventory level is observed at equal intervals of time, $T > 0$ and a replenishment order is placed every T units of time to bring the inventory position to the order-up-to-level S (Figure (1.9)). Again, $T > 0$ only if the ordering cost is positive.

We note that the (r, Q) is more reactive than the (T, S) policy. We note also that, in many practical situations such as multi-items inventory systems, the periodic review is more attractive than the continuous one since items are often ordered within a common base period of review. We note that there exist other inventory policies which can be described as a combination of (r, Q) and (T, S) policies. For example, the (T, r, Q) inventory policy is a combination between the (r, Q) and the (T, S) policies. The (s, S) policy corresponds to the case where replenishment is made to raise the inventory position to the order up to level S whenever the inventory position drops to the reorder point s or lower. The $(S - 1, S)$ is a modified (s, S) inventory policy where $s = S - 1$.

1.6.3 Optimization

The optimal parameters that minimize the total operating cost (equation 1.1) could be computed by one of the two fundamental approaches namely the sequential approach

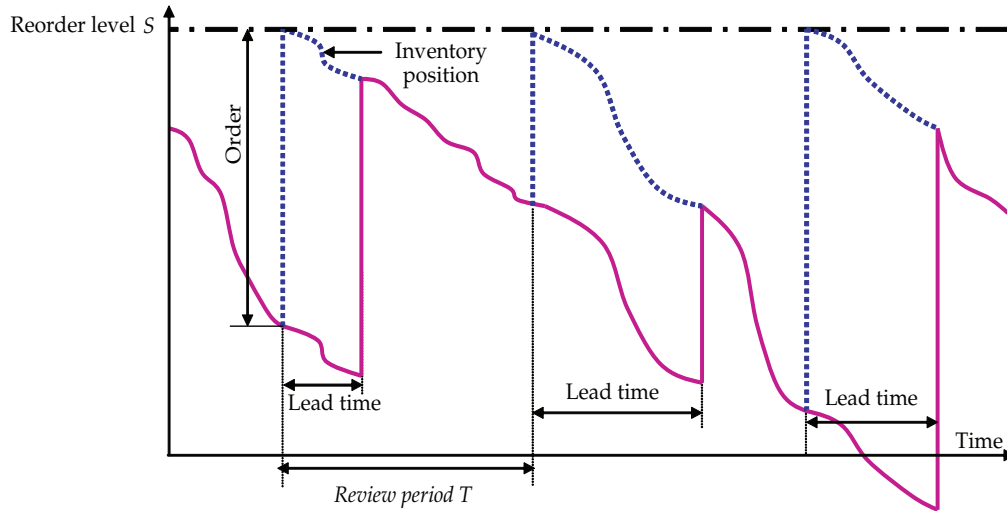

Figure 1.9: Inventory depletion under an (T,S) ordering policy

and the global one used in inventory management.

$$\begin{aligned}
 \text{Total operating cost} &= (\text{Ordering cost} + \text{Purchasing cost}) / \text{Expected cycle length} \\
 &+ (\text{Shortage cost}) / \text{Expected cycle length} \\
 &+ \text{Holding cost}.
 \end{aligned} \tag{1.1}$$

The sequential approach consists on computing the optimal order quantity in the case of deterministic demand and then finding the other parameter. For example, in the (r, Q) policy, the order Q is determined by the Wilson formula and the reorder level r is calculated by minimizing the cost function subject to a certain predetermined service level or cost. By using this procedure, the stochastic variations of the demand or the lead time (if any) are only taken into account when determining the reorder point (the parameter S for the (T, S) policy). That is, given Q (or T), a stochastic model is then used in a second step to determine the reorder point r (or the order up to level S). In the case where the global approach is used, the optimal parameters are computed simultaneously by an iterative algorithm that minimizes the total operating cost. According to [Axsater \(1996\)](#) and [Zheng \(1992\)](#) it is possible to show that sequential approach will give a cost increase compared to optimum that is always lower than 12 percent with respect to the cost parameters in the case of the (r, Q) policy. In our work, we choose to compute the optimal parameters jointly in a stochastic model (i.e, we use the global approach)

since the sequential approach does not take into account the stochastic variations of the demand and also the fact that the product in question is perishable when determining the optimal order quantity (or the review period).

1.7 Context

The motivation of this work is twofold:

- First, our interest is to investigate the impact of perishability on inventory management and to get insights in terms of cost improvement with regard to different costs parameters such as the ordering cost.
- Second, we study the effectiveness of using TTIs technology on perishable inventory management. Since this technology appears as an effective tool to reduce spoilage and its related costs by making sure that only products that are truly spoiled, or subject to imminent spoilage are removed, our second objective is therefore to study the effectiveness of different inventory situations where TTIs technology is deployed.

To do so, we place our work in the context of an uncapacitated Distribution Center (DC) that sells a perishable product which is subject to temperature perturbation (cf. Figure (1.10)). We assume that the product has constant utility throughout its lifetime and if it is not used by demand during its lifetime, is disposed off. The DC is managed using an appropriate inventory control policy (i.e, (r, Q) or (T, S) policies) and orders arrive from an external supplier to the DC after a constant replenishment lead time. The demand at the DC is assumed to be probabilistic, but based on a known distribution with known parameters.

Our aim is to compare between three different scenarios:

Scenario 1: The DC manager take into account the temperature variations and depletes the inventory based on the use by date printed on products' packaging. We assume that product's shelf life is calculated by taking a margin of precaution equal to 100% as described in Section (1.3). Once the used by date is reached, products are removed from the stock if they are not used by demand. We note that this scenario can be used when temperature variations are negligible.

Scenario 2: The DC manager monitors temperature variations throughout TTI type 1 technology. This technology is affixed to each product's packaging or to the whole order

Challenges on Modeling Perishability in Inventory Management Systems

in conjunction with the use by date label. In this scenario, the use by date affixed to products is greater than the one used in Scenario 1, since as explained before the use of a TTI technology enables to propose an extended product lifetime. We choose to fix a use by date with the minimum margin of precaution. That is, the use by date is equal to the date of production plus the maximum realization of the effective shelf life. The outdated items are removed when the TTI type 1 changes color, or when the use by date printed on products' packaging is reached, whichever occurs first. With TTI type 1, the DC-manager could detect any perished item at any time. The TTI labels are parameterized to change color once a predetermined rate of microbial development is reached.

Scenario 3: The DC manager monitors temperature variations throughout TTI type 2 technology affixed to each product's packaging and depletes the inventory based on the remaining shelf life provided by the RF reader. In this scenario, no use by date code is printed in product's packaging.

For these scenarios, we assume that excess demand occurring during the replenishment lead time is either backordered or fully lost. Holding costs are charged per unit of product per unit of time and each demand backordered/ lost incurs a shortage cost per unit of product. In addition to the holding and the shortage cost, there is a fixed ordering cost per order and a purchasing cost per unit of product.

When a product perishes at the DC, it is immediately removed from the inventory and a disposal/outdating cost is charged per unit of perished product. This cost corresponds to the lost in term of profit for an item that should be sold before perishing. However, once the item is perished, the contribution of selling that item is lost. This cost could represent the salvage value of perished items. For example, when talking about a perishable item with one period lifetime, if the order quantity for one period exceed the total demand in that period, then the inventory has to be disposed off at a lower price. The disposal /outdating cost could also include the salaries of personnel that inspect products on hand and withdraw those being perished.

To achieve our goal, we formulate the total inventory operating cost for each scenario

by the following equation:

$$\begin{aligned}
 \text{Total operating cost} &= (\text{Ordering cost} + \text{Purchasing cost}) / \text{Expected cycle length} \\
 &+ (\text{Shortage cost} + \text{Outdating cost}) / \text{Expected cycle length} \\
 &+ \text{Holding cost}.
 \end{aligned}
 \tag{1.2}$$

Where, for scenarios 2 and 3, the *purchasing cost* includes the cost of the TTI tag affixed to each product's packaging. At the first level of comparison, we only evaluate the impact of perishability on inventory management by comparing scenario 1 to a base case in which the perishability of products is ignored, i.e, products are assumed to have an infinite lifetime. Then, we evaluate scenarios 2 and 3 where the inventory is controlled throughout information stemming from TTI type 1 firstly and from TTI type 2 secondly to scenario 1 where product's lifetime determined initially within a high margin of precaution. For all comparisons we made, we choose compute the optimal total operating cost via the global approach. That is, the optimal parameters for a given ordering policy are calculated simultaneously.

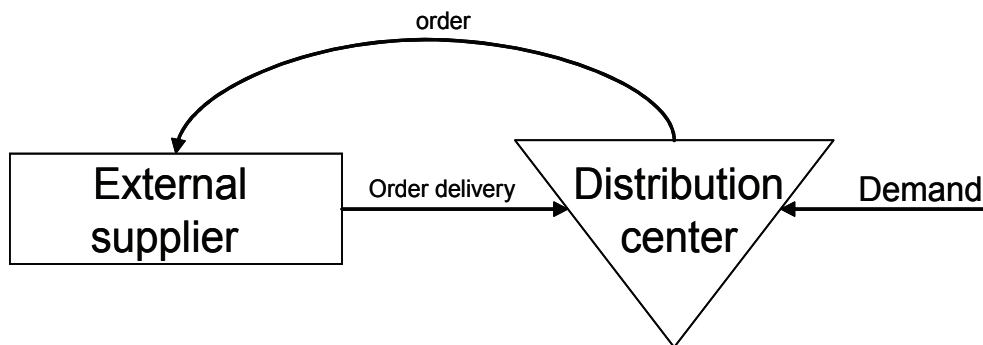

Figure 1.10: The supply chain we base our research work on

1.8 Conclusion

In this chapter, we have focused on major challenges on modeling perishability on inventory management. We have begun by sketching the complexity of modeling inventory subject to perishable products and outlined limitations on managing inventory through-

Challenges on Modeling Perishability in Inventory Management Systems

out a predetermined shelf life. Then, we have provided an overview of the role of Time Temperature technologies and its impact on supply chain management systems. We have shown that Time Temperature technologies have many qualitative benefits on perishable inventory systems such as reducing spoilage and increasing products' quality and safety. We have also defined the basic notions of inventory management including its operating costs and policies. Finally, we have drawn the general context of our work.

Chapter 2

Literature Review of Single Item Single Stage Perishable Inventory Management Systems

2.1 Introduction

In this chapter we review the literature of perishable inventory management. Our motivation is not to replicate the existing works (Nahmias, 1982; Goyal & Giri, 2001; Karaesmen *et al.*, 2009) but to highlight the complexity of modeling perishable inventory systems and to outline the major findings and lacks pertaining to the existing literature since 1970s. Perishable inventory systems are studied extensively in literature. Various classifications have been made depending on products' shelf life characteristics. Typically, two categories of models can be distinguished:

- 1) Inventory models with fixed lifetime where all on hand products with the same age will be disposed of together at the end of their usable lifetime.
- 2) Inventory models with stochastic lifetime where each product will fail at the end of his usable lifetime if it is not consumed by demand.

Accordingly, this chapter is organized as follows: in Section (2.2) we discuss the issuing policies related to perishable inventory management. In Section (2.3) we review the literature of perishable inventory with fixed lifetime (cf. Scenario 1 of section (1.7)). In Section (2.4) we consider the case of stochastic lifetime. Finally, in Section (2.5) we show

how we contribute to literature by providing motivations behind models we propose.

2.2 Issuing policies of perishable inventory management

Before presenting the literature review of perishable inventory management, a fundamental question related to the issuing policy of inventory should be considered. The question being what is the best issuing policy that should be used. There exist three important matching policies:

- The First-In-First-Out issuing policy (FIFO) means that the first product that enters to the stock will be used first to satisfy the demand.
- The Last-In-First-Out issuing policy (LIFO) means that the last product that enters to the stock will be used first to satisfy the demand.
- The Least-Shelf life-First-Out issuing policy (LSFO) means that product with the least shelf life will be used first to satisfy the demand.

Generally, the inventory is depleted according to FIFO issuing policy, however the LIFO issuing policy can be used in many real systems. For example, customers who arrive in a supermarket buy the items having the longest lifetime instead of the shortest one. In this case, the FIFO assumption is inadequate. The SLFO can be also used when TTI is deployed and it seems to outperform FIFO and LIFO (Wells & Singh, 1989). Most of existing papers assume that the inventory is depleted according to the FIFO issuing policy. The reason of that is the difficulty to build an analytical inventory model under both LIFO and LSFO policies. The LIFO and LSFO issuing policies could only be handled throughout dynamic programming approaches. However, with the dynamic programming approaches, it is more difficult to track the different ages' categories of the inventory level in the case of LIFO or LSFO than in the case of FIFO. The literature on LIFO perishable inventory systems is very scarce. The most relevant work in this context is the study of Cohen & Prastacos (1978). Their analysis is restricted to the case where the lifetime of items is equal to 2 units of time. The authors investigate the effect of the LIFO versus the FIFO depletion in perishable base stock system and show that the optimal inventory parameters are insensitive to the choice of the issuing policy.

2.3 Perishable inventory control with fixed lifetime

When items have a fixed lifetime, the problem of finding optimal ordering policy is well known as the “Fixed Life Perishability Problem” (FLPP) (Nandakumar & Morton, 1993). Several surveys address this problem and classify the existing works based on the basic notions of inventory management discussed in chapter (1) (Nahmias, 1982; Karaesmen *et al.*, 2009). The literature review of inventory control with fixed lifetime conducted by Nahmias (1982) is organized on the basis of demand pattern and relevant costs, while the review of Karaesmen *et al.* (2009) was established on the basis of the demand pattern (deterministic or probabilistic demand), the review schemes (continuous or periodic review) and on the relevant costs (purchasing cost, ordering cost, outdating cost, etc). Basically, four approaches were used to obtain analytical models: the dynamic programming approach, the queueing renewal theory and mathematical modeling.

2.3.1 Perishable inventory based on dynamic programming approach

Tables (2.1, 2.2) provide a summary of different assumptions used in perishable inventory management and based on dynamic programming approach. Most of these works deal with the base stock inventory policy which is well known as the critical number policy in the context of perishable inventory management (Nahmias, 1982). When products cannot be held in stock more than one period, the FLPP is reduced to the known Newsboy problem (Khouja, 1999). The first work that concerns inventory management of perishable items is the one of Van Zyl (1964). The author formulates a dynamic program approach for a product with a lifetime of two periods and derives the optimal policy when purchasing and shortage costs are charged to order quantity and unsatisfied demand. Van Zyl (1964) shows that if the old stock increases by one unit, the optimal order quantity will decrease, but by less than one unit. Nahmias & Pierskalla (1973) follow Van Zyl and take a different approach. They charge a cost associated with the outdating (perished items) and the shortage and show that the order quantity for a perishable item is always less than the one of non perishable item which is an unsurprising result. The work of Nahmias and Pierskalla was extended independently by Fries (1975)

and Nahmias (1975) to the case where products have three or more units of lifetime. Nahmias assumes that the cost of outdating is charged to the period in which the order arrives while Fries assumes that outdating cost is charged at the period in which the outdating occurs. These two models, apparently different, was shown by Nahmias (1977a) to be identical when the remaining number of periods in the horizon exceeds the product lifetime. Nahmias and Fries showed that the computation of an optimal policy requires the resolution of a dynamic program whose state variables has dimension $m - 1$ (where m denotes the product's lifetime). These works assume that the ordering cost is proportional to the number of units ordered. Nahmias (1978) relaxed this assumption by including the fixed ordering cost and emphasizes the difficulty to compute the optimal policy by multi dimensional dynamic programming approach. This difficulty arises since the dynamic programming approach needs to track the different ages' categories of items in stock. However, direct computation of an optimal policy turns out to be impractical because of the dimensionality of the dynamic programm generated by the different ages' categories.

The papers discussed above constitute a succession of works which look for an optimal ordering policy throughout a dynamic programming approach and enhance the complexity to track the inventory of each age. In order to avoid this difficulty, several researches have been focused on heuristic approximations. Nahmias (1976) considered only two ages: the total old quantity of on hand inventory (without distinguishing products age categories) and the new order. The heuristic gives an expected total cost within 1% of the optimal. The property of the optimal ordering, established by Fries and Nahmias, indicates that the ordering policy is more sensitive to change in newer inventory than the older one, encourages Nahmias (1977b) to derive another bound of the outdated quantity in order to reduce the state space of the multi dimensional dynamic program. The new approximation was tested in the case of three period lifetime and leads to a total cost halfway between the optimal cost and that obtained using the critical number approximation from (Nahmias, 1976). These heuristics assume that excess demand is backordered. Nandakumar & Morton (1993) consider the lost sales case and derive myopic upper and lower bounds on the order quantities for the base stock inventory policy with fixed lifetime and use these bounds to develop two heuristics. The heuristics provide a good approximation of the true optimal base stock policy by less than 1%

2.3. Perishable inventory control with fixed lifetime

average error. The models discussed above deal with the critical number policy which is known as the base stock model and use the dynamic programming approach. All of these works assume instantaneous replenishment lead time and no ordering cost except the paper of Nahmias (1976). When the replenishment lead time is positive, Williams & Patuwo (1999, 2004) provide a sensitivity analysis of the order quantity regarding to a positive lead time, ordering, holding, shortage and outdating costs. They show that the ordering and the shortage costs have greater impact on the incoming quantity than the holding and the outdating costs.

Article	Purchasing cost	Ordering cost	Shortage cost	outdating cost	Holding cost
Van Zyl (1964)	*		*		
Nahmias & Pierskalla (1973)	*			*	
Fries (1975)	*		*	*	*
Nahmias (1975)	*		*	*	*
Nahmias (1976)	*		*	*	*
Nahmias (1978)	*	*	*	*	*
Nahmias (1977b)	*		*	*	*
Nandakumar & Morton (1993)	*		*	*	*
Williams & Patuwo (1999, 2004)	*		*	*	*

Table 2.1: Costs assumptions of perishable inventory management based on dynamic programming approach

Article	Replenishment policy	Planning horizon	Type of review	Excess demand	Lead time distribution	Lifetime distribution	Demand distribution
Van Zyl (1964)	Optimal $(S - 1, S)$ policy	Finite/infinite	Periodic	Lost sales	0	Constant =2	Random
Nahmias & Pierskalla (1973)	Optimal $(S - 1, S)$ policy	Finite/infinite	Periodic	Lost sales/backlogg	0	Constant =2	Random
Fries (1975)	Optimal $(S - 1, S)$ policy	Finite/infinite	Periodic	Lost sales	0	Constant	Random
Nahmias (1975)	Optimal $(S - 1, S)$ policy	Finite	Periodic	Backlog	0	Constant	Random
Nahmias (1976)	Heuristic $(S - 1, S)$ policy	Finite	Periodic	Backlog	0	Constant	Random
Nahmias (1978)	optimal (s, S) policy	Finite	Periodic	Backlog	0	Constant	Random
Nahmias (1977b)	Heuristic $(S - 1, S)$ policy	Finite	Periodic	Backlog	0	Constant	Random
Nandakumar & Morton (1993)	Heuristic $(S - 1, S)$ policy	Infinite	Periodic	Lost sales	0	Constant	Random
Williams & Patuwo (1999, 2004)	Heuristic $(S - 1, S)$ policy	Finite	Periodic	Lost sales	Constant	Constant=2	Random

Table 2.2: A summary of perishable inventory management based on dynamic programming approach

2.3.2 Queuing-based perishable inventory models

Works dealing with queuing-based perishable inventory management are summarized in Table (2.3). These works do not consider any explicit inventory policy. They focus on deriving the steady-state distribution of the age of the oldest item in stock which is also called the virtual outdating process.

Perishable inventory using queue models are basically motivated by their applications in the case of blood bank management. The shelf life of a donated blood portion is approximately 21 days, after which the donated blood portions should be disposed off. Donations of blood portions and demands can be then modeled as an independent Poisson processes. The use of queuing models was initiated by Graves (1982) who analyzed a perishable inventory systems where customer and orders arrive according to a Poisson processes. When all demand requests are for the same quantity and without considering any explicit ordering policy, Graves shows that the inventory process is equivalent to the virtual waiting time process for an M/D/1 queue with a finite waiting room. The similarity is easy to understand because the resupply time process can be seen as the server, the inventory as the queue, and the demand request as the customer arriving at the queue. If customers arrive according to a Poisson process and request an exponential batch size, the inventory process is equivalent to the virtual waiting time process for an M/M/1 queue with reneging customers. Later, Kaspi & Perry (1983, 1984) introduced the concept of virtual death process based on analysis of M/G/1 queue with impatient customer. The virtual death process is just a reformulation of the age of the oldest item in stock used by Graves (1982). This concept was used by Perry & Stadje (1999) who derive explicit expressions of the stationary distribution of two models where arrival of items and demands are state-dependent and customers are willing to wait. This work was generalized by Nahmias *et al.* (2004) by deriving the steady-state distribution of the virtual outdating process in the context where the demand rate depend on the current value of the basic virtual outdating process.

Article	Replenishment policy	Planning horizon	Type of review	Excess demand	Lead time distribution	Lifetime distribution	Demand distribution
Graves (1982)	No explicit policy	Infinite	Continuous	Lost sales/backlogg	Exponential	Constant	compound Poisson process
Kaspi & Perry (1983, 1984)	No explicit policy	Infinite	Continuous	Lost sales/backlogg	Renewal	Constant	Poisson process
Perry & Stadje (1999)	No explicit policy	Infinite	Continuous	Lost sales/backlogg	Constant /Exponential	Constant /Exponential	Poisson process
Nahmias <i>et al.</i> (2004)	No explicit policy	Infinite	Continuous	Lost sales	Renewal	Constant	Poisson process

Table 2.3: A summary of Queuing-based perishable inventory models

2.3.3 Perishable inventory systems based on regenerative processes tool

Tables (2.4, 2.5) represent a summary of papers dealing with perishable inventory systems based on regenerative processes. These papers consider the same costs, i.e., the purchasing, ordering, outdating, shortage and holding costs. According to this table, the first study using regenerative process approach was introduced by Weiss (1980) and followed by several papers dealing with both fixed and random lifetime. The author deals with the (s, S) ordering policy with zero replenishment lead time. He demonstrated that under continuous review scheme and lost sales case, there exists an optimal policy of order up to a positive level S type when the inventory level reaches zero. For the backorder case, the optimal policy exists and it is of type order to a positive level S when the inventory level is below zero. In addition, since the replenishment lead time is instantaneous, the reorder point s is negative. Theoretically, it is always better to have $s < 0$ than $s > 0$, since orders arrive immediately. Based on Weiss's results, Liu & Lian (1999) have considered a continuous review (s, S) ordering system with general inter arrivals time and unit demand size. They construct a Semi Markov Renewal Process with two dimensions: the regeneration set space $(-1$ and $S)$ constitute the first dimension and the epochs at which the inventory makes a transition between the regenerative points is the second dimension. The authors show that the total operating cost (ordering cost plus holding cost plus disposal cost plus backorder cost) is unimodal in both the reorder point and the order-up to level. The same properties also hold for the case where demand is discrete in time. This result was shown by Lian & Liu (1999) who use the queuing theory to derive the optimal (s, S) ordering policy under zero lead time and discrete time monitoring. The epochs at which demand occurs or item perishes constitute the moments of the review. With geometric demand distribution, the authors construct matrix-analytical method and demonstrate numerically that the discrete time monitoring is a good approximation to the continuous one. Later, Lian & Liu (2001) extend the model of Liu & Lian (1999) to the case where demand arrives in batch and proposed a heuristic to manage the case of positive lead time. They show that the cost function is also unimodal in S . The heuristic is tested against simulation and leads to an error within one percent. Recently, Berk & Gurler (2008) observed that the distribution

Literature Review of Single Item Single Stage Perishable Inventory Management Systems

of the remaining shelf life at epochs when the inventory level hits Q have Markov proprieties. They show that the remaining shelf life constitutes an embedded Markov process under the assumption of Poisson demand distribution. By analyzing this process, they derived a closed form for the total ordering cost under the (r, Q) inventory type with lost sales and positive lead time.

Article	Purchasing cost	Ordering cost	Shortage cost	Outdating cost	Holding cost
Weiss (1980)	*	*	*	*	*
Liu & Lian (1999)	*	*	*	*	*
Lian & Liu (1999)	*	*	*	*	*
Lian & Liu (2001)		*	*	*	*
Berk & Gurler (2008)	*	*	*	*	*

Table 2.4: Costs assumptions of perishable inventory systems based on regenerative processes tool

Article	Replenishment policy	Planning horizon	Type of review	Excess demand	Lead time distribution	Lifetime distribution	Delmand distribution
Weiss (1980)	Optimal (s, S) policy	Infinite	Continuous	Lost sales/backlogg	0	Constant	Poisson
Liu & Lian (1999)	Optimal (s, S) policy	Infinite	Continuous	Backlog	0	Constant	Renewal
Lian & Liu (1999)	Optimal (s, S) policy	Infinite	Continuous	Backlog	0	Constant	Batch Geometric
Lian & Liu (2001)	Heuristic (s, S) policy	Infinite	Continuous	Backlog	Deterministic	Constant	Renewal
Berk & Gurler (2008)	Optimal (r, Q) policy	Infinite	Continuous	Lost sales	Deterministic	Constant	Poisson

Table 2.5: A summary of perishable inventory systems based on regenerative processes tool

2.3.4 Perishable inventory based on mathematical modeling

We provide in Tables (2.6, 2.7) below an overview of research that is based on mathematical modeling.

Optimal perishable inventory systems subject to positive lead time are quite complex to derive. The papers discussed in the previous sections propose either an exact solution where the lead time or the fixed ordering cost is omitted. Models based on queuing theory with impatient customers do not consider any explicit expression of the inventory total cost. Those, based on regenerative processes, take into account the ordering cost and propose heuristics to hand the situation where the lead time is positive. The lead time constraint adds more complexity to seek for an optimal ordering policy because more variable are needed to track the age of inventory. As stated by Schmidt & Nahmias (1985) it is unlikely to find an optimal policy under positive lead times. Due to this complexity, research has been shifted to heuristics approximations. We have mentioned the heuristic of Lian & Liu (2001) which deals with the (s, S) ordering type and consider the ordering cost, shortage, holding and outdating cost. The proposed heuristic has not been benchmarked against other existing heuristics, especially against the model of Chiu (1995a) who proposes an approximate model under the (r, Q) ordering policy. The (s, S) can be easily switched to an (r, Q) model by setting $Q = S - s$ and $s = r$ so that the comparison between the heuristic of Lian & Liu (2001) and the approximate model of Chiu (1995a) is possible. The approximate model of Chiu (1995a) considers five cost parameters (purchasing, ordering, holding, outdating and shortage), positive lead time and allows only one outstanding order. The model was tested against the optimal cost obtained by a simulation study and it is shown to deviate on average by less than one percent. However this result does not mean that the approximate expressions proposed by Chiu concerning the expected outdating quantity, shortage and inventory level are accurate: the numerical results conducted by Chiu show that the expected outdating quantity, shortage, inventory level and cycle length deviate from the optimal one by of 3.78%, -16.64%, -5.84%, -2.24% respectively. This finding is mainly due to the assumption that there is no perishability during the lead time. Later, Chiu (1999) re-examines the problem and proposes a more accurate expression of the inventory level. Another important contribution is the one made by Tekin *et al.* (2001). The authors

2.3. Perishable inventory control with fixed lifetime

simplify the problem of positive lead times and introduce the age-based inventory policy. Their model operates under a (T, r, Q) ordering system. That is, an order of Q units is placed whenever the inventory level reaches r or when T units of time have elapsed since the last instance at which the inventory level hits Q . The (r, Q) ordering system is a special case of a (T, r, Q) policy; in fact when T is set to be exactly the lifetime of products (T, r, Q) and (r, Q) are similar policies. The basic idea behind involving the parameter T is to reduce the effect of perishability by taking into account the remaining shelf life of items on hand which is ignored under the (r, Q) system. That is, in the (r, Q) inventory policy, the decision of reordering or not is based on the inventory position however, in the (T, r, Q) the reordering decision take also into account the remaining shelf lives of items in stock throughout the parameter T which represent a threshold level for reordering. The age-based inventory policy is suitable for particular items that start perishing when the order Q is unpacked for use. Typical example of such items, some foodstuffs kept in a freezer can be stored for a long time while putting them on the shelves reduces their shelf life. Tekin *et al.* (2001) find that the (T, r, Q) ordering system subject to service level constraint performs well under tight service level for items with short lifetime. Chiu's model (Chiu, 1995a) and modified (T, r, Q) of Tekin *et al.* (2001) were compared to the optimal (r, Q) policy provided by Berk & Gurler (2008). The authors found that the approximate model of Chiu performs relatively well within an average percent deviation from the optimal policy of two percent. Compared to the age-based (T, r, Q) , the optimal (r, Q) policy performs badly if the shortage cost is high. Furthermore, the (r, Q) ordering system seems to be a good heuristic for a large ordering cost, shelf lives and small shortage and perishing costs.

Finally, under a periodic review scheme, Chiu (1995b) considers a (T, S) inventory system with backorder and develop an upper and lower bound of the expected perishing quantity per cycle. The lower bound is used to approximate the amount of backorder per cycle. The author find that the approximate total operating cost deviate from the optimal one (calculated by simulation) by less than one percent.

Article	Replenishment policy	Planning horizon	Type of review	Excess demand	Lead time distribution	Lifetime distribution	Demand distribution
Chiu (1995a)	Heuristic (r, Q) policy	Infinite	Continuous	backlog	Deterministic	Constant	General
Tekin et al. (2001)	Heuristic (T, r, Q) policy	Infinite	Continuous	Lost sales	Deterministic	Constant	Poisson
Chiu (1999)	Heuristic (r, Q) policy	Infinite	Continuous	backlog	Deterministic	Constant	General
Chiu (1995b)	Heuristic (T, S) policy	Infinite	Continuous	backlog	Deterministic	Constant	General

Table 2.6: A summary of perishable inventory based on mathematical modeling

Article	Purchasing cost	Ordering cost	Shortage cost	Outdating cost	Holding cost
Chiu (1995a)	*	*	*	*	*
Tekin et al. (2001)	*	*	Service level	*	*
Chiu (1999)	*	*	*	*	*
Chiu (1995b)	*	*	*	*	*

Table 2.7: Costs assumptions of perishable inventory based on mathematical modeling

2.4 Perishable inventory control with stochastic lifetime

In the previous section, we have reviewed the literature of perishable items with fixed lifetime; we have also mentioned, in Chapter (1), that the lifetime is random in nature due to various perturbations that arise when items move through supply chain actors. Most of works dealing with random lifetime assume that each item of the incoming order has an exponential lifetime distribution. We provide in Tables (2.8, 2.9) below an overview of perishable inventory control with stochastic lifetime.

Article	Purchasing cost	Ordering cost	Shortage cost	Outdating cost	Holding cost
Kalpakam & Sapna (1994)	*	*	*	*	*
Kalpakam & Sapna (1995)	*	*	*	*	*
Liu & Yang (1999)	*	*	*	*	*
Kalpakam & Shanthi (2000)	*	*	*	*	*
Kalpakam & Shanthi (2001)	*	*	*	*	*
Kalpakam & Shanthi (1998)	*	*	*	*	*
Kalpakam & Shanthi (2006)	*	*	*	*	*
Liu & Shi (1999)	*	*	*	*	*
Lian <i>et al.</i> (2009)		*	*	*	*
Liu & Cheung (1997)			Fill rate		
Gurler & Ozkaya (2008)	*	*	*	*	*

Table 2.8: Costs assumptions of perishable inventory control with stochastic lifetime

Article	Replenishment policy	Planning horizon	Type of review	Excess demand	Lead time distribution	Lifetime distribution
Kalpakam & Sapna (1994)	Optimal (s, S) policy	Infinite	Continuous	Lost sales	Exponential	Exponential
Kalpakam & Sapna (1995)	Optimal $(S - 1, S)$ policy	Infinite	Continuous	Lost sales	General	Exponential
Liu & Yang (1999)	Optimal (s, S) policy	Infinite	Continuous	backlog	Exponential	Exponential
Kalpakam & Shanthi (2000)	Optimal $(S - 1, S)$ policy	Infinite	Continuous	Lost sales/backlogg	Exponential: state-dependent arrival	Exponential
Kalpakam & Shanthi (2001)	Optimal $(S - 1, S)$ policy	Infinite	Continuous	Lost sales	General	Exponential
Kalpakam & Shanthi (1998)	Optimal (s, S) policy	Infinite	Continuous	Lost sales	Exponential	Exponential
Kalpakam & Shanthi (2006)	Optimal (s, S) policy	Infinite	Continuous	Lost sales	Exponential	Exponential
Liu & Shi (1999)	Optimal (s, S) policy	Infinite	Continuous	backlog	0	Exponential
Lian <i>et al.</i> (2009)	Optimal (s, S) policy	Infinite	Continuous	backlog	0	Exponential
Liu & Cheung (1997)	Optimal $(S - 1, S)$ policy	Infinite	Continuous	Lost sales/backlogg	Exponential	Exponential
Gurler & Ozkaya (2008)	Heuristic (s, S) policy	Infinite	Continuous	backlog	Constant	General

Table 2.9: A summary of perishable inventory control with stochastic lifetime

2.4.1 Perishable inventory systems with exponential lifetime

We find that [Kalpakam & Sapna \(1994\)](#) were the first who studied an (s, S) model for a Poisson demand distribution where product lifetimes and lead times are assumed to be an exponential distribution. Under these assumptions, the inventory process becomes Markovian. By assuming lost sales and restricting the number of outstanding replenishment orders to, at most, one at any given time, they derived the steady state probabilities and obtained the exact cost function and some useful analytical properties regarding the reorder point s . [Kalpakam & Sapna \(1995\)](#) studied the $(S - 1, S)$ ordering policy under the same assumptions of [Kalpakam & Sapna \(1994\)](#) model but with general distribution of the lead time. They used the Markov renewal technique to analyze the behavior of the inventory level process. The authors obtained steady state system performance measures so that cost function can be constructed to obtain the optimal base stock S numerically. Later, [Liu & Yang \(1999\)](#) generalize the model of [Kalpakam & Sapna \(1994\)](#) and propose a model with backorder and no restriction on the number of outstanding replenishment orders. The authors use a matrix-geometric approach to obtain the steady states probabilities and derive the total cost function. After, they analyze the impact of the operating cost on the optimal s and S . Finally, they show that when the mean order processing time is too small, the optimal ordering policy can be obtained from the corresponding zero lead time model. [Kalpakam & Shanthi \(2000\)](#) consider a modified base stock ordering policy where orders are placed only at demand epochs. Under an instantaneous replenishment lead time, they derived the expression of the total operating cost using a matrix recursive scheme. Their model covers complete lost sales, full backlogging, and partial backordering. Later, the authors ([Kalpakam & Shanthi, 2001](#)) analyze the above modified base stock policy by integrating an arbitrary processing lead time. The matrix recursive approach is again used. The authors observed via numerical investigation that the cost function is unimodal in S and the matrix recursive approach may lead to significant saving in CPU time.

For the (s, S) ordering policy, [Kalpakam & Shanthi \(1998\)](#) consider the case of Poisson demand and exponential lifetime and suppose that orders are placed only at demand epochs. The lead time is exponentially distributed and depends on the order quantity. Recently, this work was generalized to the case of renewal demand ([Kalpakam &](#)

Shanthi, 2006). Liu & Shi (1999) focused on analyzing the reorder cycle length. Under instantaneous replenishment lead time and renewal demand process, they showed that the total cost function is convex if the expected cycle length is increasing concave in S . In keeping with this trend, Lian *et al.* (2009) studied similar model as Liu & Shi (1999) except that demand follows a Markovian Renewal process. A comparison between the Markovian and non Markovian Renewal demand is made and demonstrated that the non Markovian renewal demand may leads to a higher cost than in the case of the Markovian one.

All papers discussed above consider the shortage cost (lost sales or backorder), the only work subject to service level constraint is the paper of Liu & Cheung (1997). Liu and Cheung investigate an $(S-1, S)$ inventory policy with Poisson demand, exponential lifetime and lead time where excess demand can be completely lost or partially backordered and there is no restriction on the number of outstanding orders. The authors choose to minimize the expected on hand inventory arguing that the outdateding and the holding cost can be minimized if the on hand inventory level is also minimized. That is, no explicit cost has been considered on their objective function. The structure of the cost function and instantaneous replenishment lead time simplify considerably the problem of finding a closed form of the total operating cost.

2.4.2 Perishable inventory systems with general distribution lifetime

For other distributions of lifetime, Gurler & Ozkaya (2008) studied the (s, S) policy with random lifetime and constant lead time in order to investigate the impact of randomness of the shelf life on the total operating costs. The shelf life of each item in the incoming order is the same but may be constant or random. Various distribution of the lifetime have been considered, e.g. Gamma, Weibull, Uniform, Triangular,... Gurler and Özkaya examined firstly the case of zero lead time and after, they proposed a heuristic to deal with the case of positive and constant lead time. Based on result of Weiss (1980), who showed that, for a zero lead time and a continuous review, the reorder level s must be negative, Gurler and Ozkaya derived a closed form of the total operating cost for both discrete and continuous demand and demonstrated that the cost function is quasi-

convex in s and S for unit demand. The authors investigated the impact of random lifetime versus the fixed one and found that the consideration of randomness may leads to a substantial savings. Finally, the performance of the heuristic of positive and fixed lead time was compared to the heuristics of [Lian & Liu \(2001\)](#) throughout numerical investigation. They observed that their proposed heuristic performs slightly better for unit demand.

2.5 Conclusion

In the present chapter, we reviewed the literature on single item single location perishable inventory management systems. Although research on perishable inventory systems is widely addressed in literature by either considering fixed or random lifetime. The major efforts were mostly focused on determining the exact optimal ordering policy and its properties by assuming instantaneous replenishment lead time. However, we are aware that in terms of practical point of view, the lead time is typically positive. When the lead time and the lifetime are assumed to be exponentially distributed, the exact control policy can be obtained by using Markov Renewal approach ([Kalpakam & Sapna, 1994](#)). If the lead time is deterministic, some effective heuristics have been developed. However, these heuristics concern the (s, S) and the $(S - 1, S)$ ordering policies. For $(S - 1, S)$ ordering policy, the heuristics of [Nandakumar & Morton \(1993\)](#) and [Nahmias \(1976\)](#) are quite robust since they deviate from simulation within one percent. For (s, S) with fixed lifetime, the heuristics of [Lian & Liu \(2001\)](#) and [Gurler & Ozkaya \(2008\)](#) perform reasonably. These heuristics are derived when demand follows a renewal process. In the case of (r, Q) ordering policy, only [Chiu \(1995a\)](#) provides an approximate model. As we mentioned above, the approximate model of [Chiu \(1995a\)](#) was benchmarked against the exact solution for a Poisson demand and lost sale case (see [Berk & Gurler \(2008\)](#)). The result of comparison shows that the approximate (r, Q) model deviate slightly from the exact one. Such an approximation was not already tested for more general demand distribution (Gamma, Weibull, Uniform, Triangular, etc) or under the backorder case. In addition, we find that the approximations made by Chiu are derived under the assumption of no perishability during the lead time and by ignoring the case of batch demand. That is, Chiu does not consider the case where, at demand epochs, the size

of demanded items maybe greater than one unit. Accordingly, our contribution to the literature is three fold:

- We derive a new approximate (r, Q) under positive and fixed lead time and general demand distribution. The model we propose is more realistic since we take into account the case of perishability during the lead time. We provide a comparison with the heuristic of Chiu (1995a) and with the classical (r, Q) with infinite lifetime. Our results show that the proposed (r, Q) model outperforms the model of Chiu and the (r, Q) policy in which the perishability of products is ignored. Furthermore, we investigate the case of discrete demand distribution when, at demand epochs, the customer may request more than one unit. We demonstrate that the consideration of undershoot (the amount by which the reorder level r is crossed when an order is triggered) is crucial to obtain a good ordering policy (cf. Chapter 3).

- Although perishable inventory with random lifetime was extensively studied, to the best of our knowledge the case where the inventory is reviewed periodically and the lead time is deterministic is not investigated yet. Consequently, our motivation is to provide an exact analysis of a (T, S) inventory policy under positive lead time. We deal with the discrete time monitoring instead of the continuous one since it is often used in practice. We model the behavior of this inventory system as a Markov process which we can characterize the stationary regime. The proposed optimal (T, S) rule will be compared to the corresponding optimal policy with fixed and infinite lifetime. We show that the consideration of randomness may leads to substantial savings (cf. Chapter 4).

- Finally we assess the impact of using TTIs on inventory management and show that such technology can considerably improve the inventory management but this improvement depends on the cost of TTIs. We are aware of only one cite Ketzenberg & Bloemhof (2008) that address the value of TTIs in perishable inventory system. The authors formulate the replenishment problem as a Markov Decision Process and provided a heuristics with and without TTIs. They showed that TTIs is quite valuable since it reduces losses and spoilage. Our study differ from Ketzenberg and Bloemhof's work since we will formulate an approximate (r, Q) dealing with TTIs type 1 and 2. Also we will consider the

case of random lifetime throughout simulation and compare the performance of issuing policies such as FIFO and SLFO (cf. Chapter 5).

Chapter 3

An (r, Q) Inventory Control with Fixed Lifetime and Lead time

3.1 Introduction

In this chapter we consider an (r, Q) perishable inventory models with fixed lifetime and lead time. The aim of these models is to illustrate a fixed lifetime perishable inventory problem (cf. Chapter (2)) and also to associate such models to scenario 1 developed in Section (1.7) of Chapter (1), quantitative benefits of using TTIs on inventory management are not considered in this chapter. As presented in Chapter (2) the fixed life perishability problem has been studied extensively in literature. Two major findings regarding this problem can be outlined: First, the inventory control of perishable products with fixed lifetime is still a complex problem when products' lifetime is greater than two units of time. This complexity arises since most of existing works use multi dimensional dynamic programming approaches to find optimal control policies. These works (e.g. [Nahmias \(1977b\)](#); [Fries \(1975\)](#); [Schmidt & Nahmias \(1985\)](#)) conclude that analytical solution for perishability inventory systems with fixed lifetime cannot be obtained because the need to track the huge number different ages' categories. As a consequence, research has been shifted to heuristics approximation. Second, regarding the (r, Q) inventory policy for perishables with fixed lifetime, [Chiu \(1995a\)](#) was the first who studied an approximate (r, Q) inventory model where unsatisfied demand is backlogged. Later, [Chiu \(1999\)](#) extended his work by considering a similar model where he developed a

more accurate estimation of the expected inventory level per unit time. Recently, Berk & Gurler (2008) revisited the setting considered by Chiu (1995a) under the assumption of Poisson demand distribution. They have developed an exact solution for the (r, Q) inventory policy subject to lost sales case. They have developed an exact solution for the (r, Q) inventory policy subject to lost sales case. However, in this work the backlog case has not been treated.

The approximations of the cost elements made by Chiu are derived under the assumption of non occurrence of perishability during the lead time. The consequence of this assumption, as briefly mentioned in Section (2.3.4) of Chapter (2), is that the approximate expected backlogged quantity deviates on average by -16.64% from the optimal one. Therefore, we propose in this chapter to re-examine the (r, Q) inventory system for perishables with fixed lifetime. In keeping with literature's trend, our interests are threefold:

- We improve the approximations made by Chiu (1995a, 1999) by considering the occurrence of perishability during the lead time. In Section (3.3), we show that our (r, Q) inventory model outperforms Chiu's model especially when $r < Q$ and when the replenishment lead time takes a high value.
- We develop in Section (3.2) an approximate (r, Q) model and show that the optimal average cost associated with our model deviates on average by less than 1% from the optimal average cost pertaining to an (r, Q) system obtained by a simulation study. This emphasizes the relevancy of the approximations we made.
- We extend model developed and compare its performance to an (r, Q) inventory policy that ignores product's perishability. A sensitivity analysis of the optimal policy with respect to cost parameters and product's lifetime is conducted in Section (3.5). The extension mainly comes from the fact that in the second model we take into account the undershoot quantity. The undershoot corresponds to the amount below the reorder level r at the time when a replenishment decision is made.

The rest of the chapter is organized as follows: In Section (3.2), we derive the operating costs of our model: we develops a new approximation of the expected outdating units where the assumption of non occurrence of perishability during the lead time is relaxed. Once the expected perished items are calculated, we then derive the expressions of expected backlogged quantity and the expected on hand inventory. The optimal

parameters r and Q are calculated by minimizing the total expected average cost. Numerical studies are conducted in Section (3.3) to validate and to compare the proposed model and Chiu's model. Then, we extend this model to the case where the undershoot of the reorder point r is taken into account and compare the extended model to an (r, Q) model which ignore product's perishability (Section (3.4)). Finally, this chapter ends with some conclusions.

3.2 A continuous review (r, Q) model subject to perishability

We study a single stage, single product perishable inventory system. This system that has been introduced in Section (1.6) of Chapter (1) has the following characteristics:

1. We assume that products have a fixed lifetime, which means that they are held in stock during m time units, after which, if they are not consumed, are disposed off. This assumption corresponds to the Scenario 1 introduced in Section (1.7) of Chapter (1) as previously presented.
2. The total product's lifetime is dispatched between supply chain actors (cf. Figure (1.2) of section 1.3) so that the product's lifetime m_1 represents only one part of total lifetime. For ease of notation, we use hereafter m instead of m_1 to represent product's lifetime.
4. The inventory is controlled with an (r, Q) continuous review system; an order of size $Q > 0$, is placed whenever the inventory level (on hand inventory plus on order minus back orders) drops to the replenishment level r .
5. We assume that all products coming from the same batch Q have the same lifetime and the lifetime m has a fixed value. In a real case, each product of the batch Q would have its own distribution according to the temperature perturbations that arise throughout the supply chain, these distributions are called the effective lifetime. In order to guarantee the freshness of products and to avoid the sanitary risks, we take the lifetime of the batch Q as the minimum realization of all effective lifetime values.
6. If a unit of product is not used by demand during the m periods of lifetime, it is discarded and a unit outdate cost of W is charged. As discussed in Chapter (1), W

An (r, Q) Inventory Control with Fixed Lifetime and Lead time

corresponds to the loss in term of profit for an item that should be sold before perishing.

7. We assume that there is a constant replenishment lead time of length L units of time.

8. The inventory is depleted from stock according to a FIFO issuing policy and all unmet demands are backlogged.

9. The demand per unit time, Z , is a nonnegative random variable following a distribution with mean D , probability distribution function $f(z)$ and cumulative distribution function $F(z)$. Where z is the realizations of Z . Let $Z_i, (i = 1, 2, \dots)$ be a sequence of mutually independent random variables with mean D , probability distribution function $f(z)$ and cumulative distribution function $F(z)$. The density function of the sum ($D_n = Z_1 + Z_2 + \dots + Z_n$) is the n -fold convolution of $f(z)$ with itself and it is denoted by $f_n(d_n)$ with mean nD . The cumulative probability distribution is noted by $F_n(d_n)$. Again d_n represents the realizations of the random variable D_n .

10. The undershoot of the reorder point is not considered. This means that Q units of products are ordered exactly when the inventory position hits r (i.e. $x_1 = x_2 = 0$ in Figure (3.2)). Note that this undershoot may be caused by either demand or perishability.

The notations used in the model are as follow:

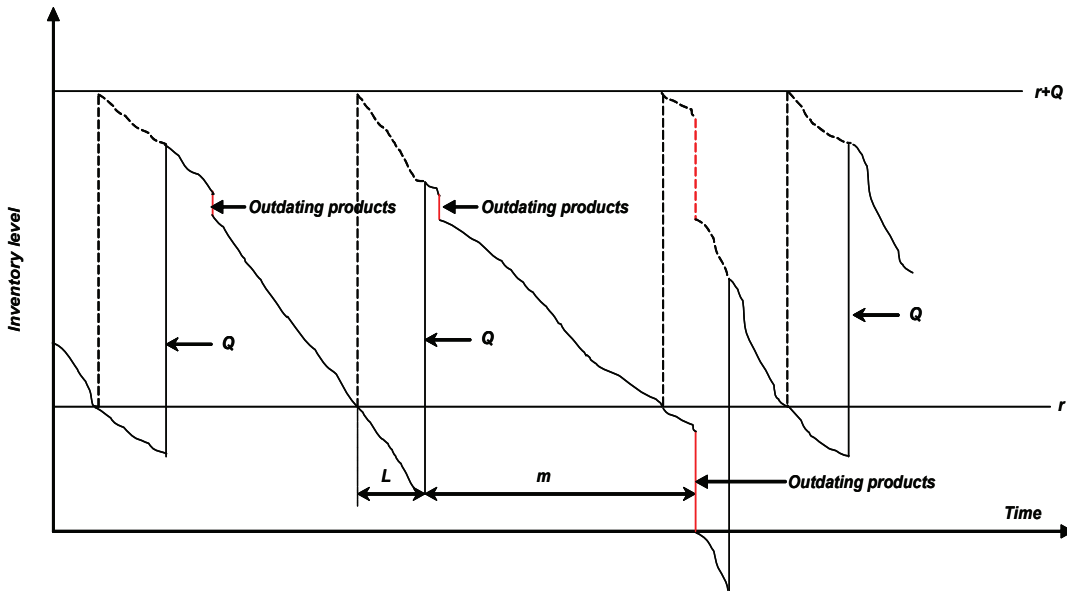

Figure 3.1: An (r, Q) inventory policy for perishable products

K : Fixed ordering cost per order

H : Holding cost per unit of product held in stock per unit of time

3.2. A continuous review (r, Q) model subject to perishability

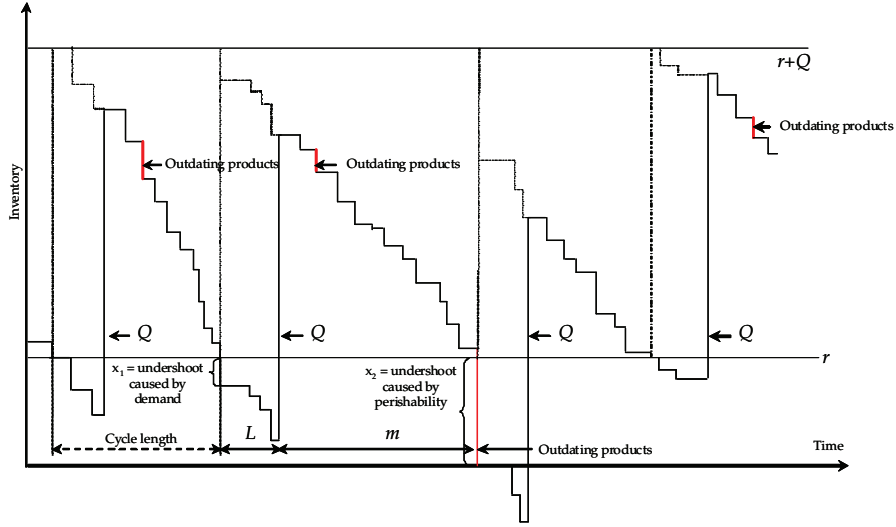

Figure 3.2: Cases which they are not considered by our model

C : Purchase cost per unit of product

P : Backlog cost per unit of product

W : Outdate cost per unit of product that perishes in stock

m : Product's lifetime

L : Replenishment lead time

$E[O]$: The expected outdating quantity associated with an order

$E[T]$: The expected cycle length, i.e., the expected time units that elapses between two successive instances where the inventory level reaches r

$E[S]$: The expected backlogged quantity per cycle

$E[I]$: The expected inventory level per unit time

The goal is to optimize the average total cost per unit of time formulated by the following equation:

$$TC(r, Q) = \frac{K + CQ + PE[S] + WE[O]}{E[T]} + HE[I] \quad (3.1)$$

Assumption 1-10 are commons with [Chiu \(1995a\)](#). In Section (3.4), assumption (10) above will be relaxed.

Additional considerations

11. The replenishment level r is less than Q (i.e. $r < Q$): This assumption was taken in order to simplify the calculation of the expected outdating quantity associated with an order. Combined with First-In-First-Out policy, this assumption implies that there

is at most two age categories of products in inventory during a cycle length.

12. There is no order triggered by perishability i.e., $E[O] \leq r$.

3.2.1 Expected outdating quantity

To find an optimal replenishment policy for perishable inventory, a recursive computation is needed in order to take into account the age distribution of products on hand. As mentioned by [Schmidt & Nahmias \(1985\)](#), it is unlikely to find an optimal policy, since the computation of this policy is not realizable when m takes large values. Therefore, using an approximate information about the different age categories of products can generate an accurate replenishment policy. Such an approximation has been made by [Nahmias \(1982\)](#) who considers that the amount of products on hand that will perish in n time units ($n < m$) have the same age. However, in this section, we do not use an approximation about products' age categories because of assumption (2). Consequently, the age distribution and the dynamic program solution are not required.

In order to evaluate the expected quantity of outdated products, we will first point out some confusing aspects on Chiu's approximation. The author shows that the expected outdating quantity associated with Q is given by:

$$\begin{aligned}
 E[O] &= \int_0^{r+Q} (r + Q - d_{m+L}) f_{m+L}(d_{m+L}) dd_{m+L} \\
 &\quad - \int_0^r (r - d_{m+L}) f_{m+L}(d_{m+L}) dd_{m+L}
 \end{aligned} \tag{3.2}$$

Chiu derives this equation by analyzing the on hand inventory after the order of size Q arrives. The author shows that there is some cases for which the current order Q may start to perish if is not totally used by demand. By considering these cases, Equation (3.2) is obtained. Also the author obtains Equation (3.2) by deriving the expected outdating quantity for the case where the lead time is zero and deduce after the expected outdating quantity for a constant lead time. However, for both ways, Equation (3.2) holds under the assumption of no perishability occurs during L .

We believe that this assumption is probably not a very good approximation since:

- There is a small probability to have $d_{m+L} < r$ because the reorder level r is designed to satisfy the lead time demand and not demand during $m + L$ units of time. As a

3.2. A continuous review (r, Q) model subject to perishability

consequence, the second term of (3.2) can be ignored and (3.2) is reduced to the first one. However, the first term is misleading since it calculates the expected quantity of perished products associated with the current order and includes the outdated products from the previous order.

- In case where $Q < r$ (e.g $Q = 1$ and r is relatively large) orders are placed frequently. Then, if r is large (which means that there may be a lot of items in stock), it is likely that a non-negligible number of units already in stock will perish during the lead time. Accordingly, there is a non null probability of occurrence of perishability during the lead time with respect to costs parameters. Therefore, our calculation of the expected outdated quantity differs from (3.2) since the occurrence of perishability during L is not disregarded.

Let $O_n, n = 1, \dots$, a sequence of positive random variables representing the outdated quantity associated with the order indexed by n , for all $n \geq 0$. We assume that these random variables are independent and identically distributed. O_n represents the total outdated items per cycle length, where the cycle length is the time separating two successive instances that the inventory level reaches r . Under the assumptions (11), (12) and (13), the amount of the outdated units of the order Q is equal to:

$$O_n = \max(0, r + Q - O_{n-1} - d_{m+L}), \forall n \geq 1 \quad (3.3)$$

In order to render Equation (3.3) tractable, we will assume that $O_{n-1} = E[O_{n-1}]$ which gives:

$$O_n \simeq \max(0, r + Q - E[O_{n-1}] - d_{m+L}) \quad (3.4)$$

If we assume that $O_n, n \geq 1$ are independent and identically distributed, then we have:

$$\begin{aligned} O_n &= \max(0, r + Q - E[O_n] - d_{m+L}) \\ \implies E[O_n] &= \int_0^{r+Q-E[O_n]} (r + Q - E[O_n] - d_{m+L}) f_{m+L}(d_{m+L}) dd_{m+L}, \\ &\forall n \geq 0 \end{aligned} \quad (3.5)$$

$$\text{Let, } \omega(x) = \int_0^{r+Q-x} (r+Q-x-d_{m+L})f_{m+L}(d_{m+L})dd_{m+L} \quad (3.6)$$

The function g is continuous and $\omega((x) \in [0, r+Q]$ for all $x \in [0, r+Q]$ and

$$\frac{d\omega((x)}{dx} = - \int_0^{r+Q-x} f_{m+L}(d_{m+L})dd_{m+L} \quad \forall x \in [0, r+Q] \quad (3.7)$$

$$\Rightarrow \left| \frac{d\omega((x)}{dx} \right| \leq 1 \quad \forall x \in [0, r+Q] \quad (3.8)$$

Then, from the fixed point theorem the equation $x = \omega(x)$ has a unique solution in $[0, r]$. The value of x satisfying $x = \omega(x)$ is the expected perished units of the order Q received m units of time before (i.e., $E[O]$). Now to find out the amount of perished units from the order Q we consider a large set of values for r and Q , then for each couple (r, Q) the expected outdated items is determined numerically by the repeated composition of ω with itself i time. That is, for any $x_0 \in [0, r]$ the expected outdated quantity is equal to:

$$E[O] = \lim_{i \rightarrow +\infty} \omega^i(x_0) \quad (3.9)$$

We note that if $E[O] > r$, it may happen that orders will be triggered by perishability. As a consequence, the inventory position will be equal to Q not to $r+Q$. In that case, Equation (3.9) is an approximation of $E[O]$.

3.2.2 Expected backlogged quantity

The amount of the backordered demands depends on whether perishability occurs in L or not. If there is no outdateding that occurs during L , a stockout occurs when the total lead time demand exceeds the replenishment level r . The r units of products are wholly used to satisfy only one part of demand. The unsatisfied demand can then be filled from the arriving of the new order Q . Let $E[S_1]$ be the expected backlog quantity in this case. $E[S_1]$ can be approximated by:

$$E[S_1] = \int_r^\infty (d_L - r)f_L(d_L)dd_L \quad (3.10)$$

If products perish during L , then only $r - E[O]$ are available to satisfy the lead time demand. In this case, the expected backlog quantity, denoted by $E[S_2]$, is approximated

3.2. A continuous review (r, Q) model subject to perishability

by:

$$E[S_2] = \int_{r-E[O]}^{\infty} (d_L - r + E[O])f_L(d_L)dd_L \quad (3.11)$$

where $E[O]$ is determined by $(E[O] = g^i(x_0))$. The total expected backlog depends on the probability of occurrence of perishability in L or not. It is easier to see that there is perishability in L if the remaining shelf life $(m + L - T)$ is smaller than L . In other words, there is a perishability in L if $D(m + L) - Q + E[O] \leq r$. We deduce that the total expected backlog is equal to:

$$\begin{aligned} E[S] &= \bar{F}_{m+L}(r + Q - E[O])E[S_1] + F_{m+L}(r + Q - E[O])E[S_2] \\ &= \bar{F}_{m+L}(r + Q - E[O]) \int_r^{\infty} (d_L - r)f_L(d_L)dd_L \\ &+ F_{m+L}(r + Q - E[O]) \int_{r-E[O]}^{\infty} (d_L - r + E[O])f_L(d_L)dd_L \end{aligned} \quad (3.12)$$

Remark: In Chiu's model (Chiu, 1995a, 1999), the expected backlogged quantity is equal to $E[S_1]$.

3.2.3 Expected inventory level per unit time

The expected inventory level can be approximated by considering separately the expected average inventory level during the lead time and the expected average inventory level from the time an order is received to the time where the next reorder is placed. Again, as in 2.2, we consider two cases, depending on whether perishability occurs during L or not.

Case 1: Perishability does not occur during L

In this case, the old products can perish after the new order Q is received, otherwise they will be used before they perish (Figure (3.3)). The expected inventory level after the arrival of the new order Q is given by the area A1:

$$\begin{aligned} A1 &= F_{m+L}(r + Q - E[O])F_L(r - E[O])[(E[T] - L)r \\ &+ \frac{E[T] - L}{2}(Q + r - DL - r - E[O]) + (m - E[T])E[O]] \end{aligned} \quad (3.13)$$

Note that the expression $F_{m+L}(r + Q - E[O])F_L(r - E[O])$ is the probability of occurrence of perishability after order arrival.

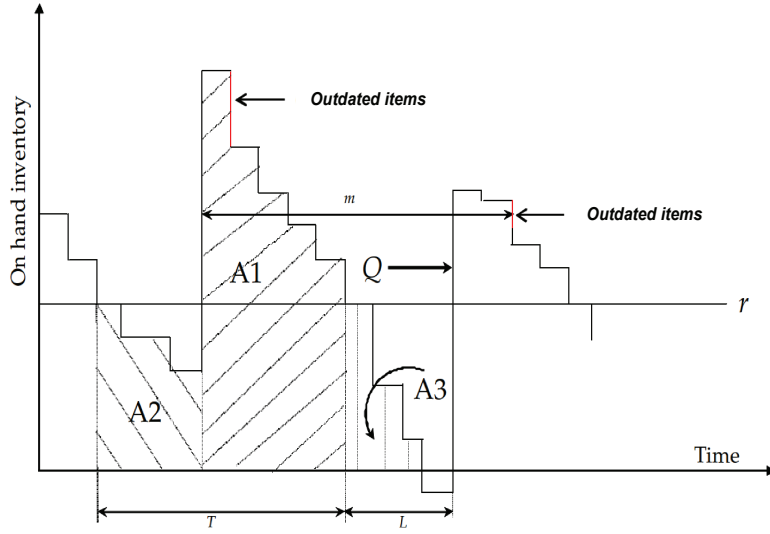

Figure 3.3: Behavior of the inventory where perishability does not occur during L

The expected average inventory level during L in the case where r meet all demand during L is given by the area A2:

$$\begin{aligned}
 A2 &= [F_{m+L}(r+Q-E[O])F_L(r-E[O]) \\
 &+ \bar{F}_{m+L}(r+Q-E[O])]\frac{L}{2}\int_0^r(2r-d_L)f_L(d_L)dd_L \quad (3.14)
 \end{aligned}$$

The expected average inventory level during the lead time where the inventory is depleted before the new order arrives is approximated by the area A3:

$$\bar{F}_{m+L}(r+Q-E[O])\frac{L}{2}\int_r^\infty\frac{r^2}{d_L}f_L(d_L)dd_L \quad (3.15)$$

Case 2: Perishability occurs during L

Using the same reasoning as in case 1, the expected inventory level after the arrival of the new order Q is approximated by the area A1:

$$\begin{aligned}
 A1 &= [F_{m+L}(r+Q-E[O])\bar{F}_L(r-E[O]) \\
 &+ \bar{F}_{m+L}(r+Q-E[O])][(E[T]-L)r+\frac{T-L}{2}(Q+r-DL-r)] \quad (3.16)
 \end{aligned}$$

3.2. A continuous review (r, Q) model subject to perishability

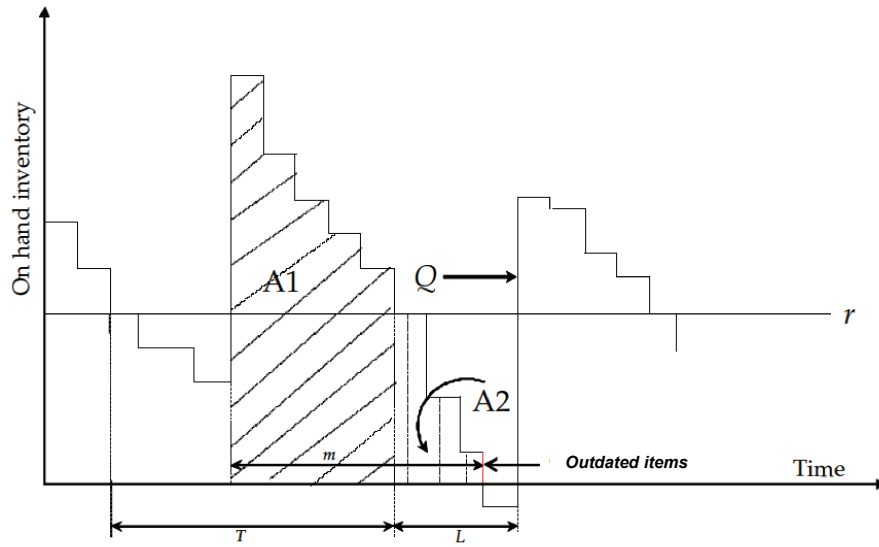

Figure 3.4: Behavior of the inventory where perishability occurs during L

The expected average inventory level during the lead time is approximated by the area A2:

$$F_{m+L}(r + Q - E[O])\bar{F}_L(r - E[O])\frac{m + L - E[T]}{2}(r + E[O]) \quad (3.17)$$

We note that Equations 3.13, 3.14, 3.15, 3.16 and 3.17 are based on the approximations developed by Kim & Park (1989) and by including the perishability issue. The total

expected average inventory level for per unit time can be written as:

$$\begin{aligned}
 E[I] = & \frac{F_{m+L}(r + Q - E[O])F_L(r - E[O])[(E[T] - L)r}{E[T]} \\
 & + \frac{(E[T] - L)(Q + r - DL - r - E[O])}{2E[T]} \\
 & + \frac{F_{m+L}(r + Q - E[O])F_L(r - E[O])(m - E[T])E[O]}{E[T]} \\
 & + \frac{[F_{m+L}(r + Q - E[O])F_L(r - E[O])L}{E[T]} \frac{L}{2} \int_0^r (2r - d_L)f_L(d_L)dd_L \\
 & + \frac{\bar{F}_{m+L}(r + Q - E[O])}{E[T]} \frac{L}{2} \int_0^r (2r - d_L)f_L(d_L)dd_L \\
 & + \frac{\bar{F}_{m+L}(r + Q - E[O])}{E[T]} \frac{L}{2} \int_r^\infty \frac{r^2}{d_L} f_L(d_L)dd_L \\
 & + \frac{[F_{m+L}(r + Q - E[O])\bar{F}_L(r - E[O])}{E[T]} [(E[T] - L)r] \\
 & + \frac{\bar{F}_{m+L}(r + Q - E[O])}{E[T]} [(E[T] - L)r] \\
 & + \frac{[F_{m+L}(r + Q - E[O])\bar{F}_L(r - E[O])}{E[T]} \left[\frac{E[T] - L}{2} (Q - DL) \right] \\
 & + \frac{\bar{F}_{m+L}(r + Q - E[O])}{E[T]} \left[\frac{E[T] - L}{2} (Q - DL) \right] \\
 & + \frac{F_{m+L}(r + Q - E[O])\bar{F}_L(r - E[O])}{E[T]} \frac{m + L - E[T]}{2} (r + E[O]) \quad (3.18)
 \end{aligned}$$

Remark: In Chiu's model (Chiu, 1995a), the expected inventory level per unit time is given by $r + \frac{Q}{2} - DL$ which is shown to be a very rough estimation in the case of perishable products. Later, Chiu (1999) develops a new approximation which is equal to:

$$E[I] = r - DL + \frac{Q}{2} + DL \frac{E[S] - E[O]}{2(Q - E[O])}$$

In Section (3.3), We use this new approximation to compare the model we propose to Chiu's model and to the simulation model.

3.2.4 The expected average total cost

Now, we can formulate the total expected average cost per unit time by Equation (3.1), where $E[O]$ is given by Equation (3.8), $E[S]$ by Equation (3.12) and $E[I]$ by Equation

3.2. A continuous review (r, Q) model subject to perishability

(3.18). That is:

$$\begin{aligned}
 TC(r, Q) &= \frac{K + CQ + P\bar{F}_{m+L}(r + Q - E[O]) \int_r^\infty (d_L - r) f_L(d_L) dd_L}{E[T]} \\
 &+ \frac{PF_{m+L}(r + Q - E[O]) \int_{r-E[O]}^\infty (d_L - r + E[O]) f_L(d_L) dd_L + WE[O]}{E[T]} \\
 &+ HE[I]
 \end{aligned} \tag{3.19}$$

Where the expected cycle length in the backlog case is equal to:

$$E[T] = \frac{Q - E[O]}{D} \tag{3.20}$$

Due to the complex form of (3.19), investigating analytical properties of the cost function and deriving the optimal values of r and Q turns out to be impractical. With the actual form, we are unable to prove analytically that $TC(r, Q)$ is a convex function. For all the numerical analysis settings considered in Section (3.3), we have verified that $TC(r, Q)$ is jointly convex in Q and r . Several illustrations of such verifications are given in Figures (3.5), (3.6), (3.7) and (3.8) below.

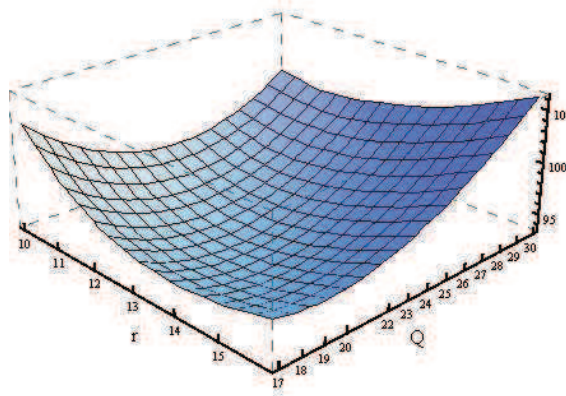

Figure 3.5: Convexity of the total expected cost for a fixed value of r (fixed parameters : Poisson demand with mean $D = 10$, $C = 5$, $P = 20$, $K = 50$, $W = 5$, $H = 1$, $L = 1$, $m = 3$)

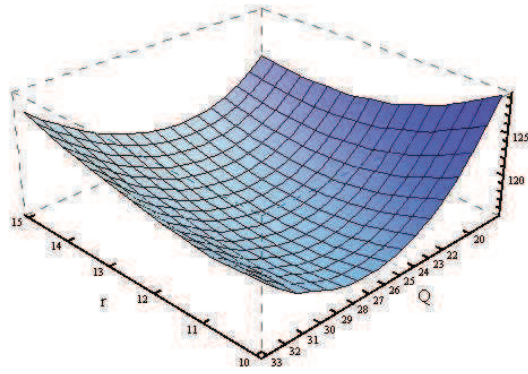

Figure 3.6: Convexity of the total expected cost for a fixed value of Q (fixed parameters : Poisson demand with mean $D = 10$, $C = 5$, $P = 20$, $K = 100$, $W = 5$, $H = 1$, $L = 1$, $m = 3$)

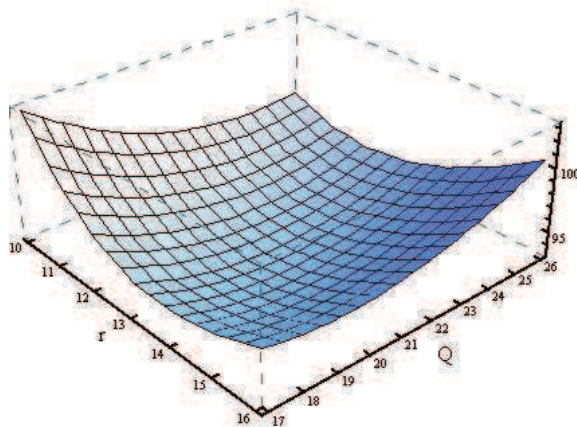

Figure 3.7: Convexity of the total expected cost for a fixed value of r (fixed parameters : Normal demand with mean $D = 10$, $Variance = 10$, $C = 5$, $P = 20$, $K = 50$, $W = 5$, $H = 1$, $L = 1$, $m = 3$)

3.3 Evaluation of the performance

In this section, we conduct a comprehensive numerical analysis in order to evaluate the performance of inventory systems subject to perishability. We evaluate Equation (3.19) by using a simple search algorithm implemented in Mathematica software. We firstly validate our model by comparing the different key operating characteristics of the model we have developed in Section (3.2) versus those obtained from a simulation model. The simulation model has been developed to verify the effectiveness of the proposed model.

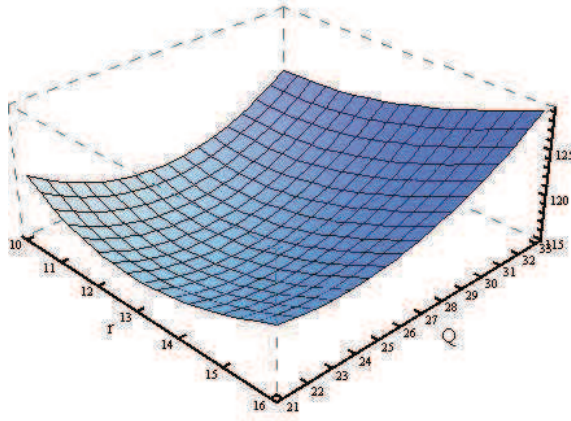

Figure 3.8: Convexity of the total expected cost for a fixed value of Q (fixed parameters : Normal demand with mean $D = 10$, Variance = 10, $C = 5$, $P = 20$, $K = 100$, $W = 5$, $H = 1$, $L = 1$, $m = 3$)

That is, we use the optimal r and Q of the proposed model as the input parameters for the simulation model. Secondly we compare the optimal ordering costs obtained from the simulation versus the proposed model and Chiu's model. The simulation model is used as a base case to compare the performance of our model versus the model developed by Chiu.

We note hereafter by Q_1 , Q_{ch} and Q_s the optimal order obtained from the proposed model, Chiu's model and the simulation model respectively. r_1 , r_{ch} and r_s the optimal reorder level obtained from the proposed model, Chiu's model and the simulation model respectively. TC_1 , TC_{ch} and TC_s the optimal total cost of proposed model, Chiu's model and the simulation model respectively.

The performance of the proposed model vs the simulation model and vs the model of Chiu is measured by the percentage differences defined as follows:

$$\Delta_{ys}E[S]\% = 100 \frac{E[S]_y - E[S]_s}{E[S]_s}$$

$$\Delta_{ys}E[O]\% = 100 \frac{E[O]_y - E[O]_s}{E[O]_s}$$

$$\Delta_{ys}E[I]\% = 100 \frac{E[I]_y - E[I]_s}{E[I]_s}$$

$$\Delta_{ys}E[T]\% = 100 \frac{E[T]_y - E[T]_s}{E[T]_s}$$

$$\Delta_{ys}TC(r, Q)\% = 100 \frac{E[TC]_y - E[TC]_s}{E[TC]_s}$$

Where $y = 1$ or $y = ch$ for the optimal operating cost of the proposed model and Chiu's model respectively.

3.3.0.1 Model validation based on a simulation study

The validity of this model is tested by a discrete simulation experiment implemented in Arena software. During a given period, the sequence of events in the simulation model is as follows:

- 1) At the beginning of the period (i.e. unit time), if an order is delivered from the supplier to the distribution center, it is added to the inventory on hand. A lifetime of $T_{now} + m$ is assigned to this arriving order. T_{now} being the time at which the order enters the DC.
- 2) Products remaining from the order received m time units before are disposed off, if they are not used to satisfy demand. The inventory position and the on hand inventory are reduced by the perished quantity.
- 3) Demand at the distribution center occurs.
- 4) If the inventory position reaches the replenishment level r or is below r , a new order of size Q is placed and will be received L time units after.

Note that at the beginning of the simulation, no order is placed, so the first event is demand. Since the lead time is positive, the initial inventory must be set high enough to absorb the lead time demand.

The setting we consider are taken from Chiu (1995a). That is, we compare our model to the simulation model for the case of Poisson and Normal demand distribution.

Case of Poisson demand distribution

Table (3.1) illustrates the inventory control parameters obtained from the proposed model and the simulation model for a Poisson demand distribution with mean $D = 10$, $m = 3$, $L = 1$ and $H = 1$. The comparison is made for a sample of 24 settings taken from Chiu (1995a). Table (3.2) presents the same comparison for $L = 2$ and for high fixed ordering cost K . For each setting considered, we set the replication length of a simulation run to be 150000 units time and we use 20 replications in order to get the average value of parameters associated to each setting. The results support the following

statements:

1) The total operating costs obtained from the proposed model and the simulation model are quite close: our model generates a total cost which deviates from the simulation model by only 0.32% and 0.90% for $L = 1$ and $L = 2$ respectively (cf Tables (3.1) and (3.2)).

2) The proposed expected outdating approximation is higher than the simulated one. The reason of this overestimation is due to the fact that in our approximation, we consider that perishability occurs for each cycle whatever its length. However, in the simulation model it may happen that perishability does not occur especially for short cycle times.

3) The expected backlogged quantity ($E[S]$) is underestimated. The underestimation is attributed to the assumption of no undershoot occurs at the reorder point r . In the simulation model the undershoot (due to the perishability) may sometimes occur. This induces a higher amount of backlog demand in the simulation compared to the proposed model.

4) $E[I]$ and $E[T]$ of the proposed model are quite close to the simulation values (cf Tables (3.1) and (3.2)). This indicates that the approximations of the expected outdating quantity (which is used to estimate $E[T]$) and the expected inventory level are quite good.

Case of Normal demand distribution

Table (3.3) summarizes the results of comparison between our model and the simulation model. We observe that the proposed model achieves an optimal cost lower than simulation by 13% on average. This finding is due to the fact that in our model, the undershoot of the reorder point is ignored. However in the simulation model the undershoot may occur, that is why the percentage difference between the total cost stemming from the simulation and our model is very high. The occurrence of the undershoot (assumption 10 in Section (3.2) will be relaxed in Section (3.4) in order to propose a more accurate cost expression.

3.3.0.2 Comparison with the simulation model and Chiu's model

Tables (3.4) and (3.5) show the results of comparison of the model we propose to the optimal solution obtained from the simulation model and the model developed by Chiu. We observe that the total operating cost of the model we propose is closer to the simulation one, in comparison with Chiu's model, especially in cases where L takes higher values (i.e. our model performs better than Chiu's for $L = 2$ rather than $L = 1$). This finding is due to the fact that Equation (3.2) calculates the total perished items during $m + L$ minus the total perished products coming from the r oldest units and under the condition that $d_{m+L} \leq r$. However, the probability to have $d_{m+L} \leq r$ is very small, in other words, Chiu (1995a) considers the total outdating of all orders that perish in $m + L$ and not the outdating quantity for one order. As a consequence, Equation (3.2) overestimates the perished quantity associated with an order so the optimal order Q_{ch} is underestimated and the total operating cost of Chiu's model is higher than the real optimal average total cost (the simulation cost). With respect to the cost parameters, the optimal reorder level r could be less than Q (for example test problem 4 in Table (3.5)). Now if we compare our model to Chiu's model for the case where the assumption $r < Q$ holds, then we observe that $\Delta_{1s}TC(r, Q)\% = 0.25\%$ and $\Delta_{chs}TC(r, Q)\% = 0.28\%$. This confirms that Chiu's model performs better for the case where $r > Q$ since our model does not take into account this case.

Test problem	Cost parameters		Proposed model							Simulation model				
	(r_1, Q_1)	$E[S]$	$E[O]$	$E[I]$	$E[T]$	$TC_1(r_1, Q_1)$	(r_1, Q_1)	$E[S]$	$E[O]$	$E[I]$	$E[T]$	$TC_s(r_1, Q_1)$		
	$C = 5, W = 5$	P	K											
1	20	10	(14, 15)	0.187	0.076	11.739	1.492	71.459	(14, 15)	0.188	0.066	11.995	1.493	71.667
2	20	50	(13, 21)	0.336	0.465	13.468	2.053	93.526	(13, 21)	0.348	0.422	13.874	2.065	93.340
3	20	100	(12, 25)	0.618	0.978	14.513	2.402	115.364	(12, 25)	0.790	0.951	14.574	2.405	116.676
4	40	10	(15, 16)	0.104	0.173	13.128	1.583	73.170	(15, 16)	0.104	0.146	13.467	1.585	73.335
5	40	50	(14, 21)	0.202	0.611	14.551	2.039	96.025	(14, 21)	0.207	0.586	14.843	2.053	95.789
6	40	100	(14, 24)	0.238	1.207	15.923	2.279	119.266	(14, 24)	0.329	1.149	16.024	2.285	120.578
	$C = 15, W = 15$	P	K											
7	20	10	(14, 15)	0.187	0.076	11.739	1.492	172.480	(14, 15)	0.188	0.066	11.995	1.493	172.578
8	20	50	(12, 20)	0.537	0.248	12.273	1.975	196.781	(12, 20)	0.539	0.238	12.479	1.988	195.770
9	20	100	(11, 23)	0.861	0.465	12.737	2.253	220.949	(11, 23)	0.935	0.432	12.851	2.258	221.062
10	40	10	(14, 15)	0.187	0.076	11.739	1.492	174.988	(14, 15)	0.188	0.066	11.995	1.493	175.096
11	40	50	(14, 18)	0.189	0.248	13.160	1.775	199.777	(14, 18)	0.193	0.218	13.448	1.781	199.272
12	40	100	(13, 21)	0.336	0.465	13.468	2.053	225.674	(13, 21)	0.348	0.422	13.874	2.065	224.684
	$C = 5, W = 15$	P	K											
13	20	10	(14, 15)	0.187	0.076	11.739	1.492	71.969	(14, 15)	0.188	0.066	11.995	1.493	72.109
14	20	50	(13, 20)	0.330	0.344	13.184	1.966	95.482	(13, 20)	0.338	0.340	13.479	1.978	95.322
15	20	100	(11, 24)	0.881	0.611	13.186	2.339	118.697	(11, 24)	1.019	0.582	13.263	2.342	119.629
16	40	10	(15, 16)	0.104	0.173	13.128	1.583	74.262	(15, 16)	0.104	0.146	13.467	1.585	74.256
17	40	50	(14, 19)	0.192	0.344	13.628	1.866	98.229	(14, 19)	0.193	0.302	13.927	1.873	97.893
18	40	100	(13, 22)	0.345	0.611	14.097	2.139	123.019	(13, 22)	0.358	0.573	14.297	2.150	122.634
	$C = 15, W = 5$	P	K											
19	20	10	(14, 15)	0.187	0.076	11.739	1.492	171.969	(14, 15)	0.188	0.066	11.995	1.493	172.136
20	20	50	(13, 20)	0.330	0.344	13.184	1.966	195.482	(13, 20)	0.338	0.340	13.479	1.978	194.737
21	20	100	(11, 24)	0.881	0.611	13.186	2.339	218.697	(11, 24)	1.019	0.582	13.263	2.342	219.621
22	40	10	(15, 16)	0.104	0.173	13.128	1.583	174.261	(15, 16)	0.104	0.146	13.467	1.585	174.281
23	40	50	(14, 19)	0.192	0.344	13.628	1.866	198.229	(14, 19)	0.199	0.298	13.897	1.869	198.193
24	40	100	(13, 22)	0.345	0.611	14.097	2.139	223.019	(13, 22)	0.358	0.573	14.297	2.150	222.300
Average percent deviation from the simulation model				4.85%	10.25%	1.84%	0.29%	0.32%						
<i>Poisson demand with mean $D = 10$; $L = 1$; $m = 3$; $H = 1$</i>														

Table 3.1: Comparison of the proposed model with the simulation one for $L = 1$

Test problem	Cost parameters		Proposed model						Simulation model					
	P	K	(r_1, Q_1)	$E[S]$	$E[O]$	$E[I]$	$E[T]$	$TC_1(r_1, Q_1)$	(r_1, Q_1)	$E[S]$	$E[O]$	$E[I]$	$E[T]$	$TC_s(r_1, Q_1)$
	$C = 5, W = 5$													
1	20	100	(22, 26)	1.146	1.411	14.933	2.459	120.660	(22, 26)	1.172	1.264	14.93	2.474	119.926
2	20	150	(21, 28)	1.625	1.665	14.815	2.634	140.436	(21, 28)	1.784	1.541	14.769	2.646	140.765
3	20	200	(21, 30)	1.807	2.235	15.601	2.776	158.699	(21, 30)	2.134	2.134	15.425	2.787	160.151
4	40	100	(24, 25)	0.632	1.665	16.165	2.334	126.981	(24, 25)	0.552	1.468	16.377	2.353	124.503
5	40	150	(24, 26)	0.688	1.937	16.491	2.406	148.316	(24, 26)	0.600	1.743	16.732	2.426	145.633
6	40	200	(23, 28)	1.011	2.235	16.477	2.576	168.472	(23, 28)	1.049	2.076	16.499	2.592	167.865
	$C = 15, W = 15$													
7	20	100	(21, 23)	1.383	0.624	12.991	2.238	228.410	(21, 23)	1.391	0.533	12.852	2.247	226.833
8	20	150	(20, 25)	1.867	0.784	12.911	2.422	249.980	(20, 25)	1.939	0.693	12.79	2.431	248.979
9	20	200	(19, 28)	2.503	1.177	13.319	2.682	269.705	(19, 28)	2.783	1.088	13.097	2.691	270.243
10	40	100	(22, 23)	1.040	0.784	13.778	2.222	238.092	(22, 23)	1.023	0.669	13.761	2.233	235.864
11	40	150	(23, 24)	0.790	1.177	15.038	2.282	260.071	(23, 24)	0.754	1.020	15.078	2.298	256.793
12	40	200	(22, 25)	1.094	1.177	14.603	2.382	281.735	(22, 25)	1.104	1.040	14.557	2.396	279.482
	$C = 5, W = 15$													
13	20	100	(22, 23)	1.040	0.784	13.778	2.222	125.205	(22, 23)	1.023	0.669	13.761	2.233	123.701
14	20	150	(21, 26)	1.477	1.177	14.172	2.482	145.978	(21, 26)	1.559	1.056	14.051	2.494	145.174
15	20	200	(20, 28)	2.022	1.411	14.080	2.659	165.112	(20, 28)	2.250	1.304	13.928	2.670	165.449
16	40	100	(23, 24)	0.790	1.177	15.038	2.282	133.008	(23, 24)	0.754	1.020	15.078	2.298	130.596
17	40	150	(23, 24)	0.790	1.177	15.038	2.282	154.916	(23, 24)	0.754	1.020	15.078	2.298	152.354
18	40	200	(23, 26)	0.888	1.665	15.699	2.434	176.152	(23, 26)	0.855	1.493	15.823	2.451	173.552
	$C = 15, W = 5$													
19	20	100	(22, 23)	1.040	0.784	13.778	2.222	225.205	(22, 23)	1.023	0.669	13.761	2.233	223.705
20	20	150	(21, 26)	1.477	1.177	14.172	2.482	246.186	(21, 26)	1.559	1.056	14.051	2.494	245.190
21	20	200	(20, 28)	2.022	1.411	14.080	2.659	265.112	(20, 28)	2.250	1.304	13.928	2.670	265.434
22	40	100	(23, 24)	0.790	1.177	15.038	2.282	233.008	(23, 24)	0.754	1.020	15.078	2.298	230.596
23	40	150	(23, 24)	0.790	1.177	15.038	2.282	254.916	(23, 24)	0.754	1.020	15.078	2.298	252.354
24	40	200	(23, 26)	0.888	1.665	15.699	2.434	276.152	(23, 26)	0.855	1.493	15.823	2.451	273.540
Average percent deviation from the simulation model				5.90%	12.43%	0.65%	0.56%	0.90%						
<i>Poisson demand with mean $D = 10 ; L = 2 ; m = 3 ; H = 1$</i>														

Table 3.2: Comparison of the proposed model with the simulation one for $L = 2$

3.4. Consideration of the undershoot in an (r, Q) perishable inventory

C	P	K	W	r_1	Q_1	$TC_s(r_1, Q_1)$	$TC_1(r_1, Q_1)$	Percentage deviation %
5	20	10	5	13	16	109.709	71.579	34.756
5	20	50	5	13	21	100.432	93.224	7.177
5	20	100	5	12	25	130.325	115.157	11.638
5	40	10	5	15	16	77.528	72.547	6.424
5	40	50	5	14	20	105.617	95.447	9.629
5	40	100	5	13	24	130.117	118.758	8.730
15	20	10	15	14	16	159.569	172.081	-7.841
15	20	50	15	13	19	190.574	196.342	-3.027
15	20	100	15	12	23	237.104	218.755	7.739
15	40	10	15	15	16	159.579	173.844	-8.939
15	40	50	15	14	19	198.480	197.803	0.341
15	40	100	15	13	22	232.394	222.636	4.199
5	20	10	15	14	16	95.951	72.081	24.877
5	20	50	15	13	19	113.713	95.342	16.156
5	20	100	15	12	23	145.653	118.755	18.467
5	40	10	15	15	16	94.854	73.844	22.150
5	40	50	15	14	19	122.933	97.841	20.411
5	40	100	15	13	22	143.397	122.636	14.478
15	20	10	5	14	16	140.265	172.999	-23.337
15	20	50	5	12	19	173.248	196.799	-13.594
15	20	100	5	11	23	217.800	221.187	-1.555
15	40	10	5	14	16	142.253	174.965	-22.996
15	40	50	5	14	18	173.211	199.511	-15.184
15	40	100	5	13	21	209.000	225.463	-7.877
Average percentage deviation								12.980
<i>Normal demand with mean $D = 10$; Variance = 10; $L = 2$; $m = 3$; $H = 1$</i>								

Table 3.3: Comparison of the proposed model with the simulation one for a normal demand distribution

3.4 Consideration of the undershoot in an (r, Q) perishable inventory

By its definition, an (r, Q) inventory policy assumes that an order is placed when the inventory position reaches the reorder point, i.e., there is no undershoot of the reorder point. In order for this to be true, the state of the system must be examined after every demand and the demand size must be at maximum equal to one. However, it may happen that the number of units requested when a demand occurs, i.e., the quantity demanded, is greater than one unit. Thus, the use of an (r, Q) inventory system implicitly requires that an order of size Q is placed when the inventory position falls to or below the reorder point r . The amount below the reorder level r at the time when a

An (r, Q) Inventory Control with Fixed Lifetime and Lead time

<i>Test problem</i>	<i>Simulation model</i>		<i>Proposed model</i>			<i>Chiu's model</i>		
	(r_s, Q_s)	$TC_s(r_s, Q_s)$	(r_1, Q_1)	$TC_1(r_1, Q_1)$	$\Delta_{1s}TC(r, Q)\%$	(r_{ch}, Q_{ch})	$TC_c(r_{ch}, Q_{ch})$	$\Delta_{chs}TC(r, Q)\%$
1	(14, 15)	71.436	(14, 15)	71.459	0.03	(15, 13)	71.219	0.30
2	(13, 21)	93.340	(13, 21)	93.526	0.20	(13, 21)	93.649	0.33
3	(12, 25)	116.342	(12, 25)	115.364	0.85	(11, 25)	116.077	0.23
4	(16, 13)	72.819	(15, 16)	73.170	0.48	(16, 13)	72.531	0.40
5	(14, 21)	95.789	(14, 21)	96.025	0.25	(14, 20)	96.192	0.42
6	(13, 23)	120.290	(14, 24)	119.266	0.86	(13, 23)	120.017	0.23
7	(14, 14)	171.901	(14, 15)	172.480	0.34	(14, 13)	171.841	0.03
8	(12, 20)	195.770	(12, 20)	196.781	0.51	(12, 19)	196.731	0.49
9	(11, 23)	221.062	(11, 23)	220.949	0.05	(11, 22)	221.417	0.16
10	(16, 12)	173.259	(14, 15)	174.988	0.99	(16, 12)	173.434	0.10
11	(14, 18)	199.272	(14, 18)	199.777	0.25	(14, 18)	199.943	0.34
12	(13, 21)	224.684	(13, 21)	225.674	0.44	(13, 20)	226.415	0.76
13	(14, 14)	71.786	(14, 15)	71.969	0.25	(15, 13)	71.598	0.26
14	(13, 21)	95.281	(13, 20)	95.482	0.21	(12, 20)	95.514	0.24
15	(12, 23)	119.211	(11, 24)	118.697	0.43	(11, 23)	119.276	0.05
16	(16, 12)	73.125	(15, 16)	74.262	1.53	(16, 12)	73.023	0.14
17	(14, 19)	97.893	(14, 19)	98.229	0.34	(14, 18)	98.426	0.54
18	(13, 22)	122.634	(13, 22)	123.019	0.31	(13, 21)	123.851	0.98
19	(14, 14)	171.619	(14, 15)	171.969	0.20	(13, 15)	171.598	0.01
20	(13, 20)	194.737	(13, 20)	195.482	0.38	(12, 20)	195.514	0.40
21	(12, 23)	219.037	(11, 24)	218.697	0.16	(11, 23)	219.276	0.11
22	(16, 12)	172.953	(15, 16)	174.261	0.75	(16, 12)	173.023	0.04
23	(14, 20)	197.507	(14, 19)	198.229	0.36	(14, 18)	198.426	0.46
24	(13, 22)	222.300	(13, 22)	223.019	0.32	(13, 21)	223.851	0.69
<i>Average percent from the deviation simulation solution</i>					0.44%			0.32%

Poisson demand with mean $D = 10$; $L = 1$; $m = 3$; $H = 1$

Table 3.4: Comparison with Chiu's model and simulation for $L = 1$

replenishment decision is made can seriously lead to a consistent error when estimating the main performances of the (r, Q) inventory system. As a consequence, care must be taken when deriving the key operating characteristics of the (r, Q) policy. In this section, we relax the assumption of non occurrence of the undershoot of the reorder point. We re-examine the problem of computing numerically the total operating cost studied in Section (3.2) and show that the ignorance of the undershoot of the reorder point can seriously affect the inventory costs especially the shortage cost.

The first work regarding the estimation of the mean and the variance of the undershoot was conducted by Ross (1970). Hill (2008) showed that the non consideration of the undershoot may introduce a consistent bias in estimating the main performances of the inventory system. For the (r, Q) policy, the undershoot occurs when customer may request a batch demand rather than one unit or when the inventory is checked

3.4. Consideration of the undershoot in an (r, Q) perishable inventory

<i>Test problem</i>	<i>Simulation model</i>		<i>Proposed model</i>			<i>Chiu's model</i>		
	(r_s, Q_s)	$TC_s(r_s, Q_s)$	(r_1, Q_1)	$TC_1(r_1, Q_1)$	$\Delta_{1s}TC(r, Q)\%$	(r_{ch}, Q_{ch})	$TC_{ch}(r_{ch}, Q_{ch})$	$\Delta_{chs}TC(r, Q)\%$
1	(23, 25)	119.456	(22, 26)	120.660	1.00	(22, 24)	121.773	1.90
2	(22, 27)	140.055	(21, 28)	140.436	0.27	(21, 27)	142.318	1.59
3	(22, 28)	159.42	(21, 30)	158.699	0.45	(20, 29)	161.379	1.21
4	(25, 26)	124.404	(24, 25)	126.981	2.03	(24, 23)	127.876	2.72
5	(25, 26)	145.246	(24, 26)	148.316	2.07	(23, 24)	150.741	3.65
6	(25, 27)	165.934	(23, 28)	168.472	1.51	(22, 27)	171.389	3.18
7	(22, 23)	226.701	(21, 23)	228.410	0.75	(21, 22)	229.236	1.11
8	(21, 24)	248.620	(20, 25)	249.980	0.54	(20, 24)	251.689	1.22
9	(20, 26)	269.188	(19, 28)	269.705	0.19	(19, 26)	272.285	1.14
10	(24, 22)	234.756	(22, 23)	238.092	1.40	(24, 19)	237.302	1.07
11	(23, 24)	256.793	(23, 24)	260.071	1.26	(23, 22)	262.112	2.03
12	(23, 24)	278.551	(22, 25)	281.735	1.13	(22, 24)	285.026	2.27
13	(22, 23)	123.701	(22, 23)	125.205	1.20	(22, 22)	126.277	2.04
14	(22, 25)	145.058	(21, 26)	145.978	0.63	(20, 25)	147.969	1.97
15	(21, 27)	165.002	(20, 28)	165.112	0.07	(19, 27)	167.903	1.73
16	(24, 24)	130.460	(23, 24)	133.008	1.92	(24, 21)	133.438	2.23
17	(24, 25)	151.991	(23, 24)	154.916	1.89	(23, 23)	157.242	3.34
18	(24, 25)	173.241	(23, 26)	176.152	1.65	(22, 25)	179.349	3.41
19	(22, 23)	223.705	(22, 23)	225.205	0.67	(22, 22)	226.277	1.14
20	(22, 25)	245.058	(21, 26)	246.186	0.46	(20, 25)	247.969	1.17
21	(21, 27)	264.987	(20, 28)	265.112	0.05	(19, 27)	247.969	6.86
22	(23, 24)	230.477	(23, 24)	233.008	1.09	(24, 21)	233.438	1.27
23	(24, 25)	252.000	(23, 24)	254.916	1.14	(23, 23)	257.242	2.04
24	(23, 25)	273.446	(23, 26)	276.152	0.98	(22, 25)	279.349	2.11
<i>Average percent from the deviation simulation solution</i>					1.01%			2.18%

Poisson demand with mean $D = 10$; $L = 2$; $m = 3$; $H = 1$

Table 3.5: Comparison with Chiu's model and simulation for $L = 2$

periodically. [Baganha et al. \(1996\)](#) tested approximations of the mean and the variance of the undershoot distribution and showed that the lower the coefficient of variation of demand distributions, the higher the errors in the approximations. [Johansen & Hill \(2000\)](#) consider a periodic review (r, Q) inventory policy with normal demand distribution and investigate the cost saving when the undershoot is incorporated. They find that for the lost sales case, the consideration of the undershoot may save 2 – 3% of the total inventory cost. Other works dealing with inventory control with undershoot consider the estimation of its mean and variance (e.g. [Morris et al. \(1988\)](#); [Janssen & de Kok \(1999\)](#)).

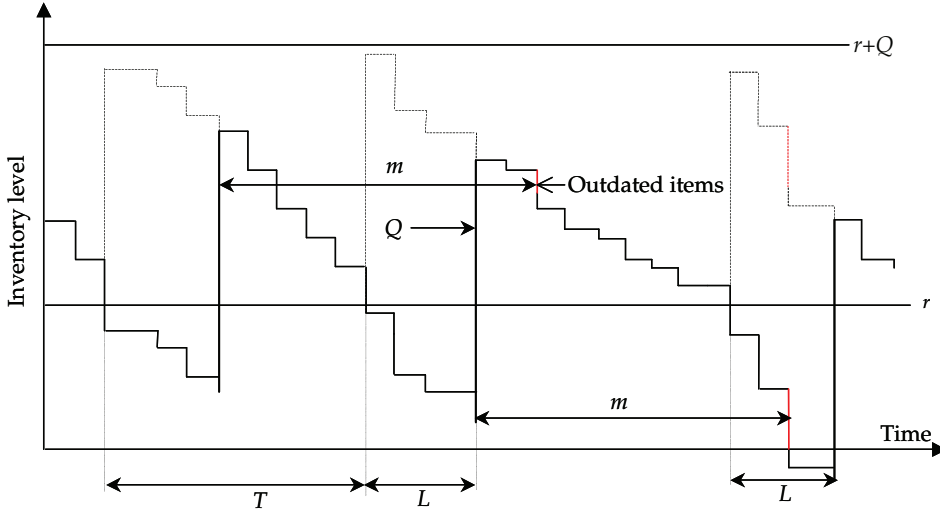

Figure 3.9: An (r, Q) inventory policy for perishable items

3.4.1 Model description

Again, we assume that items have a fixed lifetime of m units of time and the inventory is controlled with an (r, Q) review system. The depletion of the inventory over time is represented in Figure (3.9). We also assume that there is a replenishment lead time of length L units of time and once order arrives, all items in the same batch Q have the same ages. The inventory is depleted according to a *FIFO* issuing policy and all unmet demands are backlogged. The demand per unit time, z , is a nonnegative random variable following a distribution with mean μ_z and standard deviation σ_z , probability distribution function $f(z)$ and cumulative distribution function $F(z)$.

We use the same notations as in Section (3.2)

Additional notations

The undershoot distribution of the reorder point follows a nonnegative random variable u with mean μ_u , standard deviation σ_u and pdf $g(u)$. $\phi(\tau_n), \Phi_n(\tau_n)$: The pdf and the cdf of the sum of the random variable $\tau_n = u + d_n$ respectively.

Q_2 : The optimal order quantity for the proposed model with undershoots.

r_2 : The optimal reorder level for the proposed model with undershoots.

TC_2 : The average total cost for the proposed model.

The goal is to optimize the average total cost per unit of time formulated by Equation (3.1).

3.4. Consideration of the undershoot in an (r, Q) perishable inventory

The distribution of u can be approximated by the asymptotic residual lifetime distribution of the renewal process generated by demand per unit time. Following Tijms (1994), the mean and the standard deviation are denoted by:

$$\mu_u \simeq \frac{E[z^2]}{2E[z]}, \quad \sigma_u^2 \simeq \frac{E[z^3]}{3E[z]} - \frac{E[z^2]}{2E[z]} \quad (3.21)$$

Equation (3.21) holds if the order size Q satisfy the following inequations (Tijms, 1994):

$$\begin{cases} Q > (3/2)(cv_z)^2\mu_z & , \text{ if } (cv_z)^2 > 1 \\ Q > \mu_z & , \text{ if } 0.2 < (cv_z)^2 \leq 1 \\ Q > \mu_z/2cv_z & , \text{ if } 0 < (cv_z)^2 \leq 0.2 \end{cases}$$

Where cv_z is the coefficient of variation of z .

Expected outdating and backlogged quantities

following the same reasoning as in Subsections (3.2.1) and (3.2.2), the expected outdating quantity $E[O]$ and the expected backlogged quantity $E[S]$ are given by:

$$E[O] = \lim_{i \rightarrow +\infty} \omega^i(x_0) \quad (3.22)$$

$$\text{Where } \omega(x) = \int_0^{r+Q-x} (r+Q-x-y)\phi(y)dy \quad (3.23)$$

$$\text{and } \phi(\tau_{m+L}) = (g \otimes f_{m+L})(\tau_{m+L}) = \int_0^\infty g(x)f_{m+L}(\tau_{m+L}-x)dx \quad (3.24)$$

And

$$\begin{aligned} E[S] &= \bar{\Phi}_{m+L}(r+Q-E[O]) \int_r^\infty (\tau_L - r)\phi(\tau_L)d\tau_L \\ &+ \Phi_{m+L}(r+Q-E[O]) \int_{r-E[O]}^\infty (\tau_L - r + E[O])\phi(\tau_L)d\tau_L \end{aligned} \quad (3.25)$$

Where $\bar{\Phi}(\cdot) = 1 - \Phi(\cdot)$

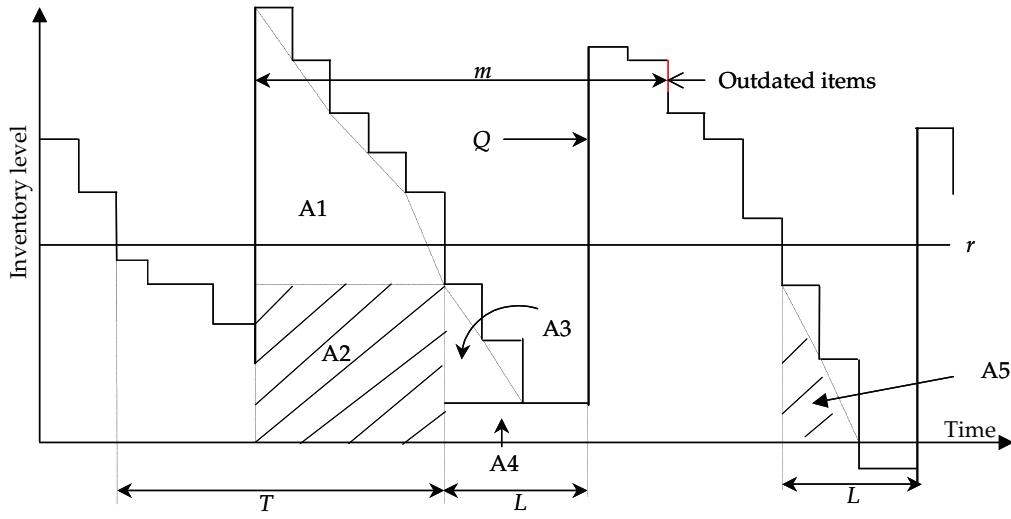

Figure 3.10: Expected inventory level

3.4.2 Expected inventory level per unit time

Again, we follow the reasoning of Subsection (3.2.3), however due to the undershoot occurrence, the expected inventory level is slightly different.

Case 1: Perishability does not occur during L

In this case, the old products can perish after the new order Q is received, otherwise they will be used before they perish. The expected inventory level after the arrival of the new order Q is given by the area $A1+A2$ as shown in Figure (3.10):

$$\begin{aligned}
 A1 + A2 &= \alpha \{E[T] - L\} \{r - \mu_u\} \\
 &+ \alpha \frac{E[T] - L}{2} \{Q - \mu_z L - E[O]\} + \alpha \{m - E[T]\} E[O] \quad (3.26)
 \end{aligned}$$

Where $\alpha = \Phi_{m+L}(r+Q-E[O])\Phi_L(r-E[O])$ is the probability of occurrence of perishability after order arrival. The first term, $\Phi_{m+L}(r+Q-E[O])$, is the probability that the order Q perishes after m units of time. The second term guarantees that the amount of perished products coming from the order Q occurs after receiving the new order Q .

The expected average inventory level during L where r meet all demand during L is

3.4. Consideration of the undershoot in an (r, Q) perishable inventory

donated by the area A3+A4:

$$\begin{aligned}
 A3 + A4 &= (\alpha + \bar{\Phi}_{m+L}(r + Q - E[O])) \left[\frac{L}{2} \int_0^r \int_0^{r-u} (d_L) f_L(d_L) g(u) dd_L du \right. \\
 &\quad \left. + L \int_0^r \int_0^{r-u} (r - u - d_L) f_L(d_L) g(u) dd_L du \right] \quad (3.27)
 \end{aligned}$$

The expected average inventory level during the lead time where the inventory is depleted before the new order arrives is approximated by the area A5:

$$A5 = \bar{\Phi}_{m+L}(r + Q - E[O]) \frac{L}{2} \int_0^r \int_{r-u}^{\infty} \frac{(r - u)^2}{d_L} f_L(d_L) g(u) dd_L du \quad (3.28)$$

Now, the total inventory level per cycle length is equal to:

$$E[I1] = \frac{A1 + A2 + A3 + A4 + A5}{E[T]} + \frac{\mu_z}{2} \quad (3.29)$$

Case 2: Perishability occurs during L

Using the same reasoning as in case 1. The expected inventory level after the arrival of the new order Q is approximated by the area A1+A2:

$$\begin{aligned}
 A1 + A2 &= [\Phi_{m+L}(r + Q - E[O]) \bar{\Phi}_L(r - E[O]) + \bar{\Phi}_{m+L}(r + Q - E[O])] \cdot \\
 &\quad [\{E[T] - L\} \{r - \mu_u\} + \frac{E[T] - L}{2} \{Q - \mu_z L\}] \quad (3.30)
 \end{aligned}$$

The expected average inventory level during the lead is approximated by the area A5:

$$A5 = \Phi_{m+L}(r + Q - E[O]) \bar{\Phi}_L(r - E[O]) \frac{m + L - E[T]}{2} \{r - \mu_u + E[O]\} \quad (3.31)$$

Now, the total inventory level per cycle length is equal to:

$$E[I2] = \frac{A1 + A2 + A5}{E[T]} + \frac{\mu_z}{2} \quad (3.32)$$

We note that Equation (3.28) is also based on the approximation developed by [Kim & Park \(1989\)](#) and by including the perishability issue. The total expected average inventory level for per unit time is the sum of $E[I1] + E[2]$.

3.4.3 The expected average total cost

The total expected average cost per unit time is now formulated by Equation (3.1), where $E[O]$ is the solution of equation $E[O] = \omega(E[O])$, $E[S]$ by Equation (3.25) and $E[I]$ is the sum of Equation (3.29) and (3.32) and

$$E[T] = \frac{Q - E[O]}{\mu_z} \quad (3.33)$$

Investigating analytical properties of the cost function (3.1) is difficult, however several numerical examples indicate that $TC_2(r, Q)$ is jointly convex in Q and r . Figure (3.11) below is an illustration of the convexity of $TC_2(r, Q)$. For the other numerical analysis settings used in Section (3.5), we have also verified the convexity of $TC_2(r, Q)$.

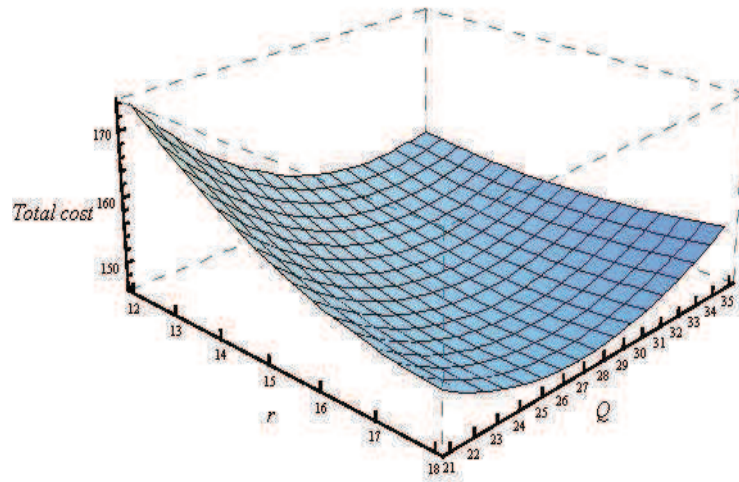

Figure 3.11: Variation of the total expected cost (fixed parameters : Normal demand $N(10, 3)$, $C = 5$, $P = 20$, $K = 150$, $W = 5$, $H = 1$, $L = 1$, $m = 3$)

3.5 Evaluation of the performance of the proposed model with undershoots

In this section, we are focusing on two comparisons:

- In order to validate our new model where the undershoot of the reorder point is taken into account, we compare the different key operating characteristics of our model versus those obtained from a simulation model.

- We compare between the expected total cost pertaining to the model we propose and the expected total cost pertaining to the classical (r, Q) inventory policy that does not take into account the perishability of products. We study the behavior of the proposed model by varying the different cost parameters and the lifetime m .

Let Q_c , r_c and TC_c be the optimal order quantity, the optimal reorder level and the average total cost for the classical (r, Q) model (which ignores the perishability of products) respectively. Denotes by Q_2 , r_2 and TC_2 the optimal order quantity, the optimal reorder level and the average total cost for the proposed (r, Q) model.

3.5.1 Comparison with the simulation model

We suppose that demand is normally distributed with mean $\mu_z = 20$ and standard deviation $\sigma_z = 5$. we set $L = 2$ and $m = 6$.

For normal demand distribution we have:

$$\begin{cases} \mu_u = \frac{\mu_z^2 + \sigma_z^2}{2\mu_z} \\ \sigma_u^2 = \frac{\mu_z^2 + 3\sigma_z^2}{3} - \mu_u^2 \end{cases}$$

Assumption (3) implies that the pdf of τ_{m+L} is normally distributed with mean $\mu_u + (m + L)\mu_z$ and standard deviation $\sqrt{\sigma_u^2 + (m + L)\sigma_z^2}$.

The performance of the proposed model in comparison with the simulation model is measured by the average percentage differences defined as follows:

$$E[X]\% = 100 \frac{E[X] - E[X]_{simulation\ model}}{E[X]_{simulation\ model}}$$

An (r, Q) Inventory Control with Fixed Lifetime and Lead time

Where $X = O, S, I, T$ or $TC(r, Q)$.

Table (3.6) illustrates the inventory control parameters obtained from the proposed model and the simulation model. We set the replication length of a simulation run to be 150000 units time and we use 20 replications. (These two simulation parameters are chosen in order to have an accurate estimation of the main parameters of system performance). Basically, the major conclusion drawn from the simulation experiments are:

- 1) The inventory control parameters obtained from the proposed model and the simulation model are almost the same: our model generates a total cost smaller than the simulated one but this underestimation is insignificant since the average deviation is only 0.19%.
- 2) The proposed expected outdated approximation is higher than the simulated one. The reason of this overestimation is due to the fact that in our approximation, we consider that perishability occurs for each cycle whatever its length. However, in the simulation model it may happen that perishability does not occur especially for short cycle times.
- 3) $E[I]$ and $E[T]$ are slightly different from the simulation values.
- 4) The non consideration of the undershoot can seriously affect the costs especially the expected backlog quantity.

Test problem	Cost parameters		Ordering Policy (r, Q)	Simulation model					Proposed model with undershoot					Proposed model without undershoot						
	C	W		P	K	$E[S]$	$E[O]$	$E[I]$	$E[T]$	$TC(r, Q)$	$E[S]$	$E[O]$	$E[I]$	$E[T]$	$TC(r, Q)$	$E[S]$	$E[O]$	$E[I]$	$E[T]$	$TC(r, Q)$
	$C = 5 \quad W = 15$																			
1	10	400	(46, 103)		6.776	0.522	57.349	5.125	250.638	6.669	0.554	57.036	5.122	250.312	0.588	0.427	58.325	5.129	239.130	
2	10	500	(43, 109)		9.240	0.767	57.193	5.413	269.459	8.909	0.808	57.339	5.410	269.226	1.345	0.773	58.207	5.411	255.947	
3	10	600	(41, 114)		11.190	1.106	57.583	5.646	287.575	10.600	1.140	59.726	5.643	286.896	2.201	1.275	58.633	5.636	273.515	
4	50	400	(60, 93)		0.960	0.821	66.287	4.610	267.014	0.898	0.910	67.063	4.605	267.637	0.002	0.922	68.301	4.604	258.206	
5	50	500	(60, 96)		0.965	1.185	67.815	4.742	288.426	0.915	1.270	68.474	4.737	289.056	0.002	1.478	68.677	4.726	280.748	
6	50	600	(59, 99)		1.202	1.493	68.202	4.876	309.676	1.123	1.558	68.771	4.872	309.839	0.004	1.939	69.059	4.853	300.724	
	$C = 5 \quad W = 30$																			
7	10	400	(45, 101)		7.418	0.341	55.410	5.034	251.961	7.353	0.368	54.520	5.032	251.193	0.776	0.213	56.415	5.039	238.811	
8	10	500	(43, 106)		9.067	0.519	55.829	5.275	271.230	8.875	0.555	55.281	5.272	270.633	1.316	0.427	56.844	5.279	256.890	
9	10	600	(41, 110)		10.851	0.677	55.773	5.467	289.682	10.521	0.716	55.626	5.464	289.271	2.096	0.641	56.832	5.468	274.499	
10	50	400	(60, 88)		0.959	0.433	63.833	4.379	270.708	0.886	0.486	65.176	4.422	270.038	0.001	0.427	65.406	4.429	259.117	
11	50	500	(59, 93)		1.137	0.739	65.361	4.614	291.634	1.078	0.808	65.924	4.610	292.230	0.003	0.773	66.332	4.611	280.653	
12	50	600	(59, 94)		1.133	0.831	65.849	4.659	313.002	1.083	0.910	66.400	4.655	313.782	0.003	0.922	66.800	4.654	302.687	
Average percent deviation from the simulation solution										4.326 %	6.818 %	1.179%	0.150%	0.194%	92.628 %	14.887%	1.816%	0.224%	4.203%	

Normal demand $N(20, 5)$; $L=2$; $m=6$; $H=1$

Table 3.6: Comparison of the proposed model with the simulation one

3.5.2 Comparison 1: $TC_2(r_2, Q_2)$ vs. $TC_c(r_c, Q_c)$

In this subsection, we compare the proposed model to the classical model which can be written as:

$$TC_c(r_c, Q_c) = \frac{K + CQ_c + PE[S_1]}{E[T]} + HE[I] \quad (3.34)$$

Where:

$$E[S_1] = \int_r^\infty (\tau_L - r)\phi(\tau_L)d\tau_L \quad (3.35)$$

$E[T] = Q/\mu_z$ and

$$\begin{aligned} E[I] &= \frac{\{E[T] - L\}\{r - \mu_u\} + \frac{E[T]-L}{2}\{Q - \mu_z L\}}{E[T]} \\ &+ \frac{L}{2T[T]} \int_0^r \int_0^{r-u} (d_L)f_L(d_L)g(u)dd_Ldu \\ &+ \frac{L}{E[T]} \int_0^r \int_0^{r-u} (r - u - d_L)f_L(d_L)g(u)dd_Ldu \\ &+ \frac{L}{2E[T]} \int_0^r \int_{r-u}^\infty \frac{(r - u)^2}{d_L} f_L(d_L)g(u)dd_Ldu \end{aligned} \quad (3.36)$$

We note that the expression of $E[I]$ is derived from Kim and Park's approximation (Kim & Park, 1989) and by integrating the undershoot distribution. We note also that the commonly known $r - \mu_z L + Q/2$ expected inventory level is inappropriate since the undershoot is not taken into account.

We suppose that demand is Normally distributed with mean $\mu_z = 10$ and standard deviation $\sigma_z = \{1, 2\}$. we set $L = 1$, $m = 3$ and $H = 1$.

For a Normal demand distribution, we have: $\mu_u = (\mu_z^2 + \sigma_z^2)/2\mu_z$ and $\sigma_u^2 = [(\mu_z^2 + 3\sigma_z^2)/3] - \mu_u^2$. Assumption (3) implies that the pdf of τ_{m+L} is also Normally distributed with mean $\mu_u + (m + L)\mu_z$ and standard deviation $\sqrt{\sigma_u^2 + (m + L)\sigma_z^2}$.

As shown in Table (3.7), $TC_c(r_c, Q_c)$ is always lower than $TC_2(r_2, Q_2)$. This is not surprising since the outdated cost is not considered in $TC_c(r_c, Q_c)$.

3.5.2.1 Comparison 2: i.e. $TC_2(r_2, Q_2)$ vs. $TC_2(r_c, Q_c)$

In the presence of perishability, if the inventory manager decides to ignore the perishable feature of products held in inventory, he/she would incur a cost equal to $TC_2(r_c, Q_c)$. This stems from the fact that the inventory control decisions are not optimised in pres-

3.5. Evaluation of the performance of the proposed model with undershoots

ence of perishability. If one compares $TC_2(r_c, Q_c)$ to $TC_2(r_2, Q_2)$ (cf. Table (3.7) and (3.8)), the following results are obtained:

1- The (r, Q) policy which does not optimize inventory control parameters, $(TC_2(r_c, Q_c))$, is inappropriate to control the inventory of perishable products. Table (3.7) shows that the percentage difference of using this policy is significantly high for the entire range of parameters considered.

2- The optimal ordering quantity increases as K increases for both the proposed and the classical model. However, this increase is higher for the classical policy in comparison to the proposed model. This can be explained intuitively by the fact that perishable products call for a smaller order quantity.

3- r_2 is slightly smaller than r_c . The reason is because of the small probability of occurrence of perishability during the lead time.

4- Results of Table (3.9) show that the expected average total cost is highly sensitive to the product lifetime m . The percentage difference between the two policies is significantly large when m decreases. When m increases the proposed model tends to converge to the classical one.

5- For a fixed value of P , the percentage difference becomes high as the setup cost K increases. However, if K becomes very high the outdate cost W has no longer effect on r_2 and Q_2 . The average total cost reaches a steady state (Figure (3.12)).

6- For a fixed value of K , the percentage difference ($TC\% = 100[TC_2(r_c, Q_c) - TC_2(r_2, Q_2)] / TC_2(r_c, Q_c)$) increases as the backlog cost P increases (Figure (3.13)).

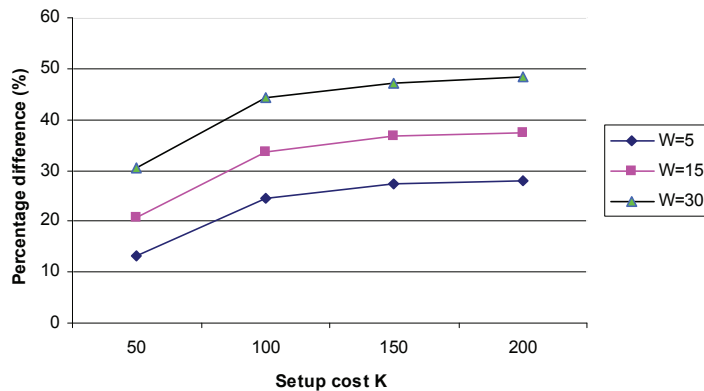

Figure 3.12: Percentage difference $TC\%$ with respect to K

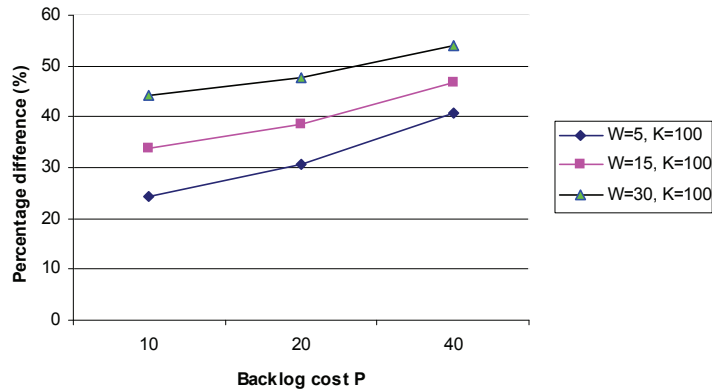

Figure 3.13: Percentage difference $TC\%$ with respect to P

3.6 Conclusion

The problem of inventory control for perishable products with fixed lifetime is known to be difficult. As mentioned by Schmidt & Nahmias (1985) it is unlikely to find or to use an optimal and exact policy. Hence, research has been shifted on finding ways to develop heuristic approaches. Our contribution is therefore to provide a comprehensive heuristic approach dealing with a large wide range of perishable products with fixed lifetime and constant replenishment lead time.

In this chapter, we have proposed a continuous review inventory model for perishable products with limited lifetime and operating under a constant lead time. Allowing the backordering case, a new approximation of the outdating quantity of products was presented. The effectiveness of model we have proposed was validated by simulation; our results are closer to the simulation values and outperforms the model of Chiu notably for large values of the lead time. When considering the undershoot of the reorder point r , we have shown that the proposed model performs better than the conventional (r, Q) policy especially for a product with short lifetime.

Possible further research can be addressed on the same problem by relaxing some assumptions. An interesting extension of this work can be addressed on the (s, S) policy which accommodate the undershoot on the way where we order up to S rather than a fixed quantity. Another perspective would be to extend the model by giving a more accurate expression of the expected backlog quantity or considering the lost sales case.

3.6. Conclusion

Test problem	Cost parameters			Proposed model			Classical model			Percentage difference		
				r_2	Q_2	$TC_2(r_2, Q_2)$	r_c	Q_c	$TC_c(r_c, Q_c)$	$TC_2(r_c, Q_c)$	$TC\%$	
	$C = 5$	$W = 5$	P	K								
1			10	50	16	24	95.428	17	35	91.632	109.899	13.17%
2			10	100	14	27	115.526	16	48	103.691	152.949	24.47%
3			10	150	13	31	133.061	15	58	113.075	183.488	27.48%
4			10	200	10	35	149.057	14	67	121.028	207.098	28.03%
5			20	50	18	22	98.796	19	34	93.058	116.415	15.13%
6			20	100	17	26	120.198	18	47	104.947	173.426	30.69%
7			20	150	16	28	139.667	17	57	114.848	215.219	35.10%
8			20	200	16	29	157.923	17	66	122.894	248.099	36.35%
9			40	50	20	21	101.472	20	35	94.343	130.182	22.05%
10			40	100	19	24	124.339	20	47	106.630	209.306	40.59%
11			40	150	19	26	145.291	19	57	116.233	273.414	46.86%
12			40	200	18	27	165.070	19	66	124.363	320.852	48.55%
	$C = 5$	$W = 15$	P	K								
13			10	50	16	22	96.891	17	35	91.632	122.259	20.75%
14			10	100	14	27	117.610	16	48	103.691	177.412	33.71%
15			10	150	12	30	135.813	15	58	113.075	215.016	36.84%
16			10	200	9	34	152.126	14	67	121.028	243.554	37.54%
17			20	50	18	21	100.251	19	34	93.058	130.793	23.35%
18			20	100	17	24	122.814	18	47	104.947	200.201	38.65%
19			20	150	16	26	143.129	17	57	114.848	249.028	42.52%
20			20	200	15	28	162.068	17	66	122.894	288.227	43.77%
21			40	50	19	20	103.685	20	35	94.343	147.453	29.68%
22			40	100	19	22	127.536	20	47	106.630	239.556	46.76%
23			40	150	18	25	149.393	19	57	116.233	310.437	51.88%
24			40	200	18	26	169.939	19	66	124.363	364.019	53.32%
	$C = 5$	$W = 30$	P	K								
25			10	50	16	21	97.973	117	35	91.632	140.798	30.42%
26			10	100	14	25	119.550	16	48	103.691	214.106	44.16%
27			10	150	12	28	138.466	15	58	113.075	262.306	47.21%
28			10	200	8	41	154.402	14	67	121.028	298.239	48.23%
29			20	50	18	20	101.963	19	34	93.058	152.36	33.08%
30			20	100	17	23	125.451	18	47	104.947	240.364	47.81%
31			20	150	16	25	146.612	17	57	114.848	299.741	51.09%
32			20	200	15	27	166.292	17	66	122.894	348.418	52.27%
33			40	50	19	20	105.620	20	35	94.343	173.36	39.07%
24			40	100	19	21	130.645	20	47	106.630	284.931	54.15%
35			40	150	15	23	153.503	19	57	116.233	365.97	58.06%
36			40	200	17	25	175.042	19	66	124.363	428.77	59.18%

$$\text{Normal demand } N(10, 2); L = 1; m = 3; H = 1; TC\% = 100 \frac{TC_2(r_c, Q_c) - TC_2(r_2, Q_2)}{TC_2(r_c, Q_c)}$$

Table 3.7: Comparison of the proposed model with classical (r, Q) for normal demand distribution with $cv = 0.2$

An (r, Q) Inventory Control with Fixed Lifetime and Lead time

Test problem	Cost parameters		Proposed model			Classical model			Percentage difference	
			r_2	Q_2	$TC_2(r_2, Q_2)$	r_c	Q_c	$TC_c(r_c, Q_c)$	$TC_2(r_c, Q_c)$	$TC\%$
	$C = 5$	$W = 5$	P	K						
1	10	50	16	25	93.184	17	34	90.967	105.966	12.06%
2	10	100	15	28	112.264	16	47	103.154	151.223	25.76%
3	10	150	13	31	129.621	15	58	112.619	183.855	29.50%
4	10	200	12	33	145.816	14	67	120.666	207.409	29.70%
5	20	50	18	23	95.4379	18	34	92.120	112.539	15.20%
6	20	100	17	26	115.765	18	47	104.484	173.983	33.46%
7	20	150	16	28	134.607	17	57	114.040	215.512	37.54%
8	20	200	16	29	152.649	17	65	122.213	246.119	37.98%
9	40	50	19	22	97.3946	19	34	93.190	121.795	20.03%
10	40	100	18	25	118.898	19	47	105.560	210.64	43.55%
11	40	150	18	27	138.825	18	57	115.260	273.951	49.32%
12	40	200	18	27	158.101	18	65	123.407	317.194	50.16%
	$C = 5$	$W = 15$	P	K						
13	10	50	16	24	93.7521	17	34	90.967	116.367	19.43%
14	10	100	14	27	113.524	16	47	103.154	174.838	35.07%
15	10	150	13	29	131.404	15	58	112.619	215.598	39.05%
16	10	200	11	32	147.897	14	67	120.666	244.074	39.40%
17	20	50	18	22	96.1744	18	34	92.120	124.557	22.79%
18	20	100	17	25	117.342	18	47	104.484	200.929	41.60%
19	20	150	16	27	136.783	17	57	114.040	249.551	45.19%
20	20	200	15	28	155.326	17	65	122.213	285.829	45.66%
21	40	50	19	20	98.5818	19	34	93.190	135.525	27.26%
22	40	100	18	24	120.613	19	47	105.560	239.322	49.60%
23	40	150	18	25	141.354	18	57	115.260	309.585	54.34%
24	40	200	17	27	161.102	18	65	123.407	358.422	55.05%
	$C = 5$	$W = 30$	P	K						
25	10	50	16	21	94.2531	17	34	90.967	131.968	28.58%
26	10	100	14	26	114.629	16	47	103.154	210.259	45.48%
27	10	150	13	28	133.018	15	58	112.619	263.213	49.46%
28	10	200	5	37	150.329	14	67	120.666	299.071	49.73%
29	20	50	18	21	96.8492	18	34	92.120	142.585	32.08%
30	20	100	17	24	118.788	18	47	104.484	241.348	50.78%
31	20	150	16	26	138.892	17	57	114.040	300.609	53.80%
32	20	200	15	27	157.859	17	65	122.213	345.394	54.30%
33	40	50	19	20	99.0663	19	34	93.190	156.119	36.54%
34	40	100	18	23	122.232	19	47	105.560	282.345	56.71%
35	40	150	17	25	143.897	18	57	115.260	363.035	60.36%
36	40	200	17	25	164.166	18	65	123.407	420.263	60.94%

$$\text{Normal demand } N(10, 1); L = 1; m = 3; H = 1; TC\% = 100 \frac{TC_2(r_c, Q_c) - TC_2(r_2, Q_2)}{TC_2(r_c, Q_c)}$$

Table 3.8: Comparison of the proposed model with classical (r, Q) for normal demand distribution with $cv = 0.1$

Lifetime	Our model			Classical model			Percentage difference
m	r_2	Q_2	$TC_2(r_2, Q_2)$	r_c	Q_c	$TC_c(r_c, Q_c)$	Δ
2	16	19	144.177	18	47	104.947	27.21%
3	16	26	120.200	18	47	104.947	12.69%
4	18	32	110.530	18	47	104.947	5.05%
5	18	39	106.510	18	47	104.947	1.47%
6	18	45	105.168	18	47	104.947	0.21%
7	18	47	104.952	18	47	104.947	0.00%
8	18	47	104.947	18	47	104.947	0.00%

Fixed parameters: $C = 5$; $P = 20$; $K = 100$; $W = 5$; $L = 1$; $m = 3$; Normal demand $N(10, 2)$

$$\Delta = 100[TC_2(r_2, Q_2) - TC_c(r_c, Q_c)]/TC_2(r_2, Q_2)$$

Table 3.9: Variation of the expected total cost with m

Chapter 4

Impact of Random Lifetime in Periodic Review Perishable Inventory Systems

4.1 Introduction

In this chapter we consider a periodic review inventory policy where items have a random lifetime. We assume that the lifetime is modeled by an exponential distribution. The memoryless property of the exponential distribution allows us to use Markov renewal theory which simplifies our analysis and then, get some useful insights on the impact of considering items' lifetime randomness on inventory management.

Perishable inventory systems with periodic review have been studied independently by [Fries \(1975\)](#) and [Nahmias \(1975\)](#). Both consider the zero lead time case and constant lifetime. By using a dynamic programming approach, they show that the base stock policy is a good approximation of the real optimal policy. However, due to the intractability of the age distribution of items available in stock, the computation of the optimal S becomes difficult. Henceforth, research has been directed towards heuristic approximations. For example, [Nahmias \(1977b\)](#) suggests to group older on hand items together in order to reduce the state space. This approximation is based on the property of the optimal ordering policy in which the order quantity decreases by less than one unit when the on hand inventory increases by one unit. This means that the order

quantity is more sensitive to the fresh available inventory rather than the older inventory. [Nandakumar & Morton \(1993\)](#) derive myopic upper and lower bounds on the order quantities for the base stock inventory policy with fixed lifetime and use these bounds to develop two heuristics. The heuristics provide a good approximation of the true optimal base stock policy by less than 1% average error.

For a stochastic products' lifetime and constant lead time, the existing efforts dealing with perishable inventory consider only the continuous review inventory policies. [Kalpakam & Sapna \(1994\)](#) have studied an (s, S) model with Poisson demand, exponential lead time and exponential lifetime. Based on Markov chain technique, the exact cost function was obtained. Some extensions of this model have been considered. [Kalpakam & Shanthi \(1998\)](#) proposed a similar model in which orders are placed only at demand epochs. Later, the authors consider the case of renewal demand ([Kalpakam & Shanthi, 2006](#)). [Liu & Yang \(1999\)](#) have considered a similar model and derived the total expected cost function.

To the best of our knowledge, the periodic review perishable inventory with stochastic lifetime is not studied yet. Our motivation is to provide the exact analysis of the order up to level policy for an item with random lifetime which allows us to get some insights on the impact of the parameters on the overall system performance in terms of costs. The procurement lead time is constant and excess demand are completely lost or fully backordered. The embedded Markov Renewal Process is used to derive the steady state probabilities and obtain the operating costs. The two proposed policies are compared to the classical (T, S) systems which ignores the perishability of items (infinite lifetime) and to the (T, S) system where products' lifetime are deterministic. Our numerical investigations show that the ignorance of randomness leads to a higher cost.

The remainder of this chapter is organized as follows: in Section (4.2), we derive the steady state probabilities of the inventory process and obtain the expected total operating cost under the full lost sales case. Section (4.3) concerns the full backorders case. In Section (4.4), we develop an algorithm to compute the optimal T and S that minimizing the total operating cost. In Section (4.5), we conduct numerical analysis. Finally, the chapter end with conclusion in section 5.

4.2 The (T,S) model with full lost sales

4.2.1 Transition probabilities

We study a (T, S) perishable inventory policy with random lifetime and fixed lead time. The inventory level is observed at equal intervals of time, T and a replenishment order is placed every T units of time to bring the inventory level to the order-up-to-level S . The demand follows a Poisson distribution with rate λ . The lifetime of each item is exponentially distributed with rate δ . An order triggered at the beginning of the period T arrives after a fixed lead time L , where $L \leq T$. Note that the condition $L \leq T$ ensures one outstanding order at any time. Figure (4.1) shows the inventory depletion through time.

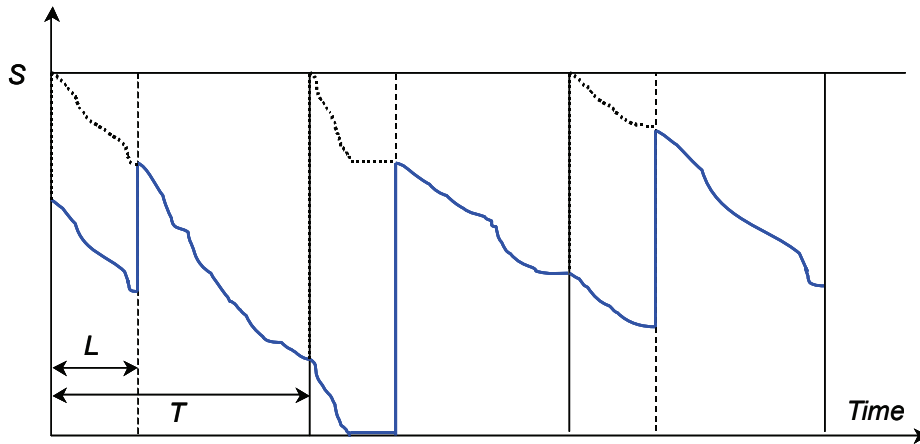

Figure 4.1: Periodic review inventory policy for perishable products

Notations

K : Fixed ordering cost per order.

H : Holding cost per unit of item held in stock per unit of time.

C : Purchase cost per unit of item.

b : Lost sale/backorder cost per unit of item.

W : Outdate cost per unit of item.

L : Replenishment lead time.

$E[O]$: The expected outdating quantity per unit time.

$E[S]$: The expected lost sales per unit time.

$E[I]$: The expected inventory level per unit time.

Impact of Random Lifetime in Periodic Review Perishable Inventory Systems

$\mathbb{N} = \{i, 0 \leq i \leq S\}$: state space of the inventory level in the lost sales case.

$p_{i,j}(t)$: Transition probability from the state i to the state j at time t , where $(i, j) \in \mathbb{N}$.

$P(i)$ steady state probability that the inventory level is i just at order arrival.

The expected average total cost per unit of time can be formulated by the following equation:

$$TC(T, S) = \frac{K}{T} + C(\lambda + E[O] - E[S]) + HE[I] + WE[O] + bE[S] \quad (4.1)$$

Let $I(t)$ be the process of the on hand inventory level at time t and $\{nT + L, n = 0, 1, 2, \dots\}$ denotes the successive epochs at which the replenishment occurs. Let $I_n = I(nT + L)$ and define the transition probability from the state $i \in \mathbb{N}$ to the state $j \in \mathbb{N}$ at time t , where $nT + L \leq t < (n + 1)T + L$, i.e,

$$p_{i,j}(t) = P\{I(t) = j \mid I_n = i, nT + L \leq t < (n + 1)T + L\}$$

The process $(\mathbf{I}) = \{I(t), nT + L \leq t \leq (n + 1)T + L, n = 0, 1, 2, \dots\}$ is a generalized death process with rate $\lambda + j\delta$. Note that $(\mathbf{I}) = \{I(t), nT \leq t \leq (n + 1)T, n = 0, 1, 2, \dots\}$ is not a death process since the procurement lead time is not exponential. As a consequence, the process $\{I_n, n = 0, 1, 2, \dots\}$ is a discrete Markov chain. We are interested in the steady state probability denoted by:

$$P(i) = \lim_{n \rightarrow \infty} \text{Probability}\{I_n = i\} \text{ for all } i \in \mathbb{N}$$

Since the process $(\mathbf{I}) = \{I(t), nT + L \leq t \leq (n + 1)T + L, n = 0, 1, 2, \dots\}$ is a puregeneralized death process, we can then write Kolmogorov's Forward Equations for the lost sales case:

$$\frac{dp_{i,j}(t)}{dt} = \begin{cases} -(\lambda + i\delta)p_{i,j}(t) & \text{if } i = j, (i, j) \in \mathbb{N} \\ -(\lambda + j\delta)p_{i,j}(t) + (\lambda + (j + 1)\delta)p_{i,j+1}(t) & \text{if } 0 \leq j \leq i - 1, (i, j) \in \mathbb{N} \end{cases} \quad (4.2)$$

Taking Laplace transform of the above equations, we obtain:

$$\begin{cases} (z + \lambda + i\delta)p_{i,j}(z) = 0 & \text{if } i = j, (i, j) \in \mathbb{N} \\ (z + \lambda + j\delta)p_{i,j}(z) = (\lambda + (j + 1)\delta)p_{i,j+1}(z) & \text{if } 0 \leq j \leq i - 1, (i, j) \in \mathbb{N} \end{cases} \quad (4.3)$$

Taking the initial condition $p_{i,i}(0) = 0$ and solving the above equations recursively, we

get:

$$p_{i,j}(z) = \frac{1}{\lambda + j\delta} \prod_{k=j}^i \frac{\lambda + k\delta}{z + \lambda + k\delta} \quad (i, j) \in \mathbb{N} \quad (4.4)$$

This equation have $i - j$ root. To invert it, we note that it is easy to decompose $p_{i,j}(z)$ into a sum of simple functions, then after simplification, we get:

$$p_{i,j}(t) = \begin{cases} \frac{e^{-(\lambda+i\delta)t} (e^{\delta t} - 1)^{i-j} \prod_{n=j+1}^i (\lambda + n\delta)}{(i-j)! \delta^{i-j}} & \text{if } 0 < j \leq i-1, (i, j) \in \mathbb{N} \\ 1 - \sum_{k=1}^i p_{i,k}(t) & \text{if } j = 0, i \in \mathbb{N} \\ 0 & \text{otherwise.} \end{cases} \quad (4.5)$$

At time $(n+1)T$ a replenishment is triggered. Starting from the state i at time $nT + L$, the probability transition from i to j at time $(n+1)T$ is given by $p_{i,j}(T - L)$. Now, at time $(n+1)T + L$ the replenishment of size $S - j$ occurs and $j - m, m \leq j, (j, m) \in \mathbb{N}$ items are either demanded or perished during L units of time. Figure (4.2) shows the probability transition from the state j at time $(n+1)T$ to the state $l = S - j + m$ at time $(n+1)T + L$. Hence,

$$p_{j,l}(L) = p_{j,m}(L) = \begin{cases} \frac{e^{-(\lambda+j\delta)t} (e^{\delta t} - 1)^{j-m} \prod_{n=m+1}^j (\lambda + n\delta)}{(j-m)! \delta^{j-m}} & \text{if } 0 < m \leq j, (j, m) \in \mathbb{N} \\ 1 - \sum_{k=1}^i p_{i,k}(t) & \text{if } m = 0, j \in \mathbb{N} \\ 0 & \text{otherwise.} \end{cases} \quad (4.6)$$

To find the transition probability from the state i at time $nT + L$ to l at time $(k+1)T + L$, we sum over all possible transitions from i to j at time $(n+1)T$ to the state l at time $(n+1)T + L$, that is:

$$p_{i,l}(T) = \sum_{j=0}^i p_{i,j}(T - L) p_{j,l}(L) \quad (4.7)$$

Where $(i, l) \in \mathbb{N}, l = S - j + m$ and $m \leq j$

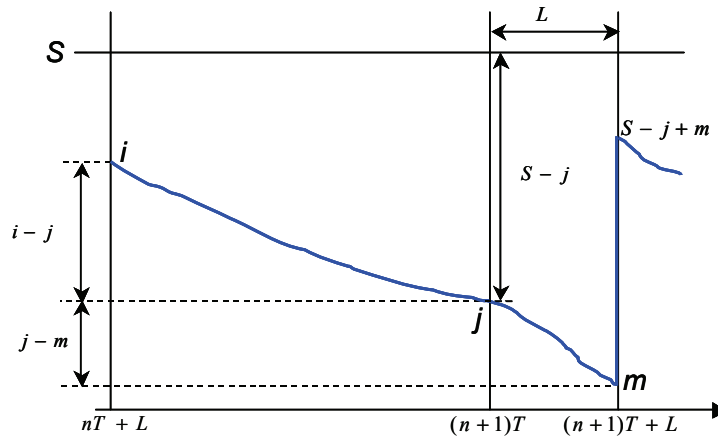

Figure 4.2: Transition probabilities

4.2.2 Steady state probability

The process $\{I_n, n = 0, 1, 2, \dots\}$ is an aperiodic irreducible discrete Markov chain with finite state space, therefore the steady state probability $P(i), i \in \mathbb{N}$ exists and it is unique. Analytically, computing $P(i)$ is not straightforward, the well known generating function technique cannot lead to a closed-form expressions of the stationary probabilities. Henceforth, we opt for a numerical solution. To do so, we use a simple algorithm of fixed point iteration defined as follows:

Let Z the transition matrix where $Z(i, j) = p_{i,j}(T - L)$ and A the transition matrix where $A(i, j) = p_{i,j}(L^-)$.

$$A = \begin{pmatrix} 1 & 0 & 0 & \cdots & 0 \\ p_{1,0}(L) & p_{1,1}(L) & 0 & \cdots & 0 \\ \vdots & \vdots & \vdots & \ddots & \vdots \\ p_{S-1,0}(L) & p_{S-1,1}(L) & p_{S-1,2}(L) & \cdots & 0 \\ p_{S,0}(L) & p_{S,1}(L) & p_{S,2}(L) & \cdots & p_{S,S}(L) \end{pmatrix} \quad (4.8)$$

At time $nT + L$ the replenishment of size $S - i$ occurs, denote by D the Matrix transition probability from the state i to the state l at exactly $nT + L$. $D(i, l) = A(i, S - l)$.

$$D = \begin{pmatrix} 0 & \cdots & 0 & 0 & 1 \\ 0 & \cdots & 0 & p_{1,1}(L) & p_{1,0}(L) \\ \vdots & \ddots & \vdots & \vdots & \vdots \\ 0 & \cdots & p_{S-1,2}(L) & p_{S-1,1}(L) & p_{S-1,0}(L) \\ p_{S,0}(L) & p_{S,1}(L) & p_{S,2}(L) & \cdots & p_{S,S}(L) \end{pmatrix} \quad (4.9)$$

Finally the matrix Z is given by:

$$Z = \begin{pmatrix} 1 & 0 & 0 & \cdots & 0 \\ p_{1,0}(T - L) & p_{1,1}(T - L) & 0 & \cdots & 0 \\ \vdots & \vdots & \vdots & \ddots & \vdots \\ p_{S-1,0}(T - L) & p_{S-1,1}(T - L) & p_{S-1,2}(T - L) & \cdots & 0 \\ p_{S,0}(T - L) & p_{S,1}(T - L) & p_{S,2}(T - L) & \cdots & p_{S,S}(T - L) \end{pmatrix} \quad (4.10)$$

$P(i)$ verify the following equation: $\mathbf{P} = \mathbf{P} \times Z \times D$, where $\mathbf{P} = \{P(i), i \in \mathbb{N}\}$.

4.2.3 Expected operating costs

The stationary probabilities are computed numerically, we can now formulate the operating costs. Starting from any state i just at order arrival, the inventory level will be in state j , ($j \leq i$) at time t ($t \leq T$) if $i - j$ items are used. This occurs with a probability of $p_{i,j}(t)$. The inventory level at time t is then $jp_{i,j}(t)$. It is easy to see that $E[I]$ is given by the expected inventory level time t integrated from 0 to T :

$$E[I] = \frac{1}{T} \sum_{i=0}^S P(i) \left(\sum_{j=0}^i j \int_0^T p_{i,j}(t) dt \right). \quad (4.11)$$

Using the same reasoning as for the expected inventory level, the expected amount of perished items is equal to:

$$E[O] = \frac{1}{T} \sum_{i=0}^S P(i) \left(\sum_{j=0}^i j \delta \int_0^T p_{i,j}(t) dt \right) = \delta E[I]. \quad (4.12)$$

The expected lost sales is slightly different from $E[I]$ and $E[O]$. To derive the expected amount of lost sales per unit time, we need the expected time with lost demand. Let T_{lost} be this time, $0 \leq T_{lost} \leq T$. Suppose that the inventory level is in the state i just at order arrival. To reach the state 0 at time $t + dt, t \leq T$, $i - 1$ items should be either demand or perished during t and the last item available will be demanded or perished at time dt . That is, the time of lost is given by:

$$T_{lost} = \sum_{i=1}^S P(i) \left(\int_0^T (\lambda + \delta)(T - t)p_{i,1}(t)dt \right). \quad (4.13)$$

Since the demand rate is λ , the expected lost sales per unit time is equal to:

$$\frac{\lambda}{T} T_{lost}. \quad (4.14)$$

Replacing $E[I]$, $E[O]$ and $E[S]$ in Equation (4.1), the average total cost per unit of time is :

$$\begin{aligned} TC(T, S) &= \frac{K}{T} + C(\lambda + E[O] - E[S]) + HE[I] + WE[O] + PE[S] \\ &= \frac{K}{T} + \lambda C + (H + \delta(W + C)) \frac{1}{T} \sum_{i=0}^S \sum_{j=0}^i \int_0^T P(i) \times j p_{i,j}(t) dt \\ &\quad + \frac{\lambda}{T} (b - C) \sum_{i=1}^S \int_0^T P(i) \times (\lambda + \delta)(T - t) p_{i,1}(t) dt. \end{aligned} \quad (4.15)$$

4.3 The (T,S) model with full backorders

4.3.1 Transition probabilities

We adopt the same notations as in the case of full lost sales. The inventory is again reviewed periodically. Each T units of time, an order is triggered to bring the inventory level up to level S . The order arrives after a constant lead time L and excess demand is fully backordered. Holding costs are charged at rate H per unit per unit time and each demand backordered incurs a shortage cost b per unit. In addition to the holding and the backorder cost, there is a fixed ordering cost K and a purchasing cost C per unit. Figure (4.3) shows the behavior of the inventory level throughout time. Recall that $I(t)$

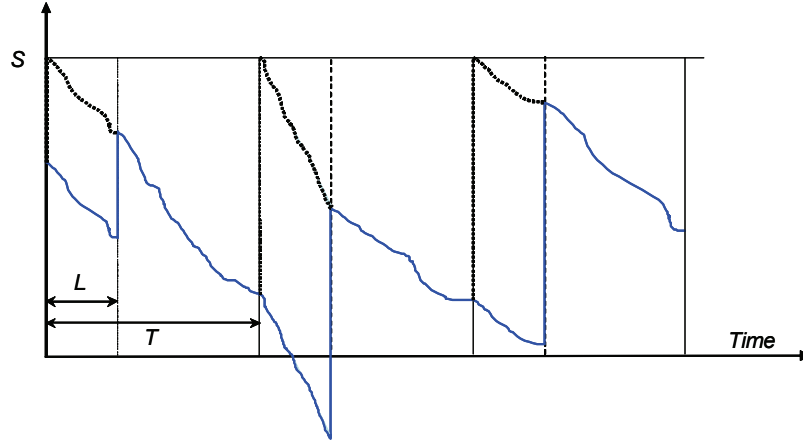

Figure 4.3: Periodic review inventory policy for perishable products

denotes the process of the on hand inventory level at time t , $\{nT + L, n = 0, 1, 2, \dots\}$ are the successive epochs at which the replenishment occurs and $I_n = I(nT + L)$.

For any t , $nT + L \leq t < (n + 1)T + L$, the transition probability from a state $i \leq S$ to a state $j \leq i$ at time t , is given by: $p_{i,j}(t) = P\{I(t) = j \mid I_n = i, nT + L \leq t < (n + 1)T + L\}$.

Again, the process $(\mathbf{I}) = \{I(t), nT + L \leq t \leq (n + 1)T + L, n = 0, 1, 2, \dots\}$ is a generalized death process with rates $\lambda + j\delta$ and λ for $0 \leq j \leq i$ and $j \leq i < 0$ respectively.

Hence, we can write Kolmogorov's Forward Equations for the backorders case:

$$\frac{dp_{i,j}(t)}{dt} = \begin{cases} -(\lambda + i\delta)p_{i,j}(t) & \text{if } i = j, (i, j) \in \mathbb{N} \\ -\lambda p_{i,j}(t) & \text{if } i = j < 0 \\ -(\lambda + j\delta)p_{i,j}(t) + (\lambda + (j + 1)\delta)p_{i,j+1}(t) & \text{if } 0 \leq j \leq i - 1, (i, j) \in \mathbb{N} \\ -\lambda p_{i,j}(t) + \lambda p_{i,j+1}(t) & \text{if } j \leq i < 0 \end{cases} \quad (4.16)$$

Taking the Laplace transform of above equations and under the initial condition $p_{i,i}(0) = 0$ we obtain:

$$p_{i,j}(z) = \begin{cases} \frac{1}{\lambda + j\delta} \prod_{k=j}^i \frac{\lambda + k\delta}{z + \lambda + k\delta} & \text{if } 0 \leq j \leq i - 1, (i, j) \in \mathbb{N} \\ \frac{1}{\lambda} \left(\frac{\lambda}{z + \lambda} \right)^j \prod_{k=j}^i \frac{\lambda + k\delta}{z + \lambda + k\delta} & \text{if } j < 0, i \in \mathbb{N} \\ \frac{1}{\lambda} \prod_{k=j}^i \frac{\lambda}{z + \lambda} & \text{if } j \leq i \leq 0 \end{cases} \quad (4.17)$$

It is easy to compute the inverse of Laplace transform for the first and the last term of Equation (4.17). The inverse of Laplace transform of the second term can not be expressed as a simple form. However, we observe that starting from a positive inventory level i , the inventory level should reach the state 0 before it reaches the state $j < 0$. Hence there exist a time $u \leq t$ at which the inventory level is on the state 0. Now from the probability transition from the state 0 to the state j is denoted by the inverse of Laplace transform of the third term of Equation (4.17). This yields to:

$$p_{i,j}(t) = \begin{cases} \frac{e^{-(\lambda+i\delta)t}(e^{\delta t} - 1)^{i-j} \prod_{n=j+1}^i (\lambda + n\delta)}{(i-j)! \delta^{i-j}} & \text{if } 0 < j \leq i-1, (i,j) \in \mathbb{N} \\ \frac{(\lambda + \delta) \prod_{n=1}^i (\lambda + n\delta)}{(i-j)! \delta^{i-j}} \int_0^t e^{-(\lambda+i\delta)u} (e^{\delta u} - 1)^{i-j} \frac{(\lambda(t-u))^j}{j!} e^{-\lambda(t-u)} du & \text{if } j < 0, i \in \mathbb{N} \\ \frac{(\lambda t)^j}{j!} e^{-\lambda t} & \text{if } j \leq i \leq 0 \\ 0 & \text{otherwise.} \end{cases} \quad (4.18)$$

To find the transition probabilities between the states of the process $\{I_n, n = 0, 1, 2, \dots\}$, we have to consider the time $(n+1)T$ at which an order is triggered. Following the same reasoning of the case of full lost sales, the transition probabilities from a state i at time $nT + L$ to a state l at time $(n+1)T + L$ is equal to:

$$p_{i,l}(T) = \sum_{j=-\infty}^i p_{i,j}(T-L)p_{j,l}(L). \quad (4.19)$$

Where $i \leq S, l \leq S$.

4.3.2 Steady state probabilities

Since we compute the steady state probabilities numerically, we have to define a state which corresponds to the maximum backorders that can be reached. Denotes by M this state. When M is reached, all demands are lost. The integer M is taken in the way that the amount of lost sales can be ignored. In other words, we approximate the

full backorders case to the partial one. It is clear that the process $\{I_n, n = 0, 1, 2, \dots\}$ is a discrete irreducible Markov chain with finite state space. Hence, the steady state probabilities $P(i)$, $i \in \{-M, \dots, S\}$ exist and they are unique. Recall that Z is the transition matrix where $Z(i, j) = p_{i,j}(T-L)$ and A the transition matrix where $A(i, j) = p_{i,j}(L^-)$.

At time nT , $n \in \{0, 1, 2, \dots\}$ an order of size $S - i$ is triggered. Let D be the transition probabilities from a state i at time nT to a state j at time $nT + L$. The matrix D is given by: $D(i, j + S + M + 1 - i) = A(i, j)$ for all $(i, j) \in \{1, 2, \dots, S + M + 1\}$ and $j \leq i$. As in the case of full lost sales, we have $\mathbf{P} = \mathbf{P} \times Z \times D$, where $\mathbf{P} = \{P(i), i \in 0, 1, \dots, S + M + 1\}$. Having the matrix \mathbf{P} , we can now get the steady states probabilities of the on hand inventory level and those when the backlog occurs (negative on hand inventory). To do so, we denote by \mathbf{G} and \mathbf{B} the steady states probabilities for the case where the on hand inventory is positive and negative respectively. \mathbf{G} and \mathbf{B} are related to \mathbf{P} by the following equation:

$$\begin{cases} G(i - M - 1) = P(i) & \text{for } i \in \{M + 2, \dots, S + M + 1\} \\ B(i) = P \times Z \times A(M - i + 1) & \text{for } i \in \{1, \dots, M\} \end{cases} \quad (4.20)$$

Notre that $P \times Z \times A$ is $1 \times M$ matrix. The matrix \mathbf{G} is defined for $i \in \{1, \dots, S\}$ we have to add the steady state probability that the on hand inventory is zero. That is, $\mathbf{G} = [P(M + 1) \ \mathbf{G}]$

4.3.3 Expected operating costs

The expected inventory level per unit time and the expected amount of perished items are given by Equations (4.11) and (4.12) except that $P(i)$ is replaced by $G(i)$. The expected amount of backordred demand is given by:

$$E[S] = \sum_{i=1}^M iB(i) \quad (4.21)$$

The total operating cost is equal to

$$\begin{aligned}
 TC(T, S) &= \frac{K}{T} + C(\lambda + E[O]) + HE[I] + WE[O] + bE[S] \\
 &= \frac{K}{T} + \lambda C + (H + \delta(W + C)) \frac{1}{T} \sum_{i=0}^S \sum_{j=0}^i \int_0^T G(i) \times jp_{i,j}(t) dt \\
 &+ \frac{b}{T} \sum_{i=1}^M iB(i).
 \end{aligned} \tag{4.22}$$

4.4 Optimization

In this section, we derive an algorithm to compute the optimal parameters T and S that minimize the total operating cost. Since the steady state probabilities are computed numerically, the convexity of the total cost for both full lost sales and backorders cannot be proved analytically. Nevertheless, several numerical examples demonstrate that the total cost is a jointly convex function in T and S for given costs parameters, demand and lifetime rate. The set of parameters that we have considered are the following: $\lambda = \{5, 10, 15\}$, $1/\delta = \{2, 3, 6\}$, $K = \{10, 50, 100\}$, $b = \{20, 40, 60\}$, $C = W = \{5, 10, 15\}$ and $H = 1$. We report in Figure (4.4, 4.5) two illustrations of convexity of both lost sales and backorders cases. The input parameters of costs, demand and lifetime are taken from the above sets. We assume hereafter the convexity of the total operating

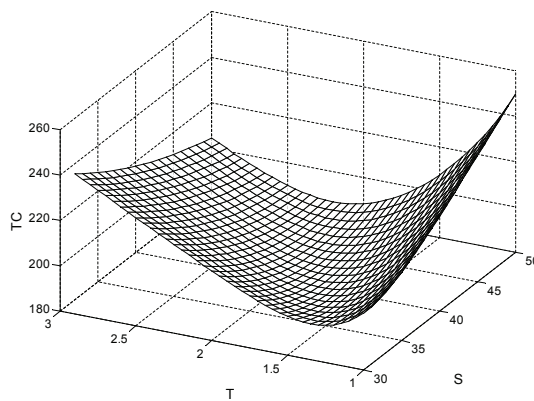

Figure 4.4: Convexity of the total operating cost for with full lost sales (fixed parameters : $\lambda=10$, $C = 5$, $b = 40$, $K = 100$, $W = 5$, $H = 1$, $L = 1$)

cost with full lost sales and full backorders. The following notations are used in this

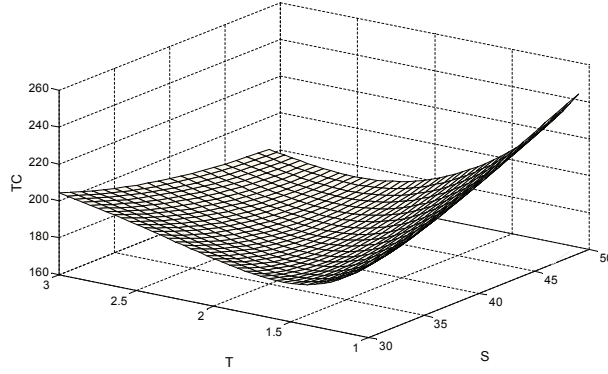

Figure 4.5: Convexity of the total operating cost for with full backorders (fixed parameters : $\lambda=10, C = 5, b = 20, K = 100, W = 5, H = 1, L = 1$)

section:

TC_k, TC_c, TC_s : Total operating cost for the model we propose, for the classical and simulation models respectively.

T_k, T_c, T_s : Optimal review period for the proposed policies and for the classical and simulation models respectively.

S_k, S_c, S_s : Optimal order up to level for the proposed policies and for the classical model respectively.

$E[I]_k, E[I]_c$ expected inventory level associated with the proposed model and the classical one respectively.

$E[S]_k, E[S]_c$ expected lost sales/backorders associated with the proposed model and the classical one respectively.

To compute T_k and S_k , we need first the following theorems:

Theorem 4.1 *If there exists an optimal policy of type order up to a positive level S , then $TC_k \leq \lambda b$ and $T_k < +\infty$.*

Proof: *The proof concerns only the lost sales case since, when backorder is allowed, the proof is similar. Following arguments of theorem 1 of Weiss (1980), if we never order then $TC_k = \lambda b$ and $T_k = +\infty$. If we order to a positive level S , then, $\lim_{T \rightarrow +\infty} p_{i,j}(T - L) = 0$ for all $0 \leq i \leq S$ and $1 \leq j \leq S$ and $p_{i,0}(T - L) = 1$ for all $0 \leq i \leq S$. That is, the steady state probabilities $P(i) = 0$ for all $0 \leq i < S$ and $P(S) = 1$ at order arrival. This means that demands are always lost before order arrives and we always order S items*

Impact of Random Lifetime in Periodic Review Perishable Inventory Systems

at time of review. $E[I]_k$ and $E[O]$ becomes independent of T and increasing the review period T will only increases $E[S]_k$. So that $\lim_{T \rightarrow +\infty} TC_k(T, S) = \lambda b$. Since the optimal policy minimize the total cost, then $T_k < +\infty$ and $TC_k \leq \lambda b$, if not the optimal policy will be of the type never order and $T_k = +\infty$.

Theorem 4.2 *If there exists an optimal policy for a given order up to level S , then $T_k \leq T_c$.*

Proof: *Trivial case: Using theorem 1, if the optimal order is of type never order, then $T_k = T_c = +\infty$. If the optimal policy is of type order up to S then, $T_k < +\infty$. Rewrite the total operating cost $TC_k(T, S)$ as follow:*

$$\begin{aligned} TC_k(T, S) &= \frac{K}{T} + C(\lambda + E[O] - E[S]) + HE[I] + WE[O] + bE[S] \\ &= TC_c(T, S) + (W + C)E[O] + (b - C)(E[S]_k - E[S]_c) + h(E[I]_k - E[I]_c). \end{aligned}$$

If an item is demanded under the classical policy, it is also demanded under the proposed policy provided that the on hand inventory level is positive. If a demand is lost under the classical policy, it also lost under the proposed one. So that $E[I]_k \leq E[I]_c$ and $E[S]_k \geq E[S]_c$ because of perishability. For any $T > T_c$, TC_c is an increasing function of T since TC_c is convex. $(W + C)E[O] + (b - C)(E[S]_k - E[S]_c) + h(E[I]_k - E[I]_c)$ is also an increasing or a decreasing function of T (see Figure (4.6)). Given S , the more T is high, the more the probability of an item perishes or demanded is high which increases the expected amount of perished items, the amount of lost sales and the expected inventory level during T . Similarly, for the classical model, the amount of lost sales and the expected inventory level during T increase with T . However, we may find a value of T (say T') after which, $E[O]$, $E[I]$ and $E[S]$ become independent of T . So that increasing the review period will only increase the amount of lost sales. Let us now return to our function $(W + C)E[O] + (b - C)(E[S]_k - E[S]_c) + h(E[I]_k - E[I]_c)$, once T' is reached $E[O]$, $E[S]_k - E[S]_c$ and $E[I]_k - E[I]_c$ start to decrease for any $T > T'$. That is $(W + C)E[O] + (b - C)(E[S]_k - E[S]_c) + h(E[I]_k - E[I]_c)$ is an increasing or decreasing function with T . To prove that $T_k \leq T_c$, we have to consider two cases.

Case 1: $(W + C)E[O] + (b - C)(E[S]_k - E[S]_c) + h(E[I]_k - E[I]_c)$ is an increasing or decreasing function for any $T > T_c$ or for any $T > T'$. TC_c increases after $T > T_c$, as

a consequence, TC_k increases for any $T > T_c$, so that $T_k \leq T_c$.

Case 2: $(W + C)E[O] + (b - C)(E[S]_k - E[S]_c) + h(E[I]_k - E[I]_c)$ is an decreasing function for any $T > T_c$. In this case, the amount of perished items becomes constant and increasing T will only increases the amount of lost sales. That is, T' is the first time at which the inventory is completely depleted. Following the proof of theorem 3 of Weiss (1980), the optimal review period for which the inventory level is completely depleted is $\inf\{T \in \zeta, TC_k \geq b\lambda\}$, where ζ is the subest of stopping times such that for any $T \in \zeta$ the inventory level is zero. If $T' \geq T_c$, then for any $T \leq T'$, TC_k is a decreasing function because TC_c and $TC_k - TC_c$ decrease. Hence, $T_k \leq T_c$.

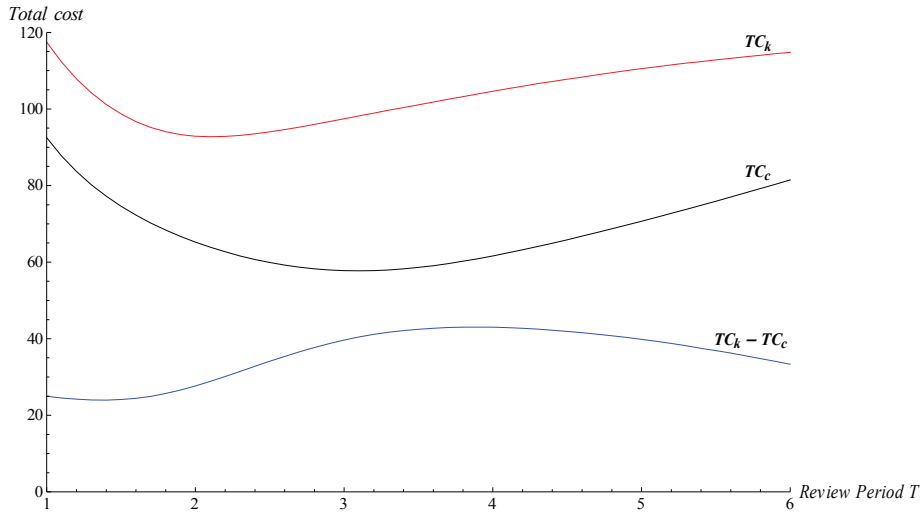

Figure 4.6: Total cost for a given S (fixed parameters : $\lambda=10, C = 5, b = 40, K = 50, W = 5, H = 1, L = 1, S = 25$)

The optimal parameters (T_k, S_k) are computed by a simple research algorithm implemented in Matlab software. We first calculate T_c for a given S , then T_c is used as an upper bound of T_k (cf. Theorem 2) which reduces considerably the time of computation. Then, using Algorithm (1), we compute T_k . Finally we select the couple (T_k, S_k) that minimizes the total operating cost. Note that Algorithm (1) can be also used to compute T_c since we know that T_c has $\sqrt{2K/H\lambda}$ as a lower bound. We choose the upper bound to be $2\sqrt{2K/H\lambda}$ then, by setting $T_{min} = \sqrt{2K/H\lambda}$ and $T_{max} = 2\sqrt{2K/H\lambda}$, T_c can be easily computed.

Algorithm 1 Computing T_k for a given S

Set $\varepsilon = 10^{-3}$ and compute T_c
Set $T_{min} = L, T_{max} = T_c$
repeat
 $z_0 = TC_k(\frac{T_{max} - T_{min}}{3}, S)$ and $z_1 = TC_k(\frac{2(T_{max} - T_{min})}{3}, S)$
if $z_0 \leq z_1$ **then**
 $T_{max} = T_{min} + \frac{2(T_{max} - T_{min})}{3}$
else
 $T_{min} = T_{min} + \frac{T_{max} - T_{min}}{3}$
end if
until $T_{max} - T_{min} \leq \varepsilon$
Set $T_k = T_{min}$.

4.5 Numerical analysis

In this section, we conduct a numerical analysis to show the impact of perishability on the optimal policy with respect to cost parameters. We compare firstly the optimal T and S obtained from our model to the classical (T, S) inventory system in which the perishability is ignored. Secondly, we compare our model to the optimal (T, S) system with fixed lifetime to show the impact of random lifetime versus the deterministic one. The optimal order up to level S and the review period T of the model with deterministic lifetime are computed using a simulation experiment. To the best of our knowledge, the exact optimal total operating cost when the lifetime is constant is not investigated yet. There is only the paper of [Chiu \(1995b\)](#), in which an approximate solution is presented. Hence, we choose the simulation in order to derive the exact solution. The simulation model is built on Arena software. The order of events has the following sequence 1) An order arrives 2) Perished products are discarded 3) Demand is observed 4) Inventory Position is reviewed 5) An order is triggered. We set the replication length of a simulation run to 200000 units of time and use 10 replications to estimate the optimal parameters T and S .

The detailed results are summarized in Tables [4.1](#), [4.2](#), [4.3](#) and [4.4](#) for a Poisson demand with mean $\lambda = 10$, mean lifetime $1/\delta = 3$, holding cost $H = 1$ and a lead time $L = 1$. The cost parameters of Table [4.1](#) and [4.3](#) are chosen in order to ensure that the optimal policy is of type *order up to a positive level S* (cf. Theorem 1). Those of Tables [4.2](#) and [4.4](#) are taken from [Chiu \(1995b\)](#). Note that the setting parameters taken from Chiu

does not guarantee the existence of an optimal policy of type *order up to a positive level* S when excess demand are lost. That is why the costs parameters of Table 4.1 and 4.3 which correspond to the lost sales case are slightly different of those of the backorders case (Table 4.2 and 4.4). Table 4.1 presents the results of comparison of the proposed model to the classical one for a full lost sales case. Table 4.2, shows the same comparison but for the full backlog. Table 4.3 and 4.4 represent the comparison between our model and simulation for the full lost sales and backlog respectively. The constant lifetime is taken as $1/\delta$. The performance of the proposed policies is measured by the percentage difference defined by:

$$TC\% = 100 \frac{TC_k(T_i, S_i) - TC_k(T_k, S_k)}{TC_k(T_i, S_i)}. \quad (4.23)$$

Where TC is the optimal cost given by Equation (4.15) or (4.22) and i is c for the classical model and s for the simulation model.

4.5.1 Comparison with inventory model when perishability is ignored

In general, we observe that the consideration of lifetime randomness achieves a good improvement. With respect to cost parameters, our results indicate a maximum improvement of 27% when excess demand are lost (cf. Table 4.1) and 51% when backorders are allowed (cf. Table 2). That is, the ignorance of perishability may lead to a higher cost.

Impact of the ordering cost K .

From Table (4.1), we underline that the percentage difference increases as the fixed ordering cost K increases. However, when K is very high, the percentage difference may decrease. For example, when $K = 200$, $C = 5$, $b = 40$ and $W = 5$, we find $(T_k, S_k) = (2.473, 51)$, $TC_k(T_k, S_k) = 229.908$, $(T_c, S_c) = (6.317, 81)$, $TC_k(T_c, S_c) = 125.907$ and $TC\% = 21.258\%$. In comparison with test problem number 3 (cf. Table 1), we observe that $TC\%$ decreases. This finding can be explained by the fact that for a higher value of K , the period of review T increases in order to reduce the effect of K on the total cost. Now, when T increases, the expected amount of lost sales also increases. As a

consequence, the order up to level S should increase to reduce the effect of lost demand on the total cost, so the expected perished items behaves similarly (because of S). It may happen that for a higher value of K , it is better to loose demand rather than to hold items in stock. That is, the expected amount of perished items may increase with K but not so much compared to the expected lost sales. This leads to a decreasing order quantity per unit time $(\lambda - E[S]_k + E[O])$ with K . Hence, the percentage difference will decrease with the expected order quantity.

For the backorder case, we observe from Table 2 an increasing percentage difference with K . As explained for the lost sales case, when K increases, T increases. This yields to more backlogged demands. The order up to level S should be set higher enough to balance the cost associated with the expected amount of backlog demand. That is, the inventory manger has to hold more items in stock, which leads to more perished items. Therefore, the percentage difference increases with the ordering cost K . Again, when K is very high, the percentage difference may decrease. For example, when $K = 150$, $C = 5$, $b = 20$ and $W = 5$, we find $(T_k, S_k) = (2.397, 44)$, $TC_k(T_k, S_k) = 196.249$, $(T_c, S_c) = (5.635, 71)$, $TC_c(T_c, S_c) = 114.657$ and $TC\% = 12.57\%$. In comparison with test problem number 3 (cf. Table 3), we also observe that $TC\%$ decreases.

Impact of the outdated cost W .

Typically, the percentage difference increases with W . This finding is expected since to reduce the impact of the outdated cost, the expected order quantity $(\lambda - E[S]_k + E[O])$ coming from (T_k, S_k) decreases with W . Moreover, the expected order quantity coming from (T_c, S_c) is constant so that $TC_k(T_c, S_c)$ increases linearly with W . Thus, $TC\% = 100(1 - TC_k(T_k, S_k)/TC_k(T_c, S_c))$ increases with W . Note that when W becomes very high, the optimal ordering policy will be of type *never order* and $TC_k(T_k, S_k) = \lambda b$, then $\lim_{W \rightarrow +\infty} TC\% = 100$ for the backorder case

We see also that $TC\%$ decreases with W (e.g. comparison of test problem 4 and 6 of Table 4.1 to test problem 16 and 18 respectively). The reason of this result is that the expected order quantity of the proposed model maybe greater than the expected order quantity coming from the parameters (T_c, S_c) . This implies that increasing W will reduce the expected order quantity until it reaches the expected order coming from (T_c, S_c) . Then, $TC\%$ attains its minimum and start increasing with W . To see more clearly this finding, let us take the parameters of test problem number 4 (cf. Table 4.1)

and variate W . We have $(\lambda - E[S]_k + E[O]) = 14.04, 13.54, 13.28, 12.72, 12.43$ for $W = 0, 5, 10, 15, 20$ respectively. The expected order quantity coming from (T_c, S_c) is 13.21 and $TC\% = 11.31, 8.56, 7.69, 7.83, 8.56$ respectively.

When backorder is allowed (cf. Tables 2), we find the same behavior as for the lost sales case. That is, the percentage difference increases with W due to the same reasons as for the lost sales case.

Impact of the purchasing and shortage costs C and b .

Two observations emerge from Table 4.1 and 4.2 regarding the purchase and the lost sales/backorder costs. We find that the percentage difference decreases when C increase. Indeed, it is more beneficial to loose/to backorder demand rather than to satisfy it, since demand satisfaction incurs a carrying and an outdated cost. For an increasing lost sales/backorder cost, the percentage difference behave similarly. This result is expected intuitively, since to reduce the amount of lost sales/backorders, the inventory manager have to buy more items which leads to more perished products and higher percentage difference.

4.5.2 Comparison with the inventory model with deterministic lifetime

When we compare the proposed policies (with lost sales and backorders) to the (T, S) policy with deterministic lifetime, we find the same insights as for the case where the perishability is ignored (classic (T, S) policy) when the costs parameters vary. In Table 4.3 and 4.4, T_k and T_s are integers. We choose to round the optimal period to nearest integer in both the proposed policies and the simulation model in order to reduce the computational efforts on estimating T_s and to facilitate the comparison. In addition, the optimal period is chosen to be an integer rather than a real number in practice. The main conclusion that can be drawn from Table 3 and 4 is that, generally, the consideration of the randomness of lifetime achieves an improvement on the total operating cost (with respect to costs parameters) between zero and 14.81% for the lost sales case and between zero and 12.57% for the backorders case.

The small percentage difference for some cases (e.g. test problem number 13 from Table 4.3) is mainly attributed to the fact that we approximate the optimal review period

to the nearest integer which, in fact, leads to the same optimal review period for both models. This finding concerns only the exponential lifetime distribution. It will be therefore interesting to consider a general distribution under a periodic review policy and investigate whether or not a general lifetime distribution provides similar results as the exponential lifetime.

4.6 Conclusion

We have considered a periodic review inventory system working under a (T, S) inventory policy with lost sales and backorders. Using a Markov renewal process, we firstly derived various performance measures and secondly developed an algorithm in order to optimize the total operating cost. We thereafter conducted a numerical study in which we have compared the considered (T, S) inventory systems with stochastic lifetimes with those with infinite and constant lifetime. The numerical results show that the consideration of lifetime's randomness may lead to a significant improvement of the total optimal cost. We also find that the proposed policies may deviate slightly from the (T, S) policies with fixed lifetime.

It would be interesting to use the results in this chapter in order to develop closed-form solutions of the stationary probabilities, instead of the numerical method derived here. Another ambitious work would be to extend the results in case of general lifetime distributions.

Test problem	Cost parameters		Proposed model			Classical model			Percentage difference	
			T_k	S_k	$TC_k(T_k, S_k)$	T_c	S_c	$TC_c(T_c, S_c)$	$TC_k(T_c, S_c)$	$TC\%$
	$C = 5, W = 5$	$b \quad K$								
1	40	10	1.000	30	114.976	1.348	32	75.0174	123.276	6.73%
2	40	50	1.320	34	151.621	3.056	49	93.5088	190.995	20.62%
3	40	100	1.818	41	183.303	4.385	62	107.101	243.439	24.70%
4	60	10	1.000	32	120.039	1.329	33	76.0215	131.278	8.56%
5	60	50	1.279	36	157.320	2.989	50	94.8864	215.102	26.86%
6	60	100	1.736	43	190.214	4.279	63	108.735	285.805	33.45%
	$C = 10, W = 5$	$b \quad K$								
7	40	10	1.000	28	178.307	1.303	31	124.662	186.380	4.33%
8	40	50	1.213	30	216.771	3.025	48	143.015	259.073	16.33%
9	40	100	1.664	35	251.705	4.368	61	156.511	311.673	19.24%
10	60	10	1.000	30	186.631	1.270	32	125.813	195.584	4.58%
11	60	50	1.145	32	225.728	3.020	50	144.606	287.727	21.55%
12	60	100	1.582	38	262.517	4.318	63	158.402	358.919	26.86%
	$C = 5, W = 10$	$b \quad K$								
13	40	10	1.000	28	130.866	1.348	32	75.0174	140.704	6.99%
14	40	50	1.161	30	169.581	3.056	49	93.5088	217.886	22.17%
15	40	100	1.639	36	205.114	4.385	62	107.101	275.082	25.44%
16	60	10	1.000	31	138.165	1.329	33	76.0215	149.682	7.69%
17	60	50	1.118	32	177.341	2.989	50	94.8864	242.824	26.97%
18	60	100	1.549	38	214.392	4.279	63	108.735	318.558	32.70%
	$C = 10, W = 10$	$b \quad K$								
19	40	10	1.000	26	191.789	1.303	31	124.662	203.033	5.54%
20	40	50	1.093	27	231.390	3.025	48	143.015	285.340	18.91%
21	40	100	1.516	31	269.441	4.368	61	156.511	342.723	21.38%
22	60	10	1.000	29	202.851	1.270	32	125.813	213.250	4.88%
23	60	50	1.023	29	242.792	3.020	50	144.606	315.382	23.02%
24	60	100	1.426	34	282.981	4.318	63	158.402	391.514	27.72%

Poisson demand with mean $\lambda = 10$; $1/\delta = 3$; $L = 1$; $H = 1$; $TC\% = 100 \frac{TC_k(T_c, S_c) - TC_k(T_k, S_k)}{TC_k(T_c, S_c)}$

Table 4.1: Comparison of the proposed model with the classical (T, S) policy: case of full lost sales

Impact of Random Lifetime in Periodic Review Perishable Inventory Systems

Test problem	Cost parameters		Proposed model			Classical model			Percentage difference	
			T_k	S_k	$TC_k(T_k, S_k)$	T_c	S_c	$TC_c(T_c, S_c)$	$TC_k(T_c, S_c)$	$TC\%$
	$C = 5, W = 5$	$b \quad K$								
1	20	10	1.000	28	109.976	1.360	31	73.987	115.614	4.88%
2	20	50	1.447	33	144.561	3.146	48	91.752	169.537	14.73%
3	20	100	1.970	39	173.527	4.536	61	104.833	203.922	14.91%
4	40	10	1.000	32	117.858	1.286	32	75.561	126.436	6.78%
5	40	50	1.342	36	154.193	3.067	50	94.042	206.841	25.45%
6	40	100	1.825	43	185.804	4.383	63	107.638	265.170	29.93%
	$C = 15, W = 5$	$b \quad K$								
7	20	10	1.000	25	235.695	1.360	31	173.987	246.661	4.45%
8	20	50	1.237	27	273.532	3.055	47	191.766	310.207	11.82%
9	20	100	1.745	31	306.820	4.536	61	204.833	351.382	12.68%
10	40	10	1.000	29	250.914	1.286	32	175.561	260.327	3.62%
11	40	50	1.103	30	290.346	3.066	50	194.042	354.175	18.02%
12	40	100	1.527	35	328.403	4.383	63	207.638	417.142	21.27%
	$C = 5, W = 10$	$b \quad K$								
13	20	10	1.000	27	123.629	1.360	31	73.987	131.138	5.73%
14	20	50	1.348	30	160.268	3.146	48	91.752	191.032	16.10%
15	20	100	1.820	34	191.831	4.536	61	104.833	227.652	15.74%
16	40	10	1.000	30	135.072	1.286	32	75.561	143.381	5.80%
17	40	50	1.229	33	173.495	3.067	50	94.042	230.508	24.73%
18	40	100	1.637	38	208.672	4.383	63	107.638	291.156	28.33%
	$C = 15, W = 10$	$b \quad K$								
19	20	10	1.000	24	246.381	1.360	31	173.987	262.185	6.03%
20	20	50	1.229	26	285.052	3.055	47	191.766	331.383	13.98%
21	20	100	1.735	29	319.443	4.536	61	204.833	375.112	14.84%
22	40	10	1.000	28	265.626	1.286	32	175.561	277.273	4.20%
23	40	50	1.021	28	305.581	3.067	50	194.042	377.842	19.12%
24	40	100	1.407	32	345.910	4.383	63	207.638	443.127	21.94%

$$\text{Poisson demand with mean } \lambda = 10; 1/\delta = 3; L = 1; H = 1; TC\% = 100 \frac{TC_k(T_c, S_c) - TC_k(T_k, S_k)}{TC_k(T_c, S_c)}$$

Table 4.2: Comparison of the proposed model with the classical (T, S) policy: case of full backorders

Test problem	Cost parameters			Proposed model			Simulation model			Percentage difference	
				T_k	S_k	$TC_k(T_k, S_k)$	T_s	S_s	$TC_s(T_s, S_s)$	$TC_k(T_c, S_c)$	$TC\%$
	$C = 5, W = 5$	b	K								
1	40	10	1	30	114.976	1	28	75.876	116.158	1.02%	
2	40	50	1	30	154.976	2	36	102.680	166.349	6.84%	
3	40	100	2	42	183.904	2	36	127.680	191.349	3.89%	
4	60	10	1	32	120.039	1	29	77.017	123.553	2.84%	
5	60	50	1	32	160.039	2	37	106.222	185.762	13.85%	
6	60	100	2	47	191.480	2	37	131.222	210.762	9.15%	
	$C = 10, W = 5$	b	K								
7	40	10	1	28	178.307	1	28	125.650	178.307	0.00%	
8	40	50	1	28	218.307	2	34	153.466	231.607	5.74%	
9	40	100	2	39	254.018	2	34	178.466	256.607	1.01%	
10	60	10	1	30	186.631	1	29	127.034	187.167	0.29%	
11	60	50	1	30	226.631	2	36	158.102	253.283	10.52%	
12	60	100	2	44	266.906	2	36	183.102	278.283	4.09%	
	$C = 5, W = 10$	b	K								
13	40	10	1	28	130.866	1	28	76.013	130.866	0.00%	
14	40	50	1	28	170.866	2	35	104.734	187.053	8.65%	
15	40	100	2	40	208.079	2	35	129.734	212.053	1.87%	
16	60	10	1	31	138.165	1	29	77.263	139.237	0.77%	
17	60	50	1	31	178.165	2	36	109.043	209.135	14.81%	
18	60	100	2	45	219.175	2	36	134.043	234.135	6.39%	
	$C = 10, W = 10$	b	K								
19	40	10	1	26	191.789	1	27	125.773	192.071	0.15%	
20	40	50	1	26	231.789	2	34	155.015	249.513	7.10%	
21	40	100	2	36	274.255	2	34	180.015	274.513	0.09%	
22	60	10	1	29	202.851	1	28	127.241	203.252	0.20%	
23	60	50	1	29	242.851	2	35	160.414	274.960	11.68%	
24	60	100	1	29	292.851	2	35	185.414	299.960	2.37%	

$$\text{Poisson demand with mean } \lambda = 10; 1/\delta = 3; L = 1; H = 1; TC\% = 100 \frac{TC_k(T_c, S_c) - TC_k(T_k, S_k)}{TC_k(T_c, S_c)}$$

Table 4.3: Comparison of the proposed model with simulation: case of full lost sales

Impact of Random Lifetime in Periodic Review Perishable Inventory Systems

Test problem	Cost parameters		Proposed model			Simulation model			Percentage difference	
			T_k	S_k	$TC_k(T_k, S_k)$	T_s	S_s	$TC_s(T_s, S_s)$	$TC_k(T_s, S_s)$	$TC\%$
	$C = 5, W = 5$	$b \quad K$								
1		20 10	1 28	109.976	1 27	74.733	110.507	0.48%		
2		20 50	2 39	148.546	2 35	99.434	151.109	1.70%		
3		20 100	2 39	173.546	2 35	124.434	176.109	1.46%		
4		40 10	1 32	117.858	1 29	76.468	120.404	2.11%		
5		40 50	1 32	157.858	2 36	104.541	180.557	12.57%		
6		40 100	2 46	186.434	2 36	129.541	205.557	9.30%		
	$C = 15, W = 5$	$b \quad K$								
7		20 10	1 25	235.695	1 27	174.879	236.752	0.45%		
8		20 50	2 33	282.722	2 34	202.237	282.961	0.08%		
9		20 100	2 33	307.722	2 34	227.237	307.961	0.08%		
10		40 10	1 29	250.914	1 28	176.782	251.442	0.21%		
11		40 50	1 29	290.914	2 35	209.160	317.500	8.37%		
12		40 100	2 41	334.422	2 35	234.160	342.500	2.36%		
	$C = 5, W = 10$	$b \quad K$								
13		20 10	1 27	123.629	1 27	74.806	123.629	0.00%		
14		20 50	1 27	163.629	2 34	100.901	167.698	2.43%		
15		20 100	2 36	192.205	2 34	125.901	192.698	0.26%		
16		40 10	1 30	135.072	1 28	76.645	137.259	1.59%		
17		40 50	1 30	175.072	2 36	106.968	197.699	11.45%		
18		40 100	2 43	211.640	2 36	131.968	222.699	4.97%		
	$C = 15, W = 10$	$b \quad K$								
19		20 10	1 24	246.381	1 27	174.952	249.874	1.40%		
20		20 50	1 24	286.381	2 33	203.300	297.060	3.59%		
21		20 100	2 30	320.510	2 33	228.300	322.060	0.48%		
22		40 10	1 28	265.626	1 28	176.919	265.626	0.00%		
23		40 50	1 28	305.626	2 35	210.981	333.698	8.41%		
24		40 100	2 39	355.101	2 35	235.981	358.698	1.00%		

$$\text{Poisson demand with mean } \lambda = 10; 1/\delta = 3; L = 1; H = 1; TC\% = 100 \frac{TC_k(T_c, S_c) - TC_k(T_k, S_k)}{TC_k(T_c, S_c)}$$

Table 4.4: Comparison of the proposed model with simulation: case of full backorders

Chapter 5

Impact of TTIs on Perishable Inventory Management

5.1 Introduction

As explained in Chapter (1), one of the main functionalities of TTI technologies is to be able to simulate in real time the impact of changing temperature conditions on products' freshness. By using this technology, supply chain actors would have accurate information on the real freshness of handled products, i.e., binary information regarding the product's lifetime through color changes when a TTI type 1 is used and the effective product's lifetime when a TTI type 2 is used.

Actually, since this technology is not used, supply chain actors are taking a high margin of precaution when determining products' lifetimes, i.e., the lifetime is fixed to a smaller value than what it could be effectively. The determination of the product lifetime assumes that the product will be maintained under time and temperature conditions that are "reasonably expected during transportation and storage". Once determined, this date is printed and affixed to the packaging of the product, in the form of a "Use by/consume by" label. Basically, the benefit of using TTIs technology on inventory management is to extend the lifetime of products. In fact, as explained in Chapter (1) the lifetime of a product is dispatched between supply chain actors to guide their stock rotation. For each actor products are removed before pre-specified remaining lifetime for the downstream parts is reached. Let us call this pre-specified remaining lifetime "the traditional sell by

date". If an actor uses TTI type 1, then the duration of holding products in stock will be extended since with TTI type 1 the color change can be calibrated to appear when a predetermined remaining product's lifetime is reached. In the worst storage conditions, the color will change at the same time as the traditional sell by date is reached. When TTI type 2 is used, products' effective lifetime can be tracked and therefore the effects of variation in temperature exposure on products' lifetime is captured. The duration of holding products in stock can be extended by removing items when the traditional sell by date is reached.

The aim of this chapter is to answer the question of whether the use of TTIs technologies can effectively reduce the total inventory operating cost. We analyze the impact of this technology on the performance of an inventory system subject to temperature perturbations.

To better clarify the type of analysis we conduct in this chapter, Figure (5.1) shows the different models we consider. We study separately the impact of using TTI technologies on continuous and periodic review inventory management, i.e. TTI technologies-based (r, Q) and (T, S) inventory control. Remember that those inventory control systems have been studied in Chapters (3) and (4). Our interest now is to compare two different scenarios where the inventory is controlled throughout information stemming from TTI type 1 firstly and from TTI type 2 secondly to a base case where the inventory is managed on the basis of fixed lifetime determined initially with a high margin of precaution. The comparison is based on an economic framework which considers costs related to inventory control.

5.2 General framework

In this section, we present the framework we consider to evaluate the potential savings associated with the deployment of TTI technologies on inventory management. The setting we consider in our study is a Distribution Center (DC) that provides a perishable product to retailers and receives replenishments from an external supplier. As Figure (5.2) shows, the supplier ships products to the DC where they are maintained until they are demanded by retailers or perished. The sojourn time of products at the DC is a duration already negotiated throughout contracting between supply chain actors and

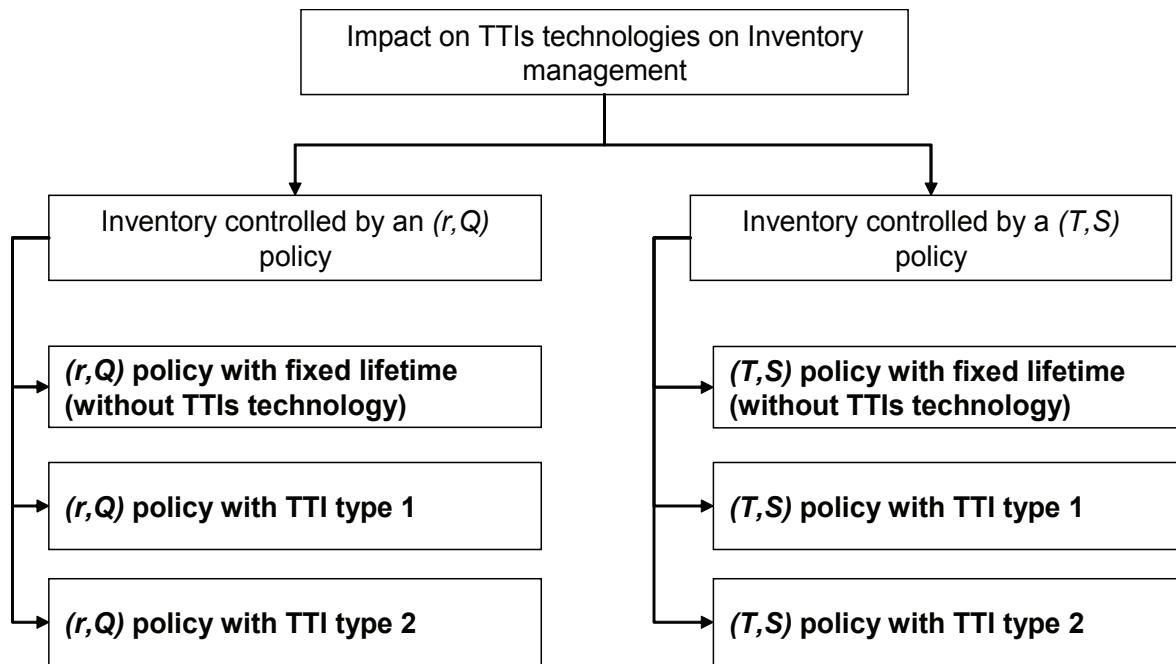

Figure 5.1: Types of models we consider in this chapter

correspond to a certain percentage of the whole lifetime of products (cf. Figure (1.2) of Chapter ??chap2)). Consequently, the DC has to offer to its retailers products with a remaining lifetime at least equal to the remaining lifetime that is specified in the contract. Products that reach their sojourn time are disposed off and salvaged at a price W . TTI technologies are used by the DC. Since the accuracy of information stemming from the deployment of these technologies depends on the placement of the tag, we distinguish three different level of the placement of the TTIs: The tag could be affixed to each individual item, at pallet level or to the whole order (if an order represents one pallet). In our models, we analyze the lower and the upper bound of an investment in TTI technologies. We consider the case where tags are affixed to each individual product and the case where only one tag is used and affixed to the whole order. In practice, tags are affixed to each individual product. Only in the (r, Q) policy the case where the tag is affixed to the whole order is studied in this chapter.

We represent the effective lifetime (ELT) of each item or of the whole batch at order arrival as a random variable x with probability mass function as shown on Figure (5.3). Each item or each order has a lifetime in the interval $[m_{min}, m_{max}]$. That is, if an item is exposed to high temperature perturbations, its lifetime will be equal to m_{min} which cor-

responds to the worst storage conditions. m_{min} represents also sojourn time of products at the DC when TTI technology is not used. Our interest is to compare a TTI-based

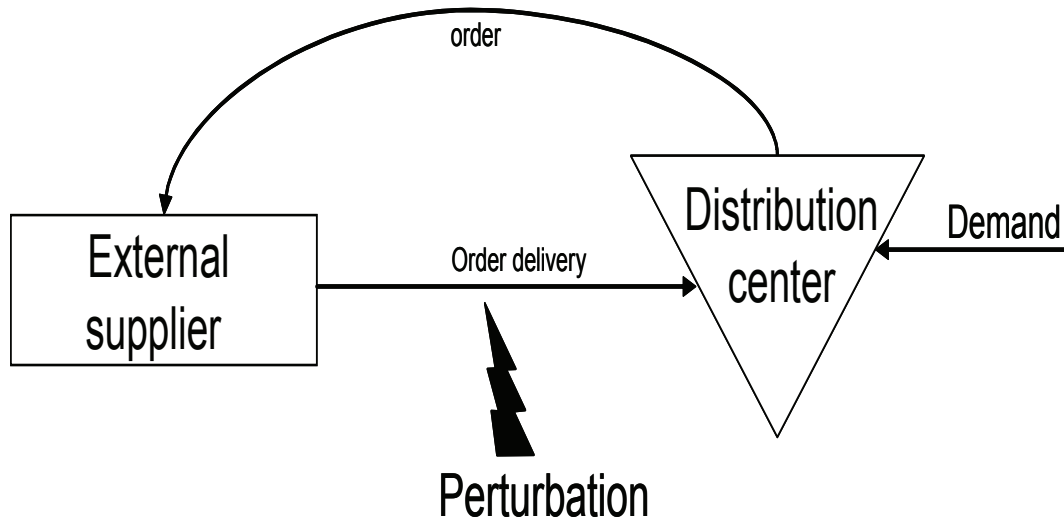

Figure 5.2: General framework of our study

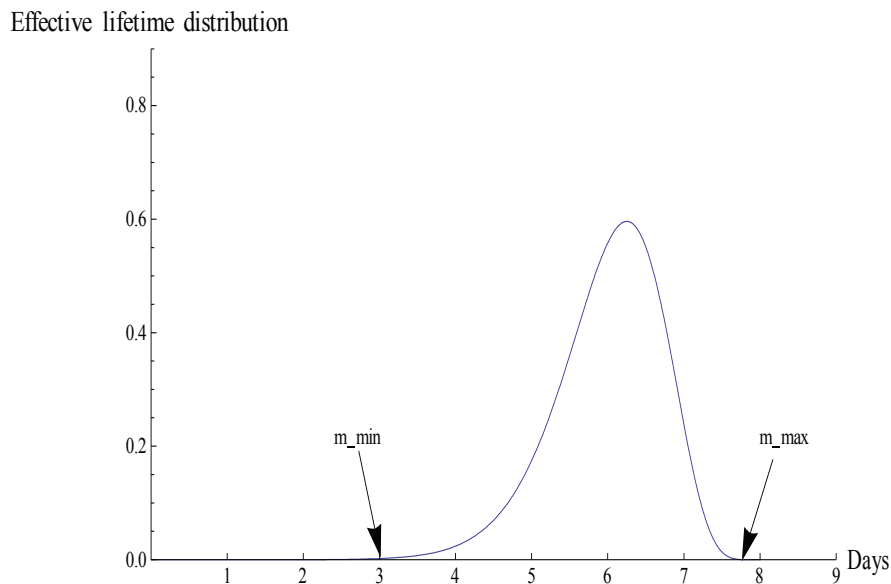

Figure 5.3: Effective lifetime (ELT) of each item at order arrival

inventory management to a base case in which the product's time and temperature history is not tracked by any technology. Accordingly, for the base case, as it is the case in actual real settings where TTI technologies are not used, the product's shelf life is fixed

to m_{min} to avoid any risk of selling products already perished to retailers (cf. Section 1.3 of Chapter (1)). When a TTI technology is used, we distinguish two situations depending whether the DC manager uses TTI type 1 or TTI type 2. Therefore, our goal is to compare three different scenarios described as follows:

Scenario 1: In this scenario no technology is used. It corresponds to the case where the DC manager ignores temperature variations or they are insignificant. The perishability of products is taken into account throughout the use by date label affixed to each individual product's packaging. The oldest products are sold before their use by dates first. In this case, the First-In-First-Out issuing policy is optimal. On receipt, the remaining shelf life of replenishment is known and fixed to the minimum shelf life of m_{min} periods. This scenario corresponds to an inventory control system with fixed shelf life, we call it **Model 1**. It represents the base case. We assume that the cost associated with the printed date on product packaging is negligible.

Scenario 2: The DC manager is aware of temperature variations. He chooses to deploy TTIs type 1 technology affixed to the whole order of to each individual product in order to control effectively his inventory. That is, a TTI type 1 with one color change is attached to each product's packaging records temperature variations and microbial growth. Therefore it allows to take decisions based on visual color change. The functionality of a TTI with one color change (green or red) can be described as follows:

- The first initial color (green) serves as an indication of the freshness of product.
- The second color (red) indicates when a product has to be removed from the stock.

By using this technology the sojourn time of products in stock will be extended compared to scenario 1. In particular, this allows the DC manager to reduce spoilage by selling products that are considered as perished in scenario 1 but can be still usable when TTI type 1 is used. The lifetime of products is printed when retailers-demand occurs. This printed lifetime is already negotiated throughout contracting between the DC and its retailers.

The issuing policy used for this scenario is FIFO since the DC manager does not know when TTI type 1 will change color. This scenario represents an inventory management with TTI Type 1 which will be referred as **Model 2**.

The cost stemming from the deployment of TTIs type 1 technology (cost of the tag) is assumed to be proportional to the unit purchasing cost if the tag is affixed to each

product. The case where the tag is affixed to the whole batch, the cost of the tag is added to the ordering cost. The fixed costs of investments necessary to implement the technology such as personnel salaries and personnel training are deliberately not part of this work since they could be easily integrated to the model.

Scenario 3: The DC manager uses a TTI type 2 in order to take into account the temperature variations. Since, with TTI type 2, the remaining lifetime is known, the DC manager depletes his inventory according to the least remaining shelf life first out. This scenario corresponds to an inventory management with TTI Type 2 which will be referred hereafter as **Model 3**.

We assume that the cost associated with the implementation of TTIs type 2 technology to be proportional to the unit purchasing cost if the tag is affixed to each product. The case where the tag is affixed to the whole batch, the cost of the tag is added to the ordering cost. The fixed costs of investments necessary to implement the technology (such as the cost of readers, processing and supporting information technology hardware and software, personnel salaries and training) is again deliberately not part of this work due to the same reasons as explained in Scenario 2.

5.3 Comparison between a TTI-based (r, Q) inventory control model to an (r, Q) inventory control model with fixed lifetime

In this section, we compare the (r, Q) policy with fixed lifetime developed in Section (3.4) of Chapter (3) which we call hereafter Model 1 to an (r, Q) inventory system where the lifetime is monitored by TTIs. Recall that the model developed in Section (3.4) of Chapter (3) is the following: the inventory is controlled by an (r, Q) inventory policy where orders arrive after a positive replenishment lead time L and excess demands are backlogged. The total operating cost of this model is denoted by Equation (3.1).

The remaining of the section is organized as follows: in Subsection (5.3.1), we study the performance of Model 2 and Model 3 when the tag is affixed to the whole batch Q . In Subsection (5.3.2) we conduct a sensitivity analysis of the performance of the technology with regard to the costs parameters, demand and lifetime distribution.

5.3. Comparison between a TTI-based (r, Q) inventory control model to an (r, Q) inventory control model with fixed lifetime

5.3.1 The technology is affixed to the whole order Q

5.3.1.1 The TTI type 1 is affixed to the whole order Q

We study here the performance of the technology where only one tag is affixed to the whole order. For this case, analytical model can be derived. We use the same notations and assumptions as in Section (3.4) of Chapter (3) and we add the following notions:

Notations

t_1 : Unit TTIs label cost, t_1 : is considered to be an additive cost per order and modeled as $t_1 = \eta\%C$.

Q_{TTI1} : The optimal order quantity for model with TTI type 1.

r_{TTI1} : The optimal reorder level for model with TTI type 1.

TC_{TTI1} :The average total cost for the proposed model with TTI type 1.

Our interest is to derive an (r, Q) inventory model in which the lifetime of products is monitored by TTI type 1. We suppose that all products in the same batch Q have the same age and each batch has a probabilistic age denoted by Equation (5.1). Furthermore:

- 1) The TTI type 1 technology is affixed to the whole order (Q) and provides a binary information regarding product's freshness.
- 2) Products are picked from stock based on the FIFO issuing policy
- 3) The ELT (effective lifetime) of the batch Q is a discrete random variable x with cumulative probability distribution function $\Psi(x)$. The set of realization of x is $\{m_{min}, m_{min} + 1, \dots, m_{max}\}$ where m_{max} is the maximum effective lifetime that can be reached before the product becomes unsafe for use and m_{min} is the minimum realization of x . When a realization of ELT is reached, products whose age equal to this realization are discarded. The probability that the batch Q perishes at exactly $x = m_{min}, x = m_{min} + 1, \dots, x = m_{max}$ is denoted by the following equation:

$$\begin{cases} x=m_{min} \text{ with probability} & \Psi(m_{min} + 1) \\ \dots & \dots \\ x=m_{max} \text{ with probability} & 1 - \Psi(m_{max}) \end{cases} \quad (5.1)$$

Let $E[O]_{TTI1}$, $E[S]_{TTI1}$ and $E[I]_{TTI1}$ be the expected perished quantity, the expected backlogged quantity and the expected on hand inventory respectively when TTI type 1

Impact of TTIs on Perishable Inventory Management

is used.

The expected total outdated units per cycle will have the same expression as Equation (3.22) except that we should calculate $E[O]$ for each value of ELT and then we sum over all possible realizations of ELT. That is, $E[O]_{TTI1}$ is the solution of the following equation:

$$\begin{aligned}
 y &= \Psi(m_{min} + 1)\omega_{m_{min}}(y) + \sum_{\substack{m_{min}+1 \leq i \\ i \leq m_{max}-1}} (\Psi(i+1) - \Psi(i))\omega_i(y) \\
 &+ (1 - \Psi(m_{max}))\omega_{m_{max}}(y) \\
 \text{Where } \omega_i(y) &= \int_0^{r+Q-y} (r+Q-y-\tau_{i+L})\phi(\tau_{i+L})d\tau_{i+L} \text{ for } m_{min} \leq i \leq m_{max}
 \end{aligned} \tag{5.2}$$

For the expected backlogged quantity, we need to know whether orders perish or not during the lead time L . However, this information depends on the remaining effective lifetime of orders. Since, the ELT has more than one realization, the probability of occurrence of perishability during L is not tractable. To overcome this difficulty, we assume that the expected perished quantity in L is equal to $E[O]_{TTI1}$. Therefore $E[S]_{TTI1}$ the expected backlogged quantity can be written as:

$$E[S]_{TTI1} = \int_{r-E[O]_{TTI1}}^{\infty} (\tau_L - r + E[O]_{TTI1})\phi(\tau_L)d\tau_L \tag{5.3}$$

To derive the expression of the expected inventory level per unit of time, we have to compute the expected inventory level for all possible realizations of the random variable x representing the ELT. Since the probabilities of occurrence of perishability are intractable, we may approximate the expected inventory level based on equations derived in (3.4) of Chapter (3). If we define the average ELT, M , by:

$$M = m_{min}\Psi(m_{min} + 1) + \sum_{\substack{m_{min}+1 \leq i \\ i \leq m_{max}-1}} i(\Psi(i+1) - \Psi(i)) + m_{max}(1 - \Psi(m_{max})) \tag{5.4}$$

Then, $E[I]_{TTI1}$ may be approximated by the summation of Equations (3.29) and (3.32) in which we substitute m by M .

5.3. Comparison between a TTI-based (r, Q) inventory control model to an (r, Q) inventory control model with fixed lifetime

Now the total expected cost can be formulated by the following equation

$$TC_{TTI1}(r, Q) = \frac{K + \eta\%C + CQ + PE[S]_{TTI1} + WE[O]_{TTI1}}{E[T]_{TTI1}} + HE[I]_{TTI1} \quad (5.5)$$

Where $E[O]_{TTI1}$ is computed by Equation (5.2), $E[S]_{TTI1}$ by Equation (5.3), $E[I]_{TTI1}$ by Equations (3.29) and (3.32) where $m = M$ and finally $E[T]_{TTI1}$ by $\frac{Q - E[O]_{TTI1}}{\mu_z}$

5.3.1.2 Validation by simulation experiment

Tables (5.1) and (5.2) illustrate the operating costs of the analytical model of the special case (equation 5.5) and the simulation results where a Normal demand distributions with mean $\mu_z = 20$ and $cv = \{0.1, 0.25\}$ are considered. The effective lifetime distribution is discrete and the batch Q has an age between $m_{min} = 3$ and $m_{max} = 11$. The probability that Q perishes at 3, 4, ..., and 11 units of time is equal to 0.1%, 0.85%, 3.95%, 20%, 25%, 31%, 18% and 1.05% respectively. The lead time is equal to 1 units of time in Table (5.1) and to 2 in Table (5.2). We set the replication length of the simulation run to be 90000 units of time and use 10 replications. These two simulations parameters are chosen in order to have an accurate estimation of the main parameters of system performances. We observe that our results are closer to the simulation especially when the coefficient of variation of the demand distribution is equal to 0.1 and $L = \{1, 2\}$ (cf. Tables (5.1), (5.2)). The expected backlogged and perished quantities per cycle ($E[S]_{TTI1}$ and $E[O]_{TTI1}$) deviate on average about 2% and 0.1% from the optimal one if $L = 1$ and about 5% and 0.7% if $L = 2$. At the same time, the total cost is only lower than the optimal total cost by less than 1%. This indicates that the approximations we made in Subsection (5.3.1) perform well. When the coefficient of variation of the demand distribution increases ($cv = 0.25$), our approximations become rough (mainly the expected backlogged quantity) with respect to different costs parameters (cf. Table (5.1), (5.2)). The average percentage difference of the expected backlogged quantity increases as the coefficient of variation of demand distribution increases. However, this increase is higher for the case where $L = 1$ than in the case where $L = 2$. The main reason of the underestimation of the expected backlogged quantity can be attributed to our assumption about the undershoot distribution. The mean and the variance of the undershoot variable may not converge to its expected values as stated in Equation (2)

Impact of TTIs on Perishable Inventory Management

because the batch Q (limited by the perishability) is not large enough in order to have a long cycle length compared to the unit of time. Further details about the performance of the approximation of the mean and the variance of the undershoot can be found in (Baganha *et al.*, 1996).

Test problem	Cost parameters			Ordering policy	(r, Q) model with TTI type 1					Simulation model					
				(r_{TTI1}, Q_{TTI1})	$E[S]_{TTI1}$	$E[O]_{TTI1}$	$E[I]_{TTI1}$	$E[T]_{TTI1}$	$TC_{TTI1}(r_{TTI1}, Q_{TTI1})$	$E[S]$	$E[O]$	$E[I]$	$E[T]$	$TC(r_{TTI1}, Q_{TTI1})$	
	N(20,2)			P	K										
1	25	150	(36, 81)	0.588	0.022	57.101	4.049	197.860	0.605	0.022	56.490	4.049	197.351		
2	25	200	(35, 92)	0.790	0.050	61.471	4.597	209.432	0.842	0.052	60.991	4.597	209.255		
3	25	250	(35, 100)	0.801	0.102	65.443	4.995	219.810	0.872	0.102	64.913	4.995	219.632		
4	50	150	(39, 80)	0.222	0.026	59.767	3.999	200.157	0.181	0.025	58.982	3.999	198.842		
5	50	200	(38, 91)	0.317	0.060	64.134	4.547	211.804	0.293	0.061	63.475	4.547	210.882		
6	50	250	(38, 99)	0.324	0.121	68.096	4.944	222.301	0.312	0.120	67.455	4.944	221.541		
Average percent deviation									-2.073%	-0.117%	0.985%	0.000%	0.306%		
	N(20,5)			P	K										
7	25	150	(39, 81)	0.709	0.046	59.451	4.048	201.060	0.791	0.046	59.483	4.048	201.587		
8	25	200	(38, 91)	0.896	0.101	63.368	4.545	212.632	0.988	0.100	63.462	4.545	213.231		
9	25	250	(37, 99)	1.125	0.185	66.322	4.941	223.173	1.227	0.182	66.426	4.941	223.782		
10	50	150	(42, 80)	0.344	0.055	62.079	3.997	204.114	0.402	0.055	61.982	3.997	204.752		
11	50	200	(42, 89)	0.350	0.120	66.529	4.444	215.877	0.416	0.119	66.437	4.444	216.525		
12	50	250	(41, 97)	0.461	0.219	69.479	4.839	226.586	0.547	0.217	69.397	4.840	227.356		
Average percent deviation									-12.505%	0.754%	0.010%	-0.005%	-0.295%		

Fixed parameters: $\eta\%=0$; $L=1$, $H=1$, $C = 5$ and $W = 10$ Effective lifetime between 3 and 10 units of time

Table 5.1: Performance of the (r, Q) inventory with TTI type 1 for $L=1$

Test problem	Cost parameters			Ordering policy	(r, Q) model with TTI type 1					Simulation model					
				(r_{TT1}, Q_{TT1})	$E[S]_{TT1}$	$E[O]_{TT1}$	$E[I]_{TT1}$	$E[T]_{TT1}$	$TC_{TT1}(r_{TT1}, Q_{TT1})$	$E[S]$	$E[O]$	$E[I]$	$E[T]$	$TC(r_{TT1}, Q_{TT1})$	
	N(20,2)			P	K										
1	25	150	(55, 83)	0.877	0.024	57.644	4.149	199.173	0.928	0.025	56.484	4.149	198.313		
2	25	200	(55, 93)	0.885	0.056	62.514	4.647	210.490	0.942	0.056	61.492	4.647	209.783		
3	25	250	(54, 102)	1.155	0.113	65.636	5.094	220.710	1.258	0.115	64.907	5.094	220.502		
4	50	150	(58, 83)	0.373	0.031	61.526	4.148	202.287	0.360	0.031	59.476	4.149	200.067		
5	50	200	(58, 92)	0.377	0.067	65.823	4.597	213.649	0.374	0.068	63.974	4.597	211.762		
6	50	250	(58, 100)	0.385	0.133	69.679	4.993	223.998	0.406	0.132	67.901	4.994	222.410		
Average percent deviation									-5.353%	-0.772%	2.243%	-0.004%	0,588%		
	N(20,5)			P	K										
7	25	150	(59, 83)	1.072	0.060	61.192	4.147	204.044	1.141	0.060	60.469	4.147	203.735		
8	25	200	(58, 93)	1.301	0.132	64.871	4.643	215.369	1.376	0.130	64.433	4.643	215.348		
9	25	250	(57, 100)	1.569	0.219	67.134	4.989	225.763	1.654	0.218	66.886	4.989	225.942		
10	50	150	(63, 83)	0.486	0.085	65.928	4.146	208.281	0.541	0.086	64.473	4.146	207.481		
11	50	200	(63, 91)	0.495	0.170	69.758	4.541	219.807	0.558	0.169	68.402	4.541	219.160		
12	50	250	(62, 97)	0.625	0.281	72.003	4.886	230.425	0.698	0.258	70.395	4.837	230.097		
Average percent deviation									-7.591%	2.796%	1.454%	0.181%	0.148%		

Fixed parameters: $\eta\%=0$; $L=2$, $H=1$, $C = 5$ and $W = 10$ Effective lifetime between 3 and 10 units of time

Table 5.2: Performance of the (r, Q) inventory with TTI type 1 for $L=2$

5.3. Comparison between a TTI-based (r, Q) inventory control model to an (r, Q) inventory control model with fixed lifetime

5.3.1.3 The TTI type 2 is affixed to the whole order Q

When a TTI type 2 is used, we have an additional information about products' effective lifetimes: the TTI technology type 2 provides the remaining lifetime of products available in stock. The inventory manager can profit from this additional information and issue products based on a Least Shelf Life First Out (LSFO) policy. We are focusing in this subsection on modeling an (r, Q) inventory system with TTI type 2 technology. To understand how TTI type 2 can help the inventory manager to reduce losses due to perished products and by deploying the LSFO instead of the FIFO issuing policy, we assume that all items coming from the same batch Q have the same age as in the case where TTI type 1 is used. If, at order arrival, the available on hand inventory has an age smaller than the age of the new batch Q , the order Q will be used to satisfy the demand after depleting the available on hand inventory. If the on hand inventory has an age larger than the age of the new batch Q then the order Q is depleted first. If the FIFO is used, it may happen that the available stock has an age greater than the new order Q . However, because of the FIFO policy the remaining available stock just before order arrives is used first. As a consequence, with the FIFO policy, the amount of outdated products is always greater than the amount of outdated products with the LSFO policy. Contrary to the TTI type 1, it is not easy to derive the expected operating costs because the age distribution of the on hand inventory is intractable. In terms of modeling of the (r, Q) model with TTI type 2, we opt for the simulation experiment to calculate the operating costs. The simulation model is built on the Arena software. The order of events has the following sequence:

- 1) An order arrives
- 2) Perished products are discarded
- 3) Demand is observed
- 4) Inventory Position is reviewed
- 5) An order is triggered.

5.3.1.4 Evaluation of the performance when the technology is affixed to the whole order Q

Additional Notations

Q_{TTI2} : The optimal order quantity for model with TTI type 2.

r_{TTI2} : The optimal reorder level for model with TTI type 2.

TC_{TTI2} : The average total cost for the for model with TTI type 2.

Q_1 : The optimal order quantity for (r, Q) model without TTIs.

r_1 : The optimal reorder level for (r, Q) model without TTIs.

TC_1 : The average total cost for (r, Q) model without TTIs.

The results of comparison between the total operating cost of models with TTI type 1 and 2 and the model without TTI(see Section (3.4) of Chapter (3)) are summarized in Table (5.3). Without loss of generality, we set $C = 5$, $P = 10$, and $W = 10$. The batch Q has an effective lifetime that varies between 3 and 11 units of time. The probability that an order arrives with an age equal to $\{3, 4, \dots, 11\}$ is $\{0.05, 0.1, 0.85, 3.95, 20, 26, 30, 18, 1.05\}$ respectively. Since the cost of the tag attached to the whole order is modeled as $\eta\%C$, the ordering cost K in our example represents the real ordering cost plus $\eta\%C$. We note that the optimal ordering policy does not change with η . That is when the cost of the tag is equal to C (so $\eta = 100$), we obtain the same ordering policy. Table (5.3) shows that with one tag, the technology leads to a cost saving of 14%. Cleraly, we see here the potential savings of of the LSFO issuing policy in comparison with the FIFO one.

The (r, Q) model with TTI type 1			The (r, Q) model with TTI type 2			Percentage difference		
r_{TTI1}	Q_{TTI1}	$TC_{TTI1}(r_{TTI1}, Q_{TTI1})$	r_{TTI2}	Q_{TTI2}	$TC_{TTI2}(r_{TTI2}, Q_{TTI2})$	$\Delta_1\%$	$\Delta_2\%$	$\Delta_3\%$
60	80	202.287	58	83	199.524	14,656	15,822	1,366

Normal demand $N(20, 2)$; $L = 2$; $H = 1$; $C = 5$; $P = 50$; $K = 150$; $W = 150$; $r_1 = 54$; $Q_1 = 54$; $TC_1(r_1, Q_1) = 237.025$; $m = 3$

$$\Delta_1\% = 100 \frac{TC_1(r_1, Q_1) - TC_{TTI1}(r_{TTI1}, Q_{TTI1})}{TC_1(r_1, Q_1)}$$

$$\Delta_2\% = 100 \frac{TC_1(r_1, Q_1) - TC_{TTI2}(r_{TTI2}, Q_{TTI2})}{TC_1(r_1, Q_1)}$$

$$\Delta_3\% = 100 \frac{TC_{TTI1}(r_{TTI1}, Q_{TTI1}) - TC_{TTI2}(r_{TTI2}, Q_{TTI2})}{TC_{TTI1}(r_{TTI1}, Q_{TTI1})}$$

Table 5.3: Performance of TTI technologies when it is affixed to the oder Q

5.3. Comparison between a TTI-based (r, Q) inventory control model to an (r, Q) inventory control model with fixed lifetime

5.3.2 The technology is affixed to each product in the batch Q

We assume in this section that a TTI tag is affixed to each unit of product. The general aim of this section is presented on Figure (5.4). We shall evaluate the performance of

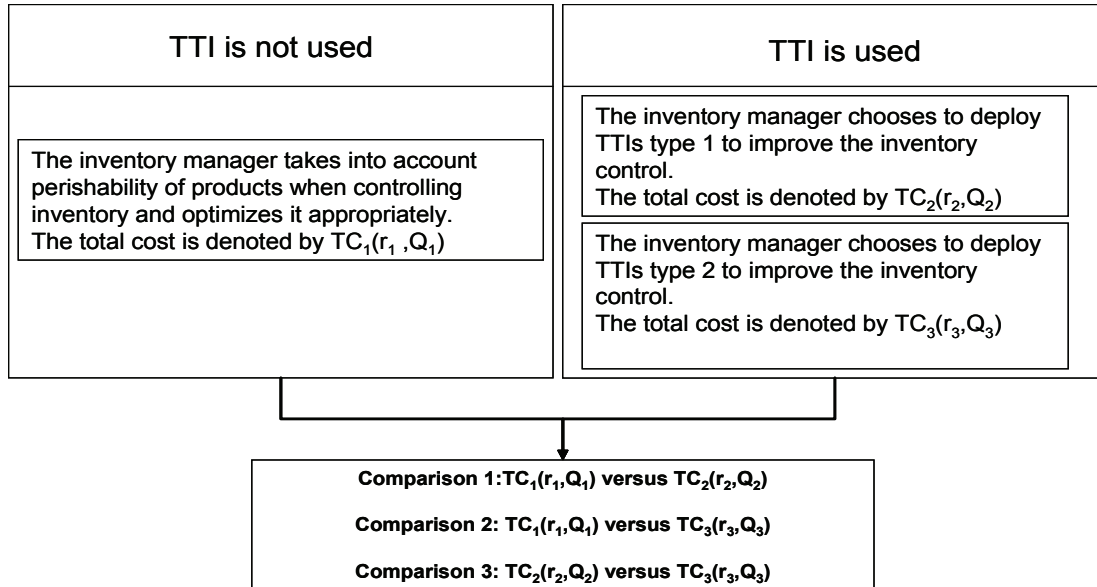

Figure 5.4: Different types of comparison

the technology by varying the mean and the variance of the demand and other cost parameters. We would like to answer the question: at which case of demand parameters and costs the technology is more attractive?

As a first step of analysis, since we have modeled the cost of the tag as a percentage of the purchasing cost C , we will evaluate the performance by varying C and the holding cost H . Intuitively, we think that the technology (type 1 or 2) performs better when the purchasing cost is high.

Secondly, we will keep the same cost C but we will varies the mean of the demand. We would like to know how the performance of the technology varies with the mean of the demand. We think that the technology (type 1 or 2) performs better when the mean of the demand increases.

Finally, we keep the same mean of the lifetime and evaluate the performance for different variance of the lifetime. Here, we think that TTI type 2 performs better than TTI type 1 when the lifetime's variance increases.

Notations

Impact of TTIs on Perishable Inventory Management

Q_2 : The optimal order quantity for the model with TTI type 12.

r_2 : The optimal reorder level for model with TTI type 1.

TC_2 : The average total cost for the proposed model with TTI type 1.

Q_3 : The optimal order quantity for the model with TTI type 2.

r_3 : The optimal reorder level for model with TTI type 2.

TC_3 : The average total cost for the proposed model with TTI type 2.

Throughout this section, we assume that the demand follows a Poisson distribution with mean $\lambda = 5; 10; 15$ and the replenishment lead time = 1 unit of time.

5.3.2.1 Sensitivity analysis with regard to the purchase cost C

Tables (5.4) and (5.5) show the performance of TTI type 1 and type 2 when the purchase cost increase. We expect to find that when C increases, the performance of the technology increases too. Results of Table (5.4) and (5.5) are unexpected. The performance of the technology decrease as C increases. This finding is attributed to the fact that when C increase, the holding cost H increases too. Hence, to reduce the impact of the holding cost, the optimal policy for both Model 2 and Model 3 calls for a smaller order Q . In our case, with respect to the cost of the technology, for $C = 5; Q = 48$ and for $C = 10; Q = 41$. Therefore, when Q decreases, the technology (type 1 or type 2) performs worse.

$\eta\% * C$	cost of the tag	Model 2			Model 3			Model 1 vs Model 2	Model 1 vs Model 3	Model 2 vs Model 3
		r_2	Q_2	$TC_2(r_2, Q_2)$	r_3	Q_3	$TC_3(r_3, Q_3)$			
0	0	13	48	87.95	14	61	84.87	18.98	22.07	65.88
5	0.25	13	48	90.52	14	61	87.38	16.41	19.55	70.97
10	0.5	13	48	93.09	14	61	89.89	13.84	17.04	76.05
15	0.75	13	48	95.66	14	61	92.40	11.27	14.53	81.13
20	1	13	48	98.23	14	61	94.91	8.70	12.02	86.21
25	1.25	13	48	100.80	14	61	97.42	6.13	9.51	91.30
30	1.5	13	48	103.38	14	61	99.94	3.56	7.00	96.38
35	1.75	13	48	105.95	14	61	102.45	0.99	4.49	101.46
40	2	13	48	108.52	14	61	104.96	-1.59	1.97	106.54

Fixed cost: $C=5; K=100; P=20; W=0; H=0.1 * C=0.5$. Model 1: $r_1=13; Q_1=25; TC_1(r_1, Q_1)=106.933$

Table 5.4: Performance of TTI technologies for $C = 5$

5.3.2.2 Sensitivity analysis with regard to the mean of the demand

As shown in Table (5.6), when the mean of the demand decreases, the performance of the technology increases. This result can be explained by the fact that when the mean

5.3. Comparison between a TTI-based (r, Q) inventory control model to an (r, Q) inventory control model with fixed lifetime

$\eta\% * C$	cost of the tag	Model 2			Model 3			Model 1 vs Model 2	Model 1 vs Model 3	Model 2 vs Model 3
		r_2	Q_2	$TC_2(r_2, Q_2)$	r_3	Q_3	$TC_3(r_3, Q_3)$			
0	0	12	41	151.72	12	47	149.53	14.80	16.99	134.74
5	0.25	12	41	156.79	12	47	154.53	9.73	11.99	144.80
10	0.5	12	41	161.85	12	47	159.53	4.67	6.99	154.86
15	0.75	12	41	166.91	12	47	164.53	-0.40	1.99	164.93
20	1	12	41	171.98	12	47	169.53	-5.46	-3.01	174.99
25	1.25	12	39	177.04	12	47	174.53	-10.52	-8.01	185.05
30	1.5	12	39	182.09	12	47	179.53	-15.57	-13.01	195.10
35	1.75	12	39	187.14	12	47	184.53	-20.62	-18.01	205.15
40	2	12	39	192.19	12	47	189.52	-25.67	-23.01	215.20
Fixed cost: $C=10;K=100;P=20;W=15;=H=0.1*C=1$. Model 1: $r_1=12; Q_1=24; TC_1(r_1, Q_1)=166.519$										

Table 5.5: Performance of TTI technologies for $C = 10$

of the demand decreases, the coefficient of variation of the demand increases. Therefore, with a high variability of the demand, the technology performs better.

When we compare between Model 2 and Model 3, we observe that Model 3 is more attractive especially for a small mean of demand because the depletion of inventory with the lowest shelf life first becomes a frequent case. That is, the LSFO policy is used frequently.

Mean demand	15 (high)			10 (average)			5 (small)		
Purchasing cost	10			10			10		
	r	Q	TC	r	Q	TC	r	Q	TC
TC Model 2	18	54	212.25	12	41	151.72	6	23	89.45
TC Model 3	18	58	211.06	12	47	149.59	6	28	85.94
TC Model 1 (lifetime=3)	18	35	222.33	12	24	166.51	5	14	109.64
Model 1 vs Model 2 (%)			4.53			8.89			18.41
Model 1 vs Model 3 (%)			5.07			10.16			21.61
Model 2 vs Model 3 (%)			0.56			1.40			3.92
Fixed cost: $C=10;K=100;P=20;W=15;=H=0.1*C=1$; cost of TTI typ1 = Cost of TTI type 2= 0									

Table 5.6: Performance of TTI technologies for different mean of demand

5.3.2.3 Sensitivity analysis with regard to the variance of the lifetime

Here, we keep the same mean of the lifetime but we vary its standard deviation.

We observe in Table (5.7) that the performance of Model 3 vs Model 1 is insensitive to the variance of the lifetime. This explains the ability of TTI type 2 to capture products that have the smallest shelf life and therefore allows the DC manager to deplete the inventory throughout the LSFO policy. When the TTI type 1 is used, we observe that the performance decreases as the variability the lifetime distribution increases. Since with TTI type 1, the FIFO issuing policy is used, an increase in the variability of the lifetime leads to more perished products. With TTI type 1, the DC manager is not able

Impact of TTIs on Perishable Inventory Management

to know if he have to allocate the oldest products on hand but may be they have the youngest age or if he have to allocate the youngest products that they just arrived but may be they have the oldest age to the present demand.

The better performance of TTI type 2 in comparison with TTI type 1 can be explained by the use of the LSFO policy instead of the FIFO policy when TTI type 2 is deployed. The LSFO depletion reduces the amount of perished products and the impact of perishability on the total cost will be lower than in the case of FIFO policy. We deduce that TTI type 2 is more attractive than TTI type 1 especially for a higher variance of the lifetime distribution. We note that [Ketzenberg & Bloemhof \(2008\)](#) is a more closely related

Lifetime distribution	Variance=0.5; mean=6			Variance=0.95; mean=6			Variance=3;mean=6		
	r	Q	TC	r	Q	TC	r	Q	TC
Model 1 (lifetime=3)	12	22	119.29	12	22	119.29	12	22	119.29
Model 2	12	40	101.45	12	39	102.81	12	31	106.24
Model 3	13	44	99.63	12	47	99.60	12	47	99.5594
Model 1 vs Model 2			14.95			13.82			10.94
Model 1 vs Model 3			16.48			16.51			16.54
Model 2 vs Model 3			1.80			3.12			6.29
Fixed cost: C=5;K=100;P=20;W=15;=H=1									

Table 5.7: Performance of TTI technologies with the variability of the lifetime distribution

study to our work. The authors evaluate the value of RFID technology that provide information about the lifetime of products at the time of receipt and the remaining lifetime of inventory available for replenishment. They find that the highest value of RFID is decreasing the spoilage of products. However, in their works [Ketzenberg & Bloemhof \(2008\)](#) do not consider the cost of implementation related to the deployment of the technology. To our knowledge no paper has been published and answer the question of whether the TTI technologies is cost effective or not.

5.4 Comparison between TTI-based (T, S) inventory control to a (T, S) inventory control with fixed lifetime

The general setting is a Distribution Center (DC) that provides a perishable product to retailer and receives replenishments from an external supplier. The DC manage his inventory using a (T, S) replenishment policy. That is, the inventory level is observed at equal intervals of time, T and a replenishment order is placed every T units of time to bring the inventory level to the order-up-to-level S . The demand follows a probabilistic random variable with mean λ . An order triggered at the beginning of the period T arrives after a fixed lead time L and excess demands are completely lost. We assume that replenishments from the supplier to the DC are exposed to fluctuating environmental parameters caused by temperature variations that affect the shelf life of each item in the consignment. Our interest is to compare is to compare three different scenarios discussed in Section (5.2).

Notations

K : Fixed ordering cost per order.

H : Holding cost per unit of product held in stock per unit of time.

C : Purchase cost per unit of product.

P : Lost sales cost per unit of demand lost.

W : Outdate cost per unit of product that perishes in stock.

t_1 : The unit TTI type 1 tag cost.

t_2 : The unit TTI type 2 tag cost.

m_{min} : Minimum Product's lifetime.

L : Replenishment lead time.

T_1, T_2, T_3 : Optimal review period for scenarios 1, 2 and 3 respectively.

S_1, S_2, S_3 : Optimal order up to level for scenarios 1, 2 and 3 respectively.

$E[I]_1, E[I]_2, E[I]_3$: The expected inventory level per unit time for scenarios 1, 2 and 3 respectively.

$E[O]_1, E[O]_2, E[O]_3$: The expected outdating quantity per unit time for scenarios 1, 2 and 3 respectively.

Impact of TTIs on Perishable Inventory Management

$E[S]_1, E[S]_2, E[S]_3$: The expected lost sale per unit time for scenarios 1, 2 and 3 respectively.

TC_1, TC_2, TC_3 : The total operating cost per unit time for scenarios 1, 2 and 3 respectively.

We simulate three (T, S) inventory policies, i.e., Model 1, 2 and 3. The simulation experiment allows us to choose a real representative distribution of the shelf life and to capture the impact of issuing policies (FIFO and LSFO) on inventory management. For each model, we record the number of outdated items, the number of excess demand during the replenishment lead time and the inventory level per unit time. Then, we calculate the total operating inventory cost for the three models as follow:

$$TC_1(T, S) = \frac{K}{T} + C(\lambda - E[S]_1 + E[O]_1) + PE[S]_1 + WE[O]_1 + HE[I]_1 \quad (5.6)$$

$$TC_2(T, S) = \frac{K}{T} + (C + t_1)(\lambda - E[S]_2 + E[O]_2) + PE[S]_2 + WE[O]_1 + HE[I]_2 \quad (5.7)$$

$$TC_3(T, S) = \frac{K}{T} + (C + t_2)(\lambda - E[S]_3 + E[O]_3) + PE[S]_3 + WE[O]_3 + HE[I]_3 \quad (5.8)$$

5.4.1 Results and discussion

The simulation model is implemented in Arena software and validated by the exact (T, S) inventory policy with full lost sales developed in Section (4.2) of Chapter (4).

The order of events is the following:

- i) Place replenishment order if necessary.
- ii) Observe demand or remove expired units from inventory.
- iii) Receive replenishment.

We set the replication length of a simulation run to 100000 units of time which is sufficiently enough for the three models to exhibit their steady-state behavior. The setting input parameters we consider are the following:

The demand follows a Poisson distribution with mean $\lambda = 10$.

The replenishment lead time = 1 unit of time.

$C \in \{5, 15\}$.

5.4. Comparison between TTI-based (T, S) inventory control to a (T, S) inventory control with fixed lifetime

$K \in \{50, 100, 150\}$.

$P \in \{20, 40\}$.

$W \in \{5, 15\}$.

$m_{min} = 3$.

$m_{max} \in \{8, 9\}$.

The probability mass function of the shelf life has a mean = 6 and variance $\in \{0.5, 0.95, 3\}$ as shown in figures (5.5, 5.6, 5.7).

Our first objective is to assess the performance of FIFO (model 2) and LSFO (model 3) issuing policies in comparison with the FIFO issuing policy used in the case of fixed shelf life inventory management. This constitutes the first level of comparison in which we do not consider the cost of the tag associated with Model 2 and 3. That is, we use the same purchasing cost for the three models. The second level of comparison consists on evaluating the performance of the TTI technologies by including the cost of the tag so that we can answer the question whether or not TTI-based inventory management is cost effective. Finally, we compare the performance of the technology when we deployed in an (r, Q) or in a (T, S) policy.

5.4.2 Impact of the issuing policy on inventory management

In general, we find that both TTI type 1 and type 2 can reduce considerably the total operating inventory cost. This reduction is mainly due to the decreased number of unsealable products and the decreased number of out-of-stocks. In Tables (5.8), (5.9), and (5.10), we report the results of comparison between the three models over a range of costs parameters and shelf life variances. We find that both Model 2 and Model 3 perform better than Model 1 over the entire range of cost parameters. Model 2 achieves a cost reduction of 10% on average, minimum = 2% and maximum = 21% from Model 1 (cf. Table (5.8)). Model 3 achieves a better performance than Model 2. The average percent deviation from Model 1 is about 12 %, minimum = 2% and maximum = 24% (cf. Table (5.8)). This confirms that the TTI-based inventory management is more efficient than an inventory management with fixed shelf life. Hence, without TTI technologies, the DC manager holds less products in order to reduce outdating. Extended lifetime provided by TTI technologies reduces outdating quantity and enables the DC manger

to enhance the total operating cost.

When comparing Model 2 to Model 3, we observe that Model 3 performs better than Model 2 since the LSFO issuing policy allows the DC manager to sell items with the least shelf life first and thus reduce the amount of outdated items. Hence, units held in stock with the lowest shelf life are allocated to demand first which creates an opportunity to reduce the amount of outdated products. Such opportunity could not be realized throughout TTI type 1. The improvement is about 1% on average, minimum = 0.1% and maximum = 3% (cf. Table (5.8)). However, when the variance of the shelf life increases, Model 3 yields an average performance of 4% from Model 2 (cf. Table (5.10)). Although the high variability of shelf life (which means high temperature perturbations), TTI type 2 enables the DC to better reduce the amount outdated products than TTI type 1 (cf. Table (5.8), (5.9), and (5.11)) so it achieves substantial cost savings. This result is explained by the fact that the high variability of shelf lives induces more age categories of items in stock. Since TTI type 2 can capture the remaining shelf life of items, the DC manager can reduce the impact of this variability by using LSFO issuing policy. However, since TTI type 1 provides a binary information to the DC manager by changing color, the situation where replenished items arrive at the DC with remaining shelf lives lower than products on hand could not be captured. In other words, a unit of inventory held in stock at the DC may expire while a “younger” unit is used to satisfy demand.

5.4.3 Sensitivity analysis regarding the cost of the TTI tag

In this subsection we compare the three models when the cost of the TTI tag is included. The unit TTI tag cost varies between 0 and 6. We observe that TTI type 1 remains attractive with respect to the unit TTI type 1 cost. The performance decreases as the cost of the tag increases. When the TTI type 1 cost is equal to 3.44, Model 1 and 2 have the same cost. In addition, when the variance of the shelf life increases from 0.5 to 3, the performance of TTI type 1, i.e. Model 2, decreases. For example if the variance is equal to 3, Model 2 performs better than Model 1 only if the cost of TTI type 1 is lower than 2.52 (cf. column 10 of Table (5.11)). This result is due to the fact that TTI type 1 can not allow the DC manager to switch between items to sell those having lowest shelf

5.4. Comparison between TTI-based (T, S) inventory control to a (T, S) inventory control with fixed lifetime

life first.

In the case of TTI type 2, we find that Model 3 yields a better performance in comparison with Model 2 for the same cost of TTI tag. Again, as Model 2, the improvement achieved by Model 3 decreases as the cost of TTI type 2 increases. When the unit TTI cost becomes 3.9, Model 3 and Model 1 have the same total inventory cost. We find also that the performance of Model 3 varies slightly as the variance of the shelf life increases. That is, Even if the DC manger has more ages categories of products in stock (because high variance of shelf life induce more products' age categories), the LSFO issuing policy enables him to efficiently match products with the lowest shelf life with demand. In conclusion, the TTI-based inventory management achieved its goal of reducing the total inventory operating cost.

In Table (5.12) we compare between Model 2 and Model 3 where the cost of TTI type 1 is fixed to 0.5 and the cost of TTI type 2 varies from 0.5 to 2. We observe that Model 3 outperforms Model 2 over a wide range of unit TTI type 2 costs. This performance increases with the variance of the shelf life. Clearly, when the shelf life's variance = 0.5, Model 3 achieves the same total inventory operating cost as Model 3 when the unit TTI type 2 cost = 0.9. For a shelf life's variance = 3, Model 3 generates a similar total inventory operating cost as Model 2 if the unit TTI type 2 cost = 1.9. This demonstrates that TTI type is more suitable to take into account temperature variations and hence to reduce the inventory cost. In addition, our results indicate that costs of commercialized TTI tags (which are less than 0.5 for TTI type 1 and less than 1 for TTI type 2 as shown in Chapter(1)) are reasonable prices.

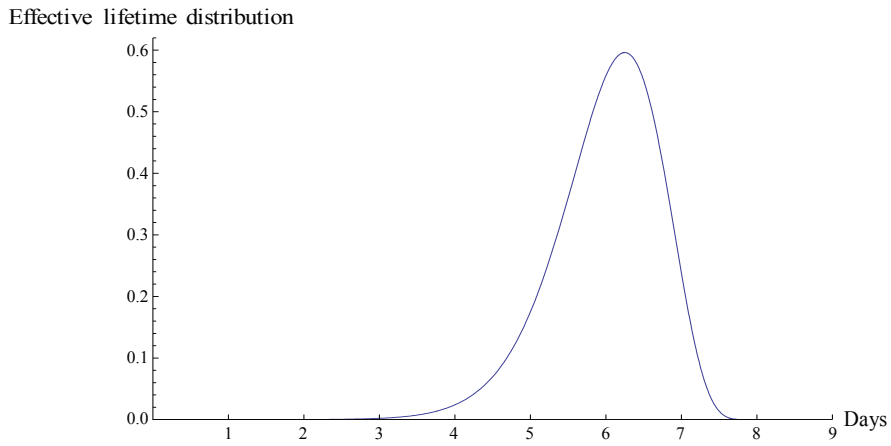

Figure 5.5: Effective lifetime distribution, mean =6, variance= 0.50

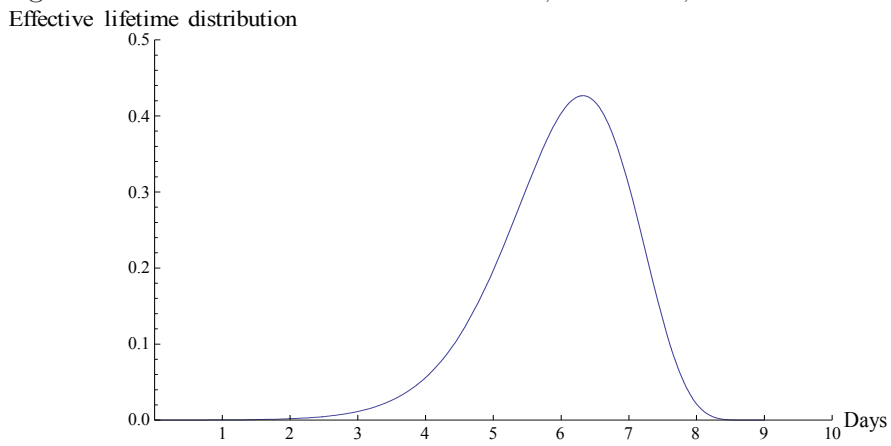

Figure 5.6: Effective lifetime distribution, mean =6, variance= 0.95

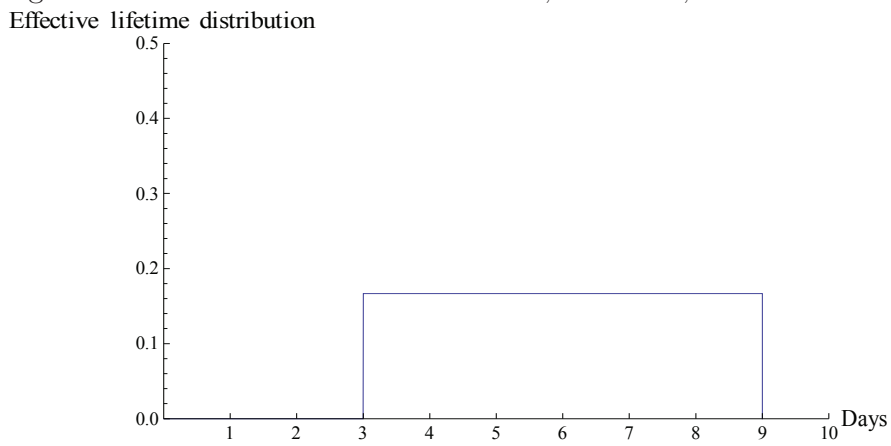

Figure 5.7: Effective lifetime distribution, mean =6, variance= 3

Test N°	Costs parameters				(T, S) inventory control without TTI						(T, S) inventory control with TTI type 1						(T, S) inventory control with TTI type 2						Percentage difference		
	C	K	P	W	T_1	S_1	$E[I]_1$	$E[O]_1$	$E[S]_1$	$TC_1(T_1, S_1)$	T_2	S_2	$E[I]_2$	$E[O]_2$	$E[S]_2$	$TC_2(T_2, S_2)$	T_3	S_3	$E[I]_3$	$E[O]_3$	$E[S]_3$	$TC_3(T_3, S_3)$	$\Delta_{1 \text{ vs. } 2\%}$	$\Delta_{1 \text{ vs. } 3\%}$	$\Delta_{2 \text{ vs. } 3\%}$
1	5	50	20	5	2	34	14.155	0.239	0.390	97.388	3	45	20.678	0.018	0.221	90.840	3	45	20.711	0.000	0.220	90.675	6.72	6.89	0.18
2	5	100	20	5	2	34	14.155	0.239	0.390	122.388	4	53	24.087	0.081	0.327	104.803	4	53	24.319	0.001	0.309	103.957	14.37	15.06	0.81
3	5	150	20	5	3	33	12.078	0.528	1.859	145.240	4	53	24.087	0.081	0.327	117.303	5	62	28.697	0.017	0.347	114.069	19.23	21.46	2.76
4	5	50	40	5	2	37	16.204	0.435	0.229	103.564	3	48	23.261	0.032	0.102	93.827	3	48	23.323	0.000	0.101	93.510	9.40	9.71	0.34
5	5	100	40	5	2	37	16.204	0.435	0.229	128.564	4	58	27.977	0.159	0.122	108.842	4	58	28.457	0.003	0.109	107.301	15.34	16.54	1.42
6	5	150	40	5	2	37	16.204	0.435	0.229	153.564	4	58	27.977	0.159	0.122	121.342	5	68	33.393	0.057	0.119	118.119	20.98	23.08	2.66
7	15	50	20	5	3	24	7.951	0.062	3.037	191.034	4	40	15.891	0.013	1.514	186.224	4	42	17.086	0.000	1.276	185.969	2.52	2.65	0.14
8	15	100	20	5	6	23	4.579	0.036	6.214	203.034	5	40	15.076	0.018	2.400	197.438	6	47	17.916	0.000	2.382	196.500	2.76	3.22	0.47
9	15	150	20	5	6	23	4.579	0.036	6.214	211.367	7	42	12.877	0.027	4.031	204.992	7	48	16.700	0.000	3.167	203.970	3.02	3.50	0.50
10	15	50	40	5	2	34	14.155	0.239	0.390	203.673	3	47	22.376	0.026	0.134	192.919	3	47	22.429	0.000	0.133	192.415	5.28	5.53	0.26
11	15	100	40	5	2	34	14.155	0.239	0.390	228.673	4	55	25.633	0.106	0.224	208.364	4	57	27.586	0.002	0.137	206.049	8.88	9.89	1.11
12	15	150	40	5	2	34	14.155	0.239	0.390	253.673	4	55	25.633	0.106	0.224	220.864	5	66	31.763	0.040	0.176	216.954	12.93	14.48	1.77
13	5	50	20	15	2	32	12.803	0.153	0.562	99.301	3	44	19.872	0.015	0.277	90.990	3	45	20.711	0.000	0.220	90.676	8.37	8.69	0.35
14	5	100	20	15	2	32	12.803	0.153	0.562	124.301	4	52	23.378	0.072	0.383	105.567	4	53	24.319	0.001	0.309	103.963	15.07	16.36	1.52
15	5	150	20	15	3	30	10.677	0.305	2.165	149.249	4	52	23.378	0.072	0.383	118.067	5	62	28.697	0.017	0.347	114.242	20.89	23.46	3.24
16	5	50	40	15	2	35	14.840	0.295	0.324	107.088	3	48	23.261	0.032	0.102	94.148	3	48	23.323	0.000	0.101	93.511	12.08	12.68	0.68
17	5	100	40	15	2	35	14.840	0.295	0.324	132.088	4	57	27.174	0.139	0.151	110.247	4	58	28.457	0.003	0.109	107.330	16.54	18.74	2.65
18	5	150	40	15	2	35	14.840	0.295	0.324	157.088	4	57	27.174	0.139	0.151	122.747	5	67	32.577	0.047	0.147	118.664	21.86	24.46	3.33
19	15	50	20	15	3	23	7.508	0.043	3.213	191.519	4	40	15.891	0.013	1.514	186.356	4	42	17.086	0.000	1.276	185.969	2.70	2.90	0.21
20	15	100	20	15	6	22	4.199	0.023	6.367	203.377	5	40	15.076	0.018	2.400	197.618	6	47	17.916	0.000	2.382	196.504	2.83	3.38	0.56
21	15	150	20	15	6	22	4.199	0.023	6.367	211.710	7	39	11.141	0.014	4.439	205.168	7	48	16.700	0.000	3.167	203.975	3.09	3.65	0.58
22	15	50	40	15	2	33	13.474	0.192	0.468	205.939	3	46	21.513	0.022	0.174	193.175	3	47	22.429	0.000	0.133	192.416	6.20	6.57	0.39
23	15	100	40	15	2	33	13.474	0.192	0.468	230.939	4	55	25.633	0.106	0.224	209.425	4	57	27.586	0.002	0.137	206.068	9.32	10.77	1.60
24	15	150	40	15	2	33	13.474	0.192	0.468	255.939	4	55	25.633	0.106	0.224	221.925	5	65	30.978	0.032	0.216	217.320	13.29	15.09	2.07
Average percent deviation																						10.57%	11.615%	1.233%	

$$\Delta_{1 \text{ vs. } 2\%} = 100(TC_1 - TC_2)/TC_1; \Delta_{1 \text{ vs. } 3\%} = 100(TC_1 - TC_3)/TC_1; \Delta_{2 \text{ vs. } 3\%} = 100(TC_2 - TC_3)/TC_2$$

Table 5.8: Comparison between Scenarios 1, 2 and 3 for a shelf life with variance =0.5

Test N°	Costs parameters				(T, S) inventory control without TTI					(T, S) inventory control with TTI type 1					(T, S) inventory control with TTI type 2					Percentage difference					
	C	K	P	W	T_1	S_1	$E[I]_1$	$E[O]_1$	$E[S]_1$	$TC_1(T_1, S_1)$	T_2	S_2	$E[I]_2$	$E[O]_2$	$E[S]_2$	$TC_2(T_2, S_2)$	T_3	S_3	$E[I]_3$	$E[O]_3$	$E[S]_3$	$TC_3(T_3, S_3)$	$\Delta_{1 \text{ vs. } 2\%}$	$\Delta_{1 \text{ vs. } 3\%}$	$\Delta_{2 \text{ vs. } 3\%}$
1	5	50	20	5	2	34	14.155	0.239	0.390	97.388	3	44	19.803	0.050	0.282	91.202	3	45	20.708	0.000	0.219	90.658	6.35	6.91	0.60
2	5	100	20	5	2	34	14.155	0.239	0.390	122.388	4	53	23.912	0.161	0.350	105.772	4	53	24.317	0.000	0.308	103.936	13.58	15.08	1.74
3	5	150	20	5	3	33	12.078	0.528	1.859	145.240	4	53	23.912	0.161	0.350	118.272	5	62	28.706	0.007	0.349	114.001	18.57	21.51	3.61
4	5	50	40	5	2	37	16.204	0.435	0.229	103.564	3	48	23.140	0.086	0.106	94.382	3	48	23.322	0.000	0.101	93.524	8.87	9.69	0.91
5	5	100	40	5	2	37	16.204	0.435	0.229	128.564	4	58	27.684	0.265	0.135	110.047	4	58	28.470	0.001	0.111	107.362	14.40	16.49	2.44
6	5	150	40	5	2	37	16.204	0.435	0.229	153.564	4	58	27.684	0.265	0.135	122.547	5	67	32.662	0.019	0.142	117.808	20.20	23.28	3.87
7	15	50	20	5	3	24	7.951	0.062	3.037	191.034	3	36	14.380	0.019	1.061	186.730	4	41	16.502	0.000	1.393	185.968	2.25	2.65	0.41
8	15	100	20	5	6	23	4.579	0.036	6.214	203.034	5	39	14.489	0.046	2.550	198.154	6	46	17.277	0.000	2.511	196.499	2.40	3.22	0.84
9	15	150	20	5	6	23	4.579	0.036	6.214	211.367	7	39	11.096	0.038	4.466	205.622	7	49	17.341	0.000	3.039	203.970	2.72	3.50	0.80
10	15	50	40	5	2	34	14.155	0.239	0.390	203.673	3	46	21.413	0.065	0.178	193.832	3	47	22.437	0.000	0.133	192.422	4.83	5.52	0.73
11	15	100	40	5	2	34	14.155	0.239	0.390	228.673	3	46	21.413	0.065	0.178	210.498	4	57	27.591	0.001	0.137	206.029	7.95	9.90	2.12
12	15	150	40	5	2	34	14.155	0.239	0.390	253.673	4	55	25.367	0.195	0.250	223.011	5	66	31.834	0.015	0.174	216.488	12.09	14.66	2.92
13	5	50	20	15	2	32	12.803	0.153	0.562	99.301	3	44	19.803	0.050	0.282	91.699	3	45	20.708	0.000	0.219	90.659	7.66	8.70	1.14
14	5	100	20	15	2	32	12.803	0.153	0.562	124.301	4	52	23.206	0.146	0.409	107.261	4	53	24.317	0.000	0.308	103.939	13.71	16.38	3.10
15	5	150	20	15	3	30	10.677	0.305	2.165	149.249	4	52	23.206	0.146	0.409	119.761	5	62	28.706	0.007	0.349	114.066	19.76	23.57	4.76
16	5	50	40	15	2	35	14.840	0.295	0.324	107.088	3	48	23.140	0.086	0.106	95.246	3	48	23.322	0.000	0.101	93.525	11.06	12.67	1.81
17	5	100	40	15	2	35	14.840	0.295	0.324	132.088	3	48	23.140	0.086	0.106	111.913	4	58	28.470	0.001	0.111	107.373	15.27	18.71	4.06
18	5	150	40	15	2	35	14.840	0.295	0.324	157.088	4	56	26.109	0.218	0.205	125.136	5	67	32.662	0.019	0.142	117.996	20.34	24.89	5.71
19	15	50	20	15	3	23	7.508	0.043	3.213	191.519	3	36	14.380	0.019	1.061	186.919	4	41	16.502	0.000	1.393	185.969	2.40	2.90	0.51
20	15	100	20	15	6	22	4.199	0.023	6.367	203.377	5	39	14.489	0.046	2.550	198.610	6	46	17.277	0.000	2.511	196.499	2.34	3.38	1.06
21	15	150	20	15	6	22	4.199	0.023	6.367	211.710	7	38	10.557	0.033	4.601	205.972	7	49	17.341	0.000	3.039	203.972	2.71	3.65	0.97
22	15	50	40	15	2	33	13.474	0.192	0.468	205.939	3	46	21.413	0.065	0.178	194.483	3	47	22.437	0.000	0.133	192.423	5.56	6.56	1.06
23	15	100	40	15	2	33	13.474	0.192	0.468	230.939	3	46	21.413	0.065	0.178	211.150	4	57	27.591	0.001	0.137	206.034	8.57	10.78	2.42
24	15	150	40	15	2	33	13.474	0.192	0.468	255.939	4	54	24.630	0.177	0.299	224.909	5	66	31.834	0.015	0.174	216.638	12.12	15.36	3.68
Average percent deviation																						9.821%	11.67%	2.135%	

$$\Delta_{1 \text{ vs. } 2\%} = 100(TC_1 - TC_2)/TC_1; \Delta_{1 \text{ vs. } 3\%} = 100(TC_1 - TC_3)/TC_1; \Delta_{2 \text{ vs. } 3\%} = 100(TC_2 - TC_3)/TC_2$$

Table 5.9: Comparison between Scenarios 1, 2 and 3 for a shelf life with variance =0.95

Test N°	Costs parameters				(T, S) inventory control without TTI						(T, S) inventory control with TTI type 1						(T, S) inventory control with TTI type 2						Percentage difference		
	C	K	P	W	T_1	S_1	$E[I]_1$	$E[O]_1$	$E[S]_1$	$TC_1(T_1, S_1)$	T_2	S_2	$E[I]_2$	$E[O]_2$	$E[S]_2$	$TC_2(T_2, S_2)$	T_3	S_3	$E[I]_3$	$E[O]_3$	$E[S]_3$	$TC_3(T_3, S_3)$	$\Delta_{1 \text{ vs. } 2\%}$	$\Delta_{1 \text{ vs. } 3\%}$	$\Delta_{2 \text{ vs. } 3\%}$
1	5	50	20	5	2	34	14.155	0.239	0.390	97.388	3	44	19.567	0.152	0.300	92.246	3	45	20.709	0.000	0.223	90.717	5.28	6.85	1.66
2	5	100	20	5	2	34	14.155	0.239	0.390	122.388	3	44	19.567	0.152	0.300	108.913	5	63	29.454	0.002	0.296	103.913	11.01	15.10	4.59
3	5	150	20	5	3	33	12.078	0.528	1.859	145.240	4	53	23.080	0.438	0.477	122.112	6	69	31.683	0.004	0.462	113.662	15.92	21.74	6.92
4	5	50	40	5	2	37	16.204	0.435	0.229	103.564	3	48	22.691	0.259	0.118	96.097	3	49	24.213	0.000	0.075	93.520	7.21	9.70	2.68
5	5	100	40	5	2	37	16.204	0.435	0.229	128.564	3	48	22.691	0.259	0.118	112.763	4	58	28.449	0.000	0.109	107.282	12.29	16.55	4.86
6	5	150	40	5	2	37	16.204	0.435	0.229	153.564	4	60	27.625	0.705	0.169	128.078	5	68	33.576	0.008	0.116	117.709	16.60	23.35	8.10
7	15	50	20	5	3	24	7.951	0.062	3.037	191.034	3	33	12.650	0.029	1.476	187.270	4	41	16.495	0.000	1.395	185.970	1.97	2.65	0.69
8	15	100	20	5	6	23	4.579	0.036	6.214	203.034	5	33	11.007	0.056	3.504	199.644	6	48	18.512	0.000	2.258	196.468	1.67	3.23	1.59
9	15	150	20	5	6	23	4.579	0.036	6.214	211.367	7	33	7.979	0.041	5.335	206.893	7	48	16.702	0.000	3.166	203.961	2.12	3.50	1.42
10	15	50	40	5	2	34	14.155	0.239	0.390	203.673	2	36	16.299	0.028	0.173	196.175	3	47	22.399	0.000	0.137	192.489	3.68	5.49	1.88
11	15	100	40	5	2	34	14.155	0.239	0.390	228.673	3	45	20.311	0.173	0.245	213.218	4	57	27.580	0.000	0.140	206.082	6.76	9.88	3.35
12	15	150	40	5	2	34	14.155	0.239	0.390	253.673	3	45	20.311	0.173	0.245	229.885	5	66	31.880	0.005	0.173	216.299	9.38	14.73	5.91
13	5	50	20	15	2	32	12.803	0.153	0.562	99.301	3	43	18.836	0.131	0.366	93.597	3	45	20.709	0.000	0.223	90.717	5.74	8.64	3.08
14	5	100	20	15	2	32	12.803	0.153	0.562	124.301	3	43	18.836	0.131	0.366	110.264	5	63	29.454	0.002	0.296	103.934	11.29	16.39	5.74
15	5	150	20	15	3	30	10.677	0.305	2.165	149.249	4	49	20.667	0.326	0.760	126.089	6	69	31.683	0.004	0.462	113.706	15.52	23.81	9.82
16	5	50	40	15	2	35	14.840	0.295	0.324	107.088	2	38	18.073	0.047	0.094	97.297	3	49	24.213	0.000	0.075	93.520	9.14	12.67	3.88
17	5	100	40	15	2	35	14.840	0.295	0.324	132.088	3	47	21.905	0.230	0.153	115.176	4	58	28.449	0.000	0.109	107.287	12.80	18.78	6.85
18	5	150	40	15	2	35	14.840	0.295	0.324	157.088	3	47	21.905	0.230	0.153	131.843	5	68	33.576	0.008	0.116	117.790	16.07	25.02	10.66
19	15	50	20	15	3	23	7.508	0.043	3.213	191.519	3	33	12.650	0.029	1.476	187.557	4	41	16.495	0.000	1.395	185.970	2.07	2.90	0.85
20	15	100	20	15	6	22	4.199	0.023	6.367	203.377	6	32	8.781	0.036	4.707	200.075	6	48	18.512	0.000	2.258	196.468	1.62	3.40	1.80
21	15	150	20	15	6	22	4.199	0.023	6.367	211.710	7	32	7.517	0.032	5.463	207.235	7	48	16.702	0.000	3.166	203.961	2.11	3.66	1.58
22	15	50	40	15	2	33	13.474	0.192	0.468	205.939	2	36	16.299	0.028	0.173	196.451	3	47	22.399	0.000	0.137	192.490	4.61	6.53	2.02
23	15	100	40	15	2	33	13.474	0.192	0.468	230.939	3	44	19.567	0.152	0.300	214.944	4	57	27.580	0.000	0.140	206.086	6.93	10.76	4.12
24	15	150	40	15	2	33	13.474	0.192	0.468	255.939	3	44	19.567	0.152	0.300	231.610	5	66	31.880	0.005	0.173	216.344	9.51	15.47	6.59
Average percent deviation																						7.971%	11.700%	4.193%	

$$\Delta_{1 \text{ vs. } 2\%} = 100(TC_1 - TC_2)/TC_1; \Delta_{1 \text{ vs. } 3\%} = 100(TC_1 - TC_3)/TC_1; \Delta_{2 \text{ vs. } 3\%} = 100(TC_2 - TC_3)/TC_2$$

Table 5.10: Comparison between Scenarios 1, 2 and 3 for a shelf life with variance =3

Impact of TTIs on Perishable Inventory Management

TTI cost	Variance =0.5				Variance =0.95				Variance =3			
	TC1	TC2	$\Delta_{1 \text{ vs. } 2\%}$	$\Delta_{1 \text{ vs. } 3\%}$	TC1	TC2	$\Delta_{1 \text{ vs. } 2\%}$	$\Delta_{1 \text{ vs. } 3\%}$	TC1	TC2	$\Delta_{1 \text{ vs. } 2\%}$	$\Delta_{1 \text{ vs. } 3\%}$
0	122.747	118.664	21.86	24.46	125.136	117.996	20.34	24.89	131.843	117.790	16.07	25.02
0.25	125.244	121.140	20.27	22.88	127.639	120.466	18.75	23.31	134.362	120.263	14.47	23.44
0.5	127.741	123.615	18.68	21.31	130.142	122.935	17.15	21.74	136.881	122.736	12.86	21.87
0.75	130.238	126.090	17.09	19.73	132.646	125.404	15.56	20.17	139.401	125.209	11.26	20.29
1	132.735	128.565	15.50	18.16	135.149	127.873	13.97	18.60	141.910	127.682	9.66	18.72
1.25	135.232	131.040	13.91	16.58	137.652	130.343	12.37	17.03	144.411	130.155	8.07	17.15
1.5	137.729	133.508	12.32	15.01	140.156	132.812	10.78	15.45	146.911	132.628	6.48	15.57
1.75	140.226	135.974	10.73	13.44	142.659	135.281	9.19	13.88	149.412	135.101	4.89	14.00
2	142.717	138.440	9.15	11.87	145.162	137.751	7.59	12.31	151.913	137.574	3.29	12.42
2.25	145.201	140.906	7.57	10.30	147.666	140.220	6.00	10.74	154.414	140.047	1.70	10.85
2.5	147.684	143.372	5.99	8.73	150.169	142.689	4.40	9.17	156.914	142.520	0.11	9.27
2.75	150.168	145.838	4.41	7.16	152.672	145.159	2.81	7.59	159.415	144.993	-1.48	7.70
3	152.652	148.304	2.82	5.59	155.175	147.628	1.22	6.02	161.916	147.466	-3.07	6.13
3.25	155.136	150.770	1.24	4.02	157.679	150.097	-0.38	4.45	164.417	149.939	-4.67	4.55
3.5	157.620	153.236	-0.34	2.45	160.182	152.566	-1.97	2.88	166.918	152.412	-6.26	2.98
3.75	160.104	155.702	-1.92	0.88	162.685	155.036	-3.56	1.31	169.418	154.886	-7.85	1.40
4	162.588	158.167	-3.50	-0.69	165.189	157.505	-5.16	-0.27	171.919	157.356	-9.44	-0.17
4.25	165.072	160.633	-5.08	-2.26	167.692	159.974	-6.75	-1.84	174.420	159.814	-11.03	-1.73
4.5	167.556	163.099	-6.66	-3.83	170.195	162.444	-8.34	-3.41	176.921	162.272	-12.62	-3.30
4.75	172.517	168.031	-9.82	-6.97	172.699	164.913	-9.94	-4.98	179.421	164.729	-14.22	-4.86
5	174.987	170.497	-11.39	-8.54	175.202	167.382	-11.53	-6.55	181.922	167.187	-15.81	-6.43
5.25	177.458	172.963	-12.97	-10.11	177.705	169.852	-13.12	-8.12	184.423	169.645	-17.40	-7.99
5.5	179.928	175.429	-14.54	-11.68	180.208	172.321	-14.72	-9.70	186.924	172.103	-18.99	-9.56
5.75	182.398	177.895	-16.11	-13.25	182.694	174.790	-16.30	-11.27	189.419	174.561	-20.58	-11.12
6	184.869	180.361	-17.68	-14.82	185.181	177.259	-17.88	-12.84	191.902	177.019	-22.16	-12.69

Fixed parameters: C=5, K=150,P=40,W=15, TC1=157,09

Table 5.11: Performance of TTI technologies with fixed TTI cost

5.4.3.1 Comparison between the performance of the technology in an (r, Q) and in a (T, S) policy

In Table (5.13), we compare the performance of TTI type 1 and type 2 when this technology is deployed in an (r, Q) inventory policy or in a (T, S) inventory policy. The results show that the technology is more attractive when it is deployed in a (T, S) policy because with this policy the ordering quantity is variable while in the (r, Q) is fixed.

5.4. Comparison between TTI-based (T, S) inventory control to a (T, S) inventory control with fixed lifetime

Cost of TTI type 2	Variance =0.5			Variance =0.95			Variance =3		
	TC1	TC2	$\Delta_{2 vs. 3\%}$	TC1	TC2	$\Delta_{2 vs. 3\%}$	TC1	TC2	$\Delta_{2 vs. 3\%}$
0.5	127.741	123.615	3.2301	130.142	122.935	5.5382	136.881	122.74	10.334
0.55		124.11	2.8426		123.429	5.1588		123.23	9.973
0.6		124.605	2.455		123.923	4.7793		123.72	9.6117
0.65		125.100	2.0675		124.416	4.3998		124.22	9.2503
0.7		125.595	1.68		124.91	4.0203		124.71	8.889
0.75		126.090	1.2925		125.404	3.6409		125.21	8.5276
0.8		126.585	0.905		125.898	3.2614		125.7	8.1663
0.85		127.080	0.5175		126.392	2.8819		126.2	7.8049
0.9		127.575	0.13		126.886	2.5024		126.69	7.4436
0.95		128.070	-0.2576		127.38	2.123		127.19	7.0822
1			< 0		127.873	1.7435		127.68	6.7209
1.05			< 0		128.367	1.364		128.18	6.3596
1.1			< 0		128.861	0.9845		128.67	5.9982
1.15			< 0		129.355	0.605		129.17	5.6369
1.2			< 0		129.849	0.2256		129.66	5.2755
1.25			< 0		130.343	-0.1539		130.15	4.9142
1.3			< 0			< 0		130.65	4.5528
1.35			< 0			< 0		131.14	4.1915
1.4			< 0			< 0		131.64	3.8301
1.45			< 0			< 0		132.13	3.4688
1.5			< 0			< 0		132.63	3.1075
1.55			< 0			< 0		133.12	2.7461
1.6			< 0			< 0		133.62	2.3848
1.65			< 0			< 0		134.11	2.0234
1.7			< 0			< 0		134.61	1.6621
1.75			< 0			< 0		135.1	1.3007
1.8			< 0			< 0		135.6	0.9394
1.85			< 0			< 0		136.09	0.578
1.9			< 0			< 0		136.58	0.2167
1.95			< 0			< 0		137.08	-0.1446
2			< 0			< 0			< 0

Fixed parameters: C=5, K=150,P=40,W=15, Cost of TTI type 1 = 0.5

Table 5.12: Comparison between Model 2 and Model 3

The variability on the order quantity leads to better performance of the technology.

	(r,Q) model			(T,S) model		
	r	Q	TC	T	S	TC
Model 1	12	24	143	2	35	157.0884
TC Model 2	13	41	117.05	4	56	125.14
TC Model 3	13	52	110.67	5	67	118.00
Model 1 vs Model 2			18.14%			20.34%
Model 1 vs Model 3			22.61%			24.89%
Model 2 vs Model 3			5.45%			5.71%

Fixed cost: C=5;K=150;P=40;W=15;H=1; Poisson demand with mena= 10; L=1.

Table 5.13: Performance of TTI technologies with the variability of the lifetime distribution

5.5 Conclusion

In this chapter, we have proposed firstly an (r, Q) inventory model with TTI type 1. For this model, we have used simulation to compare approximate outdating, shortage, inventory level, and cycle time with the simulated average counterparts. The results suggest that approximations we made are reasonably accurate. We have also compared separately an (r, Q) and a (T, S) inventory systems where TTI type 1 and type 2 are used to a base case corresponding to an inventory system controlled by an (r, Q) and (T, S) inventory without TTI technologies. We have found that the use of TTI technologies can considerably improve the inventory management but this improvement depends on the TTI's cost.

The performance of TTI technologies is mainly attributed to its ability to capture the impact of temperature variations on the remaining shelf life of products. However there is another alternative to improve the total operating inventory cost by decreasing the selling price of products as the lifetime decreases. Therefore, an interesting future investigation can be addressed to the comparison of two inventory systems: one with TTI technologies and the other with dynamic pricing to show whether or not the TTIs technology is still attractive.

Chapter 6

Conclusions and Perspectives

One significant challenge for many manufacturing organizations is managing inventories of products that frequently outdate. Academics and practitioners are continually seeking for the best tradeoff between customer satisfaction and reducing the amount of outdated products to find feasible and effective perishable inventory systems. The limited lifetime of products contribute greatly to the complexity of their management. The major challenge, however, stems from the dependency of the product's lifetime and the environmental storage conditions such as temperature. The variations in temperature often lead to drops in product's lifetime. Consequently, orders leaving the manufactures with a homogeneous lifetime may arrive at the retailer with different lifetime's levels. Modern sensor technologies such as TTIs that are able to register this type of information can help to assess the lifetime of products and therefore aid to efficiently manage perishable inventories.

The purpose of this Ph.D. dissertation is to develop new models to control the inventory of perishable products and also to quantify the benefit of using TTI technologies on inventory management. To achieve our goal, we have considered both continuous and periodic review inventory systems with deterministic lead time in order to obtain insights on the impact of perishability on inventory management and also to use such models as a base case when the performance of the inventory is enabled by TTI technologies. Our main contributions are detailed in five chapters:

Chapter (1) constitutes an introduction for this Ph.D thesis. Indeed, we have focused on understanding the complexity of incorporating the feature of perishability on inventory management and how the lifetime is determined. Then, we have described the benefits and the limitations of the deployment of TTI technologies on inventory management.

Conclusions and Perspectives

Finally we have identified three different scenarios to manage perishable inventory depending whether TTI technologies are used or not to assess the products' lifetime.

Chapter (2) is an overview of research in single item single location perishable inventory management. We have provided a classification of works based on product's lifetime assumption (deterministic or stochastic lifetime) and the approach used to characterize the optimal or near optimal policy. Our literature review revealed that inventory control of perishable products is extremely difficult and most of effort is dedicated to covering research that specifically deals with fixed lifetime case. Based on this literature review, we identified and emphasized some of the important research directions allowing us to choose the topics to be considered in priority in this thesis.

Chapter (3) aimed at developing a new (r, Q) inventory policy for perishables with fixed lifetime. The literature review conducted in Chapter two showed a gap in the body of knowledge for this type of policy. Prior studies did not attempt to consider the case where perishability may occur during the lead time neither the case of undershoots at the reorder point in the determination of an appropriate perishable inventory control policy. New insights are gained when considering the perishability during the lead time and relaxing the assumption of undershoots of reorder point. Particularly, we have shown that the model we have proposed outperforms the existing works and the traditional (r, Q) inventory policy which ignores the perishability of products. In addition, our analysis showed that the consideration of undershoots of the reorder point lead to a more accurate cost expression.

Next we have developed a periodic review inventory model for perishables with random lifetime (chapter (4)). The stochastic behavior of this inventory system is modeled as a Markov renewal process and the exact cost expression is obtained. The proposed model is tested under varying operating conditions such as product's lifetime (deterministic versus stochastic lifetime) and the cost parameters. The main conclusion that can be drawn from this chapter is that, with respect to cost parameters, the consideration of the randomness of the lifetime leads to substantial saving.

Finally, we have focused on the value of TTIs technology to manage perishable inventory. Since no analytical closed form expression for perishable inventory with TTIs technology exists, a carefully designed simulation study under varying operating conditions was conducted to evaluate the impact of using such technology. A two different models (for-

mulated in Chapter 1) where the inventory is controlled by information stemming from TTI type 1 and from TTI type 2 are compared to a base case for which the inventory is managed on the basis of fixed lifetime. This work demonstrates that use of TTIs technology can considerably improve the inventory management but this improvement depends on the TTIs' cost. Clearly, the ability of TTIs technology to capture the impact of temperature variations on product's lifetime allows suppliers to generate significant value from this technology by allocating products that have the least lifetime or products that experience the highest temperature abuse to customer demand first. Consequently this technology helps to reduce the amount of perished products and therefore leads to the best total operating cost in comparison with an inventory system without TTIs.

Perspectives

Although much work is accomplished in perishable inventory management, there are identifiable areas for potential future research. In addition to the perspectives given in chapter (3), (4) and (5), we provide here three fruitful research topics that capture our attention:

- As shown in Chapter (2), the majority of research on perishable inventory management concerns single product, however, in many sectors such as grocery, it is more likely to find inventory management systems that deals with multiple perishable products rather than single product. The Joint replenishment is a typical solution for these types of situations. Works on Joint Replenishment Problem (JRP) is restricted to non perishable products. [Khouja & Goyal \(2008\)](#) provide an excellent literature review for the JRP. Generally, two types of policies are widely studied: the periodic policies and the can-order systems denoted by (s, c, S) . Such policy operated as follows: For any item i , if its inventory drops to its reorder point s , a reorder is triggered. Other items are inspected and any item j at or below its can-order point c is included in the reorder. Items are reordered up to S . [Melchioris \(2002\)](#) shows that the can-order policies performs better when the major ordering cost is relatively low and the periodic replenishment policies performs better when the major ordering cost is relatively high. Investigating the JRP for perishables is one of possible future research directions. Particularly, the impact of perishability on the performance of periodic review and the can-order policies is an interesting direction for future topics.

- The second area of future research can be addressed to the case of multi-echelon per-

Conclusions and Perspectives

ishable inventory problems. A blood bank that replenishes multiple hospitals may be seen for example as a central warehouse multi-retailers inventory systems. Although multi-echelon inventory for non perishable products is largely studied, models dealing with multi echelon perishable inventory systems are very limited, probably due to the complexity of the optimal ordering policy for a single stage (see chapter 2). Moreover, there is no work that investigates continuous replenishment policies with perishables for multi-echelon even if continuous replenishment policies are mainly studied for single stage. Particularly, for one warehouse multi-identical retailers controlled by the (r, Q) policy, good approximate solutions exists (see [Seifbarghy & Jokar \(2006\)](#), and [Thangam & Uthayakumar \(2008\)](#)). Such solutions are derived under the assumption of Poisson distribution process for the demand at the warehouse. We think that such ordering rules could be extended to the case of perishable products with stochastic lifetime since the lifetime of products will not affect this assumption and therefore the same analysis can be used to obtain an approximate two echelon inventory system for perishables.

- Pricing has become one of the most management issue extensively studied in the last decade, especially for perishable products facing uncertain demand. The tradeoff between determining the best selling price and maximizing the revenue is the following: For a low selling price, potential revenue will be lost; but if the price is set too high, demand will be low and perishable products may be wasted when they expire. A detailed review on dynamic pricing with or without possibilities of inventory replenishment is provided by [Elmaghraby & Keskinocak \(2003\)](#). Even if several models dealing with optimal pricing and inventory allocation policies have been proposed in literature, the problem of dynamic pricing decisions that aims at reducing the amount of outdated product and shortages remain an open research topic. Interesting future research would be to combine inventory models with pricing to address the potential economic impact with more sophisticated pricing decisions and disposing strategies which incorporate the age of products. Another important research stream would be to consider a dynamic pricing decisions and the use of TTI technology, where for example the selling price change as the TTI color change, to obtain more effective inventory systems.

Bibliography

- AABB (2007). The 2007 national blood collection and utilization survey report. Tech. rep., The United States Department of Health and Human Services, also available as <http://www.hhs.gov/ohs/bloodsafety/>. 1
- AXSATER, S. (1996). Using the deterministic EOQ formula in stochastic inventory control. *Management Science*, **42**, 830–834. 22
- BAGANHA, P., PYKEB, F. & FERRER, G. (1996). The undershoot of the reorder point: Tests of an approximation. *International Journal of Production Economic*, **45**, 311–320. 71, 120
- BERK, E. & GURLER, U. (2008). Analysis of the (Q, r) inventory model for perishables with positive lead times and lost sales. *Operations Research*, **56**, 1238–1246. 35, 36, 37, 39, 45, 50
- CHIU, H. (1995a). An approximation to the continuous review inventory model with perishable items and lead times. *European Journal of Operational Research*, **87**, 93–108. 38, 39, 40, 45, 46, 49, 50, 53, 57, 60, 64, 66
- CHIU, H. (1995b). A heuristic (R, T) periodic review perishable inventory model with lead times. *International Journal of Production Economics*, **42**, 1–15. 39, 40, 102
- CHIU, H. (1999). A good approximation of the inventory level in (Q, r) perishable inventory system. *RAIRO Recherche Opérationnelle*, **33**, 29–45. 38, 40, 49, 50, 57, 60
- COHEN, M.A. & PRASTACOS, G.P. (1978). Critical number ordering policy for lifo perishable inventory systems. *Computers and Operations Research*, **8**, 185–195. 28

BIBLIOGRAPHY

- ECR EUROPE (2001). Introducing a collaborative approach to reducing stock loss in the supply chain, research report. Tech. rep., ECR Europe: Leicester University and Cranfield University. 7
- ELMAGHRABY, W. & KESKINOCAK, P. (2003). Dynamic pricing in the presence of inventory considerations: Research overview, current practices and future directions. *Management Science*, **49**, 1287–1309. 144
- ESTRADA-FLORES, S. & TANNER, D. (2008). RFID technologies for cold chain applications. Tech. rep., also available as <http://www.iifiir.org/en/doc/1177.pdf>. 16, 17
- FRIES, B. (1975). Optimal order policy for a perishable commodity with fixed lifetime. *Operations Research*, **23**, 46–61. 29, 31, 32, 49, 87
- GOYAL, S. & GIRI, B. (2001). Recent trends in modeling of deteriorating inventory. *European Journal of Operational Research*, **134**, 1–16. 6, 27
- GRAVES, S. (1982). The application of queueing theory to continuous perishable inventory systems. *Management Science*, **28**, 400–406. 33, 34
- GURLER, U. & OZKAYA, B. (2008). Analysis of the (s, S) policy for perishables with a random shelf life. *IIE Transactions*, **40**, 759–781. 41, 42, 44, 45
- HILL, R. (2008). Stock control and the undershoot of the re-order level. *The Journal of the Operational Research Society*, **39**, 173–181. 70
- JANSSEN, R. & DE KOK, H. (1999). The impact of data collection on fill rate performance in the (R,s,Q) inventory model. *The Journal of the Operational Research Society*, **50**, 75–84. 71
- JOHANSEN, S. & HILL, R. (2000). The (r,Q) control of a periodic-review inventory system with continuous demand and lost sales. *International Journal of Production Economic*, **68**, 279–286. 71
- JOINT INDUSTRY UNSALEABLES BENCHMARK SURVEY (2003). Food safety management in the cold chain through. Tech. rep. 7

- KALPAKAM, S. & SAPNA, K. (1994). Continuous review (s, S) inventory system with random lifetimes and positive leadtimes. *Operations Research Letters*, **16**, 115–119. [41](#), [42](#), [43](#), [45](#), [88](#)
- KALPAKAM, S. & SAPNA, K. (1995). (S-1, S) perishable systems with stochastic lead times. *Mathematical and Computer Modelling*, **21**, 95–104. [41](#), [42](#), [43](#)
- KALPAKAM, S. & SHANTHI, S. (1998). A continuous review perishable system with positive lead time. *International Journal of Management and Systems*, **14**, 123–134. [41](#), [42](#), [43](#), [88](#)
- KALPAKAM, S. & SHANTHI, S. (2000). Perishable system with modified base stock policy and random supply quantity. *Computations in Mathematics with Applications*, **39**, 79–89. [41](#), [42](#), [43](#)
- KALPAKAM, S. & SHANTHI, S. (2001). A perishable inventory system with modified(S-1, S) policy and arbitrary processing times. *Computers and Operations Research*, **28**, 453–471. [41](#), [42](#), [43](#)
- KALPAKAM, S. & SHANTHI, S. (2006). A continuous review perishable system with renewal demand. *Annals of Operations Research*, **143**, 211–225. [41](#), [42](#), [43](#), [88](#)
- KANOUI, S. & ESTEVE, A. (2007). Le don du sang en france en 2007: Besoins identifies, evolution des prelevements et des donneurs. Tech. rep., also available as www.dondusang.net/content/medias/.
- KARAESMEN, I., SCHELLER-WOLF, A. & DENIZ, B. (2009). Managing perishable and aging inventories: Review and future research directions. *to appear in Handbook of Production Planning (K. Kempf, P. Keskinocak, R. Uzsoy, eds.)*. *Kluwer International Series in Operations Research and Management Science*, Kluwer Academic Publishers. [27](#), [29](#)
- KARKKAINEN, M. (2003). Increasing efficiency in the supply chain for short shelf life goods using rfid tagging. *International Journal of Retail and Distribution Management*, **31**, 529 – 536. [7](#)

BIBLIOGRAPHY

- KASPI, H. & PERRY, D. (1983). Inventory systems of perishable commodities. *Advances in Applied Probability*, **15**, 674–685. [33](#), [34](#)
- KASPI, H. & PERRY, D. (1984). Inventory systems for perishable commodities with renewal input and poisson output. *Advances in Applied Probability*, **16**, 402–421. [33](#), [34](#)
- KETZENBERG, M. & BLOEMHOF, J. (2008). The value of RFID technology enabled information to manage perishables, <http://hdl.handle.net/1765/1541>. [2](#), [46](#), [128](#)
- KHOUJA, M. (1999). The single-period (news-vendor) problem: literature review and suggestions for future research. *Omega, International Journal of Management Science*, **27**, 537–553. [29](#)
- KHOUJA, M. & GOYAL, S. (2008). A review of the joint replenishment problem literature: 1989-2005. *European Journal of Operational Research*, **186**, 1–16. [143](#)
- KIM, D. & PARK, K. (1989). (Q, r) inventory model with a mixture of lost sales and time-weighted backorders. *The Journal of the Operational Research Society*, **36**, 231–238. [59](#), [75](#), [80](#)
- LIAN, Z. & LIU, L. (1999). A discrete-time model for perishable inventory systems. *Annals of Operations Research*, **87**, 103–116. [35](#), [36](#), [37](#)
- LIAN, Z. & LIU, L. (2001). Continuous review perishable inventory systems: Models and heuristics. *IIE Transactions*, **33**, 809–822. [35](#), [36](#), [37](#), [38](#), [45](#)
- LIAN, Z., LIU, X. & ZHAO, N. (2009). A perishable inventory model with markovian renewal demands. *International Journal of Production Economic*, **121**, 176–182. [41](#), [42](#), [44](#)
- LIU, L. & CHEUNG, K. (1997). Service constrained inventory models with random lifetimes and lead times. *The Journal of the Operational Research Society*, **48**, 1022–1028. [41](#), [42](#), [44](#)
- LIU, L. & LIAN, Z. (1999). (s, S) continuous review models for products with fixed lifetimes. *Operations Research*, **47**, 150–158. [35](#), [36](#), [37](#)

- LIU, L. & SHI, D. (1999). An (s, S) model for inventory with exponential lifetimes and renewal demands. *Naval Research Logistics*, **46**, 39–56. [41](#), [42](#), [44](#)
- LIU, L. & YANG, T. (1999). An (s, S) random lifetime inventory model with a positive lead time. *European Journal of Operational Research*, **113**, 52–63. [41](#), [42](#), [43](#), [88](#)
- LYSTAD, E., M., F. & ALEXOPOULOS, C. (2006). Single stage heuristic for perishable inventory control in two-echelon supply chains. *Working paper*. [7](#)
- MELCHIORS, P. (2002). Calculating can-order policies for the joint replenishment problem by the compensation approach. *European Journal of Operational Research*, **141**, 587–595. [143](#)
- MORRIS, A., COHEN, P. & KLEINDORFER, H. (1988). Service constrained (s, S) inventory systems with priority demand classes and lost sales. *Management Science*, **34**, 482–499. [71](#)
- NAHMIAS, S. (1975). Optimal ordering policies for perishable inventory. *Operations Research*, **23**, 735–749. [30](#), [31](#), [32](#), [87](#)
- NAHMIAS, S. (1976). Myopic approximations for the perishable inventory problem. *Management Science*, **22**, 1002–1008. [30](#), [31](#), [32](#), [45](#)
- NAHMIAS, S. (1977a). Comparison between two dynamic perishable inventory models. *Operations Research*, **25**, 168–172. [30](#)
- NAHMIAS, S. (1977b). Higher order approximations for the perishable inventory problem. *Operations Research*, **25**, 630–640. [30](#), [31](#), [32](#), [49](#), [87](#)
- NAHMIAS, S. (1978). The fixed charge perishable inventory problem. *Operations Research*, **26**, 464–481. [30](#), [31](#), [32](#)
- NAHMIAS, S. (1982). Perishable inventory theory: A review. *Operations Research*, **30**, 680–708. [27](#), [29](#), [54](#)
- NAHMIAS, S. (2001). *Production and Operations Analysis*. Fourth Edition, Irwin/McGraw Hill, Burr Ridge Illinois. [18](#)

BIBLIOGRAPHY

- NAHMIAS, S. & PIERSKALLA, W. (1973). Optimal ordering policies for a product that perishes in two periods subject to stochastic demand. *Naval Research Logistics Quarterly*, **20**, 207–229. [29](#), [31](#), [32](#)
- NAHMIAS, S., PERRY, D. & STADJE, W. (2004). Perishable inventory systems with variable input and demand rates. *Mathematical Methods of Operations Research*, **60**, 155–162. [33](#), [34](#)
- NANDAKUMAR, P. & MORTON, T. (1993). Near myopic heuristics for the fixed-life perishable problem. *Management Science*, **39**, 1490–1498. [29](#), [30](#), [31](#), [32](#), [45](#), [88](#)
- NSSS (2005). 2005 national supermarket shrink survey. Tech. rep., also available as <http://www.retailcontrol.com>. [1](#)
- PERRY, D. & STADJE, W. (1999). Perishable inventory systems with impatient demands. *Mathematical Methods of Operations Research*, **50**, 77–90. [33](#), [34](#)
- RAAFAT, F. (1991). Survey of literature on continuously deteriorating inventory models. *Journal of Operational Research Society*, **42**, 27–37. [6](#)
- ROBERTI, M. (2005). RFID will help keep perishables fresh. Tech. rep., also available as <http://www.rfidjournal.com/article/view/1775/1/1>. [1](#)
- ROSS, S. (1970). *Applied Probability Models with Optimality Applications*. Holden-Day, San Francisco, CA. [70](#)
- SCHMIDT, P., C & NAHMIAS, S. (1985). (S-1, S) policies for perishable inventory. *Management Science*, **31**, 719–728. [38](#), [49](#), [54](#), [82](#)
- SCOTT, B. & BUTLER, P. (2006). Packaging technologies with potential to reduce the amount of food thrown away. Tech. rep., WRAP Reference INN0014-009., also available as <http://www.wrap.org.uk/downloads/CB1.e78a386c.4657.pdf>. [15](#)
- SEIFBARGHY, M. & JOKAR, M. (2006). Cost evaluation of a two-echelon inventory system with lost sales and approximately poisson demand. *International Journal of Production Economics*, **202**, 244–254. [144](#)

- SILVER, E., PYKE, D. & PETERSON, R.P. (1998). *Inventory Management and Production Planning and Scheduling*. Third Edition, New York, John Wiley and Sons. 18, 19, 20
- SMOLANDER, M., HURME, E. & AHVENAINEN, R. (1999). Smart packaging for increased product safety. Tech. rep., VTT Biotechnology and Food Research, Espoo, Finland, also available as <http://www.nordicfoodpack.org/16044>. 14
- TAOUKIS, P.S. & LABUZA, T.P. (2003). Time-temperature indicators (TTIs). In R. Ahvenainen (ed.), *Novel food packaging techniques*. Woodhead Publishing Ltd., Cambridge, UK. 12
- TEKIN, E., GURLER, U. & BERK, E. (2001). Age-based vs. stock level control policies for perishable inventory system. *European Journal of Operational Research*, **124**, 309–329. 38, 39, 40
- THANGAM, A. & UTHAYAKUMAR, R. (2008). A two-level supply chain with partial backordering and approximated poisson demand. *European Journal of Operational Research*, **187**, 228–242. 144
- TIJMS, H. (1994). *Stochastic models: an algorithmic approach*. Wiley, Chichester. 73
- TSIROS, M. & HEILMAN, C. (2005). The effect of expiration dates and perceived risk on purchasing behavior in grocery store perishable categories. *Journal of Marketing*, **69**, 114–129. 8
- VAN WOENSEL, T., VAN DONSELAAR, K., BROEKMEULEN, R. & FRANSOO, J. (2007). Consumer responses to shelf out-of-stocks of perishable products. *International Journal of Physical Distribution*, **37**, 704–718. 8
- VAN ZYL, G. (1964). Inventory control for perishable commodities. Ph.D Thesis. *University of North Carolina*. 29, 31, 32
- WEBB, A. (2006). Ripeness sticker takes the guesswork out of picking and eating. *The Albuquerque Journal*. 1
- WEISS, H. (1980). Optimal ordering policies for continuous review perishable inventory models. *Operations Research*, **28**, 365–374. 35, 36, 37, 44, 99, 101

BIBLIOGRAPHY

- WELLS, J. & SINGH, R. (1989). A quality-based inventory issue policy for perishable foods. *Journal of Food Processing and Preservation*, **12**, 271–292. [28](#)
- WILLIAMS, C.L. & PATUWO, B. (1999). A perishable inventory model with positive order lead times. *European Journal of Operational Research*, **116**, 352–373. [31](#), [32](#)
- WILLIAMS, C.L. & PATUWO, B. (2004). Analysis of the effect of various unit costs on the optimal incoming quantity in a perishable inventory model. *European Journal of Operational Research*, **156**, 140–147. [31](#), [32](#)
- ZHENG, Y. (1992). On properties of stochastic inventory systems. *Management Science*, **38**, 87–103. [22](#)
- ZIPKIN, P. (2000). *Foundations of Inventory Management*. First Edition, McGraw-Hill. [20](#)