



**HAL**  
open science

# Environmental and socio-economic determinants, their impacts on trace metals and pharmaceuticals in watercourses: a comparison on two watersheds of France and Ukraine

Yuliya Vystavna

► **To cite this version:**

Yuliya Vystavna. Environmental and socio-economic determinants, their impacts on trace metals and pharmaceuticals in watercourses: a comparison on two watersheds of France and Ukraine. Hydrology. Université Sciences et Technologies - Bordeaux I, 2012. English. NNT : . tel-00716793

**HAL Id: tel-00716793**

**<https://theses.hal.science/tel-00716793>**

Submitted on 11 Jul 2012

**HAL** is a multi-disciplinary open access archive for the deposit and dissemination of scientific research documents, whether they are published or not. The documents may come from teaching and research institutions in France or abroad, or from public or private research centers.

L'archive ouverte pluridisciplinaire **HAL**, est destinée au dépôt et à la diffusion de documents scientifiques de niveau recherche, publiés ou non, émanant des établissements d'enseignement et de recherche français ou étrangers, des laboratoires publics ou privés.

N° d'ordre : 4486



# THÈSE

PRÉSENTÉE A

## L'UNIVERSITÉ BORDEAUX 1

ÉCOLE DOCTORALE DES SCIENCES & ENVIRONNEMENTS (ED 304)

Par

**Yuliya VYSTAVNA**

POUR OBTENIR LE GRADE DE DOCTEUR

SPÉCIALITÉ : Géoressources, Environnement

### **ENVIRONMENTAL AND SOCIO-ECONOMIC DETERMINANTS, THEIR IMPACTS ON TRACE METALS AND PHARMACEUTICALS IN WATERCOURSES:**

#### **A COMPARISON ON TWO WATERSHEDS OF FRANCE AND UKRAINE**

*Doctorat en co-direction avec la Kharkiv National Academy of Municipal Economy (Ukraine)*

Soutenue le 9 mars 2012

Devant la commission d'examen formée de :

M. Olivier DONARD, DR CNRS

M. Serge STOLL, Prof.

M. Jörg SCHÄFER, Prof.

Mme Hélène CELLE-JEANTON, MCU HDR

M. Philippe LE COUSTUMER, MCU HDR

M. Frédéric HUNEAU, MCU HDR

M. Felix STOLBERG, Prof.

M. Mikael MOTELICA-HEINO, Prof.

UMR 5254 IPREM, U. Pau

Institut Forel, U. Genève

UMR 5805 EPOC, U. Bordeaux-1

UMR 6524 LMV, U. Clermont-Ferrand

EA 4592 G&E, U. Bordeaux-1

EA 4592 G&E, U. Bordeaux-1

Kharkiv Nat. Acad. Mun. Econ.

UMR 6113 ISTO, U. d'Orléans

Rapporteur

Rapporteur

Examineur

Examineur

Co-directeur de thèse

Co-directeur de thèse

Co-directeur de thèse

Invité



**“Les missions impossibles sont les seules qui réussissent”**

*(Jacques-Yves Cousteau)*

**“А чем вы занимаетесь? – спросил я. Как и вся наука, - сказал горбоносый. –  
Счастьем человеческим.**

*(А. Стругацкий, Б. Стругацкий. ПОНЕДЕЛЬНИК НАЧИНАЕТСЯ В СУББОТУ)*



---

## FOREWORD

The presented PhD research was conducted in the framework of the scientific collaboration and co-direction of the thesis between University of Bordeaux, France and Kharkiv National Academy of Municipal Economy, Ukraine.

This PhD study is a part of the governmental scientific collaboration between France and Ukraine, what is registered as “DNIPRO Partenariat Hubert Curien” joint grant N° 19744VJ 2009/2010 in the Ministry of Foreign Affairs, France and Ministry of Education and Science, Ukraine.

The financial support, in the form of the full – time PhD scholarship was provided by European Commission in the framework of the ERASMUS MUNDUS Lot 6/7 (Belarus, Moldova, Ukraine), partly by the “Eiffel Scholarship” and “Bourse de Court Sejour de Recherche” of the Embassy of France in Ukraine.

The presented results are based definitely on own work of the candidate under the general supervising of Dr. Philippe Le Coustumer and Dr. Frederic Huneau, University of Bordeaux, France and with co-direction of Dr. Felix Stolberg, Kharkiv National Academy of Municipal Economy, Ukraine.

During the work under the project, different scientific groups have been involved. As, the sample preparation and analysis on the trace metals identification in the sediments and their dissolved form in the water have been performed in the UMR CNRS 5805 Environnements et Paléoenvironnements Océaniques Laboratory, University of Bordeaux, France under the supervision of Prof. Jorg Schafer. The analysis of DGT labile metals in water has been done in the French Geological Survey Centre (BRGM) and UMR CNRS 6113 ISTO, Campus Géosciences, University of Orléans under the supervision of Prof. Mikael Motelica-Heino. The pharmaceuticals in passive samples have been analyzed in the CNRS ERM Laboratory, University of Bordeaux, France under the supervision of Dr. Budzinski and Dr. Tapie. The field trips in Ukraine and France have been done in the collaboration with Kharkiv National Academy of Municipal Economy, Ukraine with Mr. Vergeles and Ms. Servetnyk. The work with the socio-economic parameters and modeling has been performed under the supervision of Mr. Grynenko, Dept. Economy and Management, National Academy of Municipal Economy, Ukraine.

Thus, this research is the product of the sustainable international scientific cooperation between multidiscipline laboratories and different countries.

---

## ACKNOWLEDGEMENT

Participating in the exchange in the framework of ERASMUS MUNDUS Lot 6/7 (Belarus, Moldova, Ukraine) project, I had a chance to meet and discuss with Philippe Le Coustumer and Frederic Huneau, they offer me to do the interesting PhD research in the collaboration between University of Bordeaux, France and Kharkiv National Academy of Municipal Economy, Ukraine.

This doctoral research was a real pilot project for me and I was a pilot project of this research. During the study period I was involved in different adventures and sometimes in thrillers, including the falling down under the ice, arresting, lost of ways and roads, car damage, extremely cold and extremely hot weather conditions. I was happy to meet a lot of people who helps me to survive and develop my research.

For the best management, help and valuable advices, but also for the psychological support, I would like to thank my first, very important supervisor Dr. Philippe Le Coustumer. I appreciate the confidence, freedom and respect that he gave me during the study. Also he organized my research in collaboration with different institutions and interesting people. I like his statement ‘forget about it’ as it was very helpful for the focusing on really important results.

Special thanks to my best co-supervisor Dr. Frederic Huneau who is so good in a lot of things, especially in the management of scientific articles and bureaucracy, but also in work with data and people, he helps me in the proceeding of the research and organizing of stay in Bordeaux. He was very kind and patient to me, even when I had a lot of questions.

I am grateful to Mr. Yuri Vergeles for his essential help during the sampling and data analysis. He helped me to survive in the field during + 40 °C and - 40 °C air temperature. He was not afraid to swim in the different water sampling sites even downstream of wastewater influents what helps us to get the qualitative water monitoring data.

I would like to present my acknowledgments to the co-director of my thesis, Dr. Felix Stolberg, who support and help me with my field trips and travel to Bordeaux. I appreciate that he was always on my side.

This research includes a numerous of the sampling and analysis, that can be impossible with the help and support of Dr. Jörg Schäfer, Dr. Motelic-Heino and Dr. Hélène Budzinski, who kindly learned me a lot analytical techniques. But also I would like to send my acknowledgement to Laurent, Jessy, Aurelie, Nathalie and Ninette, who help me with the analysis and data interpretation.

The participation in the conferences and other scientific events was the main part of my research and it cannot be possible without Drs. Michael van der Valk, who help me with the dissemination of results of the study and organize the financial support for the most of conferences what I have visited.

I would like to thank Dr. Michel Mench for his valuable help and important consultation concerning my research and field trips. He also helps me to discover France and inspire me to learn more about regional gastronomie, wines and culture.

Also thanks to my colleagues from GHYMAC (Adrian, Max, Nico, Hana, Mathilde, Marie, Jessica, Saber, Rasool, Thibaut, Esra, Farah, Olivier, Celine, Jessy, Yohanna...), University of Bordeaux and Dept. of Environmental Engineering and Management (Vova, Mitya, Tatiana,

Natalia, Olga, Elena....), Kharkiv National Academy of Municipal Economy, Ukraine who significantly support me during the research in France.

Coming in Bordeaux, I found a lot of friends who encourage me and care about my duties, thereby, I would like to mention Liliya, Dasha, Sacha and Katya, what were with me during all period of my study.

I would like to give individual acknowledgments to my husband, without whom this research was not possible. He gave me a motivation to work, helps me with daily duties and was patient to my travels. I also appreciate the patient of my sun Ostap, who is a good guy and wait with love when I will finish my field trips and my study. I owe my loving thanks to my family for their endless love, support, patient and motivation during my research abroad. Thanks to my grandmother, parents, parents in law, my brother and his wife, my brother in law, they inspired me to work hard.



**ABSTRACT**

The PhD study focuses on the understanding of processes of the impact of environmental and socio-economic determinants on the occurrence, accumulation and distribution of trace metals and pharmaceuticals in urban watercourses. The research has been based on the analysis of the origin; physico-chemical properties and behavior of trace pollutants. The study was performed in two general steps: (i) monitoring of trace metals and pharmaceuticals in natural waters; (ii) description and analysis of environmental and socio-economic determinants that influence the water chemistry and (iii) evaluation of trace pollutants as environmental and socio-economic indicators. The monitoring of trace metals in natural water was proceed using the combination of passive and grab water sampling techniques, in order to evaluate various forms of elements, sources, seasonal and spatial variations, accumulation and environmental risks associated with the presence of contaminants in study areas. The monitoring of pharmaceuticals was done using passive sensors to determine their capacity to register chemicals variation by the time and purpose to use environmental data for the regional medicament consumption modeling. Monitoring data were also investigated in term of potential applications of trace metals and pharmaceuticals as environmental and socio-economic indicators. Two study sites were chosen: (1) the Kharkiv region in Ukraine where research was focused on the Lopan and Udy rivers of the Seversky Donets water basin and (2) the Bordeaux region in France where water monitoring was done in the Jalle River, Garonne water basin. Sites were mainly selected to represent the water pollution status in different socio-economic regions. General PhD results can be described as follows:

1. The methodology for pilot and continuous monitoring of trace elements in the water with combination of traditional (grab) and innovative (passive) sampling procedures help to get data on trace elements presence, accumulation and sources, considering time-varying one.
2. The analysis of trace metals and pharmaceuticals in two river basins of France and Ukraine and determination of environmental factors that impact on occurrence, accumulation and distribution of these chemicals.
3. The establishment of links between regional socio-economic issues and water quality data. The socio-economic and environmental modeling helps us to understand the water pollution process in regional context and give the opportunity to propose contaminants as tracer of anthropogenic activities and water quality assessment.

Results of the PhD study are presented in the form of published or submitted peer-reviewed articles.

**Keywords:** trace metals, pharmaceuticals, passive sampling, Kharkiv, Bordeaux, environmental and socio-economic indicators, water tracer.

---

## RÉSUMÉ

### «Déterminants environnementaux et socio-économiques, leur influence sur les métaux traces et les produits pharmaceutiques dans les cours d'eau».

Les objectifs de cette étude comparative de deux bassins versants en France et en Ukraine sont de trois ordres. i) déterminer l'occurrence des micropolluants émergents (métaux traces et molécules pharmaceutiques) dans les eaux de surface, ii) permettre leur évaluation qualitative et quantitative et enfin iii) estimer leur distribution en fonction du contexte socio-économique. Cette recherche porte sur l'analyse de l'origine, sur les propriétés physico-chimiques et sur le comportement des micropolluants (métaux traces et molécules pharmaceutiques) dans les eaux des rivières Jalle (Bordeaux, France) et Udy & Lopan (Kharkiv, Ukraine). Un suivi des métaux traces et des produits pharmaceutiques dans les eaux naturelles de surface dans différents contextes et conditions climatiques a été réalisé. La description et l'analyse des facteurs environnementaux et socio-économiques influençant l'hydrochimie locale en vue de conclure sur l'opportunité et l'intérêt des micropolluants émergents comme indicateurs anthropogéniques du contexte socio-économique et environnemental d'un bassin versant ont été mis en oeuvre. L'étude a combiné des techniques de prélèvements d'échantillons d'eau classiques et par capteurs passifs in situ. L'analyse semi quantitative des micropolluants émergents a porté sur les métaux traces (sondes DGT) et les produits pharmaceutiques (POCIS). L'usage de ces capteurs a permis d'évaluer les différentes formes d'éléments, les sources, les variations saisonnières et spatiales, l'accumulation et les risques environnementaux. A partir des données environnementales collectées, acquises, actualisées et validées il a été possible de modéliser la consommation régionale de médicaments dans le cas de (1) la région de Kharkiv, en Ukraine, sur les rivières Lopan et Udy du bassin Seversky Donets et (2) la région de Bordeaux, en France, sur la rivière Jalle, du bassin de la Garonne. Les sites ont été sélectionnés pour représenter une diversité tant du point de vue de l'état de pollution des eaux (nature et flux) que de celui du paysage socio-économique (contexte urbain, social et indicateurs économiques). Les résultats majeurs de cette étude sont : (i) méthodologique pour le développement et la validation de protocoles d'échantillonnage classique et passif (intérêt, limites, recommandations), ii) analytique quant à la mesure des éléments traces des eaux de surface naturelles dans des conditions extrêmes, iii) scientifique par l'obtention d'un jeu de données sur l'hydrochimie des éléments traces ( présence, accumulation, origine et variabilité spatiale et temporelle et iv) prospectif quant à l'usage des métaux traces et de produits pharmaceutiques comme traceurs anthropiques de l'état des eaux naturelles de surfaces et reflet du contexte socio économique. La modélisation socio-économique (statistique) et environnementale (balance de masse) aide à comprendre l'évolution de la qualité des eaux de surface dans leur contexte régional et permet d'identifier certains contaminants comme des indicateurs des activités anthropiques d'un bassin versant et permet de définir une typologie. L'ensemble des résultats de la thèse ont présentés sous la forme d'articles publiés ou soumis dans des revues scientifiques internationales.

**Mots-clés:** métaux traces, produits pharmaceutiques, échantillonnage, Kharkiv, Bordeaux, indicateurs anthropiques, indicateurs socio-économiques, DGT, POCIS, traceurs, hydrochimie, eaux de surfaces, eaux naturelles, bassin versant, Jalle, Udy, Lopan.

## РЕФЕРАТ

Диссертация «Экологические и социально-экономические факторы распространения металлов и фармацевтических веществ в природных водах: на примере рек Харькова, Украина и Бордо, Франция» на соискание степени Доктора Философии (эквивалент – кандидат наук) в области природных наук (Environmental Science) подготовлена в рамках договора о научном сотрудничестве и совместном руководстве между Университетом Бордо, Франция и Харьковской национальной академией городского хозяйства, Украина, на базе научно – исследовательского проекта ДНИПРО (регистрационный номер М 163 – 2009): Министерство образования и науки Украины и Посольство Франции в Украине.

Актуальность работы связана с существующими проблемами мониторинга природных вод, недостатком исследований микро-загрязнителей водотоков как во Франции, так и в Украине, существующим экологическим риском, который возникает при поступлении и накоплении металлов и фармацевтических веществ в урбанизированных водотоках, а также возможностью использования химических веществ в качестве экологических и социально – экономических индикаторов.

Целью диссертационной работы стало усовершенствование методов мониторинга микро-загрязнителей в природных водах и оценка возможности использования отдельных микро-загрязнителей в качестве экологических и социально-экономических показателей.

Предметом исследования являются экологические и социально-экономические факторы, влияющие на распространение металлов и фармацевтических веществ в природных водах.

Объектом исследования стали реки Уды и Лопань, Харьковская область, Украина и река Жаль, регион Бордо, Франция.

Основные задачи: (1) провести мониторинг рек на различные формы металлов и фармацевтические вещества с применением стандартных и инновационных (пассивных) методов отбора проб; (2) опеределить экологические и социально-экономические факторы, которые влияют на распространение микрозагрязнителей в природных водах; (3) изучить возможность использования металлов и фармацевтических веществ в качестве индикаторов антропогенного загрязнения природных вод.

В результате проведенных исследований был:

*Впервые:*

- (а) осуществлен мониторинг лабильных форм металлов в реках бассейна Северского Донца, в результате которого определены концентрации токсичных металлов в водотоках, источники и количество их поступления;
- (б) проведен мониторинг фармацевтических веществ в природных водах Украины,
- (в) определены концентрации и основные источники поступления фармацевтических препаратов и удельные показатели потребления различных медикаментов в Харьковском регионе;

*Усовершенствованы:*

- (а) методика проведения мониторинга воды за счет применения стандартных и инновационных пассивных методов отбора проб воды в контрастных климатических и гидрологических условиях с целью исследования различных форм загрязнителей и их временных вариаций;

(б) балансово-статистическая модель, которая позволяет использовать данные мониторинга природных вод для социально-экономической характеристики регионов – водопользователей;

*Предложены:*

(а) система определения геохимического фона рек на основании торий – нормализованных концентраций металлов в донных отложениях;

(б) метод использование металлов и фармацевтических веществ в качестве индикаторов поступления сточных вод для идентификации несанкционированных сбросов.

Основу диссертационного исследования составили натурные данные полевых исследований рек Харькова и Бордо, которые были организованы и проведены с непосредственным участием автора в 2008 – 2011 гг. Большинство лабораторных анализов было лично проведено автором в сертифицированных лабораториях Университета Бордо и Университета Орлеан, Франция.

Диссертация имеет теоретическое и практическое значение для дальнейшего развития мониторинга природных вод, а также повышения уровня экологической и социальной безопасности в регионах. Апробация основных результатов исследования была проведена на международных и национальных научных конференциях, а именно, в г.Стокгольме, Швеция (2008, 2009, 2010, 2011), г.Кобленц, Германия (2009), г.Атлон, Ирландия (2010), г.Брюссель, Бельгия (2010), г.Бордо, Франция (2010), г.Квебек, Канада (2010), г.Салоники, Греция (2008), г. Берн, Швейцария (2008), г.Харьков, Украина (2009), г.Киев, Украина (2008). По теме диссертация опубликовано 4 статьи в международных журналах с высоким ИМПАКТ фактором, а также 5 статей в изданиях, регламентированных ВАК Украины и России.

Ключевые слова: пассивный мониторинг, металлы, фармацевтические вещества, водоток, Франция, Украина, экологические и социально-экономические показатели

## СТИСЛИЙ ЗМІСТ

Дисертаційна робота «Екологічні та соціально-економічні чинники розповсюдження металів та фармацевтичних речовин у природних водах: результати дослідження річок Харкова, Україна та Бордо, Франція» на здобуття ступеню Доктора Філософії (еквівалент кандидат наук в Україні) у природничих науках (Environmental Science) виконана у рамках договору про наукову співпрацю та спільне керівництво дисертаційними працями між Університетом Бордо, Франція та Харківською національною академією міського господарства, Україна.

Наукове дослідження виконано згідно програми спільних дій «ДНІПРО» (реєстраційний номер № М 163 – 2009) між Міністерством освіти та науки України та Посольством Республіки Франція в Україні.

Метою дисертаційної роботи є вдосконалення системи моніторингу природних вод на наявність мікро-забруднювачів та оцінка подальшого використання металів та фармацевтичних речовин у якості екологічних та соціально-економічних показників забруднення водотоків.

До пріоритетних завдань, що вирішуються у роботі віднесено: (1) проведення моніторингу металів у водотоках з використанням стандартних та пасивних методів відбору проб води; (2) дослідження фармацевтичних речовин у водотоках з використанням пасивних методів відбору проб води; (3) оцінка використання металів та фармацевтичних речовин у якості екологічних та соціально-економічних показників забруднення водотоків.

Об'єктом дослідження є водотоки, що розташовані у різних географічних та соціально-економічних регіонах – річки Уди та Лопань, Харківська область, Україна та річка Жаль, регіон Бордо, Франція.

Загальними методами дослідження стали проведення польових досліджень та збір екологічної інформації для подальшої її обробки статистичними методами аналізу даних та використання балансово – статистичного моделювання.

Головними результатами дослідження є:

- (а) методологія проведення моніторингу природних вод з використанням стандартних та пасивним приладів відбору проб та дослідження мікро-забруднювачів
- (б) визначення основних джерел та розрахунок балансу надходження мікро-забруднювачів до природних водотоків
- (в) обґрунтування можливості використання металів та фармацевтичних компонентів у якості екологічних та соціально- економічних показників

Новизна дослідження полягає у тому що:

Вперше:

- (1) проведено моніторинг фармацевтичних речовин у природних водах України;
- (2) запропонована методологія визначення мікро-забруднювачів з використанням пасивних та стандартних методів відбору проб води;

Удосконалена:

- (1) геохімічна оцінка водотоків на основі торій – нормалізованих концентрації металів у донних відкладах;
- (2) балансово-статистична модель розрахунку соціально-економічних показників на основі даних екологічного моніторингу;

Науково обґрунтовано можливість використання металів та фармацевтичних речовин у природних водах в якості екологічних та соціально-економічних показників.

Робота має теоретичне та практичне значення для подальшого розвитку системи екологічного моніторингу та забезпечення екологічної та соціальної безпеки регіонів.

Результати дослідження опубліковано у вигляді 4 наукових статей в міжнародних журналах з високим ІМПАКТ фактором, а також 5 статей в журналах, рекомендованих ВАК України та Росії.

Апробація результатів проводилась на всеукраїнських та міжнародних наукових конференціях в м. Харків (2009) та м.Київ, Україна (2008); в м. Стокгольм, Швеція (2008, 2009 та 2010); м. Атлон, Ірландія (2010); м. Кобленц, Німеччина (2009); м. Салоніки, Греція (2008), м. Квебек, Канада (2010); м. Берн, Швейцарія (2008); м. Бордо, Франція (2010); м. Брюсель, Бельгія (2010).

Ключові слова: метали, фармацевтичні речовини, природні водотоки, пасивний моніторинг, екологічні та соціально – економічні показники, Україна, Франція

---

**LIST OF PUBLICATIONS**

Выставная Ю.Ю., Юно Ф., Ле Кустюмер Ф. Мониторинг биологически активных форм металлов в поверхностных водах. Результат применения пассивных методов отбора проб воды в реках Украины и Франции. Вода: химия и экология № 12, декабрь 2009. –с. 2-9. [Vystavna Y., Huneau F., Le Coustumer P. (2009). Monitoring of biologically active forms of trace metals in surface waters. Results of application of passive samplers in rivers of Ukraine and France. Water: Chemistry and Ecology 12, p.2-9. Published in Russian.] ISSN: 2072-8158

Vystavna Y., Huneau F., Motelica-Heino M., Le Coustumer P., Vergeles Y., Stolberg F. (2011). Monitoring and flux determination of trace metals in rivers of the Seversky Donets basin (Ukraine) using DGT passive samplers. *Environmental Earth Sciences*. DOI: 10.1007/s12665-011-1151-4

Vystavna Y., Huneau F., Larrose A., Schafer J., Motelica-Heino M., Blanc G., Vergeles Y., Dyadin D., Le Coustumer P. The distribution of trace elements in waters and sediments of the Seversky Donets transboundary watershed (Kharkiv region, Eastern Ukraine) [submitted to Applied Geochemistry]

Vystavna Y., Huneau F., Grynenko V., Vergeles Y., Celle – Jeanton H., Tapie N., Budzinski H., Le Coustumer P. (2012) Pharmaceuticals in rivers of two regions with contrasted socio-economic conditions: occurrence, accumulation and comparison for Ukraine and France. *Water, Air and Soil Pollution*. DOI: 10.1007/s11270-011-1008-1

Vystavna Y., Huneau F., Le Coustumer P. Trace metals and pharmaceuticals as anthropogenic and socio-economic indicators of urban and industrial impact on surface waters. [submitted to Water Resources Management]

---

**LIST OF CONFERENCES**
**Oral presentations:**

Vystavna Y., Le Coustumer P., Huneau F., Stolberg F., Vergeles Y. (2011). Evaluation of pharmaceuticals in rivers of Bordeaux region (France) and Kharkiv region (Ukraine). *Visby program: scientific workshop on Swedish – Polish – Ukrainian cooperation, 8 August 2011, Stockholm, Sweden.*

Vystavna Y., Le Coustumer P., Huneau F., Budzinski H., Celle-Jeanton H. (2010). First evaluation of pharmaceuticals in rivers of Eastern Ukraine. *Hydrology, hydraulics and water resources in an uncertain environment. 5th International Conference on water resources and environmental research. 5 – 7 June 2010, Quebec, Canada.*

Vystavna Y., Le Coustumer P., Huneau F., Celle – Jeanton H., Tapie N., Budzinski H. (2010). Evaluation of pharmaceuticals in rivers of Bordeaux region, France and Kharkiv region, Ukraine. *23e Réunion des Sciences de la Terre, 25 – 29 October 2010, Bordeaux, France.*

Vystavna Y., Le Coustumer P., Huneau F., Vergeles Y. (2010). Emerging pollutants in rivers of Eastern Ukraine: monitoring, environmental risk assessment and socio-economic issues. *The Malin Falkenmark Seminar: Emerging pollutants in water resources. 5 September 2010, Stockholm, Sweden.*

Vystavna Y., Le Coustumer P., Huneau F. (2010). The distribution and accumulation of emerging pollutants in urban waters of Eastern Ukraine. *World Water Week in Stockholm, 5-11 September 2010, Stockholm, Sweden.*

Vystavna Y., Grynenko V., Huneau F., Le Coustumer P. (2010). Mass balance modelling of pharmaceuticals consumption using water-monitoring data. *National Hydrology Conference of UNESCO HP 2010, November 16, Athlone, Ireland.*

Vystavna Y., Le Coustumer P., Huneau F., Vergeles Y. (2009). Trace metals and pharmaceuticals in transboundary waters, its monitoring, toxicity and regulation in Ukraine. *International Workshop of UNESCO on Water and Health. A European Perspective, 8-9 December 2009, Koblenz, Germany.*

**Poster presentations:**

Villanueva J., Vystavna Y., Le Coustumer P., Huneau F., Granger D., Thiennot R. (2011). Monitoring of DGT-labile trace elements in urban rivers of regions with contrasted hydrological, seasonal and socio-economic conditions (Ukraine, Philippines and France). *Séminaire AQUAREF Echantillonneurs passifs et techniques alternatives de prelevement, 24 Novembre 2011, Nantes, France.*

Vystavna Y., Grynenko V., Huneau F., Le Coustumer P. (2010). Evaluation of sustainable water use in Ukraine and EU. *Sustainable Development Evaluations in Europe: From a Decade*



---

*of Practices, Politics and Science to Emerging Demands. EASY-ECO Brussels Conference 17 – 19 November 2010. Brussels, Belgium.*

Marchand L., Mench M., Vystavna Y., Kolbas A., Huneau F. (2010). Potential use of macrophytes as bioindicators of trace element contamination along the Jalle River (France). *12<sup>th</sup> International Conference on Wetland Systems for Water Pollution Control Venice (Italy), 4-8 October 2010.*

Vystavna Y., Le Coustumer P., Huneau F., Van der Valk M. (2010). Statistical Modelling of Water Pollution Scenarios Based on Socio-economic and Environmental Data. *Hydrology, hydraulics and water resources in an uncertain environment. 5th International Conference on water resources and environmental research. 5 – 7 June 2010, Quebec, Canada.*

Vystavna Y., Grynenko V. (2008). Evaluation of Sustainable Water Use. *Progress and Prospects on Water: For a Clean and Healthy World with Special Focus on Sanitation. World Water Week in Stockholm. 17-23 August 2008*

Vystavna Y., Le Coustumer P., Huneau F., Rakhmatullaev S. (2008) Impact of a municipal wastewater treatment plant on the quality of the sediments of the river Udy (Ukraine). *International CHR Workshop – Expert Consultation. Erosion, Transport and Deposition of Sediments, Berne, Switzerland 28-30 April 2008.*

Vystavna Y., Le Coustumer P., Huneau F. (2009) In situ passive sensors for constructed wetlands survey (study area: Kharkiv region, Ukraine). *3rd Wetland Pollutant Dynamics and Control-WETPOL 2009, Barcelona, 20-24 September 2009.*

Vystavna Y., Grynenko V., Le Coustumer P., Huneau F. (2008). Integrated socio-economic criteria of transboundary water use. *IV International Symposium on transboundary waters management, Thessaloniki, Greece, 15-18 October 2008.*

Vystavna Y., Servetnyk M. (2009). Legislative problems of water monitoring. International scientific conference “Urgent problems of legal supply in environmental safety, sustainable use and protection of natural resources”, *National Yaroslav Juridical Academy, Kharkiv (Ukraine), 9 – 10 October 2009.* (Виставна Ю.Ю., Серветник М.А. Правові проблеми моніторингу водних ресурсів// Матеріали міжнародної науково-практичної конференції "Актуальні питання правового забезпечення екологічної безпеки, використання та охорони природних ресурсів" 9-10 жовтня 2009 р. / за заг. редакцією проф. А.П. Гетьмана тп проф. М.В. Шульги. - Харків.: Національна юридична академія України імені Ярослава Мудрого, 2009. - С. 59-61).

**ABBREVIATIONS**

*DGT* – diffusive gradient in the thin film

*EPA* – Environmental Protection Agency

*EU*            European Union

*POCIS* – polar organic chemical integrative sampler

*PPs*            pharmaceuticals

*STP*            Sewage treatment plant

*SQG*            Sediment Quality Guidelines

*WFD*            Water Framework Directive

*WQG*            Water Quality Guidelines

---

---

**CONTENT**

<b>INTRODUCTION.....</b>	<b>5</b>
OBJECTIVE OF THE THESIS.....	7
OUTLINE OF THE THESIS.....	7
<b>CHAPTER I.....</b>	<b>11</b>
<b>LITERATURE REVIEW</b>	
1.1. GENERAL PRESENTATION ABOUT TRACE POLLUTANTS.....	11
1.2. TRACE METALS IN NATURAL WATERS.....	15
1.2.1. Speciation.....	15
1.2.2. Sources.....	18
1.2.3. Environmental and health risks.....	19
1.3. PHARMACEUTICALS IN NATURAL WATERS.....	21
1.3.1. Occurrence and characteristics.....	21
1.3.2. Sources.....	23
1.3.3. Environmental and health risks.....	27
1.4. TRACE POLLUTANT IDENTIFICATION.....	28
1.4.1. Conventional sampling techniques.....	29
1.4.2. Passive water sampling technique.....	30
Summary.....	30
<b>CHAPTER II.....</b>	<b>33</b>
<b>STUDY SITES</b>	
2.1. UKRAINIAN STUDY AREA (LOPAN AND UDY RIVERS, SEVERSKY DONETS WATER BASIN)....	33
2.1.1. Geography and climate.....	33
2.1.2. Pollution.....	35
2.1.3. Sampling sites.....	36
2.2. FRENCH STUDY AREA (JALLE RIVER, GARONNE WATER BASIN).....	42
2.2.1. Geography and climate.....	42
2.2.2. Pollution.....	43
2.2.3. Sampling sites.....	43
Summary.....	45
<b>CHAPTER III.....</b>	<b>47</b>
<b>METHODS</b>	
3.1. GENERAL METHODOLOGY OF THE RESEARCH.....	47
3.2. TRACE METALS.....	51

3.2.1. DGT – water passive, grab water and sediments sampling .....	51
3.2.2. Water quality determination.....	53
3.2.2.1. Analysis and interpretation of DGT samplers.....	53
3.2.2.2. Analysis of grab water samples .....	54
3.2.2.3. Analysis of the sediments .....	54
3.3. PHARMACEUTICALS .....	55
3.3.1. POCIS passive water sampling .....	55
3.3.2. Water quality determination.....	56
3.3.2.1. POCIS extraction and analysis .....	56
3.3.2.2. Concentration in water.....	57
Summary.....	57
<b>CHAPTER IV .....</b>	<b>58</b>
<b>MONITORING</b>	
<b><u>Vystavna Y., Huneau F., Motelica-Heino M., Le Coustumer P., Vergeles Y., Stolberg F. (2012). Monitoring and flux determination of trace metals in rivers of the Seversky Donets basin (Ukraine) using DGT passive samplers. <i>Environmental Earth Sciences</i> 65, 1715-1725 .....</u></b>	<b>58</b>
Summary.....	70
<b>CHAPTER V .....</b>	<b>72</b>
<b>ENVIRONMENTAL DETERMINANTS</b>	
<b><u>Vystavna Y., Huneau F., Larrose A., Schafer J., Motelica-Heino M., Blanc G., Vergeles Y., Dyadin D., Le Coustumer P. Distribution of trace elements in waters and sediments of the Seversky Donets transboundary watershed (Kharkiv region, Eastern Ukraine) [submitted to <i>Applied Geochemistry</i>]</u></b>	<b>72</b>
Summary.....	101
<b>CHAPTER VI.....</b>	<b>102</b>
<b>SOCIO-ECONOMIC DETERMINANTS</b>	
<b><u>Vystavna Y., Huneau F., Grynenko V., Vergeles Y., Celle – Jeanton H., Tapie N., Budzinski H., Le Coustumer P. 2012. Pharmaceuticals in rivers of two regions with contrasted socio-economic conditions: occurrence, accumulation and comparison for Ukraine and France. <i>Water, Air and Soil Pollution</i>. DOI 10.1007/s11270-011-1008-1.....</u></b>	<b>102</b>
Summary.....	117
<b>CHAPTER VII .....</b>	<b>118</b>
<b>PERSPECTIVES</b>	

---

<b>Vystavna Y., Huneau F., Le Coustumer P. Trace metals and pharmaceuticals as anthropogenic and socio-economic indicators of urban and industrial impact on surface waters [submitted into Water Resources Management].....</b>	<b>118</b>
<i>Summary</i> .....	152
<b>CONCLUSIONS.....</b>	<b>154</b>
REMIND OF OBJECTIVES .....	155
OBJECTIVE COMPLIANCE.....	155
LIMITS OF THE STUDY .....	162
PRACTICAL APPLICATION.....	164
FURTHER RESEARCH DEVELOPMENT .....	165
PROFESSIONAL DEVELOPMENT .....	169
<b>References .....</b>	<b>172</b>
<i>LIST OF TABLES</i> .....	184
<i>LIST OF FIGURES</i> .....	185



## INTRODUCTION

Urbanization, agriculture and industry exert mounting pressure on the quality of water resources. Every day an estimated two millions tones of human wastes are disposed of in watercourses. Seventy percent of industrial and household wastes in developing countries are dumped untreated into waters where they pollute the usable water supply (WWW 2010). The complexity of the challenge are revealed by many different types and forms of pollutants, the range of pollution sources and varying scales – local, regional or global – at which pollution can develop. Lack of monitoring and enforcement also makes difficulties for countries and regions to understand and deal with this challenge.

Some of pollutants *e.g.* trace pollutants are harmful for environment and human health even in very low concentration ( $\text{pgL}^{-1}$  –  $\text{ng L}^{-1}$  -  $\mu\text{g L}^{-1}$ ). With the development of the analytical chemistry, more and more trace elements can be detected in the natural water, but also the diversity of them are increasing because of the progress in chemicals production and growing consumption.

Three main approaches can be used for water quality monitoring: trace elements behaviour, biological assessment, active and passive sampling with the further chemical analysis. The traditional approach of chemical analysis by using pump or grab sampling methods reflects only instantaneous concentrations of contaminants in water (Li et al. 2010). These measurements provide a simple estimate of the present status, however in rivers, chemical characteristics can be highly time variable. The other alternative approach is the biological sampling (*e.g.* fish, mussels), but this procedure brings up other problematic issues: (1) chemical analysis of complex biological matrixes; (2) unexpected mortality of test organisms; (3) complicated data interpretation due to variability among species, age, and individual metabolism in the capacity to



accumulate pollutants (Söderstrom et al. 2009). In order to avoid limitations of biological and traditional sampling, passive sampling techniques have been widely applied for the detection of the different types of inorganic (Motelica - Heino et al. 2003) and organic pollutants (Zhang et al. 2008a; Togola and Budzinski 2007a) in various concentrations in the fresh (Dragun et al. 2008) and marine (Munksgaard and Parry 2003) waters of many countries. In Ukraine, studies on the environmental quality of rivers using passive sampling approaches are limited and water quality of general water courses have been mainly assessed with the application of biological (Vasenko et al. 2006) or grab sampling (Linnik 2003). Thereby previous studies have provided basic information on regional water quality and the distribution of limited amount of pollutants along the river courses. Furthermore, intensive environmental studies on specific pollutants *e.g.* trace metals and pharmaceuticals, are yet incipient in Ukrainian waterbasins.

Trace metals as toxic inorganic pollutants and pharmaceuticals as emerging organic pollutants become a part of the long term water monitoring in EU (*e.g.* Buzier et al. 2008; Pesavento et al. 2009), USA (*e.g.* Balistrieri and Blank 2008; Barnes et al. 2008), Canada (*e.g.* Alfaro – De la Torre et al. 2000), Australia (*e.g.* Denney et al. 1999), Japan (*e.g.* Nakada et al. 2008), China (*e.g.* Fan et al. 2009) with the application of traditional and passive sampling and their combination. Monitoring of trace elements in rivers and streams using passive sampling has resulted in the development of several methods used today for the detection of different forms of trace metals and pharmaceuticals, such as DGT - labile metals (Tusseau – Vuillemin et al. 2007) and bioavailable hydrophilic organic chemicals *i.e.* pharmaceuticals (Alvarez et al. 2005; Vrana et al. 2005; Togola and Budzinski 2007a). Based on speciation of pollutants, new environmental parameters have been developed to indicate the level of pollution (Alvarez et al. 2005), differentiate sources of pollution (Warnken et al. 2007; Bidwell et al. 2010) and assess health and environmental risks (Alvarez et al. 2008; Schintu et al. 2010). Trace metals in particulate, dissolved and labile forms have been suggested as indicators of industrial pollution (Dunn et al. 2007; Schäfer et al. 2009) and pharmaceuticals have been proposed as indicators of fecal pollution (Clara et al. 2004; Froehner et al. 2010). However, characteristics and the application of these indicators may vary depending on the regional socio-economic profile of the region, climate, hydrological and seasonal patterns in the studied watershed. Therefore, knowledge on the environmental status of river in term of the contamination by pollutants and the socio-economic conditions, what are specific for the studied area, is essential before the use of various indicators.

## Objective of the thesis

In order to improve the knowledge on occurrence, distribution and accumulation of trace metals and pharmaceuticals in natural watercourses, but also to precise the potential of these elements as environmental and socio-economic indicators, this study is focused on (i) the use of passive sampling methods for the detection of trace metals and pharmaceuticals in contrasted environmental and different socio-economic conditions; (ii) investigation of trace metals (inorganic chemicals) and pharmaceuticals (organic chemicals) in watershed as environmental indicators; (iii) explore the relation of trace metals and pharmaceuticals between the socio-economic activity of different regions and their environment.

## Outline of the thesis

The thesis presents the results on trace metals and pharmaceuticals in two contrasted socio-economic regions. In the hydrological system of the industrial Kharkiv region, Ukraine, *in situ* studies have concerned multi-sources of transboundary, urban and rural pollution and brought the first data, ever presented, on geochemical baseline of the studied watershed, including the accumulation, spatial distribution and origin of trace metals and pharmaceuticals (Chapter 4, Chapter 5, Chapter 6). Investigation conducted *in situ* in the Bordeaux region, France have been mostly focused on the pollution by organic contaminants in order to proceed the comparison of human origin influences on the hydrologically similar (size of the course, water flow regime, etc.) water bodies which to locate in contrasted socio-economic regions (Chapter 6). Finally, the perspectives of use trace metals and pharmaceuticals as specific environmental and socio-economic indicators or tracers have been assessed on the example of the river in the Kharkiv region, which is influenced by various anthropogenic inputs (Chapter 7). The seven chapters of the manuscript are described below and presented as a compilation of published, in press or submitted papers.

Chapter 1 is devoted to a general presentation of trace elements, description of monitoring tools and risks associated with presence of these chemicals in the natural waters. The special focus is on overview of trace metals and pharmaceuticals in aqueous environment, factors impacting the behaviour of chemicals and passive sampling technique for their identification.

Chapter 2 presents general information on the study area. Characteristics of the location, potential pollution sources in each sampling station are reported.

Chapter 3 is dedicated to the methodology used in the thesis and methods of the collection, analysis and interpretation of the water and sediments samples. Data treatment and modeling are also described in this chapter.

Chapter 4 reports the results on the application of the selected passive monitoring tools in contrasted climate and hydrological conditions. The identification of trace metals in the studied area has been done using *in situ* application of diffusive gradients in thin-films (DGT) passive samplers in transboundary Udy and Lopan Rivers of the Seversky Donets watershed in the Kharkiv region, Ukraine. We discuss the practice and procedure of DGT passive samplers, the presence and potential sources of DGT-labile metals in water, outlines the influence of seasonal factors on elements variation in water and pollution status. This chapter is presented in the form of the article published in *Environmental Earth Sciences*.

Chapter 5 examines environmental determinants impacting the occurrence, the distribution and the accumulation of trace metals in the watercourse. The dissolved and DGT – labile trace metals in the water and particulate metals in sediments have been monitored in the watershed of the Seversky Donets River using traditional and passive sampling techniques. Priority trace elements (As, Cd, Cr, Cu, Hg, Ni, Pb, and Zn), urban tracers (Ag) and additionally Co, Mo, V and Th were analyzed in Lopan and Udy Rivers during contrast hydrological (low and flow periods) and seasonal conditions (cold and warm seasons). The chapter presents environmental determinants i.e. regional baseline of trace elements in sediments, geochemical anomaly, water pollution and also includes results of the environmental risk assessment. This chapter is submitted into *Applied Geochemistry*.

Chapter 6 explores environmental and socio-economic determinants of water contamination by medicaments. Pharmaceuticals, their potential sources and consumption have been studied in two contrasted socio-economic and geographical regions - Bordeaux, France and Kharkiv, Ukraine. The water monitoring has been done during different seasonal conditions using POCIS - passive sensors. The chapter focuses on results of the implementation of passive sampling, presence of selected organic pollutants in water, environmental and socio-economic factors impacting the occurrence and the distribution of pharmaceuticals in watercourses. Additionally, the potential application of pharmaceuticals as environmental and socio-economic markers is discussed. The chapter is in the form of the article published in *Water, Air and Soil Pollution*.

Chapter 7 gives some trend about the perspective to use trace metals and pharmaceuticals as environmental and socio-economic indicators based on specificity (accumulation, distribution,

physical-chemical properties, speciation), temporal and seasonal variation of substances, sensitivity, accuracy, and repeatability, but also practicality of sampling and analysis techniques of pollutants identification. The chapter is given in the form of a submitted article into ***Water Resources Management***.

Conclusion underlines the main results obtained throughout this thesis in relation with our goals and offers some perspectives in the field of water quality management, integration of socio economic aspect in the relation with the environmental parameters characterizing the water surface bodies.



## CHAPTER I

### LITERATURE REVIEW

#### 1.1. General presentation about trace pollutants

Driven by demographic change and economic growth, water is increasingly withdrawn, used, reused, treated and disposed of. Surface water pollution with chemical contaminants has become one of the most crucial environmental problems within 20<sup>th</sup> century (Urban 2009). Difficulty revealed by numerous forms of pollutants (Ostacoli 1988; Valero 2004) and range of pollution sources (Kummerer 2011).

Water pollutants can exist in various forms: particulate, colloidal and dissolved (Figure 1.1).

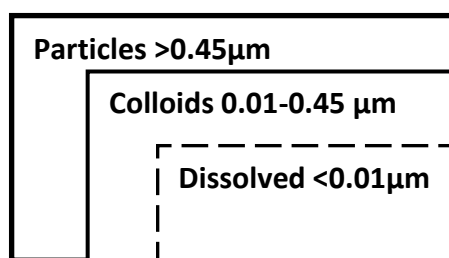

*Figure 1.1. Simple representation of the trace elements speciation in natural systems*

The bioaccumulation, toxicity, fate and transport for most of trace elements are controlled by physical chemical properties of chemicals. For example, the toxicity of trace metals is often related to dissolved forms and free ion activity (Linnik 2003; Gupta et al. 2007) but also under colloidal form especially natural organic ones such as humic and fulvic substances (Baalousha et al. 2006a; Baalousha et al. 2006b; Buffle et al. 2000; Chen et al. 2010; Rizzi et al. 2004). In this

case the determination of the total concentration of trace metals can overestimate health and environmental risks (Hirner and Hippler 2011). In turn, the toxicity of other trace elements, *e.g.* pharmaceuticals, is associated with the solubility of molecules (Cleuvers 2003). So the knowledge, of physical chemical properties of pollutants, is therefore necessary for the understanding of their behavior and their bioavailability.

Trace elements are able to get the aqueous environment via variety of sources, which are distinguished between point and non-point one (Furumai et al. 2011). Point sources of pollution occur when pollutants are discharged directly into the waterbody, *i.e.* pipelines, channels and drains from identifiable locations, *e.g.* industrial area or landscape. Non-point or diffusive sources of pollution arises from extensive land areas and are mobilized by precipitation and thus closely related to the hydrological cycle (Rose and Shea 2007; Furumai et al. 2011). Agricultural and urban run-off, air-born particulates are examples of diffusive sources, when entry points of the pollutants to receiving water are often difficult to identify (Weiner and Matthews 2003).

The general sources of water pollution (Figure 1.2.) are:

Industry: Waste and sewage from industries introduce in the environment a variety of organic and inorganic substances that can be extremely toxic for the living organism and most of them are synthetic and unusual for the pristine nature.

Households: Sewage form house or run-off from septic tanks introduces variety of toxic materials into the ecosystem, including personal care products, pharmaceuticals, trace metals and other chemicals that can harm aquatic organisms.

Agriculture: Large amounts of herbicides and pesticides are used for the agricultural production. These substances, but also veterinary care products and pharmaceuticals are particularly dangerous for the aquatic organisms (Cleuver 2003; Fent et al. 2006).

Thereby, the pollution is unavoidably linked to the economic activity and social processes on the territory (Schelwald–van der Kley and Reijerkerk 2009). A vast number of organic and inorganic compounds are used in industries and households, and some portion of these compounds enters natural waters (Urban 2009). Unless specifically removed by wastewater treatment processes, they may persist and reach receiving waters as trace pollutants.

Some inorganic and organic compounds can also infiltrate into the groundwater system potentially used for drinking water supply (Dieter 2011).

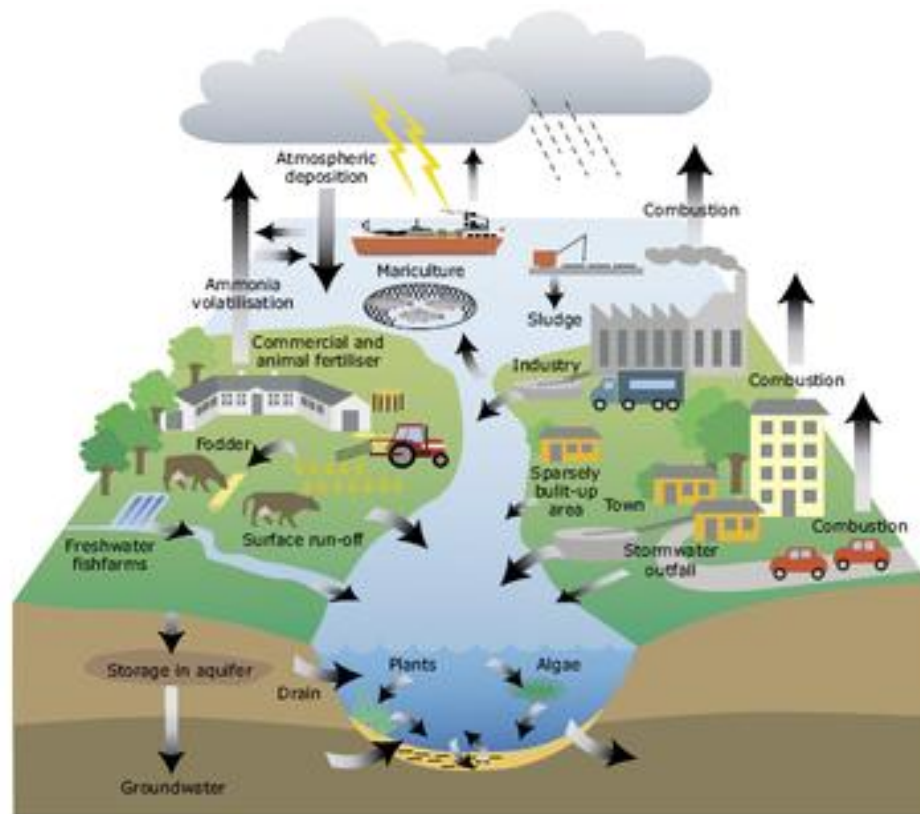

Figure 1.2. Principle scheme of water pollution sources (Urban 2009)

However, the pollution threats to human health can reach the human organism with sea products, fish and irrigated crops contaminated by toxic substances and appear in form of water-borne and water related diseases (Urban 2009).

If some pollutants are dangerous for the environment and human health only in the high concentration (*e.g.* nitrates, phosphates, etc), others, which named *trace pollutants*, can be a threat even in the extremely low concentration (up to  $\text{ngL}^{-1}$ ) (Kummerer 2011). The term trace pollutant indicates low concentrations of an environmental contaminant generally in the nanogram (ng) or microgram ( $\mu\text{g}$ ) per liter range, but sometimes even in pictograms (pg).

Numerous new trace pollutants *e.g.* metalloids, pesticides, pharmaceuticals, surfactant, etc. have been detected in natural waters for the first time due to the development of the analytical chemistry within the last 20 years (Urban 2009; Kummerer 2011). Most of tracers are persistent or very slow degrade in the natural environment and able to enter the food chain, organisms and accumulate in the ecosystem and living materials (Senesi et al. 1999; Loos et al. 2008; Parsapoor et al. 2009; Sola-Larranaga and Navarro-Blasco 2009).



Certain trace pollutants are referred to *emerging contaminants* and defined as any synthetic or naturally occurring chemicals or micro-organisms that are not commonly monitored in the environment, but have the potential to enter nature and cause known or suspected adverse ecological and (or) human health effects (Kuster et al. 2006; Hanicke et al. 2007; Kummerer 2011) (Table 1.1.).

Table 1.1. Emerging contaminants

Substance	Group	Potential impact
Pharmaceuticals	Human Illicit Veterinarian Aquaculture	Bioaccumulation in aquatic organisms, birds Feminization and changes in reproduction of aquatic organisms Combination toxicity to aquatic organisms Risks for microorganisms to responsible for beneficial processes Potential long-term effects on aquatic organisms Effects related to pharmacological mechanisms Increasing toxicity of other chemicals
Personal care products	Fragrances; preservatives; sunscreen agents; antiseptic; parabens	Endocrine toxicity to aquatic organisms Disruption of endocrine system of aquatic organisms
Manufacturing additives in consumer and industrial products	Anticorrosive; plasticizer; fire retardant; halogenated hydrocarbons; fragrances; detergent metabolites; phthalates; dioxins; bisphenols	Bioaccumulation Endocrine disruption in human and animals Cancer in human and animals
Steroids	Animal, plants and fecal steroids	Disruption normal endocrine system of aquatic organisms
Oil products	Polycyclic aromatic hydrocarbons	Mutagenic in bacterial systems Carcinogenic for mammals Chronic effect and toxicity
Agricultural synergists	Biocides, pesticides and insecticide	Bioaccumulation in aquatic organisms and seabirds Disruption endocrine system of aquatic organisms
Disinfectants and repellents	Chlorination and disinfection by-products, repellents	Genotoxic, carcinogenic and hepatotoxic to human and other organisms
Engineering nanomaterials	Nanotubes Nanoparticles (gold and silver and TiO <sub>2</sub> )	Toxicity and genotoxicity of aquatic organisms Physiological changes and effect on lipid composition of aquatic organisms Embryos development changes and mortality

Recently the continuous monitoring and environmental regulation of emerging pollutants are under consideration and the main problem that new chemicals are developed, produced and consumed. Some attempts have been done to establish regulatory and permissible levels for emerging contaminants in drinking water and environmental discharges. The U.S. EPA developed a list of 126 priority pollutants that are regulated and monitored, particularly in wastewater effluent (EPA 2011), in order to protect freshwater of the United States. The European Union Water Framework Directive (EU 2008) established environmental quality standards for surface water with the list of 33 substances, mostly, organic compounds for the identification of pollution and sources, but for a variety of emerging compounds (i.e. biocides,

polyaromatic hydrocarbons, chlorinated solvents, nanoparticles, pharmaceuticals, etc.), water quality standards and emission control are currently under discussion. The general problem of the development of new regulation is a lack of the information on the occurrence, behavior and acute toxicity of these substances (Richardson 2003).

Among other micro-contaminants, trace metals as priority substance and pharmaceuticals as emerging contaminants are one of the growing public concern pollutants (Urban 2009). In spite of the significant increasing of regional studies on trace elements, limited data are available on the occurrence of most of emerging contaminants in the freshwater water because of difficulties and expenses of trace pollutants monitoring and analysis (Murray et al. 2010) especially in certain regions, *e.g.* post-soviet European countries (i.e. Ukraine, Russia, Moldova and Belarus), South America, Africa, etc (Pal et al. 2010).

## 1.2. Trace metals in natural waters

### 1.2.1. Speciation

Trace metals present in different forms in the aquatic environment, i.e. dissolved, colloids, labile (Linnik 2003; Mello et al. 2005) (Figure 1.3).

*Dissolved trace metal concentration* comprise the variety of species including *colloids* as well as complexes with inorganic and natural and anthropogenic ligands and measured after the filtration with 0.45  $\mu\text{m}$  pore size membrane (Alfaro-De la Torre et al. 2000).

Metals are partitioned amongst soluble phases, sediments and biota in aquatic systems (Elder 1988) through mechanisms of adsorption, complexation, precipitation and biological uptake under influences of various factors (Figure 1.4.)

Numerous experiments have also shown that biological effects of trace metals are usually not related to total dissolved metal concentrations; rather it is a free metal ion activity that plays a crucial role in the bioaccumulation of metals by aquatic organisms and toxicity of metals towards these organisms (Schintu et al. 2008).

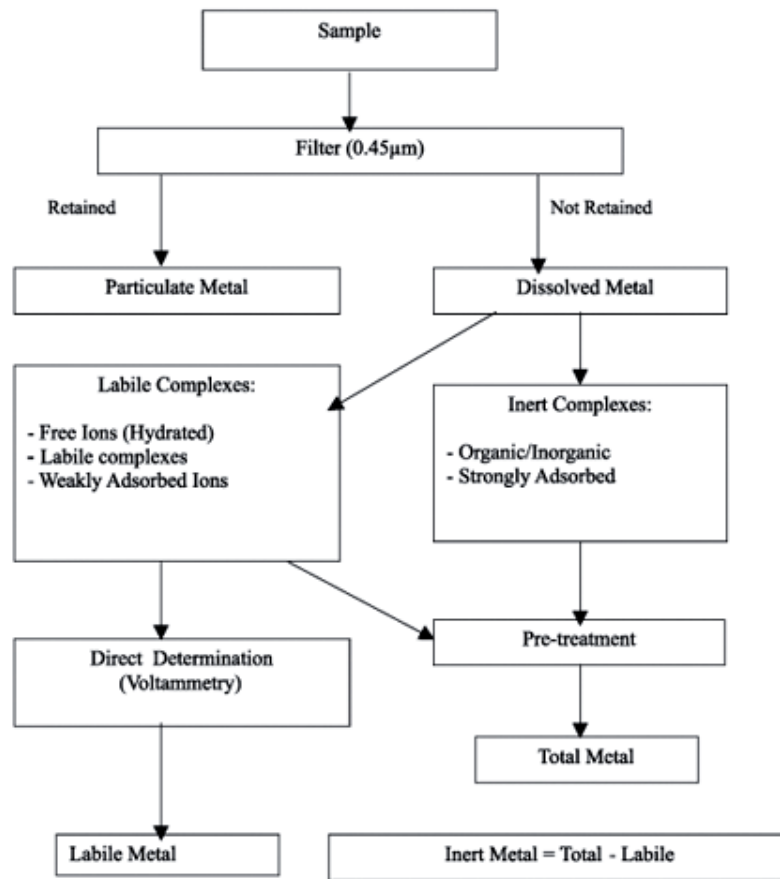

Figure 1.3. Speciation of trace metals in water (Mello et al. 2005)

Dissolved ionic forms of trace metals, that easily dissociable in complexes and represent bioavailable fractions, can be characterized as *labile metals forms* what is considered as the most toxic limit (Zhang and Davison 1995) and monitoring of these species in the water is relatively new topic of research that is developing together with analytical tools.

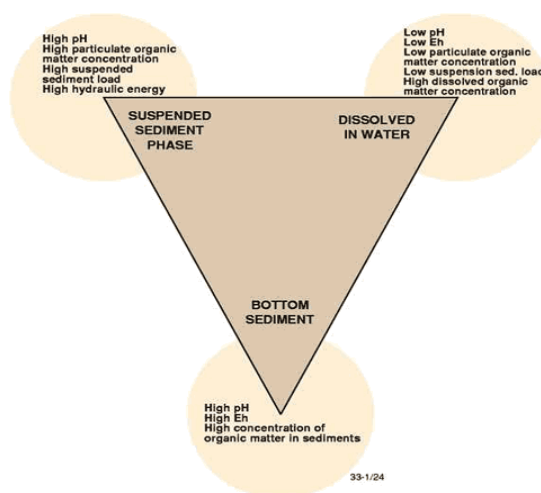

Figure 1.4. Metals partitioning in natural waters (adapted from Elder 1988)

The metal ions can be metabolically active in water, and function as an essential nutrient or mineral and transporting across the cell membrane. They are able to enter into biochemical process (Cambell et al. 2002). They recognized the interaction of a metal with an algal cell which is described in following steps: (i) diffusion of the metal from the bulk solution to the biological surface; (ii) sorption/ surface complexation of metal at passive binding sites within protection layer, or at sites on the outer of surface of the plasma membrane; (iii) uptake or “internalization” of the metal (transport across plasma membrane) (Figure 1.5).

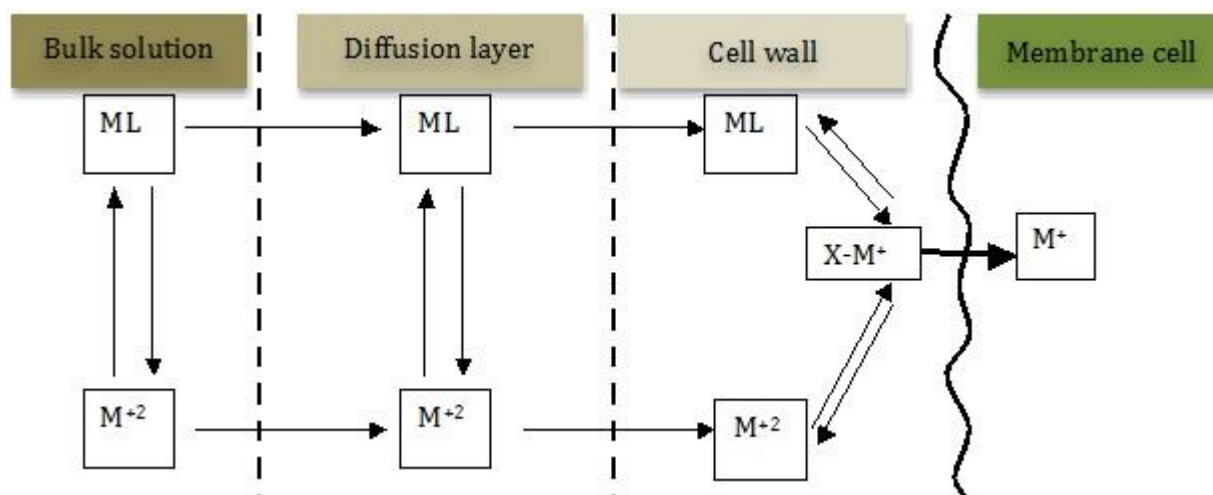

Figure 1.5. Conceptual model of metal – biomaterial interaction ( $M^{+2}$  – free metal ion; ML – metal complex in solution;  $X-M^+$  - surface metal complex (adapted from Campbell et al. 2002; Slaveykova and Wilkinson 2005)

The major mechanism for the transport of hydrophilic metal ions across a cellular membrane is believed to be by facilitated diffusion. This model assumes that equilibrium exists between all forms of metal in the bulk solution and metal bound at surface sites of the organism (Campbell et al. 2002). The interaction between a metal ion (M) or a metal-ligand complex (ML) with a ligand at the cell surface (X) resulting in the formation of a complex at the cell surface. The equilibrium concentration of a free metal ion varies under influences of physical chemical factors including: nature and concentration of all competing ligands; stability of the various metal-ligand forms; the rate at which equilibrium is attained (reaction kinetics); concentration of competing cations; redox potential; temperature; pH; salinity; hardness (Linnik 2003; Slaveykova and Wilkinson 2005; Chen et al. 2010).

In this case, the measurement of the total metal concentration in a water sample will provide little indication of potential interactions of metals with other abiotic or biotic components of the

system (Tessier and Campbell 1987) and may therefore overestimate the toxicity of the sample, assuming, that all metals are in the most toxic form (Florence 1992).

### 1.2.2. Sources

Trace metals can have both natural and anthropogenic origins. Their natural occurrence is linked to the Earth's crust and generally, products of weathering process to form the geochemical baseline of the region. The increasing of background values are usually considered as pollution processes from different sources (Nagajyoti et al. 2010):

Natural sources: Weathering processes of rocks and soil, volcanoes and etc.

Agricultural: Inorganic and organic fertilizers are most important sources of trace metals to agricultural soil as they can include liming, sewage sludge, irrigation waters and pesticides contaminated by variety of trace elements. Particularly fungicides, inorganic fertilizers and phosphate fertilizers have variable levels of Cd, Cr, Ni, Pb and Zn depending on their sources.

Industrial sources: Mining and refinement (spoil heaps and tailings, transport of ores, smelting and metal finishing and recycling of metals) are general industrial sources of trace metals in the environment. They can come into the natural water with the discharges and precipitation.

Table 1.2. Metals in industrial effluents (Nagajyoti et al. 2010)

Industry	Ag	As	Cd	Co	Cr	Cu	Hg	Mo	Pb	Ni	V	Zn
Mining operations and ore processing		X	X				X	X	X		X	
Metallurgy and electroplating	X	X	X		X	X	X		X	X		X
Chemical industries		X	X		X	X	X		X			X
Dyes and pigments		X	X			X			X			
Pottery and porcelain		X			X							
Print					X				X			X
Photography	X		X		X			X				
Leather training		X			X	X	X					X
Pharmaceuticals						X	X					
Textiles		X	X			X	X			X		
Fertilizers		X	X		X	X	X			X		X
Petroleum refining		X	X		X		X		X	X		

Domestic effluents: These wastewaters probably constitute the largest single source of elevated metal values in rivers and lakes. The use of detergents creates a possible pollution hazard as they contain Fe, Mn, Cr, Co, Zn, Sr and B.

Run-off: Urban runoff presents a serious problem of trace metal contamination, because it acts as a sink contaminated by metals from the precipitation and washing wastewaters.

Atmospheric sources: The precipitation can be a source of metal containing airborne particulates. Depending on prevailing climatic conditions, these particulates may become wind-blown over great distances.

Specific sources of trace metals include refuse incineration, landfills and transportation (automobiles, diesel-powered vehicles and aircraft). The burning of leaded gasoline has been an important source of Pb in the environment. Incinerations of municipal wastes generate significant concentrations of Zn, Pb, Al, Sn, Fe and Cu.

Thereby, aquatic ecosystems receive continuously increasing level of metals in various physical chemical forms and some of them are able to accumulate in the environment and act as the toxic substances. The degree of detoxification depends initially on the intensity of some aquatic processes as complexation with ligands of natural organic origin (Linnik 2003). The removal of trace metals during the treatment process is costly and time consuming and in some cases are low efficient (Suchkova et al. 2010). Certain forms, i.e. labile metal, are more dependent on the plant operating conditions (recirculation and reagents) than on treatment mechanisms (settling, biosorption and flocculation) and can flux in unchanged after passing the conventional WWTP with activated sludge lines (Buzier et al. 2006a).

### **1.2.3. Environmental and health risks**

Environmental and health risks has been generally determined as "...likelihood, or probability, of injury, disease, or death resulting from exposure to a potential environmental hazard"... (the source: ETC/CDS. General Environmental Multilingual Thesaurus available at <http://glossary.eea.europa.eu> last accessed on 27 January 2011). In the environmental context the risk is posed to human health and/or the environment by the actual or potential presence and/or use of specific.

Different international (e.g. WHO 2006) and national (e.g. EPA 2003) normative documents and guidelines are developed to determine the degree of environmental conditions and requirements to avoid negative and damaging effects, influences, and consequences. The environmental and health risks management includes several general steps: (i) risks research, (ii) risk assessment and (iii) risk management (Figure 1.6).

The principle procedure of the environmental and health risks assessment with the presence and accumulation of trace metals in natural water bodies are based on water chemistry monitoring (*e.g.* Cortecchi et al. 2009) or bio-monitoring (*e.g.* Gupta et al. 2007) data and rely on the established water (EU 2008) and sediments quality guidelines (de Deckere et al. 2011).

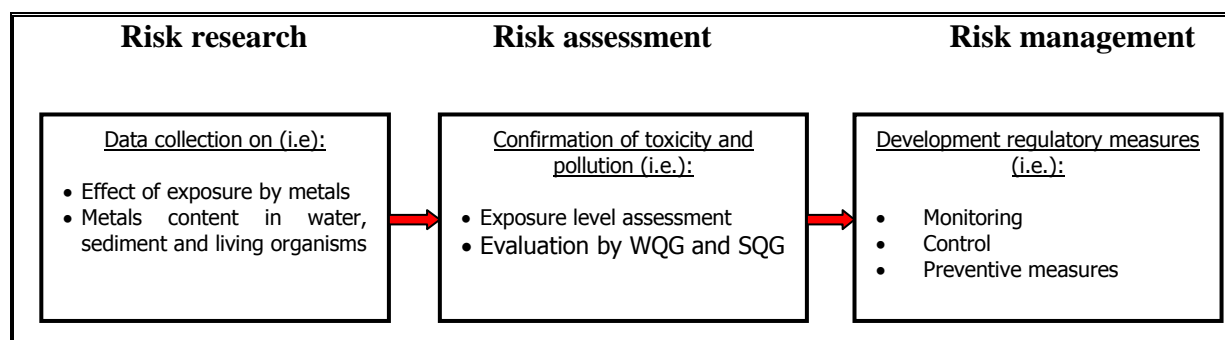

Figure 1.6. The scheme of environmental and health risks management

Water quality guidelines have been proposed for different water use: (i) drinking (*e.g.* WHO 2006); (ii) irrigation (*e.g.* FAO 1992; EPA 2004), (iii) fishing (*e.g.* Vehanen and Riihimaki 1999) and (iv) recreation (*e.g.* EU 2006).

According to these regulations, environmental and health risks assessment of trace metals contamination in water are mainly based on the total metal (GCPL 1991; SNPL 1991) or dissolved metal concentration (EU 2008).

The sediments quality guideline is developed for the assessment of the environmental risk associated with metal content in estuarine (*e.g.* MacDonald et al. 2000) and riverine (*e.g.* Ingersoll et al. 2001) sediments. A number of methods (contamination, background enrichment or ecological risk indexes) are available for the sediments quality evaluation (*e.g.* Pekey 2006).

The health risks of the trace metals content in water may occur when target analytes expose to human being through: (a) direct ingestion, (b) inhalation through the mouth and nose, and (c) dermal absorption. For metals in water environment, ingestion and dermal absorption play the most important role (Kim et al. 2004) and based on the calculated exposed dose and hazard quotients (EPA 2003; WHO 2006).

Thereby there is no universal system of the environmental and health risks assessment as they rely on various methods, standards and often depends on regional studies.

## 1.3. Pharmaceuticals in natural waters

### 1.3.1. Occurrence and characteristics

Increasing standards of living, economic changes and human population growth lead to the rising of pharmaceuticals use in households, hospitals, veterinary and aquaculture (Dietrich et al. 2004). During last 20 years, these emergent pollutants have been detected in surface waters of Austria (Clara et al. 2004), Sweden (Bendz et al. 2005), Finland (Lindqvist et al. 2005), Norway (Grund et al. 2008), Germany (Ternes 1998), Spain (Joss et al. 2006), Switzerland (Tauxe-Wuersch et al. 2005), Italy (Zuccato et al. 2005), France (Togola and Budzinski 2008), USA (MacLeod et al. 2007), Canada (Comeau et al. 2008), Korea (Choi et al. 2008), India (Larsson et al. 2007), Greece (Arditsoglou and Voutsas 2008), Romania (Moldovan 2006), Western Balkans (Terzic et al. 2008). Some of these pollutants were found even in drinking and tap waters (Heberer 2002; Kuster et al. 2006), in ground water (Barnes et al. 2008), marine and ocean waters and some aquatic organisms (Comeau et al. 2008). Recently the occurrence of pharmaceuticals in aquatic environment has become an issue of international attention and concern (Ternes 1998; Daneshvar et al. 2010).

The pharmaceuticals (i.e. medicine, medication or medicament) can be generally defined as any organic substance that is synthesized by chemists and intended for use in the medical diagnosis, cure, treatment, or prevention of disease (adapted from Ternes 1998). Medications can be classified in various ways, such as by chemical properties, mode or route of administration, biological system affected, or therapeutic effects.

The behavior (i.e. persistence, bioaccumulation, fate) and toxicity of pharmaceuticals compounds in the environment are closely contacted with a complex of physical chemical properties of a molecule (Andreozzi et al. 2003; Kasprzyk-Hordern et al. 2009a) (Table 1.3.).

Among them, the major characteristics of pharmaceuticals in term of the environmental fate and toxicity is a solubility (Girard 2005; Chemicals Profile by U.S. Environmental Protection Agency: [www.pbtprofiler.net](http://www.pbtprofiler.net); Kasprzyk-Hordern et al. 2009a,b) estimated as the water solubility or octanol – water partition coefficients (Table 1.3.), which indicate the potential for absorption across biological membranes and for the passive diffusion. Such coefficients are used for the evaluation of the potential toxicity of pharmaceuticals, which are made to be able to pass through membranes and have a high bioaccumulation potential and biological activity even in low concentrations (Ternes 1998; Petrovic and Barcelo 2007).



Table 1.3. General physical chemicals characteristics of pharmaceuticals (according to Chemicals Profile by U.S. Environmental Protection Agency: [www.pbtprofiler.net](http://www.pbtprofiler.net))

Property	Description	Criteria	Classification
Solubility	the amount of a substance that dissolves in a given volume of solvent at a specified temperature	Water solubility ( $S_w$ ) – the maximum amount of a substance that can dissolve in water at equilibrium at a given temperature and pressure	Polar molecules – hydrophilic Non polar molecules- hydrophobic
		Log $K_{ow}$ – The octanol-water partition coefficient is the ratio of the concentration of a chemical in octanol and in water at equilibrium and at a specified temperature.	Positive Log Kow – low water solubility (hydrophobic) Negative Log Kow – high water solubility (hydrophilic)
Acidity	The ability of chemicals dissolved in water, and gives a solution with pH of less than 7. An acid reacts with a base in a neutralization reaction	$pK_a$ – dissociation constant – quantitative measure of the strength of an acid in solution	< - 2: strong acid -2 – 12: weak acid > 12: bases
Persistence	ability to remain in an environment in an unchanged form: the longer a chemical persists, the higher the potential for human or environmental exposure to it.	Half life (in months or days) - length of time it takes for the concentration of a substance to be reduced by one-half relative to its initial level	< 2mnths in water and sediments – non persistent > 2mnths in water and sediments – persistent
Bioaccumulation	the process by which the chemical concentration in an aquatic organism achieves a level that exceeds that in the water, as a result of chemical uptake through all possible routes of exposure.	Bioconcentration factor (Meylan et al. 1999)	< 1,000 - non bioaccumulative > 1,000 - bioaccumulative

Other characteristics of pharmaceuticals are ability to fate under influences of different environmental (i.e. solar radiation, water chemistry, etc; Andreozzi et al. 2003) and anthropogenic factors (i.e. treatment processes; Carballa et al. 2004) (Figure 1.7), and to create variety metabolites what is also potentially toxic (Stulten et al. 2008).

The influence of these factors is found to be distinct for different pharmaceuticals and their metabolites (Andreozzi et al. 2003; Nakada et al. 2008) and the research on the phenomena is still underdevelopment (Pal et al. 2010).

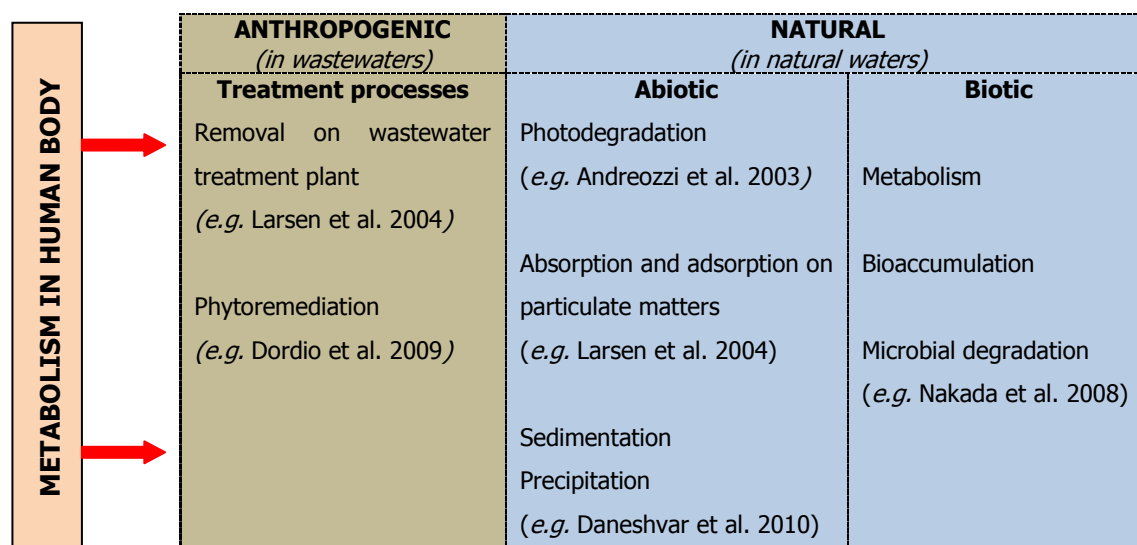

Figure 1.7. The anthropogenic and natural factors of the fate of human pharmaceuticals in water

Thus, environmental and socio-economic determinants of pharmaceuticals in natural waters should be studied in the relation to the physical chemical properties of molecules in order to obtain the information on the fate and accumulation of contaminants in the environment.

### 1.3.2. Sources

The presence of pharmaceuticals in the aqueous environment is generally related to the anthropogenic processes:

#### Pharmaceuticals production

The discharge and loss of pharmaceuticals from manufacturing processes are limited because of the huge monetary investments in drugs production and strict control of it in economically developed countries (Petrovic and Barcelo 2007). But in the developing countries and countries with transitional economy, where the control of drugs manufactory is inefficient, the situation can be totally opposite and the production can become a significant source of pharmaceuticals in the environment (Larsson et al. 2007).

#### Pharmaceuticals consumption

The consumption of human and veterinary drugs varies from country to country (Ternes 1998), that probably depends on the current pharmaceutical market, its regulation and control, but also on the impact of local climate and social conditions. For example, compare to economically developed EU-countries, Ukraine, as a country with transitional economy, has the lowest official

level of human drugs consumption in monetary and DDD (defined daily doze) values and the lowest level of access of population to the health care (Table 1.4.).

Table 1.4. Basic indicators of health market in some European countries (2007)

Country	Total population, mln.inh	Access to medical care, beds/10,000 persons	Access to pharmaceutical shops, persons/shop	Human drugs use, USD/person (DDD)	Expenses on health care, % of GDP
Ukraine	46.2	95.2	5500	18(11.84)	3.8
France	63.2	na	2000	299(32.2)	11.1
Spain	44.3	347.5	2100	210(na )	8.2
Germany	82.2	846.4	3800	260(na)	10.7
Italy	59.1	400.9	3600	212(na)	8.9

na - data were not available

Weak access of population to the health services, from one side, can mean the lower level of pharmaceuticals use in the country, from other side – the “black market” of pharmaceuticals and inappropriate use of medicaments. For example, just a half of medicaments sold on the market in Ukraine are prescribed. The low developed system of medical care and drugs prescription can effect in the wrong and chaotic use of medicaments by pollution. Such conditions result in the accumulation of date expired or unused pharmaceuticals what can be through away in the sewage or waste systems and come in the environment in non-metabolized forms (Kummerer and Hempel 2010). Ruhoy, Daughton (Ruhoy and Daughton 2008) and Kummerer (Kummerer and Hempel 2010) described various factors of the reduction of the wastage and accumulation of pharmaceuticals in the environment, including production, advertisement, sales and consumption levels.

### Wastewater treatment and discharge

Results of previous studies argue that wastewaters are main sources of pharmaceuticals in the aquatic environment (Ternes 1998; Hirsch et al. 1999; Heberer 2002; Clara et al. 2004; Bendz et al. 2005; Hing-Biu Lee et al. 2005; Lindqvist et al. 2005; Joss et al. 2006; Comeau et al. 2008). Untreated wastewaters can come direct from sewage treatment plants and/or with leakages, septic tanks (Ternes 1999), but also from the landfill (Schwarzbauer et al. 2002) (Figure 1.8). The most contaminated is hospital wastewaters (Steger- Hartmann et al. 1997) as they content high concentrated mixture of various medicaments.

The removal of pharmaceuticals on treatment plants is depends on physical chemical properties of compounds and used treatment processes (Navalon et al. 2008), biological degradation (Heberer 2002; Lindqvist et al. 2005; Joss et al. 2006), presence of other chemicals, for instant

nitrates, in water (Andreozzi et al. 2003; Vieno et al. 2007), climate conditions (Ternes 1998), seasonal variations and even geographical location (Andreozzi et al. 2003).

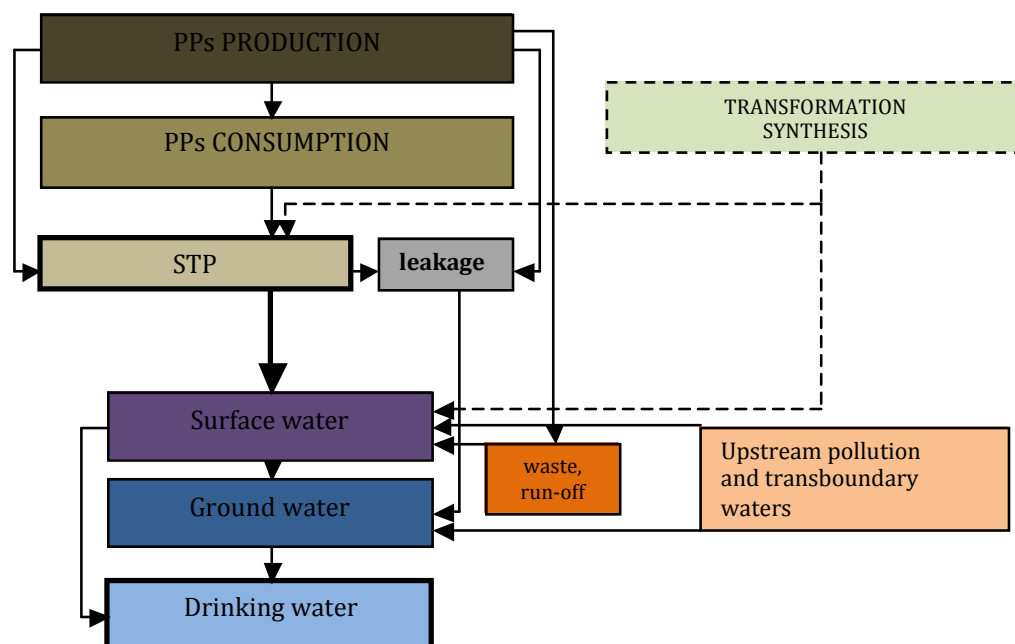

Figure 1.8. The main pathways of pharmaceuticals in water

Traditional mechanical and biological treatment process with the activated sludge to be widely used in a lot of countries have very limited facilities to remove pharmaceuticals from raw waters (Clara et al. 2004; Ternes 1998; Navalon et al. 2008; Lindqvist et al. 2005; Heberer 2002; Vieno et al. 2007; Hua et al. 2006). The elimination of drug passage through conventional municipal STP ranged from 7% (carbamazapine) to more than 99% (salicylic acid) (Terner 1998) and mainly due to the biodegradation (Petrovic and Barcelo 2007). Some modifications or improvements such as proper operating conditions and some additives during flocculation/coagulation, significant solid retention time of the combination of anoxic/aerobic steps could improve the efficiency of pharmaceuticals removal on conventional STP (Carballa et al. 2004), but the treatment of some persistent molecules still will be low.

Previous studies (Huber et al. 2005; Navalon et al. 2008) reported that even during removal processes some pharmaceuticals, *e.g.* amoxicillin, cefadroxil, macrolide, sulfonamide antibiotics, estrogens, phenazones, can react with disinfectants that leads to the creation of specific by-products which can be more biodegradable and less toxic than the original substance, but the research needs further development (Klavarioti et al. 2009).

Advance treatment techniques as active oxidation processes, ozonation, activated carbon, UV radioation, nanofiltration, reverse osmosis, membrane bioreactor and their combination are found

to be more efficient to remove pharmaceuticals from influents compare to the conventional activated sludge (Radjenovic et al. 2008; Weiss and Reemtsma 2008) (*e.g.* Table 1.5).

Table 1.5. Removal of pharmaceuticals by membrane bioreactor (MBR) and conventional activated sludge (CAS)

Substances	Removal rate by MBR, %	Removal rate by CAS, %	References
Diclofenac	23-50	17	Quintana et al. 2005 Tuaxe-Wuersch et al. 2005
Ketoprofen	50-65	15-72	Quintana et al. 2005 Tuaxe-Wuersch et al. 2005
Bezafibrate	80-95	-	Quintana et al. 2005
Naproxen	50-71	40-55	Quintana et al. 2005 Carballa et al. 2004
Ibuprofen	90-97	66-93	Quintana et al. 2005 Tuaxe-Wuersch et al. 2005
Sulfamethoxazole	>80	68	Carballa et al. 2004 Joss et al. 2005
Carbamazepine	<20	<10	Joss et al. 2005

But such techniques are more expensive, energy consumed, difficult in exploitations and adoption to existent technologies, that makes treatment costs per mass units are very high, and can be applied mainly for drinking water purification and wastewater processes in small communities and individual households (Larsen et al. 2004).

Several researches present the positive results of the application of the biotechnologies as constructed wetland (Dordio et al. 2010) and remediation fields (Herklotz et al. 2010) for the elimination of pharmaceuticals, but it needs the further development for the application. Recently the processes of degradation and occurrence of pharmaceuticals during various treatment processes are low known with a lot of uncertainties and assumptions, *e.g.* appearance of drugs metabolites and synthesis of different molecules, impact of environmental factors and its combination.

#### Waste and run-off

Compare to the wastewaters, lower amount of pharmaceuticals can enter water with the run-off from landfills and waste accumulation areas (Ternes 1998). Few studies have attempted to correlate the use of veterinary drugs in areas supporting dairy and agricultural industries with occurrence of these compounds in surface waters (Brown et al. 2006). Other significant source of pharmaceuticals, especially antibiotic, is an aquaculture (Teuber 2001; Zezhi 2001).

Some of the pharmaceuticals can be generated by synthesis of metabolites and other chemicals in the environment (Zhang et al. 2008b), also they are able to transform back to the original active components (Hirsch et al. 1999), *e.g.* N-4 acetylated sulfamethazine transform to chloramphenicol and sulfamethazine in the STP or environment (Hirsch et al. 1999).

So, molecules of pharmaceuticals are highly active and can interact with the natural environment and in the form of not metabolized or transformed pharmaceuticals can reach surface, ground or/and drinking waters (Figure 1.8).

Thereby the portion of pharmaceuticals, what are able to get into water from different sources depends on various factors: (i) management and control of pharmaceuticals manufacturing; (ii) regulation of medicaments consumption, *i.e.* quantity of prescription and sold drugs, (iii) metabolism of drugs in organisms, (iv) property of molecules, *e.g.* solubility, degradation; (v) environmental parameters, *i.e.* climate conditions, dilution and (vi) treatment processes.

Some of these factors are predictable, *e.g.* metabolism, degradation, some are unpredictable, *e.g.* improper use and disposal (Zuccato et al. 2005), but all these parameters need additional research.

### 1.3.3. Environmental and health risks

Evident, that small doze of pharmaceutical product can lead to changes of living functions in human and animals and have a huge impact on smaller organisms in the ecosystem (Comeau et al. 2008). Some studies (Cleuvers 2003) show that pharmaceuticals can be harmful to plankton, aquatic plants and fish at concentrations of 10-200 times lower than the standard human doze (Table 1.6). For example, gemfibrozil, a lipid regulator, can cause the reduction of testosterone levels in goldfish (*Carrassius auratus*). Indomethacin is capable for the decreasing of gonad size of fathead minnows (*Pimephales*). Diclofenac can be a stimulator of decline of population of vultures in India and Pakistan (Fent et al. 2006). Antibiotics can induce resistances in bacterial strains that may lead to the occurrence of serious threat to public health and aquatic organisms, because more and more infections can no longer be treated (Hirsch et al. 1999).

Effects on human health can be more pronounced in young or elderly, whom have a reduced ability to remove toxic compounds from bodies and there is also possible that they may interact with other medicals that are individual may be taking (Petrovic and Barcelo 2007).

Table 1.6. The ecotoxicity of some therapeutic groups of pharmaceuticals to microorganisms (A), algae (B), cnidaria (C), crustacea (D) and fish (F) (according to Jones et al. 2002)

Group PPs	Extremely toxic EC <sub>50</sub> < 0.1 µg L <sup>-1</sup>	Very toxic EC <sub>50</sub> 0.1-1 µg L <sup>-1</sup>	Toxic EC <sub>50</sub> 1-10 µg L <sup>-1</sup>	Harmful EC <sub>50</sub> 10-100 µg L <sup>-1</sup>	Harmful EC <sub>50</sub> > 100 µg L <sup>-1</sup>
Analgesics			D	D,E	
Antibiotics	A	B			
Antidepressants		D			
Antiepileptics			C		D,E
Cardiovascular drugs		D			

These environmental and health risks of pharmaceuticals can be determined by the predicted no-effect concentration (PNEC) in water (Lindqvist et al. 2005) and the predicted environmental concentration (PEC) (Tauxe-Wuersch et al. 2005). The risk of human exposure is considered in relation to acceptable daily intakes of medicaments (Ternes 1999; Boxall 2004) and PNEC (Schwab et al. 2005) (*e.g.* Table 1.7.).

Table 1.7. The PNEC of pharmaceuticals for children in water by three scenarios: drinking water (dw), fish consumption (f) and combined effect (dw+f) (adapted from Schwab et al. 2005)

Drug	Group	PNEC <sub>dw</sub> , µg L <sup>-1</sup>	PNEC <sub>f</sub> , µg L <sup>-1</sup>	PNEC <sub>dw+f</sub> , µg L <sup>-1</sup>
Fluoxetine	Antidepressant	42	2100	410
Gemfibrozil	Lipid regulator	800	39000	790
Ibuprofen	Anti-inflammatory	1600	48000	1600
Norfloxacin	Antibiotic	2800	130000	2700

The current normative and regulative documents on environmental and health risk assessment that associated with pharmaceuticals are in progress. Some countries, *e.g.* Norway (EPCEU 2006), are developed quality guidelines on PEC and PNEC of 14 pharmaceuticals in sewage sludge, which are used in the agriculture.

There is the lack of data on the eco-toxicology of the pharmaceuticals and their impact on human and environmental health (Ferrari et al. 2003).

#### 1.4. Trace pollutant identification

A wide range of methods and instruments can be used for sampling and analysis of trace metals and pharmaceuticals in water and sediments (Allan et al. 2008; Ort et al. 2010; Zabiegala et al. 2010).

### 1.4.1. Conventional sampling techniques

Most aquatic monitoring programs in EU and Ukraine rely on the use of the conventional water and sediments sampling approaches *e.g.* discrete grab, spot, bottle samples or bio-indication. The subsequent laboratory analysis of such samples provides a snapshot of the levels of pollutants at the time of sampling (Alvarez et al. 2005; Tan et al. 2007). Often, when pollutants are present at only trace levels, large volumes of water need to be collected (Alvarez et al. 2005; Kot-Wasik et al. 2007a). However, the disadvantage of this approach is the missing of time-varying and episodic pollution events (Alvarez et al. 2005; Katsoyiannis and Samara 2007; Zhang et al. 2008b). One solution to solve the problem is the increasing of the frequency of sampling or installation of automatic sampling systems that can take numerous water samples over a given time period (Zhang et al. 2008b). This is costly and in many cases is impractical, since a secure site and significant pre-treatment of water are required (Alvarez et al. 2005; Kot-Wasik et al. 2007). Spot sampling yields different apparent concentrations of pollutants depending on the pre-treatment applied (*e.g.* filtering; Tan et al 2007) and does not provide the information on truly dissolved, bioavailable fractions of contaminants. Additional active sampling techniques as anodic stripping voltammetry or cathodic stripping voltammetry are adaptable for the determination of metals fractions in water (Pesavento et al. 2009), but the problem is generally related to the delivery of samples in the laboratory for the analysis, because metals can change the speciation.

Another approach that gives information on biologically relevant concentrations of pollutants is the use of the biota. A number of test species has been investigated for the biomonitoring purposes. These organisms can be deployed for extended periods of time, during which they passively bioaccumulate pollutants in the surrounding water. Analysis of the tissues or lipid extracts of the test organism(s) can give an indication of the equilibrium level of waterborne contamination. Various factors can influence on the results, *i.e.* metabolism, depuration rates, excretion, stress, viability and condition of test organism. Furthermore, extraction of analytes from the tissue of animals prior to instrumental analysis is complex. The estimation of pollutant concentrations in water can also be made by measuring concentrations in benthic sediments and then using equilibrium distribution coefficients to derive levels of dissolved analytes. But the approach is limited by the assumption of equilibrium between the sediments and the water column, and organic carbon can also effects on the accounting of current equilibrium-partition models.



Conventional water sampling techniques are standardized by different official procedures (*e.g.* ISO, CEN, ASTM and EPA).

### 1.4.2. Passive water sampling technique

In response to difficulties of traditional methods, time integrated passive sampling techniques were developed for the monitoring of inorganic and organic chemicals at low concentrations in water (*e.g.* Zhang and Davison 1995; Alvarez et al. 2005; Paschke et al. 2006; Vrana et al. 2007) (Table 1.8). These techniques are based on the diffusion of chemicals from the aqueous phase into a sampling phase that has a relatively high sorptive capacity for chemicals of the interest. Passive sampling techniques provide time-weighted average water concentrations during the period of the passive sampler deployment. The concentrations are calculated from the amount of chemical sequestered in the sampler using sampling rates determined either by calibrations conducted in the laboratory or via field deployments (Zhang and Davison 1995; Togola and Budzinski 2007a,b). Advantages, such as relative simplicity, inexpensiveness, and lack of energy requirements for sampling, made passive samplers a useful complement to more conventional active sampling techniques. Passive sampling techniques, which basically consist of concentrating substances on a submerged device for a given period, should improve the monitoring, by simplifying analytical issues (lower detection limits, analysis in a simpler matrix), and allowing time integration of the contamination (Greenwood et al. 2007; Vrana et al. 2007). Various passive sampling devices are used for the trace metals identification (Table 1.8). The selection of the sampler depends on the availability of devices and analytical tools for their analysis, costs, characteristics of sampling sites, etc.

### Summary

The literature review highlighted following:

Numerous trace contaminants have been detected in natural water and among them trace metals as priority inorganic pollutants and pharmaceuticals as emergent organic substances are one of the most growing concern.

Trace metals in the natural waters can originate from both natural and anthropogenic sources. These elements metals are persistent and their potential toxicity is largely controlled by speciation (*e.g.* total, dissolved, labile metals). Environmental and health risks assessment of





metals content in water bodies are mainly based on the different international and national environmental standards.

In contrast to trace metals, almost all pharmaceuticals have an anthropogenic origin and the persistence of these chemicals in the environment depends on the physical chemical characteristics of molecules (i.e. solubility, acidity). Environmental and health risks assessment system is underdevelopment and generally based on independent ecotoxic researches.

Variety environmental (i.e. geochemical baseline, hydrology) and socio-economic (i.e. economic structure, consumption) factors influence on occurrence, distribution and accumulation of trace elements that demands additional research.

Trace elements can be identified in water with the application of conventional active and innovative passive sampling techniques and the last can significantly supplement environmental data.

Table. 1.8. Principle characteristics of some passive water samplers

Passive sampler	Photo	Membrane	Sorbent	Type of pollutants	Reference
Chemcatcher®		Various (cellulose, acetate, polyethylene)	Various (C <sub>18</sub> Empore Disk, chelating acceptor, etc)	Polar and non polar organic contaminants (herbicides, pesticides), metals, organometallic compounds	Vrana et al. 2007 Greenwood et al. 2007
MESCO (membrane enclosed sorptive coating) I and II		Cellulose or low density polyethylene	PDMS coated on a stir bar	Polar organic compounds	Paschke et al. 2006 Greenwood et al. 2007
SPMD (semipermeable membrane device)		Low density polyethylene	Triolein	Polar organic compounds	Huckins et al. 1993 Lu et al. 2002
POCIS (polar organic chemical integrative sampler)		Polyethersulfone membrane	OASIS HLB, hexane, iso - octane	Polar organic compounds (pharmaceuticals, personal care products, pesticides)	Alvarez et al. 2005 Togola 2006
DGT (diffusive gradient in the thin film)		Acrylamide gel	Metal binding resin incorporated into acrylamide gel	Inorganic compounds (metals, mercury)	Zhang and Davison 1995

## CHAPTER II

### STUDY SITES

#### 2.1. Ukrainian study area (Lopan and Udy rivers, Seversky Donets water basin)

##### 2.1.1. Geography and climate

The Seversky Donets River is the fourth largest river in Ukraine and is an important source of fresh water for industrial and urban Eastern part of the country. The total area of the water basin (coordinates  $51^{\circ} 00'' - 47^{\circ} 36' N$   $36^{\circ} 59' - 40^{\circ} 53' E$ ) is  $98,900 \text{ km}^2$  with  $54,500 \text{ km}^2$  locates in Ukraine. It originates from the Central Russian Upland, north of Belgorod, flow through three large urban and industrial areas of Ukraine: Kharkiv, Donetsk and Lugansk regions with total population is 9,732,324 people (21% of all populations of Ukraine, 2009) and then again through Russia (Rostov region) to join the Don River on the distance is about 100 km of the Azov Sea. The surface of the watershed is flat with absolute altitude variations from 150 m to 250 m and by it hydrogeological conditions belongs to the Dnieper-Donec Artesian Basin. The basin formation is occurred during the period from the Early Carboniferous through the Quarternary on the Late Devonian Rift. The crystalline foundation in the axial part of this structure lies at depth from 1 km in the North - West up to 10 km in the South - East. The different forms of erosion process dominate in the landscape structure. The depth of the erosion varies from 100 to 120 m in the top part of the watershed to 50-100 m in the low part of the watershed. Soils are black earth (chernozem) and gray podzolic loess (about 8% of humus). The big part of the watershed is

arable land, the forest covers 10% of the watershed territory and wetlands are 1%. Numerous dams and reservoirs regulate the watershed.

The Udy River is a right tributary of the Seversky Donets River. The Lopan River is the left tributary of the Udy River. Both rivers are flow through the industrial and urban centre of Eastern Ukraine - Kharkiv region (c.a. 3,000,000 inhabitants, 2009) with the Kharkiv city (c.a. 1,351,000 inhabitants 2009). The riverbed of Udy and Lopan Rivers are weakly twisting with mean width is from 6 to 8 m (max 20-35 m on some areas) and mean depth is 0.1-1.8 m (partly 3.0 m). Bottoms of rivers are primary solid and sand, partly slimy and clay. The high of the riverbank is 0.2-1.5 m and compiled by loamy and sandy soil. The river's discharges are seasonally dependent and vary from 0.9 in low flow period (summer) to  $8 \text{ m}^3 \text{ s}^{-1}$  during high flow autumn and spring seasons. The flow velocity is  $0.02\text{-}0.2 \text{ m s}^{-1}$  (Vasenko et al. 2006).

The feeding of studied water bodies is mostly by snow melting and rain and only very partly by groundwater. The structure of water use of the Udy and Lopan rivers can be approximately presented as: industrial water consumption (86% total consumption), public consumption (13.1%) and agricultural consumption (0.66%). The land use of the Udy and Lopan rivers is divided between agricultural and rural, urban and reservoirs and partly used for recreation and fishing. Both rivers receive all urban wastewaters (mixture of domestic and industrial) of the Kharkiv region (Jakovlev et al. 2002; Vasenko et al. 2006).

The climate of the study area is a typical for the Forest-Steppe natural zone i.e. continental with four seasons, namely summer, fall, winter and spring. The duration of the cold winter period varies from 125 to 130 days, and warm period is ca. 118 - 200 days. The coldest month is January (average temperature  $-7.3^\circ\text{C}$ ) (Figure 2.1.).

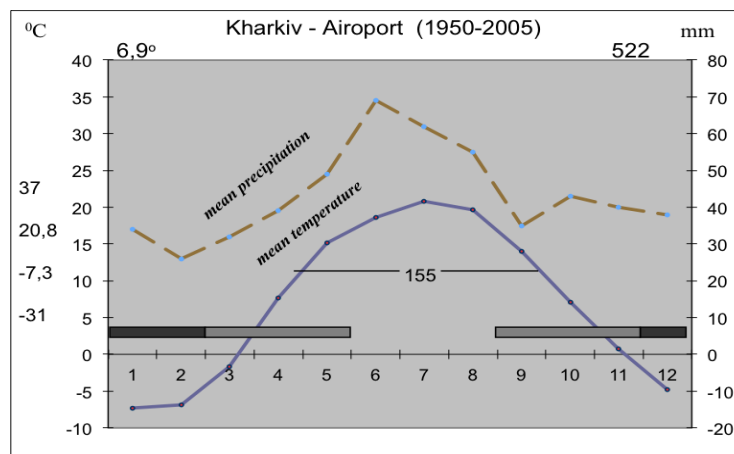

Figure 2.1. The climatic characteristics of the Kharkiv city (with maximum and minimum values of air temperature)

The warmest month is July (average temperature +20.8°C). Annual precipitation varies between 470 and 540 mm with maximum in May - June. The mean annual temperature of the air is +6.9 °C, wind velocity is 4.0 m s<sup>-1</sup> and humidity is 74%.

The Kharkiv urban agglomerate is marked by some distinct transformations in climatic factors, *e.g.* average temperature is 1 to 2°C higher, and precipitation raises by 4 to 5% (Jakovlev et al. 2002; Vasenko et al. 2006).

### 2.1.2. Pollution

The intensive economic activity and urbanization have created significant pressure and unsustainable use of natural resources on the study area (Svirenko et al. 2003; RESKhR 2008). Kharkiv region is the largest industrial and agricultural centre of Ukraine with highly developed machine-building and instrument-making industries, chemical, food-processing and other branches, which are combined into industrial areas and belts situated mainly along the periphery of these cities. Some plants and factories are interspersed among apartment blocks and housing sections (Jakovlev et al. 2002). According to the presently accepted scheme of wastewater collecting and treatment system in Ukrainian cities, includes the following subsystems:

- (i) municipal sewage collectors, sewerage facilities and sewage treatment plants,
- (ii) local waste water pretreatment plants at large enterprises, and
- (iii) storm water drainage system.

Cottage areas of urban and rural types are provided with primitive systems of drain pits and drainage ditches. But because of the aging of the local pretreatment plants, most of the hazardous industrial wastes are not treated separately or not sufficiently treated but mixed with domestic, hospital and storm wastewaters. The contaminated wastewaters are discharged into the same water basin that is used for the drinking water supply and that is a serious threat not only to the environment, but also to the human health (NRDW 2008).

There are two large-size sewage treatment plants (STP) in the Kharkiv region, what discharge wastewaters in Udy and Lopan rivers. The first and the biggest is the 'Dykanivka' STP (capacity is 700,000 m<sup>3</sup>d<sup>-1</sup>), which discharges wastewaters (c.a. 550,000 m<sup>3</sup>d<sup>-1</sup>) in the Lopan River at the volume what is more than 2 times higher of the river flow rate (Vystavna 2005). The second is 'Bezludivka' STP (capacity is 300,000 m<sup>3</sup>d<sup>-1</sup>), which discharges wastewaters (c.a. 170,000 m<sup>3</sup>d<sup>-1</sup>) in the Udy River in the volume what is also higher of the river flow rate (Suchkova et al.

2010). Domestic wastewaters consist 75% of all effluents. The wastewater treatment processes on the both STPs include mechanical and biological (aerobic) process with final disinfection (chlorination) stage and sludge storage (Suchkova et al. 2010). The scheme of the treatment processes is presented on the Figure 2.2.

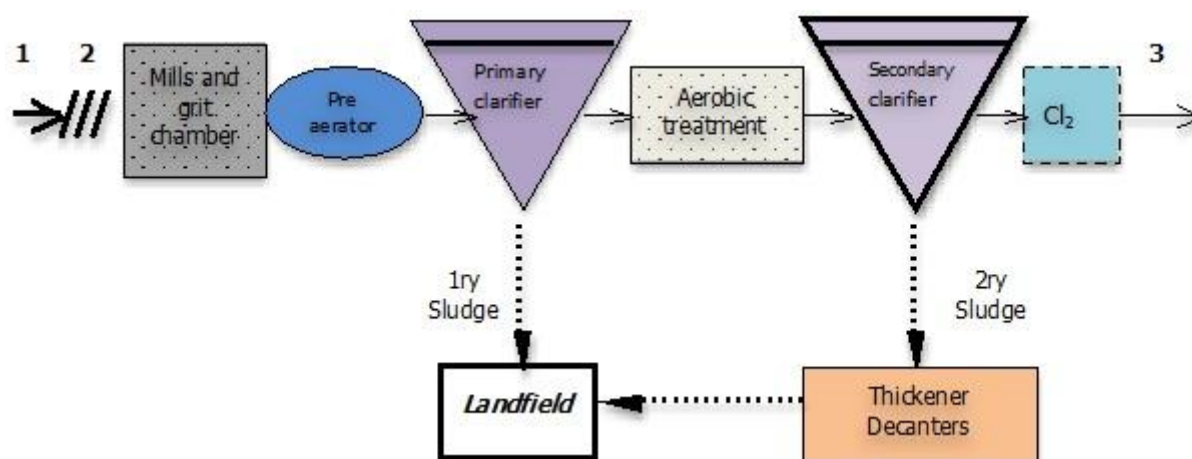

Figure 2.2. The schematic diagram of 'Bezludivka' and 'Dykanivka' STPs (1 influents; 2 screen; 3 effluents in the river)

Because of the applied conventional treatment scheme (Figure 2.2), aging of the STP, extremely low dilution of wastewaters in the receiving rivers, the water quality in both Udy and Lopan classified as 'polluted' (Vasenko et al. 2006; NRDW 2008). Downstream sites are contaminated by fecal bacteria ( $BOD_5$ : 4.98 – 8.43  $mgO_2L^{-1}$ ), sulfates (215 – 235  $mgL^{-1}$ ), nitrites (N- $NO_2$ : 1.0 – 1.7  $mgL^{-1}$ ), phosphates (P –  $PO_4$ : 1.32 – 1.44  $mgL^{-1}$ ), oil products, phenols and trace metals, i.e. Cr (0.05 – 0.06  $mgL^{-1}$ ), Pb (0.03 – 0.04  $mgL^{-1}$ ) (Vasenko et al. 2006). The pollution leads to the eutrophication of Lopan and Udy Rivers, what is evident in the hot summer period (Vasenko et al. 2006).

### 2.1.3. Sampling sites

In this thesis, 18 sampling sites have been chosen: eight stations along the Udy River and ten stations along the Lopan River (Figure 2.3).

The sampling stations have been selected based on the location of the potential pollution sources (STP, urban area, etc.), specific hydrological conditions (water storage reservoirs) and possibility to access to the sampling sites during all sampling seasons.

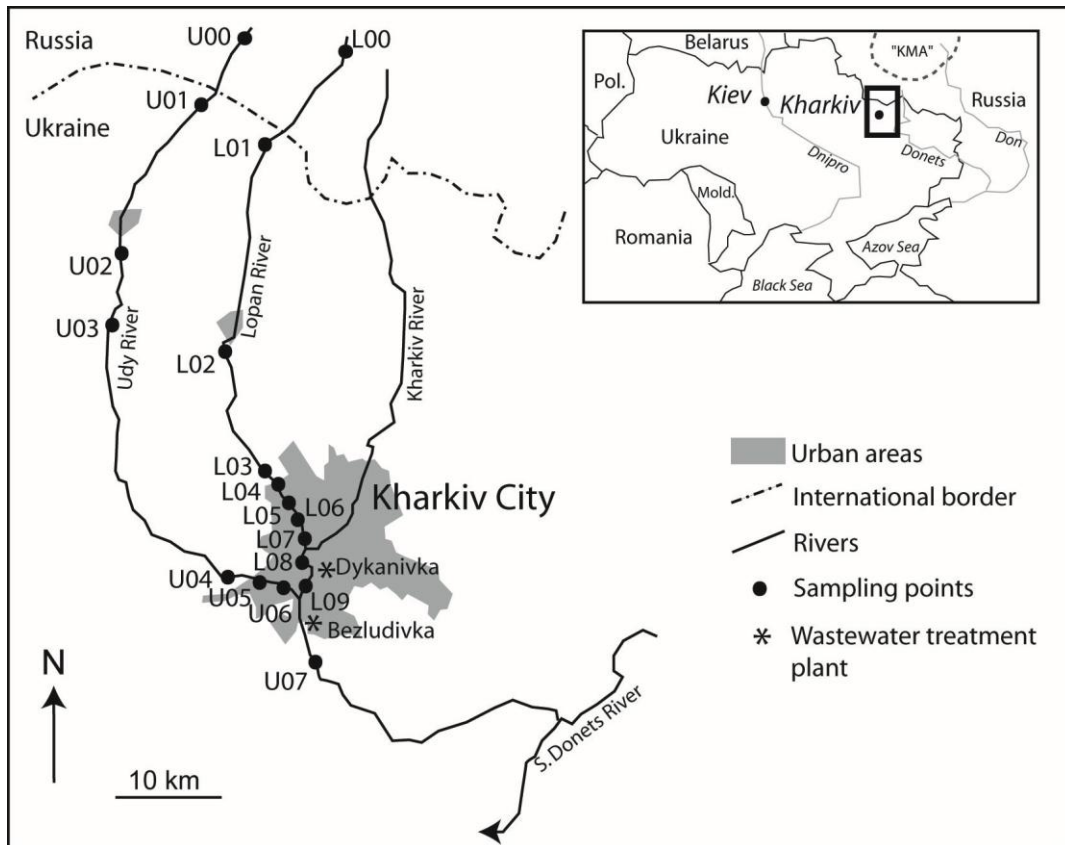

Figure 2.3. The location of the sampling sites in Ukraine

The sampling sites of on the Lopan River are located as follows:

*L00* – is at the source of the river in the Belgorod region, Russia (Figure 2.4.)



Figure 2.4. *L00*, source of the Lopan River, summer

*L01* – is at the inflow of the Lopan River in Kharkiv region from Russia, next to the Shevchenko village of Derkachi district (96,300 population, 2009) (Figure 2.5).





*Figure 2.5. L01, entrance of the Lopan River in the Kharkiv region, winter*

*L02* – is upstream of the first big settlement in the region (Derkachi town) and downstream of agricultural area

*L03* – is at inflow of the Lopan River in Kharkiv city and downstream of the Academy of Veterinary, what has a local STP

*L04* – is chosen downstream of the Alexeevskiy water reservoir, in the recreation zone and densely populated area. Also there is a chemical industry located upstream of the sampling point

*L05* – is situated in the industrial district of Kharkiv city (machine building and chemical production)

*L06* – is situated in the central part of Kharkiv city, at the confluence of Lopan and Kharkiv Rivers (Figure 2.6)

*L07* – is in the old industrial zone of the Kharkiv city (metal processing) and downstream of one of the dam

*L08* – is located upstream of the wastewater discharges from ‘Dykanivka’ STP, in the urban district of the Kharkiv city and downstream of one of the dam



*Figure 2.6. L06, Kharkiv city centre, summer*

*L09* – is downstream of wastewaters discharge from ‘Dykanivka’ STP and upstream of the inflow in the Udy River (Kharkiv city) (Figure 2.7.)



*Figure 2.7. L09, confluence of the Lopan and Udy Rivers, winter*

The Udy River sampling sites have been chosen as follows:

*U00* – is at the source of the river in the Belgorod region, Russia (Figure 2.8)

*U01* – is located at the entrance of the river in the Kharkiv region, Zolochiv district (31,600 population, 2009).



*Figure 2.8. U00, source of the Udy River*

*U02* – is situated downstream of the first big settlement in the region (Zolochiv town) with intensive agricultural activity (Figure 2.9)



*Figure 2.9. U02, Zolochiv district*

*U03* – is chosen downstream of water reservoir ‘Rogozyanskoe’ with developed local fishing and recreation activities, but also with a lot of small farms and summer cottages

*U04* - is located upstream of the inflow in the Kharkiv city

*U05* – is situated in the industrial area (machine building) of the Kharkiv city

*U06* – is upstream of the confluence Lopan and Udy Rivers and downstream of the ‘Bezludivka’ STP (Figure 2.10).



*Figure 2.10. U06, Udy River, upstream of urban discharges, summer*

U07 – is located downstream of the Bezludivka' STP (Figure 2.11).



*Figure 2.11. U07, Udy River, downstream of urban discharges, winter*

Thus, the selection of sampling sites location have been done for all specific parts of the studied rivers: (i) transboundary area - influents in the Kharkiv region (L00; L01; U00 and U01); (ii) upstream of the urban area (L02; L03; U02; U03 and U04), (iii) within the city area (L04; L05; L06; L07; L08; U05 and U06) and (iii) downstream of the Kharkiv city and urban wastewaters discharges (L09 and U07).

The sampling has been done during the contrasted seasons: hot summer period (August – September) and cold winter period (January – February) and during the different hydrological

conditions: low flow period in summer (August – September), high flow period in summer (May – June) and flow period in winter (January – February).

For the pilot survey, during the first campaign, all mentioned sites were sampled. But the following campaigns, only the most representative sites, in term of the accessibility and potential pollution sources, were chosen and monitored.

## 2.2. French study area (Jalle River, Garonne water basin)

### 2.2.1. Geography and climate

The alluvial Jalle River is a right tributary of the Garonne River and located in the South – West of France (Figure 2.12). The Jalle River flow through the north of Bordeaux city and has a 34 km of length, a depth from 0.8 to 2.5 m, and  $3 \text{ m}^3 \text{ s}^{-1}$  of average water debit, The subsurface geological structures of the area are dated from Oligocene and consist mainly of sedimentary rocks like sand and marl. The river has mostly pluvial feeding, runs through residential suburban and rural areas and receives effluents from two major municipal wastewater treatment facilities of the Bordeaux suburbs, serving greater than 100,000 people.

The climate of the study area is classified as an oceanic climate (LA CUB 2006); however, the summers tend to be warmer and the winters milder than most areas of the similar classification. Substantial summer rainfall prevents this climate from being classified as Mediterranean.

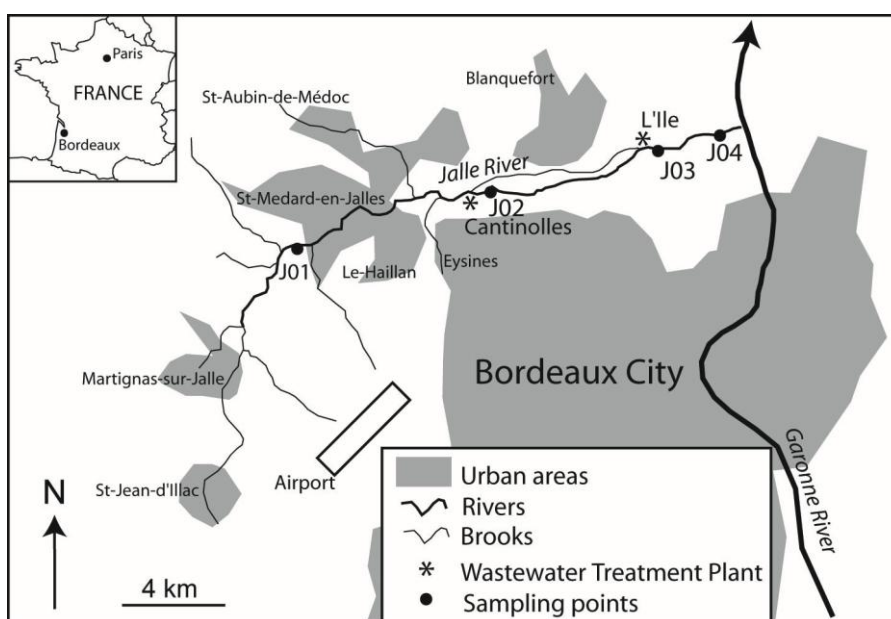

Figure 2.12. The location of the sampling sites in France

Winters are mild because of the prevalence of westerly winds from the Atlantic. Summers are warm and long due to the influence from the Bay of Biscay (surface temperature reaches 21 to 22 °C). The coldest month is January (average temperature 5 - 7°C).

The warmest month is July (average temperature 19 - 21°C). Annual precipitation varies between 711 and 820 mm with maximum in December - January. The mean annual temperature of the air is +14 °C (LA CUB 2006).

### **2.2.2. Pollution**

The Jalle River flows through rural and urban area of Bordeaux agglomeration. Also the part of the watershed is linked to the natural reservation zone, i.e. Bruges.

The water of the river is used for the recreation, irrigation and discharge of the domestic and industrial wastewaters. There are two medium – size sewage treatment plants: ‘Cantinolle’ and ‘L’Ile’ STPs (c.a. capacity 5,300 m<sup>3</sup>d<sup>-1</sup> for the each STP). Additionally, river is impacted by discharges of local chemical and mechanical processes (i.e. SNPE Materiaux Energetiques and FORD) and storm water from the industrial and transport areas (Rapport d’etude 2008).

The treated effluent accounted up to 33% of the river flow and heavily impacted on the quality of the river’s water (Labadie 2004; Othoniel 2006) what are highly contaminated by organic chemicals (i.e. alkylphenols) and trace metals (i.e. zinc, nickel and copper) (Rapport d’etude 2008).

### **2.2.3. Sampling sites**

The four sites on the Jalle River have been selected for the monitoring of trace metals and pharmaceuticals (Figure 2.12):

*J01*- is located close to the source of the river in Saint Jean d’Illac, downstream of the military area (Figure 2.13)



*Figure 2.13. J01, close to the source of the Jalle River*

*J02* – is located on an area of agricultural activity of Eysines community, famous for the bio-agriculture, and approximately 0.4 km downstream of the ‘Cantinolle’ STP (WWTP 1) (Figure 2.14);



*Figure 2.14. J02, Eysines community, downstream of the ‘Cantinolle’ STP*

*J03* – is located inside the natural reservation area of Bruges, approximately 0.5 km downstream of the ‘L’Ile’ STP (WWTP 2) (Figure 2.15).



*Figure 2.15. J03, Natural reservation area 'Bruges', downstream of the 'L'Ile' STP*

J04 –is upstream of the inflow of the Jalle River in the Garonne River.

The sampling has been done during contrasted seasons: warm high flow period in May – June and cold high flow period in November – December.

### **Summary**

Two study sites have been chosen for the research. The sites are located in different geographical and socio – economic conditions: one is in economically developed EU – country - France and other is in post-soviet European country with the transitional economy – Ukraine. The rivers have been selected to represent pollution status of basins with quite similar hydrological characteristics (length, debit, width, etc.) and find the specificity in the occurrence, accumulation and behavior of targeted compounds in different study sites.





## CHAPTER III

### METHODS

#### 3.1. General methodology of the research

The research is focus on the study of environmental and socio-economic determinants of trace metals and pharmaceuticals in water.

Among various trace elements, trace metals and pharmaceuticals have been chosen due to their specific physical chemical properties, origin and related environmental and health risks.

Research consists of three general stages: (1) monitoring of trace elements; (2) analysis of the environmental data and (3) determination of environmental and socio-economic factors of trace elements occurrence, distribution and accumulation in watercourses (Figure 3.1.).

Monitoring of different forms of trace metals in water bodies with the application of conventional and passive sampling techniques has been proceeded in the Lopan and Udy rivers, Seversky Donets water basin in Kharkiv region, Ukraine.

The selection of this area have been done based on the following: (1) presence of the potential point and non – point sources of water pollution by trace elements as the Kharkiv transboundary region has long industrial history and developed urban activity *e.g.* transport and all wastewaters discharge in the same water basin which is used for water supply; (2) lack of the research on trace metals speciation – the governmental water monitoring are provided only on the detection of four trace metals in particulate forms and the general geochemical characteristics of rivers *i.e.* geochemical sediments baseline; dissolved and labile metals forms in water, are poorly studied;

(3) contrasted climate conditions – as the study area located in the continental climate zone with cold winter and hot summer, so it was possible to estimate the time-variations of pollutants during different seasons, but also to apply the DGT-passive technique pending the ice layer on the river.

The sampling sites have been chosen based on the available information on the potential water pollution sources and cover the different socio-economic region. i.e. rural and urban territories, but also the transboundary zone with Russia.

Water sampling with the use of conventional grab and passive techniques gives us an opportunity to measure different forms of trace metals and compare the methods.

Due to the application of the passive sampling technique it becomes possible: (i) to include the time variations of pollutants in contrasted hydrological and climate conditions; (ii) to determine sources of toxic forms of trace metals in water; (iii) to estimate fluxes of metals in the water basin. The results are presented in the Chapter 4.

Applying the monitoring of dissolved and particulate trace metals in water and sediments give us an opportunity to: (1) discover the geochemical anomalies in the sediments and propose the regional trace elements baseline; (2) evaluate of the seasonal variation of trace metals in water and sediments; (3) assess the environmental and health risks what associate with the presence of trace elements in the water basin. The results are discussed in the Chapter 5.

Monitoring of pharmaceuticals has been done in two study sites – in Kharkiv region, Ukraine and Bordeaux region, France.

The sites have been selected to represent status of water contamination in basins with quite similar hydrological characteristics, but located in the different socio-economic regions.

The passive sampling technique has been selected for the monitoring of pharmaceuticals in targeted rivers of France and Ukraine. The choice of the technique was based principally on the following: (i) the inputs of pharmaceuticals in rivers can have high time variations, so the passive monitoring will help us to get the time average data on the presence of these pollutants in rivers; (ii) there are no available laboratory in Ukraine which can provide the chemical analysis of water, and samples should be transported in France for the interpretation, so the passive samplers are found to be a more convenient technique for the delivering compare to grab

samples; (iii) the available chemical laboratory of University Bordeaux in France has a validated protocol for the analysis of the passive samples.

The general tasks of the pharmaceuticals monitoring are: (1) identify the targeted organic chemicals in wastewaters receiving rivers of France and Ukraine; (2) determine the sources and distribution of molecules in water; (3) using water monitoring data find the link between environmental and socio-economic characteristics of the study area. The results of the monitoring of pharmaceuticals are concluded in the Chapter 6.

At the final stage of the research, the results of water monitoring are analyzed and summarized. The general goal of the analysis is determine the environmental and socio-economic determinants of the occurrence and distribution of trace metals and pharmaceuticals in natural water, but also to consider the perspective of trace metals and pharmaceuticals as anthropogenic and socio-economic indicators that is discussed in the Chapter 7.

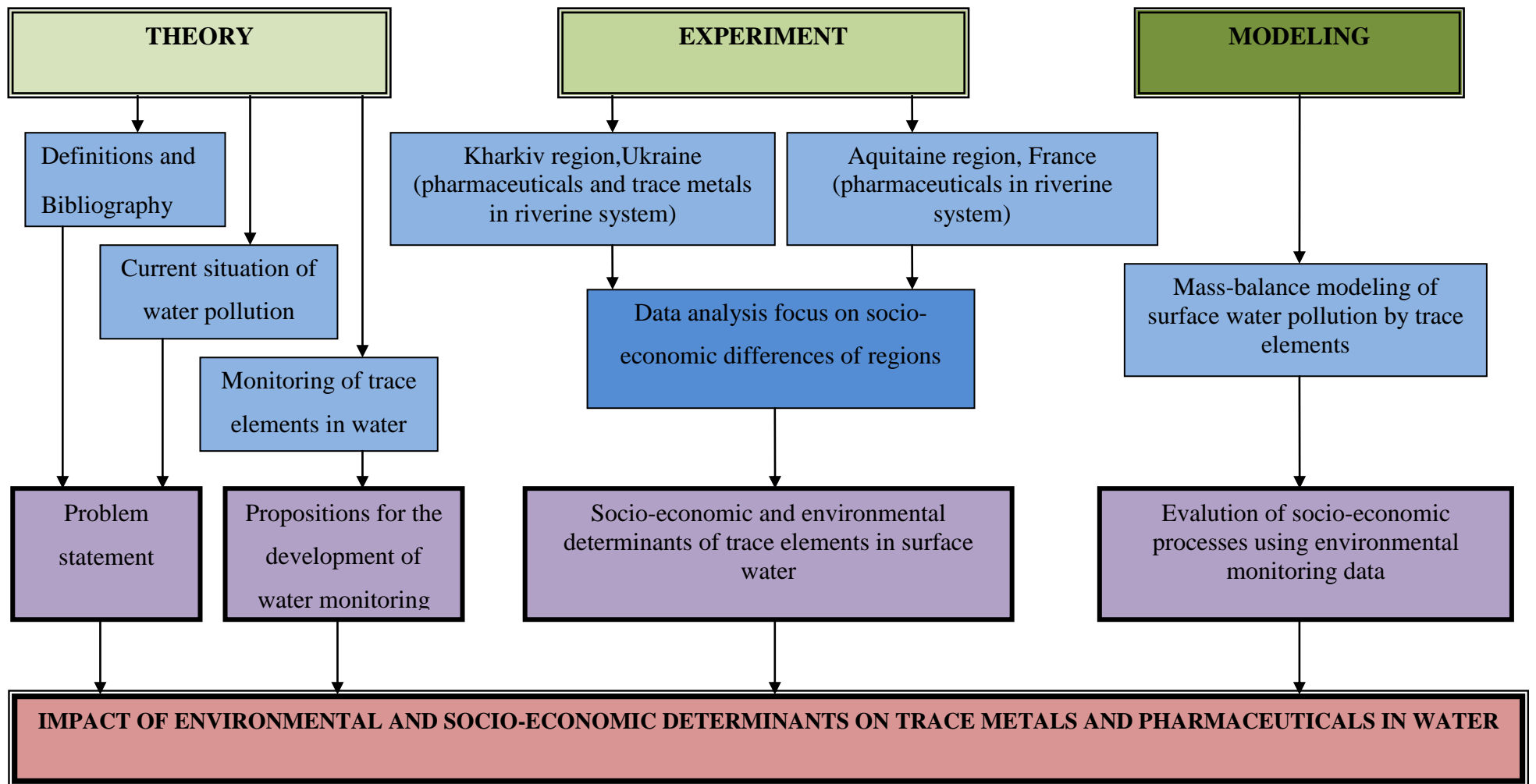

Figure 3.1. General methodology of the PhD research

## 3.2. Trace metals

### 3.2.1. DGT – water passive, grab water and sediments sampling

Standard DGT (diffusive gradient in the thin film) probes with a 0.4 mm resin gel layer, a 0.8 mm diffusive gel layer and a 0.45 µm pore-size filter were purchased from DGT Research Ltd. (Lancaster UK) (Figure 3.2.). The DGT technique was originally developed by Zhang (Zhang and Davison 1995; Zhang and Davison 2000) for the measurement of trace metal concentration in water. A device typically consists of a resin – gel overlain by hydrogel layer and a filter membrane that is in contact with the solution (Figure 3.2.). The resin has a high affinity for metals ion and acts as a zero sink, thus inducing the diffusion of metals through the diffusion layer (i.e. the membrane filter and hydrogel), before being capture on the resin.

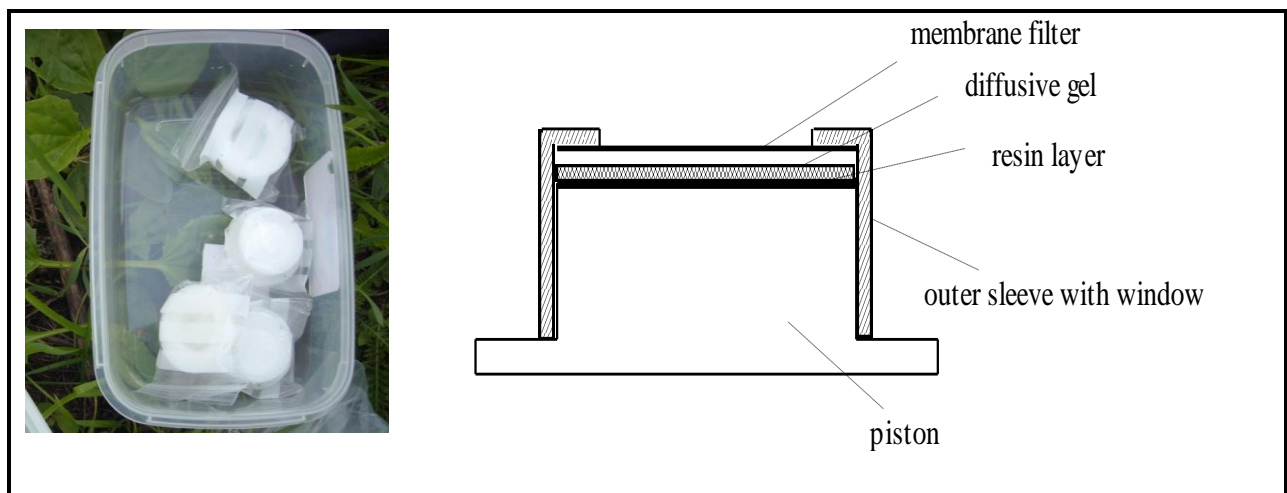

Figure 3.2. The principle scheme of DGT sensor (by Zhang and Davison 2000)

In the vicinity of the resin the free cation concentration is zero and a linear concentration gradient is established in several minutes across the diffusive gel layer (Figure 3.3.). The ion diffusion across the gel is governed by Fick's Law (Eq.1):

$$J = D (C_b - C_r) / (\Delta g + \delta) \quad (1)$$

where  $J$  is the flux of metal ion (in amount per area and time,  $\mu\text{g m}^{-2} \text{s}^{-1}$ );  $D$  is the diffusion coefficient of metal ion, in dimension of area per time,  $\text{m}^2 \text{s}^{-1}$ ;  $C_b$  is the bulk concentration of metal ion,  $\mu\text{g L}^{-1}$ ;  $C_r$  is the concentration of metal ion at the boundary between gel layers;  $\Delta g$  and  $\delta$  is the thicknesses of diffusive gel layer and boundary layers respectively, m.

Zhang and Davison (Zhang and Davison 1995) have shown that both  $C_r$  and  $\delta$  can be neglected in Eq.1. for water moving above the minimum threshold velocity that is applicable for natural waters and the equation is simplified to Eq.2.:

$$J = D C / \Delta g \quad (2)$$

The Eq.2. is a basic equation of the DGT theory which described the principles of the estimation of trace metals concentration in natural waters to measure by the passive samples.

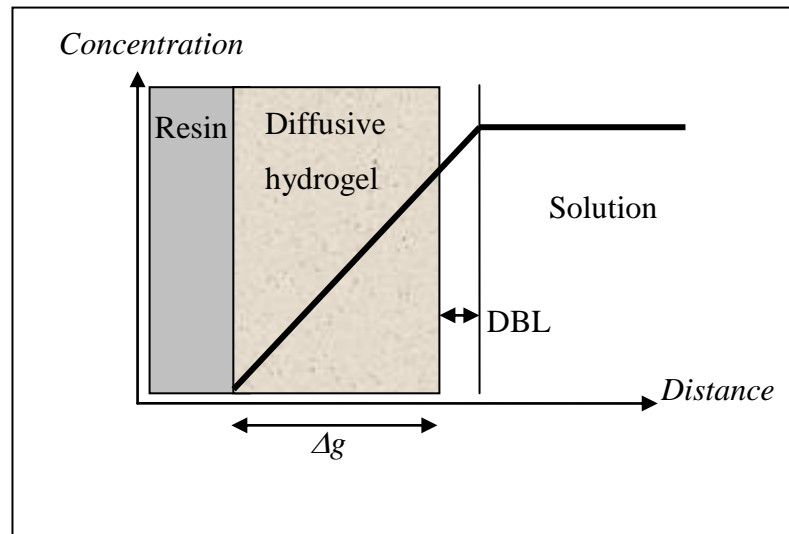

*Figure 3.3. Principle for trace metals accumulation and measurement with the DGT device. DBL: diffusive water boundary layer at the sampling surface of the device (by Zhang and Davison 1995)*

The procedure of the deployment of the DGT passive samplers has been adapted from previous researches (Denney et al. 1999; Zhang and Davison 2000; DGT Research 2002; Buzier et al. 2006b).

Passive samplers were deployed at selected sampling sites for a period from 15 to 30 days. The duration of DGT exposure was varied depending on the accessibility to sites in cold winter conditions and sampled seasons. DGT probes were exposed using a fishing line and attached at a depth of 0.20 – 0.25 m to avoid turbulent flow zones.

During the winter campaign, samplers were installed at a depth of 0.15 m below the ice-layer, the thickness of which varied from 0.05 to 0.20 m. For the each station duplicate DGT probes were installed to allow the estimation of the reproducibility of the measurements and intra-site variation. In order to prevent the contamination of DGT by trace elements from air, the probes were opened from the plastic protection at sampling sites and installed immediately in the water.

---

After the retrieval the DGT were therewith packed in the plastic protection. The DGT probes were stored before the analysis at a temperature of 4 °C in plastic bags and in humid conditions (a few drops of distilled water were added to allow some moisture). Two DGT probes were used as blanks i.e. were only exposed to air in the laboratory but not set in the water.

River water was sampled in order to determine the total dissolved and particulate (<0.2 µm) fraction of trace metals. Grab samples were taken at 1 m from the bank and at 0.2 m depth using an acid-cleaned 50 ml syringe and immediately filtered through 0.2 µm cellulose-acetate membranes (Nucleopore polycarbonate filters) acidified (HNO<sub>3</sub>, ultrapure; 1/1000 v/v; as described in Masson et al. 2009) and stored in acid cleaned 16 ml polypropylene tubes at 4 °C and in the dark until analysis. Sediments were collected close to the riverbank and stored in sterile capped containers.

Additional environmental parameters as water temperature, pH and conductivity were measured *in situ* with a WTW<sup>®</sup> Multiline P4 meter.

### 3.2.2. Water quality determination

#### 3.2.2.1. Analysis and interpretation of DGT samplers

Dissolved concentrations of trace metals in DGT samples were measured by ICP-MS at the French Geological Survey (BRGM) in Orléans, according to the European standard NF EN ISO 5667-3.

The concentration of the each metal collected by DGT ( $C_{DGT}$ ) were then calculated using the temperature dependent diffusion coefficient as proposed by DGT-manufacturer (DGT Research 2002) (Eq.3):

$$C_{DGT} = M \cdot \Delta g / (D \cdot t \cdot A) \quad (3)$$

where  $\Delta g$  is the thickness of the diffusive gel (0.8 mm) plus the thickness of the filter membrane (0.13 mm),  $D$  the diffusion coefficient of metal in the gel,  $t$  deployment time and  $A$  the exposure area ( $A=3.14 \text{ cm}^2$ ) (Zhang and Davison 1995; DGT Research 2002).

The mass of metal in the resin gel ( $M$ ) was obtained using the following equation (Eq. 4):

$$M = C_e (V_{HNO3} + V_{gel})/f_e \quad (4)$$



---

where  $C_e$  is the concentration of metals in the 1M HNO<sub>3</sub> eluting solvent ( $\mu\text{g L}^{-1}$ ),  $V_{\text{HNO}_3}$  the volume of HNO<sub>3</sub> added to the resin gel,  $V_{\text{gel}}$  the volume of the resin gel (0.16 mL), and  $f_e$  the elution factor (0.8) for all metals as given by the manufacturer.  $C_{\text{DGT}}$  corresponds to the interpreted concentration of the water sample and is a time-averaged concentration over the time of the probe deployment.

### **3.2.2.2. Analysis of grab water samples**

Total dissolved and particulate metal concentrations in filtered ( $<0.2 \mu\text{m}$ ) water samples and sediment digestates were measured by ICP-MS (X7, Thermo). The procedure and results were in accordance with previous studies performed in the EPOC-TGM laboratory (*e.g.* Schäfer and Blanc 2002; Audry et al. 2004). Particulate Hg concentrations were analyzed from the dry, homogenized sediment by cold vapour atomic absorption spectrometry after calcination in an O<sub>2</sub>-stream and amalgamation using an automated Hg analyzer (MILESTONE, DMA-80; Schäfer et al. 2006). Analyses of international certified reference sediments have been done for the estimation accuracy and precision of the blank-corrected sediment analyses.

### **3.2.2.3. Analysis of the sediments**

In the laboratory the sediments were dried to constant weight at 50°C, powdered, homogenized and stored in closed polyacrylate containers (50 mL). Representative subsamples (30 mg of dry homogenized sediment) were digested at 110°C for 2 h in acid-cleaned closed reactors with 1.5 mL HCl (12 M, suprapur), 0.75 mL HNO<sub>3</sub> (14 M, suprapur) and 2 mL HF (26 M, suprapur), using a temperature-controlled digestion system (*DigiPREP MS*<sup>®</sup>, SCP SCIENCE). After cooling, the digested samples were brought to 10 mL using 150  $\mu\text{L}$  HNO<sub>3</sub> (14 M, suprapur) and double deionized (*Milli-Q*<sup>®</sup>) water, then stored in the dark at 4 °C awaiting analysis by ICP-MS. Parallel blank digestions (without particles) and analyses of international certified reference sediments have been done for the estimation accuracy and precision of the blank-corrected sediment analyses.

### 3.3. Pharmaceuticals

#### 3.3.1. POCIS passive water sampling

The standard POCIS (polar organic chemical integrative sampler) of pharmaceuticals configuration with the Oasis HLB sorbent were purchased from Exposmeter (Tavelsjö, Sweden). The passive sampler is developed by Alvarez (Alvarez et al. 2004) and based on the approach of the free flow of pollutants from the sampled medium to a receiving phase of the device. The net flow of pollutants from one medium to the other continues until the equilibrium is established, or until the sampling period is stopped (Vrana et al. 2005). Uptake of molecules by POCIS are governed by several resistances to mass transfers: boundary layer diffusion to the sample surface, diffusion through the sampler membrane, and diffusion within the sorbent matrix and the controlled by the aqueous boundary layer (MacLeod et al. 2007).

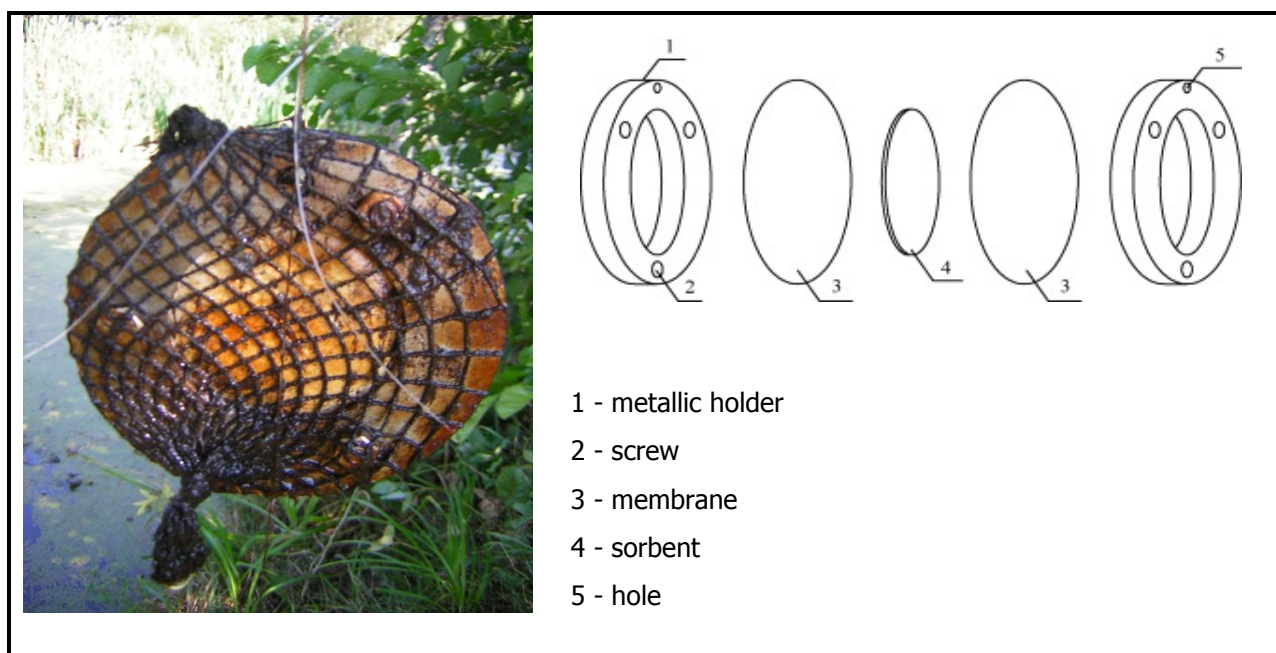

Figure 3.4. Picture (the passive sampler in cotton net) and the scheme of the POCIS (by Zhang et al. 2008)

The sampling rate of POCIS ( $R_s, \text{Ld}^{-1}$ ) is described by the equation (MacLeod et al. 2007; Eq.5.):

$$R_s = (D_w/\delta_w) A \quad (5)$$

where  $D_w$  is the aqueous diffusion coefficient;  $\delta_w$  is the thickness of aqueous stagnant film layer, and  $A$  is the available sampling surface area. The gain in sequestered analyte mass ( $n$ ) in the POCIS over the time ( $t$ ) is (Eq. 6):

---

$$dn/dt = (D_w/\delta_w) A (C_w - C_{w,pocis}) \quad (6)$$

where  $C_w$  is the analyte aqueous concentration and  $C_{w,pocis}$  is the analyte concentration at the interface of the POCIS and solution. Analyte uptake would be first order and linear with time and the sampling rate calculated by integration (MacLeod et al. 2007). However, the estimation of the sampling rate is one of the difficulties of the POCIS application for the estimation of the sampling rate and it needs the calibration of the device.

Application of the POCIS devices in this research was based on the results of previous studies (e.g. Alvarez et al. 2004; MacLeod et al, 2007; Togola and Budzinski 2007a; Tapie et al. 2010).

Samplers have been installed in the river using cotton net for the membrane protection (Photo, Figure 3.3.) on the depth 0.20 – 0.25m. After 3 weeks of the exposure, each individual POCIS device was retrieved from the water, briefly rinsed with ultrapure water in order to remove any materials adhering to the surface of the membrane (biofilm, particles, etc.).

### **3.3.2. Water quality determination**

#### **3.3.2.1. POCIS extraction and analysis**

The extraction and analytical procedures for POCIS were adapted from previously developed methods (Togola and Budzinski 2007a; Tapie et al. 2010).

The POCIS preparation and analysis have been performed in the ISM CNRS UMR Laboratory of University of Bordeaux 1, France. The surface membrane was detached from the stainless steel rings and rinsed with ultrapure water. The phase from two membranes of the each POCIS has been carefully transferred into an empty SPE tube by rinsing it with 5 mL of ultrapure water per each membrane in cartridges filled with cleaned by methanol Teflon frits, and dried under vacuum for 1 h. The sorbent was eluted in each sample using 10 mL of the each solution: methanol; methanol/dichloromethane mixture (50:50) and dichloromethane and being spiked with internal standards (Budzinski et al. 2009).

The extracts obtained from the sorbent were finally evaporated to dryness using a nitrogen flux and transferred into injection vials 50  $\mu$ L of acetonitrile. The mass of sorbent has been measured by gravimeters for each dried POCIS. Blanks were performed in the laboratory concurrently with water samples in order to monitor possible contamination. Recovery rates of the POCIS samples were determined by spike samples. Procedural blanks have been performed and corrections have been made in the data.

---

### 3.3.2.2. Concentration in water

In this study we estimated concentrations for targeted pharmaceuticals using the following equation (Macleod et al. 2007; Togola and Budzinski 2007a); (Eq.7):

$$C_w = C_s M_s / (R_s t) \quad (7)$$

where  $C_w$  and  $C_s$  are concentrations of compounds in the water ( $\text{ng L}^{-1}$ ) and in the POCIS ( $\text{ng g}^{-1}$ ) respectively;  $M_s$  is the mass of the sorbent in the POCIS (g);  $R_s$  is the sampling rate ( $\text{L d}^{-1}$ ) and  $t$  is the sampling period (days).

The sampling rate is specific for the individual analyte of interest and can be estimated using the following equation (Kot-Wasik et al. 2007b):

$$R_s = k_0 A = k_e k_{DW} V_d \quad (8)$$

where  $k_0$  is the overall mass transfer coefficient,  $A$  is the surface area of the membrane,  $k_e$  is the overall exchange rate constant,  $k_{DW}$  is the receiving phase /water partitioning coefficient and  $V_d$  is the volume of the receiving phase.

As analytes in the environment have low concentration levels, the sampling rate should have a high level (Kot-Wasik et al. 2007b).

In the research the sampling rates were obtained from the laboratory calibration test performed by Miege et al. (2011).

## Summary

The strategy of the research includes the: (i) monitoring of trace elements in selected Ukrainian and French sampling sites during contrasted climate, hydrological and socio-economic conditions using classical and passive sampling techniques; (ii) analysis of environmental and socio-economic determinants of the presence and behavior of trace metals and pharmaceuticals in natural waters; (iii) the data treatment and mass balanced modeling which aimed to determine perspectives of the application of trace elements as anthropogenic indicators of various pollution events on watercourse.

## CHAPTER IV

### MONITORING

This study is focused on the pilot evaluation of labile tracers in Ukrainian rivers and advance of the monitoring with the application of passive sampling methods. General problems of water monitoring in Ukraine are: the absence of universal authority to control water monitoring, weak environmental database, lack of the long-term monitoring; limited amount of monitored and controlled environmental indicators and scarcity of sampling sites because of low financing of regional and national water research programs, that cause the deficiency of knowledge on environmental and socio-economic determinants of water pollution. The development of water monitoring tools with inclusion of innovative sampling techniques will help to get new environmental data and find proposition for the improvement of the water monitoring system in regions with particular socio-economic, hydrological and climate conditions. Therefore, the pilot monitoring of two rivers in urban agglomeration of the Kharkiv region with application of the innovative sampling tools has been done in order to: (i) evaluate the appropriateness of the passive sampling technique in contrasted climate and hydrological conditions; (ii) obtain the first data on the trace metals presence and occurrence in the region with the limited environmental data; (iii) identify the water pollution sources. The result of this study is presented in the form of the published article:

**Vystavna Y., Huneau F., Motelica-Heino M., Le Coustumer P., Vergeles Y., Stolberg F. (2012). Monitoring and flux determination of trace metals in rivers of the Seversky Donets basin (Ukraine) using DGT passive samplers. *Environmental Earth Sciences*, 65: 1715-1725.**

## Monitoring and flux determination of trace metals in rivers of the Seversky Donets basin (Ukraine) using DGT passive samplers

Yuliya Vystavna · Frédéric Huneau ·  
Mikael Motelica-Heino · Philippe Le Coustumer ·  
Yuri Vergeles · Felix Stolberg

Received: 16 June 2010 / Accepted: 11 June 2011  
© Springer-Verlag 2011

**Abstract** This paper reports the results of the in situ application of diffusive gradients in thin-films (DGT) passive samplers for trace metals (Cd, Co, Cr, Cu, Ni, Pb and Zn) monitoring in transboundary Udy and Lopan rivers of the Seversky Donets watershed in the Kharkiv region (Ukraine), which has a long history of industrial development. The research discusses potential sources of DGT-measured labile metals in water and seasonal variations. Our results demonstrate the application of DGT for identifying and measuring labile metal concentrations in contrasted climate conditions (cold snowy winter and hot summer) and appropriateness of such a tool for continuous water monitoring with the presence of an ice cover. Results show that DGT-measured concentrations of most of trace metals were much higher downstream of the wastewater treatment plants discharges than upstream; thus wastewater treatment plants seemed not able to reduce or to remove trace metals' contaminations and become major sources of pollutants in the studied rivers. The calculation of the

average metal fluxes based on the DGT-measured concentrations confirmed that the urban wastewater discharges significantly contribute to the metal fluxes into the Udy and the Lopan rivers during both low-flow and high-flow periods. Compared to the wastewaters inputs to the rivers, the transboundary effect is limited, but should be taken into account as the origin of some metals is from sources located on the adjacent Russian territory.

**Keywords** Passive samplers · DGT · Trace metals · Transboundary rivers · Water treatment plant · Seasonal variation · Eastern Europe

### Introduction

Ukraine is one of the post-soviet East European countries (46.08 million inhabitants by 2009) with a long history of large-scale industrial and agricultural activity. It borders Romania, Slovakia, Poland, Russia, Belarus and Moldova and shares transboundary watersheds with these countries. Earlier studies on the contamination of water bodies in the eastern part of Ukraine (Linnik 2003; Vasenko et al. 2006) showed that total concentrations of Cu, Zn, Cr and Pb are not in the agreement with national water quality standards (GCPL 1991; SNPL 1991) (Table 1). These preliminary investigations suspected that the main sources of metals are transboundary effluents, discharges of treated wastewaters and run-off from urban and agricultural areas.

In spite of the importance of the evaluation of the metal contamination in natural watercourses, monitoring of these elements in Ukraine is not regular and yet insufficient. Limiting factors for an adequate water monitoring are the lack of equipment and financing for research laboratories and environmental control authorities (e.g. the Ministry of

---

Y. Vystavna · F. Huneau (✉) · P. Le Coustumer  
UFR des Sciences de la Terre et de la Mer, Université de  
Bordeaux, B18, Avenue des Facultés, 33405 Talence, France  
e-mail: frederic.huneau@u-bordeaux1.fr

Y. Vystavna · F. Huneau · P. Le Coustumer  
EA 4592 Géorressources et Environnement, Institut EGID,  
1 Allée F. Daguin, 33607 Pessac, France

Y. Vystavna · Y. Vergeles · F. Stolberg  
Department of Environmental Engineering and Management,  
National Academy of Municipal Economy at Kharkiv,  
vul. Revolutsii 12, Kharkiv 61002, Ukraine

M. Motelica-Heino  
CNRS/INSU Institut des Sciences de la Terre d'Orléans,  
Université d'Orléans, UMR 6113 ISTO, Campus Géosciences,  
1A rue de la Férellerie, 41071 Orléans, France

**Table 1** Total metals concentrations in the Udy and Lopan rivers in the Kharkiv region, Ukraine in August 2005 determined by earlier study of Vasenko et al. (2006),  $\mu\text{g L}^{-1}$ 

Sampling site	Cu	Zn	Cr	Pb
Udy River, border with Russia (close to U01)	21 ± 5	59 ± 15	22 ± 7	<1
Udy River, downstream the Zolochiv (close to U02)	17 ± 4	58 ± 15	200 ± 7	2 ± 1
Udy River, downstream of the man-made water reservoir (close to U03)	34 ± 1	43 ± 10	13 ± 4	2 ± 1
Udy River, upstream of Kharkiv city (close to U04)	10 ± 3	86 ± 22	28 ± 9	6 ± 2
Udy River, upstream of the wastewater discharge	13 ± 4	66 ± 16	34 ± 11	4 ± 2
Udy River, downstream of the wastewaters discharge (close to U07)	147 ± 37	111 ± 28	59 ± 20	41 ± 14
Lopan River, downstream of the wastewater discharge (close to L09)	92 ± 23	118 ± 30	17 ± 6	1 ± 1
GCPL <sup>a</sup> ( $\mu\text{g L}^{-1}$ )	5	10	1	0.2
SNPL <sup>b</sup> ( $\mu\text{g L}^{-1}$ )	1,000	1,000	50	30

<sup>a</sup> GCPL (1991), general code of the permitted limits and presumable safe levels of impacts of hazardous substances in the waters used for fishery (in Russian)

<sup>b</sup> SNPL (1991), sanitary norms of the permitted limits of hazardous substances contents in the waters used for drinking and municipal water use (in Russian)

Environmental Protection). Moreover, the number of sampling sites is usually limited to just two or three per river and only rivers receiving effluents from wastewater treatment plants are monitored. The water monitoring laboratories in Ukraine use mostly grab methods of sampling, which do not take into account influences (e.g. changes in hydrologic conditions and/or pollutants inputs). Additionally, only the total concentrations of metals are determined; there is no evaluation of other forms of metals or of their bioavailability. Thus, there is a lack of data on the presence of labile and dissolved metals in rivers of industrial areas of Ukraine, whereas it is well known that they play a crucial role in the bioaccumulation and ecotoxicity in living organisms (Alfaro-De la Torre et al. 2000; Janssen et al. 2003).

In order to improve the knowledge on labile metals concentrations and fluxes of these metal forms in rivers of industrial and urbanised areas of Ukraine, in situ water sampling was undertaken using the diffusive gradients in thin-films (DGT) technique. This passive sensor tool was developed about 20 years ago at Lancaster University for the integrative sampling and measurement of dissolved labile metals. It bases on the diffusion of metals through a hydrogel layer of a certain thickness to a binding phase where they are concentrated (Buffle and Horvai 2000; Zhang and Davison 2000; Motelica-Heino et al. 2003). DGT samplers have been increasingly used for measuring labile metal concentrations in the aquatic environment, soils and sediments (Meylan et al. 2004; Buzier et al. 2006a, b; Dunn et al. 2007; Roulier et al. 2008; Schintu et al. 2008). The DGT technique demonstrates simplicity of deployment and retrieval during the field procedures, minimum sample handling between installation and analysis and easy storage (Denney et al. 1999). Compared to

grab sampling and subsequent laboratory analysis of spot samples, DGT are used without additional reagents, energy sources and DGT measurements are able to reduce the risk of uncontrolled changes that can occur during the sampling, storage or treatment (Alfaro-De la Torre et al. 2000). Because of the pre-concentration capability of DGT that integrates temporal variations in the sampled media, lower metal concentrations can be measured in water in contrast to grab sampling. This integrating property helps to take into account different pollution events (run-off, random wastewaters discharge, etc.) even if the sampling frequency is not high enough.

Another important point is that DGT gives very positive results in various climatic conditions. There is evidence of success of the DGT technique from the subtropics (Denney et al. 1999; Dunn et al. 2003) to the polar environments (Larner et al. 2006; Stark et al. 2006). This is an important issue for the utilisation of these sensors in very continental regions with hot dry summer and cold snowy winter, despite potential problems with highly diluted waters (ionic strength lower than  $2 \times 10^{-4}$  M) (Alfaro-De la Torre et al. 2000). With adequate detection limits due to its pre-concentration capability, the technique suites to the monitoring of labile metals in various aquatic environments such as coastal and seawaters (Australian seawaters: Munksgaard and Parry 2003), rivers (Sava River, Croatia: Dragun et al. 2008) and lakes (five lakes in England: Gimpel et al. 2003).

This paper discusses the presence of priority trace metals such as Cd, Cu, Cr, Pb, Ni and Pb, but also the potentially toxic metal Co in labile forms in the Udy and Lopan rivers of the industrial and urbanised Kharkiv region (Ukraine), the origin and fluxes of labile trace metal forms in the studied water bodies, seasonal variations in metal concentrations and whether these metals are problematic

for the long-term exploitation of transboundary water resources according to the water regulation standards.

## Methods

### Sampling area

Deployment of DGT samplers was conducted in the Lopan and Udy rivers of the Kharkiv region (eastern part of Ukraine) during August 2008 and January 2009. These transboundary rivers are extensively used for recreation activities, drinking water supply, irrigation and fishing in the Belgorod region of Russia and the Kharkiv region of Ukraine (about 4,500,000 inhabitants totally in both regions). Major anthropogenic factors likely have an impact on these water bodies are associated with the long-term industrial and municipal water supply, as well as discharges of wastewaters (Vasenko et al. 2006).

The Kharkiv region is one of the largest industrial regions in Ukraine, with a population of ca 3 million (2009). During the Soviet times (1919–1990), an extensive industrial development took place in the region featuring military production, machinery, mechanical, electrical, chemical and radio-electronic engineering. This region is characterised by a relative scarcity and an uneven distribution of available resources of freshwater. Regional water supply for the household and industries is mostly coming from surface water sources (85% of the total consumption). The Udy and Lopan rivers, with a total catchment area in Ukraine of about 3,460 km<sup>2</sup>, along which the city of Kharkiv is located (Fig. 1) have their sources in the Forest-Steppe natural zone of the southern slopes of the mid-Russian rolling plain. Black earth and grey forest types represent soils of the region. The duration of winter is about 125–130 days, and the warm period is about 118–200 days per year. The coldest month is January (average temperature of  $-7.1^{\circ}\text{C}$ ), and the warmest is July (average temperature of  $+20.5^{\circ}\text{C}$ ). The mean annual temperature is around  $7.6^{\circ}\text{C}$  and rainfall amount varies between 470 and 540 mm per year (Jakovlev et al. 2002).

The total length of the Udy River is 164 km and its tributary, the Lopan River, is about 98 km long. The river depth ranges from 0.4 to 2.3 m and their flows are regulated by several dams constructed along the watercourses. The mean annual discharge of the Lopan River is  $1.4 \text{ m}^3 \text{ s}^{-1}$  in winter and  $0.9 \text{ m}^3 \text{ s}^{-1}$  in summer whereas the discharge of the Udy River is  $6.8$  and  $2.5 \text{ m}^3 \text{ s}^{-1}$ , respectively. Rivers are covered partly with ice from the end of November to the end of March. The subsurface geology of the catchment area is dated from Palaeogene and consists mainly of sedimentary rocks like sandstone, marl and chalk.

Both rivers are still affected by metal inputs from urban and agricultural origin despite the significant decrease of production activities after the collapse of the Soviet Union; in fact, the water quality has not improved since (NRDW 2006). These rivers receive the most of the municipal and industrial wastewaters (about 1,000,000 m<sup>3</sup> per day). Wastewaters are discharged into the same river basins, which are used for water supply, thus the aquatic pollution has a strong impact on the sanitary conditions and on the health of the population (NRDW 2006).

### River water sampling

Four sites on the Udy River and four sites on the Lopan River were selected with special attention to the potential pressure points on the watercourses, like sewage treatment plants, landfill sites or inputs from industries and the urban areas themselves (Fig. 1). Standard DGT probes with a 0.4 mm resin gel layer, a 0.8 mm diffusive gel layer and a 0.45  $\mu\text{m}$  pore-size filter were purchased from DGT Research Ltd. (Lancaster, UK). In August 2008 and January 2009, they were deployed at selected sampling sites for a period of 15–30 days. The duration of DGT exposure varied because of the difficulties to access to some sampling sites in winter conditions.

DGT probes were exposed using a fishing line and attached at a depth of 0.20–0.25 m to avoid turbulent flow zones. During the winter campaign, samplers were installed at a depth of 0.15 m below the ice-layer, the thickness of which varied from 0.05 to 0.20 m. For all stations, duplicate DGT probes were installed to allow the estimation of the reproducibility of the measurements and intra-site variation. In order to prevent the contamination of DGT by trace elements from air, the probes were opened from the plastic protection at sampling sites and installed immediately in the water. After the retrieval the DGT were therewith packed in the plastic protection. The DGT probes were stored before the analysis at a temperature of  $4^{\circ}\text{C}$  in plastic bags and in humid conditions (a few drops of distilled water were added to allow some moisture).

Two DGT probes were used as blanks, i.e. were only exposed to air in the laboratory but not set in the water. Water temperature, pH and conductivity were measured in situ with a WTW© Multiline P4 meter. The water temperature at sampling points ranged between 19.0 and  $25.0^{\circ}\text{C}$  during the summer and between 2.0 and  $7.0^{\circ}\text{C}$  during the winter sampling campaigns. Conductivity varied from 1,010 to  $1,360 \mu\text{S cm}^{-1}$  and pH from 6.8 to 7.9. Total organic carbon (TOC) was determined from spot unfiltered samples during the summer campaign only and measured by TOC-5000, Schimadzu© automated analyzer following ISO 10694. Physico-chemical parameters of the Udy and Lopan rivers for both campaigns are reported in Table 2.

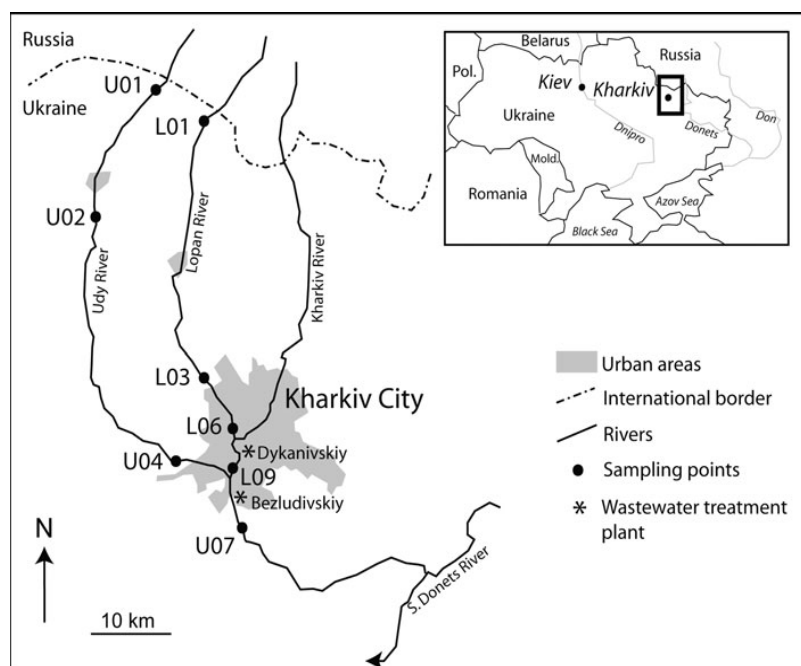

**Fig. 1** Location of sampling sites**Table 2** Physico-chemical parameters of the Udy and Lopan rivers in August 2008 and January 2009

	Temperature (°C)		Velocity (m s <sup>-1</sup> )		pH		Conductivity (μS cm <sup>-1</sup> )		HCO <sub>3</sub> <sup>-</sup> (mg L <sup>-1</sup> )		TOC (mg L <sup>-1</sup> )	
	Aug	Jan	Aug	Jan	Aug	Jan	Aug	Jan	Aug	Jan	Aug	Jan
L01	18	2	0.3	0.3	7.6	6.9	1,030	1,360	390	292	172.5	nd
L03	18	2	0.07	0.07	7.5	7.3	1,010	1,250	451	296	69.79	nd
L06	22	2	0.1	0.1	6.9	7.6	1,060	1,130	414	385	133.4	nd
L09	20	7	0.3	0.3	7.1	7.5	1,110	1,200	390	364	50.79	nd
U01	19	2	0.05	0.05	7.3	6.8	844	1,010	506	362	84.05	nd
U02	23	2.5	0.07	0.07	7.6	7.2	953	1,160	445	301	nd	nd
U04	20	4	0.07	0.07	7.2	7.4	960	1,240	427	331	63.81	nd
U07	20	8	0.17	0.17	7.4	7.3	1,120	1,280	451	339	51.57	nd

nd not determined

#### DGT retrieval and data interpretation

Elution of metals from the binding phase of the DGT probes (3.14 cm<sup>2</sup>) was carried out by immersion in 1 mL of 1 M HNO<sub>3</sub> (Supra-pure, Merck, Darmstadt, Germany) for 48 h (Zhang and Davison 2000) in the laboratory and then diluted to 10 ml with HNO<sub>3</sub> 2%. Milli-Q water (Millipore, UK) was used to prepare all samples. Analyses of trace metals (Cd, Co, Cr, Cu, Ni, Pb and Zn) in the eluted samples were performed with the use of a PQ3 (VG, Manchester, UK) ICP-MS at the French Geological Survey (BRGM) in Orléans according to the European standard NF EN ISO 5667-3. Detection limits are presented in Table 3.

The concentrations of each metal determined by DGT ( $C_{DGT}$ ) were then calculated using the temperature dependent diffusion coefficient (1):

$$C_{DGT} = M \times \Delta g / (D \times t \times A) \quad (1)$$

where  $\Delta g$  is the thickness of the diffusive gel (0.8 mm) plus the thickness of the filter membrane (0.13 mm),  $D$  the diffusion coefficient of metal in the gel,  $t$  deployment time and  $A$  the exposure area ( $A = 3.14 \text{ cm}^2$ ) (Zhang and Davison 1995; DGT Research 2002). The mass of metal in the resin gel ( $M$ ) was obtained using the following Eq. (2):

$$M = C_e (V_{\text{HNO}_3} + V_{\text{gel}}) / f_e \quad (2)$$

Environ Earth Sci

**Table 3** Detection limits and blank values

Sampling period	Cd	Co	Cr	Cu	Ni	Pb	Zn
Analytical detection limit (ng L <sup>-1</sup> )							
August 2008	0.92	0.95	1.11	0.90	0.97	0.70	0.92
January 2009	1.68	1.80	2.11	1.75	1.84	1.35	1.75
Blank value (ng L <sup>-1</sup> )							
August 2008	24.0	24.0	21.7	261	43.8	31.8	633
January 2009	38.9	4.47	1.31	721	23.0	24.0	622
Operational detection limit <sup>a</sup> (ng L <sup>-1</sup> )							
Both seasons	30	40	40	970	40	20	20

<sup>a</sup> Determined as three times standard deviation multiple measurements of blank solutions

where  $C_e$  is the concentration of metals in the 1 M HNO<sub>3</sub> eluting solvent ( $\mu\text{g L}^{-1}$ ),  $V_{\text{HNO}_3}$  the volume of HNO<sub>3</sub> added to the resin gel,  $V_{\text{gel}}$  the volume of the resin gel, equal to 0.16 mL, and  $f_e$  the elution factor is equal to 0.8 for all metals as given by the manufacturer.  $C_{\text{DGT}}$  corresponds to the interpreted concentration of the water sample and is a time-averaged concentration over the time of the probe deployment. Similarly, analytical detection limits in terms of  $C_{\text{DGT}}$  were calculated from the ICP-MS detection limits and blank values were determined from the DGT blank probes. Additionally, field detection limits used in this study were calculated as three times the standard deviation of the field blank concentrations. Blank values and detection limits are reported in Table 3.

#### Trace metal fluxes determination

In order to determine the influence of potential metal sources, labile metal fluxes were calculated using the following equation (Warnken and Santschi 2009) based on the flow corresponding to the period for which the samples were deployed:

$$F_{\text{Me}} = Q \times C \times 8.64 \times 10^{-2}, \quad (3)$$

where  $F_{\text{Me}}$  is daily flux of trace metal, kg per day,  $Q$  the mean water flow rate,  $\text{m}^3 \text{s}^{-1}$ ,  $C$  is the mean concentration of trace metal,  $\mu\text{g L}^{-1}$ , measured by DGT (blank subtracted) and the coefficient  $8.64 \times 10^{-2}$  is for the transformation of data in kg per day.

## Results and discussion

### Performance of the DGT use

The results obtained after the deployment of DGT in contrasting climate conditions confirmed the possibility of using these passive techniques for sampling under the river ice cover during winter. Taking into account the difficulties

of grab water sampling on icy river sites the DGT can help to simplify the sampling procedure, save energy and time. The accuracy of the analysis and the detection limits were evaluated for each period of sampling (Tables 3, 4). In this case, the interpretation of the data depends on the diffusion coefficient values, which vary with the water temperature and possibly impact on the data determination. As regards to other contrasted influences, earlier reported results showed minor impact of the water flow on the DGT measurements (Gimpel et al. 2003). The determination of the total dissolved concentration of highly complexed metals (e.g. Cu) by DGT could be underestimated as metal speciation directly affects the DGT measurements and hereby DGT measures the labile metal species only (Warnken et al. 2007).

### Trace metals and potential sources

The DGT-measured concentrations (blank subtracted) are presented in Table 5 and show significant spatial variability along both watercourses. Trace metal composition patterns and concentrations appeared different in the two rivers, however, in both cases average concentrations decreased in the following order  $\text{Zn} > \text{Ni} > \text{Cu} > \text{Cr} > \text{Co} > \text{Cd} > \text{Pb}$ .

In the Lopan River, maximum concentrations of Co, Cr, Ni, Zn and Pb were found downstream of the wastewater discharges (site L09), both in summer and winter. During winter sampling, the maximum concentrations of Cd and Cu were found downstream of the wastewater discharges, and in summer, the maximum Cd was measured at the sampling site located next to the border with Russia (site L01), and the maximum Cu was obtained from the sampling site at the very centre of the city (site L06).

In the Udy River, the highest concentrations of Cd, Cu, Ni and Pb were measured downstream of the wastewater discharge (site U07) for both seasons. The maximum concentrations of Co, Cr and Zn in winter period were found in U07, as well, and the maximum level of Cr and Zn

**Table 4** Calculated mean values ( $\mu\text{g L}^{-1}$ ), standard deviations (SD in  $\mu\text{g L}^{-1}$ ) and the relative standard deviations (rsd) of DGT-measured concentrations of metals in sites with replicated deployment

Site	Cd		Co		Cr		Cu		Ni		Pb		Zn	
	Mean	SD	Mean	SD	Mean	SD	Mean	SD	Mean	SD	Mean	SD	Mean	SD
August 2008														
L01	0.09	0.02	0.04	0.01	0.07	0.004	0.18	0.03	0.31	0.08	0.03	0.004	0.50	0.13
L03	0.02	0.01	0.02	0.004	0.03	0.01	0.95	0.11	0.61	0.09	0.02	0.002	0.64	0.12
L06	0.03	0.01	0.03	0.004	0.06	0.01	1.24	0.16	0.93	0.10	0.03	0.003	2.13	0.17
L09	0.07	0.04	0.05	0.003	0.32	0.25	0.64	0.06	4.32	1.07	0.04	0.01	5.45	2.50
U01	0.04	0.001	0.04	0.003	0.42	0.04	0.33	0.06	0.61	0.09	0.10	0.01	25.2	3.30
U02	0.03	0.01	0.60	0.10	0.28	0.09	0.60	0.04	0.69	0.15	0.07	0.01	7.21	3.13
U04	0.06	0.01	0.02	0.004	0.05	0.01	1.83	0.02	0.80	0.15	0.04	0.01	1.29	0.34
U07	0.20	0.14	0.16	0.10	0.39	0.13	1.83	0.13	4.85	1.91	0.11	0.01	13.6	9.10
January 2009														
L01	0.03	0.03	0.09	0.01	0.05	0.01	0.79	0.18	0.80	0.08	0.04	0.01	1.11	0.13
L03	0.02	0.004	0.06	0.01	0.04	0.01	0.87	0.08	0.69	0.07	0.04	0.01	1.27	0.10
L06	0.06	0.06	0.03	0.003	0.17	0.05	2.31	0.26	0.65	0.13	0.06	0.01	2.86	0.16
L09	0.13	0.01	0.12	0.01	0.60	0.29	3.03	1.11	4.02	0.40	0.17	0.02	9.54	1.44
U01	0.02	0.003	0.04	0.01	0.05	0.01	0.69	0.51	0.23	0.03	0.07	0.01	0.76	0.07
U02	0.03	0.02	0.08	0.001	0.05	0.01	1.59	0.59	0.43	0.08	0.04	0.01	1.36	0.21
U04	0.04	0.01	0.09	0.01	0.06	0.01	2.20	0.22	0.58	0.03	0.05	0.02	3.23	0.41
U07	0.12	0.02	0.07	0.001	0.23	0.01	1.94	0.22	2.22	0.22	0.10	0.02	5.99	0.68

Environ Earth Sci

**Table 5** Blank subtracted DGT-measured concentrations of trace metals,  $\mu\text{g L}^{-1}$

	Cd		Co		Cr		Cu		Ni		Pb		Zn	
	Aug	Jan	Aug	Jan	Aug	Jan	Aug	Jan	Aug	Jan	Aug	Jan	Aug	Jan
L01	0.09	<	0.01	0.09	0.06	0.04	0.13	<	0.33	0.73	<	0.02	0.15	0.30
L03	<	<	<	0.06	0.02	0.03	0.85	0.12	0.51	0.62	0.02	0.02	0.47	0.47
L06	0.01	0.02	0.003	0.03	0.04	0.13	1.10	1.80	0.82	0.54	0.03	0.05	1.99	2.03
L09	0.05	0.09	0.02	0.12	0.30	0.59	0.62	2.33	4.28	4.01	0.04	0.15	5.19	8.82
U01	0.01	<	0.01	0.04	0.36	0.04	0.33	0.03	0.63	0.23	0.10	0.05	27.3	<
U02	0.08	<	0.02	0.07	0.48	0.03	0.66	0.20	5.03	0.37	0.04	<	6.95	0.19
U04	0.04	<	<	0.08	0.02	0.05	0.59	0.89	0.65	0.41	0.05	0.02	0.78	0.64
U07	0.18	0.08	0.13	0.07	0.37	0.23	1.81	1.24	4.81	2.20	0.11	0.08	13.3	5.27

< less than detection limits

in August 2008 was observed in sites located close to the border with Russia (U01 and U02). The DGT-measured concentrations of Zn in U01 and U02 during summer were higher than the water quality limits (GCPL 1991). In comparison with previous study on trace metals in the Udy and Lopan rivers (Vasenko et al. 2006), the value of DGT-measured concentrations of Cu, Cr, Zn and Pb were two orders of magnitude lower than the total metal concentrations (Table 1).

The calculation of labile metals fluxes (Fig. 2) from the blank subtracted DGT metal concentrations showed that the urban wastewater discharge is a significant source of

Cd, Co, Cu, Cr, Ni, Pb and Zn for both Lopan and Udy rivers. The presence of metals in the municipal wastewaters can be attributed to the galvanic industry wastewaters discharged into the municipal sewage system from local enterprises. The Kharkiv Wastewater Treatment Plant ‘Dykanivskiy’ (WWTP ‘D’ with a capacity of 700,000  $\text{m}^3$  per day) and ‘Bezludivskiy’ (WWTP ‘B’ with a capacity of 250,000  $\text{m}^3$  per day) both apply combined biological treatment for run-off and sewage consisting of mixed household (85% of total volume) and industrial (15% of total volume) wastewaters. Before entering the municipal WWTP, galvanic wastewaters are only pre-treated by very

**Fig. 2** Average fluxes of trace metals in the Lopan River (L01–L09) and Udy River (U01–U07) in August 2008 (white bar) and January 2009 (grey bar)

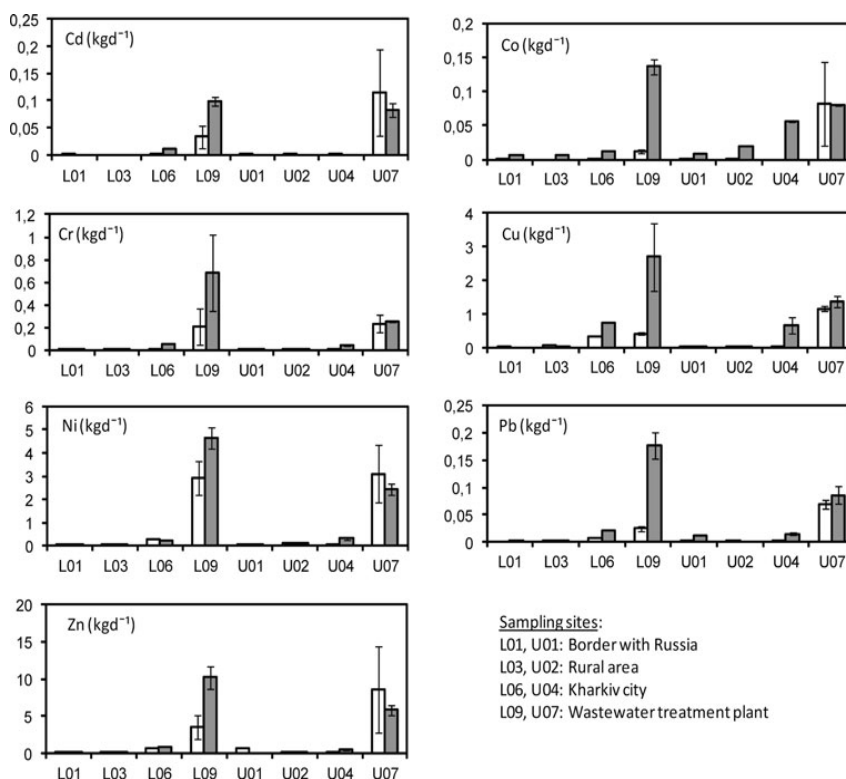

basic industrial WWTP owned and managed by the industrials. In that case, the insufficiently treated industrial wastewaters can enter the WWTP 'D' and WWTP 'B', which are not designed to cope with the reduction of the trace metals contamination in the water.

Organic matter can also influence the bioavailability of metals resulting in the complexation of labile forms with organic particles or dissolved organic matter (Tusseau-Vuillemin et al. 2007). Our results show that the TOC contamination is decreasing in sites located downstream of wastewater discharges (Table 2), but further work should be done to evaluate the origin of the organic substances as it has an impact on the complexation of metallic contaminants (Buzier et al. 2006b; Tusseau-Vuillemin et al. 2007).

#### Seasonal variations of trace metals contamination

Natural seasonal changes can influence the mobility of trace metals (Beck and Sanudo-Wilhelmy 2007; Arain et al. 2008). The dilution, complexation with ligands (Sangi et al. 2002; Tusseau-Vuillemin et al. 2007; Balistrieri and Blank 2008), sorption by particles (Linnik 2003; Baalousha et al. 2005, 2006a, b; Buzier et al. 2006a), bioaccumulation (Alfaro-De la Torre et al. 2000; Meylan et al. 2004) depend on temperature (Beck and Sanudo-Wilhelmy 2007), precipitation (Aung et al. 2008) water chemistry (Dahlqvist et al. 2007; Pernet-Coudrier et al. 2008) and ionic strength of the solution (Baalousha et al. 2006a, b). Additionally, labile forms of metals can be released from sediments, which can also contain a significant amount of absorbed elements (Vystavna et al. 2008). These factors have seasonal patterns too.

Our results showed that the summer contents of all metals at the sampling point U07 (located on the Udy River downstream of the Lopan River influence and municipal wastewaters discharge) are increasing comparing to site L09 (where the Lopan River receives wastewaters from WWTP 'D'). The variation of DGT averaged metal fluxes can be attributed to temporal changes of metals discharge of wastewaters, effluents from other sources (run-off, etc.), remobilization of additional labile forms from the river

sediments that can be caused by high water temperature, changes in metal speciation and low dissolved oxygen (Beck and Sanudo-Wilhelmy 2007). Further research on the sediments quality of the Lopan and Udy rivers is foreseen to evaluate the contamination of metals in this media and processes involved in the water-sediments interaction.

In contrast to the summer season, winter DGT-measured concentrations of metals in U07 are decreasing compared to L09 as a likely combined effect of better dilution with a high water flow (due to increased precipitation inputs) and a lower water temperature. For comparison, the rate of the wastewater effluent to the river flow in summer is 22:1, while in winter such a ratio is 5:1. In contrast, results of metals fluxes calculation show that the amounts of all measured metals in the Lopan River during the winter were higher than in the summer in the site L09 (Fig. 2). This is connected with seasonal variations in the economic activity of companies and municipal water users.

Additionally, correlations in spatial and seasonal patterns were found for almost all pairs of DGT-measured concentrations of metals for the winter season (Table 6). In contrast, for the summer season a good agreement was observed only for the Cr – Pb (Pearson's criterion,  $r = 0.9023$ ,  $a < 0.05$ ,  $n = 20$ ). The differences can be explained with changes in metals behaviour in cold high-flow and hot low-flow periods (Beck and Sanudo-Wilhelmy 2007). In addition, these strong correlations between elements indicate that they have similar sources, maybe related to a few dominant inputs during the winter. The relationship between winter and summer seasons shows, that a strongest positive correlation was recorded in the Udy River for Cd ( $r = 0.92$ ), Ni ( $r = 0.99$ ) and Pb ( $r = 0.70$ ) and in the Lopan River for Cr ( $r = 0.87$ ), Ni ( $r = 0.96$ ), Pb ( $r = 0.95$ ) and Zn ( $r = 0.83$ ). Such seasonal behaviour can be explained by the continuous release of these metals, which only slightly depends on seasons; the pedogenic origin of these elements can also be called for especially for Ni and Pb. Some negative correlations were found for Zn in the Udy River ( $r = -0.50$ ) and Cd in the Lopan River ( $r = -0.35$ ), indicating the influences of

**Table 6** Correlations between spatial patterns of paired DGT-measured metal concentrations (Pearson's coefficient), bold values for a < 0.05 (5%)

Summer winter	Cd	Co	Cr	Cu	Ni	Pb	Zn
Cd	1	-0.25	0.06	0.21	0.29	0.13	-0.34
Co	0.67	1	0.26	-0.21	-0.13	0.42	0.65
Cr	<b>0.96</b>	0.65	1	0.05	0.31	<b>0.90</b>	0.77
Cu	0.87	0.49	<b>0.94</b>	1	0.56	0.26	-0.34
Ni	<b>0.99</b>	0.70	<b>0.96</b>	<b>0.87</b>	1	0.23	-0.17
Pb	<b>0.93</b>	0.45	<b>0.89</b>	0.77	<b>0.91</b>	1	0.74
Zn	<b>0.99</b>	0.60	<b>0.96</b>	<b>0.91</b>	<b>0.99</b>	<b>0.91</b>	1

different sources on the water chemistry during summer and winter. In summer, Zn can enter the river through runoff contaminated by agricultural activities using Zn-rich pesticides. Additionally, the comparison of the two rivers pointed out, that the correlation of Zn in August was estimated as negative ( $r = -0.35$ ), which demonstrates a different origin of pollution sources, while correlations in January have a very high level ( $r = 0.99$ ).

Seasonal significant differences (standard deviation,  $SD > 5$ ) were observed in concentrations of Cu, Ni and Zn in both rivers. The higher mean concentrations of Cu, Ni and Zn in the Udy River were found in August, then Cu and Ni correlate positively with water conductivity ( $r = 0.89$  and  $r = 0.80$ ), Zn correlates positively with pH ( $r = 0.65$ ). In the Lopan River, Cu, Ni and Zn show a negative correlation with the water conductivity ( $r = -0.61$ ,  $r = -0.31$  and  $r = -0.4$ , respectively), but a positive correlation exists for Cu and Zn with the pH ( $r = 0.62$  and  $r = 0.45$ ) in January. These results indicate that other factors such as pH and conductivity can be responsible for the remobilization of the bioavailable forms of metals in the water and cause secondary water pollution (Caruso and Bishop 2009) depending on seasonal variations.

#### Transboundary issues

It was also found that the concentrations of Cd and Co in the upper Lopan River (L01) and Cd, Cr and Zn in the upper Udy River (U01) are significantly higher than downstream-located sampling sites (Table 5). Since both sampling sites are located near the border with Russia, we can assume that certain transboundary upstream influences on the water quality are taking place. It is difficult yet to identify and to evaluate the sources of metals in the neighbouring Belgorod region, Russia. There are no visible and reported industrial activities upstream of U01 and L01 on the Ukrainian part and no any referent data on the background of rivers sources were found. Downstream from the border with Russia and before entering the Kharkiv urban area (L03) contents of Cd in the Lopan River are much lower because of dilution processes. Similar patterns were also observed for Pb in the Udy River and Co in the Lopan River.

The Belgorod region (Russia), where the Lopan and the Udy rivers have their sources, is a district of the territory of the Kursk Magnetic Anomaly (KMA) with very well developed mining activities and iron ore-processing industry, metallurgical plants and at the same time with an important agricultural activity (Samarina 2008). The results of researches carried out by Samarina (2003, 2007, 2008) show that the rivers of the Belgorod region are directly affected by the mining and smelting works and confirm the anthropogenic origin of Cr, Cu, Ni, Pb and Zn in the Oskol

River (main tributary of the Seversky Donets River). Unfortunately, Samarina (2003, 2007, 2008) did not study Cd and Co, but other works have already demonstrated that high concentration of Cd and Co are connected with mining activities (Jordao et al. 1999; Kim et al. 2007) but it should be kept in mind that the transboundary pollution is limited compared to urban or wastewater derived pollution.

#### Conclusions

Our results demonstrate that the DGT technique can be applied to measure the water contamination by labile trace metals both in hot summer low-flow and cold snowy winter high-flow periods. This method appeared more convenient than the grab method of sampling, as it does not demand the collection of numerous samples for the estimation of time-weighted average concentrations of trace elements, especially in cold weather conditions (it does not require the drilling of many holes through the ice cover) and can be recommended for the continuous water monitoring of bioavailable forms of priority trace metals.

This first application of the DGT technique in Ukraine improved the knowledge on the labile trace metals contamination in one of the most industrialised region of the country and helped to point out the principal sources of metals in the rivers. Elements such as Cd, Co, Cr, Cu, Ni, Pb and Zn were found in most of the samples. The concentrations and fluxes of DGT-measured trace metals were much higher downstream of the wastewater treatment plant discharges compared to upstream. However, in locations close to the border with Russia, the concentration of Zn in the Udy River in summer exceeded the Water Quality Standards of Ukraine. Remarkably high contents of Cr and Cd were observed in the sampling sites next to the border with Russia that probably reflects the transboundary upstream influences on the water quality and needs further research focus.

The concentration in trace metals in the water displayed a seasonal variation pattern. The anthropogenic inputs (wastewater discharges) affect the trace metal concentrations in a strong manner during the low-flow summer period while increased flow conditions during the cold season provide a better dilution of pollutants.

Fluxes of metals during the hot low-flow summer period were lower compared to the cold high-flow winter period. This indicates that the metal release is continuous and at the same time seasonally variable depending on both natural and socio-economic conditions in the studied region.

Thus, this passive sampling technique can be used for the long-term water monitoring during various climatic conditions conducted by regional environmental and water related authorities of Ukraine. In a further step the data

gathered during this study will be used to model the water pollution processes considering many socio-economic indicators (demography, employment structure, economic structure, infrastructure, etc.) and changes in the hydrological conditions (Chichurin and Vystavna 2009). Such a tool (Vystavna 2005) is now necessary to be developed for the forecasting of the water quality evolution in relation to the socio-economic dynamics of the region.

**Acknowledgments** This research was conducted in the frameworks of the International Collaborative Programme “Partenariat Hubert Curien DNIPRO” (Grant No. 19744VJ 2009/2010) with the financial support from both French Ministry of Foreign Affairs and Ukrainian Ministry of Education and Science. Some authors have been granted by the European Union through the ERASMUS MUNDUS External Cooperation Window Programme (Lot 6/7—Belarus, Moldova, and Ukraine). The authors would like to thank Dr. Michel Mench from the Université de Bordeaux (UMR BIOGECO INRA 1202) for valuable comments provided during the manuscript preparation and Aliaksandr Kolbas for technical assistance.

## References

- Alfaro-De la Torre MC, Beaulieu PY, Tessier A (2000) In situ measurement of trace metals in lake water using the dialysis and DGT techniques. *Anal Chem Acta* 418:53–68
- Arain MB, Kazi TG, Jamali MK, Jalbani N, Afridi HI, Shach A (2008) Total dissolved and bioavailable elements in water and sediment samples and their accumulation in *Oreochromis mossambicus* of polluted Manshar Lake. *Chemosphere* 70:1845–1856
- Aung NN, Nakajima F, Furumai H (2008) Trace metal speciation during dry and wet weather flows in the Tama River, Japan, by using diffusive gradients in thin films (DGT). *J Environ Monit* 10:219–230
- Baalousha M, Kammer FVD, Motelica-Heino M, Le Coustumer P (2005) 3D Characterization of natural colloids by FIFFF-MALLS-TEM. *Anal Bioanal Chem* 383:549–554
- Baalousha M, Kammer FVD, Motelica-Heino M, Babrowski M, Hofmeister C, Le Coustumer P (2006a) Size-based speciation of natural colloidal particles by flow field-flow fractionation, inductively coupled plasma-mass spectroscopy, and transmission electron microscopy/X-ray energy dispersive spectroscopy: colloids-trace element interaction. *Environ Sci Technol* 40:2156–2162
- Baalousha M, Motelica-Heino M, Coustumer PL (2006b) Conformation and size of humic substances: effects of major cation concentration and type, pH, salinity and residence time. *Coll Surf A Physicochemical Eng Aspects* 272(1):48–55
- Balistrieri LS, Blank RG (2008) Dissolved and labile concentrations of Cd, Cu, Pb and Zn in the South Fork Coeur d’Alene River, Idaho: Comparisons among chemical equilibrium models and implications for biotic ligand models. *Appl Geochem* 23:3355–3371
- Beck AJ, Sanudo-Wilhelmy SA (2007) Impact of water temperature and dissolved oxygen on copper cycling in an urban estuary. *Environ Sci Technol* 41:6103–6108
- Buffle J, Horvai G (2000) General concepts. In: Buffle J, Horvai G (eds) *In situ monitoring of aquatic systems: chemical analysis and speciation*. John Wiley & Sons Ltd, USA, pp 1–17
- Buzier R, Tusseau-Vuillemin MH, Marin dit Meriadec C, Rousselot O, Mouchel JM (2006a) Trace metal speciation and fluxes within a major French wastewater treatment plant: Impact of the successive treatments stages. *Chemosphere* 65:2419–2426
- Buzier R, Tusseau-Vuillemin MH, Mouchel JM (2006b) Evaluation of DGT as a metal speciation tool in wastewater. *Sci Total Environ* 358:277–285
- Caruso BS, Bishop M (2009) Seasonal and spatial variation of metal loads from natural flows in the upper ten mile Greek watershed, Montana. *Mine Water Environ*. doi:10.1007/s10230-009-0073-9 (in press)
- Chichurin A, Vystavna YY (2009) Mathematical modeling of the river pollution by emergent pollutants. Computer algebra systems in teaching and research. *Mathematical physics and modeling in economics, finance and education*. In: proceedings of the Workshop CASTR’ 2009. College of Finance and Management, Siedlce, pp 26–30
- Dahlqvist R, Andersson K, Ingri J, Larsson T, Stolpe B, Turner D (2007) Temporal variations of colloidal carrier phases and associated trace elements in a boreal river. *Geochim Cosmochim Acta* 71:5339–5354
- Denney S, Sherwood J, Leyden J (1999) In situ measurements of labile Cu, Cd and Mn in river waters using DGT. *Sci Total Environ* 239:71–80
- Dragun Z, Biserka R, Vibor R (2008) The labile metal concentration in Sava River water assessed by diffusive gradients in thin film. *Chem Speciat Bioavailb* 20(1):33–46
- Dunn RJK, Teasdale PR, Warnken J, Schleich RR (2003) Evaluation of the diffusive gradient in a thin film technique for monitoring trace metal concentrations in estuarine waters. *Environ Sci Technol* 37(12):2794–2800
- Dunn RJK, Teasdale PR, Warnken J, Jordan MA, Arthur JM (2007) Evaluation of the in situ, time-integrated DGT technique by monitoring changes in heavy metals concentrations in estuarine waters. *Environ Pollut* 148:213–220
- GCPL (1991) General code of permitted limits and presumable save levels of impacts of hazardous substances in the waters use for fishery. Ministry of Fishery of USSR, No 12-04-11:100-142 (in Russian)
- Gimpel J, Zhang H, Davison W, Edward A (2003) In situ trace metal speciation in lake surface waters using DGT, dialysis and filtration. *Environ Sci Technol* 37:137–146
- Jakovlev VV, Svirengo LP, Chebanov OJu, Spirin OI (2002) Rising groundwater levels in North-Eastern Ukraine: hazardous trends in urban areas. In: Howard KWF, Israfilov RF (eds) *Current problems of hydrogeology in urban areas, urban agglomerates and industrial centres*. Kluwer Academic Publishers, Dordrecht, pp 221–241 (NATO ARW Series)
- Janssen CR, Heijerick DG, De Schampelaere KAC, Allen HE (2003) Environmental risk assessment of metals: tools of incorporating bioavailability. *Environ Int* 28:793–800
- Jordao CP, Pereira JL, Jham GN, Bellato CR (1999) Distribution of heavy metals in environmental samples near smelters and mining areas in Brazil. *Environ Technol* 20(5):489–498
- Kim JG, Ko K-S, Kim TH, Lee GH, Song Y, Chon C-M, Lee JS (2007) Effect of mining and geology on the chemistry of stream water and sediments in a small watershed. *Geosci J* 11(2):175–183
- Larner B, Seen AJ, Snape I (2006) Evaluation of diffusive gradients in thin film (DGT) samplers for measuring contaminants in the Antarctic marine environment. *Chemosphere* 65:811–820
- Linnik PN (2003) Complexation as the most important factor of in the fate and transport of heavy metals in Dnieper water bodies. *Anal Bioanal Chem* 376:405–412
- Meylan S, Odzak N, Behra R, Sigg L (2004) Speciation of copper and zinc in natural water freshwater: comparison of voltammetric measurements, diffusive gradient in thin films (DGT) and chemical equilibrium models. *Anal Chim Acta* 510:91–100
- Motelica-Heino M, Naylor C, Zhang H, Davison W (2003) Simultaneous release of metals and sulfide in lacustrine sediment. *Environ Sci Technol* 37(19):4374–4381

Environ Earth Sci

- Munksgaard NC, Parry DL (2003) Monitoring of labile metals in turbid coastal seawater using diffusive gradient in thin film. *J Environ Monit* 5:145–149
- NRDW (2006) National Report on drinking water quality and supply in 2006 year. [http://www.minjkg.gov.ua/editattach/bigdoc/nd\\_voda2006.doc](http://www.minjkg.gov.ua/editattach/bigdoc/nd_voda2006.doc) (in Ukrainian)
- Pernet-Coudrier B, Clouzot L, Varrault G, Tusseau-Vuillemin MH, Verger A, Mouchel J-M (2008) Dissolved organic matter from treated effluent of a major wastewater treatment plant: characterization and influence on copper toxicity. *Chemosphere* 73:593–599
- Research DGT (2002) DGT for measurements in water, soils and sediments. DGT Research Ltd, Lancaster
- Roulier JL, Tusseau-Vuillemin MH, Coquery M, Geffard O, Garric J (2008) Measurement of dynamic mobilization of trace metals in sediments using DGT and comparison with bioaccumulation in *Chironomus riparius*: first application of an experimental study. *Chemosphere* 70:925–932
- Samarina VP (2003) The effect of a mining and smelting plant on the dynamics of heavy metals in small river basins in the zone of Kursk-Belgorod magnetic anomaly. *Water Resour* 30(5):596–604
- Samarina VP (2007) Assessment of the impact of economic activity on the degree of overland flow contamination in the zone of the Kursk-Belgorod magnetic anomaly: case study of the Oskol River. *Water Resour* 34(5):582–586
- Samarina VP (2008) Effect of engineering-industrial activities in the region of the Kursk magnetic anomaly on the ecological state of the rivers waters. *Geochem Int* 46(9):998–1005
- Sangi MR, Halstead MJ, Hunter KA (2002) Use of diffusion gradient thin film method to measure trace metals in fresh waters at low ionic strength. *Anal Chim Acta* 456:241–251
- Schintu M, Durante L, Maccioni A, Meloni P, Degetto S, Contu A (2008) Measurement of environmental trace-metal levels in Mediterranean coastal areas with transplanted mussels and DGT techniques. *Mar Pollut Bull* 57:832–837
- SNPL (1991) Sanitary norms of permitted limits of hazardous substances contents in the waters use for drinking and municipal water use. Ministry of Health Protection of USSR, No 6025-91:20-66 (in Russian)
- Stark JS, Johnstone GJ, Palmer AS, Snape I, Larner B, Riddle MJ (2006) Monitoring the remediation of a near shore waste disposal site in Antarctica using the amphipod *Parameoera walkeri* and diffusive gradients in thin films (DGTs). *Mar Pollut Bull* 12(52):1595–1610
- Tusseau-Vuillemin MH, Gourlay C, Lorgeoux C, Mouchel JM, Buzier R, Gilbin R (2007) Dissolved and bioavailable contaminants in the Seine River basin. *Sci Total Environ* 375(1–3):244–256
- Vasenko OG, Lungu ML, Iljevska YA, Klymov OV, et al (2006) Research report. The integrated field research of environmental conditions of water bodies of the Udy water basins (sub-basin of the Siverskiy Dinets River). Rayder Publisher, Kharkiv (in Ukrainian)
- Vystavna Y (2005) The Balanced Model of the Sustainable Water Consumption in a Public Sector in Ukraine. Proceedings. Kalmar ECO-TECH'05. In: Conference on waste to energy, bioremediation and leachate treatment. The Second baltic symposium on environmental chemistry, November 28–30, 2005. Kalmar, Sweden, pp 455–461
- Vystavna Y, Le Coustumer P, Huneau F, Rakhmatullaev S (2008) Impact of a municipal wastewater treatment plant on the quality of the sediments of the River Udy (Ukraine). In: UNESCO International Workshop on erosion, transport and deposition of sediments, book of abstracts, April 28–30, 2008. Berne, Switzerland, pp 106–107
- Warnken KW, Santschi PH (2009) Delivery of trace metals (Al, Fe, Mn, V, Co, Ni, Cu, Cd, Ag, Pb) from the Trinity River watershed towards the ocean. *Estuaries Coasts* 32:158–172
- Warnken KW, Zhang H, Davison W (2007) In situ monitoring and dynamic speciation measurements in solution using DGT. In: Greenwood R, Mills G, Vrana B (eds) *Comprehensive analytical chemistry*, volume 48, passive sampling techniques in environmental monitoring. Elsevier, Amsterdam, pp 251–278
- Zhang H, Davison W (1995) Performance characteristics of diffusive gradients in thin films for in situ measurement of trace metals in aqueous solution. *Anal Chem* 67(19):3391–3400
- Zhang H, Davison W (2000) Direct in situ measurements of labile inorganic and organically bound metal species in synthetic solutions and natural waters using DGT. *Anal Chem* 72(18):4447–4457



## Summary

Our results demonstrate that the passive sampling technique is a relevant solution for the development of the water monitoring in particular regions. DGT technique can be applied to measure the water contamination by labile trace metals both in hot summer low-flow and cold snowy winter high-flow periods.

This method appeared convenient for the water monitoring and control authorities, but also for the long-term environmental research in sites with contrasted climate and hydrological conditions and various economic activities (i.e. agriculture, industry).

In case of the lack of the environmental data, the passive sampling can be a pilot cost-efficient technique what provide the information on the water quality, origin and sources of potentially toxic pollutants, time varying events which influenced water chemistry and environmental safety (i.e. uncontrolled and illegal wastewater discharges, run-off, etc.) on the water quality and needs further research focus. These were discovered during passive water sampling in modelled rivers.

Additionally, precise environmental data what is obtained during passive sampling, became a base for the calculation of fluxes of contaminants in watercourses and the identification of environmental and socio-economic determinants of water pollution.

In a further step the passive sampling were combined with the conventional tools in order to identify factors, which influenced water chemistry in the studied region



## CHAPTER V

### ENVIRONMENTAL DETERMINANTS

This study was focused on the identification of environmental determinants what influenced water chemistry and responsible for the presence of potentially toxic trace elements in the environment. Following the results of the previous pilot research on the passive water sampling, the selected sampling sites have been monitored using the combination of conventional and innovative monitoring tools for the assessment of factors which responsible for the occurrence and presence of tracers at the potentially dangerous levels for environmental and human health. The problem of the study of environmental determinants of trace elements in watercourses is devoted to: (i) the anthropogenic and natural origin of trace elements, therefore the regional baseline should be firstly identified; (ii) the present of trace elements in various forms in the environment (i.e. particulate, dissolved, labile), so the combination of sampling techniques should be applied in order to get the precise environmental data. On example of the regional study, the strategy of the identification of environmental determinants in the site with limited geochemical data has been considered and brought the first data on the regional baseline of the studied watershed, accumulation, spatial distribution and origin of trace metals. The result of this study is presented in the form of the submitted article:

**Vystavna Y., Huneau F., Larrose A., Schafer J., Motelica-Heino M., Blanc G., Vergeles Y., Dyadin D., Le Coustumer P. Distribution of trace elements in waters and sediments of the Seversky Donets transboundary watershed (Kharkiv region, Eastern Ukraine) [submitted to Applied Geochemistry]**

## **Distribution of trace elements in waters and sediments of the Seversky Donets transboundary watershed (Kharkiv region, Eastern Ukraine)**

Y. VYSTAVNA<sup>1,2,3</sup>, F. HUNEAU<sup>1,2</sup>, A. LARROSE<sup>4</sup>, J. SCHÄFER<sup>4</sup>, M. MOTELICA-HEINO<sup>5</sup>, G. BLANC<sup>4</sup>, Y. VERGELES<sup>3</sup>, D. DYADIN<sup>3</sup>, P. LE COUSTUMER<sup>1,2</sup>

<sup>1</sup>Université de Bordeaux, UFR Sciences de la Terre et de la Mer, B18, avenue des Facultés, 33405 Talence, France

<sup>2</sup>EA Géorressources & Environnement, Institut EGID, 1 allée François Daguin, F-33607 Pessac, France

<sup>3</sup>National Academy of Municipal Economy at Kharkiv, Department of Environmental Engineering and Management, vul. Revolutsii 12, Kharkiv, 61002, Ukraine

<sup>4</sup>Université de Bordeaux, UMR CNRS 5805 Environnements et Paléoenvironnements Océaniques, B18, avenue des Facultés, 33405 Talence, France

<sup>5</sup>Université d'Orléans, UMR CNRS 6113 ISTO, Campus Géosciences, 1A rue de la Férollerie, 41071 Orléans cedex 2, France

Contact author:

Dr. Frédéric HUNEAU, Université de Bordeaux, GHYMAC Géosciences Hydrosociences, B18, avenue des Facultés, 33405 Talence, France

Tel: +33.5.40.00.88.41 ; Fax: +33.5.40.00.31.13 ; frederic.huneau@u-bordeaux1.fr

### *Abstract*

This paper reports on the aquatic chemistry of trace elements in terms of spatial and temporal distribution, but also pollution sources in the transboundary watershed of the Seversky Donets River (Ukraine/Russia). Bed sediments, filtered water and DGT samples were collected from the Udy and Lopan Rivers at sites from river's spring in the Belgorod region (Russia) to rural and urban areas in the Kharkiv region (Ukraine) in May and August 2009. Priority trace elements (As, Cd, Cr, Cu, Hg, Ni, Pb, and Zn), urban tracer (Ag) and additionally Co, Mo, V and Th were measured in stream water and sediments during contrasting hydrological conditions. The low levels and variability of Th-normalized concentrations indicated the absence of geochemical anomalies and suggested a regional background for trace elements in bed sediments in the upstream part of the rivers. In contrast, water and sediments within the city of Kharkiv were contaminated by Ag, Pb, Cd, Cu, Cr and Zn, that was mainly attributed to municipal wastewater inputs and urban run-off. Results of the environmental quality assessment showed that elements concentrations in the sediments can be considered as potentially toxic to aquatic organisms in sites downstream of the wastewater discharges.

**Keywords:** Trace Elements, Sediments, Geochemical Baseline, Transboundary Rivers, Wastewater, Environmental Risks, Eastern Ukraine

## 1. Introduction

The presence of trace elements in rivers relates to the specific regional geochemistry and inputs from diverse anthropogenic sources. In the aquatic environment, trace elements can accumulate to toxic levels and cause severe effects to organisms and human health (Gupta et al, 2009). Various factors, i.e. the climate and hydrology (Caruso and Bishop, 2009), water chemistry (Matache et al, 2009) and biological activity (van Hattum et al, 1996) control trace metal deposition and fixation in the sediments, which may act as both sinks and sources of secondary aquatic pollution (Pekey, 2006; Coynel et al, 2007). The study of both water and sediment geochemistry is therefore necessary for the assessment of contamination status, the understanding and prevention of environmental risk and the development of regional and national water protection strategies (Neumann et al, 2005).

Eastern Ukraine, with a long history of large-scale industrial and agricultural activities from the soviet period up to present time (EPKhR, 2008), is one of the most urbanised regions in the country. The main river system of this part of Ukraine is the transboundary Seversky Donets watershed that also includes the Belgorod, Kursk and Rostov regions of the Russian Federation. The water resources are affected by the extensive multiple water uses (iron ore-mining processes, heavy and light manufacturing, power, industrial and drinking water supply infrastructures, agriculture, aquaculture) and urban inputs (NRDW, 2006). Regional and national environmental surveys in rivers of the Seversky Donets basin (Samarina, 2003; Vasenko et al, 2006) reported concentrations of dissolved Zn, Cr and Pb exceeding the valid Ukrainian water quality limits (GCPL, 1991; SNPL, 1991). This pollution may induce environmental and health risks associated with drinking water supply and recreation activities in the region.

Despite the crucial role of the Seversky Donets basin in the social and economic development of neighbouring regions of Ukraine and Russia, the recently established environmental monitoring network of the transboundary rivers is yet insufficient (Vasenko et al, 2006) and concentrations, sources and fate of most trace elements in the watershed are poorly surveyed and understood. The existing monitoring and risk assessment suffers from very limited in-situ measurements and poor sampling on the one hand and from the absence of information on regional sediment and water quality baselines on the other hand. Two rivers of the Seversky Donets water basin, with a total catchment area in Ukraine of 3460 km<sup>2</sup>, namely the Lopan and Udy Rivers, have been chosen as being representative of

many other regional rivers in terms of general properties, watershed size and land use. These rivers have their sources in the Belgorod Region (Russia) and flow downstream to the Kharkiv Region (Ukraine), where they receive substantial volumes (700 – 1000 thousands m<sup>3</sup> per day) of domestic and industrial wastewaters from the urban area.

This study is a part of a research program on the trace elements and emerging pollutants in the Kharkiv region aiming at identifying and evaluating the geochemical background (baseline), actual levels and distributions of trace metal concentrations in water and sediment, and also the major pollution sources to the Lopan and Udy Rivers. The paper discusses: (1) the spatial and temporal distribution of trace metals in water and sediments, (2) the regional geochemical baseline of trace metals in the sediments, and (3) the potential environmental risk of trace metals contamination in sediments.

## 2. Study area

### 2.1. General setting, hydroclimatology and hydrology

The study area is situated in the Forest-Steppe natural zone of the southern slopes of the Mid-Russian rolling plane with grey forest and thick grassland soil types, called *chernozems*, (Samarina, 2007).

The duration of winter is from the mid-November to the mid-March and summer is from the mid-May to early September. The coldest month is January (average temperature is -7.1°C) and the warmest is July (average temperature is +20.5°C). The high temperature during the summer period and wastewater inputs induce pronounced seasonal O<sub>2</sub>-depletion and increase of nutrients in both studied rivers due to intense organic matter degradation (Vasenko et al, 2006). The mean annual air temperature is 7.6°C and the rainfall amount varies between 470 and 540 mm per year with 145-160 mm of precipitation in winter and 140-190 mm in summer (Jakovljević et al, 2002). The Lopan and Udy Rivers are rather shallow (from 0.4 to 2.3 m in depth) and several dams along the watercourses regulate their flows. The mean high water discharge of the Lopan River is 1.4 m<sup>3</sup> s<sup>-1</sup> (winter and spring) and the mean low water discharge is 0.9 m<sup>3</sup> s<sup>-1</sup> (summer). The high water discharge of the Udy River is 6.8 m<sup>3</sup> s<sup>-1</sup> (winter and spring) and mean low water discharge is 2.5 m<sup>3</sup> s<sup>-1</sup> (summer). Water discharge is measured at sampling sites located about 1 km upstream from the Kharkiv city (Vasenko et al, 2006). The rivers are fed mostly by rainfall and partly by groundwater from Tertiary aquifers (Jakovljević et al, 2002). The above-mentioned hydrological parameters (small size, low flow rate, man-made regulation) of these rivers

suggest that both water bodies have very limited natural purification potentials (Vasenko et al, 2006).

## 2.2. Geology

The north-eastern part of Ukraine belongs to the Dnieper-Donets depression and to the Voronezh anticline of the Eastern European Platform. The Precambrian crystalline basement in the axial part of this structure outcrops to the north-east of the platform (Jakovljev et al, 2002) and is covered by Paleozoic, Mesozoic and Cenozoic sedimentary deposits such as sandstones, clays, argillites, siltstones and limestones. The uppermost formations on the study area consist of Cretaceous, Paleogene, Neogene and Quaternary deposits. The water-bearing sands in the Cretaceous (Cenomanian) deposits are protected from the pollution by a layer of marls and chalk and is used for municipal water supply in Sumy, Poltava and Kharkiv regions (Jakovljev et al, 2002). Oligocene, Eocene and Pliocene-Quaternary aquifers are also widely used by the local population for additional drinking water supply, in spite of the high nitrate content (Jakovljev et al, 2002).

The northern part of the study area is about 100 km from the Yakovlevka deposit (in the Belgorod Region of Russia) which is a part of the Precambrian banded iron formation of the iron-ore basin called the Kursk Magnetic Anomaly (KMA) (Figure 1).

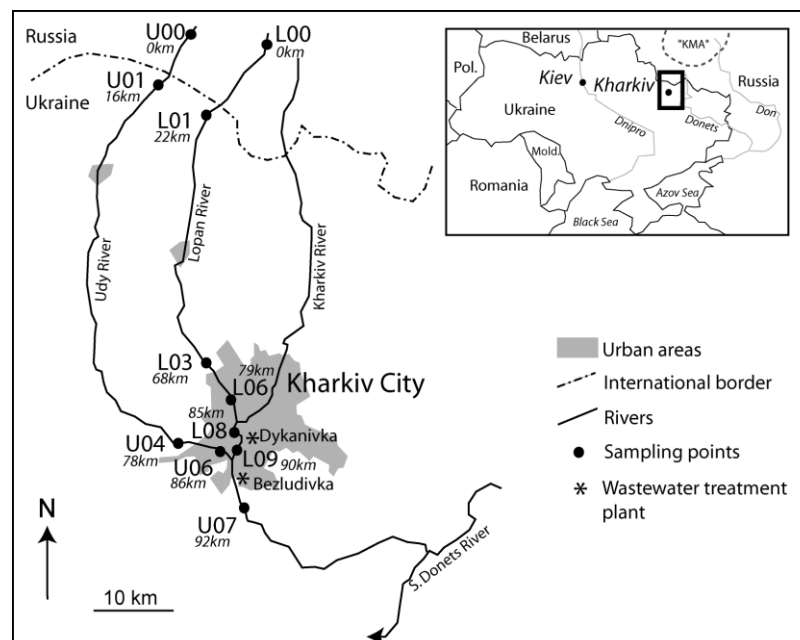

Figure 1. The location of sampling sites

The deposit contains residual, partially weathered ores with high concentrations in Cu, Zn, As, Cd, Ag and U compared to the average continental crust (Belykh et al, 2007). Samarina (2003; 2007; 2008) has reported that the exploitation of the KMA deposits in the Belgorod region (mining, iron ore-processing, metallurgy and corresponding infrastructure) has induced negative impacts on the environmental conditions and water quality of regional watercourses, increasing groundwater mineralization and concentrations of Cu, Zn, Pb and Cr.

### *2.3. Water use*

Upper parts of the Lopan and Udy River basins feature mostly rural land-uses while middle and lower parts incorporate the urban agglomeration of the city of Kharkiv with a population density of 4764 persons/km<sup>2</sup> and a total population of ca. 2 million inhabitants (as by 2009).

In the Kharkiv region, the studied rivers are mainly used for water supply and wastewater discharge. The ‘Dykanivka’ (700,000 m<sup>3</sup> d<sup>-1</sup>) and the ‘Bezludivka’ (300,000 m<sup>3</sup> d<sup>-1</sup>) are two large-size wastewater treatment plants (WWTP) which receive and treat mixed industrial effluents mainly from machinery, coke-chemistry, food-processing, light industry (25% of all influents) and domestic (75% of all influents) wastewaters from the Kharkiv agglomeration. The wastewater treatment includes mechanical and biological (aerobic) processes with a final disinfection step by chlorination. The volume of treated wastewater released by the ‘Dykanivka’ WWTP (‘D’WWTP) into the Lopan River is more than two times higher than the natural river discharge which cause aquatic pollution by suspended solids, labile organic matter, chlorides, nitrites, nitrates, ammonium, oil products and phenols and intensify eutrophication processes in the Lopan during summer (Vasenko et al, 2006). The ‘Bezludivka’ WWTP (‘B’WWTP) discharges treated wastewaters into the Udy River and is responsible for the accumulation of Cr, Zn, Cu and Pb in the sediments downstream from the wastewater treatment plant. The rivers pollution has been attributed to the low efficiency of existing treatment processes, absence of manufacturing wastewaters pre-treatment technologies and mixing of industrial and domestic wastewaters (Vasenko et al, 2006).

### *2.4. Sampling location*

The sampling sites were selected to monitor and identify potential trace metal sources (transboundary upstream area, agricultural versus urban territories, wastewater discharges)



and named according to the results of the previous monitoring (Vystavna et al, 2009). Sampling was conducted at 6 sites on the Lopan River (Figure 1): (1) the site L00 is close to the river source in the agricultural area of the Belgorod region, Russia; (2) the site L01 is in the agricultural area of the Kharkiv region, Ukraine, (3) the site L03 represents the river section upstream from the Kharkiv urban agglomeration; (4) the site L06 is in the Kharkiv city centre; (5) L08 is within the urban area and upstream of the wastewater outlet of 'D'WWTP; (6) L09 is downstream from the 'D'WWTP and upstream from the confluence of the Lopan and Udy Rivers.

Similarly, five sampling sites on the Udy River (Figure 1) were selected: (1) U00 is near to the river source in the agricultural area of the Belgorod region, Russia, (2) U01 is in the agricultural area of the Kharkiv region, Ukraine; (3) U04 is upstream from the Kharkiv urban agglomeration, (4) U06 is in the urban area, upstream of the Lopan-Udy confluence and upstream from the wastewater outlet of 'B'WWTP and (5) U07 is downstream from the discharge of the 'B'WWTP and the Lopan - Udy Rivers confluence (Figure 1). The transboundary sites L00 and U00 were sampled only once (May 2009) due to administrative problems related to the crossing of the Russian border, whereas the other sites were sampled twice in May and August 2009 in order to represent contrasting hydrological processes in rivers. During May, the discharge is relatively high, mainly due to the snow melting in March – April period, whereas during August, the river discharge is decreasing and mainly derived from groundwater inflow. During August, water temperature and eutrophication-related processes are at their maxima (Vasenko et al, 2006).

Duplicated grab samples of water and sediments have been taken at the beginning of the replicated DGT - samplers installation in May and August 2009.

### **3. Material and Methods**

Priority substances (i.e. As, Cd, Cu, Cr, Hg, Ni, Pb and Zn (European Community Directive on Priority Substances 2008/105/EC; EU Water Framework Directive 2000/60/EC; Tueros et al, 2009), Ag (urban tracer; Feng et al, 1998) and other potentially dangerous elements (Co, Mo, V; Schäfer et al, 2009)) were determined as total dissolved concentrations and DGT-separated/collected fractions in water and total trace elements concentrations in sediments.

### *3.1 In-situ measurements and dissolved phase sampling*

Water temperature, pH and electrical conductivity were measured in situ at the distance of 1 m from the river bank and at 0.2 m depth using a WTW Multiline P4 probe. Total organic carbon (TOC) was determined from spot unfiltered samples and measured by TOC-5000, Shimadzu<sup>®</sup> automated analyzer following ISO 10694.

River water was sampled at 1 m from the bank and at 0.2 m depth using an acid-cleaned 50 ml syringe and immediately filtered through 0.2 µm cellulose-acetate membranes (Nucleopore polycarbonate filters) acidified (HNO<sub>3</sub>, ultrapure; 1/1000 v/v; as described in Masson et al, 2009; Lanceleur et al, 2011) and stored in acid cleaned 16 ml polypropylene tubes at 4 °C and in the dark until analysis on the total dissolved (<0.2 µm) fraction.

In order to represent the time integrated variation of tracers (Zhang and Davison, 1995; Denney et al, 1999; Gimpel et al, 2003), the labile dissolved metal fraction was sampled using DGT passive samplers. The DGT devices with a 0.4 mm resin gel layer, a 0.8 mm diffusive gel layer and a 0.45 µm pore-size filter, were deployed during a 15 days at a 0.20 – 0.25 m water depth to avoid turbulent flow zones. After exposure, the DGT samplers were retrieved and kept humid at 4°C until elution. The metals accumulated in the binding phase of the DGT probes (3.14 cm<sup>2</sup>) were eluted by immersion in 1 mL of HNO<sub>3</sub> (1 M) for 48 hours (Zhang and Davidson, 1995). The DGT blank was additionally analysed and its concentration was calculated (by formula: Zhang and Davidson, 1995) according to the field conditions (Table 1). Finally, the blank subtracted DGT – concentrations of Cd, Co, Cr, Cu, Ni, Pb and Zn were estimated.

### *3.2. Sediment sampling and digestion*

Sediments were collected close to the river bank and stored in sterile capped containers. In the laboratory the samples were sieved to pass < 63µm, dried to constant weight at 50°C, powdered, homogenized and stored in closed polyacrylate containers (50 mL). Representative subsamples (30 mg of dry homogenized sediment) were digested at 110°C for 2 h in acid-cleaned closed reactors with 1.5 mL HCl (12 M, suprapure), 0.75 mL HNO<sub>3</sub> (14 M, suprapure) and 2 mL HF (26 M, suprapure), using a temperature-controlled digestion system (DigiPREP MS<sup>®</sup>, SCP SCIENCE). After cooling, the digested samples were brought to 10 mL using 250 µL HNO<sub>3</sub> (14 M, suprapure) and double deionized (Milli-Q<sup>®</sup>) water, then stored in the dark at 4 °C awaiting analysis by ICP-MS. Parallel blank digestions (without particles) and analyses of international certified reference

sediments (IAEA – 405 and CRM 320) allowed estimating accuracy and precision of the blank-corrected sediment analyses (Table 1).

### 3.3. Analyses

Total dissolved metal concentrations in filtered (<0.2 µm) water samples and sediment digests were measured by ICP-MS (X7, Thermo). The results were consistently within the range of certified values for SLRS – 4 (water), CRM 320 and IAEA405 (sediments) and the analytical error (relative standard deviation) was generally better than 5 % (Table 1). The procedure and results were in accordance with previous studies performed in the EPOC-TGM laboratory (Schäfer and Blanc, 2002; Audry et al, 2004). Hg concentrations were analyzed from the dry, homogenized sediments by cold vapour atomic absorption spectrometry after calcinations in an O<sub>2</sub>-stream and amalgamation using an automated Hg analyzer (MILESTONE, DMA-80; Schäfer et al, 2006). The obtained results for the international certified reference sediment IAEA 405 were consistently within the ranges of the certified values and precision was better than 5% (RSD) (Table 1).

Labile dissolved concentrations of Cd, Co, Cr, Cu, Ni, Pb and Zn in DGT samples were measured by ICP-MS at the French Geological Survey (BRGM) in Orléans, according to the European standard NF EN ISO 5667-3. The concentrations of each metal collected by DGT ( $C_{DGT}$ ) were then calculated using the temperature dependent diffusion coefficient as proposed by DGT-manufacturer (DGT Research, 2002) (1):

$$C_{DGT} = M \cdot \Delta g / (D \cdot t \cdot A) \quad (1)$$

where  $\Delta g$  is the thickness of the diffusive gel (0.8 mm) plus the thickness of the filter membrane (0.13 mm), D the diffusion coefficient of metal in the gel, t deployment time and A the exposure area ( $A=3.14 \text{ cm}^2$ ) (Zhang and Davison, 1995; DGT Research, 2002).

The mass of metal in the resin gel (M) was obtained using the following equation (2):

$$M = C_e (V_{HNO_3} + V_{gel}) / f_e \quad (2)$$

where  $C_e$  is the concentration of metals in the 1M HNO<sub>3</sub> eluting solvent ( $\mu\text{g L}^{-1}$ ),  $V_{HNO_3}$  the volume of HNO<sub>3</sub> added to the resin gel,  $V_{gel}$  the volume of the resin gel (0.16 mL), and  $f_e$  the elution factor (0.8) for all metals as given by the manufacturer.  $C_{DGT}$

corresponds to the interpreted concentration of the water sample and is a time-averaged concentration over the time of the probe deployment.

#### 3.4. *Enrichment factors estimation*

In order to determine the degree of contribution of the urban area to the sediment composition, the enrichment factor (EF) has been calculated using the following equation (e.g. Pekey, 2006):

$$(EF) = (C_x/C_{Th})_{sample} / (C_x/C_{Th})_{crust} \quad (3)$$

where  $(C_x/C_{Th})_{sample}$  is the ratio of concentration of the element being measured ( $C_x$ ) to that of Th ( $C_{Th}$ ) in the sediment sample and  $(C_x/C_{Th})_{crust}$  is the respective baseline ratio. Thorium has been used as a normaliser to compensate the constituent variability in sediments resulting from grain size variations (Coynel et al, 2007). According to Pekey (2006), elements can be divided into three major groups with respect to their corresponding enrichment factors: elements without enrichment ( $EF < 10$ ), elements with medium-level enrichment ( $10 < EF < 100$ ) and highly enriched elements ( $EF > 100$ ).

#### 3.5. *Environmental impact assessment*

To evaluate the sediment contamination and potential eco-toxicological effects associated with the observed contaminant concentration, we used the commonly applied Sediment Quality Guidelines (SQGs; MacDonald et al, 2000; Ingersoll et al, 2001; Zheng et al, 2008) and also the guidelines for the environmental quality assessment widely used in Ukraine (Saet et al, 1990).

SQGs developed for freshwater ecosystems are useful tools to assess the potential ecotoxicology of contaminants in sediments taking into account the consensus-based Threshold Effect Concentration (TEC) and Probable Effect Concentration (PEC) (MacDonald et al, 2000; Ingersoll et al, 2001; Binelli et al, 2008).

The mean probable effect concentration quotient (m-PEC-Q) which aims at estimating the probability of acute sediment toxicity due to the possible biological effects of toxicant mixtures has been calculated according to MacDonald et al. (2000):

$$m - PEC - Q = \frac{\sum_{i=1}^n (C_i / PEC_i)}{n} \quad (4)$$

where  $C_i$  is the sediment concentration of the  $i$  compound,  $PEC_i$  is the PEC for the  $i$  compound and  $n$  is the number of considered compounds.

Samples with mean PEC quotients  $< 0.5$  were predicted to be not toxic, whereas sediments with mean PEC quotients  $> 0.5$  may be considered as potentially toxic (MacDonald et al, 2000, Ingersoll et al, 2001; Zheng et al, 2008). However, recent work has shown that the reliability of this commonly applied approach depends on several factors which could affect the trace element availability from sediment to biota such as sediment grain size, organic matter content or trace element speciation (Casado-Martinez et al, 2006; Choueri et al, 2009).

The environmental risk assessment according to the Ukrainian approach implies the comparison of trace metal concentrations with their respective regional background values in sediments or/and in the continental crust (Saet et al, 1990; Svirenko et al, 2003). This approach is used both for soil and sediment environmental risk assessments. According to the proposed approach, the coefficient of concentration  $K_{cij}$  was calculated for each  $i$ -th metal element in each  $j$ -th sample:

$$Z_c = \sum_{i=1}^n (K_{cij}) |_{K_{cij} \geq 1.2} - (n - 1) \quad (5)$$

A cumulative sediment (soil) contamination index  $Z_{cj}$  was calculated for each  $j$ -th sample as follows:

$$K_{cij} = C_{ij}/C_{ib} \quad (6)$$

where  $C_{ij}$  is a concentration of the  $i$ -th element in sediment (soil) in the  $j$ -th sediment (soil) sample,  $C_{ib}$  is a background concentration of the  $i$ -th element in a large geochemical region; only those elements for which the ratio  $C_i/C_{ib}$  is  $\geq 1.2$  (considering standard error of the estimated ratio  $\leq 20\%$ ) were included into calculation, and  $n$  is the number of such elements. The degree of contamination and related environmental risk is considered as moderate if  $Z_c$  is  $\leq 16$ , as significant if  $16 < Z_c \leq 32$  and as very high for  $32 < Z_c \leq 128$ , and as dangerous for  $Z_c > 128$  (Saet et al, 1990).

Table 1. Accuracy and detection limits of the different techniques of water and sediments sampling and analysis

Trace element	Ag	As	Cd	Co	Cr	Cu	Hg	Mo	Ni	Pb	Th	V	Zn
<i>Water sampling (total dissolved metals)</i>													
Analytical detection limits, $\mu\text{g L}^{-1}$	0.001	0.020	0.002	0.020	0.100	0.080	na	0.010	0.200	0.010	0.005	0.040	0.100
Certified Reference Material - SLRS 4 (n=10)													
Measured, $\mu\text{g l}^{-1}$	na	0.68	0.012	0.033	0.320	1.620	na	0.200	0.648	0.085	na	0.350	1.040
Certified, $\mu\text{g l}^{-1}$	nc	0.68	0.012	0.033	0.330	1.810	nc	0.210	0.670	0.086	nc	0.320	0.930
95% Interval, $\mu\text{g l}^{-1}$	nc	0.62-0.74	0.010-0.014	0.027-0.039	0.31-0.35	1.73-1.89	nc	0.19-0.23	0.59-0.75	0.079-0.093	nc	0.29-0.35	0.83-1.03
Accuracy	nc	4%	4%	9%	11%	4%	nc	5%	4%	19%	nc	3%	11%
Reproducibility	nc	0%	-2%	3%	-2%	-12%	nc	-5%	-3%	-4%	nc	-11%	11%
<i>DGT – sampling in water (labile dissolved metals)</i>													
Analytical detection limits of DGT, $\mu\text{g L}^{-1}$	na	na	0.002	0.002	0.002	0.002	na	na	0.002	0.001	na	na	0.002
Blank value, $\mu\text{g L}^{-1}$	na	na	0.002	0.002	0.002	0.020	na	na	0.002	0.001	na	na	0.004
Operational detection limit*, $\mu\text{g L}^{-1}$	na	na	0.030	0.040	0.040	0.970	na	na	0.040	0.020	na	na	0.020
<i>Sediments sampling</i>													
Certified Reference Material - CRM 320 (n=16)													
Measured, $\mu\text{g kg}^{-1}$	na	75.7	0.59	18.6	122	40.1	na	0.61	81.7	38.8	10.9	96.3	128
Certified, $\mu\text{g kg}^{-1}$	nc	76.7	0.53	nc	138	44.1	1.03	nc	75.2	42.3	nc	nc	142
95% Interval, $\mu\text{g kg}^{-1}$	nc	73.3-80.1	0.51-0.56	nc	138-145	43.1-45.1	0.90-1.16	nc	73.8-76.6	40.7-43.9	nc	nc	139-145
Accuracy	nc	-1%	10%	nc	-12%	-9%	na	nc	9%	-8%	nc	nc	-10%
Reproducibility	nc	7%	6%	8%	4%	8%	na	14%	8%	7%	14%	5%	21%
Certified Reference Material - IAEA 405 (n=10)													
Measured, $\mu\text{g kg}^{-1}$	1.06	24.6	0.80	13.6	81.4	48.0	0.787	0.66	32.8	78.9	12.4	94.5	277
Certified, $\mu\text{g kg}^{-1}$	nc	23.6	0.73	13.7	84	47.7	0.81	nc	32.5	74.8	14.3	95	279
95% Interval, $\mu\text{g kg}^{-1}$	nc	22.9-24.3	0.68-0.78	13.0-14.4	80.0-88.0	46.5-48.9	0.77-0.85	nc	31.1-33.9	72.6-77.0	12.2-16.4	90-100	272-286
Accuracy	nc	4%	10%	-1%	-3%	1%	-3%	nc	1%	5%	-13%	0%	-1%
Reproducibility	6%	9%	12%	4%	3%	7%	4%	6%	8%	5%	5%	4%	12%

na - the element has not been analysed; nc - the element has not been certified; \* determined as three times the standard deviation multiple measurements of blank solutions

## 4. Results and discussion

### 4.1. Distribution of trace elements in the water

According to the concentrations of major ions (Vasenko et al, 2006), surface water of both rivers is classified as of  $\text{HCO}_3^- - \text{Ca}$  type ( $\text{HCO}_3^- > \text{SO}_4^{2-} > \text{Cl}^-$  and  $\text{Ca}^{2+} > \text{Na} + \text{K} > \text{Mg}^{2+}$ ), which is in agreement with the petrographic nature of the river beds and may be explained as the result of interaction of the water with Cretaceous carbonate rocks.

The water pH in both rivers ranged from 7.4 to 8.2. Electrical conductivity measurements showed variations in both rivers with the maximum value at the sites downstream of the inflow of the wastewater discharge from the 'D' WWTP and 'B' WWTP (site U07). Water temperature varied from 13-16 °C in May to 16-23 °C in August in both rivers (Table 2)

The concentration of dissolved Ni in August and Ag in both seasons were measured less than the detection limits. Dissolved As, Co, V and Mo in the water were found without significant increasing of the concentration from rural to the urban parts of the rivers.

Table 2. Temperature, pH, conductivity and total organic carbon at the sampling sites along the Lopan and Udy Rivers

site	May 2009				August 2009			
	T, °C	pH	E, $\mu\text{Scm}^{-1}$	TOC, $\text{mgL}^{-1}$	T, °C	pH	E, $\mu\text{Scm}^{-1}$	TOC, $\text{mgL}^{-1}$
U00	13	8.2	468	nd	nd	nd	nd	nd
U01	14	7.8	865	71	16	7.7	925	87
U04	14	8.2	930	68	21	8.1	971	84
U06	14	7.8	1077	57	20	7.4	1219	65
U07	16	7.3	1243	50	22	7.2	1243	53
L00	12	7.7	1035	nd	nd	nd	nd	nd
L01	13	7.8	1081	171	16	7.9	1073	173
L03	14	7.8	1140	85	17	7.7	799	99
L06	14	7.9	1081	103	18	7.8	787	133
L08	15	7.8	1100	98	20	7.6	901	105
L09	16	7.4	1240	47	23	7.2	1235	51

nd – the parameter has not been determined

In contrast, concentrations of dissolved Cd, Cr, Cu, Ni, Pb, and Zn in water were higher in the urban area compared to the rural reaches (Table 3) with peaks of most of them at the sites (U07 and L09) located downstream from the discharges of 'B' WWTP and 'D' WWTP.

Respectively to total dissolved concentration, the highest  $C_{DGT}$  concentrations of Cd, Cr, Ni and Zn also occurred on the urban territory (Table 3).

The comparison of the DGT – labile to total dissolved concentrations shows that Co, Cu, Pb and Zn in for DGT-collected samples were higher than total dissolved metal concentrations in the some river's parts, i.e. transboundary sections and downstream of the wastewaters discharge. DGT concentrations can be larger than instantaneous grab samples if there is variability in labile metal concentrations during the DGT deployment. This variance can occur due to instream geochemical and hydrological processes (Nimick et al, 2005), time – varying anthropogenic (e.g. uncontrolled wastewater discharges) and natural (e.g. run – off) inputs (Lambing et al, 2004) and the speciation of dissolved metals. Dissolved metal-organic carbon complexes diffuse more slowly through the hydrogel than free metal ions or inorganic complexes. Organic matter can influence the lability of metals resulting in the complexation of labile forms with organic particles or dissolved organic matter (Tusseau-Vuillemin et al, 2007). Our results show that the TOC contamination is decreasing in sites located downstream of wastewater discharges (Table 2), hereby, complexation processes can be less intensive in this part compare to the upstream that leads to the presence of the higher portion of free metal ions. The increasing of water temperature and decreasing of pH (Table 2) can additionally stimulate the growing of free metal ions ratio from the upstream to the downstream parts of the Lopan and Udy Rivers.

#### *4.2. Normalization by $^{232}\text{Th}$ and distribution of trace elements in sediments*

The concentrations of trace elements (Ag, As, Cd, Co, Cr, Cu, Hg, Mo, Ni, Pb, Th, V and Zn) in sediments showed spatial variability along the studied watercourses, varying by factors up to 33 (Figure 2). The measured metal concentrations in the Lopan and Udy Rivers are presented in the Table 3. Taking into account, that suspended sediments in the rivers consist of detritus particles including silts, clays and fine sands (Vasenko et al, 2006), grain size segregation due to particle settling during sediment transport may affect metal concentrations in the sediments. Normalisation of trace element concentrations in sediments over Th concentrations has proven the efficiency of the correction of grain size effects, allowing comparison of site-to-site variations in the trace metal concentrations in sediments of Thailand (Srisuksawad et al, 1997), Brazil (Ferreira et al, 2006) and France (Coyne et al, 2007; Larrose et al, 2010).



Table 3. Dissolved trace elements concentration in surface water ( $\mu\text{g L}^{-1}$ ) and particulate trace element concentration in the sediments ( $\text{mg kg}^{-1}$ ) from the Lopan and Udy Rivers

May 2009												August 2009											
site	Ag	As	Cd	Co	Cr	Cu	Mo	Ni	Pb	V	Zn	Ag	As	Cd	Co	Cr	Cu	Mo	Ni	Pb	V	Zn	
<b>Total dissolved metals concentration, <math>\mu\text{g/L}</math></b>																							
U00	<	3.10	<	0.18	0.80	0.51	0.95	1.32	0.05	1.65	0.22	<	nd	nd	nd	nd	nd	nd	nd	nd	nd	nd	
U01	<	2.54	<	0.35	1.74	0.59	1.19	1.74	0.03	2.13	0.83	<	3.59	<	0.29	1.44	0.44	1.52	<	1.67	2.85	0.41	
U04	<	2.99	<	0.39	2.69	0.70	2.08	1.97	0.02	2.95	0.37	<	3.44	<	0.30	2.61	0.55	2.92	<	2.57	4.07	0.26	
U06	<	2.62	<	0.33	3.03	0.89	2.14	2.00	0.01	2.73	0.36	<	2.90	0.26	0.30	5.61	2.46	2.45	<	5.82	2.81	7.09	
U07	<	2.27	0.11	0.37	5.03	2.49	2.14	5.12	0.09	2.85	7.51	<	2.81	0.09	0.29	5.80	1.33	2.27	<	6.05	2.97	4.51	
L00	<	1.80	<	0.35	6.14	1.75	3.42	2.26	0.01	2.42	0.35	<	nd	nd	nd	nd	nd	nd	nd	nd	nd	nd	
L01	<	2.05	<	0.36	2.92	0.51	2.84	2.06	0.01	1.86	0.74	<	2.24	<	0.35	1.81	0.52	3.29	<	2.02	2.41	0.83	
L03	<	2.95	0.01	0.47	2.89	0.60	3.95	2.22	0.02	2.76	0.73	<	4.95	<	0.29	1.98	0.45	2.15	<	1.67	3.58	0.25	
L06	<	2.38	0.03	0.41	6.00	0.86	3.16	2.53	0.06	2.65	1.05	<	3.79	0.01	0.31	3.95	1.00	2.74	<	2.30	3.63	0.83	
L08	<	2.31	0.01	0.41	3.43	0.76	3.09	2.59	0.11	2.78	1.17	<	nd	nd	nd	nd	nd	nd	nd	nd	nd	nd	
L09	<	2.20	0.16	0.36	4.79	2.49	2.60	3.83	0.12	2.71	8.52	<	3.56	0.01	0.23	3.54	0.56	1.90	<	1.88	2.97	0.54	
<b>DGT -measured metals concentration, <math>\mu\text{g/L}</math></b>																							
U00	nd	nd	0.03	0.07	0.12	1.50	nd	0.79	40.7	nd	5.86	nd	nd	nd	nd	nd	nd	nd	nd	nd	nd	nd	
U01	nd	nd	0.01	0.06	0.21	1.34	nd	0.77	0.80	nd	1.31	nd	nd	<	0.16	0.09	2.17	nd	0.70	0.07	nd	2.78	
U04	nd	nd	0.06	0.04	<	0.58	nd	0.53	1.69	nd	0.68	nd	nd	<	0.08	0.06	0.88	nd	0.86	0.02	nd	0.98	
U06	nd	nd	0.04	0.04	<	0.95	nd	0.59	3.01	nd	0.96	nd	nd	0.01	0.05	0.11	0.33	nd	0.58	0.04	nd	5.29	
U07	nd	nd	0.03	0.10	0.60	2.00	nd	2.43	0.85	nd	24.1	nd	nd	0.06	0.10	0.45	2.08	nd	2.99	0.07	nd	3.79	
L00	nd	nd	0.04	0.83	<	1.34	nd	1.34	0.99	nd	2.10	nd	nd	nd	nd	nd	nd	nd	nd	nd	nd	nd	
L01	nd	nd	0.01	0.04	<	0.89	nd	0.47	7.81	nd	1.50	nd	nd	<	0.17	0.11	5.77	nd	0.56	0.12	nd	1.94	
L03	nd	nd	0.02	0.14	<	1.12	nd	0.72	1.79	nd	0.97	nd	nd	<	0.17	0.09	3.21	nd	0.50	0.07	nd	1.55	
L06	nd	nd	0.35	0.07	0.03	1.66	nd	1.03	2.16	nd	1.83	nd	nd	nd	nd	nd	nd	nd	nd	nd	nd	nd	
L09	nd	nd	0.13	0.06	0.20	1.01	nd	2.79	3.80	nd	2.96	nd	nd	0.05	0.12	0.35	2.44	nd	2.54	0.07	nd	3.16	
<b>Sediments concentration, <math>\text{mg/kg}</math></b>																							
U00	0.32	13.9	0.34	17.0	86.7	26.8	1.01	53.0	23.52	122	81.2	nd	nd	nd	nd	nd	nd	nd	nd	nd	nd	nd	
U01	0.17	7.63	0.32	9.79	37.2	13.1	0.66	23.1	12.64	47.5	37.0	0.21	6.41	0.19	8.15	40.5	13.6	0.47	22.1	13.0	53.8	32.7	
U04	0.07	3.19	0.06	2.60	11.4	3.1	0.51	3.90	5.8	18.2	8.3	0.07	1.68	0.18	3.03	12.4	4.5	0.54	13.3	4.4	18.2	8.30	

U06	0.39	4.52	0.72	4.73	54.2	21.5	0.59	18.9	19.8	41.9	91.7	0.56	8.47	1.89	9.52	101	39.9	1.03	30.1	45.6	66.3	91.7
<i>U07</i>	<i>0.72</i>	<i>0.97</i>	<i>3.42</i>	<i>1.17</i>	<i>113</i>	<i>101</i>	<i>0.29</i>	<i>13.5</i>	<i>13.1</i>	<i>9.17</i>	<i>76.5</i>	<i>0.60</i>	<i>0.99</i>	<i>3.57</i>	<i>1.08</i>	<i>100</i>	<i>38.3</i>	<i>0.26</i>	<i>12.7</i>	<i>9.61</i>	<i>8.67</i>	<i>76.5</i>
L00	0.16	6.51	0.17	8.25	42.3	29.9	2.74	23.2	10.62	71.1	30.7	nd	nd	nd	nd	nd	nd	nd	nd	nd	nd	nd
L01	0.33	9.93	0.34	12.6	76.8	24.9	1.26	38.9	22.54	101	71.4	0.28	7.77	0.32	8.40	53.8	15.3	3.56	26.0	14.9	73.4	46.6
L03	0.24	4.97	0.32	6.16	44.0	15.6	0.86	21.1	19.9	50.9	59.8	0.28	7.64	0.32	8.38	58.8	24.4	1.00	30.9	28.4	73.6	78.9
L06	0.44	4.11	0.56	4.54	25.7	60.4	1.06	31.7	54.4	23.9	136	nd	nd	nd	nd	nd	nd	nd	nd	nd	nd	nd
L08	0.29	1.86	0.87	2.40	23.6	21.2	0.40	7.2	23.5	14.7	78.4	nd	nd	nd	nd	nd	nd	nd	nd	nd	nd	nd
<i>L09</i>	<i>2.80</i>	<i>3.61</i>	<i>6.45</i>	<i>5.21</i>	<i>219</i>	<i>97.9</i>	<i>1.47</i>	<i>31.8</i>	<i>46.6</i>	<i>30.5</i>	<i>291</i>	<i>0.51</i>	<i>0.89</i>	<i>0.62</i>	<i>0.97</i>	<i>32.9</i>	<i>14.7</i>	<i>0.39</i>	<i>7.7</i>	<i>10.7</i>	<i>9.47</i>	<i>38.0</i>

< less than the limit of detection (Table 1)

Thorium is known as a good tracer of the transport and source of mineral particles in the suspended sediments and makes associations with trace metals (Coynel et al, 2007). This element has a low solubility (van Calsteren and Thomas, 2006) almost totally associated with detritus minerals, i.e. independent from anthropogenic contamination, and inversely related with the grain size of the sediments. Thus, normalizing of metal concentrations by  $^{232}\text{Th}$  in the same samples allows decoupling the variability of particulate element concentrations from the grain size distribution or mineralogical effects (Masson et al, 2009). The coefficient of variation (e.g. Reimann and De Caritat, 2005) for Th (30%) was less than for other measured elements, i.e. Ag (117%), As (84%), Cr (117%), Cu (127%), Ni (61%), Pb (95%) and Zn (91%) in the sediments of the Lopan and Udy Rivers, that show the low natural variability of the referenced element compare to the ‘contaminant’ elements of interest (Reimann and De Caritat, 2005). The environmental mobility of Th is very low (Reimann and De Caritat, 1998), and controls the influence of the natural processes on the distribution of the elements in the sediments (Reimann and De Caritat, 2005). Another important factor is the absence of anthropogenic activity in the watershed (i.e. nuclear industry, coating of optical lenses) that can be responsible for the Th – pollution (Reimann and De Caritat, 1998).

Hereby, Th-normalized values were used to calculate enrichment factors (EF). Data on the Earth’s crust composition proposed by Vinogradov (1962) was used as regional reference baseline (Yaroshevsky, 2006) for the study area. Arsenic, Co, Hg, Mo, Ni and V had EF <10 and can be considered as elements without important enrichment at the sampling sites for both the Lopan and Udy Rivers (Table 4).

Other elements like Ag, Cr, Cu, Pb and Zn showed no enrichment at the sites upstream from the urban area (L00-L03; U00-U04), but within the urban area the enrichment factors of these elements ranged from 10 to 100, reflecting medium enrichment. The highest EF of Ag, Cr, Cu and Zn occurred at the sites downstream of the wastewater discharges of ‘D’ WWTP and ‘B’ WWTP. Lead showed the highest value (EF=10) at the site L06 in the city centre, where it possibly can enter with the run – off and atmospheric deposition from the traffic routes.

Results show that the studied elements are associated to the regional geochemical baseline upstream of the urban area. In contrast, the increase in EF of Ag, Cd, Cr, Cu, Pb, and Zn within the urban area indicates that these elements have an anthropogenic origin in the sediments which can be mainly attributed to municipal wastewater treatment effluents and urban run-off (Schäfer et al, 2009; Suthar et al, 2009).

Table 4. Enrichment factors (EF) calculated for the trace elements in sediments based on the Th-normalized values.

Site	Ag	As	Co	Cr	Cu	Hg	Mo	Ni	Pb	V	Zn
<i>May 2009</i>											
L00	2.9	1.8	0.7	0.8	0.9	0.2	2.4	0.4	0.9	1.0	0.7
L01	3.8	1.7	0.7	0.9	0.5	0.1	0.7	0.5	1.3	0.9	1.0
L03	5.7	1.8	0.7	1.1	0.7	0.2	1.0	0.5	2.4	0.9	1.8
L06	16.1	2.3	0.8	0.9	3.9	1.7	1.9	1.2	10.0	0.7	6.2
L08	15.9	1.6	0.7	1.3	2.1	0.7	1.1	0.4	6.5	0.6	5.4
L09	89.0	1.7	0.8	7.0	5.5	2.4	2.3	1.1	7.4	0.7	11.6
U00	3.5	2.2	0.9	0.9	0.5	0.1	0.5	0.6	1.3	1.0	1.1
U01	4.1	2.8	1.2	0.9	0.5	0.2	0.8	0.6	1.5	0.9	1.1
U04	5.3	3.9	1.0	0.9	0.4	0.1	2.0	0.3	2.3	1.1	0.8
U06	11.3	2.0	0.7	1.6	1.1	1.0	0.9	0.6	2.9	0.9	3.3
U07	76.5	1.6	0.6	12.0	18.8	1.9	1.5	1.5	6.9	0.7	10.1
<i>August 2009</i>											
L01	4.6	1.9	0.7	0.9	0.4	0.1	2.9	0.5	1.2	0.9	1.0
L03	4.5	1.9	0.7	1.0	0.7	0.2	0.8	0.5	2.3	0.9	1.6
L09	53.0	1.4	0.5	3.4	2.7	3.3	2.0	0.8	5.6	0.8	5.0
U01	4.2	2.0	0.8	0.8	0.5	0.2	0.5	0.5	1.3	0.9	0.8
U04	5.9	2.0	1.2	1.0	0.6	0.1	2.2	1.1	1.8	1.1	1.1
U06	10.9	2.5	0.9	2.0	1.4	0.7	1.0	0.6	4.5	1.0	3.8
U07	67.7	1.7	0.6	11.4	7.6	1.9	1.5	1.5	5.5	0.8	11.0

Silver was the element with the highest enrichment factor (EF from 53.0 - 89.0) in both rivers downstream of the wastewater discharges (L09 and U07). The highest accumulation of Ag in urban sediments confirms the use of Ag as an urban tracer, supported by its low crustal abundance and the variety of sources in urban catchments like photo-processing or dentistry (Feng et al, 1998), and wastewaters (Guevara et al, 2005; Lancelleur et al, 2011).

The Pearson's correlation between Th-normalized values has been determined between targeted trace elements (n=5, p<0.05). The relationship between Ag, Pb, Cd, Cu, Cr and Zn concentrations leads to the understanding that municipal wastewater inputs essentially contribute to the accumulation of these elements in sediments from the urban area (Table 5 and Table 6). Other additional sources of trace metals in water can be roofs (Zn) and traffic (Cu, Cd and Pb) (Ayrault et al, 2010).

Table 5. Pearson correlation matrix of Th-normalized values of trace elements in the sediments of the Udy River (n=5, p&lt;0.05)

May August	V	Cr	Co	Ni	Cu	Zn	As	Mo	Ag	Cd	Pb	Hg
V	1	-0.73	<b>0.97</b>	-0.27	-0.72	-0.68	0.58	0.50	-0.72	-0.72	-0.45	-0.77
Cr	-0.76	1	-0.78	0.81	<b>0.99</b>	<b>0.98</b>	-0.63	0.16	<b>0.99</b>	<b>0.99</b>	0.79	<b>0.90</b>
Co	0.48	-0.68	1	-0.29	-0.78	-0.78	0.44	0.48	-0.78	-0.78	-0.63	<b>-0.86</b>
Ni	-0.86	<b>0.97</b>	-0.67	1	0.81	0.76	-0.69	0.70	0.82	0.82	0.53	<b>0.88</b>
Cu	-0.76	<b>0.99</b>	-0.66	<b>0.97</b>	1	<b>0.99</b>	-0.62	0.16	<b>0.99</b>	<b>0.99</b>	0.80	<b>0.89</b>
Zn	-0.79	<b>0.98</b>	-0.78	<b>0.96</b>	<b>0.97</b>	1	-0.48	0.13	<b>0.98</b>	<b>0.98</b>	<b>0.89</b>	<b>0.97</b>
As	0.80	-0.61	0.77	-0.75	-0.60	-0.70	1	-0.25	-0.64	-0.66	-0.03	-0.73
Mo	0.20	0.34	-0.04	0.12	0.34	0.27	0.48	1	0.17	0.18	0.07	0.22
Ag	-0.76	<b>0.99</b>	-0.70	<b>0.97</b>	<b>0.99</b>	<b>0.99</b>	-0.61	0.35	1	<b>0.99</b>	0.79	<b>0.92</b>
Cd	-0.76	<b>0.99</b>	-0.66	<b>0.97</b>	<b>0.99</b>	<b>0.98</b>	-0.60	0.34	<b>0.99</b>	1	0.77	<b>0.89</b>
Pb	-0.69	<b>0.97</b>	-0.74	<b>0.91</b>	<b>0.97</b>	<b>0.98</b>	-0.56	0.45	<b>0.98</b>	<b>0.97</b>	1	<b>0.95</b>
Hg	-0.70	<b>0.98</b>	-0.80	0.73	<b>0.98</b>	<b>0.99</b>	-0.47	0.10	<b>0.98</b>	<b>0.97</b>	<b>0.89</b>	1

In both the Lopan and Udy Rivers, positive correlations of the Th-normalized values were observed between Ag, Cd, Cr, Cu, Hg, Ni, Pb and Zn in May (Pearson's criterion,  $r \geq 0.80$ ) and in August ( $r \geq 0.70$ ). The spatial patterns of this element group are negatively correlated with those of V and Co ( $r \geq -0.70$ ) and As ( $r \geq -0.60$ ) (Table 5 and Table 6). However, in the Lopan River in May, Co had some positive correlation ( $r \geq 0.72$ ) with As, Ni and Cu, and As with Co and Ni, that may reflect different sources e.g. run – off and groundwaters for these elements during high and low-flow periods.

Table 6. Pearson correlation matrix of Th-normalized values of trace elements in the sediments of the Lopan River (n=5, p&lt;0.05)

May August	V	Cr	Co	Ni	Cu	Zn	As	Mo	Ag	Cd	Pb	Hg
V	1	<b>-0.99</b>	<b>0.99</b>	<b>-0.99</b>	<b>-0.99</b>	<b>-0.99</b>	<b>0.99</b>	-0.04	<b>-0.99</b>	<b>-0.99</b>	<b>-0.98</b>	<b>-0.99</b>
Cr	-0.26	1	<b>-0.99</b>	<b>0.99</b>	<b>0.99</b>	<b>0.99</b>	<b>-0.99</b>	0.06	<b>0.99</b>	<b>0.99</b>	<b>0.98</b>	<b>0.99</b>
Co	-0.12	0.52	1	<b>-0.99</b>	<b>-0.99</b>	<b>-0.99</b>	<b>0.99</b>	-0.04	<b>-0.99</b>	<b>-0.99</b>	<b>-0.98</b>	<b>-0.99</b>
Ni	-0.48	0.50	<b>0.92</b>	1	<b>0.99</b>	<b>0.99</b>	<b>-0.99</b>	-0.10	<b>0.98</b>	<b>0.99</b>	<b>0.99</b>	<b>0.99</b>
Cu	-0.65	0.79	0.73	0.86	1	<b>0.99</b>	<b>-0.99</b>	-0.02	<b>0.99</b>	<b>0.99</b>	<b>0.99</b>	<b>0.99</b>
Zn	-0.70	0.85	0.57	0.73	<b>0.96</b>	1	<b>-0.99</b>	-0.06	<b>0.99</b>	<b>0.99</b>	<b>1.00</b>	<b>0.99</b>
As	-0.16	-0.18	0.72	0.74	0.32	0.10	1	0.01	<b>-0.99</b>	<b>-0.99</b>	<b>-0.99</b>	<b>-0.99</b>
Mo	-0.03	0.45	0.59	0.50	0.58	0.43	0.27	1	0.09	0.07	-0.15	0.07
Ag	-0.38	<b>0.99</b>	0.57	0.59	0.86	<b>0.92</b>	-0.09	0.48	1	<b>0.99</b>	<b>0.97</b>	<b>0.99</b>
Cd	-0.39	<b>0.99</b>	0.47	0.51	0.83	<b>0.91</b>	-0.19	0.45	<b>0.99</b>	1	<b>0.98</b>	<b>0.99</b>
Pb	<b>-0.89</b>	0.38	0.53	0.81	0.84	0.80	0.50	0.29	0.50	0.47	1	<b>0.97</b>
Hg	-0.63	0.79	0.76	0.88	<b>1.00</b>	<b>0.96</b>	0.35	0.56	<b>0.87</b>	0.83	0.83	1

Based on these observations, the studied metals can be divided into two principle groups:

Group I – Ag, Cd, Cr, Cu, Hg, Ni, Pb and Zn – the correlation between the Th-normalised concentrations of these metals is relatively strong in both rivers, suggesting a common source, transport mechanism and behaviour during different hydrological conditions. Enrichment factors of these elements significantly increases in the urban area compared to rural parts of the watershed. Peaks of Th-normalised values of Ag, Cr, Cu, Cd, Hg and Zn occurred at the sampling sites downstream of the wastewater discharges by municipal wastewater treatment plants. The anthropogenic components, estimated as the difference between the Th-normalized value of these elements in sediments at the sites downstream of the wastewater discharge (L09 and U07) and upstream of the urban area (L03 and U04) were: Ag 91-94 %, Cd 92-99 %, Cr 72-93 %, Cu 74-98 %, Hg 92-94 %, and Zn 68-92 % and were mainly attributed to wastewater discharge from the WWTPs of the Kharkiv urban agglomeration. The ‘B’WWTP and ‘D’ WWTP collect and treat mixed industrial, including galvanic and domestic wastewaters from the city and suburban areas, and the treatment processes seems to be not efficient to reduce the contamination of trace metals in raw waters as this wastewater treatment system has not been improved since the establishment of the treatment facilities during the Soviet period (1964 – 1971). The accumulation of Pb (anthropogenic component 60-76 %) and Ni (anthropogenic component 30-78 %) are probably related to urban run-off particles rather than wastewater effluents (Ohta et al, 2005; Schäfer et al, 2009; Ayrault et al, 2010). Our results on EF and anthropogenic components of metals in the sediments downstream of the wastewater treatment plants are in agreement with data of Vasenko et al (2006) reporting maximum Cr, Cu, Zn and Pb concentrations in the sediments of the Udy River in the Kharkiv city.

Group II – V, Co, As and Mo: these elements have generally negative correlations with the elements of the Group I. Thus, these elements have probably other sources, transport mechanism and behaviour than metals of the Group I. In fact, there are no clear enrichment of As, Co, Mo and V in the Udy and Lopan Rivers (EF <10) (Table 4). The stable spatial concentrations of dissolved Mo, V and Co (Table 3) are in agreement with the respective data for the sediments (Figure 2) and confirmed the mostly natural origin of these elements in the rivers with low anthropogenic inputs.

Accordingly, the first group (Ag, Cd, Cr, Cu, Hg, Ni, Pb and Zn) shows increased enrichment in sediments from the urban area with high anthropogenic components up to 99 % (Figure 2).

The second group (As, V, Mo and Co) relates mostly to the regional geochemical baseline of the sediments with a very low enrichment in the urban area.

#### *4.3. Baseline of trace metals in the sediments*

Due to the long term anthropogenic exploitation of the Seversky Donets watershed, it is difficult to find a truly pristine area. Therefore the baseline can be established as the expected range of element concentrations in sediments samples in an area without any geochemical anomalies (Williams et al, 2000; Singh et al, 2003; Njofang et al, 2007).

Results of the sediments Th-normalization at the transboundarian upstream of the urban area sites showed that upstream influences can be neglected compare to the impact of the Kharkiv urban area on the geochemistry of the Udy and Lopan Rivers. Accordingly, we propose present-day baseline values using the 75% quartile (Njofang et al, 2007) of Th-normalized values obtained for the sites upstream of the urban area (Table 7).

The Th-normalized values of Ag, As, Cd, Mo and Pb were higher compared to the Th-normalized value of the Earth's crust proposed by Vinogradov (1962). Other Th-normalized trace elements (Co, Cr, Cu, Zn and V) values were in agreement with the crust value. The comparison of Th-normalized values gained through this study with the Th-normalized values of the world sediments (Reimann and De Caritat, 1998) showed that the proposed baseline values for Ag, As, Cr, Cu, Mo, Ni, Zn and V are higher than the world sediments composition. The values for Co and Hg are at the same level.

#### *4.4. Trace elements in the water and sediments during contrasted hydrological conditions*

In both rivers, low variations of dissolved As, Ni and Pb concentrations were observed during contrasted hydrological conditions, that can relate to the decreasing of the dilution process during August and the reduction of trace metals sources and microbial activity (Audry et al, 2004; Beck and Wilhelmy, 2007; Masson et al, 2010). The increase in dissolved As in August, can be additionally attributed to the discharge-independent, temperature-related (>15°C in surface water) microbial As mobilisation previously reported for different rivers in South West France (Masson et al, 2007 and 2009). This is consistent with stable dissolved As concentrations in May (<15°C in surface water) at all river sites what is in agreement with the As patterns in sediments.

The  $C_{DGT}$  of Cu was higher in the Lopan Rivers in August, than in May (Table 3), but at the same time the total dissolved Cu shows low variation. Both elements have been shown to be released to the water column by microbial activity. The release of labile Cu from suspended particles/colloids or/and bottom sediments is favoured by high water temperature and goes along with decreasing levels of dissolved oxygen (Masson et al, 2010).

#### *4.5. Environmental risks assessment of metal concentrations in sediments*

The environmental risks assessment of metal levels in the studied sediments was performed for the sites located upstream of Kharkiv city (L03 and U04), central Kharkiv city (L06 and U06) and the sites downstream of the wastewater discharges (L09 and U07), which are also within the urban area with a high population density.

For this, we compared metal concentrations in the studied sediments to the respective threshold effect concentration (TEC) and the probable effect concentration (PEC) (Table 8). At the sites upstream of Kharkiv city only Cr exceeded TEC in the Lopan River (L03). In the central part of Kharkiv city Cu exceeded TEC in the Lopan River (L06) in May and in the Udy River (U06) in August. Chromium levels in the Udy River sediments (U06) exceeded TEC in May and PEC in August. In the downstream Lopan River (L09), Cd levels exceeded PEC in May. The estimates of *m-PEC-Q* showed that metal concentrations in the sediments must be considered as potentially dangerous for the environment at the site L09 (Lopan River, May) (*m-PEC-Q=0.75*).

According to the scale of the Ukrainian environmental risk assessment protocol (Saet et al, 1990), the results of the environmental risk assessment in May were in agreement with these for August for all sampling sites, except the site L09, where the observed difference probably reflects either sediment heterogeneity and/or grain size effect. This confirms the necessity to normalize the data in order to avoid the discrepancy. Other results of the Ukrainian approach were consistent with the assessment calculated using the Sediment Quality Guideline. The contamination of the studied sediments by metals varies from 'moderate' upstream of the city area to 'dangerous' downstream of Kharkiv city. In the city area the risk was estimated as 'significant' (L06; L08 and U06; May) and 'very high' (U06; August). Downstream of the wastewater treatment discharges, the degree of sediment pollution by metals was evaluated as 'very high' (Udy River; U06) and 'dangerous' (Lopan River; L09).



Table 8. Environmental risk assessment for the sediments (not normalized) of the Lopan and Udy Rivers

mg kg <sup>-1</sup>	As	Cd	Cr	Cu	Hg	Ni	Pb	Zn	m-PEC-Q	Z <sub>c</sub>	ER <sup>1</sup>
<b>May 2009</b>											
L03	4.97	0.32	44.0	15.6	0.03	21.1	19.9	59.8	0.18	11	moderate
L06	4.11	0.56	25.7	60.4	0.18	31.7	54.4	136	0.30	29	significant
L08	1.86	0.87	23.6	21.2	0.05	7.2	23.5	78.4	0.14	30	significant
L09	3.61	6.45	219	97.9	0.30	31.8	46.6	291	0.75	235	dangerous
U04	3.19	0.06	11.4	3.1	0.01	3.9	5.8	8.3	0.05	2	moderate
U06	4.52	0.72	54.2	21.5	0.14	18.9	19.8	91.7	0.22	30	significant
U07	0.97	3.42	113	101	0.07	13.5	13.1	76.5	0.38	118	very high
<b>August 2009</b>											
L03	7.64	0.32	58.8	24.4	0.05	30.9	28.4	78.9	0.26	13	moderate
L09	0.89	0.62	32.9	14.7	0.13	7.7	10.7	38.0	0.12	26	significant
U04	1.68	0.18	12.4	4.5	0.01	13.3	4.4	11.0	0.07	6	moderate
U06	8.47	1.89	101	39.9	0.14	30.1	45.6	154	0.41	72	very high
U07	0.99	3.57	100	38.3	0.07	12.7	9.6	77.5	0.31	122	very high
<b>Sediment quality guidelines and crust values</b>											
TEC <sup>2</sup>	9.79	0.99	43.4	31.6	0.18	33.7	35.8	121	-	-	-
PEC <sup>2</sup>	33	4.98	111	149	1.06	48.6	128	459	-	-	-
C <sup>3</sup>	6.6	0.03	100	57	0.02	95	20	80	-	-	-

<sup>1</sup>ER - Environmental risk estimated according to Saet et al. (1990); <sup>2</sup>TEC, PEC - the consensus-based threshold and probable effect concentrations; <sup>3</sup>C - Baseline was taken according to the data on the crust value by Vinogradov (1962)

Based on these environmental risk assessments the studied rivers can be divided into three parts: (1) low risk for the slightly contaminated upstream reaches (L03 and U04); (2) medium risks for central urban area (L06 and U06) and (3) high risk in the reaches downstream of the wastewater discharges (L09 and U07). High Cr and Zn levels mainly contribute to bad sediment quality at the sites downstream from the wastewater treatment plants. The bad sediment quality in the urban area reflects the historical and continued use of the Lopan and Udy Rivers as recipients for the discharge of polluted wastewaters.

## 5. Conclusions

The results of the study showed that the distribution of trace elements in water and sediments of the Lopan and Udy Rivers of the Seversky Donets basin exhibits spatial variations. The analysis of labile dissolved and dissolved metals concentration in water and Th-normalized

concentrations of metals in sediments indicates that the Kharkiv city area is the major source of Ag, Cd, Cr, Cu, Hg, Ni, Pb and Zn into the rivers. Based on the environmental risks assessment of the trace metals in the sediments, the rivers were divided into three parts: (i) low risk - relatively clean part in upper sites; (ii) medium risks - urban polluted area and (iii) high risk part in the sites downstream of the wastewater discharges. The highest accumulation was observed for Ag with a contamination along all water courses with a maximum in sampling sites located downstream from wastewater discharges. Ag shows strong correlation with other elements of anthropogenic origin and can be used as a reliable urban tracer. In order to make the first step towards the development of sediment quality guideline of the rivers within the Seversky Donets watershed, the present-day baseline concentration of the trace elements in the sediments was proposed based on the Th-normalized values. For the new environmental data collection and the development of the water monitoring strategy in Ukraine, the proposed method of sampling (i.e. combination of grab and passive water monitoring and sediments analysis) and data interpretation (i.e. Th – normalization, estimation of EF and trace elements baseline) can be applied to the rivers with similar hydrological and geochemical characteristics.

This study is a part of the pilot integrative research on the urban rivers of the industrial East Ukraine region. For the presentation of a first overview about the distribution of the elements in the watershed, the sampling was limited just to two campaigns. But for the further understanding of the presence of different forms of elements, mixing - dilution processes, continuous monitoring and replication should be carried out in contrasted seasonal and hydrological conditions at the same and additional sites with the application of active and passive sampling for the long – term and diurnal investigations.

### **Acknowledgements**

This research was conducted in the framework of the International Collaborative Programme “Partenariat Hubert Curien DNIPRO” (Grant N° 19744VJ 2009/2010) with the financial support from both the French Ministry of Foreign Affairs and the Ukrainian Ministry of Education and Science. Some authors have been granted by the European Union through the ERASMUS MUNDUS External Cooperation Window Programme (Lot 6/7 - Belarus, Moldova and Ukraine) and by the Embassy of France to Ukraine (Bourse de Court Séjour de Recherche).

Table 7. Summary of the statistics of the Th-normalized baseline values of trace elements in the sediments of the Udy and Lopan Rivers, in the sites upstream of the urban area (L00; L01; L03; U00; U01 and U04).

Parameter	Ag/Th	As/Th	Cd/Th	Co/Th	Cr/Th	Cu/Th	Hg/Th	Mo/Th	Ni/Th	Pb/Th	V/Th	Zn/Th
Average value*	0.04	1.32	0.05	1.59	8.27	3.03	0.01	0.25	4.77	2.98	11.4	8.03
Standard deviation	0.01	0.39	0.03	0.36	0.75	0.79	0.002	0.16	1.81	0.96	1.06	2.52
Geometric value*	0.04	1.28	0.05	1.56	8.24	2.95	0.01	0.21	4.54	2.84	11.3	7.71
Maximum value	0.05	2.31	0.13	2.19	9.61	4.84	0.01	0.54	9.57	4.36	13.2	13.1
Minimum value	0.03	1.05	0.03	1.25	6.85	2.22	0.003	0.09	2.83	1.72	10.1	4.98
Median value	0.04	1.19	0.04	1.44	8.19	2.72	0.01	0.17	4.37	2.59	11.1	7.69
25% quartile	0.04	1.10	0.04	1.33	8.07	2.56	0.005	0.14	3.96	2.30	10.7	6.36
75% quartile (baseline)	<b>0.05</b>	<b>1.32</b>	<b>0.06</b>	<b>1.83</b>	<b>8.66</b>	<b>3.38</b>	<b>0.01</b>	<b>0.39</b>	<b>4.91</b>	<b>3.95</b>	<b>11.8</b>	<b>8.00</b>
Crust value <sup>1</sup>	0.01	0.06	0.003	1.82	9.09	5.18	0.04	0.18	8.64	1.82	11.82	7.27
World sediments values <sup>2</sup>	0.01	0.16	0.14	1.18	5.04	1.50	0.01	0.06	2.36	-	0.08	6.30

<sup>1</sup>Crust value, proposed by Vinogradov (1962)

<sup>2</sup>World sediments, according to Reimann and Caritat (1998)

\*Average value (mean) considers that each value is independent from the others; geometric value (mean) considers that each value is dependent on the others

Figure 2. The distribution of trace metals in the sediments of Lopan and Udy Rivers

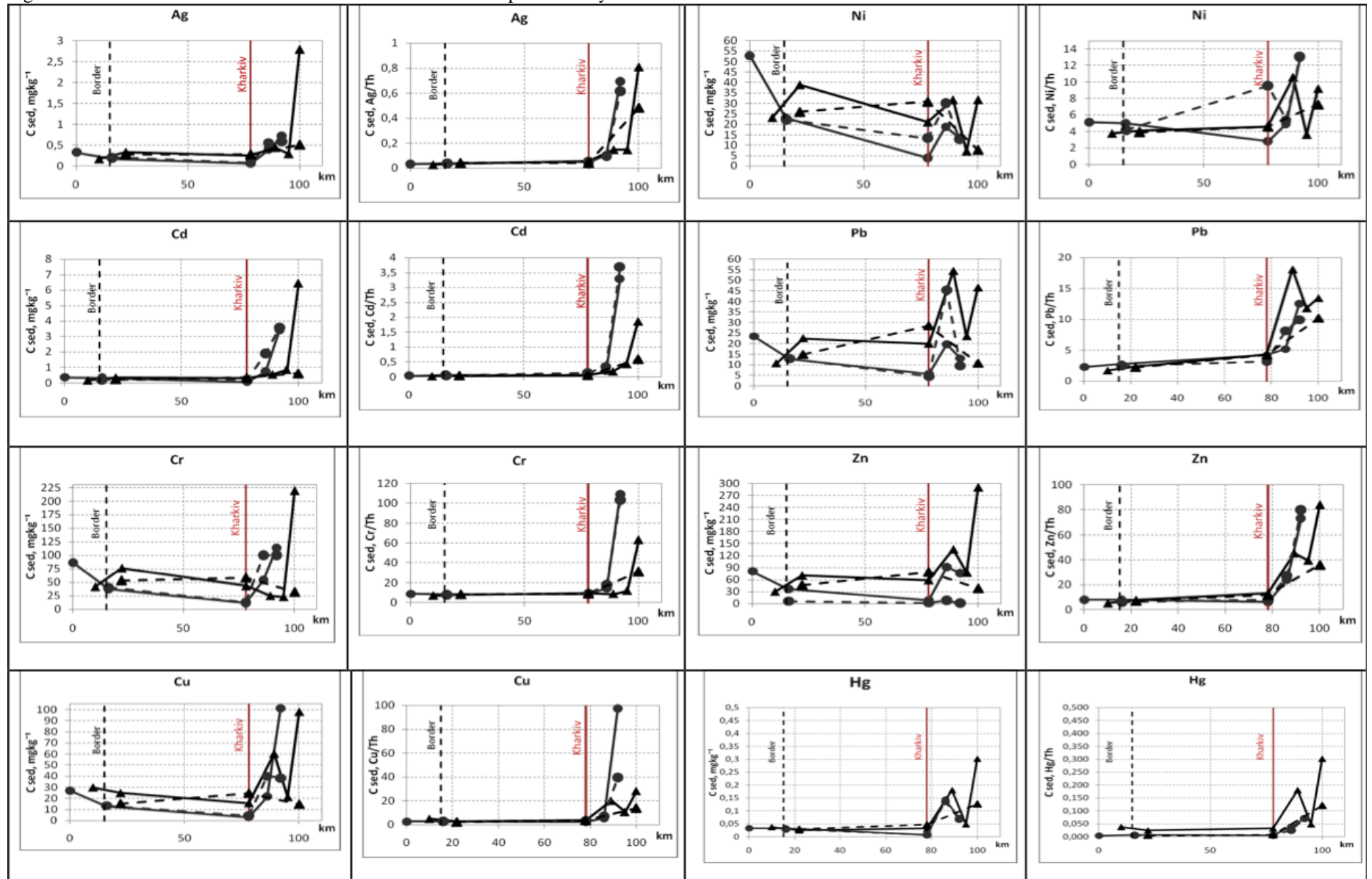

Udy R., August

Lopan R., May

## References

- Audry, S., Schäfer, J., Blanc, G., Bossy, C., Lavaux, G., 2004. Anthropogenic components of heavy metal (Cd, Zn, Cu, Pb) budgets in the Lot – Garonne fluvial system (France). *Appl. Geochem.* 19, 769-786.
- Ayrault, S., Senhou, A., Moskura, M., Gaudry, A., 2010. Atmospheric trace element concentration in total suspended particles near Paris, France. *Atmospheric Pollution* 44, 3700 – 3707.
- Beck A. J., Sanudo-Wilhelmy S. A., 2007. Impact of water temperature and dissolved oxygen on copper cycling in an urban estuary. *Environ. Sci. Technol.* 41, 6103-6108.
- Belykh, V.I., Dunai, E.I., Lugovaya, I.P., 2007. Physicochemical formation conditions of banded iron formations and high-grade iron ores in the region of the Kursk Magnetic Anomaly: Evidence from isotopic data. *Geology of Ore Deposits* 49 (2), 147-159 (in Russian).
- Binelli, A., Sarkar, S.K., Chatterjee, M., Riva, C., Parolini, M., Bhattacharya, B.D., Bhattacharya, A.K., Satpathy, K.K., 2008. A comparison of sediment quality guidelines for toxicity assessment in the Sunderban wetlands (Bay of Bengal, India). *Chemosphere* 73 (7), 1129-1137.
- Caruso, B. S., Bishop M., 2009. Seasonal and spatial variation of metal loads from natural flows in the upper tenmile greek watershed, Montana. *Mine Water Environ.* 28 (3), 166-181.
- Casado – Martinez, M.C., Buceta, J.L., Belzunce, M.J., Del Valls, T.A., 2006. Using sediment quality guidelines for dredged material management in commercial ports from Spain. *Environ. Int.* 32, 388-396.
- Choueri, R.B., Cesar, A., Abessa, D.M.S., Torres, R.J., Morais, R.D., Riba, I., Pereira, C.D.S., Nascimento, M.R.L., Mozeto, A.A., DelValls, T.A., 2009. Development of site-specific sediment quality guidelines for North and South Atlantic littoral zones: Comparison against national and international sediment quality benchmarks. *J. Hazad. Mater.* 170, 320-331.
- Coyne, A., Schäfer, J., Blanc, G., Bossy, C., 2007. Scenario of particulate trace metal transport during a major flood event inferred from transient geochemical signals. *Appl. Geochem.* 22:821-836.
- Denney, S., Sherwood, J., Leyden, J., 1999. In situ measurements of labile Cu, Cd and Mn in river waters using DGT. *Sci. Total Environ.* 239, 71-80.
- DGT Research, 2002. DGT for measurements in water, soils and sediments. DGT Research Ltd., Lancaster.
- EPKhr, 2008. Environmental passport of the Kharkiv region. Ministry of the Environmental Protection. Ukraine, 2008. <http://www.menr.gov.ua/cgi-bin/go?node=HAREko> (in Ukrainian, accessed on 1 March 2010).
- Feng, H., Cochran, J. K., Lwiza, H., Brownawell, B. J., Hirschberg, D.J., 1998. Distribution of heavy metals and PCB contaminants in the sediments of an urban estuary: the Hudson River. *Mar. Environ. Res.* 45 (1), 69-88.
- Ferreira, J.R., Fernandes, E.A.N., Franca, E.S., Tavares, G.A., Da Silva, N.C., Taddei, M.H.T., 2006. Rare earth elements in sediment profiles from marginal lagoons of the Moji-Guacu River Basin, Brazil. *J. Radioanal. Nucl. Chem.* 270 (1), 15-20.
- Gimpel, J., Zhang, H., Davison, W., Edward, A., 2003. In situ trace metal speciation in lake surface waters using DGT, dialysis and filtration. *Environ. Sci. Technol.* 37, 137-146.
- Guevara, S.R., Arribere, M., Bubach, D., Vigliano, P., Rizz, A., Alonso, M., Sancher, R., 2005. Silver contamination on abiotic and biotic compartments of Nahuel Huapi National Park lakes, Patagonia, Argentina. *Sci. Total Environ.* 336, 119-134.
- Gupta, A., Rai, D.K., Dandey, R.S., Sharma, B., 2009. Analysis of some heavy metals in the riverine water, sediments and fish from river Ganges at Allahabad. *Environ. Monit. Assess.* 157.-449-458.
- GCPL 1991: General code of permitted limits and presumable save levels of impacts of hazardous substances in the waters use for fishery (in Russian).
- van Hattum, D., van Straalen, N. M., Govers, H.A.J., 1996. Trace metals in populations of fresh isopods: influence of biotic and abiotic variables. *Arch. Environ. Contam. Toxicol.* 31, 303-318.
- Ingersoll, C.G., MacDonald, D.D., Wang, N., Crane, J.L., Field, L.J., Naverland, P.S., Kemple, N.E., Lindskoog, R.A., Severn, C., Smorong, D.E., 2001. Predictions of sediment toxicity using consensus based freshwater sediment quality guideline. *Arch. Environ. Contam. Toxicol.* 41, 8-21.

- Jakovljević, V.V., Svirenko, L.P., Chebanov, O.J., Spirin, O.I., 2002. Rising Groundwater Levels in North-Eastern Ukraine: Hazardous Trends in Urban Areas. In: Current Problems of Hydrogeology in Urban Areas, Urban Agglomerates and Industrial Centres. /Eds. K.W.F. Howard & R.F. Israfilov. – Dordrecht: Kluwer Acad. Publ. - P. 221-241 (NATO ARW Series).
- Lambing, J.H., Nimick, D.A., Cleasby, T.E., 2004. Short term variation of trace element concentrations during base flow and rainfall run – off in small basins, August 1999. US Geological Survey Professional Paper 1652, 263 – 278.
- Lanceleur, L., Schäfer, J., Bossy, C., Coynel, A., Larrose, A., Masson, M., Blanc, G., 2011. Silver fluxes to the Gironde Estuary - Eleven years (1999–2009) of monitoring at the watershed scale. *Appl Geochem.* 26, 797 – 808.
- Larrose, A., Coynel, A., Schäfer, J., Blanc, G., Massé, L., Maneux, E., 2010. Assessing the current state of the Gironde Estuary by mapping priority contaminants distribution and risk potential in surface sediment. *Appl Geochem.* 25, 1912 – 1923.
- MacDonald, D.D., Ingersoll, C.G., Berger, T.A., 2000. Development and evaluation of consensus-based sediment quality guidelines for freshwater ecosystems. *Arch. Environ. Contam. Toxicol.* 39, 20-31.
- Masson M., Schäfer J., Blanc G., 2007. Seasonal Variations and Annual Fluxes of Arsenic in three contrasting watersheds: the Garonne, Dordogne and Isle Rivers. *Sci. Total Environ.* 373, 196-207.
- Masson, M., Schäfer, J., Blanc, G., Dabrin, A., Castelle, S., Lavaux, G., 2009. Behavior of arsenic and antimony in the fresh water reaches of a highly turbid estuary, the Gironde Estuary, France. *Appl. Geochem.* 24, 1747-1759.
- Masson M., Blanc G., Schäfer J., Parlanti E., Le Coustumer P., 2011. Copper addition by organic matter degradation in the freshwater reaches of a turbid estuary. *Sci. Total Environ.* 409, 1539 - 1549
- Matache, M.L., David, I. G., Matache, M., Ropota, M., 2009. Seasonal variation in trace metals concentrations in the Ialomita River, Romania. *Environ. Monit. Assess.* 153. 273-279.
- Neumann, K., Berry Lyons, W., Graham, E.Y., Callender, E., 2005. Historical backcasting of metal concentrations in the Chattahoochee River, Georgia: population growth and environmental policy. *Appl. Geochem.* 20. 2315-2324.
- Nimick, D.A., Cleasby, T.E., McCleskey, R.B., 2005. Seasonality of diel cycles of dissolved trace metals concentrations in a Rocky Mountain. *Environmental Geology* 47 (5), 603 – 614.
- Njofang, C., Matschullat, J., Tchouankoue, J.P., Amougou, A., 2007. Contribution to the geochemistry of trace elements in the sediments of the Noun River and tributaries, Western Cameroon. *Pakistan Journal of Biological Science* 10 (18), 3048-3056.
- NRDW 2006: National Report on drinking water quality and supply in 2006 year. [http://www.minjkg.gov.ua/editattach/bigdoc/nd\\_voda2006.doc](http://www.minjkg.gov.ua/editattach/bigdoc/nd_voda2006.doc) (in Ukrainian, accessed on 1 March 2010).
- Ohta, A., Imai, N., Terashima, S., Tachbana, Y., 2005. Application of multi-element statistical analysis for regional geochemical mapping in Central Japan. *Appl. Geochem.* 20, 1017-1037.
- Pekey H., 2006. The distribution and sources of heavy metals in Izmit Bay surface sediments affected by a polluted stream. *Mar. Pollut. Bull.* 52, 1197-1208.
- Reimann, C., De Caritat, P., 1998. Chemical elements in the environment: Factsheets for the Geochemists and Environmental Scientist. Springer-Verlag Berlin Heidelberg. Printed in Germany – 400p.
- Reimann, C., De Caritat, P., 2005. Distinguishing between natural and anthropogenic sources of elements in the environment regional geochemical survey versus enrichment factors. *Sci. Tot. Environ.* 337, 91 – 107.
- Saet, Y., Revych, B.A., Yanyn, E.P. Environmental Geochemistry. Published by “Nedra” in Moscow, 1990.- 335pp. (in Russian)
- Samarina, V.P., 2003. The effect of mining and smelting plant on the dynamics of heavy metals in small river basins in the zone of Kursk-Belgorod Magnetic Anomaly. *Water Resour.* 30 (5), 596-604.
- Samarina, V.P., 2007. Assessment of the impact of economic activity on the degree of overland flow contamination in the zone of the Kursk-Belgorod Magnetic Anomaly: Case study of the Oskol River. *Water Resour.* 34 (5), 549-553.

- Samarina, V.P., 2008. Effect of engineering-industrial activities in the region of the Kursk Magnetic Anomaly on the ecological state of the river waters. *Geochem. Int.* 46 (9), 928-934.
- Schäfer, J., Blanc, G., 2002. Relationship between ore deposits in river catchments and geochemistry of suspended particulate matter from six rivers in southwest France. *Sci. Total Environ.* 298, 103-118.
- Schäfer J., Blanc G., Audry S., Cossa D., Bossy C. 2006. Mercury in the Lot-Garonne River system (France). Sources, fluxes and anthropogenic component. *Appl. Geochem.* 21, 515-527
- Schäfer, J., Norra, S., Klein, D., Blanc, G., 2009. Mobility of trace metals associated with urban particles exposed to natural waters of various salinities from the Gironde Estuary, France. *J. Soils Sediments* 9, 374-392.
- Singh, M., Muller, G., Singh, I.B., 2003. Geogenic distribution and baseline concentration of heavy metals in sediments of the Ganges River, India. *J. Geochem. Explor.* 80, 1-17.
- SNPL 1991: Sanitary norms of permitted limits of hazardous substances contents in the waters use for drinking and municipal water use (in Russian).
- Srisuksawad, K., Porntepkasemsan, B., Nouchpramool, L. S., Yamkate, P., Carpenter, R., Peterson, M.L., Hamilton, T., 1997. Radionuclide activities, geochemistry and accumulation rate of sediments in the Gulf of Thailand. *Contin. Shelf Res.* 17 (8), 925-965.
- Suthar S., Nema, A.K., Chabukdhara, M., Gupta, S.K., 2009. Assessment of metals in water and sediments of Hindon River, India: Impact of industrial and urban discharges. *J. Hazad. Mater.* 171, 1088-1095.
- Svirenko, L., Vergeles, Y., Jakovlev, V., 2003. Metal accumulation in soils and vegetation of river valleys in the city of Kharkiv, Ukraine. SUITMA 2003: Soils of Urban, Industrial, Traffic and Mining Areas: Final Program and Abstract Book. – Nancy, France, July 9-11, 2003.
- Tueros, I., Borja, A., Larreta, J., Rodriguez, J.G., Valencia, V., Millan, E., 2009. Integrating long-term water and sediment pollution data, in assessing chemical status within the European Water Framework Directive. *Mar. Pollut. Bull.* 58, 1389-1400.
- Tusseau-Vuillemin, M.-H., Gourlay, C., Lorgeoux, C., Mouchel, J.-M., Buzier, R., Gilbin, R., 2007. Dissolved and bioavailable contaminants in the Seine River basin. *Sci. Total. Env.* 375 (1-3), 244 – 256.
- van Calsteren, P.V.C., Thomas, L., 2006. Uranium-series dating applications in natural environmental science. *Earth-Sci. Rev.* 75, 155–175.
- Vasenko, O.G., Lungu, M.L., Iljevskaja, Y.A., Klymov, O.V. et al., 2006: Research report. The integrated field research of environmental conditions of water bodies of the Udy water basins (sub-basin of the Seversky Donets River)/ “Rayder” Publ., Kharkiv, 156 p. (in Ukrainian).
- Vinogradov, A.P., 1962. Average element abundances in main types of eruptive rocks in the Earth’s crust. *Geokhimiya* 7, 555-571 (in Russian).
- Vystavna, Y., Huneau, F., Le Coustumer, P., 2009. Monitoring of biologically active metals forms in surface water : the results of passive sampling in the rivers of Ukraine and France. Moscow: *Water: Chemistry and Ecology* 12, 2-9 pp. (in Russian).
- Williams, T.M., Dunkley, P.N., Cruz, E., Acitimbay, V., Gaibor, A., Lopez, E., Baez, N., Aspden, J.A., 2000. Regional geochemical reconnaissance of the Cordillera Occidental of Ecuador: economic and environmental applications. *Appl. Geochem.* 15, 531-550.
- Yaroshevsky, A.A., 2006. Abundances of chemical elements in the Earth’s crust. *Geoch. Int.* 44 (1), 48-55.
- Zhang, H. and Davison, W., 1995. Performance characteristics of diffusive gradients in thin films for in situ measurement of trace metals in aqueous solution. *Anal. Chem.* 67 (19), 3391-3400.
- Zheng, N., Wang, Q., Liang, Z., Zheng, D., 2008. Characterization of heavy metal concentrations in the sediments of three freshwater rivers in Huludao Ctiy, Northeast China. *Environ. Pollut.* 154, 135-142

## Summary

Our results outlines the investigation of particulate, dissolved and labile forms of priority trace elements (As, Cd, Cr, Cu, Hg, Ni, Pb, and Zn), urban tracers (Ag) and additionally Co, Mo, V and Th in Ukrainian watershed, examines environmental determinants which impact their occurrence, distribution and accumulation, i.e.:

*the regional baseline and the elements enrichment* – the distribution and accumulation of elements was study in the riverine sediments and Th-normalized concentration was firstly proposed as regional baseline of the watershed and, therefore, gave us possibility to assess the natural and anthropogenic components of the water contamination, but also to consider the geochemical anomalies in watercourses;

*water chemistry and hydrological conditions* – the occurrence of elements was analyzed in water and sediments using the conventional and passive sampling techniques during low and high flow periods on rivers, that helps to identify the time – variation of the trace elements and outline the instream factors which influenced water chemistry and principle pollution sources.

Finally, the environmental risk has been assessed using Ukrainian and European approaches, that lets us the opportunity to make the first step towards the development the sediment quality guideline in Eastern Ukraine.

Proposed methods of the environmental data collection and interpretation can be applied to the rivers with similar hydrological and geochemical characteristics and provide the pilot geochemical information on particular regions.

Obtain results of the study on the environmental determinants became a base for the further proposal to use certain elements as anthropogenic indicators of the water pollution, that is described in the Chapter 7.



## CHAPTER VI

### SOCIO-ECONOMIC DETERMINANTS

The following research was generally focused on the study of the socio-economic determinants of water pollution. The subject of this part was the pharmaceuticals in natural waters, as these chemicals can have only anthropogenic origin and mostly link to the regional consumption patterns. Accordingly to the results on the passive water sampling and applying the general water monitoring strategy, as described in the Chapter 4, the selected sampling sites have been censored using the passive sampling technique, i.e. POCIS for the detection of pharmaceuticals in watercourses. The main objectives of this research were: (i) assess the passive sampling technique for the monitoring of the organic micro-pollutants in order to get the first data on pharmaceuticals in the Ukrainian environment; (ii) apply the water monitoring data for the interdisciplinary study. i.e. regional socio-economic characteristics; (iii) compare the consumption patterns of medicaments, what were estimated using the obtained water monitoring data, in the region with contrasted socio-economic conditions, i.e. Ukraine and France.

The result of this study is presented in the form of the article in press:

**Vystavna Y., Huneau F., Grynenko V., Vergeles Y., Celle – Jeanton H., Tapie N., Budzinski H., Le Coustumer P. 2012. Pharmaceuticals in rivers of two regions with contrasted socio-economic conditions: occurrence, accumulation and comparison for Ukraine and France. *Water, Air and Soil Pollution*. DOI 10.1007/s11270-011-1008-1**

Water Air Soil Pollut  
DOI 10.1007/s11270-011-1008-1

## Pharmaceuticals in Rivers of Two Regions with Contrasted Socio-Economic Conditions: Occurrence, Accumulation, and Comparison for Ukraine and France

Yuliya Vystavna & Frédéric Huneau & Volodymyr Grynenko & Yuri Vergeles & Hélène Celle-Jeanton & Nathalie Tapie & Hélène Budzinski & Philippe Le Coustumer

Received: 13 May 2011 / Accepted: 17 October 2011  
# Springer Science+Business Media B.V. 2012

**Abstract** The goal of our study was to identify pharmaceuticals, their potential sources and consumption level in two different socioeconomic and geographical regions—Bordeaux, France and Kharkiv, Ukraine. These substances were monitored in rivers water during contrasted seasonal conditions with application of passive samplers. The 21 pharmaceuticals

(psychiatric drugs: alprazolam, amitriptyline, diazepam, fluoxetine, nordiazepam, carbamazepine, bromazepam; analgesics: aspirin, paracetamol; bronchodilator: clenbuterol, salbutamol, terbutaline; non-steroidal anti-inflammatory drug: diclofenac, ibuprofen, ketoprofen, naproxen; lipid regulator: gemfibrozil; stimulants: caffeine, theophylline) were identified in sites upstream and downstream of urban areas and discharge of wastewaters. Caffeine, carbamazepine, and diclofenac were relatively abundant into the surface water and could be considered as potential anthropogenic markers of wastewater discharges into rivers. A mass balance

**Capsule abstract** This work (comparing two Ukrainian and French rivers) has demonstrated the successful application: (1) of passive samplers to monitor water quality, (2) of mass balance modeling to estimate drug consumption rates, and (3) of pharmaceuticals as potential indicators of wastewater treatment efficiency.

Y. Vystavna · F. Huneau · P. Le Coustumer  
UFR des Sciences de la Terre, Université de Bordeaux,  
B18, Avenue des Facultés,  
33405 Talence, France

H. Celle-Jeanton  
CNRS, UMR 6524, LMV,  
63038 Clermont-Ferrand, France

Y. Vystavna · F. Huneau · P. Le Coustumer  
EA 4592, Géoresources & Environnement,  
Institut EGID,  
1 Allée F. Daguin,  
33607 Pessac, France

H. Celle-Jeanton  
IRD, R 163, LMV,  
63038 Clermont-Ferrand, France

Y. Vystavna · V. Grynenko · Y. Vergeles  
National Academy of Municipal Economy at Kharkiv,  
Department of Environmental Engineering and Management,  
vul. Revolutsii 12,  
Kharkiv 61002, Ukraine

N. Tapie · H. Budzinski (✉)  
LPTC-EPOC CNRS UMR 5805, Université Bordeaux-1,  
351 Cours de la Libération,  
33405 Talence, France  
e-mail: h.budzinski@ism.u-bordeaux1.fr

H. Celle-Jeanton  
Clermont Université, Université Blaise Pascal,  
Laboratoire Magmas et Volcans,  
BP 10448, 63038 Clermont-Ferrand, France

Published online: 19 January 2012

 Springer

modeling has been applied to calculate approximate consumption rates for carbamazepine, diclofenac, and caffeine in both regions to assess socio-economic factors linked with pharmaceuticals behavior.

**Keywords** Emerging pollutants · Passive sampling · POCIS · Anthropogenic wastewater markers · Mass balance modeling

## 1 Introduction

Pharmaceutical products (PPs) have been detected in various natural media: fresh surface waters (Bendz et al. 2005), drinking and tap water (Heberer 2002; Kuster et al. 2006), groundwater (Barnes et al. 2008), marine and ocean waters, and some aquatic organisms (Comeau et al. 2008) in different countries. The presence of these compounds in the environment is generally linked to effluents of metabolized and unused pharmaceuticals into natural waters through wastewater treatment facilities (Togola and Budzinski 2007a). All pharmaceuticals and metabolites are bioactive and they can have toxic effect on living organisms (Cleuvers 2003). However, due to recent developments of analytical chemistry techniques, protocols, and growing consumption rate of these substances in the world, PPs are becoming a part of the environmental monitoring.

The water monitoring on pharmaceuticals is processed using standard (Buerge et al. 2003; Kasprzyk-Hordern et al. 2009) and passive sampling techniques (MacLeod et al. 2007; Togola and Budzinski 2007a; Söderström et al. 2009). Standard approach (pump or grab sampling) can only measure the instantaneous concentrations of contaminants in water (Li et al. 2010). Such method is more time and cost efficient for short-term investigations. (Söderström et al. 2009). The main limitation of this technique is that the measured results represent the value of targeted compounds at a specific place and time, while inter- and intra-diurnal variations of pharmaceuticals can be significant (Togola and Budzinski 2007a). The other alternative for the sampling is the biological sampling (e.g. fish), but this procedure brings up other problematic issues: (1) difficulty of complex biological matrixes chemical analysis; (2) different accumulation patterns inherent to each species (e.g. age, size, metabolism rate) which make data interpretation

misleading; and (3) unexpected mortality of test organisms.

In order to avoid these limitations, the passive sampling technique can be chosen instead for the pilot identification of targeted chemicals in the rivers. Since, this technique can greatly simplify sample collection (both in handling and long time maintenance) ensuring simultaneously the obtaining of representative time-integrated samples for the identification of studied compounds (Vrana et al. 2005; Togola and Budzinski 2007a; Arditoglou and Voutsas 2008).

Polar organic chemical integrative sampler (POCIS) is one of the types of time-integrated sampler was developed for assessing the presence and potential toxicological significance of a broad spectrum of environmental contaminants (Petty et al. 2004; MacLeod et al. 2007). These sampling devices have the capacity to record large volumes of water fluxes over a period from several days to weeks. They have the ability to integrate episodic changes in distribution of environmental contaminants and their membrane is fitted for the selective sampling of polar molecules from the dissolved phase. POCISs were successfully applied in the water of various countries, e.g. Czech Republic (Grabic et al. 2010), Greece (Arditoglou and Voutsas 2008), France (Togola and Budzinski 2007b), USA (Jones-Lepp et al. 2004). The only complexity of the use of POCISs is an estimation of the sampling rate and calculation of water concentration of targeted compounds (Togola and Budzinski 2007a). The sampling rate (Zhang et al. 2008; Arditoglou and Voutsas 2008) can be affected by field conditions (water temperature, UV light, pH, flow rate, turbulence, suspended solids, organic carbon, salt content, algal growth, biofouling, degradation), but still independent from the presence of analytes in the water (Vrana et al. 2005; Togola and Budzinski 2007a).

Monitoring of pharmaceuticals in water gives us a possibility to (1) detect these emerging pollutants, (2) measure their concentration, and (3) use these environmental data for the further research. For example, due to specific properties (degradation, solubility, accumulation, etc), pharmaceuticals have been found to be efficient markers of wastewaters (Glassmeyer et al. 2005; Nakada et al. 2008). Previous studies report the application of carbamazepine as a conservative marker of treated sewage (Clara et al. 2004; Fenz et al. 2005; Nakada et al. 2008) and caffeine as a labile indicator of untreated wastewater (Buerge et al. 2003;

Benotti and Brownawell 2007) for coastal and freshwater systems.

Additionally, in perspective, the data on pharmaceuticals in the water can be used for the approximate estimation of drug consumption rates in communities. Usually, data on medicaments consumption are scarce or unavailable due to the use of a large amount of non-prescription drugs. In this case, the application of mass balance modeling provides a possible means to obtain these data (Khan and Ongerth 2004; Kasprzyk-Hordern et al. 2009; ter Laak et al. 2010).

The objective of the study was (1) identify, quantify, and compare the presence of targeted pharmaceuticals in two small rivers influenced by municipal wastewater discharges: the Jalle River, Bordeaux (France) and the Lopan River, Kharkiv region (Ukraine), (2) determine time–spatial distribution of PPs compounds in water in order to access potential pollution sources and (3) estimate drug consumption rates in two different socio-economic regions (France and Ukraine) using the mass balance modeling.

## 2 Site Selection and Sampling

The Jalle River, Bordeaux agglomeration (France), and the Lopan River, Kharkiv region (Ukraine) have been selected to introduce pollution status of river basins with similar hydrological characteristics (length, width, depth, water flow, etc.) and water usage (wastewaters discharge, irrigation, etc), representing however different socio-economic characteristics of watersheds in terms of population density, economic activities, incomes, lifestyles, etc. Surface water in both rivers was sampled in sites located upstream and downstream of the major cities and wastewater treatment plants (WWTPs). Average flow rates were obtained from annual reports of the regional Environmental Agencies.

The alluvial Jalle River is a right tributary of the Garonne River with 34 km of length, with depth from 0.8 to 2.5 m, and  $3 \text{ m}^3 \text{ s}^{-1}$  of average water debit, located on the north from Bordeaux city (Fig. 1). The subsurface geological structures of the area are dated from Oligocene and consist mainly of sedimentary rocks like sand and marl. The river has mostly pluvial feeding, runs through residential suburban and rural areas and receives effluents from two major municipal wastewater treatment facilities of the Bordeaux

suburbs, serving greater than 100,000 people. The treated effluent accounted up to 33% of the river flow and heavily impacted on the quality of the river's water (Labadie 2004; Othoniel 2006).

The Lopan River is an alluvial transboundary river, which flows through Russia and Ukraine (Vystavna et al. 2011) and is used for the recreation, drinking water supply, irrigation, and fishing in the Kharkiv region of Ukraine (c.a. 2,700,000 inhabitants; 2010). The total length of the river is about 98 km, depth ranges from 0.4 to 2.3 m and several dams constructed along the watercourses regulate the flow. The mean annual discharge of the Lopan River is  $1.4 \text{ m}^3 \text{ s}^{-1}$  in winter and  $0.9 \text{ m}^3 \text{ s}^{-1}$  in summer in the site located upstream of the Kharkiv city (Vasenko et al. 2006). River is partly covered by ice from the end of November to the end of March. The subsurface geological structures of the area are dated from Palaeogene and consist mainly of sedimentary rocks like sandstone, marl, and chalk. The major land application purposes on the watershed are: agriculture (40%), urban lands (50%), and water reservoirs (10%). The Lopan River receives mixed municipal and industrial wastewaters (about  $600,000 \text{ m}^3$  per day) from Kharkiv city and its suburbs. The wastewater discharge contributes up to  $5\text{--}6 \text{ m}^3 \text{ s}^{-1}$  to the natural flow downstream of the Kharkiv city (Vystavna et al. 2011). Wastewaters are discharged into the same river basins, which are used for water supply (NRDW 2006).

Sampling sites were chosen and named according to the results of the previous monitoring campaigns (Vystavna et al. 2009, 2010, 2011). The POCISs have been installed using a cotton net for membranes protection at three sites on the Jalle River (Fig. 1): J01 is located close to the source of the river in Saint Jean d'Illac; J02 is located on an area of agricultural activity of Eysines community, famous for the bio-agriculture, and approximately 0.4 km downstream of the "Cantinolle" WWTP (WWTP 1); and J03 is located inside the natural reservation area of Bruges, approximately 0.5 km downstream of the "L'Ile" WWTP (WWTP 2). Three sampling sites have been chosen in the Lopan River (Fig. 1): L03 is located upstream of the Kharkiv city and downstream (approximately 1 km) of the Veterinary Academy discharges; L08 is located in the Kharkiv city, upstream of the wastewater discharges; L09 is located approximately 0.7 km downstream of the wastewater discharge from the "Dykanivka" WWTP.

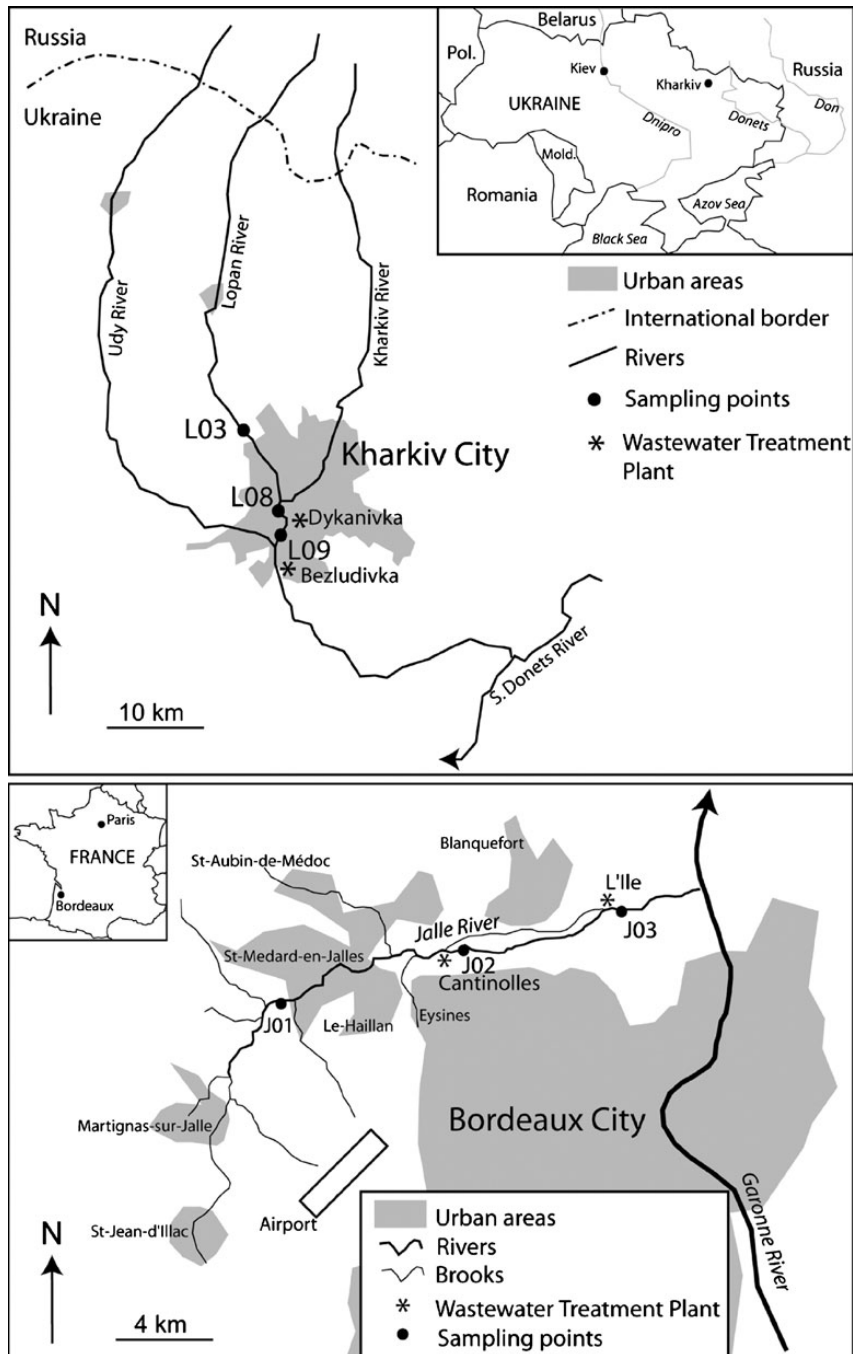

Fig. 1 The sampling sites location on the Jalle and the Lopan Rivers

All the sites both on the Jalle River and the Lopan River have been sampled in May and December 2009. Additional sampling has been provided in dry season (August 2009) on the Lopan River in the sites L03 and L09 in order to exclude the inputs of emerging pollutants due to precipitation and run-off. During the spring sampling campaign, the passive samplers at site L08 have been lost, possibly caused by pillage or active fishing of local population.

### 3 Materials and Method

#### 3.1 Chemicals and Reagents

POCIS pharmaceuticals with the Oasis HLB sorbent were purchased from Expometer (Tavelsjö, Sweden). Acetone, dichloromethane, acetonitrile, and methanol (high-performance liquid chromatography reagent grade, Scharlau) were purchased from ICS (Belin-Beliet, France). Glass solid-phase extraction (SPE) cartridges of 6 mL with Teflon frits (20  $\mu\text{m}$  porosity) filled with Oasis HLB bulk sorbent (60  $\mu\text{m}$ ) were purchased from Supelco (Saint Quentin-Fallavier, France) and Waters (Guyancourt, France), respectively. Ultrapure deionized water was obtained with a Milli-Q system (Millipore, Molsheim, France). All standards were purchased from Sigma Aldrich (St. Quentin Fallavier, France; Tapie et al. 2011).

#### 3.2 POCIS Extraction

The extraction procedures for POCIS were adapted from previously developed methods (Togola and Budzinski 2007a; Tapie et al. 2011). After 3 weeks of exposure, each individual POCIS device was retrieved from the water, briefly rinsed with ultrapure water in order to remove any materials adhering to the surface of the surface membrane (biofilm, particles, etc.).

The POCIS preparation and analysis have been performed in the ISM CNRS UMR Laboratory of University of Bordeaux 1, France. The surface membrane was detached from the stainless steel rings and rinsed with ultrapure water. The phase from the two membranes of each POCIS has been carefully transferred into an empty SPE tube by rinsing it with 5 mL of ultrapure water per each membrane in cartridges filled with cleaned by methanol Teflon frits and dried under vacuum for 1 h. The sorbent was

eluted in each sample using 10 mL of each solution of: methanol, methanol/dichloromethane mixture (50:50), and dichloromethane and being spiked with internal standards (Budzinski et al. 2009).

The extracts obtained from the sorbent were finally evaporated to dryness using a nitrogen flux and transferred into injection vials 50  $\mu\text{L}$  of acetonitrile. The mass of sorbent has been measured by gravimetry for each dried POCIS. Blanks were performed in the laboratory concurrently with water samples in order to monitor possible contamination. Recovery rates of the POCIS samples were determined by spike samples and vary from 79% to 97% of spiked amount (Table 1) for all chemicals, except aspirin, fluoxetine, and terbutaline with recoveries ranges from 51% to 62%. The lowest recovery rate (51%) has been observed for the aspirin. The residual standard deviation of the spikes values was in the range from 0% to 30% (theophylline and fluoxetine, respectively;  $n=3$ , Table 1). The aspirin (4  $\text{ng g}^{-1}$ ) and caffeine (5  $\text{ng g}^{-1}$ ) (Alvarez et al. 2005) have been detected in laboratory procedural blanks and corrections have been made for the data.

The target pharmaceuticals were selected based on resources of the chemical protocol and the list of leading medicaments, which are most frequently consumed in France (Ministère de la Santé et des Sports en France: <http://www.sante-sports.gouv.fr>) and Ukraine (Ministry of Health Protection in Ukraine: <http://www.moz.gov.ua>). Accordingly, the 21 pharmaceuticals from different therapeutic groups (psychiatric drugs: alprazolam (ALPZ), amitriptyline (AMI), diazepam (DZP), doxepin (DOX), fluoxetine (FLUOX), imipramine (IMI); nordiazepam (NDZP), carbamazepine (CBZ), bromazepam (BRMZ); analgesics: aspirin (ASP), paracetamol (PARA); bronchodilator: clenbuterol (CLENB), salbutamol (SALB), terbutaline (TERB); non-steroidal anti-inflammatory drug: diclofenac (DICLO), ibuprofen (IBU), ketoprofen (KETO), naproxen (NAP); lipid regulator: gemfibrozil (GEMF); stimulants: caffeine (CAF), theophylline (THEO)) have been analyzed in samples using liquid chromatography/tandem mass spectrometry (LC/MS/MS) with an electrospray (ESI $\pm$ ) ionization source. The limit of the detection was around 1  $\text{ng g}^{-1}$  of sorbent for all compounds (Table 1), which makes approximately a detection limit from 0.05 to 0.1  $\text{ng L}^{-1}$  depending on the exposure time when considering sampling rates ( $R_s$ ). Limits of detection are varied depending on the origin and kind

Water Air Soil Pollut

**Table 1** The targeted pharmaceuticals (PP) detected by POCIS and analytical method performance

PP	CAS no.	Therapeutic class	LOD, ng g <sup>-1</sup>	Recovery (n=3), %	
				Mean	RSD
Alprazolam	28981-97-7	Antidepressant	1	97	8.3
Amitriptyline	50-48-6	Antidepressant	1	79	19
Aspirin	50-78-2	Analgesic	1	51	13
Bromazepam	1812-30-2	Psychiatric drugs	1	93	11
Caffeine	58-08-2	Stimulant	1	88	4.1
Carbamazepine	298-46-4	Sedative	1	86	21
Clenbuterol	37148-27-9	Bronchodilator	1	92	6.9
Diazepam	439-14-15	Antidepressant	1	86	4.9
Diclofenac	15307-86-5	Non-steroidal anti-inflammatory drug	1	81	9.6
Doxepine	1668-19-5	Antidepressant	1	86	2.3
Fluoxetine	54910-89-3	Antidepressant	1	60	30
Gemfibrozil	25812-30-0	Lipid regulator	1	84	6.8
Ibuprofen	15687-27-1	Non-steroidal anti-inflammatory drug	1	90	5.5
Imipramine	50-49-7	Antidepressant	1	89	24
Ketoprofen	22071-15-4	Non-steroidal anti-inflammatory drug	1	89	3.9
Naproxen	22204-53-1	Non-steroidal anti-inflammatory drug	1	91	2.1
Nordiazepam	1088-11-5	Benzodiazepines active metabolite	1	82	8.5
Paracetamol	103-90-2	Analgesic	1	87	3.3
Salbutamol	18559-94-9	Bronchodilator	1	85	5.7
Terbutaline	23031-25-6	Bronchodilator	1	62	18
Theophylline	58-55-9	Stimulant	1	90	0.0

LOD limit of detection, RSD residual standard deviation

of water, as water presents different organic matter contents and matrix complexity. They can range between 0.1–1.5 and 0.1–2.5 ng L<sup>-1</sup> for surface water (Togola and Budzinski 2008). These low detection levels allow quantifying pharmaceuticals in the studied environment. In our research only one matrix, i.e. surface water was considered. Thereby, the quantification was performed using the stable isotope-labeled compounds (internal standards) that were spiked into the POCIS sorbent prior to analysis in order to compensate for the mass loss during the sample preparation and the matrix effects during the LC/MS/MS process. The detection limits for targeted compounds were determined by measuring the coincident instrumental response of standard solutions and spiked blank POCIS extracts, respectively, using a signal to noise ratio of 3 and 10, correspondingly (Togola 2006).

### 3.3 Calculation of POCIS Uptake Rates and Data Interpretation

Uptake rates (MacLeod et al. 2007; Bartelt-Hunt et al. 2009) have been calculated for a limited number of pharmaceuticals (Togola and Budzinski 2007a). At the present time, the research on the estimation of sampling rates of pharmaceuticals is under development (Miege et al. 2011). In this study, we estimated concentrations for most frequently detected pharmaceuticals using Eq. 1:

$$C_w = C_s M_s / (R_s t) \quad (1)$$

where,  $C_w$  and  $C_s$  are concentrations of compounds in the water (ng L<sup>-1</sup>) and in the POCIS (ng g<sup>-1</sup>) respectively;  $M_s$  is the mass of the sorbent in the POCIS (g);  $R_s$  is the sampling rate (L d<sup>-1</sup>; Table 2);

Water Air Soil Pollut

**Table 2** The sampling rates ( $R_s$ ) for POCIS (pharmaceutical configuration),  $L d^{-1}$ 

PPs	$R_s$ , $L d^{-1}$
Amitriptyline <sup>a</sup>	0.41
Caffeine <sup>a</sup>	0.13
Carbamazepine <sup>b</sup>	0.29
Diclofenac <sup>b</sup>	0.15
Diazepam <sup>a</sup>	0.40
Fluoxetine <sup>a</sup>	0.24
Gemfibrozil <sup>c</sup>	0.19
Ibuprofen <sup>a</sup>	0.30
Ketoprofen <sup>b</sup>	0.13
Naproxen <sup>a</sup>	0.14
Nordiazepam <sup>a</sup>	0.39
Paracetamol <sup>a</sup>	0.03

<sup>a</sup>Togola 2006<sup>b</sup>Budzinski et al. 2009<sup>c</sup>MacLeod et al. 2007

and  $t$  is the sampling period (days; Petty et al. 2004; Arditoglou and Voutsas 2008).

The  $R_s$  is not dependent on the concentration of target components in the sampling water (Arditsoglou and Voutsas 2008); however, it depends on the water temperature variation, salinity, pH, and other parameters (Togola and Budzinski 2007a). In our study, water turbulence and flow have no significant variations in the sampled rivers as they are alluvial and velocity has small changes during the sampling period, so these parameters were neglected for the estimation of the  $R_s$ . The pH of the rivers was 6.9–8.6 and at this low variation level has no significant influence on the diffusion of the components in the POCIS's membrane (Zhang et al. 2008). The water temperature variation has not been taken into account because of the lack of the data on POCIS calibration (Togola and Budzinski 2007a).

## 4 Results

### 4.1 Presence of Pharmaceuticals in Rivers

Among 21 targeted PPs of different therapeutic classes, 18 of them (ALPZ, ASP, AMI, BRMZ, CAF, CBZ, CLENB, DZP, DICLO, FLUOX, GEMF, IBU, KETO, NAP, NDZP, PARA, SALB, and THEO) have been identified in the Jalle River, France and 15 of targeted compounds (ALPZ, ASP, AMI, CAF, CBZ, DZP, DICLO, FLUOX, IBU, KETO, NAP, NDZP, PARA, SALB, and THEO) have been found

in the Lopan River, Ukraine (Fig. 2). The values of DOX, IMI, and TERB were lower than detection limits in all sampling sites of both rivers (Rabiet et al. 2006). In both rivers, the accumulation and diversity of pharmaceuticals vary along the sampling sites and sampling seasons.

Three general accumulation levels of pharmaceuticals were identified in set up POCIS: high accumulation level (more than 1,000  $ng g^{-1}$ ; amount of pharmaceuticals in the sorbent of the passive sampler); medium accumulation level (100–1,000  $ng g^{-1}$ ); and low accumulation level (less than 100  $ng g^{-1}$ ; Fig. 2).

In the Jalle River, high accumulation was found only for KETO. Medium accumulation was detected for DICLO, CAF, THEO, NAP, IBU, and PARA. The BRMZ, FLUOX, GEMF, AMI, NDZP, ASP, CLENB, DZP, ALPZ, and SALB were identified at low-accumulation level. In the Lopan River, the maximum accumulation was measured for CBZ, DICLO, and CAF. The KETO, THEO, AMI, and DZP were found in the medium accumulation level and FLUOX, ASP, NDZP, SALB, and ALPZ were at the low accumulation level (Fig. 2).

According to the maximum accumulation level, the river in Ukraine was more contaminated by CBZ, DICLO, DZP, AMI, and ASP than the studied river in France (Fig. 2). The PARA, THEO, SALB, ALPZ, and FLUOX show approximately the same level of accumulation in POCIS installed in both studied rivers (Fig. 2). Among the other target compounds, CAF, DICLO, and CBZ were measured at all sampling sites on the both rivers and during all sampling campaigns.

### 4.2 Concentration of Pharmaceuticals in Two Rivers

The exact concentrations of AMI, CAF, CBZ, DICLO, DZP, FLUOX, GEMF, IBU, KETO, NAP, NDZP, and PARA have been estimated (Fig. 3) using Eq. 1 and the previously published sampling rates (Table 2). In the Lopan River, the concentration and diversity of PPs changed from the upstream (L03) to downstream (L09) sites. In the upstream site (L03), the contamination of pharmaceuticals presented the following order: KETO > CAF > PARA > DICLO > CBZ. In the city center (L08), ketoprofen has not been measured, possibly due to the reduction of sources, degradation (Nakada et al. 2008) and dilution from the upstream site, where presence of KETO



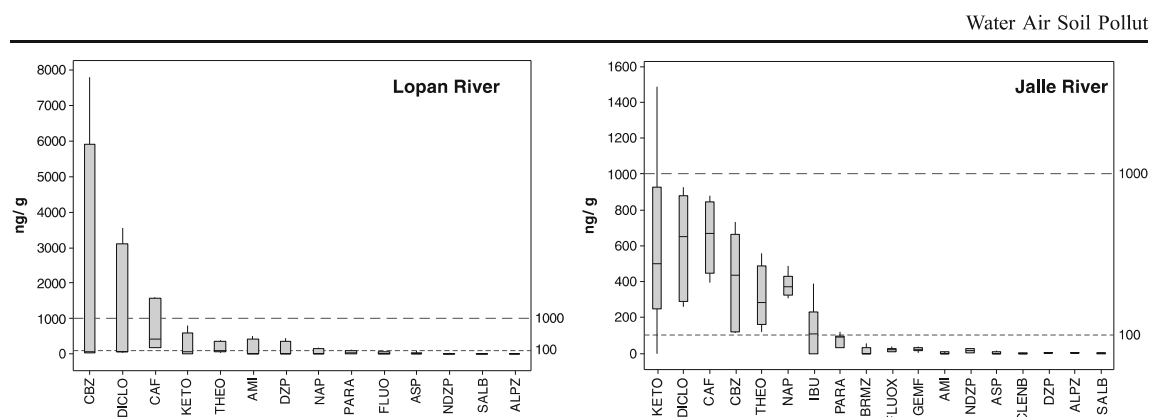

**Fig. 2** Box plots of the accumulation of pharmaceuticals ( $\text{ng g}^{-1}$ ) in POCIS installed in the Lopan and Jalle Rivers

relates to discharges from the Veterinary Academy located upstream L03 and/or with the run-off from farms (Lees et al. 2004; Curry et al. 2005). The concentration of other target compounds was in the following tendency:  $\text{CAF} > \text{PARA} \geq \text{DICLO} > \text{CBZ}$ . Downstream of the WWTP (L09), the concentration and diversity of drugs were significantly different from upstream sites (L03 and L08). There are several additional target compounds of psychiatric (DZP, AMI, and FLUOX) and anti-inflammatory (NAP) drugs were measured together with KETO, CAF, CBZ, and DICLO. The range of the concentration in L09 represents the following order:  $\text{CBZ} > \text{DICLO} > \text{CAF} > \text{KETO} > \text{NAP} \geq \text{AMI} \geq \text{DZP} > \text{PARA} > \text{FLUOX}$  (Fig. 3).

Thus, non-conservative compounds (CAF and PARA) were dominated in upstream sites and conservative compound (CBZ; Clara et al. 2004; Fenz et al. 2005; Huerta-Fontela et al. 2008) was in the majority downstream of WWTP on the Lopan River. The prescribed psychiatric drugs (NDZP, AMI, FLUOX, and DZP) were found in the Ukrainian river only downstream of the WWTP. The consumption of these medicaments is strongly regulated by the government (Ministry of Health, Ukraine: [www.moz.gov.ua](http://www.moz.gov.ua)). These pharmaceuticals generally can enter the water-courses through the WWTP with contaminated effluents from hospitals and medical institutions.

In the Jalle River, the concentration and diversity of PPs were less varied in comparison with the Lopan River. In the J01, the contamination of pharmaceuticals represented the following structure:  $\text{KETO} \geq \text{CAF} > \text{NAP} \geq \text{PARA} > \text{DICLO} > \text{IBU} > \text{CBZ} > \text{GEMF}$ . Downstream of WWTP 1 (J02), the concentration of KETO, CAF, and PARA decreased possibly due to

the combination of different factors (reduction of sources, degradation, and dilution), but the concentration of DICLO and CBZ increased. At the J03, the concentration of all substances, previously measured at J02, grew and represented the following order:  $\text{DICLO} > \text{CAF} > \text{PARA} \geq \text{NAP} > \text{CBZ} > \text{KETO} > \text{IBU} > \text{GEMF} > \text{FLUOX} > \text{NDZP} > \text{AMI}$ , which showed the domination of non-conservative substances.

Comparison with the research of Togola (2006) on the Jalle River showed, that in our study the concentration of CBZ was lower, inversely DICLO presented higher concentration level. This discrepancy can relate to the difference in the location of the sampling sites and sampling technique, but also to changes in the wastewater treatment process and drug consumptions during the last 7 years (the sampling of the Jalle River reported in Togola (2006) has been done in 2003).

The analysis of the pharmaceutical concentrations and accumulation in both rivers showed that the same trend of the accumulation of KETO was observed in the Lopan River and in the Jalle, where both the highest contamination were detected in upstream sites. The diclofenac and carbamazepine showed the tendency to accumulate along both study waters, what characterize the relatively conservative behavior of these substances (Clara et al. 2004; Fenz et al. 2005; Huerta-Fontela et al. 2008). The concentration of other widely prescribed psychiatric drugs (i.e. AMI, ALPZ, FLUOX, and DZP) increased only in the sites downstream WWTPs, thus, wastewaters can be considered as the general source of these medicaments in the studied rivers. The stimulant, caffeine, was detected upstream and downstream of the

Water Air Soil Pollut

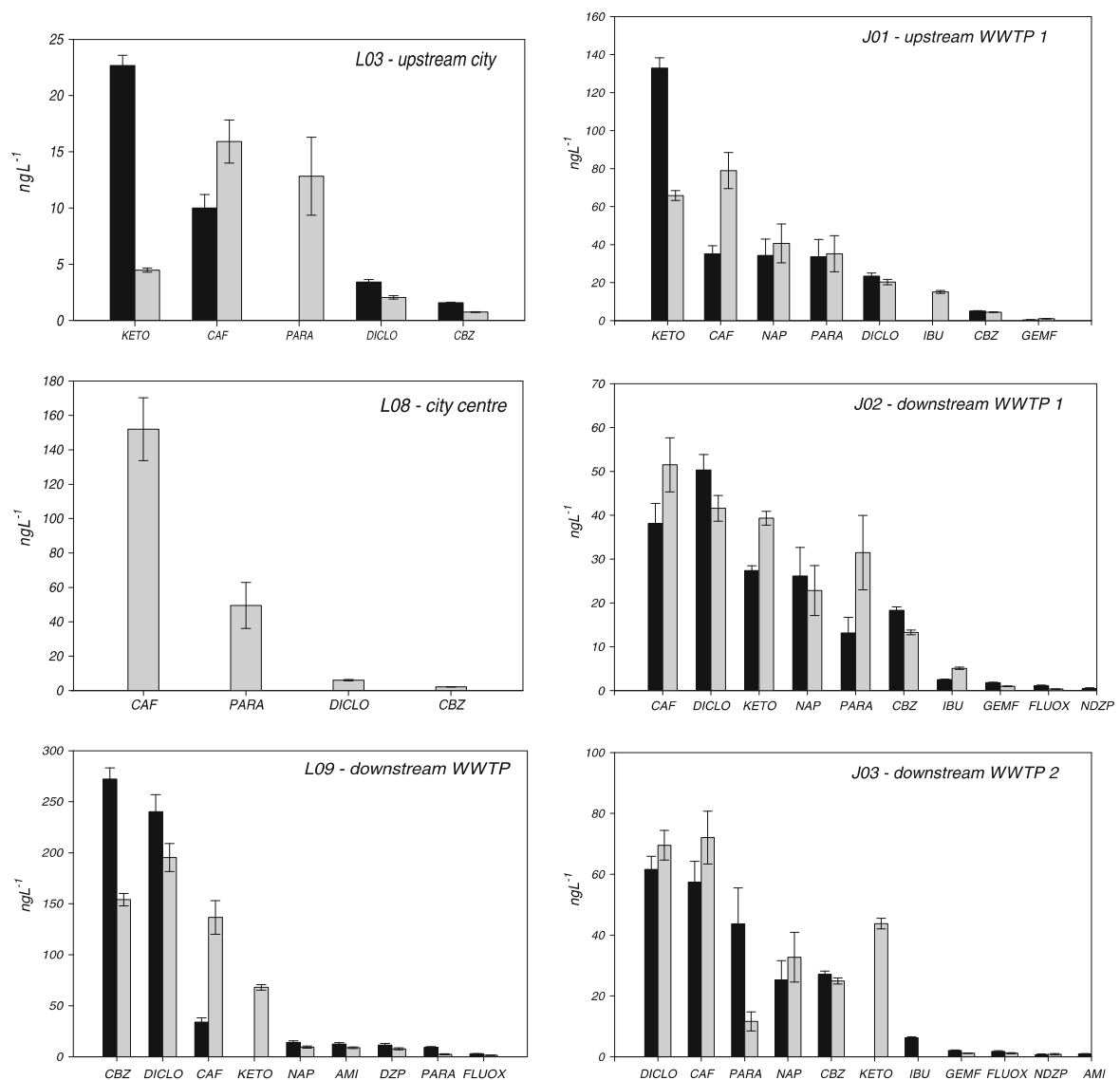

**Fig. 3** The concentration of pharmaceuticals in the Lopan and Jalle Rivers: May 2009 (black square) and December 2009 (gray square)

WWTPs (Fig. 3). This compound has a non-conservative behavior (Buerge et al. 2003; Joss et al. 2006) and easily degrades during treatment processes (more than 90% of the removal efficiency on the conventional wastewater treatment plant; KNAPPE 2008) and under influence of biological factors. Consequently, the presence of stimulants along the river can be characterized by (1) the continuous discharge of not efficiently treated wastewaters, (2)

other additional sources of pollution, e.g. run-off (Froehner et al. 2010) and/or (3) the regional “baseline” of the caffeine in water. According to the maximum concentration, the river in Ukraine was more contaminated by CBZ, DICLO, DZP, and AMI than the studied river in France (Fig. 3). The paracetamol, salbutamol, and alprazolam showed approximately the same level of contamination in studied rivers (Fig. 3).

Finally, found differences can be linked to various factors, e.g. (1) as a result of the disparity in the medicaments consumption and (2) efficiency of wastewater treatment facilities. In order to understand how the drug consumption rate per capita is related to the water quality, a mass balance approach has been applied.

#### 4.3 Mass Balance Modeling of Drug Consumption Using Water Monitoring Data

Caffeine, carbamazepine, and diclofenac were found in all sampling sites of both rivers in the highest values compared to other compounds. In our study, the calculation of the theoretical consumption rate of these pharmaceuticals in regions of Ukraine and France has been done using the data of water monitoring and their comparison with reported national data on level of the drug use. A mass balanced model includes following (Eq. 2):

$$M_c = (Q_w C_w - Q_u C_u) / (K_1(1 - K_2)) \quad (2)$$

- $M_c$  drug consumption rate in a studied settlement, which is served by sewage system ( $\text{g d}^{-1}$ )
- $K_1$  drug excretion rate (a part of a pharmaceutical component which enters a sewage system as unchanged form by human excretion;  $\text{g g}^{-1}$ ). Pharmacokinetics represents a very complex process and depends on the metabolism, age, activity, etc. We used previously reported data on the parent drugs excretion (Table 3).
- $K_2$  the efficiency of wastewater treatment processes was estimated as a part of pharmaceuticals which are efficiently removed during the treatment ( $\text{g g}^{-1}$ ). The efficiency has been used from previously published works for selected substances taking into account the treatment processes type. In the studied sites of France and Ukraine, WWTPs treatment processes have the conventional treatment scheme and consist of mechanical and biological operations.
- $C_w$ , concentrations of pharmaceuticals in the river, downstream and upstream of WWTP ( $\text{g m}^{-3}$ ), respectively.

**Table 3** The excretion and treatment efficiency of caffeine, carbamazepine, and diclofenac (data for the mass balance modeling)

PPs	Drug excretion rate, $\text{g g}^{-1}$	The treatment efficiency, $\text{g g}^{-1}$	
		France	Ukraine
Caffeine	0.10 <sup>a</sup>	0.80 <sup>c</sup>	0.80 <sup>d</sup>
Carbamazepine	0.31 <sup>b</sup>	0.20 <sup>d</sup>	0.04 <sup>d</sup>
Diclofenac	0.02 <sup>b</sup>	0.40 <sup>d</sup>	0.12 <sup>d</sup>

<sup>a</sup>Froehner et al. 2010

<sup>b</sup>Khan and Ongerth 2004

<sup>c</sup>Kosma et al. 2010

<sup>d</sup>KNAPPE 2008

$Q_w$ , the water flow rate in the river, downstream and upstream of WWTP

The daily drug consumption rate per person ( $D$ ) was estimated as:

$$D = M_c / P \quad (3)$$

where,  $P$  is the number of people using the sewage system ( $n$ =inhabitants).

In order to process the mass balance modeling, the following assumptions have been done for the estimation of the drug consumption rate:

1. Caffeine has been considered as the quickly biodegradable component, so the upstream influence has not been taken into account.
2. The served population was estimated: the Jalle River, WWTP 2—50,000 people; the Lopan River, WWTP—1,000,000 people.

We have not considered the veterinary consumption, environmental degradation, and sorption because of the absence of relevant data. The calculated data on carbamazepine and diclofenac consumption rates (Fig. 4) have been compared with reported data for France. For Ukraine, similar data were not available, as no any official statistics on the drug consumption exist and the insurance and social security system is under development (Ministry of Health Protection, Ukraine [www.moz.gov.ua](http://www.moz.gov.ua))

The calculated carbamazepine consumption rate (0.1 g per person per year) was of the same magnitude as the previously reported one (0.3 g per person per

Water Air Soil Pollut

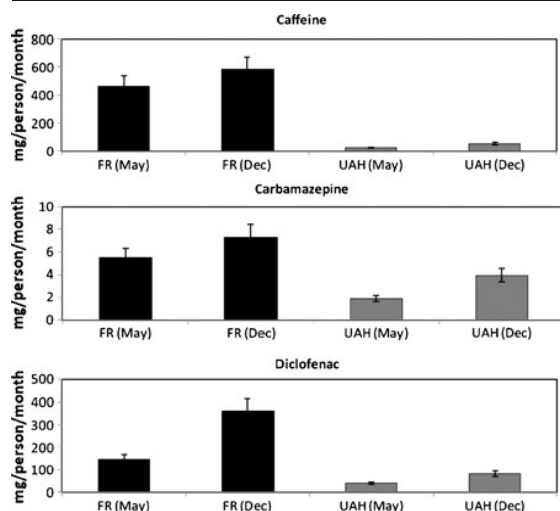

**Fig. 4** The calculated drug consumption rate in the studied regions of France (FR) and Ukraine (UAH)

year; Coetsier et al. 2009). A good agreement between predicted environmental concentration and measured environmental concentration was found in previous research on carbamazepine in the South of France (Coetsier et al. 2009). For diclofenac, the discrepancy was much higher, as we estimated an annual consumption rate of 1.7 g per person (based on the May data) and 4.3 g per person (based on the December data). However, the reported data (Coetsier et al. 2009) were much lower, approximately 0.25 g per person per year. A high discrepancy between the calculated and measured concentrations of diclofenac has been presented in research in Sweden (Bendz et al. 2005) and France (Coetsier et al. 2009). As the reported data were based on the statistics of the social security reimbursement and present only a prescribed amount, we can assume that a significant amount of diclofenac is used without prescription. Also, the results of the mass balanced modeling showed that the consumption rate of carbamazepine was twofold higher in the studied regions of France than in the Ukrainian region, as well as threefold higher diclofenac and tenfold higher caffeine. In contrast, the river in Ukraine was higher contaminated by carbamazepine, diclofenac and caffeine than the studied river in France. This can be related to the lower dilution of wastewaters in the Lopan River (dilution rate can reach 21 (wastewater):1 (riverine water); Vasenko et al. 2006) compared to that for the Jalle River (dilution

rate 1 (wastewater):3 (riverine water); Labadie 2004) and lower efficiency of the wastewater treatment. Also, the drug consumption was about 1.5- to 2-fold higher in December than in May in both countries. However, seasonal variation of these pharmaceuticals needs additional research taking into account the social and environmental data.

The results of this basic mass balance approach show that water quality monitoring can be useful for the estimation of social indicators such as the medical drug consumption rate and the illicit drug consumption rate (Huerta-Fontela et al. 2008; Zuccato et al. 2008). For further development of the approach: temporal variations, environmental degradation and other uncertainty factors can be incorporated in the mass balance model.

#### 4.4 Molecular Indicators of Wastewaters in the River

Caffeine, carbamazepine, and diclofenac show differences in behavior and diverse sources. These properties were considered for the further analysis of these pharmaceuticals as potential indicators of anthropogenic activities.

In our study, carbamazepine and caffeine showed a high abundance in natural water (with a range for carbamazepine of 17–27 ng L<sup>-1</sup> in the Jalle River, France; 2–272 ng L<sup>-1</sup> in the Lopan River, Ukraine, and for caffeine: 40–75 and 10–152 ng L<sup>-1</sup>, respectively). By using a passive sampling technique, these compounds can be detected in such values. Carbamazepine exhibits the most persistent behavior during both May and December (SD ±10% (J03) and SD ±40% (L09)) and was resistant to degradation in the natural environment. However, carbamazepine can be useful for tracing pathways of sewage water, even the treated one. In contrast, caffeine is a labile compound and easily degraded during the water treatment processes and in natural waters: it can be used for the identification of effluents of untreated wastewaters. In our study caffeine, carbamazepine, and diclofenac were detected in the Lopan River during the dry weather in August 2009 on the upstream site (L03; Fig. 5) and their occurrence can characterize uncontrolled discharges of untreated wastewaters, since the volume of the run-off is extremely small during the dry period. Untreated wastewater can come from households, which are not connected to the sewage, but also from the Veterinary

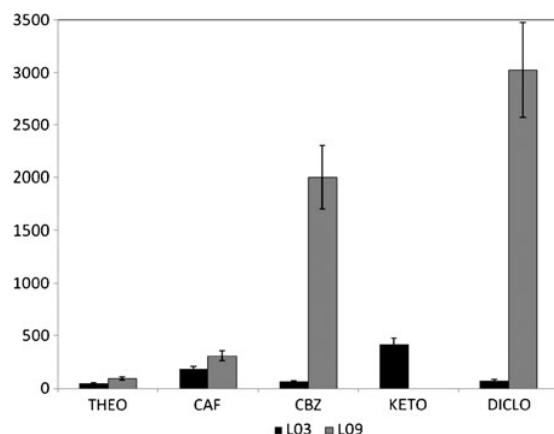

**Fig. 5** The detection of the pharmaceuticals in the Lopan River during the dry period (August 2009), ng g<sup>-1</sup>

Academy. Further monitoring is necessary to fully understand the occurrence of pharmaceuticals in the water as they can be used as a wastewater marker for surface and ground waters pollution by treated and untreated discharges.

#### 4.5 The Application of the POCIS Method

Our practical experience of the passive sampling application shows that this technique is simple for the installation in contrasted climate conditions including the ice cover on the river. Also, the installation and retrieval was handy and does not need specific knowledge. Other positive aspect is that POCIS can be easier delivered to the laboratory for the analysis, even in the case of the sample manipulation in the different geographical regions. The passive technique has limitations on the exact assessment of PPs concentrations, however for pilot and research monitoring (Allan et al. 2006) focused on the identification of the presence of compounds, pollution sources, and their behavior the quantitative data analysis can be used in order to save the expenses on the laboratory analysis and experiments.

### 5 Conclusions

1. Eighteen pharmaceuticals and their potential sources in the natural water have been detected in the Jalle River (France) and 15 in the Lopan

River (Ukraine) during the May 2009 and December 2009 using the POCIS passive sampling technique.

2. The accumulation of pharmaceuticals in the POCIS and the concentration of PPs in the rivers varied along the sampling sites and sampling seasons. Generally, the Lopan River was more contaminated by medicaments than the Jalle River in terms of the concentration of target compounds.
3. Caffeine, carbamazepine, and diclofenac were found in all samples with the high accumulation and concentration in urban area. The presence of ketoprofen was related mostly to upstream sites.
4. Mass balance modeling has been applied to estimate approximate consumption rates of carbamazepine, diclofenac, and caffeine in Bordeaux and Kharkiv regions. The results showed higher consumption rates of these pharmaceuticals in France than in Ukraine. In contrast, the levels of contamination of carbamazepine and diclofenac were higher in the Ukrainian river, this can be related to distinct efficiency in wastewater management and treatment.
5. Due to the abundance and stability in the water environment, some of measured pharmaceuticals (e.g. carbamazepine, caffeine, and diclofenac) have been proposed as potential wastewater's markers in the river for identification of different uncontrolled wastewaters discharges.

Finally, our study underlines the presence and behavior of pharmaceuticals in the Jalle River, Bordeaux (France) and the Lopan River, Kharkiv (Ukraine). It demonstrates the successful application: (1) of passive sensors to monitor water quality, (2) of mass balance modeling to estimate drug consumption rates and (3) of pharmaceuticals compounds as potential indicators of wastewater treatment efficiency.

**Acknowledgements** This research was conducted in the framework of Collaborative Program "Partenariat Hubert Curien DNIPRO" (Grant no 19744VJ 2009/2010) with the financial support from both the French Ministry of Foreign Affairs and the Ukrainian Ministry of Education and Science. Some authors have been granted through the ERASMUS MUNDUS External Cooperation Window Program (Lot 6/7—Belarus, Moldova and Ukraine), and by the Embassy of France to Ukraine (Bourse de Court Séjour de Recherche). The support of Ms. Maria Gonzalez Rey, Universidade do Algarve and Mr.

## Water Air Soil Pollut

Michael van der Valk, the Netherlands National Committee IHP-HWRP, with editing this paper are greatly acknowledged.

## References

- Allan, I. J., Mills, G. A., Vrana, B., Knutsson, J., Holmberg, A., Guigeus, N., et al. (2006). Strategic monitoring for the European Water Framework Directive. *Trends in Analytical Chemistry*, 25, 704–714.
- Alvarez, D. A., Stackelberg, P. E., Petty, J. D., Huckins, J. N., Furlong, E. T., Zaugg, S. D., et al. (2005). Comparison of a novel passive sampler to standard water—column sampling for organic contaminants associated with wastewater effluents entering a New Jersey stream. *Chemosphere*, 61, 610–622.
- Arditsoglou, A., & Voutsas, D. (2008). Passive sampling of selected endocrine disrupting compounds using polar organic chemical integrative samplers. *Environmental Pollution*, 156, 316–324.
- Barnes, K., Kolpin, D., Furlong, E., Zaugg, S., Meyer, M., & Barber, L. (2008). A national reconnaissance of pharmaceuticals and other organic wastewater contaminants in the United States—I) groundwater. *Science of the Total Environment*, 402, 192–200.
- Bartelt-Hunt, S. L., Snow, D. D., Damon, T., Shockley, J., & Hoagland, K. (2009). The occurrence of illicit and therapeutic pharmaceuticals in wastewater effluent and surface waters in Nebraska. *Environmental Pollution*, 157, 786–791.
- Bendz, D., Paxeus, N., Ginn, T., & Loge, F. (2005). Occurrence and fate of pharmaceutically active compounds in the environment, a case study: Hoje River in Sweden. *Journal of Hazardous Materials*, 122, 195–204.
- Benotti, M. J., & Brownawell, B. J. (2007). Distributions of pharmaceuticals in an urban estuary during both dry- and wet-weather conditions. *Environmental Science and Technology*, 41, 5795–5802.
- Budzinski, H., Soulier, C., Lardy, S., Capdeville, M.J., Tapie, N., Vrana, B., Miege, C., & Ait Aissa, S. 2009. Passive sampler for chemical substance monitoring and associated toxicity assessment in water. Abstract presented at the International Conference on Xenobiotics in the Urban Water Cycle, 11–13 March 2009, Cyprus.
- Buerge, I. J., Poiger, T., Muller, M. D., & Buser, H. R. (2003). Caffeine, an anthropogenic marker for wastewater contamination of surface waters. *Environmental Science and Technology*, 37, 691–700.
- Clara, M., Strenn, B., & Kreuzinger, N. (2004). Carbamazepine as a possible anthropogenic marker in the aquatic environment: investigations on the behavior of carbamazepine in wastewater treatment and during groundwater infiltration. *Water Research*, 38, 947–954.
- Cleuvers, M. (2003). Ecotoxicity of pharmaceuticals including the assessment of combination effects. *Toxicology Letters*, 142, 185–194.
- Coetsier, C. M., Spinelli, S., Lin, L., Roig, B., & Touraud, E. (2009). Discharge of pharmaceutical products (PPs) through a conventional biological sewage treatment plant: MECs vs PECs. *Environment International*, 35, 787–792.
- Comeau, F., Surette, C., Brun, G. L., & Losier, R. (2008). The occurrence of acidic drugs and caffeine in sewage effluents and receiving waters from three coastal watersheds in Atlantic Canada. *Science of the Total Environment*, 396, 132–146.
- Curry, S. L., Cogar, S. M., & Cook, J. L. (2005). Nonsteroidal anti-inflammatory drugs: a review. *Journal of the American Animal Hospital Association*, 41, 298–309.
- Fenz, R., Blaschke, A. P., Clara, M., Kroiss, H., Mascher, D., & Zessner, M. (2005). Quantification of sewer exfiltration using antiepileptic drug carbamazepine as marker species for wastewater. *Water Science and Technology*, 52, 209–217.
- Froehner, S., Scuza, D. B., Machado, K. S., & da Rosa, E. C. (2010). Tracking anthropogenic inputs in Barigui River, Brazil using biomarkers. *Water Air and Soil Pollution*, 210, 33–41.
- Glassmeyer, S. T., Furlong, E. T., Kolpin, D. W., Cahill, J. D., Zaugg, S. D., Werner, S. L., et al. (2005). Transport of chemical and microbial compounds from known wastewater discharges: potential for use as indicators of human fecal contamination. *Environmental Science and Technology*, 39, 5157–5169.
- Grabic, R., Jurcikova, J., Tomsejova, S., Ocelka, T., Halirova, J., Hypr, D., et al. (2010). Passive sampling methods for monitoring endocrine disruptors in the Svatka and Svitava rivers in the Czech Republic. *Environmental Toxicology and Chemistry*, 29, 550–555.
- Heberer, T. (2002). Tracking persistent pharmaceutical residues from municipal sewage to drinking water. *Journal of Hydrology*, 226, 175–189.
- Huerta-Fontela, M., Galceran, M. T., Martin-Alonso, J., & Ventura, F. (2008). Occurrence of psychoactive stimulatory drugs in wastewaters in north-eastern Spain. *Science of the Total Environment*, 396, 31–40.
- Jones-Lepp, T. L., Alvarez, D. A., Petty, J. D., & Huckins, J. N. (2004). Polar organic chemical integrative sampling and liquid chromatography–electrospray/ion-trap mass spectrometry for assessing selected prescription and illicit drugs in treated sewage effluents. *Archives of Environmental Contamination and Toxicology*, 47, 427–439.
- Joss, A., Zabczynski, S., Gobel, A., Hoffmann, B., Löffler, D., Mc Ardell, C., et al. (2006). Biological degradation of pharmaceuticals in municipal wastewater treatment: proposing a classification scheme. *Water Research*, 40, 1686–1696.
- Kasprzyk-Hordern, B., Dinsdale, R. M., & Guwy, A. J. (2009). Illicit drugs and pharmaceuticals in the environment—forensic applications of environmental data, part 1: estimation of the usage of drugs in local communities. *Environmental Pollution*, 157, 1778–1786.
- Khan, S. J., & Ongerth, J. E. (2004). Modelling of pharmaceutical residues in Australian sewage by quantity of use and fugacity calculations. *Chemosphere*, 54, 355–367.
- KNAPPE (2008) D. 2.1.: Report on the limitations of conventional treatment processes of the most resistant PPs and new development. In: D. Buncher (ed). pp. 45–57.
- Kosma, C. I., Lambropoulou, D. A., & Albanis, T. A. (2010). Occurrence and removal of PPCPs in municipal and hospital wastewaters in Greece. *Journal of Hazardous Materials*, 179, 804–817.

- Kuster, M., Lopez de Alda, M. J., Hernando, M. D., Petrovic, M., Alonso, J. M., & Barcelo, D. (2006). Analysis and occurrence of pharmaceuticals, estrogens, progestogens and polar pesticides in sewage treatment plant effluent, river water and drinking water in the Llobregat river basin (Barcelona, Spain). *Journal of Hydrology*, *358*, 112–123.
- Labadie, P., 2004. Determination des steroïdes hormonaux dans l'environnement: développements analytiques et application. Thèse de Doctorat en chimie analytiques et environnement, Université Bordeaux I, 270 p.
- Lees, P., Landoni, M. F., Ciraudel, J., & Toutain, P. L. (2004). Pharmacodynamics and pharmacokinetics of nonsteroidal antiinflammatory drugs in species of veterinary interest. *Journal of Veterinary Pharmacology and Therapeutics*, *27*, 479–490.
- Li, H., Helm, P. A., & Metcalfe, C. D. (2010). Sampling in the Great Lakes for pharmaceuticals, personal care products, and endocrine-disrupting substances using the passive polar organic chemical integrative sampler. *Environment and Chemistry*, *29*, 1–12.
- MacLeod, S. L., McClure, E. L., & Wong, C. S. (2007). Laboratory calibration and field deployment of the polar organic chemical integrative sampler for pharmaceuticals and personal care products in wastewater and surface water. *Environmental Toxicology and Chemistry*, *26*, 2517–2529.
- Miege, C., Budzinski, H., Jacquet, R., Soulier, C., Pelte, T., Coquery, M., et al. (2011). L'échantillonnage intégratif par POCIS—application pour la surveillance des micropolluants organiques dans les eaux résiduaires traitées et les eaux de surface. *Techniques Sciences et Methode*, *1–2*, 80–94.
- Nakada, N., Kiri, K., Shinohara, H., Harada, A., Kuroda, K., Takizawa, S., et al. (2008). Evaluation of pharmaceuticals and personal care products as water-soluble molecular markers of sewage. *Environmental Science and Technology*, *42*, 6347–6353.
- NRDW (2006) National Report on drinking water quality and supply in 2006 year. [http://www.minjkg.gov.ua/editattach/bigdoc/nd\\_voda2006.doc](http://www.minjkg.gov.ua/editattach/bigdoc/nd_voda2006.doc) (in Ukrainian). Accessed 1 March 2010
- Othoniel, C. (2006) La croissance du biofilm photosynthétique : un indicateur du statut trophique des rivières? Thèse de Doctorat en Biogéochimie de l'Environnement, Université Bordeaux I. p 277.
- Petty, J. D., Huckins, J. N., Alvarez, D. A., Brumbaugh, W. G., Cranor, W. L., Gale, R. W., et al. (2004). A holistic passive integrative sampling approach for assessing the presence and potential impacts of waterborne environmental contaminants. *Chemosphere*, *54*, 695–705.
- Rabiet, M., Togola, A., Brissaud, F., Seidel, J.-L., Budzinski, H., & Elbaz-Poulichet, F. (2006). Consequences of treated water recycling as regards pharmaceuticals and drugs in surface and ground waters of a medium-sized Mediterranean catchment. *Environmental Science and Technology*, *40*, 5282–5288.
- Söderström, H., Lindberg, R. H., & Fick, J. (2009). Strategies for monitoring the emerging polar organic contaminants in water with emphasis on integrative passive sampling. *Journal of Chromatography A*, *1216*, 623–630.
- Tapie, N., Devier, M. H., Soulier, C., Creusot, N., Le Menach, K., Aït-Aïssa, S., et al. (2011). Passive samplers for chemical substance monitoring and associated toxicity assessment in water. *Water Science and Technology*, *63* (10), 2418–2426.
- ter Laak, T. L., van der Aa, M., Houtman, C. J., Stoks, P. C., & van Wezel, A. P. (2010). Relating environmental concentrations of pharmaceuticals to consumption: a mass balance approach for the river Rhine. *Environment International*, *36*, 403–409.
- Togola, A., 2006. Presence and devenir des substances pharmaceutiques dans les écosystèmes aquatiques. PhD thesis. Université Bordeaux I, France.
- Togola, A., & Budzinski, H. (2007a). Development of polar organic integrative samplers for analysis of pharmaceuticals in aquatic systems. *Analytical Chemistry*, *79*, 6734–6741.
- Togola, A., & Budzinski, H. (2007b). Analytical development for analysis of pharmaceuticals in water samples by SPE and GC-MS. *Analytical and Bioanalytical Chemistry*, *388*, 627–635.
- Togola, A., & Budzinski, H. (2008). Multi-residue analysis of pharmaceutical compounds in aqueous samples. *Journal of Chromatography A*, *177*, 150–158.
- Vasenko, O.G., Lungu, M.L., Iljevska, Y.A., Klymov, O.V. et al. (2006) Research report. The integrated field research of environmental conditions of water bodies of the Udy water basins (sub-basin of the Seversky Donets River)“Rayder” Publ., Kharkiv, 156 p. (in Ukrainian).
- Vrana, B., Mills, G. A., Allan, I. J., Dominiak, E., Svensson, K., Knutsson, J., et al. (2005). Passive sampling techniques for monitoring pollutants in water. *Trends in Analytical Chemistry*, *24*, 845–868.
- Vystavna, Y. Y., Le Coustumer, P., Huneau, F., & Vergeles, Y. (2009). Trace metals and pharmaceuticals in transboundary waters, their monitoring, toxicity and regulation. UNESCO: International workshop on Water and Health , Koblenz, 6–7 December 2009 (available: [www.hydrology.nl/](http://www.hydrology.nl/))
- Vystavna Y., Le Coustumer, P., & Huneau, F. (2010). The distribution and accumulation of emerging pollutants in urban waters of Eastern Ukraine. Abstract volume. World Water Week in Stockholm, September 5–11, 2010 Published by Stockholm International Water Institute. Sweden, 420–421.
- Vystavna, Y., Huneau, F., Motelica-Heino, M., Le Coustumer, P., Vergeles, Y., & Stolberg, F. (2011). Monitoring and flux determination of trace metals in rivers of the Seversky Donets basin (Ukraine) using DGT passive samplers. *Environmental Earth Sciences*. doi:10.1007/s12665-011-1151-4.
- Zhang, Z., Hibberd, A., & Zhou, J. L. (2008). Analysis of emerging contaminants in sewage effluent and river water: comparison between spot and passive sampling. *Analytica Chimica Acta*, *607*, 37–44.
- Zuccato, E., Castiglioni, S., Bagnati, R., Chiabrando, C., Grassi, P., & Fanelli, R. (2008). Illicit drugs, a novel group of environmental contaminants. *Water Research*, *42*, 961–968.

## Summary

Our results demonstrate the first data on the presence of pharmaceuticals in the Ukrainian watercourse, what were obtained with the use of the passive sampling sensors, and the application of the water monitoring data for the identification and comparison of the socio-economic determinants of water pollution in different regions, i.e.:

- (i) *the regional medicaments consumption patterns* – the calculation of these outlines were based on the water monitoring data, what were obtained for the regions with contrasted socio-economic conditions. For this purpose the mass balanced approach has been applied to identify the primary pharmaceuticals consumption patterns and include both socio-economic (i.e. number of population, wastewater treatment efficiency) and hydrological (i.e. concentration of the chemicals in the watercourses, water flow rates) indicators;
- (ii) *negative activities what influenced water pollution*, i.e. illegal and uncontrolled discharges – these processes can be discriminated using the pharmaceuticals as molecular markers. This perspective was also studied in the research.

Additionally to the socio-economic, some of environmental determinants such as contrasted hydrological (i.e. low and high flow periods) and climate seasons (i.e. spring –summer and winter) has been considered in the research and used for the description of the pollution sources.

Proposed methods of the data collection and interpretation can be applied to the rivers with similar hydrological and geochemical characteristics and provide the pilot information on occurrence of micro-pollutants, but also to give the preliminary socio-economic characteristics for particular regions in term of the drug market and medicament consumption, presence of the illegal and uncontrolled discharges.

Obtain results of the study on the socio-economic and environmental determinants became a base for the detailed study on anthropogenic indicators of water pollution, what is described in the Chapter 7.



## CHAPTER VII

### PERSPECTIVES

At the final step of the research, the found results on socio-economic and environmental determinants of pharmaceuticals and trace metals, what described in Chapter 4, Chapter 5 and Chapter 6, have been used for the detailed analysis of the perspective of these contaminants as anthropogenic markers of water pollution. The part was focused on the study of physic-chemical properties, accumulation patterns, sources of trace metals and pharmaceuticals in watercourse in order to identify targeted tracers as anthropogenic indicators of urban and industrial pollution. Such approach is gathering environmental and socio-economic data for understanding processes of the water pollution (i.e. sources, instream events) and practical implementation of the water monitoring data in multidisciplinary studies.

The result of this study is presented in the form of the article that was submitted:

**Vystavna Y., Huneau F., Le Coustumer P. Trace metals and pharmaceuticals as anthropogenic and socio-economic indicators of urban and industrial impact on surface waters [submitted in Water Resources Management]**

## Trace metals and pharmaceuticals as anthropogenic and socio-economic indicators of urban and industrial impact on surface waters

Yuliya VYSTAVNA<sup>1,2,3,\*</sup>, Frédéric HUNEAU<sup>1,2</sup>, Philippe LE COUSTUMER<sup>1,2</sup>

<sup>1</sup>Université de Bordeaux, UFR des Sciences de la Terre, B18, avenue des Facultés, 33405 Talence, France

<sup>2</sup>EA 4592 Géoressources & Environnement, Institut EGID, 1 allée F. Daguin, 33607 Pessac, France

<sup>3</sup>National Academy of Municipal Economy at Kharkiv, Department of Environmental Engineering and Management, vul. Revolutsii 12, Kharkiv, 61002, Ukraine

\*Contact author:

Yuliya VYSTAVNA

Université de Bordeaux, UFR des Sciences de la Terre, B18, avenue des Facultés, 33405 Talence, France, vystavna@yahoo.com

### Abstract

The research focuses on the investigation of trace metals and pharmaceuticals as potential anthropogenic indicators of industrial and urban influences on surface water. This study includes analysis of tracers use for the indication of water pollution events and discussion of the detection method of these chemicals. The following criteria were proposed for the evaluation of indicators: specificity (physical chemical properties), variability (spatial and temporal) and practicality (capacity of the sampling and analytical techniques). The combination of grab and passive sampling (i.e. DGT and POCIS) procedure was applied for the determination of dissolved and labile trace metals (Ag, Cd, Cr, Cu, Ni, Pb and Zn) and pharmaceuticals (carbamazepine, diazepam, paracetamol, caffeine, diclofenac and ketoprofen). Samples were analysed using ICP – MS (trace metals) and LC-MS/MS ESI +/- (pharmaceuticals). Our results demonstrate the distinctive spatial and temporal patterns of trace elements distribution along the urban watercourse. Accordingly, two general groups of trace metals have been discriminated: ‘stable’ (Cd and Cr) and ‘time-varying’ (Cu, Zn, Ni and Pb). The relationship  $Cd \gg Cu > Ag > Cr \geq Zn$  was proposed as an anthropogenic signature of the industrial and urban activities pressuring the environment from point sources (municipal wastewaters) and the group Pb - Ni was discussed as a relevant fingerprint of the economic activity (industry and transport) mainly from non-point sources (run-off, atmospheric depositions, etc.). Pharmaceuticals with contrasting hydro-chemical properties of molecules (water solubility, bioaccumulation, persistence during wastewater treatment processes) were discriminated on conservative, labile and with combined properties in order to provide the information on wastewater treatment plant efficiency, punctual events (e.g. accidents on sewage works, run-off) and uncontrolled discharges. Applying mass balance modeling, medicaments were described as relevant socio-economic indicators, which can give a picture of main social aspects of the region.

**Keywords:** pharmaceuticals, trace metals, DGT, POCIS, anthropogenic indicators, socio-economic indicators, Ukraine

## Introduction

The contamination of urban water by trace elements (i.e. detected at the level  $< 1 \mu\text{gL}^{-1}$ ) is associated with regional environmental and socio-economic factors (Dickenson et al. 2011). Climate, hydrological, hydro- and geochemical regional specificity is responsible for the accumulation, dilution, complexation and degradation of chemicals and what can derive from point (i.e. treated and untreated discharges of municipal wastewater treatment plants, industrial manufacturing processes, leaky sewers, combined sewer overflow and onsite wastewater systems) and nonpoint (diffusive) sources (i.e. run-off, precipitation) (Daughton and Ternes 1999; Rowsell et al. 2010; Dickenson et al. 2011). Inputs and distribution of chemicals in urban waters are also linked to the population density, consumption patterns, economic structure and water use rate (Dickenson et al. 2011). Other important issues are physical chemical properties of elements (i.e. speciation and solubility), which can be responsible for their behavior and fate in the environment (i.e. accumulation complexation and biodegradation). Knowledge on impact factors and properties of certain tracers in the environment can be useful for the indication of changes in the environment (Dale and Bayeler 2001), assessing the degree of industrial and urban pressures on the natural water, and source identification (McGeoch [1998](#); Duelli and Obrist [2003](#)).

Our study focuses on the perspectives of the application of trace metals and pharmaceuticals with distinctive properties and origin, as regional anthropogenic and socio-economic indicators of industrial and urban pressures on watercourses.

Trace Metals and Pharmaceuticals (TMP) have been previously considered as potential indicators of anthropogenic inputs in natural waters (Kasprzyk-Hordern et al. 2009a,b; Dickenson et al. 2011). Compared to biological markers, the TMP have the following advantages: (i) they have known physical chemical properties that are linked to industrial or domestic pollution processes (Dickenson et al. 2011); (ii) monitoring of TMP typically requires less sample preparation and time for the analysis (Bull et al. 2002; Hagedorn and Weisberg 2009), and (iii) data on their occurrence can be used as socio-economic indicators in multidisciplinary studies (Kasprzyk-Hordern et al. 2009b).

Trace metals are inorganic compounds issued from natural and anthropogenic sources (e.g. Schäfer et al. 2009). Two general features discriminate metals from other trace pollutants: (1) they are not biodegradable and thus are able to accumulate in sediments and living

organisms; (2) their bioavailability and potential toxicity are largely controlled by present physical chemical forms (Alonso et al. 2004) what also affects their accumulation and distribution along water courses (Baalousha et al. 2006). The ability of trace metals to deposit in the sediments is widely used for the reflection of local industrial, mining and agricultural pressures on the area and for describing long-term pollution influences (Sanchez-Cabeza and Druffel 2009; Lepland et al. 2010). Trace metals were previously proposed as indicators (Christophoridis et al. 2009; Schäfer et al. 2009) of the economic sector (industrial and transport: e.g. Ni and Pb for the indication of pollution by fossil fuel combustion and oil refinery processes by Soldi et al. 1996 and Mazzei et al. 2008) and urban activity (e.g. Ag as the tracer of urban effluents by Guevara et al. 2005 and Lanceleur et al. 2011).

Pharmaceuticals are organic compounds signing anthropogenic origin, produced, consumed and/or excreted by humans and animals, or used in household products. They have known chemical characteristics (i.e. persistence, solubility, degradation), strong relation to the consumption level, high detection frequency and already currently developed monitoring and analytical techniques for the identification in the environment (Buerge et al. 2003; Clara et al. 2004; Bartelt-Hunt et al. 2009; Froehner et al. 2010). Pharmaceuticals are previously considered as good anthropogenic indicators of water contamination with treated and untreated domestic discharges (Clara et al. 2004; Nakada et al. 2008; Kasprzyk-Hordern et al. 2009a) and as prospective anthropogenic markers (Clara et al. 2004; Sankararamkrishnan and Guo 2005; Buerge et al. 2006; Nakada et al. 2008; Bahlmann et al. 2009) of the social activity (i.e. drug consumption rate) (Bendz et al. 2005; Kasprzyk-Hordern et al. 2009a, b).

Selected tracers (trace metals: Ag, Cd, Cr, Cu, Ni, Pb, Zn; pharmaceuticals: caffeine, carbamazepine, diazepam, diclofenac, ketoprofen and paracetamol) were monitored in the urban Udy River of the Seversky Donets watershed, in the Kharkiv region, Ukraine. Previous research carried out in the studied watershed (Vystavna et al. 2010; 2011 and 2012) revealed that discharges of wastewater effluents are responsible for the urban water contamination by trace metals and pharmaceuticals. The reason is the mixing of domestic and industrial effluents of the Kharkiv agglomeration on the municipal wastewater treatment works, low efficiency of used techniques, and weak dilution in the natural water bodies (Vystavna et al. 2011).

General tasks of this research are: (1) analyse particular properties of trace metals and pharmaceuticals in the environment using the specified criteria; (2) proceed the water monitoring on the pilot study area with the application of conventional and innovative passive sampling techniques, and (3) provide a mass balance modeling for the application of pharmaceuticals as indicators of the social activity (i.e. medicaments consumption).

### 1. Study area

The Udy River in the Kharkiv region (c.a. 3,000,000 inhabitants) has been selected as a model water body to identify principal trace elements contaminant, their distribution and sources of origin (Vystavna et al. 2011) on the industrial, agricultural and urban agglomeration of Eastern Ukraine (Table 1).

Table 1. Socio-economic characteristics of the Kharkiv region (2009)

Indicator	Value
Population total	2,780,300 persons
Urban population	80 %
Incomes of population	2200 USD person <sup>-1</sup> year <sup>-1</sup>
Economic structure	
Industry:	50 % of Gross Regional Production
Heavy industry (metallurgy, machine building, coal combustion, smelters, electroplating etc.)	28%
Food production	30%
Chemical industry (pigments, plastics, pharmaceuticals etc.)	6%
Process industry (gas, oil, wood, sand)	5%
Building materials	4%
Light industry	4%
Other	23%
Agriculture	5 % of Gross Regional Production
Gaz, energy, heat, water production and supply	17 % of Gross Regional Production
Other (transport, trade, education, service etc.)	28 % of Gross Regional Production

The Udy River is the main tributary of the Seversky Donets River. This alluvial transboundary river takes source in the Belgorod region, Russia, and flows through rural and urban areas of the Kharkiv region, Ukraine, where the watercourse is used for

recreation, drinking and industrial water supply, irrigation and fishing, and receives municipal wastewaters from the Kharkiv city (Vasenko et al. 2006). The mean annual discharge of the Udy River is  $6.8 \text{ m}^3 \text{ s}^{-1}$  in winter and  $2.5 \text{ m}^3 \text{ s}^{-1}$  in summer in the site located upstream of the Kharkiv city (Vasenko et al. 2006). River is partly covered by ice from the end of November to the end of March. Subsurface geological structures of the catchment area are dated from Paleocene and consist mainly of sedimentary rocks like sandstone, marl and chalk. The Udy River generally feeds by precipitation (Vasenko et al. 2006), so the influence of groundwaters (Seiler et al. 1999; Einsiedl et al. 2010) on the water quality can be neglected.

There are two main wastewater treatment plants in the Kharkiv region discharging treated wastewater effluents into the Udy River (Suchkova et al. 2010; Vystavna et al. 2011): WWTP 'Bezludivka' (WWTP 'B') and WWTP 'Dykanivka' (WWTP 'D'). The WWTP 'B' (c.a.  $250,000 \text{ m}^3 \text{ d}^{-1}$ ) discharges directly into the studied river and WWTP 'D' (c.a.  $600,000 \text{ m}^3 \text{ d}^{-1}$ ) wastes into the Lopan River at 500 m upstream of the Udy - Lopan confluence (Figure 1). Both WWTPs process mixed industrial (25% of total wastewaters) and domestic wastewaters (75% of total wastewaters) of the Kharkiv city and the suburban area, serving approximately 1.3 millions of population (89% of the regional urban population). The wastewater treatment includes mechanical (mills and grit chambers, pre-aerator, primary and secondary clarifiers) and biological (aerobic treatment with the activated sludge) processes with a final chlorination. Treatment of sludge generated by both WWTPs is carried out at WWTP 'B' (about  $3000 \text{ m}^3 \text{ d}^{-1}$ ). Sewage sludge is passed through thickeners, decanters and store at the land field (Suchkova et al. 2010). During the low flow period (August – September) the volume of wastewaters can be in 21 times more than the river's flow.

## **2. Materials and method**

### *2.1. Data collection*

The sampling sites were chosen taking into account potential sources of substances (i.e. wastewaters discharge), possible access to sites in contrasted climate conditions and the risk of vandalism towards installed passive sensors.

Sampling sites were: (1) U01 is in the agricultural rural area of the Kharkiv region, Ukraine, 1 km downstream from the Russian border – selected for the upstream baseline overview; (2) U04 is upstream of the Kharkiv urban area – chosen for the identification of

effluents in the city area, what can be contaminated from discharges of untreated wastewaters of rural communities and treated wastewaters of the local thermal power station; (3) U06 is in the urban area, upstream of the Lopan - Udy confluence and upstream from the wastewater outlet of both wastewater treatment plants (WWTPs) – selected for the identification of urban area impact on natural water and in order to compare upstream/downstream river parts from WWTP inputs; (4) U07 is downstream from the discharge of the WWTP ‘B’ and the Lopan - Udy Rivers confluence – the river flow is contaminated by pollutants from the urban and industrial area of the Kharkiv region (Figure 1).

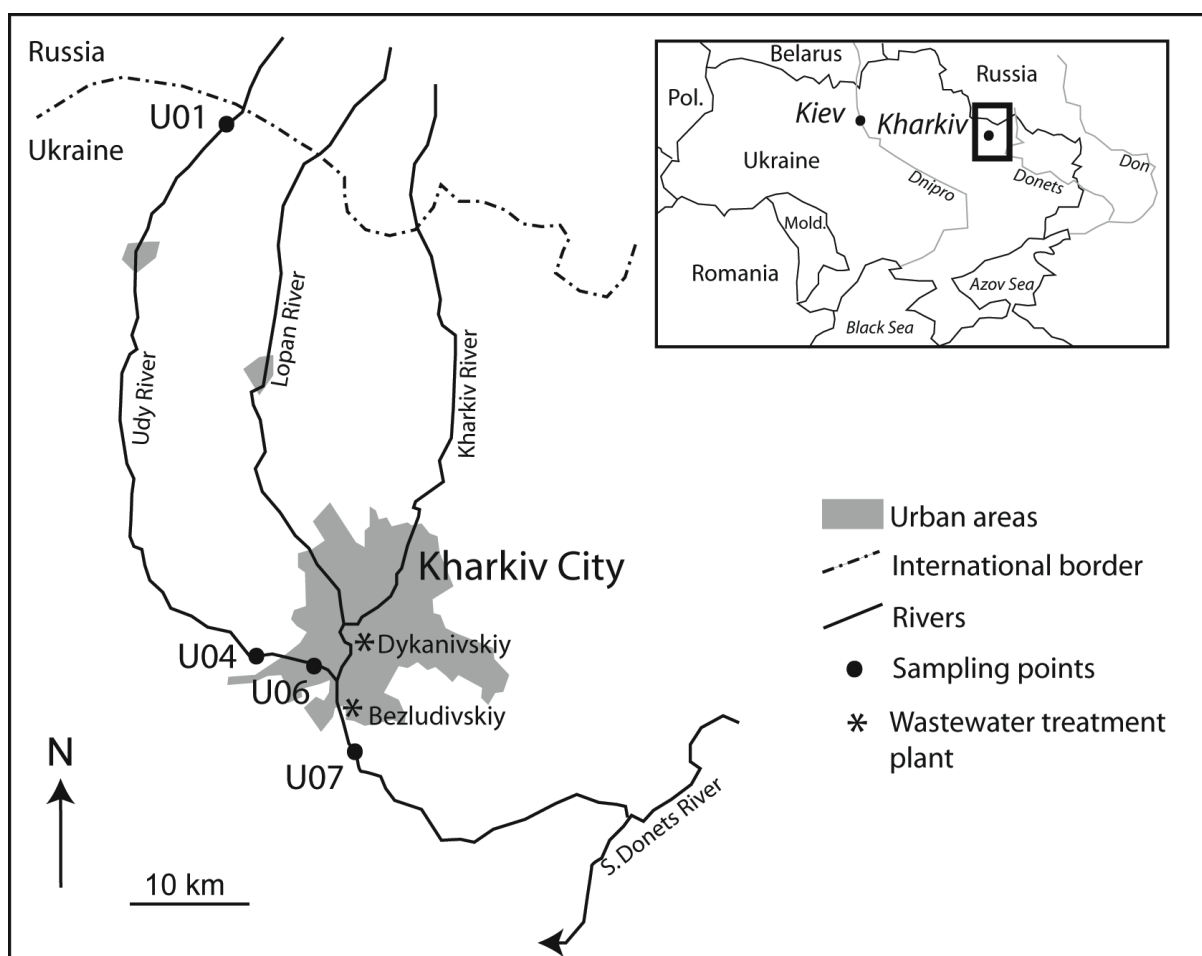

Figure 1. The location of sampling sites on the Udy River

The dissolved and DGT-labile trace elements, i.e. priority pollutants: Cd, Cr, Cu, Ni, Pb and Zn (EU 2008) in water, were measured with the duplicated samples ( $n$ , number of samples taken during the monitoring = 48 for DGT and  $n = 48$  for grab samples) in contrasted hydrological conditions: high flow in May and low flow in August from 2008 to 2010. The concentration of trace metals (Cd, Cr, Cu, Ni, Pb, Zn and the urban tracer Ag) in

the sediments was determined in the sampling campaign in May and August 2009 ( $n = 16$ ). Pharmaceuticals (i.e. carbamazepine, diazepam, caffeine, paracetamol, ketoprofen and diclofenac) were monitored using the duplication of POCIS samplers ( $n = 72$ ) in contrasted seasonal conditions: cold season in January, warm high flow season in May and warm low flow season in August from 2008 to 2010.

## 2.2. Samples collection and analysis

### 2.2.1. Trace metals in water and sediments

The dissolved (0.22  $\mu\text{m}$ ) fraction of trace metals, that includes free hydrated ions, readily dissociable (labile) complexes, species adsorbed on inorganic and organic colloids and elements strongly bound to inorganic and organic complexes, was sampled at 1 m from the bank and at 0.2 m depth using an acid-cleaned 50 ml syringe and immediately filtered through 0.2  $\mu\text{m}$  with polycarbonate filters (Nucleopore®) (Lanceleur et al. 2011), acidified ( $\text{HNO}_3$ , ultrapure; 1/1000 v/v), as described by Masson et al. (2009) and stored in acid cleaned 16 ml polypropylene tubes at 4 °C in the dark awaiting the analysis.

The labile metal fraction was sampled using the diffusive gradient in the thin film (DGT) - passive samplers to be installed at same sites and the period with the extraction of grab water samples. According to the DGT theory, these devices measure mobile and bioavailable fraction of the element, which are in the labile equilibrium with species that can bind to the binding agent of the sampler (Zhang and Davison 1995). The DGT devices with a 0.4 mm resin gel layer, a 0.8 mm diffusive gel layer and a 0.45  $\mu\text{m}$  pore-size filter, were deployed at a 0.20 – 0.25 m water depth to avoid turbulent flow zones. After 15 days, DGT samplers were retrieved and kept humid at 4°C until the analysis. Trace metals accumulated in the binding phase of the DGT probes (3.14  $\text{cm}^2$ ) were eluted by immersion into 1 mL of  $\text{HNO}_3$  (1 M) for 48 hours (Zhang and Davison 1995). The parallel blank elution was performed in the laboratory. DGT measured dissolve labile concentrations of Cd, Cr, Cu, Ni, Pb and Zn were analyzed by ICP-MS. The blank corrected concentrations of DGT-labile metal in water were estimated using the temperature dependent diffusion coefficient as proposed by the DGT-manufacturer (DGT Research 2002). The detailed procedure of the DGT sampling in severe conditions (approach and analysis) has been published in Vystavna et al. (2011).

Sediments were collected close to the riverbank and stored in sterile capped containers. In the laboratory, samples were dried at 50°C to the constant weight, powdered, homogenized



and stored in closed polyacrylate containers. After the digestion at 110<sup>0</sup>C and cooling, samples were brought to 10 mL using 250  $\mu$ L HNO<sub>3</sub> (14 M, suprapure) and double deionized (Milli-Q<sup>®</sup>) water. Dissolved metal concentrations in water samples and sediment digests were measured by ICP-MS (X7, Thermo). The results were consistently within the range of certified values for all CRM (SLRS-4 river water; IAEA405 and LGC 6187 sediments) and the analytical error (relative standard deviation) generally better than 5 % for concentrations 10 times higher than the detection limits. The procedure and results were in accordance with previous studies performed in the analytical laboratory used (e.g. Schäfer and Blanc 2002; Audry et al. 2004).

### 2.2.2. *Pharmaceuticals in water*

The polar organic chemical integrated samplers (POCIS) with the Oasis HLB sorbent were purchased from Exposmeter (Tavelsjö, Sweden). After 21 days of exposure, each individual POCIS device was removed from the water and briefly rinsed with ultrapure water. The POCIS extraction and analysis have been performed in the laboratory of the University of Bordeaux, France according to previously developed protocols (Togola and Budzinski 2007; Vystavna et al. 2012). The surface membrane was detached and rinsed with the ultrapure water. Phases of the each POCIS have been transferred into an empty SPE tube by 5 mL of ultrapure water per each membrane, through cartridges with cleaned Teflon frits, and dried under vacuum for 1 h. The sorbent was eluted using 10 mL of each solution: methanol; methanol/dichloromethane mixture (50:50) and dichloromethane and spiked with internal standards: <sup>13</sup>C<sub>3</sub>-caffeine, *d*<sub>4</sub>-diclofenac, *d*<sub>5</sub>-diazepam, *d*<sub>3</sub>-ketoprofen and *d*<sub>4</sub>-paracetamol (Budzinski et al. 2009; Vystavna et al. 2012). The obtained extracts were evaporated using a nitrogen flux and transferred into injection vials 50  $\mu$ L of acetonitrile. Blanks were performed in the laboratory concurrently with water samples. All targeted compounds were found below the limits of the detection in blank samples. Recovery rates were determined by spike samples (n=3 for the each chemical) and vary from 81 to 89 % of the spiked amount (Table 2). After the extraction step, the mass of sorbent was measured by the gravimetry for the each POCIS. The prepared samples, spikes and blanks were analyzed on the Agilent 6410 Triple Quadropole LC/MS/MS system (USA) with an electrospray (ESI+/-) ionization source. Electrospray ionization with the positive ion mode was used for the detection of paracetamol (PARA), caffeine (CAF), carbamazepine (CBZ), diazepam (DZP) and the negative ion mode was applied for diclofenac (DICLO) and ketoprofen (KETO) by multiple reaction monitoring (MRM) with the nitrogen collision

gas. The Agilent 1200 series Binary Pump and Column SL G1312B USA (50 mm x 2.1 mm, 1.8  $\mu\text{m}$ , 30  $^{\circ}\text{C}$ ) system was used for the separation at a flow rate of 0.6  $\text{mL min}^{-1}$  with a gradient of acetonitrile and 0.1% formic acid in water. Source conditions were: capillarity 3000V, gas flow at 11  $\text{L min}^{-1}$ , gas temperature 300  $^{\circ}\text{C}$  and nebulizer 30 psi.

Table 2. Targeted pharmaceuticals (PPs) detected by POCIS and analytical method performance

PPs	CAS no	Therapeutic class	Retention time (min)	MRM	Collision energy V	Cone voltage V	LOD, $\text{ng g}^{-1}$	Recovery (n=3), %		$R_s$ $\text{L d}^{-1}$
								mean	RSD	
CAF	58-08-2	Stimulant	4.01	196 > 139	20	130	1	88	4.1	0.13
CBZ	298-46-4	Sedative	6.52	237 > 192	20	120	1	86	21	0.29
DZP	439-14-15	Antidepressant	7.82	285 > 154	28	120	1	86	4.9	0.40
DICLO	15307-86-5	Non-steroidal anti-inflammatory drug	18.55	294 > 214	18	80	1	81	9.6	0.15
KETO	22071-15-4	Non-steroidal anti-inflammatory drug	14.41	253 > 212	1	60	1	89	3.9	0.13
PARA	103-90-2	Analgesic	2.95	152 > 93	26	110	1	87	3.3	0.03

The limit of the detection was determined by measuring the coincident instrumental response of standard solutions and spiked blank POCIS extracts. Environmental time weight average (TWA) concentrations of molecules were determined using the standard equation (Togola and Budzinski 2007) (Eq. 1):

$$C_w = C_s M_s / R_s t \quad (1)$$

where  $C_w$  and  $C_s$  are the concentration of the compound in the aqueous and sorbent phase ( $\text{ngL}^{-1}$ ), respectively,  $M_s$  is the mass of sorbent (g),  $R_s$  is the sampling rate ( $\text{L d}^{-1}$ ) and  $t$  is the exposure time (d). Among the suitable sampling rates (Alvarez et al. 2004; MacLeod et al. 2007; Togola and Budzinski 2007; Li et al. 2010), we used sampling rates of CAF, DZP and PARA obtained by Miege et al. (2011) and for CBZ, DICLO and the sampling rate of KETO was determined by Budzinski et al. (2009) (Table 2). Sampling rates were identified in laboratory conditions. The selection of these values were considered similar to the type used for POCIS and environmental parameters (flow conditions is 0.21  $\text{m s}^{-1}$ , installation is during 14 days, temperature is 15 - 25  $^{\circ}\text{C}$ ), which were closest to those in the field, than rates found in other previously mentioned studies. The sampling rate is independent from the aqueous concentration of analytes (Togola and Budzinski 2007), it shows insignificant variation depending on the presence of organic matter (Li et al. 2011) and at the range of pH from 7 to 9 (Li et al. 2011). A previous study (Togola and Budzinski 2007) concluded

the influence of the water temperature on the uptake of molecules in the POCIS membrane. The most pronounced effect was observed for KETO, which shows a 2-fold growing level of the sampling rate with the increasing of water temperature (Togola and Budzinski 2007). The temperature effect on the uptake of CAF, CBZ and DICLO is relatively small (less than 1.5 fold) (Togola and Budzinski 2007; Li et al. 2010) and their sampling rates were not adjusted to water temperature (Li et al. 2010; Munaron et al. 2011). So, the correction of the TWA concentration according to water temperature has not been done in this study, but the results on the TWA during cold (winter) and warm (spring and summer) was interpreted with the precaution, especially for KETO.

### 2.2.3. General physico-chemical water parameters

Water temperature, conductivity and pH were measured in the field with a WTW<sup>®</sup> Multiline P4 meter before and after passive samplers deployment. Total organic carbon (TOC) (Vystavna et al. 2011) was determined from spot unfiltered samples, taken at the same time as the installation of passive samplers, and analyzed by TOC-5000, Shimadzu<sup>®</sup> automated analyzer following ISO 10694.

Water flow rates were obtained from the Kharkiv Hydro-meteorological Agency.

### 2.3. Criteria for the selection of an indicator

The application of trace metals and pharmaceuticals as indicators were described according to the following criteria (e.g. Hagedorn and Weisberg 2009): specificity, variability and practicality.

The *specificity* was assessed based on the form, physical chemical properties and links to metabolism related and/or industrial discharges.

Trace metals were selected for the characterization of economic sector activity (industry, transport and agriculture) on the urban water.

Trace metals in the sediments were chosen for the indication of accumulation processes in urban water (Schäfer and Blanc 2002; Audry et al. 2004; Yang and Rose 2005) and were evaluated by the enrichment factor (EF) using the following equation (Liaghati et al. 2004):

$$(EF) = (C_x/C_{Th})_{sample} / (C_x/C_{Th})_{bas} \quad (2)$$

where  $(C_x/C_{Th})_{sample}$  is the ratio of measured concentration of the element ( $C_x$ ) in the sediment sample upon Th concentration ( $C_{Th}$ ), and  $(C_x/C_{Th})_{bas}$  is the respective baseline ratio (Fateev and Pashenko 1999) also normalized by Th. Researchers of the Ukrainian Academy of Science determined the mentioned baseline ratio considering the crust value proposed by Vinogradov (1962) and local hydrological and hydro-chemical characteristics of the Udy River, what were identified during 5 years of the monitoring. Thorium was used as a normalizer in order to compensate the variability of trace elements in the sediments resulting from the grain size distribution and the sampling procedure (Coynel et al. 2007).

The dissolved and DGT - labile fractions of trace metals in water were used for the indication of current inputs of elements and the representation of certain sources.

The following *specificity* of pharmaceuticals has been taken into account: persistence during wastewater treatment processes (removal efficiency, %); water solubility ( $\text{mgL}^{-1}$ ), and bioaccumulation, using octanol-water partition coefficient ( $\log K_{ow}$ ) (Girard 2005; Kasprzyk-Hordern et al. 2009a,b; U.S. EPA 2011).

*Variability* means that indicators have defined temporal (i.e. seasonal, hydrological periods, economic activity) and spatial (urban and rural area, regions, countries) patterns. Therefore, trace metals in the sediments represent the persistent and low variable model compare to dissolved and DGT labile metals, which have more pronounced seasonal and hydrological patterns, but also it can depend on the seasonal economic activity (i.e. agriculture) (Vystavna et al. 2011).

The trace metal variability in waters is estimated using the following ratio (Sangi et al. 2002; Balistrieri and Blank 2008):

$$K = C_{dgt}/C_{dis} \quad (3)$$

with  $C_{dgt}$  is the concentration measured using the integration time (within 15 - days installation period) of DGT samplers;  $C_{dis}$  is the dissolved fraction concentration ( $0.22 \mu\text{m}$  permeate) measured from the standard grab sampling.

The variability of pharmaceuticals is assessed using the coefficient of variation (CV *rsd*, %) (Shridhar et al. 2010) calculated for contrasted hydrological and seasonal periods:

$$CV \text{ rsd} = 100 * \left( \frac{\sqrt{\sum_{i=1}^n (C_{x_i} - C_{\bar{x}})^2}}{n-1} \right) / C_{\bar{x}} \quad (4)$$

with  $Cx_i$ ; is the concentration of the pharmaceutical during  $i$ -study period,  $C\bar{x}$  is the mean measured concentration of pharmaceutical in all periods, and  $n$  is the number of measurements.

The *practicality* means capacity of the available sampling and analytical techniques to monitor and analyze the indicator with the high precision (low detection limit, high reproducibility and accuracy).

The practicality of indicators is assessed using the detection ratio (DR), which was previously proposed by Sedlak (2004):

$$DR = C_{med}/LOQ \quad (5)$$

with  $C_{med}$  is the median concentration ( $\text{ngL}^{-1}$ ) and  $LOQ$  is the analytical detection limit ( $\text{ngL}^{-1}$ ) of the compound.

The ratio shows the capability of analytical tools to screen changes and quantify selected compounds with the precision.

#### 2.4. Principle component analysis

The principle component analysis (PCA, e.g. Saporta 1990) has been applied in order to estimate the linear correlation between DGT-labile trace metals and pharmaceuticals. These parameters have been sampled using the passive method and also consider as mobile fractions in the water (Zhang and Davison 1995; Alvarez et al. 2004; Vystavna et al. 2011). The PCA allows us to describe the correlation between sampled fractions of inorganic and organic compounds and find similar and divers patterns of their distribution in the Udy River in May – high flow and August – low flow periods. The data of the mean values (2008 – 2010) of 12 targeted TMP (Cd, Cr, Cu, Ni, Pb and Zn; CAF, PARA, DICLO, KETO, DZP and CBZ) have been used for the projection for sites located in the urban area (U04, U06 and U07). Trace metals have been represented in the DGT-labile concentration in  $\mu\text{gL}^{-1}$ . In order to exclude the potentially influence of various parameters on the estimation of the exact concentration of pharmaceuticals, but also the risk associated with the selection of sampling rate, these compounds have been considered in the POCIS – contamination value in ng of the contaminant per g of the OASIS sorbent of the sampler (Vystavna et al. 2012) for the PCA.

On a representing PCA plot, where the first axis (F1 and F2) describes the most significant correlation, the maximum attention is given to the point close to the circle centered at (0; 0) and whose radius is equal to 1. Points, which are close one to another, indicate the existence of a linear positive correlation between parameters and the case of the radical opposition between points shows the negative correlation of elements. Two points located on perpendicular diameters indicates an independency between values.

### 3. Results

#### 3.1. General environmental parameters

According to the water flow rate and water temperature (Table 3), the following contrasted hydrological and seasonal patterns of the Udy River have been discriminated by the following: warm high flow period in May, warm low flow period in August, and cold high flow period in January.

Table 3. Measured environmental parameters of the Udy River (mean of  $n=3 \pm S.D.$ , 2008 – 2010)

Sites and parameter	May <i>warm high flow</i>	August <i>warm low flow</i>	January <i>cold low flow</i>
<b>U01</b>			
Water flow, $m^3 s^{-1}$	1.92±0.60	0.28±0.08	2.91±0.3
Water temperature, °C	17±1	18±1	12±0.5
pH	7.80±0.10	7.61±0.07	7.27±0.48
Conductivity, $\mu S cm^{-1}$	865±19	885±41	832±100
TOC, $mg L^{-1}$	nd	87±3	nd
<b>U04</b>			
Water flow, $m^3 s^{-1}$	2.15±0.49	0.32±0.06	2.98±0.18
Water temperature, °C	18±1	21±1	3±1
pH	8.20±0.14	7.65±0.46	7.55±0.16
Conductivity, $\mu S cm^{-1}$	930±54	966±10	1010±180
TOC, $mg L^{-1}$	nd	68±9	nd
<b>U06</b>			
Water flow, $m^3 s^{-1}$	7.8±1.0	1.1±0.09	8.5±1.6
Water temperature, °C	19±1	21±1	4±1
pH	7.82±0.08	7.37±0.01	7.77±0.09
Conductivity, $\mu S cm^{-1}$	1077±61	1113±105	1227±68
TOC, $mg L^{-1}$	nd	73±5	nd
<b>U07</b>			
Water flow, $m^3 s^{-1}$	14.6±1.01	7.48±0.93	12.9±0.85
Water temperature, °C	20±1	22±1	7±1
pH	7.38±0.10	7.35±0.08	7.27±0.10
Conductivity, $\mu S cm^{-1}$	1243±81	1184±59	1282±130
TOC, $mg L^{-1}$	nd	53±9	nd

The water flow in May is about 10 times higher than in August for sites upstream of wastewater influences (U1, U4 and U06) and 2 times higher than the summer values in the

downstream sites (U07). The flow rate in January is approximately at the same level (C.V.  $\pm 18\%$ ) as in May. The difference in the water flow rate between seasons mainly related to precipitations, which were 55 mm and 7 mm (mean value of 2008 – 2010, obtained in the Kharkiv Hydro-meteorological Agency for the Kharkiv ‘Osnova’ Airport Meteorological station) in May and August correspondingly. During monitored summer and spring months, water temperature had low variation (C.V.  $\pm 12\%$ ) at the sites, but in January the water temperature decreased to 2 – 4<sup>0</sup>C in upstream and 7 - 8<sup>0</sup>C in downstream city sites. Water flow rate and water temperature were increasing from upstream to downstream sites, considering the influence of the urban area on instream environmental parameters of the river. The conductivity was growing (in more than 1.5 times) from rural to urban territories, showing additional inputs along the watercourse (Table 3). The pH had low temporal and spatial variations (C.V.  $< 10\%$ ). Measured total organic carbon was slightly decreasing from upstream to downstream sites.

### 3.2. Anthropogenic indicators of the river pollution

#### 3.2.1. Trace metals

The determined concentration of dissolved and DGT-labile trace metals (Figure 2) and their detection frequency (FD) (Table 4) displayed spatial and temporal variations of selected compounds in the studied river, confirming the influence of environmental and anthropogenic factors on the river geochemistry.

Table 4. The frequency of detection (FD) and detection ratio (DR) of tracers in Udy River

Tracer	FD, %	DR	Technique	
			Sampling	Analysis
Metals ( $n=48$ )				
Cd	58	9	DGT	ICP - MS
Cr	88	55	DGT	ICP - MS
Cu	100	335	DGT	ICP - MS
Ni	100	311	DGT	ICP - MS
Pb	92	68	DGT	ICP - MS
Zn	100	736	DGT	ICP - MS
Pharmaceuticals ( $n=72$ )				
CAF	100	618	POCIS	LC/MS/MS
CBZ	88	600	POCIS	LC/MS/MS
DICLO	100	2116	POCIS	LC/MS/MS
DZP	63	3	POCIS	LC/MS/MS
KETO	50	15	POCIS	LC/MS/MS
PARA	75	16	POCIS	LC/MS/MS

Significant spatial variation was observed for DGT-labile and dissolved Zn during May and August (Figure 2), confirming the presence of various sources of this element in the river. In this study dissolved fraction of targeted trace metals have exhibited higher dimensional differences, compare to the determined DGT-labile one (Figure 2), that can be explained by instream processes such as complexation, sedimentation and/or diverse sources of trace metals along the river.

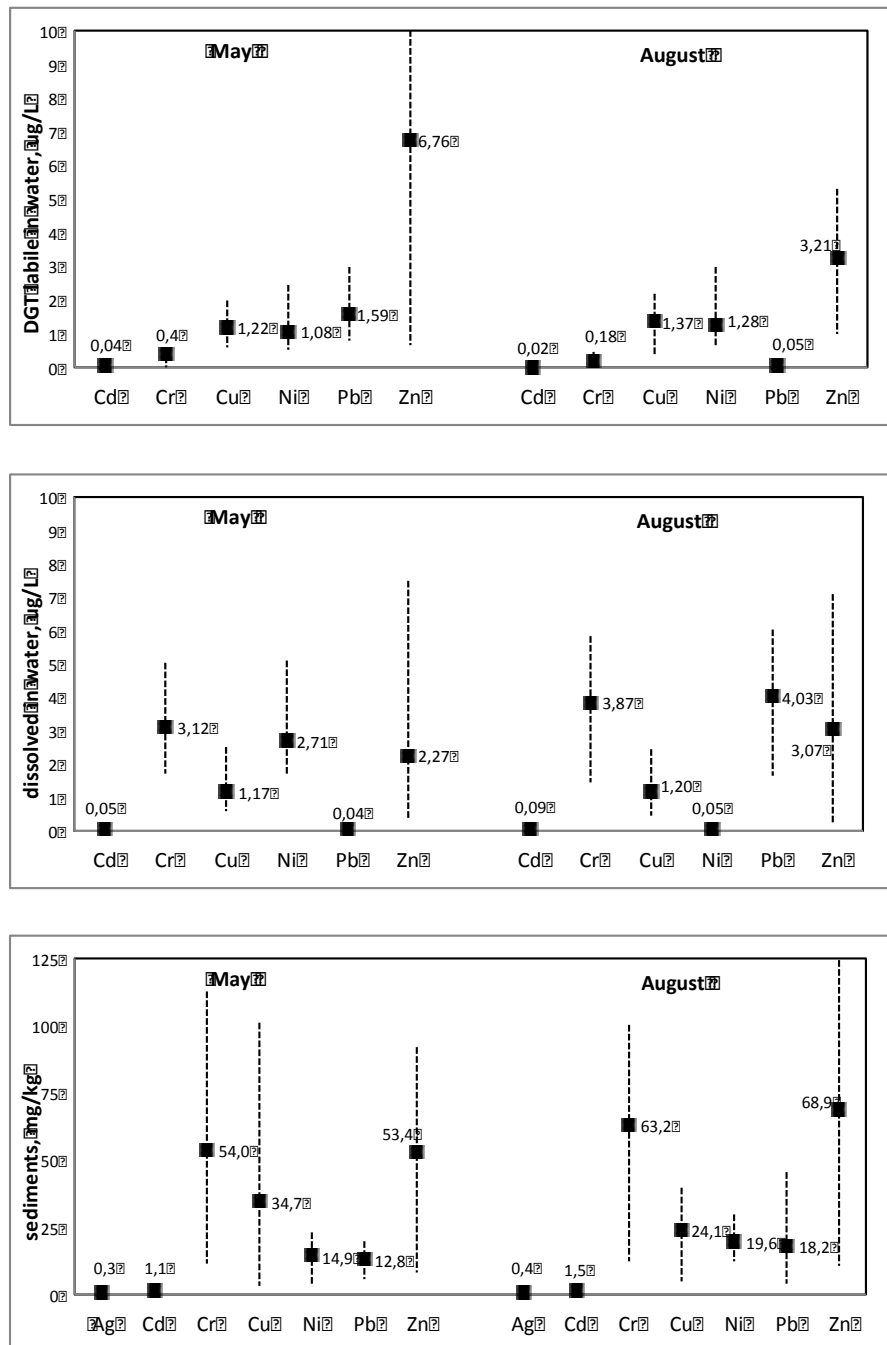

Figure 2. Determined concentration of dissolved ( $n=48$ ), DGT-labile ( $n=48$ ) and deposited in the sediments ( $n=16$ ) trace elements in the Udy River in May and August 2008 -2010 (minimum, mean and maximum values)



Maximum water concentration of all monitored metals was found in the urban area of the Kharkiv agglomeration, with peaks of Cd, Cr, Cu and Zn downstream of municipal wastewater discharges. Ni and Pb have their highest levels upstream of releases. Variation of trace metals during high and low flows period showed other patterns. Dissolved Cd, Cr, Cu and Zn presented a less than 2-fold difference between May and August. In contrast, Ni and Pb had distinctive displays with a significant decrease of dissolved Ni and increase of dissolved Pb in August. At the same time, DGT labile Pb declined during the low flow period. This situation revealed higher temporal mobility of Pb and Ni in comparison to other metals. Therefore, the presence of these metals in the Udy River is largely influenced by environmental (i.e. organic carbon) and anthropogenic (i.e. distinctive pollution sources) factors. The estimation of K-ratio (Eq.3) confirmed the significant temporal variation (K ration is more than 5) of Pb and Ni (Figure 3) in rainy and dry periods, moreover, Pb had a higher K value in the city center and in contrast, Ni had the maximum K value in the site downstream of WWTP. In addition, Cu and Zn were found to have noticeable temporal variation (K ration is less than 5) downstream of discharges (Figure 3).

In the sediments, the highest spatial variation was determined for Cr, Cu and Zn (Figure 2). It was found that concentrations of Ag, Cd, Cr, Cu and Zn increased downstream of municipal wastewaters discharges (site U07). Concurrent with the water concentration patterns, the occurrence of Pb and Ni was not only related to the discharge of WWTPs but also a significant contamination of these tracers was found in the sites (U04 and U06) upstream of the WWTP. The analysis of the accumulation level of trace metals in the sediments showed that the enrichment factor (EF) > 10 was observed for the group Cd >> Cu > Ag > Cr ≥ Zn in the site downstream of the urban wastewater discharges (Figure 3), that associated with discharges from household, industry and construction (e.g. Sörme and Lagerkvist 2002) of the Kharkiv region.

The distribution and accumulation patterns allow us to discriminate two principle groups of trace metals in terms of variation and potential sources:

‘Stable’ metals (Cd and Cr), which were enriched in the sediments (EF is more than 10 in U07) and show low (K ration less than 1) spatial and temporal variations during both contrasted hydrological periods in water. Presence of Cd and Cr can relate to long-term discharges and generally associates with point sources, as their significant enrichment (EF is 5 to 20 times higher in U07 compared to U06) was found downstream of urban

wastewater discharges (Figure 3) potentially indicating the historical and long-term river pollution by these elements.

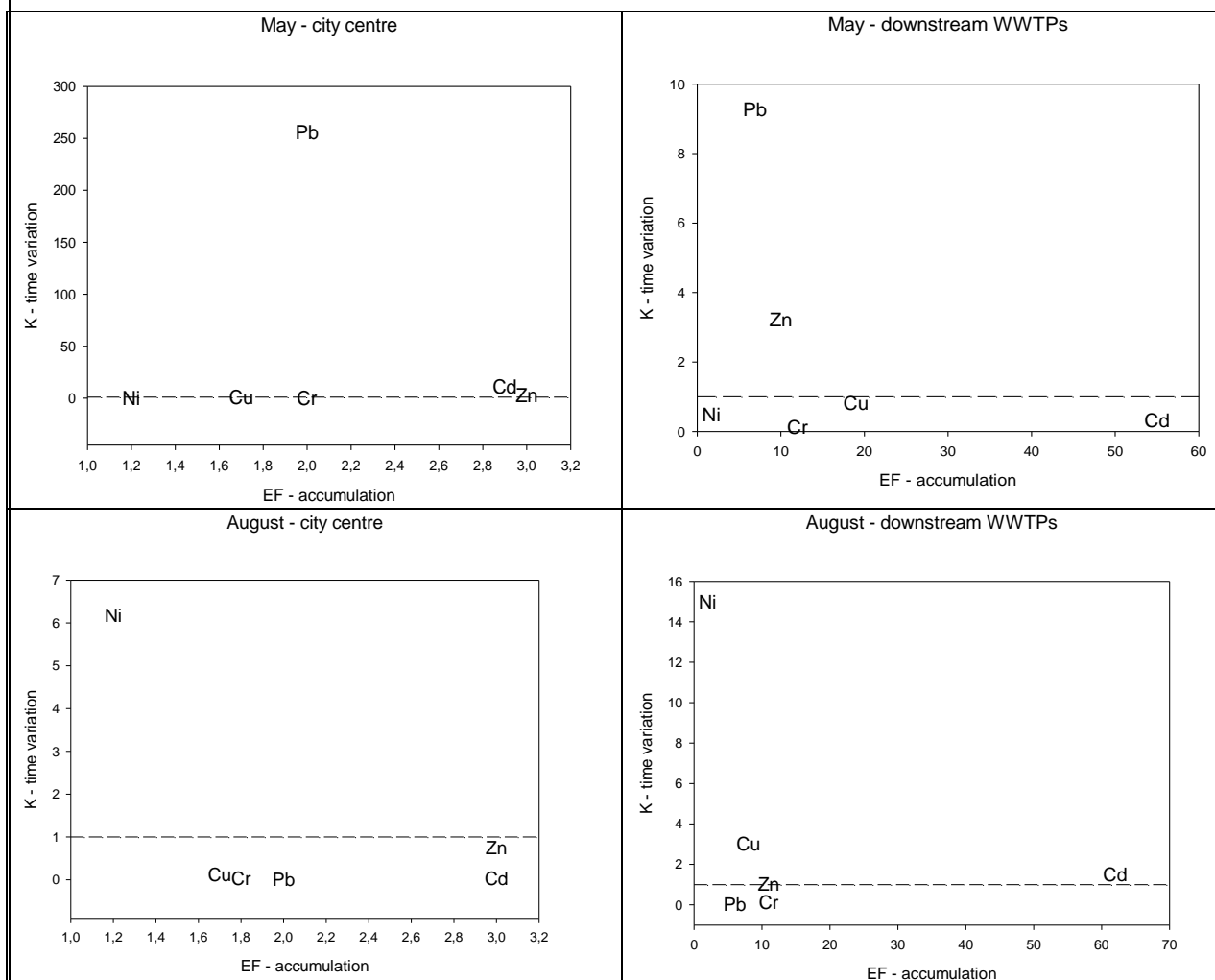

Figure 3. The accumulation (EF) and temporal distribution (K) of trace metals in the Udy River

‘Time-varying’ metals (Cu, Ni, Pb and Zn) exhibited spatial and temporal variations. The Pb and Ni demonstrated the higher temporal variations (K ratio is more than 5) compared to Cu and Zn (K ratio is from 1 to 5), but presented the lower enrichment value downstream of the WWTP (EF is less than 10) than Cu and Zn. Potentially, Pb and Ni can link to the non-point pollution sources (i.e. transport activity and atmospheric depositions from the fossil fuel burning) and/or illegal discharges of the contaminated wastewaters (Mazzei et al. 2008; Peltier et al. 2009). Possibly, the contribution of Cu and Zn from the point source (i.e. wastewaters discharge) is higher than non-point sources (i.e. run-off, deposition from the atmosphere, illegal discharges etc.).

Using this approach, we suggest that the relationship of the enrichment value  $Cd \gg Cu > Ag > Cr \geq Zn$  can be used as a anthropogenic signature of the industrial and urban

activities pressuring the environment (de Miguel et al. 2005) from point sources (municipal wastewaters) of Kharkiv urban area. The other group Pb - Ni can be a relevant fingerprint of the economic activity (industry and transport) mainly from non-point sources (run-off, atmospheric depositions, etc.).

### 3.2.2. Pharmaceuticals

Pharmaceuticals had varying frequencies of detection (Table 4) and only DICLO and CAF were detected in all selected sampling sites, indicating pathways of these tracers along the river. Significant contamination of DICLO, CAF, KETO and PARA was found in sites upstream of wastewater effluents (U04 and U06) (Figure 4), displaying that these compounds can enter natural stream with the run-off (Bartelt-Hunt et al. 2009) and/or untreated illegal discharges or during accidents on the wastewater treatment plants. CBZ was also found at the trace level ( $1 - 2 \text{ ngL}^{-1}$ ) in the upstream sites, representing contaminated discharges at this site of the river. DZP was measured at a detectable level ( $8-13 \text{ ngL}^{-1}$ ) only downstream of the WWTP.

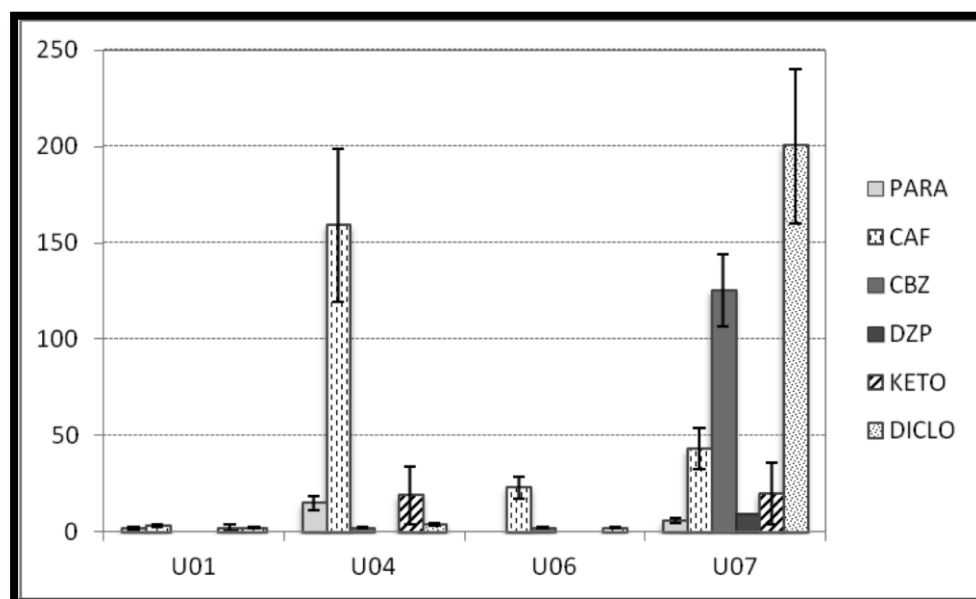

Figure 4. Determined concentration ( $\text{ngL}^{-1}$ ) of pharmaceuticals in the Udy River  
(mean value,  $\pm$ S.D.)

The comparison of the presence of pharmaceuticals in different river's parts can be described by the following order (as % of the sum of mean concentration):  $\text{CAF}_{80} > \text{KETO}_{19.5} > \text{PARA}_8 > \text{DICLO}_2 > \text{CBZ}_{0.5}$  for the site upstream of the urban area (U04);  $\text{CAF}_{52} > \text{PARA}_{44} > \text{DICLO}_3 > \text{CBZ}_1$  for the urban area at the site upstream of the municipal

wastewater discharges (U06) and DICLO<sub>38</sub>>CBZ<sub>30</sub>>CAF<sub>18</sub>>KETO<sub>12</sub>>DZP<sub>1</sub>>PARA<sub>1</sub> for the site located downstream of municipal wastewater discharges. Thus, the distribution patterns in the site located at U06 was similar to those found at the U04 site, however, at the downstream part (U07), the order of monitored pharmaceuticals changed significantly. Therefore, the spatial distribution of substances indicates the presence of various sources of these compounds in the environment, which are not only related to the municipal wastewater discharges.

Temporal distribution of targeted pharmaceuticals also showed various seasonal patterns. KETO found to exhibit significant seasonal variations (CV *rsd* > 100%) (Figure 5).

The seasonal variation of KETO can be less pronounced in the case of considering water temperature dependent on sampling rate, but the sampling rate for most chemicals is not available for the particular parameters. CBZ and DICLO had lowest seasonal variation (CV *rsd* < 30%) (Figure 5). The seasonality of pharmaceuticals can link to various factors: medicament consumption patterns, bioaccumulation and degradation under the influence of environmental factors (i.e. temperature, UV-radiation, etc.), but also can be associated with physical chemical properties of compounds. Thus, targeted pharmaceuticals were projected using three main parameters that can have a strong impact on the environment: bioaccumulation factor or  $K_{ow}$ , the water solubility factor or  $K_s$ , and the removal efficiency factor or RE (Figure 6).

As the result, monitored pharmaceuticals were divided into 3 groups:

Labile (non conservative) pharmaceuticals: CAF and PAR. These compounds have high water solubility ( $K_s$  is more than 10,000 mgL<sup>-1</sup>), low accumulation (log  $K_{ow}$  is less than 0.5) and high efficiency of treatment (RE is more than 60% of removal) by a conventional wastewater treatment processes (active sludge). In our study, these elements dominated in sites located at the upstream part of the city, the municipal wastewater discharges (Figure 4), and have high frequency of the detection (Table 4).

Conservative pharmaceuticals: DZP and CBZ. This group shows low water solubility ( $K_s$  is less than 1,000 mgL<sup>-1</sup>), a high accumulation (log  $K_{ow}$  is more than 3) and a low efficiency of treatment (RE is less than 20% of removal) on the conventional wastewater treatment plant (active sludge). In our research, these molecules dominated in the site downstream of the municipal wastewater effluents (Figure 4), have small frequency of the detection (Table 4), and exhibit low seasonal variation (Figure 5).

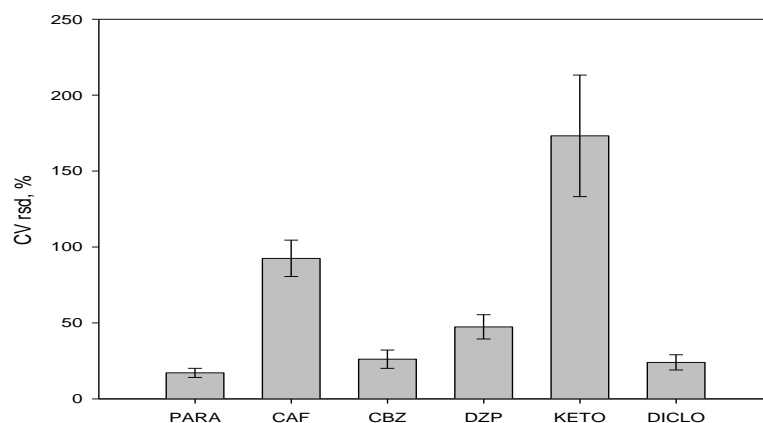

Figure 5. Seasonal variation of pharmaceuticals downstream of WWTPs (May, August and January)

Pharmaceuticals with combined (mixed) properties: DICLO and KETO. These molecules have low water solubility ( $K_s$  is less than  $1,000 \text{ mgL}^{-1}$ ), a high accumulation coefficient ( $\log K_{ow}$  is more than 3), but the treatment efficiency of these compounds is also relatively good (RE is 40-60% of removal from raw wastewaters of the conventional wastewater treatment plant), what associates with other properties e.g. photodegradation, (Nakada et al. 2008; Daneshvar et al. 2010), and additional factors that can influence the presence and behavior of these molecules.

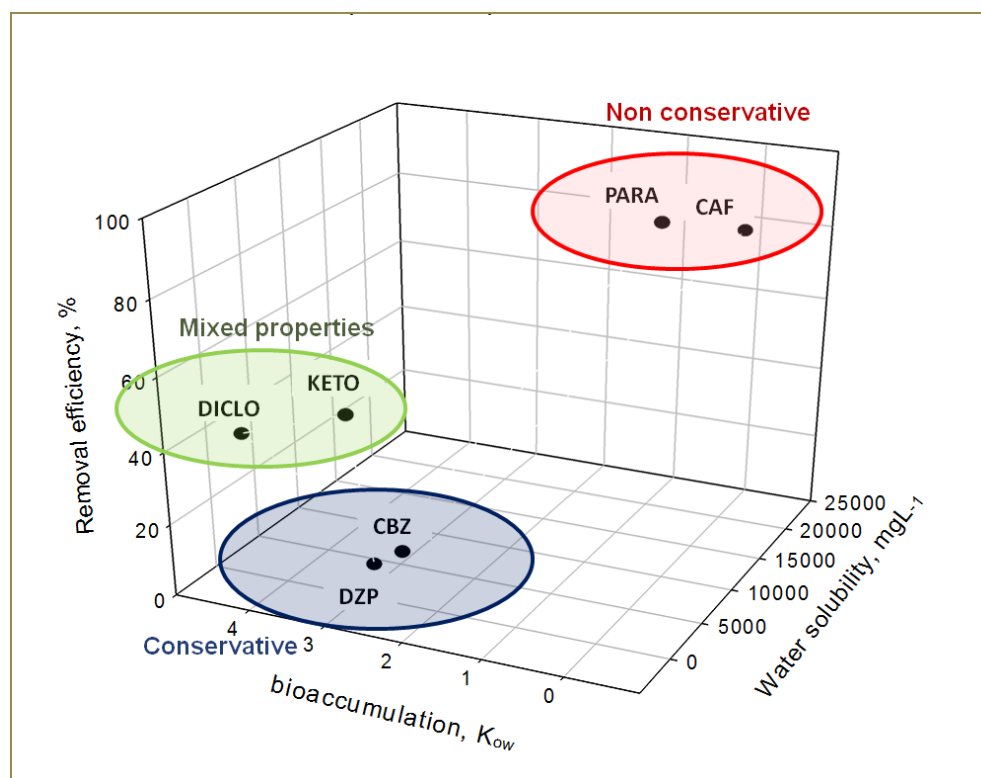

Figure 6. Physico-chemical characteristics of pharmaceuticals

Consequently, we resume, that the occurrence of the labile pharmaceuticals upstream of the city possibly connects with the continuous discharges of untreated fecal wastewaters or run-off, as there are no reported discharges of the human origin wastewaters in this part of the river. At the same time, conservative compounds are typical for the sites located downstream of the wastewater discharges and can indicate the sources of urban effluents.

Results of the principle component analysis of DGT-labile trace metals and pharmaceuticals (Figure 7) show that conservative compounds strongly correlated with metals, especially with the group identified as of ‘stable’ metals, which mainly associated with the municipal wastewater effluents.

At the same time, ‘time-varying’ metals and pharmaceuticals presented distinctive patterns during contrasted hydrological conditions.

### *3.3. Anthropogenic indicators of the socio-economic processes*

Conservative properties of some compounds gave us an opportunity to apply targeted molecules as socio-economic indicators. The regional data on the drug consumption are difficult to estimate as medicaments can be prescribed or not, used or stored. Moreover there are different ways for drug delivery (legal and illegal market), especially for specific medicaments such as psychotropic substances (e.g. carbamazepine, diazepam). In this case the water monitoring data can be used for the calculation of the preliminary data on the regional drug consumption using the mass balance approaches (Vystavna et al. 2012).

To estimate the pharmaceuticals consumption rate we propose to take into account the physical chemical properties of substances using the following formula (Eq. 5):

$$M_c = (Q_w C_w - Q_u C_u) / (K_1 - K_1 K_2) \frac{Q_w C_w - Q_u C_u}{K_1 (1 - K_2)} \quad (5)$$

$M_c$  – is drug consumption rate in a studied settlement, served by a sewage system, ( $\text{g d}^{-1}$ );

$K_1$  – is drug excretion rate (a part of a pharmaceutical component entering the sewage system under unchanged form in the human excretion), ( $\text{g g}^{-1}$ ). Pharmacokinetics represents a very complex process depending on metabolism, age, activity etc. In this study, previously reported data on the drugs excretion are used (Kasprzyk-Hordern et al.

2009b; Froehner et al. 2010). Due to the limitation of the used chemical and analytical protocols, metabolites of targeted compounds have not been included in the research.

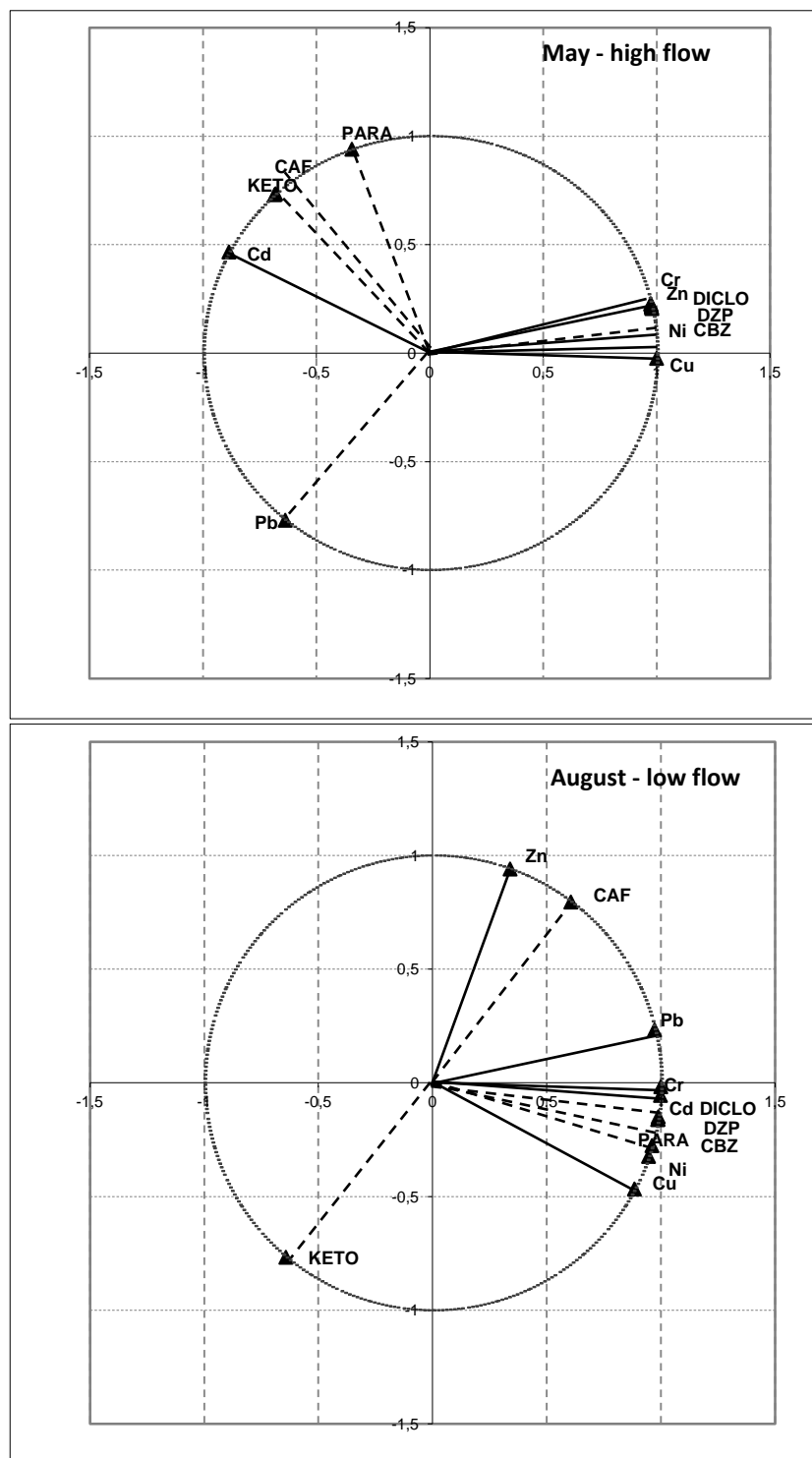

Figure 7. The principle component analysis of DGT-labile metals and pharmaceuticals in the Udy River (2008-2010) (May:  $F_1 = 74.62\%$ ;  $F_2 = 25.38\%$  and August:  $F_1 = 78.04\%$ ;  $F_2 = 21.96\%$ )

$K_2$  – is the efficiency of wastewater treatment processes, which was estimated from the part of the pharmaceutical not removed during the treatment, ( $\text{g g}^{-1}$ ). The efficiency has been used from previously published works taking into account the type of treatment processes (Table 5).

Table 5. The calculated consumption rate of pharmaceuticals in the Kharkiv city

Pharmaceutical	Metabolism <sup>a,b</sup> , $\text{g g}^{-1}$	Treatment efficiency <sup>a,b,c</sup> , $\text{g g}^{-1}$	Fluxes from the Kharkiv city, $\text{g d}^{-1}$		Consumption, $\text{g d}^{-1}$ 1000 people <sup>-1</sup>	
			May	January	May	January
CBZ	0.31	0.04	94.6	157.3	0.21	0.35
DZP	0.05	0.04	5.7	5.0	0.08	0.07
DICLO	0.02	0.12	107.3	196.5	4.07	7.44

<sup>a</sup> – Kasprzyk – Hordern et al. 2009a, <sup>b</sup> – Zhang et al. 2008, <sup>c</sup> – KNAPPE 2008

$C_u$  – is the concentration of the pharmaceuticals in the upstream part, ( $\text{g m}^{-3}$ ).

$Q_w, Q_u$  – are water flow rates in the river, downstream and upstream of WWTPs

The daily drug consumption rate per person (D) was estimated as Eq. 6:

$$D = M_c/P \quad (6)$$

where P – is the number of people that use the municipal sewage system, inhabitants.

Consequently, for the conservative substances (CBZ and DZP), as the compound with high accumulative ability, we took into account upstream influents (the distance between sites U06 and U07 is less than 5 km). Hence, we assumed that the conservative substances from the upstream part of the river are able to reach the downstream parts. For DICLO, the pharmaceuticals with mixed properties, the upstream inputs were also taken into account, because these medicaments presented properties, which are close to the conservative substances (Figure 6 and 7).

The results of our mass balance calculation shows estimated data on some medicaments consumption in the Kharkiv region, Ukraine. The comparison on medicaments consumption data in Ukraine with other countries has been done using the officially reported data on the drugs consumption and data, which was also calculated by the mass balance approach (Buerge et al. 2003; Miao et al. 2005; Zhang et al. 2008; Kasprzyk-Hordern et al. 2009b).



The estimated consumption of carbamazepine was close to the world, ( $0.45 \text{ g d}^{-1}1000 \text{ people}^{-1}$ ), Canada ( $0.2 \text{ g d}^{-1}1000 \text{ people}^{-1}$ ) (adapted from Miao et al. 2005) and USA data ( $0.34 \text{ g d}^{-1}1000 \text{ people}^{-1}$ ), but lower than in EU countries ( $1.8 - 2.6 \text{ g d}^{-1}1000 \text{ people}^{-1}$ ) (adapted from Zhang et al. 2008). The calculated consumption rate of diclofenac was 2-3 times more than in Wales ( $0.9 \text{ g d}^{-1}1000 \text{ people}^{-1}$ ) (Kasprzyk-Hordern et al. 2009b), Australia ( $0.6 \text{ g d}^{-1}1000 \text{ people}^{-1}$ ), but close to the data of Finland ( $3.0 \text{ g d}^{-1}1000 \text{ people}^{-1}$ ) and Germany ( $2.9 \text{ g d}^{-1}1000 \text{ people}^{-1}$ ) (adapted from Zhang et al. 2008).

The mass balance results showed that the level of medicaments consumption in Ukraine is lower than in the economically developed countries like USA, Canada and EU members. The general reason is the combination between the high price of pharmaceuticals and weak medical service with the lack of a well-established mechanism of social insurance. Thus, most of people adopt a self-treatment strategy using alternative methods rather than prescribed ones.

Additionally, such discrepancy in drug consumption between countries reflects differences in the age, structure, health problems of the population, and regulation of the medicament market and welfare. The other reason of the variation of pharmaceuticals between countries can be the difference in wastewater treatment efficiency during particular climate conditions (cold snowy winter and hot dry summer).

In spite of the lower medicaments consumption rate in Ukraine, compared to USA, Canada, EU countries and Australia, wastewater-receiving rivers were found to be more contaminated by tracers because of non sufficient dilution and treatment of wastewaters, but also due to discharge of untreated and uncontrolled inputs to water bodies.

#### **4. Discussion**

Results of our research revealed several patterns of the variation and behavior of trace metals and pharmaceuticals. Existence of these displays depends on forms and physical chemicals properties of compounds, environmental instream parameters, diverse sources of chemicals, but also the consumption patterns. Using these environmental and anthropogenic factors, we assumed the perspectives to apply certain substances as indicators of the regional anthropic and socio-economic activity (Table 6).

Table 6. Perspectives of trace metals and pharmaceuticals as anthropogenic and socio-economic indicators

Compound	Fraction/Properties	Type of the indicator	
		Anthropogenic	Socio-economic
Trace metals	DGT-labile	Time varying events (diffusive sources ; accidents, illegal discharges)	Components of the regional economic activity (transport, industry, agriculture, urban, etc.)
	Dissolved	Continuous effluents	
	Sediments	Long-term and historical pollution	Industrial structure
Pharmaceuticals	Conservative	Sources determination : treated and untreated inputs	Regional consumption patterns
	Non conservative	Untreated inputs (domestic wastewaters, run-off, accidents)	Presence of prohibited and illicit medicaments
	Mixed	Efficiency of the wastewater treatment in contrasted seasons	Development of regional pharmaceuticals market

#### 4.1. Trace metals as anthropogenic indicators

Considering the obtained outputs, we suggest the possibility to use Cd and Ag as the indicators of the long-term industrial pressure on the urban watershed. In our study, Cd found to have the highest enrichment (up to 60) (Figure 3), indicating the long-term industrial influence on the urban area (Yu et al. 2010). This element finds pathways to the environment generally through heavy industrial processes e.g. coal combustion, smelters, iron and still mills, electroplating, and chemicals production (Reimann and de Caritat 1998) which are prevailing in the economic structure of the Kharkiv region (Table 1). Compared to Cd, Ag has the lower crustal abundance (Lanceleur et al. 2011), but also showing the high enrichment in the sediments ( $EF=14 \pm 2$ ) in the part of the river located along industrial and urban areas (site U07). The natural pathways of Ag in the environment are not well documented (Reimann and de Caritat 1998). Various anthropogenic sources on urban area e.g. photographic industry, coins and jewelry production, batteries, brazing alloys, electroplating, electrical controls and conductors, medical service, nanotechnologies, and paints (Reimann and de Caritat 1998; Kaegi et al. 2010) are

typifying on the economy of the Kharkiv city and region (Table 1). In this case, Ag can be considered also as an indicator of the urban pressure on the environment (Lanceleur et al. 2011). Using the ratio Cd/Ag, the industrial influence on the urban area can be pointed out. Thereby, in the Udy River, the ratio Cd/Ag changed from 1.2 at the river's source (U01) to 2.6 in the city center (U06) and reach 5.3 in the site downstream of the industrial and urban water discharges (U07), demonstrating the industrial pressure on the surface water of the urban region. Other studied metals, such as Cu and Cr have high abundance and various natural pathways e.g. rock weathering, geogenic dust, animal waste (Reimann and de Caritat 1998), which limit their use as efficient indicators of the urban and industrial pollution in comparison to Ag and Cd.

Metals, with their temporal and spatial patterns, have the perspectives to be used as indicators of non-point (e.g. urban run-off and atmospheric deposits) and point sources (e.g. wastewaters from WWTP) and characterize the industrial pressure on the environment. For example, based on the accumulation and distribution of trace elements into the Udy River, the economic profile of the Kharkiv region impacting or pressuring the environment can be described as industry prevalence, followed by the transport and a moderate impact from the agriculture, that was in agreement with the documented regional socio-economic indicators (Table 1).

#### *4.2. Pharmaceuticals as anthropogenic and socio-economic indicators*

Pharmaceuticals have a potential to be used for the particular description of anthropogenic factors and consumption/usage patterns of the study area. Pharmaceuticals mainly have anthropic origin and generally well known physical chemical properties (Beausse 2004; Mompelat et al. 2009). They are designed to be water soluble, biodegradable and to have an exact half-life.

Labile pharmaceuticals were previously identified as good tracers of untreated wastewaters of the human origin (Buerge et al. 2003). The detection of caffeine and carbamazepine in upstream and downstream sites brings us to assume that WWTPs are not the main source of labile pharmaceuticals. Potentially these compounds can enter the water flow with run-off (Bartelt-Hunt et al. 2009) and/or untreated illegal discharges or during accident on the wastewater treatment plants. The main risk to use caffeine as anthropogenic marker is the presence of this compound in the nature, e.g in some plants (Buerge et al. 2003). So, in the case of an application of caffeine as an anthropogenic marker, the background

concentration of caffeine should be estimated (Froehner et al. 2010). Thereby the paracetamol, with a pure human origin, can be a more efficient indicator of domestic inputs than caffeine. Moreover paracetamol has almost the same physical chemical properties (water solubility, bioaccumulation, removal efficiency) as caffeine (Figure 6).

Conservative substances, like carbamazepine and diazepam, have been reported as efficient tracers of both untreated and treated waters (Clara et al. 2004; Miao et al. 2005; Moldovan et al, 2009). Due to their properties (Figure 4), they are able to accumulate in the natural environment. These substances have no natural sources and they point only anthropogenic inputs. It appears that CBZ is a more efficient marker of wastewaters than DZP, but also easier to identify by different sampling and analytical techniques (Table 4). Other advantages of the CBZ is related to its low seasonal variation (CV  $\text{rsd} < 30\%$ ) (Figure 5) (Moldovan et al. 2009) which is helpful for the indication during contrasted seasons.

Pharmaceuticals with combined properties were less often promoted as anthropogenic markers than conservative and labile (Kasprzyk-Hordern et al. 2009a,b; Nakada et al. 2008). Nevertheless, the specific usage of ketoprofen, as a veterinary product, can be applied for tracking pollutants not only urban, but also from rural areas, applying as a labile marker of the pollutants from the rural area. The KETO as an anthropogenic indicator should be balanced with the seasons (Daneshvar et al. 2010). Typically, in winter it shows the ability to accumulate in the environment and act as a conservative tracer, while in summer it behaves as labile indicator of inputs from rural and urban areas. Diclofenac can be also considered as a potential anthropogenic marker (Kasprzyk-Hordern et al. 2009a,b), due to low biodegradability and ability to accumulate in the aqueous environment. This study pointed out the presence of the noticeable level of diclofenac in all samples (Table 4 and Figure 4). The most probable reason comes from the wide use of the medicament prescribed and non-prescribed as an anti-inflammatory in Ukraine, due to the low price and a broad local production. But DICLO has a good removal efficiency by the WWTPs (RE is 30-60%), reducing its application as conservative environmental indicator, however, gives some opportunity to use it as a potential indicator of the domestic wastewater treatment efficiency.

### **Conclusions and perspectives**

The analysis of distinctive properties and patterns of tracers revealed that in terms of specificity, variability and practicality, trace metals and pharmaceuticals in urban water

can indicate not only a pollution event, but also reflect the regional socio-economic aspects.

Thereby, trace metals (i.e. Ag, Cd, Cr, Cu, Ni, Pb and Zn) were proposed as anthropogenic indicators of the industrial impact on the urban water system. Trace metals in the sediments are useful for the indication of the 'historical pollution processes' by regional economic activities. So, the group of elements - Cd >> Cu > Ag > Cr ≥ Zn (order by the EF) was proposed as an anthropogenic fingerprint of industrial pressure on urban area and ratio Cd/Ag were discussed as the relevant indicator of the industrial component on the urban territory. The dissolved and dissolved labile metals in the water were found convenient for the indication of time-varying influences on the environment. Thus, the group Pb - Ni can represent the river pollution by non point sources e.g. urban run-off and atmospheric deposits from different economic sectors (industry and traffic) in this regional study.

Depending on physical chemical properties, consumption patterns, seasonal variability, pharmaceutical molecules were identified as anthropogenic indicators of wastewater treatment efficiency and uncontrolled contaminated discharges. In that way, three groups of pharmaceuticals have been classified: conservative (i.e. carbamazepine and diazepam), labile (i.e. caffeine and paracetamol) and with combined properties (i.e. ketoprofen and diclofenac). Due to accumulative abilities, conservative substances were discussed as efficient tracers of treated and untreated wastewaters, revealing the long-term impact of urban wastewaters on the river and surface waters. The labile substances were considered as anthropogenic indicators of untreated wastewaters undergoing other influences (e.g. accidents on sewage works, run-off).

The chemicals with combined properties were found to act as conservative and labile tracers depending on the seasons and usage patterns. According to this specificity, they can be potential indicators of multi-varying influences (e.g. human and veterinary) and report the treatment efficiency of wastewaters.

It was described that pharmaceuticals can also provide additional data on the social aspects in the region. In this manner, the mass balanced modeling was applied for the identification of the regional drug consumption patterns, current wastewater treatment technologies, dilution processes, etc., which needs additional research and monitoring.

Concerning the monitoring approach, it was found that the combination of passive and conventional sampling technique, in term of practicality, is a convenient tool for environmental data obtaining.

This research is a pilot for the Kharkiv region, Ukraine and some aspects such as (1) seasonal and temporal behavior of micro-pollutants in the contrasted conditions; (2) discrimination of the point and non point sources; (3) mathematical modeling in order to integrate environmental and socio-economic data also needs future development. Also the database on emerging pollutants should be expanded in terms of the regular sample collection and analysis, but also the inclusion of other groups of micro-pollutants (e.g. illicit drugs, nanoparticles, surfactants, etc).

In perspective, anthropogenic indicators can be applied for the multi-disciplinary tasks, i.e. identification of uncontrolled discharges, definition of consumption of illicit and regulated drugs in the community, analysis of the market and sales of drug without prescription, and identification of the disposal of drugs leading to the overestimation of usage. Other applications of these anthropogenic indicators are the identification of the type of the human settlements (urban, industrial and rural) and presence of the animal farms (monitoring of the veterinary medicaments).

### **Acknowledgements**

This research was conducted in the framework of the International Collaborative Program “Partenariat Hubert Curien DNIPRO” (Grant N° 19744VJ 2009/2010) with the financial support from both the French Ministry of Foreign Affairs and the Ukrainian Ministry of Education and Science. Some authors have been granted by the European Union through the ERASMUS MUNDUS External Cooperation Window Program (Lot 6/7 - Belarus, Moldova and Ukraine), by the Embassy of France to Ukraine (Bourse de Court Séjour de Recherche) and Eiffel Scholarship (France). The technical support and help of Yuri Vergeles, Iulija Rusko, Grynenko Volodymyr and Maria Servetnyk from Kharkiv National Academy of Municipal Economy, Ukraine are greatly acknowledged. Special thanks to Victoria Nicole Deycard from the Université de Bordeaux, for the English language improvement and correction.

**References:**

- Alonso, E., Santos, A., Gallejon, M., Jimenez, J.C. (2004). Speciation as a screening tool for the determination of heavy metal surface water pollution in the Guadiamar river basin. *Chemosphere* 56, 561-570.
- Alvarez, D. A., Petty, J. D., Huckins, J. N., Jones-Lepp, T. L., Getting, D. T., Goddard, J. P., et al. (2004). Development of a passive, in situ, integrative sampler for hydrophilic organic contaminants in aquatic environments. *Environmental Toxicology and Chemistry* 23(7), 1640-1648.
- Audry, S., Schäfer, J., Blanc, G., Bossy, C., Lavaux, G. (2004). Anthropogenic components of heavy metal (Cd, Zn, Cu, Pb) budgets in the Lot – Garonne fluvial system (France). *Applied Geochemistry* 19, 769-786.
- Baalousha, M., Motelica-Heino, M., Coustumer, P. L., 2006 Conformation and size of humic substances : Effects of major cation concentration and type, pH, salinity and residence time, *Colloids and Surfaces A: Physicochemical and Engineering aspects* 272 (1), 48-55.
- Balistreri L. S., Blank R. G. (2008). Dissolved and labile concentrations of Cd, Cu, Pb and Zn in the South Fork Coeur d’Alene River, Idaho: Comparisons among chemical equilibrium models and implications for biotic ligand models. *Applied Geochemistry* 23, 3355-3371.
- Bartelt-Hunt, S.L., Snow, D.D., Damon, T., Shockley, J., Hoagland, K. (2009). The occurrence of illicit and therapeutic pharmaceuticals in wastewater effluent and surface waters in Nebraska. *Environmental Pollution* 157, 786-791.
- Bahlmann, A., Weller, M.G., Panne, U., Scheider, R.J. (2009). Monitoring carbamazepine in surface and wastewaters by an immunoassay based on a monoclonal antibody. *Analytical and Bioanalytical Chemistry* 395, 1809 – 1820.
- Beausse, J. (2004). Selected drugs in solid matrices: a review of environmental determination, occurrence and properties of principle substances. *Trends in Analytical Chemistry* 23, 753-761.
- Bendz D., Paxeus N., Ginn T., Loge F. (2005). Occurrence and fate of pharmaceutically active compounds in the environment, a case study: Hoje River in Sweden. *Journal of Hazardous Materials* 122, 195-204.
- Budzinski, H., Soulier, C., Lardy, S., Capdeville, M.J., Tapie, N., Vrana, B., Miede, C. and Ait Aissa, S. (2009). Passive sampler for chemical substance monitoring and associated toxicity assessment in water, Abstract presented at the International Conference on Xenobiotics in the Urban Water Cycle, 11-13 March 2009, Cyprus.
- Buerge, I.J., Poiger, T., Muller, M.D., Buser, H.R. (2003). Caffeine, an anthropogenic marker for wastewater contamination of surface waters. *Environmental Science and Technology* 37, 691-700.
- Buerge, I. J., Poiger, T., Muller, M.D., Buser, H. – R. (2006). Combined sewer overflows to surface waters detected by the anthropogenic marker caffeine. *Environmental Science and Technology* 40, 4096 – 4102.
- Bull, I.D., Lockheart, M.J., Elhmmali, M.M., Roberts, D.J., Evershed, R.P. (2002). The origin of faeces by means of biomarker detection. *Environment International* 27, 647-654.
- Christophoridis, C., Dedepsidis, P., Fytianos, K. (2009). Occurrence and distribution of selected heavy metals in the surface sediments of Thermaikos Gulf, N. Greece. Assessment using pollution indicators. *Journal of Hazardous Materials* 168, 1082-1091.
- Clara, M., Strenn, B., Kreuzinger, N. (2004). Carbamazepine as possible anthropogenic marker in the aquatic environment: investigations on the behavior of carbamazepine in wastewater treatment and during groundwater infiltration. *Water Research* 38, 947-954.
- Coynel, A., Schäfer, J., Blanc, G., Bossy, C. (2007). Scenario of particulate trace metal transport during a major flood event inferred from transient geochemical signals. *Applied Geochemistry* 22, 821-836.
- Daughton, C.G., Ternes, T.A. (1999). Pharmaceuticals and personal care products in the environment: agents of subtle change. *Environmental Health Perspective* 107, 907-938
- Dale V. H., Bayeler S. C. (2001). Challenges in the development and use of ecological indicators. *Ecological Indicators* 1, 3-10
- Daneshvar, A., Svanfelt, J., Kronberg, L., Weyhenmeyer, G. A., 2010. Winter accumulation of acidic pharmaceuticals in a Swedish river. *Environmental Science and Pollution Research* 17, 908 – 916.

- DGT Research, (2002). DGT for measurements in water, soils and sediments. DGT Research Ltd., Lancaster. Published in UK.
- Dickenson E.R.V., Snyder, S.A., Sedlak, D.L., Drewes, J.E. (2011). Indicator compounds for assessment of wastewater effluent contribution to flow and water quality. *Water Research* 45, 1199 – 1212.
- Duelli P, Obrist M. K., 2003. Biodiversity indicators: the choice of values and measures. *Agriculture, Ecosystems and Environment* 98, 87–98
- EU, 2008:** EU, DIRECTIVE 2008/105/EC OF THE EUROPEAN PARLIAMENT AND OF THE COUNCIL of 16 December 2008 on environmental quality standards in the field of water policy, amending and subsequently repealing Council Directives 82/176/EEC, 83/513/EEC, 84/156/EEC, 84/491/EEC, 86/280/EEC and amending Directive 2000/60/EC of the European Parliament and of the Council. Official Journal of the European Union 348 (2008), 84–97.
- Einsiedl, F., Radke, M., Maloszewski, P. (2010). Occurrence and transport of pharmaceuticals in a karst groundwater system affected by domestic wastewater treatment plants. *Journal of Contaminant Hydrology* 117, 26-36.
- Fateev A.I., Pashenko Y.V., 1999: Research report. The background contents of trace metals in soils of Ukraine/ Institute of Soil Science of the National Academy of Sciences of Ukraine, Kharkiv, 145 p. (in Ukrainian)
- Froehner, S., Scorza, D.B., Machado, K.S., da Rosa, E.C. (2010). Tracking anthropogenic inputs in Barigui River, Brazil using biomarkers. *Water Air and Soil Pollution* 210, 33-41.
- Girard, J.E. (2005). Principles of Environmental Chemistry. Printed in U.S., by Jones and Barlett Publishers Inc., 320 pp.
- Guevara, S.R., Arribere, M., Bubach, D., Vigliano, P., Rizz, A., Alonso, M., Sancher, R. (2005). Silver contamination on abiotic and biotic compartments of Nahuel Huapi National Park lakes, Patagonia, Argentina. *Science of the Total Environment* 336, 119-134.
- Hagedorn, C., Weisberg, S.B. (2009). Chemical based fecal source tracking methods: current status and guidelines for evaluation. *Review in Environmental Science and Biotechnology* 8, 275-287.
- Kaegi, P., Sinnet, B., Zuleeg, S., Hagendorfer, H., Mueller, E., Vonbank, R., et al. (2010). Release of silver nanoparticles from outdoor facades. *Environmental Pollution* 158 (9), 2900 – 2905.
- Kasprzyk-Hordern, B., Dinsdale, R.M., Guwy, A.J. (2009)a. Illicit drugs and pharmaceuticals in the environment – Forensic applications of environmental data, Part 2: Pharmaceuticals as chemical markers of fecal water contamination. *Environmental Pollution* 157, 1778-1786.
- Kasprzyk-Hordern, B., Dinsdale, R.M., Guwy, A.J. (2009)b. Illicit drugs and pharmaceuticals in the environment – Forensic applications of environmental data, Part 1: Estimation of the usage of drugs in local communities. *Environmental Pollution* 157, 1778-1786.
- KNAPPE 2008: D. 2.1.: Report on the limitations of conventional treatment processes of the most resistant PPs and new development [Ed.: Buncher, D.], - pp. 45-57.
- Lanceleur, L. Schäfer, J., Bossy, C., Coynel, A., Larrose, A., Masson, M., Blanc, G. (2011). Silver fluxes to the Gironde Estuary - Eleven years (1999–2009) of monitoring at the watershed scale. *Applied Geochemistry* 26, 797 – 808.
- Lepland, A., Andersen, T. J., Lepland, A., Arp, H. P. H., Alve, E., Breedveld, G. D., Rindby, A. (2010). Sedimentation and chronology of heavy metal pollution in Oslo harbor, Norway. *Marine Pollution Bulletin* 60, 1512-1522.
- Li, H., Helm, P.A., Metcalf, C.D. (2010). Sampling in the great lakes for pharmaceuticals, personal care products, and endocrine-disrupting substances using the passive polar integrative sampler. *Environmental Toxicology and Chemistry* 29 (11), 2517 – 2529.
- Li, H., Helm, P., Paterson, G., Metcalf, C.D. (2011). The effect of dissolved organic matter and pH on sampling rates for polar organic chemical integrative samplers (POCIS). *Chemosphere* 83, 271 – 280.
- Liaghati, T., Preda, M., Cox, M. (2004). Heavy metal distribution and controlling factors, within coastal plain sediments, Bells Creek Catchment, Southeast Queensland, Australia. *Environment International* 29 (7), 935-948.
- MacLeod, S.L., McClure, E.L., Wong, C.S., (2007). Laboratory calibration and field deployment of the polar organic chemical integrative sampler for pharmaceuticals and personal care products in wastewater and surface water. *Environmental and Toxicology Chemistry* 26, 2517-2529.
- Masson, M., Schäfer, J., Blanc, G., Dabrin, A., Castelle, S., Lavaux, G. (2009). Behavior of arsenic and antimony in the fresh water reaches of a highly turbid estuary, the Gironde Estuary, France. *Applied Geochemistry* 24, 1747-1759.
- Mazzei, F., D'Alessandro, A., Lucarelli, F., Nava, S., Prati, P., Valli, G., et al. (2008). Characterization of particulate matter sources in an urban environment. *Science of the Total Environment* 401 (1-3), 81-89.
- Miao, X.S., Yang, J.J., Metcalf, C.D. (2005). Carbamazepine and its metabolites in wastewater and in biosolids in municipal wastewater treatment plant. *Environmental Science and Technology* 39, 7469-7475



- Miège, C., Budzinski, H., Jacquet, R., Soulier, C., Pelte, T., & Coquery, M. (2011). Passive sampling using pocis. application for monitoring organic micropollutants in wastewater effluent and in surface water. [L'échantillonnage intégratif par Pocis Application pour la surveillance des micropolluants organiques dans les eaux résiduaires traitées et les eaux de surface] *Techniques - Sciences - Methodes*, (1-2), 80-94.
- de Miguel, E., Charlesworth, S., Ordonez, A., Seijas, E. (2005). Geochemical fingerprints and controls in the sediments of an urban river: River Manzanares, Madrid (Spain). *Science of the Total Environment* 340, 137-148.
- McGeoch, M. (1998). The selection, testing and application of terrestrial insects as bioindicators. *Biological Reviews* 73, 181–201.
- Moldovan, Z., Chiza, R., Alder, C. (2009). Environmental exposure of pharmaceuticals and musk fragrances in the Somes River before and after upgrading the municipal wastewater treatment plant Cluj-Napoca, Romania. *Environmental Science and Pollution Research* 16, S46-S54.
- Mompelat, S., Le Bot, B., Thomas, O. (2009). Occurrence and fate of pharmaceutical products and by-products, from resource to drinking water. *Environment International* 35 (5), 803-814.
- Munaron, D., Tapie, N., Budzinski, N., Andrai, B., Gonzalez, J.L. (2011). Pharmaceuticals, alkylphenols and pesticides in Mediterranean coastal waters: Results from a pilot survey using passive samplers. *Estuarine, Coastal and Shelf Science*. Doi: 10.1016/j.ecss.2011.09.009
- Nakada, N., Kiri, K., Shinohara, H., Harada, A., Kuroda, K., Takizawa, S., Takada, H. (2008). Evaluation of pharmaceuticals and personal care products as water – soluble molecular markers of sewage. *Environmental Science and Technology* 42, 6347-6353.
- Peltier, R.E., Hsu, S.-I., Lall, R., Lippman, M. (2009). Residual oil combustion: A major sources of airborne nickel in New York City. *Journal of Exposure Science and Environmental Epidemiology* 19 (6), 603 – 612.
- Reimann, C., de Caritat, P. (1998). Chemical elements in the environment: Factsheets for the Geochemists and Environmental Scientist. Springer-Verlag Berlin Heidelberg. Printed in Germany – 400p.
- Rowell, V.F., Tangney, P., Hunt, C., Voulvoulis, N. (2010). Estimating levels of micropollutants in municipal wastewater. *Water Air and Soil Pollution* 206 (1-4), 357-368.
- Sanchez – Cabeza, J.-A., Druffel, E. R. M. (2009). Environmental records of anthropogenic impacts on coastal ecosystems : An introduction. *Marine Pollution Bulletin* 59 (4-7), 87-90.
- Sangi, M. R., Halstead, M. J., Hunter, K.A. (2002). Use of diffusion gradient thin film method to measure trace metals in fresh waters at low ionic strength. *Analytica Chimica Acta* 456, 241-251.
- Sankararamkrishnan, N., Guo, Q. (2005). Chemical tracers as indicator of human fecal coliforms at atom water outfalls. *Environment International* 31 (8), 1133 – 1140.
- Saporta, G. (1990). Probability, data analysis and statistics. Gulf Publishing Company (in French).
- Schäfer, J., Blanc, G. (2002). Relationship between ore deposits in river catchments and geochemistry of suspended particulate matter from six rivers in southwest France. *Science of the Total Environment* 298, 103-118.
- Schäfer, J., Norra, S., Klein, D., Blanc, G. (2009). Mobility of trace metals associated with urban particles exposed to natural waters of various salinities from the Gironde Estuary, France. *Journal of Soils and Sediments* 9, 374-392.
- Sedlak, D.L., Huang, C.Y., Pinkston, K.E. (2004). Strategies for selecting pharmaceuticals to assess attenuation during indirect potable water reuse. In: Kummerer, K. (Ed.), *Pharmaceuticals in the environment*. Springer Publishers, Berlin.
- Seiler, R.L., Zaugg, S.D., Thomas, J.M., Harcroft, D.L. (1999). Caffeine and pharmaceuticals as indicators of wastewater contamination in wells. *Ground Water* 37, 405-410
- Shridhar, V., Khillare, P.S., Agarwal, T., Ray, S. (2010). Metallic species in ambient particulate matter at rural and urban location of Delhi. *Journal of Hazardous Materials* 175, 600-607.
- Soldi, T., Riolo, C., Alberti, G., Gallorini, M., Peloso, G.F. (1996). Environmental vanadium distribution from an industrial settlement. *Science of the Total Environment* 18, 45-50.
- Sörme, L., Lagerkvist, R., 2002. Sources of heavy metals in urban wastewater in Stockholm. *Science of the Total Environment* 298 (1-3), 131 – 145.
- Suchkova, N., Darakas, E., Ganoulis, J. (2010). Phytoremediation as a prospective method for rehabilitation of areas contaminated by long-term sewage storage: A Ukrainian – Greek case study. *Ecological Engineering* 36 (4), 373 – 378.
- Togola, A., Budzinski, H. (2007). Development of polar organic integrative samplers for analysis of pharmaceuticals in aquatic systems. *Analytical Chemistry* 79, 6734-6741.
- Vasenko, O.G., Lungu, M.L., Iljevska, Y.A., Klymov, O.V. et al. (2006): Research report. The integrated field research of environmental conditions of water bodies of the Udy water basins (sub-basin of the Seversky Donets River)/ “Rayder” Publ., Kharkiv, 156 p. (in Ukrainian).

- Vinogradov, A.P., 1962. Average element abundances in main types of eruptive rocks in the Earth's crust. *Geokhimiya* 7, 555-571 (in Russian).
- Vystavna Y., Le Coustumer, P., Huneau, F. (2010). The distribution and accumulation of emerging pollutants in urban waters of Eastern Ukraine. Abstract volume. World Water Week in Stockholm, September 5-11, 2010 Published by Stockholm International Water Institute. Sweden, 420-421
- Vystavna Y., Huneau F., Motelica-Heino M., Le Coustumer P., Vergeles Y., Stolberg F. (2011). Monitoring and flux determination of trace metals in rivers of the Seversky Donets basin (Ukraine) using DGT passive samplers. *Environmental Earth Science*. DOI:10.1007/s12665-011-1151-4
- Vystavna Y., Huneau F., Grynenko V., Vergeles Y., Celle – Jeanton H., Tapie N., Budzinski H., Le Coustumer P. (2012). Pharmaceuticals in rivers of two regions with contrasted socio-economic conditions: occurrence, accumulation and comparison for Ukraine and France. *Water Air and Soil Pollution*. DOI:10.1007/s11270-011-1008-1
- U.S. EPA, 2011. U.S. Environmental Protection Agency. Chemicals Profile: [www.pbtprofiler.net](http://www.pbtprofiler.net) accessed on 1 July 2011
- Yang, H., Rose, N. (2005). Trace element pollution records in some UK lake sediments, their history, influence factors and regional differences. *Environment International* 31 (1), 63-75.
- Yu, C., Ling, Q., Yan, S., Lia, J., Chen, Z., Peng, Z. (2010). Cadmium contamination in various environmental materials in an industrialized area, Hangzhou, China. *Chemical Speciation and Bioavailability* 22, 35 – 42.
- Zhang, H. and Davison, W. (1995). Performance characteristics of diffusive gradients in thin films for in situ measurement of trace metals in aqueous solution. *Analytical Chemistry* 67 (19), 3391-3400.
- Zhang, Y., Geiben, S. U., Gal, C. (2008). Carbamazepine and diclofenac: Removal in wastewater treatment plants and occurrence in water bodies. *Chemosphere* 73, 1151-1161.

## Summary

Thereby, results outline perspectives of the application of trace metals and pharmaceuticals for the characterization of pollution processes and description of the regional socio-economic activity, by:

- (i) *distinguishing point and non – point pollution sources*: that has become possible due to the obtained data on the presence of labile and dissolved trace metals along the watercourse
- (ii) *describing temporal and spatial patterns*: this has been done using the information on the properties, accumulation and distribution of trace elements in the river, but also the knowledge on influence of the environmental factors on instream behavior of tracers;
- (iii) *representing economic profile of the studied region*: that have been processed using the data on the enrichment of trace elements in urban river and proposal of the anthropogenic fingerprint of the region;
- (iv) *estimating regional consumption data*: this has been done exercising the physic-chemical properties of pharmaceuticals and proceeding the mass balanced modeling of the environmental and socio-economic data;
- (v) *evaluating wastewater treatment efficiency and contaminated discharges*: that has been found using the knowledge on the physic-chemical properties and distribution of tracers along the studied stream.

Potential application of tracers as anthropogenic indicators has been assessed based on the proposed criteria: specificity, variability and practicality.

The described methods can be applied for regions with the similar socio-economic and environmental conditions, but also for the cross regional and cross country-comparison of the pollution events.



## CONCLUSIONS

With the development of sampling and analytical tools, various trace pollutants have been detected in natural waters. Trace metals, as priority inorganic pollutants, and pharmaceuticals, as emergent organic substances, are one of the most growing concerns among identified chemicals in surface waters. Their occurrence can allowed to consider them as the anthropogenic tracer in the case of surface waters depending of our capacity to determine and precise their behavior into the studied system. Tracers can be introduced into the environment either by direct throwing out or by diffusive sources such as run-off, leaching, aerosols, etc. Trace metals and pharmaceuticals differ from their origin and behavior in the aquatic environment. Trace metals are ubiquitous molecule as soon as they take their origin bothly in natural and anthropogenic sources. These elements are persistent and their potential toxicity generally controlled by forms (*e.g.* total, dissolved, labile metals). Environmental and health risks assessment of metals content in water bodies are mainly based on the different international and national environmental standards. In contrast to trace metals, almost all pharmaceuticals have an anthropogenic origin and the persistence of these chemicals in the environment depends on physical chemical characteristics of molecules (*i.e.* solubility, acidity). Environmental and health risks assessment systems of these contaminants are underdevelopment and generally based on independent ecotoxic researches. The occurrence, distribution and accumulation of trace metals and pharmaceuticals in the natural media are found to be dependent on environmental (*i.e.* geochemical baseline, hydrology etc) and socio-economic (*i.e.* economic structure, consumption) factors, that demand additional research and data for different areas, taking into account the maximum of regional determinants.

## Remind of objectives

The general target of the research was to advance the knowledge on environmental and socio-economic determinants of the occurrence, distribution and accumulation of trace pollutants in natural water, particularly:

- (i) propose the convenient approach, in term of time, cost, access and data interpretation, to trace elements monitoring in the region during contrasted climate and hydrological conditions and with the lack of the information on water chemistry;
- (ii) discriminate environmental and socio-economic determinants that influence on the occurrence, accumulation and distribution of trace elements in watercourses;
- (iii) analyze the perspectives of the application of trace elements as anthropogenic indicators of water pollution.

The work is based on the environmental data that were obtained during six field trips in Kharkiv region, Ukraine and Bordeaux region, France in the period from 2008 to 2010. The water monitoring has been done with the use of conventional and passive sampling techniques. Most of the water quality data on the presence of trace metals and pharmaceuticals were firstly expanded for the Kharkiv region and East Ukraine.

## Objective compliance

Objectives were compiled in the following steps:

- (i) the selection of the targeted compounds, methods of sampling and study sites

Trace metals and pharmaceuticals were chosen for the research as they have contrast unique physico-chemical properties and origin. Also, the detection of these compounds can be done using the various sampling and analytical techniques which was with the capacity of available laboratories in University of Bordeaux. Thereby for the monitoring of targeted components the combination of two different sampling techniques were applied, i.e. conventional technique, that was used for the identification of dissolved trace metals in water and metals in the sediments, and passive technique, that was realized for the detection of dissolved labile metals and pharmaceuticals in water. The selection was based on the suggestion, that both techniques supplement each other in order to get the environmental data. The proposed sampling approach was practiced during the contrasted hydrological and seasonal conditions in the Kharkiv region,

---

Ukraine. Thus, Udy and Lopan River of the Seversky Donets water basin in East Ukraine were the first study sites; these streams had been polluted during more than 60 years and up to the present time by the Kharkiv agglomeration what is the biggest industrial and urban region in Ukraine. Jalle River was the second study site; this river flows through the urban area of Bordeaux, France and receives the industrial and municipal wastewaters from the settlements. French stream were selected in order to represent the pollution status of urban rivers in contrasted socio-economic regions.

(ii) water sampling campaigns using grab and passive techniques

During the monitoring, selected sampling sites were investigated on the presence of trace metals and pharmaceuticals in natural water, using the passive sampling devices. Firstly, dissolved labile trace metals were monitored in contrasted hydrological and seasonal conditions on 16 sites of Ukrainian rivers. Due to this pilot monitoring, the presence, occurrence, distribution and principal pollution sources of trace metals were described along the watercourses. Also it was the effort to use the passive sampling technique in the field during different seasonal and hydrological patterns. As the result, it was found the usefulness and appropriateness of chosen sampling approach for the various contrasted conditions. Thereby, the passive sampling can be applied to measure time integrative concentration of dissolved labile tracers in water both in hot summer low – flow and cold winter high flow periods. The comparison of grab and passive sampling revealed that the innovative technique is more convenient compare to the traditional one in term of: (i) the reduction of samples for the estimation of time weighted average concentration, especially in cold winter conditions with the ice cap on the watercourse; (ii) simplicity of deployment and retrieval with the minimum samples handling between installation, analysis and easy storage and transportation, as in this research, the sampling and analysis were done in different countries; (iii) low expenses on the field sampling procedures, as the application of passive sampling takes the minimum amount of reagents, supplementary materials and energy. During the water sampling we discovered also the several shortcoming of the applied technique, as the risk of the lost of devices and vandalism, what can occure during the period of the deposition. In our sampling campagnes, 5% of devices have disappeared, possible due to the different activities next to rivers, i.e. swimming, fishing, recultivation of the river bank, etc. In order to prevent the missing of the samplers, we used the masking of devices applying fishing line, camouflaged cotton net and try to find the most representative and safe place for the installation. Another problem was linked to possible biofouling of samplers, particularly in the spring and hot summer periods with the dynamic activity of macro – and

---

micro – organisms in water. Thus the period of the installation has been reduced up to 2 weeks for DGT and 3 weeks for POCIS, in order to lower the effect of the natural contaminating on the uptake of tracers. Consequently, at this step the passive sampling was tested and adapted for the following identification of environmental and socio-economic factors what influenced on the presence of trace metals and pharmaceuticals in natural waters.

Further monitoring campaigns on trace metals study were developed to discover the principle environmental determinants, which influenced the occurrence, accumulation and distribution of tracers in the watershed. Thus, the combination of the conventional (grab) and passive sampling approaches were applied for the Ukrainian watershed during the contrasted hydrological (low and high flow periods) and climate seasons (cold winter and hot summer). Such methods gave as possibility to monitor dissolved labile, dissolved and particulate forms of trace elements in water in order to describe the specific regional geochemistry and inputs from diverse anthropogenic sources.

By the way of the trace metals sampling, the monitoring of pharmaceuticals (2008 – 2010) has been done applying passive devices (POCIS), but focusing on rivers in two contrasted socio-economic conditions, i.e. Kharkiv and Bordeaux regions, for the comparison of occurrence, distribution and accumulation of organic tracers on the urban area and the evaluation of socio-economic determinants of water pollution. Sampling of pharmaceuticals has been done at the same time as for trace metals in order to optimize the time and costs of the monitoring campaigns, but also to represent the behavior of contaminants in contrasted environmental conditions. Identification of pharmaceuticals was firstly done for Ukrainian rivers and results help to obtain the pilot information on the presence of these micro-pollutants in Post Soviet East European country and compare them with the world data.

The each sampling has been done using the 2 – 3 replication in order to estimate the data quality.

Moreover, during monitoring, hydrological and hydro-chemical data were estimated, i.e. velocity, flow, temperature, conductivity, pH, major ions (Ca, Na, Mg, HCO<sub>3</sub>, SO<sub>4</sub>, Cl) and organic carbon at the most of sites in the each campaign.

(iii) samples analysis in certified laboratories

After the monitoring all samples have been preserved and conserved at 4<sup>0</sup>C and delivered for the following analysis to France, as there are no available analytical techniques for these micro-pollutants in Ukraine. Thus, analysis have been done in the certified French laboratories:



---

dissolved trace metals, trace metals in the sediments and pharmaceuticals were examined in the UMR CNRS 5805 Environnements et Paléoenvironnements Océaniques et Continentaux (University of Bordeaux<sup>1</sup>), dissolved labile metals were analysed in the UMR CNRS 6113 ISTO Campus Geosciences (University of Orleans). Used chemical protocols were verified and controlled by the experts (Prof. M. Motelica – Heino, Prof. J.Schafer, Dr. H. Budzinski, Dr. N.Tapie).

The different techniques were applied for the analysis of contaminants in samples:

The inductively coupled plasma mass spectroscopy (ICP – MS) has been used for analysis of dissolved labile and dissolved trace elements in water and sediments digests. Analyses of dissolved labile tracers in passive samples were forwarded by the extraction of targeted elements from the DGT gel during 48 hours, using nitrogeinic acid as an eluting solvent. The analyzed concentration of elements in the solvent has been recalculated in the mass value and in the environmental concentration considering the temperature dependent diffusion coefficient, proposed by the DGT – manufacturer, parameters of the device (thickness of the diffusive gel and filter membrane, exposure area), deployment time. Thus the determination of the water concentration of dissolved labile trace metals is interpreted based on the time-integrated value over the period of the deployment. Dissolved metal concentration in filtered samples and sediments digests were identified using the standard analytical protocols with the application of certified materials.

The liquid chromatography – quadrupole mass spectrometry (LC – MS/MS) has been applied for the analysis of the pharmaceuticals in POCIS passive sampling devices. The extraction of the analytes from the sorbent has been fixed using the solutions of methanol, methanol/dichloromethane mixture (50:50) and dichloromethane and spiked with internal standards; final extracts were transferred into the acetonitrile. The obtained mass of pharmaceuticals has been recalculated into the environmental concentration using the data on the mass of the POCIS sorbent, sampling rate and the deployment period. Sampling rates have been determined in previous studies and used in this research. The data have not calibrated depending on the water turbulence, salinity and pH due to the low variations of these parameters in studied watercourses. The estimation of the sampling rate is one of limits of the POCIS application, as it can be dependent on temperature, presence of organic matters and other factors. So the lack of these data gave us to consider the passive sampling as semi-quantitative technique for the monitoring of organic contaminants that needs the accurate quality control.

---

(iv) data treatment and modeling

Data treatment was done in the following steps: data quality control, data analysis and application.

Quality control of the data has been proceeding using standard approaches, i.e. the application of certified reference materials and internal standards, blank analysis, estimation of the detection limits, calculation of recovery rates (for spiked samples), standard deviation and residual standard deviation. Thus, the quality of all used data has been estimated.

Data analysis included the regular statistical analysis, i.e. estimation of mean, medium, maximum and minimum values, 25%, 50% and 75% percentile, assessment of the correlation between elements (by Pearson's coefficient) and principal component analysis (the result of PCA are not presented in the manuscript because of difficulties with the data interpretation).

Other applied methods of data treatment were: the comparison of the concentration along the watercourse, between contrasted hydrological and climate conditions, and regions; estimation of the enrichment factors, Th – normalization values, the environmental risk assessment by Ukrainian and EU guidelines and identification of the regional baseline for trace elements in the sediments and calculation of the elements variability.

Mass balance modeling has been used for the assessment of trace elements fluxes in the watershed, but also for the calculation of medicament consumption values in the studied regions.

Outcomes of the data treatment gave us opportunities to discover and describe the principal environmental and socio-economic determinants, which relate to the occurrence, accumulation and behavior of trace metals and pharmaceuticals.

Firstly, study focused on such environmental determinants as water chemistry, hydrological and seasonal conditions, which can influence on the occurrence, distribution, accumulation and behavior of tracers. Impact of environmental determinants on trace metals in natural waters was presented only for Ukrainian rivers, due to the particular hydrological and seasonal patterns of the watershed. It was found that the water chemistry of studied Ukrainian rivers is formed by the influence of both natural and anthropogenic factors. It was discovered that the urban territory and wastewater treatment plants in Kharkiv are major sources of Cd, Co, Cr, Cu, Ni, Pb and Zn in the studied Udy and Lopan rivers. The independent water chemical data were treated for the low and high flow periods and help us identify the weight of the natural dilution process in the distribution and accumulation of tracers. It was described that the natural watering is extremely

---

low and not efficient for the reduction of trace elements in studied watercourses. Data treatment for seasonal patterns revealed the potential influence of water temperature and microbial activity on the mobilization of certain tracers in natural water. It was found the particular behavior of As (trace element) and Cu during hot and cold seasons and demonstrated the possible influence of seasonal variations on trace metals dynamics. Concentrations of trace metals were found to be higher in the summer mainly due to the low dilution, but at the same time, fluxes of trace metals were observed at the upper level during the winter period showing the dependence of tracer's variability on both natural and socio-economic conditions.

Secondly, additional environmental determinants, as regional baseline and the trace element enrichment were described based on the data treatment results. These environmental determinants help us to identified the anthropogenic component of water contamination and assess the environmental risk. The Th-normalized concentration of trace metals in the sediments and enrichment factors approved that the Kharkiv city area was the principal contributor of Ag, Cd, Cr, Cu, Hg, Ni, Pb and Zn to the natural water. According to the environmental risk assessment, the medium risk was observed on the urban area and high risk was at the site downstream of wastewaters discharge. The highest enrichment and accumulation in the sediments was detected for Ag, what gave as a possibility to consider silver as an urban tracer in the following step of the research. Based on the obtained data of tracer's contamination in the sediments, the present day baseline concentration of trace elements was proposed using the Th-normalized values.

Thirdly, it was found that certain socio – economic determinants can influence the water chemistry. At this step, the data on pharmaceuticals were treated and modeled for the description of potential socio-economic factors such as the consumption patterns, which can impact on the presence of these organic contaminantes in natural streams. For this purpose, 21 pharmaceuticals of different therapeutic groups (antidepressants, analgesics, psychiatric drugs, stimulants, sedatives, broncholidators, non–steroidal anti–inflammatories and lipid regulators) were monitored along the studied Ukrainian and French rivers. Among them 18 medicaments (alprazolam, aspirin, amitriptyline, bromazepam, caffeine, carbamazepine, clenbuterol, diazepam, diclofenac, fluoxetine, gemfibrozil, ibuprofen, ketoprofen, naproxen, nordiazepam, paracetamol, salbutamol and theophylline) have been found in the Jalle River in France and 15 of these targeted compounds (alprazolam, aspirin, amitriptyline, caffeine, carbamazepine, diazepam, diclofenac, fluoxetine, ibuprofen, ketoprofen, naproxen, nordiazepam, paracetamol, salbutamol and theophylline) were detected in the Lopan River, Ukraine. The distribution of

---

pharmaceuticals in streams showed the different patterns, with the domination of the stimulants and non-prescription drugs in upstream sites and prescription medicaments in the sites downstream of municipal wastewaters discharges and urban areas. According to the maximum concentration values, the Ukrainian river has been found more contaminated by targeted organics compare to the French river that can be linked to disparity in the medicament consumption, efficiency of wastewater treatment and natural dilution of anthropogenic inputs. However, in order to understand the influence of the consumption patterns, environmental data have been used for the estimation of intake of selected medicaments (diclofenac, caffeine and carbamazepine) in studied regions. For this commitment, the mass balanced modeling using the data on the drug excretion, efficiency of treatment, water flow and environmental concentrations has been realized. As results, the comparison of pharmaceuticals in two rivers of Ukraine and France revealed that consumption patterns of medicaments influenced on the accumulation of these micro-pollutants together with the another parameters, such as the wastewater treatment efficiency and management, natural instream hydrological and hydrochemical processes. Outcomes of mass balance modelling suggest that water monitoring can be used for the estimation of particular social indicators as medical and illicit drug consumption rate.

(v) description of the perspectives

Results of the water monitoring campaigns, data treatment and modeling revealed to proposal of the environmental data application in the multidisciplinary studies. Thereby, in this part of the research, trace metals and pharmaceutical were analyzed as potential indicators of urban and industrial impact on surface waters.

Indicators were assessed by proposed criteria: specificity, variability and practicality. As outcomes, the analysis of the distinctive behavior of trace metals (Ag, Cd, Cr, Cu, Ni, Pb and Zn) and properties of pharmaceuticals (carbamazepine, diclofenac, diazepam, paracetamol, caffeine and ketoprofen) described that these tracers in urban water can indicate not only pollution events, but also reflect the regional socio-economic processes. Thereby, trace metals were proposed as anthropogenic indicators of industrial impact on the urban water. Tracers, deposited in the sediments, were found to be useful indicators of 'historical pollution processes'; dissolved and dissolved labile trace metals can characterize the time varying influences on the environment and discriminate non-point and point pollution sources.

Pharmaceuticals were identified as indicators of the social process, i.e. medicament consumption patterns, wastewater treatment efficiency and uncontrolled discharges. Depending on the

---

physical chemical properties, pharmaceuticals have been classified on conservative (carbamazepine and diazepam), labile or non-conservative (caffeine and paracetamol) and with combined properties (ketoprofen and diclofenac). The conservative substances were considered as efficient tracers of treated and untreated wastewaters, indicating the long term impact of urban territory on the natural water. The labile compounds were applied as anthropogenic indicators of untreated inputs, undergoing other influences such as accidents on sewage works, run – off, etc. Chemicals with combined properties, which can act as conservative and labile tracers depending on the season and usage patterns, were described as potential indicators of multi-varying influences (human and veterinary) and report the treatment efficiency of wastewaters.

(vi) dissemination and publication of the results

All results of the study were presented in the form of four publications in peer-review journals and discussed on international conferences in Swiss, Sweden, France, Ukraine, Germany, Canada, Ireland and Greece.

## **Limits of the study**

This research was a pilot in term of the applied sampling technique, selected study areas and environmental matrix. Thus, the following limits of the study should be considered:

(i) in the selection of targeted compounds, methods and study area

Partly, our targeted compounds and used passive sampling technique (i.e. POCIS and DGT) were limited to the available analytical protocols, methods of the environmental concentration estimation (i.e. absence of the validated sampling rates) of the analysis. For example, only 21 pharmaceuticals have been analysed, among more than 300 of medicaments what exists in the world market. Antibiotics, as another potentially toxic substances, have not been included in the monitoring due to the lack of analytical tools (limits of internal standars), précised sampling rates and high costs of the technique.

Only two passive sampling devices (POCIS and DGT) have been applied among other which exist on the market, such as membrane enclosed sorptive coating (MESCO), Chemcatcher, semipermeable membrane device (SPMD), etc. So, we were not able to compare the application of various passive sampling tools and their efficiency. Thus, the selection of the sampling approach was based on the availability of analytical tools and experts, on the presence of

referenced publication about chosen methods and previously reported results on the advantage and disadvantage of tools.

The proceeding of the sampling campaign exhibited a number of difficulties:

*Access to the sampling sites* was difficult because of the lack of accessible vehicles and roads, climate-related bad travel conditions (rain and mud) and legal authorization (especially in the transboundary Russian - Ukrainian part of the Udy and Lopan Rivers; as there are still no any scientific agreement between both countries on the monitoring of transboundary rivers).

*Sample transportation.* Because of the absence of adequate laboratory equipments in Ukraine, the samples were immediately transported to French laboratories by airplane. Thereby, the number of samples was limited.

*Private properties,* as it was not possible to get the permission to do the monitoring campaigns in sites on the Jalle River in France, which are located on the private area with restricted entrance to the stream.

In the future, additional sites should be sampled and the sampling strategy must be optimized for the precised identification of the point and non-point pollution sources in the respective watersheds.

(ii) in the use of the sampling technique

Generally the replication of samples was limited to the duplication, but not to the triplication, what reduced the obtained environmental data and their quality control. But the additional replication significantly increased the difficulties of the transportation and costs of sampling and analysis, as the research was done in the very limited budget and time value.

(iii) in data treatment and modeling

This study is a part of the pilot integrative research on the urban rivers of the industrial East Ukraine region. For the presentation of a first overview about the distribution of the elements in the watershed, the sampling was limited just to six campaigns in 2008 - 2010.

Thus, the number of samples was limited and provided first overview on what is going on in the study area, so it was not possible to produce highly robust statistical treatment of the data. But for the further development of the database in order to understand the presence of different forms of elements, mixing - dilution processes, continuous monitoring and replication should be done

---

in contrasted seasonal and hydrological conditions at the same and additional sites with the application of active and passive sampling for the long – term and diurnal investigations.

So, in this research, we tried to optimize time, money, human and energy resources in order to get (the first) accurate data for the water system.

## **Practical application**

The PhD study has been done in the framework of the French – Ukrainian scientific collaboration by the research project “DNIPRO” (2009 – 2011) what was financed by Ministry of Education and Science, Ukraine: Ref. M/163-2006 and Ministry of Foreign Affaires, France: Ref. 19744VJ. The results of the thesis have been practically applied during the duration and ending of the project, as:

- (i) The method of the sampling with the combination of conventional and passive sampling techniques of tracers has been proposed in the form of the guideline “Development of the urban water sampling for the Environmental Authority”. The guide has been published in the Final “DNIPRO” Project Report and distributed by Ukrainian Ministry via regional environmental authorities. As the feedback, the new project “Monitoring of effluents from the pharmaceutical enterprises of the East Ukraine” was initiated by the Kharkiv regional environmental authorities, managed by the Regional Kharkiv Administration. The significant part of the project will be dedicated to the development of the monitoring and control of effluents from the pharmaceutical production enterprises. The project is approved by the City and Regional Councils and starts in 2012.
- (ii) The used approach, methodology and results of the PhD work have been used in the study process in Kharkiv National Academy of Municipal Economy, Ukraine, i.e. in the courses “Introduction to the speciality” (1<sup>st</sup> year students), “Environmental Monitoring” (professionals and students of 2<sup>nd</sup> year studies), “Environmental management and audit” (professionals and students of 5<sup>th</sup> year study), “The essentials of the scientific research” (professionals and students of 6<sup>th</sup> year study). Results of the thesis were discussed in the form of case studies during the learning process and published in student’s handbooks of mentioned courses. Additionally, two Master’s researches have been done during the ongoing PhD project and supervised by Mrs. Vystavna Yuliya. Both of Master Works have been honored as “Best national students research” by Ministry of Education and Science, Ukraine in 2010 and 2011.

---

(iii) The proposed method of sampling (i.e. combination of grab and passive water monitoring and sediments analysis) and data interpretation (i.e. Th – normalization, estimation of EF and trace elements baseline) will be applied to the rivers with similar hydrological and geochemical characteristics and used for the long-term water monitoring during various climatic conditions conducted by regional environmental and water authorities of Ukraine in international projects as EU Framework FP7 and NATO Scientific Programme.

(iv) The proposed regional baseline and approach on estimation of Th-values of trace metals in the sediments of Ukrainian river will be used for the Geological Authority in the Kharkiv region (under the direction of Prof. Valeriy Jakovlev) for the development of the first Sediments Quality Guidelines in the East Ukrainian watershed.

Thus the research finds the practical implementation on different levels, i.e. regional, national and international.

## Further research development

This study helps to point new challenges for the development of the research and further cooperation with the University of Bordeaux and other international institutions.

The further development of the research is proposed by following directions (Figure A):

(i) Extension of tasks of the investigative monitoring:

Investigative monitoring is the type of water monitoring described in the Water Framework Directive as the monitoring which aimed at assessing the cause of the risk or failing of the environmental objectives of the The advance of the research can link to the development of new tasks of the investigative monitoring what can provide additional information on environmental and socio-economic processes, what influence the water quality. WFD and exist as the additional part of the surveillance<sup>1</sup> and operational monitoring<sup>2</sup>.

---

<sup>1</sup> Surveillance monitoring aimed at assessing long-term quality changes and providing the baseline data on river basin (WFD)

<sup>2</sup> Operational monitoring aimed at providing additional and essential data on water bodies at risk or failing environmental objectives of the WFD (WFD).



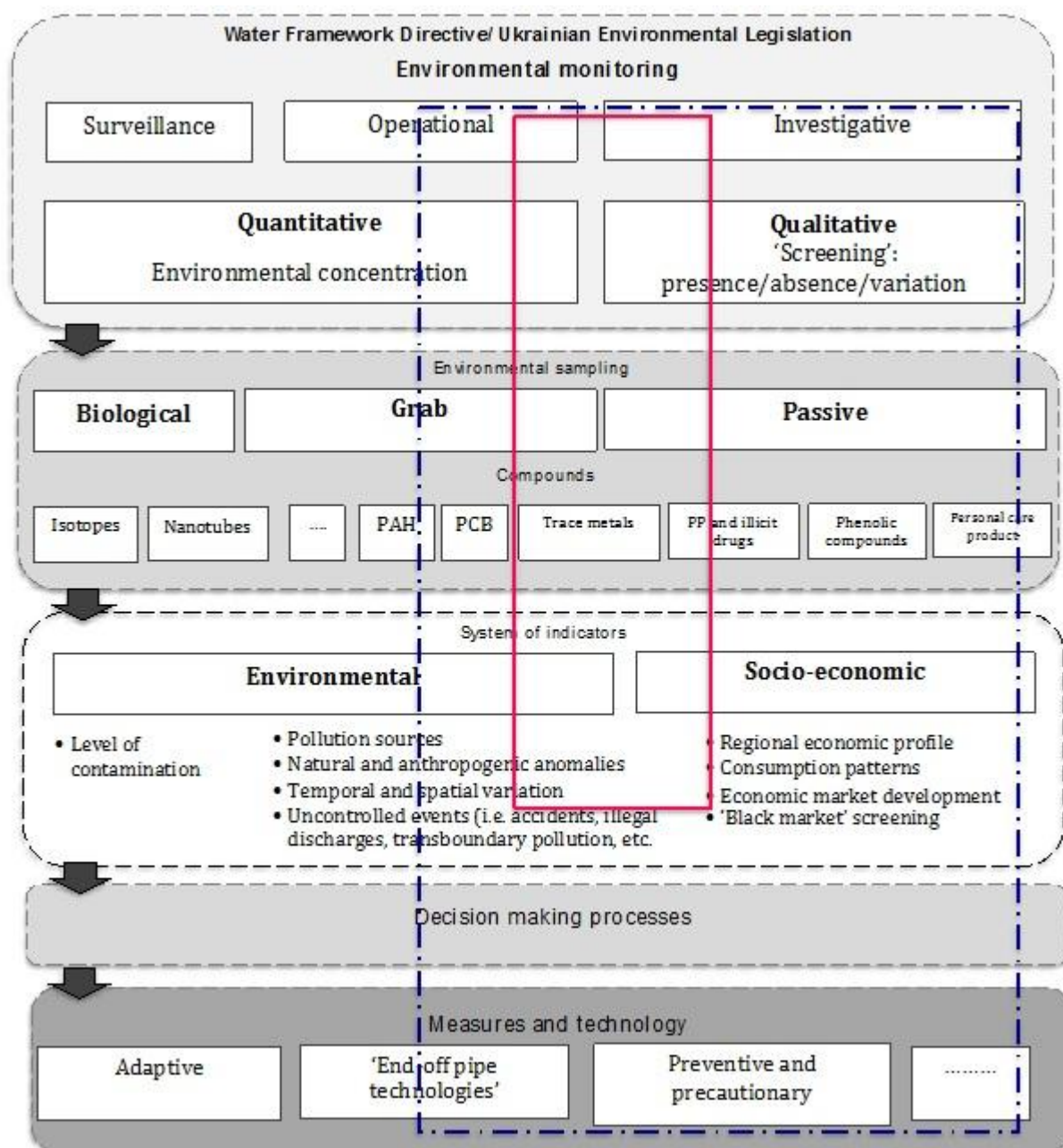

Figure A. The current (red) and further development (blue) of the presented research

*Environmental processes* can be characterised as any anthropogenic or natural activity that directly affects the contamination of water bodies by various types of compounds. It can be of varying types (run-off, precipitation, accidental events, illegal discharges, overloading of treatment facilities, etc.) or continuous inputs (treated and untreated municipal and industrial wastewater releases).

Advanced tasks of the investigative monitoring can be the tracking of the uncontrolled inputs of contaminants, including the illegal discharges, accidental events and untreated wastewaters

---

(Cherkashina and Vystavna 2009). Discrimination of sources, description of temporal and spatial patterns of contamination can be done using the system of environmental and anthropogenic tracers (Huneau 2011) what have inorganic and organic origin with contrasting physical chemical properties and association with the particular type of the source. These tasks can be realised using both quantitative (obtaining the exact environmental concentration) and qualitative (obtaining the other values that help to get monitoring objectives).

Tracking the uncontrolled pollution events and sources discrimination will be helpful for the practical implementation of the Environmental Law and protection of the water.

*Socio-economic processes* can be described as any social and economic interests, what indirectly influence the changing of the water chemistry. It can be the regional economic structure (industrial, agricultural, urban, mining, transport components, etc.), market development (presence of the 'black' market) and social activity (consumption patterns, level of the education, etc.). The understanding of the regional economic profile, drug and illicit drug consumption, presence of abuse chemicals on the market can be studied in the future research development using the system of indicators and mass balance modelling tools.

The study of the socio-economic processes by the water monitoring tools is useful for the social (evaluation of the consumption patterns), economic (discription of the regional economic profile and market development) and criminal (identification of illicit and abused drug roots and their intake rates) research.

(ii) advancement of monitoring tools by the inclusion of the passive sampling techniques in the surveillance, operational and investigative monitorings

Taking into account the time variation of the uncontrolled discharges and the range of the environmental and anthropogenic indicators, the passive sampling can be an efficient semi-quantitative tool for the environmental monitoring.

But for the compitent practical implementations of passive samplers for different monitoring tasks, futher researches are still necessary on:

*technical aspects* of the passive samplers installation (i.e. estimation of the deployment period; automatization of the passive sampling method, application in groundwaters etc.)

*analytical aspects* of the analysis and validation of passive samplers (i.e. study on the type of the measured fractions and kynetics; identification of the sampling rate and calculation

of the environmental concentration; quality assurance; unification of detailed extraction protocols and analysis; estimation of the befouling and matrix effect, etc.)

*socio-economic aspects* of the selection of the passive sampling method (i.e. cost-ratio analysis of sampling techniques; estimation of the public participation and opinion, etc.)

*legislative aspects* of the practical use of samplers (i.e. standardization of the passive sampling technique <sup>3</sup>; accreditation and certification of samplers; development of the environmental legislation and monitoring programs).

Other important development should be done for the estimation of (a) uncertainties and risks related to the each step of the passive sampling implementation, i.e. deployment, calibration and analysis; (b) data quality control, that can give the more accurate comparison between different passive samplers and between passive, standard and biological sampling for the tolerable environmental data link and their validation.

iii) inclusion of another micro-pollutants in the water monitoring and their application as various tracers and indicators

Various different trace elements can be also monitored in the natural environment using the principles of this study: identification of the sampling sites; chosen of monitoring tools; selection of tracers and indicators; application of water monitoring data in multi-disciplinary research.

Among trace elements, phenolic compounds (alkylphenols and bisphenol A), personal care products, hormones, industrial nanomaterials are one of them with the growing of interests for environmentalists, chemists, toxicologists and the society.

Thus, the main further development of the research can be associated with the expansion of tasks, tools and compounds of the water monitoring.

The next step can be the improvement of the decision-making processes by the inclusion of new environmental and socio-economic data gathered from the environmental monitoring. Obtained data can be ranked and divided on categories and subcategories according to the hierarchy of the decision making tasks and problems.

---

<sup>3</sup> The first assumption is done in ISO 5667-23:2011 Water Quality Sampling – Part 23: Guidance on passive sampling in surface waters

The final step can be associated with the environmental and human health protection measures, particularly:

*Precautionary and preventive measures* are necessary for the preservation of the environment from the growing of the contamination by the different chemicals. Educational programs, social surveys, legislative acts, economic tools can play the role of the basic precautionary measures.

*End-of-pipe measures* are essential for the reduction of the current contamination of compounds in the environment. Different advanced treatment techniques, as ozonation, UV, and membranes, but also the phytoremediation and biological methods are already shown their efficiency in the treatment of chemicals from the water.

*Adaptive measures* are the adaptation to the change in the environment. These measures relate not to the changing of the present contamination status, but help to adjust to the current situation. The example can be the implementation of new antibiotics instead to these what are already present in the environment and bacteria becomes resistant to them. Such measures are common for the developing countries, but they are not useful for the solving of the contamination problem.

Thereby, the further development of the investigative monitoring can be associated not only with the use of the water monitoring data to study environmental, but also for the description of socio-economic processes and for the following multi-disciplinary application of the environmental data in the decision making and environmental protection planning. In an advanced step the data gathered during this study should be used to model the water pollution processes considering many socio-economic indicators (demography, employment structure, economic structure, infrastructure, ...) and changes in the hydrological conditions (Chichurin and Vystavna 2009). Such tool (Vystavna 2005) is necessary for the forecasting the water quality in relation with the socio-economic dynamic of the region.

## **Professional development**

The study in the University of Bordeaux, France was an exceptional opportunity for the development of the international cooperation and career, but also to explore Ukrainian regions with the lack of the environmental data.

Master Degree in Environmental Science (with the honour), and all professional and personal skills obtained during the master study in the Kharkiv National Academy of Municipal

Economy, Ukraine (Figure B) became an excellent background for the further development of the international scientific research and starting the PhD in University Bordeaux, France.

Working with the high level specialists in Environmental Study, access to the analytical equipment, presentation of scientific results on international conferences, participation in projects and workshop during the PhD study significantly upgraded both professional and personal skills.

Contacts, knowledges and skills obtained during the study in France will be important for the further career development, focusing on: (i) preparation and participation in the international projects; (ii) teaching in the University and supervising of student's works and (iii) processing the post-doctoral research in order to increase the scientific qualification.



Figure B. The career development

Thus, PhD study is an opportunity to establish a long-term cooperation between Ukrainian, French and other international scientific institutions and develop the novel and innovative ideas in the field of the Environmental science, but also in the University Management.



---

## References

- Alfaro-De la Torre M.-C., Beaulieu P.-Y., Tessier A. 2000. In situ measurement of trace metals in lake water using the dialysis and DGT techniques. *Analytica Chimica Acta*, 418, 53-68.
- Allan I.J., Knutsson J., Guigues N., Mills G.A., Fouillac A. – M., Greenword R. 2008. Chemcatcher and DGT passive sampling devices for regulatory monitoring of trace metals in surface water. *Journal of Environmental Monitoring* 10 (7), 821 – 829.
- Alvarez D. A., Petty J. D., Huckins J. N., Jones-Lepp T. L., Getting D. T., Goddard J. P., et al. 2004. Development of a passive in situ integrative sampler for hydrophilic organic contaminants in aquatic environments. *Environmental Toxicology and Chemistry* 23(7), 1640-1648.
- Alvarez D.A., Stackelberg D.E., Petty J.D., Huckins J.N., Furlong E.T., Zaugg S.D., Meyer M.T. 2005. Comparison of a novel passive sampler to standard water column sampling for organic contaminants associated with wastewater effluents entering a New Jersey stream. *Chemosphere* 61 (5), 610 – 622.
- Alvarez D. A., Cranor W. L., Perkins S. D., Clark R. C., Smith S. B. 2008. Chemical and toxicologic assessment of organic contaminants in surface water using passive samplers. *Journal of Environmental Quality* 37(3), 1024-1033.
- Andreozzi R., Raffaele M., Nicklas P. 2003. Pharmaceuticals in STP effluents and their solar photodegradation in aquatic environment. *Chemosphere* 50, 1319-1330.
- Arditsoglou A., Voutsas D. 2008. Passive sampling of selected endocrine disrupting compounds using polar organic chemical integrative samplers. *Environmental Pollution* 156 (2), 316-324.
- Audry S., Schäfer J., Blanc G., Bossy C., Lavaux G. 2004. Anthropogenic components of heavy metal (Cd, Zn, Cu, Pb) budgets in the Lot – Garonne fluvial system (France). *Applied Geochemistry* 19, 769-786
- Balistrieri L. S., Blank R. G. 2008. Dissolved and labile concentrations of Cd, Cu, Pb and Zn in the South Fork Coeur d'Alene River, Idaho: Comparisons among chemical equilibrium models and implications for biotic ligand models. *Applied Geochemistry* 23, 3355-3371.
- Baalousha M., Kammer F. V. D., Motelica-Heino M. Baborowski M., Hofmeister C., Le Coustumer P. 2006a. Size-based speciation of natural colloidal particles by flow field-flow fractionation, inductively coupled plasma-mass spectroscopy, and transmission electron

---

microscopy/ X-ray energy dispersive spectroscopy: colloids-trace element interaction. *Environmental Science and Technology* 40, 2156-2162.

Baalousha M., Motelica-Heino M., Coustumer P. L. 2006b. Conformation and size of humic substances: Effects of major cation concentration and type, pH, salinity and residence time, *Colloids and Surfaces A: Physicochemical and Engineering aspects* 272 (1), 48-55.

Barnes K., Kolpin D., Furlong E., Zaugg S., Meyer M., Barber L. 2008. A national reconnaissance of pharmaceuticals and other organic wastewater contaminants in the United States – I) Groundwater. *Science of the Total Environment* 402, 192-200.

Benz D., Paxeus N., Ginn T., Loge F. 2005. Occurrence and fate of pharmaceutically active compounds in the environment, a case study: Hoje River in Sweden. *Journal of Hazardous Materials* 122, 195-204.

Bidwell J. R., Becker C., Hensley S., Stark R., Meyer M. T. 2010. Occurrence of organic wastewater and other contaminants in cave streams in northeastern Oklahoma and northwestern Arkansas. *Archives of Environmental Contamination and Toxicology* 58(2), 286-298.

Boxall A. 2004. The environmental side effects of medication. *European Molecular Biology Organization*, 1110 – 1116.

Brown K.D., Kulis J., Thomson B., Chapman H. 2006. Occurrence of antibiotics in hospital, residential and dairy effluent, municipal wastewater and Rio Grande in New Mexico. *Science of the Total Environment* 366 (2-3), 772 – 783.

Budzinski H., Soulier C., Lardy S., Capdeville M.J., Tapie N., Vrana B., Miege C., Ait Aissa S. 2009. Passive sampler for chemical substance monitoring and associated toxicity assessment in water, Abstract presented at the International Conference on Xenobiotics in the Urban Water Cycle, 11-13 March 2009, Cyprus.

Buffle J., Horvai G. 2000. General concepts. In: Buffle, J., Horvai, G. (Eds.), *In Situ Monitoring of Aquatic Systems: Chemical Analysis and Speciation*. John Wiley & Sons Ltd, USA, pp.1-17.

Buzier R., Tusseau-Vuillemin M.-H., Marin dit Meriadec C., Rousselot O., Mouchel J.-M., 2006a. Trace metal speciation and fluxes within a major French wastewater treatment plant: Impact of the successive treatments stages. *Chemosphere* 65, 2419-2426.

Buzier R., Tusseau-Vuillemin M.-H., Mouchel J.M., 2006b. Evaluation of DGT as a metal speciation tool in wastewater. *Science of the Total Environment*, 358, 277-285.

Buzier R., Tusseau-Vuillemin M. -H., Keirsbulck M., Mouchel J. 2008. Inputs of total and labile trace metals from wastewater treatment plants effluents to the Seine river. *Physics and Chemistry of the Earth (in press)* doi.org/10.1016/j.pce.2008.09.003

Campbell P. G. C., Errécalde O., Fortin C., Hiriart-Baer V. P., Vigneault B. 2002. Metal bioavailability to phytoplankton - applicability of the biotic ligand model. *Comparative Biochemistry and Physiology - C Toxicology and Pharmacology* 133(1-2), 189-206

Carballa M., Omil F., Lema J., Llopart M., Carcia-Jares G., Rodriguez I., Gomez M., Ternes T. 2004. Behavior pharmaceuticals, cosmetics and hormones in a sewage treatment plant. *Water Research* 38, 2918-2926.



- Chen Z., Zhu L., Wilkinson K.J. 2010. Validation of the biotic ligand model in metal mixture: Bioaccumulation of lead and copper. *Environmental Science and Technology* 44 (9), 3580-3586.
- Cherkashina M., Vystavna Y. 2009. The legislative problems of wastewater discharges in surface water. *Naukovij Vysnik Cherniveskogo Universitetu* 35, 85 – 91 (in Ukrainian).
- Choi K., Kim Y., Park J., Park C., Kim M., Kim H., Kim P. 2008. Seasonal variations of several pharmaceutical residues in surface water and sewage treatment plants of Han River, Korea. *Science of the Total Environment* 405, 120-128.
- Clara M., Strenn B., Kreuzinger N. 2004. Carbamazepine as a possible anthropogenic marker in the aquatic environment: investigations on the behavior of carbamazepine in wastewater treatment and during groundwater infiltration. *Water Research* 38, 947-954.
- Cleuvers M. 2003. Ecotoxicity of pharmaceuticals including the assessment of combination effects. *Toxicology Letters* 142, 185-194.
- Comeau F., Surette C., Brun G.L., Losier R. 2008. The occurrence of acidic drugs and caffeine in sewage effluents and receiving waters from three coastal watersheds in Atlantic Canada. *Science of the Total Environment* 396 (2-3), 132-146.
- Cortecci G., Boschetti T., Dinelli E., Cidu R., Odda F., Doveri V. 2009. Geochemistry of trace elements in surface waters of the Arno River Basin, northern Tuscany, Italy. *Applied Geochemistry*, 24 (5), 1005 – 1022.
- Daneshvar A., Svanfelt J., Kronberg L., Weyhenmeyer G.A. 2010. Winter accumulation of acidic pharmaceuticals in a Swedish river. *Environmental Science and Pollution Research* 17, 908 – 916.
- Denney S., Sherwood J., Leyden J. 1999. In situ measurements of labile Cu, Cd and Mn in river waters using DGT. *Science of the Total Environment*, 239, 71-80.
- de Deckere E., de Cooman W., Leloup V., Meire P., Schmitt C., von der Ohe P. C. 2011. Development of sediment quality guidelines for freshwater ecosystems. *Journal of Soils and Sediments* 11(3), 504-517.
- Dietrich D.R., Webb S.F., Petry T. 2004. Hot spot pollutants: Pharmaceuticals in the environment. Academic press, 325p.
- Dieter H. 2011. Drinking water toxicology and its regulatory framework. *Treatise on Water Science* 3, 377 – 415.
- DGT Research, 2002. DGT for measurements in water, soils and sediments. DGT Research Ltd., Lancaster
- Dordio A., Carvalho A.J.P., Teixeira D.M., Dias C.B., Pinto A.P. 2010. Removal of pharmaceuticals in microcosm constructed wetlands using *Typha spp.* and LECA. *Bioresource Technology* 101, 886-892.
- Dragun Z., Biserka R., Vibor R. 2008. The labile metal concentration in Sava River water assessed by diffusive gradients in thin film. *Chemical Speciation and Bioavailability* 20 (1), 33-46.

- Dunn R.J.K, Teasdale P.R., Warnken J., Jordan M.A., Arthur J.M. 2007. Evaluation of the in situ, time-integrated DGT technique by monitoring changes in heavy metals concentrations in estuarine waters. *Environmental Pollution* 148, 213-220.
- Elder J.F. 1988. Metal Biogeochemistry in Surface-Water Systems - A Review of Principles and Concepts. U.S. Geological Survey Circular 1013.
- EPA 2004. Guidelines for water reuse. EPA/625/R-04/108, Washington. 450p.
- EPA 2011. Priority pollutants. <http://www.epa.gov/waterscience/methods/pollutants.htm>, last access on 13 October 2011
- EU 2006. Directive 2006/7/EC of the European Parliament and of the Council of 16 February 2006 Concerning the Management of Bathing Water Quality and Repealing Directive 76/160/EEC. Official Journal of the European Union L64, pp. 37-51.
- EU 2008. Directive 2008/105/EC of the European Parliament and the Council of 16 December 2008 Concerning the Environmental quality standards in the field of water policy, amending and subsequently repealing Council Directives 82/176/EEC, 83/513/EEC, 84/156/EEC, 84/491/EEC, 86/280/EEC and amending Directive 2000/60/EC of the European Parliament and of the Council, *Official Journal of the European Union* L 348 (2008), pp. 84–97.
- Fan H., Sun T., Li W., Sui D., Jin S., Lian X. 2009. Sodium polyacrylate as a binding agent in diffusive gradients in thin films technique for the measurement of  $\text{Cu}^{2+}$  and  $\text{Cd}^{2+}$  in water. *Talanta*, 79, 1228 – 1232.
- FAO 1992. Wastewater treatment and use in agriculture. Irrigation and Drainage Paper 47, M.B. Pescod, Rome, p. 125.
- Fent K., Weston A., Caminada D. 2006. Ecotoxicology of human pharmaceuticals. *Aquatic Toxicology* 76 (2), 122-159.
- Ferrari B., Paxeus N., Giudice R., Pollio A., Garric J. 2003. Ecotoxicological impact of pharmaceuticals found in treated wastewaters: study of carbamazepine, clofibric acid and diclofenac. *Ecotoxicology and Environmental Safety* 55, 359-370.
- Florence T. M., Morrison G. M., Stauber J. L. 1992. Determination of trace element speciation and the role of speciation in aquatic toxicity. *Science of the Total Environment* 125, 1-13.
- Froehner S., Scuza D.B., Machado K.S., da Rosa E.C. 2010. Tracking anthropogenic inputs in Barigui River, Brazil using biomarkers. *Water Air and Soil Pollution* 210, 33-41.
- Furumai H., Nakajima F., Katayama H., 2011. Urban nonpoint source pollution focusing of micropollutants and pathogens. *Treatise on Water Science* 4, 265 – 276.
- Girard J.E. 2005. Principles of Environmental Chemistry. Printed in U.S., by Jones and Barlett Publishers Inc., 320 pp.
- GCPL 1991. General code of permitted limits and presumable safe levels of impacts of hazardous substances in the waters use for fishery. Ministry of Fishery of USSR. No.12-04-11:100-142 (in Russia)

- Greenwood R., Mills G.A., Vrana B., Allan I., Aguilar – Martinez R., Morrison G. 2007. Chapter 9. Monitoring of priority pollutants in water using Chemcatcher passive sampling devices. *Comprehensive Analytical Chemistry* 48, 199 – 229.
- Grund M., Kallqvist Y., Sakshaug S., Skurtveit S., Thomas K. 2008. Environmental Assessment of Norwegian priority pharmaceuticals based on EMEA guideline. *Ecotoxicology and Environmental Safety* 71, 328-340.
- Gupta V.K., Ali I., Aboul – Enein N.Y. 2007. Chapter 3. Metal ions speciation in the environment: distribution, toxicities and analysis. *Developments in Environmental Sciences* 5, 33 – 56.
- Hanicke R., Oros D.R., Oram J., Taberski K. 2007. Adapting an ambient monitoring program to the challenge in the San Francisco Estuary. *Environmental Research* 105, 132-144.
- Heberer T. 2002. Tracking persistent pharmaceutical residues from municipal sewage to drinking water. *Journal of Hydrology*, 226, 175-189.
- Herklotz P., Gurung P., Heuvel B.V., Kinney C.A. 2010. Uptake of human pharmaceuticals by plants grown under hydroponic conditions. *Chemosphere* 78, 1416-1421.
- Hing – Biu Lee L., Peart T.E., Svoboda L. 2005. Determination of endocrine disrupting phenols, acidic pharmaceuticals and personal-care products in sewage by solid-phase extraction and gas chromatography – mass spectrometry. *Journal of Chromatography A* 1094, 122-129.
- Hirner A.V., Hippler J. 2011. Trace metal(loid)s (As, Cd, Cu, Hg, Pb, PGE, Sb and Zn) and their species. *Treatise on Water Science* 3, 31 – 57.
- Hirsch R., Thernes Thomas A., Haberer K., Kratz K.-L. 1999. Occurrence of antibiotics in the aquatic environment. *Science of the Total Environment* 225, 109-118.
- Hua W., Bennett E., Letcher R. 2006. Ozone treatment and the depletion of detectable pharmaceuticals and atrazine herbicides in drinking water sources from the upper Detroit River, Ontario, Canada. *Water Research* 40, 2259-2266.
- Huber M., Korhonen S., Ternes T., von Gunten U. 2005. Oxidation of pharmaceuticals during water treatment with chlorine dioxide. *Water Research* 39, 3607 – 3617.
- Huckins G.K., Manuweera J.D., Petty D., Mackay D., Lebo J.A. 1993. Lipid-containing semipermeable membrane devices for monitoring organic contaminants in water. *Environmental Science Technology* 27, 2489 – 2496.
- Huneau F. 2011. Contribution des traceurs naturels et anthropiques à la compréhension de la dynamique et de la vulnérabilité des écoulements superficiels et souterrains. Habilitation à Diriger des Recherches. – 403p.
- Jakovlev V.V., Svirenko L.P., Chebanov O.J., Spirin O.I. 2002. Rising Groundwater Levels in North-Eastern Ukraine: Hazardous Trends in Urban Areas. In: Current Problems of Hydrogeology in Urban Areas, Urban Agglomerates and Industrial Centres. /Eds. K.W.F. Howard & R.F. Israfilov. – Dordrecht: Kluwer Acad. Publ. - P. 221-241 (NATO ARW Series).
- Jones O.A.H., Voulvoulis N., Lester J.N. 2002. Aquatic environmental assessment of the top 25 English prescription pharmaceuticals. *Water Research* 36 (20), 5013 – 5022.

- Joss A., Keller A., Alder A.C., Gobel A., McArdell C.S., Ternes T., Siegrist H. 2005. Removal of pharmaceuticals and fragrances in biological wastewater treatment. *Water Research* 39, 3139-3152.
- Joss A., Zabczynski S., Gobel A., Hoffmann B., Löffler D., McArdell C., Ternes T.A., Thomsen A., Siegrist H. 2006. Biological degradation of pharmaceuticals in municipal wastewater treatment: Proposing a classification scheme. *Water Research* 40, 1686-1696.
- Ingersoll C.G., MacDonald D.D., Wang N., Crane J.L., Field L.J., Naverland P.S., Kemple N.E., Lindskoog R.A., Severn C., Smorong D.E. 2001. Predictions of sediment toxicity using consensus based freshwater sediment quality guideline. *Archieve on Environmental Contaminant and Toxicology* 41, 8-21.
- Kasprzyk-Hordern B., Dinsdale R.M., Guwy A.J. 2009a. Illicit drugs and pharmaceuticals in the environment – Forensic applications of environmental data, Part 1: Estimation of the usage of drugs in local communities. *Environmental Pollution* 157, 1778-1786.
- Kasprzyk-Hordern B., Dinsdale R.M., Guwy A.J. 2009b. Illicit drugs and pharmaceuticals in the environment – Forensic applications of environmental data, Part 2: Pharmaceuticals as chemical markers of fecal water contamination. *Environmental Pollution* 157, 1778-1786.
- Katsoyiannis A., Samara C. 2007. Comparison of active and passive sampling for the determination of persistent organic pollutants in sewage treatment plants. *Chemosphere* 67 (7), 1375 – 1382.
- Kim E.Y., Little J.C., Chiu N. 2004. Estimating exposure to chemical contaminants in drinking water. *Environmental Science Technology* 38, 1799–1806.
- Klavarioti M., Mantzavinos D., Kassinos D. 2009. Removal of residual pharmaceuticals from aqueous systems by advance oxidation processes. *Environment International* 35 (2), 402-417.
- Kot-Wasik A., Debska J., Namiesnik J. 2007a. Analytical techniques in studies of the environmental fate of pharmaceuticals and personal care products. *Trends in Analytical Chemistry* 26 (6), 557 – 568.
- Kot-Wasik A., Zabiegala B., Urbanowicz M., Dominiak E., Wasik A., Namiesnik J. 2007b. Review: Advances in passive sampling in environmental studies. *Analytica Chimica Acta* 602, 141 – 163.
- Kuster M., Lopez de Alda M. J., Hernando M. D., Petrovic M., Alonso J. M., Barcelo D. 2006. Analysis and occurrence of pharmaceuticals, estrogens, progestogens and polar pesticides in sewage treatment plant effluent, river water and drinking water in the Llobregat river basin (Barcelona, Spain). *Journal of Hydrology* 358, 112-123.
- Kummerer K. 2011. Emerging contaminants. *Treatise on Water Science* 3, 69 – 87.
- Kummerer K., Hempel M. 2010. Green and sustainable pharmacy. Springer. Printed in London. – 314p.
- Labadie P. 2004. Determination des steroids hormonaux dans l'environnement: developpements analytiques et application. Thèse de Doctorat en chimie analytiques et environnement, Université Bordeaux 1, 270 p.( in French)

- LA CUB 2006: PLU.1. Plan locale d'urbanisme de la communaute urban de Bordeaux. PLU approve par deliberation du conseil CUB du 21/07/2006. Rapport de presentation – A1: L'etat initial de l'environnement (in French).
- Larsen T., Lienert J., Joss A., Siegrist H. 2004. How to avoid pharmaceuticals in the aquatic environment. *Journal of Biotechnology* 113, 295-304.
- Larsson D., Pedro C., Paxeus M. 2007. Effluent from drug manufactures contains extremely high level of pharmaceuticals. *Journal of Hazardous Materials* 148, 751-755.
- Li H., Helm P.A., Metcalfe C.D. 2010. Sampling in the Great Lakes for pharmaceuticals, personal care products, and endocrine – disrupting substances using the passive polar organic chemical integrative sampler. *Environmental Chemistry* 29, 1-12.
- Lindqvist N., Tuhkanen T., Kronberg L. 2005. Occurrence of acidic pharmaceuticals in raw and treated sewages and in receiving waters. *Water Research* 39, 2219-2228.
- Linnik P. N. 2003. Complexation as the most important factor of in the fate and transport of heavy metals in Dnieper water bodies. *Analytical and Bioanalytical Chemistry* 376, 405-412.
- Loos R., Gawlik B., Locoro G., Rimaviciute E. 2009. EU-wide survey of polar organic persistent pollutants in European river waters, *Environmental Pollution* 157 (2), 561-568
- Lu Y., Wang Z., Huckins J. 2002. Review of the background and application of triolein containing semipermeable membrane devices in aquatic environmental study. *Aquatic Toxicology* 60 (1-2), 139 – 153.
- MacDonald D.D., Ingersoll C.G., Berger T.A. 2000. Development and evaluation of consensus-based sediment quality guidelines for freshwater ecosystems. *Archives of Environmental Contamination and Toxicology* 39, 20-31.
- MacLeod S.L., McClure E.L., Wong C.S. 2007. Laboratory calibration and field deployment of the polar organic chemical integrative sampler for pharmaceuticals and personal care products in wastewater and surface water. *Environmental Toxicology and Chemistry* 26, 2517-2529.
- Masson M., Schäfer J., Blanc G., Dabrin A., Castelle S., Lavaux G. 2009. Behavior of arsenic and antimony in the fresh water reaches of a highly turbid estuary, the Gironde Estuary, France. *Applied Geochemistry* 24, 1747-1759.
- Mello L.C., Claudino A., Rizzatti I., Bortoluzzi R.L., Zanette D.R. 2005. Analysis of trace metals Cu<sup>2+</sup>, Pb<sup>2+</sup>, Zn<sup>2+</sup> in coastal marine water samples from Florianopolis, Sants Catarina State, Brazil. *Journal of the Brazilian Chemical Society* 16 (3), 308 – 315.
- Meylan W.M., Howard P.H., Boethling R.S., Aronson D., Printup H., Gouchie S. 1999. Improved Method for Estimating Bioconcentration Factor (BCF) from Octanol-Water Partition Coefficient. *Environmental Toxicology and Chemistry* 18, 664-72.
- Miège C., Budzinski H., Jacquet R., Soulier C., Pelte T., Coquery M. 2011. Passive sampling using POCIS. Application for monitoring organic micropollutants in wastewater effluent and in surface water. [L'échantillonnage intégratif par POCIS Application pour la surveillance des micropolluants organiques dans les eaux résiduaires traitées et les eaux de surface] *Techniques - Sciences - Methodes* (1-2), 80-94.
- Moldovan Z. 2006. Occurrences of pharmaceutical and personal care products as micropollutants in rivers from Romania. *Chemosphere* 64(11), 1808-1817.

- Motelica-Heino M., Naylor C., Zhang H., Davison W. 2003. Simultaneous release of metals and sulfide in lacustrine sediment. *Environmental Science Technology* 37 (19), 4374-4381.
- Munksgaard N.C., Parry D.L. 2003. Monitoring of labile metals in turbid coastal seawater using diffusive gradient in thin film. *Journal of Environmental Monitoring* 5, 145-149.
- Murray, K., Thomas, S.M., Bodour, A.A. 2010. Prioritizing research for trace pollutants and emerging contaminants in the freshwater environment. *Environmental Pollution* [in press].
- Nagajyoti P.C., Lee K.D., Sreekanth T.V.M. 2010. Heavy metals, occurrence and toxicity for plants: a review. *Environmental Chemistry Letter* 8 (3), 199-216.
- Nakada N., Kiri K., Shinohara H., Harada A., Kuroda K., Takizawa S., Takada H. 2008. Evaluation of pharmaceuticals and personal care products as water – soluble molecular markers of sewage. *Environmental Science and Technology* 42, 6347-6353.
- Navalon S., Alraro M., Garcia H. 2008. Reaction of chlorine dioxide with emergent water pollutants: Product study of the reaction of three  $\beta$ -lactam antibiotics with  $\text{ClO}_2$ . *Water Research* 42 (8-9), 1935-1942.
- NRDW 2008: National Report on Drinking Water quality and supply in 2008 year. – Ministry of the Municipal Economy, Ukraine. – 266 p.
- Ort C., Lawrence M.G., Reickermann J., Joss, A. 2010. Sampling for pharmaceuticals and personal care products (PPCPs) and illicit drugs in wastewater systems: Are your conclusions valid? A critical review. *Environmental Science and Technology* 44 (16), 6024 – 6035.
- Ostacoli G. 1988. Characterization, distribution and dispersion of typical pollutants in an ecosystem. *Studies in Environmental Science* 34, 17 – 29.
- Othoniel C., 2006. La croissance du biofilm photosynthétique : un indicateur du statut trophique des rivières? Thèse de Doctorat en Biogéochimie de l'Environnement, Université Bordeaux 1, 277 p.
- Pal A., Yew – Hoong Gin K., Yu-Chen Lin A., Reinhard M. 2010. Impact of emerging organic contaminants on freshwater resources: review of recent occurrences, fate and effects. *Science of the Total Environment* 408, 6062 – 6069.
- Parsapoor A., Khalili M., Mackizadeh R. 2009. The behavior of the trace and rare elements (REE) during hydrothermal alteration in the Rangan area (Central Iran). *Journal of Asian Earth Sciences* 34, 123-134.
- Paschke A., Schwab R., Brummer J., Schuurmann G., Paschke H., Popp P. 2006. Rapid semi-continuous calibration and field-testing of membrane-enclosed silicone collector as passive water sampler. *Journal of Chromatography A*, 1124, 187 – 195.
- Pekey H. 2006. The distribution and sources of heavy metals in Izmit Bay surface sediments affected by a polluted stream. *Marine Pollution Bulletin* 52, 1197-1208.
- Pesavento M., Alberti G., Biesuz R. 2009. Analytical methods for determination of free ion concentration, labile species fraction and metal complexation capacity of environmental waters: A review. *Analytica Chimica Acta* 631 (1), 129 – 141.
- Petrovic M., Barcelo D. 2007. Analysis, fate and removal of pharmaceuticals in the water cycle. Elsevier, 600p.

- Quintana J.B., Weiss S., Reemtsma J. 2005. Pathways and metabolites of microbial degradation of selected acidic pharmaceuticals and their occurrence in municipal wastewater treated by a membrane bioreactor. *Water Research* 39, 2654-2664.
- Radjenovic J., Petrovic M., Ventura F., Barcelo O. 2008. Rejection of pharmaceuticals in nanofiltration and reverse osmosis membrane drinking water treatment. *Water Research* 42 (14), 3601-3610.
- Rapport d'étude 2008: Action de recherche et de reduction de rejets de substances dangereuses dans l'eau par les installations classees, d'autres installations synthese des resultats pour la region Aquitaine. RAPPORT D'ÉTUDE 30/04/2008, N° - DRC-07-87942-15826C.
- RESKhr 2008: Report on environmental status in the Kharkiv region in 2008.-Ministry of Environmental Protection, Ukraine. -Kharkiv 2009. [http://www.menr.gov.ua/cgi-bin/go?node=reg\\_dop\\_08](http://www.menr.gov.ua/cgi-bin/go?node=reg_dop_08) (in Ukrainian, accessed on 1 March 2010)
- Richardson S.D. 2003. Water analysis: emerging contaminants and current issues. *Analytical Chemistry* 75, 2831–2857.
- Rizzi F.R., Stoll S., Senesi N., Buffle J. 2004. A transmission electron microscopy study of the fractal properties and aggregation processe of humic acids. *Soil Science* 169 (11), 765-775.
- Rose S., Shea J. 2007. Chapter 6. Environmental geochemistry of trace metal pollution in urban watersheds. *Developments in Environmental Sciences* 5, 99 – 131.
- Ruhoy I.S., Daughton C. 2008. Beyond the medicine cabinet: Analysis of where and why medications accumulate. *Environment International* 34, 1157-1169.
- Schäfer J., Blanc G. 2002. Relationship between ore deposits in river catchments and geochemistry of suspended particulate matter from six rivers in southwest France. *Science of the Total Environment* 298, 103-118.
- Schäfer J., Blanc G., Audry S., Cossa D., Bossy C. 2006. Mercury in the Lot-Garonne River system (France). Sources, fluxes and anthropogenic component. *Applied Geochemistry* 21, 515-527
- Schäfer J., Norra S., Klein D., Blanc G. 2009. Mobility of trace metals associated with urban particles exposed to natural waters of various salinities from the Gironde Estuary, France. *Journal of Soils and Sediments* 9, 374-392
- Schelwald-van der Kley, L., Reijerkerk, L. Water a way of life: Sustainable water management in a cultural context. Taylor & Francis Group. London, UK, 2009.- 138p.
- Schintu M., Durante L., Maccioni A., Meloni P., Degetto S., Contu A. 2008. Measurement of environmental trace-metal levels in Mediterranean coastal areas with transplanted mussels and DGT techniques. *Marine Pollution Bulletin* 57, 832-837.
- Schintu M., Marras B., Durante L., Meloni P., Contu A. 2010. Macroalgae and DGT as indicators of available trace metals in marine coastal waters near a lead-zinc smelter. *Environmental Monitoring Assessment* 167, 653 – 662.
- Scwab B., Hayes E.D., Fiori J.M., Mastrocco F.J., Roden N.M., Cragin D., Meyerhoff R.D., D'Aco V.J., Anderson P.D. 2005. Human pharmaceuticals in US surface waters: A human health risk assessment. *Regulatory Toxicology and Pharmacology* 42 (3), 296 – 312.

- Schwarzbauer J., Heim S., Brinker S., Littke R. 2002. Occurrence and alteration of organic contaminants in seepage and leakage water from a waste deposit landfill. *Water Research* 36, 2275-2287.
- Senesi G., Baldassarre G., Senesi N., Radina B. 1999. Trace elements inputs into soil by anthropogenic activities and implication for human health. *Chemosphere* 39 (2), 343-377.
- Slaveykova V. I., Wilkinson K.J. 2005. Predicting of the bioavailability of metals and metal complexes: Critical review of the biotic ligand model. *Environmental Chemistry* 2(1), 9-24.
- SNPL 1991. Sanitary norms of permitted limits of hazardous substances contents in the water use for drinking and municipal water use. Ministry of Health Protection of USSR. No. 6025-91:20-66 (in Russian)
- Söderström H., Lindberg R. H., Fick J. 2009. Strategies for monitoring the emerging polar organic contaminants in water with emphasis on integrative passive sampling. *Journal of Chromatography A* 1216, 623-630.
- Sola-Larranaga C., Navarro-Blasco I. 2009. Chemometric analysis of minerals and trace elements in raw cow milk from the community of Navarra, Spain. *Food Chemistry* 112, 189-196.
- Steger-Hartmann T., Kummerer K., Hartmann A. 1997. Biological degradation of Cyclophosphamide and its occurrence in sewage water. *Ecotoxicology and Environmental Safety* 36, 174-179.
- Stülten D., Zühlke S., Lamshöft M., Spiteller M. 2008. Occurrence of diclofenac and selected metabolites in sewage effluents. *Science of the Total Environment* 405(1-3), 310-316.
- Suchkova N., Darakas E., Ganoulis J. 2010. Phytoremediation as a prospective method for rehabilitation of areas contaminated by long-term sewage sludge storage: A Ukrainian – Greek case study. *Ecological Engineering* 36, 373 – 378.
- Svirenko L., Vergeles Y., Jakovlev V. 2003. Metal accumulation in soils and vegetation of river valleys in the city of Kharkiv, Ukraine. SUITMA 2003: Soils of Urban, Industrial, Traffic and Mining Areas: Final Program and Abstract Book. – Nancy, France, July 9-11, 2003.
- Tan B.L.L., Hawker D.W., Muller J.F., Leusch F.D.L., Tremblay L.A., Chapman H.F. 2007. Comprehensive study of endocrine disrupting compounds using grab and passive sampling at selected wastewater treatment plants in South East Queensland, Australia. *Environment International* 33 (5), 654 – 669.
- Tapie N., Devier M.H., Soulier C., Creusot N., Le Menach K. Aït-Aïssa S., Vrana B., Budzinski H. 2010. Passive samplers for chemical substance monitoring and associated toxicity assesment in water. *Water Science and Technology*, in press.
- Taxe-Wuersch A., Alencastro L.F., Grandjean D., Tarradelas J. 2005. Occurrence of several acidic drugs in sewage treatment plants in Switzerland and risk assessment. *Water Research* 39, 1761-1772.
- Terzic S., Senta I., Ahel M., Gros M., Petrovic M., Barcelo D., Muller J., Marti I., Ventura F., Jovancic P., Jabucar D. 2008. Occurrence and fate of emerging wastewater contaminants in Western Balkan Region. *Science of the Total Environment* 399, 66-77.
- Ternes T. 1998. Occurrence of drugs in German sewage treatment plants and rivers. *Water Research* 32(11), 3245-3260.



- Ternes T. 1999. Preface: Drugs and hormones as pollutants of aquatic environment: Determination and ecotoxicological impacts. *Science of the Total Environment* 225(1-2), 1-2
- Tessier A., Campbell P. G. C. 1987. Partitioning of trace metals in sediments: Relationships with bioavailability. *Hydrobiologia* 149(1), 43-52
- Teuber M. 2001. Veterinary use and antibiotic resistance. *Current Opinion in Microbiology* 4, 493-499.
- Togola A., Budzinski H. 2007a. Development of polar organic integrative samplers for analysis of pharmaceuticals in aquatic systems. *Analytical Chemistry* 79, 6734-6741.
- Togola A., Budzinski H. 2007b. Analytical development for analysis of pharmaceuticals in water samples by SPE and GC-MS. *Analytical Bioanalytical Chemistry* 388, 627-635.
- Togola A., Budzinski H. 2008. Multi-residue analysis of pharmaceutical compounds in aqueous samples. *Journal of Chromatography A*, 177, 150-158.
- Tusseau-Vuillemin M.-H., Gourlay C., Lorgeoux C., Mouchel J.-M., Buzier R., Gilbin R. 2007. Dissolved and bioavailable contaminants in the Seine River basin. *Science of the Total Environment* 375 (1-3), 244 – 256.
- Urban 2009: Urban water security: managing risks/Edited by B. Jimenez and J.Rose. – UNESCO: Urban water series, 2009. - 303 p.
- US EPA 2003 National Primary Drinking Water Regulations. <http://www.epa.gov/safewater>.
- Valero D.A. Environmental contaminants: Assessment and control. Elsevier, 2004. –832p.
- Vasenko O.G., Lungu M.L., Iljevskaja Y.A., Klymov O.V. et al. 2006: Research report. The integrated field research of environmental conditions of water bodies of the Udy water basins (sub-basin of the Siverskiy Dinets River)/ “Rayder” Publ., Kharkiv, 156 p. (in Ukrainian).
- Vehanen T., Riihimäki J. 1999. Integrating environmental characteristics and fisheries management in northern Finland river impoundments. *Environmental Management* 23(4), 551-558
- Vieno N., Tuhkanen T., Kronberg L. 2007. Elimination of pharmaceuticals in sewage treatment plants in Finland. *Water Research* 41, 1001-1012.
- Vrana B., Mills G. A., Allan I. J., Dominiak E., Svensson K., Knutsson J., Morrison G., Greenwood R. 2005. Passive sampling techniques for monitoring pollutants in water. *Trends in Analytical Chemistry* 24, 845 – 868.
- Vrana B., Mills G.A., Kottermann M., Leonards P., Booij K., Greenwood R. 2007. Modelling and field application of the Chemcatcher passive sampler calibration data for the monitoring of hydrophobic organic pollutants in water. *Environmental Pollution* 145 (3), 895 – 904.
- Vystavna Y. 2005. The Balanced Model of the Sustainable Water Consumption in a Public Sector in Ukraine. Proceedings. Kalmar ECO-TECH'05. Conference on Waste to Energy, Bioremediation and Leachate Treatment. The Second Baltic Symposium on Environmental Chemistry, November 28-30, 2005 – Kalmar, Sweden, 455-461.
- Warnken K.W., Zhang H., Davison W. 2007. In situ monitoring and dynamic speciation measurements in solution using DGT. In Greenwood, R., Mills, G., Vrana, B., (Eds.),

- 
- Comprehensive Analytical Chemistry, Volume 48, Passive Sampling Techniques in Environmental Monitoring, Elsevier, pp. 251-278.
- Weiner R.F., Matthews R.A. 2003. Nonpoint source water pollution. *Environmental Engineering* 4, 233 – 249.
- Weiss S., Reemtsma T. 2008. Membrane bioreactor for municipal wastewater treatment – A viable option to reduce the amount of polar pollutants discharged into surface waters. *Water Research* 42, 3837-3847.
- WHO 2006. Guidelines for drinking water quality, 3rd edn. Incorporating first addendum. Recommendations, vol. I, WHO, Geneva
- WWW 2010: World Water Week. Responding to Global Changes – Prevention, Wise Use and Abatement. Programme. 5 – 11 September 2010, Stockholm, Sweden. [www.worldwaterweek.org](http://www.worldwaterweek.org) – accessed on 15 December 2010)
- Zabiegala B., Kot – Wasik A., Urbanowicz M., Namiesnik J. 2010. Passive sampling as a tool for obtaining reliable analytical information in environmental quality monitoring. *Analytical Bioanalytical Chemistry* 396, 273 – 296.
- Zhang H., Davison W. 1995. Performance characteristics of diffusive gradients in thin films for the in situ measurement of trace metals in aqueous solution. *Analytical Chemistry* 67 (19), 3391-3400.
- Zhang H., Davison W. 2000. Direct In Situ Measurements of Labile Inorganic and Organically Bound Metal Species in Synthetic Solutions and Natural Waters Using DGT. *Analytical Chemistry* 72 (18), 4447-4457.
- Zhang Z., Hibberd A., Zhou J.L. 2008a. Analysis of emerging contaminants in sewage effluent and river water: Comparison between spot and passive sampling. *Analytica Chimica Acta* 607 (1), 37 – 44.
- Zhang Y., Geiben S.-U., Cal C. 2008b. Carbamazepine and diclofenac: Removal in wastewater treatment plants and occurrence in water bodies. *Chemosphere* 73, 1151-1161
- Zezi J. S. 2001. Aquaculture pharmaceuticals and biologicals: current perspectives and future possibilities. *Advanced Drug Delivery Review* 50 (3), 229-243.
- Zuccato E., Castiglioni, S., Fanelli, R. 2005. Identification of the pharmaceuticals for human use contaminating the Italian aquatic environment. *Journal of Hazardous Materials* 122, 205-209

---

## LIST OF TABLES

Note: The list of tables is presented only for the Introduction, Chapter 1, Chapter 2 and Chapter 3. Another chapters are in the form of published or articles in press.

TABLE 1.1. EMERGING CONTAMINANTS .....	14
TABLE 1.2. METALS IN INDUSTRIAL EFFLUENTS (NAGAJYOTI ET AL. 2010) .....	18
TABLE 1.3. GENERAL PHYSICAL CHEMICALS CHARACTERISTICS OF PHARMACEUTICALS (ACCORDING TO CHEMICALS PROFILE BY U.S. ENVIRONMENTAL PROTECTION AGENCY: WWW.PBTProfiler.NET).....	22
TABLE 1.4. BASIC INDICATORS OF HEALTH MARKET IN SOME EUROPEAN COUNTRIES (2007) ...	24
TABLE 1.5. REMOVAL OF PHARMACEUTICALS BY MEMBRANE BIOREACTOR (MBR) AND CONVENTIONAL ACTIVATED SLUDGE (CAS) .....	26
TABLE 1.6. THE ECOTOXICITY OF SOME THERAPEUTIC GROUPS OF PHARMACEUTICALS TO MICROORGANISMS (A), ALGAE (B), CNIDARIA (C), CRUSTACEA (D) AND FISH (F) (ACCORDING TO JONES ET AL. 2002) .....	28
TABLE 1.7. THE PNEC OF PHARMACEUTICALS FOR CHILDREN IN WATER BY THREE SCENARIOS: DRINKING WATER (DW), FISH CONSUMPTION (F) AND COMBINED EFFECT (DW+F) (ADAPTED FROM SCHWAB ET AL. 2005) .....	28
TABLE. 1.8. PRINCIPLE CHARACTERISTICS OF SOME PASSIVE WATER SAMPLERS .....	32

---

## LIST OF FIGURES

Note: The list of figures is presented only for the Introduction, Chapter 1, Chapter 2 and Chapter 3. Another chapters are in the form of published or articles in press.

FIGURE 1.1. SIMPLE REPRESENTATION OF THE TRACE ELEMENTS SPECIATION IN NATURAL SYSTEMS.....	11
FIGURE 1.2. PRINCIPLE SCHEME OF WATER POLLUTION SOURCE (URBAN 2009).....	13
FIGURE 1.3. SPECIATION OF TRACE METALS IN WATER (MELLO ET AL. 2005) .....	16
FIGURE 1.4. METALS PARTITIONING IN NATURAL WATERS (ADAPTED FROM ELDER 1988).....	16
FIGURE 1.5. CONCEPTUAL MODEL OF METAL – BIOMATERIAL INTERACTION ( $M^{+2}$ – FREE METAL ION; ML – METAL COMPLEX IN SOLUTION; $X-M^{+}$ - SURFACE METAL COMPLEX (ADAPTED FROM CAMPBELL ET AL. 2002; SLAVEYKOVA AND WILKINSON 2005)).....	17
FIGURE 1.6. THE SCHEME OF ENVIRONMENTAL AND HEALTH RISKS MANAGEMENT.....	20
FIGURE 1.7. THE ANTHROPOGENIC AND NATURAL FACTORS OF THE FATE OF HUMAN PHARMACEUTICALS IN WATER.....	23
FIGURE 1.8. THE MAIN PATHWAYS OF PHARMACEUTICALS IN WATER .....	25
FIGURE 2.1. THE CLIMATIC CHARACTERISTICS OF THE KHARKIV CITY (WITH MAXIMUM AND MINIMUM VALUES OF AIR TEMPERATURE) .....	34
FIGURE 2.2. THE SCHEMATIC DIAGRAM OF ‘BEZLUDIVKA’ AND ‘DYKANIVKA’ STPs (1 INFLUENTS; 2 SCREEN; 3 EFFLUENTS IN THE RIVER) .....	36
FIGURE 2.3. THE LOCATION OF THE SAMPLING SITES IN UKRAINE .....	37
FIGURE 2.4. L00, SOURCE OF THE LOPAN RIVER, SUMMER.....	37
FIGURE 2.5. L01, ENTRANCE OF THE LOPAN RIVER IN THE KHARKIV REGION, WINTER.....	38
FIGURE 2.6. L06, KHARKIV CITY CENTRE, SUMMER .....	39
FIGURE 2.7. L09, CONFLUENCE OF THE LOPAN AND UDY RIVERS, WINTER.....	39
FIGURE 2.8. U00, SOURCE OF THE UDY RIVER .....	40
FIGURE 2.9. U02, ZOLOCHIV DISTRICT .....	40
FIGURE 2.10. U06, UDY RIVER, UPSTREAM OF URBAN DISCHARGES, SUMMER .....	41
FIGURE 2.11. U07, UDY RIVER, DOWNSTREAM OF URBAN DISCHARGES, WINTER .....	41
FIGURE 2.12. THE LOCATION OF THE SAMPLING SITES IN FRANCE.....	42
FIGURE 2.13. J01, CLOSE TO THE SOURCE OF THE JALLE RIVER.....	44
FIGURE 2.14. J02, EYSINES COMMUNITY, DOWNSTREAM OF THE ‘CANTINOLLE’ STP.....	44
FIGURE 2.15. J03, NATURAL RESERVATION AREA ‘BRUGES’, DOWNSTREAM OF THE ‘L’ILE’ STP.....	45

---

FIGURE 3.1. GENERAL METHODOLOGY OF THE PHD RESEARCH.....	50
FIGURE 3.2. THE PRINCIPLE SCHEME OF DGT SENSOR (BY ZHANG AND DAVISON 2000) .....	51
FIGURE 3.3. PRINCIPLE FOR TRACE METALS ACCUMULATION AND MEASUREMENT WITH THE DGT DEVICE. DBL: DIFFUSIVE WATER BOUNDARY LAYER AT THE SAMPLING SURFACE OF THE DEVICE (BY ZHANG AND DAVISON 1995).....	52
FIGURE 3.4. PICTURE (THE PASSIVE SAMPLER IN COTTON NET) AND THE SCHEME OF THE POCIS (BY ZHANG ET AL. 2008) .....	55
FIGURE A. THE CURRENT (RED) AND FURTHER DEVELOPMENT (BLUE) OF THE PRESENTED RESEARCH .....	166
FIGURE B. THE CAREER DEVELOPMENT.....	170