



**HAL**  
open science

# Couplage éléments finis et méthode de transformation probaliste

Seifedine Kadry

► **To cite this version:**

Seifedine Kadry. Couplage éléments finis et méthode de transformation probaliste. Mécanique [physics.med-ph]. Université Blaise Pascal - Clermont-Ferrand II, 2007. Français. NNT : 2007CLF21747 . tel-00717847

**HAL Id: tel-00717847**

**<https://theses.hal.science/tel-00717847>**

Submitted on 13 Jul 2012

**HAL** is a multi-disciplinary open access archive for the deposit and dissemination of scientific research documents, whether they are published or not. The documents may come from teaching and research institutions in France or abroad, or from public or private research centers.

L'archive ouverte pluridisciplinaire **HAL**, est destinée au dépôt et à la diffusion de documents scientifiques de niveau recherche, publiés ou non, émanant des établissements d'enseignement et de recherche français ou étrangers, des laboratoires publics ou privés.

**Université BLAISE PASCAL – Clermont II**

*École Doctorale*

*Sciences pour l'Ingénieur de Clermont – Ferrand*

**T H È S E**

Présentée par

*Seifedine Kadry*

Informaticien de l'Université Libanaise

Pour obtenir le grade de

**Docteur d'Université**

Spécialité :

**Sciences pour l'Ingénieur**

**Couplage éléments finis et méthode de  
transformation probabiliste**

*"Coupled finite element and probabilistic  
transformation method"*

**Soutenue publiquement le 16 mai 2007 devant le jury:**

**Messieurs**

<b>A. MEBARKI</b>	<b>Univ. de Marne-la-Vallée</b>	<b>Président du jury, Rapporteur</b>
<b>J.M. BOURINET</b>	<b>IFMA</b>	<b>Examineur</b>
<b>Ph. BRESSOLETTE</b>	<b>Univ. Blaise Pascal</b>	<b>Examineur</b>
<b>A. CHATEAUNEUF</b>	<b>Univ. Blaise Pascal</b>	<b>Directeur de thèse</b>
<b>A. EL HAMI</b>	<b>INSA de Rouen</b>	<b>Rapporteur</b>
<b>Kh. EL-TAWIL</b>	<b>Univ. Libanaise</b>	<b>Co-directeur de thèse</b>
<b>F. SCHOEFS</b>	<b>Univ. de Nantes</b>	<b>Examineur</b>

À ma grand-mère Charifa  
À mes parents  
À ma fiancée Diana  
À mes sœurs et frères.

# *Remerciements*

Cette thèse est élaborée au sein du Laboratoire de Mécanique et Ingénieries LaMI, de l'Institut Français de Mécanique Avancée et de l'Université Blaise Pascal, France.

Cette thèse est aussi le fruit d'un travail d'équipe. J'ai, en effet, été encadré par M. **Alaa Chateauneuf**, directeur de cette thèse, ainsi que M. **Khaled El-Tawil**, Maître de conférences à l'Université Libanaise, co-directeur de cette thèse. Ils sont, pour moi, des modèles de rigueur, de disponibilité et de persévérance. Je tiens à les remercier d'avoir accepté de diriger ce travail de recherche. Qu'ils trouvent ici l'expression de ma plus grande gratitude pour leur suivi scientifique indispensable pour l'avancement de ces travaux et aussi pour leur soutien et la confiance qu'ils m'ont manifestée.

J'exprime aussi toute ma reconnaissance aux deux rapporteurs de ce travail: M. **Ahmed Mebarki**, Professeur à l'Université de Marne la Vallée et M. **Abdelkhalak Elhami**, Professeur à l'I.N.S.A de Rouen. Merci d'avoir expertisé ce travail et d'avoir apporté toute l'attention nécessaire à l'évaluation de cette recherche. Leurs remarques constructives m'ont permis de clarifier et compléter ce travail.

Merci aux autres membres du jury: M. **Franck Schoefs**, Maître de conférences à l'Université de Nantes, M. **Jean-Marc Bourinet**, Maître de conférences à l'IFMA, et M. **Philippe Bressolette**, Maître de conférences à l'Université Blaise Pascal, pour l'intérêt qu'ils ont porté à ma thèse.

Une mention toute particulière pour M. Mohamed Zoater, Professeur et doyen de la faculté de génie à l'Université Libanaise, M. Rafic Younès, Maître de conférences à l'Université Libanaise, M. Raed Koutta, Maître de conférences à l'Université de Technologie de Belfort - Monbeliard, qui m'ont donné l'envie de poursuivre mes études doctorales.

Je souhaite remercier très chaleureusement M. Ahmed Jamal, M. Nabil Nassif, M. Mohamed Smeily et M. Khaled Smeily pour leurs aides, conseils et amitié.

Un immense merci à Rabia Khelif, pour son aide précieuse.

Enfin, j'aimerais remercier très sincèrement tous mes collègues au laboratoire, et spécialement Jalaa Ahmad et Younès Aoues.

# Contents

## Partie I: Synthèse générale 1

I.1 Introduction-----	2
I.2 Position du problème-----	2
I.2.1 Probabilité de défaillance-----	3
I.2.2 Simulations de Monte-Carlo-----	5
I.2.3 Couplage éléments finis et fiabilité-----	6
I.2.4 Méthode des éléments finis stochastiques-----	7
I.2.4.1 Méthodes intrusives -----	7
I.2.4.2 Méthodes non intrusives-----	10
I.3 Méthode de Transformation Probabiliste (PTM)-----	11
I.3.1 Transformation probabiliste-----	11
I.3.1.1 Théorie de la PTM-----	12
I.3.1.2 Limitations et extensions-----	12
I.3.2 Couplage PTM-FEM-----	13
I.3.2.1 Algorithme général -----	14
I.3.2.2 Evaluation de la fonction de densité-----	15
I.4 Applications: analyse de fiabilité d'un treillis à 25-barres-----	19
I.5 Conclusion-----	24

## Part II: Reliability of Structures 25

### II.1. Reliability Methods 25

II.1.1 Introduction-----	26
II.1.2 Principle of reliability analysis-----	26
II.1.2.1 Probability of failure-----	26
II.1.2.2 Monte-Carlo Simulation-----	29
II.1.2.3 FORM/SORM-----	30
II.1.2.4 Probabilistic Transformation-----	31
II.1.3 Reliability with finite element analysis-----	33
II.1.3.1 Direct coupling method-----	34
II.1.3.2 Response Surface Method-----	34
II.1.3.3 Neural Network Method-----	35
II.1.4 Stochastic Finite Element Method-----	35
II.1.4.1 Intrusive Methods-----	36
II.1.4.1.1 Perturbation Method-----	36
II.1.4.1.2 Spectral Stochastic Finite Element Method (SSFEM)--	37
II.1.4.1.3 Advantages and limitations of SSFEM-----	44
II.1.4.2 Non-Intrusive method-----	45

II.1.4.2.1 Projection method-----	46
II.1.4.2.2 Collocation method-----	47
II.1.4.3 SFEM for non-linear problems-----	48
II.1.5 Comparative analysis-----	49
II.1.5.1 Comparisons of SFEM techniques-----	49
II.1.6.Conclusion-----	50
<b>II.2. Probabilistic Transformation Method (PTM)</b>	<b>51</b>
II.2.1 Introduction-----	52
II.2.2 Probabilistic Transformation-----	53
II.2.2.1 Probabilistic Transformation Method (PTM)-----	53
II.2.2.2 Limitations and extension of PTM-----	57
II.2.3 Coupled PTM-FEM technique-----	58
II.2.3.1 Analytic <i>pdf</i> for Static behavior -----	59
II.2.4 PTM-FEM for engineering problems-----	83
II.2.4.1 PTM in structural dynamics -----	83
II.2.4.2 PTM in reliability analysis-----	86
II.2.4.3 PTM in structural optimization-----	87
II.2.5 Conclusion-----	88
<b>II.3. Validation</b>	<b>89</b>
II.3.1 Introduction-----	90
II.3.2 Random Differential Equation-----	90
II.3.3 Probabilistic analysis of a Cantilever Beam-----	92
II.3.4 Probabilistic analysis of two-rod system-----	94
II.3.5 Stochastic eigenvalue of beam structure-----	96
II.3.6 Reliability Analysis of 3-bar truss structure-----	98
II.3.7 RBDO of 6-bar truss structure-----	100
II.3.8 Conclusion-----	103
<b>II.4. Applications</b>	<b>104</b>
II.4.1 Introduction-----	105
II.4.2 Space truss with 25-Bars -----	105
II.4.3 Perforated plate under tension -----	111
II.4.4 Two-story frame -----	114
II.4.5 Conclusion-----	116
<b>General conclusion and Perspectives</b>	<b>117</b>
<b>References</b>	<b>120</b>

# Résumé

La modélisation d'un système mécanique peut être introduite comme l'idéalisation mathématique des phénomènes physiques qui le commandent. Cela demande bien évidemment de définir des variables d'entrée (paramètres géométriques du système, conditions de chargement...) et des variables de sortie (déplacements, contraintes,...) qui vont permettre de comprendre l'évolution du système mécanique. Les modèles utilisés sont de plus en plus complexes et précis et l'enjeu actuel est l'identification des paramètres les constituant. En effet, on ne peut plus se permettre, en traitant certains types de problèmes, d'utiliser des modèles purement déterministes où les paramètres interviennent seulement à travers leur valeurs nominales, étant donné que ceci conduit généralement à une représentation très erronée de la réalité. De ce fait, il est intéressant d'introduire les incertitudes sur l'estimation des paramètres et de considérer leur variabilité. L'aspect fondamental des études stochastiques ou probabilistes est donc de prendre en compte le caractère aléatoire et la variabilité spatiale de paramètres tels que les propriétés des matériaux.

Les méthodes fiabilistes ont pour objectif principal la détermination d'un niveau de confiance à accorder à la structure étudiée. En effectuant a priori certaines hypothèses sur le dimensionnement et les grandeurs aléatoires mises en jeu, et en définissant un état dit de "défaillance" pour la structure, il s'agit de trouver l'évolution de la probabilité de défaillance de cette structure tout au long de sa durée de vie et de vérifier que le dimensionnement respecte les règles de sécurité en vigueur.

L'application des méthodes probabilistes en vue du dimensionnement nécessite de disposer d'un outil efficace permettant d'évaluer la fiabilité des structures concernées. Lorsque le comportement mécanique d'une structure est explicitement déterminé, son étude fiabiliste est aisée grâce à un nombre important de méthodes qui ont montré leur efficacité. Par contre, lorsque la modélisation mécanique est numérique (méthode des éléments finis par exemple) une méthode permettant le "mariage" entre les modélisations mécanique et probabiliste doit être utilisée : c'est l'objet du *couplage mécano-fiabilise*.

Le couplage mécano-fiabiliste [LEM00] peut être défini comme étant le mariage d'un code éléments finis et d'un code fiabiliste, de telle façon à ce que l'on obtienne la solution de la manière la plus efficace possible. Dans ce genre d'approche, c'est le code fiabiliste qui pilote le calcul FEM et qui assure la convergence.

La méthode des éléments finis stochastiques est une modélisation numérique fondée sur une méthode d'éléments finis dans laquelle certaines variables d'état (variables intervenant dans la matrice de rigidité) ou d'action (intervenant dans les vecteurs de charge) sont des variables aléatoires. Cette approche nous permet d'évaluer les propriétés stochastiques de la réponse d'un modèle mécanique.

Dans ce contexte, l'objectif de cette thèse consiste à proposer une méthode d'analyse probabiliste de la réponse d'un système mécanique avec des paramètres aléatoires. Une nouvelle technique, dite "exacte", est proposée pour le couplage des modèles éléments finis et de la méthode de transformation probabiliste, en vue de l'évaluation; sous forme analytique, de la fonction de densité de la réponse. Cette méthode est ensuite appliquée à différents types de problèmes en vue de démontrer ses avantages et ses limites.

Dans un premier temps, une synthèse générale en français des travaux réalisés. La deuxième partie, écrite en anglais, comprend les contenus détaillés de ce travail.

Le chapitre 1 est consacré aux méthodes de fiabilité. Les méthodes FORM/SORM ont pour but d'évaluer l'indice de fiabilité pour permettre une approximation de la probabilité de défaillance. La méthode des éléments finis stochastiques s'intéresse principalement à la détermination des paramètres statistiques (moyenne et écart-type) de la réponse aléatoire d'un système mécanique dont une de ses propriétés est représentée par un champ aléatoire.

Dans le chapitre 2, nous développons la méthode de couplage proposée, au moyen de la combinaison de la méthode des éléments finis et de la méthode de transformation probabiliste. Contrairement à d'autres méthodes numériques, l'approche adoptée permet de définir de façon «exacte», voire analytique, la fonction de densité de probabilité de la réponse mécanique. Nous pourrions donc facilement calculer la probabilité de défaillance du système.

Les chapitres 3 et 4 sont consacrés à la validation de notre méthode. Après une série de validations sur quelques problèmes mécaniques (chapitre 3), la technique proposée est ensuite appliquée sur des structures plus moins complexes nécessitant l'utilisation d'un code éléments finis (chapitre 4).



# *Abstract*

The modeling of mechanical systems can be defined as the mathematical idealization of the physical phenomena controlling it. This implies to define the input variables (geometrical parameters, loading conditions...) and the output variables (displacements, stresses...) allowing to understand the evolution of the mechanical system. The used models are more and more complex and precise and the difficulty lies in the identification of the parameters constituting them. Indeed, we cannot admit to use the deterministic models where only the average parameters are considered, because it generally leads to wrong representation of the reality. Hence, it is interesting to introduce the uncertainties in parameter evaluation and to consider their variability. The fundamental issue of probabilistic studies is therefore to take into account the uncertain character and the spatial variability of parameters.

The reliability methods have for main objective the determination of a safety level of the structure. Under some hypotheses on the uncertain quantities, and by defining the state of failure, it can be possible to find the evolution of the failure probability of the structure along its life span and to verify that the design satisfies the safety considerations.

The application of probabilistic methods in design requires to have an effective tool to evaluate the reliability of the considered structure. When the mechanical behavior is explicitly modeled, its reliability analysis becomes easy, due to the large number of available methods which can be used efficiently. On the other hand, when the mechanical model of the structure is numerical (finite element method for example) a method allowing the combination of mechanical and probability models must be applied: it is the goal of *mechanical-reliability coupling*.

The mechanical-reliability coupling [LEM00] is defined by the combination of finite element software and reliability algorithms, in such way that the solution can be obtained in the most effective way. In this kind of approach, the reliability code drives the finite element analysis procedures and ensures the convergence.

The Stochastic Finite Element Method (SFEM) is a numerical modeling in which some variables of the structural state (variables in the stiffness matrix) or of the actions (load vector) are uncertain variables. So, we try to find the stochastic properties of the mechanical response.

The objective of this thesis is therefore to analyze and to study the probabilistic response of a mechanical system with uncertain parameters. Contrary to other

methods, the proposed technique couples the deterministic finite element method and the probabilistic transformation method, to evaluate the probability density function of the response in closed-form. To show the advantage of the proposed method, we have carried out different applications to cover several structural engineering contexts: static, dynamic, reliability and optimization.

This thesis is divided into two parts:

The first one constitutes a synthesis of the achieved work in French. However, the second part, written in English, consists of the detailed contents of this work.

Chapter 1 gives an overview of the reliability methods, especially First order reliability methods and Stochastic finite element methods.

Chapter 2 describes the proposed technique through the combination of finite element method and probabilistic transformation method. The extension to multivariate case is described to deal with realistic structural models.

The validation of the proposed technique is shown in Chapter 3. The comparison with Monte Carlo simulations allows us to verify the quality of the proposed method in static, dynamics, reliability and optimization.

Chapter 4 presents three structural problems: a space truss with 25 bars, a perforated plate and a two-story framed structure.

# Partie I

## Synthèse Générale

*Cette partie présente la synthèse des travaux réalisés, qui sont ensuite détaillés dans la deuxième partie en version anglaise.*

I.1 Introduction-----	2
I.2 Position du problème-----	2
I.2.1 Probabilité de défaillance-----	3
I.2.2 Simulations de Monte-Carlo-----	5
I.2.3 Couplage éléments finis et fiabilité-----	6
I.2.4 Méthode des éléments finis stochastiques-----	7
I.2.4.1 Méthodes intrusives -----	7
I.2.4.2 Méthodes non intrusives-----	10
I.3 Méthode de Transformation Probabiliste (PTM)-----	11
I.3.1 Transformation probabiliste-----	11
I.3.1.1 Théorie de la PTM-----	12
I.3.1.2 Limitations et extensions-----	12
I.3.2 Couplage PTM-FEM-----	13
I.3.2.1 Algorithme général -----	14
I.3.2.2 Evaluation de la fonction de densité-----	15
I.4 Applications: analyse de fiabilité d'un treillis à 25-barres-----	19
I.5 Conclusion-----	24

## **I.1. Introduction**

La conception des systèmes mécaniques consiste à assurer les ressources nécessaires pour satisfaire aux besoins tout au long de la durée de vie espérée. Dans un monde où règnent d'irréductibles incertitudes, le processus de conception nous met en face des effets de la nature, avec le risque de perdre ou la chance de gagner. Etant donné que l'objectif de l'ingénieur est principalement de gagner dans la grande majorité des cas, il se trouve donc obligé de prendre des mesures contre les aléas de la nature, c'est ce qu'on appelle la marge de sûreté. Cette marge est d'autant plus grande que les conséquences de perte sont catastrophiques. N'oublions pas que cette marge mobilise des moyens considérables (humains, financiers, temporels,...), elle ne peut donc pas être infinie, puisque l'utilisateur final ne peut pas supporter les coûts d'une sur-fiabilité exagérée. Le but de la conception est donc de définir la meilleure performance, permettant d'établir un compromis raisonnable entre des besoins contradictoires, tels que la fiabilité et le coût.

Cette partie donne une vue globale du travail effectué et des principaux résultats obtenus. Après une présentation de la théorie de la fiabilité et de la méthode des éléments finis stochastiques, la méthode de transformation probabiliste est développée pour les cas uni- et multi-variables, respectivement. Le couplage avec la méthode des éléments finis est le fil conducteur des différents développements. L'application numérique sur des structures permet la validation de la méthode et montre le potentiel à une telle approche.

## **I.2. Position du problème**

La conception et le dimensionnement des structures et des machines et la prévision de leur bon fonctionnement conduisent à la vérification de règles résultant de la connaissance physique, mécanique et experte des constructeurs. Elles traduisent, sous des formes plus ou moins complexes, des critères à respecter comprenant des valeurs admissibles de contraintes ou de déplacements.

Chaque règle représente un mode élémentaire et leurs enchaînements sont définis comme des scénarios de défaillance du système entier [LEM92]. La vérification d'une règle de dimensionnement traduit simplement la vérification d'un mode potentiel de défaillance parmi d'autres modes possibles.

La connaissance des variables entrant dans l'écriture d'un scénario de défaillance n'est, au mieux, qu'une connaissance statistique et nous admettons une représentation par variables aléatoires. L'objectif est alors d'évaluer une probabilité, celle de se trouver dans une situation de défaillance.

### I.2.1 Probabilité de défaillance

La première étape dans l'analyse de la fiabilité consiste à définir les variables de conception  $X_i$  représentant un niveau significatif de fluctuation. Ces variables, dites de base, peuvent être les actions extérieures (charges, vent, houle, séisme), les caractéristiques géométriques (dimensions, aire, moment d'inertie) ou les propriétés des matériaux (limite élastique, module de Young, coefficient de Poisson). Pour chacune de ces variables  $X_i$ , on choisit d'affecter une loi de probabilité traduisant l'aléa correspondant. Ceci peut être obtenu à travers les études statistiques, les observations physiques ou, manque de moyens, les appréciations des experts. La qualité des informations se reflète sur la précision des résultats obtenus.

La deuxième étape consiste à définir un certain nombre de scénarios de défaillance potentiels. Pour chacun d'entre eux, une fonction de performance  $G(X_i)$  est établie (par exemple : résistance supérieure à la sollicitation ou bien déplacement inférieur à la valeur admissible). De cette façon, la fonction de performance divise l'espace des variables en deux régions : domaine de sûreté  $G > 0$  et domaine de défaillance  $G \leq 0$ . La frontière entre ces domaines est définie par  $G = 0$ , appelée *état limite*.

La probabilité de défaillance est donnée par :

$$P_f = P[G(X_i) \leq 0] = \int_{D_f} f_{X_i}(x_i) dx_1 \dots dx_n \quad (I.1)$$

où  $f_{X_i}(x_i)$  est la densité de probabilité conjointe des variables de base  $X_i$  et  $D_f$  est le domaine de défaillance. L'évaluation de cette intégrale est très coûteuse en temps de calcul, car il s'agit d'une quantité très petite et car toute l'information nécessaire sur la densité conjointe de probabilité n'est pas disponible. Pour ces raisons, des méthodes plus efficaces sont proposées ; elles se basent sur le calcul de certains indices appelés indices de fiabilité, puis sur une approximation de la probabilité de défaillance.

**Indice de fiabilité** : l'indice de fiabilité est une mesure du degré de sûreté du système. Il est directement lié à la probabilité de défaillance et permet la comparaison des différents systèmes. L'indice le plus couramment utilisé, noté  $\beta$ , a été proposé par Hasofer et Lind [HAS74]. Ces auteurs ont proposé, au lieu de rester dans l'espace des variables physiques, d'effectuer un changement de variables et ainsi de se placer dans un espace de variables gaussiennes réduites (moyennes nulles et écarts-types unitaires) statistiquement indépendantes. La transformation des variables  $X_i$  en variables normales standardisées  $U_i$  est notée par :

$$U_i = T_i(X_j) \quad (I.2)$$

Cette transformation est nommée transformation iso-probabiliste. Elle est représentée sur la figure I.1 qui illustre complètement la démarche [LEM92]. La fonction de performance s'écrit alors :

$$G(X_i) = G(T_i^{-1}(U_j)) \equiv H(U_j) = 0 \quad (I.3)$$

Selon la définition de Hasofer et Lind, l'indice de fiabilité  $\beta$  est la distance minimale de l'origine à la fonction d'état limite  $H(u)=0$  dans l'espace  $U$ . Cette distance définit un hyperplan tangent à la fonction d'état limite et un point  $P^*$ , dit *point de défaillance le plus probable* ou *point de conception* (figure I.1). Une première approximation de  $P_f$  est obtenue en remplaçant la fonction d'état limite  $H(u)=0$  en  $P^*$  par un hyperplan, c'est la Méthode de Fiabilité du Premier Ordre, FORM (First Order Reliability Method).

La probabilité de défaillance est alors approchée par la relation :

$$P_f \approx \Phi(-\beta) \quad (I.4)$$

où  $\Phi(\cdot)$  est la fonction de répartition normale centrée réduite. Le degré de précision est fonction de la non linéarité de la fonction d'état limite.

Une meilleure approximation est obtenue en tenant compte des courbures de l'état limite, il s'agit des méthodes du second ordre SORM (Second Order Reliability Method).

Trouver  $\beta$  est donc un problème d'optimisation avec une contrainte :

$$\beta = \min d, \quad \text{avec } d = \sqrt{U^t U} \quad (I.5)$$

sous la contrainte :  $H(U) = 0$

où  $d$  est la distance de l'origine à l'état limite dans l'espace normé. Le problème est résolu avec une des méthodes d'optimisation adaptée à la forme particulière de ce problème.

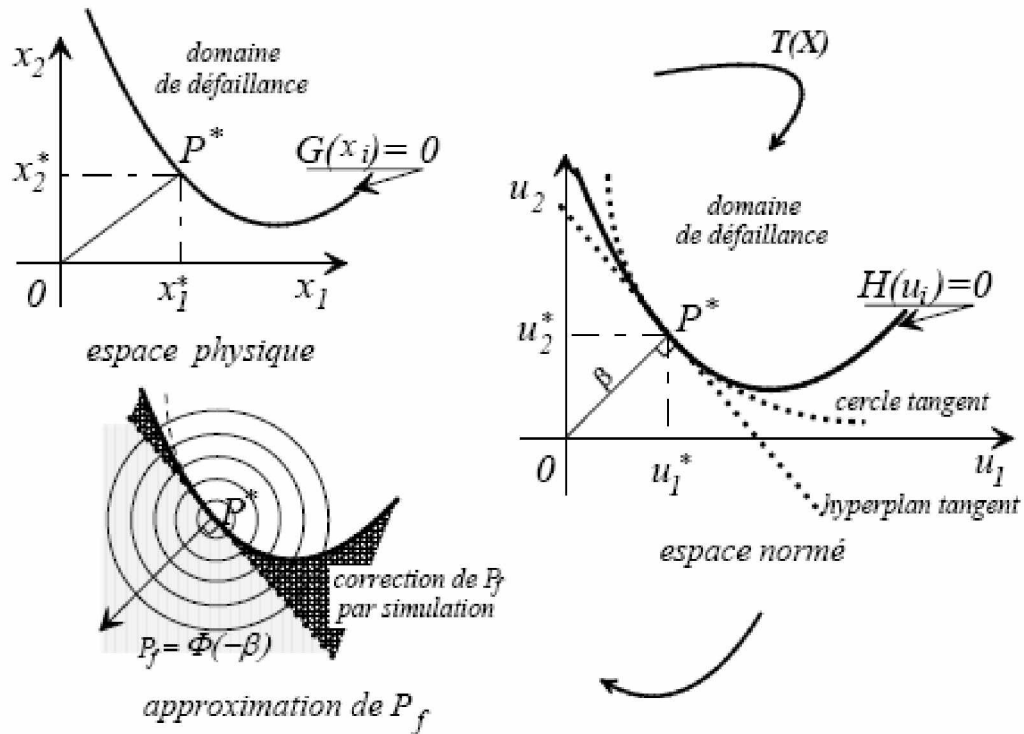

Figure I.1: Transformation entre l'espace physique et l'espace normé [LEM92].

## I.2.2 Simulations de Monte-Carlo

Les simulations de Monte Carlo représentent l'approche la plus générale pour l'évaluation de la probabilité de défaillance. L'évaluation de l'intégrale I.1 est directement effectuée au prix d'un certain nombre d'appels à la fonction d'état limite.

**Simulations de Monte Carlo (MC)** [MOH95] : c'est la méthode la plus générale et la plus coûteuse. Les tirages sont effectués dans tout l'espace normé, suivant la loi multi-normale (figure I.2). Pour  $N$  tirages aléatoires, l'espérance de l'intégrale I.1 est évaluée par le rapport du nombre d'échantillons défaillants  $N_f$  sur le nombre total de tirages  $N$  ( $P_f = N_f / N$ ).

D'une manière générale, pour évaluer une probabilité de l'ordre de  $10^{-n}$ , il faut effectuer de  $10^{n+2}$  à  $10^{n+3}$  simulations (i.e. nombre de calculs par éléments finis). Il est évident que cette méthode est loin d'être efficace pour les grands systèmes à très faible probabilité de défaillance.

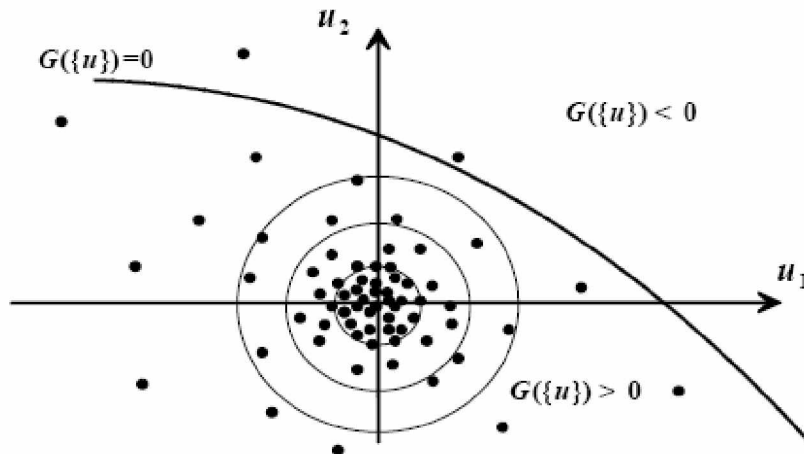

Figure I.2: Simulations directes de Monte-Carlo.

### I.2.3 Couplage éléments finis et fiabilité

Dans la plupart des cas industriels, la fonction d'état limite ne peut pas être définie par une fonction explicite des variables aléatoires et il faut avoir recours à une définition implicite comme par exemple un code de calcul aux éléments finis. C'est à ce niveau qu'interviennent les méthodes de couplage entre l'outil mécanique et l'outil fiabiliste.

Ayant défini le modèle mécanique et les incertitudes associées, deux méthodes de couplage mécano-fiabiliste peuvent être employées en vue de l'évaluation de la probabilité de défaillance. La première méthode est basée sur l'évaluation directe de l'indice de fiabilité par une procédure d'optimisation utilisant le code éléments finis et la deuxième est basée sur la méthode de surface de réponse approximant l'état limite  $G$ , suivie de l'évaluation de l'indice  $\beta$  de Hasofer et Lind pour cette surface. Ces méthodes exigent un lien entre le code éléments finis et le logiciel de calcul de fiabilité.

#### *Couplage direct*

Par la méthode de couplage direct, nous entendons toute procédure de fiabilité basée sur un algorithme de recherche de l'indice  $\beta$  en utilisant directement le modèle éléments finis [TAW93]. A chaque itération, des appels au code éléments finis sont effectués pour l'évaluation de la fonction d'état limite. L'indice  $\beta$  peut être obtenu par une méthode quelconque d'optimisation permettant la résolution de l'équation (I.5). En utilisant les algorithmes basés sur les différences finies, il n'y a pas besoin de connaître la forme analytique de la fonction d'état limite pour déterminer la probabilité de défaillance. Tout ce



dont nous avons besoin, c'est l'ensemble des valeurs de l'état limite et de son gradient aux points de calcul.

### ***Méthode de surface de réponse polynomiale***

La Méthode de Surface de Réponse MSR [MUZ92] permet d'obtenir une fonction d'approximation qui représente le comportement des phénomènes physiques dans un domaine de variation donné. En fiabilité des structures, le domaine de variation est celui des variables aléatoires et la fonction à approximer est la fonction d'état limite. Le but de la méthode est de déterminer une relation explicite (et approchée) entre la réponse mécanique et les variables d'entrée du système.

### ***Approximations par réseaux de Neurones***

Dans ce cas, l'idée est d'utiliser la propriété selon laquelle les réseaux de neurones sont des approximateurs universels parcimonieux [LEM97b, MOH95] ; c'est-à-dire, qu'à une précision fixée, ils sont capables d'approximer toute fonction continue avec un nombre de paramètres ajustable inférieur à celui requis par une régression classique. Le nombre de paramètres ajustables étant inférieur, l'approximation nécessite moins de points par rapport à l'évaluation de l'état limite. Cet avantage est tout à fait intéressant puisque le nombre de calculs mécaniques est un facteur important dans ce type d'analyse.

## **I.2.4 Méthode des éléments finis stochastiques**

La Méthode des Eléments Finis Stochastiques SFEM, dans sa forme actuelle, a été introduite dans l'ouvrage de Ghanem et Spanos [GHA91]. Bien que le terme et l'idée d'incorporer l'aléa dans une formulation éléments finis aient une plus longue histoire (voir [SCH97] pour une vue d'ensemble du travail précédent, en particulier dans le domaine de la mécanique stochastique), cela constitue probablement la première approximation systématique déterministe et aléatoire de Galerkin [SUD00].

Nous distinguons deux types d'approches, en fonction de la nécessité d'intervenir dans le code de calcul : méthodes intrusives ou non-intrusives.

### **I.2.4.1 Méthodes intrusives**

L'idée de ces méthodes est de considérer l'incertitude comme une dimension supplémentaire du problème traité, en utilisant la discrétisation spatiale

proposée par le concept des éléments finis. Nous pouvons traiter la dimension associée à l'incertitude par deux approches générales, la *méthode de perturbation* et la *méthode spectrale*.

### **Méthode de perturbation**

La première méthode utilisée est basée sur l'étude de la perturbation de la réponse en fonction des variations des paramètres incertains du modèle [BAE81]. La première étape concerne la discrétisation spatiale des champs stochastiques. Pour cela, la méthode du point-milieu, la méthode de la moyenne locale et la méthode des intégrales pondérées, ont été utilisées.

La deuxième étape consiste à approcher les fonctions des variables aléatoires par leur développement en série de Taylor autour de leurs valeurs moyennes, à l'ordre un ou deux, en supposant que les variables aléatoires sont peu dispersées autour de leurs valeurs moyennes. Pour le problème discrétisé  $KU=F$ , le développement à l'ordre deux par rapport aux variables aléatoires  $\varepsilon_k$ , nous donne :

$$K = K^0 + \sum_{i=1}^n K_i^I \varepsilon_i + \sum_{i=1}^n \sum_{j=1}^n K_{ij}^{II} \varepsilon_i \varepsilon_j \quad (\text{I.6})$$

$$U = U^0 + \sum_{i=1}^n U_i^I \varepsilon_i + \sum_{i=1}^n \sum_{j=1}^n U_{ij}^{II} \varepsilon_i \varepsilon_j$$

où  $K^0, K_i^I$  et  $K_{ij}^{II}$  désignent respectivement la moyenne, la première et la deuxième dérivée de la matrice de raideur  $K$  par rapport aux variables incertaines ;  $U^0, U_i^I$  et  $U_{ij}^{II}$  sont les quantités analogues définies pour le champ de déplacement  $U$ .

La résolution est faite successivement comme suit :

$$\begin{aligned} K^0 U^0 &= F \\ K^0 U_i^I &= -K_i^I U^0 \\ K^0 U_{ij}^{II} &= -K_i^I U_j^I - K_j^I U_i^I - K_{ij}^{II} U^0 \end{aligned} \quad (\text{I.7})$$

De nombreuses applications aux problèmes linéaires et non linéaires ont été proposées, en statique comme en dynamique, avec de bons résultats quand les paramètres incertains fluctuent dans une bande étroite autour de la valeur moyenne [ELI95, MUS00].

**Méthode des éléments finis stochastiques spectrale**

L'équilibre d'une structure pour des problèmes d'élasticité linéaire s'écrit par la méthode des éléments finis sous la forme :

$$K U = F \quad (\text{I.8})$$

Dans cette expression,  $K$  est la matrice de rigidité,  $U$  est le vecteur des déplacements nodaux et  $F$  est le vecteur des forces nodales.

Dans la méthode des éléments finis stochastiques [GHA91], du fait de l'introduction des propriétés aléatoires des matériaux, de la géométrie et du chargement, la matrice  $K$  et le vecteur  $F$  deviennent aléatoires. Ainsi le vecteur des déplacements nodaux devient également aléatoire ; on le note  $U(\theta)$ , où  $\theta$  indique la dimension probabiliste. Chaque composante de ce vecteur est une variable aléatoire qui peut se décomposer sur la base de polynômes orthogonaux (chaos polynomial) comme suit :

$$U(\theta) \approx \sum_{q=1}^Q A_q \Psi_q(\xi_1(\theta), \dots, \xi_M(\theta)) \quad (\text{I.9})$$

où  $\xi_1(\theta), \dots, \xi_M(\theta)$  sont des variables aléatoires gaussiennes centrées réduites ayant servi à discrétiser les variables d'entrée du problème et  $\Psi_q(\cdot)$  sont des polynômes d'Hermite multidimensionnels qui forment la base du chaos polynomial. Les coefficients  $A_q$  sont calculés en utilisant une minimisation au sens de Galerkin.

Ce type de résolution, qui implique le calcul des résidus de l'équation d'équilibre, s'accompagne d'une implémentation spécifique dans le code éléments finis.

De nouvelles méthodes de résolution ont été récemment développées pour calculer ces coefficients à l'aide de calculs aux éléments finis déterministes et de calculs analytiques. De ce fait, ces méthodes sont appelées non intrusives, car elles ne nécessitent pas d'implémentation à l'intérieur du code éléments finis, mais seulement la réalisation d'une série de calculs déterministes et leur post-traitement.

### I.2.4.2 Méthodes non intrusives

Les méthodes non intrusives sont basées sur une minimisation au sens de la norme  $L^2$  entre la solution exacte et la solution approchée par le chaos polynomial [BER05]. La première étape est le passage de l'espace physique à l'espace normé pour chacune des variables aléatoires d'entrée, rassemblées dans un vecteur aléatoire  $X$ . Si les variables  $X_i$  sont indépendantes, cette transformation s'écrit :

$$\xi_i = \Phi^{-1}(F_i(X_i)) \quad (\text{I.10})$$

où  $\Phi(\cdot)$  est la fonction de répartition d'une loi normale centrée réduite et  $F_i(X_i)$  sont les fonctions de répartition des  $X_i$  ( $i=1,2,\dots,M$ ). Supposons que l'on veuille approximer le vecteur aléatoire des déplacements nodaux par un développement tronqué sur la base du chaos polynomial :

$$U_q \approx \tilde{U}_q = \sum_{j=0}^{P-1} U_{q_j} \Psi_j(\xi_r) \quad (\text{I.11})$$

où  $\Psi_j(\cdot)$  ( $j=0,\dots,P-1$ ) sont  $P$  polynômes d'Hermite multidimensionnels dont le degré est inférieur ou égal à  $p$  ; nous avons la relation suivante :

$$P = \frac{(M+p)!}{M!p!}$$

Ayant  $n$  réalisations du vecteur aléatoire  $\xi_r$ , soit  $\xi_r^{(k)}$  (avec  $k=1,\dots,n$ ). Pour chaque réalisation  $\xi_r^{(k)}$ , la transformation isoprobabiliste permet d'obtenir le vecteur aléatoire des variables d'entrée  $X^{(k)}$ . En utilisant le code éléments finis, le vecteur réponse  $U^{(k)}$  peut être calculé et la solution probabiliste peut être déterminée.

### I.3. Méthode de transformation probabiliste (PTM)

D'après ce qui précède, nous constatons ce qui suit :

- les méthodes fiabilistes (FORM, SORM, MSR,...) sont des méthodes approchées et ne permettent pas de donner la fonction de densité de probabilité de la réponse.
- la méthode des éléments finis stochastiques (SFEM) permet l'évaluation des propriétés stochastiques de la réponse mécanique, en particulier la moyenne et l'écart type, mais elle ne donne pas la fonction de densité qui représente la caractéristique statistique la plus importante.

*Dans ce contexte, l'objet de cette thèse est de proposer et de développer une méthode pour évaluer analytiquement (ou semi-analytiquement) la fonction de densité de la réponse d'un système mécanique stochastique.*

La solution d'un système mécanique stochastique est complètement définie par l'obtention de la fonction de densité de probabilité de la réponse. Cela ne peut pas être accompli par la plupart des méthodes et techniques disponibles, telles que l'équation de Fokker-Planck, la série de Wiener-Hermite et la méthode de linéarisation stochastique. Quelques solutions exactes existent pour la moyenne et l'écart-type de la réponse sont introduites dans [ELI99, SHI88].

La Méthode de Transformation Probabiliste PTM permet d'évaluer la fonction de densité de probabilité *pdf* d'une fonction à variable aléatoire, en multipliant la densité conjointe des arguments par le Jacobien de la fonction inverse. Ainsi, la *pdf* "exacte" peut être obtenue en utilisant la méthode de la transformation probabiliste (PTM) avec la méthode déterministe des éléments finis (FEM) [KAD05b]. Dans la méthode de la transformation probabiliste, la *pdf* de la réponse peut être obtenue analytiquement lorsque la *pdf* des variables aléatoires d'entrées est connue.

Dans ce qui suit, nous développons la méthode proposée dans ce travail (appelée PTM-FEM), dans laquelle la théorie de transformation probabiliste est combinée à la méthode des éléments finis pour obtenir la *pdf* de la réponse mécanique stochastique.

#### I.3.1 Transformation Probabiliste

Dans la résolution des équations différentielles stochastiques, nous devons déterminer la distribution probabiliste d'une fonction dont les arguments sont des variables aléatoires. Plusieurs techniques sont disponibles, mais leurs avantages varient en fonction du problème étudié. La méthode la plus utilisée en théorie des probabilités, est la Méthode de Transformation probabiliste [PAP02].

### I.3.1.1 Théorie de la transformation probabiliste

L'idée principale de la transformation probabiliste est donnée par le théorème suivant :

*Théorème* : supposons que  $X$  est une variable aléatoire de *pdf* :  $f_X(x)$ , définie sur  $A \subset \mathbb{R}$  et  $f_X(x) > 0$  différentiable et monotone (ou monotone par morceaux). Considérons la variable aléatoire  $Y = u(X)$ , où  $y = u(x)$  est une transformation bijective de l'ensemble  $A$  vers l'ensemble  $B \subset \mathbb{R}$  afin que l'équation  $y = u(x)$  puisse être résolue uniquement pour  $x$  en fonction de  $y$ , dites  $x = u^{-1}(y)$ . Alors, la *pdf* de  $Y$  est (figure I.3):

$$f_Y(y) = f_X[u^{-1}(y)]|J|, \quad y \in B \quad (\text{I.12})$$

où  $J = \frac{dx}{dy} = \frac{du^{-1}(y)}{dy}$  est le Jacobien de la transformation qui doit être continu en tout point  $y \in B$ .

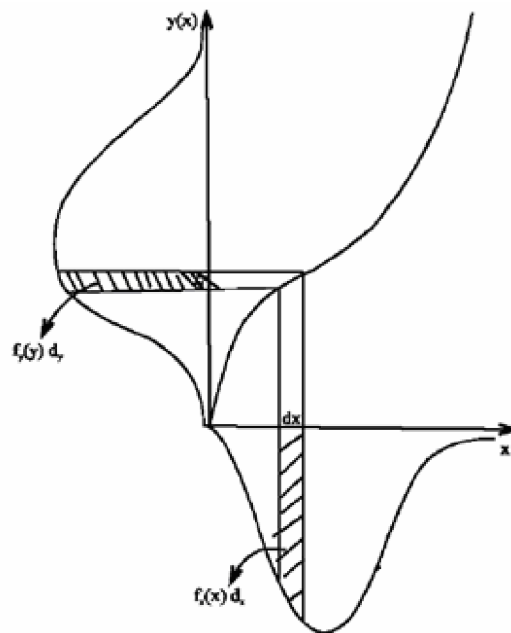

Figure I.3: Méthode de Transformation.

### I.3.1.2 limitations et extensions

La méthode de transformation présente certaines limites pour la recherche de la distribution de la sortie  $f_Y(y)$  connaissant celle de l'entrée  $f_X(x)$  :

- il n'est pas toujours évident de trouver la fonction inverse  $x = u^{-1}(y)$  de façon explicite ;
- il faut que la fonction soit bijective pour que l'on puisse calculer son inverse ;
- le déterminant du Jacobien doit être non nul, i.e.  $u^{-1}(\cdot)$  existe.

Ces limitations sont souvent rencontrées lorsque le nombre de variables d'entrée est différent de celui des variables de sortie (en général, on s'intéresse à une seule variable de sortie). Pour palier cette difficulté, des variables auxiliaires doivent être introduites pour permettre la résolution du système. Pour un système à  $n$  entrées et à une seule sortie  $y_1 = f(x_1, x_2, \dots, x_n)$ , nous procédons comme suit :

$$\text{Soit } \begin{cases} u : \mathbb{R}^n \rightarrow \mathbb{R}^n \\ Y \rightarrow Y = u(X) \end{cases} \quad \text{avec: } u(x) = \begin{cases} y_1 = u(x_1, x_2, \dots, x_n) \\ y_i = x_i \quad i = 2, \dots, n \end{cases}$$

La fonction  $u(\cdot)$ , définie ci-dessus, est inversible si et seulement si le déterminant du Jacobien est non nul [KAD05a] :

$$|J| = \begin{vmatrix} \frac{\partial u}{\partial x_1} & \cdot & \cdot & \cdot & \frac{\partial u}{\partial x_n} \\ 0 & 1 & 0 & \cdot & 0 \\ \cdot & 0 & 1 & \cdot & \cdot \\ \cdot & \cdot & \cdot & 1 & 0 \\ 0 & \cdot & \cdot & 0 & 1 \end{vmatrix} = \frac{\partial u}{\partial x_1} \neq 0$$

Etant donné qu'il existe au moins, une variable «  $x_i$  » tel que  $\frac{\partial u}{\partial x_i} \neq 0$ , on en déduit que la fonction inverse  $u^{-1}$  existe.

### I.3.2 Couplage EF et PTM

La technique PTM-FEM [KAD05a, KAD05b] est une combinaison de la méthode des éléments finis (FEM) et la méthode de la transformation probabiliste (PTM) [HOG89]. Contrairement aux approches basées sur le développement en série, les problèmes de convergence ne se posent pas dans cette approche, parce que la PTM est une méthode analytique. Les équations d'équilibre du système sont résolues en utilisant la méthode des éléments finis. Cette résolution est ensuite utilisée pour obtenir la *pdf* de la réponse en utilisant la méthode de la transformation probabiliste. Cette technique évalue la fonction de densité de probabilité de la réponse en multipliant la *pdf* de l'entrée par le Jacobien de la fonction inverse. Lorsque le nombre de variables aléatoires est petit, cette approche a l'avantage de donner analytiquement la fonction de la densité de la réponse.

### I.3.2.1 Algorithme général

L'algorithme général de la technique PTM-FEM (figure I.4) commence par l'application de la méthode des éléments finis pour obtenir la relation entre la sortie (vecteur de déplacement) et l'entrée (matrice de rigidité et vecteur des forces nodales). A partir de ce système d'équilibre, la fonction inverse est déterminée pour le calcul du déterminant de la Jacobien de la transformation. Finalement, la *pdf* de la réponse est obtenue par le produit du déterminant de la Jacobienne par la *pdf* conjointe de l'entrée.

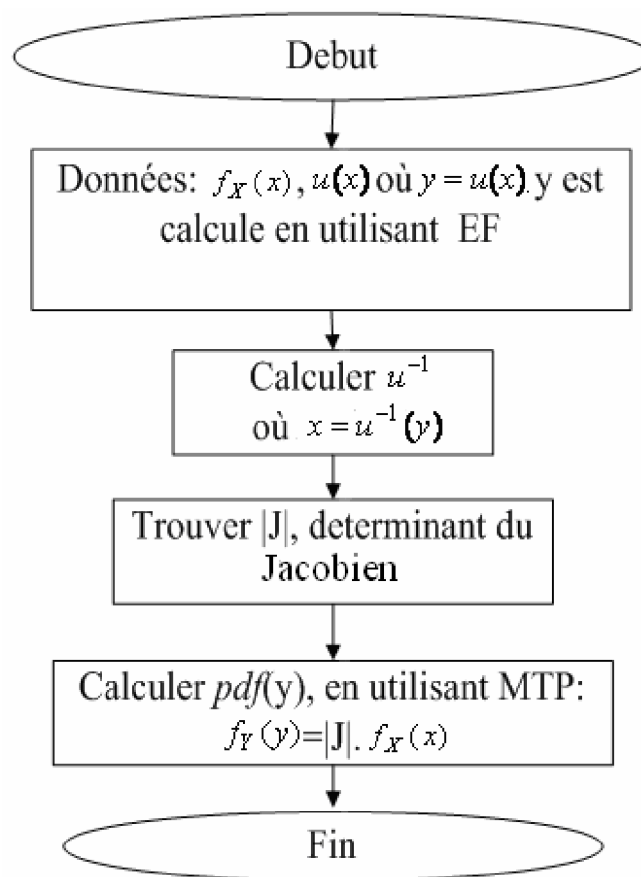

Figure I.4: Algorithme général de la technique PTM-FEM .

L'avantage de la technique PTM-FEM dans le contexte de l'analyse statique réside dans sa capacité de fournir la *pdf*, qui est la caractéristique la plus importante de la réponse, sous forme analytique ou semi-analytique, contrairement à d'autres méthodes numériques qui donnent seulement les deux premiers moments de la réponse et la *pdf* numériquement.



### I.3.2.2 Evaluation de la fonction de densité

Notre objectif est de déterminer la *pdf* de la réponse sous forme "exacte", si possible, en utilisant l'algorithme présenté ci-dessus. Pour cela, nous considérons tout d'abord le cas scalaire en vue d'illustrer la méthode, puis nous développons le cas matriciel en contexte éléments finis.

#### I- Cas scalaire

Pour un système à un degré de liberté, l'équation d'équilibre s'écrit :

$$k u = f \quad (\text{I.13})$$

où  $k$ ,  $u$  et  $f \in R$ . Nous considérons, à titre d'exemple, que la raideur est aléatoire et la force est déterministe : la fonction de densité de  $k$  est donnée par  $f_k(k)$  et nous nous intéressons à la *pdf* de son inverse :

$$h = k^{-1} = \frac{1}{k}$$

Le Jacobien de cette transformation est :

$$J = \left| \frac{\partial h}{\partial k} \right| = |k|^{-2} = \frac{1}{|k|^2} \quad (\text{I.14})$$

La technique de transformation permet d'écrire la fonction de densité de  $h$  :

$$f_h(h) = \left| \frac{\partial k}{\partial h} \right| f_k(k) = |h|^{-2} f_k\left(\frac{1}{h}\right)$$

Dans l'exemple où  $k$  suit une loi log-normale de moyen  $m_{\ln k}$  et d'écart type  $\sigma_{\ln k}$ , la fonction de densité de  $k$  est donnée par :

$$f_k(k) = \frac{1}{k \sqrt{2\pi} \sigma_{\ln k}} e^{-\frac{1}{2} \left( \frac{\ln k - m_{\ln k}}{\sigma_{\ln k}} \right)^2}$$

D'après la démarche décrite ci-dessus, nous obtenons :

$$f_h(h) = \frac{|h|^{-1}}{\sqrt{2\pi} \sigma_{\ln k}} e^{-\frac{1}{2} \left( \frac{-\ln h - m_{\ln k}}{\sigma_{\ln k}} \right)^2}$$

L'étape finale de l'algorithme est de multiplier la *pdf* de  $h=k^{-1}$  par celle de la force (cas où  $f$  et  $k$  sont indépendants).

$$\text{i.e. } f_u(u) = |J| f_h(h) \times f_F(f)$$

En général, l'inverse de la matrice de rigidité présente des termes non linéaires. La généralisation de la technique proposée doit donc admettre certaines approximations en fonction du problème traité. Il est aussi possible de faire appel à la méthode de surface de réponse pour obtenir une approximation de la fonction inverse liant la sortie aux entrées du système mécanique.

### ***Cas matriciel***

Nous remarquons que l'étape principale dans la technique PTM-FEM réside dans le calcul du Jacobien de la transformation. Pour cela deux méthodes sont développées : la première (paramétrique) est basée sur les opérateurs de sensibilité pour calculer directement le Jacobien, et la deuxième (non paramétrique) est basée sur le calcul de la *pdf* de l'inverse de la matrice de rigidité.

#### ***A) Méthode paramétrique : opérateur de la sensibilité***

L'équation générale d'équilibre de la structure est de la forme  $KU = F$  ; elle admet pour solution :

$$U = K^{-1}F \quad (\text{I.19})$$

Pour appliquer la technique PTM-FEM, nous avons besoin seulement de calculer le Jacobien de la transformation, c'est-à-dire  $\frac{\partial U}{\partial \alpha} = \frac{\partial (K^{-1}F)}{\partial \alpha}$  (où  $\alpha$  est une variable aléatoire). On peut procéder suivant une des deux démarches suivantes :

##### **1) Dérivation de la matrice $K^{-1}$**

La dérivée de l'équation (I.19) donne :

$$\frac{\partial U}{\partial \alpha} = \frac{\partial}{\partial \alpha} (K^{-1}F) = \frac{\partial K^{-1}}{\partial \alpha} F + K^{-1} \frac{\partial F}{\partial \alpha} \quad (\text{I.20})$$

$$\text{i.e. } |J| = \left| \frac{\partial K^{-1}}{\partial \alpha} F + K^{-1} \frac{\partial F}{\partial \alpha} \right|$$

Pour simplifier le problème, nous supposons que l'aléa se situe au niveau de la matrice de rigidité, c'est-à-dire  $\alpha = k_{ij}$ . Dans ce cas, nous avons  $\frac{\partial F}{\partial k_{ij}} = 0$  et

$$|J| = \left| \frac{\partial K^{-1}}{\partial k_{ij}} F \right|.$$

Pour évaluer numériquement, nous procédons comme suit :

$$K^{-1}K = I$$

$$\frac{\partial}{\partial k_{ij}} (K^{-1}K) = \frac{\partial I}{\partial k_{ij}}$$

$$\frac{\partial K^{-1}}{\partial k_{ij}} K = -K^{-1} \frac{\partial K}{\partial k_{ij}}$$

$$\frac{\partial K^{-1}}{\partial k_{ij}} = -K^{-1} \frac{\partial K}{\partial k_{ij}} K^{-1}$$

Il devient donc possible d'évaluer le Jacobien de l'inverse  $K^{-1}$  en fonction de la dérivée de la matrice de rigidité elle-même (ce qui est beaucoup plus simple à calculer, soit analytiquement, soit numériquement).

## 2) Calcul direct du Jacobien

La différentiation directe de l'équation d'équilibre par rapport à  $k_{ij}$ , donne :

$$\frac{\partial}{\partial k_{ij}} (KU) = \frac{\partial}{\partial k_{ij}} (F)$$

$$\frac{\partial K}{\partial k_{ij}} U + K \frac{\partial U}{\partial k_{ij}} = \frac{\partial F}{\partial k_{ij}}$$

$$\frac{\partial U}{\partial k_{ij}} = -K^{-1} \frac{\partial K}{\partial k_{ij}} U$$

$$|J| = \left| -K^{-1} \frac{\partial K}{\partial k_{ij}} U \right|$$

Dans ces deux approches, le calcul symbolique du Jacobien, en utilisant Mathematica par exemple, est possible pour 3 ou 4 degrés de liberté. Pour les structures pratiques, l'évaluation numérique est le seul moyen. Pour le calcul numérique, Lund [LUN94] a proposé une différenciation numérique *exacte* pour le calcul de  $\frac{\partial K}{\partial k_{ij}}$ , surtout par rapport aux variables géométriques.

Pour valider la méthode proposée, différentes applications ont été proposées dans les domaines suivants :

- équations différentielles stochastiques [KAD07] ;
- fiabilité des structures [KAD06a, KAD06b] ;
- optimisation d'une structure [KAD07c] ;
- problèmes de dynamique [KAD06c, KAD07d].

### ***B) Méthode non paramétrique : calcul exact du Jacobien pour une raideur aléatoire***

Dans l'approche non paramétrique, la fonction de la densité de probabilité *pdf* de la matrice de rigidité  $K$  peut être donnée par :

$$f_K(K) : R^{n \times n} \rightarrow R \quad (I.15)$$

Etant donné que la solution du problème mécanique s'écrit  $U=K^{-1}F$ , le problème principal consiste à trouver la *pdf* de  $K^{-1}$  ; cela implique l'obtention de la densité de probabilité conjointe de tous les éléments de  $K^{-1}$ . Ainsi, nous nous intéressons à la *pdf* de la matrice inverse :

$$H = K^{-1} \in R^{n \times n} \quad (I.16)$$

Les éléments de  $H$  sont des fonctions non linéaires des éléments de  $K$ . Même si les éléments de  $K$  ont une distribution simple (Gaussienne par exemple), la distribution conjointe des éléments de  $H$  est difficile à déterminer. Le développement mathématique de la Jacobienne de la transformation entre  $K$  et  $K^{-1}$  nous permet d'écrire :

$$J = |K|^{-(n+1)} \quad (I.17)$$

Cette formule représente une généralisation du cas scalaire. Ayant le Jacobien, le reste de la procédure est identique au cas scalaire.

$$f_H(H) = |H|^{-(n+1)} f_K(H^{-1}) \quad (I.18)$$

Cette formule a l'avantage d'être applicable à toute matrice symétrique aléatoire. Lorsque la *pdf* de  $K$  est disponible, cette expression permet d'obtenir la *pdf* de la matrice aléatoire inverse sous forme explicite. Ainsi, il devient possible d'obtenir la *pdf* du vecteur de déplacement  $U$ .

### I.4 Applications

Dans ce paragraphe, la technique PTM-FEM est appliquée pour l'analyse probabiliste d'une structure formée de 25 barres avec des paramètres aléatoires.

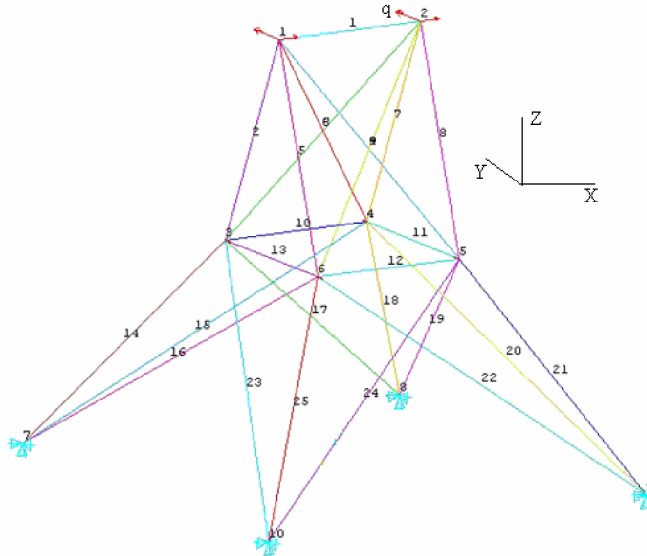

Figure I.5: Treillis à 25 barres.

La méthode de la force unitaire permet le calcul du déplacement nodal en utilisant la formule suivante :

$$u = \sum_{i=1}^n \frac{N_i \overline{N}_i}{ES_i} L_i$$

où  $N_i$  est l'effort normal dans la barre  $i$  dû aux forces extérieures,  $\overline{N}_i$  est l'effort normal dû à une force unitaire appliquée selon le degré de liberté concerné,  $E$  est le module d'élasticité,  $S_i$  et  $L_i$  sont respectivement la section et la longueur de la barre  $i$ .

Par symétrie, les sections des barres sont regroupées selon le tableau suivant :

Barre	Section
1	$S_1$
2,5,7,8	$S_2$
3,4,6,9	$S_3$
10,11,12,13	$S_4$
14,18,21,25	$S_5$
15,16,17,19,20,22,23,24	$S_6$

Le tableau ci-dessous indique les efforts normaux obtenus par les forces verticales et horizontales, ainsi que par des forces unitaires selon les trois degrés de liberté aux nœuds 1 et 2.

Barre	Force verticale(N)	force horizontale (N)	Fx1=1(N)	Fy1=1(N)	Fz1=1(N)	Fx2=1(N)	Fy2=1(N)	Fz2=1(N)	longueur Li(mm)
1	118496	0	-0.44778	0	-0.116842	0.44778	0	-0.116842	18000
2	-182632	-108058	0.39318	-0.88916	0.4508	0.31882	-0.04387	-0.08319	25632
3	-103094	-181168	-0.48044	-0.65356	0.101654	-0.38958	0.053606	0.101654	31321
4	-103094	24564	-0.48044	0.65356	0.101654	-0.38958	-0.053606	0.101654	31321
5	-182632	236220	0.39318	0.88916	0.4508	0.31882	0.04387	-0.08319	25632
6	-103094	-34814	0.38958	0.053606	0.101654	0.48044	-0.65356	0.101654	31321
7	-182632	-227820	-0.31882	-0.04387	-0.08319	-0.39318	-0.88916	0.4508	25632
8	-182632	99670	-0.31882	0.04387	-0.08319	-0.39318	0.88916	0.4508	25632
9	-103094	191418	0.38958	-0.053606	0.101654	0.48044	0.65356	0.101654	31321
10	-2112.2	27160	0.021874	0.075444	-0.013032	-0.021874	0.075444	-0.013032	18000
11	25438	25416	0.142222	0	-0.010987	0.140172	0	-0.071498	18000
12	-2112.2	-27160	0.021874	-0.075444	-0.013032	-0.021874	-0.075444	-0.013032	18000
13	25438	-25416	-0.140172	7.5292E-17	-0.071498	-0.142222	0	-0.010987	18000
14	-261700	-84148	0.57096	-0.52328	0.35794	0.57524	-0.6071	0.022956	32031
15	-142550	-129638	-0.147116	-0.034886	-0.041108	-0.154788	-0.54426	0.24192	43474
16	-136254	138918	0.2779	0.17921	0.17797	0.27976	0.122694	0.009951	43474
17	-142550	-78852	0.154788	-0.54426	0.24192	0.147116	-0.034886	-0.041108	43474
18	-261700	-322780	-0.57524	-0.6071	0.022956	-0.57096	-0.52328	0.35794	32031
19	-136254	-30232	-0.27976	0.122694	0.009951	-0.2779	0.17921	0.17797	43474
20	-136254	-70148	-0.27976	-0.122694	0.009951	-0.2779	-0.17921	0.17797	43474
21	-261700	116470	-0.57524	0.6071	0.022956	-0.57096	0.52328	0.35794	32031
22	-142550	133196	0.154788	0.54426	0.24192	0.147116	0.034886	-0.041108	43474
23	-136254	-38536	0.2779	-0.17921	0.17797	0.27976	-0.122694	0.009951	43474
24	-142550	75296	-0.147116	0.034886	-0.041108	-0.154788	0.54426	0.24192	43474
25	-261700	290460	0.57096	0.52328	0.35794	0.57524	0.6071	0.022956	32031

L'application du théorème de la force unitaire permet ainsi le calcul du déplacement horizontal au nœud 2 selon l'axe y :

$$u_{y2} = \frac{q}{180000E} \left( \frac{0}{S_1} + \frac{7850940221}{S_2} + \frac{4285580903}{S_3} + \frac{73766125.44}{S_4} + \frac{1.464\,698\,375 \times 10^{10}}{S_5} + \frac{6428099237}{S_6} \right)$$

avec  $q$  la force horizontale appliquée.

Pour simplifier les calculs sans perte de généralité, nous prenons une section identique pour toutes les barres ; i.e.  $S_i=S$  ; ce qui donne :

$$u_{y2} = \frac{184918,72q}{ES}$$

Pour l'analyse probabiliste, nous considérons les cas suivant :

Cas 1:  $E$  suit une loi uniforme  $U[10^5(N/m^2), 3 \times 10^5(N/m^2)]$

La technique PTM-FEM permet d'écrire la distribution du déplacement sous la forme explicite :

$$\begin{aligned} pdf(u_{y2}) &= |J| pdf(E) = \left| \frac{\partial E}{\partial u_{y2}} \right| pdf(E) \left( \frac{184918,72q}{u^2_{y2}S} \right) pdf(E) \\ &= \begin{cases} \frac{184918,72 \times 10^{-5} q}{2u^2_{y2}S} & \text{pour } \frac{184918,72q}{3 \times 10^5 S} \leq u_{y2} \leq \frac{184918,72q}{10^5 S} \\ 0 & \text{ailleurs} \end{cases} \end{aligned}$$

La figure ci-dessous illustre cette fonction de densité pour les valeurs numériques :  $q = 180 \text{ kN}$  et  $S = 2000 \text{ mm}^2$ .

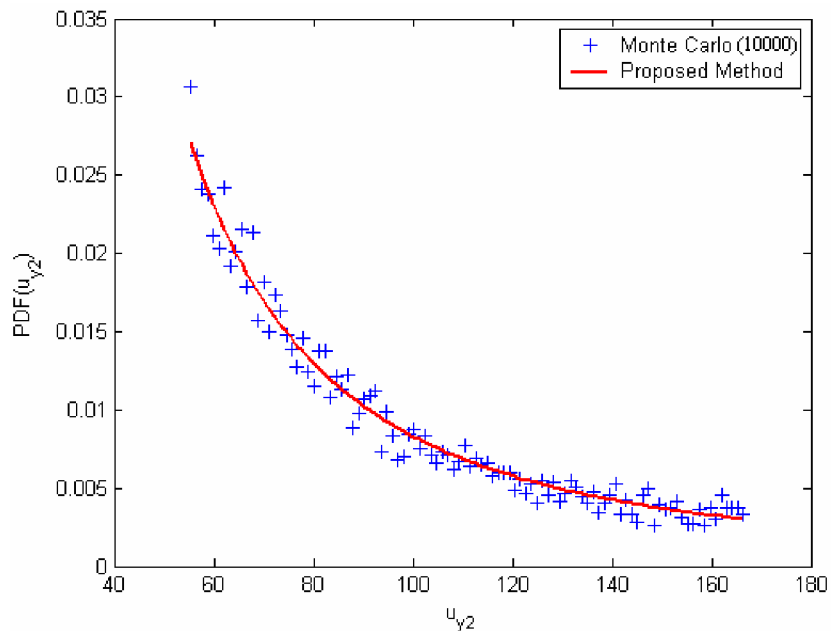

Figure I.6: pdf de  $u_{y2}$ .

Pour un déplacement admissible défini par 120mm, la probabilité de défaillance est obtenue par  $P_f = \Pr[u_{y2} > 120]$ . Le calcul explicite de cette probabilité donne :

$$P_f = \int_{120}^{\infty} pdf(u_{y2}) du_{y2} = \int_{120}^{\infty} \frac{1,8492q}{2u^2_{y2}S} du_{y2} = \int_{120}^{166} \frac{166,42685}{2.u^2_{y2}} du_{y2} = 0,19$$

Ce résultat est validé par 10000 simulations de Monte Carlo indiquant une probabilité de 0,189.

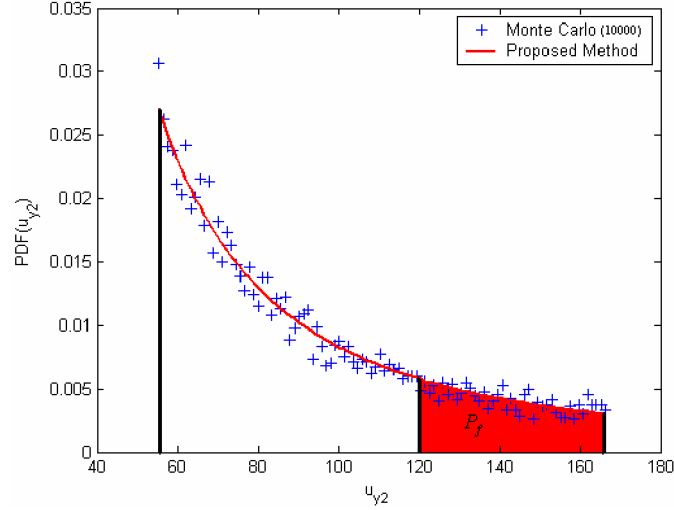

Figure I.7: Probabilité de défaillance.

Cas 2:  $q$  suit une loi exponentielle de paramètre 1.

La technique proposée donne la fonction de densité :

$$f_{u_{y2}}(u_{y2}) = |J| f_q(q) = \left( \frac{ES}{184918,72} \right) f_q(q) = \frac{ES}{184918,72} e^{-\frac{ESu_{y2}}{184918,72}}$$

Avec un module  $E=200000\text{MPa}$ , la figure ci-dessous illustre la distribution du déplacement  $u_{y2}$ .

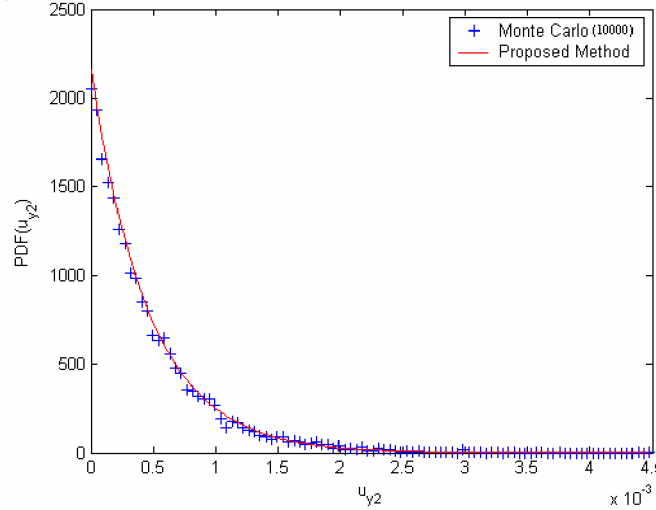

Figure I.8: pdf de  $u_{y2}$ .

Pour une limite de déplacement par unité de charge définie par :  $0,0005\text{mm}$ , La probabilité de défaillance est calculée par :

$$\begin{aligned} P_f &= \int_{0,0005}^{\infty} f_{u_{y2}}(u_{y2}) du_{y2} = \int_{0,0005}^{\infty} \frac{ES}{184918,72} e^{-\frac{ESu_{y2}}{184918,72}} du_{y2} \\ &= \int_{0,0005}^{0,004} 4,6 \times 10^{-4} e^{-4,6 \times 10^{-4} u_{y2}} du_{y2} = 0,34 \end{aligned}$$



Ce résultat est également très proche de celui de Monte Carlo : 0,3382.

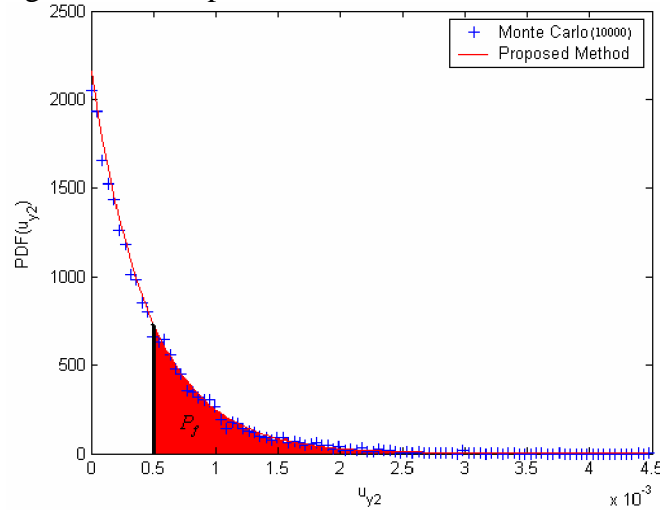

Figure I.9: Probabilité de défaillance.

Cas 3:  $S$  suit une loi de gauss de moyenne égale à  $2000 \text{ mm}^2$  et d'écart-type de  $100 \text{ mm}^2$ . La technique PTM-FEM nous donne :

$$f_{u_{y2}}(u_{y2}) = |J| f_S(S) = \left( \frac{184918,72 q}{E u_{y2}^2} \right) f_S(S) = \frac{184918,72 q}{E u_{y2}^2} \cdot \frac{1}{\sqrt{2\pi}} e^{-\frac{1}{2} \left( \frac{184918,72 q}{E u_{y2}} - 20 \right)^2}$$

Pour un déplacement limite de  $85 \text{ mm}$ , la probabilité de défaillance s'écrit :

$$\begin{aligned} P_f &= \int_{85}^{\infty} f_{u_{y2}}(u_{y2}) du_{y2} = \int_{85}^{105} \frac{184918,72 q}{E u_{y2}^2} \cdot \frac{1}{\sqrt{2\pi}} e^{-\frac{1}{2} \left( \frac{184918,72 q}{E u_{y2}} - 20 \right)^2} du_{y2} \\ &= \int_{85}^{105} \frac{1,66426}{u^2_{y2}} \cdot \frac{1}{\sqrt{2\pi}} e^{-\frac{1}{2} \left( \frac{1,66426}{u_{y2}} - 20 \right)^2} du_{y2} = 0,33 \end{aligned}$$

Ce qui correspond au résultat des simulations de Monte Carlo 0,3334.

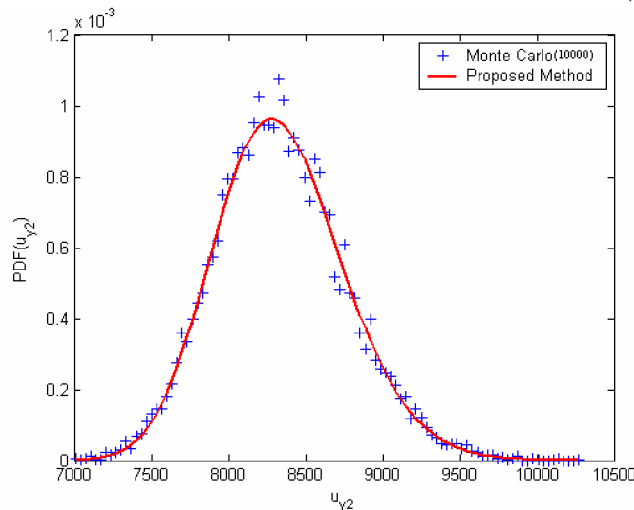

Figure I.10: pdf de  $u_{y2}$ .

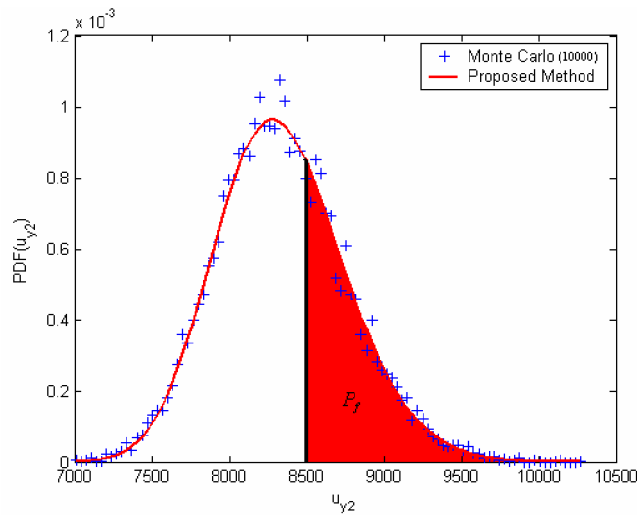

Figure I.11: Probabilité de défaillance.

## I.5. conclusion

Ce chapitre donne une synthèse du travail de recherche effectué, qui est détaillé dans la partie en langue anglaise. Après une présentation rapide des méthodes permettant l'analyse de la fiabilité, en particulier les méthodes FORM/SORM qui sont basées sur l'évaluation de l'indice de fiabilité suivie par des approximations du premier et du second ordre pour le calcul de la probabilité de défaillance, la méthode des éléments finis stochastiques est principalement développée pour le calcul approché des caractéristiques statistiques (en particulier, moyenne et écart-type) de la réponse mécanique des structures.

La méthode proposée dans ce travail est basée sur le couplage entre la méthode des éléments finis et la méthode de transformation probabiliste pour définir d'une manière « exacte » la densité de probabilité de la réponse ; ce qui permet d'obtenir directement les moments statistiques et la probabilité de défaillance. Cette méthode détermine la fonction de densité conjointe de la sortie en multipliant celle de l'entrée par le Jacobien de la transformation inverse. La technique est étendue au cas multi-variables pour les modèles éléments finis. Dans certains cas, surtout ceux des barres et poutres, le Jacobien peut être écrit sous une forme analytique ou semi-analytique. Dans le cas général, des approximations, telles que les surfaces de réponse, permettent l'obtention d'une solution analytique approchée. L'intérêt de la technique proposée a été démontré au moyen d'un certain nombre d'applications en statique, en dynamique, en analyse fiabiliste et en optimisation mécano-fiabiliste.

# *Part II: chapter 1*

## *Reliability Methods*

II.1.1 Introduction-----	26
II.1.2 Principle of reliability analysis-----	26
II.1.2.1 Probability of failure-----	26
II.1.2.2 Monte-Carlo Simulation-----	29
II.1.2.3 FORM/SORM-----	30
II.1.2.4 Probabilistic Transformation-----	31
II.1.3 Reliability with finite element analysis-----	33
II.1.3.1 Direct coupling method-----	34
II.1.3.2 Response Surface Method-----	34
II.1.3.3 Neural Network Method-----	35
II.1.4 Stochastic Finite Element Method-----	35
II.1.4.1 Intrusive Methods-----	36
II.1.4.1.1 Perturbation Method-----	36
II.1.4.1.2 Spectral Stochastic Finite Element Method (SSFEM)--	37
II.1.4.1.3 Advantages and limitations of SSFEM-----	44
II.1.4.2 Non-Intrusive method-----	45
II.1.4.2.1 Projection method-----	46
II.1.4.2.2 Collocation method-----	47
II.1.4.3 SFEM for non-linear problems-----	48
II.1.5 Comparative analysis-----	49
II.1.5.1 Comparisons of SFEM techniques-----	49
II.1.6.Conclusion-----	50

## II.1.1 Introduction

The design of mechanical systems consists in assuring the necessary resources to satisfy the needs all over the expected life span. In a world full of irreducible uncertainties, the process of design consists in accepting to play against the effects of the nature, with the risk to loose or the chance to win. Since the engineer's objective is mainly to win in most of the cases, he has therefore to take some measures against the risks by the means of what is called the “safety margin”. This margin is especially large when the failure consequences are catastrophic. However, this margin requires considerable resources (human, financial, delay,...), it cannot be therefore infinite, since the user cannot afford the costs of over-reliability. The goal of the design is therefore to define the best performance, allowing to establish a reasonable compromise between contradictory needs of reliability and cost.

This chapter presents, first, a brief review of the mathematical basis of reliability methods, in order to introduce the subsequent formulations of the methodology proposed in this work. An overview of the stochastic finite element methods is then presented with highlights on the advantages and limitations of each method.

## II.1.2 Principle of Reliability Analysis

The design of structures and machines and the prevision of their good functioning lead to the verification of a certain number of rules resulting from the knowledge of physical and mechanical experience of designers and constructors. These rules traduce the necessity to limit the loading effects such as stresses and displacements. Each rule represents an elementary event and the occurrence of several events leads to a failure scenario [LEM92]. The verification of a design rule is simply the verification of one potential failure among many other possibilities.

The knowledge of the variables influencing the failure scenario is not, at best, more than statistical information and we admit a representation in the form of random variables. Therefore, the objective is to evaluate the failure probability, corresponding to the occurrence of a specific failure situation.

### II.1.2.1 Probability of failure

Once the design rules are given, the basic variables considered as random are chosen by defining their distribution and parameter estimates. Subsequently, we proceed to the evaluation of the failure probability with respect to the chosen scenario.

Two important assumptions are necessary:

- (1) the state of the structure can be defined in the space of random variables;
- (2) at any time, the structure should be in one of the two possible states: the state of failure or the state of safety. The limit between these two states is known as the limit state surface.

The safety is the state where the structure (or the machine) is able to fulfill all of the functioning requirements: mechanical and serviceability for which it is designed. In the simple case of two variables: the resistance  $R$  and the loading effect  $S$ , the function  $Z = G(R, S)$  defines the limit state for the basic component by the difference between resistance and loading effect; thus, the safety margin is given by:

$$Z = G(R, S) = R - S \quad (\text{II.1.1})$$

where  $G > 0$  defines the state of safety and  $G \leq 0$  defines the state of failure; the limit state surface is defined by  $G = 0$ . The failure probability is then given by:

$$P_f = \int_{G \leq 0} f_Z(z) dz \quad (\text{II.1.2})$$

where  $P_f$  is the failure probability and  $f_Z(z)$  is the density function of  $Z$ . As a matter of fact, the statistical parameters of the loading effect  $S$ , even those of resistance  $R$ , are not directly accessible, because the measurements and the observations are carried out only for the basic variables,  $X_i$ . As the problem becomes multidimensional in terms of  $X_i$ , the variable  $Z$  and the vector  $X_i$  are related by a transformation called the “mechanical transformation” [LEM97a]:

$$Z = G(X_i) \quad (\text{II.1.3})$$

In general, this transformation is assumed to be known, even if for most of the structures, it is only available by the mean of algorithms, such as Finite Element Analysis software. The failure probability becomes:

$$P_f = P(G(X_i) \leq 0) = \int_{D_f} f_{X_i}(x_i) dx_1 \dots dx_n \quad (\text{II.1.4})$$

where  $f_{X_i}(x_i)$  is the joint density function of the vector  $X_i$  and  $D_f$  is the failure domain.

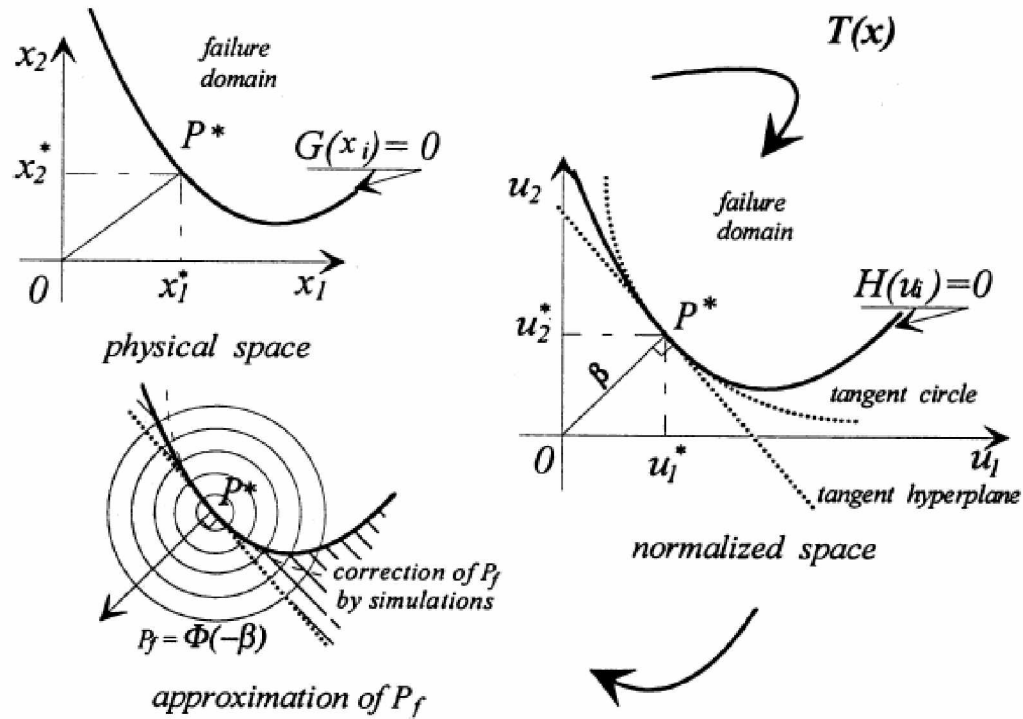

Figure II.1.1: Reliability analysis methodology [LEM92].

### Evaluation of the failure probability

The evaluation of the integral II.1.4 is not easy, because it represents a very small quantity and all the necessary information for the joint density function are not available. For these reasons, the First and the Second Order Reliability Methods FORM/SORM [DIT96] have been developed. They are based on the reliability index concept, followed by an estimation of the failure probability.

The most used index  $\beta$  was proposed by Hasofer and Lind [HAS74], who proposed to work in the space of standard independent gaussian variables instead of the space of physical variables. The transformation from the variables  $X_i$  to the normalized variables  $U_i$  is given by:

$$U_i = T_i(X_j) \quad (\text{II.1.5})$$

This transformation is called the ‘probabilistic transformation’. It is represented in figure II.1.1 which illustrates the complete analysis methodology. In this standard space, the limit state function is written as:

$$G(X_i) = G(T_i^{-1}(U_j)) \equiv H(U_j) = 0 \quad (\text{II.1.6})$$

and the failure probability is given by:

$$P_f = \int_{H(U) \leq 0} \phi_n(u) du_1 \dots du_n \quad (\text{II.1.7})$$

where  $\phi_n(u)$  is the standard density function in  $n$  dimensions;  $n$  being the number of random variables.

The reliability problem is easily solved if we have the reliability index. Finding  $\beta$  is an optimization problem under one constraint [HAS74]:

$$\begin{aligned} \beta &= \min d, \text{ with } d = \sqrt{U^t U} \\ &\text{under the constraint } H(U) = 0 \end{aligned} \quad (\text{II.1.8})$$

where  $d$  is the distance between the origin and the limit state in the standard space. This problem can be solved with any appropriate optimization method [ABD90, LEM97b].

### II.1.2.2 Monte Carlo Simulation

The Monte-Carlo simulations represent the most general approach for the evaluation of the failure probability. The computation of the integral II.1.4 is done directly by a certain number of calls to the limit state function (i.e. mechanical calls). Among the different sampling methods, one can distinguish the Direct Monte Carlo [MOH95] which is the most general method, but also the most expensive. The samplings are done in all the standard space according to the multi-normal distribution (figure II.1.2). For  $N$  uncertain sampling, the mean of the integral II.1.4 is valued by the ratio of the failed samples over the total number of sampling. To estimate a probability of the order of  $10^n$ , it requires  $10^{n+2}$  to  $10^{n+3}$  simulations (i.e. Finite Element Analyses). It is obvious that this method is impossible to use for large-scale systems with low failure probability. For this reason, other sampling techniques have been widely developed in order to reduce the variance of the probability estimate. However, the computation cost is still large for practical engineering structures.

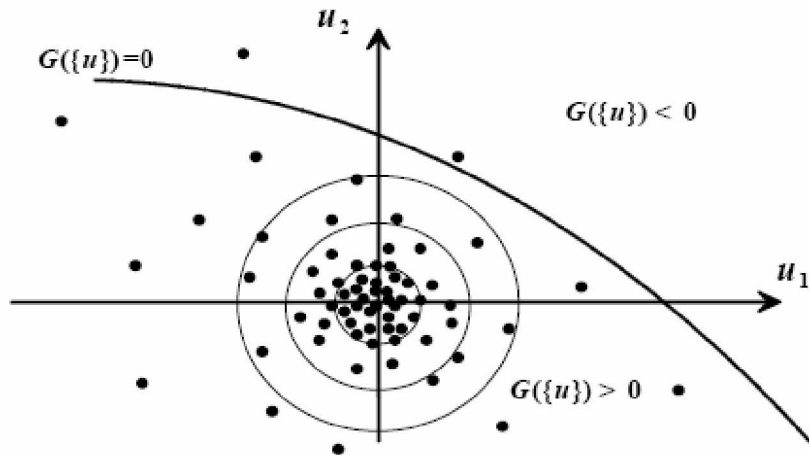

Figure II.1.2: Direct Monte-Carlo simulation.

### II.1.2.3 FORM/SORM

A first approximation of  $P_f$  is gotten by replacing the limit state  $H(u_i)=0$  by a tangent hyperplane at the design point  $P^*$ , which is known as the First Order Reliability method, **FORM** [MAD86]. By taking into account the axis-symmetry of the Gaussian probability density, we can estimate this probability by:

$$P_f \approx \Phi(-\beta)$$

where  $\Phi(\cdot)$  is the univariate Gauss distribution. The precision of this approximation depends on the non-linearity of the limit state (figure II.1.3).



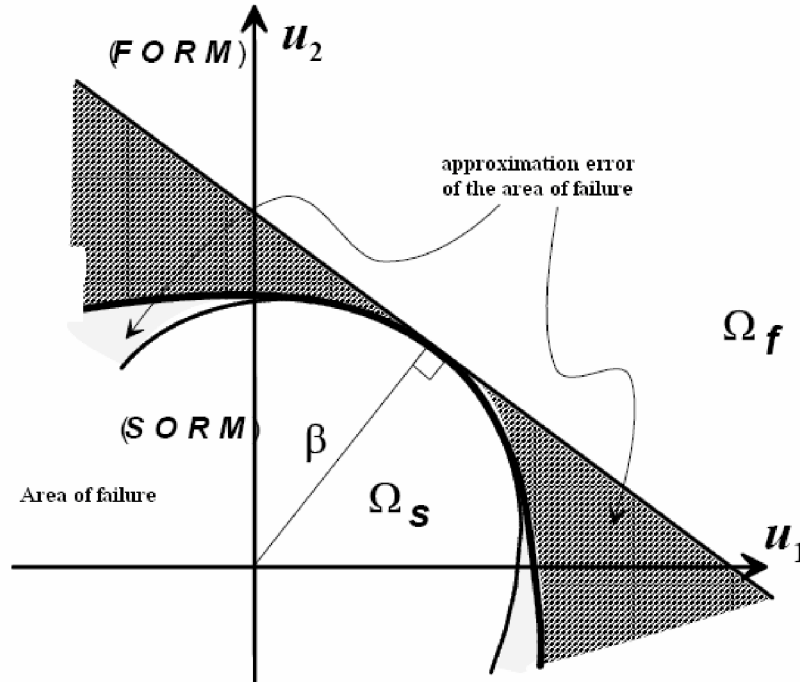

Figure II.1.3: approximation of  $P_f$  by FORM/SORM.

A better approximation is obtained by taking into account the curvatures of the limit state. For this purpose, several methods have been proposed. For example, Breitung [BRE84] proposed an approximation by a hyper-paraboloidal having the same tangent and the same principal curvatures as the limit state surface at the design point. The asymptotic development gives the probability as follows:

$$P_f \approx \Phi(-\beta) \prod_{i=1}^{n-1} (1 + \beta k_i)^{-1/2}$$

with  $k_i$  the principal curvatures in the principal directions at the design point  $P^*$ .

#### II.1.2.4 Probabilistic Transformation

A very important point in the algorithm lies in the probabilistic transformation  $T(\cdot)$ . This transformation defines the correspondence between physical and normalized variables. If the basic random variables are independent, each variable is transformed by the equivalence between the physical and the standard cumulated functions (figure II.1.4), leading to:

$$\Phi(u_i) = F_{x_i}(x_i), \quad i = 1, \dots, n$$

The probabilistic transformation is then:

$$u_i = T(x_i) = \Phi^{-1}(F_{X_i}(x_i)), \quad i = 1, \dots, n,$$

When the basic variables are not mutually independent, the Rosenblatt's transformation [ROS52] is the best solution [MAD86], however, it implies the knowledge of the joint density function of the random variables  $X_i$ , which is not a realistic condition in most practical cases where we have, at best, the marginal distribution function of  $X$  (with mean  $m_{X_i}$  and standard deviation  $\sigma_{X_i}$ ) and the correlation matrix  $\rho_{ij}$ . To carry out the probabilistic transformation, Der Kiureghian and Liu [DER86] proposed to use the approximation given by Nataf [NAT62]. Let us consider, for example, two correlated random variables  $X_1$  and  $X_2$ . The marginal functions  $F_{X_i}(x_i)$  are known,  $\hat{U}_1$  and  $\hat{U}_2$  are standard normal variables but correlated; they are defined by the transformation:

$$\hat{u}_i = \Phi^{-1}(F_{X_i}(x_i)), \quad i = 1, 2$$

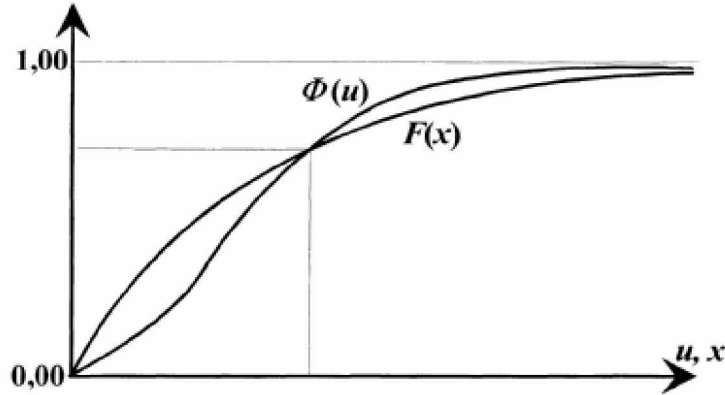

Figure II.1.4: independent variables transformation.

Knowing the joint normal distribution of  $\hat{U}_1$  and  $\hat{U}_2$ , Nataf [NAT62] associates a joint density function with  $X_1$  and  $X_2$ , by the mean of the following relationship:

$$f_{X_1, X_2}(x_1, x_2) = \phi_2(\hat{u}_1, \hat{u}_2, \rho_{0,12}) \frac{f_{X_1}(x_1) f_{X_2}(x_2)}{\phi(\hat{u}_1) \phi(\hat{u}_2)}$$

where  $f_{X_i}(x_i) = \frac{dF_{X_i}(x_i)}{dx_i}$  and  $\phi_2(\hat{u}_1, \hat{u}_2, \rho_{0,12})$  is the bi-normal density function, with zero mean, unit variance and correlation  $\rho_{0,12}$ . The relationship between

$\rho_{0,12}$  and  $\rho_{12}$  is obtained by the correlation definition. Therefore,  $\rho_{0,12}$  can be calculated in function of the marginal density of  $X_i$ :

$$\rho_{12} = \int_{-\infty}^{\infty} \int_{-\infty}^{\infty} \frac{x_1(\hat{u}_1) - m_{x_1}}{\sigma_{x_1}} \frac{x_2(\hat{u}_2) - m_{x_2}}{\sigma_{x_2}} \phi_2(\hat{u}_1, \hat{u}_2, \rho_{0,12}) d\hat{u}_1 d\hat{u}_2$$

This relationship defines the correlation coefficient to be used. To get the standard independent variables, we have to uncorrelate these normal variables:

$$u_i = T(x_i) = \Gamma_{0,ij} \hat{u}_j = \Gamma_{0,ij} \Phi^{-1}(F_{X_j}(x_j))$$

where  $[\Gamma_0] = [L]^{-1}$  is the inverse of the lower triangular matrix of Cholesky's decomposition of  $[\rho_0]$ . Figure II.1.5 illustrates the transformation procedure proposed by Nataf [NAT62].

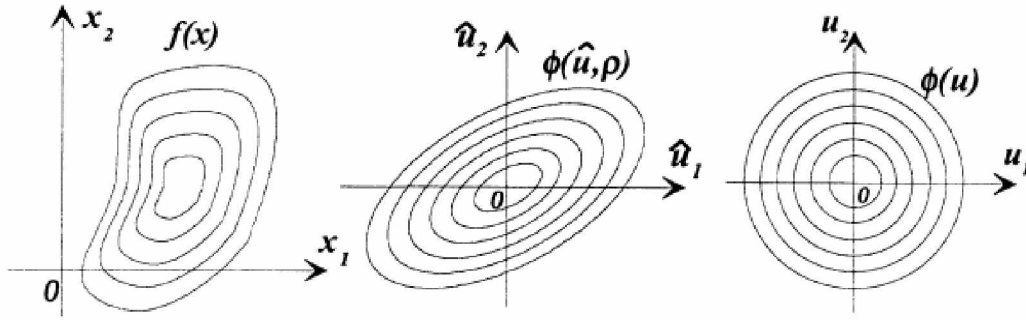

Figure II.1.5: variable spaces in Nataf's transformation.

### II.1.3 Reliability with Finite Element Analysis (implicit functions)

In most of industrial cases, the limit state function cannot be defined by an explicit function in terms of the uncertain variables and, hence, it is necessary to find an implicit modeling as for example the Finite Element Analysis (FEA). Two approaches have been proposed: the first one is based on a direct computation of the reliability index using the FEA by specific optimization procedures. This approach requires a combination between the finite element and the reliability software. The second one is based on the computation of an approximated form of the loading effect, through a response surface to be used

for the reliability analysis, either by FORM/SORM techniques or by Monte Carlo simulations.

### II.1.3.1 Direct coupling method

By the direct coupling method, we mean any reliability procedure based on the design point search using directly the FEA each time the limit state function has to be evaluated. The design point search can be carried out by any optimization method allowing to solve equation (II.1.8). By using the coupled model, there is no need to know the closed-form of the limit state function to determine the failure probability. All what we need are the values of the limit state and its gradient (and maybe the Hessian) at the computation points. Historically, the Rackwitz and Fiessler algorithm [RAC78] has been frequently used in reliability analysis but some instability problems were observed. The convergence rate has been well improved by the Abdo and Rackwitz algorithm [ABD90], which is a simplified form of the sequential quadratic programming algorithm. As for most of optimization methods, there is no guarantee that the calculated minimum really corresponds to the global one; only good engineering sense allows us to get a logical interpretation of the coherence of the failure configuration.

### II.1.3.2 Polynomial Response Surface Method [TAW93]

The Response Surface Method (RSM) [MUZ92] allows us to get an explicit approximation that simulates the behavior of the physical system in a given domain of variation. In the field of structural reliability, the domain of variation is the one of the uncertain variables and the function to approximate is the limit state function (generally, an output of the finite element analysis). The goal of the method is to determine an explicit relationship between the response and the input variables.

In general, the response surface method consists in building a polynomial expansion of the limit state function  $G(x_i)$  or  $H(u_i)$  [MUZ92]. The Quadratic Response Surface is usually chosen as the best compromise since it includes a possible calculation of curvatures and it avoids possible oscillations of higher order polynomials. We choose to build the approximation in the standardized space. For  $N$  random variables in the standardized space, the approximation  $\tilde{H}(u_i)$  of  $H(u_i)$  can be written as:

$$\tilde{H}(u_i) = c + \sum_{i=1}^N b_i u_i + \sum_{i=1}^N \sum_{j=1}^N a_{ij} u_i u_j$$

where  $c$ ,  $b_i$  and  $a_{ij}$  are constants to be determined. The function  $\tilde{H}(u_i)$  is defined by at least  $(N+1)(N+2)/2$  realizations of the mechanical model.

### II.1.3.3 Neural Network approximation

The idea is to use the property of parsimonious universal approximations of the Neural networks [DRE02, HOR89], i.e. for a fixed precision, they are to approximate all continuous function with a number of adjustable parameters lower than the one required by classic regression. This point is therefore quite interesting since the number of data or mechanical calculations is an important factor in this type of analysis. In the reliability analysis, the type of network used is the perception multilayered with a hidden layer (figure II.1.6).

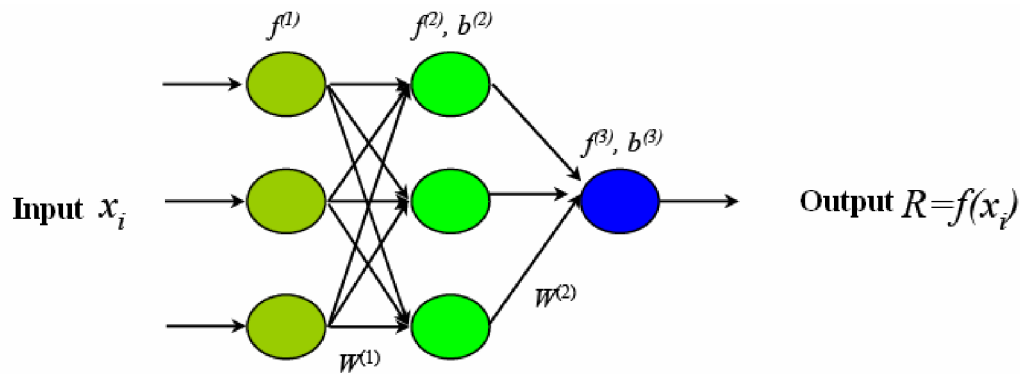

Figure II.1.6: Neural network approximation.

Their principle in the case of reliability lies on the evaluation of the response  $S$  with respect to the inputs  $x_i$  by using combination of adapted functions  $f$  (of sigmoidal type):

$$S = f^{(3)} \left[ W^{(2)} \cdot f^{(2)} \left( W^{(1)} \cdot f^{(1)}(x_i) + b^{(2)} \right) + b^{(3)} \right]$$

where  $W^{(i)}$  and  $b^{(i)}$  are the parameters (weight and slanted), evaluated by the Levenberg-Marquadt algorithm [HOR89].

## II.1.4 Stochastic Finite Element Method

Although the idea of incorporating randomness in a finite element formulation has a long history (see [SCH97] for overviews of earlier work, particularly in the area of stochastic mechanics), the work of Ghanem and Spanos [GHA91] probably constitutes the first systematic Galerkin approximation, leading to the Stochastic Finite Element Method (SFEM) in its current form. The work of Sudret and Der Kiureghian [SUD00] gives an interesting survey of the SFEM formulations and algorithms in reliability analysis.

The SFEM can be divided into two categories: intrusive methods and non-intrusive methods, depending on whether the formulation requires or not an implementation in the finite element software.

### **II.1.4.1 Intrusive Methods**

The idea is to consider the uncertainty as a supplementary dimension of the treated problem, by using the space discretization according to the concept of the finite element. The uncertainty is then considered as an additional degree of freedom. For efficiency and stability reasons, a stochastic mesh is adopted, which is generally larger than finite element mesh; usually, the stochastic element is formed by a group of finite elements. In this approach, the uncertainty effects are considered by one of the two approaches: the Perturbation Method and the Spectral Method.

#### **II.1.4.1.1 Perturbation Method**

This method is based on the analysis of the perturbed response of the model induced by the perturbation the uncertain input parameters [BAE81]; it works like sensitivity analysis of the finite element response.

The first step concerns the space discretization of the stochastic fields, which can be performed by one of the following techniques:

- a) Mid-point method: this is the simplest way to proceed; it consists in associating an uncertain variable to every element of the stochastic mesh, by supposing that the value at the middle of the element represents the stochastic field over the element [SHI88]. The statistical moments of the uncertain variables are then obtained by considering those of the stochastic field at the different mid-points of the mesh.
- b) Local average method: it consists in taking the uncertain variable associated to each element by considering the average value of the stochastic field over the element [VAN83]. Different numerical techniques exist to calculate the statistical moments of these uncertain variables according to the characteristics of the initial stochastic field.
- c) Weighted integral method: this method transforms the initial stochastic field to a vector of nodal uncertain variables for the numerical integration required for the evaluation of the element stiffness matrix [TAK90a-b, DEO91a-b]. It has been shown that this discretization gives a very good approximation of the response variance [TAK92],

while the mid-point discretization leads to overestimate this variance, and the local average discretization tends to underestimate it.

The second step consists in approximating the functions of the uncertain variables by first and second order developments of Taylor series in the neighborhood of the mean value, by assuming little variations of the random variables around their mean values.

For the case of finite element analysis, the discretized problem to be solved takes the form:  $K U = F$ , the second order development in terms of the  $n$  random variables  $\varepsilon_k$  leads to:

$$K = K^0 + \sum_{i=1}^n K_i^I \varepsilon_i + \sum_{i=1}^n \sum_{j=1}^n K_{ij}^{II} \varepsilon_i \varepsilon_j$$

$$U = U^0 + \sum_{i=1}^n U_i^I \varepsilon_i + \sum_{i=1}^n \sum_{j=1}^n U_{ij}^{II} \varepsilon_i \varepsilon_j$$

where  $K^0, K_i^I$  and  $K_{ij}^{II}$  are respectively the mean, the first and the second derivatives of the stiffness matrix  $K$  with respect to the random variables;  $U^0, U_i^I$  and  $U_{ij}^{II}$  are the corresponding quantities defined for the displacement vector  $U$ ; the subscripts  $i, j$  vary from 1 to the number of variables  $n$ . The solution for displacement characteristics is successively performed order by order:

$$K^0 U^0 = F$$

$$K^0 U_i^I = -K_i^I U^0$$

$$K^0 U_{ij}^{II} = -K_i^I U_j^I - K_j^I U_i^I - K_{ij}^{II} U^0$$

In the literature, many applications to linear and nonlinear problems has been carried out, in static and in dynamics, with good results when the uncertain parameters fluctuate in a narrow band [ELI95, MUS00]. In structural dynamics, some researchers [VAN03b, GHA99b] have developed an original modal approach that allows us to directly calculate the perturbation of Function Response in Frequency (FRF) where uncertainties concern the structural stiffness and geometry. From the numerical point of view, the coupling of the perturbation method with Monte Carlo sampling allows us to efficiently deal with the variability of the FRF.

#### II.1.4.1.2 Spectral Method

This Spectral Stochastic Finite Element Method (SSFEM) as been widely developed by Ghanem and Spanos [GHA91] for the solution of mechanical problems with space varying random fields.

The SSFEM may be based on the Karhunen-Loève (KL) decomposition of the random fields. This KL decomposition can be seen as the continuous counterpart of the decorrelation of a set of random variables [VAN03a]. It allows us to approximate a random process by a linear combination of orthonormal deterministic functions (known as KL modes) with uncorrelated random coefficients.

A similar decomposition is performed at the level of the finite element equations, which is represented by a combination of linear system of equations with random coefficients. Two techniques are applied to solve the SSFEM equations for a system with random stiffness. The first technique is based on Monte Carlo simulations of the independent Gaussian KL coefficients. The second technique is based on the projection of the response on the polynomial chaos, which are represented by a set of Hermite polynomials of KL coefficients. A Galerkin approach is followed to calculate the projections of the response for these polynomials.

### **Karhunen-Loève decomposition**

Consider a mechanical problem where one of the system properties is modeled as a scalar random process  $S(x,\theta): D \times \Omega \rightarrow R$ . This process is defined on the probability space  $(\Omega, \Sigma, P)$  over the set  $D \subset R^d$ ; where  $R^d$  represents the  $d$ -dimensional physical domain of the problem. The process  $S(x,\theta)$  is characterized by its marginal Probability Distribution Function (*pdf*)  $f_s(s): R \rightarrow R^+$  and its covariance function  $C_s(x_1, x_2): D \times D \rightarrow R$ . In order to assemble the SSFEM equations, the random process  $S(x,\theta)$  has to be expressed as a deterministic function of a finite number of random variables. This discretization is achieved by the mean of Karhunen-Loève decomposition [GHA91].

The non-zero mean random process  $S(x,\theta)$  is decomposed as follows:

$$S(x,\theta) = m_s(x) + Y(x,\theta) \quad (\text{II.1.9})$$

where  $m_s(x) = E\{S(x,\theta)\}$  is the mean value of the random process  $S(x,\theta)$  and  $Y(x,\theta)$  is a zero mean random process. Both the correlation function  $R_Y(x_1, x_2)$  and the covariance function  $C_Y(x_1, x_2)$  of the zero mean random process  $Y(x,\theta)$  are equal to the covariance function  $C_s(x_1, x_2)$  of the non-zero mean random process  $S(x,\theta)$ . All three are denoted by  $C_s(x_1, x_2)$  in the following.



Let  $\Theta$  be the Hilbert space of random variables  $Z(\theta):\Omega \rightarrow R$  defined in the probability space  $(\Omega, \Sigma, P)$ , with the product  $\langle Z_1(\theta), Z_2(\theta) \rangle_{\Theta} = E\{Z_1(\theta)Z_2(\theta)\}$ . Let  $\xi_j(\theta)$  be a Hilbert basis of  $\Theta$ . The KL decomposition of the zero mean random process  $Y(x, \theta)$  consists of the projection of the process on the Hilbert basis  $\xi_j(\theta)$ . This leads to the following expansion:

$$Y(x, \theta) = \sum_{j=1}^{\infty} c_j(x) \xi_j(\theta) \quad (\text{II.1.10})$$

The covariance function  $C_S(x_1, x_2)$  of the zero mean random process  $Y(x, \theta)$  is equal to:

$$C_S(x_1, x_2) = E\{Y(x_1, \theta)Y(x_2, \theta)\} = \sum_{j=1}^{\infty} \sum_{k=1}^{\infty} c_j(x_1)c_k(x_2)E\{\xi_j(\theta)\xi_k(\theta)\} = \sum_{j=1}^{\infty} c_j(x_1)c_j(x_2) \quad (\text{II.1.11})$$

where the orthogonality of the Hilbert basis vectors  $\xi_j(\theta)$  is taken into account. The covariance function  $C_S(x_1, x_2)$  has the following spectral decomposition:

$$C_S(x_1, x_2) = \sum_{j=1}^{\infty} \lambda_j f_j(x_1) f_j(x_2) \quad (\text{II.1.12})$$

where  $f_j(x)$  and  $\lambda_j$  are the normalized eigenfunctions and the eigenvalues of the covariance function  $C_S(x_1, x_2)$ . The eigenfunctions are orthonormal and the eigenvalues are positive since  $C_S(x_1, x_2)$  is a real symmetric function. They are obtained as the solution of the eigenvalue problem found by the projection of equation (II.1.12) on  $f_k(x_1)$ :

$$\int_D C_S(x_1, x_2) f_k(x_1) dx_1 = \lambda_k f_k(x_2) \quad (\text{II.1.13})$$

An expression for the function  $c_j(x)$  in equation (II.1.10) is obtained by the elimination of  $C_S(x_1, x_2)$  from equations (II.1.11) and (II.1.12):

$$c_j(x) = \sqrt{\lambda_j} f_j(x) \quad (\text{II.1.14})$$

Introducing equation (II.1.14) in equation (II.1.10) gives:

$$Y(x, \theta) = \sum_{j=1}^{\infty} \sqrt{\lambda_j} f_j(x) \xi_j(\theta) \quad (\text{II.1.15})$$

or equivalently:

$$S(x,\theta) = m_s(x) + \sum_{j=1}^{\infty} \sqrt{\lambda_j} f_j(x) \xi_j(\theta) \quad (\text{II.1.16})$$

Equation (II.1.15) is known as the KL decomposition of the zero mean random process  $Y(x,\theta)$ , i.e. the decomposition in terms of a set of normalized uncorrelated random variables  $\xi_j(\theta)$ .

The discretization of the random process  $S(x,\theta)$  is accomplished by a truncation of the infinite series in equation (II.1.16) for the terms corresponding to the highest  $M$  eigenvalues  $\lambda_j$ :

$$S(x,\theta) \approx m_s(x) + \sum_{j=1}^M \sqrt{\lambda_j} f_j(x) \xi_j(\theta) \quad (\text{II.1.17})$$

where  $M$  is called the order of the KL decomposition. As the terms in the decomposition are not correlated (the variables  $\xi_j(\theta)$  are orthonormal random variables), the KL decomposition is the most efficient decomposition of a random process: it minimizes the truncation error for a given number of terms. Ghanem and Spanos [GHA91] gave a proof of this error minimizing property of the KL decomposition.

An expression for the KL coefficient  $\xi_k(\theta)$  is obtained by the projection of equation (II.1.15) on  $f_k(x)$ :

$$\xi_k(\theta) = \frac{1}{\sqrt{\lambda_k}} \int_D Y(x,\theta) f_k(x) dx \quad (\text{II.1.18})$$

If the process  $S(x,\theta)$  has a Gaussian marginal *pdf*, then  $Y(x,\theta)$  reduces to a zero mean Gaussian variable for a fixed position  $x$  and the integral in equation (II.1.18) can be interpreted as an infinite series of zero mean Gaussian variables. As a result, the integral itself is a zero mean Gaussian variable, and so is  $\xi_k(\theta)$ . Thus the KL coefficients are uncorrelated standard Gaussian variables and therefore independent. By virtue of this independence, the realizations of the KL coefficients are easily generated within the frame of Monte Carlo simulations. The realizations of the random process  $S(x,\theta)$  are then obtained according to equation (II.1.17).

### SSFEM system equations

This section covers the assembly of the SSFEM equations for a system with random characteristics, based on the KL decomposition [GHA91].

Consider a stochastic static finite element problem with deterministic mechanical boundary conditions and zero displacements as kinematic boundary conditions. The equilibrium equations for the system are written as follows:

$$K(\theta) U(\theta) = F \quad (\text{II.1.19})$$

where the stochastic stiffness matrix  $K(\theta)$  is linearly dependent on a random process  $S(x, \theta): D \times \Omega \rightarrow R$ . This relationship is expressed using the following operator:

$$K(\theta) = \kappa(S(x, \theta)) \quad (\text{II.1.20})$$

The random process  $S(x, \theta)$  is discretized according to equation (II.1.17). The stiffness matrix is decomposed accordingly:

$$K(\theta) = \kappa(S(x, \theta)) \approx K_0 + \sum_{j=1}^M K_j \xi_j(\theta) \quad (\text{II.1.21})$$

$K_0$  is the stiffness matrix of the mean system. The deterministic matrices  $K_j$  are given by the operator:

$$K_j = \begin{cases} \kappa(m_s(x)) & j = 0 \\ \kappa(\sqrt{\lambda_j} f_j(x)) & j = 1, \dots, M \end{cases} \quad (\text{II.1.22})$$

The SSFEM equations of the static problem become:

$$\left( K_0 + \sum_{j=1}^M K_j \xi_j(\theta) \right) U(\theta) = F \quad (\text{II.1.23})$$

In the following sections, two techniques are presented for the solution of these SSFEM equations with random characteristics modeled as a Gaussian process. The first technique is based on Monte Carlo simulations of the independent Gaussian KL coefficients. The second technique is based on the projection of the response on the polynomial chaos.

### Solution by Monte Carlo simulations

Consider the SSFEM problem defined by equations (II.1.19-II.1.23). The KL coefficients  $\xi_j(\theta)$  in equation (II.1.23) are independent standard Gaussian variables since  $S(x, \theta)$  is a Gaussian process. The solution of this equation can be obtained by Monte Carlo simulations as follows:

1. assembly of the system matrices  $K_j$  according to equation (II.1.22),
2. generation of the sets  $\{\xi_1(\theta_i), \dots, \xi_M(\theta_i)\}$  with  $i = 1, \dots, n_{MCS}$  of independent standard Gaussian variables,

3. assembly of the stiffness matrix  $K(\theta_i)$  according to equation (II.1.21) for every realization  $i$  and solution of the deterministic system of equations  $K(\theta_i)U(\theta_i) = F$ ,
4. estimation of the *pdf* of the response based on the statistics of  $\{U(\theta_i)\}_i$ .

### Solution using polynomial Chaos

Consider the SSFEM problem defined by equations (II.1.19-II.1.23), the stochastic response  $U(\xi_1(\theta), \dots, \xi_M(\theta))$  is projected on the polynomial chaos of order  $P$ :

$$U(\theta) \approx \sum_{q=1}^Q A_q \Psi_q(\xi_1(\theta), \dots, \xi_M(\theta)) \quad (\text{II.1.24})$$

where  $A_q$  is a deterministic vector of the same length as the response vector  $U(\theta)$  and  $\Psi_q(\cdot)$  are polynomial functions.

The polynomial chaos is a Hilbert basis of the random variables space  $\Theta$ , consisting of the  $M$ -dimensional Hermite polynomials  $\Psi_q(\xi_1(\theta), \dots, \xi_M(\theta))$ , in terms of the KL coefficients  $\{\xi_j(\theta)\}_j$ . The polynomial chaos of order  $P$  is the subset of this basis containing the polynomials up to order  $P$ . The restriction to this subset in equation (II.1.24) results in a  $P$ -th order polynomial approximation of the response  $U(\xi_1(\theta), \dots, \xi_M(\theta))$ .

The  $M$ -dimensional Hermite polynomials are defined as follows:

$$\Psi_q(Z) = \prod_{k=1}^M h_{\eta_{qk}}(z_k) \quad (\text{II.1.25})$$

Herein, the  $Q \times M$  dimensional matrix  $\eta$  collects all multi-indices  $\eta_q \in N^M$  satisfying  $\sum_{k=1}^M \eta_{qk} \leq P$ .  $h_n(z)$  is the  $n$ -th order normalized one-dimensional Hermite polynomial, defined as:

$$h_n(z) = \frac{1}{\sqrt{n!}} H_n(z) \quad (\text{II.1.26})$$

where the polynomial  $H_n(z)$  follows from the recurrence relationship:

$$H_0(z) = 1, \quad H_1(z) = z \quad \text{and} \quad H_{n+1}(z) = zH_n(z) - nH_{n-1}(z) \quad (\text{II.1.27})$$

The  $M$ -dimensional Hermite polynomials  $\Psi_q(Z)$  are orthonormal with respect to the Gaussian probability measure, so if  $Z$  is a  $M$ -dimensional standard Gaussian variable then:

$$E\{\Psi_q(Z)\Psi_r(Z)\} = \int_{\mathbb{R}^M} \Psi_q(Z)\Psi_r(Z) \frac{1}{\sqrt{(2\pi)^n}} \exp\left(-\frac{\|Z\|^2}{2}\right) dz = \delta_{qr} \quad (\text{II.1.28})$$

The introduction of equation (II.1.24) in equation (II.1.23) leads to:

$$\sum_{q=1}^Q \left( K_0 + \sum_{j=1}^M K_j \xi_j(\theta) \right) A_q \Psi_q(\xi_r(\theta)) \approx F \quad (\text{II.1.29})$$

There is no exact equality in equation (II.1.29) due to the restriction of the Hilbert basis to the polynomial chaos of order  $P$ . According to the Galerkin finite element method, the orthogonality of Hermite polynomials and the truncation errors, the equality in equation (II.1.29) is enforced. This leads to:

$$\sum_{q=1}^Q \left( \sum_{j=1}^M K_j c_{jq} \right) A_q = F \delta_{0r}, \quad r = 1, \dots, Q \quad (\text{II.1.30})$$

where  $c_{jq}$  is defined as:

$$c_{jq} = \begin{cases} E\{\Psi_q \Psi_r\} & \text{for } j = 0 \\ E\{\xi_j \Psi_q \Psi_r\} & \text{for } j = 1, \dots, M \end{cases} \quad (\text{II.1.31})$$

From the recurrence relationship (II.1.27) and the orthonormality property (II.1.28), the following expression for  $c_{jq}$  is derived:

$$c_{jq} = \begin{cases} \delta_{qr} & j = 0 \\ \left( \sqrt{\eta_{rj}} \delta_{\eta_{qj}+1, \eta_{rj}} + \sqrt{\eta_{qj}} \delta_{\eta_{rj}+1, \eta_{qj}} \right) \prod_{\substack{k=1 \\ k \neq j}}^M \delta_{\eta_{qk}, \eta_{rk}} & j \neq 0 \end{cases} \quad (\text{II.1.32})$$

The set of equations (II.1.30) can be written in matrix notation:

$$K_{pc} A_{pc} = F_{pc} \quad (\text{II.1.33})$$

with:

$$K_{pc} = \begin{bmatrix} \sum_{j=0}^M K_j c_{j11} & \cdot & \cdot & \cdot & \sum_{j=0}^M K_j c_{j1Q} \\ \cdot & \cdot & \cdot & \cdot & \cdot \\ \cdot & \cdot & \cdot & \cdot & \cdot \\ \cdot & \cdot & \cdot & \cdot & \cdot \\ \sum_{j=0}^M K_j c_{jQ1} & \cdot & \cdot & \cdot & \sum_{j=0}^M K_j c_{jQQ} \end{bmatrix}, \quad A_{pc} = \begin{bmatrix} A_1 \\ \cdot \\ \cdot \\ \cdot \\ A_Q \end{bmatrix} \quad \text{and} \quad F_{pc} = \begin{bmatrix} F \\ 0 \\ \cdot \\ \cdot \\ 0 \end{bmatrix} \quad (\text{II.1.34})$$

The solution of the system of equations (3.33) leads to the vectors  $\{A_q\}_q$ . A polynomial approximation of the response  $U(\xi_1(\theta), \dots, \xi_M(\theta))$  is obtained by substitution of these vectors  $\{A_q\}_q$  in equation (II.1.24).

The mean value  $m_U$  of the response is obtained as:

$$m_U = \sum_{q=1}^Q A_q E\{\Psi_q\} = \sum_{q=1}^Q A_q \delta_{1q} = A_1 \quad (\text{II.1.35})$$

where we assume without loss of generality that  $\eta_1 = 0$ . The response correlation matrix  $R_U$  is obtained as:

$$R_U = \sum_{q=1}^Q \sum_{r=1}^Q A_q A_r^T E\{\Psi_q \Psi_r\} = \sum_{q=1}^Q \sum_{r=1}^Q A_q A_r^T \delta_{qr} = \sum_{q=1}^Q A_q A_q^T \quad (\text{II.1.36})$$

#### II.1.4.1.3 Advantage and limitation of SSFEM

The main obstacle in developing a substantial user-community of stochastic finite element methods has been the lack of general-purpose formalism for addressing issues of general engineering interest. Ghanem [GHA99b] proposed the main ingredients for developing a general-purpose version of the spectral SFEM.

However, the following limitations of the method have to be recognized:

- a) The basic formulation is practically limited to linear problems. Material non-linearity (e.g. plasticity) or geometrical non-linearity can hardly be dealt with by SSFEM in its latest state of development without significant computation cost.
- b) The amount of computation required for a given problem is much greater than that of the equivalent deterministic problem. Typically, 15-35 coefficients are needed to characterize each nodal displacement. As a

consequence, a huge amount of output data is available. The question of whether this data is really useful for practical engineering problems has not been addressed.

- c) The truncation of the series involved in SSFEM introduces approximation. So far, no error estimator has been developed and no real study of the accuracy of the method has been carried out, except some comparisons with Monte Carlo simulations.
- d) Although it is claimed in different papers that the reliability analysis is a straightforward post-processing of SSFEM. However, the application of SSFEM to reliability analysis remains broadly an open problem. Important issues such as the accuracy of SSFEM in representing the tails of the *pdf* of the response have to be addressed for this purpose.
- e) When non-normal random fields are used, another accuracy issue comes up. Even for a single variable, only an infinite number of terms in the expansion reproduce the distribution characteristics. This means that the input field defined by using only a few terms in the polynomial chaos expansion can be far from the actual distribution field.

As a conclusion, it is noted that SSFEM is a quite new approach [SUD00] and many new developments are intensively ongoing. Although limited for the time being, it deserves further investigation and comparisons with other approaches to assess its efficiency.

#### II.1.4.2 Non-Intrusive Method

The non-intrusive method is based on a least square minimization between the exact solution and the solution approximated using the polynomial chaos [MAH03-BER05]. First the input random variables are transformed into a standard normal vector  $\xi_i$ . If these  $M$  variables are independent, the one-to-one mapping reads:

$$\xi_i = \Phi^{-1}(F_i(X_i)) \quad (\text{II.1.37})$$

where  $\Phi(\cdot)$  is the standard normal Cumulative Distribution Function (*cdf*) and  $F_i(X_i)$  are the marginal *cdf* of  $X_i$ ; with the subscript  $i=1,2, \dots, M$ . Assume that we want to approximate the random nodal displacement vector by the truncated series expansion:

$$U_i \approx \tilde{U}_i = \sum_{j=0}^{p-1} U_{ij} \Psi_j(\xi_r) \quad (\text{II.1.38})$$

Where  $\Psi_j(\xi_r)$  are  $P$  multidimensional Hermite polynomials of  $\xi_r$  whose degree is less or equal than  $p$ . Note that the following relationship holds:

$$P = \frac{(M + p)!}{M! p!} \quad (\text{II.1.39})$$

Let us denote by  $\xi_r^{(k)}$  ( $k=1,2,\dots,n$ ) the  $n$  outcomes of the standard normal random vector  $\xi_r$ . For each outcome  $\xi_r^{(k)}$ , the probabilistic transform yields a vector of input random variables  $X_r^{(k)}$ . Using a classical finite element code, the response vector  $U^{(k)}$  can be computed.

Let us denote by  $\Gamma^2(\theta, F, P)$  the Hilbert space of random variables with finite variance and consider a random variable  $X$  with a prescribed distribution  $f_X(x)$ . The classical results [MAL97] allow expanding  $X$  in Hermite polynomial series:

$$X = \sum_{i=0}^{\infty} a_i H_i(\xi) \quad (\text{II.1.40})$$

where  $\xi$  denotes a standard normal variable,  $a_i$  are coefficients to be evaluated and  $H_i$  are Hermite polynomials defined by:

$$H_i(x) = (-1)^i e^{\frac{x^2}{2}} \frac{d}{dx} \left( e^{-\frac{x^2}{2}} \right) \quad (\text{II.1.41})$$

Two approaches are given for this purpose: the *projection method* and the *collocation method*.

### II.1.4.2.1 Projection Method

This projection method is applied by several researchers [PUI02, XIU02]. Due to the orthogonality of the Hermite polynomials with respect to the Gaussian measure, it comes from equation (II.1.40):

$$E[X \cdot H_i(\xi)] = a_i E[H_i^2(\xi)] \quad (\text{II.1.42})$$

where  $E[H_i^2(\xi)] = i!$ . Let  $F_X(x)$  denotes the cumulative distribution function of the variable to be approximated and  $\Phi(\cdot)$  the standard normal *cdf*. By using the transformation to the standard normal space  $X \rightarrow \xi : F_X(x) = \Phi(\xi)$ , we can write:

$$X(\xi) = F_X^{-1}(\Phi(\xi)) \quad (\text{II.1.43})$$

Thus:



$$a_i = \frac{1}{i!} E[X(\xi) \cdot H_i(\xi)] = \frac{1}{i!} \int_R F_X^{-1}(\Phi(t)) H_i(t) \phi(t) dt \quad (\text{II.1.44})$$

where  $\phi(\cdot)$  is the standard normal *pdf*. If  $X$  is a normal or lognormal random variable, the coefficients  $a_i$  can be evaluated analytically:

$$\begin{aligned} X \equiv N(\mu, \sigma) &\Rightarrow a_0 = \mu, a_1 = \sigma, a_i = 0 \quad \text{for } i \geq 2 \\ X \equiv LN(\lambda, \zeta) &\Rightarrow a_i = \frac{\zeta^i}{i!} \exp\left[\lambda + \frac{1}{2}\zeta^2\right] \quad \text{for } i \geq 0 \end{aligned} \quad (\text{II.1.45})$$

For other types of distribution, the quadrature methods may be used for evaluating the integral in equation (II.1.44) [BER03].

### II.1.4.2.2 Collocation Method

This method was introduced by Isukapalli [ISU99]. It is based on a least square minimization of the discrepancy between the input variable  $X$  and its truncated approximation  $\tilde{X}$ :

$$\tilde{X} = \sum_{i=0}^p a_i H_i(\xi) \quad (\text{II.1.46})$$

Let  $\xi^{(1)}, \dots, \xi^{(n)}$  be the  $n$  outcomes of  $\xi$ . From equation (II.1.43), we can obtain  $n$  outcomes  $X^{(1)}, \dots, X^{(n)}$ . The least square method allows us to minimize the following quantity with respect to  $a_i$  ( $i = 0 \dots p$ ):

$$\Delta X = \sum_{i=1}^n \left( X^{(i)} - \tilde{X}^{(i)} \right)^2 = \sum_{i=1}^n \left( X^{(i)} - \sum_{j=0}^p a_j H_j(\xi^{(i)}) \right)^2 \quad (\text{II.1.47})$$

This leads to the following linear system yielding the coefficients  $a_i$ :

$$\begin{pmatrix} \sum_{i=1}^n H_0(\xi^{(i)}) H_0(\xi^{(i)}) & \dots & \sum_{i=1}^n H_0(\xi^{(i)}) H_p(\xi^{(i)}) \\ \dots & \dots & \dots \\ \sum_{i=1}^n H_p(\xi^{(i)}) H_0(\xi^{(i)}) & \dots & \sum_{i=1}^n H_p(\xi^{(i)}) H_p(\xi^{(i)}) \end{pmatrix} \begin{pmatrix} a_0 \\ \vdots \\ a_p \end{pmatrix} = \begin{pmatrix} \sum_{i=1}^n X^{(i)} H_0(\xi^{(i)}) \\ \vdots \\ \sum_{i=1}^n X^{(i)} H_p(\xi^{(i)}) \end{pmatrix} \quad (\text{II.1.48})$$

For illustration purpose, figure II.1.7 shows the approximation obtained by both methods in the case of lognormal distribution with mean equal to 2 and standard deviation equal to 0.6 (corresponding to the distribution parameters  $m_{\ln X} = 0.6501$  and  $\sigma_{\ln X} = 0.2936$ ).

Method	$a_0$	$a_1$	$a_2$	$a_3$
Projection	2.0000	0.5871	0.0862	0.0084
Collocation	1.9986	0.5869	0.0872	0.0085

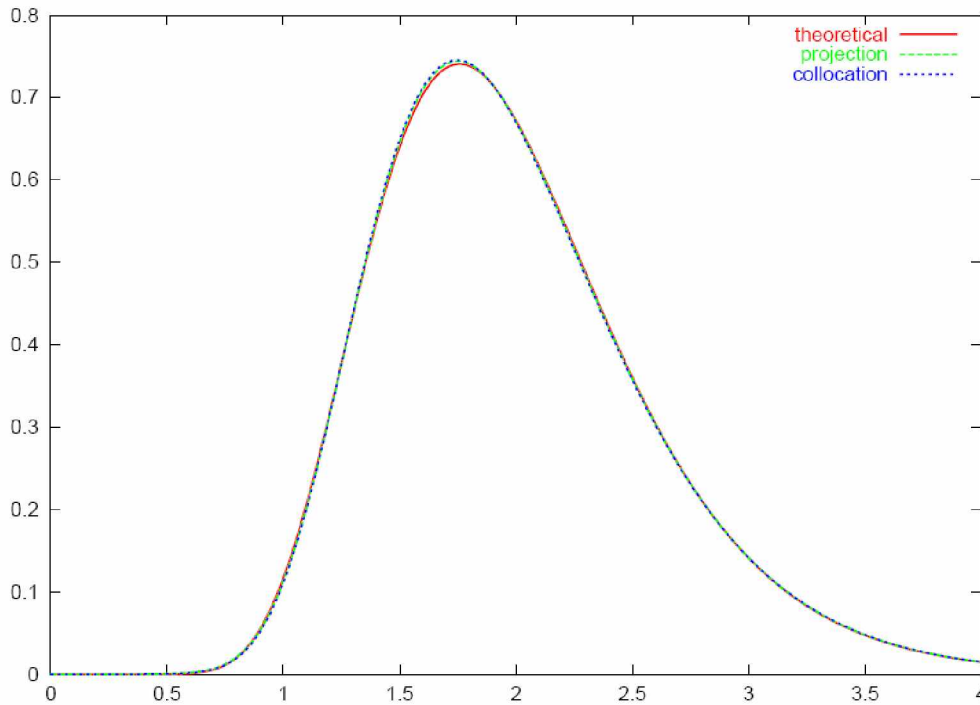

Figure II.1.7: Theoretical and approximated *pdf* for a lognormal distribution LN(0.6501, 0.2936) – Coefficients of the expansion ( $p = 3$ ).

### II.1.4.3 SFEM for nonlinear problems

For nonlinear systems, Baroth *et al.* [BAR06] proposed an approach based on the coupling of two known techniques which have never been combined in this context:

- The projection of the response on a basis of Hermite polynomials gives us a development in exact series of the mechanical response. The development of the response undergoes two approximations: the series truncation on one hand, and the series coefficient approximation on the other hand; the proposed approach is thus related to the response surface;
- The interpolation by cubic B-splines of the response, in order to approximate the series coefficients with a reasonable number of mechanical calls. Finally, it becomes easy to evaluate the statistical moments of the considered mechanical response.

## II.1.5 Comparative analysis

It doesn't exist, to our knowledge, an exhaustive comparative study (benchmark) on Stochastic Finite Element Methods. Some works propose a comparison of some methods using specific examples, but which remain relatively limited. Usually, the example of a simply supported beam in bending is considered for method validation [CRI97, ELI95, BAR03], as the simplicity of the structural analysis allows for simple illustrations, which is very useful to introduce the new ideas in SFEM. In the next section, we considered the comparative studies performed by Baldeweck [BAL99], Brzakala *et al.* [BRZ01] and Sudret *et al.* [SUD00].

### II.1.5.1 Comparisons of SFEM techniques

Baldeweck [BAL99] studied a beam with variable stiffness subjected to uniformly distributed load. The stiffness is modeled by uncertain field of uniform probability distribution. The mean and the covariance of the displacement to mid-span are calculated analytically then by Monte Carlo simulations (20000 simulations) and three SFEM: the perturbation method, the spectral method and the quadrature method. In this study, the first four statistical moments have been estimated and compared. While the perturbation method is more precise for the mean estimation, the quadrature method is more precise for the estimation of other quantities.

Brzakala and Elishakoff [BRZ01] presented a comparative study of SFEM in the example of the beam in bending. The modulus of elasticity of the beam is modeled by uniform random variable. The mean and the variance of the displacement of the free beam end is estimated by different ways: the perturbation method, the spectral approach based on Legendre polynomials [ZHA98] and the response surface method based on the same polynomials. This last approach appears to be the most precise.

Sudret and Der Kiureghian [SUD00, SUD02] presented a study on elastic soil, where the modulus of elasticity is a lognormally distributed field. The mean and the variance of the soil are analytically available. The spectral method as well as the perturbation method give good estimations of the standard deviation, provided that the developments used in these methods include sufficient terms. Nevertheless, the computation time required for the SSFEM is much higher than the perturbation method.

The study of the different SFEM application fields can lead to some classification criteria. Each technique should be evaluated according to the degree of mechanical non-linearity, on one hand, and to the degree of probabilistic analysis, on the other hand.

- The structural non-linearity can be classified according to the type of non-linearity: the material non-linearity is much more studied than geometrical non-linearity, because it is simpler to be implemented.
- The degree of probabilistic analysis can be classified according to the number of random variables, which may be independent or correlated. The high number of variables is usually a result of the discretization of stochastic fields. Another classification criterion is related to an indicator of the ratio between accuracy and computation time. In particular, the calculation cost is directly related to the number of finite element runs. It could also be interesting to distinguish the methods according to the degree of modification of the finite element model.

## II.1.6 Conclusion

In this chapter, the coupling between reliability and finite element analyses can be carried out by the use of FORM/SORM. For this purpose, the direct differentiation method can be allowed to allow for sensitivity analysis including linear and nonlinear behavior in static as well as in dynamics.

The response surface method has been presented as an alternative to direct coupling. It is applicable to practically any general problem and does not require the implementation of gradients inside the finite element code. However, the efficiency of the response surface method decreases with the number of random variables.

The spectral stochastic finite element method has been applied to linear problems, and it is not yet suitable for general nonlinear problems. However, it is a rather new approach and requires further explorations. In spite the fact that the Spectral SFEM is computationally demanding, it gives a full characterization of the output quantities. Whether this information is really needed for practical applications is an open question. So is also the question of the efficiency and accuracy of SSFEM in the context of reliability analysis.

In this context, the present work aims to develop a method to define an “exact” form (or a semi-exact) of the response distribution function, contrary to FORM/SORM which gives us an approximation of the *pdf* and to SFEM which gives mostly the mean and the standard deviation of the mechanical response.

# Chapter 2

## Probabilistic Transformation Method (PTM)

II.2.1 Introduction-----	52
II.2.2 Probabilistic Transformation-----	53
II.2.2.1 Probabilistic Transformation Method (PTM)-----	53
II.2.2.2 Limitations and extension of PTM-----	57
II.2.3 Coupled PTM-FEM technique-----	58
II.2.3.1 Analytic <i>pdf</i> for Static behavior -----	59
II.2.4 PTM-FEM for engineering problems-----	83
II.2.4.1 PTM in structural dynamics -----	83
II.2.4.2 PTM in reliability analysis-----	86
II.2.4.3 PTM in structural optimization-----	87
II.2.5 Conclusion-----	88

## II.2.1 Introduction

As discussed in the above chapter, the Stochastic Finite Element Method (SFEM) represents a new approach to solve mechanical systems with stochastic characteristics. The SFEM is based on the deterministic Finite Element Method in which some variables related to the structural state (variables involved in the stiffness matrix) and to the applied actions (involved in the load vector) are uncertain. In other words, the SFEM tries to look for the stochastic properties of the mechanical response.

The solution of a stochastic mechanical system is completely defined through the evaluation of the probability density function of the response process. This cannot be analytically achieved through most of the available methods and techniques such as Fokker-Planck equation, Wiener-Hermite expansion, perturbation methods, stochastic linearization, WHEP technique, decomposition method and stochastic finite element methods. Some exact solutions are available for the mean and standard deviation, not for the *Probability Density Function (pdf)*, of the solution process [ELI99, SHI88].

In this chapter, we propose a method named PTM-FEM in which the *Probabilistic Transformation Method (PTM)* is combined with the deterministic *Finite Element Method (FEM)* in order to determine the *pdf* of the response of a stochastic mechanical system with random excitation and/or stiffness.

The Probabilistic Transformation Method is based on one-to-one mapping between the random output(s) and input(s) where the transformation Jacobean  $J$  can be computed. The *pdf* of the output(s) is then computed through the known joint *pdf* of the inputs multiplied by the determinant of transformation Jacobean matrix. The one-to-one mapping condition can be relaxed through some mathematical tricks.

This PTM-FEM allows us to express the “exact” *pdf* of the mechanical response [KAD05c], provided that the transformation Jacobean can be defined. For many cases, the *pdf* of the response can be obtained in a closed-form in terms of the joint distribution of the input random variables.

After presenting the theory of probabilistic transformation, the PTM-FEM is formulated and extended to several engineering problems.

## II.2.2 Probabilistic Transformation

Frequently, in the solution of a stochastic differential equation, one encounters the need to derive the probability distribution of a function of one or more random variables. This allows us to give the complete solution of the stochastic differential equation. One of the available methods for finding the distribution of a function of random variables is the *Cumulative distribution function technique*. That is, if  $X_1, X_2, \dots, X_n$  are continuous random variables with joint *pdf*  $f_{X_1, X_2, \dots, X_n}(x_1, x_2, \dots, x_n)$ , the distribution of the random function  $Y = u(X_1, X_2, \dots, X_n)$  is determined by computing the cumulative distribution function (*cdf*) of  $Y$  as follows:

$$G(y) = \Pr[Y \leq y] = \Pr[u(X_1, X_2, \dots, X_n) \leq y] \quad (\text{II.2.1})$$

$$G(y) = \int_A f_{X_1, X_2, \dots, X_n}(x_1, x_2, \dots, x_n) dx_1 dx_2 \dots dx_n$$

where  $A$  is a set of points  $(x_1, x_2, x_3, \dots, x_n)$  in  $n$ -dimensional space defined by the inequality  $u(x_1, x_2, x_3, \dots, x_n) \leq y$ . Even in what superficially appears to be very simple, this can be quite tedious especially for irregular domain  $A$  and for complicated joint density function  $f_{X_1, X_2, \dots, X_n}(x_1, x_2, \dots, x_n)$ . This points up the desirability of having, if possible, various methods to determine the distribution of a function of random variables. One may find that several techniques are available, but often each technique is superior to the others in a given situation. In theory of probability, the most sound methods are the Probabilistic Transformation Method (PTM) [PAP02] and the moment generating function technique [HOG89]. In our work, we focus on the first technique, which is valid for both types of random variables: discrete and continuous. In this technique, if the joint distribution function of the input variables  $X_1, X_2, \dots, X_n$  is known in a closed-form, the theory of PTM gives the joint *pdf* of the output functions  $Y_i = u_i(X_1, X_2, \dots, X_n)$  (with  $i=1, 2, \dots, n$ ) under some mathematical conditions. In the following sections, we introduce some theorems and some related proofs for continuous random variable transformation.

### II.2.2.1 Probabilistic Transformation Method (PTM)

Suppose that  $X$  is a continuous random variable with a known *pdf*  $f_X(x)$  and  $A \subset \mathfrak{R}$  is the one-dimensional space where  $f_X(x) > 0$  is bijective, differentiable and monotonic. Consider the function  $y = u(x)$  and let us suppose the following two cases:

- *Case 1:  $y = u(x)$  is a monotonic increasing function*

- Case 2:  $y = u(x)$  is a monotonic decreasing function

Case 1: the probability of the event  $y \in [a, b]$  is written:

$$\Pr[a < Y < b] = \Pr[u^{-1}(a) < X < u^{-1}(b)] = \int_{u^{-1}(a)}^{u^{-1}(b)} f(x) dx \quad (\text{II.2.2})$$

Changing the variable of integration from  $x$  to  $y$  where  $x = u^{-1}(y)$ , we obtain:

$$\Pr[a < Y < b] = \int_a^b f_Y(y) dy = \int_a^b f_X[u^{-1}(y)] \frac{\partial(u^{-1}(y))}{\partial y} dy \quad (\text{II.2.3})$$

From the previous integral we find:

$$f_Y(y) = f_X[u^{-1}(y)] \frac{\partial(u^{-1}(y))}{\partial y} = f_X[u^{-1}(y)] J \quad (\text{II.2.4})$$

We recognize  $J = \frac{\partial(u^{-1}(y))}{\partial y}$  as the reciprocal of the slope of the tangent line of the increasing function  $y = u(x)$ , it is the obvious that  $J = |J|$  and hence,

$$f_Y(y) = f_X[u^{-1}(y)] |J|. \quad (\text{II.2.5})$$

### Case 2

In this case, the desired probability is calculated by:

$$\Pr[a < Y < b] = \Pr[u^{-1}(b) < X < u^{-1}(a)] = \int_{u^{-1}(b)}^{u^{-1}(a)} f(x) dx. \quad (\text{II.2.6})$$

Changing the variable of integration, we obtain:

$$\Pr[a < Y < b] = - \int_a^b f[u^{-1}(y)] \frac{\partial(u^{-1}(y))}{\partial y} dy. \quad (\text{II.2.7})$$

From the previous integral we find:

$$f_Y(y) = -f_X[u^{-1}(y)] \frac{\partial(u^{-1}(y))}{\partial y} = -f_X[u^{-1}(y)] J. \quad (\text{II.2.8})$$

But in this case, the slope of the curve is negative and  $J = -|J|$ . Hence

$$f_Y(y) = f[u^{-1}(y)] |J|, \quad (\text{II.2.9})$$



This result leads to the following theorem:

**Theorem 2.1: Single input-single output system**

Suppose that  $X$  is a continuous random variable with *pdf*  $f_X(x)$  and  $A \subset \mathfrak{X}$  is the one-dimensional space where  $f_X(x) > 0$ , is differentiable and monotonic. Consider the random variable  $Y = u(X)$ , where  $y = u(x)$  defines a one-to-one transformation that maps the set  $A$  onto a set  $B \subset \mathfrak{Y}$  so that the equation  $y = u(x)$  can be uniquely solved for  $x$  in terms of  $y$ , say  $x = u^{-1}(y)$ . Then, the *pdf* of  $Y$  is (figure II.2.1):

$$f_Y(y) = f_X[u^{-1}(y)] |J|, \quad y \in B \quad (\text{II.2.10})$$

where,  $J = \frac{dx}{dy} = \frac{du^{-1}(y)}{dy}$  is the transformation Jacobean, which must be continuous for all points  $y \in B$ .

We notice in the previous theorem that the function  $u(\cdot)$  should be monotonic. For the general case of non monotonic functions, the following theorem allows us to consider a piecewise monotonic transformation.

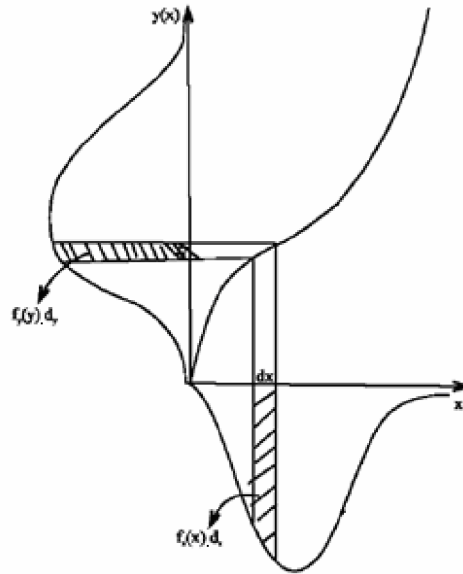

Figure II.2.1: transformation method.

**Theorem 2.2: pdf of piecewise monotonic transformation**

Let  $X$  be a continuous random variable with *pdf*  $f_X(x)$  and  $Y = u(X)$  be a transformation of  $X$ . If there exists a partition  $A_0, \dots, A_k$  of  $A \subset R$  and functions  $u_1(x), \dots, u_k(x)$  such that:

1.  $P(X \in A_0) = 0$

2. Each  $A_i$  for  $i \in \{1, 2, \dots, k\}$  is an interval  $]a_i, b_i]$  (the endpoints are irrelevant, they can always be placed in  $A_0$ . It is possible for  $a_i$  to tend to  $-\infty$  and for  $b_i$  to tend to  $\infty$ ).
3.  $u(x) = u_i(x)$  for all  $x \in A_i$ .
4.  $u_i(x)$  is monotonic on each  $A_i$ .
5.  $u_i(x)$  is differentiable over  $A_i$ .

Then

$$f_Y(y) = \sum_{i=1}^k f_X(u_i^{-1}(y)) \left| \frac{\partial u_i^{-1}(y)}{\partial y} \right| \quad (\text{II.2.11})$$

The proof of this theorem can be found in [HOG89].

Theorem 2.1 has a natural extension to  $n$ -fold integrals. This extension can be generalize in the following manner:

From one-to-one correspondence between  $A$  and  $B$ :

$$\begin{aligned} \Pr[(Y_1, Y_2, Y_3, \dots, Y_n) \in B] &= \Pr[(X_1, X_2, X_3, \dots, X_n) \in A] \\ &= \int \dots \int_A f(x_1, x_2, \dots, x_n) dx_1 dx_2 \dots dx_n. \end{aligned} \quad (\text{II.2.12})$$

Changing the variables of integration  $x_1, x_2, \dots, x_n$  to  $y_1, y_2, \dots, y_n$  using the inverse function  $x_i = u_i^{-1}(y_1, y_2, \dots, y_n)$ ,  $i = 1, 2, \dots, n$ , we obtain:

$$\Pr[(Y_1, \dots, Y_n) \in B] = \int \dots \int_B f[u_1^{-1}(y_1, \dots, y_n), \dots, u_n^{-1}(y_1, \dots, y_n)] |J| dy_1 \dots dy_n, \quad (\text{II.2.13})$$

where  $J$  is the Jacobean of the transformation defined as:

$$J = \begin{vmatrix} \partial x_1 / \partial y_1 & \partial x_1 / \partial y_2 & \dots & \partial x_1 / \partial y_n \\ \partial x_2 / \partial y_1 & \partial x_2 / \partial y_2 & \dots & \partial x_2 / \partial y_n \\ \cdot & \cdot & \dots & \cdot \\ \cdot & \cdot & \dots & \cdot \\ \cdot & \cdot & \dots & \cdot \\ \partial x_n / \partial y_1 & \partial x_n / \partial y_2 & \dots & \partial x_n / \partial y_n \end{vmatrix}$$

Consequently, the joint *pdf* of  $\{Y_i\}_{i=1}^n$  is:

$$f_{y_1, y_2, \dots, y_n}(y_1, y_2, \dots, y_n) = f_{x_1, x_2, \dots, x_n} \left[ \left\{ u_j^{-1}(y_1, y_2, \dots, y_n) \right\}_{j=1}^n \right] |J|, \quad (y_1, y_2, \dots, y_n) \in B$$

According to the previous theorem, we can find the marginal density distribution of any output variable say  $Y_k$  through the following integral:

$$f_{Y_k}(y_k) = \int_{-\infty}^{\infty} \dots \int_{-\infty}^{\infty} f_{y_1, y_2, \dots, y_n}(y_1, y_2, \dots, y_n) dy_1 \dots dy_{k-1} dy_{k+1} \dots dy_n \quad (\text{II.2.14})$$

where  $y_k$  belongs to the region limited by  $B$ . This result leads to the following theorem:

### Theorem 2.3: $n$ -inputs and $n$ -outputs system

Suppose  $\{X_i\}_{i=1}^n$  is a set of continuous random variables with joint *pdf*  $f(x_1, x_2, \dots, x_n)$  and  $A \subset \mathfrak{R}^n$  is a set in the  $n$ -dimensional space over which  $f(x_1, x_2, \dots, x_n) > 0$ . Let  $\{Y_i = u_i(X_1, X_2, \dots, X_n)\}_{i=1}^n$  be a set of random functions each of it defines a one- to- $n$  transformation that maps the set  $A$  onto a set  $B \subset \mathfrak{R}^n$  in the  $y_1, y_2, \dots, y_n$  space so that, the system of equations  $y_i = u_i(\{x_j\}_{j=1}^n)$ ,  $i = 1, 2, \dots, n$ , may be uniquely solved for  $\{x_j\}_{j=1}^n$  in terms of  $\{y_i\}_{i=1}^n$ , say  $x_j = u_j^{-1}(\{y_i\}_{i=1}^n)$ ,  $j = 1, 2, \dots, n$ . Then, the joint *pdf* of  $\{Y_i\}_{i=1}^n$  is:

$$f_{Y_1, Y_2, \dots, Y_n}(y_1, y_2, \dots, y_n) = f_{X_1, X_2, \dots, X_n} \left[ \{u_j^{-1}(y_1, y_2, \dots, y_n)\}_{j=1}^n \right] |J| \quad (\text{II.2.15})$$

where the Jacobean  $J$  is the  $n \times n$  determinant

$$J = \begin{vmatrix} \partial x_1 / \partial y_1 & \partial x_1 / \partial y_2 & \dots & \partial x_1 / \partial y_n \\ \partial x_2 / \partial y_1 & \partial x_2 / \partial y_2 & \dots & \partial x_2 / \partial y_n \\ \cdot & \cdot & \dots & \cdot \\ \cdot & \cdot & \dots & \cdot \\ \cdot & \cdot & \dots & \cdot \\ \partial x_n / \partial y_1 & \partial x_n / \partial y_2 & \dots & \partial x_n / \partial y_n \end{vmatrix} \quad (\text{II.2.16})$$

where all first order derivatives are continuous and  $J$  does not vanish for all points  $(y_1, y_2, y_3, \dots, y_n) \in B$ .

#### II.2.2.2 Limitations and extensions of the PTM

The common mathematical condition in all previous theorems is that the transformation must be one-to-one. A problem arises frequently when we wish to find the probability distribution of the random function  $Y = u(X)$  when  $X$  is a continuous random variable and the transformation is not one-to-one. This is usually the case of finite element analysis, where the interest is often focussed on only one output variable (maximum stress or displacement), in terms of several input random variables.

In general, the two major limitations of the PTM are:

- The transformation function  $u(x)$  should be bijective.
- The determinant of the Jacobean should be not nil.

These two limitations can be avoided by suitable definition of the transformation problem, where additional output variables are added to ensure an equivalent one-to-one transformation.

In the case where we have only one output variable as a function of  $n$  input variables, we can proceed as following:

$$\text{Let } \begin{cases} u: R^n \rightarrow R^n \\ Y \rightarrow Y = u(X) \end{cases} \text{ with } u(x) = \begin{cases} y_1 = u(x_1, x_2, \dots, x_n) \\ y_i = x_i \quad \text{for } i = 2, \dots, n \end{cases} \quad (\text{II.2.17})$$

The function  $u(\cdot)$  is reversible if and only if the determinant of the following Jacobean is not nil [KAD05a]:

$$|J| = \begin{vmatrix} \frac{\partial u}{\partial x_1} & \cdot & \cdot & \cdot & \frac{\partial u}{\partial x_n} \\ 0 & 1 & 0 & \cdot & 0 \\ \cdot & 0 & 1 & \cdot & \cdot \\ \cdot & \cdot & \cdot & 1 & 0 \\ 0 & \cdot & \cdot & 0 & 1 \end{vmatrix} = \frac{\partial u}{\partial x_1} \neq 0$$

There is, at least, one  $i$  such that  $\frac{\partial u}{\partial x_i} \neq 0$ , and  $u^{-1}(\cdot)$  exists.

### II.2.3 Coupling PTM-FEM Technique

The PTM-FEM technique [KAD05a-b] is a combination of the deterministic Finite Element Method (FEM) and the Probabilistic Transformation Method (PTM) [HOG89]. Contrary to the methods based on series developments, there is no convergence problem in the proposed technique since the PTM is an exact method. Figure II.2.2 shows the general algorithm of this technique in which the stochastic equation of equilibrium is solved first using deterministic finite element analysis. This solution is used to compute the function between the input and the output, which is then inverted for the calculation of the determinant of the transformation Jacobean. Finally, the response *pdf* at any point in the domain can be deduced by using the probabilistic transformation method. This is simply defined by multiplying the input *pdf* by the Jacobean of

the inverse mechanical function. For small number of random variables, this approach has the advantage of giving a closed-form of the density function of the response, which is very helpful for reliability analysis of mechanical systems.

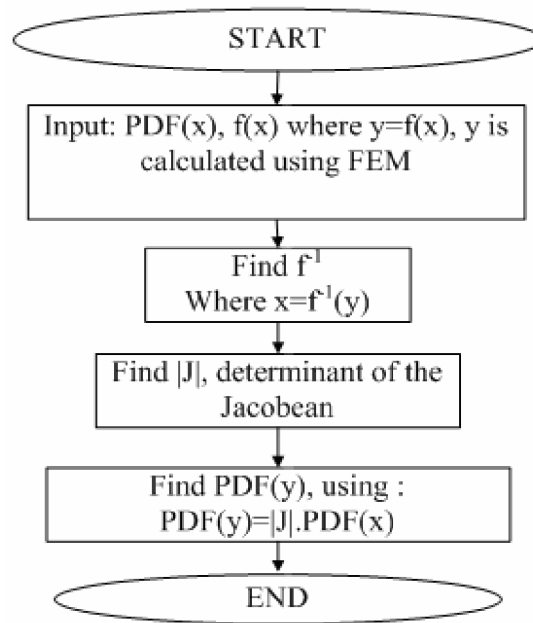

Figure II.2.2: general algorithm of PTM-FEM.

The advantage of the PTM-FEM technique in the context of static system is clear: it gives the *pdf*, which is the most complete characteristic in probabilistic analysis, of the response in a closed-form expression, contrary to other numerical methods like perturbation and spectral methods which give only first and second moments of the response under some conditions.

### II.2.3.1 Analytical *pdf* for static behavior

The uncertainty assessment in mechanical systems plays a crucial role in establishing the credibility of the underlying numerical model. There are two complementary approaches to assess the uncertainties in a model: parametric and non-parametric approaches. In the parametric approach, the uncertainties associated with the system parameters, such as Young's modulus, mass density, Poisson's ratio, damping coefficient and geometrical parameters are quantified using statistical methods and are then propagated by using, for example, the stochastic finite element method. This type of approaches is suitable to quantify aleatoric uncertainties. Epistemic uncertainty on the other hand do not explicitly depend on the system parameters. For example, there can be unquantified errors associated with the equation of motion (linear or nonlinear), in the damping model (viscous or non-viscous), in the model of structural

joints, and also in the numerical methods (e.g. discretization of displacement fields, truncation and round off errors, tolerances in the optimization and iterative algorithms, step-sizes in the time-integration methods). The parametric approach is not suitable to quantify this type of uncertainties and a non-parametric approach is needed for this purpose.

In many stochastic mechanical problems, whether a parametric or a non-parametric method is used, one finally needs to solve a system of linear stochastic equations.

$$KU = F \quad (\text{II.2.18})$$

Here  $K \in R^{n \times n}$  is a  $n \times n$  real positive definite random matrix,  $F \in R^n$  is a  $n$ -dimensional input vector (usually load) and  $U \in R^n$  is a  $n$ -dimensional real uncertain output vector which we want to determine. Equation (II.2.18) typically arises due to the discretization of stochastic partial differential equations. In the context of linear structural mechanics,  $K$  is known as the stiffness matrix,  $F$  is the loading vector and  $U$  is the vector of structural displacements.

Our goal now is to find the *pdf* of output in “analytical” form, when possible. For that reason, we consider two cases: univariate and multivariate cases.

### II.2.3.1.a. Univariate Case

Before considering the random matrix case, we first look at the univariate case. For a single degree-of-freedom system ( $n = 1$ ), Eq. (II.2.18) reduces to:

$$k u = f \quad (\text{II.2.19})$$

where  $k, u, f \in R$ .

Let us consider the following cases:

1. the stiffness is random and the load is deterministic;
2. the load is random and the stiffness is deterministic;
3. the load and the stiffness are random;
4. the stiffness is random with nonlinear terms.

#### 1- The stiffness is random and load is deterministic

Suppose the probability density function (maybe non-Gaussian) of the random variable  $k$  is given by  $f_K(k)$  and we are interested in deriving the *pdf* of:

$$h = k^{-1} \quad (\text{II.2.20})$$

The Jacobean of the above transformation is:

$$J = \left| \frac{\partial h}{\partial k} \right| = |k|^{-2} \quad (\text{II.2.21})$$

Using the Jacobean, the probability density function of  $h$  can be obtained using theorem 2.1, as:

$$f_h(h) = \left| \frac{\partial k}{\partial h} \right| f_k(k) = |h|^{-2} f_k\left(\frac{1}{h}\right) \quad (\text{II.2.22})$$

The final step of the algorithm is then to multiply the *pdf* of  $h$  by the load  $f$  which is supposed to be deterministic in this case.

$$\text{i.e. } f_u(u) = |J| \cdot f \cdot f_h(h)$$

In order to illustrate formula (II.2.22), let us consider the two following examples:

**Example 1.**  $k$  has a normal distribution with mean  $m_k$  and standard deviation  $\sigma_k$ ; the *pdf* of  $k$  is:

$$f_k(k) = \frac{1}{\sqrt{2\pi}\sigma_k} e^{-\frac{1}{2}\left(\frac{k-m_k}{\sigma_k}\right)^2}$$

Using Eq. II.2.22, the *pdf* of  $h = k^{-1}$  is obtained as:

$$f_h(h) = |h|^{-2} f_k(h^{-1}) = \frac{|h|^{-2}}{\sqrt{2\pi}\sigma_k} e^{-\frac{1}{2}\left(\frac{h^{-1}-m_k}{\sigma_k}\right)^2}$$

It is to be noted that Gaussian distribution is not suitable for most of mechanical properties as they are strictly positive quantities. The inverse Gaussian distribution derived in the above equation has an essential singularity at  $h=0$  and the expressions of the moments cannot be obtained in a closed-form.

**Example 2.**  $k$  has log-normal distribution with  $m_{\ln k}$  and standard deviation  $\sigma_{\ln k}$ ; The *pdf* of  $k$  is given by:

$$f_k(k) = \frac{1}{k\sqrt{2\pi}\sigma_{\ln k}} e^{-\frac{1}{2}\left(\frac{\ln k - m_{\ln k}}{\sigma_{\ln k}}\right)^2}$$

By following the PTM procedure, we get:

$$f_h(h) = \frac{|h|^{-1}}{\sqrt{2\pi}\sigma_{\ln k}} e^{-\frac{1}{2}\left(\frac{-\ln h - m_{\ln k}}{\sigma_{\ln k}}\right)^2}$$

### 2- The load is random and the stiffness is deterministic

Suppose the probability density function of the random variable  $f$  is given by  $f_F(f)$ , in his case the PTM is straightforward:

$$u = k^{-1} f \quad (\text{II.2.23})$$

The Jacobean of the above transformation is:

$$J = \left| \frac{\partial u}{\partial f} \right| = |k|^{-1} \quad (\text{II.2.24})$$

Using the Jacobean, the *pdf* of  $u$  can be obtained using theorem 2.1, as:

$$f_U(u) = |J| f_f(f) = |k|^{-1} f_f\left(\frac{u}{k}\right) \quad (\text{II.2.25})$$

### 3- The load and the stiffness are random

In this case, we have two input variables and only one output variable. As it has been mention above, the PTM is basically a one-to-one mapping procedure. To overcome this difficulty, we introduce a fictitious random output variable, which is an arbitrary function of the random inputs. Let us put  $z=k$ , as a second output. The transformation equations between inputs and outputs become:

$$\begin{cases} u = \frac{f}{k} \\ z = k \end{cases}$$

where  $(k, f) \in D_{k,f}$  and the domain  $D_{k,f}$  is completely defined by the distributions of  $k$  and  $f$ . Now, the Jacobean of transformation is written:

$$J = \begin{vmatrix} \partial k / \partial u & \partial k / \partial z \\ \partial f / \partial u & \partial f / \partial z \end{vmatrix} = k$$



Using the PTM technique, we get:

$$f_{u,z}(u, z) = f_{k,f}(k, f) |J|$$

In the considered case, the independence of the material property and the load allows us to write:

$$f_{k,f}(k, f) = f_k(k) \cdot f_f(f).$$

Finally, the *pdf* of the response is evaluated by the following integral:

$$f_u(u) = \int_{D_{u,z}} f_{u,z}(u, z) \cdot dz$$

which gives the exact *pdf* of  $u$ .

#### 4- The stiffness contains random nonlinear terms

In many cases, the random variables are represented as nonlinear terms in the stiffness matrix, and the difficulties arise when applying the PTM to random nonlinear functions, as we cannot get a closed-form expression of the response. To overcome this difficulty, it is proposed to transform the random terms of the stiffness matrix to an equivalent linear ones, by using step-by-step variable changes. The PTM-FEM is thus applied to the equivalent linear term and then a backward substitution is carried out.

To illustrate this idea, let us consider the following cases:

##### *a. The nonlinearity in the numerator:*

In this case, the uncertain variable is present as a nonlinear numerator in the stiffness term, e.g.  $k_i = \frac{\alpha^\gamma}{\beta}$  (with  $\alpha$  as random, and  $\gamma > 1$ ). To obtain an equivalent linear form, we put  $\delta = \alpha^\gamma$ , then we apply the PTM technique to get the *pdf* of  $\delta$ .

For example, in truss members with circular cross-sections with random diameter  $d_i$ , the stiffness matrix contains the term:  $k_i = \frac{E S_i}{L_i} = \frac{\pi E d_i^2}{4L_i}$ . By

putting  $M_i = d_i^2$ , the PTM can be applied twice: the first time to get the *pdf* of

$M$  and the second time to the linear stiffness term  $k_i = \frac{E_i M_i}{L_i}$ . It is thus possible

to get a closed-form of the response *pdf*.

b. *The nonlinearity in the denominator:*

In this case, the nonlinear term appears in the denominator, i.e.  $k_i = \frac{\alpha}{\sum \beta^\gamma}$  ( $\beta$  is random). We proceed by the following substitutions:  $\delta = \beta^\gamma$  to get the *pdf* of  $\delta$ ,  $\mu = \sum \beta^\gamma$  to get the *pdf* of  $\mu$  and finally  $\lambda = \frac{1}{\mu}$  to get the *pdf*  $\lambda$ . The final stiffness term becomes  $k_i = \lambda\alpha$  which is linear in terms of random variable.

For example, let  $k_i = \frac{E_i I_i}{\sum_i \frac{1}{l_i}}$  where the lengths  $l_i$  being random variables. We

put  $M_i = \frac{1}{l_i}$  and then apply PTM to get  $f_{M_i}(M_i)$ , then  $L = \sum_i M_i$  to get  $f_L(L)$ , and

finally we put  $T = \frac{1}{L}$  to get  $f_T(T)$ . In this case, the stiffness term becomes linear in the form  $k_i = E_i I_i T$  and the PTM is easily applied to get a closed-form expression of the *pdf* of  $k_i$ .

Even with linear stiffness terms, the inverse of the stiffness matrix is always composed of nonlinear terms, and even that the PTM-FEM can give the *pdf* of the response in a closed-form, it becomes very difficult to generalize the application of PTM-FEM to get a closed form for realistic structures. For this reason, the application of PTM-FEM should be studied problem by problem, depending on the type of finite elements and the considered analyses.

In the following sections, the multivariate case is discussed and an extension of the PTM-FEM is proposed. Two approaches are considered: parametric and non-parametric. In the parametric approach, the randomness is related to the stiffness matrix terms, while in the non-parametric approach, the *pdf* of the whole stiffness matrix is taken into account without considering the specific stiffness terms.

### II.2.3.1.b. Multivariate Case

In the following sections, we will extend the univariate case to the general  $n \times n$  system of  $n$  equations with  $n$  unknowns. As it has been shown, the *pdf* of the response is easily computed when the Mechanical Transformation Jacobean is known. Consequently, the extension to the multivariate case is focussed on how to evaluate the determinant of this Jacobean in the case of finite element models. Two methods are developed: the first one is based on displacement sensitivity to calculate directly the Jacobean of the transformation (this approach is parametric) and the second method is based on the calculation of the *pdf* of the inverse of the stiffness matrix (this approach is non-parametric).

#### 1° Parametric approach

The parametric approach considers the randomness of some variables in the stiffness matrix and in the load vector. The mechanical transformation Jacobean has to be calculated in order to evaluate the joint *pdf* of the structural response. For this purpose, it is proposed to use either the sensitivity operators or the Response Surface Methods. The former is more efficient for large number of variables and hence, it is developed hereafter.

##### A) Jacobean evaluation by using sensitivity operators

The displacement formulation of finite element gives the structural equilibrium in the form:

$$KU = F \quad (\text{II.2.26})$$

where the solution is simply written:

$$U = K^{-1}F \quad (\text{II.2.27})$$

To apply the PTM-FEM we need to calculate the Jacobean of the transformation, i.e.  $\frac{\partial U}{\partial \alpha} = \frac{\partial(K^{-1}F)}{\partial \alpha}$ , where  $\alpha$  is the considered random variable.

We can proceed by two ways:

### 1) Differentiation of the stiffness matrix inverse

Differentiating the structural solution (equation II.2.26), we can write:

$$\frac{\partial U}{\partial \alpha} = \frac{\partial}{\partial \alpha}(K^{-1}F) = \frac{\partial K^{-1}}{\partial \alpha}F + K^{-1}\frac{\partial F}{\partial \alpha} \quad (\text{II.2.28})$$

This leads to the mechanical transformation Jacobean:

$$|J| = \left| \frac{\partial U}{\partial \alpha} \right| = \left| \frac{\partial K^{-1}}{\partial \alpha}F + K^{-1}\frac{\partial F}{\partial \alpha} \right| \quad (\text{II.2.29})$$

It is easy to deal with the case where the uncertainty is related to the load vector, because the displacement becomes proportional to loading. For this reason, we are interested in dealing with the randomness in the stiffness matrix only, i.e.  $\alpha = k_{ij}$ . In this case, we get  $\frac{\partial F}{\partial \alpha} = \frac{\partial F}{\partial k_{ij}} = 0$  and  $|J| = \left| \frac{\partial K^{-1}}{\partial k_{ij}}F \right|$ .

To evaluate numerically  $\frac{\partial K^{-1}}{\partial k_{ij}}$ , we can proceed as follows:

$$\begin{aligned} K^{-1}K &= I \\ \frac{\partial}{\partial k_{ij}}(K^{-1}K) &= \frac{\partial I}{\partial k_{ij}} \\ \frac{\partial K^{-1}}{\partial k_{ij}}K &= -K^{-1}\frac{\partial K}{\partial k_{ij}} \\ \frac{\partial K^{-1}}{\partial k_{ij}} &= -K^{-1}\frac{\partial K}{\partial k_{ij}}K^{-1} \end{aligned} \quad (\text{II.2.30})$$

This development shows that the derivative of the inverse stiffness  $K^{-1}$  can be computed in terms of the stiffness derivative, which is much easier to evaluate. For several types of finite elements, the derivative  $\frac{\partial K}{\partial k_{ij}}$  can be carried out analytically. For more general cases (especially for isoparametric 2D and 3D

elements), we suggest to use the exact numerical differentiation of  $\frac{\partial K}{\partial k_{ij}}$  proposed by Lund [LUN94] for shape optimization.

## 2) Direct calculation of the Jacobean

The direct differentiation of the equilibrium equation with respect to  $k_{ij}$  gives:

$$\begin{aligned}\frac{\partial}{\partial \alpha}(KU) &= \frac{\partial}{\partial \alpha}(F) \\ \frac{\partial K}{\partial \alpha}U + K \frac{\partial U}{\partial \alpha} &= \frac{\partial F}{\partial \alpha} \\ \frac{\partial U}{\partial \alpha} &= -K^{-1} \left( \frac{\partial K}{\partial \alpha}U - \frac{\partial F}{\partial \alpha} \right)\end{aligned}\tag{II.2.31}$$

For  $\alpha = k_{ij}$ , the load derivative is nil, and the Jacobean can be written:

$$|J| = \left| -K^{-1} \frac{\partial K}{\partial k_{ij}} U \right|$$

In these two ways, the symbolic calculation of the Jacobean, using Mathematica for example, is only possible for 3 or 4 degrees of freedom. For practical structures, the numerical evaluation is carried out. Lund [LUN94] proposed an exact numerical differentiation with respect to shape parameters.

## Exact numerical differentiation of stiffness matrix $K$

In numerical analysis, we can approximate the derivative of a function by using finite difference approximation. For a function  $f(x_1, x_2, \dots, x_n)$ , the derivative is:

$$\frac{\partial f}{\partial x_i} \approx \frac{\Delta f}{\Delta x_i}\tag{II.2.32}$$

Lund [LUN94] has proposed a corrective factor  $cr_i$ , allowing to transform the equation (II.2.32) from approximate to exact one:

$$\frac{\partial f}{\partial x_i} = cr_i \frac{\Delta f}{\Delta x_i}\tag{II.2.33}$$

where  $cr_i$  is defined as below.

$$\begin{aligned}
cr_0 &= 0 \\
cr_1 &= 1 \\
cr_2 &= \left(1 + \frac{1}{2} \frac{\Delta x_i}{x_i}\right)^{-1} \\
cr_3 &= \left(1 + \frac{\Delta x_i}{x_i} + \frac{1}{3} \left(\frac{\Delta x_i}{x_i}\right)^2\right)^{-1} \\
cr_4 &= \left(1 + \frac{3}{2} \frac{\Delta x_i}{x_i} + \left(\frac{\Delta x_i}{x_i}\right)^2 + \frac{1}{4} \left(\frac{\Delta x_i}{x_i}\right)^3\right)^{-1} \\
&\dots\dots \\
cr_k &= \left(\frac{1}{k} \sum_{p=0}^{k-1} \binom{k}{p} \left(\frac{\Delta x_i}{x_i}\right)^{(k-1-p)}\right)^{-1}
\end{aligned}$$

This development can be easily applied to finite element formulation, in order to calculate the exact differentiation of the stiffness matrix in the general case. For isoparametric finite elements, the stiffness matrix  $K_e$  is given by

$$K_e = \int_{\Omega} B^T C B |J_G| d\Omega \quad (\text{II.2.34})$$

where  $\Omega$  is the finite element domain,  $B$  is the strain-displacement matrix,  $C$  is the elasticity matrix and  $|J_G|$  is the determinant of the geometrical Jacobean matrix  $J_G$ .

The differentiation variable may belong to one of the two categories: Shape variables or Material variables.

#### Shape variables:

The only affected quantity in this case is the strain-displacement matrix  $B$  and the geometrical Jacobean  $J_G$ . The derivation of the stiffness matrix gives:

$$\frac{\partial K_e}{\partial \alpha} = \int_{\Omega} \left[ \frac{\partial B^T}{\partial \alpha} C B + B^T C \frac{\partial B}{\partial \alpha} \right] |J_G| d\Omega + \int_{\Omega} B^T C B \frac{\partial |J_G|}{\partial \alpha} d\Omega \quad (\text{II.2.35})$$

The derivative  $\frac{\partial B}{\partial \alpha}$  can be written as:

$$\frac{\partial B}{\partial \alpha} = \left[ \frac{\partial b_1}{\partial \alpha} \quad \frac{\partial b_2}{\partial \alpha} \quad \dots \quad \frac{\partial b_i}{\partial \alpha} \quad \dots \quad \frac{\partial b_n}{\partial \alpha} \right] \quad (\text{II.2.36})$$

which leads to the derivatives of nodal coordinates with respect to the shape parameters of the structure.

The derivative of the Jacobean can be written as:

$$\frac{\partial |J_G|}{\partial \alpha} = cr_j \frac{\Delta J_G}{\Delta \alpha} = \frac{1}{\Delta \alpha} \left( \left| J_G \left( \left( 1 + \frac{\Delta \alpha}{\alpha} \right) \alpha \right) \right| - |J_G(\alpha)| \right) \quad (\text{II.2.37})$$

For a given finite element mesh, it is required to link the geometrical variables to the nodal coordinates of the elements. As the above formula gives us the stiffness derivatives with respect to nodal coordinates, it is required to calculate the sensitivity of nodal positions due to a perturbation of the structural geometry. This can be carried out by applying finite difference operators to the mesh procedure. This can be efficiently performed, as no finite element solution is required at this stage.

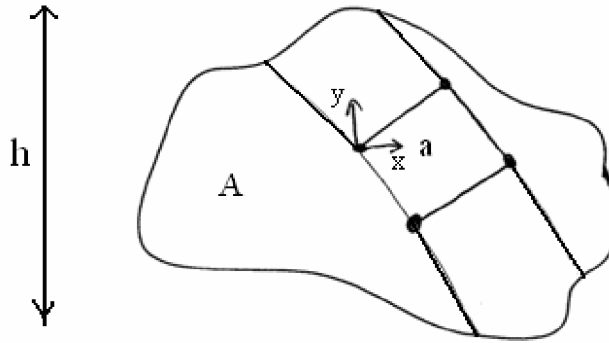

Figure II.2.3: geometrical variables and nodal coordinates.

For a perturbation of the geometrical parameter  $h$ , the nodal derivatives  $\frac{\partial x_i}{\partial h}$  and  $\frac{\partial y_i}{\partial h}$  can be used to calculate the element stiffness derivative by the chain rule:

$$\frac{\partial K_e}{\partial h} = \frac{\partial K_e}{\partial x_i} \frac{\partial x_i}{\partial h} + \frac{\partial K_e}{\partial y_i} \frac{\partial y_i}{\partial h} \quad (\text{II.2.38})$$

The derivative of the “global” stiffness matrix with respect to  $h$  is then calculated by the assembly of the element stiffness derivatives:

$$\frac{\partial K_g}{\partial h} = \sum_{elements} \sum_i \left( \frac{\partial K_e}{\partial x_i} \cdot \frac{\partial x_i}{\partial h} + \frac{\partial K_e}{\partial y_i} \cdot \frac{\partial y_i}{\partial h} \right) \quad (\text{II.2.39})$$

Material Variables:

In the case of material variables, such as Young's modulus and Poisson's ratio, the only affected quantity is the elasticity matrix  $C$ . The sensitivity of the stiffness matrix becomes:

$$\frac{\partial K_e}{\partial \alpha} = \int_{\Omega} B^T \frac{\partial C}{\partial \alpha} B |J_G| d\Omega \quad (\text{II.2.40})$$

Exact numerical differentiation of mass matrix  $M$ 

The exact numerical differentiation of mass matrix  $M$  is mandatory for dynamic analysis. The consistent element mass matrix  $M$  is given by:

$$M_e = \int_{\Omega} \rho N^T N |J_G| d\Omega \quad (\text{II.2.41})$$

where  $\Omega$  is the element volume,  $\rho$  is the material density,  $N$  is the matrix of shape functions and  $|J_G|$  is the determinant of the geometrical Jacobean matrix.

The derivative of this matrix with respect to shape variables is given by:

$$\frac{\partial M_e}{\partial \alpha} = \int_{\Omega} \rho N^T N \frac{\partial |J_G|}{\partial \alpha} d\Omega \quad (\text{II.2.42})$$

The “exact” numerical derivative can be evaluated by introducing the Lund’s correction factor.



Special case of line elements

In this section, the explicit derivatives are given for usual line elements.

1- Bar element

In general, the stiffness matrix of a 2-node bar element of length  $L$  is:

$$K_e = \frac{ES}{L} \begin{bmatrix} 1 & 0 & -1 & 0 \\ 0 & 0 & 0 & 0 \\ -1 & 0 & 1 & 0 \\ 0 & 0 & 0 & 0 \end{bmatrix}$$

In this case, the stiffness derivatives are simply:

$$\frac{\partial K_e}{\partial E} = \frac{S}{L} \begin{bmatrix} 1 & 0 & -1 & 0 \\ 0 & 0 & 0 & 0 \\ -1 & 0 & 1 & 0 \\ 0 & 0 & 0 & 0 \end{bmatrix} \quad \frac{\partial K_e}{\partial S} = \frac{E}{L} \begin{bmatrix} 1 & 0 & -1 & 0 \\ 0 & 0 & 0 & 0 \\ -1 & 0 & 1 & 0 \\ 0 & 0 & 0 & 0 \end{bmatrix} \quad \frac{\partial K_e}{\partial L} = -\frac{ES}{L^2} \begin{bmatrix} 1 & 0 & -1 & 0 \\ 0 & 0 & 0 & 0 \\ -1 & 0 & 1 & 0 \\ 0 & 0 & 0 & 0 \end{bmatrix}$$

2- Beam Element:

In general, the stiffness matrix of a beam element of length  $L$  takes the form:

$$[K] = \int_0^L EI B^T B dx$$

For classical beam element, the stiffness matrix is:

$$[K] = \frac{EI}{L^3} \begin{bmatrix} 12 & 6L & -12 & 6L \\ 6L & 4L^2 & -6L & 2L^2 \\ -12 & -6L & 12 & -6L \\ 6L & 2L^2 & -6L & 4L^2 \end{bmatrix}$$

In this case the derivatives of the stiffness matrix with respect to  $E$ ,  $I$  and  $L$ , are respectively:

$$\frac{\partial K_e}{\partial E} = \frac{I}{L^3} \begin{bmatrix} 12 & 6L & -12 & 6L \\ 6L & 4L^2 & -6L & 2L^2 \\ -12 & -6L & 12 & -6L \\ 6L & 2L^2 & -6L & 4L^2 \end{bmatrix}$$

$$\frac{\partial K_e}{\partial I} = \frac{E}{L^3} \begin{bmatrix} 12 & 6L & -12 & 6L \\ 6L & 4L^2 & -6L & 2L^2 \\ -12 & -6L & 12 & -6L \\ 6L & 2L^2 & -6L & 4L^2 \end{bmatrix}$$

$$\frac{\partial K_e}{\partial L} = \frac{EI}{L^3} \begin{bmatrix} -36/L & -12 & 36/L & -12 \\ -12 & -4L & 12 & -2L \\ 36/L & 12 & -36/L & 12 \\ -12 & -2L & 12 & -4L \end{bmatrix}$$

### PTM-FEM for Random field

In general, the discretization of the random field  $V(x, y; \theta)$  using **Karhunen-Loève (KL)** decomposition is given by (see chapter 1):

$$V(x, y; \theta) \approx m_V(x) + \sum_{j=1}^M \sqrt{\lambda_j} f_j(x, y) \xi_j(\theta) \quad (\text{II.2.43})$$

where  $M$  is the order of *KL* decomposition. Let us consider the case of Young's modulus field as a function of the coordinate  $x$ :

$$E(x; \theta) \approx m_E + \sum_{j=1}^M \sqrt{\lambda_j} f_j(x) \xi_j(\theta) \quad (\text{II.2.44})$$

where  $m_E$  is the mean of  $E$  et  $\xi_j$  are independent standard random variables.

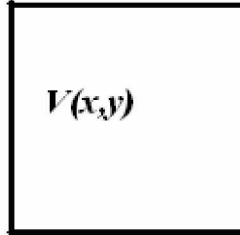

Figure II.2.4: Random field.

In this case, the mechanical response  $y$  (i.e. displacement) is a function of  $E$ , and the application of the PTM-FEM leads to:  $f_y(y) = f_E(E) \left| \frac{\partial y}{\partial E} \right|^{-1}$ . The term  $\left| \frac{\partial y}{\partial E} \right|$  can be calculated by finite element sensitivity. The stochastic field distribution  $f_E(E)$  can be obtained by the application of PTM to the

**Karhunen-Loève (KL)** decomposition. In the case of  $M = 1$ , the density function is:  $f_E(E) = f_{\xi_1}(\xi_1) \left| \frac{\partial E}{\partial \xi_1} \right|^{-1}$ . If  $M > 1$ , we should add  $M - 1$  auxiliary variables and then use the PTM technique.

### **Special cases:**

In the following, the random fields can be conveniently integrated in the PTM for two special cases: Beam and plate elements.

- *Beam element with stochastic Young's modulus:*

The elastic modulus is assumed to vary randomly along the beam finite element according to the function:

$$E^{(e)}(x) = E_0^{(e)} [1 + f^{(e)}(x)] \quad (\text{II.2.45})$$

where  $E_0^{(e)}$  is the mean elastic modulus in element ( $e$ ), and  $f^{(e)}(x)$  is the associated zero-mean homogeneous stochastic field. According to Deodatis and Graham [DEO97], the stochastic element stiffness matrix for this beam element can be expressed as:

$$K^{(e)} = K_0^{(e)} + X_1^{(e)} \cdot \Delta K_1^{(e)} + X_2^{(e)} \cdot \Delta K_2^{(e)} + X_3^{(e)} \cdot \Delta K_3^{(e)} \quad (\text{II.2.46})$$

where  $X_k^{(e)}; k = 1, 2, 3$  are weighted integrals (which are random variables) associated with the stiffness matrix,  $K_0^{(e)}$  is the part of the stiffness obtained using the mean elastic modulus and  $\Delta K_k^{(e)}; k = 1, 2, 3$  are deterministic matrices.

- *Plate with stochastic Young's modulus*

For two-dimensional plate problem, the elastic modulus is assumed to vary randomly within the element ( $e$ ) according to:

$$E^{(e)}(x, y) = E_0^{(e)} [1 + f^{(e)}(x, y)] \quad (\text{II.2.47})$$

where  $E_0^{(e)}$  is the mean modulus in element ( $e$ ) and  $f^{(e)}(x, y)$  is the associated zero-mean homogeneous stochastic field. According to Deodatis and Graham [GRA98], the stochastic element stiffness matrix for this plate bending element can be expressed as:

$$K^{(e)} = K_0^{(e)} + X_1^{(e)} \cdot \Delta K_1^{(e)} + \dots + X_6^{(e)} \cdot \Delta K_6^{(e)} + f^{(e)}(\bar{x}, \bar{y}) \cdot \Delta K_7^{(e)} \quad (\text{II.2.48})$$

where  $X_k^{(e)}; k = 1, \dots, 7$  are weighted integrals (which are random variables) associated with the stiffness matrix,  $f^{(e)}(\bar{x}, \bar{y})$  is the value of stochastic field  $f^{(e)}(x, y)$  at the center of element  $(e)$ ,  $K_0^{(e)}$  is the part of the element stiffness obtained using the mean elastic modulus and  $\Delta K_k^{(e)}; k = 1, \dots, 7$  are deterministic matrices.

For those two formulations, the PTM can be applied without any difficulty, as the superposition principle can be applied.

## 2°/ Non-parametric approach

In the non-parametric approach, the whole stiffness matrix is considered as random and we search for the stochastic response of the system related to the randomness of this matrix. Before going in the details, we shall introduce some concepts of the theory of random matrices, which are relevant to stochastic mechanical problems:

A random matrix can be considered as an observable entity representable in the form of a matrix which under repeated observation yields different non-deterministic outcomes. A random matrix is therefore simply a collection of random variables which may satisfy certain rules (for example symmetry, positive definiteness etc). Random matrices were introduced by Wishart [WIS28] in the late 1920s in the context of multivariate statistics.

However, random matrix theory (RMT) was not used in other branches until 1950s when Wigner [WIG58] published his works (leading to the Nobel price in Physics in 1963) on the eigenvalues of random matrices arising in high-energy physics. Since then research on random matrices has continued to attract interests in multivariate statistics, physics, number theory and more recently in mechanical and electrical engineering.

The probability density function of a random matrix can be defined in a manner similar to that of a random variable or random vector. If  $A$  is a  $n \times m$  real random matrix, then the matrix probability density function of  $A \in R^{n \times m}$ , denoted by  $f_A(A)$ , is a mapping from the space of  $n \times m$  real matrices to the real line, i.e.,  $f_A(A): R^{n \times m} \rightarrow R$ . We can define probability density functions of some random matrices which are relevant to stochastic mechanics problems.

Gaussian random matrix: a rectangular random matrix  $X \in R^{n \times p}$  is said to have a matrix variate Gaussian distribution with mean matrix  $M \in R^{n \times p}$  and covariance matrix  $\Sigma \otimes \Psi$ , where  $\Psi \in R_p^+$  and  $\Sigma \in R_n^+$  provided the *pdf* of  $X$  is given by:

$$f_X(X) = (2\pi)^{-np/2} |\Sigma|^{-p/2} |\Psi|^{-n/2} \text{etr} \left\{ -\frac{1}{2} \Sigma^{-1} (X - M) \Psi^{-1} (X - M)^T \right\} \quad (\text{II.2.49})$$

where  $\text{etr}\{\bullet\} = \exp\{\text{Trace}(\bullet)\}$ . This distribution is usually denoted as  $X \rightarrow N_{n,p}(M, \Sigma \otimes \Psi) \mathbf{X}$ .

Symmetric Gaussian random matrix:

Let  $Y \in R^{n \times n}$  be a symmetric random matrix and  $M, \Sigma$  and  $\Psi$  are  $n \times n$  constant matrices such that the commutative relation  $\Sigma\Psi = \Psi\Sigma$  holds. If the  $n(n+1)/2$  vector:  $\text{vech}(Y)$  formed from  $Y$  is distributed as (the definition of  $\text{vech}$  and  $G_n$  are given later):

$$N_{n(n+1)/2,1}(\text{vech}(M), G_n^T (\Sigma \otimes \Psi) G_n) \quad (\text{II.2.50})$$

then  $Y$  is said to have symmetric matrix variate Gaussian distribution with mean  $M$  and covariance matrix  $G_n^T (\Sigma \otimes \Psi) G_n$  and its *pdf* is given by:

$$f_Y(Y) = (2\pi)^{-n(n+1)/4} |G_n^T (\Sigma \otimes \Psi) G_n|^{-1/2} |\Psi|^{-n/2} \text{etr} \left\{ -\frac{1}{2} \Sigma^{-1} (Y - M) \Psi^{-1} (Y - M)^T \right\} \quad (\text{II.2.51})$$

This distribution is usually denoted as  $Y = Y^T \rightarrow SN_{n,n}(M, G_n^T (\Sigma \otimes \Psi) G_n)$ .

For a symmetrical matrix  $Y \in R^{n \times n}$ ,  $\text{vech}(Y)$  is a  $n(n+1)/2$  dimensional column vector formed by the upper triangular matrix of  $Y$  (i.e. elements above and including the diagonal of  $Y$  taken column wise).

Wishart matrix: a  $n \times n$  symmetric positive definite random matrix  $S$  is said to have a Wishart distribution with parameters  $p \geq n$  and  $\Sigma \in IR_n^+$ , if its *pdf* is given by:

$$f_S(S) = \left\{ 2^{\frac{1}{2}np} \Gamma_n \left( \frac{1}{2} p \right) |\Sigma|^{\frac{1}{2}p} \right\}^{-1} |S|^{\frac{1}{2}(p-n-1)} \text{etr} \left\{ -\frac{1}{2} \Sigma^{-1} S \right\} \quad (\text{II.2.52})$$

This distribution is usually denoted as  $S \rightarrow W_n(p, \Sigma)$ . Using the maximum entropy approach, Adhikari [ADH06] proved that the system matrices arising in linear structural dynamics should be Wishart matrices.

Matrix variate gamma distribution: a  $n \times n$  symmetric positive definite random matrix  $W$  is said to have a matrix variate gamma distribution with parameters  $a$  and  $\Psi \in IR_n^+$ , if its *pdf* is given by:

$$f_W(W) = \left\{ \Gamma_n(a) |\Psi|^{-a} \right\}^{-1} |W|^{a-\frac{1}{2}(n+1)} \text{etr}\{-\Psi W\} \quad (\text{II.2.53})$$

This distribution is usually denoted as  $W \rightarrow G_n(a, \Psi)$ . The matrix variate gamma distribution was used by Soize [SOI05] for the random system matrices of linear dynamical systems.

As conclusion, the Wishart and gamma distribution will always result in symmetric and positive definite matrices. Therefore, they can be possible candidates for modeling random system matrices arising in probabilistic structural mechanics.

### Transformation Jacobean for random stiffness matrix

After a brief description of Random Matrix basics, we are now interested in the extension of the PTM-FEM to the general case of  $n \times n$  real symmetrical random matrices. Assume that the matrix-variate probability density function of the non-singular stiffness matrix  $K$  is given by:

$$f_K(K) : R^{n \times n} \rightarrow R.$$

Because in general  $U = K^{-1}F$  and the main problem is to find the *pdf* of  $K^{-1}$ , let:

$$H = K^{-1} \in R^{n \times n} \quad (\text{II.2.54})$$

In fact, we want to determine the joint probability density functions of all the elements of  $H$ . The elements of  $H$  are complicated nonlinear functions of the elements of  $K$ . Therefore, even if the elements of  $K$  have Gaussian distribution, in general the joint distribution of the elements of  $H$  will be non-Gaussian. Also note that  $H$  may not have any banded structure even if  $K$  is of banded nature.

The key step to obtain the *pdf* of the inverse of a random matrix is the calculation of the Jacobean of the nonlinear matrix transformation of the above equation. For this reason, we have shown that the Jacobean determinant can be given by the following formula:

$$J = |K|^{-(n+1)} \quad (\text{II.2.55})$$

This is the matrix-variate generalization of the simple univariate case obtained before.

This result can be illustrated for the calculation of two degrees-of-freedom system:

$$K = \begin{bmatrix} a & b \\ b & c \end{bmatrix}$$

Here  $a$ ,  $b$  and  $c$  are real scalar variables which can be random. From the direct matrix inversion we have:

$$H = K^{-1} = \frac{1}{ac - b^2} \begin{bmatrix} c & -b \\ -b & a \end{bmatrix}$$

Differentiating the upper triangular part of the  $H$  matrix with respect to the independent elements of the  $K$  matrix, one has:

$$\begin{aligned} J = \left| \frac{\partial H}{\partial K} \right| &= \begin{vmatrix} \frac{\partial H_{11}}{\partial a} & \frac{\partial H_{12}}{\partial a} & \frac{\partial H_{22}}{\partial a} \\ \frac{\partial H_{11}}{\partial b} & \frac{\partial H_{12}}{\partial b} & \frac{\partial H_{22}}{\partial b} \\ \frac{\partial H_{11}}{\partial c} & \frac{\partial H_{12}}{\partial c} & \frac{\partial H_{22}}{\partial c} \end{vmatrix} = \left| \frac{1}{(ac - b^2)} \begin{bmatrix} -c^2 & bc & -b^2 \\ 2bc & -ac - b^2 & 2ab \\ -b^2 & ab & -a^2 \end{bmatrix} \right| \\ &= \frac{-c^2}{(ac - b^2)^6} \begin{vmatrix} -ac - b^2 & 2ab \\ ab & -a^2 \end{vmatrix} - \frac{bc}{(ac - b^2)^6} \begin{vmatrix} 2bc & 2ab \\ -b^2 & -a^2 \end{vmatrix} - \frac{-b^2}{(ac - b^2)^6} \begin{vmatrix} 2bc & -ac - b^2 \\ -b^2 & ab \end{vmatrix} \\ &= \frac{1}{(ac - b^2)^6} \left[ -a^3c^3 - a^2b^2c^2 + 2a^2b^2c^2 + 2a^2b^2c^2 - 2ab^4c - 2ab^4c + ab^4c + b^6 \right] \\ &= \frac{1}{(ac - b^2)^6} (ac - b^2)^3 = (ac - b^2)^{-3} = (ac - b^2)^{-(2+1)} = |K|^{-3} \end{aligned}$$

### General Proof:

The matrix differential of  $H = K^{-1}$  is:

$$\partial H = -K^{-1} \partial K K^{-1} \quad (\text{II.2.56})$$

It is sometimes convenient when we work with matrix differentiation to rearrange the elements of a  $m \times n$  matrix  $A = \{a_{ij}\}$  in the form on an  $mn$ -dimensional column vector. The conventional way of doing so is to successively stack the first, second, ...,  $n^{\text{th}}$  columns  $a_1, a_2, \dots, a_n$  of  $A$  one under the other, giving the  $mn$ -dimensional column vector:  $(a_1 \ a_2 \ \dots \ a_n)^T$ , this  $mn$ -dimensional column vector is referred to as the  $\text{vec}(A)$ . A special case appears

when the matrix  $A$  is symmetrical, we need to stack only the elements that are on or below the diagonal in this case  $vec(\cdot)$  become  $vech(\cdot)$  ( $h$  indicates half-matrix).

To illustrate this notation, let us consider the example of a matrix  $A$  given by:

$$A = \begin{bmatrix} a_{11} & a_{12} \\ a_{21} & a_{22} \end{bmatrix}$$

$$\text{We can write: } vec(A) = \begin{bmatrix} a_{11} \\ a_{12} \\ a_{21} \\ a_{22} \end{bmatrix},$$

$$\text{and if } A \text{ is symmetrical (i.e. } a_{12}=a_{21}\text{), we can write: } vech(A) = \begin{bmatrix} a_{11} \\ a_{12} \\ a_{22} \end{bmatrix}.$$

Applying theorem 16.2.1 in the work of A. Gupta [GUP00] to equation (II.2.56), we get:

$$vec(\partial H) = -vec(K^{-1} \otimes K^{-1}) vec(\partial K) \quad (\text{II.2.57})$$

where  $\otimes$  is the *Kronecker* operator. We can easily demonstrate that equation (II.2.57) can be written:

$$vech(\partial H) = -[H_n(K^{-1} \otimes K^{-1})G_n] vech(\partial K) \quad (\text{II.2.58})$$

where  $G_n$  (is called the duplication matrix) can be described in terms of its rows or columns. For  $i \geq j$ , the  $[(j-1)n+i]^{\text{th}}$  and  $[(i-1)n+j]^{\text{th}}$  rows of  $G_n$  are equal to the  $[(j-1)(n-j/2)+i]^{\text{th}}$  row of  $I_{n(n+1)/2}$ , that is, they are equal to the  $(n(n+1)/2)$ -dimensional row vector whose  $[(j-1)(n-j/2)+i]^{\text{th}}$  element is 1 and whose remaining elements are 0; and for  $i < j$ , the  $[(j-1)(n-j/2)+i]^{\text{th}}$  column of  $G_n$  is an  $n^2$  dimensional column vector whose  $[(j-1)n+i]^{\text{th}}$  and  $[(i-1)n+j]^{\text{th}}$  elements are 1 and whose remaining  $n^2-1$  (if  $i=j$ ) or  $n^2-2$  (if  $i > j$ ) elements are 0.  $H_n$  is the inverse matrix of  $G_n$ .

The Jacobean associated with the above transformation is simply the determinant of the matrix  $H_n(K^{-1} \otimes K^{-1})G_n$ , again by using theorem 16.4.2 of [GUP00] one obtains:

$$|H_n(K^{-1} \otimes K^{-1})G_n| = |K|^{-(n+1)} \quad (\text{II.2.59})$$



This is the generalization of the simple case of the PTM-FEM. This expression of the Jacobean of the inverse matrix transformation plays the central role in the determination of the response of linear stochastic systems.

Once the Jacobean is obtained, the rest of the procedure to obtain the *pdf* of  $H$  is very similar to that of the univariate case. In particular, we have:

$$f_H(H) = |H|^{-(n+1)} f_K(K) \quad (\text{II.2.60})$$

Once, the *pdf* of the inverse of stiffness matrix is known, the calculation of the *pdf* of the response is straightforward.

This formula is applicable to any symmetrical square random matrices, as long as the *pdf* of  $K$  is available (regardless of whether it is Gaussian or not). In the following, the application of this formula is illustrated on three common examples of random matrices.

**Example I: Gaussian stiffness matrix**

Let  $K$  be a symmetrical gaussian random matrix, the *pdf* of  $H = K^{-1}$  (i.e. joint *pdf* of all the elements of  $H$ ) can be obtained using the PTM technique:

$$f_H(H) = |H|^{-(n+1)} (2\pi)^{-n(n+1)/4} |B_n^T (\Sigma \otimes \Psi) B_n|^{-1/2} |\Psi|^{-n/2} \text{etr} \left\{ -\frac{1}{2} \Sigma^{-1} (H^{-1} - M) \Psi^{-1} (H^{-1} - M)^T \right\} \quad (\text{II.2.61})$$

In the special univariate case when  $n=1$ , this equation reduces to its corresponding univariate case. It is to be noted that Gaussian random matrix still has some probability to be non-positive definite, and hence it is not suitable for modeling stiffness matrix.

**Example II: Wishart stiffness matrix**

Wishart matrices are symmetrical and positive definite with probability one. In a recent paper, Adhikari [ADH06] showed that if only the mean of a system matrix is known, then its maximum entropy probability distribution follows the Wishart distribution with proper parameters. Wishart matrices are therefore the most important class of random matrices arising in linear mechanical systems.

When  $K$  is a Wishart matrix, the *pdf*  $H = K^{-1}$  can be obtained by:

$$f_H(H) = |H|^{-(p+n+1)/2} \left\{ 2^{\frac{1}{n}np} \Gamma_n \left( \frac{1}{2} p \right) |\Sigma|^{1/2^p} \right\}^{-1} \text{etr} \left\{ -\frac{1}{2} \Sigma^{-1} H^{-1} \right\} \quad (\text{II.2.62})$$

Using this exact *pdf*, the moments of the inverse matrix can be easily obtained.

**Example III:** Two-rod system

Let us consider the system illustrated below, where the mean of the stiffness matrices is given by:

$$\bar{K} = \begin{bmatrix} k_1 + k_2 & -k_2 \\ -k_2 & k_2 \end{bmatrix}$$

where the rigidities are given by:  $k_1 = EA_1/L$  and  $k_2 = EA_2/L$ .

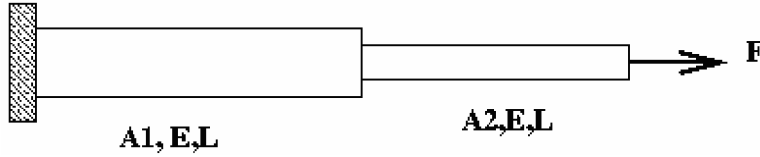

Figure II.2.5: Two-rod system.

For example, the joint *pdf* of the stiffness matrix follows a Wishart distribution, with parameters  $p = 7$  and  $\Sigma = \frac{1}{2\sqrt{7}} \bar{K}$ . This *pdf* is written:

$$f_K(K) = \left\{ 2^7 \Gamma_2 \left( \frac{1}{2} 7 \right) \bar{K}^{-\frac{1}{2} 7} \right\}^{-1} |K|^{\frac{1}{2}(4)} \text{etr} \left\{ -\frac{1}{2} \frac{\bar{K}^{-1}}{2\sqrt{7}} K \right\}$$

The system equilibrium is given by:  $KU = F$ . As  $K$  and  $F$  are independent, we have:

$$f_U(U) = f_K(K^{-1}) \cdot f_F(F)$$

Using the developed Jacobean formula, we can write:

$$f_U(U) = (k_1 k_2 + k_2 k_3 + k_1 k_3)^{-3} f_K(K) \cdot f_F(F)$$

This result is illustrated in the figure II.2.6, with the parameter values:

$$\bar{K} = \begin{bmatrix} 2 & -1 \\ -1 & 1 \end{bmatrix} \text{ and } f_F(F) = 1$$

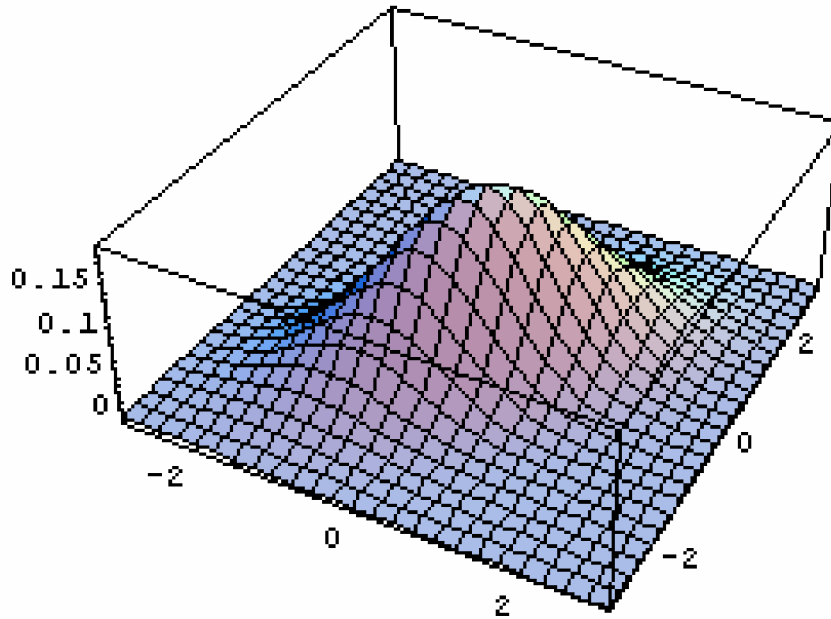
Figure II.2.6: joint pdf of  $(U_1, U_2)$ .

### Substructuring method

The method of substructuring, formulated by Przemieniecki in 1963 [IMB91], still plays an important role in the analysis of complex structures. This method consists in subdividing the structure into substructures (figure II.2.7) which are analyzed separately.

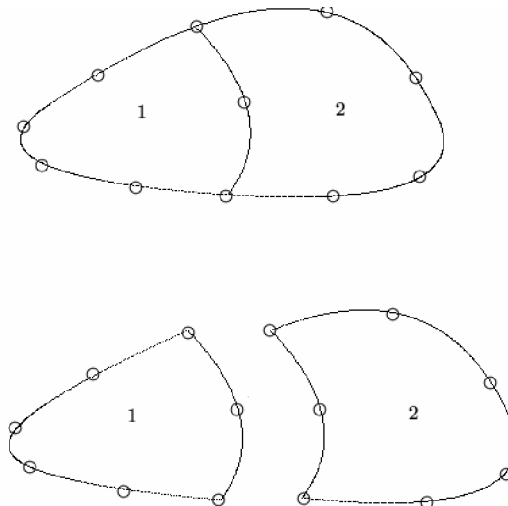

Figure II.2.7: substructure region.

We assume that the analyzed structure contains random sub-regions: for example, part (1) in the figure II.2.7 contains random parameters while part (2) is deterministic.

In general, the stiffness matrix become:

$$K = \begin{bmatrix} & & & ! & & & \\ & K_{ii} & & ! & & K_{ij} & \\ & & & ! & & & \\ - & - & - & ! & - & - & - \\ & & & ! & & & \\ & K_{ji} & & ! & & K_{jj} & \\ & & & ! & & & \end{bmatrix}$$

Where  $K_{ij}$  and  $K_{ji}$  represent two independent random substructure.

The static mode of link become:

$$\Phi_{ij} = -K_{ii}^{-1} K_{ij} \quad (\text{II.2.63})$$

Where  $K_{ii}$  is the stiffness matrix of the random part and  $K_{ij}$  for the constant part (in this situation  $K_{ii}$  and  $K_{ij}$  are independent).

And here we apply our formula and the PTM technique to evaluate the *pdf* of  $\Phi_{ij}$ :

$$f_{\Phi_{ij}}(\Phi_{ij}) = -|K_{ii}|^{-(i \times i - 1)} f_{K_{ii}}(K_{ii}) f_{K_{ij}}(K_{ij}) \quad (\text{II.2.64})$$

Using this formula we can calculate in exact form the *pdf* of complex structures or any part of any complex structures.

## II.2.4 PTM-FEM for engineering problems

In the following sections, we show how the PTM can be applied for different engineering problems: structural dynamics, reliability analysis and reliability-based optimization.

### II.2.4.1 PTM in structural dynamics

The dynamic characteristics of linear structural systems are governed by the natural frequencies and vibration modes. The determination of these natural frequencies and modes requires the solution of an eigenvalue problem. This problem could either be a differential eigenvalue problem or a matrix eigenvalue problem, depending on whether a continuous model or a discrete model is used to describe the given vibrating system.

The random eigenvalue problem of undamped systems is expressed by:

$$K\Phi_i = \omega_i M\Phi_i \quad (\text{II.2.65})$$

where  $\omega_i$  and  $\Phi_i$  are the eigenvalues and the eigenvectors of the dynamical system. The matrices  $M \in R^{n \times n}$  and  $K \in R^{n \times n}$  define the internal state of the structure. The statistical properties of the dynamical system are completely described by the joint *pdf* of  $\omega_i$  and  $\Phi_i$ . So, the main goal of studying random eigenvalue problems is to obtain the joint *pdf* of the eigenvalues and the eigenvectors.

In the following section, we consider the univariate and the multivariate cases.

#### II.2.4.1.a. Univariate Case

To better illustrate the procedure, let us consider the case of one degree of freedom.

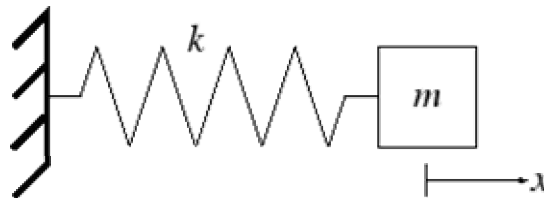

Figure II.2.8: Mass-Spring system.

The equation of motion in free vibration is noted:

$$m\ddot{x} + kx = 0 \quad (\text{II.2.66})$$

where  $m$  is the mass,  $k$  is the stiffness and  $x$  is the displacement. The eigenvalue is simply given by:

$$\omega = \sqrt{\frac{k}{m}}$$

Assume that *pdf* of the random variable  $k$  is given by  $f_k(k)$ , the response  $\omega$  becomes random where the *pdf* can be determined by the PTM. The Jacobean of the transformation is given by:

$$J = \left| \frac{\partial \omega}{\partial k} \right| = \left| \frac{1}{\sqrt{km}} \right|$$

The probability density function of  $\omega$  is thus:

$$f_\omega(\omega) = \left| \frac{\partial k}{\partial \omega} \right| \times f_k(k) = \sqrt{km} \times f_k(k) \quad (\text{II.2.67})$$

The case of random mass is quite similar.

#### II.2.4.1.b. Multivariate Case

In the multivariate case, the main problem is the unavailable analytical method to solve the system of eigenvalues  $K\Phi_j = \omega_j M\Phi_j$  for a dynamical system. Only for some problems we can find, in closed form, the *pdf* of the eigenvalue. For general problems, iterative numerical methods like the Power Method and Lanczos Method [BOS93] are available for solving such a problem.

In the context of structural dynamics [GMU97], it is necessary to consider random eigenvalue problems. In the following, the joint *pdf* of the eigenvalues is developed for the case of free vibrations.

The mass matrix is considered as random. The equation of motion in free vibration is written:

$$M\ddot{X} + KX = 0 \quad (\text{II.2.68})$$

This differential equation has a general solution  $X = A\cos(\omega t)$ , where  $A$  is the amplitude and  $\omega$  is the angular frequency. Replace  $X$  in (II.2.68):

$$KA - M\omega^2 A = 0 \quad (\text{II.2.69})$$

A non trivial solution is possible if the following determinant is nil:

$$|M^{-1}K - \omega^2 I| = 0 \quad (\text{II.2.70})$$

Knowing the *pdf* of  $M$ , the *pdf* of  $M^{-1}$  can be evaluated by the proposed formula in the above sections ( $J = |M|^{-(n+1)}$ ). The PTM can be thus applied to get  $f_{\omega}(\omega)$ .

The algorithm is shown in the following figure. The angular frequency is calculated in terms of the random variables. The Jacobean determinant is calculated for the frequency function. This may be carried out either analytically, or numerically. The *pdf* of the eigenvalue can thus be obtained by direct application of the PTM.

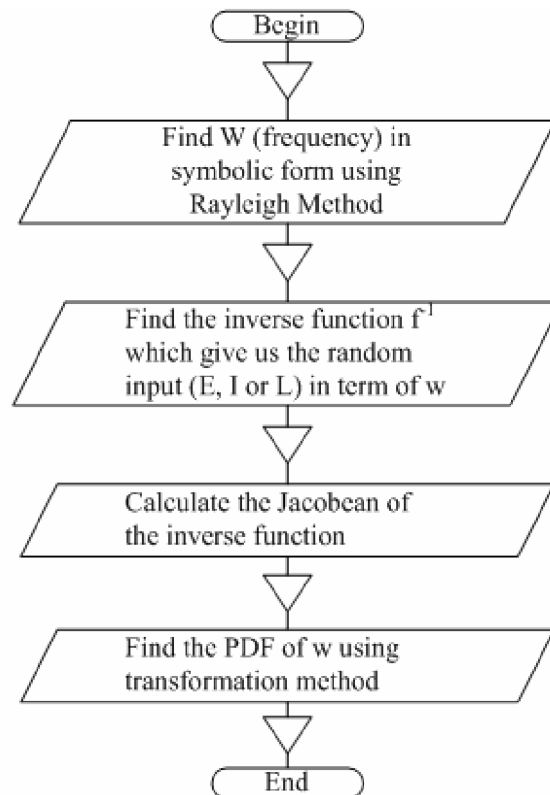

Figure II.2.9: Algorithm of Rayleigh-PTM method.

### II.2.4.2 PTM-FEM in Reliability Analysis [KAD06a]

The reliability analysis is based on the calculation of the failure probability. As the information on the probability density function of the mechanical response is not available, approximate methods like First and second order reliability method (FORM/SORM) as well as Monte Carlo simulations, have to be applied. The main drawbacks of these methods are that the mapping of the failure function onto a standardized set involves significant computational effort for nonlinear black box numerical models. In addition, simultaneous evaluation of probabilities corresponding to multiple failure criteria would involve significant additional effort.

As the PTM-FEM technique allows us to determine the *pdf* of the mechanical response with high precision, even for the distribution tails, the flowchart for reliability analysis becomes simple as it consists in integrating the *pdf* of the response over the failure region. Usually, this can be carried out by one-dimensional numerical integration.

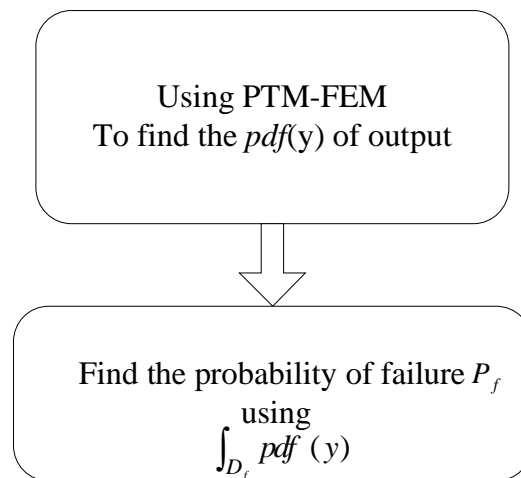

Figure II.2.10: PTM-FEM and failure probability.

For several cases, we can get the *pdf* of the response in closed form then we evaluate the failure probability in close form also by using simple one-dimensional integral. In this case, the PTM has the advantage of high accuracy with low computation time, compared to other approximation methods.



### II.2.4.3 PTM-FEM in structural optimization

The general goal of engineering design is to maximize the system utility or to minimize its life-cycle cost, which includes the costs for developing, manufacturing and maintaining the system. The design of engineering structures on the basis of probability concepts leads to more consistent safety levels. Since there are large conflicts between the design goals, a compromise is required to balance the utility and cost over the lifetime of the system.

The Reliability-Based Design Optimization (RBDO) aims to find the best compromise between cost reduction and safety assurance. The RBDO solution that reduces the structural weight in uncritical regions both provides an improved design and a higher level of confidence in the structure. In general, the RBDO is based on two optimization loops: the outer one concerns the design variables to be optimized and the inner one concerns the evaluation of the reliability index for a given configuration (figure II.2.11).

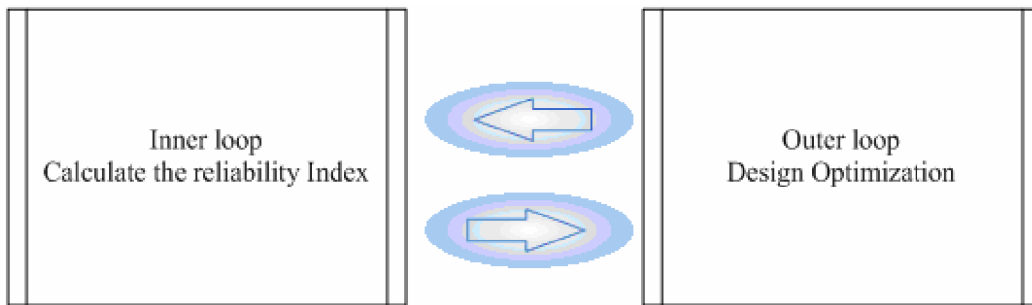

Figure II.2.11: classic RBDO

In order to avoid the calculation of the reliability index and the separation of the solution in two spaces which leads to very large computational time, the probabilistic transformation method (PTM) allows us to define a closed form expression of the response, and hence the inner loop can be suppressed. The computation cost is thus strongly reduced, as the inner loop is not needed. The optimization problem under failure probability and deterministic constraints is:

$$\begin{aligned}
 \min \quad & : f(x) \\
 \text{subject to} \quad & : g_k(x) \leq 0 \quad k = 1, \dots, K \\
 \text{and} \quad & : P_f(x, u) \leq P_{f,t}
 \end{aligned}$$

where  $f(x)$  is the objective function,  $g_k(x) \leq 0$  are the deterministic constraints,  $P_f(x, u)$  is the failure probability of the structure and  $P_{f,t}$  is the admissible failure probability.

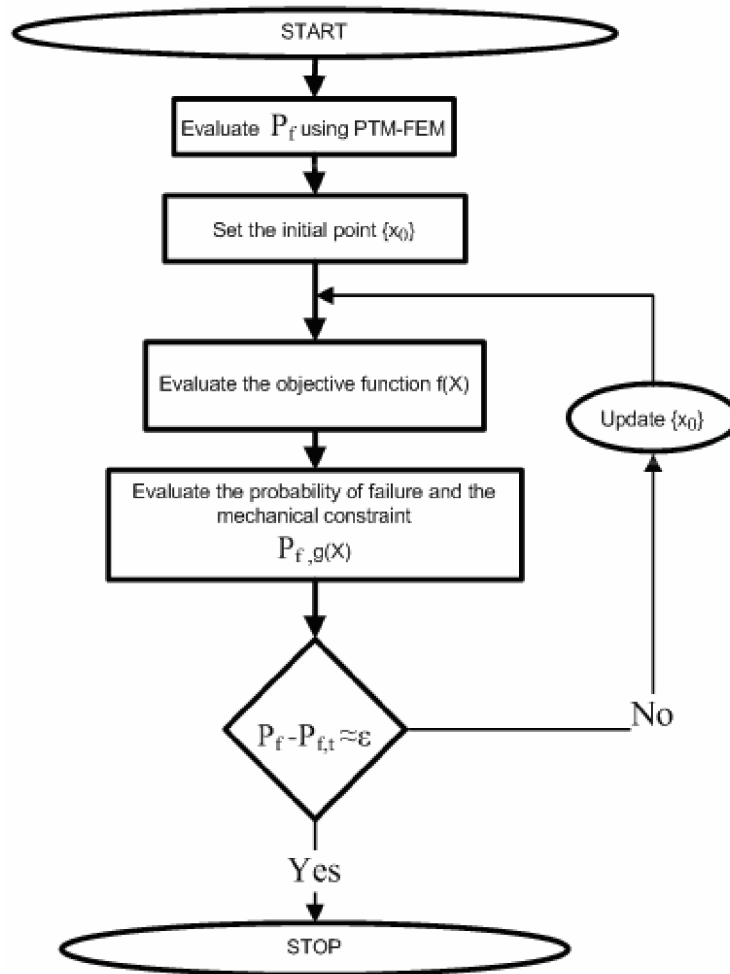

Figure II.2.12: PTM-FEM and RBDO.

The advantage of the PTM-FEM in the context of the structure optimization is considerable as the computation time for the failure probability is extremely reduced. The RBDO is solved in only one outer loop.

## II.2.5 Conclusion

In this chapter, the new proposed PTM-FEM technique is presented. The theory and the generalization of this technique is developed for static and dynamic problems. The efficiency of this technique makes it suitable for coupling with finite element models. It is also to mention that this procedure allows us to obtain the whole probability density function of the mechanical response, allowing for accurate reliability analysis and structural optimization.

# Chapter 3

## Validation

II.3.1 Introduction-----	90
II.3.2 Random Differential Equation-----	90
II.3.3 Probabilistic analysis of a Cantilever Beam-----	92
II.3.4 Probabilistic analysis of two-rod system-----	94
II.3.5 Stochastic eigenvalue of beam structure-----	96
II.3.6 Reliability Analysis of 3-bar truss structure-----	98
II.3.7 RBDO of 6-bar truss structure-----	100
II.3.8 Conclusion-----	103

### II.3.1 Introduction

The aim of this chapter is to validate the Probabilistic Transformation Method on simple examples, in order to verify its performance and domain of validity for solving engineering problems. It aims also to show how the PTM can be applied in practice. This validation is mandatory before dealing with more realistic structures, which is the goal of chapter 3.

The simple examples are chosen to cover different structural analysis fields:

- 1- Random differential equation
- 2- Static analysis
- 3- Structural dynamics
- 4- Reliability analysis
- 5- Structural optimization

For these examples, the accuracy of the proposed method is evaluated by comparison with Monte Carlo simulations.

### II.3.2 Random Differential Equation

This example aims to combine the PTM technique with some numerical techniques to solve linear random differential equations.

Random differential equations appear in many applications related to random evolutions, such as interface growth and evolution of surfaces, and fluids subject to random forces.

The solution of a linear random differential equation is obtained by knowledge of the probability density function of the output variable [KAD07a]. For this purpose, several methods can be applied, such as Fokker-Planck equation, Wiener-Hermit development, perturbation method, local stochastic linearization, decomposition method and stochastic finite element method. Contrary to many of these methods, the PTM gives an analytical description of the *pdf* of the solution. For nonlinear differential equations, we propose a method based on the combination of Newton and the Continuation method [GRA98, KAD07b].

Two cases are shown below:

a) Let us solve the following differential equation with random parameter ( $k$ ):

$$\frac{dy}{dx} - kx = 0 \quad (x \neq 0)$$

with  $y_0 = 1$  and  $k$  a uniformly distributed random variable over the range  $[1,2]$  (i.e.  $k \Rightarrow U[1,2]$ ).

The solution is simply:  $y = \frac{kx^2}{2} + 1$ , which allows us to write the transformation Jacobean as:  $|J| = \frac{dk}{dy} = \frac{2}{x^2}$ . For  $x=2$  the *pdf* of the solution is thus:  $f_y(y) = \frac{2}{4} f_k(k)$ , as shown in figure II.3.1.

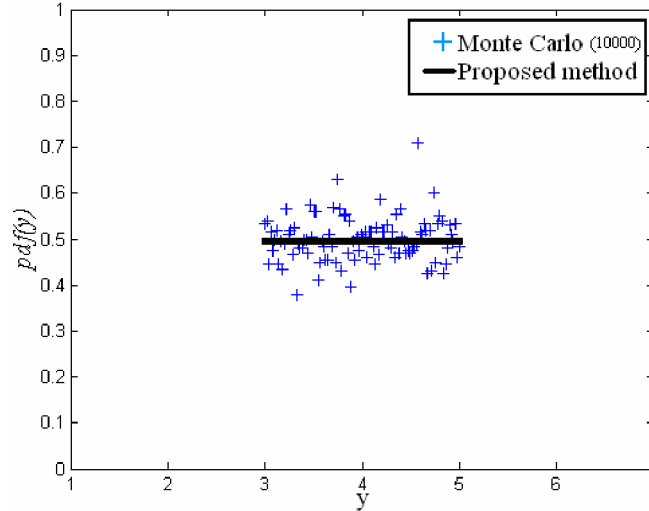

Figure II.3.1: Probability Density Function of  $y$  when  $k \in U(1,2)$ .

b) Let us now consider the non-homogeneous random differential equation:

$$\frac{dy}{dx} = y + x^2$$

with  $y_0 = k$ ;  $k$  being a standard random normal variable. The solution of this differential equation is:

$$y = (k+2)e^x - (x^2 + 2x + 2)$$

and hence by inversion:

$$k = e^{-x}(y + (x^2 + 2x + 2)) - 2$$

The determinant of the Jacobean  $|J| = -e^{-x}$  allows us to write the *pdf* of the solution as:

$$f_y(y) = e^{-x} f_k(k)$$

Naturally, the *pdf* of  $y$  evolves with the parameter  $x$ , as the solution of the differential equation is a function of this coordinate. Figure II.3.2 shows the *pdf* of  $y$  at the origin  $x=0$ .

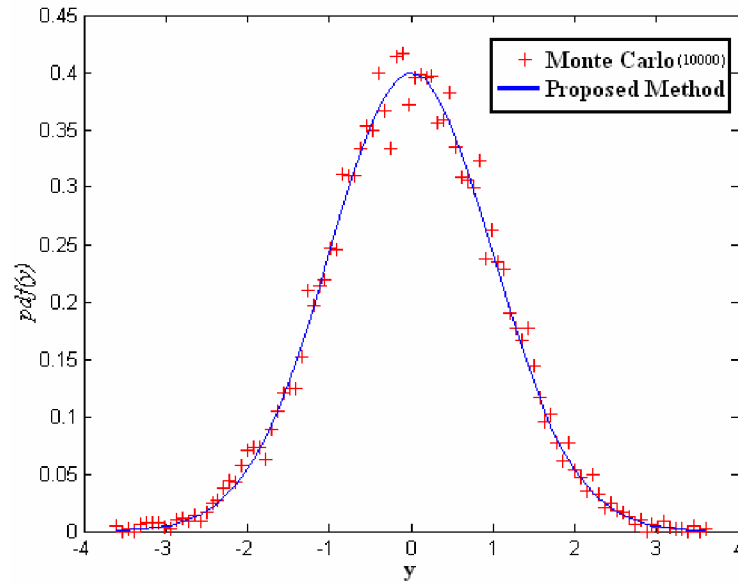

Figure II.3.2: Probability Density Function of  $y$  when  $k$  is  $N[0,1]$ .

### II.3.3 Probabilistic Analysis of a Cantilever Beam [KAD06a]

The goal of this example is to evaluate the *pdf* of the cantilever beam displacement (figure II.3.3), in a closed-form, knowing the input random variables: Young's modulus  $E$  and distributed load  $w$  [KAD06c].

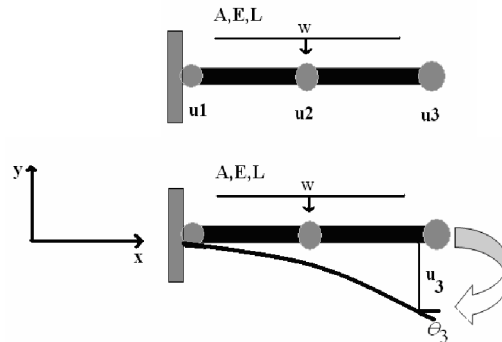

Figure II.3.3: cantilever beam.

The analysis of this beam with two finite elements leads to the following system:

$$\frac{8EI}{L^3} \begin{bmatrix} 24 & -12L & -12 & 6L \\ -12L & 8L^2 & -6L & 2L^2 \\ -12 & 6L & 12 & -6L \\ 6L & 2L^2 & -6L & 4L^2 \end{bmatrix} \begin{bmatrix} u_2 \\ \theta_2 \\ u_3 \\ \theta_3 \end{bmatrix} = \begin{bmatrix} \frac{wL}{3} \\ \frac{wL^2}{48} \\ \frac{wL}{3} \\ \frac{wL^2}{48} \end{bmatrix}$$

Under some simplifications, the displacement of node 3 is given by:  $u_3 = \frac{wL^4}{8EI}$ . For probabilistic analysis, two cases are considered:

**Case 1:** Young's modulus  $E$  is uniformly distributed in the range  $[10^8, 3 \times 10^8]$  kPa. The application of the PTM technique leads to the following result (figure II.3.4):

<i>pdf of E</i>	<i>pdf of <math>u_3</math></i>
$\begin{cases} \frac{1}{2 \cdot 10^8} & \text{if } \frac{1}{3 \cdot 10^8} \leq E \leq \frac{1}{10^8} \\ 0 & \text{if not} \end{cases}$	$\begin{cases} \frac{wL^4}{16 \cdot 10^8 I u_3^2} & \text{if } \frac{wL^4}{24 \cdot 10^8 I} \leq u_3 \leq \frac{wL^4}{8 \cdot 10^8 I} \\ 0 & \text{if not} \end{cases}$

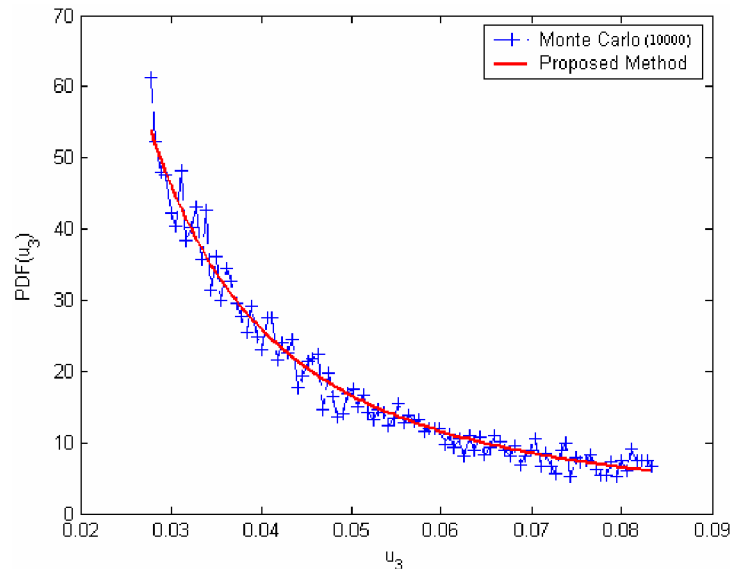

Figure II.3.4: Probability Density Function of  $u_3$  when  $E$  is  $U[10^8, 3 \times 10^8]$ .

**Case 2:**  $w$  is normally distributed with mean equal to 12 kN/m and standard deviation equal to 1 kN/m. The PTM leads to the *pdf* of the displacement (figure II.3.5).

<i>pdf of <math>w</math></i>	<i>pdf of <math>u_3</math></i>
$\left\{ \frac{1}{\sqrt{2\pi}} e^{-(w-12)^2/2} \right.$	$\left. \left\{ \frac{8EI}{L^4 \sqrt{2\pi}} e^{-\frac{1}{2} \left( \frac{8EIu_3}{L^4} - 12 \right)^2} \right. \right.$

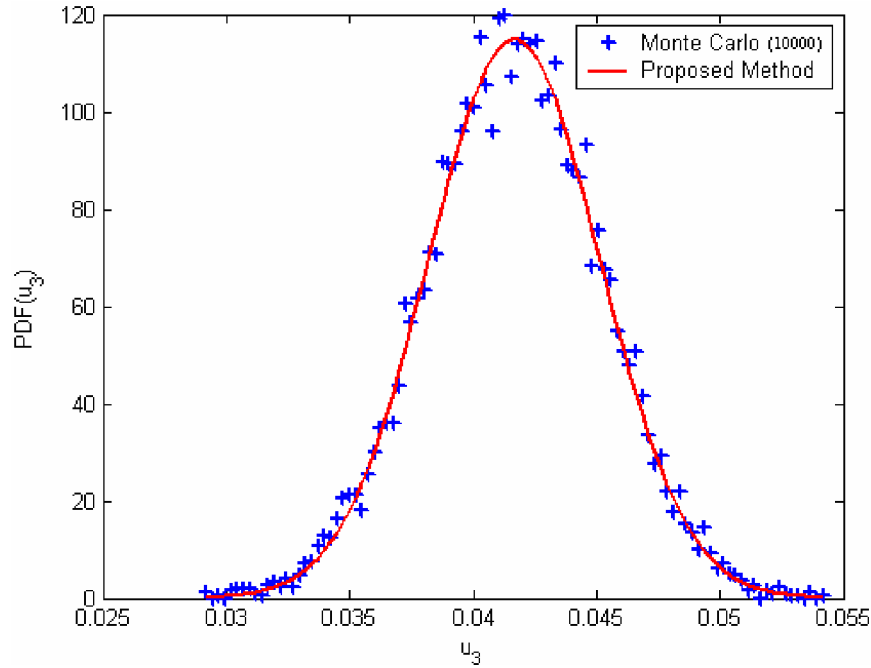

Figure II.3.5: Probability Density Function of  $u_3$  when  $w$  is  $N[12,1]$ .

### II.3.4 Probabilistic response of two-rod system [KAD06b]

In this example, the PTM technique is applied to evaluate the probability density function of a two-rod system (figure II.3.6) with uncertain parameters. In this example, we consider the load  $F$  and the stiffness  $E$  as random (i.e. 2 input random variables and one output).

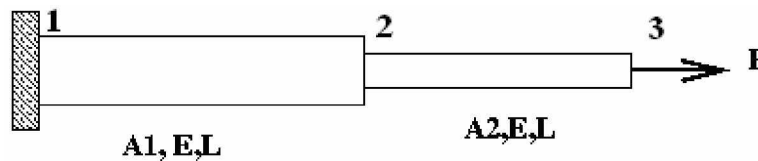

Figure II.3.6: two rod system.

Each rod has a cross-section area  $A_i$ , with Young's modulus  $E$  and length  $L$ . The axial rigidity of the element is simply:  $k_i = \frac{EA_i}{L}$ . The structure is modeled with two classical bar elements, leading to the following equilibrium equations:

$$\begin{bmatrix} k_1 & -k_1 & 0 \\ -k_1 & k_1 + k_2 & -k_2 \\ 0 & -k_2 & k_2 \end{bmatrix} \begin{bmatrix} u_1 \\ u_2 \\ u_3 \end{bmatrix} = \begin{bmatrix} f_{11} \\ f_{12} + f_{22} \\ f_{23} \end{bmatrix}$$



In our case, all forces are nil unless  $f_{11}$  and  $f_{23} = F$ . The boundary condition implies  $u_1 = 0$ , leading to:

$$\begin{bmatrix} k_1 + k_2 & -k_2 \\ -k_2 & k_2 \end{bmatrix} \begin{bmatrix} u_2 \\ u_3 \end{bmatrix} = \begin{bmatrix} 0 \\ F \end{bmatrix}$$

The solution of this system leads to:  $u_2 = \frac{F}{k_1}$ ,  $u_3 = F \left( \frac{1}{k_1} + \frac{1}{k_2} \right)$ . The *pdf* of the displacement is considered, when the load  $F$  is exponentially distributed with mean equal to 0.05 (i.e.  $f_F(F) = 0.05 e^{-0.05F}$ ) and the bar rigidity  $k_1$  is uniformly distributed in the range  $[10^8, 3 \times 10^8]$ . The joint *pdf* of these two independent variables is (figure II.3.7):

$$f_{k_1, F}(k_1, F) = \begin{cases} \frac{1}{40 \cdot 10^8} \exp(-0.05F), & \text{for } 0 \leq F, 10^8 \leq k_1 \leq 3 \times 10^8 \\ 0.0, & \text{Otherwise} \end{cases}$$

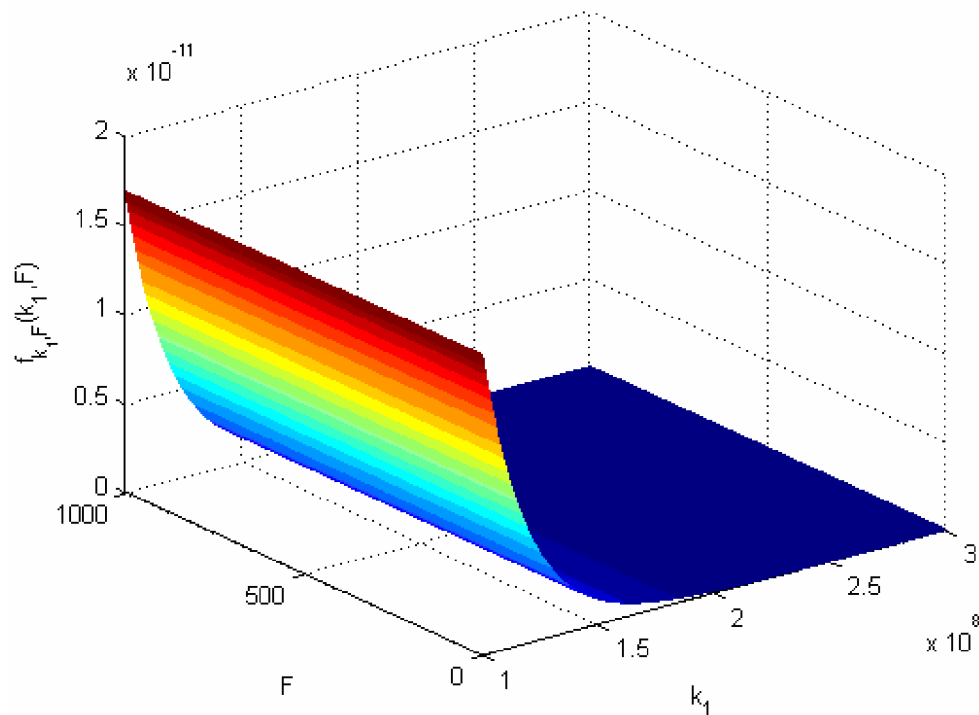

Figure II.3.7: Joint density function of load and rigidity.

As we have two input variables, an auxiliary variable  $Z$  has to be defined in order to allow for one-to-one transformation; for this reason, we choose  $Z=E$ . The joint *pdf* of  $U_2$  and  $Z$  is thus obtained by the PTM:

$$f_{U_2,Z}(u_2, z) = \begin{cases} \frac{z}{145440 \times 10^8} \exp\left(-\frac{z u_2}{72720}\right) & \text{for } u_2 \geq 0, 10^8 \leq Z \leq 3.10^8 \\ 0.0, & \text{Otherwise.} \end{cases}$$

The marginal *pdf* of  $U_2$  is obtained by integration of the joint *pdf* over the range of  $Z$ , leading to (figure II.3.8):

$$f_{U_2}(u_2) = \begin{cases} \frac{10^{-8}}{2u_2} \left[ \left( 3 \times 10^8 - \frac{72720}{u_2} \right) \exp\left(\frac{5 \times 10^6}{1212} u_2\right) - \left( 10^8 - \frac{72720}{u_2} \right) \exp\left(\frac{5 \times 10^6}{3636} u_2\right) \right], & u_2 > 0. \\ 0.0, & \text{Otherwise} \end{cases}$$

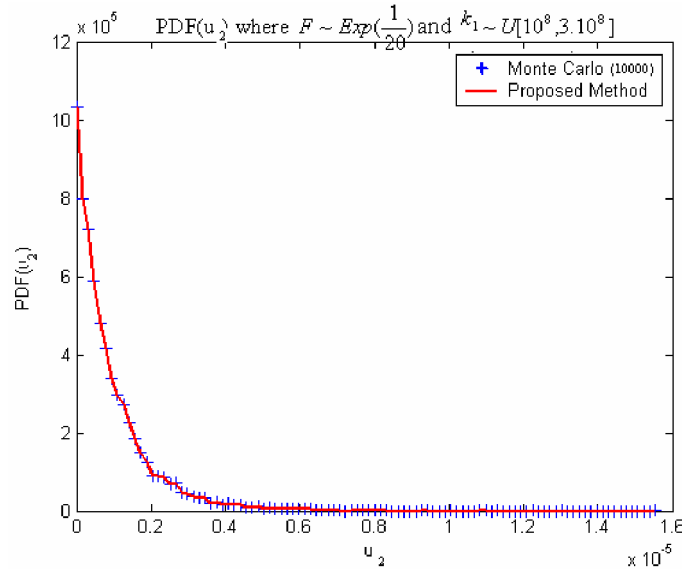

Figure II.3.8: Density function of the displacement  $u_2$ .

### II.3.5 Stochastic eigenvalue beam structure [KAD06c]

For structural dynamics analysis of beam structures, the PTM technique is combined with the Rayleigh method to get the *pdf* of the natural frequency under random input parameters. Figure II.3.9 shows a simply supported beam which lumped mass  $M$  and concentrated load  $F$ .

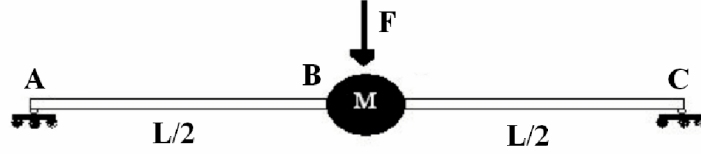

Figure II.3.9: beam subjected to a central point F.

The deflected shape of the left-hand side of the beam is given by:

$$y = A \left[ 3 \left( \frac{x}{L} \right) - 4 \left( \frac{x}{L} \right)^3 \right]$$

where  $A$  is the deflection amplitude. The maximum kinetic energy of the point mass is given by  $\frac{1}{2} M \omega^2 A^2$  and the deformation kinetic energy of an element  $dx$  with self-mass  $m$  per unit length is  $\frac{1}{2} (mdx) \omega^2 y^2$ . Integrating the latter value over the beam length, the total kinetic energy of the whole system can be written as:

$$T_{\max} = 0.5 M \omega^2 A^2 + 2 \times \frac{1}{2} m \omega^2 A^2 \int_0^{L/2} \left[ 3 \left( \frac{x}{L} \right) - 4 \left( \frac{x}{L} \right)^3 \right]^2 dx = \omega^2 A^2 (0.5M + 0.243mL)$$

Since the external work for the deflected shape is  $FA$  in which  $A = \frac{FL^3}{48EI}$ , the maximum strain energy is:  $V_{\max} = \frac{24EIA^2}{L^3}$ . Therefore, from the virtual work principle  $\delta T_{\max} = \delta V_{\max}$ , the natural frequency is found as:

$$\omega = \sqrt{\frac{24EI}{(0.5M + 0.243mL)L^3}}$$

In order to apply the PTM technique, the above relationship is inverted to give the Young's modulus expression:

$$E = f^{-1}(\omega) = \frac{\omega^2 (0.5M + 0.243mL)L^3}{24I}$$

The Jacobean is now  $|J| = \frac{\omega(0.5M + 0.243mL)L^3}{12I}$ . By applying the PTM, we obtain the pdf of  $\omega$ :

$$f_{\omega}(\omega) = \frac{\omega(0.5M + 0.243mL)L^3}{12I} \cdot f_E(E)$$

For illustrative purpose,  $E$  is assumed to be exponentially distributed with mean equal to 1, leading to (see figure II.3.10):

$$f_{\omega}(\omega) = \frac{\omega(0.5M + 0.243mL)L^3}{12I} \cdot e^{-\frac{\omega^2(0.5M+0.243mL)L^3}{24I}}$$

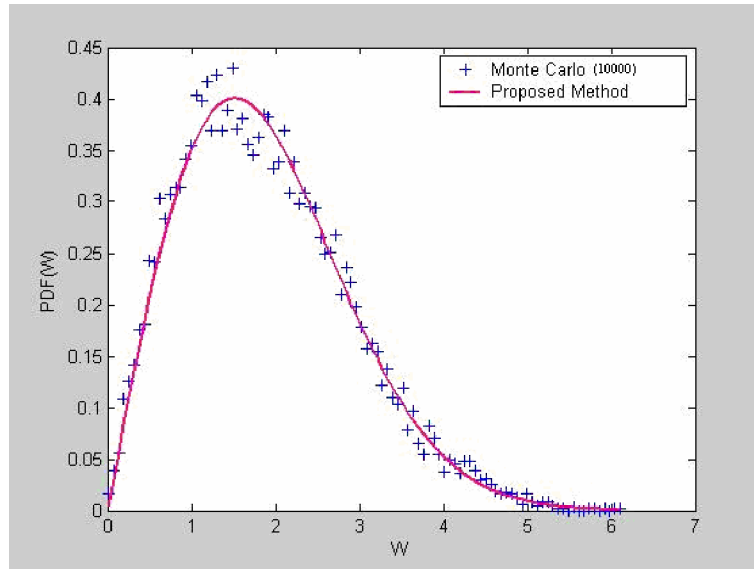

Figure II.3.10:  $f_{\omega}(\omega)$  when  $E$  is exponentially distributed.

### II.3.6 Reliability analysis of 3-Bar truss structure

Contrary to the above examples, this application aims to show how the PTM can be used for reliability analysis. The three-bar truss [TAW91] shown in figure II.3.11, is subjected to random applied force  $P$ . The goal is to give a closed-form evaluation of the failure probability of the limit state related to vertical displacement of node 2. The accuracy of the PTM technique is compared with results obtained by 10000 Monte Carlo simulations.

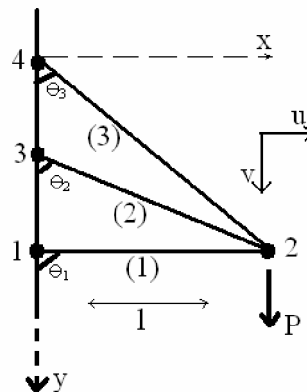

Figure II.3.11: Three-bar truss structure.

For a truss element, the stiffness matrix, in global coordinates, is given by:

$$[K^e]^{(i)} = \frac{A^i E^i}{l_i} \begin{bmatrix} \lambda^2 & \lambda\mu & -\lambda^2 & -\lambda\mu \\ \lambda\mu & \mu^2 & -\lambda\mu & -\mu^2 \\ -\lambda^2 & -\lambda\mu & \lambda^2 & \lambda\mu \\ -\lambda\mu & -\mu^2 & \lambda\mu & \mu^2 \end{bmatrix}$$

where  $i$  is the element number,  $A$  is the cross-section,  $E$  is the Young's modulus,  $l$  is the element length,  $\lambda = \cos \alpha$  and  $\mu = \sin \alpha$ , with  $\alpha$  the angle between local and global coordinate systems. For the studied truss, the global stiffness matrix is:

$$[K]^g = \frac{AE}{l_1} \begin{bmatrix} \frac{8+3\sqrt{3}+2\sqrt{2}}{8} & \frac{3+2\sqrt{2}}{8} \\ \frac{3+2\sqrt{2}}{8} & \frac{3+2\sqrt{2}}{8} \end{bmatrix}$$

The solution gives the vertical displacement of node 2 as:

$$v_2 = 3.25 \frac{Pl_1}{AE}$$

In the case of  $P$  normally distributed with mean equal to 1.2 and standard deviation of 0.9, the PTM gives:

<i>pdf of P</i>	<i>pdf of v<sub>2</sub></i>
$\left\{ \frac{1}{0.9\sqrt{2\pi}} e^{-\frac{(P-1.2)^2}{2 \times 0.9^2}} \right\}$	$\left\{ \frac{AE}{3.25l_1} \cdot \frac{1}{0.9\sqrt{2\pi}} e^{-\frac{(\frac{AEv_2}{3.25l_1} - 1.2)^2}{2 \times 0.9^2}} \right\}$

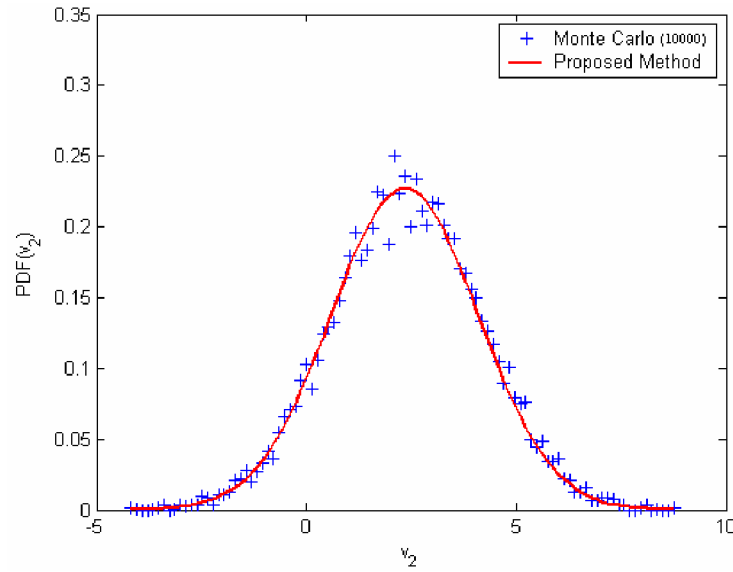
Figure II.3.12:  $pdf$  of  $v_2$  where  $P$  is  $N[1.2,0.9]$ .

For reliability analysis, the displacement is limited to  $v_{2l} = 2mm$ . Using the data:  $E = 5 daN/cm^2$ ,  $l_1 = 3 cm$  and  $A = 1 cm^2$ , it is required to calculate the failure probability:  $P_f = \Pr[v \geq v_{2l}]$ .

$$P_f = \int_2^{\infty} PDF(v_2) = \int_2^{\infty} \frac{AE}{3.25l_1} \cdot \frac{1}{0.9\sqrt{2\pi}} \cdot e^{-\frac{(\frac{AEv_2}{3.25l_1} - 1.2)^2}{2 \times 0.9^2}} dv_2 = \int_2^{8.7562} \frac{5}{9.75} \cdot \frac{1}{0.9\sqrt{2\pi}} \cdot e^{-\frac{(\frac{5v_2}{9.75} - 1.2)^2}{2 \times 0.9^2}} dv_2 = 0.5840$$

This result is confirmed by 1000 Monte Carlo simulations giving 0.5823.

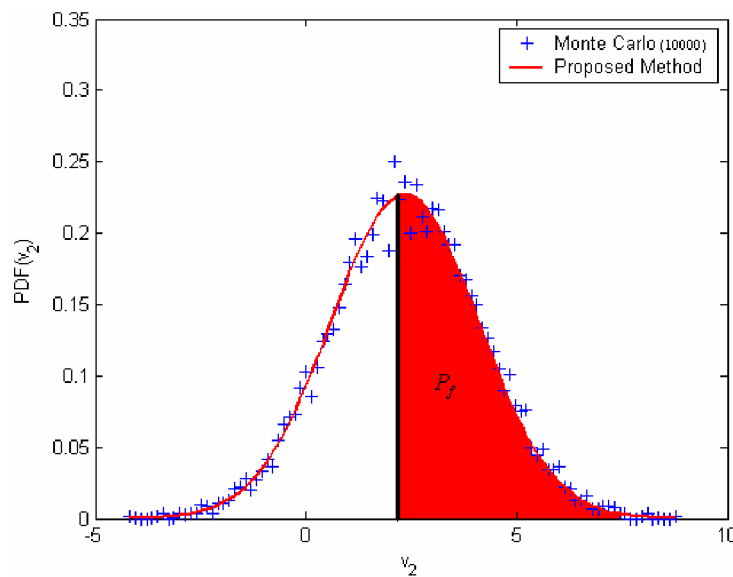

Figure II.3.13: probability of failure.

### II.3.7 Reliability Base Design Optimization of 6-bar truss structure [KAD07c]

The interest of PTM is highly important in Reliability-Based Design Optimization RBDO, as it allows us to avoid many reliability evaluations and numerical errors, leading to very large computer time reduction. The explicit knowledge of the failure probability is also very interesting, as it gives the exact gradient operator without numerical errors, which strongly accelerates the optimization algorithm. In this example, the RBDO is applied for a six-bar truss (figure II.3.14) with random modulus  $E$  and applied force  $F$ . The truss width and height are given by:  $L=10\text{m}$ , and the cross-section areas are:  $A=0.0015\text{m}^2$ .

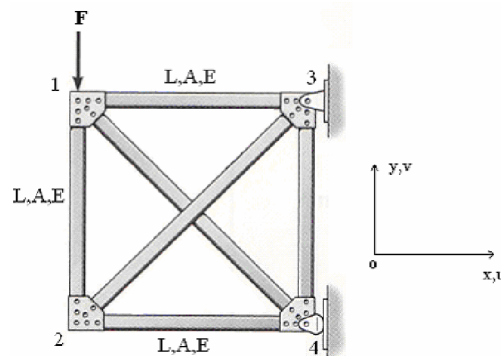

Figure II.3.14: 6-bar truss structure.

The stiffness matrices for the bar elements are given by:

Bar 3-1	Bar 4-2	Bar 4-3
$\frac{EA}{L} \begin{bmatrix} 1 & -1 \\ -1 & 1 \end{bmatrix} \begin{bmatrix} u_3 \\ u_1 \end{bmatrix}, \begin{bmatrix} F_{x3} \\ F_{x1} \end{bmatrix}$	$\frac{EA}{L} \begin{bmatrix} 1 & -1 \\ -1 & 1 \end{bmatrix} \begin{bmatrix} u_4 \\ u_2 \end{bmatrix}, \begin{bmatrix} F_{x4} \\ F_{x2} \end{bmatrix}$	$\frac{EA}{L} \begin{bmatrix} 1 & -1 \\ -1 & 1 \end{bmatrix} \begin{bmatrix} v_4 \\ v_3 \end{bmatrix}, \begin{bmatrix} F_{y4} \\ F_{y3} \end{bmatrix}$
Bar 2-1	Bar 3-2	Bar 4-1
$\frac{EA}{L} \begin{bmatrix} 1 & -1 \\ -1 & 1 \end{bmatrix} \begin{bmatrix} v_4 \\ v_3 \end{bmatrix}, \begin{bmatrix} F_{y2} \\ F_{y1} \end{bmatrix}$	$\frac{EA}{4L} \begin{bmatrix} 1 & -1 & -1 & 1 \\ -1 & 1 & 1 & -1 \\ -1 & 1 & 1 & -1 \\ 1 & -1 & -1 & 1 \end{bmatrix} \begin{bmatrix} u_3 \\ v_3 \\ u_2 \\ v_2 \end{bmatrix}, \begin{bmatrix} F_{x3} \\ F_{y3} \\ F_{x2} \\ F_{y2} \end{bmatrix}$	$\frac{EA}{4L} \begin{bmatrix} 1 & 1 & -1 & -1 \\ 1 & 1 & -1 & -1 \\ -1 & -1 & 1 & 1 \\ -1 & -1 & 1 & 1 \end{bmatrix} \begin{bmatrix} u_4 \\ v_4 \\ u_1 \\ v_1 \end{bmatrix}, \begin{bmatrix} F_{x4} \\ F_{y4} \\ F_{x1} \\ F_{y1} \end{bmatrix}$

The assembly leads to the global equilibrium system which is given to simplify under reduced form:

$$\frac{EA}{4L} \begin{bmatrix} 5 & -1 & -1 & 1 \\ 1 & 5 & 1 & -1 \\ 0 & 0 & 5 & -1 \\ 0 & -4 & -1 & 5 \end{bmatrix} \begin{bmatrix} u_1 \\ v_1 \\ u_2 \\ v_2 \end{bmatrix} = \begin{bmatrix} F_{x1} \\ F_{y1} \\ F_{x2} \\ F_{y2} \end{bmatrix}$$

where the solution gives:

$$u_1 = \frac{6FL}{11EA}, \quad v_1 = -\frac{30FL}{11EA}, \quad u_2 = -\frac{5FL}{11EA}, \quad v_2 = -\frac{25FL}{11EA}$$

The force  $F$  and the modulus  $E$  are independent random variables. To apply the PTM on this system, we introduce a fictitious random variable, say  $Z=E$ , as a second probabilistic output. The transformation Jacobean is thus:

$$J = \begin{vmatrix} \partial E/\partial u_1 & \partial E/\partial Z \\ \partial F/\partial u_1 & \partial F/\partial Z \end{vmatrix} = \frac{11ZA}{6L}$$

Using the PTM technique, we can get:

$$f_{u_1,Z}(u_1, Z) = f_{E,F}[E, F] \cdot |J|$$

The independence of  $F$  and  $E$  allows us to write:

$$f_{E,F}(E, F) = f_E(E) \cdot f_F(F)$$

Finally, the *pdf* of the response is computed from the following integral:

$$f_{u_1}(u_1) = \int_{D_{u_1,z}} f_{u_1,Z}(u_1, z) \cdot dz \quad ,$$

For numerical application, let us consider the example where  $F$  and  $E$  are uniformly distributed in the ranges  $[10,30]$  and  $[10^8, 3 \times 10^8]$  respectively. In this case, the PTM leads to:

Joint <i>pdf</i> of E and F	Joint <i>pdf</i> of $u_1$ and z
$f_{E,F}(E, F) = \begin{cases} \frac{10^{-8}}{40}, & \text{if } 10 \leq F \leq 30, 10^8 \leq E \leq 3.10^8 \\ 0.0, & \text{Otherwise} \end{cases}$	$f_{u_1,Z}(u_1, Z) = \begin{cases} \frac{11ZA}{240 \cdot 10^8 L}, & \text{if } \frac{60L}{11ZA} \leq u_1 \leq \frac{180L}{11ZA}, \\ & 10^8 \leq Z \leq 3.10^8 \\ 0.0, & \text{Otherwise.} \end{cases}$

The *pdf* of the displacement  $u_1$  is:

$$f_{u_1}(u_1) = \begin{cases} \frac{1}{8 \times 3636 \times 10^9} \left[ \left( \frac{30 \times 3636}{u_1} \right)^2 - 10^{16} \right] & ; \frac{3636}{10^7} \leq u_1 \leq \frac{10908}{10^7} \\ \frac{1}{8 \times 3636 \times 10^9} \left[ 9 \cdot 10^{16} - \left( \frac{10 \times 3636}{u_1} \right)^2 \right] & ; \frac{3636}{3 \cdot 10^7} \leq u_1 \leq \frac{3636}{10^7} \\ 0.0 & ; \text{Otherwise.} \end{cases}$$



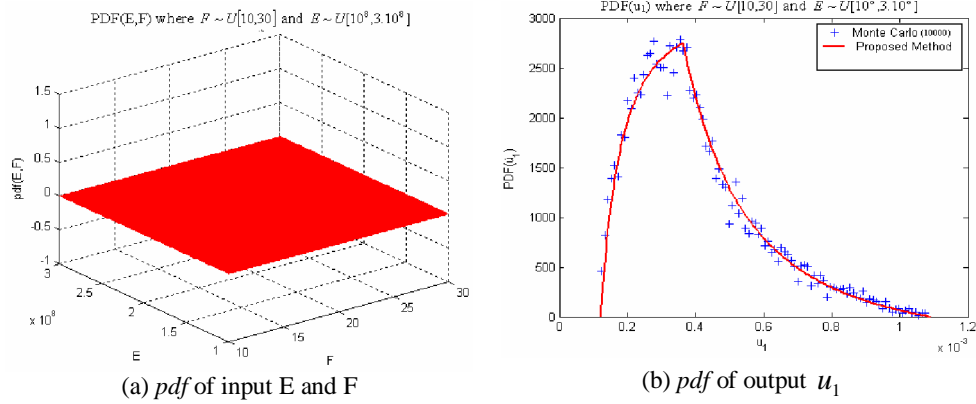

Figure II.3.15: pdf of input v/s pdf of output.

Let us admit a limit displacement is  $u_{l1} = 6.10^{-5}$  mm, it is required to find the failure probability  $P_f = P(u_1 \geq u_{l1}) = \int_{u_{l1}}^{\infty} f_{u_1}(u_1) \cdot du_1$ .

$$P_f = \int_{0.00006}^{\infty} f_{u_1}(u_1) \cdot du_1 = \int_{0.00006}^{0.00109} \frac{1}{8 \times A \times 2424 \times 10^{12}} \left[ \left( \frac{30 \times 3636}{u_1} \right)^2 - 10^{16} \right] du_1 = \frac{11}{A.50} = \frac{0.22}{A}$$

It becomes very easy to formulate explicitly the RBDO problem. If the cross-section area is defined by the breadth  $w$  and the thickness  $t$ , the RBDO is written:

$$\min_{w,t} f = w * t$$

subject to

$$1 \leq w, \quad t \leq 5, \quad 6.32 \leq w + t \leq 6.33$$

and

$$P_f = \frac{0.22}{w * t} \leq 0.0013$$

The solution of the above problem is found as:  $w = 2.48\text{cm}$ ,  $t = 3.84\text{cm}$ . The comparison with classical RBDO (using FORM) shows that the computation time for this application is divided by more than 100, when the PTM is applied.

### II.3.8 Conclusion

In this chapter, the validity of the Probabilistic Transformation Method for solving engineering problems is verified on a number of simple examples. The comparison with Monte Carlo Simulations confirms the sound basis of the method and techniques proposed in the previous chapter. More complex structures will be considered in the following chapter.

# Chapter 4

## Applications

II.4.1 Introduction-----	105
II.4.2 Space truss with 25-Bars -----	105
II.4.3 Perforated plate under tension -----	111
II.4.4 Two-story frame -----	114
II.4.5 Conclusion-----	116

## II.4.1 Introduction

In this chapter, the PTM-FEM is applied to more realistic structures. The first one concerns the stochastic response of a 25-bar space truss, where the random variables are related to the modulus of elasticity, the applied load and the member cross-sections. The second application is focussed on plane elasticity problem given by a perforated plate under tension, where the perforation radius is considered as random.

## II.4.2 Space truss with 25-Bars

The space truss, illustrated in figure II.4.1, is formed of twenty-five bar elements and subjected to vertical dead loads and horizontal loads representing the wind action. The random variables are related to Young's modulus  $E$ , cross-section  $S$  and horizontal load  $q$ . The limit state to be considered is given by the ultimate displacement.

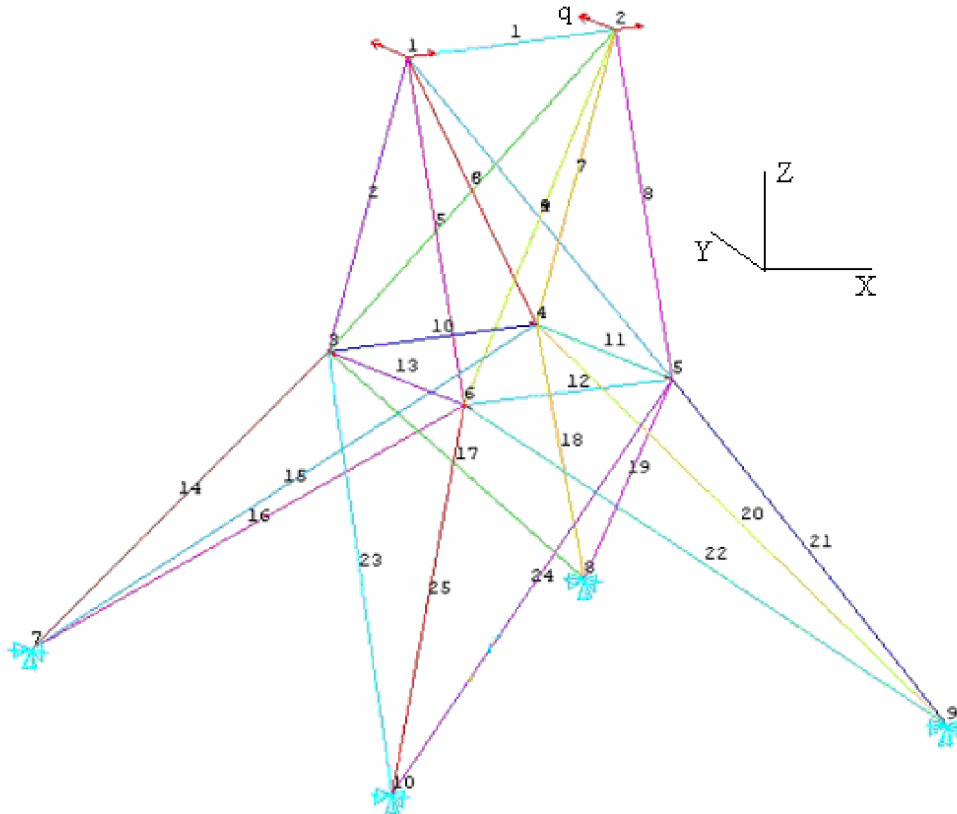

Figure II.4.1: 25-Bar truss structure.

By symmetry, the cross-sections are grouped in six categories, as indicated in the following table:

Bar	Section
1	$S_1$
2,5,7,8	$S_2$
3,4,6,9	$S_3$
10,11,12,13	$S_4$
14,18,21,25	$S_5$
15,16,17,19,20,22,23,24	$S_6$

An alternative to the inversion of the stiffness matrix consists in computing the structural flexibility. As our interest is focussed on the nodal displacements, the unit load theorem (derived from the virtual work principle) allows us to calculate the nodal displacement by applying the following formula:

$$u = \sum_{i=1}^n \frac{N_i \bar{N}_i}{ES_i} L_i$$

where  $N_i$  is the normal effort due to the applied load,  $\bar{N}_i$  is the normal effort due to a unit load applied at the considered node in the displacement direction,  $E$  is the Young's modulus,  $S_i$  and  $L_i$  are respectively the cross-section and the length of the bar number “ $i$ ”.

The following table indicates the normal forces in the truss members due to: vertical load, horizontal load and unit loads in the three directions at nodes 1 and 2, as well as the member lengths.

Bar	Vertical Load(N)	Horizontal Load(N)	$F_{x1} = 1(N)$	$F_{y1} = 1(N)$	$F_{z1} = 1(N)$	$F_{x2} = 1(N)$	$F_{y2} = 1(N)$	$F_{z2} = 1(N)$	Length $L_i$ (mm)
1	118496	0.000	-0.44778	0.000	-0.116842	0.44778	0.000	-0.116842	18000
2	-182632	-108058	0.39318	-0.88916	0.4508	0.31882	-0.04387	-0.08319	25632
3	-103094	-181168	-0.48044	-0.65356	0.101654	-0.38958	0.053606	0.101654	31321
4	-103094	24564	-0.48044	0.65356	0.101654	-0.38958	-0.053606	0.101654	31321
5	-182632	236220	0.39318	0.88916	0.4508	0.31882	0.04387	-0.08319	25632
6	-103094	-34814	0.38958	0.053606	0.101654	0.48044	-0.65356	0.101654	31321
7	-182632	-227820	-0.31882	-0.04387	-0.08319	-0.39318	-0.88916	0.4508	25632
8	-182632	99670	-0.31882	0.04387	-0.08319	-0.39318	0.88916	0.4508	25632
9	-103094	191418	0.38958	-0.053606	0.101654	0.48044	0.65356	0.101654	31321
10	-2112.2	27160	0.021874	0.075444	-0.013032	-0.021874	0.075444	-0.013032	18000
11	25438	25416	0.142222	0.000	-0.010987	0.140172	0.000	-0.071498	18000
12	-2112.2	-27160	0.021874	-0.075444	-0.013032	-0.021874	-0.075444	-0.013032	18000
13	25438	-25416	-0.140172	0.000	-0.071498	-0.142222	0.000	-0.010987	18000
14	-261700	-84148	0.57096	-0.52328	0.35794	0.57524	-0.6071	0.022956	32031
15	-142550	-129638	-0.147116	-0.034886	-0.041108	-0.154788	-0.54426	0.24192	43474
16	-136254	138918	0.2779	0.17921	0.17797	0.27976	0.122694	0.009951	43474

17	-142550	-78852	0.154788	-0.54426	0.24192	0.147116	-0.034886	-0.041108	43474
18	-261700	-322780	-0.57524	-0.6071	0.022956	-0.57096	-0.52328	0.35794	32031
19	-136254	-30232	-0.27976	0.122694	0.009951	-0.2779	0.17921	0.17797	43474
20	-136254	-70148	-0.27976	-0.122694	0.009951	-0.2779	-0.17921	0.17797	43474
21	-261700	116470	-0.57524	0.6071	0.022956	-0.57096	0.52328	0.35794	32031
22	-142550	133196	0.154788	0.54426	0.24192	0.147116	0.034886	-0.041108	43474
23	-136254	-38536	0.2779	-0.17921	0.17797	0.27976	-0.122694	0.009951	43474
24	-142550	75296	-0.147116	0.034886	-0.041108	-0.154788	0.54426	0.24192	43474
25	-261700	290460	0.57096	0.52328	0.35794	0.57524	0.6071	0.022956	32031

By applying the unit force theorem, the calculation of the horizontal displacement, i.e. the maximal displacement,  $u_{y2}$  at node 2 in the  $y$  direction, leads to:

$$u_{y2} = \frac{10^6 q}{180E} \left( \frac{0}{S_1} + \frac{7.85094}{S_2} + \frac{4.28558}{S_3} + \frac{0.073766}{S_4} + \frac{14.64698}{S_5} + \frac{6.428099}{S_6} \right)$$

where  $E$  is the Young's modulus,  $q$  is the horizontal Load and  $S_i$  is the cross-section of the  $i^{th}$  bar.

### **Probabilistic study of $u_{y2}$**

For simplicity and without loss of generality, we assume a constant cross-sections for the truss members (i.e.  $S_i=S$ ), leading to:

$$u_{y2} = \frac{184918.72 q}{E S}$$

Let us consider the cases where one of the three variables  $E$ ,  $q$  or  $S$  is random.

Case 1:  $E$  is uniformly distributed in the range  $[10^5, 3 \times 10^5]$ . The *pdf* of the displacement is thus:

$$f_{U_{y2}}(u_{y2}) = |J| f_E(E) = \frac{184918.72 q}{u_{y2}^2 S} f_E(E)$$

$$= \begin{cases} \frac{184918.72 q 10^{-5}}{2u_{y2}^2 S} & \text{for } \frac{184918.72 q}{3 \times 10^5 S} \leq u_{y2} \leq \frac{184918.72 q}{10^5 S} \\ 0 & \text{otherwise} \end{cases}$$

Figure II.4.2 illustrates  $f_{U_{y2}}(u_{y2})$  for  $q = 180$  kN and  $S = 2000$  mm<sup>2</sup>.

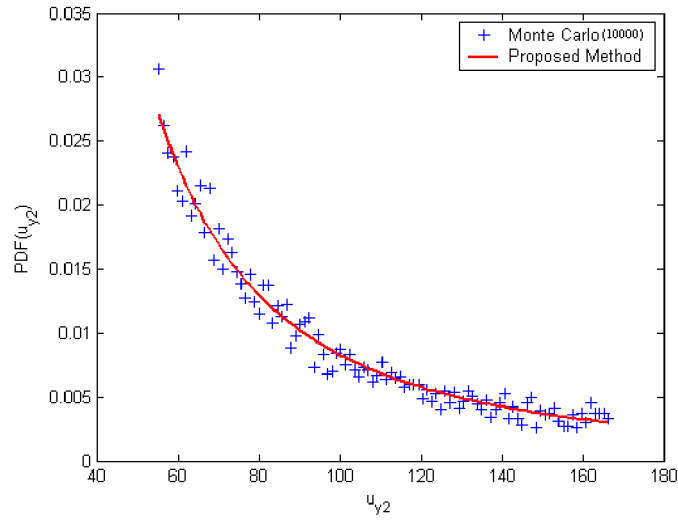
Figure II.4.2: *pdf* of  $u_{y2}$ .

For a limit displacement given by:  $\bar{u} = 120\text{mm}$ , it is required to calculate the failure probability (figure II.4.3)  $P_f = \Pr[u_{y2} \geq \bar{u}]$ , which is as follows:

$$P_f = \int_{120}^{\infty} f_{U_{y2}}(u_{y2}) du_{y2} = \int_{120}^{\infty} \frac{1.8491872 q}{2u_{y2}^2 S} du_{y2} = \int_{120}^{166} \frac{166.42685}{2u_{y2}^2} du_{y2} = 0.19$$

This result is confirmed by 10000 Monte Carlo simulations giving 0.1890.

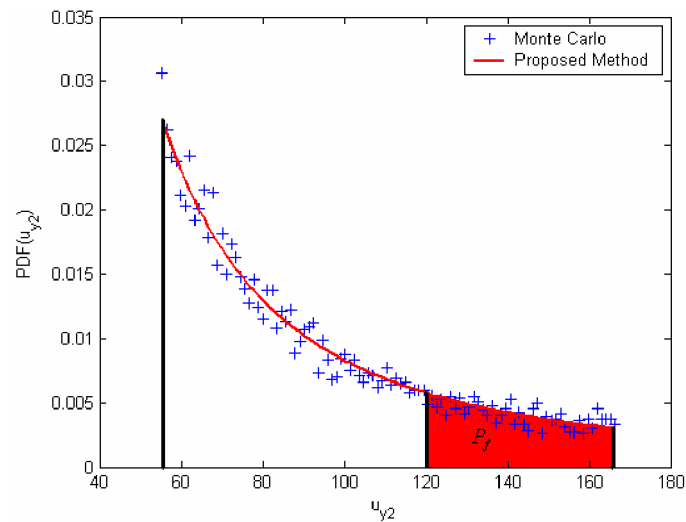

Figure II.4.3: Probability of failure.

Case 2:  $q$  is exponentially distributed with unit mean. In this case, we can write:

$$f_{U_{y_2}}(u_{y_2}) = |J| f_q(q) = \left( \frac{ES}{184918.72} \right) f_q(q) = \frac{ES}{184918.72} e^{-\frac{ESu_{y_2}}{184918.72}} \quad (\text{figure II.4.4})$$

with the numerical values:  $E = 200000$  MPa and  $S = 2000$  mm<sup>2</sup>. For a limit displacement per unit load given by:  $u_{y_2} = 0.0005$ , the failure probability (figure II.4.5) is:

$$\begin{aligned} P_f &= \int_{0.0005}^{\infty} f_{U_{y_2}}(u_{y_2}) du_{y_2} = \int_{0.0005}^{\infty} \frac{ES}{184918.72} e^{-\frac{ESu_{y_2}}{184918.72}} du_{y_2} \\ &= \int_{0.0005}^{0.004} 4.6 \times 10^{-4} e^{-4.6 \times 10^{-4} u_{y_2}} du_{y_2} = 0.34 \end{aligned}$$

which is close to Monte Carlo result: 0.3382.

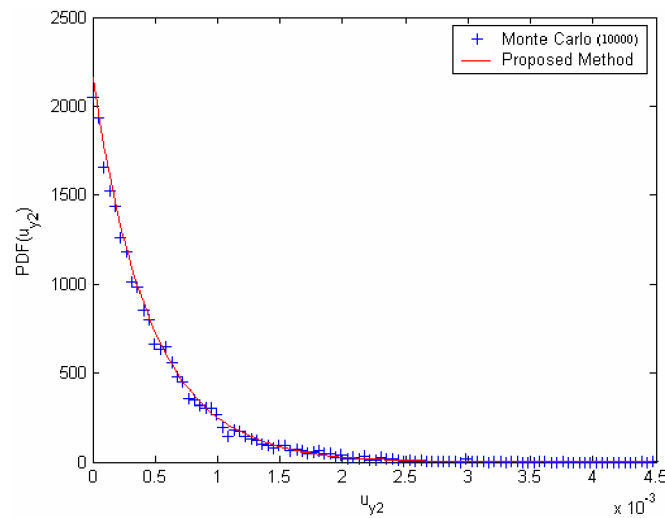

Figure II.4.4: *pdf* of  $u_{y_2}$ .

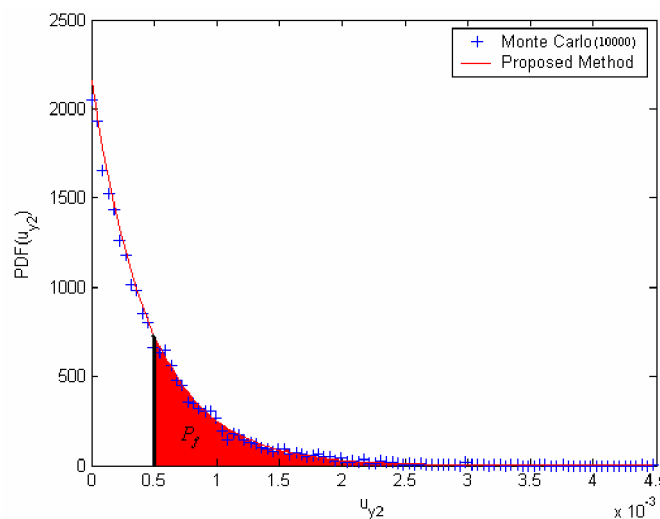

Figure II.4.5: Probability of failure.

Case 3:  $S$  is normally distributed with mean equal to 20 and standard deviation equal to 1. The displacement  $pdf$  is written:

$$f_{U_{y_2}}(u_{y_2}) = |J| f_S(S) = \frac{184918.72 q}{E u_{y_2}^2} f_S(S)$$

$$= \frac{184918.72 q}{E u_{y_2}^2} \cdot \frac{1}{\sqrt{2\pi}} e^{-\frac{1}{2} \left( \frac{184918.72 q}{E u_{y_2}^2} - 20 \right)^2} \quad (\text{figure II.4.6})$$

with  $q = 180$  kN and  $E = 200000$  MPa. If the limit displacement is set to:  $u_{y_2} = 8500$ , the failure probability (figure II.4.7) is:

$$P_f = \int_{8500}^{\infty} f_{U_{y_2}}(u_{y_2}) du_{y_2} = \int_{8500}^{10272} \frac{184918.72 q}{E u_{y_2}^2} \cdot \frac{1}{\sqrt{2\pi}} e^{-\frac{1}{2} \left( \frac{184918.72 q}{E u_{y_2}^2} - 20 \right)^2} du_{y_2}$$

$$= \int_{8500}^{10272} \frac{1.66426}{u_{y_2}^2} \times \frac{1}{\sqrt{2\pi}} e^{-\frac{1}{2} \left( \frac{1.66426}{u_{y_2}} - 20 \right)^2} du_{y_2} = 0.33$$

which is almost the same as Monte Carlo result: 0.3334.

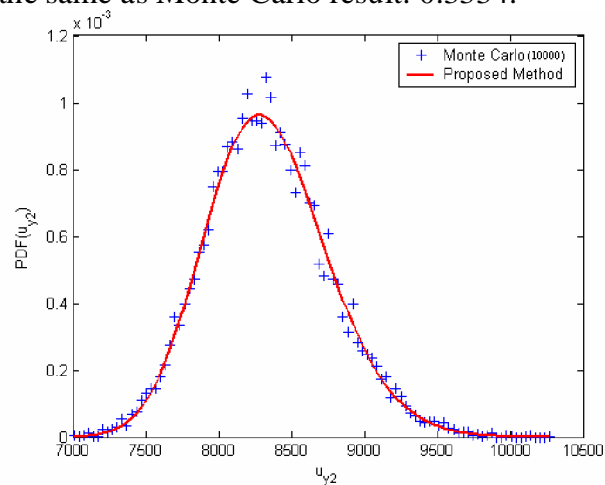

Figure II.4.6:  $pdf$  of  $u_{y_2}$ .

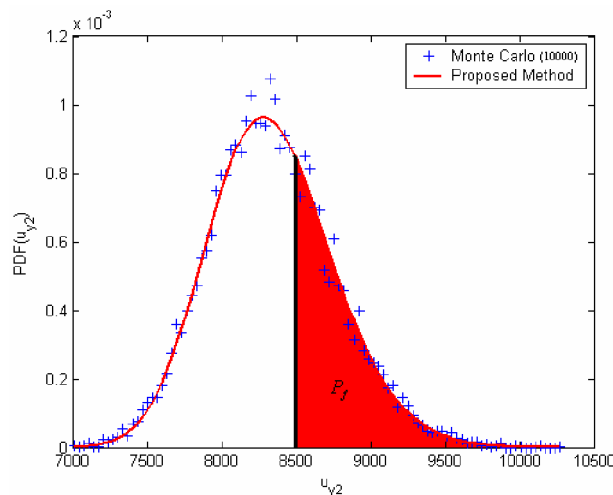

Figure II.4.7:  $pdf$  of  $u_{y_2}$ .



### II.4.3 Perforated plate under tension

The PTM-FEM approach is applied to a thin perforated plate fixed at one end and under tension on the other end (figure 4.8). The plate, of thickness  $t = 1$  mm, has for half-width  $B = 100$  mm and for hole radius  $R = 30$  mm. The applied tensile force  $T = 10$  kN is uniformly distributed over the plate edge. The material is isotropic with Young's modulus  $E = 210$  GPa, Poisson's ratio  $\nu = 0.3$  and yield stress  $f_Y = 200$  MPa. In this application, the hole radius  $R$  is considered as uncertain variable.

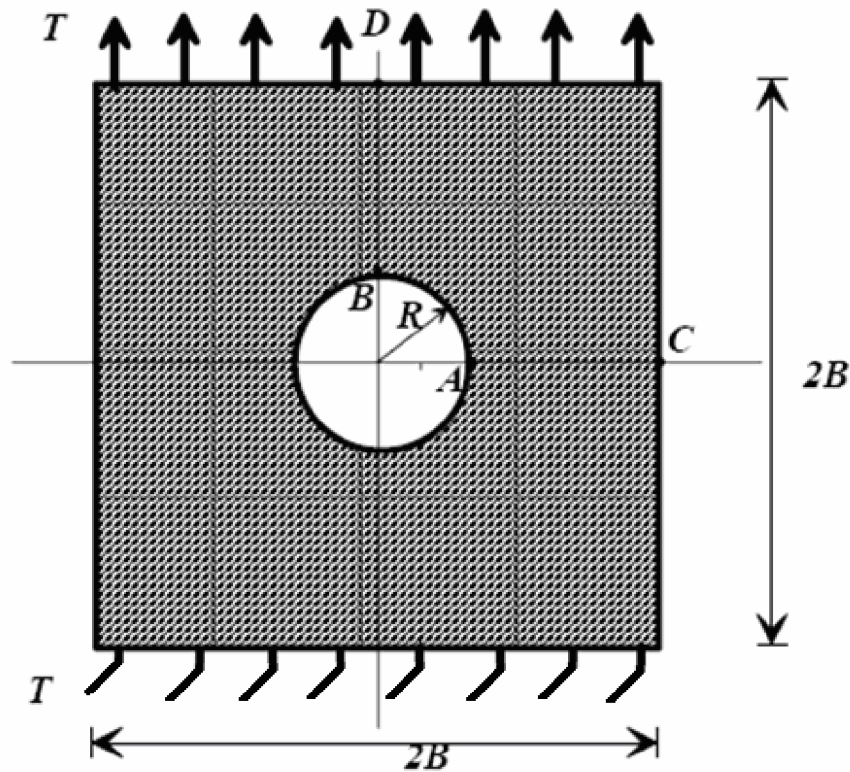

Figure II.4.8: Perforated plate.

The software Matlab has been used to the discretization of this structure with the finite element mesh shown in the figure II.4.9.

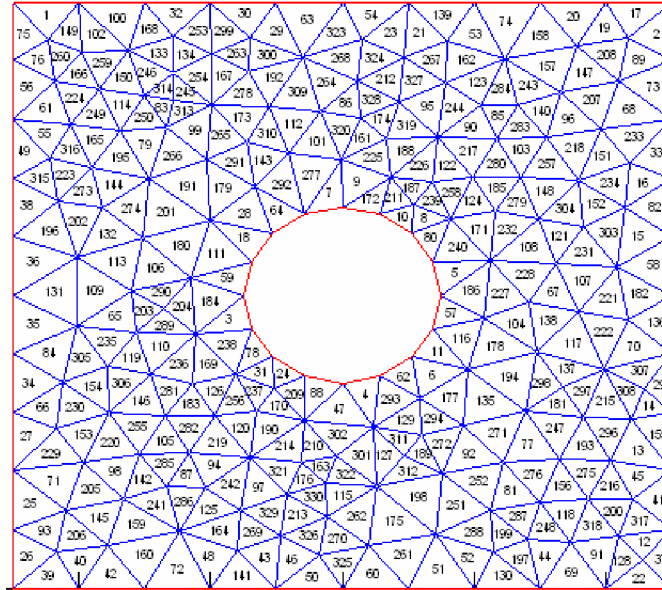

Figure II.4.9: Discretization of the perforated plate.

Figure II.4.10 gives a 3D representation of the plate displacement. It is to be noted that the lower edge has been fixed while the tensile force is applied on the upper edge.

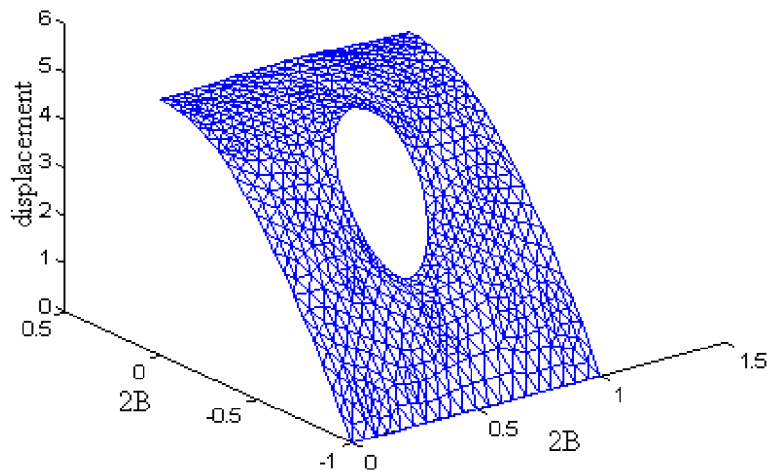

Figure II.4.10: Displacement of the perforated plate.

For this plate, the maximum stress ( $\sigma_A$ ) is localized at the hole perimeter on the axis of symmetry: i.e. point A in figure II.4.8. In order to apply the PTM method, we have built a regression curve (figure II.4.11) relating the tensile stress to the hole radius (random variable of the system). This curve leads to the following relationship:

$$\sigma_A = 81.36 - 1839.70 R + 12335.05 R^2 - 24259.87 R^3$$

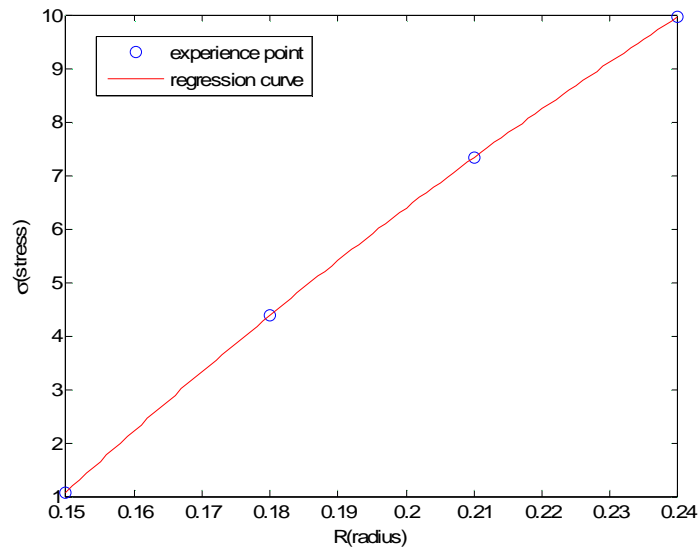

Figure II.4.11: Regression curve  $\sigma_A$ -R.

For the computation of the transformation Jacobean, the inverse function is required. The third degree polynomial is also applied for regression (figure II.4.12), leading to:

$$R = 0.141878 + 8.094 \times 10^{-3} \sigma_A - 1.1988 \times 10^{-5} \sigma_A^2 + 1.5984 \times 10^{-5} \sigma_A^3$$

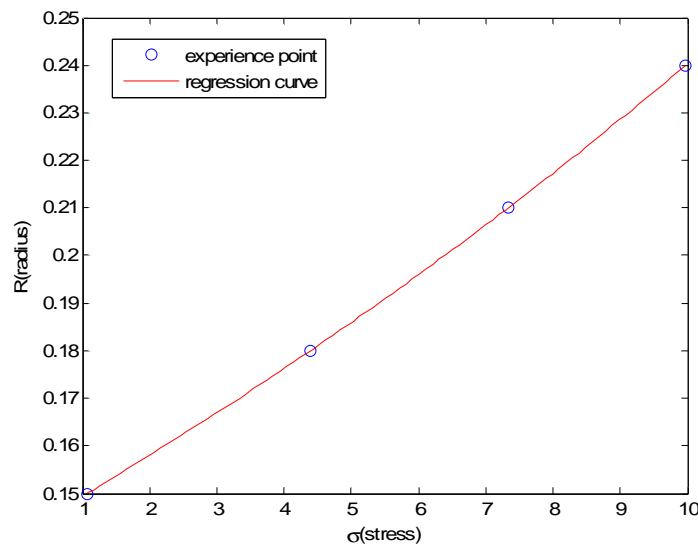

Figure II.4.12: Regression curve R- $\sigma_A$

Using the PTM-FEM, the *pdf* of the maximum tensile stress when the radius uniformly distributed in the range [0.15, 0.24] is (figure II.4.13):

$$f_{\sigma_A}(\sigma_A) = |J| f_R(R) = \left(0.008094 - 0.000024\sigma_A + 0.000048\sigma_A^2\right) \frac{100}{9}$$

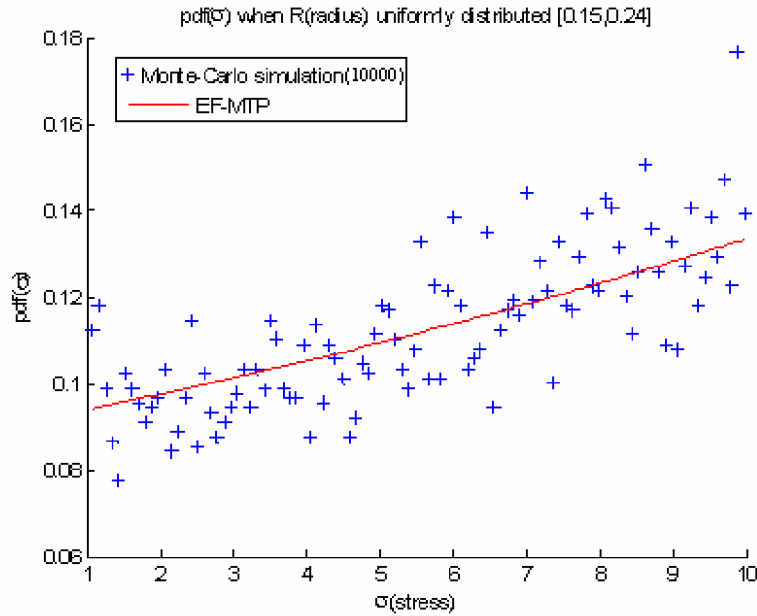

Figure II.4.13: *pdf* of  $\sigma_A$

## II.4.4 Two story frame

The goal of this application is to evaluate the joint *pdf* of the response of two-story frame by coupling the PTM-FEM technique with the Response Surface Method (RSM). The two-story frame (figure II.4.14) presents a bracing system with bar elements. It is assumed that the load  $F$ , Young's modulus of the beams  $E_1$  and of the bars  $E_2$  are independent random variables.

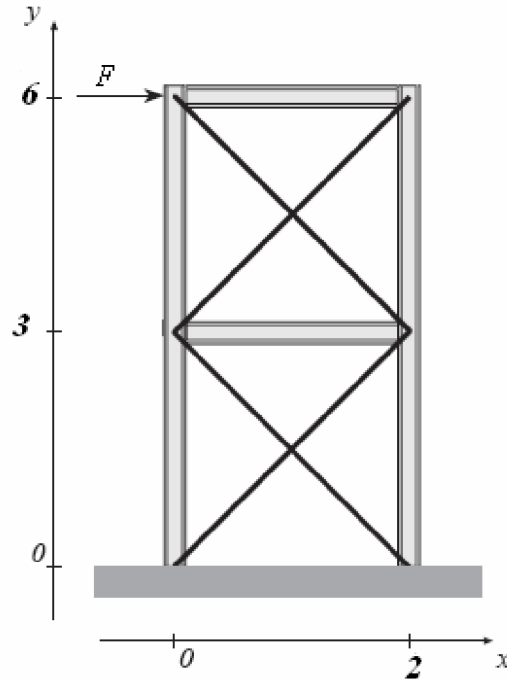

Figure II.4.14: Two story frame

As we have three input random variables, it becomes suitable to evaluate the joint *pdf* of the displacements at nodes 4, 5 and 6 (figure II.4.15). For this purpose, the combination of the PTM-FEM and the RSM allows us to define easily the transformation Jacobean.

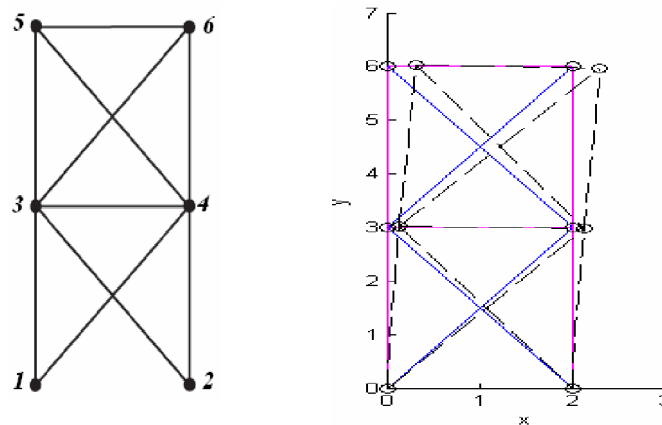

Figure II.4.15: finite element model and solution of the frame

A quadratic response surface is chosen to approximate the relationship between the displacements of nodes 4, 5 and 6 and the input random variables:  $F, E_1$  and  $E_2$ . The quadratic model has the following form:

$$y = a_0 + a_1 F + a_2 E_1 + a_3 E_2 + a_{12} F E_1 + a_{13} F E_2 + a_{23} E_1 E_2 + a_{11} F^2 + a_{22} E_1^2 + a_{33} E_2^2$$

The regression application to the considered structure leads to:

$$\begin{aligned} u_4 &= 0.2 + 1.9F - 2.1E_1 + 2.3E_2 - 3.6FE_1 - 1.9FE_2 + 2.1E_1E_2 - 6.1F^2 + 3.2E_1^2 + 0.1E_2^2 \\ u_5 &= 2.9 + 2.6F - 3.7E_1 + 5.1E_2 - 4.1FE_1 - 4.5FE_2 + 2.3E_1E_2 - 8.1F^2 + 3.6E_1^2 + 1.7E_2^2 \\ u_6 &= 3.2 + 2.3F - 3.3E_1 + 5.4E_2 - 4.1FE_1 - 4.4FE_2 + 2.5E_1E_2 - 9.2F^2 + 4.1E_1^2 + 1.1E_2^2 \end{aligned}$$

The Jacobean of the transformation is thus:

$$\begin{aligned} |J| &= \frac{2096271}{1000}F - \frac{479713}{500}E_1 + \frac{260881}{1000}E_2 - \frac{2385584}{1000}E_1F - \frac{160883}{200}E_1E_2 \\ &\quad - \frac{40711}{100}E_2^2 - \frac{1523}{500}E_1E_2F + \frac{368973}{100}F^2 + -\frac{268163}{250}E_1^2 \\ &\quad + \frac{5377}{500}E_1F^2 - \frac{8853}{1000}E_1^2F - \frac{643}{125}E_2F^2 + \frac{223}{500}E_2^2F - \frac{1163}{500}E_1^2E_2 \\ &\quad - \frac{233}{1000}E_1^3 - \frac{4833}{250}F^3 - \frac{559}{500}E_1E_2^2 - \frac{113}{500}E_2^3 + \frac{28581}{200} \end{aligned}$$

The joint *pdf* can then be obtained either analytically or numerically by the expression:

$$\begin{aligned} f(y_4, y_5, y_6) &= |J|^{-1} f(F, E_1, E_2) \\ &= \frac{1}{|J|} f(F) \cdot f(E_1) \cdot f(E_2) \end{aligned}$$

## II.4.5 Conclusion

In this chapter, three structures have been analyzed by the proposed technique: space truss, perforated plate and two-story frame. For low number of variables, the PTM-FEM allows us to write the analytical expression of the response density function. However, for more general applications, it is suitable to combine the PTM with the response surface method in order to describe an approximate form of the transformation Jacobean.

## *Conclusions and Perspective*

This thesis has considered the probabilistic approaches to determine the solution of a class of mechanical engineering systems whose behavior is governed by differential equations with coefficients that are modeled as random variables which can be thought of as realizations of an appropriate second-order stochastic process.

Emphasis has been given to Probabilistic Transformation Method (PTM) to determine the solution characteristics. This approach involves two stages. In the first stage, the well-known deterministic finite element method (FEM) is performed to get the mechanical response as a function of the random processes involved in the problem. In the second stage, the solution formula obtained in the first stage is used as a transformation between the input and output variables of the problem. The theory of random variable transformation can be successfully applied to get the *pdf* of the mechanical response under certain mathematical conditions concerning the existence of a closed form joint *pdf* for the input stochastic variables.

The literature review of some available Stochastic Finite Element Methods like Perturbation Method, Spectral SFEM and Non-intrusive Methods, has shown that there is still a great effort to perform in this field, in order to allow for full description of the stochastic response in practical engineering problems.

The proposed technique, named PTM-FEM, is a new approach in which the theory of probabilistic transformation method is combined with deterministic finite element method to get the *pdf* of the mechanical response in closed form. The probabilistic transformation method requires the evaluation of the transformation Jacobian, which is not straightforward in general. For that reason, we have considered different approaches to determine an "exact" Jacobean evaluation. The technique definitely fails when the inputs have no defined *pdf* and become difficult to apply when the number of input variables become big.

Different applications in structural mechanics have shown the validity of the proposed technique. For bar and beam structures, it is easy to define an algorithm for "exact" evaluation of the response *pdf*. For large-scale structures, the use for some approximations allows us to define a closed form expression of the required *pdf*. In addition to applications in structural static and dynamics, the interest of this technique is very large in reliability-based optimization, as many reliability analyses are required during the solution procedure. For the treated examples, the comparison with Monte Carlo simulations allowed us to verify the accuracy of the proposed method.



It is believed that the material presented in this thesis constitutes a meaningful tool to calculate the failure probability which represents the basis of many research fields, such as: Reliability analysis, Structural optimization, Fatigue design and Maintenance planning.

The good results obtained by using PTM-FEM technique encourage us, in the future, to apply this technique on more complicated stochastic problems, especially static and dynamical large-scale systems.

It can also be interesting to combine the SFEM with the proposed technique in order to take account for stochastic fields, particularly when nonlinear behavior is considered.

## *References*

- [ABD90] Abdo T., Rackwitz R., 1990. A new b-point Algorithm for Large Time-Invariant and Time-Variant Reliability Problems. Reliability and Optimisation of Structures. Proceeding Of the third WG 7.5 IFIP Conference, pp. 1–11.
- [ADH06] Adhikari S., 2006. A non-parametric approach for uncertainty quantification in elastodynamics, in: 47th AIAA/ASME/ASCE /AHS/ASC Structures, Structural Dynamics & Materials Conference, New-port, Rhode Island, USA.
- [BAE81] Baecher G. B. et Ingra T. S., 1981. Stochastic FEM in settlement predictions. Journal of the Geotechnical Engineering Division, 107(4): 449–463.
- [BAL99] Baldeweck H., 1999. Méthodes aux éléments finis stochastiques, Application a la géotechnique. Thèse de doctorat, Université d'Evry.
- [BAR03] Baroth J., Bode L., Bressolette Ph., Fogli M., 2003. Numerical convergence of a stochastic finite element method in a lognormal context. Appl. of Sta. and Prob. in Civil Engineering, Millpress, 1:217224.
- [BAR06] Baroth J., Bodé L., Bressolette Ph., Fogli M., 2006. SFE method using Hermite Polynomials : an approach for solving nonlinear problems with uncertain parameters. Comp. Meth. Appl. Mech. Engrg., 195:6479-6501.
- [BER03] Berveiller M., Sudret B., 2003. Thèse sur les éléments finis stochastiques. Rapport d'avancement 1. Technical Report HT-26/03/039/A, EDF R&D internal report.
- [BER05] Berveiller M., 2005. "Elements finis stochastique: approches intrusives et non intrusives pour des analyses de fiabilité". These de doctorat-IFMA & UBP.
- [BOS93] Boswell L.F., Mello C., 1993. Dynamics of Structural Systems. Blackwell Scientific Publications.
- [BRE84] Breitung K., 1984. Asymptotic approximations for multinormal integrals. Journal of Engineering Mechanics, 110(3), pp. 357-366.
- [BRZ01] Brzakala W., Elishakoff I., 2001. Lessons pertaining to the finite element method for stochastic problems, learned from simplest example. Chaos, solution and fractals, 12 :1217-1232.
- [CRI97] Crisfield M. A., 1997. Non-linear Finite Element Analysis of Solids and Structures, Vol. 1 : Essentials. J. Wiley & Sons, New York.
- [DEO91a] Deodatis G., 1991a. Weighted integral method - I. Stochastic stiffness matrix. Journal of Engineering Mechanics, 117(8) : 1851–1864.
- [DEO91b] Deodatis G., 1991b. Weighted integral method - II. Response

- variability and reliability. *Journal of Engineering Mechanics*, 117(8) : 1865–1877.
- [DEO97] Deodatis G., Graham L., 1997. The Weighted Integral Method and the Variability Response Function as Part of a SFEM Formulation. *Uncertainty Modeling in Finite Element, Fatigue & Stability of Structures*. World Scientific:71-116.
- [DER86] Der Kiureghian A., Liu P.L., 1986. Structural Reliability under Incomplete Probability Information. *J. Eng. Mech.* 112 (1), 85–104.
- [DIT96] Ditlevsen O., Madsen H.O., 1996. *Structural reliability methods*. Wiley, New York.
- [DRE02] Dreyfus G., Martinez J.-M., Samuelides M., Gordon M.B., Badran F., Thiria S. et Héroult L., 2002. *Réseaux de neurones – Méthodologie et application*, Eyrolles.
- [ELI95] Elishakoff I., Ren Y. J., Shinozuka M., 1995. Improved finite element method for stochastic problems. *Chaos, Solitons and Fractals*, 5(5): 833–846.
- [ELI95] Elishakoff I., 1995. Ren Y., Shinozuka M. Some exact solutions for the bending of beams with spatially stochastic stiffness. *Int. J. Solids Structures*, 32(16) :2315-2327.
- [ELI99] Elishakoff, I., Impollonia, N., Ren, Y.J., 1999. New exact solutions for randomly loaded beams with stochastic flexibility, *Int. J. of Solids and Structures* 36, pp. 2325-2340.
- [GHA91] Ghanem R.G. and Spanos P.D., 1991, *Stochastic finite elements - A spectral approach*, Springer Verlag.
- [GHA99b] Ghanem R., 1999b. Stochastic finite elements with multiple random non-Gaussian processes, *J. of Engrg. Mech. ASCE*, Vol. 125, No. 1, pp. 26-40.
- [GMU97] Gmür T., 1997. *Dynamique des structures*. Presses Polytechniques et Universitaires Romandes..
- [GRA98] Graham, L.L, Deodatis G., 1998. "Variability Response Functions for Stochastic Plate Bending Problems". *Structural Safety* 20,2:167-188
- [GUP00] Gupta A., D. Nagar, 2000. *Matrix Variate Distributions, Monographs & surveys in Pure & Applied Mathematics*, Chapman & Hall/CRC, London.
- [HAS74] Hasofer A.M., Lind N.C., 1974. An Exact and Invariant First Order Reliability Format. *J. Eng. Mech.*, ASCE, 100, EM1, pp. 111–121.
- [HOG89] Hogg, R. V., Craig A. T., 1989. *Introduction to mathematical statistics*", 4th edition. New York: Macmillan Publishing Co., Inc.
- [HOR89] Hornik K., Stinchcombe M. et White H., 1989. Multilayer feedforward networks are universal approximators, *Neural Networks*, 2:359-366.
- [IMB91] Imbert J.F., 1991. *Analyse des structures par éléments finis*. Crepadues – éditions.

- [ISU99] Isukapalli S., 1999. Uncertainty Analysis of Transport-Transformation Models. Ph. D. thesis, The State University of New Jersey.
- [ISU99] Isukapalli S.S., 1999. Uncertainty Analysis of Transport-Transformation Models. Ph. D. thesis, The State University of New Jersey.
- [KAD05a] Kadry S., Younes R., 2005a. Etude Probabiliste d'un Système Mécanique à Paramètres Incertains par une Technique Basée sur la Méthode de Transformation. Proceeding of CanCam. Canada.
- [KAD05b] Kadry S., 2005b. A Proposed Method to Solve A Non-Linear Mechanical System with Uncertain Parameters. Proceeding of 10th Jubilee National Congress on Theoretical and Applied Mechanics 13-16 September. 2005. Volume 1 pp 104-108.
- [KAD05c] Kadry S., 2005c. A Probabilistic Analysis of Uncertain Mechanical Structure. Proceeding of 10th Jubilee National Congress on Theoretical and Applied Mechanics 13-16 September, Volume 1 pp 99-103.
- [KAD06a] Kadry S., El-Tawil K, Chateauneuf A., 2006a. One-Dimensional Transformation Method in Reliability Analysis. Proceedings of the 8th international conference on Computational and Structure Technology. CST 2006. Spain.
- [KAD06b] Kadry S., El-Tawil K, Chateauneuf A., 2006b. Multi-Dimensional Transformation Method in Reliability Analysis. Proceedings of the 13th IFIP conference on Reliability and Optimization of Structural Systems. Japan.
- [KAD06c] Kadry S., El-Tawil K, Chateauneuf A., 2006c. Random eigenvalue problem in stochastic system. Proceedings of the 8th international conference on Computational and Structure Technology. CST 2006. Spain.
- [KAD07a] Kadry S., Chateauneuf A., El-Tawil K, 2007a. Statistical analysis of linear random differential equation. WSEAS transaction on Mathematics. Accepted (in press).
- [KAD07b] Kadry S., 2007b. Analysis of a non-linear system by a new technique based on the Continuation method. Journal of Mathematics and Computation. Accepted (in press).
- [KAD07c] Kadry S., El-Tawil K, Chateauneuf A., 2007c. An Efficient Method (TRBDO) for Reliability-Based Design Optimization based on Transformation with Finite Element Analysis. 48th AIAA/ASME/ASCE/AHS/ASC Structures, Structural Dynamics, and Materials Conference. Hawaii.
- [KAD07d] Kadry S., El-Tawil K, Chateauneuf A., Probabilistic Analysis of Eigenvalue of Stochastic Systems. Journal of Applied Sciences. ISSN: 1812-5654. 2007d.
- [LEM00] Lemaire M., Mohamed, A., 2000: Finite Element and Reliability: A happy marriage? In: Nowak, A. and Szerszen, M. (eds), Reliability and optimization of structural systems, (185), 3-14.

- [LEM92] Lemaire M., 1992. Evaluation des indices de fiabilité associés a des modèles de mécanique des structures. *Revue Française de Mécanique*, 2.
- [LEM97a] Lemaire M., 1997a. Reliability and mechanical design. *Reliab. Eng. Syst. Saf.* 55, 163–170.
- [LEM97b] Lemaire M., Mohamed A., Flores-Macias O., 1997b. The use of finite element codes for the reliability of structural systems. In: Frangopol, D.M., Corotis, R.B., Rackwitz, R. (Eds.), *Reliability and Optimization of Structural Systems' 96*, 7th IFIP WG 7.5 Working Conference, Boulder, 2–4 April, Elsevier, New York.
- [LUN94] Lund E. 1994. Finite Element based design sensitivity analysis and optimization. Ph.D. thesis, Aalborg University, Denmark.
- [MAD86] Madsen H.O., Krenk S., Lind N.C., 1986. *Methods of Structural Safety*. Prentice-Hall, Inc., Englewood Cliffs, N.J.
- [MAH03] Mahadevan S., Huang S., Rebba R., 2003. A stochastic response surface method for random field problems. *Proc. 9th Int. Conf on Applications of Statistics and Probability Civil Engineering (ICASP9)*, 177–184.
- [MAL97] Malliavin P., 1997. *Stochastic Analysis*. Springer.
- [MOH95] Mohamed A. and Lemaire M., 1995. Linearized mechanical model to evaluate reliability of offshore structures. *Structural Safety*, Vol. 17, pp. 167-193.
- [MUS00] Muscolino G., Ricciardi G. et Impollonia N., 2000. Improved dynamic analysis of structures with mechanical uncertainties under deterministic input. *Probabilistic Engineering Mechanics*, 15 : 199–212.
- [MUZ92] Muzeau J.P., Lemaire M., EL-Tawil K.- Méthodes Fiabilistes des Surfaces de Réponse Quadratique (SRQ) et évaluation des Règlements. *Revue Construction Métallique*, C.T.I.C.M., St-Remy-les-Chevreuse, France, no. 3, Septembre 1992.
- [NAT62] Nataf A., 1962. Détermination des distributions dont les marges sont données. *Comptes Rendus de l'Académie des Sciences* 225, 42–43.
- [PAP02] Papoulis A., 2002. *Probability, Random Variables and Stochastic Processes*, 4th Edition McGraw-Hill, Boston, USA.
- [PUI02] Puig B., Poirion F., Soize C., 2002. Non-Gaussian simulation using Hermite polynomial expansion : convergences. *Prob. Eng. Mech.* 17, 253-264.
- [RAC78] Rackwitz R, Fiessler B., 1978. Structural reliability under combined random load sequences. *Computer Struct*:489–94.
- [ROS52] Rosenblatt M., 1952. Remarks on Multivariate Transformation. *Ann. Math. Stat.*, vol. 23.
- [SCH97] Schuëller G. I., Bergman L. A., Bucher C. G., Dasgupta G., Deodatis G., R. G. Ghanem, M. Grigoriu, M. Hoshiya, E. A. Johnson, A. Naess, H. J. Pradlwarter, M. Shinozuka, K. Sobczyk, P. D. Spanos, B. F. Spencer, A. Sutoh, T. Takada, W. V. Wedig,

- S. F. Wojtkiewicz, I. Yoshida, B. A. Zeldin et R. Zhang. A state-of-the-art report on computational stochastic mechanics. *Probabilistic Engineering Mechanics*, 12(4) : 197–321, 1997.
- [SHI88] Shinozuka M., Yamazaki F., 1988. *Stochastic Structural Dynamics: Progress in Theory and Applications*, chapitre Stochastic Finite Element Analysis: an Introduction. Elsevier Applied Sciences, éditeurs : S. T. Ariaratnam, G. I. Schuëller, I. Elishakoff.
- [SHI88] Shinozuka, M. and Yamazaki, F., 1988. Stochastic finite element analysis: an introduction. In Ariaratnam, S. T., Schueller, G. I., and Elishakoff, I., editors, *Stochastic structural dynamics: progress in theory and application*. Elsevier Applied Sciences Publ. Ltd.
- [SOI05] Soize C., 2005. Random matrix theory for modeling uncertainties in computational mechanics, *Computer Methods in Applied Mechanics and Engineering* 194 (12-16) 1333-1366.
- [SUD00] Sudret B., Der Kiureghian A., 2000. Stochastic finite elements and reliability", a state of-the-art report. Technical Report UCB/SEMM-2000/08, Dept. of Civil and Environmental engineering, Univ. of California, Berkeley, November.
- [SUD02] Sudret B., Der Kiureghian A., 2002. Comparison of finite element methods. *Prob. Eng. Mech.*, 17 :337348.
- [TAK90a] Takada T., 1990a. Weighted integral method in stochastic finite element analysis. *Probabilistic Engineering Mechanics*, 5(3) : 146–156.
- [TAK90b] Takada T. 1990b. Weighted integral method in multi-dimensional stochastic finite element analysis. *Probabilistic Engineering Mechanics*, 5(4) : 158–166.
- [TAK92] Takada T, 1992. Variability response functions and stochastic field discretization in stochastic finite element methods. Dans *Proceedings of the 6th Specialty Conference on Probabilistic Mechanics and Structural and Geotechnical Reliability*, Denver, Connecticut, juillet.
- [TAW91] EL-Tawil K., Lemaire M., Muzeau J.P. – Reliability Method to Solve Mechanical Problems With Implicit Limit States. 4th IFIP WG 7.5 Working Conference on Reliability and Optimization of Structural Systems 91, Munich, Germany, Sep. 11-13, 1991.
- [TAW93] El-Tawil K, *Méthodes Fiabilistes Adaptées Aux Structures A Comportement Mécaniques Complexes et Applications a l'Evaluation de Règlements de Construction Métallique*. Thèse de doctorat de l'école doctorale sciences pour l'ingénieur de Clermont-Ferrand, université Blaise Pascal. France, 1993.
- [VAN03a] Van den Nieuwenhof B, 2003a. Stochastic Finite Elements for Elastodynamics: Random Field and Shape Uncertainty Modelling Using Direct and Modal Perturbation-Based Approaches. Thèse de doctorat, Université catholique de Louvain - Faculté des sciences appliquées - Unité de Génie Civil et Environnemental.

- [VAN03b] Van den Nieuwenhof B., Coyette J.-P. , 2003b. Modal approaches for the stochastic finite element analysis of structures with material and geometric uncertainties. *Computer Methods in Applied Mechanics and Engineering*, 192: 3705–3729.
- [VAN83] Vanmarcke E. H., Grigoriu M., 1983. Stochastic finite element analysis of simple beams. *Journal of Engineering Mechanics*, 109(5): 1203–1214.
- [WIG58] Wigner E. P., 1958. On the Distribution of the Roots of Certain Symmetric Matrices. *Annals of Mathematics*, Vol. 67, No. 2, pp. 325-327.
- [WIS28] Wishart J., 1928. The generalized product moment distribution in samples from a normal multivariate population. *Biometrika*, Vol. 20, No. A, pp. 32-52.
- [XIU02] Xiu D. and Karniadakis G.E., 2002. The Wiener-Askey polynomial chaos for stochastic differential equations. *J. Sci. Comput.* 24(2), 617-644.
- [ZHA98] Zhang J., Ellingwood B., 1998. SFEM in nonlinear reliability analysis. *Proc. of ICOSSAR'97*, 2:867874.

# Couplage éléments finis et méthode de transformation probabiliste

Seifedine Kadry  
Docteur de l'Université Blaise Pascal

La modélisation des systèmes mécaniques peut être définie comme étant l'idéalisation mathématique des phénomènes physiques qui les commandent. Ce qui demande la définition, plus ou moins précise, des variables d'entrée (paramètres géométriques, conditions de chargement...) et des variables de sortie (déplacements, contraintes,...), en vue de permettre la simulation du comportement mécanique. Les modèles utilisés sont de plus en plus complexes et l'enjeu actuel est l'identification des paramètres les constituant. En effet, on ne peut plus se permettre d'utiliser des modèles déterministes où interviennent seulement les moyennes des paramètres, car cela conduit généralement à une représentation erronée de la réalité. De ce fait, il est intéressant d'introduire les incertitudes sur l'estimation des paramètres et de considérer leur variabilité. Les méthodes probabilistes permettent de prendre en compte le caractère aléatoire et la variabilité spatiale de paramètres tels que les propriétés des matériaux.

Les méthodes fiabilistes ont pour objectif la détermination du niveau de confiance à accorder à la structure étudiée, en effectuant certaines hypothèses sur les modèles physiques et sur les grandeurs aléatoires mises en jeu, et en définissant l'état de défaillance par rapport à la règle de dimensionnement. Il s'agit de trouver l'évolution de la probabilité de défaillance de la structure tout au long de sa durée de vie et de vérifier que le dimensionnement respecte bien les règles de sécurité.

L'application des méthodes probabilistes en vue du dimensionnement nécessite de disposer d'un outil efficace permettant le calcul de la fiabilité des structures. Lorsque le comportement mécanique est déterminé par des modèles explicites, son étude fiabiliste est aisée grâce au grand nombre de méthodes qui ont montré leur efficacité. Par contre, lorsque la modélisation mécanique est numérique (modèles éléments finis par exemple), une méthode permettant le couplage des modélisations mécanique et probabiliste doit être utilisée : c'est l'objet du *couplage mécano-fiabilise*.

Le couplage mécano-fiabiliste peut être défini comme étant le "mariage" d'un code éléments finis et d'un code fiabiliste, de telle façon à ce que l'on obtienne la solution de la manière la plus efficace possible. Dans ce type d'approche, c'est le code fiabiliste qui pilote le calcul MEF et qui assure la convergence.

Dans ce contexte, l'objectif de cette thèse consiste à proposer une méthode d'analyse probabiliste de la réponse d'un système mécanique avec des paramètres aléatoires. Une nouvelle technique, dite "exacte", est proposée pour le couplage des modèles éléments finis et de la méthode de transformation probabiliste, en vue de l'évaluation, sous forme analytique ou semi-analytique, de la fonction de densité de la réponse. Cette méthode est ensuite appliquée à différents types de problèmes en vue de montrer ses avantages et ses limites.



# Coupled finite element and probabilistic transformation method

Seifedine Kadry  
Docteur of Blaise Pascal University

The modeling of mechanical systems can be defined as the mathematical idealization of the physical phenomena controlling it. This implies to define the input variables (geometrical parameters, loading conditions...) and the output variables (displacements, stresses...), allowing to understand the evolution of the system. The behavior models are more and more complex and the difficulty lies is the identification of the input parameters. As a matter of fact, we cannot admit to use the deterministic models where only the average parameters are considered, because it generally leads to wrong representation of the reality. Hence, it is interesting to introduce the uncertainties in the parameter evaluation and to consider their variability. The fundamental issue of probabilistic studies is therefore to take into account the uncertain character and the spatial variability of the parameters.

The reliability methods have for main objective the determination of the structural safety level, based on some assumptions related to the uncertainties, and by defining the state of failure. Therefore, the failure probability can be evaluated along the structure life span and consequently, the design can be verified with respect to safety considerations.

The application of probabilistic methods in design requires the use of efficient tools to evaluate the reliability of the considered structure. When the mechanical behavior is given by explicit models, the reliability analysis becomes easy, due to the large number of available methods which can be efficiently used. However, when the mechanical model is numerical (finite element method for example), a method allowing the combination of mechanical and probability models must be applied: it is the goal of *mechanical-reliability coupling*.

The mechanical-reliability coupling is defined by the combination of finite element models and reliability algorithms, in such a way that the solution can be efficiently obtained. In this kind of approach, the reliability code drives the finite element analysis procedures and ensures the convergence.

The objective of this thesis is therefore to analyze and to study the probabilistic response of mechanical systems with uncertain parameters. Contrary to other methods, the proposed technique couples the deterministic finite element method and the probabilistic transformation method, in order to evaluate the probability density function of the response, in a closed-form or in a semi-analytical form. To show the advantage of the proposed method, we have carried out different applications to cover several structural engineering fields: static, dynamic, reliability and optimization.