



**HAL**  
open science

# Home Health Care Operations Management : Applying the districting approach to Home Health Care,

Emna Benzarti

► **To cite this version:**

Emna Benzarti. Home Health Care Operations Management : Applying the districting approach to Home Health Care,. Other. Ecole Centrale Paris, 2012. English. NNT : 2012ECAP0022 . tel-00718914

**HAL Id: tel-00718914**

**<https://theses.hal.science/tel-00718914>**

Submitted on 4 Jul 2014

**HAL** is a multi-disciplinary open access archive for the deposit and dissemination of scientific research documents, whether they are published or not. The documents may come from teaching and research institutions in France or abroad, or from public or private research centers.

L'archive ouverte pluridisciplinaire **HAL**, est destinée au dépôt et à la diffusion de documents scientifiques de niveau recherche, publiés ou non, émanant des établissements d'enseignement et de recherche français ou étrangers, des laboratoires publics ou privés.



**ÉCOLE CENTRALE DES ARTS  
ET MANUFACTURES  
« ÉCOLE CENTRALE PARIS »**

**THÈSE**

**présentée par**

**Emna BENZARTI**

**pour l'obtention du**

***GRADE DE DOCTEUR***

**Spécialité : Génie Industriel**

**Laboratoire d'accueil : Laboratoire Génie Industriel**

**SUJET:**

**Home Health Care Operations Management: Applying the districting approach to  
Home Health Care**

**soutenue le : 20 avril 2012**

**devant un jury composé de :**

**Mr. Michel Gourgand-----Président  
Mme. Maria Di Mascolo-----Rapporteur  
Mr. Dominique Feillet-----Rapporteur  
Mr. Yves Dallery-----Directeur de thèse  
Mme. Evren Sahin-----Co-directrice de thèse**



## ***REMERCIEMENTS***

Pour commencer, je tiens à remercier très chaleureusement mes deux directeurs de thèse, Yves Dallery et Evren Sahin pour la qualité de leur encadrement et du soutien qu'ils m'ont accordés au cours de ces trois années.

Je remercie également Maria Di Mascolo et Dominique Feillet pour l'intérêt qu'ils ont porté à cette thèse en acceptant d'en être les rapporteurs. Ma reconnaissance va également à Michel Gourgand qui m'a fait l'honneur d'être le président de mon jury de thèse.

Mes remerciements vont ensuite à tous les membres du Laboratoire Génie Industriel de l'Ecole Centrale Paris qui m'ont accueillie et m'ont permis de travailler dans la convivialité et la bonne humeur. J'ai une pensée particulière pour Myriam, Oualid, Toufic, Moustapha, Zied, Nydia, Céline, Laura, Anne, Sylvie, Corinne et bien sûr, Bill.

Enfin, je n'aurais jamais pu surmonter toutes les difficultés rencontrées sans le soutien inconditionnel et les encouragements de ma famille et des amis. Merci à Rim, Yosra, Sarrah, Meriem, Slim et Seif qui ont suivi au jour le jour les hauts et les bas. Merci à mes parents et mes sœurs sans qui tout cela ne serait pas arrivé. Ce travail leur est dédié.

Emna

## ***RESUME***

Dans le cadre des contraintes économiques et des évolutions démographiques auxquelles doit faire face le secteur de la santé, l'Hospitalisation à Domicile (HAD) qui a été créée il y a une soixantaine d'années s'est largement développée en France durant cette dernière décennie. L'objectif principal de cette alternative à l'hospitalisation complète est de raccourcir les séjours hospitaliers voire même de les éviter en vue de remédier à l'engorgement des hôpitaux tout en améliorant les conditions de vie des patients. Dans ce travail de recherche, nous nous intéressons à la gestion des opérations dans les structures d'HAD.

Dans la première partie, nous développons une analyse qualitative de la gestion des opérations dans les établissements d'HAD. De façon plus détaillée, nous identifions les différents facteurs de complexité auxquels la gestion des opérations fait face dans ce type de structures. Nous présentons ensuite les travaux existants dans la littérature qui s'intéressent à la gestion des opérations dans les HADs. Sur la base de cette synthèse, nous identifions les pistes de recherche, intéressantes d'un point de vue organisationnel mais qui n'ont pas encore été traitées dans la littérature.

Dans la deuxième partie, nous nous intéressons à la problématique de partitionnement des équipes soignantes dans le cadre des activités d'une HAD. Nous commençons d'abord par proposer deux modèles de partitionnement prenant en compte un ensemble de critères tels que l'équilibre de la charge de travail, la compacité, la compatibilité et l'indivisibilité des unités élémentaires. Nous présentons également quelques exploitations possibles de ces modèles et proposons deux extensions à la formulation de base. Après avoir formulé le problème avec une approche statique, nous développons également une extension dynamique qui permet d'intégrer les différentes variations pouvant être observées dans l'activité d'une HAD d'une période à l'autre. Nous introduisons un nouveau critère de partitionnement qui concerne la continuité des soins, évaluée sur la base de deux sous-critères. En fonction des préférences des décideurs par rapport à la prise en compte de ces deux sous-critères, nous distinguons alors trois scénarii pour lesquels nous proposons les modèles associés.

**Mots-clés** hospitalisation à domicile, facteurs de complexité, partitionnement du territoire, approche statique, approche dynamique, continuité des soins.

# ***ABSTRACT***

Within the framework of economic constraints and demographic changes which the health care sector is confronted to, the Home Health Care (HHC) which has been created sixty years ago, has known an important growth during this last decade. The main objective of this alternative to the traditional hospitalization consists in solving the problem of hospitals' capacity saturation by allowing earlier discharge of patients from hospital or by avoiding their admission while improving or maintaining the medical, psychological and social welfare of these patients. In this thesis, we are interested in the operations management within the HHC structures.

In the first part, we develop a qualitative analysis of the operations management in the context of HHC structures. More specifically, we identify the complexity factors that operations management has to face up within this type of structures. Thereafter, we survey operations management based models proposed in the literature within the HHC context. Based on this literature review, we identify several emerging issues, relevant from an organizational point of view, that have not been studied in the literature and thus represent unexplored opportunities for operations management researchers.

In the second part, we are interested in the partitioning of the area where the HCC structure operates into districts. We begin by proposing two mathematical formulations for the HHC districting problem on which we consider criteria such as the workload balance, compactness, compatibility and indivisibility of basic units. We also present a numerical analysis of the computational experiments carried out on randomly generated instances to validate these two models. After formulating the problem with a static approach, we also develop a dynamic extension which allows the integration of the different variations that can be observed within the activities of an HHC structure from period to period. We then introduce a new partitioning criterion that concerns the continuity of care evaluated on the basis of two sub-criteria. Depending on the preferences of the decision-makers concerning these two sub-criteria, we then distinguish three scenarios for which we propose the associated mathematical formulations.

**Keywords** home health care, complexity factors, districting problem, static approach, dynamic approach, continuity of care.



## ***RESUME ETENDU***

Dans le cadre des contraintes économiques et des évolutions démographiques auxquelles doit faire face le secteur de la santé, l'Hospitalisation à Domicile (HAD) qui a été créée il y a une soixantaine d'années, s'est largement développée en France durant cette dernière décennie, lui valant de migrer de la fonction de relais aux établissements hospitaliers à la fonction d'une réelle alternative à l'hospitalisation à temps complet. En effet, le nombre total de places autorisées et le nombre de places effectivement installées sont passés respectivement de 3908 et 3832 places en 1999 à 4739 et 4206 en 2002 pour atteindre 7500 et 6200 places en 2006. Ces places ont été réparties sur 68 établissements en 1999, 108 en 2002 et 166 en 2006. Notons que l'objectif du gouvernement était d'installer 15 000 places pour 2010. Cependant, ce sont 10 939 places d'HAD qui ont été installées et réparties entre 292 établissements. Le développement de ces établissements a été accéléré grâce à la pression continue des gouvernements pour maîtriser les coûts du système de santé, aux changements démographiques liés à la croissance de l'espérance de vie entraînant le vieillissement de la population, à l'augmentation du pourcentage de la population ayant des maladies chroniques ou des handicaps physiques ou mentaux mais également au développement de nouvelles technologies telle que la nanotechnologie ou la télémédecine.

L'objectif principal de cette alternative à l'hospitalisation complète est de raccourcir les séjours hospitaliers voire même de les éviter en vue de remédier à l'engorgement des hôpitaux tout en améliorant les conditions de vie des patients. Ainsi, l'HAD représente un enjeu économique et social. Toutefois malgré l'intérêt qu'elle représente, l'HAD n'a pas connu le développement attendu au niveau organisationnel. En effet, les structures d'hospitalisation à domicile se sont davantage focalisées sur leur cœur de métier qui est la prestation des services de soins aux patients d'où l'émergence d'un besoin important en termes d'outils de gestion des opérations permettant de mieux organiser la production des soins.

Dans ce travail de recherche, nous nous intéressons à la gestion des opérations dans les structures d'HAD. L'objectif principal de la gestion des opérations consiste à trouver l'organisation la plus efficace en termes de ressources humaines et matérielles garantissant une qualité de service satisfaisante à la fois vis-à-vis des patients et vis-à-vis des soignants



tout en réduisant les coûts (achat de matières, personnel, transport, stockage des ressources matérielles consommables, etc.). De manière plus spécifique, cette thèse a pour objectif de développer un outil d'aide à la décision pour le problème de partitionnement géographique du territoire desservi par une HAD qui consiste à regrouper des unités élémentaires où résident les patients en zones, tout en satisfaisant un certain nombre de critères. Ces critères peuvent être liés au niveau d'activité nécessaire (équilibre de la charge de travail entre les zones), aux caractéristiques démographiques (équilibre de la population) ou géographiques (contiguïté, compacité) des unités élémentaires. Ces unités élémentaires peuvent typiquement être des codes postaux, des rues, etc. Elles sont caractérisées par des mesures telles que le nombre d'habitants, les ventes potentielles, la charge de travail, etc. Chacune de ces zones est ensuite affectée à une équipe de soignants. Le partitionnement permet ainsi d'améliorer le recouvrement géographique, de garantir la continuité des soins (vu que les patients reçoivent les soins de la part d'une même équipe ce qui leur permet de nouer des liens à long terme avec les professionnels de santé), d'équilibrer la charge de travail des soignants, de réduire les temps moyens de transport et par conséquent d'allouer plus de temps aux soins directs. Cette approche peut donc s'insérer dans une politique d'amélioration de la qualité du service des soins délivrés aux patients et des conditions de travail des équipes soignantes ainsi que dans une politique de réduction des coûts. Dans ce cadre, nous proposons des modèles de partitionnement adaptés aux spécificités des structures d'HAD. Après avoir formulé le problème avec une approche statique, nous en proposons une extension dynamique qui permet de remettre à jour le partitionnement d'une période à l'autre (avec ou sans prise en compte du critère de continuité de soins).

De manière plus détaillée, le manuscrit de thèse s'articule autour de 4 chapitres, comme détaillé ci-dessous.

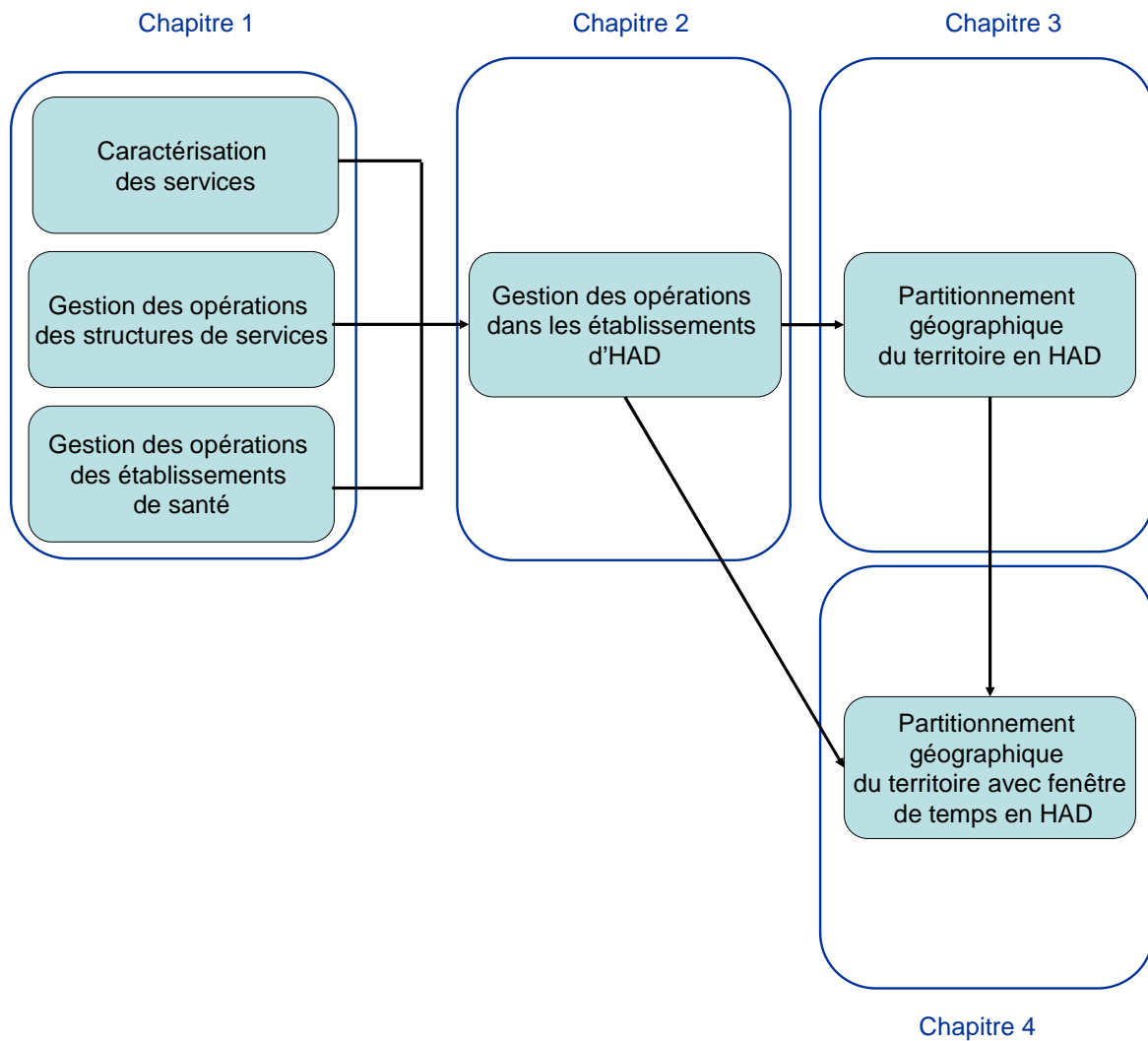

**Figure 1:** Plan de la thèse

Dans le **Chapitre 1**, nous nous intéressons à la notion de service. Nous commençons tout d'abord par présenter les différentes définitions proposées dans la littérature qui présentent plusieurs différences et similarités. En se basant sur les différents aspects mentionnés dans la littérature, nous assumons qu'un service est une activité (un processus ou une performance) ou une série d'activités (une série de processus ou de performances), réalisée par des ressources humaines ayant des compétences et des connaissances particulières et/ou des moyens matériels qui interagissent avec le client ou avec un bien appartenant à ce client dans le but d'apporter des solutions à ses problèmes. Ce service résulte en un changement des conditions du client ou de son bien.

Par la suite, nous soulignons les caractéristiques des services qui les différencient des biens à savoir : l'intangibilité, l'inséparabilité c-à-d la simultanéité de la production et la livraison des

services, l'interaction directe avec le client (cette caractéristique se base sur le fait que le client (ou un bien appartenant au client) est généralement présent tout au long du processus de production des services), la proximité aux clients, l'hétérogénéité et la périssabilité.

Vu la grande diversité des services, plusieurs classifications des services ont été proposées dans la littérature. Sur la base de ces classifications, nous avons mis en évidence les principales différences au niveau organisationnel entre les structures manufacturières et les structures de services d'un côté et entre les différents types de structures de services de l'autre. En effet, développer des outils de gestion des opérations qui soient valables pour toutes les structures de services est difficile. Il est donc important de classer les services de façon à ce que les pratiques en gestion des opérations soient adaptées à chaque classe de services. Les outils et méthodes devraient donc être développés de façon appropriée pour chaque classe de services. Par conséquent, le développement de classifications est primordial pour la compréhension des problèmes managériaux des structures de services.

Nous présentons également les différentes décisions relevant de la gestion des opérations dans les établissements de services que nous classifions en trois niveaux en fonction de l'horizon de décision qui concernent essentiellement la conception du système de production de service, la planification des opérations à moyen et court termes et le pilotage des opérations à très court terme.

Par la suite, nous nous sommes focalisés sur un type de service particulier, i.e. le service de production de soins, en soulignant les spécificités de ce type de service. En effet, les services de santé consistent en la réalisation d'activités de soins en vue de transformer (améliorer ou stabiliser l'état (physique, psychologique) d'un patient à l'aide de ressources humaines et matérielles. Les soins peuvent être de nature médicale, paramédicale, psychologique et incluent de plus en plus un volet social, surtout dans le cas d'une prise en charge du patient à domicile. Ces services impliquent plusieurs acteurs et nécessitent la contribution du patient ce qui explique la nature co-productive des services de santé. Le système de santé est également caractérisé par la diversité des services proposés où les soins délivrés aux patients sont uniques vu que les soins sont adaptés aux besoins des patients, par l'incertitude des opérations liée à la participation du patient dans le processus de livraison des soins et par la périssabilité de sa capacité de production. L'activité de production des soins est supportée par des activités organisationnelles qui permettent d'améliorer la performance globale du système de santé en termes de réduction des coûts, de satisfaction des patients et de gestion des ressources humaines. Dans ce cadre, il est important de développer des outils de management et d'aide à la décision adaptés aux spécificités de ce type de structures. En effet, la gestion des opérations

dans les établissements de services s'est largement développée ces dernières années pour diverses applications. Dans ce chapitre, nous présentons les différentes décisions en gestion des opérations qui peuvent y être associées.

Dans le **Chapitre 2**, nous définissons l'hospitalisation à domicile et examinons son évolution dans le contexte français. Par la suite, nous identifions les différents facteurs de complexité auxquels la gestion des opérations doit faire face dans les établissements d'HAD et analysons l'impact de chaque facteur sur les différentes décisions en gestion des opérations dans les structures d'HAD. Ces facteurs concernent :

- La diversité de l'offre des services liée à la variété des conditions cliniques, sociales et psychologiques des patients. Cette diversité de l'offre des services nécessite une définition de la stratégie du marché. Ceci permettra par la suite de bien dimensionner les ressources de l'établissement en vue de répondre à la demande des patients avec un niveau de qualité satisfaisant et au moindre coût.
- La diversité des ressources humaines et matérielles intervenant dans les processus de production des soins. Ceci représente donc un facteur de complexité dont la gestion des opérations doit tenir compte dans les établissements d'HAD et plus particulièrement, au niveau de l'organisation des tournées du personnel soignant et des tournées de livraison des ressources matérielles. Cette diversité explique également la pertinence de la synchronisation et de la coordination de ces ressources pendant la prise en charge du patient.
- Les sources d'incertitude à savoir l'incertitude de la demande, l'incertitude relative au processus de production des soins et l'incertitude de la disponibilité des ressources humaines et/ou matérielles. Pour faire face à cette incertitude, il serait intéressant de proposer des modèles de prévision de la demande, de définir des politiques de gestion des admissions/sorties des patients mais aussi de concevoir des stratégies de gestion des priorités des demandes.
- Le lieu de production des soins à savoir le domicile du patient. Ce facteur de complexité engendre la prise en compte d'un certain nombre de décisions à savoir le partitionnement du territoire desservi par l'établissement d'HAD en zones, l'affectation d'une équipe pluridisciplinaire de soignants à chaque zone. Par la suite, l'affectation des soignants aux patients doit tenir compte de la compatibilité entre la zone dans laquelle le domicile du patient se trouve et la zone dans laquelle le soignant travaille.

- Nécessité d'assurer un niveau de qualité des services satisfaisant vis-à-vis des patients et vis-à-vis des professionnels de santé intervenant dans le processus de production des soins qui considèrent différents critères de qualité de services. Ces critères doivent être intégrés au niveau de certaines décisions relatives à la gestion des opérations dans le cadre de l'hospitalisation à domicile à savoir : la définition de la stratégie du marché et le dimensionnement des ressources dans le but de garantir les compétences et le matériel nécessaires pour satisfaire la demande au niveau de qualité requis. Il est également important de prendre en compte ces critères au niveau des décisions prises sur le court/très court terme.
- Nécessité de constituer des réseaux de soins avec les autres établissements de santé. Ceci nécessite donc d'élaborer, à travers la gestion des opérations, une stratégie de partenariat avec les autres établissements de santé mais aussi de coordonner les ressources partagées entre ces différents établissements.

Nous présentons ensuite les travaux existants dans la littérature qui s'intéressent à la gestion des opérations dans les HADs. Cette analyse de la revue de littérature montre que cinq problématiques ont été traitées à savoir : le dimensionnement des ressources, le partitionnement du territoire en zones, l'affectation des ressources aux zones, l'affectation des ressources humaines aux patients (ou aux visites) et l'ordonnement des activités de chacune des ressources humaines. Cependant, les deux dernières problématiques qui sont en général considérées simultanément représentent les problématiques les plus importantes en termes de nombre de publications.

Sur la base de cette synthèse, nous identifions des pistes de recherche qui n'ont pas encore été traitées dans la littérature. En effet, chacun des travaux analysés se base sur une partie seulement des facteurs de complexité que nous venons de présenter. A titre d'exemple, tous les travaux qui traitent du problème de la planification des activités des soignants dans les établissements d'HAD ne considèrent qu'un seul type de ressources humaines à savoir les infirmiers.

A la suite de notre étude, différentes perspectives sont à envisager en vue de développer des approches intégrant les spécificités de ce type d'hospitalisation. Tout d'abord, la multiplicité des ressources humaines intervenant auprès du patient, la variété des décisions cliniques et organisationnelles définissant les processus de livraison des soins, l'importance de la continuité des soins en tant que critère de qualité des services pour le patient prouvent la nécessité de développer des outils pour coordonner et synchroniser les flux des ressources humaines et matérielles. Par la suite, il est essentiel de proposer une organisation de la

livraison des soins qui prend en considération les différentes sources d'incertitude en concevant des solutions pour faire face à la variation de la demande, du processus de production de soins ou de la disponibilité des ressources grâce par exemple à des modèles de prévision de la demande (par pathologie, par type de soins, par zone géographique, etc.) efficaces. Enfin, la nécessité de constituer des réseaux de soins avec les autres établissements de santé prouve l'importance de développer des stratégies de partenariat et d'organiser le partage des ressources en vue d'améliorer l'efficacité du système de santé dans sa globalité.

Dans le **Chapitre 3**, nous nous intéressons à la problématique de partitionnement du territoire desservie par une structure d'HAD en des zones. Nous commençons d'abord par une revue de la littérature des travaux relatifs au partitionnement du territoire. En effet, cette problématique a été traitée pour diverses applications à savoir : la définition des circonscriptions électorales, la création de zones à attribuer aux commerciaux et la définition des zones pour les établissements de services telle que la définition des zones d'influence scolaire, des zones à patrouiller par les forces de sécurité, des zones à attribuer aux compagnies de distribution d'énergie, des zones de travail des ressources humaines dans les établissements d'HAD, etc. Cependant, le domaine politique et le domaine commercial représentent les deux applications les plus importantes en termes de nombre de publications. Cet état de l'art montre que malgré la diversité des applications du problème de partitionnement, plusieurs similarités existent entre ces domaines. Nous pouvons donc supposer que les différents critères utilisés dans la modélisation de ce problème sont analogues. Ceci nous permet de proposer une classification des différents critères utilisés dans la modélisation de ce problème en quatre groupes :

- les critères géographiques à savoir la compacité, la contiguïté, l'accessibilité et le temps de réponse aux appels.
- les critères relatifs à l'activité. Cette classe de critères peut être divisée en deux sous-groupes : les critères d'équilibrage de l'activité (équilibrage de la population, équilibrage de la charge de travail, équilibrage des clients, respect des limites de capacités) et les critères d'équilibrage des profils selon un attribut donné (homogénéité socio-économique, représentation des minorités).
- les critères de comparaison entre différents partitionnements à savoir la similarité avec le partitionnement existant et la conformité du partitionnement aux frontières administratives.
- le critère organisationnel à savoir l'indivisibilité des unités élémentaires.

Nous proposons ensuite deux formulations mathématiques du problème de partitionnement géographique du territoire dans le cadre de l'HAD en prenant en compte un ensemble de critères à savoir :

- la compacité qui peut être formulé soit sous forme de contrainte forte en limitant la distance maximale entre deux unités élémentaires pouvant être affectées à la même zone (c-à-d Modèle 1) ou en tant que fonction objectif à optimiser et auquel cas une mesure de la compacité doit être minimisée à savoir la distance maximale entre deux unités élémentaires affectées à la même zone (c-à-d Modèle 2).
- l'équilibre de la charge de travail des différentes zones qui consiste à avoir à peu près la même charge de travail dans toutes les zones. Cette charge de travail est composée de la charge de travail des soins directs et le temps de transport. Le temps de transport étant directement lié aux distances entre les différentes unités élémentaires dont la réduction est garantie par le critère de compacité, nous considérons uniquement la charge de travail des soins directs qui dépend du nombre de patients visités par les soignants ainsi que des profils des patients.
- l'accessibilité est essentielle dans le contexte de l'HAD vu que c'est lié à la facilité avec laquelle les professionnels de santé peuvent se déplacer dans une zone, par exemple via les transports publics, les voitures privées, etc. Le critère d'accessibilité peut également concerner le respect des obstacles géographiques tel que les montagnes, rivières, etc.
- la conformité des zones aux frontières administratives est un critère qui facilite la coopération avec les collectivités locales.

Nous groupons les deux derniers critères en un seul critère à savoir la compatibilité. En effet, nous supposons que deux unités élémentaires peuvent être incompatibles pour différentes raisons :

- a) Existence d'obstacles géographiques entre ces unités.
  - b) Difficulté ou impossibilité de se déplacer entre ces unités.
  - c) Ces deux unités n'appartiennent pas à la même zone administrative.
- l'indivisibilité des unités élémentaire qui consiste à affecter chaque unité élémentaire à une et une seule zone.

En fonction des préférences des décideurs en HAD, deux formulations peuvent être développées pour modéliser le problème de partitionnement en HAD :

- Le modèle 1 correspond au cas où le décideur en HAD préfère définir un minimum pour la réactivité moyenne des soignants travaillant dans la même zone. Ceci peut être garanti en fixant une limite maximale pour la distance entre deux unités élémentaires affectées à une même zone ( $d_{\max}$ ). Le modèle 1 peut également être utilisé dans les cas où le décideur en HAD veut distribuer la charge de travail équitablement, de telle sorte que la charge de travail de l'équipe affectée à chaque zone soit la plus proche possible de la charge de travail moyenne. Cette équilibrage de la charge de travail peut être réalisé en considérant la fonction objectif suivante :  $Minimiser \max_{j=1...M} |w_j - \bar{w}|$  où  $w_j$  correspond à la charge de travail de la zone  $j$  ( $j=1...M$ ) et  $\bar{w}$  correspond à la charge de travail moyenne.
- Le modèle 2 correspond au cas où le décideur en HAD préfère définir un intervalle de tolérance qui garantit que la charge de travail de chaque zone ne dévie pas par rapport à la charge de travail moyenne de plus d'un pourcentage prédéfini  $\tau$ . L'objectif consisterait donc à minimiser une mesure de compacité à savoir la distance maximale entre deux unités élémentaires affectées à une même zone comme suit :  $Minimiser \max_{j=1...M} (d_{ik} * x_{ij} * x_{kj})$  où  $d_{ik}$  correspond à la distance entre les deux unités  $i$  ( $i=1...N$ ) et  $k$  ( $k=1...N$ ),  $x_{ij}$  (respectivement  $x_{kj}$ ) est une variable binaire qui égale à 1 si l'unité élémentaire  $i$  (respectivement  $k$ ) est affectée à la zone  $j$  ( $j=1...M$ ) et 0 sinon. Cette fonction objectif permettrait d'améliorer la réactivité des soignants et de réduire le temps d'attente des patients.

Notons que les formulations des modèles proposées dans ce chapitre sont statiques et ne s'intéressent qu'à une seule période de temps.

Nous conduisons également une analyse numérique des résultats associés à ces modèles sur la base d'instances générées aléatoirement. Les résultats de cette analyse montrent que pour améliorer l'équilibrage de la charge de travail (Modèle 1), il faudrait réduire le nombre de zones à concevoir. Au contraire, afin de réduire les distances parcourues, il serait préférable de répartir le territoire autant que possible. Cette analyse numérique montre également que le respect des contraintes fortes relatives à la compatibilité et la compacité/équilibrage de la charge de travail expliquent l'existence d'instances infaisables ainsi que la détérioration de l'équilibrage de la charge de travail/la mesure de compacité.



A la fin du chapitre, nous présentons deux exploitations possibles de ces modèles. La première exploitation concerne l'évaluation du meilleur nombre de zones à concevoir qui correspond au nombre garantissant la faisabilité du problème et engendrant le meilleur équilibrage de la charge de travail ou la meilleure compacité pour un  $d_{\max}$  ou un  $\tau$  donné. Une deuxième exploitation possible des modèles consiste à déterminer les valeurs de  $d_{\max}$  ou  $\tau$  les plus adéquates qui permettent d'avoir une solution faisable et correspondent au meilleur équilibre de charge ou à la meilleure compacité.

Enfin, nous proposons deux extensions aux formulations de base. La première consiste à séparer les différents profils des patients et de les modéliser différemment et la deuxième repose sur la distinction entre les différents types de professionnels incluant non seulement les infirmiers mais également les médecins, les physiothérapeutes, les assistantes sociales, etc.

Dans le **Chapitre 4**, nous considérons la problématique du partitionnement dans sa version dynamique en développant la formulation du problème et son optimisation non plus sur une seule période de temps mais sur une fenêtre de temps dans le cadre du modèle 1 développé dans le chapitre 3. Cette nouvelle formulation permet d'intégrer les différentes variations observées dans l'activité d'une HAD : variations au niveau des projets thérapeutiques des patients existants (i.e. fréquence ou volume de soins nécessaires), variations au niveau du nombre de patients présents dans le système, etc. En pratique, l'aspect dynamique du problème peut être pris en compte grâce à la prévision de la charge de travail (la fiabilité des prévisions est supposée être égale à 100% à travers un horizon de  $L$  périodes). Les données relatives à chaque période sont donc déterministes et connues à l'avance. En fonction de l'horizon de prévision  $L$ , trois possibilités du problème de partitionnement avec fenêtres de temps peuvent être considérées à savoir : l'optimisation période par période, l'optimisation avec fenêtres de temps et l'optimisation globale. La solution globale au problème de partitionnement (à travers  $K$  périodes correspond à la somme des solutions des problèmes de partitionnement élémentaires résolus sur un horizon de  $L$  périodes.

Nous introduisons un nouveau critère de partitionnement qui concerne la continuité des soins, évaluée sur la base de deux sous-critères. Dans nos modèles, nous supposons que la continuité des soins est garantie en affectant chaque unité élémentaire à la même zone tout au long de l'horizon de partitionnement  $K$  et que la continuité des soins est liée à l'indivisibilité des unités élémentaires. En fonction des préférences des décideurs par rapport à la prise en compte des critères de continuité des soins dans le problème de partitionnement, nous

distinguons alors trois scénarii pour lesquels nous proposons les modèles associés dans le cadre d'une optimisation avec fenêtres de temps :

- Le scénario A correspond au cas de la continuité totale des soins où les deux sous-critères précédemment cités sont respectés.
- Le scénario B est relatif à la relaxation du premier sous-critère de la continuité totale des soins. Ceci consiste à permettre des changements d'affectation des unités élémentaires aux zones d'une période à une autre. Cependant, le nombre total de changements par période est limité.
- Le scénario C consiste à permettre la divisibilité des unités élémentaires entre plusieurs zones tout en limitant le nombre maximal de zones entre lesquelles chaque unité élémentaire peut être divisée.

Ce chapitre s'achève par une analyse numérique des modèles mathématiques développés sur la base d'instances générées aléatoirement. Cette analyse numérique montre que l'équilibre de la charge de travail peut être amélioré en considérant un horizon de prévision plus long. Par conséquent, l'approche de partitionnement devrait être appliquée à travers la fenêtre de temps la plus large possible en fonction des prévisions des données. Les résultats numériques obtenus indiquent également que le déséquilibre de charge lié au respect des deux contraintes relatives à la continuité totale des soins peut être réduit au mieux en permettant des changements d'affectation des unités élémentaires aux zones d'une période à une autre tout en limitant le nombre maximal de changements pendant chaque période.

En conclusion, cette thèse contribue au développement d'outils d'aide au pilotage des activités de soins dans les structures d'HAD en vue de mieux organiser les processus de livraison des soins dans ce type de structures. Ces outils sont destinés à améliorer le partitionnement du territoire desservi par les structures d'HAD en respectant des contraintes à différents niveaux tels que l'équilibre de la charge de travail des soignants, la réduction des temps de parcours de visites ou le respect de la continuité des soins. Les résultats obtenus dans le cadre de cette thèse ont été présentés dans l'article «**Operations Management Applied to Home Care Services: Analysis of the Districting Problem**» accepté dans le journal «Decision Support System».



# Contents

List of Figures .....	23
List of Tables.....	24
Introduction .....	28
CHAPTER 1.....	33
Service and Health Care Operations Management .....	33
1.    Introduction .....	33
2.    Characterization of services.....	35
2.1    Service Definitions.....	36
2.2    Service characteristics.....	38
2.3    Service classifications .....	40
3.    Service Operations Management.....	47
3.1    Design of the production systems of services structures .....	50
3.2    Planning service operations at medium and short term .....	52
3.3    Very short term planning of service operations .....	53
4.    Health Care: a special service type.....	55
5.    Review of research on health care operations management.....	57
5.1    Design of health care structures .....	59
5.2    Planning health care operations at medium and short term .....	60
5.3    Very short term planning of health care operations.....	63
5.4    Medical management .....	63
6.    Conclusion .....	64
CHAPTER 2.....	68
Home Health Care Operations Management .....	68
1.    Introduction .....	68
2.    Appearance and evolution of HHC in France .....	69
2.1    Appearance of the HHC in France.....	70
2.2    Evolution of the HHC in France .....	71
3.    Evaluation of HHC services .....	74
3.1    Development factors and barriers to HHC.....	74

3.2	Pros and cons of HHC.....	76
3.3	Analysis of HHC costs.....	78
4.	Complexity factors of the HHC Operations Management .....	80
4.1	Diversity of the services proposed.....	81
4.2	Diversity of the resources involved in the care delivery process.....	84
4.3	Sources of uncertainty.....	87
4.4	Location of the care delivery .....	88
4.5	Necessity to guarantee a satisfactory service quality level.....	89
4.6	Necessity to design a care network with the other health structures .....	91
5.	HHC Operations Management literature review .....	92
5.1	The resources dimensioning problem .....	93
5.2	The districting problem.....	94
5.3	Allocation of resources to districts .....	95
5.4	Assignment of human resources to patients/visits and routing problem .....	96
6.	Conclusion .....	102
CHAPTER 3.....		105
Home Health Care Districting Problem .....		105
1.	Introduction .....	105
2.	Literature review of the districting problem and classification of the districting criteria.....	106
2.1	Literature review .....	107
2.2	Districting Criteria Classification .....	113
3.	Problem description and modeling.....	117
3.1	Assumptions.....	117
3.2	Criteria considered .....	119
3.3	Decision Variables .....	120
3.4	Parameters .....	120
3.5	Formulations of the problem.....	121
4.	Computational results .....	124
4.1	Model 1 .....	126
4.2	Model 2 .....	132
4.3	Illustration of the use of models developed .....	137
4.4	Duality between Model 1 and Model 2.....	141
5.	Extensions of the HHC districting model.....	142

5.1	Distinction between patients' profiles .....	143
5.2	Distinction between types of care givers .....	143
6.	Conclusion and perspectives .....	144
CHAPTER 4.....		147
Time window optimization of the Home Care Services Districting Problem.....		147
1.	Introduction .....	147
2.	The Time-Window HHC Districting Problem Description.....	148
2.1	Assumptions.....	159
2.2	Criteria considered .....	160
2.3	Decision variables .....	162
2.4	Parameters .....	162
2.5	Formulations of the scenarios .....	163
3.	Computational results .....	172
3.1	Problem instance generation .....	172
3.2	Influence of the forecasting horizon .....	173
3.3	Comparison of Scenarios A, B and C .....	176
4	Conclusion and perspectives .....	179
General Conclusion and perspectives.....		181
Appendix A .....		184
Main Indicators of the OECD economies .....		184
Appendix B .....		186
employment of Health Care sector in the OECD economies .....		186
Appendix C .....		187
Computational results associated to Model 1 for M=3 .....		187
Appendix D .....		192
Computational results associated to Model 2 for M=3 .....		192
Appendix E.....		196
Extensions of the HHC districting models .....		196
1	Distinction between the patients' profiles .....	196
1.1	Decision Variables .....	196
1.2	Parameters .....	196
1.3	Model 3 .....	196
1.4	Model 4 .....	198
2	Distinction between the types of care givers.....	199

2.1	Decision Variables .....	199
2.2	Parameters .....	199
2.3	Model 5 .....	199
2.4	Model 6 .....	201
Appendix F.....		202
Computational results.....		202
1	Problem instance generation .....	202
2	Comparison of Model 1 versus Model 3 .....	203
3	Comparison of Model 1 and Model 5 .....	206
References .....		212

# ***LIST OF FIGURES***

Figure I-1: Organization of the thesis .....	29
Figure 2-1: Evolution of the HHC structures number in France.....	72
Figure 2-2: Distribution of the HHC structures according to their sizes in 2009 .....	74
Figure 2-3: Distribution of the HHC structures according to their status in 2009.....	74
Figure 2-4: Projections for the proportion of the population in various age groups in the European Union (27 countries) between 2005 and 2050 .....	75
Figure 2-5: Distribution of the direct medical costs.....	78
Figure 2-6: Review of Operations Management models in HHC structures .....	93
Figure 2-7: Complexity factors not studied in the existing operations management related papers .....	102
Figure 3-1: Mean <i>distance</i> of Scenario 0 .....	133
Figure 3-2: Mean <i>distance</i> for Scenario 1 for M=2 .....	134
Figure 4-1: Variability sources of HHC operations management.....	149
Figure 4-2: Forecasting Data for K=5 .....	150
Figure 4-3: Different optimization possibilities depending on data available .....	151
Figure 4-4: Illustrative example for period per period optimization.....	153
Figure 4-5: Illustrative example for the time-window optimization .....	155
Figure 4-6: Illustrative example for the global optimization .....	156
Figure 4-7: Continuity of care scenarios .....	157
Figure 4-8: Illustrative case for Scenario A .....	165
Figure 4-9: Illustrative case for Scenario B .....	168
Figure 4-10: Illustrative case for Scenario C.....	170
Figure D-1: Mean <i>distance</i> for Scenario 1 for M=3.....	192



## ***LIST OF TABLES***

Table 1-1: Different aspects of services' definitions .....	38
Table 1-2: Service organizations typologies proposed in the literature .....	41
Table 1-3: Services' classification proposed by [Hill, 1977] .....	42
Table 1-4: Examples of SOM related decisions .....	50
Table 2-1: HHC activity per region in 2009 .....	73
Table 2-2: Activity per care protocol in 2008 .....	84
Table 2-3: Complexity factors in the HHC operations management models .....	100
Table 3-1: Criteria considered in each scenario .....	125
Table 3-2: Mean <i>gap_max</i> of Scenario 0 .....	127
Table 3-3: Feasibility percentage and mean <i>gap_max</i> of Scenario 1 for M=2 .....	128
Table 3-4: Feasibility percentage and mean <i>gap_max</i> of Scenario 2 for M=2 .....	129
Table 3-5: Feasibility percentage and mean <i>gap_max</i> of Scenario 3 for N=10 and M=2 .....	131
Table 3-6: Feasibility percentage and mean <i>gap_max</i> of Scenario 3 for N=20 and M=2 .....	131
Table 3-7: Feasibility percentage and mean <i>gap_max</i> of Scenario 3 for N=40 and M=2 .....	132
Table 3-8: Feasibility percentage and mean <i>gap_max</i> of Scenario 3 for N=100 and M=2 ...	132
Table 3-9: Feasibility percentage and mean <i>distance</i> of Scenario 2 for M=2.....	135
Table 3-10: Feasibility percentage and mean <i>distance</i> of Scenario 3 for N=10, 20 and M=2 .....	136
Table 3-11: Feasibility percentage and mean <i>distance</i> of Scenario 3 for N=40, 100 and M=2 .....	136
Table 3-12: Mean <i>gap_max</i> of Model 1 .....	138
Table 3-13: Mean <i>distance</i> of Model 2 .....	139
Table 3-14: Value of <i>gap_max</i> for $d_{\max} \in [100,150]$ .....	140
Table 3-15: Value of <i>gap_max</i> for $d_{\max} \in [160,200]$ .....	140
Table 3-16: Value of <i>distance</i> for $\tau \in [1\%,5\%]$ .....	140
Table 3-17 : Value of <i>distance</i> for $\tau \in [6\%,10\%]$ .....	141
Table 3-18: Results of Scenario 1 considered for Model 1 and Model 2 for instances 1, 5, 10, 15 and 20 .....	142

Table 3-19: Mean values of $\tau_1$ .....	142
Table 4-1: Mean <i>gap_max_total</i> of scenario A.....	174
Table 4-2: Mean <i>gap_max_total</i> of scenario B.....	175
Table 4-3: Mean <i>gap_max_total</i> of scenario C.....	176
Table 4-4: Divisibility of the basic units for instance 1 .....	176
Table A-1: Percentage of the average annual growth of output of the OECD economies.....	184
Table A-2: Structure of output of the OECD economies .....	185
Table B-1: Percentage of health employees in the total active persons between 1985 and 1995 .....	186
Table B-2: Percentage of health employees in the total active persons between 1996 and 2005 .....	186
Table B-3: Percentage of health employees in the total active persons between 2006 and 2010 .....	186
Table C-1: Feasibility percentage and mean <i>gap_max</i> of Scenario1 for M=3.....	187
Table C-2 : Feasibility percentage and mean <i>gap_max</i> of Scenario 2 for M=3.....	188
Table C-3: Feasibility percentage and mean <i>gap_max</i> of Scenario 3 for N=10 and M=3.....	189
Table C-4: Feasibility percentage and mean <i>gap_max</i> of Scenario 3 for N=20 and M=3.....	190
Table C-5: Feasibility percentage and mean <i>gap_max</i> of Scenario 3 for N=40 and M=3.....	190
Table C-6: Feasibility percentage and mean <i>gap_max</i> of Scenario 3 for N=100 and M=3...	191
Table D-1: Feasibility percentage of Scenario 1 for M=3 .....	192
Table D-2 : Feasibility percentage and mean <i>distance</i> of Scenario 2 for M=3.....	193
Table D-3: Feasibility percentage and mean <i>distance</i> of Scenario 3 for N=10, 20 and M=3	194
Table D-4: Feasibility percentage and mean <i>distance</i> of Scenario 3 for N=40, 100 and M=3 .....	195
Table F-1: Feasibility percentage and mean <i>gap_max</i> of Model 1 and Model 3.....	204
Table F-2: Feasibility percentage and mean <i>gap_max</i> of Model 3 ( $\tau_1=25\%$ , 10%, 1%) .....	204
Table F-3: Feasibility percentage and mean <i>gap_max</i> of Model 1 and Model 3 ( $\tau_2=100\%$ , 50%) .....	205
Table F-4: Feasibility percentage and mean <i>gap_max</i> of Model 3 ( $\tau_2=25\%$ , 10%, 1%) .....	205
Table F-5: Care workload deprivation between Model 1 and Model 3 for $\tau_1= \tau_2=1\%$ .....	206
Table F-6: Proportion of each profile care workload .....	206
Table F-7: Feasibility percentage and mean <i>distance</i> of Model 1 .....	207
Table F-8: Feasibility percentage of Model 5 .....	208

Table F-9: Mean <i>gap_max</i> of Model 5.....	209
Table F-10: Care workload $\Delta (\tau_{s_2})$ deprivation between Model 1 and Model 5.....	210
Table F-11: Care workload $\Delta (\tau_{s_1})$ deprivation between Model 1 and Model 5.....	210
Table F-12: Proportion of each profile care workload.....	210



## ***INTRODUCTION***

Within the framework of economic constraints and demographic changes which the health care sector is confronted to, the Home Health Care (HHC) which has been created sixty years ago, has known an important growth during this last decade. HHC has thus evolved from being an intermediary type of hospitalization to a real substitute to the traditional hospitalization. Indeed, the total number of the authorized places and the places effectively installed rose respectively from 3 908 and 3 832 places in 1999 to 4 739 and 4 206 in 2002 and reach 7 500 and 6 200 places in 2006. These places have been split among 68 structures in 1999, 108 in 2002 and 166 in 2006. Recently, 10 939 HHC places have been set up (and split among 292 structures) in 2010.

The main objective of this alternative to the traditional hospitalization consists in solving the problem of hospitals' capacity saturation by allowing earlier discharge of patients from hospital or by avoiding their admission while improving or maintaining the medical, psychological and social welfare of these patients. Thus, HHC represents social and economic stakes. However, despite the importance of this type of health structures, the HHC did not meet the expected performance from an organizational perspective. Indeed, HHC structures have mainly focused their attention on the medical aspect of their activities namely the delivery of care to patients which explains an important growing need in terms of operations management tools to better organize the care delivery process.

In this research, we are interested in the operations management within the HHC structures. The main objective of operations management consists in finding the most efficient organization in terms of human and material resources that guarantees a satisfactory service quality towards patients as well as care givers while reducing costs (staffing costs, medicines' purchase and equipments investment costs, consumable material resources' inventory costs, transportation costs, etc.). More specifically, the main objective of this thesis is to develop decision-making tools for the problem of districting the territory where an HHC structure operates. This problem consists in grouping basic units where patients live into larger clusters, i.e. "districts", so that these districts are "good" according to relevant criteria. Each district

would then be managed by a dedicated nurses’ team. This approach is expected to enable the improvement of the geographical coverage, the guarantee of the continuity of care, the balance of care givers’ workload and the reduction of the travel time of care givers and thus the increase of the time dedicated to the direct care. Consequently, this approach fits the policies of improvement of the quality of care delivered to patients and the working conditions of care givers as well as cost reduction. After formulating the problem with a static approach, we also develop a dynamic extension which allows the update of the partitioning from period to period, with or without considering the continuity of care criterion.

This thesis comprises 4 chapters, as detailed below:

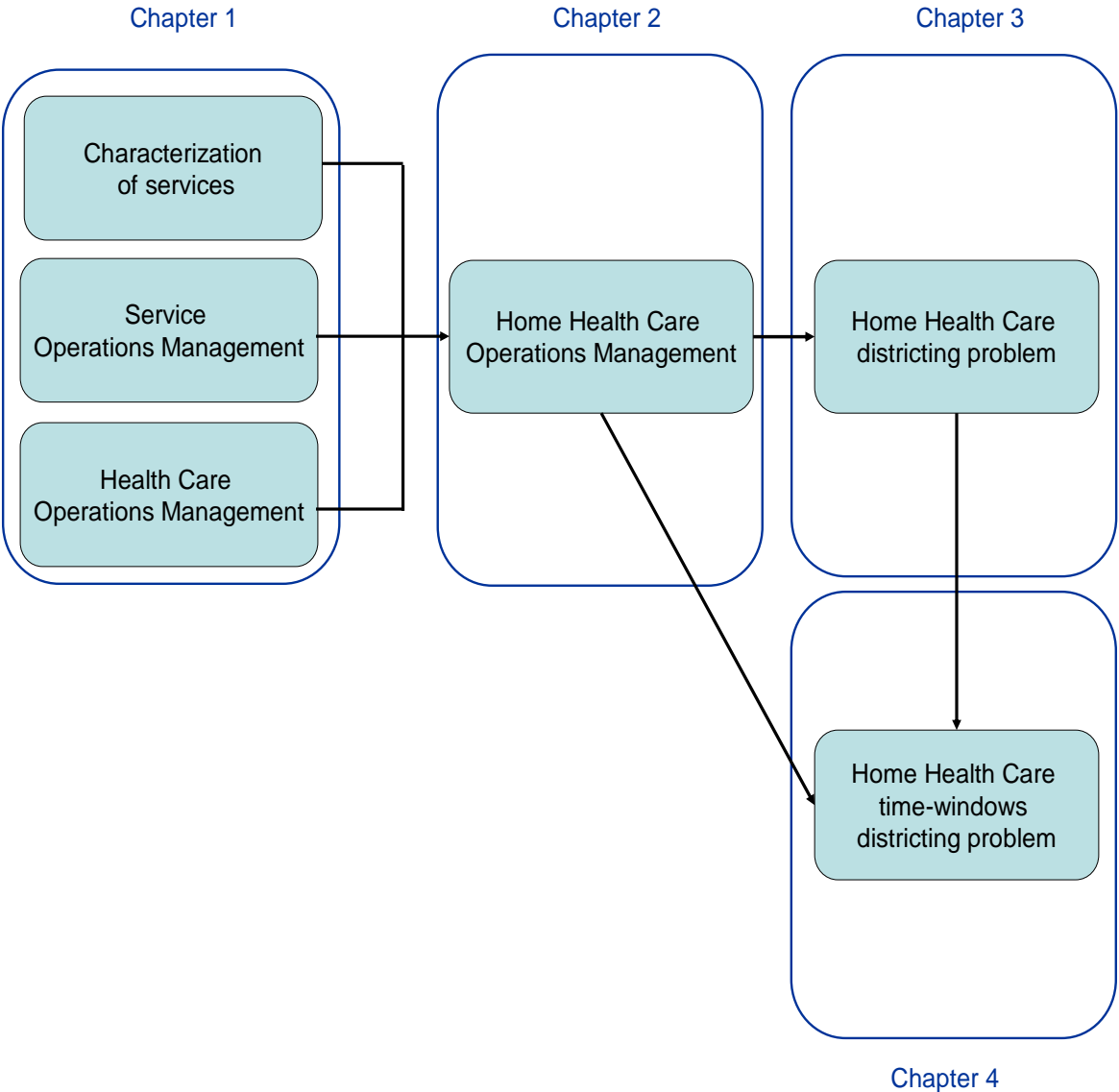

**Figure I-1:** Organization of the thesis

In **Chapter 1**, we are interested in the concept of service by defining what services are, emphasizing the characteristics of services and displaying the different classifications proposed in the literature. Based on these classifications, we highlight the main differences at the organizational level between the manufacturing structures and service structures on one hand and between the different types of service structures on the other hand. We also present the different decisions related to the service operations management that we classify according to their time horizon. After that, we focus on a specific type of services i.e. health care services by emphasizing the specificities of this type of services and by presenting the different operations management decisions that can be associated to it.

In **Chapter 2**, we focus on the operations management within one type of health care structures namely the HHC structures. We begin by giving a general overview of the HHC through the definition of this alternative to the traditional hospitalization, analysis of its evolution within the French context, presentation of the factors and barriers to its development, etc. After that, we identify the complexity factors that operations management has to face up in the context of HHC structures. For each complexity factor, we discuss how it can affect the organization of the care delivery. These factors pertain to the diversity of the services proposed, the location of care delivery, the uncertainty sources, etc. Thereafter, we survey operations management based models proposed in the literature within the HHC context. Based on this literature review, we identify several emerging issues, relevant from an organizational point of view, that have not been studied in the literature and thus represent unexplored opportunities for operations management researchers.

In **Chapter 3**, we are interested in the partitioning of the area where the HCC structure operates into districts. We begin by surveying the literature related to the models that are developed in the operations management literature applied to the districting approach. This state of the art allows us to propose a classification of the different criteria that may be considered in the districting problem. We then propose two mathematical formulations for the HHC districting problem on which we consider criteria such as the workload balance, compactness, compatibility and indivisibility of basic units. We also present a numerical analysis of the computational experiments carried out on randomly generated instances to validate these two models. The formulations of the models proposed in this chapter are static and concern only one period of time. At the end of this chapter, we present two possible exploitations of these models and propose two extensions to these basic formulations.

In **Chapter 4**, we consider the districting problem in its dynamic version by developing the formulation of the problem and its optimization no more over a unique period of time but over a time-window i.e. several periods of operation. This new formulation allows the integration of the different variations that can be observed within the activities of an HHC structure: variations related to the therapeutic projects of patients that are already present in the HHC system (i.e. frequency and average duration of the necessary care), variations related to the number of patients treated by the HHC structure, etc. We then introduce a new partitioning criterion that concerns the continuity of care evaluated on the basis of two sub-criteria. Depending on the preferences of the decision-makers concerning the sub-criteria related to the continuity of care in the districting problem, we then distinguish three scenarios for which we propose the associated mathematical formulations. This chapter ends with a numerical analysis of the developed models based on randomly generated instances.

In conclusion, this thesis contributes to the development of decision-making tools for better organizing the care delivery processes within HHC structures. These tools intend to improve the partitioning of the territory covered by the HHC structures. This improvement is guaranteed by the respect of different criteria such as the balance of the care givers' workload, the reduction of the travel time or the respect of the continuity of care. The results obtained within this thesis are presented in the article «**Operations Management Applied to Home Care Services: Analysis of the Districting Problem**» accepted in the journal “Decision Support System”.





# ***CHAPTER 1***

## ***SERVICE AND HEALTH CARE OPERATIONS MANAGEMENT***

### **1. Introduction**

In recent years, most of the industrial nations have evolved from primarily manufacturing-based economies to primarily service-based economies. According to [Machucca et al., 2007], developed economies have been characterized in recent decades by the extraordinary role played by the service sector in production and employment as well as by the integration of the service activities into manufacturing companies.

Indeed, services' output has grown by 1.2% in Germany, 2.1% in France, 1.7% in Switzerland and 2.9% in the USA between 2000 and 2008. For more details on the growth and structure of the output of the different economical sectors in various countries, the reader is referred to Table A.1 and Table A.2 of Appendix A. Furthermore, the service sector employs most of the working population in the economies of the OECD: the services dominate with 83% and 66.1% of the active persons employed in 2006 respectively in the USA and in the European Union (i.e. it employs 68.1% of the active population in Germany, 70.3% in France, 73.1% in Switzerland, etc).

This rapid growth of the service sector is related to several factors. First, the changes of the customer's behaviour and the increase of the customer outcome explain the maturity of their expectations and thus the development of new types of services that did not exist before e.g. dry cleaning, home delivery service. Second, many manufacturing companies now realize they can create more value for their customer with services e.g call centres services, after-sales services; these new services provide manufacturers with a competitive advantage and prove to be very profitable. Third, the evolution and the diversity of the activities performed in companies conducts to the outsourcing of the ancillary activities that are not the primary missions of the company to firms that are typically specialized in that particular services such

as janitorial services, security, food services. Fourth, advances in technology allow the dynamism of some services namely the telecommunications, internet sales, financial services, insurance, etc.

We thus focus in this chapter on the service sector due to its importance in the economy of every industrialized nation in terms of added value and employment. More specifically, we focus our attention on the operations of services. This can be explained by the fact that the operations function employs more personnel than the other functional areas [Metters et al., 2006]. Knowing how the largest group of employees work is then essential. Another reason to study operations management is related to the fact that studying Operations Management allows having a global view of the processes that can be useful for other functions such as human resources management, marketing, etc. Furthermore, the study of service operations is also motivated by the necessity to improve the productivity of the services in order to enlarge the portion of the service sector in the economy compared to the manufacturing and agriculture whose productivity improvements continue. Finally, we study the service operations management because it represents the general context of the main research area of this thesis namely the operations management within a specific health care structure namely the home health care (which is a special case of services).

That is why we choose to focus in the second part of this chapter on the health care services to which 10.2% of the total articles on services operations management refer ([Machuca et al., 2007]). Indeed, the use of operational research in health care has been developed considerably due to a number of factors. First, health care is a service that necessitates permanent interaction with customers and thus represents a complex human activity system with many people involved either as employees in health care structures or as consumers of health care services ([Roysten, 2009]). For example, the health service has employed 12.06%, 11.47%, 11.33% and 9.52% of the total active persons in 2006<sup>1</sup> respectively in United States, Switzerland, Germany and France. More details of the percentage of health service in the total employment in these countries between 1985 and 2010 are presented on Tables B.1, B.2 and B.3 of Appendix B. Second, the development of operations management within the health care context is related to the increasing needs of the population and the objective of the health care system namely the optimization of the resources' use so as to contain costs and to improve the service quality which represents two primary issues within the operations management field. Third, modeling in health care area have been developed rapidly thanks to

---

<sup>1</sup> <http://stats.oecd.org/index.aspx?lang=fr>

the technological progress in software and hardware which enable the construction of more complex models with lesser computation time and costs [Lagergen, 1998].

The objectives of this chapter consist in presenting a synthesis of the service concept by defining what services are, highlighting the main characteristics of services, displaying the different categories of services whose managerial challenges differ and displaying the different service operations management decisions that have been studied in the literature. After that, we focus on health care service that represents “one of the sectors where the principles of scientific management and of its successor, industrial engineering, were applied early on” [Chase and Apte, 2007]. The objective of this second part consists in emphasizing the specificities of this type of services with a focus on the consequences of these specificities on health care operations management.

This chapter is organized as follows: in Section 2, we survey the literature associated to the definitions of the service concept proposed in the literature, we also discuss the main characteristics of services and present an overview of the different services’ typologies proposed in the literature. Moreover, we present in Section 3 several reviews of the literature related to service operations management models and propose a classification of operations management decisions in services that have been studied in the literature. After that, we focus on a specific type of services namely the health care by defining it and presenting its main characteristics in Section 4. In Section 5, we synthesize the most relevant health care operations management decisions that have been studied in the literature. Finally, in Section 6, we present some concluding remarks and identify the perspectives that can be considered for future research in Section 6.

## **2. Characterization of services**

Over the years, the service sector has outdistanced the other economical sector and accounts now for the vast majority of the economies of industrialized countries [Davis and Heineke, 2002]. Additionally, the service sector presents a high diversity varying from service industries (e.g. health care services, retail services, etc.), ancillary and support services (e.g. janitorial services, security, etc.) to services in manufacturing (e.g. the support services and upgrading advertised by a company, etc.). These services can be either B2C or B2B oriented. That is why, it is important to understand the concept of service. In the literature, the services have been characterized in two ways: first, by defining what services are and second, by

identifying their characteristics. Other investigations aim at classifying services. Existing classifications are mostly marketing, sociology or psychology oriented. The interest of such a classification, if this is done with an operations management perspective, would be to identify classes of services using the same tools in terms of operations management.

## **2.1 Service Definitions**

There has been several attempts to define the notion of service, especially in the marketing field ([Hill, 1977], [Kotler, 1977], [Gronröos, 1990], [Murdick et al., 1990], [Flipo and Jöel, 1991], [Lovelock, 1991], [Gadrey, 1992], [Collier and Meyer, 1998], [Pine and Gilmore, 1999], [Gardey, 2000], [Zarifian, 2001], [Vargo and Lusch, 2004], [Giard, 2005], etc.). In this section, we present some of the well known authors' definitions.

The first definition has been proposed by [Hill, 1977] who has defined a service as “a change in the condition of a person, or a good belonging to some economic unit, which is brought about as the result of the activity of some other economic unit with the prior agreement of the former person or economic unit”. For example, health care represents a service that modifies the condition of a person (his body and/or his mind) while the dry cleaning service influences the clothes belonging to a person.

After this, [Gronröos, 1990] has argued that a service is “an activity or series of activities of more or less intangible nature that normally, but not necessarily, take place in interactions between the customer and service employees and/or systems of the service providers, which are provided as solutions to customer problems”. Indeed, the customer needs to interact with the hairdresser when he goes to a beauty salon while it is less the case when he buys a book on internet.

Another definition has been proposed by [Flipo and Jöel, 1991] who has presented "a service as an act (or a succession of acts) of duration and localization defined, achieved thanks to human and/or material means, implemented for the benefit of an individual or collective customer, according to processes, codified procedures and behaviors". We remark that this definition is not valid for all types of services. For example, the duration and localization of the services delivered by a fire brigade can not be defined in advance; however, this type of services responds to codified procedures and processes. On the contrary, the services of the juridical advisors are provided on their offices (fixed localization) according to procedures that are not as much codified as the ones used by the firemen.

Furthermore, [Lovelock, 1991] has presented the services residually by delineating services from goods. Indeed, he has asserted that a service is “a process or performance rather than a thing.” Indeed, the services provided by a consulting firm for other companies can be considered as processes or performances while the rental agencies deliver cars to the customers for a fixed duration.

[Zarifian, 2001] has also observed that a service is “a transformation of existence mode and/or dispositions of the person himself, of his body and his mind. While goods modify the existence conditions, services modify the existence modes where goods are only supports”. For example, the maintenance represents a service that concerns goods belonging to a customer and changes the goods’ states while education services change the conditions of the persons’ minds.

[Vargo and Lusch, 2004] has also presented the services as “the application of specialized competences (skills and knowledge), through deeds, processes, and performances for the benefit of another entity or the entity itself (self-service). For example, the service provided in a restaurant necessitates specific competences of the cooks and is delivered through deeds and performances while the internet-sale which is based on a specialized human resources’ knowledge is provided through processes.

It is clear that these definitions which present many similarities and differences are complementary in the sense that some aspects of the services’ concept have been mentioned by different authors; however, none of these definitions is based on all of these aspects. Indeed, [Hill, 1977], [Lovelock, 1991] and [Vargo and Lusch, 2004] have focused on the impact of the services on the customers while [Gronröos, 1990] has concentrated his definition on the nature of the activities and on the type of contact between service providers and customers.

In the following table, we summarize the different aspects of the service concept and the references that emphasize each of these aspects.

As we have noted in this section, the services’ definitions are heterogeneous, meaning that it is difficult for customers and service providers to really understand what services represent and what are their common characteristics.

Based on the different aspects identified in the literature, we would assume that a service is an activity (process or performance) or a series of activities (a series of processes or performances), performed by human resources with particular skills and knowledge and/or material means that interact with the customer or the good belonging to this customer in order

to provide solutions to his problems. This service results in a change in the conditions of the customer or his good according to processes, codified procedures and behaviours.

In the following sub-section, the main characteristics that differentiate services from goods are going to be analyzed based on a literature review on services' characteristics.

**Table 1-1:** Different aspects of services' definitions

<b>Aspects</b>	<b>References</b>
a process or performance rather than a thing	[Lovelock, 1991] [Vargo and Lusch, 2004]
an activity or series of activities of more or less intangible nature	[Gronröos, 1990]
an act (or a succession of acts) of duration and localization defined	[Flipo et Joel, 1991]
achieved thanks to human and/or material means	[Flipo et Joel, 1991]
the application of specialized competences (skills and knowledge)	[Vargo and Lusch, 2004]
according to processes, codified procedures and behaviors	[Flipo et Joel, 1991]
takes place in interactions between the customer and service employees and/or systems of the service provider	[Gronröos, 1990]
implemented for the benefit of another entity owned by the person (an individual or collective customer) requesting the service or the entity itself (self-service)	[Vargo and Lusch, 2004] [Flipo et Joel, 1991] [Hill, 1977]
A change in the condition of a person, or a good belonging to some economic unit	[Hill, 1977] [Zarifan, 2001]
provided as solutions to customer problems	[Gronröos, 1990]

## 2.2 Service characteristics

Services are generally distinguished from goods by different characteristics which are interrelated namely: intangibility, inseparability i.e. simultaneous production and consumption, direct customer interaction, proximity with customer, heterogeneity and

perishability i.e. impossibility of their inventory. Goods are defined by [Hill, 1977] as “physical objects which are appropriable and therefore, transferable between economic units”. The first characteristic that distinguishes services from goods is their intangibility. Indeed, [Mills and Margulies, 1980] have argued that a service is “an abstract thing that cannot be reasonably stored”. However, [Vargo and Lusch, 2004] have asserted that the representation of all the services is, in some forms, tangible. [Metters et al., 2006] have also considered that most services come with “facilitating goods”. Indeed, we cannot touch a medical examination performed by a doctor whereas a car that has been rented from a rental agency is tangible and can be used.

Services also differ from goods by their inseparability that is related to the simultaneous production and consumption [Cowell, 1988]. For example, the healthcare services are produced by doctors at the same time of the services’ consumption by patients while the internet sales are produced when the customer sales the product on internet, however, he consumes this service when he receives the product.

This characteristic implies another characteristic that distinguishes services from goods which lies in the fact that the customer (or a good belonging to the customer) is often present all over the service delivery process [Davis and Heineke, 2002]. Indeed, an important interaction between the customers and services providers is necessary for the health care services, transportation services, dry cleaning, automobile repair, etc. which is based on the presence and the cooperation of the customers (or properties of the customers) during the actual delivery of services. Some services, however, such as postal services, janitorial work, bill payments through internet banking, can be produced during the absence of the customer.

This latter characteristic ties up with another one proposed by [Metters et al., 2006] which is related to the proximity to the customer where many services such as health care services and police protection must be physically close to the customer. However, we remark that proximity is not always essential in services like internet-based services.

Another characteristic of services is their heterogeneity which is related, according to [Jaw et al., 2010], to their differences according to times, employee and customer’s perceptions of the services related to the reliability, tangibility, responsiveness of the services, etc. This heterogeneity explains the relative inability to standardize the output of services such as health care services, consulting services. Some services, however, can be standardized namely: care rental, purchase of theatre tickets, etc.

Finally, services are also characterized by their perishability which means that service can not be produced in advance, inventoried and then sold when it would be demanded [John and



Strey, 1988]. Indeed, when a demand occurs, it must be satisfied at the time and in the location where it happens otherwise it is lost. [Hill, 1977] have explained that services can not be put in stock due to the fact that they consist in changes which are logically not permanent nor physically durable. Services must then be provided in a very short time otherwise sales are lost. However, some exceptions are notable. For example, restaurants reservations allow the backordering of the service; retailing firms, hotels or airlines must manage physical inventories of cars, hotel rooms or airline seats.

This foregoing discussion shows that service systems present characteristics that differentiate them from manufacturing systems. Although the characteristics of services identified in the literature are valid for most of services, one can always find exceptions that have not the identified characteristics. However, identifying classes of services enable to better manage them since different services face different managerial challenges. For example, companies that propose perishable services should develop efficient automation activities to faster the service delivery process while the inventory management is necessary within the durable services context in order to alleviate the insufficiency of the production capacity [Jaw et al., 2010].

### **2.3 Service classifications**

Services organizations involve a heterogeneous array of activities that render the concept of services quite nebulous [Mills and Margulies, 1980]. Developing operations management practices that are valid for all service organizations is thus difficult. It is then important to classify the service systems in a meaningful way so that the operations management practices can be adapted to each class of services. Indeed, the study of operations management lies on the common problems and challenges that can be found for different types of services. To determine which industries share similar characteristics, it is useful to classify service firms into homogeneous categories of service entities. Within each category, certain managerial concerns dominate. Thus, the management methods should be developed in an appropriate way to each service type. Consequently, the development of classifications for services represents an important contribution to the operations management literature due to the fact that these classifications facilitate the understanding of service operations management issues and “serve as a guide for helping managers make decisions on appropriate process design given the nature of service encounters that customers want” [Collier and Meyer, 1998]. A

number of services' classifications have thus been proposed in the operations management literature. In Table 1-2, we present the main classifications proposed in this literature.

**Table 1-2:** Service organizations typologies proposed in the literature

References	Classification criteria
[Hill, 1977]	<ul style="list-style-type: none"> <li>- Services on persons or goods</li> <li>- Types of the changes (mental or physical)</li> <li>- Length of time over which the change may persist</li> <li>- Reversibility of the changes</li> </ul>
[Mills and Margulies, 1980]	<ul style="list-style-type: none"> <li>- Relationship between service employee and customer</li> </ul>
[Chase, 1981]	<ul style="list-style-type: none"> <li>- Degree of customer contact</li> </ul>
[Schmenner, 1986]	<ul style="list-style-type: none"> <li>- Degree of customer interaction and customization</li> <li>- Degree of labor intensity</li> </ul>
[Wemmerlov, 1989]	<ul style="list-style-type: none"> <li>- Type of customer contact</li> <li>- Degree of routinisation</li> <li>- Objects of the service process</li> </ul>
[Silvestor et al., 1992]	<ul style="list-style-type: none"> <li>- Equipment/people focus</li> <li>- Customer contact per transaction</li> <li>- Degree of customization</li> <li>- Degree of discretion</li> <li>- Added value back office/front office</li> <li>- Product/process focus</li> </ul>
[Kellogg and Nie, 1995]	<ul style="list-style-type: none"> <li>- Service process</li> <li>- Service package</li> </ul>
[Collier and Meyer, 1998]	<ul style="list-style-type: none"> <li>- Degree of customer discretion, freedom and decision making power</li> <li>- Degree of repeatability of the service encounter activity sequence(s).</li> <li>- Number of unique pathways.</li> <li>- Management degree of control designed into the service delivery system.</li> </ul>

The first services' classification has been proposed by [Hill, 1977] who has separated the services performed on goods from services affecting persons. The former represents a transformation in the physical state of the goods (e.g. transportation, cleaning, repair and maintenance) while the latter consists in changes of the physical or mental conditions of persons (e.g. hairdressing, medical treatment, education, entertainment). [Hill, 1977] has also distinguished between permanent (e.g. medical treatments) services and temporary (e.g. cleaning) services based on the length of time over which the change may persist. Finally, the author has suggested that the services may be distinguished according to the reversibility of the change. For example, the transportation of goods or persons is reversible whereas many forms of medical treatment are not. The combination of these four properties conducts to a cross-classification of services into nine-subgroups as shown in Table 1-3. It is assumed in this Table that the transitory changes cannot be irreversible and that no service affecting goods consists of changes in mental conditions. This classification is of interest to job design and the determination of appropriate employee skills i.e. technical skills associated with the specific service being delivered and interpersonal skills to properly interact with customers.

**Table 1-3:** Services' classification proposed by [Hill, 1977]

		Services affecting goods		Services affecting persons	
		Permanent	Transitory	Permanent	Transitory
Physical changes	Reversible	Painting a house	Cleaning an automobile	Transportation of persons	Hairdressing
	Irreversible	Repair of machines		Surgery	
Mental changes	Reversible			Entertainment	Communication
	Irreversible			Education	

After that, [Mills and Margulies, 1980] have suggested that services should be approached based on the critical relationship or personal interface between the service organization and the customer. The services organizations are thus subdivided into maintenance-interactive (the aim of the continuous interaction between employees and customers consists in building a trust and confidence so that the relationship is sustained for an indefinite time period e.g. financial institutions, banks, insurance companies, etc.), task-interactive (the interaction between customers and employees necessitates specific techniques for accomplishing or

obtaining a service and thus create a more complex relation between the customers and the employees who control more information relative to the client/customer e.g. advertising, engineering) and personal-interactive services (this type of services focuses on the enhancement of the direct and intimate well-being of the customers who are unqualified to evaluate their own needs and are thus dependent of the employees e.g. schools, professionals). The decisions that may change from one class of service structures to another are the job design and the determination of appropriate employee skills, as in the classification proposed by [Hill, 1977].

The customer contact model has been suggested by [Chase, 1981] where the degree of customer contact refers to the proportion of time the customer is in contact with the service (service providers and/or material resources) in relation to the total service delivery time for that customer. [Chase, 1981] has thus distinguished between: pure service (high contact e.g. delivering care to a patient, consultancy), mixed service (medium contact e.g. postal services, branch offices of banks and insurance firms), or quasi-manufacturing (low contact e.g. mail storing, distribution centers) organizations. The service providers' skills required, the control measures used and the efficiency of the service production process may differ radically from one type to another. Note that according to the customer contact approach the higher is the contact level, the lower would be the managerial control and thus the potential efficiency of the service system. Indeed, a high degree of customer contact introduces an element of uncertainty into the service environment that can negatively affect the efficiency. For example, the interaction with customers may slow the speed of the service delivery or the service providers may have difficulties for respecting the schedules. In order to reduce the uncertainty involved with providing complex services, contact-reduction strategies such as appointment systems or Automated Teller Machines are appropriate for high contact services while traditional manufacturing techniques could effectively be used to increase efficiency in the low contact services.

Another services' classification is the service Process Matrix which has been proposed by [Schmenner, 1986] and which is based on two criteria "the degree of customer interaction and customization" and "the degree of labor intensity of the process". This service process matrix categorizes service firms into: service factories (low labor intensity and low interaction e.g. airlines, hotels), mass services (high labor intensity and low interaction e.g. retailing, wholesaling), service shops (low labor intensity and high interaction e.g. hospital, auto repair) and professional services (high labor intensity and high interaction e.g. consultants, lawyers). The different managerial challenges that face each quadrant are listed in [Schmenner, 1986].

These challenges are essentially related to the operations management, human resources management and marketing fields. The challenges that are on the operations management topic are the following: technological advances, managing demand and scheduling service delivery for the service factory and service shop (low labor intensity); scheduling workforces as well as cost and quality controls for the mass service and professional service (high labor intensity); standardization of processes to assure consistency of service for the service factory and the mass service (low interaction and customization) and maintaining quality for the service shop and professional services (high interaction and customization).

After that, [Wemmerlöv, 1989] have selected three variables for building a services' taxonomy namely: the nature of the customer/service system interaction (direct customer contact e.g. schools, restaurants; indirect contact e.g. computer support line; and no customer contact e.g. mail storing or check processing), the degree of routinisation of the service process (rigid service processes with low levels of task variety, technical skills and information exchange e.g. serving in a restaurant, dry cleaning; and fluid service processes with high levels of task variety, technical skills and information exchange e.g. health care services, auto repair, etc.) and the objects towards which the service activities are directed (either goods e.g. washing car, people e.g. haircutting, or information/images e.g. counseling). Within the context of this classification, the service system design decisions such as service facility location, facility layout, workforce scheduling, customer scheduling, quality control, etc. as well as the design of the service processes; vary based on the variable related to the type of customer contact. Furthermore, the technical skills and general purpose equipment depends on the degree of routinisation where a fluid service process requires a high technical or analytical skill level in the workforce while the rigid process needs low technical skills level. For more details on the impact of each factor on the managerial issues, the reader is referred to [Wemmerlöv, 1989].

[Silvestro et al., 1992] have also considered six dimensions to classify services namely: the equipment/people focus, customer contact per transaction, degree of customization, degree of discretion (the degree of discretion is considered as low if the alteration of the service package can be made only with superiors' authorization whereas a high degree of discretion refers to the case where the workforce can alter the changes to service provision without referring to their superiors), added value back office/front office (value can take many forms and means different things to different customers. Adding value means providing additional benefits like selling something at Amazon.com that is less expensive, providing services that are faster or more convenient such as ordering groceries on line, personalising services as when a

customer goes to an hotel where the staff know his/her preferences, etc. Note that a service is considered as front-office oriented if the proportion of the front-office staff to the total staff is large) and the product/process focus (a service is considered as product-oriented when it emphasizes on what the customer buys whereas a service is assumed to be process-oriented if it emphasizes on how the service is delivered to the customer). The authors have distinguished between three types of services: professional services (process-oriented services with high degrees of customer contact per transaction, customization and discretion where most of the added value is in the front office e.g. management consultancy), mass services (product-oriented services with low degrees of customer contact per transaction, customization and discretion where most of the added value is in back office e.g. transport) and services shops (the levels of the classifications dimensions fall between the other two extremes e.g. hotels). Note that in this typology, the service factory is absent due to the fact that it “has been rarely applied as a descriptor of service organizations”. Moreover, the service factories represent the service-oriented manufacturing companies which become “an integrated view of product and service”. As the different classes of this typology are incorporated in the service process matrix proposed by [Schmenner, 1986], the impact of this classification on the Operations Management decisions is the same as the one related to the Schmenner’ classification.

A service process/service package (SP/SP) positioning matrix has been proposed by [Kellogg and Nie, 1995]. The first axis of this matrix is the service process dimension which is related to the degree of the influence of the customer who is a part of the service process on both service content and delivery. This axis is organized into three categories of customer influence: the expert service (a high degree of customer influence where the customer and the service-provider work together to define, produce and deliver the service package e.g. accounting, consulting), the service shop (a medium level of customer influence where the customer collaborate with the service provider but with some limitations due to the service standardization e.g. education, healthcare) and the service factory (the customer impact on the system is very minimal e.g. fast food restaurants). The second axis of the SP/SP matrix is the service package and the degree to which it is customized and is defined by four categories: unique (it is full customized e.g. beautician), selective (some parts of the service package are standardized but the customer can choose from a wide range of options e.g. hotel service), restricted (most of the service package is standardized and the customer selection is limited e.g. preventive health programs) and generic (there is no customization e.g. movie theater). This classification is very useful for understanding the service operations strategy as it combines the service package offered with process used to create the service (such as facility

layout, facility location, technological choices, job design and capacity management). For example, the design of facility layout aims at improving the flexibility of the expert service process, at minimizing the customer travel distance for the service shop process and at balancing the tasks among work stations in order to improve the utilization rates of the service factory process.

The service positioning matrix proposed by [Collier and Meyer, 1998] presents two axes. The first one is the customer's service encounter activity sequence while the second one is the number of pathways (routes) built into the service system designed. The first axis is characterized by two criteria namely: the degree of customer interaction, freedom and decision making power in selecting their service encounter activity sequence(s) and the degree of repeatability of service encounter activity sequence(s) (it is related to the frequency of duplication of a specific service activity sequence from one customer to another). The second axis is defined as follows: the number of unique pathways (routes) that customers can take in the service system during the delivery of the service and the management's degree of control designed into the service delivery system. Based on these criteria, the authors have distinguished three states that describe most services: customer routed services (customers have broad freedom to select from many possible routes through the service delivery system e.g. parks, museums, surfing the Internet etc.), co-routed services (customers may select from a moderate number of routes e.g. consulting, legal and medical services) and provider routed services (customers are constrained to follow a very small number of possible routes e.g. newspaper dispenser, automatic teller machine (ATM), etc.). This classification is interesting from a managerial view point due to the fact that different decisions vary regarding the previous criteria namely: job design, process design, facility design, etc.

We can also propose to classify the services based on the places of service production and delivery and consequently on the necessity of service providers or customers displacements. The services can be classified into three classes: the services where the customer travels to the supplier (e.g. theater, hospitals, etc.), the services where the supplier travels to the customer (e.g. home care, on-site maintenance, etc.) and the case where neither the supplier nor the customer move (e.g. call centers, remote maintenance, etc.). This classification has an important impact on the operations management in terms of facility location and the scheduling of the service providers' activities at the short term.

The foregoing discussion shows that classifying the different types of services represents a basis for highlighting the managerial specificities associated with each service type. Moreover, the analysis of the different services' classifications proposed in the literature

shows that the classifications that are interesting from an operations management point of view, are the ones proposed by [Chase, 1981], [Wemmerlov, 1989] and [Kellogg and Nie, 1995] as they are more exhaustive in terms of operations management related decisions.

Once the type of the service organization is identified, the managers should determine the managerial challenges faced by this type of service structures and choose the appropriate operations management techniques which are more adapted to the specificities of this structure.

### **3. Service Operations Management**

The Service Operations Management presents several differences compared to the manufacturing sector. For example, one of the most important challenges of the service operations management consists in the alleviation of the uncertainty aspect that characterizes the production and delivery of services which stems from the customers' presence and participation in the service production and delivery processes. Moreover, the inseparability of production and consumption as well as the intangibility of services makes standardization of quality in service context more difficult than in the manufacturing context. On one hand, the quality management of goods' production is based on the conformance of quality measures to specifications. On the other hand, the service quality depends on the customer's perception of the service. It is then difficult to standardize quality as in the manufacturing context. Several studies that deal with service operations management have thus been developed in the literature and can be classified into four classes:

- Application of the methods developed for the production management to the services context for solving the problems that are similar to the ones encountered in the production context such as transportation of goods, provision of goods (services involving goods that can be inventoried), etc.
- Study of a specific type of services e.g. health care, fire stations, etc.
- Study of a specific operations management decision e.g. facility location, dynamic pricing, etc.
- Literature review of the works that deal with service operations management.

In this section, we are interested on the fourth type of investigations which show that two approaches are possible within the services operations management context. On one hand, many researchers have focused on the similarities of the operations management related to the



two sectors and thus asserted that the manufacturing approaches are adequate to manage service organizations. [Bowen et al., 1989] have concluded that “In sum, the extension of manufacturing concepts to service organizations has received considerable attention”. On the other hand, the services organizations present unique characteristics (i.e. intangibility, simultaneous production and consumption, perishability and heterogeneity) that differentiate them from manufacturing systems which explain that much of the references pointed out that adopting the manufacturing approaches is not possible due to the fact that “the use of product-based models and language to describe and manage service business restricts thinking in a way that limits innovative management approaches” [Thomas, 1978]. For example, we can not improve the efficiency of the process by anticipating the demand and constituting safety inventory levels as in a manufacturing context.

Consequently, research in service operations management has evolved from a simple transfer of the manufacturing management concepts to service sector, to a specific research field. Note that the service operations management decisions grow in number with the complexity of service structures. For example, if we consider an airline company, the decisions considered are: the choice of the countries/towns served by the company; the choice of the network’s structure (routing, hubs’ localization, etc.); flight planning (how many planes are necessary for each type of connection); yield management (dynamic pricing or revenue management); medium-term planning of the flights (number of flights per plane and per day, which plane would be used for each connection); medium-term planning of the human resources (recruitment); allocation of places to the different categories of passengers; allocation of the equipage to the planes; management of the planes’ lateness, strikes, technical problems, etc. Among the material resources operations management of the airlines companies, we find the decisions related to the plane acquisition (number, type, capacity); planning of the equipment maintenance; inventory planning of the goods offered during the flight (meals, drinks, etc).

In this section, we review the major service operations management decisions that have been studied in the literature. These decisions are divided into three levels as shown in Table 1-4. The first level involves the design of the service systems. The second level is related to the planning of service operations at medium and short term. The third level deals, in turn, with the very short term planning of service operations.

We remark that this discipline is interconnected to the other functions in service systems namely: the human resources management, the marketing and the information system management. Hence, the characterization of customers or service providers’ behaviors can be linked to both service operations management and human resources management fields. In the

same sense, the selection of the services proposed to the customers, the identification of the target market to serve, the definition of pricing policies represent service operations management decisions and marketing decisions at the same time. Finally, the interconnection between the service operations management and the information system management fields lies in the design and dimensioning of new technologies and information systems as well as in the automation of a part of the service delivery process.

Actually, we are going to focus on some of the operations management decisions that have been most studied in the service operations management literature. Note that the term “Services Operations Management” covers the activities, decisions and responsibilities of operations in service organizations such as: configuration of resources and processes that create and deliver service to the customer, organization of these resources (including staff, equipment, technology and facilities), etc. [Johnston and Clark, 2005].

**Table 1-4:** Examples of SOM related decisions

<ol style="list-style-type: none"><li>1. Design of service systems<ol style="list-style-type: none"><li>1.1. Selection of the services proposed to customers</li><li>1.2. Identification of the customers and the “target market” to serve</li><li>1.3. Identification of the strategic quality issues in services</li><li>1.4. Selection and design of the service delivery system (districting of the territory, workforce design, types and number of service facilities, service facilities’ location, etc.)</li><li>1.5. Long-term capacity and demand design (equipments, new technologies, Information systems, etc.)</li><li>1.6. Subcontracting or outsourcing the services</li><li>1.7. Establishment of contracts with suppliers (good suppliers or service providers)</li></ol></li></ol>
<ol style="list-style-type: none"><li>2. Planning service operations at medium and short term<ol style="list-style-type: none"><li>2.1. Demand forecasting at the medium and short term</li><li>2.2. Yield management and co-production of the service by the service providers and the customers</li><li>2.3. Specification of the necessary workforce skills</li><li>2.4. Capacity and demand management (selection of the strategies of demand and capacity equilibrium)</li><li>2.5. Medium-term Capacity dimensioning (means of transport for the services of type “server to customer”)</li><li>2.6. Short-term scheduling of the human and material resources (in front office and back office)</li></ol></li></ol>
<ol style="list-style-type: none"><li>3. Very short term planning of service operations<ol style="list-style-type: none"><li>3.1. Selection of the resources necessary to satisfy the demand</li><li>3.2. Management of the achievement of the activities’ priorities</li><li>3.3. Scheduling of the activities and the resources associated to these activities</li><li>3.4. Management of uncertainty</li><li>3.5. Measuring of service quality</li></ol></li></ol>

### **3.1 Design of the production systems of services structures**

The first decision related to the design of the service systems consists in the strategic positioning which determines the services proposed to customers as well as the “target

market” (or “target customers”) the company will serve and how it will differentiate its services from the competitors (what are the expectations of the “target customers” and how the service company can come up to these expectations?) [Thiétart, 1984].

Identifying strategic quality objectives also represents an important issue in the design of service systems that consists in defining what quality means and determining the targets values of the quality measures that would be achieved by the service structures.

After that, the service delivery system must be designed. Indeed, a first design issue is related to the districting of the territory which consists in grouping basic units into larger clusters i.e. “districts” according to relevant criteria. These latter can be related to the activity level (workload balance, customers equality, etc.) or the geographical characteristics (compactness, contiguity) of the basic units. Adopting this approach by service structures is motivated by the desire to better cover a territory with the existing service providers or to alleviate the changes of human resources or customers numbers ([D’Amico et al., 2003], [Blais et al., 2003], [Benzarti et al., 2011]).

Moreover, it is necessary to design the workforce which involves the determination of the types and number of human and material resources necessary to deliver the services proposed to the target customers ([Atlason and Epelman, 2004]).

Another issue related to the service delivery system design concerns the determination of the type and number of service facilities (a single-site versus multi-site structure) as well as the location of these facility(ies). These location(s) depend(s) on the degree and type of contact with the customer. If a direct contact with the customers is necessary for delivering the service, the location of these facilities must be based on the proximity to the customers in order to be convenient to them and to best meet their demand. On the contrary, for services where direct customer contact is reduced, this decision is equivalent to the site selection process for a manufacturing facility which is based on the costs’ minimization or the proximity to specific entities. Note that the site selection is also based on other criteria such as population density, average family size, average household income, level of education, age, etc. as well as labor costs, building costs, distribution costs, etc. ([Badri et al., 1998], [Brick and Uchoa, 2009]).

It is also necessary to design the service system capacity in terms of material resources by defining equipments, technology and information system requirements which is related to the survival of the service organization in the high-tech marketplace. Indeed, [Kellogg and Nie, 1995] have asserted that a high level of customization can be carried out (while the level of

customer influence on the service process is minimal) when information technologies are used in the service delivery process.

Another interesting issue of the service system design consists in choosing to subcontract or outsource a part of the services. Thus, the service managers must also select the good suppliers and the external service providers and establish contracts with them ([Aksin et al., 2006]).

### **3.2 Planning service operations at medium and short term**

After determining the type and number of service facilities as well as the location of these facility(ies), it is important to plan the service operations at medium and short term.

The first decision consists in the forecasting of the customer demand which is characterized by its uncertainty in order to improve the efficiency of the operations management decisions namely: the workforce scheduling, capacity dimensioning, etc. Indeed, [Davis and Heineke, 2002] have asserted that two situations must be addressed by the service managers: the sustained growth in demand that necessitates the addition of capacity when demand exceeds the current capacity and the normal variation of demand over time concerned with the labor scheduling ([Taylor, 2008]).

At this level, a possible decision is related to the yield management which is defined by [Pfeifer, 1989] for the airlines as the “process by which discount fares are allocated to scheduled flights for the purposes of balancing demand and increasing revenues”. Three different techniques of yield management exist namely: the overbooking (i.e. accepting more requests for service than can be provided), differential pricing to different customer groups and capacity allocation among customer groups. The purpose of yield management is to sell the right capacity to the right customer at the right price in order to control the tradeoff between capacity and demand. Another way to adapt the capacity is related to the co-production of the service with the customers that consists in making the customers work in order to adapt the capacity. This decision is related to a specificity of the service operations management namely the role and influence of the customer in the service production and delivery processes where the role of the customer varies from service-receiving role to service-producing role [Langeard and Eiglier, 1983], [Berry and Lampo, 2000]. Indeed, customers must be included by service firms as potential partners and thus considered as a part of the organization [Zeithaml and Bitner, 2000]. This can create managerial challenges for service structures not founded in manufacturing sector.

Based on these forecasts, the human resources skills necessary to satisfy the demand are determined. Within the service context, a part of the service providers' tasks consists in customer interaction. The human resources skills are thus of two types: technical skills and interpersonal communication skills.

It is also important to manage both demand and capacity that consists in applying strategies for dealing efficiently with the fluctuations of the demand namely: conducting training for staff, using part-time employees to expand labour-constrained capacity, renting facilities and equipment so that the fixed costs can be reduced, inventorying demand by making customers wait in line and finding ways to divert them, requiring customers to make reservations, offering different services, positioning a service differently, etc.

The capacity must also be dimensioned at the medium term in order to determine the labor necessary to satisfy the forecasted demand. Indeed, too much capacity results in a high level of demand satisfaction but generates high costs. On the contrary, too little capacity conducts to the inability to provide services when needed, resulting in losing both current and future customers. For example, the means of transport necessary to deliver services in the "server to customer" structures must be dimensioned.

After that, the human and material resources must be scheduled at medium and short term based on the demand forecasting related to the number of customers and the time of their arrival while taking into account the mean service times and the service providers' illness and vacations or the equipments' availability ([Bard et al., 2003], [Kabak et al., 2008], [Pasin and Giroux, 2005], [Ingolfsson et al., 2002], [Chevalier et al., 2004], [Duffuaa and Al-Sultan, 1999]).

### **3.3 Very short term planning of service operations**

The planning of service operations at the very short term is translated into the selection of the resources necessary to satisfy the demand based on the skills needed to manage and work with customers, the management of the activity priorities and the scheduling of these activities as well as the scheduling of the resources selected.

At this level, the service managers must manage the uncertainty that characterizes the production of the services which are co-produced by the workers and the customers. However, the customer's ability to participate in the service production and delivery processes and the degree of interaction with the service providers can distort the predictability of service

duration. The customer presence and participation can thus be considered as a source of uncertainty [Klassen and Rohlender, 2001].

After that, the service quality would be measured and controlled. The measurement of service quality represents thus an important issue in the very short term planning of service operations. Indeed, quality service is a large concept which encompasses many dimensions that includes; according to [Johnston, 1999]; availability, flexibility, reliability, security, etc. [Parasuraann et al., 1998] have presented five dimensions of the global measurement for service quality namely: reliability, tangibility, responsiveness, assurance and empathy. Contrary to the manufacturing goods whose quality has been well defined and measured, the quality in service sector remains largely undefined and un-researched [Chase and Apte, 2007].

In this section, we reviewed the literature related to service operations management and distinguished three decision levels: long term, mid-term and operational level. What is important to say is that at the different decision levels, the impact of persons on the service system performance is of huge importance. This human aspect can stem from both customers and service providers' behaviors. However, we remark that most of models developed for solving SOM problems ignore the importance of the human factor in real systems. Indeed, [Boudreau et al., 2003] have asserted that most OM model-based research often uses oversimplified assumptions requiring that people are (1) not a major factor in the phenomena under study in the sense that human side is omitted entirely, (2) deterministic in their actions, (3) predictable in their actions, (4) independent of others, (5) not part of the service i.e. the impact of system structure on how customers interact with workers is ignored, (6) emotionless, (7) "stationary" i.e. no learning, tiredness or other patterns exist and (8) observable i.e. measurement error is ignored.

It is thus necessary to incorporate behavioural principles into descriptive, simulation and optimization models used to analyze and improve service systems. As the success of service operations management tools and techniques relies heavily on the understanding of human behaviour, the real research challenges consist then in properly describing the impact of customer behavior, in better understanding the worker behavior and in predicting how this would affect the delivered quality of service.

#### **4. Health Care: a special service type**

Until now, we have analyzed different types of services at a generic level by defining what the service concept means, presenting their characteristics, reviewing the typologies proposed in the literature and discussing the major trends in service operations management research. Indeed, the human behaviour seems to be a prevailing characteristic in the service sector.

In the rest of this chapter, we are going to focus on a significant service type in most of developed nations namely the health care area. Indeed, the service delivered by a system of care delivery (for example doctor's surgery, hospital, home health care structures) consists in accomplishing care activities (specification, production and delivery of care) in order to transform (improve or stabilize) the patient state (physical or psychological). This transformation intends to re-establish or improve the clinical and/or psychological conditions of the patient. The care delivered to the patient can be of different types: medical, paramedical, psychological, social and even of delivering goods (drugs, medical equipments used at home, etc.) within the context of delivering care at home. These care necessitate the involvement of different actors as well as the contribution of the patient by providing the necessary information to the care givers either by directly describing his/her aches or by measuring his/her state (blood analysis, scanner, etc.). The patient is thus at the same time consumer and producer of care, his participation to the treatment depends on different factors such as: the level of knowledge about the disease from which he/she suffers or the treatment he/she receives, his/her emotional conditions, disease progress, etc. The influence of the patient in the care delivery process (specification and production of care) is related to the co-productive nature of the health care service: the patient can make an auto-diagnosis, he/she is physically present during the production and delivery of services at variable degrees and based on different modalities, he/she develops interactions with the production of care service. The patient has thus a crucial role at different stages of the service production namely: the stage of the specification of care (decide to ask for care, answer exhaustively and honestly to the doctor's questions, approve or not the treatments proposed by the doctor, etc.), the production stage (provide samples for the analysis, respect the protocols of analysis, etc.) or the treatment stage (take the prescribed medicines regularly). The human factor is thus very important in the care delivery process where it is difficult to anticipate or control the patients' reactions.



The health care system is also characterized by the diversity of services provided where the care delivered to the patients are unique due to the fact that care are adapted to the patients' needs based on his/her medical state, his/her specific attributes (age, weight, dependence level, personal preferences, psychological situation, financial situation, etc.) and can thus lead to a partial differentiation of the patient's treatment. Indeed, the patient path evolves according to his/her state but also according to the availability of resources. As the service quality is essentially based on the patients' perceptions, the service must be conceived in such a way that the care are adjusted to the needs of each individual patient so that the patient would be confident in the individualized care that he/she would receive in response to his/her needs.

Moreover, the health care system is also characterized by the operations uncertainty. Indeed, the participation of the patient represents a source of variability which is inherent to the health care service and can generate delays or additional costs to the care suppliers: the patients can sometimes provide incomplete information during the stage of the specification of care, can not formulate their needs or achieve certain activities related to the care production, etc.

The health care system is also characterized by the perishability of its production capacity: this type of systems creates an added value by the mean of the availability and expertise of the human and material resources, when these resources are unused, the added value that could be created is lost due to the fact that the services can not be produced before the receipt of the demand. The perishable aspect of the capacity is also related to the randomness of the demand. Indeed, even if a part of the demand is predictable (seasonal pathologies, scheduled activities, etc.), the demand enclose a random part related to the nature, volume and frequency of the demand (level of care necessary to each profile of patients, occurrence of emergencies or natural disaster, etc.). Different strategies can be used to balance between the demand and the capacity: it is possible to develop the flexibility of the capacity by relying on temporary workers, by improving the polyvalence of care givers, by using the new technologies such as the telemedicine in order to improve the productivity, by resorting to the sharing of the capacity or the externalization of a part of the production. It is also possible to develop approaches such as co-production of the service by more involving the patient and his/her family in the production of a part of the service.

The care delivery activities are supported by organizational activities. Indeed, the delivery of care in a hospital is generally achieved by health units where patients can consult doctors or be hospitalized. This main activity of care delivery is supported by additional services related to the logistic sector namely: services of hotel business, catering, patients' transport, waste

treatment, equipments maintenance, etc. [Gourgand, 2008] has thus asserted that the hospital represents a system that interacts with entities that provide logistic or medical services. The author has thus assimilated the hospital system to a supply chain by defining the hospital supply chain (HSC) as a set crossed by human, material, informational and financial flows. This set is composed of varied and autonomous entities (suppliers, hospital services (emergency medical service, surgical units, pharmacy, cardiology, etc.), logistic providers, medical providers, etc.) that use limited resources (time, equipments, capital, human resources, etc.) and coordinate their actions through an integrated logistic process in order to improve the collective performance (patient satisfaction, global optimisation of the hospital system functioning) as well as the individual performance (maximisation of an entity profit). [Gourgand, 2008] has also asserted that the hospital systems need to organize their structures in order to reach the goals of costs' reduction, patients' satisfaction and time management. For achieving this, the hospital systems needs management and decision-aids tools adapted to their specificities.

In the rest of this chapter, we are thus going to focus on the health care operations management where the health care represents “one of the sectors where the principles of scientific management and of its successor, industrial engineering, were applied early on” [Chase and Apte, 2007].

## **5. Review of research on health care operations management**

Due to the complexity of the health care context which mainly stems from the demographic, social, organizational, political, strategic and technological evolutions; health care organizations are under tremendous pressure to provide effective and efficient health care services by satisfying the patients and reducing costs ([Jun et al., 1999], [Butler et al., 1996], [Harper and Pitt, 2004]). This is guaranteed by reducing patient waiting time, shortening the length of stay within health care organizations, maintaining adequate staff utilization rates, insuring the availability of operating rooms, etc. ([Jun et al., 1999], [Butler et al., 1996]). These health care challenges represent the main operations management issues.

Although many problems related to the operations management in health care context are not analytically different from problems in other industries, different problems are unique due to the characteristics of the health care delivery system namely: the difficulty of measuring quality and performance; the possibility of the patients' death or low quality of remaining life; the multitude of decision-makers (physicians, nurses and administrators); the variation of the

health care system from country to country but also variation between hospitals and alternatives to hospital; the intrinsic uncertainty of health care needs, demands and outcomes, etc.

Indeed, health care operations management has evolved rapidly over the past decades in order to support the health care delivery process with a multitude of applications i.e. public health, community service planning, patient scheduling and admissions, technology acquisition, workforce management, quality management, etc. Due to the important number of papers dealing with this area, many authors have reviewed the literature related to health care operations management and proposed several classifications of the existing literature.

To our knowledge, the first literature review related to health care operations management has been developed by [Fries, 1976] who has grouped the papers reviewed into categories based on the area of their application namely: health status, health planning and program evaluation, forecasting demand, hospital location, ambulance requirements and deployment, hospital occupancy-bed complement, hospital occupancy-elective admissions, special facilities size and scheduling, staffing, appointment systems, hospital inventories, blood banking, examination scheduling and miscellaneous. After that, the same author developed a complementary literature review in [Fries, 1979] and added three new sections: the control of epidemics, the use of auxiliary medical personnel and the medical management of patients.

[Pierskalla and Brailer, 1994] have also surveyed the health care operations management related papers and categorized them under three main topics: system design and planning, management of operations and medical management.

More recently, [Li et al., 2002] have classified papers into long-term structural decisions, infrastructural operations decisions and productivity improvement program. Long-term structural (facility and service choices) decisions involve location facility, capacity and equipment/process technology. Infrastructural operations decisions are more tactical and are related to workforce management, production planning and control, quality assurance and organization design. Productivity improvement programs are related to quality management and continuous improvement.

After that, [Fone et al., 2003] have also reviewed the discrete event simulation modeling in health care delivery. The authors have identified five topics: hospital scheduling and organization, screening and miscellaneous, infection and communicable disease, costs of illness and economic evaluation.

Finally, [Brailsford and Vissers, 2011] have classified the health care operations management papers according to two criteria: the stages of developing and managing a service and the

level at which the process is taking place. First, the development and management of a service is composed of nine stages: identifying consumer requirements, designing a new service to meet these requirements, forecasting demand for such a service, securing resources for it, allocating these resources, developing programs and plans to use these resources for delivering the service, establishing criteria for service delivery, managing the performance of the service and finally evaluating its performance. Second, the authors have proposed three decision making levels namely: the individual patient or provider level, the unit or the hospital level and the regional or national level.

The purpose of this section is to present the main health care operations management research issues that have been considered in the literature. The presentation of these issues is based on the classification proposed for service operations management decisions in Section 3 to which we add medical management related decisions that are specific to health care services.

### **5.1 Design of health care structures**

The first decision related to the design of the health care systems that has been studied in the literature concerns the selection of the services proposed to customers ([Rizakow et al., 1991], [Schneider, 1981], etc). This long-term decision is related to hospital business strategy defined by [Shortell et al., 1985] though the following questions: what services the organization should provide? How the hospital should compete with the selected services? In other words, the design of the health care systems concerns first the choice of services related to the types of inpatient services (services that require an overnight stay of the patients in hospital) and outpatient services (services delivered to patients admitted to a hospital or clinic for treatment that does not require an overnight stay) or other community oriented activities such as wellness programs and day care centers [Butler et al., 1996].

Another long-term decision that has been considered in the literature is related to the contraction, opening, expansion or integration of services and/or construction of new facilities and departments. This decision represents an important and recurrent question which is complicated by the interdependency of the services in health care institutions [Pierskalla and Brailer, 1994].

Furthermore, the facilities location is another decision which is based on the balance between the closeness to customers and the minimization of location and operations' costs. This decision depends on a number of factors such as the nature of the area where the location would be implemented (i.e. urban areas versus rural areas), population density, etc. Health

care facilities location decisions have been classified by [Pierskalla and Brailer, 1994] into five categories: the regionalization of health care facilities, the sitting or removal of a simple facility, the location of ambulatory neighborhood clinics, the location of specialized long-term care facilities and the sitting of emergency medical services (EMS). In addition to the factors previously mentioned, the sitting of emergency medical services (EMS) also depends on additional factors such as accident density or road transport systems and necessitates the establishment of performance standards i.e. the maximum response time requirements.

Moreover, the design of the care delivery systems relies on the workforce design that consists in determining the number and the skills of the care givers (nurses, technicians, physicians, etc.) needed at different times i.e. quarterly, semiannually or annually such that the supply level match the demand level while guaranteeing acceptable patient waiting times, minimizing inefficiencies and delays in delivering health care service and maximizing staff utilization rates. This workforce plans includes hiring, training, transferring between jobs and discharging [Pierskalla and Brailer, 1994].

Similarly to the workforce design, the capacity must be designed which consists in determining the total capacity needed in the health organization (capital equipment capacity, total bed capacity, total room capacity, medical technologies, information systems, etc.) necessary to meet the demand, satisfy the patients and maximize the equipment utilization rates which enables the health care organization to maintain its profitability and quality level as well as to develop its competitiveness.

Once the necessary workforce and capacity are dimensioned, they must be allocated to the different services (surgical services, ancillary services, operating rooms, recovery units, intensive care units, etc.). After that, the workforce/capacity of each service must be assigned across a number of specialties (allocation of operating room capacity to surgical specialties, etc.) ([Vassilacopoulos, 1985], [Dumas, 1985]).

## **5.2 Planning health care operations at medium and short term**

The objective of this class of decisions is to provide techniques that allow the use of existing resources in the most efficient way. These decisions are related to demand forecasting at medium and short terms, patient scheduling, staff scheduling, etc.

First of all, the demand forecasting is of huge importance due to the fact that it may influence almost all the operations management decisions ([Kamenetzky et al., 1982], [Kao and Tung, 1980], [Kao and Pokladnik, 1978]). Consequently, improving the methods of forecasting the

demand would improve the efficiency of the care delivery process. [Perskalla and Brailer, 1994] have presented the main forecasting techniques that have been used in health care settings based on the papers of [Harrington, 1977] and [Hogarth and Makridakis, 1977].

Through the demand forecasting, the health care structure can determine the skills of the workforce necessary to satisfy the demand. In order to guarantee the availability of these skills, health care structures must improve staff flexibility by increasing staff training and enhancing their skills [Li et al., 2002].

After that, the activities of the workforce must be scheduled. Indeed, most of works that deal with the workforce scheduling focuses on the nursing scheduling problem and especially in shift scheduling where shift schedules are developed on a daily basis for each nurse for four to eight weeks ahead to match between nursing staff availabilities and the expected workload among units [Ernst et al., 2004], [Pierskalla and Brailer, 1994]. Indeed, the objective of the shift scheduling consists in satisfying the patients' needs at minimal costs. Despite this, the shift scheduling must develop personnel satisfaction by meeting the care givers' preferences, allowing days off and distributing night and weekend shifts equitably among them. In addition, the shift scheduling must also respect the working regulations in the health care context for example the maximum length of a work shift, the number of day off per week, etc. Among the policies developed for this problem is the cyclic schedule within which all the nurses perform exactly the same shift (day on and day off).

The use of the material resources can also be scheduled so that the objectives of minimizing patient waiting times and maximizing the facilities' utilization rates are reached. Different scheduling policies have then been developed in the literature. For example, [Murphy and Sigal, 1985] have developed a simulation model for the surgical center scheduling using the block scheduling method where a block time of a surgical operating room is booked to a surgeon or a group of surgeons. [Ritzpatrick et al., 1993] have also studied the first-come-first-served scheduling, variable and mixed block scheduling for the operating rooms where the variable block scheduling considers the fluctuation of the demand.

Another way that allows the improvement of the hospital costs' performance is the patient scheduling which allows the matching of the demand with the supply of service available while satisfying both patients and health care givers [Fone et al., 2003]. Indeed, according to [Li et al., 2002], hospital must "develop guidelines to manage the issues of hospital inpatient admission, inpatient and outpatient surgical schedules based on expected length of stay and the mix of diagnosis related groups (DRG)". This topic concerns the trade-off between patient

waiting times and staff utilization and thus allows the reduction of staffing costs and congestion in hospitals.

First, the outpatient scheduling involves fixing the times of the appointments in a given day as well as the duration of time between these appointments. Despite this, the outpatient scheduling includes determining the types of human resources who will be responsible for delivering care to the patients [Jun et al., 1999]. Three methods are used to design the appointment system: block scheduling ([Penneys, 2000]), modified block scheduling ([O'Keefe, 1985]) and individual scheduling ([Vissers and Wijngaard, 1979]). The difference between the two first scheduling is that in the first one, all patients are scheduled for one appointment time and then served on a first-come-first served (FCFS) basis while in the second scheduling, the day is partitioned into smaller blocks and smaller sets of patients are scheduled into those times [Pierskalla and Brailer, 1994]. Despite this, [Williams et al., 1967] have asserted that the block scheduling emphasizes on minimizing the care givers' idle time whereas the objective of the modified block scheduling is to reduce the patient waiting time.

Second, the inpatient scheduling whose objective consists in optimizing the trade-off between patient satisfaction and hospital efficiency is classified into three interrelated dimensions: the daily scheduling of elective admissions (elective admissions are those which occur as a consequence of referral to hospital by a general practitioner, medical consultant, a visit to the hospital outpatient department or a planned transfer from another hospital) and emergent admissions into the corresponding units of the hospital ([Kolesar, 1970]), the daily scheduling of inpatients to the corresponding units of the hospital for treatment or diagnoses through their stay ([Kuzdrall et al., 1981]) and the scheduling of the discharges of patients to their homes or other care delivery institutions ([Trivedi, 1980]). Nevertheless, according to [Pierskalla and Brailer, 1994], the shortcoming of the studies developed within this context is that they consider only the inpatient scheduling in a single service of the hospital without considering the other services such as radiology, laboratory, etc. by which the patient can pass during his stay within the hospital which would conduct to extend the length of stay unnecessarily. This can be explained by the relatively poor internal forecasting and information systems in the hospital.

### **5.3 Very short term planning of health care operations**

Among the decisions related to the very short term planning of service operations within the health care context, the management of uncertainty has been studied in the literature. Note that the uncertainty that characterizes the daily operations is related to the permanent interaction between patients and care givers who must be available at the appropriate times for different patients 24 hours per day and 7 days per week. This variability is thus managed by the corrective allocations which represent, according to [Pierskalla and Brailer, 1994], the third decision level of the workforce planning and scheduling. These allocations are done daily by respecting the individual preferences, working conditions, individual availabilities and capabilities. Despite this, these corrective allocations allow the meeting of the expected response times for emergency services.

Another topic related to the health care operations management at the very short term that has been studied in the literature is the service quality measurement. Indeed, measuring and reporting quality is a key question in the health care context due to the fact that it allows the monitoring of the patient and employee well-being [Butler et al., 1996].

### **5.4 Medical management**

This type of decisions is specific to health care and involves patient disease detection and treatment at policy and patient levels. [Pierskalla and Brailer, 1994] have distinguished two medical management decisions namely: screening for disease and clinical-decision making.

First, the operations research models developed within the context of screening for disease are related either to medical diagnosis or disease detection by means of tests which can be applied to an individual i.e. ‘individual screening’ or to large subsets of the population i.e. ‘mass screening’. These cases are modeled differently due to the distinctness between the objectives of the decision makers as well as to the constraints and parameters affecting these decisions. The literature contains the application of a large variety of decision models including mathematical programming, Markov decision and simulation. Note that the works that deal with the screening for disease cover contagious diseases e.g. HIV, hepatitis A, B, syphilis, etc. as well as non-contagious diseases such as cancer, heart disease, malaria ([Fone et al., 2003] and [Pierskalla and Brailer, 1994]). On one hand, the individual screening’s objective may be to extend life, to minimize the expected detection delay (the time from disease incidence until its detection) or to maximize the lead time (the time from detection by screening until self-



detection or until symptomatic). The constraints may be related to the screening effectiveness, reliability of tests and the lead time gained from detection, the individual's ability or willingness to pay and the parameters to the individual's characteristics (age, sex, prior histories, etc.). On the other hand, the mass screening's objective consists in minimizing the expansion of the contagious diseases in the population by studying the risk factor development which would be used for the planning of intervention strategies or information campaigns [Lagregen, 1998]. Moreover, mass screening protocols are chosen based on several factors namely: the trade-off between testing costs and testing benefits to be achieved from detecting the defect in an earlier stage of development, the reliability characteristics and costs of testing technology chosen, the frequency of testing decided, the susceptibility of the different subpopulations to the disease, etc.

Second, a growing area of both health services research and operations research is related to the development of operations research methodologies for clinical decision-making to prevent diseases and to manage ill persons. This area combines the mathematics; structural analysis of operations research and solution approaches including optimization and simulation as well as a deep knowledge of biological, economic and sociological aspects of patient care. According to [Pierskalla et Brailer, 1994], the use of decision analysis for the clinical decision-making can be divided into three areas namely: aid in the structuring of medical decisions, improving the performance of testing strategies and of diagnostic accuracy for chronic and acute conditions as well as analyzing health care policies and those policies that affect large populations. Different tools can be used: decision trees for complex problems, simulation models for problems that are either too complex or contain states that are highly independent, tree structuring and network modeling, cost effectiveness analysis (CEA) or cost benefit analysis (CBA), etc.

## **6. Conclusion**

In this chapter, we considered a growing sector in the modern developed countries' economies namely the service sector. We aimed at better defining what service means in order to improve the qualitative understanding of service systems characterized by their heterogeneity. We also presented typologies that have been proposed in the literature to classify the different types of services. Based on these typologies, we extracted the essential

differences that exist in terms of managerial challenges between manufacturing structures and service structures on one hand and between the different classes of services on the other hand. Another contribution of this chapter is to highlight the major decisions of service operations research such as districting of the territory, facilities location, workforce scheduling, etc. We then focused on a specific type of service on which the human behaviours of both service providers and customers are of huge importance namely the health care service that we analyzed by defining it, characterizing it and surveying the literature related to operations management methods and tools developed for this type of service. This review pointed out that the workforce planning and scheduling is a major activity within the health care structures due to the importance of both clinical imperatives and staffing costs. Indeed, [Brailsford and Vissers, 2011] have asserted that the papers that deal with workforce planning and scheduling represent 24% of all papers presented in ORAHS meetings between 1975 and 2009.

Based on the work carried out in this chapter, we can present some areas for future research. First, developing an empirical study related to the classifications of services represents an interesting research challenge. This study would allow the validation of the differences between the different classes of services that have been highlighted in this chapter through the quantitative and qualitative analysis of suitable tests, observations and experiments. Based on this validation, it would also be possible to provide a more evolved service operations management decisions framework customised according to the type of service considered. Moreover, identifying the quality indicators for each type of service is essential to help the service structures to control the consistency of the services delivered to the customers and to define policies for finding solutions if the service quality is not satisfactory for the customers. Again, based on empirical work, we can identify the more suitable quality indicators associated to each class of services.

Second, as explained in Section 3, the impact of the personnel behaviour on the efficiency of the service delivery system is very important. Indeed, studying how human resources practices interact with the service delivery process and influence the performance outcomes is interesting. Modelling this interaction and integrating it in operations management models are challenging research directions. In the same line, finding ways to motivate service providers is also an interesting operations management/human resource management issue that would yield to the improvement of customer perceived service quality and the profitability of the service delivery system.

Finally, despite the important growth of modelling papers as well as the relevance and reliability of the models' results, the number of papers that deal with the outcomes of models' implementation is very modest ([Wilson, 1981], [Buhaug, 2002], [Fone et al., 2003]). Indeed, [Wilson, 1981] have considered that operations research studies are difficult to implement within the health care context due to the absence of a decision-making hierarchy and due to the predominance of the political considerations of the decisions. Consequently, the development of works that test the implementation of the tools and models developed in real hospitals represents an opportunity for the operations management researchers.

The review of health care operations management models also showed that the application which has been most considered by researchers is the hospital context. This can be explained by the strategic role of hospitals within the health care delivery system. However, over these last decades, the health care system is moving towards promoting new modes of health care delivery that are alternatives to the traditional hospitalization in order to improve the efficiency of the entire health care system. As these alternatives are facing new challenges, operations management models are also developed within this specific context. In the rest of this thesis, we are going to focus on one of these alternatives namely Home Health Care (HHC) service providers.



## ***CHAPTER 2***

# ***HOME HEALTH CARE OPERATIONS MANAGEMENT***

### **1. Introduction**

The health care system mainly consists in the hospital sector (regional hospitals, general hospitals, private hospitals, clinics, etc.) and the ambulatory sector (doctors' offices, pharmacies, Home Health Care structures, Nursing Homes, specialized treatments at home, in-home support services, etc.) [Bonnici, 2003]. This sector is thus characterized by the diversity and the recent development of alternatives to the traditional hospitalization.

In this chapter, we focused on one type of these alternatives namely the Home Health Care (HHC) which has been created in order to solve the problem of hospital capacity saturation by allowing early discharge of patients from hospital or by avoiding their admission [Jones et al., 1999]. Furthermore, HHC aims at satisfying clinical, psychological and social needs of patients by providing them at home the necessary services delivered by formal and informal care givers [Tarricone and Tsouros, 2008].

During this last decade, this type of structures that has emerged as a real substitute to the traditional hospitalization has known an important growth. In fact, the total number of HHC structures in France rose from 68 in 1999 to 123 in 2005 and to 231 in 2008. More precisely, the HHC activity in France has evolved between 2005 and 2008 by 84% in terms of number of days and by 78% in terms of numbers of sojourns. The average duration of stay remains stable and is equal to 15 days whereas the average age of the patients has increased from 61 to 63 years old. Note that in 2008, 60% of the sojourns are related to perinatal care, palliative care and care protocols related to the cancer disease [Durand et al., 2010].

The development of this type of structures has been accelerated by the continuous governmental pressure to contain the health care costs; the demographic changes related to the ageing of the population; the increase of the number of people having chronic illnesses, physical and mental disabilities as well as by the development of new technologies such as nanotechnology or telemedicine.

Therefore, HHC represents social and economic stakes by improving or maintaining the medical, psychological and social welfare of patients at home while containing operations costs. However, despite the importance of this type of health structures, the number of studies dealing with Operations Management within the HHC context remains modest. HHC structures thus fall behind hospitals in terms of operations management and organization of the care delivery process.

The objectives of this chapter are thus twofold: first, we give a general overview of the HHC by defining it, analyzing its evolution within the French context, etc. Second, we analyze the operations management issue by reviewing the models developed in the literature and identifying the complexity factors that operations management has to face in the context of HHC structures. We would thus underline the necessity of developing approaches adapted to this type of structures in order to better organize the delivery of care by improving the service quality towards patients as well as towards care givers while reducing the operation costs.

The remainder of this chapter is as follows. We define in Section 2 the HHC and analyze its evolution within the French context. We also present in Section 3 the factors and barriers to its development as well as its advantages and disadvantages. After that, HHC costs are analyzed. We also examine the different complexity factors and analyze how each factor can affect the organization of care delivery in Section 4. Section 5 surveys operations management based models proposed in the literature within the HHC context and points out the complexity factors that have not been considered in the HHC operations management based models. Concluding remarks and perspectives are provided in Section 6.

## **2. Appearance and evolution of HHC in France**

One of the dominant characteristics in the delivery of health care over the past decade has been the development of different types of alternatives to the traditional hospitalization. Indeed, the economical context of the health care system explains the necessity of reducing the number of hospital beds i.e. the hospitalization rate. As a consequence, many aspects of care now take place in alternatives to the traditional hospitalization that allow, aside from the reduction of the hospitals' deficits, the improvement of the patients' living conditions.

The different alternatives that exist in France can be classified according to [Zerbib, 1990] as follows:

- Alternatives inside the hospital: day care hospital, ambulatory surgery, etc.

- Alternatives in open structures (for the psychiatric sector): psychiatric day care, psychiatric night care, therapeutic houses, etc.
- Alternatives in patients' homes: Home Health Care, Nursing Home, Specialized Treatments at home (self-dialysis at home, breathing assistance at home), In-Home Support Services.

In the rest of this chapter, we are going to deal with one of these alternatives namely the HHC.

## **2.1 Appearance of the HHC in France**

The concept of HHC was initiated on 1947 in the United States. After that, the first HHC structure was created in Tenon Hospital in France on 1951 followed by the HHC structure of the APHP on 1957 and the structure "Santé-services" on 1958.

In parallel to the creation of these structures, the legal existence of this type of hospitalization has been declared on the hospital law of 31<sup>st</sup> December 1970 that has specified that "the services of the hospitals can be extended at home, subject to approval of the patient or her/his family, to continue the delivery of care with the participation of the attending physician." On 1973, the National Federation of Home Health Care Structures (Fédération Nationale des Etablissements d'Hospitalisation A Domicile-FNEHAD) has been set up in order to group HHC structures and on 1974, a medical and administrative structuring of the HHC has begun with the apparition of a law and a circular where the medical and social criteria for patients' admission as well as the conditions of their care are described.

Thereafter, the HHC has been recognized by the circular of 12<sup>th</sup> March 1986 as an intermediary structure between the hospital and the ambulatory sector where "the HHC recovers all the medical and paramedical care delivered at home to patients whose state does not justify their keeping in hospital. These care have to be of a nature and intensity comparable to those who might be delivered to them within a traditional hospitalization."

Afterwards, the 31<sup>st</sup> July 1991's hospital reform and the 2<sup>nd</sup> October 1992's decree have recognized the HHC as an alternative to the traditional hospitalization and have defined the specific role of the coordinating physician and the nurses as well as the continuity of care, permanence of care, HHC prescription's modalities, etc. Additionally, the decree of 2<sup>nd</sup> October 1992 indicates that the care are insured for a limited but reviewed period according to the evolution of the patient's therapeutic project defined as being a project which "formalizes

all the clinical, psychological and social care necessary for the state of the patient". Moreover, the types of care givers necessary, the duration of the patient's sojourn within the HHC system, the drugs to administrate, the frequency and average duration of visits, the times and place of care delivery, the additional home helps that the patients may need as well as the modalities of exit from the HHC structure are specified in the therapeutic project.

More recently, the 30<sup>th</sup> May 2000's circular specifies the admission criteria and the objectives of care where "the HHC concerns the patients affected by acute or chronic, evolutionary or unstable pathologies".

Moreover, the 4<sup>th</sup> February 2004's circular defines the terms of the admission in perinatality, pediatrics and psychiatry which enlarge the scope of care practiced in HHC structures.

This voluntarist politic of the authorities has thus conducted to an important development of the HHC in terms of number of structures and number of patients admitted as we are going to explain in the following sub-section.

## **2.2 Evolution of the HHC in France**

The HHC sector has known an important growth since its creation sixty years ago and especially over this last decade as shown in Figure 2-1. Indeed, the number of HHC structures has increased by 87.7% between 2005 and 2008. During the same period, the number of days during which patients are followed up by HHC's care givers has risen steadily from 1 505 814 to 3 298 104 which correspond to an increase of 119.02%. Similarly, the number of patients has increased by 147.52% between 2005 and 2008<sup>2</sup>.

---

<sup>2</sup> [http://www.fnehad.fr/images/stories/1.Evolution\\_offre\\_HAD\\_0509\\_Site\\_FNEHAD.pdf](http://www.fnehad.fr/images/stories/1.Evolution_offre_HAD_0509_Site_FNEHAD.pdf)



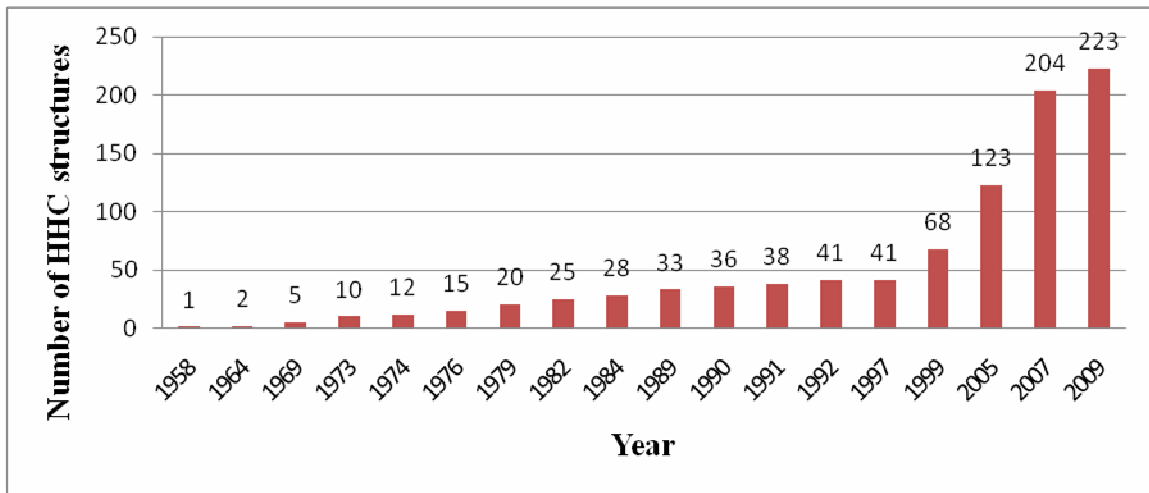

**Figure 2-1:** Evolution of the HHC structures number in France

According to [Durand et al., 2010], all the regions have known an increase of the HHC activity over the last five years, but with inconstant proportions. More precisely, the average coverage rate i.e. percentage of the territory where HHC structures deliver care, increased by 14.70% between 2008 and 2009 but this coverage rate varies from region to another i.e. +10% in Ile-de-France, +78% in Languedoc Roussillon, +36% in Champagne Ardenne, etc. Consequently, the supply and the activity of HHC are still inequitably split over the French territory where the HHC structures are distributed unequally between urban and rural regions. In Table 2-1, the number of structures and number of days during which patients are followed up by HHC's care givers in each region over 2009 are presented. According to [Durand et al., 2010], the nature of care delivered to the patients also varies from a region to another. This heterogeneity is due to the unequal geographical distribution of the population over all the territory, the importance of the transportation times in rural zones, the existence of an important number of hospitals in the urban zones which represent a source of patients that can be potentially admitted in the HHC structures, the dependence of the creation of an HHC structure on the regional health politics [Zerbib, 1990].

Additionally, the HHC system is characterized by the diversity of its structures in terms of size with a majority of "small structures" as shown on Figure 2-2. Indeed, according to the circular of 1<sup>st</sup> December 2006, the "desirable minimum level of activity" is set up at 9000 days per year.

**Table 2-1: HHC activity per region in 2009**

Region	Number of HHC structures	Number of days	Number of days/ 100 000 habitants
Ile-de-France	16	849 838	7 238,70
Champagne-Ardenne	7	26 413	1 916,80
Picardie	15	108 810	5 585,80
Haute-Normandie	10	65 945	3 549,80
Centre	12	108 060	4 159,30
Basse-Normandie	13	91 046	6 047,50
Bourgogne	16	63 004	3 737,60
Nord-Pas-de-Calais	16	279 919	6 842,10
Lorraine	19	53 915	2 251,60
Alsace	8	74 360	3 998,80
Franche-Comté	8	47 831	4 001,80
Pays-de-la-Loire	8	120 028	3 348,20
Bretagne	10	112 330	3 488,90
Poitou-Charentes	11	78 814	4 393,30
Aquitaine	13	189 264	5 845,60
Midi-Pyrénées	15	114 853	3 974,40
Limousin	5	57 474	7 568,20
Rhône-Alpes	26	288 082	4 634,60
Auvergne	7	45 237	3 274,20
Languedoc-Roussillon	13	42 830	1 637,20
Corse	3	28 135	9 239,70
PACA	26	289 704	5 858,70
France	298	3 298 104	5 071,60

Beyond their sizes, HHC structures also differ according to their legal status [Aligon et al., 2003]. Indeed, these structures can be of four types: public, PHPS (Participating in the Hospital Public Service) private, associative private, profit-making private. The biggest part of the activity (64%) is carried out by non-profit making private (PHPS private and associative private) structures. The profit-making private sector deals only with 9% of the HHC activity in 2009 while the public sector represents 27% of the activity (see Figure 2-3).

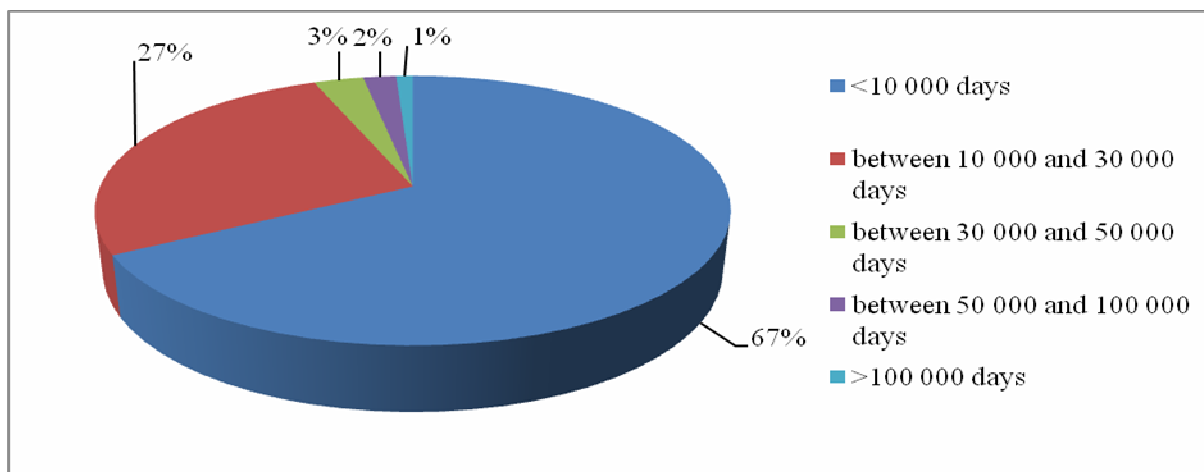

**Figure 2-2:** Distribution of the HHC structures according to their sizes in 2009

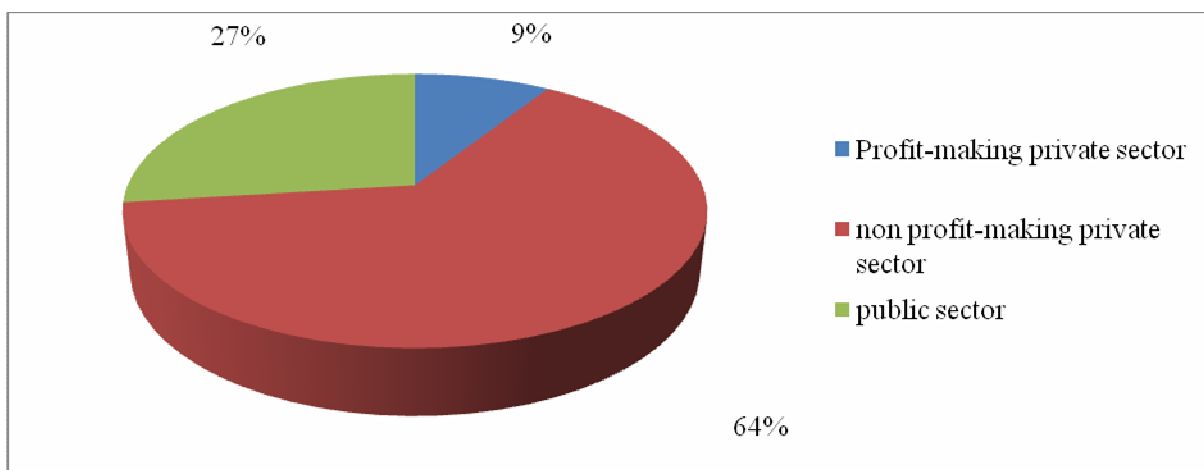

**Figure 2-3:** Distribution of the HHC structures according to their status in 2009

### 3. Evaluation of HHC services

#### 3.1 Development factors and barriers to HHC

The HHC has known an important growth during this last decade. According to [Tarricone and Tsouros, 2008], [Woodward et al., 2004], [Chahed et al., 2007], etc. many factors drive the need and demand for HHC namely:

- Demographic changes: due to the life expectancy rose, the proportion of elderly people is increasing steadily in many European countries and is predicted to rise further in the coming decades (see Figure 2-4). These demographic changes explain

the increasing rates of care-dependent elderly people and thus lead to an increased demand for HHC.

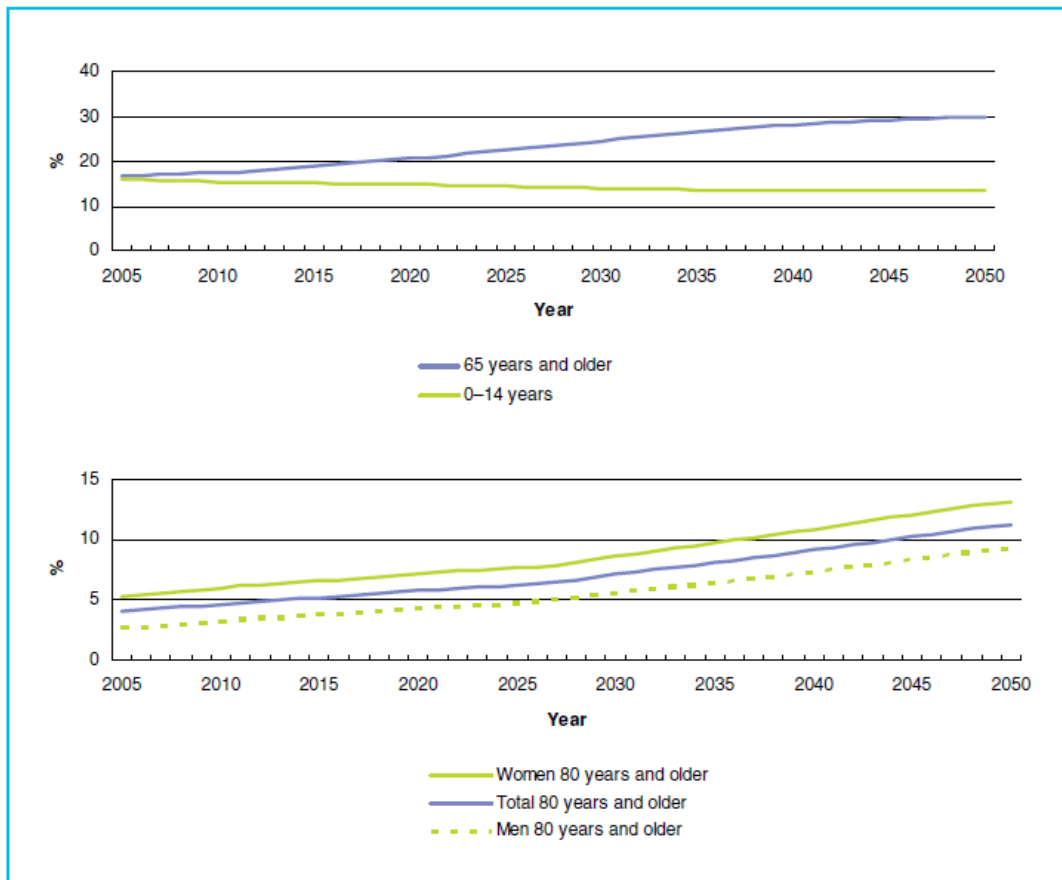

**Figure 2-4:** Projections for the proportion of the population in various age groups in the European Union (27 countries) between 2005 and 2050<sup>3</sup>

- Changes in epidemiology: the mental illness such as Alzheimer’s disease and dementia are more prevalent. The treatment for these types of diseases in community care is preferred to institutionally based care. Moreover, the number of people having chronic diseases or living with the consequences of stroke, cancer, heart diseases, respiratory diseases, diabetes, etc. can be effectively treated within a home setting.
- Science and technological (both medical and non-medical) innovation: medical and non-medical advances have contributed to improve clinical outcomes, reduce the length of stay in hospitals, reduce reoccurrence and readmission rates, increase life expectancy and improve quality of life of persons with complex care needs.

<sup>3</sup> [Tarricone and Tsouros, 2008]

- Changes in attitudes and expectations: the increased focus on user-centred services, the importance given to the individualization and customization of care as well as the necessary humanization of care delivery (by allowing people to remain in their homes as long as possible) are at the origin of the development of HHC.
- The governmental pressure: there is a continuous governmental pressure via a range of policy priorities and choices to reconfigure health systems by encouraging the development of HHC structures to improve responsiveness, continuity of care, efficiency and equity. Indeed, HHC presents clinical, social and emotional benefits for the individual users and their families but is also financially interesting for the public expenditure due to the fact that it is more effective and efficient than institutionalized care [Tarricone and Tsouros, 2008].

Nevertheless, the rapid growth of the HHC is slowed down, according to [Chahed, 2008] and [Lebrun, 2003] by some barriers namely:

- The unclearness, at least in France, of the limit between the Home Health Care practice and the Nursing Home practice.
- The ignorance of some health professionals and/or patients to this type of hospitalization.
- The sharing of the responsibilities around the patients is not well defined and this has not allowed the improvement of the collaboration between the hospital sector and the HHC sector.
- The absence of encouragement from the practitioners to use this type of hospitalization.
- The difficulties to develop HHC structures in rural zones.
- The wavering of the social security to create new HHC structures in order to avoid additional expenditures

### **3.2 Pros and cons of HHC**

The HHC has largely evolved during this last decade thanks to its human, medical and economical advantages. Indeed, according to [Com-Ruelle and Lebrun, 2003], 93% of the patients consider that the main advantage of the HHC is to be treated in their familial environment. This would allow, according to [Raffy-Pihan, 1997], the free time organization. It would also reduce the risk of appearance or worsening of a dependence state linked to a

hospital sojourn. Furthermore, the HHC avoids the desocialization generally caused by the traditional hospitalization which is psychologically harmful for the patients. Moreover, the HHC is also advantageous for the family members as it supports them psychologically and avoids them to go to the hospital every day. The HHC also guarantees the continuity of care by collaborating with hospital care givers and coordinating the care delivered by the different care givers. Despite this, the HHC is also advantageous for the practitioners as it enables them to take care of a reduced number of patients and thus to be less stressed, more autonomous and closer to their patients.

The HHC also presents a medical advantage that consists in reducing considerably the risks of hospital-acquired infections by approximately three times.

Finally, the HHC represents an economical advantage by avoiding the hospital capacity saturation which would lead to the containment of the whole health system's costs. Indeed, the HHC reduces the average duration of stay within hospitals and accelerates the turnover of the hospital beds and consequently allows keeping highly specialized human and material resources to the patients with acute diseases. The HHC is thus less costly than the traditional hospitalization [Alignon et al., 2003]. The economical advantage is going to be explained in more details in sub-section 3.3.

However, despite all its advantages, the HHC also presents some disadvantages. The most important disadvantage of the HHC is the absence of a permanent medical supervision (guaranteed 24 hours per day). This type of hospitalisation necessitates thus the permanent presence and availability of the family members who feel themselves stressed and overloaded by the domestic work [Raffy-Pihan, 1997].

Additionally, due to the intensity and frequency of care to deliver and severity of the pathologies treated, the HHC is perceived by the general practitioners who can prescribe it since October 1992 as a badly defined responsibility that is heavy to take for.

Finally, even if the HHC is economically interesting for the health system as a whole, it can paradoxically cost much for the patients and their families due to the fact that a part of the costs is shifted to the patients and their families such as lighting, hot water, acquisition of medical and/or paramedical equipments (wheelchair, specialized beds, etc.), etc. For more details, the reader is referred to the following section.

### 3.3 Analysis of HHC costs

Reducing costs by avoiding admission to hospital and decreasing hospital length of stay are often presented as central goals of HHC. Different researchers have thus been interested in the economical evaluation of HHC. Three topics have been studied namely: the analysis of the types of costs involved in the HHC practice, the comparison between the HHC costs and the traditional hospitalization costs and the analysis of the economic factors of both types of hospitalization.

First, different researchers have distinguished between the different types of costs involved in the HHC practice. [Jones et al., 1999] have identified five types of HHC costs namely: staffing costs, consumable costs, equipment costs, overhead costs (e.g. administration, car leasing, travel costs, etc.) and capital costs. [Aligon et al., 2003] have also distinguished between the direct medical care costs and the costs of medico-social coordination and administrative functioning. Another typology of HHC costs has been proposed by [Vergnenègre et al., 2006] who have identified four types of costs: staffing (nurses, doctors, etc.), coordination, consumable and travel costs.

In what follows, we are interested in the direct medical costs. Indeed, these latter are composed of the nurses and auxiliary nurses' salaries (39% of the direct medical costs), pharmacy (21%), medical material (18%), etc. Figure 2-5 illustrates the distribution of the direct medical costs.

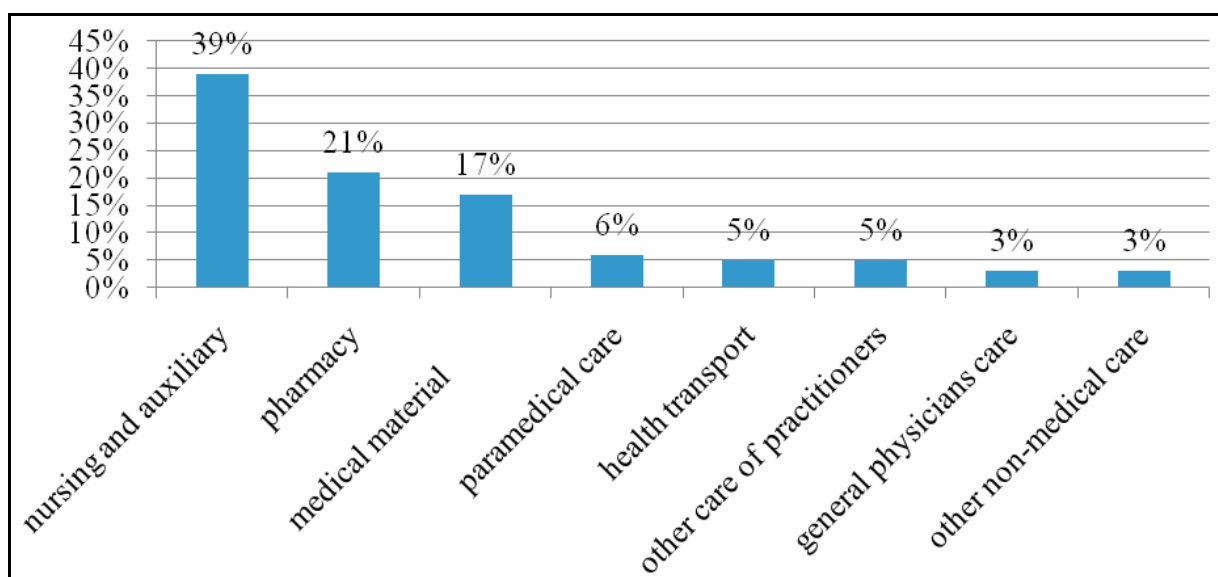

**Figure 2-5:** Distribution of the direct medical costs

Second, several comparisons between HHC and traditional hospitalization costs have been developed in the literature. Indeed, the first comparison has been developed by [Jones et al., 1999] who have concluded that the HHC structure can deliver care with similar or lower costs than the traditional hospitalization for an equivalent admission. [O'Brien and Nelson, 2002] have also conducted a comparison between the traditional hospitalization costs and the HHC costs for elderly people who need acute care. The conclusion is that the HHC is less expensive than the traditional hospitalization as it allows the saving of 30 billion dollars per year. After that, [Aligon et al., 2003] have compared the average costs of nursing care within the HHC context and the traditional hospitalization context between 2005 and 2007. The results of this study clearly prove that the HHC is less expensive than traditional hospitalization. Another economic analysis has been developed by [Vergnenègre et al., 2006] in which the authors have compared the costs of the chemotherapy delivered to patients suffering from bronchi-pulmonary cancers at home and in hospital. The results of this study prove that the HHC allows the saving of 16.15% of the chemotherapy costs per treatment's cycle compared to the traditional hospitalization.

The papers presented above have conducted to the same conclusion: HHC is less costly than the traditional hospitalization. However, other studies have proved the opposite. The results of the study developed by [Wilson et al., 1999] who have concentrated their work on the patients suffering from heart failure prove that the HHC for this type of patients is more expensive than the traditional hospitalization as the weekly costs increase on average by 1.382 dollars per patient. This conclusion can be explained by the critical clinical conditions of the patients involved in this study and the inconsistency of the quality of care delivered to the patients (this study involves 18 different HHC structures).

Third, the economic factors that considerably increase costs must be analyzed in order to compare the costs of both types of hospitalization as pertinently as possible. [O'Brien and Nelson, 2002] have enumerated these factors. On one hand, the four factors that explain the increase of the traditional hospitalization's costs have been presented: medical errors (annual additional costs of 200 billion dollars), hospital acquired infections (the annual costs related to the infections are estimated to 4 billion dollars), decline of patients' autonomy (the hospital stay of 75% of the patients aged of more than 75 years old is extended by 12.3 days that corresponds to 4.233 dollars per patient and per day) and death rate. On the other hand, the authors have explained that HHC costs can increase due to the risks that patients make errors for taking the corresponding drugs, for using a medical equipment, etc. during the absence of the care givers. The HHC costs can also increase due to the additional costs related to the



home fitting; home support; transportation services; acquisition of non-medical equipment such as special chairs, ramps into the house, adapted toilets, showers, baths, special beds, etc. [Tarricone and Tsouro, 2008], [Aligon et al., 2002]. According to the circular of the 29<sup>th</sup> October 1974, even if the care delivery within the HHC context may be more expensive than the traditional hospitalization, the stay of the patient at home and the participation of the family to the care allow the reduction of the total HHC costs due to the fact that a part of the costs is shifted to the patients and their families. More precisely, [Jones et al., 1999] have affirmed that 44% of the patients use more lighting, 30% more laundry, 27% more heating, 17% more hot water and this generates more expenditures for the patients and their families. Moreover, if the care delivered by the family's members are achieved by formal care givers, the annual costs of HHC would increase from 45 billion dollars to 75 billion dollars.

Note that different authors have mentioned that the results of the HHC economic analysis may vary according to different criteria related to the clinical conditions of the patient (the duration of stay, the nature of the main care protocol, the age and the dependency of the patient, the mode of exit from the HHC structure) and the type of HHC structure (its status, its size, the national setting within which the HHC structure operates) [Com-Ruelle et al., 2003], [Armstrong et al., 2008]

#### **4. Complexity factors of the HHC Operations Management**

In this section, we focus on the HHC operations management whose main objective consists in finding the most efficient organization in terms of human and material resources that guarantees a satisfactory service quality towards patients as well as towards care givers while reducing costs. Guaranteeing a service quality towards the patient involves an improvement of the quality of care, a reduction of the waiting time and a satisfaction of his/her personal preferences (e.g. affinity with certain care givers, respect of preferential days or time windows for visits, etc.). Guaranteeing a service quality towards the care givers implies a fair distribution of the workloads between them and the satisfaction of their personal preferences (e.g. periods of vacancies, respect of preferential days, etc.). Reducing the costs in the HHC context consists in reducing the staffing costs, drug purchase and equipment acquisition costs, consumable material resources storage costs, transportation costs, etc.

In this section, we analyze the complexity factors that operations management has to face within this type of care structures.

## **4.1 Diversity of the services proposed**

Due to the variety of patients' clinical, social and psychological needs, the clinical and organizational processes which result from these needs can be of high diversity. Consequently, services provided by HHC structures are heterogeneous which implies that the care delivery processes cannot be totally standardized. A definition of the market strategy is thus necessary to determine the nature of the services proposed by the HHC structure, the profiles of patients who can be admitted in the HHC structure, the expected satisfaction level of patients, etc. This market strategy definition would allow the dimensioning of the HHC structures' resources in order to satisfy the demand by delivering services with a satisfactory quality level and lower costs. The diversity of the services proposed by HHC structures stems from the nature of these services, the different types of care delivered to patients, the different pathologies for which patients are admitted within HHC structures and the care protocols used to treat these pathologies. These aspects are detailed below:

### **4.1.1 Nature of services proposed by HHC structures**

In order to improve patients' living conditions, HHC structures provide them health services as well as auxiliary services. Indeed, we can distinguish five categories of services namely:

- Medical services
- Paramedical services
- Psychological support and coaching of patients (and their families) by counseling and advising them in order to improve their behavior, relation and communication.
- Health promotion, disease prevention and education of the patients and their families.
- Social services: [Williams, 2006] and [Com-Ruelle et al., 2002] have enumerated four types of social services: house keeping (house cleaning, laundry services, shopping, administrative paperwork such as budget management); meal preparation; personal care (feeding, dressing and undressing, bathing, disposal) and assistance at home (patients' supervision, displacements inside the home). We can also add a fifth type of social services which concerns the transfer of patients outside home. Indeed, it is possible that the patient needs to move outside home during his stay within the HHC structure. These displacements can be managed, according to his clinical conditions and his mobility, by the patient himself (or by his family) or by the HHC structure.

The last case requires a prior organization for the vehicle booking, the arrangement of the meeting with professionals of another health unit who would deliver the care, the planning of the activity of the care giver who would take the patient to the health unit.

#### **4.1.2 Types of care**

The care delivered to the patients during their stay within the HHC structures can be classified into five categories. This classification is based on the duration and the technical nature of the care namely:

- Punctual care are technical, heavy and complex care. This type of care is intended for patients having not stabilized pathologies and treated for periods determined beforehand. They can be reiterated frequently (for example: chemotherapy, antibiotic treatment).
- Continuous care are technical care that are more or less complex, delivered for an undetermined duration which can go to the terminal phase to patients having evolutionary pathologies (cancer, cardiac or pulmonary diseases) in order to maintain current functioning levels.
- Terminal phase's care are intended for patients in a terminal phase and whose stay's duration does not exceed few days.
- Follow-up and rehabilitation care concern essentially patients treated for a determined duration, after an acute stage of neurological, orthopedic or cardiologic pathology.
- Resumption care of the parents' autonomy: the objective of these care is to readapt children at home by learning to the parents how to deliver care. These children are treated for a determined duration after an acute stage of a disease.

#### **4.1.3 Pathologies covered by HHC structures**

[Com-Ruelle and Lebrun, 2003] have presented the main pathologies treated by HHC structures in France namely:

- Cancer (50% of the admissions in 2000)
- Pregnancy- childbirth- perinatal (8% of the admissions in 2000)
- Nervous system diseases (7% of the admissions in 2000)
- Traumas- poisonings- osteo-articular diseases (7% of the admissions in 2000)

- Circulatory system diseases (6% of the admissions in 2000)
- Endocrinal diseases, nutrition and metabolism (5% of the admissions in 2000)
- Breathing apparatus diseases (4% of the admissions in 2000)
- Infectious and parasitic diseases (3% of the admissions in 2000)
- Digestive system diseases (2% of the admissions in 2000)
- Skin diseases (1% of the admissions in 2000)
- Others (6% of the admissions in 2000)

However, it is rather frequent that patients are treated for multiple pathologies. Indeed, [Sentihles-Mankom, 2006] have considered that HHC is adapted to complex and multi-pathological patients. Furthermore, [Com-Ruelle and Lebrun, 2003] have asserted that "28 % of the admitted patients and 50 % of the patients who are present in the HHC structure for more than three months have at least five additional diagnoses associated to the main diagnosis".

#### **4.1.4 Care protocols (treatment modes)**

Patients admitted in a HHC structure receive medical and paramedical care according to one or several protocols prescribed by the coordinating doctor. During the patients' stay within the HHC structure, their care protocols may change when their clinical conditions vary.

The French circular of May 30<sup>th</sup>, 2000 lists 24 care protocols. Table 2-2 presents details on the activity related to each care protocol in 2008.

**Table 2-2: Activity per care protocol in 2008**

<b>Main care protocol</b>	<b>Number of days in 2008</b>	<b>Percentage</b>	<b>Average patient age in 2008</b>	<b>Number of sojourn in 2008</b>	<b>Percentage</b>
Antibiotic treatment	141 161	5,1%	59,5	10 821	8,2%
Breathing assistance	116 103	4,2%	62,8	2 940	2,2%
Chemotherapy	73 218	2,6%	61,2	15 440	11,6%
Education of the patient and his family	51 782	1,9%	50,3	2 212	1,7%
Enteric feeding	187 817	6,8%	61,3	4 048	3,1%
Parenteric feeding	102 455	3,7%	62	4 539	3,4%
Complex bandages	518 734	18,7%	68,9	11 936	9,0%
Pathological post-partum	67 055	2,4%	29,9	11 066	8,3%
Psychological post-partum	37 698	1,4%	29,6	8 996	6,8%
Post-operation treatment	109 370	3,9%	58,9	6 117	4,6%
New-born treatment	27 923	1,0%	0,2	5 571	4,2%
Radiotherapy	3 458	0,1%	62,4	175	0,1%
Neurological reeducation	50 858	1,8%	67,4	1 474	1,1%
Orthopedic reeducation	59 288	2,1%	73	1 703	1,3%
Heavy nursing	251 627	9,1%	73,4	5 892	4,4%
Palliative care	658 231	23,7%	69,7	21 689	16,4%
Aplasia supervision	5 011	0,2%	39,9	385	0,3%
Pregnancy with risk supervision	65 665	2,4%	31	2 914	2,2%
Post-chemotherapy supervision	75 269	2,7%	55,1	4 788	3,6%
Pain treatment	64 267	2,3%	66,1	3 046	2,3%
Blood transfusion	618	0,0%	70,9	263	0,2%
Other treatments	109 515	3,9%	60,7	6 530	4,9%
<b>Total</b>	<b>2 777 123</b>	<b>100,0%</b>	<b>63,2</b>	<b>132 545</b>	<b>100,0%</b>

#### **4.2 Diversity of the resources involved in the care delivery process**

As soon as the patient is admitted within the HHC structure, his/her therapeutic project is established so that the types and number of human and material resources required for the

care delivery can be determined. This therapeutic project is defined by the French health decree of 2<sup>nd</sup> October 1992 as being a project which “formalizes all the clinical, psychological and social care necessary for the state of the patient”. More precisely, the information mentioned in this project are: the types of care givers necessary to deliver the care, the drugs to administrate, the frequency and average duration of visits, the additional home helps that the patients needs as well as the modalities of exit from the HHC structure. This project is defined for a limited and reviewed period and can be changed if the patient’s conditions necessitate it. It ends when the therapeutic objectives fixed at the admission of the patient are reached or when the patient is dead.

The diversity of human resources involved in the care delivery process explains the necessity of assigning to each patient a reference care giver whose role is to manage care, communicate the therapeutic project’s modifications to the other care givers and ensure the delivery of all the services needed by patients. It also explains the necessity to communicate on time the information related to patients’ conditions, coordinate all these resources during the patient stay within the HHC structure. However, the human resources do not work in the same unit, do not meet and possibly do not know each other. Consequently, the communication of the information related to the patients is complicated in the HHC context which would conduct to heterogeneous points of view and decisions related to the therapeutic projects of the patients. Furthermore, the variety of these resources coupled with the uncertainty of demand complicates the adjustment of the capacity to demand. In order to remedy to this, most of HHC structures work more with external care givers, develop the multi-disciplinarity of the internal care givers, use more new technologies such as telemedicine, nanotechnology, etc.

Furthermore, as detailed below, different types of material resources requires the organization of their supply chain by selecting material and equipments’ suppliers, defining inventory management policies related to the consumable material resources, organizing resources’ delivery to the patient home, planning the medical and paramedical equipments’ maintenance procedures, etc.

#### **4.2.1 Types of human resources**

The care delivered by HHC structures is performed by a multidisciplinary team composed of medical and paramedical care givers among whom we can distinguish:

- The physicians responsible for the definition and update of the patients’ therapeutic projects by specifying the types and the frequencies of the necessary care.

- The nurses who represent the largest group of HHC employees. They evaluate the conditions of the patients who receive HHC services, provide the necessary care, make sure that the physicians' prescriptions are carried out, coordinate the visits of all care givers, update the patient' file by mentioning the activities performed and the changes of his/her conditions, take care of the medical equipment and have an educational role with patients and their families.
- The therapists such as physical, occupational and speech therapists who consider therapy needs, develop care and rehabilitation plans and have oversight for any assistants involved in providing therapy.
- The nutritionists who can also participate in the delivery of care to the patients.
- The social workers who support the patients and their families in accessing to community assistance, overcoming their financial and social problems that can influence the delivery of care by determining their needs in terms of additional helps (house cleaning, meal preparation, etc.).
- The home care assistants and the home health aides who “are the foundation of the home care workforce because of the wide variety of services they provide” [Tarricone and Tsouro, 2008]. The home care assistants are responsible for the assistance with therapy while the home health aides are responsible for house keeping, meal preparation, eating, transfer, displacement inside home, grooming, toileting, dressing, etc.
- The psychologists responsible for the psychological support of patients.
- The pharmacists providing prescribed medicines.
- The informal careers i.e. the patient's family, friends or neighbors whose participation in the care delivery process and the patient supervision is very important. Since HHC relies on the permanent availability of the informal care givers who cannot be always guaranteed, the organization of the care delivery is complicated. According to [Tarricone and Tsouro, 2008], the balance between informal and formal care givers depends on political, economic, demographic and cultural factors.

These care givers are either multi-disciplinary, able to treat all patients whatever the care needed, or specialized in one or some specific pathology(ies) so that they can deliver care to one or some patients' categories. Care givers can be full-time employees (internal resources of the HHC structure) or part-time employees (external resources). According to [Chahed et al., 2006], it is necessary to combine these two categories of care givers in order to satisfy the

patients' demand. Indeed, the internal resources allow the service quality improvement thanks to the diversification of their skills while the external resources cost less to the HHC structure and enable the expansion of the area of the HHC intervention particularly in rural areas, the enhancement of the flexibility and reactivity of the structure when an emergency occurs. Additionally, the external resources allow the coordination of the activities all over the care process, before, during and after the stay within the HHC structure and thus the guarantee of the care continuity.

Note that we can also distinguish between these various care givers according to their experience level which influences their performance but also according to their degrees which would condition the types of activities assigned to them. For example, [Hertz and Lahrichi, 2006] differentiate between case manager nurses who obtained a Bachelor's degree and nurse technicians who hold a community college degree. These degrees enable to identify the types of activities assigned to them.

#### **4.2.2 Types of material resources**

Material resources can be consumable (drugs, single-use material, dietetic products, single-use equipments, etc.) or non consumable (fleet vehicles, medical and paramedical equipments, information system, etc.). The non consumable material resources can be, depending on the size of the HHC structure, rented or bought. The consumable material resources can be managed either by the Pharmacy for Internal Use (PIU) of the HHC structure or by a private pharmacy agreed by the HHC structure. According to the FNEHAD (Fédération Nationale des Etablissements d'Hospitalisation A Domicile), among the 208 HHC structures existing in 2007, 118 have PIU and 90 work with private pharmacies. The HHC structures that have a PIU must use secure transport (available 24h/24, adapted vehicles, etc.), implement strict procedures related to the transmission of information between the care givers and the HHC structure. The use of a PIU can however generate important costs and complex operations especially when it is necessary to deliver consumable products to patients living in rural areas.

#### **4.3 Sources of uncertainty**

The uncertainty within the HHC context is one of the difficulties operations management practice is facing. In order to reduce the uncertainty effects, it would be interesting to propose



models for forecasting more accurately the demand (by pathology, by type of care, by geographical zone, etc.) which would in turn facilitate the allocation of resources to the geographical zones but also to define policies for the management of patient's admission/exist. Another solution would be to design strategies for the management of the demands' priorities (scheduled activities versus emergencies). Among these policies, the HHC structure can set aside a time slot per planning period in order to react rapidly when an urgent demand occurs. It is also possible to reorganize in real-time the schedules of the care givers according to the demands' priority or to form, as [Lahrichi et al., 2006] have proposed, a surplus team to cope with the emergencies related to the variation of some patients' demand or to absorb the increase of demand in order to avoid the overload of the care givers.

There are three uncertainty sources. First of all, the uncertainty of demand which is related to the number of patients who need the care, the level of care required by each patient and the time when this demand would arise. Second, the uncertainty of the care delivery process depends on the travel time, the duration of the visits, the duration of the stay within the HHC system and the evolution of the patients' needs. Third, the uncertainty of the material and/or human resources availability can be due to the inventory shortage of consumable material resources, the non consumable material resources' breakdowns, the unexpected absences of the human resources (disabilities, illness, ...) but also to the arrival of urgent demands that would create an additional workload, the changes of the patients' home or the unpredictable evolutions of the patients' conditions.

#### **4.4 Location of the care delivery**

The most important characteristic of the HHC compared to the traditional hospitalization is the integration of the patients' home within the care supply chain due to the fact that the care are delivered at home. Consequently, additional constraints are to be considered. Indeed, the particular clinical but also psychological and social conditions of each patient must be taken into account. Furthermore, the care must be delivered to one patient at a time due to the fact that the patients are not hospitalized within the same unit. Third, the fact that the care givers involved in the care delivery process are not grouped within the same unit, do not have regular meetings and do not know each other well make the coordination of their activities very difficult.

This complexity factor generates a certain number of decisions to consider namely the geographical partition of the area, where the HHC structure provides the services into

districts, which favor the care givers' mobility such that the travel between the patients' home is easy. Each district would be under the responsibility of a multidisciplinary team composed of care givers who deliver care to patients within this district. Thereafter, the assignment of care givers to patients or jobs must be based on the compatibility between the district where the patient lives and the one where the care giver works. It is also important to organize the care givers' routes on the basis of the geographical proximity between the patients' homes in order to decrease the travel time. Furthermore, the care givers can move to the site(s) of the HHC structure to get back necessary material resources, to have meetings with the other care givers, etc. These displacements give rise to four types of professionals' tours namely: the one during which the professional does not go to the site, the one that begins from the site, the one that ends in the site and finally the one that begins and ends in the site.

#### **4.5 Necessity to guarantee a satisfactory service quality level**

The HHC structures must guarantee a satisfactory service quality level towards the patients (and their families) as well as towards the care givers who consider different and heterogeneous criteria for service quality. These criteria must be taken into account at different levels of the operations management with the HHC context namely: the definition of the market strategy by specifying the standard of the services offered and the performance objectives of the structure, the resources dimensioning in order to guarantee the human resources skills' required and the necessary material resources. It is also important to consider these criteria at the short/very short term and more particularly for the assignment of human resources to patients or to visits. This assignment must guarantee the continuity of care, as well as the respect of the patients and care givers' preferences. Despite this, the time windows or preferential days' preferences must be considered for the scheduling and routing of the care givers' activities so that the workload is balanced equitably among them. Finally, the reactivity can be improved by the management of the demands' priorities and the coordination of care. In this section, we present:

##### **4.5.1 The quality criteria for patients**

The service quality towards the patients depends on:

- The medical and /or paramedical quality of care: the quality of care is perceived by the degree of improvement of the patient's medical conditions thanks to the treatments

which he/she receives within the HHC structure. It depends, according to [Chesteen et al., 2005], on health deficiency, severity of deficiency and frequency of deficiency.

- The patient waiting times before the admission in the HHC structure and during the stay within the HHC structure [Sentihles-Mankom, 2006]: these waiting times can be improved by the management of the demand priorities.
- The satisfaction of the personal patients' preferences: according to [Chahed et al., 2007], it is important to take into account the preferences of the patients in terms of time windows or preferential days for the care delivery but also in terms of affinities with certain care givers.
- The continuity of care defined by [Shortell et al., 1985] as being the extent to which the medical and paramedical care are delivered by means of a sequence of coordinated and uninterrupted activities consistent with the medical care needs of the patients.
- The existence of trusting relationships and partnerships between the patients (and the members of their families) and care givers who must have, according to [Sentihles-Mankom, 2006], the appropriate skills to deliver care required by the patients and must be aware of the changes related to the patients' conditions.
- The reactivity and availability of the care givers which consists in delivering the necessary care in a rapid and efficient way when urgencies related to the survival and the welfare of the patients occur. This reactivity can be improved by the management of the demand priorities and the coordination of care.
- The emotional support of the care givers to the patients: [Exley and Allen, 2007] have considered that the delivery of care within the HHC context is conditioned by the establishment of "emotionally intimate social relationships".

#### **4.5.2 The quality criteria for care givers**

The position of the care givers in the HHC structure is twofold: first, they interact with the patients and provide care to them; second, they are customers in that "they rely on one another to do their jobs properly" [Leebov, 1988]. It is then important to integrate the quality criteria concerning the care givers which are related to:

- The balance of the workload between different teams as well as the workload of the different care givers working in the same team (nature of activities performed, working hours, working conditions, etc.) so that the care givers perceive fairness.

- The satisfaction of their personal preferences in terms of time windows or preferential days, vacations, achievement of particular activities or care, allocation to a specific working district, affinities with certain patients, etc.
- The guarantee of a good communication between the care givers whose activities must be coordinated. Indeed, [Williams, 2006] have asserted that the communication is more difficult within the HHC context due to the fact that the care givers do not meet each other and thus they cannot easily exchange information. This would explain the necessity of investing in information and communication technology that would allow information to be simultaneously shared with the entire home care team and stored for future use.
- The improvement of care givers' well-being by developing the teamwork and the cooperation at all levels, respecting vacations, preventing the burn out syndrome, etc. This would create a comfortable working environment and motivate care givers [Chesteen et al., 2005].
- The training of care givers so that the HHC remains viable despite the increase of the demand, the complexity of care, etc. More specifically, the training should be more integrated and multidisciplinary including skill training in developing interpersonal relationships and in using the technologies [Tarricone and Tsouro, 2008].

However, as explained by [Leebov, 1988], other stakeholders of the HHC structure emphasize different criteria namely the third-party payers and regulatory authorities. The first who are businesses, insurance companies, unions, etc. are looking for the best care delivery process such that both patients and care givers are satisfied at minimum costs. The latter consider that service quality is guaranteed by creating jobs and satisfying the population demand.

It is thus clear that the stakeholders' groups differ in importance and in emphasis and thus must be treated differently.

#### **4.6 Necessity to design a care network with the other health structures**

The HHC is considered as an intermediary type of hospitalization which proposes a graduated care and guarantees, according to [Sentilhes-Mankom, 2006] and [Afrite et al., 2009], the progressive transition between different types of care delivery. Consequently, it is important to develop collaborations between the HHC structures and the other health structures. This requires the elaboration, through the operations management, of a partnership strategy with

the other health structures and the coordination of the resources shared with these structures. However, the inter-professional coordination is difficult to achieve due to the conflicting priorities or professional standards, lack of transparency of the responsibilities' definition, etc. This coordination would allow the adaptation of the health system to the patients' needs, the guarantee of the care continuity within the HHC structure or during the patient transfer from one care network's structure to another by allowing a safe early discharge of the patients from hospital and/or from HHC structures; reducing the readmission rate of the people discharged from hospitals; avoiding inappropriate admissions, multiplication of diagnoses tests and procedures as well as medical errors; decreasing waiting lists; etc. This is particularly true, as no health care structure is able to completely cover the needs of all patients. As a consequence, adopting this care network would improve the health care system efficiency as well as the quality of the care delivered to patients and reduce the total health system's costs. Thereby, the recent development of this type of hospitalization and the fact that the health system is governed by strong administrative constraints and regulations (employment regulations, large number of procedures and protocols to be followed, conditions of the HHC functioning, etc.) also represent complexity factors for operations management within the HHC structures.

This section shows the importance of developing innovative approaches adapted to the complexity factors of the HHC structures. In order to determine the issues that are relevant from an organizational point of view that have not been studied yet, we propose to analyze in section 5 the literature related to the operations management within the HHC structures.

## **5. HHC Operations Management literature review**

Due to the important growth of the HHC, this type of hospitalisation has interested a number of researchers in different fields namely: statistics and economy ([Aligon et al., 2003], [Wilson et al., 1999], [O'Brien et Nelson, 2002]), performance management ([Sentilhes-Monkam, 2006], [Fleming and Taylor, 2007], [Woodward & al., 2004], [Olaison & al., 2006]), information systems ([Alexander and Wakefield, 2009]), advantages of providing HHC services ([Chuang et al., 2007], [Exley & Allen, 2007]) and operations management ([Blais et al., 2003], [Lahrichi et al., 2006], [Hertz et Lahrichi, 2006], etc.).

In this section, we survey operations management based models which have been proposed in the HHC literature. This literature review shows that there are five main issues studied in the

literature, as represented in Figure 2-6, namely: the resources dimensioning issue, the problem of partitioning a territory into districts (i.e. districting), the allocation of resources to districts, the assignment of care givers to patients (or to visits) and the routing problem. Hence, the last two issues (i.e. the assignment and routing problems) which are in general considered simultaneously represent the most important ones in terms of publications numbers.

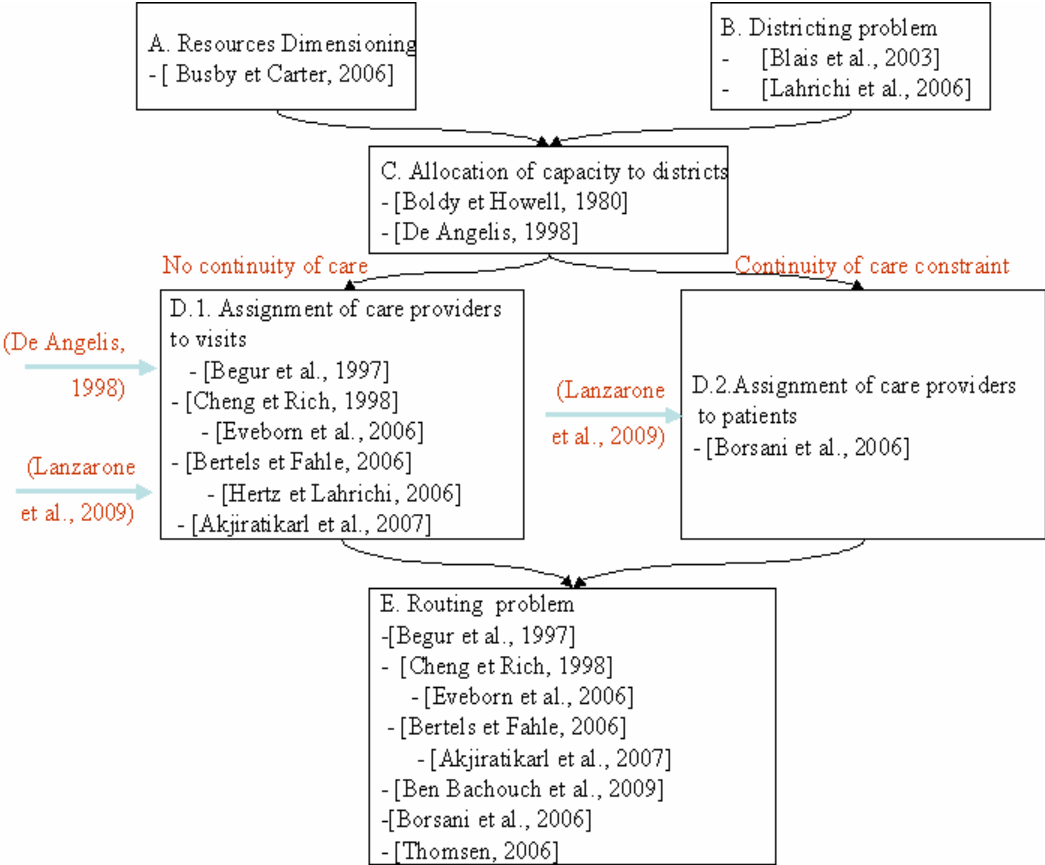

**Figure 2-6:** Review of Operations Management models in HHC structures

**5.1 The resources dimensioning problem**

This problem is the one dealing with the determination of the number of care givers, with particular skills and the quantity of material resources, of different types, necessary to meet the predicted demand with the satisfactory service quality level and minimum costs. The funding problem of a single organization or a government within the HHC context has been studied by [Busby and Carter, 2006] who have created a decision tool for the Simcoe County Community Care Access Center (SCCCAC) in Ontario. This decision tool enables the SCCCAC to determine the trade-offs between three key factors: costs, service quality (defined in terms of number of visits per patient) and patient waiting time. Indeed, this tool which

gives the SCCCAC the opportunity to perform a “what-if” analysis can be used to determine the effects of changes related to demand, patient priority distribution, budgets, etc. on the three key factors previously mentioned.

Based on these trade-offs, the SCCCAC is able to negotiate with the government the funding levels necessary to satisfy the demand for a given quantity and quality of care provided with an associated waiting time and to inform the patients about how long they have to wait before receiving the services. The SCCCAC could also use this evaluation for determining the number of care givers with particular skills necessary to satisfy the demand, with the expected service quality level and waiting time and to appropriately allocate these care givers to the different patients’ groups. This decision tool also enables the government to compare the results of the SCCCAC to the predicted costs, service quality and waiting times; to determine the factors that cause these differences; to make a “what-if” analysis to foresee the impact of the different factors’ variation; to elaborate the long-term home care funding policy to satisfy the expected new demand, etc.

## **5.2 The districting problem**

The districting problem consists in grouping small geographic areas, i.e. basic units, into larger clusters called “districts” in a way that these latter are “good” according to relevant criteria, each district being under the responsibility of a multidisciplinary team.

This approach has been studied by [Blais et al., 2003] for the case of the Côtés-des-Neiges local community health clinic in Montreal, Canada. For partitioning this community into six districts, the authors have proposed a multi-criteria approach similar to the one proposed by [Bozkaya et al., 2003] for the political districting problem, where the criteria related to the visiting personnel mobility and the workload equilibrium are combined into a single objective function whereas the criteria related to the indivisibility of the basic units, the respect of borough boundaries and the connectivity are considered as hard constraints. The problem is solved by means of a Tabu search technique.

After that, [Lahrichi et al., 2006] have reviewed the optimality of the method proposed by [Blais et al., 2003] by analyzing the historical data of the years 1998-1999 and 2002-2003 related to the total number of visits and the distribution of these visits among districts. This analysis has proved that the territorial approach presents two main shortcomings. First, this approach could be behind a workload imbalance between the care givers due to the fact that it can not forecast the fluctuation of the demand in each district. This imbalance could conduct

to inequities in terms of the service quality between the districts. Second, this approach is not flexible enough in terms of the assignment of the care givers to the districts which does not encourage the collaboration between the different care givers.

In order to alleviate these shortcomings, [Lahrichi et al., 2006] have proposed two solutions. The first one is a dynamic approach which consists in assigning the patients to the care givers according to the care givers' workload and the patients' caseload instead of the geographical location of patients. The second solution consists in combining the approach proposed by [Blais et al., 2003] with the dynamic approach. To do this, the care givers are splitted into two groups: the first one represents care givers assigned to a fixed district while the second one groups care givers that can work in all or a part of the territory.

Once the territory is divided into districts, the different resources must be equitably assigned to the designed districts so that the workload of the care givers and the quality of the services delivered to the patients are roughly the same. In the following sub-section, we focus on the allocation of resources to the districts.

### **5.3 Allocation of resources to districts**

Within this context, [Boldy and Howell, 1980] have conducted a case-study related the allocation of a certain amount of home help resources to four geographical districts within the Devon Social Services Department. This approach is divided into three main parts: the assessment process (it consists in evaluating the nature and level of the services required), the allocation procedure (how to distribute equitably the service units between the districts according to the average level of the service required for each type of client and the number of clients of each type within each district) and the survey information (information related to the patients i.e. age, disability, charge paid, housing conditions, etc.; provision of related services already available within the same territory; amount of home help actually received and ideal amount of home help to provide). This approach can be considered as a decision-making tool which does not produce one solution but proposes different possible allocations to the decisions-makers who would choose the best one according to the assumptions that they consider to be the most important ones.

[De Angelis, 1998] has also addressed this problem for HHC structures delivering services to AIDS patients (local problem) and the problem of evaluating the suitability of the budgets assigned to the HHC structures by public-health authorities (global problem) in the city of Rome, Italy. The author has developed a stochastic linear programming model which is linked



to an epidemiological model and has integrated the uncertainty in terms of patients' number and level of care required by each patients' class (the patients are classified into classes of dependency between which transition rates are defined). This model aims at maximizing the number of new patients admitted based on constraints related to resources' availability, minimum standard of service, variability of the demand, transition rates among classes and fixed budget.

#### **5.4 Assignment of human resources to patients/visits and routing problem**

The majority of works in the HHC literature concerns the scheduling of care givers' activities which involves two hierarchical decisions. First, care givers are assigned to patients or to visits. Then, individual routes are constructed for each care giver by determining at what time the visits must be done. Improving the scheduling of care givers' activities allows the reduction of the travel time and thus the reduction of the transportation costs as well as the improvement of the service quality towards the patients and towards the care givers. We now discuss papers devoted to these problems.

To our knowledge, there are two works that deal with the scheduling problem within the continuity of care context which necessitates the association of a reference care giver to each patient such that he/she can benefit from a long-term relationship with the medical and or paramedical team. The first one has been conducted by [Borsani et al., 2006]. The authors have indeed been interested in two planning levels: the assignment of a reference care giver (or a set of care givers), who would be responsible of the care delivery to new patients admitted in the HHC structure and the weekly scheduling of the care givers' visits. First, the assignment of the reference care givers to patients aims at balancing the care givers' workload while respecting the qualifications requirements as well as the geographical coherence between the district where the patient lives and the one where the care giver works. Second, the weekly scheduling is modeled as a multi-criteria integer linear programming model where the criteria related to outsourced visits executed by the caregivers, the care continuity (the visits are carried out by the reference care givers), the geographic coherence and the preferential days are combined into a single objective function. The criteria related to the visits and care givers' time windows, the qualifications requirements, the planning of all the visits, the care givers' burn out level, the maximum number of visits to schedule during each time window, the maximum number of visits for each patient per day and the care givers' working hours are considered as hard constraints. By guaranteeing the continuity of care,

respecting the preferential days and the burn out levels, balancing the workload, etc.; the model improves the service quality and thus the patients and the care givers' satisfaction.

More recently, [Ben Bachouch et al., 2008] have approached the routing problem by a mixed linear programming model whose objective function consists in minimizing the total distance traveled by nurses. This model is subject to the constraints of visits' and nurses' time windows, nurses' meal breaks, assignment of the patients to the necessary number of nurses, care continuity (the patient is always visited by his reference nurse during his stay within the HHC system), start and end of each nurse route at the HHC structure and maximum distance between two consecutive visits done by the same nurse.

In the contrary, the scheduling problem without considering the continuity of care has been studied by various authors. In this context, the patient is assimilated to a visit or a set of visits. The first decision support system has been proposed by [Begur et al., 1997] who have presented a spatial decision support system (SDSS) for the Visiting Nurses Association that contains a special module for the daily scheduling of care givers' activities. This module simultaneously assigns care givers to patients' visits and generates the sequence in which the visits would be done. It is based on a heuristic approach that combines a set of procedures for the building and the improvement of daily care givers' routes such that the k-optimal procedure, sweep algorithm, insertion procedures, etc. The objective of this heuristic is to minimize the total travel time so that the care givers' working hours are used optimally while the constraints related to the route construction, care givers' time windows and skills' requirements are respected. Note that the balance of the day-to-day workload is handled interactively by performing a "what-if" analysis rather than as a part of the optimisation model.

[Cheng and Rich, 1998] have addressed the daily scheduling problem as a multi-depot vehicle routing problem with time windows and compatibility information. The authors have distinguished between the nurses working full-time and that working half-time. The objective of this daily scheduling is to minimize the total costs associated with the amount of overtime hours of the full-time nurses and the amount of hours of the part-time nurses such that each patient is visited exactly once; each nurse visits at least one patient, starts and ends her route at her home and takes a lunch break within the lunches' time windows. Despite this, the maximum nurses' shift length, nurses' qualification requirements, visits' and nurses' time windows must be respected. The problem is formulated as a mixed integer linear programming model in two ways: the first one uses double indexed variables while the second one is with triple indexed variables. The problem is solved by a two-phase heuristic: first,

several routes are built simultaneously then, these latter are improved. The numerical results of a problem with four nurses and ten patients show that the second formulation is the most efficient one.

After that, [Eveborn et al., 2006] have developed a decision support system, called “LAPS CARE” for the local authorities in Sweden where the scheduling problem has been formulated as a set partitioning model and solved by a “repeated matching algorithm”. The objective consists in minimizing the total cost of assigning care givers to the schedules related to the travel time, scheduled hours, preferences, etc. while respecting the criteria of the visits’ time windows; the care givers’ skills requirements, time windows and meals breaks; the achievement of each visit by one care giver; etc. The visit plans developed are evaluated according to two performance criteria: the schedules efficiency related to the saved planning time and the quality of the routes (if all visits are allocated to care givers) and the service quality evaluated according to how well the continuity with reference care giver is kept.

[Bertels and Fahle, 2006] have also proposed a combination of linear programming, constraint programming and heuristics to assign the care givers to visits and sort optimally the visits assigned to each care giver such that the total transportation cost is minimized and the satisfaction of both patients and care givers is maximized while respecting a variety of soft constraints i.e. affinities between the patients and care givers, preferences of care givers for certain visits, number of care givers’ changes, soft visits’ and care givers’ time windows, soft skills requirements, etc. These schedules must also respect a set of hard constraints such as the assignment of all the visits only once, hard skills requirements, work time limitations, hard time windows of visits, etc. This optimization tool presents different possible solutions of high quality to the managers who select the most convenient one or re-calculate parts of the solutions.

Moreover, [Hertz and Lahrichi, 2006] have proposed two mixed integer programming models for the allocation of care givers to patients in the Côtés-des-Neiges local community health clinic in Montreal, Canada: the first one is with linear constraints and quadratic objective function optimized by means of CPLEX while the second one is with non linear constraints solved by the Tabu search heuristic. The objective of this assignment is the balance of the nurses workload by minimizing the weighted sum of the visit load (depends on the heaviness of each visit compared to a witness visit), case load (depends on the number of patients assigned to a nurse in each category) and travel load (depends on the distances traveled by the nurse) while respecting constraints related to the upper bounds of the visit load, case load, travel load and the assignment of each patient to exactly one nurse of type  $k$ . In this work, the

authors have considered the possibility of assigning a patient from a district to a nurse who does not work within this district so as to reduce the workload imbalance created by the demand fluctuations. This method is interesting in terms of time and resources consuming and patients follow-up compared to the reorganization of the districts.

Another decision tool has been proposed by [Thomsen, 2006] who has formulated the daily scheduling problem as a vehicle routing problem with time windows and shared visits (visits that have to be carried out by two care givers). The shared visits represent the special feature of this work. The objective consists in minimizing the total travel time, the number of unshared and unlocked visits (the visits are carried out by a non reference care giver) and the number of shared and unlocked visits (the visits are carried out by two non reference care givers) while respecting the visits' and care givers' time windows, assignment of at least one visit to each care giver, start and end of pairs of visits that constitute shared visits at the same time. This problem is solved by means of an insertion heuristic and Tabu search technique.

[Akjiratikarl et al., 2007] have also addressed the daily scheduling problem as a vehicle routing problem with time windows and solved it by means of an algorithm which combines the Particle Swarm Optimization (PSO) meta-heuristic, the Earliest Start Time Priority with Minimum Distance Assignment (ESTPMDA) technique and the insertion and swap Local Improvement Procedure (LIP). The objective function consists in minimizing the total traveled distance while respecting constraints related to visits and care givers' time windows, assignment of each visit to only one care giver with the highest priority corresponding to its ideal start time and the route construction i.e. start and end of each route at the care giver's home.

More recently, [Chahed et al., 2009] have coupled two stages of the anti-cancer drug supply chain within the context of the chemotherapy at home. The authors have proposed six models for this supply chain based in three criteria: time windows, number of routes and objective function. This latter consists either in minimizing production and delivery costs or maximizing the number of patients visited (maximizing profit). After that, they have presented numerical results for one of the models and analyzed the impact of the variation of the anti-cancer drug key parameters namely: the anti-cancer drug's shelf life time, its production time and its service time. These results point out the existence of three solutions' fields: in the first one, no solution exists; in the second one, there is an optimal solution different from the solution of the routing problem studied separately and in third one, the two optimal solutions coincide.

All these models proposed do not consider the uncertainty of the demand which makes the scheduling of the care givers' activities inaccurate. In order to support this scheduling, [Lanzarone et al., 2009] have proposed a patient model which entails two parts: a care pathway model related to the stochastic evolution of the patient's needs and a cost model which describes the resources required by the patient according to his pathway. The care pathway model is based on a Markov chain in which the states correspond to the care profile of the patients. Transition matrices between these care profiles are defined based on historical data and differ according to the first care profiles assigned to the patient when he/she is admitted in the HHC structure. This model provides estimations of the patient care duration, the number of cared patients while the cost model estimates the number of requested visits in a weekly horizon for each patient care profile. This model can thus help to estimate the number of care givers necessary to satisfy the demand, to schedule efficiently the care givers' activities, to assign the care givers to the new patients in order to balance the care givers' workload while guaranteeing the continuity of care, etc. This model can thus conduct to the improvement of the service quality and the operations management efficiency.

The review of the literature related to the operations management based models developed for HHC shows that the amount of these models is modest. Moreover, this review points out that the two problems which have been most studied are the assignment of care givers to patients or visits and the routing problem. Furthermore, these models do not consider all the factors that the operations management has to face up within the HHC structures. For example, all works which deal with the routing problem consider only a unique type of care givers namely the nurses despite the fact that the HHC is characterized by the diversity of the human resources involved in care delivery. In Table 2-3, we present all the papers that deal with home health care operations management mentioned in the literature. We put a mark if that paper considers the complexity factor that we have presented in Section 4. Note that these factors are referenced by the number of their corresponding paragraph in this chapter.

**Table 2-3:** Complexity factors in the HHC operations management models

	References	4.1				4.2		4.3	4.4	4.5		4.6
		4.1.1	4.1.2	4.1.3	4.1.4	4.2.1	4.2.2			4.5.1	4.5.2	
Resources dimensioning	[Busby and Carter, 2006]	✓								✓		
Districting problem	[Blais et al., 2003]										✓	

	[Lahrichi et al., 2006]					✓					✓	
Allocation of resources to districts	[Boldy and Howell,1980]	✓	✓							✓		
	[De Angelis, 1998]	✓	✓			✓		✓		✓		
Assignment of human resources to patients and routing problem	[Borsani et al., 2006]					✓				✓	✓	
	[Ben Bachouch et al., 2008]								✓	✓	✓	
Assignment of human resources to visits and routing problem	[Begur et al., 1997]								✓	✓	✓	
	[Cheng and Rich, 1998]					✓			✓	✓	✓	
	[Bertels and Fahle, 2006]					✓				✓	✓	
	[Eveborn et al., 2006]	✓				✓				✓	✓	
	[Hertz and Lahrichi, 2006]			✓						✓	✓	
	[Thomsen, 2006]									✓	✓	
	[Akjiratikarl et al., 2007]								✓	✓	✓	
	[Chahed et al., 2009]					✓		✓	✓			
	[Lanzarone et al., 2009]			✓					✓			

These results support that the complexity factors that have not been considered in the operations management literature are: the diversity of the services proposed according to the different pathologies covered or according to the different care protocols, the distinction between the care givers according to their experience, the material resources' types, the uncertainty related to the material resources availability and the necessity to design a care network with other health structures. These factors are presented on Figure 2-7. Note however that various qualitative papers e.g. [Afrite et al., 2009], [Chahed et al., 2006], etc. put the emphasis on the importance of these factors.

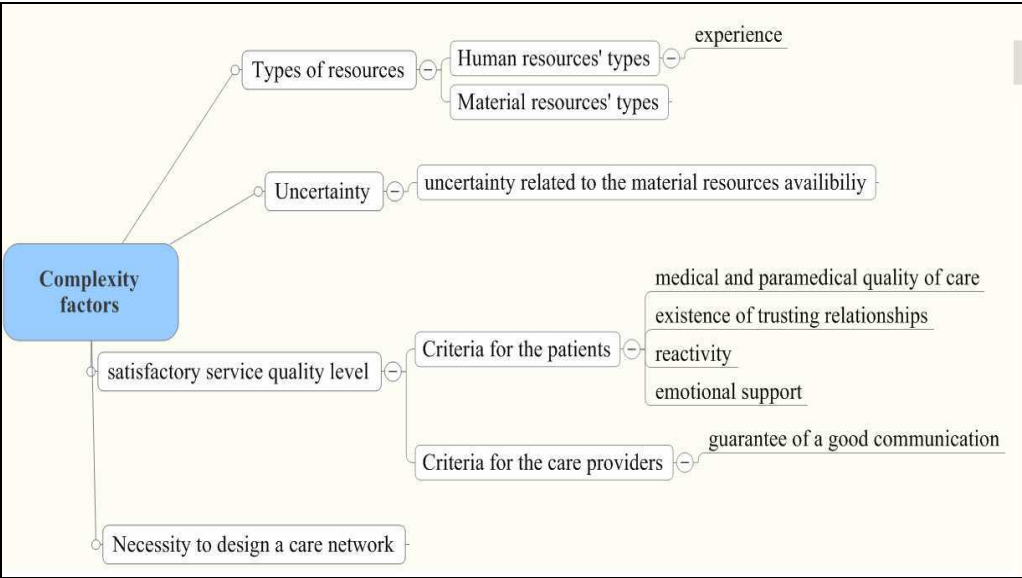

**Figure 2-7:** Complexity factors not studied in the existing operations management related papers

**6. Conclusion**

In this chapter, we give a general overview of the HHC system by positioning it in the global health care system and discussing its evolution within the French context.

After that, we focused on operations management by surveying the models developed in the literature for HHC structures. This literature review pointed out that, although the concept of HHC exists for sixty years now, the amount of existing operations management based models developed for HHC structures is modest.

We also showed the complexity of activities within HHC structures that has to be potentially taken into account in the operations management based models. The qualitative analysis of the complexity factors thus emphasized the importance of developing approaches adapted to

the specificities of the HHC in order to improve the organization of the care delivery processes within this type of structures.

One natural extension of this work would be the development of an empirical study in real HHC structures in order to validate the complexity factors presented in this chapter. This study would also allow the evaluation of the relative importance of each factor identified.

Based on both the literature review and the qualitative analysis, various perspectives, relevant from an organizational point of view, that have not been studied in the literature can be considered for future research.

First of all, the importance of the material resources for the care delivery processes shows the necessity of developing approaches for the organization of their supply chain by the selection of material and equipments' suppliers, the definition of inventory management policies related to the consumable material resources, the organization of the resources delivery to the patient home, the planning of the medical and paramedical equipments' maintenance, etc.

After that, the importance of the HHC as intermediate type of hospitalization requires the elaboration, through the operations management, of a strategy of partnership with the other types of health structures but also the coordination of the resources shared with these structures.

Moreover, due to the diversity of the uncertainty sources, it would be interesting to propose models for forecasting the demand (by pathology, by type of care, by geographical zone, etc.) which would facilitate the allocation of resources to the geographical zones. We also suggest defining policies for the management of patients' admissions/exit. Another solution would be to design strategies for the management of the demands' priorities (scheduled activities versus emergencies). Among these policies, the HHC structure can set aside a time slot per planning period in order to react rapidly when an urgent demand occurs. It is also possible to reorganize in real-time the schedules of the care givers according to the demands' priority or to form, as [Lahrichi et al., 2006] have proposed, a surplus team to cope with the emergencies related to the variation of some patients' demand and to absorb the demand's increase in order to avoid the overload of the care givers.

Another interesting issue is related to the diversity of the human resources delivering the care to the patients, the variety of the clinical and organizational decisions defining the care delivery processes and the importance of the care continuity as a quality criterion for the patient. All these elements require the necessity of developing tools to coordinate the activities of the different types of care givers, the human and material resources, the resources management and the patients' admission, etc.





## ***CHAPTER 3***

### ***HOME HEALTH CARE DISTRICTING PROBLEM***

#### **1. Introduction**

As presented in previous chapters, the districting of the territory represents a major decision of service operations management that is largely used for different types of services where the customers are dispersed over a large area. This strategic decision that consists in partitioning the territory into sub-areas would allow the achievement of service operations management objectives in terms of quality and costs. However, this issue has not been considered yet in the HHC context. We thus focus, in this chapter on the HHC districting problem due to the importance of such a decision in the management of the care delivery process. Among the complexity factors that have been presented in Chapter 2, the modeling of HHC districting problem will capture the factors related to the location of care delivery and the necessity to guarantee a satisfactory service quality level towards the patients through the insurance of the continuity of care.

The HHC districting approach consists thus in partitioning the area where the HCC structure operates into districts, each of them being managed by a dedicated care givers' team. This approach allows the improvement of the care delivery efficiency in terms of costs and quality towards patients as well as towards care givers. Indeed, this approach aims at reducing the travel time of care givers and thus the operations' costs. Moreover, the fact that each district is under the responsibility of a care givers' team allows the guarantee of the continuity of care due to the fact that patients receive the care from the same team and thus do not have to continuously change their relationships with a new care team. Finally, this approach may improve care givers' working conditions through the workload balance and reinforced collaboration inside the team which would enhance the satisfaction of care givers. Within this chapter, we consider the workload balance as a criterion for improving working conditions.

The main objectives of this chapter is to formulate the HHC districting problem by considering the continuity of care, the workload balance and minimizing the distances traveled by care givers.

The remainder of this chapter is organized as follows. In Section 2, we survey the literature related to the models that are developed in the operations management literature applied to the districting approach and propose a classification of the different criteria that may be considered in the districting problem. We then propose two mathematical formulations for the HHC districting problem that we present in Section 3. Results of the computational experiments carried out on randomly generated instances to validate these two models as well as illustrations of the use of these two models are presented in Section 4. In section 5, we propose three possible extensions to these models. Finally, Section 6 presents some conclusions and perspectives that can be considered for future research.

## **2. Literature review of the districting problem and classification of the districting criteria**

The districting of a territory is a strategic decision which consists in grouping basic units into larger clusters, i.e. “districts”, so that these districts are “good” according to relevant criteria. These latter can be related to the activity level required (workload balance between the districts), demographical (population equality) or geographical characteristics (contiguity, compactness, etc.) of the basic units. These basic units can typically be zip code areas, postal areas, streets, geo-codes addresses, etc. They are characterized by measures such as the number of inhabitants, sales potential, workload, etc.

Districting problems are motivated by different applications including the political districting, the sales territory alignment and the more general service applications ranging from the establishment of districts for schools or salt spreading over the definition of police command or electrical power districting to the definition of districts for the HHC workers. Hence, the political and sales areas are the two most important applications in terms of number of publications. In the former application, the main objective is to respect the principle of “one man-one vote”. In the latter realm, designing sales districts allows meeting the need of a company which employs a sales force to subdivide the market area into districts of responsibility. Similarly to the sales territory alignment, designing service districts permit the attending of the customers, technical facilities or service incidents.

Adopting the districting approach in the HHC context would allow the improvement of the service quality towards patients as well as towards care givers. First, the fact that patients are grouped in different districts (where each district is under the responsibility of a unique care givers' team) induces the reduction of the travel time of care givers and consequently the increase of the time dedicated to the direct care which in turn would reduce operations' costs and increase the reactivity of care givers (in case of emergencies for instance). Consequently, adopting the districting approach would conduct to better satisfy patients. Second, this approach may improve care givers' working conditions since it aims at balancing the workload between the teams associated with each district whose members would be more satisfied and thus more motivated. Additionally, working in smaller areas, i.e. districts rather than the whole territory covered by the HHC structure, within a smaller team may enhance each care giver's motivation since he/she can find a reinforced collaboration inside the team he/she belongs to and a better dialogue with the manager responsible of the team. Finally, the fact that each district is under the responsibility of a single team may allow the development of long term relationships between care givers and patients which would result in higher efficiency of care givers and the guarantee of the continuity of care. Thus, this would contribute in the improvement of the quality of care towards patients and care givers.

## **2.1 Literature review**

This problem has been widely considered in the Operations Research literature since the late sixties in a broad range of applications. Several approaches have been proposed in the operations research literature to solve the districting problem. Among these approaches, we can distinguish two categories: the managerial and the exact methods based on mathematical programming techniques. There are two major types of mathematical models related to the districting problems: the location-allocation models and the set-partitioning models. The first approach consists in defining the centers of the districts (i.e. location of the central basic units) and then determining their associated set of basic units (allocating the basic units to the centers) while the second approach decomposes the original set of basic units (the whole territory) into several subsets of basic units (districts).

In the following sub-sections, we present some of the works dealing with the districting problem that are classified according to their realm and sorted by their year of appearance. For each one of them, we precise the different criteria considered as well as the approach used to model the problem. Note that the criteria used in the literature are the following:

compactness, contiguity, accessibility, response time to calls for service, population equality, workload balance, customer balance, respect of the capacity limitation, socio-economic homogeneity, minority representation, similarity with the existing plan, conformity of the districts designed to the administrative boundaries and indivisibility of basic units. These criteria are going to be better defined and classified in the sub-section 2.2.

### **2.1.1 Political districting**

In the political districting problem, a territory has to be partitioned into a predetermined number of districts from which political candidates are elected. The districting procedure must respect the “one-man-one-vote” principle: since each district elects one member, the districts designed must have approximately the same number of voters while satisfying some other criteria.

The first mathematical programming approach has been proposed by [Hess et al., 1965] who has formulated the political districting problem as a location-allocation problem (capacitated  $m$ -median facility location problem) for designing compact and contiguous districts which respect the indivisibility of basic units’ constraints and whose populations must lie within a predetermined interval.

After that, [Garfinkel and Nemhauser, 1970] have addressed the problem of political districting as a set partitioning problem. They have presented a two-stage enumerative procedure which minimizes the maximum deviation of each district size from the average size. In the first stage, they have generated feasible districts based on criteria related to population equality (total voters within an interval), compactness and contiguity. In the second stage, they have determined the set of  $M$  optimal districts that minimize the maximum deviation of each district’s population from the average population while respecting the indivisibility of basic units.

More recently, [Hojati, 1996] have applied a three-stage location-allocation approach to divide a territory into a given number of districts while respecting criteria related to contiguity, compactness and population equality. By using this methodology, district centers are determined. Then, basic units are allocated to those districts. Finally the basic units that are divided between two districts are reassigned to only one district.

Furthermore, [Mehrotra et al., 1998] have built their work based on the previous work of [Garfinkel and Nemhauser, 1970] and have formulated the problem as a set-partitioning problem. The objective function corresponds to the minimization of the overall compactness

of the districts. These latter are characterized by population equality, contiguity, non-splitting of the basic units and respect of administrative boundaries as much as possible.

[Bozkaya et al., 2003] have also proposed a weighted multi-criteria approach based on five criteria: contiguity, population equality, compactness, socio-economic homogeneity and similarity with the existing plan where the first criterion is considered as a hard constraint while the others are combined in a weighted additive multi-criteria objective function.

After that, [Ricca and Simeone, 2008] have formulated the political districting problem as a multi-criteria set partitioning problem. The criteria considered are: indivisibility of basic units, contiguity, population equality, compactness and conformity to administrative boundaries. The main objective of this problem is to minimize one or a convex combination of the three last criteria.

### **2.1.2 Sales territory alignment**

The sales territory design consists in grouping sales coverage units into districts of different salesmen's responsibilities which must have approximately similar sizes in terms of number of customers or workloads generated.

[Hess and Samuels, 1971] have first applied a location-allocation model in order to maximize the total compactness of all districts while minimizing the changes of the existing boundaries and balancing the "activity" of the entire salesmen. The authors have proposed different "activity" measures such as the number of sale calls or sale potential and highlighted the importance of selecting well the "activity" measure since it influences the quality of the solution.

[Easingwood, 1973] have also proposed a heuristic approach for first constructing sales regions and then subdividing each region into sales districts. These districts are built by starting with their centers and are extended so that the workload of each salesman is approximately equal to the average workload of the region without splitting the basic units between districts and by respecting administrative boundaries while integrating managers' preferences. The shortcoming of this approach is that it does not provide a methodology for partitioning the territory since it represents a manual adaptation of managers' preferences.

Another heuristic approach based on managers' preferences which maximizes the profit while balancing the workload has been suggested by [Lodish, 1975]. This profit depends on the time spent in each district and the number of trips made in each district. This heuristic procedure

determines the optimal sales call frequencies simultaneously with the optimal partition of the territory into districts.

More recently, [Ronen, 1983] has suggested a mixed integer programming model for the sales territory alignment problem. The objective considered in this case is the minimization of the total travel driving distance of salesmen while respecting the balance of the travel driving distance between districts, indivisibility of basic units, compactness and contiguity of districts. This model has been solved via an interactive heuristic which gives the managers the possibility of changing the assignments of basic units to districts so that they can take into account the non quantifiable considerations.

After this, [Zoltners and Sinha, 1983] have developed four properties of a “good” sales territory design which are the indivisibility of the basic units, activity balance according to predefined attributes, contiguity of the districts and compatibility with geographical obstacles. In order to satisfy these four properties, [Zoltners and Sinha, 1983] have proposed a location-allocation model whose objective would be the minimization of the travel time or the maximization of the profitability.

[Fleischmann and Paraschis, 1988] have also approached the sales territory alignment problem by a location-allocation model which respects the workload balance, compactness of the districts and indivisibility of basic units.

More recently, [Rios-Mercado and Fernandez, 2009] have suggested a location-allocation model where the objective is the maximization of the total compactness while balancing activity measures such as the number of customers, product demand and workload among the contiguous districts.

### **2.1.3 Other services districting**

Various districting models have been developed for different types of services in the Operations Research literature. Among these investigations, we can identify the school districting problem, salt spreading application, electrical power and police districting problems.

#### **2.1.3.1 School districting**

The school districting problem consists in specifying, for each school, students who would attend it. It differs from the previous realms by the fact that, in this context, it is not the

salesmen/service providers that travel to the customers but it is the students that have to travel to schools so that they can attend the courses. The criterion related to the minimization of the distances is thus more important in this area than in the other ones.

Among school districting studies, [Schoepfle and Church, 1989] have formulated the problem of assigning students to schools as a location-allocation model whose objective consists in minimizing the total weighted distance associated with the assignment of students to schools while respecting capacity limitations and racial balance constraints.

[Ferland and Guenette, 1990] have also proposed an interactive decision support system that includes multiple heuristics so as to design contiguous districts which guarantee that students attend the same school from year to year while respecting the capacity constraint of each school. Indeed, they have not presented an optimization model but the users have the possibility to interact with the system to modify solutions in order to improve the contiguity, homogeneity or respect of school capacities for some grades criteria. This system also allows a very rapid, precise and easy analysis of scenarios in order to determine the most suitable solutions.

Using an approach similar to those proposed by [Zoltners and Sinha, 1983], [Caro et al., 2004] have identified seven criteria for the school districting problem: indivisibility of the basic units, respect of grades' capacities, contiguity, compatibility with geographical obstacles, compactness related to the total distance traveled by all students, assignment of students to the same school for all the grades and similarity with the existing districting pattern. Furthermore, the authors have considered an additional criterion related to the maximum distance walked by students in order to guarantee the individual satisfaction. The objective function considered in the optimization model proposed is the minimization of the total walking distance. This model has been coupled with a commercial Geographic Information System (GIS) whose integration allows an interaction between the user and the model in different manners which permits the involvement of other issues not considered in the model such as teachers' availability and opinion or the parents' point of view. The advantage of this interaction is that it allows the users to solve highly subjective problems where it is important to handle complexity and human's intuition and experience.

Note that it may also be interesting to develop such systems for solving the home health care districting problem that would integrate the care givers' point of view and availability in a way that an adequate equilibrium between this qualitative criterion and the best solution obtained through the mathematical formulation is reached.



### **2.1.3.2 Salt spreading services**

The design of districts for salt spreading and road maintenance operations involves the partition of a large geographical region into districts in order to facilitate the organization of the operations to be performed within this region. This case has been studied in the literature by [Mulydermans et al., 2002] and [Muyldermans et al., 2003] who have assumed that the partitioning of the territory's road network into districts must favor the contiguity, compactness, non-splitting of basic units criteria but also the centrality of the depots (whose locations are given) such that each route starts and ends at a depot. The objective function to optimize can be: the minimization of the number of trucks, minimization of the total distance, minimization of the number of vehicles required or the balance of the workload.

### **2.1.3.3 Electrical power districting problem**

Another type of services for which districting models have been developed is the electrical power problem. Within this context, the districting problem involves grouping electricity users' units into districts of approximately equal revenue. A mathematical programming approach developed by [Bergey et al., 2003a] and [Bergey et al., 2003b] is based on a multi-criteria model that minimizes both the total compactness and the total deviation of revenue potential in each district from a target value.

### **2.1.3.4 Police districting**

In the Operations Research literature, the districting problem within the police patrol context has been studied by [D'Amico et al., 2003]. They model the problem as a set-partitioning problem subject to constraints of compactness, contiguity and also quality of service considerations related to the response time to calls for service which has to be minimized and/or lies within an interval. Note that the "goodness" of a district is related to the disparity between the maximum workload and the minimum workload of the patrol officers and also to the average response time to a call. After the design of the districts, the optimal number of patrol cars is determined for each district.

Based on this literature review, we assume that despite the various applications of the districting problem, there are many similarities between them. More precisely, the HHC

districting problem share common features with the applications characterized by the importance of the human factor namely: the sales territory alignment and the service districting problem. Indeed, the partitioning proposed would have an important impact on the employees (salesmen and service providers) and the customers. The criteria used within these areas whose respect allows the improvement of the service quality towards the employees and/or the customers as well as the improvement of the service delivery or sales processes' efficiency (e.g. compactness, indivisibility of basic units, activity balance, etc.) must thus been considered for the HHC districting problem in order to enhance the objectives of adopting this approach within the HHC context. Nevertheless, we assume that the criteria used in the political field are identical (such as compactness, contiguity, indivisibility of basic units, etc.) or analogous to the ones used in the others applications in the sense that they aim at balancing an attribute which can be population number for the political area or workload, number of customers, etc. for the sales and service areas. That is why we are going to propose in the next sub-section a classification of these criteria which most of districting models are based on.

## **2.2 Districting Criteria Classification**

This sub-section identifies the features that are common to all districting applications.

To the best of our knowledge, two classifications of the districting criteria have been proposed in [Kalcsics et al., 2005] and [Tavares-Pereira, 2007]. In the first work, [Kalcsics et al., 2005] have identified the geographical criteria used in the political districting and sales and service territory alignment problems. Furthermore, the demographic criteria (in the political districting problem) and the activity related criteria (in the sales and service territory problem) have been emphasized. In the second work, [Tavares-Pereira, 2007] has classified the criteria into four groups namely: the homogeneity criteria (these criteria aim at homogenizing a given attribute i.e. services, population; this homogenization can be associated to each district individually or to the whole partitioning), the geographical criteria (the objective of these criteria is to define districts that correspond to a geographical attribute like the districts' shape which must be as close as possible to a given geometric form (circle, square, etc.)), the criteria related to the optimization of the flows between the districts (if a flow of populations, goods, etc. is transferred from one district to another; these criteria aims at optimizing this flow) and

the similarity criteria (if a territory has been already partitioned into districts, it would be preferable that the new partition is as close as possible to the current partition).

Complementary to these existing works, we propose a more general classification identifying four classes of districting criteria namely: criteria related to the geographical aspects, criteria related to the activity measures, criteria related to the comparison between different territory partitions and organizational criteria.

The differences between the classification proposed in [Tavares-Pereira, 2007] and ours is twofold. First, [Tavares-Pereira, 2007] has not considered the profile balance (see sub-section 2.2.2.2) and the organizational criteria (see sub-section 2.2.4). Second, as we do not find in the literature any work that deals with the transfer of flows between districts, we have not represented the class of the flows' optimization criteria.

The reader is warned that, in the literature, we found several terms that refer to the same criterion. That is why, for each identified criterion, we provide the associated used synonyms.

### **2.2.1 Criteria related to the geographical aspects**

The distances considered in the districting problem are often expressed in terms of Euclidean distances, straight lines or networks distances. It is important that the measure used reflects not only the travel time but also the difficulties to move between the basic units. The criteria that are related to the geographical aspect of the districting problem are as follows:

- **Compactness.** Although this criterion is widely considered in the literature, we did not find a rigorous definition but many authors have considered that a district is geographically compact if it is somewhat circular or square in shape rather than long and thin [Garfinkel and Nemhauser, 1970]. It is very important especially in the political field due to the fact that it prevents from gerrymandering. This latter is defined by [Grilli di Cortona et al., 1999] as a practice that consists in “Manipulating the districts in favor of some political parties or candidates. The original gerrymander was created in 1812 by Massachusetts governor Elbridge Gerry, who successfully managed to design the district map of the state of Massachusetts in order to guarantee his reelection”. The compactness is also very important in other applications such as the sales and service territory design since it aims at reducing the total travel time of salesmen or service providers and thus improves their efficiency.
- **Contiguity (or connectivity).** This criterion refers to the fact that it is possible to reach any basic unit in a district from any other one assigned to the same district without

going through another district. It is, according to many authors, a desirable property but few of them consider it in an explicit manner in the models developed. According to [Grilli di Cartona et al., 1999], compactness implies contiguity.

- Accessibility (or mobility). This criterion is related to the easiness with which the personnel (salesmen or service providers) can travel within a district; for example by means of public transportation, private cars, etc. The accessibility can be assessed by the respect of natural obstacles such as mountains or bodies of water or by the possibility of using public transportation (or a private car) which means that if the transfer between two basic units via the public transport (or the route) is too complicated, then these two basic units should not be assigned to the same district. This criterion is crucial in the sales and service territory alignment since the salesmen/service providers visit the customers.
- Response time to calls for service. This is a criterion that enables to measure the reactivity of the system. It is closely related to the distance between the centers of the districts and the scenes of emergencies (places of calls). This criterion represents a performance indicator for the systems such as police district design that must respect a predefined value of the customers waiting times.

## **2.2.2 Criteria related to the activity measures**

The second group of criteria used in the districting models existing in the literature refers to the measures relative to the amount of activity generated in each district. This class of criteria can be divided into two subclasses:

### **2.2.2.1 Activity balance criteria**

These criteria aim at balancing the different districts according to specific attributes such as:

- Population equality (voter equality) which requires the design of districts that have the same number of persons. As the exact equality is very difficult to obtain, deviations from the average population are allowed. Population equality is especially used in the political field as it embodies the respect of the “one-man-one-vote” principle.
- Workload balance (workload equilibrium) is generally used within the context of sales and services territory alignment problems for the design of “good” districts. This

criterion is related to the desire of fairly distributing the workload among the workers belonging to different districts (salesmen or service providers).

- Customer balance (balance of product/service demand/revenue potential). This criterion is analogous to the previous one since the number of customers is an activity measure that could be considered for designing balanced districts within the context of sales and services territory alignment problems. In this case, the main motivation is the fair distribution of potential prospects or profit [Kalcsics et al., 2005].
- Respect of the capacity limitation. It is generally used for the school district design and consists in respecting a specified capacity for each school that can not be exceeded.

#### **2.2.2.2 Profile balance criteria**

This sub-class of criteria enables to distinguish, according to an attribute, between different types of inhabitants, customers or activities done by the workers in different districts. These criteria can be expressed as follows:

- Socio-economic homogeneity. This criterion refers to the personal incomes of the inhabitants and guarantees a better representation of residents who “share common concerns or views” [Bozkaya et al., 2003]. This homogeneity is important in the sense that it ensures that all the socio-economic classes have the same opportunities to be represented.
- Minority representation (racial balance). This criterion is crucial in the school districting problem since it ensures the same educational opportunities to all races.

#### **2.2.3 Criteria related to the comparison between different territory partitions**

The third group of criteria than can be used in the districting problem concerns the comparison between different territory partitions that can be of different types (i.e. administrative subdivisions like census tracts, townships, etc. versus political/commercial partitions) or of the same type i.e. redistricting problem.

- Similarity with the existing plan. This criterion is essentially used in the redistricting context when the problem consists in designing new districts that maintain a certain degree of similarity with the current ones since it is unrealistic and impractical to

create a whole new partition instead of what, the efficiency of the current partition in terms of compactness, population equality, workload balance, etc. is improved.

- Conformity of the districts designed to the administrative boundaries. In most of the references mentioned in this work, the districts designed must be coherent with the administrative boundaries in order to facilitate the works with the various organizations and with community agencies.

#### **2.2.4 Organizational criteria**

In addition to the criteria already presented, almost all the references mentioned in this work consider that is necessary to satisfy the criterion regarding the indivisibility of basic units (exclusive assignment of basic units, integrity of basic units, non-splitting of basic units) which consists in assigning each basic unit to one and only one district. This indivisibility allows, in the sales or the services territory context, the establishment of long-term relationships between salesmen/service providers and customers. Furthermore, it avoids the interference of the salesmen/service providers' works since it guarantees that each basic unit is under the exclusive responsibility of one salesman/service provider (or a group of workers). The different criteria presented in this taxonomy have been formulated mathematically in various manners (as objective functions to optimize or hard constraints to satisfy) within the literature related to the districting problem. In the rest of this chapter, we are interested in the modeling of the HHC districting problem.

### **3. Problem description and modeling**

In this section, we propose two mathematical formulations for the HHC districting problem for which we present assumptions adopted, criteria considered and notations used.

#### **3.1 Assumptions**

In the models we have developed, we would assume, without loss of generality, that:

A.1. A basic unit is an aggregation of patients living in the same location. Typically, a basic unit can be a zip code area, postal area, geo-code address, etc.

A.2. A distance that separates two patients living in the same basic unit is negligible.

A.3. Patients considered in this study suffer from the same pathology. At this level, it is important to mention that most of HHC structures classify patients' therapeutic projects into categories named "profiles". Indeed, patients whose therapeutic projects have similarities in terms of the expected duration of care, type, number and average duration of visits are grouped into the same profile.

A.4. Patients who live in a given basic unit can have different profiles.

A.5. A patient profile is assumed to be known when he/she is admitted to the HHC structure and does not change during his/her stay within the HHC system.

A.6. The number and average duration of visits that are required by each patient are known and are the same among the patients who have the same profile.

A.7. The number of patients admitted to the HHC structure (at each basic unit) is known in advance and does not change while considering the districting problem.

A.8. The number of patients leaving the HHC structure (at each basic unit) is known in advance and does not change while considering the districting problem.

A.9. All basic units are covered which means that all patients admitted to the HHC have to be assigned to a district.

A.10. Human resources delivering care to patients are of the same type, namely the nurses, who are multi-skills, i.e. able to treat the different profiles associated with the pathology considered, among all the basic units.

A.11. There is an enough number of nurses available. Each nurse has a predetermined capacity (i.e. he/she can handle a certain volume of workload). This capacity is identical between the different nurses.

A.12. Each district is under the responsibility of a unique nurses' team.

A.13. The number of districts to design is predetermined by HHC managers.

A.14. The speed pertaining the travel between two basic units is considered as deterministic.

A.15. The distance metric used is the network distance since it reflects the real time spent by a nurse between the basic units.

A.16. The districting is done once for a relatively long period of time which corresponds to the districting horizon.

As explained earlier, the human aspect is a major characteristic of HHC services. The districting problem can directly impact care givers' performance in several ways. Indeed, the organization of districts (and the associated team in charge of the district) would have an impact on the working conditions of care givers which in turn impact the satisfaction of human resources. In our model, this aspect is captured via the workload balancing criteria.

### 3.2 Criteria considered

We consider the following criteria for the HHC districting problem:

- The compactness criterion can be integrated into the models in two ways. First, the compactness can be formulated as a hard constraint by limiting the maximum distance between two basic units that would be assigned to the same district (i.e. Model 1). The second formulation consists in minimizing a compactness measure which is the maximum distance between two basic units that would be assigned to the same district (i.e. Model 2).
- The workload balance criterion is the second criterion used for the design of “good” districts. It consists in having almost the same workload among all different districts. The workload is essentially composed of the care workload and the travel time. Since the travel time is directly related to the distances between the different basic units whose reduction is guaranteed by the compactness criterion, we consider only the care workload which depends on the number of patients visited by the care givers as well as the profile of these patients.
- The accessibility criterion is also crucial in the HHC context since it is related to the easiness by which the care givers can travel within a district, for example by means of public transportation, private cars, etc. The accessibility criterion can also refer to the respect of geographical obstacles such as mountains, bodies of water, etc.
- The conformity of the districts to the administrative boundaries is a criterion that facilitates the organization of health care delivery procedures and the work with community agencies.

We group the last two criteria into one criterion namely the compatibility. Indeed, we assume that two basic units can be incompatible for several reasons:

- a) Existence of geographical obstacles between them.
  - b) Difficulty or impossibility to travel from one basic unit to another by the means of transportation used by care givers (public transportation, private cars, etc.).
  - c) They do not belong to the same administrative district.
- The indivisibility of basic units’ criterion which implies that each basic unit is assigned to one and only one district. This criterion is considered in order to avoid the interference between care giver teams’ responsibilities and to establish long term relationships with patients.

In the existing literature, the unique Operations Research work that treats the HHC districting problem has been conducted by [Blais et al., 2003]. Indeed, the authors have proposed a multi-criteria approach, similar to the one proposed by [Bozkaya et al., 2003] for the political



districting problem, where the criteria related to the visiting personnel mobility (via public transportation and respect of the geographical obstacles) and the workload equilibrium (measured by the sum of the travel time and the visit time) are combined into a single objective function whereas the criteria related to the indivisibility of the basic units, respect of borough boundaries and contiguity are considered as hard constraints.

Note that in comparison with our models, [Blais et al., 2003] have not considered the different patients' profiles separately. Moreover, we propose two models where the accessibility criterion can be considered as a hard constraint to respect whereas they have considered it as an objective function to optimize. Additionally, they have formulated the workload as the sum of the total travel time and the total visit time (care workload) that has been optimized. On the contrary, our models aim at balancing the districts according to the care workload, the travel time being related to the compactness criterion. Hence, based on the preferences that HHC managers would have, we propose two mathematical formulations for the HHC districting problem (Model 1 and Model 2) which consider the compactness and care workload balance criteria either as a hard constraint to respect or an objective function to optimize.

### 3.3 Decision Variables

We define the following decision variables:

- $x_{ij}$ : assignment decision variables.  $x_{ij}=1$  if the basic unit  $i$  ( $i=1\dots N$ ) is assigned to district  $j$  ( $j=1\dots M$ ) and 0 otherwise.
- $w_j$ : total care workload of district  $j$  ( $j=1\dots M$ ).
- $gap\_max$ : the maximum deviation (expressed as a percentage) between the care workload associated to each district and the average care workload among all districts (used in Model 1).
- $distance$ : the maximum distance that separates two basic units that are in the same district, among all districts (used in Model 2).

### 3.4 Parameters

We use the following notations for the parameters of the models:

- $N$ : number of basic units.
- $M$ : number of districts to design.

- $H$ : number of patients' profiles considered.
- $b_h$ : number of visits required by a patient of profile  $h$  ( $h=1\dots H$ ) during his/her stay within the HHC system.
- $T_h$ : average duration of a visit relative to the profile  $h$  ( $h=1\dots H$ ).
- $P_{ih}$ : number of patients living in the basic unit  $i$  ( $i=1\dots N$ ) and having the profile  $h$  ( $h=1\dots H$ ).
- $d_{ik}$ : distance between the basic units  $i$  ( $i=1\dots N$ ) and  $k$  ( $k=1\dots N$ ).
- $d_{\max}$ : maximum distance allowed between two basic units that can be assigned to the same district (used in Model 1).
- $D$ : set of basic units' pairs  $(i, k)$  where  $(i, k) \in D$  if and only if  $d_{ik} > d_{\max}$  (used in Model 1).
- $\bar{w}$ : average care workload among all districts.
- $\tau$ : admissible percentage deviation of the workload associated to a given district in comparison with the average workload among all districts (used in Model 2).
- $e_{ik}$ : compatibility index.  $e_{ik}=1$  if the basic units  $i$  and  $k$  are compatible and 0 otherwise.
- $E$ : set of basic units' pairs  $(i, k)$  where  $(i, k) \in E$  if and only if  $e_{ik}=0$ .

### 3.5 Formulations of the problem

Depending on HHC managers' preferences, two formulations can be developed for modeling the HHC districting problem.

#### 3.5.1 Model 1

This model corresponds to the case where a HHC manager prefers to define a minimum average reactivity for patients that belong to the same district. This can be guaranteed by fixing an upper bound for the distance allowed between two basic units that are assigned to the same district ( $d_{\max}$ ). Alternatively, Model 1 can be used in cases where the HHC manager wants to achieve an objective of equitable care workload's distribution, so that the total care workload of the team working in each district is as close as possible to the average care workload. This workload equilibrium can be achieved by considering the following objective function:

$$\text{Minimize } \max_{j=1..M} |w_j - \bar{w}| \quad (1)$$

Since this expression is not linear, the resolution of the corresponding mathematical model is difficult. However, it is possible to linearize it by introducing another decision variable  $gap\_max$  and adding two hard constraints that relate  $gap\_max$  to  $w_j$  and  $\bar{w}$ . To summarize, the formulation of Model 1 is as follows:

$$\text{Minimize } gap\_max \quad (2)$$

s.to

$$w_j = \sum_{i=1}^N \sum_{h=1}^H P_{ih} b_h T_h x_{ij} \quad \forall j = 1..M \quad (3)$$

$$\bar{w} = \frac{\sum_{i=1}^N \sum_{h=1}^H P_{ih} b_h T_h}{M} \quad (4)$$

$$gap\_max \geq \frac{w_j - \bar{w}}{w} \quad \forall j = 1..M \quad (5)$$

$$gap\_max \geq \frac{\bar{w} - w_j}{w} \quad \forall j = 1..M \quad (6)$$

$$\sum_{j=1}^M x_{ij} = 1 \quad \forall i = 1..N \quad (7)$$

$$x_{ij} + x_{kj} \leq 1 \quad \forall (i,k) \in E, j = 1..M \quad (8)$$

$$x_{ij} + x_{kj} \leq 1 \quad \forall (i,k) \in D, j = 1..M \quad (9)$$

$$x_{ij} \in \{0,1\} \quad \forall i=1..N \quad j=1..M \quad (10)$$

The objective function (2) coupled with constraints (5) and (6) guarantee the minimization of the maximum deviation of the care workload from the average care workload among all districts. Constraints (3) and (4) define respectively the care workload of each district and the average care workload among all districts. Constraint (7), together with constraint (10), assume that each basic unit is assigned to one and only one district. The compatibility is guaranteed by constraint (8). Finally, constraint (9) is related to the compactness criterion where the distance between two basic units assigned to the same district is bounded by  $d_{max}$ . This upper bound guarantees the containment of the travel time and thus enables a better reactivity within each district.

### 3.5.2 Model 2

In Model 1, we consider the case where the main objective is to balance the care workload. However, a HHC manager could prefer defining a tolerance interval that ensures that each district's care workload does not deviate from the average care workload by more than a pre-specified percentage  $\tau$ . The main objective would then consist in minimizing the compactness measure, i.e. the maximum distance between two basic units assigned to the same district, as follows:

$$\text{Minimize} \left( \max_{\substack{i=1\dots N \\ k=1\dots N}} (d_{ik} * x_{ij} * x_{kj}) \right) \quad (11)$$

This objective function would help to improve the reactivity of care givers and to reduce the waiting time of patients as much as possible. Similarly to Model 1, this objective function is not linear. It is possible to transform it into a linear one by introducing a decision variable *distance* to minimize which must respect an additional constraint. To summarize, the formulation of Model 2 is as follows:

$$\text{Minimize } \textit{distance} \quad (12)$$

s.to

$$\textit{distance} \geq d_{ik} * (x_{ij} + x_{kj} - 1) \quad \forall \quad i = 1\dots N \quad k = 1\dots N \quad j = 1\dots M \quad (13)$$

$$w_j = \sum_{i=1}^N \sum_{h=1}^H P_{ih} b_h T_h x_{ij} \quad \forall \quad j = 1\dots M \quad (14)$$

$$\bar{w} = \frac{\sum_{i=1}^N \sum_{h=1}^H P_{ih} b_h T_h}{M} \quad (15)$$

$$\sum_{j=1}^M x_{ij} = 1 \quad \forall \quad i = 1\dots N \quad (16)$$

$$x_{ij} + x_{kj} \leq 1 \quad \forall \quad (i,k) \in E, \quad j = 1\dots M \quad (17)$$

$$(1 - \tau)\bar{w} \leq w_j \quad \forall \quad j = 1\dots M \quad (18)$$

$$w_j \leq (1 + \tau)\bar{w} \quad \forall \quad j = 1\dots M \quad (19)$$

$$x_{ij} \in \{0,1\} \quad \forall \quad i = 1\dots N \quad j = 1\dots M \quad (20)$$

Comments on constraints (14), (15), (16), (17) and (20) of Model 2 are the same as for Model 1. The objective function (12) and constraint (13) guarantee the minimization of the maximum distance travelled among all districts, the care workload equilibrium being considered in constraints (18) and (19) which define the minimum and maximum allowable care workload within each district as a percentage of  $\bar{w}$ .

#### 4. Computational results

The purpose of this section is to analyze the behavior of the models proposed for the HHC districting problem by testing each model on 4 scenarios. Table 3-1 presents the objective function and hard constraints that have to be respected in each of the eight scenarios considered. Details pertaining to these scenarios can be found in sections 5.1 (for Model 1) and 5.2 (for Model 2).

For each scenario, the numerical analysis starts by setting the values of the number of basic units  $N$ , the number of districts to design  $M$ , the number of profiles  $H$ , the maximum distance between two basic units assigned to the same district  $d_{\max}$  (in Model 1) or the percentage deviation  $\tau$  (in Model 2). After that, for one instance, we generate randomly the distance matrix  $d_{(N,N)}$ , the number of visits  $b_h$  and the average duration of the visits  $T_h$  relative to the profile  $h$ , the number of patients  $P_{ih}$  having the profile  $h$  and living in the basic unit  $i$  and the compatibility matrix  $e_{(N,N)}$ . Note that the latter parameter is generated only for scenarios 2 and 3 where we consider the compatibility constraint. We solve the problem for one instance where we calculate the value of *gap\_max* (Model 1) or *distance* (Model 2). If a solution (optimal or simply feasible) could be obtained within 60 minutes of computation, the problem is considered feasible for this instance. We repeat the random generation of  $d_{(N,N)}$ ,  $b_h$ ,  $T_h$ ,  $P_{ih}$  and  $e_{(N,N)}$  20 times and then evaluate the mean *gap\_max* (Model 1) or the mean *distance* (Model 2) over these 20 instances that have the same values of  $N$ ,  $M$ ,  $H$  and  $d_{\max}$  (or  $\tau$ ) and different values of  $d_{(N,N)}$ ,  $b_h$ ,  $T_h$ ,  $P_{ih}$  and  $e_{(N,N)}$ . We also assess the feasibility percentage which corresponds to the number of feasible instances over these 20 instances.

**Table 3-1:** Criteria considered in each scenario

	<b>Model 1</b>	<b>Model 2</b>
<b>Scenario 0</b>	Objective function (2) Constraints (3), (4), (5), (6), (7), (10)	Objective function (12) Constraints (13), (14), (15), (16), (20)
<b>Scenario 1</b>	Objective function (2) Constraints (3), (4), (5), (6), (7), (9), (10)	Objective function (12) Constraints (13), (14), (15), (16), (18), (19), (20)
<b>Scenario 2</b>	Objective function (2) Constraints (3), (4), (5), (6), (7), (8), (10)	Objective function (12) Constraints (13), (14), (15), (16), (17), (20)
<b>Scenario 3</b>	Objective function (2) Constraints (3), (4), (5), (6), (7), (8), (9), (10)	Objective function (12) Constraints (13), (14), (15), (16), (17), (18), (19), (20)

The parameters considered in each instance are generated as follows:

- The problem dimension: it refers to the number of basic units  $N$  and the number of districts to design  $M$ . By considering 4 different values of  $N \in \{10, 20, 40, 100\}$  and  $M \in \{1, 2, 3, 4\}$ , we generate 4 groups of instances: very small ( $N=10$  and  $M \in \{1, 2, 3, 4\}$ ), small ( $N=20$  and  $M \in \{1, 2, 3, 4\}$ ), medium ( $N=40$  and  $M \in \{1, 2, 3, 4\}$ ) and large size ( $N=100$  and  $M \in \{1, 2, 3, 4\}$ ) instances. Note that the case  $M=1$  corresponds to the organization of the care delivery without adopting the districting approach and will serve as a basis for our numerical analysis.
- The number of profiles  $H$  is equal to 2.
- The number of visits  $b_h$  and the average duration of the visits  $T_h$  relative to the profile  $h$  are generated randomly from uniform distributions respectively  $DU(0, 2)$  and  $DU(0, 5)$ .
- The number of patients  $P_{ih}$  having the profile  $h$  and living in the basic unit  $i$  is generated randomly from a discrete uniform distribution  $DU(0, 20)$ .
- The distance matrix  $d_{(N,N)}$  is generated as follows:
  - For each basic unit  $i$ , we randomly generate an abscissa  $X_i$  and an ordinate  $Y_i$  from a uniform distribution  $DU(0, 200)$ .
  - For each pair of basic units  $i$  and  $k$ , the distance  $d_{ik}$  is then calculated according to the formula:  $d_{ik} = \sqrt{(X_i - X_k)^2 + (Y_i - Y_k)^2}$

- The maximum distance between two basic units assigned to the same district  $d_{\max}$  can take different values that vary from 90 to 300:  $d_{\max} \in \{90, 110, 130, \dots, 250, 270, 290\}$  for scenarios 1 and 2 of Model 1 and  $d_{\max} \in \{100, 150, 200, 250, 300\}$  for scenario 3 of Model 1.
- The percentage deviation  $\tau$  of each district care workload from the average care workload can be equal to 100%, 10% or 1%.
- The compatibility matrix  $e_{(N, N)}$  is generated as follows:
  - We fix a weight  $p_{\max}$  that represents, for each basic unit  $i$ , the maximum ratio of incompatibilities with the other basic units  $k$  ( $k=i+1 \dots N$ ):  $p_{\max} \in \{0, 0.05, 0.1, \dots, 0.3, 0.35\}$
  - For each line  $i$  of  $e$ :
    - a) We fix  $e_{ii}=1$ .
    - b) We randomly generate  $e_{ik}$  ( $k=i+1 \dots N$ ) such that the ratio of the number of zeros in the right part of the line  $i$  is less or equal to  $p_{\max}$ .
  - For each column  $i$  of  $e$ :
    - a)  $e_{ik}$  ( $k=i+1 \dots N$ ) =  $e_{ki}$

The models proposed are coded in C++. All tests were run under Windows XP with an Intel Core Duo CPU (3 GHz) and 2 Go of RAM. We used a standard MIP software (CPLEX11.1) with the solver default settings.

## 4.1 Model 1

### 4.1.1 Scenario 0

Numerical analysis performed for this scenario aim at analyzing the effect of varying the number of basic units  $N$  and the number of districts to design  $M$  on the mean  $gap_{\max}$ . Therefore, we consider different values of  $N \in \{10, 20, 40, 100\}$  and  $M \in \{1, 2, 3, 4\}$  and we randomly generate for each couple  $(N, M)$  20 instances as explained before. Since this scenario does involve neither the compatibility nor the compactness constraints i.e. constraints (8) and (9), feasible solutions could be found for all the instances considered. Results from Table 3-2 that displays the values of mean  $gap_{\max}$  of each set of 20 instances associated with a given couple  $(N, M)$  show that:

- For a given  $N$ , the higher is  $M$ , the worse is the mean  $gap_{\max}$  (i.e. the worse is the workload balance) since it is more difficult to have equal workloads among the districts.

- For a given M, the higher is N, the better is the mean *gap\_max* due to the fact that a high number of basic units increases the chance of getting equitably loaded districts.

**Table 3-2:** Mean *gap\_max* of Scenario 0

<b>N</b>	<b>10</b>	<b>20</b>	<b>40</b>	<b>100</b>	
<b>M</b>	<b>1</b>	0,0000%	0,0000%	0,0000%	0,0000%
	<b>2</b>	0,4031%	0,1448%	0,0192%	0,0008%
	<b>3</b>	1,5112%	0,3955%	0,0472%	0,0033%
	<b>4</b>	6,3625%	0,7809%	0,0834%	0,0132%

For the remaining scenarios, in order to simplify the analysis, all our numerical examples have been run for values of M=2 and M=3. Since the results of different values of M yield the same qualitative behavior, we therefore present the numerical results associated to the case M=2 in the following sub-sections. Results pertaining to M=3 are provided in Appendix C.

#### 4.1.2 Scenario 1

Within the framework of this scenario, we intend to study the impact of the compactness constraint on the mean *gap\_max* for different values of  $N \in \{10, 20, 40, 100\}$ . Since the key parameter related to the compactness constraint is  $d_{max}$ , we experiment different values of  $d_{max}$  which vary between 90 and 290 in steps of 20. For each combination  $(N, d_{max})$ , we generate randomly 20 instances as explained before. Notice that the value of  $d_{max}$  is defined by HHC managers on the basis of the target satisfaction level of patients admitted to the HHC structure. Indeed, a small value of  $d_{max}$  increases the average reactivity of the system (especially in case of emergencies) which would improve the service quality level. In Table 3-3 and Table C-1 (Appendix C), we display the feasibility percentage of each set of 20 instances relative to a combination  $(N, d_{max})$  and the mean *gap\_max* values of each set of 20 instances which are associated to 100% of feasibility for respectively M=2 and M=3.



**Table 3-3:** Feasibility percentage and mean *gap\_max* of Scenario 1 for M=2

N	10		20		40		100	
	Feasibility Percentage	mean <i>gap_max</i>	Feasibility Percentage	mean <i>gap_max</i>	Feasibility Percentage	mean <i>gap_max</i>	Feasibility Percentage	mean <i>gap_max</i>
<b>90</b>	0%		0%		0%		0%	
<b>110</b>	10%		0%		0%		0%	
<b>130</b>	25%		5%		0%		0%	
<b>150</b>	45%		25%		5%		0%	
<b>170</b>	100%	1,8699%	70%		10%		0%	
<b>190</b>	100%	0,6504%	85%		75%		5%	
<b>210</b>	100%	0,4248%	100%	0,1574%	100%	0,0471%	100%	0,0026%
<b>230</b>	100%	0,4212%	100%	0,1465%	100%	0,0423%	100%	0,0019%
<b>250</b>	100%	0,4031%	100%	0,1448%	100%	0,0403%	100%	0,0012%
<b>270</b>	100%	0,4031%	100%	0,1448%	100%	0,0398%	100%	0,0010%
<b>290</b>	100%	0,4031%	100%	0,1448%	100%	0,0192%	100%	0,0008%

From Table 3-3 and Table C-1, we can make the following observations:

- For a given N, the percentage of feasible instances increases when the value of  $d_{max}$  increases.
- On the contrary, for a given  $d_{max}$ , the feasibility percentage decreases as long as the value of N increases.
- For a given M, the value of  $d_{max}$  from which the problem becomes feasible for all the instances increases when N increases.
- For a given N, the value of  $d_{max}$  from which the problem becomes feasible for all the instances decreases when M increases.
- For a given  $d_{max}$ , the higher is N, the better is the mean *gap\_max*.
- For a given N, by increasing the maximum distance  $d_{max}$ , we decrease the mean *gap\_max*. Indeed, by increasing  $d_{max}$ , we enlarge the number of possible basic units' grouping which leads to an improvement of the mean *gap\_max*.

### 4.1.3 Scenario 2

The objective of this scenario is to study the impact of the compatibility constraint on the feasibility percentage and the mean *gap\_max* for different values of  $N \in \{10, 20, 40, 100\}$ . We then vary the key parameter  $p_{\max}$  between 0 and 0.35 in steps of 0.05. Remember that the value of  $p_{\max}$  captures the nature of the territory where the HHC delivers care to patients. Indeed, important values of  $p_{\max}$  would characterize rural areas or urban areas where the travelling between the different basic units is difficult. Tables 3-4 and C-2 (Appendix C) show the feasibility percentage of each 20 randomly generated instances' set relative to a pair  $(N, p_{\max})$  and the mean *gap\_max* values of the 20 instances' sets which correspond to 100% of feasibility.

**Table 3-4:** Feasibility percentage and mean *gap\_max* of Scenario 2 for  $M=2$

N	10		20		40		100	
$p_{\max}$	Feasibility Percentage	Mean <i>gap_max</i>	Feasibility Percentage	mean <i>gap_max</i>	Feasibility Percentage	mean <i>gap_max</i>	Feasibility Percentage	mean <i>gap_max</i>
0	100%	0,4031%	100%	0,1448%	100%	0,0019%	100%	0,0008%
0,05	100%	0,4031%	100%	0,1448%	100%	0,0665%	0%	
0,1	100%	0,4031%	100%	0,2216%	0%		0%	
0,15	100%	0,9815%	30%		0%		0%	
0,2	100%	2,4092%	0%		0%		0%	
0,25	75%		0%		0%		0%	
0,3	45%		0%		0%		0%	
0,35	0%		0%		0%		0%	

According to Tables 3-4 and C-2:

- For a fixed value of  $N$ , as long as the ratio of incompatibilities increases, the feasibility percentage decreases.
- Similarly, for a given value of  $p_{\max}$ , the higher is  $N$ , the worse is the feasibility percentage.
- The threshold value of  $p_{\max}$  from which the feasibility percentage becomes equal to 0 decreases when  $N$  increases.

Indeed, the last two points can be explained by the fact that, for a fixed value of  $p_{\max}$ , the number of incompatibilities increases when  $N$  increases which leads to the reduction of the basic units' grouping possibilities.

- For a fixed value of  $N$ , by increasing the ratio  $p_{\max}$ , the mean *gap\_max* increases. Actually, when  $p_{\max}$  increases, the number of grouping's possibilities decreases and thus the mean *gap\_max* increases.

#### 4.1.4 Scenario 3

This scenario represents a generalization of the last two scenarios. Three key parameters are varied  $N \in \{10, 20, 40, 100\}$ ,  $d_{\max} \in \{100, 150, 200, 250, 300\}$  and  $p_{\max} \in \{0, 0.05, \dots, 0.3, 0.35\}$ . We present in Tables 3-5, 3-6, 3-7 and 3-8 the results for  $N=10, 20, 40$  and  $100$  and  $M=2$  and in Tables C-3, C-4, C-5 and C-6 (Appendix C) the results for  $N=10, 20, 40$  and  $100$  for  $M=3$ . Notice that Scenario 1 is a special case of Scenario 3 for which  $p_{\max}$  is equal to 0 as well as Scenario 2 is a special case of Scenario 3 for which  $d_{\max}=300$ . Consequently, as Tables 3-5 to 3-8 and Tables C-3 to C-6 (Appendix C) show, the results obtained in both scenarios 1 and 2 can be generalized for the different values of respectively  $p_{\max}$  and  $d_{\max}$ . In addition to the others conclusions, these tables display that for a given  $N$ , the higher is  $p_{\max}$ , the higher is the threshold value of  $d_{\max}$  from which the problem becomes feasible.

**Table 3-5:** Feasibility percentage and mean *gap\_max* of Scenario 3 for N=10 and M=2

<b>d<sub>max</sub></b>			<b>100</b>	<b>150</b>	<b>200</b>	<b>250</b>	<b>300</b>
<b>p<sub>max</sub></b>	<b>0</b>	<b>Feasibility Percentage</b>	10%	45%	100%	100%	100%
		<i>mean gap_max</i>			0,4356%	0,4031%	0,4031%
	<b>0,05</b>	<b>Feasibility Percentage</b>	10%	45%	100%	100%	100%
		<i>mean gap_max</i>			0,4356%	0,4031%	0,4031%
	<b>0,1</b>	<b>Feasibility Percentage</b>	10%	45%	100%	100%	100%
		<i>mean gap_max</i>			0,4356%	0,4031%	0,4031%
	<b>0,15</b>	<b>Feasibility Percentage</b>	5%	30%	100%	100%	100%
		<i>mean gap_max</i>			1,9070%	0,9815%	0,9815%
	<b>0,2</b>	<b>Feasibility Percentage</b>	5%	20%	85%	100%	100%
		<i>mean gap_max</i>				2,4092%	2,4092%
	<b>0,25</b>	<b>Feasibility Percentage</b>	0%	5%	65%	75%	75%
		<i>mean gap_max</i>					
	<b>0,3</b>	<b>Feasibility Percentage</b>	0%	5%	35%	45%	45%
		<i>mean gap_max</i>					
	<b>0,35</b>	<b>Feasibility Percentage</b>	0%	0%	0%	0%	0%
		<i>mean gap_max</i>					

**Table 3-6:** Feasibility percentage and mean *gap\_max* of Scenario 3 for N=20 and M=2

<b>d<sub>max</sub></b>			<b>100</b>	<b>150</b>	<b>200</b>	<b>250</b>	<b>300</b>
<b>p<sub>max</sub></b>	<b>0</b>	<b>Feasibility Percentage</b>	0%	25%	100%	100%	100%
		<i>mean gap_max</i>			0,1632%	0,1448%	0,1448%
	<b>0,05</b>	<b>Feasibility Percentage</b>	0%	25%	100%	100%	100%
		<i>mean gap_max</i>		3,3296%	0,1632%	0,1448%	0,1448%
	<b>0,1</b>	<b>Feasibility Percentage</b>	0%	0%	65%	100%	100%
		<i>mean gap_max</i>				0,2216%	0,2216%
	<b>0,15</b>	<b>Feasibility Percentage</b>	0%	0%	5%	30%	30%
		<i>mean gap_max</i>					
	<b>0,20-0,35</b>	<b>Feasibility Percentage</b>	0%	0%	0%	0%	0%
		<i>mean gap_max</i>					

**Table 3-7:** Feasibility percentage and mean *gap\_max* of Scenario 3 for N=40 and M=2

$d_{max}$			100	150	200	250	300
$p_{max}$	0	Feasibility Percentage	0%	0%	95%	100%	100%
		mean <i>gap_max</i>				0,0404%	0,0192%
	0,05	Feasibility Percentage	0%	0%	20%	95%	100%
		Mean <i>gap_max</i>					0,0665%
	0,1-0,35	Feasibility Percentage	0%	0%	0%	0%	0%
		Mean <i>gap_max</i>					

**Table 3-8:** Feasibility percentage and mean *gap\_max* of Scenario 3 for N=100 and M=2

$d_{max}$			100	150	200	250	300
$p_{max}$	0	Feasibility Percentage	0%	0%	60%	100%	100%
		mean <i>gap_max</i>				0,0019%	0,0008%
	0,05-0,35	Feasibility Percentage	0%	0%	0%	0%	0%
		mean <i>gap_max</i>					

## 4.2 Model 2

### 4.2.1 Scenario 0

Numerical analysis performed for this scenario aim at analyzing the impact of varying the number of basic units N and the number of districts to design M on the mean *distance*. We then consider different values of  $N \in \{10, 20, 40, 100\}$  and  $M \in \{1, 2, 3, 4\}$ . Since this scenario does not involve neither the compatibility nor the workload balance constraints i.e. constraints (17), (18) and (19); the problem is feasible for all the instances. The mean *distance* obtained for different values of N and M are presented in Figure 3-1 which shows that:

- For a given N, the mean *distance* decreases when the number of districts to design M increases. Indeed, the design of an increasing number of districts may conduct to grouping basic units that are closer to each other.
- For a given M, the higher is N, the higher is the mean *distance*. Indeed, by increasing the number of basic units, we increase the probability of grouping basic units that are far from each other.

As for Model 1, we have conducted numerical tests for  $M=2$  and  $3$  whose results have the same qualitative behavior. We therefore present the numerical results associated to the case  $M=2$  in the following sub-sections. Results pertaining to  $M=3$  are provided in Appendix D.

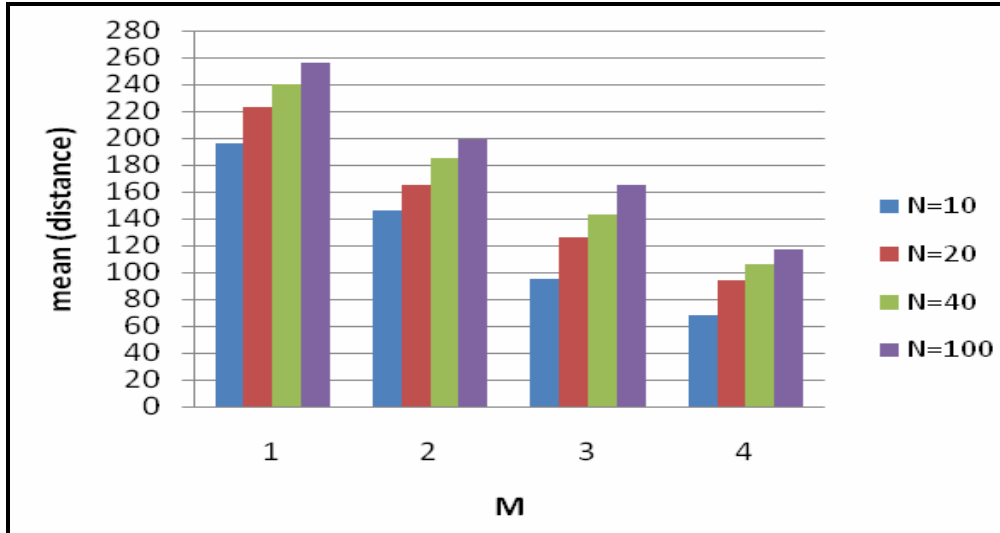
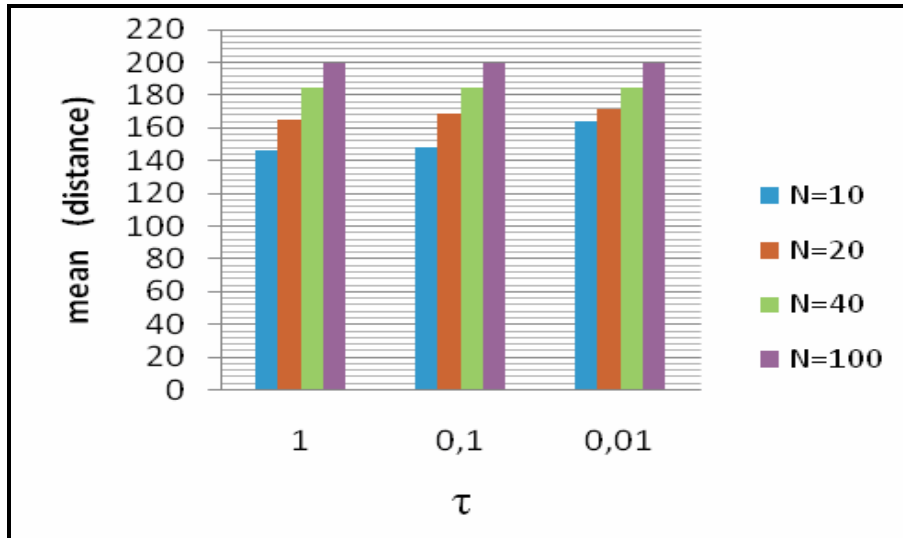

**Figure 3-1:** Mean *distance* of Scenario 0

#### 4.2.2 Scenario 1

The objective of this scenario is to analyze the effect of the workload balance constraint on the mean *distance* for different values of  $N$  ( $N \in \{10, 20, 40, 100\}$ ). Since this criterion depends on the admissible percentage deviation of the district workload from the average workload i.e.  $\tau$ , we vary the value of  $\tau$  ( $\tau \in \{100\%, 10\%, 1\%\}$ ). Within the framework of this scenario, feasible solutions could be found for all the instances considered for  $M=2$ . The feasible percentages that correspond to the different couples  $(N, \tau)$  for  $M=3$  are presented in Table D-1 (Appendix D). As can be seen from Figure 3-2 and Table D-1 which display the mean *distance* related to the different pairs  $(N, \tau)$  for respectively  $M=2$  and  $M=3$ :

- For a given  $\tau$ , the higher is  $N$ , the higher are the feasibility percentage and the mean *distance*.
- For a given  $N$ , by decreasing the admissible percentage deviation  $\tau$ , we decrease the feasibility percentage and increase the mean *distance*. Indeed, when we decrease  $\tau$ , we reduce the tolerance interval of the care workload and thus the number of possible combinations between the basic units which leads to a worse value of the mean *distance*.



**Figure 3-2:** Mean *distance* for Scenario 1 for M=2

### 4.2.3 Scenario 2

In this scenario, we vary the key parameter  $p_{\max} \in \{0, 0.05, \dots, 0.3, 0.35\}$  in order to analyze the mean *distance* behavior when we integrate the compatibility constraint for different values of  $N \in \{10, 20, 40, 100\}$ . Tables 3-9 and D-2 (Appendix D) which display the feasibility percentage and the mean *distance* of each set of 20 instances relative to a couple  $(N, p_{\max})$  (for respectively M=2 and M=3) show the impact of  $p_{\max}$  and N on the feasibility percentage as well as the impact of N on the threshold value of  $p_{\max}$  from which all the instances become infeasible. There are similar to the first three results presented in Sub-section 4.1.3. Moreover, the computational results presented in Tables 3-9 and D-2 (Appendix D) show that:

- For a given value of  $p_{\max}$ , the higher is N, the higher is the mean *distance*.
- For a given value of N, the mean *distance* increases when the ratio of incompatibilities increases. Actually, when  $p_{\max}$  increases, the number of grouping possibilities decreases and thus the mean *distance* increases.

**Table 3-9:** Feasibility percentage and mean *distance* of Scenario 2 for M=2

<i>N</i>		<b>10</b>		<b>20</b>		<b>40</b>		<b>100</b>	
		<b>Feasibility Percentage</b>	<b>mean <i>distance</i></b>	<b>Feasibility Percentage</b>	<b>mean <i>distance</i></b>	<b>Feasibility Percentage</b>	<b>mean <i>distance</i></b>	<b>Feasibility Percentage</b>	<b>mean <i>distance</i></b>
<b>p<sub>max</sub></b>	<b>0</b>	100%	145,908	100%	165,000	100%	184,927	100%	199,577
	<b>0,05</b>	100%	145,908	100%	165,000	100%	211,915	0%	
	<b>0,1</b>	100%	145,908	100%	196,828	0%		0%	
	<b>0,15</b>	100%	155,798	30%		0%		0%	
	<b>0,2</b>	100%	167,167	0%		0%		0%	
	<b>0,25</b>	75%		0%		0%		0%	
	<b>0,3</b>	45%		0%		0%		0%	
	<b>0,35</b>	0%		0%		0%		0%	

#### 4.2.4 Scenario 3

As explained in sub-section 4.1.4, this scenario represents a generalization of the last two scenarios within which we vary the values of three key parameters i.e.  $N \in \{10, 20, 40, 100\}$ ,  $\tau \in \{1, 0.1, 0.01\}$  and  $p_{\max} \in \{0, 0.05, \dots, 0.3, 0.35\}$ . The analysis of Tables 3-10, 3-11, D-3 and D-4 (Appendix D) which display the feasibility percentage and the mean *distance* for respectively  $N=10, 20$  and  $N=40, 100$  for  $M=2, 3$  indicate that the results of scenarios 1 and 2 are valid for respectively different values of  $p_{\max}$  and  $\tau$ .

Furthermore, Tables 3-10, 3-11, D-3 and D-4 point out that:

- For a given  $N$  and a given  $p_{\max}$ , the feasibility percentage decreases as long as the value of  $\tau$  decreases.
- For a given  $\tau$  and a given  $p_{\max}$ , the higher is  $N$ , the worse is the feasibility percentage.
- The threshold value of  $p_{\max}$  from which all the instances become infeasible increases when  $\tau$  increases.



**Table 3-10:** Feasibility percentage and mean *distance* of Scenario 3 for N=10, 20 and M=2

N			10			20		
$\tau$			1	0,1	0,01	1	0,1	0,01
$p_{max}$	0	Feasibility Percentage	100%	100%	100%	100%	100%	100%
		mean <i>distance</i>	145,908	147,802	164,426	165,000	168,691	171,135
	0,05	Feasibility Percentage	100%	100%	100%	100%	100%	100%
		mean <i>distance</i>	145,908	147,802	164,426	165,000	168,691	171,135
	0,1	Feasibility Percentage	100%	100%	100%	100%	100%	100%
		mean <i>distance</i>	145,908	147,802	164,426	196,828	196,846	201,879
	0,15	Feasibility Percentage	100%	100%	75%	30%	25%	10%
		mean <i>distance</i>	155,798	156,043	168,076			
	0,2	Feasibility Percentage	100%	100%	55%	0%	0%	0%
		mean <i>distance</i>	167,167	174,625				
	0,25	Feasibility Percentage	75%	35%	5%	0%	0%	0%
		mean <i>distance</i>						
	0,3	Feasibility Percentage	45%	10%	0%	0%	0%	0%
		mean <i>distance</i>						
	0,35	Feasibility Percentage	0%	0%	0%	0%	0%	0%
		mean <i>distance</i>						

**Table 3-11:** Feasibility percentage and mean *distance* of Scenario 3 for N=40, 100 and M=2

N			40			100		
T			1	0,1	0,01	1	0,1	0,01
$p_{max}$	0	Feasibility Percentage	100%	100%	100%	100%	100%	100%
		Mean <i>distance</i>	184,927	184,927	184,927	199,577	199,577	199,577
	0,05	Feasibility Percentage	100%	100%	100%	0%	0%	0%
		mean <i>distance</i>	211,915	211,915	212,561			
	0,1- 0,4	Feasibility Percentage	0%	0%	0%	0%	0%	0%
		mean <i>distance</i>						

These results show that for improving the workload balance (Model 1), we should reduce the number of districts to design. On the contrary, for reducing the distances traveled within each district (Model 2), it is better to partition the territory as much as possible. It is also clear that

the respect of the hard constraints related to the compatibility and workload/compactness explains the existence of infeasible instances as well as the worsening of the workload balance or the compactness measure.

### 4.3 Illustration of the use of models developed

The contribution of the models developed so far is first a quantitative assessment of the mean *gap\_max* (for Model 1) and mean *distance* (for Model 2) for HHC structures that want to design the partition of the territory they operate in. They can also be used in other different contexts, as described in the illustrations below.

#### 4.3.1 Evaluating the best number of districts to design

Consider the case of a HHC structure that does not have a precise idea about the number of districts to be designed and wants to take the best decision, regarding the value of  $M$  to choose. The best value of  $M$  would be the one which guarantees the feasibility of the problem and corresponds to the best workload balance (minimum *gap\_max*) or compactness (minimum *distance*) for a given value of  $d_{\max}$  or  $\tau$ . As described in the numerical analysis, for improving the workload balance (Model 1), we should reduce the number of districts to design. On the contrary, for reducing the distances traveled within each district (Model 2), it is better to partition the territory as much as possible. Within this context, the HHC managers would no more fix the value of the number of districts to design  $M$  instead of what they define the minimum and maximum numbers of districts that can be designed  $M_{\min}$  and  $M_{\max}$ . Consequently, the best value of  $M$  for Model 1 would be the smallest value of  $M$  which guarantees the feasibility of the problem for a given value of  $d_{\max}$ , while for Model 2, the optimal value of  $M$  would be  $M_{\max}$ .

For illustrating this, we are going to use one of the instances generated for the numerical analysis namely instance 1 for which we apply scenario 1 in the context of Model 1 and Model 2.

##### 4.3.1.1 Model 1

For instance 1, we consider:

- The number of basic units  $N$  is equal to 20.

- The minimum number of districts that can be designed  $M_{\min}$  is equal to 2.
- The maximum number of districts that can be designed  $M_{\max}$  is equal to 5.
- The maximum distance between two basic units assigned to the same district  $d_{\max}$  is varied between 50 and 300 in steps of 50.

In Table 3-12, we present the *gap\_max* for different combinations of  $M$  and  $d_{\max}$  where  $M$  and  $d_{\max}$  varies respectively between 2 and 5 in step of 1 and between 50 and 300 in step of 50 i.e.  $M \in \{2, 3, 4, 5\}$  and  $d_{\max} \in \{50, 100, 150, 200, 250, 300\}$ . Table 3-12 shows that for a given value of  $d_{\max}$ , the higher is  $M$ , the worse is the *gap\_max*. Despite this, this table proves that the optimal value of  $M$  corresponding to a given value of  $d_{\max}$  is the smallest value of  $M$  that guarantees the feasibility of the problem. For example, if the managers decide to limit the distance allowed between two basic units that can be assigned to the same district to  $d_{\max}=200$ , the 20 basic units would be divided best into  $M=2$  districts.

**Table 3-12: Mean *gap\_max* of Model 1**

<b>M</b>		<b>2</b>	<b>3</b>	<b>4</b>	<b>5</b>
<b>d<sub>max</sub></b>	<b>50</b>				
	<b>100</b>				43,848%
	<b>150</b>		2,631%	3,761%	37,795%
	<b>200</b>	0,186%	0,335%	0,485%	0,708%
	<b>250</b>	0,112%	0,224%	0,485%	0,555%
	<b>300</b>	0,112%	0,224%	0,485%	0,555%

#### 4.3.1.2 Model 2

For illustrating Model 2, we use instance 1 generated for the numerical analysis of Model 2 for which we vary the parameter  $\tau$  that represents the percentage deviation of each district care workload from the average care workload related to the profile  $h$  ( $h=1\dots H$ ) and which can be equal to 100%, 10% and 1%. The values of the objective function *distance* that correspond to the various couples of  $(M, \tau)$  are summarized in Table 3-13 which shows that the best way to optimize the compactness is to divide the territory as much as possible. Consequently, the optimal value of  $M$  is the highest value allowed by the decisions makers. The optimal value of  $M$  is then  $M=M_{\max}=5$  for  $\tau=100\%$ ,  $\tau=10\%$  and  $\tau=1\%$ .

**Table 3-13:** Mean *distance* of Model 2

M		2	3	4	5
$\tau$	100%	198,263	127,157	102,444	90,039
	10%	198,263	154,904	140,068	135,898
	1%	198,263	159,133	162,183	160,038

#### 4.3.2 Finding the $d_{\max}$ or $\tau$ values

In Section 4.3.1, we assumed that the number of districts to design  $M$  is no more predefined by the decisions-makers. However, it is possible that the decisions-makers want to partition the territory into exactly  $M$  districts but do not fix the value of  $d_{\max}$  or  $\tau$ . The models proposed for the HHC districting problem can thus be used to find the most suitable value of  $d_{\max}$  or  $\tau$  which conduct to a feasible solution of the problem and corresponds to the best workload balance (minimum *gap\_max*) or the least compactness (minimum *distance*). Within this context, the HHC managers would precise an interval for the values that can take  $d_{\max}$  or  $\tau$  i.e.  $[d_1, d_2]$  or  $[\tau_1, \tau_2]$  as well as the accuracy degree i.e. the steps by which the values of  $d_{\max}$  or  $\tau$  varies.

Note that the minimum value of *gap\_max* is obtained with  $d_{\max}=d_2$ , the upper bound of the interval defined by the HHC managers, due to the fact that, as shown before, *gap\_max* decreases by increasing the maximum distance. However, the value of *gap\_max* obtained with  $d_{\max}=d_2$  can be equal to the value of *gap\_max* obtained with other values  $d_3$  such that  $d_3 \in [d_1, d_2]$ . The most suitable value of  $d_{\max}$  corresponds then to the minimum value of  $d_3$  such that  $gap\_max(d_3)=gap\_max(d_2)$ .

Similarly, the minimum value of *distance* is obtained by  $\tau=\tau_2$ , the upper bound of the interval. This can be explained by the fact that the higher is the admissible percentage deviation  $\tau$ , the lower is the value of *distance*. Furthermore, the minimum value of *distance* can be obtained by  $\tau= \tau_3$  such that  $\tau_3 \in [\tau_1, \tau_2]$ . The objective consists then in finding the smallest value of  $\tau_3$  such that  $distance(\tau_3)=distance(\tau_2)$ .

In order to back up these conclusions, we are going to present an example for both Model 1 and Model 2 namely instance 1 generated before.

### 4.3.2.1 Model 1

We consider instance 1 for which  $H=2$ ,  $N=20$  and  $M=3$ . The maximum distance allowed  $d_{\max}$  varies between 100 and 200 in step of 10. For each  $d_{\max}$ , we calculate the corresponding  $gap\_max$  by using Model 1. The corresponding results are presented in Tables 3-14 and 3-15. We see from these tables that workload balance increases with the maximum distance allowed  $d_{\max}$  and that the values of  $gap\_max$  for  $d_{\max}=190$  and  $d_{\max}=200$  are equal. Limiting the distance allowed between two basic units assigned to the same district to 190 for partitioning these 20 basic units into 3 districts conducts then to the best solution.

**Table 3-14:** Value of  $gap\_max$  for  $d_{\max} \in [100,150]$

$d_{\max}$	100	110	120	130	140	150
$gap\_max$				9,625%	6,871%	2,631%

**Table 3-15:** Value of  $gap\_max$  for  $d_{\max} \in [160,200]$

$d_{\max}$	160	170	180	190	200
$gap\_max$	1,807%	1,433%	1,323%	0,335%	0,335%

### 4.3.2.2 Model 2

We now illustrate how Model 2 can be used for determining the most suitable value of  $\tau$  for instance 1 for which  $H=2$ ,  $N=20$  and  $M=3$  districts. We vary the values of  $\tau$  between 1% and 10% by a step of 1%. The objective function *distance* corresponding to each  $\tau$  is provided in Tables 3-16 and 3-17. It is clear from these results that the suitable value of  $\tau$  is equal to 5%.

**Table 3-16:** Value of distance for  $\tau \in [1\%,5\%]$

$\tau$	1%	2%	3%	4%	5%
<i>Distance</i>	159,133	159,133	159,133	159,133	154,904

**Table 3-17** : Value of *distance* for  $\tau \in [6\%,10\%]$

$\tau$	6%	7%	8%	9%	10%
<i>Distance</i>	154,904	154,904	154,904	154,904	154,904

Since now, we have analyzed the results of applying the two models proposed for the HHC districting problem. However, even if the mathematical formulations of these two models differ, they represent the same criteria among which the workload balance and the compactness criteria are formulated differently. Consequently, it is possible to obtain, for given values of N and M the same performance in terms of workload balance and compactness by applying either Model 1 or Model 2. In the next sub-section, we use an illustrative example to compare the different results obtained by both models.

#### **4.4 Duality between Model 1 and Model 2**

For testing the duality of the two models, we consider Scenario 1. We begin by fixing the key parameter of Model 2,  $\tau=1$  and varying  $N \in \{10, 20, 40, 100\}$ . For each instance k ( $k=1\dots 20$ ) corresponding to a pair (N, 1), we apply Model 2 in the context of Scenario 1. This gives us the value of the maximum *distance* between two basic units that can be assigned to the same district for each instance. We consider that this value “*distance<sub>k</sub>*” corresponds to the maximum distance that must be respected for this instance k according to the constraint (9) of Model 1. We can thus determine, by solving Model 1 the *gap<sub>max</sub>* of each instance k ( $k=1\dots 20$ ) corresponding to the pair (N, *distance<sub>k</sub>*). Table 3-18 presents the performance measures of the two models for five instances among the twenty instances tested by applying the procedure described above.

**Table 3-18:** Results of Scenario 1 considered for Model 1 and Model 2 for instances 1, 5, 10, 15 and 20

		Instance	1	5	10	15	20
N	10	model 2 distance	132,012	155,285	157,971	131,781	164,535
		model 1 gap_max	no solution	78,654	no solution	no solution	15,745
	20	model 2 distance	198,263	168,708	155,940	141,963	165,321
		model 1 gap_max	2,680	no solution	0,477	4,390	7,865
	40	model 2 distance	186,993	177,787	199,215	187,052	187,522
		model 1 gap_max	2,111	3,604	1,073	no solution	1,638
	100	model 2 distance	190,589	203,882	197,695	205,872	198,222
		model 1 gap_max	no solution	no solution	0	no solution	0,015717

After that, we calculate for Model 1, the percentage deviation of the care workload from the average care workload of each instance  $k$ . This percentage deviation is formulated as  $(\tau_1)_k = 1 - gap\_max_k$ . The mean values of  $\tau_1$  that correspond to the different values of  $N$  are presented in Table 3-19. Notice that the values of  $\tau_1$  are close to  $\tau$  and that the bigger is  $N$ , the closer is  $\tau_1$  to the value of  $\tau$  that we consider for Model 2.

**Table 3-19:** Mean values of  $\tau_1$

N	10	20	40	100
$\tau_1$	0,918	0,988	0,999	1,000

## 5. Extensions of the HHC districting model

The models proposed for the HHC districting models can be extended in several ways:

- Rather than doing a general workload (including all patient profiles) balance per district, one can try to separate the different patient profiles and model them differently. This leads to Model 3 and Model 4.
- Rather than considering one type of care givers, the workload balance can be established for different care givers' types, including not only the nurses but also

the physicians, physiotherapists, social workers, etc. This leads to Model 5 and Model 6 where we distinguish various specialties.

### **5.1 Distinction between patients' profiles**

When a patient is admitted in a HHC structure, his/her therapeutic project is established. These therapeutic projects are classified by the HHC structures into categories named profiles. Each profile is characterized by the expected duration of the patient's stay within the HHC structure, the frequency at which the patient will be visited by the HHC care givers and the average duration of each visit.

In the two models previously proposed, we have assumed that the patients who live in a given basic unit can have different profiles but we have not distinguished these different profiles when we calculate the care workload. However, they can influence differently the workload associated to a district or the burn out level of the care givers. This explains the necessity of considering patients' profiles separately.

Hence, we consider that  $h_1$  is the profile (or a set of profiles) whose imbalance could conduct to a large inequity between the districts' workload or whose psychological impact on care givers is the most important. The rest of the profiles are grouped into a set noted  $h_2$ . By doing this, we give the decisions-makers the opportunity to treat the profiles differently by defining a tolerance interval for each set of profiles depending on the decisions-makers' preferences. The formulations of Model 3 and Model 4 can be found in Appendix E.

### **5.2 Distinction between types of care givers**

Apart from this, the care workload that results from the profile of the patient varies according to care givers' specialties. Indeed, the care received within the HHC structures are delivered by a multidisciplinary team composed of medical and paramedical care givers among whom we distinguish: physicians, nurses, physiotherapists, social workers, home support workers, pharmacists, etc. Note that the workload generated by a given profile varies from one type of care givers to another. These workloads differ according to the importance of the activities achieved by each type of care givers. Consequently, it would be interesting to separate the various specialties and to model them differently. In this context, we need to modify one of the assumptions considered for modeling the problem. Indeed, the care givers delivering care to patients are no more of the same type. We then assume that  $s_1$  represents the care givers'



type (or a set of types) that has the smallest workload or that represents the type (or a set of types) that correspond to the most important portion of care givers among the total number of care givers. The rest of the care givers' types are grouped into a set noted  $s_2$ . The formulations of these models i.e. Model 5 and Model 6 are presented in Appendix E.

Numerical analysis that aim at comparing Model 1 to respectively Model 3 and Model 5 have been presented in Appendix F. On one hand, the computational experiments carried out to compare Model 1 and Model 3 show that fewer instances are solved exactly by using the extended formulation i.e. Model 3 which also increases the mean  $gap\_max$ . Moreover, the results show that the relative gaps generated by the addition of a tolerance interval related to profile h (i.e. the use of the extended formulation) increases when the ratio  $\frac{\overline{w_h}}{w}$  decreases. On

the other hand, by comparing the initial formulation i.e. Model 1 and the extended one i.e. Model 5 according to the second extension, we conclude that using the extended formulation (i.e. Model 5) decreases the feasibility percentage and increases the mean  $gap\_max$ . Furthermore, the relative gaps between using Model 1 and Model 5 increases when  $d_{max}$  increases and when  $\tau_{s_2}$  or  $\tau_{s_1}$  increases. The difference between the relative gaps of  $\tau_{s_1}$  and  $\tau_{s_2}$  is related, as for the case of the first extension, to the importance of the care workload of each type of care givers.

The computational results show that adopting these extensions would deteriorate the quality of the results i.e. feasibility percentage and mean  $gap\_max$  or mean  $distance$ . However, the distinction between the different types of profiles or different types of care givers would allow the improvement of the employees' management due to the fact that it takes into account the social and psychological impact of the different profiles and separate the various types of care givers. Consequently, these distinctions would improve the satisfaction of care givers.

## 6. Conclusion and perspectives

In this chapter, we developed two models for the districting problem that can be applied to HHC structures. We also proposed two extensions of these models which consist in distinguishing between patients' profiles and separating the various care givers' specialties. We finally provided some computational results based on different instances generated randomly which enabled us to evaluate the impact of the key parameters on the workload balance and compactness criteria.

Since our numerical analysis is not based on a real case study but aims at better understanding the behaviour of the models we have developed, we chose to generate randomly several parameters necessary for the models. In particular, the random variables we considered were generated from a uniform distribution. The use of this distribution was arbitrary, meaning that other types of distributions could also be chosen in the numerical tests. An interesting perspective to this chapter would be to consider other distributions such as normal distribution to generate these parameters and to see if the results found in this chapter are still valid when we change the distributions from which we generate the data.

Among the possible research directions suggested by the chapter, it might be worth investigating the development of a heuristic solution approach so as to be able to provide good feasible partitionings for real size instances within a reasonable computation time.

Another perspective to this chapter would be the generalization of the districting models so that they capture dynamically the variation of patients' care needs, the changes of care givers' number, etc. from period to period. This is the objective of Chapter 4.

Moreover, significant opportunities for future research exist at the boundaries of operations management and human resource management within the context of HHC districting problem. One of them can be to integrate quantitative measures of behavioural parameters such as learning, fatigue, burn out level, stress, etc. in the districting models in order to consider more realistic HHC operations. These parameters can be used to adjust the care giver speed or the quality of care delivered. Another interesting perspective concerns the integration of parameters pertaining to the team structure into the districting models. Indeed, the districting approach may enable a better team management which in turn may allow more responsible, autonomous and motivated care givers. Developing models where the optimization criteria explicitly consider the improvement of care givers' motivation or work satisfaction due to reinforced team management practices represents another interesting research perspective.

Overall, we must keep in mind that the objective of this work is not to develop a total automatic procedure but to propose a decision support system for the HHC managers who would modify solutions obtained by the mathematical models based on their experience. This interaction would probably conduct to more suitable solutions according to the criteria that are difficult to quantify such as the cooperation between two care givers' teams, the preferences of care givers in terms of basic units, etc.



## **CHAPTER 4**

# ***TIME WINDOW OPTIMIZATION OF THE HOME CARE SERVICES DISTRICTING PROBLEM***

### **1. Introduction**

In Chapter 3, we have proposed two models for the HHC districting problem. Through these models, the HHC managers can partition the territory where the HHC structure delivers care into districts. We have assumed that the partitioning is made once at the beginning of the districting horizon based on data relative to the first period of this horizon. The partitioning made at the first period does not change during the whole horizon i.e. we keep the same districting for all the following periods.

However, as presented in Chapter 2, HHC operations are often subject to variations and therefore, data related to HHC operations can change from period to period. We thus propose an extension for models proposed in Chapter 3 that consists in revising periodically the districting in order to integrate the new information on demand related to the number of patients who need care, the level of care required by each patient, the changes in the number of care givers, etc. It is important to note that this extension does not consider the stochastic nature of the problem. It is a dynamic formulation of the districting problem where data related to each period are assumed to be deterministic and known when the districting is solved. This principle of the integration of the update of data is similar to the “rolling horizon” concept used in production planning. Thus, this extension takes into account, when solving the districting problem, the variations in patients’ therapeutic projects over  $L$  periods ( $L > 1$ ) rather than considering these variations over one period, as it was the case of the models developed in Chapter 3.

After introducing the problem, we focus our attention on the time window districting problem which consists in designing districts whose workload are balanced over several periods of operation. Furthermore, we also consider the modeling of the continuity of care constraint

since this is a lever that enables to preserve the service quality towards patients who can receive care from the same care giver and thus do not have to continuously change their relationships with new ones.

This chapter is organized as follows. In Section 2, we propose different scenarios which depend on the criteria pertaining to the continuity of care and develop mathematical formulations for modelling these scenarios. Results of computational experiments carried out on randomly generated instances to validate these models are presented in Section 3. Finally, Section 4 provides some concluding remarks and perspectives that can be considered for future research.

## **2. The Time-Window HHC Districting Problem Description**

We consider the HHC districting problem over an horizon of  $K$  periods, typically 6 to 12 months. Within this horizon, time is discretized into periods of identical duration (typically 2 months). The districting problem is then solved for  $L$  periods ( $1 \leq L \leq K$ ).

In the previous chapter, we have formulated the HHC districting problem in a way that the territory is partitioned once at the beginning of the districting horizon based on data relative to the first period of this horizon (i.e.  $L=1$ ). We also assumed that the partitioning proposed at the beginning of the first period is kept during all the districting horizon (i.e.  $K$  periods) without integrating the changes in data related to the 2<sup>nd</sup>, 3<sup>rd</sup>, ...,  $K^{\text{th}}$  periods.

However, as we have underlined in Chapter 2, HHC operations are characterized by the variability of patients' existing in the system. This variability can stem from the exit of previous HHC patients due to the change of their addresses, the evolution of their profiles or the arrival of new patients that would create additional workload. Moreover, data related to patients' profiles may change according to the evolution of patients' therapeutic projects where the therapeutic project aims at "formalizing all the clinical, psychological and social care necessary for the state of the patient". This therapeutic project is revised periodically in order to be adapted to the patient's needs. The following Figure illustrates the different variability sources for HHC operations.

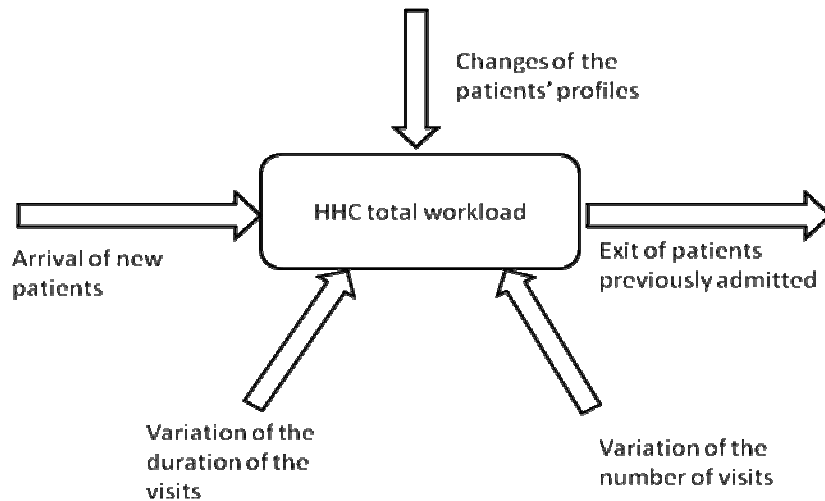
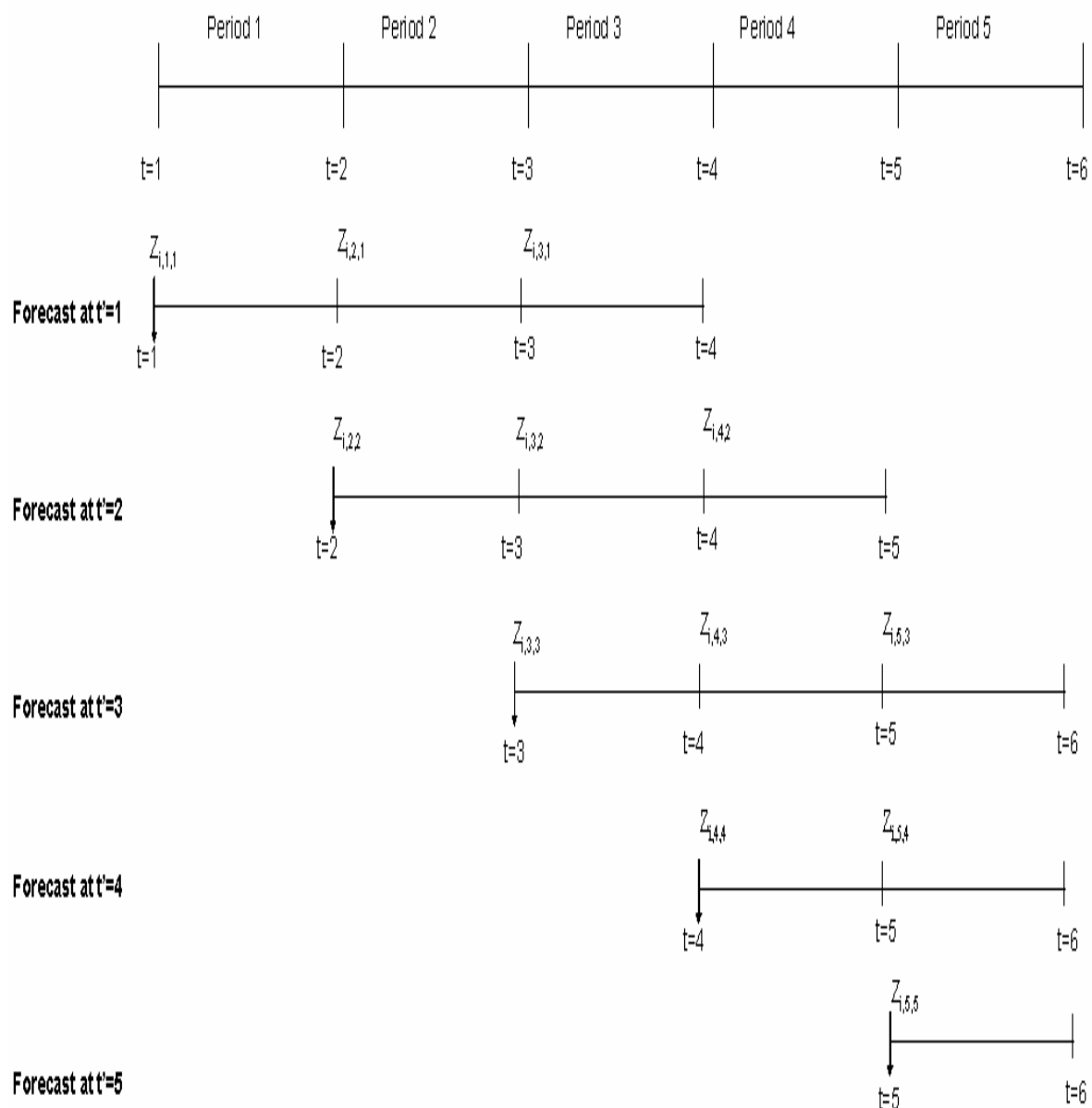

**Figure 4-1:** Variability sources of HHC operations management

An update of the data used to partition the territory into districts is thus necessary due to the fact that the parameters of the problem are dynamic. In practice, this dynamic aspect can be captured through forecasts of the workload (not 100% accurate) made over the horizon  $L$ . Let  $Z_{i,t,t'}$  be any data associated with the basic unit  $i$  ( $i=1\dots N$ ) during the period  $t$  ( $t=1\dots K$ ) that is forecasted at the beginning of period  $t'$  ( $t'=1\dots K$ ). Note that  $Z_{i,t,t'}$  can correspond to:

- $E_{i,t,t'}$ : the number of patients living in the basic unit  $i$  ( $i=1\dots N$ ) that arrive in the HHC system at the beginning of each period  $t$  ( $t=1\dots K$ ), forecasted at the beginning of period  $t'$  ( $t'=1\dots K$ ).
- $S_{i,t,t'}$ : the number of patients living in the basic unit  $i$  ( $i=1\dots N$ ) that exit the HHC system at the beginning of each period  $t$  ( $t=1\dots K$ ), forecasted at the beginning of period  $t'$  ( $t'=1\dots K$ ).
- $b_{t,t'}$ : the number of visits necessary to the patients during each period  $t$  ( $t=1\dots K$ ), forecasted at the beginning of period  $t'$  ( $t'=1\dots K$ ).
- $T_{t,t'}$ : the duration of the visits necessary to the patients at the beginning of each period  $t$  ( $t=1\dots K$ ), forecasted at the beginning of period  $t'$  ( $t'=1\dots K$ ).

Figure 4-2 illustrates the forecasting process through an example for which  $K=5$  and  $L=3$ .



**Figure 4-2:** Forecasting Data for  $K=5$

Within the framework of this study, we assume that:

- The HHC structure is able to forecast precisely (i.e. forecast accuracy is equal to 100%) the data over an horizon of  $L$  periods ( $1 \leq L \leq K$ ). This means that  $Z_{i,t,t}$  values forecasted over an horizon of  $L$  periods ( $1 \leq L \leq K$ ) are deterministic.
- $Z_{i,t,t}$  values forecasted do not change from a forecasting period to another. For instance,  $Z_{i,2,1}=Z_{i,2,2}$ ;  $Z_{i,3,1}=Z_{i,3,2}=Z_{i,3,3}$ ; etc.

Since the parameter  $t'$  does not influence the value of the forecasted data, we thus simplify the notations used in our models by removing the parameter  $t'$ . The parameters are thus noted as  $Z_{i,t}$ .

Since the districting is optimized over an horizon of  $K$  periods, the forecasted data are thus related to these  $K$  periods which means that HHC managers do not need to forecast the data beyond period  $K$ . Consequently; if  $t'+L-1 \leq K$ , the forecast that begins at period  $t'$  would concern the periods  $t'$  to  $t'+L-1$  i.e.  $L$  periods; otherwise it would concern the periods  $t'$  to  $K$  i.e.  $(K-t'+1)$  periods. In other words, the forecast that begins at period  $t'$  would concern all periods  $t$  such that  $t' \leq t \leq \min(t'+L-1, K)$ . Let consider the example used in Figure 4-2: the forecasts that start at  $t'=1$ ,  $t'=2$  and  $t'=3$  concern the data related to respectively periods 1, 2 and 3; periods 2, 3 and 4 and periods 3, 4 and 5. The forecast that begins at  $t'=4$  pertains to periods 4 and 5. The forecast that begins at  $t'=5$  pertains to period 5.

The model we develop in this chapter is an extension of Model 1 proposed in Chapter 3 where we solve the districting problem over  $L$  periods. The approach developed here can also be used to extend Model 2.

The overall districting problem solution (over  $K$  periods) is obtained from the solutions of the (elementary) districting problems solved over  $L$  periods. For simplicity, we consider one type of patient profile. Based on the forecasting horizon  $L$  (thus data available), three possibilities for the HHC multi-period districting problem can be considered namely: the period per period optimization, the time-window optimization and the global optimization approaches (See Figure 4-3).

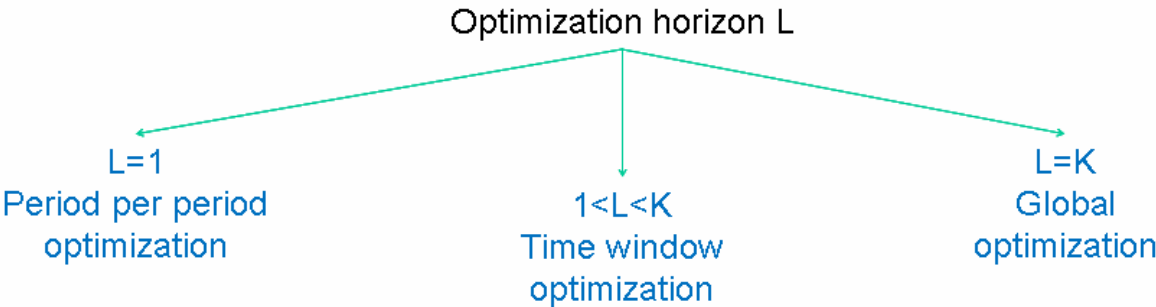

**Figure 4-3:** Different optimization possibilities depending on data available

In the first case ( $L=1$ ), data available at the beginning of each period  $t$  is as follows:



- $E_{i,t}$ : the number of patients living in the basic unit  $i$  ( $i=1\dots N$ ) that arrive in the HHC system at the beginning of period  $t$ , forecasted at the beginning of this period  $t$  ( $t=1\dots K$ ).
- $S_{i,t}$ : the number of patients living in the basic unit  $i$  ( $i=1\dots N$ ) that exit the HHC system at the beginning of period  $t$ , forecasted at the beginning of this period  $t$  ( $t=1\dots K$ ).
- $b_t$ : the number of visits necessary to patients during the period  $t$ , forecasted at the beginning of this period  $t$  ( $t=1\dots K$ ).
- $T_t$ : the duration of the visits necessary to the patients during the period  $t$ , forecasted at the beginning of this period  $t$  ( $t=1\dots K$ ).

Thus, the territory would be partitioned period per period which means that the first districting is made at the beginning of the first period based on data pertaining to this period and is applicable only during it. At the beginning of the second period, the partition of the territory is revised due to the update of problem parameters concerning period 2. Then, a third partition is made at the beginning of the third period and so on until the  $K^{\text{th}}$  period. The decision variables are denoted by  $x_{ijt}$  where  $x_{ijt}=1$  if the basic unit  $i$  ( $i=1\dots N$ ) is assigned to district  $j$  ( $j=1\dots M$ ) during the period  $t$  ( $t=1\dots K$ ) and 0 otherwise. Note that Model 1 proposed in Chapter 3 corresponds to this type of optimization.

We illustrate this approach in Figure 4-4 where we consider an example for which  $K=5$  and  $L=1$ . In this case, since the optimization is done over  $L=1$ , the use of the parameter  $K$  is thus necessary to define the districting problem scope (i.e. when to stop the districting approach) as well as to compare problems that may have different values of  $L$ .

Note that the performance of this approach is evaluated through the sum of the solutions of the elementary districting problems solved over each period i.e.  $\sum_{t=1}^K gap\_max_t$ .

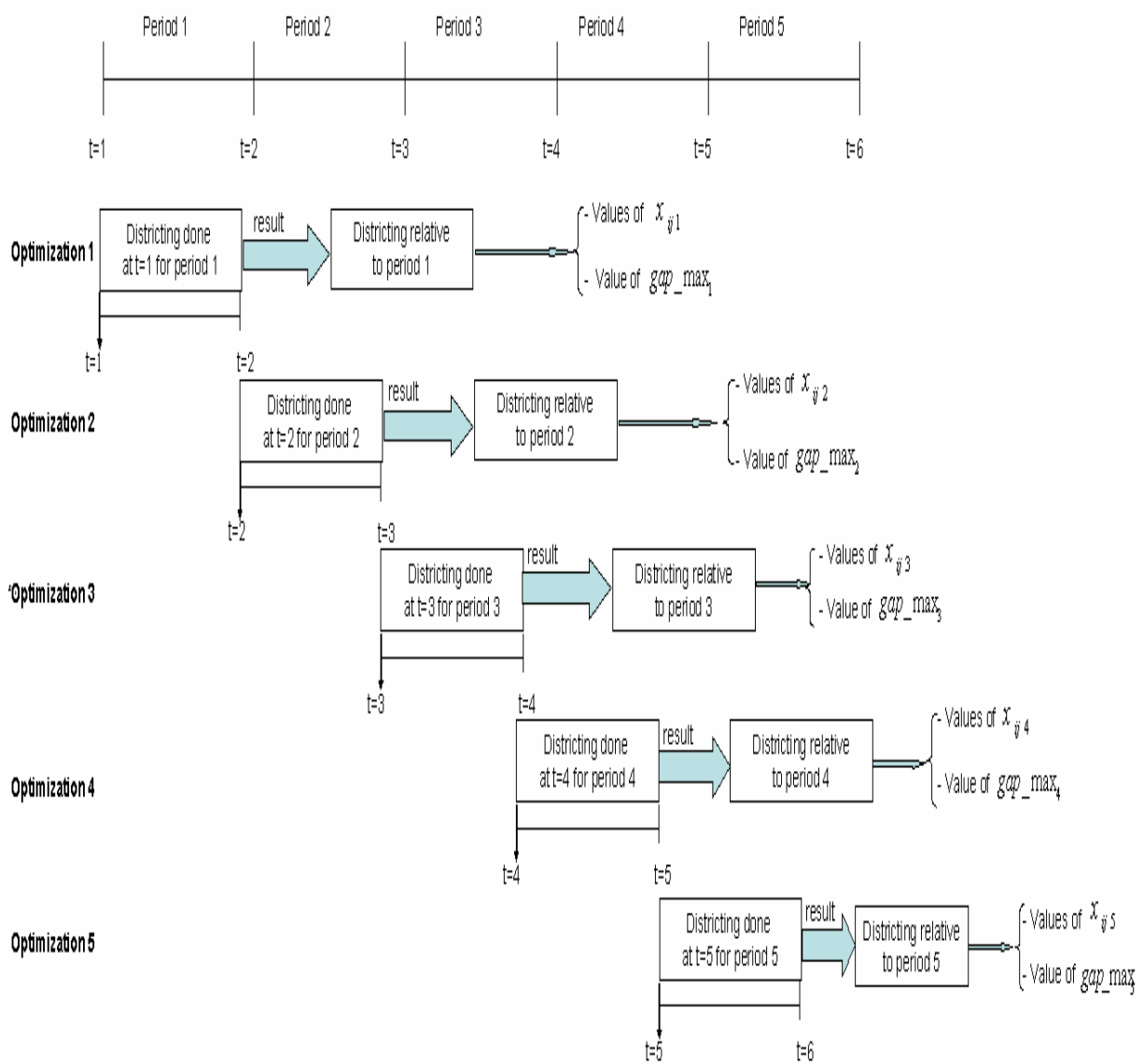

**Figure 4-4:** Illustrative example for period per period optimization

The second type of optimization ( $1 < L < K$ ) corresponds to the time-window districting problem which consists in balancing the care workload of the different districts over  $L$  periods.

At the beginning of each period  $t'$  ( $t' = 1 \dots (K-L+1)$ ), the available data are as follows:

- $E_{i,t}$ : the number of patients living in the basic unit  $i$  ( $i = 1 \dots N$ ) that arrive in the HHC system at the beginning of each period  $t$  ( $t' \leq t \leq \min(t'+L-1, K)$ ), forecasted at the beginning of period  $t'$  ( $t' = 1 \dots (K-L+1)$ ).

- $S_{i,t}$ : the number of patients living in the basic unit  $i$  ( $i=1\dots N$ ) that exit the HHC system at the beginning of each period  $t$  ( $t' \leq t \leq \min(t'+L-1, K)$ ), forecasted at the beginning of period  $t'$  ( $t'=1\dots(K-L+1)$ ).
- $b_t$ : the number of visits necessary to the patients during each period  $t$  ( $t' \leq t \leq \min(t'+L-1, K)$ ), forecasted at the beginning of period  $t'$  ( $t'=1\dots(K-L+1)$ ).
- $T_t$ : the duration of the visits necessary to the patients at the beginning of each period  $t$  ( $t' \leq t \leq \min(t'+L-1, K)$ ), forecasted at the beginning of period  $t'$  ( $t'=1\dots(K-L+1)$ ).

At the beginning of the first period, the data available is related to the  $L$  first periods. Based on these data, we optimize the districting of these  $L$  periods by minimizing the sum over  $t$ ,  $t$  varying between 1 and  $L$ , of the maximum deviation of the care workload of each district from the average care workload for each period  $t$  ( $1 \leq t \leq L$ ). The result that we keep from this optimization procedure is the partitioning relative to period  $t=1$  i.e. values of  $x_{ij1}$  and  $gap\_max_1$ . After that, at the beginning of the second period, we consider the data relative the periods varying from 2 to  $(L+1)$  and we balance the total care workload corresponding to these periods. Based on this optimization procedure, the optimal districting related to the second period i.e. values of  $x_{ij2}$  and  $gap\_max_2$  are determined.

This approach is applied  $t^*$  times where  $t^*$  is equal to  $(K-L+1)$ . This can be explained by the fact that the districting of periods from  $t^*$  to  $K$  results from the optimization of the total workload balance that begins at period  $t^*$  and that is based on data related to periods  $t^*$  to  $K$ . This means that the results that we keep from the optimization procedure that begins at  $t^*$  are the partitioning relative to periods  $t^*$  to  $K$  i.e. values of  $x_{ijt^*}$ ,  $x_{ij(t^*+1)} \dots x_{ijK}$  and  $gap\_max_{t^*}$ ,  $gap\_max_{(t^*+1)}$ ,  $\dots$ ,  $gap\_max_K$ . Indeed, the partitioning related to period  $(t^*+1)$  obtained through the districting approach that begins at period  $(t^*+1)$  and based on data relative to periods  $(t^*+1)$  to  $K$  is the same as the one that has been obtained at period  $t^*$  and based on data relative to periods  $t^*$  to  $K$ . This is related to the fact that the data are deterministic and do not change from period to another. The balancing of the total care workload related to periods  $(t^*+1)$  to  $K$  are thus included in the balancing of the total care workload related to periods  $t^*$  to  $K$  and obtained at  $t^*$ . The same reasoning is valid for the partitionings related to periods  $(t^*+2)$ ,  $(t^*+3)$ ,  $\dots$ ,  $K$  that are optimized in the districting procedure which begins at  $t^*$  and is based on data related to periods  $t^*$  to  $K$ .

This time-window approach is illustrated in Figure 4-5 where we use an example for which we consider that  $K=5$  and  $L=3$  which means that the districting of the territory would be made over an horizon of  $K=5$  periods while the data concerning the problem parameters are

available over  $L=3$  periods. As the forecast is accurate for  $L=3$  periods, the districting problem will be optimized 3 times.

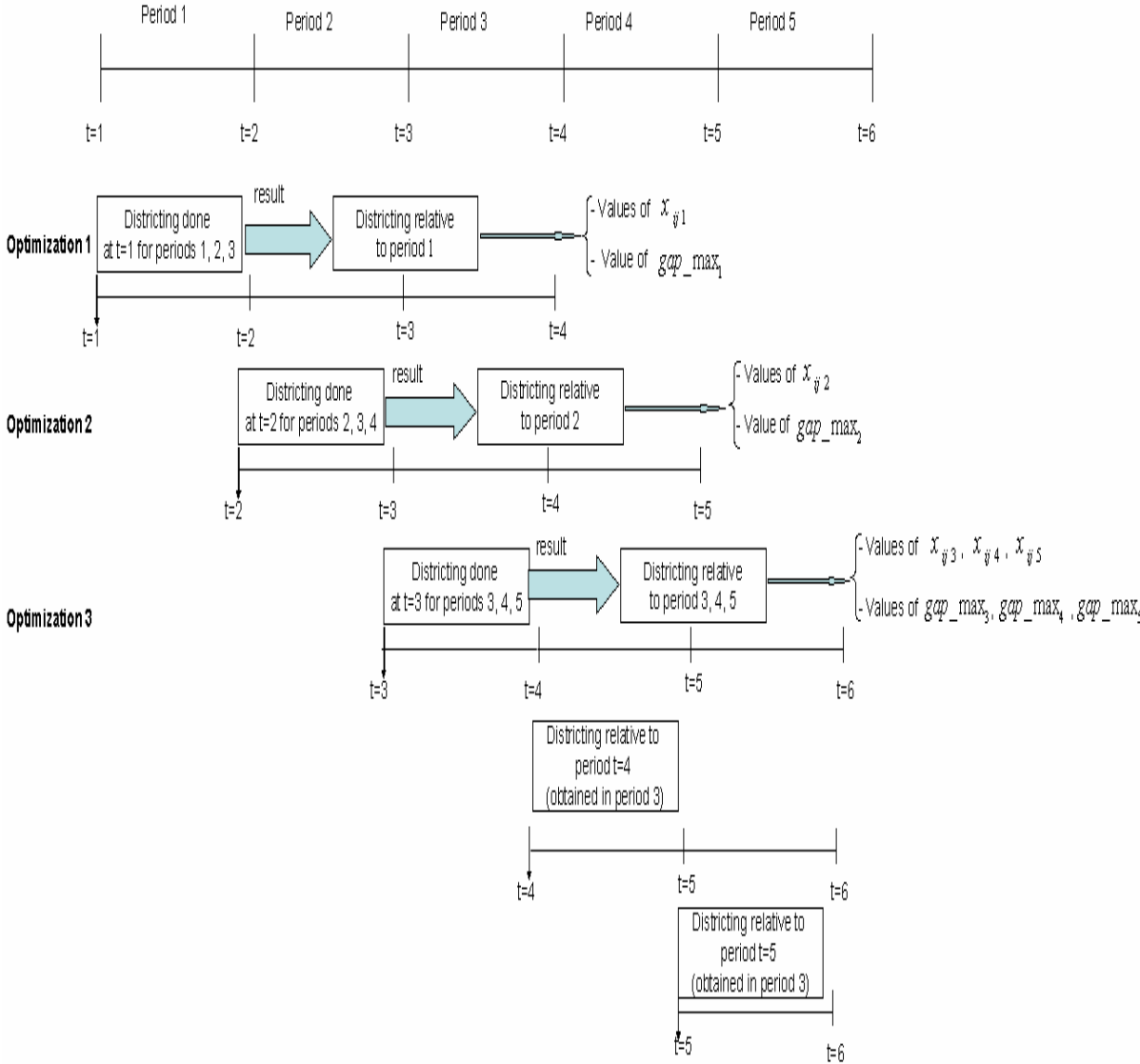

**Figure 4-5:** Illustrative example for the time-window optimization

Finally, the third possibility presented in Figure 4-6 corresponds to the global optimization ( $L=K$ ) where the territory is partitioned once at the beginning of the first period by taking into account the demand of  $K$  periods which are all assumed available at the beginning of the districting horizon. The data available at the beginning of the first period are thus the following:

- $E_{i,t}$ : the number of patients living in the basic unit  $i$  ( $i=1\dots N$ ) that arrive in the HHC system at the beginning of each period  $t$  ( $t=1\dots K$ ), forecasted at the beginning of period 1.

- $S_{i,t}$ : the number of patients living in the basic unit  $i$  ( $i=1\dots N$ ) that exit the HHC system at the beginning of each period  $t$  ( $t=1\dots K$ ), forecasted at the beginning of period 1.
- $b_t$ : the number of visits necessary to the patients during each period  $t$  ( $t=1\dots K$ ), forecasted at the beginning of period 1.
- $T_t$ : the duration of the visits necessary to the patients at the beginning of each period  $t$  ( $t=1\dots K$ ), forecasted at the beginning of period 1.

Figure 4-6 represents an example for which we consider that  $K=L=5$ .

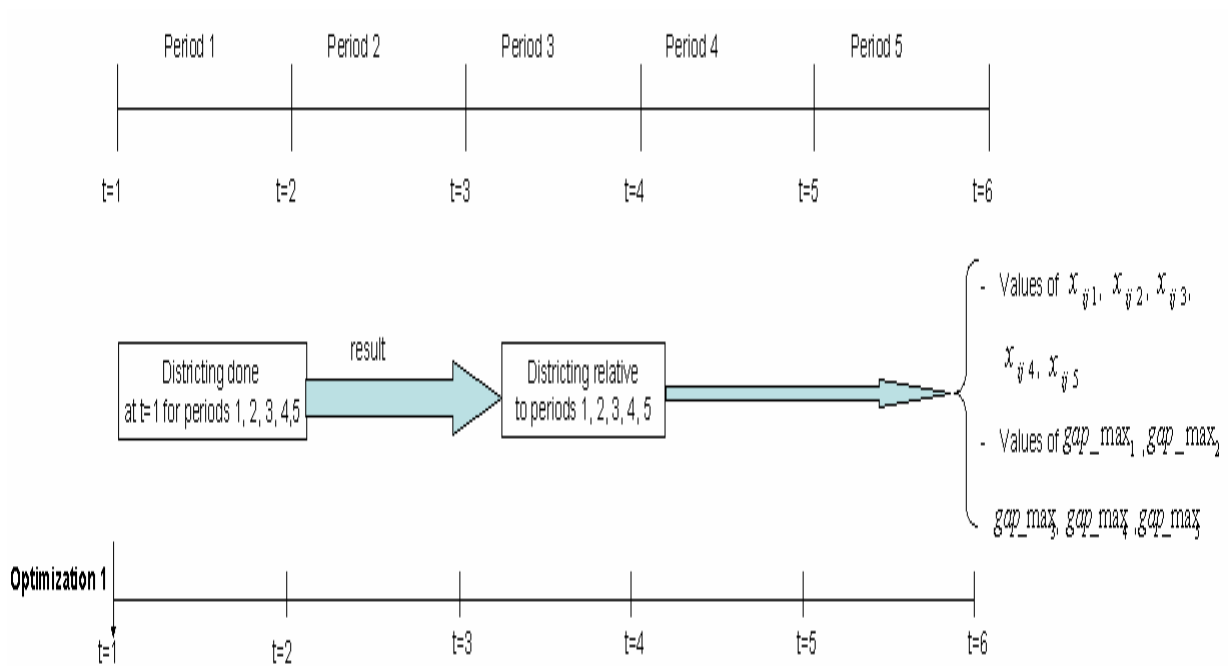

**Figure 4-6:** Illustrative example for the global optimization

As we have explained before, the districting approach may consider the continuity of care constraints. In our models, the continuity of care will not be expressed at patient level but at basic unit level where a basic unit represents an aggregation of patients. Therefore, the transposition of the continuity of care constraint in our model is twofold:

- We assume that the continuity of care is achieved by assigning each basic unit to the same district all over the periods during the districting horizon  $K$ . Since each district is assumed to be under the responsibility of a unique care givers' team, this constraint ensures that the basic units assigned to a given district (and thus patients living in these basic units) are treated by the same team over the  $K$  periods. Note that this

formulation of the continuity of care constraint is slightly different from the more traditional definition of the continuity of care expressed often at each patient level.

- The second component of the continuity of care is related to the indivisibility of each basic unit which means that each basic unit is assigned to one and only one district over the K periods. This constraint ensures that all patients living in a same basic unit are treated by the same care givers' team.

Hence, based on these constraints considered for guaranteeing the continuity of care, we distinguish three scenarios that are presented in Figure 4-7.

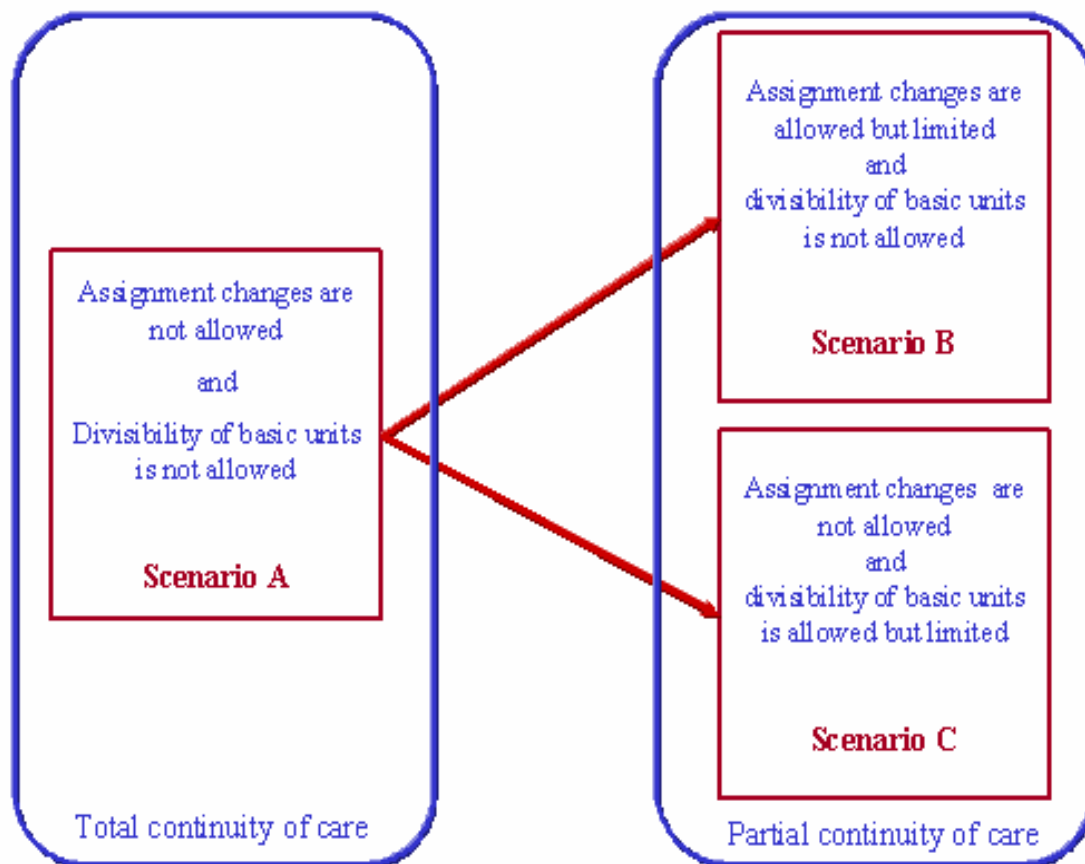

**Figure 4-7:** Continuity of care scenarios

Indeed, Scenario A corresponds to the case of total continuity of care where both constraints mentioned above are respected which means that the first assignments of the basic units to districts that result from the partitioning over the first L periods (i.e. optimization 1) are kept constant in the following elementary optimizations. Additionally, in each elementary L periods' optimization, all basic units must be assigned to one and only one district during each period. This is reported as "assignment changes are not allowed" and "divisibility of basic

units is not allowed” on Scenario A of Figure 4-7. Note that the model developed in Chapter 3 corresponds to this scenario (with  $L=1$ ).

However, these two constraints could conduct to the worsening of the objective function and thus to an important imbalance of care workload between the districts over the forecasting horizon  $K$ .

As the main objective of the districting approach is to design districts balanced as much as possible, it is necessary to improve the workload balance over the time-window. We thus consider the relaxation, within the context of Scenario B, of the total continuity of care constraint by allowing changes in the assignments of basic units to districts from period to period. However, HHC managers may want to limit the total number of assignments’ changes from one period to another, which is ensured by defining an upper bound for the number of assignment changes. The relaxation of this criterion leads to a better workload equilibrium and would guarantee a partial continuity of care.

As the total continuity of care (i.e. Scenario A) also depends on the indivisibility of the basic units over all periods, it is possible to improve the workload balance of Scenario A by allowing, within the context of Scenario C, the basic units’ division into different districts while limiting the number of districts into which each basic unit can be divided. As in Scenario B, the number of districts into which each basic unit can be divided is restricted by an upper bound predetermined by the HHC manager. We can limit the percentage of the workload of each basic unit assigned to a district during each period by an upper bound in order to strengthen the workload balance criteria.

Note that it is also possible to relax both continuity of care sub-criteria by allowing simultaneously the assignments’ changes (and limiting the total number of changes) and the divisibility of basic units (and limiting the number of districts into which each basic unit can be divided). This would improve the workload balance more than Scenario B and Scenario C but would affect the continuity of care criterion.

In the following sub-sections, we present the different models associated with the 3 scenarios described above. These models are based on the formulation of Model 1 developed in Chapter 3. Since the period per period optimization ( $L=1$ ) and the global optimization ( $L=K$ ) represent special cases of the time-window optimization approach, we present in this chapter the formulations relative to this latter case i.e.  $1 < L < K$ . This time-window HHC districting is based on the update of workload data with a principle of rolling horizon approach (i.e. update the number of patients that need care and the parameters of the care delivery process that may change from period to period) coupled with the guarantee of the continuity of care which is

related to the assignments of these basic units to districts and/or the indivisibility of the basic units.

## 2.1 Assumptions

In the models we have developed, we would assume, without loss of generality, that:

A.1. A basic unit is an aggregation of patients living in the same location. Typically, a basic unit can be a zip code area, postal area, geo-code address, etc.

A.2. A distance that separates two patients living in the same basic unit is negligible.

A.3. The districting problem is considered for a time horizon composed of  $K$  periods.

A.4. The districting problem is solved over a time window composed of  $L$  periods ( $1 \leq L \leq K$ ).

A.5. The patients considered in this study suffer from the same pathology.

A.6. The patients considered in this study have the same profile.

A.7. This profile can be of type I, II or III with respect to workload. Let  $v_{it}$  be the care workload of basic unit  $i$  ( $i=1\dots N$ ) during the period  $t$  ( $t=1\dots K$ ).  $v_{it} = P_{it}b_tT_t \quad \forall i=1\dots N \quad \forall t=1\dots K$ , where  $P_{it}$ ,  $b_t$  and  $T_t$  correspond respectively to the total number of patients living in the basic unit  $i$  ( $i=1\dots N$ ), number of visits and average duration of a visit required by patients during the period  $t$  ( $t=1\dots K$ ).

A profile is of type I if and only if the care workload of each basic unit during each period cannot be equal to zero i.e. if  $v_{it} \neq 0 \quad \forall i=1\dots N \quad \forall t=1\dots K$ . Type II represents the profiles whose workload can be equal to zero at any period  $t$  ( $t=\dots K$ ). However, if the care workload of a basic unit  $i$  is not null during a period  $t$ , it cannot be null during all the succeeding periods until the  $K^{\text{th}}$  period i.e. if  $v_{it} \neq 0$  then  $v_{it'} \neq 0 \quad \forall i=1\dots N \quad \forall t=1\dots K \quad \forall t'=(t+1)\dots K$ .

Indeed, both profile types I and II correspond to profiles characterized by a long duration of stay within the HHC system. In other words, patients that are admitted in the HHC system during period  $t$  ( $t=1\dots K$ ) would be treated for all the succeeding periods until  $t=K$ . These profiles generally correspond to continuous care (see Chapter 2) such as breathing assistance that are delivered for an undetermined duration in order to maintain current functioning levels to patients. The difference between them is that type I represents the case where, at the beginning of period  $t=1$ , there are already patients having these profiles in all the basic units covered by the HHC system. On the contrary, profile type II corresponds to the profiles that



do not exist in all the basic units at  $t=1$ .

Finally, a profile is of type III if there is no restriction on  $v_{it}$ . This type of profile corresponds to the punctual care such as chemotherapy, antibiotherapy which are intended for patients having not stabilized pathologies and treated for periods determined beforehand. Care can be reiterated frequently.

Indeed, we need to distinguish between the different types of profiles in order to be able to model the criterion related to the change of the basic units' assignments to districts.

A.8. The number and average duration of visits that characterize the patient profile are the same among the patients and known with 100% of accuracy over  $L$  periods.

A.9. The number of patients admitted to the HHC structure (at each basic unit) is known with 100% of accuracy over  $L$  periods

A.10. The number of patients leaving the HHC structure (at each basic unit) is known with 100% of accuracy over  $L$  periods

A.11. All the basic units are covered which means that all patients admitted to the HHC structure during each period have to be assigned to a district.

A.12. Human resources delivering care to patients are of the same type, namely the nurses, among all the basic units.

A.13. There is an enough number of nurses available. Each nurse has a predetermined capacity (i.e. he/she can handle a certain volume of workload). This capacity is identical between the different nurses.

A.14. Each district is under the responsibility of a unique care givers' team.

A.15. The number of districts to design is predetermined by the HHC managers.

A.16. The speed pertaining to the travel between two basic units is considered as deterministic.

A.17. The distance metric used is the network distance since it reflects the real time spent by a nurse between the basic units.

## **2.2 Criteria considered**

We consider the following criteria for the HHC districting problem:

- The compactness is formulated as a hard constraint by limiting the maximum distance between two basic units that would be assigned to the same district.
- The workload balance is essential for the design of "good" districts. It consists in having almost the same workload in the different districts.

- The continuity of care is crucial for guaranteeing a good time-window districting process. As we have explained before, the continuity of care constraint is modeled by the indivisibility of the basic units and the fact that changes in the assignments of these basic units to districts are not allowed. Based on these two criteria, 3 scenarios have been distinguished before (c.f. Figure 4-7) namely:
  - The basic units must be assigned to the same districts from period to period over the districting horizon, i.e.  $K$  periods, and the basic units must be assigned to one and only one district during each period. This case corresponds to Scenario A
  - The basic units must be assigned to one and only one district during each period while the assignments of these basic units to districts may change from period to period but the number of changes should be limited. This number can be calculated by introducing a decision variable  $chg_{ijt}$  and adding a hard constraint that limits the total number of changes over all the basic units by an upper bound  $Chg_t$  during each period  $t$ . This case corresponds to Scenario B.
  - The basic units must be assigned to the same districts from period to period over the districting horizon while these basic units can be divided between a limited number of districts during each period. We thus need to integrate a decision variable  $y_{ijt}$  that counts the number of district over which each basic unit  $i$ 's workload is split during each period  $t$  ( $t=1\dots K$ ). These numbers must be less than a parameter  $SP_t$  that corresponds to the maximum number of districts into which each basic unit's workload can be divided. This case corresponds to Scenario C.
- For simplicity, the compatibility criterion presented in Chapter 3 (related to the accessibility of the basic units and conformity of the districts to the administrative boundaries) is not considered in the models.

As explained earlier, the human aspect is a major characteristic of HHC services. In our models, the human aspect related to the satisfaction of care givers is captured via the workload balancing criteria. Other factors such as the motivation and learning aspects that can be associated with the structure of care givers teams are not explicitly integrated to our model. The human aspect related to the satisfaction of patients is captured via the continuity of care constraint which ensures that the patient receives care from the same care givers team responsible of the district which the patient belongs to.

## 2.3 Decision variables

We define the following decision variables:

- $x_{ijt}$ : binary assignment decision variables.  $x_{ijt}=1$  if the basic unit  $i$  ( $i=1\dots N$ ) is assigned to district  $j$  ( $j=1\dots M$ ) during the period  $t$  ( $t=1\dots K$ ) and 0 otherwise. This variable is used in Scenario A and Scenario B.
- $x'_{ijt}$ : assignment decision variables. ( $0 < x'_{ijt} \leq 1$ )  $x'_{ijt}$  refers to the proportion (i.e. percentage of patients living in basic unit  $i$ ) of the basic unit  $i$  ( $i=1\dots N$ ) assigned to district  $j$  ( $j=1\dots M$ ) during the period  $t$  ( $t=1\dots K$ ). This variable is used in Scenario C.
- $y_{ijt}$ : division decision variables.  $y_{ijt}=1$  if a proportion of the basic unit  $i$  ( $i=1\dots N$ ) is assigned to district  $j$  ( $j=1\dots M$ ) during the period  $t$  ( $t=1\dots K$ ) and 0 otherwise. This variable is used in Scenario C.
- $w_{jt}$ : total care workload of district  $j$  ( $j=1\dots M$ ) during the period  $t$  ( $t=1\dots K$ ).
- $gap\_max_t$ : the maximum deviation (expressed as a percentage) between the care workload associated to each district and the average care workload among all districts during the period  $t$  ( $t=1\dots K$ ).
- $chg_{ijt}$ : change decision variables.  $chg_{ijt}=1$  if the assignment of the basic unit  $i$  ( $i=1\dots N$ ) to district  $j$  ( $j=1\dots M$ ) changes between period  $(t-1)$  and period  $t$  ( $t=2\dots K$ ) and 0 otherwise. This variable is used in Scenario B.

## 2.4 Parameters

We use the following notations for the parameters of the models:

- $N$ : number of basic units.
- $M$ : number of districts to design.
- $K$ : time horizon of the districting approach.
- $L$ : time horizon during which forecasts are assumed 100% accurate.
- $a$ : period at which each time-window districting problem is optimized ( $1 \leq a \leq t^*$ ).
- $b_t$ : number of visits required by patients during the period  $t$  ( $t=1\dots K$ ).
- $T_t$ : average duration of a visit required by patients during the period  $t$  ( $t=1\dots K$ ).
- $E_{it}$ : number of patients living in the basic unit  $i$  ( $i=1\dots N$ ) that arrive in the HHC system at the beginning of the period  $t$  ( $t=1\dots K$ ).

- $S_{it}$ : number of patients living in the basic unit  $i$  ( $i=1\dots N$ ) that exit the HHC system at the beginning of the period  $t$  ( $t=1\dots K$ ).
- $P_{it}$ : total number of patients living in the basic unit  $i$  ( $i=1\dots N$ ) during the period  $t$  ( $t=1\dots K$ ).
- $v_{it}$ : care workload of basic unit  $i$  ( $i=1\dots N$ ) during the period  $t$  ( $t=1\dots K$ ).
- $\overline{w_t}$ : average care workload among all districts during the period  $t$  ( $t=1\dots K$ ).
- $Chg_t$ : maximum number of total assignments' changes allowed over all the basic units during each period  $t$  ( $t=2\dots K$ ) (used in Scenario B).
- $SP_t$ : maximum number of districts into which each basic unit's workload can be divided during each period  $t$  ( $t=1\dots K$ ) (used in Scenario C).
- $d_{ik}$ : distance between the basic units  $i$  ( $i=1\dots N$ ) and  $k$  ( $k=1\dots N$ ).
- $d_{max}$ : maximum distance allowed between two basic units that can be assigned to the same district.
- $D$ : set of basic units' pairs  $(i, k)$  where  $(i, k) \in D$  if and only if  $d_{ik} > d_{max}$ .

## 2.5 Formulations of the scenarios

As explained before, three scenarios can be modelled based on managers' preferences concerning the two criteria related to the continuity of care. In the models developed, we assume that:

- There are no patients exiting the HHC system at the beginning of the districting horizon, i.e. during period  $t=1$ , which means that:  $S_{i1} = 0 \quad \forall \quad i = 1\dots N$  (1)
- As there are no patients that exit the HHC system during the first period, the total number of patients living in each basic unit  $i$  during the first period is equal to the number of patients living in the basic unit  $i$  that arrive in the HHC system during the period 1 i.e.  $P_{i1} = E_{i1} \quad \forall \quad i = 1\dots N$  (2)
- The total number of patients living in the basic unit  $i$  that are in the HHC system during each period  $t$  corresponds to the total number of patients living in the basic unit  $i$  that are in the HHC system during the period  $(t-1)$  to which are added the new patients living in the basic unit  $i$  that are admitted in the HHC system during the period  $t$  and to which are removed the patients living in the basic unit  $i$  that exit the

HHC system during the period  $t$ . This corresponds to:

$$P_{it} = P_{i(t-1)} + E_{it} - S_{it} \quad \forall i = 1 \dots N \quad \forall t = 2 \dots K \quad (3)$$

- The care workload of each basic unit  $i$  during each period  $t$  is equal to the product of the total number of patients into the number of visits required and the average duration

$$v_{it} = P_{it} b_i T_i \quad \forall i = 1 \dots N \quad \forall t = 1 \dots K \quad (4)$$

The mathematical formulations of the scenarios are presented below. Remember that these formulations are relative to the time-window optimization since the period per period optimization ( $L=1$ ) and the global optimization ( $L=K$ ) represent special cases of the time-window optimization ( $1 \leq L \leq K$ ).

### 2.5.1 Scenario A

Scenario A corresponds to the case where the main objective of the HHC managers would be to design well balanced districts according to the care workload while guaranteeing the total continuity of care over the optimization horizon  $K$ . This latter can be guaranteed by forbidden changes in basic units-districts assignments from period to period and the divisibility of the basic units over all periods. Figure 4-8 illustrates through the same example used before the time-window optimization approach within the context of scenario A.

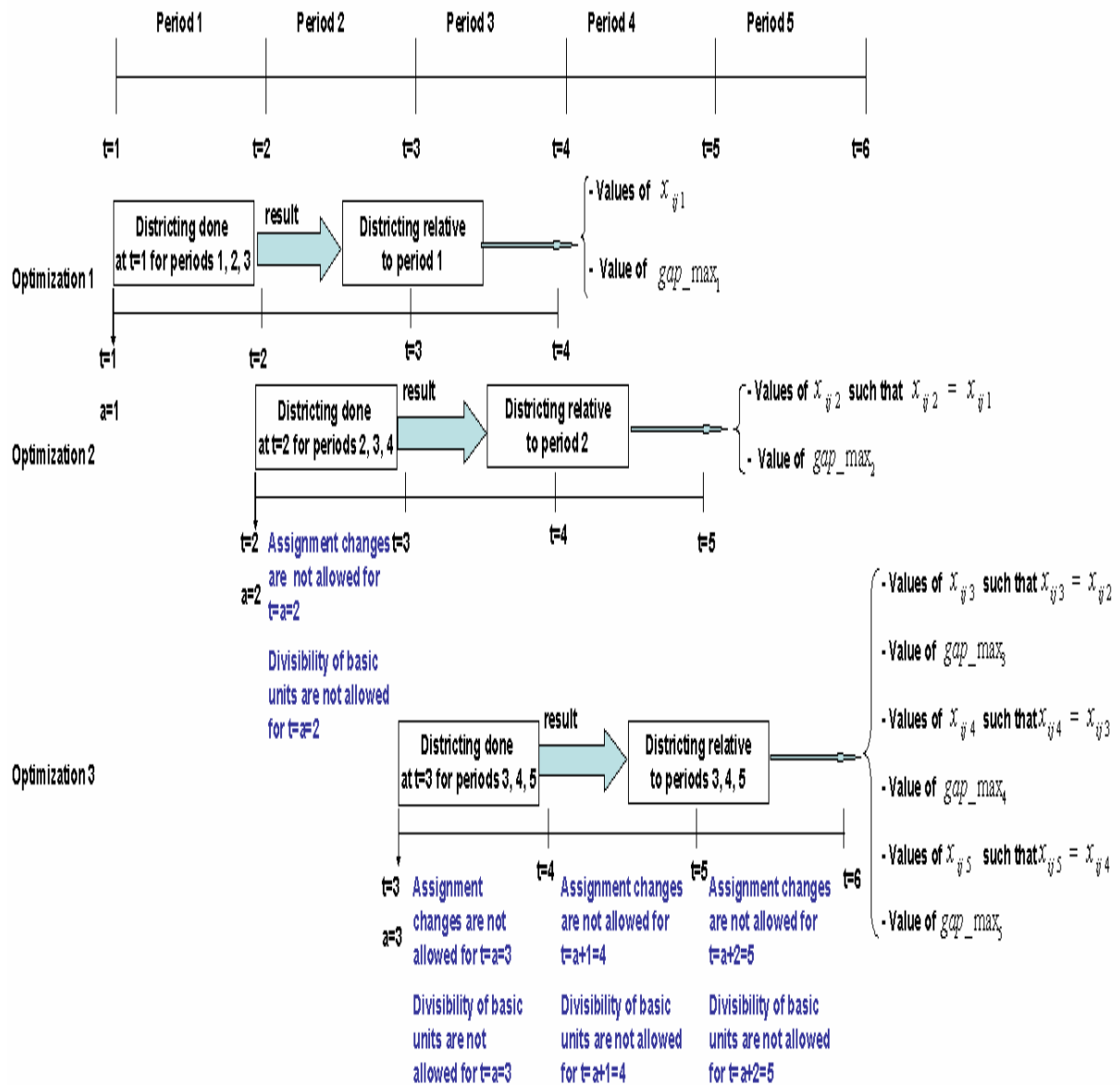

**Figure 4-8:** Illustrative case for Scenario A

In this Scenario, the partition related to the first period results from the minimization of the workload imbalance over the first  $L$  periods (that starts at  $a=1$ ). After that, the partition related to each period  $t$  ( $t=2 \dots K$ ) is based on the constraint that the assignment of the basic units to the districts can not change from period to period. Consequently, we deduce that within Scenario A there is only one districting problem solved which corresponds to the first time-window optimization that concerns periods 1 to  $L$ . Hence, the assignments of the basic units to districts are kept the same during all the  $K$  periods i.e.  $x_{ijt} = x_{ij1} \quad \forall i = 1 \dots N \quad \forall j = 1 \dots M \quad \forall t = 2 \dots K$ . Similarly, within Scenario A,  $gap\_max_1$

is the unique workload balance that is optimized, the other  $gap\_max_t$  ( $t=2\dots K$ ) are not optimized but deduced from the values of  $x_{ijt}$  and thus from the values of  $x_{ijl}$  where  $x_{ijt} = x_{ijl} \quad \forall i=1\dots N \quad \forall j=1\dots M \quad \forall t=2\dots K$ . The formulation of scenario A is as follows:

$$\text{Minimize } \sum_{t=a}^{L+a-1} gap\_max_t \quad (5)$$

s.to

$$w_{jt} = \sum_{i=1}^N v_{it} x_{ijt} \quad \forall j=1\dots M \quad \forall t=a\dots(L+a-1) \quad (6)$$

$$\bar{w}_t = \frac{\sum_{i=1}^N v_{it}}{M} \quad \forall t=a\dots(L+a-1) \quad (7)$$

$$gap\_max_t \geq \frac{w_{jt} - \bar{w}_t}{\bar{w}_t} \quad \forall j=1\dots M \quad \forall t=a\dots(L+a-1) \quad (8)$$

$$gap\_max_t \geq \frac{\bar{w}_t - w_{jt}}{\bar{w}_t} \quad \forall j=1\dots M \quad \forall t=a\dots(L+a-1) \quad (9)$$

$$\sum_{j=1}^M x_{ijt} = 1 \quad \forall i=1\dots N \quad \forall t=a\dots(L+a-1) \quad (10)$$

$$x_{ijt} + x_{kjt} \leq 1 \quad \forall (i,k) \in D \quad \forall j=1\dots M \quad \forall t=a\dots(L+a-1) \quad (11)$$

$$\begin{cases} \text{if } a \in [2\dots(t^*-1)] & x_{ija} = x_{ijl} \quad \forall i \in Q_a \quad \forall j=1\dots M \quad \forall l \in O_{ia} \\ \text{if } a = t^* & x_{ijt} = x_{ijl} \quad \forall i \in Q_t \quad \forall j=1\dots M \quad \forall t = (t^* \dots K) \quad \forall l \in O_{it} \end{cases} \quad (12)$$

$$x_{ijt} \in \{0,1\} \quad \forall i=1\dots N \quad \forall j=1\dots M \quad \forall t=a\dots(L+a-1) \quad (13)$$

The objective function (5) together with constraint (8) and (9) guarantee the balance of the total care workload between the different districts by minimizing the sum over L periods of the maximum deviation of the care workload from the average care workload among all districts during each period. Constraints (6) and (7) define respectively the care workload of each district and the average care workload among all districts during each period. Constraints (10) and (13) assume that each basic unit is assigned to one and only one district during each period. The compactness is related to constraint (11) where the distance between two basic units assigned to the same district is bounded by the distance  $d_{max}$ . Finally, Constraint (12)

asserts that during each period, all the basic units must be assigned to the district to which they were assigned during the previous periods.

In this Scenario, the partition related to the first period results from the minimization of the workload imbalance over the first  $L$  periods (that starts at  $a=1$ ). If  $a=1$ , Constraint (12) is relaxed. The partition related to the second period that is related to the time-window optimization which starts at  $a=2$  results from the fact that the assignment of the basic units to the districts can not change from period to period. Hence, during the second period, each basic unit is assigned to the same district to which it was assigned during the first period i.e.  $x_{ij2} = x_{ij1} \quad \forall i = 1 \dots N \quad \forall j = 1 \dots M$ . This is the case for each period  $t$  such that  $t=a$  and  $2 \leq a \leq t^* - 1$ . This means that if  $a \in [2 \dots (t^* - 1)]$ , the partition pertaining to period  $t=a$  ( $\forall t \in [2 \dots (t^* - 1)]$ ) must be exactly equal to the one obtained for  $l=1, l=2, \dots, l=a-1$ .

As the partitioning that corresponds to each  $t$  such that  $t^* \leq t \leq K$  is obtained through the time-window optimization that starts at  $a=t^*$ , the fact that the assignments of basic units to districts can not change from period to period must be respected for each period  $t, t^* \leq t \leq K$  (which means that  $x_{ij3} = x_{ij2}, x_{ij4} = x_{ij3}$  and  $x_{ij5} = x_{ij4} \quad \forall i = 1 \dots N \quad \forall j = 1 \dots M$  in Figure 4-8). Consequently, if  $a=t^*$ , the latter condition must be respected for each  $t \in [t^* \dots K]$ .

Additionally, constraint (11) is applied during each period  $t$  to the basic unit  $i$  for which  $v_{it} \neq 0$  such that there is at least one period  $l$  ( $l < t$ ) for which  $v_{il} \neq 0$ . We thus define:

- $O_{it}$ : set of periods  $l$  ( $l=1 \dots (t-1)$ ) where  $l \in O_{it}$  if and only if  $v_{il} \neq 0 \quad \forall i = 1 \dots N \quad \forall t = 1 \dots K$ .
- $Q_i$ : set of basic units  $i$  ( $i=1 \dots N$ ) where  $i \in Q_i$  if and only if  $v_{it} \neq 0 \quad \forall t = 1 \dots K$ .

Indeed, this can be explained by the fact that if the workload of a basic unit  $i$  during a period  $t$  is equal to zero, the assignment of this basic unit to a district is fictive. It is then useless to force this basic unit to be assigned to the district to which it was assigned during the previous periods. Additionally, if  $v_{it} = 0$ , the assignment of the basic unit  $i$  during the period  $l$  is fictive; consequently, the assignment of this basic unit  $i$  during the period  $t$  must not be the same as the one obtained during the previous periods  $l$  ( $l < t$ ).

## 2.5.2 Scenario B

This scenario corresponds to the relaxation of the total continuity of care by allowing changes in the assignments of basic units to districts while guaranteeing that the total number of



assignments' changes does not exceed a predefined upper bound. In our formulation, we choose to limit the total number of changes over all the basic units during each period. Scenario B is illustrated in Figure 4-9.

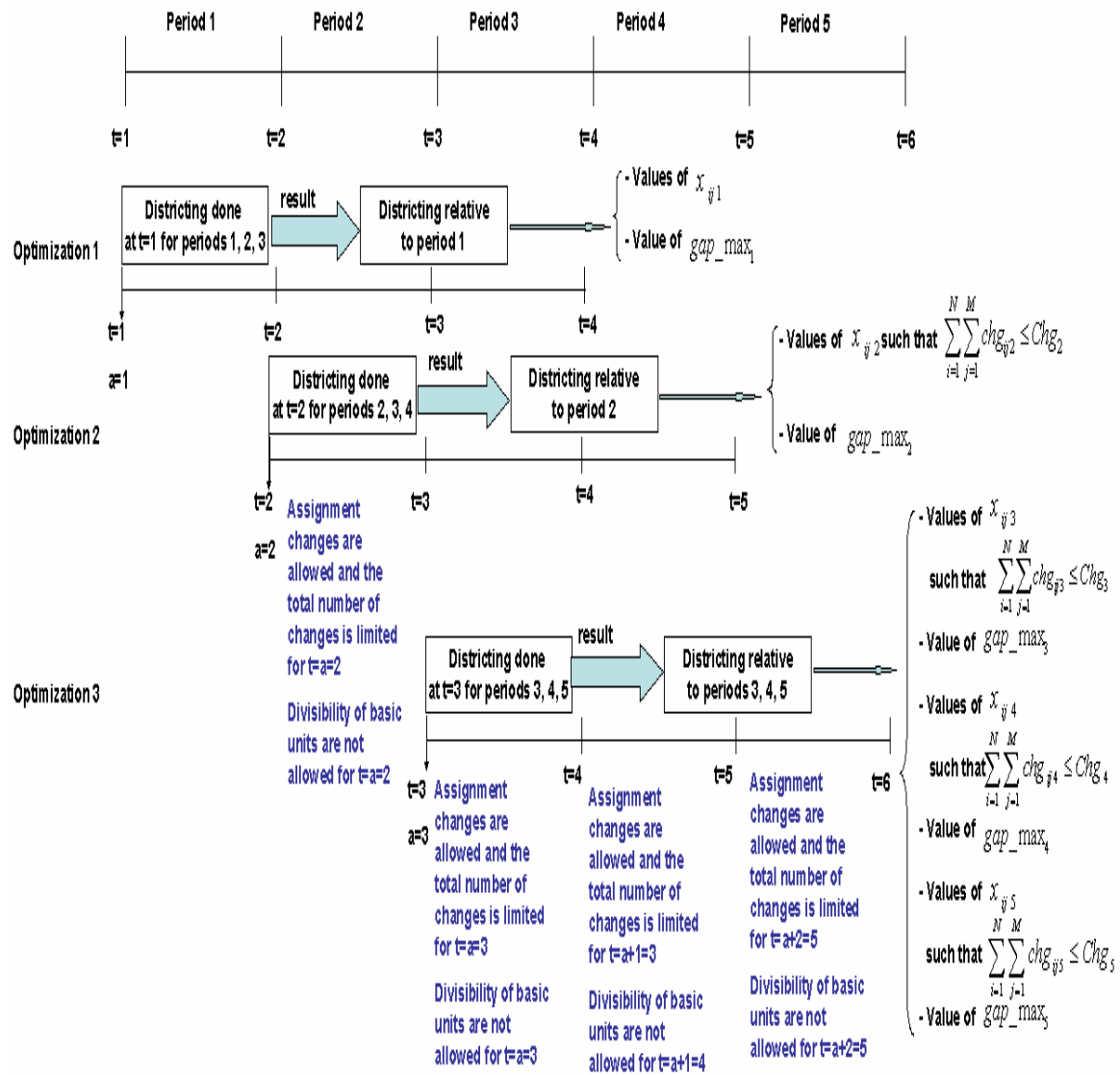

Figure 4-9: Illustrative case for Scenario B

Scenario B can thus be formulated as follows:

$$\text{Minimize } \sum_{t=a}^{L+a-1} gap\_max_t \quad (14)$$

s.to

$$w_{jt} = \sum_{i=1}^N v_{it} x_{ijt} \quad \forall j=1 \dots M \quad \forall t=a \dots (L+a-1) \quad (15)$$

$$\overline{w}_t = \frac{\sum_{i=1}^N v_{it}}{M} \quad \forall t = a \dots (L+a-1) \quad (16)$$

$$gap\_max_t \geq \frac{\overline{w}_{jt} - \overline{w}_t}{\overline{w}_t} \quad \forall j = 1 \dots M \quad \forall t = a \dots (L+a-1) \quad (17)$$

$$gap\_max_t \geq \frac{\overline{w}_t - \overline{w}_{jt}}{\overline{w}_t} \quad \forall j = 1 \dots M \quad \forall t = a \dots (L+a-1) \quad (18)$$

$$x_{ijt} + x_{kjt} \leq 1 \quad \forall (i,k) \in D \quad \forall j = 1 \dots M \quad \forall t = a \dots (L+a-1) \quad (19)$$

$$\sum_{j=1}^M x_{ijt} = 1 \quad \forall i = 1 \dots N \quad \forall t = a \dots (L+a-1) \quad (20)$$

$$\begin{cases} \text{if } a \in [2 \dots (t^* - 1)] & chg_{ija} \geq x_{ijl} - x_{ija} \quad \forall i \in Q_a \quad \forall j = 1 \dots M \quad \forall l \in O_{ia} \\ \text{if } a = t^* & chg_{ijt} \geq x_{ijl} - x_{ijt} \quad \forall i \in Q_t \quad \forall j = 1 \dots M \quad \forall t = t^* \dots K \quad \forall l \in O_{it} \end{cases} \quad (21)$$

$$\begin{cases} \text{if } a \in [2 \dots (t^* - 1)] & \sum_{i=1}^N \sum_{j=1}^M chg_{ija} \leq Chg_a \\ \text{if } a = t^* & \sum_{i=1}^N \sum_{j=1}^M chg_{ijt} \leq Chg_t \quad \forall t = a \dots K \end{cases} \quad (22)$$

$$x_{ijt} \in \{0,1\} \quad \forall i = 1 \dots N \quad \forall j = 1 \dots M \quad \forall t = a \dots (L+a-1) \quad (23)$$

$$chg_{ijt} \in \{0,1\} \quad \forall i = 1 \dots N \quad \forall j = 1 \dots M \quad \forall t = a \dots (L+a-1) \quad (24)$$

In this scenario, the analysis of the objective function (14) as well as constraints (15), (16), (17), (18), (19) and (23) is the same as for the model of Scenario A. Constraints (21) and (24) define the change decision variables. Indeed, we consider that a change has occurred and thus must be counted, if and only if the basic unit  $i$  ( $i=1 \dots N$ ) that was assigned to district  $j$  ( $j=1 \dots M$ ) during the period  $(t-1)$  ( $t=2 \dots K$ ) is no more assigned to it during the period  $t$  ( $t=2 \dots K$ ) which means that  $chg_{ijt}$  must be equal to 1 if and only if  $x_{ij(t-1)}=1$  and  $x_{ijt}=0$ . Similarly to constraint (11) of Scenario A, if  $a=1$ , constraint (21) is relaxed. If  $a=2 \dots (t^*-1)$ , it is applied only to  $t=a$ . Finally, if  $a=t^*$ , it must be respected for each  $t$  ( $t^* \leq t \leq K$ ). Furthermore, constraint (21) concerns only the basic units  $i$  ( $i=1 \dots N$ ) for which  $v_{it} \neq 0$  during the period  $t$  ( $t=1 \dots K$ ) such that there is at least one period  $l$  ( $l < t$ ) for which  $v_{il} \neq 0$ . Finally, constraint (22) is related to the limitation of the assignments' criterion where the number of changes of basic units' assignments to districts is bounded by "Chg<sub>t</sub>" during each period  $t$  ( $t=2 \dots K$ ). This upper bound guarantees the partial continuity of care during each period  $t$  ( $t=2 \dots K$ ). Note that the

conditions concerning the values of the parameter  $a$  to apply constraint (22) are the same that the ones related to constraint (21).

### 2.5.3 Scenario C

Within the context of Scenario C, it is possible to improve the workload balance of Scenario A by relaxing the constraint related to the indivisibility of the basic units. Similarly to Scenario A, since the partition related to each period  $t$  ( $t=2\dots K$ ) is based on the constraint that the assignment of the basic units to the districts can not change from period to period, there is only one districting problem solved which corresponds to the first time-window optimization that concerns periods 1 to  $L$ . This scenario is illustrated in Figure 4-10.

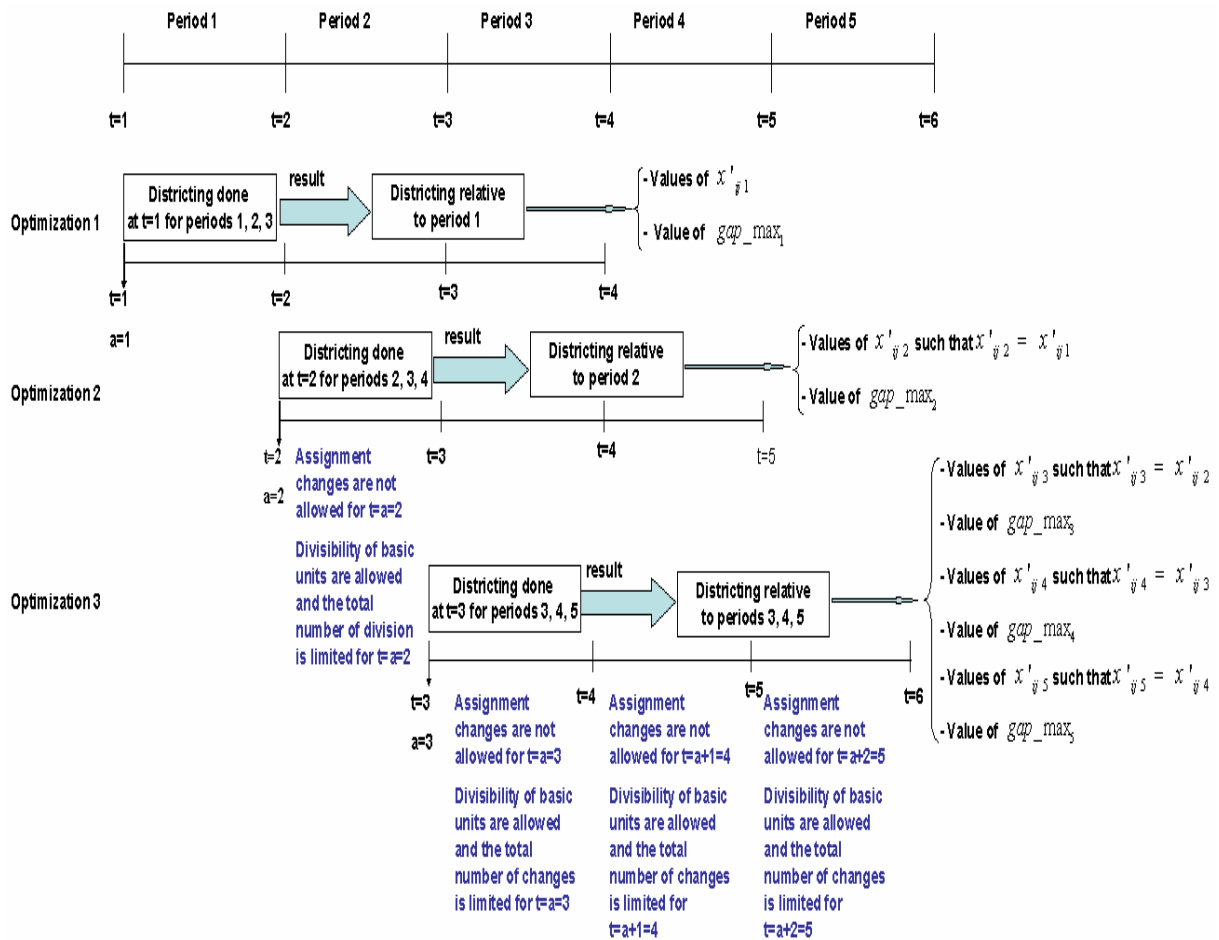

Figure 4-10: Illustrative case for Scenario C

As in Scenario B, the number of districts into which each basic unit can be divided is limited by an upper bound predetermined by the HHC manager. We then replace the binary

assignment decision variables  $x_{ijt}$  by another assignment decision variables  $x'_{ijt}$  which is not binary but  $0 \leq x'_{ijt} \leq 1 \quad \forall i=1..N \quad \forall j=1..M \quad \forall t=1..K$ . We also integrate another decision variable  $y_{ijt}$  that gives the number of divisions of each basic unit  $i$  ( $i=1..N$ ) during the period  $t$  ( $t=1..K$ ). These decision variables must respect additional constraints. To summarize, the formulation of scenario C is as follows:

$$\text{Minimize } \sum_{t=a}^{L+a-1} \text{gap\_max}_t \quad (25)$$

s.to

$$w_{jt} = \sum_{i=1}^N v_{it} x'_{ijt} \quad \forall j=1..M \quad \forall t=a...(L+a-1) \quad (26)$$

$$\overline{w}_t = \frac{\sum_{i=1}^N v_{it}}{M} \quad \forall t=a...(L+a-1) \quad (27)$$

$$\text{gap\_max}_t \geq \frac{w_{jt} - \overline{w}_t}{w_t} \quad \forall j=1..M \quad \forall t=a...(L+a-1) \quad (28)$$

$$\text{gap\_max}_t \geq \frac{\overline{w}_t - w_{jt}}{w_t} \quad \forall j=1..M \quad \forall t=a...(L+a-1) \quad (29)$$

$$\sum_{j=1}^M x'_{ijt} = 1 \quad \forall i=1..N \quad \forall t=a...(L+a-1) \quad (30)$$

$$y_{ijt} \geq x'_{ijt} \quad \forall i=1..N \quad \forall j=1..M \quad \forall t=1...(L+a-1) \quad (31)$$

$$y_{ijt} + y_{kjt} \leq 1 \quad \forall (i,k) \in D \quad \forall j=1..M \quad \forall t=a...(L+a-1) \quad (32)$$

$$\sum_{j=1}^M y_{ijt} \leq SP_t \quad \forall i=1..N \quad \forall j=1..M \quad \forall t=1...(L+a-1) \quad (33)$$

$$\begin{cases} \text{if } a \in [2....(t^*-1)] & x'_{ija} = x'_{ijl} \quad \forall i \in Q_a \quad \forall j=1..M \quad \forall l \in O_{ia} \\ \text{if } a = t^* & x'_{ijt} = x'_{ijl} \quad \forall i \in Q_t \quad \forall j=1..M \quad \forall t = t^*...K \quad \forall l \in O_{it} \end{cases} \quad (34)$$

$$y_{ijt} \in \{0,1\} \quad \forall i=1..N \quad \forall j=1..M \quad \forall t=a...(L+a-1) \quad (35)$$

$$0 \leq x'_{ijt} \leq 1 \quad \forall i=1..N \quad \forall j=1..M \quad \forall t=a...(L+a-1) \quad (36)$$

The analysis of the objective function (25) as well as constraints (26), (27), (28), (29) and (34) is the same as for the model of Scenario A. Constraint (30), together with constraints (36) assume that during each period, 100% of each basic unit (and thus all patients living in these basic units) must be assigned to a district. Constraint (31) is related to the division decision

variables. Indeed, if  $x'_{ijt} \neq 0$  then  $y_{ijt}$  which is a binary variable will consequently be equal to 1.

In other words,  $\sum_{j=1}^M y_{ijt}$  will be equal to the number of districts for which a percentage of the patients living in the basic unit  $i$  ( $i=1 \dots N$ ) are assigned during period  $t$  ( $t=1 \dots K$ ). Constraint (32) is equivalent to constraint (10) of Scenario A and is thus related to the compactness criterion. Finally, constraints (33) and (35) are related to the basic units' division criterion where each basic unit must be assigned at most to "SP<sub>t</sub>" districts during each period.

### 3. Computational results

In this section, we discuss results of some computational experiments carried out to evaluate the scenarios' formulations proposed in Section 2. These experiments are also set up to show the influence of the optimization horizon  $L$  on the districting performance so that the period per period, time-window and global optimizations can be compared.

#### 3.1 Problem instance generation

We create several sets of randomly generated instances based on the following procedure. For each set, we begin by fixing the values of the problem dimension which is related to the number of basic units  $N$ , the number of districts  $M$  and the number of periods  $K$ . We choose to partition  $N=20$  basic units into  $M=4$  districts during  $K=5$  periods. In addition, the maximum distance between two basic units that can be assigned to the same district  $d_{\max}$  is the same for all instances and is equal to  $d_{\max}=150$ .

After that, for one instance, we generate randomly the other problem parameters namely:

- The forecasting horizon  $L$  can take different values  $L$  ( $L \in \{1, 2, 3, 4, 5\}$ ).
- The distance matrix  $d_{(N,N)}$  is generated as follows:
  - For each basic unit  $i$ , we randomly generate an abscissa  $X_i$  and an ordinate  $Y_i$  from a uniform distribution  $DU(0, 200)$ .
  - For each pair of basic units  $i$  and  $k$ , the distance  $d_{ik}$  is then calculated according to the formula:  $d_{ik} = \sqrt{(X_i - X_k)^2 + (Y_i - Y_k)^2}$

- The number of visits  $b_t$  and the average duration of the visits  $T_t$  during the period  $t$  ( $t=1\dots K$ ), are generated randomly from discrete uniform distributions respectively DU (0, 2) and DU (0, 5).
- The number of patients  $P_{it}$  living in the basic unit  $i$  during the period  $t$  ( $t=1\dots K$ ) are generated as follows:
  - For each period  $t$  ( $t=1\dots K$ ), we randomly generate an average number of patients per period  $\bar{P}_t$  where  $\bar{P}_t = \sum_{i=1}^N P_{it} \quad \forall t=1\dots K$  from a normal distribution DN (250, 100).
  - For each period  $t$  ( $t=1\dots K$ ), the number of patients  $P_{it}$  is randomly generated from a normal distribution DN( $\bar{P}_t, \sigma_t$ ) such that  $\frac{\sigma_t}{\bar{P}_t} = 0.3$ .

If a solution (optimal or simply feasible) could be obtained within 120 minutes of computation, the problem is considered as feasible for this instance. For each possible combination of parameters  $N$ ,  $M$ ,  $K$ ,  $d_{\max}$  and  $L$ , 10 instances are generated randomly. We solve the problem for each instance where we evaluate a performance measure denoted *gap\_max\_total* which aims at evaluating the total workload balance associated with a problem and is defined as  $gap\_max\_total = \sum_{t=1}^K gap\_max_t$ . We then evaluate the mean *gap\_max\_total* over the 10 instances considered.

All tests were run on a Pentium 4 (3 Ghz) with 2 Go of RAM, running under Windows XP. We used the default settings of CPLEX MILP (CPLEX 11.1) solver. The computational results obtained with the three formulations are displayed in the following sub-sections.

Note that the problem is feasible for all instances generated in this chapter which means that a feasible solution can be found for all instances after 2 hours of computation.

### 3.2 Influence of the forecasting horizon

We carried out some numerical tests to evaluate the influence of the forecasting horizon on the districting performance. More precisely, we built instances with:

- Period per period optimization: the data are forecasted period per period i.e.  $L=1$ .
- Time-window optimization: the data are forecasted over  $L$  periods where  $1 < L < K$ .
- Global optimization: the data are forecasted over the entire districting horizon  $L=K$ .

### 3.2.1 Influence of the forecasting horizon on Scenario A

We intend to study the impact of the optimization horizon on the mean  $gap\_max\_total$  obtained within the context of Scenario A for different values of  $L$  ( $L \in \{1, 2, 3, 4, 5\}$ ). For each value of  $L$ , we generate randomly 10 instances as explained before. Table 4-1 which displays the mean  $gap\_max\_total$  values shows that the results obtained with Scenario A for  $L=1$ ,  $L=2$ , to  $L=K-1$  are equal i.e.  $mean\ gap\_max\_total(L=1) = mean\ gap\_max\_total(L=2) = \dots = mean\ gap\_max\_total(L=K-1)$ .

As we have explained before, within Scenario A, there is only one optimization problem that corresponds to the first time-window districting problem concerning periods 1 to  $L$ . The main objective consists then in minimizing  $\sum_{t=1}^L gap\_max_t$ , which allows the determination of the optimal values of  $x_{ij1}$ . Based on the formulation of Scenario A, it is clear that for each  $L$  such that  $1 \leq L < K$ , the decision variables  $x_{ij1}$  respect exactly the same constraints. We thus obtain the same results concerning the partitioning of period  $t=1$  i.e.  $gap\_max_1$  and  $x_{ij1}$ . Consequently, for each  $L$  such that  $1 \leq L < K$ , we obtain the same partitionings pertaining to all periods  $t$  ( $t=1 \dots K$ ). This is not the case when we consider the global optimization within Scenario A. Indeed, an additional constraint i.e. constraint (12) must be respected ( $L=5$  and  $a=1=t^*$ ), the results obtained are thus different from the results pertaining to  $L < K$ .

**Table 4-1:** Mean  $gap\_max\_total$  of scenario A

<b>L</b>	<b>1</b>	<b>2</b>	<b>3</b>	<b>4</b>	<b>5</b>
<b>mean(gap_max_total)</b>	92,478%	92,478%	92,478%	92,478%	33,279%

We can deduce from these results that, as expected, the global optimization allows the improvement of the workload balance within the context of total continuity of care. Indeed, the global optimization reduces the mean  $gap\_max\_total$  by 64,015% compared to the period per period optimization (and the time-window optimization).

### 3.2.2 Influence of the forecasting horizon on Scenario B

We consider different values of the optimization horizon  $L$  ( $L \in \{1, 2, 3, 4, 5\}$ ) and of the upper bound of the total number of changes over all the basic units for each period  $t$  ( $t=2 \dots K$ )  $Chg_t$  ( $Chg_t \in \{0, 2, 4, 10, 20\}$ ) such that:

$$Chg_2 = Chg_3 = ..Chg_t = Chg_K = Chg \quad \forall t = 2...K$$

For each combination (Chg, L), we randomly generate 10 instances. The results presented in Table 4-2 prove that:

- For a given Chg, mean *gap\_max\_total* decreases when L increases.
- For a given L, the higher is Chg, the lower is mean *gap\_max\_total*.

**Table 4-2:** Mean *gap\_max\_total* of scenario B

	L	1	2	3	4	5
Chg	0	92,478%	92,478%	92,478%	92,478%	33,279%
	2	24,787%	24,249%	21,681%	19,195%	14,729%
	4	11,355%	10,493%	9,699%	8,629%	8,019%
	10	4,436%	4,436%	4,063%	3,013%	2,761%
	20	3,074%	3,074%	2,850%	2,651%	2,663%

### 3.2.3 Influence of the forecasting horizon on Scenario C

We randomly generate sets of 10 instances for each pair (SP, L) such that:

$$SP_1 = SP_2 = ..SP_t = SP_K = SP \quad \forall t = 1...K$$

As can be seen from Table 4-3, using the formulation of Scenario C does not conduct to the same conclusion obtained for scenarios A and B related to the forecasting horizon on the districting performance. Indeed, we cannot deduce that for a given SP, mean *gap\_max\_total* decreases when L increases. However, results obtained show that for a given SP, the maximum mean *gap\_max\_total* over L is obtained for L=1 while the minimum mean *gap\_max\_total* over L is obtained for L=5.

This can be explained by the fact that if  $SP > 2$ , all the basic units divided between several districts will not be assigned to SP districts but to  $SP' \leq SP$  districts. In order to illustrate this, we display in Table 4-4, the percentage of the basic units that are divided into 2, 3 or 4 districts for a given SP and a given L related to instance 1. For example, if  $SP=4$ , for the values of L, no basic unit has been divided into 4 districts. Moreover, the assignments of basic units to districts do not change from period to period which explains the fact that it is not possible to guarantee with this formulation that for a given SP, the higher is L, the better is *gap\_max\_total*.



**Table 4-3:** Mean *gap\_max\_total* of scenario C

	<b>L</b>	<b>1</b>	<b>2</b>	<b>3</b>	<b>4</b>	<b>5</b>
<b>SP</b>	<b>1</b>	92,478%	92,478%	92,478%	92,478%	33,279%
	<b>2</b>	84,104%	73,107%	70,056%	80,378%	14,548%
	<b>3</b>	81,443%	74,372%	76,060%	79,858%	14,408%
	<b>4</b>	73,950%	81,415%	85,649%	72,534%	14,402%
	<b>min(2,3,4)</b>	73,950%	73,107%	70,056%	72,534%	14,402%

**Table 4-4:** Divisibility of the basic units for instance 1

	<b>L</b>	<b>1</b>	<b>2</b>	<b>3</b>	<b>4</b>	<b>5</b>	
<b>SP</b>	<b>2</b>	15% divided into 2 districts	15% divided into 2 districts	15% divided into 2 districts	15% divided into 2 districts	55% divided into 2 districts	
		15% divided into 2 districts	15% divided into 2 districts	15% divided into 2 districts	15% divided into 2 districts	45% divided into 2 districts 5% divided into 3 districts	
	<b>3</b>	15% divided into 2 districts	10% divided into 2 districts	15% divided into 2 districts	15% divided into 2 districts	15% divided into 2 districts	45% divided into 2 districts 5% divided into 3 districts
		15% divided into 2 districts	5% divided into 3 districts	15% divided into 2 districts	15% divided into 2 districts	15% divided into 2 districts	5% divided into 3 districts
	<b>4</b>	15% divided into 2 districts	15% divided into 2 districts	15% divided into 2 districts	15% divided into 2 districts	15% divided into 2 districts	5% divided into 3 districts
		15% divided into 2 districts	15% divided into 2 districts	15% divided into 2 districts	15% divided into 2 districts	15% divided into 2 districts	5% divided into 3 districts

### 3.3 Comparison of Scenarios A, B and C

The purpose of this section is to compare the performance of the three scenarios within the time-window optimization.

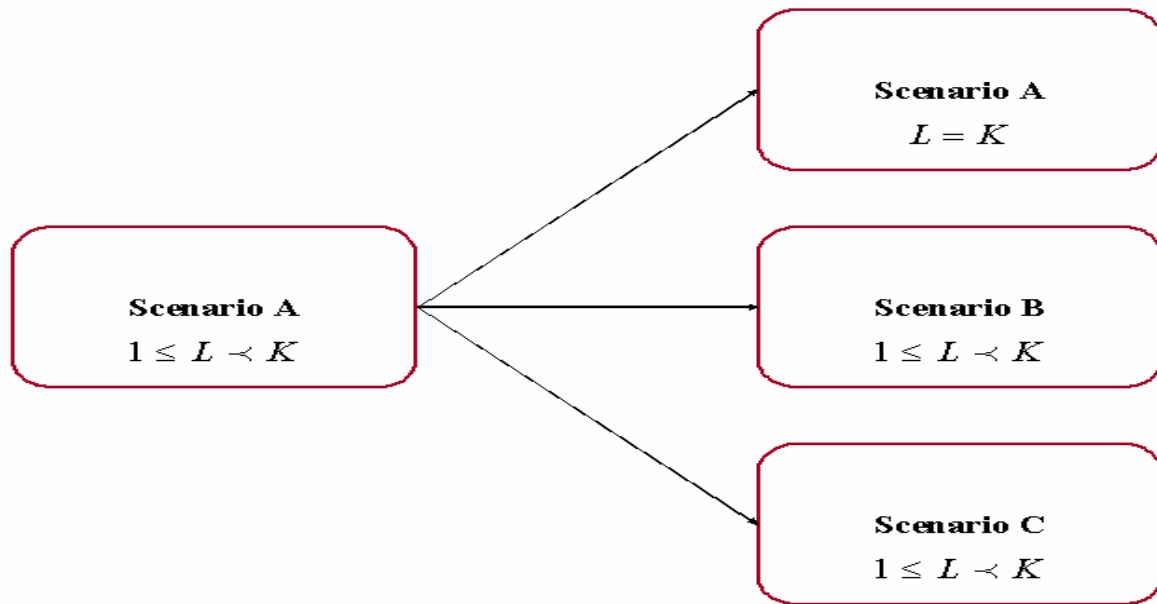

**Figure 4-11:** Comparison of Scenarios A, B and C

As shown in Figure 4-11, the case of reference is the case where the total continuity of care is respected, i.e. Scenario A, over a time-window of  $L$  periods, i.e. time-window optimization. As explained before, the respect of total continuity of care criteria generates an important workload imbalance which can be reduced in three ways:

- Optimizing the workload balance through the entire districting horizon which means that the total continuity of care is respected, i.e. Scenario A, over  $K$  periods. This global optimization requires the forecasting of the data over  $K$  periods. If the forecasting can not be achieved through  $K$  periods, it is possible to improve the workload balance by :
- Optimizing the workload through the forecasting horizon  $L$  while relaxing the constraint related to assignments' changes, i.e. limiting the number of changes of the assignments of basic units to districts from period to period. This corresponds to the case of Scenario B within the context of a time-window optimization.
- Optimizing the workload through the forecasting horizon  $L$  while relaxing the constraint related to indivisibility of basic units, i.e. limiting the number of districts into which each basic unit can be divided. This corresponds to the case of Scenario C within the context of a time-window optimization.

Based on Tables 4-1, 4-2 and 4-3, we can deduce that:

- For a given  $L$  ( $1 \leq L < K$ ) and a given  $Chg$  ( $0 \leq Chg \leq 20$ ), the mean *gap\_max\_total* of scenario B is smaller than mean *gap\_max\_total* of scenario A.
- For a given  $L$ , as long as the value of  $Chg$  increases, the difference between mean *gap\_max\_total* of Scenario A and mean *gap\_max\_total* of Scenario B increases.
- For a given  $L$  ( $1 \leq L < K$ ), a given  $Chg$  ( $0 \leq Chg \leq 20$ ) and a given  $SP$  ( $2 \leq SP \leq 4$ ), the mean *gap\_max\_total* of scenario B is smaller than mean *gap\_max\_total* of scenario C.
- For a given  $L$  and a given  $SP$  ( $2 \leq SP \leq 4$ ), as long as the value of  $Chg$  increases, the difference between mean *gap\_max\_total* of Scenario C and mean *gap\_max\_total* of Scenario B increases.
- For a given  $L$  ( $1 \leq L < K$ ) and a given  $SP$  ( $2 \leq SP \leq 4$ ), scenario C gives better results than scenario A i.e. the mean *gap\_max\_total* of Scenario A is bigger than mean *gap\_max\_total* of Scenario C.
- For a given  $Chg$  ( $0 \leq Chg \leq 20$ ) and a given  $L$  ( $1 \leq L < K$ ), the mean *gap\_max\_total* of scenario B within the context of the period-per-period optimization or the time-window optimization ( $1 \leq L < K$ ) is smaller than the mean *gap\_max\_total* of scenario A within the context of the global optimization.

Thus, results from Tables 4-1, 4-2 and 4-3 confirm that when we adopt the period-per-period or the time-windows optimization within the context of Scenario B, even with two changes in the basic units' assignments to districts per period (10% of the total number of the basic units), it is possible to improve the workload balance more than adopting the global optimization ( $L=K$ ) within the context of Scenario A.

Consequently, we can deduce that the improvement of the performance of the model developed in Chapter 3 which corresponds to the respect of the total continuity of care constraints, i.e. Scenario A, within the context of period-per-period optimization can be achieved in two ways: either by optimizing the districting problem globally by forecasting the data over the whole districting horizon, i.e.  $L=K$ , or by relaxing one of the two total continuity of care constraints. On one hand, the first case depends on the ability of the HHC managers to forecast accurately the data over  $K$  periods which is not always possible. On the other hand, the second case does no more guarantee the total continuity of care and generates thus the reduction of the service quality level. However, this case allows the improvement of the total workload balance more than the respect of the total continuity of care within the global optimization context.

To conclude, we can assume that for the case of the instances generated below, it is more efficient to relax the constraint related to the changes of the assignments of the basic units to districts while optimizing the districting approach over the largest possible time-window based on data forecasting.

#### **4 Conclusion and perspectives**

In this chapter, we focused on the time-window HHC districting problem that we applied to Model 1 of Chapter 3 and distinguished three scenarios for which we proposed mathematical formulations. These scenarios differ according to the HHC managers' preferences related to the continuity of care sub-criteria. We also presented a numerical analysis based on randomly generated instances. The computational results showed that the workload balance gets better when the forecasting horizon increases. Consequently, based on data forecasted, the districting approach should be applied over the largest possible time-window. These computational experiments also indicated that the workload imbalance that is related to the respect of the total continuity of care constraints can be alleviated at best by allowing to change some assignments of basic units to districts from period to period while limiting the maximum number of these changes during each period.

In our ongoing research, it would be worth investigating to apply the time-window approach to the second formulation (Model 2) proposed in Chapter 3 where the workload balance is considered as a hard constraint to respect.

Moreover, since we assumed that the data related to the different periods are known in advance and deterministic, it would be interesting to consider the stochastic aspect of the problem that allows the integration of the data uncertainty.



## ***GENERAL CONCLUSION AND PERSPECTIVES***

Due to the economic constraints as well as the demographic, technological and therapeutic evolutions, different types of alternatives to the traditional hospitalization have been created among which the Home Health Care (HHC). This alternative has been created sixty years ago in order to solve the problem of hospitals' capacity saturation by providing to the patients, at their home, complex and coordinated medical and paramedical care for a limited period which can be extended depending on patients' needs.

In this thesis, we carried out a qualitative study where we identified the different complexity factors that operations management has to face up within the HHC structures. We also reviewed the operations management based models developed within this context and highlighted the main research opportunities. After that, we developed a quantitative study where we considered one of the many operations management problems within the HHC context. This problem has been earlier studied in the literature for different applications. We thus proposed a classification of the criteria used for the districting problem. In addition, we studied two variants of this problem where the first one is the static version of the problem while the second one represents the dynamic version. Our contributions can be declined into:

- Static variant: we developed two models for the HHC districting problem where the criteria related to compatibility, indivisibility of basic units are hard constraints to respect while criteria related to workload balance and compactness can be formulated either as a hard constraint to respect or an objective function to optimize.
- Dynamic variant: we incorporated the different sources of variability in order to generalize the districting problem in a deterministic context by formulating and optimizing the problem over a time-window. In addition to the criteria considered for the static variant of the problem, we integrated another criterion related to the continuity of care. Based on the two continuity of care sub-criteria, we distinguished three scenarios for which we propose the associated mathematical formulations.

For each of these variants, we proposed MIP formulations for the corresponding problem which is solved thanks to a commercial MIP solver. Moreover, we carried out computational experiments to evaluate these formulations.

A possible extension of this work, from a practical point of view, would be to test the models developed on a real case study. This would not only contribute to validate the insights obtained from our models but also enable to better understand the impact of the districting approach on increasing care givers' motivation and work satisfaction.

In addition to the concluding sections of the previous chapters, several interesting areas of future research can be identified.

First, further analysis should be required to strengthen the formulations proposed in the present work. We can thus investigate an enhanced formulation for the compatibility constraints based on the analysis of the associated constraint graph and the use of valid inequalities deduced from maximal cliques. This method would allow the replacement of the large number of compatibility constraints by stronger and less numerous ones: the clique constraints. We note here that similar approaches have been used on other optimisation problems such as assembly line design [Pinnoi and Wilhelm, 1998], cellular telecommunications networks design [Kalvenes et al., 2005] or air line crew scheduling [Zeghal and Minoux, 2006].

Second, one of the major limitations of the time-window districting models developed in the present work is the assumptions of deterministic demand and processing times (number of visits and average duration of these visits). Districting is mostly based on data about future demand which are estimated by forecasting models. But in practice there will always be more or less important forecast errors. Moreover, the districting process may be affected by uncertainties both in demand and in processing times which may deteriorate the quality of the service delivered to the patients and the working conditions of the care givers. Incorporating uncertainties into districting models thus opens an interesting area for further research.

Third, the districting models discussed here focus on the partitioning of the territory into districts independently from the other decisions of the HHC operations management. It may thus be worth investigating the integration of districting into more global models. Indeed, once the districts are designed, care givers should be assigned to districts designed. Thus, it can be interesting to consider a model that aims at districting and assigning care givers to districts simultaneously. This joint model would help to determine the best partitioning of the territory as well as the best human resources organization in terms of the care givers' team sizes that guarantees the minimization of staffing and transportation costs as well as the balance of the care givers teams' workload.





## APPENDIX A

### MAIN INDICATORS OF THE OECD ECONOMIES

**Table A-1:** Percentage of the average annual growth of output of the OECD economies

	Gross domestic product		Agriculture		Industry		Manufacturing		Services	
	1990-2000	2000-08	1990-2000	2000-08	1990-2000	2000-08	1990-2000	2000-08	1990-2000	2000-08
<b>Australia</b>	3.6	3.3	3.1	0.0	2.7	2.6	1.8	1.3	4.2	3.7
<b>Belgium</b>	2.1	2.0	2.7	-2.7	1.8	1.4	3.1	1.1	1.9	2.2
<b>China</b>	10.6	10.4	4.1	4.4	13.7	11.7	12.9	11.6	11.0	10.7
<b>Denmark</b>	2.7	1.6	4.6	-3.5	2.5	0.4	2.2	0.4	2.7	1.7
<b>France</b>	1.9	1.8	2.0	-0.1	1.1	1.0	..	0.8	2.2	2.1
<b>Germany</b>	1.8	1.2	0.1	0.2	-0.1	1.9	0.2	2.8	2.9	1.2
<b>Greece</b>	2.2	4.2	0.5	-4.3	1.0	4.5	..	5.2	2.6	4.8
<b>Italy</b>	1.5	1.0	2.1	0.0	1.0	0.4	1.6	-0.4	1.6	1.3
<b>Japan</b>	1.1	1.6	-1.3	-1.1	-0.3	1.9	..	1.9	2.0	1.6
<b>Switzerland</b>	1.0	1.9	-0.9	-0.8	0.3	2.1	..	2.1	1.2	1.7
<b>Spain</b>	2.7	3.3	3.1	-1.3	2.3	2.3	5.2	1.2	2.7	3.8
<b>United Kingdom</b>	2.8	2.5	-0.2	1.1	1.5	0.2	1.3	-0.4	3.4	3.2
<b>United States</b>	3.5	2.4	3.7	2.8	3.7	1.2	..	2.5	3.4	2.9

**Table A-2: Structure of output of the OECD economies**

	Gross domestic product (\$ millions)		Agriculture (\$ millions)		Industry (\$ millions)		Manufacturing (\$ millions)		Services (\$ millions)	
	1990-2000	2000-08	1990-2000	2000-08	1990-2000	2000-08	1990-2000	2000-08	1990-2000	2000-08
<b>Australia</b>	361 306	1 015 217	3	3	29	29	15	10	68	68
<b>Belgium</b>	284 321	504 206	2	<i>1</i>	28	23	20	<i>16</i>	70	76
<b>China</b>	728 007	4 326 996	20	11	47	49	34	34	33	40
<b>Denmark</b>	181 984	341 255	3	<i>1</i>	25	26	17	15	71	73
<b>France</b>	1 569 983	2 856 556	3	2	25	20	..	<i>12</i>	72	78
<b>Germany</b>	2 522 792	3 649 494	1	<i>1</i>	32	30	23	24	67	69
<b>Greece</b>	131 718	355 876	9	3	21	20	..	<i>10</i>	70	77
<b>Italy</b>	1 126 041	2 303 079	3	2	30	27	22	<i>18</i>	66	71
<b>Japan</b>	5 247 610	4 910 840	2	<i>1</i>	34	29	23	<i>21</i>	64	69
<b>Spain</b>	596 751	1 604 235	5	3	29	29	18	<i>15</i>	66	68
<b>Switzerland</b>	315 940	491 950	2	<i>1</i>	30	28	20	20	68	71
<b>United Kingdom</b>	1 157 119	2 674 057	2	<i>1</i>	31	24	21	..	67	76
<b>United States</b>	7 342 300	14 591 381	2	<i>1</i>	26	22	19	<i>14</i>	72	77

## APPENDIX B

### EMPLOYEMENT OF HEALTH CARE SECTOR IN THE OECD ECONOMIES

**Table B-1:** Percentage of health employees in the total active persons between 1985 and 1995

	Year	1985	1986	1987	1988	1989	1990	1991	1992	1993	1994	1995
% of total employment	France	..	..	..	..	..	7.95	8.11	8.41	8.73	8.92	9
	Germany	..	..	..	..	..	..	7.91	8.16	8.49	8.78	9.08
	Switzerland	..	..	..	..	..	..	8.09	8.48	8.88	9.2	9.35
	United States	..	..	..	..	..	..	..	..	..	..	..

**Table B-2:** Percentage of health employees in the total active persons between 1996 and 2005

	Year	1996	1997	1998	1999	2000	2001	2002	2003	2004	2005
% of total employment	France	9.07	9.09	9.06	9.01	8.93	8.88	8.97	9.17	9.33	9.45
	Germany	9.47	9.76	9.91	9.82	9.98	10.12	10.45	10.75	11.39	11.23
	Switzerland	9.73	10.11	10.25	10.26	10.41	10.4	10.58	11.02	11.2	11.48
	United States	..	..	..	..	..	..	..	11.93	11.96	11.93

**Table B-3:** Percentage of health employees in the total active persons between 2006 and 2010

	Year	2006	2007	2008	2009	2010
% of total employment	France	9.52	..	..	..	..
	Germany	11.33	11.38	11.48	11.94	..
	Switzerland	11.47	11.39	11.54	11.84	..
	United States	12.06	12.21	12.54	..	..

## APPENDIX C

### COMPUTATIONAL RESULTS ASSOCIATED TO MODEL 1 FOR M=3

In this appendix, we present the computational results associated with Model 1 when we consider scenarios 1, 2 and 3 for M=3.

**Table C-1:** Feasibility percentage and mean *gap\_max* of Scenario1 for M=3

N	10		20		40		100	
	Feasibility Percentage	Mean <i>gap_max</i>	Feasibility Percentage	mean <i>gap_max</i>	Feasibility Percentage	mean <i>gap_max</i>	Feasibility Percentage	mean <i>gap_max</i>
<b>90</b>	35%		0%		0%		0%	
<b>110</b>	70%		15%		0%		0%	
<b>130</b>	95%		60%		20%		0%	
<b>150</b>	100%	9,2841%	95%		55%		5%	
<b>170</b>	100%	2,0086%	100%	0,0851%	100%	0,1528%	65%	
<b>190</b>	100%	1,7642%	100%	0,0147%	100%	0,1173%	100%	0,0176%
<b>210</b>	100%	1,6051%	100%	0,0048%	100%	0,1115%	100%	0,0107%
<b>230</b>	100%	1,5861%	100%	0,0026%	100%	0,1043%	100%	0,0073%
<b>250</b>	100%	1,5861%	100%	0,0022%	100%	0,1043%	100%	0,0071%
<b>270</b>	100%	1,5861%	100%	0,0022%	100%	0,1043%	100%	0,0080%
<b>290</b>	100%	1,5861%	100%	0,0022%	100%	0,1043%	100%	0,0068%

**Table C-2 : Feasibility percentage and mean *gap\_max* of Scenario 2 for M=3**

N	10		20		40		100	
	Feasibility Percentage	mean <i>gap_max</i>	Feasibility Percentage	mean <i>gap_max</i>	Feasibility Percentage	Mean <i>gap_max</i>	Feasibility Percentage	mean <i>gap_max</i>
<b>0</b>	100%	1,5112%	100%	0,4212%	100%	0,1043%	100%	0,0068%
<b>0,05</b>	100%	1,5112%	100%	0,4212%	100%	0,1188%	100%	0,0606%
<b>0,1</b>	100%	1,5112%	100%	0,4212%	100%	0,1576%	0%	
<b>0,15</b>	100%	1,9519%	100%	0,4629%	15%		0%	
<b>0,2</b>	100%	2,3756%	100%	1,2655%	0%		0%	
<b>0,25</b>	100%	4,2716%	80%		0%		0%	
<b>0,3</b>	100%	4,7516%	5%		0%		0%	
<b>0,35</b>	100%	9,1318%	0%		0%		0%	
<b>0,4</b>	95%		0%		0%		0%	
<b>0,45</b>	65%		0%		0%		0%	
<b>0,5</b>	65%		0%		0%		0%	
<b>0,55</b>	10%		0%		0%		0%	
<b>0,6</b>	0%		0%		0%		0%	

**Table C-3:** Feasibility percentage and mean *gap\_max* of Scenario 3 for N=10 and M=3

$d_{max}$		100	150	200	250	300	
$p_{max}$	0	Feasibility Percentage	60%	100%	100%	100%	100%
		mean <i>gap_max</i>		9,2841%	1,6051%	1,5861%	1,5861%
	0,05	Feasibility Percentage	60%	100%	100%	100%	100%
		mean <i>gap_max</i>		9,2841%	1,6051%	1,5861%	1,5861%
	0,1	Feasibility Percentage	60%	100%	100%	100%	100%
		mean <i>gap_max</i>		9,2841%	1,6051%	1,5861%	1,5861%
	0,15	Feasibility Percentage	30%	100%	100%	100%	100%
		mean <i>gap_max</i>		11,4592%	2,2967%	2,0323%	2,0323%
	0,2	Feasibility Percentage	20%	95%	100%	100%	100%
		mean <i>gap_max</i>			2,7419%	2,4595%	2,4595%
	0,25	Feasibility Percentage	10%	75%	100%	100%	100%
		mean <i>gap_max</i>			4,9273%	4,4392%	4,4392%
	0,3	Feasibility Percentage	5%	75%	100%	100%	100%
		mean <i>gap_max</i>			5,2794%	4,9193%	4,9193%
	0,35	Feasibility Percentage	0%	65%	100%	100%	100%
		mean <i>gap_max</i>			10,3941%	9,5487%	9,5487%
	0,4	Feasibility Percentage	0%	55%	95%	95%	95%
		mean <i>gap_max</i>					
	0,45	Feasibility Percentage	0%	25%	60%	65%	65%
		mean <i>gap_max</i>					
0,5	Feasibility Percentage	0%	10%	10%	10%	10%	
	mean <i>gap_max</i>						

**Table C-4:** Feasibility percentage and mean *gap\_max* of Scenario 3 for N=20 and M=3

$d_{max}$			100	150	200	250	300
$p_{max}$	0	Feasibility Percentage	0%	95%	100%	100%	100%
		mean <i>gap_max</i>			0,0881%	0,0844%	0,0844%
	0,05	Feasibility Percentage	0%	95%	100%	100%	100%
		mean <i>gap_max</i>			0,4063%	0,3946%	0,3946%
	0,1	Feasibility Percentage	0%	75%	100%	100%	100%
		mean <i>gap_max</i>			0,4289%	0,4170%	0,4170%
	0,15	Feasibility Percentage	0%	50%	100%	100%	100%
		mean <i>gap_max</i>		6,7289%	0,5063%	0,4585%	0,4585%
	0,2	Feasibility Percentage	0%	5%	95%	100%	100%
		mean <i>gap_max</i>				1,2684%	1,2684%
	0,25	Feasibility Percentage	0%	0%	55%	75%	80%
		mean <i>gap_max</i>					
	0,3	Feasibility Percentage	0%	0%	5%	5%	5%
		mean <i>gap_max</i>					
	0,35-0,5	Feasibility Percentage	0%	0%	0%	0%	0%
		mean <i>gap_max</i>					

**Table C-5:** Feasibility percentage and mean *gap\_max* of Scenario 3 for N=40 and M=3

$d_{max}$			100	150	200	250	300
$p_{max}$	0	Feasibility Percentage	0%	55%	100%	100%	100%
		mean <i>gap_max</i>			0,1120%	0,003%	0,003%
	0,05	Feasibility Percentage	0%	5%	95%	100%	100%
		mean <i>gap_max</i>				0,1211%	0,1200%
	0,1	Feasibility Percentage	0%	0%	80%	100%	100%
		mean <i>gap_max</i>				0,1590%	0,1576%
	0,15	Feasibility Percentage	0%	0%	0%	10%	10%
		mean <i>gap_max</i>					
	0,2-0,5	Feasibility Percentage	0%	0%	0%	0%	0%
		mean <i>gap_max</i>					

**Table C-6:** Feasibility percentage and mean gap\_max of Scenario 3 for N=100 and M=3

$d_{\max}$		<b>100</b>	<b>150</b>	<b>200</b>	<b>250</b>	<b>300</b>	
$p_{\max}$	<b>0</b>	<b>Feasibility Percentage</b>	0%	5%	100%	100%	100%
		<i>mean gap_max</i>			0,0110%	0,0071%	0,0068%
	<b>0,05</b>	<b>Feasibility Percentage</b>	0%	0%	0%	100%	100%
		<i>mean gap_max</i>				0,0598%	0,0616%
	<b>0,1-0,35</b>	<b>Feasibility Percentage</b>	0%	0%	0%	0%	0%
		<i>mean gap_max</i>					



## APPENDIX D

### COMPUTATIONAL RESULTS ASSOCIATED TO MODEL 2 FOR $M=3$

As in Appendix C, we present in this Appendix the computational results associated to Model 2 when we consider scenarios 1, 2 and 3 for  $M=3$ .

**Table D-1:** Feasibility percentage of Scenario 1 for  $M=3$

$\tau$	10	20	40	100
1	100%	100%	100%	100%
0,1	100%	100%	100%	100%
0,01	25%	100%	100%	100%

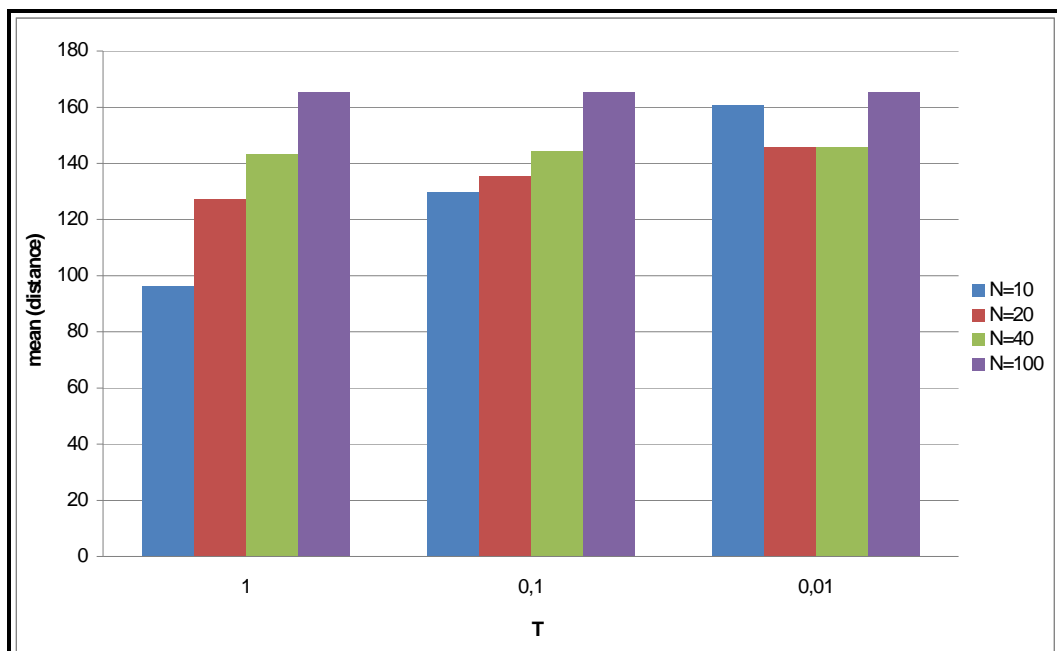

**Figure D-1:** Mean *distance* for Scenario 1 for  $M=3$

**Table D-2** : Feasibility percentage and mean *distance* of Scenario 2 for M=3

N		10		20		40		100	
		Feasibility Percentage	mean <i>distance</i>	Feasibility Percentage	mean <i>distance</i>	Feasibility Percentage	Mean <i>distance</i>	Feasibility Percentage	mean <i>distance</i>
P <sub>max</sub>	<b>0</b>	100%	96,340	100%	126,476	100%	143,549	100%	165,442
	<b>0,05</b>	100%	96,340	100%	126,476	100%	171,488	100%	219,764
	<b>0,1</b>	100%	96,340	100%	143,768	100%	191,334	0%	
	<b>0,15</b>	100%	106,580	100%	155,526	10%		0%	
	<b>0,2</b>	100%	112,410	80%		0%		0%	
	<b>0,25</b>	100%	131,486	5%		0%		0%	
	<b>0,3</b>	100%	136,230	0%		0%		0%	
	<b>0,35</b>	90%		0%		0%		0%	
	<b>0,4</b>	65%		0%		0%		0%	
	<b>0,45</b>	10%		0%		0%		0%	
	<b>0,5</b>	10%		0%		0%		0%	
	<b>0,55</b>	0%		0%		0%		0%	
	<b>0,6</b>	0%		0%		0%		0%	

**Table D-3:** Feasibility percentage and mean *distance* of Scenario 3 for N=10, 20 and M=3

N		10			20			
T		1	0,1	0,01	1	0,1	0,01	
P <sub>max</sub>	0	Feasibility Percentage	100%	100%	65%	100%	100%	100%
		mean <i>distance</i>	95,410	126,796		126,476	135,012	145,714
	0,05	Feasibility Percentage	100%	100%	65%	100%	100%	100%
		mean <i>distance</i>	95,410	126,796		126,476	135,012	145,714
	0,1	Feasibility Percentage	100%	100%	65%	100%	100%	100%
		mean <i>distance</i>	95,410	126,796		143,768	148,070	159,302
	0,15	Feasibility Percentage	100%	100%	30%	100%	100%	100%
		mean <i>distance</i>	106,603	132,196		155,526	161,269	175,971
	0,2	Feasibility Percentage	100%	100%	20%	100%	100%	55%
		mean <i>distance</i>	112,410	134,745		179,163	185,116	
	0,25	feasibility percentage	100%	90%	5%	80%	20%	0%
		mean <i>distance</i>	131,486					
	0,3	Feasibility Percentage	100%	80%	5%	5%	5%	0%
		mean <i>distance</i>	136,230					
	0,35	Feasibility Percentage	100%	70%	0%	0%	0%	0%
		mean <i>distance</i>	143,975					

**Table D-4:** Feasibility percentage and mean *distance* of Scenario 3 for N=40, 100 and M=3

N		40			100			
$\tau$		1	0,1	0,01	1	0,1	0,01	
$P_{\max}$	0	Feasibility Percentage	100%	100%	100%	100%	100%	100%
		mean <i>distance</i>	143,549	144,310	145,780	165,442	165,442	165,442
	0,05	Feasibility Percentage	100%	100%	100%	100%	100%	100%
		mean <i>distance</i>	171,488	171,488	172,055	219,764	219,862	220,228
	0,1	Feasibility Percentage	100%	100%	100%	0%	0%	0%
		mean <i>distance</i>	190,509	190,998	195,032			
	0,15	Feasibility Percentage	10%	0%	0%	0%	0%	0%
		mean <i>distance</i>						
	0,2-0,4	Feasibility Percentage	0%	0%	0%	0%	0%	0%
		mean <i>distance</i>						

# ***APPENDIX E***

## ***EXTENSIONS OF THE HHC DISTRICTING MODELS***

### **1 Distinction between the patients' profiles**

#### **1.1 Decision Variables**

We define the following decision variables in addition to the ones used for Model 1 and Model 2:

- $w_{jh}$ : total care workload of district  $j$  ( $j=1,\dots,M$ ) related to profile  $h$  ( $h=1\dots H$ ).

#### **1.2 Parameters**

We use the following notations for the additional parameters of the models:

- $\bar{w}_h$ : average care workload among all districts related to profile  $h$  ( $h=1\dots H$ ).
- $\tau_h$ : admissible percentage deviation of the workload related to profile  $h$  ( $h=1\dots H$ ) and associated to a given district in comparison with the average workload among all districts.

#### **1.3 Model 3**

In the context of Model 1, we propose to balance the workload related to both set of profiles by minimizing the maximum deviation of the total care workload of the district from the average workload.

The care workload equilibrium of the set of profiles  $h_1$  and  $h_2$  is modeled as a hard constraint to respect by defining for  $h_1$  and  $h_2$  two tolerance intervals depending on the decisions-makers' preferences. The mathematical formulation of Model 3 is the following:

$$\text{Minimize } gap\_max \quad (E.1)$$

s.to

$$w_{jh_1} = \sum_{i=1}^N \sum_{\substack{h=1 \\ h \in h_1}}^H P_{ih} b_h T_h x_{ij} \quad \forall j = 1 \dots M \quad (E.2)$$

$$w_{jh_2} = \sum_{i=1}^N \sum_{\substack{h=1 \\ h \in h_2}}^H P_{ih} b_h T_h x_{ij} \quad \forall j = 1 \dots M \quad (E.3)$$

$$w_j = \sum_{i=1}^N \sum_{h=1}^H P_{ih} b_h T_h x_{ij} \quad \forall j = 1 \dots M \quad (E.4)$$

$$\overline{w_{h_1}} = \frac{\sum_{i=1}^N \sum_{\substack{h=1 \\ h \in h_1}}^H P_{ih} b_h T_h}{M} \quad (E.5)$$

$$\overline{w_{h_2}} = \frac{\sum_{i=1}^N \sum_{\substack{h=1 \\ h \in h_2}}^H P_{ih} b_h T_h}{M} \quad (E.6)$$

$$\overline{w} = \frac{\sum_{i=1}^N \sum_{h=1}^H P_{ih} b_h T_h}{M} \quad (E.7)$$

$$gap\_max \geq \frac{w_j - \overline{w}}{\overline{w}} \quad \forall j = 1 \dots M \quad (E.8)$$

$$gap\_max \geq \frac{\overline{w} - w_j}{\overline{w}} \quad \forall j = 1 \dots M \quad (E.9)$$

$$(1 - \tau_{h_1}) \overline{w_{h_1}} \leq w_{jh_1} \quad \forall j = 1 \dots M \quad (E.10)$$

$$w_{jh_1} \leq (1 + \tau_{h_1}) \overline{w_{h_1}} \quad \forall j = 1 \dots M \quad (E.11)$$

$$(1 - \tau_{h_2}) \overline{w_{h_2}} \leq w_{jh_2} \quad \forall j = 1 \dots M \quad (E.12)$$

$$w_{jh_2} \leq (1 + \tau_{h_2}) \overline{w_{h_2}} \quad \forall j = 1 \dots M \quad (E.13)$$

$$\sum_{j=1}^M x_{ij} = 1 \quad \forall i = 1 \dots N \quad (E.14)$$

$$x_{ij} + x_{kj} \leq 1 \quad \forall (i,k) \in E, j = 1 \dots M \quad (E.15)$$

$$x_{ij} + x_{kj} \leq 1 \quad \forall (i,k) \in D, j = 1 \dots M \quad (E.16)$$

$$x_{ij} \in \{0,1\} \quad \forall i = 1 \dots N, j = 1 \dots M \quad (E.17)$$

#### 1.4 Model 4

Similarly to Model 3, it is also possible to distinguish between two profiles' sets  $h_1$  and  $h_2$  so that the impact of both profiles' sets is separated. This distinction is made by defining two admissible percentage deviation of the workload associated to a given district in comparison with the average workload among all districts.

Minimize *distance* (E.18)

s.to

$$distance \geq d_{ik} * (x_{ij} + x_{kj} - 1) \quad \forall \quad i = 1 \dots N \quad k = 1 \dots N \quad j = 1 \dots M \quad (E.19)$$

$$w_{jh_1} = \sum_{i=1}^N \sum_{\substack{h=1 \\ h \in h_1}}^H P_{ih} b_h T_h x_{ij} \quad \forall \quad j = 1 \dots M \quad (E.20)$$

$$w_{jh_2} = \sum_{i=1}^N \sum_{\substack{h=1 \\ h \in h_2}}^H P_{ih} b_h T_h x_{ij} \quad \forall \quad j = 1 \dots M \quad (E.21)$$

$$\overline{w_{h_1}} = \frac{\sum_{i=1}^N \sum_{\substack{h=1 \\ h \in h_1}}^H P_{ih} b_h T_h}{M} \quad (E.22)$$

$$\overline{w_{h_2}} = \frac{\sum_{i=1}^N \sum_{\substack{h=1 \\ h \in h_2}}^H P_{ih} b_h T_h}{M} \quad (E.23)$$

$$\sum_{j=1}^M x_{ij} = 1 \quad \forall \quad i = 1 \dots N \quad (E.24)$$

$$(1 - \tau_{h_1}) \overline{w_{h_1}} \leq w_{jh_1} \quad \forall \quad j = 1 \dots M \quad (E.25)$$

$$w_{jh_1} \leq (1 + \tau_{h_1}) \overline{w_{h_1}} \quad \forall \quad j = 1 \dots M \quad (E.26)$$

$$(1 - \tau_{h_2}) \overline{w_{h_2}} \leq w_{jh_2} \quad \forall \quad j = 1 \dots M \quad (E.27)$$

$$w_{jh_2} \leq (1 + \tau_{h_2}) \overline{w_{h_2}} \quad \forall \quad j = 1 \dots M \quad (E.28)$$

$$x_{ij} + x_{kj} \leq 1 \quad \forall \quad (i, k) \in E, \quad j = 1 \dots M \quad (E.29)$$

$$x_{ij} \in \{0, 1\} \quad \forall \quad i = 1 \dots N \quad j = 1 \dots M \quad (E.30)$$

## 2 Distinction between the types of care givers

### 2.1 Decision Variables

We define the following decision variables in addition to the ones used for Model 1 and Model 2:

- $w_{js}$ : total care workload of district  $j$  ( $j=1,\dots,M$ ) related to the care givers' type  $s$  ( $s=1\dots S$ ).

### 2.2 Parameters

We use the following notations for the additional parameters of the models:

- $S$ : number of care givers' types considered.
- $b_{hs}$ : number of visits achieved by a care giver of type  $s$  ( $s=1\dots S$ ) and required by a patient of profile  $h$  ( $h=1\dots H$ ) during his/her stay within the HHC system.
- $T_{hs}$ : average duration of a visit achieved by a care giver of type  $s$  ( $s=1\dots S$ ) relative to the profile  $h$  ( $h=1\dots H$ ).
- $\bar{w}_s$ : average care workload among all districts related to the care givers' type  $s$  ( $s=1\dots S$ ).
- $\tau_s$ : admissible percentage deviation of the workload of a care giver of type  $s$  ( $s=1\dots S$ ) associated to a given district in comparison with the average workload among all districts.

### 2.3 Model 5

$$\text{Minimize } gap\_max \tag{E.31}$$

s.to

$$w_{js_1} = \sum_{i=1}^N \sum_{h=1}^H \sum_{\substack{s=1 \\ s \in s_1}}^S P_{ih} b_{hs} T_{hs} x_{ij} \quad \forall j = 1 \dots M \tag{E.32}$$

$$w_{js_2} = \sum_{i=1}^N \sum_{h=1}^H \sum_{\substack{s=1 \\ s \in s_2}}^S P_{ih} b_{hs} T_{hs} x_{ij} \quad \forall j = 1 \dots M \tag{E.33}$$

$$w_j = \sum_{i=1}^N \sum_{h=1}^H \sum_{s=1}^S P_{ih} b_{hs} T_{hs} x_{ij} \quad \forall j = 1 \dots M \tag{E.34}$$



$$\overline{w}_{s_1} = \frac{\sum_{i=1}^N \sum_{h=1}^H \sum_{\substack{s=1 \\ s \in s_1}}^S P_{ih} b_{hs} T_{hs}}{M} \quad (\text{E.35})$$

$$\overline{w}_{s_2} = \frac{\sum_{i=1}^N \sum_{h=1}^H \sum_{\substack{s=1 \\ s \in s_2}}^S P_{ih} b_{hs} T_{hs}}{M} \quad (\text{E.36})$$

$$\overline{w} = \frac{\sum_{i=1}^N \sum_{h=1}^H \sum_{s=1}^S P_{ih} b_{hs} T_{hs}}{M} \quad (\text{E.37})$$

$$\text{gap}_{-} \max \geq \frac{\overline{w}_j - \overline{w}}{\overline{w}} \quad \forall \quad j = 1 \dots M \quad (\text{E.38})$$

$$\text{gap}_{-} \max \geq \frac{\overline{w} - w_j}{\overline{w}} \quad \forall \quad j = 1 \dots M \quad (\text{E.39})$$

$$(1 - \tau_{s_1}) \overline{w}_{s_1} \leq w_{js_1} \quad \forall \quad j = 1 \dots M \quad (\text{E.40})$$

$$w_{js_1} \leq (1 + \tau_{s_1}) \overline{w}_{s_1} \quad \forall \quad j = 1 \dots M \quad (\text{E.41})$$

$$(1 - \tau_{hs}) \overline{w}_{s_2} \leq w_{js_2} \quad \forall \quad j = 1 \dots M \quad (\text{E.42})$$

$$w_{js_2} \leq (1 + \tau_{s_2}) \overline{w}_{s_2} \quad \forall \quad j = 1 \dots M \quad (\text{E.43})$$

$$\sum_{j=1}^M x_{ij} = 1 \quad \forall \quad i = 1 \dots N \quad (\text{E.44})$$

$$x_{ij} + x_{kj} \leq 1 \quad \forall \quad (i,k) \in E, \quad j = 1 \dots M \quad (\text{E.45})$$

$$x_{ij} + x_{kj} \leq 1 \quad \forall \quad (i,k) \in D, \quad j = 1 \dots M \quad (\text{E.46})$$

$$x_{ij} \in \{0,1\} \quad \forall \quad i = 1 \dots N \quad j = 1 \dots M \quad (\text{E.47})$$

## 2.4 Model 6

Minimize *distance* (E.48)

s.to

$$distance \geq d_{ik} * (x_{ij} + x_{kj} - 1) \quad \forall \quad i = 1 \dots N \quad k = 1 \dots N \quad j = 1 \dots M \quad (E.49)$$

$$w_{js_1} = \sum_{i=1}^N \sum_{h=1}^H \sum_{\substack{s=1 \\ s \in s_1}}^S P_{ih} b_{hs} T_{hs} x_{ij} \quad \forall \quad j = 1 \dots M \quad (E.50)$$

$$w_{js_2} = \sum_{i=1}^N \sum_{h=1}^H \sum_{\substack{s=1 \\ s \in s_2}}^S P_{ih} b_{hs} T_{hs} x_{ij} \quad \forall \quad j = 1 \dots M \quad (E.60)$$

$$\overline{w_{s_1}} = \frac{\sum_{i=1}^N \sum_{h=1}^H \sum_{\substack{s=1 \\ s \in s_1}}^S P_{ih} b_{hs} T_{hs}}{M} \quad (E.61)$$

$$\overline{w_{s_2}} = \frac{\sum_{i=1}^N \sum_{h=1}^H \sum_{\substack{s=1 \\ s \in s_2}}^S P_{ih} b_{hs} T_{hs}}{M} \quad (E.62)$$

$$\sum_{j=1}^M x_{ij} = 1 \quad \forall \quad i = 1 \dots N \quad (E.63)$$

$$(1 - \tau_{s_1}) \overline{w_{s_1}} \leq w_{js_1} \quad \forall \quad j = 1 \dots M \quad (E.64)$$

$$w_{js_1} \leq (1 + \tau_{s_1}) \overline{w_{s_1}} \quad \forall \quad j = 1 \dots M \quad (E.65)$$

$$(1 - \tau_{s_2}) \overline{w_{s_2}} \leq w_{js_2} \quad \forall \quad j = 1 \dots M \quad (E.66)$$

$$w_{js_2} \leq (1 + \tau_{s_2}) \overline{w_{s_2}} \quad \forall \quad j = 1 \dots M \quad (E.67)$$

$$x_{ij} + x_{kj} \leq 1 \quad \forall \quad (i, k) \in E, \quad j = 1 \dots M \quad (E.68)$$

$$x_{ij} \in \{0, 1\} \quad \forall \quad i = 1 \dots N \quad j = 1 \dots M \quad (E.69)$$

# ***APPENDIX F***

## ***COMPUTATIONAL RESULTS***

In this appendix, we discuss the results of some computational experiments carried out to evaluate the two first extensions proposed in section 5.1 of Chapter 3 and applied to Model 1.

### **1 Problem instance generation**

In this appendix, we create different sets of 20 instances generated randomly following the procedure described in Section 4 of Chapter 3. Indeed:

- The number of basic units  $N$  is equal to 20.
- The number of districts to design  $M$  is equal to 2.
- The number of profiles  $H$  is equal to 2.
- The maximum distance between two basic units assigned to the same district,  $d_{\max}$  is varied between 0 and 300 in steps of 50.
- The percentage deviation  $\tau_h$  of each district care workload from the average care workload related to the profile  $h$  ( $h=1\dots H$ ) can be equal to 100%, 50%, 25%, 10% and 1%.
- The maximum ratio of incompatibilities between each basic unit  $i$  and the other basic units  $k$  ( $k=i+1\dots N$ ) related to the compatibility matrix  $e_{(N,N)}$  can have two values 0.05 and 0.15.
- The distance matrix  $d_{(N,N)}$  is generated as follows:
  - For each basic unit  $i$ , we randomly generate an abscissa  $X_i$  and an ordinate  $Y_i$  from a uniform distribution  $DU(0, 200)$ .
  - For each pair of basic units  $i$  and  $k$ , the distance  $d_{ik}$  is then calculated according to the formula:  $d_{ik} = \sqrt{(X_i - X_k)^2 + (Y_i - Y_k)^2}$
- The number of visits  $b_1$  and the average duration of the visits  $T_1$  relative to the profile 1, are generated randomly from uniform distributions respectively  $DU(0, 25)$  and  $DU(0, 4)$ .
- The number of visits  $b_2$  and the average duration of the visits  $T_2$  relative to the profile 2, are generated randomly from uniform distributions respectively  $DU(0, 2)$  and  $DU(0, 5)$ .

- The number of patients  $P_{ih}$  having the profile  $h$  and living in the basic unit  $i$  is generated randomly from a discrete uniform distribution  $DU(0, 20)$ .

For each series of results, we provide:

- The feasibility percentage over the 20 instances: we assume that a solution is feasible if it can be obtained within 60 minutes of computation.
- The mean *gap\_max* or *distance* over the 20 instances' sets that correspond to 100% of feasibility.

All tests were run under Windows XP with an Intel Core Duo CPU (3 GHz) and 2 Go of RAM. We used a standard MIP software (CPLEX11.1) with the solver default settings to solve the problem, using the different formulation presented in Appendix E.

## 2 Comparison of Model 1 versus Model 3

We carried out some computational experiments in order to evaluate the formulation of Model 3 proposed in sub-section 1.3 of Appendix E. We fix the value of  $p_{\max}$  to 0.05. We also consider different values of  $d_{\max} \in \{0, 50, 100, 150, 200, 250, 300\}$ ,  $\tau_1 \in \{1\%, 10\%, 25\%, 50, 100\% \}$  and  $\tau_2 \in \{1\%, 10\%, 25\%, 50, 100\% \}$  and for each couple  $(d_{\max}, \tau_1)$  or  $(d_{\max}, \tau_2)$ , we generate randomly 20 instances as explained before. The computational results obtained with the initial and extended formulations are displayed in Tables F-1, F-2, F-3 and F-4.

**Table F-1:** Feasibility percentage and mean *gap\_max* of Model 1 and Model 3  
( $\tau_1=100\%, 50\%$ )

	Model 1		Model 3			
$\tau_1$			100%		50%	
$d_{max}$	Feasibility Percentage	mean <i>gap_max</i>	Feasibility Percentage	mean <i>gap_max</i>	Feasibility Percentage	mean <i>gap_max</i>
<b>0</b>	0%		0%		0%	
<b>50</b>	0%		0%		0%	
<b>100</b>	0%		0%		0%	
<b>150</b>	25%		25%		25%	
<b>200</b>	100%	0,163%	100%	0,163%	100%	0,174%
<b>250</b>	100%	0,145%	100%	0,145%	100%	0,167%
<b>300</b>	100%	0,145%	100%	0,145%	100%	0,167%

**Table F-2:** Feasibility percentage and mean *gap\_max* of Model 3 ( $\tau_1=25\%, 10\%, 1\%$ )

	Model 3					
$\tau_1$	25%		10%		1%	
$d_{max}$	Feasibility Percentage	mean <i>gap_max</i>	Feasibility Percentage	mean <i>gap_max</i>	Feasibility Percentage	Mean <i>gap_max</i>
<b>0</b>	0%		0%		0%	
<b>50</b>	0%		0%		0%	
<b>100</b>	0%		0%		0%	
<b>150</b>	25%		20%		5%	
<b>200</b>	100%	0,223%	100%	0,276%	100%	0,356%
<b>250</b>	100%	0,222%	100%	0,276%	100%	0,307%
<b>300</b>	100%	0,222%	100%	0,276%	100%	0,307%

**Table F-3:** Feasibility percentage and mean *gap\_max* of Model 1 and Model 3 ( $\tau_2=100\%$ , 50%)

	Model 1		Model 3			
$\tau_2$			100%		50%	
$d_{\max}$	Feasibility Percentage	mean <i>gap_max</i>	Feasibility Percentage	mean <i>gap_max</i>	Feasibility Percentage	Mean <i>gap_max</i>
0	0%		0%		0%	
50	0%		0%		0%	
100	0%		0%		0%	
150	25%		25%		25%	
200	100%	0,163%	100%	0,163%	100%	0,163%
250	100%	0,145%	100%	0,145%	100%	0,145%
300	100%	0,145%	100%	0,145%	100%	0,145%

**Table F-4:** Feasibility percentage and mean *gap\_max* of Model 3 ( $\tau_2=25\%$ , 10%, 1%)

$\tau_2$	25%		10%		1%	
$d_{\max}$	Feasibility Percentage	mean <i>gap_max</i>	Feasibility Percentage	mean <i>gap_max</i>	Feasibility Percentage	Mean <i>gap_max</i>
0	0%		0%		0%	
50	0%		0%		0%	
100	0%		0%		0%	
150	25%		20%		10%	
200	100%	0,163%	100%	0,163%	100%	0,163%
250	100%	0,145%	100%	0,145%	100%	0,145%
300	100%	0,145%	100%	0,145%	100%	0,145%

The results presented in these tables also show that, by using the initial formulation i.e. Model 1, for  $d_{\max}=150$ , 25% of the problems can be solved exactly within the computational limits and for  $d_{\max} \geq 200$ , 100% of the problems can be solved exactly within the computational limits. We compare these results with the ones obtained while using the extended formulation i.e. Model 3. Indeed, for  $d_{\max}=150$ ; 20%, 5%, 20% and 10% of the problems are solved exactly respectively when  $\tau_1=10\%$ ,  $\tau_1=1\%$ ,  $\tau_2=10\%$  and  $\tau_2=1\%$ . It is then clear that fewer instances are solved exactly by using the extended formulation which also increases the mean

*gap\_max*. Indeed, by decreasing the value of  $\tau_1$  (respectively  $\tau_2$ ), the feasibility percentage decreases and the mean *gap\_max* increases. Table F-5 which represents the relative gaps between using Model 1 and Model 3 for respectively  $\tau_1=1\%$  and  $\tau_2=1\%$  shows that the relative gaps generated by the addition of a tolerance interval related to profile 1 (118.335% for  $d_{\max}=200$ ) is far more important than the one related to profile 2 (0.000% for  $d_{\max}=200$ ). The main explanatory factor for this is related to the fact that, as shown in Table F-6, mean ( $\overline{w_1}$ ) and mean ( $\overline{w_2}$ ) represent respectively 0.4124% and 95.588% of the mean ( $\overline{w}$ ). Indeed, on one hand, the optimal solution obtained by using Model 1 is the same than the one obtained by using Model 3 where we add a hard constraint related to the care workload of profile 2 which represents on average 95.588% of the total care workload. In other words, the effect of adding this hard constraint is negligible. On the other hand, adding a hard constraint on  $\overline{w_1}$  which corresponds on average to 0.4124% of  $\overline{w}$  may strongly modify the results obtained by using the initial formulation.

**Table F-5:** Care workload deprivation between Model 1 and Model 3 for  $\tau_1= \tau_2=1\%$

$d_{\max}$	0	50	100	150	200	250	300
$\tau_1$					118,335%	112,232%	92,166%
$\tau_2$					0,000%	0,000%	0,000%

**Table F-6:** Proportion of each profile care workload

$\overline{w}$	$\overline{w_1}$	$\frac{\overline{w_1}}{\overline{w}}$	$\overline{w_2}$	$\frac{\overline{w_2}}{\overline{w}}$
523,835	2,156	0,412%	521,679	99,588%

### 3 Comparison of Model 1 and Model 5

In this sub-section, we compare the initial formulation i.e. Model 1 and the extended one i.e. Model 5 presented in sub-section 2.3 of Appendix E according to the second extension that consists in separating the different types of care givers due to the importance of the gap that may exist between the care workload of each care givers' type. As the parameters  $\tau_{s1}$  and  $\tau_{s2}$  related to each type of care givers have an impact on the results, we group the instances by sets of 20 where  $\tau_{s1} \in \{100\%, 50\%, 25\%, 10\%, 1\%\}$  and  $\tau_{s2} \in \{100\%, 50\%, 25\%, 10\%, 1\%\}$ .

The analysis of Tables F-7, F-8 and F-9 which display the feasibility percentage and the mean *gap\_max* point out that, for a given  $\tau_{s_1}$  (respectively  $\tau_{s_2}$ ), the mean *gap\_max* decreases as long as the value of  $\tau_{s_2}$  (respectively  $\tau_{s_1}$ ) increases. By comparing the results obtained with both Model 1 and Model 5, we conclude that using the extended formulation (i.e. Model 5) decreases the feasibility percentage and increases the mean *gap\_max*. The relative gaps between using Model 1 and Model 5 for respectively  $\tau_{s_1}=1\%$  and  $\tau_{s_2}=1\%$  are displayed in Tables F-10 and F-11. This relative gaps increases when  $d_{\max}$  increases and when  $\tau_{s_2}$  or  $\tau_{s_1}$  increases. The difference between the relative gaps of  $\tau_{s_1}$  and  $\tau_{s_2}$  is related, as for the case of the first extension, to the importance of the care workload of each type of care givers (see Table F-12).

**Table F-7:** Feasibility percentage and mean *gap\_max* of Model 1

<b><math>d_{\max}</math></b>	<b>Feasibility Percentage</b>	<b>Mean <i>gap_max</i></b>
<b>0</b>	0%	
<b>50</b>	0%	
<b>100</b>	0%	
<b>150</b>	25%	
<b>200</b>	100%	0,034%
<b>250</b>	100%	0,028%
<b>300</b>	100%	0,028%



**Table F-8: Feasibility percentage of Model 5**

		$\tau S_2$											
$\tau S_1$	$d_{max}$	100%	50%	25%	10%	1%	$\tau S_1$	$d_{max}$	100%	50%	25%	10%	1%
<b>100%</b>	<b>0</b>	0%	0%	0%	0%	0%	<b>50%</b>	<b>0</b>	0%	0%	0%	0%	0%
	<b>50</b>	0%	0%	0%	0%	0%		<b>50</b>	0%	0%	0%	0%	0%
	<b>100</b>	0%	0%	0%	0%	0%		<b>100</b>	0%	0%	0%	0%	0%
	<b>150</b>	25%	25%	25%	20%	10%		<b>150</b>	25%	25%	25%	20%	10%
	<b>200</b>	100%	100%	100%	100%	100%		<b>200</b>	100%	100%	100%	100%	100%
	<b>250</b>	100%	100%	100%	100%	100%		<b>250</b>	100%	100%	100%	100%	100%
	<b>300</b>	100%	100%	100%	100%	100%		<b>300</b>	100%	100%	100%	100%	100%
<b>25%</b>	<b>0</b>	0%	0%	0%	0%	0%	<b>10%</b>	<b>0</b>	0%	0%	0%	0%	0%
	<b>50</b>	0%	0%	0%	0%	0%		<b>50</b>	0%	0%	0%	0%	0%
	<b>100</b>	0%	0%	0%	0%	0%		<b>100</b>	0%	0%	0%	0%	0%
	<b>150</b>	25%	25%	25%	20%	10%		<b>150</b>	20%	20%	20%	20%	10%
	<b>200</b>	100%	100%	100%	100%	100%		<b>200</b>	100%	100%	100%	100%	100%
	<b>250</b>	100%	100%	100%	100%	100%		<b>250</b>	100%	100%	100%	100%	100%
	<b>300</b>	100%	100%	100%	100%	100%		<b>300</b>	100%	100%	100%	100%	100%
<b>1%</b>	<b>0</b>	0%	0%	0%	0%	0%							
	<b>50</b>	0%	0%	0%	0%	0%							
	<b>100</b>	0%	0%	0%	0%	0%							
	<b>150</b>	15%	15%	15%	15%	5%							
	<b>200</b>	100%	100%	100%	100%	100%							
	<b>250</b>	100%	100%	100%	100%	100%							
	<b>300</b>	100%	100%	100%	100%	100%							

**Table F-9:** Mean *gap\_max* of Model 5

		$\tau_{S_2}$				
$\tau_{S_1}$	$d_{max}$	100%	50%	25%	10%	1%
<b>100%</b>	<b>0</b>					
	<b>50</b>					
	<b>100</b>					
	<b>150</b>	3,284%	3,284%	3,284%	1,239%	0,914%
	<b>200</b>	0,034%	0,034%	0,034%	0,034%	0,056%
	<b>250</b>	0,028%	0,028%	0,028%	0,028%	0,056%
	<b>300</b>	0,028%	0,028%	0,028%	0,028%	0,056%
<b>50%</b>	<b>0</b>					
	<b>50</b>					
	<b>100</b>					
	<b>150</b>	3,284%	3,284%	3,284%	1,239%	0,914%
	<b>200</b>	0,034%	0,034%	0,034%	0,034%	0,056%
	<b>250</b>	0,028%	0,028%	0,028%	0,028%	0,056%
	<b>300</b>	0,028%	0,028%	0,028%	0,028%	0,056%
<b>25%</b>	<b>0</b>					
	<b>50</b>					
	<b>100</b>					
	<b>150</b>	3,284%	3,284%	3,284%	1,239%	0,914%
	<b>200</b>	0,034%	0,034%	0,034%	0,034%	0,056%
	<b>250</b>	0,028%	0,028%	0,028%	0,028%	0,056%
	<b>300</b>	0,028%	0,028%	0,028%	0,028%	0,056%
<b>10%</b>	<b>0</b>					
	<b>50</b>					
	<b>100</b>					
	<b>150</b>	0,996%	1,239%	1,239%	1,239%	0,914%
	<b>200</b>	0,034%	0,034%	0,034%	0,034%	0,056%
	<b>250</b>	0,028%	0,028%	0,028%	0,028%	0,056%

	<b>300</b>	0,028%	0,028%	0,028%	0,028%	0,056%
<b>1%</b>	<b>0</b>					
	<b>50</b>					
	<b>100</b>					
	<b>150</b>	0,223%	0,292%	0,292%	0,292%	0,448%
	<b>200</b>	0,035%	0,035%	0,035%	0,035%	0,056%
	<b>250</b>	0,032%	0,032%	0,032%	0,032%	0,056%
	<b>300</b>	0,032%	0,032%	0,032%	0,032%	0,056%

**Table F-10:** Care workload  $\Delta$  ( $\tau_{s2}$ ) deprivation between Model 1 and Model 5

$\tau_{s1}$	$d_{max}$						
	<b>0</b>	<b>50</b>	<b>100</b>	<b>150</b>	<b>200</b>	<b>250</b>	<b>300</b>
<b>100%</b>					66,858%	100,669%	100,669%
<b>50%</b>					66,858%	100,669%	100,669%
<b>25%</b>					66,858%	100,669%	100,669%
<b>10%</b>					66,858%	100,669%	100,669%
<b>1%</b>					62,099%	75,708%	75,708%

**Table F-11:** Care workload  $\Delta$  ( $\tau_{s1}$ ) deprivation between Model 1 and Model 5

$\tau_{s2}$	$d_{max}$						
	<b>0</b>	<b>50</b>	<b>100</b>	<b>150</b>	<b>200</b>	<b>250</b>	<b>300</b>
<b>100%</b>					2,936%	14,206%	14,206%
<b>50%</b>					2,936%	14,206%	14,206%
<b>25%</b>					2,936%	14,206%	14,206%
<b>10%</b>					2,936%	14,206%	14,206%
<b>1%</b>					0,000%	0,000%	0,000%

**Table F-12:** Proportion of each profile care workload

$\bar{w}$	$\bar{w}_1$	$\frac{\bar{w}_1}{\bar{w}}$	$\bar{w}_2$	$\frac{\bar{w}_2}{\bar{w}}$
5542,6	4659	84,058%	883,6	15,942%



## **REFERENCES**

- Afrite A., Com-Ruelle L., Or Z. and Renaud T. (2007). L'hospitalisation à domicile, une alternative économique pour les soins de suite et de réadaptation. *Question d'économie de la santé*, Vol N°119, p. 1-8.
- Afrite A., Chaleix M., Com-Ruelle L. and Valdelièvre H. (2009). L'hospitalisation à domicile, une prise en charge qui s'adresse à tous les patients. Exploitation des données du PMSI HAD 2006. *Questions d'économie et de santé*, Vol N°140, p. 1-8.
- Akjiratikarl C., Yenradee P. and Drake P.R. (2007). PSO-based algorithm for home care worker scheduling in the UK. *Computers and industrial engineering*, Vol. N°53, p. 559-583.
- Aksin O.Z., de Vericourt F. and Karaesmen F. (2006). Call center outsourcing contract analysis and choice. *Management Science*, Vol N°54, p. 354-368.
- Aksin Z., Armony M. and Mehrotra V.(2007). The modern call center: a multi-disciplinary perspective on Operations Management Research. *Production and Operations Management*, Vol N°16, p. 665-688.
- Alexander G.L. and Wakefield D.S. (2009). Information Technology Sophistication in Nursing Homes. *Journal of the American Medical Directors Association*, Vol N°10, p. 398-407.
- Aligon A., Com-Ruelle L., Renaud T. and Lebrun E. (2003). Le coût de prise en charge en hospitalisation à domicile (HAD). *Questions d'économie de la santé*, Vol N°67, p.1-6.
- Armstrong C.D., Hogg W.E., Lemelin J., Dahrouge S., Martin C., Viner G.S. and Saginur R. (2008). Home-based intermediate care program vs hospitalization, Cost comparison study. *Canadian Family Physician*, Vol N° 54, p. 66-73.
- Atlason J. and Epelman M.A. (2004). Call Center staffing with Simulation and Cutting Plane Methods. *Annals of Operations Research*, Vol N°127, p. 333-358.
- Badri M.A., Mortagy A.K. and Alsayed A. (1998). A multi-objective model for locating fire stations. *European Journal of Operational Research*, Vol N° 110, p. 243-260.
- Bard J.F., Binici C. and DeSilva A. (2003). Staff scheduling at the United States postal service. *Computers and Operations Research*, Vol N°30, p. 745-771.
- Begur S.V., Miller D.M. and Weaver J.R. (1997). An integrated spatial Decision Support System for scheduling and routing HHC nurses. *Interfaces*, Vol N° 27, p. 35-48.

- Ben Bachouch R., Fakhfakh M., Guinet A. and Hajri-Gabouj S. (2008). Planification de la tournée des infirmiers dans une structure de soins à domicile. *Conférence Francophone en Gestion et Ingénierie des Systèmes Hospitaliers (GISEH)*, Switzerland.
- Benzarti E., Sahin E. and Dallery Y. (2010a). Modeling approaches for the HHC districting problem. *The 8<sup>th</sup> International Conference of Modeling and Simulation - MOSIM'10*, Hammamet, Tunisia.
- Benzarti E., Sahin E. and Dallery Y. (2010b). A literature review on Operations management based models developed for HHC services. *European Conference of Operational Research Applied to Health Care*, Genova, Italy.
- Benzarti E., Sahin E. and Dallery Y. (2010c). Facteurs de complexité auxquels la gestion des opérations doit faire face dans les établissements d'Hospitalisation A Domicile. *Conférence Francophone de Gestion et Ingénierie des Systèmes Hospitaliers (GISEH)*, Clermont-Ferrand, France.
- Benzarti E., Sahin E. and Dallery Y. (2011). Operations Management Applied to Home Care Services: Analysis of the Districting Problem. *Decision Support system*, Accepted article.
- Bergey P.K., Ragsdale C.T. and Hoskote M. (2003a). A decision support system for the electrical power districting problem. *Decision Support Systems*, Vol N°36, p. 1-17.
- Bergey P.K., Ragsdale C.T. and Hoskote M. (2003b). A simulated annealing genetic algorithm for the electrical power districting problem. *Annals of Operations Research*, Vol N°121, p. 33-55.
- Berry L.L. and Lampo S.L. (2000). Teaching an Old Service New Tricks: the promise of Service Redesign. *Journal of Service Research*, Vol N° 2, p. 265-275.
- Bertels S. and Fahle T. (2006). A hybrid setup for a hybrid scenario: combining heuristics for the HHC problem. *Computers and Operations Research*, Vol N°33, p. 2866-2890.
- Blais M., Lapierre S.D. and Lapierre G. (2003). Solving a home-care districting problem in an urban setting. *Journal of Operational Research Society*, Vol N°54, p. 1141-1147.
- Boldy D. and Howell N. (1980). The geographical allocation of community care resources\_a case study. *Journal of the Operational Research Society*, Vol N°31, p.123-129.
- Bonnici B. (2003). La politique de santé en France. *Presses Universitaires de France*.
- Borsani V., Matta A., Beschi G. and Sommaruga F. (2006). A home care scheduling model for human resources. *The International Conference on Service Systems and Service Management (ICSSSM)*, Troyes, France.
- Bowen D.E., Siehl C. and Schneider B.(1989). A framework for analyzing customer service orientations in manufacturing. *Academy of Management Review*, Vol N°14, p. 75-95.

- Bozkaya B., Erkut E. and Laporte G. (2003). A Tabu search heuristic and adaptive memory procedure for political districting. *European Journal of Operational Research*, Vol N° 44(1), p. 12–26.
- Brailsford S. and Vissers J. (2011). OR in healthcare: A European perspective. *European Journal of Operational Research*, Vol N°212, p. 223–234.
- Brick E.S. and Uchoa E. (2009). A facility location and installation of resources model for level of repair analysis. *European Journal of Operational Research*, Vol N°192, p. 479-486.
- Buhaug T. (2002). Long waiting lists in hospitals. *British Medical Journal*, Vol N°324, p. 252-253.
- Busby C.R. and Carter M.W. (2006). A Decision Tool for Negotiating Home Care Funding Levels in Ontario. *HHC Services Quarterly*, Vol N°25, p. 91-106.
- Butler T.W., Leong G.K. and Everett L.N. (1996). The operations management role in hospital strategic planning. *Journal of Operations Management*, Vol N°14, p. 137-156
- Caro F., Shirabe T., Guignard, M. and Weintraub A. (2004). School Redistricting: Embedding GIS Tools with Integer Programming. *The Journal of the Operational Research Society*, Vol N°55, p. 836- 849.
- Chahed S., Sahin E. and Dallery Y. (2006). Modélisation et comparaison du fonctionnement de trois établissements d’Hospitalisation à Domicile en France. *Conférence Francophone en Gestion et Ingénierie des Systèmes Hospitaliers (GISEH)*, Luxembourg.
- Chahed S., Marcon E., Sahin E. and Dallery Y. (2007). What about operations research opportunities in the home care domain? *The 33rd International Conference on Operational Research Applied to Health Services (ORAHS)*, Saint-Etienne, France.
- Chahed-Jebalia S. (2008). Modélisation et analyse de l’organisation et du fonctionnement des structures d’Hospitalisation A Domicile. *Thesis Report, Industrial Engineering, Ecole Centrale Paris*.
- Chahed S., Marcon E., Sahin E., Feillet D. and Dallery Y. (2009). Exploring new operational research opportunities within the Home Care context: the chemotherapy at home. *Health Care Management Science*, Vol N°12, p. 179-191.
- Chase R.B. (1981). The customer contact approach to services: theoretical bases and practical extensions. *Operations Research*, Vol N° 29, p. 698-706.
- Chase R.B. (1996). The mall is my factory: reflections of a service junkie. *Production and Operations Management*, Vol N° 5 (4), p. 298–308.
- Chase R.B. and Apte U.M. (2007). A History of research in service operations: what’s the big idea? *Journal of Operations Management*, Vol N°15, p. 375-386.

- Cheng E. and Rich J.L. (1998). A home care routing and scheduling problem. *Technical Report TR98-04, Department of Computational and Applied Mathematics, Rice University.*
- Chesteen S., Helgheim B., Randall T. and Wardell D. (2005). Comparing quality of care in non-profit and for-profit nursing homes: a process perspective. *Journal of Operations Management*, Vol. N° 23, p. 229-242.
- Chevalier P., Shumsky R.A. and Tabordon, N. (2004). Routing and Staffing in Large Call Centers with Specialized and Fully Flexible Servers. *Working paper.*
- Chuang K.Y., Wu S.C., Dai Y.T. and Mad A-H.S. (2007). Post-hospital care of stroke patients in Taipei: Use of services and policy implications. *Health Policy*, Vol N°82, p. 28-36.
- Collier D.A. and Meyer S.M. (1998). A service positioning matrix. *International Journal of Operations and Production Management*, Vol N°18 (12), p. 1223-1244.
- Com-Ruelle L., Dourgnon P. and Midy F. (2002). L'infirmier libéral et la coordination avec les services d'aide au maintien à domicile. *Questions d'économie de la santé*, Vol N°55, p. 1-4.
- Com-Ruelle L., Dourgnon P., Perronnin M. and Renaud T. (2003a). Construction d'un modèle de tarification à l'activité de l'hospitalisation à domicile. *Questions d'économie de la santé*, Vol N°69, p. 1-6.
- Com-Ruelle L. and Lebrun E. (2003b). Indicateurs d'état de santé des patients hospitalisés à domicile (ENHAD 1999-2000). *Questions d'économie et de santé*, Vol N°77, p. 1-6.
- Cowell D.W. (1988). New service development. *Journal of Marketing Management*, Vol N°3 (3), p. 296-312.
- D'Amico S.J., Wang S.J., Batta R., and Rump C.M. (2002). A simulated annealing approach to police district design. *Computers and Operations Research*, Vol N°29(6), p. 667-684.
- Davis M. and Heineke J. (2002). Managing services: using technology to create value. *McGraw-Hill Inc., US (December 2002).*
- De Angelis V. (1998). Planning Home Assistance for AIDS Patients in the City of Rome, Italy. *Interfaces*, Vol N°28, p. 75-83.
- Duffuaa S.O. and Al-Sultan K.S. (1999). A stochastic programming model for scheduling maintenance personnel. *Applied Mathematical Modelling*, Vol N°25, p. 385-397.
- Dumas M. (1985). Hospital Bed Utilization: An implemented simulation approach to adjusting and maintaining appropriate levels. *Health Services Research*, Vol N° 20, p. 43-61.
- Durand N., Lannelongue C. and Legrand P. (2010). Hospitalisation à Domicile (HAD). *IGAS, RAPPORT N°RM2010-109P.*



- Easingwood C. (1973). A heuristic Approach to Selecting Sales Regions and Territories. *Operational Research Quarterly*, Vol N°24 (4), p. 527-534.
- Ernst A.T., Jiang H., Krishnamoorthy M. and Sier D. (2004). Staff scheduling and rostering: A review of applications, methods and models. *European Journal of Operational Research*, Vol N°153, p. 3-27.
- Eveborn P., Flisberg P. and Ronnqvist M. (2006). LAPS CARE—an operational system for staff planning of home care”. *European Journal of Operational Research*, Vol N°171, p. 962-976.
- Exley C. and Allen D. (2007). A critical examination of home care: End of life care as an illustrative case. *Social Science and Medicine*, Vol N°65, p. 2317–2327.
- Ferland J.A. and Guenette G. (1990). Decision Support System for the School Districting Problem. *Operations Research*, Vol N° 38, p. 15-21.
- Fleischmann B. And Paraschis J. (1988). Solving a large scale districting problem: a case report. *Computers and Operations Research*, Vol N°15 (6), p. 521-533.
- Fleming G.B.A. and Taylor B.J. (2007). Battle on the home care front: perceptions of home care workers of factors influencing staff retention in Northern Ireland. *Health and Social Care in the Community*, Vol N°15 (1), p. 67–76.
- Fitzpatrick E.K, Baker J.R. and Dave D.S. (1993). An application of computer simulation to improve scheduling of hospital operating room facilities in the United States. *International Journal of Computer Applications in Technology*, Vol N°6, p. 215-224.
- Fitzsimmons J.A. and Fitzsimmons M.J. (2000). *Service Management: Operations, Strategy, and Information Technology*. Irwin Professional Pub, 4<sup>th</sup> edition (March 2004)
- Flipo J.P. and Joël B. (1991). Quand les services se mettent au service des entreprises. *Revue Française de Gestion*.
- Ford R.C. and Heaton C.P. (1999). *Managing the guest experience in hospitality*. Delmar/Thomson Learning (Albany, N.Y.)
- Fottler M.D. (1987). Health care organizational performance: Present and future research. *Journal of Management*, Vol N°13 (2), p. 367-391.
- Fries B.E. (1976). Bibliography of Operations Research in Health-Care Systems. *Operations Research*, Vol N°24(5), Special Issue on Health Care (Sep. - Oct., 1976), p. 801-814.
- Fries B.E. (1979). Bibliography of Operations Research in Health-Care Systems: An Update. *Operations Research*, Vol N°27 (2), p. 408-419.
- Gadrey J. (2000). The characterization of goods and services: an alternative approach. *Review of Income and Wealth*, Vol N°46 (3), p. 369-387.

- Garfinkel R.S. and Nemhauser G.L. (1970). Optimal political districting by implicit enumeration techniques. *Management Science*, Vol N° 16, p. 495-508.
- Giard V. (2004). Ingénierie des Services. [http://11.lamsade.dauphine.fr/~giard/Giard Ingenierie Service.pdf](http://11.lamsade.dauphine.fr/~giard/Giard_Ingenierie_Service.pdf)
- Gourgand M. (2008). La modélisation, la simulation et l'optimisation des flux dans les systèmes hospitaliers. *Bulletin de la Société Française de Recherche Opérationnelle et d'Aide à la Décision (ROADEF)*, N°21 - Automne - Hiver 2008, p. 8-12.
- Graw-Hill Mc., Fone B.D., Hollinghurst S., Temple M., Round A., Lester N., Weightman A., Roberts K., Coyle E., Bevan G. and Palmer S. (2003). Systematic review of the use and value of computer simulation modelling in population health and health care delivery. *Journal of Public Health medicine*, Vol N° 25 (4), p. 325-335.
- Grilli di Cortona P., Manzi C., Pennisi A., Ricca F. and Simeone B. (1999). Evaluation and Optimization of Electoral Systems. *SIAM (Society for Industrial and Applied Mathematics) Monographs on Discrete Mathematics and Applications: Philadelphia, PA*.
- Gronröos C. (1990). Relationship approach to marketing in service contexts: The marketing and organizational behavior interface. *Journal of Business Research*, Vol N°20 (1), p. 3-11.
- Gronröos C. (2000). Service management and marketing: a customer relationship management approach. *West Sussex, UK, Wiley*.
- Harper P.R. and Pitt M.A. (2004). On the Challenges of Healthcare Modelling and a Proposed Project Life Cycle for Successful Implementation. *The Journal of the Operational Research Society*, Vol N°55(6), p. 657-661.
- Harrington M.B.(1977). Forecasting area-wide demand for health care services: A critical review of major techniques and their application. *Inquiry*, Vol N°14, p. 254-268.
- Hayes J.M. and Hill A.V. (2001). A preliminary investigation of the relationships between employee motivation and vision, service learning, and perceived quality. *Journal of Operations Management*, Vol N°3 (19), p. 335-349.
- Hertz A. and Lahrichi N. (2006). A patient assignment algorithm for home care services. *Les cahiers du GERAD*, G-2006-80.
- Hess S.W., Weaver J.B., Siegfeldt H.J., Whelan J.N. and Zitlau P.A. (1965). Non partisan Political Redistricting by Computer. *Operations Research*, Vol N°13(6), p. 998-1006.
- Hess W. and Samuels S.A. (1971). Experiences with a Sales Districting Model: Criteria and Implementation. *Management Science*, Vol N°18(4), p. 41-54.

- Hill T.P. (1977). On goods and services. *Review of Income and Wealth*, Vol N°23 (4), p. 315–338.
- Hogarth R.M. and Makridakis S. (1981). Forecasting and planning: an evaluation. *Management Science*, Vol N°27 (2), p. 115-138.
- Hojati M. (1996). Optimal political districting. *Computers and Operations Research*, Vol N°23 (12), p. 1147-1161.
- Ingolfsson A., Haque Md.A. and Umnikov A. (2002). Accounting for time-varying queuing effects in workforce scheduling. *European Journal of Operational Research*, Vol N°139 (3), p. 585–597.
- Jaw C., Lo J.Y. and Lin Y.H. (2010). The determinants of new service development: Service characteristics, market orientation, and actualizing innovation effort. *Technovation*, Vol N°30, p. 265-277.
- Johne A. and Storey C. (1998). New service development: a review of the literature and annotated bibliography. *European Journal of Marketing*, Vol N°32 (3–4), p. 184–251.
- Johnston R. (1999). Service operations management: return to roots. *International Journal of Operations and Production Management*, Vol N°19 (2), p. 104-124.
- Jonhston R. and Clark G. (2005). Service Operations Management. Improving Service Delivery. *Pearson Education Limited*, p. 4-5.
- Jones J., Wilson A., Wynn A., Jagger C., Spiers N. and Parker G. (1999). Economic evaluation of hospital at home versus hospital care: cost minimisation analysis of data from randomised controlled trial. *British Medical Journal*, Vol N°319, p. 1547-1550.
- Jun J.B., Jacobson S.H. and Swisher J.R. (1999). Application of Discrete-Event Simulation in Health Care Clinics: A Survey. *The Journal of the Operational Research Society*, Vol N°50 (2), p. 109-123.
- Kabak O., Ulengin F., Aktas E., Onsel S. and Topcu Y. (2008). Efficient shift scheduling in the retail sector through two-stage optimization. *European Journal of Operational Research*, Vol N°184, p. 76–90.
- Kalcsics J., Nickel S. and Schröder M. (2005). Toward a unified territorial design approach: applications, algorithms, and GIS integration. *Top*, Vol N° 13, p. 1–74.
- Kalvenes J., Kennington J. and Olinick E. (2005). Hierarchical cellular network design with channel allocation. *European Journal of Operational Research*, Vol. N°160, p. 3-18.
- Kamentzky R., Shuman H. and Wolfe H. (1982). Estimating need and demand for pre hospital care. *Operations Research*, Vol N°30, p. 1148-1167.

- Kao E. and Pokladnik F. (1978). Incorporating exogeneous factors in adaptive forecasting of hospital health care census. *Management Science*, Vol N°24, p. 1677-1686.
- Kao E. and Tung G. (1980). Forecasting demands for inpatient services in a large public health care delivery system. *Sociology Economy Planning Science*, Vol N°14, p. 97-106.
- Katzenbach J.R. and Smith D.K. (1993). The wisdom of teams: creating the high performance organization. *Harvard Business School Press*, p. 45.
- Kellogg D.L. and Nie W. (1995). A framework for strategic service management. *Journal of Operations Management*, Vol N°3(4), p. 323-337.
- Klassen K.J. and Rohlender T.R. (2001). Combining operations and marketing to manage capacity and demand in services. *The Service industries Journal*, Vol N°21(2), p. 1-30.
- Kolesar P. (1970). A Markovian model for hospital admission scheduling. *Management Science*, Vol N°16(6), p. 384-396.
- Kotler P. (1977). *Marketing Management: Analysis, Planning, Implementation, and Control*, 3<sup>rd</sup> ed. Upper Saddle River, NJ: Prentice Hall.
- Kuzdrall P.J., Kwak N.K and Schnitz H.H. (1981). Simulating space requirements and scheduling policies in a hospital surgical suite. *Simulation*, Vol N°36, p. 163-171.
- Lagergren M. (1998). What is the role and contribution of models to management and research in the health services? A view from Europe. *European Journal of Operational Research*, Vol N°105, p. 257-266.
- Lahrichi N., Lapierre S.D., Hertz A., Talib A. and Bouvier L. (2006). Analysis of a territorial approach to the delivery of nursing home care services based on historical data. *Journal of Medical Systems*, Vol N°30, p. 283-291.
- Langeard E. and Eiglier P. (1983). Strategic management of service development, emerging perspectives on services marketing. In M. Venkatesan, D.M. Schmalensee & C. Marshall (Eds), *Chicago: American Marketing Association*.
- Lanzarone E., Matta A. and Scaccaborozzi G. (2009). A Patient stochastic model to support human resource planning in home care. *Production Planning and Control*, Vol N°1, p. 1-23.
- Lataste M. (1997). Le Projet d'hospitalisation à domicile : application à l'Aquitaine. *Bull. Soc. Pharm. Bordeaux*, Vol N°136, p. 99-128.
- Lebrun E. (2003). Analyse et construction d'une procédure de classement en groupes homogènes des patients en Hospitalisation à Domicile (H.A.D.). *Université Lyon III – I.U.P. Santé*.
- Leebov W. (1988). *Service Excellence: The Customer Relations strategy for health care*. American Hospital Association Publishing, Chicago.

- Li L.X., Benton W.C. and Keong L.G. (2002). The impact of strategic operations management decisions on community hospital performance. *Journal of Operations Management*, Vol N°20, p. 389-408.
- Lodish L.M. (1975). Sales Territory Alignment to Maximize Profit. *Journal of Marketing Research*, Vol N°12, p. 30-36.
- Lovelock C. (1991). *Service Marketing*. Englewoods Cliffs, NJ: Prentice Hall.
- Lowery J.C. and Martin J.B. (1992). Design and validation of a critical care simulation model. *Journal of Society Health System*, Vol N°3, p. 15-36.
- Machuca J.A.D., Gonzalez-Zamora M.M. and Aguilar-Escobar V.G. (2007). Service Operations Management research. *Journal of Operations Management*, Vol N°25, p. 585-603.
- Mehrotra A., Jonshon E. L. and Nemhauser G. L. (1998). An optimisation based heuristic for political districting. *Management Science*, Vol N° 44(8), p. 1100-1114.
- Metters R.D., King-Metters K.H., Pullman M. and Walton S.V. (2005). *Successful Service Operations Management*. South-Western, Division of Thomson Learning.
- Mills P.K. and Margulies N. (1980). Toward a core typology of service organizations. *Academy of Management*, Vol N° 5 (2), p. 255-265.
- Murdick R., Render B. and Russell R.S. (1190). *Service Operations Management*. Boston: Ally and Bacon.
- Murphy D.R. and Sigal E. (1985). Evaluating surgical block scheduling using computer simulation. In: Gantz DT, Blais GC and Solomon SL (eds). *Proceedings of the 1985 Winter Simulation Conference*. Institute of Electrical and Electronics Engineers, San Francisco, California, USA, Vol N°11-13, p. 551-557.
- Muyldermans L., Cattrysse D., Van Oudheusen S. and Lotan T. (2002). Districting for salt spreading operations. *European Journal of Operational Research*, Vol N°139, p. 521-532.
- Muyldermans L., Cattrysse D. and Van Oudheusen (2003). District design for arc-routing applications. *Journal of Operational Research Society*, Vol N°54, p. 1209-1221.
- O'Brien L. and Nelson C.W. (2002). Home or Hospital Care: An Economic Debate of Health Care Delivery Sites for Medicare Beneficiaries. Policy, *Politics and Nursing Practice*, Vol N°3 (1), p. 73-80.
- OECD (2005a). Main Economic Indicators, Basic Structural Statistics, August 2005. <http://www.oecd.org/dataoecd/8/4/1874420.pdf>.
- OECD (2005b). Labour Force Statistics, Paris. <http://www1.oecd.org/scripts/cde/members/lfsindicatorsauthenticate.asp>.

O’Keefe R.M. (1985). Investigating outpatient department: implementable policies and qualitative approaches. *Journal of Operational Research*, Vol N°22, p. 705-712.

Olaison A. and Cedersund E. (2006). Assessment for home care: Negotiating solutions for individual needs. *Journal of Aging Studies*, Vol N° 20, p. 367–380.

Orsburn J.D., Moran L., Musselwhite E. and Zenger J.H. (1990). Self-directed work teams: the new American challenge (*Burr Ridge, IL: Business One Irwin, 1990*).

Ouvrage collectif CREDES et IMAGE, 2001. L’évaluation des réseaux de soins. Enjeux et recommandations. *Questions d’économie et de santé*, Vol N° 37, p. 1-4.

Parasuraman A., Zeithaml V.A. and Berry L. L. (1988). SERVQUAL: a Multiple Item Scale for Measuring Customer Perceptions of Service Quality. *Journal of Retailing*, Vol N°64 (1), p. 12-43.

Pasin F. and Giroux H. (2005). Capacity planning and scheduling in services: a spreadsheet application. *Production and Operations Management Journal*, Vol N°3, p. 1-13.

Penneys N.S. (2000). A comparison of hourly block appointments with sequential patient scheduling in a dermatology practice. *Journal of the American Academy of Dermatology*, Vol N°443, p. 809–813.

Pierskalla P.W. and Brailer D.J. (1994). Applications of Operations Research in Health Care Delivery. *Handbooks in OR and MS*, Vol N°16, p. 469-505.

Pine B. J. and Gilmore J. (1998). Welcome to the Experience Economy. *Harvard Business Review*, Vol N° 76 (4), p. 97-105.

Pinnoi A. and Wilhelm W.E. (1998). Assembly system design: a branch and cut approach. *Management Science*, Vol N° 44(1), p. 103-118.

Quinn J.B. (1992). Intelligent enterprise: a knowledge and service based paradigm for industry. *The Free Press, a Division of McMillan Inc., New York, NY*.

Raffy-Pihan N. (1997). L’hospitalisation à domicile: une alternative également adaptée aux personnes âgées. *Communication au colloque « SYSTED 97 » à Chicago*.

Ricca F. and Simeone (2008). Local search algorithms for political districting. *European Journal of Operational Research*, Vol N°189, p. 1409-1426.

Rizakow E., Rosenhead J. and Reddington K. (1991). AIDSPLAN: A decision support model for planning the provision of HIV/AIDS related services. *Interfaces*, Vol. N°21(3), p.117-129.

Rios-Mercado R.Z. and Fernandez E. (2009). A reactive GRASP for a commercial territory design problem with multiple balancing requirements. *Computers and Operations research*, Vol N°36 (3), p. 755-776.

- Ronen D. (1983). Sales Territory Alignment for Sparse Accounts. *The international journal of Management Science*, Vol N°11, p. 501-505.
- Royston G. (2009). One hundred years of Operational Research in Health-UK 1948-2048. *Journal of Operational Research Society*, Vol N° 60, p. 169-179.
- Schneider D. (1981). A methodology for the analysis of compatibility of services and financial impact of closure of obstetrics services. *Medical Care*, Vol N°19, p. 393-409.
- Schoepfle O.B. and Church R.L. (1989). A Fast, Network-Based, Hybrid Heuristic for the Assignment of Students to Schools. *The Journal of the Operational Research Society*, Vol N°40, p. 1029-1040.
- Schonberger R. (1986). World Class Manufacturing: The Lessons of Simplicity Applied. *Free Press, New York*.
- Segal M. and Weinberger D.B. (1977). Turfing. *Operations Research*, Vol N°25, p. 367-386.
- Sentilhes-Monkam A. (2006), L'hospitalisation à domicile et la prise en charge de la fin de vie : le point de vue des patients et de leurs proches, *Santé publique*, Vol N° 18, p. 443-457.
- Shortell S.M. (1976). Continuity of Medical Care: conceptualization and Measurement. *Medical Care*, Vol N°14 (5), p. 377-391.
- Shortell S.M., Morrison E. and Robbins S. (1985). Strategy making in health care organizations: A framework and agenda for research. *Medical Care Review*, Vol N°42 (2), p. 219-266.
- Silvestro R., Fitzgerald L. and Jonhston R. (1992). Towards a classification of service processes. *International Journal of Service and Industry Management*, Vol N°3, p. 62-75.
- Schmenner R.W. (1986). How can service businesses survive and prosper? *Sloan Management Review*, Vol N° 27(3), p. 21-32.
- Tarricone R. and Tsouros A.D. (2008). The solid facts: Home Care in Europe. *World Health Organization*.
- Tavares-Pereira F.M. (2007). Partition multicritère d'un territoire en zones : modèles, algorithmes et applications. *Thèse de doctorat, Université de Coimbra, faculté d'économie et l'université Paris-Dauphine*.
- Tavares-Pereira F.M., Figeira J.R, Mousseau V. and Roy B. (2009). Comparing two territory partitions in districting problems Indices and practical issues. *Socio-economic Planning sciences*, Vol N° 43, p. 72-88.
- Taylor W. (2007). A comparison of univariate time series methods for forecasting intraday arrivals at a call center. *Management Science*, Vol N°54, p. 253-265.

- Thiétart R.A. (1984). La stratégie d'entreprise: Formulation et mise en oeuvre. *Mc Graw-Hill Editions*.
- Thomas D.R.E. (1978). Strategy is different in service businesses. *Harvard Business Review*, Vol N° 56, p. 158-165.
- Thomsen K. (2006). Optimization on home care. *Thesis Report, Informatics and Mathematical Modeling, Technical University of Denmark*.
- Trivedi V.M. (1980). A stochastic model for predicting discharges: applications for achieving occupancy goals in hospitals. *Socio-Economic. Planning Science*, Vol N°14, p. 209-215.
- Vargo S. L. and Lusch R.F. (2004). The four service marketing myths. Ramnants of agoods-based, manufacturing model. *Journal of Service Research*, Vol N°6 (4), p. 324-335.
- Vassilacopoulos G. (1985). A simulation model for bed allocation to hospital inpatient departments. *Simulation*, Vol N° 45, p. 233-241.
- Vergnenègre A., Decroisette C., Vincent F., Dalmay F., Melloni B., Bonnaud F. and Eichler B. (2006). Analyse économique de l'administration d'une chimiothérapie en hospitalisation à domicile (HAD) comparée à l'hospitalisation de jour dans les cancers bronchopulmonaires non à petites cellules de stade IV. *Revue des Maladies Respiratoires*, Vol N°23, p. 255-63.
- Vissers J. and Wijngaard J. (1980). The outpatient appointment system: Design of a simulation study. *European Journal of Operational Research*, Vol N°3, p. 459-463.
- Wemmerlöv U. (1989). Taxonomy for service processes and its implications for system design. *International Journal of Service Industry Management*, Vol N°1 (3), p. 20-40.
- Williams W.J., Covert R.P. and Steele J.D. (1967). Simulation modeling of a teaching hospital clinic. *Hospitals*, Vol N°41, p. 71-75.
- Williams A.M. (2006). Restructuring home care in the 1990s: Geographical differentiation in Ontario, Canada. *Health and Place*, Vol N°12, p. 222-238.
- Wilson T. (1981). Implementation of computer simulation projects in Health Care. *The Journal of the Operational Research Society*, Vol N°32 (9), p. 825-832.
- Wilson J.R., Smith J.S, Dahle K.L and Ingersoll G.L. (1999). Impact of HHC on health care costs and frequency in patients with heart failure. *The American Journal of Cardiology*, Vol N° 83, p. 615-617.
- Woodward C.A., Abelson J., Tedfort S. and Hutchison B. (2004). What is important to continuity in home care? Perspectives of key stakeholders. *Social Science and Medicine*, Vol N°58, p.177-192.
- Zarifian P. (2001). Le modèle de la compétence. Trajectoire historique, enjeux actuels et propositions. *Editions Liaisons*.



Zeghal F.M. and Minoux M (2006). Modeling and solving a crew assignment problem in air transportation. *European Journal of Operational Research*, Vol. N° 175, p. 187-209.

Zeithaml V. and Bitner M.J. (2002). *Services Marketing: Integrating Customer Focus across the Firm*, 2nd ed., New York: McGraw-Hill/Irwin.

Zerbib E. (1990). Les alternatives à l'hospitalisation : intérêts et perspectives pour le pharmacien. *Thèse de doctorat en pharmacie : Université de Bordeaux II*.

Zoltners. A. and Sinha P. (1983). Sales territory alignment: a preview and model. *Management Science*, Vol N°29 (11), p. 1237-1256.