



HAL
open science

Matière diffuse et molécules interstellaires

José Cernicharo

► **To cite this version:**

José Cernicharo. Matière diffuse et molécules interstellaires. Astrophysique stellaire et solaire [astro-ph.SR]. Université Paris-Diderot - Paris VII, 1988. Français. NNT: . tel-00725658

HAL Id: tel-00725658

<https://theses.hal.science/tel-00725658v1>

Submitted on 27 Aug 2012

HAL is a multi-disciplinary open access archive for the deposit and dissemination of scientific research documents, whether they are published or not. The documents may come from teaching and research institutions in France or abroad, or from public or private research centers.

L'archive ouverte pluridisciplinaire **HAL**, est destinée au dépôt et à la diffusion de documents scientifiques de niveau recherche, publiés ou non, émanant des établissements d'enseignement et de recherche français ou étrangers, des laboratoires publics ou privés.

THESE

PRESENTEE A

L'UNIVERSITE DE PARIS VII

POUR L'OBTENTION DU GRADE DE

DOCTEUR d'ETAT ès SCIENCES

PAR

José CERNICHARO

MATIERE DIFFUSE ET MOLECULES
INTERSTELLAIRES

Soutenu le 24 Juin 1988

Devant la commission d'examen :

Mr P. LENA	<i>Président</i>
Mr M. GUELIN	<i>Directeur</i>
Mr A. BAUDRY	<i>Rapporteur</i>
Mr R. LUCAS	<i>Rapporteur</i>
Mr D. DOWNES	<i>Examineur</i>
Mr P. ENCRENAZ	<i>Examineur</i>
Mr J. GOMEZ-GONZALEZ	<i>Examineur</i>
Mr J. HEYVAERTS	<i>Examineur</i>
Mr A. OMONT	<i>Examineur</i>

THESE

PRESENTEE A

L'UNIVERSITE DE PARIS VII

POUR L'OBTENTION DU GRADE DE

DOCTEUR d'ETAT ès SCIENCES

PAR

José CERNICHARO

MATIERE DIFFUSE ET MOLECULES

INTERSTELLAIRES

Soutenu le 24 Juin 1988

Devant la commission d'examen :

Mr P. LENA	<i>Président</i>
Mr M. GUELIN	<i>Directeur</i>
Mr A. BAUDRY	<i>Rapporteur</i>
Mr R. LUCAS	<i>Rapporteur</i>
Mr D. DOWNES	<i>Examineur</i>
Mr P. ENCRENAZ	<i>Examineur</i>
Mr J. GOMEZ-GONZALEZ	<i>Examineur</i>
Mr J. HEYVAERTS	<i>Examineur</i>
Mr A. OMONT	<i>Examineur</i>

.....

*Escribir por ejemplo : "La noche está estrellada,
y tiritan, azules, los astros a lo lejos".*

El viento de la noche gira en el cielo y canta

.....

Pablo Neruda

A Maria Angeles

REMERCIEMENTS

Je tiens à exprimer ici ma sincère reconnaissance à Michel Guélin qui a dirigé une partie importante des travaux de cette thèse et dont le support constant, la disponibilité et l'aide morale m'ont été très précieux. C'est en discutant avec lui, au jour le jour, que je me suis initié et formé aux différents aspects de l'astrophysique moléculaire et de la radioastronomie millimétrique.

Je voudrais remercier Jesús Gómez-González pour son soutien et son amitié inconditionnels.

Je voudrais exprimer mes plus vifs remerciements à toutes les personnes qui ont apporté leur contribution au travail présenté ici. En particulier je voudrais remercier R. Bachiller, G. Duvert, A. Castets, et E. Nercessian. Sans eux ce travail n'aurait pas pu être fini dans une période de temps raisonnable.

Merci aussi à tous les membres de l'Observatoire de Bordeaux qui m'ont accueilli chaleureusement pendant mon séjour à POM I. Sans l'aide technique constante des ingénieurs du groupe de radioastronomie millimétrique de Bordeaux une partie importante de cette thèse n'aurait pas pu être réalisée. Je tiens à remercier tout particulièrement A. Baudry, D. Despois et M. Pérault qui ont fait de la période de démarrage de POM I une phase importante d'apprentissage instrumental et le meilleur souvenir de mon époque Bordelaise.

Je tiens à remercier A. Omont de m'avoir accueilli dans son groupe d'Astrophysique de Grenoble et de son appui scientifique et moral. Je voudrais également exprimer ma reconnaissance à Pierre Encrenaz pour son soutien.

Je voudrais remercier tous les membres du groupe d'Astrophysique pour l'excellente ambiance de travail qu'ils ont su créer, et tout particulièrement Liliane de Giacomo pour sa gentillesse et sa disponibilité.

Je voudrais enfin remercier les membres du jury et les rapporteurs qui ont accepté de juger ce travail.

AVANT PROPOS

Cette thèse présente l'essentiel du travail que j'ai effectué au département de Radioastronomie millimétrique de l'Observatoire de Meudon, au groupe de Radioastronomie millimétrique de l'Observatoire de Bordeaux, au groupe d'Astrophysique de l'Université de Grenoble, et à l'Institut de Radioastronomie millimétrique (IRAM).

J'ai commencé ce travail à mon arrivée à Meudon en 1979 où je me suis initié à la Radioastronomie à l'aide d'un microscope. Bien que cela puisse paraître étonnant, une partie non négligeable des résultats exposés dans cette thèse, prend ses sources dans les comptages d'étoiles que j'ai effectués avec un instrument aussi inattendu.

Ces comptages d'étoiles ont été les premières données observationnelles pour un projet d'étude des nuages sombres proches du soleil. La région choisie pour cet étude fut le complexe de nuages sombres du TAUREAU-COCHER-PERSEE. Les études existantes sur cette région étaient restreintes à quelques condensations de forte densité (TMC1, TMC2, NGC1333, B5, ...) et les propriétés physiques du gaz dans lequel ces condensations sont enfouies étaient assez mal connues. Il était évident qu'une étude systématique de la région faisant appel aux techniques radioastronomiques, infrarouges, et optiques, pouvait nous fournir des renseignements importants sur la structure des nuages sombres et sur les causes des différences de composition chimique trouvées tout au long du complexe dans les fragments de forte densité.

Les observations radio à grande échelle ont été effectuées principalement avec le radiotélescope de 2.5-m de l'Observatoire de Bordeaux. Compte tenu de l'étendue angulaire du complexe du

Taureau-Cocher-Persée (plus de 400 degrés carrés), ce radiotélescope était particulièrement bien adapté à son étude. La proximité du complexe (≈ 140 pc) permet d'obtenir une résolution spatiale suffisante avec une résolution angulaire modérée ($\approx 5'$ à 3 mm. de longueur d'onde). Nous avons pu ainsi cartographier plusieurs dizaines de degrés carrés du complexe, étudier la structure des nuages sombres, et déterminer l'abondance de ^{13}CO et C^{18}O . Des informations importantes sur les fragments les plus denses (taille typique ≈ 0.2 pc) ont été obtenus, mais leur structure à petite échelle n'a pas pu être déterminée précisément.

Il était nécessaire d'observer ces condensations avec une meilleure résolution angulaire si l'on voulait dériver leurs propriétés. J'ai donc utilisé différents radiotélescopes pour pouvoir étudier leur structure et déterminer leurs conditions physico-chimiques (42-m. de NRAO, 7-m. de Bell Labs., 5-m. du MWO, 20-m. d'Onsala, 14.7-m. du FCRAO, le 30-m. de l'IRAM et tout récemment POM II). Ces observations constituent un ensemble de données cohérent à partir duquel on peut tenter d'analyser la physico-chimie des nuages sombres. Le lecteur pourra lui même en juger en lisant la première partie de cette thèse.

La deuxième partie de ce travail est dédiée à l'étude des rapports isotopiques dans le milieu interstellaire et à la recherche de nouvelles molécules. Les données observationnelles ont été obtenues principalement pendant la période 1986-1987 avec le radiotélescope millimétrique de 30-m de l'IRAM. Le gain en sensibilité fourni par ce télescope nous a permis de détecter et d'identifier plusieurs nouvelles molécules (dont trois sont des radicaux) et de confirmer l'identification des deux premières molécules cycliques détectées dans le milieu interstellaire, SiC_2 et C_3H_2 (via la détection de $^{29}\text{SiCC}$, $^{30}\text{SiCC}$, Si^{13}CC , $^{13}\text{CC}_2\text{H}_2$, et de $\text{C}^{13}\text{CCH}_2$). Tout récemment nous avons découvert dans l'espace quatre molécules métalliques : ClNa , ClK , ClAl , et FAI .

L'essentiel des résultats sur ces deux thèmes a fait l'objet d'articles publiés dans des revues internationales. Je les ai fait précéder d'un bref résumé en français. Plutôt que de suivre un ordre chronologique j'ai classé ces articles par sujet.

La troisième, et dernière, partie de cette thèse traite des travaux instrumentaux que j'ai été amené à réaliser sur différents radiotélescopes. Ces travaux, auxquels j'ai consacré près du tiers de mon temps depuis le début de ma thèse, constituent une partie importante de celle-ci. De fin 1979 à fin 1981 j'ai participé, avec Didier Despois et Michel Pérault, sous la direction de A. Baudry, à la mise en route du radiotélescope de Bordeaux. Les travaux que j'ai effectués sur ce radiotélescope sont divers: détermination des corrections de pointage, détermination du diagramme de rayonnement, calibration des observations, programmes pour le dépouillement des données et pour le contrôle en temps réel du radiotélescope, etc. C'est pendant cette période que j'ai acquis la plupart de mon expérience et de mes connaissances sur les radiotélescopes.

En 1984 la plupart des articles sur le complexe du Taureau-Cocher-Persée étaient écrits et je me voyais sur le point de rédiger ma thèse. Mais, et il y a toujours un "mais" quand il s'agit de rédiger, il m'a fallu choisir entre rédiger et ... participer à l'aventure extraordinaire qu'était la mise en route du 30-m de l'IRAM. Je n'ai pas hésité longtemps et dès Septembre 1984 j'ai mis mon expérience Bordelaise au service du 30-m sous la direction de M. Guélin.

Finalement, pendant l'année 1986 et surtout pendant 1987 j'ai participé à la mise en route du radiotélescope POM II, ainsi qu'au démarrage de la première antenne de l'interféromètre de l'IRAM, sur le Plateau de Bure.

Je ne voudrais pas oublier mes tous premiers débuts instrumentaux avec le radiotélescope du Centro Astronómico de Yebes sous la direction de Jesús Gómez-González (période 1978-1979). Mon goût pour le pointage des radiotélescopes vient de cette époque.

Pour que cette thèse ne devienne pas interminable j'ai choisi pour cette troisième partie les thèmes susceptibles d'intéresser les radioastronomes débutants. Resteront ainsi dans l'oubli, sur des étagères poussiéreuses, les innombrables calculs théoriques de diagrammes de rayonnement, de rendement, etc.

PARTIE I

MATIERE DIFFUSE ET MOLECULES INTERSTELLAIRES:

CONTRIBUTION A L'ETUDE DES CONDITIONS PHYSICO-CHIMIQUES DES

NUAGES SOMBRES DE LA CONSTELLATION

TAUREAU-COCHER-PERSEE

I.01) INTRODUCTION.	15
I.02) CATALOGUE D'EXTINCTION VISUELLE DANS LE COMPLEXE TAUREAU-COCHER-PERSEE.	25
I.03) LE COMPLEXE DE NUAGES SOMBRES DU TAUREAU-COCHER-PERSEE. LE PROFIL DE DENSITE	51
I.04) OBSERVATIONS DE HCO ⁺ , H ¹³ CO ⁺ , ¹³ CO, et C ¹⁸ O DANS QUELQUES REGIONS DENSES DU TAUREAU.	63
I.05) L'ETAT PHYSIQUE ET CHIMIQUE DU NUAGE SOMBRE HCL2.	81
I.06) ETUDE DE TROIS REGIONS DE FORTE DENSITE SIMILAIRES A TMC1.	101
I.07) NOUVELLES SOURCES DE CYANOPOLYINES DANS LE TAUREAU.	113
I.08) ANOMALIES HYPERFINES DE HCN A GRANDE ECHELLE.	119
I.09) UN SURVEY MOLECULAIRE DE TROIS NUAGES SOMBRES DANS LE TAUREAU.	125
I.10) LA REGION AUTOUR DE TMC2. LE COMPLEXE L1529-L1506.	137
I.11) LA DISTRIBUTION DES MASSES DANS LE COMPLEXE DE NUAGES SOMBRES DU TAUREAU.	153

- I.12) POLARISATION DES TRANSITIONS MILLIMETRIQUES MOLECULAIRES
DANS LES NUAGES A FAIBLE GRADIENT DE VITESSE. 167
- I.13) OBSERVATIONS MOLECULAIRES DE B1 : UN GLOBULE DENSE
DANS PERSEE. 195
- I.14) CONDITIONS PHYSIQUES ET CHIMIQUES DANS LES GLOBULES
DE PERSEE A PARTIR DE NH₃ ET HC₃N. 205
- I.15) LA RELATION ENTRE L'EMISSION DU MONOXIDE DE CARBONE ET
L'EXTINCTION VISUELLE DANS LE COMPLEXE DE PERSEE. 217
- I.16) LA REGION AUTOUR DE o-PER. 227
- I.17) APPENDICE A :
UN NUAGE MOLECULAIRE DANS LA CONSTELLATION DU DRAGON :
UN NUAGE MOLECULAIRE DANS L'HALO GALACTIQUE ?. 239
- I.18) APPENDICE B :
OBSERVATIONS DE NH₃ DANS LA REGION DE HH1-2 249
- I.19) APPENDICE C :
OBSERVATIONS DE NEBULEUSES COMETAIRES.LE CAS DE R-MON. 255

PARTIE II

MATIERE DIFFUSE ET MOLECULES INTERSTELLAIRES :

DETERMINATION DES RAPPORTS ISOTOPIQUES DANS LE MILIEU

INTERSTELLAIRE.

DETECTION DE NOUVELLES MOLECULES.

II.01) INTRODUCTION	271
II.02) L'ABONDANCE ISOTOPIQUE DE L'OXYGENE INTERSTELLAIRE DETERMINE A PARTIR DES OBSERVATIONS DES RAIES A 18 cm DE LA MOLECULE OH.	299
II.03) DETECTION DE $HC^{17}O^+$ DANS SGRB2.	309
II.04) DETECTION DE $^{29}SiC_2$ ET DE $^{30}SiC_2$ DANS IRC+10216.	317
II.05) DETECTION DES ISOTOPES DE C_3H_2 DANS SGRB2.	323
II.06) RAPPORTS ISOTOPIQUES DU CARBONE, AZOTE, SOUFRE ET SILICIUM DANS L'ENVELOPPE CIRCUMSTELLAIRE DE L'ETOILE CARBONNE IRC+10216.	327
II.07) UN NOUVEAU RADICAL LIBRE DANS IRC+10216.	341
II.08) DETECTION DE C_5H DANS IRC+10216.	347
II.09) DETECTION DE C_5H DANS L'ETAT ELECTRONIQUE $^2\Pi_{3/2}$ DANS IRC+10216.	353
II.10) DETECTION DE LA STRUCTURE HYPERFINE DE C_5H .	359

II.11) DETECTION D'UN RADICAL LINEAIRE LOURD DANS IRC+10216 : LE RADICAL C ₆ H ?.	363
II.12) C ₆ H : ETUDE DE SA STRUCTURE FINE ET HYPERFINE.	369
II.13) DETECTION DU METHYLE ISOCYANURE DANS LE CENTRE GALACTIQUE.	375
II.14) NOUVEAUX DOUBLETS DANS IRC+10216: C ₄ H DANS UN ETAT VIBRATIONNEL EXCITE ?	379
II.15) DETECTION AU LABORATOIRE DES ETATS VIBRATIONNELS ¹ v ₇ ET ² v ₇ DE C ₄ H ET LEUR IDENTIFICATION ASTRONOMIQUE.	385
II.16) MOLECULES SOUFREES DANS IRC+10216.	393
II.17) METAUX DANS IRC+10216: DETECTION DE NaCl, AlCl, KCl, ET AlF.	399

PARTIE III

**CONTRIBUTION A LA MISE EN OPERATION DU RADIOTELESCOPE DE 2.5-m
DE L'OBSERVATOIRE DE BORDEAUX, DES RADIOTELESCOPES L'IRAM ET DU
RADIOTELESCOPE SUBMILLIMETRIQUE DE L'OBSERVATOIRE DE GRENOBLE**

III.01) AMELIORATION DU POINTAGE.	407
III.01.A) Introduction.	409
III.01.B) Description des erreurs.	412
III.01.C) Détermination de la came de pointage.	431
III.02) LA CALIBRATION DES OBSERVATIONS.	435
III.02.A) La calibration	437
III.02.A.1) Température de calibration.	438
III.02.A.2) Température de récepteur.	443
III.02.A.3) Température de système.	445
III.02.B) L'atmosphère. Détermination de l'opacité atmosphérique	446
II.03) DETERMINATION DE L'OPACITE ATMOSPHERIQUE A PARTIR D'UN MODELE D'ATMOSPHERE.	453
III.04) LE TELESCOPE MILLIMETRIQUE DE 2.5-M. DU PLATEAU DE BURE.	485

I.01) INTRODUCTION

FIGURE 1

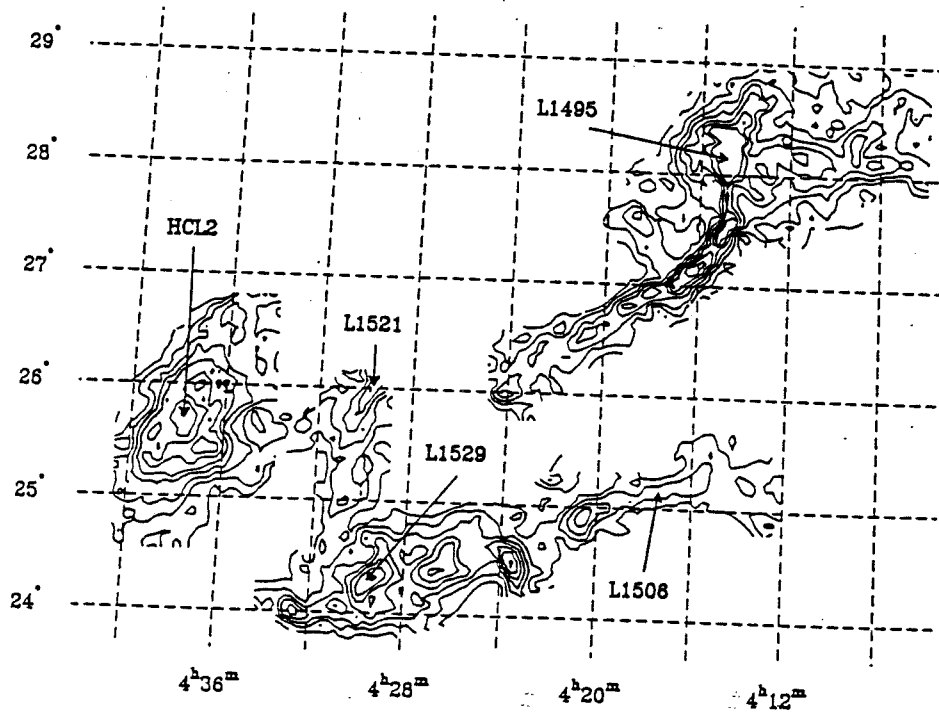
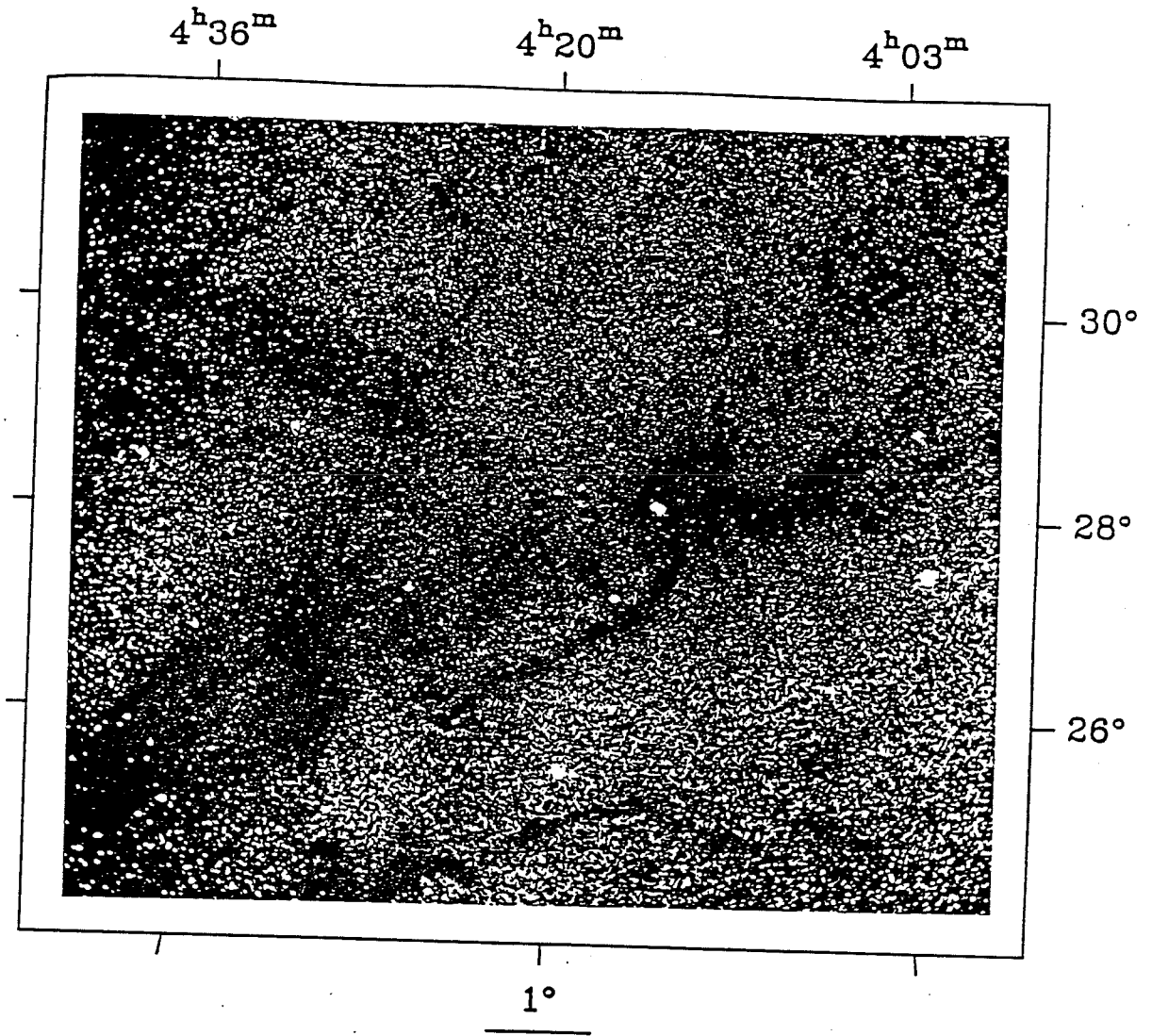

La figure d'en haut montre la région centrale de la constellation du Taureau photographiée en 1927 par Barnard (Carnegie Institution of Washington. Publication N. 247, I). La figure d'en bas montre l'intensité intégrée de ^{13}CO observée avec le radiotélescope POM I dans la même région (voir I.05, I.09, et I.10).

Dans la première partie de ce mémoire nous allons étudier le complexe de nuages sombres Taureau-Cocher-Persée (voir Fig. 1) en poursuivant un triple objectif : déterminer la distribution des isotopes du monoxyde de carbone, étudier la structure à grande et à petite échelle des nuages sombres, et évaluer quels traceurs moléculaires des propriétés physico-chimiques peuvent être utilisés pour les différentes régions de ces nuages. La Fig. 2 donne un aperçu des différents outils moléculaires, ou autres, que j'ai utilisé pour atteindre ces objectifs.

Le complexe Taureau-Cocher-Persée est une des plus grandes associations de gaz et de poussière du milieu interstellaire local et il montre une grande variété de propriétés physiques et chimiques. La région de Persée est physiquement liée à l'association d'étoiles OB PerOB2 et elle est caractérisée par deux régions de formation d'étoiles, IC348 et NGC1333, ayant des températures intermédiaires entre celles des nuages sombres et celles des nuages moléculaires géantes. Ces deux régions sont reliées entre elles par une chaîne de nuages sombres (Bachiller et Cernicharo, 1984, 1986; voir I.13, I.14). Les nuages du Taureau, bien qu'ils soient souvent considérés comme les prototypes des nuages sombres, présentent des particularités chimiques extraordinaires. La plupart des sources riches en longues molécules carbonées se trouvent dans cette région (Benson et Myers, 1983; Cernicharo et al. 1984, 1986, voir I.06 et I.07). C'est aussi dans ce complexe que se trouve TMC1, une source surprenante qui attire tout particulièrement les radioastronomes depuis que HC₃N y a été détectée (Morris et al., 1976). Des espèces aussi compliquées que HC₁₁N et C₆H y ont été détectées (Bell et

FIGURE 2

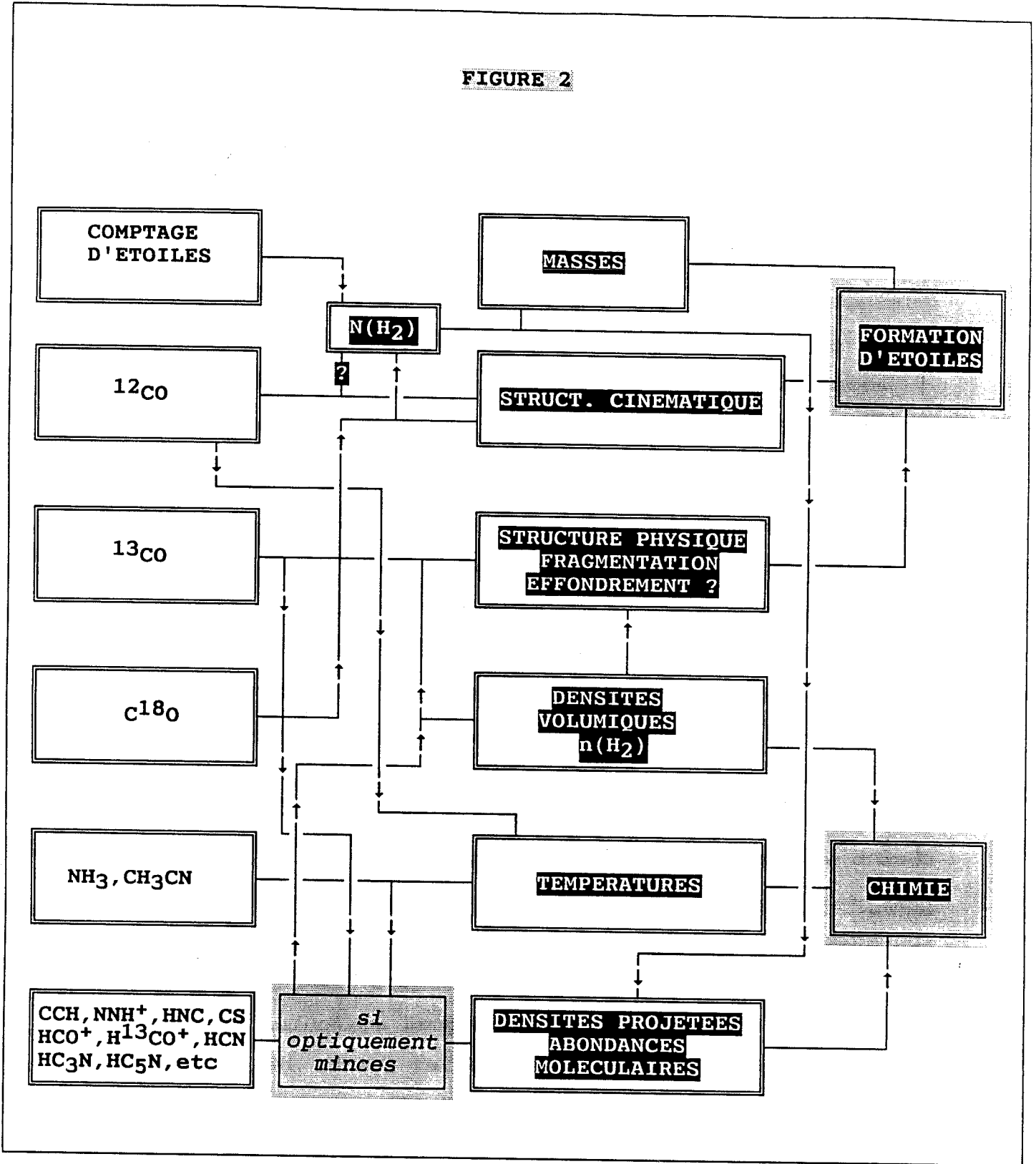

Matthews, 1985, Cernicharo et al. 1987; voir II.12). Cette source est aussi la plus riche en molécules deutérées (Guélin et al., 1982).

Avant mon travail, plusieurs cartographies à grande échelle de ce complexe avaient été effectuées en ^{12}CO et en OH afin d'en obtenir ses propriétés physiques (Baran, 1983; Wouterloot, 1981; voir aussi Ungerechts et Thaddeus, 1987). La résolution angulaire de ces études était toutefois très insuffisante; de plus l'émission de ^{12}CO et d'OH étant difficile à interpréter, les résultats obtenus étaient limités. Bien que quelques petits fragments denses de ce complexe aient été étudiés très en détail avec des résolutions angulaires de l'ordre de la minute d'arc, le complexe, dans son ensemble, restait fort mal connu.

La mise en opération du petit télescope de l'observatoire de Bordeaux nous a permis d'entreprendre une étude du complexe Taureau-Cocher-Persée avec une résolution angulaire bien adaptée à la taille des nuages (voir avant propos). Les espèces moléculaires choisies ont été les trois isotopes du monoxyde de carbone et des molécules à fort moment dipolaire comme HCO^+ , H^{13}CO^+ , HCN, et HC_3N . Le monoxyde de carbone, ayant un faible moment dipolaire, est facilement thermalisé par collisions et donne une bonne information sur la température cinétique (cas de ^{12}CO), et sur les densités projetées du gaz moléculaire (cas de ^{13}CO et C^{18}O). Les molécules à fort moment dipolaire, étant moins abondantes et plus difficiles à exciter par collisions, sont des traceurs des régions plus denses (si l'opacité des raies observées n'est pas trop élevée). La Fig. 2 montre comment ces molécules nous informent sur les différentes propriétés des nuages. Bien que dans cette Figure les comptages d'étoiles ne prennent

qu'une petite place, je voudrais insister sur la grande importance de cette méthode dans l'étude des nuages sombres locaux.

Bien que l'on dispose aujourd'hui de différents traceurs du gaz (CO, HI, FIR,...), les comptages d'étoiles (Bok, 1937, 1956, Bok and Cordwell, 1973; voir I.02 et I.03) restent la méthode la plus directe pour déterminer la densité projetée du gaz moléculaire, et donc la masse des nuages interstellaires proches. L'extinction visuelle, A_V , étant corrélée avec la densité projetée du gaz, $N(H+2H_2)$ (Bohlin et al., 1978), il est possible de relier l'émission moléculaire (par exemple $C^{18}O$) à A_V . En conséquence on peut déterminer les abondances fractionnelles de CO et de ses isotopes (Encrenaz et al., 1975; Dickman, 1976, 1978; voir I.05, I.09, I.10, I.15).

Les principaux résultats de cette première partie peuvent être résumés de la façon suivante (voir Figure 3) :

- * Dans les nuages proches la masse totale peut être obtenue à l'aide d'une plaque photographique et d'un microscope (voir I.02 et I.03).
- * $C^{18}O$ est le meilleur traceur de la densité projetée de l'hydrogène moléculaire pour les régions internes des nuages ($AV \geq 2$ mag). En particulier cette molécule est le seul traceur de la densité projetée du gaz dans les régions les plus obscures ($AV \geq 5$ mag.) (voir I.05, I.09, I.10, et I.15).

FIGURE 3

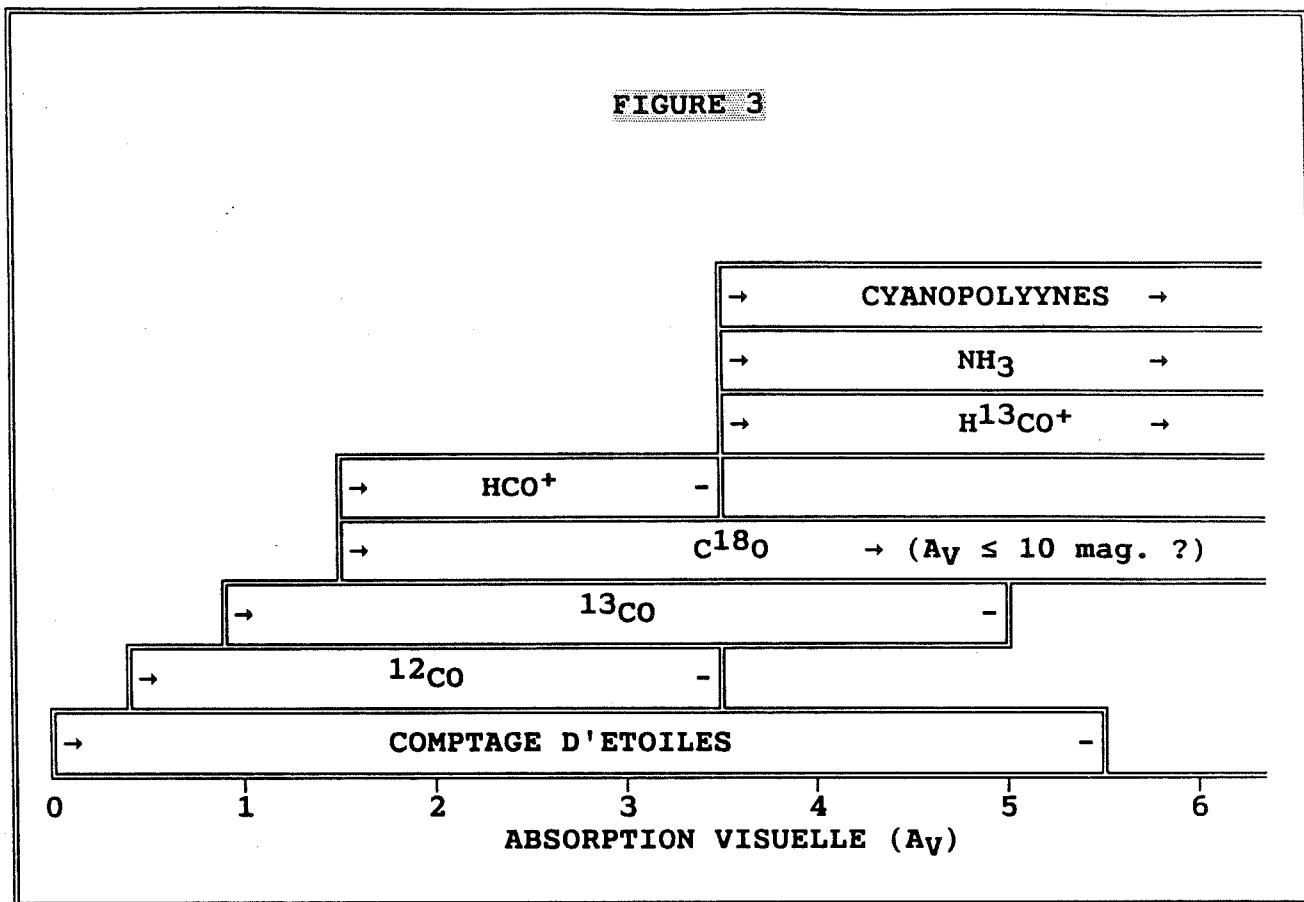

* ^{13}CO est un traceur intéressant pour les régions $1 \leq A_V \leq 5$ mag. Aux faibles A_V , l'abondance de cet isotope, et pourtant le rapport $N(^{13}\text{CO})/A_V$, sont affectés par le fractionnement isotopique. Ce fractionnement toutefois excède rarement un facteur 2; par ailleurs, les raies de ^{13}CO sont tellement plus faciles à détecter dans ces régions que celles de C^{18}O , que l'on préférera comme traceur de masse pour l'ensemble du nuage (voir I.05, I.09, I.10, et I.15).

* L'émission ^{12}CO est linéairement corrélée avec l'absorption visuelle pour $A_V \leq 3.5$ mag. Puisque la plupart de la masse dans un complexe de nuages sombres se

trouve dans un halo étendu, diffus, et de faible AV, les raies optiquement épaisses de ^{12}CO donnent, paradoxalement, une bonne estimation de la masse des complexes (voir I.05 et I.11).

- * Le rapport d'intensité intégré de ^{12}CO sur ^{13}CO , $w(^{12}\text{CO})/w(^{13}\text{CO})$, utilisé assez souvent pour déterminer la masse des nuages, donne nécessairement des valeurs erronées car, ce rapport n'est constant que pour $AV \geq 2-3$ mag. (voir I.05).
- * La structure en densité des nuages sombres peut être décrite par un modèle à trois composantes : halo, enveloppe, et coeurs ou régions denses. Le halo contient la plupart de la masse des nuages; sa densité est faible, qqs 10^2 cm^{-3} , et il peut être observé grâce à l'émission de ^{12}CO et par l'absorption visuelle. L'enveloppe correspond aux régions $1 \leq A_V \leq 5$ mag.; la densité se trouve entre qqs 10^2 et qqs 10^3 cm^{-3} , la température cinétique est $\approx 10\text{K}$. Le profil de densité dans l'enveloppe, déterminé à partir de comptages d'étoiles, suit une loi en $r^{-1.3}$. Finalement, les coeurs, ou régions denses, ont des densités $\approx 10^4-10^5 \text{ cm}^{-3}$ et ne représentent qu'une faible fraction de la masse totale du nuage (voir I.03, I.04 et I.05).
- * Les longues molécules carbonées sont détectées dans les nuages du Taureau pour $A_V \geq 3.5-4$ mag. Dans les nuages denses de Persée, bien que les conditions physiques soient similaires (voir I.13, et I.14), les cyanopolyynes sont beaucoup moins abondantes (voir I.06, I.07, et I.14).

- * Dans la région de Persée le rayonnement UV des étoiles OB de l'association PerOB2 chauffe les bords des nuages. Dans les nuages du Taureau cet effet paraît beaucoup moins important (voir I.16).

- * Dans les nuages sombres, où la largeur des raies est de l'ordre du km/s, tous les points des nuages sont connectés radiativement. Les photons émis par les molécules des régions denses (coeurs des nuages) sont absorbés dans l'enveloppe dès que l'opacité des raies est élevée. Si la désexcitation par collisions est peu importante dans l'enveloppe, alors ces photons sont réémis sur un volume plus grand. Cette diffusion du rayonnement produit une image erronée de l'étendu angulaire de l'émission moléculaire (voir I.05, I.11, et I.12).

REFERENCES

- Bachiller, R., Cernicharo, J.:1984, *Astron. Astrophys.*, 140, 414.
- Bachiller, R., Cernicharo, J.:1986, *Astron. Astrophys.*, 168, 262.
- Baran, G.P.:1983, Ph. D. Université de Columbia.
- Bell, M.B., Matthews, H.E.:1985, *Ap. J. Letters*, 291, L63).
- Benson, P.J., Myers, P.C.:1983, *Ap. J.*, 270, 589.
- Bohlin, R.C., Savage, B.D., Drake, J.F.:1978, *Ap. J.*, 224, 132.
- Bok, B.J.:1937, "The distribution of stars in Space", Univ. Chicago Press, Chicago.
- Bok, B.J.:1956, *Astron. J.*, 61,309.
- Bok, B.J., Cordwell, C.S.:1973, "Molecules in The Galactic Environment", eds. M.A. Gordon, L.E. Snyder, Wiley, New York, page 53.
- Cernicharo, J., Guélin, M., Askne, J.:1984, *Astron. Astrophys.* 138, 371 [1.06].
- Cernicharo, J., Bachiller, R., Duvert, G.:1986, *Astron. and Astrophys.*, 160, 181. [1.07].
- Cernicharo, J., Guélin, M., Menten, K.M., Walmsley, C.M.:1987, *Astron. Astrophys.*, 181, L1
- Dickman, R.L.:1976, Ph. D., Université de Columbia.
- Dickman, R.L.:1978, *Ap. J. Suppl.*, 37, 407.
- Encrenaz, P.J., Falgarone, E., Lucas, R.:1975, *Astron. Astrophys.*, 44, 73.
- Guélin, M., Langer, W.D., Wilson, R.W.:1982, *Astron. Astrophys.*, 107, 107).
- Morris, M., Turner, B.E., Palmer, P., Zuckerman, B.:1976, *Ap. J.*, 205, 82).
- Ungerechts, H., Thaddeus, P.:1987, *Ap. J. Suppl.*, 63, 645.
- Wouterloot, J.G.A:1981, Ph. D., Université de Leiden.

**I.02) CATALOGUE D'EXTINCTION VISUELLE DANS LE COMPLEXE DE
NUAGES SOMBRES TAUREAU-COCHER-PERSEE**

I.02) CATALOGUE D'EXTINCTION VISUELLE DANS LE COMPLEXE DE
NUAGES SOMBRES TAUREAU-COCHER-PERSEE

Un catalogue d'extinction visuelle dans la région Taureau-Cocher-Persée a été compilé à partir de comptages d'étoiles avec une résolution angulaire de 2.5' sur les plaques du Palomar Observatory Sky Survey (POSS). Ce catalogue peut être utilisé pour la recherche de sources moléculaires et infrarouges, ainsi que pour la recherche d'objets protostellaires et de régions de forte densité. Mais le catalogue est surtout une source de données statistiques pour la fragmentation et les études des propriétés physiques des nuages sombres. La méthode des comptages d'étoiles est discutée et en particulier nous analysons les différentes sources d'erreur dans les valeurs déterminées pour A_V .

Astron. Astrophys. Suppl. Ser. 58, 327-350 (1984)

A catalogue of visual extinction in Taurus and Perseus

J. Cernicharo ⁽¹⁾ and R. Bachiller ⁽²⁾Groupe d'Astrophysique, CERMO, Université Scientifique et Médicale de Grenoble (*), B. P. 68,
38402 St Martin d'Hères Cedex, France*Received March 23, accepted May 23, 1984*

Summary. — A catalogue containing high angular resolution data on visual extinction in Taurus and Perseus has been compiled from star counts on the prints of the Palomar Observatory Sky Survey (POSS). This catalogue may serve as a finding list for infrared and radio molecular searches of protostellar objects and high density regions. It could be used as a statistical source of data for fragmentation and physical properties studies of dark clouds. The star counts procedure is discussed.

Key words : interstellar absorption and extinction — dark clouds — star formation.

1. Introduction.

The catalogue contains data for most of the dark clouds between $3^{\text{h}}30^{\text{m}} \leq \alpha \leq 5^{\text{h}}$ and $20^\circ \leq \delta \leq 35^\circ$ (see Table I). The data are presented in two forms. In the first we give tables of visual extinction for every counted cloud. In the second we give a catalogue of dark fragments for Taurus and Perseus. This catalogue contains information about the genealogical pattern of the cloudlets or fragments within the clouds, and could be used to study the degree of fragmentation in dark clouds and as a list of high visual extinction regions (see Cernicharo *et al.*, 1984, Paper I).

2. Star counts.

The general method to obtain the visual extinction from star counts in dark clouds involves the counting of stars with division into apparent magnitude intervals. A transparent rectilinear grid of squares is placed upon the plate (or the print) to be analyzed, and stars with apparent magnitude within a given interval are counted. This procedure also allows to estimate the distance of the cloud if the luminosity and stellar density functions are known. A detailed description of the whole procedure is given by Bok and Cordwell (1973).

Our counts were made on the red and blue negative prints of the Palomar Observatory Sky Survey (POSS). The statistical error expected with a count of N stars in a given region on the sky is \sqrt{N} (Bok, 1937). In order to avoid poor statistics, a large number of stars must be

counted. For this reason the general method of star counts might be only applicable for large regions of the clouds or when the number of stars per square degree and per interval of magnitude is sufficiently high. Another method consists in counting the stars to the limiting magnitude of the plate or print in each part of the cloud for which the value of A_V is to be obtained (Bok, 1956 ; Dickman, 1978). Even in this case the total number of stars per square degree in the red POSS print, and for the best reference fields of Taurus and Perseus is $\sim 1.5 \times 10^4$ and $\sim 10^4$ respectively. These low values for the total number of stars and the necessity to obtain comparable spatial resolution between visual extinction and radio-molecular observations favours the second method. The counts were made on the red negative prints of the Palomar Observatory Sky Survey (POSS). Reference fields and a few clouds were counted also in the blue prints to compare visual extinctions derived from two colors counts (see Sect. 2.1). The resolution of the star counts, i.e. the size of the squares in the rectilinear grid, was 2.24 arcminutes. Some clouds were counted with a resolution of 2.5 arcminutes to have a direct comparison of the counts with Bordeaux radio observations. A microscope with a magnification of 10 or 30 was used to reach the fainter stars on the print.

Visual extinctions are generally referred to a dust free comparison field. This field must be close enough to the cloud to avoid any significant variation of the expected number of stars. These variations could be due to the change in the galactic position of the two fields or to their different distances to the centre of the plate (variation of the limiting magnitude across the plate (see Sect. 2.2). The choice of a good comparison field is then necessary to eliminate zero-points errors (see Sect. 2.3).

From counts at wavelength, λ , the extinction in a square of the rectilinear grid is given by :

$$A_\lambda = \log (N_\lambda^*/N_\lambda)/b_\lambda \quad (1)$$

⁽¹⁾ Observatoire de Meudon, 92190 Meudon, France.

⁽²⁾ On leave from Centro Astronómico de Yebes, Gualajara, Spain.

(*) E.R.A. CNRS, n° 961.

Send offprint requests to : J. Cernicharo.

where N_λ is the number of stars in the considered position of the cloud and N_λ^* is the number of stars for a similar area in the reference field. In the relation (1) we have assumed, following Dickman (1978), that the logarithm of the number of stars brighter than m_λ , N_λ , is a linear function of the magnitude m_λ ; the slope of this relation is defined as $b_\lambda = d \log(N_\lambda)/dm_\lambda$. The value of b_B (blue color) can be obtained from the Van Rhijn's tables (1929) of stellar surface density. These tables give the logarithm of the number of stars brighter than m_B in the « photographic » color (close to the blue color) as a function of the old galactic coordinates and of m_B with $m_B < 18$ magnitudes. In order to reduce counts made on blue plates or prints, and since the limiting magnitudes of the POSS are 21.1 and 20.0 for blue and red plates respectively (Minkowski and Abell, 1963), it is necessary to make a linear extrapolation from $m_B = 18$ mag to $m_B = 21$ mag. From the Van Rhijn's tables we obtain $b_B = 0.4$ for Taurus and $b_B = 0.34$ for Perseus. Red counts reduction is a more complicated problem due to the lack of stellar surface densities at such wavelength. Encrenaz *et al.* (1975) have used $b_B = b_R = 0.4$ in ρ -Oph to obtain the visual extinction from red counts. Dickman (1978), using counts in the blue and red colors, has shown that the approximation $b_R \sim b_B$ leads to at most 15-20 % errors in the derived values of red and infrared extinctions. We have adopted also the same approximation, i.e. $b_R \approx b_B$ in order to reduce our star counts in Taurus and Perseus (see Sect. 2.1).

Another method to obtain visual extinction from blue counts, without counting over a reference field, also involves the use of the Van Rhijn's tables. It consists in determining the photographic magnitude m_B , for which the logarithm of the number of stars brighter than m_B , from the tables, agrees with the observed value in each square of the rectilinear grid. If the limiting magnitude of the plate is m_B^* , then the photographic or blue extinction in each square may be given by $A_B = m_B^* - m_B$. The main problem with this method is the determination of m_B^* because in general, star counts are not necessarily complete to the extreme limit of the plate (Bok, 1956), and because this extreme limit is not uniform over the plate (see Sect. 2.1) Bok and Cordwell have argued that this procedure may be also applicable to red counts using the ratio of numbers of red to blue counts in the reference fields as a scaling factor to go from red to blue counts. In fact, due to the difference of extinction in the two colors, this scaling factor is only correct when the visual extinction is zero. The expected number of stars in the blue color for the same square where red counts are made is given by $N_B = N_R \cdot N_B^* \cdot N_R^{*-1} \times 10^{(-A_R \cdot b \cdot (f_{BR} - 1))}$, where f_{BR} is the transformation factor between blue and red extinction (Sect. 2.1). It seems clear that the number of stars in the blue color cannot be inferred from red counts when the visual (or red) extinction is unknown.

The treatment of the opaque areas in dark clouds has been discussed by Dickman (1978) and Rossano (1980). Dickman has argued that the only bias-free approach to give a lower limit to the visual extinction in the direction of the regions without stars is to assign one star to the total simply connected area of the cloud over which no stars are seen; this procedure assumes that the areas free of stars pertain to a single cloudlet and that the resolution of star counts has been chosen to have good statistics outside of

these regions. Rossano (1980) has analyzed, from a theoretical point of view, the errors in the star counts procedure, particularly the problem associated with the sampling of the counts. He concludes that an opaque cloud must fill 1/4 of a sampling element if it is to be detected and that half beam sampling is preferred to full beam sampling. We have chosen a full beam sampling with the necessary square size to resolve roughly the cloudlets. Let us consider a square degree of the sky with N uniformly distributed stars; if we require that at least one star must be present by mesh element then the size of the squares are given by $60/\sqrt{N}$ arcmin. However if the stars are uniformly distributed over the surface, then it is straightforward to show that the mean nearest neighbor distance between stars will be $60/\sqrt{3N}$ arcmin. In order to resolve the cloudlets, the size of our squares in the transparent grid was equal to the mean nearest neighbor distance between stars when the visual extinction is ~ 4.5 magnitudes. This extinction corresponds to the typical value of A_V at the edge of the cloudlets. For Taurus and Perseus this distance is ~ 2.5 . Counts with an angular resolution higher than 2.5 will add the area between the stars to the surface of the cloudlets and will give a wrong picture of the cloud.

2.1 THE REDUCTION TO VISUAL EXTINCTION. — The optical extinction derived from star counts in the blue or red prints of the POSS must be reduced to visual extinction, A_V , in order to determine column densities of molecular hydrogen. This reduction is straightforward if the interstellar extinction law is known in the direction where the star counts are made. Following Dickman (1978) the visual extinction is related to the extinction at the wavelength λ by $A_V = A_\lambda (R / (R + f(\lambda^{-1})))$, where $f(\lambda^{-1}) = E(\lambda-V)/E(B-V)$, with E denoting the usual color excess. The ratio of total to selective absorption, R , is given by $R = A_V/E(B-V)$. Using the normal interstellar reddening curve and $R = 3.2$, we obtain $A_V = 0.76 \cdot A_B$, $A_V = 1.21 \cdot A_R$ and $A_B = 1.59 \cdot A_R$.

In order to test if the above relations are correct for the Taurus clouds we counted the stars in the blue and in the red colors over a 0.8 square degrees region close to HCL2. The position of the grid on plates or prints is extremely critical to compare the optical extinction derived from counts in the two colors. We took special care in this comparison by making the counts in two steps. In the first, we used a microscope (with a magnification of 30), and a transparent rectilinear grid of 2.5 arcminutes (~ 2.2 mm on the prints) to record the position, x and y , of each star on an auxiliary paper grid of 2.5 cm \times 2.5 cm squares. Only a square of the transparent grid was seen in the field of view of the microscope. Each square of the paper grid was a large scale drawing of the same square over the print. The errors in the position of individual stars were < 0.2 arcminutes. In the second step we counted the stars on the second grid in the two colors using five arcminutes cells. We derived blue and red extinctions from (1) with $b_R = b_B = 0.4$. Figure 1 shows the red extinction in each cell against the blue extinction in the same cells. The solid line is the best fit to the data for $A_B \leq 3.7$ (for $A_B > 3.7$ the noise in the data increases due to the low number of stars). This line represents the relation $A_B = (1.6 \pm 0.11) \cdot A_R$, in good agreement with the relation given above and supports that the mean interstellar extinction law in

Taurus is normal for optical wavelengths, with $A_B/A_R = 1.6 \pm 0.1 \approx \lambda_R/\lambda_B \sim 1.56$ (for infrared wavelengths see Elias, 1978). The ratio A_B/A_R we find disagrees with the value of the same ratio $A_B/A_R = (\lambda_R/\lambda_B)^{1.3}$, found by Frerking *et al.* (1982) using a reduced number of automatic star counts in Taurus. For the Perseus dark clouds, the study of the stars of the Per OB2 association by Guetter (1977) shows that the interstellar extinction law at optical wavelengths is normal, with a value of R of 3.2 ± 0.2 derived from the variable extinction method and the color difference method.

2.2 THE LOSS IN SENSIVITY OF THE POSS PRINTS. — The POSS, with the faint limiting magnitudes (Minkowski and Abell, 1963; Lund and Dixon, 1973), are ideal to study the optical properties of dark clouds. The non-vignetted area of the plates, of a total square field of 6.6 degrees, is 5.4 degrees large in diameter and the computed loss in sensitivity due to vignetting is < 0.2 magnitude (Minkowski and Abell, 1963). For blue and red prints a visual inspection shows a strong decrease in the number of stars at its extreme corners. Several interesting dark clouds, HCL2, B5, L134, L134N, etc., are placed at the corners of the prints and star counts on them can be contaminated by systematic effects. We have made star counts in the blue and red colors on two prints (which were expected to be free of nebulae) to evaluate quantitatively the loss of sensitivity with the distance to their centers. The cell dimensions were $9' \times 9'$. The cells were placed in the directions East, Northeast and Southeast of the prints. On red prints, the number of stars by cell was $\approx 300-400$ around the center and $\approx 150-200$ at the corners. A total of 70 cells were counted. The loss in sensitivity of the blue and red prints is shown in figure 2 as a function of the distance to the center of the prints. The values of the loss, A_{BR} , were obtained from equation (1) using the center of the prints as reference fields. The value of b_B was derived from Van Rhijn's tables (1929) for the two prints and $b_R \approx b_B$ was assumed. The change in the number of stars with the galactic position (derived from Van Rhijn's tables) was taken in account to eliminate the systematic variations in the number of stars from cell to cell. No difference was found between the loss in sensitivity in the blue and red colors down to the noise limit. For a distance of 17 cm the loss in sensitivity is $\approx 0.2-0.3$ magnitude for blue and red prints, in excellent agreement with the value given by Minkowski and Abell. For distances > 17 cm the loss in sensitivity may be as large as 0.6 magnitudes; consequently a correction for the visual extinction determined by star counts is then necessary. The loss in sensitivity may be well represented by the function

$$A_{B,R} = d^2 \times 10^{-3} \text{ mag} \quad (2)$$

where d is the distance to the center of the print in centimeters.

2.3 THE EXTINCTION IN THE REFERENCE FIELD. — Since visual extinction derived from star counts is relative to a reference field, the true visual extinction, A_V^* , is given by $A_V^* = A_V + A_V^\circ$ where A_V° is the extinction in the reference field and A_V is the extinction in the cloud. The value of A_V° is necessary to compare correctly molecular emission with visual extinction. From the early work in Taurus and Perseus by Mc Cuskey (1938, 1939, 1941) and from the study of the dark matter distribution in Perseus

by Heeschen (1951) and Lynds (1969), it seems clear that it is impossible to find any reference field (close to the clouds) free of extinction. From the figure 3 of Mc Cuskey's paper (1938) and from the figure 1 of Heeschen's paper it is obvious that most of the reference field in Taurus and Perseus will be contaminated by more than 0.5 magnitudes of visual extinction. The regions given by Mc Cuskey as unobscured are, in general, too far from the dark clouds to be used as reference fields.

The obscuration by dust of most of the whole region of the Taurus and Perseus complexes may also be seen from Van Rhijn's tables. From these tables we made Wolf diagrams for the total complex using as reference field the Van Rhijn's counts for the same galactic longitude but for positive latitude. In figure 3 we show these Wolf diagrams for $130^\circ \leq l^I \leq 150^\circ$ and $10^\circ \leq |b^I| \leq 20^\circ$. It is evident from this figure that dust is present over all the region and that the amount of photographic extinction is at least ≈ 1.0 magnitude. Van Rhijn's counts were made in « areas free of extinction »; for areas close to the opaque clouds the extinction should be > 1.0 magnitude. This problem was analyzed from star counts by Bok (1956) using two fields at $l^I = 135^\circ, 137^\circ$ and $b^I = -13^\circ, -16^\circ$ and as reference fields the region of the sky at the same l^I and $b^I = +13^\circ, +16^\circ$. He derived a photographic extinction in the reference fields of 1.7 and 2.0 magnitudes. From star counts is not possible to determine if the extinction in the reference field is associated to the complex or to matter behind it. We have used the published stellar spectrophotometric data close to our reference field in the central part of Taurus to determine the amount of visual extinction and the distance of the obscuring matter. In table II we give the stars with optical data from the catalogues of Jaschek *et al.* (1964), Blanco *et al.* (1968), Kennedy and Buscombe (1974) and Buscombe (1977, 1980, 1981). Absolute magnitudes and intrinsic color excess were taken from Johnson (1966) and from Allen (1973). From this table we obtain an average visual extinction in the reference field of 1.1 ± 0.5 magnitudes and an upper limit to the distance of the dust of 200 pc. This value for the extinction in our reference field agrees with the ones derived by Bok for his two fields. The value of distance for the obscuring dust enables us to associate it to the clouds of the complex.

Finally, the adopted values for A_V° were 0.5 magnitudes of visual extinction for Perseus and most of the Taurus's clouds and 1.0 magnitude of visual extinction in the central part of the Taurus complex (HCL2, L1529, L1536, L1506).

3. Tables of visual extinction.

In tables III to XVI we give the values of the visual extinction in the counted clouds of the Taurus and Perseus complexes. Additional counts for two clouds out of Taurus-Perseus, L134N and L134, are given in tables XVII, XVIII and XIX. The results are presented in a double entry table form. The visual extinction is corrected for the extinction in the comparison fields. Every element I, J of the matrixes corresponds to a square of the rectilinear grid used for the counts and gives the value of the visual extinction in units of 0.1 magnitude. Visual extinctions larger than 6.5 magnitudes for Taurus and larger than 6 magnitudes for Perseus should be regarded

as lower limits to the true visual extinction. The offsets for the point I, J in right ascension and declination from the center position (I_0, J_0) are given in units of arcminutes by the expressions

$$\begin{aligned}\Delta\alpha &= -(I - I_0).RS \\ \Delta\delta &= -(J - J_0).RS\end{aligned}$$

where RS is the resolution used in the counts (2.24 or 2.5 arcminutes). The coordinates α and δ of the center of the counts and the wavelength and the angular resolution used are given in table I for each cloud. In tables III to XIX the center position is indicated by a square or a cross. The counts for Perseus fill the total region of this complex and were made around six separated center positions (B 5, IC 348, B 3, B 1, NGC 1333 and L 1448). For Taurus we used one center per cloud and the counts were restricted to 1° - 2° around it. In the notes of table I we give the position of dark clouds, T-Tauri stars, Herbig-Haro objects, and reflection nebulae within the counted regions.

4. The catalogue.

The catalogue (Table XX) contains data about the centers of gravity, masses, radii, areas, and genealogical patterns of the clouds. The adopted classification is in increasing right ascension. For each cloud, the surface $A_V = A_V(\alpha, \delta)$ was cut at different levels of constant visual extinction (every 0.5 magnitudes). In each constant A_V plane, an automatic routine has counted the number of well differentiated objects and compared the external contour of the new fragments with the last contour of the previously defined ones. The catalogue lists the properties of each

cloud at two levels of A_V : the first (lowest) A_V at which it becomes an individual entity, and the last before it splits and gives birth to fragments (or the higher A_V contour if the object remains unfragmented). For each object the catalogue gives the number of its father fragment.

DESCRIPTION OF THE CATALOGUE (Table XX).

Col. (1)	: Number of the fragment.
Col. (2)	: Values of the first and last contours of visual extinction of the fragment (see text).
Col. (3) and Col. (4)	: α (1950) and δ (1950) corresponding to the center of gravity of the region within the minimal and maximal A_V contours.
Col. (5) and Col. (6)	: I^{II} and b^{II} of the same points.
Col. (7)	: Number of the father fragment (see text).
Col. (8)	: Mass within the minimal and maximal A_V contours (in solar masses). The total mass of the fragment corresponds to the mass within the lowest A_V contour.
Col. (9)	: Surface, in square degrees, of the regions within the minimal and maximal A_V contours.
Col. (10)	: Radius, in parsecs, of the same regions (calculated from $R = \sqrt{S/\pi}$). The adopted distances for Taurus and Perseus are 140 pc and 200 pc respectively (see Paper I).

References

- ALLEN, C. W. : 1973, *Astrophysical Quantities* (Athlone, London).
 BERGH, S. Van den : 1966, *Astron. J.* **71**, 990.
 BERNES, C. : 1976, *Astron. Astrophys. Suppl. Ser.* **29**, 65.
 BLANCO, V. M., DOUGLAS, G. G. and FITZGERALD, M. P. : 1968, *Publ. U. S. Naval Obs.*, Volume XXI.
 BOK, B. J. : 1937, *The distribution of Stars in Space* (Univ. Chicago Press).
 BOK, B. J. : 1956, *Astron. J.* **61**, 309.
 BOK, B. J. and CORDWELL, C. S. : 1973, in *Molecules in the Galactic Environment*, ed. by M. A. Gordon and L. E. Snyder (Wiley, New York), p. 53.
 BUSCOMBE, W. : 1977, *MK Spectral classification* (Evaston).
 BUSCOMBE, W. : 1980, *MK Spectral classification* (Evaston).
 BUSCOMBE, W. : 1981, *MK Spectral classification* (Evaston).
 CERNICHARO, J., BACHILLER, R., DUVERT, G. : 1984, in preparation, Paper I.
 COHEN, M., KUHI, L. V. : 1979, *Astrophys. J. Suppl. Ser.* **41**, 743.
 DICKMAN, R. L. : 1978, *Astron. J.* **83**, 363.
 ELIAS, J. H. : 1978, *Astrophys. J.* **224**, 857.
 ENCRENAZ, P. J., FALGARONE, E. and LUCAS, R. : 1975, *Astron. Astrophys.* **44**, 73.
 FRERKING, M. A., LANGER, W. A., and WILSON, R. W. : 1982, *Astrophys. J.* **262**, 590.
 GUETTER, H. H. : 1977, *Astron. J.* **82**, 598.
 GYULBUDAGHIAN, A. L., GLUSHKOV, Y. I. and DENISYUK, E. K. : 1978, *Astrophys. J. Lett.* **224**, L137.
 HASCHICK, A. D. and MORAN, J. M., RODRIGUEZ, L. F. and HO, P. T. P. : 1983, *Astrophys. J.* **265**, 281.
 HASCHICK, A. D., MORAN, J. M., RODRIGUEZ, L. F., BURKE, B. F., GREENFIELD, P. and GARCIA-BARRETO, J. A. : 1980, *Astrophys. J.* **237**, 26 ; *Astrophys. J. Lett.* **224**, L137.
 HEESCHEN, D. S. : 1951, *Astrophys. J.* **114**, 132.
 HERBIG, G. H. : 1954, *Publ. Astron. Soc. Pac.* **66**, 19.
 HERBIG, G. H. : 1974, *Lick Obs. Bull.*, No. 658.
 HERBIG, G. H., RAO, N. K. : 1972, *Astrophys. J.* **174**, 401.
 JASCHEK, C., CONDE, H., DE SIERRA, A. C. : 1964, *Catalogue of stellar spectra classified in the MK System* (Observatorio Astronómico de la Universidad Nacional de la Plata).

- JOHNSON, H. L. : 1966, *Ann. Rev. Astron. Astrophys.* **4**, 193.
JONES, B. F., HERBIG, G. H. : 1979, *Astron. J.* **84**, 1872.
KENNEDY, P. M., and BUSCOMBE, W. : 1974, *MK Spectral Classification* (Evaston).
KHAVTASSI, J. Sh. : 1955, *Bull. Abastumani Obs.*, No. **18**.
KHAVTASSI, J. Sh. : 1960, *Atlas of Galactic Dark nebulae*, (Abastumani Astrophysical Observatory).
LIU CAI-PIN, ZHANG CHUNG-SHENG, KIMURA, H. : 1980, *Acta Astron. Sinica* **21**, 354 ; 1981, *Chin. Astron. Astrophys.* **5**, 276.
LUND, J. M., DIXON, R. S. : 1973, *Publ. Astron. Soc. Pac.* **85**, 230.
LYNDS, B. T. : 1962, *Astrophys. J. Suppl. Ser.* **7**, 1.
LYNDS, B. T. : 1969, *Publ. Astron. Soc. Pac.* **81**, 496.
MC CUSKEY, S. W. : 1938, *Astrophys. J.* **88**, 209.
MC CUSKEY, S. W. : 1939, *Astrophys. J.* **89**, 568.
MC CUSKEY, S. W. : 1941, *Astrophys. J.* **94**, 468.
MINKOWSKI, R. L. and ABELL, G. O. : 1963, in *Basic Astronomical Data*, ed. by K. Aa. Strand (University of Chicago Press).
ROSSANO, G. S. : 1980, *Astron. J.* **85**, 1218.
STROM, S. E., STROM, K. M. and CARRASCO, L. : 1974, *Publ. Astron. Soc. Pac.* **86**, 798.
STROM, S. E., VRBA, F. J. and STROM, K. M. : 1976, *Astron. J.* **81**, 314.
STRUVE, O., STRAKA, W. C. : 1962, *Publ. Astron. Soc. Pac.* **74**, 474.
VAN RHIJN, P. J. : 1929, *Publ. Kapteyn Astron. Lab., Groningen*, No. **43**.

TABLE I.

NAME	ALPHA	DELTA	RS	C	I_0	J_0	No	NOTES
L 1489	4 1 42.0	26 12 12	2.50	R	6.5	10.5	3	a
L 1544	5 1 00.0	25 10 00	2.24	R	10.0	8.0	4	b
L 1517	4 52 00.0	30 29 00	2.50	R	9.5	13.5	5	c
L 1536	4 31 20.0	22 38 00	2.24	R	8.0	24.0	6	d
HCL2	4 38 38.0	25 35 45	2.24	R	7.0	31.0	7	e
L 1495	4 14 44.9	28 13 36	2.50	R	15.5	18.5	8	f
L 1506	4 17 00.0	25 10 00	2.24	R	33.0	8.0	9	g
L 1529	4 29 43.0	24 16 55	2.24	R	28.0	19.0	10	h
B 5	3 44 22.6	32 42 44	2.50	R	15.5	19.5	11	i
IC 348	3 40 50.7	31 52 27	2.50	R	15.5	21.5	12	j
B 3	3 36 8.1	31 52 27	2.50	R	9.5	19.5	13	k
B 1	3 30 39.8	31 2 27	2.50	R	21.5	23.5	14	l
NGC1333	3 25 56.0	31 10 12	2.50	R	15.5	23.5	15	m
L 1448	3 21 15.5	31 10 12	2.50	R	13.5	24.5	16	n
L 134N	15 51 30.0	-2 43 31	2.24	R	7.5	6.5	17	o
L 134N	2.24	B	7.5	6.5	18	o
L 134	15 50 50.0	-4 26 00	2.24	B	20.0	15.0	19	p

Description of table I.

- Col. (1) : The most usual name of the cloud or the name of the cloud closest to the reference position.
 Col. (2) and Col. (3) : $\alpha(1950)$ and $\delta(1950)$ of the center position (I_0, J_0), of the cloud.
 Col. (4) : Resolution of the counts in arcminutes.
 Col. (5) : Wavelength used for the counts (R red, B blue).
 Col. (6) and Col. (7) : Indexes of the reference point in the matrixes of data.
 Col. (8) : Number of table with the A_V data.

Notes to table I.

Notes a) to p) give the name and position of dark clouds, T-Tauri stars, Herbig-Haro objects and reflection nebulae in each mapped area. The positions of these objects ($\Delta\alpha, \Delta\delta$) relative to the reference points to table I, are given in arcminutes. Positions for dark clouds are taken from Lynds (1962) and Khavtassi (1955, 1960). T-Tauri positions are taken from Jones and Herbig (1979), Cohen and Kuhl (1979), Herbig and Rao (1972), Liu *et al.* (1980) (stars with $H\alpha$ emission denoted by LZK *n* in the notes), and Strom *et al.* (1974, 1976). The positions of H-H objects are taken from Herbig (1974) and Gyulbudaghian *et al.* (1978) — GGD in the notes. Reflection nebulae positions are taken from Struve and Straka (1962), van den Bergh (1966) and Bernes (1976).

a) Dark clouds :

L 1489 (0.0, 7.8), L 1491 (- 1.3, - 3.2).

b) Dark clouds :

L 1544 (0.0, 0.0).

c) Dark clouds :

L 1515 (- 25.8, 21.0), L 1517 (0.0, 1.0), L 1519 (6.5, 1.0).

T-Tauri stars :

SU Aur (10.3, 0.3), GM Aur (0.1, - 11.5).

The Ae star AB Aur is at the position (7.6, - 0.3).

Reflection Nebulae :

vdB/Bernes 76/DG 48/SS 37 (7.8, 29.3).

d) Dark clouds :

L 1536 (- 18.4, 22.0).

T-Tauri stars :

EY Tau (- 49.6, - 6.6), CI Tau (- 6.4, 6.3) EZ Tau (12.2, 15.2), FF Tau (14.0, 10.3), HO Tau (14.2, - 11.6).

Reflection Nebulae :

SS 21 (- 44.4, 39.9).

e) The central position corresponds to TMC 1.

Dark clouds :

L 1527 (- 35.5, 34.2), L 1528 (- 62.6, 4.2), L 1532 (- 22.1, 4.2), L 1534 (- 22.1, - 5.7), K 79 (- 21.1, 0.6).

T-Tauri stars :

GL Tau (- 58.3, - 39.1), HT Tau (- 51.8, 42.3), DO Tau (- 43.5, 29.2), HV Tau (- 42.0, 29.0), GN Tau (- 31.8, 3.4), H6-32 (- 8.5, 16.5), S 9557 (- 8.2, - 50.4), DP Tau (12.7, - 25.8), SVS 1099 (16.6, - 24.7), LkH α 332 (6.1, - 17.9), LkH α 332/G1 (6.0, - 18.0), LkH α 332/G2 (5.6, - 18.2).

Reflection Nebulae :

Bernes 77 (- 42.2, 29.3), IC 2087/Bernes 79/SS 31 (- 23.4, 4.2), SS 30 (- 49.2, 34.7), SS 33 (0.4, - 31.6).

f) *Dark clouds :*

L 1495 (3.3, - 44.6), K 55 (31.2, - 72.0).

T-Tauri stars :

FO Tau (- 40.0, - 8.6), CY Tau (- 3.8, - 0.1), V410 Tau (8.8, 6.4), DD Tau (8.9, - 4.4), CZ Tau (9.0, - 3.9), Elias 1 (10.9, - 1.6), FQ Tau (17.9, 8.8), BP Tau (18.3, 45.7), Hubble 4 (12.3, - 0.7), FR Tau (22.9, 6.6), Infrared source near DD Tau (11.1, - 2.3) — Cohen and Kuhl (1979) —, Star 1 (14.0, 0.4) — Cohen and Kuhl (1979).

Reflection Nebulae :

Bernes 72/DG 29 (11.0, - 5.6), SS 15 (27.2, - 0.9).

g) *Dark clouds :*

L 1501 (- 68.0, - 10.0), L 1506 (0.0, 0.0).

T-Tauri stars :

FV Tau (48.4, - 13.9), GT Tau (48.6, - 21.6), FT Tau (49.3, - 20.7).

h) The central position corresponds to TMC 2.

Dark clouds :

L 1524 (- 64.4, 13.1), L 1529 (- 9.8, 3.1), L 1531 (- 9.8, - 3.9), L 1533 (47.4, 32.1), L 1535 (38.2, - 28.9), K 66 (- 23.1, - 4.0), K 69 (- 9.1, 31.9), K 73 (45.4, 13.7).

T-Tauri stars :

ZZ Tau/B (- 33.7, 16.1), FX Tau (- 30.8, 3.4), ZZ Tau/R (- 25.8, 19.0), LkH α 331 (- 18.4, - 12.4), GX Tau (- 17.0, 33.7), HK Tau (- 12.3, 1.0), HK Tau/G1 (0.8, - 2.6), HK Tau/G2 (- 8.6, - 1.0), Haro 6-16 (- 3.5, - 7.8), GZ Tau (- 8.2, 32.2), GY Tau (- 8.1, 34.7), HI Tau (- 4.9, 36.6), FY Tau H 6-17 (- 3.2, - 3.3), FY Tau H 6-18 (- 2.9, - 3.2), SVS 1849 (9.0, - 23.7), AA Tau (29.7, 5.8), DN Tau (37.1, - 8.0), FG Tau (47.0, - 20.1), HD 283759 (55.7, - 10.0), GL Tau (62.9, 39.8), GH Tau (5.1, - 13.3), GI Tau (11.4, - 1.6), GK Tau (11.5, - 1.8), Star 3 (40.8, - 11.3) — Cohen and Kuhl (1979).

Reflection Nebulae :

Bernes 78/DG 37 (- 5.7, - 0.9), Bernes 80/DG 38 (- 3.0, - 2.9), Bernes 81/DG 39 (12.1, - 2.9), Bernes 82 (39.5, - 12.9), SS 24 (- 2.5, 1.9), SS 25 (0.2, - 1.1), SS 26 (9.8, 0.8), SS 28 (39.9, 0.7).

i) *Dark clouds :*

L 1471 (5.3, 2.3).

T-Tauri stars :

LkH α 98 (- 32.8, - 42.9), LkH α 329 (- 24.2, - 26.1), LkH α 330 (- 21.8, - 27.9).

j) *Dark clouds :*

L 1470 (- 10.8, - 12.5), L 1472 (- 36.6, - 52.4), K 41 (16.4, 11.4).

T-Tauri stars :

LkH α 86 (- 3.0, 6.4), LkH α 87 (- 0.1, 15.6), LkH α 88 (0.0, 9.6), LkH α 89 (0.0, 12.5), LkH α 90 (4.8, 8.4), LkH α 91 (4.9, 10.1), LkH α 92 (5.8, 2.6), LkH α 93 (6.5, 8.8), LkH α 94 (7.7, 5.7), LkH α 95 (8.2, 5.9), LkH α 97 (9.7, 2.2). (See also Herbig, 1954). Infrared Source from Strom *et al.* (1974), IC348/IR (0.1, 0.0).

Reflection Nebulae :

IC 348/vdB 19/Bernes 67/DG 23 (7.1, 7.6), Bernes 66/DG 24 (9.6, 17.6).

k) *Dark clouds :*

L 1468 (11.1, - 37.4), L 1472 (24.0, - 52.4).

l) *T-Tauri stars :*

LZK 19 (- 33.2, - 23.0), LZK 20 (- 31.5, - 23.0), LZK 21 (- 15.3, - 11.7), LkH α 327 (- 3.2, - 1.6), LkH α 328 (3.4, 2.1).

m) *Dark clouds :*

L 1450 (7.3, - 0.2), L 1452 (- 12.1, - 40.2).

T-Tauri stars :

LkH α 351 (- 3.3, - 3.9), LkH α 352 (- 2.3, - 2.2), LkH α 353 (- 0.4, 1.3), LkH α 270 (3.4, 2.3), LkH α 354 (3.6, 2.9), LkH α 271 (4.3, - 4.9), LZK 16 (9.1, - 14.5), LZK 15 (11.2, 0.4), LZK 17 (13.0, - 6.9), LZK 7 (- 17.0, - 59.7), LkH α 352 (- 2.1, - 66.5), LkH α 325 (- 1.9, - 36.4), LkH α 164 (22.3, - 47.7), LkH α 326 (25.1, - 47.5).

Stars around NGC 1333 from Table 14 of Cohen and Kuhl (1979) : Star 2 (- 15.1, - 69.4), Star 3 (- 3.3, - 2.0), Star 4 (- 3.1, - 1.8), Star 5 (- 2.0, - 18.3), Star 6 (- 1.3, - 48.6).

Herbig-Haro Objects :

HH 14B (- 2.4, - 19.4), HH 14C (- 2.6, - 19.7), HH 14D (- 2.4, - 19.1), HH 12G (- 0.6, 0.2), HH 12B (- 0.6, 0.0), HH12C (- 0.8, 0.1), HH 12D (- 0.8, - 0.3), HH 12E (- 0.5, - 0.4), HH 12F (- 0.5, - 0.7), HH 15 (- 0.5, - 12.5), HH 11 (0.6, - 4.6), HH 10 (0.8, - 4.7), HH 8 (1.0, - 4.9), HH 9 (1.0, - 4.6), HH 7D (1.4, - 5.0), HH 7B (1.4, - 5.0), HH 7C (1.3, - 5.1), HH 16 (1.5, - 11.3), HH 6F (2.4, - 1.8), HH 6B (2.4, - 1.7), HH 6C (2.2, - 1.9), HH 6D (2.1, - 2.0), HH 6E (2.3, - 1.8), HH 17 (4.0, - 1.9), HH 5 (4.0, - 7.6), HH 4 (4.8, - 0.5), HH 18A (5.4, - 12.8), HH 18B (5.3, - 13.2), GGD 2 (- 3.0, - 12.2), GGD 3 (- 1.7, - 16.2).

*NGC 1333 Water Masers (from Haschick *et al.* (1980)) :*

H₂O(A) (0.5, - 4.5), H₂O(B) (0.1, - 4.9), H₂O(C) (1.9, - 6.5).

*Radio Continuum Source (from Haschick *et al.* (1980)) :*

NGC 1333/VLA (0.1, - 4.9).

Reflection Nebulae :

vdB 16/Bernes 64/DG 16 (- 9.6, - 93.2), vdB 17/Bernes 56/DG 18 (2.1, 2.8), Bernes 55 (- 4.3, - 3.2), Bernes 63 (22.9, - 48.2).

n) Dark clouds :

L 1448 (22.5, - 40.2), L 1451 (22.6, - 70.2), L 1452 (48.4, - 40.2).

T-Tauri stars :

LZK 1 (- 30.0, - 29.0), LZK 2 (15.3, - 24.0), LZK 5 (19.0, - 23.3), LZK 3 (19.1, - 12.4), LZK 4 (19.1, - 10.3), LZK 6 (27.3, - 8.5). Star 1 (11.3, - 33.4) — Cohen and Kuhi (1979).

Reflection Nebulae :

vdB 12/Bernes 52/DG 14 (14.6, 22.8), Bernes 53 (10.9, - 34.2), vdB 13/Bernes 54/DG 15 (19.9, - 25.2).

o) Dark clouds :

L 169 (- 22.5, - 26.5), L 183 (- 3.0, - 16.5).

p) Dark clouds :

L 134 (2.5, - 4.0).

TABLE II. — *Stars close to the reference field in Taurus.*

HD	SP	m	(B-V)	A _v	r
283382	K1 III	10.34	1.55	1.35	390
283384	K2 III	10.21	1.39	0.69	550
283389	K2 III	9.29	1.57	1.23	280
283390	K0 III	10.37	1.43	1.17	400
283394	K5 III	8.54	1.88	1.02	320
283409	A8 V	11.40	0.45	0.72	430
283452	G0 III	10.97	1.48	2.28	340
283454	K2 III	10.54	1.24	0.24	800
283456	G8 III	10.44	1.11	0.48	470
283458	K0 III	10.33	1.72	2.04	260
283459	G2 III	10.52	1.10	1.02	500
283462	A8 V	10.81	0.64	1.29	250
283464	K0 III	9.40	1.44	1.20	250
283465	G2 III	10.77	1.23	1.41	470
283466	G8 III	9.41	1.13	0.54	280
283469	G0 V	11.25	0.61	0.06	210
283474	G8 III	10.36	1.40	1.35	300
283486	G8 III	9.43	1.21	0.78	260
283523	K3 III	9.48	1.85	1.65	280
283525	K0 III	10.79	1.45	1.23	470
283527	A8 V	9.76	0.63	1.26	160
283528	K2 III	9.37	1.71	1.65	240

Description of table II.

- Col. (1) : HD number of the star.
- Col. (2), Col. (3) and Col. (4) : Spectral type, visual magnitude and the *B-V* color difference from the catalogues of MK spectral classification by Kennedy and Buscombe (1974), Buscombe (1977, 1980, 1981), Jaschek *et al.* (1964), and Blanco *et al.* (1968).
- Col. (5) : Visual extinction computed assuming *R* = 3.0 and using intrinsic colors and absolute magnitude from Johnson (1966).
- Col. (6) : Distance calculated from the relation $\log(r) = (m_v - M_v - A_v + 5)/5$.

CATALOGUE OF VISUAL EXTINCTION IN TAURUS AND PERSEUS

TABLE III.

L 1489

	1	2	3	4	5	6	7	8	9	10	11	12	13	14	15	16
1	12	9	11	16	12	10	19	11	10	17	22	16	13	20	15	13
2	7	7	12	7	11	9	10	10	15	13	19	8	16	19	12	17
3	12	11	10	10	12	10	11	12	17	16	19	12	15	12	10	9
4	8	7	16	16	13	15	13	25	15	19	11	12	15	20	16	13
5	9	15	12	11	5	11	16	16	13	20	11	19	13	10	10	13
6	9	10	13	10	15	13	22	22	22	20	17	15	11	15	17	12
7	9	10	16	12	13	10	28	22	10	22	11	10	13	12	16	13
8	19	11	10	12	16	20	22	20	15	15	19	17	11	15	13	11
9	17	8	15	15	15	22	37	15	25	19	15	13	13	22	11	10
10	8	11	20	16	28	46	37	19	20	25	10	15	17	13	17	15
11	10	17	13	20	20	46	31	17	15	20	15	13	7	22	13	19
12	13	11	17	12	17	46	20	11	19	20	8	13	12	11	12	13
13	10	9	9	7	9	12	25	28	17	13	28	19	12	10	19	13
14	13	11	13	12	7	11	17	9	7	9	16	8	9	13	15	15
15	15	13	12	9	25	25	13	12	15	12	12	11	8	10	13	10
16	10	15	13	16	20	15	11	17	11	11	12	11	10	9	13	19
17	10	17	10	11	16	16	10	12	6	10	8	15	11	13	15	16
18	10	10	6	11	15	10	19	10	16	13	12	8	6	19	10	12

TABLE IV.

L 1544

	1	2	3	4	5	6	7	8	9	10	11	12	13	14	15	16	17	18
1	13	19	10	15	16	11	20	19	28	12	19	10	16	17	17	25	11	10
2	15	13	20	22	15	16	15	10	20	10	7	16	6	19	28	7	16	13
3	17	10	12	13	19	12	13	15	25	13	17	12	22	10	17	13	19	7
4	16	17	19	19	17	22	11	20	11	22	19	31	28	20	13	13	10	13
5	12	19	22	17	10	10	13	8	11	20	31	28	25	13	12	20	12	9
6	10	19	12	11	16	19	10	16	16	22	31	47	46	20	19	19	22	11
7	17	9	13	15	8	20	20	16	17	31	37	37	17	19	9	10	9	12
8	15	15	8	13	20	20	31	37	46	67	67	31	16	15	11	12	13	13
9	11	31	17	16	28	31	46	46	67	46	37	25	20	22	9	10	15	13
10	20	10	17	20	28	28	67	67	20	20	15	17	16	25	13	16	13	13
11	17	10	13	15	17	22	20	22	31	12	15	10	10	9	13	12	8	11
12	6	10	10	11	13	12	15	13	15	13	11	4	12	15	10	11	10	12
13	9	12	13	12	19	17	9	11	6	7	6	8	15	12	10	9	11	10
14	10	8	6	7	11	15	20	10	10	5	13	12	16	6	12	13	13	7
15	10	9	19	11	10	13	7	9	20	10	9	10	10	13	13	15	10	7
16	13	7	8	15	17	12	13	10	19	11	13	6	6	17	7	10	15	11

TABLE V.

L 1517

	1	2	3	4	5	6	7	8	9	10	11	12	13	14	15	16	17	18	19	20
1	7	4	9	11	3	9	6	15	6	13	11	5	8	15	12	10	11	14	15	
2	5	15	12	6	10	11	9	12	12	10	13	8	11	14	11	10	17	9	15	14
3	6	9	10	11	6	8	13	6	12	11	11	11	8	8	10	11	19	11	16	13
4	8	4	11	20	12	11	13	7	20	14	11	11	12	6	11	13	16	20	11	17
5	8	8	11	11	12	6	11	11	9	11	14	12	7	13	9	13	29	20	17	15
6	8	9	5	8	12	11	10	16	12	6	12	11	13	9	38	15	16	24	20	29
7	11	5	3	6	8	13	19	27	15	12	17	17	24	15	19	13	13	13	16	19
8	10	8	5	6	10	2	11	12	16	14	29	16	22	19	19	11	11	11	11	13
9	10	7	7	9	8	13	27	15	14	33	33	16	16	14	10	9	15	12	8	6
10	8	7	14	11	14	24	22	33	38	33	29	19	15	15	16	13	11	12	12	12
11	10	8	8	7	33	47	33	20	38	24	15	20	20	15	13	15	10	15	19	7
12	11	8	10	10	27	47	24	24	47	24	47	57	33	38	16	24	19	11	15	17
13	7	10	11	13	15	29	20	16	47	33	47	57	47	47	27	15	14	11	11	16
14	7	5	11	20	14	17	24	15	33	38	20	14	11	11	16	13	12	6	12	7
15	11	10	7	7	11	12	17	16	27	16	22	17	11	9	6	11	14	16	8	11
16	10	7	10	8	11	10	11	14	15	7	11	12	11	6	10	11	11	10	12	14
17	11	8	7	2	8	11	15	16	9	12	16	7	8	8	6	8	11	7	10	8
18	8	7	6	3	4	11	8	8	7	9	10	11	15	11	5	11	13	12	14	10
19	5	5	1	6	7	9	5	5	2	6	10	2	5	10	12	10	9	7	7	12
20	7	7	8	6	12	6	15	6	9	6	16	10	9	7	9	8	11	14	15	14
21	6	2	4	5	8	5	11	6	11	13	10	8	11	6	14	8	11	15	9	11

TABLE XX. — Catalogue of dark fragments.

No.	AV	ALPHA	DELTA	LII	BII	REF	M ₀	S	R	No.	AV	ALPHA	DELTA	LII	BII	REF	M ₀	S	R
1	2.0	3 19 22.9	29 31 30	158.119	-22.663	59	13	0.021	0.28	21	3.0	3 22 43.1	31 6 25	157.742	-20.961	22	6	0.007	0.16
2	2.0	3 19 50.9	29 49 19	158.019	-22.363	59	9	0.014	0.23	22	2.5	3 23 4.5	31 13 12	157.737	-20.824	57	35	0.042	0.40
	2.5	3 20 0.6	29 51 25	158.027	-22.314		5	0.007	0.16	23	3.0	3 23 4.8	29 36 24	158.768	-22.121	30	6	0.007	0.16
3	2.5	3 19 52.1	30 9 48	157.806	-22.084	57	15	0.021	0.28	24	3.0	3 23 4.9	29 46 24	158.661	-21.987	30	6	0.007	0.16
4	3.0	3 20 34.1	30 49 5	157.525	-21.465	6	12	0.014	0.23	25	3.0	3 23 15.5	30 12 20	158.416	-21.617	30	379	0.361	1.18
5	2.5	3 20 35.4	29 8 56	158.590	-22.812	57	10	0.014	0.23	26	2.5	3 23 17.7	30 48 52	158.035	-21.123	57	10	0.014	0.23
6	2.5	3 20 40.2	30 54 46	157.484	-21.376	57	55	0.069	0.52	27	3.5	3 23 28.8	30 4 49	158.538	-21.689	25	215	0.194	0.87
7	2.5	3 20 46.8	29 21 27	158.492	-22.619	57	5	0.007	0.16	28	3.0	3 23 30.0	31 14 9	157.805	-20.758	22	13	0.014	0.23
8	3.0	3 21 9.7	29 51 27	158.245	-22.167	30	6	0.007	0.16		3.5	3 23 30.0	31 16 22	157.781	-20.728		8	0.007	0.16
9	4.0	3 21 9.7	30 26 27	157.874	-21.696	17	8	0.007	0.16	29	2.0	3 23 57.0	29 9 58	159.217	-22.361	59	15	0.021	0.28
10	2.5	3 21 9.8	29 1 27	158.780	-22.838	57	5	0.007	0.16	30	2.5	3 24 4.0	30 28 29	158.394	-21.297	57	877	0.917	1.89
11	4.0	3 21 23.5	30 11 27	158.076	-21.868	27	24	0.014	0.23	31	1.5	3 24 16.0	31 48 45	157.580	-20.196	62	7	0.014	0.23
	7.5	3 21 32.9	30 11 26	158.106	-21.848		14	0.007	0.16	32	2.5	3 24 18.7	29 11 25	159.269	-22.294	29	6	0.007	0.16
12	3.0	3 21 32.8	29 39 7	158.449	-22.283	30	13	0.014	0.23	33	4.0	3 24 29.2	29 58 57	158.789	-21.637	27	32	0.028	0.33
	3.5	3 21 32.8	29 41 27	158.424	-22.252		7	0.007	0.16	34	4.0	3 24 40.0	31 16 25	157.995	-20.579	40	8	0.007	0.16
13	3.0	3 21 33.0	30 56 26	157.631	-21.242	6	7	0.007	0.16	35	4.5	3 25 3.6	30 51 26	158.333	-20.863	38	9	0.007	0.16
	3.5	36	4.0	3 25 27.1	30 16 28	158.780	-21.279	27	24	0.021	0.28
14	2.5	3 21 44.6	31 8 58	157.535	-21.049	57	10	0.014	0.23	37	2.5	3 25 27.3	29 31 26	159.267	-21.877	41	5	0.007	0.16
15	4.5	3 21 56.1	30 31 26	157.966	-21.530	18	11	0.007	0.16	38	4.0	3 25 36.9	30 57 20	158.372	-20.713	40	62	0.049	0.43
	5.5	39	4.5	3 25 49.3	31 0 11	158.380	-20.648	38	37	0.028	0.33
16	2.5	3 22 5.1	29 1 26	158.955	-22.718	57	11	0.014	0.23		5.5	3 25 26.8	31 1 26	158.298	-20.680		10	0.007	0.16
	3.5	3 21 55.5	29 1 27	158.925	-22.739		7	0.007	0.16	40	3.0	3 25 49.4	31 12 12	158.252	-20.488	30	216	0.188	0.85
17	3.5	3 22 10.1	30 28 13	158.044	-21.544	25	60	0.049	0.43		3.5	3 25 48.6	31 11 22	158.258	-20.500		187	0.153	0.77
18	4.0	3 22 24.0	30 30' 6	158.067	-21.489	17	38	0.028	0.33	41	2.0	3 25 50.0	29 17 9	159.493	-22.017	59	57	0.090	0.59
19	4.0	3 22 26.4	29 58 10	158.414	-21.912	27	26	0.021	0.28	42	3.5	3 25 50.2	30 36 27	158.637	-20.963	25	7	0.007	0.16
	4.5	3 22 19.0	30 1 26	158.356	-21.885		9	0.007	0.16	43	3.0	3 25 56.7	29 55 39	159.096	-21.491	30	21	0.021	0.28
20	4.5	3 22 42.5	30 28 46	158.139	-21.468	18	19	0.014	0.23		4.5	3 25 50.2	29 51 27	159.121	-21.562		9	0.007	0.16
	5.0	3 22 42.5	30 26 25	158.164	-21.499		10	0.007	0.16	44	4.5	3 25 58.7	31 17 13	158.227	-20.401	45	41	0.028	0.33
											6.5	3 25 50.2	31 16 26	158.209	-20.429		13	0.007	0.16
										45	4.0	3 26 9.4	31 20 9	158.228	-20.339	40	90	0.069	0.52
										46	2.5	3 26 24.6	29 8 57	159.690	-22.050	41	10	0.014	0.23
										47	4.5	3 26 37.1	31 31 26	158.192	-20.129	45	9	0.007	0.16

TABLE XX (continued).

NO.	AV	ALPHA	DELTA	LII	BII	REF	M _⊙	S	R
48	2.0	3 26 59.2	29 34 5	159.523	-21.641	59	10	0.014	0.23
	2.5	3 26 59.3	29 36 26	159.498	-21.609		5	0.007	0.16
49	2.5	3 27 11.1	30 4 0	158.911	-20.820	57	10	0.014	0.23
50	4.0	3 27 11.6	30 11 25	159.156	-21.119	51	22	0.014	0.23
	5.5
51	2.5	3 27 33.1	30 14 41	159.187	-21.029	57	87	0.090	0.59
	3.5	3 27 26.1	30 13 57	159.173	-21.054		44	0.035	0.37
52	2.5	3 27 47.9	31 56 23	158.139	-19.646	57	6	0.007	0.16
	3.0
53	4.0	3 28 9.2	30 16 22	159.279	-20.927	51	8	0.007	0.16
54	3.0	3 28 9.5	30 31 22	159.117	-20.728	75	8	0.007	0.16
	4.0
55	2.5	3 28 42.2	29 53 36	159.628	-21.156	57	12	0.014	0.23
	3.5	3 28 31.7	29 51 21	159.620	-21.208		7	0.007	0.16
56	6.0	3 29 35.8	30 48 56	159.189	-20.308	58	26	0.014	0.23
	6.5
57	2.0	3 29 47.5	30 51 50	159.193	-20.244	59	3594	4.299	4.08
58	4.5	3 29 49.8	30 49 13	159.228	-20.273	60	100	0.063	0.49
	5.5	3 29 50.5	30 49 16	159.230	-20.271		81	0.049	0.43
59	1.5	3 29 56.6	30 53 53	159.198	-20.197	62	5523	8.139	5.62
60	3.5	3 30 1.5	30 56 54	159.180	-20.146	61	242	0.174	0.82
	4.0	3 30 2.8	30 56 1	159.194	-20.155		222	0.153	0.77
61	3.0	3 30 1.6	30 56 27	159.185	-20.152	75	309	0.250	0.98
62	1.0	3 30 9.9	30 57 5	159.203	-20.126	65	6933	12.208	6.88
63	4.5	3 30 29.6	31 8 46	159.136	-19.929	60	67	0.042	0.40
	7.5	3 30 34.0	31 6 27	159.174	-19.950		14	0.007	0.16
64	6.0	3 30 34.0	30 51 27	159.337	-20.147	58	12	0.007	0.16
	6.5
65	0.0	3 30 39.0	31 0 28	159.254	-20.017	65	7450	15.646	7.79
	0.5	3 30 34.5	30 59 56	159.245	-20.034		7397	14.333	7.46
66	3.0	3 31 43.4	30 46 30	159.600	-20.059	75	13	0.021	0.28
67	3.5	3 31 44.1	31 11 26	159.330	-19.731	61	7	0.007	0.16
68	1.5	3 32 19.4	30 19 58	159.999	-20.328	62	13	0.028	0.33
69	3.0	3 33 17.6	31 0 1	159.734	-19.674	75	111	0.083	0.57
	7.5	3 32 54.0	31 1 22	159.648	-19.709		14	0.007	0.16
70	3.5	3 34 3.9	31 13 55	159.718	-19.390	91	14	0.014	0.23
71	3.5	3 34 50.6	31 16 26	159.829	-19.254	91	8	0.007	0.16

NO.	AV	ALPHA	DELTA	LII	BII	REF	M _⊙	S	R
	4.0
72	1.0	3 34 50.9	32 2 57	159.320	-18.646	65	6	0.021	0.28
73	2.5	3 35 8.8	30 31 35	160.378	-19.797	74	21	0.028	0.33
	3.0	3 35 14.1	30 31 27	160.395	-19.787		6	0.007	0.16
74	2.0	3 35 16.0	30 31 4	160.405	-19.788	59	56	0.083	0.57
75	2.5	3 35 43.5	31 18 7	159.966	-19.114	57	1447	1.410	2.34
76	2.5	3 36 0.5	30 26 26	160.589	-19.748	74	7	0.007	0.16
	3.0
77	3.5	3 36 2.0	31 19 58	160.000	-19.049	91	24	0.021	0.28
	4.5	3 36 0.9	31 21 26	159.981	-19.033		9	0.007	0.16
78	2.0	3 36 12.3	32 6 26	159.520	-18.422	59	8	0.014	0.23
79	1.5	3 36 23.2	32 34 13	159.247	-18.036	62	9	0.021	0.28
80	3.5	3 36 24.2	31 11 26	160.160	-19.111	91	8	0.007	0.16
	4.0
81	3.0	3 37 10.8	31 1 23	160.408	-19.136	75	6	0.007	0.16
82	3.5	3 37 11.1	31 21 23	160.187	-18.877	91	7	0.007	0.16
83	5.5	3 37 11.6	31 46 23	159.912	-18.551	85	11	0.007	0.16
84	3.0	3 37 21.5	31 11 23	160.328	-18.983	75	13	0.014	0.23
	3.5	3 37 10.9	31 11 24	160.297	-19.007		7	0.007	0.16
85	4.5	3 37 41.7	31 35 59	160.115	-18.619	92	110	0.069	0.52
	5.0	3 37 36.4	31 36 51	160.090	-18.620		93	0.056	0.46
86	5.5	3 37 51.2	31 35 8	160.152	-18.609	85	53	0.028	0.33
	7.5	3 37 46.7	31 36 21	160.125	-18.603		29	0.014	0.23
87	1.5	3 37 52.4	32 9 13	159.779	-18.164	62	10	0.021	0.28
88	2.5	3 38 20.3	30 46 19	160.780	-19.175	57	5	0.007	0.16
89	3.0	3 38 20.8	31 1 19	160.614	-18.980	75	6	0.007	0.16
90	4.0	3 38 47.2	31 46 8	160.193	-18.341	95	8	0.007	0.16
91	3.0	3 38 49.2	31 34 14	160.331	-18.491	75	644	0.576	1.50
92	4.0	3 39 9.9	31 37 55	160.350	-18.397	95	297	0.208	0.90
93	5.0	3 39 10.9	31 36 9	160.372	-18.417	98	10	0.007	0.16
94	2.0	3 39 15.3	30 44 33	160.961	-19.072	59	13	0.021	0.28
95	3.5	3 39 22.0	31 38 33	160.377	-18.361	91	383	0.292	1.06
96	2.0	3 39 46.1	30 57 38	160.904	-18.834	59	17	0.028	0.33
	2.5	3 39 34.9	31 1 10	160.832	-18.814		5	0.007	0.16

TABLE XX (continued).

No.	Av	ALPHA	DELTA	LII	BII	REF	M ₀	S	R	No.	Av	ALPHA	DELTA	LII	BII	REF	M ₀	S	R
97	5.5 6.5	3 39 57.9	31 31 11	160.563	-18.376	99	13	0.007	0.16	121	3.5	4 13 30.8	28 33 20	168.243	-15.629	122	22	0.042	0.28
98	4.5	3 40 12.1	31 39 31	160.512	-18.236	92	103	0.069	0.52	122	3.0	4 13 50.8	28 14 54	168.525	-15.790	126	313	0.569	1.04
99	5.0	3 40 17.7	31 39 20	160.530	-18.226	98	66	0.042	0.40	123	4.0	4 13 53.7	28 29 50	168.347	-15.610	121	4	0.007	0.11
100	2.0 2.5	3 40 21.1 3 40 21.1	32 28 28 32 26 11	159.994 160.019	-17.585 -17.615	59	9 5	0.014 0.007	0.23 0.16	124	3.5	4 13 57.3	28 10 6	168.602	-15.829	122	197	0.319	0.78
101	5.5 6.5	3 40 44.8	31 46 12	160.531	-18.077	99	13	0.007	0.16	125	2.0	4 14 10.3	28 1 46	168.741	-15.891	127	602	1.326	1.59
102	4.5 5.5	3 41 8.3	31 31 11	160.766	-18.216	92	11	0.007	0.16	126	2.5	4 14 10.7	28 2 54	168.728	-15.877	125	489	0.951	1.34
103	2.5	3 41 54.5	32 26 23	160.283	-17.403	107	6	0.007	0.16	127	0.5 1.5	4 14 18.8 4 14 8.3	27 58 6 27 57 7	168.809 168.794	-15.911 -15.950	127	885 794	2.667 2.146	2.25 2.02
104	2.0 2.5	3 42 8.3 3 42 19.2	32 6 10 32 6 10	160.547 160.578	-17.632 -17.607	59	9 5	0.014 0.007	0.23 0.16	128	3.0	4 14 31.6	25 5 26	171.023	-17.859	146	2	0.006	0.10
105	3.0	3 42 41.8	32 31 26	160.360	-17.233	108	6	0.007	0.16	129	3.5 4.0	4 14 39.2	27 44 50	169.029	-16.009	122	4	0.007	0.11
106	3.0 3.5	3 43 40.6 3 43 29.2	32 31 28 32 31 28	160.526 160.494	-17.100 -17.126	108	13 7	0.014 0.007	0.23 0.16	130	5.5	4 14 39.2	28 9 51	168.717	-15.721	134	5	0.007	0.11
107	2.0	3 43 49.5	32 37 33	160.483	-17.002	59	130	0.167	0.80	131	4.5 5.5	4 14 39.2 4 14 39.2	27 57 35 27 59 50	168.870 168.842	-15.862 -15.836	133	9 5	0.014 0.007	0.16 0.11
108	2.5	3 44 10.8	32 40 6	160.515	-16.921	107	96	0.111	0.66	132	3.5 7.0	4 14 46.1 4 14 50.5	27 25 22 27 24 51	169.292 169.310	-16.215 -16.210	135	39 13	0.049 0.014	0.30 0.16
109	3.0	3 44 16.6	32 56 28	160.348	-16.699	108	6	0.007	0.16	133	4.0	4 15 4.5	28 11 41	168.761	-15.633	124	105	0.167	0.56
110	3.0 4.5	3 44 38.6 3 44 16.7	32 43 27 32 41 28	160.555 160.516	-16.816 -16.891	108	37 9	0.035 0.007	0.37 0.16	134	4.5 5.0	4 15 12.3 4 15 21.0	28 13 51 28 13 20	168.754 168.783	-15.587 -15.570	133	57 35	0.083 0.049	0.40 0.30
111	1.5	4 0 14.2	26 12 56	167.795	-19.368	112	2	0.009	0.13	135	3.0	4 15 26.7	27 15 4	169.529	-16.225	126	82	0.125	0.49
112	0.5 1.0	4 1 18.7 4 1 15.7	26 14 53 26 15 3	167.954 167.943	-19.176 -19.182	112	92 79	0.495 0.377	0.97 0.85	136	5.5 6.0	4 15 35.4 4 15 24.6	28 14 50 28 14 50	168.803 168.774	-15.514 -15.543	134	11 6	0.014 0.007	0.16 0.11
113	1.5 4.5	4 1 26.1 4 1 47.6	26 15 34 26 10 57	167.966 168.084	-19.149 -19.148	112	34 3	0.120 0.005	0.48 0.10	137	2.5	4 15 47.0	27 44 50	169.209	-15.829	125	2	0.007	0.11
114	3.0 3.5	4 11 38.3	27 49 43	168.486	-16.432	126	3	0.007	0.11	138	3.5 5.5	4 15 49.4 4 15 50.7	25 11 19 25 9 59	171.159 171.179	-17.578 -17.589	140	20 4	0.033 0.006	0.25 0.10
115	2.0	4 11 38.9	27 29 43	168.736	-16.663	127	2	0.007	0.11	139	3.5 7.5	4 16 18.2 4 16 9.1	27 3 16 27 4 49	169.814 169.771	-16.222 -16.229	135	32 7	0.049 0.007	0.30 0.11
116	2.5	4 12 1.2	27 39 45	168.671	-16.488	125	3	0.007	0.11	140	3.0	4 16 18.4	25 10 7	171.252	-17.511	146	34	0.067	0.36
117	4.0 7.5	4 12 3.9 4 11 37.8	28 8 27 28 9 43	168.321 168.236	-16.147 -16.201	124	59 7	0.083 0.007	0.40 0.11	141	2.0	4 16 60.0	24 54 18	171.567	-17.576	143	3	0.011	0.15
118	3.5 5.0	4 12 15.3 4 12 22.4	28 38 11 28 39 46	167.983 167.982	-15.771 -15.734	122	13 5	0.021 0.007	0.20 0.11	142	2.0	4 17 4.6	24 59 1	171.519	-17.510	143	274	0.741	1.19
119	2.5 3.5	4 12 42.2 4 12 42.8	24 52 37 24 49 43	170.888 170.927	-18.306 -18.338	142	30 6	0.072 0.011	0.37 0.15	143	1.0 1.5	4 17 22.7 4 17 21.5	24 58 25 24 58 35	171.575 171.570	-17.466 -17.468	143	397 383	1.288 1.199	1.56 1.51
120	4.0	4 13 19.7	28 37 22	168.164	-15.612	121	8	0.014	0.16	144	3.5	4 17 29.7	25 5 30	171.503	-17.367	140	3	0.006	0.10
										145	3.5 4.0	4 18 9.3	25 5 30	171.609	-17.257	148	3	0.006	0.10

TABLE XX (continued).

No.	Av	ALPHA	DELTA	LII	BII	REF	M _☉	S	R	No.	Av	ALPHA	DELTA	LII	BII	REF	M _☉	S	R
146	2.5	4 18 12.9	25 1 49	171.666	-17.288	142	127	0.268	0.71	170	4.0	4 29 23.3	24 41 33	173.689	-15.623	167	3	0.006	0.10
147	5.0	4 19 48.0	24 56 27	171.989	-17.084	149	4	0.006	0.10	171	1.0	4 29 29.2	22 49 16	175.182	-16.825	171	417	1.232	1.53
	5.5	171	2.0	4 29 36.2	22 48 33	175.210	-16.812	361	0.976	1.36	
148	3.0	4 19 48.9	24 57 0	171.984	-17.075	146	58	0.106	0.45	172	4.5	4 29 42.7	22 53 31	175.161	-16.740	176	7	0.011	0.15
149	3.5	4 20 1.5	24 56 50	172.020	-17.042	148	40	0.067	0.36	172	5.0	4 29 42.8	22 51 24	175.189	-16.762	4	0.006	0.10	
	4.5	4 19 58.2	24 55 40	172.026	-17.064	27	9	0.039	0.27	173	4.5	4 29 43.0	24 14 31	174.094	-15.860	169	11	0.017	0.18
150	5.0	4 20 27.4	24 54 5	172.124	-17.000	149	9	0.011	0.15	173	5.0	4 29 43.0	24 10 11	174.151	-15.907	4	0.006	0.10	
	6.0	4 20 27.4	24 51 55	172.152	-17.025	5	5	0.006	0.10	174	3.0	4 30 2.1	23 4 51	175.061	-16.561	177	2	0.006	0.10
151	2.0	4 21 46.3	25 8 11	172.152	-16.622	143	5	0.017	0.18	175	3.5	4 30 22.3	24 19 9	174.134	-15.697	157	3	0.006	0.10
152	3.5	4 23 48.1	24 33 30	172.922	-16.665	157	9	0.017	0.18	176	3.0	4 30 26.5	22 40 59	175.441	-16.747	177	97	0.173	0.57
	4.0	4 23 48.5	24 32 9	172.940	-16.679	3	3	0.006	0.10	176	4.0	4 30 35.5	22 39 18	175.487	-16.738	60	0.089	0.41	
153	3.5	4 25 6.5	24 32 20	173.143	-16.456	157	9	0.017	0.18	177	2.5	4 30 29.1	22 44 27	175.402	-16.702	171	173	0.385	0.86
	4.0	4 24 47.5	24 32 17	173.093	-16.510	3	3	0.006	0.10	178	3.0	4 30 49.0	24 2 6	174.427	-15.805	159	13	0.028	0.23
154	3.5	4 25 7.6	24 23 22	173.262	-16.552	157	3	0.006	0.10	178	3.5	4 30 42.3	24 2 17	174.407	-15.822	11	0.022	0.21	
155	3.5	4 26 26.5	24 25 48	173.437	-16.300	157	35	0.061	0.34	179	4.5	4 30 50.9	22 35 46	175.574	-16.731	176	34	0.045	0.29
	4.5	4 26 30.4	24 25 13	173.455	-16.295	17	17	0.028	0.23	179	6.0	4 30 54.1	22 35 2	175.592	-16.730	14	0.017	0.18	
156	3.0	4 26 46.3	24 5 36	173.752	-16.465	159	2	0.006	0.10	180	3.0	4 31 39.5	22 55 55	175.432	-16.372	177	2	0.006	0.10
157	3.0	4 27 32.0	24 21 28	173.664	-16.161	159	228	0.463	0.94	181	2.5	4 32 55.7	24 2 9	174.751	-15.437	163	28	0.067	0.36
158	2.5	4 27 34.3	22 50 9	174.870	-17.150	171	21	0.050	0.31	181	6.0	4 32 39.6	24 1 7	174.723	-15.495	4	0.006	0.10	
159	2.5	4 27 39.8	24 20 42	173.694	-16.147	163	356	0.808	1.24	182	1.0	4 33 4.9	24 39 9	174.287	-15.012	182	26	0.123	0.48
160	3.0	4 27 41.5	22 48 11	174.915	-17.151	158	11	0.022	0.21	182	2.5	4 33 0.1	24 36 56	174.303	-15.049	2	0.006	0.10	
	4.0	4 27 46.1	22 51 17	174.886	-17.104	3	3	0.006	0.10	183	4.0	4 34 8.0	26 22 31	173.092	-13.714	198	3	0.006	0.10
161	3.0	4 27 45.9	23 0 15	174.767	-17.007	158	2	0.006	0.10	184	3.0	4 34 10.4	25 19 49	173.918	-14.384	185	2	0.006	0.10
162	2.5	4 28 3.0	23 18 58	174.565	-16.754	171	26	0.067	0.36	185	2.5	4 34 24.4	25 11 59	174.056	-14.429	194	25	0.067	0.36
163	1.0	4 28 3.7	24 17 38	173.796	-16.112	163	707	2.102	2.00	186	4.0	4 34 36.6	26 8 10	173.350	-13.787	198	16	0.028	0.23
	2.0	4 28 0.9	24 17 50	173.786	-16.118	564	564	1.483	1.68	186	4.5	4 34 48.6	26 4 40	173.426	-13.791	3	0.006	0.10	
164	3.0	4 28 5.6	23 22 40	174.523	-16.706	162	8	0.017	0.18	187	3.0	4 34 37.1	25 9 24	174.122	-14.420	185	7	0.017	0.18
	3.5	4 28 24.3	23 22 41	174.572	-16.651	3	3	0.006	0.10	188	4.0	4 35 9.1	25 46 47	173.711	-13.925	198	3	0.006	0.10
165	3.0	4 28 24.5	23 13 44	174.690	-16.748	162	3	0.006	0.10	189	4.0	4 35 49.0	25 42 22	173.869	-13.859	198	3	0.006	0.10
	3.5	189	4.5
166	4.5	4 28 44.1	24 10 11	173.999	-16.077	169	3	0.006	0.10	190	4.5	4 35 49.2	25 33 24	173.987	-13.954	199	4	0.006	0.10
167	3.5	4 29 0.6	24 18 28	173.933	-15.939	157	82	0.151	0.53	191	4.0	4 35 49.4	25 24 26	174.105	-14.050	198	3	0.006	0.10
168	4.5	4 29 3.7	24 19 9	173.932	-15.923	169	4	0.006	0.10	192	4.5	4 36 28.4	26 0 7	173.734	-13.555	199	11	0.017	0.18
	5.0	192	5.5	4 36 28.4	26 0 19	173.731	-13.553	4	0.006	0.10	
169	4.0	4 29 12.2	24 16 17	173.991	-15.930	167	43	0.072	0.37	193	6.0	4 36 28.9	25 35 41	174.056	-13.816	197	9	0.011	0.15

TABLE XX (continued).

No.	A _V	ALPHA	DELTA	LII	BII	REF	M _⊙	S	R	No.	A _V	ALPHA	DELTA	LII	BII	REF	M _⊙	S	R
194	1.5	4 36 40.7	25 39 48	174.031	-13.738	195	952	2.342	2.11	207	5.5	4 38 28.1	25 20 4	174.558	-13.638	201	4	0.006	0.10
	2.0	4 36 45.8	25 38 42	174.059	-13.735		850	1.912	1.91										
195	1.0	4 36 43.9	25 41 29	174.017	-13.710	195	997	2.592	2.22	208	1.5	4 39 0.2	26 39 48	173.588	-12.696	195	7	0.028	0.23
196	2.5	4 37 1.1	25 39 39	174.084	-13.681	194	691	1.394	1.63	209	4.0	4 39 7.7	25 6 37	174.833	-13.666	198	3	0.006	0.10
	3.0	4 36 59.9	25 40 14	174.073	-13.678		600	1.143	1.47	210	1.5	4 39 21.2	26 13 52	173.980	-12.912	195	4	0.017	0.18
197	5.5	4 37 3.1	25 27 21	174.251	-13.806	201	27	0.033	0.25	211	4.0	4 39 27.5	25 15 34	174.764	-13.514	198	3	0.006	0.10
198	3.5	4 37 9.0	25 38 40	174.117	-13.668	196	444	0.786	1.22	212	1.5	4 50 17.0	30 50 20	171.899	-8.136	214	7	0.026	0.22
199	4.0	4 37 25.1	25 38 48	174.155	-13.620	198	257	0.418	0.89	213	4.0	4 51 29.2	30 31 6	172.316	-8.135	215	7	0.010	0.14
200	4.0	4 37 28.8	25 2 12	174.646	-14.001	198	9	0.017	0.18		5.5	4 51 31.0	30 31 29	172.314	-8.126		3	0.003	0.08
201	5.0	4 37 32.6	25 24 37	174.360	-13.750	203	47	0.061	0.34	214	0.5	4 51 39.8	30 36 8	172.273	-8.053	214	123	0.679	1.14
202	6.0	4 37 39.0	25 20 3	174.436	-13.781	197	10	0.011	0.15		1.0	4 51 31.5	30 37 36	172.235	-8.061		96	0.424	0.90
	6.5	4 37 48.4	25 20 3	174.459	-13.753		5	0.006	0.10	215	3.5	4 51 40.8	30 31 48	172.333	-8.095	216	13	0.021	0.20
203	4.5	4 37 45.4	25 26 57	174.361	-13.689	199	101	0.145	0.52	216	1.5	4 51 51.4	30 34 35	172.320	-8.037	214	44	0.120	0.48
204	4.5	4 38 3.2	25 56 58	174.010	-13.317	199	14	0.022	0.21		3.0	4 51 53.9	30 33 6	172.345	-8.045		22	0.040	0.28
205	5.0	4 38 17.7	25 37 59	174.296	-13.478	203	8	0.011	0.15	217	4.0	4 52 5.8	30 31 29	172.393	-8.028	215	2	0.003	0.08
	5.5	4 38 8.2	25 37 59	174.272	-13.505		4	0.006	0.10		4.5
206	3.5	4 38 18.5	24 53 11	174.889	-13.952	196	7	0.011	0.15	218	3.5	4 52 40.6	30 33 59	172.439	-7.905	216	2	0.003	0.08
	5.0	4 38 28.1	24 53 11	174.913	-13.924		4	0.006	0.10		4.5
										219	0.5	5 1 6.0	25 10 2	177.919	-9.717	219	86	0.394	0.87
											6.5	5 1 5.9	25 7 45	177.950	-9.740		6	0.007	0.12

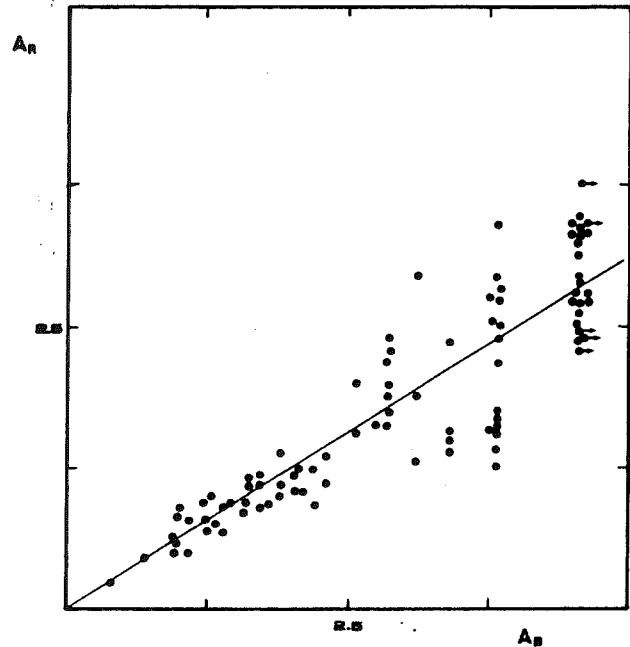

FIGURE 1. — The variation of the extinction in the red against the extinction in the blue for Taurus. The best fit is $A_R = 0.62 A_B$. Both, red and blue extinction, are calculated from $A_{B,R} = 2.5 \cdot \log (N^*/N)$, where N^* and N are the number of stars in the reference field in the reddened area.

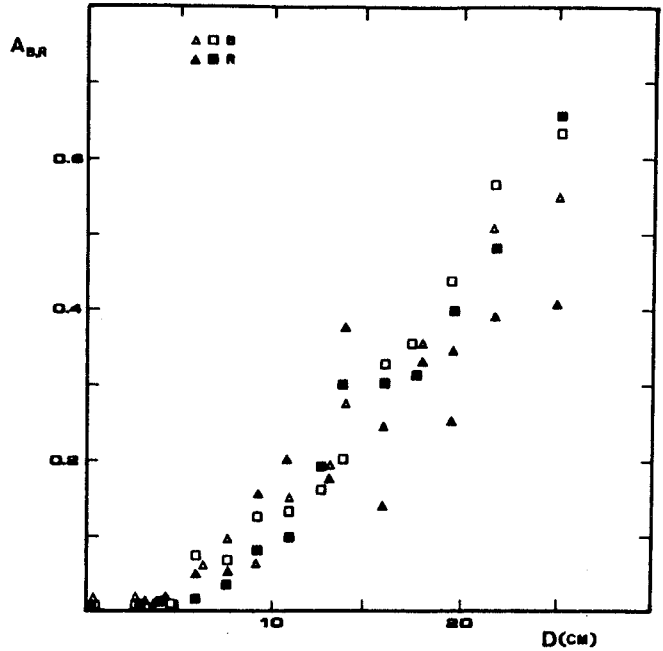

FIGURE 2. — The loss in the limiting magnitude of the Palomar prints (red and blue) in function of the distance to the center of the print. Symbols \triangle and \blacktriangle are for the print number 276, and \square , \blacksquare for the print number 669. The loss in the limiting magnitude is well represented by $A_{B,R} = d^2 \times 10^{-3}$ magnitudes, where d is the distance to the center of prints in centimeters.

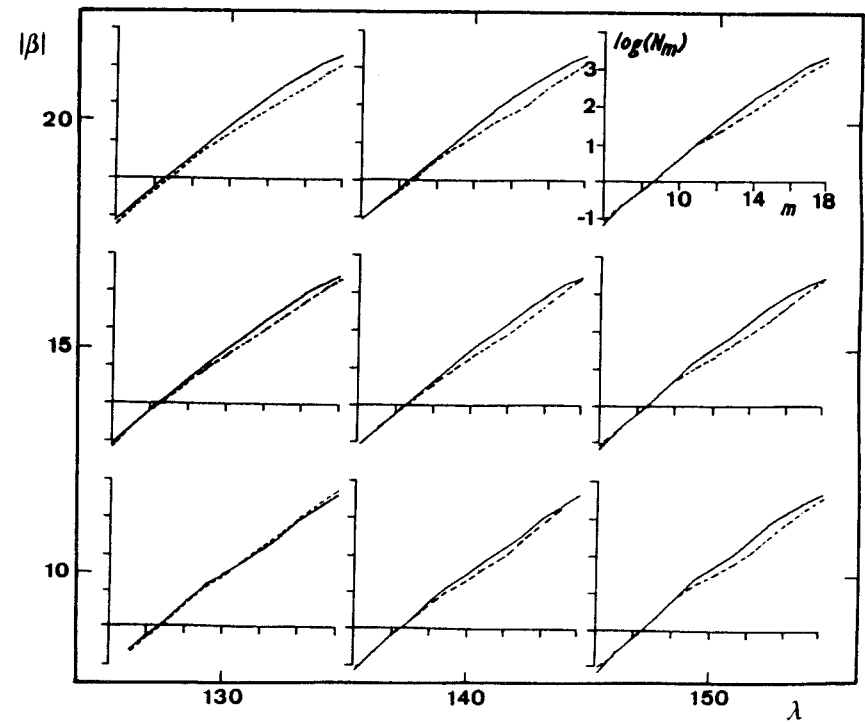

FIGURE 3. — Comparison of the variation of the logarithm of the number of stars brighter than m_B for $b^l = \pm 10^\circ, \pm 15^\circ, \pm 20^\circ$ and $l^l = 130^\circ, 140^\circ, 150^\circ$, where l^l and b^l are the old galactic coordinates. Continuous lines are for positive galactic latitude; this area is free of dark material and may be used as a reference field for the negative galactic latitude (discontinuous lines). The difference between the two regions of the sky is due to the dust associated with the complex of dark clouds of Taurus and Perseus (see text).

I.03) LE COMPLEXE DE NUAGES SOMBRES TAUREAU-COCHER-PERSEE :

PROFIL DE DENSITE

I.03) LE COMPLEXE DE NUAGES SOMBRES TAUREAU-COCHER-PERSEE :
PROFIL DE DENSITE

Nous avons effectué des comptages d'étoiles, avec une résolution angulaire de 2.5', sur tous les nuages sombres du complexe Taureau-Cocher-Persée pour lesquels $A_V \geq 1$ mag.. Ces comptages ont été effectués sur les plaques rouges du POSS (Palomar Observatory Sky Survey) et nous ont permis d'obtenir une image à haute résolution du milieu interstellaire local ($d \leq 200$ pc.) pour l^{II} de 160° à 180° et pour b^{II} de -10° à -20° . Le problème de la distance des nuages est évoqué. La masse du complexe de Persée est de $7 \cdot 10^3 M_\odot$. Pour la partie centrale du complexe du Taureau nous avons déterminé une masse de $6.5-9.5 \cdot 10^3 M_\odot$. La plupart de cette masse se trouve dans un halo étendu de faible densité.

En utilisant les comptages d'étoiles nous déterminons un profil de densité $n(r) \propto r^{-1.3}$. Les relations de Larson entre la dispersion en vitesse et la taille des nuages est une conséquence de la distribution de densité dans les nuages moléculaires s'ils sont virialisés.

The Taurus-Auriga-Perseus complex of dark clouds

I. Density structure

J. Cernicharo, R. Bachiller*, and G. Duvert

Groupe d'Astrophysique, E.R.A. 961 du C.N.R.S., Université Scientifique et Médicale de Grenoble, BP. 68, F-38402 St. Martin d'Hères Cedex, France

Received October 15, 1984; accepted February 4, 1985

Summary. Star counts covering all the dark clouds of $A_V > 1$ mag in the Taurus-Auriga-Perseus complex have been carried out on the red prints of the Palomar Observatory Sky Survey (POSS) with a ≈ 2.5 resolution. They enable us to sketch a high resolution picture of the local interstellar medium within 200 pc from the Sun from $l^{\text{II}} = 160^\circ$ to 180° and from $b^{\text{II}} = -10^\circ$ to -20° . The distance of the complex is discussed. The mass of the Perseus complex is $\approx 7 \cdot 10^3 M_\odot$. For the Taurus complex we derive a mass of $6.5-9.5 \cdot 10^3 M_\odot$ and most of the mass is an extended halo. We use the star counts to study the density, mass and column density distribution in dark clouds. We find that $n(r) \propto r^{-1.3}$ fits well the observed visual extinction maps. Visual extinction towards other local dark clouds are also fitted by the same density law, suggesting a similarity in the formation and evolution mechanisms of dark clouds. Larson's relation between velocity dispersion and radius arises as a consequence of the gas density distribution in molecular clouds, if they are in virial equilibrium.

Key words: interstellar absorption and extinction - dark clouds - star formation

1. Introduction

The strip of dark clouds stretching in the sky from Taurus to Perseus is one of the largest local associations of dark matter. In the last years, some cloudlets of Taurus - small regions of high density embedded in the clouds - have shown peculiar physical and chemical properties. For example, most of the cyanopolyne sources are located in Taurus (Benson and Myers, 1983). The Perseus complex differs in many respects from the Taurus complex. It may be physically associated with the Per OB2 star association and it is characterized by two hot spots, IC 348 and NGC 1333 where star formation is going on, connected by a filamentary chain of dark clouds with strong molecular emission (Bachiller and Cernicharo, 1984).

In the different attempts to obtain the physical and chemical properties of the two complexes, both large scale surveys and studies of small size regions have been carried out. Baran (1983) has mapped completely both complexes in the $J=1-0$ line of ^{12}CO . Unfortunately, his spectral resolution, beam size and

sampling were not sufficient to study in detail the different parts of the clouds. Wouterloot (1981) has mapped the whole Taurus complex in the 18-cm lines of OH. Due to the beam size and the difficulty in the OH lines interpretation, Wouterloot's survey, as well as Baran's, gives information about physical conditions in the complex only on a very large scale. On the other hand, many interesting cloudlets (TMC1, TMC2, NGC 1333, ...) have been studied carefully by different authors using high spatial resolution and many molecular lines, including rare isotopes. The area observed in these regions is restricted to the high density cores. As a consequence, the global physical properties of the clouds are poorly known.

Measurement of the column density of molecular hydrogen in dark clouds is given by the visual extinction, assuming that the $N(\text{H}_2)/E(B-V)$ relation of Bohlin et al. (1978) holds for large A_V . Star counts from photographic plates is a classical procedure to determine the visual extinction in local dark clouds (see for example Bok, 1937; Bok and Cordwell, 1973; Dickman, 1976, 1978a; Cernicharo and Bachiller, 1984, henceforth referred to as CB).

The relative nearness of the complex studied here makes star counts a powerful measuring tool down to scales of ≈ 0.1 pc, without introducing large statistical errors. We have made star counts on the red prints of the POSS over all dark clouds of the Taurus-Auriga-Perseus complex with $A_V \geq 1$ mag (see CB). A total surface area of ≈ 40 square degrees has been counted at resolution of ≈ 2.5 . These star counts complement the systematic survey in several molecular lines of the Taurus-Auriga-Perseus complex carried out recently with the 2.5 m telescope of the Bordeaux observatory. The main goals of our molecular and visual extinction surveys are: (i) to obtain relations between molecular column density and molecular hydrogen column density, $N(^{13}\text{CO})/N(\text{H}_2)$ and $N(\text{C}^{18}\text{O})/N(\text{H}_2)$, in Taurus and Perseus (Cernicharo and Guélin, 1985a; Bachiller and Cernicharo, 1985; Duvert et al., 1985); and (ii) to study the structure of the dark clouds of the complex from their smallest (few 0.1 pc) to their largest structures (few $\times 10$ pc).

In this paper we analyze the global structure of the complex and the mass, density and column density distribution in the dark clouds from the CB star counts. A further paper analyzing the fragmentary and velocity structure of the complex is in progress (Cernicharo et al., 1985). The plan of this paper is the following: in Sect. 2 we present the visual extinction maps for the surveyed clouds. The distance of the Perseus complex, its possible connection with the Taurus complex, and the masses of the two complexes are discussed in Sect. 3. In Sect. 4 we use the derived visual extinctions to study the density structure of dark clouds. In

Send offprint requests to: J. Cernicharo

* On leave from Centro Astronómico de Yebes, Guadalajara, Spain

274

Sect. 5 we compare the density profile derived in this work to those given by other authors from molecular observations or from theoretical models. Larson's law between mass and radius is analyzed.

2. Visual extinction maps

The results of our star counts in the Taurus and Perseus complexes are given as gray scale maps in Fig. 1a-m. These maps were made from a two dimensional Hanning smoothing of the original data. The errors introduced by this procedure are less than 10% for moderate A_V and of the order of 20% at the edges of the smallest

cloudlets. The highest values of A_V are lower limits to the actual visual extinction. The corrections for the extinction in the reference fields and for the loss of limiting magnitude of the prints are included. The known young stars in each counted region are plotted as black or white stars in Fig. 1; these stars are probably associated to the dark clouds, and star counts give only lower limits to the visual extinction toward them. The error introduced in A_V is low when only one T-Tauri star is counted in one square. For regions of active star formation like NGC 1333 or IC 348, the visual extinction derived from star counts becomes unreliable. These regions, as well as reflection nebulae, are indicated by circles (black or white) in Fig. 1, see CB.

In Figs. 1k, 1l, and 1m we show counts for L134N (red and blue counts) and for L134. These counts, in clouds which are not part of

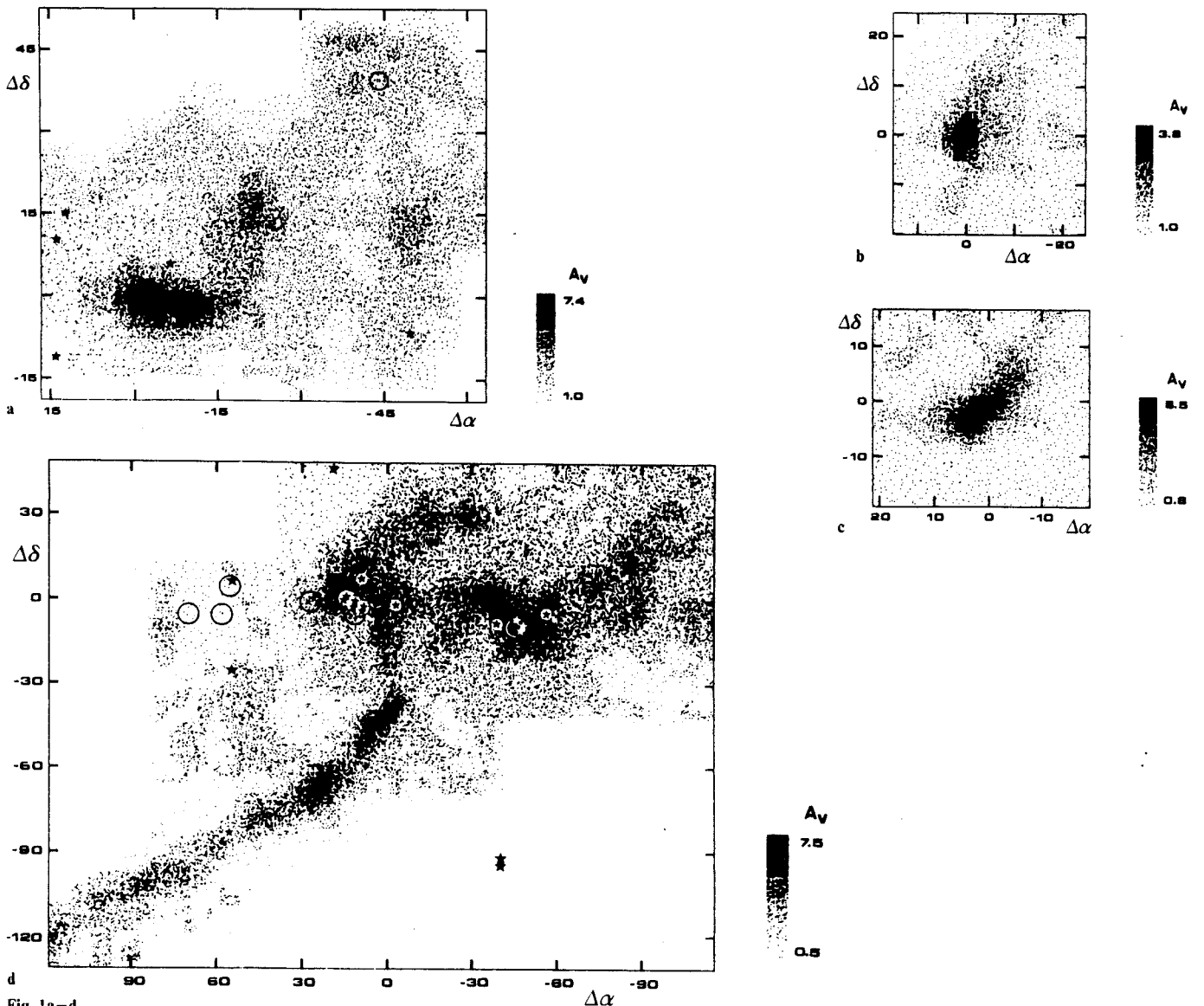

Fig. 1a-d

Fig. 1a-m. Visual extinction contours towards: a L 1536; b L 1489; c L 1544; d L 1495; e L 1506; f L 1529 (the central position corresponds to TMC2); g Heiles Cloud 2 (L 1534. The central position corresponds to TMC1); h L 1517; i B 5; j Composite view of the visual extinction in Perseus [the ticks on the axes indicate the positions of the reference points where the transparent grids were centered: $\alpha(1) = 3^h44^m22^s.6$, $\alpha(2) = 3^h40^m50^s.7$, $\alpha(3) = 3^h35^m19^s.9$, $\alpha(4) = 3^h30^m39^s.8$, $\alpha(5) = 3^h25^m56^s.0$, $\alpha(6) = 3^h21^m15^s.5$, $\delta(A) = 32^\circ42'44''$, $\delta(B) = 31^\circ52'27''$, $\delta(C) = 31^\circ10'12''$, $\delta(D) = 30^\circ10'12''$]; k L 134N (counts in the red print of the POSS); l L 134N (counts in the blue print of the POSS); m L 134 (counts in the blue print of the POSS). Units for $\Delta\alpha$ and $\Delta\delta$ are arcminutes. The resolution of the counts is ≈ 2.5 before smoothing (see Table 2) and roughly $5'$ after smoothing

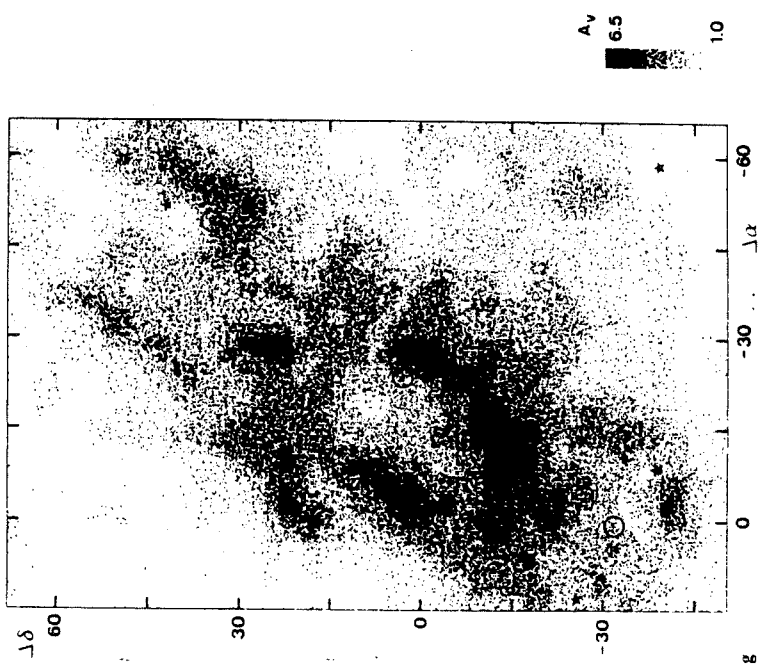
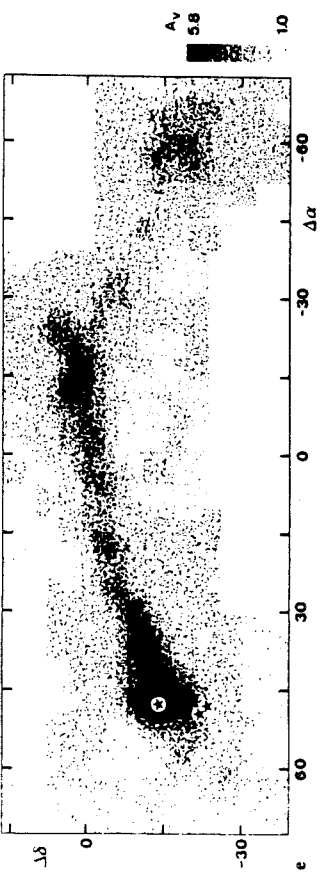
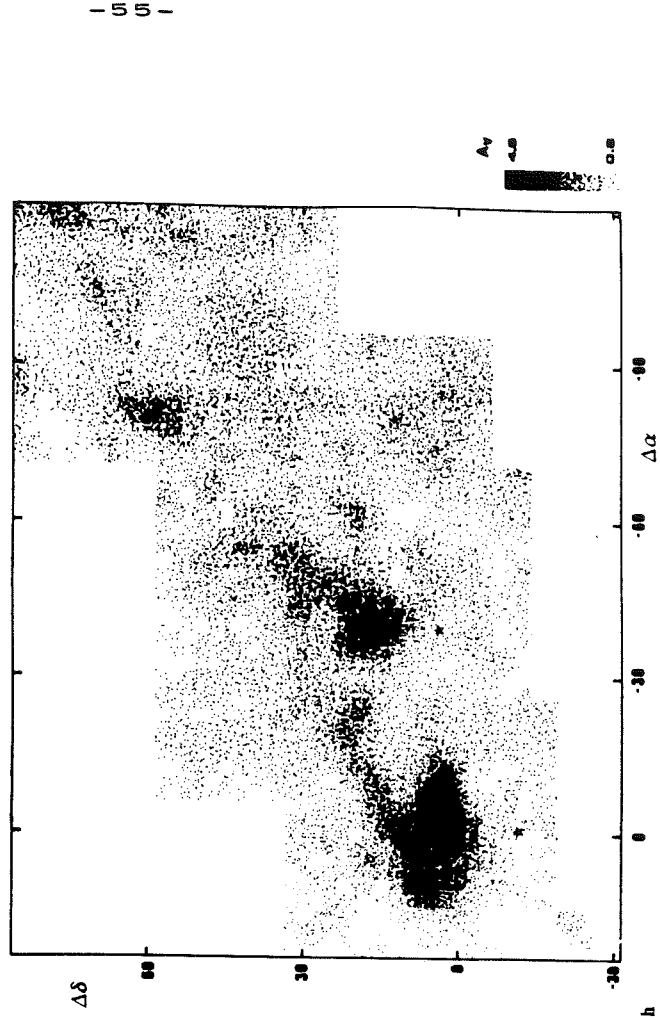
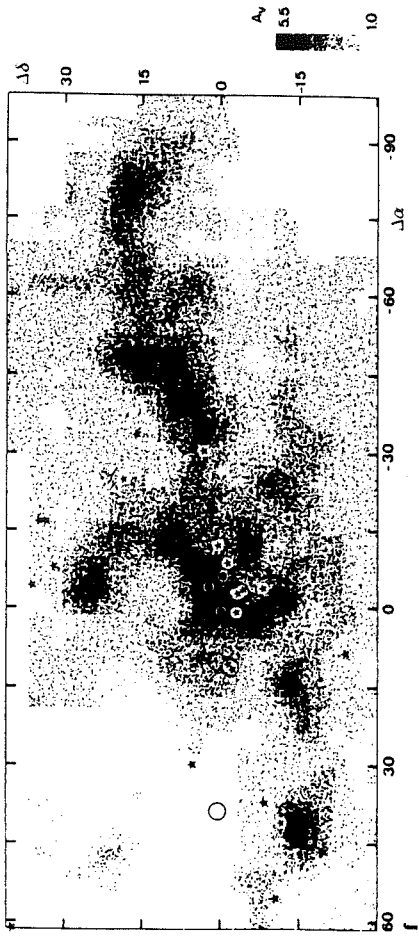

Fig. 1e-h

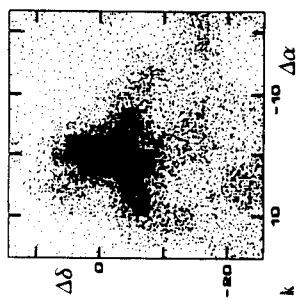
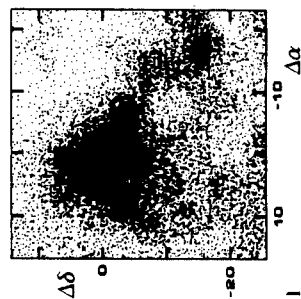
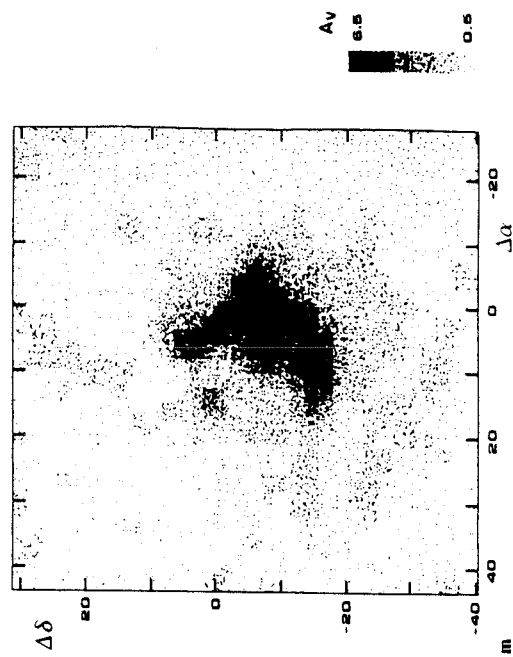
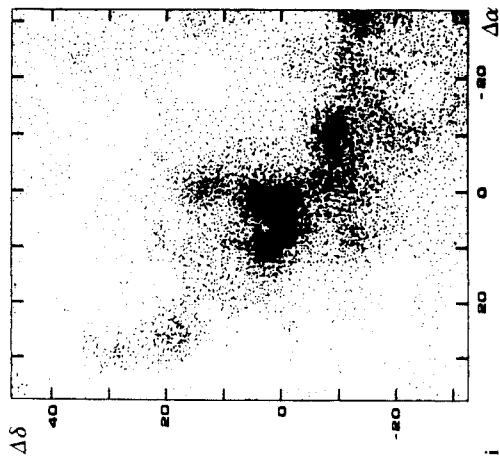
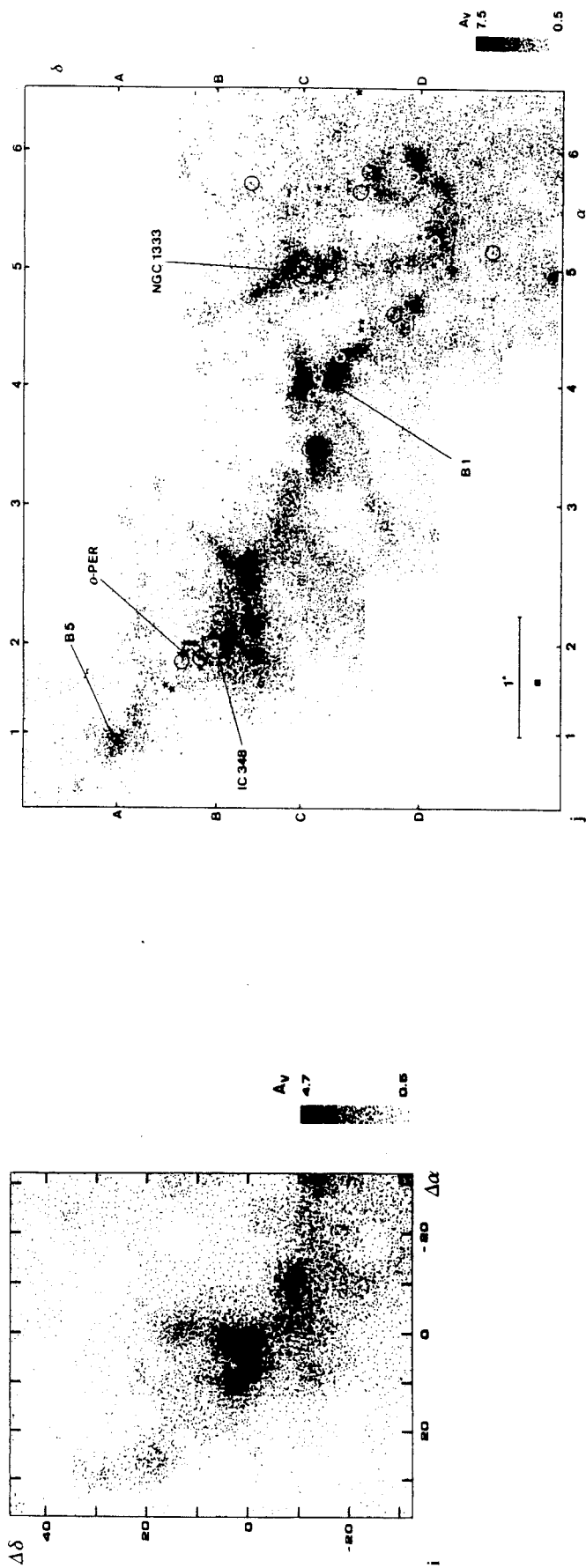

Fig. 11-m

the Taurus-Perseus complex, are used in Sect. 4 to derive global properties of dark clouds.

Previous systematic star counts in Taurus and Perseus (McCuskey, 1938, 1939, 1941; Heeschen, 1951) have a lower resolution than our counts. Our maps of visual extinction agree with those counts for $A_V \leq 3$ mag. Two clouds of Taurus, L1529 and HCL2 have been counted with high resolution by Batrla et al. (1981) and by Sherwood and Wilson (1982) respectively. However, their counts present some fundamental differences with ours. They have used counts with a resolution of 1:1 and as a consequence they find an artificially large area without stars in the core of the clouds – see CB. When they average their counts over $\approx 10'$ squares, their visual extinction contours agree very well with our counts degraded to the same resolution. Our stars counts in HCL2 show that several fragments of high visual extinction, comparable in opacity and size to TMC1, are spread around the central hole characterizing this cloud. Recent millimeter molecular observations with the Bordeaux telescope (Cernicharo and Guélin, 1985a, b), and high angular molecular observations of the fragments (Cernicharo et al., 1984), show that our star counts match exactly the position of the cloudlets (typical size $\approx 5'$). These cloudlets are not visible in the Sherwood and Wilson's 1:1 counts due to the poor statistical significance of their data for $A_V \geq 4$ mag. Bok (1956) has counted a field around HCL2 with a resolution of 5:6. Gaida et al. (1984) have counted with a 4:5 resolution three clouds studied in this paper (L1517, L1495, L1506). Their counts agree well with ours. Partial contour maps from our counts in L1529 and L1506 are given by Baudry et al. (1981).

3. Distances and masses in the Taurus-Auriga-Perseus complex

The mean distance of the Taurus complex is well known to be ≈ 135 pc (Elias, 1978) but individual clouds may be at different distances. The distance of the Perseus complex is still an unsolved problem. The values of the distance found in the literature range from 150 pc (Rydgren, 1971), to 500 pc (Strom et al., 1976). Thus, its actual value is known within a factor of 3 and the mass may be wrong by a factor of 10! Our star counts shed some light on this problem. The number of stars within a given area is a function of the opacity of the cloud and of its distance. Assuming that a fragment has a known A_V , – or at least a lower limit to A_V –, we can derive an upper limit to the number of stars we should find in its direction as a function of the distance using the standard luminosity and stellar density functions of Bahcall and Soneira (1980) – see also Bok and Cordwell (1973). Areas free of stars are uniformly distributed over the chain of globules between IC 348 and NGC 1333. From their surface area we can give an upper limit

to the distance of the closest clouds of ≈ 200 pc. This value is in agreement with Rydgren's for matter Northeast of the Perseus complex and with the distance of some reflection nebulae of this complex (Racine, 1968).

The distance of the Per OB2 association (Borgman and Blaauw, 1964), and of the open cluster IC 348 (Strom et al., 1974) is ≈ 300 pc. Strom et al. have derived the distance to IC 348 from spectrophotometric data of seven stars. Two of them, σ Per and BD 31°643, could be associated with the complex and their distances to the Sun are 290 and 230 pc respectively. The distance of σ Per has also been determined by Borgman and Blaauw (1964) to be 200 pc; Guetter (1977) has derived for this star a distance of 250 pc.

The discrepancies in the distance of σ Per could arise from the value of $R = A_V/E(B-V)$ taken by the different authors. Strom et al. (1974) have found that the ratio of total to selective extinction increases in the regions of the cloud which have the largest obscuration. For their seven stars with well established spectral type, five have $\langle R \rangle = 3.2 \pm 0.1$, in excellent agreement with the value derived by Guetter (1977). The two other stars have R close to 4. Borgman and Blaauw (1964) have also used seven stars and the value of R derived by Johnson and Borgman (1963) for the stars ϵ Per and τ Per ($R = 3.75$) to derive the distance of the Per OB2 association. Although the value of R is not very critical when deriving visual extinction from star counts (Dickman, 1978a), it is the main source of errors in the determination of stellar distances.

The low number of stars used by Strom et al. (1974) and by Borgman and Blaauw (1964) makes their distance determination uncertain. Guetter (1977) has used a larger sample of data to derive the distance of the Per OB2 association. He has found a mean distance of 400 pc for 84 O8–A2 stars. It is, however, possible to analyze his data using a division of the stars by range of distance modulus. In Table 1 we give the mean distance modulus and the mean colour excess for 100 stars of Guetter's paper. No difference is found in the mean colour excess for each group. We can see that all the stars are reddened more or less uniformly and that the first layer of absorbing matter is at ≈ 200 pc in good agreement with the distance derived from our star counts. The low A_V values in Table 1 correspond to Guetter's selection of low reddened stars.

Strom et al. (1976) have established a value for the distance of NGC 1333 of 500 pc. This result has been derived from observations of only one strongly reddened star and could be uncertain in view of the large errors associated with this type of determinations.

We conclude that, in the direction of the Perseus complex the first layer of obscuring matter is at a distance of ≈ 200 pc. Another layer at ≈ 300 pc is probably the site of the Per OB2 association.

Table 1. Mean distance and colour excess for stars towards Perseus (Guetter, 1977). Column (1): Range of distance modulus. Column (2): Mean distance modulus. Column (3): Mean distance (pc). Column (4): Mean colour excess. Column (5): Mean visual extinction assuming $R = 3.2$ (see text). Column (6): Number of stars

$m - M$	$\langle m - M \rangle$	$\langle d \rangle$	$\langle E_{(B-V)} \rangle$	$\langle A_V \rangle$	n
< 7	6.7 ± 0.40	220 ± 40	0.19 ± 0.10	0.61 ± 0.32	14
7.0–7.5	7.4 ± 0.14	300 ± 20	0.23 ± 0.08	0.74 ± 0.25	16
7.5–8.0	7.9 ± 0.14	370 ± 24	0.21 ± 0.09	0.67 ± 0.29	28
8.0–8.5	8.3 ± 0.13	450 ± 30	0.19 ± 0.09	0.61 ± 0.32	26
> 8.5	9.0 ± 0.50	650 ± 150	0.26 ± 0.09	0.83 ± 0.29	16

Table 2. Column (1): The most usual name of the cloud. Columns (2) and (3): α (1950) and δ (1950) of the reference point. Column (4): Resolution of the counts in arcmin. Column (5): Wavelength used for the counts (R red, B blue). Column (6): Extinction, relative to the reference field, at $0.7 \cdot R \cdot A_0$ is roughly the mean visual extinction of the cloud relative to the reference field – see text. Extinctions in the reference fields are given in Col. 9. Column (7): Mass relative to the reference field (M_\odot). Column (8): Total radius (in pc) of the cloud defined by $R_T = \sqrt{S_T/\pi}$, where S_T is the surface within the lowest A_V contour. Column (9): Adopted visual extinction in the reference field. Column (10): Mass corrected for the extinction in the reference field (M_\odot)

Name	Alpha	Delta	RS	C	A_0	M	R	A_V	M
HCL2	4 38 38.0	25 35 45	2.24	R	1.7	640	2.23	1.0	1000
L 1517	4 52 00.0	30 29 00	2.50	R	1.2	278	2.30	0.5	457
L 1536	4 31 20.0	22 38 00	2.24	R	1.5	250	1.53	1.0	410
L 1506	4 17 00.0	25 10 00	2.24	R	1.0	242	1.64	1.0	430
L 1529	4 29 43.0	24 16 55	2.24	R	1.3	440	2.11	1.0	740
L 1495	4 14 44.9	28 13 36	2.50	R	1.9	1480	3.51	0.5	1900
L 1544	5 1 00.0	25 10 00	2.24	R	1.0	57	0.87	0.5	83
L 1489	4 1 42.0	26 12 12	2.50	R	0.7	58	0.97	0.5	92
B5	3 44 22.6	32 42 44	2.50	R	1.0	210	2.13	0.5	360
Perseus	3 30 34.3	30 59 13	2.50	R	1.6	5400	7.57	0.5	7450
L 134N	15 51 30.0	- 2 43 31	2.24	R	1.5	52	0.64	0.5	66
L 134N	- - -	- - -	2.24	B	-	38	-	0.5	52
L 134	15 50 50.0	- 4 26 00	2.24	B	0.8	98	1.12	0.5	140

The mass of the clouds can be obtained from star counts if their distance to the Sun is known. Although the mass of each individual cloud depends very sensitively on its distance, the mass of the whole complex can be well estimated using its mean distance. From Dickman (1976, 1978a) we can write

$$M_T = (\alpha d)^2 \mu \beta \Sigma A_V^i, \tag{1}$$

where α is the angular resolution of the counts in radians, d is the distance to the cloud in cm, μ is the mean mass per particle, which includes a 30% correction for helium abundance (Allen, 1973) and where $\beta \approx 10^{21} \text{ cm}^{-2} \text{ mag}^{-1}$ is the standard relation between molecular hydrogen column density and visual extinction (Bohlin et al., 1978).

Table 2 contains (column 7) the masses of the counted clouds given by (1) when only raw values of star counts in the reference field are used, and (column 10) the masses of the same clouds when visual extinction in the reference field is taken into account. Individual masses must be taken with some caution.

The total mass of the Perseus complex, assuming a value of 200 pc for its distance, is $\approx 7 \cdot 10^3 M_\odot$. The total mass of the Taurus clouds relative to the raw reference fields is $\approx 3450 M_\odot$ ($5100 M_\odot$ relative to the reference fields corrected for extinction). This mass may actually be larger due to the extended halo surrounding the complex (see CB). Assuming uniform visual extinction of 0.5–1.0 mag across the complex, the mass per square degree will be of 60–120 M_\odot at the distance of 135 pc. From McCuskey's low resolution star counts in Taurus, we derive a value of at least ≈ 50 square degrees for the surface of the central region of the Taurus complex contaminated by dust – in addition to the surface area covered by our counts. Therefore the total mass of Taurus becomes $\approx 6.5\text{--}9.5 \cdot 10^3 M_\odot$. This value agrees with Wouterloot's (1981) estimate of the Taurus mass from OH observation.

From McCuskey's (1938, 1939, 1941) work in Taurus, or the Baran (1983) and Wouterloot (1981) surveys, or from an inspection of the Palomar prints between Taurus and Perseus, it seems that a physical connection exists between the two complexes. The distance of the first clouds in the direction of the Perseus complex

derived from our star counts supports the existence of the Taurus-Perseus "bridge" and the idea of a large complex of dark matter near the Sun (100–200 pc). This idea is also supported by the data of Gottlieb and Upson (1969) and Perry and Johnson (1982). This complex could contain the Taurus, Pleiades and most of the Perseus and Auriga clouds (see the discussion of its kinematic structure by Wouterloot, 1981). The mass of the big complex of local clouds in the anticenter direction could then be as large as $5 \cdot 10^4 M_\odot$.

4. Density structure of dark clouds

Star counts can be used as a tracer of the physical structure of dark clouds: the observed dust distribution can give the distribution of mass, density and column density in dark clouds.

The clouds studied here are at different distances (see Sect. 2) and we have to use distance-free parameters in the analysis of the whole data. Whatever distance an observed cloud is, it is possible, as soon as it is resolved, to define on its apparent surface contours of equal value in some observed parameter – here we take A_V . To the apparent surface s of some contour will correspond a reduced (distance-independent) surface $\bar{S} = s/S_T$, where S_T is the total apparent surface of the cloud. Since we can write $s = \pi \rho^2$, $S_T = \pi R_T^2$, we define a reduced projected radius $\epsilon = \rho/R_T$. We define then the normalized mass within ρ as $\bar{M}(\epsilon) = M(\rho)/M_T$, where M_T is the total mass of the cloud. Finally, we define the *normalized* visual extinction for a *normalized* projected radius ϵ , as $\bar{A}_V(\epsilon) = A_V(\epsilon)/A_0$, where A_0 is the visual extinction for $\rho = 0.7 R_T$ (see below). Just like ϵ , the three functions $\bar{M}(\epsilon)$, $\bar{A}_V(\epsilon)$ and $\bar{S}(\epsilon)$ are independent of the distance.

In Fig. 2 we have plotted $\log(\bar{M}(\epsilon))$ versus $\log(\epsilon)$ (or versus $\log(\bar{S}(\epsilon))$). Total mass and radius, determined using uniform criterion, for the clouds are given in Table 2. Every point of Fig. 2 represents a contour of given A_V . From this figure we see that the mass of the clouds may be parametrised as a function of $\bar{S}(\epsilon)$ and therefore of the normalized projected radius ϵ . In Fig. 2 we have included two dark globules counted by Dickman (1978), and our

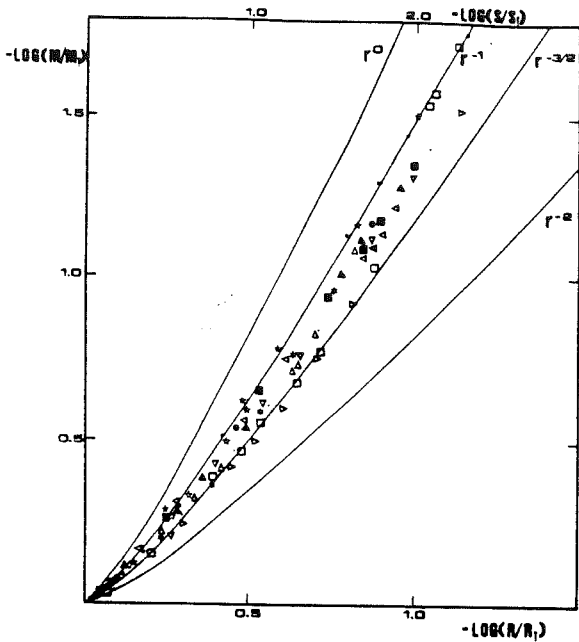

Fig. 2. The logarithm of the mass within a projected radius q normalized to the total mass of the cloud, M_T as a function of the logarithm of q/R_T , where R_T is the total radius of the cloud. Solid lines represent spheres with a density law $n(r) \propto r^{-\alpha}$ for $\alpha=0, 1, 3/2$, and 2 . The upper scale is the logarithm of the surface within q normalized to the total surface. Symbols are: \bullet B 5, \circ HCL2, \cdot L 134N (red counts), \ast B 134 (data from Dickman, 1978), \circ B 92 (data from Dickman, 1978), \blacksquare L 1489, \triangle L 1495, ∇ L 1506, \triangleright L 1517, \triangleleft L 1536, \blacktriangle Perseus, \square L 1544, \bullet L 1529

red counts for L134N. The counts for L134 presented in Sect. 2 and the counts for the other small dark globules of Dickman's paper (1978a), are not included because most of their masses come from the regions free of stars where A_V values are only lower limits due to the large opacities of the cores. No difference is found in the relation $\log(\bar{M}(\epsilon))$ against $\log(\epsilon)$ between our clouds and Dickman's globules.

From the uniformity of the observed values of $\bar{M}(\epsilon)$ in all those clouds with different sizes and masses, we are able to say that probably dark clouds are characterised by some internal property independent of their total size and mass. Could $\bar{M}(\epsilon)$ be parametrised as a function of other cloud parameters? We have plotted in Fig. 3 the parameter \bar{M} as a function of \bar{A}_V for the clouds of Fig. 1. The values of A_0 for each cloud are given in Table 1 and vary between 1.0 and 1.9 magnitudes. The difference in position of the points between Figs. 2 and 3 relative to the solid lines – see below –, are comparable with those due to the errors in the measurement of A_0 . Figure 3 shows that the mass within a given contour of $\bar{A}_V(\epsilon)$ is the same function of this parameter for all the clouds. As a consequence of Figs. 2 and 3, $\bar{A}_V(\epsilon)$ can be parametrised as a function of ϵ .

From Figs. 2 and 3 we can see that only a small fraction of the total mass of the clouds pertains to the high visual extinction regions.

If our results are the consequence of a physical property of the clouds, then the most reliable parameter, once given the reduced mass and A_V , is their density. Let us consider a sphere of total radius R_T with a density law:

$$n(r, \alpha) = cr^{-\alpha}, \quad (2)$$

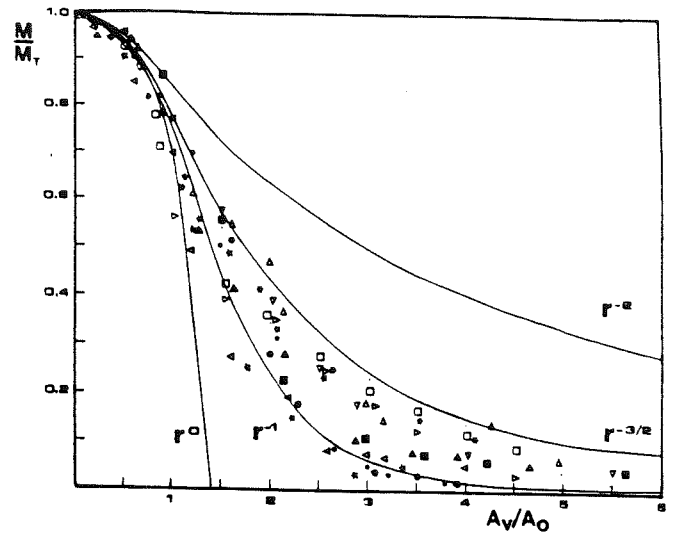

Fig. 3. The mass within a given contour of A_V , normalized to the total mass of the cloud, as a function of the visual extinction normalized to the visual extinction at $0.7 \cdot R_T$, where R_T is the total radius of the cloud (see text). Solid lines represent spheres with a density law $n(r) \propto r^{-\alpha}$ for $\alpha=0, 1, 3/2$ and 2 . Symbols are as in Fig. 2

where r is the radial distance from the center of the sphere; α is a positive real value with $0 \leq \alpha < 3$, and c is a constant. For a projected radius ϵ , the visual extinction is given by $\bar{A}_V(\epsilon, \alpha) = A_V(\epsilon, \alpha)/A_0 = g(\epsilon, \alpha)$, where

$$g(\epsilon, \alpha) = \epsilon^{(1-\alpha)} \int_0^{\frac{1-\epsilon^2}{\epsilon^2}} (1+t^2)^{-\alpha/2} dt \quad (3)$$

with $0 \leq g(\epsilon, \alpha)$ and $A_0 = 2cR_T^{(1-\alpha)}\beta \text{ mag}$ (β is the standard $N(\text{H}_2)/A_V$ ratio). The normalised mass within the circle of radius ϵ is given by $\bar{M}(\epsilon, \alpha) = M(\epsilon, \alpha)/M_T = f(\epsilon, \alpha)$, where $f(\epsilon, \alpha)$ is given by

$$f(\epsilon, \alpha) = (3-\alpha) \int_0^{\frac{1-\epsilon^2}{\epsilon^2}} zg(z, \alpha) dz \quad (4)$$

with $0 < f(\epsilon, \alpha) \leq 1$. The total mass of the sphere is given by

$$M_T(\alpha) = 4\pi c\mu(3-\alpha)^{-1} R_T^{(3-\alpha)}, \quad (5)$$

where μ is the mean mass per particle. The normalized surface within the normalized radius ϵ is given by:

$$\bar{S}(\epsilon, \alpha) = S(\epsilon, \alpha)/S_T = \epsilon^2. \quad (6)$$

The mean density and the mean visual extinction in the cloud are given by:

$$\langle n(\alpha) \rangle = cR_T^{-\alpha}/(1-\alpha/3) = n_0/(1-\alpha/3), \quad (7)$$

$$\langle A_V(\alpha) \rangle = 2A_0/(3-\alpha), \quad (8)$$

where $n_0 = cR_T^{-\alpha}$, i.e., the mean density has the same power law in R_T as the density within the cloud in r .

For any sphere, A_0 is reached for a projected radius $\epsilon_0 = \rho_0/R_T$ given by the condition $g(\epsilon, \alpha) = 1$. From the above equations we obtain $\epsilon_0 = 0.0, 0.65, 0.70, 0.74$ for $\alpha = 0, 1, 3/2$ and 2 . If $\alpha > 0$ and $\alpha < 3$ then the value of ϵ_0 is well given by $\epsilon_0 \approx 0.7$. In Fig. 3 the visual extinction is normalized to A_V corresponding to this value of ϵ_0 . In Fig. 2 we have plotted $\log(\bar{M}(\epsilon, \alpha))$ against ϵ and in Fig. 3, $\bar{M}(\epsilon, \alpha)$ versus \bar{A}_V for $\alpha = 0, 1, 3/2$ and 2 (solid lines). The best fit to the data

is given by $\alpha = 1.3 \pm 0.2 (3\sigma)$, i.e., the density law in the dark clouds considered, may be written as:

$$n(r) = cr^{-1.3} \quad (9)$$

in excellent agreement with the density law found in ρ Oph by Myers et al. (1978) from star counts. From (8) and (9) we see that A_0 is roughly the mean visual extinction of the cloud.

Two questions arise looking at Figs. 2 and 3: 1) Why spheres?; and 2) What is the largest scale of validity of this density law? The answer to both questions may have the same origin. From Fig. 1 we see that only the smallest globules ($R_T \leq 1$ pc) have a roughly spherical geometry; all the other clouds are chains of smaller clouds. In Figs. 2 and 3 we have considered the large clouds (HCL2, Perseus, L1529, L1495) as isolated objects, but it is clear that this idea is not correct; why, then, do we not find more dispersion in these figures?

If we consider other geometries for the clouds, the independence of the position of the spheres relative to the line of sight disappears. If we consider cylinders (or disks) with a density gradient towards their symmetry axis and with this axis in the direction of the line of sight then the theoretical relation between mass and projected radius is $\log(\bar{M}(\epsilon)) = (2 - \alpha) \log(\epsilon)$, with $\alpha < 2$. The normalised visual extinction is given by $\epsilon^{-\alpha}$. The observational data of Fig. 2 are roughly fitted by cylinders with $\alpha = 1.3$. However the data of Fig. 3 cannot be fitted by any value of α in this particular geometry for the clouds. Moreover, if clouds are cylinder-like, then we must find every orientation of their symmetry axis relative to the line of sight. In this case, for a given α the $\log(\bar{M})$ versus $\log(\epsilon)$ relation depends on this orientation and we should find a larger dispersion in the data shown in Figs. 2 and 3. For example, if the above cylinders have their symmetry axis perpendicular to the line of sight, then the data of Fig. 3 can be roughly fitted by $\alpha = 0.7$, but the data of Fig. 2 cannot be fitted by any α . Our observational data can be only fitted by density profiles peaked towards a center of symmetry (spheres or spheroids).

Let us consider a large cloud ($R_T \geq 1$ pc) as formed by N non-overlapping spherical clouds, each of mass M_T^i and radius R_T^i . The total mass of this cloud is $M_T^* = \Sigma M_T^i$ and the total surface $S_T^* = \Sigma S_T^i$, with $R_T^* = \sqrt{S_T^*/\pi}$. The contours of equal A_V are circles and ϵ , the normalized projected distance from the center of each cloud, is a well defined parameter. With a given ϵ for the isolated globules (which corresponds to different values of the projected radius ρ for each globule), the total mass and surface within the corresponding contour of normalized visual extinction $\bar{A}_V(\epsilon)$ will be given by

$$M^*(\epsilon) = \Sigma M^i(\epsilon) = \Sigma M_T^i \cdot f(\epsilon, \alpha) = M_T^* \cdot f(\epsilon, \alpha), \quad (10)$$

$$S^*(\epsilon) = \Sigma S^i(\epsilon) = \Sigma S_T^i \cdot \epsilon^2 = S_T^* \cdot \epsilon^2, \quad (11)$$

$$\epsilon' = \sqrt{S(\epsilon)/\pi} \cdot R_T^{*-1} = \epsilon, \quad (12)$$

i.e., $M^*(\epsilon)/M_T^* = f(\epsilon, \alpha)$ and $S^*(\epsilon)/S_T^* = \epsilon^2$. From a formal point of view, our ideal large clouds composed of small globules have the same relation between $\log(\bar{M}(\epsilon))$ and $\log(\epsilon)$ or between \bar{M} and \bar{A}_V as the isolated small spherical clouds. However, our actual large clouds are not spherical and ϵ cannot be directly derived: we need to use A_V as observable parameter to derive \bar{S} and \bar{M} . We then expect some dispersion in Figs. 2 and 3 because a fixed value of visual extinction in a large cloud corresponds to different values of ϵ in each of their small globules. If the globules form a filamentary or more complicated structure, with some overlapping regions, then the relation $M^*(\epsilon) = M_T^* \cdot f(\epsilon, \alpha)$ remains valid but not the $S^*(\epsilon) = S_T^* \cdot \epsilon^2$ and the $\epsilon = \epsilon'$ ones. However if the total overlapping

area is small compared to the total area then we expect only some little deviations in the relations \bar{M} versus ϵ and versus \bar{A}_V .

We conclude from our observational data that the most likely density law in dark clouds is $n(r) \propto r^{-1.3}$ and that this law applies for clouds of radius ≤ 1.0 pc. On the other hand, star counts are limited by opacity in the smallest parts of the cloud and therefore the density law we derive applies only for sizes larger than a few 0.1 pc; typical radius of the regions free of stars. The density structure in the cores of dark clouds can be derived from molecular observations.

5. Discussion

5.1. Comparison with published density structure

The radial density structure of some molecular clouds has been determined by Westbrook et al. (1976) and by Cheung et al. (1980) observing dust emission at 1 mm. The 1 mm data are suitable for this purpose because the low optical depth of dust at this wavelength enables one to see through the center of the source. However, the radial variation of the dust temperature must be known to derive $n_d(r)$. Assuming $T_d(r) \propto r^{-a}$, with $a \approx 0.4-0.5$, they found $n_d(r) \propto r^{-1.5 \pm 0.5}$, in reasonable agreement with our result for dark clouds. The hypothesis of a linear relation between optical extinction and molecular hydrogen column density directly implies that the gas density profile is the same as the dust's. The relation between total gas column density and visual extinction is confirmed for $A_V \leq 3$ mag (Bohlin et al., 1978) and probably applies for A_V as large as 10 mag (Dickman, 1976, 1978b; Cernicharo and Guélin, 1958a; Bachiller and Cernicharo, 1985). Moreover, Righini-Cohen et al. (1978) have found a good correlation between $^{13}\text{CO } J=1-0$ column density and 1 mm emission in molecular clouds. Consequently, the gas density law in molecular clouds would be given by $n(r) \propto r^{-1.3}$. The molecular clouds studied by Westbrook et al. (1976) and by Cheung et al. (1980) are distant and their spatial resolution allows sampling of the regions corresponding to the "envelopes" of the clouds, i.e., the same region where our density profile applies.

Tomita et al. (1979) have used star counts to study 14 large globules with a roughly spherical geometry. They found that $\log(A_V) \propto \log(\rho)^{-\nu}$ where ν ranges from 2.2 to 3.6. The mean value of ν is 2.5 ± 0.4 for their clouds (we have weighted ν by the number of points in each cloud). By fitting a power law $\epsilon^{-\nu}$ to the function $g(\epsilon, \alpha)$ in the range where $\log(g(\epsilon, \alpha))$ is linear with $\log(\epsilon)$, i.e., $0.4 \leq \epsilon \leq 0.98$, we find that the best values for ν are 1.6, 2.1, 2.4, 2.5, and 2.8 for $\alpha = 0, 1, 1.3, 3/2$ and 2 respectively - roughly $\alpha \approx \nu - 1$. From these values of ν we deduce that the density in the clouds of Tomita et al. is given by $n(r) \propto r^{-1.5 \pm 0.4}$ in good agreement with our result.

The density structure of the molecular component may be obtained from molecular observations. The $J = 1-0$ line of ^{13}CO or C^{18}O should give the same result as star counts due to the linear relation between the gas column density derived from these molecules and A_V (Dickman, 1976, 1978b; Cernicharo and Guélin, 1985a; Bachiller and Cernicharo, 1985; Duvert et al., 1985). For high dipole moment molecules it is necessary to observe several lines and to make some assumptions about their abundances and excitation conditions to derive the H_2 density profile from a transfer model. This procedure gives reasonable results for moderate opacities. For large opacity lines the interpretation of the observations by theoretical models is often unrealistic. Loren et al. (1983) have used 2 cm and 2 mm H_2CO lines in ρ Oph and in

R Cra to derive from a LVG model a radial variation of the density following a power law $\propto R^{-(1.5-2.0)}$. The main objection to derivations of a density profile from molecular observations and a LVG model is that all the observed transitions are assumed to be formed in the same region of the cloud. Sandqvist and Bernes (1980), have used H_2CO observations and a Monte Carlo radiative transfer program, which permits the use of a model with a radial change of the density, to derive the density structure in L1551. They found a power law close to r^{-1} . In spite of the potential problems associated with radiation transfer models, Loren et al. (1983) and Sandqvist and Bernes (1980) have obtained a radial variation of the gas density comparable to the one given in this work.

5.2. The density profile of a self-gravitating cloud

The data of Figs. 2 and 3 cannot be explained by the expected density profile of an isothermal self-gravitating cloud in equilibrium, which is $n(r) \propto r^{-2}$ (Larson, 1969; Penston, 1969a). However, as has been shown by Shu (1977), an isothermal self-gravitating cloud will form a centrally condensed object with a spherical accretion flow of density profile $\propto r^{-3/2}$ around it. In his model the outer region of the cloud is a nearly static envelope with density profile $\propto r^{-2}$. These three regions, external envelope, internal envelope and centrally condensed object form during the later stages of collapse. Shu's calculations refer to a small cloud of $1 M_\odot$ but we can scale them to the typical mass of the dark clouds studied here.

Let us assume the three component model of dark clouds discussed by Bachiller and Cernicharo (1984) and Cernicharo and Guélin (1985b), where cores are the regions with high densities ($A_V > 5$), envelopes the regions with $1 < A_V < 5$ and halos the regions with $A_V < 1.0$ mag. The density profile $n(r) \propto r^{-1.3}$ we derive applies to the envelope alone. It would be interesting to fit the data by a model where the density law varies across the cloud. However, star counts are inadequate towards the core and the present counts are restricted in surface because the halo of Taurus and Perseus extends over several hundred square degrees in the sky. Large scale molecular surveys should be used for this purpose. The molecular observations in the direction of some cloudlets in HCL2 (Cernicharo et al., 1984) show that the density changes strongly between the core, the density of which is $\approx \text{few } 10^4 \text{ cm}^{-3}$, and the envelope, where the density is $\approx 4-5 \cdot 10^3$. Such a variation of density by a factor of ≈ 10 , over a scale comparable to the cloudlets size ($\approx 2-3$), implies a sharp change in the density in the core-envelope transition region.

The density profile derived in this work for the envelopes agrees well with that Shu's accretion flow. However, this agreement must be regarded with some caution first due to the efficiency of star formation implied by a collapsing isothermal self-gravitating cloud and also because isothermal conditions may not occur in dark clouds (Young et al., 1982). Further, Shu's core has about a half of the cloud mass, while in dark clouds only a few percent of the total cloud mass pertains to the high visual extinction regions (see Figs. 2 and 3).

Penston (1969b) has studied the dynamics of self-gravitating spherical clouds under the effects of ionic cooling and cosmic ray heating. The density profile he has found shows a centrally condensed object with an accretion flow of very sharp density profile in the neighborhood of the core. For radius $> 0.1 R_T$ and $< 0.5 R_T$ the density profile follows a law $\propto r^{-1.2/7}$, i.e., the same as for an isothermal cloud. This is due to the near isothermal behavior of his model (T_K changes between 7 and 12 K).

Recently, Falgarone and Puget (1985) have studied the density structure of thermally supported self-gravitating condensations of interstellar gas mixed with dust. They have included in their calculations cooling by molecular emission, heating by UV photons and cosmic rays, dissipation of turbulence and interaction of dust with gas. Their more complete treatment gives also a central condensation having 10% of the total radius of the cloud. This condensation is composed by an isothermal core with density profile $\propto r^{-2}$ and an envelope where density changes sharply. This core-envelope region corresponds to our core as defined above. They find that in a large part of the cloud ($r > 0.1 R_T$), density changes slowly with a roughly r^{-1} law. This region may correspond to our envelope as defined above. It is interesting to note that any self-gravitating hydrostatic sphere having an ideal-gas equation of state and which is hotter on the outside than in the inside will possess a density profile more shallow than the r^{-2} characteristic of the isothermal case (see Dickman and Clemens, 1983).

From a qualitative point of view, self-gravitating collapsing or thermally supported spherical clouds give a density structure which corresponds well with the observed one in dark clouds. However, these calculations are poor approximations to real, highly fragmented, dark clouds. More theoretical input, including magnetic fields (Mouschovias, 1976a, b) and interaction between the fragments (Scalo and Pumphrey, 1982; Pumphrey and Scalo, 1983) could be needed to understand the core-envelope-halo structure and the low star formation efficiency of dark clouds.

5.3. The Larson relation between mass and radius

Larson (1979, 1981) has found from molecular observations that the velocity dispersion in interstellar matter shows a general power-law correlation with the radius of the region given by $\Delta v (\text{km s}^{-1}) = 1.43 R_T (\text{pc})^{0.38}$. Moreover, he has found that this velocity dispersion is also correlated with the total mass of the cloud by $\Delta v (\text{km s}^{-1}) = 0.42 M (M_\odot)^{0.20}$. These relations hold for cloud sizes between a few tenths of pc and some hundreds of pc. From the above relations we can derive $M_T (M_\odot) = 460 R_T (\text{pc})^{1.9}$ and $\langle n(\text{H}_2) (\text{cm}^{-3}) \rangle = 1600 R_T (\text{pc})^{-1.1}$.

If the density profile in molecular clouds is given by (9) then their total masses and their mean densities are given by $M_T = (7.4 \pm 0.9) \cdot c \cdot R_T^{1.7 \pm 0.2}$ and $\langle n(\text{H}_2) \rangle = (1.8 \pm 0.2) \cdot c \cdot R_T^{-1.3 \pm 0.2}$, i.e. the total mass and the mean density for clouds with this density profile agree with the corresponding Larson's relations. These relations apply mainly to the global properties of the clouds. However, Larson (1981) has already pointed out that the velocity dispersion law holds also within each particular cloud. He has suggested that the observed motions in molecular clouds are part of a common hierarchy of interstellar turbulent motions without preferred length-scale. However, if the virial theorem applies for molecular clouds and if their density structure is given by (9) then we can derive $\Delta v (\text{km s}^{-1}) \propto R_T (\text{pc})^{0.33}$ which is in excellent agreement with the Larson's relation between velocity dispersion and size for molecular clouds. Larson has argued that the relation Δv versus R is better defined than the $\langle n(\text{H}_2) \rangle$ versus R one and that the turbulence process should be more fundamental than the process giving structures with $\langle n \rangle R^{1.3} \approx \text{const}$ and satisfying the virial theorem. In fact, the narrow relation of Fig. 2 and the relatively narrow relation of Fig. 3 are as well defined as the Larson relation between velocity dispersion and radius. Myers (1983) has analyzed the dependence of the mean density and velocity dispersion for small regions ("dense cores") where turbu-

lence is subsonic. He has derived a relation $\langle n \rangle \propto R_T^{-1.3}$ and $\Delta v \propto R_T^{0.5}$. If these small regions are roughly spherical then the density law within them is also given by $n(r) \propto r^{-1.3}$ (see Sect. 4). Thus, the law of virial equilibrium is closely satisfied in both, cores and envelopes. We conclude that the present data do not permit to distinguish between the two physical processes discussed above.

The value of the constant c in the density profile of dark clouds can be derived from the Larson relations to be $c = 62 M_\odot \text{pc}^{-1.3} = 890 \text{cm}^{-3} \text{pc}^{-1.7}$. However, the value of c will change if another criterion is accepted for the definition of a cloud, i.e., c is a function of the first contour of A_V – or of molecular emission – that one uses to derive the mass of the cloud. It is a consequence of the parametrisation of the clouds we found in Sect. 4.

6. Conclusions

Star counts have been used to give the visual extinction and the physical structure of the Taurus and Perseus complexes.

Systematic star counts with automatic machines should be an excellent procedure to derive the physical structure of the local complexes of dark clouds. The mass of the Perseus complex is $7 \cdot 10^3 M_\odot$. For Taurus the total mass is $6.5\text{--}9.5 \cdot 10^3 M_\odot$ and about a half of it pertains to an extended halo of visual extinction ≤ 1 mag.

Only a few percent of the total mass of the clouds is within the high visual extinction regions.

Dark clouds can be modeled by a three component medium: core-envelope-halo. The density profile in the envelopes has been derived from star counts to be $n(r) \propto r^{-1.3}$. This density law seems to apply to all the molecular clouds.

The velocity dispersion-radius relation has been derived, assuming virial equilibrium and the density law given above, to be $\Delta v \propto R_T^{0.35}$, i.e., the same power law as derived by Larson (1981) from molecular observations.

Acknowledgements. We wish to thank B. Lazareff for his comments in the early phase of this work, and to A. Castets and C. Kahane for a critical reading of the manuscript. We would like to thank our referee, R. Dickman, for his constructive criticism, advice, and improvement of the English.

References

- Allen, C.W.: 1973, *Astrophysical Quantities*, Athlone, London
- Bachiller, R., Cernicharo, J.: 1984, *Astron. Astrophys.* **140**, 414
- Bachiller, R., Cernicharo, J.: 1985, *Astron. Astrophys.* (submitted)
- Bahcall, J.N., Soneira, R.M.: 1980, *Astrophys. J. Suppl.* **44**, 73
- Baudry, A., Cernicharo, J., Perault, M., Despois, D., De la Noé, J.: 1981, *Astron. Astrophys.* **104**, 101
- Baran, G.P.: 1983, Ph. D. dissertation, Columbia University
- Batrla, W., Wilson, T.L., Rahe, J.: 1981, *Astron. Astrophys.* **96**, 202
- Benson, P.J., Myers, P.C.: 1983, *Astrophys. J.* **270**, 589
- Bohlin, R.C., Savage, B.D., Drake, J.F.: 1978, *Astrophys. J.* **224**, 132
- Bok, B.J.: 1937, *The distribution of Stars in Space*, Univ. Chicago Press, Chicago
- Bok, B.J.: 1956, *Astron. J.* **61**, 309
- Bok, B.J., Cordwell, C.S.: 1973, in *Molecules in the Galactic Environment*, eds. M.A. Gordon, L.E. Snyder, Wiley, New York, p. 53
- Borgman, J., Blaauw, A.: 1964, *Bull. Astron. Netherlands* **17**, 358
- Cernicharo, J., Bachiller, R.: 1984, *Astron. Astrophys. Suppl.* **58**, 327
- Cernicharo, J., Guélin, M., Askne, J.N.: 1984, *Astron. Astrophys.* **138**, 371
- Cernicharo, J., Guélin, M.: 1985a, *Astron. Astrophys.* (submitted)
- Cernicharo, J., Guélin, M.: 1985b (in preparation)
- Cernicharo, J., Bachiller, R., Duvert, G.: 1985 (in preparation)
- Cheung, L.H., Frogel, J.A., Gezari, D.Y., Hauser, M.G.: 1980, *Astrophys. J.* **240**, 74
- Dickman, R.L.: 1976, Ph. D. dissertation, Columbia University
- Dickman, R.L.: 1978a, *Astron. J.* **83**, 363
- Dickman, R.L.: 1978b, *Astrophys. J. Suppl.* **37**, 407
- Dickman, R.L., Clemens, D.P.: 1983, *Astrophys. J.* **271**, 143
- Duvert, G., Cernicharo, J., Baudry, A.: 1985 (submitted)
- Falgarone, E., Puget, J.L.: 1985, *Astron. Astrophys.* **142**, 157
- Elias, J.H.: 1978, *Astrophys. J.* **224**, 857
- Gaida, M., Ungerechts, H., Winnewisser, G.: 1984, *Astron. Astrophys.* **137**, 17
- Gottlieb, D.M., Upson, W.L.: 1969, *Astrophys. J.* **157**, 611
- Guetter, H.H.: 1977, *Astron. J.* **82**, 598
- Heeschen, D.S.: 1951, *Astrophys. J.* **114**, 132
- Johnson, H.L., Borgman, J.: 1963, *Bull. Astron. Netherlands* **17**, 15
- Larson, R.B.: 1969, *Monthly Notices Roy. Astron. Soc.* **145**, 271
- Larson, R.B.: 1979, *Monthly Notices Roy. Astron. Soc.* **186**, 479
- Larson, R.B.: 1981, *Monthly Notices Roy. Astron. Soc.* **194**, 809
- Loren, R.B., Sandqvist, A., Wootten, A.: 1983, *Astrophys. J.* **270**, 620
- McCuskey, S.W.: 1938, *Astrophys. J.* **88**, 209
- McCuskey, S.W.: 1939, *Astrophys. J.* **89**, 568
- McCuskey, S.W.: 1941, *Astrophys. J.* **94**, 468
- Mouschovias, T.Ch.: 1976a, *Astrophys. J.* **206**, 753
- Mouschovias, T.Ch.: 1976b, *Astrophys. J.* **207**, 141
- Myers, P.C., Ho, P.T.P., Schneps, M.H., Chin, G., Pankonin, V., Winnberg, A.: 1978, *Astrophys. J.* **220**, 864
- Myers, P.C.: 1983, *Astrophys. J.* **270**, 105
- Penston, M.V.: 1969a, *Monthly Notices Roy. Astron. Soc.* **144**, 425
- Penston, M.V.: 1969b, *Monthly Notices Roy. Astron. Soc.* **145**, 29
- Pumphrey, W.A., Scalo, J.M.: 1983, *Astrophys. J.* **269**, 531
- Perry, C.L., Johnston, L.: 1982, *Astrophys. J. Suppl.* **50**, 451
- Racine, R.: 1968, *Astron. J.* **73**, 233
- Righini-Cohen, G., Simon, M.: 1977, *Astrophys. J.* **213**, 1977
- Rydgreen, A.E.: 1971, *Publ. Astron. Soc. Pacific* **83**, 656
- Sanqvist, A., Bernes, C.: 1980, *Astron. Astrophys.* **89**, 187
- Scalo, J.M., Pumphrey, W.A.: 1982, *Astrophys. J. Letters* **258**, L29
- Sherwood, W.A., Wilson, T.L.: 1981, *Astron. Astrophys.* **101**, 72
- Shu, F.H.: 1977, *Astrophys. J.* **214**, 488
- Strom, S.E., Strom, K.M., Carrasco, L.: 1974, *Publ. Astron. Soc. Pacific* **86**, 798
- Strom, S.E., Vrba, F.J., Strom, K.M.: 1976, *Astron. J.* **81**, 314
- Tomita, Y., Saito, T., Ohtani, H.: 1979, *Publ. Astron. Soc. Japan* **31**, 407
- Westbrook, W.E., Werner, M.W., Elias, J.H., Gezari, D.Y., Hauser, M.G., Lo, K.Y., Neugebauer, G.: 1976, *Astrophys. J.* **209**, 94
- Wouterloot, J.G.A.: 1981, Ph. D. dissertation, Leiden University
- Young, J.S., Goldsmith, P.F., Langer, W.D., Wilson, R.W., Carlson, E.R.: 1982, *Astrophys. J.* **261**, 513

I.04) OBSERVATIONS DE HCO^+ , H^{13}CO^+ , ^{13}CO , ET C^{18}O DANS LES
CONDENSATIONS DU COMPLEXE DU TAUREAU

I.04) OBSERVATIONS DE HCO^+ , H^{13}CO^+ , ^{13}CO , ET C^{18}O DANS LES

CONDENSATIONS DU COMPLEXE DU TAUREAU

Un nouveau instrument travaillant à des longueurs d'onde millimétriques a été mis en opération pour cartographier, avec une résolution spatiale modérée ($\approx 5'$), les nuages moléculaires interstellaires dans la plage de fréquences de 75 à 115 GHz.

Dans ce travail nous avons observé les transitions $J=1-0$ de HCO^+ , H^{13}CO^+ , ^{13}CO , et C^{18}O dans la direction de plusieurs condensations du Taureau. Les cartes d'émission de HCO^+ montrent que cette molécule peut être utilisée pour déterminer l'étendu des condensations moléculaires dans les régions fortement obscurcies. La taille typique à mi-hauteur de l'émission de HCO^+ est de l'ordre de $4'-8' = 0.16$ à 0.32 pc. Les comptages d'étoiles détaillés que nous avons fait de la région (voir I.02 et I.03) ont révélé plusieurs fragments (taille $\approx 4'-10'$) avec des extinctions visuelles $A_V \geq 4-5$ mag. Quelques condensations ont une taille $\leq 3'$ (0.12 pc).

Le rapport apparent d'intensités $\text{HCO}^+/\text{H}^{13}\text{CO}^+ \approx 1-10$, et la faible intensité de l'émission de HCO^+ ($T_A[\text{HCO}^+]$ est typiquement entre 0.2 et 2 K, avec une valeur moyenne de 0.7 K) sont expliqués par l'auto-absorption de HCO^+ . Des profils asymétriques de HCO^+ ont été obtenus dans différentes sources. Un modèle simple à deux composantes, comprenant une région dense entourée d'une couche de gaz de plus faible densité, a été utilisé pour déterminer la densité projetée de HCO^+ dans les deux composantes.

Les températures d'antenne observées pour ^{13}CO sont entre 1 et 5 K; celles de C^{18}O sont entre 0.5 et 1.5 K. En général

la largeur observée pour la raie J=1-0 de C¹⁸O est la moitié de celle de la raie J=1-0 de ¹³CO. Nos données montrent que C¹⁸O est un bon traceur des régions de forte densité projetée. ¹³CO est optiquement opaque pour $A_V \geq 4$ mag. Pour A_V faible on observe un enrichissement de l'abondance de ¹³CO grâce au fractionnement isotopique.

Les profils de la transition J=1-0 de ¹³CO indiquent que dans le Taureau les composantes doubles en vitesse sont assez fréquentes et qu'il n'est pas possible d'expliquer la structure en vitesse du complexe par de mouvements systématiques simples.

Observations of HCO^+ , H^{13}CO^+ , ^{13}CO , and C^{18}O in Taurus Cloudlets

A. Baudry, J. Cernicharo*, M. Pérault, J. de la Noë, and D. Despois

Observatoire de l'Université de Bordeaux, F-33270 Floirac, France, et ERA n° 380 du C.N.R.S.

Received May 13, accepted August 10, 1981

Summary. A new millimeter wave instrument has been put into operation in order to survey with moderate spatial resolution ($\sim 5'$) interstellar molecular clouds in the frequency range 75–115 GHz.

In this work we have observed the $J=1-0$ transition of HCO^+ , H^{13}CO^+ , ^{13}CO , and C^{18}O in the direction of several Taurus dark clouds extending from Barnard 18 and Taurus Molecular Cloud 2 to Barnard 212 and 210. Maps of HCO^+ emission show that this molecule can be used to delineate the extent of molecular cloudlets in obscured areas. The typical size at half intensity of HCO^+ emission is of the order of $4'-8' = 0.16-0.32$ pc. The detailed star counts that we have made in the same region reveal the presence of many $4'-10'$ cloudlets with visual extinction $A_v \gtrsim 4-5$ mag. Some globules have sizes $\lesssim 3' = 0.12$ pc.

The apparent intensity ratio $\text{HCO}^+/\text{H}^{13}\text{CO}^+$, in the range 1 to 10, and the relatively low HCO^+ intensity ($T_{\text{R}}^*(\text{HCO}^+)$) is typically in the range 0.2 to 2 K with a mean value around 0.7 K) are explained best by self-absorption in HCO^+ . Asymmetric HCO^+ line profiles have been obtained in several sources. A simple two component model with a dense core and an absorbing layer is used to estimate the column densities in both components.

Corrected antenna temperatures typically lie in the range 1 to 5 K for ^{13}CO and 0.5 to 1.5 K for C^{18}O . In general C^{18}O line widths are one-half those of ^{13}CO . Our data also show that C^{18}O is a better molecule than ^{13}CO to reveal the most obscured areas in Taurus. C^{18}O and ^{13}CO column densities are derived and show that ^{13}CO fractionation generally occurs. The implications of possible subthermal excitation in the forward diffuse layer are examined.

The $J=1-0$ transition of ^{13}CO indicates that double velocity components are frequent in the Taurus clouds. This result and other molecular line data prove that there is no simple systematic cloud motion in the Taurus Molecular Cloud 2 region.

Key words: interstellar molecules – isotopic ratios – obscured cloudlets – fragmentation

I. Introduction

The Taurus cloud complex contains various reflection nebulae, H α objects, Herbig-Haro objects and T Tauri stars which, presumably,

Send offprint requests to: A. Baudry, Observatoire de l'Université de Bordeaux, F-33270 Floirac, France

* Also at the Observatoire de Meudon, F-92190 Meudon, France. On leave from Observatorio Nacional, Centro Astronómico de Yebes, Spain

are the sign posts of widespread and recent star formation. Haro (1968) mentions an age of about 10^6 yr for the young Taurus stellar aggregate. The presence of dark globules embedded in the gas, the fragmentary appearance and the complex kinematical structure of this gas suggest that star formation is still active in Taurus. Recently, heavy linear molecules have been detected in two dense clumps, Taurus molecular cloud 1 and 2 (TMC 1 and 2), which might be protostellar clouds (e.g. Tölle et al., 1981; Myers et al., 1979).

Until now only the immediate vicinity of TMC 1 and TMC 2 has been investigated in millimeter line works. In this paper we present the results of a large scale molecular study and of detailed star counts in the clouds extending from Barnard 18 and TMC 2 to Barnard 212 and 210. Our observations of the $J=1-0$ transition of HCO^+ , H^{13}CO^+ , ^{13}CO , and C^{18}O were made with a new millimeter wave instrument in the direction of selected obscured areas (with visual extinction $\gtrsim 2-5$ mag).

Three main objectives were pursued in this work. 1. To measure the isotopic ratios of HCO^+ and CO and to estimate the abundances of these species. 2. To investigate the spatial structure of Taurus cloudlets. 3. To analyze the kinematical structure of elongated filaments.

In Sects. II and III we present the new instrumentation and the observations. In Sects. IV and V saturation effects and self-absorption in HCO^+ are discussed. Estimates of molecular abundances are given in Sects. V and VI on the basis of radiative transfer calculations and of isotopic ratio measurements. The relationship of HCO^+ emission with visual extinction and a model for the complex kinematical structure of Taurus clouds are presented in Sects. VII and VIII.

II. Equipment

The observations were conducted at the Bordeaux Observatory with a 2.5 m telescope which has recently been equipped with a cooled receiver and a 256×100 kHz filter bank. The molecular spectra discussed in the present paper are the first astronomical results obtained with this new equipment which, accordingly, will be described briefly. A preliminary report on this new spectroscopic facility has been given by the "Groupe de Radioastronomie Millimétrique" (Baudry et al., 1980).

Table 1 shows the main characteristics of the system. The surface accuracy of the reflector allows observations at wavelengths greater than about 1 mm. The dish is altitude-azimuth mounted. A PDP 11/34 computer is in charge of the telescope controls, the synthesizer settings, the data collection and reduction.

Table 1. Telescope characteristics and system performances

Dish size	2.5 m
f/D	0.4
Surface accuracy	0.05 mm (r.m.s.)
Half power beamwidth	5.4 arc min at 90 GHz 4.4 arc min at 110 GHz
Beam efficiency	90 % on moon
Telescope efficiency (ohmic losses × rearward spillover and scattering)	0.89 ± 0.02
Pointing residuals	30 arc sec (peak to peak)
Frequency coverage	75 - 115 GHz
Receiver temperature (SSB)	370 K (upper side band) } 85 GHz 420 K (lower side band) } 780 K around 110 GHz
Spectral coverage	256 × 100 kHz
Velocity resolution	0.33 km/s at 90 GHz 0.27 km/s at 110 GHz

The optical pointing residuals are about 10" (r.m.s) in both coordinates as determined by observations of several stars with a 7 cm refractor attached to the telescope. The radio collimation constants were measured by tracking the Sun and a star at the same declination. Radio pointing residuals are 30" (peak to peak deviation in both coordinates). The Cassegrain focus is located behind the vertex of the parabola within the cooled frontend. The focal adjustment and beamwidth measurements were obtained from observations of the limbs of the Sun. Around 90 GHz and 110 GHz the half-power beamwidth is 5.4 and 4.4 respectively.

The receiver includes a Schottky diode mixer and an intermediate frequency (4.755 GHz) system cooled at 20 K. During our observing period the best measured single side band (SSB) receiver temperature was about 400 K around 85 GHz (local oscillator frequency). Because the noise performances are optimized for frequencies below 100 GHz the receiver temperature is relatively high around 110 GHz: ~800 K (SSB). The noise temperature of the intermediate frequency stages is about 20 K. Image rejection (~13 to 23 dB) is achieved by adjusting a moveable dielectric backshort. Line calibration is obtained by switching between a load at ambient temperature and the sky. The sky temperature is derived from a two layer atmospheric model very similar to that described by Kutner (1978). The zenith sky opacity is usually determined by antenna tipping at 1, 2, and 3 air masses. It can also be determined by fitting an exponential curve to several measurements of the sky emissivity. This procedure combined with a measurement on a cooled load (liquid nitrogen) gives the telescope efficiency for ohmic losses and rearward spillover and scattering. This efficiency is close to 0.9 (see Table 1).

III. Observations and Results

We have observed the $J = 1 - 0$ line emission of HCO^+ , H^{13}CO^+ , ^{13}CO , and C^{18}O in the direction of several obscured areas lying

in the filaments which extend from Barnard 18 and TMC2 to Barnard 212 and 210. The filaments and the T Tauri or $\text{H}\alpha$ stars found in the same region are shown in Fig. 1. The cloud positions were selected on the basis of two main criteria: large visual extinction and presence of NH_3 emission according to the observations of Myers et al. (1979). We have made detailed star counts by using a 2.2 × 2.2 element transparent grid on the Palomar Sky Survey red prints. The method which was used here was that described by Bok and Cordwell (1973) and Dickman (1976, 1978a). The NH_3 positions of Myers et al. do not always coincide exactly with the most obscured regions found from our star counts with position accuracy better than about 1'. Figure 2 presents all positions observed in HCO^+ and contours of visual extinction. The positions designated with Arabic numerals (Taurus 1 to Taurus 9) correspond to the source designation adopted by Myers et al. in their Table 2. Roman numerals (Taurus I to Taurus IV) indicate obscured areas which have been added to the NH_3 cloud positions for observations of the formyl ion. Additional cloud positions not shown in Fig. 1 have also been observed in ^{13}CO ; they are designated by TC 1 to 8 in Table 4.

The HCO^+ and H^{13}CO^+ observations were carried out only on clear days from late May to early September 1980. At 89 and 87 GHz the zenith opacities were in the range 0.15 to 0.3 with typical values around 0.2 corresponding to a water vapor content of about 10 mm. The ^{13}CO and C^{18}O observations were carried out in January and February 1981. Zenith opacities were typically of the order of 0.3 to 0.4.

In all observations of the formyl ion the image sideband was suppressed. However because of difficult single sideband operation around 110 GHz most carbon monoxide observations were done with both image bands. The reference oscillator was frequency switched every 5 to 10 s. For the dark clouds investigated here, only symmetrical and overlapping "switches" were used. Calibration against the sky and the room temperature load was usually made

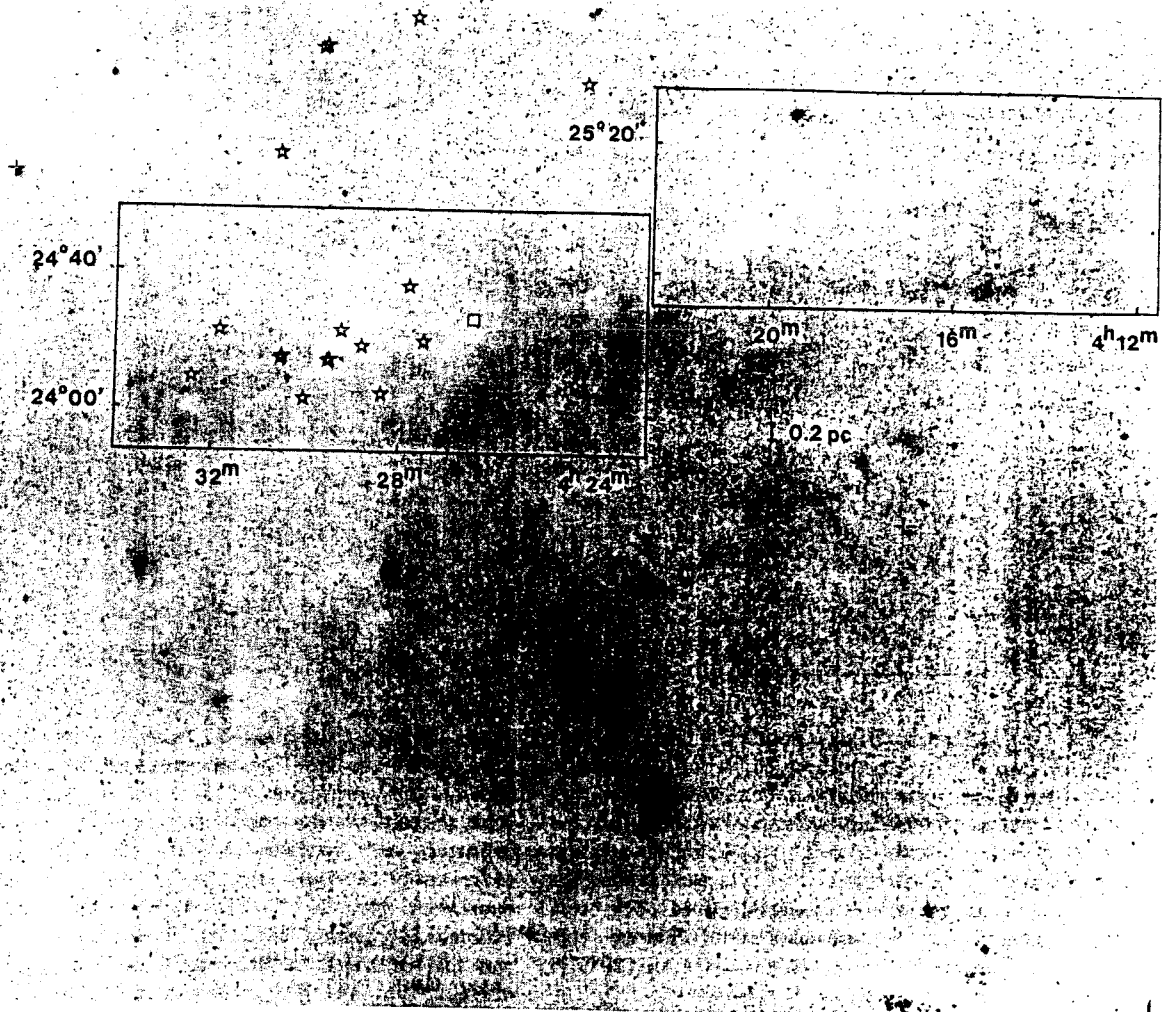

Fig. 1. T Tauri and/or H α objects (*) superimposed on a Palomar Observatory sky survey red print. The two frames extending from 4^h12^m to 4^h20^m and from 4^h24^m to 4^h32^m delimit the region investigated in this work. The star positions are taken from Herbig and Rao (1972) and from Elias (1978). No known T Tauri object coincides with the western filaments (Barnard 215, 212, and 210). The eastern filaments (Barnard 18) contain the Taurus Molecular Cloud 2 object discussed in text and the Haro 6–10 object (□) studied by Elias; Haro 6–10 lies in the Taurus 5 region shown in Fig. 2. The vertical bar has a length of 0.2 pc (roughly the size of our radio half-power-beamwidth) at the distance of the Taurus clouds (135 pc)

every either 5 or 10 min and Taurus 3C and TMC 1 were used as reference sources (Fig. 3a and b). Our line intensity measurements fluctuate by about 10 to 20% around a mean value.

The HCO⁺ and H¹³CO⁺ observations are presented in Tables 2 and 3 respectively. In Table 3 the line parameters obtained towards TMC 1, our calibration source, and towards L 134 N and DR 21 (OH) are also summarized for the purpose of comparison. The antenna temperature in TMC 1 is very close to that obtained by convolving our antenna beamwidth with the antenna temperatures measured with the 7 m antenna at Holmdel (Guélin et al., 1981). The ¹³CO and C¹⁸O observations are shown in Table 4. All data are corrected for atmospheric absorption and antenna losses, yielding corrected antenna temperatures, T_A^* .

Maps of HCO⁺ emission in Taurus 1, Taurus I and Taurus 7 are shown in Figs. 4–6 respectively. Data points have been taken every 2.5' in Taurus 1 and every 5' in Taurus I and Taurus 7.

IV. Analysis of the HCO⁺ and H¹³CO⁺ Line Data

a) The Line Data

If there is no spatial variation of HCO⁺ emission within the antenna beam one deduces from the measured intensities given in Table 2 Rayleigh-Jeans brightness temperatures in the range $0.3 \lesssim T_B \lesssim 2$ K. With our relatively broad beamwidth we have not observed apparent HCO⁺/H¹³CO⁺ intensity ratios (see Table 5) as low as those obtained in TMC 1, L 134 N and TMC 2 with the Holmdel antenna (Langer et al., 1978; Guélin et al., 1981). However two sources, Taurus 5B and Taurus 8, are exceptional since we have measured $T_A^*(H^{13}CO^+) \simeq 1/2 T_A^*(HCO^+)$ (Fig. 7). The H¹³CO⁺ measurements made by Guélin et al. (1981) in the TMC 2 region with two arc min resolution show good correlation of cores of line emission with regions without any star ($A_v > 5$). In the

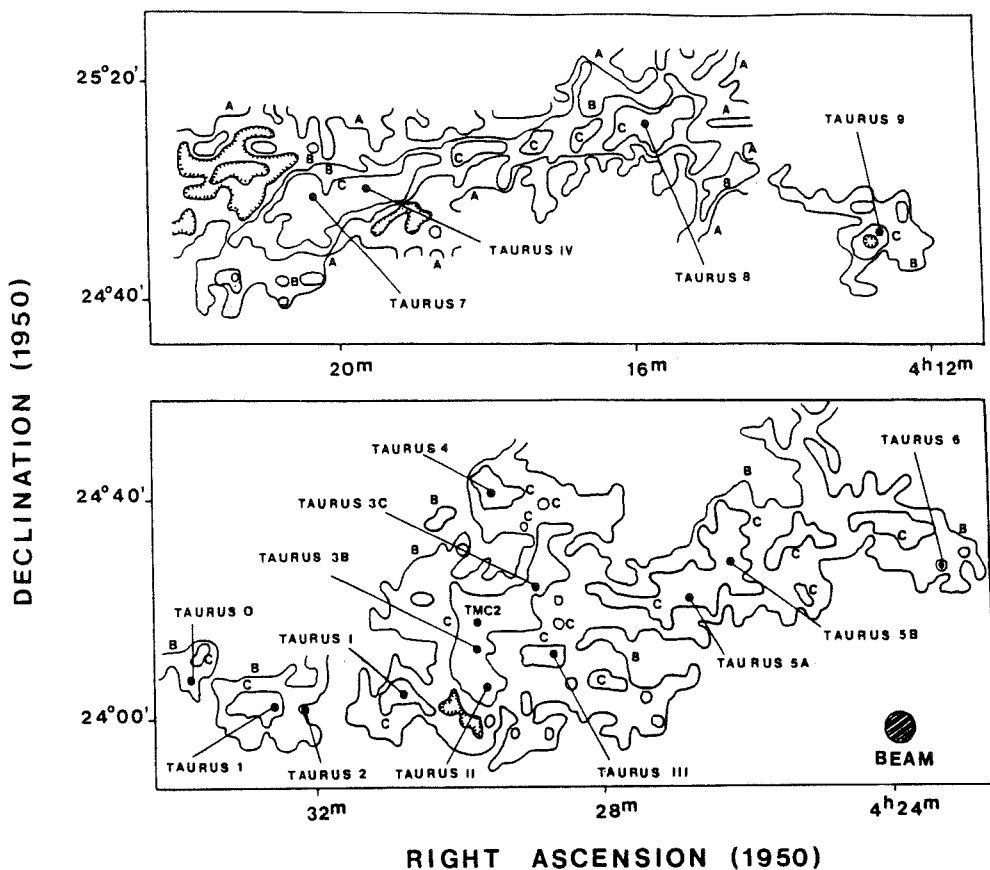

Fig. 2. Contours of visual extinction for the two areas delimited in Fig. 1. The A, B and C contours correspond to $A_v > 1.5-2$, $A_v > 2.5-3$ and $A_v > 4$ mag respectively. The contours without an A, B or C and with sizes of about 2/5 correspond to $A_v > 5$ mag. The hatched areas outline holes in the visual extinction contours. The source positions studied in HCO^+ are marked with (●). Precise coordinates are given in Table 2. The hatched circle (Beam) shows the size of the half-power-beamwidth of the telescope at 89 GHz. Other cloud positions, not shown in this figure, have been observed in ^{13}CO ; they are designated by TC 1 to 8 in Table 4

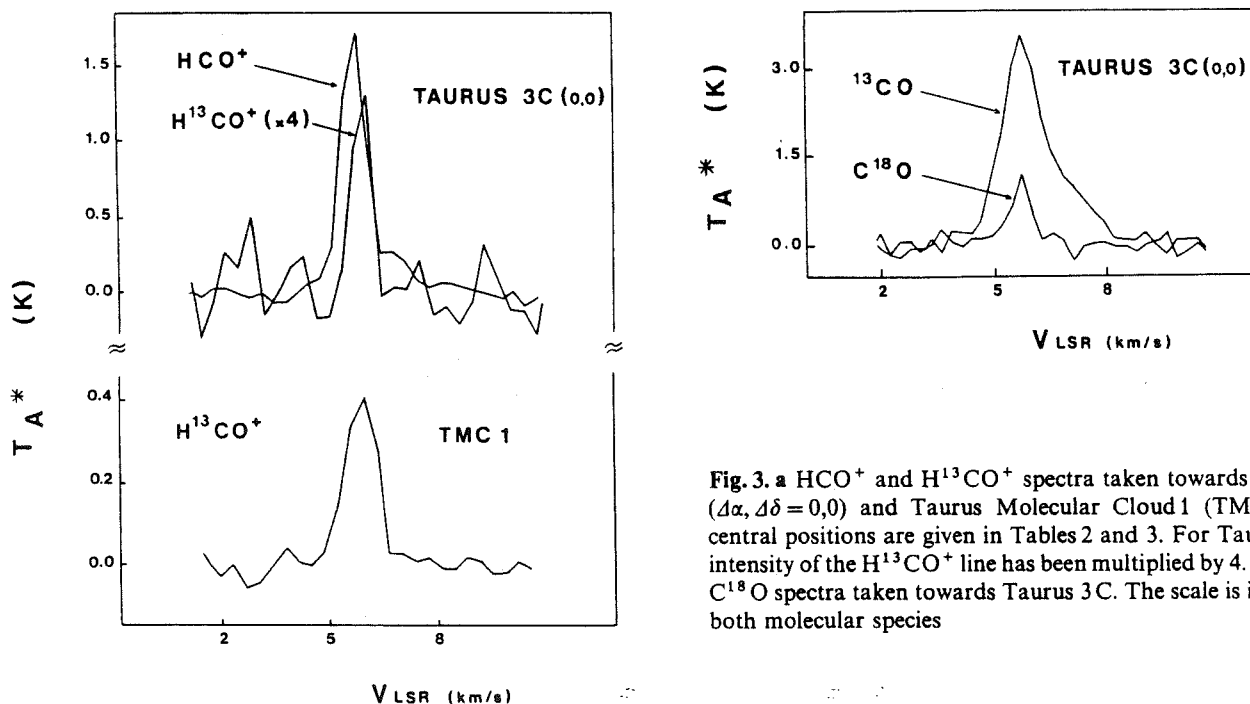

Fig. 3. a HCO^+ and H^{13}CO^+ spectra taken towards Taurus 3C ($\Delta\alpha, \Delta\delta = 0,0$) and Taurus Molecular Cloud 1 (TMC1) whose central positions are given in Tables 2 and 3. For Taurus 3C the intensity of the H^{13}CO^+ line has been multiplied by 4. b ^{13}CO and C^{18}O spectra taken towards Taurus 3C. The scale is identical for both molecular species

Table 2. HCO⁺ line parameters^a

Source	α (1950)	δ	$\Delta\alpha, \Delta\delta$ (arc min)	T_A^* (K)	V_{LSR} (km s ⁻¹)	ΔV (km s ⁻¹)
Taurus 0	4 ^h 33 ^m 48 ^s	24°06'48"	0,0	<0.15		
Taurus 1 ^b	4 32 32	24 01 42	0,0	1.5	5.85	0.85
Taurus 2			-6,0	0.25?	6.15	?
Taurus I ^c	4 30 51.6	24 03 30	0,0	1.1	6.7	1.0
Taurus 3B	4 29 51	24 11 48	0,0	0.9	6.5	1.2
TMC 2	4 29 43	24 16 54	0,0	1.9	6.0	0.95
Taurus 3A			0,2	2.0	6.2	0.9
Taurus II	4 29 38	24 04 36	0,0	0.35	6.3	0.95
Taurus 4	4 29 30	24 41 48	0,0	0.3	6.5	0.8?
Taurus 3C	4 28 54	24 25 30	0,0	1.75	5.8	0.85
			-5,0	0.7	5.8	1.15
Taurus III	4 28 44	24 11 18	0,0	0.4	6.2	1.1
			3,0	0.3	6.0	1.2
Taurus 5A	4 26 48	24 22 24	0,0	0.45	6.5	1.65 ^e
			2.5,-1	0.50	6.45	1.45 ^e
Taurus 5B	4 26 05	24 28 54	0,0	0.45	6.55	0.9
			0,-2.5	0.6	6.4	0.95
			2.5,-1	0.65	6.6	1.00
Taurus 6	4 23 44	24 32 48	0,0	0.55	6.4	0.75
			5,0	0.40	6.6	0.8
Taurus 7 ^d	4 20 23	24 58 36	0,0	0.65	7.25	0.8
Taurus IV	4 19 47.6	25 00 24	0,0	0.35	7.3	0.8
Taurus 8	4 15 49	25 12 12	0,0	0.3	7.6	0.7
			3,1	0.20	7.6	0.95
Taurus 9	4 12 29	24 52 42	0,0	<0.15		

^a T_A^* = peak temperature; $V_{LSR} = \sum_{line} T_A^* V_i / \sum_{line} T_A^*$; ΔV = full width to half maximum uncorrected for instrumental broadening; rest frequency of the $J=1 \rightarrow 0$ transition of HCO⁺ = 89.188523 GHz

^b See map of HCO⁺ emission in Fig. 4

^c See map of HCO⁺ emission in Fig. 5

^d See map of HCO⁺ emission in Fig. 6

^e Two blended features (?)

Table 3. H¹³CO⁺ line parameters⁽¹⁾

Source	$\Delta\alpha, \Delta\delta$ ⁽²⁾ (arc min)	T_A^* (K)	V_{LSR} (km/s)	Δv (km/s)
Taurus 1	0,0 3,-3	0.18 <0.15	5.85	0.45
Taurus I	0,0	0.14	6.85	0.5
Taurus 3B	0,0	<0.14		
TMC 2	0,0	0.29	6.35	0.75
Taurus II	0,0	<0.15		
Taurus 3C	0,0	0.34	5.95	0.65
Taurus III	0,0	<0.15		
Taurus 5A	2.5,-1	0.07? 0.12	5.5? 6.5	0.55
Taurus 5B	2.5,-1	0.31	6.35	0.6
Taurus 6	0,0	0.08?	7.0?	
Taurus 7	0,0 5,0	<0.12 0.22?	6.85	?
Taurus IV	0,0	<0.25		
Taurus 8	0,0	0.15	7.45	0.55
TMC 1 ⁽³⁾		0.4	5.8	0.9
L 134 N ⁽³⁾		0.3	2.6	0.8
DR 21(OH) ⁽³⁾		0.29	-2.9	4.05

(1) Line parameters determined as in Table 2; the upper limits are about 2 to 3 (ΔT_A^*) r.m.s.; rest frequency of the $J=1 \rightarrow 0$ transition of H¹³CO⁺ = 86.75433 GHz.

(2) Central positions are given in Table 2.

(3) The positions used for TMC 1, L 134 N and DR 21(OH) are (α, δ_{1950}) = (4h38m18s, 25°41'0), (15h51m30s, -2°43'5), (20h37m14s, 42°13'5) respectively.

Table 4. ^{13}CO and C^{18}O line parameters⁽¹⁾

Source ⁽²⁾	^{13}CO			C^{18}O		
	T_A^* (K)	v_{LSR} (km/s)	Δv (km/s)	T_A^* (K)	v_{LSR} (km/s)	Δv (km/s)
Taurus 0	1.25 ^{a)}	5.65	0.8			
Taurus 1	4.	5.85	1.1	1.26 ^{a)}	5.9	0.55
Taurus I	1.55 3.85	5.3 6.7	0.85 0.9	0.65	6.7	0.55
Taurus 3 B	3.7	6.3	1.35	0.95	6.4	0.55
TMC 2	4.7	6.3	1.1	1.25	6.3	0.6
Taurus II	3.25	6.2	1.25	0.3 ?	6.15	0.65 ?
Taurus 4	2.7	6.35	1.1			
Taurus 3 C	3.55 ^{a)}	6.	1.3	1.3	5.85	0.7
Taurus III	3.25 ^{a)}	6.15	1.2	1.0	5.85	0.5
Taurus 5 A	4.1 ^{a)}	6.6	1.25	1.55	6.4	0.7
Taurus 5 B	3.3 ^{a)}	6.45	1.3	1.2	6.35	0.9
Taurus 6	2.85 3.1	5.05 6.8	0.6 1.05	0.5 1.1	5.1 6.75	0.7 0.8
Taurus 7	3.4	7.15	1.05	1.3	7.2	0.65
Taurus IV	2.6	7.3	0.8	1.1	7.15	0.55
Taurus 8	0.65 2.05	3.45 7.4	0.55 0.8	1.1	7.5	0.55
Taurus 9	3.3	7.8	0.8			
TC 1	1.2 1.3	5.3 6.8	? ?			
TC 2	2.7 ^{a)}	6.55	1.35			
TC 3	0.6 2.85 ^{a)}	4.6 6.65	0.55 0.8			
TC 4	1.5 ^{a)}	6.75	0.7			
TC 5	2.35	7.4	1.1			
TC 6	1.5	7.1	0.8			
TC 7	1.3 ^{a)}	6.9	0.95			
TC 8	0.45 0.7	4.7 6.85	0.65 ?			
TMC 1 ⁽³⁾	3.6 ^{a)}	5.9	1.55	1.95 ^{a)}	5.8	0.75

(1) Line parameters derived as in Table 2; the rest frequencies of the $J=1-0$ transition of ^{13}CO and C^{18}O are 110.20137 and 109.78218 GHz respectively

(2) Source positions are given in Table 2; all positions, except Taurus 5A where $\Delta\alpha, \Delta\delta = 2'.5, -1'$, are for $\Delta\alpha, \Delta\delta = 0, 0$. For TC1 to 8 the galactic coordinates are (l, b) = (1'74.50, -15.62); (173.74, -16.06); (173.00, -16.50); (172.43, -16.94); (171.43, -17.36); (171.70, -17.25); (172.50, -16.80); (172.70, -16.68)

(3) For CO observations the TMC1 position was $\alpha = 4^{\text{h}}38^{\text{m}}38^{\text{s}}$ (1950) $\delta = 25^{\circ}35'48''$

a) Asymmetric line profile

TAURUS 1

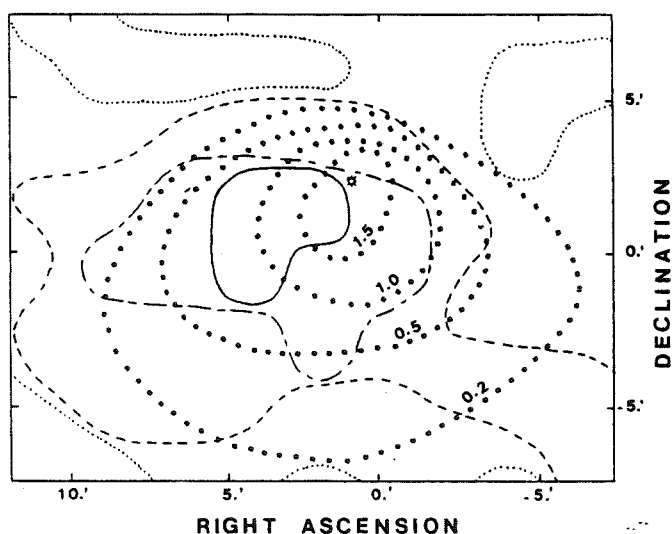

Fig. 4. Spatial map of HCO^+ emission and extinction contours in Taurus 1. The half-circles (●) correspond to $T_A^* = 1.5, 1.0, 0.5$ and 0.2 K. The central position is given in Table 2. The continuous line encloses a region with visual extinction $A_v > 6$. The dashed and dotted lines outline regions with: $A_v > 4$ (---), $A_v > 3$ (---), $A_v > 2$ (···). The star \star marks the position of the reflection nebula, Bernes 82 (Bernes; 1977)

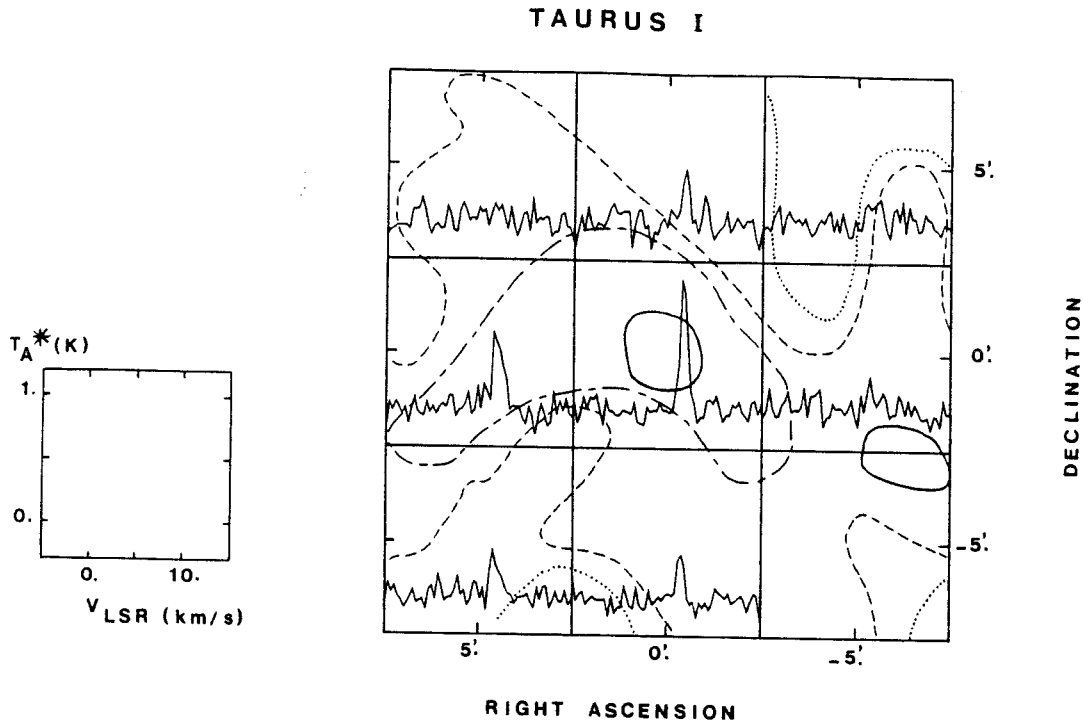

Fig. 5. HCO⁺ spectra and extinction contours obtained in the direction of Taurus I. The position and line parameters for ($\Delta\alpha, \Delta\delta = 0,0$) are given in Table 2. The continuous lines enclose a region with $A_v > 5$. The dashed and dotted lines have same meaning as in Fig. 4

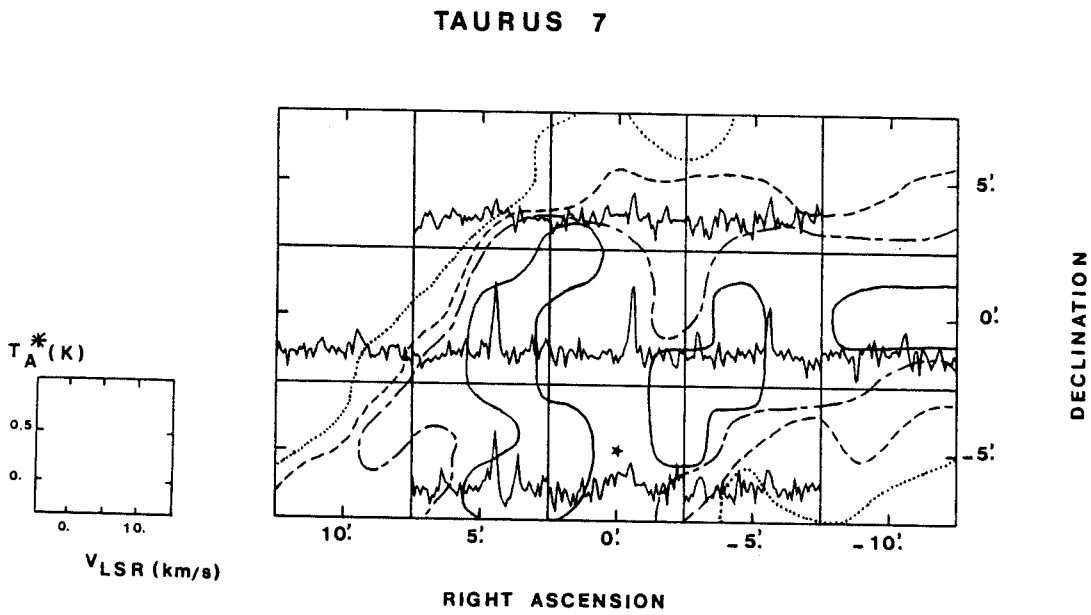

Fig. 6. HCO⁺ spectra and extinction contours obtained in the direction of Taurus 7. The position and line parameters for ($\Delta\alpha, \Delta\delta = 0,0$) are given in Table 2. The eastern and western continuous lines delimit regions with $A_v > 7$ and 6 mag respectively. The dashed and dotted lines have same meaning as in Fig. 4. The star (*) located at ($\Delta\alpha, \Delta\delta = 0, -5'$) marks a position near the object number 3 studied by Elias (1978). With a visual extinction of 8 mag we derive, according to the photometric data of Elias, that it is located behind the Taurus dust clouds at a distance greater than 300 pc

Table 5. Ratios of isotopic lines

Source ⁽¹⁾	H ¹² CO ⁺ /H ¹³ CO ⁺		C ¹³ CO/C ¹⁸ O		R _A ⁽⁶⁾
	R _I ⁽²⁾	R _T ⁽³⁾	R _I ⁽²⁾	R _T ⁽³⁾	
Taurus 1	11.5 ± 5	8.3 ± 3.4	7.1 ± 1.3	3.2 ± 0.4	8.8
Taurus I	12. ± 4	7.9 ± 2.7	10. ± 5.3	5.9 ± 1.8	13.6
Taurus 3B			7.1 ± 1.6	3.9 ± 0.8	13.1
TMC 2	11. ± 4.6	6.6 ± 2.2	6. ± 1.2	3.8 ± 0.7	10.7
Taurus 3C	7.2 ± 2 ⁽⁴⁾	5.1 ± 1.1	6.9 ± 1.1	2.7 ± 0.4	6.5
Taurus III			6.7 ± 1.5	3.3 ± 0.6	9.8
Taurus 5A	?	4.2 ± 2.1 ⁽⁵⁾	5. ± 0.7	2.6 ± 0.3	6.4
Taurus 5B	4.2 ± 2	2.1 ± 0.7	4.3 ± 0.9	2.8 ± 0.4	5.
Taurus 6			6. ± 2.1 4. ± 0.7	5.7 ± 1.8 2.8 ± 0.6	6.3 4.5
Taurus 7	?	3 ? ± 1.6	4.3 ± 1	2.6 ± 0.4	5.4
Taurus IV			5.9 ± 2.3	2.4 ± 0.5	4.
Taurus 8	2.1 ± 0.9	2. ± 1.1	2.3 ± 0.5	1.9 ± 0.3	2.9
TMC 1	1.3 ± 0.8	1.2 ± 0.4	3.5 ± 0.4	1.8 ± 0.2	4.6

(1) Source positions are those given in Table 2 for $\Delta\alpha, \Delta\delta = 0, 0$ except for Taurus 5A where $\Delta\alpha, \Delta\delta = 2.5, -1$ and for Taurus 7 in H¹³CO⁺ where $\Delta\alpha, \Delta\delta = 5, 0$. For TMC 1 see notes 3 in Tables 3 and 4.

(2) R_I is determined from the ratio of $\int T_A^*(v) dv$.

(3) R_T is the ratio of the peak T_A^{*}.

(4) Not accounting for the weaker HCO⁺ feature at 6.9 km/s.

(5) Ratio for the 6.5 km/s feature.

(6) -R_A is the abundance ratio deduced from LTE analysis (see Table 6).

directions where we have detected H¹³CO⁺ emission, regions with $A_v > 5$ do not fill our 5' beam and we expect a dilution factor of $\sim 4/10$. This explains the fact that the HCO⁺/H¹³CO⁺ ratio obtained by us towards TCM 1, L 134 N and TMC 2 is higher than that obtained towards the same sources at Holmdel. Beam dilution is also suggested because of the low upper limits quoted in Table 3. Thus the H¹³CO⁺ intensities given in Table 3 would correspond to $T_B \approx 0.3$ to 0.8 K.

The HCO⁺ line profiles are usually complex. Asymmetric line shapes were particularly well observed towards Taurus 3C (Fig. 3a), Taurus 5A, Taurus 5B and Taurus 8 (Fig. 7), Taurus I, Taurus II, Taurus III, Taurus 6 (Fig. 9) and Taurus 7.

Our carbon monoxide data also show asymmetric profiles and in some cases two velocity components are observed in ¹³CO and C¹⁸O. The weaker velocity component, when present, is well separated from the main component which always coincides with the HCO⁺ feature. This is illustrated in Fig. 9 for Taurus 6 where asymmetry (or self-reversal) in HCO⁺ and two velocity features in ¹³CO and C¹⁸O are present simultaneously. The case of Taurus 3C is particular. A weaker HCO⁺ feature appears near

6.9 km⁻¹s (Fig. 3a) which is not well resolved in ¹³CO (Fig. 3b), suggesting the presence of two clouds. However, although it is not seen with the present spectral resolution, we cannot exclude self-absorption in the main HCO⁺ velocity component.

b) A Two Component Model

The kinetic temperature inferred from NH₃ observations in Taurus (Ho et al., 1977; Myers et al., 1979) is $T_K \approx 8$ to 12 K. Since $T_A^*(\text{HCO}^+) \ll T_K$ and since fractionation processes play a minor role in the enrichment of HCO⁺ in ¹³C [H¹³CO⁺/HC¹⁸O⁺ is nearly terrestrial according to Guélin et al. (1981)] we are left with two main possibilities to explain simultaneously low HCO⁺ intensities and low HCO⁺/H¹³CO⁺ intensity ratios:

(i) saturated line emission from clouds strongly diluted in our beam,

(ii) self-absorption in HCO⁺.

Hypothesis (i) would lead to too much complex developments in view of the limited data presently available. On the other hand

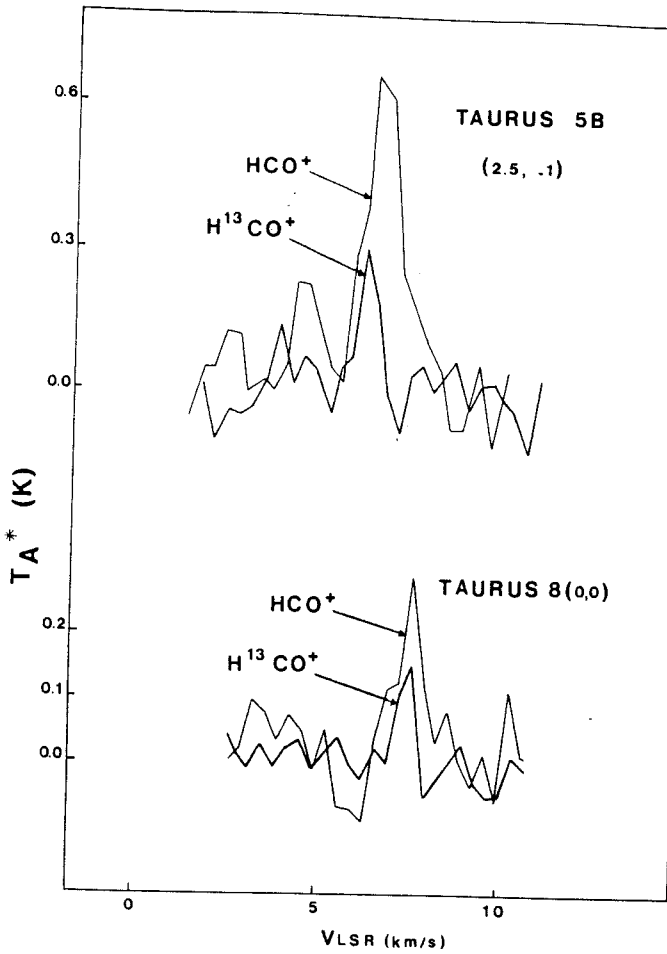

Fig. 7. HCO⁺ and H¹³CO⁺ spectra in the direction of Taurus 5B ($\Delta\alpha, \Delta\delta = 2:5, -1'$) and of Taurus 8 ($\Delta\alpha, \Delta\delta = 0,0$)

hypothesis (ii) was shown by Langer et al. (1978) to be the only possible explanation to the extreme cases where $T_B(\text{HCO}^+) < T_B(\text{H}^{13}\text{CO}^+)$ as in L 134 N and TMC 1. Therefore we think that a two component model where a low density, weakly excited component (component-a) absorbs the radiation emitted by a higher density core (component-b) located behind component-a, may be appropriate to interpret our data.

V. Self Absorption in HCO⁺, Physical Parameters

In the following we wish to derive some physical parameters of the clouds where HCO⁺ and H¹³CO⁺ are observed, using the two component cloud model just defined. Within this frame the H¹³CO⁺ line emission is associated with component-b, for which we think that a large velocity gradient (LVG) radiative transfer model can give a useful estimate of the H¹³CO⁺ column density.

a) Analysis Using the LVG Model (Component-b)

Figure 8 shows for a spherical cloud model with uniform density, temperature and velocity gradient dv/dr , the relative abundance $X(\text{HCO}^+)/dv/dr = n_{\text{HCO}^+}/n_{\text{H}_2} dv/dr$ in the planes n_{H_2}, T_B

and (n_{H_2}, τ) where τ is the peak line opacity. The rotational excitation of HCO⁺ by collisions with H₂ was derived according to Green's calculations for N₂H⁺ - He (Green, 1975) without any correction. For the rates of spontaneous emission we have used $\mu(\text{HCO}^+) = 4.07$ Debye (Haese and Woods, 1979). The results can also be used for H¹³CO⁺; the brightness temperatures obtained for both isotopic species differ by less than about 3%.

Component-b, responsible for H¹³CO⁺ emission, is supposed to contain most of the gas. An estimate of the cloud density can be deduced from the observed correlation of HCO⁺ with visual extinction (Figs. 4-6). The extinction averaged over our radio beam is $\overline{A_v} > 3.5$ mag for all sources surveyed (Taurus 0 and 9 excepted). Assuming spherical geometry and that the gas to dust ratio adopted by Bohlin et al. (1978) is also valid in Taurus we derive, in the case $\overline{A_v} \geq 4$, $n_{\text{H}_2} \geq 6 \cdot 10^3 \text{ cm}^{-3}$ at a distance of 135 pc (Elias, 1978). Myers et al. (1979) find $n_{\text{H}_2} \approx 4 \cdot 10^4 \text{ cm}^{-3}$ from their HC₃N observations towards Taurus 3A and Walmsley et al. (1980) use $n_{\text{H}_2} = 10^4 \text{ cm}^{-3}$ to derive HC₃N and HC₅N column densities in TMC 2. With $T_K = 10$ K and $n_{\text{H}_2} = 10^4 \text{ cm}^{-3}$ we get for $T_B(\text{H}^{13}\text{CO}^+) \approx 0.3$ to 0.8 K, $X(\text{H}^{13}\text{CO}^+)/dv/dr \approx 1.5$ to $5.5 \cdot 10^{-10} (\text{km s}^{-1}/\text{pc})^{-1}$. In this range the intensity remains roughly proportional to the H¹³CO⁺ abundance and saturation effects are not important.

The H¹³CO⁺ column densities for component-b, $N(\text{H}^{13}\text{CO}^+)$, can be derived in units of cm^{-2} from the relationship $N(\text{H}^{13}\text{CO}^+) = 3 \cdot 10^{18} X(\text{H}^{13}\text{CO}^+)/dv/dr \times n_{\text{H}_2} \times \Delta V$. The results are presented in Table 6 for $n_{\text{H}_2} = 10^4 \text{ cm}^{-3}$ using $\Delta V (\text{km s}^{-1})$ given in Table 3. Uncertainty in $N(\text{H}^{13}\text{CO}^+)$ depends on n_{H_2} : for $T_B < 1$ K, $N(\text{H}^{13}\text{CO}^+)$ varies roughly in inverse ratio to n_{H_2} .

$N(\text{HCO}^+)$ was derived from $N(\text{H}^{13}\text{CO}^+)$ and from $\text{HCO}^+/\text{H}^{13}\text{CO}^+ = 89$ assuming that fractionation does not affect the H¹³CO⁺ data (see Table 6).

Since HCO⁺ emission was detected, with same radial velocity, in every NH₃ source of Myers et al. (1979), it is interesting to compare the NH₃ and HCO⁺ column densities. Myers et al. find $6 \cdot 10^{12} < N(\text{NH}_3) < 10^{14} \text{ cm}^{-2}$ and we have computed $5 \cdot 10^{13} < N(\text{HCO}^+) < 3 \cdot 10^{14} \text{ cm}^{-2}$. In both molecular surveys the brightest line emission is observed towards the same sources, but there is no detailed correlation of the NH₃ and HCO⁺ intensities. However the results are affected by different spatial resolutions and self-absorption in HCO⁺.

b) The Diffuse Component

In the case where the two components -a and -b are uniformly excited the Rayleigh-Jeans brightness temperature above the cosmic background ($T_{bg} = 2.8$ K) is:

$$T_B = T'_{exa}(1 - e^{-\tau}) + T'_{exb}(1 - e^{-\tau})e^{-\tau} \quad (1)$$

where $T'_{ex} = J(T_{ex}) - J(T_{bg})$ and $J(T) = (\exp(h\nu/kT) - 1)^{-1} h\nu/k$.

The expected HCO⁺ emission of component-b can be estimated, with the help of Fig. 8, from $T_B(\text{H}^{13}\text{CO}^+) \approx 0.3$ to 0.8 K. Assuming $[\text{HCO}^+/\text{H}^{13}\text{CO}^+] = 89$ we obtain $T'_{exb}(1 - e^{-\tau}) \approx 4 - 5.5$ K, and deduce from the observed peak intensities the minimum optical depth for component-a, $\tau_{a\min} \approx 1 - 3$. The corresponding minimum projected density is given by:

$$N(\text{HCO}^+)_{\min} (\text{cm}^{-2}) \approx 2.3 \cdot 10^{11} \tau_{a\min} \Delta V_{\min} (\text{km s}^{-1}) T_{exa\min} / (1 - \exp(-4.28/T_{exa\min})).$$

For $T_{exa\min} \approx 2.8$ K and $\Delta V_{\min} \approx 1 \text{ km s}^{-1}$ we get $N(\text{HCO}^+)_{\min} \approx 0.8 - 2.5 \cdot 10^{12} \text{ cm}^{-2}$.

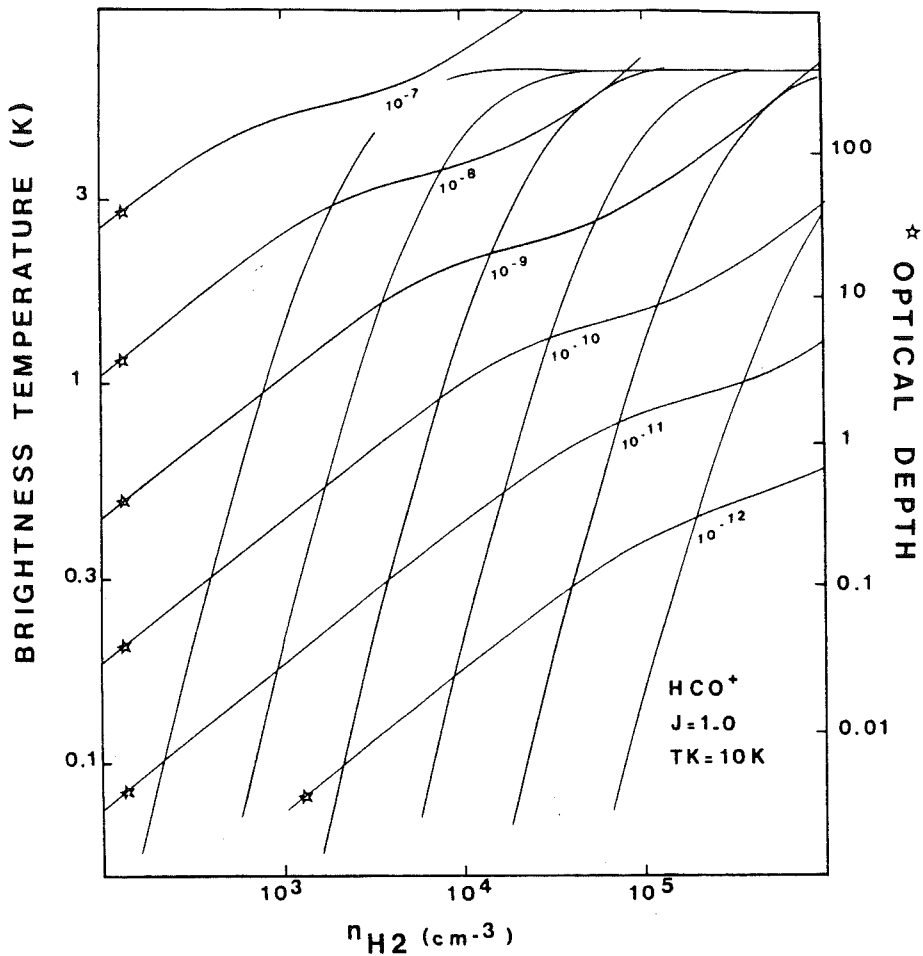

Fig. 8. Brightness temperature and optical depth (contours marked with a star) obtained for densities and relative abundances in the range $10^2 \leq n_{H_2} \leq 10^6 \text{ cm}^{-3}$ and $10^{-12} \leq n_{HCO^+}/n_{H_2}/dv/dr \leq 10^{-7} (\text{km s}^{-1}/\text{pc})^{-1}$. A large velocity gradient radiative transfer model and seven rotational levels have been used in the calculations. The brightness temperature T_B was derived from $T_B = (J(T_{ex}) - J(2.8)) (1 - \exp - \tau)$ where $J(T) = hv/k (\exp hv/kT - 1)^{-1}$. Collision rates were taken from Green (1975). With same kinetic temperature the relative abundances derived for $H^{13}CO^+$ differ by less than about 3% from those derived for the main isotopic species

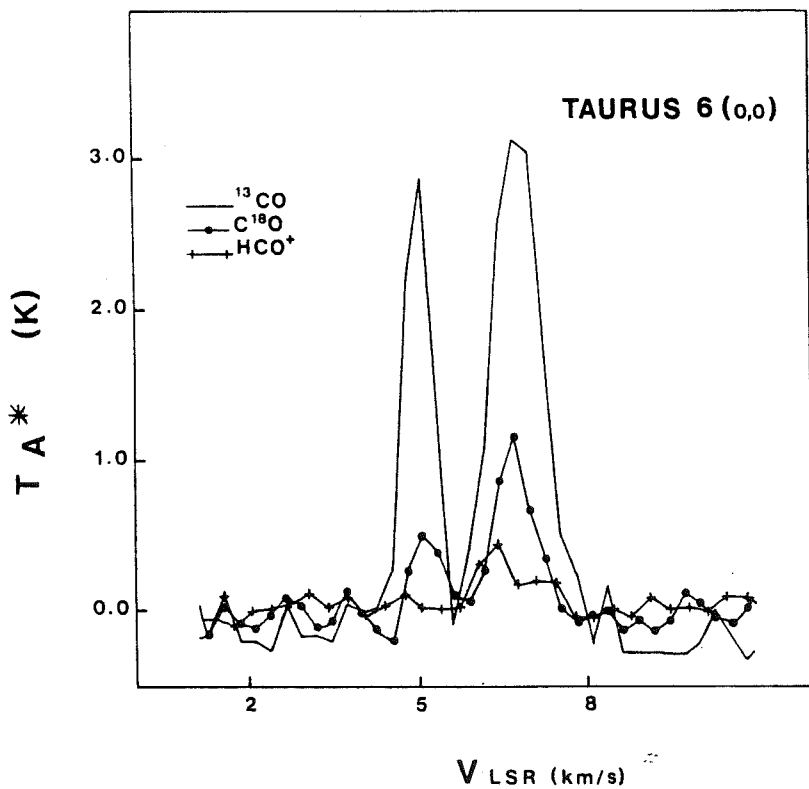

Fig. 9. ^{13}CO , $C^{18}O$, and HCO^+ spectra obtained towards Taurus 6 ($\Delta\alpha, \Delta\delta = 0,0$). Two velocity components are visible in ^{13}CO and in $C^{18}O$. The main component seen around 6.8 km s^{-1} coincides with self-reversal in HCO^+ . The intensity scale is the same for the three molecular species

Table 6. Column densities and visual extinction in Taurus

Source	$N(\text{H}^{13}\text{CO}^+)^{(1)}$ $\times 10^{12}\text{cm}^{-2}$	$N(\text{H}^{12}\text{CO}^+)^{(2)}$ $\times 10^{14}\text{cm}^{-2}$	$N(\text{C}^{18}\text{O})^{(3)}$ $\times 10^{15}\text{cm}^{-2}$	$N(^{13}\text{CO})^{(4)}$ Dickman's law $\times 10^{15}\text{cm}^{-2}$	$N(^{12}\text{CO})^{(5)}$ $\times 10^{17}\text{cm}^{-2}$	$\overline{A_V}^{(6)}$ (magnitude)	
Taurus 1	1.1	1.	0.7	5.9	>11	3.3	> 4.5
Taurus I	1.0	0.9	0.35	4.5	> 9.5	1.6	> 3.8
Taurus 3 B			0.5	6.4	>12	2.4	> 5.
TMC 2	3.4	3.	0.75	7.8	>12	3.6	> 5.
Taurus 3 C	3.7	3.3	0.9	5.8	>10	4.4	> 4.
Taurus III			0.5	4.7	>10	2.4	> 4.
Taurus 5 A	0.7 ?	0.6 ?	1.1	7.	> 9.5	5.3	> 3.8
Taurus 5 B	2.9	2.6	1.	5.2	> 8.8	5.1	> 3.5
Taurus 6			0.3	2.	> 8.5	1.6	> 3.4
	0.6 ?	0.5 ?	0.85	3.8	> 8.5	4.1	> 3.4
Taurus 7	1.4 ?	1.2 ?	0.8	4.4	10.	4.	~ 4.
Taurus IV			0.6	2.3	> 9.	2.8	> 3.6
Taurus 8	1.2	1.1	0.6	1.7	> 8.5	2.8	> 3.4

(1) From LVG analysis (see text).

(2) Assuming $[\text{HCO}^+/\text{H}^{13}\text{CO}^+] = 89$.

(3) From LTE analysis (see text).

(4) The figures on the left are from LTE analysis; the figures on the right have been obtained from $A_V = 4 \times 10^{-16} N(^{13}\text{CO})$ (Dickman, 1978-b) using A_V given at the end of this Table.

(5) From $N(^{12}\text{CO}) = 490 N(\text{C}^{18}\text{O})$.

(6) Mean extinction within an area of size ≈ 5 arc min.

With $A_V < 2.5$ mag (the Taurus globules are embedded in a diffuse cloud with $A_V \approx 2 - 2.5$; see Sect. VII) and $N(\text{H}_2)/A_V = 9.6 \cdot 10^{20} \text{cm}^{-2} \text{mag}^{-1}$ (Bohlin et al., 1978) we derive $[\text{HCO}^+/\text{H}_2] > 0.3 - 1 \cdot 10^{-9}$. If component-a does not contribute significantly to HCO⁺ line emission ($\tau_a \approx \tau_{a,\text{min}}$) then the predicted HCO⁺ abundance ($\sim 10^{-9}$) is much lower than that which can be deduced for component-b from Table 6 ($[\text{HCO}^+/\text{H}_2] \approx 3 \cdot 10^{-8}$), even when one accounts for corrections due to uncertainties in n_{H_2} and collision cross sections. A large $[\text{HCO}^+/\text{H}_2]$ abundance in the dense component is consistent with the low value of $[e/\text{H}_2]$ found by Guélin et al. (1981) for dark clouds.

VI. CO Isotopic Abundances

a) The $^{13}\text{CO}/\text{C}^{18}\text{O}$ Ratio

In Table 5 we give three ratios: R_I which is derived from the integrated line profiles, R_T which is determined from the peak antenna temperatures, and R_A the abundance ratio which is

obtained from a simple LTE analysis. Difficulties in deducing abundance ratios from observations have been investigated by several authors (e.g. Langer et al., 1980). Radiative transfer problems become harder within the frame of the two component model used for HCO⁺. Even with the simple formulation of Sect. Vb [Eq. (1)] it is impossible without more complete data to determine exact excitation conditions in both components.

However, important information is available. First with $n_{\text{H}_2} \gtrsim 10^4 \text{cm}^{-3}$ CO isotopes are thermalized in component-b ($T_{\text{ex}} \approx 10 \text{K}$). Second the antenna temperature ratios give some indication about the optical depths. From the values of R_T we know that ^{13}CO is nearly saturated excepted maybe in the cases of Taurus I and Taurus 6. From the mean value $\overline{R_I} = 5.7$ which is, despite saturation effects, close to the terrestrial double ratio $[^{13}\text{C}/^{12}\text{C}] \times [^{16}\text{O}/^{18}\text{O}] = 5.5$, we must admit (unless element abundances are not terrestrial) that ^{13}CO fractionation is important. In some cases $\tau_a(^{13}\text{CO})$ could be not at all negligible. We have shown in section V that for low density in component-a $[\text{HCO}^+/\text{H}_2] \sim 10^{-9}$; fractionation may enhance sufficiently the $[^{13}\text{CO}/\text{HCO}^+]$ ratio (up to a few times 10^3) to give comparable

opacities for both species. Furthermore $\tau_a(^{13}\text{CO})$ is necessarily close to 1 if fractionation is limited to the diffuse component. On the other hand the low visual extinction in this component implies that C^{18}O is optically thin. Finally the optical depth of component-a being very likely higher for CO than for HCO^+ , the observed CO antenna temperatures (unpublished results) lead to $T'_{\text{exa}}(\text{C}^{18}\text{O}) \leq T'_{\text{exa}}(^{13}\text{CO}) \leq T'_{\text{exa}}(\text{CO}) \simeq 6\text{K}$.

b) Column Densities

If one assumes $T'_{\text{exa}} = T'_{\text{exb}}$ for ^{13}CO and C^{18}O , Eq. (1) reduces to $T_B = T'_{\text{ex}}(1 - e^{-\tau})$ where $\tau = \tau_a + \tau_b$. This equation (with $T_B = T_A^*$ and $T_{\text{ex}} = 10\text{K}$) and the relationship $N(\text{cm}^{-2}) \simeq 5.9 \cdot 10^{15} \times \Delta v (\text{km s}^{-1}) \times \tau$ were used to derive the ^{13}CO and C^{18}O column densities given in Table 6.

The hypothesis of equal excitation temperatures is not really compatible with $\tau_a(^{13}\text{CO}) \sim 1$ and $T_B(^{13}\text{CO}) \lesssim 2 - 5\text{K}$. Corrections for subthermal excitation in the diffuse component should then be included. Despite an expected correction larger for C^{18}O than for ^{13}CO , very different opacities for both species in component-a lead to enhanced values of R_A . Probable beam dilution (in C^{18}O) and possible overestimate of T'_{exb} (for example in Taurus IV and in Taurus 8) also affect the derived column densities (by a factor which is not likely to exceed 1.5).

In this context the CO column densities given in Table 6 from $N(\text{C}^{18}\text{O}) \times 490$ are lower limits. Comparison of photometric and star count estimates of visual extinction (Frerking et al., 1981) indicates that the values of A_v may be 2 to 3 times larger than the lower limits implied by star counts. Using $N(\text{H}_2)(\text{cm}^{-2}) = 9.6 \cdot 10^{20} A_v$ (Bohlin et al., 1978) we obtain a mean ratio $[\text{CO}/\text{H}_2]$ in the range $0.3 - 1.2 \cdot 10^{-4}$. From the relationship $N(^{13}\text{CO}) = 2.5 \cdot 10^{15} A_v$ (Dickman, 1978b) one deduces lower limits for $N(^{13}\text{CO})$ which exceed the LTE values of Table 6 by a mean factor of 2. This is easily explained by discrepancies in the choice of T_{ex} and by the fact that our set of observations is not representative of the average of Dickman's sample.

VII. The Fragmentary Appearance of Taurus and the HCO^+/A_v Correlation

a) General Aspect

One can see in Fig. 2 that the Barnard 18 and TMC 2 region (Lynds 1531, 1529, 1524, 1533, 1535) and that the western filaments Barnard 215, 212 and 210 (Lynds 1506 and 1501) contain several high opacity globules with sizes $\simeq 4$ to $10'$. These globules are embedded in a very large cloud (total size $\simeq 3^\circ \times 1^\circ$) whose mean visual extinction is $2 - 2.5$ mag. Our star counts on the Palomar blue print (comparison field) and red print and a study of the early measurements made by Van Rhijn (1929) show that the extinction in the comparison field is $\gtrsim 1$ mag. This is in good agreement with Bok's results (Bok, 1956). Within the $4 - 10'$ globules the extinction is typically $\gtrsim 6$ mag.

Even smaller spatial structure, of the order of $3'$, is observed towards TMC 2 in NH_3 , HC_5N and HC_3N (Myers et al., 1979; Walmsley et al., 1980). Star counts also reveal isolated globules with sizes $\lesssim 3'$ (0.12pc) and $A_v \gtrsim 5$ mag. These globules correspond to a clear decrease of the number of stars and cannot be ascribed to statistical fluctuations in our star counts. Small globules ($\lesssim 3'$) are observed in the direction of Taurus I, 4, 6, 5B and 8.

b) Correlation of HCO^+ Emission with Extinction

Maps of the $J = 1 - 0$ line of HCO^+ have been made towards Taurus 1, I and 7 (Figs. 4, 5 and 6) in order to study the possible correlation of HCO^+ emission with visual extinction, A_v .

Taurus 1 is a globule located roughly $30'$ west and $15'$ south of TMC 2. Our star counts give $A_v \simeq 3 - 4$ mag and $A_v \gtrsim 4$ mag in areas with typical sizes of about $8'$ and $6'$ respectively. Using a formula similar to that used by Dickman (1978a) we find that at the Taurus distance the mass is given by $M(M_\odot) = 0.2 \sum A_v$ where the summation extends over 2.2×2.2 squares. Within the $6'$ to $8'$ region the total mass is $M \simeq 8 M_\odot$. Taurus 1 has a core with size $\sim 4'$ and $A_v > 6$ mag. Figure 4 shows good correlation of HCO^+ emission with extinction even though there are position errors in our star counts ($\lesssim 1'$), Taurus 1 is embedded in an extended cloud with $A_v \gtrsim 2$ mag, and the spatial resolution of our observations in HCO^+ is low.

Taurus I is a globule with visual extinction $\simeq 4$ mag in a region of about $8'$. In this source we have also identified a core with size $\sim 2 - 3'$ and extinction $A_v \gtrsim 5$ mag. The core has a mass of about $1 M_\odot$.

Two ^{13}CO velocity features have been observed in Taurus I. The weaker 5.3 km s^{-1} component not observed in HCO^+ and C^{18}O presumably corresponds to a less dense cloud than the 6.7 km s^{-1} cloud.

Figure 5 shows that in Taurus I, as in Taurus 1, HCO^+ emission and extinction are correlated.

In Taurus 7 at least two dark globules are observed and again HCO^+ emission appears to be stronger in the most obscured areas (Fig. 6). In the eastern and western globules we have measured $A_v \gtrsim 7$ and 6 mag corresponding to masses of the order of 8 and $5 M_\odot$ respectively. We note that the infrared source detected by Elias (1978) in this area has a visual extinction of 8 mag in good agreement with our data.

c) Are the Taurus Globules Collapsing?

The HCO^+ maps made in Taurus 1, I and 7 indicate that the characteristic mean size, L , corresponding to line emission with intensity $\gtrsim 1/2 T_A^* \text{ max}$, is $L \simeq 4' - 8' = 0.16 - 0.32\text{pc}$. This size can be compared to the Jeans length, $\lambda_J(\text{pc}) = 8 T_K^{1/2} n_{\text{H}_2}^{-1/2}$; $\lambda_J = 0.25\text{pc}$ if $T_K = 10\text{K}$ and $n_{\text{H}_2} = 10^4\text{cm}^{-3}$. Since $\lambda_J \sim L$ it is interesting to compare intrinsic molecular line widths to line widths derived for collapsing spheres, Δv_{ff} . For HCO^+ , when the contributions due to instrumental broadening ($\sim 0.3\text{ km s}^{-1}$) and to thermal broadening ($\sim 0.12\text{ km s}^{-1}$) are removed from observed line widths (typically in the range $0.7 - 1.2\text{ km s}^{-1}$), we obtain $\Delta v_l \simeq 0.6 - 1.1\text{ km s}^{-1}$. With $\Delta v_{\text{ff}}(\text{km s}^{-1}) \simeq 0.1 (M(M_\odot)/R(\text{pc}))^{1/2}$, $R \simeq L/2$ and $M \simeq 5 - 8 M_\odot$ (see Sect. VII b) we get $\Delta v_{\text{ff}} \simeq \Delta v_l$. However the intrinsic linewidths could also be caused by radial velocity gradients (the influence of the velocity gradient across the line of sight which is $\sim 0.25\text{ km s}^{-1}\text{pc}^{-1}$ according to Fig. 11 is negligible) and would correspond to $dv/dr \simeq \Delta v_l/L \simeq 2 - 7\text{ km s}^{-1}\text{pc}^{-1}$. In addition any interpretation of the HCO^+ line widths is severely hampered by self-absorption and no clear conclusion can be drawn from the above calculations. In this regard an analysis of $\Delta v_l(\text{C}^{18}\text{O})$ would be more fruitful but it requires mapping in the C^{18}O line.

On the other hand cores with sizes $\sim 2' - 3' = 0.1\text{pc}$ such as the Taurus I core discussed in paragraph b) are gravitationally stable according to the Jeans criterion; with $T_K = 10\text{K}$ and $n_{\text{H}_2} = 10^4\text{cm}^{-3}$; $\lambda_J = 0.25\text{pc} > 0.1\text{pc}$. Our HCO^+ data indicate that

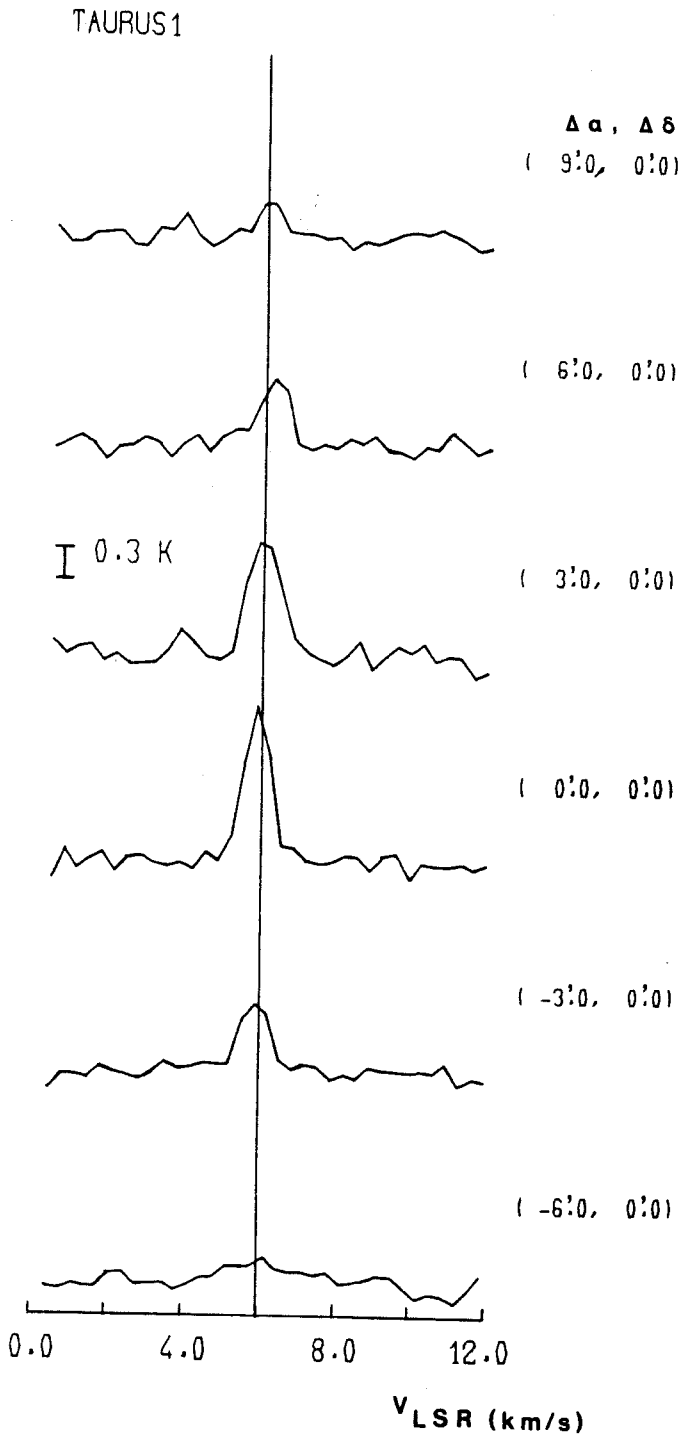

Fig. 10. HCO⁺ spectra taken at 3' intervals along an East/West axis in the direction of Taurus 1. A slight velocity displacement is observed towards ($\Delta\alpha, \Delta\delta = 3'$ to $6', 0$). The vertical bar corresponds to $T_{\text{rot}}^* = 0.3 \text{ K}$.

no local rotation exists within the Taurus I and 7 globules. However Fig. 10 shows that in Taurus 1 slightly higher velocities are observed to the East of the central position. The velocity shift, of the order of one channel, is smaller than the critical velocity

$v \text{ (km s}^{-1}\text{)} \approx 0.1 (M(M_{\odot})/R(\text{pc}))^{1/2} \approx 0.8 \text{ km s}^{-1}$ that would be required to stabilize a spherical cloud against gravity. Therefore the Taurus I core like TMC2 and TMC1 (Myers et al., 1979a; Tölle et al., 1981) might be in hydrostatic equilibrium.

VIII. On the Kinematical Structure of the Taurus Filaments

A systematic velocity pattern in the filaments which are investigated here was first suggested by Crutcher (1973). Clark et al. (1977) and Clark and Johnson (1978) interpret their ¹³CO and H₂CO observations towards the globule Barnard 213 as the result of orbital motion of three fragments with velocities 5, 6.7 and 7.7 km s⁻¹.

In general, our HCO⁺ observations along the axis of the elongated dust clouds show only one velocity component. On the other hand our ¹³CO data show double velocity components in several sources. Other line observations also show multiple velocity features (Crutcher, 1973; Heiles and Katz, 1976; Clark et al., 1977; Combes et al., 1980). In Fig. 11 we present the velocity information available in the literature and in this work as a function of the distance along the dust cloud axis.

In the eastern filaments (TMC2 region) there is no obvious correlation between velocity and position. One could interpret the velocity dispersion as resulting from the presence of various clouds lying on the line of sight with velocities between ~ 4.5 and 7 km s^{-1} . Around TMC2 all velocities between 5 and 7 km s^{-1} are observed. In the less obscured areas the ¹³CO observations also show double velocity components.

In the western filaments the velocity varies systematically with axial position, but a lower velocity component was also clearly detected in Taurus 8 and in Taurus Cloud 8.

There are several possible explanations to the velocity dispersion observed in Taurus: rotation, gravitational collapse, cloud collision, instability in the vicinity of expanding shells. In the following we speculate on the cloud collision hypothesis which is suggested by the velocity dispersion observed in Fig. 11.

If two clouds with velocities say around 4.5 and 7 km s^{-1} have collided one would expect to observe emission from the two parent-clouds and from high density fragments which could have been formed at the cloud-cloud interface. (TMC 1 and TMC 2 with sizes ~ 0.1 to 0.3 pc might be good examples of these dense fragments.) Several arguments are in favour of this model. In particular: (i) The two color photographic photometry made by Adolfsson (1955), Kalandadze (1969) and Metreveli (1975) reveals the presence of several clouds lying on the line of sight. (ii) Similar velocities (dispersion $\sim 0.2 \text{ km s}^{-1}$), observed around 5, 6 or 7 km s^{-1} in regions separated by as much as ~ 15 to 20 pc (Heiles and Katz, 1976; Clark et al., 1977; and this work) imply that a large scale orbital motion of fragments is improbable. A cloud-cloud collision is consistent with this observation but does not exclude gravitational binding of fragments on a smaller scale.

If the collision occurred $\sim 10^6 \text{ yr}$ ago (at a time where the T Tauri stars were formed) then the relative velocity difference of the colliding clouds $\sim 3 \text{ km s}^{-1} = 3 \text{ pc}/10^6 \text{ yr}$ leads to a penetration length of about 3 pc much smaller than the total size of the dark clouds observed in Taurus ($> 30 \text{ pc}$). Therefore the Taurus region may still be forming new fragments and the highly obscured and densest areas in Taurus could be used as a reservoir for future massive stars (O-B stars) which are presently not observed.

Finally the discussion above and Fig. 11 reveal that the kinematical structure is complex but that the systematic velocity

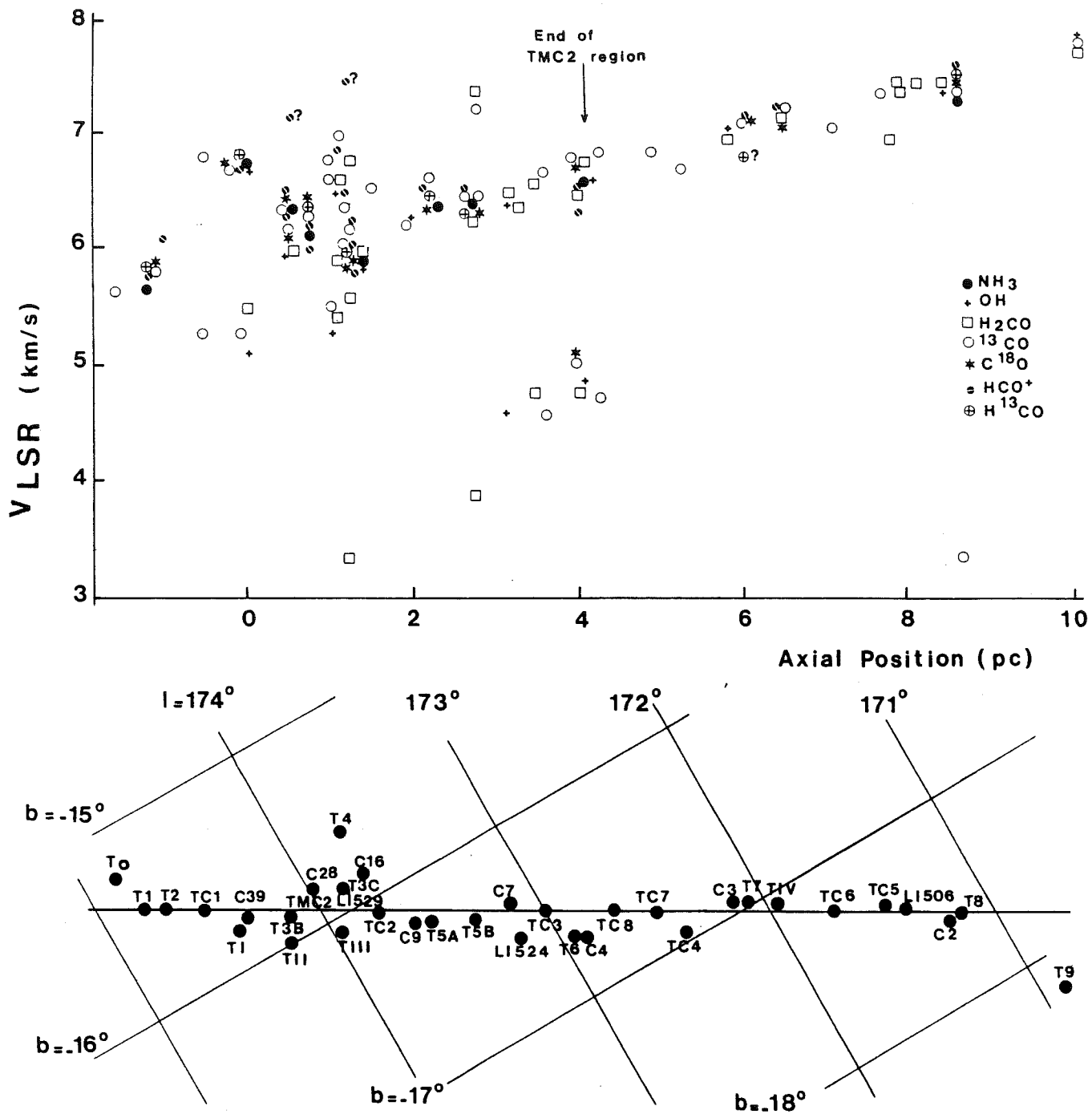

Fig. 11. Velocity field along the axis of the Taurus filaments lying between $l \approx 171^\circ$ and $l \approx 175^\circ$. The OH and NH₃ data are from Crutcher (1973) and Myers et al. (1979). The H₂CO data are from Heiles and Katz (1976), Dieter (1973) and M. Kutner as quoted in Crutcher's paper. The ¹³CO, C¹⁸O, HCO⁺, and H¹³CO⁺ data are from this work. The vertical arrow marks the end of the TMC2 region i.e. of the eastern filaments shown in Figs. 1 and 2. The axial position is given in parsecs assuming a distance of 135 pc. The reference position corresponds to C39, the source number 39 in Crutcher's paper. The lower part of the figure shows all sources detected in this work, Taurus 0 to 9 and I to IV (designated by T0, T1...), Taurus Cloud 1 to 8 (designated by TC1 to 8) and the sources with $171^\circ < l < 175^\circ$ studied by Crutcher (designated by C39, C16...)

A. Baudry et al.: HCO⁺ and CO Observations in Taurus

115

pattern mentioned by Crutcher (1973) cannot be dismissed. However the idea of a large scale rotation suggested by Crutcher seems much too simple in view of the velocity dispersion observed in the TMC 2 region.

IX. Conclusion

We have used the relatively broad beamwidth ($\sim 5'$) of a new millimeter wave facility to sample or to map selected obscured regions in Taurus. The $J = 1 - 0$ transition of HCO⁺ was chosen to show that the extent of molecular clouds is well correlated with visual extinction. The typical size at half intensity of HCO⁺ clouds is $\sim 4'$ to $8'$. Smaller globules, with sizes comparable to those measured for TMC 1 and TMC 2 i.e. $\lesssim 3'$, were also revealed by our star counts.

H¹³CO⁺ was detected in the direction of several sources. A two component model accounting for self absorption in HCO⁺ explains the low HCO⁺/H¹³CO⁺ intensity ratios obtained here. Analysis using a uniform density LVG model with $n_{\text{H}_2} \approx 10^4 \text{ cm}^{-3}$ and $T_K \approx 10 \text{ K}$ gives for the dense core $N(\text{H}^{13}\text{CO}^+) \approx 1 - 4 \cdot 10^{12} \text{ cm}^{-2}$, which corresponds to a large [HCO⁺/H₂] abundance ($\sim 3 \cdot 10^{-8}$). This ratio may be overestimated if (i) excitation is more efficient than assumed (higher H₂ density or collision rates), (ii) the [HCO⁺/H¹³CO⁺] abundance ratio is lower than 89, or (iii) the H₂ column densities have been underestimated. From the expected HCO⁺ emission we deduce a minimum column density in the absorbing layer: $N(\text{HCO}^+) \gtrsim 10^{12} \text{ cm}^{-2}$; in the case of very low excitation in this layer, $N(\text{HCO}^+)$ will be close to this lower limit, corresponding to $[\text{HCO}^+/\text{H}_2] \sim 10^{-9}$.

C¹⁸O emission was detected in all sources studied in H¹³CO⁺. With $[\text{CO}/\text{C}^{18}\text{O}] = 490$ we have derived $N(\text{CO}) \gtrsim 3 \cdot 10^{17} \text{ cm}^{-2}$ and $[\text{CO}/\text{H}_2] \sim 0.6 \cdot 10^{-4}$ (within a factor of 2). Comparison to ¹³CO shows that in most cases ¹³CO fractionation is important; an accurate determination of the [¹³CO/C¹⁸O] abundance ratio strongly depends on the excitation conditions in the forward diffuse component, which may be optically thick in ¹³CO.

¹³CO emission was detected in every sampled cloud direction and showed that double velocity components are common in Taurus. Comparison of this result with similar observations made in other molecules (e.g. Heiles and Katz, 1976) indicates that there are no systematic kinematics within the TMC 2 region and that a simple large scale rotation in Taurus is unlikely. Observation of a large velocity dispersion for nearby cloud locations (separated by a few arc min) and of identical velocities for regions separated by as much as 15 to 20 pc suggests a fragmentation process. The fragments could have been formed in a collision of two clouds some 10⁶ yr ago.

Remerciements. Nous remercions vivement les membres de l'atelier de mécanique et du groupe électronique de l'Observatoire de Bordeaux, J.M. Desbats, F. Gérard, J. Lacroix, G. Montignac, M. Soulette, qui ont assuré la maintenance de cette nouvelle opération millimétrique. G. Beaudin de l'Observatoire de Meudon nous a constamment aidés pour la maintenance et une utilisation optimale du récepteur refroidi. P. Encrenaz et M. Guélin nous ont encouragés tout au long de ce projet.

Enfin nous remercions vivement W.D. Langer, P.C. Myers, P.F. Goldsmith et J. Lequeux de leurs intéressantes critiques de ce manuscrit.

L'installation à l'Observatoire de Bordeaux d'un récepteur spectral millimétrique a été soutenue par l'I.N.A.G. et les E.R.A. du C.N.R.S. numéros 380 et 762.

References

- Adolfsson, T.: 1955, *Arkiv för Astronomi*, **1**, Nr. 34, 495
 Baudry, A., Brillet, J., Desbats, J.M., Lacroix, J., Montignac, G., Encrenaz, P., Lucas, R., Beaudin, G., Dierich, P., Germont, A., Landry, P., Rérat, G.: 1980, *J. Astrophys. Astron.* **1**, 193
 Bernes, C.: 1977, *Astron. Astrophys. Suppl.* **29**, 65
 Bohlin, R.C., Savage, B.D., Drake, J.F.: 1978, *Astrophys. J.* **224**, 132
 Bok, B.: 1956, *Astron. J.* **61**, 309
 Bok, B.J., Cordwell, C.S.: 1973, *Molecules in the Galactic Environment*, eds. Gordon M.A. and Snyder L.E., Wiley, N.Y.
 Clark, F.O., Giguere, P.T., Crutcher, R.M.: 1977, *Astrophys. J.* **215**, 511
 Clark, F.O., Johnson, D.R.: 1978, *Astrophys. J.* **220**, 500
 Combes, F., Falgarone, E., Guibert, J., Nguyen-Q-Rieu: 1980, *Astron. Astrophys.* **90**, 88
 Crutcher, R.M.: 1973, *Astrophys. Letters* **14**, 147
 Dieter, N.H.: 1973, *Astrophys. J.* **183**, 449
 Dickman, R.L.: 1976, Ph. D., Columbia University
 Dickman, R.L.: 1978a, *Astron. J.* **83**, 363
 Dickman, R.L.: 1978b, *Astrophys. J. Suppl.* **37**, 407
 Elias, J.H.: 1978, *Astrophys. J.* **224**, 857
 Frerking, M.A., Langer, W.D., Wilson, R.L.: 1981, *Astrophys. J.* (in press)
 Green, S.: 1975, *Astrophys. J.* **201**, 366
 Guélin, M., Langer, W.D., Wilson, R.W.: 1981, *Astron. Astrophys.* (in press)
 Haese, N.N., Woods, R.C.: 1979, *Chem. Phys. Letters* **61**, 396
 Haro, G.: 1968, *Nebula and Interstellar Matter*, eds. Middelhurst, B.M. and Aller, L.H., Chicago Press
 Heiles, C.E., Katz, G.: 1976, *Astron. J.* **81**, 37
 Herbig, G.H., Rao, N.K.: 1972, *Astrophys. J.* **174**, 401
 Ho, P.T.P., Barrett, A.H., Martin, R.N., Myers, P.C.: 1977, *Astrophys. J.* **215**, L29
 Kalandaze, N.B.: 1969, *Abastumansk. Obs. Bull.* **38**, 3
 Kutner, M.L.: 1978, *Astrophys. Letters* **19**, 81
 Langer, W.D., Goldsmith, P.F., Carlson, E.R., Wilson, R.W.: 1980, *Astrophys. J.* **235**, L39
 Langer, W.D., Wilson, R.W., Henry, P.S., Guélin, M.: 1978, *Astrophys. J.* **225**, L139
 Metreveli, M.D.: 1969, *Abastumansk. Obs. Bull.* **38**, 93
 Myers, P.C., Ho, P.T.P., Benson, P.J.: 1979, *Astrophys. J.* **233**, L141
 Tölle, F., Ungerechts, H., Walmsley, C.M., Winnewisser, G., Churchwell, E.: 1981, *Astron. Astrophys.* **95**, 143
 Van Rhijn, P.J.: 1929, *Groningen Publ.*, Vol. 43
 Walmsley, C.M., Winnewisser, G., Tölle, F.: 1980, *Astron. Astrophys.* **81**, 245

I.05) L'ETAT PHYSIQUE ET CHIMIQUE DU NUAGE SOMBRE

HEILES CLOUD 2

I.05) L'ETAT PHYSIQUE ET CHIMIQUE DU NUAGE SOMBRE
HEILES CLOUD 2

Nous avons cartographié, avec une résolution angulaire de 5', l'émission des raies J=1-0 de ^{12}CO , ^{13}CO , $^{12}\text{C}^{18}\text{O}$, H^{12}CO^+ , et H^{13}CO^+ dans Heiles Cloud 2 (HCL2), le nuage sombre contenant le coeur dense TMC1. Nous avons aussi cartographié, avec une plus grande résolution angulaire, les parties les plus obscures de ce nuage dans les raies J=2-1 et J=1-0 des trois isotopes de CO. Pour $2 \leq A_V \leq 6$ mag, la densité projetée de C^{18}O varie linéairement avec l'extinction visuelle déterminée à partir de comptages d'étoiles (voir I.02 et I.03) et suit la relation:

$$N(\text{C}^{18}\text{O}) = 2.5 \pm 0.5 (A_V - 1.5 \pm 0.3) \cdot 10^{14} \text{ cm}^{-2}.$$

C^{18}O n'a pas été détecté vers les couches externes du nuage qui contribuent avec 1.5 mag. à l'extinction visuelle dans la ligne de visée. Cela s'explique par une excitation de C^{18}O insuffisante et, probablement, par la photodissociation sélective de cet isotope de CO. Le seuil de 1.5 mag pour C^{18}O est réduit à $\approx 0.5-0.7$ mag pour ^{12}CO et ^{13}CO , car ces isotopes sont plus abondants et peuvent être excités radiativement. A l'intérieur du nuage, la relation linéaire suggère que l'abondance fractionnelle de CO est constante est $\approx 10^{-4}$.

Les données suggèrent que HCL2 est composé de deux filaments de masse $\approx 130 M_{\odot}$, entourés d'une enveloppe de masse comparable. Les filaments sont clairement visibles en C^{18}O et ^{13}CO et contiennent plusieurs condensations détectées en H^{13}CO^+ . L'émission de H^{12}CO^+ qui est observée essentiellement dans la direction des filaments, provient probablement de la diffusion du rayonnement issu des régions les plus denses.

Une redétermination de la distance de HCL2 donne 100 pc.

The physical and chemical state of HCL2

J. Cernicharo^{1,2} and M. Guélin³

¹ Groupe d'Astrophysique, Université de Grenoble, ERA 708 du CNRS, BP 68, F-38402 St. Martin d'Hères Cedex, France

² Observatoire de Meudon, DEMIRM, F-92195 Meudon, France

³ IRAM, Domaine Universitaire de Grenoble, Voie 10, F-38406 St. Martin d'Hères, France

Received March 4, accepted September 8, 1986

Summary. We have mapped, with a 5' angular resolution, the emission from the $J=1 \rightarrow 0$ lines of $^{12}\text{C}^{16}\text{O}$, $^{13}\text{C}^{16}\text{O}$, $^{12}\text{C}^{18}\text{O}$, $\text{H}^{12}\text{C}^{16}\text{O}^+$, and $\text{H}^{13}\text{C}^{16}\text{O}^+$ over Heiles Cloud 2, the dark cloud which contains the source TMC1. We have also surveyed with a higher resolution the darkest parts of this cloud in the $J=2 \rightarrow 1$ and $J=1 \rightarrow 0$ lines of the three CO isotopes. The C^{18}O column density is found to vary linearly with the visual extinction derived from star counts for $2 < A_v < 6$: $N(\text{C}^{18}\text{O}) = 2.5 \pm 0.5 (A_v - 1.5 \pm 0.3) 10^{14} \text{cm}^{-2}$. A linear relation is also found between $N(\text{C}^{18}\text{O})$ and the 100 μm continuum flux.

The C^{18}O molecule is not detected in the external layers of the cloud which contribute 1.5 mag to the extinction along the line-of-sight. This results from insufficient excitation of C^{18}O and, possibly, from selective photodissociation of this species. The 1.5 mag threshold is reduced to $\approx 0.5-0.7$ mag for ^{12}CO and ^{13}CO , which are much more abundant and can be radiatively excited. Inside the cloud, the linear relation suggests that the CO fractional abundance is constant and equal to $\approx 10^{-4}$.

The data suggests that HCL2 consists of two bending filaments of mass $\approx 100 M_\odot$, surrounded by an envelope of comparable mass. The filaments are most clearly visible in C^{18}O and ^{13}CO and enclose dense clumps detected in H^{13}CO^+ . The H^{12}CO^+ emission is observed throughout the filaments; it probably results from scattering of the clump radiation by the filament outer parts.

The distance to HCL2 has been re-determined, and found to be equal to 100 pc.

Key words: interstellar medium = molecules - abundances - clouds = individual: Taurus complex, HCL2

chemical models of evolving clouds (e.g. Glassgold et al., 1985; Tarafdar et al., 1985; d'Hendecourt et al., 1985). Time is now ripe for the comprehensive study of one cloud where one could confront theoretical predictions and observational facts.

Much effort along this line has been devoted to TMC1, a nearby clouddlet of the Taurus region, particularly rich in complex molecules and favorably located in the northern sky. To date, more than forty molecules have been detected in this source, not including isotopic substitutes. The only interstellar cloud where HC_{11}N is observed (Bell and Matthews, 1985), it is also the richest source in deuterated molecules (Guélin et al., 1982). Line excitation studies have revealed a clumpy, elongated structure with some chemical differentiation between the clumps. The most striking result, however, is the large difference in molecular abundances between TMC1 and other, seemingly similar dark clouds: in TMC1, carbon chain molecules appear one to two orders of magnitude more abundant than in most clouds and the abundance of HNC exceeds that of its stable isomer HCN.

Attempts to explain chemical differences between TMC1 and clouds of similar size, temperature and density invoke non steady-state chemistry and dynamical evolution (see e.g. Walmsley et al., 1980). Little can be said however on the evolution of TMC1, without a thorough knowledge of Heiles Cloud 2 (HCL2), the large body of gas to which it belongs.

Surprisingly enough, although it is one of the very first clouds observed in molecular emission (Heiles, 1968), the data available so far on HCL2 was either crude or fragmentary. Maps of the entire 1.5×1.5 cloud have been reported in the $J=1 \rightarrow 0$ lines of $^{12}\text{C}^{16}\text{O}$ and $^{13}\text{C}^{16}\text{O}$ (Baran, 1985; Schloerb and Snell, 1984; Takano et al., 1985) and in the centimetric lines of H₁, OH, and H₂CO (Wilson and Minn, 1978; Wouterloot and Habing, 1985; Sume et al., 1975). These maps, however, either lack of angular resolution, or are blunted by line opacity and do not reveal much of the cloud inner structure. More complete studies were restricted to TMC1.

We present here the results of an extended multi-molecule study of HCL2, which gives more insight into the cloud's physical and chemical structure. It combines complete maps in the $J=1 \rightarrow 0$ lines of 6 molecular species (the main isotopes of CO and HCO^+ , plus HCN), observed with a 5' angular resolution with the 2.5-m Bordeaux telescope. It also combines partial maps of the $J=2 \rightarrow 1$ and $J=1 \rightarrow 0$ lines of CO, observed with angular resolutions of 80", 160", and 22" with the Millimeter Wave Observatory (MWO) and Institut de Radioastronomie Millimétrique (IRAM) telescopes, as well as restricted maps of the densest

1. Introduction

Progress in our understanding of dense cloud chemistry has increased the need for extensive, high quality observational data. More and more it seems clear that present molecular abundances are coupled to the dynamical evolution of the clouds, that past irradiation by UV, or compression by shocks, still affects the gas chemical state. The role of photodissociation, self-shielding, accretion by dust grains and desorption from these grains has been reinvestigated and these processes are being incorporated in

Send offprint requests to: J. Cernicharo

regions in several transitions of HC_3N , HC_5N , C_4H , and NH_3 . The data relative to these latter species and the HCN data have already been reported elsewhere (Cernicharo, Guélin, and Askne, 1984; hereafter denoted Paper I; Cernicharo et al., 1984), as has been a study of the visual extinction in Taurus (Cernicharo and Bachiller, 1984, hereafter CB; Cernicharo et al., 1985). In this paper, we emphasize the data relevant to the two oxygen-bearing species, CO and HCO^+ , and attempt to give a general picture of HCL2.

The star counts and radio observations are described in Sect. 2. In Sect. 3 we derive a crude model of the gas density which will help analyzing the radio data. The CO/A_v relation and the behaviour of the CO abundance as one deepens into the cloud are discussed in Sect. 4. The HCO^+ brightness distribution is analyzed in Sect. 5. Finally, a schematic model of the cloud dynamics is proposed in Sect. 6.

2. Observations

2.1. Star counts

Provided that the gas to dust ratio is constant in dense clouds – as it is in diffuse clouds –, star counts offer a powerful way to estimate the mass of clouds with moderate extinction ($A_v \approx 2\text{--}6$ mag). Such estimates rely on a correct determination of the cloud distance (which is discussed in Appendix A) and require a careful assessment of the extinction in the reference field.

A $1^\circ \times 1^\circ$ area, centered at $\alpha = 4^{\text{h}}37^{\text{m}}$, $\delta = 25^\circ40'$ (1950) and covering the C^{18}O Bordeaux observations, has been selected for accurate star counts. These were made on the red and blue POSS prints over 2.5×2.5 cells using the two step procedure described by CB. The number of stars derived was averaged over 4 adjacent cells, to synthesize the area covered by the Bordeaux beam. The extinctions were then derived following the method of Bok (1937, see e.g. CB). A cruder extinction map over the whole HCL2 with a 2.2×2.2 mesh area is presented in Fig. 1a.

The determination of the visual extinction in HCL2 from star counts presupposes that the luminosity function of the stars and the extinction in the reference field are known. Because HCL2 is heavily absorbed, reference fields free of absorption are not available on the same plate. An apparently uniformly obscured region was selected as reference field. Its absorption is $A_v = 1.1$ (± 0.5) mag from the reddening of background stars. A correction for the decrease in sensitivity between the centre and the edge of the plate has been applied (CB).

The average obscuration in HCL2 from star counts, after correction for extinction in the reference field, is found equal to 3.5 mag.

2.2. Radio observations

The Bordeaux 2.5-m millimeter wave telescope and its cooled-mixer 3 mm receiver have been described by Baudry et al. (1981). The HCO^+ and H^{13}CO^+ $J=1 \rightarrow 0$ lines were observed between 1980 September and 1981 April, the ^{13}CO and C^{18}O $J=1 \rightarrow 0$ lines during the same period of the next year, the ^{12}CO $J=1 \rightarrow 0$ observations were carried out in Spring 1982. Finally the $J=1 \rightarrow 0$ line of HCN was observed in 1983 Spring and Fall. The telescope beam efficiency was ≈ 0.9 , its angular resolution $4.5\text{--}5.5$ (see Table 1 of Paper I). The velocity resolution of the 256×100 kHz filterbank was ≈ 0.3 km s^{-1} and the r.m.s. noise in one 100 kHz channel between 0.02 and 0.5 K (see Table 1 of Paper I). This r.m.s.

noise for C^{18}O , HCO^+ , and H^{13}CO^+ was 0.06, 0.07, and 0.04 K. Reference positions and other positions of interest were observed with a higher sensitivity.

For HCO^+ and CO isotopes, image sideband rejection in the RF mixer was achieved by adjusting a movable dielectric backshort. The observations were made by switching in frequency by ± 3.2 MHz (± 6.4 MHz for HCN). Line intensities were calibrated by means of a chopper wheel and atmospheric tipping scans. For ^{12}CO and HCN, which were observed in double side band, a model of atmospheric transmission was used to calculate the opacity in the image side band.

To insure good relative calibration of the different maps, the observations were restricted to clear days with zenith atmospheric opacity < 0.3 (0.5 for ^{12}CO) and to elevations $> 30^\circ$ (at transit, the source elevation is $\approx 70^\circ$). Every 3 or 4 h a reference position was observed: usually the cyanopolyyne peak of TMC1. Day to day variations of the antenna temperature were less than 20%. The absolute calibration scale was checked by comparing our line intensities with those measured with the 7-m Bell Laboratory and 5-m MWO telescopes. Smoothing to our $5'$ resolution the 7-m telescope HCO^+ and H^{13}CO^+ data (Guélin, Langer, and Wilson 1982, hereafter GLW) and the MWO C^{18}O and ^{13}CO $J=1 \rightarrow 0$ data (Castets et al., 1987) yielded temperatures within 10% of those observed at Bordeaux. Our temperatures also agree with those reported by Schloerb and Snell (1984) in their ^{13}CO survey of HCL2, carried out with the 14-m Five College Radio Astronomy Observatory (FCRAO) telescope. The FCRAO data have a higher ($1'$) angular resolution than ours, but less coverage and sensitivity. Schloerb and Snell have observed in the $J=1 \rightarrow 0$ line of C^{18}O some fragments of Cloud 2. Here also, on the average, their antenna temperature scale agrees with ours.

To check the thermalisation of the CO $J=1 \rightarrow 0$ lines, the $J=2 \rightarrow 1$ line of ^{12}CO , ^{13}CO , and C^{18}O were observed in the Spring of 1983 and 1984 with the MWO telescope (HPBW $\approx 1.3'$) along selected right ascension and declination strips. The observing procedure was similar to that described above; the telescope parameters and sensitivity limits are listed in Table 1 of Paper I. The $J=2 \rightarrow 1$ and $J=1 \rightarrow 0$ MWO data are presented in Table 1.

Finally, to estimate the gas clumpiness in the direction of reddened stars, we have observed in the fall of 1985, using the IRAM 30-m telescope, the $J=1 \rightarrow 0$ lines of C^{18}O and C^{17}O with a $22''$ angular resolution. The velocity resolution was ≈ 0.15 km s^{-1} . The results are given in Sect. 4.2.2.

3. Gas density distribution

The analysis of the radio data (mostly the HCO^+ data for which we observed only one rotational transition), requires knowledge of the gas density distribution. This latter can be estimated, independently of the molecular observations, from the size of the iso-extinction contours of Fig. 1a. It can also be derived from the degree of excitation of embedded molecules. The first method, in addition to a rough spherical symmetry, assumes that the gas to dust ratio and the distance to the cloud are known. It yields lower limits to $n(\text{H}_2)$ in directions with large extinctions ($A_v > 5$ mag). The second method requires that the molecules used as density probes are well distributed throughout the gas. It yields line-of-sight averaged values biased toward the densities where the probe is the most sensitive.

Figure 1a shows that obscuration is not uniform over HCL2. Obscuration heavier than average ($A_v = 3.5$ mag) delineates a

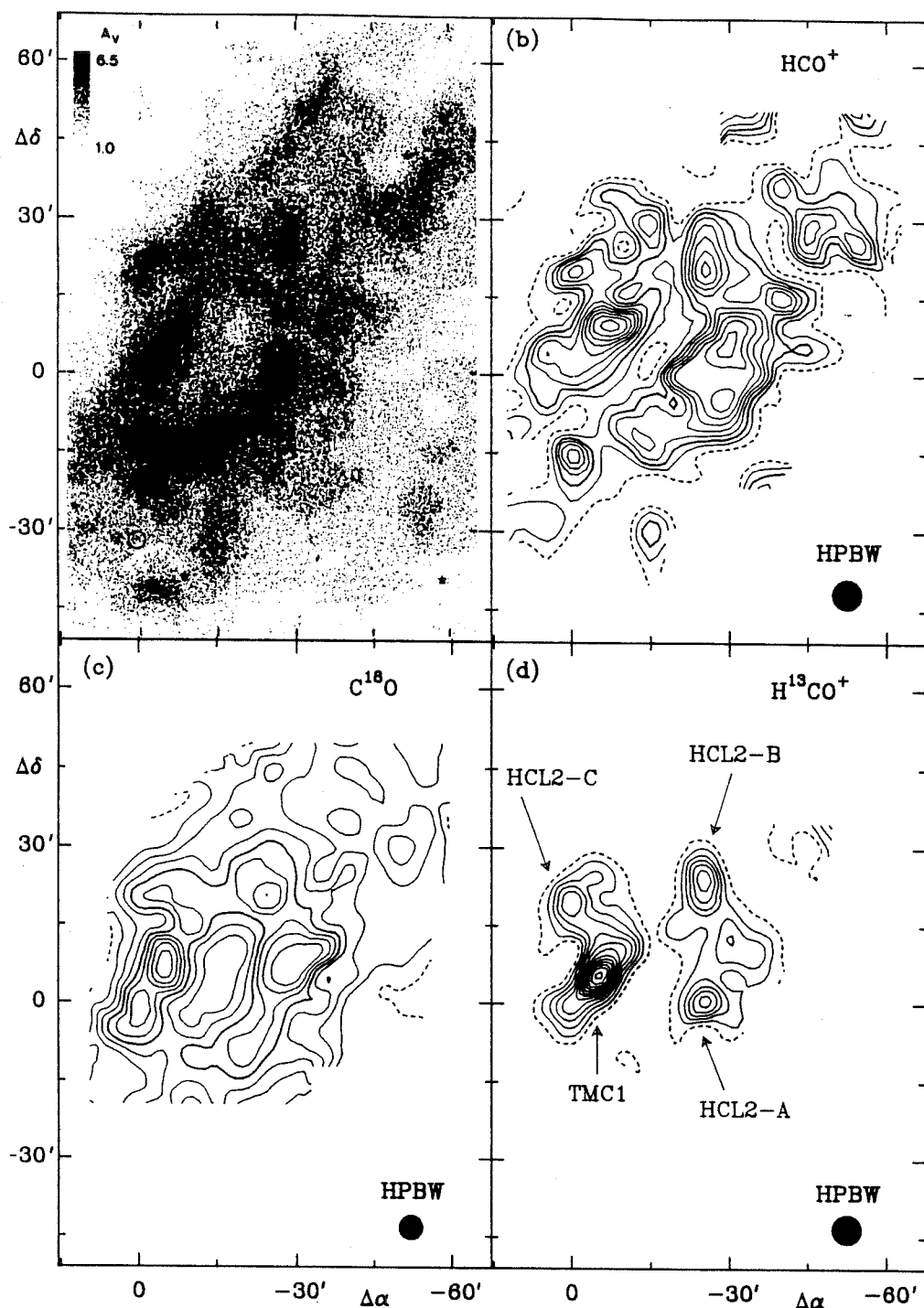

Fig. 1. a Visual extinction map of HCL2 derived from star counts. The extinction scale is in magnitudes; the black shading value (6.5 mag) is only a lower limit. b-d velocity-integrated intensity contours observed in the $J = 1 \rightarrow 0$ lines of $C^{18}O$, $H^{12}CO^+$ and $H^{13}CO^+$ with a $5'$ angular resolution. First contour (discontinuous line; 3σ values), second contour and step are: 0.15, 0.23, and 0.08 K km s^{-1} for HCO^+ , 0.1, 0.35, and 0.35 K km s^{-1} for $C^{18}O$, and 0.04, 0.07, and 0.03 K km s^{-1} for $HC^{13}CO^+$. The thick contour corresponds to 0.31 K km s^{-1} for HCO^+ and 1.1 K km s^{-1} for $C^{18}O$. Position (0,0) corresponds to the HC_3N source in TMC1; its coordinates are $\alpha = 4^h 38^m 38^s$, $\delta = 25^\circ 35' 45''$ (1950.0)

U-shaped region, or "loop", with a southeast-northwest axis whose extent is $1^\circ \times 0.7$. At the center of the region, the "hole", the obscuration is minimal. Along the loop are several high opacity clumps (obscuration $A_v \geq 6$ mag). One of these dark patches is TMC1. The "loop" is surrounded by a broad envelope which also fills the central "hole". Finally, as we have seen, the whole area

shown in Fig. 1a is embedded in a very extended halo, with $A_v \leq 1$ mag, which is responsible for the extinction in the reference field.

According to Fig. 1a, the clumps, in the direction of which $A_v \geq 6$ mag, have a characteristic size $l_c \leq 5'$; the "loop", for which $A_v \geq 3.5$ mag, has a width of $l_c \approx 15'$ (0.4 pc); finally, the envelope,

with $A_v \geq 1.5$ mag, has $l_c \approx 40'$. Taking into account the 3-dimensional disposition of the components, we estimate the extinctions inside the envelope, the loop and the clumps to be respectively 1, 3, and ≥ 3 mag. The density in each component is then readily calculated by dividing these values by the component size, l_c , and by using relation (4) below. The results are given in Table 2 where they are compared with the densities derived from line intensity ratios. In view of the crude assumptions inherent to each method, the agreement between the two sets of values is rather good. The gas density is found to increase from few 10^2 cm^{-3} , in the region with $A_v \approx 1$, to $\geq 3 \cdot 10^4 \text{ cm}^{-3}$ in some opaque clumps. In the halo, it is probably $\leq 10^2 \text{ cm}^{-3}$. For self-consistency, we adopt throughout this paper the simplified 4-component model of HCL2 defined by Table 3 (see Sect. 4 for the evaluation of the gas temperature and velocity dispersion). The mass of each component within the boundaries of Fig. 1a is given in columns 5 and 6 of Table 3. It was calculated assuming that the gas to dust ratio is constant and given by relation (4). The mass of the clumps was derived from the C^{18}O line intensity, using the $\text{C}^{18}\text{O}/A_v$ relation derived below [relation (6)].

4. Carbon monoxide distribution

4.1. The CO brightness distribution

The profiles of the $J=1 \rightarrow 0$ ^{12}CO , ^{13}CO , and C^{18}O lines and the C^{18}O velocity-integrated intensities, are presented in Fig. 1 and 2. Saturation in the first two lines makes the three intensity distributions very dissimilar. ^{12}CO emission, which actually extends far beyond the borders of Fig. 2a (see e.g. Baran, 1985), is broad ($\Delta v \approx 2-3 \text{ km s}^{-1}$) and probably saturated over most of the surveyed area. It is nearly constant ($T_A^* = 5-7 \text{ K}$) within the region with $A_v \geq 2.5$ mag. In the border region (the four corners of Fig. 2a), its intensity decreases with A_v (see Fig. 3a), according roughly to the relation:

$$I(^{12}\text{CO}) = 5.0 \pm 0.5 \cdot (A_v - 0.5 \pm 0.2) \text{ K km s}^{-1} \quad (0.5 \leq A_v (\text{mag}) \leq 3). \quad (1)$$

The ^{13}CO emission (Fig. 2b) shows more of the cloud inner structure. It starts to be detected at $A_v = 1$ mag and saturates only at $A_v = 3-4$ mag. For $A_v > 4$ mag, the ^{13}CO peak temperature is fairly constant and only 1 K weaker than that of ^{12}CO . The ^{13}CO line width varies through this high obscuration region, the profiles being broader in the southern part of the "loop"; there, at places, one discerns two velocity components. In the low obscuration region ($1 \leq A_v \leq 4$ mag), the ^{13}CO integrated intensity decreases with A_v (see Fig. 3b) according to the relation:

$$I(^{13}\text{CO}) = 1.4 \pm 0.2 \cdot (A_v - 0.7 \pm 0.3) \text{ K km s}^{-1} \quad (1 \leq A_v (\text{mag}) \leq 4). \quad (2)$$

The maps which give the best insight into the cloud patchy-loop structure are certainly the C^{18}O emission maps (Figs. 1c and 2c). Overall these maps are similar to the visual extinction map (Fig. 1a). The $\text{C}^{18}\text{O}/A_v$ correlation is best illustrated by Fig. 3d, where we have plotted the C^{18}O intensity as a function of A_v for the 150 positions observed in the cloud: from $A_v = 1.5$, the lowest extinction for which C^{18}O is detected, to $A_v = 6$, the highest extinction measurable in our cells, the C^{18}O intensities follow the linear relation:

$$I(\text{C}^{18}\text{O}) = 0.28 \pm 0.05 \cdot (A_v - 1.5 \pm 0.3) \text{ K km s}^{-1} \quad (1.5 \leq A_v (\text{mag}) \leq 6), \quad (3)$$

a least square fit giving a correlation coefficient of 0.88.

Table 1

MWO J=2-1 AND J=1-0 DATA				
C^{18}O J=2-1	T_A^* (K)	I (Kkm/s)	Δv (km/s)	V_{LSR} (km/s)
HCL2(*)				
(-40.00, 0.00)	0.22	0.32	1.36	6.19
(-30.00, 0.00)	0.94	0.82	0.82	6.09
(-30.00, 5.00)	1.19	0.83	0.65	6.16
(-25.00, 0.00)	0.63	0.68	1.02	6.11
(-20.00, 0.00)	0.32	0.22	0.69	5.85
(-10.00, 0.00)	0.18	0.52	2.61	5.14
(-5.00, 0.00)	0.62	0.27	0.42	5.60
(0.00, 0.00)	1.12	1.15	1.03	5.73
(0.00, 20.00)	0.98	0.74	0.70	5.24
(-2.50, 20.00)	1.41	0.71	0.55	5.17
(-1.25, 18.75)	1.28	0.71	0.52	5.26
(-4.00, 6.00)	1.52	1.24	0.78	5.70
^{13}CO J=2-1	T_A^* (K)	I (Kkm/s)	Δv (km/s)	V_{LSR} (km/s)
HCL2(*)				
(-60.00, 0.00)	0.55	0.48	0.83	4.64
	0.52	0.88	1.57	6.11
(-55.00, 0.00)	0.50	0.46	0.85	4.69
	0.64	0.63	0.93	6.00
(-50.00, 0.00)	0.54	0.87	1.52	4.78
	0.85	0.99	1.09	6.28
(-45.00, 0.00)	0.85	0.57	0.64	5.27
	1.18	1.45	1.15	6.27
(-40.00, 0.00)	0.71	1.12	1.47	5.08
	1.32	1.32	0.94	6.41
(-35.00, 0.00)	1.98	1.34	0.64	5.58
	1.62	1.51	0.88	6.48
(-30.00, 0.00)	2.95	3.73	1.19	6.03
(-25.00, 0.00)	2.48	3.81	1.49	6.10
(-20.00, 0.00)	1.64	1.40	0.80	5.61
	1.36	1.33	0.92	6.51
(-15.00, 0.00)	1.66	3.77	2.13	6.09
(-10.00, 0.00)	1.46	2.86	1.83	6.00
(-5.00, 0.00)	2.12	3.44	1.52	5.69
(0.00, 0.00)	2.50	2.29	0.89	5.42
	1.85	1.98	1.01	6.38
(5.00, 0.00)	1.52	3.57	2.20	5.89
(10.00, 0.00)	0.90	0.64	0.67	4.84
	0.85	0.69	0.76	6.15
(0.00, 5.00)	1.54	2.80	1.71	5.71
(0.00, 10.00)	1.71	1.47	0.80	5.07
	1.14	1.68	1.39	6.34
(0.00, 15.00)	2.16	1.62	0.70	5.39
(0.00, 20.00)	1.73	2.39	1.31	5.27
(0.00, 22.50)	1.64	1.28	0.73	5.46
	1.30	0.95	0.68	6.41
(0.00, 25.00)	1.65	1.30	0.74	5.42
(0.00, 27.50)	1.00	1.35	1.32	5.42
(0.00, 30.00)	0.62	0.77	1.12	5.36
(0.00, 32.50)	0.68	0.73	1.00	5.82
(0.00, 35.00)	0.40	0.65	1.51	5.61
(0.00, 37.50)	0.64	0.46	0.68	5.52
(0.00, 40.00)	0.32	0.22	0.70	4.40
	0.55	0.21	0.43	5.76
(0.00, 42.50)	0.48	0.38	0.74	5.67
(0.00, 45.00)	0.32	0.31	0.89	6.00
	0.33	0.14	0.40	4.69
(-5.00, 45.00)	0.99	0.89	0.84	5.34
(-35.00, -10.00)	2.22	2.85	1.20	5.00
	1.58	1.74	1.04	6.78

This correlation is not sustained in the southern edge of the loop, where the darkest areas of Fig. 1a exhibit only moderate or weak C^{18}O emission. There, the ^{13}CO line profiles have two components, which means that there are two distinct clouds along the line of sight. C^{18}O emission (and to a lesser degree ^{13}CO

Table 1 (continued)

$^{12}\text{CO } J=2-1$	T_A^* (K)	I (Kkm/s)	Δv (km/s)	V_{LSR} (km/s)
<u>HCL2(*)</u>				
(0.00, 0.00)	4.60	12.96	2.65	5.96
(0.00, 20.00)	4.47	11.29	2.37	5.73
(0.00, 22.50)	4.42	8.10	1.72	5.98
(0.00, 25.00)	4.52	8.76	1.82	5.77
(0.00, 27.50)	4.58	8.20	1.68	5.70
(0.00, 30.00)	3.75	6.28	1.57	5.67
(0.00, 32.50)	3.36	6.42	1.80	5.60
(0.00, 35.00)	2.96	4.62	1.46	5.59
(0.00, 37.50)	2.32	3.88	1.57	5.51
(0.00, 40.00)	1.83	2.68	1.38	5.55
(0.00, 42.50)	2.59	3.57	1.30	5.52
(0.00, 45.00)	1.84	2.52	1.29	5.58
(0.00, 21.30)	4.65	10.61	2.14	6.14
(0.00, 23.70)	4.33	8.57	1.86	5.99
(0.00, 26.20)	4.32	9.80	2.13	6.12
(0.00, 28.80)	4.26	7.58	1.67	5.90
(0.00, 31.30)	3.29	5.26	1.50	6.13
(0.00, 33.70)	3.05	5.23	1.61	5.85
(0.00, 36.30)	3.22	4.03	1.18	6.07
(0.00, 38.80)	1.99	5.03	2.38	6.14
(0.00, 41.20)	2.74	5.12	1.76	6.24
(0.00, 43.80)	2.39	3.85	1.51	5.82
(0.00, 46.30)	2.04	2.58	1.19	5.99
(0.00, 48.70)	2.04	4.28	1.97	6.12
(0.00, 47.50)	1.53	2.11	1.29	5.52
(0.00, 50.00)	1.58	2.62	1.56	5.95
(0.00, 51.30)	1.28	3.96	2.91	6.29
(-25.00, 0.00)	5.56	15.00	2.53	6.68
(-27.50, 0.00)	6.20	17.27	2.62	6.67
(-30.00, 0.00)	4.99	13.87	2.61	6.35
(-32.50, 0.00)	5.63	16.39	2.74	6.23
(-35.00, 0.00)	5.79	16.62	2.69	6.26
(-37.50, 0.00)	5.68	16.16	2.67	6.32
(-40.00, 0.00)	4.93	14.81	2.82	6.12
(-42.50, 0.00)	4.50	12.07	2.52	6.22
(-45.00, 0.00)	5.05	15.53	2.89	6.18
(-47.50, 0.00)	4.01	11.46	2.68	5.86
(-50.00, 0.00)	3.76	9.22	2.30	5.97
(-52.50, 0.00)	3.53	9.18	2.44	5.90
(-55.00, 0.00)	3.84	11.95	2.92	5.78
(-57.50, 0.00)	3.26	9.12	2.63	5.70
(-60.00, 0.00)	2.96	6.65	2.11	5.42
(-22.50, 0.00)	5.83	13.75	2.22	6.26
(-20.00, 0.00)	5.23	15.00	2.69	6.21
(-17.50, 0.00)	4.76	12.78	2.52	6.28
(-15.00, 0.00)	5.17	15.49	2.81	6.35
(-12.50, 0.00)	4.93	16.30	3.11	6.21
(0.00, 0.00)	5.58	17.35	2.92	6.33
(-10.00, 0.00)	5.07	14.32	2.65	6.41
(-7.50, 0.00)	4.75	13.51	2.67	6.45
(-5.00, 0.00)	4.51	13.68	2.85	6.28
(-2.50, 0.00)	4.04	11.38	2.64	6.38
(2.50, 0.00)	5.09	14.48	2.67	6.36
(5.00, 0.00)	4.21	14.01	3.13	6.21
(7.50, 0.00)	3.96	13.52	3.21	6.09
(10.00, 0.00)	3.24	11.90	3.45	6.30
(12.50, 0.00)	3.34	11.27	3.16	6.34
(15.00, 0.00)	3.51	11.43	3.06	6.49
(0.00, 2.50)	3.83	10.82	2.66	6.18
(0.00, 5.00)	3.07	8.94	2.74	6.18
(0.00, 7.50)	2.99	10.79	3.39	6.26
(0.00, 10.00)	2.64	8.40	2.99	6.17
(0.00, 12.50)	2.71	9.61	3.33	6.39
(0.00, 15.00)	2.81	8.40	2.80	6.01
(0.00, 17.50)	3.65	11.77	3.03	6.26
(0.00, 18.70)	3.97	9.23	2.18	5.77
(0.00, 16.20)	2.98	11.67	3.68	6.20
(0.00, 13.80)	2.33	9.55	3.85	6.23
(0.00, 11.20)	3.46	11.25	3.05	6.22
(0.00, 8.70)	3.48	10.29	2.77	6.24
(0.00, 6.30)	3.51	9.18	2.45	6.20
(0.00, 3.70)	4.37	11.39	2.45	6.09

Table 1 (continued)

$^{12}\text{CO } J=2-1$	T_A^* (K)	I (Kkm/s)	Δv (km/s)	V_{LSR} (km/s)
<u>HCL2(*)</u>				
(0.00, 1.20)	4.52	15.00	3.12	6.20
(-35.00, -10.00)	4.99	18.39	3.46	6.10
(-37.50, -12.50)	5.83	20.53	3.31	6.20
(-40.00, -15.00)	4.10	12.73	2.92	5.79
(-42.50, -17.50)	3.69	13.89	3.53	5.94
(-45.00, -20.00)	3.85	11.70	2.85	6.06
(-47.50, -22.50)	3.65	10.08	2.60	5.32
(-50.00, -25.00)	3.02	8.87	2.76	5.38
(-52.50, -27.50)	2.62	6.60	2.37	5.77
(-55.00, -30.00)	2.37	9.16	3.64	5.81
(-57.50, -32.50)	1.89	5.11	2.55	5.41
(-60.00, -35.00)	1.59	4.48	2.65	5.95
(1.30, 50.00)	1.56	1.21	0.73	5.93
(-1.30, 50.00)	1.39	3.53	2.39	5.95
(-1.30, 45.00)	1.78	4.67	2.47	6.53
(1.30, 45.00)	2.15	1.92	0.84	5.97
(1.30, 40.00)	2.52	4.72	1.75	5.68
(-1.30, 40.00)	2.21	6.49	2.76	6.07
(-2.50, 50.00)	1.39	2.04	1.38	5.88
(2.50, 50.00)	1.76	1.81	0.96	6.34
(2.50, 45.00)	2.05	1.60	0.74	5.98
(-2.50, 45.00)	2.08	2.35	1.06	5.92
(-2.50, 40.00)	2.28	4.09	1.69	6.09
(2.50, 40.00)	2.70	4.58	1.59	5.87
(2.50, 35.00)	2.86	4.67	1.54	5.73
(-2.50, 35.00)	2.54	4.59	1.70	5.92
(-1.30, 35.00)	3.47	6.08	1.65	5.95
(1.30, 35.00)	2.22	4.71	1.99	6.02
(-30.00, 5.00)	5.05	12.79	2.38	6.16
(-35.00, 35.00)	5.47	12.96	2.23	6.11
(-30.00, 35.00)	5.09	11.69	2.16	6.08
(-25.00, 5.00)	5.44	14.12	2.44	6.62
(-20.00, 5.00)	4.05	11.93	2.77	6.50
(-27.50, 5.00)	6.37	18.06	2.66	6.31
(-22.50, 7.50)	4.31	11.99	2.61	6.44
(-22.50, 7.50)	4.51	11.72	2.44	6.38
<u>C$^{18}\text{O } J=1-0$</u>				
<u>HCL2-A(#)</u>				
(2.50, 7.50)	0.63	0.98	1.23	6.27
(2.50, 6.25)	0.94	1.17	1.17	6.35
(2.50, 5.00)	1.11	1.50	1.27	6.36
(2.50, 2.50)	1.74	1.71	0.92	6.35
(2.50, 0.00)	2.00	1.35	0.64	6.34
(2.50, -2.50)	1.75	1.18	0.63	6.30
(2.50, -5.00)	1.32	1.28	0.91	6.25
<u>HCL2-B(\$)</u>				
(0.00, 0.00)	1.21	1.05	0.82	6.04
<u>$^{12}\text{CO } J=2-1$</u>				
<u>HCL2-C(+)</u>				
(0.00, 7.50)	0.36	0.28	0.72	5.38
(0.00, 6.25)	1.03	0.54	0.49	5.38
(0.00, 5.00)	1.65	1.01	0.57	5.32
(0.00, 3.75)	2.18	1.31	0.56	5.29
(0.00, 2.50)	2.52	1.68	0.62	5.24
(0.00, 1.25)	2.89	1.79	0.58	5.18
(0.00, 0.00)	2.85	1.71	0.57	5.21
(0.00, -1.25)	2.78	1.49	0.50	5.30
(0.00, -2.50)	2.73	1.52	0.52	5.32
(0.00, -3.75)	2.16	1.21	0.53	5.29
(0.00, -5.00)	1.62	0.85	0.49	5.27
(0.00, -6.25)	1.44	0.64	0.42	5.31

Table 1 (continued)

$^{12}\text{CO } J=2-1$	T_A^* (K)	I (K km/s)	Δv (km/s)	V_{LSR} (km/s)
(0.00, -7.50)	1.14	0.57	0.47	5.33
(5.00, 0.00)	0.30	0.26	0.82	5.29
(3.75, 0.00)	1.40	0.59	0.40	5.21
(2.50, 0.00)	2.04	0.89	0.41	5.20
(1.25, 0.00)	2.31	1.30	0.53	5.21
(-1.25, 0.00)	2.36	1.45	0.58	5.21
(-2.50, 0.00)	2.06	1.16	0.53	5.20
(-3.75, 0.00)	1.42	1.01	0.67	5.25
(-5.00, 0.00)	1.21	0.54	0.42	5.23
(-6.25, 0.00)	1.09	0.73	0.63	5.20
(-7.50, 0.00)	1.50	0.78	0.49	5.20
(2.50, 2.50)	0.84	0.57	0.64	5.33
(-2.50, 2.50)	2.33	1.35	0.55	5.18
(-5.00, 2.50)	2.28	1.10	0.45	5.21
(-7.50, 2.50)	1.83	0.99	0.51	5.24
(-2.50, 5.00)	1.50	0.70	0.44	5.26
(-5.00, 5.00)	2.00	0.98	0.46	5.20
(-7.50, 5.00)	2.02	0.95	0.44	5.25

NOTES :

(*) Reference position for HCL2 is $\alpha=4^{\text{h}} 38^{\text{m}} 38^{\text{s}}$ and $\delta=25^{\circ} 35' 45''$.

(#) Reference position for HCL2-A is $\alpha=4^{\text{h}} 36^{\text{m}} 36^{\text{s}}$ and $\delta=25^{\circ} 35' 45''$.

(\$) Reference position for HCL2-B is $\alpha=4^{\text{h}} 36^{\text{m}} 47^{\text{s}}$ and $\delta=25^{\circ} 58' 15''$.

(+) Reference position for HCL2-C is $\alpha=4^{\text{h}} 38^{\text{m}} 26.7^{\text{s}}$ and $\delta=25^{\circ} 55' 45''$.

emission) is usually weaker in the higher velocity cloud, which, as we will argue in Sect. 4.2.3 could be reduced in this direction to a diffuse envelope where C^{18}O is either subthermally excited, or photodissociated.

The ^{12}CO line brightness temperature (including the 3 K background) is 8–11 K toward the opaque region of the cloud; that of ^{13}CO is only marginally lower in the direction of the ring. Both brightness temperatures are close to the kinetic temperature derived from NH_3 observations inside the densest clumps (8–10 K according to Paper I) or from methyl acetylene toward TMC1 (10 ± 2 K, Askne et al., 1984). This suggests that the gas temperature, T_K , is fairly uniform throughout most of the UV-shielded region. A comparison of the 2→1 and 1→0 ^{12}CO , ^{13}CO , and C^{18}O line intensities, observed with the MWO telescope, support this view and yields $T_K = 8\text{--}12$ K inside the cloud. At the border, T_K derived from the ^{12}CO 2→1 to 1→0 intensity ratio in 10 directions is $\approx 5\text{--}15$ K, and shows little evidence of heating by external UV radiation. This can be interpreted as an effect of diffusion of the 115 GHz line radiation (see below).

4.2. The CO and dust abundances

4.2.1. Previous UV and millimeter-wave studies

The well known correlation between the reddening of star light and the amount of hydrogen (atomic and molecular) along the line of sight (Bohlin et al., 1978) shows that the dust to gas ratio is nearly constant in the nearby diffuse molecular clouds. For these

clouds, where $A_V < 1.8$ mag (we assume here $R=3$, Savage and Mathis, 1979), Bohlin et al. derive:

$$N(\text{H} + 2\text{H}_2) = 5.8 \cdot 10^{21} E(B-V) \approx 2 \cdot 10^{21} A_V \text{ cm}^{-2}. \quad (4)$$

For the more opaque clouds, although it is reasonable to assume that the amount of dust will continue to scale up with the amount of gas, the validity of relation (4) is all but proven (see however Sect. 4.2.4).

The CO to hydrogen and CO to $E(B-V)$ relations have been studied in the diffuse clouds from UV absorption measurements (Federman et al., 1980; Tarafdar and Krishna Swamy, 1982). CO roughly appears to increase like $N(\text{H}_2)^2$, as expected from the ion-molecule formation scheme. The CO dependence on $E(B-V)$ is even steeper than the power 2 below $E(B-V) = 0.3$ mag ($A_V \leq 1$ mag), due to the fast increase of the molecular hydrogen abundance at this extinction.

No UV data exists for the thicker clouds where, as yet, the CO/H_2 relation can only be inferred from CO millimeter-wave observations and, as concerns $N(\text{H}_2)$, either from geometrical and excitation considerations, or from star counts and the extrapolation of Bohlin et al.'s relation. This latter approach is more reliable in the range $A_V = 1\text{--}6$ (i.e. $N(\text{H}_2) = 1\text{--}6 \cdot 10^{21} \text{ cm}^{-2}$).

The CO/A_V relation has been studied in this way in several dark clouds, mostly using the $J=1 \rightarrow 0$ rotational line of the rare ^{13}CO isotope, as the ^{12}CO line is optically thick. Within the errors, the $^{13}\text{CO}/A_V$ ratio was found constant in the range 1–5 mag, and about equal to $2.5 \cdot 10^{15} \text{ cm}^{-2} \text{ mag}^{-1}$ (Encarnaz, Falgarone and Lucas 1975, Dickman, 1978). Although its $J=1 \rightarrow 0$ line is easy to detect, the use of ^{13}CO for evaluating the CO to dust ratio in cold clouds has two serious drawbacks: for small A_V (< 2), the ^{13}CO abundance is affected by fractionation and does not reflect the total CO abundance (see Sect. 4.2.3); for large A_V ($> 3\text{--}4$), the $^{13}\text{CO } J=1 \rightarrow 0$ line is optically thick. These problems are greatly eased (at the expense however of line strength) if one uses C^{18}O . The $\text{C}^{18}\text{O}/A_V$ ratio, because of the relative weakness of the C^{18}O line, has been so far studied only toward a few dozens of directions scattered over several clouds (e.g. Frerking, Langer and Wilson, 1982, hereafter FLW). The present survey, which covers nearly one square degree in a single cloud, represents the largest and most systematic study of this kind.

4.2.2. The $\text{C}^{18}\text{O}/A_V$ relation in HCL2

The notable features of the $I(\text{C}^{18}\text{O})/A_V$ plot of Fig. 3d are: i) the relatively small scatter of the data points; ii) that these points can be fitted by a single straight line (up to $A_V = 6$ mag, the limiting magnitude of star counts); and iii) that the best-fit line intersects the $I(\text{C}^{18}\text{O}) = 0$ line at $A_V = 1.5$ mag and not at $A_V = 0$ mag.

First, it should be stressed that the vertical scale of Fig. 3d is just proportional to the C^{18}O column density:

$$N(\text{C}^{18}\text{O}) = 9 \cdot 10^{14} I(\text{C}^{18}\text{O}) \text{ cm}^{-2}, \quad (5)$$

(I in K km s^{-1}) provided that the gas density is larger than $2 \cdot 10^3 \text{ cm}^{-3}$ (the first two rotational levels of C^{18}O are then thermalized), that the kinetic temperature is constant and around 10 K, and that the C^{18}O column density is smaller than 10^{15} cm^{-2} (for the line widths considered here, the $J=1 \rightarrow 0$ line is then optically thin). The linear relation we derive is:

$$N(\text{C}^{18}\text{O}) = (2.5 \pm 0.5) \cdot 10^{14} \times (A_V - 1.5 \pm 0.3) \text{ cm}^{-2}, \quad (6)$$

$(A_V = 1.5\text{--}6 \text{ mag}).$

Table 2. Densities in HCL2 derived by methods (1) and (2)

component or observed direction	A_v (mag) #	density(1) (cm^{-3})	molecule	transition	density(2) (cm^{-3})	ref.
halo	< 1	<100				
envelope envelope	1	150	OH	18 cm	300	WH
loop	2-3	few $\times 10^3$				
loop			C^{18}O & ^{13}CO	1+0,2+1	$>2\times 10^3$	CG
TMC1(0,10)			CS	1+0,2+1	$>2\times 10^3$	SLF
HCL2-C(outside clumps)			NH_3	(1,1)&(2,2)	$1-8\times 10^3$	CGA
TMC1			HC_2N	8+7,17+16	10^3	BGMT
clumps	>3	$>5\times 10^3$				
TMC1			HC_3N	5+4,11+10	$1-3\times 10^4$	BGMT
TMC1			HC_3N	5+4,9+8,12+11	$5-10\times 10^4$	SSY*
TMC1			NH_3	(1,1)&(2,2)	$1-3\times 10^4$	TUWWC, BM
TMC1			CS	1+0,2+1	$>1-4\times 10^4$	SLF
HCL2-A			HC_3N	2+1,10+9,12+11	$2-3\times 10^4$	CGA
HCL2-A			NH_3	(1,1)&(2,2)	10^4	CG
HCL2-B			HC_3N	2+1,10+9,12+11	2×10^4	CGA
HCL2-B			NH_3	(1,1)&(2,2)	1.6×10^4	CGA
HCL2-C			HC_3N	2+1,10+9,12+11	10^4	CGA
HCL2			NH_3	(1,1)&(2,2)	$1-4\times 10^4$	CGA, BM

notes:

#) contribution to the extinction along the line of sight

*) adopted $T_K=15\text{K}$ (instead of 9-10K in the other studies)**references:**

BGMT: Bujarrabal et al. 1981; CG: This paper; CGA: Cernicharo et al. 1984;

BM: Benson and Meyers, 1983; SLF: Snell et al. 1982; SSY: Schloerb et al. 1983;

TUWWC: Tölle et al. 1981; WH: Wouterloot and Habing 1985.

Table 3. A 4-component model of HCL2

component	T_K (K)	lc (pc)	$n(\text{gas})$ (cm^{-3})	Δv (kms^{-1})	mass (M_\odot)	mass fraction (%)
halo	?	>3	30	?	>230	>0.38
envelope	15K	1.5	300	1.00	290	<0.48
loop	10K	0.4	3(3)	0.70	55	<0.09
clumps	10K	0.15	3(4)	0.30	28	<0.05

Frerking et al. (1982) have observed the $J=1 \rightarrow 0$ line of the rare isotopes of CO toward 14 directions in Taurus. These directions are those of field (or believed so) stars, for which Elias (1979) has derived visual extinctions from infrared 2-10 μm photometric measurements; four of them fall into the area covered by our survey. Using Elias's values of A_v for large extinctions, FLW find that $N(\text{C}^{18}\text{O})$ cannot be represented by a single linear function of A_v . They find that $N(\text{C}^{18}\text{O})$, which is very small as long as $A_v < 4$ mag, increases drastically at that point (a factor of 5 in less than 1 mag) to reach a more stable regime, where it scales about linearly with A_v . In the linear portion ($4 < A_v < 21$ mag), FLW derive $N(\text{C}^{18}\text{O}) = 1.7 \cdot 10^{14} \cdot (A_v - 1.9) \text{cm}^{-2}$, a relation not signi-

ficantly different from ours in view of the small number of points in their fit (7 points). The steep increase at $A_v = 4$ mag is interpreted by Bally and Langer (1982) as the effect of C^{18}O self-shielding against photodissociation.

The difference between the complex law found by FLW and our simple relation is worth discussing, because the CO/H_2 abundance ratio is a crucial parameter in the oxygen chemistry. The main asset of FLW's study is that, theoretically, it extends to very high visual magnitudes (up to $A_v = 21$ mag) and that it includes C^{17}O data. Its drawbacks are: i) the small number of directions observed, ii) that these directions in Taurus are scattered over four different clouds with different (and poorly

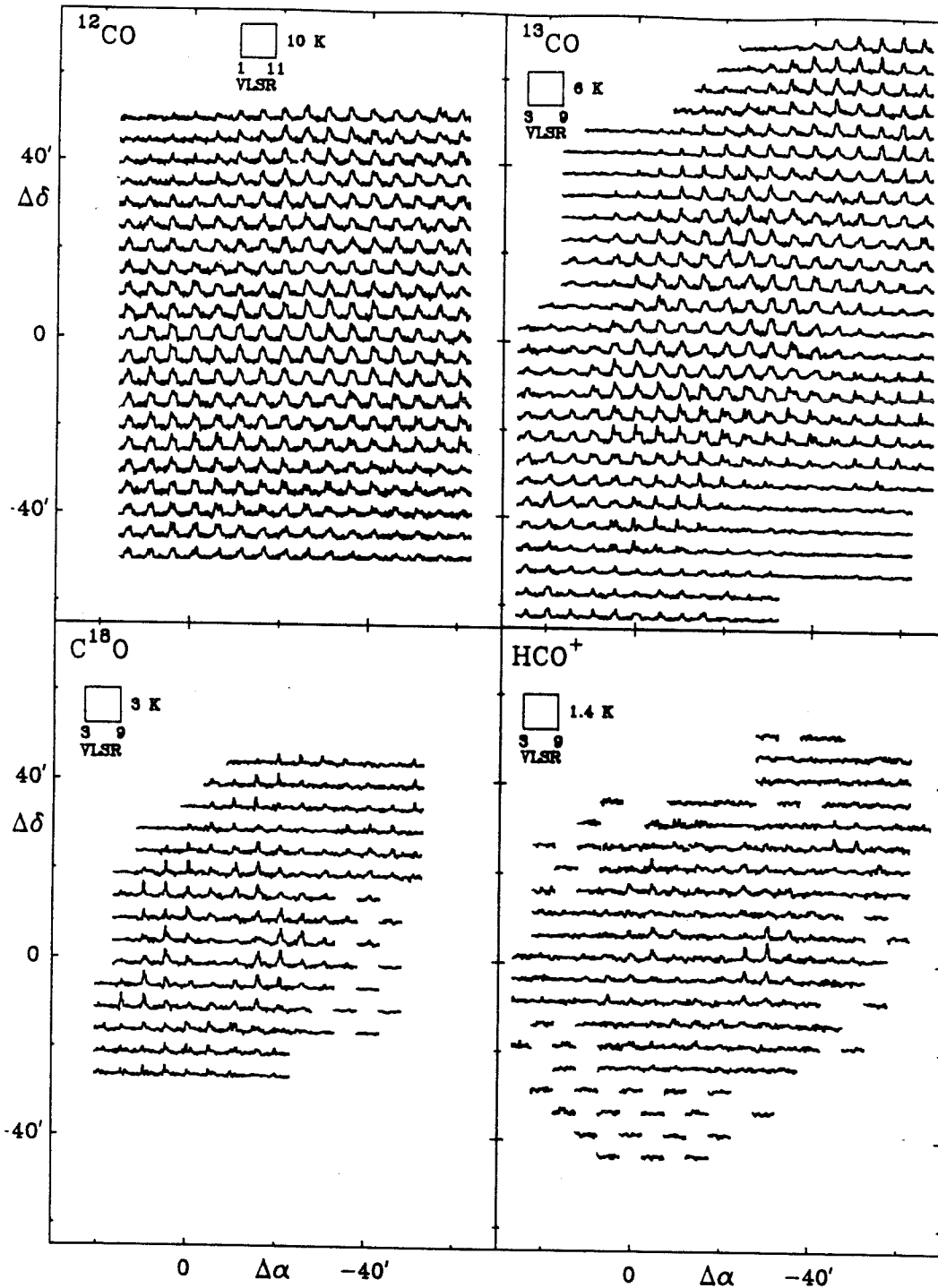

Fig. 2. The profiles of the $J=1 \rightarrow 0$ lines of ^{12}CO , ^{13}CO , C^{18}O , and H^{12}CO^+ , plotted against the offset from position (0,0) ($\alpha = 4^{\text{h}}38^{\text{m}}38^{\text{s}}$, $\delta = 25^{\circ}35'45''$). Temperatures are in Kelvin, velocities (relative to the LSR velocity) in km s^{-1}

known) kinetic and rotation temperatures; and iii) that the CO and A_v measurements refer to very different solid angles: since Elias's stars are biased toward high reddening, they will preferentially lie behind dense clumps which may not be resolved by the 2' antenna beam of FLW. In fact, as will be discussed below, some of the most reddened stars used by FLW coincide with IRAS far-IR point-sources: they are probably surrounded by a cocoon

which may contribute heavily to the IR reddening, but only very slightly to the CO emission.

Our data, which are restricted to $1.5 < A_v < 6$ mag, refer to a number of directions nearly one order of magnitude larger, to a single cloud where, by all evidence, the bulk of the gas has a nearly uniform temperature, and to CO and A_v measurements made with the same angular resolution. Obviously, in Fig. 3, the C^{18}O

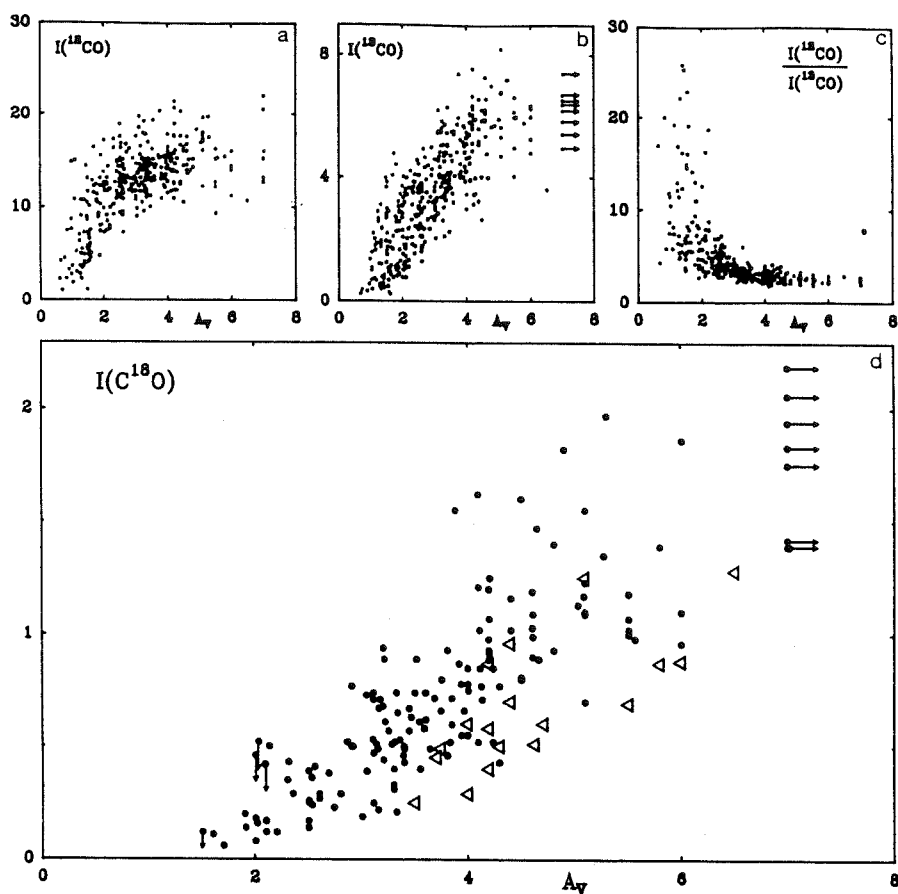

Fig. 3. Integrated brightness temperature (K km s^{-1}) versus visual extinction (mag) for the $J=1 \rightarrow 0$ lines of the three CO isotopes. Most of the C^{18}O points lying well below the fitted line (open triangles) correspond to double profiles and must be shifted by ≈ 1.5 mag to the left before being compared to the other data points (see text). Figure 3c illustrates the variation of the $^{12}\text{C}/^{13}\text{C}$ ratio across HCL2; it shows that the usual assumptions of a constant ratio ≈ 3 may lead to large errors in the CO mass determination

intensity does not show any peculiar increase around $A_v = 4$ mag. Could such an increase nevertheless be present in $N(\text{C}^{18}\text{O})$?

The derivation of $N(\text{C}^{18}\text{O})$ from $I(\text{C}^{18}\text{O})$ necessarily relies on approximations, the simplest of which leads to the density-independent relation (5). We have tried to estimate the errors introduced by this relation, by assuming that the structure of HCL2 is known (namely the model of Table 3) and by performing LVG or multi-component Monte-Carlo calculations.

At high A_v , the main problems lie with the C^{18}O line optical thickness and with the determination of A_v . Model calculations, using the $2 \rightarrow 1$ and $1 \rightarrow 0$ C^{18}O observations, indicate that the $J=1 \rightarrow 0$ C^{18}O line opacity must be low everywhere except in the high density clumps detected in ammonia. Toward these clumps, only lower limits to A_v can be derived from star counts, so that they are anyway excluded from our analysis. The C^{17}O observations of FLW support these model results and confirm that C^{18}O opacity invalidates relation (5) only for very high A_v (> 6 mag). For smaller gas and CO column densities, the C^{18}O opacity correction is reduced roughly to $\tau/[1 - \exp(-\tau)]$; it never exceeds 15% for our data, assuming that τ is uniform within the 2' MWO telescope beam and that the gas kinetic temperature is not lower than 9 K.

At low A_v , the most critical assumptions are the thermalization of C^{18}O and the constancy of the gas kinetic temperature. Once the gas density drops below 10^3 cm^{-3} , the lowest rotational levels of C^{18}O are no longer thermalized, which, in a cold cloud like HCL2, may result in large deviations from relation (5). In this case, however, the $J=2$ level population should decrease more than that of the $J=1$ level, and the $J=2 \rightarrow 1/J=1 \rightarrow 0$ line

intensity ratio should be small. Our data (Table 4) show little variation of this ratio for ^{13}CO or C^{18}O , down to at least $A_v = 3$ mag. This is not surprising, as the gas density is $> 2 \cdot 10^3 \text{ cm}^{-3}$ in the opaque region (see Table 2). The results are less clear in the region $A_v = 2-3$ mag, as T_K may be higher and as we have observed only few directions in $2 \rightarrow 1$ C^{18}O . From LVG or from multi-component calculations, we find however C^{18}O column densities which are not significantly different from those derived using relation (5) [the differences are found smaller than the uncertainty on $I(\text{C}^{18}\text{O})$, which typically reaches 30% as the line is very weak; they should have no influence on the slope of relation (6)]. For $A_v < 2$ mag, our models indicate on the contrary that $T_{\text{ex}}(\text{C}^{18}\text{O})$ could be very low; this will be discussed below in more detail.

To illustrate the effects of opacity we have plotted, as a function of A_v , the values of $N(\text{C}^{18}\text{O})$ derived from LVG calculations and averaged per intervals of A_v (Fig. 4). For reference, we have reported on the same graph the uncorrected (i.e. derived from relation 5) $N(\text{C}^{18}\text{O})$. One sees that the "corrected" data points can still be fit by a straight line, the slope of which differs only marginally from (6). No turnover can be seen near $A_v = 4$ mag. We conclude that there is no obvious departure of $N(\text{C}^{18}\text{O})/A_v$ from a straight line between 2 and 6 mag.

4.2.3. The CO abundance and excitation at the periphery of HCL2

Relation (6) shows that inside dense clouds the amount of CO is proportional to the amount of dust. A priori, one would then

Table 4. CO 2-1/1-0 line intensity ratios at selected positions

offset	^{12}CO		^{13}CO		C^{18}O	
	$T_A^*(2-1)$	$I(2-1)$	$T_A^*(2-1)$	$I(2-1)$	$T_A^*(2-1)$	$I(2-1)$
	$T_A^*(1-0)$	$I(1-0)$	$T_A^*(1-0)$	$I(1-0)$	$T_A^*(1-0)$	$I(1-0)$
	(0,0)	1.00	1.07	1.02	0.99	0.87
(-5,0)	1.00	1.06	1.01	0.96	0.86	0.65
(-5,5)					1.12	0.81
(-10,0)	1.06	1.09	0.65	0.82	0.51	1.19
(-15,0)	1.21	1.27	0.85	1.17		
(-20,0)	1.19	1.14	0.76	0.77	0.48	0.37
(-25,0)	1.10	1.07	0.97	0.82	0.60	0.65
(-30,0)	1.29	1.28	1.18	0.89	0.67	1.04
(-30,5)					0.81	0.95
(-35,0)	1.26	1.28	0.77	0.68		
(-40,0)	1.23	1.36	0.86	1.16	0.63	1.27
(-45,0)	1.21	1.21	0.94	1.03		
(-50,0)	1.10	1.09	1.01	1.27		
(-55,0)	1.19	1.30	0.91	1.20		
(-60,0)	1.23	1.15	0.87	0.89		
(0,5)	0.96	1.02				
(0,10)	0.76	0.78				
(0,15)	1.19	1.27				
(0,20)	1.27	1.35				
(0,25)	1.11	1.16				
(0,30)	1.29	1.18				
(0,35)	0.86	1.19				
(0,40)	0.80	1.54				
(0,45)	0.89	1.25				
(0,50)	0.71	1.61				

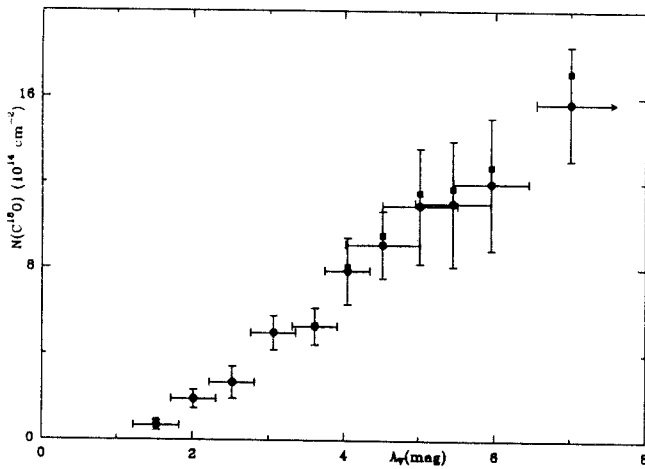

Fig. 4. The C^{18}O column density/visual extinction relation in HCL2. The column density is calculated in two ways: using relation (5) (black dots) and via an LVG transfer code (black squares). The derived values are then averaged by intervals of 0.5 mag. They refer only to regions collisionally excited and ignore the low excitation envelope and halo (see text)

expect $N(\text{C}^{18}\text{O})$ to reach 0 for $A_v = 0$ mag and not for $A_v = 1.5$. One can think of four possible reasons for such a shift: i) sensitivity ii) an overestimation of the extinction in the reference field; iii) photodissociation of C^{18}O in the external layers of the cloud; and finally, as we have seen, iv) a subthermal excitation of C^{18}O in these layers. A comparison between the ^{12}CO , ^{13}CO , and C^{18}O data helps clarifying these points.

A few considerations show that i) and ii) can be discarded. Relation (6) mostly results from the fit of high signal-to-noise ratio data and should't be much affected by the sensitivity limit. $N(\text{C}^{18}\text{O})$ could be underestimated if the weak emission from the outer layers of the cloud had a larger velocity spread than the core (or a different velocity). This is not the case, however, except in the southern part of HCL2 where the ^{13}CO line profiles are split. In fact, the same threshold of 1.3–1.6 mag in the $\text{C}^{18}\text{O}/A_v$ relation is observed for the dark clouds L1495 and B1 (Duvert et al., 1986; Bachiller and Cernicharo, 1986) although these clouds were studied with a lower sensitivity. Our lowest ^{12}CO detections correspond to $A_v = 0.5$ mag in our extinction scale. This value is in good agreement with the reddening limit below which, according to the UV data, $N(\text{CO})$ decreases steeply ($E(B-V) = 0.2$, or $A_v = 0.6$ mag); this gives us confidence that our A_v scale is correct within few tenths of magnitude.

The 1.5 mag threshold of Fig. 4 is then real and must be due to a lack of C^{18}O emission in the external layers of HCL2. These layers extend not only sidewise, but all around the dense core of the cloud, so that the line-of-sight integrated $I(\text{C}^{18}\text{O})$ is affected even in the direction of the cloud centre. In a simple model where the core of HCL2 is immersed into an extended envelope of low density gas, inside which $I(\text{C}^{18}\text{O})/A_v$ is very small, the $I(\text{C}^{18}\text{O})$ vs A_v plot remains a straight line, but is shifted toward high values of A_v , just as in Fig. 4.

The low C^{18}O emission in the cloud external layers could be due to photodestruction. The photodissociation of CO by interstellar UV has recently been rediscussed in the light of new theoretical and laboratory data (Glassgold, Huggins, and Langer, 1985; hereafter GHL). Although the total CO photodestruction

rate remains poorly known, there is increasing evidence that it occurs exclusively through lines (Rostas, 1986, private communication). Self-shielding, as well as shielding by other atomic or molecular lines (mostly H_2), contribute to maintain a large CO abundance up to the very edges of the molecular cloud (i.e. up to the H_2 self-shielding border). The efficiency of self-shielding is smaller for the less abundant isotopic species, $C^{18}O$, which is photodissociated deeper inside the cloud. On the other hand, the abundance of ^{13}CO , hence its ability to shield itself, remains relatively large at $A_v \approx 1-2$ mag, due to isotopic fractionation.

Our data provide an opportunity to check the importance of these mechanisms. The limiting extinctions at which ^{12}CO , ^{13}CO , and $C^{18}O$ are detected (0.5, 0.7, and 1.5 mag) increase, as expected, from the abundant, easily self-shielded isotope, to the rarest isotope. Our difference of 1 mag between the ^{12}CO and $C^{18}O$ limits, which ideally would correspond to two 0.5 mag layers with ^{12}CO but no $C^{18}O$ emission, is in the range of the model predictions of GHL (see Fig. 5 of GHL) and can be explained by photodissociation. Also, the relatively large difference between the ^{13}CO and $C^{18}O$ limits is present in GHL's low temperature model calculations, where it results from CO enhancement in ^{13}C through fractionation inside the $A_v \approx 1$ mag region.

An alternate explanation for the lack of $C^{18}O$ emission in the outer layers is insufficient excitation. In the halo and the envelope, collisional excitation is inefficient. The optically thin $C^{18}O$ lines are barely excited above the 3K background; those of ^{12}CO , which are still optically thick, remain radiatively excited. For the parameter values of Table 3 and assuming $X(CO) = 10^{-5}$ (Tarafdar et al., 1985), we get in the LVG approximation $T_{ex} - T_{bg} = 1$ K for $C^{18}O$, versus 5 K for ^{12}CO . The opacity of the ^{12}CO line is then ≈ 5 and its brightness temperature 3-4K higher than T_{bg} , in good agreement with what is observed (Fig. 2).

For a "normal" ^{13}CO abundance, the $J=1 \rightarrow 0$ ^{13}CO line is optically thin, $T_{ex}(^{13}CO) \approx T_{ex}(C^{18}O)$, and the outer envelope should contribute as little to the ^{13}CO intensity as in the case of $C^{18}O$. Radiative heating will become significant only when $\tau > 1$, $N(^{13}CO) > 2 \cdot 10^{15} \text{ cm}^{-2}$, or $^{12}CO/^{13}CO \leq 5$, i.e. for a ^{13}CO abundance about 15 times larger than that observed in the dense clouds (e.g. Langer et al., 1980). Such a large ^{13}CO enhancement is predicted to occur, due to ^{13}C fractionation, in a cloud with $n(H_2) \approx 300 \text{ cm}^{-3}$ and $T_K < 15$ K (e.g. GHL). There seems to be no other way of explaining the large ^{13}CO intensity in the envelope if the density is low. (Increasing the CO fractional abundance to 10^{-4} - probably a maximum - while keeping a terrestrial $^{12}C/^{13}C$ isotopic ratio in CO, would simplify but not solve the problem, as we would have $\tau(^{13}CO) \approx 0.5$ and $T_{ex} - T_{bg} = 1.5$ K; as concerns photodestruction, although it may increase the $^{13}CO/C^{18}O$ abundance ratio, its first effect is to decrease the abundance of these species, hence the ^{13}CO column density.)

In conclusion, we find that the dark region of HCL 2 (the $C^{18}O$ emission cloud) is surrounded by a low density envelope ($n(H_2) \approx \text{few} \times 10^2 \text{ cm}^{-3}$). In the dark region, the $C^{18}O$ column density is proportional to the visual extinction and is well represented by relation (6). This relation shows that the CO to dust ratio stays constant when $n(H_2)$ varies by at least one order of magnitude. In the envelope, the ^{13}CO abundance is high ($> 10^{-6}$), probably because of ^{13}C fractionation. $C^{18}O$ emission on the other hand is weak, partly because CO is weakly excited by collisions, possibly because $C^{18}O$ is photodissociated. Unfortunately, the uncertainty on the density in the envelope does not allow to judge the relative importance of photodestruction versus subthermal excitation, hence to estimate the strength of the UV field at the edges of HCL 2.

4.2.4. CO condensation on grains

The good fit of the $C^{18}O$ data by the linear relation (6) suggests that Bohlin et al.'s relation (or a similar proportionality law between A_v and $N(H_2)$) continues to hold inside the dense gas and that $X(CO)$ remains constant for a large range of gas densities. Indeed, for the well shielded regions of cold clouds, the prime reason for variations of $X(CO)$ and of the gas to dust ratio is molecule condensation on grains. The grain-molecule collision rate is bound to increase with the gas density and the sticking probability may become larger as dust gets cooler. As one deepens into the cloud, molecules are thus expected to be more and more depleted from the gas and grains are expected to grow in size. CO depletion and grain growth both contribute to lower the CO A_v ratio (see e.g. Tarafdar et al., 1985). That we see no evidence of such a change in our data, i.e. for an increase of the gas density from $\approx 10^2$ to $\approx 10^4 \text{ cm}^{-3}$ and for a very low temperature, seems significant.

Further evidence for a near constancy of the grain size and of $X(CO)$ comes first from the value of R , the total to selective extinction ratio, and second from the good correlation between the $100 \mu\text{m}$ flux and A_v .

Cernicharo and Bachiller (1984) have derived $R=3$ and $A_v/A_b = 1.6$, from star counts near HCL 2 in the magnitude range $A_v = 1-4$ mag (see above and their Fig. 1). Vrba and Rydgren (1985) find $R=3.1$ from the reddening of six stars (with $A_v = 1.7-3.2$) in the Taurus region. These values are identical to the average value of R observed in diffuse clouds (e.g. Savage and Mathis, 1979) and imply that the "visual" grains in clouds with $A_v = 3-4$ mag keep the same size as in clouds with $A_v = 0.1-0.3$ mag. It is true that R is somewhat larger ($R=3.5$) toward the star HD 29647, which is located at the edge of HCL 2-C (Vrba and Rydgren, 1985). Apart from a possible contribution of a circumstellar envelope to the reddening for this particular star, we note that the change of R from 3 to 3.5 corresponds for the "visual" grains to a change in size of 20% at most.

The $100 \mu\text{m}$ flux measured by IRAS in $5' \times 5'$ cells, corrected for extended foreground emission (Fig. 5a), is compared in Fig. 5b to the visual extinction derived from star counts in the same cells. Both quantities show a good linear correlation, with a regression coefficient $\rho = 0.85$. The $100 \mu\text{m}$ flux depends mainly on the volume filled by dust grains as well as on their temperature; the latter, in the dense and cold regions is controlled by the gas temperature. The visual extinction depends more directly on the grain microscopic properties (cross section, surface composition ...). That the ratio of these two quantities remains so nearly constant not only means that the dust temperature is uniform over most of HCL 2, but also suggests that the size of the grains stays roughly constant between the inner and outer parts of the cloud. It is worth noting that contrary to visible light, the $100 \mu\text{m}$ radiation freely escapes through large column densities of dust. In a cloud like HCL 2 where the $100 \mu\text{m}$ flux correlates with A_v , this flux offers a safer way than star counts to estimate the dust (and gas) column density in directions where $A_v \geq 6$ mag. We have plotted in Fig. 6 $I(C^{18}O)$ in function of the $100 \mu\text{m}$ flux (three data points corresponding to $60 \mu\text{m}$ - hence presumably hot - sources have been discarded in this Figure): this graph shows no indication of a decrease of the CO intensity for the large IR fluxes (i.e. for the large dust column densities); like Fig. 3d, it follows a straight line as one would expect for a constant CO/dust abundance ratio.

It is tempting to see, from the similarity of relation (6) with the $C^{18}O/A_v$ relation derived by FLW for very large A_v ($4 < A_v \leq 21$ mag) yet another argument for the constancy of the CO

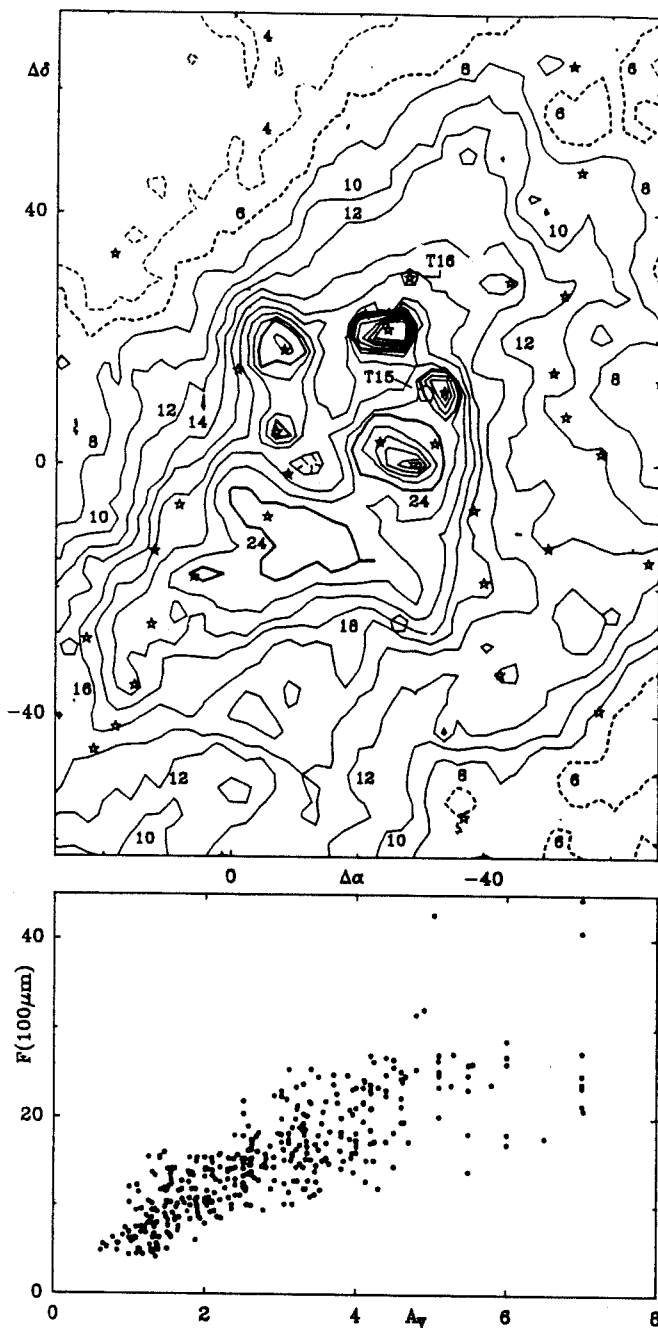

Fig. 5. a) IRAS 100 μm emission map of a $90' \times 140'$ area around HCL2 (from IRAS SKYFLUX maps). Units are MJy/str. A constant offset of 22 MJy/str has been removed (to account for extended foreground emission, zodiacal emission ...). IRAS point sources are indicated by stars. Note the four bright sources at the north of HCL2 (three of which coincide with HCL2-A, B, and C), and the position of the stars T15 and T16 of FLW (which are indicated by open pentagons). b) the correlation between the 100 μm flux of a) and the visual extinction derived from star counts

fractional abundance in the densest parts of the cloud. However, several of the stars observed by FLW (in particular, their most reddened star, T16, with $A_v = 21$ mag) are likely to be surrounded by a dust cocoon, since they coincide within $10''$ with IR point sources. This cocoon dominates in the near IR the foreground emission of the cloud, as shown by the IRAS data, but contributes

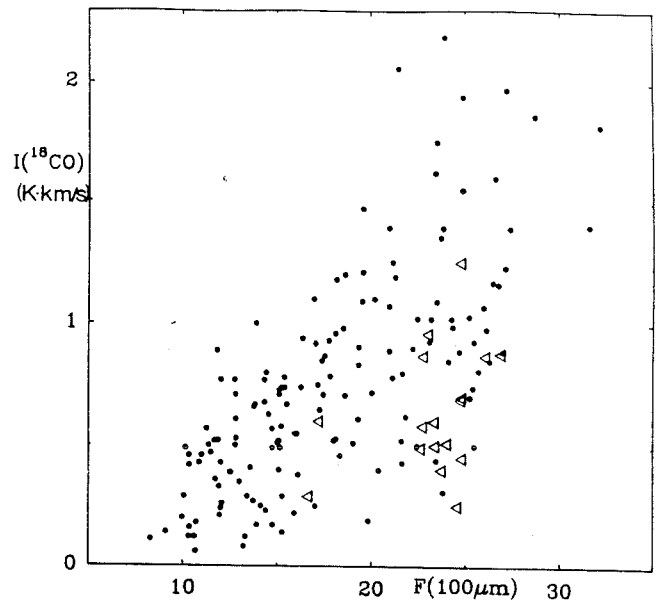

Fig. 6. The C^{18}O integrated brightness temperature versus the 100 μm flux (from IRAS skyflux maps). As in Fig. 6, the open triangles correspond to double line profiles

little to the CO emission seen by the Bell Labs 7-m antenna. The comparison of CO emission with reddening for these stars is thus irrelevant. Two other reddened stars of FLW (T14 and T13, with $A_v = 5.4$ and 12 mag) are not associated with IRAS point sources, but are also likely to lie in a cocoon. They fall in cells of our survey where both star counts and the 100 μm flux indicate moderately low extinctions (3–5 mag). Using the IRAM 30-m telescope, we have re-observed these stars, as well as T16, in C^{18}O and C^{17}O . In spite of a gain in spatial resolution by a factor of ≈ 20 , we find brightness temperatures similar to or smaller than, but never larger than those reported by FLM. The CO/A_v ratio toward these stars fits well with relation (6), if we use the A_v value from star counts, but falls too low if we adopt FLW's IR-derived extinctions. We conclude that the interstellar extinction on the line of sight to T14, T15 and T16 is much smaller than the high values adopted by FLW.

The deuterium to hydrogen abundance ratio in molecules may yield finally some clues, (although model dependent), on molecule depletion in the densest parts of the clouds. As is well known (see e.g. GLW), hydrides such as HCO^+ or N_2H^+ are enhanced in deuterium in cold dark clouds by factors of $\approx 10^3$ with respect to the interstellar atomic deuterium abundance. This enhancement is thought to be caused by deuterium exchange reactions involving HD or D (e.g. Dalgarno and Lepp, 1984). If the H_2D^+ recombination rate is very small (Smith and Adams, 1984), the deuterium enhancement of H_3^+ in very cold clouds is limited essentially by the reaction of H_2D^+ with CO. The $\text{DCO}^+/\text{HCO}^+$ abundance ratio, which should at least be $1/3$ of $\text{H}_2\text{D}^+/\text{H}_3^+$, provides then a lower limit to the CO fractional abundance [and a measure of this abundance if deuterium enhancement in HCO^+ and N_2D^+ comes from H_2D^+ – see, however Dalgarno and Lepp (1984)]. In TMC1, as well as in other similarly cold cloudlets, this ratio is found constant, as one deepens into the cloud core, and equal to ≈ 100 . This yields $X(\text{CO}) \approx 2 \cdot 10^{-4}$, a value similar to that derived from relation (6) in the less dense portion of the cloud.

5. HCO⁺ and H¹³CO⁺ brightness distributions: radiation scattering?

Limited HCO⁺ and H¹³CO⁺ emission maps have been observed by GLW around TMC1 and around TMC2, another dark cloudlet in Taurus. The main features of these maps are: i) H¹²CO⁺ emission extends to regions of relatively low extinction ($A_v = 3.5$ mag), hence, presumably, of low gas density; ii) the H¹³CO⁺/H¹²CO⁺ line intensity ratio is surprisingly large toward the clumps (≥ 1); and iii) the HCO⁺ emission often peaks in the same direction as H¹³CO⁺. Point (ii) was interpreted as the result of self-absorption of the H¹²CO⁺ line in a foreground envelope of density $< 10^3 \text{ cm}^{-3}$ and extinction $A_v > 1$ mag. The present survey, which covers an area 20 times larger, allows us to test this hypothesis.

It is readily seen in Figs. 1 and 2 that the above results extend to most of HCL2: the HCO⁺ $J=1 \rightarrow 0$ line is detected at almost every position where the C¹⁸O $J=1 \rightarrow 0$ line is relatively strong (> 0.5 K) and the lowest HCO⁺ emission contour usually follows well the $A_v = 3.5$ mag contour. There are two exceptions to this: in the southern part of the loop, where the C¹⁸O/ A_v relation breaks down, HCO⁺ is not detected at places where $A_v = 4-5$ mag; in the dark spur (coord. $-30', > 40'$) to the north of the loop, HCO⁺ is not observed although the C¹⁸O line is strong and narrow. Within the loop region, the HCO⁺ line intensity poorly correlates with the C¹⁸O intensity, except in the western part, near HCL2-A.

It is difficult to check whether the H¹³CO⁺ line, which as in TMC1 and TMC2 probably arises from dense cores unresolved by our 5' beam, peaks at the same place as the HCO⁺ or C¹⁸O lines. It is clear, however, that the H¹³CO⁺/HCO⁺ intensity ratio is large toward all clumps and that H¹²CO⁺ shows a maximum wherever H¹³CO⁺ is strong (with the exception of HCL2-A).

We have seen that star counts, as well as CO and OH data, show the presence of an envelope of size ≥ 1 pc and density $\approx 300 \text{ cm}^{-3}$. The gas column density across this envelope is $\approx 1.5 \cdot 10^{21} \text{ cm}^{-2}$ and the HCO⁺ column density $\approx 10^{13} \text{ cm}^{-2}$ (we assume a fractional abundance $X(\text{HCO}^+) \approx \text{few} \times 10^{-9}$, equal to that inside TMC1, GLW). For $T_K = 15$ K and $\Delta v = 1 \text{ km s}^{-1}$ (Table 3), the $J=1 \rightarrow 0$ HCO⁺ line opacity is 9 and $T_{\text{ex}} = T_{\text{bg}} + 0.04$ K in the absence of scattering. The envelope is undetectable in emission in HCO⁺, but absorbs completely the HCO⁺ radiation from the inner cloud. Among the components of Table 3, only the clumps are dense enough to emit noticeable radiation in the $J=1 \rightarrow 0$ H¹³CO⁺ line. Their brightness temperature is $T_b(\text{H}^{13}\text{CO}^+) \geq 0.3$ K. This radiation freely escapes through the loop and the envelope, which are optically thin in the H¹³CO⁺ line, as H¹³CO⁺ is at least 40 times less abundant than H¹²CO⁺. That H¹³CO⁺ appears stronger than HCO⁺ is thus readily explained.

The problem is: why do we see any HCO⁺ emission at all, and why does this emission peak in TMC1 and TMC2 at exactly the same place as the H¹³CO⁺ emission from the clumps?

A first answer could be that HCO⁺ is less abundant in the envelope, that its distribution is clumpy or that the envelope is thinner at places: decreasing the HCO⁺ column density by a factor of ≈ 5 reduces the envelope opacity to ≈ 1.5 , so that some radiation from the inner region gets through. An outside observer can then detect the HCO⁺ emission from the loop (its intensity, from a simple LVG calculation, using the parameters of Table 3 and a "normal" HCO⁺ abundance, is $T_b \approx 0.3$ K). The loop, however, is optically thick in the HCO⁺ line and any information about the clump position should be lost. Why then do the H¹³CO⁺ and HCO⁺ peaks coincide?

The clump cores may have a larger velocity dispersion than the ring and the envelope, so that the radiation in the line wings is not absorbed. This probably happens in TMC1 ($-4', 6'$), where there is an exact coincidence between the emission peaks and where the HCO⁺ line is shifted in velocity with respect to the H¹³CO⁺ line (see Fig. 1 b of GLW); this does not seem to happen, however, in other condensations (e.g. Fig. 2 b of GLW).

Our favored explanation is that we see essentially the HCO⁺ radiation from the clumps scattered by the loop. From the parameters of Table 3, the HCO⁺ line intensity emitted by the 0.2 pc clumps is ≈ 4 K. This emission is absorbed and scattered by the loop, which is a cylinder of width ≈ 0.5 pc. The intensity of the scattered radiation is roughly equal to that of the clump radiation, times the dilution factor ($\approx 1/6$ in our case); it is seen to dominate the loop proper emission (0.3 K). To check this hypothesis, we have performed multi-component statistical equilibrium calculations using a Monte-Carlo radiative transfer code and the component parameters of Table 3. The results (e.g. Fig. 7) confirm the importance of scattered radiation in the HCO⁺ emission map. They also show that if the clump is not at the centre of the scattering envelope, this latter is not uniformly illuminated and presents a bright spot in front of the clump's position. A blurred picture of the clump will then be seen. As a corollary, it is worth noting that the mere detection of HCO⁺ at the border of a cloud, does not necessarily imply that the gas density is high at this place, but may just mean that the line opacity is ≥ 2 .

The HCO⁺ brightness distribution around HCL2-A (coord. $-30', 5'$ on Fig. 2c and d) is another puzzle. It is completely different from the H¹³CO⁺ brightness distribution, but quite similar to that of C¹⁸O: the HCO⁺/C¹⁸O intensity ratio is $\approx 1/2$ over most of the $20' \times 20'$ region. Contrary to what is observed in the other parts of the cloud, the centre velocities of the HCO⁺ and C¹⁸O lines coincide and, as one would expect in the optically thin case, the HCO⁺ line is narrower than the C¹⁸O line. Higher angular resolution observations of NH₃ (Paper I) have shown that HCL2-A consists of several dense fragments. It seems, from the present data, that the densest fragment (coord. $-25', 0'$), from which the bulk of H¹³CO⁺ emission arises, lies deep inside the "loop" component, while the others, less dense and perhaps hotter, are close to its surface. If the envelope at this place is thin, the HCO⁺ radiation from the less dense fragments escapes nearly unaltered. These fragments cannot be optically very thick (otherwise, the HCO⁺ line would be broader) but should give rise to strong C¹⁸O lines. This seems contradictory, unless the fragments are hotter than 10 K or have a low HCO⁺ abundance. The presence near HCL2-A of a strong 60 μm and 100 μm source (Fig. 5a) and of a reflection nebula seems to support the first hypothesis. High angular resolution observations of HCO⁺ and C¹⁸O would be needed for a proper evaluation of the optical thicknesses.

Does scattering also play a role in CO emission at the edges of the clouds? This question is worth asking, as the ¹²CO lines are often used to derive the gas kinetic temperature T_K in the outer region. If scattering there dominates ¹²CO emission, the rotational temperatures observed may well not be related to the physical conditions of this region, but to those of the inner cloud.

Obviously, as CO is easily excited by collisions, this can happen only for gas densities much lower than in the case of HCO⁺. The conditions of low collisional excitation and large opacity are:

$$T_{\text{ex}} = \frac{hv/k}{hv/kT_K + \ln[1 + A/C\tau(1 - \exp^{-\tau})]} \leq T_K/4,$$

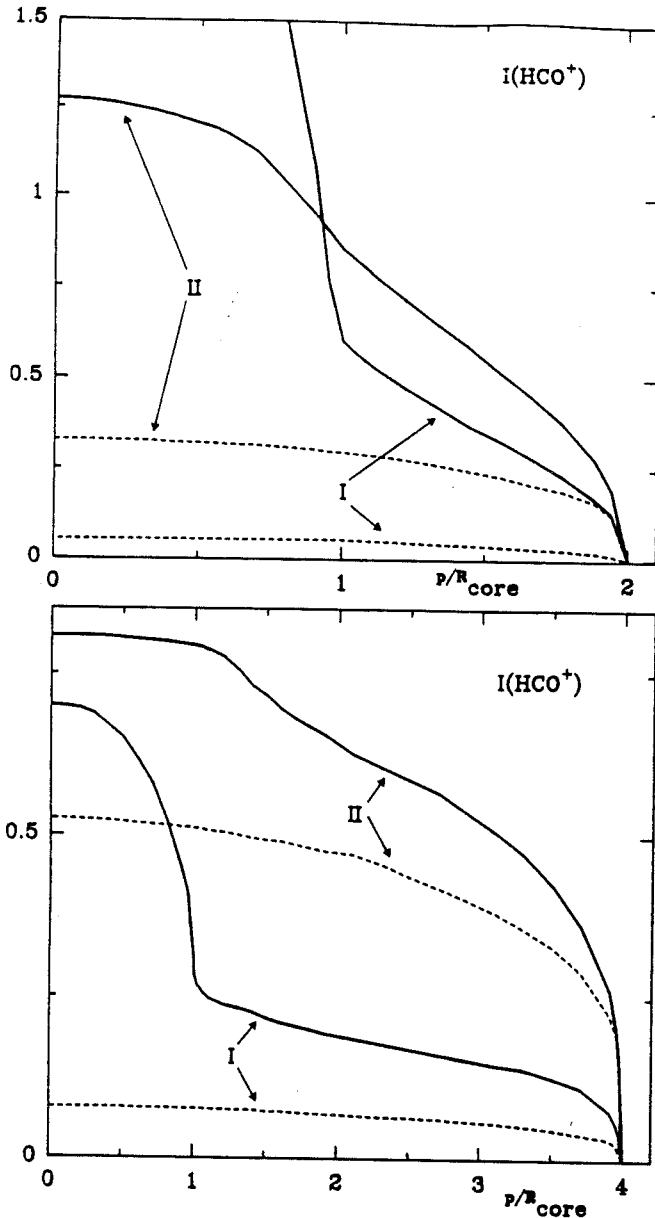

Fig. 7a and b. $\text{HCO}^+ J=1 \rightarrow 0$ line brightness temperature distribution for spherical "core-halo" cloud models, as predicted from Monte Carlo radiative transfer calculations. The radius of the core is $R_c = 10^{17} \text{ cm}^{-2}$; its density is $3 \times 10^4 \text{ cm}^{-3}$ and its kinetic temperature is 10 K. The "halo" has a radius of $2R_c$ in a, and $4R_c$ in b; its kinetic temperature is 10 K. Its density is 10^3 cm^{-3} in case I and $3 \times 10^3 \text{ cm}^{-3}$ in case II. Velocity dispersion is 0.3 km s^{-1} in the core and 0.7 in the halo. The large difference between the dashed lines (emission of the halo alone) and the full lines (halo illuminated by the core) shows the importance of diffusion. Even in case II where the opacity of the halo is large, we can see a blurred image of the core

where $A = 7.4 \times 10^{-8} \text{ s}^{-1}$ is the Einstein spontaneous transition probability for the $J=1 \rightarrow 0$ line of CO and where the optical depth τ is ≥ 2 .

For $T_K \geq 10 \text{ K}$ and $\Delta v \geq 1 \text{ km s}^{-1}$, these conditions are fulfilled only when $n(\text{gas}) \leq 100 \text{ cm}^{-3}$ and $N(\text{CO}) > 10^{16} \text{ cm}^{-2}$. This means $N(\text{H} + \text{H}_2) > \text{few} \times 10^{20} \text{ cm}^{-2}$ hence a halo radius $> \text{few pc}$. For the dilution factor not to be too small, the inner

cloud where CO is thermalized should have a radius of at least 1 pc: the halo of Table 3, if it really surrounds HCL 2 and is not just a sheet of distant foreground material, could well be illuminated by CO radiation originating in the deeper layers. The envelope, on the other hand, seems dense enough to be mainly excited by collisions. A Monte-Carlo analysis, similar to that for HCO^+ described above, confirms these results.

6. HCL2: a γ -shaped filament?

The velocity distribution inside HCL2 has already been discussed by several authors (e.g. Heiles and Gordon, 1975; Wilson and Minn, 1977; Wouterloot and Habing, 1985; Schloerb and Snell, 1984; Takano et al., 1985). These authors invoke a shock front moving across the cloud, two clouds in collision, or a single cloud in rotation, to explain the complex pattern which is observed. Schloerb and Snell, for example, invoke a slow rotation around a tilted axis in the NE-SW plane; the loop component of Fig. 1a is then interpreted as a ring, or rather a torus of dense gas, rotating around its axis. Their model naturally explains the overall NW-SE velocity gradient, but fails to account for the double-peaked profiles and the general admixing of the velocity components. Collision of two clouds along a NW-SE line (Takano et al., 1985) fails on the other hand to explain the NW-SE gradient.

In this paper, we would like to propose another model of HCL2 in which the cloud is extended along the line of sight. The model is suggested by the filamentary structure of the other dark clouds of the Taurus region: L1495, L1506, L1529, L1544, ... These appear on the POSS prints, and on the IRAS $100 \mu\text{m}$ maps as extended lanes, or filaments, of absorbing material with $A_v \geq 3 \text{ mag}$ and of width $\approx 10' - 20'$; their length is 1-3 deg. HCL2, with its more compact structure, appears somewhat unique among the heavily obscured clouds of the region. Since the filament widths in Taurus are similar to the width of the HCL2 loop component, it is tempting to speculate that HCL2 is in fact a bent filament projecting itself as a gamma-shaped loop on the plane of the sky. This filament has a clumpy inner structure and a low density envelope; it also has a slow bending motion. Double or broadened profiles are therefore observed where the two filament tails appear to cross each other on the plane of the sky (to the south of the loop) and where the filament is almost viewed longitudinally. The bending motion and a possible longitudinal motion of the clumps inside the filament explains the observed velocity field without the need of rotation.

A close examination of the individual velocity-channel maps of ^{13}CO and C^{18}O suggests that there are actually two distinct filaments (see e.g. the maps at 5.2 and 6.5 km s^{-1} in Fig. 8). Duality is also clear on Fig. 9, which represents the distribution of the velocities in HCL2, as derived from a gaussian fit of the ^{13}CO and C^{18}O profiles of Fig. 2: the velocities essentially fall into two intervals: $5.0 - 5.7 \text{ km s}^{-1}$ and $6.2 - 6.7 \text{ km s}^{-1}$. The integrated intensity maps corresponding to each interval are presented in Fig. 10 (more exactly, rather than intensities integrated over a velocity band, Fig. 10 displays the areas of the gaussian fitted components whose centre velocity falls into that band). These maps show the tracing of the filaments: the first (Fig. 10a) runs downwards from coordinate $(-40', 50')$ to TMC1, then westwards; the second (Fig. 10b) runs upwards from coordinate $(10', -30')$ straight to the northeast across HCL2-A; the clump HCL2-B (Fig. 2d) could be a branching of this last filament. Support for this drawing of the filamentary structure comes from the extinction map of Fig. 1a and from the POSS red plate. Both

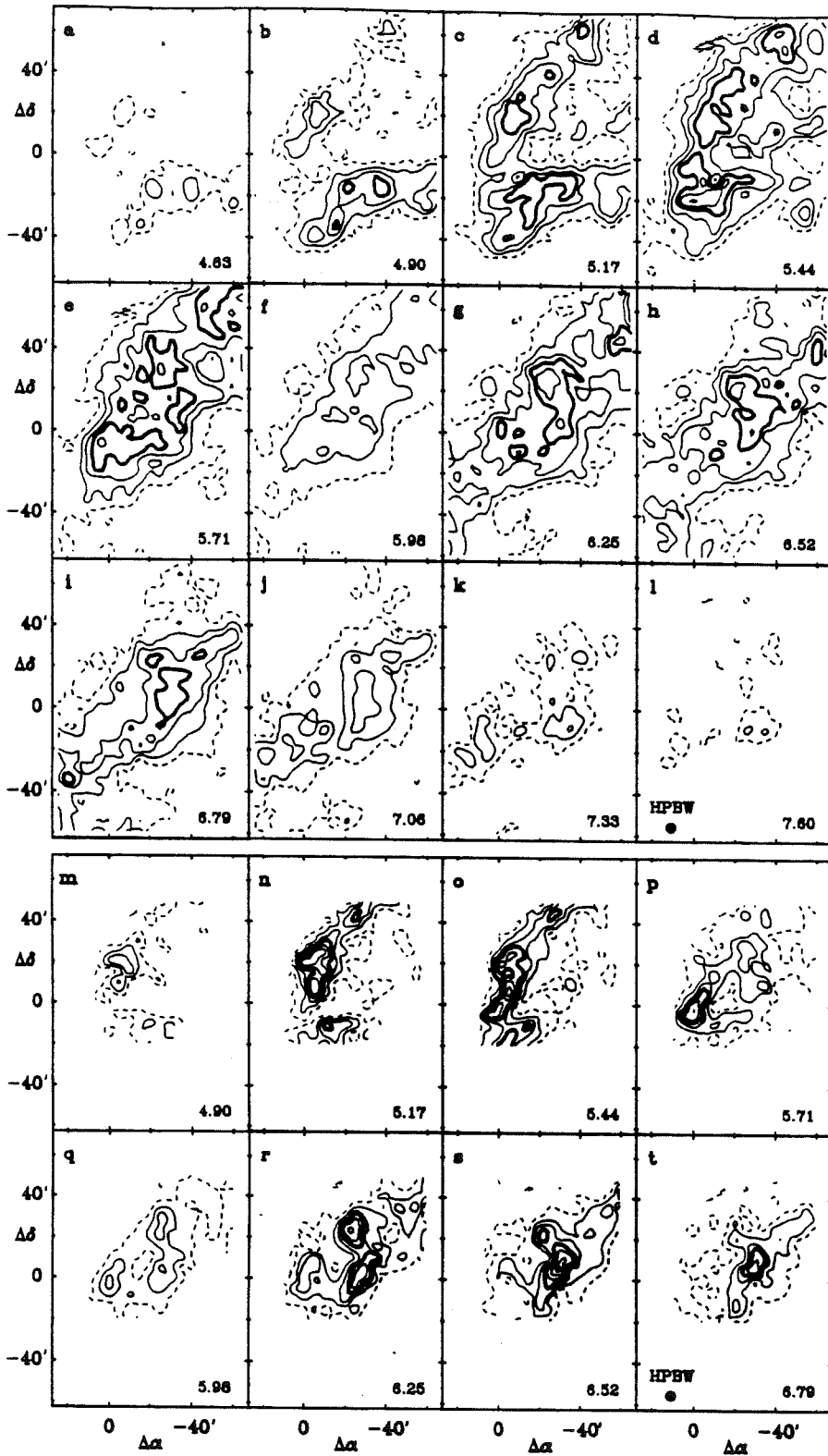

Fig. 8a-l. ^{13}CO and m-t C^{18}O brightness temperature in the individual 100 kHz-wide velocity channels. First contour and step are 0.75 K for ^{13}CO and 0.2 and 0.3 K for C^{18}O . Thick contour corresponds to 3 K for ^{13}CO and 1.1 K for C^{18}O .

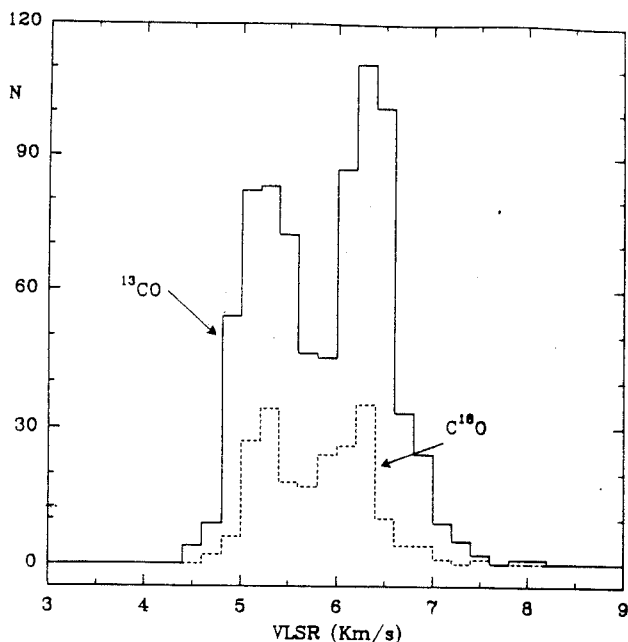

Fig. 9. Distribution of the velocities derived from a gaussian fit of the ^{13}CO and C^{18}O profiles of Fig. 3

filaments can be followed on the latter far beyond the limits of our molecular emission survey.

The first filament, which has the shape of a tilted "U", has its largest velocity gradient between the two branches of the "U" (compare Fig. 8b and d); This suggests that it lies in a plane inclined on the plane of the sky and that it is still in the process of bending around its densest fragment, TMC1. Since at least one of the branches of the "U" is more or less perpendicular to the galactic plane (the $b = -13.6$ parallel is tangent to the filament at the location of TMC1) the whole picture is not without reminding Parker's instability (e.g. Parker, 1967).

What causes and keeps the filamentary shape of the clouds in Taurus is a problem general to the whole region. The presence of a relatively strong and ordered magnetic field is likely and, as in the case of the filaments of HCL2, would seem the most natural agent for confining the matter. The limited measurements available so far (Nurmanova, 1982; Moneti et al., 1984) indicate that the magnetic field around HCL2 is generally perpendicular to the filaments, while, at places, toward some clumps, it becomes parallel. Such a pattern is not incompatible with Parker's scenario, in which the lines of force are pulled perpendicularly to their general direction at the vicinity of the gas concentrations. These latter, TMC1 and HCL2-C in our context, would be slowly sinking toward the galactic plane (i.e. toward the east) as they get bloated by more and more material flowing down along the distorted lines. Clearly too little is known on the 3-d distributions of the magnetic field and of the gas, to do more than suggest this scheme for the genesis of TMC1. If confirmed, it would provide an easy way of estimating the cloudlet's age, which would be of the order of the instability characteristic growth time, $\approx 10 g^{1/2} \text{LB}^{-1}$. With the values quoted above, it yields a minimum age of few $\times 10^6$ yr for a field strength of $30 \mu\text{G}$.

7. Conclusion

The present study of the dark cloud HCL2 has yielded the following results:

HCL2 consists of two thick filaments of gas overlapping in the plane of the sky and surrounded by an extended halo. Each filament has three components: the clumps, e.g. TMC1, located at the middle of the filaments, the "loop" ($n_{\text{H}_2} = \text{few} \times 10^3 \text{cm}^{-3}$), a tube of dense gas which defines the shape of the filaments, and a thick envelope, which wraps the loop. The gas density ranges from $100\text{--}200 \text{cm}^{-3}$ in the envelope to at least $\text{few} \times 10^4 \text{cm}^{-3}$ in the clumps. The gas temperature is close to 10 K and appears remarkably constant throughout the bulk of the cloud.

The emission in the $J = 1 \rightarrow 0$ line of the $^{12}\text{C}^{16}\text{O}$, $^{13}\text{C}^{16}\text{O}$ and $^{12}\text{C}^{18}\text{O}$ isotopes mostly arises from the envelope, the loop and the

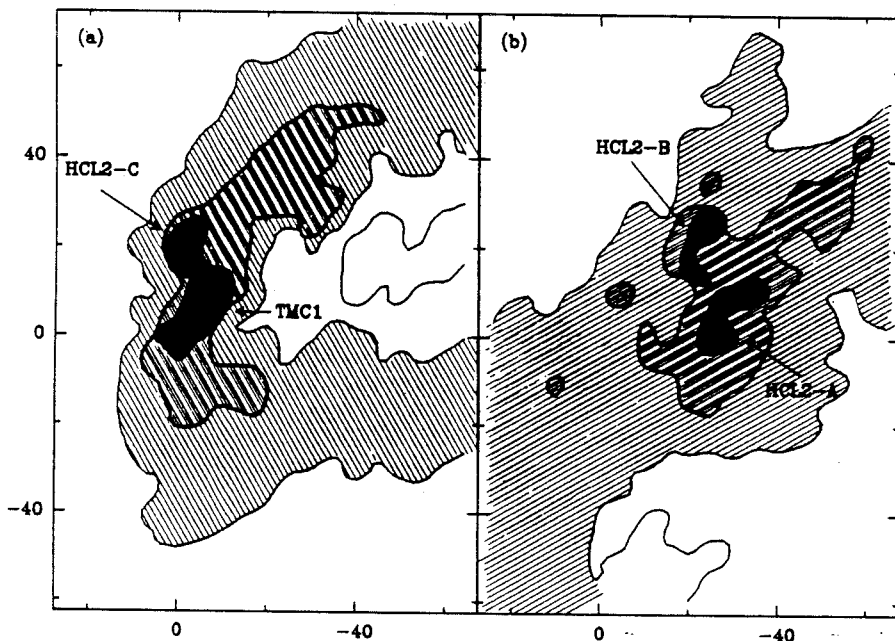

Fig. 10a and b. The velocity-integrated emission pertaining to the low velocity (a) and high velocity (b) components of Fig. 9. The outer contour corresponds to ^{13}CO , the middle contour to C^{18}O and the inner contour (dark areas) to H^{13}CO^+ . The two maps outline two distinct filaments which overlap on the plane of the sky. The three contours of each map can be viewed as delineating the clumps, the "loop" component and the envelope of the filaments (see text)

clumps, respectively. $^{12}\text{C}^{16}\text{O}$, and $^{13}\text{C}^{16}\text{O}$ because its abundance is enhanced in the envelope, are nearly thermalized in all three components. $^{12}\text{C}^{18}\text{O}$ is thermalized only in the latter two.

The $J=1 \rightarrow 0$ line of H^{12}CO^+ is observed toward the clumps and the loop, even though the density in the loop seems insufficient for its excitation. In fact, the bulk of the HCO^+ emission observed in HCL2, comes probably from the diffusion by the filament of the radiation emitted by the clumps. The H^{13}CO^+ emission, on the other hand, is restricted to the densest clumps; it is detected in TMC1 and in 4 similar cloudlets.

There is a good linear correlation between the $^{12}\text{C}^{18}\text{O}$ $J=1 \rightarrow 0$ line intensity and the visual extinction derived from star counts [see relation (6)], as well as between the $^{12}\text{C}^{18}\text{O}$ intensity and the $100\ \mu\text{m}$ continuum flux, $F(100\ \mu\text{m})$. The $^{12}\text{C}^{18}\text{O}$ line is not detected below 1.5 mag of extinction; between 2 and 6 mag, its intensity increases linearly with ($A_v - 1.5$ mag). The threshold of 1.5 mag is due to a lack of C^{18}O emission in the envelope, partly because this molecule is weakly excited, maybe because it is photodissociated. For $^{12}\text{C}^{16}\text{O}$ and $^{13}\text{C}^{16}\text{O}$, the detection threshold is only ≈ 0.5 mag: these species are abundant enough to shield themselves against photodissociation and are excited radiatively in the envelope. The abundance of $^{13}\text{C}^{16}\text{O}$ is enhanced in the envelope by ^{13}C fractionation. A difference in the detection thresholds for the three CO isotopes is also observed in other dark clouds of Taurus.

Inside the region with $2 < A_v < 6$ mag, the $N(\text{C}^{18}\text{O})/A_v$ ratio is $2.5 \pm 0.5 \cdot 10^{14} \text{ cm}^{-2} \text{ mag}^{-1}$. Assuming a $\text{C}^{16}\text{O}/\text{C}^{18}\text{O}$ abundance ratio of 490, equal to the terrestrial $^{16}\text{O}/^{18}\text{O}$ isotopic ratio, the CO column density is then $\approx 1.2 \cdot 10^{17} \text{ cm}^{-2}$ per mag of extinction. The CO/A_v ratio is found constant through out the region, in spite of the two order of magnitude variation of the gas density. We see no trace of the drastic change reported by Frerking et al. (1982) at $A_v \approx 4$ mag.

The constancy of the CO/A_v and $\text{CO}/F(100\ \mu\text{m})$ ratios above 2 mag (or 1 mag in depth into the cloud) suggests that the gas to dust and the CO to gas ratios are constant through the bulk of the UV-shielded region. Presumably, the dust to gas ratio in HCL2 is the same as in the diffuse clouds, i.e. is given by relation (4); the constancy of the CO to gas ratio would imply that CO condensation on grains is not very efficient up to A_v (in depth) ≈ 3 mag, or rather that it is quenched by an efficient desorption mechanism – as for example impulsive heating of the grains by heavy cosmic rays, (Leger et al., 1985).

Although the CO/A_v ratio we derive is similar to that reported by FLW for very large extinctions [i.e. up to $A_v(\text{total}) = 21$ mag], it is premature to conclude that the CO abundance remains constant that deep inside the dense clouds: some of the stars for which FLW find the largest extinctions appear to coincide with IR point sources, i.e. are probably surrounded by a dusty cocoon. It is probable, however, that this ratio does not decrease before A_v (in depth) $\approx 3-4$ mag, as CO must remain abundant inside the core of TMC1 to limit the enhancement in deuterium of H_3^+ , HCO^+ and N_2H^+ .

From the star counts and the C^{18}O observations, we derive, using relations (4) and (6), the mass of each gas component (Table 3). The mass of the cloud covered by Fig. 2 amounts to $\approx 600 M_\odot$; this mass would have been overestimated by a factor of 1.5 if it had been derived from the $^{12}\text{C}^{16}\text{O}$ observations alone, using the standard CO intensity-mass of H_2 conversion factor (in particular, assuming a $^{12}\text{CO}/^{13}\text{CO}$ intensity ratio of 3, see Liszt, 1982). The overestimation factor would have been even much larger if the external parts of the halo were considered (see Fig. 3c). The mass in the loop component amounts to 1/3 of the

total. We suggest that the magnetic field-constrained filaments are bending, due to the sinking of this dense gas toward the galactic plane. The instability linked to this motion could be at the origin of TMC1 and the other dense clumps.

Acknowledgements. We would like to thank A. Baudry, G. Beaudin, J.M. Desbats, J. Lacroix, and G. Montignac, for assistance during our observations at Bordeaux. We would like also to thank L. Mundy for assistance during our observing run at MWO¹. G. Duvert provided us the infrared IRAS maps of the HCL2 region. D. Downes, P. Ecrenaz, A.E. Glassgold, W. Langer, and A. Omont made useful comments on the manuscript.

Appendix A

Distance to HCL2

The distribution of absorbing material in the Taurus complex has been investigated by several authors by means of star counts as well as of optical spectrophotometric studies. We briefly summarize the main – partly contradictory – results of McCuskey (1938, 1940, 1941), Adolffsson (1955) and Racine (1968).

The early Wolf diagrams (number of stars versus magnitude) derived by McCuskey in the whole Taurus area (400 squares degrees) can be explained by a single absorbing cloud, with a thickness along the line of sight of ≈ 100 pc, located at $d \approx 140$ pc from the Sun. Wolf diagrams of a smaller area ($3^\circ \times 2^\circ 0$) yield more accurate distances for HCL2 and L1529: $d = 113$ and 125 pc respectively. This result is disputed by Adolffsson, who finds, from his more complete study of a 100 deg^2 area centred on the same region, three separate clouds, DC1, DC2, and DC3, located at $\approx 50, 170,$ and 600 pc from the Sun. DC1 and DC2, according to Adolffsson, couldn't be distinguished in McCuskey's data, who treated them as a single cloud and derived an erroneous distance. For Adolffsson, the darkest area in Taurus (which covers HCL2 and L1529) is associated with the closest cloud and lies at $d \approx 50$ pc.

No further evidence for absorbing gas at such a small distance is found by Racine (1968) who derives $d = 135$ pc from the spectroscopic parallax of 4 stars associated with reflection nebulae in Taurus.

To discriminate between the two distances we repeated Adolffsson's analysis on a small area centered on HCL2, using better stellar photometric data (Jaschek et al., 1964; Blanco et al., 1968; Kennedy and Buscombe, 1974 and Buscombe, 1977, 1980, 1981). These data provide UBV colors, as well as spectral and luminosity class for stars of magnitude < 12 , from which reliable distance moduli and extinctions can be derived, once $R = A_v/E(B-V)$ is known. The $E(B-V)$ -distance diagram derived in this way (Fig. 11) shows a single narrow sheet of absorbing material at ≈ 100 pc. We identify this material with HCL2; there is no significant reddening at lower distances.

Our distance of 100 pc relies on the determination of $R = 3$ in HCL2 (see CB), a value identical to the standard interstellar value; Adolffsson derived $R = 4$ from his lower quality photometric data. Changing R from 4 to 3 nearly doubles the distance of

¹ The Millimeter Wave Observatory is operated by the Electrical Engineering Research Laboratory, the University of Texas at Austin, with support from the National Science Foundation and McDonald Observatory

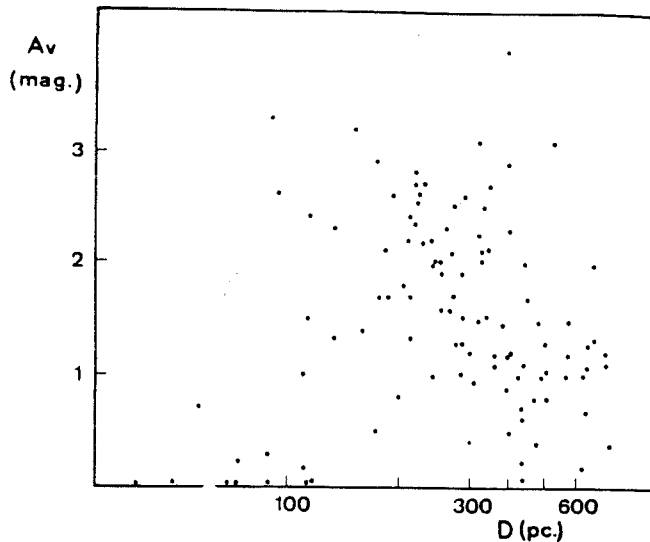

Fig. 11. Reddening versus distance for the stars of the HCL2 area. Note the increase of the reddening at 100 pc, which is probably the distance to the cloud

the stars with color excess ≈ 1 mag (typical of the stars behind HCL2), and would bring Adolfsson's distance of DC1 to ≈ 100 pc. In Fig. 11, there is no evidence for absorption of DC2, but our analysis refers to a 30 times smaller area than studied by Adolfsson. Evidence for absorbing material corresponding to DC2 can be found in the northwest part of the Taurus region where the first reddened stars are at distances of ≈ 300 pc.

We conclude that the most probable distance to HCL2 is 100 ± 10 pc. With $R = 3$ and Fig. 11 we derive a value for the average extinction in the central square degree of HCL2 of $A_v \approx 3.5$ mag.

References

- Askne, J., Höglund, B., Hjalmarsen, Å., Irvine, W.M.: 1984, *Astron. Astrophys.* **130**, 311
- Adolfsson, T.: 1955, *Ark. Astron.* **1**, 495
- Bachiller, R., Cernicharo, J.: 1986, *Astron. Astrophys.* (submitted)
- Bally, J., Langer, W.D.: 1982, *Astrophys. J.* **255**, 143
- Baran, G.P.: 1985, Ph. D. dissertation, Columbia University
- Baudry, A., Cernicharo, J., Perault, M., Despois, D., De la Noë, J.: 1981, *Astron. Astrophys.* **104**, 101
- Bell, M.B., Matthews, H.E.: 1985, *Astrophys. J. Letters* **291**, L63
- Benson, P.J., Myers, P.C.: 1983, *Astrophys. J.* **270**, 589
- Blanco, V.M., Douglass, G.G., Fitzgerald, M.P.: 1968, *Publ. U.S. Naval Obs.* Vol. XXI
- Bohlin, R.C., Savage, B.D., Drake, J.F.: 1978, *Astrophys. J.* **224**, 132
- Bok, B.J.: 1937, *The distribution of Stars in Space* Univ. Chicago Press Chicago
- Bujarrabal, V., Guélin, M., Morris, M., Thaddeus, P.: 1981, *Astron. Astrophys.* **99**, 239
- Buscombe, W.: 1977, 1980, 1981, *MK Spectral classification*, Evaston
- Castets, A., Cernicharo, J., Mundy, L.: 1987 (in preparation)
- Cernicharo, J., Bachiller, R.: 1984, *Astron. Astrophys. Suppl.* **58**, 327 (CB)
- Cernicharo, J., Bachiller, R., Duvert, G.: 1985, *Astron. Astrophys.* **149**, 273
- Cernicharo, J., Guélin, M., Askne, J.: 1984, *Astron. Astrophys.* **138**, 371 (Paper I)
- Cernicharo, J., Castets, A., Duvert, G., Guilloteau, S.: 1984, *Astron. Astrophys.* **139**, L13
- Dalgarno, A., Lepp, S.: 1984, *Astrophys. J. Letters* **287**, L47
- D'Hendecourt, L.B., Allamandola, L.J., Greenberg, J.M.: 1985, *Astron. Astrophys.* **152**, 130
- Dickman, R.L.: 1978, *Astrophys. J. Suppl.* **37**, 407
- Duvert, G., Cernicharo, J., Baudry, A.: 1986, *Astron. Astrophys.* **164**, 349
- Elias, J.H.: 1979, *Astrophys. J.* **224**, 857
- Encrenaz, P.J., Falgarone, E., Lucas, R.: 1975, *Astron. Astrophys.* **44**, 73
- Federman, S.R., Glassgold, A.E., Jenkins, E.B., Shaya, E.J.: 1980, *Astrophys. J.* **242**, 545
- Frerking, M.A., Langer, W.A., Wilson, R.W.: 1982, *Astrophys. J.* **262**, 590 (FLW)
- Glassgold, A.E., Huggins, P.J., Langer, W.D.: 1985, *Astrophys. J.* **290**, 615 (GHL)
- Guélin, M., Langer, W.D., Wilson, R.W.: 1982b, *Astron. Astrophys.* **107**, 107 (GLW)
- Heiles, C.: 1968, *Astrophys. J.* **151**, 919
- Heiles, C., Gordon, M.A.: 1975, *Astrophys. J.* **199**, 361
- Jaschek, C., Conde, H., de Sierra, A.C.: 1964, *Catalogue of stellar spectra classified in the MK System*, Observatorio astronómico de la Universidad Nacional de la Plata
- Kennedy, P.M., Buscombe, W.: 1974, *MK Spectral Classification*, Evaston
- Leger, A., Jura, M., Omont, A.: 1985, *Astron. Astrophys.* **144**, 147
- Liszt, H.S.: 1982, *Astrophys. J.* **262**, 198
- McCuskey, S.W.: 1938, *Astrophys. J.* **88**, 209
- McCuskey, S.W.: 1939, *Astrophys. J.* **89**, 568
- McCuskey, S.W.: 1941, *Astrophys. J.* **94**, 468
- Moneti, A., Pipher, J.L., Helfer, H.L., McMillan, R.S., Perry, M.L.: 1984, *Astrophys. J.* **282**, 508
- Nurmanova, U.A.: 1982, *Sov. Astron.* **26**, 37
- Parker, E.N.: 1967, *Astrophys. J.* **145**, 811
- Racine, R.: 1968, *Astron. J.* **73**, 233
- Savage, B.D., Mathis, J.S.: 1979, *Ann. Rev. Astron. Astrophys.* **17**, 73
- Schloerb, F.P., Snell, R.L.: 1984, *Astrophys. J.* **283**, 129
- Schloerb, F.P., Snell, R.L., Young, J.S.: 1983, *Astrophys. J.* **267**, 163
- Smith, D., Adams, N.: 1984, *Astrophys. J.* **284**, L13
- Snell, R.L., Langer, W.D., Frerking, M.A.: 1982, *Astrophys. J.* **255**, 149
- Sume, A., Downes, D., Wilson, T.L.: 1975, *Astron. Astrophys.* **39**, 435
- Takano, T., Fukui, Y., Ogawa, H.: 1985, *Astron. Astrophys.* **144**, 363
- Tarafdar, S.P., Prasad, S.S., Huntress, W.T., Jr., Villere, K.R., Black, D.C.: 1985, *Astrophys. J.* **289**, 220
- Tarafdar, S.P., Krishna Swamy, K.S.: 1982, *Monthly Notices Roy. Astron. Soc.* **200**, 431
- Tölle, F., Ungerrechts, H., Walmsley, C.M., Winnewisser, G., Churchwell, E.: 1981, *Astron. Astrophys.* **95**, 143
- Vrba, F.J., Rydgren, A.E.: 1985, *Astron. J.* **90**, 1490
- Walmsley, C.M., Winnewisser, G., Tölle, F.: 1980, *Astron. Astrophys.* **81**, 245
- Wilson, T.L., Minn, Y.K.: 1977, *Astron. Astrophys.* **54**, 933
- Wouterloot, J.G.A., Habing, H.J.: 1985, *Astron. Astrophys. Suppl.* **60**, 43

I.06) ETUDE DE TROIS REGIONS DE FORTE DENSITE SIMILAIRES A

TMC1

I.06) ETUDE DE TROIS REGIONS DE FORTE DENSITE SIMILAIRES A TMC1

Nous avons observé dans l'émission de NH_3 , HC_3N , HC_5N , HC_7N , C_3N , et C_4H , trois condensations de Heiles Cloud 2 similaires à TMC1. Une de ces condensations est la source d'émission de cyanopolyynes la plus intense du ciel, après TMC1, et la quatrième source dans laquelle HC_7N et C_3N ont été détectés. Une autre condensation montre un très fort gradient du rapport d'abondance NH_3 /cyanopolyynes sur une distance de 0.2 pc.

TMC1-Like cloudlets in HCL2

J. Cernicharo^{1,2}, M. Guélin³, and J. Askne⁴

¹ Observatoire de Meudon, F-92190 Meudon, France

² Groupe d'astrophysique, CERMO, Université de Grenoble, ERA 961 du CNRS, BP 68, F-38402 St. Martin d'Hères, France

³ IRAM, Av. Divina Pastora 7, Bloque 6, Granada, Spain

⁴ Onsala Space Observatory, Sweden

Received January 13, accepted April 6, 1984

Summary. We have studied, in the lines of NH_3 , HC_3N , HC_5N , HC_7N , C_3N , and C_4H , the three most conspicuous gas condensations of Heiles' Cloud 2 (HCL2) besides TMC1 (Taurus molecular cloud one). One of these condensations appears to be the strongest source of cyanopolyynes (HC_{2n+1}N) emission in the sky, after TMC1, and is the fourth source in which HC_7N and C_3N have been detected. Another condensation shows a strong gradient in the NH_3 /cyanopolyne abundance ratio over a distance of 0.2 pc.

Key words: interstellar molecules - abundances - HCL2 - Taurus

I. Introduction

Among the very many interstellar clouds studied for molecular line emission, TMC1 appears in many respects as unique. The first dark cloud where HC_3N has been detected, is the strongest source of emission from the heavy carbon chain molecules (HC_5N , HC_7N , C_3N , ...), and the only cloud where species as complex as HC_9N and $\text{CH}_3\text{C}_3\text{N}$ (Broten et al., 1978, 1984) have been observed to date. Emission from these remarkable molecules, just as that from the more common species HCO^+ and NH_3 , mainly arises from a narrow ridge, or chain of cloudlets, barely resolvable with the largest radiotelescopes: it consists of a blend of exceedingly narrow (quasi thermal) velocity components.

What causes the strength of molecular emission in TMC1 remains so far an open question; does it result from the lucky conjunction of a large gas column density, due to the peculiar shape of the source, and of favourable excitation conditions, or is it linked to exceptional chemical processes? (see Bujarrabal et al., 1981; Tölle et al., 1981). In the latter case, to what main physical parameter is related the efficiency of these processes?

An answer to these questions can come from a careful evaluation of the physical conditions in the dark clouds and from an extensive study of the molecular abundance ratios. Much effort has been recently devoted to these tasks. In particular, systematic searches for carbon chain molecule emission have been carried out in more than one hundred high obscuration regions, distributed over the whole northern sky (Little et al., 1978; Churchwell et al.,

1978; Walmsley et al., 1980; Myers et al., 1979; Benson and Myers, 1980). The result is quite puzzling: although many dark cloudlets have densities, temperature, and CO and NH_3 emission quite similar to those of TMC1, HC_5N emission is almost everywhere exceedingly weak, HC_7N and C_3N are detected in only one cloudlet (TMC2), and HC_9N in none.

In this paper, we report the detection of HC_7N , C_4H , and C_3N emission in a new cloudlet. This emission is the strongest observed so far outside TMC1. It seems significant that it arises in a source only 20' away from TMC1, a source which has, just as TMC1, the

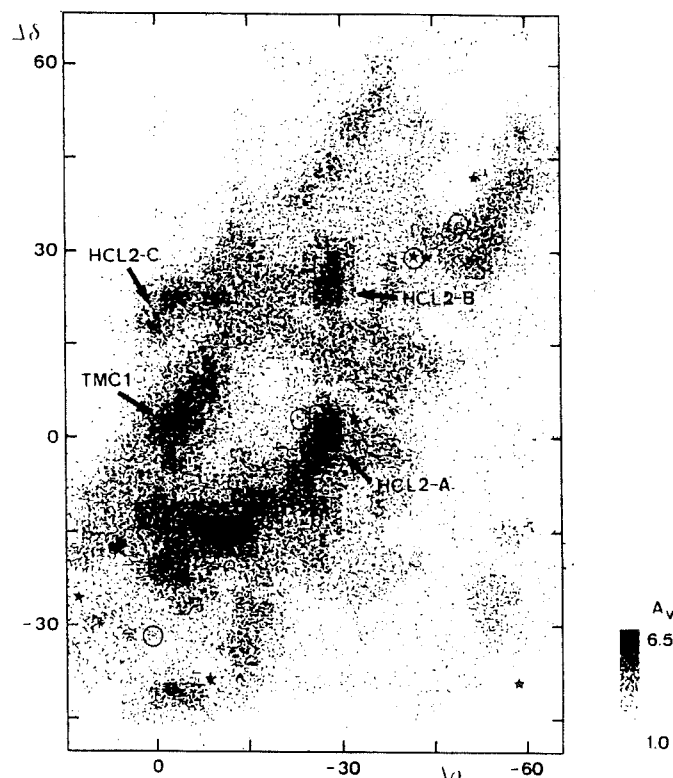

Fig. 1. Visual extinction map towards HCL2 from star counts (Cernicharo and Bachiller, 1984). The three cloudlets studied in this paper (HCL2 A, B, C) are indicated by arrows. Indicated visual extinctions are only lower limits when $A_v \geq 6.5$ mag (black contours). Circles indicate positions of reflection nebulae, black stars of T-Tauri stars. The very dark fragment, south of the central hole, was not detected in H^{13}CO^+

Send offprint requests to: J. Cernicharo

Table 1. Observational parameters

Molecule and transition	Frequency (MHz)	Velocity resolution (km s ⁻¹)	Telescope	ϱ	HPBW	σ
HC ₃ N $J=2-1$ $F=3-2$	18196.312	0.080	42-m NRAO	0.25	1'65	0.06 K
	18196.218	0.080	42-m NRAO	0.25	1'65	0.06 K
HC ₃ N $J=3-2$ $F=4-3$ $F=3-2$ $F=2-1$	27294.347	0.171	20-m Onsala	0.70	2'00	0.10 K
	27294.295	0.171	20-m Onsala	0.70	2'00	0.10 K
	27294.078	0.171	20-m Onsala	0.70	2'00	0.10 K
HC ₃ N $J=10-9$	90978.894	0.165	7-m B.T.L.	0.90	2'00	0.06 K
		0.083	7-m B.T.L.	0.90	2'00	0.06 K
HC ₃ N $J=12-11$	109173.634	0.170	5-m MWO	0.85	1'90	0.07 K
HC ₅ N $J=8-7$	21301.259	0.069	42-m NRAO	0.25	1'40	0.05 K
		0.034	42-m NRAO	0.25	1'40	0.05 K
HC ₇ N $J=21-20$	23687.889	0.069	42-m NRAO	0.25	1'26	0.02 K
NH ₃ (1,1)	23694.506	0.124	42-m NRAO	0.25	1'26	0.06 K
		0.062	42-m NRAO	0.25	1'26	0.02 K
NH ₃ (2,2)	23722.634	0.124	42-m NRAO	0.25	1'26	0.01 K
		0.062	42-m NRAO	0.25	1'26	0.02 K
C ₄ H (N, J, F) (2,3/2,2)- (1,1/2,1)	19054.476	0.077	42-m NRAO	0.25	1'26	0.04 K
C ₃ N (N, J, F) (2,5/2,7/2)- (1,3/2,5/2)	19781.094	0.080	42-m NRAO	0.25	1'26	0.01 K
¹² CO $J=1-0$	115271.204	0.260	2.5-m Bordeaux	0.85	4'44	0.50 K
¹³ CO $J=1-0$	110201.370	0.270	2.5-m Bordeaux	0.85	4'50	0.25 K
C ¹⁸ O $J=1-0$	109782.182	0.270	2.5-m Bordeaux	0.85	4'50	0.10 K
HCO ⁺ $J=1-0$	89188.523	0.336	2.5-m Bordeaux	0.85	5'50	0.07 K
H ¹³ CO ⁺ $J=1-0$	86754.330	0.345	2.5-m Bordeaux	0.85	5'50	0.04 K
¹² CO $J=2-1$	230538.001	0.325	5-m MWO	0.70	1'10	0.50 K
¹³ CO $J=2-1$	220398.714	0.327	5-m MWO	0.70	1'10	0.20 K
C ¹⁸ O $J=2-1$	219560.369	0.327	5-m MWO	0.70	1'10	0.06 K

ϱ is the beam efficiency. HPBW is the half power beamwidth (see text, however, for the NRAO telescope). σ is the typical rms of the spectra

shape of a narrow ridge oriented in the southeast-northwest direction.

The new cloudlet (Cernicharo, 1981, 1983) has been found with two other gas condensations during a H¹³CO⁺ survey of Cloud 2, the dark nebula which surrounds TMC1. Inside one of these condensations, we definitely observe a variation of the cyanopolyne to ammonia abundance ratio.

II. Observations

Our initial survey of the Cloud 2 region (Cernicharo and Guélin, 1984), was carried out between summer 1980 and winter 1982 in the $J=1-0$ lines of CO, ¹³CO, C¹⁸O, HCO⁺, and H¹³CO⁺, with the Bordeaux 2.5-m telescope. The angular resolution was 4'-5', the

velocity resolution about 0.3 km s⁻¹. H¹³CO⁺ emission and strong C¹⁸O emission have been observed in three cloudlets, located respectively 20' north of TMC1, 25' west, and 25' north - 25' west (see Fig. 1). The three cloudlets have been subsequently mapped with an angular resolution of 2' in the 3-2 and 10-9 lines of HC₃N using the Onsala 20-m and the Holmdel 7-m telescopes. The comparison of the intensities of the 3-2 and 10-9 lines offers a simple way to estimate the density of the gas, once the kinetic temperature is known (see below). In order to determine this latter parameter, the cloudlets were mapped simultaneously in the (1,1) and in the (2,2) lines of ammonia with the NRAO¹ telescope.

1 The National Radio Astronomy Observatory is operated by Associated Universities, Inc., under contract to the National Science Foundation

Table 2. Ammonia line parameters towards selected positions

Position	(1,1)														(2,2)								
	VL		L1		L2		M1		M2		H1		H2		VH1		VH2		VLSR	σ			
	T_A	Δv	T_A	Δv	T_A	Δv	T_A	Δv	VLSR	T_A	Δv	T_A	Δv	T_A	Δv	T_A	Δv	T_A			Δv		
HCL2A																							
(0.00, -1.25)	0.27	0.46	0.23	0.35			0.40	0.37	6.05	0.30	0.39	0.29	0.33	0.21	0.37	0.17	0.36			0.05			
q (0.00, 0.00)	0.14	0.34	0.15	0.30	0.11	0.39	0.40	0.43	6.30	0.25	0.36	0.20	0.32	0.12	0.33	0.16	0.28	0.04	0.35	6.23	0.01		
(-1.25, 0.00)	0.27	0.32	0.21	0.30			0.48	0.80 ^a	6.30			0.32	0.37	0.18	0.41	0.31	0.28	0.25	0.24		0.06		
(-2.50, 0.00)	0.18	0.33	0.19	0.39			0.30	0.81 ^a	6.30												0.06		
e (0.00, 5.00)	0.06	0.47	0.07	0.48 ^b			0.17	0.87 ^a	6.42			0.09	0.47 ^c			0.07	0.41	0.05	0.42		0.02		
(-2.50, 5.00)	0.18	0.32					0.25	0.54 ^a	6.48												0.05		
f (-0.00, 7.50)							0.14	1.1 ^a	6.55												0.03		
HCL2B																							
(0.00, 0.00)	0.19	0.34	0.17	0.32	0.11	0.40	0.40	0.46	5.88	0.35	0.34	0.20	0.34	0.13	0.30	0.15	0.36	0.13	0.27	0.06	0.25	5.91	0.01
HCL2C																							
(2.50, -2.50)	0.15	0.38	0.18	0.30	0.13	0.33	0.36	0.34	5.30	0.24	0.38	0.14	0.36	0.12	0.37	0.17	0.27	0.12	0.22				0.03
(1.25, -2.50)	0.19	0.37	0.20	0.35			0.47	0.41	5.18	0.30	0.45	0.20	0.35	0.17	0.21	0.20	0.36	0.19	0.25				0.05
(2.50, -1.25)	0.18	0.54					0.40	0.32	5.18	0.25	0.35	0.23	0.26	≈0.13	0.30								0.05
a (1.25, -1.25)	0.36	0.53	0.35	0.40	0.25	0.40	0.77	0.42	5.23	0.62	0.47	0.41	0.40	0.23	0.42	0.35	0.29	0.22	0.29	0.11	0.20	5.21	0.01
d (2.50, 0.00)	0.18	0.41	0.20	0.36	0.14	0.35	0.35	0.37	5.26	0.31	0.30	0.22	0.28	0.14	0.30	0.23	0.28	0.15	0.20				0.03
b (0.00, 0.00)	0.20	0.36	0.31	0.26	0.18	0.32	0.59	0.29	5.18	0.44	0.35	0.31	0.30	0.20	0.27	0.28	0.31	0.17	0.26	0.06	0.30	5.21	0.01
(-2.50, 0.00)	0.15	0.41	0.17	0.30			0.23	0.57	5.05	0.19	0.31					0.15	0.33						0.05
(-1.25, 1.25)	0.20	0.33	0.21	0.43			0.54	0.38	5.18	0.33	0.39	0.22	0.73 ^b										0.06
d (-2.50, 1.25)	0.31	0.30	0.30	0.36	0.21	0.21	0.56	0.34	5.11	0.43	0.41	0.22	0.36	0.16	0.20	0.30	0.24	0.15	0.29				0.04
(-1.25, 2.50)	0.17	0.34	0.15	0.34			0.30	0.48	5.18	0.27	0.35												0.06
(0.00, 2.50)	0.15	0.36	0.11	0.37			0.31	0.44	5.18	0.22	0.45	0.17	0.27	0.11	0.30	0.18	0.25	0.11	0.28				0.03

Notes to Table 2: ^a Sum of the *M1* and *M2* HF components. ^b Sum of the *L1* and *L2* HF components. ^c Sum of the *H1* and *H2* HF components. The (1,1) ammonia lines are denoted following Ungerechts et al. (1980). σ is the rms noise in one channel for the (1,1) and the (2,2) lines. Components not detected are denoted by blank spaces. Δv is the full width at half-power of the line defined as $T_A \cdot \Delta v = \int T_A \cdot dv$. Offsets are given in arcmin

Finally, observations of the $J=2-1$ lines of HC_3N , C_3N and C_4H , as well as high J lines of HC_5N , HC_7N , and HC_9N , were made near 20 GHz with the 42-m telescope in December 1982. The half power beamwidth of the NRAO telescope was about 1'3–1'7, but the actual resolution is somewhat poorer, due to the conspicuous sidelobes which distort the telescope response pattern at high frequencies. To keep the response pattern as clean as possible, we restricted these observations to ± 3.5 h from transit. Pointing was checked every 2 h against the quasar 3C 123. Recently, Benson and Myers (1983) have reported NH_3 and HC_5N measurements in the northern cloudlet with the 42-m NRAO and the 36.7-m Haystack telescopes. Their data, which are less extensive and somewhat less sensitive, are in excellent agreement with our data.

Although the 3–2 and 10–9 lines of HC_3N were observed with the same angular resolution, the derivation of their relative intensities is not easy in view of the difference in calibration methods (noise tube for the 3–2 and 2–1 lines, chopper wheel for the 10–9 line), and because of radiation scattering by the radome enclosing the Onsala dish. The 10–9 to 3–2 line intensity ratio, however, is very sensitive to n_{H_2} for the range of physical conditions considered here, so that even a large error on this ratio results in an uncertainty on n_{H_2} smaller than those introduced by the optical thickness of the 10–9 line and the uncertainties on collisional cross sections. For $T_K \sim 10$ K and n_{H_2} in the range $10^3 - 10^5 \text{ cm}^{-3}$, for example, an underestimation by 30% of the 10–9 to 3–2 ratio, leads to an underestimation of n_{H_2} by roughly the same factor. On the other hand, the optical thickness correction for the 10–9 line is typically a factor of 3 and is uncertain by at least 50%. In fact, the use of the 2–1 HC_3N line instead of the 3–2 line (the two lines

were observed with different telescopes) leads to values of n_{H_2} , which are the same within 20–30%, which confirms that calibration errors are not decisive. L. Mundy (private communication) has observed with the 5-m MWO² telescope the $J=12-11$ line of HC_3N toward the center of the 3 cloudlets as a further check of our density determinations. Within the noise limit ($3\sigma = 0.20$ K) the $J=12-11$ line of HC_3N was not detected, which is in good agreement with the value of its intensity estimated from an LVG analysis of the other lines (0.15–0.20 K).

All observations (parameters given in Table 1) were made in the frequency switching mode. The resulting contour maps, spectra, and derived line parameters are given in Figs. 2–5 and Tables 2–4.

III. The northern cloudlet (HCL2-C)

Figure 2 represents the peak antenna temperature contour maps of the NH_3 (1,1), HC_3N (2–1), HC_5N (8–7), C_4H (2–1) lines in the cloudlet located 20' north of TMC1 (HCL2-C in Fig. 1). The four maps were observed near 20 GHz with the 42-m NRAO telescope and have similar angular resolutions. As noted above, Benson and Myers (1983) have published maps of the NH_3 (1,1) and HC_5N (8–7) line emission in this cloudlet, which agree well with Figs. 2.1 and 2.3. The highest NH_3 contours delineate a narrow ridge oriented along the southeast-northwest diagonal. This ridge

2 The Millimeter Wave Observatory is operated by the Electrical Engineering Research Laboratory, the University of Texas at Austin, with support from the National Science Foundation and McDonald Observatory

Table 3. Observed line parameters

Position	HC ₃ N J=2-1			HC ₃ N J=3-2						HC ₃ N J=10-9			HC ₃ N J=12-11					
	F=3-2		VLSR	F=2-1		F=4-3		F=3-2		F=2-1		VLSR	T _k	Δv	VLSR	T _k	Δv	VLSR
	T _k	Δv		T _k	Δv	T _k	Δv	T _k	Δv	T _k	Δv							
HCL2A																		
(0.00, -2.50)	0.24	0.26	6.21			0.37	0.42	6.00 ^a										
(2.50, 0.00)						0.50	0.45	6.31	0.20	0.33	0.40	0.38	≤0.20					
q (0.00, 0.00)	0.27	0.35	6.38	0.16	0.34	0.55	0.45	6.20	0.50	0.42	0.39	0.42	≤0.40	0.49	6.32	≤0.20		
(-2.50, 0.00)						0.40	0.23	5.98 ^a										
(5.00, 2.50)						0.36	0.44	5.59 ^a										
(0.00, 2.50)	0.12	0.28	6.12			0.32	0.19	5.92 ^a					≤0.20					
(2.50, 5.00)						0.33	0.53	6.41 ^a										
e (0.00, 5.00)	0.32	0.30	6.45	0.16	0.28	0.78	0.38	6.42	0.62	0.40	0.53	0.38	0.84	0.28	6.49			
(-2.50, 5.00)						≤0.25												
f (0.00, 7.50)	0.26	0.29	6.45	0.13	0.30								0.70	0.57	6.58	≤0.20		
(-2.50, 10.00)						0.28	0.41	5.87	0.28	0.49	0.22	0.44						
HCL2B																		
(0.00, 0.00)	0.34	0.27	6.00	0.17	0.30	0.50	0.45	5.81	0.34	0.14			0.85	0.49	5.82	≤0.20		
(0.00, 2.50)						0.28	0.46	6.14 ^a					≤0.20					
(0.00, 5.00)						0.35	0.47	6.11 ^a					≤0.20					
(0.00, -2.50)													≤0.20					
HCL2C																		
(2.50, -5.00)						0.37	0.31	6.23 ^a										
(2.50, -2.50)	0.12	0.21	5.24			0.70	0.38	5.27	0.50	0.40	0.35	0.45	0.30	0.33	5.25			
(1.25, -2.50)	≤0.15																	
(0.00, -2.50)	≤0.15																	
(2.50, -1.25)	0.22	0.26	5.21															
a (1.25, -1.25)	0.63	0.27	5.25	0.26	0.35													
(0.00, -1.25)	0.64	0.28	5.37	0.52	0.25													
(-1.25, -1.25)	0.25	0.34	5.29															
(-2.50, -1.25)	≤0.15																	
d (2.50, 0.00)	0.15	0.43	5.32			1.3	0.43	5.30	0.72	0.40	0.65	0.38	≤0.15					
(1.25, 0.00)	0.71	0.27	5.32	0.40	0.30													
b (0.00, 0.00)	1.3	0.22	5.30	0.72	0.22	1.1	0.38	5.13	0.96	0.40	0.70	0.39	0.94	0.35	5.33	≤0.20		
(-1.25, 0.00)	0.65	0.31	5.29	0.54	0.26													
(-2.50, 0.00)	0.50	0.34	5.21	0.40	0.23	0.40	0.48	5.23 ^a										
(-3.75, 0.00)	0.27	0.14	5.13															
(1.25, 1.25)	0.34	0.19	5.21	0.25	0.16													
(0.00, 1.25)	0.47	0.21	5.21	0.32	0.18													
(-1.25, 1.25)	0.40	0.22	5.21	0.30	0.18													
e (-2.50, 1.25)	0.66	0.35	5.24	0.35	0.35													
(-3.75, 1.25)	0.23	0.18	5.20															
(0.00, 2.50)	≤0.12					0.35	0.36	5.08	0.19	0.38	0.16	0.25						
(-1.25, 2.50)	≤0.12																	
(-2.50, 2.50)	0.32	0.23	5.21	0.13	0.23													
(-3.75, 2.50)	0.48	0.23	5.29	0.20	0.21													

Notes to Table 3: ^a F = 4 - 3 + F = 3 - 2. VLSR is the velocity of the peak of T_k. Δv is the full width at half-power of the line defined as T_k · Δv = ∫ T_k · dv.

Offsets are given in arcmin. rms noise on one channel is 0.07 K for HC₃N J = 12 - 11 and J = 10 - 9, 0.1 K for HC₃N J = 3 - 2 and 0.06 K for HC₃N J = 2 - 1. HC₃N J = 3 - 2 was not detected towards HCL2A (2.5, -2.5), (2.5, -5.0), (7.5, -5.0), (-2.5, 2.5), (-2.5, 7.5), (-5.0, 5.0), (-7.5, 5.0), (5.0, 0.0), (7.5, 0.0) and towards HCL2C (-2.5, 5.0), (-2.5, 0.0), (0.0, -2.5), (2.5, 5.0), (2.5, 2.5), (5.0, 0.0), (5.0, 2.5), (5.0, -2.5), (7.5, 0.0)

consists of three peaks (a, b, c on Fig. 2.1) separated by ≈ 2'; it is surrounded by an area of low level emission which extends over the region of optical extinction A_v > 3 mag. The NH₃(1,1) line is a good tracer of the dense regions, since the critical density for its excitation is a few 10⁴ cm⁻³; as will be seen below, the three emission peaks of Fig. 2.1 correspond to three gas condensations.

The emission from HC₃N, HC₅N, and C₄H is restricted to the ridge region. The lines of these three species do not peak in a, like the NH₃(1,1) line, but in b, in the middle of the ridge. Their intensities are the highest observed in any source, except TMC1, which prompted us to search for HC₇N and C₃N, so far observed in only two dark clouds (TMC1 and TMC2). HC₇N was detected

in a and b (Fig. 3) and C₃N in b (Fig. 4). Time lacked us to search at other positions or to derive a low limit on HC₉N emission.

The shape, size and orientation of the NH₃ ridge, its strength in cyanopolyne emission, and the displacement of the cyanopolyne peak with respect to the NH₃ peak, make of the Northern cloulet a source remarkably like TMC1. Does this similarity extend to the gas physical properties?

In our NH₃ survey, we observed the (2,2) line together with the (1,1). The (2,2) line is everywhere much weaker than the (1,1) line, and is detected at only two positions, a and b. The (2,2) to (1,1) intensity ratio is a good probe of the gas temperature, T_k, as long as the latter does not exceed 20 K (see e.g. Walmsley and Ungerechts,

Table 4. Observed line parameters

Position	HC ₅ N <i>J</i> = 8-7			C ₄ H <i>N</i> = 2-1		
	<i>T_A</i>	Δv	VLSR	<i>T_A</i>	Δv	VLSR
HCL2-A						
q (0.00, 0.00)	0.14	0.44	6.20	0.22	0.20	6.30
(0.00, 2.50)	≤ 0.09					
f (0.00, 5.00)	0.09	0.60	6.30	0.22	0.20	6.45
e (0.00, 7.50)	0.11	0.63	6.61	0.19	0.19	6.50
HCL2-B						
(0.00, 0.00)	0.13	0.51	5.90	0.06	0.49	5.92
HCL2-C						
a (1.25, -1.25)	0.30	0.50	5.26	0.24	0.33	5.30
(0.00, -1.25)	0.18	0.30	5.30	0.24	0.21	5.38
(-1.25, -1.25)	≤ 0.12					
(1.25, -2.50)	0.14	0.20	5.13	0.14	0.17	5.22
d (2.50, 0.00)	≤ 0.12					
(1.25, 0.00)	0.28	0.47	5.20	0.17	0.22	5.42
b (0.00, 0.00)	0.37	0.54	5.23	0.34	0.27	5.34
(-1.25, 0.00)	0.16	0.57	5.24	0.14	0.23	5.22
(-2.50, 0.00)	0.15	0.21	5.00			
c (2.50, 1.25)				≤ 0.10		
(1.25, 1.25)	≤ 0.10					
(0.00, 1.25)	0.18	0.32	5.10	0.25	0.20	5.30
(-1.25, 1.25)	0.21	0.23	5.10	≤ 0.10		
(-2.50, 1.25)	0.34	0.30	5.03			
(-3.75, 1.25)	≤ 0.13					
(-2.50, 2.50)	0.18	0.35	5.27			
			HC ₇ N		C ₃ N	
	<i>T_A</i>	Δv	VLSR	<i>T_A</i>	Δv	VLSR
HCL2-C						
a (1.25, -1.25)	0.065	0.25	5.23			
b (0.00, 0.00)	0.060	0.27	5.23	0.04	0.19	5.23
HCL2-B						
(0.00, 0.00)	≈ 0.03	≈ 0.20	5.90			

rms noise on one channel is ≈ 0.04 , 0.04, 0.006, and 0.003 K for HC₅N, C₄H, HC₇N, and C₃N, respectively.

Δv is the full width at half-power of the line defined as $T_A \cdot \Delta v = \int T_A \cdot dv$

1983). The weakness of the (2,2) line implies that $T_k \leq 15$ K throughout the new cloudlet. For positions **a** and **b**, we derive (from the main to satellite line intensity ratio and assuming equal excitation temperatures for all these lines (see e.g. Ungerechts et al., 1980) optical depths of the (1,1) line of 9 and 10, and a common kinetic temperature, $T_k = 8.5 \pm 1$ K (see Table 5). That the "envelope" region is not much hotter than the ridge, is indicated by the low limit on the (2,2) line intensity, obtained by averaging all the spectra of this region. We find $T_A(2,2)_{aver} < 0.03$ K and $T_A(1,1)_{aver} = 0.22 \pm 0.01$, which implies $T_k < 10$ K. Taking into account the (1,1) line opacity ($\tau(1,1)_{aver} \sim 4$) would even slightly lower this upper limit. The CO 1-0 and 2-1 excitation temperatures being also ~ 8 K throughout the region (Cernicharo and Guélin, 1984), we conclude that the kinetic temperature in the northern cloudlet is uniform and about equal to that in the TMC1 ridge (c.f. Töle et al., 1981).

Once the kinetic temperature and the (1,1) opacity are known, it is possible to estimate the gas density from the intensity of the (1,1) line. Using an LVG model, a filling factor of 1, and the NH₃-He collisional excitation rates of Green (1983) (multiplied by a factor of 1.7 to take into account the larger NH₃-H₂ collisional rates and the presence of the Helium atoms), we derive: $n_{H_2} = \text{few } 10^4 \text{ cm}^{-3}$ in the ridge, and $(n_{H_2})_{aver} \sim 4 \cdot 10^3 \text{ cm}^{-3}$ in the "envelope". Note that the beam filling factor in the ridge should not be much smaller than 1, since the beam-averaged excitation temperatures which are derived (6-7 K) are close to T_k ; higher resolutions observations would be needed for more precise estimates.

An independent estimate of the density can be made from the HC₃N line intensities. The $J = 10$ rotational level of this molecule lies $\sim 16.5 \text{ cm}^{-1}$ above the ground level, and the collisional excitation of the $J = 10-9$ line, at 10 K, requires $n_{H_2} > 10^4 \text{ cm}^{-3}$.

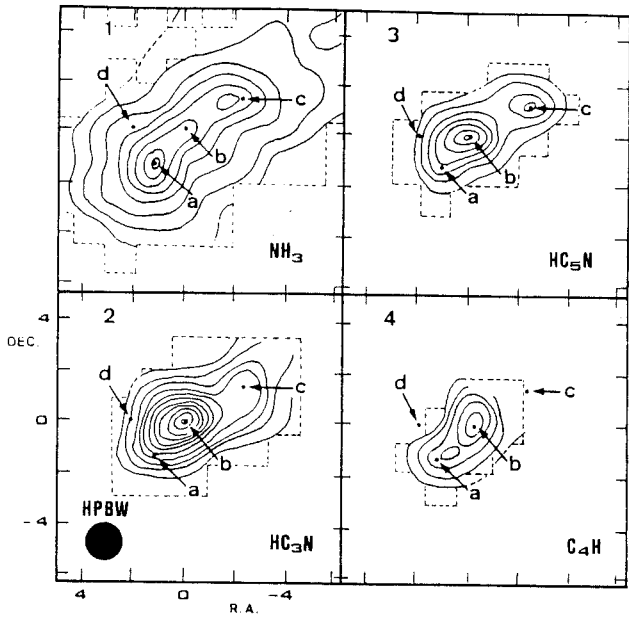

Fig. 2. Antenna temperature contours maps of the Northern cloulet (HCL2-C) for: (1) the (1,1) main line of ammonia, (2) the $J=2-1 F=3-2$ line of HC_3N , (3) the $J=8-7$ line of HC_5N , (4) the $N=2-1 J=5/2-3/2 F=3-2$ line of C_4H . The coordinates of the central position are $\alpha = 4^h 38^m 26.7^s$, $\delta = 25^\circ 55' 45''$. Positions a, b, c, d (see text) are denoted by points. Contour intervals are 0.1 K for NH_3 , 0.1 K for HC_3N , and 0.05 K for HC_5N and C_4H . The first contours are respectively 0.1 K (2σ), 0.2 K (3σ), 0.1 K (3σ) and 0.1 K (3σ). Data points were taken every $1/25 \times 1/25$ inside area delimited by the dashed lines

This line is observed in the ridge and is particularly strong in b ($T_4 = 1.0$ K). It is not detected in d, at the edge of the ridge, although the opacity of the $3-2$ line (and of the $2-1$ line averaged over a $2'$ beam), is only 2-3 times weaker than in b. From LVG calculations, we derive in b opacities for the $10-9$, $3-2$, and $2-1$ lines, of 2.1, 2.5, and 1.1; the two latter values are in reasonable agreement with those calculated from the hyperfine intensity ratios (3.3 and 0.7). Using the HC_3N-He collisional excitation rates of Green and Chapman (1978) scaled for collisions with H_2 , we find that n_{H_2} is $\approx 1 \cdot 10^4 \text{ cm}^{-3}$ in b, a value which agrees well with that calculated from NH_3 . The densities derived in the core and the envelope of the cloulet are similar to those in TMC1 (see e.g. Bujarrabal et al., 1981).

Having specified the physical conditions, we can estimate the molecular column densities in the ridge. Again in the LVG approximation, adopting the collisional cross sections of Green and Chapman and the scaling factors given by Bujarrabal et al. (1981), we derive at position b (see Table 5): $N(HC_3N) = 4 \cdot 10^{13} \text{ cm}^{-2}$, $N(HC_3N)/N(HC_5N) \sim 3$ and $N(HC_5N)/N(HC_7N) \sim 4$. The HC_3N column density is only a factor of ~ 2 lower than toward the HC_5N peak in TMC1, and the $C_n/C_{(n+2)}$ abundance ratios are the same as in TMC1 (Bujarrabal et al., 1981).

Other abundance ratios of interest for investigating the efficiency of molecular formation processes, are the ratios of HC_3N to C_3N , C_4H , and NH_3 . These ratios (assuming LVG and collisional excitation rates for C_4H and C_3N identical to those calculated by Green and Chapman for HC_3N) are found in b respectively equal to 10, 1/4, and 1/25, i.e., again comparable to those observed toward the TMC1- HC_5N peak (12, 1/3, 1/20

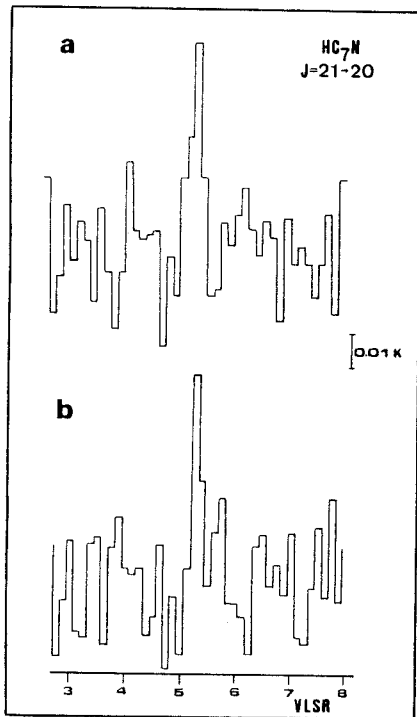

Fig. 3. The HC_7N spectra toward positions a and b of the Northern cloulet (HCL2-C)

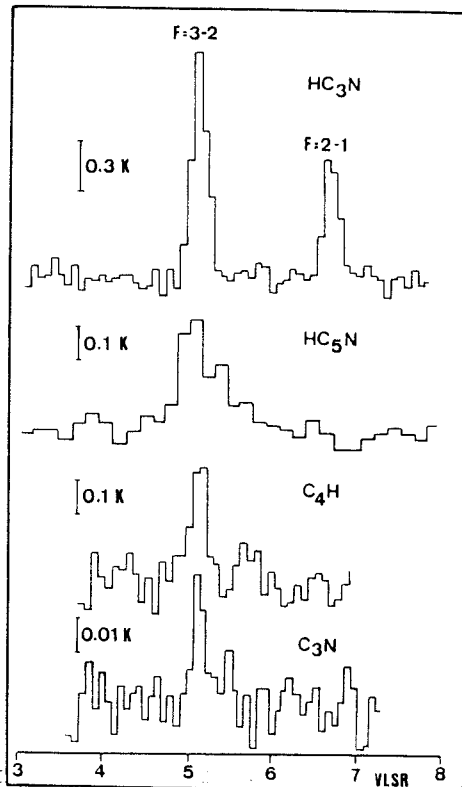

Fig. 4. The $HC_3N J=2-1 F=3-2$ and $F=2-1$, $HC_5N J=8-7$, $C_3N N=2-1 J=5/2-3/2 F=7/2-5/2$ and $C_4H N=2-1 J=5/2-3/2 F=3-2$ spectra toward position b of the Northern cloulet

Table 5. Physical parameters at selected positions

	T_K	n_{H_2} NH ₃	n_{H_2} HC ₃ N	$N(\text{NH}_3)$	$N(\text{HC}_3\text{N})$	$N(\text{HC}_5\text{N})$	$N(\text{C}_4\text{H})$	$N(\text{HC}_7\text{N})$	$N(\text{C}_3\text{N})$
	(K)	(cm ⁻³)		(cm ⁻²)					
HCL2-A									
e (0.00, 0.00)	9.0 ± 1.0	1.0 10 ⁴	2.0 10 ⁴	8.0 10 ¹⁴	1.0 10 ¹³	4.0 10 ¹²	2.0 10 ¹⁴		
f (0.00, 5.00)	9.0 ± 2.0 *		3.2 10 ⁴	1.6 10 ¹⁴ ±	1.6 10 ¹³	4.0 10 ¹²	1.6 10 ¹⁴		
f (0.00, 7.50)	9.0 ± 2.0 *		3.0 10 ⁴	1.6 10 ¹⁴	2.0 10 ¹³	4.0 10 ¹²	2.0 10 ¹⁴		
HCL2-B									
(0.00, 0.00)	9.0 ± 2.0	1.6 10 ⁴	≈ 2.0 10 ⁴	5.0 10 ¹⁴	1.3 10 ¹³	4.0 10 ¹²	1.0 10 ¹⁴	≈ 1.0 10 ¹²	
HCL2-C									
(2.50, -2.50)	9.0 ± 2.0 *	6.3 10 ³	1.3 10 ⁴	6.3 10 ¹⁴	1.0 10 ¹³				
(1.25, -2.50)	9.0 ± 2.0 *	1.3 10 ⁴		4.0 10 ¹⁴	≲ 8.0 10 ¹² +	1.6 10 ¹²	1.0 10 ¹⁴		
(2.50, -1.25)	9.0 ± 2.0 *	6.3 10 ³		8.0 10 ¹⁴	1.0 10 ¹³ +				
a (1.25, -1.25)	8.4 ± 0.5	4.0 10 ⁴		1.3 10 ¹⁵	4.0 10 ¹³ +	1.0 10 ¹³	3.1 10 ¹⁴	3.1 10 ¹²	
(0.00, -1.25)	9.0 ± 2.0 *	5.0 10 ³		8.0 10 ¹⁴	2.5 10 ¹³ +	4.0 10 ¹²	2.0 10 ¹⁴		
d (2.50, 0.00)	9.0 ± 2.0 *	5.0 10 ³		8.0 10 ¹⁴	1.6 10 ¹³ +	≲ 3.0 10 ¹²			
(1.25, 0.00)	9.0 ± 2.0 *	8.0 10 ³		1.0 10 ¹⁵	2.5 10 ¹³ +	8.0 10 ¹²	1.6 10 ¹⁴		
b (0.00, 0.00)	8.8 ± 0.5	1.3 10 ⁴	1.0 10 ⁴	1.0 10 ¹⁵	4.0 10 ¹³	1.3 10 ¹³	4.0 10 ¹⁴	3.2 10 ¹²	4.0 10 ¹²
(-1.25, 0.00)	9.0 ± 2.0 *	6.3 10 ³		6.3 10 ¹⁴	2.5 10 ¹³ +	6.3 10 ¹²	1.3 10 ¹⁴		
(-2.50, 0.00)	9.0 ± 2.0 *	3.0 10 ³		8.0 10 ¹⁴	1.6 10 ¹³ +	2.0 10 ¹²			
(0.00, 1.25)	9.0 ± 2.0 *	6.3 10 ³		8.0 10 ¹⁴	2.0 10 ¹³ +	4.0 10 ¹²	1.6 10 ¹⁴		
(-1.25, 1.25)	9.0 ± 2.0 *	2.0 10 ⁴		8.0 10 ¹⁴	1.6 10 ¹³ +	3.2 10 ¹²			
c (-2.50, 1.25)	9.0 ± 2.0 *	1.0 10 ⁴		6.3 10 ¹⁴	3.2 10 ¹³ +	6.3 10 ¹²			
(-2.50, 2.50)	9.0 ± 2.0 *					4.0 10 ¹²			
(-1.25, 2.50)	9.0 ± 2.0 *	1.0 10 ⁴		2.5 10 ¹⁴	≲ 8.0 10 ¹² +				
(0.00, 2.50)	9.0 ± 2.0 *	8.0 10 ³		4.0 10 ¹⁴	≲ 8.0 10 ¹² +				

Notes to Table 5: (+) From $n_{\text{H}_2}(\text{NH}_3)$. (=) From $n_{\text{H}_2}(\text{HC}_3\text{N})$, assuming NH₃ optically thin. (*) From CO $J = 1 - 0$ and $J = 2 - 1$ data (see text)

Guélin et al., 1982a; Tölle et al., 1981). The $N(\text{H}_2)$ column density toward **b** is estimated to be $\sim 7 \cdot 10^{21} \text{ cm}^{-2}$, using the $\text{C}^{18}\text{O } 2-1$ and $1-0$ intensities, and the $N(\text{C}^{18}\text{O})/A_v$ relation derived in Cloud 2 by Cernicharo and Guélin (1984). It is a factor of 1.5 smaller than that in the TMC1-HC₅N source ($\sim 10^{22} \text{ cm}^{-2}$ according to Cernicharo and Guélin) so that the fractional abundances of HC₃N, HC₅N, HC₇N, C₃N, and C₄H in **b** should be roughly equal to those in TMC1 (HC₃N) (see Table 5).

The HC₃N/HC₅N, HC₅N/HC₇N, and HC₃N/C₄H abundance ratios are the same in **a** as in **b**, while the NH₃/cyanopolyne ratio is found ~ 1.5 times larger in **a** – a marginal difference in view of the uncertainties on n_{H_2} and of possible radiative trapping in the NH₃ (1,1) line by the envelope.

In summary, we can say that the northern cloudlet appears in nearly all respects (geometry, physical conditions and molecular content) similar to TMC1, a source considered until now as unique. The northern cloudlet presents a broad “envelope”, not observed in NH₃ around TMC1. It should be noted, however, that no sensitive search for NH₃ emission has been reported outside the TMC1 ridge, and that HCO⁺ emission in this cloudlet presents a halo component (Guélin et al., 1982b).

IV. The western cloudlet (HCL2-A)

This cloudlet (HCL2-A on Fig. 1) lies west of the central hole of Cloud 2, in the middle of an extended region of high obscuration. It was detected with the Bordeaux telescope in C^{18}O , HCO⁺ and even H^{13}CO^+ .

The NH₃ (1,1) emission has a clumpy distribution showing at least three fragment (e, f, g see Fig. 5). This emission peaks on the

southernmost clump (g), at the position where H^{13}CO^+ was observed. We have detected the NH₃ (2,2) line in g and derive a gas kinetic temperature of 9 ± 1 K (Table 5). The total opacity of the (1,1) line is found to be ~ 8 , which, for $T_A(1,1) \sim 0.5$ K and a velocity dispersion $\Delta v \sim 0.30 \text{ km s}^{-1}$, leads to a gas density $n_{\text{H}_2} \sim 10^4 \text{ cm}^{-3}$. Although we did not detect the NH₃ (2,2) line toward the other fragments, we can estimate from the $1-0$ and $2-1$ ¹²CO (Cernicharo and Guélin, 1984) intensities their kinetic temperature to be also ≈ 9 K.

We have observed HC₃N, HC₅N, and C₄N toward the three fragments. We find, like in TMC1 and HCL2C, that the emission peak of these molecules is shifted with respect to that of NH₃ (by 5'–7' to the north, according to Fig. 5). Bujarrabal et al. (1981) have interpreted the shift of the NH₃ and cyanopolyne peaks in TMC1 as an effect of excitation. They point out that the HC₃N 10–9 line, unlike the easy to excite HC₃N 1–0 lines, does not peak toward the “cyanopolyne source” but toward the “NH₃ source”, which means that the latter has a higher density. Because of this higher density, the intensities of the NH₃ and H^{13}CO^+ line must be enhanced as is the 10–9 HC₃N line. Whether the enhancement is large enough to explain the peaking of the NH₃ lines $\approx 7'$ away from the cyanopolyne source, without a NH₃ to cyanopolyne abundance variation, remains however unclear in view of the uncertainties on the excitation parameters.

In the case of the western cloudlet, the situation is much clearer. There, the HC₃N 10–9 line peaks at the same place as the HC₃N 2–1 and 3–2 lines, (toward the northern source **e**), and the HC₃N 10–9/2–1 intensity ratio is larger toward **e** than toward the NH₃ peak **g**, which means that the gas density is higher in **e** (from the 10–9/2–1 and 10–9/3–2 intensity ratios, we derive $n_{\text{H}_2} = 3 \cdot 10^4 \text{ cm}^{-3}$ in **e**, and $2 \cdot 10^4 \text{ cm}^{-3}$ in **g**). This time, the effect of

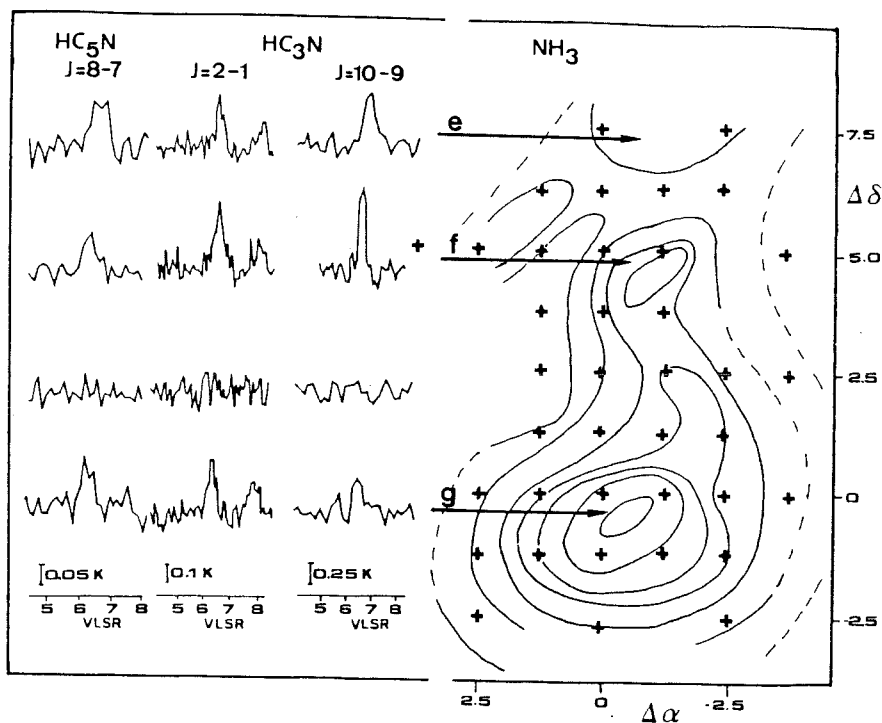

Fig. 5. Right: Antenna temperature contours of the (1,1) line of ammonia in the western cloulet (HCL2A: 0.0 is $\alpha = 4^h 36^m 36^s$, $\delta = 25^\circ 35' 45''$). Crosses indicate the positions observed. First contour is 0.15 K (3σ) and contour step is 0.05 K. Left: the $J = 2 - 1$, $J = 10 - 9$ lines of HC_3N , and the $J = 8 - 7$ line of HC_5N at selected positions. Cyanopolyyne column densities are found constant along the north-south strip ($\Delta\alpha = 0.0$), while the ammonia column density peaks to the south (point g)

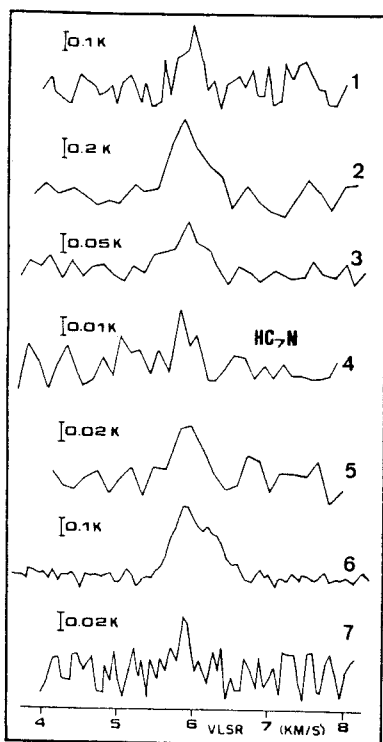

Fig. 6. Molecular lines towards the Northwest cloulet (HCL2B: $\alpha = 4^h 36^m 47^s$, $\delta = 25^\circ 58' 15''$): (1) $\text{HC}_3\text{N } J = 2 - 1, F = 3 - 2$; (2) $\text{HC}_3\text{N } J = 10 - 9$; (3) $\text{HC}_5\text{N } J = 8 - 7$; (4) $\text{HC}_7\text{N } J = 21 - 20$; (5) $\text{C}_4\text{H } N = 2 - 1$ (average of the hyperfine components); (6) $\text{NH}_3 (1,1)$ main line; and (7) $\text{NH}_3 (2,2)$. Vertical bars are calibrated in antenna temperature

density is to enhance the NH_3 and H^{13}CO^+ intensities in the "cyanopolyyne source" e where, yet, they are observed to be weaker. It thus seems hard to avoid the conclusion that NH_3 must be relatively less abundant in e than in g. From LVG calculations we derive $\text{NH}_3/\text{HC}_3\text{N} = 8$ in e, and a value 10 times larger in g (see Table 1). The $\text{HC}_3\text{N}/\text{HC}_5\text{N}$ and $\text{HC}_3\text{N}/\text{C}_4\text{H}$ abundance ratios (4 and 1/16), within a factor of 2, are the same in the two clumps.

V. The northwest cloulet (HCL2-B)

Besides TMC1, this is the third fragment of HCL2, where we have detected H^{13}CO^+ at Bordeaux. This cloulet (HCL2-B in Fig. 1) was also observed in $^{12}\text{CO} (2-1 \text{ and } 1-0)$, $\text{C}^{18}\text{O} (1-0)$, $\text{NH}_3 (1,1)$ $\text{NH}_3 (2,2)$, $\text{HC}_3\text{N} (2-1, 3-2, \text{ and } 10-9)$, $\text{HC}_5\text{N} (8-7)$, $\text{C}_4\text{H} (2-1)$, and marginally detected in $\text{HC}_7\text{N} (3\sigma \text{ detection - see Fig. 6.4})$. The NH_3 source, according to our north-south strip maps, has a compact core ($\leq 2'$) and a weak, extended envelope. Toward the core, we have detected the (1,1) and (2,2) lines and derived a kinetic temperature of $9.0 \pm 2 \text{ K}$, in good agreement with the excitation temperature of the $^{12}\text{CO } 2-1$ line. The $\text{HC}_3\text{N } 10-9$ emission is restricted to the NH_3 core, while the $3-2$ one, which also peaks on the NH_3 core, extends at least $5'$ to the north. The core density is $\approx 1.5 \cdot 10^4$ according to the NH_3 data and $1 - 5 \cdot 10^4$ from the HC_3N data. The $\text{NH}_3/\text{HC}_3\text{N}$ ratio is found equal to ~ 40 , the $\text{HC}_3\text{N}/\text{HC}_5\text{N}$ ratio is ~ 3 and the $\text{HC}_5\text{N}/\text{HC}_7\text{N}$ ratio is ~ 4 (see Table 5).

Conclusions

The physical conditions derived in the cores of our 3 cloulets are remarkably similar to those in TMC1: kinetic temperature of $8 - 10 \text{ K}$, densities $\approx 1 - 4 \cdot 10^4 \text{ cm}^{-3}$. This similarity, of course, partly reflects our selection criterium, the detection of $\text{H}^{13}\text{CO}^+ J = 1 - 0$, since this line would be hard to excite at densities $\leq 10^4 \text{ cm}^{-3}$.

The abundances of HC_3N and C_4H , relative to that of HC_3N (as those of HC_7N and C_3N , wherever these species are detected), are found constant within a factor of 2 and the same as in TMC1, a result which is consistent with previous studies of cyanopolyynes abundances in dense cold clouds (Bujarrabal et al., 1981; Guélin et al., 1982). On the other hand, the abundance of NH_3 relative to HC_3N , (and thus to all the cyanopolyynes), appears to vary from one cloudlet to the other, and, at least in one cloudlet, appears to change by a factor of ~ 10 over $7'$ (0.2 pc for a distance to HCL2 of 100 pc). A similar variation of the $\text{HC}_3\text{N}/\text{NH}_3$ abundance ratio was proposed by Little et al. (1979) and Tölle et al. (1981) to explain the difference between the NH_3 and HC_3N intensity distributions in TMC1 (in that case, however, the situation was less clear, since the $\text{NH}_3/\text{HC}_3\text{N}$ intensity variations were at least partly due to a change in excitation conditions).

If molecular abundance variations across distances as small as 0.2 pc seem now better established, their cause remains unclear, as the gas temperature appears constant throughout HCL2-A and TMC1, and as the density in HCL2-A changes only by a factor of two between clumps e and g.

Further studies of the structure of HCL2 are under progress and will be reported elsewhere (Cernicharo and Guélin, 1984).

Acknowledgements. We thank J. Uson and D.T. Wilkinson who kindly observed for us the C_3N 2-1 line in HCL2-C and NH_3 (2,2) and HC_7N in HCL2-B, and P. Friberg for assistance in the HC_3N 3-2 observations. L. Mundy kindly communicated his results on the $J=12-11$ line of HC_3N prior to publication.

References

- Benson, P.J., Myers, P.C.: 1980, *Astrophys. J. Letters* **242**, L87
 Benson, P.J., Myers, P.C.: 1983, *Astrophys. J.* **270**, 589

- Brotten, N.W., Oka, T., Avery, L.W., MacLeod, J.M., Kroto, H.W.: 1978, *Astrophys. J. Letters* **223**, L105
 Brotten, N.W., MacLeod, J.M., Avery, L.W., Irvine, W.M., Höglund, B., Friberg, P., Hjalmarson, Å.: 1984, *Astrophys. J. Letters* **276**, L25
 Bujarrabal, V., Guélin, M., Morris, M., Thaddeus, P.: 1981, *Astron. Astrophys.* **99**, 239
 Cernicharo, J.: 1981, Premier colloque du Groupe de Radio-astronomie Millimétrique, Observatoire de Bordeaux, Mars 1981
 Cernicharo, J.: 1983, Deuxième colloque du Groupe de Radio-astronomie Millimétrique, Observatoire de Bordeaux, Mars 1983
 Cernicharo, J., Bachiller, R.: 1984 to be published in *Astron. & Astrophysics Suppl. Series*
 Cernicharo, J., Guélin, M.: 1984 (in preparation)
 Churchwell, E., Winnewisser, G., Walmsley, C.M.: 1978, *Astron. Astrophys.* **67**, 139
 Green, S.: 1983 (preprint)
 Green, S., Chapman, S.: 1978, *Astrophys. J. Suppl.* **37**, 169
 Guélin, M., Friberg, P., Mezaoui, A.: 1982a, *Astron. Astrophys.* **109**, 23
 Guélin, M., Langer, W.D., Wilson, R.W.: 1982b, *Astron. Astrophys.* **107**, 107
 Little, L.T., Macdonald, G.H., Riley, P.W., Matheson, D.N.: 1978, *Monthly Notices Roy. Astron. Soc.* **183**, 45 P
 Little, L.T., Macdonald, G.H., Riley, P.W., Matheson, D.N.: 1979, *Monthly Notices Roy. Astron. Soc.* **189**, 539
 Myers, P.C., Ho, P.T.P., Benson, P.J.: 1979, *Astrophys. J. Letters* **233**, L141
 Tölle, F., Ungerechts, H., Walmsley, C.M., Winnewisser, G., Churchwell, E.: 1981, *Astron. Astrophys.* **95**, 143
 Ungerechts, H., Walmsley, C.M., Winnewisser, G.: 1980, *Astron. Astrophys.* **88**, 259
 Walmsley, C.M., Winnewisser, G., Tölle, F.: 1980, *Astron. Astrophys.* **81**, 245
 Walmsley, C.M., Ungerechts, H.: 1983, *Astron. Astrophys.* **122**, 164

I.07) NOUVELLES SOURCES DE CYANOPOLYINES DANS LE TAUREAU

I.07) NOUVELLES SOURCES DE CYANOPOLYINES DANS LE TAUREAU

Nous avons détecté la transition $J=17-16$ de HC_7N dans six condensations du complexe des nuages sombres du Taureau. La densité projetée de HC_7N sur la ligne de visée de ces condensations est comprise entre $0.8 \cdot 10^{12}$ et $4.0 \cdot 10^{12} \text{ cm}^{-2}$, c'est à dire, 4-20 fois plus petite que dans la direction de TMCl . Cependant, le rapport de densités projetées de HC_5N et HC_7N , $N(\text{HC}_5\text{N})/N(\text{HC}_7\text{N})$, est de 3.6, c'est à dire, similaire à celui de TMCl . Ce rapport d'abondances varie très peu de nuage à nuage quelque soit la densité projetée totale des cyanopolyines. Une des condensations étudiées est une nouvelle source de cyanopolyines et ses conditions physiques et chimiques ont été déterminées à partir d'observations de NH_3 , HC_3N et HC_5N .

New HC₇N cloudlets in Taurus

J. Cernicharo, R. Bachiller*, and G. Duvert**

Groupe d'Astrophysique, CERMO, Université Scientifique et Médicale de Grenoble, U.A. 708 du CNRS, B. P. 68, F-38402 St. Martin d'Hères Cedex, France

Received November 4, accepted December 4, 1985

Summary. We report the detection of the $J = 17 - 16$ line of HC₇N towards six cloudlets of the Taurus dark clouds complex. The HC₇N column densities towards these globules range between $0.8 \cdot 10^{12}$ and $4 \cdot 10^{12} \text{ cm}^{-2}$, i.e., 4–20 times lower than towards TMC1. However, the average column density ratio $N(\text{HC}_5\text{N})/N(\text{HC}_7\text{N})$ is 3.6, i.e., similar to the TMC1 one. Little variations of this abundance ratio are found from cloud to cloud whatever the total cyanopolyne column density is. One of these cloudlets, L1495, is a new cyanopolyne source and physical conditions towards it are derived from NH₃, HC₃N, and HC₅N observations.

Key words: interstellar: molecules (cyanopolyynes), abundances – nebulae individual: Taurus

1. Introduction

The Taurus complex of dark clouds is characterized by an unusually strong emission from rotational lines of cyanopolyynes (HC_{2n+1}N). The lightest member of this carbon chain family, HC₃N (Turner, 1971), has been observed towards a large variety of molecular clouds and stellar envelopes. Since its detection towards TMC1 by Morris et al. (1976), other long carbon chains have been observed towards this source: HC₅N (Little et al., 1977), HC₇N (Kroto et al., 1978), HC₉N (Brotten et al., 1978), and HC₁₁N (Bell and Matthews, 1985). Cyanobutadiyne, HC₅N (Avery et al., 1976), is also observed towards several molecular clouds presenting different physical conditions. However, the Taurus complex has the largest spatial density of HC₅N sources (Benson and Myers, 1980, 1983). Cyanohexatriyne, HC₇N, has only been observed in three cloudlets in Taurus: TMC1 (Kroto et al., 1978), TMC2 (Little et al., 1978) and HCL2-C (Cernicharo et al., 1984, henceforth referred as Paper I) and towards the molecular envelope of IRC + 10216 (Winnewisser and Walmsley, 1978). The other carbon chains have until now been observed only in TMC1 (see above) and towards IRC + 10216 (Bell et al., 1982).

Current chemical models fail to explain the observed cyanopolyne abundances, due to ignorance of the dominant reactions for carbon chain formation. Moreover, the observed spatial

variations of the cyanopolyne abundances, relative to ammonia, show a rather complicated behaviour: for apparent similar physical conditions (density, temperature) these abundance ratios change in some Taurus cloudlets by a factor of ≈ 10 over scales of 0.2 pc (Bujarrabal et al., 1981; Tölle et al., 1981, Paper I). Finally, the ratio $R_{2n+1, 2n+3} = x(\text{HC}_{2n+1}\text{N})/x(\text{HC}_{2n+3}\text{N})$ has been determined to be roughly constant with n for n as high as 4 in TMC1 (Bell and Matthews, 1985). However, the $R_{3,5}$ ratio is larger by at least a factor of four towards Ori-A (Bujarrabal et al., 1981). $R_{2n+1, 2n+3}$ should be a function of the cloud's age, density and chemistry (Leung et al., 1984; Millar and Freeman, 1984; Stahler, 1984).

It therefore seems that more observational input is necessary to understand whether the observed cyanopolyne abundances and the $R_{2n+1, 2n+3}$ ratios are related to special physical and chemical conditions in a few Taurus sources (TMC1, TMC2, HCL2-C) or to some peculiarities of the whole Taurus complex.

In this paper we report the detection of HC₇N towards six cloudlets pertaining to different clouds of the Taurus complex. We derive a constant $R_{5,7}$ ratio of $\approx 3.6 \pm 0.7$ for all the observed cloudlets. The observed HC₇N column densities are a factor 4 to 20 lower than towards TMC1.

2. Observations and results

The HC₇N observations were carried out with the 42-m NRAO¹ telescope in January 1985. The half power beamwidth of the NRAO telescope was $\approx 1'.6$, but the actual resolution is somewhat poorer due to the sidelobes which distort the telescope response pattern at high frequencies. To keep the beam as clean as possible, we restricted our observations to ± 3.5 h from transit and we selected the lowest frequency HC₇N line ($J = 17 - 16$) within the maser band of the 42-m NRAO telescope. Receiver temperature was 40–45 K. Pointing and focus were checked every 2 h against the quasar 3C84. The observations used a 1024 channel Mark IV autocorrelator with a spectral resolution of 0.038 km s^{-1} . Observed spectra were smoothed to 0.076 km s^{-1} to improve the signal-to-noise ratio. All observations were made in frequency switching mode.

Due to the expected weakness of HC₇N emission, our sources were selected on the basis of their HC₅N emission: L1544, L1521-B, TMC-1C, and L1512 are all known to have large HC₅N

Send offprint requests to: J. Cernicharo

* Present address: Observatorio Astronómico Nacional, Alfonso XII, 3, E-28014 Madrid, Spain

** Also at the Sterrewacht Leiden, Postbus 9513, NL-2300 RA Leiden, The Netherlands

¹ The National Radio Astronomy Observatory is operated by Associated Universities, Inc., under contract to the National Science Foundation

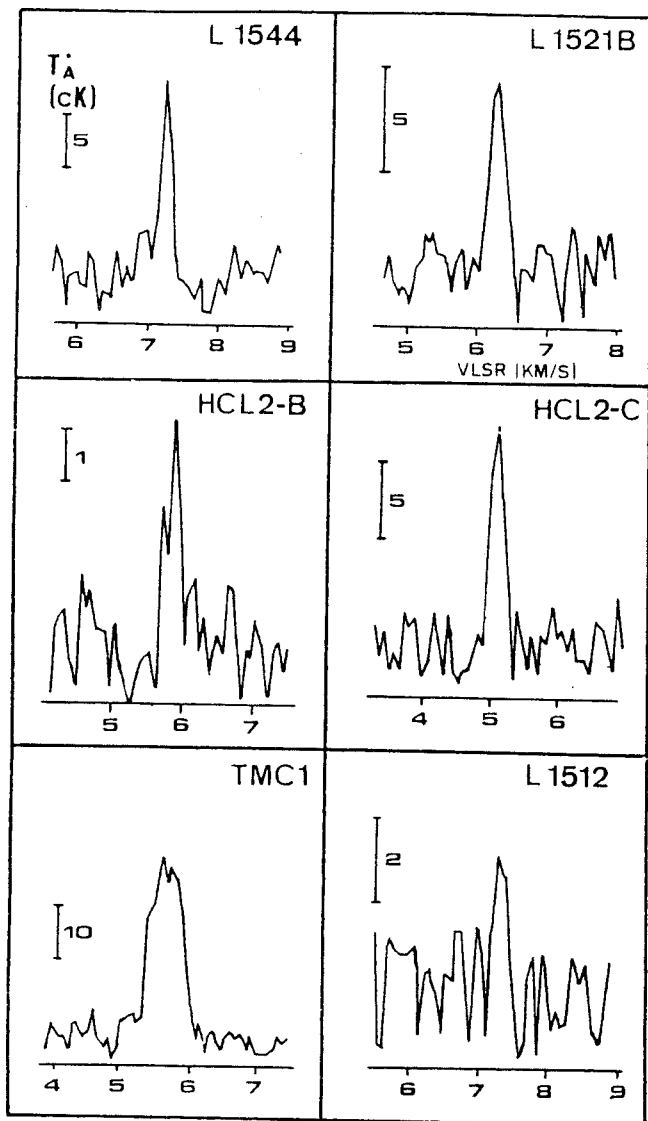

Fig. 1. Observed HC_7N ($J=17-16$) spectra in Taurus cloudlets. Vertical bars indicate antenna temperature (in units of 10^{-2} K). Velocity resolution is 0.076 km s^{-1} (see text)

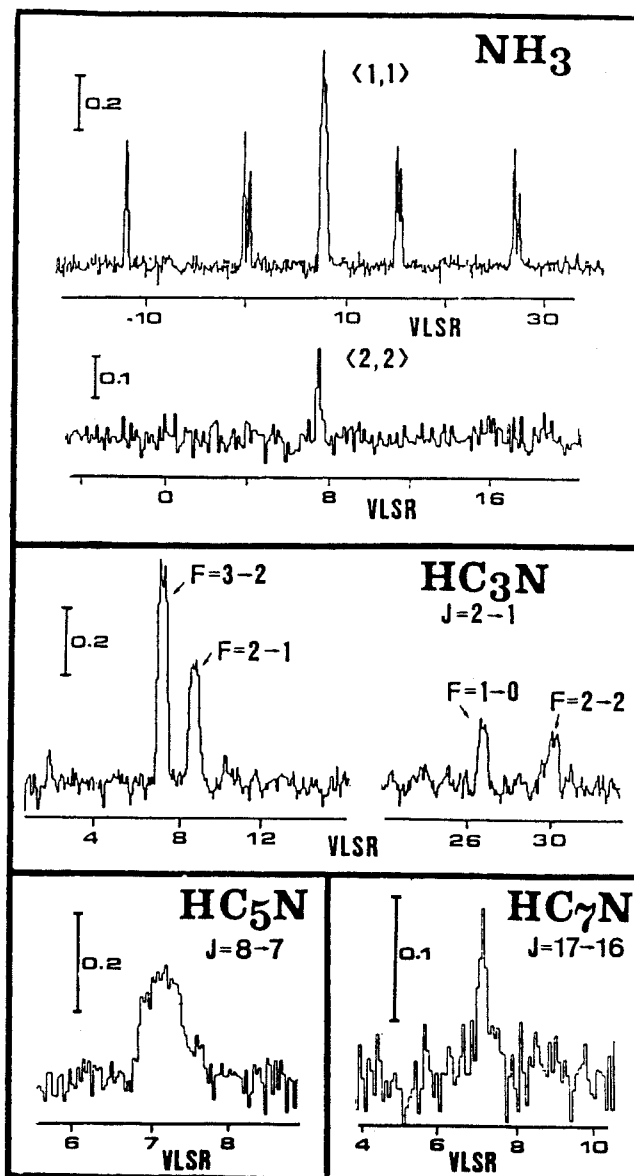

Fig. 2a-d. Observed spectra towards L 1495 (C^{18}O peak, see text). Vertical bars indicate antenna temperature (K). a NH_3 (1,1) and (2,2) lines; spectral resolution is 0.12 km s^{-1} . b Hyperfine components of the HC_3N $J=2-1$ line; spectral resolution is 0.08 km s^{-1} . c HC_5N ($J=8-7$); spectral resolution is 0.034 km s^{-1} . d HC_7N ($J=17-16$); spectral resolution is 0.076 km s^{-1} (see text)

column densities (Benson and Myers, 1983; Paper I; Snell et al., 1981); HCL2-B is a small globule embedded in Heiles cloud 2 where a 3σ HC_7N detection has been reported (see Paper I). Observed parameters of the HC_7N $J=17-16$ line are listed in Table 1 and resulting spectra are displayed in Fig. 1. TMC1 was observed in the same HC_7N line and in the $J=8-7$ line of HC_5N as reference source. The resulting HC_7N data have been added to Fig. 1 and Table 1.

In addition to these sources we have observed NH_3 (1,1) and (2,2), HC_3N ($J=2-1$), HC_5N ($J=8-7$) and HC_7N ($J=17-16$) towards L 1495, a large cloud northwest of Heiles's Cloud 2, where strong C^{18}O emission has been detected with the 2.5-m telescope of the Bordeaux Observatory (Duvert et al., 1986). The ammonia observations towards this cloud were made in position switching

mode with a spectral resolution of 0.12 km s^{-1} . Previously Benson and Myers (1983) had searched for the $J=8-7$ line of HC_5N one degree away from the C^{18}O peak. They had detected HC_5N in one among five observed positions with $T_A^* = 0.05 \text{ K}$. However, towards the C^{18}O peak HC_5N is as strong ($T_A^* \approx 0.3 \text{ K}$) as towards L 1544, L 1521-B or HCL2-C (Myers et al., 1979, Paper I). The NH_3 and cyanopolyynes spectra towards L 1495 are given in Fig. 2.

From the ammonia spectra of Fig. 2 and assuming equal excitation temperature for all these lines (see Ungerechts et al., 1980) we derive for L 1495 $T_k = 10 \pm 0.3 \text{ K}$, $n(\text{H}_2) = 1.5 \cdot 10^4 \text{ cm}^{-3}$ and $N(\text{NH}_3) = 5 \cdot 10^{14} \text{ cm}^{-2}$, i.e., typical values of kinetic temperature and density in Taurus cloudlets. The HC_3N column density towards L 1495 can be derived using a LVG code and the collisional cross sections for HC_3N of Green and Chapman (1978).

Table 1. Observed $J=17-16$ HC₇N^a parameters

Source	$\alpha(1950)$	$\delta(1950)$	T_A^a	Δv	V_{LSR}	rms ^b
L1544	5 ^h 01 ^m 14.0	25°07'00"	0.19	0.17	7.21	0.025
L1521-B	4 ^h 21 ^m 8.5	26°30'00"	0.10	0.27	6.35	0.013
L1512	5 ^h 00 ^m 54.4	32°39'00"	0.04	0.20	7.10	0.010
L1495 ^c	4 ^h 15 ^m 24.6	28°19'51"	0.13	0.32	7.20	0.023
HCL2-B	4 ^h 36 ^m 47.0	25°58'15"	0.05	0.18	5.89	0.007
TMC1-C	4 ^h 38 ^m 30.0	25°55'00"	0.14	0.23	5.14	0.015
TMC1	4 ^h 38 ^m 38.0	25°35'45"	0.36	0.43	5.68	0.030

^a $\nu(\text{HC}_7\text{N}, J=17-16) = 19175.950$ MHz

^b The rms is the noise in the off-line channels. Δv is the full width of the line at half intensity in km s^{-1} . V_{LSR} is in km s^{-1} . T_A^* is the peak antenna temperature in Kelvin

^c This source has been also observed in the $J=8-7$ line of HC₅N ($\nu = 21301.247$ MHz), in the $J=2-1$ hyperfine lines of HC₃N ($F=2-2$, $\nu = 18194.9206$ MHz, $F=1-0$, $\nu = 18195.3176$ MHz, $F=2-1$, $\nu = 18196.2183$, $F=3-2$, $\nu = 18196.3119$ MHz), and in the (1, 1) and (2, 2) lines of NH₃ (see text)

Table 2. HC₇N and HC₅N column densities

Source	$N(\text{HC}_7\text{N})$	Ref.	$N(\text{HC}_5\text{N})$	Ref.	$N(\text{HC}_5\text{N})/N(\text{HC}_7\text{N})$
L1544	$2.9 \cdot 10^{12}$	1	$1.3 \cdot 10^{13}$	5	4.4
L1521-B	$2.4 \cdot 10^{12}$	1	$0.7 \cdot 10^{13}$	5	3.0
L1512	$\approx 0.8 \cdot 10^{12}$	1	$0.3 \cdot 10^{13}$	2*	3.7
L1495	$3.8 \cdot 10^{12}$	1	$1.2 \cdot 10^{13}$	1	3.1
HCL2-B	$0.8 \cdot 10^{12}$	1	$0.4 \cdot 10^{13}$	3	5.0
HCL2-Ca	$3.1 \cdot 10^{12}$	3	$1.0 \cdot 10^{13}$	3	3.2
HCL2-Cb	$3.2 \cdot 10^{12}$	3	$1.3 \cdot 10^{13}$	3	4.0
TMC1-C ^a	$2.9 \cdot 10^{12}$	1	$1.0 \cdot 10^{13}$	2	3.4
TMC1	$1.4 \cdot 10^{13}$	1	$3.5 \cdot 10^{13}$	1	2.5
TMC2	$3.0 \cdot 10^{12}$	4	$1.2 \cdot 10^{13}$	4	3.1
Average					3.6 ± 0.7

References: 1) This work (the adopted value for T_K is 10 K). 2) Benson and Myers (1983). 2*) $\int T_B \cdot dv$ from Table 1 of Benson and Myers (1983). 3) Paper I. 4) For TMC2 we have used the data of Bujarrabal et al. (1981) and their one-component transfert model to derive HC₅N and HC₇N column densities, which have been multiplied by a factor ≈ 2 to be normalised to the 42-m NRAO telescope beam efficiency adopted by Benson and Myers (1983) and in Paper I. 5) $\int T_B \cdot dv$ from Myers et al. (1979).

^a This source (Benson and Myers, 1983) corresponds to HCL2-C in Paper I. The observed position is roughly 1' away of HCL2-Ca, b

We obtain $N(\text{HC}_3\text{N}) = 5 \cdot 10^{13} \text{ cm}^{-2}$ and $N(\text{NH}_3)/N(\text{HC}_3\text{N}) = 10$. For HC₅N we derive (see below) $N(\text{HC}_5\text{N}) = 1.2 \cdot 10^{13} \text{ cm}^{-2}$ and $N(\text{HC}_3\text{N})/N(\text{HC}_5\text{N}) = 4$. These abundance ratios are similar to those found in other Taurus cloudlets (Paper I).

Due to the expected large collisional cross sections of HC₅N and HC₇N, the population of the rotational levels of these molecules should be thermalized as soon as the molecular hydrogen density is larger than a few 10^3 cm^{-3} , a condition completely fulfilled in the cores of dark clouds. Assuming LTE and $T_K = 10$ K (Benson and Myers, 1983, Paper I) we derive straightforwardly $N(\text{HC}_7\text{N}) = 2.3 \cdot 10^{13} \cdot \int T_B(J=17-16) \cdot dv \text{ cm}^{-2}$ and $N(\text{HC}_5\text{N}) = 1.8 \cdot 10^{13} \cdot \int T_B(J=8-7) \cdot dv \text{ cm}^{-2}$. The derived column densities are given in Table 2. In order to check the validity of this approximation we have also calculated the HC₅N and HC₇N

column densities using a LVG code and the collisional cross sections for HC₃N (Green and Chapman, 1978) with the scaling factors given by Bujarrabal et al. (1981). Using the molecular hydrogen densities for these clouds given in Paper I and Myers and Benson (1983) we derive, as expected for densities $> 10^4 \text{ cm}^{-3}$, the same HC₇N and HC₅N column densities as in the LTE approximation.

3. Discussion

The ratio $R_{3,5}$ for Taurus clouds can be found to be 4.4 ± 1.1 from data of Paper I (including the Bujarrabal et al. observations of TMC1 and TMC2). From the data presented here (Table 2), we

derive $R_{5,7} = 3.6 \pm 0.7$, where the uncertainty is the rms of the data of Table 2. The cyanopolyynes data used to derive these ratios come from observations with the same telescope and at similar frequencies. Consequently, even if the beam filling factor is less than 1, the uncertainty on the derived ratios is probably low if we assume that the two molecules coexist spatially. However, this point needs a more precise study because the presence of a core-envelope structure towards cyanopolyynes sources could substantially modify the derived ratios (see Bujarrabal et al., 1981). In any case it is worth to note that the $R_{5,7}$ ratio is better determined than the $R_{3,5}$ one because: (i) the HC_3N lines, for typical conditions in Taurus cyanopolyynes sources, are not optically thin; (ii) the rotational levels of HC_3N are not thermalized for moderate densities.

The two ratios given above suggest a constant abundance ratio $R_{2n+1,2n+3} \approx 4$ for the Taurus clouds. This ratio seems to be independent of the cyanopolyynes HC_{2n+1}N column densities. If the cyanopolyynes HC_{2n+1}N abundance depends on the HC_{2n-1}N one, as suggested by Huntress (1977) and Walmsley et al. (1980), then, one could expect $R_{2n+1,2n+3}$ to increase with the index n until molecular abundances reach equilibrium. Stahler (1984) has suggested that the observed $R_{2n+1,2n+3}$ ratios could be used as a tracer of the cloud age. Our results show that these ratios are constant (at least until $n=3$) and then, if main path to cyanopolyynes formation is sequential, that all the Taurus clouds should have the same age. From the time-dependent chemical model of Leung et al. (1984) it can be seen that agreement between calculated and observed HC_3N and HC_5N abundances is obtained only for times \approx few 10^5 y and densities $\approx 10^5 \text{ cm}^{-3}$. For a time of 10^7 y, i.e. steady-state, their model fails to explain the observed cyanopolyynes abundances in Taurus by several orders of magnitude. However, Millar and Freeman (1984) using a different path to form cyanopolynes, and in a steady-state chemical model, have derived a good agreement between observed and calculated HC_3N column densities towards TMC1. In the Leung et al. model, cyanopolynes are abundant only if the C I abundance is high and if the $[\text{C}]/[\text{CO}]$ ratio is ≈ 1 . It is interesting to note that the Taurus clouds seem to have a lower (a factor of 2) ^{13}CO abundance than the dark clouds in Perseus (Cernicharo and Guélin, 1986; Bachiller and Cernicharo, 1986a) and that the cyanopolyynes abundance in Perseus clouds is lower than in Taurus, for roughly the same physical conditions, by a factor ≈ 10 (Bachiller and Cernicharo, 1986b). In the Perseus clouds we also measured $R_{3,5} \geq 6$ (Bachiller and Cernicharo, 1984, 1986b).

We conclude that the long carbon chain sources are uniformly distributed through the Taurus complex. The $R_{5,7}$ ratio is constant and ≈ 4 . A detailed comparative study of several complex of dark clouds could permit to determine what physical conditions should be related to the high cyanopolyynes abundances in Taurus. HC_9N should be easily detected towards these new HC_7N sources.

References

- Avery, L.W., Broten N.W., MacLeod, J.M., Oka, T., Kroto, H.W.: 1976, *Astrophys. J. Letters* **205**, L173.
- Bachiller, R., Cernicharo, J.: 1984, *Astron. Astrophys.* **140**, 414
- Bachiller, R., Cernicharo, J.: 1986a, b, *Astron. Astrophys.* (in press)
- Bell, M.B., Feldman, P.A., Kwok, S., Matthews, H.E.: 1982, *Nature* **295**, 389
- Bell, M.B., Matthews, H.E.: 1985, *Astrophys. J. Letters* **291**, L63
- Benson, P.J., Myers, P.C.: 1980, *Astrophys. J. Letters* **242**, L87
- Benson, P.J., Myers, P.C.: 1983, *Astrophys. J.* **270**, 589
- Broten, N.W., Oka, T., Avery, L.W., MacLeod, J.M., Kroto, H.W.: 1978, *Astrophys. J. Letters* **223**, L105
- Bujarrabal, V., Guélin, M., Morris, M., Thaddeus, P.: 1981, *Astron. Astrophys.* **99**, 239
- Cernicharo, J., Guélin, M., and Askne, J.: 1984, *Astron. Astrophys.* **138**, 371 (Paper I)
- Cernicharo, J., Guélin, M.: 1986, *Astron. Astrophys.* (submitted)
- Duvert, G., Cernicharo, J., Baudry, A.: 1986 (in press)
- Green, S., Chapman, S.: 1978, *Astrophys. J. Suppl.* **37**, 169
- Huntress, W.T.: 1977, *Astrophys. J. Suppl.* **33**, 495
- Kroto, H.W., Kirby, C., Walton, D.R.M., Avery, L.W., Broten, N.W., MacLeod, J.M., Oka, T.: 1978, *Astrophys. J.* **219**, L133
- Leung, C.M., Herbst, E., Huebner, W.F.: 1984, *Astrophys. J. Suppl. Series* **56**, 231
- Little, L.T., Riley, P.W., Matheson, D.N.: 1977, *Monthly Notices Roy. Astron. Soc.* **181**, 33P
- Little, L.T., MacDonald, G.H., Riley, P.W., Matheson, D.N.: 1978, *Monthly Notices Roy. Astron. Soc.* **183**, 45P
- Millar, T.J., Freeman, A.: 1984, *Monthly Notices Roy. Astron. Soc.* **207**, 405
- Morris, M., Turner, B.E., Palmer, P., Zuckerman, B.: 1976, *Astrophys. J.*, **205**, 82
- Myers, P.C., Ho, P.T.P., Benson, P.J.: 1979, *Astrophys. J. Letters* **233**, L141
- Myers, P.C., Benson, P.J.: 1983, *Astrophys. J.* **266**, 309
- Snell, R.L., Schloerb, F.P., Young, J.S., Hjalmarson, Å., Friberg, P.: 1981, *Astrophys. J.* **244**, 45
- Stahler, S.W.: 1984, *Astrophys. J.* **281**, 209
- Töle, F., Ungerrechts, H., Walmsley, C.M., Winnewisser, G., Churchwell, E.: 1981, *Astron. Astrophys.* **95**, 143
- Turner, B.E.: 1971, *Astrophys. J. Letters* **163**, L35
- Ungerrechts, H., Walmsley, M.C., Winnewisser, G.: 1980, *Astron. Astrophys.* **88**, 259
- Walmsley, C.M., Winnewisser, G., Toelle, F.: 1980, *Astron. Astrophys.* **81**, 245
- Winnewisser, G., Walmsley, C.M.: 1978, *Astron. Astrophys.* **70**, L37

I.08) ANOMALIES HYPERFINES DE HCN A GRANDE ECHELLE

I.08) ANOMALIES HYPERFINES DE HCN A GRANDE ECHELLE

Nous avons observé la transition $J=1-0$ de HCN dans Heiles Cloud 2 (HCL2). Une surface d'un demi degré carré a été cartographiée dans l'émission de cette molécule avec le radiotélescope de Bordeaux. Dans chaque position observée les deux rapports, $R_{02}=I(F=0-1)/I(F=2-1)$ et $R_{12}=I(F=1-1)/I(F=2-1)$, sont loin de leur valeur à l'ETL et montrent une distribution spatiale compliquée. Nous suggérons que l'absorption et la diffusion dans une enveloppe de faible densité du rayonnement émis dans les régions denses est responsable du comportement observé de l'émission de HCN. Il y a quelques évidences pour des changements de l'abondance de HCN de source à source.

*Letter to the Editor***Large-scale HCN hyperfine anomalies**

J. Cernicharo, A. Castets, G. Duvert, and S. Guilloteau

Groupe d'Astrophysique, ERA No. 961 du C.N.R.S., Université de Grenoble, CERMO, BP 68, F-38402 St. Martin d'Hères, France

Received June 28, accepted August 7, 1984

ABSTRACT

We report observations of the $J=1-0$ line of HCN in Heiles Cloud 2 (HCL2). About half a square degree was mapped in the emission of this line. In each observed position the two ratios $R_{02}=I(F=0-1)/I(F=2-1)$ and $R_{12}=I(F=1-1)/I(F=2-1)$ are far from their LTE values, and they show a complicated spatial distribution. We suggest that absorption and diffusion of the radiation emitted from the core in a low density envelope is responsible for the observed behaviour of the HCN emission. There is some evidence that the HCN abundance changes from source to source.

Key words : Interstellar : molecules, abundances. Nebulae individual : HCL2, Taurus.

I INTRODUCTION

Rotational transitions of molecules with high dipole moment are useful probes of high density regions of interstellar clouds. However, the mechanisms of line formation in cold dark clouds are poorly understood. Low density foreground gas is responsible for the absorption of the radiation from the densest regions. The optically thick lines are mainly formed in these low density regions or "envelopes" (Cernicharo and Guélin, 1984, henceforth referred to as CG). Observational evidence for anomalous isotopic intensities in the transitions of the polar molecules $H^{13}CO^+$, $HN^{13}C$ and $H^{13}CN$ relative to HCO^+ , HNC and HCN have been reported by Langer et al (1978), Frerking et al (1979) and Irvine and Schloerb (1984). These anomalies have been also observed in the emission of DCO^+ and DNC (see for example Guélin et al (1982), Wootten et al (1982), Snell and Wootten (1979)) and have been interpreted in terms of chemical fractionation and opacity in the lines.

Anomalies in the relative intensities of the hyperfine components of the $J=1-0$ line of HCN have been observed in warm and cold molecular clouds (Gottlieb et al (1975), Baudry et al (1980) and Walmsley et al (1982)). Guilloteau and Baudry (1981) have shown that thermal overlap effects in the hyperfine components of the transitions of $J>1$ are responsible for some of the observed HCN anomalies in warm molecular clouds. The velocity shift between the $F=2-1$ and $F=3-2$ hyperfine components of the $J=2-1$ line of HCN is only ≈ 0.4 km/s, i. e. comparable to the velocity dispersion in cold dark clouds. Consequently the predicted anomalies for these clouds would be

similar to those observed in warm molecular clouds : the $F=0-1$ and $F=1-1$ components of the $J=1-0$ triplet should be weakened and the $F=2-1$ enhanced; the ratios $R_{02}=I(F=0-1)/I(F=2-1)$ and $R_{12}=I(F=1-1)/I(F=2-1)$ should be lower than their LTE values (0.2 and 0.6 respectively). The observations towards dark clouds show that the $F=0-1$ and $F=1-1$ hyperfine components are enhanced and the $F=2-1$ weakened (Walmsley et al (1982), Irvine and Schloerb (1984)), i. e. just the opposite than expected from thermal overlap effects. We conclude that other transfer mechanisms must be present in cold dark clouds in order to explain the observed anomalies in the $J=1-0$ triplet of HCN.

CG have shown, from a systematic survey of HCL2 in the $J=1-0$ lines of ^{12}CO , ^{13}CO , $C^{18}O$, HCO^+ , and $H^{13}CO^+$, that the $H^{13}CO^+$ emission comes from the cores of the cloud, and the HCO^+ emission from a low density envelope ($nH_2 \approx 10^3$ cm $^{-3}$) where radiation from the densest regions is absorbed and reemitted over a larger volume.

In order to determine if the diffusion effects observed in the HCO^+ emission also apply to the polar molecule HCN, we have observed the $J=1-0$ triplet of this molecule in TMC1 and the three clumps found by CG (see also Cernicharo et al, 1984) in HCL2. Our observations are not restricted to the cores of the cloud, and the line profiles in these directions can give a valuable information about the physical conditions in the gas where the lines are formed.

OBSERVATIONS AND RESULTS

The observations were carried out in spring and fall of 1983 using the 2.5-m telescope of the Bordeaux Observatory (Baudry et al, 1980, 1981). The beamwidth at the observing frequency was 5.5' and the beam efficiency ≈ 0.9 . The receiver SSB temperature was ≈ 600 K and the sky opacity in the observing period was $\tau \approx 0.2$. The backend consisted of 256 x 100 KHz channels giving a velocity resolution at the HCN $J=1-0$ frequency of ≈ 0.3 km/s. All the observations were made in the frequency switching mode (± 64 channels). The three hyperfine components were observed simultaneously. The data were calibrated using the chopper wheel method. Calibration errors from point to point are lower than 20 %.

Figure 1a shows the integrated intensity contours of the $J=1-0$ line of HCN in the central region of HCL2. For comparison, Fig. 1b shows the same contours for HCO^+ (from CG). The arrows indicate the center of TMC1 and of the three clumps HCL2-A, B, C

Send offprint requests to: J. Cernicharo

L14

LETTER

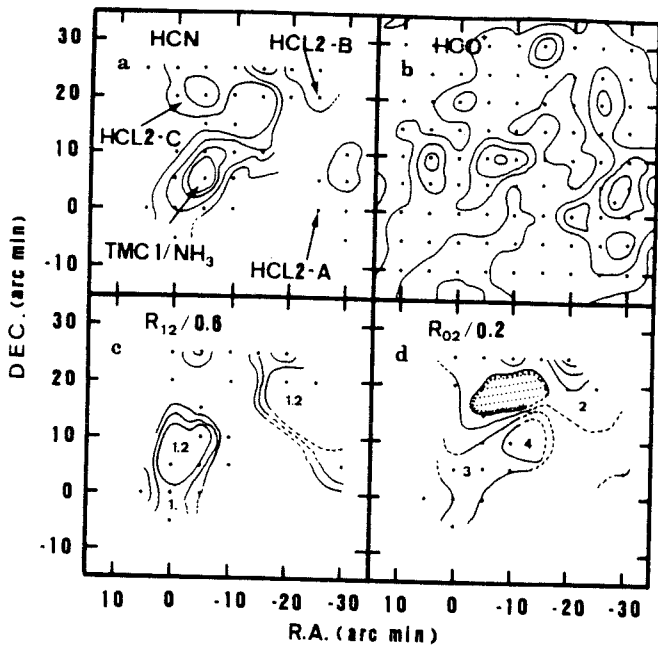

FIGURE 1

a and b) Integrated intensity contour maps of the $J=1-0$ line of a) HCN: the levels are 0.6, 0.9, 1.2 and 1.4 K km/s, and b) HCO^+ (partial HCO^+ map from CG): the levels are 0.25, 0.5, 0.7 and 0.9 K.km/s. The positions of the clumps are indicated by arrows. c) Contour map of the hyperfine intensities ratio $R_{12}/0.6$ (see text). d) Contour map of the hyperfine intensities ratio $R_{02}/0.2$ (see text). Observed positions are indicated by points. For figures c and d, only positions with good signal to noise ratio are used. The shaded area in d corresponds to a region where HCN was barely detected. The reference position corresponds to the source TMC1/ HC_3N ($\alpha=4^h 38^m 38^s$, $\delta = 25^\circ 35' 45''$).

(Cernicharo et al, 1984). The HCN emission extends over a larger surface than the $H^{13}CO^+$ (Guélin et al 1982, CG), as is also the case for HCO^+ . The HCN emission peaks towards TMC1/ NH_3 . The HCO^+ emission towards the TMC1 ridge peaks five arcmin away of the NH_3 source. In the direction of HCL2-A, HCN was not detected in three positions where HCO^+ is strong and $H^{13}CO^+$ is also detected. Even though the difference in the emission peaks of HCO^+ and HCN in TMC1 can be easily understood in terms of opacity in the $J=1-0$ line of HCO^+ , this is not the case for the emission of the two molecules in HCL2-A. Cernicharo et al (1984) have found that, in HCL2-A, cyanopolyynes ($HC_{2n+1}N$) peak 5' north of ammonia. HCN was detected 5' north and 5' west of HCL2-A/ NH_3 , but our poor angular resolution forbids any conclusion about the HCN and cyanopolyynes distribution. The failure to detect HCN towards HCL2-A/ NH_3 suggests a cloud to cloud variation of the HCN/ HCO^+ abundance ratio.

The intensities of the $J=1-0$ HCN triplet were determined by fitting the observed line profile by three dependent gaussians with fixed separation. Figures 1c and 1d show the contours of the ratios, $R_{12} = I(F=1-1)/I(F=2-1)$ and $R_{02} = I(F=0-1)/I(F=2-1)$, normalised to their LTE, optically thin values (0.6 and 0.2). Anomalies in the R_{12} ratio never exceed 20%. However, the R_{02} ratio is anomalous in all of the

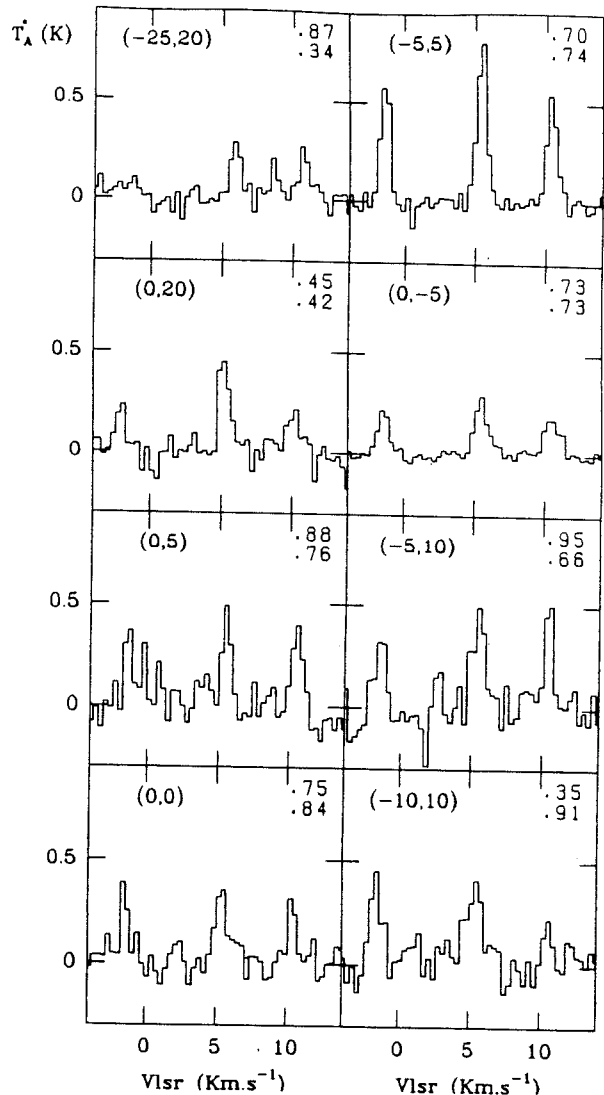

FIGURE 2

Observed spectra of the $J=1-0$ triplet of HCN in TMC1, HCL2-B and C. Offsets relative to TMC1/ HC_3N are indicated at the top left corner of each spectra. The derived values of R_{12} and R_{02} in each position are written in the top right corner.

observed positions. This ratio is larger than twice its LTE value over all of the TMC1 ridge, and is particularly strong towards the edge of TMC1. Figure 2 shows the observed spectra around TMC1 and towards HCL2-B and HCL2-C.

The cloudlets of HCL2 are elongated along the direction of the filaments in which they are embedded (Tölle et al (1981), Guélin et al (1982), Cernicharo et al (1984), CG). The size of the high density region in TMC1 is $2' \times 6'$ (Tölle et al, 1981). In figures 1c, 1d and 2 large anomalies are seen, both outside and towards the different cloudlets. This suggests that these anomalies are produced in the envelopes rather than in the cores. Additional evidence for this comes from a comparison between our observed line intensities towards TMC1 (resolution $5.5'$) and those of Walmsley et al with higher angular resolution ($1'$): the intensity ratio is only two when one would

expect a ratio of five from the size of TMC1 given above. Walmsley et al have proposed that these anomalies have the same origin as the ones observed in the intensities of the rare isotopes of HCO^+ . However, due to their failure to detect H^{13}CN , they concluded that the opacities in the $J=1-0$ triplet of HCN must be moderate.

CG have shown that, for clouds with low velocity dispersion, i.e. clouds where all the points are connected radiatively, the absorption of photons by foreground gas is a scattering process. The size of the regions where diffusion is important is a function of the opacities of the lines. The envelopes of the cores in HCL2 have been defined by CG as the regions where C^{18}O is detected; their sizes are 4-5 times the size of the cores (corresponding to the regions $1.5 < A_V < 5$ mag.). If HCN is optically thick, then one would expect that diffusion will play an important role in determining the observed spatial distribution of the intensities and hyperfine anomalies of HCN.

Recently, Irvine and Schloerb (1984) have detected the $J=1-0$ lines of H^{13}CN and HC^{15}N towards TMC1/NH₃. They conclude that the hyperfine components of H^{13}CN show no evidence for anomalies and that the H^{13}CN column density is $1-3 \cdot 10^{12} \text{ cm}^{-2}$, i.e. H^{13}CN is as abundant as H^{13}CO^+ (Guélin et al, 1982). We can estimate the opacities of H^{13}CN and HCN using the model of Guilloteau and Baudry (1981), which takes in account the thermal overlap of the hyperfine components. From the observations of Irvine and Schloerb and a density of $3 \cdot 10^4 \text{ cm}^{-3}$ (Bujarrabal et al, 1982), we derive the following results for H^{13}CN : $\tau(0-1) \sim 0.22$, $\tau(2-1) \sim 1.1$, $\tau(1-1) \sim 0.7$, $R_{12} = 0.61$, $R_{02} = 0.25$ and $N(\text{H}^{13}\text{CN}) \sim 3 \cdot 10^{12} \text{ cm}^{-2}$. Assuming $^{12}\text{C}/^{13}\text{C} = 90$, we obtain for HCN in the core: $\tau(0-1) \sim 9$, $\tau(2-1) \sim 21$, $\tau(1-1) \sim 20$, $R_{12} = 0.41$ and $R_{02} = 0.18$. Our observed ratios at this point are $R_{12} = 0.7$ and $R_{02} = 0.8$.

If the HCN abundance is supposed to be similar in the core and in the envelope, then the total HCN column density in the line of sight should be $\approx 3 \cdot 10^{14} \text{ cm}^{-2}$. Using the model of Guilloteau and Baudry we derive these properties for the envelope (with $n_{\text{H}_2} = 10^3 \text{ cm}^{-3}$): $\tau(0-1) \sim 4$, $\tau(2-1) \sim 18$, $\tau(1-1) \sim 11$, $\text{Tex}(0-1) = 2.9$, $\text{Tex}(2-1) = 3.1$ and $\text{Tex}(1-1) = 2.9$. These opacities are sufficient to fully absorb the radiation from the cores. However, we cannot explain the observed anomalies without scattering, because the expected anomalies in the envelope are similar to those in the core. On the other hand, when scattering effects are taken into account, the three HCN hyperfine components are formed in different regions. Then, scattering of the $F=0-1$ line is restricted to a small volume around the core and, in the direction of the core, the emission comes both from core and envelope. On the edges of the core, scattering of the $F=0-1$ line is important, but far from the core we should only observe the proper emission of the envelope. However, for the two optically thick components, $F=2-1$ and $F=1-1$, the photons emitted in the core will be completely absorbed and reemitted over a larger volume. Their emission comes only from the external shells of the envelope where excitation temperatures are dominated by radiative process and not by collisions (if $n_{\text{H}_2} < \text{few } 10^3 \text{ cm}^{-3}$). Due to their similar opacities, these two components should be formed approximately in the same region. Our observations confirm this picture; the three hyperfine components are stronger in the directions of the TMC1 core than towards the cloud edges but the anomalies extend far from the core. The ratio R_{02} is anomalous over the ridge of TMC1 and at its edges but

decreases far from the core. The ratio R_{12} is only anomalous towards the core, and roughly normal outside, i.e. the 2-1 and 1-1 lines show a nearly constant intensity ratio over TMC1 - as expected if scattering is going on in an envelope around it.

CONCLUSIONS

Our HCN observations show that the reported anomalies in the intensity ratios of the hyperfine components by Walmsley et al are not restricted to the core of the clouds but are present over a larger area.

The abundance of HCN is similar to HCO^+ in TMC1. Total opacities of the $J=1-0$ line of HCN as large as 60 are expected in the high densities regions of dark clouds.

The failure to detect HCN towards a cloulet where HCO^+ is strong, indicates that the HCN abundance varies from cloud to cloud.

We suggest that scattering of radiation from the core in a moderate density envelope ($n_{\text{H}_2} \sim \text{few } 10^3 \text{ cm}^{-3}$) is responsible of the observed anomalies in the $J=1-0$ triplet of HCN.

ACKNOWLEDGEMENTS

We thank M. Guélin and A. Baudry for useful discussion and R. Lucas, A. E. Glassgold and an anonymous referee for a critical reading of the manuscript. We thank L. di Giacomo for a careful typing of the manuscript.

REFERENCES

- Baudry, A., Brillet, J., Desbats, J. M., Lacroix, J., Montignac, G., Encrenaz, P., Lucas, R., Beaudin, G., Dierich, P., Germont, A., Laudry, P., Rérat, G.: 1980, *J. Astrophys. Astron.*, **1**, 193.
- Baudry, A., Cernicharo, J., Pérault, M., Despois, D., De La Noë, J.: 1981, *Astron. & Astrophysics*, **104**, 101.
- Baudry, A., Combes, F., Pérault, M., Dickman, R. L.: 1980, *Astron. & Astrophysics*, **85**, 244.
- Bujarrabal, V., Guélin, M., Morris, M., Thaddeus, P.: 1981, *Astron. & Astrophysics*, **99**, 239.
- Cernicharo, J., Guélin, M.: 1984, to be submitted to *Astron. & Astrophysics*.
- Cernicharo, J., Guélin, M., Askne, J.: 1984, *Astron. & Astrophysics* (in press).
- Frerking, M. A., Langer, W. D., Wilson, R. W.: 1979, *Ap. J. Letters* **225**, L65.
- Guélin, M., Langer, W. D., Wilson, R. W.: 1982, *Astron. & Astrophysics*, **107**, 107.
- Guilloteau, S., Baudry, A.: 1981, *Astron. & Astrophysics*, **97**, 213.
- Gottlieb, C. A., Lada, C. J., Gottlieb, E. W., Lilley, A. E., Litvak, M. M.: 1975, *Ap. J.*, **202**, 655.
- Irvine, W. M., Schloerb, F. P.: 1984, to be published in *Ap. J.*, July.
- Langer, W. D., Wilson, R. W., Henry, P. S., Guélin, M.: 1978, *Ap. J. Letters*, **225**, L139.
- Snell, R. L., Wootten, A.: 1979, *Ap. J.*, **228**, 748.
- Töle, F., Ungerechts, H., Walmsley, C. M., Winnewiser, G., Churchwell, E.: 1981, *Astron. & Astrophysics*, **95**, 143.
- Walmsley, C. M., Churchwell, E., Nash, A., Fitzpatrick, E.: 1982, *Ap. J. Letters*, **258**, L75.
- Wooten, A., Loren, R. B., Snell, R. L.: 1982, *Ap. J.*, **255**, 160.

**I.09) UN SURVEY MOLECULAIRE DE TROIS NUAGES SOMBRES
DANS LE TAUREAU**

I.09) UN SURVEY MOLECULAIRE DE TROIS NUAGES SOMBRES
DANS LE TAUREAU

L'émission de la transition $J=1-0$ de ^{13}CO a été cartographiée dans trois nuages sombres du Taureau (L1495, L1517, et L1489), avec le radiotélescope de 2.5-m. de Bordeaux. La corrélation de la densité projetée de ^{13}CO , déterminée à l'ETL, et la densité projetée de H_2 , déterminée à partir de comptages d'étoiles (voir I.02 et I.03), est étudiée en détail. Nous avons obtenons

$$N(^{13}\text{CO})=2.2\pm 0.3 \cdot (A_V-0.3\pm 0.3) \cdot 10^{15} \text{ cm}^{-2}$$

$$N(^{13}\text{CO})=1.8\pm 0.5 \cdot (A_V-0.3\pm 0.5) \cdot 10^{15} \text{ cm}^{-2}$$

$$N(^{13}\text{CO})=2.2\pm 0.4 \cdot (A_V-0.6\pm 0.5) \cdot 10^{15} \text{ cm}^{-2}$$

dans L1495 (=800 points), L1517 (=400 points), et L1489 (=40 points), respectivement.

Dans L1495 nous avons déterminé à partir de ≈ 80 directions observées :

$$N(\text{C}^{18}\text{O})=2.5\pm 0.8 \cdot (A_V-1.1\pm 0.5) \cdot 10^{14} \text{ cm}^{-2} ;$$

cette valeur est très proche de celle observée avec le même radiotélescope dans d'autres nuages du Taureau.

L1495 montre une structure en vitesse compliquée que nous interprétons comme due à l'interaction d'au moins deux filaments. L1517 montre aussi une structure filamenteuse double avec un gradient de vitesse simple. L1489 est un petit globule dense enfoui dans une enveloppe de faible densité grossièrement sphérique.

A molecular survey of three dark clouds in Taurus

G. Duvert^{1,*}, J. Cernicharo¹, and A. Baudry²

¹ Groupe d'Astrophysique, CERMO, Université Scientifique et Médicale de Grenoble, U.A. 961 du CNRS, B. P. 68, F-38402 St. Martin d'Hères Cedex, France

² Observatoire de l'Université de Bordeaux I, U.A. 352 du CNRS, F-33270 Floirac, France

Received November 14, 1985; accepted March 7, 1986

Summary. A molecular survey of three dark clouds in Taurus – L 1495, L 1517 and L 1489 –, has been carried out in the $J = 1 - 0$ line of ^{13}CO and C^{18}O with the Bordeaux 2.5-m telescope. Correlation of ^{13}CO projected densities, derived in the LTE approximation, with H_2 column densities derived from star counts, has been investigated in detail. We obtain

$$N(^{13}\text{CO}) = (2.2 \pm 0.3) \cdot (A_v - 0.3 \pm 0.3) 10^{15} \text{ cm}^{-2}$$

$$N(^{13}\text{CO}) = (1.8 \pm 0.5) \cdot (A_v - 0.3 \pm 0.5) 10^{15} \text{ cm}^{-2}$$

$$N(^{13}\text{CO}) = (2.2 \pm 0.4) \cdot (A_v - 0.6 \pm 0.5) 10^{15} \text{ cm}^{-2}$$

in L 1495 (≈ 800 points), L 1517 (≈ 400 points) and L 1489 (≈ 40 points) respectively.

In L 1495 we have derived in ≈ 80 observed directions

$$N(\text{C}^{18}\text{O}) = (2.5 \pm 0.8) \cdot (A_v - 1.1 \pm 0.5) 10^{14} \text{ cm}^{-2},$$

which is very close to the value obtained towards other Taurus clouds with the same telescope.

L 1495 shows a complex velocity structure that we interpret as being due to the interaction of at least two filaments. L 1517 also shows a double filamentary structure with a simple velocity gradient, while L 1489 is a small and dense globule embedded in a low density, roughly spherical, envelope.

Key words: galaxy (the): solar neighbourhood – interstellar medium: clouds: general – interstellar medium: molecules

1. Introduction

The local interstellar medium is dominated by the presence of numerous dark cloud complexes, some of them covering more than one hundred square degrees. Among the nearest, the dark lanes of Taurus (Fig. 1) have focussed much interest, since they contain rare molecules (Broten et al., 1978, 1984) which may reflect peculiar chemical or physical processes (Tölle et al., 1981; Bujarrabal et al., 1981). Their proximity [the distance to Taurus is estimated to be ≈ 140 pc by Elias (1978)], allows good spatial resolution even with

Send offprint requests to: G. Duvert

* Also at Sterrewacht Leiden, Postbus 9513, 2300 RA Leiden, The Netherlands

small diameter radiotelescopes. Therefore small scale structures and high density clumps can be investigated with arc minute resolutions (e.g. Baudry et al., 1981; Cernicharo et al., 1984). It is expected that the chemical and physical properties of the Taurus dark clouds are similar to those in regions of distant giant molecular clouds (GMCs). In particular, the CO abundance, as derived in nearby molecular clouds, provides an estimate of the mass of these GMCs.

Proximity of the Sun, however, is a handicap when one wants to obtain both good spatial resolution and extended spatial coverage, since each massive cloud of the Taurus-Auriga complex covers more or less five square degrees of the sky. High spatial resolution is necessary if we want to unravel the structure down to the densest clumps. Extended mapping is also necessary since it is unclear whether high resolution mapping of several arbitrarily chosen cloudlets of a same parent dark cloud will give valuable information about each particular cloudlet, independently of any thermal, dynamical and chemical relation with the rest of the parent cloud. In this regard, the 2.5 m telescope of the Bordeaux observatory offers a good compromise for spatial resolution vs. coverage with its 2.5 beam.

Dark clouds are non-homogeneous objects and it is possible to define three different regions – halo, envelope and cores –, in order to explain their observed molecular emission and their physical structure (Cernicharo, Bachiller, and Duvert, 1985, hereafter CBD). In this work we present extensive maps made with moderate resolution ($0.3\text{pc} \times 0.3\text{pc}$) in the direction of three Taurus dark clouds (L 1495, L 1517, L 1489) in the $J = 1 - 0$ line of ^{13}CO and C^{18}O . The regions where we have ^{13}CO and C^{18}O measurements and star counts correspond to envelopes where $A_v \leq 5$ mag. Our measurements double the total number of individual ^{13}CO measurements in the Taurus region obtained until now with the Bordeaux 2.5 m telescope.

In Sect. 2 we describe the observing procedure. In Sect. 3 we investigate the physical properties derived from our data, with particular attention to the velocity structure. In Sect. 4 we discuss the ^{13}CO and C^{18}O abundances deduced from correlations between molecular column densities and A_v , and we summarize our results in Sect. 5.

The velocity structure of the whole Taurus-Auriga-Perseus complex, as deduced from the Bordeaux, ($J = 1 - 0$) ^{13}CO survey, will be discussed in a forthcoming paper.

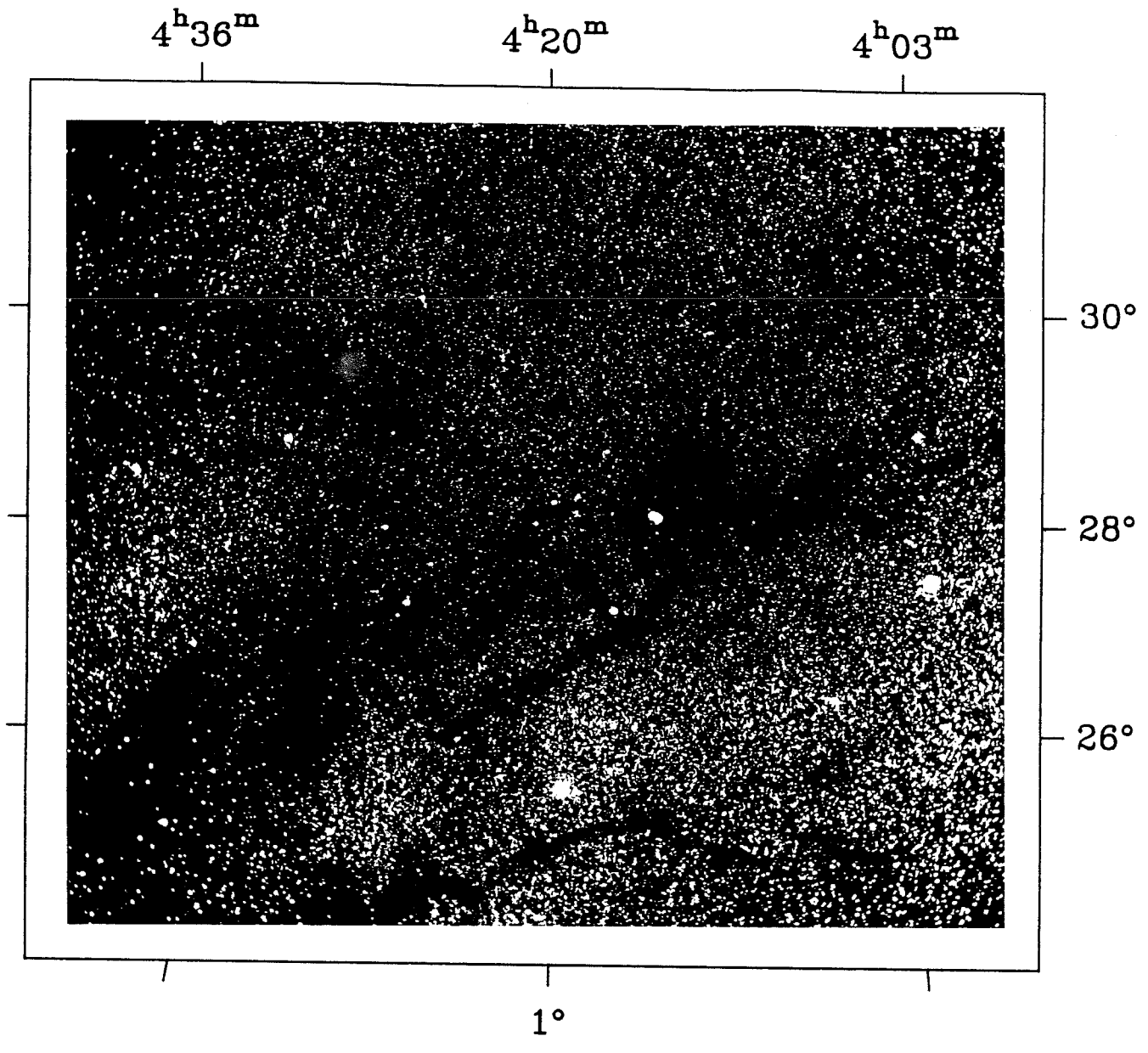

Fig. 1. Visual photograph of the central part of the Taurus region, taken from Barnard (1927). L 1495 is easily recognizable (compare with Fig. 2). The dark patch in the Southwest corner is Cloud 2 (HCL2 or TMCl)

2. Observations

The ^{13}CO ($J=1-0$) and C^{18}O ($J=1-0$) observations were carried out at the Bordeaux Observatory with the 2.5-m telescope during the 1982 and 1983 falls and the 1983-1984 winter. The telescope is equipped with a cooled (20 K) Schottky diode, an intermediate frequency (4.75 GHz) cooled FET amplifier, and two 100 kHz and 500 kHz filter banks (see Baudry et al., 1981). The present results were obtained with the 256×100 kHz filters, giving a velocity resolution of 0.27 km s^{-1} at the frequency of the ^{13}CO and C^{18}O lines. Around 110 GHz the half power beamwidth is $4'.4$. The local oscillator, previously a 100 GHz klystron, was replaced in December 1983 by a 55 GHz klystron followed by a frequency doubler. We have checked that, as expected with the same phase-

lock loop system, the reference spectra obtained during the winter observations are comparable to the autumn ones.

Spectra were obtained in the frequency switch mode. In the 1982 observations, image rejection was achieved by adjusting a movable dielectric backshort (Baudry et al., 1981). For the 1983-1984 observations image band rejection was not available. However, when compared with the 1982 data, the intensity variations measured in the reference spectra are less than 15%.

The single side band receiver temperature was $\approx 600 \text{ K}$ at 110 GHz. The zenith sky opacity in the signal sideband was measured from antenna tipping every 2 h. It was generally stable over the daily 10 h observations, and was measured to lie between 0.12 and 0.2. A theoretical model of the atmosphere was used to derive the image sideband sky opacity. Five minutes were

necessary to obtain a typical noise level of about 0.3 K. Calibration was obtained by switching between an ambient temperature load and the sky and by measuring every 2 h well-known standard sources (TMC1, TMC2, IC348, NGC1333) and the reference points of our three clouds maps.

L 1495, L 1517, L 1489 were mapped in the $J = 1 - 0$ ^{13}CO line with a 5' spacing in every direction where star counts were available (CBD and Cernicharo and Bachiller, 1984, hereafter CB). In the regions of low visual absorption A_v , the map boundary contour was arbitrarily fixed to 0.5 K in corrected peak antenna temperature. C^{18}O was mapped around the (0,0) positions of all three clouds, and more extensively in L 1495. The ^{13}CO map of L 1495 is shown in Fig. 2a.

The star AB Aur lying in L 1517 was observed in the ($J = 2 - 1$) line of ^{12}CO and ^{13}CO with the 5 m MWO¹ telescope in spring 1983. The half power beamwidth and velocity resolution were 1.3 and 0.3 km s⁻¹ respectively.

Complementary star counts of L 1495 and L 1517 on the POSS red prints were made to extend the previous star counts of CB. The general procedure was similar, with the same 2.5 × 2.5 mesh area. As L 1495 extends over three different POSS prints, we took into account the effects of the gradually decreasing sensitivity towards the prints edges. Figures 2b and 4a are taken from CBD, and identify on the A_v maps of the two clouds L 1495 and L 1517 the different clumps catalogued by Lynds and Barnard.

3. Dark cloud structure

3.1. The L 1495 region

As shown in Fig. 2b, the cloud number 1495 in the Lynds (1962) catalogue is only the central part of the observed region, which also comprises L 1486 and the Barnard cloudlets B 7, B 10, B 209, B 211, B 213, B 214, B 216, and B 217. (We will call the whole obscured area "L 1495", from the name of its densest part, rather than "Barnard's Cloud" which would be historically more adequate.) L 1495 is the largest cloud of the Taurus complex (5 by 3 degrees). Its straight "dark lane", delineated in several places by a conspicuous "halo" visible in Fig. 1 early drew the attention of astronomers (see Barnard, 1907). L 1495 has been investigated in a variety of large scale surveys (Heiles and Katz, 1976; Elias, 1978; Gilmore, 1980), or of rather restricted mappings of some of its subcondensations (Clark et al., 1977; Clark and Johnson, 1978). Star counts in L 1495 have recently been made with a 4.5 resolution (Gaïda et al., 1984) and with a 2.5 resolution (CB, CBD). The visual extinction map of Fig. 2b, where the filamentary structure and embedded cloudlets are well apparent is taken from the latter work. T Tauri stars and reflection nebulae are plotted on this map (for positional information and identification, see CB). It is worth noting the presence of T Tauri and Herbig Ae stars in the densest parts (hence biasing the star counts statistics which thus tend to underestimate the true visual absorption). The total mass of L 1495, deduced from star counts, is roughly 1900 M_{\odot} , with half of this mass in regions where $A_v \leq 2.5$ mag and 5% in regions where $A_v \geq 6.5$ mag. Similar values are found in other Taurus clouds (see CBD). The high visual absorption associated with the half-mass

contour does not come from an incomplete coverage of the cloud, favouring regions of high A_v , since the mean density of this 6.5 square degree cloud compares well with the mean density in other Taurus clouds (300 cm⁻³). It is rather due to the large dimensions of this massive cloud.

Figure 2a presents our ^{13}CO integrated intensity map. Comparison with Fig. 2b shows that ^{13}CO is well correlated with A_v . This correlation tends to disappear because of saturation effects when $A_v \geq 4$ mag (see also Fig. 7a where we have plotted $N(^{13}\text{CO})$ versus A_v). Figure 2a also presents the C^{18}O integrated intensity contour map, in the central region where ^{13}CO is saturated. As in HCL 2 (Cernicharo and Guélin, 1986), the C^{18}O emission follows closely the contours of high A_v .

3.2. The kinematics of L 1495

As in many Taurus clouds, some parts of L 1495 (viz., the region extending from B 7 to B 211) present double ^{13}CO components. This is for example the case in HCL 2 and in the TMC 2 region. In HCL 2, Schloerb and Snell (1984) see a rotating ring when Little et al. (1978) favour a collision between clouds. In TMC 2, Baudry et al. (1981) have speculated on the hypothesis of a two cloud collision. The kinematics of L 1495 is extremely complicated and does not support, for example, a simple rotating-ring explanation. We have used different visualisation means in order to understand the velocity pattern of L 1495. In Fig. 3b-f, we have plotted the ^{13}CO emission of L 1495 in each of the five velocity intervals shown in Fig. 3a.

A striking feature is the presence, in a small velocity interval, of extended filaments running parallel to the galactic plane from L 1486 to B 216 (compare Figs. 3d and Fig. 2b), together with a complicated structure around B 10. The B 10 region, where the lines are both wide and saturated, exhibits both a blue ($v_{\text{lsr}} \approx 5$ km s⁻¹, Fig. 3b) component which finally merges with the South-East filament, and a red ($v_{\text{lsr}} \geq 7$ km s⁻¹, Fig. 3e and f) North-West component in the direction of B 7.

It seems unlikely that a projection effect of two (or more) non interacting filaments would give such a complex structure, especially as newly formed stars (see Fig. 2b) tend to cluster in the regions where the velocity pattern is very complex, and since the ^{13}CO lines are well correlated in velocity from point to point. In addition the complicated aspect of the velocity distribution tends to rule out any interpretation in terms of global rotation of the whole cloud. It is possible to interpret some velocity shifts as a partial rotation of the cloud, however the direction and the magnitude of the vector J_{rot} change dramatically from one region to another. For example, the combination of a blue ($V_{\text{lsr}} \approx 5$ km s⁻¹) component around the position (+5', -50') with a red one ($V_{\text{lsr}} \approx 8$ km s⁻¹) around the position (-30', +40') gives a velocity gradient of 0.9 km s⁻¹ pc⁻¹ with J_{rot} making a 15° angle with J_{gal} . This result is comparable in magnitude with that of Schloerb and Snell (1984), but with antiparallel direction. However, the velocity shift along the filament visible in Fig. 3c gives a velocity gradient of 0.1 km s⁻¹ pc⁻¹ with J_{rot} parallel to J_{gal} , a result similar to that of Clark et al. (1977). We are thus left with a deceptive picture of the L 1495 velocity structure oscillating between the extreme cases reviewed by Goldsmith and Sernyak (1984).

Our preferred explanation is based almost entirely on the assumption that the blue and red components around the center of L 1495 are due to systematic movements in two colliding filaments. The first of these two filaments would run from East of B 10 to the Perseus clouds. The second filament - or part of a broken one -

¹ The MWO is operated by the Electrical Engineering Research Laboratory, the University of Texas at Austin, with support from the National Science Foundation and McDonald Observatory

352

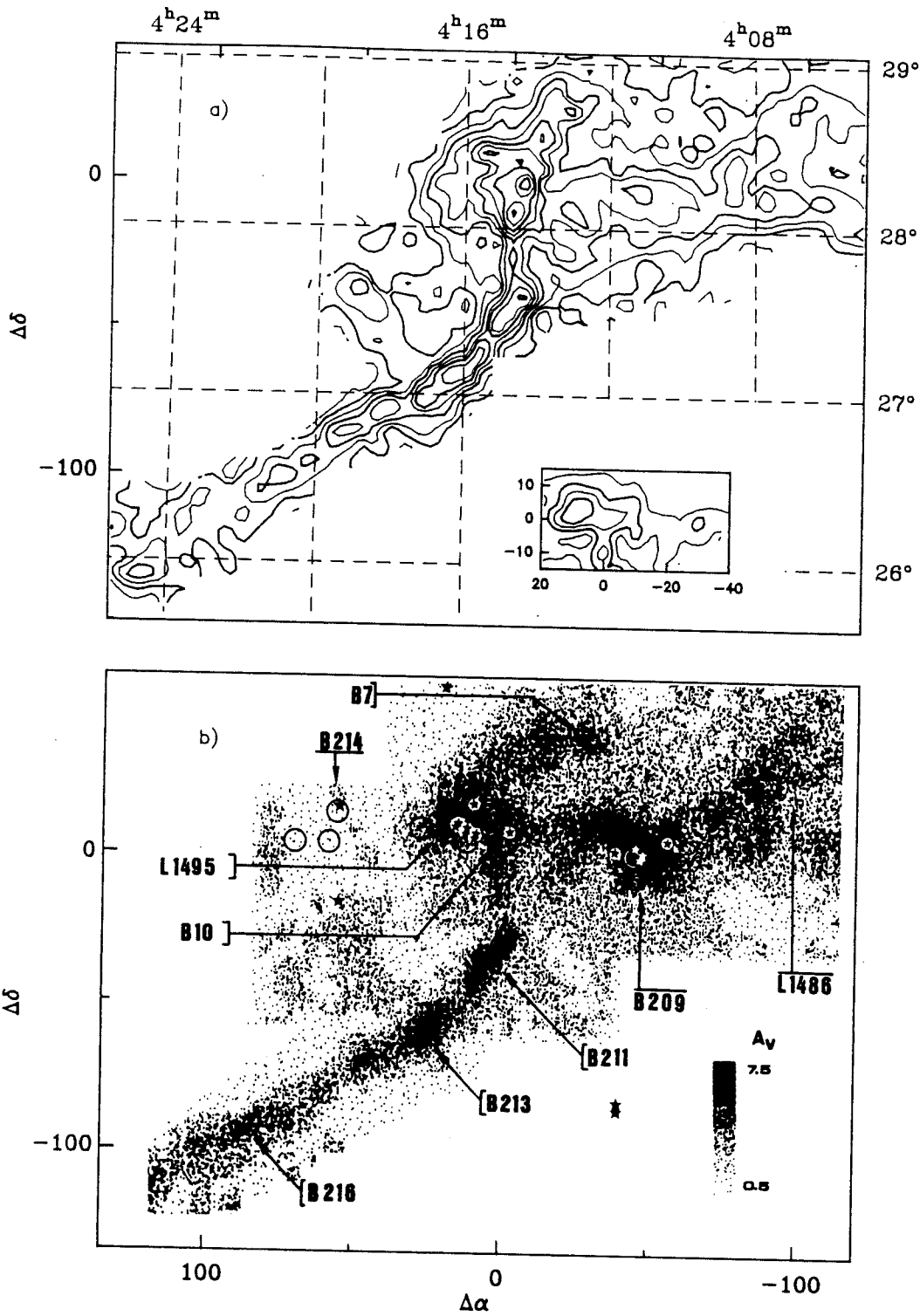

Fig. 2a and b. The L1495 region. a Map of integrated $^{13}\text{CO}(J=1-0)$ emission, derived from a gaussian fit, observed towards the L1495 region. Contours intervals are $1\text{ K} \cdot \text{km} \cdot \text{s}^{-1}$ and the lowest contour is $1\text{ K} \cdot \text{km} \cdot \text{s}^{-1}$. Offsets in arc min from the $(0', 0')$ position ($\alpha(1950) = 4^{\text{h}}14^{\text{m}}44^{\text{s}}.9$, $\delta(1950) = 28^\circ13'36''$), as well as absolute (1950) coordinates are given. A map of integrated $\text{C}^{18}\text{O}(J=1-0)$ emission in the central part of L1495 is presented in the inset. Contours are 20%, 40%, 60%, and 80% of the maximum peak value $2.0\text{ K} \cdot \text{km} \cdot \text{s}^{-1}$. b Sketch of the L1495 region, based on the A_V map of CBD. The darkest patches are at $A_V \geq 6$ mag. A nomenclature of the Lynds and Barnard clouds, as well as the positions of T Tauri stars (marked as *) and reflection nebulae (marked as o), is given

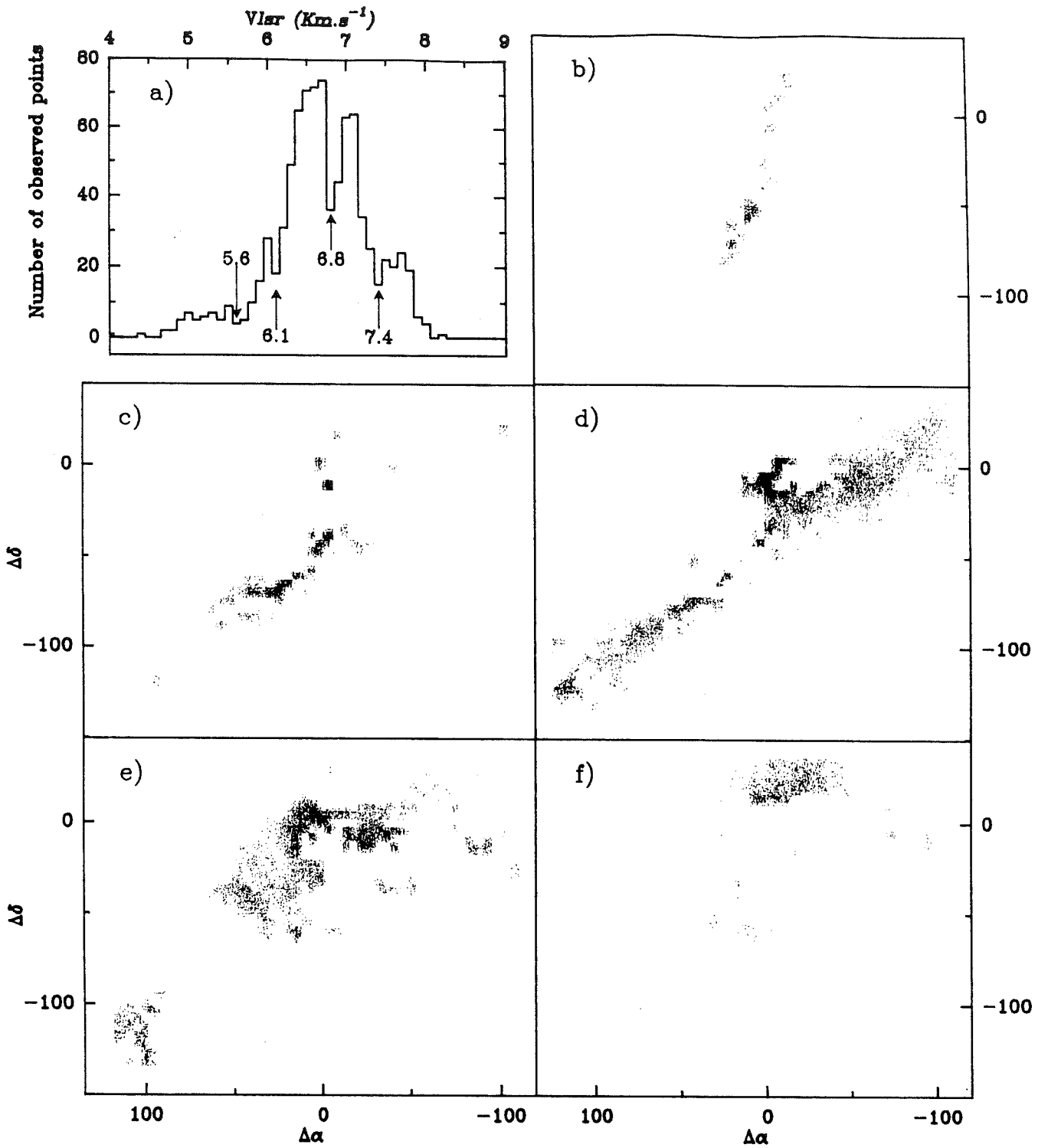

Fig. 3a-f. The velocity structure of the L1495 region. a Histogram of ¹³CO peak velocities found after gaussian fits in the L1495 region. The different values of V_{lsr} , corresponding to the velocity intervals of b-f, are indicated. b-f Composite picture of the integrated ¹³CO ($J=1-0$) emission of the L1495 region in the 5 different velocity intervals defined in a). Grey scale interval is 1 K · km · s⁻¹, with the lowest contour at 1 K · km · s⁻¹. The velocity intervals are (in km · s⁻¹): b: 0 → 5.6, c: 5.6 → 6.1, d: 6.1 → 6.8, e: 6.8 → 7.4, f: 7.4 → 9.0

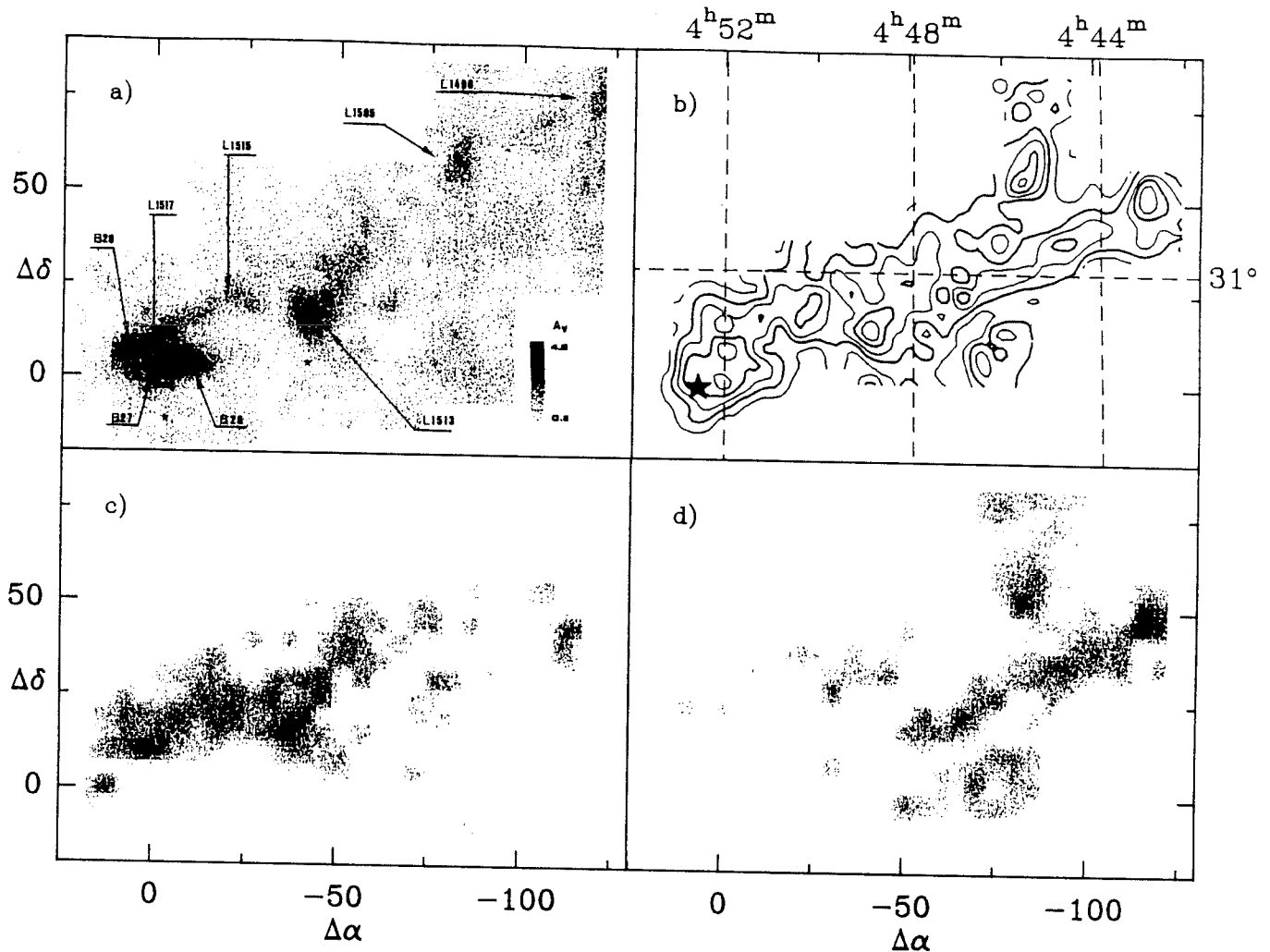

Fig. 4a-d. The L 1517 region. a Sketch of the L 1517 region, based on the A_v map of Cernicharo et al. (1985). The darkest patches are at $A_v \geq 4$ mag. A nomenclature of the Lynds and Barnard clouds, as well as the position of T Tauri stars (marked as \star) and reflection nebulae (marked as \circ), are given. b ^{13}CO integrated intensity map of the L 1517 region. Contour intervals are $0.5 \text{ K} \cdot \text{km} \cdot \text{s}^{-1}$ and the lowest contour is $1.0 \text{ K} \cdot \text{km} \cdot \text{s}^{-1}$. Offsets in arcmin from the $(0', 0')$ position ($x(1950) = 4^{\text{h}}52^{\text{m}}$, $\delta(1950) = 30'29''$), as well as absolute (1950) coordinates are given. c and d Grey-scale composite map of the integrated $^{13}\text{CO}(J=1-0)$ emission in the two representative velocity intervals of the L 1517 region: c V_{lsr} from 3.0 to 6.3. d V_{lsr} from 6.3 to 8.0. The grey scale interval is $0.3 \text{ K} \cdot \text{km} \cdot \text{s}^{-1}$ and the lowest contour is $0.3 \text{ K} \cdot \text{km} \cdot \text{s}^{-1}$.

would stretch from B218 to B213NW, bend in the Northeast direction, cross the other filament around B10, and get back to its original direction towards B7. It is worth noting that polarization measurements of Moneti et al. (1984) towards this region show that starlight inside a filament is polarized along the filament axis (outside the clouds, the measurements show polarization axis, if any, roughly perpendicular to the galactic plane), and that two stars around the center of L 1495 have their light polarized in the general direction of both filaments. The recent IRAS maps of this region clearly show that the East-West filament extends beyond the region mapped in this work in the direction of the Perseus clouds. There is also an indication that the second filament might extend in the general direction of the California Nebula far past B7. Thus the kinematics of the Taurus and Perseus clouds could be interrelated. The fact that T Tauri stars are situated in the region of L 1495 which shows the most complicated structure calls for higher resolution observations. Such observations would indicate whether we are witnessing a star forming region where star formation is triggered by collision between clouds or between two

filaments, or whether the existence of young embedded stars tends to disrupt the velocity structure of their parent cloud.

3.3. The L 1517 region

The region we have mapped in ^{13}CO around L 1517 comprises several small condensations running from L 1517 to L 1496 (see Fig. 4a). It does not contain condensations as dense as those found in L 1495, and, accordingly, its ^{13}CO lines are narrower and dimmer. The Southwest region, which contains the densest clumps, near the bright star AB Aur, is discussed in the following section. The mass of the mapped area, deduced from stars counts, is around $450 M_{\odot}$, with half of the mass in regions where $A_v \leq 1-1.5$ mag and 99% of the mass in regions where $A_v \leq 4$ mag (this seems to be typical of Taurus clouds, see CBD). The ^{13}CO integrated intensity map is shown in Fig. 4b and is rather well correlated with A_v (compare Fig. 4a and b). The velocity pattern of L 1517, derived as for L 1495 (see Fig. 4c and d), shows a continuous velocity drift from 5.3 km s^{-1} (at the location of B27) to 7.2 km s^{-1} (near

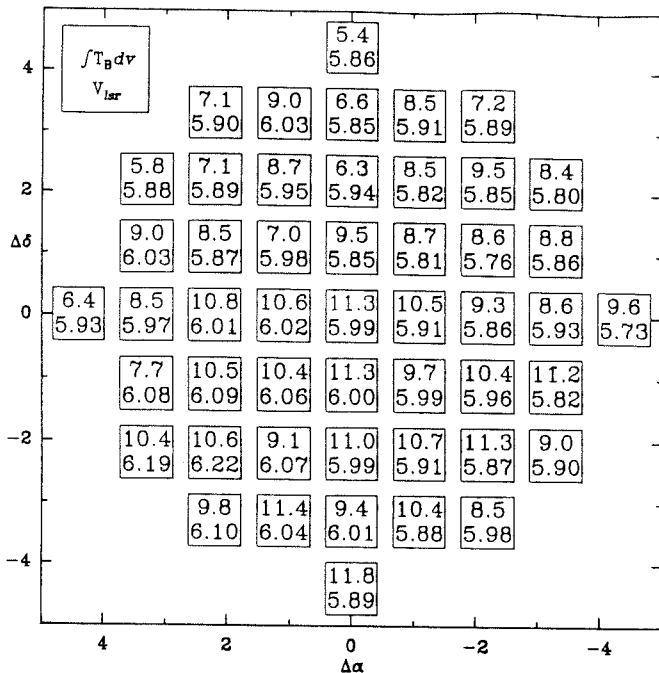

Fig. 5. Table of observed integrated ^{13}CO ($J=2-1$) emission and peak velocity towards AB Aur, derived from gaussian fit. Offsets are in arc minute from the $(0', 0')$ position ($\alpha(1950) = 4^{\text{h}}52^{\text{m}}33^{\text{s}}$, $\delta(1950) = 30^{\circ}28'20''$)

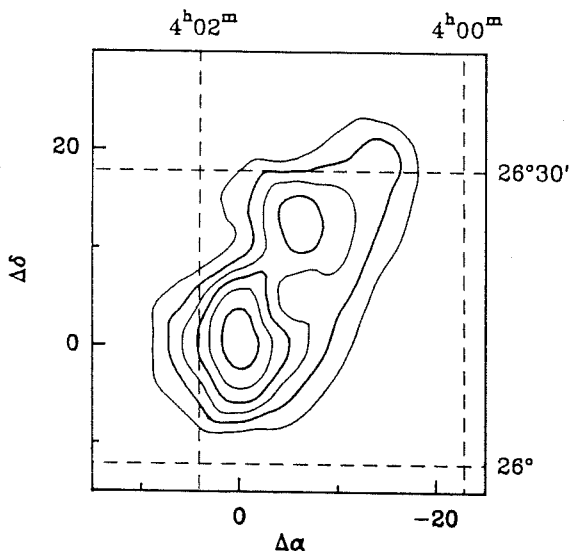

Fig. 6. ^{13}CO integrated intensity map of the L1489 globule. Contour interval is $0.5 \text{ K} \cdot \text{km} \cdot \text{s}^{-1}$ and the lowest contour is $0.5 \text{ K} \cdot \text{km} \cdot \text{s}^{-1}$. Offsets in arcmin from the $(0', 0')$ position ($\alpha(1950) = 4^{\text{h}}01^{\text{m}}42^{\text{s}}$, $\delta(1950) = 26^{\circ}12'12''$), as well as absolute (1950) coordinates are given

L 1496), i.e., a velocity gradient of $0.4 \text{ km s}^{-1} \text{ pc}^{-1}$ with, (if we interpret it as a rotation feature) J_{rot} parallel to J_{gal} . However, the presence of double velocity components near L 1513 can be interpreted as the overlap along the line of sight, of two filaments. The first one lies in the L 1517-L 1505 direction, and the second one in the L 1513-L 1496 direction (this one well visible on Fig. 4d). On the average, each high density clump in the mapped area is part of a more extended and diffuse ribbon of matter.

3.4. The region around AB Aur

Our $J=1-0$, ^{13}CO map (Fig. 4b) shows a clear enhancement of the ^{13}CO line towards the star AB Aur. The same trend was also observed by Nachman (1979) in his $J=1-0$, CO and ^{13}CO maps and is confirmed by our $J=2-1$, CO map in the same direction (see Fig. 5). The maximum $J=2-1$ line intensity, $T_B^* \approx 11 \text{ K}$ at 6 km s^{-1} is observed in the direction of AB Aur in a region where the visual absorption is only $A_v \approx 2 \text{ mag}$ (see CB). AB Aur is a Herbig Ae-type variable showing chromospheric activity with mass outflow (Praderie et al., 1982) and it is tempting to associate the stellar activity with the heating of the gas and/or peculiar chemistry. The infrared emission in the AB Aur vicinity, as seen by IRAS, is also enhanced relative to standard dark cloud emission, and the star itself shows up very conspicuously in the IRAS point source catalogue, especially in the 60 and 100 micron bands. Our iso-velocity contour maps obtained in the $J=2-1$ line of CO tend to show a systematic shift of 0.5 km s^{-1} across the AB Aur region (corresponding to a $2.5 \text{ km s}^{-1} \text{ pc}^{-1}$ gradient with J_{rot} parallel to J_{gal} if rotation is invoked) which should be investigated further with large radiotelescopes.

We can derive the hydrogen density and the ^{13}CO column density towards AB Aur using a LVG code. From the ^{13}CO $J=1-0$ (HPBW = $65''$) data of Nachman and our ^{13}CO $J=2-1$ data (HPBW = $70''$) we derive $N(^{13}\text{CO}) = 3.5 \cdot 10^{15} \text{ cm}^{-2}$ and $n(\text{H}_2) = 3 \cdot 10^3 \text{ cm}^{-3}$. The kinetic temperature is 15 K as derived from the $1-0$ and $2-1$ lines of CO. This high density in a low A_v region is also necessary to explain the observed $J=1-0$ and $J=2-1$ ^{12}CO antenna temperatures. The ^{13}CO column density which we derive from the linear correlations discussed in Sect. 4 is $2.8 \cdot 10^{15} \text{ cm}^{-2}$ in good agreement with the LVG results. We also derive a kinetic temperature of 10 K , i.e., the kinetic temperature of the parent cloud, for points $4'$ away of the AB Aur central position.

High resolution observations would be necessary in order to derive the density and temperature structure around AB Aur and to determine if the molecular gas is clumpy or not.

3.5. L 1489

L 1489 is a small ($r \approx 0.1 \text{ pc}$ and $r \approx 0.6 \text{ pc}$ respectively for the core and the envelope) and dense ($n_{\text{H}_2} \geq 10^4 \text{ cm}^{-3}$) globule of roughly spherical appearance around $\alpha(1950) = 4^{\text{h}}01^{\text{m}}42^{\text{s}}$, $\delta(1950) = 26^{\circ}12'12''$. The ^{13}CO ($J=1-0$) integrated intensity map, shown in Fig. 6, displays a secondary maximum of emission $10'$ West and $10'$ North of the reference point. C^{18}O is detected at the $(0', 0')$ position – with an integrated emission of 0.6 K km s^{-1} – and at the $(0', +5')$ position near the ^{13}CO peak emission. According to the abundance of C^{18}O derived in IV, we deduce a lower limit of $A_v = 2.2 \text{ mag}$ in the central region, where star counts provide (in a 2.5 grid) an A_v of 3 mag . There is a slight drift in the velocity of the ^{13}CO line throughout the cloud, in a general N-S direction, from 6.6 km s^{-1} around position $(0', 10')$ to 7.0 km s^{-1} around the $(0', -5')$ position, but this effect has to be measured again with a better velocity resolution. We note that the presence of a strong embedded (IRAS) infrared source in the core of L 1489 [at $\alpha(1950) = 4^{\text{h}}01^{\text{m}}40^{\text{s}}.4$, $\delta(1950) = 26^{\circ}10'46''.9$] does not seem to interfere with the surrounding gas at least at the scale at which our observations were made.

4. Correlation of projected densities with A_v

The correlation of ^{13}CO and C^{18}O column densities with A_v which we discuss here is of particular importance since it has been

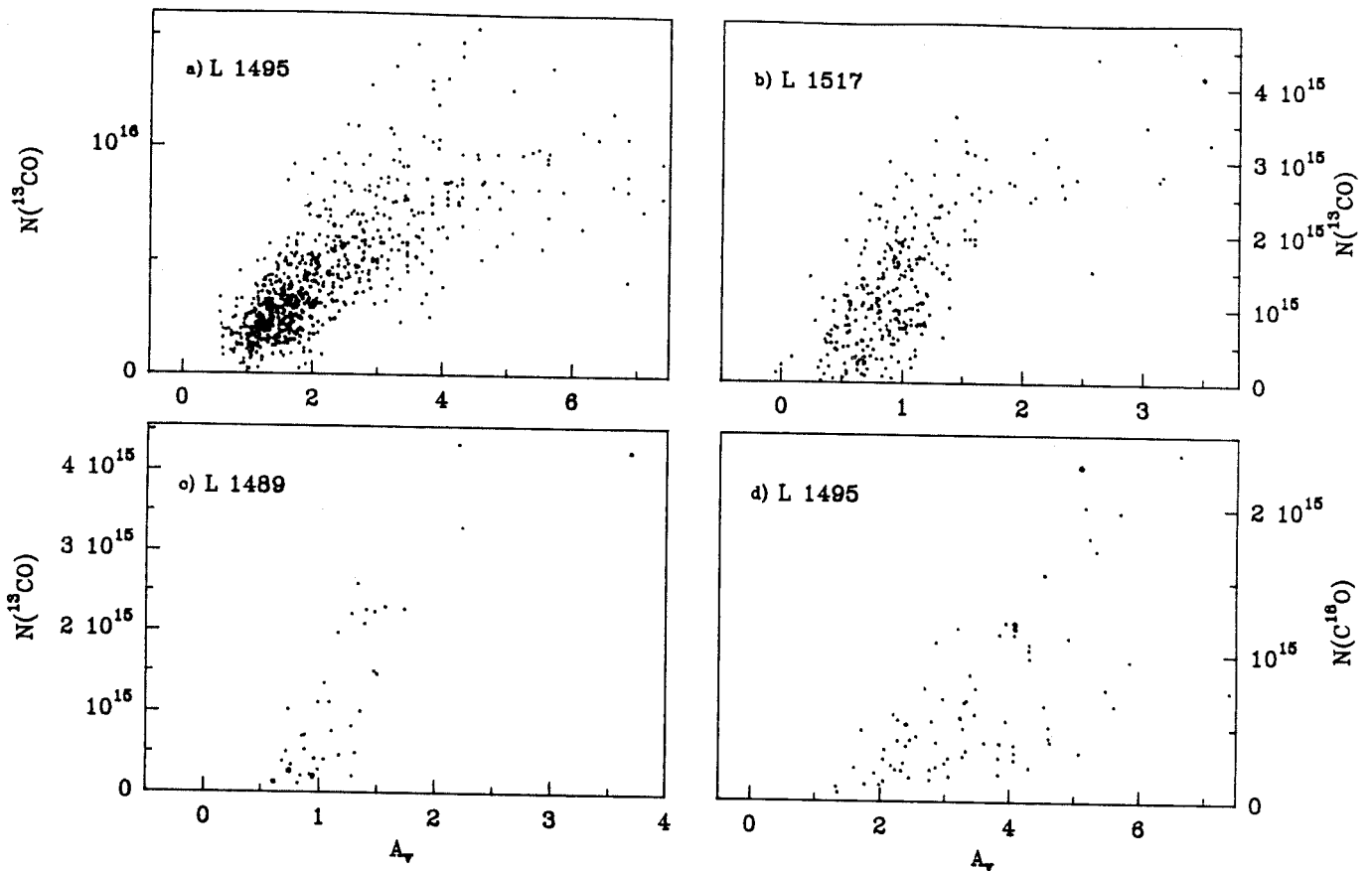

Fig. 7a-d. Column density vs. A_v . a-c ^{13}CO column densities versus A_v in L1495, L1517 and L1489 respectively. Scale, linear in A_v and in $N(^{13}\text{CO})$, is different for each cloud. d C^{18}O column density versus A_v in the central part of L1495 (see inset of Fig. 2a)

obtained from hundreds of individual data points and from comparable spatial resolutions in line observations and star counts.

Figure 7 shows the observed correlation $N(^{13}\text{CO})/A_v$ in L1495, L1517 and L1489 and the correlation $N(\text{C}^{18}\text{O})/A_v$ in L1495. The column density of ^{13}CO has been derived in the LTE approximation assuming that the excitation temperature of the ^{13}CO line observed towards the three clouds at different locations is identical to the excitation temperature of the ^{12}CO line (see Dickman (1978) for a discussion of this method). The uncertainties on column densities and visual absorptions are not constant throughout the figure. In the 0-3 mag region the maximum uncertainty in A_v is ± 0.25 mag and increases rapidly with A_v . The points with high obscuration and large uncertainties are few exceptions. Some of them are related to star-forming regions, faint stars leading to wrong values of A_v in the star count procedure. These points, corresponding to large ^{13}CO column densities fall in a region of the $N(^{13}\text{CO}) - A_v$ plane located far from the average correlation. Independently of the validity of the LTE approximation, the uncertainty in the values of $N(^{13}\text{CO})$ due to noise in the spectra, does not exceed in most cases $2 \cdot 10^{14} \text{ cm}^{-2}$.

Due to the above uncertainties, we discarded the few points with anomalous A_v and we fitted a linear relation between column densities and visual absorptions in the 0 to 4-5 mag range, with a standard linear regression program. The 3σ errors obtained are quoted along with the results of the fitting procedure; they show essentially that, the A_v measurements are independent but also noisy. The slope, $N(^{13}\text{CO})/A_v \approx 1.8-2.2 \cdot 10^{15} \text{ cm}^{-2}$, is similar in

the three clouds investigated here, but is nearly 1.5 times larger than the slope obtained with the same telescope in Cloud 2 (Cernicharo and Guélin, 1986) and smaller than the mean value, $2.5 \cdot 10^{15} \text{ cm}^{-2}$, obtained in Perseus from ≈ 1000 data points by Bachiller and Cernicharo (1986). The observed discrepancies can be ascribed to differences in abundances and temperatures or to fractionation effects which dominate when $A_v \leq 2-3$ mag. It is worth noticing that the mean value $N(^{13}\text{CO})/A_v = 2.0 \cdot 10^{15} \text{ cm}^{-2}$ obtained by Dickman (1978; see also Dickman and Clemens, 1983) from a rather non homogeneous sample of clouds is close to the mean value of the slopes now derived in the Taurus-Perseus region. This mean value is still of much interest to derive masses of distant clouds for which star counts are not available.

The LTE approximation gives correct CO column densities when the rotational levels of CO are thermalised, a condition fulfilled when, as usual in dark clouds, $n_{\text{H}_2} \geq 10^3 \text{ cm}^{-3}$ and $T_k \approx 10 \text{ K}$. For large values of A_v , ^{13}CO emission shows saturation and the derived column densities are only lower limits. For low values of A_v , ^{13}CO is fractionated (i.e. ^{13}CO is enhanced) as shown in Taurus and Perseus (see Cernicharo and Guélin, 1986; Bachiller and Cernicharo, 1986). These effects are not present for C^{18}O , whose relative abundance to ^{13}CO is ≈ 0.2 , and which is not affected by chemical fractionation. The value of $N(\text{C}^{18}\text{O})/A_v = 2.5 \cdot 10^{14} \text{ cm}^{-2}$ derived in L1495 is identical (within the uncertainties) with that found by Cernicharo and Guélin (1986), and Bachiller and Cernicharo (1986) in Cloud 2 and Perseus respectively and is close to the mean value of $N(\text{C}^{18}\text{O})/A_v$ derived by Baudry et al. (1981) in the TMC2 region. This proves

that $C^{18}O$, although it requires a minimum of 1.1 to 1.5 mag of visual absorption to be detected, is a more secure tracer of highly obscured regions than ^{13}CO . Using the Bohlin et al. (1978) relation between $N(H_2)$ and A_v , we derive $N(C^{18}O)/N(H_2) \approx 2.5 \cdot 10^{-7}$ across the Taurus-Perseus complex.

5. Conclusion

Our observations of the dark cloud regions around L 1495, L 1517 and L 1489 give a new set of molecular data on the particularly interesting Taurus region. The main results obtained here concern the abundance of ^{13}CO and $C^{18}O$ as well as the velocity structure of the most massive member of the Taurus clouds.

Our ^{13}CO data and star counts give

$$N(^{13}CO) = (2.2 \pm 0.3) \cdot (A_v - 0.3 \pm 0.3) 10^{15} \text{ cm}^{-2}$$

$$N(^{13}CO) = (1.8 \pm 0.5) \cdot (A_v - 0.3 \pm 0.5) 10^{15} \text{ cm}^{-2}$$

$$N(^{13}CO) = (2.2 \pm 0.4) \cdot (A_v - 0.6 \pm 0.5) 10^{15} \text{ cm}^{-2}$$

for L 1495, L 1517 and L 1489 respectively. The abundance of ^{13}CO , using the Bohlin et al. (1978) relation, is

$$\chi(^{13}CO) \approx 2 \cdot 10^{-6}.$$

From a limited sample of points (≈ 80), we derive in L 1495

$$N(C^{18}O) = (2.5 \pm 0.8) \cdot (A_v - 1.1 \pm 0.5) 10^{14} \text{ cm}^{-2},$$

and for the abundance of $C^{18}O$

$$\chi(C^{18}O) \approx 2.5 \cdot 10^{-7}$$

which is comparable to other determinations across the Taurus-Perseus complex.

Compared with other molecular data in the same dark cloud complex, our measurements clearly show a variation within a factor of two of the ^{13}CO abundance from cloud to cloud in the Taurus-Auriga-Perseus complex, while the $C^{18}O$ abundance seems constant. This leads to the conclusions that:

1. The value derived by Dickman and Clemens (1983) for the abundance of ^{13}CO is a rough average of a fluctuating actual value, giving a 50% error on ^{13}CO column densities and H_2 masses; this error appears to be unimportant when compared to that involved in the estimation of the distance of GMCs,

2. $C^{18}O$, showing none of the variations observed in ^{13}CO , is a safer mass tracer of the central regions of molecular clouds.

The velocity pattern of L 1495 is found to be very complex and inconsistent with a simple global rotation. This suggests that a more complicated interaction between two or more filamentary clouds, such as a collision, is likely to take place in this region, where newly formed stars are also observed. This work has revealed the possible association of young stars with a complex velocity structure in dark filaments. However new observations with both high spatial and spectral resolutions are requested to get further insight into the physics of star formation within dark clouds.

Acknowledgements. The authors wish to thank the staff of the Bordeaux Observatory and D. Despois, for their help during the observations.

References

- Barnard, E. E.: 1907, *Astrophys. J.* **25**, 218
 Barnard, E. E.: 1927, Carnegie Institution of Washington Publications No. 247, 1
 Bachiller, R., Cernicharo, J.: 1984, *Astron. Astrophys.* **140**, 414
 Bachiller, R., Cernicharo, J.: 1986, *Astron. Astrophys.* (in press)
 Baudry, A., Cernicharo, J., Pérault, M., De la Noë, J., Despois, D.: 1981, *Astron. Astrophys.* **104**, 101
 Bohlin, R. C., Savage, B. D., Drake, J. F.: 1978, *Astrophys. J.* **224**, 132
 Broten, N. W., Oka, T., Avery, L. W., MacLeod, J. M., Kroto, H. W.: 1978, *Astrophys. J. Letters* **223**, L105
 Broten, N. W., MacLeod, J. M., Avery, L. W., Irvine, W. M., Höglund, B., Friberg, P., Hjalmarsen, Å.: 1984, *Astrophys. J. Letters* **276**, L25
 Bujarrabal, V., Guélin, M., Morris, M., Thaddeus, P.: 1981, *Astron. Astrophys.* **99**, 239
 Cernicharo, J., Guélin, M., Askne, J.: 1984, *Astron. Astrophys.* **138**, 371
 Cernicharo, J., Guélin, M.: 1986, *Astron. Astrophys.* (in press)
 Cernicharo, J., Bachiller, R.: 1984, *Astron. Astrophys. Suppl. Series* **58**, 327
 Cernicharo, J., Bachiller, R., Duvert, G.: 1985, *Astron. Astrophys.* **149**, 273
 Clark, F. O., Johnson, D. R.: 1978, *Astrophys. J.* **220**, 500
 Clark, F. O., Guiguere, P. T., Crutcher, R. M.: 1977, *Astrophys. J.* **215**, 511
 Dickman, R. L.: 1978, *Astron. J.* **83**, 363
 Dickman, R. L., Clemens, Dan P.: 1983, *Astrophys. J.* **271**, 143
 Elias, J. H.: 1978, *Astrophys. J.* **224**, 857
 Gaïda, M., Ungerechts, H., Winnewisser, G.: 1984, *Astron. Astrophys.* **137**, 17
 Gilmore, W.: 1980, *Astron. J.* **85**, n° 7
 Goldsmith, P. F., Sernyak, M. J. Jr.: 1984, *Astrophys. J.* **283**, 140
 Heiles, K., Katz, G.: 1976, *Astron. J.* **81**, n° 1
 Herbig, G. H.: 1977, *Astrophys. J.* **214**, 747
 Little, L. T., Mac Donald, G. H., Riley, P. W., Matheson, D. N.: 1978, *Monthly Notices Roy. Astron. Soc.* **183**, 45 P
 Lynds, B. T.: 1962, *Astrophys. J. Suppl.* **7**, 1
 Moneti, A., Pipher, J., Helfer, H. L., McMillan, R. S., Perry, M. L.: 1984, *Astrophys. J.* **282**, 508
 Nachman, P.: 1979, *Astrophys. J. Suppl.* **39**, 103
 Praderie, F., Talavera, A., Felenbok, P., Czarny, J., Boesgaard, A. M.: 1982, *Astrophys. J.* **254**, 658
 Schloerb, F. P., Snell, R. L.: 1984, *Astrophys. J.* **283**, 129
 Tölle, F., Ungerrechts, H., Walmsley, C. M., Winnewisser, G., Churchwell, E.: 1981, *Astron. Astrophys.* **95**, 143

I.10) LA REGION ATOUR DE TMC2. LE FILAMENT L1529-L1506.

I.10) LA REGION AUTOUR DE TMC2. LE FILAMENT L1529-L1506.

Nous avons observé l'émission de ^{13}CO dans les nuages sombres L1529 et L1506 du complexe du Taureau avec une résolution modérée (5'). Nos données, combinées avec les extinctions visuelles déduites de comptages d'étoiles (voir I.02 et 1.03), donnent pour l'abondance de ^{13}CO :

$$N(^{13}\text{CO}) = 1.49 \pm 0.1 \cdot (A_V - 0.6 \pm 0.2) \cdot 10^{15} \text{ cm}^{-2} \quad \text{dans L1529}$$

$$N(^{13}\text{CO}) = 0.90 \pm 0.1 \cdot (A_V - 0.9 \pm 0.2) \cdot 10^{15} \text{ cm}^{-2} \quad \text{dans L1506}$$

Nous déterminons une masse de 700 M_{\odot} pour L1529, et de 460 M_{\odot} pour L1506. La densité moyenne est de $\approx 400 \text{ cm}^{-3}$ pour chaque nuage. L'abondance de ^{13}CO montre des variations de nuage à nuage dans tout le complexe du Taureau-Cocher-Persée. Les conditions physiques locales, telles la densité d'hydrogène moléculaire, la température cinétique et le champ du rayonnement UV pourraient être responsables des variations d'abondance de ^{13}CO observées.

La structure en vitesse de la région est très confuse et ne peut être expliquée par une rotation rigide. Dans L1506 nous observons un très fort gradient de vitesse.

A molecular study of the dark clouds L 1506 and L 1529 in Taurus

E. Nercessian¹, A. Castets¹, J. Cernicharo^{1,2}, and J.J. Benayoun¹

¹ Groupe d'Astrophysique de l'Observatoire de Grenoble, Université Scientifique et Médicale de Grenoble, CERMO, B.P. 68, F-3842 Saint Martin d'Hères Cedex, France, UA 708 du CNRS

² I.R.A.M. Domaine Universitaire de Grenoble Voie 10, F-38406 Saint Martin d'Hères, France

Received March 23, accepted June 22, 1987

Summary. We have surveyed at moderate resolution (5') the ^{13}CO ($J=1-0$) emission of the Taurus dark clouds L 1529 and L 1506. Our data together with the visual extinction A_v derived from star counts, give two values of the ^{13}CO abundance

$$N(^{13}\text{CO}) = 1.4 \pm 0.1 (A_v - 0.6 \pm 0.2) 10^{15} \text{ cm}^{-2} \quad \text{in L 1529}$$

$$N(^{13}\text{CO}) = 0.9 \pm 0.1 (A_v - 0.9 \pm 0.2) 10^{15} \text{ cm}^{-2} \quad \text{in L 1506}$$

The masses of L 1529 and L 1506 are found to be 700 and 460 M_\odot respectively. The mean density is 400 cm^{-3} for both clouds. The ^{13}CO abundance show variations from place to place across the whole Taurus-Auriga-Perseus complex. Local physical conditions like hydrogen density, kinetic temperature and the UV radiation field could be responsible for such variations through the photo-chemical processes.

The velocity structure of the region is found to be very confused and could not be explained by rigid-body rotation; the only clear feature is a strong radial velocity gradient along L 1506. The gravitational stability of the clouds is examined.

Key words: interstellar clouds – interstellar molecules – molecular abundances

1. Introduction

The central part of the Taurus complex is characterized by the presence of several dark clouds with filamentary appearance (see Fig. 1 of Duvert, Cernicharo and Baudry, 1986 hereafter referred as DCB). This complex shows many sign posts of recent low mass star formation, such as T-Tauri stars and Herbig-Haro objects. Elias (1978) and Cohen and Kuhl (1979) have made extensive optical, near-infrared and infrared studies of the embedded and pre-main-sequence $H\alpha$ emission stars from which estimates of the visual extinction in the stars' line of sight and stellar age have been derived. The presence of high visual extinction clumps throughout the whole Taurus complex (Cernicharo and Bachiller, 1984; Cernicharo, Bachiller and Duvert, 1985, hereafter referred as CB and CBD respectively), the fragmentary appearance of the clouds and the confused kinematic structure of the Taurus dark clouds, suggest that star formation is still active in this region (Baudry et al., 1981; Myers, 1982; Murphy and Myers, 1985; Cernicharo and Guélin, 1987, hereafter referred as CG; DCB; this paper).

Send offprint requests to: E. Nercessian

The Taurus dark clouds show, in addition to the star formation activity, a rather complex chemical behaviour. Several small size cloudlets of the complex are the strongest cyanopolyynes emitters in the sky. They show chemical abundance variations over scales of a few tenths of pc (Töle et al., 1981; Cernicharo et al., 1984). The reasons for such behaviour are not well understood, and it is clear that a systematic study of the large clouds in which the cloudlets are embedded is necessary in order to derive their physical and chemical properties.

The chain of filamentary globules going from L 1535 to L 1506 (Lynds, 1962) (see Fig. 1) have been the subject of several molecular studies. The H_2CO observations of Kutner (1973), and the OH study of Crutcher (1973) have shown that the B 18 cloud may be rotating like a rigid-body. However, the systematic ^{13}CO and HCO^+ observations of Baudry et al. (1981), and the H_2CO observations of Heiles and Katz (1976) show that the velocity structure of B 18 is too complex to be explained by a single rotating cloud. Actually, several clouds must be present on the line of sight in order to explain the double velocity ^{13}CO components and the complex velocity pattern found in many positions. Murphy and Myers (1985) have modelised the B 18 cloud from ^{12}CO observations to be a shell fragment of diameter ~ 3 pc expanding at 2 km s^{-1} . However, as shown by CG, ^{12}CO is too optically thick in the Taurus clouds and it is unlikely to be a good tracer of the structure and physical properties of the inner parts of the cloud.

The proximity of the Taurus complex (≈ 140 pc, Elias, 1978), permit us to resolve both large and small size regions with telescopes of moderate size. Consequently, we can obtain morphological and kinematic information of the condensed regions where stellar birth takes place. In order to obtain a detailed picture of the region and to derive its physical properties, we have made a systematic ^{13}CO survey of the L 1529 and L 1506 clouds with the Bordeaux 2.5-m millimeter radiotelescope (HPBW = 4'4" at 2.6 mm). The data reported here cover an area of $\approx 5.5 \text{ deg}^2$. The spectra together with the visual extinction values of CB permit us to derive the ^{13}CO abundance across the cloud together with its mass and density structure. The ^{13}CO abundance is found, as in other Taurus clouds (CG; DCB; Bachiller and Cernicharo, 1986, hereafter referred as BC), to vary across the region studied. In order to understand these ^{13}CO abundance variations, we have performed calculations of the CO isotope abundances with a steady state chemical model, under various physical conditions.

In Sects. 2 and 3 we describe the observations and salient results. Section 4 is devoted to the kinematical structure of the cloud. In Sect. 5 we describe the chemical model whose results are

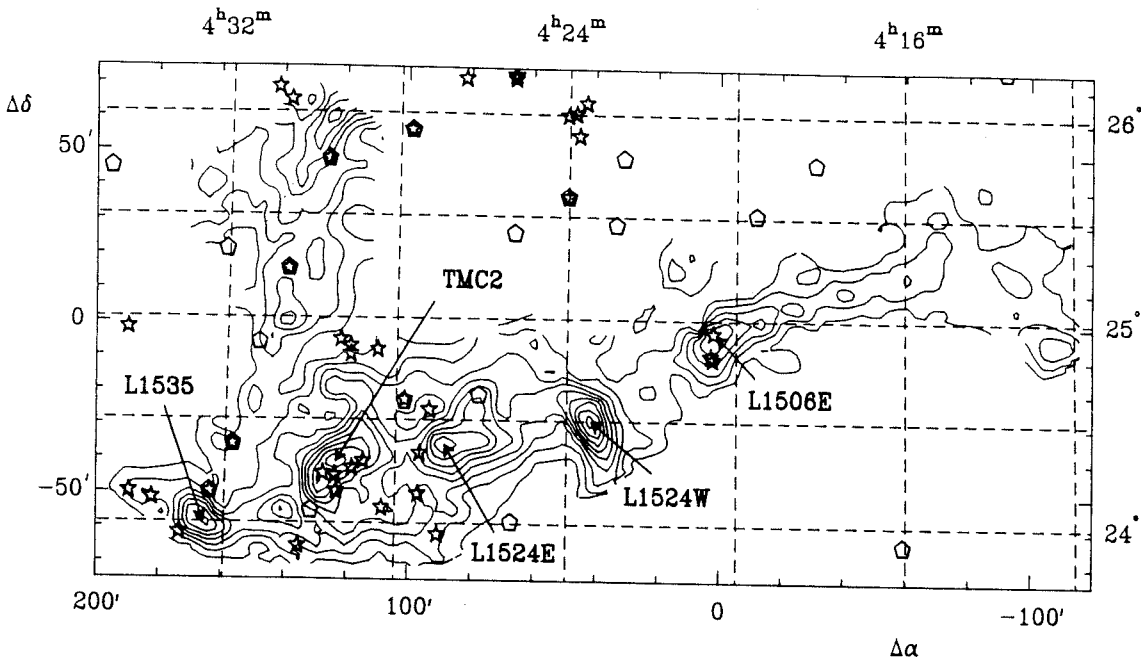

Fig. 1. LTE column density map of the whole region surveyed. Contour levels range from 10^{15} cm^{-2} to $9 \cdot 10^{15} \text{ cm}^{-2}$ with a step of 10^{15} cm^{-2} . The positions of the condensations are indicated. The black stars represent the positions of the T Tauri stars and the Herbig-Haro objects, while the open polygons indicate the infrared point sources from the IRAS catalog. The coordinates of the center are $(\alpha, \delta) = (4^{\text{h}}20^{\text{m}}23^{\text{s}}, 24^{\circ}58'36'')$

discussed in Sect. 6. The gravitational stability of the region is also discussed in this latter section.

2. Observations

The data consist of 816 $^{13}\text{CO } J=1-0$ spectra obtained from 1983 to early 1985 with the 2.5 m diameter millimeter-wave telescope of the Bordeaux Observatory. The half power beam-width at this frequency is 4.4 arcmin and the beam-efficiency close to 0.9. The receiver includes a Schottky diode mixer and an IF system cooled to 20 K. The whole system has been described in detail by Baudry et al. (1981). During the observing run typical system temperature were 800–1200 K.

All the observations were made in the frequency switching mode (± 5 MHz) and with a $5'$ spacing. The spectral system consists of 256×100 kHz channels giving at the ^{13}CO frequency a velocity resolution of 0.27 km s^{-1} . The data were calibrated every 5 min by switching between a load at ambient temperature and the sky. The zenith sky opacity was determined every two hours from sky dips.

The standard reference positions used during the Bordeaux survey of the Taurus-Auriga-Perseus complex (see CB; CBD; CG; BC; DCB) were observed several time every day to insure a good relative calibration across this complex. The data toward these reference positions were then compared to the data obtained with other radio-telescopes in order to insure a good absolute calibration (see CG).

3. Results

3.1. ^{13}CO column density and clouds structure

Polynomial baselines of degree two were removed from the raw data before a Gaussian analysis of each spectrum was made. In each observed position, the line center, width, intensity and

integrated intensity have been derived from a gaussian fit to the data. Typical linewidth of single line spectra were 0.6 to 1.1 km s^{-1} . The peak temperatures lie between 0.5 and 4.3 K , depending on the position in the cloud. Some spectra, most of them situated in the L1524 west side (see Fig. 1), were obviously double-peaked. The remaining ones show a confused shoulder aspect, with a linewidth of about 2.5 km s^{-1} . For all these multiple-lined spectra, a multi-Gaussian analysis has been applied; the resulting integrated intensity is the sum of all the components.

The ^{13}CO column density has been derived in the LTE approximation assuming an identical excitation temperature for the ^{13}CO and ^{12}CO lines (see Dickman, 1978a). This familiar procedure has been used by CG, BC and DCB to derive the ^{13}CO and C^{18}O column densities in several clouds of the Taurus-Auriga-Perseus complex. From Myers' (1982) ^{12}CO map of B18, which corresponds to our L1529 map minus the west part of the L1524 region, we assumed an excitation temperature of 10 K across the whole region. Goldsmith and Sernyak (1984) adopted 13.4 K in one condensation L1535 but it is certainly too high for the entire cloud.

Figure 1 shows the derived ^{13}CO LTE column density in the L1529 and L1506 clouds. This figure also shows the positions of the T-Tauri and Herbig-Haro objects. The infrared point sources from the Infrared Astronomical Satellite (IRAS) catalog and the dark clouds from the Lynds catalog are also indicated. From this map, we define the L1529 cloud to be the area intercepted in the range of offsets $\Delta\alpha = 200'$ to $20'$ and $\Delta\delta = -10'$ to $-70'$, and the L1506 one the west side beyond $\Delta\alpha = 20'$.

The L1529 and L1506 clouds show together an elongated structure extending from south-east to north-west; in this map, we can distinguish a chain of five condensations corresponding to a column density higher than $5 \cdot 10^{15} \text{ cm}^{-2}$, with a mean size of 20 arcmin (0.8 pc at a distance of 140 pc). The L1529 cloud contains three of them which for simplicity will be referred in the

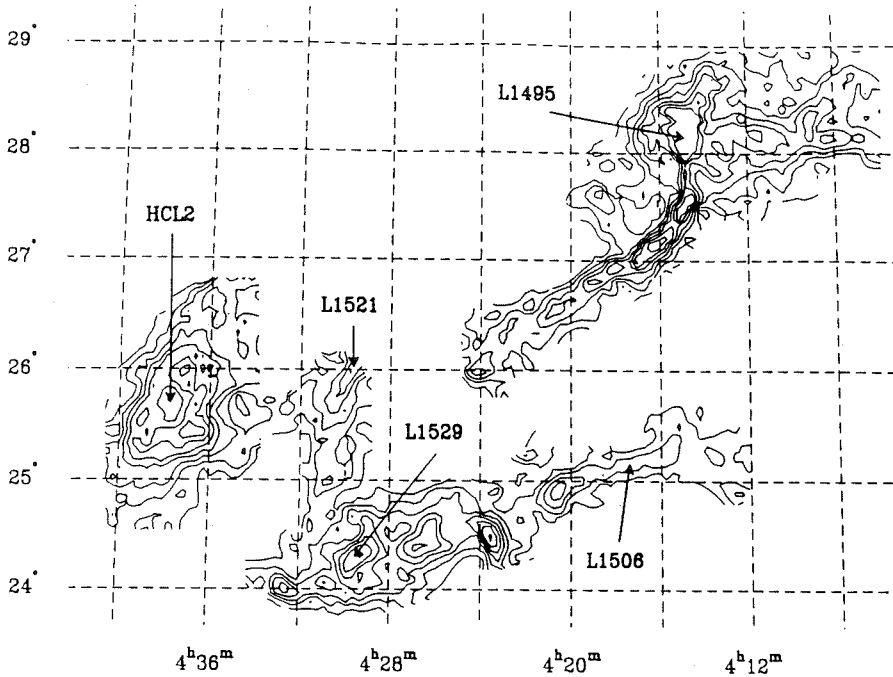

Fig. 2. Map of the integrated intensity of the $^{13}\text{CO} (J=1-0)$ line in several clouds of the Taurus complex collected with the same telescope. The lowest contour level is 1 K km s^{-1} , the contour interval is 1 K km s^{-1} . HCL 2 and L 1495 data are respectively taken from CG and DCB

following to as, from east to west, L1535, TMC2 and L1524E. A fourth one is situated in the L1506 cloud and will be hereafter referred to as L1506E. Due to the presence of double-peaked lines, leading to a possible superposition of two clouds on the line of sight, the situation in the last condensation, referred hereafter as L1524W, is more confused. However in the following, in order to be consistent with the star counts maps of CB, all the calculations will be made considering that L1524W pertains to the L1529 cloud.

According to Fig. 2 showing a collection of observations made in the Taurus region with the same telescope (CG; DCB), the northern part of L1529 up to L1521 corresponds to a bridge of low density material between two parts of the complex. This is in agreement with the separation in "HCL2" and "DL2" made by Murphy and Myers (1985) in the same region.

3.2. Correlation $^{13}\text{CO}/A_v$

To derive the visual extinction A_v , CB and CBD have performed star counts in Taurus and Perseus. The procedure used is described in great detail in their papers. Figure 3 displays their derived A_v values against our integrated intensity data and shows clearly the close correlation between visual extinction and ^{13}CO emission. The unmatched resolution between radio observations ($5'$) and star counts ($2.5'$) requires an A_v averaging over the radio beam. The correlation has been obtained by minimizing the usual quantity (mean least square method):

$$\sum_i (N_i - a A_v^i - b)^2$$

in which N_i and A_v^i are individual values of column densities (in cm^{-2}) and visual extinction (in mag.), a and b are the slope and the intercept of the fitted line.

In order to detect a possible peculiar behaviour, this minimization has been performed on one hand in each condensation, and on the other hand over the entire clouds L1506 and L1529.

The results for both situations are illustrated in Figs. 4 and 5 and summarized in Table 1. The salient features are:

i) the two correlations obtained in both clouds

$$N_{\text{ite}}(^{13}\text{CO}) = 1.4 \pm 0.1 (A_v - 0.6 \pm 0.2) 10^{15} \text{ cm}^{-2} \text{ in L1529}$$

$$N_{\text{ite}}(^{13}\text{CO}) = 0.9 \pm 0.1 (A_v - 0.9 \pm 0.2) 10^{15} \text{ cm}^{-2} \text{ in L1506}$$

We note that the value of the slope in L1506 is the lowest one found in the Taurus-Perseus complex.

ii) the changes in $^{13}\text{CO}/A_v$ ratios from one region to another. Indeed, the slope of the correlation goes from $0.9 10^{15} \text{ cm}^{-2} \text{ mag}^{-1}$ in L1506 up to $1.9 10^{15} \text{ cm}^{-2} \text{ mag}^{-1}$ in L1524W, the densest part of the surveyed area (see below).

In Sect. 4, using a chemical model for molecular clouds, we examine the influence of the local conditions on the $^{13}\text{CO}/A_v$ correlation.

3.3. Masses, densities and sizes

To calculate the masses, we assume the column density of H_2 molecules to be related to A_v by $N(\text{H}_2) = 0.94 10^{21} A_v \text{ cm}^{-2}$ (Bolhin, Savage and Drake, 1978). Then a crude estimate to the cloud mass is obtained by:

$$M_{\text{max}} = (1 + 4/9) m(\text{H}_2) \sum_i N_i(\text{H}_2) S_i$$

where $m(\text{H}_2)$ is the mass of the H_2 molecule with the factor $4/9$ allowing for 10% helium, $N_i(\text{H}_2)$ is the column density of hydrogen deduced from ^{13}CO column density combined with the Bolhin's et al. relation, and S_i is the area intercepted by a 5 arcmin lobe at a distance of 140 pc. The summation is performed over the observed positions of the region under interest.

The L1529 and L1506 cloud masses are found to be respectively 700 and 460 solar masses; a value of the column density corresponding to an A_v equal to 1 mag was chosen as the external limit of the clouds.

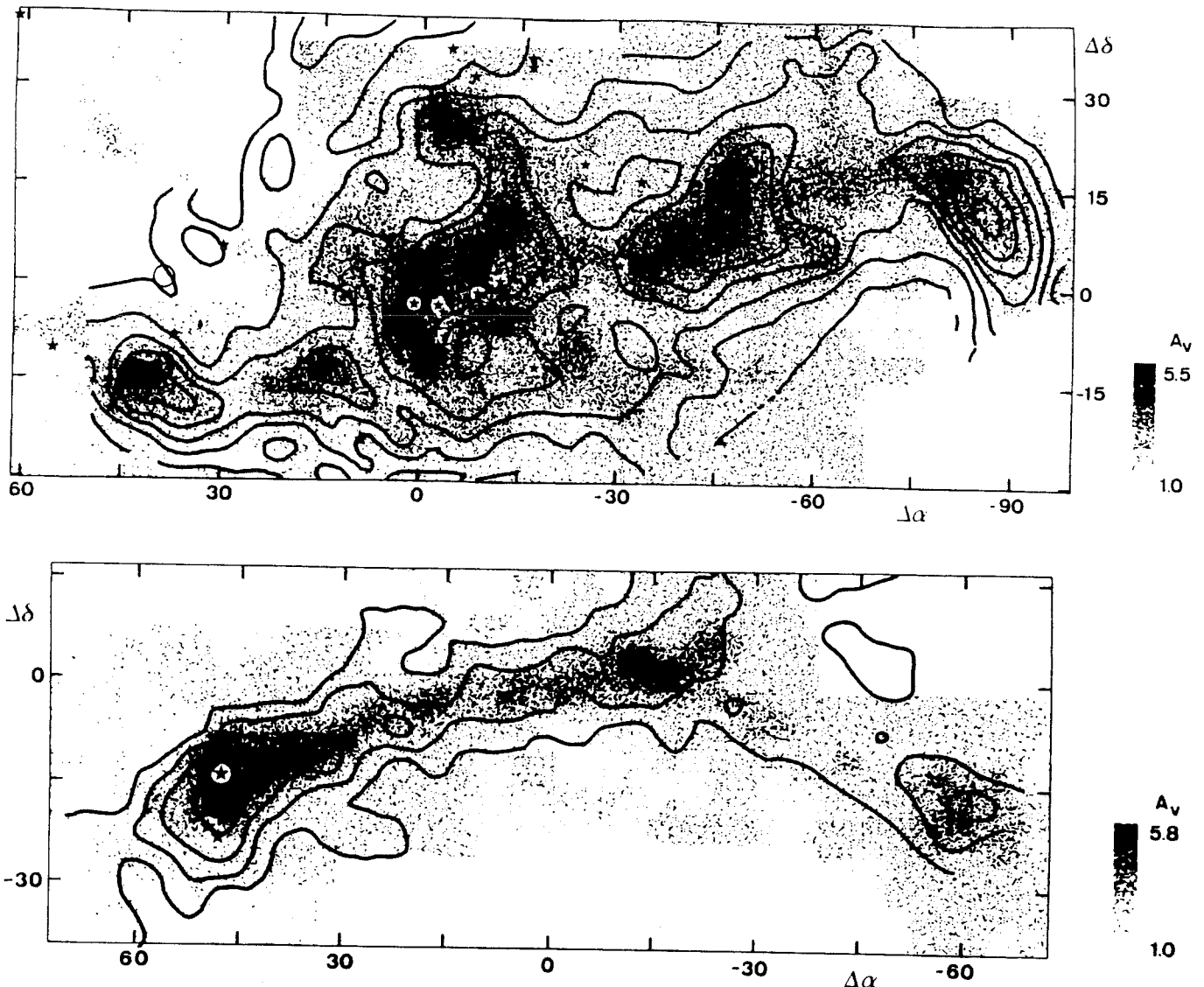

Fig. 3a and b. Visual extinction in the L1529 (a) and L1506 (b) regions from star counts (see CB; CBD) together with $^{13}\text{CO}(J=1-0)$ emission. Contour levels are identical to Fig. 2

The evaluation of the corresponding mean density was made with the assumption that the volume of each cloud is well modelled by a cylinder. This was suggested, in agreement with Myer's model of B18 (Myers, 1982), by the elongated appearance of the ^{13}CO map and the visible obscuration of the cloud. The cylinder axis was supposed to lie in the plane of the sky. Its length and radius were evaluated as respectively 7.0 and 1.1 pc for L1529, 5.0 and 0.9 pc for L1506. That this axis is skewed in front of the sky will not affect the conclusions reached here.

Both mean densities are satisfactorily found to be very close to each other, that is to say 370 and 400 cm^{-3} for L1529 and L1506 respectively.

Since each condensation, described in Sect. 3.1, exhibits a roughly spherical symmetry (contrarily to the clouds shape), we decided to use this geometry for the evaluation of their density. In a condensation, a value of the column density arbitrarily chosen as $3/4$ of the column density in the center, defines the limit of the "core". In the same way, we used a value of $1/2$ for the outer limit of the condensation.

The radii, masses and density obtained are shown in Table 2. These results confirm the conclusions reached by many authors concerning the radial dependence of the density into globules and cores: indeed we deduce a $n(r) = cr^{-1.3}$ law in good agreement with previous works (see the discussion in CBD).

A comparison of these mass estimates with others based on different methods, shows great variations. In the B18 cloud, our value of $670 M_{\odot}$ (B18 corresponds to L1529 minus L1524W) has to be compared to the $900 M_{\odot}$ found by Myers (1982) by modeling the visual extinction in the region, or to the $300 M_{\odot}$ obtained through integrated ^{12}CO intensity (Murphy and Myers, 1985). However, in the latter case, because of the opacity of the ^{12}CO lines, this molecule is not very appropriate for the evaluation of cloud masses (see CG).

Conversely, ^{13}CO has been used as a mass tracer by Goldsmith and Sernyak (1984) in L1535 to find $20 M_{\odot}$, and by Heyer (1985) in L1535, TMC2, L1524E and L1524W to get 13, 62, 54 and $29 M_{\odot}$ respectively, all these results being in agreement with the values listed in Table 2.

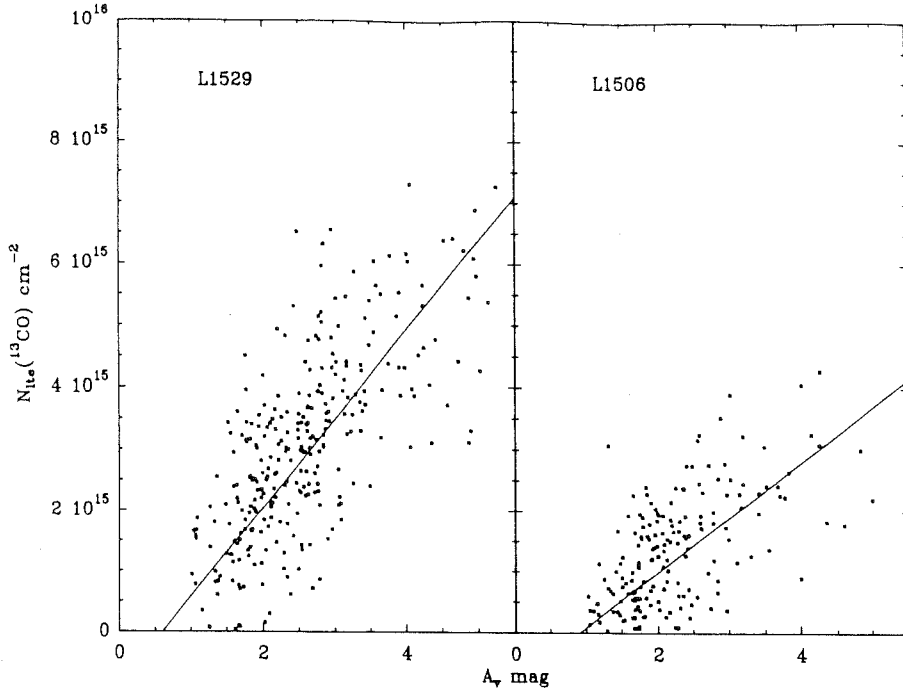

Fig. 4. The ^{13}CO column density versus visual extinction A_v in both clouds L 1529 and L 1506. The solid lines are the regression lines of $N_{\text{LTE}}(^{13}\text{CO})$ on A_v (see Table 1)

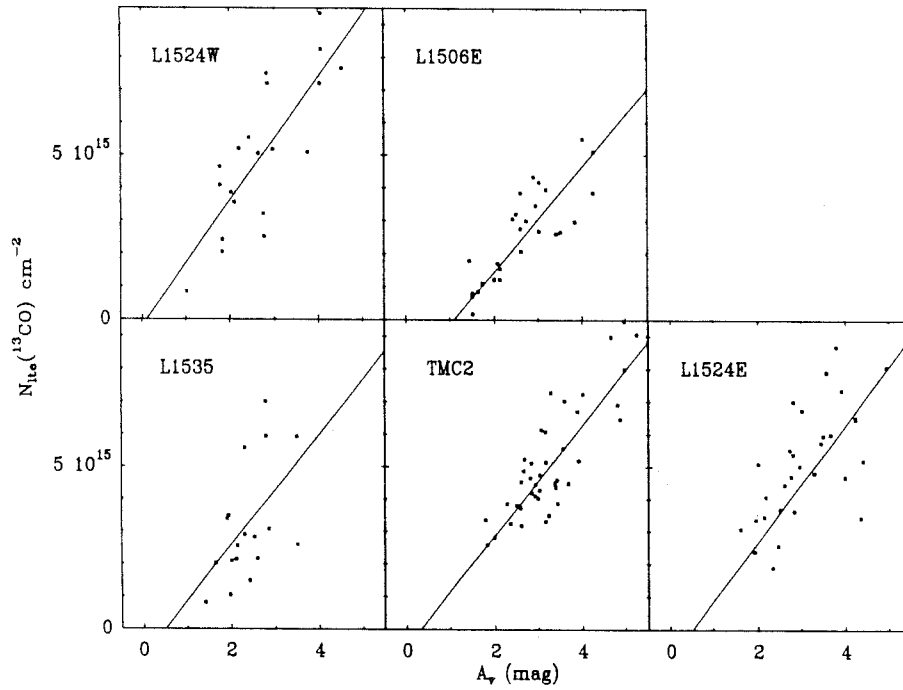

Fig. 5. The ^{13}CO column density versus the visual extinction A_v in the condensations. The solid lines are the regression lines of the least square fits (see Table 1)

The mean densities obtained by Myers (1982) for his B18 model are systematically higher (610 cm^{-3} versus 370 cm^{-3} for us), a discrepancy also seen in the Goldsmith and Sernyak (1984) results for the L 1535 condensation (4500 cm^{-3} versus 2500 cm^{-3}).

On the other hand, the largest part of the cloud mass is contained in a region of faint nebulosity ($500 M_{\odot}$ for the regions where A_v is lower than 4 mag versus 200 for the darkest parts of the cloud). In fact, the contribution to the total mass of the cloud by the opaque region is at most 40 percent, depending on which contour of the ^{13}CO column density we use to separate the opaque and the faint regions. A more realistic value is certainly close to

30 percent. In that case, if, according to our geometrical analysis for the whole cloud, the opaque region lies within a cylindrical region, the radius would be 0.37 pc, a result in good agreement with Myers' (1982) estimate.

4. Velocity structure

As in many Taurus clouds, some parts of the region observed here present double ^{13}CO components. This is for example the case in HCL2 (CG) and in L 1495 (DCB).

Table 1. Correlation of ^{13}CO column density with the visual extinction in the least square sense, both in the condensations and in the whole clouds

Name	Slope $10^{15} \text{cm}^{-2} \text{mag}^{-1}$	N-intercept mag	Coefficient of correlation	Number of points
L1535	1.7 ± 0.7	0.5 ± 0.4	0.60	18
TMC2	1.7 ± 0.2	0.3 ± 0.2	0.87	41
L1524E	1.8 ± 0.3	0.5 ± 0.4	0.93	30
L1524W	1.9 ± 0.3	0.1 ± 0.1	0.92	20
L1506E	1.6 ± 0.1	1.1 ± 0.1	0.97	29
L1529	1.4 ± 0.1	0.6 ± 0.2	0.75	280
L1506	0.9 ± 0.2	0.9 ± 0.2	0.85	160

Table 2. Radii, masses and densities in the spherical globules (1/2 intensity) and cores (3/4 intensity) of the condensations identified in the L 1529 and L 1506 clouds. The correlations used in each condensation are recalled

Name	Correlation $^{13}\text{CO}/A_v$ 10^{15}cm^{-2}	Radius pc	Mass M_{\odot}	Density cm^{-3}
L1535 condensation	1.70 ($A_v - 0.50$)	0.30	18	2200
L1535 core		0.26	15	2900
TMC2 condensation	1.70 ($A_v - 0.30$)	0.55	68	1400
TMC2 core		0.36	36	2500
L1524E condensation	1.80 ($A_v - 0.50$)	0.59	69	1100
L1524E core		0.34	29	2400
L1524W condensation	1.90 ($A_v - 0.10$)	0.41	33	1500
L1524W core		0.30	21	2500
L1506E condensation	1.60 ($A_v - 1.10$)	0.51	50	1200
L1506E core		0.38	31	1900

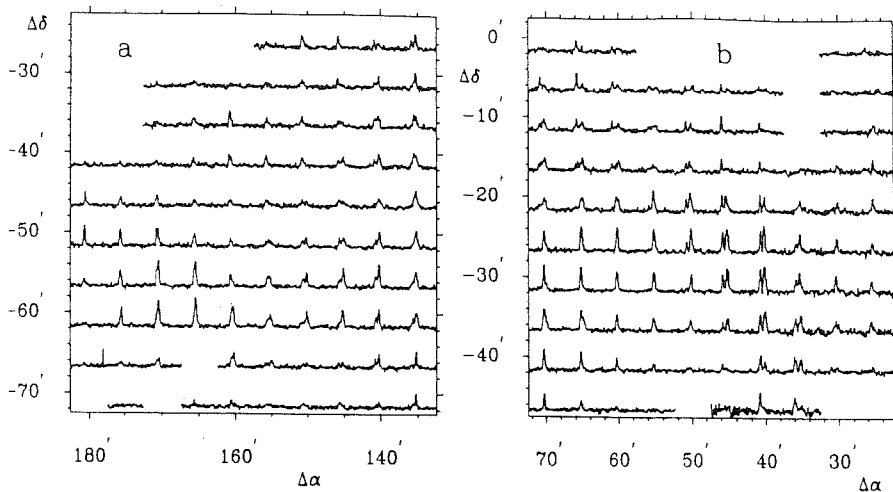

Fig. 6a and b. 10×10 spectra maps of L1535 (a) and L1524W (b) regions. The antenna temperature range in one spectrum goes from -1 K to 5 K, the velocity range from 0 to 10 km s $^{-1}$. The origin of these maps is the same as Fig. 1

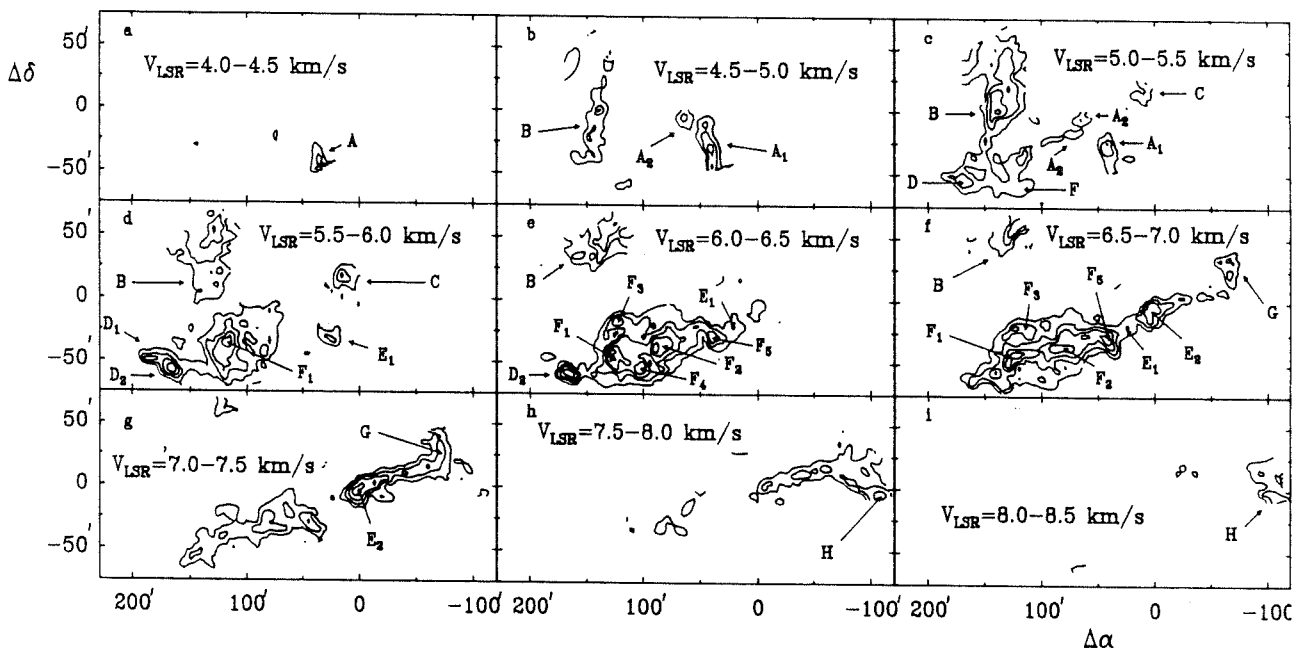

Fig. 7. Maps of integrated ^{13}CO ($J=1-0$) line intensity in 9 velocity ranges. The levels are from 0.4 K km s $^{-1}$ to 2.0 K km s $^{-1}$ by 0.4 K km s $^{-1}$. The corresponding velocity intervals are indicated in each sub-figure. The origin of these maps is the same as in Fig. 1

Figure 6b shows a 10×10 spectra map of L1524W, which is close to the overlap region between B18 and L1506. Two velocity components can be clearly seen. In some directions, up to three velocity components were observed (see Fig. 6b, offset $\Delta\alpha = 60'$ to $70'$ and $\Delta\delta = -10'$ to $-20'$). The same behaviour is found towards other directions. For example, Fig. 6a shows another 10×10 spectra map of the region around L1535. In the south of this map, the low velocity component is weak and makes a bridge of gas between L1535 and TMC2 (see below). Elsewhere, towards the north, the low velocity component shows a strong radial velocity gradient. However, the more conspicuous velocity structure in the region is a well defined radial velocity gradient from southeast to northwest of DL2, first suggested by Crutcher (1973) and analysed in detail by Baudry et al. (1981).

The rather complex velocity structure of DL2 can be seen in Fig. 7 which shows the line intensity integrated over different

velocity ranges. Two clouds, labelled in Fig. 7 as A and B, appear at the lowest velocity range. Cloud A is composed of two filaments with very narrow lines. The first, cloud A_1 , is nearly perpendicular to DL2 and crosses it in L1524W (see Fig. 6b and Figs. 7a, b, c). Its extension is $\approx 10' \times 40'$ and its mass $30 M_{\odot}$. The ^{13}CO linewidths and the line velocity are ≈ 0.6 km s $^{-1}$ and 5 km s $^{-1}$ respectively. A similar cloud is also observed towards L1495 (DCB), where a filament is found nearly perpendicular to the bulk of the ^{13}CO emission in the region (see our Fig. 2 position $\alpha \approx 4^{\text{h}}18^{\text{m}}$, $\delta \approx 27^{\circ}30'$).

The position of the ^{13}CO emission maxima of cloud A_1 was observed by Baudry et al. (1981) in the $J=1-0$ line of HCO^+ and C^{18}O (see their Fig. 9). The C^{18}O emission was found to be weak, and HCO^+ was not detected. This suggests that the ^{13}CO emission is optically thin and that the hydrogen density is not too high. From our data, we derive an average hydrogen density over cloud

A_1 of 500 cm^{-3} . In the direction of the emission peak, we derive $N(^{13}\text{CO}) \approx 3.5 \cdot 10^{15} \text{ cm}^{-2}$ corresponding to a visual extinction of 3 mag. Only the region showing strong double velocity components in Fig. 6b has an obvious counterpart in the optical extinction map of Fig. 3a.

Cloud A_2 is parallel to DL2 and perpendicular to cloud A_1 . In Fig. 7 we can see that cloud A_2 appears after a minimum of emission northeast of cloud A_1 and extends towards the southeast (see Fig. 7c). Its ^{13}CO emission is weak and it can be seen in the spectra as a blue shoulder. The mass of cloud A_2 is $20 M_\odot$. There is not a clear counterpart for this cloud in the visual extinction map (see Fig. 3a); however, it is clearly seen in the ^{12}CO map of Murphy and Myers (1985) at radial velocity of 5 km s^{-1} .

At $\Delta\alpha = +120'$ and $\Delta\delta = -40'$, a new low velocity component can be seen in Fig. 7b. This cloud, labelled B , crosses a bridge of gas in the south at radial velocity of 6.0 km s^{-1} , which goes from L1535 (cloud D) to TMC2 (cloud F_1); in the L1535 region, the spectra are clearly doubled peaked (see Fig. 6a). For $\Delta\delta > -20'$, cloud B shows single narrow lines, and extends to the northeast: Fig. 7c shows that it intercepts the 5.3 km s^{-1} filament of HCL2 (see CG) at $\Delta\alpha = +140'$ and $\Delta\delta = +40'$. Across cloud B , there is a strong radial velocity gradient of $0.40 \pm 0.07 \text{ km s}^{-1} \text{ pc}^{-1}$. The mass of this cloud is about $270 M_\odot$.

In Fig. 7c and 7d, an isolated cloud, apparently unrelated to the bulk of the ^{13}CO emission, appears (cloud labelled C). It is roughly spherical with a radius of $\approx 10' = 0.4 \text{ pc}$. Its mass is $25 M_\odot$ and its average density $\approx 700 \text{ cm}^{-3}$.

At velocities $\geq 5.5 \text{ km s}^{-1}$ several clouds are located along DL2 (clouds labelled D to H) and coincide with optical patches of visual extinction (Figs. 3a and 3b). Cloud D is the eastern fragment of DL2 and roughly corresponds to L1535. It appears fragmented in two cloudlets: the first one D_1 can be seen in Fig. 3a as a low visual extinction region of $10 M_\odot$ and $10'$ extension northeast of L1535; the second one D_2 is L1535 and can be seen in Figs. 7c to 7e; the mass of L1535 is $20 M_\odot$.

Cloud F is B18 (see Figs. 7d to 7g) and it is fragmented in several clumps coinciding in position with the more conspicuous features of the visual extinction map (see Fig. 3a). For example, clump F_1 is TMC2 and shows ^{13}CO emission from 5.0 to 7.5 km s^{-1} , clump F_2 is L1524E and clump F_3 is L1524W. The masses of F_1 , F_2 , F_3 , F_4 and F_5 are estimated to be 60, 60, 25, 25 and $30 M_\odot$ respectively, while the mean density is everywhere roughly constant at $1500\text{--}2000 \text{ cm}^{-3}$. Across cloud F there is some radial velocity variation of the ^{13}CO lines; however, there is no clear evidence for a radial velocity gradient: the velocity structure in this region, which represents the bulk of the ^{13}CO emission in B18, is chaotic and probably reflects the fragmentary appearance of the cloud.

The more obvious velocity gradient is of $0.13 \pm 0.01 \text{ km s}^{-1} \text{ pc}^{-1}$ along cloud E_1 to cloud H . Cloud E_1 appears in the $5.5\text{--}6.0 \text{ km s}^{-1}$ velocity range (Fig. 7d) and is evidently disconnected from cloud F . It seems to form a bridge of $10 M_\odot$ of low density gas ($\approx 400 \text{ cm}^{-3}$) between clump F_5 and the cloud L1506 (clump $E_2 \approx \text{L1506E}$ to H). This bridge of gas corresponds to a low visual extinction hole between L1529 and L1506 in Figs. 3a and 3b. Gravitational stability and cloud binding in the whole region will be discussed in Sect. 6.2.

5. Chemical model

Several authors have approached the problem of a quantitative comparison of carbon monoxide column densities with visual

extinctions. Some have studied single clouds (Tucker et al., 1976; Elmegreen and Elmegreen, 1979; CG; BC) while others like Dickman (1978b) used a statistical approach, surveying many locations in a large number of clouds. The values related for the $^{13}\text{CO}/A_v$ and $\text{C}^{18}\text{O}/A_v$ ratios are widespread (see Table 1 of BC plus our results in L1506 and L1529).

In order to study the correlations between different clouds, we have constructed a steady-state model of interstellar clouds from the recent one of Viala (1986). The influence of the various local physical conditions is studied through the variation of four main parameters: (i) the visual extinction A_v throughout the cloud, (ii) the hydrogen density distribution $n_{\text{H}}(r)$, (iii) the kinetic temperature distribution $T_{\text{K}}(r)$ and (iv) the intensity of the UV interstellar radiation field.

The chemical reaction scheme affects 86 species formed from H, He, C, O, ^{13}C and ^{18}O , and connected by 1216 reactions. Some processes involving Mg, Fe, S and Si are included because of the strong dependence of the ionization equilibrium on the presence of these heavy elements.

Species are H, H_2 , H^+ , H_3^+ , H_3^+ , Fe, Fe^+ , Si, Si^+ , Mg, Mg^+ , e, C, C^+ , O, O^+ , O_2 , O_2^+ , CH, CH^+ , CH_2 , CH_2^+ , CH_3 , CH_3^+ , CH_4 , CH_4^+ , CH_5^+ , C_2 , C_2^+ , C_2H , C_2H^+ , C_2H_2 , C_2H_2^+ , C_2H_3^+ , CO, CO^+ , HCO, HCO^+ , CO_2 , OH, OH^+ , H_2O , H_2O^+ , H_3O^+ and the isotopic substitutions including ^{13}C or/and ^{18}O . The reactions are those used by Viala (1986) for the species mentioned above; updated rates from laboratory measurements at low temperature are listed in Table 3. To study isotopic chemistry, the reactions involving carbon and oxygen in the set of basic reactions are replicated in the sense of Langer et al. (1984). Isotopic fractionation, first introduced by Watson et al. (1976) is included: rates of these reactions are taken from Langer et al. (1984).

Gas phase reactions alone are considered except H_2 formation on grains. Since for $A_v > 5 \text{ mag}$ there is no evidence for a decrease of CO abundance in the inner part of clouds (CG), the condensation of CO on dust grains suggested by Leger (1983) is not included.

Ionizations and dissociations by cosmic rays (with a primary ionization rate of 10^{-17} s^{-1}) are taken into account because of their important role in initiating the dense cloud chemistry.

Most of the molecules are photodissociated by a continuum, some by a two photon process (H_2); others have a continuum contribution added to predissociation (OH, CO). For CO and its isotopes we calculate, as Glassgold et al. (1985) did, the selective dissociation in three absorption bands with the data given in their Table 1. All the allowed transitions from the four lowest rotational levels are included, assuming them to be populated with a constant excitation temperature taken equal to the kinetic one. The formation and destruction of CO is described in the Appendix.

The chemical equilibrium is solved together with a transfer equation in a self-consistent way: in order to get an analytic solution to the transfer problem and hence to reduce the computational time, the cloud is assumed to have a limited plane parallel geometry, while the diffusion phase function for the grains is chosen to be strictly forward (see Viala, 1986). The model provides the photodestruction rates and the abundances relative to hydrogen of the chemical species as a function of position in the cloud. The column densities throughout the whole cloud are then computed with the standard basic hypothesis for the gas to dust ratio in the interstellar medium. The calculations are performed for constant density and temperature distributions. The elemental abundances of C and O in the gas phase are chosen to be $\text{C}_v = 10^{-4}$ and $\text{O}_v = 2 \cdot 10^{-4}$; the elemental isotopic ratios are fixed at

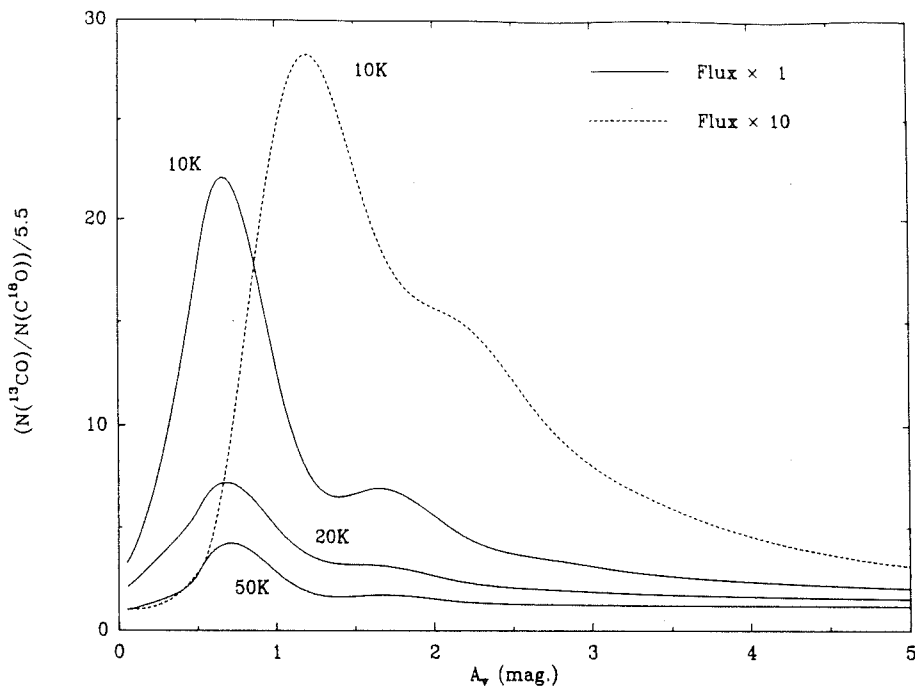

Fig. 8. Effect of changing temperature or the UV flux intensity on the $^{13}\text{CO}/\text{C}^{18}\text{O}$ enhancement ratio normalized to the terrestrial value

Table 3. The modified reactions from the previous model of Viala (1986) are taken in (1) Rowe et al. (1985a), (2) Rowe et al., (1985b), (3) Federer et al. (1985)

Reactions	Rates ($\text{cm}^3 \text{s}^{-1}$)	References
$125 \text{ He}^+ + \text{H}_2\text{O} \longrightarrow \text{OH}^+ + \text{He} + \text{H}$	$7.9 \cdot 10^{-8} \text{ T}^{-0.94}$	(1)
$126 \text{ He}^+ + \text{H}_2\text{O} \longrightarrow \text{H}_2\text{O}^+ + \text{He}$	$1.6 \cdot 10^{-8} \text{ T}^{-0.94}$	(1)
$165 \text{ C}^+ + \text{H}_2\text{O} \longrightarrow \text{HCO}^+ + \text{H}$	$2.4 \cdot 10^{-7} \text{ T}^{-0.91}$	(1)
$235 \text{ O}^+ + \text{O}_2 \longrightarrow \text{O}_2^+ + \text{O}$	$7.7 \cdot 10^{-10} \text{ T}^{-0.65}$	(2)
$395 \text{ CH}_4^+ + \text{H}_2 \longrightarrow \text{CH}_5^+ + \text{H}$	$5.8 \cdot 10^{-6} \text{ T}^{-2.08}$	(3)
$780 \text{ CO}^+ + \text{H}_2 \longrightarrow \text{H}^+ + \text{CO}$	$8.0 \cdot 10^{-10}$	(3)

$^{12}\text{C}_i/^{13}\text{C}_i = 90$ and $^{16}\text{O}_i/^{18}\text{O}_i = 500$ (Langer et al., 1980; Penzias, 1983), The Fe, Mg, Si and S abundances are respectively taken equal to $2 \cdot 10^{-7}$, 10^{-6} , $8.3 \cdot 10^{-7}$ and $8.3 \cdot 10^{-6}$.

6. Discussion

6.1. Abundance of the isotopes of CO and mass determination

Because of the non-observability of the homonuclear molecule H_2 in opaque clouds, the matter in the extended molecular clouds is

usually studied through the emission of the rotational lines of CO isotopes, together with star counts and Bohlin's et al. (1978) relation between hydrogen column density and visual extinction. This shows the importance of using an appropriate molecule with a stable abundance across different molecular regions. Because the ^{12}CO rotational lines are optically thick, most of the studies have used the rarer isotopes ^{13}CO and C^{18}O . A large sample of relationships between ^{13}CO , C^{18}O and A_v have been reported in the literature. For example, different values of $N(^{13}\text{CO})/A_v$ ratios, all obtained in the Taurus clouds with the Bordeaux radiotelescope, range from $0.9 \cdot 10^{15} \text{ cm}^{-2} \text{ mag}^{-1}$ in L1506 (this work) to

$2.0 \cdot 10^{15} \text{ cm}^{-2} \text{ mag}^{-1}$ in L 1495 (DCB), with intermediate values at $1.3 \cdot 10^{15} \text{ cm}^{-2} \text{ mag}^{-1}$ and $1.4 \cdot 10^{15} \text{ cm}^{-2} \text{ mag}^{-1}$ in HCl2 (CG) and L1529 (this work). The correlations reported in Sect. 3.2 in some restricted locations in L1506 and L1529 lead also to comparable values between $1.6 \cdot 10^{15} \text{ cm}^{-2} \text{ mag}^{-1}$ and $1.9 \cdot 10^{15} \text{ cm}^{-2} \text{ mag}^{-1}$. In the same conditions, a rather high value of $2.5 \cdot 10^{15} \text{ cm}^{-2} \text{ mag}^{-1}$ has been derived by BC in Perseus. From all these data, it is possible to say that ^{13}CO becomes detectable at $A_v \approx 0.6\text{--}0.8$ mag both in Taurus and Perseus. It is interesting to note that Dickman (1978b) early attributed a mean value of $1.9 \cdot 10^{15} \text{ cm}^{-2} \text{ mag}^{-1}$ to $N(^{13}\text{CO})/A_v$ from a rather non homogeneous sample of dark clouds in Taurus, a value which is roughly representative of the Taurus-Perseus situation. Frerking et al. (1982) have extended the Dickman's relation by finding in Taurus a correlation between the visual extinction and the C^{18}O and ^{13}CO column densities. For ^{13}CO they found $1.4 \cdot 10^{15} \text{ cm}^{-2} \text{ mag}^{-1}$, a value equal to the one in L1529 and intermediate between L1506 and L1495.

For $N(\text{C}^{18}\text{O})/A_v$, CG found $2.5 \cdot 10^{14} \text{ cm}^{-2} \text{ mag}^{-1}$ in HCl2, DCB reported $2.2 \cdot 10^{14} \text{ cm}^{-2} \text{ mag}^{-1}$ in L1495 while BC derived $3.4 \cdot 10^{14} \text{ cm}^{-2} \text{ mag}^{-1}$ in one globule B1 of Perseus. In every case, a minimum of 1.1 to 1.6 magnitude of visual extinction is required for C^{18}O to be detected. Frerking et al. (1982) found $2.4 \cdot 10^{14} \text{ cm}^{-2} \text{ mag}^{-1}$ for extinctions larger than 2.9 mag and $0.7 \cdot 10^{14} \text{ cm}^{-2} \text{ mag}^{-1}$ for extinctions between 1.9 and 2.9 magnitude.

Thus a variation within a factor 2 in the $N(^{13}\text{CO})/A_v$ ratio is revealed between the Taurus and Perseus regions (the higher value in Taurus is found in L1495 which is the nearest of Perseus), while only a slight variation within a factor 1.3–1.5 is observed in the $N(\text{C}^{18}\text{O})/A_v$ ratio. All the data implicated here were calibrated in the same way and with identical reference sources, so that the errors could not be higher than 20%. The observed discrepancy in the abundances must be understood in terms of variations in the local conditions which have an influence upon the interpretation of data and upon photochemical processes. Let us now discuss these two points.

6.1.1. The interpretation of the data

To infer column densities from millimeter-wavelength emission lines is not straightforward, and assumptions must be involved in the sense that the line intensity is a complicated function of source parameters such as local density, kinetic temperature, velocity field or cloud geometry. Every reference mentioned above, as well as this paper, have accepted the assumption that the populations of the energy levels of all isotopic species of CO are in LTE, i.e. that the excitation temperature T_{ex} is the same for all levels of all species. However, the LTE assumption is certainly not correct in the low A_v regions where the density is $\approx 10^2\text{--}10^3 \text{ cm}^{-3}$, while at sufficiently higher densities collisions are able to bring all levels of all isotopic species into LTE. The most abundant species ^{12}CO will come into LTE with $T_{\text{ex}} \approx T_{\text{K}}$ at the lowest density because of the trapping of photons emitted by ^{12}CO molecules in the inner parts of the cloud. For less abundant species, the line optical depths are smaller, trapping is less important, and $T_{\text{ex}} < T_{\text{K}}$, so that the excitation temperature must depend on the details of radiative transfer which requires knowledge of the local molecular abundance and velocity field. As the kinetic temperature increases, the LTE approximation overestimates the column densities compared with detailed radiative transfer calculations.

Thus, errors in the ^{13}CO column density estimates could be incriminated in both ^{13}CO abundance variations from cloud to

cloud and data scatter in the $^{13}\text{CO}/A_v$ relation within a given cloud.

First, the column density derived in a particular line of sight must be interpreted as an average through regions of different physical conditions, and consequently will depend on the density profile and cloud structure.

Second, the saturation of emission lines observed in many lines of sight, particularly in Taurus, leads to an underestimate of column densities under the LTE assumption; this effect is less important in Perseus. And third, the conditions of excitation of ^{13}CO could be subthermal in the external layers of the Taurus envelope where the hydrogen density is $n_{\text{H}} \approx 3 \cdot 10^2 \text{ cm}^{-3}$ (CG), and could lead also to an underestimate of the column densities through non-LTE effects. Except the first point, these experimental difficulties are not so critical for C^{18}O because no saturation occurs in the range $A_v = 3\text{--}6$ mag, and because C^{18}O is not detected at low visual extinction where ^{13}CO is subthermally excited.

An additional source of scatter in the $^{13}\text{CO}/A_v$ relation within one cloud is due to the cloud structure: as discussed in Sect. 4 and in CG and BC, the Taurus and Perseus clouds often show multiple velocity components. Our analysis of the ^{13}CO data in L1529 and L1506 shows that several clouds could contribute to the ^{13}CO emission in this region. Because it is not possible to derive the contribution to the total visual extinction of each individual cloud, the $^{13}\text{CO}/A_v$ relations quoted in Table 1 concern the whole cloud. In that case the data scatter will be larger due to the comparison of points with different physical conditions and to the contribution of each cloud to the A_v cutoff in the ^{13}CO emission (as an example, compare the $^{13}\text{CO}/A_v$ relation of Fig. 4 for the whole clouds and those of Fig. 5 for selected area within the clouds).

6.1.2. The photochemical processes

Now let us examine through our chemical model, which processes can modify the ^{13}CO and C^{18}O abundances, that is to say the observed $N(^{13}\text{CO})/A_v$ and $N(\text{C}^{18}\text{O})/A_v$ ratios, as the physical conditions change. For simplicity in the following the physical parameters of hydrogen density, kinetic temperature and intensity of the UV radiation field are treated as independent even if they are closely correlated by the thermal balance.

(i) *Density*: There is a large difference between high and low density conditions because fractionation (see Appendix) which occurs in the external layers of clouds, must compete with other reactions of C^+ in order to be important. However, in diffuse clouds, the chemical reactivity is determined by the UV radiation field whose effects are proportional to n_{H}^{-1} : thus, fractionation will be less important at low density and the consequences of an increasing density on the $^{13}\text{CO}/A_v$ and $\text{C}^{18}\text{O}/A_v$ correlations are an increasing slope and a decreasing intercept. The ^{13}CO abundance grows up into the cloud proportionally faster than C^{18}O because no $\text{C}^{18}\text{O}/\text{CO}$ fractionation enhancement occurs, and because the ^{13}CO photodissociation rate is smaller throughout the cloud due to selective photodissociation. For the same reasons, the intercepts decrease less fast for C^{18}O than for ^{13}CO (see column 1 of Table 4). As the density becomes high, a cloud is comparable to a dark place with no radiation. The chemical reaction set makes ^{13}CO and C^{18}O the main sink of ^{13}C and ^{18}O respectively in the cloud. The following upper limits for $N(^{13}\text{CO})/A_v$ and $N(\text{C}^{18}\text{O})/A_v$ will be reached in our constant distribution model:

$$N(^{13}\text{CO})/A_v = N_{\text{H}}/A_v \times {}^{13}\text{C}_i = 2.1 \cdot 10^{15} \text{ cm}^{-2} \text{ mag}^{-1}$$

$$N(\text{C}^{18}\text{O})/A_v = N_{\text{H}}/A_v \times {}^{12}\text{C}_i \times {}^{18}\text{O}_i/{}^{16}\text{O}_i = 3.7 \cdot 10^{14} \text{ cm}^{-2} \text{ mag}^{-1}$$

Table 4. ^{13}CO and C^{18}O correlations with visual extinction A_v , respectively in unit of 10^{15} and 10^{14}cm^{-2} , calculated for different density, temperature and UV flux conditions

T(K) , UV flux n (cm^{-3})		T(K) , UV flux				
		10 × 1	10 × 10	10 × 100	20 × 1	50 × 1
3000	^{13}CO	$2.1(A_v - 0.3)$				
	C^{18}O	$3.0(A_v - 0.8)$				
1000	^{13}CO	$2.0(A_v - 0.6)$	$1.8(A_v - 1.3)$	$1.3(A_v - 2.6)$		
	C^{18}O	$2.1(A_v - 1.1)$	$1.1(A_v - 1.8)$	$0.4(A_v - 2.6)$		
300	^{13}CO	$1.7(A_v - 0.9)$			$1.3(A_v - 1.0)$	$1.1(A_v - 1.0)$
	C^{18}O	$0.8(A_v - 1.2)$			$1.1(A_v - 1.2)$	$1.4(A_v - 1.1)$
100	^{13}CO	$0.6(A_v - 1.0)$				
	C^{18}O	$0.2(A_v - 1.3)$				

Therefore, several relevant parameters like the cloud thickness, the gas to dust ratio and the elemental abundances are of critical importance. The $N(^{13}\text{CO})/A_v$ ratio reaches its saturated value for densities lower than $N(\text{C}^{18}\text{O})/A_v$; C^{18}O seems to be a better gas tracer of dense places.

(ii) *Temperature:* The temperature dependence of the fractionation reaction (A 15) is able to explain why ^{13}CO in a warm cloud is less enhanced than in a cold one, so that $N(^{13}\text{CO})/A_v$ decreases when T_k increases. The corresponding reaction (A 16) for C^{18}O has a contrary effect: $N(\text{C}^{18}\text{O})/A_v$ is enhanced when the kinetic temperature is increased. These variations are accentuated or moderated by the temperature dependence of the neutral reactions between hydrocarbons and oxygen (A 12)–(A 13)–(A 14) in $T^{1/2}$ and of the electronic recombination of HCO^+ in T^{-1} (Adams et al., 1984). Temperature variations in a cloud with constant density of 300cm^{-3} and a standard UV flux are shown in line 3 of Table 4: the slopes of the correlations range from $1.7 \cdot 10^{15}$ to $1.1 \cdot 10^{15} \text{cm}^{-2} \text{mag}^{-1}$ for ^{13}CO , and from $0.8 \cdot 10^{14}$ to $1.4 \cdot 10^{14} \text{cm}^{-2} \text{mag}^{-1}$ for C^{18}O as the temperature increases from 10 to 50 K. The intercepts are of course unchanged by these temperature variations.

(iii) The influence of an enhanced UV radiation field on the reaction set is to increase all the photodestruction rates. In the external layers, the competition between the photodestruction of OH and C_xH_y , and the formation of CO through these species (see Appendix) turns to the advantage of the first channel: shielding must occur to recover a normal situation deeper into the cloud. This effect added to direct photodissociation of CO makes the $N(^{13}\text{CO})/A_v$ and $N(\text{C}^{18}\text{O})/A_v$ ratios lower and the intercepts

higher when the UV flux is increased. The effect is always stronger for C^{18}O than ^{13}CO (see line 2 of Table 4) due first to the selective photodissociation stronger for C^{18}O than for ^{13}CO , and second to the enhanced abundance of C^+ which increases the isotopic fractionation efficiency (see Fig. 8): the $^{13}\text{CO}/A_v$ fall is slowed by the fractionation while the $\text{C}^{18}\text{O}/A_v$ one is accelerated.

Thus the moderate variations of the ^{13}CO abundance through the Taurus dark clouds which are all exposed to roughly the same environment can be the consequence of rather non homogeneous conditions of density and temperature, and of fractionation effects which dominate when $A_v \approx 1-3 \text{mag}$, combined with some non-LTE effects. Concerning C^{18}O , thermalisation is certainly achieved in most of the observed positions in Taurus, positions which correspond to the darkest places where ^{13}CO is optically thick. In these places, conditions of low temperature and high density, together with the absence of fractionation effects on the C^{18}O molecule, make the C^{18}O abundance relatively uniform across Taurus.

Considering that the observational difficulties mentioned early cannot alone explain the observed features in the $N(^{13}\text{CO})/A_v$ and $N(\text{C}^{18}\text{O})/A_v$ correlations from Taurus to Perseus, the theoretical results must be important. In the north-east of Perseus lies the Per OB2 association of OB stars, so that the UV radiation field must be enhanced by a significant factor in this region compared with Taurus (see BC). Hence it is expected that the temperature should increase towards the edge of the cloud; a temperature around 60–80 K has been computed in cloud models which included thermal balance of the gas (Boland and de Jong, 1984). In a warm cloud with enhanced UV flux, the slope of the $\text{C}^{18}\text{O}/A_v$ correlation can be roughly constant or even slightly increased with respect to a standard cold cloud, the intercept lying

in a range of magnitude in agreement with the observed values. Indeed we calculated $N(\text{C}^{18}\text{O}) = 2.1 \cdot 10^{14} (A_v - 1.1) \text{cm}^{-2}$ in a cloud with $n_{\text{H}} = 1000 \text{cm}^{-3}$, $T_k = 10 \text{K}$ and a standard UV flux and $N(\text{C}^{18}\text{O}) = 3.1 \cdot 10^{14} (A_v - 1.4) \text{cm}^{-2}$ in a model with the same density but $T_k = 50 \text{K}$ and an UV flux enhanced by a factor 10.

On the contrary, the $N(^{13}\text{CO})/A_v$ ratio drops systematically both with enhanced temperature and UV flux. In order to appreciate if some change in the carbon isotopic ratio could occur in Perseus with respect to Taurus and thus help to enhance $N(^{13}\text{CO})/A_v$ in spite of warm and illuminated conditions, we have performed a model calculation with density $n_{\text{H}} = 1000 \text{cm}^{-3}$, temperature $T_k = 50 \text{K}$ and an UV flux enhanced by a factor 10, together with an isotopic ratio $^{12}\text{C}_i/^{13}\text{C}_i$ reduced to a value of 60 (instead of its terrestrial value of 90). The result is in agreement with the expected behaviour since it is found that $N(^{13}\text{CO}) = 2.8 \cdot 10^{15} (A_v - 1.0) \text{cm}^{-2}$ in these conditions, to be compared with $N(^{13}\text{CO}) = 2.0 \cdot 10^{15} (A_v - 0.6) \text{cm}^{-2}$ in our standard cloud where $n_{\text{H}} = 1000 \text{cm}^{-3}$, $T_k = 10 \text{K}$ and the UV flux is normal.

Thus the variations of $N(^{13}\text{CO})/A_v$ ratios through a sample of comparable observations can be understood in term of variations in the local conditions: problems in the column densities estimate due to lines opacity or to the conditions of molecular excitation in Taurus, rather non homogeneous conditions from place to place due to the cloud structure, photochemical processes brought out by the strong UV radiation environment of Perseus, coupled with a possible reduced carbon isotopic ratio.

C^{18}O is a good column density tracer since its emission lines are optically thin up to high visual extinction. In addition C^{18}O is less sensitive to the phenomena described above for ^{13}CO , and although it requires more visual extinction to be detected, it can be used as a good tracer in the darkest regions.

In order to derive a cloud mass, we need coupled observations of ^{13}CO across the whole cloud and C^{18}O observations in the high A_v regions. The variations from place to place of the $^{13}\text{CO}/A_v$ ratio, which at most of a factor two, should affect the determination of the cloud mass, but the weakness of this factor compared to the cloud distance uncertainty makes ^{13}CO the best mass tracer for molecular clouds. The situation is different for the high A_v regions where ^{13}CO lines are certainly saturated and where, in addition to the mass, one want also to derive some informations about the size and the structure of the condensations. For these regions the C^{18}O emission is the best gas tracer.

6.2. Gravitational stability

In a recent study performed by Murphy and Myers (1985) using the $^{12}\text{CO} (J=1-0)$ line emission, the clouds quoted in Sect. 4 as A_1 , A_2 , D_1 and D_2 were considered as a unique expanding cloud with a $\approx 3 \text{pc}$ radius and a $\approx 2 \text{km s}^{-1}$ expanding velocity. Our ^{13}CO data which are representative of the inner cloud structure do not suggest such a simple feature. The low mass clouds quoted above look like unrelated filaments perhaps in orbital motion around the largest cloud B18. Hence it is important to examine whether the masses obtained for the different condensations identified in Sects. 3 and 4 lead to gravitational equilibrium or not.

Criteria for dynamical equilibrium can be derived either from the virial theorem or from the growth of a perturbation of small amplitude in a given cloud. The first method used by Murphy and Myers (1985) in order to compare gravitational energy to macroscopic turbulent motions, has the advantage of giving an overall picture of the system without entering into the details of complicated models. In that case the equilibrium mass is found to

be proportional to the square of the ^{13}CO linewidth: a cloud of mass larger than this equilibrium mass will contract with its own gravity. As in most condensations and clumps described in the previous sections the typical linewidth lies in the range $0.8-1.4 \text{km s}^{-1}$, the equilibrium masses are larger by a factor 2-4 than the masses derived from the ^{13}CO emission. Even if our masses estimations have been found to be in agreement with other authors and ^{13}CO has been clearly shown to be a good mass tracer of the cloud contents, an error in the clouds distance could be responsible of a factor ≈ 2 in the mass determinations. Alternatively instrumental difficulties could undergo a $\approx 10\%$ error in the velocity width while line opacity effects could broaden the ^{13}CO lines by an additional 20% as soon as the optical depth is around 1. Thus error bar in the equilibrium mass could be as large as twice the mass. Therefore following this virial point of view, no clear conclusion could be given about fragmentation or clouds binding.

The second approach has been investigated by Jeans (Nakano, 1981) who found that clouds more massive than the following so-called Jeans mass cannot be in equilibrium and will undergo fragmentation:

$$M_J = 570 M_{\odot} \left[\frac{1 M_{\odot}}{M} \right]^{1/2} \left[\frac{R}{1 \text{pc}} \right]^{3/2}$$

The mass of Jeans for the L 1506 and L 1529 clouds are found to be $100 M_{\odot}$ and $80 M_{\odot}$ respectively to be compared to our ^{13}CO experimental determinations of $700 M_{\odot}$ and $460 M_{\odot}$. Even taking into account an error of a factor 2 in our determination, both cloud masses are far from their masses of Jeans. Consequently if we limit our discussion to these large clouds, we could conclude to a gravitationally bound and unstable situation. Unfortunately a similar analysis applied to the condensations and clumps again shows that the experimental and Jeans masses are comparable within a factor 2.

This discussion supports once more the fact that ^{13}CO is still a good tracer for the large scale masses but is subject to controversy when applied to small scale structure.

7. Conclusion

The observation of the $^{13}\text{CO} (J=1-0)$ emission described in this paper shows the following results:

- The region around the L1529 and L1506 dark clouds exhibits an elongated structure extending from south-east to north-west, in which five condensations of ^{13}CO column density higher than $5 \cdot 10^{15} \text{cm}^{-2}$ have been detected.

- ^{13}CO emission is closely correlated to the visual extinction A_v through the following relations:

$$N(^{13}\text{CO}) = 1.4 \pm 0.1 (A_v - 0.6 \pm 0.2) \cdot 10^{15} \text{cm}^{-2} \quad \text{in L1529}$$

$$N(^{13}\text{CO}) = 0.9 \pm 0.1 (A_v - 0.9 \pm 0.2) \cdot 10^{15} \text{cm}^{-2} \quad \text{in L1506.}$$

Significant changes in the $^{13}\text{CO}/A_v$ ratio from place to place show that higher values are found in some more restricted regions.

- The H_2 masses intercepted within an external limit of the clouds corresponding to an A_v of 1 magnitude, are found to be $700 M_{\odot}$ and $460 M_{\odot}$ for L1529 and L1506 respectively; crude cylinder approximations lead to mean densities of $\approx 400 \text{cm}^{-3}$ for both clouds. Comparison with others estimates shows that ^{13}CO is still a good tracer of moderately dense material, giving an acceptable error on H_2 masses compared to the uncertainties in the giant clouds distances.

- The velocity structure shows a very confused situation: intricate interactions between filamentary clouds and the presence of several components on lines of sight are found in the whole region. Nevertheless, two radial velocity gradients are observed: one of $0.40 \pm 0.07 \text{ km s}^{-1} \text{ pc}^{-1}$ towards the north, and a second of $0.13 \pm 0.01 \text{ km s}^{-1} \text{ pc}^{-1}$, well known, through the chain of condensations DL2.

Some theoretical reflexions have led us to the following conclusions:

- The local physical conditions have an influence upon the CO isotope abundances through photochemical processes. The consequence of an increasing density is to increase the ^{13}CO and C^{18}O abundances up to saturation when the cloud becomes completely shielded from outside radiation. The ^{13}CO abundance decreases when the kinetic temperature increases while the C^{18}O increases: both decrease when the UV flux is enhanced. Combinations of all these effects are able to lead to a sample of $^{13}\text{CO}/A_v$ correlations. Some relevant parameters like the carbon isotopic ratio which could be reduced in Perseus compared with Taurus, the cloud geometry or the gas to dust ratio are of critical importance.

- The use of observations with the ^{13}CO isotope which seems to be the best tracer for the determination of large cloud masses, together with a Jeans like analysis, lead to the conclusion of the L1506 and L1529 clouds instability. Controversely the same observations applied to small scale structures are not conclusive showing the limits of ^{13}CO ($J=1-0$) observations.

Postscript

According to high resolution absorption spectra in the far UV recently performed by Letzelter et al. (1987), the CO unshielded photodissociation rate should be increased by a factor 20, together with a much steeper variation with optical depth. These new molecular data lead to moderate changes in the $N(^{13}\text{CO})/A_v$ and $N(\text{C}^{18}\text{O})/A_v$ ratios: upper limits of these ratios are obtained for lower densities than previously and their decrease with an increasing UV flux are slowed down. We then conclude that these new data will not strongly affect our conclusions.

Appendix: formation and destruction of CO

The method for the synthesis of CO in diffuse clouds is a two step process initiated by the progenitor reaction



which is endothermic by 232 K. A substitute to this path in more shielded regions is



which depends directly upon the cosmic ray flux through H_3^+ . The radical OH is then produced by a fast sequence

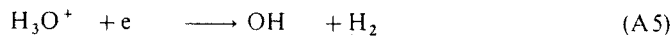
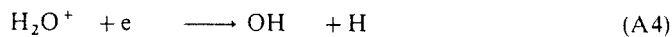
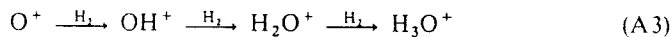

and CO if formed from C^+ by the reactions

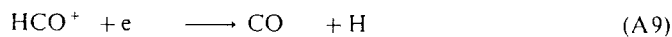
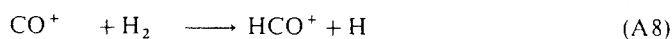
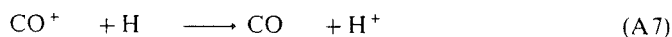
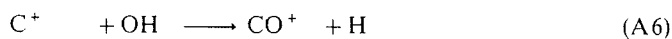

or by neutral reaction with C

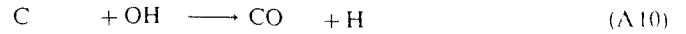

Another scheme which is important at higher densities is believed to be initiated by the radiative association

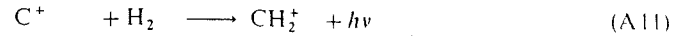

whose rate coefficient is not very well known (Litsz, 1978); following Black and Dalgarno (1977) we have attributed a rate of $5 \cdot 10^{-16} \text{ cm}^3 \text{ s}^{-1}$ which, from calculations of Herbst (1982), could decrease at higher temperature.

The neutral species C_xH_y are then formed and lead to CO by neutral reactions with O

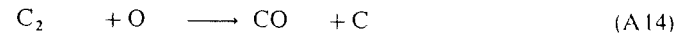
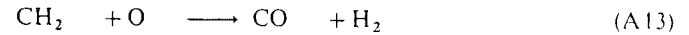
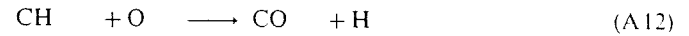

the main feature being the reaction (A 12); this reaction of CH with O has been studied by Messing et al. (1981) at room temperature of 298 K; we have adopted their overall rate constant of $9.5 \cdot 10^{-11} \text{ cm}^3 \text{ s}^{-1}$ at this temperature and assumed a $T^{1/2}$ dependence.

It is important to note that the formation of CO depends on the efficiency of the UV photons in dissociating the intermediate species OH and C_xH_y which are involved in the (A 6)-(A 10) and (A 11)-(A 14) sequences. Accordingly the photodestruction rates of OH and C_xH_y have been calculated by using the same cross-sections as in Viala (1986). Actually they are found to be smaller by a factor 2-3 than the recent estimations of Van Dishoeck (1986).

In the external layers of clouds, CO is mainly destroyed by UV photons, while in inner parts shielding occurs and gas phase chemistry dominates, He^+ and H_3^+ being the main sinks of CO.

Two processes can alter the isotopic ratios:

- First, the chemical fractionation originated by the reactions

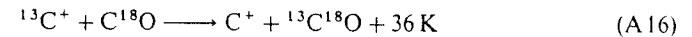
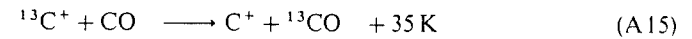

which enhance the $^{13}\text{CO}/\text{CO}$ and $^{13}\text{C}^{18}\text{O}/\text{C}^{18}\text{O}$ ratios if the kinetic temperature is about 35 K. Other reactions have the ability to produce isotope fractionation: isotopes of both carbon and oxygen can be transferred between molecules by proton switching reactions between formyl ions and carbon monoxide

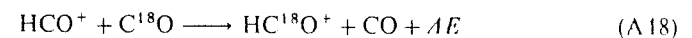
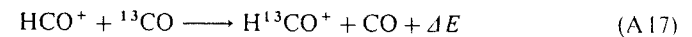

Smith and Adams (1980) have measured the rate parameters at temperature as low as 80 K; Langer et al. (1984) used a general approach for extrapolating the forward and reverse rates at temperature below 80 K.

- Second, the selective dissociation of the isotopes of CO which is thought to occur through absorption lines in the $C-X(1-0)$, $E-X(0-0)$ and $E-X(1-0)$ bands at respectively 1063, 1076 and 1053 Å. As investigated early by Bally and Langer (1982) and Chu and Watson (1983), line self shielding reduces the CO photodestruction rates by a larger factor than for ^{13}CO and C^{18}O due to the very different column densities for the CO isotopes. Glassgold et al. (1985) discussed this shielding problem including H_2 line blocking absorption and dust extinction: in summary, the effects of self and mutual shielding of the different

isotopes lead to a much stronger destruction of the rarer isotopes throughout the cloud.

The selective photodissociation has a minor effect on $^{13}\text{CO}/\text{CO}$ ratio compared with the fast chemical fractionation, while it can increase the $\text{CO}/\text{C}^{18}\text{O}$ ratio by a factor of 3 in region where the optical depth is $\tau_v \approx 0.5-1$ mag.

References

- Adams, N.G., Smith, D., Alge, E.: 1984, *J. Chem. Phys.* **81**, 1778
- Bachiller, R.: 1985, *Thèse d'Etat*, Université Grenoble I
- Bachiller, R., Cernicharo, J.: 1986, *Astron. Astrophys.* **166**, 283 (BC)
- Bally, J., Langer, W.D.: 1982, *Astrophys. J.* **255**, 143
- Baudry, A., Cernicharo, J., Perault, M., Despois, D., De la Noë, J.: 1981, *Astron. Astrophys.* **104**, 101
- Black, J.H., Dalgarno, A.: 1977, *Astrophys. J. Suppl.* **34**, 405
- Bohlin, R.C., Savage, B.D., Drake, J.F.: 1978, *Astrophys. J.* **224**, 132
- Boland, W., de Jong, T.: 1984, *Astron. Astrophys.* **134**, 87
- Cernicharo, J., Bachiller, R.: 1984, *Astron. Astrophys. Suppl.* **58**, 327 (CB)
- Cernicharo, J., Bachiller, R., Duvert, G.: 1985, *Astron. Astrophys.* **149**, 273 (CBD)
- Cernicharo, J., Guélin, M., Askne, J.: 1984, *Astron. Astrophys.* **138**, 371
- Cernicharo, J., Guélin, M.: 1987, *Astron. Astrophys.* **176**, 299 (CG)
- Chu, Y.H., Watson, W.D.: 1983, *Astrophys. J.* **267**, 151
- Cohea, M., Kuhl, L.V.: 1979, *Astrophys. J.* **227**, L105
- Crutcher, R.M.: 1973, *Astrophys. J.* **185**, 857
- Dickman, R.L.: 1978a, *Astron. J.* **83**, 363
- Dickman, R.L.: 1978b, *Astron. J. Suppl.* **37**, 407
- Duvert, G., Cernicharo, J., Baudry, A.: 1986, *Astron. Astrophys.* **164**, 101 (DCB)
- Elias, J.P.: 1978, *Astrophys. J.* **224**, 587
- Elmegreen, D.M., Elmegreen, B.G.: 1979, *Astron. J.* **84**, 615
- Federer, M., Willinger, H., Tosi, P., Bassi, D., Ferguson, E.E., Linding, W.: 1985, *Molecular Astrophysics*, Dierckens, Huebner and Langhoff (Eds.), 649
- Frerking, M.A., Langer, W.D., Wilson, R.W.: 1982, *Astrophys. J.* **262**, 590
- Glassgold, A.E., Huggins, P.J., Langer, W.D.: 1985, *Astrophys. J.* **290**, 615
- Goldsmith, P.F., Sernyak, M.J.: 1984, *Astrophys. J.* **283**, 140
- Herbst, E., 1982, *Astrophys. J.* **252**, 810
- Heyer, M.C.: 1985, Proc. of a meeting held at Haystack
- Heiles, K., Katz, G.: 1976, *Astron. J.* **81**, 1
- Kutner, M.L.: 1973, in *Molecules in the Galactic Environment*, eds. by M.A. Gordon and L.E. Snyder (Wiley, New York), p. 199
- Langer, W.D., Graedel, T.E., Frerking, M.A., Armantrout, P.B.: 1984, *Astrophys. J.* **227**, 581
- Langer, W.D., Goldsmith, P.F., Carlson, E.R., Wilson, R.W.: 1980, *Astrophys. J.* **235**, L39
- Léger, A.: 1983, *Astron. Astrophys.* **123**, 271
- Letzelter, C.E., Eidelsberg, M., Rostas, F., Breton, J., Thieblemont, B.: 1987, *Chem. Phys.* **114**, 273
- Liszt, H.S.: 1978, *Astrophys. J.* **222**, 484
- Lynds, B.T.: 1962, *Astrophys. J. Suppl.* **7**, 1
- Messing, I., Filseth, S.V., Sadowski, C.M., Carrington, T.: 1981, *J. Chem. Phys.* **74**, 3874
- Murphy, D.C., Myers, P.C.: 1985, *Astrophys. J.* **298**, 818
- Myers, P.C.: 1982, *Astrophys. J.* **257**, 620
- Nakano, T.: 1981, *Suppl. of the Progress of Theoretical Physics* **70**, 54
- Penzias, A.A.: 1983, *Astrophys. J.* **273**, 195
- Rowe, B.R., Marquette, J.B., Dupeyrat, G., Poissant, G., Rebrion, C.: 1985a, Colloque d'ATP CNRS, Observatoire de Paris-Meudon
- Rowe, B.R., Marquette, J.B., Dupeyrat, G., Ferguson, E.E.: 1985b, *Chem. Phys. Letters* **113**, 403
- Smith, D., Adams, N.G.: 1980, *Astrophys. J.* **242**, 424
- Tölle, F., Ungerrechts, H., Walmsley, C.M., Winnemisser, G., Churwell, E.: 1981, *Astron. Astrophys.* **95**, 143
- Tucker, K.D., Dickman, R.L., Encrenaz, P.J., Kutner, M.L.: 1976, *Astrophys. J.* **210**, 679
- Van Dishoeck, E.F.: 1986, in *Astrochemistry*, eds. Vardia, M.S., Tarafdar, S.P., D. Reidel Publishing Company, Dordrecht
- Viala, Y.P.: 1986, *Astron. Astrophys. Suppl.* **64**, 391
- Watson, W.D., Anicich, V.G., Huntress, W.T.: 1976, *Astrophys. J. Letters* **205**, L165

I.11) DISTRIBUTION DES MASSES DANS LE COMPLEXE DE NUAGES

SOMBRES DU TAUREAU.

I.11) DISTRIBUTION DES MASSES DANS LE COMPLEXE DE NUAGES SOMBRES DU TAUREAU.

Les masses du complexe du Taureau, de HCL2, et de TMC1, ont été évaluées à partir de leur extinction visuelle, de l'émission de CO et ses isotopes, ainsi que à partir du théorème du viriel [voir II.02 à II.10]. Paradoxalement, l'émissivité dans la raie optiquement épaisse J=1-0 de ^{12}CO donne, en utilisant le facteur de conversion CO-H₂ de Bloemen et al. (1986), une meilleure estimation de la masse totale du complexe du Taureau que celle des raies optiquement minces ^{13}CO et C^{18}O . En effet la plus grande partie de la masse gazeuse se trouve dans un halo diffus qui émet en ^{12}CO , mais pas en ^{13}CO et C^{18}O [voir II.03, II.05, II.09, et II.10]. La densité du halo est trop faible pour peupler efficacement par collisions les niveaux moléculaires; ^{13}CO et C^{18}O sont donc difficilement excités et elles pourraient être photo-dissociées.

A l'intérieur de HCL2, où la densité est élevée et CO est thermalisée par collisions, il est préférable d'utiliser les isotopes ^{13}CO et C^{18}O pour déterminer plus précisément la masse du nuage. La structure des fragments de forte densité, comme TMC1, est convenablement tracée par des molécules à fort moment dipolaire comme C_3H_2 et HC_3N . TMC1 est une chaîne de petits globules de taille 0.03-0.05 et apparemment virialisés.

MASS DISTRIBUTION IN THE TAURUS COMPLEX

M. Guélin and J. Cernicharo

IRAM PREPRINT N° 124

Proceedings Conference "Molecular Clouds in the Milky Way and External Galaxies",
Amherst/USA, 2-4 November 1987, Reidel, in press

MASS DISTRIBUTION IN THE TAURUS COMPLEX

Michel Guélin¹ and José Cernicharo^{1,2}

¹IRAM, Domaine Universitaire de Grenoble, voie 10, 38406, St. Martin d'Herès, France
²Observatoire de Grenoble, C.E.R.M.O., BP 68, 38402, Saint Martin d'Herès, France

Summary. The masses of the Taurus cloud complex, Heiles Cloud 2, and TMC1 are evaluated from their dust content, from the brightness of the ^{12}CO , ^{13}CO and C^{18}O lines, and from virial equilibrium. Paradoxically, the optically thick ^{12}CO line, whose integrated brightness can be converted into H_2 mass by using Bloemen et al's (1986) conversion factor, yields a better evaluation of the mass of the Taurus complex than do the optically thin ^{13}CO and C^{18}O lines. This is not just an effect of sensitivity. The mass lies mostly in a diffuse halo, bright in the $^{12}\text{CO}(J=1-0)$ line, but barely detectable in ^{13}CO and not detectable at all in C^{18}O . The halo density is so low that CO collisional excitation is inefficient; here, ^{13}CO and C^{18}O are hardly excited and could be photodissociated.

Inside HCL2, the gas density is high enough that CO is thermalized by collisions; ^{13}CO and C^{18}O , rather than ^{12}CO , should be used to trace the mass. The structure of the tiniest clumps is best observed through high excitation lines, such as the 10-9 line of HC_3N and the $2_{12}-1_{01}$ line of C_3H_2 . In TMC1, these two lines show a chain of clumps of size 0.03-0.05 pc. These tiny clumps, just as HCL2 itself, appear to be virialized.

Introduction

The difficulty of observing H_2 in dense interstellar clouds obliges us to turn to indirect methods for estimating the mass of the molecular gas. These methods use extinction by dust, dust far-IR emission, diffuse gamma-ray emission, and the CO integrated brightness temperature as gas tracers, or simply assume virial equilibrium (see e.g. van Dishoeck and Black 1986). The most popular method, the CO brightness, is the only one practical for external galaxies. It assumes the integrated intensity of the ^{12}CO , ^{13}CO , or C^{18}O rotational line is proportional to the gas column density; the proportionality "constant" is determined by comparison with other methods. Observations and theoretical arguments supporting a $N(\text{H}_2)/\text{CO}$ proportionality relation have been advanced (Dickman et al. 1986). In this article we discuss the validity of this relation for a well studied region, the Taurus complex of dark clouds.

The Taurus clouds are only 100 - 150 pc from the sun * and have a uniform temperature. Their proximity makes star counts and high resolution radio observations possible; it also ensures the

* for the sake of simplicity, following Elias (1978) and Cernicharo et al. (1985), we adopt an average distance of 135 pc.

external cosmic ray flux is similar to that observed at the Earth, greatly easing the interpretation of the gamma-ray data. The uniform temperature makes it easier to convert the ^{13}CO and C^{18}O line intensities into column densities. (Cernicharo and Guélin 1987 - hereafter CG). Judging from the 21 cm HI line observations (e.g. Wilson and Minn 1977), only a small ($\leq 10^{-1}$) fraction of the gas associated with the Taurus cloud complex is in the form of atomic hydrogen; this simplifies interpretation of the molecular data.

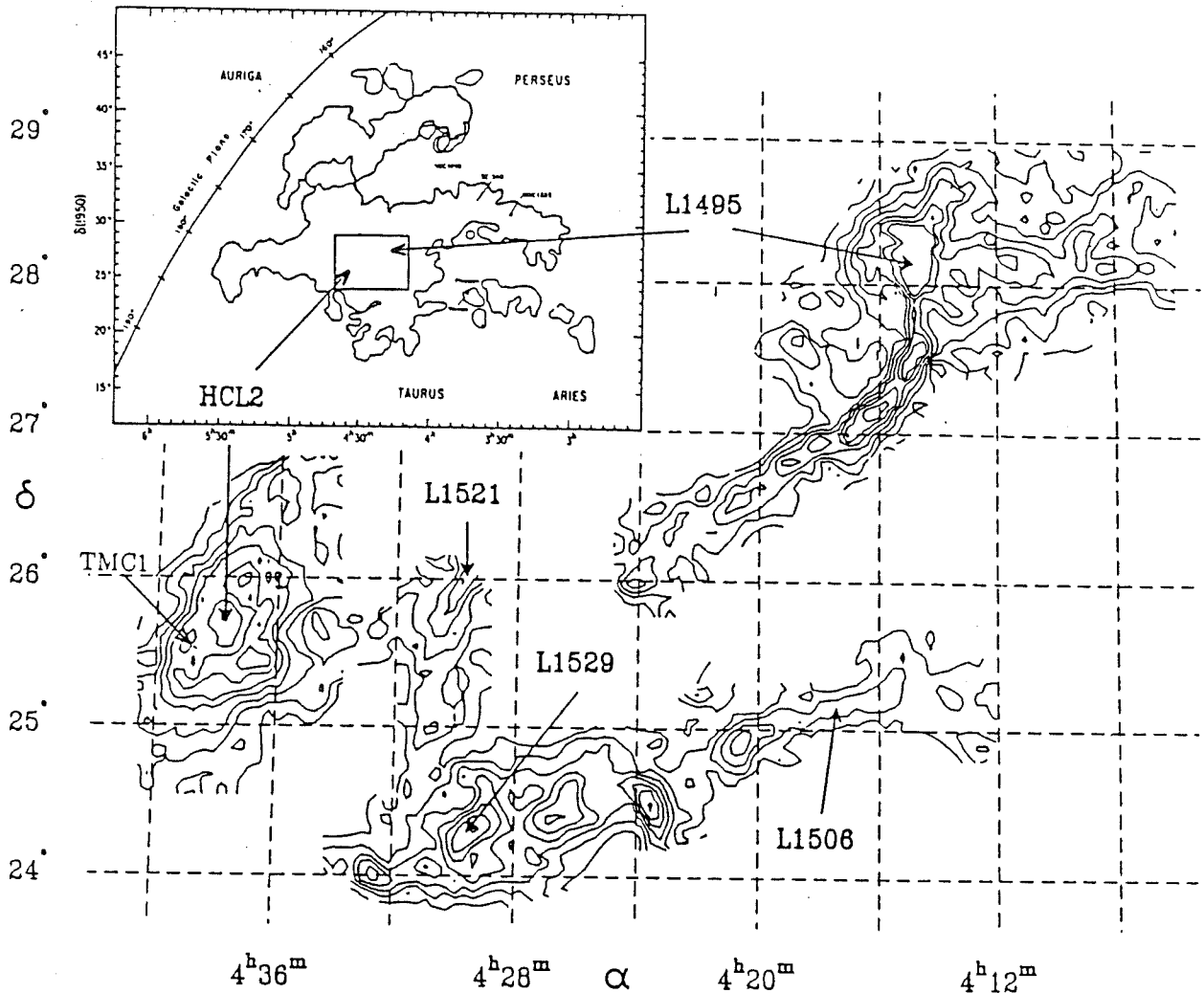

Figure 1: $^{13}\text{CO}(J=1-0)$ integrated intensity contours, $\int T_a^* dv$, observed with the Bordeaux 2.5 m antenna in the central Taurus region (the surveyed area is shown against Ungerecht and Thaddeus's (1987) ^{12}CO map of the Taurus-Perseus complex in the upper left insert). The lowest contour and the contour interval are 1 K km s^{-1} . The ^{13}CO data is from CG, Duvert et al. (1986) and Nercessian et al. (1988).

Mass of the Taurus central region from star counts.

The safest method of deriving hydrogen column densities in the Taurus complex relies on star counts and the assumption of a constant gas to dust ratio. The Taurus complex is particularly well suited for this method:

i) Its rich stellar background allows accurate counts with up to 5 magnitudes of visual extinction (in Taurus, $A_v=5$ mag corresponds to 4 stars per $5' \times 5'$ cell on the red POSS prints);

ii) The dust optical properties, at least on a large scale, are similar to those in the nearby diffuse clouds. Comparison of counts in the blue and in the red suggests a "normal" extinction curve and a total to selective extinction ratio, R , close to the canonical value of 3.2 (Cernicharo and Bachiller 1984 - hereafter CB). That R is close to 3 over most of Taurus (and the adjacent Perseus region) is supported by the star light reddening measurements made by Vrba and Rydgren (1985), who derive $R = 3.1$ for 6 Taurus stars with $A_v=1-3.2$ mag, and by Guetter (1977), who finds $R = 3.2$ toward the Per OB2 association;

iii) The wealth of stellar photometric data in the Taurus-Perseus region allows accurate calibration of the extinctions derived from star counts ((to better than 0.3 mag - CB).

The gas to dust ratio is constant in the nearby diffuse clouds and is given by (Bohlin et al. 1978):

$$N(H + 2H_2)/A_v = 2 \cdot 10^{21} \text{ cm}^{-2} \text{ mag}^{-1}. \quad (1)$$

Relation (1) has been derived for clouds with $A_v < 2$ magnitudes. Point (ii) above and the good linear relation between the IRAS 100-micron flux and A_v (Fig. 2, see also CG) suggest, however, that it holds in Taurus at least up to $A_v=4-5$ mag. Local deviations from this law may occur, particularly in the direction of cloud cores (e.g. Vrba and Rydgren 1985), but they are unlikely to lead to large errors in the cloud masses.

Mc Cuskey (1938, 1939) has published low angular resolution star counts over the whole Taurus-Perseus region; he quotes, for the central part of Taurus corresponding to the 30 deg^2 area of Fig. 1, an average visual extinction of 1.7 mag. CB (also Cernicharo et al. 1985), from high resolution star counts made on POSS prints, find for the same region 1.8 mag average extinction. From this latter value and from relation (1) we derive a mass inside the area shown in Fig. 1 of $5800 M_\odot$. This mass is divided about equally between the opaque clouds (with $A_v > 2$) and a surrounding halo.

Mass of the Taurus central region from ^{12}CO .

The area in Fig. 1 has been mapped in $(1-0) \text{ }^{12}\text{CO}$ with the Columbia 1.2 m telescope (Un- gerechts and Thaddeus 1987) and in $(1-0) \text{ }^{13}\text{CO}$ and C^{18}O with the 2.5 m Bordeaux telescope (CG, Duvert et al. 1986, Nercessian et al. 1988). Here, we compare the masses derived from these data to those obtained from star counts.

The ^{12}CO line intensity, integrated over velocity and the area shown in Fig. 1, is $220 \text{ K km s}^{-1} \text{ deg}^2$. Various empirical factors converting $W(^{12}\text{CO})$, the line intensity integrated over velocity, to $N(\text{H}_2)$, the column density of hydrogen molecules, have been published in the literature. Among the most popular are those of Liszt (1982), Li et al. (1983), Bhat et al. (1985), and Bloemen et al. (1986).

Liszt's factor, $^{12}X = N(\text{H}_2)/W(^{12}\text{CO}) = (5 \pm 2.5) \cdot 10^{20} \text{ molecules cm}^{-2} (\text{K km s}^{-1})^{-1}$, yields a mass of $13000 M_\odot$, about a factor of two larger than the mass calculated from star counts.

From the assumption of a constant $W(^{12}\text{CO})/W(^{13}\text{CO})$ intensity ratio equal to 5.5, from Dickman's $A_v/N(^{13}\text{CO})$ relation (Dickman 1978), and from equation (1), Li et al. (1983) arrive at $^{12}X = 1.2 \cdot 10^{20} \text{ M cm}^{-2} (\text{K km s}^{-1})^{-1}$. The factor 1.2 stands for a ^{12}CO line excitation temperature of 12 K, close to that observed in Taurus, and assumes 1/5 of the gas is not detected. M , which accounts for gas metallicity, equals to 1 for the nearby Taurus clouds. Li et al.'s conversion factor leads to a mass of $3000 M_{\odot}$.

Diffuse gamma-ray radiation produced by the interaction of cosmic rays with the interstellar gas has been mapped by the COSB satellite. This radiation has been used to derive the column density of H nuclei in the galactic plane and in some nearby clouds (Lebrun et al. 1983, Li et al. 1983, Bhat et al. 1985, Bloemen et al. 1984, 1986). From this data $N(\text{H}_2)$ then can be derived wherever $N(\text{HI})$ and $N(\text{HII})$ are known. The results vary greatly, however, depending on whether or not allowance is made for cosmic-ray and metallicity gradients (Bhat et al. 1985). For the Orion-Monoceros cloud complex, Bloemen et al. (1984) find $^{12}X = (2.6 \pm 1.2)$ (in units of $10^{20} \text{ cm}^{-2} (\text{K km s}^{-1})^{-1}$), whereas Bhat et al. (1985) derive $^{12}X = 1-1.8$. Bhat, Issa, Houston, Mayer and Wolfendale* (1985) argue for a value of ^{12}X in the inner Galaxy 2-4 times lower than that near the sun (the "local" value is $^{12}X = 1.5$, according to Wolfendale, this conference). Bloemen et al. (1986), on the other hand, find ^{12}X constant throughout the Milky Way ($^{12}X \approx 2.8$).

Ungerecht and Thaddeus's integrated ^{12}CO intensity measurement yields a mass of $7500 M_{\odot}$ for $^{12}X = 2.8$ (Bloemen et al.'s galactic average value) and of $4000 M_{\odot}$ for $X = 1.5$ (Wolfendale's "local" value). The mass of $5800 M_{\odot}$ we derive from star counts corresponds to $^{12}X = 2.2 \cdot 10^{20} \text{ cm}^{-2} \text{K}^{-1} \text{ km}^{-1} \text{ s}$.

In summary, the $^{12}\text{CO}-\text{H}_2$ conversion factors commonly quoted in the literature yield, within a factor of $\simeq 2$, the mass derived from star counts. Bloemen et al.'s galactic-average conversion factor, in particular, gives a surprisingly close result.

Mass from the rare CO isotopes

The ^{13}CO (1-0) line integrated intensity contours, observed with the Bordeaux telescope, are presented on Fig. 1. Most of the area of the figure has been surveyed (however, with a sparser sampling outside the main clouds). Except for a limited region north of L1521 that was not mapped, these contours show ^{13}CO 1-0 emission down to an intensity limit of 1 K km s^{-1} .

The $W(^{13}\text{CO})/A_v$ correlation has been studied for the clouds in Fig. 1, as well as for a number of nearby clouds in Taurus and Perseus (CG, Duvert et al. 1986, Nercessian et al. 1988, Bachiller and Cernicharo 1986). The results, summarized in Table 1, show, for A_v typically between 0.7 and 4 magnitude, that $W(^{13}\text{CO})$ and $N(^{13}\text{CO})$ increase linearly with A_v . The slope of the $W(^{13}\text{CO})-A_v$ relation is between 1.4 and $2.8 \text{ K km s}^{-1} \text{ mag}^{-1}$, with a weighted average value of $2.2 \text{ K km s}^{-1} \text{ mag}^{-1}$ in Taurus (roughly $2.0 \cdot 10^{15} \text{ cm}^{-2} \text{ mag}^{-1}$ for $N(^{13}\text{CO})/A_v$).

This average value, which results from analysis of 2000 lines of sight in 10 Taurus clouds, is very close to that derived by Dickman (1978) from a sample of 73 directions scattered over 38 clouds;

* Note Wolfendale and coworkers use $\alpha = 2X$, with α in units of $\text{atoms cm}^{-2} (\text{K km s}^{-1})^{-1}$

it is somewhat higher than the value of $1.3 \text{ K km s}^{-1} \text{ mag}^{-1}$ derived by Heyer et al. (1987) for L1517 and L1544, two isolated clouds in Taurus. Converting A_v into $N(\text{H}_2)$ by applying relation (1), our mean Taurus value yields $^{13}X = N(\text{H}_2)/W(^{13}\text{CO}) = 4.5 \cdot 10^{20} \text{ cm}^{-2} (\text{K kms}^{-1})^{-1}$. The mass of molecular gas derived from ^{13}X and the ^{13}CO contours of Fig. 1 is $3000 M_\odot$ (or $3300 M_\odot$, if we allow for the northern half of L1551 on the basis of its dust content); this is almost a factor of two smaller than the mass derived from the star counts.

The ^{13}CO derived mass is too small mostly because ^{13}CO is essentially undetected between the clouds. Obviously, the observations' sensitivity limit is one reason for this nondetection, but it is not the main one. From our data, we can estimate the *average* emission below the first contour of Fig. 1 does not exceed 0.5 K km s^{-1} , so the intercloud mass calculated from ^{13}X is less than $600 M_\odot$ and is much smaller than the "missing" mass derived from the star counts. Most of the gas in the halo is just not visible in ^{13}CO ; we come back to this point in the next section, when we discuss in more detail the halo of HCL2.

Saturation of the (1-0) ^{13}CO line is another factor that could lead to an underestimation of the cloud mass. This line, however, starts to be optically thick in Taurus only for $A_v > 4$, i.e., for a small fraction of the area occupied by the clouds. The opacity correction on the overall mass is then small. The C^{18}O line is optically thin everywhere; yet, an analysis of the C^{18}O data shows it misses completely the halo and would lead to an even larger underestimation of the mass.

On the scale of Fig 1, the C^{18}O and ^{13}CO lines thus appear to be poorer tracers of the gas than the optically thick ^{12}CO line. The same result applies at the scale of the entire Taurus-Perseus complex (see Ungerechts and Thaddeus 1987).

Table 1: Correlation between $W(^{13}\text{CO})$ and $W(\text{C}^{18}\text{O})$ and A_v , for the Taurus and Perseus clouds.

Cloud	$W(^{13}\text{CO})$ K km s^{-1} (A_v in mag)	$W(\text{C}^{18}\text{O})$ $\text{K (km s}^{-1})$	$N(\text{C}^{18}\text{O})$ cm^{-2}	Mass M_\odot
Taurus:				
HCL2	$1.4(A_v - 0.7 \pm 0.3)$	$0.28(A_v - 1.5 \pm 0.3)$	$2.5(A_v - 1.5)$	640
L1489	$2.4(A_v - 0.6 \pm 0.5)$			100
L1495	$2.4(A_v - 0.3 \pm 0.5)$	$0.27(A_v - 1.1 \pm 0.5)$	$2.5(A_v - 1.1)$	1900
L1506	$1.6(A_v - 0.9 \pm 0.3)$			430
L1517	$2.0(A_v - 0.3 \pm 0.5)$			460
L1529	$1.0(A_v - 0.6 \pm 0.3)$			740
L1535	$1.9(A_v - 0.5 \pm 0.4)$			
Perseus:				
(B1+B5+B202 +B204) B1	$2.7(A_v - 0.8 \pm 0.4)$	$0.37(A_v - 1.6)$	$3.4(A_v - 1.6)$	7500

The last column gives the mass of the clouds (excluding the halo) derived from star counts (Cernicharo et al. 1985). The CO data are from CG, Duvert et al. 1986, Bachiller and Cernicharo 1986, and Nercessian et al. 1988. Note that for 10 directions in Taurus, Frerking et al. 1982 find: $W(^{13}\text{CO}) = 1.6(A_v - 1)$ and $N(\text{C}^{18}\text{O}) = 1.7(A_v - 1.3)$.

Fig. 2 shows the correlation of $W(^{13}\text{CO})$ and $W(\text{C}^{18}\text{O})$ with A_v in Heiles Cloud 2 (HCL2), the best studied of the clouds of Fig. 1. Two results appear on this figure: *i*) deep inside the cloud, both $W(\text{C}^{18}\text{O})$ and $W(^{13}\text{CO})$ increase linearly with A_v and hence, presumably, $N(\text{H}_2)$ (up to $A_v=4$ mag for ^{13}CO); *ii*) the linear relations break down at $A_v=1.5$ mag for C^{18}O , and $A_v=0.7$ mag for ^{13}CO ; below these extinctions C^{18}O and ^{13}CO are not detected.

The temperature inside HCL2 is fairly uniform (10 K) and the density in the obscured region is large enough for CO to be thermalized by collisions. The $W(\text{C}^{18}\text{O})$ - A_v proportionality relation in the inner region is readily translated in terms of $N(\text{C}^{18}\text{O})$, the C^{18}O column density. We find: $N(\text{C}^{18}\text{O})/A_v = 2.5 \cdot 10^{14} \text{ cm}^{-2} \text{ mag}^{-1}$ and, from relation (1), $N(\text{H}_2)/N(\text{C}^{18}\text{O}) = 4 \cdot 10^6$, or $N(\text{H}_2)/N(\text{CO}) = 8 \cdot 10^3$. Very similar ratios are derived for other clouds in Taurus and Perseus. The constancy of $W(\text{C}^{18}\text{O})/A_v$ inside HCL2 and between several clouds with similar temperature probably means the fractional abundance of CO and the gas to dust ratio stay constant throughout the cloud cores and they are the same for all the studied clouds.

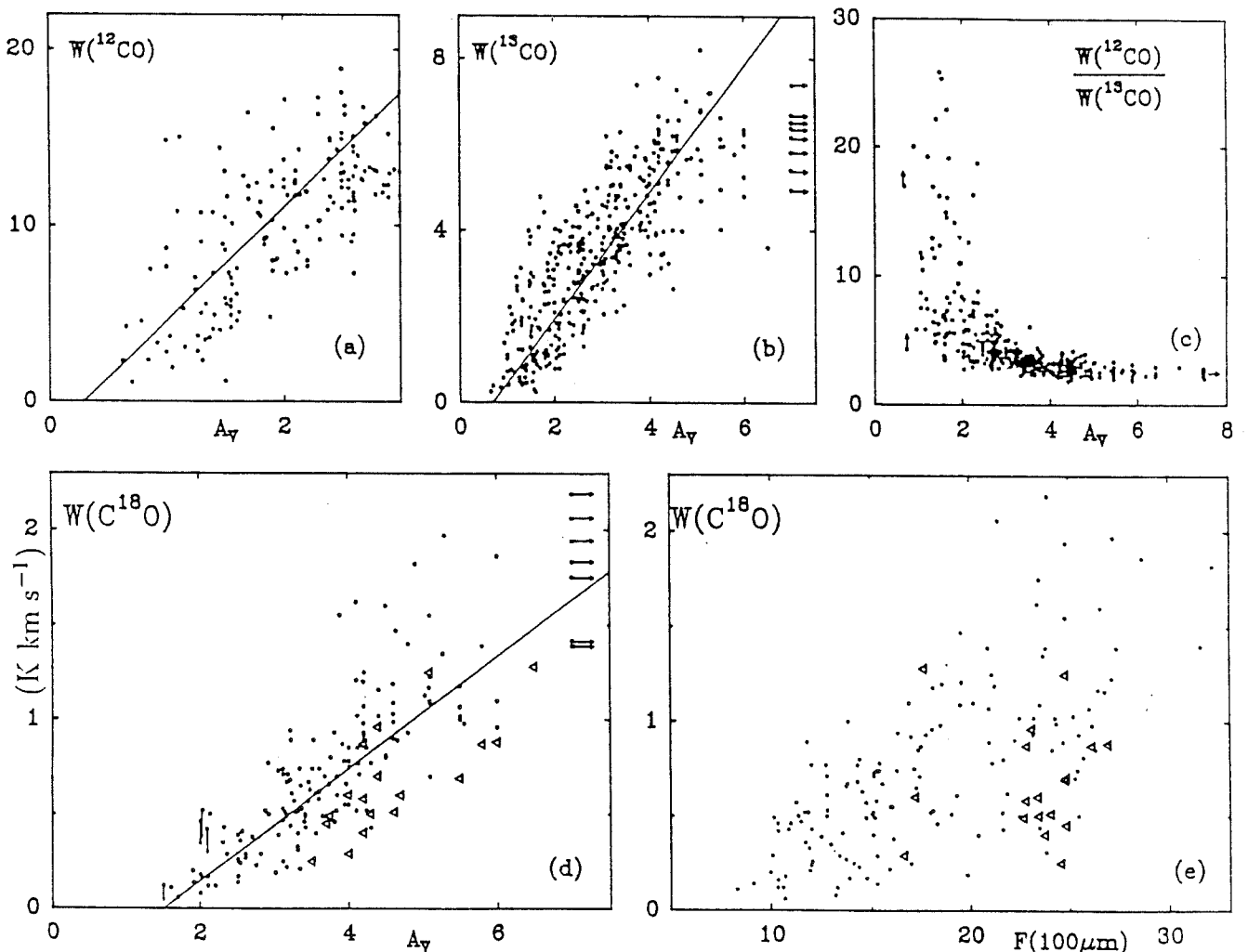

Figure 2: a to d the CO integrated brightness temperature - visual extinction correlation diagrams in Heiles Cloud 2. Triangles in d correspond to double profiles. e same as d, but A_v is replaced by the 100μ emission flux measured by IRAS. The CO data are from CG. Note the correlation of $W(^{12}\text{CO})$ with A_v for small visual extinctions.

The mass of HCL2 derived from the $C^{18}O$ contours is $\approx 500 M_{\odot}$; that calculated from ^{13}X and the ^{13}CO contours is $700 M_{\odot}$; the mass estimated from ^{12}CO is $400 M_{\odot}$ (using $X=2.2 \text{ cm}^{-2}$, and integrating over the area where ^{13}CO is detected). These values can be compared to the masses derived from the star counts: $640 M_{\odot}$ for the cloud core (excluding the 1 mag thick layer corresponding to the background halo), and $1000 M_{\odot}$ if one integrates along the whole line of sight. It is clear $C^{18}O$ and ^{13}CO mostly trace the cloud core, whereas the optically thick ^{12}CO essentially shows the halo. In fact, HCL2 is barely noticeable against the halo on Ungerechts and Thaddeus's ^{12}CO map. The mass of $640 M_{\odot}$ and the average ^{13}CO linewidth of 1.4 km s^{-1} imply that the HCL2 core is nearly in virial equilibrium.

As CG show, $C^{18}O$ and ^{13}CO are not detected in the halo primarily because these species are subthermally excited and, maybe, photodissociated, (see e.g. Viala et al., 1988), and not because of insufficient sensitivity. (The detection threshold, for example, is two times larger in the direction of double-peaked line profiles, where the halo contribution to the extinction is expected to be twice as large.) Because its lines are optically thick (see below), the main isotope, ^{12}CO , is radiatively excited throughout most of the halo and easily detectable. ^{13}CO , whose abundance is intermediate between those of ^{12}CO and $C^{18}O$, is excited at an intermediate depth.

The presence of a halo transparent in the $C^{18}O$ and ^{13}CO lines is not peculiar to HCL2 and the clouds of Fig. 1. Such a halo is also observed for L1506 and L1535, in Taurus, as well as around B1 and several other Perseus clouds (see Table 1). For those clouds mapped in $C^{18}O$, the $C^{18}O$ threshold and the $W(C^{18}O)/A_v$ ratio are about the same, 1.1 - 1.6 mag and 2.2 - 3.4 $\text{K km s}^{-1} \text{ mag}^{-1}$, respectively. A larger scatter is observed in the case of ^{13}CO , partly because the threshold value is smaller and more difficult to measure and partly because of ^{13}CO enhancement at the cloud edges.

Dickman, Snell and Schloerb (1986, see also van Dishoeck and Black 1986) have attempted to explain the empirical $N(H_2)-W(^{12}CO)$ relation by modeling a cloud complex with a set of independently emitting clouds in virial equilibrium. For clouds with temperatures and densities similar to those in HCL2, they find $N(H_2)/W(^{12}CO)$ should be close to the ^{12}X value we observe in Taurus. The agreement is largely fortuitous, however, since there is no halo in the model. The halo component yet represents one half of the total mass of the gas in Fig. 1 and about the three quarters of the mass of the whole Taurus complex.

In fact, the $N(H_2)-W(CO)$ relation is mainly determined by the halo. As can be seen in Fig. 2a, despite the optical thickness of the ^{12}CO line, $W(^{12}CO)$ increases more or less linearly with A_v between 0.5 and 2 mag, in the halo. A least squares fit to the data yields $W(^{12}CO)/(A_v-0.3) = 6.5 \text{ K km s}^{-1} \text{ mag}^{-1}$, or $N(H_2)/W(^{12}CO) = 1.5 \cdot 10^{20} \text{ cm}^{-2} \text{ K}^{-1} \text{ km}^{-1} \text{ s}$, a value not much different from the average ^{12}X .

In the diffuse halo, the gas density is so low collisional excitation is relatively inefficient. After several absorptions and reemissions, most of the photons succeed in escaping from the cloud, prior to a collisional de-excitation. In this "low excitation" approximation, $W(^{12}CO)$ is expected to remain proportional to $N(CO)$, even if the opacity is large (Goldreich and Kwan 1974). Actually, a large fraction of the halo emission may come from scattered core radiation. If the core is not at the center

of the halo, but closer to its front border, or if the halo is more extended in the plane of the sky than along the line of sight, the brightness of the scattered radiation increases when one observes closer to the center (see CG). Virialized clouds with uniform temperature and uniform density, embedded in a diffuse halo, would yield about the correct $W(^{12}\text{CO})-N(\text{H}_2)$ relation.

Small scale structure in HCL2

Although the large scale distribution of mass in cloud complexes is better traced by the emission from ^{12}CO , small scale clumpiness can only be studied from less abundant species, such as ^{13}CO ,

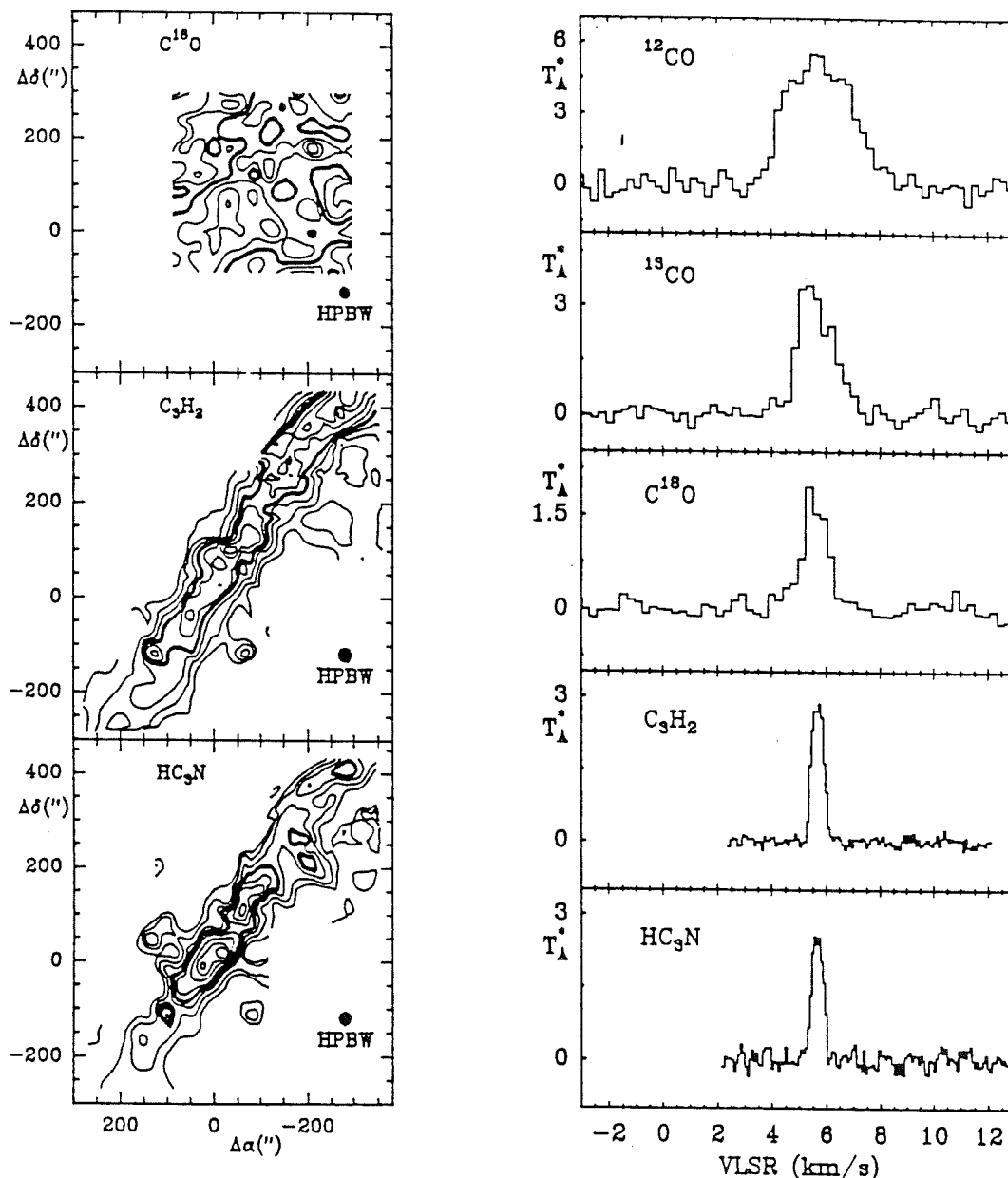

Figure 3: The (1-0) C^{18}O , (2₁₂-1₀₁) C_3H_2 , and (10-9) HC_3N integrated intensity contours observed in TMC1 with the IRAM 30 m telescope (Cernicharo, Baudry and Guélin, in preparation). Position (0,0) is $\alpha = 4^{\text{h}}38^{\text{m}}38.0^{\text{s}}$, $\delta = 25^{\circ}35'45''$. The thick contour corresponds to half of the peak intensity. **Figure 4:** The corresponding line profiles and the (1-0) ^{12}CO and ^{13}CO line profiles observed toward position (0,0).

$C^{18}O$, and, for the densest clumps, CS, HC_3N , and C_3H_2 . The emission from $C^{18}O$ (1-0), HC_3N (10-9), and C_3H_2 (2₁₂-1₀₁) has recently been mapped with 23-25" angular resolution in TMC1, a well known condensation of HCL2, using the IRAM 30 m telescope (see Fig. 3).

On the scale of TMC1 (see also Fig. 1c of CG), $C^{18}O$ shows little structure, since the characteristic size of the $C^{18}O$ clumps is $\sim 4'$ (0.17 pc for a distance of 135 pc, and 0.12 pc for a distance of 100 pc: according to CG, HCL2 is on the near side of the Taurus complex). A much richer structure is visible on the HC_3N and C_3H_2 emission contours; the two maps, which are biased toward high density gas ($n(H_2) > 10^4 \text{ cm}^{-3}$), show a chain of tiny clumps with characteristic size $\sim 1'$, or about 0.03-0.04 pc. This structure is the smallest so far observed in any interstellar cloud.

Previous studies of clumpiness in dark clouds (e.g., Larson 1981 and Myers 1983) show the clump sizes scale with the gas velocity dispersion as $\Delta v^{1/2}$, a relation usually explained by a turbulent energy cascade from large to small gas condensations. This transfer process is supposed to break down for clouds small and dense enough that the turbulent velocity dispersion becomes subsonic; smaller clouds, not supported by turbulence, should collapse on a short time scale and hence be scarce. Extrapolation of Myers's data suggests the limiting size is $\simeq 0.1$ pc. Since our smallest clumps are a factor of 2-3 smaller, it is interesting to check their linewidths.

The ^{13}CO , $C^{18}O$, C_3H_2 and HC_3N line profiles, observed in the direction of the HC_3N peak, are presented in Fig. 4. Their gaussian-fitted HPFW are respectively 1.5, 1.1, 0.5 and 0.5 km s^{-1} . Thermal broadening for these species is negligible in front of the observed widths, so we can directly compare the latter with the clump sizes: $l \simeq 15'$ for ^{13}CO (see CG), $4'$ for $C^{18}O$, and, as we have seen, $1'$ for C_3H_2 and HC_3N . The sizes are found to scale with $\Delta v^{1/2}$, but the $\Delta v^{1/2}/l$ ratio lies well above the Myers's (1983) best-fit line. Optical thickness of the C_3H_2 and HC_3N lines and insufficient angular resolution in Myers's data may both contribute to the discrepancy. We note, however, that the optically thin 2₁₂-1₀₁ line of $C_2^{13}CH_2$, observed with the FCRAO 14 m telescope with $1'$ angular resolution and 0.18 km s^{-1} spectral resolution (Madden et al. 1986), has the same width as the 2₁₂-1₀₁ line of the main isotope, observed with the same instrument (0.69 km s^{-1}). The velocity dispersion in the C_3H_2 clumps, in spite of their small size, is definitely supersonic. The density implied by the HC_3N data is $\sim 10^5 \text{ cm}^{-3}$, so the clumps seem in virial equilibrium.

Conclusion

Optical thickness, subthermal excitation, and photodissociation all mean no single molecular species can be substituted for H_2 in measuring the mass of molecular gas. In the Taurus complex, the (1-0) ^{12}CO line is a reasonably good mass tracer in regions where $0.5 \leq A_v \leq 1.5$ mag, the (1-0) ^{13}CO line is a good mass tracer where $1 \leq A_v \leq 4$ mag, and the (1-0) $C^{18}O$ line is good where $1.5 \leq A_v \leq 6$ mag. Since the mass of the Taurus cloud complex is mostly in the halo component, where $A_v \leq 1.5$ mag, (1-0) ^{12}CO yields a better estimate of this mass than $C^{18}O$ or even ^{13}CO . (This may not be true for the J=2-1 line, which is harder to excite.) The clouds themselves should be studied in ^{13}CO or, better, $C^{18}O$, since their average A_v is 3-3.5 mag. Because of the different excitation thresholds of ^{13}CO and $C^{18}O$, determination of the $^{13}CO/C^{18}O$ isotopic ratio is not straightforward. The

above prescriptions may not apply to the hotter and denser giant cloud complexes associated with HII regions.

Cold cloud complexes like the Taurus complex are observed in CO throughout the Milky Way. Their masses are $\approx 10^4 - 10^5 M_{\odot}$, comparable to those of the hot giant clouds. More numerous than the hot clouds, the cold cloud complexes contain a large, if not dominant, fraction of the molecular gas in the Galaxy. They certainly contribute much to extragalactic CO emission, so that interpretation of the ^{12}CO and ^{13}CO emission from external galaxies should be made with caution.

We thank D. Downes and S. Radford for helpful comments on the manuscript.

References:

- Bachiller, R., Cernicharo, J., 1986, *Astron. Astrophys.*, 166, 283
Bhat, Ch.L., Issa, M.R., Houston, B.P., Mayer, C.J., Wolfendale, A.W., 1985, *Nature*, 314, 511
Bloemen, J.B.G.M., 1984, *Astron. Astrophys.*, 139, 37
Bloemen, J.B.G.M., 1986, *Astron. Astrophys.*, 154, 25
Cernicharo, J., Bachiller, R., 1984, *Astron. Astrophys. Suppl. Ser.*, 58, 327
Cernicharo, J., Bachiller, R., Duvert, G., 1985, *Astron. Astrophys.*, 149, 273
Cernicharo, J., Guelin, M., 1987, *Astron. Astrophys.*, 176, 299 (CG)
Dickman, R.L., 1978, *Astrophys. J. Suppl.*, 37, 407
Dickman, R.L., Snell, R.L., Schloerb, F.P., 1986, *Astrophys. J.*, 309, 326
Duvert, G., Cernicharo, J., Baudry, A., 1986, *Astron. Astrophys.*, 164, 349
Elias, J.M., 1978, *Astrophys. J.*, 224, 857
Frerking, M.A., Langer, W.A., Wilson, R.W., 1982, *Astrophys. J.*, 262, 590
Goldreich, P., Kwan, J., 1974, *Astrophys. J.*, 189, 441
Guetter, H.M., 1977, *Astron. J.*, 82, 598
Heyer, M.H., Vrba, F.J., Snell, R.L., Schloerb, F.P., Strom, St.E., Goldsmith, P.F., Strom, K.M., 1987, *Astrophys. J.*, 321, 855
Larson, R.B., 1981, *M.N.R.A.S.*, 194, 809
Li, T. P., Riley, P.A., Wolfendale, A.W., Liszt, H.S., 1982, *Astrophys. J.*, 262, 198
Meyers, P.C., 1983, *Astrophys. J.*, 270, 105
Madden, S.C., Irvine, W.M., Matthews, H.E. 1986, *Astrophys. J. (Letters)*, 311, L27
Nercessian, E., Castets, A., Cernicharo, J., Benayoun, J.J., 1988, *Astron. Astrophys.*, 189, 207
Ungerechts, H., Thaddeus, P. 1987, *Astrophys. J. (Suppl.)*, 63, 645
van Dishoeck, E.F., Black, J.H., 1986, NATO/ASI "Physical Processes in Interstellar Clouds", Irsee, ed. M. Scholer, Reidel, in press
Viala, Y.P., Letzelter, C., Eidelsberg, M., Rostas, F., 1988, *Astron. Astrophys.*, in press
Vrba, F.J., Rydgren, A.E., 1985, *Astron. J.*, 90, 1490
Wilson, T.L., Minn, Y.K., 1977, *Astron. Astrophys.*, 54, 933

**I.12) POLARISATION DES TRANSITIONS MOLECULAIRES MILLIMETRIQUES
DANS LES NUAGES A FAIBLE GRADIENT DE VITESSE**

I.12) POLARISATION DES TRANSITIONS MOLECULAIRES MILLIMETRIQUES
DANS LES NUAGES A FAIBLE GRADIENT DE VITESSE.

Nous présentons un modèle sur la polarisation linéaire des raies optiquement minces émises dans les nuages sombres. Des limites observationnelles pour HCO^+ et H^{13}CO^+ ont été obtenues avec le radiotélescope de 14-m. de FCRAO. Le modèle abandonne l'hypothèse LVG et prédit une polarisation $\approx 2\%$ pour H^{13}CO^+ dans le plus favorable des cas. Dans le cas de HCO^+ le modèle prédit une polarisation maximale de 7% (cas optiquement mince); compte tenu de l'opacité des raies et des problèmes de diffusion discutés dans I.05, la polarisation réelle sera moins importante.

Nous avons tenté sans succès de mesurer cette polarisation pour HCO^+ et H^{13}CO^+ dans quatre nuages sombres. Les limites supérieures typiques obtenues sur le pourcentage de polarisation est de 2-10% (3σ) avec une polarisation instrumentale $\approx 1\%$. Il faudrait augmenter considérablement la sensibilité des observations si l'on voulait étudier de cette façon la structure du champ magnétique dans les nuages denses.

LINEAR POLARIZATION OF MILLIMETER-WAVE EMISSION LINES
IN CLOUDS WITHOUT LARGE VELOCITY GRADIENTS

D.C. Lis, P.F. Goldsmith, R.L. Dickman, C.R. Predmore

Five College Radio Astronomy Observatory
University of Massachusetts, Amherst

and

A. Omont, J. Cernicharo

Observatoire de Grenoble
Université Scientifique et Médicale de Grenoble

Submitted to *The Astrophysical Journal*, 15 August 1987

Received _____

ABSTRACT

We present a model for the linear polarization of optically thin molecular line emission from dark molecular clouds and observational upper limits for HCO^+ and H^{13}CO^+ . The model abandons the large velocity gradient (LVG) assumption used in the work of Goldreich and Kylafis (1981, 1982), and Deguchi and Watson (1984). It predicts a polarization of about 2% in the $J=1\rightarrow 0$ line of H^{13}CO^+ in the most favorable case, taking into account the effect of the hyperfine structure which reduces the observed polarization by a factor of 3. In the case of HCO^+ , our model predicts polarizations up to about 7%, but as the optical depth of HCO^+ lines is expected to be large, multiple scattering which has not been included in this work will significantly reduce any observed polarization. We have searched for linear polarization of HCO^+ and H^{13}CO^+ lines in 4 dark clouds with only negative results. Typical 3σ upper limits achieved are 2-10%. The instrumentation employed in the observations sets a lower limit of about 1% for the smallest detectable polarization. However, as the lines observed are weak, the integration time required to achieve this limit is very large. A significant improvement in the sensitivity is therefore required for the linear polarization measurements of millimeter-wave emission lines to be an efficient way for studying magnetic fields inside dense molecular clouds.

1. Introduction

Magnetic fields can play a very important role in the evolution of molecular clouds. Methods of measuring interstellar magnetic fields have been discussed recently by Heiles (1986), who points out three basic techniques to measure the direction of the magnetic field component perpendicular to the line of sight: polarization of starlight, linear polarization of synchrotron radiation, and linear polarization of radio-frequency spectral lines. Of these methods only the last one is likely to permit the study of the magnetic field deep within dense, dark molecular clouds. Magnetic field components parallel to the line of sight can be studied using either the Faraday rotation or the Zeeman effect. Zeeman splitting of the 21-cm HI line was detected both in absorption against strong radio continuum sources (Verschuur 1968, 1969, 1970), and in emission (Troland and Heiles 1982). Zeeman splitting of the 18-cm OH absorption lines has also been detected recently against Ori B, W22 and Cas A (Heiles and Stevens 1986), and against NGC 2024 and W22 (Kazès and Crutcher 1986). For mm-wavelength lines, however, Doppler linewidths are much larger than expected Zeeman splittings, making this type of observation of little use.

The fact that interstellar radio frequency lines may possess a significant degree of linear polarization was first pointed out by Goldreich and Kylafis (1981). They consider a simple two-level system in the strong field limit, and using the Sobolev (or Large Velocity Gradient) approximation (Sobolev 1960, Castor 1970, Lucy 1971), predict that the linear polarization of emitted radiation may attain a maximum of about 7% for an optical depth $\tau \cong 1$. The direction of polarization may be either perpendicular or parallel to the projection of the magnetic field on the plane of the sky, and may thus be used to trace the magnetic field direction. In a second paper (Goldreich and Kylafis 1982) the authors consider both the strong and weak field limits, and predict even larger polarizations up to about 14%. These predictions stand in contradiction with the observations. The extensive search performed by Wannier, Scoville and Barvainis (1983) for a number of sources (including hot cores, as well as the centers and edges of dark clouds) did not result in any positive detection of polarized emission, although the observational limits achieved were often a factor of 3 or more below the theoretical predictions. A recent

search for linear polarization in ammonia line emission from OMC-1 (Barvainis and Wootten 1987) was also unsuccessful. Subsequent calculations by Deguchi and Watson (1984) for multi-level systems do not qualitatively change the results of Goldreich and Kylafis. While polarization is decreased by a factor of 2, a few percent linear polarization is still expected to be common for millimeter-wave emission lines. The suggestion that the emergent polarization is reduced by a lack of uniformity in magnetic field structure over length scales comparable to the resolution of existing millimeter telescopes, has not been confirmed by optical polarization measurements, which often show an impressive degree of large-scale order (Moneti *et al.* 1984; Jones, Hyland and Bailey 1984; McCutcheon *et al.* 1986). This suggests that either the cloud parameters chosen in previous computations are unrealistic, or that the LVG approximation is not valid for most dark clouds.

Morris, Lucas and Omont (1985) present a model for molecular emission from expanding circumstellar envelopes in which molecular excitation is dominated by infrared transitions to vibrationally excited states, followed by decay to higher rotational levels of the ground vibrational state. The detailed computations suggest that the polarization of emergent radiation may be as large as 5%, and can thus be detected by existing large millimeter telescopes.

The goal of the present paper is to present an equivalent model for linearly polarized emission of optically thin lines in dark clouds without embedded infrared sources, which abandons the LVG assumption. Molecular clouds generally consists of a high density core surrounded by an envelope with density decreasing with the distance from the core. If the density contrast between the core and the outer portion of the envelope is large, the excitation temperature can drop rapidly with radius. Gradients in the excitation temperature through the cloud can be expected to produce an anisotropic radiation field away from the cloud center. If the excitation temperature gradient is large enough, this anisotropy may produce significant differences in the population of different Zeeman sublevels of a given rotational level J , resulting in the polarization of emergent radiation. In section 2, we develop this theoretical model. In section 3, we present observations of H^{13}CO^+ and HCO^+ obtained at FCRAO. The significance of the upper limits obtained is discussed in section 4.

2. Theoretical Model

Consider the emission at an offset, p , from the center of a spherical cloud (Fig.1). In the following discussion the magnetic field is assumed to be either zero or radial; the implications of a non-radial magnetic field are discussed at the end of this section. The Zeeman splitting is assumed to be smaller than the Doppler linewidth (preventing production of circular polarization) and much larger than the natural linewidth. The last condition refers to the "strong field limit" (Goldreich and Kylafis 1981) and is generally satisfied for radio-frequency lines and some infrared lines. The model cloud has a 1.5 pc radius with 0.05 pc radius constant density core, a r^{-2} density distribution outside the core, a uniform turbulent velocity dispersion equal to 1 km s^{-1} FWHM, and a uniform kinetic temperature $T_k = 15 \text{ K}$. The above parameters were chosen to match those of L1450 (Guélin, Langer, and Wilson 1981).

Typical values for molecular hydrogen densities in the core used in the computations are $5 \cdot 10^4 - 5 \cdot 10^5 \text{ cm}^{-3}$. In general the molecule selected for the computations should be widely distributed in dark clouds so that its fractional abundance will be reasonably constant through the core and envelope of the cloud. Further, because all radiative rates are proportional to μ^2 , where μ is the permanent dipole moment, the largest gradients in the excitation temperature are expected for molecules having a large dipole moment, which are relatively difficult to thermalize by collisions. Molecules with a small dipole moment, such as CO, are close to thermalization even in the outer parts of the envelope, and have a relatively uniform excitation temperature. Finally, because the multiple scattering associated with opacity effects can be expected to reduce the net polarization of an emitted spectral line, the molecular transition selected for modeling should be optically thin; multiple scattering is not treated quantitatively in the present work.

The ion H^{13}CO^+ with a dipole moment $\mu = 3.3 \text{ D}$ (Woods *et al.*, 1975) seems to be a very good candidate for polarized emission. The fractional abundance of HCO^+ varies from 0.3 - $1.0 \cdot 10^{-8}$ (Irvine, Goldsmith and Hjalmanson 1987, and references therein), therefore, the fractional abundance of H^{13}CO^+ should be on the order of $X = 10^{-10}$. This is sufficiently low that one can expect the optically thin emission required for the single scattering model to be applicable.

In order to estimate the emergent polarization the following procedure was applied :

(i) Using the Monte Carlo method described by Bernes (1979), the excitation temperature of HCO^+ and H^{13}CO^+ within the cloud was first found without accounting for different Zeeman sublevels of the molecules.

(ii) Differences in the sublevel populations were then calculated assuming that the molecules are excited by an isotropic component of the radiation field, equivalent to a blackbody with the temperature T_{iso} , as well as by excess emission from the central cloud core with excitation temperature T_o and optical depth at line center τ_o . The values of T_o and τ_o , obtained for the $J=1 \rightarrow 0$ transition from the Monte Carlo calculations were assumed to be constant for all transitions. The value of T_{iso} was then determined such that for fixed T_o and τ_o the average excitation temperature between $J=0$ and the sublevels of $J=1$ was equal to the value obtained from the Monte Carlo calculations, T_{ex} .

Under the above assumptions the rate equation for the population of a sublevel M of the rotational level J of a linear molecule with $^1\Sigma$ ground electronic state without hyperfine structure, denoted $n_{J, M}$, may be written as

$$\frac{dn_{J, M}}{dt} = \sum_{M'=-J}^{J-1} \left[n_{J-1, M'} A_{J, M \rightarrow J-1, M'} (J_{\text{iso}} + J_o \alpha) - n_{J, M} A_{J, M \rightarrow J-1, M'} (1 + J_{\text{iso}} + J_o \alpha) \right] + \sum_{M'=-J+1}^{J+1} \left[n_{J+1, M'} A_{J+1, M' \rightarrow J, M} (1 + J_{\text{iso}} + J_o \alpha) - n_{J, M} A_{J+1, M' \rightarrow J, M} (J_{\text{iso}} + J_o \alpha) \right]. \quad (1)$$

In the above expression we have taken

$$J_{\text{iso}} = \left[\exp\left(\frac{h\nu_{Jf}}{kT_{\text{iso}}}\right) - 1 \right]^{-1}, \quad (2)$$

and

$$J_o = \left\{ \left[\exp\left(\frac{h\nu_{Jf}}{kT_o}\right) - 1 \right]^{-1} - J_{\text{iso}} \right\} Y W(r). \quad (3)$$

$W(r)$ is the dilution factor, given by

$$W(r) = \frac{\Omega}{4\pi} = \frac{1}{2} \left[1 - \sqrt{1 - \left(\frac{r_o}{r}\right)^2} \right], \quad (4)$$

where r_0 is the radius of the core, r the distance from its center to the observation point, and Ω is the solid angle of the core as observed from point A (Fig.1). Y is the optical depth correction,

$$Y = \int \Phi_\nu [1 - \exp(-\tau_\nu)] d\nu, \quad (5)$$

where $\tau_\nu = \tau_0 \exp[-(\nu - \nu_0)^2 / 2\sigma^2]$, ν_0 is the line center frequency, and the normalized line profile, Φ_ν , is assumed to be Gaussian. The integral is carried out over the line.

The spontaneous emission coefficient for a $J', M' \rightarrow J, M$ transition is given by

$$A_{J', M' \rightarrow J, M} = A_{J' \rightarrow J} | \langle J, 1, M, M' - M | J', M' \rangle |^2 \quad (6)$$

where $\langle J, 1, M, M' - M | J', M' \rangle$ is the appropriate Clebsch-Gordan coefficient and

$$A_{J' \rightarrow J} = \frac{512 \pi^4 \mu^2 B^3 J'^4}{3 h c^3 (2J' + 1)} \delta_{J' - 1, J} \quad (7)$$

μ being the permanent dipole moment, and B the rotational constant of the molecule in units of frequency. The factor

$$\alpha = \frac{3}{2} (1 - \delta_{M, M'}) \quad (8)$$

in eq. (1) excludes transitions with $\Delta M = 0$ induced by radiation from the core. The choice of quantization axis in the radial direction results in different selection rules for transitions induced by the isotropic radiation and those induced by radiation from the core. In the limit of a very small core, photons emitted from the core travel along the quantization axis, so that the photon spin projection is +1 or -1 and never 0. In fact, because of the finite size of the core, there is a finite probability that the photon spin projection is zero. Therefore, our results are upper limits to the polarization of the emitted radiation.

The polarization of the emitted radiation seen by the observer is defined as

$$P = \frac{I_r - I_l}{I_r + I_l}, \quad (9)$$

where I_r, I_l are the intensities in the perpendicular and parallel directions as defined in Figure 1. For optically thin emission

$$I_{r,l} = \int [S_{r,l} - \frac{1}{2} B(T_{bb})] d\tau_{r,l} , \quad (10)$$

where $B(T_{bb})$ is the Planck function at the temperature of the cosmic background, $T_{bb} = 2.7$ K. The source functions, $S_{r,l}$, and the absorption coefficients for the polarized radiation are given by Deguchi and Watson (1984). (Notice that equation (5) of Deguchi and Watson should be divided by 2 in order that for $\Theta=0$, k_r and k_l be equal). The integral is carried out from 0 to the maximum optical depth for a given impact parameter. Clearly, integration along the line of sight reduces the emergent polarization, and an upper limit for P is given by taking the results for $\Theta = \pi / 2$ only, which yields

$$P = \frac{S_r k_r - S_l k_l - \frac{1}{2} B(T_{bb})(k_r - k_l)}{S_r k_r + S_l k_l - \frac{1}{2} B(T_{bb})(k_r + k_l)} . \quad (11)$$

For the $J=1 \rightarrow 0$ transition, which is expected to have the highest degree of polarization, eq. (11) takes the simple form

$$P = \frac{n_{11} - n_{10}}{n_{11} + n_{10} - 2n_{00} \exp(-\frac{h\nu}{kT_{bb}})} . \quad (12)$$

The computations were performed for five values of the central hydrogen density, $n_0 = 5 \cdot 10^4$, 10^5 , $2 \cdot 10^5$, $4 \cdot 10^5$, and $8 \cdot 10^5$ cm^{-3} . Values of T_0 , τ_0 , Y and the line center optical depth from the center to the edge of the cloud, τ_1 , for the different models are given in Table 1. Levels with $J \leq 4$ were included in the Monte Carlo computations and the collisional cross sections were taken from Monteiro (1985). These are generally of the order of few times 10^{-10} $\text{cm}^3 \text{ s}^{-1}$, about a factor of 2 larger than those of Green (1975), after correction for difference in the reduced mass between hydrogen and helium. The collisional rates between different sublevels of a given rotational level, J , are generally considered to be much smaller than those between different J levels (Oka, 1973; Bomsdorf and Mader, 1983; Brechignac *et al.* 1980).

Because the spontaneous emission rate for $J=1 \rightarrow 0$ transition is $A_{1 \rightarrow 0} = 3 \cdot 10^{-5} \text{ s}^{-1}$, the critical density, for which the spontaneous emission rate is equal to the collisional deexcitation rate, is of the order of 10^5 cm^{-3} . Figure 2 shows the excitation temperature of the $J=1 \rightarrow 0$ transition of H^{13}CO^+ in

our model cloud as a function of radius for different central densities. Because the excitation temperature drops rather rapidly with radius, the core of the cloud is well defined, and the two component model adopted for the radiation field seems to be a good approximation.

The results of the computations for a kinetic temperature $T_k = 15$ K and a fractional abundance $X = 10^{-10}$, appropriate for $H^{13}CO^+$, are presented in Figure 3a and Table 1 (models 1A to 1E). For a given central density, polarization of the emitted radiation is a slowly increasing function of the offset from the cloud center, p . It decreases for small p because T_{ex} approaches T_0 . For low central densities ($n_0 < 10^5$ cm $^{-3}$), P is basically independent of the value of n_0 . As n_0 increases above 10^5 cm $^{-3}$, the polarization decreases due to the near-thermalization of relevant level populations. It should be pointed out, however, that for small central densities, the predicted line intensity is low, which makes detection more difficult. In addition, for small central densities the brightness temperature, presented in Figure 4, drops rather rapidly with the offset from the center of the cloud. Although as shown in Figures 3a-d, the *polarization* is predicted to be greater for larger offsets from the cloud center, the drop in *intensity* and lower signal to noise attainable will limit the distance to which one can profitably search for polarized emission.

In order to check how our results are affected by different model parameters, we varied T_0 , τ_0 and T_{iso} successively. Changes of 0.1 K in T_0 and 0.1 in τ_0 produce a change of about 0.1% in P for all offsets. Variations in the value of T_{iso} had the most important impact, especially for low excitation temperatures. A change of 0.01 K in T_{iso} can produce a change in P of about 0.05% for $T_{ex} \cong 3$ K. We also checked the effect of optical depth on the observed polarization, treating the fractional abundance, X , as a free parameter, and running additional models for $X = 2 \cdot 10^{-10}$, $5 \cdot 10^{-10}$ and 10^{-9} (models 2,3 and 4 respectively). For any particular value of X we observe the same trends as for $X = 10^{-10}$. Polarization in the single scattering model, however, increases with X . The highest degree of polarization is predicted for $X = 10^{-9}$, approximately the fractional abundance of HCO^+ . In this case, even for values of n_0 as small as $2.5 \cdot 10^4$ the optical depth from the center to the edge of the cloud, τ_1 , is larger than 1 and multiple scattering will reduce the observed polarization significantly. For smaller values of n_0 , the

excitation temperature through the cloud is too small for observation of polarized emission. Because P is a slowly varying function of the offset, p , beam averaging should not significantly affect the predicted polarization.

It was assumed in the computations, that T_0 and τ_0 are constant for all transitions. In order to check the validity of this assumption we calculated another model with density, kinetic temperature, and fractional abundance equivalent to the model 1A, assuming one value of T_0 and τ_0 for $J=1 \rightarrow 0$ transition and another for all higher transitions. Two values of T_{iso} were fitted to obtain correct excitation temperatures for the $J=1 \rightarrow 0$ and $J=2 \rightarrow 1$ transitions. The emergent polarization was found to be smaller by about 10 - 15% than that in model 1A. As the effect of transitions higher than $J=2 \rightarrow 1$ for the polarization of $J=1 \rightarrow 0$ line is expected to be insignificant, we conclude that the results presented in Figures 3a-d are really upper limits for the polarization of emergent radiation.

The calculations presented above were made under the assumption that any magnetic field in the cloud is either zero or radial. In the presence of a nonradial magnetic field, the radial direction is no longer the appropriate choice for the quantization axis. The magnetic field term in the Hamiltonian causes mixing of different Zeeman sublevels and the only natural choice for the quantization axis is the magnetic field direction, which in general makes an angle, ψ , with the propagation direction. In this case the polarization of $J=1 \rightarrow 0$ transition is given by

$$P = \frac{\sin^2\psi (n_{11} - n_{10})}{n_{11} (1 + \cos^2\psi) + n_{10} \sin^2\psi - 2 n_{00} \exp(-\frac{h\nu}{kT_{bb}})} \quad (13)$$

where the sublevel populations are calculated with the quantization axis in the direction of the magnetic field. For $\psi=90^\circ$ it is equivalent to equation (12). The difference in sublevel populations itself depends on the angle ψ . It varies as $0.5(3\cos^2\psi - 1)$, (Morris, Lucas, and Omont 1985). In the most extreme case, $\psi=0$ (magnetic field parallel to the line of sight), the photon spin projection is always zero, so that one can expect significant differences in sublevel populations, but unpolarized emitted radiation.

The observed polarization will be further reduced by the hyperfine structure of HCO^+ and H^{13}CO^+ . An attempt was made to estimate the effect of the hyperfine structure on the polarization of scattered radiation for a simple two level system with $J=0$ and $J=1$ levels only and no background radiation field. In the case of a molecule with a nuclear spin $I = 1/2$ (HCO^+), the polarization of radiation scattered at the angle $\pi/2$ is reduced from 100% to 43%, while for a molecule with two nuclear spins, $I_1 = I_2 = 1/2$ (H^{13}CO^+), it is reduced to about 28%. Our predicted results for HCO^+ should thus be scaled down by about a factor of 2, and results for H^{13}CO^+ by about a factor of 3. The maximum polarization of H^{13}CO^+ is then smaller than 2% in the most favorable case with $n_0 < 10^5 \text{ cm}^{-3}$, and may just be barely detectable. The effect of the hyperfine structure is quite significant. It may be, therefore, reasonable to look for a molecule without hyperfine structure. The dipole moment of simple molecules is, however, smaller than that of HCO^+ , and thermalization of relevant rotational levels occurs at lower densities. For example the critical density of the $J=1 \rightarrow 0$ transition of CS is about 17 times smaller than that of HCO^+ .

3. Observations.

Polarization measurements of the $J=1 \rightarrow 0$ transitions of HCO^+ (89.188545 GHz) and H^{13}CO^+ (86.754340 GHz) in dark clouds were made during one four-day observing session in March 1986 using the FCRAO 14m telescope at New Salem, Massachusetts. Additional observations of the Kleinmann-Low nebula in Orion were made in May 1987. The receiver used during the observations employed a cooled Schottky diode mixer and a quasioptical single sideband filter with cooled image termination. The typical single sideband system temperature (referred to above the earth's atmosphere) was about 500 K. We used a 256 channel filterbank backend, each channel having a resolution of 100 kHz, equivalent to 0.33 km s^{-1} . A detailed description of the FCRAO polarimeter and data taking procedures may be found in Wannier *et al.* (1983) and Barvainis and Predmore (1985). Jupiter and Saturn were used as calibration sources. The beam size was determined to be 58" FWHM at 86.8 GHz. Assuming source temperatures of 179 K for Jupiter, and 153 K for Saturn (Ulich *et al.* 1980) the aperture and beam efficiencies were determined to be 0.49 and 0.57, respectively. The resulting conversion factor

from antenna temperature T_A^* to unpolarized flux density for a source filling the antenna main beam is then 33.0 Jy K^{-1} .

The HCO^+ line was observed at 10 positions in 4 sources and the H^{13}CO^+ line was observed at 4 positions in 3 sources (Tables 2a and 2b). The average integration time was about 2 hours for each position. Assuming three standard deviations to be an acceptable detection level, we conclude that no evidence of polarization was detected. The upper limits for HCO^+ and H^{13}CO^+ observations are presented in Tables 2a and 2b, respectively. Figures 5a-d show these positions of L1450 and N2264 where our best limits were achieved. [Detailed maps of the sources we observed can be found in Guélin, Langer and Wilson (1983).] The coordinates of the HCO^+ peak emission are: (-1,0) for L134N and (-3,0) for TMC-2. H^{13}CO^+ emission peaks at the following positions: (0,1.5) for L134N, (1.5,-6) for L1450, and (0,0) for N2264. Thus, all of our positions correspond to projected offsets of 1.5 to 7 arcminutes from the peak of the emission. The value of p/r_0 (Fig.1) ranges from 1 to 10, assuming the distances given by Guélin, Langer and Wilson (1982): 100 pc for L134N and TMC-2, 300 pc for L1450, and 800 pc for N2264, together with 0.05 pc for a typical core radius.

In order to check whether the achieved limits are really statistical and not corrupted by instrumental errors, additional observations were made of the Kleinmann-Low nebula in Orion, where the emission is not expected to be polarized because of the high density in the cloud. Figure 6a presents the averaged result of over 10 hours of integration on different days, and at different parallactic angles of the source. The formal 1σ limits achieved for the polarization are on the order of 0.15% at the line center. A residual polarization of about 0.5% is present over the whole line. If it is assumed that the emission is unpolarized, 0.5% represents the instrumental limit of the polarimeter. In order to check the validity of this assumption, we made a series of independent measurements on different days, at different parallactic angles. Because the HCO^+ line in Orion KL is very strong ($T_A^* \cong 10\text{K}$), limits as low as 0.2% can be achieved in approximately 2 hours of integration. If the observed polarization were real, we would have obtained similar polarization patterns for all parallactic angles. Figures 6b and 6c present typical results of observations made on the same day, before transit (average parallactic angle \cong

-20°) and after transit (average parallactic angle \cong 25°). The fact that the polarization pattern is completely different convinces us that we are dealing with an instrumental effect. The residual polarization may be produced, for example, by changes in telescope pointing produced by rotation of the polarimeter. For off-center observations of a centrally peaked cloud, a small change in pointing may produce a relatively large difference in the antenna temperature between the parallel and perpendicular polarizations. The smallest detectable polarization, which taking into account the instrumental errors discussed above is on the order of 1%, is still below typical predictions of our theoretical model.

4. Conclusion.

We have presented a model for the linear polarization of optically thin radio-frequency lines from dark molecular clouds which abandons the large velocity gradient assumption. It is based on the asymmetry of the radiation field produced by a moderately optically thick, relatively highly excited dense core of the cloud occupying a restricted solid angle as seen from positions along an offset line of sight. The maximum fractional polarization predicted by LVG models has varied from 14% (Goldreich and Kylafis 1982) down to 7% (Deguchi and Watson 1984). For H^{13}CO^+ the present model predicts smaller values of fractional polarization, with a maximum of 5% ignoring the hyperfine structure, which has the effect of reducing the linear polarization by a factor of 3. The final fractional polarization in our model is about 2% in the most favorable case with magnetic field in the radial direction. Our calculations predict a maximum fractional polarization of 15% for HCO^+ but multiple scattering effect, which has not been included in the calculations, will significantly reduce the observed polarization of this optically thick line. The HCO^+ polarization will also be reduced due to the hyperfine structure by a factor of 2.

We have carried out observations of HCO^+ and H^{13}CO^+ lines in a number of sources, which reveal no evidence of linear polarization. The limits achieved are comparable to or somewhat higher than our theoretical predictions. However, our observations together with those of Wannier *et al.* (1983) exclude the possibility of the large polarization predicted by previous LVG models.

With the instrumental errors of about 0.5%, the smallest polarization that could be detected is on the order of 1%, which would require 1σ statistical uncertainty $\leq 0.3\%$. Even for the strongest HCO^+ lines from dark clouds, the statistical errors achieved in the present work are a factor of 3 higher than this. In order to reduce the statistical uncertainty to the point where the instrumental errors become the limiting factor, one would have to increase the integration time by an order of magnitude. Therefore, about 20 hours of integration for each position would be required in order to definitely answer the question of whether HCO^+ emission from dark molecular clouds is linearly polarized at the 1% level. In the case of H^{13}CO^+ the situation is even worse, because the lines are substantially weaker. Although theoretically the quality of the instrumentation available is high enough to obtain limits at the level of 1%, the amount of time required to obtain these limits is very large. We therefore conclude that even if the polarization of radio frequency lines from dark molecular clouds is discovered in the future, considerably improved sensitivity will be required to make it a practical method for studying magnetic field structures within these regions.

The Five College Radio Astronomy Observatory is operated with support from the National Science Foundation (Grant AST 85-12903), and with permission of the Metropolitan District Commission. Groupe d'Astrophysique is associated with CNRS (UA 708). This is contribution 633 of the Five College Astronomy Department.

R.L. DICKMAN, P.F. GOLDSMITH, D.C. LIS, and C.R. PREDMORE: Five College Radio Astronomy Observatory, 619 Lederle Graduate Research Tower B, University of Massachusetts, Amherst, MA 01003, USA.

J. CERNICARO and A. OMONT: Groupe d'Astrophysique, Observatoire de Grenoble, Université Scientifique et Médicale de Grenoble, B.P.68, F-38402 St. Martin d'Heres Cedex, France.

References

- Bomsdorf, and H., Mader, H., 1983, *J. Chem. Phys.*, **78**, 3467
- Barvainis, R., and Predmore, C.R., 1985, *Ap. J.*, **288**, 694
- Barvainis, R., and Wootten, A., 1987, *Astr. J.*, **92**, 168
- Bernes, C., 1979, *Astr. Ap.*, **73**, 67
- Brechignac, P., Picard-Berselini, A., Charneau, R., and Launay, J.M., 1980, *Chem. Phys.*, **53**, 165
- Castor, J.I., 1970, *M. N. R. A. S.*, **149**, 111
- Deguchi, S., and Watson, W.D., 1984, *Ap. J.*, **285**, 126
- Goldreich, P., and Kylafis, N.D., 1981, *Ap. J. Lett.*, **243**, L75
- Goldreich, P., and Kylafis, N.D., 1982, *Ap. J.*, **253**, 606
- Green, S., 1975, *Ap. J.*, **201**, 36
- Guélin, M., Langer, W.D., and Wilson, R.W., 1982, *Astr. Ap.*, **107**, 107
- Heiles, C., and Stevens, M., 1985, *Ap. J.*, **301**, 331
- Heiles, C., 1986, Preprint
- Irvine, W.M., Goldsmith, P.F., and Hjalmanson, A., 1987, in *Interstellar Processes*, D.J. Hollenbach, H.A. Thronson, ed. Dordrecht: Reidel, 561
- Jones, T.J., Hyland, A.R., and Bailey, J., 1984, *Ap. J.*, **282**, 675
- Kazès, I., and Crutcher, R.M., *Astr. Ap.*, **164**, 328
- Lucy, L.B., 1971, *Ap. J.*, **163**, 95
- McCutcheon, W.H., Vrba, F.J., Dickman, R.L., and Clemens, D.P., 1986, *Ap. J.*, **309**, 619
- Moneti, A., Pipher, J.L., Helfer, H.L., McMillan, R.S., and Perry, M.L., 1984, *Ap. J.*, **282**, 508
- Monteiro, T.S., *M. N. R. A. S.*, 1985, **214**, 419
- Morris, M., Lucas, R., and Omont, A., 1985, *Astr. Ap.*, **142**, 107
- Oka, T., 1973, *Adv. Atomic Mol. Phys.*, **2**, 127
- Sobolev, V.V., 1960, *Moving Envelopes of Stars*. Cambridge: Harvard University Press
- Ulich, B.L., Daus, J.H., Rhodes, P.J., Hollis, J.M., 1980, *IEEE Trans. Ant. Prop.*, **AP-28**, 367
- Verschuur, G.L., 1968, *Phys. Rev. Lett.*, **21**, 775
- Verschuur, G.L., 1969, *Ap. J.*, **156**, 861
- Verschuur, G.L., 1970, *Ap. J.*, **161**, 867
- Wannier, P.G., Scoville, N.Z., and Barvainis, R., 1983, *Ap. J.*, **267**, 126
- Woods, R.C., Dixon, T.A., Saykally, R.T., and Szanto, P.G., 1975, *Phys. Rev. Lett.*, **35**, 1269

Table 1. Parameters of Monte Carlo models^a.

Model	n_o	X	T_o	τ_o	τ_1	Y
1A	$5 \cdot 10^4$	$1 \cdot 10^{-10}$	6.04	0.34	0.45	0.210
1B	$1 \cdot 10^5$	$1 \cdot 10^{-10}$	9.53	0.37	0.64	0.226
1C	$2 \cdot 10^5$	$1 \cdot 10^{-10}$	14.32	0.41	0.89	0.247
1D	$4 \cdot 10^5$	$1 \cdot 10^{-10}$	17.25	0.58	1.26	0.327
1E	$8 \cdot 10^5$	$1 \cdot 10^{-10}$	16.48	1.06	1.93	0.504
2A	$1 \cdot 10^5$	$2 \cdot 10^{-10}$	10.23	0.66	1.18	0.362
2B	$2 \cdot 10^5$	$2 \cdot 10^{-10}$	15.03	0.74	1.61	0.394
3A	$5 \cdot 10^4$	$5 \cdot 10^{-10}$	7.46	1.26	1.88	0.561
3B	$1 \cdot 10^5$	$5 \cdot 10^{-10}$	11.56	1.34	2.53	0.603
4A	$2.5 \cdot 10^4$	$1 \cdot 10^{-9}$	5.49	1.90	2.40	0.695
4B	$5 \cdot 10^4$	$1 \cdot 10^{-9}$	8.65	2.03	3.27	0.715

^aThe cloud parameters which are varied in the models are

n_o - central density of the model cloud (cm^{-3}),

X - molecular fractional abundance.

Other important aspects of the models are

T_o - central excitation temperature (K),

τ_o - optical depth through the core,

τ_1 - optical depth from the center to the edge of the cloud,

Y - optical depth correction (eq. 5).

The velocity distribution of molecules is assumed to be a Gaussian with FWHM equal to 1 km s^{-1} in all models, and the kinetic temperature of the gas is 15 K.

Table 2a. Observational limits for fractional linear polarization of HCO⁺ emission.

Source	Position ^a	Limit ^b	t _{int} ^c	T _A ^d
L134N	(+0,+5)	9.	4.2	0.3
	(+2,+0)	12.	1.5	0.3
	(-4,+2)	15.	2.1	0.3
L1450	(+0,+2)	9.	2.1	0.4
	(-2,-6)	2.1	2.4	1.7
	(+0,+0)	2.4	2.3	2.8
TMC2	(+0,+0)	6.	2.2	1.7
N2264	(-4,+0)	21.	2.7	0.5
	(+2,+0)	6.	2.7	2.1
	(-2,+0)	3.	2.5	1.3

Table 2b. Observational limits for fractional linear polarization of H¹³CO⁺ emission.

Source	Position ^a	Limit ^b	t _{int} ^c	T _A ^d
L134N	(+0,+0)	27.	3.8	0.7
L1450	(+0,+0)	3.6	4.2	0.8
	(+0,-6)	7.5	3.5	0.5
N2264	(+2,+0)	15.	0.9	0.6

^a Offset from central position in minutes of arc in Right Ascension and declination. The coordinates of the (0,0) positions are:

L134N: $\alpha = 15^{\text{h}}51^{\text{m}}30^{\text{s}}$, $\delta = -2^{\circ}43'31''$;

L1450: $\alpha = 3^{\text{h}}25^{\text{m}}56^{\text{s}}$, $\delta = 31^{\circ}10'38''$;

N2264: $\alpha = 6^{\text{h}}38^{\text{m}}25^{\text{s}}$, $\delta = 9^{\circ}32'29''$;

TMC-2: $\alpha = 4^{\text{h}}29^{\text{m}}43^{\text{s}}$, $\delta = 24^{\circ}16'55''$.

^b 3σ in a single channel at the line center having 0.33 km s^{-1} velocity resolution (%).

^c Integration time (hours) including reference position for total intensity measurements.

^d Peak antenna temperature (K) corrected for atmospheric absorption but not corrected for coupling efficiency, which is determined to be 0.57 for a source filling the main beam.

Figure Captions.

Figure 1. Geometry of the cloud with a radial magnetic field. R_{cl} and r_0 are the cloud and the core radius respectively, p is the offset from the cloud center, and τ_0 is the optical depth through the core. For any position along the line of sight the quantization axis makes an angle, Θ , with the direction of observation. At the point of the closest approach, A, $\Theta = 90^\circ$ and the upper limit for the polarization is given by equation (12).

Figure 2. The excitation temperature of $J=1 \rightarrow 0$ transition of $H^{13}CO^+$ as a function of distance from the center of the cloud, for models with different central densities: $n_0 = 5.10^4, 10^5, 2.10^5, 4.10^5$ and 8.10^5 cm s^{-1} for models 1A to 1E respectively.

Figures 3a-d. Predicted linear polarization for different models from Table 1. $P > 0$ means $I_r > I_l$. The results do not include any effects of the hyperfine structure which will reduce observed polarization, as discussed in text.

Figure 4. The predicted radiation temperature (equivalent to T_A for perfectly coupled antenna having infinitesimal beamwidth) of $J=1 \rightarrow 0$ transition of $H^{13}CO^+$ as a function of the offset from the center of the cloud, for models with different central densities.

Figure 5a-d. The observed limits for linear polarization of HCO^+ and $H^{13}CO^+$ emission

- a) N2264 (-2,0), HCO^+
- b) L1450 (-2,-6), HCO^+
- c) L1450 (0,0), HCO^+
- d) L1450 (0,0), $H^{13}CO^+$

For these positions there is a possible indication of a detection at the 2σ level but we do not consider this to be significant. The total integration time of about 20 hours for each HCO^+ position would be required to reduce statistical errors to the level below the instrumental limits (see discussion in section 3). Note that in L1450 the peak of the emission is at the (1.5,0) position so that figures 6c and 6d are off-peak observations.

Figure 6a-c. The observed polarization of HCO^+ emission from Orion KL ($\alpha = 5^{\text{h}}32^{\text{m}}47^{\text{s}}$, $\delta = -5^{\circ}24'20''$). Because of high density and optical depth, the emission is expected to be unpolarized. The observed polarization suggests that 0.5% is the instrumental limit for FCRAO polarimeter. Figure 6a represents the averaged result of 10 h of integration on different days and for different parallactic angle. Figures 6b and c are independent observations with 2 h integration time, made on the same day, at different parallactic angles, before and after transit respectively. The difference in observed polarization pattern between 6b and 6c, confirms our assumption that the HCO^+ emission from Orion KL is unpolarized, and that the residual polarization of about 0.5% observed is caused by instrumental errors.

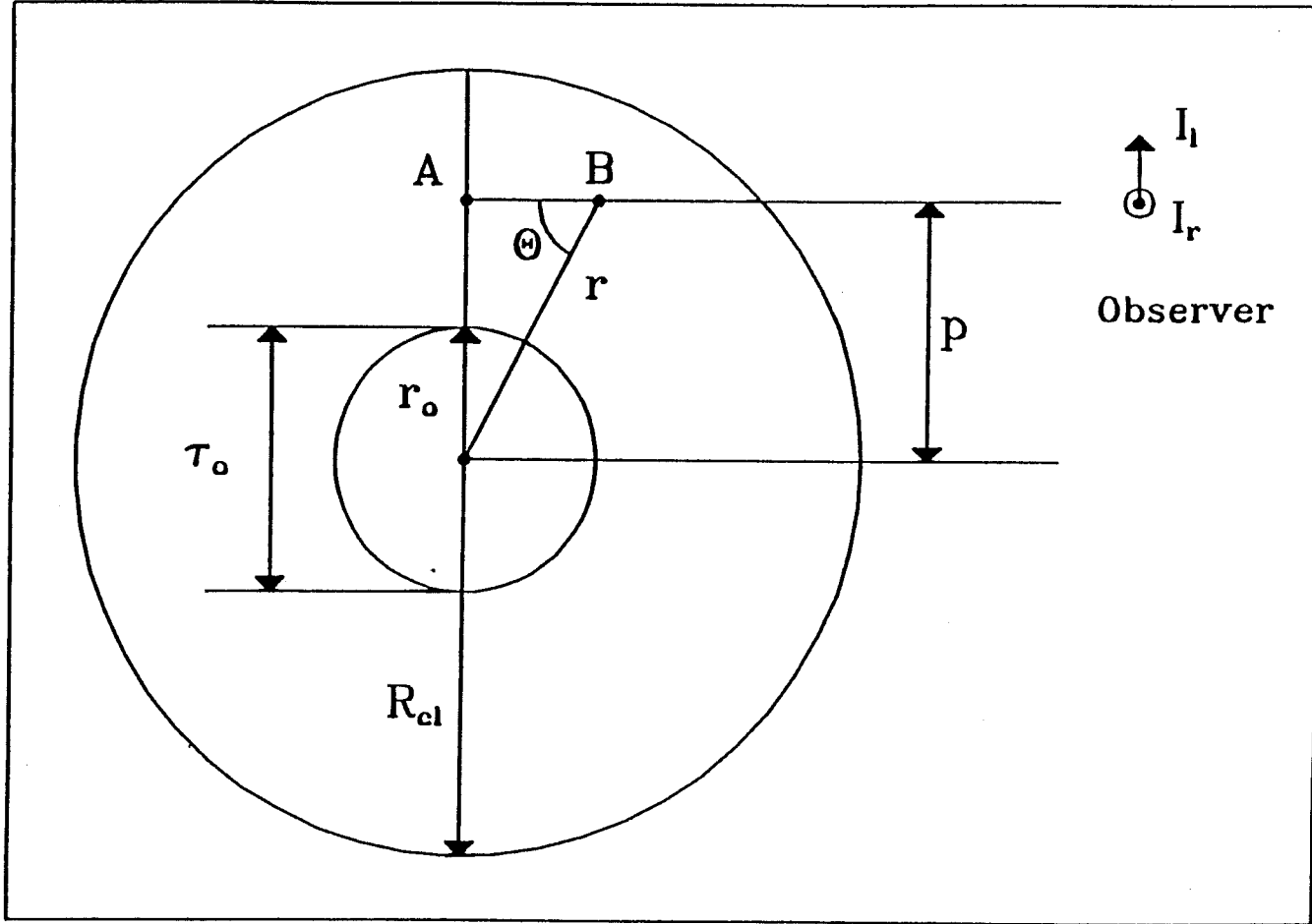

Figure 1.

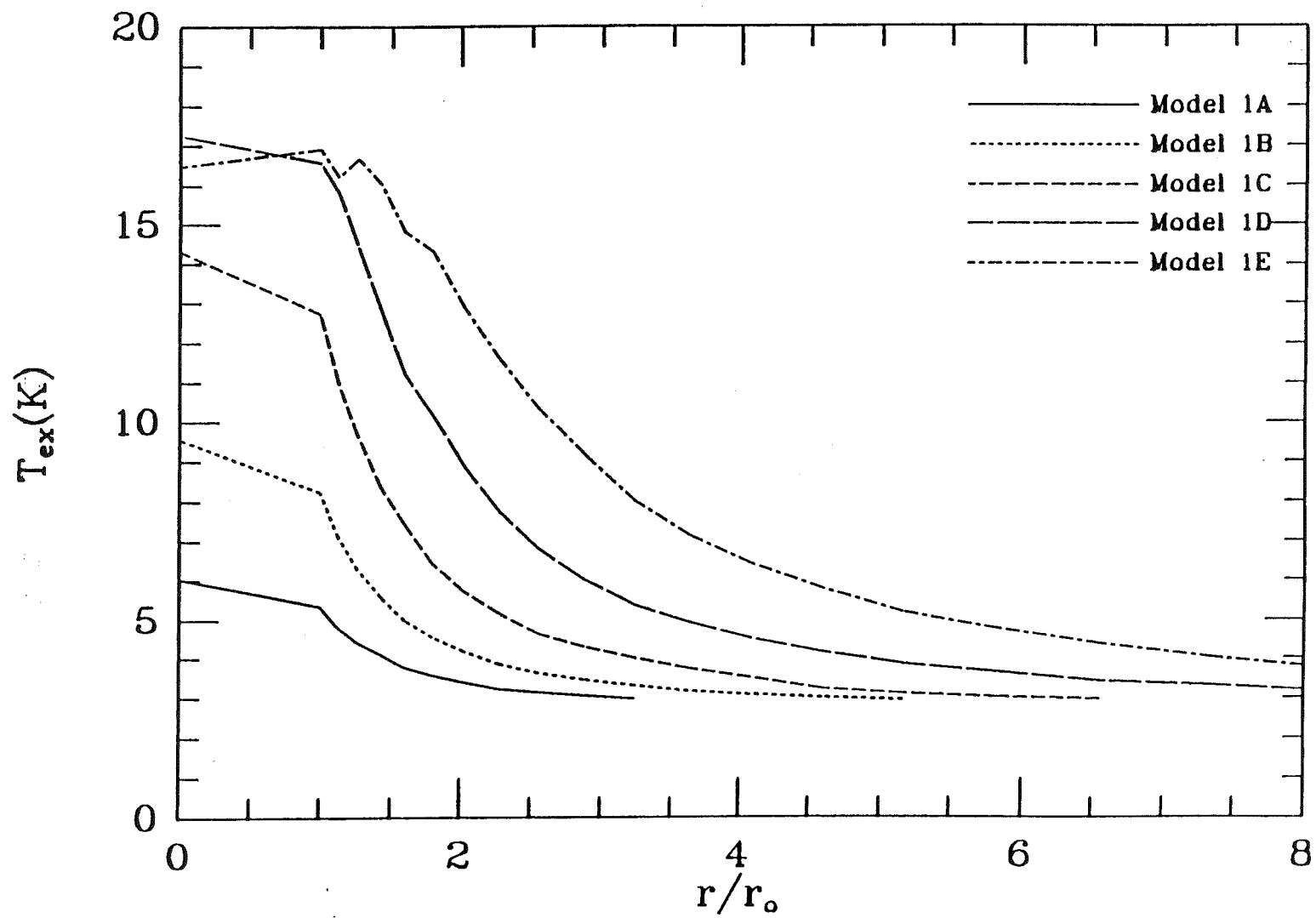

Figure 2.

Figure 3a.

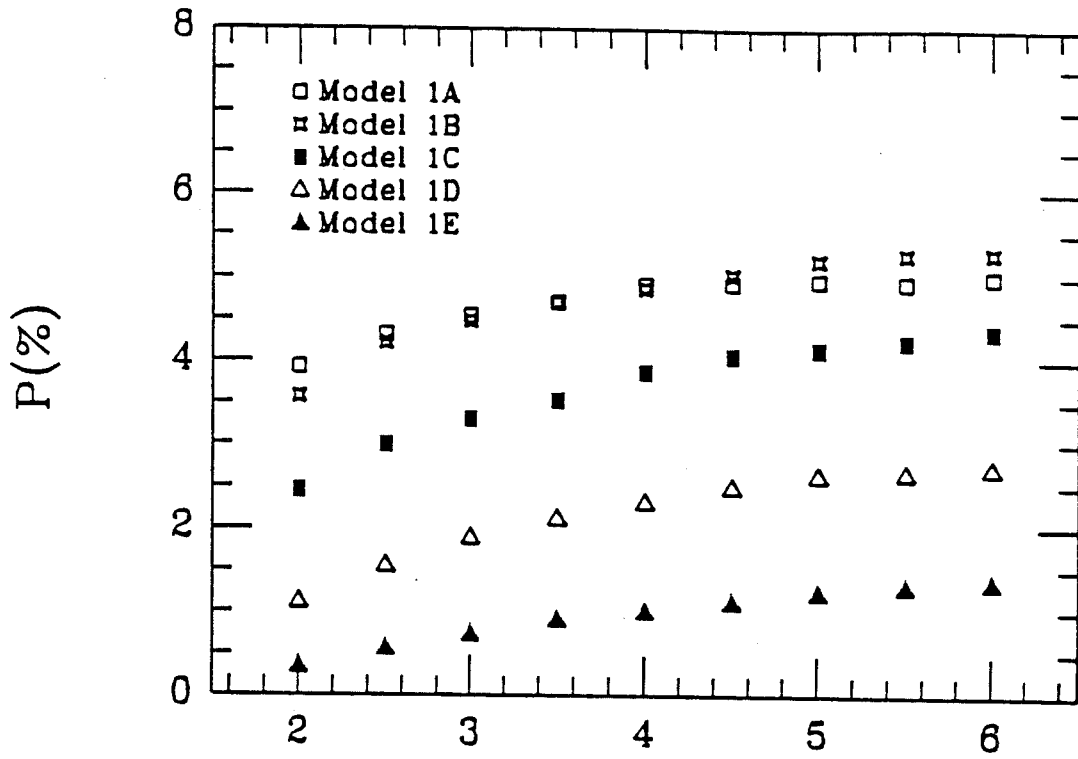

Figure 3b.

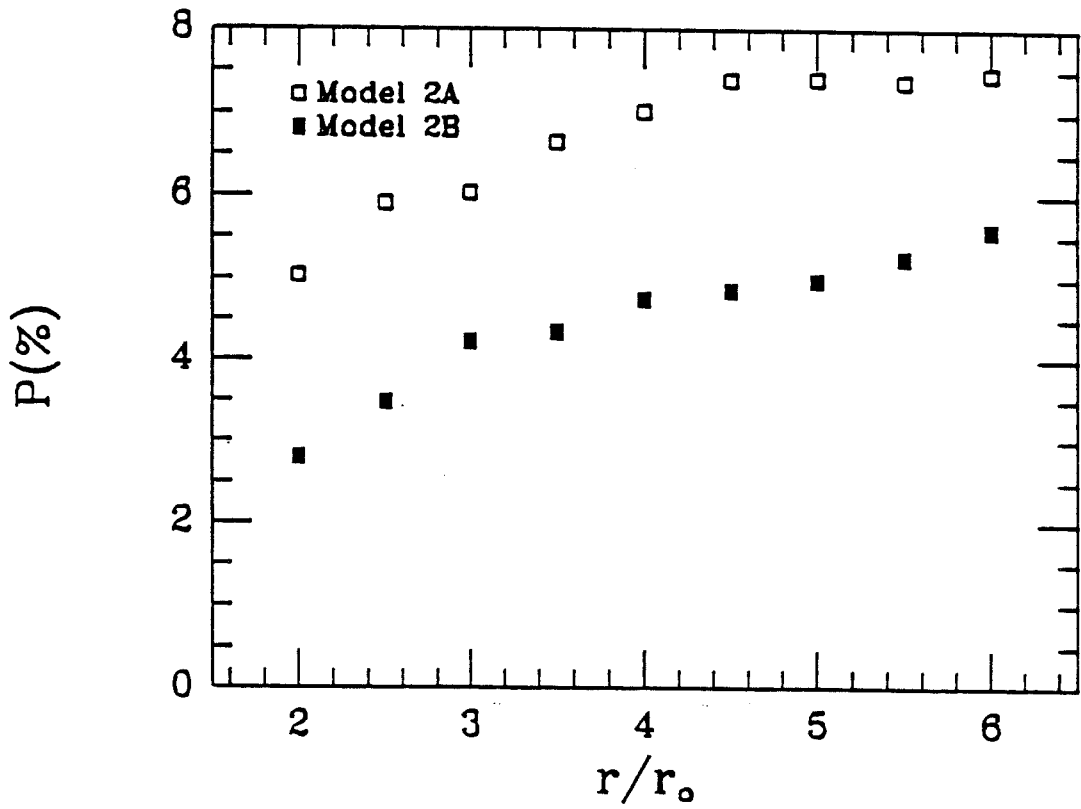

Figure 3c.

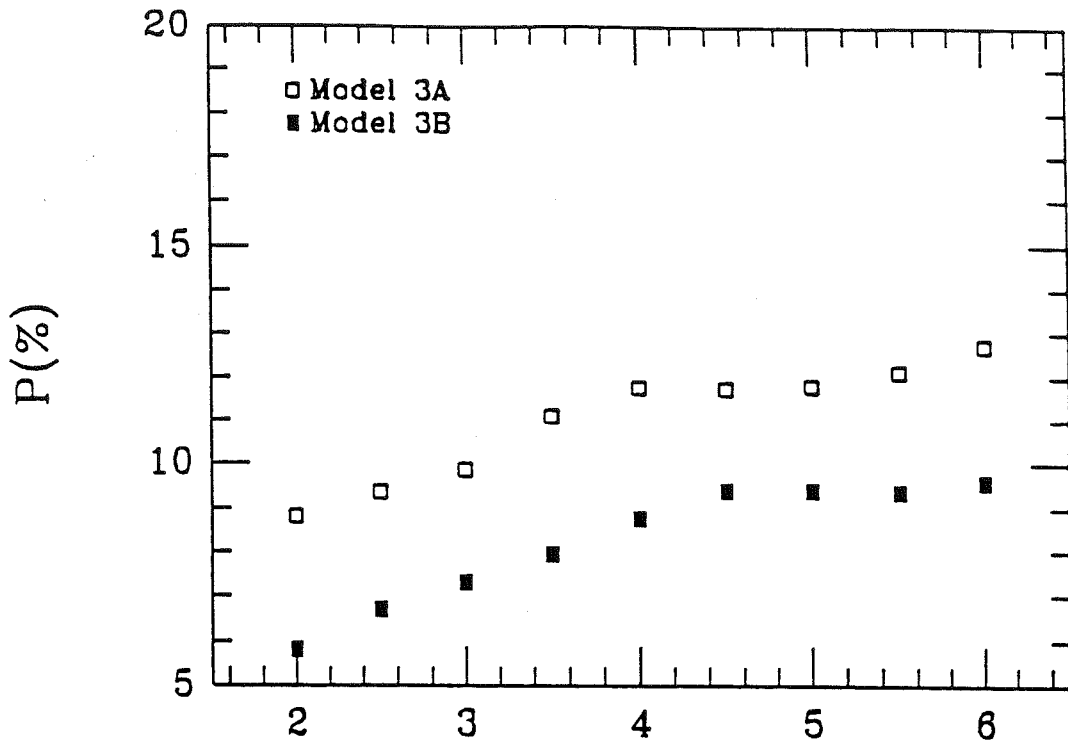
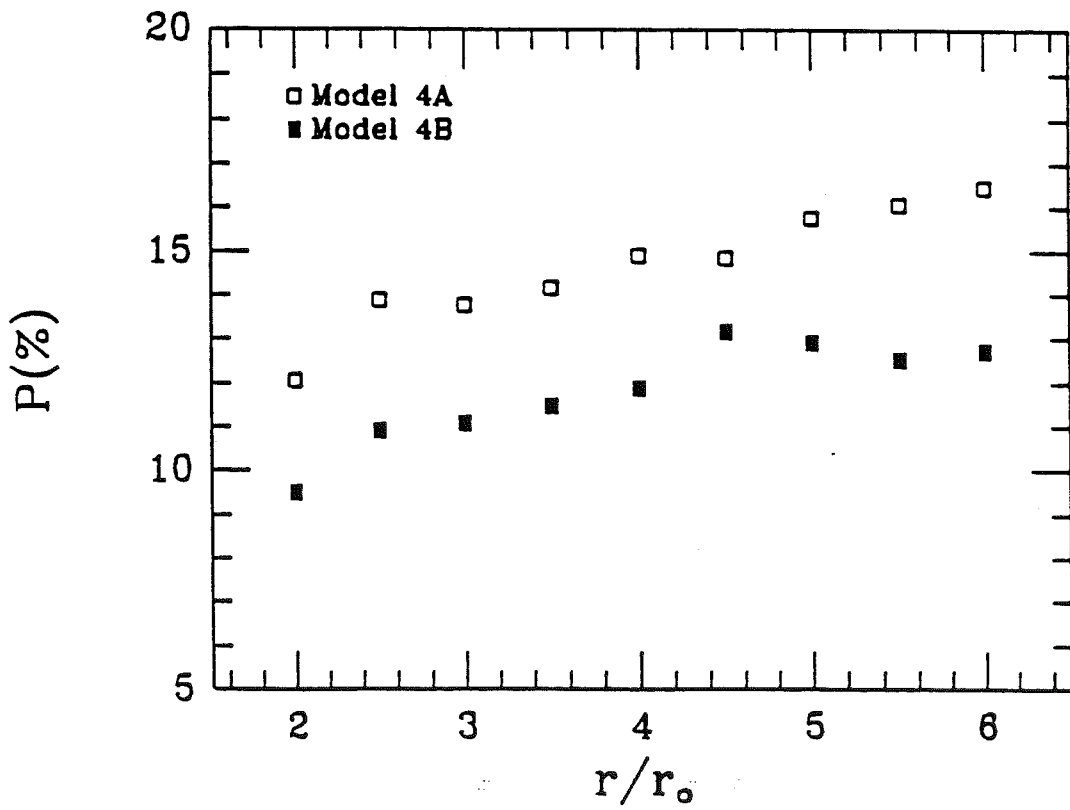

Figure 3d.



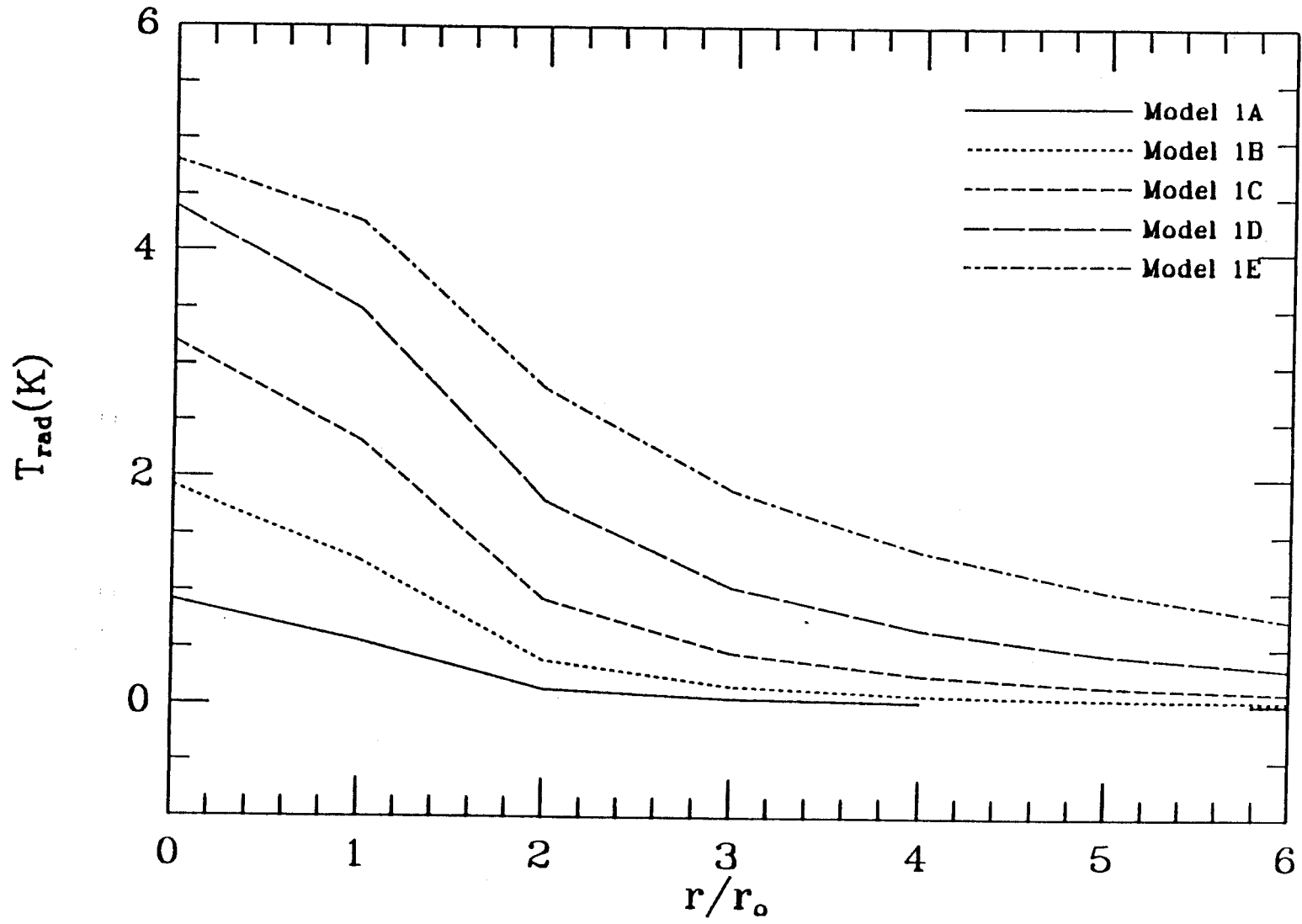

Figure 4.

Figure 5a.

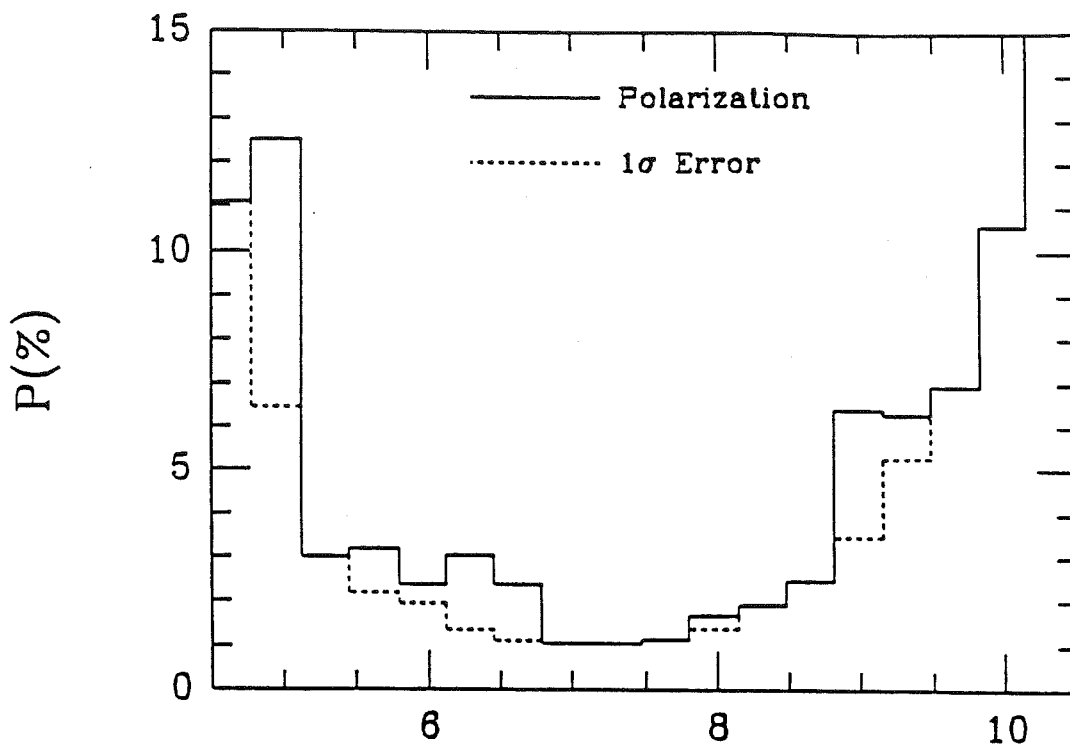

Figure 5b.

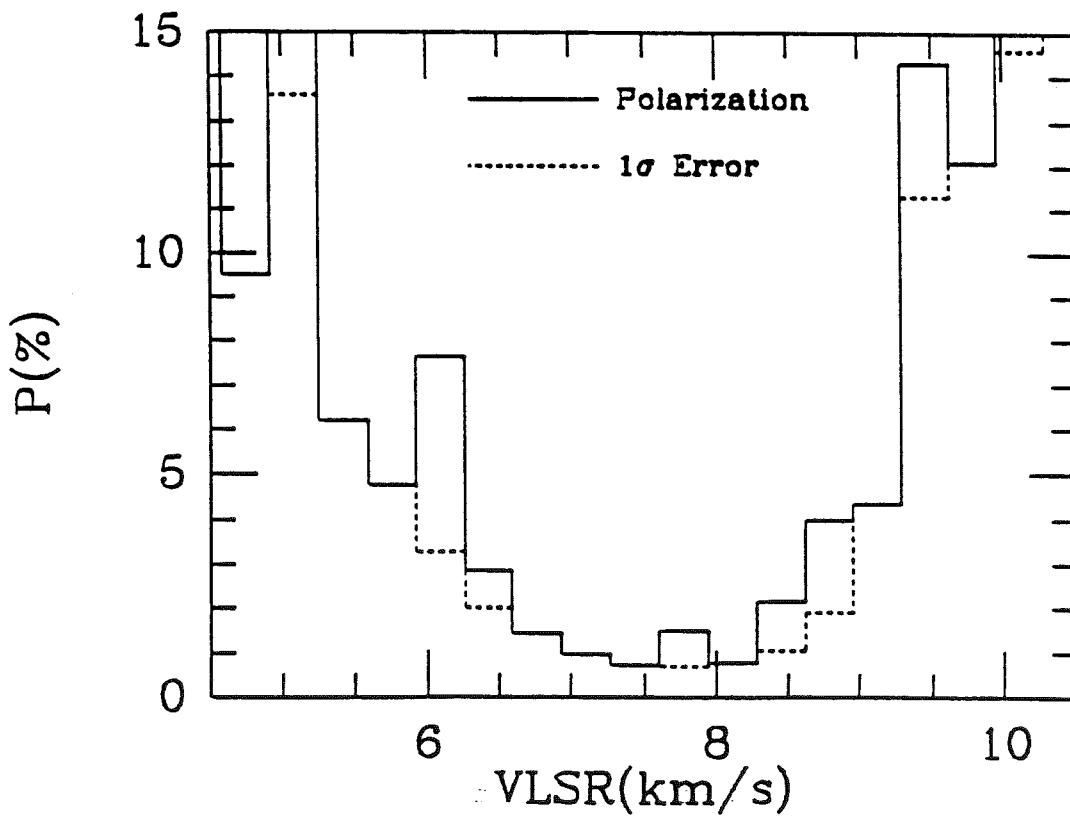

Figure 5c.

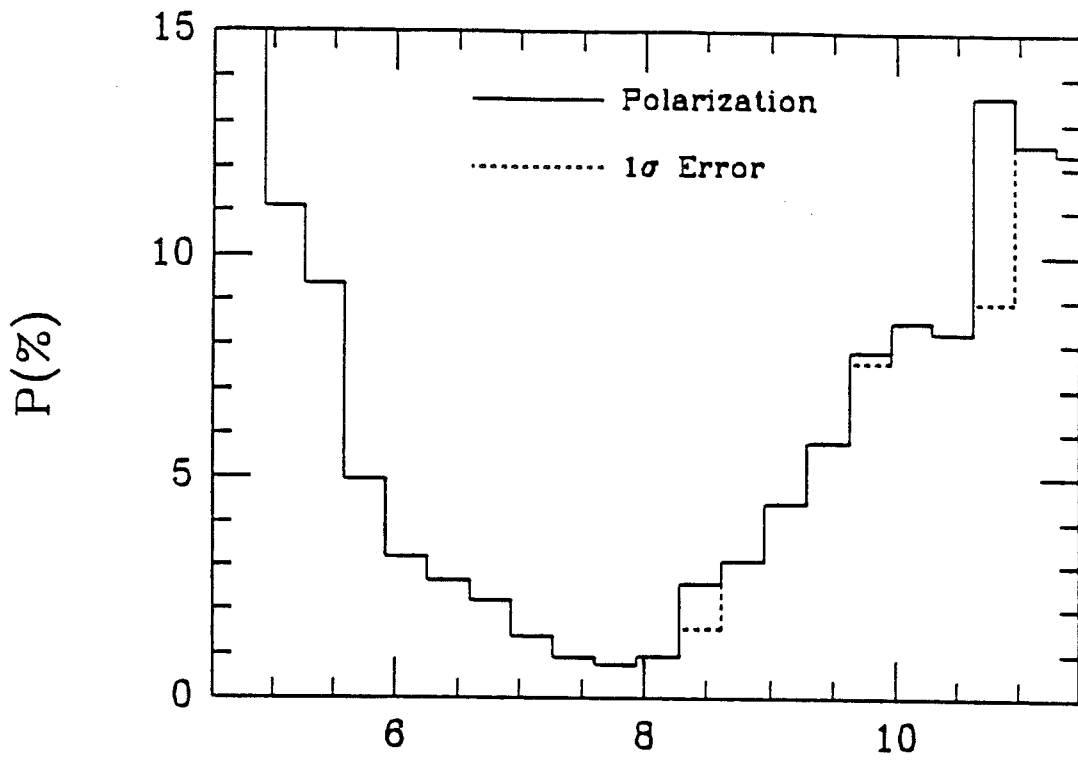
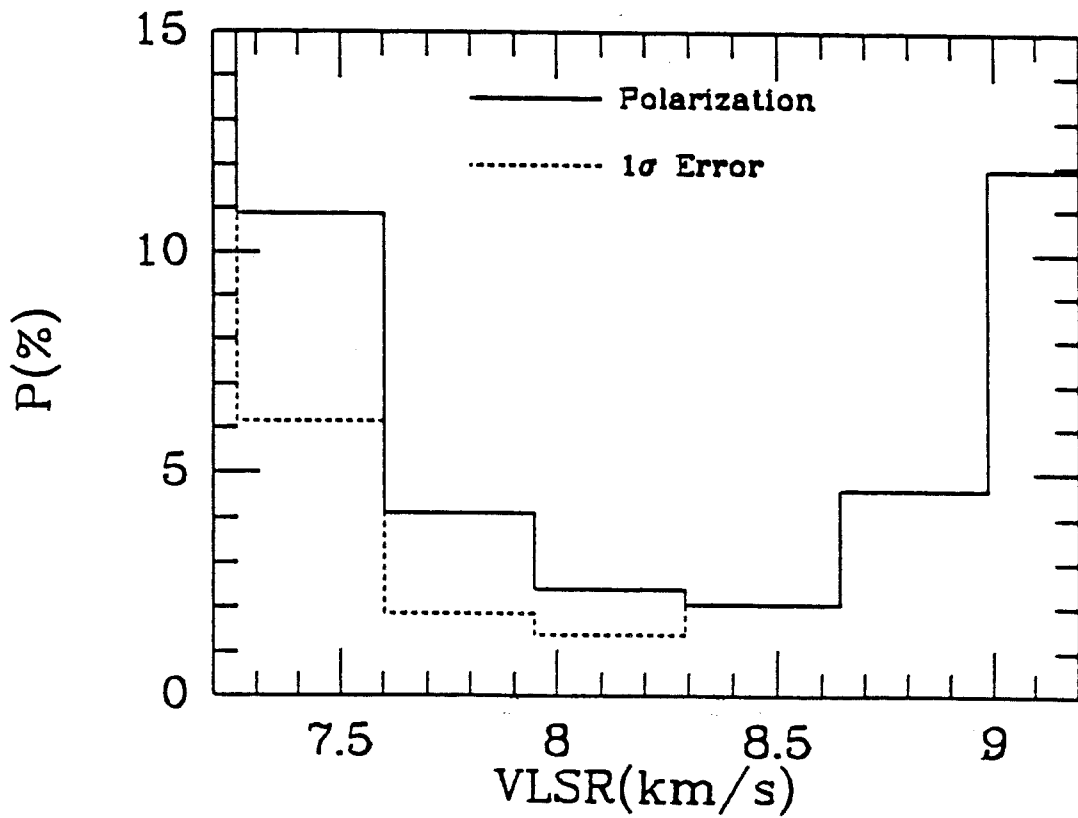

Figure 5d.



**I.13) OBSERVATIONS MOLECULAIRES DE B1 : UN GLOBULE DENSE
DE PERSEE**

I.13) OBSERVATIONS MOLECULAIRES DE B1 : UN GLOBULE DENSE DE PERSEE

Nous avons cartographié l'émission J=1-0 de CO, ^{13}CO , C^{18}O , HCO^+ , et H^{13}CO^+ dans B1, une source moléculaire intense dans le filament qui connecte B5, IC348 et NGC1333 dans le complexe de Persée. Des comptages d'étoiles (voir I.02 et I.03) ont été aussi utilisés pour étudier cette région. La taille de B1 est de 2 pc et sa masse de $400 M_{\odot}$ (pour une distance adoptée de 200 pc). La température cinétique est de 12 K. La région dense, où les raies de NH_3 ont été détectées, a une taille de 0.5 pc, une masse de $60 M_{\odot}$ et une température cinétique de 12 K. L'extinction visuelle totale dans la région dense est ≥ 10 mag. et la densité dans le maximum d'émission de NH_3 est $\approx 3 \cdot 10^4 \text{ cm}^{-3}$.

Les abondances des molécules observées ont été déterminées. Dans les parties denses nous avons obtenu $\text{H}^{13}\text{CO}^+/\text{C}^{18}\text{O} \approx 7 \cdot 10^{-4}$. B1 peut être modélisé par une structure de trois régions de densité différente.

Molecular observations of B 1: a dense globule in Perseus

R. Bachiller^{1,*} and J. Cernicharo^{1,2}

¹ Groupe d'Astrophysique, CERMO, Université Scientifique et Médicale de Grenoble, E.R.A. 961 du CNRS, B.P. 68, F-38402 St. Martin d'Heres Cedex, France

² Observatoire de Meudon, F-92190 Meudon, France

Received April 12, accepted July 16, 1984

Summary. We report CO, ¹³CO, C¹⁸O, HCO⁺, H¹³CO⁺, and NH₃ observations and star counts of B 1, a strong molecular source in the ridge connecting B 5, IC 348 and NGC 1333 in Perseus. The size of B 1 is 2 pc and its mass 400 M_⊙ (at the adopted distance of 200 pc), its kinetic temperature is 12 K. The core, where the NH₃ (1, 1) line was detected, has a size of 0.5 pc, a temperature of 12 K, a mass of 60 M_⊙, the visual extinction is ≥ 10 mag and the density n_{H₂} (peak) ≈ 3 10⁴ cm⁻³.

The chemical abundances of the observed molecules are estimated; in the core we find H¹³CO⁺/C¹⁸O ≈ 7 10⁻⁴. B 1 is modelled by a three-zone structure surrounding the dense core. The HCO⁺ absorption occurs in an envelope inside the one responsible for the CO absorption. Rotation, if it occurs, is too slow to prevent the collapse of the cloud.

Key words: dark clouds – interstellar medium: molecules – interstellar medium: dust

1. Introduction

The Per OB2 dark cloud covers 6° × 2°, and is composed of a chain of fragments between a hot spot toward the open cluster IC 348 and another toward the reflection nebula NGC 1333. These two hot spots are separated by ≈ 20 pc (at a distance of 200 pc). The numerous young stellar objects near NGC 1333, the young cluster IC 348 and the Per OB2 stellar association all indicate recent star formation.

Large-scale OH and H I maps of the Per OB2 dark cloud by Sancisi et al. (1974) were compared with visual extinction derived from low resolution (0.9") star counts (McCuskey, 1938). Sancisi et al. suggested that the Perseus cloud is part of an expanding shell in the region of the Per OB2 association. Sancisi (1973) explained the kinematics in a model where stars were still forming in the expanding shell. Sargent (1979) mapped the region in CO, and concluded that the Per OB2 association and the molecular cloud do not follow the pattern of sequential star formation often claimed for OB associations, because there are only two, well-separated stellar birth sites, IC 348 and NGC 1333. Barrett et al. (1980) from another CO map argued, like Sargent, that there is no evidence of sequential star formation. The whole Taurus-Perseus-

Auriga complex of molecular clouds has been mapped in CO by Baran (1983), and the whole Per OB2 complex has been surveyed with the Bordeaux radio telescope in the J=1–0 line of ¹³CO. The most interesting regions have been mapped in the J=1–0 lines of CO, C¹⁸O, HCO⁺, and H¹³CO⁺. The global results will be presented by Bachiller and Cernicharo (1984) (BC), and Bachiller (1985).

The globule Barnard 1, or B 1, is a well differentiated condensation of <A_v> ≥ 3 mag embedded in a filamentary cloud of A_v ≈ 1–2 mag, 1° E of NGC 1333 (Cernicharo and Bachiller, 1984; CB). The three young stellar objects, LkHα 327, LkHα 328, and LZK 21, lie in the center of B 1 (Cohen and Kuhl, 1979; Liu et al., 1980) indicating that low-mass star formation has recently occurred. B 1 is, with IC 348 and NGC 1333, the most conspicuous source in our ¹³CO Bordeaux map.

2. Equipment and observations

The CO, ¹³CO, C¹⁸O, HCO⁺, and H¹³CO⁺ were observed during 1981–1982 with the 2.5-m Bordeaux telescope (Baudry et al., 1980). The half-power beamwidth was 4.4' at 110 GHz and the beam efficiency was 0.85. The receiver was a Schottky diode mixer with a receiver noise temperature of 500–800 K (SSB), followed by a filter bank of 256 channels of 100 kHz width (0.27 km s⁻¹ at 110 GHz). The observations were calibrated by the chopper wheel method. A reference position was observed several times each session, and all the observations were made with frequency switching. Typical rms noise was ΔT_A^{*} = 0.8 K for CO, 0.2 K for ¹³CO and 0.1 K for C¹⁸O and HCO⁺.

Ammonia was observed in 1982 December at the NRAO¹ 42 m telescope. The maser receiver, with system temperature 60 K, was followed by an autocorrelator split in two 5 MHz bands of 512 channels each, centered at NH₃(1, 1) and (2, 2) frequencies, with a spectral resolution of 0.12 km s⁻¹. The half-power beamwidth was 1.4, the aperture efficiency was 0.2 and the observations were made with a 1.5 spacing. Almost all observations were made in frequency-switching mode. Typical rms noise was ΔT_A^{*} = 0.06 K.

Star counts were made on a 2.5 × 2.5 grid on the Palomar Sky Survey red prints. The determination of the visual extinction was similar to that described by Bok and Cordwell (1973) and Dickman (1976, 1978a, b) and is explained in detail by CB.

Send offprint requests to: R. Bachiller

* On leave from Centro Astronómico de Yebes, Guadalajara, Spain

¹ The National Radio Astronomy Observatory is operated by Associated Universities, Inc., under contract with the National Science Foundation

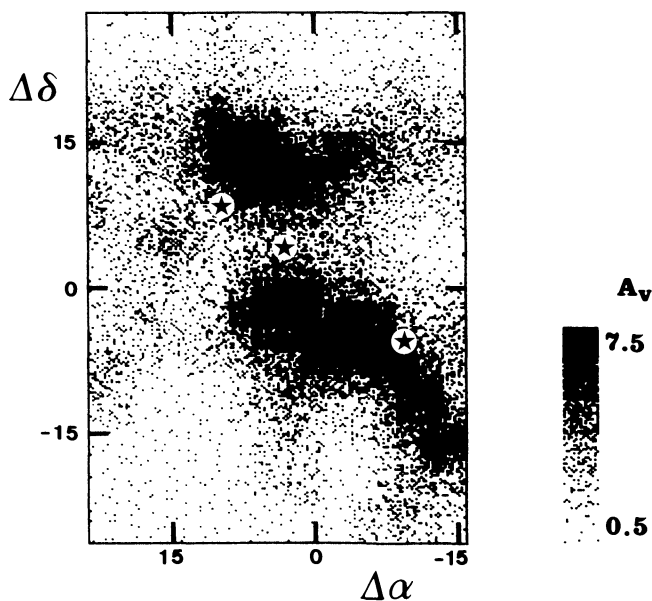

Fig. 1. Visual extinction in B 1 from star counts on the Palomar red prints. The spatial resolution of the counts was 2.5. Black stars display the positions of the objects LZK 21, LKH α 327, and LKH α 328 (in order of right ascension). The central position is 03^h30^m16.5^s, 30°57'26" (1950). Offsets from the central position are in arcmin

3. Analysis

The globule B 1 lies in the central region of the Perseus dark cloud at 03^h30^m16.5^s, 30°57'26" (1950). The size of the $A_v \geq 3$ mag region is $\approx 35'$, or 2 pc at a distance of 200 pc. The star counts and molecular observations discussed here cover $40' \times 55'$, including the whole region where $A_v \geq 3$ mag. Contour maps are given for A_v (Fig. 1), HCO⁺ (Fig. 5) and NH₃ (Fig. 7) and spectral maps for CO (Fig. 2), ¹³CO (Fig. 3) and C¹⁸O (Fig. 4).

3.1. Star counts

The visual extinction map from star counts (Fig. 1) shows B 1 to be composed of two condensations of $A_v \geq 5$ mag where there are no stars on the Palomar red prints. The area of the black zones without stars is 35 arcmin², consistent with a distance of ≤ 200 pc (See CB for a discussion of the distance derivation.) The mass of the cloud, derived from $N(\text{H}_2)/A_v = 1.1 \cdot 10^{21} \text{ cm}^{-2} \text{ mag}^{-1}$ (Bohlin et al., 1978) is $M \geq 400 M_\odot$, for a Helium number abundance of 10%. This is a lower limit because A_v cannot be obtained accurately in the opaque zones of the cloud.

3.2. Millimeter data

The CO line has nearly uniform intensity in the mapped area, with a slight tendency to increase from S to N. Assuming that CO is optically thick, we obtain $T_K \approx 12$ K in the region of $A_v \geq 3$ mag. The CO lines are broader than those of ¹³CO and C¹⁸O, and peak at slightly different velocities, presumably because of self-absorption and opacity broadening. In particular, self-absorption is important to the south, where $T_A^*(\text{CO})$ decreases and $T_A^*(^{13}\text{CO})$ does not, so $T_K = 12$ K is a lower limit.

Emission at $\approx 3 \text{ km s}^{-1}$, to the SE, does not come from B 1, but from a cloud which has its maximum about 30' E of the B 1 peak (Bachiller, 1985).

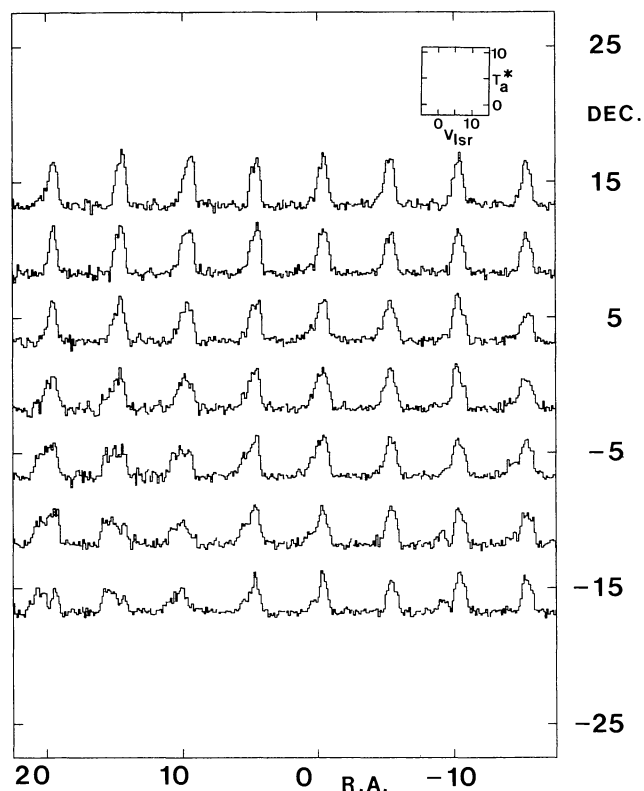

Fig. 2. CO ($J=1-0$) spectra in B 1. The velocity range is $V_{\text{lsr}} = -5$ to 15 km s^{-1} . The temperature range is $T_A^* = -2$ to 11 K. The spectral resolution has been smoothed to 0.52 km s^{-1} . The central position and offsets are as in Fig. 1

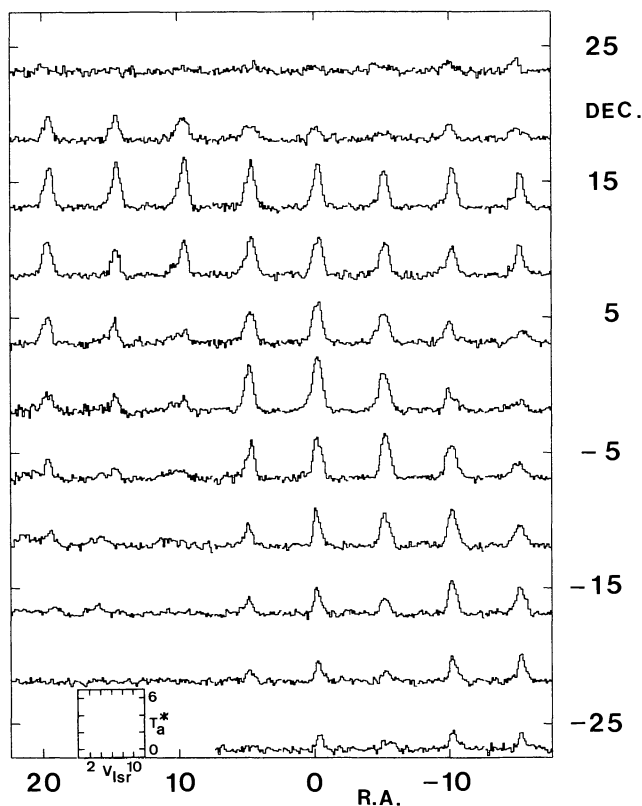

Fig. 3. ¹³CO ($J=1-0$) spectra in B 1. The velocity range is $V_{\text{lsr}} = 0$ to 12 km s^{-1} . The temperature range is $T_A^* = -1$ to 7 K. The spectral resolution is 0.27 km s^{-1} . The central position and offsets are as in Fig. 1

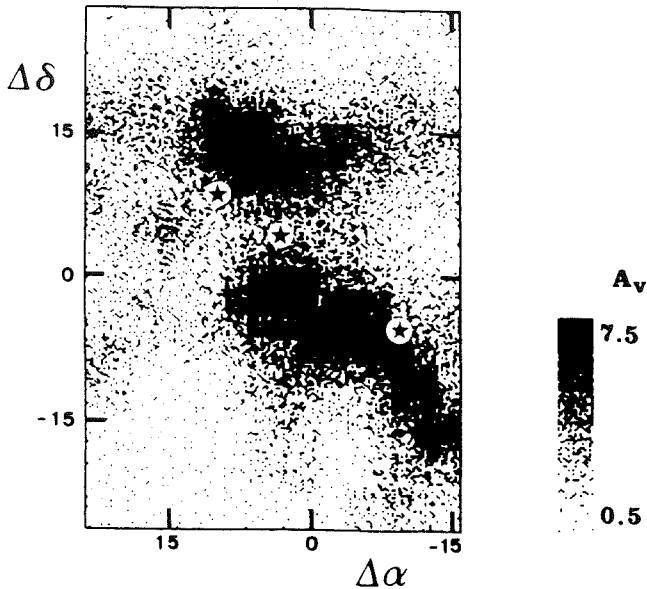

Fig. 1. Visual extinction in B 1 from star counts on the Palomar red prints. The spatial resolution of the counts was 2.5. Black stars display the positions of the objects LZK 21, LKH α 327, and LKH α 328 (in order of right ascension). The central position is 03^h30^m16.5^s, 30[°]57'26" (1950). Offsets from the central position are in arcmin

3. Analysis

The globule B 1 lies in the central region of the Perseus dark cloud at 03^h30^m16.5^s, 30[°]57'26" (1950). The size of the $A_v \geq 3$ mag region is $\approx 35'$, or 2 pc at a distance of 200 pc. The star counts and molecular observations discussed here cover $40' \times 55'$, including the whole region where $A_v \geq 3$ mag. Contour maps are given for A_v (Fig. 1), HCO⁺ (Fig. 5) and NH₃ (Fig. 7) and spectral maps for CO (Fig. 2), ¹³CO (Fig. 3) and C¹⁸O (Fig. 4).

3.1. Star counts

The visual extinction map from star counts (Fig. 1) shows B 1 to be composed of two condensations of $A_v \geq 5$ mag where there are no stars on the Palomar red prints. The area of the black zones without stars is 35 arcmin², consistent with a distance of ≤ 200 pc (See CB for a discussion of the distance derivation.) The mass of the cloud, derived from $N(\text{H}_2)/A_v = 1.10^{21} \text{ cm}^{-2} \text{ mag}^{-1}$ (Bohlin et al., 1978) is $M \geq 400 M_\odot$, for a Helium number abundance of 10%. This is a lower limit because A_v cannot be obtained accurately in the opaque zones of the cloud.

3.2. Millimeter data

The CO line has nearly uniform intensity in the mapped area, with a slight tendency to increase from S to N. Assuming that CO is optically thick, we obtain $T_K \approx 12$ K in the region of $A_v \geq 3$ mag. The CO lines are broader than those of ¹³CO and C¹⁸O, and peak at slightly different velocities, presumably because of self-absorption and opacity broadening. In particular, self-absorption is important to the south, where $T_A^*(\text{CO})$ decreases and $T_A^*(^{13}\text{CO})$ does not, so $T_K = 12$ K is a lower limit.

Emission at $\approx 3 \text{ km s}^{-1}$, to the SE, does not come from B 1, but from a cloud which has its maximum about 30' E of the B 1 peak (Bachiller, 1985).

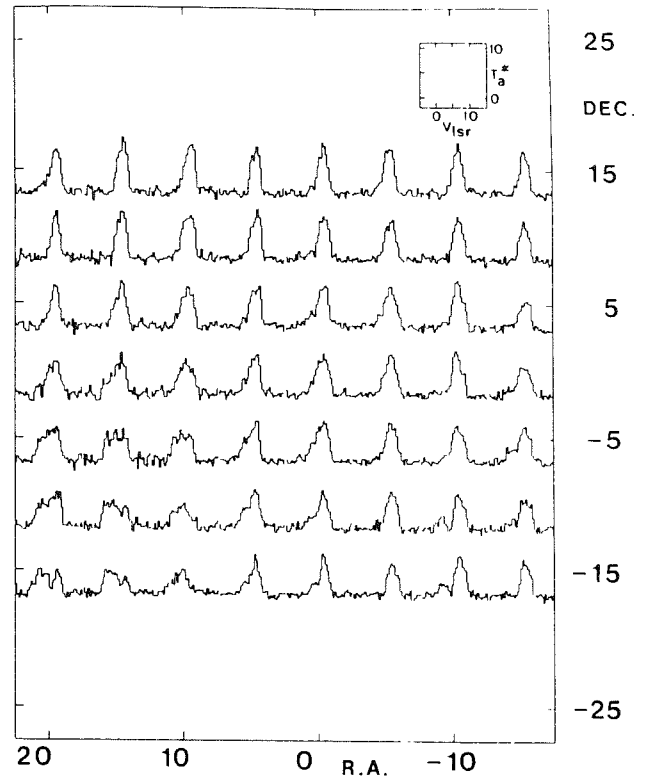

Fig. 2. CO ($J=1-0$) spectra in B 1. The velocity range is $V_{\text{lsr}} = -5$ to 15 km s^{-1} . The temperature range is $T_A^* = -2$ to 11 K. The spectral resolution has been smoothed to 0.52 km s^{-1} . The central position and offsets are as in Fig. 1

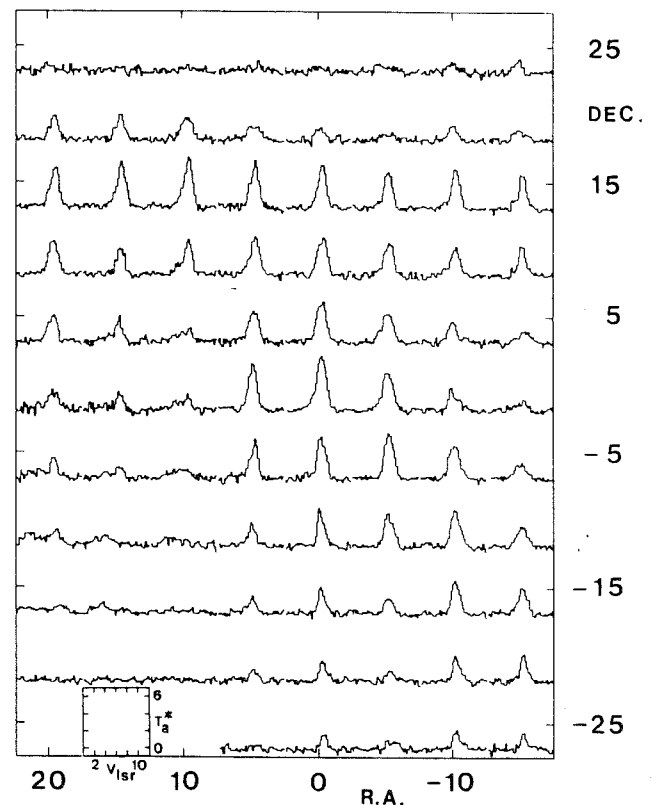

Fig. 3. ¹³CO ($J=1-0$) spectra in B 1. The velocity range is $V_{\text{lsr}} = 0$ to 12 km s^{-1} . The temperature range is $T_A^* = -1$ to 7 K. The spectral resolution is 0.27 km s^{-1} . The central position and offsets are as in Fig. 1

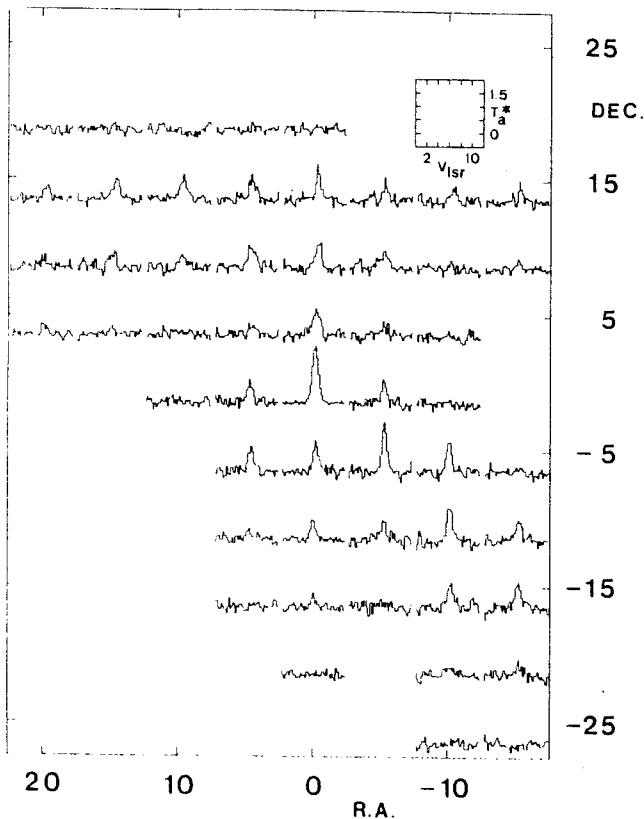

Fig. 4. $C^{18}O$ ($J=1-0$) spectra in B1. The velocity range is $V_{lsr}=0$ to 12 km s^{-1} . The temperature range is $T_A^*=-0.5$ to 2 K . The spectral resolution is 0.27 km s^{-1} . The central position and offsets are as in Fig. 1

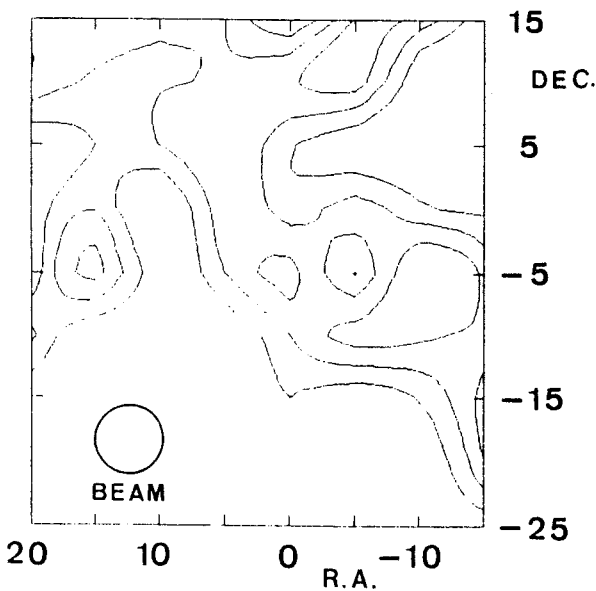

Fig. 5. Contour map of the HCO^+ ($J=1-0$) integrated intensity. Contours are $0.2, 0.4,$ and $0.6 \text{ K} \cdot \text{km s}^{-1}$. The central position and offsets are as in Fig. 1

The ^{13}CO map is similar to the A_v map. The ^{13}CO profiles and the slight variations in brightness temperature in the more opaque zone indicate that ^{13}CO is saturated in the central region. Many profiles are asymmetric, with broad wings. These wings are mostly blue-shifted to the north and the center, and red-shifted to the

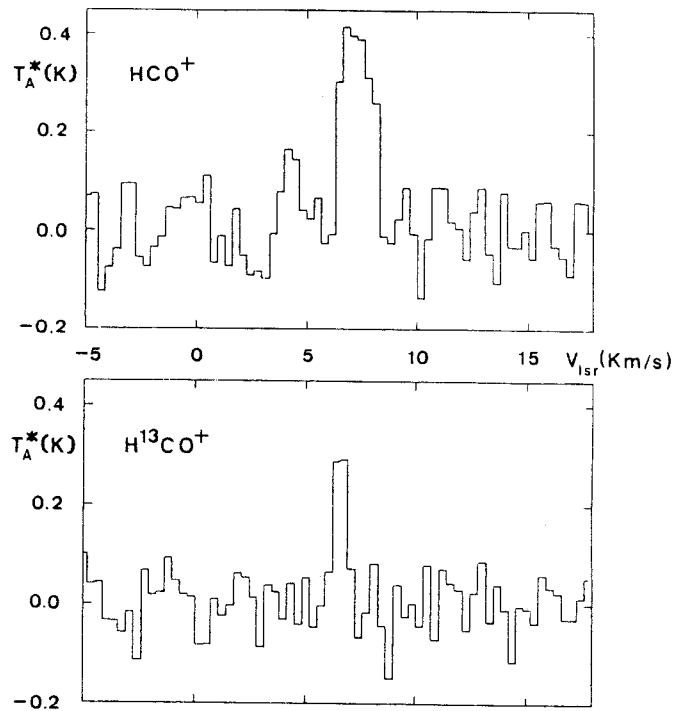

Fig. 6. HCO^+ ($J=1-0$) and $H^{13}CO^+$ ($J=1-0$) spectra in the direction of the central position of B1. The spectral resolution is 0.33 km s^{-1}

south-west. The velocity centroid is constant (6.5 km s^{-1}) in the center and the south but in the northern region the line velocities increase gradually from west (6.5 km s^{-1}) to east (7.2 km s^{-1}), with a gradient of $0.3 \text{ km s}^{-1} \text{ pc}^{-1}$. ^{13}CO column densities calculated with a simple LTE model range from 10^{15} to 10^{16} cm^{-2} .

Because of saturation, ^{13}CO data give poor information about column densities, for $A_v \geq 3 \text{ mag}$. However, the optically-thin $C^{18}O$ line should be a better tracer of column density in the more opaque region of the cloud. We mapped the $C^{18}O$ emission in the region where $T_A^*(^{13}CO) \geq 3 \text{ K}$. As expected, the variations in brightness temperature of $C^{18}O$ are stronger than for ^{13}CO . The $C^{18}O$ maximum in the southern condensation is prominent ($T_A^* \approx 2 \text{ K}$). Assuming LTE, we find $N(C^{18}O) = 3 \cdot 10^{15} \text{ cm}^{-2}$ at the peak.

HCO^+ lines are weak in B1 ($T_A^* \approx 0.4 \text{ K}$ at the peak), but the lines are detected where $T_A^*(^{13}CO) \geq 4 \text{ K}$. HCO^+ peaks are not prominent, indicating that the lines are strongly saturated and may be self-absorbed as suggested by the $H^{13}CO^+$ detection toward the southern condensation. At this position we observe a velocity shift between the HCO^+ and $H^{13}CO^+$ lines (Fig. 6). Similar shifts have been observed by Guélin et al. (1982) in other clouds.

3.3. Ammonia

The $NH_3(1, 1)$ and $(2, 2)$ lines were observed toward the $C^{18}O$ maximum in the southern region. The maps of integrated intensity of the main $(1, 1)$ and $(2, 2)$ lines (Fig. 7) show a half-power diameter of the $(1, 1)$ emission region of $5'$. (0.3 pc at 200 pc). The $(2, 2)$ line was detected toward 10 positions of the central region. Optical depths, excitation temperatures and column densities were derived from NH_3 with procedures following those of Rydbeck et al. (1977)

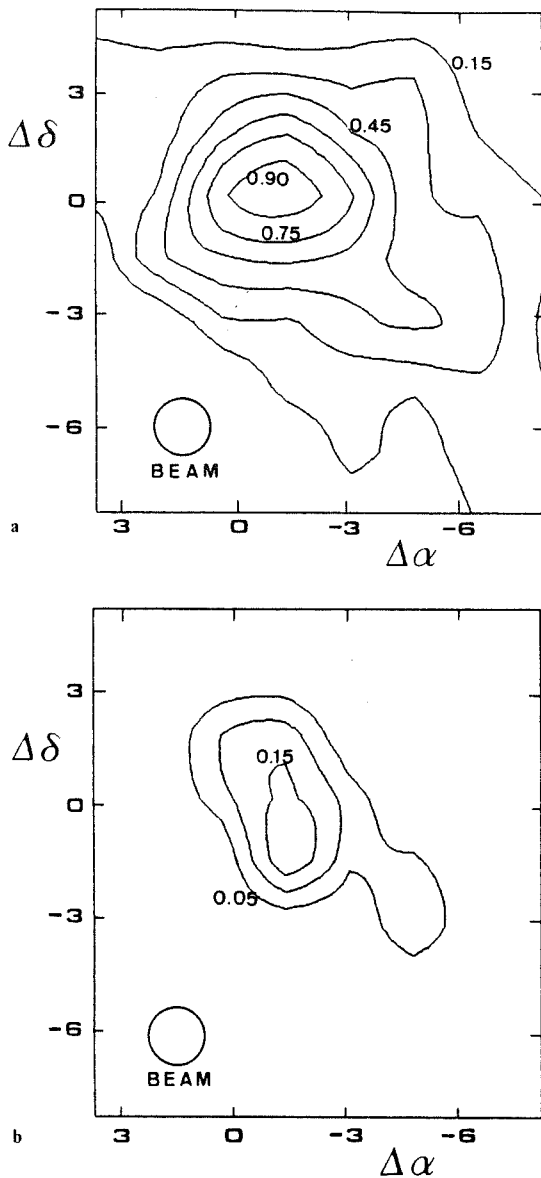

Fig. 7. a Contour map of the $\text{NH}_3(1,1)$ integrated intensity of the main hyperfine components. b Contour map of the $\text{NH}_3(2,2)$ integrated intensity of the main hyperfine components. The central position and offsets are as in Fig. 1

and Ungerechts et al. (1980). The results are described in the next section.

4. Physical conditions and chemical abundances

4.1. Kinetic temperature

The ammonia data give us information about the physical conditions in the B 1 core. We find the rotational temperature T_R to be 10–14 K in the central region of the core where the (2,2) line was detected. $T_K = T_R$ is a good assumption for $T_K \leq 15$ K (Walmley and Ungerechts, 1983), and a value of $T_K = (12 \pm 2)$ K is also consistent with the CO observations and our CO and C^{18}O ($J=2-1$) unpublished data. From CO, there is no evidence for any change in kinetic temperature in the mapped area. Also, the

inner part of the cloud, as mapped in NH_3 , and the outer part, as mapped in CO seem to have the same temperature. Heating by the ambient UV radiation (Clavel et al., 1978) as inferred by Young et al. (1983) from their observations in the neighbouring globule B 5 is not expected for B 1: The ambient cloud of $A_v \approx 1-2$ mag protects it from interstellar UV radiation. There is no evidence for an enhancement of temperature near LkH α 327, LkH α 328, and LZK 21, but our sensitivity and spatial resolution are not high enough to be conclusive about this point.

4.2. Central conditions

From the ^{13}CO and C^{18}O observations and assuming LTE we find $N(^{13}\text{CO})_{\text{peak}} = 2 \cdot 10^{16} \text{ cm}^{-2}$ and $N(\text{C}^{18}\text{O})_{\text{peak}} = 3 \cdot 10^{15} \text{ cm}^{-2}$. The ^{13}CO emission is not optically thin, so the ^{13}CO column density must be regarded with caution. The ratio $^{13}\text{CO}/\text{C}^{18}\text{O}$ is thus ≥ 7 towards the center of the globule. Assuming a value of $3 \cdot 10^{-7}$ for the abundance of C^{18}O (see below) we estimate the core mass (the region where the $\text{NH}_3(1,1)$ line is detected) to be $M(\text{core}) = 60 M_\odot$. The average extinction in the 5' beam, where C^{18}O peaks, is $A_v(\text{core}) \approx 10$ mag.

The NH_3 column density averaged over the Bordeaux beam at this position is $\approx 1 \cdot 10^{15} \text{ cm}^{-2}$. Then from the column densities, ammonia is 3 times less abundant than C^{18}O .

The densities calculated from the ammonia observations, with a two-level model and a filling factor = 1, range from a few 10^3 to $3 \cdot 10^4 \text{ cm}^{-3}$. The calculated averaged density in the Bordeaux central position is about $1 \cdot 10^4$. Given the density we can use a large velocity gradient (LVG) model to estimate the H^{13}CO^+ column density (Goldreich and Kwan, 1974; Scoville and Solomon, 1974). Using the collisional cross sections given by Green (1975) for N_2H^+ , we compute $N(\text{H}^{13}\text{CO}^+) \approx 2 \cdot 10^{12} \text{ cm}^{-2}$ and $\tau \approx 2.5$. The $\text{H}^{13}\text{CO}^+/\text{C}^{18}\text{O}$ abundance ratio is $7 \cdot 10^{-4}$ and $x(\text{H}^{13}\text{CO}^+) \approx 2 \cdot 10^{-10}$. This value agrees with the determinations by Guélin et al. (1982) and CG in some dense molecular clouds.

The determination of the HCO^+ abundance from that of H^{13}CO^+ is not straightforward: Langer et al. (1978) have proposed that the $\text{H}^{13}\text{CO}^+/\text{HCO}^+$ ratio is enhanced by the proton transfer reaction

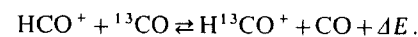

However, Guélin et al. (1982) have shown that, in typical dark cloud conditions ($T_K \approx 10$ K, $x_e \approx$ a few 10^{-8}), the estimates of column density of HCO^+ , derived by scaling the H^{13}CO^+ ones by $\text{C}/^{13}\text{C}$, are not likely in error by more than a factor of two. Taking $\text{H}^{13}\text{CO}^+/\text{HCO}^+ = ^{13}\text{C}/\text{C} = 1/89$ (terrestrial ratio) we have $N(\text{HCO}^+) = 2 \cdot 10^{14} \text{ cm}^{-2}$ and $x(\text{HCO}^+) = 2 \cdot 10^{-8}$. This abundance is consistent with the value derived by Baudry et al. (1981) and CG in the densest components of some Taurus cloudlets.

The similarity of the HCO^+ and NH_3 abundances in Taurus and Perseus prompted us to observe the ($J=8-7$) line of HC_5N with the NRAO 42-m telescope toward the NH_3 peak. No emission was detected a limit of 0.15 K. LVG calculations show that in the B 1 core $N(\text{HC}_5\text{N}) \leq 1.5 \cdot 10^{12} \text{ cm}^{-2}$. The $\text{NH}_3/\text{HC}_5\text{N}$ abundance ratio in the NH_3 peak is $\geq 10^3$, i.e., about 10 times larger than in the Taurus cloudlets (Cernicharo et al., 1984).

4.3. Large scale properties

In an observational way, we can distinguish around the B 1 core three different CO zones, each one characterised by strong emission in the CO, ^{13}CO or C^{18}O lines, successively (see Fig. 8

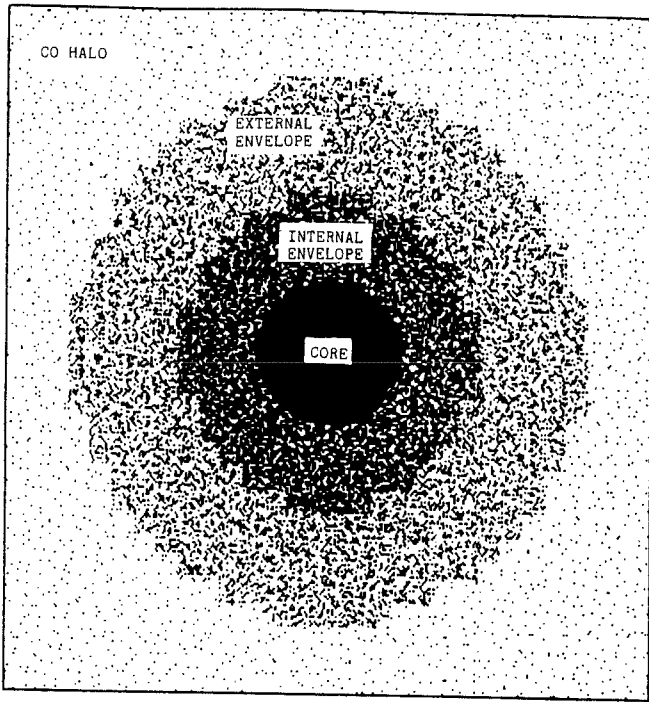

Fig. 8. Schematic drawing showing the different zones of the B 1 model. The halo and the envelopes are seen in CO isotopes lines. The core is observed in ammonia. The physical properties of these zones are described in Tables 1 and 2. (See text for more details)

Table 1. Structure of B 1

	CO Halo	External Envelope	Internal Envelope	Core
A_v (mag)	$A_v < 2$	$2 < A_v < 3-4$	$A_v > 3-4$	$A_v \sim 10$
CO	Subthermally excited	Thermalized, $\tau \gg 1$		
^{13}CO	Weak emission	$T_A^* \geq 1\text{K}$	$\tau = 1$	$\tau > 1$
C^{18}O		Weak emission	$T_A^* \geq 0.5\text{K}$	$\tau \approx 1$
HCO^+		Low T_{ex}	$T_A^* \approx 0.5\text{K}, \tau \approx 50$	
H^{13}CO^+				$T_A^* \approx 0.3\text{K}$
$\text{NH}_3(1,1)$				$T_A^* \approx 1\text{K}$

and Table 1). We call the most external zone the "halo". This halo, where CO is detected but ^{13}CO is not very strong ($T_A^* \approx 1-2\text{K}$), corresponds to the ambient cloud of $A_v \approx 1-2$ mag and extends far from our B 1 maps. In this region the UV radiation can heat the gas (Young et al., 1982) and selectively photodissociate the CO isotopes (Bally and Langer, 1982; Chu and Watson, 1983). Around this molecular halo Wannier et al. (1983) have observed in the Per OB2 molecular cloud a warm ($T_k \approx 100\text{K}$) H I halo.

We distinguish two envelopes: an "external" envelope, where ^{13}CO ($J=1-0$) is detected but C^{18}O is weak ($T_A^* \leq 0.5\text{K}$), and an "internal" envelope, where C^{18}O ($J=1-0$) is strong ($T_A^* \geq 0.5\text{K}$). The external envelope has $A_v \approx 2-3$ mag, the CO ($J=1-0$) lines are saturated and the UV radiation is shielded. ^{13}CO is a useful molecule for the determination of the mass within this envelope if its abundance is known. The ^{13}CO and C^{18}O abundances have

been determined in the Taurus complex (CG) and in the Perseus molecular clouds (BC) from star counts and Bordeaux observations. CG have obtained, from a complete survey of ^{13}CO and C^{18}O in Heiles Cloud 2 the relations $N(^{13}\text{CO}) = 1.3 \cdot 10^{15} (A_v - 0.5)$ and $N(\text{C}^{18}\text{O}) = 2.3 \cdot 10^{14} (A_v - 1.5)$. However, BC have derived, from more than one thousand ^{13}CO spectra in Perseus, a $N(^{13}\text{CO})/A_v$ ratio that is twice the Taurus one, and from a more reduced number of C^{18}O data a relation between $N(\text{C}^{18}\text{O})$ and A_v consistent with the one of Taurus. The variations of the $N(^{13}\text{CO})/A_v$ ratio between Taurus and Perseus and the value of this ratio over the whole Perseus complex will be analyzed elsewhere (BC). From the data presented in this paper we derive in the B 1 area $N(^{13}\text{CO}) = 2.4 \cdot 10^{15} (A_v - 0.3)$ and $N(\text{C}^{18}\text{O}) = 2.9 \cdot 10^{14} (A_v - 1)$. Using these B 1 values for the ^{13}CO and C^{18}O abundances we get $350 M_\odot$ for the mass of the region responsible of the strong ^{13}CO ($J=1-0$) emission. This is about one tenth of the whole ^{13}CO Perseus complex. Due to the saturation effects in the ^{13}CO ($J=1-0$) lines, this value of $350 M_\odot$ represents a lower limit to the actual mass in the envelopes and in the core.

The internal envelope, where C^{18}O ($J=1-0$) is strong, is very extended in B 1 (about 1 pc). In this region ^{13}CO is optically thick and the extinction reaches $A_v \geq 3$ mag. With a C^{18}O abundance of $3 \cdot 10^{-7}$ we find that the mass within the internal envelope is $200 M_\odot$. The young stellar objects and the NH_3 globule are embedded in this region.

HCO^+ emission is detected ($\sigma \approx 0.1\text{K}$) toward the internal envelope. The HCO^+ lines are weaker and broader than the C^{18}O ones. The HCO^+ emission is optically thick and the profiles are probably self-reversed. In the central position HCO^+ shows a velocity shift relative to H^{13}CO^+ (Fig. 6). Self-reversed HCO^+ profiles have been observed in some other molecular clouds (Loren and Wootten, 1980; Perault and Falgarone, 1982; Baudry et al., 1981; CG).

CG have shown that, for optically thick HCO^+ ($J=1-0$) lines, important scattering effects occur, if the lines are narrow and their profiles are dominated by small scale turbulent motions. The HCO^+ line widths in B 1 are about 2 km s^{-1} and probably most of these widths come from systematic motions. In these conditions, line radiation scattering is negligible and the excitation of the HCO^+ ($J=1-0$) lines is purely collisional. The density necessary to excite the HCO^+ ($J=1-0$) lines to the observed brightness temperature is $\geq 2 \cdot 10^3\text{ cm}^{-3}$. This value is a lower limit for the density in the internal envelope.

The weakness of the (optically thick) HCO^+ lines can be explained if the beam dilution is important (filling factor ≤ 0.1) and/or the lines are subthermally excited. LVG calculations show that this later mechanism must be crucial, subthermal excitation appears as a consequence of the high dipolar moment (4 Debye) of the HCO^+ molecule. Thus, HCO^+ emission forms in the core and in the internal envelope and is absorbed in a more external shell. In the halo ($A_v \approx 1-2$ mag) the UV radiation produces a high electron abundance and HCO^+ should be destroyed by recombination. It seems that the region responsible for the HCO^+ self-reversal is the external envelope. There is no evidence for HCO^+ self-reversals deeper than those of CO. However this effect is observed in some molecular clouds by Loren and Wootten (1980). A density in the external envelope lower than that in the internal one could explain a very low excitation in HCO^+ which will produce a deep self-reversal. CO is optically thick in the external envelope (^{13}CO emission is strong) and probably thermalized (a density of 10^3 cm^{-3} is enough for the CO thermalization). The CO self-reversal is probably produced in the halo where the density diminishes and the CO excitation is sub-thermal.

From star counts we conclude (CB) that in the Perseus complex roughly one half of the total mass is contained in the region of $A_v \leq 2$ mag. We have calculated $350 M_\odot$ for the region within the external envelope. The total mass, when we consider the $A_v \leq 2$ mag halo will be $700 M_\odot$. Consequently the core (NH_3 globule) have only a moderate contribution (about 10%) to the overall mass.

Cernicharo (1983) and CG have modeled Heiles Cloud 2 in a similar way; their envelope corresponds to our external and internal envelopes.

5. Discussion

Let us consider the dynamical state of B 1. In Table 2 we give the free-fall time and the Jeans mass for the regions within the envelopes and for the core. In all cases, $M \gg M_J$ and B 1 should collapse quickly. However, the age of the embedded pre-main sequence stars LkH α 327 and LkH α 328 is (4-6) 10^6 yr (Cohen and Kuhl, 1979) indicating that the cloud is older than the free-fall timescale ($\leq 10^6$ yr). The velocity gradient observed from molecular data is lower than required for the rotational support of a uniform, spheroidal cloud (see Table 2). So, if rotation occurs, it is too slow to prevent collapse in B 1. However, the values of the magnetic field required for stabilization (see Table 2) are in agreement with expectations for dark clouds (Mouschovias, 1978). Moreover, the line widths could partially be due to turbulent motions which are known to play a decisive role supporting molecular clouds (Larson, 1981; Leung et al., 1982; Myers, 1983).

B 1 is an example of big fragments observed in the nearby complexes of dark clouds. Objects with similar sizes and masses are, for example, B 5 in the Perseus complex (Young et al., 1982;

CB) and the fragments found by Myers et al. (1978) in ρ Oph. The Taurus complex is fragmented in several clouds which have characteristics close to that of B 1. From the star count study of CB, it appears that L 1506 and L 1536 have also similar size and mass. Heiles Cloud 2, L 1529 and L 1495 are somewhat more large and massive ($L \approx 3-4$ pc, $M \approx 800-1000 M_\odot$). However, although the Taurus clouds are embedded in an ambient cloud of $A_v \approx 1$ mag, massive fragmentation occurs in Perseus for $A_v \approx 3$ mag (CB). All these clouds are, at least approximately, in virial equilibrium (Larson, 1981) and contain dense cores embedded in them.

Dense clumps, similar to the B 1 core, have been observed in lines of NH_3 and long chain molecules (Myers and Benson, 1983; Benson and Myers, 1983; Cernicharo et al., 1984). In spite of the similarity in volume densities and temperatures for different clumps, the NH_3 /cyanopolyne abundance ratio shows remarkable variations across the clumps and from clump to clump. We observe, at the NH_3 peak of B 1, a $\text{NH}_3/\text{HC}_5\text{N}$ abundance ratio at least 10 times larger than the one observed in the TMC1-like cloudlets (Cernicharo et al., 1984). The reason for these variations is an open question today. We plan further searches for cyanopolyynes around the NH_3 peak of B 1.

The three known young stellar objects LkH α 327, LkH α 328 and LZK 21 lie in the vicinity of the B 1 core. The association of young objects and strong NH_3 emission has been already observed by Ho and Barrett (1980) in NGC 1333 and Serpens clouds and by Myers and Benson (1983) in Taurus clouds. From star counts we find $A_v = 2.7$ mag and $A_v = 4.1$ mag in the line of sight of LkH α 327 and LkH 328 in agreement with Cohen and Kuhl (1979). For LZK 21 we find $A_v = 3.8$ mag. There is no coincidence between the position of the NH_3 peak and the positions of the young stellar objects, but these are preferably situated in the periphery of the NH_3 globule. This fact is observed also in the NH_3 maps of Ho and Barrett (1980). However, given the high extinction in the direction of the NH_3 peak ($A_v \geq 10$ mag), stars embedded in the core, if any, could be very faint in the visible. Further sensitive IR and optical searches of faint embedded objects would be interesting.

Table 2. Physical parameters of B 1

	External Envelope	Internal Envelope	Core
(1) T_K (K)	12 ± 2	12 ± 2	12 ± 2
* (2) M (M_\odot)	> 350	> 200	60
* (3) R (pc)	~ 1	~ 0.5	~ 0.3
(4) n (cm^{-3})	$< 10^3$	$> 2 \cdot 10^3$	$> 10^4$
(5) $\frac{\Delta v}{\Delta r}$ ($\text{km}/\text{s}/\text{pc}$)	< 0.3	< 0.3	< 0.8
* (6) τ_{ff} (yr)	$\sim 10^5$	$\sim 6 \cdot 10^5$	$\sim 4 \cdot 10^5$
* (7) M_J (M_\odot)	~ 10	~ 6	~ 5
(8) $\frac{(\Delta v/\Delta r)}{(\text{km}/\text{s}/\text{pc})} n$	~ 0.5	~ 1.7	~ 3
* (9) B_{min} (μG)	~ 30	~ 70	~ 70

Notes. - (1) Kinetic temperature. (2) Mass. (3) Radius. (4) Estimated volume density in each zone. (5) Observed velocity gradient. (6) Free-fall time (Silk, 1980). (7) Jeans mass (Silk, 1980). (8) Minimum velocity gradient for rotational stabilization (Silk, 1980). (9) Minimum magnetic field for stabilization (Silk, 1980). * All the parameters labelled by a * are integrated from the center of the cloud to the external limit of the considered zone.

6. Conclusions

B 1 is, with NGC 1333 and IC 348, among the strongest molecular sources in the Per OB2 complex of dark clouds.

The size (≈ 2 pc), mass ($\approx 400 M_\odot$) and temperature (≈ 12 K) of B 1 are similar to those of other clouds in Perseus, Taurus or ρ Oph. We have modelled B 1 with several zones surrounding a dense core. HCO^+ and CO lines are both self-absorbed, but the HCO^+ dip seems to be forming in a zone (the "external envelope") inside the halo responsible for the CO self-absorption.

Molecular abundances in B 1 are estimated to be $x(^{13}\text{CO}) \approx 2.4 \cdot 10^{-6}$, $x(\text{C}^{18}\text{O}) \approx 2.9 \cdot 10^{-7}$ and $x(\text{H}^{13}\text{CO}^+) \approx 2 \cdot 10^{-10}$, in good agreement with other determinations in dark clouds.

From our ammonia observations, the dense core has a temperature close to that of the envelope; its size is ≈ 0.5 pc and its mass $\approx 60 M_\odot$. The central density is $\approx 3 \cdot 10^4 \text{ cm}^{-3}$. Ammonia is about 3 times less abundant than C^{18}O .

Even if the velocity variations are interpreted as rotation, this rotation is too slow to prevent gravitational contraction in both the core and the envelope. However, magnetic fields and/or turbulence can be crucial in supporting the cloud.

Acknowledgements. We would like to thank the staff of the Bordeaux Observatory for their considerable assistance during the observations. We are also grateful to D. Downes, M. Guélin, S. Guilloteau, and A. Omont for reading through the manuscript and for helpful suggestions. One of us (R. B.) acknowledges the support of a grant from Spanish and French Governments.

References

- Bachiller, R.: 1983, 2^{ème} Colloque du Groupe de Radioastronomie Millimétrique, edited by A. Baudry, Observatoire de Bordeaux
- Bachiller, R.: 1985, (in preparation)
- Bachiller, R., Cernicharo, J.: 1984, *Astron. Astrophys.* (submitted) (BC)
- Bally, J., Langer, W.D.: 1982, *Astrophys. J.* **255**, 143
- Baran, G.P.: 1983, Ph. D. dissertation, Columbia University
- Barrett, J.W., de Zafra, R.L., Sanders, D.B., Solomon, P.M.: 1980, *IAU Symp.* **87**, 185
- Baudry, A., Brillet, J., Desbats, J.M., Lacroix, J., Montignac, G., Encrenaz, P., Lucas, R., Beaudin, G., Dierich, P., Germont, A., Landry, P., Rérat, G.: 1980, *J. Astrophys. Astron.* **1**, 193
- Baudry, A., Cernicharo, J., Perault, M., Despois, D., Dela Noe, J.: 1981, *Astron. Astrophys.* **104**, 101
- Benson, P.J., Myers, P.C.: 1983, *Astrophys. J.* **270**, 589
- Bohlin, R.C., Savage, B.D., Drake, J.F.: 1978, *Astrophys. J.* **224**, 132
- Bok, B.J.: 1937, The distribution of Stars in Space, Univ. Chicago P., Chicago
- Bok, B.J.: 1956, *Astron. J.* **61**, 309
- Bok, B.J., Cordwell, C.S.: 1973, In *Molecules in the Galactic Environment*, ed. by M.A. Gordon and L.E. Snyder, Wiley, New York, p. 53
- Cernicharo, J.: 1983, 2^{ème} Colloque du Groupe de Radioastronomie Millimétrique, ed. by A. Baudry, Observatoire de Bordeaux
- Cernicharo, J., Guélin, M., Askne, J.: 1984, *Astron. Astrophys.* (in press)
- Cernicharo, J., Bachiller, R.: 1984, *Astron. Astrophys. Suppl.* **58**, 327 (CB)
- Cernicharo, J., Guélin, M.: 1984, *Astron. Astrophys.* (submitted) (CG)
- Chu, Y.H., Watson, W.D.: 1983, *Astrophys. J.* **267**, 151
- Clavel, J., Viala, Y.P., Bel, N.: 1978, *Astron. Astrophys.* **65**, 435
- Cohen, M., Kuhl, L.V.: 1979, *Astrophys. J. Suppl.* **41**, 743
- Dickman, R.L.: 1976, Ph. D. dissertation, Columbia University
- Dickman, R.L.: 1978a, *Astron. J.* **83**, 363
- Dickman, R.L.: 1978b, *Astrophys. J. Suppl.* **37**, 407
- Goldreich, P., Kwan, J.: 1974, *Astrophys. J.* **189**, 441
- Green, S.: 1975, *Astrophys. J.* **201**, 366
- Guélin, M., Langer, W.D., Wilson, R.W.: 1982, *Astron. Astrophys.* **107**, 107
- Heeschen, D.S.: 1951, *Astrophys. J.* **114**, 132
- Ho, P.T.P., Barrett, A.H.: 1980, *Astrophys. J.* **237**, 38
- Langer, W.D., Wilson, R.W., Henry, P.S., Guélin, M.: 1978, *Astrophys. J.* **225**, L 139
- Larson, R.B.: 1981, *Monthly Notices Roy. Astron. Soc.* **194**, 809
- Leung, C.M., Kutner, M.L., Mead, K.N.: 1982, *Astrophys. J.* **262**, 583
- Liu, Cai-pin., Zhang Chung-sheng, Kimura, H.: 1980, *Acta Astron. Sinica* **21**, 354; *Chin. Astron. Astrophys.* **5**, 276
- Loren, R.B., Wootten, A.: 1980, *Astrophys. J.* **242**, 568
- Martin, R.N., Barrett, A.H.: 1978, *Astrophys. J. Suppl.* **36**, 1
- McCuskey, S.W.: 1938, *Astrophys. J.* **88**, 209
- Mouschovias, T.C.: 1978, in *Protostars and Planets*, ed. by T. Gehrels, Univ. Arizona Press
- Myers, P.C.: 1975, *Astrophys. J.* **198**, 331
- Myers, P.C.: 1983, *Astrophys. J.* **270**, 105
- Myers, P.C., Ho, P.T.P., Schneps, M.H., Chin, G., Pankonin, V., Winnberg, A.: 1978, *Astrophys. J.* **220**, 864
- Myers, P.C., Benson, P.J.: 1983, *Astrophys. J.* **266**, 309
- Perault, M., Falgarone, E.: 1982, in *Regions of Recent Star Formation*, ed. by R.S. Roger and P.E. Dewdney, Reidel Publ., p. 315
- Rydbeck, O.E.A., Sume, A., Hjalmarson, A., Eldér, J., Ronnong, B.O., Kollberg, E.: 1977, *Astrophys. J.* **215**, L 35
- Sancisi, R.: 1973, *IAU Symp.* **60**, 115
- Sancisi, R., Goss, W.M., Anderson, C., Johansson, L.E.B., Winnberg, A.: 1974, *Astron. Astrophys.* **35**, 445
- Sargent, A.I.: 1979, *Astrophys. J.* **233**, 163
- Scoville, N.Z., Solomon, P.M.: 1974, *Astrophys. J. Letters* **187**, L 67
- Silk, J.: 1980, in *Star Formation*, ed. by I. Appenzeller, J. Lequeux, and J. Silk (S.A.A.S.)
- Spitzer, L.: 1978, *Physical Processes in the Interstellar Medium*, Wiley, New York
- Townes, C.H., Schawlow, A.L.: 1975, *Microwave Spectroscopy*, Dover Pub., New York
- Ungerechts, H., Walmsley, C.M., Winnewisser, G.: 1980, *Astron. Astrophys.* **88**, 259
- Wannier, P.G., Lichten, S.M., Morris, M.: 1983, *Astrophys. J.* **268**, 727
- Walmsley, C.M., Ungerechts, H.: 1983, *Astron. Astrophys.* **122**, 164
- Young, J.S., Goldsmith, P.F., Langer, W.D., Wilson, R.W., Carlson, E.R.: 1982, *Astrophys. J.* **261**, 513

I.14) CONDITIONS PHYSIQUES ET CHIMIQUES DES GLOBULES DE PERSEE

A PARTIR D'OBSERVATIONS DE NH₃ ET HC₃N

I.14) CONDITIONS PHYSIQUES ET CHIMIQUES DES GLOBULES DE PERSEE
A PARTIR D'OBSERVATIONS DE NH₃ ET HC₃N

Nous avons observé en NH₃ et HC₃N deux globules de Persée, L1448 et L1455. Ces observations ont montré que la partie centrale des globules est fragmentée en condensations de 1-20 M₀, ayant des densités de $\approx 10^4 \text{ cm}^{-3}$ et une température de 12 K. Le rapport $R = \text{NH}_3 / \text{HC}_3\text{N}$ dans les globules de Persée est ≈ 10 fois plus grand que dans les condensations du Taureau (TMC1, HCL2-A-B-C, L1495, ... -voir I.06 et I.07).

Les globules de Persée sont en train de former de nouvelles étoiles. Toutefois, à la précision de nos observations, nous n'avons pas pu détecter une quelconque augmentation de la température du gaz autour de la position des étoiles ($\Delta T \leq 2 \text{ K}$ pour une résolution de 1.3').

Physical and chemical conditions in Perseus globules from NH_3 and HC_3N observations

R. Bachiller* and J. Cernicharo

Groupe d'Astrophysique**, Université Scientifique et Médicale de Grenoble, CERMO, B.P. 68, F-38402 St. Martin d'Herès Cedex, France

Received February 10, accepted July 15, 1986

Summary. Ammonia observations of the globules L1448 and L1455 in Perseus show that their dense cores are fragmented in clumps of $1-20 M_\odot$, which have central densities \approx a few 10^4 cm^{-3} and temperatures $\approx 12 \text{ K}$. HC_3N observations, when compared to the NH_3 observations, show that the ratio $R = [\text{NH}_3]/[\text{HC}_3\text{N}]$ in the Perseus globules (L1448, L1455, and B1) is $\approx 80-90$, i.e. about 10 times larger than in the Taurus cloudlets (TMC1, HCL2-A, B, C, ...).

The Perseus globules appear active in forming low mass stars. However, with the precision of our observations, we did not detect any gas heating around the positions of the stars ($\Delta T \leq 2 \text{ K}$ within our 1.3 beam).

1. Introduction

The local complex of dark clouds in Perseus lies $\approx 10^\circ$ away from Taurus. The spatial distance between the two complexes is probably 100-200 pc (the uncertainty arising mainly from the inaccuracy in the Perseus distance determinations). From an extensive survey of this complex in several molecular lines and star counts, Bachiller (1985) showed that the molecular cores in Perseus have densities and temperatures similar to those of the Taurus clumps (see also Bachiller and Cernicharo, 1984, 1986, henceforth BCa and BCb).

The Taurus dark clouds are characterized by an unusually strong emission from rotational lines of cyanopolyynes. Regions with comparable density and temperature show remarkable disparities in the molecular abundances. For example, in TMC1 and HCL2-A the ratio $[\text{NH}_3]/[\text{HC}_3\text{N}]$ varies by a factor of $\approx 6-10$ between the position of the ammonia peak and the position of the cyanopolyynes peak (Tölle et al., 1981; Churchwell et al., 1984; Cernicharo et al., 1984). In both clouds, the distance between peaks is $\approx 0.2 \text{ pc}$.

The $[\text{NH}_3]/[\text{HC}_{2n+1}\text{N}]$ ratios are of great interest in investigating the efficiency of certain gas phase reactions in the

dense interstellar medium (see for example Mitchell et al., 1979; Graedel et al., 1982). Moreover, the values of these abundance ratios may be related to the ages of molecular clouds (Myers et al., 1979; see also Stahler, 1984; Cernicharo et al., 1986). Hence, it would be useful to measure these abundance ratios in a wide sample of clouds, and particularly in the dense Perseus globules, whose proximity (distance $\approx 300 \text{ pc}$) might avoid problems of beam dilution.

To estimate the cyanopolyynes abundances in Perseus we observed the lightest and more abundant member of the HC_{2n+1}N family, HC_3N , in the $J=2 \rightarrow 1$ line. In a preliminary search for cyanopolyynes in B1 (a Perseus dense globule, see BCa), HC_5N was not detected, indicating that the $\text{NH}_3/\text{HC}_5\text{N}$ ratio is at least 10 times higher than in the cyanopolyne peak of TMC1 or HCL2-A, B, C (Cernicharo et al., 1984).

The same globules have been mapped in the NH_3 (1,1) and (2,2) lines to determine the physical conditions in the molecular gas. Position and fluxes of infrared objects around the line of sight to the globules were obtained from the IRAS point source catalogue to study star formation activity in the Perseus clouds.

2. Observations and analysis

The observations were done in February 1985 with the NRAO¹ 42-m telescope. The half-power beamwidth was $1.6'-1.3'$ and the system temperature 40-60 K depending on the frequency (18-22 GHz). The 1024-channel autocorrelator was split in two bands of 512 and 256 channels in order to observe simultaneously the (1,1) and (2,2) ammonia lines. The spectral resolution was $\approx 0.12 \text{ km s}^{-1}$.

The telescope pointing and focus were checked every two hours on the radio source 3C84. The data were calibrated with a noise tube, and were corrected for atmospheric attenuation by using continuum tipping curves provided by Batrla (1985) and for variations of antenna aperture efficiency with hour angle. The aperture efficiency at 22 GHz (ammonia frequencies) and for $\delta \approx 30^\circ$ was 0.20 at the meridian, and 0.12 two hours east and west off the meridian. At 18 GHz (HC_3N $J=2-1$ frequency) the

Send offprint requests to: R. Bachiller

* Present address: Observatorio Astronómico Nacional, Alfonso XII, 3, E-28014 Madrid, Spain

** U.A. 708 du CNRS

¹ The National Radio Astronomy Observatory is operated by Associated Universities, Inc., under contract to the National Science Foundation

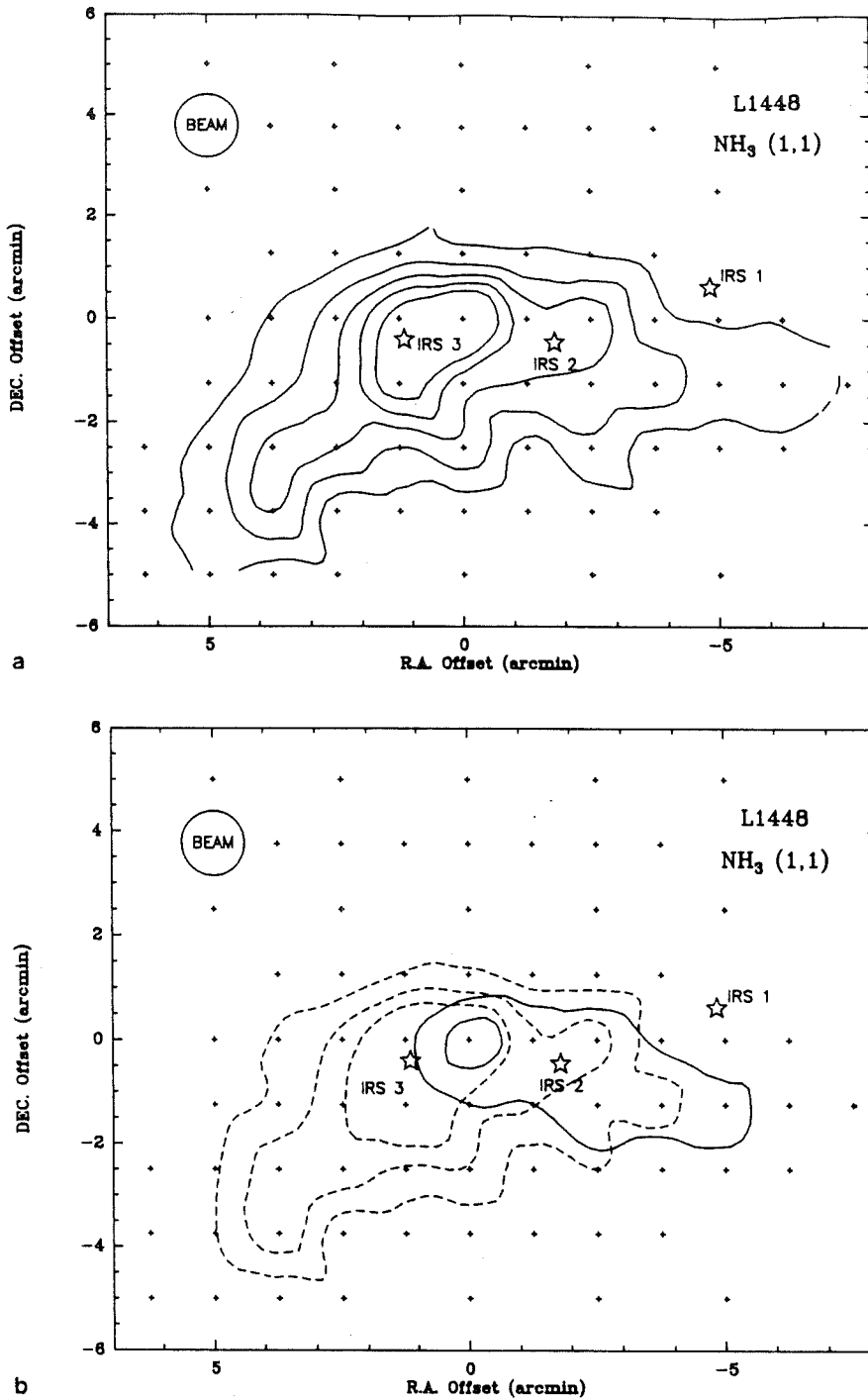

Fig. 1. a Integrated line intensity map (all velocities) of the main NH_3 group of hyperfine components in L 1448. Central position is $\alpha(1950) = 03^{\text{h}}22^{\text{m}}26^{\text{s}}.0$, $\delta = 30^{\circ}35'12''$. First contour corresponds to 0.7 K km s^{-1} . The step is 0.7 K km s^{-1} . IRAS sources are indicated by stars. Crosses indicated the observed positions. b As for a but for velocities between 4.0 and 4.5 km s^{-1} (continuous line), and between 4.5 and 5.0 km s^{-1} (discontinuous line).

aperture efficiency was 0.27 at the meridian, and 0.16 two hours east and west off the meridian. From the aperture efficiency we obtain a main-beam efficiency at the meridian of 0.30 at 22 GHz, and 0.40 at 18 GHz. Our main-beam brightness temperature (T_B) scale is believed to be accurate to better than 20%.

The globules were selected from our CO maps of the Perseus complex (Bachiller, 1985; BCb). The L 1448 and L 1455 globules were mapped in ammonia with a 1.25 spacing (Figs. 1 and 2). High quality spectra were obtained in the central positions of these globules in order to derive accurate temperatures and column

densities. We mapped other regions in the Perseus complex, but observed only weak emission ($T_B \leq 1 \text{ K}$).

The central regions of L 1448, L 1455 and B1 (B1 was mapped in NH_3 (1, 1) and (2, 2) by BCa) were also mapped in the HC_3N ($J=2 \rightarrow 1$) line, with 1024 channels and a spectral resolution of $\approx 0.08 \text{ km s}^{-1}$. Although this configuration covered all the hyperfine components, only the $F=3 \rightarrow 2$ and $F=2 \rightarrow 1$ lines were detected with good signal/noise ratio (Figs. 3 and 4).

In each position where HC_3N was observed, $N(\text{HC}_3\text{N})$ was estimated using the physical parameters derived from our NH_3

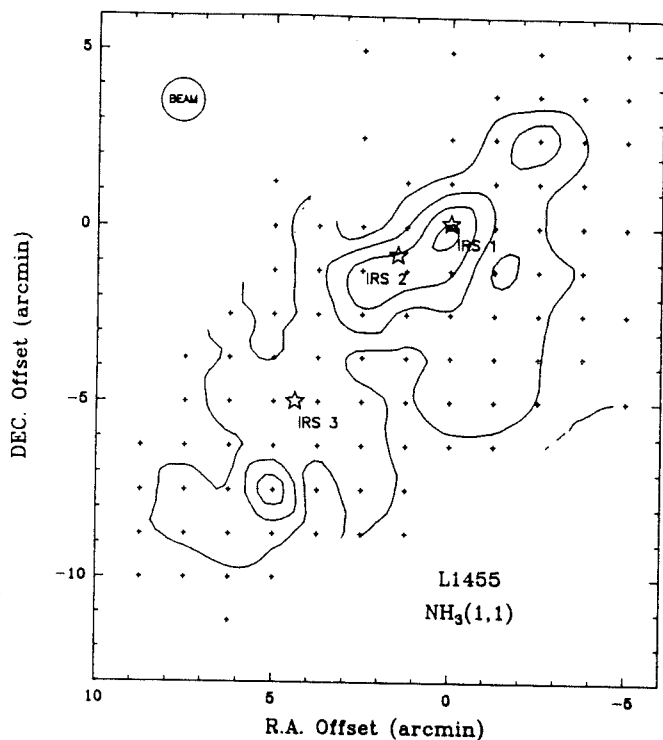

Fig. 2. Integrated line intensity map of the main NH_3 group of hyperfine components in L 1455. Central position is $\alpha(1950) = 03^{\text{h}}24^{\text{m}}36.2^{\text{s}}$, $\delta = 30^{\circ}02'40''$. First contour and step are 0.7 K km s^{-1} . IRAS sources are indicated by stars. Observed positions by crosses

observations and a LVG model with 20 levels. The collisional cross sections were those by Green and Chapman (1978). The LVG calculations show that the HC_3N lines are optically thin, so that for uniform physical conditions, the total HC_3N column density is proportional to the integrated line intensity. For the $F=3 \rightarrow 2$ component, at $T_K = 10 \text{ K}$, and densities $\sim 10^4 \text{ cm}^{-3}$, the total HC_3N column density is given by $N(\text{HC}_3\text{N}) \approx 4 \cdot 10^{13} T_B \Delta v \text{ cm}^{-2}$, where T_B and Δv are the brightness temperature (in K) and linewidth (in km s^{-1}) of the $F=3 \rightarrow 2$ component. This result agrees with the calculations of Churchwell et al. (1984).

3. The globule L 1448

3.1. Molecular emission

L 1448 lies in the periphery of a molecular hole $\approx 1^\circ$ South-West from NGC 1333. On the ^{13}CO and visual extinction maps of the Perseus complex from BCb, this globule appears very opaque. However, it was never observed before with high spatial resolution. On the C^{18}O Bordeaux map of BCb, L 1448 has a size of $\approx 15' \times 7'$ ($1.3 \text{ pc} \times 0.7 \text{ pc}$ at a distance of 300 pc). The column density of C^{18}O is $1.5 \cdot 10^{15} \text{ cm}^{-2}$ at the Bordeaux C^{18}O peak (beam $\approx 5'$). From the $\text{C}^{18}\text{O}/A_V$ ratio derived by Cernicharo and Guélin (1986) and BCb, the visual extinction averaged on the central $5'$ region is $A_V \approx 5 \text{ mag}$ and the mass of the region which presents strong C^{18}O emission is $\approx 10^2 M_\odot$.

Figure 1a displays the $\text{NH}_3(1,1)$ map. In NH_3 , L 1448 is elongated in the same direction as in ^{13}CO or C^{18}O , but the NH_3 emission is restricted to $1 \text{ pc} \times 0.5 \text{ pc}$. The kinetic temperature averaged over the central region of the globule is $T_K = 12 \pm 1 \text{ K}$.

The central density (position $\Delta\alpha = 1.25$, $\Delta\delta = 0$ in Fig. 1) deduced from excitation arguments (two level model) is $2.9 \cdot 10^4 \text{ cm}^{-3}$ and the total (ortho + para) NH_3 column density is $\approx 9.5 \cdot 10^{14} \text{ cm}^{-2}$ at this position. The average NH_3 column density in the central $5'$, where C^{18}O peaks, is $\approx 2 \cdot 10^{14} \text{ cm}^{-2}$. Hence, the $[\text{C}^{18}\text{O}]/[\text{NH}_3]$ ratio is ≈ 7.5 and the NH_3 abundance $x(\text{NH}_3) \approx 5 \cdot 10^{-8}$. The mass of the NH_3 core is $50 M_\odot$ (at a distance of 300 pc).

Figure 1b shows the integrated intensity of the main group of hyperfine components of the $\text{NH}_3(1,1)$ line in the $4.0\text{--}4.5 \text{ km s}^{-1}$ and $4.5\text{--}5.0 \text{ km s}^{-1}$ velocity intervals. There is a systematic trend in the line velocities. Emission at $\approx 4.2 \text{ km s}^{-1}$ predominates in the West and at $\approx 4.7 \text{ km s}^{-1}$ in the East. As this velocity shift is of the same order as the linewidths, it is very hard to distinguish between a single rotating clump or two different clumps with similar radial velocities. The lines are wider ($\Delta v \approx 0.8 \text{ km s}^{-1}$) at the possible overlap region than at the periphery ($\Delta v \approx 0.5 \text{ km s}^{-1}$). Although this effect could be due to the blend of two velocity components, such a line broadening could also be explained by an increased turbulence caused by the interaction of the sources IRS 2 and IRS 3 with the gas.

However, the possibility of two clumps remains more convincing to us because (i) no velocity gradient is observed in the East region ($\Delta\alpha \geq 2.5$) where the velocity is $4.7 \pm 0.1 \text{ km s}^{-1}$ and (ii) toward the position (1.25, 0) the NH_3 and HC_3N spectra show some evidences for double peaked profiles (see Fig. 3).

3.2. Stellar content

In the vicinity of L 1448, there are three objects identified in the IRAS point source catalogue (see Figs. 1, 5, and Table 1). IRS 1 was also observed in the visible by Cohen and Kuhi (1979). This star has an apparent magnitude $V = 19.5 \text{ mag}$ and strong $\text{H}\alpha$ emission; it lies on the periphery of the ammonia globule. Its position corresponds to that of the red and nebulous object RNO 13 in the list of Cohen (1980). From the IRAS observations, there are some indications that this may be a variable star. The colour temperature from the IRAS flux ratios range from $\approx 25 \text{ K}$ ($60 \mu\text{m}/100 \mu\text{m}$ ratio) to $100\text{--}150 \text{ K}$ ($25 \mu\text{m}/60 \mu\text{m}$ and $12 \mu\text{m}/25 \mu\text{m}$). The total luminosity of IRS 1, estimated from the IR flux, could be about $5 L_\odot$.

IRS 2 was detected by IRAS at $25 \mu\text{m}$ and $60 \mu\text{m}$. The colour temperature of the dust from the $25 \mu\text{m}/60 \mu\text{m}$ ratio is about 50 K . The luminosity of IRS 2 is $\sim 1 L_\odot$ in the $60 \mu\text{m}$ band and $\sim 0.1 L_\odot$ in the $25 \mu\text{m}$ band.

IRS 3 is very luminous at $100 \mu\text{m}$. This object corresponds to RNO 14, described by Cohen (1980) as a bright star associated with an irregular nebula. It was detected by IRAS in the four bands. The values of the $60 \mu\text{m}/100 \mu\text{m}$, $25 \mu\text{m}/60 \mu\text{m}$, and the $12 \mu\text{m}/25 \mu\text{m}$ ratios indicates the presence of dust at ≈ 25 , 50 and 115 K , respectively. The luminosity integrated over the four IRAS bands is $\approx 8 L_\odot$ (the $100 \mu\text{m}$ luminosity alone contributes $5 L_\odot$). As the infrared spectrum suggests that a star is associated with hot dust, the gas could be heated around the star. IRS 3 is situated within the ammonia peak. At this position, the kinetic temperature from the ammonia data is, $T_K = 12.6 \pm 0.2 \text{ K}$ and it is not higher than the temperature at adjacent positions. The gas and dust temperature distribution will be discussed in Sect. 6.2.

A reflection nebula (vdB 13 = DG 15 = Bernes 54) is visible on the POSS $\approx 5'$ North of L 1448. This nebula is excited by the B8 V star BD + $30^\circ 540$ which has a distance of 288 pc (Racine, 1968). Therefore the bright nebulosity is probably physically associated with the dark cloud. The star is $\approx 1 \text{ pc}$ from the edge of the cloud and its luminosity is $L_* \approx 10^2 L_\odot$ (Allen, 1973). The UV radiation

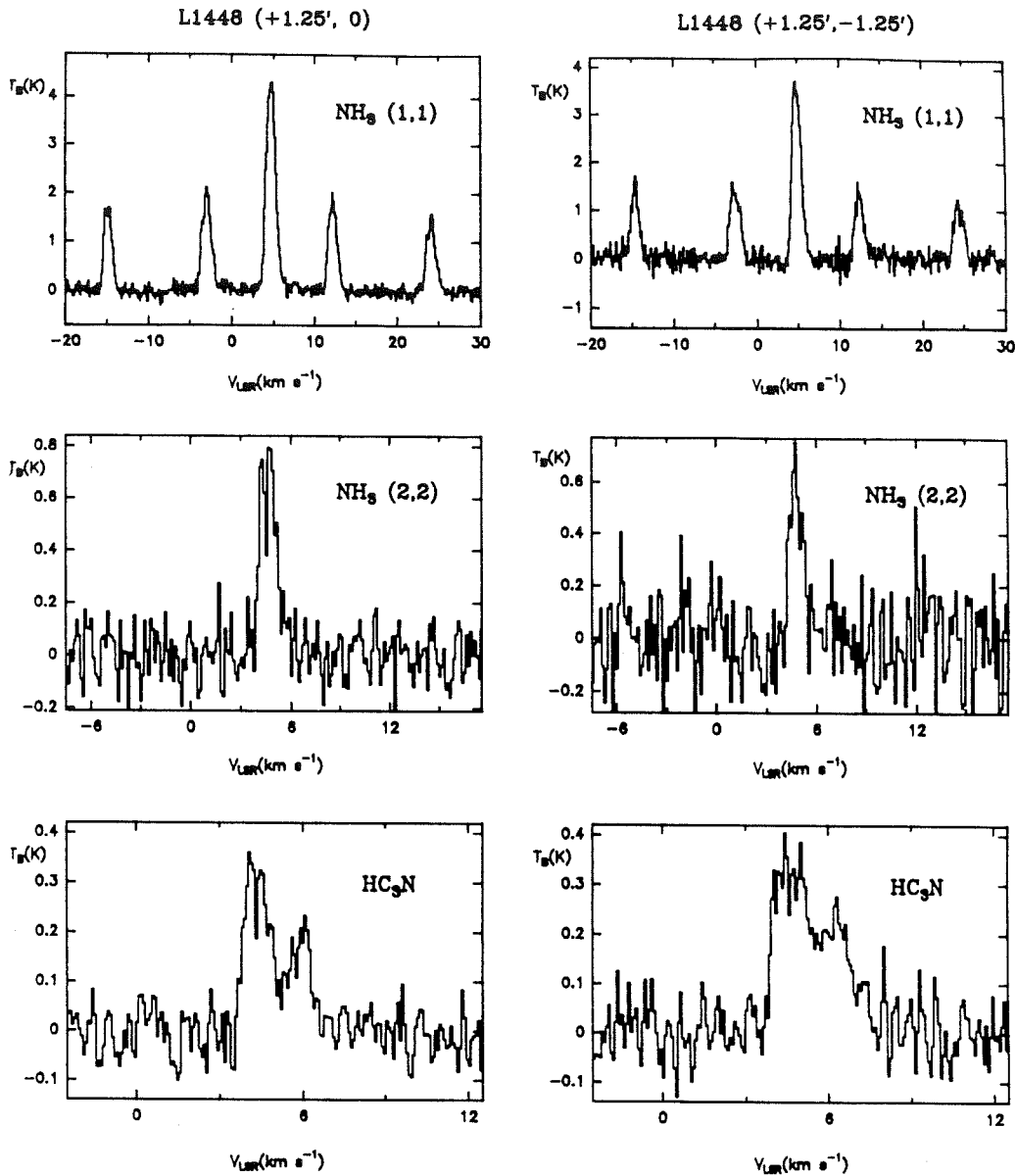

Fig. 3. Ammonia [(1,1), (2,2)] and HC_3N [$J=2-1$, $F=3-2$, $F=2-1$] spectra towards central positions of L 1448. Spectral resolution is 0.12 and 0.08 km s⁻¹ for ammonia and HC_3N respectively. The velocity scale for HC_3N is relative to the $F=3-2$ component

field at the NH_3 globule edge is therefore probably twice as high as the usual interstellar value.

4. The globule L 1455

4.1. Molecular emission

L 1455 (= B 204, B 206) lies $\approx 1^\circ$ South of NGC 1333. Our observations show an extended ($\approx 1 \text{ pc} \times 0.5 \text{ pc}$) region where NH_3 (1,1) is strong. The ammonia peak is on the line of sight to the infrared source studied by Davidson and Jaffe (1984), which is designated here IRS 1 on our NH_3 (1,1) map (Fig. 2). The average kinetic temperature in the central region of the main NH_3

fragment is $\approx 12 \text{ K}$ and no temperature variations are observed in this region ($\Delta T \leq 2 \text{ K}$). In the position of the NH_3 peak we deduce $n(\text{H}_2) \approx 1.4 \cdot 10^4 \text{ cm}^{-3}$ and a column density $N(\text{NH}_3) \approx 4 \cdot 10^{14} \text{ cm}^{-2}$. The mass of this main fragment is $20 M_\odot$. The two minor condensations, at the North and at the South, have masses of $1-2 M_\odot$. The total mass in the mapped area is about $40 M_\odot$.

Recently, Schwartz et al. (1985) and Torrelles et al. (1986a) have reported NH_3 (1,1) mapping of L 1455. Their data, which are less extensive and somewhat less sensitive, are in excellent agreement with ours.

Ferking and Langer (1982) detected high velocity CO near the main ammonia peak of L 1455. Goldsmith et al. (1984) mapped the CO wings in a region of $\approx 10' \times 10'$ around the NH_3 peak. The

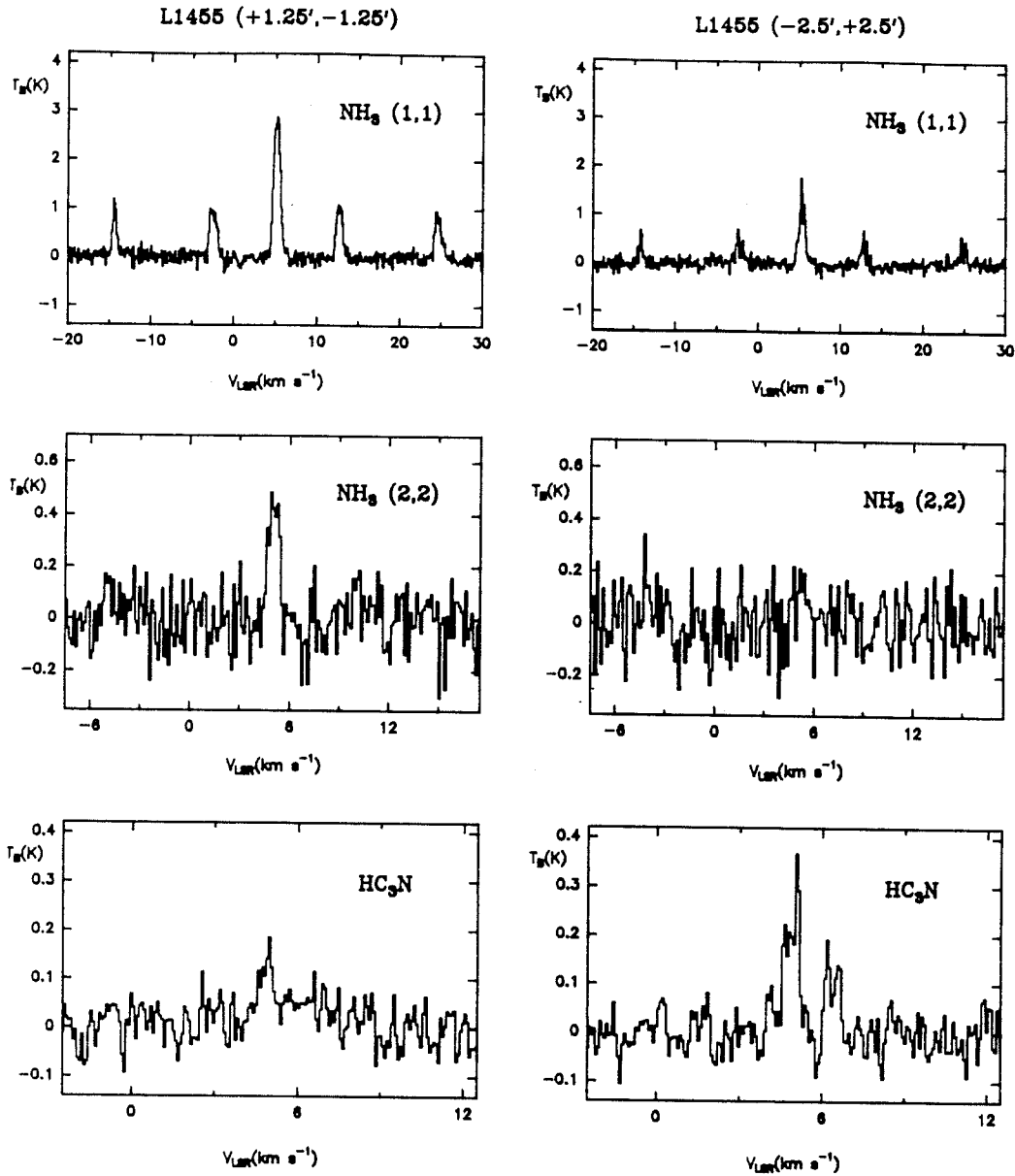

Fig. 4. As Fig. 3 but for L 1455

NH₃ emission is more extended than the high velocity CO emission. There is no evidence that the NH₃ emission is concentrated in a disk or torus structure. We conclude for L 1455, as Walmsley and Wilson (1985) for the B 335 and L 1551 clouds, that the relative orientations of NH₃ and CO contours are probably not very significant.

4.2. Stellar content

In the IRAS point source catalogue we found three objects near L 1455.

IRS 1 lies on the ammonia peak. Its infrared spectrum peaks at 100 μm. This source was also observed from the ground by Davidson and Jaffe (1984) who measured fluxes 2–3 times lower than the IRAS fluxes. These differences are probably due

to calibration problems. The color temperatures estimated from the IRAS data are 30–40 K (from the 60 μm/100 μm ratio) and 50–60 K (from the 25 μm/60 μm ratio). The source luminosity integrated over the four IRAS bands is about 7 L_⊙. The ammonia data do not show any significant increase of the kinetic temperature at the IRS 1 position ($T_k = 13.0 \pm 0.8$ K).

IRS 2 corresponds to a faint H α emission star (NGC 1333 star 2) observed by Cohen and Kuhi (1979) and to the nebulous object RNO 15 of Cohen (1980). This source was detected by IRAS only at 12 μm ($S_{12} \approx 1.8$ Jy). Its luminosity integrated over the four IRAS bands is < 4 L_⊙.

IRS 3 was detected only at 60 μm ($S_{60} = 0.68 \pm 0.05$ Jy) and its nature is unknown. However, this source is presumably associated with L 1455, because, as pointed out by Rowan-Robinson et al. (1984), the density of the 60 μm IRAS sources is only 0.65

Table 1. IRAS sources in L 1448 and L 1455

	Position		Flux density (Jy)				Color temperature (K)			Comments
	α (1950)	δ (1950)	S_ν (12 μm)	S_ν (25 μm)	S_ν (60 μm)	S_ν (100 μm)	12/25	25/60	60/100	
<i>L 1448</i>										
IRS 1	03 ^h 22 ^m 04.7	30°35'49"	0.90 ± 0.05	2.8 ± 0.2	~4.0 ± 0.4	~9.6 ± 1.2	150	~100	~25	CK 1, RNO 13, ~5 L_\odot
IRS 2	03 ^h 22 ^m 17.9	30°34'40"	<0.3	0.65 ± 0.08	14 ± 2	<167		50		
IRS 3	03 ^h 22 ^m 31.5	30°34'49"	0.61 ± 0.05	5.2 ± 0.4	25 ± 5	167 ± 23	115	70	20	RNO 14?, L (100 μm) ~ 5 L_\odot
<i>L 1455</i>										
IRS 1	03 ^h 24 ^m 34.9	30°02'36"	<0.3	3.4 ± 0.2	47 ± 5	92 ± 21	-	55	30	(*)
IRS 2	03 ^h 24 ^m 43.2	30°01'40"	1.8 ± 0.1	<1.2	<2.5	<92	-	-	-	CK 2, RNO 15
IRS 3	03 ^h 24 ^m 56.2	29°57'40"	<0.3	<0.4	0.68 ± 0.05	<7	-	-	-	-

* This source has also been observed by Davidson and Jaffe (1984). See Fig. 5

sources/(deg)². The luminosity of IRS 3 integrated over the four IRAS bands is < 0.4 L_\odot .

4.3. The origin of the molecular outflow

The high velocity gas in L 1455 has a complex structure interpreted by Goldsmith et al. (1984) as the combination of two nearby bipolar outflows. These authors suggest that the northwest outflow is from an obscured, undetected, source, and that IRS 2 is the source of the main outflow. The arguments of Goldsmith et al. are (i) IRS 2 is close to the center of symmetry of the main part of the outflow and (ii) here is a ¹³CO peak in the direction of IRS 2 which could indicate heating of the molecular gas near the star.

The IRAS data and our NH₃ maps do not support Goldsmith et al.'s conclusions: (i) No source was detected by IRAS at the Northwest of L 1455 and (ii) no peak in the gas kinetic temperature was observed, from NH₃, toward IRS 2 (see, however, Sect. 6.2). Anyway, a peak in ¹³CO may simply be due to higher opacity rather than a rise in kinetic temperature. The BCb Perseus survey shows that at most of the observed positions, the ¹³CO $J = 1 - 0$ line is optically thin, so the ¹³CO peaks are indeed likely to follow the opacity variations.

The interpretation of Goldsmith et al. in terms of nearby bipolar outflows is not unique. The observed structure may be simply the result of the interaction of a single outflow with the ambient cloud. The "blue beam" (directed to the observer) may have fragmented in two components when it collided with the high density material of the NH₃ globule. In this interpretation, IRS 1 is closer to the center of symmetry and is likely to be the source of the outflow. [A similar interpretation is given by Torrelles et al. (1986b) to explain the structure of the HL/XZ Tau outflow.]

5. The [NH₃]/[HC₃N] ratio in Perseus

Table 2 lists the values of the HC₃N column density in the central positions of L 1448, L 1455, and B 1. These column densities were computed from an LVG model, with the density and kinetic temperature derived from the ammonia data. The HC₃N lines are optically thin in all positions and the $F = 3 - 2/F = 2 - 1$ intensity ratio has the same value (1.86) as in local thermodynamic equilibrium.

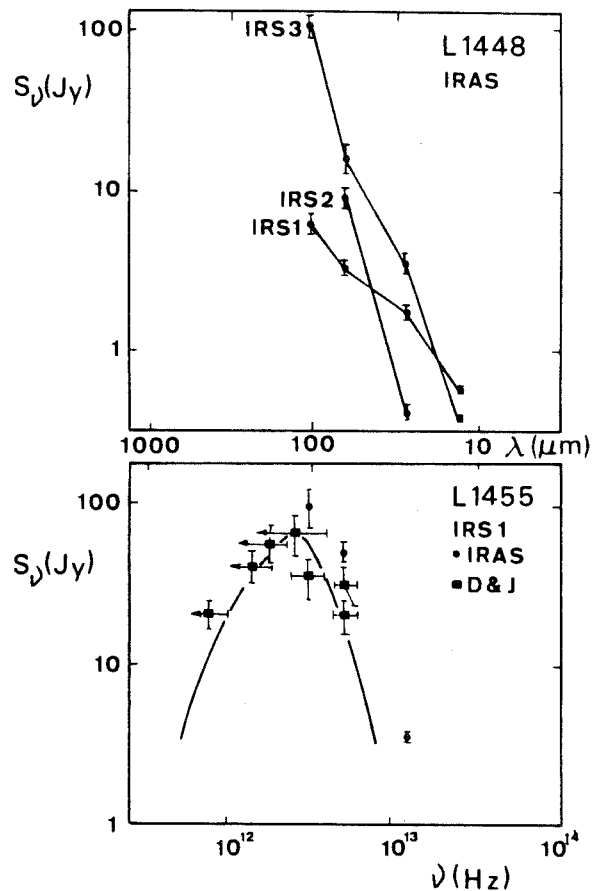

Fig. 5. Continuum spectra of IRAS point sources in L 1448 (top) and in L 1455 (bottom). For L 1455 the measurements of Davidson and Jaffe (1984) are indicated by squares. Continuous line is the function $\nu \cdot B_\nu$ (30 K), i.e., the expected flux density for dust emissivity proportional to frequency

There are important variations in the ratio $R = N(\text{NH}_3)/N(\text{HC}_3\text{N})$. For example, the position L 1455 (-2.5, +2.5) has a ratio $R \approx 37$; however, the value averaged over all positions in L 1455 where HC₃N is detected is $\langle R \rangle \approx 85$. In L 1448 the mean value is $\langle R \rangle \approx 81$. Towards the ammonia peak of B 1, the ratio is

Table 2. Temperatures, densities and abundance ratio derived from NH₃ and HC₃N

Position ^a	T_k (K)	$n(\text{H}_2)$ (10^4 cm^{-3})	$\frac{N(\text{NH}_3)}{N(\text{HC}_3\text{N})}$		R
			(10^{13} cm^{-2})		
L 1448 (0,0)	11.5 ± 0.5	1.9	81	0.77	105
(1:25, -1:25)	11.9 ± 0.5	2.3	76	1.9	40
(1:25, 0)	12.6 ± 0.2	2.9	95	1.5	65
(2:5, -2:5)	13.0 ± 2	0.27	24	0.21	114
(2:5, -1:25)	13.1 ± 1.0	1.1	39	0.49	80
(2:5, 0)	10.5 ± 1.5	1.4	36	<0.35	>103
(3:75, -3:75)	8.5 ± 1.0	0.71	72	<0.35	>206
(3:75, -2:5)	11.5 ± 1.0	1.2	46	<0.35	>131
(-1:25, 0)	11.1 ± 0.7	0.88	42	<0.35	>120
L 1455 (0,0)	13.0 ± 0.8	0.75	27	~0.4	~68
(-2:5, 2:5)	11 ± 2	0.90	22	0.56	37
(-1:25, 1:25)	14 ± 2	0.88	22	~0.4	~55
(0, -1:25)	12.0 ± 0.7	1.44	43	0.5	86
(1:25, -1:25)	12.5 ± 0.5	1.61	38	0.21	181
B 1 (NH ₃ peak) ^b	12 ± 2	3.0	100	1.1	91

^a The reference positions (1950) are: L 1448, $\alpha = 03^{\text{h}}22^{\text{m}}26^{\text{s}}.0$, $\delta = 30^{\circ}35'12''$, L 1455, $\alpha = 03^{\text{h}}24^{\text{m}}36^{\text{s}}.2$, $\delta = 30^{\circ}02'40''$, B 1, $\alpha = 03^{\text{h}}30^{\text{m}}09^{\text{s}}.5$, $\delta = 30^{\circ}57'26''$

^b NH₃ data from unpublished Effelsberg observations (see also BCa)

$R \approx 91$. Therefore, the mean $[\text{NH}_3]/[\text{HC}_3\text{N}]$ ratio in the Perseus globules is about 10 times larger than in the Taurus cloudlets TMC 1 ($R \approx 5$), HCL 2-A, B, C ($R \approx 10$, Cernicharo et al., 1984) and L 1495 ($R \approx 10$, Cernicharo et al., 1986).

The reasons for these variations are unknown. Bujarrabal et al. (1981) proposed that a density change by a factor of 3 within TMC 1 could explain, by excitation effects, the observed variations in the $[\text{NH}_3]/[\text{HC}_3\text{N}]$ ratio (the molecular abundances remaining constant). However, Gaida et al. (1984), from an ammonia map of TMC 1 do not find evidences for important density variations. In HCL 2-A, strong variations in the $[\text{NH}_3]/[\text{HC}_3\text{N}]$ ratio are also observed in positions which have similar densities (Cernicharo et al., 1984). Finally, the central densities of the Perseus globules ($1 - 4 \times 10^4 \text{ cm}^{-3}$) are comparable to those of Taurus cloudlets, but the $[\text{NH}_3]/[\text{HC}_3\text{N}]$ ratio differs by a factor of ≈ 10 . We conclude that density variations alone cannot explain the observed variations in the $[\text{NH}_3]/[\text{HC}_3\text{N}]$ ratio.

It is possible that the abundance changes are correlated with temperature variations. However the kinetic temperature of Perseus clumps ($T_k \approx 12 \text{ K}$) is comparable to that of Taurus globules ($T_k \approx 10 \text{ K}$), and the $[\text{NH}_3]/[\text{HC}_3\text{N}]$ ratio differs by a factor of ≈ 10 . Also in this way, Churchwell et al. (1984) computed a ratio $R \approx 800$ in L 183 S, a dark cloud with $T_k \approx 10 \text{ K}$. They found a similar value for S 106a warm cloud ($T_k \approx 25 \text{ K}$). So it appears that the abundance variations are not correlated with kinetic temperature.

Finally, one could argue that the variations in R are due to a distance effect. Let us assume that the spatial extent of the HC₃N distribution is smaller than that of NH₃. In nearby clouds, where the emission in NH₃ and HC₃N are well resolved, R will be well measured. For more distant clouds, the HC₃N emission could suffer more dilution in the beam and R would appear greater.

However, our maps show that the nearby Perseus globules (distance $\approx 300 \text{ pc}$) are well resolved in HC₃N with the NRAO beam. As pointed out above $R \approx 80-90$ in these globules. In addition, even nearer clouds seem to have a puzzling variety of R values: $R \approx 800$ in L 183 S (distance $\approx 100 \text{ pc}$) and $R \approx 5-10$ in Taurus cloudlets (distance $\approx 140 \text{ pc}$). Thus, even if the HC₃N emission were less extended than that of NH₃, a distance effect could not account for the observed variations in R , at least in nearby clouds.

Churchwell et al. (1984) suggested that there is a correlation between the ratio R and the column density of NH₃. We have compared their measurements with those of Cernicharo et al. (1984) and ours. We also find a tendency for the ratio R to increase with $N(\text{NH}_3)$. However, the difference in excitation conditions between ammonia and cyanopolyynes and the difference in observing conditions (distance, beam size, pointing) can introduce large uncertainties in the measured ratios. Higher resolution observations, including multi-line studies of HC₃N, will be necessary to determine if the observed increase of the $N(\text{NH}_3)/N(\text{HC}_3\text{N})$ ratio with $N(\text{NH}_3)$ is statistically significant or not.

6. Discussion

The association of strong NH₃ emission with low mass young stellar objects (similar to these in L 1448 and L 1455) has been already observed in a great number of local clouds (Taurus clouds, Myers and Benson, 1983, and Benson et al., 1984; B 335, Menten et al., 1984; L 134 N, Ungerechts et al., 1980; B 5, L 1262, ..., Ungerechts et al., 1982). Individual clumps in these cores have masses of a few solar masses, central densities of a few 10^4 cm^{-3} and temperatures $T_k \approx 9-12 \text{ K}$. Other greater and more massive

cores with higher density and temperature have also been detected (NGC 1333 and Serpens: Ho and Barrett, 1980; Rho Oph. Zeng et al., 1984; S140, Ungerechts et al., 1986; W33, W49, ... Ho et al., 1981). They seem to be associated with the formation of more massive stars. In some of these massive cores (for example S140) there are observational evidences, from ammonia observations, for gas heating around the luminous stellar sources.

In this discussion we will deal with the possible influence of the low mass stars on the cloud stability and on the gas heating in the L 1448 and L 1455 cores.

6.1. Fragmentation and equilibrium

The NH_3 globules in L 1448 and L 1455 have a kinetic temperature of ≈ 12 K and masses of ≈ 40 – $50 M_\odot$. These globules are fragmented in at least 2–3 clumps which have a few (1–20) solar masses each. The virial equilibrium condition (see, for example, Myers, 1985a): $\sigma_v = 1.6 \cdot n^{0.5} (\text{cm}^{-3})^{1/2} \cdot L (\text{pc}) \text{ km s}^{-1}$ is roughly verified by these clumps. Dynamical equilibrium is also required by the fact that the ages of the young stellar objects associated with the clouds, are typically a few 10^6 yr (see Cohen and Kuhl, 1979, for the age of L 1448/IRS 1 and L 1455/IRS 2 which correspond to their stars NGC 1333–1 and NGC 1333–2, respectively) indicating that the clumps are at least an order of magnitude older than their present free-fall timescales (\approx a few 10^5 yr).

The clumps could be supported by the turbulent motions which are probably the origin of the main contribution to the linewidths. Norman and Silk (1980) and Silk (1985) have suggested that outflows from embedded young stellar objects could account for cloud linewidths and provide support against gravitational collapse on a free-fall timescale. Accordingly one should expect the molecular lines to be wider near the positions of the young stellar objects. Such a tendency is not obvious in our L 1455 map, perhaps due to sensitivity limitations. In L 1448 the problem is aggravated by the possible presence of two different clumps. However, it is clear that the L 1448 and L 1455 lines are wider than lines from clumps without stellar content (e.g. TMC 1). In addition, Myers (1985b) has presented evidence for such a systematic effect in a homogeneous sample of clouds indicating that, as pointed out above, outflows are probably important in supporting dense cores.

6.2. Gas and dust temperatures

Five of the six IRAS sources imbedded in the globules are probably T Tauri stars (L 1455/IRS 3 was only detected at $60 \mu\text{m}$). The IRAS data indicate that the dust temperature around the stars is 20–150 K. The gas temperature, as deduced from the ammonia data, is ≈ 12 K, considerably colder than the dust. Moreover, no enhancement of the gas temperature, as derived from our NH_3 observations, is observed toward the IRAS source positions. Thus the interaction between the low mass stars and the gas does not appear to be important (at the angular resolution of our observations). This effect is also observed by Menten et al. (1984) in L 1551/IRS 5 and B 335/IR, which are strong FIR sources.

The gas temperature of L 1448 and L 1455 (≈ 10 – 14 K) is, roughly, that expected for cosmic ray heating (Goldsmith and Langer, 1978) and/or turbulence dissipation heating (Myers, 1983). Detailed thermal calculations which consider the gas-dust coupling (Falgarone and Puget, 1985; Ho et al., 1981) show that the gas is not heated by the dust for densities lower than 10^5 cm^{-3} . The densities we computed from NH_3 observations in L 1448 and

L 1455 are $\leq 3 \cdot 10^4 \text{ cm}^{-3}$, so it seems consistent not to see any trace of gas heating at the $\approx 1'$ scale of our NH_3 observations.

There is, however, some observational evidence for high density material in the immediate vicinity of L 1455/IRS 1: The IR observations of Davidson and Jaffe (1984) for L 1455/IRS 1 indicate the existence of a dense clump of size $< 30''$ (not resolved by their observations) which has a dust temperature $T_d \approx 30$ – 40 K, $A_V \approx 30$ mag and $n(\text{H}_2) \geq 2 \cdot 10^5 \text{ cm}^{-3}$. In the high density region, gas and dust might be thermally coupled (see the models of Falgarone and Puget, 1985; Ho et al., 1981; Krugel et al., 1984). However, as this dense region is small, one should expect significant beam dilution effects in the radio observations.

Let us make a rough estimate of such beam dilution effects: For $A_V \approx 30$ mag, and an ammonia abundance of $x(\text{NH}_3) \approx 5 \cdot 10^{-8}$, we get $N(\text{NH}_3)^{\text{HDR}} \approx 1.5 \cdot 10^{15} \text{ cm}^{-2}$ for the ammonia column density in the high density region. In the $80''$ beam we observe $\langle \text{NH}_3 \rangle \approx 3 \cdot 10^{14} \text{ cm}^{-2}$ and similar values for adjacent positions; if we assume that the variations found between these positions, $\Delta N(\text{NH}_3) \approx 10^{14} \text{ cm}^{-2}$, are due to the high density material, then the beam filling factor must be ≤ 0.07 giving a source size of $\leq 24''$ (0.035 pc). Krugel et al. (1984) have derived theoretically the dust temperature profile for a cloud of central density $\approx 10^{4.5} \text{ cm}^{-3}$ with an embedded star of $L_* \approx 10 L_\odot$. The size of the warm ($T_d > 30$ K) and dense region is $L \leq 0.03$ pc or $\approx 20''$ at the distance of L 1455. These numbers are in agreement with those suggested by our measurements. So, only observations with high angular resolution ($\leq 20''$) could show the dense and warm gas around the low mass stars.

7. Conclusions

The main conclusions of this paper are:

1. The ammonia clumps in the local (distance ≈ 300 pc) Perseus globules L 1448 and L 1455 have typical masses of 1– $20 M_\odot$, temperatures of 10–14 K and central densities of a few 10^4 cm^{-3} .
2. Apparently embedded in these globules are young low mass stellar objects, which from IRAS and optical (Cohen and Kuhl, 1979) observations appear to have moderate luminosities (see Table 1).
3. The dust is warm ($T_d \geq 50$ K) around the young stellar objects, but the gas is colder ($T_K \approx 10$ – 14 K). Only in the immediate vicinity (≤ 0.03 pc or $20''$) of the young stellar sources, the density could be high enough to thermally couple gas to dust; this effect is not seen in our ammonia maps, probably because of dilution in the $\approx 80''$ beam.
4. The ratio $R = [\text{NH}_3]/[\text{HC}_3\text{N}]$ in the Perseus globules (L 1448, L 1455 and B 1) is 80–90, i.e. about 10 times larger than in Taurus cloudlets (TMC 1, HCL 2A, B, C).

Acknowledgements. We wish to thank Drs. D. Downes, S. Guilloteau, and J. M. Torrelles for helpful discussions. We are also grateful to the referee, Dr. P. T. P. Ho, for valuable comments and suggestions.

References

- Allen, C. W.: 1973, *Astrophysical Quantities*, The Athlone Press, London
- Bachiller, R.: 1985, Ph. D. Thesis, Université de Grenoble

- 270
- Bachiller, R., Cernicharo, J.: 1984, (BCa), *Astron. Astrophys.* **140**, 414
- Bachiller, R., Cernicharo, J.: 1986, (BCb) *Astron. Astrophys.* **166**, 283
- Batrla, W.: 1985 (private communication)
- Benson, P.J., Myers, P.C., Wright, E.L.: 1984, *Astrophys. J. Letters*, **279**, L 27
- Bujarrabal, V., Guélin, M., Morris, M., Thaddeus, P.: 1981, *Astron. Astrophys.* **99**, 239
- Cernicharo, J., Guélin, M., Askne, J.: 1984, *Astron. Astrophys.* **138**, 371
- Cernicharo, J., Guélin, M.: 1986, *Astron. Astrophys.* (in press)
- Cernicharo, J., Bachiller, R., Duvert G.: 1986, *Astron. Astrophys.* **160**, 181
- Churchwell, E., Nash, A. G., Walmsley, C. W.: 1984, *Astrophys. J.* **287**, 681
- Cohen, M.: 1980, *Astron. J.* **85**, 29
- Cohen, M., Kuhl, L. V.: 1979, *Astrophys. J. Suppl.* **41**, 743
- Davidson, J. A., Jaffe, D. T.: 1984, *Astrophys. J. Letters* **277**, L 13
- Falgarone, E., Puget, J. L.: 1985, *Astron. Astrophys.* **142**, 157
- Frerking, M. A., Langer, W. D.: 1982 *Astrophys. J.* **256**, 523
- Gaida, M., Ungerechts, H., Winnewisser, G.: 1984, *Astron. Astrophys.* **137**, 17
- Goldsmith, P. F., Langer, W. D.: 1978, *Astrophys. J.* **222**, 881
- Goldsmith, P. F., Snell, R. L., Hemeon-Heyer, M., Langer, W. D.: 1984, *Astrophys. J.* **286**, 599
- Graedel, T. E., Langer, W. D., Frerking, M. A.: 1982, *Astrophys. J. Suppl.* **48**, 321
- Green, S., Chapman, S.: 1978, *Astrophys. J. Suppl.* **37**, 169
- Ho, P. T. P., Barrett, A. H.: 1980, *Astrophys. J.* **237**, 38
- Ho, P. T. P., Martin, R. N., Barrett, A. H.: 1981, *Astrophys. J.* **246**, 761
- Krügel, E., Walmsley, C. M.: 1984, *Astron. Astrophys.* **130**, 5
- Menten, K. M., Walmsley, C. M., Krügel, E., Ungerechts, H.: 1984, *Astron. Astrophys.* **137**, 108
- Mitchell, G. F., Huntress, W. T., Prasad, S. S.: 1979, *Astrophys. J.* **233**, 102
- Myers, P. C.: 1983, *Astrophys. J.* **270**, 105
- Myers, P. C.: 1985a, *Protostars and Planets*, II. eds. D. C., Black M. S., Matthews, Tucson, Univ. Arizona Press
- Myers, P. C.: 1985b, Proc. of the European IAU Symp., Toulouse, France
- Myers, P. C., Benson, P. J.: 1983, *Astrophys. J.* **266**, 309
- Myers, P. C., Ho, P. T. P., Benson, P. J.: 1979, *Astrophys. J. Letters* **233**, L 141
- Norman, C., Silk, J.: 1980, *Astrophys. J.* **238**, 158
- Racine, R.: 1968, *Astron. J.* **73**, 233
- Rowan-Robinson, M., Clegg, P. E., Beichman, C. A., Neugebauer, G., Soifer, B. T., Aumann, H. H., Beintema, D. A., Boggess, N., Emerson, J. P., Gautier, T. N., Gillet, F. C., Hauser, M. G., Houck, J. R., Low, F. J., Walker, R. G.: 1984, *Astrophys. J. Letters* **278**, L 7
- Schwartz, P. R., Frerking, M. A., Smith, H. A.: 1985, *Astrophys. J.* **295**, 89
- Silk, J.: 1985, *Astrophys. J. Letters* **292**, L 71
- Stahler, S. W.: 1984, *Astrophys. J.* **281**, 209
- Toelle, F., Ungerechts, H., Walmsley, C. M., Winnewisser, G., Churchwell, E.: 1981, *Astron. Astrophys.* **95**, 143
- Torrelles, J. M., Ho, P. T. P., Moran, J. M., Rodriguez, L. F., Cantó, J.: 1986a (to appear in *Astrophys. J.*)
- Torrelles, J. M., Anglada, G., Rodriguez, L. F., Cantó, J., Barral, J. F.: 1986b (preprint)
- Ungerechts, H., Walsmley, C. M., Winnewisser, G.: 1980, *Astron. Astrophys.* **88**, 259
- Ungerechts, H., Walsmley, C. M., Winnewisser, G.: 1982, *Astron. Astrophys.* **111**, 339
- Ungerechts, H., Walsmley, C. M., Winnewisser, G.: 1986, *Astron. Astrophys.* **157**, 207
- Walmsley, C. M., Wilson, T. L.: 1985, Proc. of the IAU Regional Symp. 80, Toulouse
- Zeng, Q., Batrla, W., Wilson, T. L.: 1984, *Astron. Astrophys.* **141**, 127

Note added in proof: Recently (September 1986) we have carried out a search at near infrared wavelengths around the L1448, L1455 IRAS sources with the german 1.23-m telescope at Calar Alto (Spain). A relatively bright infrared source has been detected close to the L1455/IRS 3 position, at $\alpha(1950) = 3^{\text{h}}24^{\text{m}}56^{\text{s}}2 \pm 0.4$, $\delta(1950) = 29^{\circ}58'30'' \pm 7''$. The *J*, *H* and *K* magnitudes for this object are $J = 11.6 \pm 0.2$, $H = 10.7 \pm 0.2$, $K = 10.3 \pm 0.2$.

We are grateful to Dr. C. Eiroa for his assistance during these observations.

**I.15) LA RELATION ENTRE L'EMISSION DU MONOXYDE DE CARBONE ET
L'EXTINCTION VISUELLE DANS LE COMPLEXE LOCAL DE PERSEE**

I.15) LA RELATION ENTRE L'EMISSION DU MONOXYDE DE CARBONE ET L'EXTINCTION VISUELLE DANS LE COMPLEXE LOCAL DE PERSEE

Une analyse de près de 1200 lignes de visée dans le complexe de Persée (voir I.02 et I.03) nous a permis d'établir la relation

$$N_{LTE}(^{13}\text{CO}) = 2.5 \pm 0.5 (A_V - 0.8 \pm 0.4) 10^{15} \text{ cm}^{-2}$$

dans la zone $1 \text{ mag} \leq A_V \leq 5 \text{ mag}$. Ce résultat est comparé à celui de Cernicharo et Guélin (voir I.05) dans le nuage sombre du Taureau Heiles Cloud 2. Le rapport $^{13}\text{CO}/A_V$ diffère par un facteur 2 entre les deux régions, différence que nous interprétons comme le résultat d'un champ ultraviolet moyen plus intense dans Persée que dans le Taureau. Le surcroît d'intensité pourrait être attribué aux étoiles OB de l'association Per OB2.

L'émission de ^{13}CO est affectée pour de grandes valeurs de l'extinction visuelle par l'opacité de la raie; pour de faibles valeurs de l'extinction visuelle elle est affectée par le fractionnement isotopique. Ces deux effets sont marginaux pour C180 qui paraît donc être un meilleur traceur du gaz des nuages denses. Cependant, les variations observées dans l'abondance de ^{13}CO dans les nuages sombres proches sont seulement ≈ 2 . Ce petit facteur (en comparaison avec d'autres incertitudes dans la détermination des masses) et l'intensité de la raie J=1-0 de ^{13}CO (≥ 5 fois l'intensité de la raie J=1-0 de C^{18}O) font de ^{13}CO le meilleur traceur du gaz dans les nuages moléculaires étendus.

The relation between carbon monoxide emission and visual extinction in the local Perseus dark clouds

R. Bachiller* and J. Cernicharo

Groupe d'Astrophysique***, Université Scientifique et Médicale de Grenoble, CERMO, B.P. 68, F-38402 St. Martin D'Herès Cedex, France

Received December 24, 1985; accepted April 16, 1986

Summary. An analysis of nearly 1200 measurements of ^{13}CO column density and visual extinction A_V in the Perseus complex, leads to the relation

$$N_{\text{LTE}}(^{13}\text{CO}) = (2.5 \pm 0.5) 10^{15} (A_V - 0.8 \pm 0.4) \text{cm}^{-2}$$

in the range $1 \text{ mag} < A_V < 5 \text{ mag}$. This result is compared to those of Cernicharo and Guélin (1986) in the Taurus cloud Heiles cloud 2. The $^{13}\text{CO}/A_V$ ratio differs by a factor of ≈ 2 . We interpret this difference as due, mainly, to the enhanced ultraviolet field in Perseus owing to OB stars (such a strong ultraviolet field is implicated by optical and IRAS data).

The ^{13}CO data are affected for large A_V by line saturation and for small A_V by isotopic fractionation. These effects are reduced for C^{18}O in the range of visual extinction considered here. However, the observed differences of the ^{13}CO abundance in local dark clouds are within a factor of 2. This small factor (in comparison with other uncertainties in mass calculations) and the intensity of the ^{13}CO lines (≥ 5 times stronger than C^{18}O lines) makes ^{13}CO the best gas tracer for extended molecular clouds.

Key words: dark clouds - interstellar molecules - molecular abundances

1. Introduction

The knowledge of the $^{12}\text{C}^{16}\text{O}$, $^{13}\text{C}^{16}\text{O}$, and $^{12}\text{C}^{18}\text{O}$ (hereafter CO, ^{13}CO , and C^{18}O) abundances in the interstellar medium is extremely valuable in delineating the structure and calculating the masses of molecular clouds. Because H_2 is difficult to observe, the molecular gas is usually traced by observations of CO isotopes. Particularly useful is the mapping in the $J = 1 - 0$ transitions of ^{13}CO and C^{18}O . These transitions often are not severely affected by saturation, and are easily thermalized because of the small value of the dipole moment. If the distance to the cloud and the molecular abundance relative to hydrogen are known, the calculation of the gaseous mass within the cloud is straightforward.

Many efforts have been devoted in the last decade to the determination of the CO abundance (Encrenaz et al., 1975; Tucker et al., 1976; Dickman, 1976, 1978b; Elmegreen and Elmegreen,

1979; Duvert et al., 1986; Frerking et al., 1982; Cernicharo and Guélin, 1986 - henceforth referred to as FLW and CG respectively). Generally the column densities of the CO isotopes are calculated from observations of the millimeter rotational transitions using crude radiative models. A detailed comparison between CO column density and visual extinction (A_V) requires the determination of A_V averaged over the beam of the CO observations. This task presents many difficulties for distant clouds. However, for local clouds, star counts on photographic plates is a powerful method to derive the visual extinction with a spatial resolution comparable to that of radio observations. Cernicharo and Bachiller (1984) and Cernicharo et al. (1985) have discussed this method in detail. They have mapped the Taurus and Perseus complexes and have used their data to discuss the density structure of dark clouds.

In determining the H_2 column densities from A_V , a problem arises: the correlation between H_2 column density and visual extinction has been established only for $A_V \leq 2 \text{ mag}$ by Bohlin et al. (1978) who found $N_{\text{H}_2}/A_V = 0.94 10^{21} \text{ molec cm}^{-2} \text{ mag}^{-1}$. For larger extinctions there is insufficient observational evidence to justify the extension of the range of validity of this value. However, Dickman (1976, 1978b) argued that the value of the gas-to-dust ratio holds for visual extinctions as large as $A_V \approx 10 \text{ mag}$.

The main goal of this paper is to determine the $^{13}\text{CO}/A_V$ ratio in the Perseus complex. For this purpose we have used the stars counts of Cernicharo and Bachiller (1984) and a systematic survey of the ^{13}CO ($J = 1 - 0$) line. In addition, C^{18}O ($J = 1 - 0$) observations have been carried out mainly toward the positions where the ^{13}CO ($J = 1 - 0$) lines are strong. The Perseus complex was chosen for this work because it presents several differences from the nearby Taurus clouds, which are relatively well studied. The main differences are 1) The vicinity of the Per OB2 association, 2) The presence of bright nebulae on the prints of the Palomar Observatory Sky Survey, 3) The presence of CO hot spots. We aim to investigate if these differences could influence the values of the CO isotopic abundances.

In Sect. 2 we describe the experimental methods. In Sect. 3 we report the results. In Sect. 4 we discuss the CO abundance and we compare our determinations with previous works and theoretical calculations.

2. Observations and star counts

The ^{13}CO , C^{18}O , and CO ($J = 1 - 0$) data were obtained between July 1981 and September 1982, and during the spring 1984, with the 2.5-m. antenna of the Bordeaux Observatory. The

Send offprint requests to: R. Bachiller

* Now at the Observatorio Astronómico Nacional, Alfonso XII, 3. E-28014 Madrid, Spain

** U.A. 708 du CNRS

radiotelescope has been described by Baudry et al. (1981). The antenna has a HPBW of $4.4'$ at 110 GHz and a beam efficiency close to 0.85. The receiver includes a Schottky diode mixer and an intermediate frequency system cooled to 20 K. The spectrometer consisted of a filter bank of 256 channels of 100 KHz width ($\approx 0.27 \text{ km s}^{-1}$ at 110 GHz). The receiver single sideband noise temperature was between 500 K and 800 K at 110 GHz. The observations were calibrated by the chopper wheel method. Systematic errors in the line intensities were avoided by observing a reference position several times during each session. All the observations were made in frequency switching mode and with a $5'$ spacing. Typical noise was $\Delta T_{\text{R}}^* \approx 0.8 \text{ K}$ for CO, 0.2 K for ^{13}CO and 0.1 K for C^{18}O .

Star counts were made using a $2.5' \times 2.5'$ element transparent grid on the Palomar Observatory Sky Survey red prints, and a microscope with a magnification of 10 and/or 30. Several reference fields were measured at positions on the cloud's print and on those immediately adjacent in order to accurately determine the zero-point. The star count method and the procedure for

deriving the visual extinction are presented in detail elsewhere (Cernicharo and Bachiller, 1984). As discussed in that paper, most of the reference fields in Taurus and Perseus are contaminated by ≥ 0.5 magnitudes of visual extinction. In Cernicharo and Bachiller (1984) we adopted a value of 0.5 magnitudes for the visual extinction in the Perseus reference field. Our A_V data were corrected for this extra amount of dust around the Perseus clouds. Visual extinction maps were binned to a resolution of $5'$ in order to compare with radio observations. Figure 1 displays the A_V map of the Perseus complex (from Cernicharo and Bachiller, 1984 and Cernicharo et al., 1985). The ^{13}CO ($J = 1 - 0$) integrated intensity map is presented in Fig. 2. Some of the CO, ^{13}CO and C^{18}O spectra are displayed in Figs. 2, 3 and 4 of Bachiller and Cernicharo (1984).

3. Results

An overview of Figs. 1 and 2 shows the good correlation between ^{13}CO emission and visual extinction. Condensations of $A_V \geq$

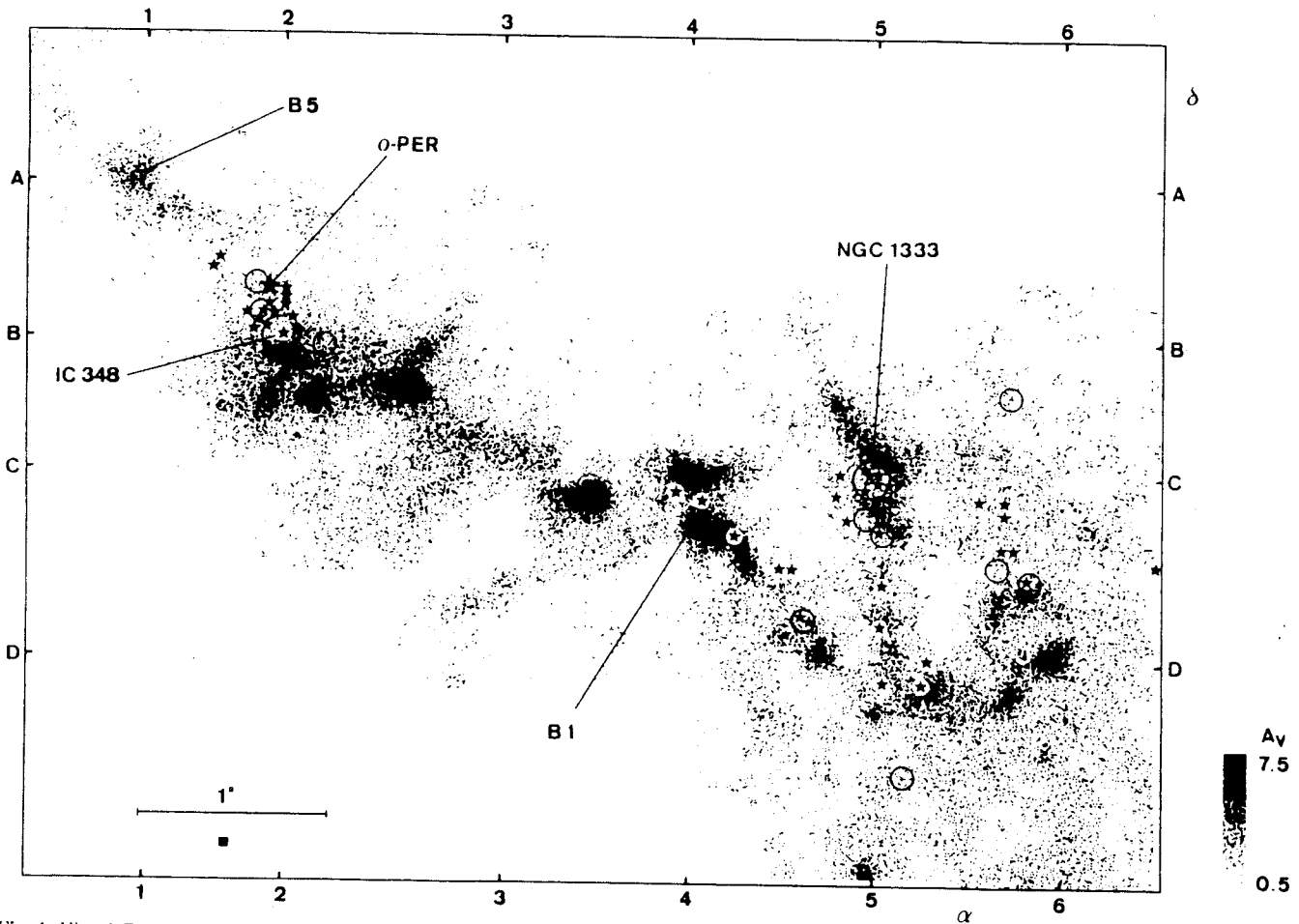

Fig. 1. Visual Extinction in the Perseus complex from star counts in the red prints of the Palomar Observatory Sky Survey (See Cernicharo and Bachiller, 1984, and Cernicharo et al., 1985). The spatial resolution of the counts is $2.5'$ (black square on the lower left corner). Stars represents the positions of the young stellar objects and circles are reflection nebulae. The ticks on the axes indicate the positions of the reference points where the transparent grids were centered: $\alpha(1) = 3^{\text{h}}44^{\text{m}}22.6^{\text{s}}$, $\alpha(2) = 3^{\text{h}}40^{\text{m}}50.7^{\text{s}}$, $\alpha(3) = 3^{\text{h}}35^{\text{m}}19.9^{\text{s}}$, $\alpha(4) = 3^{\text{h}}30^{\text{m}}39.8^{\text{s}}$, $\alpha(5) = 3^{\text{h}}25^{\text{m}}56.0^{\text{s}}$, $\alpha(6) = 3^{\text{h}}21^{\text{m}}15.5^{\text{s}}$, $\delta(A) = 32^{\circ}42'44''$, $\delta(B) = 31^{\circ}52'27''$, $\delta(C) = 31^{\circ}10'12''$, $\delta(D) = 30^{\circ}10'12''$.

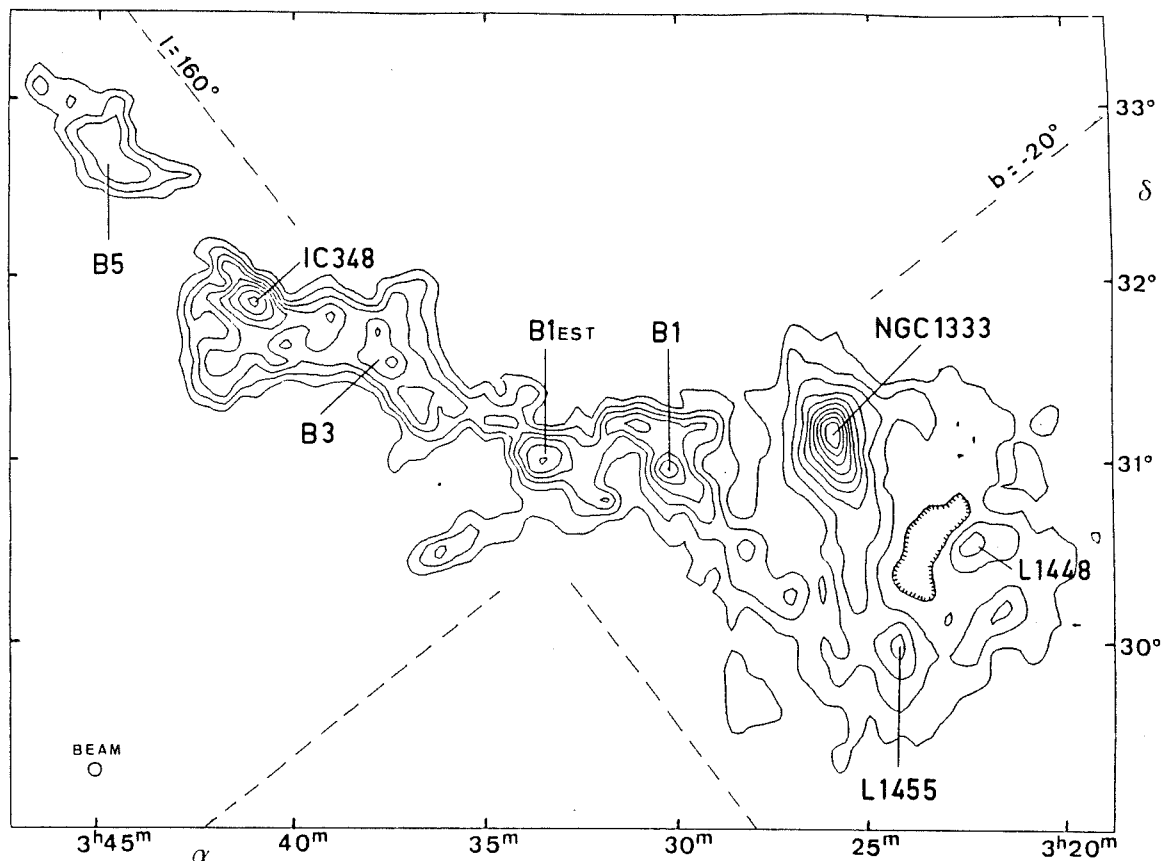

Fig. 2. Map of the integrated intensity of the ^{13}CO ($J = 1 - 0$) line in the Perseus complex. The angular resolution is $5'$. The lowest contour corresponds to 2 K km s^{-1} , contour interval is 2 K km s^{-1} . The positions of NGC 1333, B1, IC 348 and B5 are indicated

3 mag are visible in both maps, and the apparent thickness and shape of the fragments are in very good agreement. Differences arise only around IC 348 and NGC 1333 (big circles in Fig. 1) where star counts are contaminated by the presence of young stars and protostellar objects. As usual in molecular clouds, the sites of star formation correspond to CO maxima (see for example Fig. 1 of Sargent, 1979).

The distance, the mass and the density structure of the complex are discussed by Bachiller (1985) and Cernicharo et al. (1985). From the visual extinction map, we estimate the mass of the complex to be $\approx 1.7 \cdot 10^4 M_{\odot}$ (for a distance of 300 pc). The contour $A_V = 2 \text{ mag}$ divides the cloud in two zones with, roughly, the same mass. The fraction of mass in the dense cores ($A_V \geq 5 \text{ mag}$) is $\leq 10\%$ (Bachiller, 1985). Figure 2 does not contain information about the cloud kinematics. The radial velocity varies from clump to clump. Along the filamentary structure, the v_{LSR} of the clumps goes from $\approx 4 \text{ km s}^{-1}$ toward the West ($\alpha \approx 3^{\text{h}}22^{\text{m}}$, $\delta \approx 30^{\circ}30'$) up to $\approx 10 \text{ km s}^{-1}$ toward the East ($\alpha \approx 3^{\text{h}}45^{\text{m}}$, $\delta \approx 32^{\circ}45'$). This behaviour in radial velocity could be explained either by a rotation or by an expansion movement. This second possibility appears more suitable because it is in good agreement with the H I velocity structure observed by Sancisi (1974) at larger scales. A supernova explosion, a few 10^6 yr ago, could have been the origin of such an expansion. The Per OB2 association and the molecular cloud should have been formed during the collision of the expanding shell with an ambient H I cloud (a more detailed discussion on the Perseus velocity structure is given in Bachiller,

1985, and Bachiller and Cernicharo, 1986b).

Both Figs. 1 and 2 reveal a structure that was not obvious on the ^{12}CO maps (Sargent, 1979; Barrett et al., 1980; Baran, 1985). In fact, the CO emission is strongly saturated and does not match the cloud inner structure. The filamentary structure of the Perseus complex is clearly seen on both our maps. The main filament goes from B5 to B1 and L1455. Its direction makes an angle of about 60° with the galactic plane. As in other local clouds (Taurus, ρ Oph) the filaments are connected by a chain of globular condensations. Only two of these globules have been studied so far with high ($\approx 1'$) angular resolution: B5 by Young et al. (1982) and B1 by Bachiller and Cernicharo (1984). Recent observations of two more clumps, L1448 and L1455, will be presented elsewhere (Bachiller and Cernicharo, 1986a).

The number of positions where both ^{13}CO and A_V measurements are available is about 1200. For all these positions we have calculated the ^{13}CO column density under the assumption of LTE. Numerical simulations with the Bernes (1979) transfer program, which use a Monte Carlo method, show that the error in the determination of the ^{13}CO column density, in the LTE assumption, is no more than 20–30% in the range 10–20 K (see also Dickman, 1978; Snell, 1981). Given the low value of the ^{13}CO dipole moment, it is reasonable to assume that the $J = 1 - 0$ line is thermalized. Although CO was not observed in every position where ^{13}CO was, our CO observations extend over ≈ 3 square degrees and show that, outside the hot spots IC 348 and NGC 1333, the kinetic temperature is 10–12 K. The estimation of

^{13}CO column densities is almost insensitive to such uncertainties. ^{13}CO is optically thin toward most of the observed positions. However, around the condensations, the ^{13}CO opacity becomes high and saturation is important. We carried out C^{18}O observations mainly toward positions along the filament axes, where ^{13}CO is probably optically thick. The C^{18}O column densities are computed under the same assumptions as for ^{13}CO . One could think that C^{18}O is subthermally excited. However, large velocity gradient (LVG) calculations show that the first two C^{18}O rotational levels are thermalized for densities $\geq 3 \cdot 10^3 \text{ cm}^{-3}$. The mass of the Perseus gaseous complex is $1.7 \cdot 10^4 M_{\odot}$. Then assuming that the cloud is a cylinder of 6 pc long and of 2 pc radius, the mean density will be $\approx 4 \cdot 10^3 \text{ cm}^{-3}$. Hence, for most of the positions seen in C^{18}O , where the density is certainly higher than the mean value, the assumption of thermalisation for the C^{18}O levels seems reasonable.

Our correlations have been fitted in the usual least square sense, i.e. by minimizing the quantity $\sum [N(^{13}\text{CO})_i - aA_{V_i} - b]^2$, where $N(^{13}\text{CO})_i$ and A_{V_i} are individual values of column density and visual extinction, a and b are the slope and the $N(^{13}\text{CO})$ intercept of the fitted line. The correlation between ^{13}CO column density and visual extinction is plotted in Fig. 3. The regression line of $N(^{13}\text{CO})$ on A_V is given by:

$$N(^{13}\text{CO}) = (2.5 \pm 0.5) \cdot 10^{15} (A_V - 0.8 \pm 0.4)$$

where $N(^{13}\text{CO})$ is expressed in cm^{-2} and A_V in mag. We have eliminated the points around IC 348 and NGC 1333 where we

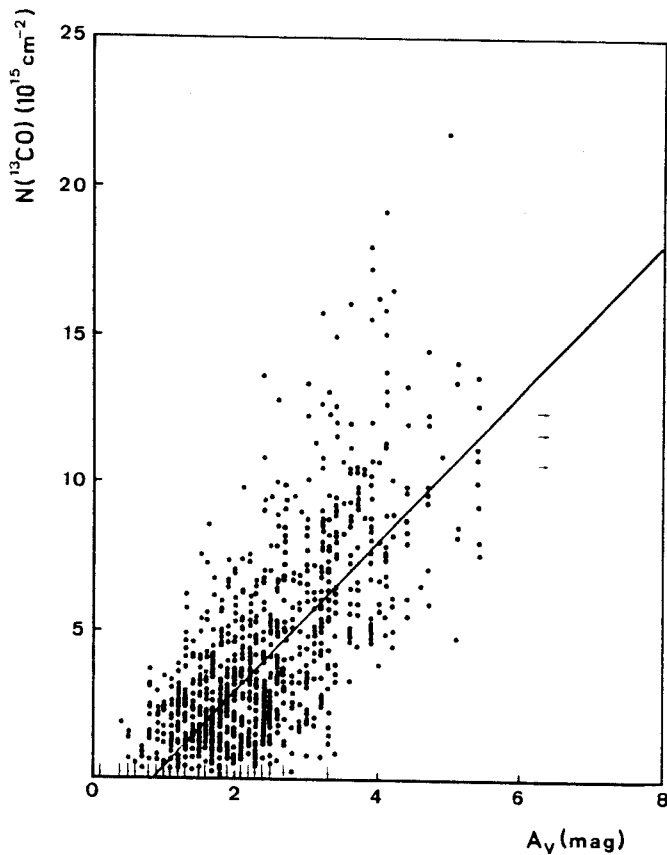

Fig. 3. The LTE column density $N(^{13}\text{CO})$ (in cm^{-2}) versus visual extinction A_V (in mag) relation in the Perseus complex. The solid line is the regression line of $N(^{13}\text{CO})$ on A_V : $N(^{13}\text{CO}) = 2.5 \cdot 10^{15} (A_V - 0.8)$. This relation has been derived from more than 1200 observed positions

lack of realistic values of A_V . The dispersion is important and it has a multiple origin: noise on star counts and spectra, errors in the determination of A_V and column densities, and finally, the variations in physical conditions (volume density, temperature, ultraviolet flux, ...) across the complex. In fact, the study of the local $^{13}\text{CO}/A_V$ correlation shows that the dispersion is lower in each restricted region. Points for the globule B5 and for the globule L1455 (= B202, B204, 1° South of NGC 1333) are displayed in Fig. 4. The individual correlation coefficients for both families of points are $\rho \approx 0.85$. Moreover, from Fig. 4, the $^{13}\text{CO}/A_V$ ratio seems different in each region, the slope of the least squares line is $(2.9 \pm 0.4) \cdot 10^{15} \text{ cm}^{-2} \text{ mag}^{-1}$ in B5 and $(2.0 \pm 0.3) \cdot 10^{15} \text{ cm}^{-2} \text{ mag}^{-1}$ in L1455. This difference could be of the same origin as the differences between the Taurus and Perseus global correlations (see the next section).

The relation between C^{18}O and A_V in the globule B1, where our map is complete, is plotted in Fig. 5 (the spectra are displayed in Bachiller and Cernicharo, 1984). The regression line of $N(\text{C}^{18}\text{O})$ on A_V is $N(\text{C}^{18}\text{O}) = 3.4 \cdot 10^{14} (A_V - 1.6)$. Our C^{18}O data are insufficient to allow the study of local correlations as we did for ^{13}CO . Note that C^{18}O becomes detectable only for $A_V \approx 1$ mag higher than the ^{13}CO detection limit.

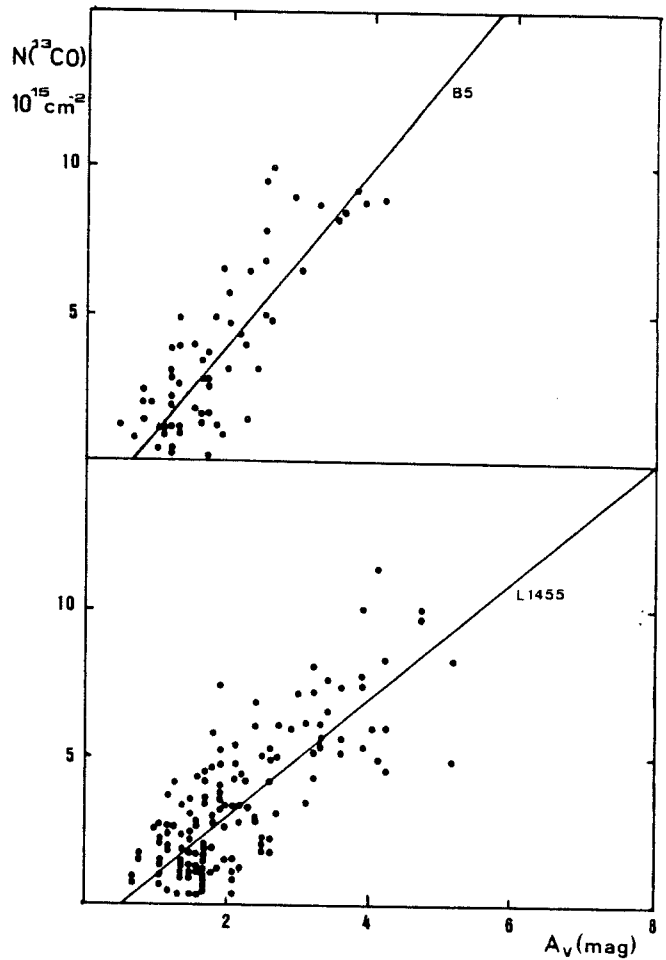

Fig. 4. The LTE column density $N(^{13}\text{CO})$ (in cm^{-2}) versus the visual extinction A_V (in mag) relation in the globule B5 and in L1455 (= B202, B204). The slope of the least squares line are $(2.9 \pm 0.4) \cdot 10^{15} \text{ cm}^{-2} \text{ mag}^{-1}$ in B5 and $(2.0 \pm 0.3) \cdot 10^{15} \text{ cm}^{-2} \text{ mag}^{-1}$ in L1455

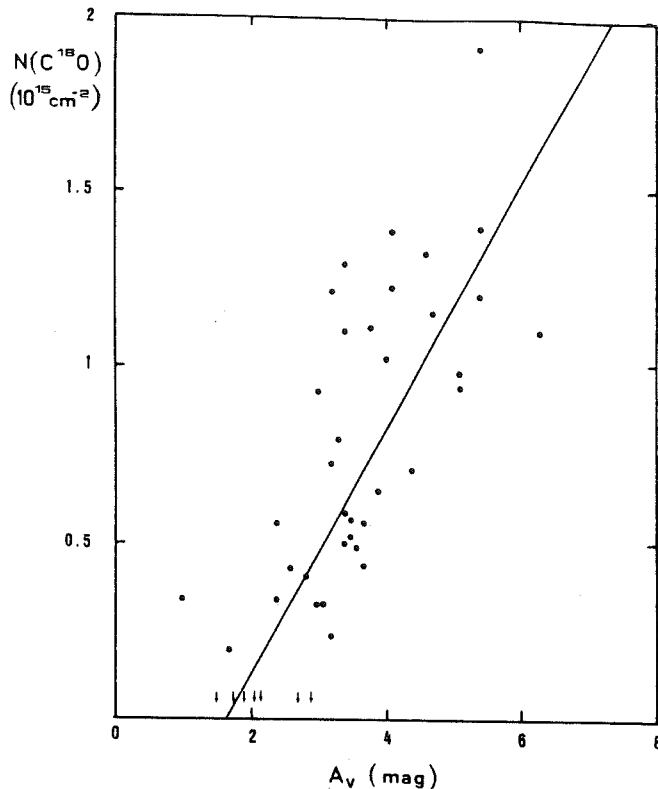

Fig. 5. The LTE column density $N(\text{C}^{18}\text{O})$ (in cm^{-2}) versus the visual extinction A_V (in mag) relation in the globule B1. The regression line of $N(\text{C}^{18}\text{O})$ on A_V is $N(\text{C}^{18}\text{O}) = 3.4 \cdot 10^{14} (A_V - 1.6)$.

The ratio $N(^{13}\text{CO})/N(\text{C}^{18}\text{O})$, normalized to the terrestrial value 5.5, as a function of $N(\text{C}^{18}\text{O})$ is plotted in Fig. 6. Each point results from an average of $N(\text{C}^{18}\text{O})$ over a 10^{14}cm^{-2} wide interval. It appears that the double isotopic ratio $^{13}\text{CO}/\text{C}^{18}\text{O}$ depends on the gas column density in the cloud and remains higher than the terrestrial value for $A_V \approx 2-6$ mag. The reasons for these isotopic alterations are discussed in the next section.

The main results of the observations are that the ^{13}CO and C^{18}O column densities increase linearly with A_V in the range $1-2 \text{ mag} \leq A_V \leq 5 \text{ mag}$. For $A_V \geq 5 \text{ mag}$, saturation effects in ^{13}CO may be important. Moreover, "star counts saturation", due to the small number of stars in the field of view, is also important for $A_V \geq 5 \text{ mag}$. Saturation in C^{18}O is much less important, but the $\text{C}^{18}\text{O}/A_V$ correlations may be affected by the "star counts saturation". The isotopic ratio $^{13}\text{CO}/\text{C}^{18}\text{O}$ decreases with A_V in the range $A_V \approx 2-6 \text{ mag}$.

4. Discussion

The abundances of carbon monoxide isotopes have been the object of many recent studies (Dickman, 1976; Langer, 1976, 1977; Gerola and Glassgold, 1978; Federman et al., 1980; Graedel et al., 1982; FLW). The formation of CO is believed to be initiated by the radiative association reaction $\text{C}^+ + \text{H}_2 \rightleftharpoons \text{CH}_2^+ + h\nu$ and by reaction of H_3^+ with C and O. These reactions produce, probably, CO via the formation of the neutral species CH, CH_2 , OH, and H_2O . In the external regions of molecular clouds, CO is destroyed by photodissociation by ultraviolet radiation. In

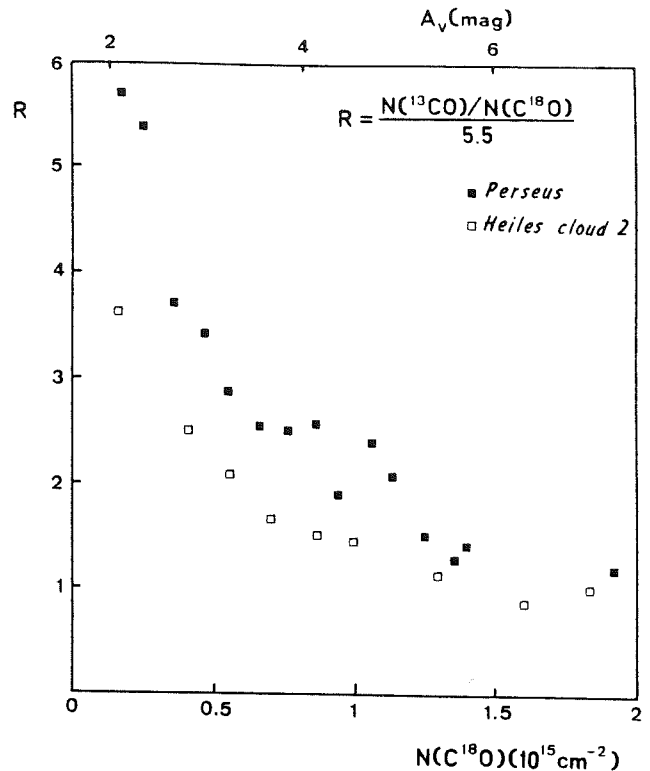

Fig. 6. The ratio of the ^{13}CO and C^{18}O LTE column densities normalized to the terrestrial value (5.5) is plotted versus $N(\text{C}^{18}\text{O})$ (in cm^{-2}). Each point results from an average of $N(\text{C}^{18}\text{O})$ over a 10^{14}cm^{-2} wide interval. The filled squares are the R values for Perseus (C^{18}O data from Bachiller, 1985, were also considered). The open squares are the corresponding values for Heiles cloud 2 (data from CG). In the upper horizontal axis we indicate the visual extinctions (in mag) calculated from $N(\text{C}^{18}\text{O})$. $^{13}\text{CO}/\text{C}^{18}\text{O}$ ratios significantly higher than the terrestrial value are observed for $A_V < 4 \text{ mag}$. Moreover, the same value of R is reached in Perseus about 1-1.5 mag deeper into the cloud than for Heiles cloud 2 (see text for interpretation).

interior regions where the ultraviolet radiation is shielded, destruction of CO occurs by dissociative reactions with ions, particularly He^+ . In the inner regions, where the ultraviolet photons do not penetrate, most of the carbon is, probably, in the form of CO (Graedel et al., 1982). However, theoretical calculations seem to indicate that, in molecular cloud interiors, CO condenses on dust grains (Léger, 1983).

For $A_V \geq 5 \text{ mag}$ we do not have any evidence of a CO abundance decrease in the inner regions of the clouds. Thus the condensation of CO on dust grains suggested by Léger (1983) may be countered by some process which removes molecules from grains (see Léger et al., 1985).

Two processes have been invoked for altering the isotopic ratios. First, chemical fractionation originated by the reaction $\text{CO} + ^{13}\text{C}^+ \rightleftharpoons ^{13}\text{CO} + \text{C}^+ + 35 \text{ K}$ (Watson et al., 1976) enhances the $^{13}\text{CO}/\text{CO}$ ratio in regions of $T_K < 35 \text{ K}$. Second: in the outer regions of clouds, the more abundant isotopic species could be self-shielded from ultraviolet radiation at a visual extinction lower than for the rarer species. This "selective photodissociation" should reduce the abundances of the rarer species (Bally and Langer, 1982). Chu and Watson (1983) have shown that, for a temperature of 20 K, the $^{13}\text{CO}/\text{CO}$ ratio is not strongly

Table 1

Cloud	$N(^{13}\text{CO})$ (cm^{-2})	$N(\text{C}^{18}\text{O})$ (cm^{-2})	Reference
ρ Oph	$2.5 \cdot 10^{15} A_V$		a
L134	$3.8 \cdot 10^{15} A_V$		b
Dark cloud			
sampling	$2.0 \cdot 10^{15} A_V$		c
L43	$1.5 \cdot 10^{15} A_V$		d
Taurus	$1.4 \cdot 10^{15} (A_V - 1.0)$ ($1 < A_V < 5$)	$0.7 \cdot 10^{14} (A_V - 1.9)$ ($2 < A_V < 4$)	e
ρ Oph	$2.7 \cdot 10^{15} (A_V - 1.6)$ ($4 < A_V < 15$)	$1.7 \cdot 10^{14} (A_V - 3.9)$ ($4 < A_V < 15$)	e
Heiles cloud 2	$1.3 \cdot 10^{15} (A_V - 0.5)$	$2.5 \cdot 10^{14} (A_V - 1.5)$	f
L1495	$2.0 \cdot 10^{15} (A_V - 0.5)$	$2.2 \cdot 10^{14} (A_V - 1.1)$	g
Perseus	$2.5 \cdot 10^{15} (A_V - 0.8)$		h

References: (a) Encrenaz et al., 1975; (b) Tucker et al., 1976; (c) Dickman, 1978; (d) Elmegreen and Elmegreen, 1976; (e) FLW; (f) CG; (g) Duvert et al., 1985; (h) This work

altered by selective photodissociation since chemical fractionation is a faster process. However, selective photodissociation could increase the CO/C¹⁸O ratio by a factor of 2 in the region of $A_V \approx 1-2$ mag. These results have been confirmed by the recent calculations of Glassgold et al. (1985a).

4.1. Comparison with previous works

The values found in the literature for the $^{13}\text{CO}/A_V$ ratio are widespread. They are summarized in Table 1. Different values, ranging from $1.3 \cdot 10^{15}$ to $3.8 \cdot 10^{15} \text{cm}^{-2} \text{mag}^{-1}$ were deduced for different clouds. Dickman (1978) derived $1.9 \cdot 10^{15} \text{cm}^{-2} \text{mag}^{-1}$ for a large sample of local dark clouds (see also Dickman and Clemens, 1983).

FLW have compared observations of the CO isotopes and visual extinction in Taurus and ρ Oph. They have derived visual extinction were determined for lines of sight toward stars within gas-dust correlation up to 20 mag. However, their results must be regarded with caution for two main reasons: 1. the visual extinction were determined for lines of sight toward stars within the radio beam, and are not averaged values over the beam. 2. their data have a poor statistical significance because of the relatively few positions studied. In ρ Oph, the FLW results are different from those of Encrenaz et al. In Taurus, the C¹⁸O/ A_V ratio found by FLW in the range $A_V = 2-4$ mag disagrees with that of CG. It seems possible that these differences are a consequence of the reduced sampling of FLW.

The thresholds of 0.8 mag and 1.6 mag for the observation of ^{13}CO and C¹⁸O may be due to (i) photodissociation in the external regions of the cloud and (ii) subthermal excitation in these external layers. As pointed out by CG it is very hard to discriminate between these two effects. If the UV field is stronger in the North-East boundary of the Perseus cloud (see Sect. 4.2), one could expect the thresholds to be greater in Perseus than in other clouds. We can notice that our C¹⁸O/ A_V correlation (Fig. 5) is referred to B1, a globule far away from the Per OB2 stars (see Figs. 1 and 2) in which the UV field is probably normal. It is hence not surprising to find here a C¹⁸O threshold comparable to that of Heiles cloud 2. For ^{13}CO , the threshold we find (0.8 ± 0.4 mag) is somewhat higher than the value of 0.5 mag reported

by CG for Heiles cloud 2. However, the scatter of ^{13}CO measurements at low A_V does not allow to conclude about the significance of this difference.

From Figs. 3 and 5 it is possible to say that, in Perseus, ^{13}CO becomes detectable at $A_V = 0.8$ mag. For C¹⁸O, the threshold is $A_V \approx 1.6$ mag. For Heiles cloud 2 CG have obtained 0.5 mag and 1.5 mag respectively. FLW have found similar thresholds in Taurus. However, in ρ Oph, FLW argued that C¹⁸O becomes detectable at $A_V \approx 4$ mag, and that the ^{13}CO column density remains small for $A_V < 4$ mag and then rises sharply similar to $N(\text{C}^{18}\text{O})$. This effect in ρ Oph is probably due to the under-sampling of FLW.

4.2. Variations in the $^{13}\text{CO}/A_V$ ratio from cloud to cloud

The $^{13}\text{CO}/A_V$ ratio for Perseus is among the highest determined up to now. In addition, from Table 1 and Fig. 4, it appears that, variations of the $^{13}\text{CO}/A_V$ ratio occur from one cloud to another. Differences in calibration could give account, at least partially, for these variations.

The CG data in Heiles cloud 2 were calibrated in the same way as ours, and with the same reference sources as calibrators. The calibration errors never exceeded 20%. Hence, the difference of a factor of 2 found in the $^{13}\text{CO}/A_V$ ratio between Heiles cloud 2 and Perseus (see Table 1) must have another origin than calibration

These observed variations in the $^{13}\text{CO}/A_V$ ratio could be understood as a result of the different local conditions in the clouds. In the particular case of Heiles cloud 2 and Perseus, the differences could arise from a combination of three effects:

1. For large A_V the ^{13}CO opacities in Heiles cloud 2 are greater than those of Perseus: the ^{13}CO lines in Heiles cloud 2 present dramatic effects of saturation and even self-reversed profiles are observed by CG. This is not the case for Perseus. Hence, for $A_V \approx 4-6$ mag, underestimates of column densities due to LTE model are more important in Heiles cloud 2 than in Perseus.

2. CG have suggested that a massive envelope surrounds the Taurus clouds. In this envelope, the density is $\approx 3 \cdot 10^2 \text{cm}^{-3}$, and ^{13}CO is subthermally excited and could absorb the radiation of

the cores. Under these conditions, LTE will also produce important underestimates of the actual column densities. Note that the Perseus regions which seem to exhibit the lowest $^{13}\text{CO}/A_V$ ratios are globules SW from NGC 1333. These globules appear to be embedded in an envelope extending over a large area in the sky (see Figs. 1 and 2).

3. The OB association PerOB2 lies in the vicinity of the Perseus complex. So that we suspect the ultraviolet radiation field to be stronger in Perseus than in Heiles cloud 2. In fact, bright nebulae are visible, on the prints of the Palomar Sky Survey, at the North-East region of the cloud, and a weak extended H II region related to the OB association was detected by Sivan (1974). The increase of the ultraviolet radiation in this particular region is also implicated by the IRAS SKYFLUX maps. Strong $60\mu\text{m}$, $100\mu\text{m}$ emission was detected by IRAS in the North-East region of the cloud, near the PerOB2 association. Assuming that this far infrared radiation is emitted by the dust, which is heated by the ambient ultraviolet field, Bachiller (1985) has estimated that the local ultraviolet flux is 10–100 times stronger than the average interstellar ultraviolet flux. This enhancement factor is in agreement with the expectations from the apparent location of the OB stars with respect to the cloud, and with ammonia measurements of the gas temperature (Bachiller et al., 1986).

For a cloud with a temperature of 10 K and a density of 10^3cm^{-3} , in a typical interstellar field, the ^{13}CO enhancement by chemical fractionation peaks at $A_V \approx 1$ mag (see Fig. 2 of Langer, 1976). For Perseus, if the ultraviolet field is richer, important ^{13}CO enhancement will occur deeper into the cloud. For $A_V \geq 1$ mag, ^{13}CO should be more enhanced in Perseus than in Heiles cloud 2. The $^{13}\text{CO}/A_V$ ratio should be greater in Perseus, and this effect will be more pronounced in the North-East region of the cloud, near the OB stars. This expected behaviour is in good agreement with our observations: in fact we observe that (i) the $^{13}\text{CO}/A_V$ ratio in Perseus is twice the Heiles cloud 2 value and (ii) the $^{13}\text{CO}/A_V$ ratio seems greater in the North-East region of Perseus (around B5) than in other regions (for example L1455, see Fig. 4).

Obviously, the isotopic fractionation mechanism is operative in the cloud regions which are not too warm ($T_K < 35\text{K}$) (see Glassgold et al., 1985a, for calculations at 20 K including selective photodissociation).

4.3. The $^{13}\text{CO}/\text{C}^{18}\text{O}$ ratio

Figure 6 shows that the normalized ratio $R = N(^{13}\text{CO})/N(\text{C}^{18}\text{O})/5.5$ increases strongly toward the cloud edge. This behaviour cannot be explained only in terms of ^{13}CO saturation. Actually, from Fig. 3 it appears that ^{13}CO increases linearly with A_V in the range 1–5 mag. The ^{13}CO saturation is important for $A_V \geq 4$ –5 mag, but certainly not in the region of $A_V < 4$ mag where we observe a sharp decreasing in the value of R .

Glassgold et al. (1985a) have studied the photodissociation of the CO isotopes as a function of the depth into a molecular cloud. They have estimated the CO self-shielding and shielding of H_2 lines. Their calculations show that the normalized $^{13}\text{CO}/\text{C}^{18}\text{O}$ column density ratios are significantly greater than 1 for $A_V \approx 1$ mag, in addition, values greater than 1 persist for $A_V > 2$ mag. In particular, for a cloud with density of 300cm^{-3} and a temperature of 20 K, they find that R decreases from ≈ 10 to ≈ 3 in the range $A_V \approx 1$ –2 mag (see their Fig. 11). For a colder

cloud (for example $T_K = 10\text{K}$) chemical fractionation must increase the value of R very efficiently. In Perseus $T_K \approx 10$ –12 K from CO observations, but the $A_V < 2$ mag region could be hotter (Young et al., 1982; Bachiller, 1985). In Perseus, the ultraviolet flux is stronger than the typical interstellar flux, we must also expect a large value of R in the $A_V \approx 1$ –2 mag range. We have found $R \approx 5.5$ for $A_V \approx 2$ mag. Given the uncertainties on the cloud parameters (temperature, density, ultraviolet flux, inhomogeneities), the agreement of our data with the theoretical models of Glassgold et al. (1985a) seems reasonable.

In Fig. 6 we display also the value of R in Heiles cloud 2 (data from CG). In the range $A_V \approx 2$ –6 mag, R remains greater in Perseus than in Heiles cloud 2. This behaviour is a consequence of the reasons discussed above. The two diagrams coincide in the $A_V \approx 2$ –4 mag region, when that of Heiles cloud 2 is shifted by about 1–1.5 mag in the direction of the increasing A_V . In other words: the same value of R is reached in Perseus about 1–1.5 mag deeper into the cloud. If this difference was due only to the ultraviolet field, the required ultraviolet flux in Perseus should be ≈ 10 –100 times that of Heiles cloud 2 (Glassgold et al., 1985b; see also Figs. 2 and 3 of Chu and Watson, 1983). This value is in agreement with the estimates of Bachiller (1985) from optical and infrared (IRAS) data. In the $A_V > 5$ mag region of the diagram, the Heiles cloud 2 ratios remain somewhat lower than the Perseus ones due to the more important ^{13}CO saturation effects in the former cloud.

McCutcheon et al. (1980) have determined R values ≈ 3 –5 in the vicinity of a B0 V star in IC5146 where the ultraviolet field is increased by the stellar radiation. Their values are in good agreement with those observed in the Perseus $A_V = 2$ –4 mag zone.

5. Conclusions

From two maps, one of visual extinction and one of ^{13}CO ($J = 1 - 0$) emission, of the local complex of dark clouds in Perseus, we have determined the regression line of $N(^{13}\text{CO})$ on A_V for the range $1\text{ mag} < A_V < 5\text{ mag}$

$$N(^{13}\text{CO}) = (2.5 \pm 0.5) 10^{15} (A_V - 0.8 \pm 0.4)$$

where $N(^{13}\text{CO})$ is the LTE column density measured in cm^{-2} and A_V the visual extinction in mag. From a C^{18}O map of the globule B1 we have estimated: $N(\text{C}^{18}\text{O}) = 3.4 10^{14} (A_V - 1.6)$.

The $^{13}\text{CO}/A_V$ ratio differs by a factor of 2 from the result found by Cernicharo and Guélin (1986) in Heiles cloud 2. Furthermore, different regions in Perseus seem to exhibit different $N(^{13}\text{CO})/A_V$ ratios.

We suggest that these variations could result from the different local conditions in clouds. In particular, differences in the ultraviolet fields, and in the saturation effects of the ^{13}CO lines for large A_V could explain such variations.

C^{18}O is not affected by isotopic fractionation nor by saturation in the range of visual extinction considered here. However, the observed differences in the ^{13}CO abundance in local dark clouds is within a factor of 2. The modicity of this factor (in comparison with other uncertainties in cloud mass calculations) and the intensity of the ^{13}CO lines (≥ 5 times stronger than the C^{18}O lines) make ^{13}CO the best gas tracer for extended molecular clouds. The Dickman ratio $N(^{13}\text{CO})/A_V \approx 2 10^{15} \text{cm}^{-2} \text{mag}^{-1}$ represents a good average of the individual values in different molecular clouds.

Acknowledgements. It is a pleasure to thank Drs. A.E. Glassgold, M. Guélin and A. Omont for helpful discussions and suggestions. We are also grateful to the staff of the Bordeaux Observatory for their considerable assistance during the observations. Finally, we would like to thank the referee, R.L. Snell, for his constructive criticism and useful comments.

References

- Bachiller, R.: 1985, Thèse d'Etat, Université Grenoble I
- Bachiller, R., Cernicharo, J.: 1984, *Astron. Astrophys.* **140**, 414
- Bachiller R., Cernicharo, J.: 1986a, *Astron. Astrophys.* (in press)
- Bachiller, R., Cernicharo, J.: 1986b, *Astron. Astrophys.* (in preparation.)
- Bachiller, R., Guilloteau, S., Kahane, C.: 1986, *Astron. Astrophys.* (submitted)
- Bally, J., Langer, W.D.: 1982, *Astrophys. J.* **255**, 143
- Baran, G.P.: 1985, Ph.D. dissertation, Columbia University
- Barrett, J.W., de Zafra, R.L., Sanders, D.B., Solomon, P.M.: 1980, *IAU Symposium* No. 87, 185
- Baudry, A., Cernicharo, J., Pérault, M., Despois, D., De la Noë, J.: 1981, *Astron. Astrophys.* **104**, 101
- Bernes, C.: 1979, *Astron. Astrophys.* **73**, 67
- Bohlin, R.C., Savage, B.D., Drake, J.F.: 1978, *Astrophys. J.* **224**, 132
- Cernicharo, J., Bachiller, R.: 1984, *Astron. Astrophys. Suppl. Ser.* **58**, 327
- Cernicharo, J., Bachiller, R., Duvert, G.: 1985, *Astron. Astrophys.* **149**, 273
- Cernicharo, J., Guélin, M.: 1986, *Astron. Astrophys.* (in press)(CG)
- Chu, Y.H., Watson, W.D.: 1983, *Astrophys. J.* **267**, 151
- Dickman, R.L.: 1976, Ph.D. dissertation, Columbia University
- Dickman, R.L.: 1978a, *Astron. J.* **83**, 363
- Dickman, R.L.: 1978b, *Astrophys. J. Suppl.* **37**, 407
- Dickman, R.L., Clemens, D.P.: 1983, *Astrophys. J.* **271**, 143
- Duvert, G., Cernicharo, J., Baudry, A.: 1986, *Astron. Astrophys.* **164**, 2.
- Elmegreen, D.M., Elmegreen, B.G.: 1979, *Astron. J.* **84**, 615
- Encrenaz, P.J., Falgarone, E., Lucas, R.: 1975, *Astron. Astrophys.* **44**, 73
- Federman, S.R., Glassgold, A.E., Jenkins, E.B., Shaya, E.J.: 1980, *Astrophys. J.* **242**, 545
- Frerking, M.A., Langer, W.D., Wilson, R.W.: 1982, *Astrophys. J.* **262**, 590 (FLW)
- Gerola, H., Glassgold, A.E.: 1978, *Astrophys. J. Suppl.* **37**, 1
- Glassgold, A.E., Huggins, P.J., Langer, W.D.: 1985a, *Astrophys. J.* **290**, 615
- Glassgold, A.E., Huggins, P.J., Langer, W.D.: 1985b, private communication
- Graedel, T.E., Langer, W.D., Frerking, M.A.: 1982, *Astrophys. J. Suppl.* **48**, 321
- Langer, W.D.: 1976, *Astrophys. J.* **206**, 699
- Langer, W.D.: 1977, *Astrophys. J. Letters* **212**, L39
- Léger, A.: 1983, *Astron. Astrophys.* **123**, 271
- Léger, A., Jura, M., Omont, A.: 1985, *Astron. Astrophys.* **144**, 147
- McCutcheon, W.H., Dickman, R.L., Shuter, W.L.H., Roger, R.S.: 1980, *Astrophys. J.* **237**, 9
- Sancisi, R.: 1974, *IAU Symp.* **60**, 115
- Sargent, A.I.: 1979, *Astrophys. J.* **233**, 163
- Sivan, J.P.: 1974, *Astron. Astrophys. Suppl.* **16**, 163
- Snell, R.L.: 1981, *Astrophys. J. Suppl.* **45**, 121
- Tucker, K.D., Dickman, R.L., Encrenaz, P.J., Kutner, M.L.: 1976, *Astrophys. J.* **210**, 679
- Watson, W.D., Anicich, V.G., Huntress, W.T.: 1976, *Astrophys. J. Letters* **205**, L165
- Young, J.S., Goldsmith, P.F., Langer, W.D., Wilson, R.W., Carlson, E.R.: 1982, *Astrophys. J.* **261**, 513

I.16) LA REGION ATOUR DE O-PER

I.16) LA REGION AROUND DE o-PER

Nous avons observé avec une résolution $\approx 1'$ l'émission de CO et ^{13}CO autour de l'étoile B1III o-Per. Le nuage moléculaire présente un "trou" près de la position de l'étoile dans lequel la température cinétique est élevée. Il est tentant de penser que o-Per est à l'origine de ce "trou" d'émission moléculaire. Le chauffage observé au bord du nuage, les données optiques, infrarouges (IRAS), et les observations des raies de recombinaison du carbone suggèrent toutefois que le champ ultraviolet local n'est amplifié par o-Per tout au plus que par un facteur 10-100. o-Per devrait être située au moins à quelques pc du nuage moléculaire pour pouvoir causer le trou observé. Celui-ci ne paraît aligné avec l'étoile que par hasard. D'autres étoiles OB voisines (principalement BD+31°643, τ Per, et X Per) pourraient contribuer plus que o-Per elle-même, à un renforcement du champ ultraviolet. Ce renforcement semble s'étendre sur plusieurs degrés vers le bord Nord-Est du nuage moléculaire de Persée.

The vicinity of Omicron Per

R. Bachiller^{1,2}, J. Cernicharo¹, P. Goldsmith³, and A. Omont¹

¹ Groupe d'Astrophysique de l'Observatoire de Grenoble, Université Scientifique et Médicale de Grenoble, CERMO B.P. 68, F-38402 St. Martin D'Hères Cedex, France, U.A. 708 du CNRS

² Centro Astronómico de Yebes, O.A.N., Apartado 148, E-19080 Guadalajara, Spain

³ F.C.R.A.O., Univ. of Massachusetts, Amherst, MA 01003, USA

Received February 3, accepted April 17, 1987

Summary. We have mapped the region around the B1 III star σ Per (HD 23180) in the emission of the $J = 1 - 0$ and $J = 2 - 1$ lines of ^{12}CO and ^{13}CO with ≈ 1 arcmin resolution. The molecular cloud morphology suggests the presence of a warm hole near the position of the star. It is tempting to think that σ Per is the cause of this molecular gap. However, the observed heating of the cloud edge, as well as optical, infrared (IRAS) and carbon recombination line data, all suggest that the local ultraviolet field is enhanced only by a factor 10-100. Therefore σ Per must be located at least a few parsecs away from the cloud, and the precise alignment of the observed hole with the star is probably mainly due to chance. Furthermore, other neighbouring OB stars (mainly BD + 31°643, ζ Per and X Per) could contribute appreciably (even more than σ Per) to the ultraviolet enhancement which seems extend over several degrees on the north-east edge of the Perseus local molecular cloud.

Key words: dark clouds - interstellar molecules - molecular abundances

1. Introduction

The local Perseus dust complex extends over ≈ 15 degrees on the sky and includes bright clouds (as the California nebula) as well as very opaque globules (B 1, B 5, L 1455, L 1448, ...). Within the clouds there are young low mass objects in abundance (*T* Tauri stars, IR sources, HH objects, ...), presenting their major concentration in two foci (NGC 1333 and IC 348). Furthermore, it is believed that the nearby Per OB 2 association was formed from the same complex.

The rich star formation activity in this region and its proximity (about 300 pc from the Sun, which allows a good spatial resolution in the observations) make the Perseus complex a very suitable region to study in detail the cloud structure and the interaction between clouds and young stars. For that reason, the complex was extensively mapped in visual extinction by star counting (McCuskey, 1938; Cernicharo and Bachiller, 1984; Cernicharo et al., 1985), in the centimetric lines of OH and H I (Sancisi, 1974), in the $J = 1 - 0$ line of ^{12}CO (Sargent, 1979;

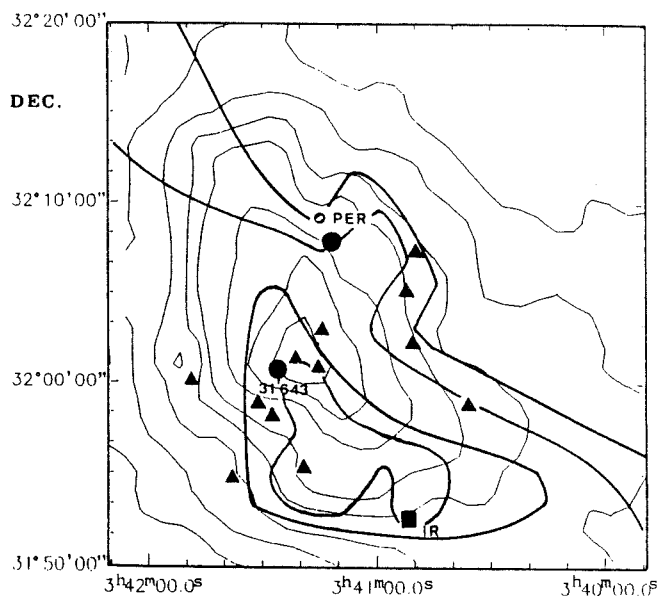

R. A.

Fig. 1. Overview of the region around σ Per. Thick contours: CO peak antenna temperature (4, 10, 10 and 24 K) from Baran (1985). Thin contours: Flux density at $100\ \mu\text{m}$ from the IRAS SKYFLUX data (levels are 50, 70, 100, 150, 200, 300, 400 and $500\ \text{MJy sr}^{-1}$). Triangles are H α emission stars (positions from Strom et al., 1974). The symbol \blacksquare represents the $2\ \mu\text{m}$ source detected by Strom et al. (1974). The positions of the B stars σ Per and BD + 31°643 are also indicated

Barrett et al., 1980; Baran, 1985), and in the $J = 1 - 0\ ^{13}\text{CO}$ line (Bachiller and Cernicharo, 1986). Moreover, several interesting regions were mapped with high angular resolution in many molecular lines (see Bachiller, 1985, for a review).

From the large-scale kinematic study of Sancisi (1974) (developed later by Sargent, 1979, and Bachiller, 1985) it appears probable that the Per OB 2 association and the dust cloud were formed in the collision of a gaseous expanding shell (probably produced by a supernova explosion) with an ambient H I cloud. The active star formation sites IC 348 and NGC 1333 may have been formed by the action of the OB star winds on the parent cloud or by clump-clump collisions (as suggested by Loren, 1976, for the NGC 1333 region).

Among the numerous clouds and young stars related to the Perseus region, the star σ Per stands out since it is one of the

Send offprint requests to: R. Bachiller²

brightest ($V = 3.82$ mag). This B1 III star is moderately reddened ($E(B - V) = 0.31$ mag) and is seen projected on an edge of the molecular complex.

In spite of the considerable work devoted to study this attractive region, the relation of the star σ Per with the dust complex and with the two stellar groups (Per OB 2 association and IC 348 cluster) remains unclear. σ Per is located 2° away from the Per OB 2 center, and about $10'$ north from IC 348. Assuming that the absolute magnitude for a B1 III star is $M_V = -4.4$ mag (Schmidt-Kaler, 1982) and that the ratio of total to selective absorption is $R = A_V/E(B - V) \approx 3$ we obtain a distance to σ Per of 280 ± 50 pc, the uncertainty arising mainly from the inaccuracy in the absolute calibration for stars of this spectral type. The distance of the Per OB 2 association (Borgman and Blaauw, 1964) and of the IC 348 cluster (Strom et al., 1974) is ≈ 300 pc. However, although the distances of σ Per, Per OB 2 and IC 348 are comparable, a comparison of the σ Per proper motion with those of the Per OB 2 and IC 348 stars (see Delhaye and Blaauw, 1953, and Fredrick 1956, respectively) makes the possible connexion of σ Per with the two stellar groups doubtful.

The position of the star with respect to the cloud is also uncertain. σ Per has a color excess $E(B - V) = 0.31$ mag and the material in front of the star, which has been the object of several studies in the visible and in the ultraviolet (Chaffee, 1974; Snow, 1976; Federman, 1980; Hobbs, 1981), appears to be moderately dense ($n_{\text{H}_2} \approx 100 \text{ cm}^{-3}$) and warm ($T_K \approx 100$ K). The H II column density in front of the star is not too high ($N(\text{H II}) \approx 6 \cdot 10^{19} \text{ cm}^{-2}$; Snow, 1976).

Relatively few radio observations of the σ Per vicinity have been carried out. On the CO $J = 1 - 0$ maps of Crutcher (1976), Sargent (1979) and Baran (1985) the star appears to be located in a kind of gap or tear of a few arcmin wide. As the cloud and the star are located at comparable distances, it is tempting to assume that the star is embedded in the cloud edge, and that the tear has been created by the star. This idea is reinforced by the study of Snow (1976) based on Copernicus data. However, Crutcher (1977), analyzing carbon recombination line observations, claimed that the star is located behind the cloud and happens to be visible because of a fortuitous coincidence in position with a hole in the foreground cloud.

The contradiction between these two studies showed that new and more sensitive observations of the vicinity of σ Per were needed. In order to study the relation between σ Per and the Perseus gas complex, we have observed millimeter $J = 1 - 0$ and $J = 2 - 1$ lines of CO and ^{13}CO , with $\approx 1'$ angular resolution around σ Per. Observation of all these four lines should allow us to trace some physical parameters in the molecular cloud, and hence to study if the gas seen around the line of sight of σ Per is influenced by the presence of the star.

The instrumentation is described in Sect. 2. The results from our CO observations are reported in Sect. 3. Sect. 4 deals with the structure of the ionized material around σ Per. Finally, in Sect. 5, we discuss the causes of the heating of the cloud boundary.

2. Observations

The observations of the CO and ^{13}CO $J = 1 - 0$ lines were carried out with the 13.7-m radiotelescope of the Five College Radio Astronomy Observatory (FCRAO) in New Salem, Massachusetts, in April 1983. The half power beamwidth of the FCRAO

antenna was $0.8'$ at 115 GHz, its efficiency on extended sources was close to 0.6. The receiver was a cooled Schottky diode mixer with a single sideband filter and cooled image load. The spectrometer consisted of a filter bank of 256 channels of 100 kHz width (0.26 km s^{-1} at 115 GHz). The receiver noise temperature was about 200 K (SSB).

The CO and ^{13}CO $J = 2 - 1$ data were obtained with the 4.9-m telescope of the Millimeter Wave Observatory near Fort Davis, Texas, also in April 1983. The antenna HPBW was $1.1'$ and the efficiency on extended sources about 0.8. The receiver was a cooled Schottky diode mixer with a noise temperature of about 1500 K (SSB), which was followed by a filter bank of 128 channels of 250 kHz width (0.33 km s^{-1} at 230 GHz). The observations with both telescopes were made in a frequency switching mode and were calibrated by the chopper wheel method. We mapped the CO and ^{13}CO $J = 1 - 0$, $J = 2 - 1$ lines around the position of σ Per with a $1.1'$ spacing. All the spectra are shown in Fig. 2a,b,c,d.

In order to study the large scale structure of the molecular cloud we observed recently (December 1986) the CO $J = 2 \rightarrow 1$ line with the new POM II 2.5-m radiotelescope of the Grenoble Observatory at Plateau de Bure (France). The telescope has been described by Lucas et al. (1987). The HPBW was $2.2'$ at 230 GHz and the efficiency on extended sources about 0.7. The telescope was equipped with a cooled Schottky receiver of 500 DSB noise temperature. The spectrometer was an autocorrelator which gave velocity resolution of 0.20 km s^{-1} at this frequency. The observations were carried out by frequency switching. The spectra are shown in Fig. 2e.

Carbon recombination lines were observed with the Nançay radiotelescope. The antenna, which has a Kraus-type mounting, allows observation of σ Per for 60 min around its culmination. The HPBW was $3.9' \times 19'$ at the frequency of C 158 α (1651.541 MHz). The cooled receiver had a noise temperature of 40 K and the spectrometer was an autocorrelator which was split into 4 bands of 256 channels of 0.8 kHz width (0.14 km s^{-1} at 1670 MHz). Four recombination lines (C 156 α to C 159 α) were observed simultaneously with frequency switching. The spectrum displayed in Fig. 3 was obtained by averaging of the 4 individual spectra, in order to improve the signal to noise ratio. Nevertheless, as in the Crutcher NRAO observations, also shown in Fig. 3, the line was only marginally detected.

3. Results from the CO observations: the molecular cloud toward σ Per

The CO and ^{13}CO ($J = 1 - 0$, $J = 2 - 1$) $1'$ resolution maps displayed in Fig. 2a,b,c,d show the existence of strong emission in the south and south-east regions. This structure is in good agreement with the trend observed in the more extended $2.2'$ resolution $J = 2 - 1$ map of Fig. 2e.

The emission peaks about $15'$ south of σ Per, around IC 348. This young cluster is embedded in a dense region where Strom et al. (1974) found evidences for large grains and Bachiller et al. (1987) detected a rich structure in ammonia. The CO $J = 1 - 0$ line intensities decrease abruptly toward the North-East region and a kind of gap or tear appears near the star position. This gap is also manifest on the CO $J = 2 - 1$ map, and the $J = 2 - 1/J = 1 - 0$ intensity ratio is higher here than toward other positions. On the ^{13}CO maps the gap is also visible. In Fig. 4 we

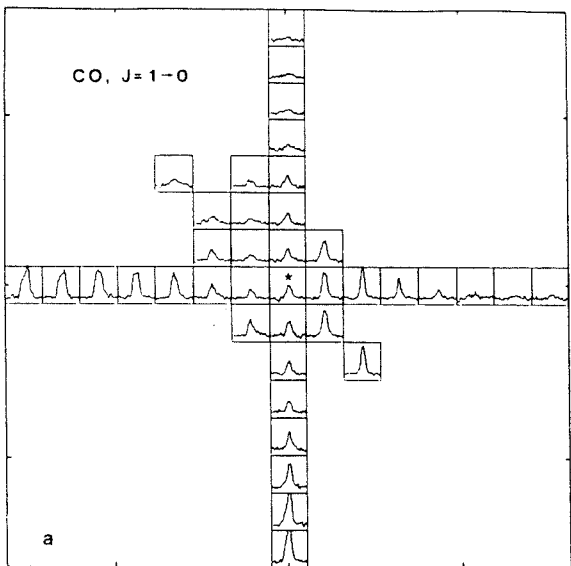

+ 5' 0 - 5'
R. A. OFFSET

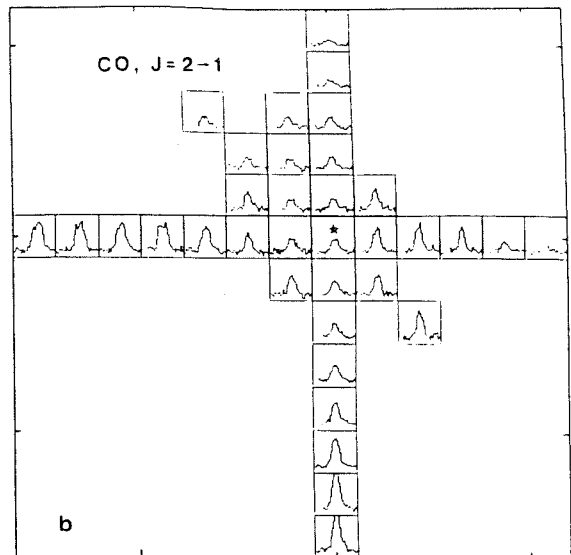

+ 5' 0 - 5'
R. A. OFFSET

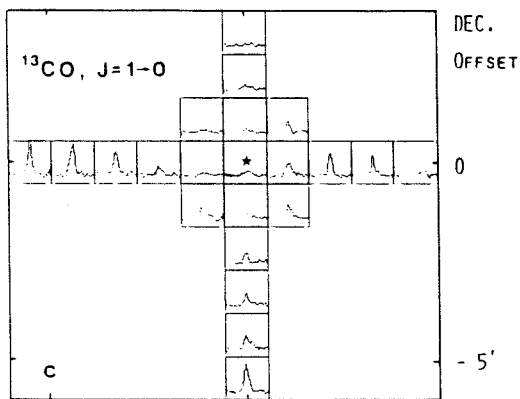

+ 5' 0 - 5'
R. A. OFFSET

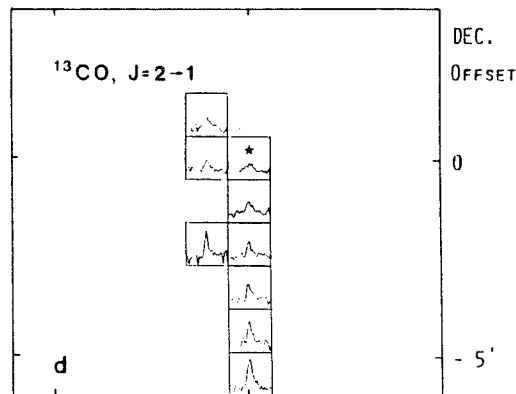

+ 5' 0 - 5'
R. A. OFFSET

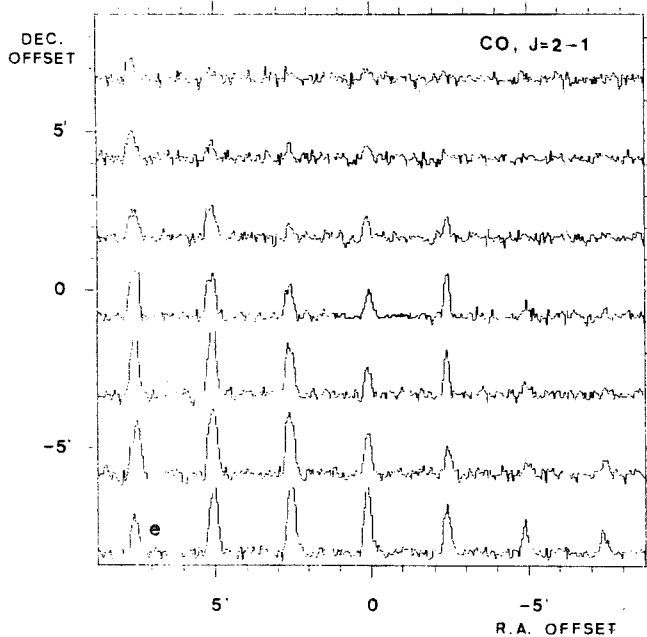

Fig. 2. a CO ($J = 1 - 0$) spectra observed around o Per. The central position is that of o Per as indicated by the \star symbol. The spacing is $1.1'$. The velocity range is 3 to 13 km s^{-1} and the T_A^* range is from -3 to 15 K . b As a but for CO ($J = 2 - 1$). c As a but for ^{13}CO ($J = 1 - 0$). The T_A^* range is -1 to 4 K . d As a but for ^{13}CO ($J = 2 - 1$). The T_A^* range is -1 to 4 K . e CO $J = 2 - 1$ spectra observed with the POM II telescope around o Per. The central position corresponds to that of the star and the spacing of the data is $2.5'$. The velocity range is 0 to 18 km s^{-1} and the T_A^* range is -2 to 15 K . The spectral resolution has been smoothed to 0.4 km s^{-1} .

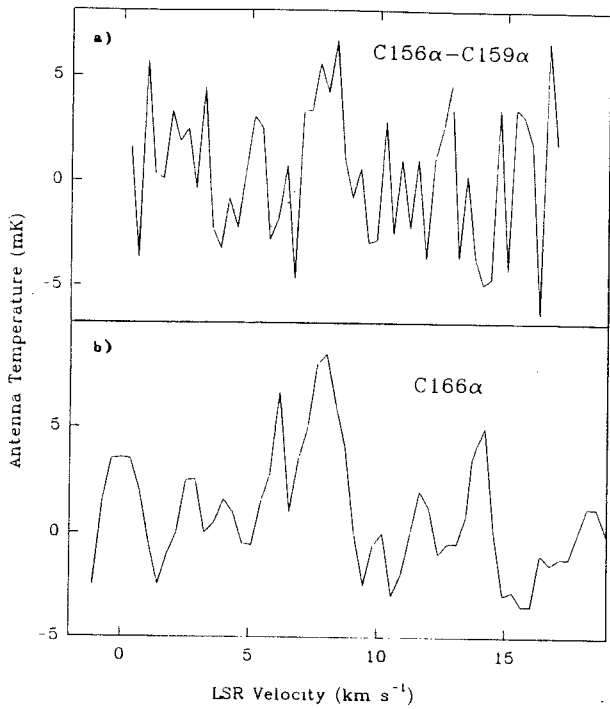

Fig. 3. Carbon recombination lines toward o Per. (a) Average spectrum of the C 156α, C 157α, C 158α and C 159α from Nancay observations (beam size = 3.9' × 19'). (b) NRAO observations (21' beam) of the C 166α line from Crutcher (1977)

present the intensity ratios for CO and ¹³CO. These ratios are notably higher in the gap region.

3.1. LVG calculations

We have carried out large velocity gradient (LVG) calculations of radiative transfer in order to estimate the physical conditions of the gas which could explain the observed behaviour of line intensities. The results of the calculations are the following:

1. Estimated ¹³CO column densities are not too sensitive to changes in density and temperature. The ¹³CO column density decreases rapidly from the South ($N(^{13}\text{CO}) = 4 \times 10^{15} \text{ cm}^{-2}$ toward (0, -5.5)) to the star position ($N(^{13}\text{CO}) = 0.7 \times 10^{15} \text{ cm}^{-2}$)
2. CO lines are optically thick in the inner part of the cloud. At positions where ¹³CO is weak, the CO column density necessary to explain the line intensities is $> 10^{16} \text{ cm}^{-2}$.
3. In southern positions (within the inner part of the cloud) the CO lines are thermalized and the kinetic temperature is $T_K \approx 15-20 \text{ K}$. The density necessary to explain the ¹³CO and CO $J = 2 - 1/J = 1 - 0$ intensity ratios is $n(\text{H}_2) \approx \text{a few } 10^3 \text{ cm}^{-3}$.
4. The kinetic temperature cannot be assumed constant across the area mapped. For example, let us suppose a constant temperature $T_K = 20 \text{ K}$. At the position (0, -5.5), which is on the cloud, $N(^{13}\text{CO}) = 4 \times 10^{15} \text{ cm}^{-2}$. We can calculate the corresponding visual extinction by using the ¹³CO/ A_V relation $N(^{13}\text{CO}) = 2.5 \times 10^{15} (A_V - 0.8) \text{ cm}^{-2}$ determined by Bachiller and Cernicharo (1986) for the Perseus complex. In this way, we obtain

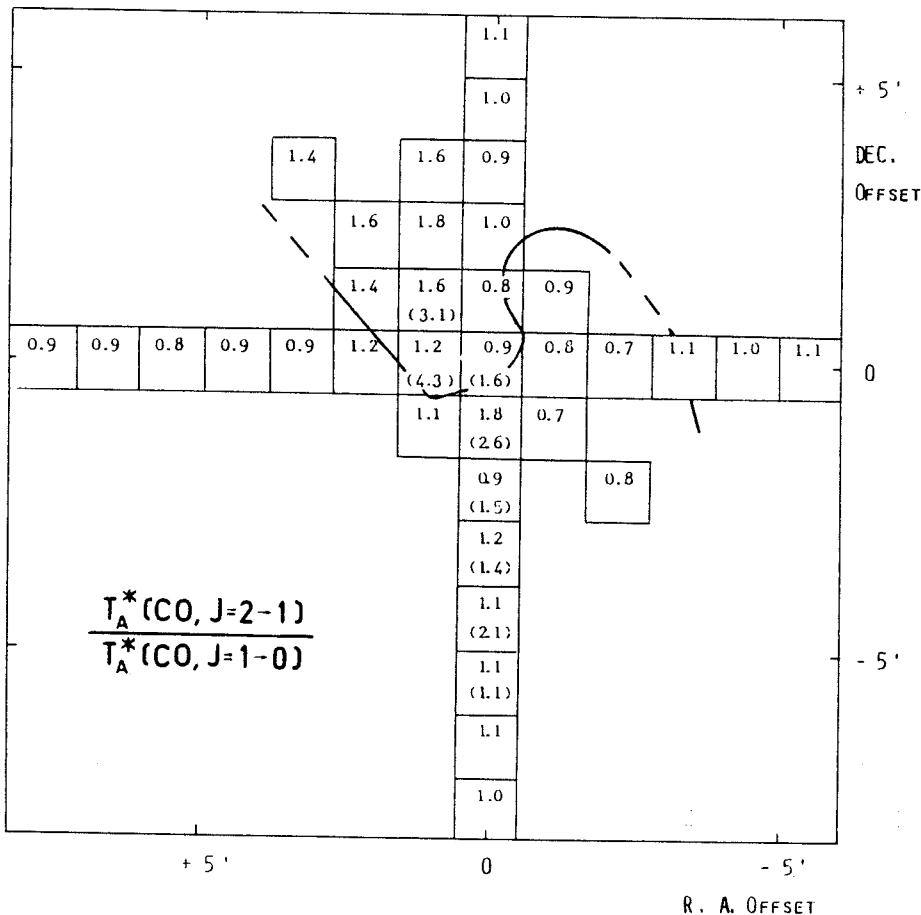

Fig. 4. $T_A^*(J = 2 - 1) / T_A^*(J = 1 - 0)$ ratios from CO observations. The ¹³CO ratios are quoted in parenthesis. The thick line represents the $T_A^* = 0.5 \text{ K}$ contour of ¹³CO ($J = 1 - 0$) emission. Central position and spacing are as in Fig. 2a

$A_V \approx 2.4$ mag. The $^{13}\text{CO } J = 2 - 1/J = 1 - 0$ ratio in this position require, for $T_K = 20$ K, a density $n(\text{H}_2) \approx 3 \cdot 10^3 \text{ cm}^{-3}$. The cloud thickness is then ≈ 0.3 pc assuming the Bohlin et al. (1979), relation $N(\text{H}_2) = 0.94 \cdot 10^{21} A_V \text{ cm}^{-2}$. On the other hand, at positions on the molecular gap, like (1.1, 0) and (1.1, 1.1), $N(^{13}\text{CO}) \approx 10^{15} \text{ cm}^{-2}$ and, in order to explain the high observed values of the $^{13}\text{CO } (J = 2 - 1)/(J = 1 - 0)$ ratios, we need (at $T_K = 20$ K) a density of $n(\text{H}_2) \approx 3 \cdot 10^5 \text{ cm}^{-2}$. Then the cloud thickness at the gap would be excessively small ($\approx 10^{-3}$ pc). Thus, it seems preferable to suppose that the temperature increases toward the positions in the molecular gap. If we suppose a constant density $n(\text{H}_2) \approx 3 \cdot 10^3 \text{ cm}^{-3}$, we obtain a kinetic temperature of 50–70 K in the gap region.

3.2. Comparison between UV and radio measurements of CO

It is interesting to compare the CO column density as obtained from UV observations with the results of millimeter observations. Snow (1975), from observations of the CO lines at 1150 Å, found $N(\text{CO}) = 8 \cdot 10^{14} \text{ cm}^{-2}$, Black (1980) from IUE spectra at 1400–1500 Å found $N(\text{CO}) = 1.5 \cdot 10^{14} \text{ cm}^{-2}$. Our millimeter observations with a 1' beam give $N(\text{CO}) > 10^{16} \text{ cm}^{-2}$, in good agreement with the observations of Crutcher (1976) and Baran (1985). So, it appears that the CO column density calculated from UV observations is about two orders of magnitude lower than the value determined from radio observations. This discrepancy was noted before by Crutcher (1976), who also pointed out that, toward o Per, optical OH, CH and H I column densities are in agreement with the radio column densities measured with a $\approx 20'$ beam. On the CO and ^{13}CO maps of the Perseus cloud (see for example Sargent, 1979; Bachiller and Cernicharo, 1986) a rich structure at scales of few arcmin is manifest. Presumably, such a rich structure exists also in OH, CH and H I emission. In particular, structure on a scale of $\approx 8'$ has been observed in H I by Wannier et al. (1983) using the Arecibo beam. Hence, the agreement between the radio column densities of OH, CH and H I (resolution $\approx 20'$) and the optical column densities (resolution equal to the stellar angular diameter) is probably not highly significant.

What is the cause of the discrepancy in the CO column density measurements? As o Per has $E(B - V) = 0.31$ mag, there is a cloud of $A_V \approx 1$ mag in front of the star. Because of the importance of the CO photodissociation in such a thin cloud, the expected column density would be low, in rough agreement with the UV measurements. A high value for the CO radio column density could be due to the possible presence of a second cloud behind o Per. However there is no indication of distinct clouds in the observed profiles since the millimeter lines observed toward the star show a single-peaked profile (typically the CO linewidths are ≈ 1.5 – 2.5 km s^{-1}) at the same velocity as the UV absorption lines.

The differences in the CO column density measurements quoted above could also be explained if the foreground cloud was clumped on a scale $< 1'$ with the line of sight toward o Per avoiding dense clumps. Only CO mapping with high angular resolution would allow a confirmation of this point. However, available CO maps show that the line of sight toward o Per crosses a very abrupt edge of the molecular cloud; hence, the existence of unresolved structure within the 1' arcmin beam seems quite possible.

3.3. Gas and star velocities

The CO ($J = 2 - 1, J = 1 - 0$) lines are about 1.5 – 2.5 km s^{-1} broad and no systematic changes are observed in the velocity in a 5' region around the star. The LSR velocity of the molecular emission is $V_{\text{LSR}} \approx 8.5 \text{ km s}^{-1}$, $V_{\text{LSR}}^* = 12 \text{ km s}^{-1}$ being the LSR radial velocity of o Per (Blaauw and van Albada, 1963). If we assume that the star was formed at the cloud boundary and that the radial velocities of the cloud and star have remained unchanged, we deduce that the star is separating from the cloud at a rate of ≈ 3.5 pc each 10^6 years. Hence, as the typical age for a star like o Per is \geq a few 10^6 – 10^7 years, the present separation of cloud and star could be considerable (\geq a few parsecs).

In conclusion, the CO data we have presented in Sect. 3 indicate that the molecular cloud toward o Per is clumped on scales ≤ 1 arcmin and presents a small (a few arcmin), warm ($T_K \approx 50$ – 100 K) hole. However, it is worth noting that (i) from the difference in the star and cloud velocities it seems possible that at this time the star is far away from the cloud; (ii) in addition, the large-scale CO $J = 2 - 1$ map of Fig. 2c suggests that the emission maximum at positions $(-2.5', 0$ and $-2.5', -2.5')$ corresponds to a condensation well differentiated from the large molecular cloud (and perhaps at a somewhat different distance). In such a case the apparent hole may not be related to the star.

Thus, CO data are not really conclusive on the distance from the star to the cloud. In order to try to decide this question, we examine in the next section the data concerning the ionized material around o Per.

4. The ionized region around o Per

4.1. The H II region

First let us suppose that o Per is embedded in the molecular cloud. Thus the stellar UV radiation ionizes the surrounding medium. The Stromgren radius for a B1 III star within a cloud of $n(\text{H}_2) \approx 3 \cdot 10^3 \text{ cm}^{-3}$ is $R(\text{H II}) \approx 0.02$ pc (about 14 arcsec at 300 pc of distance). The expected flux produced by free-free emission in this H II region is about 1 Jy.

Gilmore (1980) carried out a survey of the Perseus complex at 6 cm. He detected no sources in the line of sight of o Per. However, the detection limit in Gilmore's observations (10–30 mJy with a $\approx 3'$ beam) should allow the detection of a compact H II region of 1 Jy around o Per without difficulty. We thus conclude that there is no evidence for a compact H II region around o Per.

There are two possible explanations for this lack of strong emission. First, o Per could possess a stellar wind which absorbs a large fraction of the ionizing photons remaining as a weak continuum radio source (flux \approx a few mJy, see for instance Felli and Panagia, 1981). A similar situation is discussed by Rodriguez and Cantó (1983) for the BO star MWC 1080. If an ionized stellar wind is pushing the molecular material, one could expect to observe CO emission at high velocities and, in fact, this is the case for MWC 1080. However, in our observations of o Per there are no evidences for CO emission at high velocities at a level of 0.2 K r.m.s.

A second, more plausible, explanation for the lack of strong radio continuum emission from the vicinity of o Per is that the star is not embedded in the molecular cloud. If the star is not

too far from the cloud, the stellar UV radiation could ionize the cloud periphery and form an extended H II region.

Sivan (1974) and Gull (1977) from H α photographs of the Perseus region, detected (in addition to the California nebula) a weak, extended (≥ 15 square degrees) H II region around the Per OB 2/o Per region. On the Palomar Observatory Sky Survey prints, extended, weak emission nebulae are also visible near the Per OB 2 association and around the dust cloud surrounding IC 348. In addition, a small reflection nebula which is illuminated by the B5 V star BD + 31°643 (Johnson, 1960) lies within the IC 348 cluster. The relative contribution of o Per and Per OB 2 stars to the excitation of this weak extended H II region are unknown.

Additional information about the ionized interstellar material can be obtained by observing its infrared emission. The IRAS satellite provided us with simultaneous measurements at 12, 25, 60 and 100 μm . We have examined the IRAS standard sky maps (SKYFLUX, Chester et al., 1985) which have a spatial resolution of 2'–4'. The absolute calibration is accurate to 5% at 12 and 25 μm and 10% at 60 and 100 μm (Neugebauer et al., 1984). In order to convert intensities to brightness, we have assumed a flat energy spectrum for the source.

The o Per region shows extended emission at all four IRAS bands (Figs. 1 and 5). The intensity increases from 12 to 100 μm and peaks near the position of o Per/IC 348, where a strong point source is located. By integrating the intensity in 4 square degrees around o Per, we can estimate the total emission of the extended FIR region (we removed an offset from the SKYFLUX maps as due to very extended emission). We obtain $L(100\mu\text{m}) \approx 3.5 \cdot 10^3 L_{\odot}$ for the 100 μm integrated intensity of the extended source. We estimate $L(\text{IR}) \approx 10^4 L_{\odot}$ for the total IR luminosity

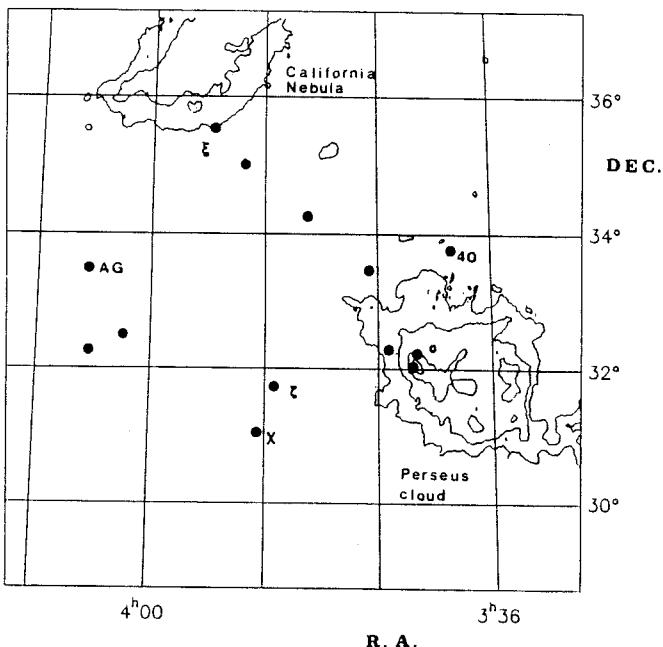

Fig. 5. 100 μm emission in the Per OB 2 region from IRASSKYFLUX data. An offset of 22 MJy sr $^{-1}$ corresponding to a very extended emission (including zodiacal light) has been removed. Contours are 20, 40, 100 and 300 MJy sr $^{-1}$. The positions of the brightest stars are indicated. Note that o Per and BD + 31°643 as well as the open cluster IC 348 are sited near the 100 μm emission peak (see also Fig. 1)

of the cloud. This luminosity comes partially from the diffuse H I/H II region and partially from the molecular cloud.

4.2. The C II region

Let us suppose again a star embedded in a dense cloud. As atomic carbon has about 10^{-4} the abundance of hydrogen, we expect the C II region to be more extended than the H II region. Furthermore, as the ionization potential of carbon is very close to the dissociation potential of CO, the C II region will be approximately coincident with the region where CO is photodissociated. It is believed that the intermediate region where C I is abundant is very thin, because when the gas is shielded from UV radiation, carbon forms CO efficiently (see for example the chemical models of Graedel et al., 1982).

The visual extinction, $A_V(\text{C II}/\text{CO})$, from the illuminated edge to the C II/CO transition region has been evaluated by Bachiller (1985) with the method of Langer 1976a,b and the photodissociation model parameters of Bally and Langer (1982). It is determined by the point at which the photodissociation rate of CO is equal to its formation rate through the chain

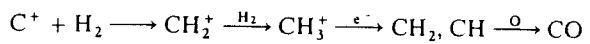

It is thus found that $A_V(\text{C II}/\text{CO})$ is approximately given by

$$A_V(\text{C II}/\text{CO}) = 6.4 + \log(F_5 \chi_{-2}^{1/2} / n_3) \text{ mag.}$$

where $F_5 = F/10^5$ and F is an enhancement factor of the UV field at the edge of the cloud with respect to the standard interstellar UV field; $\chi_{-2} = \chi/10^{-2}$ is the CO self-shielding parameter (see Bally and Langer 1982) and $n_3 = n(\text{H}_2)/10^3 \text{ cm}^{-3}$ is the cloud density. This result slightly depends on the assumption on the CO photodissociation process. It is in good agreement with the results of Tielens and Hollenbach (1985). It would be slightly different with the new laboratory measurements of Letzelter et al. (1987) (see also Glassgold et al., 1985) which support a complete self-shielding and a larger unshielded photodissociation rate.

A B1 III star has a luminosity of $4 \cdot 10^4 L_{\odot}$ (Schmidt-Kaler, 1982). At a distance of 0.1 pc from the star the UV field will be about 10^4 – 10^5 times the standard interstellar UV field. For $n(\text{H}_2) \approx 3 \cdot 10^3 \text{ cm}^{-3}$, and taking $\chi = 10^{-2}$, we find, using the above equation, that the C II/CO transition is located at $A_V \approx 6$ mag from the star. If this region has a constant density = $3 \cdot 10^3 \text{ cm}^{-3}$ we obtain $N(\text{H}_2) \approx 6 \cdot 10^{21} \text{ cm}^{-2}$ for the corresponding H_2 column density (from the Bohlin et al., 1978, dust/gas ratio), and the diameter of the C II region will be ≈ 1 pc. This value is about 5 times greater than the size of the CO gap observed around o Per.

Carbon recombination line observations could give direct information about the C II region around o Per. Crutcher (1977), who observed the C 166 α line with a 21' beam, concluded that the UV field (at 1000 \AA) in the C II region around o Per is about 5.5 times stronger than the average interstellar UV field. Crutcher assumed a cloud density $n(\text{H}) \approx 10^3 \text{ cm}^{-3}$, and in order to explain the intensity of the UV field, he estimated the cloud-star distance to be ≈ 20 pc.

Our observations of the C 158 α line were carried out with a $3.9' \times 19'$ beam, i.e. about 6 times smaller (in solid angle) than that used in Crutcher's observations. In spite of the differences in the beam sizes, the line we observe is not stronger than that

observed by Crutcher. We therefore deduce that dilution in the beam is unimportant, and that the actual C II region is quite extended ($>20'$ or >2 pc at 300 pc of distance). This is more extended than the expected C II region if o Per were embedded in the cloud (≈ 1 pc, see above).

As was suggested above, the CO hole caused by a star within a molecular cloud must have a size comparable to that of the C II region. The CO hole we observe around o Per (see Fig. 2) is considerably smaller than the C II region and, as a consequence, is probably not related to the presence of the star, but simply reflects the small scale structure of the cloud around o Per (see Sect. 3).

Snow (1976) estimated from Copernicus UV observations of the o Per line of sight the C II/C I, Si II/S I, Ca II/Ca I and Fe II/Fe I ratios to be relatively low. These ratios and the non-detection of the O VI and Si IV lines indicate that the matter in front of o Per is not highly ionized. The H II column density would be $N(\text{H II}) \approx 10^{19} \text{ cm}^{-2}$, and Snow concluded that the existence of such a ionized region could be explained, for a cloud density $n(\text{H}) \approx 10^3 \text{ cm}^{-3}$, if the star were far from the cloud. For example, its distance would be 5 pc if the hydrogen is 3% ionized in the C II region.

We conclude that the data concerning the ionized material around o Per indicate this star is presently located at least a few pc away from the molecular cloud. However, it is not excluded that the star was closer to the cloud in the past; and it is not possible with the present data to decide whether the star projects onto the abrupt cloud edge just by chance, or if this coincidence is related to its formation.

5. Heating of the cloud edge

5.1. Thermal equilibrium calculations

In order to explain the structure of the ionized region around the o Per position, we must place the star far from the molecular cloud (a few parsecs). On the other hand, we have concluded, from the CO ($J = 1 - 0$, $J = 2 - 1$) observations, that the cloud edge is at a temperature of 50–70 K. Temperatures of the same order were also determined for matter on the o Per line of sight by Hobbs (1981) who calculated $T_{\text{ex}} = 116 \pm 16$ K for the excitation temperature of C₂, and by Snow (1976) who obtained $T_{\text{K}} = 48$ K from H₂. We thus investigate if such a temperature is consistent with current ideas on molecular cloud energetics. The most efficient process for heating a cloud edge is believed to be the photoelectric effect on dust grains (de Jong, 1977, 1980): electrons emitted by grains heat the gas by collisions. The electron ejection rate depends on the grain charge, which is determined by the electron abundance, the temperature, and the UV field. If the grain is highly positively charged, the electrons will need to surmount a high potential barrier to escape; thus, the more positively charged are the grains, the less efficient is the heating.

For densities $n(\text{H}_2) = 10^3 - 10^4 \text{ cm}^{-3}$ and temperatures of $\approx 10^2$ K, the most efficient cooling mechanisms are the emission $^2P_{3/2} - ^2P_{1/2}$ of C II at $150 \mu\text{m}$, and rotational emission from CO (see e.g. Tielens and Hollenbach, 1985). For higher densities ($\geq 10^5 \text{ cm}^{-3}$), if the dust is hotter than the gas, gas heating via collisions between grains and molecules is important (see e.g. Falgarone and Puget, 1985).

In thermal equilibrium, the gas temperature in a cloud position is determined by the equality between heating and cooling

rates:

$$\Gamma = \Lambda$$

In order to obtain the temperature of the cloud edge, we have solved this equation for different values of A_V ; CO and C II abundances as a function of A_V were obtained by using the simple model described in Sec. 4.2 (Bachiller 1985). The photoelectric heating rate was calculated with the expressions of de Jong (1977, 1980). Heating by cosmic rays was evaluated following Goldsmith and Langer (1978). Cooling by C II emission was estimated by using the calculations of Flower et al. (1977). For the CO cooling (Goldsmith and Langer, 1978; Young et al., 1982) we have assumed that the emission is optically thin; hence, our calculations are suited only for the molecular cloud edge.

Some results of the calculations are shown in Fig. 6. It appears that, as expected, the temperature increases toward the external region of the cloud. For intense UV fields, the temperature presents a maximum and a small decrease at the edge. This effect is

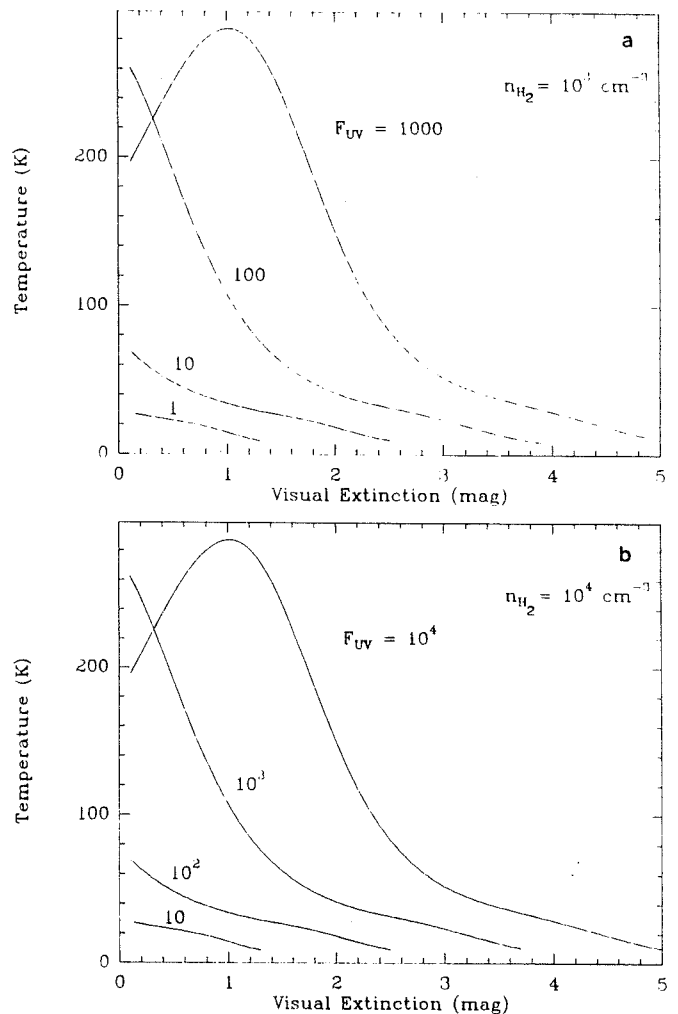

Fig. 6. Kinetic temperature profile for the edge of an homogeneous cloud illuminated by a strong ultraviolet field. The calculations assume heating by photoelectric effect on dust grains and by cosmic rays. Cooling is caused by C II and CO emission (see text). Each curve is labelled with the value of the enhancement factor of the ultraviolet field at the cloud boundary respect to the standard interstellar value. a cloud density $n(\text{H}_2) = 10^3 \text{ cm}^{-3}$. b $n(\text{H}_2) = 10^4 \text{ cm}^{-3}$

caused by the saturation of the grain charge: when the grains have a charge close to their maximal value, photoelectric heating is less important, but C II cooling is very efficient.

The results shown in Fig. 6, which have been obtained from these simple considerations, are in good agreement with more refined models (Tielens and Hollenbach, 1985).

In order to obtain temperatures of 50–100 K in the region of $A_V \approx 1-3$ mag in a cloud of $n(\text{H}_2) \approx \text{a few } 10^3 \text{ cm}^{-3}$, we need a UV flux at the cloud edge of about 10–100 times the typical interstellar UV flux. We note that these values are in agreement with the initial idea that o Per is a few parsecs from the cloud: the energy density of the standard UV (912–1110 Å) interstellar field is $u_{UV}^0 \approx 1.5 \cdot 10^{-14} \text{ erg cm}^{-3}$ (Witt and Johnson, 1973; Mathis et al., 1983). From the model of Kurucz et al. (1974), at a distance of $d(\text{pc})$ from o Per we get

$$u_{UV}(\text{o Per}) = 335 u_{UV}^0 / d(\text{pc})^2$$

so, o Per enhances the UV field by a factor of 10 at a distance of 6.0 pc, or by a factor of 1000 at a distance of 0.6 pc.

5.2. Possible heat sources

Within a radius of a few degrees (1 degree ≈ 0.6 pc at 300 pc of distance) around the o Per position there are several luminous stars. These stars belong to the Per OB 2 or IC 348 groups and their distances to the Sun are comparable to that of o Per (see Sect. 1). Thus their contribution to the enhancement of the UV field in the o Per region must be considered.

The stars in the o Per region with spectral type earlier than B6 are listed in Table 1. Luminosities have been taken from Schmidt-Kaler (1982). We have calculated for each star the parameter $\phi = L/4\pi \cdot \rho^2 \cdot c$, where ρ is the projected-on-sky distance between the star and the o Per position. For each star ϕ should represent the contribution to the radiation enhancement in the o Per position if it were located in the same plane as the molecular cloud; as the radial distances between the cloud and the stars are unknown, we cannot calculate the actual enhancement factor, but only its upper limit ϕ .

Table 1. Stars in the o Per region with spectral type earlier than B6

HD or BD	Name	$\rho(\text{pc})$	$L/10^3 L_\odot$	$\phi(10^{-13} \text{ erg cm}^{-3} \text{ s}^{-1})$
21483		19.9	5.0	0.13
21856		20.9	16.	0.39
22951	40 Per	8.9	23	3.1
23060		9.4	8	0.96
23180	o Per		40	
+31°643		0.5	0.83	35.3
23478		2.6	3.5	5.5
23625		7.9	3.8	0.6
24131		13.6	34	1.9
24190		13.6	5.7	0.3
24398	ζ Per	11	150.	13.2
24534	X Per	14.1	200.	10.7
24640		19.9	28.	0.7
24912	ξ Per	24.6	620.	$\ll 10.9(d > 300 \text{ pc})$
25539		22.5	1.9	0.04
25799		24.6	1.9	0.03
25833	AG Per	25.7	0.83	0.01

ξ Per is a special case. It is very likely that this star is located very far away from the molecular cloud. ξ Per is a Per OB 2 runaway star which moves at a LSR radial velocity of $\approx 65 \text{ km s}^{-1}$ (Lesh, 1969), i.e. about 50 km s^{-1} greater than the mean radial velocity of the other Per OB 2 stars. The age of the Per OB 2 association ranges between $1.3 \cdot 10^6 \text{ yr}$ (kinematic age from Blaauw, 1952; Delhaye and Blaauw, 1953; Lesh, 1969) and $4 \cdot 10^6 \text{ yr}$ (spectroscopic age from Blaauw, 1964). Therefore, ξ Per is sited now about 65–200 pc from the association center and does not contribute appreciably to the illumination of the molecular cloud.

From Table 1 it appears that the stars which could contribute considerably to the UV enhancement in the o Per region are BD + 31°643, ζ Per, and X Per. The former is the B5 V star which illuminates the reflection nebula in IC 348; although this star has a moderate luminosity ($\approx 820 L_\odot$), it could be very close to the o Per position ($\geq 0.5 \text{ pc}$). ζ Per and X Per are so luminous that, even if they are situated far from the cloud edge ($> 10 \text{ pc}$ and 14 pc respectively), they may contribute appreciably to the ambient UV flux. The contribution of the remaining stars should not be so important ($\sum \phi_i = 1.37 \cdot 10^{-12} \text{ erg cm}^{-3} \text{ s}^{-1}$).

In conclusion, the UV intensification by a factor of 10–100, which is apparent from discussions of Sects. 3 and 4, is not exclusively due to o Per. Other neighbouring OB stars (mainly BD + 31°643, ζ Per and X Per) could contribute significantly to this UV enhancement. Further, the strong UV field seems (from optical and infrared images) not to be restricted to the position near the o Per line of sight, but extended, over several degrees, to the overall north-east edge of the Perseus molecular cloud.

6. Conclusion

From CO and ^{13}CO ($J = 2 - 1, J = 1 - 0$) observations of the cloud toward o Per we have probed the structure of a molecular cloud which appears to have a kind of hole centered near the position of the star. One might that o Per were the cause for this molecular gap. However, several facts imply that o Per is situated at least a few parsecs away from the cloud:

1. The kinetic temperature at the boundary of the cloud ($A_V \approx 1-3$ mag) is 50–100 K. Thus for $n_{\text{H}_2} = 10000 \text{ cm}^{-3}$ the UV field is enhanced only by a factor of 100, corresponding to a distance of $\approx 2 \text{ pc}$ between the star and the cloud.
2. There is a significant difference between the velocity of the molecular gas and that of the star.
3. There is no detected emission from any H II region associated with o Per, as would be anticipated if it were located in a dense region.
4. The C II region toward o Per is extended ($> 2 \text{ pc}$). Furthermore, as the associated CO hole should have a size on the same order as the C II region, the CO gap in our maps (Fig. 2) presumably reflects simply the small scale structure of the gas.
5. The diffuse UV and IRAS infrared emission indicates the lack of a single dominant heat source.

Thus, we conclude that the precise alignment of the small CO hole with o Per is probably due to chance although it is not impossible that the hole resulted, as well as the neighbouring sharp cloud edge, from an interaction of the cloud and the star. The UV field is enhanced over several degrees on the North-East boundary of the Perseus local molecular complex. The OB stars BD + 31°643, ζ Per and X Per could contribute appreciably (even more than o Per) to this UV enhancement.

Acknowledgements. We thank the staffs of FCRAO, MWO and Nançay Observatory for their assistance during observations. We also thank Dr. Gilles Duvert for his considerable help analyzing the IRAS data, and Dr. W.D. Langer for very useful suggestions. One of us (R.B.) acknowledges partial support from Spanish CAICYT (project 477/84).

The Five College Radioastronomy Observatory is operated by permission of the Metropolitan District Commission, and with support from the NSF. This is contribution 631 of the Five College Astronomy Department.

The Millimeter Wave Observatory is operated by the Electrical Engineering Research Laboratory, the University of Texas at Austin, with support from the NSF and McDonald Observatory.

References

- Bachiller, R.: 1985, Thèse d'Etat. Univ. Grenoble I
 Bachiller, R., Cernicharo, J.: 1986, *Astron. Astrophys.* **166**, 283
 Bachiller, R., Guilloteau, S., Kahane, C.: 1987, *Astron. Astrophys.* **173**, 324
 Bally, J., Langer, W.D.: 1982, *Astrophys. J.* **255**, 143
 Baran, G.P.: 1985, Ph.D., Columbia Univ.
 Barrett, J.W., de Zafra, R.L., Sanders, D.B., Solomon, P.M.: 1980, *I.A.U. Symp.* **87**, 185
 Blaauw, A.: 1952, *Bull. Astron. Inst. Neth.* **11**, 405
 Blaauw, A.: 1964, *Annual Rev. Astron. Astrophys.* **2**, 213
 Blaauw, A., van Albada, T.S.: 1963, *Astrophys. J.*, **137**, 791
 Black, J.H.: 1980, *I.A.U. Symp.* **87**, 257
 Bohlin, R.L., Savage, B.D., Drake, J.F.: 1978, *Astrophys. J.* **224**, 132
 Borgman, J., Blaauw, A.: 1964, *Bull. Astron. Inst. Neth.* **17**, 358
 Cernicharo, J., Bachiller, R.: 1984, *Astron. Astrophys. Suppl.* **58**, 327
 Cernicharo, J., Bachiller, R., Duvert, G.: 1985, *Astron. Astrophys.* **149**, 273
 Chaffee, F.H.: 1974, *Astrophys. J.* **189**, 427
 Chester, T., and the IRAS team: 1985, IRAS explanatory supplement
 Crutcher, R.M.: 1976, *Astrophys. J. Letters* **206**, L171
 Crutcher, R.M.: 1977, *Astrophys. J. Letters* **217**, L109
 Delhaye, J., Blaauw, A.: 1953, *Bull. Astron. Inst. Neth.* **12**, 72
 Falgarone, E., Puget, J.L.: 1985, *Astron. Astrophys.* **142**, 157
 Federman, S.R.: 1980, *Astrophys. J. Letters* **241**, L109
 Felli, M., Panagia, N.: 1981, *Astron. Astrophys.* **102**, 424
 Flower, D.R., Launay, J.M., Roueff, E.: 1977, XXI^e colloque d'Astrophysique, Université de Liège
 Fredrick, L.W.: 1956, *Astron. J.* **61**, 437
 Gerola, H., Glassgold, A.E.: 1978, *Astrophys. J. Suppl.* **37**, 1
 Gilmore, W.: 1980, *Astron. J.*, **85**, 894
 Glassgold, A.E., Huggins, P.J., Langer, W.D.: 1985, *Astrophys. J.* **290**, 615
 Goldsmith, P.F., Langer, W.D.: 1978, *Astrophys. J.* **222**, 881
 Graedel, T.E., Langer, W.D., Frerking, M.A.: 1982, *Astrophys. J. Suppl.* **48**, 321
 Gull, T.: 1977, quoted by Baran (1985)
 Hoops, L.M.: 1981, *Astrophys. J.* **243**, 485
 Johnson, H.M.: 1960, *Publ. Astron. Soc. Pacific.* **72**, 10
 de Jong, T.: 1977, *Astron. Astrophys.* **55**, 137
 de Jong, T.: 1980, *Highlights of Astron.* **5**, 301
 Kurucz, R.L., Peytremann, E., Avrett, E.H.: 1974, "Blanketed model atmospheres for early-type stars", Smithsonian Astrophysical Observatory
 Langer, W.D.: 1976a, *Astrophys. J.* **206**, 699
 Langer, W.D.: 1976b, *Astrophys. J. Letters* **212**, L39
 Lesh, J.R.: 1969, *Astron. J.* **74**, 891
 Letzelter, C., Eidelsberg, M., Rostas, F., Breton, J., Thieblemont, B.: 1987, *Chem. Phys.* (in press)
 Loren, R.B.: 1976, *Astrophys. J.* **209**, 466
 Lucas, R., and the POM II team, *Astron. Astrophys.*, to be submitted.
 Mathis, J.S., Mezger, T.P., Panagia, N.: 1983, *Astron. Astrophys.* **128**, 212
 McCuskey, S.W.: 1938, *Astrophys. J.*, **88**, 209
 Neugebauer, G., and the IRAS team: 1984, *Astrophys. J. Letters* **278**, L1
 Panagia, N.: 1973, *Astron. J.* **78**, 929
 Rodriguez, L.F., Cantó, J.: 1983, *Rev. Mexicana Astron. Astrof.* **8**, 163
 Sancisi, R.: 1974, *I.A.U. Symp.* **60**, 115
 Sargent, A.I.: 1979, *Astrophys. J.* **233**, 163
 Schmidt-Kaler: 1982, In: Landolt-Bornstein, ed. K.H. Hellwege, Springer-Verlag, Berlin Heidelberg New York
 Sivan, J.P.: 1974, *Astron. Astrophys. Suppl.* **16**, 163
 Snow, T.P.: 1975, *Astrophys. J. Letters* **201**, L21
 Snow, T.P.: 1976, *Astrophys. J.* **204**, 759
 Strom, S.E., Strom, K.M., Carrasco, L.: 1974, *Publ. Astron. Soc. Pacific* **86**, 798
 Tielens, A.G.G.M., Hollenbach, D.: 1985, *Astrophys. J.* **291**, 722
 Wannier, P.G., Lichten, S.M., Morris, M.: 1983, *Astrophys. J.* **268**, 727
 Witt, A.N., Johnson, M.W.: 1973, *Astrophys. J.* **181**, 363
 Young, J.S., Goldsmith, P.F., Langer, W.D., Wilson, R.W., Carlson, E.R.: 1982, *Astrophys. J.* **261**, 513

**I.17) APPENDICE A: UN NUAGE MOLECULAIRE DANS LA
CONSTELLATION DU DRAGON: UN NUAGE MOLECULAIRE DANS L'HALO
GALACTIQUE ?**

I.17) APPENDICE A: UN NUAGE MOLECULAIRE DANS LA
CONSTELLATION DU DRAGON: UN NUAGE MOLECULAIRE DANS L'HALO
GALACTIQUE ?

Une nébuleuse étendue et brillante ($l=91^\circ$, $b=38^\circ$) dans la constellation du Dragon a été observée dans l'émission des raies de HI à 21 cm, de CO à 2.6 mm et de ^{13}CO à 2.7 mm; nous avons aussi observé l'absorption de la raie à 6.2 cm de H_2CO . Cette émission coïncide avec une région brillante des plaques rouge et bleu du POSS. Une étude photométrique UBV de ≈ 60 étoiles localisées à l'intérieur des régions les plus brillantes de la nébuleuse du Dragon donne une distance ≥ 800 pc, c'est à dire, une distance ≥ 500 pc du plan galactique. A 800 pc, la masse totale de deux des condensations de la nébuleuse du Dragon est de 27 et 219.

The Draco nebula: A molecular cloud in the galactic halo?

U. Mebold¹, J. Cernicharo², L. Velden¹, K. Reif¹, C. Crezelius¹, and W. Goerigk¹

¹ Radioastronomisches Institut der Universität Bonn, Auf dem Hügel 71, D-5300 Bonn 1, Federal Republic of Germany

² Groupe d'Astrophysique QUE CERMO, Université Scientifique et Médicale de Grenoble P.P. 68, F-38402 Saint Martin d'Hères, Cedex, France

Received July 20, 1984; accepted June 21, 1985

Summary. An extended and faint bright nebula ($l \cong 91^\circ$, $b \cong 38^\circ$) in the constellation Draco exhibits H I $\lambda 21$ cm, CO $\lambda 2.6$ mm and $\lambda 2.7$ mm emission and H₂CO $\lambda 6.2$ cm absorption lines in detailed positional agreement with the optical brightness distribution at the red and blue prints of the Palomar Observatory Sky Survey. Three colour *UBV* photometry of $\cong 60$ stars located within the brightest part of the "Draco nebula" indicates a distance of ≥ 800 pc, or a distance of ≥ 500 pc from the galactic plane. With this distance the total mass of two of the molecular clumps in the Draco nebula is 27 and 219 M_\odot and they appear to be gravitationally bound systems. Further, positional coincidences are found with the low latitude end of the high velocity cloud complex HVC CI of Hulsbosch (1979) and with soft X-ray emission features on SAS as well as HEAO-1 satellite sky maps. These let us suggest an astrophysical relationship between these phenomena.

Key words: molecular clouds - radio frequency lines: molecular lines - 21 cm line - interstellar absorption and extinction

1. Introduction

Extended and faint bright nebulae have been found at intermediate and high galactic latitudes on the Palomar Observatory Sky Survey (POSS) plates by Lynds (1965) and - more numerous - on very deep plates of the galactic polar caps by Sandage (1976). In one of these nebulae, located in the constellation Draco and called "Draco nebula" or even shorter "Dracula" Goerigk et al. (1983) found an H I emission line (brightness temperature $T_B \cong 20$ K, velocity dispersion ≥ 1.0 km s⁻¹, centre velocity $V_{LSR} \cong -21$ km s⁻¹) in detailed positional coincidence with the bright nebula. Estimates of the colour excess in the nebula from star counts give $E_{B-V} \leq 0.3$ mag if the gradient in star density with increasing distance from the galactic plane can be neglected. If Dracula is far above the galactic plane, say > 500 pc, as shown in this paper, the quoted colour excess must be revised upwards.

The corresponding ratio of H I column density to colour excess $N(\text{H I})/E_{B-V}$ is about a factor of 10 smaller than the standard ratio of the column density of hydrogen nuclei to colour excess $N_{\text{H}}/E_{B-V} = 1.9 \cdot 10^{21} \text{ cm}^{-2} \text{ mag}^{-1}$. As no significant amount of ionized hydrogen, H II, could be detected in the radio wave length range the apparent lack of single hydrogen nuclei lead us to search for molecules which are considered to be tracers for molecular

hydrogen, H₂, like CO or H₂CO. CO has been detected at the positions of the brightest patches on the POSS prints (Mebold et al., 1983).

The equipment used for our molecular line observations and the corresponding results are described in Sect. 2. Our observations and the observations available in the literature are discussed in Sect. 3.

2. Observations and results

2.1. CO-observations at Bordeaux

¹²CO $\lambda 2.6$ mm and ¹³CO $\lambda 2.7$ mm line observations of the optically brightest parts of Dracula were carried out in two observing periods in August 1982 and in March 1983 with the Bordeaux telescope, receiver and line backend as described by Baudry et al. (1980, 1981). The telescope beam efficiency is 85% and the half power beam width HPBW = 4.4'. The backend used at the time of the observations consisted of a 256 channel filter bank with 100 kHz filter width providing a velocity resolution of 0.26 km s⁻¹. All line intensities are corrected for atmospheric extinction and calibrated by reference to DR21(OH). The observations were made using a frequency switching technique.

During the search for ¹²CO emission two fields bounded by $89^\circ 10' \leq l \leq 90^\circ 25', 38^\circ 10' \leq b \leq 39^\circ 15', 90^\circ 45' \leq l \leq 91^\circ 18', 36^\circ 55' \leq b \leq 37^\circ 45'$ and by their optical boundary of the cloud were mapped at 5' sampling. The velocity coverage is $-40 \leq V_{LSR} \leq -10$ km s⁻¹.

The results are presented in Table 1 and Figs. 1 and 2. Table 1 gives for all positions (l, b given in Cols. 1 and 2) with a detected signal the ¹²CO $\lambda 2.6$ mm parameters, maximum brightness temperature, T_B (Col. 3), centre velocity, V_{LSR} (Col. 4), and half power line width, ΔV (Col. 5). At two positions the emission line is clearly split into two components.

In Fig. 1 we display the ¹²CO line integral,

$$W_{\text{CO}} = \int T_B dv \text{ [K km s}^{-1}]$$

in the form of isophotes (full lines) superimposed on the isophotes of 21 cm line brightness temperature, $T_B(21 \text{ cm})$ from Goerigk et al. (1983, broken lines).

The ¹²CO-line brightness distribution essentially shows four CO-clumps. These clumps, which for morphological reasons we call Dracula's "Fang" and "Wart", "Drop" and "Horn" on Dracula's nose, are centered at the positions (l, b) listed in Table 2, Col. 2. Their approximate half power sizes ($\Delta l, \Delta b$) are given in Col. 3. We find that these CO-clumps are in good positional

Send offprint requests to: U. Mebold

Tabelle 1. ^{12}CO and ^{13}CO line parameter

l (1)	b (2)	T_B (3)	V_{LSR} (4)	ΔV (5)	
91°11'	36°59'	4.2	- 25.2	1.3	
		0.5	- 25.1	0.8	^{13}CO
91°12'	37°04'	1.4	- 24.0	4.4	
91°18'	38°02'	0.8	- 22.7	4.0	
90°36'	38°03'	1.2	- 18.7	3.7	
89°23'	38°20'	1.2	- 23.0	1.7	
89°29'	38°20'	2.3	- 23.3	3.0	
89°36'	38°20'	0.9	- 23.1	2.0	
89°29'	38°25'	4.5	- 23.5	2.0	
89°32'	38°24'	5.5	- 23.7	2.0	
		0.7	- 23.3	1.4	^{13}CO
89°35'	38°25'	4.5	- 22.9	1.9	
89°42'		1.0	- 22.8	1.5	
89°49'		1.1	- 21.7	2.8	
89°29'	38°30'	3.0	- 24.0	1.6	
89°36'	38°30'	2.4	- 23.8	1.5	
89°42'	38°30'	0.9	- 23.2	2.1	
90°01'	38°30'	1.0	- 24.8	0.8	
89°49'	38°35'	0.5	- 23.6	2.1	
89°55'	38°35'	2.2	- 23.9	1.7	
90°01'	38°35'	2.7	- 24.6	2.2	
		1.0	- 20.7	3.2	
89°55'	38°40'	0.7	- 24.0	1.6	
90°01'	38°40'	1.0	- 25.2	2.5	
90°08'	38°40'	2.1	- 24.3	2.1	
90°14'	38°40'	0.9	- 23.2	1.5	
89°42'	38°45'	2.0	- 23.8	0.9	
89°49'	38°45'	1.6	- 24.1	0.8	
90°01'	39°45'	2.2	- 23.8	1.6	
90°08'	38°45'	1.6	- 23.9	1.9	
90°14'	38°45'	1.7	- 22.7	1.3	
90°27'	38°45'	0.9	- 23.6	2.7	
89°42'	38°50'	2.0	- 23.9	1.3	
89°49'	38°50'	3.5	- 24.2	1.5	
89°55'	38°50'	1.8	- 24.1	1.3	
90°01'	38°50'	1.2	- 23.8	2.0	
90°08'	38°50'	1.0	- 23.9	2.2	
90°14'	38°50'	1.1	- 22.7	1.6	
90°21'	38°50'	2.1	- 22.4	1.6	
89°49'	38°55'	2.8	- 24.0	1.5	
89°55'	38°55'	3.7	- 24.3	1.4	
90°01'	38°55'	2.1	- 23.6	3.1	
90°08'	38°55'	2.6	- 22.9	2.1	
90°14'	38°55'	1.2	- 22.0	1.2	
90°21'	38°55'	1.5	- 22.2	0.7	
89°55'	39°00'	2.5	- 22.9	0.6	
		2.3	- 24.4	1.4	
90°01'	39°00'	1.0	- 22.8	3.7	
89°55'	39°05'	2.9	- 24.7	1.1	
90°14'	39°05'	0.8	- 23.4	2.0	
90°14'	39°10'	1.7	- 23.6	1.2	

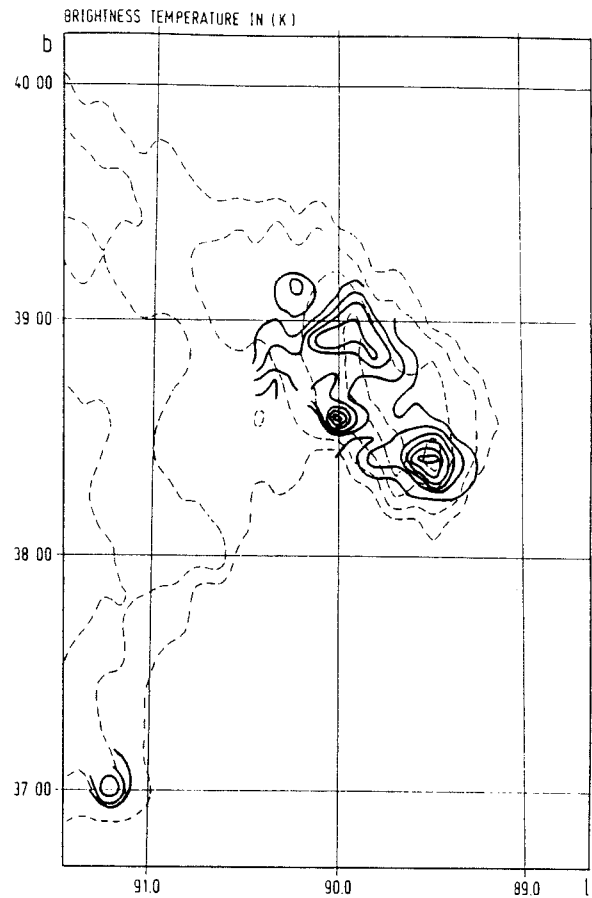

Fig. 1. Isophotes of integrated ^{12}CO brightness temperatures (full lines) superimposed on the distribution of the maximum 21 cm line brightness temperature (broken lines) for the Draco cloud. ^{12}CO -contours are at intervals of 1.5K km s^{-1} starting at 1.5K km s^{-1} , H I contours are 1.5, 5, 10, 15 and 20K

sponding amplitudes, GV , and position angles, PA , are listed in Cols. 5 and 6, respectively. PA is the angle between the direction towards the north galactic pole and the receding half of the velocity gradient oriented such that $PA = 90^\circ$ for the direction of increasing galactic longitude. For two of the clumps, the Drop and the Horn, an increase of the line width from the centre to the rim – and even a double line close to the centre – can be seen in the data. This is indicated by a ratio of the line widths at the centre and the rim of $\Delta v(\text{centre})/\Delta v(\text{rim}) > 1$ in Table 2, Col. 7. For the other two clumps the reverse may be true, $\Delta v(\text{centre})/\Delta v(\text{rim}) < 1$.

In Fig. 2 we display the ^{12}CO $\lambda 2.6\text{mm}$ and the ^{13}CO $\lambda 2.7\text{mm}$ line profiles found at the peak positions ($l = 89^\circ 32'$, $b = 38^\circ 24'$ and $l = 91^\circ 11'$, $b = 36^\circ 59'$) of the Wart and Fang, respectively. The ^{13}CO line parameters are given along with the ^{12}CO line parameters in Table 1 and are marked correspondingly in Col. 6.

2.2. H_2CO observations

Observations of the $1_{10} \rightarrow 1_{11}$ $\lambda 6.2\text{cm}$ H_2CO line in Dracula were carried out during several second-priority 12 hours sessions between June and October 1983 with the Effelsberg 100 m telescope, the 4.6 GHz secondary focus receiver system, and the 1024 channel autocorrelation spectrometer. The half power beamwidth is $\text{HPBW} = 3.2'$ and the beam efficiency is $\eta_B = 0.7$. Depending

agreement with the brightest dust patches on the POSS prints. $\langle V_{\text{LSR}} \rangle$ in Col. 4 is the intensity weighted average of the observed radial velocities.

The radial velocity distribution is characterized by an apparent radial velocity gradient for each of the clumps. The corre-

Table 2. Observational parameters of the CO-clumps in Dracula

(1)	(2)		(3)		(4)		(5)		(6)		(7)
	<i>l</i>	<i>b</i>	Δl	Δb	V_{LSR}	GV	V_{LSR}	GV	<i>PA</i>	Centre/Rim line width ratio	
			arc	min	km s^{-1}	$\text{km s}^{-1}/\text{arcmin}$	km s^{-1}	$\text{km s}^{-1}/\text{arcmin}$	deg		
Fang	91°11'	36°59'	5'	8'	-24.2	0.3			45	< 1	
Wart	89°32'	38°24'	15'	15'	-23.3	0.1			135	$\cong 1$	
Drop	90° 1'	38°35'	5'	5'	-24.0	0.2			135	> 1	
Horn	89°55'	38°55'	25'	20'	-23.7	0.1			45	> 1	

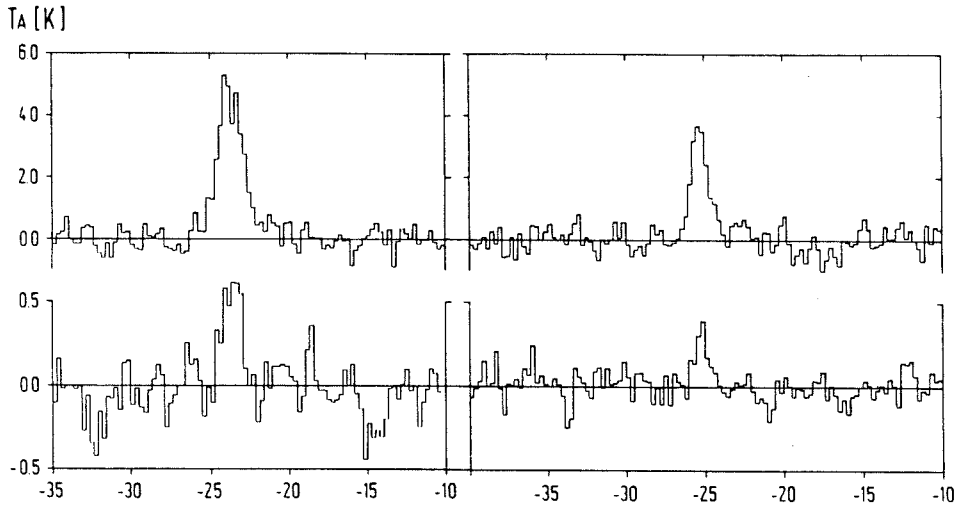
**Fig. 2.** ^{12}CO $\lambda 2.6\text{ mm}$ (upper) and ^{13}CO $\lambda 2.7\text{ mm}$ (lower) line profiles observed with the 2.5 m Bordeaux telescope at the peak positions of Draculas Wart ($l = 89^\circ 32'$, $b = 38^\circ 24'$) (left) and Fang ($l = 91^\circ 11'$, $b = 36^\circ 59'$) (right)**Table 3.** Parameters of the $\text{H}_2\text{CO } 1_{10} \rightarrow 1_{11}$ lines in Dracula

Name	Fang		Wart
Position	<i>l</i>	91° 12'	89° 32'
	<i>b</i>	36° 39'	38° 24'
Size	Δl	$\leq 3'$	
	Δb	$\cong 5'$	
Line depth	T_L	$-48 \pm 8\text{ mK}$	$-65 \pm 7\text{ mK}$
Velocity	V_{LSR}	$-25.1 \pm 1\text{ km s}^{-1}$	$-23.8 \pm 0.5\text{ km s}^{-1}$
Velocity gradient	$\Delta V/\text{min}$	$\cong 2\text{ km s}^{-1}\text{ arc min}^{-1}$	
	<i>PA</i>	340°	
Line width	ΔV	$1.5 \pm 0.2\text{ km s}^{-1}$	$1.2 \pm 0.2\text{ km s}^{-1}$
Intrinsic line width	ΔV_i	$0.9 \pm 0.4\text{ km s}^{-1}$	$0.7 \pm 0.2\text{ km s}^{-1}$
Optical depth	τ	$\lesssim 1$	$\lesssim 1$

on weather conditions the cold sky system temperature varied between 37 K and 65 K. We used a spectrometer bandwidth of 3 MHz giving a velocity resolution of 0.18 km s^{-1} and a frequency switching technique with both signal and reference bands covering the line.

We have obtained a coarse map of the H_2CO distribution of the Fang ($l, b = 91^\circ 11', 36^\circ 59'$) in order to study its extension relative to its optical boundary. The results are summarized in Table 3, Col. 1.

Estimates of the centre position (l, b), the half power size ($\Delta l, \Delta b$), and the absorption line depth in the centre (T_L) were obtained by a two dimensional gauss-fit to the observed line

depths. The centre velocity (V_{LSR}) is the intensity weighted average of the observed centre velocities, the amplitude and the position angle of a velocity gradient across the Fang (GV, PA) (defined in the same way as for the CO-velocities) are eye estimates. The half power line width (ΔV) was derived by fitting a single gaussian to the line profile observed at the position $l = 91^\circ 11'$, $b = 36^\circ 59'$ ($\Delta l = 1'$ from the centre position) and displayed in Fig. 3. Attempts to derive the optical depth τ by fitting the six hyperfine components into the spectrum in Fig. 3 failed due to insufficient signal to noise ratio. From these attempts we estimate the intrinsic "one component" line width ΔV_i and the upper limit in τ given in Table 3 also. The line obtained at the "Wart" is

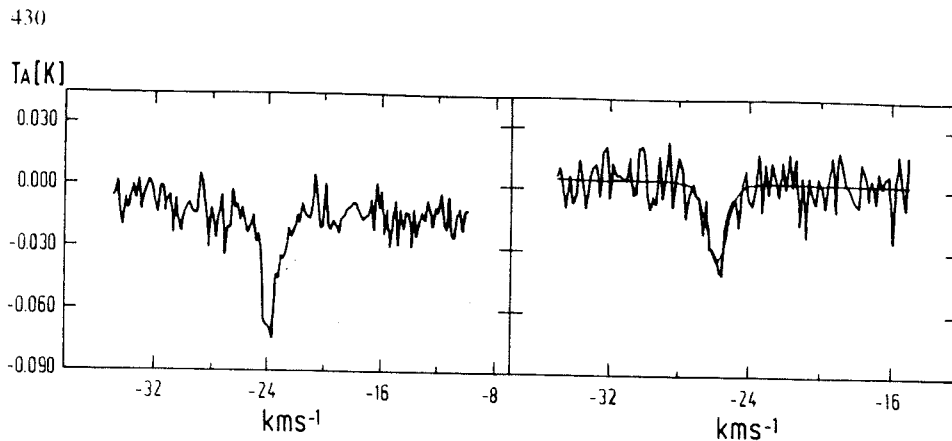

Fig. 3. H_2CO $1_{10} \rightarrow 1_{11}$ $\lambda 6.2$ cm line spectra observed with the Effelsberg 100 m telescope on Draculas Wart (left) and Fang (right)

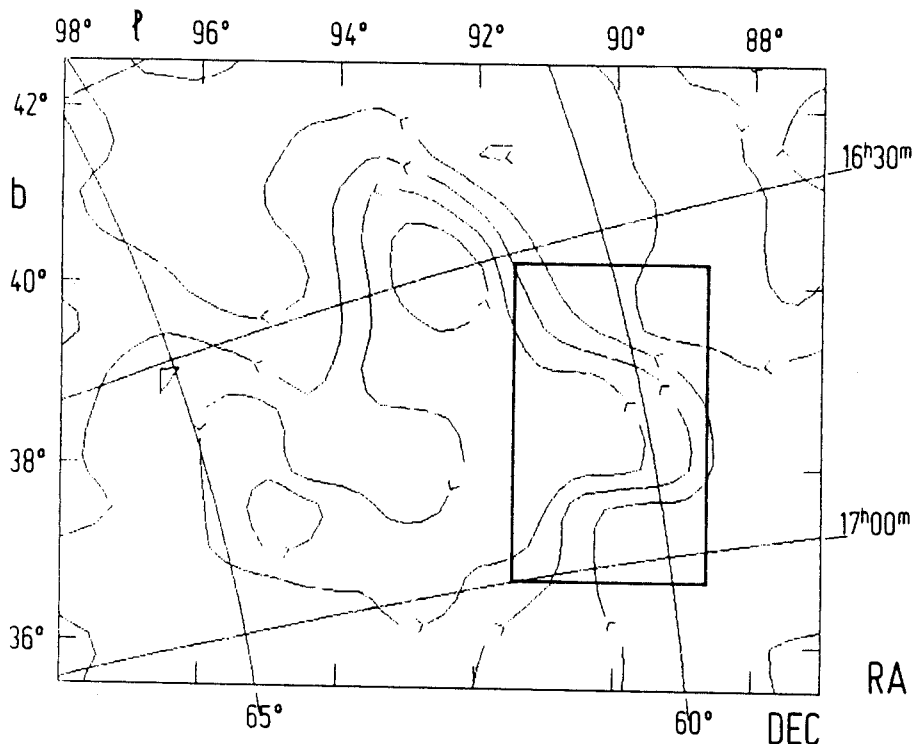

Fig. 4. Map of the mean H I 21 cm line brightness temperature averaged over the velocity interval $-23 \text{ km s}^{-1} < V_{\text{LSR}} < -19 \text{ km s}^{-1}$. The data are from the 21 cm Berkeley line survey (Heiles and Habing, 1974). H I contours are at 4, 8, 12, 16 and 20 K

displayed in Fig.3, parameters obtained by fitting a single gaussian (T_L, V_{LSR} and ΔV) and the estimates of ΔV_i and τ by attempts to fit the set of six hyperfine components are given in Table 3, Col.2. For the other two clumps, the Drop and the Horn, we obtained upper limits of $T_L < 30$ mK, respectively.

2.3. The H I data

In Fig.4 we display H I 21 cm line map obtained from the 21 cm line survey of Heiles and Habing (1974). The isophotes are in line brightness temperatures averaged over the velocity interval from $v = -23 \text{ km s}^{-1}$ to -19 km s^{-1} . The extent of the Effelsberg map in Fig.1 is indicated by a rectangular frame. Obviously the Effelsberg map covers only a fraction of a large horseshoe shaped complex. The whole complex has a size of $\Delta l \times \Delta b \cong 5^\circ \times 4^\circ$ and we find that only 1/3 of it - located in the part towards small longitudes - is visible as bright nebulae at the POSS prints. We have searched for CO lines at a few sample positions in the large longitude part of the map where the H I line is brightest. The negative result is consistent with no or only weak indications of bright patches at the POSS prints.

3. Discussion

3.1. The nature of the optical emission

In the Lynds (1965) Catalogue of Bright Nebulae Dracula ranks with the faintest objects which are close to the surface brightness limit of the plates $V = 24 \text{ mag arcsec}^{-2}$. Dracula is classified about equally bright on the red and blue plates. With these characteristics and a visual extinction of $A_V \cong 1$ mag, derived by Goe-rigk et al. (1983) from star counts, Dracula matches the relation

$$SB_V = 24.2 - 2.5 \log A_V$$

derived by Sandage (1976) for dust clouds located above the galactic plane and reflecting the integrated light of the stars in the galactic disk. For the numerical constants in this relation an albedo of $\gamma = 0.5$ and an extinction efficiency factor of the grains of $\Omega = 2$ were adopted. Hence we conclude that Draco is a molecular and dust cloud located above the galactic plane, has dust properties typical for objects in the plane and is illuminated and possibly also excited by radiation emanating from the galactic

disk. More specific than the general validity of the Sandage relation for Dracula is that the CO-clumps displayed in Fig.1 are in good positional agreement with the brightest patches at the POSS prints. Although a quantitative analysis of this correlation is not possible here because no POSS gas copies are available to us, this shows that investigations of the optical brightness of Dracula or similar objects may be used in the future to derive more details about the dust distribution.

3.2. The distance

The star counts published in Goerigk et al., 1983 can be used to estimate the distance of Dracula. The method is based on the idea that the number of stars ΔN which disappear from the POSS prints due to a given extinction A_V increases with decreasing distance of Dracula from the observer. From Goerigk et al. (1983) we know the total number of stars counted in a field of 1 cm^2 on Dracula, $N_{\text{ON}} = 128 \pm 3$, and off Dracula, $N_{\text{OFF}} = 149 \pm 2$. Hence the star count deficit $\Delta N = N_{\text{OFF}} - N_{\text{ON}}$ at Dracula relative to N_{OFF} is

$$\Delta N/N_{\text{OFF}} = 0.14 \pm 0.02.$$

As these counts were made at the blue POSS prints i.e. in the photographic wavelength range this ratio has been converted into the visual band V :

$$\Delta N/N_{\text{OFF}} = 0.11 \pm 0.02.$$

To derive N_{OFF} from models (cf. Scheffler, 1982) of the stellar density distribution at high galactic latitudes we consider the integrals over the stellar density distribution, $n(r)$, along the line of sight for stars of a certain absolute luminosity, M_V , extended from the observer to the distance $r(M_V)$ where these stars fall below the limiting magnitude $m_G = 21 \text{ mag}$ of the blue POSS prints. N_{OFF} is obtained by weighting these integrals according to the stellar luminosity function, $a(M_V)$ and summing them over all abundant absolute luminosities. N_{ON} is the corresponding sum of integrals extended over slightly modified limits for r . For the luminous stars with $M_V < M_{V,0}$, where $M_{V,0}$ is the absolute luminosity of the faintest visible stars located immediately behind the obscuring dust in Dracula, the integrals over $n(r)$ are to be extended from the observer to the distance $r(M_V + A_V)$, where the obscured stars become invisible. For stars fainter than $M_{V,0}$ the integrals over $n(r)$ are to be extended up to $r(M_V)$ again. Correspondingly, for ΔN the integrals over $n(r)$ are to be extended from $r(M_V + A_V)$ up to $r(M_V)$, but only for stars equally or more luminous than $M_{V,0}$.

Adopting $n(r) \propto \exp(-z/\langle z \rangle)$ with $\langle z \rangle = 270 \text{ pc}$ for distances above the galactic plane (say $z \geq 100 \text{ pc}$) and using the luminosity function, $a(M)$ for visual magnitudes as given by Scheffler (1982) we derive

$$\frac{\Delta N}{N_{\text{OFF}}} = \frac{\sum_{M_V=6}^{M_{V,0}} a(M_V) \int_{z(M_V+A_V)}^{z(M_V)} e^{-z/\langle z \rangle} dz}{\sum_{M_V=6}^{22} a(M_V) \int_{z=0}^{z(M_V)} e^{-z/\langle z \rangle} dz}$$

where

$$z(M_V) = 10^{(0.2(m_G - M_V) + 1)} \cdot \sin b,$$

$$z(M_V + A_V) = 10^{(0.2(m_G - A_V - M_V) + 1)} \cdot \sin b,$$

$m_G = 21 \text{ mag}$, the limiting magnitude of the blue POSS prints and $b = 38.5^\circ$ the average latitude of Dracula.

The lower limit of $M_V \geq 6 \text{ mag}$ for the brightest stars in the sums is not critical because the contributions for $M_V \leq 5 \text{ mag}$ are negligible.

The distance of Dracula now is approximately equal to the distance $r(M_{V,0})$ of the star with absolute luminosity $M_{V,0}$, required to match the relative star count deficit found for Dracula. The value of $\Delta N/N_{\text{OFF}}$ is fairly insensitive to changes of the scale height $\langle z \rangle$ used here.

In Fig.5 we display the run of $\Delta N/N_{\text{OFF}}$ versus the distance D of Dracula for a set of values for A_V . We see that $\Delta N/N_{\text{OFF}} = 0.11 \pm 0.02$ implies a distance of $D = 300 \pm 100 \text{ pc}$ for Dracula if the extinction is adopted to be $A_V = 1 \text{ mag}$ as claimed by Goerigk et al. (1983). But it is also evident that within the present model $\Delta N/N_{\text{OFF}}$ could even be explained by the extreme distance of $D \cong 2.5 \text{ kpc}$ if Dracula were opaque ($A_V > 15 \text{ mag}$) in the visual wavelength regime.

Therefore we have started a program to determine the distance of Dracula by measuring the reddening of stars towards Dracula as a function of their distance. The result of a three colour (UBV) photoelectric photometry of $\cong 60$ stars is that in the optically bright parts of Dracula no reddened main sequence star is found up to a distance of about 800 pc . A distance of 800 pc according to Fig.5 is consistent with $\Delta N/N_{\text{OFF}} = 0.11 \pm 0.02$ only if $A_V \geq 2 \text{ mag}$. This value is still compatible with the Sandage relation as the constants in this relation and the surface brightness of Dracula are not accurately known. The details of our UBV photometry and a discussion of the uncertainties of the quoted distance limit due to a possible change in metallicity of the

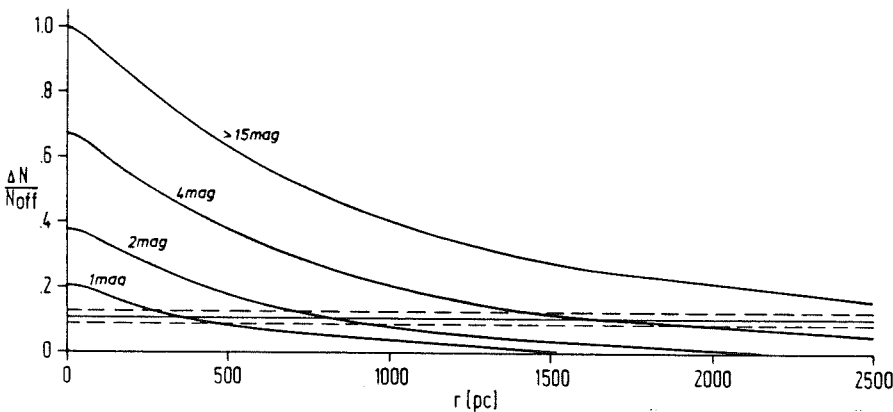

Fig. 5. The star count deficit $\Delta N/N_{\text{OFF}}$ versus the linear distances r for an absorbing dust cloud of a given visual extinction. $\Delta N = N_{\text{OFF}} - N_{\text{ON}}$ is the difference in star counts at an unabsorbed reference field (N_{OFF}) and at the dust cloud. The four curves correspond to the indicated values of the visual extinction. The star count deficit for Dracula and its uncertainty are indicated by the full and the broken horizontal lines, respectively

observed stars with increasing distance will be published in due course.

For the discussion in the present paper we will first adopt the two distances $D = 800$ pc and $D = 300$ pc and then show that the former distance is more consistent with the visual extinction estimated from the molecular content of Dracula.

3.3. Density and temperature

We have derived the LTE excitation temperature, T_{ex} , for the ^{12}CO and the ^{13}CO molecules, the optical depth τ^{13} and the column density $N(^{13}\text{CO})$ (eg. Dickman, 1978) for the CO-gas at the two positions, the Fang and the Wart, where both the ^{12}CO and the ^{13}CO lines could be observed. The corresponding values are given in Table 4.

As the signal to noise ratio of the Fang and the Wart H_2CO spectra is insufficient for a determination of the corresponding optical depths, these spectra were evaluated assuming an excitation temperature of $T_{\text{ex}} = 2.0 \pm 0.5$ K. The column densities $N(\text{H}_2\text{CO})$ derived from the line depths, T_L , given in Table 3, the assumed values of $T_{\text{ex}} = 1.5, 2$ and 2.5 K and an ortho to para correction factor of 1.25 are listed in Table 4.

We will now estimate the total gas column and – by using our distance estimates – the volume densities for the Wart and the Fang. To estimate the total column densities of hydrogen nuclei $N_T = N(\text{H I}) + 2N(\text{H}_2)$ we need the molecular hydrogen column densities $N(\text{H}_2)$. As the extinction A_V is not well determined we will estimate $N(\text{H}_2)$ from $N(^{13}\text{CO})$ by using standard scaling factors from the literature. In doing so one must of course be aware of the fact that these factors may not be applicable to Dracula

- 1) because the environment of Dracula may be totally different from that for disk objects if it is in fact located more than 500 pc above the galactic plane and
- 2) because a considerable scatter of these scaling factors is even found for disk objects.

Table 4. Physical parameters

Parameter		Fang	Wart
$T_{\text{ex}}(\text{CO})$	[K]	7.4	8.8
τ^{13}		1.2	1.3
$N(^{13}\text{CO})$	[cm^{-2}]	$3.4 \cdot 10^{14}$	$8.6 \cdot 10^{14}$
$T_{\text{ex}}(\text{H}_2\text{CO})$	[K]	1.5, 2.0, 2.5	1.5, 2.0, 2.5
$N(\text{H}_2\text{CO})$	[$10^{12} \cdot \text{cm}^{-2}$]	3.1, 6.3, 19.0	2.8, 8.5, 25.5
$N_{\text{H I}}(\text{UV})$	[cm^{-2}]	$1.6 \cdot 10^{21}$	$2.6 \cdot 10^{21}$
$N_{\text{H I}}(A_V)$	[cm^{-2}]	$1.2 \cdot 10^{21}$	$1.6 \cdot 10^{21}$
$N_{\text{H I}}$	[cm^{-2}]	$0.8 \cdot 10^{20}$	$1.1 \cdot 10^{20}$
N_T	[cm^{-2}]	$2.9 \cdot 10^{21}$	$4.3 \cdot 10^{21}$
A_V	[mg]	1.6	2.3
size	[arc min]	6.5	15
<i>D = 800 pc</i>			
d	[pc]	1.51	3.49
$n(800)$	[cm^{-3}]	620	400
$M(800)$	[M_\odot]	27	219
$\sigma^2(\kappa M/r)^{-1}$		0.74	0.69
<i>D = 300 pc</i>			
d	[pc]	0.57	1.32
$n(300)$	[cm^{-3}]	1650	1050
$M(300)$	[M_\odot]	3.9	31
$\sigma^2(\kappa M/r)^{-1}$		2.2	1.8

First we estimate $N(\text{H}_2)$ from a direct observational correlation with $N(\text{CO})$, the total CO-column density. Federman et al. (1980), from observations in the UV-wavelength range of CO- and H_2 - molecules towards bright stars find $N(\text{CO}) = 6.3 \cdot 10^{13} (N(\text{H}_2)/10^{20} \text{ cm}^{-2})^2 \text{ cm}^{-2}$. In Table 4 we give $N(\text{H}_2)(\text{UV})$ derived from this relation by using $N(^{13}\text{CO})$ from Table 4 and adopting a CO-isotopic ratio of $N(^{12}\text{CO})/N(^{13}\text{CO}) = 50$.

Second we estimate $N(\text{H}_2)$ from observational correlations of $N(^{13}\text{CO})$ and A_V and the "standard" ratio $N(\text{H}_2)/A_V = 0.94 \cdot 10^{21} \text{ molecules cm}^{-2} \text{ mag}^{-1}$. Using this correlation in the form given by Frerking et al. (1982) for the Taurus region $N(\text{H}_2) = (N(^{13}\text{CO})/1.4 \cdot 10^{15} + 1) \cdot 10^{21} \text{ cm}^{-2}$ we derive H_2 column densities, $N(\text{H}_2)(A_V)$, which are similar to the $N(\text{H}_2)(\text{UV})$ values (see Table 4).

Finally we use our rather uncertain estimates of $N(\text{H}_2\text{CO})$ in Table 4 for a check of the above $N(\text{H}_2)$ values. The compilation of $\text{H}_2\text{CO}/\text{H}_2$ ratios by Sherwood (1979) suggests $N(\text{H}_2) \cong 10^8 N(\text{H}_2\text{CO}) \cong 7 \cdot 10^{20} \text{ cm}^{-2}$. Considering the uncertainty of about a factor of 3 this is consistent with the $N(\text{H}_2)$ values in Table 4.

N_T , the total column densities of hydrogen nuclei, given in Table 4, is now derived from the average of $N(\text{H}_2)(\text{UV})$ and $N(\text{H}_2)(A_V)$ and the neutral hydrogen column density $N(\text{H I})$ observed by Goerigk et al. (1983). Using the standard ratio $\langle N_T \rangle / A_V = 1.87 \cdot 10^{21} \text{ cm}^{-2} \text{ mag}^{-1}$ we derive A_V as given in Table 4 and find that the observed relative lack of stars $\Delta N/N_{\text{OFF}} = 0.11 \pm 0.02$ towards Dracula is consistent with a distance of $D = 800$ pc. But in view of the uncertainties quoted above and for comparison the volume densities, n , the estimates of the total gas mass, M , and stability considerations are presented for $D = 800$ pc and 300 pc.

The volume densities, n , and the total masses, M , are derived from the column densities N_T and the linear dimensions, d , estimated from angular sizes of $6.5'$ and $15'$ for the Fang and the Wart, respectively, and the adopted distances. The virial theorem has been used to test whether or not these clumps are bound systems. Using the velocity dispersion $\sigma = \Delta V/2.355$ of the ^{13}CO lines listed in Table 1, the total masses, M , and the linear dimensions, $d = 2r$, listed in Table 4 we have ($\kappa =$ gravitational constant)

$$\sigma^2(\kappa M/r)^{-1} = > 1 \text{ for unbound clumps,}$$

$$\sigma^2(\kappa M/r)^{-1} = < 1 \text{ for bound clumps.}$$

We see that the Fang and the Wart with our distance (≥ 800 pc) and column density estimates are gravitationally bound molecular clouds. This result – to our knowledge – presents the first clear indication that sites of star formation are located more than 500 pc above the galactic plane.

As all of these results are based on estimates of as yet unknown uncertainty we will briefly discuss some of the peculiarities of Dracula which cause these uncertainties. Here it must be emphasized again that the total column density N_T has been estimated by using the "standard" conversion relations which were derived for disk objects. This may be grossly wrong if the "halo" environment of Dracula, e.g. the radiation field and the element abundances, differ from those in the galactic disk.

3.4. The environment of Dracula

Evidence that the environment of Dracula may indeed be different from that in the disk comes from the rather small column

density of atomic hydrogen $N(\text{H I}) \cong 1.10^{20} \text{ cm}^{-2}$ observed in Dracula. This column density called the "transition" column density, N_{TR} , essentially is the atomic complement of the molecular hydrogen column density which shields the interior of the molecular clumps from the dissociating interstellar radiation field (cf. Federman et al., 1979).

The difference of N_{TR} in Dracula to the more typical values $N_{\text{TR}} = 5.10^{20} \text{ cm}^{-2}$ in the galactic plane may indicate that the interstellar radiation field at the location of Dracula is less intense than the mean interstellar radiation field. Following Federman et al. (1979) we have

$$N_{\text{TR}}/10^{20} \text{ cm}^{-2} = (1.4 \cdot 10^{-4})^{-1.4} (2n \cdot R/G)^{-1.4}$$

where $R \cong 3 \cdot 10^{-17} \text{ cm}^3 \text{ s}^{-1}$ is the rate constant for the formation of molecular hydrogen on dust grains, $G (\cong 6 \cdot 10^{-11} \text{ s}^{-1})$ is the photo dissociation rate of molecular hydrogen due to the mean interstellar radiation field and n is the mean density of H-nuclei – in practice equal to the atomic hydrogen density $N(\text{H I})$ – in the transition region between the cloud surface and depth where 10% by column densities is converted to H_2 . Adopting $N_{\text{TR}} = N(\text{H I})$ from Table 4 and estimating n by using the total linear dimension given in Table 4 we find that G is about a factor of 10 smaller for Dracula than the value quoted above for the mean interstellar radiation field. A typical value of G would result if n were a factor 10 larger, i.e. if the transition region were only 1/10 of the total linear dimension. As this is not very likely we suggest that the rather small values for $N(\text{H I})$ are indicative of an reduced intensity of the interstellar radiation field at the location of Dracula. This may be compared to the assumptions made in estimating the reflected brightness of Dracula in the visual wavelength band. Within the uncertainties the reduced intensity of the radiation field is consistent with a location of Dracula above the galactic plane and with a typical interstellar radiation field incident over 2π only rather than 4π for disk objects.

Finally we shall briefly discuss the situation of the whole Dracula complex relative to our Galaxy. The total mass of the Dracula complex may be estimated from the total extend of the complex of $\Delta l \times \Delta b \cong 5^\circ \times 5^\circ$ (cf. Fig.4) and by adopting a mean column densities of H-nuclei of $N_{\text{T}} = 5.10^{20} \text{ cm}^{-2}$. On this basis we derive a total mass of $M \cong 10^4 M_\odot$. The radial velocity of $V_{\text{LSR}} \cong -22 \text{ km s}^{-1}$, the positive velocity gradient of the H I gas at the boundary towards small l and small b (galactic position angle $\cong 225^\circ$, see Fig.4; cf. Goerigk et al., 1983) and the filamentary morphology of the dust at that boundary suggest that Dracula as a whole is falling towards the galactic plane and is being decelerated by interaction with a probably non-neutral galactic gas.

This interaction may be related to the fact that dust and molecules are preferentially observed in the small $-l$, small $-b$ part of Dracula. The deceleration will be acting only in a narrow interface region and will be causing a compression of the gas within this interface region. If we hypothesize that the dust and the molecules are located in just this interface region and if we combine this with the observed radial velocity of $\cong -22 \text{ km s}^{-1}$ we get a rough idea of the path of Dracula in space: The direction of motion in the plane of the sky is somewhere around a galactic position angle of about 225° (defined counter clockwise from the direction towards the galactic north pole). If we adopt further that the tangential velocity is equal to the observed radial velocity, the velocity vector would be inclined by 45° from the direction towards us and would have an absolute value of about 30 km s^{-1} .

The interaction of the gas in Dracula with the galactic gas may further be related to two very interesting positional coincidences: Dracula is located at the low-latitude end of the high velocity cloud complex CI, also called HVC CI (Hulsbosch, 1979). Indeed high negative velocity H I-gas ($-180 < V_{\text{LSR}} < -60 \text{ km s}^{-1}$) is observed over all the region covered by Dracula and its morphology is very suggestive of a direct interaction with Dracula (Kalberla et al., 1984).

Further, Dracula coincides in position with a C-band X-ray emission feature in the SAS-satellite sky maps (Clark, 1984) and the low energy band of the soft X-ray maps of the HEAO-1 satellite (Nousek et al., 1984). See also the C-, M- and J- band maps of McCammon et al. (1982). It is therefore very suggestive that the X-ray emission is thermal bremsstrahlung produced by electrons and ions in HVC CI and the galactic gas. Such a hypothesis can, however, only be tested by new, more detailed X-ray observations.

In summary we have the following results: Dracula is a bright dust cloud probably located more than 500 pc above the galactic plane and reflecting the integrated star light of the galactic disk. The quoted z -value is estimated from UBV photometry of about 60 stars in the field of Dracula. Dracula exhibits $\lambda 2.6 \text{ mm}^{12}\text{CO}$ and $\lambda 2.7 \text{ mm}^{13}\text{CO}$ line emission. The line intensities imply $A_V \cong 2 \text{ mag}$ of visual extinction, if the "standard" relations, i.e. relations derived for the galactic disk, between the column densities of ^{13}CO , molecular hydrogen and A_V also apply to Dracula. Both this value for A_V and the quoted z -value are reinforced by star counts obtained at the POSS prints and an interpretation of these counts on the basis of models for the distribution of stars in high galactic latitudes.

Mass estimates and dynamical considerations for the molecular clumps in Dracula indicate that these clumps may be gravitationally bound systems – a first clear hint that star formation in our galaxy may not only occur close to the galactic plane. The total mass of the whole Dracula complex is estimated to be about $10^4 M_\odot$. Three facts, namely its negative radial velocity, a positive velocity gradient at the boundary facing small $-l$ and small $-b$ values and its location at the low latitude end of a high velocity gas stream together with the positional coincidence with enhanced soft X-ray emission suggest that Dracula is an object representing an intermediate phase of the evolution of an halo or even extragalactic gas cloud in its process of merging with our Galaxy.

References

- Baudry, A., Brillet, J., Desbats, J.M., Lacroix, J., Montignac, G., Encrenaz, P., Lucas, R., Beaudin, G., Dierich, P., Germont, A., Landry, P., Rerat, G.: 1980, *J. Astron. Astrophys.* **1**, 193
 Baudry, A., Cernicharo, J., Perault, M., de la Noe, J., Despois, D.: 1981, *Astron. Astrophys.* **104**, 101
 Clark, G.: 1984, in *The Local Interstellar Medium, IAU Coll.* **81**, Madison, Wisconsin
 Dickman, R.L.: 1978, *Astrophys. J. Suppl.* **37**, 407
 Federman, S.R., Glassgold, A.E., Kwan, J.: 1979, *Astrophys. J.* **227**, 466
 Federman, S.R., Glassgold, A.E., Jenkins, E.B., Shaya, E.J.: 1980, *Astrophys. J.* **242**, 545
 Frerking, M.A., Langer, W.D., Wilson, R.W.: 1982, *Astrophys. J.* **262**, 590

- Goerigk, W., Mebold, U., Reif, K., Kalberla, P.M.W., Velden, L.: 1983, *Astron. Astrophys.* **120**, 63
- Heiles, G., Habing, H.J.: 1974, *Astron. Astrophys. Suppl.* **14**, 1
- Hulsbosch, A.: 1979, in *IAU Symp.* **84**, 525
- Kalberla, P.M.W., Herbstmeier, U., Mebold, U.: 1984, in *The Local Interstellar Medium, IAU Coll. 81*, Madison, Wisconsin
- Lynds, B.T.: 1965, *Astrophys. J. Suppl.* **12**, 163
- Mebold, U., Cernicharo, J., Velden, L., Crezelius, C., Reif, K.: 1983, *Mitt. Astron. Ges.* **60**, 418
- Nousek, J.A., Garmire, G.D., Weaver, G.: in *The Local Interstellar Medium, IAU Coll. 81*, Madison, Wisconsin (to be published)
- McCammon, D., Burrows, D.N., Sanders, W.T., Kraushaar, W.L.: 1982, *Astrophys. J.* **269**, 107
- Sandage, A.: 1976, *Astron. J.* **81**, 954
- Scheffler, H.: 1982, in Landolt-Börnstein, Vol. 2, p. 175
- Sherwood, W.A.: 1979, in *Interstellar Molecules, IAU Coll. 87*, ed. B.H. Andrew, Reidel Publ. Comp., p. 101

I.18) APPENDICE B: OBSERVATIONS DE NH₃ DANS HH1-2

I.18) APPENDICE B: OBSERVATIONS DE NH₃ DANS HH1-2

Nous présentons dans cet article des observations des raies d'inversion (1,1) and (2,2) de NH₃ dans la direction de HH1-2. Nous avons trouvé plusieurs fragmentats avec des vitesses radiales comprises entre 8.3 et 10.3 kms⁻¹. Deux de ces fragments sont près de la source d'excitation des objets HH1-2. Leur faible température cinétique et le très haut degré de collimation du flot bipolaire suggèrent qu'ils ne jouent pas un rôle important dans la collimation du vent stellaire. La distribution spatiale de NH₃ suggère que le vent stellaire a ouvert une cavité dans le nuage moléculaire.

Letter to the Editor

NH₃ observations of the HH1-HH2 region

J. Martín-Pintado^{1,2} and J. Cernicharo^{3,4}

¹ Centro Astronómico de Yebes (OAN), Apartado 148, E-19080 Guadalajara, Spain

² IRAM, Av. Divina Pastora N. 7, Núcleo Central, E-18012 Granada, Spain

³ Groupe d'Astrophysique de l'Observatoire de Grenoble, Université de Grenoble, CERMO, BP 68, F-38402 St. Martin d'Hères Cedex, France

⁴ IRAM, Domaine Universitaire de Grenoble, Voie 10, F-38406 St. Martin d'Hères, France

Received January 30, accepted February 12, 1987

SUMMARY

We present observations of the (1,1) and (2,2) ammonia inversion lines towards the HH1-2 region. We observe several clumps at radial velocities between 8.3 and 10.3 km s⁻¹. Two of these clumps are close to the excitation source of the HH1-2 objects. Their low kinetic temperatures (11 and 14 K respectively) and the highly collimated outflow suggest that these condensations do not play an important role in the initial focussing of the stellar wind. This may occur at smaller size scales. The spatial distribution of ammonia suggests that the stellar wind has opened a cavity in the molecular cloud and compressed the material close to the cavity walls.

Key words: Interstellar medium:molecules,clouds: HH1-2; Star formation.

HH1 and HH2, prototypes of the Herbig-Haro objects, were discovered independently by Herbig (1951) and Haro (1952). It is now well established that HH objects originate in the cooling region of shock waves that arise from the interaction of the stellar wind of young stars with the ambient material (see e.g. Schwartz 1983). The proper motions of HH1 and HH2 reveal that they have been ejected or accelerated to velocities up to 350 km s⁻¹ (Herbig and Jones 1981). There has been some controversy over which source is responsible for powering this high collimated mass outflow. However, Pravdo et al. (1985) discovered a radio continuum source at the midpoint between HH1 and HH2. Pravdo et al. (1985), Strom et al. (1985) and Harvey et al. (1986) have shown that this source is powering the mass outflow. Other sites of recent star formation are found in this region. A time-variable radio continuum source was detected by Pravdo et al. (1985) in the direction of the H₂O maser located 24" west and 15" south of HH1 (Lo et al. 1975, Haschick et al. 1983).

Because the HH1-2 system is nearly perpendicular to the line of sight (Herbig and Jones, 1981) and the reflection nebula is probably bipolar (Strom et al., 1985), this region is a very good candidate for studying the collimation mechanisms of mass outflows and the interaction of stellar winds with ambient molecular clouds. Torrelles et al. (1985) mapped the region of HH1-2 in the (1,1) inversion line of NH₃, and found a toroid of dense material centered at the position of the central radio continuum source and aligned perpendicular to the HH1-2 bipolar flow.

To study with high angular resolution and sensitivity the physical conditions of the high density molecular gas around HH1-2, we have mapped this region in the (1,1) and (2,2) inversion lines of NH₃. The observations were made in March 1986 with the 100 m. radio telescope of the MPIFR. At the frequency of the (1,1) line the HPBW of the radio telescope is 40". The receiver was a K-band maser with a receiver temperature of 40 K. The 1024 channel autocorrelator was split in two spectrometers, each with a bandwidth of 6.25 MHz and a resolution of 12.2 KHz (0.15 km s⁻¹). Each spectrometer was centered at one of the two lines so that both lines were observed simultaneously. Spectra were taken using position switching. The data were calibrated by continuum cross scans of DR21 (assumed flux density 19 Jy, see Baars et al. 1977). The line intensities are given in terms of main beam brightness temperature. The rms noise of the observed line intensities varies between 0.08 and 0.15 K. Pointing and focus were checked every two hours with the radio continuum sources DR21 and NGC7027. Observed and derived parameters at selected positions are given in Table 1.

Fig. 1 shows the integrated line intensity of the main hyperfine component of the (1,1) line. This map is centered on the exciting source of the HH1-2 objects. The crosses indicate the observed positions. The (1,1) line was undetected only at the most western positions. The NH₃ map of Torrelles et al. (1985), made with lower angular resolution (1.4'), roughly agrees with ours. Our 40" resolution map, however, shows that the NH₃ distribution is more complex than the single elongated condensation they suggested: Figure 1 shows a "V" shaped structure with the vertex on the central radio source. The symmetry axis of this structure nearly coincides with the line joining HH1 and HH2, and with the optical reflection nebula.

The ammonia velocity distribution can be seen in Fig. 2, which shows the NH₃ emission at different velocities superposed on the I plate of Strom et al. (1985). Towards the central radio source, two velocity components at 8.3 and 10.3 km s⁻¹ are found (see Fig. 2a,b and 2e,f). The doubled peaked profile can be seen towards several positions around the central source without change in the radial velocities of the two components. The 8.3 km s⁻¹ clump, hereafter called A, has a deconvolved size of 0.12x0.2 pc. The 10.3 km s⁻¹ clump, hereafter called B (Fig. 2f), has a similar size to that of clump A. The most attractive framework for modeling the ammonia emission of clumps A and B could be that of an expanding disk or toroid surrounding the central radio source and aligned perpendicular to the direction of the mass outflow (see Torrelles et al., 1985). However, for an expanding disk, one should expect to observe ammonia emission at intermediate

Send offprint requests to: J. Martín-Pintado

L28

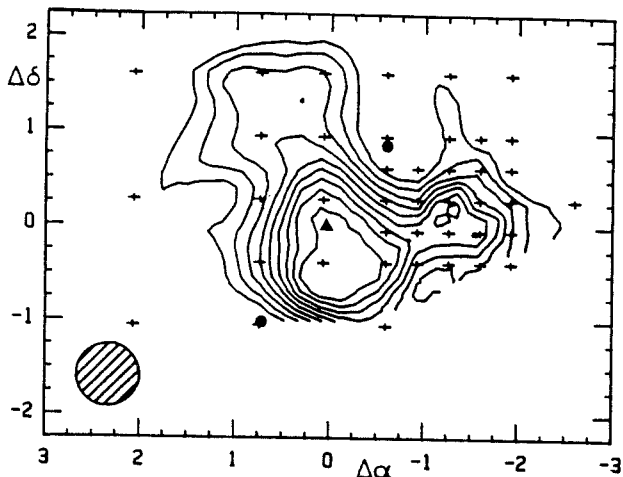

FIGURE 1: Map of the integrated intensity of the main component of the (1,1) transition of NH_3 . The lowest contour is 1.7 K km s^{-1} and the interval is 0.6 K km s^{-1} . The crosses show the observed positions. The positions of HH1-HH2 are indicated by filled circles, and the central radio source (Pravdo et al., 1985) by a filled triangle. The beam is shown as a hatched circle at the lower left corner.

velocities (9.3 km s^{-1}) at the edges of the disk. Emission at this velocity is only observed far from clumps A and B (clumps C to E -see Fig. 2 and below). In addition, clumps A and B, if produced by an expanding toroid with symmetry axis in the plane of the sky, should overlap spatially, and their ammonia emission peaks must be in the same direction. As it can be seen in Fig. 2, clump A has its ammonia emission peak $30''$ east of the central excitation source and clump B $50''$ south. Moreover, the widths of the ammonia line, as well as the derived hydrogen densities are larger for clump B than for A (see Table 1), implying the two clumps have different physical conditions. Because our data barely resolve the clumps structure, we can not rule out rotation of fragments A and B. Condensations similar to our clumps A and B have been

found surrounding other sources with mass loss (see Wilking et al., 1986, and Walmsley and Menten, 1986).

The NH_3 emission at radial velocities around 9.3 km s^{-1} (Fig. 2) consists of several condensations at the edges of the biconical reflection nebula. The emission is very weak towards the reflection nebula and the central radio source. The good agreement between the edges of the reflection nebula and the spatial distribution of the clumps could be explained if the reflection nebula is in fact more extended than observed but its size and shape are determined by the clumps located in front of it. However, the extremely well defined conical shape of the reflection nebula, with the vertex close to the exciting source, and the HH objects located at its symmetry axis suggest a cavity opened in the parent molecular cloud by the stellar wind from the central radio source rather than a projection effect. The positions of the ammonia maxima move away from the central radiosource as the radial velocity increases. The clumps at both sides of the reflection nebula shift parallel to the HH1-2 axis. In the right arm of the "V" structure the ammonia emission peak shifts by 1 arcminute from condensations A (see Fig. 2a and 2b) to C (see Fig. 2c and 2d). A similar behaviour is shown by condensations D and E in the left arm of the "V" structure. This ordered motion suggests that the stellar wind has compressed, fragmented and accelerated the material close to the cavity walls (see Fig. 2c). An expanding and fragmented shell, with a conical hole produced by the highly collimated mass outflow (the shell has a paraboloid shape), could fit the observed velocity structure of the ammonia clumps. In this picture, clumps A and B should be moving away from the central radiosource nearly along the line of sight. The difference between the radial velocities of the two clumps gives an estimation of the expansion velocity ($\approx 1 \text{ km s}^{-1}$). Along the cavity walls, i.e. at the edges of the expanding shell, the ammonia clumps have radial velocities unperturbed by the expansion because they move on a plane tilted by no more than 5° with respect to the plane perpendicular to the line of sight (Herbig and Jones, 1981). Clumps C, D and E should have radial velocities around 9.3 km s^{-1} (the mean velocity of clumps A and B), as observed. Another possibility to explain these velocity differences is that clumps C to E are accelerated along the cavity walls. However, taking into account the low inclination of the HH1-2

TABLE 1
OBSERVED PARAMETERS AND DERIVED PHYSICAL CONDITIONS AT SELECTED POSITIONS

Position (arcsec)	Clump	(1,1)			(2,2) ^a			$n(H_2)$ ^b cm^{-3}	$N(NH_3)$ cm^{-2}	T_K (K)
		T_B (K)	Δv kms^{-1}	V_{LSR1} kms^{-1}	T_B (K)	Δv kms^{-1}	V_{LSR-1} kms^{-1}			
(0,+17)	A	2.4 ± 0.1	0.5 ± 0.1	8.3 ± 0.1	<0.20					
	B	1.5 ± 0.1	1.2 ± 0.1	10.4 ± 0.2	0.27 ± 0.07	1.1 ± 0.3	10.3 ± 0.3	$>3 \times 10^4$	9.0×10^{13}	<11
(0,-23)	A	1.8 ± 0.1	0.5 ± 0.1	8.3 ± 0.3	<0.30				1.3×10^{14}	14 ± 3
	B	2.4 ± 0.1	1.0 ± 0.1	10.4 ± 0.3	0.45 ± 0.07	1.3 ± 0.3	10.3 ± 0.4	7.0×10^{13}	1.7×10^{14}	≤ 12
(-80,+17)	C	3.7 ± 0.1	0.8 ± 0.1	9.4 ± 0.1	1.40 ± 0.10	0.9 ± 0.2	9.4 ± 0.1	6×10^4	2.1×10^{14}	14 ± 3
(+40,+57)	D	2.4 ± 0.1	0.6 ± 0.1	8.6 ± 0.1	0.81 ± 0.08	0.9 ± 0.2	8.6 ± 0.1	2×10^4	1.0×10^{14}	17 ± 2
(0,+97)	E	1.5 ± 0.1	0.6 ± 0.1	9.1 ± 0.1	0.52 ± 0.05	0.5 ± 0.1	9.0 ± 0.1	2×10^4	6.0×10^{13}	16 ± 4
(-80,+57)	M ^c	0.9 ± 0.1	1.3 ± 0.2	9.2 ± 0.1	0.47 ± 0.09	1.3 ± 0.4	9.0 ± 0.3	$>7 \times 10^3$	8.0×10^{13}	22 ± 4
(-40,+57)	HH1	0.6 ± 0.1	2.0 ± 0.4	8.9 ± 0.2	0.40 ± 0.10	1.7 ± 0.7	9.4 ± 0.4		9.0×10^{13}	23 ± 6

a) The data of the (2,2) line have been hanning smoothed.

b) The excitation temperatures have been derived from the lines intensities and opacities by assuming a filling factor of 1.

c) This position is $15''$ north of the H_2O maser/IR/radio continuum source.

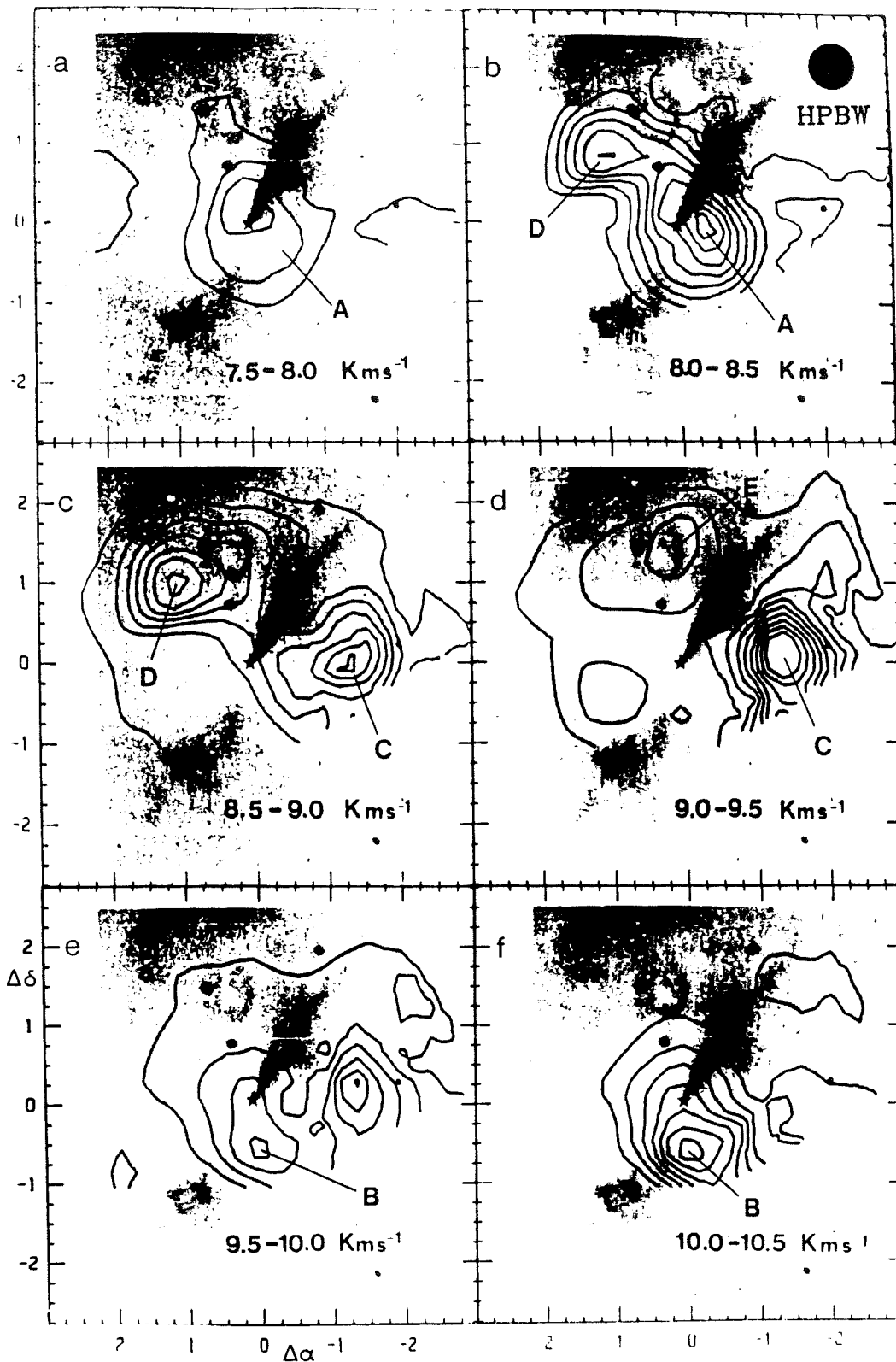

FIGURE 2 : Spatial distribution of the (1,1) line intensity, integrated over the velocity range indicated in the panels, superposed on the I plate taken by Strom et al. (1985). The star shows the position of the central radio source. The first contour is 0.16 K km s⁻¹ and the interval is 0.22 K km s⁻¹. Coordinate offsets (arc min.) are relative to the central radiosource. The labels indicate the condensations discussed in the text.

L30

system, the observed velocity difference between clumps in the cavity walls would correspond to an energy larger than that provided by the stellar wind (see below). Our data seem to indicate that the observed velocity changes along the cavity walls are not continuous and that they correspond to well defined fragments. However, higher angular observations are needed to resolve the structure of these clumps.

The total mass of the gas in the clumps is $10 M_{\odot}$. If the clumps are expanding at a velocity of 1 km s^{-1} , a luminosity of $1 L_{\odot}$ must be supplied by the central radio source over a dynamical time of $\approx 10^3$ years (Herbig and Jones 1981). This luminosity is comparable to the wind luminosity, $1.4 L_{\odot}$, estimated from a mass loss rate of $4 \times 10^{-7} M_{\odot} \text{ y}^{-1}$ (Pravdo et al 1985) and a wind velocity of 200 km s^{-1} (Herbig and Jones 1981). We conclude that the observed NH_3 velocity structure can be explained by a fragmented and expanding shell of gas, i.e., the ammonia clumps should be the residual gas left from the star formation process.

By combining our measurements of the (1,1) and (2,2) lines (see Ungerechts et al. 1986) we determine the rotational temperature, T_{12} , at several positions (see Table 1). The typical uncertainty in the derived rotational temperatures is $\approx 4 \text{ K}$ (see Table 1). Walmsley and Ungerechts (1983) have established that the rotational temperature is generally a lower limit to the kinetic temperature. For rotational temperatures between 11 to 15 K, it is a good approximation to assume the kinetic temperature equals the derived rotational temperature. The kinetic temperature toward the central continuum source is $< 11 \text{ K}$ for clump A and $\approx 14 \text{ K}$ for clump B. It is worth noting the lack of an increase of gas kinetic temperature towards the central radiosource. This source is associated with a local maximum of dust temperature that Harvey et al. (1986) interpreted as dust heated by an embedded source located near or at the central radiosource. The bulk of ammonia emission we observe must arise, then, in a low temperature gas not heated by the central exciting source.

The highest rotational temperature, $\approx 23 \text{ K}$, is found towards HH1 and $\approx 15''$ north of the H_2O maser/IR/radio continuum source, just at the edge of an ammonia condensation. There is good agreement in position for the ammonia rotational temperature and dust temperature maxima (see Harvey et al. 1986). The heating source responsible for this temperature maximum can be: i) an embedded IR source at the position of the highest rotational temperature that, so far, remains undetected because of the large extinction -our data cannot rule out completely a condensation of radius $< 7''$ ($A_V/2 > 50$ mag. for $n(\text{H}_2) > 10^6 \text{ cm}^{-3}$) surrounding the undetected IR source; ii) the IR source found at the position of the H_2O maser/radio continuum source (see discussion of Harvey et al., 1986), or iii) the shock wave responsible for the HH1 object.

In summary, our ammonia observations show that the structure of the gas around HH1-2 is more complex than the toroid proposed by Torrelles et al. (1985). The cloud seems to be fragmented in several clumps positioned along the walls of a conical cavity opened by the stellar wind. The velocity structure can be fitted by an expanding parabolic shell with a expansion velocity of 1 km s^{-1} . The highest rotational temperature we find is no associated with any IR source. Higher angular resolution observations are needed to determine what is the heating source responsible for this gas temperature peak.

Acknowledgements

We thank Dr. Mauersberger for help during the observations. J.M.P. has been partially supported from CAICYT grant No. 477/84. We would like to thank M. Guélin, S. Radford, B. Lazareff, and P. Harvey for useful suggestions and discussions.

REFERENCES

- Baars, J.W.M., Genzel, R., Pauling-Toth, I.I.K., Witzel, A.: 1977, *Astron. Astrophys.*, **61**, 99.
 Cohen, M., Harvey, P.M., Schwartz, R.D., Wilking, B.A.: 1984, *Ap. J.*, **278**, 671.
 Harvey, P.M., Marshall, J., Lester, D.F., Wilking, B.A.: 1986, *Ap. J.*, **301**, 346.
 Haschick, A.D., Moran, J.M., Rodriguez, L.F., Ho, P.T.P.: 1983, *Ap. J.*, **265**, 281.
 Herbig, G.M., Jones, B.F.: 1981, *Astron. J.*, **86**, 1232.
 Herbig, G.M.: 1951, *Ap. J.*, **113**, 697.
 Haro, G.: 1952, *Ap. J.*, **115**, 572.
 Lo, K.Y., Burke, B.F., Haschick, A.D.: 1975, *Ap. J.*, **202**, 81.
 Pravdo, S.H., Rodriguez, L.F., Curiel, S., Canto, J., Torrelles, J.M., Becker, R.M., Sellgren, K.S.: 1985, *Ap. J.*, **293**, L35.
 Schwartz, R.D.: 1983, *Rev. Mexicana Astron. Astrof.*, **7**, 27.
 Scoville, N.Z., and Kwan, J.: 1976, *Ap. J.*, **206**, 718.
 Strom, S.E., Strom, K.M., Grasdalen, G.L., Sellgren, K., Wolf, S., Morgan, J., Stocke, J., Mund, R.: 1985, *Astron. J.*, **90**, 2281.
 Torrelles, J.M., Canto, J., Rodriguez, L.F., Ho, P.T.P., Moran, J.M.: 1985, *Ap. J.*, **294**, L117.
 Ungerechts, H., Walmsley, C.M., Winnemissner, G.: 1986, *Astron. Astrophys.*, **157**, 207.
 Walmsley, C.M., Ungerechts, M.: 1983, *Astron. Astrophys.*, **122**, 164.
 Walmsley, C.M., Menten, K.M.: 1986, *Proceedings of an ESA-workshop on a Space Borne Submillimeter Astronomy mission*, pag. 203.
 Wilking, B.A., Mundy, L.G., Schwartz, R.: 1986, *Ap. J.*, **303**, L61.

I.19) APPENDICE C: OBSERVATIONS DE NEBULEUSES COMETAIRES.

LE CAS DE R-MON.

I.19) APPENDICE C: OBSERVATIONS DE NEBULEUSES COMETAIRES. LE CAS DE R-MON.

Nous avons observé la nébuleuse cométaire NGC2261, qui est excitée par l'étoile R-Mon, dans les raies J=1-0 de ^{12}CO et de ^{13}CO avec le radiotélescope de 30-m de l'IRAM. La résolution angulaire aux fréquences de ^{12}CO et ^{13}CO est de 20".

La comparaison de l'émission moléculaire avec des données optiques nous a permis d'étudier la structure cinématique et la nature de cet objet. Nos observations suggèrent que la nébuleuse cométaire NGC2261 est la partie brillante d'une nébuleuse bipolaire. La nébuleuse optique a la forme d'un cône avec R-Mon, l'étoile excitatrice, dans son vertex. Le gaz moléculaire semble s'écouler le long des parois du cône.

Vers la position de R-Mon nous avons trouvé un maximum d'émission moléculaire qui pourrait être le résidu du fragment à partir duquel R-Mon s'est formée.

Observations of young cometary nebulae
with the IRAM 30-m telescope : the case of R Mon

R. Bachiller¹, J. Cernicharo^{2,3}, J. Martín-Pintado^{1,4}

- 1) Centro Astronómico de Yebes (O.A.N.-I.G.N.). Apartado 148. 19080 GUADALAJARA. Spain.
- 2) Groupe d'Astrophysique de l'Observatoire de Grenoble. USMG. CERMO. BP. 68. 38402 St. Martin d'Hères. France.
- 3) IRAM. Voie 10. Domaine Universitaire de Grenoble. 38406 St. Martin d'Hères. France.
- 4) IRAM. Av. Divina Pastora, 7. Núcleo Central. 18012 GRANADA. Spain.

Abstract

The prototypical young cometary nebula NGC 2261, around the star R Mon, has been extensively observed with 20" resolution in the J=1-0 line of CO and ^{13}CO by using the IRAM 30-m telescope (located on the Pico Veleta, near Granada, Spain).

The molecular line maps are compared to optical observations in order to obtain detailed information on the nature of this cometary nebula as well as on the kinematic structure of the gas. Our observations suggest that cometary nebula NGC 2261 is actually the brightest fan of a bipolar nebula. Furthermore, it appears that the optical nebula is a hollow cone which has been emptied by the action of winds from R Mon, the star located at the tip of the nebula. High velocity CO is flowing along the cone walls. Toward the position of the star R Mon we observe a molecular maximum which could be due to residual material originated during the collapse process that led to the formation of the star.

1. Introduction

Because of their conspicuous fan-shaped aspect, their brightness variations and their striking changes in form, cometary nebulae have attracted the attention of astronomers for two centuries.

The most famous cometary nebula, NGC 2261, was discovered in 1783 by Herschel. In the apex of the nebula is located the star R Monocerotis. The variability of R Mon, in a range 9- 13 mag and on time-scales of months, was first detected by Schmidt in 1861. In 1916, Hubble detected important changes in the brightness and in the shape of NGC 2261.

That NGC 2261 is illuminated by reflected light of R Mon was first showed by Slipher (1912), who observed similar spectra from the star and from the nebula, and it is additionally demonstrated by the orientation of the electric field vector in NGC 2261, which is perpendicular to the direction to R Mon (Khatchikian, 1958).

About 7' north from R Mon, along the NGC 2261 axis, lies HH 39, an agglomeration of HH objects first evidenced by Herbig (1968). These objects move with a tangential velocity of about 300 km/s, away from R Mon and NGC 2261 (Jones and Herbig, 1982). Therefore, the observations indicate that R Mon, NGC 2261 and HH 39 are physically associated. In this paper we will assume (following Jones and Herbig, 1982) that these objects are located at the same distance (800 pc) as the young cluster NGC 2264, which lies less than 1° away. This distance is in rough agreement with the value of 690 pc determined by Johnson (1968) from photometry of the star R Mon.

Cantó et al. (1981) observed a CO high-velocity outflow around R Mon. The CO emission is blue-shifted in the north region (NGC 2261) and it is red-shifted toward the south. Observations from Bruegel et al. (1984) show the existence of ionized bipolar jets on scales of ~2000 A.U. and conclude that the collimation mechanism should occur in a circumstellar region. Beckwith et al. (1984, 1986) observed with high angular

resolution ($\sim 2-6''$) in the near-infrared (speckle) and in the CO (J=1-0) line. These observations show that around R Mon there is a circumstellar clump of size ~ 2400 A.U. Nevertheless, the detailed structure and motions of the neutral gas in the vicinity of cometary nebulae (and in particular around NGC 2261) remains poorly known.

The aim of this work is to study the nature and origin of cometary nebulae. We decided to approach this problem by studying the structure of the neutral gas in the prototypical cometary nebulae around R Monocerotis and PV Cephei. The resolution of the IRAM 30-m telescope at 115 GHz (about $20''$) is very suitable for mapping these nebulae with size $\sim 2'$. We chose to map in the CO and ^{13}CO (J=1-0) lines in order to probe the matter in the outflow (CO) as well as more opaque regions, for which the less optically thick ^{13}CO line appears more appropriate. Several observations were made in the CS (J=2-1, J=3-2) lines toward a few positions of particular interest (for instance the positions of the stars) in order to probe the most dense regions.

In this short paper we present the preliminary results concerning R Mon. A more detailed report of our work, including observations of PV Cep, will be published in *Astronomy and Astrophysics*.

2. Observations

The observations were carried out with the IRAM 30-m telescope located on the Pico Veleta, near Granada (Spain), in October 1986. At 115 GHz, the halfpower beamwidth of the telescope was about $21''$, and the coupling coefficient of the antenna with an extended source (the "moon efficiency") about 0.7. The system allowed the simultaneous operation of two receivers and, hence, the simultaneous observation of two molecular lines.

The CO and ^{13}CO (J=1-0) lines were observed simultaneously by using, for CO, a cooled Schottky diode mixer with a noise temperature of about 250 K (DSB) and, for ^{13}CO , a SIS receiver with system temperature of about 150 K (DSB). The CS (J=2-1, J=3-2) lines were observed also simultaneously: the Schottky receiver was used for the J=2-1 line, and a SIS receiver operating in the 150 GHz range, with noise temperature of about 150 K (DSB), was employed for the J=3-2 line (the HPBW of the antenna at 150 GHz is about $16''$).

In all cases the spectrometer was a filter bank with 256 channels of 100 kHz width (0.26 km/s at 115 GHz) split in two parts of 128 channels each. The observations were made in the position switching mode. Pointing was frequently checked on continuum sources and was found to be better than $\pm 3''$. The data were calibrated by the chopper-wheel method. All the intensities in this paper are corrected for atmospheric extinction, and for the coupling of the antenna with extended sources.

3. Observational Results

The line profiles toward the NGC 2261/R Mon region show several velocity components. In order to investigate the kinematics of the gas, we show, in Figs. 1 and 2, the maps of the CO and ^{13}CO emission integrated by velocity intervals of 1 km/s. We will comment several features observed in the CO maps:

a) In the velocity range 7- 8 km/s (blue-shifted gas, Fig. 1b) the emission presents a fan-shaped structure which is located in the center of the optical cometary nebula NGC 2261 (Fig. 1a). The shape of the optical nebula is also well recognized in the 8-9 km/s map (Fig. 1c). However, the CO along the nebula axis is the most blue-shifted.

We conclude that the blue-shifted gas is flowing on the optical nebula, and that the CO near the edge of the nebula moves more slowly than the CO in the nebula axis.

b) The red-shifted gas (velocity range 11 to 12 km/s, Fig. 1f) lies toward the south of R Mon, in a symmetrical position relative to NGC 2261/blue-shifted gas.

c) The outflow velocity increases with the distance to R Mon. This effect is well evidenced in Fig. 3, where we show a declination-velocity diagram along the NGC 2261 axis: from the R Mon position, the velocity changes systematically by +2 km/s toward the north and by -2 km/s toward the south. At the end of the outflow, the velocity changes abruptly to the ambient gas velocity value.

d) The "ambient" gas (velocity range 8 to 10 km/s, Figs. 1c and 1d) presents an elongated structure with several maxima.

e) In the velocity range from 9 to 10 km/s (Fig. 1d) a lack of emission is seen toward the position of NGC 2261. This hole perfectly matches the shape of the optical nebula/blue-shifted emission.

In the south region there is a kind of semicircular "gulf" centered at position (0, -70"). Although the fitting is no so spectacular as for the blue-shifted gas, this southern hole matches well the shape of the red-shifted emission.

In the ^{13}CO maps in Fig. 2, we will note several features:

a) As for CO, the fan-shaped hole at the position of NGC 2261 is clearly seen at velocities 9-10 km/s (Fig. 2b). The shape of the hole is exactly the same as that of the optical nebula/blue-shifted CO (however, the high velocity gas associated to the optical nebula is not detected in the ^{13}CO line).

Toward the south from NGC 2261 a kind of "gulf" is observed (similar to this of CO) at ambient gas velocities. This gulf lodges the red-shifted CO.

b) A condensation of size $\sim 60'' \times 40''$ is seen toward the position of R Mon. This condensation is elongated in a direction close to east-west, and presents two maxima. The first one exactly lies toward the star position and is moving at 8-9 km/s. A second maximum, toward the west is seen at higher velocities. In addition, a small clump is observed on the western edge of NGC 2261 at the velocity range 8-9 km/s (Fig. 2a).

4. Implications from observations

The behaviour of the CO and ^{13}CO emission at different velocities leads to the following scenario for the NGC 2261/R Mon region:

a) Bipolarity. NGC 2261 is actually the brightest fan of a bipolar nebula. The counterfan is located $70''$ toward the south of R Mon, as indicated by the situation of the red-shifted CO emission. This fact is supported by sensitive photographs (Herbig, 1968) which show weak nebulosities south from R Mon. In addition, CCD images from Warren-Smith et al. (1987) display a feature toward the southwest that could be the bright rim of the obscured counterlobe.

b) Evidence for a cavity. That NGC 2261 is a hollow structure is strongly suggested by the lack of ^{13}CO emission observed toward the body of the nebula. In addition, at the edges of the nebula the ^{13}CO emission indicates high gas column densities, as we could expect if we were observing the walls of the cavity. This morphology strongly suggests that the stellar wind has swept the molecular gas toward the edges of NGC 2261. Moreover, we observe that the blue-shifted CO near the edge of NGC 2261 is moving more slowly than the gas near the axis of the nebula. This can be explained if we assume that the gas is moving along the walls, because we expect that the gas in contact with the walls will be slowed down by friction.

c) "Acceleration" of the outflow. The increase of the velocity with the distance to the star could be interpreted as a real acceleration of the outflow (see Fridlung et al., 1984, for the acceleration of the L1551 outflow). However, in the particular case of R Mon we will note that this interpretation is not unique. The observed velocity increase could be due to a projection effect, because we only measure the radial velocity of the gas. If the gas were flowing with constant velocity on a surface which is curved with respect to the line of sight, we should also observe a gradient in the radial velocity. We know (from optical images, see Fig. 1a) that the walls of the NGC 2261 cavity are curved in the region up to $50''$ north of R Mon. At this point the contour of the nebula becomes close to a straight line. In Fig. 3 it is possible to see that the CO velocity increases toward the north in the first $50''$ and then remains constant, as expected from projection effects for a flow with constant velocity.

d) Mass estimate. From the ^{13}CO ($J=1-0$) observations it is possible to estimate the mass of the molecular cloud around NGC 2261/R Mon. We have assumed that the ^{13}CO ($J=1-0$) line is formed under local thermodynamical equilibrium and that the ^{13}CO abundance is $\sim 2 \cdot 10^{-6}$ (Bachiller and Cernicharo, 1986). By taking a kinetic temperature of the gas in the range 10- 20 K we obtain a mass of $\sim 20 M_{\odot}$ for the region of $\sim 3' \times 2'$ ($\sim 0.69 \text{ pc} \times 0.46 \text{ pc}$) around R Mon. Hence, the mean density of this region is $n(\text{H}_2) \sim 2.5 \cdot 10^3 \text{ cm}^{-3}$. However, the detection of $\text{CS}(J=2-1, J=3-2)$ implies a higher density ($> 10^4 \text{ cm}^{-3}$) toward certain positions of the clump.

e) Gas concentration around R Mon. ^{13}CO observations (Fig. 2) show the existence of an unresolved gas concentration surrounding R Mon. This clump was detected by Beckwith et al. (1986) from interferometric observations in the (optically thick) CO ($J=1-0$) line. Our ^{13}CO observations allow to estimate the mass of this clump. If we assume a ^{13}CO excitation temperature in the range 10- 20 K, the circumstellar mass necessary to account for the observed maximum is $\sim 0.2 M_{\odot}$. However, it is possible that the excitation temperature be somewhat higher in the immediate vicinity of the star, because the stellar radiation heats the dust and, for densities $> \text{a few } 10^4 \text{ cm}^{-3}$, the dust grains are very efficient in transferring energy to the gas through collisions. In such a case the mass could be somewhat greater than $0.2 M_{\odot}$.

Finally, it is worth noting that although the ^{13}CO cloud around R Mon is U-shaped, with an elongated structure near the star (Fig. 2b), we find no evidences for a possible torus around the star (however, see Cantó et al., 1981). In fact the star is not placed symmetrically between two ^{13}CO maxima, but it is exactly coincident with a maximum. If such a torus exists, it must have a size $< 0.03 \text{ pc}$ (see also Beckwith et al., 1984, 1986).

REFERENCES

- Bachiller, R., and Cernicharo, J.: 1986. *Astron. Astrophys.*, 166, 283.
- Beckwith, S., Zuckerman, B., Strutskie, M.F., and Dyck, H.M.: 1984. *Astrophys. J.*, 287, 793.
- Beckwith, S., Sargent, A.I., Scoville, N.Z., Masson, C.R., Zuckerman, B., and Phillips, T.G.: 1986. *Astrophys. J.*, 309, 755.
- Bruegel, E.W., Mundt, R., and Bührke, T.: 1984. *Astrophys. J.*, 287, L73.
- Cantó, J., Rodriguez, L.F., Barral, J.F., and Carral, P.: 1981. *Astrophys. J.*, 244, 102
- Fridlung, C.V.M., Sandqvist, A., Nordth, H.L., and Olofsson, G.: 1984. *Astron. Astrophys.*, 137, L17.
- Herbig, G.H.: 1968. *Astrophys. J.*, 152, 439.
- Hubble, E.P.: 1916. *Astrophys. J.*, 44, 190.
- Johnson, H.M.: 1968. *Pub. Astr. Soc. Pac.*, 72, 10.
- Jones, B.F., and Herbig, G.H.: 1982. *Astron. J.*, 87, 1223.
- Khatchikian, E.E.: 1958. *Soob. Burakan Obs.*, 25, 67.
- Schmidt, J.F.J.: 1861. *Astr. Nach.*, 55, 91.
- Slipher, V.M.: 1912. *Lowell Obs. Bull.*, No.2.
- Warren-Smith, R.F., Draper, P.W., and Scarrott, S.M.: 1987. *Astrophys. J.*, 315, 500.

FIGURE CAPTIONS

Figure 1.- a) Sketch of the NGC 2261 optical nebula and R Mon. Crosses indicate the positions observed in CO and ^{13}CO (J=1-0). The size of the beam is also indicated. b,c,d,e,f) CO emission integrated by velocity intervals of 1 km/s width. The first level and the level spacing are 1.5 K km/s.

Figure 2.- ^{13}CO (J=1-0) emission integrated in the 3 velocity intervals indicated in the panels. The first level and the level spacing are 0.5 K km/s.

Figure 3.- Declination-velocity diagram for the CO (J=1-0) emission across the axis of the NGC 2261 nebula (line with $\Delta\delta = 0$)

R Mon, CO (J=1-0)

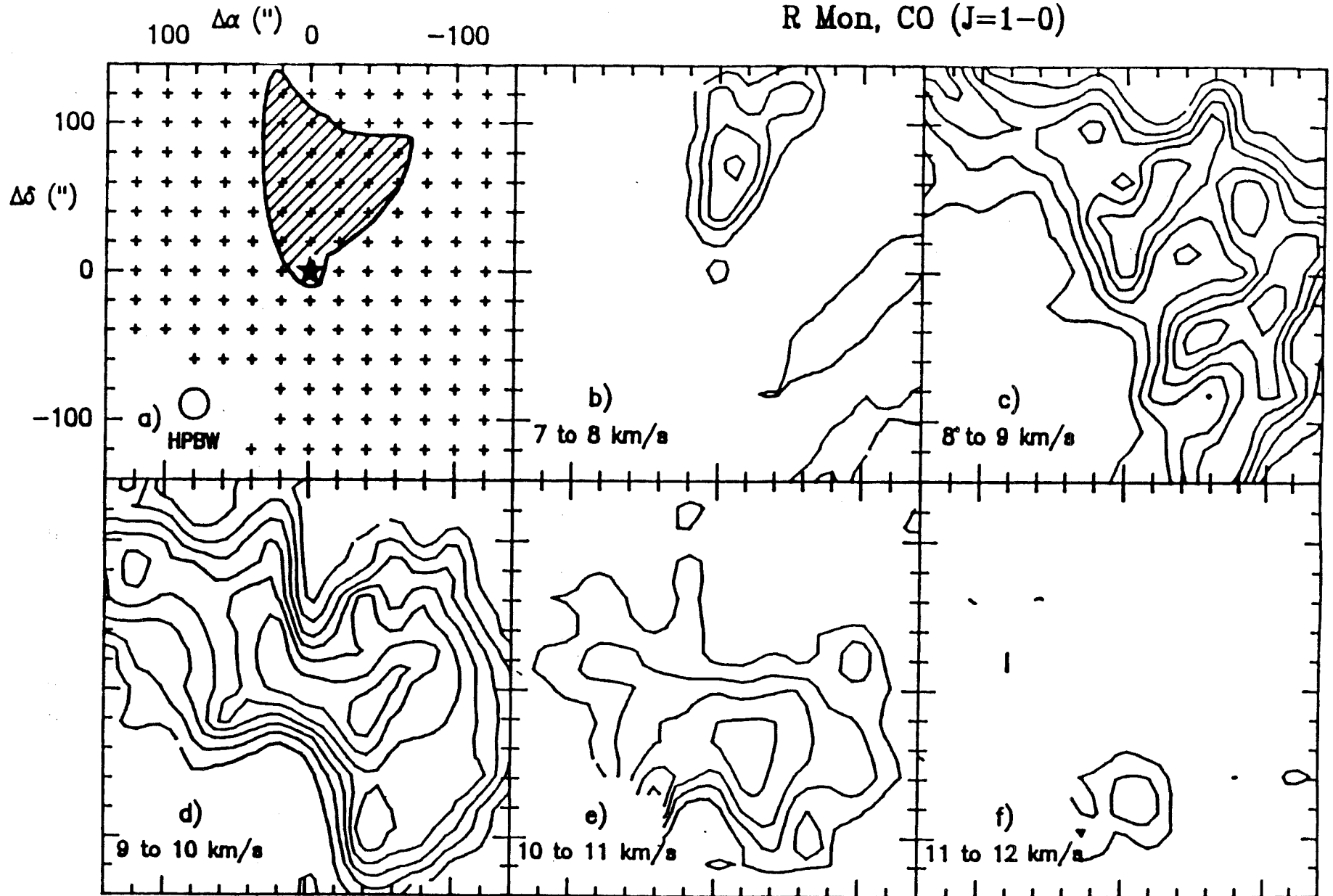

FIGURE 1

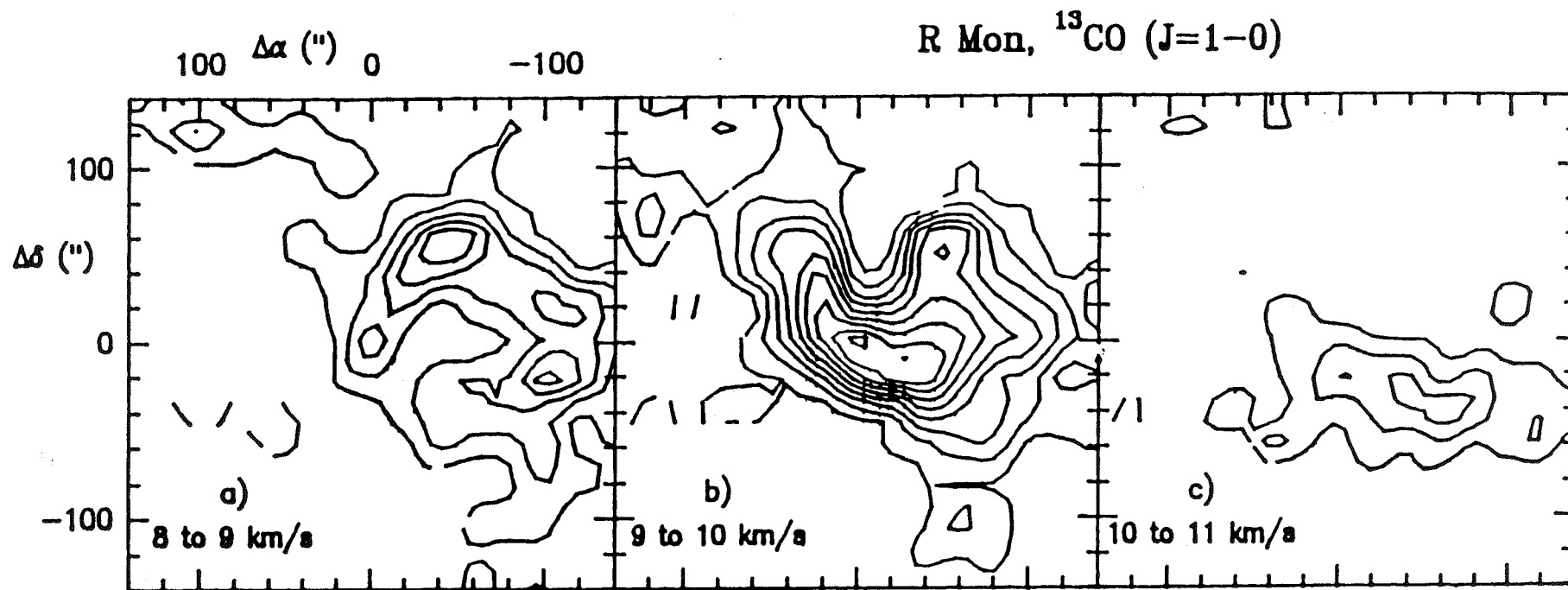
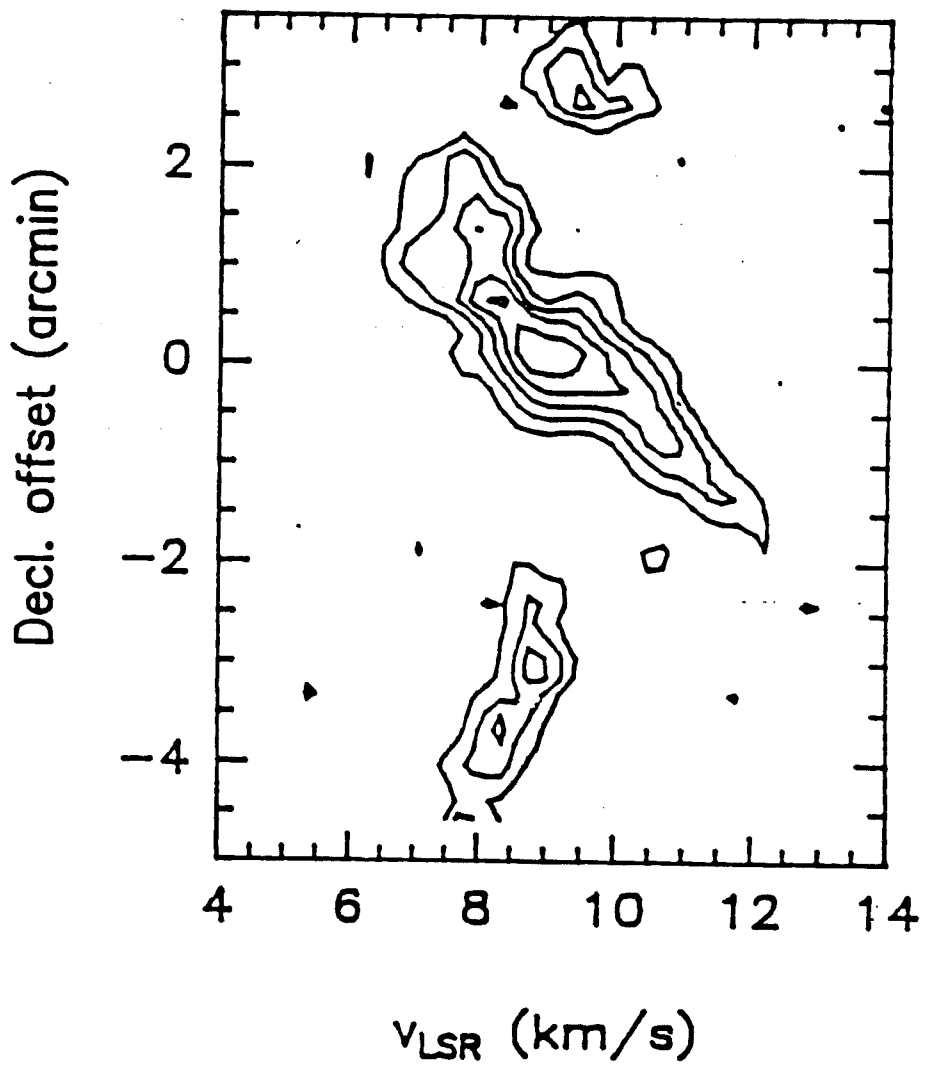

FIGURE 2

FIGURE 3



PARTIE II

MATIERE DIFFUSE ET MOLECULES INTERSTELLAIRES:

DETERMINATION DES RAPPORTS ISOTOPIQUES DANS LE MILIEU

INTERSTELLAIRE.

DETECTION DE NOUVELLES MOLECULES.

II.01) INTRODUCTION	271
II.02) L'ABONDANCE ISOTOPIQUE DE L'OXYGENE INTERSTELLAIRE DETERMINE A PARTIR DES OBSERVATIONS DES RAIES A 18 cm DE LA MOLECULE OH.	299
II.03) DETECTION DE HC^{17}O^+ DANS SGRB2.	309
II.04) DETECTION DE $^{29}\text{SiC}_2$ ET DE $^{30}\text{SiC}_2$ DANS IRC+10216.	317
II.05) DETECTION DES ISOTOPES DE C_3H_2 DANS SGRB2.	323
II.06) RAPPORTS ISOTOPIQUES DU CARBONE, AZOTE, SOUFRE ET SILICIUM DANS L'ENVELOPPE CIRCUMSTELLAIRE DE L'ETOILE CARBONNE IRC+10216.	327
II.07) UN NOUVEAU RADICAL LIBRE DANS IRC+10216.	341
II.08) DETECTION DE C_5H DANS IRC+10216.	347
II.09) DETECTION DE C_5H DANS L'ETAT ELECTRONIQUE $^2\Pi_{3/2}$ DANS IRC+10216.	353
II.10) DETECTION DE LA STRUCTURE HYPERFINE DE C_5H .	359

- II.11) DETECTION D'UN RADICAL LINEAIRE LOURD DANS IRC+10216 :
LE RADICAL C_6H ? . 363
- II.12) C_6H : ETUDE DE SA STRUCTURE FINE ET HYPERFINE. 369
- II.13) DETECTION DU METHYLE ISOCYANURE DANS LE CENTRE
GALACTIQUE. 375
- II.14) NOUVEAUX DOUBLETS DANS IRC+10216: C_4H DANS UN ETAT
VIBRATIONNEL EXCITE ? 379
- II.15) DETECTION AU LABORATOIRE DES ETATS VIBRATIONNELS 1_{v7}
ET 2_{v7} DE C_4H ET LEUR IDENTIFICATION ASTRONOMIQUE. 385
- II.16) MOLECULES SOUFREES DANS IRC+10216. 393
- II.17) METAUX DANS IRC+10216: DETECTION DE NaCl, AlCl, KCl,
ET AlF. 399

II.01) INTRODUCTION

FIGURE 1

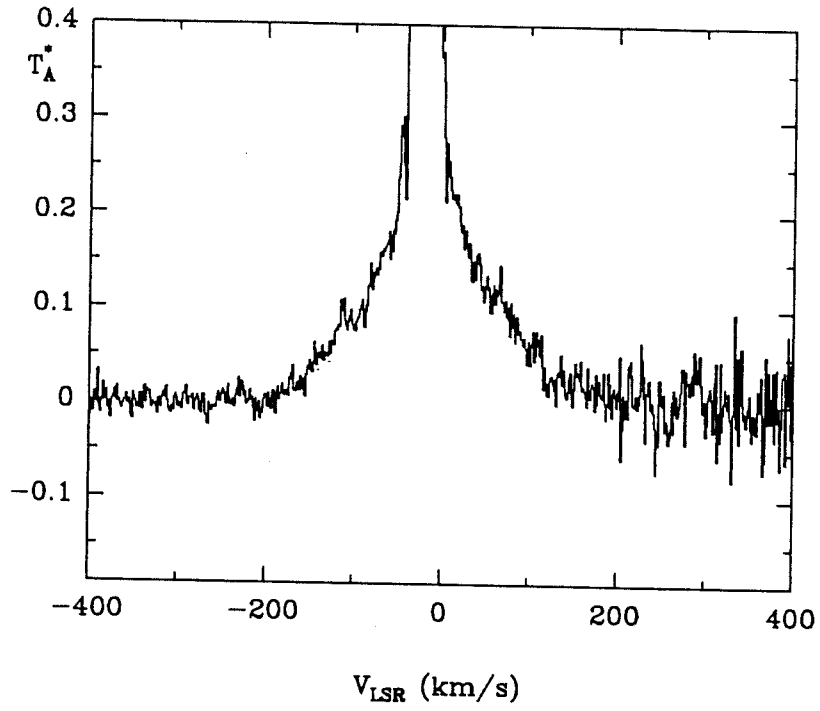

Profil de CO ($J=2-1$) observé dans la direction de la
nebuluse protoplanetaire CRL618.

On trouve parfois sans chercher...

PRESENTATION

Nous avons étudié dans la première partie de cette thèse la structure des nuages moléculaires interstellaires et nous avons déterminé l'abondance des isotopes du monoxyde de carbone. Dans cette deuxième partie nous allons étudier comment les rapports isotopiques peuvent nous renseigner sur l'évolution chimique de la galaxie et nous tenterons d'évaluer la richesse chimique du milieu interstellaire en essayant de détecter des espèces moléculaires exotiques.

Les observations de cette partie de la thèse ont été obtenues pendant la période 1986-1987 avec le radiotélescope de 30-m. de l'IRAM. En réalité nous avons déjà commencé à préparer ces observations quelques années avant. Il était évident qu'avec le gain en sensibilité fourni par les nouveaux télescopes millimétriques de nombreuses nouvelles raies seraient observées et que les problèmes de recouvrement des raies deviendraient cruciaux sur l'interprétation et l'exploitation des données. Nous avons donc établi un catalogue de fréquences des molécules à couches ouvertes, complémentaire de celui de Lovas (1984), catalogue qui allait être l'outil de base de nos recherches de nouvelles molécules et de débroussaillage des déterminations des rapports isotopiques. La création d'un tel catalogue nous a demandé (C. Kahane et moi-même) un énorme effort bibliographique et de programmation qui s'est étalé sur deux ans avant les premières observations avec le 30-m de l'IRAM. Ne contenant au début que les quelques espèces moléculaires "évidentes" manquantes dans le catalogue de Lovas, il s'est enrichi au fur et à mesure que nous découvriions de nouvelles molécules et que de nouvelles

données spectroscopiques étaient publiées. Ce catalogue contiennent aujourd'hui plus d'une centaine d'espèces moléculaires et presque 15000 transitions moléculaires calculées à partir de leurs constantes spectroscopiques. Le travail d'établir ce catalogue et de calculer les fréquences revêt un double aspect : astrophysique et spectroscopique.

MATIERE DIFFUSE ET MOLECULES INTERSTELLAIRES

DETERMINATION DES RAPPORTS ISOTOPIQUES DU CARBONE, AZOTE,

OXYGENE, SOUFRE, ET SILICIUM

L'abondance des éléments dans le milieu interstellaire est gouvernée par les processus de nucléosynthèse à l'intérieur des étoiles et par les processus de perte de masse des étoiles évoluées. L'observation des enveloppes de ces étoiles, ainsi que l'observation des nuages moléculaires du milieu interstellaire peut nous informer qualitativement et quantitativement sur ces processus (voir par exemple Guélin et Lequeux, 1980).

Les abondances des éléments dans le système solaire étant à peu près figées depuis le moment de sa formation, il y a quelques 5×10^9 ans, une comparaison avec les abondances observées dans le milieu interstellaire fournira des renseignements importants sur l'évolution "chimique" de la galaxie au cours des derniers 5×10^9 ans. Puisque les abondances isotopiques dépendent aussi de la nucléosynthèse dans les coeurs des étoiles, ces abondances seront aussi des traceurs de l'évolution chimique de la galaxie.

La détermination des abondances des éléments dans le milieu interstellaire est basée sur l'observation des transitions quantiques des atomes et des molécules qu'il contient. Cependant, la détermination directe de ces abondances est affectée par de nombreux phénomènes physiques et chimiques rendant difficile l'interprétation des observations (excitation des niveaux d'énergie, condensation des éléments sur les grains, comportement chimique différente, etc). D'autre part, les nuages moléculaires du milieu interstellaire contiennent essentiellement des molécules, et des mesures directes et

systematiques des abondances des éléments dans ces objets sont en dehors de la portée des instruments optiques actuels.

Heureusement, la présence de molécules entre et autour des étoiles permet, bien que non sans problèmes, la comparaison des abondances des molécules par l'observation de leurs transitions électroniques dans le domaine optique, de leurs transitions vibrationnelles dans le domaine infrarouge, et surtout de leurs transitions rotationnelles dans le domaine radio.

Nous avons vu dans la première partie de cette thèse que la détermination des abondances moléculaires dans les nuages de gaz et de poussière du milieu interstellaire est souvent une tâche ardue, car d'une part les transitions des molécules abondantes deviennent rapidement opaques, ce qui complique l'interprétation des observations, et d'autre part l'intensité des raies des espèces moins abondantes deviennent rapidement trop faibles pour être observées. C'est ainsi que la plupart des rapports isotopiques déterminés dans les enveloppes des étoiles ou dans le milieu interstellaire ont été déterminés dans la direction des sources moléculaires les plus intenses à partir des isotopes des molécules les plus abondantes, avec les problèmes d'opacité de raie mentionnés, donnant un aperçu très partiel, et sans doute erroné, des rapports isotopiques dans la galaxie (voir Penzias, 1980; Wannier, 1985; Wannier et Sahai, 1987).

La mise en opération du 30-m de l'IRAM et l'amélioration des récepteurs millimétriques ont permis de changer notablement la situation puisque le nombre de molécules observables a considérablement augmenté. Les études systématiques du spectre millimétrique des sources moléculaires (voir paragraphe suivant) a permis d'éliminer, au moins en partie, les problèmes de la calibration relative des observations, ouvrant la voie ouverte à

la détermination des rapports isotopiques à partir des raies de plus en plus faibles, libres des problèmes de saturation [voir II.04, II.05, et II.06] (mais malheureusement pas des problèmes de confusion spectrale, voir Fig. 2).

Armés de notre catalogue spectral et de celui de Lovas (1984), ainsi qu'avec le radiotélescope de 30-m. de l'IRAM, nous avons commencé une étude systématique d'IRC+10216 avec un double objectif : détecter de nouvelles molécules [voir II.07 à II.17] et déterminer un grand nombre homogène de rapports isotopiques [voir II.04 à II.07]. Ce deuxième objectif était une continuation du programme que nous avons entrepris en 1980 avec le grand radiotélescope de Nançay pour la détermination des rapports d'abondances des isotopes de l'oxygène [voir II.02 et II.03].

Les principaux résultats concernant les rapports isotopiques sont :

- * Le rapport $^{16}\text{O}/^{18}\text{O}$ déterminé à partir d'OH est biaisé par l'opacité des raies infrarouges de ^{16}OH dans la direction du centre galactique où seulement une limite inférieure de 250 peut être obtenue [voir II.02]. Par contre, dans les nuages du disque galactique, ce rapport est proche de la valeur terrestre de 490.
- * Le rapport $^{18}\text{O}/^{17}\text{O}$ déterminé à partir de ^{18}OH et ^{17}OH , ainsi que de HC^{18}O^+ et de HC^{17}O^+ , est de 3.6 dans les nuages moléculaires du milieu interstellaire [voir II.02 et II.03]. Dans les étoiles évoluées, ce rapport, qui était déterminé auparavant à partir des raies J=1-0 de C^{18}O et de C^{17}O (Penzias, 1981; Wannier et Sahai, 1987), doit être révisé car, comme le montre la Fig. 2, ces deux raies sont

FIGURE 2

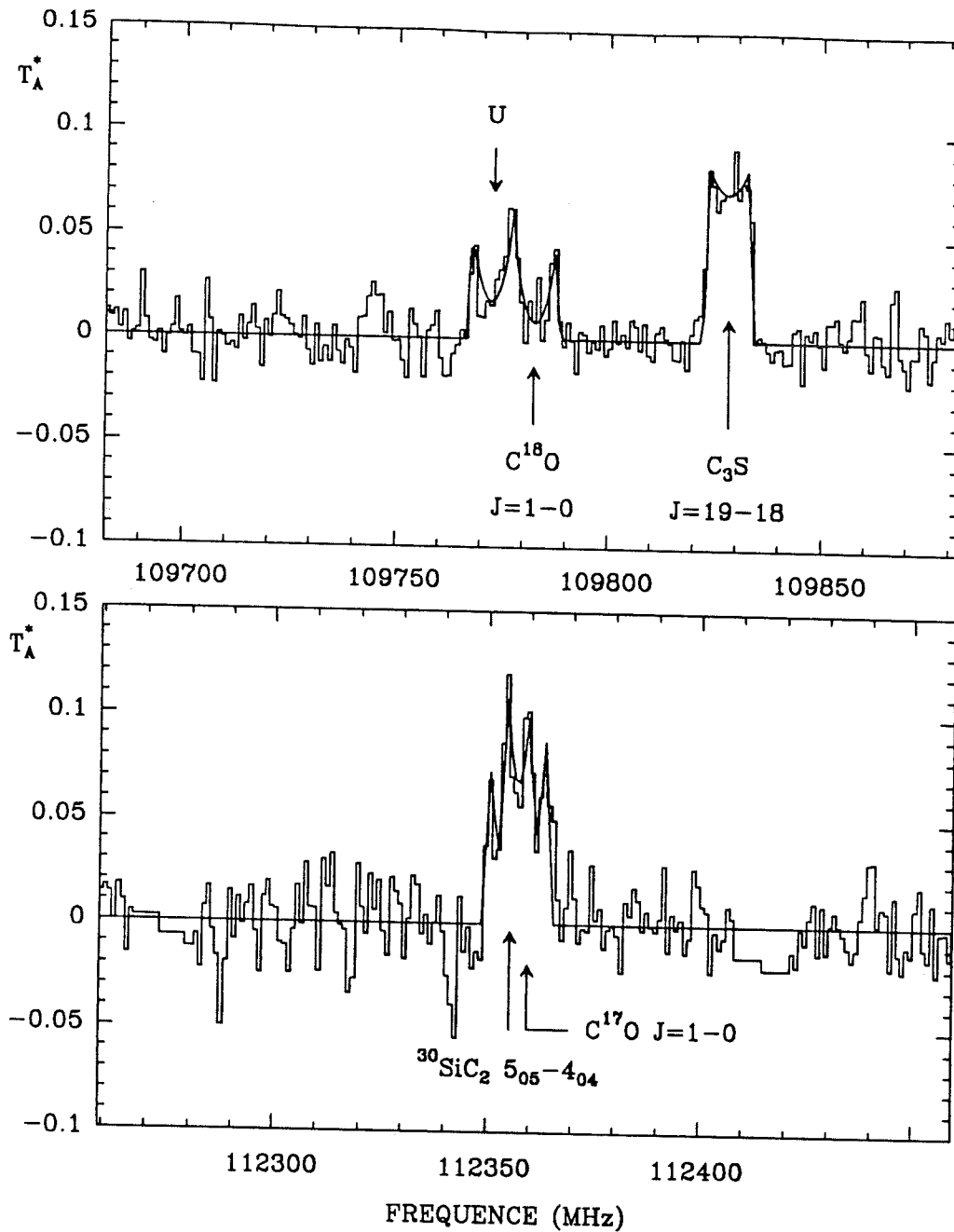

Profil des raies $J=1-0$ de $C^{18}O$ et $C^{17}O$ observées avec le radiotélescope de 30-m de l'IRAM dans la direction d'IRC+10216. La raie de $C^{18}O$ est contaminée par une raie non identifiée, pendant que la raie de $C^{17}O$ est brouillée par la raie $5_{05}-4_{04}$ de $^{30}SiC_2$ (voir II.04). La ligne continue représente le profil des raies ajusté par une méthode de moindres carrés pour une vitesse d'expansion de 29 kms^{-1} et en supposant que les raies sont optiquement minces.

brouillées par $^{30}\text{SiC}_2$ dans le cas de C^{17}O , et par une raie inconnue dans le cas de C^{18}O .

- * Les rapports $^{28}\text{Si}/^{29}\text{Si}$, $^{28}\text{Si}/^{29}\text{Si}$, $^{29}\text{Si}/^{30}\text{Si}$, $^{32}\text{S}/^{33}\text{S}$, $^{32}\text{S}/^{34}\text{S}$, et $^{33}\text{S}/^{34}\text{S}$ dans IRC+10216 sont, dans la limite des faibles erreurs observationnelles, identiques à ceux du système solaire [voir II.04 et II.06]. Ce résultat est cohérent avec nos idées actuelles de la nucléosynthèse dans des étoiles du type d'IRC+10216.
- * Le rapport $^{14}\text{N}/^{15}\text{N}$ dans IRC+10216 est ≥ 4400 , c'est-à-dire, au moins 15 fois plus grande que dans le système solaire [voir II.06].
- * Le rapport $^{12}\text{C}/^{13}\text{C}$ a été déterminé dans la direction d'IRC+10216 à partir de plusieurs molécules, incluant des espèces peu abondantes comme $^{13}\text{C}^{34}\text{S}$ ou Si^{13}CC . La valeur que nous avons trouvé, 47 ± 6 , est deux fois plus faible que la valeur terrestre [voir II.06]

MATIERE DIFFUSE ET MOLECULES INTERSTELLAIRES

SPECTROSCOPIE DANS LE MILIEU INTERSTELLAIRE.

DETECTION DE NOUVELLES MOLECULES

Etant données les conditions physiques régnant sur terre, les molécules réactives, ou radicaux, ont une durée de vie très courte. La synthèse de ces molécules au laboratoire est donc difficile et leur observation par spectroscopie micro-ondes est souvent une tâche ardue. Dans le milieu interstellaire, où les températures, pressions, et densités sont particulièrement basses, ces molécules, une fois formées, peuvent survivre pendant longtemps si elles sont bien protégées du rayonnement UV¹. C'est ainsi qu'une partie importante des radicaux libres observés à des longueurs d'onde millimétriques dans le milieu interstellaire y ont été découverts avant que les fréquences de leurs transitions rotationnelles soient déterminées dans les laboratoires spectroscopiques terrestres.

Le milieu interstellaire est aussi un laboratoire intéressante pour l'étude par spectroscopie Hertzienne de la structure hyperfine des transitions rotationnelles moléculaires. La séparation en fréquence des différentes composantes de ces transitions est souvent bien plus petit que la résolution spectrale obtenue au laboratoire terrestre. Par contre, dans le coeur des nuages froids du milieu interstellaire, où la largeur des raies est purement thermique, on peut obtenir des résolutions spectrales de l'ordre de quelques KHz (Guélin, Friberg, et Mezaoui, 1982; Cernicharo et al., 1987a, 1987b [voir II.10 et II.12]). La combinaison de ces données avec celles obtenues au laboratoire terrestre fournit un excellent ensemble de constantes rotationnelles moléculaires (voir par exemple

1) C'est le cas des coeurs des nuages moléculaires ou des parties internes des enveloppes des étoiles évoluées.

Gottlieb et al., 1984 pour C_3N et C_4H , ou Pearson et al., 1988 pour C_6H).

La plupart des molécules observées dans l'espace ont été découvertes dans les années 70-80. L'étude spectrale systématique des sources moléculaires entreprise dans différents observatoires² au début des années 80, a donné des résultats plutôt décevants en comparaison des efforts engagés. La plus grande partie des raies observées dans ces études provient de molécules déjà connues et de leurs espèces isotopiques. Il semblait donc qu'il n'y avait plus de nouvelles molécules susceptibles d'être détectées avec les radiotélescopes existants. La mise en route du radiotélescope de 45-m de l'Observatoire de Nobeyama, et tout particulièrement celle du radiotélescope de 30-m de l'IRAM, a substantiellement changé le panorama des études spectrales du milieu interstellaire.

Dès nos premières observations avec le 30-m il était évident que les études mentionnées plus haut avaient été fortement limitées en sensibilité et que le spectre millimétrique des sources moléculaires révélé par ce télescope pouvait être décrit comme étant "une forêt de raies non identifiées" (voir Fig. 3). Les chapitres II.07 à II.17 de cette partie de ma thèse sont un bon exemple de la richesse moléculaire mise en évidence par le radiotélescope de 30-m de l'IRAM.

2) Orion et IRC+10216 ont été observées dans l'observatoire d'Onsala entre 70 et 90 GHz par Johansson et al. 1984, 1985; Orion a été aussi observé entre 215 et 270 GHz par Sutton et al. 1985, et par Blake et al. 1986, avec une des antennes de l'interféromètre de Caltech; SgrB2 a été observé entre 75 et 150 GHz par Cummins et al. -1986- avec le télescope de Bell Labs.

FIGURE 3

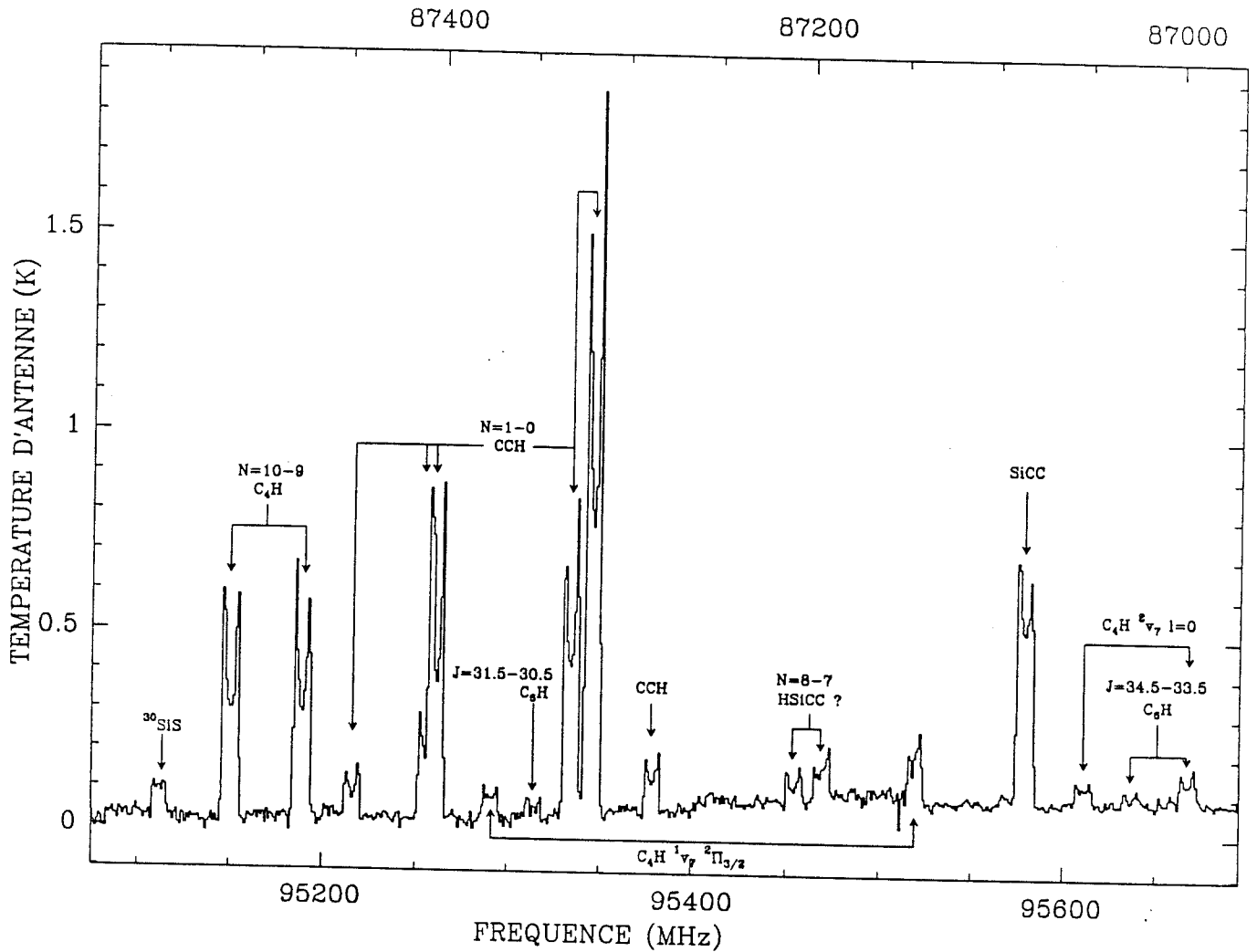

Spectre observé avec le radiotélescope de 30-m de l'IRAM pendant notre étude spectrale d'IRC+10216. Toutes les raies d'intensité ≤ 0.2 K sont passées inaperçues dans les études précédentes (Johansson et al., 1984,1985). Ces raies, initialement non identifiées, proviennent en fait de C_6H , C_4H vibrationnellement excité, et peut être de HSiCC (voir II.07, II.11, II.12, II.14, et II.15).

Les principaux problèmes associés à l'identification d'une nouvelle espèce moléculaire dans le milieu interstellaire sont d'une part celui de la sélection des raies appartenant à la molécule, et d'autre part celui de la contamination spectrale par d'autres espèces moléculaires.

Le premier problème ne pose pas trop de complications quand la molécule est linéaire ou légèrement asymétrique puisque les fréquences des raies sont en relation harmonique, mais il dévient particulièrement astreignant si la molécule est asymétrique ou son état électronique fondamental est un peu exotique (π, Δ, \dots). Il faut alors procéder par itérations jusqu'au moment où un ensemble de raies correctement assignées permet la prédiction des fréquences d'autres transitions à quelques MHz d'erreur.

Le problème lié à la contamination spectrale est malheureusement insoluble. L'expérience nous a montré que dans IRC+10216, dès que l'on s'intéresse aux raies faibles, une raie sur quatre est partiellement ou totalement recouverte par une autre raie³ d'intensité similaire (voir par exemple les Fig. 2 et 3). Les catalogues de fréquences sont alors un outil unique pour le débroussaillage des observations (voir plus haut).

Une fois que les raies sont correctement attribuées à des transitions données, il est possible d'obtenir les constantes rotationnelles de la molécule mère ainsi qu'une bonne idée de sa masse et de sa structure. Puisque dans le milieu interstellaire seules les éléments les plus abondantes⁴ entrent dans la

3) L'expérience nous a aussi montré que dans le cas de SgrB2 et d'Orion il n'y a pas de raies faibles non contaminées.

4) Hydrogène, Carbone, oxygène, azote, soufre, et parfois silicium. La situation pour les enveloppes circumstellaires est un peu différente puisque la détection des halogénures métalliques dans l'enveloppe de

composition des molécules observables, le nombre de molécules "vraisemblables" est en pratique limité. Les particularités chimiques de la source observée serviront pour choisir le meilleur "candidat". Dans la plupart des cas, il sera toutefois nécessaire de recourir à l'observation de plusieurs sources interstellaires, avec une "chimie" différente, pour obtenir la confirmation de l'identification⁵. C'est de cette façon que les radicaux C_3N , C_4H , C_5H , et C_6H ont été découverts dans IRC+10216, puis dans TMC1 (Guélin et Thaddeus, 1977; Guélin, Green, et Thaddeus, 1978; Cernicharo et al. 1986a, 1986b, et 1987b [voir II.08, II.09, et II.10]; Guélin et al. 1987 [voir II.11]; Suzuki et al., 1986; Cernicharo et al. 1987 [voir II.12]). Ces identifications ont été depuis confirmées par l'observation au laboratoire des espèces moléculaires proposées (Gottlieb et al., 1984, Gottlieb, Gottlieb, et Thaddeus 1986, Pearson et al., 1988).

L'étude spectrale systématique d'une source moléculaire peut parfois révéler des aspects jusqu'alors inattendus. C'est ainsi qu'après avoir détecté plusieurs radicaux linéaires dans IRC+10216 [voir II.07 à II.16] nous nous sommes trouvés face à quatre nouvelles espèces dans un état électronique 1Σ ayant des constantes de distorsion particulièrement grandes, compte tenu de leur constante de rotation. Par des arguments similaires à ceux donnés dans II.07 on aurait pu conclure qu'il s'agissait de quatre nouvelles molécules, non répertoriées dans notre

*l'étoile carbonée IRC+10216 a considérablement élargi les possibilités d'ingrédients dans la cuisine chimique de ces sources (Cernicharo et Guélin, 1987; voir II.17).
5) Par exemple, si des raies non identifiées sont observées dans l'enveloppe de l'étoile carbonée IRC+10216 et dans le nuage sombre TMC1, alors elles ont pas mal de chances d'appartenir à une chaîne moléculaire carbonée.*

FIGURE 4

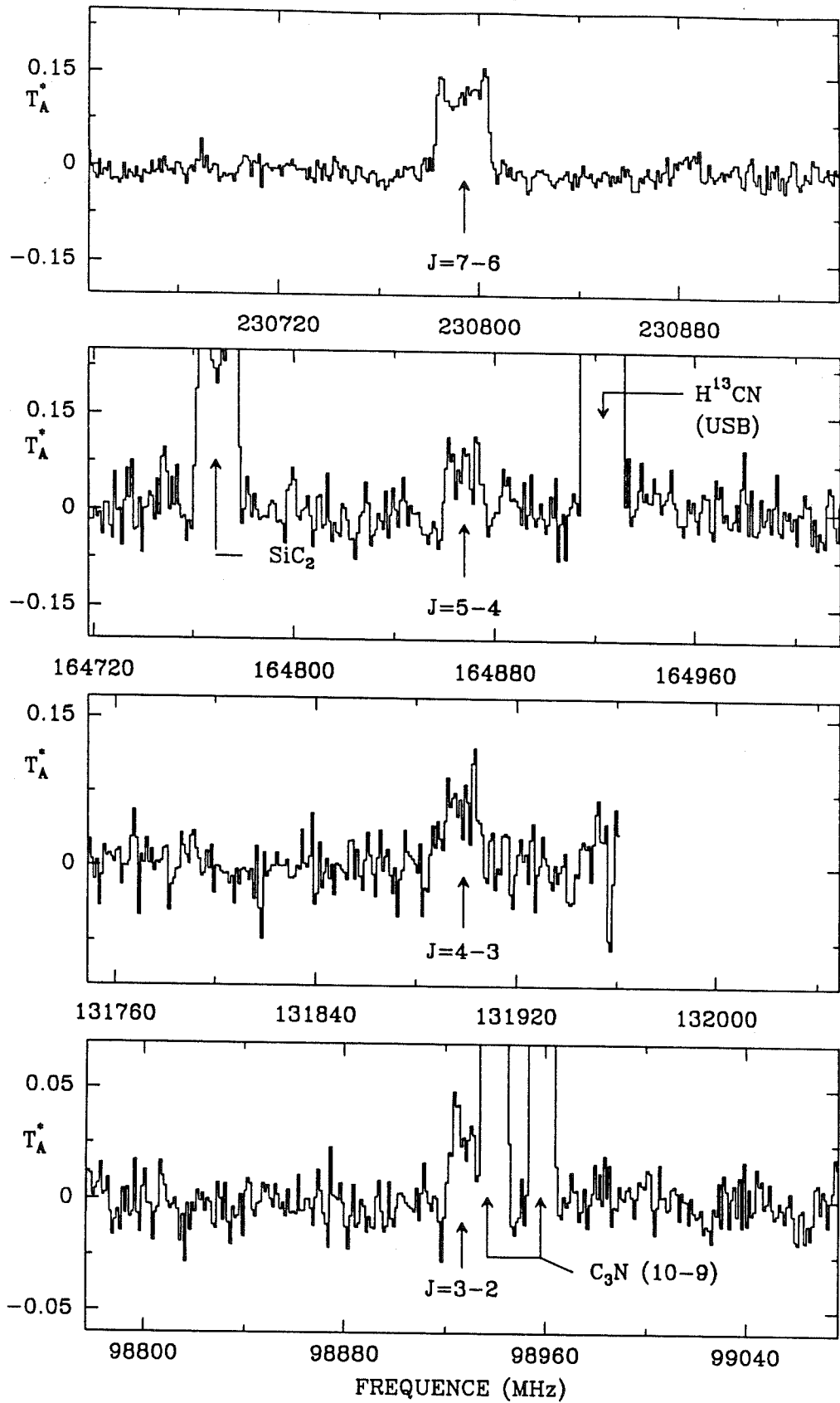

Spectres observés avec le 30-m de l'IRAM dans la direction d'IRC+10216 aux fréquences des transitions $J=3-2$, $J=4-3$, $J=5-4$, et $J=7-6$ du Fluorure d'Aluminium. La transition $J=7-6$ a été observée récemment confirmant l'identification de cette molécule (voir II.17).

catalogue ni dans celui de Lovas, et ayant la particularité d'être, toutes les quatre, légèrement asymétriques. Pour nous, quatre était trop, et nous nous sommes aperçus que si l'on relâche les forces des liaisons atomiques dans une molécule linéaire on doit forcément augmenter la valeur de sa constante de distorsion. C'est ainsi que nous avons commencé à introduire dans nos réflexions des molécules à liaison ionique plutôt que covalente. C'est cette "ouverture d'esprit" celle qui nous a permis d'identifier pour la première fois dans l'espace les halogénures métalliques NaCl, AlCl, KCl, et AlF (Cernicharo et Guélin, 1987; [voir II.17]). La Figure 4 montre les spectres observés du Fluorure d'Aluminium dans la direction d'IRC+10216.

ETUDE SPECTROSCOPIQUE DE LA MOLECULE CYCLIQUE SiC₂.

Un cas particulièrement intéressant de spectroscopie dans l'espace est celui de SiC₂. En 1956 Kleman avait montré que les bandes optiques dans le bleu et le vert observées dans la direction des étoiles carbonées pouvaient être attribuées au spectre électronique d'une molécule ne contenant que du carbone et du silicium. Il proposa le dicarbure de silicium comme étant le meilleur candidat. Pendant très longtemps SiC₂ fut considéré comme étant une molécule linéaire.

Michalopoulos et al. (1984) ont montré, à partir d'observations optiques au laboratoire, que SiC₂ devrait avoir une structure triangulaire plutôt que linéaire. Les calculs *ab initio* de Grev et Schaeffer III (1984) montrent aussi que la géométrie de SiC₂ devrait être triangulaire. Avec cette nouvelle conception de la géométrie de SiC₂, Thaddeus, Cummins, et Linke (1984) ont attribué neuf raies intenses du spectre millimétrique de l'enveloppe circumstellaire de l'étoile carbonée IRC+10216 à cette molécule. Cette identification est basée sur l'accord partiel des constantes qu'ils ont déterminées avec celles de Michalopoulos et al., et sur le fait observationnel de que les raies observées dans IRC+10216 devraient provenir d'une molécule appartenant au groupe de symétries C_{2v}. Toutefois, les constantes déterminées par Thaddeus, Cummins, et Linke étaient 3% plus petites que celles déterminées optiquement par Michalopoulos et al., un écart vraiment à la limite des erreurs expérimentales reconnues et qui pouvait laisser douter l'identification de SiC₂.

Le dicarbure de silicium, étant difficile à observer au laboratoire micro-ondes, la meilleure manière de confirmer son identification était de détecter dans IRC+10216 les transitions

rotationnelles de ses espèces isotopiques $^{29}\text{SiC}_2$, $^{30}\text{SiC}_2$, et $^{28}\text{Si}^{13}\text{CC}$. Les constantes spectroscopiques de ces espèces, bien qu'inconnues, pouvaient être estimées avec une bonne précision à partir de celle de la molécule mère $^{28}\text{SiC}_2$ grâce à sa symétrie C_{2v} (voir II.04, et Gordy et Cook, 1970, pag. 502). En suivant cette suggestion de A. Omont, nous avons rapidement trouvé dans notre survey spectral d'IRC+10216 trois raies de $^{29}\text{SiC}_2$ et de $^{30}\text{SiC}_2$ aux fréquences prédites pour leurs transitions 404-303, 423-322, et 422-321, confirmant ainsi la détection de la première molécule cyclique dans l'espace et permettant une mesure précise des rapports isotopiques $^{28}\text{Si}/^{29}\text{Si}$ et $^{28}\text{Si}/^{30}\text{Si}$ (Cernicharo et al., 1986c, [voir II.04]).

Avec l'extension du survey spectral d'IRC+10216 à la région de 1-2 mm de longueur d'onde nous avons continué à détecter de nouvelles transitions des différents isotopes de SiC_2 et en particulier 14 raies de $^{28}\text{Si}^{13}\text{CC}$. Ces raies se sont révélées très nombreuses dans le spectre millimétrique d'IRC+10216 : 12% des raies observées dans cette source entre 1-2 mm de longueur d'onde proviennent des espèces isotopiques de SiC_2 . Les tables 1, 3, 5, et 7 donnent les fréquences observées de $^{28}\text{SiC}_2$, $^{29}\text{SiC}_2$, $^{30}\text{SiC}_2$, et $^{28}\text{Si}^{13}\text{CC}$. Pour l'isotope principal les fréquences peuvent être obtenues assez précisément grâce aux profils bicornus et aux intensités des raies. Pour les autres isotopes seulement quelques raies ont été observées avec un rapport signal sur bruit suffisant pour mesurer les fréquences à mieux que 1 MHz. D'autre part, comme les raies sont bien plus faibles, le problème de recouvrement des raies avec celles d'autres espèces devient crucial au moment de la détermination des fréquences et des intensités des raies (voir Fig. 2). Quoiqu'il en soit, ces transitions représentent un ensemble unique

de données permettant la détermination des constantes rotationnelles et de la structure géométrique de SiC₂.

SiC₂ étant une toupie asymétrique, les fréquences des transitions rotationnelles peuvent être obtenues à partir de l'Hamiltonien (Gordy et Cook, 1970, page 229):

$$\begin{aligned}
 H = & AP_Z^2 + BP_X^2 + CP_Y^2 - DJP^4 - DJKP^2P_Z^2 - DKP_Z^4 - dJP^2(P_X^2 - P_Y^2) \\
 & - dK[P_Z^2(P_X^2 - P_Y^2) + (P_X^2 - P_Y^2)P_Z^2] + \\
 & H_JP^6 + H_JKP^4P_Z^2 + H_KJP^2P_Z^4 + H_KP_Z^6 + \dots
 \end{aligned}$$

Les constantes de ce Hamiltonien peuvent être déterminées par une méthode de moindres carrés non linéaire à partir des fréquences observées. La validité des résultats obtenus est estimée en calculant l'écart type réduit défini comme $X = \text{sqrt}[\sum_i ((y_i - f(x_i))/\sigma_i)^2]$; y_i sont les fréquences mesurées, $f(x_i)$ les fréquences ajustées, et σ_i l'incertitude estimée sur les fréquences observées.

Le nombre de coefficients pouvant être déterminés dépend du nombre de transitions observées et de la précision des mesures. Dans notre cas, le nombre de transitions observées des isotopes rares de SiC₂ (Tables 1, 3, 5, et 7) ne permet de déterminer de façon significative que 5 paramètres.

Nous avons ajusté aux données de la Table 1 (²⁸SiC₂) plusieurs ensembles de constantes et avons trouvé une forte corrélation entre la plupart des constantes. Dans le calcul final nous n'avons retenu que les constantes peu corrélées et déterminées à mieux que trois fois leur erreur estimée. Pour ²⁸SiC₂ il a été nécessaire d'introduire les constantes d'ordre six H_{JK} et H_{KJ} pour réduire X de 1.6 à 0.5. Les valeurs trouvées pour ces deux constantes sont sept fois plus grandes que l'incertitude sur ces valeurs et nous considérons qu'elles

sont réellement nécessaires pour reproduire les fréquences observées. Pour les espèces isotopiques nous n'avons pas pu obtenir de valeurs significatives pour H_{JK} et H_{KJ} , bien que l'ordre de grandeur de ces constantes soit le même que pour l'isotope principal ($H_{JK} = -2.1 \pm 1.0 \cdot 10^{-4}$, $H_{KJ} = 4.4 \pm 2.0 \cdot 10^{-4}$ MHz pour $^{29}\text{SiC}_2$; $H_{JK} = -1.37 \pm 0.15 \cdot 10^{-4}$ et $H_{KJ} = 7.1 \pm 0.7 \cdot 10^{-4}$ MHz pour $^{28}\text{SiC}_2$).

La constante de rotation A est bien déterminée dans le cas de $^{28}\text{SiC}_2$ ($\sigma = 0.2$ MHz) et de $^{28}\text{Si}^{13}\text{CC}$ ($\sigma = 5.2$ MHz) mais mal déterminée pour $^{29}\text{SiC}_2$ et $^{30}\text{SiC}_2$ ($\sigma = 30$ MHz, $A = 52436$ MHz). La variation espérée de la constante de rotation A pour une substitution isotopique Z' dans une molécule ZY_2 est pratiquement négligeable (voir le cas de SO_2 -Lovas 1978-, ou celui de C_3H_2 -Bogey et al. 1987, ou II.04). En conséquence, pour les espèces $^{29}\text{SiC}_2$ et $^{30}\text{SiC}_2$, nous avons fixé les valeurs de A , d_J , H_{JK} , et H_{KJ} comme étant égales à celles l'isotope principal. Pour $^{28}\text{Si}^{13}\text{CC}$ les constantes de distorsion ont été aussi fixées égales à celles de $^{28}\text{SiC}_2$. Les autres constantes de distorsion (D_J , D_{JK} et d_K), ont été ajustées pour tous les isotopes. Les résultats sont donnés dans les tables 2, 4, 6, et 8. Les erreurs données dans ces tables sont une fois l'écart quadratique moyen. La différence entre les fréquences observées et celles calculées est donnée dans les tables 1, 3, 5, et 7.

Le lecteur pourra trouver d'autres exemples de spectroscopie dans le milieu interstellaire dans les chapitres II.03, II.04, II.07, II.08, II.09, II.10, II.11, II.12, II.14, II.15, et II.16 de cette thèse.

TABLE 1

$^{28}\text{SiC}_2$

FREQUENCES OBSERVEES

Transition	Freq. Obser. (MHz)	O-C (MHz)
101-000	23600.19 ± 0.1*	-0.04
404-303	93063.87 ± 0.2	0.14
423-322	94245.50 ± 0.3	0.17
422-321	95579.31 ± 0.4	0.03
505-404	115382.43 ± 0.4	-0.08
606-505	137180.76 ± 0.2	-0.12
625-524	140920.03 ± 0.3	-0.13
643-542	141751.17 ± 0.6	-0.06
642-541	141755.16 ± 0.6	0.05
624-523	145325.74 ± 0.3	-0.08
707-606	158499.30 ± 0.2	0.06
726-625	164069.05 ± 0.2	0.02
762-661	164770.59 ± 1.0	0.00
761-660	164770.59 ± 1.0	-0.00
725-624	170742.00 ± 1.5\$	1.07
726-707	175843.50 ± 1.5	-0.00
927-826	222009.31 ± 0.4	0.01
1047-946	237150.05 ± 1.0	0.31
1046-945	237331.20 ± 1.0	-0.31

*) Snyder et al. 1984.

\$) Thaddeus et al. 1984.

TABLE 2

Constantes rotationnelles de $^{28}\text{SiC}_2$ (MHz)

A	52424.18 (21)
B	13157.793 (46)
C	10442.491 (40)
D _J	1.308 (18) 10 ⁻²
D _{JK}	1.5395 (28)
d _J	9.3 (21) 10 ⁻⁴
d _K	8.948 (75) 10 ⁻¹
H _{JK}	-1.37 (15) 10 ⁻⁴
H _{KJ}	7.09 (69) 10 ⁻⁴

nombre de raies = 19

déviatiun typique = 0.380 MHz

déviatiun typique réduite = 0.513

TABLE 3

$^{29}\text{SiC}_2$

FREQUENCES OBSERVEES

Transition	Freq. Obser. (MHz)	O-C (MHz)
404-303	91771.80 ± 0.3	0.08
423-322	92882.00 ± 0.3	-0.13
422-321	94137.30 ± 0.3	0.07
505-404	113820.15 ± 0.4	-0.04
524-423	115943.69 ± 0.8	-0.86
606-505	135371.19 ± 0.3	-0.11
625-524	138901.77 ± 0.7	-0.22
643-542	139678.56 ± 1.0	2.37
642-541	139681.21 ± 1.0	1.61
624-523	143061.65 ± 0.4	0.26
707-606	156456.48 ± 0.3	0.04
762-661	162371.64 ± 1.0	-0.73
761-660	162371.64 ± 1.0	-0.73
744-643	163081.89 ± 1.0	0.24
743-642	163093.13 ± 1.0	0.13
725-624	168049.51 ± 1.0	-2.18
927-826	218507.11 ± 1.0	0.10
1029-928	229304.74 ± 1.0	0.22

TABLE 4

Constantes rotationnelles de $^{29}\text{SiC}_2$ (MHz)

A*	52424.18 (0)
B	12947.907 (96)
C	10309.658 (72)
DJ	1.307 (65) 10^{-2}
DJK	1.4944 (31)
dJ*	9.32 (0) 10^{-4}
dK	8.88 (31) 10^{-1}
HJK*	-1.37 (0) 10^{-4}
HKJ*	7.09 (0) 10^{-4}

nombre de raies = 18
 déviation typique = 1.077 MHz
 déviation typique réduite = 1.120

*) Paramètres fixés.

TABLE 5

³⁰SiCC

FREQUENCES OBSERVEES

Transition	Freq. Obser. (MHz)	O-C (MHz)
404-303	90562.10 ± 0.5	0.08
423-322	91608.90 ± 0.5	-0.05
422-321	92793.60 ± 0.5	-0.53
505-404	112354.90 ± 0.8	-0.50
524-423	114361.90 ± 1.0	-0.20
624-523	140956.20 ± 0.5	0.24
744-643	160815.53 ± 0.4	0.04
743-642	160825.62 ± 0.4	0.07
726-625	159552.64 ± 0.6	0.20
606-505	133672.86 ± 0.4	0.11
625-524	137015.90 ± 0.8	-0.33
643-542	137739.93 ± 0.8	0.37
642-541	137742.42 ± 0.8	-0.15
1046-945	230509.80 ± 1.5	-1.55
1028-927	240050.10 ± 1.5	0.36

TABLE 6

Constantes rotationnelles de ³⁰SIC₂ (MHz)

A*	52424.18 (0)
B	12752.521 (85)
C	10185.027 (77)
DJ	1.135 (46) E-02
DJK	1.4628 (27)
dJ*	9.32 (0) E-04
dK	8.45 (27) E-01
HJK*	-1.37 (0) E-04
HkJ*	7.09 (0) E-04

nombre de raies = 15
 déviation typique = 0.594 MHz
 déviation typique réduite = 0.606

*) Paramètres fixés.

TABLE 7

$^{28}\text{Si}^{13}\text{C}$

FREQUENCES OBSERVEES

Transition	Freq. Obser. (MHz)	O-C (MHz)
414-313	86565.40 ± 1.0	1.07
423-322	92065.00 ± 1.5	0.76
413-312	97294.96 ± 0.4	0.00
515-414	107971.70 ± 2.0	-1.46
505-404	112593.60 ± 1.0	0.04
616-515	129248.00 ± 2.0	-1.26
606-505	133813.15 ± 0.3	-0.02
625-524	137637.02 ± 0.5	0.12
634-533	138807.50 ± 1.5	-1.84
624-523	142138.86 ± 0.3	-0.03
615-514	145136.39 ± 0.3	-0.07
726-625	160229.55 ± 1.0	-0.39
734-633	162638.20 ± 1.0	0.70
716-615	168657.26 ± 0.3	0.07

TABLE 8

Constantes rotationnelles de $^{28}\text{Si}^{13}\text{C}$ (MHz)

A	50429.9 (52)
B	12874.36 (10)
C	10181.033 (64)
DJ	1.498 (86) 10^{-2}
DJK	1.4925 (78)
dJ*	9.32 (0) 10^{-4}
dK	9.63 (38) 10^{-1}
HJK*	-1.37 (0) 10^{-4}
HkJ*	7.09 (0) 10^{-4}

nombre de raies = 14
 déviation typique = 1.090 MHz
 déviation typique réduite = 0.764

*) Paramètres fixés.

CONCLUSIONS ET PERSPECTIVES

L'étude systématique du spectre millimétrique d'une source interstellaire est de loin la meilleure méthode pour comprendre ses conditions physico-chimiques (températures, abondances moléculaires, densités, masses, rapports isotopiques, etc). La couverture en fréquence fournit un ensemble homogène de données sur une grande variété d'espèces moléculaires, connues ou inconnues, et permet d'éliminer, ou tout au moins de cerner, des problèmes observationnels potentiels qui pourraient dégrader la qualité des données (tels que la calibration relative des observations, ou la confusion par des raies de la bande image du récepteur, etc). C'est ainsi que nous avons pu déterminer, le long des chapitres de cette deuxième partie de ma thèse, et dans la limite des erreurs observationnelles, un ensemble cohérent de densités projetées moléculaires qui pourront être la clé observationnelle des modèles chimiques des étoiles carbonées.

Les données obtenues sont aussi intéressantes pour l'étude des liaisons chimiques et de la structure des chaînes moléculaires carbonées, ainsi que pour la détermination des constantes spectroscopiques des molécules instables sur terre. Un cas particulièrement significatif est celui de C_6H [II.11 et II.12] où il nous a fallu convaincre, contre vents et marées, les experts quantiques que cette molécule devrait avoir un état fondamental 2Π irrégulier comme nos observations l'indiquaient, et non pas 2Σ comme il fallait s'attendre à partir de considérations théoriques. En conséquence, les calculs *ab initio* sur la structure moléculaire des longs radicaux carbonés ont dû être peaufinés.

La découverte des halogénures métalliques [II.17] a ouvert une voie totalement nouvelle pour l'étude des processus

de condensation des métaux sur les grains dans les enveloppes des étoiles évoluées.

Malheureusement, nos données ne sont complètes que pour IRC+10216, et une comparaison avec la physico-chimie d'autres enveloppes circumstellaires (ou d'autres sources moléculaires comme Orion ou SgrB2) n'a pas pu être entreprise. Il sera donc souhaitable, dans le futur, d'élargir nos observations à d'autres étoiles pour pouvoir étudier en détail la chimie de ces objets.

Une collaboration étroite avec les spectroscopistes est nécessaire pour identifier le nombre non négligeable des raies inconnues restant encore dans le spectre de IRC+10216. La détection de C_4H vibrationnellement excité et des halogénures métalliques dans IRC+10216 [II.14, II.15, II.17], suggère que d'autres espèces dans des états vibrationnels excités, comme C_5H et C_6H , ou des molécules métalliques, comme $MgCl$ ou $FeCl$, pourraient être responsables d'une partie importante de ces raies.

REFERENCES

- Blake, G.A., Sutton, E.C., Masson, C.R., Phillips, T.G.:Ap. J. Suppl., 60, 357.
- Bogey, M., Demuyneck, C., Destombes, J.L.:1987, J. Mol. Spectrosc., 122, 313.
- Gordy, W., Cook, R.L.:1970, "Microwave Molecular Spectroscopy", John Wiley & Sons, New York.
- Cernicharo, J., Guélin, M.:1987, Astron. Astrophys. Letters, 183, L10 [voir II.17].
- Cernicharo, J., Guélin, M., Menten, K.M., Walmsley, C.M.:1987a, Astron. Astrophys. Letters, 181, L4 [voir II.12].
- Cernicharo, J., Guélin, M., Walmsley, C.M.:1987b, Astron. Astrophys. Letters, 172, L5 [voir II.10].
- Cernicharo, J., Kahane, C., Gómez-González, J., Guélin, M.:1986a, Astron. Astrophys. Letters, 164, L1 [voir II.8].
- Cernicharo, J., Kahane, C., Gómez-González, J., Guélin, M.:1986b, Astron. Astrophys. Letters, 167, L5 [voir II.9].
- Cernicharo, J., Kahane, C., Gómez-González, J., Guélin, M.:1986c, Astron. Astrophys. Letters, 167, L9 [voir II.04].
- Cummins, S.E., Linke, R.A., Thaddeus, P.:1986, Ap. J. Suppl., 60, 819.
- Gottlieb, C.A., Gottlieb, E.W., Thaddeus, P., Kawamura, H.:1984, Ap. J., 275, 916.
- Gottlieb, C.A., Gottlieb, E.W., Thaddeus, P.:1986, Astron. Astrophys. Letters, 164, L5.
- Grev, R.S., Schaeffer III, H.F.:1984, J. Chem. Phys., 80, 3552.
- Guélin, M., Cernicharo, J., Kahane, C., Gómez-González, J., Walmsley, C.M.:1987, Astron. Astrophys. Letters, 175, L5 [voir II.11].
- Guélin, M., Cernicharo, J., Kahane, C., Gómez-González, J.:1987, Astron. Astrophys. Letters, 175, L5 [voir II.7].
- Guélin, M., Lequeux, J.:1980, dans "Interstellar Molecules", I.A.U. Symposium No.87, ed. par B.H. Andrew, Reidel, Holland.
- Guélin, M., Friberg, P., Mezaoui, A.:1982, Astron. Astrophys., 109, 2.
- Guélin, M., Green, S., Thaddeus, P.:1978, Ap. J. Letters, 224, L27.
- Guélin, M., Thaddeus, P.:1977, Ap. J. Letters, 212, L81.

- Johansson, L.E.B., Anderson, C., Ellder, J., Friberg, P., Hjalmarson, A., Hoglund, B., Irvine, W.M., Olofsson, H., Rydbeck, G.:1984, *Astron. Astrophys.*, 130, 227.
- Johansson, L.E.B., Anderson, C., Ellder, J., Friberg, P., Hjalmarson, A., Hoglund, B., Irvine, W.M., Olofsson, H., Rydbeck, G.:1985, *Astron. Astrophys. Suppl. Ser.*, 60, 135.
- Kleman, R.:1956, *Ap. J.*, 123, 162.
- Lovas, F.J.:1978, *J. Chem. Ref. Data*, 7, 1445.
- Lovas, F.J.:1984, SLAIM Magnetic Tape Version I-84, private communication.
- Michalopoulos, D.L., Geusic, M.E., Langridge-Smith, P.R.R., Smalley, R.E.:1984, *J. Chem. Phys.*, 80, 3556.
- Pearson, J.C., Gottlieb, C.A., Woodward, D.R., Thaddeus, P.:1988, *Astron. Astrophys. Letters*, 189, L13.
- Penzias, A.A.:1980, dans "Interstellar Molecules", I.A.U. Symposium No.87, ed. par B.H. Andrew, Reidel, Holland, pag. 397.
- Penzias, A.A.:1981, *Ap. J.*, 249, 518.
- Snyder, L.E., Henkel, C., Hollis, J.M., Lovas, F.J.:1985, *Ap. J. Letters*, 290, L29.
- Sutton, E.C., Blake, G.A., Masson, C.R., Phillips, T.G.:1985, *Ap. J. Suppl.*, 58, 341.
- Suzuki, H., Ohishi, M., Kaifu, N., Ishikawa, S., Kasuga, T.:1986, *Publ. Astron. Soc. Japan*, 38, 911.
- Thaddeus, P., Cummins, S.E., Linke, R.A.:1984, *Ap. J. Letters*, 283, L45.
- Wannier, P.G.:1985, dans "Production and distribution of CNO elements", ed. par J. Danzinger (Garching: ESO), pag 233.
- Wannier, P.G., Sahai, R.:1987, *Ap. J.*, 319, 367.

**II.02) L'ABONDANCE ISOTOPIQUE DE L'OXYGENE INTERSTELLAIRE
DETERMINEE A PARTIR D'OBSERVATIONS DES RAIES
A 18-cm DE LA MOLECULE OH.**

II.02) L'ABONDANCE ISOTOPIQUE DE L'OXYGENE INTERSTELLAIRE
DETERMINEE A PARTIR D'OBSERVATIONS DES RAIES A 18-cm DE LA
MOLECULE OH.

Nous montrons dans ce chapitre que dans la plupart des nuages moléculaire géants dans lesquels ^{18}OH a été détecté en absorption, le rapport d'abondances $^{16}\text{OH}/^{18}\text{OH}$ peut être affecté par le pompage rotationnel des raies à 18-cm d'OH. Ce rapport peut être déterminé sans trop d'erreur seulement dans les nuages froids ($T_K \leq 20$ K) où l'intensité des raies de ^{18}OH est faible.

Nous avons observé l'absorption de ^{18}OH dans un nuage froid proche du centre galactique et dans un nuage sombre proche du soleil. Le rapport $^{16}\text{OH}/^{18}\text{OH}$ déterminé dans ces sources est plus grand que celui déterminé auparavant dans les nuages chauds. Il est égal, aux erreurs près, au rapport terrestre $^{16}\text{O}/^{18}\text{O}$.

Dû a leur faible abondance, les molécules ^{18}OH et ^{17}OH , ne présentent pas d'excitation anormale. Le rapport de l'opacité de leurs raies à 18 cm est donc directement proportionnel à la densité projetée de la molécule OH. Nos observations de ^{18}OH et de ^{17}OH dans SgrB2 donnent un rapport d'abondances de 3.6 ± 0.5 . Ce rapport est similaire à celui déterminé pour $\text{C}^{18}\text{O}/\text{C}^{17}\text{O}$ et $\text{HC}^{18}\text{O}^+/\text{HC}^{17}\text{O}^+$, et 1.5 fois plus petit que le rapport terrestre $^{18}\text{O}/^{17}\text{O}$.

The isotopic abundance of interstellar oxygen derived from 18-cm line observations

V. Bujarrabal^{1,2}, J. Cernicharo^{1,3}, and M. Guélin⁴

¹ Observatoire de Paris-Meudon, F-92190 Meudon, France

² Observatorio Astronomico Nacional, Centro Astronomico de Yebes, Apartado 148, Guadalajara, Spain

³ Groupe d'Astrophysique, CERMO, B.P. 68, F-38402 Saint Martin d'Heres Cedex, France

⁴ IRAM, Avenida Divina Pastora, 7, Bl. 6-2B Granada, Spain

Received February 22, accepted June 8, 1983

Summary. Rotational pumping of the ^{16}OH 18-cm lines may lower the apparent $^{16}\text{OH}/^{18}\text{OH}$ abundance ratio in most giant molecular clouds in which ^{18}OH absorption has been detected. This ratio can be safely derived only in cold quiescent clouds ($T_K < 20\text{ K}$), where the ^{18}OH lines are weak. We report here the observation of ^{18}OH absorption in a cold cloud located near the galactic center, and in another close to the sun. The $^{16}\text{OH}/^{18}\text{OH}$ ratio in these sources is found higher than the ratios previously derived in hot sources and equal, within the rather large errors, to the terrestrial $^{16}\text{O}/^{18}\text{O}$ ratio.

Due to their low abundance, ^{18}OH and ^{17}OH are unlikely to be anomalously excited, and their 18-cm opacity ratio is expected to be equal to their column density ratio. Our observations of ^{18}OH and ^{17}OH in Sgr B2 yield an abundance ratio of 3.6 ± 0.5 , similar to the $\text{C}^{18}\text{O}/\text{C}^{17}\text{O}$ and $\text{HC}^{18}\text{O}^+/\text{HC}^{17}\text{O}^+$ ratios and 1.5 times smaller than the terrestrial $^{18}\text{O}/^{17}\text{O}$ abundance ratio.

Key words: interstellar molecules – isotopic abundances – OH

I. Introduction

In spite of their importance as tracers of chemical evolution, the interstellar abundance ratios $a = ^{16}\text{O}/^{18}\text{O}$ and $b = ^{16}\text{O}/^{17}\text{O}$ remain poorly known. Not from lack of interest, as shown by recent observations of C^{18}O , C^{17}O , $^{13}\text{C}^{18}\text{O}$, and HC^{17}O^+ (Penzias, 1980 and 1983; Guélin et al., 1982). The new data, however, have a limited value for the derivation of a and b . The two ratios are so large (their terrestrial values are $a = 490$ and $b = 2700$) that the ^{18}O and ^{17}O isotopic species can be detected in emission only when the lines of the main ^{16}O species are saturated, making its abundance difficult to assess. Thus, the $\text{C}^{16}\text{O}/\text{C}^{18}\text{O}$ abundance ratio is never directly determined from $^{12}\text{C}^{16}\text{O}$ and $^{12}\text{C}^{18}\text{O}$ (or from $^{13}\text{C}^{16}\text{O}$ and $^{13}\text{C}^{18}\text{O}$) observations, but only inferred from the average values of the $^{12}\text{C}^{18}\text{O}/^{13}\text{C}^{18}\text{O}$ and $^{13}\text{C}^{16}\text{O}/^{12}\text{C}^{18}\text{O}$ double isotopic ratios. These average values pertain to different regions of clouds (typically, the first ratio is measured at the line center, where $^{13}\text{C}^{16}\text{O}$ is saturated, and the second in the wings, where $^{13}\text{C}^{18}\text{O}$ is too weak to be detected), which may bias the value of the $\text{C}^{16}\text{O}/\text{C}^{18}\text{O}$ ratio, due to cloud-to-cloud variations or to ^{13}C enhancement at the edges of the clouds.

Another way to derive a and b is to observe the lines in absorption against a continuum source. The line intensity then

depends as much on the strength of the background source as on its opacity, and the rare ^{18}O and ^{17}O isotopes can sometimes be observed when the ^{16}O species is still not too opaque. Unfortunately, continuum sources are strong only at centimeter wavelengths, where molecular lines are scarce, and the method can be used only on a few molecules with complex energy diagrams (namely, the 18-cm lines of OH and the centrimetric lines of H_2CO). The intensities of these lines are sensitive to the molecules' excitation and the determination of a or b remains a delicate problem.

In view of these difficulties, it is not surprising that the emission and absorption line observations (mainly of CO and OH) lead to discrepant results: CO observations yield values of a larger than or about terrestrial in all giant molecular clouds located outside the galactic center region; the OH values, on the contrary, are twice as low.

As pointed out above, inherent limitations leave little prospect for improving the emission line studies. This is not the case for the OH isotope measurements which, up to now, had never been analyzed in the light of these molecules' excitation peculiarities. We show that OH 18-cm line absorption measurements in *selected* sources offer the best hope for accurately determining a and b .

II. Excitation of the OH molecule

a) The ^{16}OH and ^{18}OH energy level diagrams

The ground vibrational state of ^{16}OH (Fig. 1) is split by 200 cm^{-1} into two states of different electronic angular momenta ($\Omega = 1/2$ and $3/2$). Each of these states consist of a ladder of rotational levels connected by far infrared lines. The lowest rotational level (the $\Omega, J = 3/2, 3/2$ level) is coupled to four levels of the $\Omega = 3/2$ and $\Omega = 1/2$ ladders by four sets of lines with large Einstein coefficients. (A typically between 0.01 and 0.1 s^{-1} .) Transitions from this level to the upper ones occur in the interstellar medium through collisions and absorption of infrared photons emitted by hot dust. These transitions, however, are immediately followed by radiative cascades to the ground rotational level which is the only populated level. The opacity τ_{lu} of the infrared lines depends only on the total OH column density, $N(\text{OH})$ and on the line width, $\Delta\nu$:

$$\tau_{lu} \simeq \sigma_{lu} N(\text{OH}), \quad (1)$$

where $\sigma_{lu} = hB_{lu}/\Delta\nu$ is the cross section of "pure" absorption. For the strongest lines, the $120\text{ }\mu\text{m}$ lines connecting the two lowest rotational levels, the A value of the strongest hyperfine component is 0.14 s^{-1} and $\sigma\Delta\nu$ is $4 \cdot 10^{-14}\text{ cm}^2\text{ km s}^{-1}$; τ is then larger

Send offprint requests to: J. Cernicharo

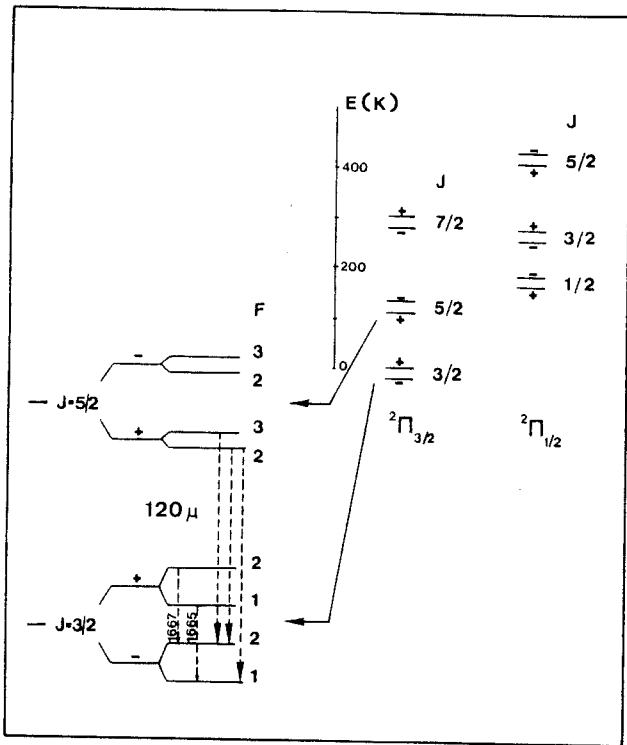

Fig. 1. Lowest rotational energy levels of ^{16}OH , showing hyperfine splittings of the $^2\Pi_{3/2}$ $J=3/2$ and $J=5/2$ levels, and the 18-cm main lines and 120- μm transitions. The 80, 53, and 35 μm transitions quoted in the text connect the $J=3/2$ ground level to the $J=1/2, 3/2,$ and $7/2$ upper levels

than unity as soon as $N(\text{OH})/\Delta\nu$ reaches $10^{14}\ \text{cm}^{-2}\ \text{km}^{-1}\ \text{s}$ - a value certainly exceeded in dense clouds as the OH column density is typically $10^{14}\ \text{cm}^{-2}$ per magnitude of extinction; more direct evidence of high opacity in the 120 μm lines is presented below.

As is well known, the rotational levels of ^{16}OH are split by A -doubling and magnetic hyperfine interactions. The ground rotational level is first divided by A -doubling into two sublevels of opposite parities, separated by $0.06\ \text{cm}^{-1}$ (or $0.08\ \text{K}$); each sub-level in turn, is split into two hyperfine sublevels by the weak coupling between the H nucleus spin and the molecule's electronic momenta. The 18-cm lines connect the two highest hyperfine sublevels to the lowest two; they correspond to transitions of large intrinsic strength (their Einstein B coefficients are in fact similar to those of the infrared lines) but of small spontaneous emission probabilities. (A , which scales as v^3 , is 10^{-10} - $10^{-11}\ \text{s}^{-1}$ for these lines.) Since the hyperfine sublevels are very close, their populations, N_i , in a first approximation are just proportional to the statistical weights (g_i). For a "homogeneous" cloud, the opacity of these lines is:

$$\tau_A = \sigma_A (1 - N_u g_u / N_l g_l) N(\text{OH}) \approx \sigma_A N(\text{OH}) 0.08 / T_{ex} \quad (2)$$

As the Einstein B coefficients are similar for the 18-cm and 120 μm lines, σ_A is about equal to σ_{IR} so that, according to (1) and (2),

$$\tau_{IR} \approx 12 T_{ex} \tau_A \quad (3)$$

(T_{ex} is the excitation temperature of the 18-cm line).

In common clouds, outside maser regions, T_{ex} is between a few Kelvins and 20 K and the opacity of the infrared lines is typically 20-100 times larger than that of the 18-cm lines. For most of the clouds observed in ^{18}OH , τ_A for the main isotope is at least of the order of 1 and τ_{IR} could be as large as 100.

The energy diagram of the ^{18}OH molecule is identical to that of ^{16}OH except for a slight displacement of the levels. The 18-cm transitions are shifted to 1639, 1637, 1692, and 1548 MHz, but have the same relative intensities as the ^{16}OH lines ($9 \div 5 \div 1 \div 1$). The line opacities are still given by relations (1) and (2), but since $N(\text{OH})$ stands now for the ^{18}OH column density, which is several hundred times smaller than $N(^{16}\text{OH})$, the rotational transitions are optically thin.

b) The rotational cycles

The similarity between ^{18}OH and ^{16}OH leads usually to assume that the opacity ratio of these species' 18-cm lines is equal to the molecule column density ratio - an assumption difficult to avoid if one wants to estimate the $^{16}\text{OH}/^{18}\text{OH}$ abundance ratio. The 18-cm line opacity, τ_A , results however from a balance between pure absorption and stimulated emission (see relation 2). It is proportional to $1 - N_u g_u / (N_l g_l) \approx 0.08 / T_{ex} \sim 10^{-2}$, and can be changed significantly by just a very slight variation of the upper level, it is enough, for example, to increase the population of the upper level by one per cent to decrease τ_A by almost a factor of two. There are several ways to produce such an increase. The most efficient ones result from the excitation of the so-called "rotational cycles", i.e. through transitions from the ground level to upper levels followed by cascades to the ground level. These cycles, triggered by collisions or infrared radiation, redistribute the populations of the ground sublevels. Collisions of OH with H_2 depopulate the lower A doublet of the ground rotational state, and increase the excitation of all the 18-cm lines. Trapping in the infrared transitions transfers molecules between the ground $F=2$ and $F=1$ sublevels (see below). These two processes can lead to any anomaly in any of the 18-cm lines, provided the excitation is high enough. The observation of masers (1665 MHz, but also 1667 MHz and satellite line masers) near H II regions (and in particular, near the H II regions studied for ^{18}OH absorption) shows that large excitations anomalies actually happen. Of course, most of the gas observed in OH absorption is not in the hot and dense masering regions and is not much affected by infrared radiation. In "giant clouds", however, collisional excitation of the rotational cycles is large enough to significantly perturb the intensities of the 18-cm lines, as we now show.

Consider a dense ($n \approx 10^4\ \text{cm}^{-3}$) cloudlet of molecular column density $N(\text{H}_2) \approx 10^{22}\ \text{cm}^{-2}$, $N(^{16}\text{OH}) \approx 10^{15}\ \text{cm}^{-2}$, $N(^{18}\text{OH}) \approx 2 \cdot 10^{12}\ \text{cm}^{-2}$, and a velocity dispersion of $\Delta v \approx 2\ \text{km s}^{-1}$. As has been seen, the opacity of the rotational lines does not depend on temperature and is given by $\tau_{IR} = \sigma N(\text{OH})$. We get $\tau = 20$ for the strongest 120 μm hyperfine components (the $J, F=5/2, 3 \rightarrow 3/2, 2$ components), $\tau = 0.5$ for the strongest 80 μm components ($J=1/2 \rightarrow 3/2$), and $\tau = 0.4$ and 0.1 for the strongest 53 μm ($J=3/2 \rightarrow 3/2$) and 35 μm ($J=5/2 \rightarrow 3/2$) components.

If the temperature of the gas (T_K) and the dust (T_d) is low ($T_K < 15\ \text{K}$), neither collisions nor infrared radiation excite the rotational cycles. Even for $T_K = 20\ \text{K}$, collisional excitation remains unimportant: upward transitions to the $(\Omega, J) = (3/2, 5/2)$ level, at 120 K above the ground rotational level, occur at a rate $\alpha_c = C_1 n e^{-120/T_K}$, and are about 10^3 times less probable than transitions among the ground level sublevels [rate $\alpha_E = C_0 n$,

where $C_0 \sim 2C_1 \sim 10^{-10} \text{ cm}^3 \text{ s}^{-1}$ according to Dewangan and Flower (1982)]. Since these latter transitions tend to thermalize the ground level populations, collisions cause no departure from thermodynamic equilibrium larger than 10^{-3} . If the dust temperature, T_d , reaches 20 K, infrared excitation of the $J=5/2$ level becomes significant: the dust opacity near $120 \mu\text{m}$ is $\tau_d \approx 10^{-24} N(\text{H}_2) \approx 10^{-2}$ and the radiative transition rate to the $J=5/2$ level, $\alpha_{\text{IR}} \approx A\tau_d e^{-120/T_d}$ is 10^{-6} s^{-1} ; α_{IR} thus exceeds α_E , the collision rate within the ground level, as long as $n < 10^4 \text{ cm}^{-3}$. Purely radiative excitation of the $J=5/2$ level, however, does not change the ground level populations since deexcitation of the $J=5/2$ level is also radiative. Hence, as long as T_k and T_d are $\leq 20 \text{ K}$, neither collisions, nor IR radiation perturb the 18-cm line intensities.

The situation changes drastically when T_k reaches or exceeds 30 K. The fraction of inelastic collisions exciting the $J=5/2$ level, α_C/α_E , then exceeds 1% and population deviations of this order can occur. We now describe a mechanism leading to such deviations; to simplify, we first consider the *lower A* sublevels of the $J=5/2$ and $J=3/2$ (ground) rotational levels, since these are radiatively decoupled from the upper *A* sublevels, to first approximation ($A_{\text{I}} \ll A_{\text{IR}}$).

i) Lower sublevels

The *lower* two sublevels of $J=5/2$ are connected to those of $J=3/2$ by three IR transitions: $3^+ \rightarrow 2^-$, $2^+ \rightarrow 2^-$, and $2^+ \rightarrow 1^-$ (see Fig. 1; selection rules are $+ \rightarrow -$ and $\Delta F=0, \pm 1$). The three lines are optically thick ($\tau=20$ for the $3^+ \rightarrow 2^-$ transition, $\tau=1$ and 13 for the $2^+ \rightarrow 2^-$ and $2^+ \rightarrow 1^-$ ones) and have similar "effective" transition probabilities A/τ . Those, of course, are very large compared with the collisional transition probabilities ($A/\tau > 10^5 n C_1$) so that de-excitation of the $J=5/2$ level is purely radiative. The process is as follows:

OH molecules in the ground rotational level, are hit by H_2 molecules and excited to the $J=5/2$, $F=3^+$ sublevel. Within a tenth of a second, they emit a $120 \mu\text{m}$ photon and relax to the 2^- ground level (see Fig. 1). But the $3^+ \rightarrow 2^-$ line is only 17 MHz (less than a Doppler width) below the $2^+ \rightarrow 2^-$ line; both are optically thick, so about half of the $3^+ \rightarrow 2^-$ photons are absorbed in the overlapping $2^+ \rightarrow 2^-$ line. Subsequent de-excitation of the $J=5/2$, 2^+ sublevel brings the OH molecules to either the 1^- ground sublevel, or back to the 2^- one.

The effect of the *line overlap* has been to transfer molecules from the 2^- ground sublevel to the 1^- one. (Note that the OH molecules could have been excited into the 2^+ instead of the 3^+ sublevel; however the overlap of the $3^+ \rightarrow 2^-$ and $2^+ \rightarrow 2^-$ lines has no effect on the ground level population, as the radiative de-excitation of the 3^+ sublevel necessarily leads back to the 2^- sublevel.) Of course, the effect of the complete cycle is more complex. As mentioned above, the mere collisional excitation to the $J=5/2$ level, because of collisional selection rules, tends to depopulate the lower $J=3/2$ sublevels (the 2^- and 1^- sublevels) relative to that of the higher sublevels (the 2^+ and 1^+); similarly, trapping in the infrared lines (in absence of overlap) increases the 2^- and 2^+ sublevel populations relative to those of the 1^- and 1^+ sublevels. These processes, however, like most 18-cm line inversion mechanisms, affect identically ^{16}OH and ^{18}OH (as do the collision rules) or are symmetric in *A* (IR line trapping without overlap affects the 2^+ and the 2^- sublevels equally). They can change the excitation temperature of the 18-cm lines, but probably not the $^{16}\text{OH}/^{18}\text{OH}$ main line opacity ratios. In contrast,

infrared line overlap, because it depends on *frequency* differences (and on opacities) rather than on intensities of the rotational lines, affects differently levels of opposite parities (e.g. 2^+ and 2^-) as well as different species as ^{16}OH and ^{18}OH . It thus acts directly on the $^{16}\text{OH}/^{18}\text{OH}$ opacity ratios.

ii) Upper sublevels

Let us turn back now to the *upper A*-sublevels of the $J=5/2$ and $J=3/2$ levels. These sublevels are linked by three radiative transitions ($3^- \rightarrow 2^+$, $2^- \rightarrow 2^+$, and $2^- \rightarrow 1^+$) which are "images" of those just considered ($3^+ \rightarrow 2^-$, $2^+ \rightarrow 2^-$, and $2^+ \rightarrow 1^-$). All the above discussion holds for the four "image" sublevels, except for the hyperfine separation, which for the $3^- \rightarrow 2^+$ and $2^- \rightarrow 2^+$ lines is about 1.4 times larger than for the $3^+ \rightarrow 2^-$ and $2^+ \rightarrow 2^-$ lines. Line overlap is thus less effective for the $3^- \rightarrow 2^+$ and $2^- \rightarrow 2^+$ lines, and the population transfer from the 2^+ to the 1^+ upper sublevels less important than from the 2^- to the 1^- lower sublevels.

Hence, the excitation temperature of the 1667 MHz line (connecting 2^+ to 2^-) is increased, and that of the 1665 MHz line (connecting 1^+ to 1^-) decreased. Nothing similar happens for ^{18}OH , since the line frequencies are different and the opacity of the IR lines is small; for $^{16}\text{OH}/^{18}\text{OH}$, the ratio of the main lines therefore differs from that of the column densities.

It should be stressed that this population transfer – and the deviation of the line opacity ratio from the abundance ratio – necessarily occurs as soon as τ is larger than 1 and T_k larger than 30 K. Its magnitude depends mostly on T_k and Δv . It leads to underestimate the $^{16}\text{OH}/^{18}\text{OH}$ abundance ratio derived from the 1667 and 1639 MHz lines. For $T_k=35 \text{ K}$ and $\Delta v=2 \text{ km s}^{-1}$, the population of the 2^+ sublevel is increased with respect to that of the 2^- sublevel by one per cent, and the excitation temperature of 1667 MHz line is increased by a factor of ~ 2 . The apparent $^{16}\text{OH}/^{18}\text{OH}$ abundance ratio (a) is then typically half of its true value.

As the temperature increases, the $120 \mu\text{m}$ lines are more excited, the population transfer is more important, and other rotational cycles get involved. The first such cycle involves the $\Omega=1/2$, $J=1/2$ rotational level, 180 K above the ground level. Kinetic temperatures of at least 50 K are needed to excite this level significantly. De-excitation from the $J=1/2$ to the $J=3/2$ ground level occurs through six $80\text{-}\mu\text{m}$ transitions, two of which ($0^+ \rightarrow 1^-$ and $1^+ \rightarrow 1^-$) overlap when $\Delta v > 0.5 \text{ km s}^{-1}$. This time, the overlap effect is opposite to that for the $120 \mu\text{m}$ lines, depopulating the 1^- ground sublevel relative to 2^- . Its magnitude is insensitive to Δv (as long as $\Delta v > 1 \text{ km s}^{-1}$) but depends critically on the OH column density: for our cloud model ($N(\text{OH})=10^{15} \text{ cm}^{-2}$), the $1^+ \rightarrow 1^-$ line opacity is only ~ 0.1 , so the effect is marginal. Other infrared lines, at 53 and $35 \mu\text{m}$, involving higher rotational levels, can overlap in molecular clouds. These lines have low opacities however, and, are unlikely to lead to noticeable effects except in dense maser regions. Maser regions are discussed by Guilloteau et al. (1981), who show that infrared line overlap may cause the strong masers at 1665 MHz.

Infrared radiation emitted by hot dust can produce anomalies of the 18-cm lines with or without line overlap (see e.g. Bujarrabal et al., 1980; Guilloteau, 1982). Mechanisms involve either radiative excitation of the $53 \mu\text{m}$ line, and require a large OH column density and a dust temperature of a least 40 K, or that of the $120 \mu\text{m}$ line, and require a dust temperature larger than 60 K. In the latter case (Guilloteau, 1982), collisional deexcitation of the $J=5/2$ level overpopulates the $J=3/2$ lower two sublevels and

decreases the excitation temperature of all four 18-cm lines. Since 120 μm radiation is needed at the outset, the decrease is larger for ^{18}OH than for ^{16}OH , which self-shields, thereby lowering the $^{16}\text{OH}/^{18}\text{OH}$ line intensity ratio.

c) Effect of 18-cm line opacity

So far, we have only considered the influence of the higher rotational levels on the ground level populations. Obviously, a large opacity in the 18-cm lines may also affect these populations. Photon trapping in the ^{16}OH 18-cm lines increases their excitation temperatures leading to an underestimate of the $^{16}\text{OH}/^{18}\text{OH}$ abundance ratio. The effect depends on geometry and collisional excitation efficiency and is maximum for homogeneous and low density clouds ($n(\text{H}_2) < 10^3 \text{ cm}^{-2}$). In that case, the 1667 MHz excitation temperature increases by 15% for $\tau(1667) = 1$ and by 40% for $\tau(1667) = 2$. 1667 MHz opacities larger than 1 are often observed in giant clouds such as Sgr B2; they are however unlikely to arise from a simple homogeneous cloud, but rather come from several clouds distributed along the line of sight; their effect on excitation temperatures should therefore be less severe.

We conclude that the excitation of the 18-cm lines is different for ^{16}OH and ^{18}OH in clouds with $T_k > 30 \text{ K}$ or $T_{\text{dust}} > 40 \text{ K}$ and with large internal velocity dispersion. In the hottest clouds, or close to bright IR sources, the $^{16}\text{OH}/^{18}\text{OH}$ intensity ratio can deviate either way from the molecule's abundance ratio. In moderate-temperature clouds ($30 < T_k < 60 \text{ K}$), far from hot sources, the abundance ratio probably exceeds the intensity ratio. Finally, in cold clouds where $T_k < 30 \text{ K}$, the two ratios should be about equal as long as $\tau(1667) \leq 1$.

III. Isotope ratios toward SGR B2

^{18}OH absorption has been reported in the direction of five H II regions: Sgr B2, Sgr A, RCW 38, RCW 57, and Orion B (Whiteoak and Gardner 1975, 1978, 1981). The absorption line is broad (10–30 km s^{-1}) and strong toward the first four sources where it probably arises in the turbulent molecular cloud associated with the continuum source. It is narrow (about 2 km s^{-1}) and weak toward Orion B where, as argued by Whiteoak and Gardner, the absorption is probably not close to the H II region but rather in a quiescent foreground cloud. The $^{16}\text{OH}/^{18}\text{OH}$ abundance ratio, derived by Whiteoak and Gardner, assuming equal excitation temperatures for the 18-cm ^{18}OH and ^{16}OH lines, increases from 200–300, in the four giant molecular clouds associated with the Sagittarius and RCW sources, to some 500–900 in the quiescent clouds.

Whiteoak and Gardner speculate that the ^{18}O relative abundance is enhanced in the hot giant molecular clouds. In the light of the discussion of Sect. II, we think that the ^{16}OH 18-cm intensities in these sources are simply lowered with respect to those of ^{18}OH by infrared line overlap (or perhaps some other mechanism). To illustrate this point, let us consider Sgr B2, the best studied of the source exhibiting broad ^{18}OH absorption.

Figure 2 shows ^{16}OH and ^{18}OH absorption profiles observed toward that source with the Nançay telescope (see appendix). These profiles are similar to those reported earlier by Whiteoak and Gardner (1975) but have clearer baseline and a higher signal-to-noise ratio, allowing accurate comparison of ^{16}OH and ^{18}OH intensities in the weaker features as well as the main one.

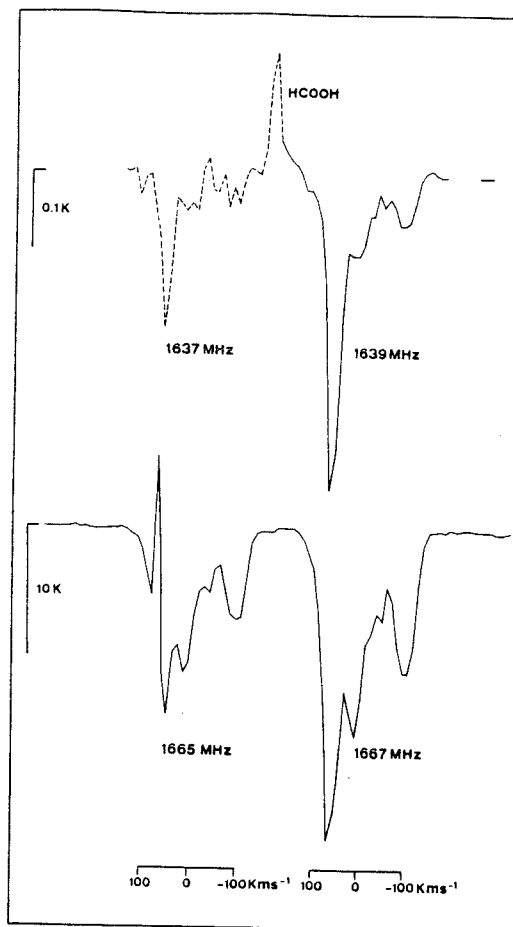

Fig. 2. ^{16}OH and ^{18}OH main line absorption observed toward Sgr B2. The emission between the two ^{18}OH lines comes from $l_{10} \rightarrow l_{11}$ line of HCOOH

The three main absorption features originate in unrelated clouds. The strongest feature, at 60 km s^{-1} , is clearly associated with the Sgr B2 molecular cloud, which is located only some 100 pc from the galactic center. High resolution observations of this feature show 1665 MHz masers concentrated around the continuum peaks. Far infrared and molecular (ammonia, methylcyanide, ...) observations indicate that gas and dust temperatures, at least at places, largely exceed 60 K. The second strongest features, at $\sim 10 \text{ km s}^{-1}$ is present in 6 cm formaldehyde as well as 21 cm H I spectra, but has no counterpart in the other molecule lines. It is believed to arise in the Sagittarius arm, which intersects the line of sight at $\sim 1 \text{ kpc}$ from the sun. H I observations (Riegel and Jennings, 1969) indicate kinetic temperatures $\leq 20 \text{ K}$. The weakest feature, at -90 km s^{-1} , is associated with the so called "central molecular ring" which can be followed in H I, H_2CO , and CO maps, over $l = \pm 1^\circ 2$.

Although there is little information on the physical conditions in the molecular ring, the absence of any recombination line at negative velocities suggests that the OH absorption does not arise in giant molecular clouds.

With a large 1667 MHz opacity, high kinetic temperature, broad velocity dispersion and embedded infrared and maser

sources, the 60 km s⁻¹ cloud appears as the archetype of a cloud where ¹⁶OH excitation anomalies would be expected.

The masers, which cover completely the center of the 60 km s⁻¹ absorption feature in the 1665 MHz line, preclude the use of the closure relation

$$\tau(1667)/9 + \tau(1665)/5 = \tau(1612) + \tau(1720) \quad (4)$$

to derive the ¹⁶OH line opacities from the observed antenna temperatures.

These can be roughly estimated from the restricted relation

$$\frac{2}{3}\tau(1667) = \tau(1612) + \tau(1720) \quad (5)$$

which assumes that the 1667 and 1665 MHz excitation temperatures are equal outside the maser regions. From the line intensities (Figs. 2 and 4), using (5) and $T \sim (1 - e^{-\tau})^{-1}$, one derives a peak opacity for the 1667 MHz line of 2.1, close to that calculated by Whiteoak and Gardner (1981) with similar hypothesis. The ¹⁸OH lines being optically thin, we have:

$$\frac{\tau(1667)}{\tau(1639)} = \frac{T_A(1667)}{T_A(1639)} \frac{\tau(1667)}{1 - e^{-\tau(1667)}} \approx 200 \quad (6)$$

and $\tau(1639) \approx 0.01$.

The next step would be to assume, as did Whiteoak and Gardner (1981), that $T_{ex}(1667) = T_{ex}(1639)$, which leads to $N(^{16}\text{OH})/N(^{18}\text{OH}) \approx 200$. We know, however, that for $\tau_{1667} = 2$, the opacities of the 120 μm $2^+ \rightarrow 2^-$ and $3^+ \rightarrow 2^-$ lines are respectively of the order of 14 and 200, since T_{ex} in such a dense and hot cloud must be about 10–20 K; hence, even if the 60 km s⁻¹ absorption originates in several independent cloudlets, the 120 μm line opacity is likely to be high in each of them. Moreover, the turbulent velocity in the cloudlets certainly exceeds 2 km s⁻¹ so that the $2^+ \rightarrow 2^-$ and $3^+ \rightarrow 2^-$ lines will overlap. In the parts of the clouds where $T_K \geq 30\text{--}40$ K, (e.g. where the $K > 4$ transitions of CH₃CN are detected, Linke et al., 1982) the 120 μm cycle will be efficiently excited and trapping in the $2^+ \rightarrow 2^-$ and $3^+ \rightarrow 2^-$ lines will increase $T_{ex}(1667)$, as explained in Sect. II. One thus expects $T_{ex}(1667) > T_{ex}(1639)$ and $N(^{16}\text{OH})/N(^{18}\text{OH}) > \tau_{1667}/\tau_{1639}$: at most, the ratio of 200 derived from (5) for the 60 km s⁻¹ cloud should be considered as a lower limit to the ¹⁶OH/¹⁸OH abundance ratio.

The excitation of the infrared cycles is probably much weaker in the +10 km s⁻¹ and -90 km s⁻¹ clouds, although the small velocity shift between the 1612 MHz and the 1720 MHz absorption features suggests that some rotational excitation is present in the latter cloud.

No maser emission is detected at 1665 MHz near these velocities. So, we can thus use relation (4) together with the intensities of Figs. 2 and 4 to derive $\tau(1667) \approx 1.1$ and $\tau(1667)/\tau(1639) \approx 370$ in the -90 km s⁻¹ cloud and $\tau(1667) \approx 1.5$ and $\tau(1667)/\tau(1639) \approx 440$ in the +10 km s⁻¹ cloud.

As expected, the value of the 1667 MHz to 1639 MHz line opacity ratio is higher in these clouds than in the hot 60 km s⁻¹ cloud, approaching the terrestrial ¹⁶O/¹⁸O ratio in the 10 km s⁻¹ cloud, the only cloud where we have no evidence of any IR pumping. This suggests that the low ¹⁶OH to ¹⁸OH opacity ratio in Sgr B2 may entirely be caused by one of the excitation mechanisms described in Sect. II. Note that the difference in opacity ratio between Sgr B2 and the +10 and -90 km s⁻¹ clouds cannot be due to a variation of a with galactocentric distance, such as that suggested by the CO data (Penzias, 1981), since the -90 km s⁻¹ cloud is about as close to the galactic center as Sgr B2.

Besides Sgr B2, Whiteoak and Gardner observed a low 1667 MHz to 1639 MHz opacity ratio in Sgr A, RCW 38, and RCW 57. The Sgr A cloud has a high ¹⁶OH optical depth, a large velocity dispersion and, according to the NH₃ measurements (Güsten et al., 1981), a temperature of a least 40–50 K, i.e. all the conditions required for a non-thermal excitation of the ¹⁶OH 18-cm lines. Although no temperature measurement is available for the RCW clouds, as pointed out by Whiteoak and Gardner, these are also hot and turbulent, judging from their broad ($\Delta V = 15\text{--}20$ km s⁻¹) and deep absorption features.

Hence, in the RCW clouds as well as in the Sgr A cloud, the ¹⁶OH to ¹⁸OH opacity ratio may be affected by IR trapping, so that the low values observed for this ratio do not necessarily reflect the true isotopic abundance.

Gérard et al. (1983) have extended Whiteoak and Gardner's ¹⁸OH absorption survey with the Nançay radiotelescope. Their results agree with the conclusion of Sect. II: in three warm clouds associated with H II regions, they observe broad absorption, 1665 MHz masers, large satellite line anomalies and a 1667 MHz to 1639 MHz line intensity ratio lower than the terrestrial ¹⁶O/¹⁸O abundance ratio. The line ratio varies from source to source and is as low as 250 in M 17, which, if the 1667 MHz line excitation were normal, would imply that the ¹⁶OH/¹⁸OH abundance ratio in that source is at least twice as low as the C¹⁶O/C¹⁸O ratio. Toward Orion B, as toward all the sources where the line of sight encounters only cold or narrow velocity clouds, Gérard et al. observe large 1667 MHz to 1639 MHz opacity ratios consistent with the terrestrial ¹⁶O/¹⁸O and the interstellar C¹⁶O/C¹⁸O opacity ratio.

IV. The abundance of ¹⁷OH

The relative strength of ¹⁸OH absorption in Sgr B2 has prompted us to search for the very rare ¹⁷OH isotope.

Due to the presence of a ¹⁷O nucleus, with spin 5/2, ¹⁷OH has an energy level diagram more complex than ¹⁸OH and ¹⁶OH. Its sublevels have up to five hyperfine components due to the nuclear spin-molecular field interactions: instead of four sublevels as in ¹⁶OH, the ground $J = 3/2$ rotational level consists of 16 hyperfine sublevels connected by 34 transitions. The transitions with the largest strength (the "main lines") are those with $\Delta F = \Delta F_1 = \Delta N (= 0)$. The strongest, the $(F_1, F) = (4, 9/2) \rightarrow (4, 9/2)$ transition, at 1626 MHz, has 15% of the total 18-cm line intensity. The line has already been detected in Sgr A by Gardner and Whiteoak (1976). Figure 3 presents its absorption profile toward Sgr B2 observed with the Nançay telescope. This profile was obtained simultaneously with the ¹⁸OH 1639 MHz profile, ensuring proper calibration of the two lines (see appendix).

Despite the complex ¹⁷OH energy levels, the ¹⁸OH/¹⁷OH abundance ratio is easier to derive than the ¹⁶OH/¹⁸OH ratio. The low abundance of ¹⁸OH and ¹⁷OH ensures that the IR line opacity is small so the ground level populations are not affected by line trapping (the 1639 to 1637 MHz line ratio in Fig. 2 is indeed close to the "normal" ratio of 9:5). Therefore one has: $T_{ex}(1626) \approx T_{ex}(1639)$, and

$$\frac{N(^{18}\text{OH})}{N(^{17}\text{OH})} = 0.27 \frac{\tau(1639)}{\tau(1626)} = 0.27 \frac{T_A(1639)}{T_A(1626)},$$

where 0.27 is the ratio of intrinsic line strengths (Valtz and Soglasnova, 1873).

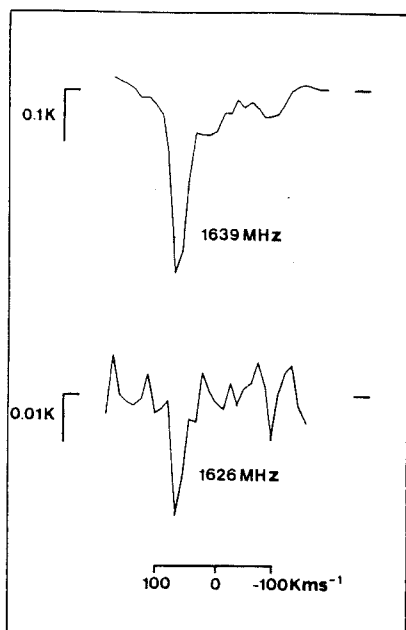

Fig. 3. The ^{18}OH 1639 MHz and ^{17}OH 1626 MHz lines, observed simultaneously toward Sgr B2

The 1639 to 1626 MHz line ratio is 13.5 ± 1.7 in Fig. 3. We then find a beam-averaged $^{18}\text{OH}/^{17}\text{OH}$ abundance ratio in the $+60 \text{ km s}^{-1}$ cloud of 3.6 ± 0.5 . The weakness of the 1626 MHz line unfortunately prevents us to derive any value in the $+10 \text{ km s}^{-1}$ and -90 km s^{-1} clouds, hence to directly measure the $^{16}\text{O}/^{17}\text{O}$ abundance ratio.

Our value of 3.6 ± 0.5 in the $+60 \text{ km s}^{-1}$ cloud agrees well with the $\text{C}^{18}\text{O}/\text{C}^{17}\text{O}$ and $\text{HC}^{18}\text{O}^+/\text{HC}^{17}\text{O}^+$ abundance ratios derived by Penzias (1981) and Guelin et al. (1982) in the same source. Since OH and CO are formed in molecular clouds by different processes, this probably means that the oxygen isotope abundance is not contaminated by chemical fractionation in Sgr B2, and hence that the $^{18}\text{O}/^{17}\text{O}$ elemental abundance ratio in this source is very close to 3.5. As pointed out by Penzias (1981), this ratio is a factor ~ 1.5 smaller than the terrestrial $^{18}\text{O}/^{17}\text{O}$ elemental ratio.

V. Conclusion

Collisional pumping of rotational cycles perturbs the excitation of the four 18-cm ^{16}OH lines, not just in maser regions, but throughout giant molecular clouds. The pumping is efficient at kinetic temperatures $\geq 30 \text{ K}$. In the absence of hot external sources, its main effect is to decrease the opacity of the 1667 MHz ^{16}OH main line, and to perturb the satellite lines. Under such conditions, the $^{16}\text{OH}/^{18}\text{OH}$ 18-cm opacity ratio could be a factor of two lower than the $^{16}\text{OH}/^{18}\text{OH}$ column density ratio. Excitation anomalies of this type, rather than a high ^{18}O abundance, could explain why the 1667 MHz/1639 MHz opacity ratio is smaller than the terrestrial $^{16}\text{O}/^{18}\text{O}$ ratio in giant molecular clouds.

The collisional pumping becomes inefficient for gas kinetic temperatures $\lesssim 20 \text{ K}$. The $^{16}\text{OH}/^{18}\text{OH}$ abundance ratio can thus be safely derived from the 1667 to 1639 MHz opacity ratio in cold

dark clouds where $\tau(1667)$ is small. An attempt to do so in two (presumably) cold clouds, one in the molecular ring close to the galactic center, the other in the solar neighborhood, yields abundance ratios of the order of 400, consistent with the terrestrial $^{16}\text{O}/^{18}\text{O}$ ratio of 490.

No anomalous excitation is expected for the 18-cm lines of the rare ^{18}OH and ^{17}OH isotopes. The $^{18}\text{OH}/^{17}\text{OH}$ abundance ratio derived in Sgr B2 by assuming equal excitation for the two species is $3.6 \pm 0.5 \text{ K}$, close to the $\text{C}^{18}\text{O}/\text{C}^{17}\text{O}$ abundance ratio and 1.5 times smaller than the terrestrial $^{18}\text{O}/^{17}\text{O}$ elemental abundance ratio.

Acknowledgements. We thank E. Gérard, A. M. Lesqueren, and M. Perault for discussions and for letting us use their results prior to publication, A. Hayem and D. Potard for their help in the Sgr B2 observations, and D. Downes, S. Guilloteau, and A. Omont for suggestions.

Appendix

Our observations of ^{18}OH and ^{17}OH main lines toward Sgr B2 and of ^{16}OH main and satellite lines (Figs. 2–4) were carried out between January 1980 and June 1981 with the Nançay telescope. During these observations the system temperature was 120 K, including a contribution of 60 K from Sgr B2 and 20 K from the galactic disk emission. We used a filterbank consisting of 384 channels, with widths of 6, 60, 300 or 900 MHz. For Sgr B2, where the near blending of 1665 with 1667 MHz lines and 1637 with 1639 MHz lines requires broad ($>4 \text{ MHz}$) bandwidth coverage, the most useful data were obtained with the 60 kHz and broader channels.

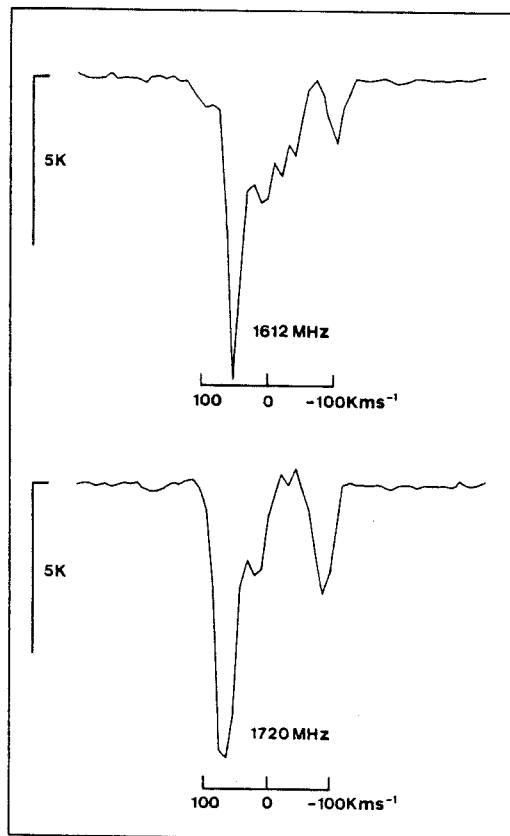

Fig. 4. ^{16}OH satellite lines in absorption against Sgr B2

For accurate calibration and smooth baselines, the filterbank was split into two parts centred on two different lines of the same isotope, or on corresponding lines of two different isotopes. Every six minutes, the frequencies of the two filterbank halves were exchanged and a fast scan was made across the source; the beam was then switched from the source to a reference field 45' east; during the OFF-phase, a noise diode compensated for the decrease of power. Finally, the feed horn was periodically shifted by $\lambda/4$ along the telescope axis. By this technique, we were able to calibrate the line intensities against the continuum source and to minimize the baseline problems. Despite these precautions, the ^{18}OH and ^{17}OH spectra had a slight broad-band curvature due to coupling of the noise diode to the horn. This curvature was eliminated by subtracting a second-order polynomial fitted over a 8 MHz broad baseline.

References

- Bujarrabal, V., Guibert, J., Nguyen-Q-Rieu, Omont, A.: 1980, *Astron. Astrophys.* **84**, 311
- Dewangan, D.P., Flower, D.R.: 1982, *Monthly Notices Roy. Astron. Soc.* **199**, 457
- Gardner, F.F., Whiteoak, J.B.: 1976, *Monthly Notices Roy. Astron. Soc.* **176**, 57P
- Gérard, E., Lesqueren, A.M., Perault, M.: 1983 (private communication)
- Guélin, M., Cernicharo, J., Linke, R.A.: 1982, *Astrophys. J.* **263**, L89
- Güsten, R., Walmsley, C.M., Pauls, T.: 1981, *Astron. Astrophys.* **103**, 197
- Guilloteau, S., Lucas, R., Omont, A.: 1981, *Astron. Astrophys.* **97**, 347
- Guilloteau, S.: 1982, *Astron. Astrophys.* **116**, 101
- Linke, R.A., Cummings, S.A., Green, S., Thaddeus, P.: 1982, in *Proceedings of Symposium on neutral Clouds near H II Regions*, ed. B. C. Penticton, Reidel, Dordrecht
- Penzias, A.A.: 1980, *Science* **208**, 663
- Penzias, A.A.: 1981, *Astrophys. J.* **249**, 518
- Penzias, A.A.: 1983, *Astrophys. J.* (in press)
- Riegel, K.W., Jennings, M.C.: 1969, *Astrophys. J.* **157**, 563
- Valtz, J.E., Soglasnova, V.A.: 1973, *Astrophys. Letters* **13**, 23
- Whiteoak, J.B., Gardner, F.F.: 1975, *Proc. Astron. Soc. Australian* **2**, 360
- Whiteoak, J.B., Gardner, F.F.: 1978, *Monthly Notices Roy. Astron. Soc.* **183**, 67P
- Whiteoak, J.B., Gardner, F.F.: 1981, *Monthly Notices Roy. Astron. Soc.* **197**, 39P

II.03) DETECTION DE $\text{HCl}^{17}\text{O}^+$ DANS SGRB2

II.03) DETECTION DE HC¹⁷O⁺ DANS SGRB2.

Nous avons détecté dans SgrB2(OH) une raie d'émission à 87.057 GHz que nous avons attribué à la transition J=1-0 de HC¹⁷O⁺. Le rapport d'abondances HC¹⁸O⁺/HC¹⁷O⁺ est de 3.1±0.6, plus faible que sa valeur terrestre de 5.5. Ce rapport est par contre en très bon accord avec ceux déterminés dans la même source à partir de C¹⁸O/C¹⁷O et de ¹⁸OH/¹⁷OH (voir II.02).

DETECTION OF HC^{17}O^+ IN SAGITTARIUS B2

M. GUÉLIN AND J. CERNICHARO
 Observatoire de Paris

AND

R. A. LINKE
 Bell Laboratories, Crawford Hill Laboratory
 Received 1982 June 23; accepted 1982 August 23

ABSTRACT

Line emission at 87.057 GHz attributed to the $J = 1 \rightarrow 0$ rotational transition of the formyl ion HC^{17}O^+ has been detected in Sgr B2 (OH). The $\text{HC}^{18}\text{O}^+/\text{HC}^{17}\text{O}^+$ abundance ratio found (3.1 ± 0.6) is lower than the terrestrial $^{18}\text{O}/^{17}\text{O}$ elemental abundance ratio (5.5) and agrees, within the errors, with the $\text{C}^{18}\text{O}/\text{C}^{17}\text{O}$ and $^{18}\text{OH}/^{17}\text{OH}$ abundance ratios observed in that source.

Subject heading: interstellar: molecules

I. INTRODUCTION

The knowledge of atomic isotope abundances throughout the Galaxy provides important clues to our understanding of the process of nucleosynthesis and galactic evolution. The galactic center region is of particular interest since the processing of gas in stars is thought to have reached an exceptionally high level there.

The oxygen isotopes, ^{16}O , ^{17}O , and ^{18}O , are well suited for this type of study since they are observable in a number of molecular forms. Moreover, ^{16}O , ^{17}O , and ^{18}O have very different nucleosynthetic origins: according to current theories, ^{16}O , the main isotope, is a typical "primary" element formed essentially in the massive stars of the first generation; ^{17}O and ^{18}O , in contrast, are two "secondary" elements released in interstellar space during nova and supernova explosions (Audouze *et al.* 1977). Comparison of the $^{16}\text{O}/^{17}\text{O}$ and $^{16}\text{O}/^{18}\text{O}$ abundance ratios in the galactic center region gas with those in the solar system and solar neighborhood helps us to check these theories and tells us about the occurrence of explosive events.

It is unfortunate that the $^{16}\text{O}/^{17}\text{O}$ and $^{16}\text{O}/^{18}\text{O}$ ratios (respectively 2750 and 500 in the solar system) are so large that they cannot be measured directly with high accuracy: the opacity in the line of an ^{16}O -bearing molecule is always large when the corresponding line of the ^{17}O species can be detected. In contrast, the $^{18}\text{O}/^{17}\text{O}$ ratio is only of the order of a few (5.5 in the solar system) and should be measurable with high precision when sensitive enough equipment is used. So far, because of the weakness of the lines, ^{17}O has been observed only in CO and OH. The $\text{C}^{18}\text{O}/\text{C}^{17}\text{O}$ abundance ratio has been derived in several giant molecular clouds, on the assumption that it is about equal to the intensity ratio of the C^{18}O to C^{17}O $J = 1-0$ lines (Wannier *et al.*

1976; Penzias 1981). It is found to be approximately the same in the galactic center sources (Sgr B2 and Sgr A) as in the sources of the galactic disk region and 1.5 times smaller than the solar system $^{18}\text{O}/^{17}\text{O}$ elemental ratio. The ^{17}OH observations toward Sgr B2 and Sgr A seem to support this result (Gardner and Whiteoak 1976; Bujarrabal, Cernicharo, and Guélin 1983).

The finding that the interstellar $^{18}\text{O}/^{17}\text{O}$ ratio at the same time is constant throughout the Galaxy and differs from the solar system value is surprising in view of the differences in the synthesis of these two elements. The observations have been interpreted to be a result of ^{17}O enrichment in the interstellar medium (Wannier *et al.* 1976). Another proposed interpretation of the observations is that the gas of the presolar nebula has been enriched in the ^{18}O isotope by some local violent event (see, e.g., Penzias 1981). It is clearly desirable to confirm the reported results through observations of another molecule. In this *Letter*, we report the first detection of HC^{17}O^+ and estimate the $\text{HC}^{18}\text{O}^+/\text{HC}^{17}\text{O}^+$ abundance ratio in the dense core of Sgr B2.

II. HC^{17}O^+ 1-0 TRANSITION FREQUENCY

Despite the lack of HC^{17}O^+ laboratory study, the center frequency, ν , of the $1 \rightarrow 0$ rotational transition of this species can be fairly accurately calculated, using the data available on other HCO^+ isotopes as well as the vibration-rotation constants computed by Henning, Kraemer, and Dierksen (1977). Following the standard procedure (e.g., Townes and Schawlow 1955), we find

$$\begin{aligned}
 B(\text{HC}^{17}\text{O}^+) &= B(\text{HC}^{16}\text{O}^+) \left| 1 - \lambda + \lambda \frac{B(\text{HC}^{16}\text{O}^+)}{B(\text{HC}^{18}\text{O}^+)} \right|^{-1} \\
 &= 43528.9 \text{ MHz}, \quad (1)
 \end{aligned}$$

where B stands for the rotational constants of the HCO^+ isotopes [$B(\text{HC}^{16}\text{O}^+)$ and $B(\text{HC}^{18}\text{O}^+)$ are taken from Bogey, Demuyneck, and Destombes 1982], and where

$$\lambda = \frac{m(\text{O}^{17} - \text{O}^{16})}{m(\text{O}^{18} - \text{O}^{16})} \frac{m(\text{HC}^{18}\text{O}^+)}{m(\text{HC}^{17}\text{O}^+)} = 0.5177436 \quad (2)$$

depends only on the masses of the O, C, and H atoms. The distortion constant of HC^{17}O^+ , to a very good approximation, can be derived from a weighted average of those of HC^{16}O^+ and HC^{18}O^+ to be $D = 73$ kHz. Then,

$$\nu_0 = 2B - 4D = 87057.5 \text{ MHz.}$$

The uncertainty in ν_0 is quite small. It first comes from the use in equation (1) of effective rotational constants (B_0), whereas this relation strictly applies to the equilibrium constants B_e ($B_0 = B_e - \alpha$, where $\alpha = \frac{1}{2}\sum_i \alpha_i$, is the rotation-vibration constant). Changing B_e to B_0 in relation (1) supposes that α has the same dependence on mass variation, Δm , as B_e , which is true only to a first approximation. A rough estimate of the error resulting from the B_e to B_0 substitution can be made by assuming that the dependence of α on Δm is the same for HCO^+ and HCN , a molecule isoelectronic with HCO^+ for which accurate measurements exist; we find $\Delta\nu_0 \approx 0.5$ MHz. In comparison, the uncertainties in the B and D values of HC^{16}O^+ and HC^{18}O^+ , resulting from the laboratory measurements, are negligible. We conclude that

$$\nu_0 = 87057.5 \pm 0.5 \text{ MHz.}$$

That the uncertainty in the value of ν_0 is actually much smaller than 0.5 MHz is suggested by parallel calculations carried out on the well-studied molecules, CO, OCS and NNO. Using the laboratory frequencies of the main as well as ^{16}O and ^{18}O isotopes of these species, we obtain values of the $J = 1 \rightarrow 0$ line center frequencies of C^{17}O , ^{17}OCS , and NN^{17}O accurate to within few times 10^{-7} .

Owing to the ^{17}O nucleus (spin = 5/2), the HC^{17}O^+ $1 \rightarrow 0$ line is split into three hyperfine components, whose relative frequencies depend on the value of the

quadrupole coupling constant, eQq . This constant is a measure of the strength of the interaction between the ^{17}O nucleus quadrupole moment (Q) and the surrounding charge distribution. Its value can be estimated by scaling up the eQq constant of HC^{14}N (whose distribution of charges around the N nucleus should be very similar to that around the ^{17}O nucleus in HC^{17}O^+) by the ratio $Q(^{17}\text{O})/Q(^{14}\text{N})$ of the ^{17}O and ^{14}N quadrupole moments (i.e., by a factor -2.6). This yields $eQq = 12$ MHz, a value whose uncertainty could be perhaps as large as 30%. Adopting the ν_0 and eQq values so derived leads to the three-line pattern shown in Figure 1a.

III. OBSERVATIONS

The observations were carried out at Crawford Hill Laboratory, Holmdel, New Jersey, with the Bell Laboratories (BTL) 7 m telescope during the 1979-1980 and 1981-1982 observing seasons. The antenna resolution, at the frequencies of the HC^{18}O^+ and HC^{17}O^+ $J = 1-0$ lines (85.2 and 87.1 GHz), was close to 2'. The spectrometer resolution was 1 MHz (3.5 km s^{-1}). A quasi-optical feed system provided rejection of the mixer's image sideband to better than 15 dB. The two spectra of Figure 1 were obtained by switching in position between the source and a reference field and correcting for atmospheric attenuation but not beam efficiency ($\sim 94\%$ at these frequencies).

Detection of the HC^{18}O^+ $J = 0 \rightarrow 1$ line toward Sgr B2 has previously been reported by Guélin and Thaddeus (1979) and by Stark (1981). The spectrum of Figure 1b includes the Stark data together with new data also obtained at BTL as part of a survey of the millimeter spectrum of Sgr B2 (Linke, Cummins, and Thaddeus 1983). The HC^{18}O^+ line appears simultaneously in emission and in absorption against the continuum source associated with the OH maser. As noted by Guélin and Thaddeus, the narrow ($\Delta V = 13 \text{ km s}^{-1}$) HC^{18}O^+ emission line has a velocity of 54 km s^{-1} similar to that observed for the lines of other rare isotopic species, but lower than the value of 62 km s^{-1} associated with emission from many other molecules in Sgr B2 (see, e.g., Scoville, Salomon, and Penzias 1975). The weak absorption feature, which can be seen between +35 and -45 km s^{-1} , has been shown by Linke, Stark, and Frerking

FIG. 1.—The $J = 1 \rightarrow 0$ transitions of HC^{17}O^+ and HC^{18}O^+ observed in the direction to Sgr B2 (OH) with a spectral resolution of 1 MHz. (a) The HC^{17}O^+ transition consists of three hyperfine components whose relative positions and intensities are indicated by the three-line pattern at the bottom of (a) (we assume here that $\nu_0 = 87057.5$ MHz, $eQq = 12$ MHz, and $V = 54 \text{ km s}^{-1}$, see text). The broad line on the right is the $J = 1 \rightarrow 0$ transition of HN^{13}C at 87090.9 MHz; note that the emission of this line, as that of the abundant isotopes HN^{12}C and HCO^+ , is strictly limited to velocities lower than 145 km s^{-1} and should not interfere with HC^{17}O^+ emission. (b) The HC^{18}O^+ line appears in emission between 45 and 65 km s^{-1} and in absorption between -45 and $+35 \text{ km s}^{-1}$. The line on the left is the $J = 7 \rightarrow 6$ transition of OCS; note that contrary to HCO^+ $J = 1 \rightarrow 0$, the high- J lines of this molecule show no absorption, so that the OCS 7-6 line should not interfere with HC^{18}O^+ emission. (c) The same spectrum as in (b) showing the totality of the 512 MHz instantaneous bandwidth. Molecular line emission in Sgr B2 has been relatively well investigated near 3 mm so that, although the line density is high, the chances of accidental blend with a narrow, unpredicted line are rather low. In the 85.0-85.4 GHz frequency range, only two clear spectral features remain unidentified: the well-known line U85.3 (Thaddeus, Guélin, and Linke 1981), and a weak feature at 85.231 GHz. This latter feature could be a blend of the two strongest $N = 1-0$ hyperfine components of C^{13}CH , for which we estimate frequencies of 85.217 and 85.220 ($= 10$ MHz), using the equilibrium structure CI calculations of W. D. Kraemer (1982, private communication).

(1981) to arise from the gas of the nuclear disk. Absorption features are observed for H^{13}CO^+ and HCO^+ down to $V = -125 \text{ km s}^{-1}$, suggesting that, in Figure 1b, HC^{18}O^+ absorption is partly blended with the nearby HC_3N line. Between 0 and $+30 \text{ km s}^{-1}$, the average absorption depth is -0.02 K , which corresponds to an apparent optical depth $\tau = 0.1$ (vs. 0.3 for H^{13}CO^+). The presence of a negative feature adds some uncertainty to the intensity of the emission spike; in Figure 1b, the baseline has been defined over a 200 MHz band by discarding the 85.12–85.21 GHz interval (see Fig. 1c).

At the frequency predicted for the $J = 1 \rightarrow 0$ transition of HC^{17}O^+ , a significant feature is present in Figure 1a. Since a careful compilation of known or expected interstellar molecules predicts no other line of this strength near ν_0 (or near the frequency corresponding to ν_0 in the image sideband), we identify the new line with HC^{17}O^+ .

Owing to the closeness of the frequencies of the HC^{17}O^+ and HC^{18}O^+ lines (which lie less than 2 GHz apart) and to the reliable line calibration procedure in use on the Holmdel telescope, the temperature scales of the HC^{18}O^+ and HC^{17}O^+ spectra are directly comparable with relative calibration errors expected to be no greater than 5%. The antenna temperature ratio should, therefore, be equal within the noise to the line intensity ratio. This latter ratio, averaging the three central channels of each line, is found to equal 3.1 ± 0.4 where the error reflects statistical uncertainty. This intensity ratio accurately reflects the $\text{HC}^{18}\text{O}^+/\text{HC}^{17}\text{O}^+$ column density ratio in Sgr B2 only if: (1) HC^{18}O^+ emission in the 54 km s^{-1} Sgr B2 cloud is optically thin; (2) the disk foreground absorption is negligible at this velocity—or at least affects similarly the HC^{17}O^+ and HC^{18}O^+ lines; (3) the intensity of the HC^{17}O^+ line is not decreased by hyperfine splitting; and (4) there is no isotope fractionation. The first two conditions are likely to be fulfilled, or at least are unlikely to lead to a large ($> 20\%$) error: the $\text{HC}^{13}\text{O}^+/\text{HC}^{18}\text{O}^+$ brightness ratio at $50\text{--}54 \text{ km s}^{-1}$ (3–4) approaches two-thirds of the $(^{13}\text{C}:^{12}\text{C})/(^{18}\text{O}:^{16}\text{O})$ double isotopic ratio in Sgr B2 (6 from the H_2CO observations of Henkel, Wilson, and Downes 1979); yet, this ratio should be much more sensitive to the effects of line opacity than the $\text{HC}^{18}\text{O}^+/\text{HC}^{17}\text{O}^+$ ratio, since the optical depth is a factor of 6 larger for HC^{13}O^+ than for HC^{18}O^+ . Hyperfine splitting, in principle, can reduce the peak intensity of the HC^{17}O^+ line by as much as 50% (see Fig. 1); in the case of Sgr B2, however, the line width (4.5 MHz according to the HC^{18}O^+ spectrum) is too broad to allow the resolution of the two strongest hyperfine components. For $eQq = 12 \text{ MHz}$, the value estimated above, the line peak intensity is still 80% of the unsplit value and the 3 MHz averaged intensity is even closer; an important effect (e.g., intensity reduced to

70% of its unsplit value) arises only for improbably large values of eQq ($> 20 \text{ MHz}$). In fact, there is no evidence, according to Figure 1a, that the HC^{17}O^+ line is any broader than the HC^{18}O^+ line, which suggests that eQq actually is smaller than 12 MHz. Combining the uncertainty in the $R = \text{HC}^{18}\text{O}^+/\text{HC}^{17}\text{O}^+$ abundance ratio due to the receiver noise with the errors introduced by hyperfine splitting and possible HC^{18}O^+ line opacity (two errors of opposite sign which in fact should partly balance each other), we derive

$$R = \text{HC}^{18}\text{O}^+/\text{HC}^{17}\text{O}^+ = 3.1 \pm 0.6.$$

Note that the use of the line-integrated intensity ratio instead of the 3 MHz smoothed peak intensity ratio would not have improved the accuracy of R since the total widths of the lines and the HC^{18}O^+ baseline are not well defined.

In addition to observing Sgr B2 emission, we have searched for HC^{17}O^+ in Orion A and NGC 2264. The limits derived in these sources, where the HC^{18}O^+ line is very weak, are, however, too high to be meaningful (they yield: $R > 2$).

Two reasons make it unlikely that the observed $^{18}\text{O}/^{17}\text{O}$ ratio in Sgr B2 is altered by chemical fractionation. First, there seems to be no known isotope exchange reaction capable of efficiently enhancing ^{17}O or ^{18}O in CO in the cold dense clouds (see, e.g., Guélin, Langer, and Wilson 1982). Second, even if such a reaction were to exist, it should affect the HCO^+ , CO, and OH data unequally: isotope exchange reactions are sensitive to temperature, and the lines of these three molecules are known to arise from regions with very different physical conditions (in fact, as already noted, the center velocity of the HC^{17}O^+ and HC^{18}O^+ lines differ from those of the CO and OH lines). Finally, mass fractionation mechanisms, as well as selective CO photodissociation (Bally and Langer 1982), might increase the $^{18}\text{O}/^{17}\text{O}$ ratio but could not be responsible for an artificially depressed value.

Within the errors, the $\text{HC}^{18}\text{O}^+/\text{HC}^{17}\text{O}^+$ abundance ratio in Sgr B2 (3.1 ± 0.6) is thus found to equal the $\text{C}^{18}\text{O}/\text{C}^{17}\text{O}$ ratios of 3.2 ± 0.2 and 3.6 ± 0.1 reported by Wannier *et al.* (1976) and Penzias (1981) and the $^{18}\text{OH}/^{17}\text{OH}$ ratio (3.5 ± 0.5 , Bujarrabal, Cernicharo, and Guélin 1983). It is a factor of ~ 1.8 smaller than the solar system $^{18}\text{O}/^{17}\text{O}$ elemental abundance ratio (5.5).

IV. DISCUSSION

It is customary to refer to the solar system isotopic abundance values as representative of those in the interstellar gas some 5 billion years ago. In that case, the factor of ~ 1.5 difference between the solar and the interstellar $^{18}\text{O}/^{17}\text{O}$ ratios reflects an abundance change since that epoch, due to stellar processing of the gas. Then, one would expect some measurable change be-

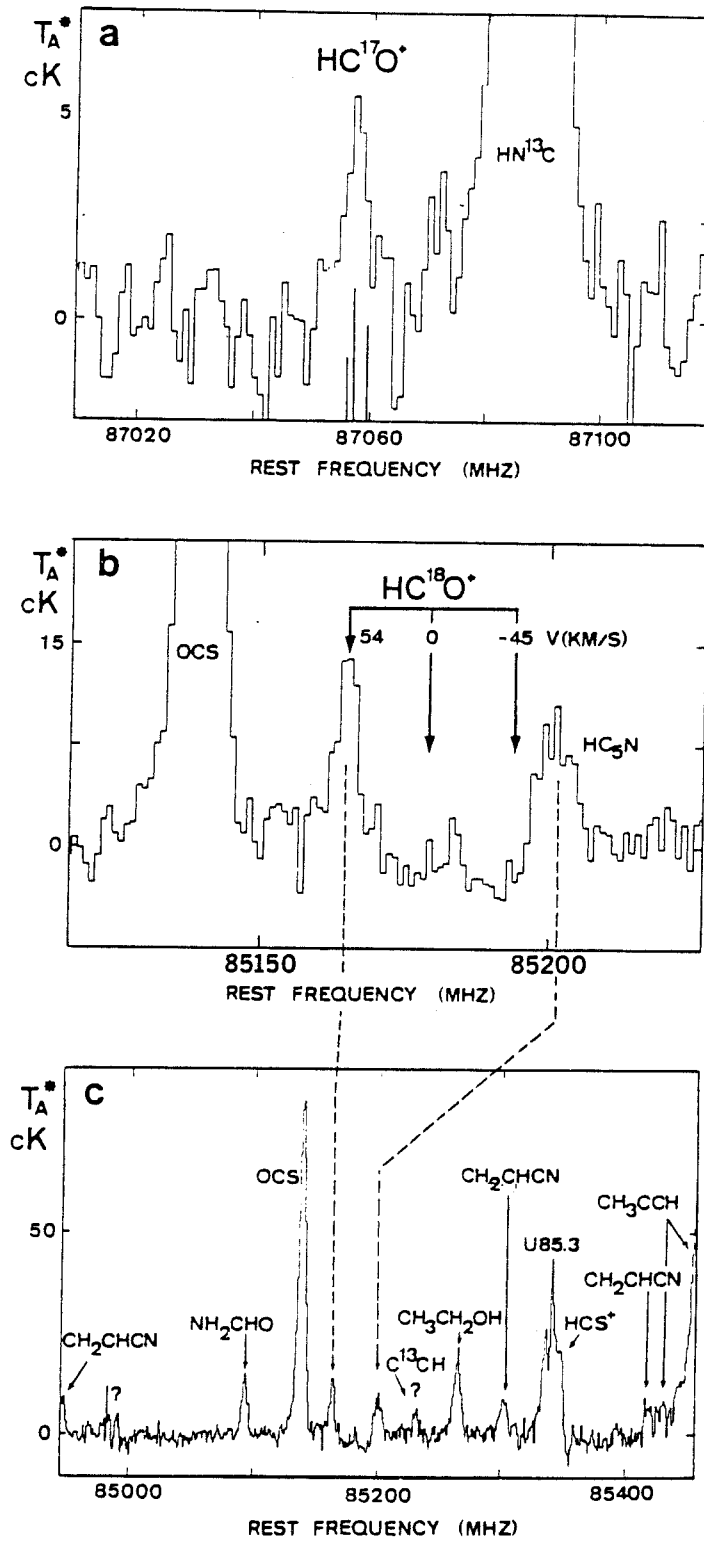

FIG. 1.—See legend on facing page.

tween the highly processed gas of the galactic center region and the gas of the remote parts of the galactic disk, a change which is not supported by the data (Penzias 1981).

This difficulty could be lessened if efficient mixing of the interstellar gas on the scale of the entire galaxy were to take place in a time of a billion years. Alternatively, as suggested by Penzias (1981), it could mean that the presolar nebula (whose mass was very small compared with the mass of the molecular clouds) was enriched in ^{18}O . Such enrichment would be the result of a nearby supernova explosion. In fact, the small anomalies in

oxygen isotope abundances, observed in some meteorites, have been interpreted as evidence of such an explosion (see Clayton 1977).

Unfortunately, there are formidable theoretical difficulties associated with each of these proposals. Clearly more theoretical as well as observational work is required before this challenging question can be settled.

The authors would like to thank Peter Wannier for a careful critical reading of the text and Antony Stark for allowing the inclusion of his HC^{18}O^+ data in Figures 1b and 1c.

REFERENCES

- Audouze, J., Legueux, J., Rocca-Volmerange, B., and Vigroux, L. 1977, in *CNO Isotopes in Astrophysics*, ed. J. Audouze (Boston: Reidel), p. 155.
- Bally, J., and Langer, W. D. 1982, *Ap. J.*, **255**, 143.
- Bogey, J., Demuyck, C., and Destombes, J. L. 1982, *Molec. Phys.*, **43**, 1043.
- Bujarrabal, V., Cernicharo, J., and Guélin, M. 1983, in preparation.
- Clayton, R. N. 1977, in *CNO Isotopes in Astrophysics*, ed. J. Audouze (Boston: Reidel), p. 3.
- Gardner, F. F., and Whiteoak, J. B. 1976, *M.N.R.A.S.*, **776**, 57P.
- Guélin, M., Langer, W. D., and Wilson, R. W. 1982, *Astr. Ap.*, **107**, 107.
- Guélin, M., and Thaddeus, P., 1979, *Ap. J. (Letters)*, **227**, L139.
- Henkel, C., Wilson, T. L., and Downes, D. 1979, *Astr. Ap.*, **73**, L13.
- Henning, P., Kraemer, W. P., and Dierksen, G. H. 1977, M.P.I. Internal Report.
- Linke, R. A., Cummins, S. E., and Thaddeus, P. 1983, in preparation.
- Linke, R. A., Stark, A. A., and Frerking, M. A. 1981, *Ap. J.*, **243**, 147.
- Penzias, A. A. 1981, *Ap. J.*, **249**, 518.
- Scoville, N. Z., Salomon, P. M., and Penzias, A. A. 1975, *Ap. J.*, **201**, 352.
- Stark, A. A. 1981, *Ap. J.*, **245**, 99.
- Thaddeus, P., Guélin, M., and Linke, R. A. 1981, *Ap. J. (Letters)*, **246**, L41.
- Townes, C. H., and Schawlow, A. L. 1955, *Microwave Spectroscopy* (New York: McGraw-Hill).
- Wannier, P. G., Lucas, R., Linke, R. A., Encrenaz, P. J., Penzias, A. A., and Wilson, R. W. 1976, *Ap. J.*, **205**, L169.

J. CERNICHARO and M. GUÉLIN: IRAM 38406 St. Martin d'Hères, France

R. A. LINKE: Bell Laboratories, Crawford Hill Laboratory, Box 400, Holmdel, NJ 07733

II.04) DETECTION DE $^{29}\text{SiC}_2$ ET $^{30}\text{SiC}_2$ DANS IRC+10216.

II.04) DETECTION DE $^{29}\text{SiC}_2$ ET $^{30}\text{SiC}_2$ DANS IRC+10216.

Nous avons observé six nouvelles raies dans le spectre millimétrique de IRC+10216 aux fréquences prédites pour les transitions 404-303, 423-322, et 422-321 de $^{29}\text{SiC}_2$ et $^{30}\text{SiC}_2$. Ces prédictions sont basés sur la géométrie de SiCC déterminée par Thaddeus et al. (1984). Notre résultat confirme définitivement la détection de SiC₂ dans IRC+10216. Pour les trois isotopes du silicium nous trouvons des rapports d'abondances très proches des rapports isotopiques terrestres.

Letter to the Editor

Detection of $^{29}\text{SiC}_2$ and $^{30}\text{SiC}_2$ toward IRC+10216

J. Cernicharo^{1,2}, C. Kahane¹, J. Gómez-González^{2,3}, and M. Guélin²

¹ Groupe d'Astrophysique, Université de Grenoble, CERMO, BP68, F-38402 St. Martin d'Hères Cedex, France

² IRAM, Domaine Universitaire de Grenoble, Voie 10, F-38406 St. Martin d'Hères, France, and Av. Divina Pastora 7, Granada, Spain

³ Centro Astronómico de Yebes, OAN, Apartado 148, E-19080 Guadalajara, Spain

Received June 12, accepted July 16, 1986

SUMMARY

Six new lines in the millimetre spectrum of IRC+10216 have been observed at the frequencies predicted for the $4_{0,4} \rightarrow 3_{0,3}$, $4_{2,1} \rightarrow 3_{2,2}$, and $4_{2,2} \rightarrow 3_{2,1}$ transitions of $^{29}\text{SiC}_2$ and $^{30}\text{SiC}_2$. The predictions are based on the geometrical structure of SiC_2 derived by Thaddeus et al. (1984). Our result definitely confirms the identification of this species in IRC+10216. We find abundance ratios between the three silicon isotopes which are very close to the terrestrial elemental isotopic ratios.

Keywords: molecules-stars: circumstellar matter.

Kleman (1956) has shown that the blue-green bands observed in the stellar atmospheres of carbon-rich stars can be assigned to the electronic absorption spectrum of a molecule containing silicon and carbon. He postulated as best carrier of these bands the SiC_2 radical. For long, SiC_2 has been assumed linear by analogy with C_3 . However, Michalopoulos et al. (1984), from optical spectroscopy of jet-cooled SiC_2 , and Grev and Schaeffer III (1984), from ab-initio calculations, have shown that the most stable structure of SiC_2 is actually triangular. Recently, Thaddeus, Cummings and Linke (1984) have assigned 9 lines of the millimetre spectrum of IRC+10216 to rotational transitions of the abundant isotope $^{28}\text{Si}^{12}\text{C}_2$. The basis for this assignment was, first, the excellent fit to the astronomical frequencies by an asymmetrical top molecule with rotational constants similar to those observed by Michalopoulos et al (1984) and, second, the lack of observable transitions from levels with odd K numbers, which implied a C_{2v} symmetry. Whereas the quality of the fit left no doubt that the 9 lines arose from a single molecule with an XY_2 structure (see e.g. Snyder et al., 1985), the identity of the molecule was not definitely established: the SiC_2 rotational constants derived in the optical laboratory were 3% larger than the astronomical ones, a difference at the limit of the measurement uncertainty. In view of the difficulty of observing a species like SiC_2 by microwave laboratory techniques, the best way to confirm the identification was to observe isotopic substitutes in space. In this Letter, we report the detection of the rare isotopic species $^{29}\text{Si}^{12}\text{C}_2$ and $^{30}\text{Si}^{12}\text{C}_2$, and the marginal detection of $^{29}\text{Si}^{13}\text{C}^{12}\text{C}$.

No laboratory determination, even crude, exists for the rotational constants of the rare SiC_2 isotopes. Yet, these constants are not unknown, as they can be

derived from the geometrical structure of the main isotope. The calculated values should be quite accurate in the case of silicon substitution, since this simply shifts the molecule's center of gravity along the symmetry axis (a).

From the expression of the equilibrium inertia moments for an XY_2 molecule (see Gordy and Cook 1970, p. 502), we can write for its $\text{X}'\text{Y}_2$ substitute:

$$A'_e = A_e \quad (1)$$

$$B'_e = \rho B_e \quad (2)$$

$$C'_e = \rho A_e B_e \times (A_e + \rho B_e)^{-1} \quad (3)$$

where $\rho = m_{\text{X}} M' / m_{\text{X}}' M$, $M = m_{\text{X}} + 2m_{\text{Y}}$ and $M' = m_{\text{X}}' + 2m_{\text{Y}}$.

Relations (1)-(3) strictly apply only to the equilibrium constants A'_e , B'_e and C'_e . In a slightly modified form, however, they can provide fairly accurate estimates of the effective constants A'_0 , B'_0 and C'_0 . These latter are indeed linked to the equilibrium constants through relations of the form:

$$B'_0 = B_e - \alpha^a$$

where $\alpha^{a,b,c} = \sum \alpha_i^{a,b,c}$, and where the α_i are the vibration-rotation constants associated with the normal vibrational modes. The dependance of the α_i on ρ is rather involved (see e.g. Darling and Dennison 1940) and ranges from ρ^0 for the bending constant α_2^a , to $\rho^{3/2}$ for the constant associated with symmetrical stretching along the X-Y bonds, α_1^b (the dependance of this latter on ρ is similar to that in a diatomic molecule). Altogether, the zero-point vibration correction terms α^a and α^b can roughly be assumed to scale respectively as A and B, so that relations (1) and (2) can be simply re-written:

$$A'_0 = A_0 \quad (4)$$

$$\text{and} \quad B'_0 = \rho B_0 \quad (5)$$

Assuming the same inertial defect for the two isotopic species, the third constant, C'_0 , is readily derived from A_0 and B_0 . We get:

$$C'_0 = \rho C_0 B_0 \times [\rho B_0 + (1-\rho) C_0]^{-1} \quad (6)$$

An estimation of the errors introduced by relations (4)-(6) can be made by comparing the calculated and observed rotation constants for the diatomic and XY_2 molecules studied in the laboratory. Equation (2) is identical to the equation relating the equilibrium

Send offprint requests to: J. Cernicharo

constants in diatomic molecules. For these latter, α varies as $\rho^{3/2}$ (an extreme case for an XY_2 molecule), and the correct form for relation (5) is $\rho B \alpha (1 - \rho^{1/2}) \alpha$. For molecules like SiS, CS, SiO₂, etc., the correction term $\rho(1 - \rho^{1/2}) \alpha$ is small ($\approx 2 \times 10^{-5}$), so that the dependence of α on ρ doesn't have to be known exactly. In fact, the use of relations (4)-(6) to XY_2 molecules with known spectroscopic constants (SO₂, O₃, C₂H₂...), leads to errors on the rotational constants of their $X^{13}Y_2$ isotopic substitutes which are smaller than 2×10^{-5} (see e.g. Table 1). The accuracy of relations (4) to (6) for species like SO₂ is actually well known: it stems from the close similarity between these molecules' substitution and equilibrium structures (see e.g. Gordy and Cook, *ibid.*, p. 524).

The rotational constants of $^{29}\text{SiC}_2$ and $^{30}\text{SiC}_2$, calculated from expressions (4) to (6), are given in the even rows of Table 1. The rotational parameters of $^{29}\text{Si}^{13}\text{C}$ cannot be derived from similar simple expressions, since the substitution of an off-axis C atom causes a rotation of the principal axes of inertia. These parameters have to be calculated through diagonalization of the inertia matrix. The computed values are given in Table 1 (line 6); judging from the results of parallel calculations on S¹⁷O¹⁶O (Table 1, line 12), they should be accurate to a few $\times 10^{-5}$.

TABLE 1

OBSERVED AND EXPECTED ROTATIONAL CONSTANTS (MHz)

MOLECULE	A	B	C
$^{29}\text{SiCC}$	52390.0* [52390.0]	12947.1# [12946.6]	10314.0# [10314.8]
$^{30}\text{SiCC}$	52390.0* [52390.0]	12752.2# [12751.5]	10189.1# [10190.6]
$^{29}\text{Si}^{13}\text{CC}$	-- [50381.8]	-- [12687.8]	-- [10185.2]
^{33}SOO	59856.5 [59857.2]	10318.2 [10318.0]	8780.2 [8780.2]
^{34}SOO	58991.2 [58992.5]	10318.4 [10318.0]	8761.4 [8761.4]
$^{32}\text{S}^{17}\text{OO}$	59883.5 [59885.2]	10008.1 [10007.4]	8555.2 [8554.9]

notes:

The observed values (odd rows) are derived from this paper or taken from Lovas (1978); between brackets (even rows) are given the values estimated from expressions (4) to (6) or from diagonalization of the matrix of inertia (see text).

*) Fixed value.

#) Adopting the distortion constants of Thaddeus et al. for $^{29}\text{SiC}_2$ (see text).

To complete our prediction of the rotational frequencies of the rare isotopes, we need to assume a value for the distortion constants. As these should not be too different from the distortion constants of the main isotope, we simply adopt the values derived by Thaddeus et al. (1984). The resulting "expected" frequencies for the $4_{04} \rightarrow 3_{03}$, $4_{23} \rightarrow 3_{22}$, and $4_{22} \rightarrow 3_{21}$ transitions of $^{29}\text{SiC}_2$ and $^{30}\text{SiC}_2$ are given in Table 2.

For SO₂ and C₂H₂ (Lovas 1978, Bogey et al. 1986) the difference between the distortion parameters of the

main and the rare isotopes are at most a few percent. Transposed to SiC₂, they lead to an uncertainty in the frequencies of low J-low K rotational transitions which is of the same order as that discussed above for the rotational constants. Altogether, the uncertainties in the predicted frequencies in Table 2 should thus amount to 2-4 MHz.

The observation of the SiC₂ isotopes was made with the IRAM 30 m telescope at Pico Veleta, Spain. The telescope was equipped with 3-mm SIS and 3-mm Schottky receivers with DSB noise temperatures of 100 - 300 K. The observing procedure has been described by Guélin et al. (1986). During most of the observations, the weather was clear and the atmospheric opacity was below 0.1. The pointing was checked every two hours on the quasar 3C273 and found to be accurate within 5", or $\approx 1/5$ of the antenna beamwidth. The line temperatures in Fig. 1 and Table 3 (T_{eff}) are effective SSB antenna temperatures above the atmosphere. Each line of Fig. 1 (as well as a number of nearby lines observed simultaneously in the 512 MHz wide filterbank) was observed during two, often three, observing sessions. The intensities of the strong lines were found to be reproducible within 10% (2σ), a scatter which reflects the calibration uncertainty. This latter is reduced when one averages the data from independent sessions. The uncertainties in the intensity ratios of Table 3 were estimated accordingly.

TABLE 2

OBSERVED LINE REST FREQUENCIES (MHz)

TRANSITION	$^{29}\text{SiCC}$			$^{30}\text{SiCC}$		
	Observed	O-E [§]	O-C [#]	Observed	O-E [§]	O-C [#]
$4_{04} \rightarrow 3_{03}$	91772.0	-2.2	-0.3	90562.0	-2.0	-0.6
$4_{23} \rightarrow 3_{22}$	92882.0	0.2	0.6	91608.8	1.3	1.0
$4_{22} \rightarrow 3_{21}$	94137.3	0.4	-0.3	92793.5	1.5	-0.5

notes :

+) Measured rest frequencies assuming $V_{\text{LSR}} = -27 \text{ km s}^{-1}$. Frequency uncertainties are 0.5 MHz.

§) Observed minus expected frequencies (expected values are derived from the "estimated" rotational constants of Table 1).

#) Observed minus calculated frequencies (calculated values are derived from the "recommended" rotational constants -see text).

Among the many new lines uncovered during our molecule search in IRC+10216 (see e.g. Guélin et al. 1986, Cernicharo et al. 1986a,b), we have detected, within 2 MHz of the predicted frequencies, the six lines presented in Fig. 1d to 1i. These lines, compared with the $^{29}\text{SiC}_2$ lines of Fig. 1a-c, have the intensity expected for the $4_{04} \rightarrow 3_{03}$, $4_{23} \rightarrow 3_{22}$, and $4_{22} \rightarrow 3_{21}$ transitions of $^{29}\text{SiC}_2$ and $^{30}\text{SiC}_2$. They can be exactly fitted in frequency, together with the lines of the main isotope, with a single substitution structure which differs only slightly from the effective structure derived by Thaddeus et al. (1984 -- see Table 2). They must then belong to the ^{29}Si and ^{30}Si isotopic substitutions of the molecule discovered by Thaddeus et al.. The new molecule must certainly contain an on-axis silicon atom. From our data, we can set an upper limit

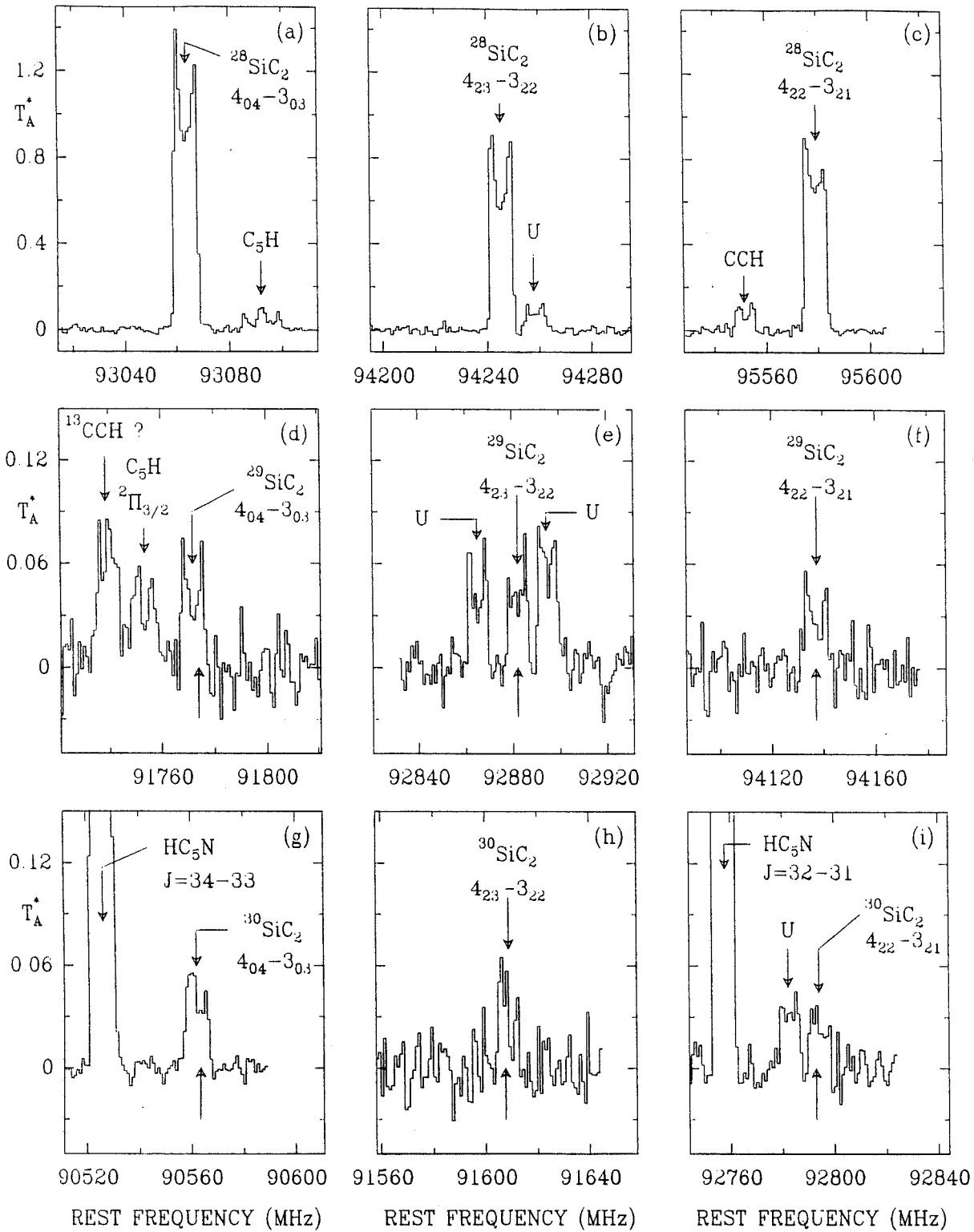

FIGURE 1: The $4_{04} \rightarrow 3_{03}$, $4_{23} \rightarrow 3_{22}$, and $4_{22} \rightarrow 3_{21}$ transitions of $^{28}\text{SiC}_2$, $^{29}\text{SiC}_2$ and $^{30}\text{SiC}_2$, observed towards IRC+10216 with the IRAM 30m telescope. The lower arrows in (d) to (i) indicate the positions expected a-priori for these lines (i.e. calculated from equations (4)-(6)). The upper arrows indicate the calculated positions after the rotation constants have been fitted (Table 1). The CCH line of (c) and most U-lines lie in the image sideband. The C_5H $2\Pi_{3/2}$ $J=35/2-33/2$ line of Fig. 1d and the line tentatively assigned to ^{13}CCH in the same figure are also in the image side band (Cernicharo et al., 1986b).

as high as 60 to the intensity ratio of the odd to even- K_1 transitions for the main isotope, showing that the odd K levels have indeed a statistical weight near to zero; as noted by Thaddeus et al. (see also Michalopoulos et al. 1984), the zero statistical weight implies a C_{2v} symmetry and two off-axis nuclei with an even mass number. The presence of a silicon atom, the C_{2v} symmetry, and the values of the inertia moments, determine completely the composition and structure of the molecule. We can thus definitely confirm the assignment of SiC_2 proposed by Thaddeus et al. (1984).

Being certain that the six new lines of Fig. 1 belong to $^{29}SiC_2$ and $^{30}SiC_2$, we can use their rest frequencies to improve the molecules' rotational constants. Assuming that the constant A and the distortion constants are identical for the three silicon isotopes, we derive from the fit of Watson's Hamiltonian (e.g. Kirchoff 1972) the values in the odd rows of Table 1. The rotational transition frequencies, calculated from the fitted constants, are listed in Table 2.

The frequencies expected for the $4_{04} + 3_{03}$ and $4_{23} + 3_{22}$ transitions of $^{28}Si^{13}CC$ are respectively 90831.5 and 92040.7 MHz. In our spectral survey, we have covered both frequencies and marginally detected two lines with the expected intensities, respectively 1 and 4 MHz below the predicted frequencies. Higher sensitivity observations would be needed to confirm these detections and to derive accurate transition frequencies.

TABLE 3

LINE	LINE INTEGRATED INTENSITIES [§] (Kkms ⁻¹)		
	I($^{28}SiCC$)	I($^{29}SiCC$)	I($^{30}SiCC$)
$4_{04} + 3_{03}$	33.5±1.68	1.35±0.15	1.05±0.05
$4_{23} + 3_{22}$	21.7±1.10	1.33±0.10	0.83±0.09
$4_{22} + 3_{21}$	21.1±1.10	0.97±0.09	0.59±0.07

§) The estimated uncertainties (1 σ) include calibration errors (see text).

TABLE 4

LINE	ISOTOPIC RATIOS		
	$^{29}Si/^{28}Si$	$^{30}Si/^{28}Si$	$^{29}Si/^{30}Si$
$4_{04} + 3_{03}$	25.0±4.0	31.9±3.0	1.29±0.20
$4_{23} + 3_{22}$	16.3±2.0	26.1±4.1	1.60±0.27
$4_{22} + 3_{21}$	21.8±3.1	35.8±6.1	1.64±0.35
AVERAGE [†]	19.0±1.5	30.7±2.3	1.44±0.15
TERRESTRIAL	19.6	29.8	1.52

†) Weight proportional to $1/\sigma^2$.

The U-shaped $^{28}SiC_2$ profiles of Fig. 1 are typical of optically thin, spatially resolved lines, so that, for each transition, the line integrated intensity ratios directly reflect the isotopic abundance ratios. These intensity ratios are listed in Table 4. As expected, they are found equal for the three observed transitions. The $^{29}Si/^{28}Si$, $^{30}Si/^{28}Si$, and $^{29}Si/^{30}Si$ isotopic ratios, averaged over the three transitions, are respectively 19.0±1.5, 30.7±2.3 and 1.44±0.15 (1 σ). They are very close to the terrestrial (19.6, 29.8 and 1.52) and interstellar elemental isotopic ratios ($^{29}Si/^{30}Si=1.4±0.1$ according to Wolf 1980 and Penzias 1980). Our $^{28}SiC_2/^{29}SiC_2$ and $^{29}SiC_2/^{30}SiC_2$ abundance ratios also agree with the $^{28}SiS/^{29}SiS$ and $^{29}SiS/^{30}SiS$ ratios observed in IRC+10216 : 18.9±2.2 and 1.42±0.25 respectively (Kahane et al., 1986).

The isotopes of Si are probably produced during the explosive phase of the evolution of very massive stars (see e.g. Arnett 1978); their abundance shouldn't be much affected by nuclear processing in a cool red giant like IRC+10216. It is therefore not surprising that this abundance reflects the interstellar and solar system abundances.

We would like to thank A. Omont for helpful suggestions during this work.

REFERENCES

- Arnett, W.D.:1978, Ap. J. 219, 1008.
 Bogey M., Demuyneck, C., Destombes, J.L. and Dubus, H.:1986, J. Mol. Spectr. in press.
 Cernicharo, J., Kahane, C., Gómez-González, Guélin, M.:1986a, Astron. Astrophys. Letters, 164, L1.
 Cernicharo, J., Kahane, C., Gómez-González, Guélin, M.:1986b, Astron. Astrophys. Letters, in press.
 Darling, B.T., Dennison, D.M.:1940, Physical Review, 57, 128.
 Gordy, W., and Cook, R.L.1970, "Microwave Molecular Spectra", Chemical Applications of Spectroscopy, Part II, Wiley-Interscience, New York.
 Grev, R.S., Schaeffer III, H.F.:1984, J. Chem. Phys., 80, 3552.
 Guélin, M., Cernicharo, J., Kahane, C., Gómez-González, J.:1986, Astron. Astrophys., 157, L17.
 Kahane, C., Gómez-González, J., Cernicharo, J., Guélin, M.:1986, submitted to Astron. and Astrophys.
 Kirchoff, W.H.:1972, J. Mol. Spectrosc., 41, 333.
 Kleman, R.:1956, Ap. J. 123, 162.
 Lovas, F.J.:1978, J. Chem. Ref. Data, 7, 1445.
 Michalopoulos, D.L., Geusic, M.E., Langridge-Smith, P.R.R., R.E. Smalley, R.E.:1984, J. Chem. Phys., 80, 3556.
 Penzias, A.:1980, Science, 208, 663.
 Snyder, L.E., Henkel, C., Hollis, J.M., Lovas, F.J.:1985, Ap. J. Letters, 290, L29.
 Thaddeus, P., Cummings, S.E., Linke, R.A.:1984, Ap. J. Letters, 283, L45.
 Wolf, R.S.:1980, Ap. J., 242, 1005.

II.05) DETECTION DES ISOTOPES ^{13}C DE C_3H_2 .

II.05) DETECTION DES ISOTOPES ^{13}C DE C_3H_2 .

Nous avons détecté deux isotopes de C_3H_2 dans la direction de SgrB2(OH). Le rapport isotopique $^{12}\text{C}/^{13}\text{C}$ déterminé dans le centre galactique avec cette molécule est de 28.

Detection of interstellar ^{13}C isotopes of C_3H_2

J. Gómez-González^{1,2}, M. Guélin¹, J. Cernicharo³, C. Kahane³, and M. Bogey⁴

¹ IRAM, Domaine Universitaire de Grenoble, Voie 10, F-38406 St. Martin d'Herès, France and Av. Divina Pastora 7, Granada, Spain

² Centro Astronomico de Yebes, OAN, Apartado 148, E-19080 Guadalajara, Spain

³ Groupe d'Astrophysique, Observatoire de Grenoble, Université Scientifique Technologique et Médicale de Grenoble, CERMO, BP68, F-38402 St. Martin d'Herès Cedex, France

⁴ Université de Lille I, Laboratoire de Spectroscopie Hertzienne, F-59655 Villeneuve d'Ascq, France

Received July 15, accepted September 18, 1986

SUMMARY

We report the detection of the two ^{13}C isotopes of C_3H_2 in the molecular source SgrB2(OH). The $^{12}\text{C}/^{13}\text{C}$ isotopic abundance ratio for this ring molecule is found to be ≈ 28 .

keywords: molecules - stars: circumstellar matter

Cyclopropenylidene, C_3H_2 , is a reactive species which has been detected in space prior to its rotational spectrum being observed in the laboratory (Thaddeus, Guélin and Linke 1981; Matthews and Irvine 1985; Thaddeus, Vrtilik and Gottlieb 1985). Observed in about every dense molecular cloud, it is the only ring molecule known to be abundant in interstellar clouds; although little has been speculated on its role in interstellar chemistry, there is no doubt that it will become one of the key species to test the carbon chemistry models. In this Letter, we report the first detection in space of its rare isotopic species $^{13}\text{C}_2\text{H}_2$ and C^{13}CHCH .

The microwave spectrum of the two singly-substituted ^{13}C isotopes of C_3H_2 has been studied in the laboratory by Bogey and Destombes (1986) and the frequencies of these species' rotational transitions are precisely known. The symmetrical isotope ($^{13}\text{C}_2\text{H}_2$), just as formaldehyde and the main ^{12}C isotope of C_3H_2 (see Thaddeus, Vrtilik and Gottlieb 1985), presents an ortho-para level segregation, due to the presence of two indiscernible H atoms. The asymmetrical ^{13}C isotope of C_3H_2 has no ortho/para level segregation and no enhanced transitions. This lack is however more than compensated by a twice larger abundance (the asymmetrical isotope can be formed by substituting any of the two off-axis C atoms of C_3H_2), so that this isotope is in fact the easiest to detect.

Due to a high dipole moment, which makes radiative cooling very efficient, the apparent rotational temperature of the main C_3H_2 isotope is low in most molecular clouds ($< 15\text{K}$, according to Thaddeus, Vrtilik and Gottlieb 1985), and the strongest lines are those which arise from the lowest ortho transitions: namely, in the 3mm band, the $2_{1,2}+1_{0,1}$ transition at 85339 MHz (Thaddeus, Guélin and Linke 1981) and, to a lesser degree, the $3_{1,2}+3_{0,3}$ transition at 82966 MHz (another strong ortho line, the $3_{0,3}+2_{1,2}$ transition, falls at 117 GHz and is not observable from the ground; the $4_{3,2}+4_{2,3}$ line, at 85656 MHz, lies already too high in energy--

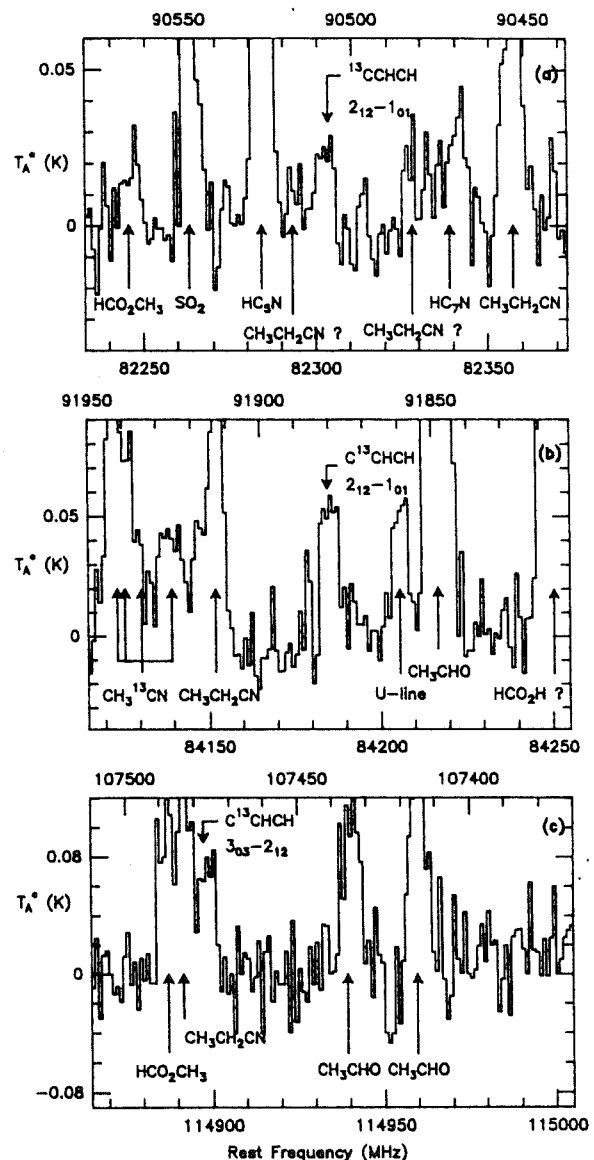

The lines of the ^{13}C isotopes of C_3H_2 detected in SgrB2(OH) with the IRAM 30-m telescope. The spectral resolution is 1 MHz. The upper and lower frequency scales correspond to upper and lower sidebands and assume a source LSR velocity of 60 km s^{-1} .

TABLE 1: LINE PARAMETERS

Isotope	Transition (J_{K-1K+1}) $_u \rightarrow 1$	Frequency ⁺ (MHz)	S	E/k (K)	Ta* (K)	Ta·Δv (K·ms ⁻¹)	V _{LSR} (kms ⁻¹)	FWPW (kms ⁻¹)
MAIN	2 ₀₂ →1 ₁₁	82093.6	1.4 [§]	6.4	0.6	5.80(0.4)	58(2)	15(2)
SYM	2 ₁₂ →1 ₀₁	82303.7	1.5 [§]	6.3	0.035	0.67(0.1)	62(2)	18(3)
ASYM	2 ₁₂ →1 ₀₁	84185.6	1.5	6.3	0.05	0.87(0.1)	61(2)	16(2)
ASYM	3 ₀₃ →2 ₁₂	114897.4	2.4	11.9	0.07	0.9 (0.2)	58(3)	18(5)

Notes to the table:

- + rest frequencies are from Bogey and Destombes (1986);
- § for calculating the line intensities of the symmetrical species, S, the transition strength, has to be multiplied by statistical weight factors (1/2 for the 2₀₂→1₁₁ transition and 3/2 for the 2₁₂→1₀₁ one);
- E/k is the energy in Kelvins of the upper level.
- the numbers in parenthesis are one r. m. s. deviation.

see Cummins, Linke and Thaddeus 1986). The 2₁₂→1₀₁ transition and the 3₀₃→2₁₂ one, which is now shifted at 114 GHz, should be the most favorable for detecting the symmetrical ¹³C isotope in the 3mm band. The same transitions should also be the best ones for detecting the asymmetrical isotope.

We have searched for these 4 transitions in SgrB2(OH), the molecular source where the 2₁₂→1₀₁ line of the main isotope, although self-absorbed, has the largest integrated intensity (Guélin and Thaddeus, unpublished data). Three lines were detected with roughly the expected relative intensity; they are presented in Fig. 1. Time lacked us unfortunately to derive for the fourth line, the weakest, a significant spectrum.

The observations were carried out with the IRAM 30m telescope, at Pico Veleta, Spain. The observing procedure and antenna characteristics were the same than in Guélin et al. (1986). Although the calibration of the spectra was checked by observing the strong lines falling in the IF band with the help of a Fabry-Perot SSB filter, the actual observations were made without filter, in double-sideband mode, to insure lower noise and flatter baselines (a procedure which unfortunately increased the already severe problem of line confusion). The sideband of each of the features of Fig 1 has been checked by changing the LO frequency.

A result of our observations has been the unexpectedly large intensity and the reduced width of most lines observed with the 30m telescope. Although the bulk of molecular emission in SgrB2 is known to be spread over a source several minutes of arc wide, a fair fraction of the molecular gas is actually constrained in a clump of small angular size and low velocity dispersion, located in the direction of the OH maser. The emission from this clump is diluted in the low angular resolution observations made with the 7m Bell Laboratories antenna (Cummins et al. 1986), but dominates the broad emission from the surrounding clouds (at least for optically thin lines) in the 30m telescope data. The enhancement and narrowing of the lines offers the possibility, using a large telescope, to lower the detection limit in this uniquely rich molecular source of the galactic centre region.

The strongest of the 3 observed lines is, as expected, the 2₁₂→1₀₁ transition of the asymmetrical isotope, C¹³CHCH. This line (Fig 1b) lies in a clean region of the spectrum and is apparently free of confusion. Its rest velocity is 61±2 kms⁻¹, in good agreement with the velocity of the main isotope lines, 60 kms⁻¹ according to our data (see also Cummins et

al. 1986, Hollis et al. 1983 -- we discard in that comparison the line at 85339 GHz which is heavily self-absorbed); its width is 16±2 kms⁻¹. The 3₀₃→2₁₂ transition of the same isotope (Fig. 1c) is contiguous to another spectral line and its parameters are more difficult to measure; within the uncertainties, it has however the same velocity, width and intensity than the line of Fig. 1b. The third line, the 2₁₂→1₀₁ transition of the symmetrical ¹³C isotope (Fig. 1a), is 1.5 times weaker than its asymmetrical counterpart, but has about the same velocity and width (see Table 1).

Taken separately, the detections of each ¹³C isotope can only be dubbed as tentative, in view of the wealth of SgrB2 in molecular lines. Together, they make however a strong case. It would indeed be hard to argue that one ¹³C isotope could be present without the other or that their abundance ratio may differ much from 2. Our identifications rely thus on three lines with the right frequency and width and with consistent intensities: they are very unlikely to be the result of chance coincidences.

Our detection of ¹³C C₂H₂ allows us to make a crude estimate of the C₂H₂ ¹²C/¹³C isotopic abundance ratio in the 60 kms⁻¹ cloud of SgrB2. Assuming a single rotation temperature for all isotopes, we calculate a value of 28±5. Clearly, more observations would be needed to determine accurately this ratio, as well as to derive the abundance ratios between the two ¹³C isotopes or between the ortho and para symmetric species. At most can we say from our data that the two latter ratios are consistent with their LTE values of 2 and 3.

REFERENCES

- Bogey, M. and Destombes, J.L.: 1986, *Astron. Astrophys.* **159**, L8.
 Cummins, S.E., Linke, R.A. and Thaddeus, P.: *Ap. J.* (Supplement) **60**, 819.
 Guélin, M., Cernicharo, J., Kahane, C. and Gómez-González, J.: 1986, *Astron. Astrophys.* **157**, L17.
 Hollis, J.M., Suenram, R.D., Lovas, F.J. and Snyder, L.E.: 1983, *Astron. Astrophys.* **126**, 393.
 Matthews, H.E. and Irvine, W.M.: 1985, *Ap. J.* (Letters) **298**, L61.
 Thaddeus, P., Guélin, M. and Linke, R.A.: 1981, *Ap. J.* (Letters) **246**, L41.
 Thaddeus, P., Vrtiliek, J.M. and Gottlieb, C.A.: 1985, *Ap. J.* (Letters) **299**, L63.

**II.06) DETERMINATION DES RAPPORTS ISOTOPIQUES DU CARBONE, DU
SOUFRE, DE L'AZOTE, ET DU SILICIUM DANS
L'ENVELOPPE CIRCUMSTELLAIRE DE L'ETOILE IRC+10216.**

II.06) DETERMINATION DES RAPPORTS ISOTOPIQUES DU CARBONE, DU SOUFRE, DE L'AZOTE, ET DU SILICIUM DANS L'ENVELOPPE CIRCUMSTELLAIRE DE L'ETOILE IRC+10216

En utilisant des observations à haute sensibilité de raies optiquement minces, observées à 2 et 3 mm avec le radiotélescope de 30-m de l'IRAM, nous avons déterminé les rapports isotopiques du carbone, du soufre, de l'azote, et du silicium dans l'enveloppe circumstellaire de l'étoile carbonée IRC+10216. Chaque rapport a été déterminé à partir de deux ou trois molécules différentes, sauf pour $^{14}\text{N}/^{15}\text{N}$ qui n'a pu être obtenu qu'à partir du rapport $\text{HC}^{13}\text{N}/\text{HC}^{15}\text{N}$. Dans tous les cas, les rapports isotopiques obtenus avec ces différentes molécules sont compatibles entre eux.

Les rapports isotopiques du soufre et du silicium sont semblables à ceux obtenus dans le système solaire.

Le rapport $^{12}\text{C}/^{13}\text{C}$ est deux fois plus petit que le rapport terrestre tandis que le rapport $^{14}\text{N}/^{15}\text{N}$ est au moins 15 fois plus grand. Ces rapport correspondent à ceux attendus pour une étoile évoluée du type d'IRC+10216.

Carbon, nitrogen, sulfur and silicon isotopic ratios in the envelope of IRC + 10216

C. Kahane¹, J. Gomez-Gonzalez^{2,3}, J. Cernicharo^{1,2}, and M. Guélin²

¹ Groupe d'Astrophysique, Observatoire de Grenoble, Université Scientifique Technologique et Médicale de Grenoble, CERMO, BP68, F-38402 St. Martin d'Hères Cedex, France

² IRAM, Domaine Universitaire de Grenoble, Voie 10, F-38406 St. Martin d'Hères, France, and Av. Divina Pastora 7, Granada, Spain

³ Centro Astronomico de Yebes, OAN, Apartado 148, E-19014 Guadalajara, Spain

Received December 15, 1986; accepted June 22, 1987

Summary. Using high sensitivity observations of optically thin lines, made at 2 mm and 3 mm with the IRAM 30 m telescope, we have made a redetermination of the carbon, sulfur and silicon elemental isotopic ratios in the envelope of the carbon star IRC + 10216. Except for $^{14}\text{N}/^{15}\text{N}$, which was estimated only from H^{13}CN and HC^{15}N observations, each ratio was derived from two or three different molecules; in all cases, the molecular isotopic ratios were found to be consistent. The silicon and sulfur isotopic ratios are found to be very close to their solar system values. The carbon $^{12}\text{C}/^{13}\text{C}$ ratio is smaller than the terrestrial elemental ratio by almost exactly a factor of 2. ^{15}N is underabundant relative to ^{14}N by at least a factor of 15. These carbon and nitrogen ratios reflect the isotopic enrichments expected for a late-type star.

Key words: molecules-stars: circumstellar matter – interstellar medium: abundances, nucleosynthesis

1. Introduction

The formation of the heavy elements ($A > 12$) is believed to have occurred in the interior of massive stars, these elements being subsequently expelled into the interstellar gas via nova and supernova explosions or, more gently, via stellar winds. The observation of the nucleosynthetic products ejected during these events, and the comparison of their relative abundances with those observed in the solar system and interstellar medium, offer a unique chance of understanding the chemical evolution of the Galaxy.

From available data, it appears that the winds from evolved stars carry a large fraction of the processed matter returned to the interstellar medium (see for instance Dupree, 1986). More specifically, cool red giants with large mass loss rates (C, S, and M stars) expel enough material to change the "chemical" composition of the interstellar gas. This material, prior to mixing with the surrounding gas, is ejected into expanding shells, whose molecular composition can be accurately analyzed with present infrared and radio techniques (see e.g. Zuckerman, 1980). Of special interest are isotope abundance measurements in such shells: as long as the

same transition is observed for the various isotopes of a single molecule, the isotopic abundance ratios can be determined almost independently of the physical and chemical conditions in the shell. These ratios, which often critically depend on the physical conditions in the cores of the stars where the isotopes were formed, are convenient tracers of the nucleosynthetic history of the gas.

Studies of isotopic ratios in circumstellar envelopes, using infrared and radio techniques, are in a state of rapid growth (see Wannier, 1985). Until recently, however, they have been largely restricted to the bright envelope of the nearby carbon star IRC + 10216. Even there, radio studies have mainly dealt with the most intense lines, which are optically thick, and have often yielded limits rather than actual values on the main isotopic abundance ratios. The present study, which benefits from the high sensitivity of the 30 m IRAM telescope, is a first attempt to derive reliable values of the circumstellar isotopic ratios by observing optically thin radio lines. We report here observations of carbon, nitrogen, sulfur and silicon isotopes of HCN, HNC, HC_3N , CS, SiO, SiS, and SiCC in IRC + 10216. They include the first detection of C^{33}S , Si^{33}S , HN^{13}C , and $^{13}\text{C}^{34}\text{S}$ in that source, as well as Si^{13}CC (see Cernicharo et al., 1987) and a tentative detection of C^{13}CH .

2. Observations and data reduction

Our data were obtained with the Institut de Radioastronomie Millimétrique (IRAM) 30 m telescope at Pico Veleta, Spain, between October 1985 and May 1987. The telescope was equipped with 3 mm and 2 mm SIS receivers with a typical single sideband (SSB) temperature of 160–200 K. The observations were made in SSB or DSB mode. In the last case, the signal-to-image gain ratio was checked by observing strong lines with and without an image rejection filter. [The observing procedure has been described by Guélin et al. (1986)]. During most of the observations, the weather was clear and the zenith atmospheric opacity below 0.1 at 3 mm (0.15 at 2 mm). The temperatures reported on the spectra of Figs. 1–7 and in Table 2 (denoted T_{λ}^*) are effective single sideband antenna temperatures above the atmosphere. They are related to the main beam averaged brightness temperatures T_B by $T_{\lambda}^* \approx 0.6 T_B$.

Send offprint requests to: C. Kahane

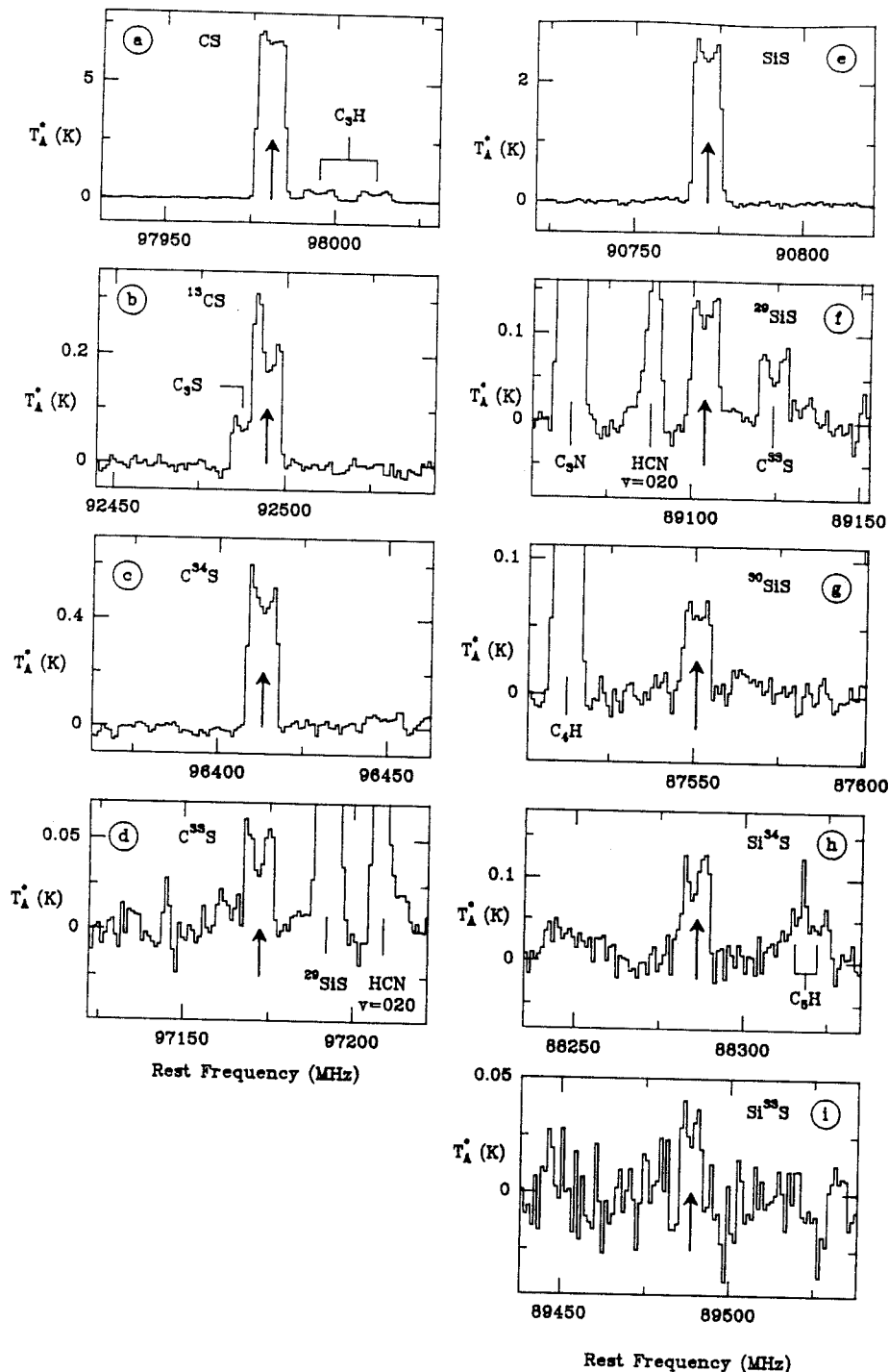

Fig. 1a-i. The CS ($J=2-1$) isotopes (a-d) and the SiS ($J=5-4$) isotopes (e-i) observed with the IRAM 30 m telescope in the IRC +10216 molecular envelope. The spectral resolution is 1 MHz; it corresponds to a velocity resolution of about 3 km s^{-1} at a frequency of 90 GHz. The arrows indicate the line frequencies reported in Table 1. The ^{13}CS line appears partially blended with another line. The spectra plotted in d and f are image and signal sidebands of the same frequency. This observation has already been reported by Lucas et al. (1986). Note that the SiS line (e) presents a clear U-shape, indicative of a low opacity

To estimate the calibration error (atmospheric stability, receiver sideband ratio, ...), each observation was repeated several times during independent sessions. In the DSB mode, there was always at least one strong line in the spectral band covered by the $512 \times 1 \text{ MHz}$ filterbank. At 3 mm, the intensity of this line was found to be reproducible within 20%, peak to peak, between the different sessions, a scatter which reflects the relative calibration uncertainty (30% at 2 mm). The data discussed below result from the average of these independent observations and present a calibration uncertainty at 3σ of less than 20% at 3 mm and 30% at

2 mm. The 1 sigma error bars reported in Table 2 take into account both the calibration uncertainties and the receiver noise.

It is worth noting that, when allowance is made for the difference in telescope angular resolution and the size of the molecular emission region (assumed to be $\approx 20''-30''$ FWHM), the intensities of the strong lines of our survey agree usually well with those reported in the Onsala spectral survey (Johansson et al., 1984a, b).

The line profiles observed with the 30 m telescope are plotted in Figs. 1-5. Rest frequencies are listed in Table 1 and intensities

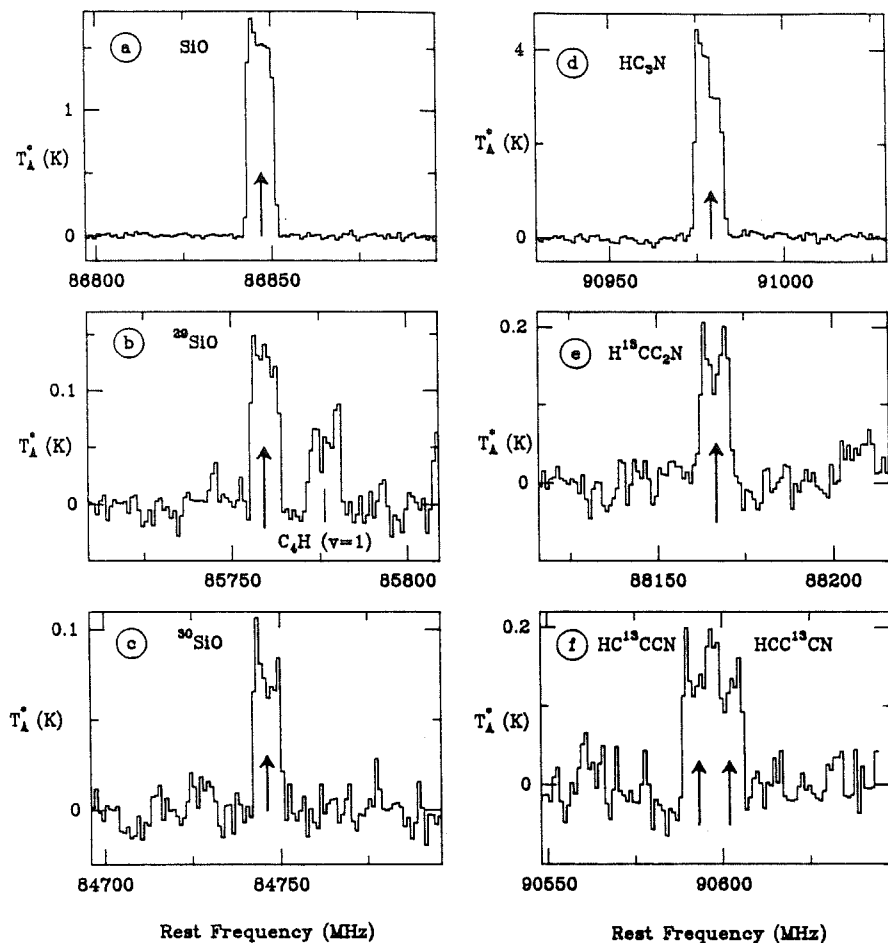

Fig. 2a-f. The same as Fig. 1 for the SiO ($J=2-1$) isotopes (a-c) and the HC₃N isotopes (d-f). The two isotopes of Fig. 2f, HC¹³CCN and HCC¹³CN appear to blend each other

given in Table 2. To our knowledge, the spectra plotted in Figs. 1d, 1i, and 3e are the first detections of C³³S, Si³³S, and HN¹³C in the envelope of IRC + 10216. The assignment of the weak and very broad line in Fig. 4b to a blend of C¹³CH hyperfine (hf) components is still tentative. The rest frequencies of the Si³³S and C¹³CH lines have been calculated assuming an LSR central velocity of -27 km s^{-1} for the envelope.

The first difficulty encountered in deriving isotopic ratios from line brightness temperatures arises from the optical thickness of the lines, which usually leads to underestimates of the abundances of the most abundant isotopes.

When observed with a sufficient sensitivity, molecular emission from IRC + 10216 exhibits line profiles (referred to below as round topped or *U*-shaped) characteristic of an expanding shell. The reasonably well known geometrical and kinematical properties of this source make the interpretation of the line shapes fairly straightforward in terms of line opacity (see for instance Olofsson et al., 1982), so that one can avoid using lines recognized as optically thick, or, at least, be aware of their optical thickness in deriving isotopic ratios. One type of shell profile can unambiguously be identified as optically thin, at least when no anomalous excitation process, such as maser pumping, occurs: the *U*-shaped profiles of weak lines. In contrast, round topped profiles can either be due to spatially unresolved, optically thin emission or to optically thick emission. Due to the good signal to noise ratio of most of our spectra (in particular for the strong lines, which are

likely to be optically thick), the line shapes are clearly defined and can be fitted by "shell type" profiles, which are simply truncated parabolas. The results of the fits are given in Table 2 and an example of a composite shell-type profile fit is plotted in Fig. 6.

The rare isotopes of CS, HC₃N, and HNC (Figs. 1-5) all have weak *U*-shaped lines, typical of optically thin and resolved emission. For these species, the molecular source must be larger than the antenna beam (we measure for CS and HCN sources of size $\approx 25''$). Similarly, the abundant isotopes HNC and CCH also exhibit *U*-shaped lines with moderate intensities (1-2 K), which must arise from extended sources and are probably optically thin.

The lines of the rare SiS isotopes, which have slightly marked *U*-shaped profiles at low frequencies (see Fig. 1e-i), are formed in a source smaller than the beam (we measure a source size $\approx 12''$). They are weak and must be optically thin. The $J=5-4$ line of the main SiS isotope has exactly the same shape as those of the rare isotopes and, despite its larger intensity, is probably also optically thin.

The CS (3-2) and (2-1) lines and the SiS (8-7) line present asymmetric profiles, an effect interpreted by Morris et al. (1985) as due to self-absorption. The ¹²CS lines are likely to be optically thick, the ¹²CS line intensity being almost equal for the (2-1) and the (3-2) lines. In contrast, the rare CS isotopes and all the SiS isotopes present a significant intensity enhancement (by a factor of 1.5-3) from low to high frequency, indicative of small optical depth.

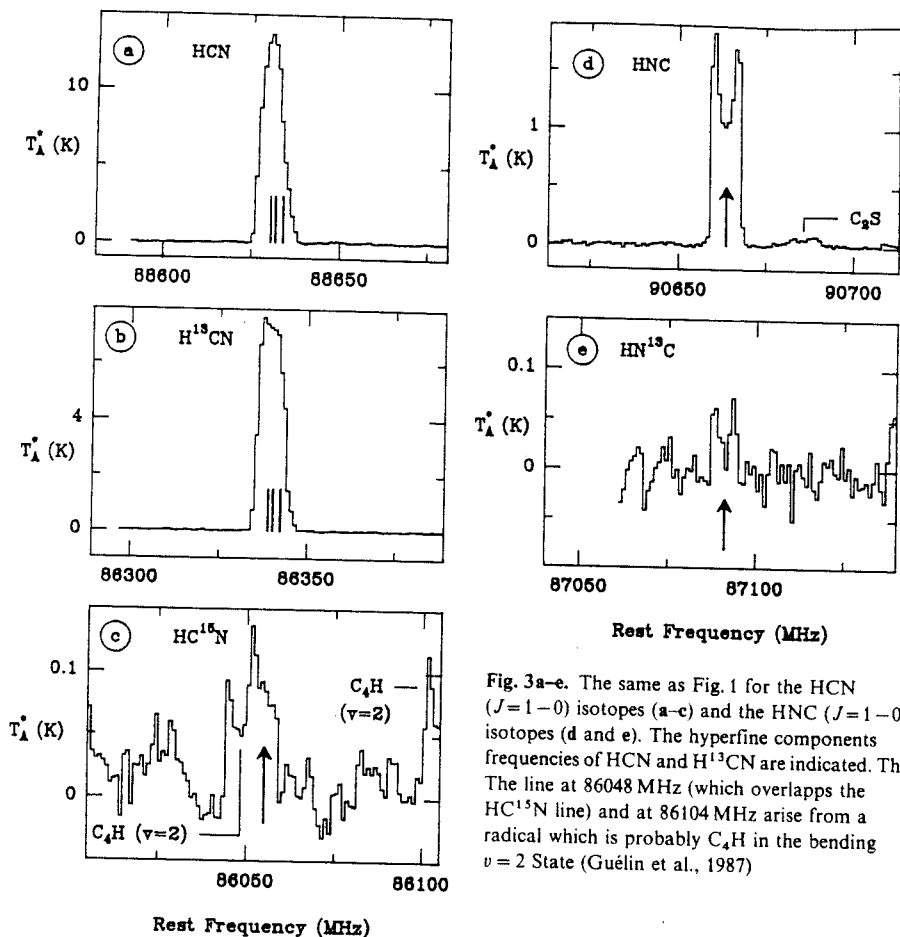

Fig. 3a-e. The same as Fig. 1 for the HCN ($J=1-0$) isotopes (a-c) and the HNC ($J=1-0$) isotopes (d and e). The hyperfine components frequencies of HCN and $H^{13}CN$ are indicated. The line at 86048 MHz (which overlaps the $HC^{15}N$ line) and at 86104 MHz arise from a radical which is probably C_4H in the bending $\nu=2$ State (Guélin et al., 1987)

The round topped line observed for the abundant isotope of HC_3N looks quite different from the deep U -shaped lines of this molecule's rare species and must be optically thick. Its intensity (3.5 K) is in fact only a factor of 3-4 smaller than those of the optically very thick CO and HCN lines (12-13 K).

Finally, the line opacity of the main ^{28}SiO isotope is more difficult to estimate, since the shape of the ^{29}SiO and ^{30}SiO lines is ill defined. Judging from the average profile of the latter two lines, the line of the main isotope seems optically thick.

Depending on line opacities, the molecular abundance ratios have been derived from the velocity-integrated intensities or from the intensities at the center of the line given by shell profile fits. For ratios involving an optically thick line, the center-of-line ratio is closer to the line opacity ratio (hence to the abundance ratio), since the optical depth is smaller at the line center. For optically thin lines, both ratios are equal and closely reflect the abundance ratio; the integrated intensity ratio, which is more accurately determined, is then to be preferred. In all cases, the values of both ratios have been reported in Table 2, (the data for the SiCC isotopes come from Cernicharo et al., 1986).

Even for optically thin lines involving analogous transitions of two isotopes of the same molecule, the line intensity ratio differs slightly from the abundance ratio for three reasons: the change in line excitation, the frequency dependence of the transition strengths, and the change in beam dilution. We now discuss these three effects in some details. In IRC+10216, absorption of infrared photons, emitted by hot dust in the inner envelope,

contributes efficiently to the excitation of the rotational levels of polar molecules, as attested by the observation of CS, SiS, and HC_3N in vibrationally excited states (Blundell et al., 1987). The abundance difference between isotopes affects the infrared line opacities and may cause large differences in the excitation of the microwave lines. This effect is important only for radiatively excited species with large infrared opacities. It usually tends to decrease the line intensity of the more abundant isotope (at least for the lines arising from low energy levels) and can be neglected for the lines of the rare isotopic species discussed below. Note that the intensity ratios of Table 3 were derived for pairs of lines observed during the same week to avoid possible intensity variations related to changes in IR radiation.

The change in transition strength introduces a factor proportional to ν^2 in the line intensities and affects the microwave as well as the infrared transitions. The difference in microwave transition strength is small, $\approx 5-6\%$, except in the case of the double ratio $C^{34}S/^{13}CS$, where it reaches 8%. It has been taken into account in the calculations of the abundance ratios of Table 3. The difference in infrared transition strengths affects the excitation of the microwave lines, but only for radiatively excited species. Its effect usually goes in the direction opposite to the preceding one, but its magnitude is smaller; it is hard to evaluate without a detailed model of the source and, consequently, has been neglected.

The beam dilution factor, which results from a change in antenna beam size, is difficult to calculate because it depends on the source size, thus varies from one molecule to the other. This

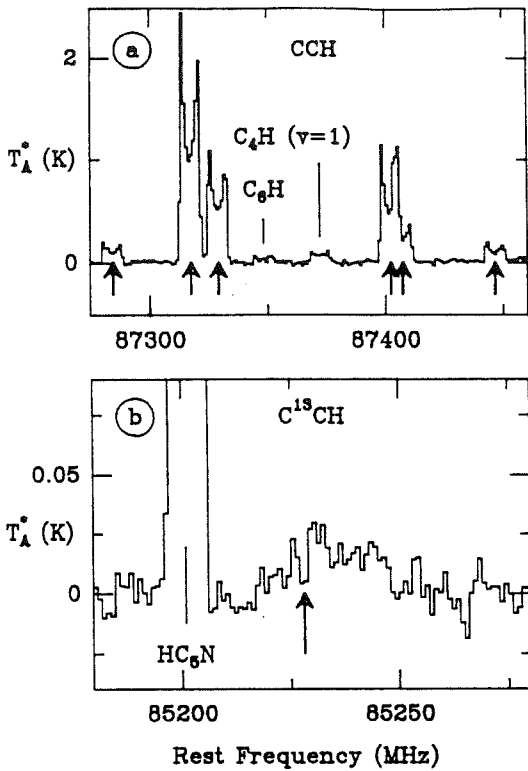

Fig. 4. a shows the six hyperfine components of CCH ($N=1-0$) while the broad feature in the middle of b is tentatively assigned to a blend of several hyperfine components of $C^{13}CH$ (the arrow indicates a rough estimate of the expected frequency of the main hyperfine component)

effect is even smaller than the previous ones: in the extreme case of SiS, for which we observe a source size of only $12''$, the change in beam dilution factor from ^{28}SiS $J=5-4$ to ^{30}SiS $J=5-4$ is 3-4%. It has been taken into account by the introduction of an additional uncertainty of 3% in Table 3.

3. Discussion

3.1. The $[^{28}Si]/[^{29}Si]$, $[^{28}Si]/[^{30}Si]$, and $[^{29}Si]/[^{30}Si]$ ratios

The first estimate of the $[^{28}Si]/[^{29}Si]$ ratio has been made by Olofsson et al. (1982) from ^{28}SiO and ^{29}SiO $J=2-1$ line intensity measurements made with the Onsala 20 m telescope. Due to the low signal-to-noise ratio of these observations, the line shapes were ill-defined and the authors incorrectly assumed that the main isotope line was probably optically thin. They derived an isotopic ratio of 16 ± 3 , which is actually only a rough lower limit.

Combining observations of the ^{28}SiS and ^{29}SiS $J=5-4$ lines, made with the Onsala telescope (Johansson et al., 1984b), with those of the ^{30}SiS ($J=5-4$) line made with the 14 m Five College Radio Astronomy Observatory (FCRAO) telescope, Ziurys et al. (1984) derived that the $[^{28}SiS]/[^{30}SiS]$ and $[^{29}SiS]/[^{30}SiS]$ ratios were respectively 31 and 1.3. Due to low signal to noise ratio and to the large uncertainties inherent in the comparison of observations made with different telescopes, the uncertainty on these values is however very large.

We have observed several transitions of each silicon isotope of SiO, SiS, and SiCC. Considering only optically thin lines, we derive the values listed in Table 3: the isotopic ratios derived from the three molecular species are in very good agreement, which confirms that the abundance ratios are not affected by optical depth effects. This probably indicates that Si-bearing molecules are not sensitive to isotopic fractionation and that the molecular abundance ratios faithfully reflect the elemental isotopic ratios.

The average isotopic ratio values we derive, using $1/\sigma^2$ weights, are reported in Table 4. They are much more accurate than

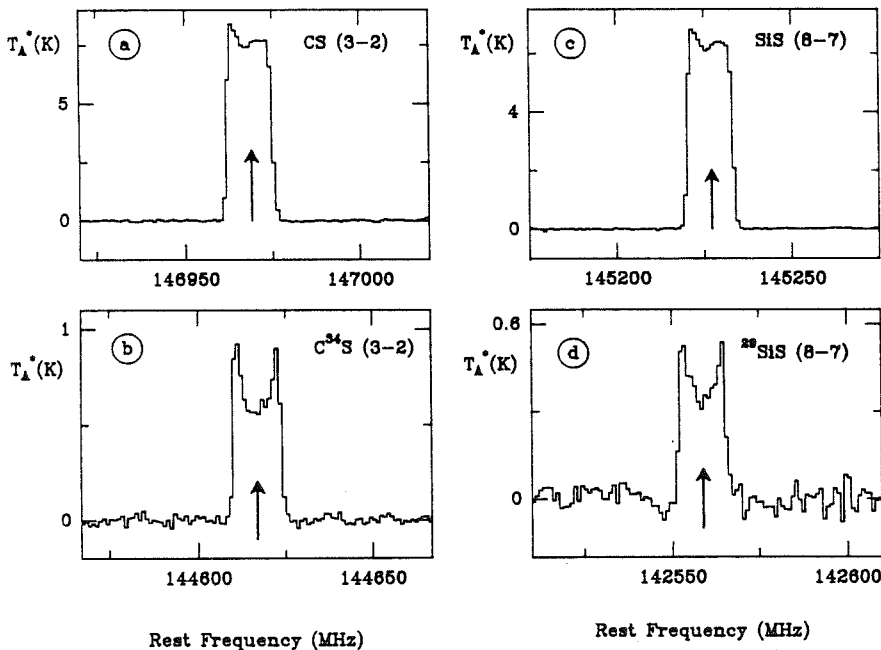

Fig. 5. Two CS (3-2) isotopes (a and b) and two SiS (8-7) isotopes (c and d) observed in the 2 mm range with the IRAM 30 m telescope. The spectral resolution is 1 MHz; it corresponds to a velocity resolution of about 1.8 km s^{-1} at a frequency of 140 GHz. Note that the rare isotopes lines show U-shape profiles indicative of optically thin emission; in contrast the CS and SiS main isotopes present identical asymmetric profiles, due to larger opacity (see text)

Table 1

Molecule ⁽¹⁾	Transition	Frequency (MHz)	Ref. ⁽²⁾
¹² C ³² S	J = 2-1	97980.968	1
¹³ C ³² S	J = 3-2	146969.049	1
	J = 2-1	92494.299	1
	J = 3-2	138739.309	1
¹² C ³⁴ S	J = 2-1	96412.982	1
	J = 3-2	144617.147	1
¹² C ³³ S	J = 2-1	97172.086	1
¹³ C ³⁴ S	J = 3-2	136386.990	1
²⁸ Si ³² S	J = 5-4	90771.546	1
	J = 8-7	145226.965	2
²⁹ Si ³² S	J = 5-4	89103.730	1
	J = 8-7	142558.72*	2
³⁰ Si ³² S	J = 5-4	87550.545	1
	J = 8-7	140073.887	2
²⁸ Si ³⁴ S	J = 5-4	88285.809	1
	J = 8-7	141250.194	2
²⁸ Si ³³ S	J = 5-4	89488.4	3
	J = 8-7	143175.465	2
²⁸ Si ¹⁶ O	J = 2-1 v = 0	86846.998	1
²⁹ Si ¹⁶ O	J = 2-1 v = 0	85759.132	1
³⁰ Si ¹⁶ O	J = 2-1 v = 0	84746.036	1
H ¹² C ¹² C ¹² C ¹⁴ N	J = 10-9	90978.993	1
H ¹³ C ¹² C ¹² C ¹⁴ N	J = 10-9	88166.808	1
H ¹² C ¹³ C ¹² C ¹⁴ N	J = 10-9	90593.059	1
H ¹² C ¹² C ¹³ C ¹⁴ N	J = 10-9	90601.791	1
H ¹² C ¹⁴ N	J = 1-0 F = 1-1	88630.416	1
	F = 2-1	88631.847	1
	F = 0-1	88633.936	1
H ¹³ C ¹⁴ N	J = 1-0 F = 1-1	86338.767	1
	F = 2-1	86340.184	1
	F = 0-1	86342.274	1
H ¹² C ¹⁵ N	J = 1-0	86054.961	1
H ¹⁴ N ¹² C	J = 1-0	90663.543	1
H ¹⁴ N ¹³ C	J = 1-0	87090.900	1
¹² C ¹² CH	N = 1-0 F = 3/2,1-1/2,1	87284.156	1
	F = 3/2,2-1/2,1	87316.925	1
	F = 3/2,1-1/2,0	87328.624	1
	F = 1/2,1-1/2,1	87402.004	1
	F = 1/2,0-1/2,1	87407.165	1
	F = 1/2,1-1/2,0	87446.512	1
¹² C ¹³ CH	N = 1-0 F = 3/2,2-1/2,1	85228	3

(1) In the text, the atomic number of the main isotopes have been omitted. (i.e. ¹²C³⁴S is referred to as C³⁴S)

(2) References: 1 = Lovas, 1986; 2 = Tiemann, 1976; 3 = this work.

previously reported estimates. They show that the silicon isotopic ratios in the envelope of IRC + 10216 are very close to the solar system and ISM values (e.g. Penzias, 1981).

3.2. The [³²S]/[³⁴S], [³²S]/[³³S], and [³⁴S]/[³³S] ratios

To our knowledge, the only measurement of a sulfur isotopic ratio in IRC + 10216 is that of Wannier and Linke (1978). From the line intensity ratio of the (3-2) transitions of C³²S and C³⁴S, observed with the MW0 5 m telescope, these authors derive an abundance ratio of 22. They take into account the IR excitation of the lines, but assume incorrectly that the main isotope line is optically thin. Furthermore, the C³⁴S line observed with this small antenna is so weak that it is barely detected, so that the uncertainty on its intensity is very large. That Wannier and Linke's C³²S/C³⁴S

ratio agrees with the solar system [³²S]/[³⁴S] elemental ratio is purely fortuitous.

Our data include the optically thin Si³²S (J = 5-4) line and the first detection of ³³S isotopes in IRC + 10216. We derive [³²S]/[³⁴S] and [³²S]/[³³S] from the SiS family to avoid optical depth effects. [³⁴S]/[³³S] can be estimated both from CS and SiS.

Derivation of [C³⁴S]/[C³³S] is not straightforward because of the quadrupole hyperfine structure of the ³³S nucleus. The L.T.E. hyperfine pattern of C³³S (J = 2-1) is shown in Fig. 7a, superimposed on the observed spectrum. The C³³S (J = 2-1) emission is dominated by the F = 7/2-5/2 and F = 5/2-3/2 components, the only hf components emerging from the noise on the spectrum of Fig. 1c. These components plus the weak F = 1/2-1/2 component contribute about 70% to the total N = 1-0 integrated intensity. The line integrated intensity in

Table 2

Transition	$\int T_A dv$ (K.km/s)	σ (K.km/s)	T_A (K)	σ (K)
CS (2-1)	198.3	6.0	6.76	0.26
CS (3-2)	205	20	7.41	0.75
¹³ CS (2-1)	5.41	0.18	0.175	0.008
¹³ CS (3-2)	9.58	0.75	0.282	0.031
C ³⁴ S (2-1)	13.93	0.34	0.415	0.022
C ³⁴ S (3-2)	20.6	1.6	0.553	0.062
C ³³ S (2-1) ⁽¹⁾	1.38	0.35	0.030	0.015
¹³ C ³⁴ S (3-2)	0.47	0.17	0.010	0.005
SiS (5-4)	66.5	1.4	2.463	0.077
SiS (8-7)	171	17	6.06	0.62
²⁹ SiS (5-4)	3.31	0.30	0.118	0.011
²⁹ SiS (8-7)	12.2	1.2	0.309	0.046
³⁰ SiS (5-4)	2.21	0.21	0.089	0.010
³⁰ SiS (8-7)	7.71	0.49	0.212	0.048
Si ³⁴ S (5-4)	3.07	0.33	0.090	0.018
Si ³⁴ S (8-7)	10.3	1.0	0.295	0.036
Si ³³ S (5-4)	0.63	0.13	0.022	0.014
Si ³³ S (8-7)	1.89	0.20	0.063	0.013
SiO	36.0	1.0	1.60	0.11
²⁹ SiO	3.09	0.26	0.130	0.012
³⁰ SiO	1.80	0.11	0.067	0.009
HCCCN	89.9	4.6	3.54	0.54
H ¹³ CCCN	4.81	0.35	0.128	0.029
HC ¹³ CCN	4.75	0.75	0.119	0.030
HCC ¹³ CN	4.29	0.75	0.110	0.030
HCN	268.3	7.9	13.43	0.64
H ¹³ CN	162.2	8.3	7.46	0.52
HC ¹⁵ N	1.73	0.28	0.079	0.011
HNC	38.3	1.0	1.06	0.14
HN ¹³ C	0.93	0.16	0.020	0.007
CCH ⁽²⁾	88.4	4.4	2.29	0.29
C ¹³ CH ⁽³⁾	1.10	0.45		

(1) Integrated intensity and center antenna temperature of the strongest components (see text).

(2) Integrated intensity and center antenna temperature are the sum of that of the six CCH lines (see text).

(3) Integrated intensity of the two strongest components (see text)

Table 2 refers only to these hyperfine components; the ratios in Table 3 refer to the total C³³S $N=1-0$ emission.

The high J transitions of Si³³S have no resolvable hf structure (see Fig. 7b). The Si³²S/Si³³S isotopic ratio can then directly be derived from the integrated intensity ratios. The good agreement between the sulfur isotopic ratios in CS and SiS (see Table 3) strongly suggests that sulfur-bearing molecules are not affected by isotopic fractionation, so that the molecular isotopic ratios can be considered as reliable measurements of the elemental ratios. The average values of the sulfur isotopic ratios reported in Table 4 appear to be very close to the solar system and ISM isotopic ratios.

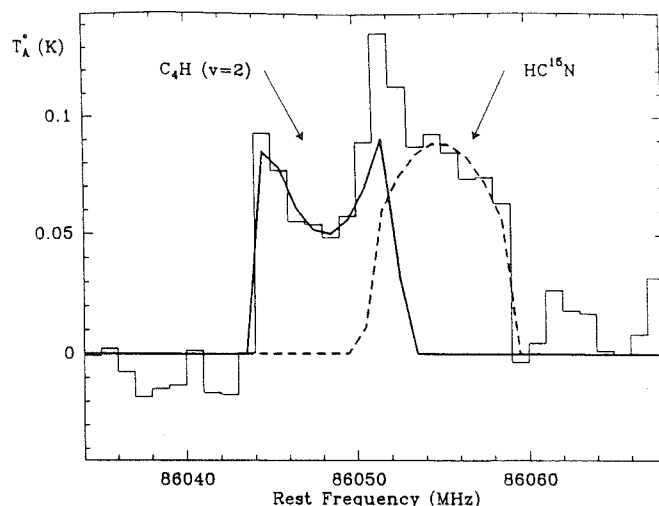

Fig. 6. An example of composite shell-type fit. The synthetic profile is a truncated parabola with sharp edges convolved with the spectral resolution of 1 MHz. The C₄H line presents a U-shape profile, indicative of optically thin resolved emission. In contrast, the round-topped HC¹⁵N profile corresponds to optically thin unresolved emission

3.3. The [¹²C]/[¹³C] ratio

The [¹²C]/[¹³C] elemental ratio is an interesting probe of the nucleosynthetic and mixing processes, but its determination is difficult: when the ¹³C isotope line is reasonably strong, the ¹²C line is likely to be optically thick; conversely, when the main isotope line can be considered as optically thin, the rare isotope line is so weak that the chances of accidental blending with lines of similar strength become significant.

The first attempts to determine this ratio from millimeter observations used optically very thick lines of CO and HCN (Morris et al., 1971; Kwan and Hill, 1977). They relied on complicated modeling and had little reliability. IR observations of the vibration-rotation lines of ¹²CO and ¹³CO offered a slightly better insight and led to a value of ¹²CO/¹³CO ≈ 20 , uncertain by a factor 2 (Barnes et al., 1977). From their observations of the ¹³C isotopes of HC₃N, Olofsson et al. (1982) derived a lower limit of 20 to the [¹²C]/[¹³C] ratio. Finally, using the BTL 7 m dish, Wannier and Linke (1978) derived a ¹²CS/¹³CS $J=2-1$ line intensity ratio of 40 (+18, -10, 1 σ), which, as mentioned by the authors, must be considered as a lower limit to the ¹²CS/¹³CS abundance ratio, since the ¹²CS line is not optically thin.

In order to get a more reliable value of the [¹²C]/[¹³C] ratio in IRC+10216, we have observed the ¹²C and ¹³C isotopes of five carbon-bearing molecules: HC₃N, CS, HNC, CCH, and SiCC.

The main isotope of the first two species presents optically thick lines and yields only lower limits to the isotopic ratio (see Table 3). It can however be noted that the lines of the ¹³C isotopes of HC₃N have the same intensity, which shows, as expected, that the ¹³C abundance in HC₃N is probably not affected by isotopic fractionation.

So far, the millimeter spectrum of the ¹³C species of CCH has not been observed in the laboratory. Only one submillimeter rotational transition has been marginally detected (Destombes, 1986), but the assignment of its components is very tentative. The center frequency of the $N=1-0$ rotational transition of the ¹³C isotopes can nevertheless be accurately derived from those of the

Table 3

Isotope Ratio	Molecules	Line area Ratio ⁽¹⁾	Temperature Ratio ⁽¹⁾
$[^{12}\text{C}]/[^{13}\text{C}]$	$^{12}\text{CS}/^{13}\text{CS}$ (2-1)	32.7 (+2.4, -2.3)	34.4 (+3.4, -3.1)
	$^{12}\text{CS}/^{13}\text{CS}$ (3-2)	19.0 (+4.0, -3.5)	23.4 (+6.2, -5.0)
	$\text{C}^{34}\text{S}/^{13}\text{C}^{34}\text{S}$ (3-2)	38 (+30, -14)	49 (+68, -23)
	HCCCN/H ¹³ CCCN	17.6 (+2.5, -2.2)	26 (+13, -8.6)
	HCCCN/HC ¹³ CCN	18.8 (+4.7, -3.4)	29 (+16, -9.6)
	HCCCN/HCC ¹³ CN	21.0 (+5.7, -4.0)	32 (+19, -11)
	HNC/HN ¹³ C	38 (+10, -7.0)	49 (+39, -19)
	CCH/C ¹³ CH	33 (+25, -11)	
	HCN/H ¹³ CN	1.57 (+0.14, -0.12)	1.71 (+0.23, -0.20)
$[^{28}\text{Si}]/[^{29}\text{Si}]$	SiS/ ²⁹ SiS (5-4)	19.4 (+2.5, -2.1)	20.1 (+2.9, -2.4)
	SiS/ ²⁹ SiS (8-7)	13.5 (+3.1, -2.5)	18.9 (+5.8, -4.3)
	SiO/ ²⁹ SiO	11.4 (+1.5, -1.1)	12.0 (+2.2, -1.8)
	SiCC/ ²⁹ SiCC	18.4 (+1.7, -1.4)	22.8 (+7.1, -3.9)
$[^{28}\text{Si}]/[^{30}\text{Si}]$	SiS/ ³⁰ SiS (5-4)	28.0 (+3.9, -3.2)	25.7 (+4.5, -3.6)
	SiS/ ³⁰ SiS (8-7)	20.6 (+3.8, -3.4)	26.6 (+12, -7.7)
	SiO/ ³⁰ SiO	19.1 (+1.9, -1.7)	22.7 (+5.6, -4.3)
	SiCC/ ³⁰ SiCC	29.0 (+2.4, -2.1)	31.9 (+7.6, -4.4)
$[^{29}\text{Si}]/[^{30}\text{Si}]$	²⁹ SiS/ ³⁰ SiS (5-4)	1.45 (+0.31, -0.25)	1.28 (+0.31, -0.25)
	²⁹ SiS/ ³⁰ SiS (8-7)	1.53 (+0.27, -0.24)	1.41 (+0.71, -0.45)
	²⁹ SiO/ ³⁰ SiO	1.68 (+0.27, -0.23)	1.89 (+0.51, -0.39)
	²⁹ SiCC/ ³⁰ SiCC	1.39 (+0.16, -0.13)	1.26 (+0.56, -0.32)
$[^{32}\text{S}]/[^{34}\text{S}]$	CS/C ³⁴ S (2-1)	13.8 (+0.8, -0.7)	15.8 (+1.6, -1.4)
	CS/C ³⁴ S (3-2)	9.6 (+1.9, -1.6)	13.0 (+3.2, -2.6)
	SiS/Si ³⁴ S (5-4)	20.5 (+3.1, -2.5)	26.9 (+7.9, -5.3)
	SiS/Si ³⁴ S (8-7)	15.7 (+3.6, -3.0)	19.4 (+5.2, -4.1)
$[^{32}\text{S}]/[^{33}\text{S}]$	CS/C ³³ S (2-1) ⁽²⁾	85 (+19, -14)	133 (+65, -35)
	SiS/Si ³³ S (5-4)	103 (+30, -20)	109 (+205, -46)
	SiS/Si ³³ S (8-7)	88 (+21, -17)	94 (+37, -25)
$[^{34}\text{S}]/[^{33}\text{S}]$	$\text{C}^{34}\text{S}/\text{C}^{33}\text{S}$ (2-1) ⁽²⁾	6.1 (+1.3, -0.9)	8.4 (+4.2, -2.2)
	Si ³⁴ S/Si ³³ S (5-4)	5.0 (+1.9, -1.2)	4.2 (+9.4, -2.1)
	Si ³⁴ S/Si ³³ S (8-7)	5.6 (+1.3, -1.0)	4.8 (+1.9, -1.3)
$[^{34}\text{S}][^{12}\text{C}]/[^{32}\text{S}][^{13}\text{C}]$	$\text{C}^{34}\text{S}/^{13}\text{CS}$ (2-1)	2.37 (+0.15, -0.14)	2.18 (+0.25, -0.22)
	$\text{C}^{34}\text{S}/^{13}\text{CS}$ (3-2)	1.98 (+0.36, -0.31)	1.80 (+0.49, -0.39)

(1) Numbers in parenthesis are 1σ errorbars.

(2) A corrective factor has been applied to the line ratios to take into account the C³³S hyperfine structure (see text)

Table 4

Isotope Ratio	Average Value ⁽¹⁾	Terrestrial Ratio	Method
$[^{28}\text{Si}]/[^{29}\text{Si}]$	18.7 (+1.3, -1.0)	19.6	²⁸ SiS/ ²⁹ SiS, ²⁸ SiCC/ ²⁹ SiCC
$[^{28}\text{Si}]/[^{30}\text{Si}]$	28.6 (+1.8, -1.5)	29.8	²⁸ SiS/ ³⁰ SiS, ²⁸ SiCC/ ³⁰ SiCC
$[^{29}\text{Si}]/[^{30}\text{Si}]$	1.47 (+0.11, -0.09)	1.52	²⁹ SiS/ ³⁰ SiS, ²⁹ SiCC/ ³⁰ SiCC, ²⁹ SiO/ ³⁰ SiO
$[^{32}\text{S}]/[^{34}\text{S}]$	20.2 (+2.6, -2.1)	22.5	Si ³² S/Si ³⁴ S
$[^{32}\text{S}]/[^{33}\text{S}]$	100 (+23, -16)	125	Si ³² S/Si ³³ S
$[^{34}\text{S}]/[^{33}\text{S}]$	5.7 (+0.8, -0.6)	5.5	Si ³⁴ S/Si ³³ S, C ³⁴ S/C ³³ S
$[^{12}\text{C}]/[^{13}\text{C}]$	47 (+6, -5)	89	C ³⁴ S/ ¹³ CS
$[^{14}\text{N}]/[^{15}\text{N}]$	> 4400	277	H ¹³ CN/HC ¹⁵ N

(1) Numbers in parenthesis are 1σ errorbars.

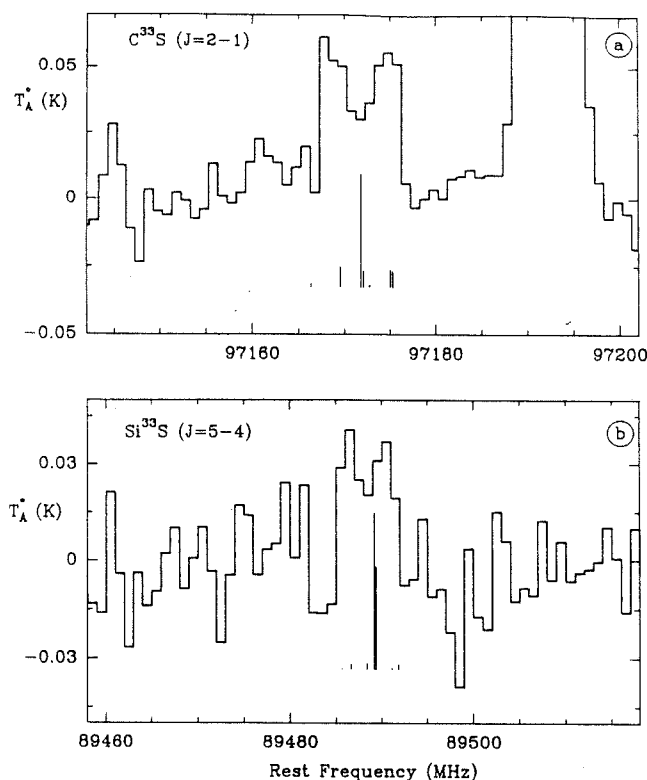

Fig. 7a and b. The frequencies and the relative L.T.E. intensities of the hyperfine components of the $C^{33}S$ ($J=2-1$) transition (a) and of the $Si^{33}S$ ($J=5-4$) transition (b) are represented by thin lines. The spectra are the same as in Fig. 1d and i

main and deuterated species. The fine structure splitting of the lines can also be obtained from that of the main isotope, as it should scale with the rotation constant B (see, e.g., Townes and Schawlow, 1975). On the other hand, the hyperfine splitting, which is dominated by the ^{13}C nucleus can only be roughly estimated from ESR measurements. Fortunately, the frequency of the strongest hyperfine component, the ($F, F_1 = 2, 5/2 \rightarrow 1, 5/2$) component, is relatively insensitive to the value of the hyperfine parameters. We calculate it to be 85228 ± 6 MHz, for $C^{13}CH$, and 84129 ± 10 MHz for ^{13}CCH ; the next strongest hf component, ($F, F_1 = 2, 3/2 \rightarrow 1, 1/2$), is predicted to lie only $\approx 3-5$ MHz below and must partly overlap.

According to these calculations, the two strongest hf components of $N=1-0$ $C^{13}CH$ fall within the broad spectral feature apparent on Fig. 4b. We tentatively assign this feature to $C^{13}CH$ (A broad line in SgrB2, with a central frequency of 85231 MHz, has already been assigned to this species by Guélin et al., 1982). Considering the high density of lines in our spectra (see for instance Fig. 1f), we cannot rule out that part of this weak feature comes from another molecule.

Assuming that the feature in Fig. 4b arises only from the two hf components mentioned above (they contribute to 25 and 16% respectively of the total $N=1-0$ transition strength), we can calculate the total $N=1-0$ velocity-integrated intensity (Table 2) and compare it with that observed for the main isotope (the six hyperfine components of the main isotope – see Fig. 4a – show U -shaped profiles and their relative intensities are equal to the expected LTE values; they are thus optically thin). This leads to

$C^{12}CH/C^{13}CH = 33$ (see Table 3). The actual abundance ratio could be larger if an unrelated species contributed to the feature assigned to $C^{13}CH$.

The HNC molecule is also a good candidate for the measurement of the $^{12}C/^{13}C$ isotopic ratio: the $J=1-0$ line of the main isotope is optically thin and its hyperfine splitting can be neglected (see Fig. 3d); moreover, the $HN^{13}C$ ($1-0$) line frequency is accurately known. We report here the first detection of this rare isotope in IRC+10216. As in the case of $C^{13}CH$, the $HN^{13}C$ line is very weak and the chances of accidental blending with another line are not small. The $HNC/HN^{13}C$ integrated intensity ratio given in Table 3 (38) could then only be a lower limit to the molecular abundance ratio.

Finally, four transitions of $Si^{13}CC$ have been recently detected in IRC+10216 by Cernicharo et al. (1987). These lines are very weak (≤ 0.03 K) and their intensities poorly determined. The $^{12}C/^{13}C$ ratio we derive is 45 (+20, -12).

A way to avoid dealing with optically thick lines and very weak lines simultaneously consists in measuring double isotopic ratios. The most interesting ratio in this respect is the $[^{12}C][^{34}S]/[^{13}C][^{32}S]$ double ratio derived from the CS molecule. As we have seen, the $[^{32}S]/[^{34}S]$ ratio seems accurately determined from the SiS observations; the main uncertainty on the derivation of $[^{12}C]/[^{13}C]$ is then a hypothetical ^{13}C fractionation in CS.

When comparing the different values or limits derived for the $^{12}C/^{13}C$ ratio:

- 33 (+24, -11) and 38 (+10, -7) from CCH and HNC respectively;

- 47 (+6, -5) from the double $C^{34}S/^{13}CS$ isotopic ratio it appears that all determinations agree. This result is also in agreement with our detection of the very weak ($J=3-2$) transition of $^{13}C^{34}S$ (see Table 2): the $^{12}C^{34}S/^{13}C^{34}S$ ratio presents large uncertainties but leads to a $^{12}C/^{13}C$ ratio $\approx 40-50$ (see Table 3). We conclude that, although they are less accurate than the Si and S isotope ratios, our $^{12}C/^{13}C$ measurements rule out a large ^{13}C isotopic fractionation. This result agrees with the ionization models of IRC+10216 (Glassgold et al., 1986), which predict that C^+ , the main ion thought to be responsible for ^{13}C fractionation, is abundant only in the external parts of the envelope and thus is unlikely to affect our high resolution on-source measurements.

In conclusion, the CS double isotopic ratio, which is probably free from optical depth and isotopic fractionation effects, provides the most accurate measurement of the $[^{12}C]/[^{13}C]$ isotopic ratio in the envelope of IRC+10216. Its value indicates a ^{13}C enrichment by a factor of 2 with respect to the solar system abundance.

3.4. The $[^{14}N]/[^{15}N]$ ratio

$HC^{15}N$ was detected for the first time in IRC+10216 by Wannier et al. (1981) who derived a double ratio $H^{13}CN/HC^{15}N$ of 77 ± 23 (the $H^{12}C^{14}N$ lines in IRC+10216 are so saturated that the $HC^{14}N/HC^{15}N$ line intensity ratio is meaningless). The uncertainty on this value is large: observed with the Kitt Peak 11 m antenna, the $HC^{15}N$ line is very weak and hardly detected; furthermore, its width seen with the IRAM 30 m telescope is larger than that of $H^{13}CN$ and indicates a partial blend with another weak line (see Fig. 6); finally, the $H^{13}CN$ line is probably optically thick.

Owing to the gain in sensitivity provided by the IRAM 30 m antenna, the signal to noise ratio in the $HC^{15}N$ ($J=1-0$) spectrum is good enough to resolve the $HC^{15}N$ line from the partly overlapping line, using standard shell-type profiles (see

Fig. 6). We get a lower limit of 90 to the $\text{H}^{13}\text{CN}/\text{HC}^{15}\text{N}$ isotopic abundance ratio and, adopting the value of 47 derived above for the $[\text{C}^{12}/\text{C}^{13}]$ isotopic ratio, derive an elemental ratio $[\text{N}^{14}]/[\text{N}^{15}] > 4400$. Our limit indicates that ^{15}N is probably underabundant with respect to ^{14}N by a factor of at least 15.

4. Conclusions

Until recently, attempts to derive isotopic ratios in carbon-rich stellar envelopes had to face great difficulties: with the lack of sufficient spatial resolution and receiver sensitivity, observations of the rare isotopes were limited to the most abundant molecules, so that the main isotope lines were optically thick; analyses of the observational data had then to rely on complicated modeling or could only lead to limits to the isotopic ratios. Furthermore, the signal to noise ratios were not always sufficient to analyse the line profiles in terms of optical depth and some transitions were misinterpreted as optically thin because they appeared weak, leading to underestimates of the isotopic ratios.

With the increase in sensitivity brought by the IRAM 30 m telescope, it was possible to initiate a programme of measurements of isotopic ratios in stellar envelopes. The first candidate was of course IRC+10216 and we have made a redetermination of the carbon, nitrogen, sulfur and silicon isotopic ratios in this source.

The accurate profiles obtained for the strong lines of the main isotopes allow a good determination of the line shapes; those are useful indicators of the line opacity, and we have rejected from our analysis all the lines suspected to be optically thick. In contrast to previous determinations, we derive values, not just limits to the isotopic ratios. Furthermore, except in the case of nitrogen, we determine the isotopic ratios from several independent species and check that the values should not be affected by chemical fractionation. The results can be summed up as follows:

- Rare silicon and sulfur isotopes of SiCC, SiO, SiS, and CS previously not or hardly detected in IRC+10216, are observed with good signal-to-noise ratios; the silicon and sulfur elemental isotopic ratios are all accurately derived and are found consistent with those in the solar system.

- The best estimate of the $[\text{C}^{12}]/[\text{C}^{13}]$ ratio in IRC+10216 comes from the double $^{12}\text{C}^{34}\text{S}/^{13}\text{C}^{32}\text{S}$ abundance ratio; it is a factor of 2 smaller than the terrestrial $^{12}\text{C}/^{13}\text{C}$ elemental ratio; the factor of 2 agrees with the less accurate single ratios derived from the detection of the ^{13}C isotopes of CCH, HNC, SiCC, and C^{34}S .

- The very weak HC^{15}N ($J=1-0$) line yields a $[\text{N}^{14}]/[\text{N}^{15}]$ ratio at least 15 times larger than the terrestrial ratio.

Many studies have been devoted to the determination of the $^{12}\text{C}/^{13}\text{C}$ ratio in the circumstellar and interstellar gas. We briefly discuss how they compare with our results in IRC+10216.

Observations of CN and CO lines at optical and/or near IR wavelengths, are powerful methods to derive $^{12}\text{C}/^{13}\text{C}$ in the atmosphere of red giants without too thick envelopes. They yield values ranging from 5 to 30 in O-rich and SC-type stars (see e.g. Wannier, 1985 and references herein). For the brightest stars, the major uncertainty on these measurements comes from line saturation and from the determination of the excitation temperature of the lines and is typically ≈ 5 (1σ).

In diffuse clouds, the determination of the $^{12}\text{C}/^{13}\text{C}$ ratio relies mainly on optical observations of CH^+ : the lines' opacity is probably small and the species is not severely affected by chemical fractionation. Until recently however, the $^{12}\text{C}/^{13}\text{C}$ ratio measurements have suffered from insufficient sensitivity. The latest work of Hawkins and Jura (1987) towards several diffuse clouds lead to

a $^{12}\text{C}/^{13}\text{C}$ ratio of 43, significantly lower than previous measurements ($\approx 60-70$, see e.g. Snell et al., 1977; Vanden Bout and Snell, 1980).

In the giant molecular clouds and in the local dust clouds, the measurements are based on the observation of rotational lines of various molecules in the mm and cm ranges. To minimize optical depth and chemical fractionation effects, the $^{12}\text{C}/^{13}\text{C}$ ratio is preferentially derived from the double $\text{H}_2\text{C}^{18}\text{O}/\text{H}_2^{13}\text{CO}$ ratio; the dense cloud values are, with a rather large uncertainty, in agreement with the terrestrial value (≈ 90), at least in the galactic disk. Towards the galactic center, the determination of the $^{12}\text{C}/^{13}\text{C}$ ratio is even more uncertain: most molecules lead to a $^{12}\text{C}/^{13}\text{C}$ ratio $\approx 20-30$, significantly smaller than the values (ranging from 45 to 80) derived from $\text{H}_2\text{C}^{18}\text{O}/\text{H}_2^{13}\text{CO}$ (see for instance Penzias, 1980; Langer et al., 1984).

From this brief summary of the $^{12}\text{C}/^{13}\text{C}$ measurements in various galactic objects, it appears that accurate determinations are rare; the major uncertainties come from optical depth and chemical fractionation effects. As we have shown, our measurement of the $^{12}\text{C}/^{13}\text{C}$ ratio in IRC+10216 is probably free from both effects so that our determination is among the more accurate and reliable ones.

Our measurements of the isotopic ratios in the envelope of IRC+10216 seem consistent with current ideas on nucleosynthesis: the rare silicon isotopes, ^{29}Si and ^{30}Si , and the rare sulfur isotopes ^{34}S and ^{33}S are synthesized at very high temperatures, which are not reached in red giants such as IRC+10216 (see, e.g., Arnett, 1978). The sulfur and silicon isotopic ratios in IRC+10216 are then expected to have kept their original ISM values and to be close to the solar system ones.

^{13}C on the other hand, is mainly produced in the CNO cycles in red giants (see, e.g., Audouze, 1985). ^{15}N is believed to be produced by explosive burning in novae and possibly supernovae while quiet CNO burning efficiently destroys this isotope and leads to an enrichment in ^{14}N (ibidem). For the range of temperatures and densities which should prevail in the H-burning zone of a star like IRC+10216, the equilibrium $^{14}\text{N}/^{15}\text{N}$ isotopic ratio is very large and the $^{12}\text{C}/^{13}\text{C}$ ratio is of the order of 1-10 (For instance, according to Clayton, 1968, at $T \approx 2.5 \cdot 10^7$ K and $n \approx 10^{-2} \text{ g cm}^{-3}$, these equilibrium ratios are respectively $\approx 10^4$ and 3). If we assume that the initial ratios were the terrestrial ones, we can explain the values observed in the IRC+10216 envelope as the result of admixing of unprocessed gas with enriched matter: the fraction of this latter must be ≈ 0.5 according to the carbon isotopic ratio and > 0.2 according to the nitrogen isotopic ratio limit. Both ratios are then consistent with a very simple model of cold CNO cycle and admixing of the products in the envelope.

Acknowledgements. We would like to thank the IRAM Granada staff, particularly H. Hein and S. Navarro for their assistance during observations. It is also a pleasure to thank Dr. Glassgold for his comments and Dr. Vivekanand for a careful review of the manuscript.

References

- Arnett, W.D.: 1978, *Astron. Astrophys.* **219**, 1008
- Audouze, J.: 1985, in *Production and Distribution of C, N, O Elements*, Proceedings of the ESO Workshop, eds. I.J. Danziger, F. Matteucci, K. Kjar
- Barnes, T.G., Beer, R., Hinkle, K.H., Lambert, D.L.: 1977, *Astrophys. J. Letters* **162**, L15

- Blundell, R., Cernicharo, J., Guélin, M.: 1987 (in preparation)
- Cernicharo, J., Kahane, C., Gomez-Gonzales, J., Guélin, M.: 1986, *Astron. Astrophys.* **167**, L9
- Cernicharo et al.: 1987 (in preparation)
- Clayton, D.D.: 1968, *Principles of Stellar Evolution and Nucleosynthesis*, McGraw-Hill, New York
- Destombes, J.L.: 1986 (private communication)
- Dupree, A.K.: 1986, *Ann. Rev. Astron. Astrophys.* **24**, 377
- Glassgold, A.E., Lucas, R., Omont, A.: 1986, *Astron. Astrophys.* **157**, 35
- Guélin, M., Cernicharo, J., Linke, R.A.: 1982, *Astrophys. J.* **263**, L89
- Guélin, M., Cernicharo, J., Kahane, C., Gomez-Gonzales, J.: 1986, *Astron. Astrophys.* **157**, L17
- Guélin, M., Cernicharo, T., Navarro, S., Woodward, D.R., Gottlieb, C.A., Thaddeus, P.: 1987, *Astron. Astrophys.* **182**, L37
- Hawkins, I., Jura, M.: 1987, *Astrophys. J.* (in press)
- Johansson, L.E.B., Andersson, C., Eilder, J., Friberg, P., Hjalmarson, A., Hoglund, B., Irvine, W.M., Olofsson, H., Rydbeck, G.: 1984a, *Astron. Astrophys.* **130**, 227
- Johansson, L.E.B., Andersson, C., Eilder, J., Friberg, P., Hjalmarson, A., Hoglund, B., Irvine, W.M., Olofsson, H., Rydbeck, G.: 1984b, *Astron. Astrophys. Suppl. Ser.* **60**, 135
- Kwan, J., Hill, F.: 1977, *Astrophys. J.* **215**, 781
- Langer, W.D., Graedel, T.E., Frerking, M.A., Armentrout P.B.: 1984, *Astrophys. J.* **277**, 581
- Lucas, R., Omont, A., Guilloteau, S., Nguyen, Q Rieu: 1986, *Astron. Astrophys.* **154**, L11
- Morris, M., Lucas, R., Omont, A.: 1985, *Astron. Astrophys.* **142**, 107
- Morris, M., Zuckerman, B., Palmer, P., Turner, B.E.: 1971, *Astrophys. J. Letters* **170**, L109
- Olofsson, H., Johansson, L.E.B., Hjalmarson, A., Nguyen-Q. Rieu: 1982, *Astron. Astrophys.* **107**, 128
- Penzias, A.A.: 1980, in *Interstellar Molecules, IAU Symp.* **87**, ed. B.H. Andrew, Reidel, Dordrecht, p. 397
- Penzias, A.A.: 1981, *Astrophys. J.* **249**, 513
- Rank, D.M., Geballe, T.R., Wollman, E.R.: 1975, *Astrophys. J. Letters* **187**, L111
- Snell, R., Tull, R., Vanden Bout, P., Vogt, S.: 1977, in *CNO Isotopes in Astrophysics*, ed. J. Audouze, Reidel, Dordrecht
- Tiemann, E.: 1976, *J. Phys. Chem. Ref. Data* **5**, 1147
- Townes, C.H., Schawlow, A.L.: 1975, *Microwave spectroscopy*, Dover, New York, p. 24
- Vanden Bout, P.A., Snell, R.L.: 1980, *Astrophys. J.* **236**, 460
- Wannier, P.G.: 1985, in *Production and Distribution of C, N, O Elements*, Proceedings of the ESO Workshop, eds. I.I. Danziger, F. Matteucci, K. Kjar
- Wannier, P.G., Linke, R.A.: 1978, *Astrophys. J.* **225**, 130
- Wannier, P.G., Linke, R.A., Penzias, A.A.: 1981, *Astrophys. J.* **247**, 522
- Wannier, P.G., Sahai, R.: 1987, *Astrophys. J.* **319**, 367
- Ziurys, L.M., Clemens, D.P., Saykally, R.J., Colvin, M., Schaefer, H.F.: 1984, *Astrophys. J.* **281**, 219
- Zuckerman, B.: 1980, *Ann. Rev. Astron. Astrophys.* **18**, 263

Note added in proof: Wannier and Sahai (1987) have just reported a redetermination of the $^{12}\text{C}/^{13}\text{C}$ isotopic ratio from CS isotopes. They derive a value (32 ± 4) which is smaller than ours.

II.07) UN NOUVEAU RADICAL DANS IRC+10216.

II.07) UN NOUVEAU RADICAL DANS IRC+10216.

Nous avons découvert une nouvelle molécule "non terrestre" dans l'enveloppe moléculaire de l'étoile carbonée IRC+10216. Cette molécule est linéaire ou légèrement asymétrique et doit posséder un nombre impair d'électrons. Son état électronique fondamental est très probablement dédoublé par l'interaction spin-rotation, c'est à dire, que si la molécule est linéaire elle doit être dans un état électronique 2Σ . Sa constante de rotation est de 5966.8 MHz et la constante d'interaction spin-rotation est de ± 15.1 MHz. Les candidats les plus vraisemblables sont HSiCC (et son isomère HCCSi) et HSCC.

Letter to the Editor

A new free radical in IRC + 10216

M. Guélin^{1,2}, J. Cernicharo^{1,3}, C. Kahane³, and J. Gomez-Gonzalez^{1,2}

¹ IRAM, Domaine Universitaire de Grenoble, Voie 10, F-38406 St. Martin d'Hères, France

² Av. Divina Pastora 7, E-Granada, Spain

³ Groupe d'Astrophysique, Université de Grenoble, CERMO, BP 68, F-38402 St. Martin d'Hères Cedex, France

Received November 26, 1985; accepted January 28, 1986

ABSTRACT

We report the discovery of a new "non terrestrial" molecule in the envelope of the carbon star IRC+10216. This molecule is linear or slightly asymmetric and must have an odd number of electrons; its electronic ground state is very probably split by spin-rotation interaction, i.e. must be $^2\Sigma$ if the molecule is linear. The rotation and spin-doubling constants are found to be 5966.8 MHz and ± 15.1 MHz, respectively. The most likely candidates for such a radical are HSiCC (or its isomer HCCSi) and HSCC.

keywords: molecules - stars: circumstellar matter

The envelope of the infrared star IRC+10216 is a prime site for the study of reactive carbon or silicon compounds. The free radicals C_2H , C_3H , C_4H , and C_3N have indeed been found in this source prior to being observed in a spectroscopic laboratory, and the linear carbon chain molecule HC_3N , which has been discovered in IRC+10216, has not yet been seen in the lab. This envelope is also the strongest source of SiCC emission in the sky (Thaddeus et al., 1984).

The discovery of these species was accidental, as was that of most reactive interstellar molecules. It arose from the observation of millimeter lines with a characteristic pattern which couldn't be assigned to any known interstellar or terrestrial species. In the cases of C_3N and C_3H (Guélin and Thaddeus 1977, Guélin et al. 1978) the pattern consisted of doublets of equal splittings, whose center frequencies were in a simple ratio of each other. This signature was specific enough to show that the line carrier was a linear molecule in a $^2\Sigma$ state, composed of four atoms consisting of second row elements. In a carbon star where all but a few of the observed molecules are composed of C, N and H, these properties pointed to only two likely molecules, the cyanoethynyl and the butadienyl radicals. In this Letter we report the discovery of a new molecule with a similar line pattern.

The evidence for the new molecule lies in the three doublets of Fig. 1. We have detected the two upper doublets while searching for C_3N , another linear molecule with a $^2\Sigma$ ground state. These doublets, which have equal splittings and frequencies in the ratio 9/8, seemed exactly what we were looking for. If they belonged to the $N=36-35$ and $32-31$ transitions of C_3N , the frequencies of the other rotational transitions would be easy to find. We failed however to detect between 90 and 107 GHz any other doublet harmonically related in frequency: we searched unsuccessfully for the 30/32th (which is also the 15/16th, see Fig. 2b),

33/32 and 35/32th harmonics of 95.461 GHz, as well as for its 22/24th, 23/24th and higher order harmonics. On the other hand, we readily detected the third doublet of Fig. 1 at exactly 7/8th of 96.461 GHz, confirming that the accurate match between the first lines was not a chance coincidence.

The observations were made with the IRAM 30-m telescope at Pico Veleta, Spain. The telescope was equipped with a new 3-mm SIS receiver with a DSB temperature of about 100 K. The receiver was tuned for the best DSB performances, and the signal-to-image gain ratio was checked after each tuning by observing strong lines in IRC+10216 or Orion-KL, with and without an image sideband rejection filter. This allowed us, while doubling the covered frequency range, to make sure that no line was missed due to accidental rejection of one of the sidebands. The temperature scale was frequently calibrated by successively observing a cold load, a room-temperature load, and the sky; the atmospheric absorption was estimated in both sidebands with the help of an atmospheric model and found to be almost the same, at least below 110 GHz. During the observing, the sky was clear and the atmospheric opacity below 110 GHz was typically $\approx 0.07-0.10$, so that corrections anyway were small. The main-beam efficiency (at the receiver window, including all ohmic and spillover losses in the various reflections) was measured to be $\approx 60\%$. The temperatures in Fig. 1 and Table 1 (denoted T_A) are single sideband antenna temperatures reported above atmosphere. The observing procedure was to subtract from each 30 s on-source observation two 15 s off-source observations made just before and after. This procedure yielded most of the time impressively flat baselines. Only first-degree polynomials have been subtracted from Figs. 1 and 2.

Owing to the high sensitivity of the observations and to the DSB observing mode, we had to worry about line confusion before deriving accurate line intensities or frequencies. In the ≈ 9 GHz frequency range surveyed, we have observed at least 80 lines. They cover 1/6th of the observed spectrum, once the two sidebands are folded; the chances of accidental line blends are thus high. An illustration of this is given by Fig. 1 and by Fig. 2a, which presents the same doublet than Fig. 1a observed with a different center frequency. The low frequency component of this doublet (Fig. 2a) appears more intense than its counterpart as it falls at only 1. MHz of the weak $J=6-5$ $Si^{33}S$ line. (The intensity of the $6-5$ $Si^{33}S$ line is known to be ≈ 0.03 K from observations of the $J=5-4$ transitions - see Fig. 2b). The high frequency component of the lower doublet (Fig. 1c) is partly blended with an unidentified line from the signal sideband.

Send offprint requests to: M. Guélin (French address)

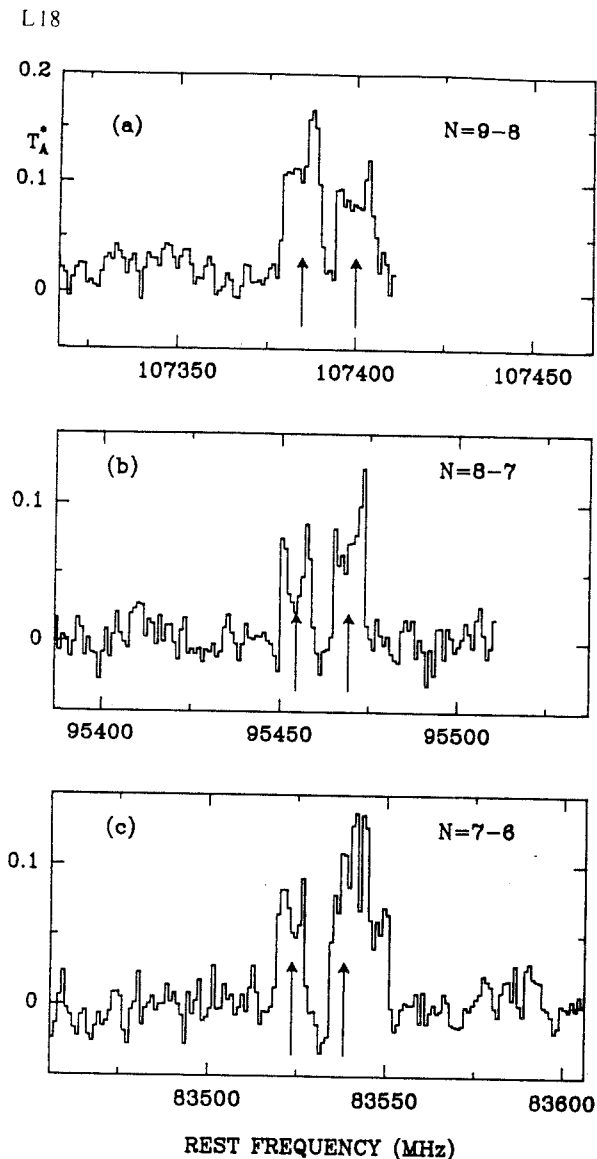

FIGURE 1: The three doublets observed in IRC+10216 with the IRAM 30-m telescope. The spectral resolution is 1 MHz. The frequency scale has been calculated for a source velocity $V_{lsr} = -27 \text{ km} \cdot \text{s}^{-1}$. Baselines of order 0 or 1 were subtracted from the original data. The arrows indicate the position of the six line components, as derived from the values of B_0 and D_0 given in the text. The right component in Fig 1c is the blend of three lines (see text).

Fortunately, the lines in IRC+10216 present clear-cut edges and have exactly the same velocity width, so that half-blended lines can be resolved when the signal-to-noise ratio is good. So, the high frequency component of Fig 1c is readily resolved into three 8 MHz wide, U-shaped lines of unequal strengths. The lowest and strongest of these lines is found to have a rest frequency of $83538.0 \pm 0.3 \text{ MHz}$ and to lie 15.1 MHz above the low frequency component (Table 1). This 15.1 MHz splitting, within the small uncertainties ($< 0.5 \text{ MHz}$), is equal to that in the 95.5 and 107.4 GHz

doublets (14.9 and 15.2 MHz, respectively).

The equality of the three splittings and the very good low order harmonic relation between the doublet center frequencies (the 1.7 MHz difference between the harmonic and the actual frequencies is in the direction expected for centrifugal distortion) leaves practically no chance that the six lines of Fig 1 could be unrelated. These lines have about the same intensities and stand up among the strongest of our unidentified lines. They must arise from the same molecule. But which molecule is it?

As discussed for C_3N by Guélin and Thaddeus (1977), a line pattern such as that of Fig 1 is specific enough to tell us much about its carrier. The constancy of the doublet splitting and the apparent absence of any other line component (see Fig 1b) strongly suggest that the splitting results from electron spin-rotation interaction and that the molecule has an odd number of electrons. Other fine or hyperfine line splittings in molecules, just as l-type doubling, are known to vary at least as the first power of the rotational quantum number (e.g. Townes and Schawlow 1975). Moreover, the simple relation between the doublet center frequencies most certainly implies that we are dealing with a linear molecule, a slightly asymmetric top, or a symmetric top. A symmetric top is unlikely, as our lines appear free of K-structure broadening; K-structure is clearly observed in IRC+10216 for the lines of CH_3CN , the only symmetric top detected in this source (Fig 2c). Since we didn't detect any intermediate doublet, we know that we observed the $N=9-8$, $8-7$ and $7-6$ rotational transitions and can determine the molecule's rotational constants. Assuming that the molecule is linear, we derive :

$$B_0 = 5966.82 \pm 0.05 \text{ MHz,}$$

and

$$D_0 = 3.5 \pm 0.50 \text{ KHz.}$$

The spin-doubling constant is $|\gamma| = 15.1 \pm 0.2 \text{ MHz}$. If the molecule is slightly asymmetric, we have:

$$(B+C)/2 = 5967 \text{ MHz,}$$

with an asymmetry parameter (e.g. Townes and Schawlow, *ibid*):

$$|b_p| < 3 \cdot 10^{-4}.$$

To our knowledge, there is no known astrophysical or terrestrial molecule with such spectroscopic constants. Known molecules with similar rotational constants are (see e.g. Demaison et al. 1974, 1982) OCS (6080 MHz), NCS (6100 MHz), HNCS (5860 MHz) and H_2CCS (5612 MHz), all of which have three heavy atoms, and C_3N (4948 MHz), which has four heavy atoms. If we are dealing with a species consisting only of cosmically abundant elements, then any linear molecule not composed either of two second row and one third row atoms, or of four second row atoms, would be far too heavy or too light to have the proper rotational constant. For a slightly asymmetric top molecule, it should have a linear backbone of three heavy atoms (including one of the third row) plus 1 or 2 hydrogen atoms.

As the molecule has an odd number of electrons and its ground state is split by spin-rotation interaction, we are not left with very many species. Restricting ourselves to elements found in other interstellar molecules (H, C, N, O, S and Si) and ignoring the ions, we have CCNC, HCCS, HCCSi, NCSi and their isomers as obvious candidates.

CCNC, an isomer of C_3N , may seem appealing as many

carbon-nitrogen chain molecules are observed in IRC+10216 and, in particular, as C₃N is abundant in that source. It is predicted to be linear and to have the correct (²Σ) ground state (Wilson 1978). The line splitting for CCNC is expected to be roughly the same than that of C₃N (18.7 MHz), in agreement with what is observed. On the other hand, the rotation constant of CCNC, estimated by Wilson (1978) from Hartree-Fock calculations, seems too low (5458 MHz or 8.5% below the observed value). It should be noted, nevertheless, that Hartree-Fock calculations are ill-suited for open-shell systems and that similar calculations on the simpler CCN radical underestimated B₀ by as much as 5% (Green 1980). The distortion constant D₀ that we derive (the minimum allowed by our data for a linear molecule is 2.5 kHz) is at least a factor of 3 larger than that of C₃N. Even though this difference is not conclusive (D₀ should scale as B₀³ and the C-N bond-stretching frequency in CC-NC must be smaller than the C-C one in CC-CN), atop of the too large B₀ it leaves little hope that CCNC is the species sought. If the B and D values of the new molecule appear at the limit of those possible for CCNC, they are probably too large for any other open-shell molecule with four heavy atoms. If it is not CCNC, the new molecule must then contain sulfur or silicon.

TABLE 1

observed rest frequency (MHz)	obs-calc ⁺ (MHz)	intensity (K)
107399.8 (.4)	-0.1	0.11 ^b
107384.6 (.3)	-0.2	0.12 ^b
95469.3 (.2)	-0.1	0.11
95454.4 (.3)	0.1	0.09
83538.0 ^c (.5)	-0.1	0.11 ^b
83522.9 (.3)	-0.1	0.10

notes:

* rest frequencies have been calculated for a source Vlsr of -27 km s⁻¹ (estimated from the lines of ¹³CS, CCH and C₂H, observed with a resolution of 100 kHz); the 95.5 GHz doublet is also present in the CCH spectrum of Lucas et al. (1986) who derive frequencies very close to ours.

+ Calculated frequencies assume a linear structure with B=5966.820 MHz, D=3.57 kHz, and Y=15.1 MHz.

b line intensities are estimated from the average of the two peaks (one peak for the blended components denoted by b).

c derived from the low frequency edge of the line, assuming a line width of 8 MHz, (which correspond, after scaling in frequency, to the width of the CCH lines)--see text.

From the examples given above, it is clear that a molecule like NCS, if it were not for its ²Π ground state, would be very close to what we are seeking. HCCS, or its isomer HSCC, which have the same weight as NCS, must also have about the correct rotation constant. From the geometries of H₂CCS and HSCCH, we derive (B+C)/2=6025 MHz for a bent HCCS and 6100 MHz for HSCC. Cooper (1981), however, finds from SCF ab-initio calculations that the most stable form of HCCS, like for NCS, is a ²Π linear state. Its rotational transition frequencies should then be half-integer multiples, and not as we observe integer multiples, of a common 2B frequency. In any case the linear HCCS has been studied in the lab (Krishnamachari and Ramsay

1981) and found to have a rotation constant smaller than our B₀. HSCC, on the other hand, is certainly bent on the S atom and must behave spectroscopically like a ²Σ molecule, hence could well fit our data. Its main drawback (as well as that of an hypothetical bent HCCS with a higher energy) as the carrier of the new doublets is that it contains sulfur. Only two sulfur molecules have been detected so far in IRC+10216: CS and SiS. H₂S, H₂CS, HNCS, SO, OCS and HCS, have been searched for, but not seen, and we couldn't find any trace of H₂CCS.

The large abundance of SiS, with respect to CS, and the observation of strong SiCC lines, show that silicon is relatively abundant in IRC+10216 and could well be a constituent of the new radical. Plausible silicon compounds are HCCSi, HSiCC and SiCN. Using standard bond lengths and angles, we get respectively for these species B = 5700, 5900 and 6000 MHz, assuming they are linear, and (B+C)/2 = 5900 and 6050 MHz for HCCSi and HSiCC, if the H atom is outside the SiCC axis. In spite of these molecules' analogy with HCC and CCN, which both have a linear ²Π ground state, their nature and geometry is hard to guess. It is well known that analogous silicon and carbon compounds often have different structures and ground states (see e.g. C₃ and SiCC, Grev and Schaefer 1984). If linear, any of these molecules may well have a ²Σ ground state and HSiCC is likely to be bent on the Si atom; in both cases the molecules could fit the data.

We have seen that the distortion constant of the new molecule, assuming it is linear, is relatively large. This provides some evidence that the molecule may actually be a slightly asymmetric top. The asymmetry in a near prolate top introduces a displacement of the rotational energy levels which, for the K=0 levels and large N, behaves like that caused by centrifugal stretching in a linear molecule. The correction term which adds to D₀ is then $-A \cdot b^2 / 8$, where $b = (C-B) / (2A-B-C)$ is the molecule asymmetry parameter. Assuming D₀ = 1 KHz, as for HNCS, we derive $b = -2.5 \times 10^{-4}$, an asymmetry a bit larger than that of HNCS^b, but quite in the range expected for HSiCC or HSCC, which have a longer H-X bond length. A better determination of the line frequencies would be needed to make the argument conclusive.

If they seem the most probable, the molecules discussed above are certainly not the only possible ones as the carrier of our three doublets. We have not considered ions on the grounds that they are unabundant in IRC+10216, as shown by the low HCO/CO abundance ratio (Lucas et al. 1986). Likewise, we ignored the molecules containing unimportant elements as none is observed in interstellar or circumstellar clouds (with the possible exception of chlorine). It is conceivable that the new radical is one of such species. A species slightly lighter than ClCCH (B=5684 MHz, Demaison et al. 1982), such as ClCC for example, would fit perfectly.

In summary, we have detected in the envelope of the carbon star IRC+10216 three doublets which, because they have the same intensity and the same splitting, and because their frequencies are almost exactly in the ratio 7/8/9, must belong to the same molecule, as a matter of fact a radical: it has an odd number of electrons and must be linear or be a slightly asymmetric top; its asymmetry parameter is found smaller than 3×10^{-4} . Its ground state must be split by spin-rotation interaction. The moment of inertia is precisely determined and implies that the new molecule is composed of either three, or four heavy atoms. These

L20

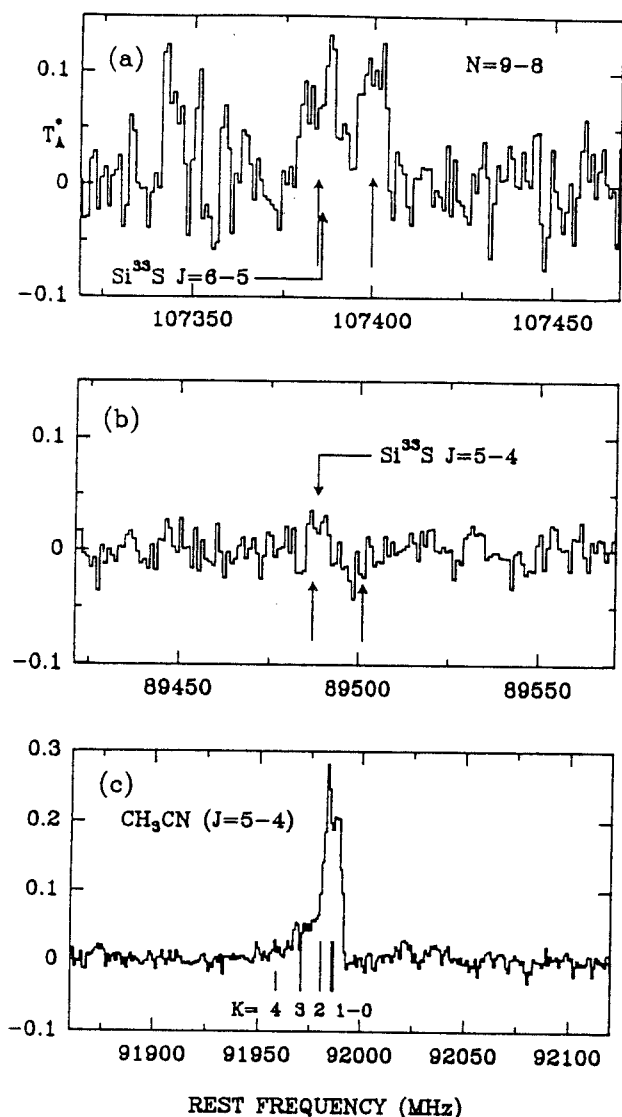

FIGURE 2: Three relevant spectra observed with the IRAM 30-m telescope towards IRC+10216. The frequency resolution is 1 MHz. Fig. 2a: the same doublet as in Fig 1a, observed with a different local oscillator setting. The left component is blended with a weak line, which is the 6-5 transition of Si^{33}S . Fig 2b: the 5-4 transition of Si^{33}S and the position where a fourth doublet identical to those of Fig 1 would lie, if these doublets were transitions of quantum number 14, 16 and 18 (or 28,32,34) and not 7, 8 and 9. Fig 2c: K-splitting in the 5-4 rotational transition of CH_3CN . A "rotation" temperature of $\approx 20-40$ K can be derived from the relative intensity of the K components.

properties, plus the chemical characteristics of the source, notoriously deficient in oxygen and in charged species, leave only a few likely candidates. The isocyanoethynyl radical, CCNC , is predicted to have a too large moment of inertia. HSCC could have the right moment of inertia, but hardly seems abundant enough.

HSiCC and, to a lesser degree its isomer HCCSi and NCSi, seem the most likely to have the proper abundance and the correct spectroscopic properties, but very little is known about their actual structure.

An astronomical test which could help to decide among these or other molecules, would be the observation of more rotational transitions. The detection of a low-lying transition could allow resolution of the hyperfine structure and thus a check on whether it arises from hydrogen or nitrogen (e.g. Guélin et al. 1982). It would also provide, just as the detection of a higher rotational transition, a better determination of $(D_{\perp} - A \cdot b^2/8)$ and allow us to decide whether or not the molecule has an H atom off its axis and to which atom (i.e. first or second row) this hydrogen is bound. The best source for searching a low transition of HSCC could be the dark cloud TMC1. Since we didn't detect the new molecule in Orion-KL, IRC+10216 remains the best object for the observation of higher transitions. From the theoretical side, an evaluation of the structure and dipole moment of the proposed species would be most valuable.

Acknowledgements

We would like to thank G. Bertier, J.L. Destombes, G.H.F. Diercksen, Y. Ellinger, A. Omont, F. Pauzat, and R. Subra for helpful discussions, and the IRAM Granada staff, particularly H. Hein and S. Navarro, for their assistance during the observations.

REFERENCES

- Cooper, D.L.:1981, Chem. Phys. Letters **81**, 479.
- Demaison, J., Huttner, W., Starck, B., Buck, I., Tischer R., Winnewisser, M.:1974, Landolt-Bornstein, II/6; Springer-Verlag.
- Demaison, J., Dubrulle, A., Huttner, W., Tiemann, E.:1982 Landolt-Bornstein, II/14; Springer-Verlag.
- Green, S.:1980, Ap. J. **240**, 962.
- Grev, R.S. and Schaefer, H.F.:1984, J. Chem. Phys. **80**, 3552.
- Guélin, M., and Thaddeus, P.: 1977, Ap. J. Letters, **212**, L81.
- Guélin, M., Green, S., and Thaddeus, P.:1978, Ap. J. Letters, **224**, L27.
- Guélin, M., Friberg, P. and Mezaoui, A.:1982, Astron. Astrophys., **109**, 23.
- Krishnamachari, S.L.N.G. and Ramsay, D.A.:1981, Discuss. Faraday Soc., **71**, 205.
- Lucas, R., Omont, A. Guilloteau, S., and Nguyen-Q.-Rieu:1986, Astron. Astrophys. **154**, L12.
- Thaddeus, P., Cummings, S.E. and Linke, R.A.:1984, Ap. J. Letters, **283**, L45.
- Townes, C.H., and Schawlow, A.L.:1975, Microwave Spectroscopy, Dover Public. Inc. New York.
- Wilson, S.:1978, Ap. J., **220**, 363.

II.08) DETECTION DE C₅H DANS IRC+10216.

II.08) DETECTION DE C₅H DANS IRC+10216.

En utilisant le radiotélescope de 30-m de l'IRAM nous avons découvert six doublets dans le spectre millimétrique de IRC+10216. Nous avons identifié ces raies comme étant les transitions rotationnelles $J=31/2-29/2$ et $J=35/2-33/2, \dots, 43/2-41/2$ d'un nouveau radical possédant un état électronique fondamental $^2\Pi$. Les constantes de rotation et de distorsion de cette molécule sont $B_0=2387.01\pm 0.02$ MHz et $D_0=50\pm 20$ KHz (2σ). Nous avons identifié ce nouveau radical comme étant C₅H, pour lequel nous pouvons prédire $B_0 \approx 2375$ MHz à partir des valeurs typiques des longueurs de liaison C-H, C-C, et C \equiv C. Un autre candidat possible, mais moins probable, serait C₅N.

Letter to the Editor

Tentative detection of the C_5H radicalJ. Cernicharo^{1,2}, C. Kahane¹, J. Gómez-González^{2,3}, and M. Guélin²¹ Groupe d'Astrophysique, Université de Grenoble, CERMO, BP 68, F-38402 St. Martin d'Hères Cedex, France² IRAM, Domaine Universitaire de Grenoble, Voie 10, F-38406 St. Martin d'Hères, France and Av. Divina Pastora 7, E-Granada, Spain³ Centro Astronómico de Yebes, OAN, Apartado 148, E-19080 Guadalajara, Spain

Received April 22, accepted May 22, 1986

SUMMARY

Six line doublets, discovered with the IRAM 30m telescope in the millimetre-wave spectrum of IRC+10216, have been identified as the $J=31/2 \rightarrow 29/2$ and $J=35/2 \rightarrow 33/2$ to $43/2 \rightarrow 41/2$ rotational transitions of a new radical with a $^2\Pi$ ground state. The rotation and distortion constants of this radical are $B_0=2387.01 \pm 0.02$ MHz and $D_0 = 50 \pm 20$ Hz (2σ). We tentatively identify the new radical with C_5H , for which we estimate $B_0 \approx 2375$ MHz from standard bond length considerations. An alternate, although less likely candidate would be C_4N .

Keywords: molecules - stars: circumstellar matter

Since the discoveries of the carbon chain radicals C_2H , C_3N and C_4H (Tucker et al. 1974, Guélin et al. 1977, 1978), which all have an even number of non hydrogen atoms, the question has arisen whether linear radicals with an odd number of heavy atoms could also be detected in space. The "even" radicals are obtained by clipping one H atom from the stable cyanopolyynes and acetylenic chains, and can be described by a standard valence bond structure. In contrast, the "odd" radicals have no standard bond structure and cannot be formed from closed-shell molecules without thorough rearrangement. "Odd" radicals are expected to be more reactive than the "even" and their abundance much smaller. The recent identification of the C_3H radical in the envelope of the IR star IRC+10216 (Thaddeus et al. 1985) was the first evidence that odd radicals were detectable. In this Letter, we report the tentative discovery of the next member of the odd chain, the pentynylidyne radical, C_5H . C_5H is the largest linear molecule with non-zero electronic orbital angular momentum observed so far.

To our knowledge, C_5H has never been observed in the laboratory and, prior to this work, its spectroscopic constants had not been measured. No ab-initio quantum mechanical calculation of the radical's structure had been reported, either. Yet, this structure was not so unknown as to hinder a search for C_5H in space.

The molecular structure C_5H can probably be obtained from that of C_3H by insertion of the stable acetylenic group $C \equiv C$ between the H and C atoms, since the structures of C_3H and C_4H can approximately be derived from CH and C_2H in this way (see e.g. Green 1980). The insertion of C_2 into CH and C_2H preserves

these molecules' linear geometry and the nature of their ground state ($^2\Pi$ for CH and C_3H and $^2\Sigma$ for C_2H and C_4H). C_5H is thus probably linear like C_3H and must have a $^2\Pi$ ground state. The inertia moments and rotation constants of C_3H and C_4H can be derived to within 1% from the geometries of CH and C_2H , using standard covalent bond lengths for the additional C_2 group (see Table 1). Making the same assumption for the extra C_2 group of C_5H we calculate a rotation constant $B_0=2375$ MHz. This value of B_0 is very close to that derived by simply clipping the N atom from HC_3N (Table 1); owing to the molecule's length, it should be as accurate as the value of B_0 derived for C_3H by clipping the nitrogen atom from HC_3N ($\approx 1\%$).

Because C_5H is heavy, its ground state is probably close to Hund's case (a). The rotational energy levels are distributed between two ladders (the $^2\Pi_{1/2}$ and $^2\Pi_{3/2}$ ladders), and the rotational frequencies in each ladder are simply given by $2Be_{eff}J$, where J is half-integer and B_{eff} , the effective rotation constant, is equal to B_0 to the accuracy of our estimate (see below). The rotational levels of both ladders being split in two by the weak interaction between the electronic and rotational motions (Λ -doubling), the millimetre spectrum of C_5H consists of two series of close doublets, with center frequencies almost exactly in ratios of half-integer numbers. In addition to Λ -doubling, the unpaired electron and the hydrogen atom give rise to hyperfine structure; this structure, however, decreases as $1/J^2$ and is unresolvable at millimetre wavelengths.

TABLE 1: OBSERVED AND CALCULATED ROTATIONAL CONSTANTS

MOLECULE	Bo(obs)	Be(estimated)		error (obs-est)
		[1]	[2]	
C_3H	11186	11090	11140	1.0%
C_4H	4759	4762	4764	0.2%
C_5H	2387	2371	2377	
C_2N	11938		12160	2.0%
C_4N			2417	

notes to the Table:

[1] Calculated from the geometries of CH, C_2H or C_3H by insertion of the acetylenic group C_2 ($C-C: 1.37$ Å; $C \equiv C: 1.21$ Å).

[2] Calculated from the bond lengths in HC_3N or HC_5N by removing N or CH.

References: C_3H = Gottlieb et al. (1985); C_4H = Guélin et al. (1978), CCN = Kakimoto and Kasuya (1982). CH = Brazier and Brown (1984). C_5H = this paper.

Send offprint requests to: J. Cernicharo

L2

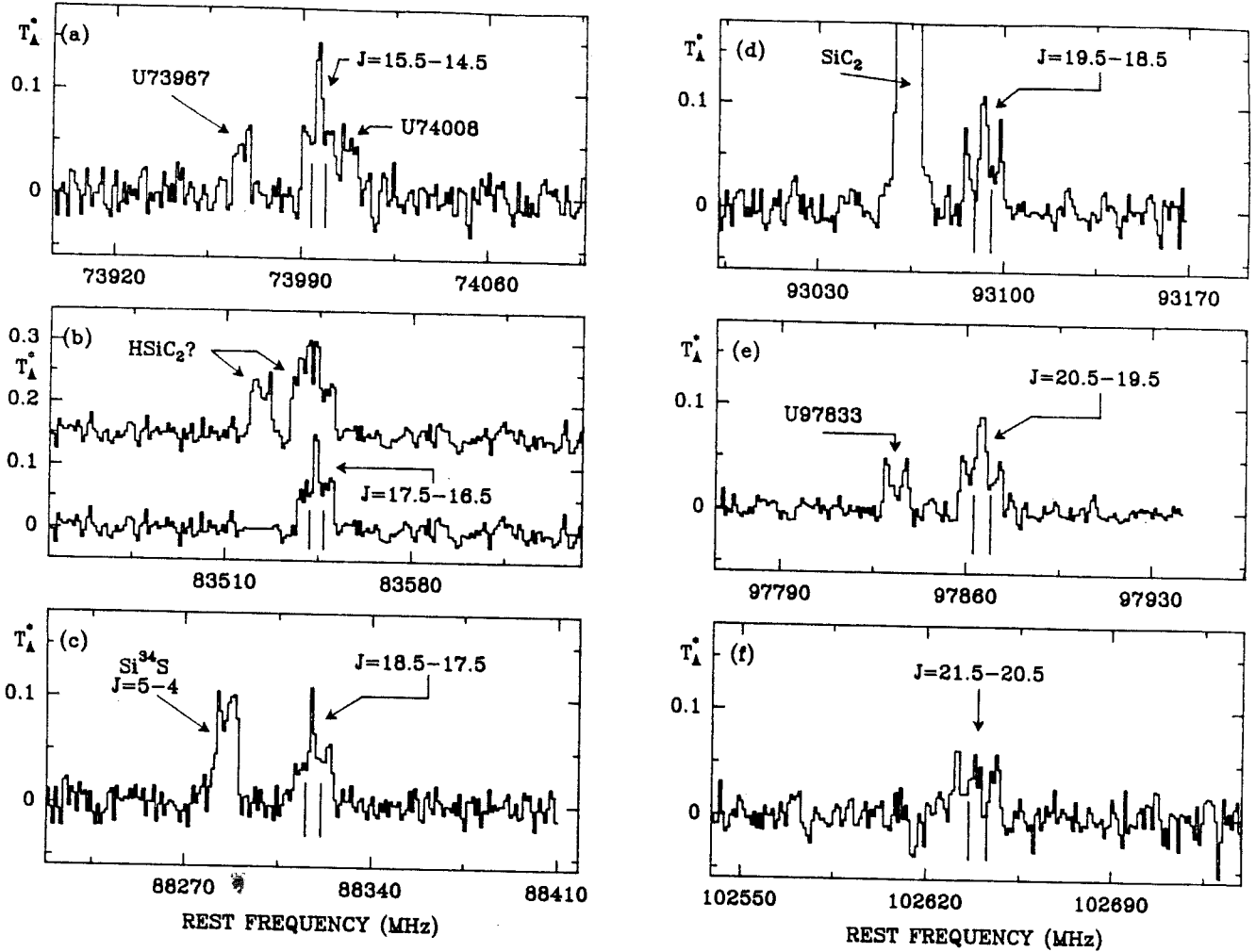

FIGURE 1: Six spectra, with centre frequencies in ratios of half-integer numbers, observed in IRC+10216 with the IRAM 30-m telescope. The broad features, at the centre of the spectra, are doublets arising from the new radical identified with C_3H ; the doublet components are indicated by vertical marks. The doublet at 83545 MHz (upper spectrum of Fig 1b) is blended with another doublet which is the $N=8-7$ transition of a $^2\Sigma$ radical (could arise from $HSiC_2$ --see Guélin et al. 1986); this latter doublet has been tentatively removed in the lower spectrum of Fig 1b (see text).

The doublet structure, the approximate rotational frequencies and especially the nearly exact harmonic relations among these frequencies are specific enough to identify the lines of C_3H , if only a few rotational transitions of this species could be detected. We therefore embarked on a search for C_3H , by observing, in IRC+10216, several 1-2 GHz-wide spectral bands centred on the predicted frequencies.

The observations were made at a wavelength of 3 mm with the IRAM 30 m telescope at Pico Veleta, Spain. The telescope was equipped with 3-mm SIS and 3-mm Schottky receivers with DSB noise temperatures of 100 - 300 K. The observing procedure has been described by Guélin et al. (1986). During most of the observations, the weather was clear and the atmospheric opacity was below 0.1. The pointing was checked every two hours on the quasar 3C273 and found to be accurate within 5", or $\approx 1/5$ of the antenna beamwidth. The temperature scale (T_A , the SSB antenna temperature reported above atmosphere) should be correct to within 15%.

Among the many new lines uncovered during the search (see e.g. Guélin et al. 1986), we have detected

the six characteristic features presented in Fig 1. The lines in IRC+10216 are known to have clear-cut edges and a velocity width of 28.5 km s^{-1} ; when optically thin, they are U-shaped and look like the C_3H lines of Fig 2b. The central features in Fig 1a-f have much larger widths (40 to 65 km s^{-1}) and exhibit a central peak; they must consist of a blend of lines. Using a "standard" line profile similar to that of the C_3H lines, we can resolve each one of the features in a,c,d,e,f into two slightly overlapping components of equal strengths (see e.g. Fig. 2c and 2d). The upper spectrum of Fig 1b was already reported in a previous paper (Guélin et al. 1986) and is known to consist of 4 lines, two of which belong to the 8-7 rotational transition of a radical which could be $HSiC_2$. Although only the low frequency component of this transition is resolved in Fig 1b, we know that the high frequency component has the same strength and lies exactly 15.1 MHz higher. In the lower spectrum of Fig 1b, we have subtracted from the original spectrum the low frequency component and its image shifted by 15 MHz. There remains right at the center a 15 MHz (45 km s^{-1})-broad, centrally peaked feature, almost identical to that of Fig 1a; this feature is readily resolved into two "standard" lines of equal intensities.

The result of the "standard" line fit to the six central features of Fig 1 is given in Table 2 (see also the vertical marks on Fig 1). It shows that the six line doublets have, from a to f, a regularly increasing splitting and a decreasing strength. Most remarkably, the six doublet center frequencies are, within 1 MHz, half-integer multiples of a common frequency, 4774 MHz. (They should not be considered as integer multiples of half that frequency, since we couldn't detect any even multiple of 2387 MHz --see e.g. Fig 3). Almost certainly all six doublets are related and arise from a single linear molecule. This latter, because the multiples are half-integer, must have a $^2\Pi$ ground state. Its rotation constant is 2387 MHz, so close to the B_0 value derived above, that it is hard not to conclude that we have detected C_3H or a very closely related species.

TABLE 2: LINE PARAMETERS

Ju	Jl	Freq. Obser. ¹ (MHz)	Obs-Calc ² (MHz)	Split. (MHz)	Intensity K kms
15.5	14.5	73993.8 (0.3)	-0.3	5.1	2.0 (0.2)
		73998.9 (0.4)	0.0		1.9 (0.2)
17.5	16.5	83541.5 (0.8)	0.0	5.6	1.7 (0.3)
		83547.1 (0.6)	0.2		2.2 (0.2)
18.5	17.5	88315.2 (0.4)	0.1	5.8	0.8 (0.2)
		88321.0 (0.4)	0.0		1.1 (0.2)
19.5	18.5	93089.0 (0.3)	0.2	5.9	1.3 (0.1)
		93094.9 (0.4)	0.1		1.5 (0.1)
20.5	19.5	97862.6 (0.4)	0.1	6.2	1.2 (0.1)
		97868.8 (0.4)	0.0		1.1 (0.1)
21.5	20.5	102635.7 (0.7)	-0.3	6.7	1.1 (0.2)
		102642.4 (0.7)	-0.3		1.0 (0.2)

1) for $V_{lsr} = -27 \text{ kms}^{-1}$.

2) see text.

The numbers in parenthesis are 1σ deviation.

Before discussing what species the new radical could be besides C_3H , let us derive more precisely its spectroscopic constants. In the limiting case (a) of Hund, where $2BoJ$ is small compared with the spin-orbit coupling constant A , the rotation frequencies, taking into account centrifugal stretching, are given by:

$$\nu(J+J-1) = 2Bo(1 \pm Bo/A \pm \dots)J - 4(D_0 \pm Bo^2/A^3 \pm \dots)J^3, \quad (1)$$

where the - signs apply to transitions between $^2\Pi_{1/2}$ levels and the + signs to transitions between $^2\Pi_{3/2}$ levels; D_0 is the stretching constant. The energy splitting is given for low J for the $^2\Pi_{1/2}$ levels by:

$$E/h(J+J-1) = 2q_A J, \quad (2)$$

and for the $^2\Pi_{3/2}$ levels by:

$$E/h(J+J-1) = 2q'_A J(J^2 - 1/4). \quad (3)$$

For large J , when $2BoJ$ is comparable to A , additional terms should be added to these relations, which become rather involved (see e.g. Townes and Schawlow 1975, p.186 and 190).

We have fitted the line frequencies of Table 2 by the empirical expression:

$$\nu(J+J-1) = 2B_{eff}J - 4D_{eff}J^3 \pm 1/2 \times q_{eff} J, \quad (4)$$

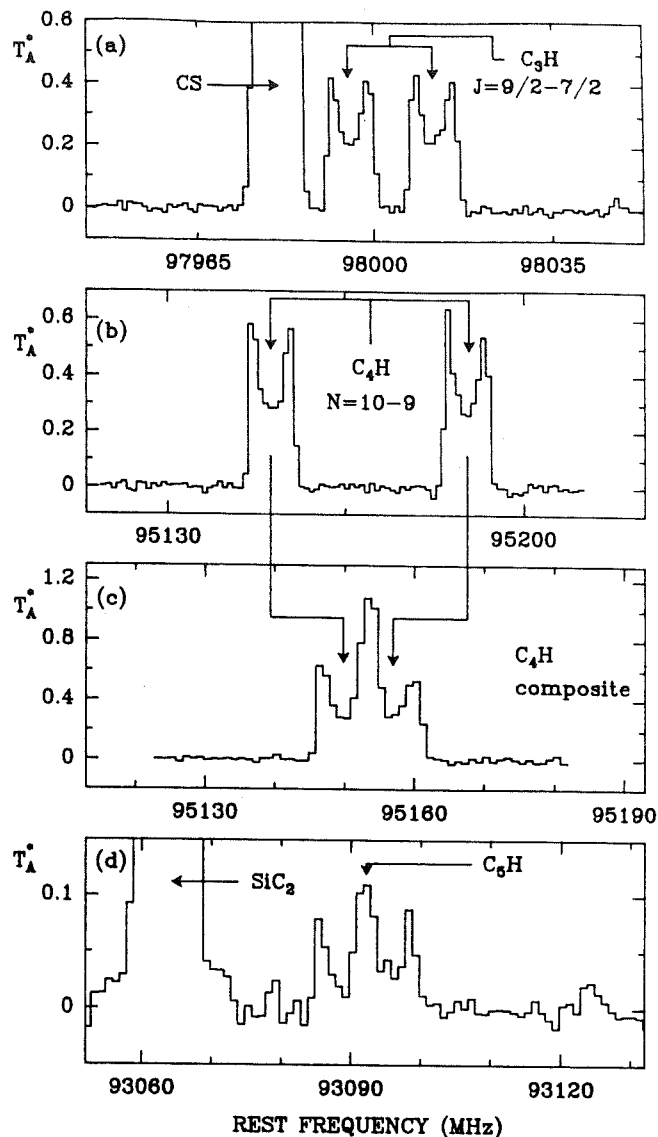

FIGURE 2: a) and b) the $\Omega=1/2$ $J=9/2+7/2$ transition of C_3H and the $N=10+9$ transition of C_4H , observed towards IRC10216 with the 30-m. telescope. c) The $N=10+9$ transition of C_4H , as it would appear if the doublet splitting were 6 MHz instead of 39 MHz. d) The central feature of Fig. 1d in an expanded scale.

and found:

$$\begin{aligned} B_{eff} &= 2387.01 \pm 0.02 \text{ MHz}, \\ D_{eff} &= 50 \pm 20 \text{ Hz}, \\ q_{eff} &= 320 \pm 40 \text{ kHz}, \end{aligned}$$

where the errors are twice the standard deviation.

The residuals to the fit (Table 2) are ≈ 0.2 MHz and are of the same order of magnitude as the estimated accuracy of the measurements (0.4 MHz). This shows that eqs (1) and (4) are quite adequate for describing the observed spectrum, and that rotational frequencies with quantum numbers as high as 20 still follow Hund's case (a): the spin-orbit coupling constant, A , must therefore be relatively large.

L4

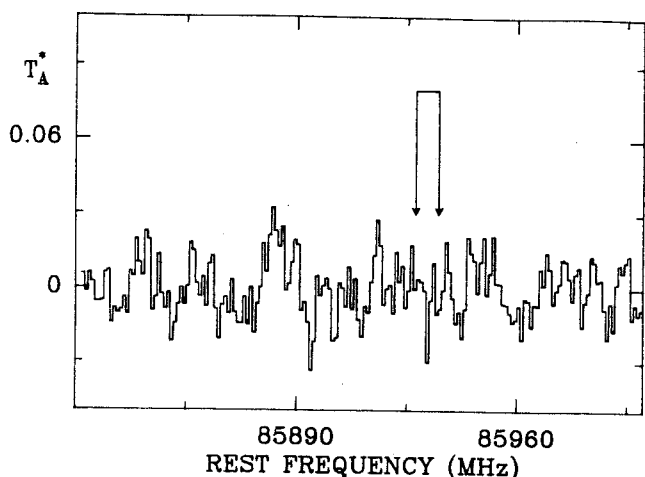

FIGURE 3: The position where a seventh doublet identical to those of Fig 1 would lie, if these doublets were transitions of quantum numbers 31, 35... and not 31/2, 35/2.

A lower limit to the constant A (which gives the difference in energy between the $^2\Pi_{1/2}$ and the $^2\Pi_{3/2}$ ladders) can be derived from the value found for Deff, the J^3 term of eq (1). Deff is the difference between Do (the distortion constant) and Bo^4/A^3 (a spin uncoupling term). Do should not be much larger than 100 Hz for a molecule of the weight of C_5H (see e.g. CH_3C_2H , for which $D_J = 86.7 \text{ Hz}$, Bester et al. 1984), so that probably $A \geq 28 \text{ cm}^{-1}$. This large value of A implies that $Bo - Beff = B/A \leq 3 \cdot 10^{-3}$, so that the $^2\Pi_{3/2}$ transitions lie at most $\approx 500 \text{ MHz}$ above the observed ones (We assume that C_5H has a "regular" fine structure, like CH , C_3H and CCN). We didn't detect these transitions to a level $\approx 1/3$ of those observed. This is not surprising, since the $^2\Pi_{3/2}$ rotational levels are found to lie more than 40 K above the corresponding $^2\Pi_{1/2}$ levels.

Could any molecule, other than C_5H , be the carrier of our six doublets? If yes, it should be linear, have a $^2\Pi_{1/2}$ ground state and have a rotation constant of 2387 MHz. For this, it must have an odd number of electrons and, if it consists of cosmically abundant elements, it should be formed of 5 second row element atoms, plus may be one, possibly two H atoms. Indeed, linear molecules with 4 or 6 second row atoms are far too short or too long to match the experimental Bo value (for example, the rotation constant of HC_3N is 4549 MHz and that of HC_5N 1331 MHz). A molecule with three second row and one third row atom could come closer to the sought value (the estimated Bo values for the likeliest species, such as HC_3Si , are $\approx 10\%$ too high, however), but seems less likely from abundance considerations.

Among the molecules with 5 second row atoms, the most obvious candidate, besides C_5H , is C_4N . This radical is isoelectronic with C_5H and must have the correct $^2\Pi$ ground state. Its rotational constant can be estimated to be very close to the observed value (Table 1). On spectroscopic grounds, this molecule seems thus as likely as C_5H . Abundance considerations, however, favor C_5H . In IRC+10216, as in interstellar clouds, the carbon-hydrogen radicals C_2H , C_3H and C_4H are known to be 3 to 10 times more abundant than their carbon-nitrogen analogs, CN , C_2N and C_3N . One would similarly expect that C_5H is more abundant than C_4N .

Yet, we didn't detect another molecule with a similar Bo constant in a 10-GHz broad frequency survey of the spectrum of IRC+10216. As there is no evidence that the dipole moment of C_5H must be significantly lower than that of C_4N , it seems reasonable to conclude that we have probably detected C_5H .

An astronomical test which could help to decide between C_5H and C_4N , would be the detection of a low quantum number rotational transition. For J values equal to 9/2 or smaller ($\nu(9/2 \rightarrow 7/2) = 21.48 \text{ GHz}$), the hyperfine structure could be resolvable in a low velocity dispersion source like TMC1. C_5H has already been observed in that source and the new molecule could well be detectable there; the resolution of the hyperfine structure would tell if it has an H or an N atom. Of course, the best confirmation of the radical's identity would be its detection in the laboratory.

We are indebted to C. Demuyck for comments on the manuscript.

Note added in proof:

Gottlieb, Gottlieb and Thaddeus have just succeeded in observing our new radical in the laboratory and confirm that it must be C_5H rather than C_4N . They describe their work in the following Letter where they derive more accurate spectroscopic constants. Using these constants, we were able finally to detect the $^2\Pi_{3/2}$ ladder.

REFERENCES

- Bester, M., Yamada, K., Winnewisser, G., Joentgen, W., Altenbach, H. -J., and Vogel, E. :1984, *Astron. and Astrophysics Letters*, 137, L20.
 Brazier, C. R., Brown, J. M. :1984, *Can. Journal of Physics*, 62, 1563.
 Gottlieb, C. A., Vrtilik, J. M., Gottlieb, E. W., Thaddeus, P. :1985, *Ap. J. Letters*, 294, L55
 Green, S.:1980, *Ap. J.* 240, 962.
 Guélin, M., and Thaddeus, P. : 1977, *Ap. J. Letters*, 212, L81.
 Guélin, M., Green, S. and Thaddeus, P.:1978, *Ap. J. Letters*, 224, L27.
 Guélin, M., Cernicharo, J., Kahane, C., Gomez-Gonzalez, J. : *Astron. Astrophys.*, 157, L17
 Kakimoto, M., Kasuya, T. :1982, *J. Molec. Spectrosc.*, 94, 380.
 Thaddeus, P., Gottlieb, C. A., Hjalmanson, A., Johansson, L. E. B., Irvine, W. M., Friberg, P. and Linke, R. A. :1985, *Ap. J. Letters*, 294, L49.
 Townes, C. H., Schawlow, A. L. :1975, *Microwave Spectroscopy*, Dover, New York.
 Tucker, K. D., Kutner, M. L., Thaddeus, P. :1974, *Ap. J. Letters*, 193, L115.

II.09) DETECTION DE C₅H DANS L'ETAT ELECTRONIQUE $2\Pi_{3/2}$ DANS
IRC+10216.

II.09) DETECTION DE C₅H DANS L'ETAT ELECTRONIQUE $2\Pi_{3/2}$ DANS IRC+10216.

Nous avons détecté dans l'enveloppe moléculaire de l'étoile carbonée IRC+10216 quatre doublets appartenant à l'état $2\Pi_{3/2}$ de C₅H, un nouveau radical récemment découvert dans cette étoile par Cernicharo et al. (1986, voir II.05). A partir des intensités des raies nous déterminons une température de rotation de 14 K pour l'état $2\Pi_{1/2}$ et de 24 K pour l'état $2\Pi_{3/2}$. La densité projetée de C₅H, moyennée sur un lobe de 25", est de qqs 10^{13} cm⁻². Le rapport d'abondances C₅H/HC₅N vaut 40 à un facteur 2 près.

Letter to the Editor

Detection of the ${}^2\Pi_{3/2}$ state of C_5H

J. Cernicharo^{1,2,3}, C. Kahane¹, J. Gómez-González^{2,3,4}, and M. Guélin^{2,3}

¹ Groupe d'Astrophysique, Université de Grenoble, CERMO, BP68, F-38402 St. Martin d'Hères Cedex, France

² IRAM, Domaine Universitaire de Grenoble, Voie 10, F-38406 St. Martin d'Hères, France

³ Av. Divina Pastora 7, Granada, Spain

⁴ Centro Astronómico de Yebes, OAN, Apartado 148, E-19080, Spain

Received July 15, accepted August 1, 1986

SUMMARY

We report the detection in the molecular envelope of IRC+10216 of four doublets of the ${}^2\Pi_{3/2}$ ladder of C_5H , a new radical recently discovered by Cernicharo et al. (1986a). From the line intensities we derive rotational temperatures of 14 and 24 K for the ${}^2\Pi_{1/2}$ and ${}^2\Pi_{3/2}$ ladders respectively. The C_5H column density, averaged over our 25" beam, is found to be about $few \cdot 10^{13} cm^{-2}$. The abundance ratio HC_5N/C_5H is found to be ≈ 40 within a factor 2.

Keywords: molecules-circumstellar matter

The pentynylidyne radical, C_5H , has recently been discovered in the envelope of the IR star IRC+10216 through the observation of 6 rotational transitions (Cernicharo et al., 1986a). The observed lines, which consisted of doublets with harmonically related center frequencies, bore the unmistakable signature of a linear, open-shell molecule, in a ${}^2\Pi$ electronic ground state. The effective rotational constant of the new radical could precisely be derived and, among the species likely to be abundant in IRC+10216, pointed to C_5H with little ambiguity. This astronomical identification of C_5H was subsequently confirmed in the laboratory (Gottlieb, Gottlieb and Thaddeus, 1986).

The interaction between the unpaired electron of C_5H and the orbital angular momentum splits the Π electronic ground state into two substates (with $\Omega=1/2$ and $\Omega=3/2$ respectively), consisting each of a ladder of rotational levels (see Fig. 1). The ${}^2\Pi_{3/2}$ ladder is found to lie $23.7 cm^{-1}$ (or 34 K) above the ${}^2\Pi_{1/2}$ ladder (Gottlieb, Gottlieb and Thaddeus, 1986). The rotational levels of both ladders are further split by lambda-doubling. As a result, the millimeter spectrum of this radical consists of two serial of regularly spaced doublets.

In our original survey, we observed the ${}^2\Pi_{1/2}$ ladder, but failed to detect any transition of the ${}^2\Pi_{3/2}$ ladder because its lines are weaker and because we could only crudely guess its transition frequencies. The detection of the ${}^2\Pi_{3/2}$ ladder in the laboratory, and the accurate measurement of its spectroscopic constants by Gottlieb, Gottlieb and Thaddeus (1986), prompted us back to the telescope to re-observe, with a better sensitivity, at the laboratory derived frequencies. Because of the expected weakness of the C_5H ${}^2\Pi_{3/2}$ lines, we concentrated ourselves on the lowest transitions reachable with the low noise 3-mm SIS receiver.

Send offprint requests to: J. Cernicharo

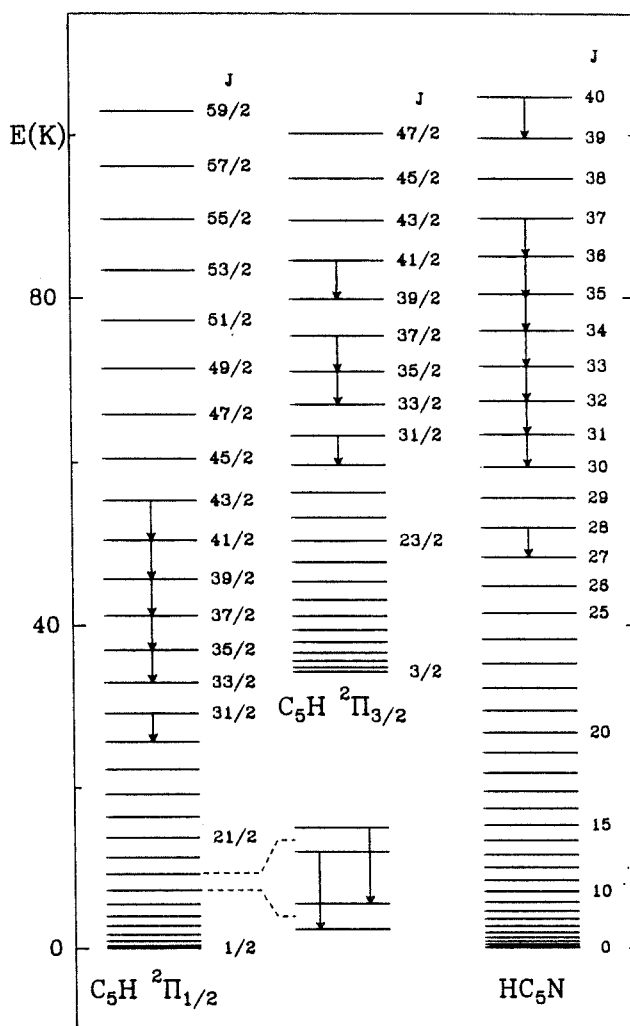

FIGURE 1 : Lower rotational energy levels of C_5H and HC_5N . The energy difference between the ${}^2\Pi_{3/2}$ and the ${}^2\Pi_{1/2}$ ladders is 34 K (Gottlieb, Gottlieb and Thaddeus, 1986). The lambda-doubling splitting of the levels is shown in an expanded scale for two energy levels of the ${}^2\Pi_{1/2}$ ladder. HC_5N is a closed-shell molecule; several transitions of this molecule were observed during our C_5H search. The observed transitions of C_5H and HC_5N are denoted by arrows. The transitions of the C_5H ${}^2\Pi_{1/2}$ ladder are those reported by Cernicharo et al., (1986a).

L6

The observations were made in May 1986 with the IRAM 30-m telescope at Pico Veleta, Spain. The telescope was equipped with a 3-mm SIS receiver with DSB noise temperature of 100 K. The observing procedure has been described by Guélin et al. (1986). During most of the observing period, the weather was clear and the atmospheric opacity was ≈ 0.05 . The pointing and focus were checked every two hours on the quasar 3C273. Pointing was found to be accurate within 3". Figure 2 shows the four lines we detected at the frequencies of the $J_u=41/2, 37/2, 35/2$ and $31/2$ $^2\Pi_{3/2}$ rotational transitions (see also Table 1). The ordinate scale is T_A^* , the effective SSB antenna temperature above atmosphere. The abscissa is rest frequency, assuming a source LSR velocity of -27 kms^{-1} .

The widths of the central features of Fig. 2a to 2c are systematically 1-2 MHz larger than those of unsplit lines, such as the HCN lines of Fig. 2a and 2d. They correspond to the width expected for two overlapping lines of equal strength, whose separation is equal to the lambda-doubling splitting. The four features having nearly equal intensities, we are confident that they are the sought transitions of the $^2\Pi_{3/2}$ ladder.

The integrated line brightness temperatures of the four doublets are given in Table 1. They have been corrected for beam dilution assuming a source size of 20" (equal to the size of the HCN source). The errors quoted in Table 1 include a calibration error of 10% (2 σ , see Cernicharo et al., 1986b).

TABLE 1

DERIVED C_5H $^2\Pi_{3/2}$ LINE PARAMETERS				
TRANSITION	ν (MHz) ⁺	S ⁺	Eu (K) ⁺	W (Kkms ⁻¹)
31/2-29/2	74497.176	15.339	63.3	5.2 \pm 1.0
	74498.617	15.339	63.3	
35/2-33/2	84108.582	17.357	71.1	4.7 \pm 0.8
	84110.414	17.357	71.1	
37/2-35/2	88914.140	18.365	75.4	4.9 \pm 0.7
	88916.185	18.365	75.4	
41/2-39/2	98524.939	20.378	84.6	4.5 \pm 0.9
	98527.443	20.378	84.6	

notes:

⁺) From Gottlieb, Gottlieb and Thaddeus (1986).

The integrated line brightness temperatures of the observed transitions in the $^2\Pi_{1/2}$ and $^2\Pi_{3/2}$ ladders are represented in Fig. 3 as a function of the upper rotational level energy. To make the graph directly interpretable in terms of rotation temperatures, the ordinate is as usual $\log(3kW/8\pi^3\nu S)$, where S is the line strength, ν the line frequency, and W the integrated line intensity. In this standard representation, rotational transitions excited to a single rotation temperature, T_R , should fall on a straight line of slope $\log(e)/T_R$. The intersection point of this line with the y axis is $\log(Nu^2/Z)$, where Z is the partition function, N the column density, and μ the molecule dipole moment.

Although the data points on Fig. 3 show that the $\Omega=1/2$ and $\Omega=3/2$ ladders can each be fitted by a straight line, it is clear that no single rotation temperature accounts for the whole data. The $\Omega=1/2$ and $\Omega=3/2$ ladders being radiatively connected only by weakly allowed transitions, the cross ladders temperature, T_{CR} , may be closer to the kinetic temperature than to the intra-ladder rotation

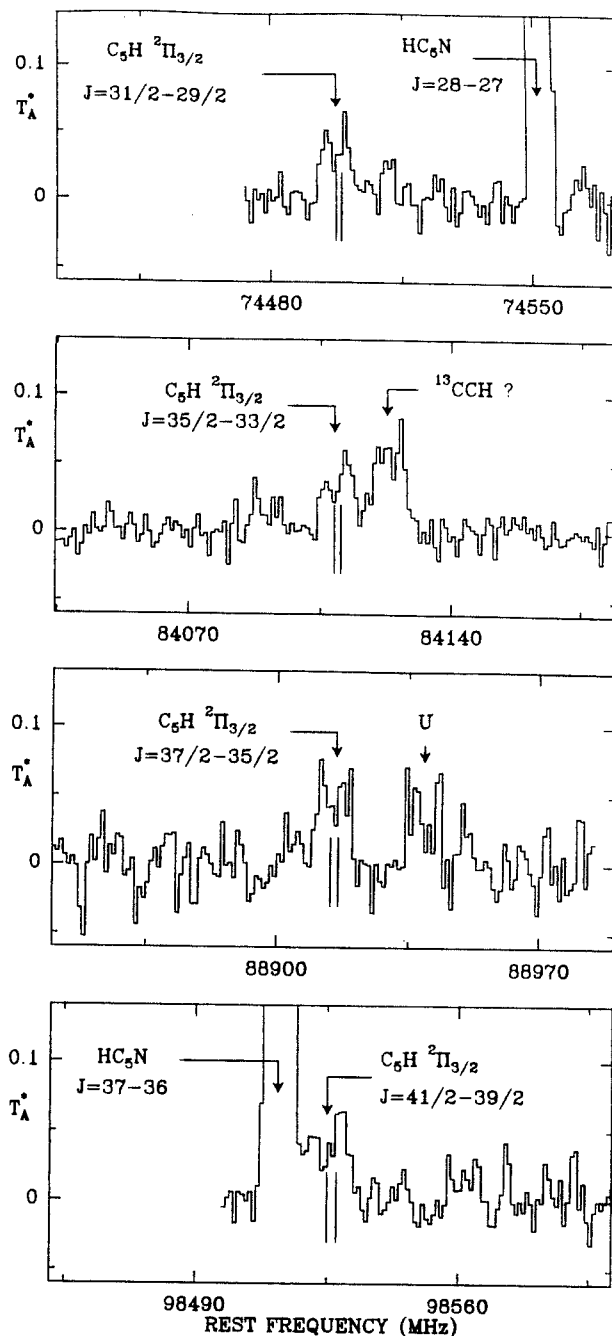

FIGURE 2 : The four C_5H $^2\Pi_{3/2}$ doublets observed towards IRC+10216. Rest frequencies were derived for a LSR source velocity of -27 kms^{-1} . The line 15 MHz above the C_5H line in Fig. 2b is tentatively assigned to the $N=1+0$ transition of ^{13}CCH (see text). The weak feature 20 MHz below the C_5H line of Fig. 2b is the residual of a line of $^{29}SiC_2$ in the image side band (Cernicharo et al., 1986b).

temperature. That we find $T_{CR}=50-90 \text{ K}$ is therefore not surprising. What is more significant is that we derive different rotation temperatures for the $\Omega=1/2$ and $3/2$ ladders, 14 ± 2 and $24\pm 3 \text{ K}$. This shows, as could have been anticipated, that the IRC+10216 molecular envelope cannot be represented by an homogeneous shell with an uniform temperature. The molecular excitation in the IRC+10216 envelope, due to collisions and/or IR

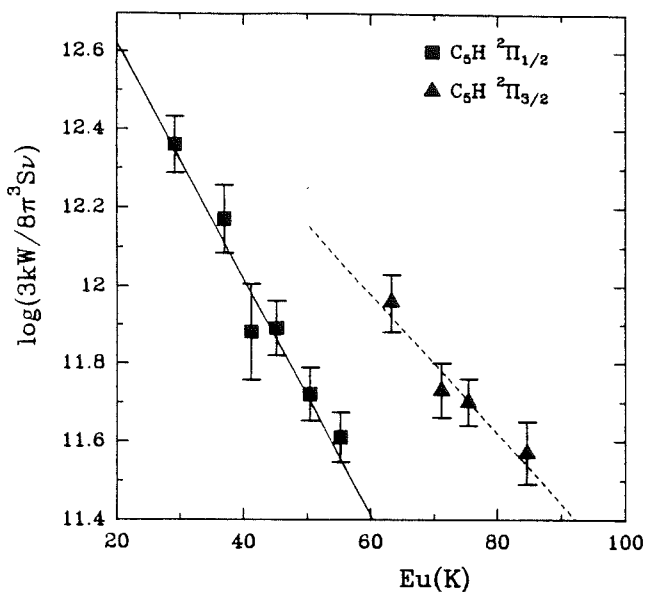

FIGURE 3 : Rotation temperature diagram of C_5H in IRC+10216. Each data point represents the sum of the two lambda-doubling components of the transitions reported in Table 1 (this paper) and Table 2 of Cernicharo et al., 1986a (the intensities have been corrected for beam dilution).

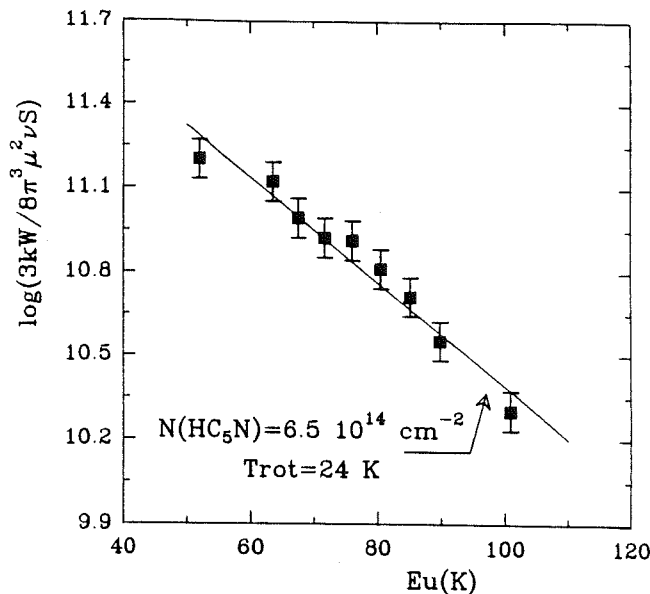

FIGURE 4 : Rotational temperature diagram of HC_5N in IRC+10216. Line parameters are given in Table 2.

radiation, is probably a function of the distance to the central star, so that no single parameter can account for the excitation along the line of sight.

It is interesting to make the same analysis for HC_5N , a heavy linear molecule of high abundance in IRC+10216. Fig. 1 shows the rotational energy level diagram of HC_5N and Fig. 4 the standard rotation temperature diagram of this molecule in IRC+10216. The nine HC_5N transitions of Fig. 4 were observed during our C_5H search (Cernicharo et al., 1986a). Their integrated line intensities, corrected for beam dilution and beam efficiency, are given in Table 2. The rotational temperature we derive for HC_5N is 24 ± 2 K, i.e., equal to that of the $2\Pi_{3/2}$ ladder of C_5H . Because the energies involved for these HC_5N transitions are similar to those of the C_5H $2\Pi_{3/2}$ ladder, this agreement supports the multilayer molecular excitation model in IRC+10216.

Determination of column densities in a source with non uniform excitation requires the observation

of a large number of rotational transitions spread on a wide range of energy levels. From our limited data, we can only make rough estimates of the C_5H and HC_5N column densities. For C_5H we have first to guess a value of the dipole moment. It seems reasonable to assume that this moment is larger than that of C_3H (the dipole moment of cyanopolyynes increases regularly from HCN to HC_5N), but smaller than that of HC_3N ; we adopt then $\mu = 4 \pm 1$ D. The column density we derive for C_5H is $1.7 \times 10^{14} \text{ cm}^{-2}$ (the partition function was calculated assuming different rotation temperatures for the $\Omega = 1/2$ and $\Omega = 3/2$ ladders). That of HC_5N , assuming $T_{rot} = 24 \pm 2$ K, is $6.5 \times 10^{14} \text{ cm}^{-2}$. We therefore derive a HC_5N/C_5H abundance ratio of 4, which should be correct within a factor of 2.

The upper line of Fig. 2b has a rest frequency ($\nu = 84124$ MHz) close to those which can be derived for the $N=1+0$, $J=3/2+1/2$, $F=5/2+3/2$ and $3/2+1/2$ hyperfine components of ^{13}CCH ($\nu = 84129$ and 84134 MHz respectively). Its width (12 MHz) is 4 MHz larger than the width of the HC_5N line of Fig. 2a (8 MHz), and could result from the overlap of these two ^{13}CCH components. The 84124 line is also observed in Sgr B2 (unpublished results), a source where Guélin, Cernicharo and Linke (1982), have tentatively assigned an unknown line to the $N=1+0$ transition of $C^{13}CH$, the other ^{13}C isotope of CCH.

TABLE 2

DERIVED HC_5N LINE PARAMETERS

TRANSITION	ν (MHz)	S	Eu(K)	W (Kkm s^{-1})
28+27	74551.13	28	51.9	37.1 ± 5.6
31+30	82539.24	31	63.4	39.7 ± 6.0
32+31	85201.56	32	67.5	30.1 ± 4.5
33+32	87863.87	33	71.7	26.7 ± 4.0
34+33	90526.15	34	76.0	27.7 ± 4.1
35+34	93188.41	35	80.5	26.3 ± 3.9
36+35	95850.65	36	85.1	19.5 ± 2.9
37+36	98512.86	37	89.8	14.5 ± 2.2
40+39	106499.35	40	104.8	9.5 ± 1.4

REFERENCES

Cernicharo, J., Kahane, C., Gómez-González, J., Guélin, M.:1986a, *Astron. and Astrophys. Letters*, **164**, L1.
 Cernicharo, J., Kahane, C., Gómez-González, J., Guélin, M.:1986b, *Astron. and Astrophys. Letters*, in press.
 Gottlieb, C.A., Gottlieb, E.W., Thaddeus, P.:1986, *Astron. and Astrophys. Letters*, **164**, L5.
 Guélin, M., Cernicharo, J., Kahane, C., Gómez-González, J.:1986, *Astron. and Astrophys. Letters*, **157**, L17.
 Guélin, M., Cernicharo, J., Linke, R.A.:1982, *Ap. J. Letters*, **263**, L89.

II.10) DETECTION DE LA STRUCTURE HYPERFINE DE C₅H.

II.10) DETECTION DE LA STRUCTURE HYPERFINE DE C₅H.

Nous avons détecté dans TMC1 la transition $J=9/2-7/2$ de C₅H, le radical récemment découvert par Cernicharo et al. (1986, voir II.05 et II.06). C'est la première fois que la structure hyperfine de cette molécule est résolue. Nous avons déterminé les valeurs des paramètres magnétiques hyperfins $a-(b+c)/2$ et d , et nous avons estimé la densité projetée de C₅H.

Letter to the Editor

Detection of the hyperfine structure of the C₅H radical

J. Cernicharo^{1,2}, M. Guélin², and C. M. Walmsley³

¹ Groupe d'Astrophysique, Observatoire de Grenoble, Université Scientifique Technologique et Médicale de Grenoble, CERMO, BP68, F-38402 St. Martin d'Hères Cedex, France

² IRAM, Domaine Universitaire de Grenoble, Voie 10, F-38406 St. Martin d'Hères, France

³ Max-Planck-Institut für Radioastronomie, Auf dem Hügel 69, D-5300 Bonn 1, Federal Republic of Germany

Received October 21, accepted November 22, 1986

SUMMARY

We report the detection in TMC1 of the J=9/2-7/2 transition of C₅H, the radical recently discovered by Cernicharo et al. (1986a). The hyperfine structure of this reactive species is resolved for the first time. We derive the values of the magnetic hyperfine parameters $a-(b+c)/2$ and d , and estimate the C₅H column density.

assumed to be 5.8 Jy. The autocorrelator was split in two halves, so that the + and - Λ -doubling components, which are separated by 3.9 MHz, could be observed simultaneously with a good spectral resolution (6.1 kHz, or 0.085 km s⁻¹). The resulting spectra are shown in Fig. 1 and the observed line parameters are given in Table 1.

Keywords: molecules-circumstellar matter

The rotational levels of the $^2\Pi_{1/2}$ state of C₅H are twice split into two, due to Λ -type doubling and magnetic dipole interactions (see Fig. 1). The Λ -doubling and magnetic hyperfine parts of the Hamiltonian have been derived for similar type molecules by several authors, and in particular by Dousmanis, Sanders and Townes, 1955 and, more recently, Brown et al. 1978. For heavy molecules like C₅H, for which the fine structure constant A is much larger than the rotational constant B ($A/B=296.4$, Gottlieb et al. 1986b), the energies associated with Λ -doubling and magnetic dipole interactions reduce, for the lowest rotational levels, to the diagonal matrix elements and take the simple forms:

$$W_{\Lambda} = \pm p'(J+1/2)/2 \quad (1)$$

$$W_{\text{hfs}} = [a' \pm d(J+1/2)][F(F+1) - I(I+1) - J(J+1)]/2J(J+1) \quad (2)$$

where $p' = (p+2q)$ is the effective doubling constant, $a' = a - (b+c)/2$ the effective magnetic hf constant and d the hyperfine doubling constant.

Equation (1) states that the Λ -doubling splitting of the rotational levels increases regularly with J . Equation (2) shows a more complex behaviour for the hyperfine splitting. The term in a' of (2) gives rise to identical hf structure for each member of the Λ doublet. The term in d gives rise to opposite contributions: the sign in front of d in (2) depends on the Λ doublet considered and is the same as the sign in front of p' in (1); it is positive for the Λ doublet components with $W_{\Lambda} = +p'(J+1/2)/2$, and negative for the others. Because of the term in d , the hf splittings between the upper and lower sublevels of same J are different. This difference also appears in the $\Delta J=1$ transition frequencies (see Fig. 1).

The number of allowed $\Delta J=1$ transitions originating from each Λ doublet of the $J=9/2$ level is three. Only two, those with $\Delta F=1$, are however strong enough to be detected (see Fig. 1). Their theoretical intensities are 55% ($F=5 \rightarrow 4$ component) and 44% ($F=4 \rightarrow 3$ component) of the total transition strength. Their frequencies can be calculated from relation (2) to be:

$$\nu^{\pm}(F=5 \rightarrow 4) = \nu_c \pm p'/2 + (-a' \pm d/2)/99 \quad (3)$$

and

$$\nu^{\pm}(F=4 \rightarrow 3) = \nu_c \pm p'/2 + (a' \pm d/2)/63 \quad (4)$$

where ν_c is the unsplit rotational frequency.

Observation of molecular lines in space offers an opportunity to study highly reactive species which are difficult to synthesize in the terrestrial laboratory. When such species are detected in low velocity dispersion sources, such as the dark cloud TMC1, the line frequencies can be measured so accurately, that it becomes possible to determine the spectroscopic constants with a precision comparable to the best laboratory works. A good example of spectroscopy "in space" is given by the cyanoethynyl and butadiynyl radicals (C₃N and C₄H), the rotational, rho-doubling, and hyperfine constants of which have been fully derived from astronomical observations (Guélin, Friberg and Mezaoui 1982) prior to these species being even detected in the laboratory. To date, even though we have learned how to synthesize C₃N and C₄H in the laboratory (Gottlieb et al. 1983), the astronomical measurements remain the only ones capable of resolving their hyperfine structure. The knowledge of the magnetic hyperfine coupling constants of a family of radicals like CH, C₂H, C₃H, and C₄H, allows to study the localisation of the unpaired electron as molecular length increases (see e.g. Gottlieb et al. 1986a). In this Letter, we report the detection in TMC1 of the next member of the family, the pentynylidyne radical C₅H, and the first measurement of some of its hyperfine constants.

The observations were carried out in August 1986 with the Effelsberg 100-m radio telescope, equipped with the MPI K-band maser and the 1024 channel autocorrelator. We observed the J=9/2-7/2 transition of the $^2\Pi_{1/2}$ ground state of C₅H (Cernicharo et al. 1986a, Gottlieb, Gottlieb and Thaddeus 1986b) in the direction of the cyanopolyne emission peak in TMC1 ($\alpha = 4^{\text{h}} 38^{\text{m}} 38^{\text{s}}$, $\delta = 25^{\circ} 35' 45''$, 1950.0). At the frequency of this transition ($\nu=21.48$ GHz), the antenna half-power beamwidth is 42". The telescope pointing and focussing were checked every two hours on the radiogalaxy 3C123. For calibration purposes, we observed the planetary nebula NGC7027, whose flux was

Send offprint requests to: J. Cernicharo

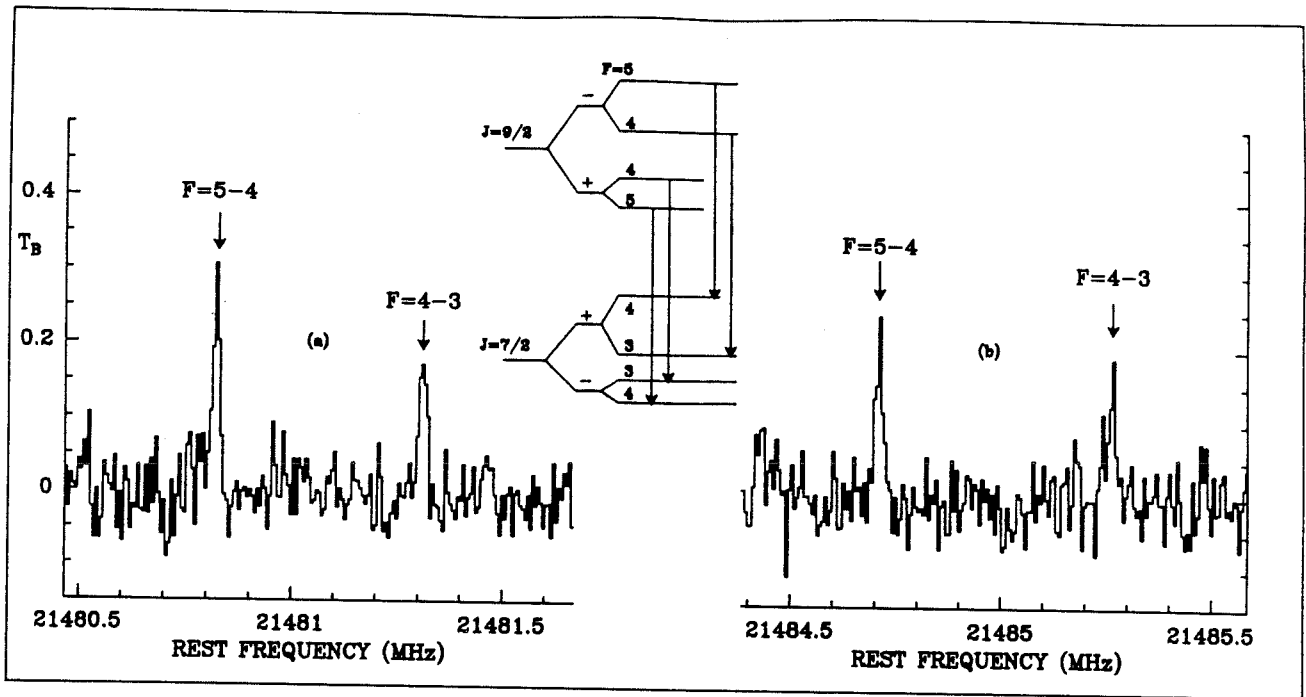

Figure 1: The four main hyperfine components of the $J=9/2-7/2$ transition of C_5H observed towards TMC1 ($\alpha=4^h 38^m 38^s, \delta=25^\circ 35' 45''$, 1950.0) with 6.1 KHz resolution. Ordinate scale is main beam brightness temperature.

The difference in line intensity between the $F=5+4$ and the $F=4+3$ hf components allows us to identify unambiguously these components on Fig. 1. The $F=5+4$ component having the lowest frequency, a' must be positive. From relations (3) and (4), we can easily compute the frequency difference between these components for each Λ doublet. We find $2[a'/77 \pm d/693]$. From the values of Table 1, we then derive: $a'=20.04 \pm 0.15$ MHz and $|d|=10.9 \pm 0.6$ MHz.

TABLE 1 : LINE PARAMETERS

Transition	Frequency (MHz)	$T_B \times \Delta v$ $K \times km \times s^{-1}$	Δv $km \times s^{-1}$
$J=9/2-7/2$ F=5-4 a	21480.823(1.1)	0.077(7)	0.26(3)
F=4-3	21481.312(1.7)	0.057(7)	0.28(5)
F=5-4 b	21484.710(1.3)	0.066(7)	0.29(4)
F=4-3	21485.262(2.5)	0.057(9)	0.41(8)

notes:

The line parameters are derived from a gaussian fit. The temperatures are brightness temperatures averaged over the main beam. Rest frequencies have been calculated for a source LSR velocity of 5.8 km s^{-1} (the uncertainty on this value, $+0.3 \text{ km s}^{-1}$, yields an additional uncertainty of $\approx 20 \text{ kHz}$ on the absolute rest frequencies).

The parameter d must be positive, since it has the sign of μ_z , the magnetic momentum of the H nucleus. We indeed derive a positive value, if we assume that the sign in front of d , in relations (3) and (4), is positive for the upper frequency doublet of Fig. 1 and negative for the lower frequency doublet. Since this sign is the same as that in front of p' , we can conclude that $p'=(p+2q)$ is also positive. The signs of the absolute values have been derived by Gottlieb et

al. (1986a), are then respectively positive and negative.

For an optically thin line and a dipole moment of 4.3 D (Francoise Puzat, private communication), the column density of C_5H molecules in the $J=7/2$ level is $\approx 2.1 \times 10^{11} \text{ cm}^{-2}$. If we assume a thermal distribution with a rotational temperature of 10 K (similar to that of HC_3N , Tölle et al., 1981), we derive $N(C_5H)=3.5 \times 10^{12} \text{ cm}^{-2}$. Adopting the HC_3N column density derived by Tölle et al (1981) with the same telescope, the $N(HC_3N)/N(C_5H)$ ratio is found to be ≈ 30 . This value is close to that derived by Cernicharo et al. (1986b) towards IRC+10216 (≈ 40). For a total hydrogen column density $N(H_2)=10^{22} \text{ cm}^{-2}$ (Cernicharo and Guélin, 1986), the fractional abundance of C_5H is 3.5×10^{-10} , about 100 times smaller than that of C_4H (Guélin, Friberg and Mezaoui 1982).

REFERENCES

- Brown, J. M., Kaise, M., Kerr, C. M. L., Milton, D.J.: 1978, *Molecular Phys.*, **36**, 553.
 Cernicharo, J., Kahane, C., Gómez-González, and Guélin, M.:1986a, *Astron. and Astrophys.*, **164**, L1.
 Cernicharo, J., Kahane, C., Gómez-González, and Guélin, M.:1986b, *Astron. and Astrophys.*, **167**, L5.
 Cernicharo, J., and Guélin, M.:1986, *Astron. and Astrophys.*, in press.
 Dousmanis, G.C., Sanders, T.M., and Townes, C.H.:1955 *Phys. Rev.*, **100**, 1735.
 Gottlieb, C. A., Gottlieb, E. W., Thaddeus, P., and Kawamura, H.:1983, *Ap. J.*, **275**, 916.
 Gottlieb, C. A., Gottlieb, E. W., Thaddeus, P., and Vrtilik, J. M.:1986a, *Ap. J.*, **294**, L55.
 Gottlieb, C. A., Gottlieb, E. W., Thaddeus, P.:1986b, *Astron. and Astrophys.*, **164**, L5.
 Guélin, M., Friberg, P., Mezaoui, A.:1982, *Astron. and Astrophys.*, **109**, 23.
 Tölle, F., Ungerechts, H., Walmsley, C.M., Winnewisser, G., Churchwell, E.:1981, *Astron. and Astrophys.*, **95**, 143.

II.11) DETECTION D'UN RADICAL LOURD DANS IRC+10216 : LE

RADICAL C₆H ?.

II.11) DETECTION D'UN RADICAL LOURD DANS IRC+10216 : LE
RADICAL C₆H ?.

Avec le radiotélescope de 30-m de l'IRAM nous avons détecté six nouveaux doublets et deux raies, dans le spectre millimétrique de l'étoile IRC+10216. Nous les avons identifiés comme étant les transitions $J=53/2-51/2$, et $J=59/2-57/2, \dots, 71/2-69/2$ d'une nouvelle molécule "non terrestre" dans un état électronique $^2\Pi$. Ce nouveau radical a une constante de rotation effective de 1386.245 MHz et doit contenir cinq ou six atomes lourds. Les transitions centimétriques de cette molécule ont été observées dans TMC1, un nuage sombre froid connu comme une source riche en longues molécules carbonées. Nous identifions le nouveau radical comme étant C₆H.

Detection of a heavy radical in IRC + 10216: The hexatriynyl radical C₆H?

M. Guélin¹, J. Cernicharo^{1,2}, C. Kahane³, J. Gomez-Gonzalez^{1,3}, and C. M. Walmsley⁴

¹ IRAM, Domaine Universitaire de Grenoble, Voie 10, F-38406 St. Martin d'Hères, France, and Av. Divina Pastora 7, Granada, Spain

² Groupe d'Astrophysique, Université de Grenoble, CERMO, BP 68, F-38402 St. Martin d'Hères Cedex, France

³ Centro Astronomico de Yebes, OAN, Apartado 148, E-19080 Guadalajara, Spain

⁴ Max-Planck-Institut für Radioastronomie, Auf dem Hügel 69, D-5300 Bonn 1, Federal Republic of Germany

Received December 18, 1986, accepted January 17, 1987

Summary. Six line doublets and two related lines, discovered with the IRAM 30 m telescope in the millimetre-wave spectrum of IRC+10216, are identified as the $J=26.5 \rightarrow 25.5$ and $J=29.5 \rightarrow 28.5$ through $35.5 \rightarrow 34.5$ rotational transitions of a new "non terrestrial" molecule in a $^2\Pi$ state. The new radical has an effective rotation constant of 1386.245 MHz and is thought to contain 5-6 heavy atoms. It is observed at centimetre wavelengths in TMC1, a cold interstellar cloud, known to be rich in carbon chain molecules. We identify it with C₆H.

keywords: radio lines : molecular; stars : circumstellar matter; interstellar medium : molecules.

Since the discovery of the heavy radicals C₃N and C₄H in the envelope of the carbon star IRC+10216 (Guélin and Thaddeus 1977, Guélin et al. 1978), it has become clear that many reactive species can be detected in space. First of all, C₅N and C₆H.

The radicals C₃N and C₄H have an electronic structure very like those of cyanoacetylene (HC₃N) and diacetylene (HC₄H), and are probably formed together with these stable species (see e.g. Kroto et al. 1986). Similarly, C₅N and C₆H are linked with HC₃N and HC₆H, the next members of the cyanopolyyne and polyacetylene families, and should have related abundances. In IRC+10216, the abundance of cyanopolyynes decreases slowly from HC₃N to HC₁₁N; a similar behaviour is expected for the carbon chain radicals. In fact, the abundances of C₃N and C₄H are only a factor of ~5 smaller than those of CN and C₂H and are still quite large. C₅N and C₆H should not be much less abundant than these species; they should be detectable if they are polar molecules. The same reasoning, based on the observed abundance of C₃H (Thaddeus et al. 1985), had convinced us previously that C₅H could also be detected.

Neither C₅N nor C₆H have been observed so far in the laboratory (and this was the case for C₅H prior to our work). The observation of these species in space, besides yielding clues to the carbon chain chemistry, offers the possibility of deriving basic spectroscopic data on a remarkable family of

radicals. In a previous Letter (Cernicharo et al. 1986), we reported the discovery of C₅H. In this Letter, we report that of a heavier radical which may be C₆H.

The observations were made between October 1985 and May 1986 with the IRAM 30m telescope at Pico Veleta, Spain. The telescope characteristics and the observing procedure have been described previously (Guélin et al. 1986). The pointing accuracy was better than 5", or 1/5 of the antenna beam (HPBW= 25" at 90 GHz); the temperature scale (T_a*, the effective SSB antenna temperature above the atmosphere) should be correct to within 20%.

The linear open shell radicals C₅N and C₆H have a millimetre spectrum consisting of regularly spaced doublets with doublet separations of about 2.8 GHz (see below and Table 2). In order to cover several doublets of each species, we surveyed four 5 GHz-wide frequency bands in the 3mm spectrum of IRC+10216. During these observations, we discovered a number of new lines, among which three regular series of doublets which we couldn't assign to any known interstellar or terrestrial molecule. Two of these doublet series were assigned to two new open shell radicals, one of which is C₅H (Cernicharo et al. 1986, Guélin et al. 1986). The evidence for the third series is presented in Fig. 1.

It consists of 6 doublets of roughly similar intensity, with centre frequencies almost exactly in the ratio of half integer numbers and with doublet splittings regularly increasing with frequency (Table 1). Despite the high harmonic numbers involved, and despite the high density of weak lines in the spectrum of IRC+10216, the precise harmonic relation between the centre frequencies leaves no doubt that the doublets belong to a single molecule: this relation holds to better than $2 \cdot 10^{-5}$ and the residuals vary in a systematic way. In fact, we had detected only 8 lines when we first noticed the harmonic relation. Later, coming back to the telescope, we were able to find 6 more lines at the predicted frequencies (another line, at 87331 MHz, cannot be observed as it is coincident with the strong N₂J,F=1,3/2,1→0,1/2,0 line of CCH).

The harmonic relation, which tells us that the centre frequencies are the 26.5th and the 29.5th through 35.5th multiples of a common $2B_{eff} = 2772.5$ MHz frequency, implies

L6

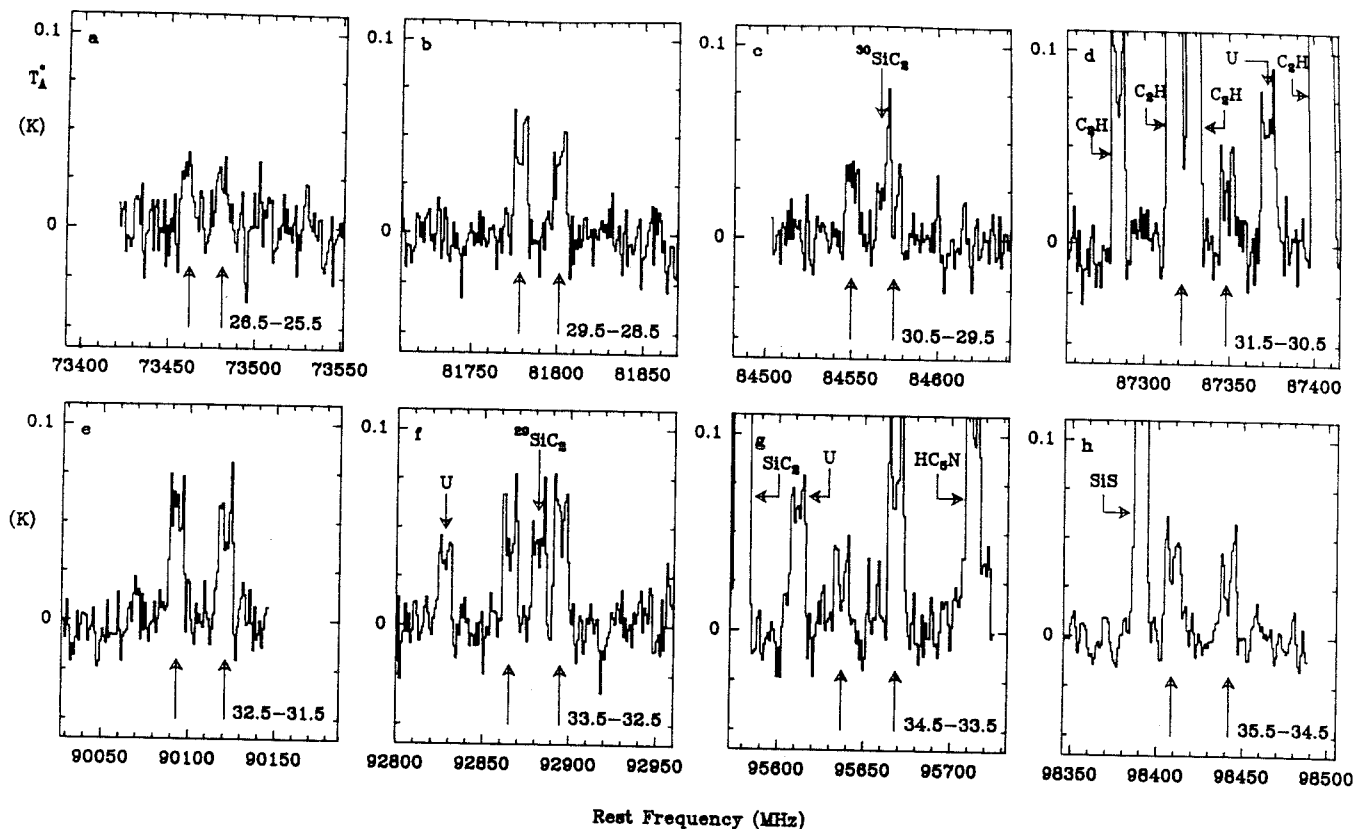

Fig. 1. Eight spectra, with centre frequencies in ratios of half-integer numbers, observed toward IRC+10216 with the IRAM 30-m telescope. The line doublets, indicated by vertical arrows, are rotational transitions of a heavy linear radical in a 2Π state, identified with C_6H . They all belong to the signal sideband. Some of the other lines lie in the image sideband.

that the doublet carrier is linear. As we failed to detect any related doublet between those of Fig. 1 (in particular at half the doublet separation), we know they are successive rotational transitions with half-integer J numbers. This means that the new molecule has an odd number of electrons and, very probably, a 2Π ground state. It also tells us that the effective rotation constant is 1386.2 MHz and that the moment of inertia is close to $364 \text{ amu} \cdot \text{Å}^2$: a heavy molecule, indeed!

In Table 2, we have compared the rotation constants observed for linear carbon chain radicals with those calculated from standard covalent bond lengths. That both sets of values are so close is a puzzling, but well known result (see e.g. Guélin and Thaddeus 1977, Cernicharo et al. 1986); it gives us some confidence that the constants of C_5N and C_6H can be predicted by this crude method with some accuracy. What is clear, going down the list of Table 2, is that the addition of an extra C atom to the carbon backbone changes the rotation constant by roughly a factor of two. This change is much larger than any one resulting from the substitution of a C atom by an N atom (or an O atom), or from the addition of an

extra H atom, so that, provided the new molecule is composed only of abundant elements (H, C, N and O --this latter being unlikely as it is locked into CO in the envelope of IRC+10216), the knowledge of the rotation constant fixes the number of C,N,O atoms to be six.

There are not many species composed of H,C and N (or even O) having an odd number of electrons and a linear backbone consisting of 6 heavy atoms. The most obvious are C_5N (and its isomer C_4NC) and C_6H . From Table 2, we see that the rotation constants predicted for C_5N and C_4NC seem large with respect to the observed value (although the accuracy of the prediction is not sufficient to rule out these species); the rotation constant of C_6H , on the other hand, is just right. Also on abundance grounds, C_6H stands out as the most attractive candidate: just as C_4H is more abundant than C_3N and $CCNC$, C_6H is likely to be more abundant than C_5N and much more abundant than C_4NC (neither C_2NC , nor even HC_2NC have been detected so far). C_6H would be the obvious choice, if it were not for one point: by analogy to C_4H and C_3N , the radicals C_6H and C_5N are expected to have a 2Σ ground state.

Before discussing in more detail the question of the ground state, let us see if other species could fit the observational data. Besides H, C, N and O, sulfur and silicon have been observed in the envelope of IRC+10216. Sulfur, is observed only in CS and SiS and is probably mostly locked into these two species (just as oxygen is locked into CO and SiO). Silicon, in contrast, is observed in 4, maybe 5 molecules, and is likely to be present in others. Assuming our molecule contains one silicon (or sulfur) atom, it can have the proper moment of inertia only if it also contains 4 (and only 4) second row atoms (probably C or N atoms). For stability reasons, silicon (or sulfur) would be likely to be located at the end of the heavy atom backbone, as indicated by quantum mechanical calculations on smaller compounds. This suggests HC₄Si which, by analogy with C₅H, could have a ²Π ground state (see however Guélin et al. 1986) and for which we derive a rotation constant (1390 MHz) very close to the observed one. Species like NC₃Si, HC₄S or NC₃S would also fit reasonably well, but seem less likely to be abundant.

To help to decide between C₅N, C₆H and a silicon compound, we have searched for the new molecule in the dark cloud TMC1, which is known to be rich in carbon chain molecules and radicals (C₄H and C₅H are there quite strong) and which is so cold that all silicon atoms must be condensed on grains. Because the temperature is low, the 3mm transitions are hardly excited, as they involve rotational levels with energies > 50 K. We have thus searched for a lower transition, namely the J=7.5→6.5 transition, at 20.8 GHz. This low-J transition, besides being easy to excite and yet reasonably strong, has the advantage that its hyperfine structure starts to be resolved in a source like TMC1 which has a low velocity dispersion.

In an open-shell molecule like C₆H, the presence of an unpaired electron and of a nucleus with non-zero spin gives rise to hyperfine structure: each of the two lambda-doubling components of the C₆H J=7.5→6.5 transition are split into 3 lines with relative intensities 1/0.87/0.01. For C₅N, however, the corresponding components are split into 5, because the N nucleus has a spin of 1, and their relative hyperfine intensities are 1/0.87/0.76/0.01/0.01. Therefore, the observation of the hyperfine components and the measurement of the line intensities can, in principle, allow us to distinguish between H- and N-bearing species.

The 20 GHz observations were made with the Effelsberg 100m telescope. The observed profile consists of 4 line components grouped in two sets of two, with intensities in the ratios ≈ 1/0.9 (see Table 3). The center frequency of the 4 lines is 20793.69 MHz and the spacing between the two sets 1.57 MHz, values which agree precisely with the center frequency and lambda-doubling splitting we predict from the fit of the new molecule's 3mm data. Since there are not many lines as strong as 0.4 K in the 1 cm spectrum of TMC1, we are sure that the 4 lines are those we were seeking.

TABLE 1 : LINE PARAMETERS

J _u	J _l	Observ. Freq. (MHz)	Obs-Calc (MHz)	Split (MHz)	Intensity (K)
source: IRC+10216 (α ₁₉₅₀ = 9 ^h 45 ^m 14.8 ^s , δ ₁₉₅₀ = 13°30'40"; V _{lsr} = -27 km.s ⁻¹)					
35.5	34.5	98441.7 (0.5)	-0.1	32.8	0.035
		98408.9 (0.4)	+0.3		0.04
34.5	33.5	95668.3 (0.6)*		31.7	0.09*
		95636.6 (0.3)	-0.3		0.045
33.5	32.5	92894.9 (0.3)	0.0	29.7	0.06
		92865.2 (0.3)			0.05
32.5	31.5	90121.4 (0.5)	0.0	28.4	0.055
		90093.0 (0.4)	-0.3		0.05
31.5	30.5	87348.3 (0.5)	+0.4		0.045
		-----			----
30.5	29.5	84574.5 (0.5)*	0.0	24.6	0.03
		84549.9 (0.4)	+0.2		0.04
29.5	28.5	81801.1 (0.3)	-0.1	23.0	0.04
		81778.1 (0.3)	+0.2		0.05
26.5	25.5	73480.5 (1.0)	-0.7	20.5	0.03
		73460. (1.0)	-2.2		0.035
source: TMC1 (α ₁₉₅₀ = 4 ^h 38 ^m 38.0 ^s , δ ₁₉₅₀ = 25°35'45"; V _{lsr} = 5.8 km.s ⁻¹)					
7.5	6.5	20794.511			0.38
		20794.441			0.37
		20792.944			0.36
		20792.872			0.40

* Blended line components

Taken together, the centimetre and millimetre line frequencies can be fitted accurately by the relation:

$$\nu(J \rightarrow J-1) = 2B_{\text{eff}}J - 4D_{\text{eff}}J^3 \pm (q_1 J + q_2 J^2) / 2 \quad (1),$$

which is a simplified form of the general relations derived for ²Π molecules by Hill and Van Vleck and Mulliken and Christy (e.g. Townes and Schawlow 1975); relation (1) was shown to fit adequately the rotational levels of C₅H (Cernicharo et al. 1986, Gottlieb, Gottlieb and Thaddeus 1986).

We derive: $B_{\text{eff}} = 1386.2449 (\pm 6 \cdot 10^{-4})$ MHz

$D_{\text{eff}} = -10.4 (\pm 1)$ Hz

$q_1 = 15 (\pm 4)$ kHz

and $q_2 = 26.1 (\pm 3)$ kHz.

For J as large as 30, fine structure stretching terms are expected to become important even for the Π_{1/2} fine structure state. Hence, although we find that q₂ is larger than q₁, it is not possible to determine from the present data which of the ²Π_{1/2} or ²Π_{3/2} state we have observed.

The detection of the new radical in TMC1 and the strength of the lines strongly supports the case of C₆H. First, it seems to rule out all silicon compounds. Second, it favors C₆H with respect to C₅N, since C₄H is very abundant in that source (a factor of 30 more abundant than C₃N ---Guélin, Friberg and

Mezaoui 1982): at centimetre wavelengths our 0.4 K lines are second in strength only to those of HC₃N, HC₅N and C₄H; if they were to arise from C₅N, this species would have to be more abundant than C₃N. Finally, the number of hyperfine components which are observed also strengthens the case for C₆H against C₅N.

Except for its apparent ground state, C₆H stands out in every respect as the best candidate for our new radical. It thus seems reasonable to query whether this ground state has really to be the same as in C₄H. We know, from quantum mechanical calculations (Pauzat and Ellinger, private communication), that the lowest electronic Π states of CCH and C₄H do not lie much higher than the Σ ground state. The energy difference between the ground Σ and the Π state decreases strongly from CCH to C₄H and is expected to change sign for longer members of the (CC)_nH family. In fact, Pauzat and Ellinger (private communication) find from preliminary RHF calculations that both states are close for C₆H, and that the $^2\Pi_{3/2}$ state lies ≈ 6 kcal/mole below the Σ state.

Additional support for C₆H comes from the value of its permanent dipole moment. This is sensitive to the localisation of the unpaired electron and differs considerably between the Π and Σ states. Pauzat and Ellinger derive from their calculations a large dipole moment ($\mu = 4.3$ D) for the lowest Π state of C₆H, and a small one (0.9 D) for the nearby Σ state; for C₅N they find on the other hand that the Π state has by far the smallest dipole moment: 0.07 D, vs 3.2 D for the Σ state. (The uncertainty in these values should be rather small, since, for a given state, the dipole moment is not sensitive to the final bond length optimisation.) As the line strengths scale with μ^2 , the Π state of C₅N should not be detectable and it seems clear that our $^2\Pi$ radical cannot be C₅N. In contrast, the large μ value of the Π state of C₆H means that this state will be detected preferentially.

TABLE 2: OBSERVED AND CALCULATED ROTATION CONSTANTS (In MHz)

molecule	B ₀ (observed)	B ₀ (calc.)	(B ₀ -B _{calc})/B ₀
C ₃ H	11186	11140	0.4 %
C ₄ H	4759	4784	0.1 %
C ₅ H	2395	2377	0.9 %
C ₆ H	1386 (?)	1388	0.2 %
C ₂ N	11938	12314	3 %
C ₃ N	4948	4963	0.3 %
C ₄ N		2418	
C ₅ N		1398	

Bond lengths adopted in the calculations are (in Å) :

C-C 1.37; C=C 1.21; C=N 1.16; C-H 1.07;

In summary, we have detected six doublets and two related lines in the millimetre spectrum of IRC+10216. They are successive rotational transitions of the $^2\Pi$ state of a linear radical with a rotation constant $B_{\text{eff}} = 1386$ MHz. This radical has not been observed so far in the laboratory and it is not observed in the molecular source Orion KL. We have detected its $J=7.5 \rightarrow 6.5$ transition in the dark cloud TMC1: each lambda-doubling component of this low-J transition is resolved into 2 hyperfine lines. The rotation constant, the line intensities and the number of hyperfine lines agree with those expected for the free radical C₆H. Contrary to C₄H, this latter is expected from preliminary *ab initio* calculations to have a $^2\Pi$ ground state. Other obvious molecules which could have the right rotation constant are C₅N and HC₄Si, but both are ruled out by our TMC1 observations. Other possible species would be HC₄S or more exotic compounds with cosmically unimportant elements, but none of these seems likely.

The present observational data are so much in favor of C₆H, that we conclude that we have probably detected the hexatriynyl radical. A definitive answer on whether this identification is correct may come from laboratory studies.

We thank F. Pauzat and Y. Ellinger for having communicated to us the preliminary results of their quantum mechanical calculations.

References

- Cernicharo, J., Kahane, C., Gomez-Gonzalez, J., and Guélin, M.: 1986, *Astron. Astrophys.*, 164, L1.
 Gottlieb, C.A., Gottlieb, E.W., and Thaddeus, P.: 1986, *Astron. Astrophys.*, 164, L5.
 Guélin, M., and Thaddeus, P.: 1977, *Ap. J. Letters*, 212, L81.
 Guélin, M., Green, S., and Thaddeus, P.: 1978, *Ap. J. Letters*, 224, L27.
 Guélin, M., Friberg, P., and Mezaoui, A.: 1982, *Astron. Astrophys.*, 109, 2.
 Guélin, M., Cernicharo, J., Kahane, C., and Gomez-Gonzalez, J.: 1986, *Astron. Astrophys.*, 157, L17.
 Kroto, H.W., Heath, J.R., O'Brien, S.C., Curl, R.F., and Smalley, R.E.: 19, *Ap. J.*, in press.
 Thaddeus, P., Gottlieb, C.A., Hjalmarsen, A., Johansson, L.E.B., Irvine, W., Friberg, P., and Linke, R.A.: 1985, *Ap. J. Letters*, 294, L49.
 Townes, C.H., and Schawlow, A.L.: 1975, *Microwave Spectroscopy*, Dover, New York.

Note added in proof:

We have succeeded in detecting in IRC+10216 a new series of doublets arising from the other fine structure state of our new radical. From the analysis of the complete data, we derive the radical's main spectroscopic constants and determine that the transitions reported in this Letter belong to the $^2\Pi_{3/2}$ state (Cernicharo et al. 1987, in preparation).

II.12) ETUDE DE LA STRUCTURE FINE ET HYPERFINE DE C₆H.

II.12) ETUDE DE LA STRUCTURE FINE ET HYPERFINE DE C₆H.

Nous avons détecté l'état $^2\Pi_{1/2}$ de structure fine du radical C₆H récemment découvert par Guélin et al. (voir II.08) dans IRC+10216. Nous avons aussi observé plusieurs nouvelles transitions de l'état $^2\Pi_{3/2}$. Ces données nouvelles (50 raies observées) nous ont permis de déterminer les constantes rotationnelles, ainsi que les constantes fines et hyperfines, de cette molécule. Nous avons estimé la densité projetée de C₆H à $3 \cdot 10^{14}$ cm⁻² dans IRC+10216 et à 10^{13} cm⁻² dans TMC1. Les rapports C₆H/C₅H dans ces deux sources sont respectivement de 2 et 3.

Letter to the Editor

C₆H: astronomical study of its fine and hyperfine structure

J. Cernicharo^{1,2}, M. Guélin², K. M. Menten³, and C. M. Walmsley³

¹ Groupe d'Astrophysique de l'Observatoire de Grenoble, Université Scientifique et Médicale de Grenoble, CERMO, BP 68, F-38402 St. Martin d'Hères Cedex, France

² IRAM, Domaine Universitaire de Grenoble, Voie 10, F-38406 St. Martin d'Hères, France

³ Max-Planck-Institut für Radioastronomie, Auf dem Hügel 69, D-5300 Bonn 1, Federal Republic of Germany

Received January 5, accepted April 14, 1987

Summary. We report the detection of the $^2\Pi_{1/2}$ fine structure state of C₆H the new radical discovered by Guélin et al. (1986a,1987) and Suzuki et al. (1986), as well as further observations of its $^2\Pi_{3/2}$ state. The new data, which consist of 50 lines, allow us to determine accurately the radical's rotation and distortion constants as well as its main fine and hyperfine parameters. We estimate the C₆H column density to be $3 \cdot 10^{14} \text{ cm}^{-2}$ in IRC+10216 and 10^{13} cm^{-2} in TMC1. The C₆H/C₅H abundance ratios are 2 and 3, respectively, in these two sources.

Keywords: radio lines: molecular, identification; stars: circumstellar matter; interstellar medium: molecules.

1 Introduction

Radio observations of interstellar and circumstellar sources have revealed a number of reactive molecules unfamiliar on earth. The most recent, a heavy linear radical in an $^2\Pi$ state discovered by Guélin et al. (1986a, 1987) in IRC+10216 and TMC1 and Suzuki et al. (1986) in TMC1, was tentatively identified with C₆H.

C₆H has not been observed in the laboratory and all the astronomical data, so far, have pertained to the lower fine structure state, presumably the $^2\Pi_{3/2}$ state. Its fine structure and rotation constants were only crudely known. In this Letter, we report the detection of the upper fine structure state, as well as high spectral resolution-high sensitivity observations of the $J = 15/2 \rightarrow 13/2$ and $J = 17/2 \rightarrow 15/2$ transitions of the $^2\Pi_{3/2}$ state.

2 Observations

The millimetre-wave observations were made between October 1985 and December 1986 with the IRAM 30-m telescope (see e.g. Guélin et al. 1986b for the observing procedure and telescope characteristics). The pointing accuracy was better than 5", or 1/5th of the antenna HPBW. The millimetre line temperatures reported here are effective SSB antenna temperatures above the atmosphere, T_A^* (T_A^* is related to the main beam-averaged brightness temperature T_B by $T_A^* \approx 0.6T_B$). Altogether, we observed in IRC+10216 42 lines from 26 rotational transitions of the $^2\Pi_{1/2}$ and $^2\Pi_{3/2}$ states. The line parameters are given in Table 1. Some of the spectra are presented in Fig. 1 (see also Fig. 1 of Guélin et al. 1987).

The centimetre-wave observations were carried out in August and October 1986 with the Effelsberg 100-m telescope, equipped with the MPI K-band maser and a 1024 channel autocorrelator. The telescope pointing and focussing were checked every two hours on 3C123; the temperature scale (T_B , the main-beam brightness temperature) was fixed assuming a flux of 5.8 Jy for NGC7027. The telescope angular resolution was $\approx 40''$, the

spectral resolution 6.1 kHz ($\approx 0.08 \text{ km s}^{-1}$).

The two spectra observed in TMC1 at the position of the cyanopolyne emission peak ($\alpha = 4^{\text{h}}38^{\text{m}}38^{\text{s}}$, $\delta = 25^{\circ}35'45''$, 1950.0) are shown in Fig. 2. They each consist of a pair of close doublets separated by 1.5-2 MHz (Table 2). The doublet identified with the $J = 8.5 \rightarrow 7.5$ transition of C₆H has also been observed by Suzuki et al. (1986), although with a lower frequency resolution. In addition to the lines we assign to C₆H we observe an unidentified feature at 20792.588 MHz.

Although we have not searched for the 1-cm transitions of the $^2\Pi_{1/2}$ state, we know from a low sensitivity frequency survey (Walmsley, unpublished data) that its $J = 17/2 \rightarrow 15/2$ lines in TMC1 are at least a factor of two weaker than those presented in Fig 2. This is consistent with our finding (see below) that the $^2\Pi_{1/2}$ spin component lies $\approx 13 \text{ cm}^{-1}$ higher in energy than the $^2\Pi_{3/2}$ component.

TABLE 1
C₆H LINES OBSERVED TOWARDS IRC+10216

Ju A	C ₆ H $^2\Pi_{3/2}$			C ₆ H $^2\Pi_{1/2}$		
	Obs. Freq. (MHz)	T_{dv} Kkms ⁻¹	O-C ⁺ (MHz)	Obs. Freq. (MHz)	T_{dv} Kkms ⁻¹	O-C ⁺ (MHz)
26.5 a	73460.7(10)	1.70(20)	-1.57	73967.7(3)	1.30(18)	+0.09
26.5 b	73461.2(10)	1.50(19)	-0.15	74008.5(3)	1.30(18)	-0.02
29.5 a	81778.1(4)	1.50(10)	+0.22	—	—	—
29.5 b	81801.1(4)	1.21(10)	-0.23	82384.5(5)	1.10(20)	+0.28
30.5 a	84550.0(4)	1.21(8)	+0.31	85131.1(4)	1.37(15)	+0.28
30.5 b	84574.7(5)	1.09(8)	+0.06	85178.0(4)	1.45(15)	+0.05
31.5 a	—	—	—	87921.7(3)	1.19(20)	+0.19
31.5 b	87348.3(4)	1.30(20)	+0.25	87967.7(3)	1.31(20)	+0.00
32.5 a	90093.0(3)	1.66(10)	-0.32	90712.2(3)	1.09(15)	+0.15
32.5 b	90121.4(3)	1.44(10)	-0.15	90759.3(3)	1.21(18)	-0.00
33.5 a	92865.2(3)	1.48(13)	+0.13	93502.2(10)	0.90(20)	-0.28
33.5 b	92894.9(3)	1.52(14)	-0.10	93550.9(5)	1.20(18)	+0.03
34.5 a	95638.8(4)	1.22(14)	-0.25	96292.5(3)	1.12(25)	-0.28
34.5 b	—	—	—	96342.4(3)	1.28(20)	-0.09
35.5 a	98408.9(3)	1.29(7)	+0.33	99083.2(5)	0.97(10)	+0.10
35.5 b	98441.7(3)	1.11(8)	-0.21	99133.8(5)	1.05(20)	-0.11
36.5 a	101180.3(3)	1.20(30)	+0.06	101873.6(10)	0.75(12)	+0.32
36.5 b	101215.0(15)	0.70(30)	-0.48	101925.2(7)	0.78(12)	-0.11
37.5 a	103951.9(4)	1.25(19)	-0.14	—	—	—
37.5 b	103989.0(4)	0.90(20)	-0.01	—	—	—
38.5 a	—	—	—	107453.2(3)	0.66(10)	-0.14
38.5 b	106762.7(3)	1.00(20)	+0.12	107507.9(4)	0.58(10)	-0.00
39.5 a	—	—	—	110243.4(10)	0.76(15)	+0.12
39.5 b	—	—	—	110229.8(10)	0.74(20)	+0.71
41.5 a	115038.4(7)	0.52(6)	-0.30	—	—	—
41.5 b	115084.0(7)	0.42(6)	+0.54	—	—	—

+) O-C is the observed minus calculated frequency (from the rotational constants of Table 3 "best fit")

Send offprint requests to: J. Cernicharo

L2

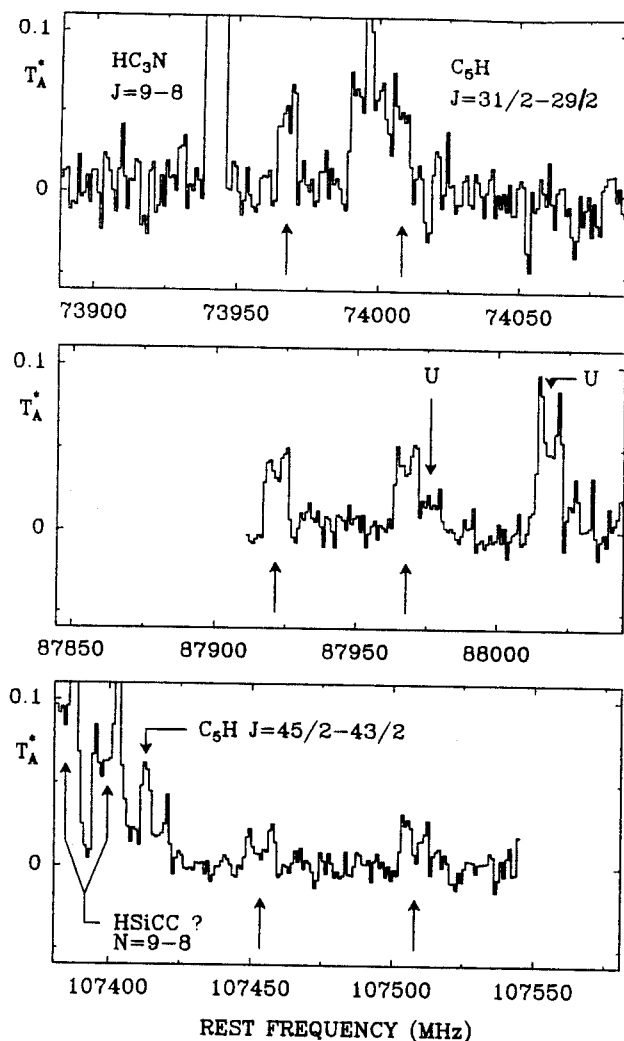

Figure 1: Three spectra, observed towards IRC+10216 with the IRAM 30-m telescope, showing the $J = 53/2 \rightarrow 51/2$, $J = 63/2 \rightarrow 61/2$, and $J = 77/2 \rightarrow 75/2$ rotational transitions of the ${}^2\Pi_{1/2}$ state of C_6H . The position of the Λ -doubling components, calculated for effective rotation and distortion constants $B_{eff} = 1396.134$ MHz and $D_{eff} = 95$ Hz, are marked by vertical arrows. The line at 88018 MHz is unidentified.

3 Spectroscopic Constants

We have least-squares fitted the 50 millimetre and centimetre lines frequencies of Tables 1 and 2 with the Hamiltonian of Brown et al. (1978) for ${}^2\Pi$ molecules (see e.g. Gottlieb et al. 1986 for the matrix elements). This Hamiltonian depends on 18 constants, only 9 of which are significant in the present study: the spin-orbit constant A , the rotation and distortion constants B and D , the lambda-doubling parameters p, p_d, q , and q_d , and the hyperfine (hf) constants $h = a + (b+c)/2$ and d . Due to the large moment of inertia of C_6H one need only consider the centrifugal distortion parameters D, p_d , and q_d .

We first assumed that the ${}^2\Pi$ state is regular; then that it is inverted. The spin-rotation constant γ , which is expected to be small (J. Brown, 1987, private communication) and is strongly correlated with A , was set a priori equal to zero: in this way, we determine an effective A value, A_{eff} , rather than A . As expected, the least-squares fit was excellent for the inverted case, the reduced standard deviation S (see e.g. Brown et al. *ibid*) being as low as 0.8 (a slightly better fit, with $S=0.5$, is obtained

TABLE 2
THE ${}^2\Pi_{3/2}$ TRANSITIONS OF C_6H OBSERVED TOWARDS TMC1

Transition $J-J'$	Λ^\dagger	$F-F'$	Frequency* MHz	$\int T_B dv$ Kkms $^{-1}$	Δv kms $^{-1}$	Notes
			20792.588	0.114	0.49	U line
7.5-6.5 a	8-7		20792.872	0.224	0.52	
		7-6	20792.944	0.167	0.43	R.I.=1:0.75
7.5-6.5 b	8-7		20794.441	0.181	0.46	
		7-6	20794.511	0.178	0.45	R.I.=1:0.98
6.5-7.5 a	9-8		23565.141	0.253	0.45	
		8-7	23565.213	0.253	0.45	R.I.=1:0.52
6.5-7.5 b	9-8		23567.162	0.232	0.39	
		8-7	23567.224	0.147	0.41	R.I.=1:0.63

*)The typical uncertainty on the frequencies is 20 KHz; it includes a of 0.3 km s $^{-1}$ uncertainty on the LSR velocity of TMC1. The spectral resolution of the observations is 6 KHz.
+)R.I. is the integrated intensity ratio of the hf components.
*)Transitions between lower (higher) energy Λ components are designated a (b) -Brown et al., 1975-

by allowing γ to vary; we find then: $\gamma = -147$ MHz and $A = -430.792$ GHz). The fit was 9 times worse ($S=6$) for the regular case, which confirms that the ${}^2\Pi_{3/2}$ state lies below the ${}^2\Pi_{1/2}$ one. The negative value of A is consistent with the ${}^2\Pi$ nature of the ground electronic state, which suggests that the dominant electronic configuration is $\dots(2p\sigma)^2(2p\pi)^3$. C_6H in this respect differs from C_3H and C_5H which both have a regular ground state (Gottlieb et al. 1986a, 1986b). The observed-calculated frequency differences are listed in Tables 1 and 2; the values derived for the spectroscopic parameters are given in Table 3. Not unexpectedly, our values of B , and D , which are based on extensive data from both fine structure states, differ from those of Suzuki et al. (1986), which result from an assumed value of A . They should be preferred.

The observed B is 2% higher than the equilibrium rotational constant calculated *ab initio* by Puzat and Ellinger (private communication 1987 - uncorrected value from URF calculations) and 1% higher than that of Murakami et al. 1987. The B_e value of C_6H calculated by Puzat and Ellinger, is lower than the observed B_0 by a similar amount (1.5 %). This gives one hope that empirically corrected *ab initio* values can yield the rotation constants of the next carbon chain radicals, C_7H and C_8H , with adequate accuracy. The distortion constant of C_6H is larger than that of HC_5N (30 Hz: Yamada and Winnewisser 1981) by

TABLE 3
ROTATIONAL CONSTANTS OF C_6H

	γ set to zero	"best fit"
A_{eff} (MHz)	-387372 (100)	-430792 (10000)
B_0 (MHz)	1391.2052 (15)	1391.1918 (30)
D_0 (Hz)	49 (1)	43.2 (12)
γ_{eff} (MHz)	0.0	-147 (30)
$p+2q$ (MHz)	27.34 (50)	27.65 (80)
q (MHz)	1.363 (15)	1.43 (2)
p_d+2q_d (kHz)	-2.61 (15)	-2.69 (26)
q_d (Hz)	-11 (10)	-10 (8)

The values in parenthesis denote two standard deviations.

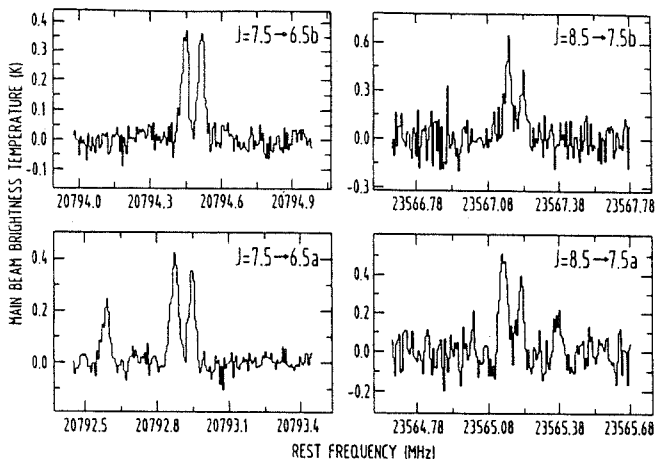

Figure 2 : The main hyperfine components of the $J = 15/2 \rightarrow 13/2$, and $J = 17/2 \rightarrow 15/2$ rotational transitions of the $^2\Pi_{3/2}$ state of C_6H , observed towards TMC1 with the Effelsberg telescope.

a factor of 1.5, which is close to the ratio between the distortion constants of C_4H and HC_3N .

The constant A of C_6H has about the same magnitude as that of the ground state of C_3H ; it is nearly twice as small as in C_5H . As expected, $\lambda = A/B$ is very large. Because we resolved the hf structure only for the $\Omega = 3/2$ ladder and because the hf splittings of Fig. 2 are only a few linewidths, we were not able to derive a, b and c , but only $h = a + (b + c)/2$, the diagonal hf-term of the Hamiltonian; for this, we assumed that b , the off-diagonal hf-term, is not much larger than h and does not contribute significantly to the observed splittings; we derive $h = 3.0 \pm 0.5$ MHz, a value similar to that of Suzuki et al. (1986). The hyperfine doubling constant d , which does not appear in the $\Pi_{3/2}$ diagonal term, is poorly determined ($d = 11 \pm 5$ MHz).

4 Abundance of C_6H

We give in Table 1 the integrated intensity ($\int T_A^* dv$) of the lines observed in IRC+10216, and in Fig. 3 we plot the log of the upper level column density per substate, $N_u / (2J + 1) = 3kW / 8\pi^3 S \mu^2 \nu$ expressed in cm^{-2} as a function of the upper level energy, $E_u = h/kBJ(J + 1)$. Here, J is the upper level quantum number, $W = 2 \int T_B dv$ is the sum of the velocity-integrated line brightness temperatures of the two -doubling components, $S = J$ is the line strength, and $\mu = 5$ D is the dipole moment of C_6H (as derived from CI calculations by Pauzat and Ellinger, private communication; see also Murakami et al. 1987). Source brightness temperatures were derived from the observed intensities by assuming a uniform source of size $25''$. Such a size is suggested by the line profiles of Fig. 1 (see also Fig. 1 of Guélin et al. 1987), which are flat-topped at 74 GHz (HPBW $30''$) and U-shaped at 107 GHz (HPBW = $22''$); it is similar to the size of the C_4H source derived by Guilloteau et al. (1987) with the 30m telescope. The data points of the $\Pi_{1/2}$ and $\Pi_{3/2}$ states can be fitted by two parallel lines, of slope $\log(e) / T_{rot} = 0.015 K^{-1}$: the populations of each state appear to follow a Boltzmann distribution with a rotation temperature $T_{rot} \approx 30$ K. The two states, however, are not in equilibrium at this temperature, since the cross-ladder temperature deduced from our data is much higher ($T_{cr} \geq 70$ K). A similar situation is observed for the 3mm transitions of C_5H , although T_{rot} is in the range 14-24 K (Cernicharo et al. 1986). Assuming the 30 K rotation temperature applies also to all rotational levels, we derive from Fig. 3 a C_6H column density (relative to a $25''$ source) of $\approx 3 \cdot 10^{14} cm^{-2}$ about equally distributed between the $^2\Pi_{3/2}$ state and the $^2\Pi_{1/2}$ state.

In spite of its relative complexity, C_6H is quite abundant in the envelope of IRC+10216. Large abundances are there a common feature of the linear carbon chain molecules and radicals. In Fig. 4, we show the dependence of these abundances on the number of heavy atoms. For the sake of simplicity, all column densities refer to a uniform source of size $25''$. Except for HC_7N (Winnewisser and Walmsley 1978) and $HC_{11}N$ (Bell et al. 1982), they are derived from unpublished 30-m telescope data, and, except for C_2H , CN and HCN (for which we have observed only one transition and have assumed $T_{rot} = 15$ K) have been calculated from rotational temperature diagrams similar to those of Fig. 3. As the lines of CN, HCN, HNC, and HC_3N are optically thick, the column densities of these species have been derived from their ^{13}C isotopes, by adopting a value of 47 for the $^{12}C/^{13}C$ abundance ratio (Kahane et al. 1987).

According to Fig. 4, C_6H is only slightly more abundant than C_5H ($1.5 \cdot 10^{14} cm^{-2}$ -note that the C_5H column density quoted by Cernicharo et al. 1986 is a factor of 9 too low), which is surprising since C_4H and C_2H are both 1-2 orders of magnitude more abundant than C_3H . The odd-even effect, whereby members of the C_nH sequence with an even number of C atoms are more abundant than members with an odd number, seems thus less apparent when one reaches C_5H and C_6H .

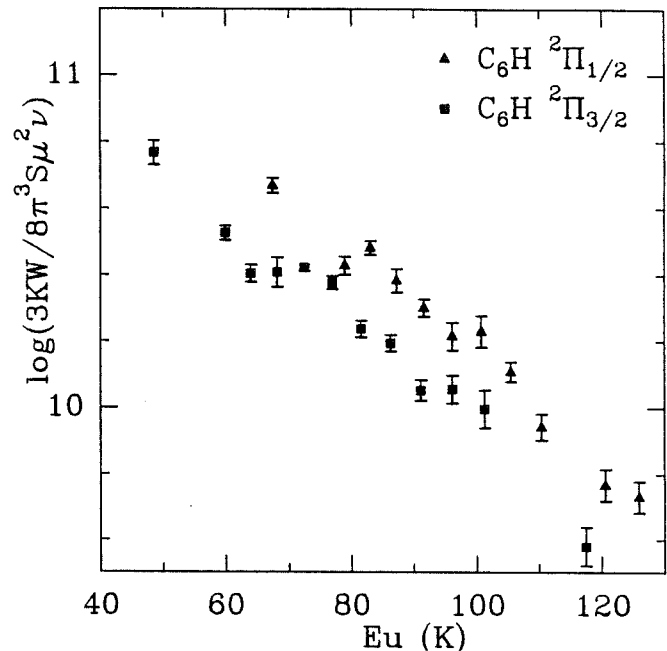

Figure 3 : Rotation temperature diagram of C_6H in IRC+10216. Each data point is the sum of the two Λ -doubling components.

In TMC1, our two measured transitions and our upper limit on the $^2\Pi_{1/2}$ state do not suffice to allow a useful estimate of the rotation and cross-ladder temperatures to be made. However, for T_{rot} and T_{cr} assumed to be in the range 7-9 K, we can derive a beam-averaged column density, N , using the optically thin case formula:

$$N = 0.7 \cdot 10^{16} \frac{T_{rot} T'_{rot}}{T'_{rot} - T_{bg}} (\nu \mu)^{-2} e^{E_u/kT_{rot}} \sum \int T_B dv \text{ cm}^{-2},$$

where $T' = h\nu/k (e^{h\nu/kT} - 1)^{-1}$,
i. e. $T'_{bg} = 2.2$ K, for $T_{bg} = 2.7$ K.

We have neglected the population of the $^2\Pi_{1/2}$ state, which lies 19 K above the $^2\Pi_{3/2}$ state. We find $N = 10^{13} cm^{-2}$ a column density a factor of 3 larger than that of C_5H (Cernicharo, Guélin and Walmsley, 1987). This is fairly insensitive to the choice of T_{rot} . We note that the C_6H column density derived by Suzuki et al. (1986) for an assumed $40''$ diameter source is an order of

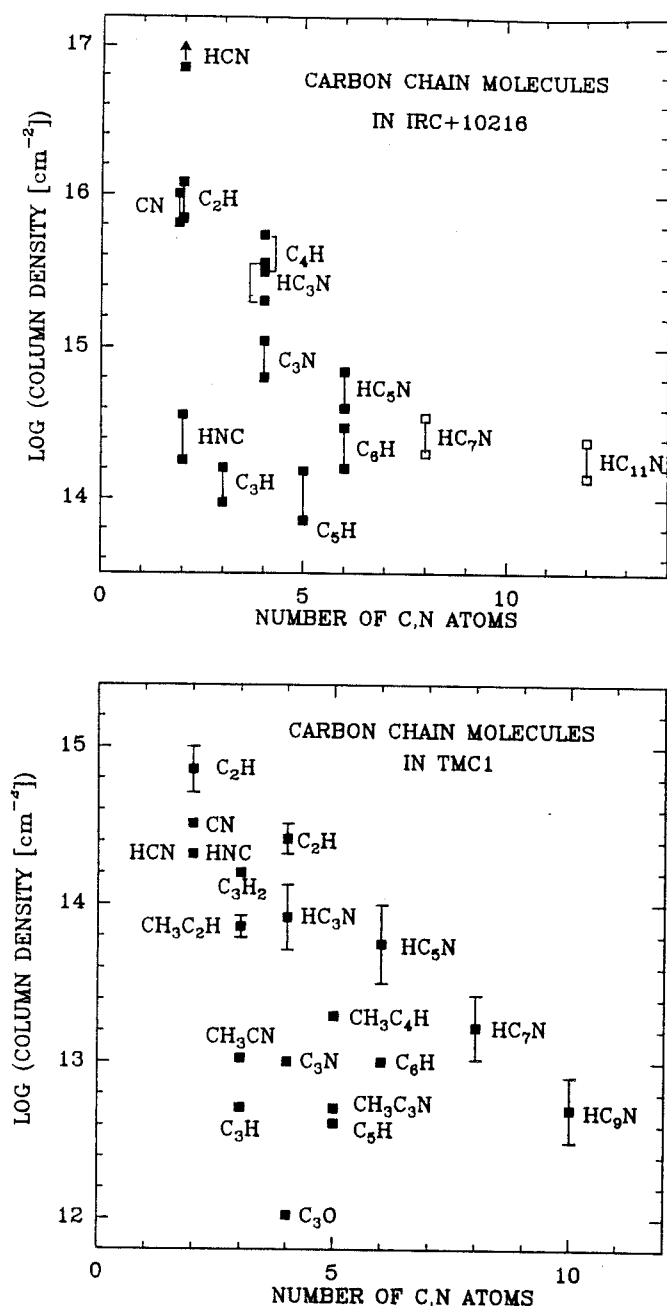
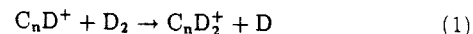

Figure 4 : a) Column density of carbon-rich species in IRC+10216 as a function of their number of heavy atoms. The column densities have been calculated for uniform-brightness sources of diameter 25" (upper squares) and 50" (lower squares). b) Column density of carbon-rich species in TMC1 as a function of their number of heavy atoms (the left part of the diagram is taken from Snyder et al., 1986)

magnitude smaller than ours. This discrepancy partly results from the lower strength of their lines. For a total hydrogen column density $N(\text{H}_2) = 10^{22} \text{ cm}^{-2}$ (Cernicharo and Guélin 1987), the fractional abundance of C_6H is $\approx 10^{-9}$. Figure 5, which is an extension of the diagram of Snyder et al. (1986), shows the dependence of the abundance on heavy atom number for several carbon rich species in TMC1. One sees that C_6H is much less abundant than HC_5N and (as in IRC+10216) the abundance contrast between species with odd and even numbers of carbon atoms is not so marked for $\text{C}_6\text{H}/\text{C}_5\text{H}$ as for $\text{C}_4\text{H}/\text{C}_3\text{H}$.

It seems likely that the long carbon chain radicals are formed by the dissociative recombination of acetylenic and related ions, such as C_5H_2^+ and C_6H_2^+ (see e.g. Leung et al. 1984, Millar and Nejad 1985). Even though the present chemical schemes do not really allow quantitative estimates, reactions of the type:



which have been observed to proceed faster for $n=4$ and 6, than for $n=5$ and 7 (Mc Elvaney et al. 1987), show one way in which the odd-even abundance contrast could be created. Reactions (1), which have rates well below the Langevin value, compete with radiative association pathways involving the reactions:

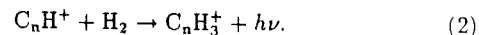

The rate of radiative association reactions is likely to increase with the carbon chain length (e.g. Herbst et al. 1984), so that reaction (2) may dominate and, possibly, smear off the odd-even contrast for the longer members of the series.

We thank F. Pauzat and H. Ellinger for communicating to us their results prior to publication and J.M. Brown and G. Winnewisser for comments on the manuscript.

5 References

- Bell, M. B., Feldman, P. A., Kwok, S. and Matthews, H. E.: 1982, *Nature*, **295**, 389.
- Brown, J. M., Kaise, M., Kerr, C. M. L., and Milton, D. J.: 1978, *Molec. Phys.*, **36**, 553.
- Brown, J. M.: 1987, private communication.
- Cernicharo, J., Kahane, C., Gómez-González, J., and Guélin, M.: 1986, *Astron. Astrophys. Letters*, **167**, L5.
- Cernicharo, J., Guélin, M., and Walmsley, C. M.: 1987, *Astron. Astrophys. Letters*, **172**, L5.
- Cernicharo, J., and Guélin, M.: 1987, *Astron. Astrophys.*, **176**, 299.
- Gottlieb, C. A., Gottlieb, E. W., and Thaddeus, P.: 1986a, *Astron. Astrophys. Letters*, **164**, L5.
- Gottlieb, C. A., Gottlieb, E. W., Thaddeus, P., and Vrtilik, J. M.: 1986b, *Astrophys. J.*, **303**, 446.
- Guélin, M., Cernicharo, J., Kahane, C., and Gómez-González, J.: 1986a, *Proc. Symposium "Molecules in Physics, Chemistry and Biology"*, Paris June 1986, ed. J. Maruani, D. Reidel Publ. Comp., Dordrecht, in press.
- Guélin, M., Cernicharo, J., Kahane, C., and Gómez-González, J.: 1986b, *Astron. Astrophys. Letters*, **157**, L17.
- Guélin, M., Cernicharo, J., Kahane, C., and Gómez-González, J.: 1987, *Astron. Astrophys. Letters*, **175**, L5.
- Guilloteau, S.: 1987, private communication.
- Herbst, E., Adams, N. G., and Smith, D.: 1984, *Astrophys. J.*, **285**, 618.
- Leung, C. M., Herbst, E., and Huebner, W. F.: 1984, *Astrophys. J. Suppl.*, **56**, 231.
- Mc Elvaney, S. W., Dunlap, B. I., and O'Keefe, A.: 1987, *J. Chem. Phys.*, **86**, 715.
- Millar, T. J., and Nejad, A. M.: 1985, *Mon. Not. R. astr. Soc.*, **217**, 507.
- Murakami, A., Kawaguchi, K., and Saito, S.: 1987, quoted by Suzuki et al. 1986.
- Snyder, L. E., Dykstra, C., Bernholdt, D.: 1986, in "Masers, Molecules, and Mass outflows in Star Forming Regions," ed. A. Haschick.
- Suzuki, H., Ohishi, M., Kaifu, N., Ishikawa, S., and Kasuga, T.: 1986, *Publ. Astron. Soc. Japan*, **38**, 911.
- Toelle, F., Ungerechts, H., Walmsley, C. M., Winnewisser, G., Churchwell, E.: 1981, *Astron. Astrophys.*, **95**, 143.
- Winnewisser, G., and Walmsley, C. M.: 1978, *Astron. Astrophys.*, **70**, L37.
- Yamada, K., and Winnewisser, G.: 1981, *Z. Naturforsch.*, **36a**, 1052.

**II.13) DETECTION DE L'ISOCYANURE DE METHYLE DANS LE CENTRE
GALACTIQUE.**

II.13) DETECTION DE L'ISOCYANURE DE METHYLE DANS LE CENTRE GALACTIQUE.

Nous avons détecté trois raies dans SgrB2 correspondant aux fréquences des transitions $J=4-3$, $J=5-4$, et $J=7-6$ de CH_3NC . Le rapport $\text{CH}_3\text{NC}/\text{CH}_3\text{CN}$ est ≤ 0.05 . La fréquence de la transition $J=5-4$ est proche de la transition $J=4-3$ de NaOH . Cependant, nous n'avons pas réussi à détecter les transitions $J=3-2$, $J=5-4$, et $J=6-5$ de NaOH ($T_A^* \leq 0.07 \text{ K}$).

Letter to the Editor

Tentative detection of CH_3NC towards Sgr B2J. Cernicharo^{1,2}, C. Kahane², M. Guélin¹, and J. Gomez-Gonzalez³¹ IRAM, Domaine Universitaire de Grenoble, Voie 10, F-38406 St. Martin d'Herès, France² Groupe d'Astrophysique de l'Observatoire de Grenoble, USTMG, CERMO, BP 68, F-38402 St. Martin d'Herès Cedex, France³ Centro Astronómico de Yebes, OAN, Apartado 148, Guadalajara, Spain

Received August 27, accepted September 16, 1987

Summary.

We report the detection in Sgr B2 of three millimetre lines at the frequencies of the $J=4\rightarrow 3$, $J=5\rightarrow 4$, and $J=7\rightarrow 6$ transitions of methyl isocyanide. If these lines arise from CH_3NC , the $\text{CH}_3\text{NC}/\text{CH}_3\text{CN}$ abundance ratio is ≈ 0.05 . The frequency of the $J=5\rightarrow 4$ line is close to that of the $J=4\rightarrow 3$ transition of NaOH. However, we don't find any signal at the expected frequencies of the $J=3\rightarrow 2$, $J=5\rightarrow 4$, and $J=6\rightarrow 5$ transitions of NaOH ($T_A^* \leq 0.07\text{K}$).

Keywords: molecules: lines - identification; interstellar medium: abundances.

The observation of chemically related isomers in interstellar clouds provides a crucial test of molecule formation schemes (e.g. DeFrees, 1987). Current models of gas phase chemistry in dense clouds (e.g. DeFrees et al. 1985) predict sizable abundances for the metastable isomers of HCN and CH_3CN , HNC and CH_3NC . So far, however, only HNC was detected. The weak spectral feature in TMC1, tentatively identified by Irvine and Schloerb with the $1_0 \rightarrow 0_0$ line of CH_3NC , was shown by Matthews and Sears (1986) to be spurious. Matthews and Sears derive an upper limit to the $\text{CH}_3\text{NC}/\text{CH}_2\text{CN}$ abundance ratio (0.05) which is 30 times smaller than HNC/HCN (Irvine and Schloerb 1984) and a factor of three smaller than the theoretical estimate of DeFrees et al. (1985). CH_3CN , however, is not very abundant in TMC1, and it was interesting to check whether the limit of 0.05 could be lowered, or CH_3NC be detected, in sources with different chemical characteristics. We report here the detection in Sgr B2 of three broadened lines which we identify with the $J=4\rightarrow 3$ through $7\rightarrow 6$ rotational transitions of CH_3NC .

The observations were made in May, August, and October 1986, and in March 1987 with the IRAM 30-m telescope at Pico Veleta, Spain. The telescope was equipped with 2 and 3-mm SIS receivers with DSB noise temperatures of 150 and 100 K. The pointing and focus were checked every two hours against the radio continuum sources Sgr B2(M), NRAO150 and 3C84. A 512 x 1 MHz channel spectrometer provided a velocity resolution of $\approx 3\text{ km s}^{-1}$ at 3 mm, and $\approx 2\text{ km s}^{-1}$ at 2 mm. Figure 1 shows the spectra observed in Sgr B2(OH) (1950 RA = $17^{\text{h}}44^{\text{m}}11^{\text{s}}$, Dec = $-28^{\circ}22'30''$) at the frequencies of the $J=4\rightarrow 3$, $J=5\rightarrow 4$, and $J=7\rightarrow 6$ lines of CH_3NC , and Figure 2 shows a spectrum centered on the $5\rightarrow 4$ line of $\text{CH}_3^{13}\text{CN}$. Figure 1a,b and Figure 2 were observed in the DSB mode, Figure 1c with a 12 dB rejection of the upper side band. The ordinate on both figures is T_A^* , the effective SSB antenna temperature above the atmosphere. The abscissa is rest frequency, for a source LSR velocity of 60 km s^{-1} for Figure 1 and 57 km s^{-1} for Figure 2. Main beam brightness temperature can be obtained from the antenna temperatures through the relation $T_B \approx T_A^*/0.6$.

Send offprint requests to: J. Cernicharo

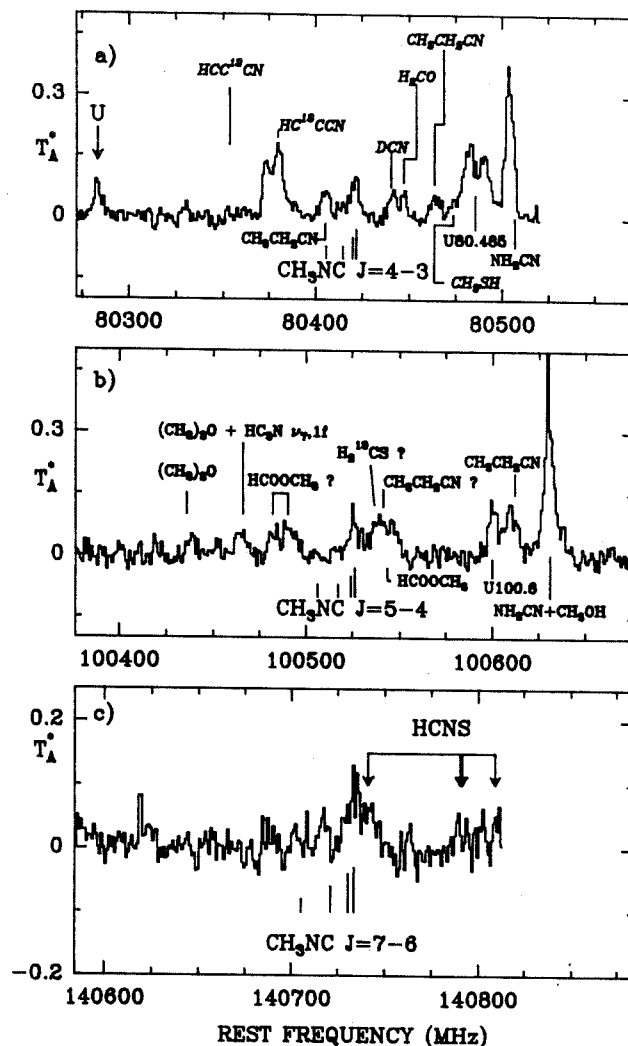

Figure 1. $J=4\rightarrow 3$, $J=5\rightarrow 4$, and $J=7\rightarrow 6$ transitions of CH_3NC observed towards Sgr B2(OH) with the IRAM 30-m telescope. The expected positions of the $K=0,1,2$, and 3 components of these transitions are indicated by vertical lines. The spectral resolution is 1 MHz. Lines in the image sideband are labelled in italics. The frequency scale is for a source LSR velocity of 60 km s^{-1} . Ordinate is antenna temperature, corrected for the atmosphere.

L2

The large density of spectral lines on Figure 1 and 2 makes difficult the identification of weak features. There is however compelling evidence that the three features at the centre of Figure 1 arise from CH_3NC . Firstly, for a source LSR velocity of $58\text{--}60\text{ km s}^{-1}$ equal to that derived from the CH_3CN and $\text{CH}_3^{13}\text{CN}$ lines (Table 1), the observed line peaks coincide in frequency with the $K=0$ and $K=1$ components of the CH_3NC rotational transitions. Secondly, these features have no plausible alternative assignment; yet, few lines remain unidentified in Figure 1 and 2. The $22(8,15)\text{--}23(7,16)$ transition of $\text{CH}_3\text{CH}_2\text{CN}$, which relates two levels of energy 170 K has a rest frequency of 140733 MHz , very close to the $J=7\text{--}6, K=0$ transition of CH_3NC (140734 MHz); ethyl cyanide is however unobundant in Sgr B2 and we couldn't detect in this source any transition with similar energy levels. We did not search for the $J=8\text{--}7$ transition of CH_3NC , the highest transition we could reach with our present SIS receivers, since it is blended with the strong and broad $10(0,10)\text{--}9(1,9)$ line of SO_2 .

The broad (30-MHz wide) feature adjacent to the line we identify with $\text{CH}_3\text{NC } J=5\text{--}4$ (Figure 1b) was first detected by Hollis and Rhodes (1982). These authors assigned it to the $J=4\text{--}3$ transition of NaOH and suggested, to explain its peculiar shape, that it is self-absorbed. This assignment appears incorrect since we could not detect the $\text{NaOH } J=3\text{--}2$ and $6\text{--}5$ rotational transitions down to a 3σ level of 0.07 K (a similar upper limit on the $J=5\text{--}4$ line intensity comes from Cummins et al. (1986) spectral survey). Hollis and Rhodes's feature on Figure 1 can be resolved into three partially blended lines: the $J=5\text{--}4$ CH_3NC line at 100525 MHz , the $3(1,2)\text{--}2(1,2)$ H_2^{13}CS line at 100535 MHz , and a line at $\approx 100542\text{ MHz}$, which might be HCOOCH_3 $12(1,11)\text{--}12(1,12)$ or $\text{H}62\sigma$, but which does not agree in frequency with NaOH (100529 MHz).

The $\text{CH}_3\text{NC}/\text{CH}_3\text{CN}$ abundance ratio, R , can be derived from the data of Figures 1 and 2. The intensity ratio derived by comparing the intensity of the blended $J=5\text{--}4, K=0$ and $K=1$ lines of CH_3CN to the average intensity of the $J=4\text{--}3$ and $5\text{--}4, K=0$ and 1 lines of CH_3NC is ≈ 0.05 . This ratio, strictly speaking, is an upper limit to the abundance ratio, R , as the CH_3CN line might be optically thick and the lines assigned to CH_3NC , conceivably, could still arise from unrelated molecules. As far as optical thickness is concerned, there are good reasons to believe that the CH_3CN line opacity is not large. The excitation temperature of the $\text{CH}_3\text{CN } 5\text{--}4$ line ($\geq 20\text{ K}$ according to Cummins et al. 1983) is large with respect to the observed line brightness temperature ($\approx 1.8\text{ K}$ above the continuum background). Moreover, our line intensity is not much different from that observed by Cummins et al. with a 20 times poorer resolution, so that clumpiness does not seem to affect Cummins et al's calculations, at least for the lowest K components. The $5\text{--}4$ transition lies high enough that strong absorption by cool foreground material seems unlikely. Finally, the $\text{CH}_3^{12}\text{CN}$ to $\text{CH}_3^{13}\text{CN}$ line intensity ratio we observe (≈ 15) is close to the $^{12}\text{C}/^{13}\text{C}$ isotopic ratio observed in Sgr B2 for many other molecules (e.g. Penzias, 1980). Since the dipole moments of CH_3NC and CH_3CN are about equal (3.89 and 3.93 D respectively, Römheld, 1978), we conclude that $R \leq 0.05$ and, probably, $R \approx 0.03\text{--}0.05$.

The HNC/HCN abundance ratio in Sgr B2 cannot be derived from these species' abundant isotopes, since their lines are optically very thick. Cummins, Linke and Thaddeus (1986) have observed the $1\text{--}0$ lines of the rare isotopes H^{13}CN , HN^{13}C

Table 1. Observed⁺ line parameters for CH_3NC , CH_3CN , and $\text{CH}_3^{13}\text{CN}$

Transition	$V_{\text{LSR}}(\text{km s}^{-1})$	$\Delta v(\text{km s}^{-1})$	$T_A^* dv$
$\text{CH}_3\text{NC } J=4\text{--}3$	60 ± 2.0	22.2 ± 2	2.7 ± 0.3
$\text{CH}_3\text{NC } J=5\text{--}4$	60 ± 1.5	19.7 ± 3	1.8 ± 0.2
$\text{CH}_3\text{NC } J=7\text{--}6$	58 ± 3.0	19.5 ± 2	1.9 ± 0.3
$\text{CH}_3\text{CN } J=5\text{--}4$	60 ± 2.0	27.0 ± 3	36.7 ± 2.0
$\text{CH}_3^{13}\text{CN } J=5\text{--}4$	57 ± 3.0	21.8 ± 2	2.4 ± 0.3

+) Gaussian fit to the $K=0$ and $K=1$ components

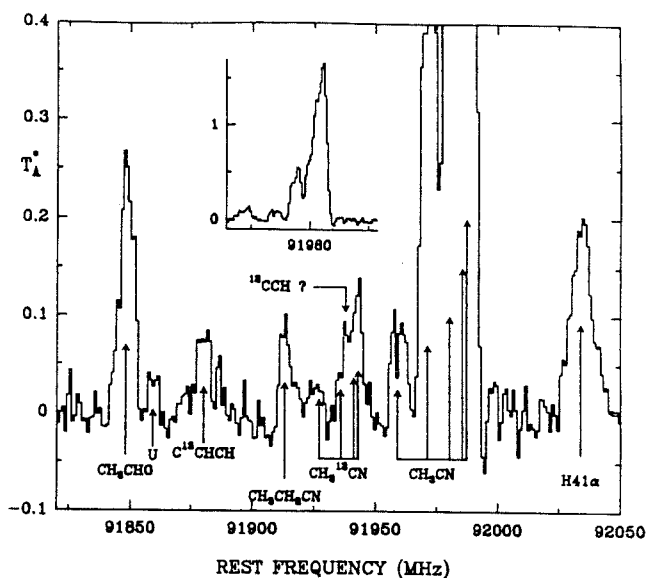

Figure 2. $J=5\text{--}4$ ($K=0,1,2,3,4$) lines of CH_3CN and $\text{CH}_3^{13}\text{CN}$. The frequency and ordinate scales are as in Figure 1. The arrows indicating the position of the $\text{CH}_3^{13}\text{CN}$ lines are for an assumed LSR velocity of 57 km s^{-1} .

and HC^{15}N , and set an upper limit to the H^{15}NC line intensity. Their data yield a $\text{HN}^{13}\text{C}/\text{H}^{13}\text{CN}$ intensity ratio of 0.4 ± 0.08 , which is only an upper limit to the HNC/HCN abundance ratio, since the H^{13}CN line is optically thick (the dipole moments of these two species are about equal). The upper limit to HNC/HCN which can be derived from H^{15}NC and HC^{15}N is somewhat higher. The detection of H^{15}NC would be needed in order to measure properly the HNC/HCN abundance ratio. From the available data, however, it seems likely that HNC/HCN is larger than $\text{CH}_3\text{NC}/\text{CH}_3\text{CN}$.

In the ion-molecule schemes, CH_3NC , CH_3CN , HNC and HCN are formed from the dissociative recombination of their protonated ions, CH_3NCH^+ , CH_3CNH^+ , and HCNH^+ . However, whereas HNC and HCN have a common ion precursor, their methyl analogs form from different ions, since the CH_3CNH^+ and CH_3NCH^+ backbone structures are unlikely to isomerize during the recombination process (Green and Herbst 1979). Though CH_3CNH^+ and CH_3NCH^+ probably have a common origin, both resulting from the radiative association of CH_3^+ with HCN (DeFrees et al. 1985), the isomerization of HCN and CH_3CN follow different paths and the HNC/HCN and $\text{CH}_3\text{NC}/\text{CH}_3\text{CN}$ ratios are expected to be different.

We have also tried to observe the $J=4\text{--}3$, $J=5\text{--}4$, and $J=8\text{--}7$ lines of methyl isocyanide towards the molecular envelope of the carbon star $\text{IRC}+10216$. We obtain an upper limit of 0.03 K for the emission of CH_3NC , and an abundance ratio $\text{CH}_3\text{NC}/\text{CH}_3\text{CN} \leq 0.1$.

References

- Cummins, S.E., Green S., Thaddeus, P., Linke, R.A.: 1983, *Ap. J.*, **266**, 331.
 Cummins, S.E., Linke, R.A., Thaddeus, P.: 1986, *Ap. J., Suppl. Series* **60**, 819.
 DeFrees, D.J.: 1987, in *IAU Symp 120*, ed. S.P. Tarafdar, Reidel, Dordrecht, p. 203.
 DeFrees, D.J., McLean, A.D., Herbst, E.: 1985, *Ap. J.*, **293**, 236.
 Green S., Herbst E.: 1979, *Ap. J.*, **229**, 121.
 Hollis, J.M., Rhodes, P.J.: 1982, *Ap. J., Letters*, **262**, L1.
 Irvine, W.M., Schloerb, F.P.: 1984, *Ap. J.*, **282**, 516.
 Matthews, H.E., Sears, T.J.: 1986, *Ap. J.*, **300**, 766.
 Römheld, M.: 1978, Ph. D. Dissertation, Ulm.

II.14) NOUVEAUX DOUBLETS DANS IRC+10216: C₄H
VIBRATIONNELLEMENT EXCITE ?.

II.14) NOUVEAUX DOUBLETS DANS IRC+10216: C₄H
VIBRATIONNELLEMENT EXCITE ?

Nous avons découvert dans l'enveloppe de l'étoile carbonée IRC+10216 une nouvelle série de doublets appartenant à une molécule réactive dans un état 2Σ ou $2A$. Cette molécule a aussi été observée au laboratoire dans une décharge d'acétylène d'où il résulte que c'est probablement un radical hydrocarbure. Ses constantes de rotation et distorsion étant très proches de celles de C₄H, nous suggérons qu'il s'agit de cette dernière molécule dans un état vibrationnel ou électronique excité.

Letter to the Editor

New doublets in IRC + 10216: Vibrationally excited C₄H?M. Guélin^{1,2}, J. Cernicharo^{1,3}, S. Navarro¹, D. R. Woodward⁴, C. A. Gottlieb⁵, and P. Thaddeus⁵¹ IRAM, Domaine Universitaire de Grenoble, Voie 10, F-38406 St. Martin d'Hères, France² Divina Pastora n° 7, E-18012 Granada, Spain³ Observatoire de Grenoble. USMG-CERMO, BP 68, F-38402 St. Martin d'Hères, France⁴ Division of Applied Sciences, Harvard University, Cambridge, MA 02138, USA⁵ Center for Astrophysics, 60 Garden Street, Cambridge, MA 02138, USA

Received May 26, accepted June 15, 1987

Summary.

We have discovered in the envelope of the carbon star IRC+10216 a new series of doublets arising from a reactive species in a $^2\Sigma$ or 2A state. This new molecule is also observed in the laboratory in an acetylene discharge and it is therefore probably a hydrocarbon radical. Its rotation and centrifugal distortion constants are quite close to those of ground state C₄H suggesting that we are observing C₄H in an excited state, vibrational or electronic.

Keywords: radio lines: molecular, identification; stars: circumstellar matter; interstellar medium: molecules.

In the course of a survey of the millimetre spectrum of IRC+10216, made with the IRAM 30m telescope (see e.g. Guélin et al. 1986 and Cernicharo et al. 1987 for telescope characteristics and observing procedure), we have discovered the 9 line doublets presented in Fig. 1 and Table 1. These doublets are remarkable in that they all have equal splittings and their centre frequencies are integer multiples of a common frequency $2B = 9564$ MHz. Such behavior is typical of a linear (or slightly asymmetric top) molecule in a $^2\Sigma$ (or 2A) state (see e.g. Guélin et al. *ibid*). We derive for this molecule, from the astronomical data, a rotation constant $B = 4782.165 \pm 0.006$ MHz and an effective distortion constant $D_{eff} = 0.936 \pm 0.014$ kHz, two values which are very close to those measured for C₄H in the ground vibrational state: $B_0 = 4758.656$ MHz and $D_0 = 0.863$ kHz (Gottlieb et al. 1983).

Since D_{eff} is similar to D_0 , the centrifugal distortion constant of C₄H, our new molecule must have a nearly linear heavy atom backbone: already, a single off-axis H atom, located at the end of a carbon atom backbone at an angle of 120° , would contribute to D_{eff} by $-A.b_p^2/8 \approx 0.1$ kHz (e.g. Guélin et al. *ibid*); an off-axis C or N atom at an angle $\leq 150^\circ$ would contribute to D_{eff} by ≥ 1 kHz, and therefore is excluded. The molecule should have a moment of inertia nearly identical to that of C₄H and should have an odd number of electrons. As discussed by Guélin et al. (1978), there are very few molecules composed of cosmically abundant elements with such characteristics. The most obvious are C₄H and C₃N, both already detected in space.

The striking similarity of the new B and D constants with those of C₄H made us believe, when we discovered the line doublets, that we were observing C₄H in an excited bending mode. CS and SiS in the first excited stretching mode (see Fig. 1a and Blundell et al. 1987) and HCN and HC₃N, in excited bending modes (Ziurys and Turner 1986, Blundell et al. *ibid*), have been observed in IRC+10216. The vibrational energy of C₄H is expected to be comparable to that of HC₃N. By analogy with this latter species (see e.g. Yamada and Creswell 1986), the rotational constant of C₄H in its lowest bending state, the $(\nu_1, \nu_7) = (0, 0, 0, 1)$ state, can be predicted to be 1.003 times larger than in its ground state, i.e. one must have very roughly $B_1 \approx 4774$ MHz. The energy of the $\nu_7 = 1$ state, relative to the ground vibrational state, should be only about 300 K.

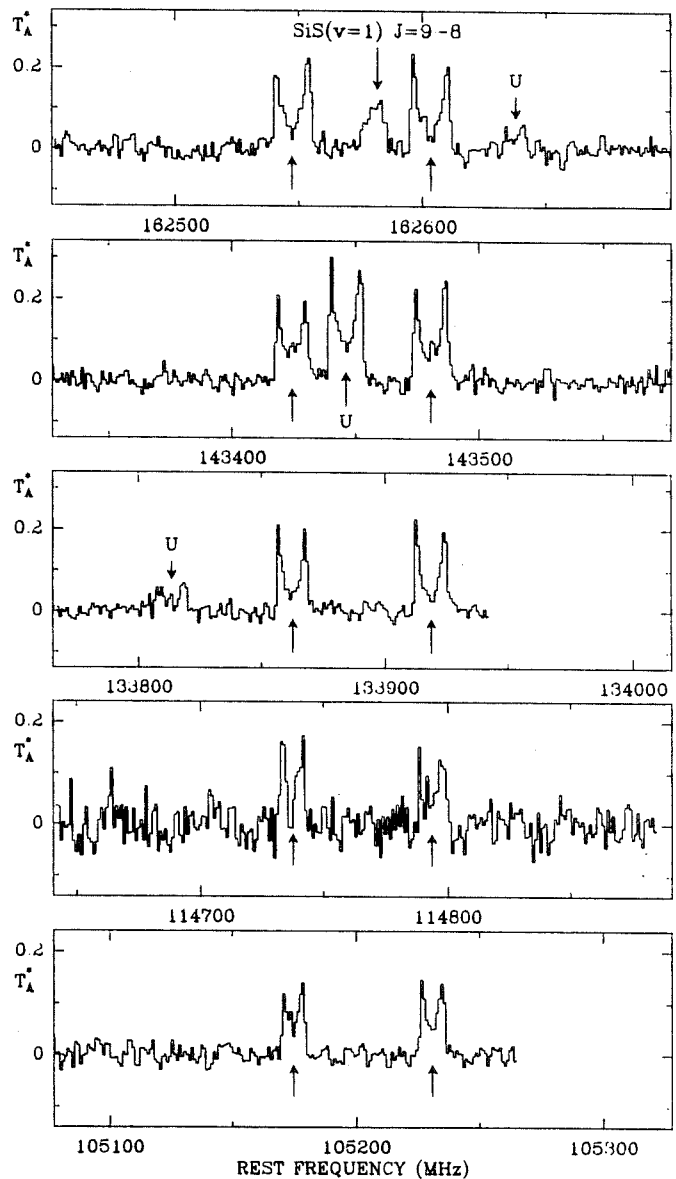

Fig. 1: Five spectra, with centre frequencies multiples of $2B = 9564$ MHz, observed toward IRC+10216 with the IRAM 30m telescope. The doublets denoted by arrows at the centre of each spectrum, are rotational transitions of a $^2\Sigma$ radical which could be excited C₄H. The narrow line at 162582 MHz is the $J=9-8$ transition of SiS in the $v=1$ vibrational state (see Blundell et al. 1987).

TABLE 1: ASTRONOMICAL DATA

transition N - N'		observed (MHz)	uncer. (MHz)	obs.-calc. (KHz)
9 - 8	l	86,048.50	0.25	271.2
9 - 8	u	86,104.44	0.25	151.4
10 - 9	l	95,611.13	0.25	-418.5
10 - 9	u	95,667.89	0.25	281.6
11 - 10	l	105,174.58	0.20	-64.4
11 - 10	u	105,230.65	0.20	-54.2
12 - 11	l	114,737.17	0.20	-324.0
12 - 11	u	114,793.82	0.35	266.2
14 - 13	l	133,862.50	0.20	135.3
14 - 13	u	133,918.54	0.20	115.4
15 - 14	l	143,424.39	0.20	48.9
15 - 14	u	143,480.41	0.20	9.0
16 - 15	l	152,986.00	0.20	18.3
16 - 15	u	153,041.88	0.20	-161.5
17 - 16	l	162,547.41	0.15	146.0
17 - 16	u	162,603.18	0.15	-143.9
18 - 17	l	172,108.36	0.50	194.3
18 - 17	u	172,164.12	0.80	-105.0

The uncertainty is 1 r.m.s. deviation. Calculated frequencies are derived from the "astronomical" constants of Table 3.

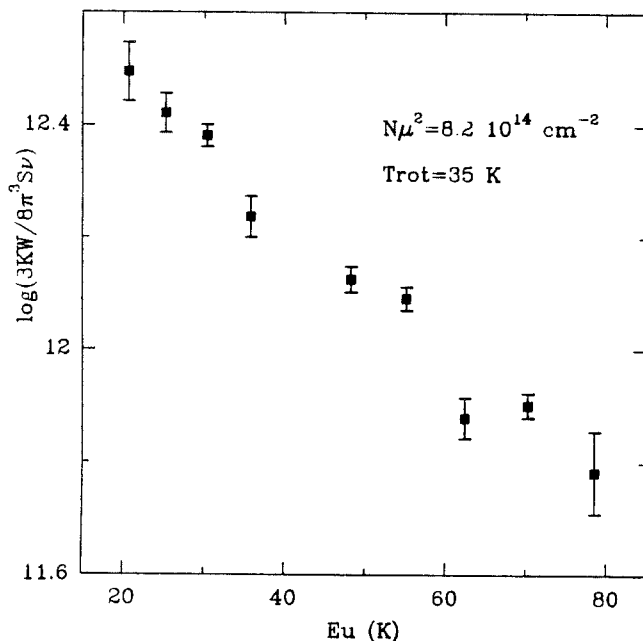

Fig. 2: Rotation temperature diagram of the doublets observed in IRC+10216. Each data point is the sum of the two doublet components.

Two results, however, are hard to reconcile with the assignment of the new lines to C_4H , $\nu_7=1$: i) the relatively large intensity and U-shaped profile of the lines and, especially, ii) our failure so far to detect the parallel series of doublets expected from l-doubling. The new lines have an intensity which is $\approx 1/7$ of that of ground state C_4H and exhibit a U-shaped profile characteristic of a resolved source (for comparison, the HC_3N $\nu_7=1$ lines are a factor 30 weaker than those of HC_3N $\nu=0$ and, as much as we can tell, seem flat-topped - Blundell et al. 1987). It is difficult to see how it is possible to keep in the outer IRC+10216 envelope a large fraction of C_4H excited at ≈ 300 K above the ground state. The effective rotation temperature T_{rot} and column density N of the new doublet carrier can be estimated from Fig. 2, in which the \log of $N_u\mu^2/(2J+1) = 3kN/8\pi^3S\nu$, the normalized upper level column density per substate, is plotted versus the upper level energy. The values we derive are $T_{rot}=35\pm 5$ K and $N = 8.2 \pm 3 \times 10^{14}$ (1 debye/ μ)² cm^{-2} , which should be compared with the values found for ground state C_4H , 24 K and $5 \times 10^{15} \text{ cm}^{-2}$. In addition, we have covered a sufficiently large portion of the millimetre wave spectrum of IRC+10216 to be fairly certain that no other series of harmonically related doublets exists every 8-10 GHz with intensities more than half of those of Table 1.

Another possibility we considered is that C_4H is slightly bent in its ground electronic state and that the "normal" C_4H doublets and the new doublets are a-type transitions of the $K=0$ and the $K=+1$ ladders respectively. The energy associated with the "excited" $K=1$ ladder would be smaller than 300 K, so that the line shapes of Fig. 1 would be more readily explained. However, this hypothesis, in which the $K=\pm 1$ components are in many ways similar to the $l=\pm 1$ l-doubling components, does not alleviate the presence of an additional series of doublets

In an attempt to further characterise the carrier of our doublets, we have searched for related lines in the laboratory (see Gottlieb et al. 1983 for a description of the Zeeman-modulated spectrometer). We succeeded in observing five doublets, with centre frequencies integer multiples of the astronomical B constant, in a liquid nitrogen-cooled DC discharge through a mixture of acetylene and argon (Table 2): several have been shown to be paramagnetic and we presume they all are. The discharge conditions are close to those which best yield C_4H (Gottlieb et al. *ibid*), the actual gas temperature being of the order of 200 K; the relative intensity of the new doublets, with respect to that of the nearby C_4H lines, is about 1/3. Traces of nitrogen or

TABLE 2: LABORATORY DATA

transition N - N'	measured frequencies (MHz)	uncer. (MHz)	measured- calculated (MHz)
18 - 19	181,669.38	0.03	-0.02
	181,725.00	0.05	0.02
19 - 20	191,229.68	0.04	0.03
	191,285.01	0.06	-0.01
20 - 21	200,789.44	0.04	-0.03
	200,844.62	0.04	0.00
21 - 22	210,348.87	0.05	0.05
	210,403.74	0.04	-0.01
22 - 23	219,907.70	0.03	-0.01
	219,962.41	0.05	0.02

The uncertainty is 1 r.m.s. deviation. Calculated frequencies are derived from the "laboratory" spectroscopic constants of Table 3.

other elements may be present in the spectrometer tube, but are unlikely to alter significantly the composition of the discharge products, and it has been demonstrated that the intensity of the new lines does not change when oxygen, nitrogen and sulfur compounds are added to the discharge. This indicates that we are very probably observing a hydrocarbon radical which, owing to its B value, contains just four carbon atoms. If this radical is C_4H in the ground electronic state, the intensity ratio of 1/3 means that the new lines arise from a ladder with an energy of a few hundred K, similar to that expected for the $\nu_7=1$ state, but too high for the $K=1$ ladder of an asymmetric top molecule. A search for a second series of doublets, which would have confirmed the excited bending state hypothesis, has not yet yielded any detection within the range of expected l-doubling values; this search is presently being pursued over a wider range.

Although, from this preliminary study, we cannot identify with certainty the carrier of our new doublets, the number of plausible candidates is evidently extremely limited and the best remains C_4H . Despite our present failure to detect another set of doublets, it could be C_4H in an excited $l=1$ bending mode of large amplitude (and probably large anharmonicity). We could also be observing a non degenerate ($l=0$) vibrational state, although the strength and shape of the lines in IRC+10216 would be difficult to explain. The possibility of the $K=1$ state of a hypothetically bent C_4H seems less likely. The carrier, on the other hand, might be an isomer or a metastable excited electronic state of C_4H .

In spite of the laboratory constraints, the possibility of observing an entirely new species cannot be excluded. Radicals such as HC_2N_2 and some silicon or sulfur compounds could have the proper rotation constant, but they seem very unlikely to be present in our discharge. An ion, such as $C_4H_2^+$ (or HC_3N^+), may offer an alternate possibility; this ion, however, must be polar and yet have a small or zero asymmetry parameter. Clearly, more laboratory data would be needed to solve this puzzle.

We would like to thank J.M. Brown, R.D. Brown, P.D. Godfrey and J. Rostas for comments on l-type doubling in polyatomic radicals.

TABLE 3: SPECTROSCOPIC CONSTANTS

Constant	astronomical value	laboratory value	astronomical plus laboratory
B (MHz)	4782.165 (6)	4782.167 (2)	4782.160 (2)
D (Hz)	936 (14)	918 (3)	910 (2)
γ (MHz)	-56.06 (20)	-57.5 (2)	-56.97 (13)
γ_d (kHz)	0	1.79 (15)	1.40 (9)

The numbers in parenthesis are 1 r.m.s. deviations on the last digit. The sign of γ is negative by analogy with C_4H .

References

- Blundell, R., Cernicharo, J., and Guélin, M.: 1987, *Astron. Astrophys.*, submitted for publication.
 Cernicharo, J., Guélin, M., Hein, H., and Kahane, C.: 1987, *Astron. Astrophys. (Letters)*, in press.
 Gottlieb, C.A., Gottlieb, E.W., Thaddeus, P., and Kawamura, H.: 1983, *Astrophys. J.*, **275**, 916.
 Guélin, M., Green, S., and Thaddeus, P.: 1978, *Astrophys. J. (Letters)*, **224**, L27.
 Guélin, M., Cernicharo, J., Kahane, C., and Gómez-González, J.: 1986, *Astron. Astrophys.*, **157**, L17.
 Yamada, K.M.T. and Creswell, R.A.: 1986, *J. Mol. Spec.*, **116**, 384.
 Ziurys, L.M. and Turner, B.E.: 1986, *Astrophys. J. (Letters)*, **300**, L19.

II.15) SPECTROSCOPIE MICRO-ONDES DES ETATS VIBRATIONNELS ν_7 ET $2\nu_7$ DE C_4H ET SON IDENTIFICATION ASTRONOMIQUE.

II.15) SPECTROSCOPIE MICRO-ONDES DES ETATS VIBRATIONNELS v_7 ET $2v_7$ DE C_4H ET SON IDENTIFICATION ASTRONOMIQUE

Nous avons observé au laboratoire par spectroscopie micro-onde les transitions rotationnelles du radical C_4H ($2\Sigma^+$) dans ses états vibrationnels v_7 et $2v_7$ ($l=0$ (Σ) et $l=2$ (Δ)). Les constantes rotationnelles ainsi que les constantes d'interaction spin-orbite ont été déterminées. Sur la base de ces constantes nous avons pu identifier 22 raies de l'état v_7 dans le spectre millimétrique de l'étoile IRC+10216. D'autre part, la série de doublets détectés par Guélin et al. (voir II.14) a été attribuée définitivement à des transitions de l'état vibrationnel $2v_7(\Sigma)$ de cette molécule.

LABORATORY MICROWAVE SPECTROSCOPY OF THE VIBRATIONAL SATELLITES FOR THE ν_7 AND $2\nu_7$ STATES OF C_4H AND THEIR ASTRONOMICAL IDENTIFICATION

SATOSHI YAMAMOTO AND SHUJI SAITO
 Department of Astrophysics, Nagoya University

M. GUÉLIN
 IRAM, Domaine Universitaire de Grenoble

J. CERNICHARO
 Groupe d'Astrophysique de l'Observatoire de Grenoble; and IRAM, Domaine Universitaire de Grenoble

AND

HIROKO SUZUKI AND MASATOSHI OHISHI
 Nobeyama Radio Observatory¹

Received 1987 August 10; accepted 1987 September 21

ABSTRACT

The rotational transitions of the C_4H radical ($X^2\Sigma^+$) in the lowest bending state, ν_7 , and its overtone state [$2\nu_7$, $l = 0(\Sigma)$ and $2(\Delta)$] were observed by laboratory microwave spectroscopy and were analyzed to determine the molecular constants. The spin-orbit interaction constants for ν_7 and $2\nu_7(\Delta)$ are found to be large. Based on the observed and calculated frequencies, 22 previously unidentified lines in IRC +10216 are assigned to transitions in the ν_7 state. Furthermore, the series of line doublets recently detected by Guélin *et al.* toward IRC +10216 is definitely assigned to transitions in the $2\nu_7(\Sigma)$ state.

Subject headings: laboratory spectra — molecular processes

Several molecules in vibrationally excited states such as HCN (Ziurys and Turner 1986), CS (Turner 1987a), and SiS (Guélin *et al.* 1987b; Turner 1987b) have so far been detected in the envelope of IRC +10216 by radioastronomy. The excitation mechanisms for the vibrational states through the radiative and collisional pumpings were discussed in detail by Deguchi *et al.* (1979) and Goldsmith *et al.* (1982).

The C_4H radical is known to be abundant in IRC +10216. Since this molecule has low vibrationally excited states, the vibrational satellites of C_4H may also be detectable. Recently, Guélin *et al.* (1987b) detected a series of line doublets in IRC +10216, which they tentatively assigned to a vibrational satellite of C_4H . However, the definite identification of these doublets was still left to be solved. The present *Letter* describes the laboratory microwave spectroscopy of the vibrational satellites of C_4H and their identifications in IRC +10216.

A source modulation microwave spectrometer at Nagoya University (Yamamoto and Saito 1987) was used for the laboratory observations. The spectrum of the C_4H radical was measured by discharging the mixture of C_2H_2 and He. The production condition was optimized by monitoring the transitions of the ground vibrational state (Gottlieb, Gottlieb, and Thaddeus 1983); 30 mtorr of C_2H_2 and 10 mtorr of He at the cell temperature of about $-100^\circ C$ with the discharge current of about 300 mA.

A typical pattern of the vibrational satellites is shown in Figure 1. We have readily detected six paramagnetic lines, whose intensities are about 80% of those of the ground-state lines. The patterns of the satellites depend on the rotational transitions as shown in Figure 1. We have assigned four of

them to transitions in the ν_7 state and two of them to those in the $2\nu_7(\Delta)$ state (Fig. 1), where ν_7 is the lowest bending mode of C_4H . Furthermore, we have detected near the $2\nu_7(\Delta)$ satellites several lines with intensities of about 30%–40% of those of the ground-state lines. These transitions show doublet structure with frequency splittings of about 53 MHz and were assigned to transitions in the $2\nu_7(\Sigma)$ state.

We measured 31, 16, and 15 transitions for the ν_7 , $2\nu_7(\Sigma)$, and $2\nu_7(\Delta)$ states, respectively, in the frequency region between 220 and 300 GHz. The observed spectra were analyzed by conventional Hamiltonians for $^2\Sigma$, $^2\Pi$, and $^2\Delta$ vibronic states. The Hund's case *a* basis set was used for calculating the Hamiltonian matrix for the $^2\Pi$ and $^2\Delta$ states, since the spin-orbit interaction constant is not negligible. The molecular constants were determined by a least-squares analysis. The standard deviations of the fits were 24, 14, and 31 kHz for the ν_7 , $2\nu_7(\Delta)$, and $2\nu_7(\Sigma)$ states, respectively. The results are shown in Tables 1–3.

The spin-orbit interaction terms for the ν_7 and $2\nu_7(\Delta)$ states are surprisingly large. This suggests that the C_4H radical has a low-lying electronically excited state, $\bar{A}^2\Pi_i$. A related radical, $C_2H(\bar{X}^2\Sigma^+)$, also has a low-lying electronic state, $\bar{A}^2\Pi_i$, at about 3612 cm^{-1} above the ground electronic state (Jacox 1975). The energy difference between $\bar{A}^2\Pi_i$ and $\bar{X}^2\Sigma^+$ states becomes even smaller for C_4H , whereas for C_6H the $^2\Pi_i$ state lies below the $^2\Sigma^+$ state (Suzuki *et al.* 1986; Guélin *et al.* 1987a; Murakami, Kawaguchi, and Saito 1987). The vibronic interaction between the $\bar{A}^2\Pi_i$ state and the ν_7 state ($^2\Pi$) of $\bar{X}^2\Sigma^+$ is strong in C_4H , and the mixing of the wavefunctions of both states makes the spin-orbit interaction term of the ν_7 state of $\bar{X}^2\Sigma^+$ very large. The negative sign of the spin-orbit interaction constant supports this mixing, since the \bar{A} state has a negative spin-orbit interaction constant. A similar situation is observed for the C_2H radical in the high vibrational states of

¹ Nobeyama Radio Observatory (NRO), Tokyo Astronomical Observatory, The University of Tokyo, is a facility open for researchers in the field of astrophysics and astrochemistry.

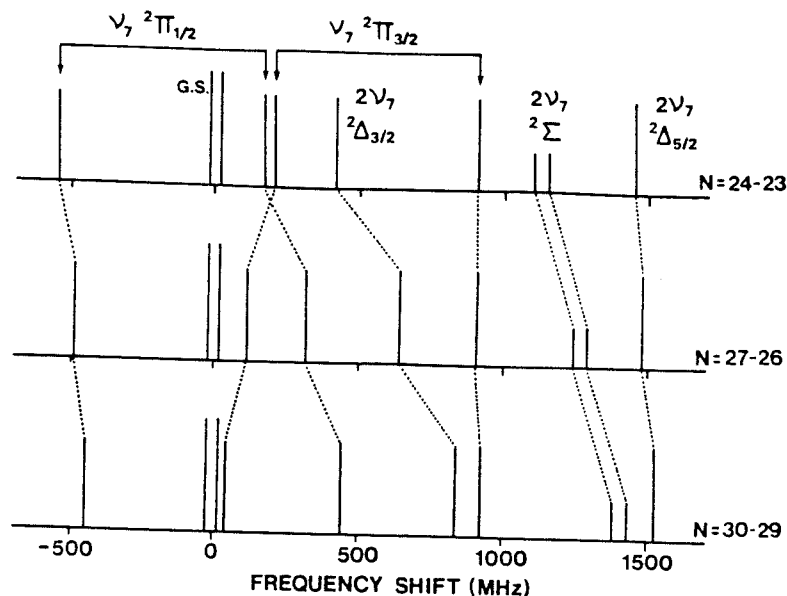

FIG. 1.—Typical patterns of the vibrational satellites of C₄H for the N = 24–23, 27–26, and 30–29 transitions. The frequency difference from the center of the ground-state doublets is defined as a frequency shift. Vertical bars represent the relative intensities. There are other weak paramagnetic lines, which are not shown in this figure.

TABLE I
MOLECULAR CONSTANTS OF THE VIBRATIONALLY EXCITED STATES OF C₄H
(MHz) *

Parameter	$\nu_7(^2\Pi_i)$	$2\nu_7(^2\Delta_i)$	$2\nu_7(^2\Sigma^+)$
B	4762.8472(15)	4778.5698(12)	4782.1727(28)
D	0.00089118(98)	0.00090085(74)	0.0009216(18)
A	-89799(18)	-101147(20)	...
γ	-37.92(20)	-37.40(16)	-58.29(30)
γ_D	0.00217(13)
p	17.834(52)
q	14.9674(30)
q_D	-0.0001183(20)

* The numbers in parentheses represent three standard deviations in units of the last significant digits.

TABLE 2
TRANSITIONS IN THE ν_7 STATE OF C₄H OBSERVED IN LABORATORY (MHz)*

J'	J''	$^2\Pi_{1/2}(e)$	$^2\Pi_{1/2}(f)$	$^2\Pi_{3/2}(e)$	$^2\Pi_{3/2}(f)$
47/2	45/2	227824.287(-17)	228539.418(33)
49/2	47/2	237357.418(-17)	238102.184(5)	228575.521(18)	229273.306(-25)
51/2	49/2	246887.252(-15)	247661.525(-9)	238054.128(-5)	238781.549(-7)
53/2	51/2	256414.113(-11)	257217.796(15)	247534.778(-2)	248291.644(-22)
55/2	53/2	265938.285(5)	266771.187(-12)	257017.139(18)	257803.362(16)
57/2	55/2	275460.008(42)	276322.020(-4)	266500.885(8)	267316.334(15)
59/2	57/2	284979.382(-1)	285870.445(-13)	275985.839(36)	276830.324(-22)
61/2	59/2	294496.711(14)	295416.656(-15)	285471.648(-39)	286345.258(45)
63/2	61/2	294958.304(-35)	...

* The numbers in parentheses represent the residuals ($\nu_{obs} - \nu_{calc}$) in the least-squares analysis in units of kHz.

TABLE 3
TRANSITIONS IN THE $2v_7$ STATE OF C_4H OBSERVED IN
LABORATORY (MHz)^a
A. $l = 2$ STATE

J'	J''	${}^2\Delta_{3/2}$	${}^2\Delta_{5/2}$
47/2	45/2	228787.478(7)	...
49/2	47/2	238375.506(-8)	229818.927(9)
51/2	49/2	247959.536(-5)	239335.667(-12)
53/2	51/2	257539.938(13)	248854.972(-8)
55/2	53/2	267116.983(-7)	258376.487(32)
57/2	55/2	276691.012(-1)	267899.762(-21)
59/2	57/2	286262.227(-7)	277424.673(-7)
61/2	59/2	295830.868(7)	286950.900(5)
63/2	61/2	...	296478.208(2)

B. $l = 0$ STATE

N'	N''	F_1	F_2
24	23	229466.026(-6)	229520.525(-48)
25	24	...	239078.115(-4)
26	25	248581.205(-10)	248635.121(16)
27	26	258137.989(25)	258191.550(41)
28	27	267694.099(-24)	267747.334(24)
29	28	277249.702(33)	277302.508(23)
30	29	286804.550(-30)	286856.971(-41)
31	30	296358.843(9)	296410.856(-13)

^a The numbers in parentheses represent the residuals ($v_{obs} - v_{calc}$) in the least-squares analysis in kHz.

TABLE 4
OBSERVED LINE PARAMETERS OF THE v_7 SATELLITE LINES OF C_4H IN IRC + 10216

Transition	Observed Frequency (MHz)	$\int T_A^* dv$ (K km s ⁻¹)	Δv^a (MHz)	Telescope
${}^2\Pi_{1/2}(e)$ 15/2-13/2	74141.7 ± 0.3	1.38 ± 0.20	-0.17	IRAM
${}^2\Pi_{1/2}(e)$ 17/2-15/2	83879.8 ± 0.4	1.52 ± 0.20	0.40	IRAM
${}^2\Pi_{1/2}(f)$ 17/2-15/2	84123.4 ± 0.3	2.10 ± 0.35	0.23	IRAM
${}^2\Pi_{1/2}(e)$ 19/2-17/2	93586.5 ± 0.3	1.80 ± 0.25	0.17	IRAM
	93586.3 ± 0.2	1.29 ± 0.11	-0.03	NRO
${}^2\Pi_{1/2}(f)$ 19/2-17/2	93863.3 ± 1.0 ^b	2.40 ± 0.50 ^b	-0.06	IRAM
${}^2\Pi_{3/2}(e)$ 19/2-17/2	87142.3 ± 0.4	1.45 ± 0.27	-0.26	IRAM
${}^2\Pi_{3/2}(f)$ 19/2-17/2	87371.8 ± 0.4	2.40 ± 0.54	-0.15	IRAM
${}^2\Pi_{1/2}(e)$ 21/2-19/2	103266.0 ± 0.3	2.75 ± 0.35	-0.39	IRAM
${}^2\Pi_{1/2}(f)$ 21/2-19/2	103576.5 ± 0.3	2.50 ± 0.21	-0.07	IRAM
${}^2\Pi_{1/2}(e)$ 21/2-19/2	96478.3 ± 0.3	2.85 ± 0.45	-0.29	IRAM
	96479.0 ± 0.2	1.75 ± 0.06	0.41	NRO
${}^2\Pi_{1/2}(e)$ 23/2-21/2	112922.5 ± 0.4	3.01 ± 0.37	-0.62	IRAM
${}^2\Pi_{1/2}(f)$ 23/2-21/2	113265.9 ± 0.3	3.67 ± 0.38	-0.29	IRAM
${}^2\Pi_{3/2}(e)$ 23/2-21/2	105838.0 ± 0.3	3.50 ± 0.40	0.26	IRAM
${}^2\Pi_{3/2}(f)$ 23/2-21/2	106132.8 ± 0.3	3.10 ± 0.40	-0.43	IRAM
${}^2\Pi_{3/2}(e)$ 25/2-23/2	115216.8 ± 0.3	3.05 ± 0.40	-0.02	IRAM
${}^2\Pi_{1/2}(e)$ 27/2-25/2	132178.9 ± 0.5	5.90 ± 0.50	-0.30	IRAM
${}^2\Pi_{1/2}(f)$ 27/2-25/2	132586.8 ± 0.3	5.30 ± 0.30	-0.26	IRAM
${}^2\Pi_{1/2}(e)$ 29/2-27/2	141783.3 ± 0.4	4.60 ± 0.20	-0.58	IRAM
${}^2\Pi_{1/2}(f)$ 29/2-27/2	142223.7 ± 0.3	4.70 ± 0.20	0.07	IRAM
${}^2\Pi_{3/2}(f)$ 29/2-27/2	134415.5 ± 0.3	4.50 ± 0.30	-0.31	IRAM
${}^2\Pi_{3/2}(e)$ 31/2-29/2	143446.3 ± 0.3	5.10 ± 0.30	-0.16	IRAM
${}^2\Pi_{3/2}(f)$ 31/2-29/2	143870.0 ± 0.3	5.10 ± 0.30	-0.34	IRAM

^a $\Delta v = v_{obs} - v_{pred}$, where v_{pred} is calculated by using the molecular constants in Table 1.

^b Blended with the $J, N = 8, 7-7, 6$ line of CCS.

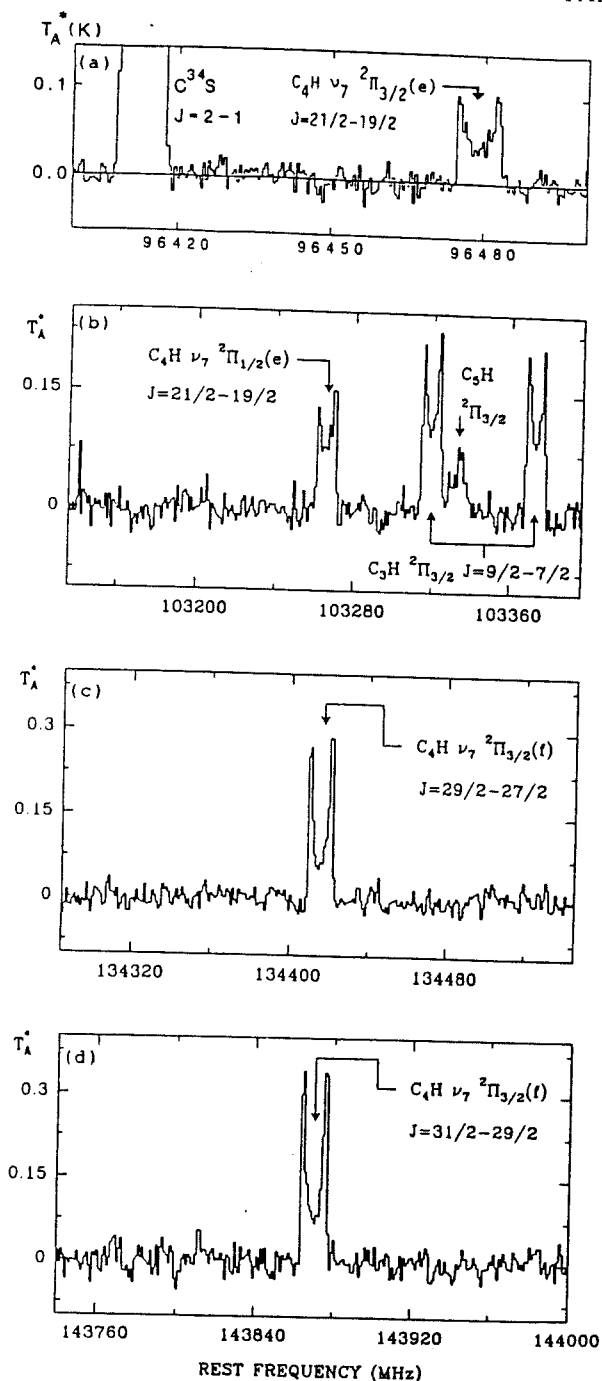

FIG. 2.—The spectrum of C_4H in the ν_7 state toward IRC +10216 [$\alpha(1950.0) = 9^h35^m15^s$, $\delta(1950.0) = 13^\circ30'40''$]. The adopted v_{LSR} is -27 km s^{-1} . The profiles *b-d* are obtained with the IRAM 30 m radiotelescope. Spectral resolution is 1 MHz, and the main beam efficiency is ~ 0.6 in the 2–3 mm band. The observing procedure has been described by Guélin *et al.* (1986). The profile *a* is obtained with the NRO 45 m radiotelescope. The original data were averaged by four channels so that the effective frequency resolution is 0.5 MHz. The main beam efficiency is ~ 0.55 .

$X^2\Sigma^+$ (Curl, Carrick, and Merer 1985). The *l*-type doubling of the $2\nu_7(\Delta)$ state was not resolved in the present observation, and hence, it was neglected in the analysis. Because of the overlap of two *l*-type doubling components, the lines of the $2\nu_7(\Delta)$ state were about twice as intense as those of the $2\nu_7(\Sigma)$ state.

The intensities of the vibrational satellites are comparatively strong, which implies that the vibrational energy of the ν_7 mode is fairly low. The vibrational energy of the bending mode of the C_2H radical is about 370 cm^{-1} (Kanamori and Hirota 1987), which is much lower than that of HCN, 712 cm^{-1} (Murrell, Carter, and Halonen 1982). This originates mainly from the interaction between $X^2\Sigma^+$ and $A^2\Pi_1$ (Curl, Carrick, and Merer 1985). Therefore, the vibrational energy of the ν_7 mode for C_4H is also expected to be much lower than that of HC_3N , about 220 cm^{-1} (Yamada and Creswell 1986). It is roughly estimated from the observed *q* constant to be 131 cm^{-1} .

In an independent study, Guélin *et al.* (1987*b*) reported a series of line doublets toward IRC +10216. These lines were also detected in their laboratory by microwave spectroscopy. Based on the present survey of the vibrational satellites, these lines are assigned to transitions in the $2\nu_7(\Sigma)$ state of C_4H . The molecular constants reported by Guélin *et al.* (1987*b*) agree well with those for the $2\nu_7(\Sigma)$ state determined in the present study. Since the spectrum of the $2\nu_7$ state is observed in IRC +10216, the spectrum of the ν_7 state must also be detected. In fact, we have assigned 22 unidentified lines, which were detected by IRAM and NRO telescopes, to transitions in the ν_7 state (Table 4). The astronomical frequencies agree well with those predicted from the molecular constants listed in Table 1. The profiles of four of these lines are shown in Figure 2. Some of other lines were already reported in the literature as unidentified; U87372 (Guélin *et al.* 1987*a*), U103576 (Cernicharo *et al.* 1987), and U143446 (Guélin *et al.* 1987*b*).

In order to understand the pumping mechanism for these vibrational states of C_4H , it is important to observe the $2\nu_7(\Delta)$ state. A preliminary survey of the IRAM 30 m telescope data shows that at least five lines of this state are detected. These lines, however, are very weak compared to the $2\nu_7(\Sigma)$ state lines (typically a factor of 3 weaker). This seems to imply that the radiative pumping directly from the ground vibrational state dominates the excitation of the ν_7 and $2\nu_7$ states, since, contrary to ν_7 and $2\nu_7(\Sigma)$, the $2\nu_7(\Delta)$ state is not radiatively connected to the ground vibrational state. The details of the excitation mechanism for these states will be discussed in a separate publication.

We are grateful to P. Thaddeus, C. A. Gottlieb, and N. Kaifu for invaluable discussions. We are also grateful to K. Kawaguchi and E. Hirota for helpful discussions on the spectroscopy of C_4H . We thank M. Tanimoto for lending us OKI klystrons. S. Y. thanks Research Aid of Inoue Foundation for Science for financial support. This work is supported by Grants-in-Aid from the Ministry of Education, Science, and Culture (60430006 and 61740270).

REFERENCES

- Cernicharo, J., Guélin, M., Hein, H., and Kahane, C. 1987, *Astr. Ap.*, **181**, L9.
 Curl, R. F., Carrick, P. G., and Merer, A. J. 1985, *J. Chem. Phys.*, **82**, 3479.
 Deguchi, S., Nakada, Y., Onaka, T., and Umeyama, M. 1979, *Pub. Astr. Soc. Japan*, **31**, 105.
 Goldsmith, P. F., Snell, R. L., Deguchi, S., and Krotkov, R. 1982, *Ap. J.*, **260**, 147.
 Gottlieb, C. A., Gottlieb, E. W., and Thaddeus, P. 1983, *Ap. J.*, **275**, 916.
 Guélin, M., Cernicharo, J., Kahane, C., and Gómez-González, J. 1986, *Astr. Ap.*, **157**, L17.
 Guélin, M., Cernicharo, J., Kahane, C., Gómez-González, J., and Walmsley, C. M. 1987*a*, *Astr. Ap.*, **175**, L5.
 Guélin, M., Cernicharo, J., Navarro, S., Woodward, C. R., Gottlieb, C. A., and Thaddeus, P. 1987*b*, *Astr. Ap.*, **182**, L37.
 Jacox, M. E. 1975, *Chem. Phys.*, **7**, 424.

No. 2, 1987

ROTATIONAL TRANSITIONS OF C₄H RADICAL

L153

Kanamori, H., and Hirota, E. 1987, Abstract of the 42d Symposium on Molecular Spectroscopy, TF12.
Murakami, A., Kawaguchi, K., and Saito, S. 1987, *Pub. Astr. Soc. Japan*, **39**, 189.
Murrel, J. N., Carter, S., and Halonen, L. O., 1982, *J. Molec. Spectrosc.*, **93**, 307.
Suzuki, H., Ohishi, M., Kaifu, N., Ishikawa, S., Kasuga, T., Saito, S., and Kawaguchi, K. 1986, *Pub. Astr. Soc. Japan*, **38**, 911.

Turner, B. E. 1987a, *Astr. Ap.*, **182**, L15.
———. 1987b, *Astr. Ap.*, **183**, L23.
Yamada, K. M. T., and Creswell, R. A. 1986, *J. Molec. Spectrosc.*, **116**, 384.
Yamamoto, S., and Saito, S. 1987, in preparation.
Ziurys, L. M., and Turner, B. E. 1986, *Ap. J. (Letters)*, **300**, L19.

J. CERNICARO: Groupe d'Astrophysique de l'Observatoire de Grenoble, Cermo, BP 68, 38402, St. Martin d'Herès, France

M. GUÉLIN: IRAM, Domaine Universitaire de Grenoble, Voie-10, F-38406, St. Martin d'Herès, France

MASATOSHI OHISHI and HIROKO SUZUKI: Nobeyama Radio Observatory, Minamimaki-mura, Minamisaku-gun, Nagano 384-13, Japan

SHUJI SAITO and SATOSHI YAMAMOTO: Department of Astrophysics, Nagoya University, Chikusa-ku, Nagoya 464, Japan

II.16) LE SOUFRE DANS IRC+10216

II.16) LE SOUFRE DANS IRC+10216.

Nous avons détecté 12 raies de C_2S et 11 de C_3S dans l'enveloppe circumstellaire de l'étoile carbonée IRC+10216. Ces raies, qui réalisent un bon échantillonnage des énergies rotationnelles, nous ont permis de déterminer la densité projetée des deux molécules.

Nous avons comparé l'abondance de C_2S et de C_3S aux abondances d'autres molécules soufrées et des chaînes carbonées. C_2S et C_3S sont 40 fois moins abondantes que CS mais à peu près aussi abondantes que C_5H et C_6H , deux chaînes carbonées de poids similaire.

La détection de ces molécules et de H_2S montre que la chimie du soufre dans IRC+10216 est plus compliquée que l'on supposait.

Letter to the Editor

Sulfur in IRC + 10216

J. Cernicharo¹, M. Guélin², H. Hein³, and C. Kahane¹

¹ Groupe d'Astrophysique de l'Observatoire de Grenoble, Université Scientifique et Médicale de Grenoble, CERMO, BP 68, F-38402 St. Martin d'Hères Cedex, France

² IRAM, Domaine Universitaire de Grenoble, Voie 10, F-38406 St. Martin d'Hères, France

³ IRAM, Divina Pastora No. 7, Granada, Spain

Received April 21, accepted May 12, 1987

SUMMARY

We report the detection of 12 lines of C₂S and 11 lines of C₃S in IRC+10216. These lines, which sample a large range of rotational energies, yield accurate values of these species' column densities. The abundances of C₂S and C₃S are compared to those of other sulfur molecules and carbon chains. C₂S and C₃S are a factor of ≈ 40 less abundant than CS, but about as abundant as C₃H and C₆H, two carbon chain radicals of similar weight.

The detection of these molecules and of H₂S shows that sulfur chemistry in circumstellar envelopes is more interesting than previously thought.

keywords: radio lines; molecular; stars; circumstellar matter.

The envelope of the star IRC+10216 is rich in carbon molecules, but notoriously poor in oxygen-bearing compounds. Heavy cyanopolynes (H(CC)_nCN n=2-5), and acetylenic radicals (C_nH n=2-6) are abundant there, whereas the simplest oxygen molecules, besides CO and SiO, are not even detected. Until now, the wealth of carbon and nitrogen compounds was thought to have no sulfur counterpart; only two diatomic species, CS and SiS, were detected and the sulfur chemistry seemed as limited as that of oxygen. This viewpoint is now obsolete. Following the identification in IRC+10216 of a radical which could be HSCC (Guélin et al. 1986) and the detection of H₂S (Lucas et al. 1987), we report in this Letter the detection of two heavy sulfur compounds, C₂S and C₃S.

The observations, made in May, October, and December 1986, were part of a general survey of the 2mm and 3mm spectrum of IRC+10216 with the IRAM 30m telescope. The observing procedure and telescope characteristics have been described already (e.g. Guélin et al. 1986). Most of the observing was made in double sideband (DSB) mode, so that a larger frequency range could be covered. Typically, the DSB receiver temperature was 100 - 150 K (200K above 160 GHz), with a slight imbalance (≈4/3 to 3/2) in favor of the lower sideband. The telescope beam and surface efficiencies (≈0.55 and 0.45,

respectively) are roughly similar at 2mm and 3mm; the half power beamwidth (HPBW) varies from 25" at 90 GHz to 16" at 160 GHz.

The survey has revealed a large number of new lines, many of which could not be assigned to any molecule with known spectroscopic constants. Among these are the lines presented in Table 1 and 2 and Fig. 1 and 2.

The 11 lines of Table 1 and Fig. 1 have harmonically related frequencies. A least-squares fit, using the standard relation $\nu = 2BJ - 4DJ^3$, yields B = 2890.387 MHz and D = 0.24 KHz, two values so close to those expected for C₃S and C₃Si, that we concluded, when we noticed the lines, that we had observed one of these two species. Our B and D values agree with those derived recently for C₃S from laboratory measurements (Yamamoto et al. 1987); the identification of C₃S in IRC+10216 is now certain.

TABLE 1 : C₃S line parameters

J' - J	Observed Frequency (MHz)	$\int T_A^* dv$ (K.km.s ⁻¹)
13 - 12	75148.09 ± 0.5	2.3 ± 0.4
15 - 14	86708.72 ± 0.3	2.4 ± 0.7
16 - 15	92488.78 ± 0.3	2.2 ± 0.3
17 - 16	98268.43 ± 0.3	2.2 ± 0.3
18 - 17	104048.37 ± 0.3	2.1 ± 0.3
19 - 18	109828.42 ± 0.5	2.7 ± 0.4
23 - 22	132945.75 ± 0.7	1.4 ± 0.4
24 - 23	138725.29 ± 0.3	1.6 ± 0.3
25 - 24	144504.88 ± 0.4	1.4 ± 0.3
27 - 26	156062.70 ± 0.4	1.0 ± 0.3
29 - 28	167619.63 ± 0.7	1.0 ± 0.5

Send offprint requests to: J. Cernicharo

L10

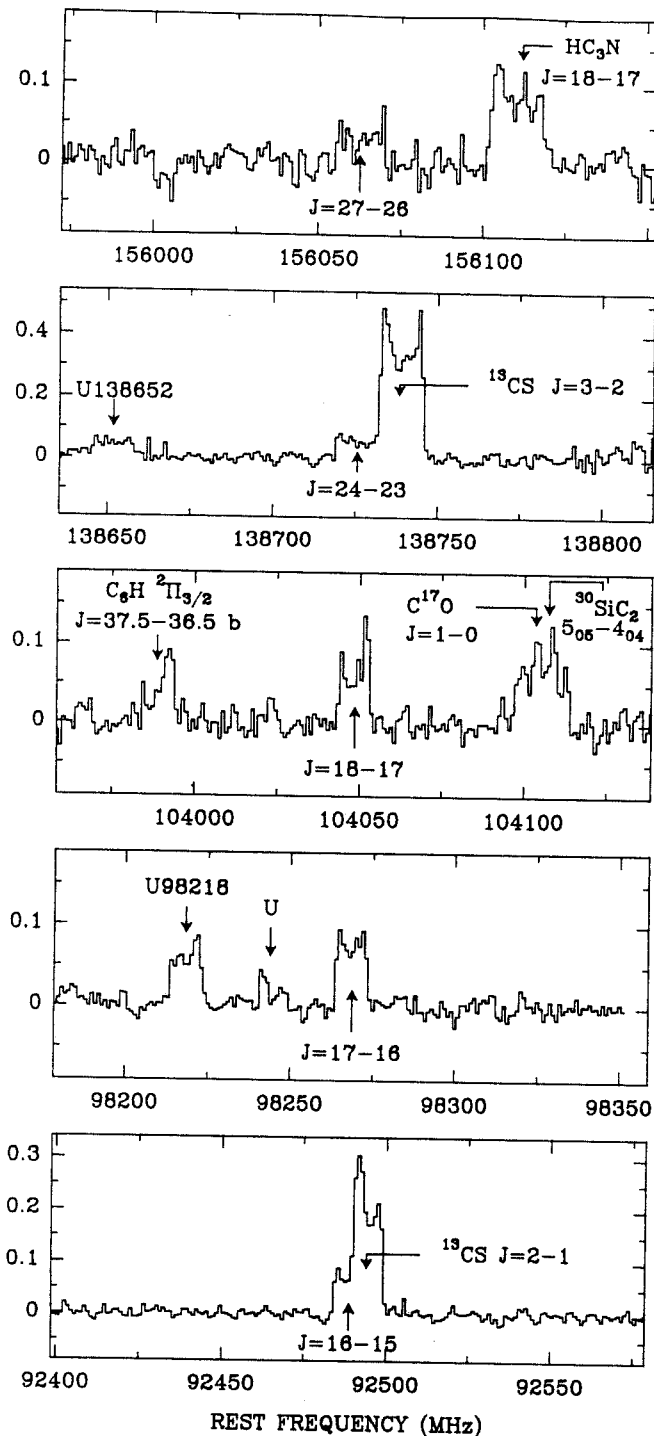

Figure 1: Five spectra, observed with the IRAM 30m telescope toward IRC+10216, showing five rotational transitions of C_2S . The four upper spectra were observed in the DSB mode, the lower with a 15 dB rejection of the image sideband. The ordinate scale, T_A^* , the effective antenna temperature above the atmosphere, refer to the sideband of the C_2S lines. The $C^{17}O$ line, the HC_3N line, the $^{30}SiCC$ line, and some of the U lines lie in the image sideband and are not to scale. The spectral resolution is 1 MHz.

Saito et al. (1987) have observed a related species, C_2S , in their laboratory. They measured the rotational spectrum of this radical and were able to assign several lines of TMC1 and SgrB2 to it. We have covered in our IRC+10216 spectral survey the frequencies of 14 transitions of C_2S and detected the 12 transitions of lower energy (see Table 2 and Fig. 2). We have also covered the frequency of the $1_{10}+1_{01}$ transition of H_2S (168.762 GHz), as well as several transitions of H_2CS , H_2C_2S , CS, NS, SiS, SO, SO_2 , OCS, CCO and C_3O . There is a weak line at the frequency of the H_2S line (see Lucas et al. 1987); except for CS and SiS (Kahane et al. 1987), none of the other molecules is detected.

From the lines in Table 1 and 2, which sample a large range of rotational energies (15-60 K for CCS, 25-120 K for C_2S), it was possible to calculate the rotational level populations and to derive with some accuracy the column densities of C_2S and C_3S by assuming the molecules' dipole moments; we have adopted here the moment values calculated by Murakami (1987): 2.9 D for C_2S and 2.6 D for C_3S .

TABLE 2 : C_2S line parameters

$J' N' - J N$	Observed Frequency (MHz)	$\int T_A^* dv$ (K.km.s $^{-1}$)
7 6 - 6 5	81505.11 \pm 0.2	4.0 \pm 0.3
6 7 - 5 6	86181.20 \pm 0.2	1.6 \pm 0.2
7 7 - 6 6	90686.00 \pm 0.3	3.0 \pm 0.3
8 7 - 7 6	93870.10 \pm 0.2	3.4 \pm 0.2
7 8 - 6 7	99866.50 \pm 0.2	1.8 \pm 0.2
8 8 - 7 7	103640.12 \pm 0.2	2.3 \pm 0.2
9 8 - 8 7	106347.40 \pm 0.2	3.1 \pm 0.4
8 9 - 7 8	113410.18 \pm 0.5	2.1 \pm 0.3
11 10 - 10 9	131551.80 \pm 0.2	3.4 \pm 0.3
10 11 - 9 10	140180.09 \pm 1.0	1.8 \pm 0.4
12 12 - 11 11	155454.20 \pm 1.0	1.3 \pm 0.5
13 12 - 12 11	156981.30 \pm 1.0	1.7 \pm 0.3
13 13 - 12 12	168406.80	\leq 1.1
14 13 - 13 12	169753.41	\leq 1.1

In Fig. 3, we have plotted the log of the C_2S and C_3S column densities per substate, $N_U/(2J+1) = 3kW/8\pi^3JvU^2$, as a function of the upper level energy, $E_U = (h/k)BJ(J+1)$. The velocity - integrated brightness temperature, $W = \int T_B dv$, has been derived from the antenna temperatures listed in Table 1 by dividing $\int T_A^* dv$ by $0.6(1 - \exp(-20.8/HPBW)^2)$. Here, the factor 0.6 is the ratio of the main beam to forward beam efficiencies, HPBW is the

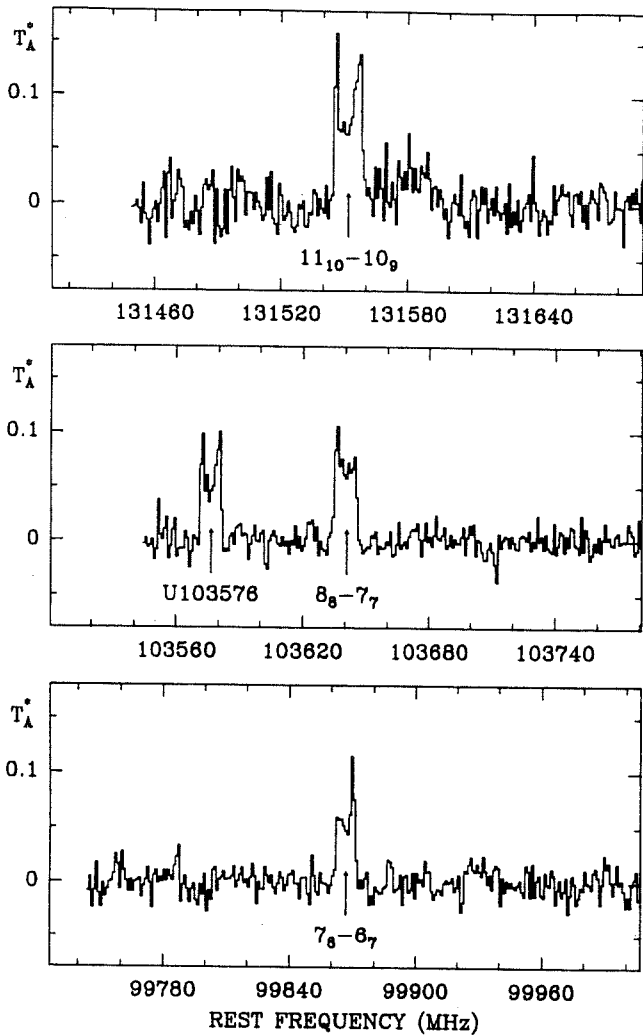

Figure 2: The $11_{10}-10_9$, 8_8-7_7 , and 7_8-6_7 rotational transitions of C_2S .

half-power main-beam width expressed in arc seconds and $(1-\exp(-(20.8/HPBW)^2))$ is the beam dilution factor for a source of uniform brightness and of diameter 25". Such a model of the source is a crude approximation of the C_2H brightness distribution derived by Guilloteau et al. (1987) from 30 m telescope data.

The C_2S data of Fig. 3 follow a straight line with slope $0.434/T_{rot} = 0.031 K^{-1}$. This relationship shows that, within the 10 K - 50 K energy range, the rotational level population is thermalized at a temperature $T_{rot} = 14 \pm 3$ K. The C_3S data can also be fitted by a straight line, but with a larger slope; we find for this molecule $T_{rot} = 28 \pm 4$ K for the levels between 25 and 120 K. The temperatures derived from Fig. 3 are not very sensitive to the source size, as long as this latter is larger than 15"; T_{rot} for C_2S varies from 13 to 17 K as the source size increases from 15 to 40", and the corresponding values for C_3S are 25 and 33 K. That $T_{rot}(C_3S) > T_{rot}(C_2S)$ is not surprising. A similar increase is observed between C_3H ($T_{rot} = 14K$), C_5H ($=20K$) and C_6H ($30K$, see e.g. Cernicharo et al. 1986, 1987).

It probably results from enhancement in radiative excitation, since the larger species, which have lower bending energies, are more easily excited by the infrared radiation of the surrounding dust.

Assuming that a single rotation temperature, $T_{rot} = 14$ K, holds for all the rotational levels, the C_2S column density averaged over a 25" source is found equal to $1.5 \cdot 10^{14} cm^{-2}$. A similar column density ($N = 1.1 \cdot 10^{14} cm^{-2}$) is derived for C_3S , assuming a source size of 25", $T_{rot} = 28$ K and $\mu = 2.6$ D. The actual values of $N(C_2S)$ and $N(C_3S)$ depend on the source size and shape, as well as on the single rotation temperature assumption. There is an indication in Fig. 3, that the upper rotational levels of C_3S have a higher rotation temperature (40 K) than the lower levels (22 K). Considering this effect and the uncertainty on the source size, our column densities could well be a factor of 2 too small or too large. The column densities of C_2S and C_3S are a factor 20-80 smaller than that of CS (Table 3) and, surprisingly, similar to those of C_2H , C_3H and C_6H (e.g. Cernicharo et al. 1987). In comparison, the limits we can set on C_2O and C_3O (Table 3) are $\approx 10^5$ times smaller than the CO column density.

C_2S and C_3S can be formed at chemical equilibrium in the outer stellar atmosphere. They can also be formed further in the envelope from CS, by ion-molecule reactions. In the equilibrium chemistry, the abundance of sulfur molecules is a good probe of the Si/S elemental abundance ratio (see e.g. Tsuji 1973). At first glance, it could seem that this ratio is low, since the detection of C_2S and C_3S means that sulfur is not all locked in SiS or CS. However, the low abundance of H_2S and the large abundance of SiCC, which is 10-20 times larger than those of C_2S and C_3S (see Table 3), argue for $Si \geq S$, as in the sun.

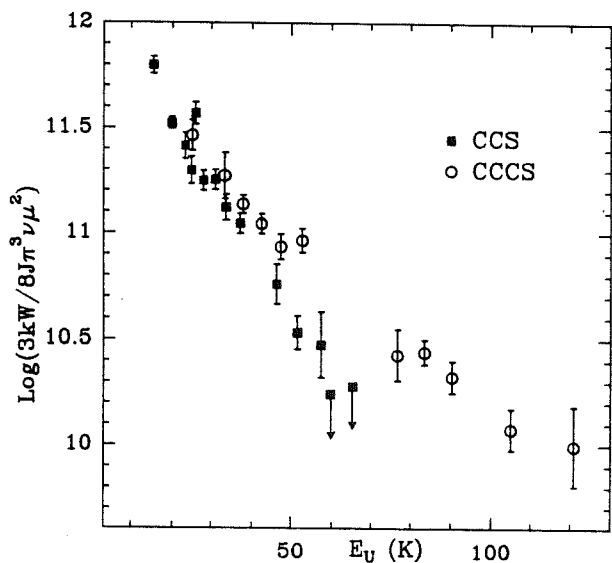

Figure 3: The rotation temperature diagrams of C_2S and C_3S in IRC+10216. The source is assumed to be a uniform brightness disk of diameter 25".

TABLE 3 : Molecular abundances in IRC+10216

Molecule	T_{rot}^* (K)	Column density ‡ (cm^{-2})
SiS	80 ^d	$7 \cdot 10^{15}$
CS	15 ^a	$4 \cdot 10^{15}$
SiCC	20 ^c	$2 \cdot 10^{15}$
CCS	14 ^c	$1.5 \cdot 10^{14}$
CCCS	28 ^c	$1.1 \cdot 10^{14}$
H ₂ S	15 ^a	$1 \cdot 10^{13}$
SO	15 ^a	$\leq 2 \cdot 10^{13}$
OCS	15 ^a	$\leq 1.5 \cdot 10^{14}$
NS	15 ^a	$\leq 1.5 \cdot 10^{13}$
H ₂ CS	15 ^a	$\leq 1 \cdot 10^{13}$
CCO/CO	15 ^a	$\leq 5 \cdot 10^{-6}$
CCCO/CO	15 ^a	$\leq 10^{-6}$

‡ except for SiS, for a source diameter of 25" (see text)

* a: assumed; c: calculated; d: calculated T_{rot} would decrease to 40 K for a source diameter of 15"

Reactions with hydrocarbon ions, such as C_2H_2^+ , and with C^+ are thought to dominate the chemistry in the part of the IRC+10216 envelope where our observations are the most sensitive (3-30", or 10^{16} - 10^{17} cm from the star-- see e.g. Glassgold et al. 1987). In situ ion-molecule reactions could transform part of the CS formed near the star into C_2S , C_3S and even longer sulfur-bearing carbon chain molecules, in a way similar to the build up in dense clouds of long carbon chain molecules from C_2H_2 (e.g. Winnewisser and Herbst 1987). It is true that the abundances of C_2S and C_3S , with respect to CS, are an order of magnitude lower in IRC+10216 than in the cool dense cloud TMC1 (compare the values of Table 3 with those of Yamamoto et al. 1987); a similar difference between IRC+10216 and TMC1 is observed, however, for the $\text{HC}_3\text{N}/\text{HCN}$ and $\text{HC}_4\text{N}/\text{HC}_3\text{N}$ abundance ratios (see Fig. 4a,b of Cernicharo et al. 1987). This difference could be explained by a lower abundance of ions in IRC+10216 and/or by a decrease of reaction rates at the relatively high temperatures prevailing in this source (the kinetic temperature in the IRC+10216 envelope is ≥ 70 K, versus ≈ 10 K for TMC1--see e.g. Cernicharo et al. 1987, Cernicharo and Guélin 1987). A decrease by factors ≈ 4 in the reaction rates is predicted for ion-polar neutral reactions (such as the reactions of CS and HCN with ions) between 10 and 50 K (Adams et al. 1985). The observation of longer sulfur compounds would help to appraise the relative efficiencies of molecular formation in the stellar atmosphere and in the envelope.

The detection of C_2S , C_3S and H_2S makes it likely that some of the unidentified lines in IRC+10216 arise from sulfur molecules. We have reported previously the discovery of a $^2\Sigma$ radical, which according to its rotation constant ($B = 5967$ MHz) should be HSC_2 , HSiC_2 , HC_2Si or NCSi (Guélin et al. 1986). We have observed two more rotational transitions of this radical and derive an "effective" distortion constant $D_{\text{eff}} = 4.3 \pm 0.2$ kHz, much larger than the stretching constant D_0 expected for a linear carbon chain molecule of similar weight (e.g. $D_0(\text{C}_3\text{N}) = 0.9$ kHz). This means (as argued by Guélin et al. 1986) that the radical is a slightly asymmetric top, i.e. that it has a linear backbone and an off axis H atom, like H-SCC and H-SiCC (but contrary to NCSi or H-CCSi). The main point against HSC_2 was that few sulfur molecules were observed in IRC+10216. This argument does not apply any more and both HSC_2 and HSiC_2 now seem as likely.

In conclusion, after $\text{H}(\text{CC})_n\text{CN}$, C_nH , and C_nN , the first members of a new series of carbon chain molecules, C_nS ($n=1-3$), have been detected in the envelope of IRC+10216. The $\text{C}_2\text{S}/\text{CS}$ and $\text{C}_3\text{S}/\text{CS}$ abundance ratios are found to be $\approx 20-80$, and are similar to the $\text{HC}_3\text{N}/\text{HCN}$ ratio derived in that source. All three ratios are one order of magnitude larger in IRC+10216 than in the cold dark cloud TMC1. The detections of C_2S and C_3S , together with those of H_2S and of a $^2\Sigma$ radical which could be HSCC , raise to 5 or 6 the number of sulfur molecules identified in IRC+10216.

REFERENCES

- Adams, N.G., Smith, D., and Clary, D.C.: 1985, *Astrophys. J. Letters*, **296**, L31.
- Cernicharo, J., Kahane, C., Gomez-Gonzalez, J., and Guélin, M.: 1986, *Astron. Astrophys. Letters*, **167**, L5.
- Cernicharo, J., Guélin, M., Menten, K.M., and Walmsley, C.M.: 1987, *Astron. Astrophys.*, in press.
- Cernicharo, J., and Guélin, M.: 1987, *Astron. Astrophys.*, in press.
- Glassgold, A.E., Mamon, G.A., Omont, A., and Lucas, R.: 1987, preprint.
- Guilloteau, S., Lucas, R., and Omont, A.: 1987, private communication.
- Guélin, M., Cernicharo, J., Kahane, C., and Gomez-Gonzalez, J.: 1986, *Astron. Astrophys. Letters*, **157**, L17.
- Kahane, C., Cernicharo, J., Gomez-Gonzalez, J. and Guélin, M., 1987, submitted for publication.
- Lucas, R. et al.: 1987, in preparation.
- Murakami, A.: 1987, quoted by Saito et al. (1987) and Yamamoto et al. (1987).
- Saito, S., Kawaguchi, K., Yamamoto, S., Ohishi, M., Suzuki, H., and Kaifu, N.: 1987, preprint.
- Thaddeus, P., Cummins, S.E., and Linke, R.A.: 1984, *Astrophys. J. Letters*, **283**, L45.
- Tsuji, T.: 1973, *Astron. Astrophys.*, **23**, 411.
- Winnewisser, G., and Herbst, E.: 1987, *Topics in Current Chemistry*, **139**, 119.
- Yamamoto, S., Saito, S., Kawaguchi, K., Kaifu, N., Suzuki, H., and Ohishi, M.: 1987, preprint.

II.17) METAUX DANS IRC+10216 : DETECTION DE NaCl, AlCl, KCl, et

AlF.

II.17) METAUX DANS IRC+10216 : DETECTION DE NaCl, AlCl, KCl, et AlF

Nous avons détecté pour la première fois quatre molécules contenant des éléments métalliques dans la direction de l'étoile carbonée IRC+10216. Les profils de ces raies suggèrent que ces molécules sont concentrées dans les parties les plus internes de l'enveloppe circumstellaire.

Les abondances déterminées pour NaCl, AlCl, KCl, et AlF sont entre 10^6 et 10^8 fois plus faibles que celle de H_2 . Elles sont en bon accord avec les calculs à l'équilibre chimique de Tsuji (1973) pour une atmosphère stellaire carbonée à 1200-1550 K.

Les raies de NaCl et de AlCl observées avec le 30-m sont suffisamment intenses pour nous permettre la détection des molécules isotopées avec ^{37}Cl . Nous avons ainsi déterminé un rapport $^{35}Cl/^{37}Cl$ de 2.3 ± 0.5 , lequel est consistant avec le rapport isotopique terrestre.

Letter to the Editor

Metals in IRC + 10216: detection of NaCl, AlCl, and KCl,
and tentative detection of AlFJ. Cernicharo^{1,2} and M. Guélin¹¹ IRAM, Domaine Universitaire de Grenoble, voie 10, F-38406 St. Martin d'Hères, France² Groupe d'Astrophysique de l'Observatoire de Grenoble, USTMG, CERMO,
BP 68, F-38402 St. Martin d'Hères Cedex, France

Received June 25, accepted July 7, 1987

Summary.

We report the first detection of metal halides in IRC+10216. The millimetre - wave line profiles suggest that these species are concentrated in the inner circumstellar envelope. The abundances derived for NaCl, AlCl, KCl, and tentatively for AlF, are in the range 10^{12} - 10^{14} cm⁻² and are 10^6 - 10^8 times lower than the abundance of H₂. They agree with the chemical equilibrium abundances calculated by Tsuji (1973) for a carbon-rich stellar atmosphere with a temperature 1200 - 1500 K.

The lines of NaCl and AlCl, observed with the IRAM 30m telescope, are strong enough to allow the detection of these species' rare ³⁷Cl isotopes. The derived ³⁵Cl/³⁷Cl isotopic ratio (2.3 ± 0.5) is consistent with the terrestrial elemental isotopic ratio.

Keywords: radio lines: molecular, identification; stars: circumstellar matter, metals; interstellar medium: molecules, metals.

One of the most puzzling results of the millimetre-wave spectral survey, carried out with the IRAM 30m telescope, is the large number of unidentified lines detected toward IRC +10216 (e.g. Guélin et al. 1986). The IRC+10216 circumstellar envelope is known to be exceptionally rich in linear carbon, nitrogen and hydrogen compounds, but poor in oxygen molecules and saturated hydrocarbons. The number of linear carbon chain molecules, which are polar and light enough that their millimetre lines can be excited in the outer envelope, is not large and most of them are known (e.g. Cernicharo et al. 1987a). Besides, sensitive searches for oxygen compounds have revealed nothing but the long known CO and SiO. Clearly, in order to explain the approximately 150 new lines, our view of IRC+10216 has to be revised.

The recent identifications of heavy silicon and sulfur compounds in IRC+10216 (Cernicharo et al. 1987b) and the detection of molecules in vibrationally excited states (Guélin et al. 1987, Blundell, Cernicharo, and Guélin 1987) is a first step in this direction. The number of lines assignable to such species remains however limited: the simplest non-linear sulfur and silicon molecules remain undetectable and few molecules are abundant enough to show up in excited states. Most of the unidentified lines must arise from a different class of molecules, most likely from molecules with less abundant elements. In this Letter, we report the assignment of 19 lines to NaCl, AlCl and KCl, and the tentative assignment of 3 lines to AlF.

The observations were part of the spectral survey made between October 1985 and May 1987 with the IRAM 30m telescope. The observing procedure and the antenna and receiver characteristics have already been described elsewhere (see e.g. Guélin et al. 1986, Blundell et al. 1987). Most of the spectra of Fig. 1 - 3 and most of the lines of Table 1 have been observed in the single sideband (SSB) mode, with a ≈ 15 dB rejection of the upper sideband. The temperature scale on these figures and in

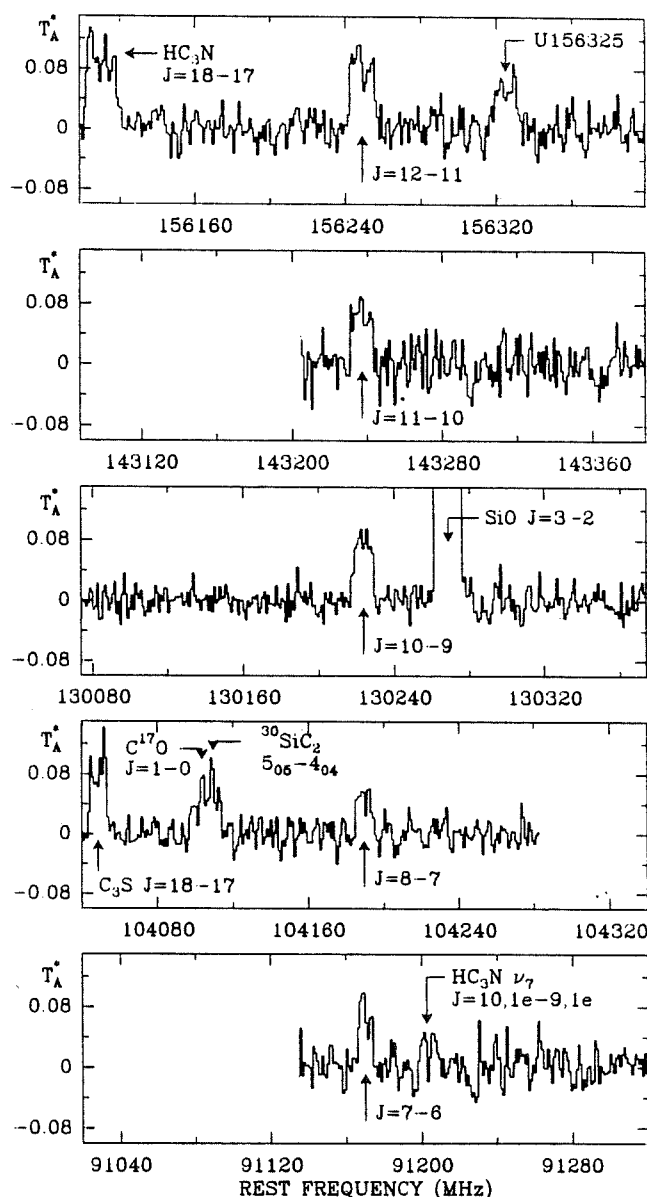

Fig. 1: Five spectra, observed toward IRC+10216 with the IRAM 30m telescope, showing the J=7-6 to 12-11 rotational transitions of NaCl. The HC₃N line in the upper spectrum lies in the upper sideband of the receiver and has been rejected by 15 dB.

Send offprint requests to: J. Cernicharo

the table is T_A^* , the equivalent antenna temperature above the atmosphere; T_A^* is related to the main beam brightness temperature, T_B , by $T_A^* \approx 0.6 T_B$. During the observing periods, the atmospheric opacity was typically below 0.15.

While searching for linear molecules, we noticed the five lines of Fig. 1. These lines have similar strengths and the same flat shape; quite remarkably, their frequencies are almost exactly in the ratios 12:11:10:8:7. A least-squares fit, using the standard linear molecule relation $\nu = 2BJ - 4DJ^3$, yields $B = 6513.035 \pm 0.015$ MHz and $D = 9.3 \pm 0.1$ kHz, with very small residuals (0.3 MHz).

The small residuals and the subsequent detection of a sixth line, right at the frequency predicted for the $J=13-12$ transition (Table 1), leave little doubt that the lines are related and arise from a linear, or slightly asymmetric top molecule. The value of B , which is between those of C_3H and C_4H , is too small for a molecule with three C or N atoms and too large for a molecule with four C or N atoms. It suggests a molecule with roughly the weight of SiS. The value of D , which is ≈ 2 times larger than that of SiS, argues on the other hand for a slightly asymmetric top, or for a linear species with weaker bonds. This last point made us think of a metal halide. A quick survey of the laboratory data showed that the new molecule is NaCl ($B=6513.050 \pm 0.008$ MHz, $D=9.34 \pm 0.007$ kHz - Lovas and Tiemann 1974), an identification that we soon confirmed by detecting the ^{37}Cl isotope of this species (Fig. 2).

Our detection of NaCl in IRC+10216 seems at first surprising: so far, not a single molecule bearing a sodium atom had been observed in space. The U100529 SgrB2 line, assigned by Hollis and Rhodes (1982) to NaOH $J=4-3$, is in fact a blend of the $H_2^{13}\text{CS}$ $3_{12} - 2_{11}$ and CH_3NC $4-3$ transitions (Cernicharo et al., in preparation). Also, except perhaps for HCl in Orion (Blake et al. 1985), chlorine had never been detected by the radio techniques. The nature of the IRC+10216 envelope, which is formed of gas expelled by a cool carbon star, allows us however to understand why Cl and Na were detected in NaCl, rather than associated with more abundant elements.

A large fraction of the molecules present in the IRC+10216 envelope have probably been formed in the outer atmosphere of the central star. There, the gas density is high enough that molecular abundances reflect chemical equilibrium, i.e. they depend essentially on the molecular dissociation energies. NaCl is one of the most stable chlorine molecules. Since Na is more abundant than Cl (and largely available in atomic form), a large fraction of Cl must be locked into this molecule. Chemical equilibrium calculations in fact indicate that most of chlorine is in the form of NaCl in stellar atmospheres with temperatures of the order of 1000 K, (Tsuji 1973). The cosmic abundance of Cl, relative to hydrogen, is $3 \cdot 10^{-7}$ and hence NaCl could be as abundant as SiO. Provided the original abundance is preserved in the envelope, the very large dipole moment of NaCl (9 debye) would then ensure its radio detection.

In order to derive the column density of NaCl, we have to estimate a source size. Judging from the rather flat line shapes in Fig. 1, the source is not resolved by the antenna beam (a direct measurement of the size was not attempted in view of the weakness of the lines). The NaCl lines look more similar to the flat-topped SiS line, for which we measure a source size of $\approx 14''$, than to the U-shaped C_4H lines, which arise from a source of size $\approx 20''$ (e.g. Kahane et al. 1987). Actually, the NaCl line widths seem smaller than the width of most lines in IRC+10216 ($29-30 \text{ kms}^{-1}$) and are about equal to the widths of the SiS lines (26.5 kms^{-1}): averaging the three upper lines of Fig. 1, we find $\Delta\nu = 26.6 \pm 0.4 \text{ kms}^{-1}$. We conclude that the NaCl source is at most $15''$ and could be much smaller. Assuming a uniformly bright source of size $15''$, we derive from the six transitions of Table 1 a rotation temperature of 17 K and a total NaCl column density of $5 \cdot 10^{12} \text{ cm}^{-2}$. (These values would become 16 K and $3 \cdot 10^{13} \text{ cm}^{-2}$, respectively, for a source size of $3''$.)

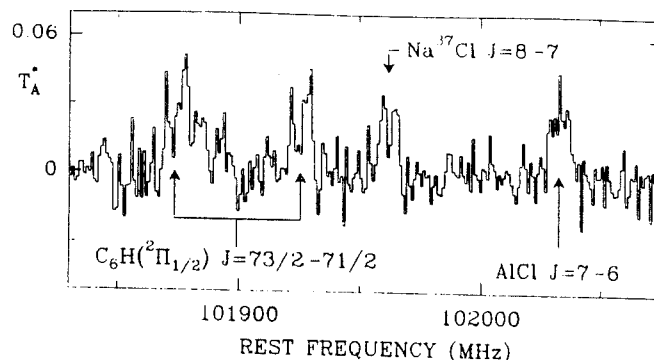

Fig. 2: The $J=8-7$ transition of the rare ^{37}Cl isotope of NaCl and the $J=7-6$ transition of AlCl toward IRC+10216.

TABLE 1
METAL HALIDES LINES IN IRC+10216

Obs. Freq. (MHz)	$\int T_A^* dv$ K kms $^{-1}$	Transition	Obs-Lab ¹⁾ (MHz)
NaCl			
91169.7 (3)	1.91 (20)	$J = 7 - 6$	-0.2
104189.8 (3)	1.24 (14)	$J = 8 - 7$	0.1
130223.4 (3)	1.93 (9)	$J = 10 - 9$	-0.2
143237.0 (4)	1.47 (23)	$J = 11 - 10$	-0.4
156248.6 (2)	1.52 (13)	$J = 12 - 11$	0.0
169258.3 (10)	1.54 (30)	$J = 13 - 12$	1.1
Na^{37}Cl			
101961.9 (5)	0.68 (9)	$J = 8 - 7$	0.3
AlCl			
87457.9 (5)	0.73 (20)	$J = 6 - 5$	0.3
102032.4 (5)	0.82 (10)	$J = 7 - 6$	0.5
145744.2 (3)	2.42 (10)	$J = 10 - 9$	-0.4
160311.9 (3)	3.56 (35)	$J = 11 - 10$	-0.2
Al^{37}Cl			
142322.5 (5)	1.10 (20)	$J = 10 - 9$	0.7
156546.8 (10)	1.52 (30)	$J = 11 - 10$	-0.4
KCl			
99928.5 (10)	0.43 (15)	$J = 13 - 12$	-0.9
107611.3 (10)	0.25 (13)	$J = 14 - 13$	-0.1
130650.2 (6)	0.51 (11)	$J = 17 - 16$	-0.2
146002.1 (10)	0.39 (6)	$J = 19 - 18$	-1.1
153678.7 (10)	0.71 (12)	$J = 20 - 19$	1.3
161349.4 (15)	1.00 (40)	$J = 21 - 20$	-0.6
AlF			
98926.6 (5)	0.97 (10)	$J = 3 - 2$	-0.1
131898.0 (10)	0.80 (18)	$J = 4 - 3$	-0.7
164867.7 (6)	1.90 (40)	$J = 5 - 4$	-0.1

When non specified Cl refers to the main isotope ^{35}Cl . The numbers in parentheses are in one σ uncertainties.

¹⁾Observed minus laboratory frequencies (laboratory data are taken from Lovas and Tiemann, 1974).

The abundance of NaCl in the inner envelope is two to three orders of magnitude smaller than those of SiS, CS, SiCC, and SiO (Cernicharo et al. 1987b). It is probably 10^8 times smaller than that of H_2 . This is consistent with the abundances calculated by Tsuji (1973) at chemical equilibrium in a carbon rich atmosphere with a temperature of ≈ 1000 to 1400 K. Provided our interpretation of the NaCl line profiles is correct, the fractional abundance of NaCl in the outer atmosphere is smaller, as appears to be the case for SiS and SiO. A decrease of the abundances of the refractory species SiS, SiO and NaCl in the relatively cold outer envelope is expected, due to condensation onto grains.

The chemical equilibrium calculations predict that other metal halides form together with NaCl at temperatures of ≈ 1000 K. For a carbon rich atmosphere where, except for C and O, the elemental abundances are similar to those in the sun, the most abundant are KCl, AlF, AlCl and $CaCl_2$ (see Fig. 3g of Tsuji 1973). The first three are polar molecules (their permanent dipole moments are $\mu = 10.3$, 1.5 and ≈ 1.5 debye, respectively) and we have searched for their rotational transitions in our data. The results are shown in Table 1. There are 6 lines with frequencies corresponding to transitions of KCl, 3 lines to transitions of AlF (Fig. 3), and 4 lines to $Al^{35}Cl$. The other transitions of these species are either blended with lines from other molecules, or fall outside our frequency survey. The strongest lines belong to AlCl and we have searched for the ^{37}Cl isotope of this species, since the terrestrial $^{35}Cl/^{37}Cl$ ratio is only 3.1. We see two lines with the expected intensity at the 10-9 and 11-10 transition frequencies (Table 1). Although some of the lines are so weak that their frequencies are not as well determined as in the case of NaCl, the detection of KCl, AlCl, and even AlF seems clear. We failed, on the other hand, to find any trace of $CaCl$, a molecule observed in the visible spectrum of some C and CS stars, as well as of NaF, CCl, SiCl, NCl, PCl, NCCl and FeO.

The lines of the ^{37}Cl isotopes of NaCl and AlCl we detect (see Table 1) are weak and allow only a rough determination of the $Na^{35}Cl/Na^{37}Cl$ and $Al^{35}Cl/Al^{37}Cl$ abundance ratios: 2 ± 1 and 2.4 ± 0.6 , respectively. At most, we can say that these ratios are compatible with the terrestrial $^{35}Cl/^{37}Cl$ isotopic ratio.

The identification of NaCl, AlCl, and KCl, and the tentative detection of AlF in the millimetre spectrum of IRC+10216, show that metals can be abundant in the gas phase not only in stellar atmospheres, but also in cool circumstellar envelopes. Metal halides, which are refractory molecules, are unlikely to form in cool envelopes and must have been recently ejected from the central star. They are useful probes of the physical condition in the stellar atmosphere and may help assessing the stellar mass loss rate. At equilibrium, for example, the AlCl/NaCl abundance ratio depends critically on temperature (see Tsuji 1973). The value of ≈ 40 we observe would correspond to an atmosphere temperature of 1200 to 1500 K for a terrestrial Al/Na abundance ratio. The abundances derived for KCl and AlF (respectively ≈ 0.3 and 8 times the abundance of NaCl) are roughly consistent with this result.

Our present search for metal-bearing molecules has been strongly biased by the lack of laboratory data, particularly in the case of radicals. It has also been restricted to one source. Many more metallic molecules and radicals must be present in circumstellar envelopes and their rotational spectrum can be complex. It is likely that these species contribute significantly to the rich millimetre-wave spectrum of IRC+10216. The radical in a $^2\Sigma$ state with a rotation constant of 5967 MHz, discovered in IRC+10216 by Guélin et al. (1986), could well be for example C_2Cl .

We thank S. Guilloteau who kindly observed for us the spectrum of Fig. 2.

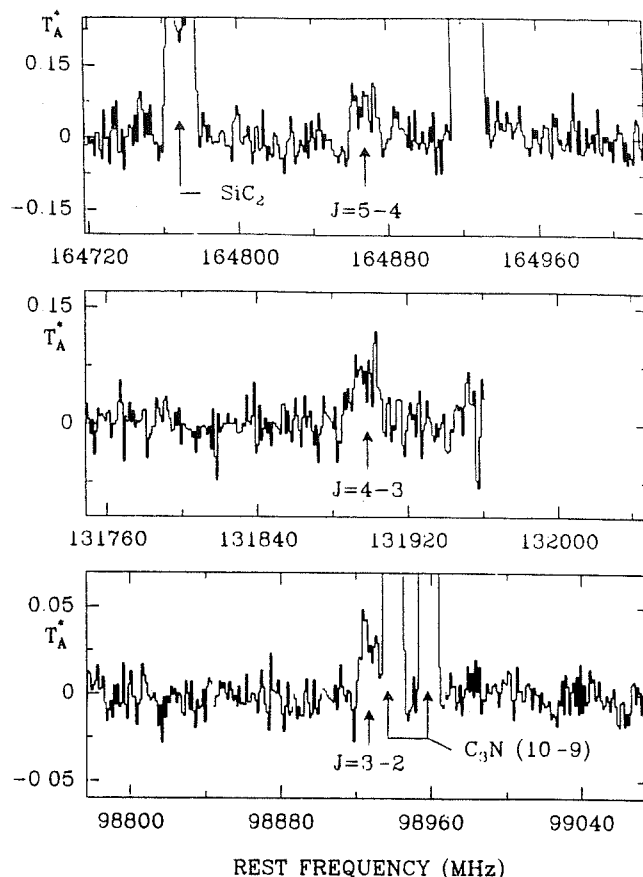

Fig. 3: The three lines tentatively assigned to the 3-2 through 5-4 rotational transitions of AlF.

References

- Blake, G.A., Keene, J., and Phillips, T.G.: 1985, *Astrophys. J.*, **295**, 501.
- Blundell, R., Cernicharo, J., and Guélin, M.: 1987, submitted.
- Cernicharo, J., Guélin, M., Menten, K.M. and Walmsley, C.M.: 1987a, *Astron. Astrophys. (Letters)*, in press.
- Cernicharo, J., Guélin, M., Hein, H. and Kahane, C.: 1987b, *Astron. Astrophys. (Letters)*, in press.
- Guélin, M., Cernicharo, J., Kahane, C. and Gómez-González, J.: 1986, *Astron. Astrophys. (Letters)*, **157**, L17.
- Guélin, M., Cernicharo, J., Navarro, S., Woodward, C.R., Gottlieb, C.A., and Thaddeus, P.: 1987, *Astron. Astrophys. (Letters)*, in press.
- Hollis, J.M., and Rhodes, P.J.: 1982, *Astrophys. J. (Letters)*, **262**, L1.
- Kahane, C., Cernicharo, J., Gómez-González, J., and Guélin, M.: 1987, *Astron. Astrophys.*, in press.
- Lovas, F., and Tiemann, E.: 1974, *J. Phys. Chem. Ref. Data*, **3**, 609.
- Tsuji, T.: 1973, *Astron. Astrophys.*, **23**, 411.

PARTIE III

**CONTRIBUTION A LA MISE EN OPERATION DU RADIOTELESCOPE DE 2.5-m
DE L'OBSERVATOIRE DE BORDEAUX, DES RADIOTELESCOPES L'IRAM ET DU
RADIOTELESCOPE SUBMILLIMETRIQUE DE L'OBSERVATOIRE DE GRENOBLE**

III.01) AMELIORATION DU POINTAGE.	407
III.01.A) Introduction.	409
III.01.B) Description des erreurs.	412
III.01.C) Détermination de la came de pointage.	431
III.02) LA CALIBRATION DES OBSERVATIONS.	435
III.02.A) La calibration	437
III.02.A.1) Température de calibration.	438
III.02.A.2) Température de récepteur.	443
III.02.A.3) Température de système.	445
III.02.B) L'atmosphère. Détermination de l'opacité atmosphérique	446
III.03) DETERMINATION DE L'OPACITE ATMOSPHERIQUE A PARTIR D'UN MODELE D'ATMOSPHERE.	453
III.04) LE TELESCOPE MILLIMETRIQUE DE 2.5-M. DU PLATEAU DE BURE.	485

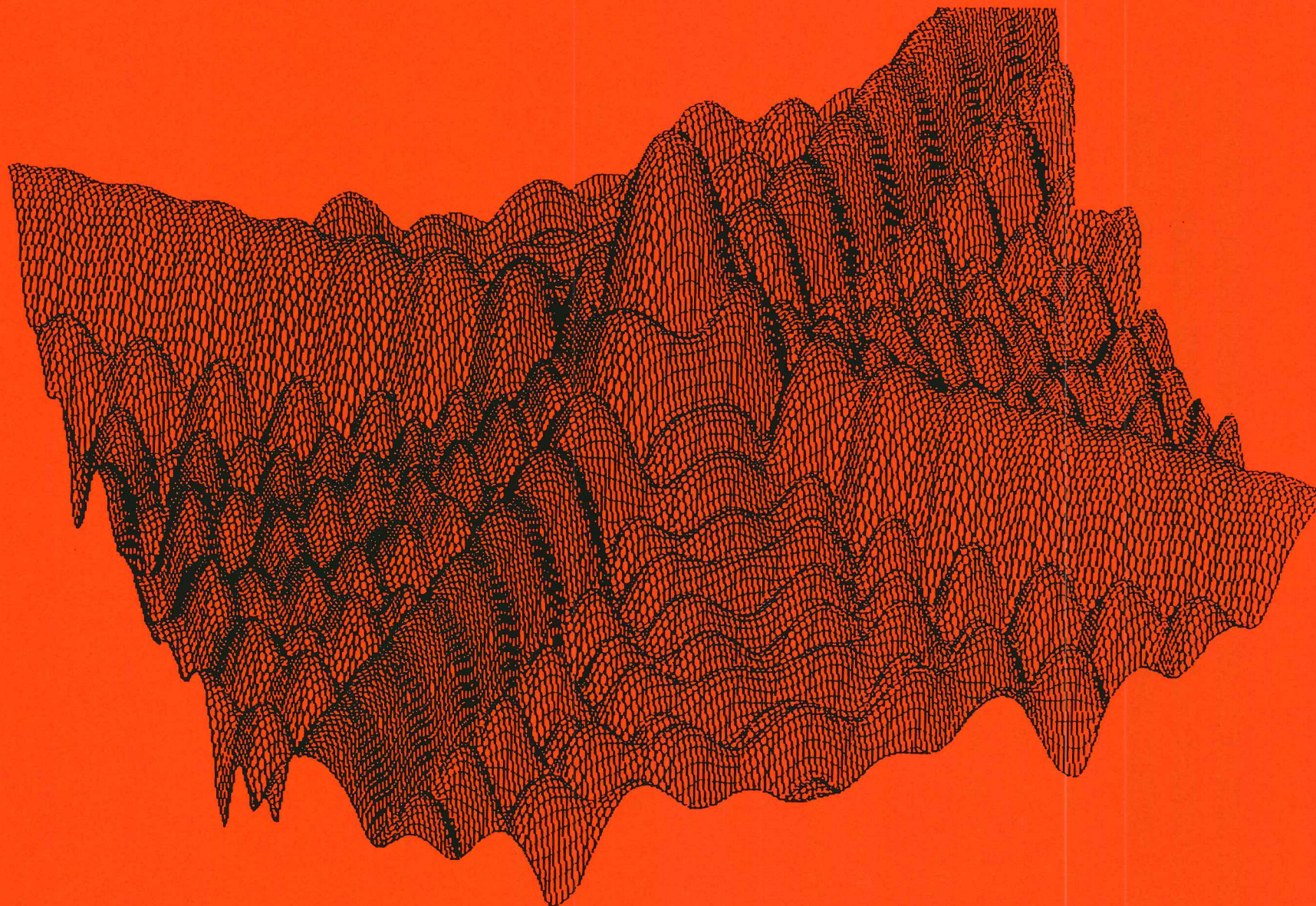

Convolution du diagramme de rayonnement theorique du 30-m avec une source de 18" de rayon ($\lambda=3.5$ mm). Le premier lobe secondaire est à 22 db. La croix est due au quadroupode de l'antenne.

III.01) AMELIORATION DU POINTAGE D'UN RADIOTELESCOPE

ALTAZIMUTAL

**III.01) AMELIORATION DU POINTAGE D'UN RADIOTELESCOPE
ALTAZIMUTAL**

III.01.A) INTRODUCTION

III.01.B) DESCRIPTION DES ERREURS DE POINTAGE

III.01.B.1) Inclinaison de l'axe d'azimut.

III.01.B.2) Inclinaison de l'axe d'élévation.

III.01.B.3) Positionnement et alignement des codeurs.

III.01.B.4) Collimation.

III.01.B.5) Réfraction atmosphérique.

III.01.B.6) Coordonnées géocentriques.

III.01.B.7) Déflexion gravitationnelle.

III.01.C) DETERMINATION DE LA CAME DE POINTAGE.

III.01.A) INTRODUCTION

Les antennes des radiotélescopes modernes sont des instruments altazimutaux. Les antennes du radiotélescope de Bordeaux, du radiotélescope de 30-m. de l'IRAM, ainsi que celle du radiotélescope de 2.5-m. du Groupe d'Astrophysique, pour ne citer que les instruments étudiés dans cette thèse, en sont un bon exemple. La direction du ciel pointée dans ces télescopes est mesurée par rapport au système astronomique du lieu, c'est-à-dire, par rapport au plan tangent à la surface de la terre -ou plan horizontal astronomique-, et par rapport à la verticale du lieu. Les coordonnées à utiliser seront, donc, l'azimut et l'élévation -ou hauteur. La relation entre les coordonnées équatoriales et horizontales est donnée par les expressions :

$$\begin{aligned}\cos(H)\cos(A) &= \sin(\theta)\cos(\delta)\cos(h) - \sin(\delta)\cos(\theta) \\ \cos(H)\sin(A) &= \cos(\delta)\sin(h) \\ \sin(H) &= \cos(h)\cos(\theta)\cos(\delta) + \sin(\theta)\sin(\delta)\end{aligned}\tag{1}$$

où

H, et A sont l'élévation et l'azimut de la source
h, et δ sont l'angle horaire et la déclinaison de la
source.

$h = \text{T.S.L.} - \alpha$

α est l'ascension droite de la source

T.S.L. est le temps sidéral local

θ est la latitude géocentrique de l'observatoire.

En général le système astronomique n'est pas le même que le système dit instrumental -lié aux axes de l'antenne-, et cela est dû entre autres aux différentes erreurs d'alignement des axes d'azimut et d'élévation. Cette différence dans les systèmes de référence introduit une erreur de pointage puisque l'azimut et l'élévation calculés par l'ordinateur seront exécutés dans le plan instrumental. D'autre part l'axe électrique de l'antenne peut être différent de celui du paraboloïde (erreur de collimation), les coordonnées du site peuvent être fausses, les codeurs peuvent être mal placés, etc. A cause de tous ces problèmes, la direction visée ne sera pas la même que celle de la source qu'on veut observer. L'écart de pointage peut devenir très important par rapport aux dimensions du lobe principal et une correction de pointage s'impose avant de faire des observations sérieuses. Dans ce chapitre nous allons décrire les différentes sources des erreurs de pointage et nous déterminerons des expressions simples reliant les erreurs de pointage à quelques paramètres physiques d'un radiotélescope.

Nous allons adopter la définition suivante des erreurs de pointage : Soient R_A et R_H les transformations qui permettent de passer du système instrumental au système astronomique :

$$\begin{aligned} R_A([A_C]_{ins}, [H_C]_{ins}) &= [A_S]_{ast} \\ R_H([A_C]_{ins}, [H_C]_{ins}) &= [H_S]_{ast} \end{aligned} \quad (2)$$

où A_S et H_S sont l'azimut et l'élévation de la source à observer calculés à partir des expressions (1). Les indices "ins" et "ast" indiquent le système dans lequel sont mesurés les différents angles. A_C et H_C sont l'azimut et l'élévation

qu'il faut commander dans le système instrumental pour viser la source; les erreurs ΔA et ΔH sont définies par les conditions :

$$\begin{aligned} RA([A_S + \Delta A]_{ins}, [H_S + \Delta H]_{ins}) &= [A_S]_{ast} \\ RA([A_S + \Delta A]_{ins}, [H_S + \Delta H]_{ins}) &= [H_S]_{ast} \end{aligned} \quad (3)$$

Il est évident que à partir de (2) et (3), et indépendamment de R_A et R_H , nous pouvons écrire :

$$\begin{aligned} \Delta A &= A_C - A_S \\ \Delta H &= H_C - H_S \end{aligned} \quad (4)$$

Maintenant il s'agit de trouver les expressions analytiques reliant ΔA et ΔH aux différentes erreurs d'alignement possibles. On montrera que si les écarts à la perpendicularité des axes sont faibles on peut obtenir une expression simple et linéaire pour les corrections de pointage (Voir Meeks, 1968, Schraml, 1969, Ulich, 1976, Cernicharo 1979).

III.01.B) DESCRIPTION DES ERREURS DE POINTAGE

III.01.B.1) Inclinaison de l'axe d'azimut

Soit XYZ le système astronomique et X'Y'Z' le système instrumental (Voir Figure 1). Si l'axe d'azimut est incliné d'un angle ϕ dans la direction ϕ nous définirons l'axe de niveau comme la droite d'intersection du plan astronomique et du plan instrumental et nous désignerons par $k_A = \phi - 90^\circ$ l'azimut de cet axe. Dans la Figure 1 les axes X et X' sont sur l'axe de niveau. Soit maintenant OP la direction visée dans le ciel; les composantes de ce vecteur dans le système XYZ sont :

$$\begin{aligned} OP_x &= -\cos(k_A - A_S) \cos(H_S) \\ OP_y &= -\sin(k_A - A_S) \cos(H_S) \\ OP_z &= \sin(H_S) \end{aligned} \quad (5)$$

dans le système X'Y'Z' elles auront les mêmes expressions, mais en changeant "s" (source) par "c" (commande). Les deux systèmes sont reliés par la transformation $X_j' = b_{jk} \cdot X_k$ avec :

$$B = [b_{jk}] = \begin{vmatrix} 1 & 0 & 0 \\ 0 & \cos\phi & -\sin\phi \\ 0 & \sin\phi & \cos\phi \end{vmatrix} = \begin{vmatrix} 1 & 0 & 0 \\ 0 & 1 & -\phi \\ 0 & \phi & 1 \end{vmatrix} \quad (6)$$

et

$$OP_{ins} = B \cdot OP_{ast} \quad (7)$$

A partir de (5), (6) et (7) nous obtenons :

FIGURE 1

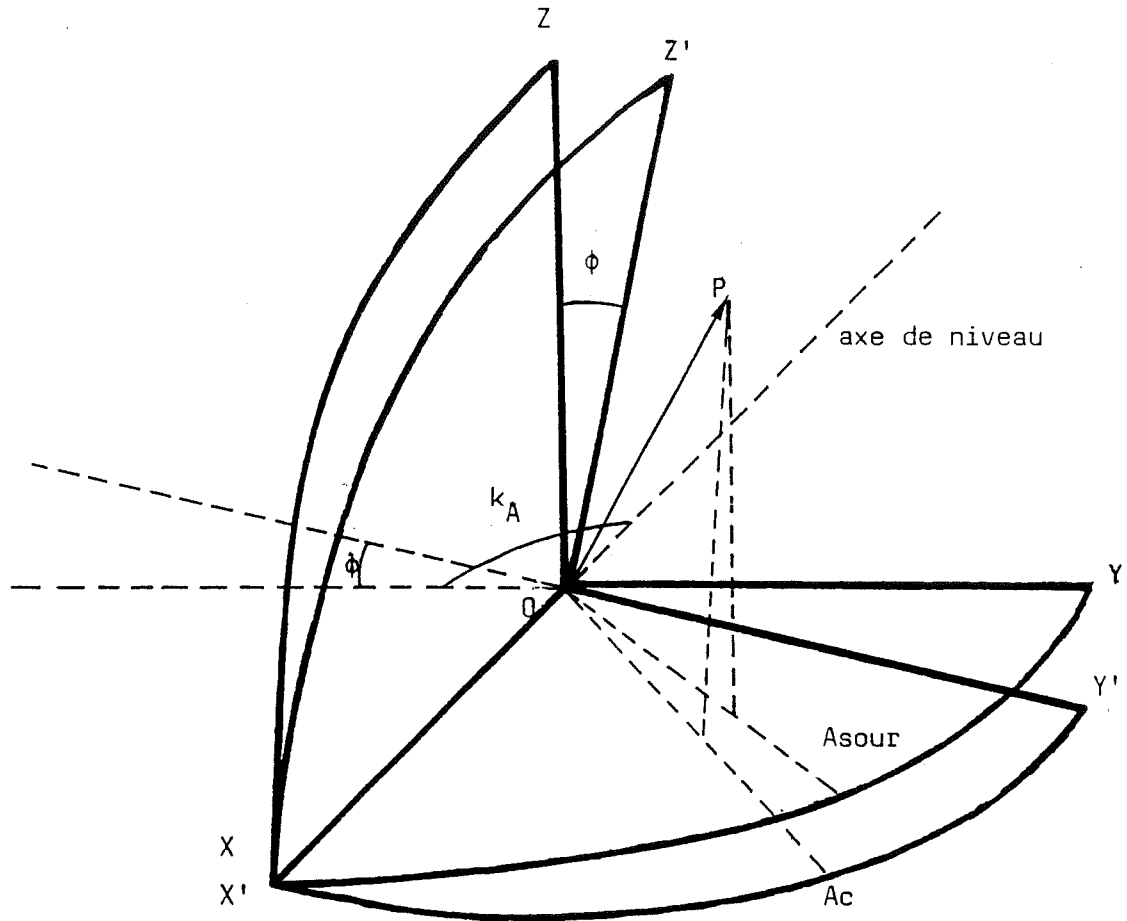

- ϕ Inclinaison de l'axe d'azimut
- k_A Azimut de l'axe de niveau
- \vec{OP} Direction observée (axe électrique de l'antenne)
- A_c Azimut commandé par l'ordinateur ($A_{source} + \Delta A$)
- A_{sour} Azimut de la source calculé par l'ordinateur
- Z, Z' Zénith astronomique et instrumental

FIGURE 1 : Erreur de pointage due à une inclinaison de l'axe d'azimut

$$\Delta A = -\phi \cos(k_A - A_S) \tan(H_S) \quad (8)$$

$$\Delta H = -\phi \sin(k_A - A_S) \quad (9)$$

L'écart de pointage en élévation ne dépend que de l'azimut et il s'agit d'un vrai écart de pointage dans le ciel. L'écart en azimut est ramené au plan astronomique et pour obtenir l'erreur vraie dans le ciel il faut multiplier la valeur de ΔA donnée par l'expression (8) par $\cos(H_S)$. Dans le cas d'une très grande inclinaison de l'axe d'azimut les expressions (8) et (9) ne sont plus valables et il faut utiliser les expressions non linéaires :

$$\Delta H = -H_S + \arcsin[\sin(H_S)\cos(\phi) - \sin(k_A - A_S)\sin(\phi)\cos(H_S)] \quad (10)$$

$$\Delta A = k_A - A_S - \arctan[\cos(\phi)\tan(k_A - A_S) + \sin(\phi)\sin(H_S)/\cos(k_A - A_S)] \quad (11)$$

Il est intéressant de noter que l'expression (9) prédit une erreur de pointage nulle en élévation pour $A_S = k_A$ et cela pour quelque soit l'élévation. Par contre, l'expression non linéaire (10) prédit des erreurs de pointage non nulles pour $A_S = k_A$. Ces erreurs peuvent devenir importantes à haute élévation, même pour de faibles inclinaisons de l'axe d'azimut. Par exemple pour une inclinaison de l'axe d'azimut de 7 minutes d'arc et $A_S = k_A$, l'erreur de pointage en élévation sera de -1" pour $H_S = 66.85^\circ$, de -3" pour $H_S = 81.89^\circ$, de -5" pour $H_S = 85.11^\circ$, et de -7' pour $H_S = 90^\circ$.

III.01.B.2) Inclinaison de l'axe d'élévation

Soit ϵ l'angle entre l'axe d'élévation et un axe perpendiculaire à l'axe d'azimut -qu'on supposera maintenant parfait-. L'écart de pointage dû à cette inclinaison est produit par le fait que l'axe du paraboloïde se déplace dans un plan qui ne contient pas l'axe d'azimut (Figure 2). Soit à nouveau XYZ le système astronomique et X'Y'Z' le système instrumental. Pour les deux systèmes de référence l'axe Y est dirigé vers l'azimut commandé. XYZ et X'Y'Z' sont reliés par une rotation d'angle ϵ autour de l'axe commun. Cette rotation est représentée par

$$B = \begin{vmatrix} \cos\epsilon & 0 & \sin\epsilon \\ 0 & 1 & 0 \\ -\sin\epsilon & 0 & \cos\epsilon \end{vmatrix} = \begin{vmatrix} 1 & 0 & \epsilon \\ 0 & 1 & 0 \\ -\epsilon & 0 & 1 \end{vmatrix} \quad (12)$$

La direction visée OP a les composantes

$$\begin{aligned} OP_x &= \sin(\Delta A) \cos(H_S) \\ OP_y &= \cos(\Delta A) \cos(H_S) \\ OP_z &= \sin(H_S) \end{aligned} \quad (13)$$

et dans le système X'Y'Z'

$$\begin{aligned} OP_{x'} &= 0 \\ OP_{y'} &= \cos(H_C) \\ OP_{z'} &= \sin(H_C) \end{aligned} \quad (14)$$

en utilisant (12) et à partir de $OP = B \cdot OP'$, nous obtenons

$$\Delta A = \epsilon \tan(H_S) \quad (15)$$

$$\Delta H = (\epsilon^2/2) \tan(H_S) \quad (16)$$

Ainsi, en première approximation, une inclinaison de l'axe

FIGURE 2

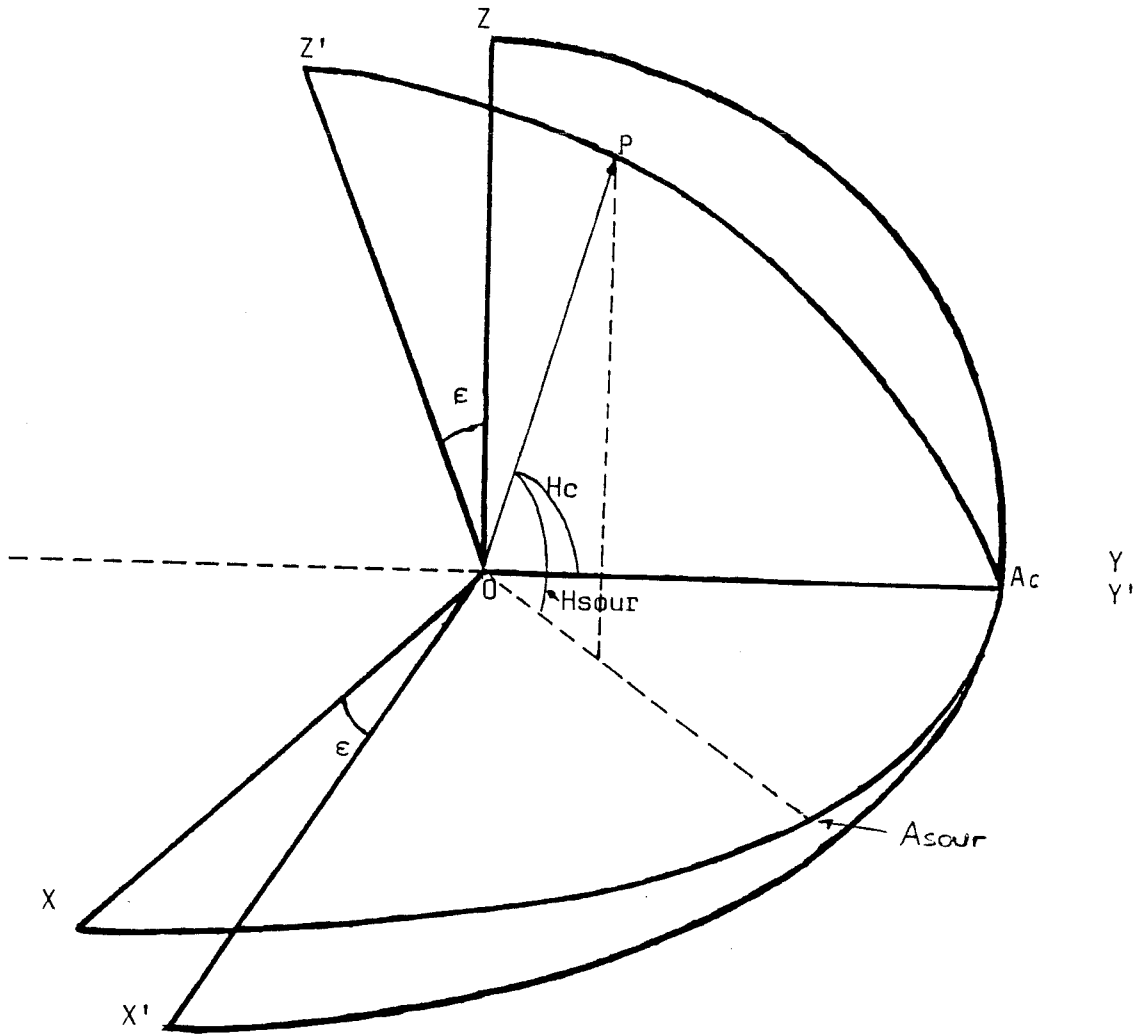

- ϵ Inclinaison de l'axe d'élévation
- H_c Elévation commandée par l'ordinateur ($H_{sour} + \Delta H$)
- A_c Azimut commandé par l'ordinateur ($A_{sour} + \Delta A$)
- H_{sour} Elévation de la source
- A_{sour} Azimut de la source
- Z, Z' Zénith astronomique et instrumental

FIGURE 2 : Erreur de pointage due à une inclinaison de l'axe d'élévation

d'élévation n'introduit pas d'erreur de pointage en élévation, mais elle introduit une erreur proportionnelle à la tangente de l'élévation en azimut (référée au plan astronomique). Les expressions non linéaires, valables quelque soit la valeur de ϵ , sont :

$$\Delta A = \arcsin[\tan(\epsilon) \cdot \tan(H_S)] \quad (17)$$

$$\Delta H = -H_S + \arcsin[\sin(H_S) / \cos(\epsilon)] \quad (18)$$

III.01.B.3) Positionnement et alignement des codeurs

Les codeurs servent à déterminer avec précision la position de l'antenne. En général ils fournissent deux signaux sinusoïdaux déphasés de 90° et liés au mouvement du télescope. La qualité du pointage et de la poursuite des sources dépend donc de la qualité de ces signaux. Evidemment un premier écart de pointage peut venir de l'alignement du zéro de mesure avec le zéro astronomique (typiquement la direction Nord ou Sud pour l'azimut et le plan de l'horizon pour l'élévation).

L'erreur d'alignement des codeurs introduit des écarts de pointage constants sur le système astronomique :

$$\Delta A = K_A$$

$$\Delta H = K_H \quad (19)$$

Puisque généralement l'alignement est fait d'une façon grossière les valeurs de K_A et K_H peuvent être fausses de plusieurs minutes d'arc, voir même de degrés. Mais en plus de leur alignement, les codeurs peuvent être excentriques par rapport aux axes du télescope autour desquels ils tournent. Les écarts de pointage sont alors petits et en conséquence difficiles à mesurer. La figure 3 montre le cas d'une excentricité des codeurs. Nous pouvons constater que l'angle commandé AOB (Ω) n'est pas égal à l'angle lu AO'B (Ω'). Si la

ERREUR DE POINTAGE DU A UNE EXCENTRICITE DES ENCODEURS

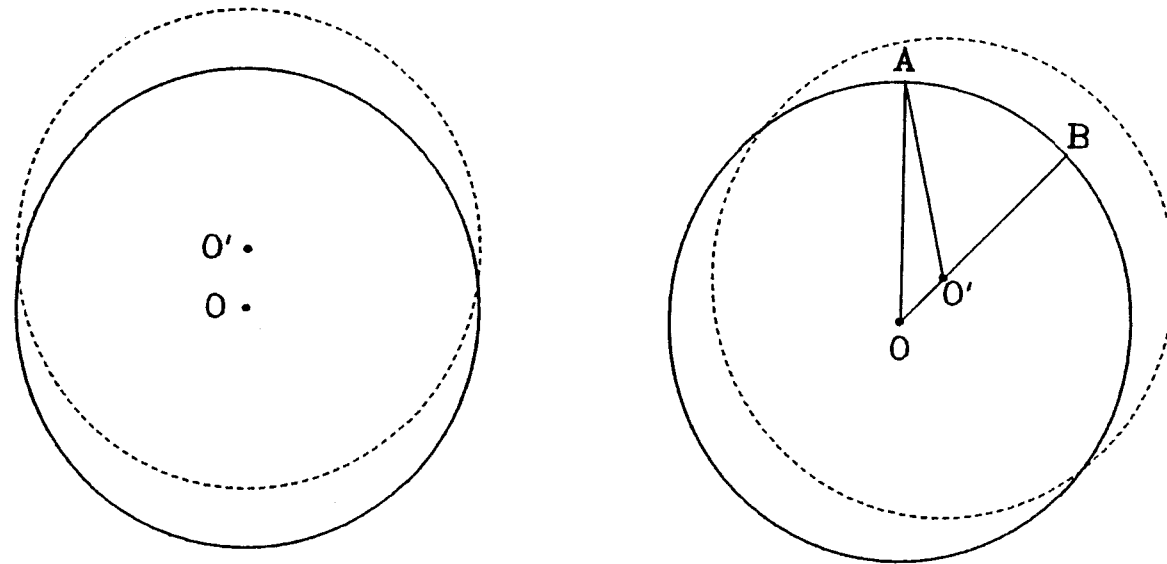

O est l'axe de rotation
O' est le centre des encodeurs
 \widehat{AOB} est l'angle commandé
 $\widehat{AO'B}$ est l'angle lu

FIGURE 3

Erreur de pointage du a une
inclinasion des encodeurs

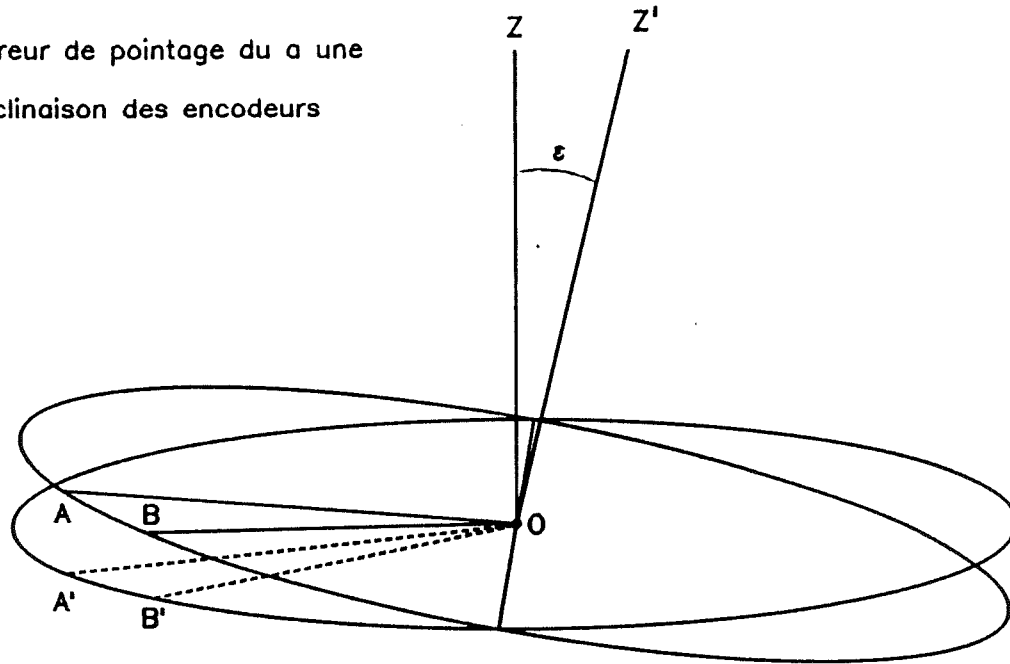

\widehat{AOB} est l'angle de rotation

$\widehat{A'OB'}$ est l'angle lu

OZ' est l'axe de rotation

$$\tan(\widehat{A'OB'}) = \cos(\varepsilon) \tan(\widehat{AOB})$$

$$\widehat{A'OB'} - \widehat{AOB} = (\varepsilon^2/4) \cos(2\widehat{AOB}) + O(\varepsilon^4)$$

FIGURE 4

ERREURS DE POINTAGE EN AZIMUT

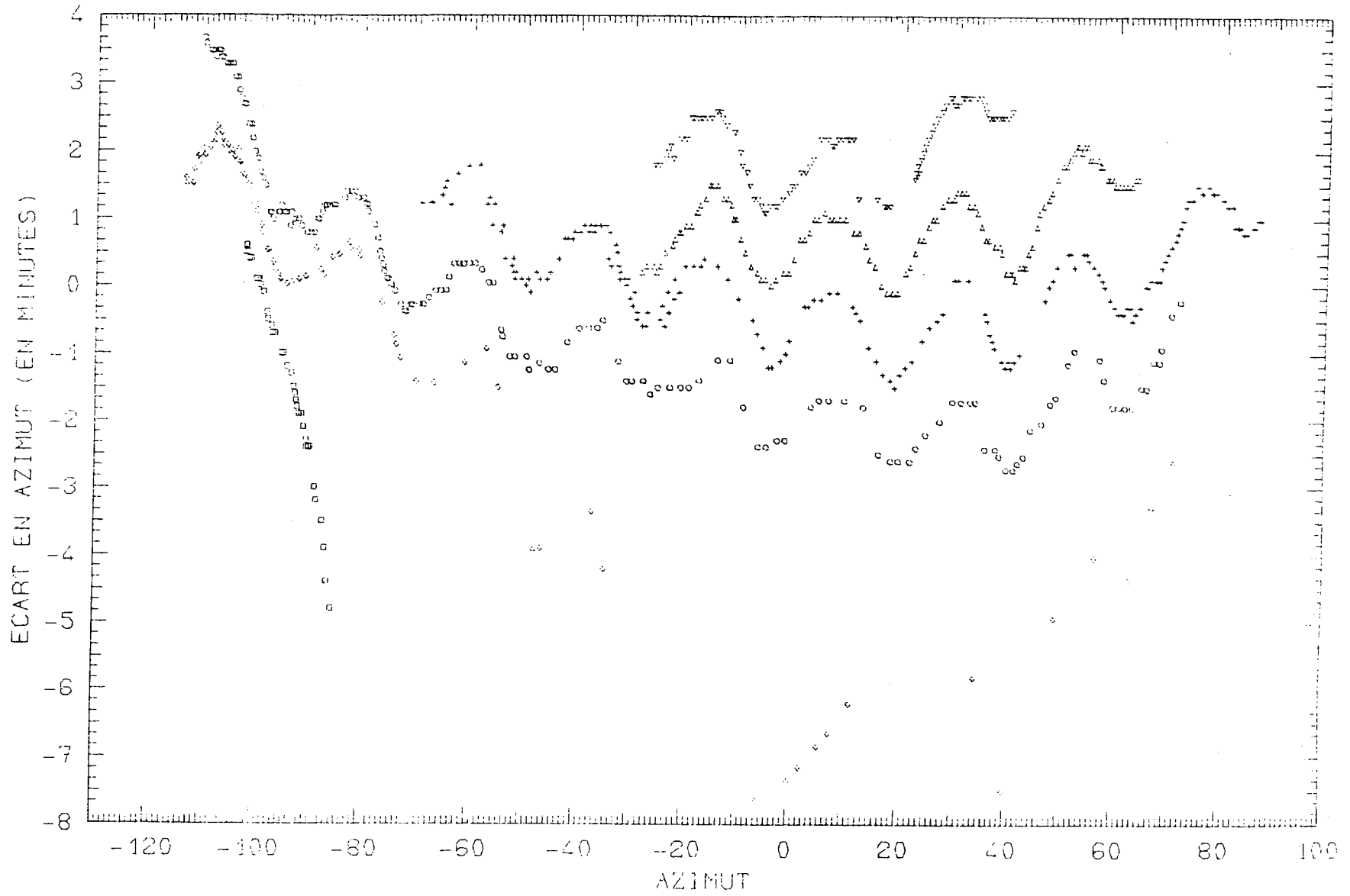

FIGURE 5

différence entre O et O' est e et si l'on écrit $\Omega' = \Omega + \Delta\Omega$ nous pouvons déterminer

$$\Delta\Omega \approx \sin(\Delta\Omega) = e/R \sin(\Omega) \quad (20)$$

où R est le rayon des codeurs. Pour un écart OO' de 0.01 mm et pour $R=10$ cm. l'amplitude de l'erreur sera de 20.6". Il est impossible de déterminer e pour les codeurs d'élévation à partir de mesures radioastronomiques (même dépendance fonctionnelle que l'erreur introduite par la déflexion gravitationnelle de l'antenne).

Les codeurs peuvent aussi être inclinés par rapport à leur axe de rotation (voir Figure 4). Si σ est l'angle d'inclinaison la relation entre l'angle commandé et l'angle lu est donnée par $\tan(\Omega') = \cos(\sigma)\tan(\Omega)$, d'où on dérive en supposant $\cos(\Delta\Omega) \approx 1$ et $\sin(\Delta\Omega) \approx \Delta\Omega$

$$\Delta\Omega \approx -\tan^2(\sigma/2) \sin(2\Omega) \quad (21)$$

L'amplitude de l'erreur sera $\leq 2''$ si $\sigma \leq 20'$. La Figure 5 montre les erreurs de pointage en azimuth mesurées sur le radiotélescope POM I. La sinusoïde de 22° de période est due à une excentricité des codeurs (sur POM I les encodeurs tournent 16 fois plus vite que l'antenne).

III.01.B.4) Erreur de collimation

On appelle ainsi la non orthogonalité de l'axe d'élévation et de l'axe électrique de l'antenne (Figure 6). La collimation en élévation est équivalente à un décalage en élévation et elle est incluse dans le terme K_H . La collimation

FIGURE 6

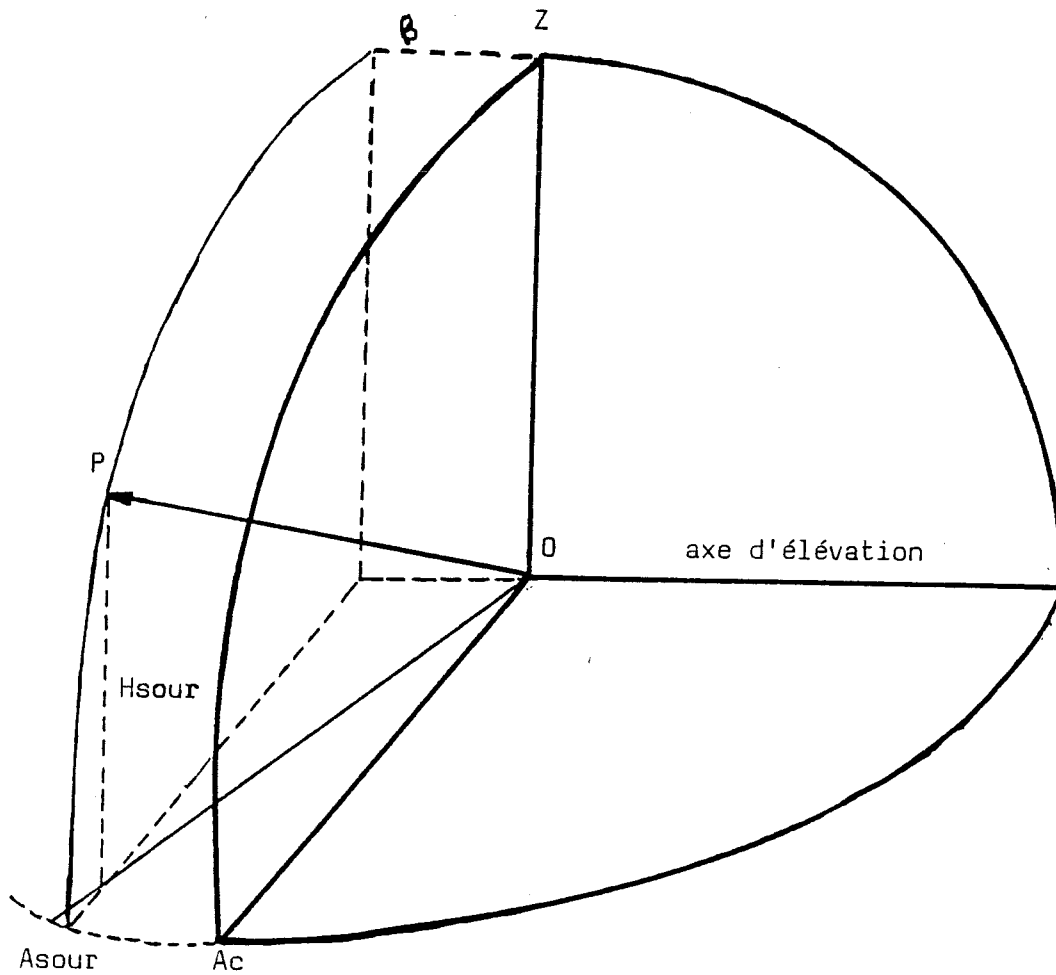

- θ erreur de collimation
- Ac Azimut comandé
- Hsour Elévation de la source
- Asour Azimut de la source

FIGURE 6 : Erreur de pointage due à une erreur de collimation

en azimut introduit un mouvement de l'axe électrique du radiotélescope en dehors du plan défini par le zénith du lieu et l'azimut commandé (voir Fig. 6). Si A_C est l'azimut commandé dans le système instrumental et A_S celui de la source nous pouvons écrire :

$$\Delta A = -\beta / \cos(H_S) \quad (22)$$

où β est l'angle de collimation¹

Les expressions non linéaires sont :

$$\Delta A = \arcsin[-\sin(\beta) / \cos(H_S)] \quad (23)$$

$$\Delta H = -H_S + \arcsin[\sin(H_S) / \cos(\beta)] \quad (24)$$

L'erreur de pointage en élévation dû à la collimation a la même dépendance fonctionnelle que celui dû à une inclinaison de l'axe d'élévation (voir l'expression (18)).

III.01.B.5) Réfraction atmosphérique

Une onde électromagnétique est soumise à une déviation continue de sa direction quand elle traverse un milieu d'indice de réfraction variable. Si l'atmosphère terrestre était plane et uniforme, l'effet de la réfraction serait facile à évaluer, mais les conditions physiques de l'atmosphère dépendent fortement de l'altitude. La constante de réfraction est donnée par (Waters, 1976; Thompson, Moran et Swenson, 1986) :

1) L'erreur de collimation est dû à un déplacement latéral du cornet du récepteur par rapport à l'axe électrique de l'antenne. β , ainsi que tous les angles considérés ici, sont mesurés dans le sens des aiguilles d'une montre, avec le zéro d'azimut situé au Nord.

$$N \cdot 10^6 = K_1 P_d/T + K_2 P_w/T + K_3 P_w/T^2 + K_4 P_c/T \text{ radians} \quad (25)$$

avec $K_1=77.6$, $K_2=64.8$, $K_3=3.776 \cdot 10^5$ et $K_4 = 5/3 K_1$ et où P_w est la pression de la vapeur d'eau, P_c celle du CO et P_d celle de tous les autres composants de l'atmosphère; T est la température en K. L'indice de réfraction est donné par $n=1+N$. Puisque $P_t=P_d+P_w$ on peut réécrire (25), en prenant les valeurs numériques des constantes, comme

$$N(")=16.00615 \cdot P_t/T - 2.64019 \cdot P_w/T + 77885.6 \cdot P_w/T^2 \quad (26)$$

où toutes les pressions sont en millibars et les températures en K.

Dans le cas général d'une atmosphère à géométrie sphérique l'angle de réfraction est donné par (Danjon, 1986):

$$R = \sin(z_0) \int_1^{n_0} (n \sqrt{-\sin^2(z_0) + (rn/r_0 n_0)^2})^{-1} dn \quad (28)$$

où z_0 est l'angle zénithal du télescope, n_0 est l'indice de réfraction au niveau de l'observatoire, n est l'indice de réfraction pour une altitude $r-r_0$, et où r_0 est le rayon de la Terre.

Si z_s est l'angle zénithal de la source, l'angle que l'on devrait commander au télescope pour viser correctement est donné par $z_0=z_s+R$ et l'équation

$$R = \sin(z_S + R) \int_1^{n_0} (n \sqrt{-\sin^2(z_S + R) + (rn/r_0 n_0)^2})^{-1} dn \quad (29)$$

doit être résolue pour déterminer l'angle de réfraction R.

Pour pouvoir calculer l'expression (28) nous devons connaître la variation de l'indice de réfraction avec l'altitude. La figure 7 montre la contribution à l'angle de réfraction en fonction de l'altitude pour un observatoire situé à 2550 mètres (Plateau de Bure); nous avons utilisé le modèle d'atmosphère décrit dans le chapitre III.03 et l'intégration de (28) a été effectuée par une technique de traçage des ondes le long de l'atmosphère. On peut en déduire que la déviation de la trajectoire des ondes électromagnétiques se produit principalement dans les 15 premiers Km de l'atmosphère. Il faut donc connaître des conditions physiques de ces premières couches pour corriger les effets de la réfraction. Heureusement on peut utiliser des expressions qui ne font intervenir que les conditions physiques au sol.

Pour des longueurs d'onde optiques on peut appliquer la loi de Gladstone $(n-1)/d=(n_0-1)/d_0$, où d est la densité de l'air. Il est alors possible d'exprimer l'angle de réfraction comme (Danjon, 1986)

$$R = \sum_j C_j \tan^j z_0 \quad (30)$$

où $C_j=0$ pour j pair et

$$C_1 = \alpha_0(1 - \beta_0)$$

$$C_3 = -\alpha_0(\beta_0 - \alpha_0/2)$$

$$C_5 = 3\alpha_0(\beta_0 - \alpha_0/2)^2$$

$$C_7 = -3.5\alpha_0(\beta_0 - \alpha_0/2)^3 \quad (31)$$

avec $\alpha_0 = n_0 - 1 = 7.884 \times 10^{-5} P_t(\text{mbar})/T(\text{K})$ et $\beta_0 = 4.593 \times 10^{-6} T(\text{K})$ radians (pour une longueur d'onde de 5750 Å). P_t et T sont la pression et la température au niveau de l'observatoire. β_0 dépende de l'échelle caractéristique des principaux composants de l'atmosphère N_2 et O_2 (≈ 8 Km). L'échelle caractéristique de la vapeur d'eau étant différente de celle des autres composants, il n'est pas possible d'utiliser une formule similaire pour de longueurs d'onde millimétriques, car la loi de Gladstone n'est plus applicable. Par contre il est possible de développer des expressions empiriques qui rendent le calcul de la réfraction atmosphérique plus aisé que celui fourni par l'expression (28). En première approximation les coefficients C_j peuvent être séparés en deux termes, l'un pour l'atmosphère sans H_2O , l'autre pour la vapeur d'eau :

$$C_1 = \alpha_0^d(1 - \beta_0^d) + \alpha_0^w(1 - \beta_0^w)$$

$$C_3 = -\alpha_0^d(\beta_0^d - \alpha_0^d/2) - \alpha_0^w(\beta_0^w - \alpha_0^w/2)$$

$$C_5 = 3\alpha_0^d(\beta_0^d - \alpha_0^d/2)^2 + 3\alpha_0^w(\beta_0^w - \alpha_0^w/2)^2$$

$$C_7 = -3.5\alpha_0^d(\beta_0^d - \alpha_0^d/2)^3 - 3.5\alpha_0^w(\beta_0^w - \alpha_0^w/2)^3 \quad (32)$$

où $\alpha_0^d(") = 16.00615 P_t/T$ et $\beta_0^d(") = 0.9474 T$ sont les constantes associées à l'atmosphère sèche, et où $\alpha_0^w(") = -2.64019 P_w/T + 77885.6 P_w/T^2$ et $\beta_0^w(") = 0.3 T$ sont les constantes associées à la vapeur d'eau². Nous avons adopté une échelle caractéristique de H_2O de 2.5 Km.

2) Dans le calcul des C_j , les valeurs de α et β doivent être en radians.

U.S. STANDARD ATMOSPHERE FOR WINTER AT 45 D OF LATITUDE

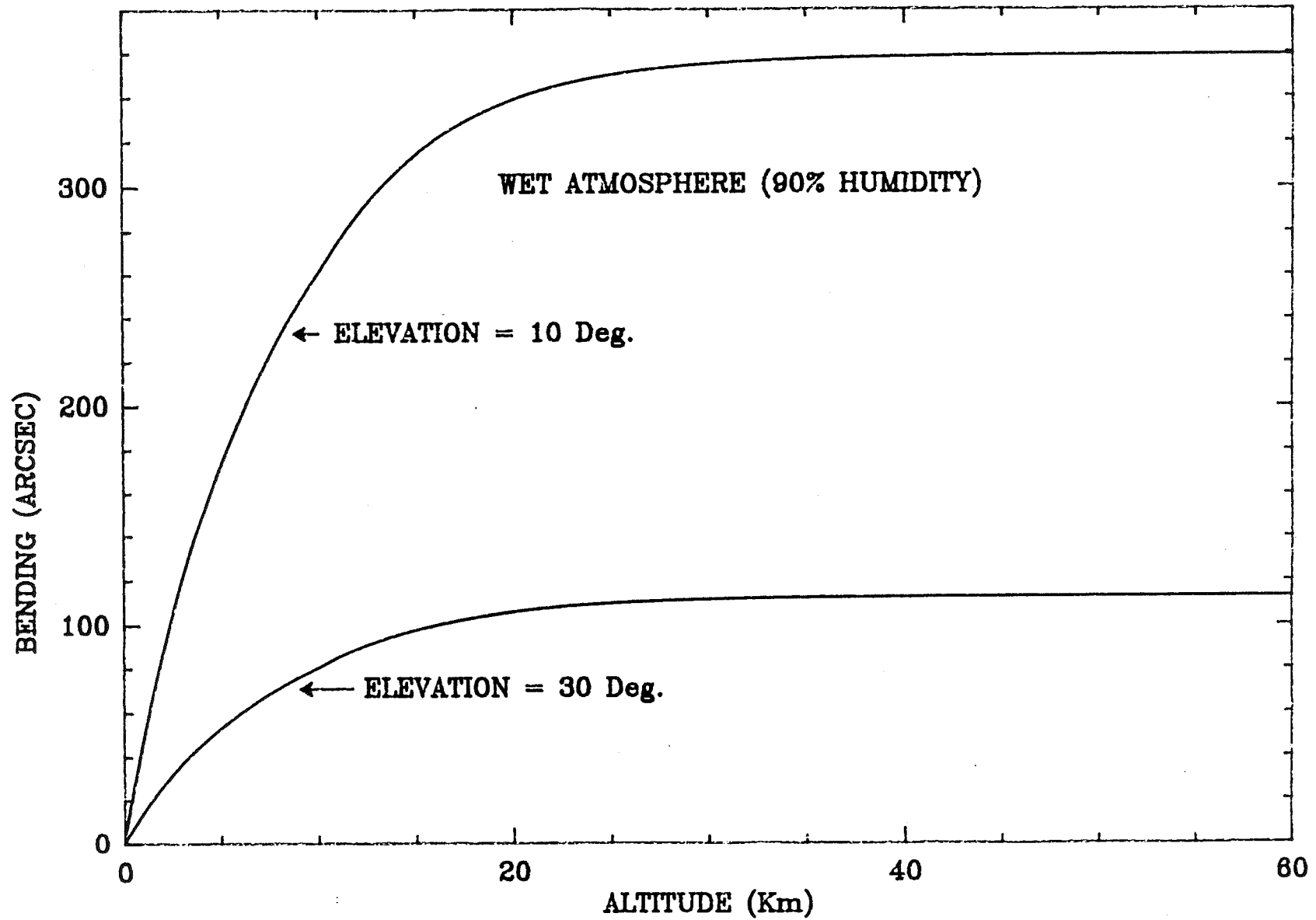

FIGURE 7

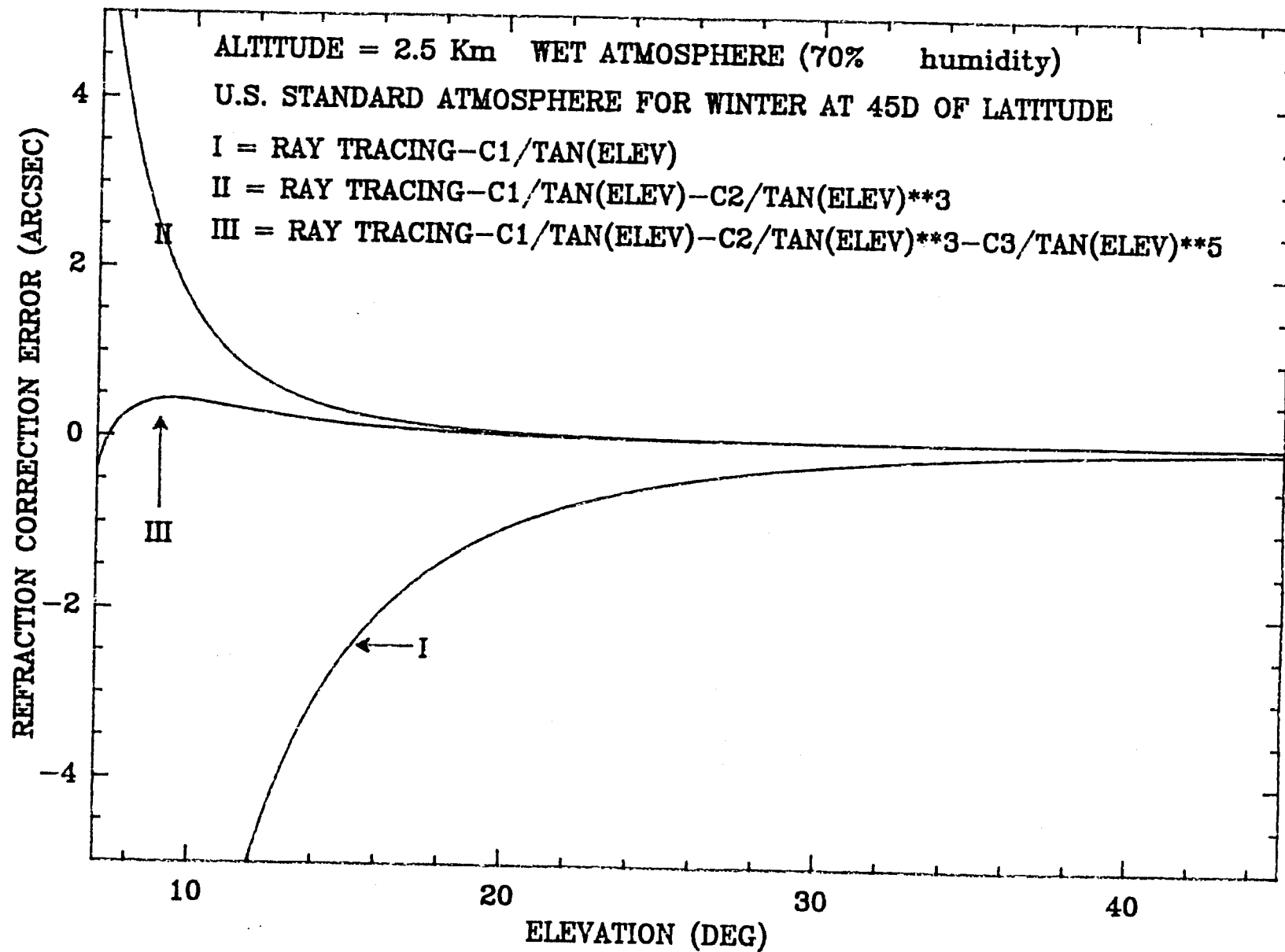

FIGURE 8

La Figure 8 montre la différence entre la valeur de l'angle de réfraction calculé à partir de (28) et la valeur donnée par (30) avec les valeurs des C_j donnée par (32). On peut en déduire que cette approximation donne des résultats très satisfaisants pour des élévations $\geq 10^\circ$.

Cette méthode, avec les termes C_1 , C_3 , et C_5 , est utilisée dans le calcul de la réfraction pour la première antenne de l'interféromètre du Plateau de Bure.

III.01.B.6) Coordonnées géocentriques

Les expressions (1) nous donnent l'azimut et l'élévation en fonction de h , et ϕ . Il est évident qu'une erreur dans les coordonnées géocentriques (ou une erreur dans le T.U.) introduira une erreur dans l'azimut et l'élévation. Nous pouvons obtenir à partir de (1) et après quelques manipulations :

$$\begin{aligned}\Delta A &= - \xi \cos(k_A - A) \tan(H) - \Delta l \sin(\theta) \\ \Delta H &= - \xi \sin(k_A - A)\end{aligned}\tag{33}$$

où

$$\xi = \sqrt{(\Delta\theta)^2 + (\Delta l \cos\theta)^2}\tag{34}$$

$$\tan(k_A) = \Delta\phi / [\Delta l \cos(\theta)]$$

$\Delta\theta$ est l'erreur dans la latitude géocentrique
du télescope

Δl est l'erreur dans la longitude géocentrique
du télescope (ou dans le T.U.)

c'est-à-dire, une erreur dans les coordonnées géocentriques du télescope est équivalente à une inclinaison de l'axe d'azimut

donnée par (22) et à un offset en azimut égal à $\rho \sin(\theta)$. Si l'erreur sur les coordonnées géocentriques ou sur la pendule est trop grande il faut utiliser les expressions non linéaires (10) et (11).

III.01.B.8) Déflexion gravitationnelle

A cause de la gravitation le réflecteur primaire de l'antenne se déformera d'une façon non symétrique entre ses parties supérieure et inférieure. La surface résultante de la déflexion pourra être ajustée par un paraboloïde avec un axe légèrement différent de celui d'un paraboloïde parfait et il en résultera un déplacement et une déviation du faisceau de l'antenne. Le traitement des erreurs de pointage et des variations de gain en fonction de l'élévation n'est pas toujours évident. Il est accepté que pour un radiotélescope construit en suivant le principe de homologie, l'erreur de pointage est donnée par

$$\Delta H = \tau \cos(H) \quad (35)$$

où τ est une constante à déterminer. Si la monture de l'antenne est altazimutale, alors il n'y aura pas d'erreur de pointage en azimut.

III.01.C) DETERMINATION DE LA CAME DE POINTAGE

Les constantes de pointage discutées dans ce chapitre sont liées à des paramètres physiques des télescopes. Une première estimation de quelques uns de ces paramètres peut être obtenue par des mesures mécaniques. Par exemple, l'inclinaison de l'axe d'azimut peut être obtenue par des mesures avec deux inclinomètres placés perpendiculairement dans l'axe de tourillons d'élévation. Ces mesures mécaniques sont en général très délicates et seulement quelques télescopes disposent d'un tel système installé en permanence (Le 30-m., par exemple).

Pour obtenir une came globale, les constantes de pointage doivent être déterminées à partir d'un ajustement par moindres carrés aux erreurs de pointage observées sur des sources astronomiques. Les erreurs totales de pointage peuvent être exprimées comme :

$$\begin{aligned}\Delta A &= \sum_j C_j F_{AZ}^j(A,H) \\ \Delta H &= \sum_j D_j F_{EL}^j(A,H)\end{aligned}\quad (36)$$

C_j et D_j sont les paramètres à déterminer. Les fonctions $F_{AZ}^j(A,H)$ et $F_{EL}^j(A,H)$ sont spécifiques à chacune des erreurs de pointage discutées précédemment. Il est possible de trouver, au cours des mesures de pointage, d'autres corrections que celles traitées ici. Ces erreurs additionnelles doivent être corrigées empiriquement en fonction de l'allure des résidus de pointage. La plupart du temps il ne faut pas considérer les paramètres obtenus par moindres carrés comme de paramètres

physiques, mais comme de paramètres effectifs. On peut commencer à considérer ces constantes comme des paramètres réellement liés au radiotélescope seulement si le nombre de mesures dévient important et si la couverture en azimut et en élévation est suffisamment complète.

Il est souhaitable, pour débroussailler le pointage, d'utiliser une lunette optique placée dans l'axe électrique du radiotélescope. Pour des surfaces collectrices modérées le nombre de radiosources détectables est réduit au soleil et aux planètes. La lunette fourni alors la seule méthode valable pour déterminer une came de pointage correcte sur tout le ciel. Des problèmes potentiels qui sont difficiles à déceler par de mesures radioastronomiques, comme la qualité de la poursuite du télescope, déviennent évidents si l'on dispose d'une lunette. Aux erreurs de pointage du radiotélescope il faut ajouter ceux associées à la lunette elle-même. Mais malgré cela, la détermination optique des corrections de pointage fourni très rapidement la plupart des constantes de pointage. L'inclinaison de l'axe d'azimut, le zéro d'azimut, l'inclinaison de l'axe d'élévation, ainsi que les constantes associées à l'excentricité et l'inclinaison des codeurs peuvent être déterminées en deux ou trois heures. La collimation radio et le zéro d'élévation resteront à déterminer mais pour obtenir ces paramètres quelques mesures radio suffiront.

REFERENCES

- Cernicharo, J.:1979, Tesina, Universidad Complutense de Madrid. (Pointage du radiotélescope du Centro Astrónomico de Yebes).
- Danjon,:1986., *Astronomie Générale*, Ed. Blanchard.
- Meeks, M.L., Ball, J.A., Hull, A.B.:1968, IEEE Transactions on Antennas and Propagation, Vol. AP-16, No. 6, 746. (Calibration du pointage du radiotélescope de Haystack).
- Schraml, J.:1969, NRAO INTERNAL REPORT, September 1969. (Pointage du télescope de 36 pieds).
- Thompson, A.R., Moran, J.M., Swenson, G.W.:1986, "Interferometry and Synthesis in Radio Astronomy", chap. 13.
- Ulich, B.L.:1976, NRAO, TUCSON OPERATIONS, INTERNAL REPORT No. 1. (Pointage du télescope de 36 pieds).
- Waters, J.W.:1976, "Methods of experimental Physics", Ed. par M.L. Meeks, Academic Press. (Absorption et émission dans l'atmosphère terrestre).

III.02) LA CALIBRATION DES OBSERVATIONS MILLIMETRIQUES

III.02) LA CALIBRATION DES OBSERVATIONS MILLIMETRIQUES

III.02.A) LA CALIBRATION

III.02.A.1) Température de calibration

III.02.A.2) Température de récepteur

III.02.A.3) Température de système

III.02.B) MESURE DE L'OPACITE ATMOSPHERIQUE

III.02.B.1) Détermination de l'opacité à partir de deux
mesures de l'émissivité atmosphérique

III.02.B.2) Détermination de l'opacité à partir de
plusieurs mesures de l'émissivité atmosphérique

III.02.A) LA CALIBRATION

Le signal collecté par un radiotélescope et amplifié par le récepteur se trouve en unités arbitraires à la sortie du banc de filtres (bits ou volts). La calibration a pour objet la transformation de ces unités en degrés Kelvin, c'est à dire, dans l'échelle d'intensité communément utilisée en radioastronomie. Pour des longueurs d'onde millimétriques la calibration doit corriger des effets indésirables de l'atmosphère (absorption et émission de rayonnement, voir III.02.B), ainsi que d'autres paramètres qui dépendent de la qualité de l'antenne.

La philosophie du problème est la même que pour les ondes centimétriques, mais la technique à utiliser est complètement différente dans les deux cas. Ceci est dû au fait que pour des longueurs d'onde centimétriques l'atmosphère est pratiquement transparente, et que les sources de bruit qui sont utilisées en radioastronomie centimétrique, (tubes à bruit ou tubes de décharge montés sur des guides d'onde), ne peuvent pas être utilisées d'une façon convenable en radioastronomie millimétrique à cause des petites dimensions des guides d'onde.

La technique la plus couramment utilisée en radioastronomie millimétrique est celle du "chopper wheel" (Penzias et Burrus, 1973) qui consiste à introduire un absorbant à température ambiante devant le cornet et à utiliser la différence entre ce signal et celui que l'on obtient quand l'antenne pointe vers le ciel pour calibrer les observations. Dans la version originale de cette méthode on

suppose que la température moyenne de l'atmosphère est égale à la température ambiante, ce qui donne des erreurs importantes de calibration quand l'opacité de l'atmosphère devient grande, et en particulier pour des fréquences proches de celles des transitions de H₂O et O₂ (voir Davis et Vanden Bout (1973), Ulich et Haas (1978)). Le grand avantage de la méthode du "chopper" est qu'elle corrige en premier ordre les effets de l'atmosphère¹. Malheureusement il n'est pas toujours facile de refroidir un absorbant à une température² donnée et la technique utilisée est celle du "chopper", corrigée de l'atténuation de l'atmosphère déterminée à partir de mesures de son émissivité.

III.02.A.1) Température de calibration

Supposons que nous pouvons utiliser deux absorbants à de températures³ T₁ et T₂ (ce qui est d'ailleurs le plus souhaitable pour avoir une procédure de calibration correcte), et supposons que le récepteur est réglé en simple

1) Ulich (1980), a montré que si l'on utilise un absorbant refroidi à la température moyenne de l'atmosphère on obtient des signaux de calibration pratiquement indépendants de l'opacité atmosphérique.

2) Cette température n'est pas d'ailleurs constante puisque la température moyenne de la atmosphère dépend de l'élévation du radiotélescope. Il s'agit pas d'une température physique mais d'une température effective telle que l'émissivité du ciel est représenté par $T_{atm} \cdot (1 - e^{-\tau})$ où τ est l'opacité totale de l'atmosphère à la fréquence considérée.

3) Dans les expressions de ce chapitre nous utilisons directement les températures physiques des absorbants ou de l'atmosphère dans un but de clarté. En fait, il faut comprendre qu'il s'agit de températures effectives de rayonnement, $J(\nu, T) = \frac{h\nu}{k} (e^{h\nu/kT} - 1)^{-1}$, d'un corps noir à la fréquence ν et à la température physique T .

bande (SSB). Soient $V_j(T_1)$ et $V_j(T_2)$ les signaux détectés par le canal j quand le premier et deuxième absorbants sont mis devant le cornet, et soient $V_j(S)$ et $V_j(R)$ les signaux détectés par le même canal j quand l'antenne pointe vers la source et vers un champ de référence (ou pour une fréquence de référence).

La température d'antenne pour le canal j , corrigée de l'atténuation atmosphérique et des pertes sur l'antenne est donnée par:

$$T^*_j = (V_j(S) - V_j(R)) \cdot (V_j(T_1) - V_j(T_2))^{-1} \cdot e^{\tau A} \cdot (T_1 - T_2) / n_s$$

que nous pouvons écrire comme⁴ :

$$T^*_j = \Delta V_j(\text{signal}) \cdot \Delta V_j(\text{cal})^{-1} \cdot T_{\text{cal}} \quad (1)$$

où la température de calibration, T_{cal} , est donnée par :

$$T_{\text{cal}} = (T_1 - T_2) \cdot e^{\tau A} / n_s \quad (2)$$

où

τ_s est l'opacité atmosphérique au zénith à la fréquence de la bande signal.

A est la masse d'air = $1/\sin(\text{Elevation})$.

$$\Delta V_j(\text{signal}) = V_j(S) - V_j(R).$$

$$\Delta V_j(\text{cal}) = V_j(T_1) - V_j(T_2).$$

n_s est le coefficient de couplage de l'antenne avec les sources extérieurs.

4) Dans l'expression (1) nous avons supposé que l'émissivité des absorbants est indépendante de la fréquence et que la réponse du récepteur est linéaire.

La différence (T_1-T_2) doit être suffisamment grande pour que l'erreur sur $\Delta V(\text{cal})$ soit faible⁵ (le temps d'intégration pour la calibration n'est en général que de quelques secondes). Normalement un des absorbants est à la température ambiante et l'autre à la température de l'azote liquide (ou à une température supérieure à l'ambiante). On obtient ainsi des températures de calibration qui sont typiquement $\approx 200-300$ fois plus grandes que les signaux que l'on veut mesurer, et parfois, même deux ou trois fois plus grandes que la propre température du récepteur (récepteurs SIS).

L'expression donnée plus haut pour la température de calibration n'est valable que dans le cas où le récepteur est réglé en SSB; dans le cas plus général d'un récepteur réglé en double bande (DSB) la température de calibration est donnée par

$$T_{\text{cal}} = [G_s \cdot (T_1 - T_2) + G_i \cdot (T_1 - T_2)] \cdot e^{\tau A} / (n_s G_s) \quad (3)$$

où

G_s est la transmission dans la bande signal

G_i est la transmission dans la bande image

et où nous avons introduit le terme $1/G_s$ pour tenir compte du fait que en double bande le signal de calibration est reçu dans les deux bandes tandis que le signal à mesurer n'est reçu que dans une bande. Le gain de chaque bande est, en général, très difficile à mesurer et il est souhaitable, tant que possible, de travailler en SSB. S'il est impossible d'éliminer la bande image on suppose alors que $G_s = G_i = 0.5$ et de

5) Par contre elle ne doit pas être très grande par rapport au signal provenant de la source moléculaire, de façon à éliminer les erreurs dans la calibration dues à une possible non linéarité du récepteur.

(3) on obtient $T_{\text{cal}}(\text{DSB})=2 \cdot T_{\text{cal}}(\text{SSB})$. Il faut comprendre que même si le récepteur est réglé en double bande, $T_{\text{cal}}(\text{DSB})$ est une température de calibration SSB (les raies ne sont que sur une seule bande).

Dans le cas où deux absorbants à différentes températures ne seraient pas disponibles on peut remplacer l'un d'eux par l'atmosphère. La température d'antenne, à une fréquence ν , quand le télescope pointe vers le ciel est donnée par :

$$T_{\text{ciel}}=(1-n_1) \cdot T_{\text{amb}}+n_1 \cdot T_{\text{atm}} \cdot (1-e^{-\tau(\nu)})+n_1 T_{2.7} \cdot e^{-\tau(\nu)} \quad (4)$$

où

$\tau(\nu)$ est l'opacité de l'atmosphère à la fréquence ν

T_{atm} est la température moyenne effective de l'atmosphère,

n_1 est le coefficient de couplage de l'antenne avec le ciel

$T_{2.7}$ est la température du rayonnement cosmologique.

et où nous avons supposé que l'atmosphère peut être modélisée par une seule couche de température T_{atm} et d'opacité $\tau(\nu)$. En réalité, la distribution en hauteur des principaux absorbants atmosphériques O_2 et H_2O n'est pas la même et il faut faire appel à des modèles plus compliqués qui rendent compte de cette différence⁶ (voir par exemple le modèle à deux couches de Kutner (1978)). La température de calibration en SSB peut être obtenue à partir de (2) et de (4) comme :

6)Malheureusement, le nombre de paramètres -d'ailleurs difficiles à mesurer-, augmente avec la complexité du modèle et celui à une seule couche est le plus utilisé du fait de sa simplicité et la faible erreur qu'il donne sur l'opacité totale.

$$T_{cal}(SSB)=[T_{abs}-T_{amb}+n_1 \cdot (T_{amb}-T_{atm})+n_1 \cdot T_{atm} \cdot e^{-\tau A}] \cdot e^{\tau A}/n_s \quad (5)$$

où T_{abs} est la température de l'absorbant.

Dans la version original de la méthode du "chopper wheel" on suppose $T_{atm}=T_{amb}=T_{abs}$ ce qui donne $T_{cal}(SSB)=n_1 \cdot T_{atm}/G_s$. Il peut être montré que $T_{atm}=T_{amb}-20$ est assez souvent une bonne approximation. Si $T_{abs}=T_{amb}$ on obtient :

$$T_{cal}(SSB)=((T_{amb}-20) \cdot n_1 + 20 \cdot e^{\tau A} \cdot n_1)/G_s; \quad (5b)$$

si $\tau_s A$ est faible alors les corrections dues à l'absorption atmosphériques sont petites par rapport au premier terme de (5b). Par contre, pour des opacités ≈ 0.4 -comme c'est le cas pour la fréquence de la raie $J=1-0$ de $^{12}CO-$, la contribution du terme en τ peut atteindre le 30-40% de la température de calibration.

Quand le récepteur est réglé en DSB la température de calibration est donnée par :

$$T_{cal}(DSB)=[(T_{abs}-T_{amb})+(T_{amb}-T_{atm}) \cdot (G_s \cdot n_1^s + G_i \cdot n_1^i)] + (T_{atm}-T_{2.7}) \cdot (G_s \cdot n_1^s e^{-\tau A} + G_i \cdot n_1^i e^{-\tau A}) \cdot e^{\tau A}/(n_s \cdot G_s) \quad (6)$$

où nous avons supposé $G_s+G_i=1$, et où n_1^s et n_1^i sont les coefficients de couplage de l'antenne avec le ciel pour les fréquences signal et image respectivement. Pour un radiotélescope équipé d'un récepteur à faible fréquence intermédiaire ce deux coefficients sont pratiquement égaux. Pour un récepteur de fréquence intermédiaire élevée (4-5 GHz), la différence entre les fréquences des bandes signal et image peut être $\approx 10\%$ de la fréquence typique de travail. Pour un tel écart en fréquence, l'illumination de l'antenne

par le cornet sera différente et de mesures de n_1 aux deux fréquences s'imposent.

Si nous supposons que $G_s = G_i = 0.5$ et que $n_1^s = n_1^i = n_1$ alors de (6), avec $\Delta\tau = \tau_s - \tau_i$, on obtient :

$$T_{\text{cal}}(\text{DSB}) = \left([T_{\text{abs}} - T_{\text{amb}}] + n_1 \cdot [T_{\text{amb}} - T_{\text{atm}}] + 0.5 \cdot n_1 \cdot (T_{\text{atm}} - T_{2.7}) \cdot e^{-\tau A} \cdot [1 + e^{-\Delta\tau A}] \right) \cdot 2 \cdot e^{\tau A} / n_s \quad (7)$$

De (7) on peut voir que $T_{\text{cal}}(\text{DSB}) \approx 2 \cdot T_{\text{cal}}(\text{SSB})$ puisque la différence $\Delta\tau$ est dans le plupart de cas petite (voir III.02.B).

III.02.A.2) Température de récepteur

La température du récepteur peut être calculée à partir des signaux mesurés sur deux absorbants à différente température placés devant le cornet du récepteur. Nous aurons:

$$\begin{aligned} V(T_1) &\propto T_{\text{réc}} + T_1 \\ V(T_2) &\propto T_{\text{réc}} + T_2 \end{aligned} \quad (8)$$

d'où

$$T_{\text{réc}} = (T_1 - y \cdot T_2) / (y - 1) \quad (9)$$

avec

$$y = V(T_1) / V(T_2)$$

et où toutes les mesures sont effectuées sur toute la bande passante du système.

Si au lieu d'utiliser deux absorbants on n'en utilise qu'un seul et l'émissivité de l'atmosphère, il suffit de remplacer T_2 par l'expression donnée par (4) pour T_{ciel} . On obtient ainsi une mesure de $T_{\text{réc}}$ qui dépend de l'opacité atmosphérique. Nous pouvons utiliser cette mesure pour suivre les fluctuations de l'atmosphère en supposant $T_{\text{réc}}$ connu.

En général la température des deux absorbants est bien connue, mais il n'est pas de même quand on utilise un absorbant et l'atmosphère puisque l'incertitude sur T_{ciel} peut être facilement⁷ dans ce cas de l'ordre de 20-30 K, ce qui donne des erreurs de 30-40% pour $T_{\text{réc}}$. Il est facile de voir à partir de (4) que

$$\Delta T_{\text{réc}} \propto -(\Delta T_{\text{atm}} \cdot (1 - e^{-\tau A}) + \Delta \tau_s \cdot A \cdot e^{-\tau} \cdot A \cdot (T_{\text{atm}} - T_{2.7})), \quad (10)$$

et ainsi si l'opacité diminue la température de récepteur calculée est sous-estimée, etc.

⁷) C'est souvent le cas quand l'opacité est élevée et l'élévation $\leq 20^\circ$.

III.02.A.3) Température de système

La température du système est définie comme la température que devrait avoir un récepteur installé sur une antenne parfaite hors de l'atmosphère pour que ce système soit équivalent au radiotélescope situé sur le sol. La température de système inclut en fait la température de la source et elle est nécessaire pour moyenner les observations faites à différents élévations. Si $V(\text{ciel})$ est la tension détectée à la sortie du récepteur sur toute sa bande quand l'antenne pointe vers le ciel, la température du système ramenée en SSB est donnée par :

$$\begin{aligned} T_{\text{sys}} &= V(\text{ciel}) \cdot [T_1 - T_2] \cdot e^{\tau A} / n_s / (V(T_1) - V(T_2)) / G_s \\ &= V(\text{ciel}) \cdot [V(T_1) - V(T_2)]^{-1} \cdot T_{\text{cal}} \end{aligned} \quad (11)$$

où T_{cal} est donnée par (2) ou par (3) selon que le récepteur soit réglé en SSB ou en DSB si l'on utilise les deux absorbants, ou par (5) ou (6) si l'on utilise qu'un absorbant et l'atmosphère. Si la température du récepteur est connue, alors la température du système peut être calculée à partir de l'expression générale :

$$\begin{aligned} T_{\text{sys}} &= [T_{\text{réc}} + T_{\text{amb}} \cdot (1 - n_1) + (T_{\text{atm}} - T_{2.7} - T_{\text{sour}}) \cdot n_1 \cdot \\ &\quad (G_s \cdot (1 - e^{-\tau A}) + G_i \cdot (1 - e^{-\tau A})) \\ &\quad + T_{2.7} + T_{\text{sour}}] \cdot e^{\tau A} / n_s G_s \end{aligned} \quad (12)$$

où $T_{\text{réc}}$ est la température du récepteur en DSB. Dans (12)
 T_{sour} est la température de la source.

III.02.B) MESURE DE L'OPACITE ATMOSPHERIQUE

L'opacité de l'atmosphère peut être calculée en utilisant l'émission d'une radio-source suffisamment intense, comme la lune ou une planète. Si le diagramme de rayonnement et la distribution de brillance de la source sont connus alors une seule mesure suffit pour calculer τ puisque le signal détecté, par rapport à un point du ciel à la même élévation que la source, sera proportionnel à

$$\int e^{-\tau} A \cdot P(\theta, \phi) \cdot T(\theta - \theta_0, \phi - \phi_0) d\Omega$$

et une fois le signal calibré on peut déterminer τ . En général ni le diagramme de rayonnement, ni la brillance de la source sont suffisamment connus pour donner une valeur fiable de τ et la technique habituelle consiste à effectuer plusieurs mesures de la même source à des élévations différentes. Le logarithme du signal, pas nécessairement calibré, a une dépendance linéaire avec A dont la pente est τ .

La Figure 1 montre le logarithme de l'intensité de Jupiter observée avec la première antenne de l'interféromètre du Plateau de Bure en fonction de la masse d'air. Le ciel est resté clair et stable pendant les observations. La pente de la ligne droite reproduisant au mieux les données est 0.106 ± 0.009 . Par comparaison, le programme ATM (voir chapitre III.03) prédit, par une toute autre méthode, une opacité au zénith de 0.103 pour les conditions atmosphériques mesurées

FIGURE 1

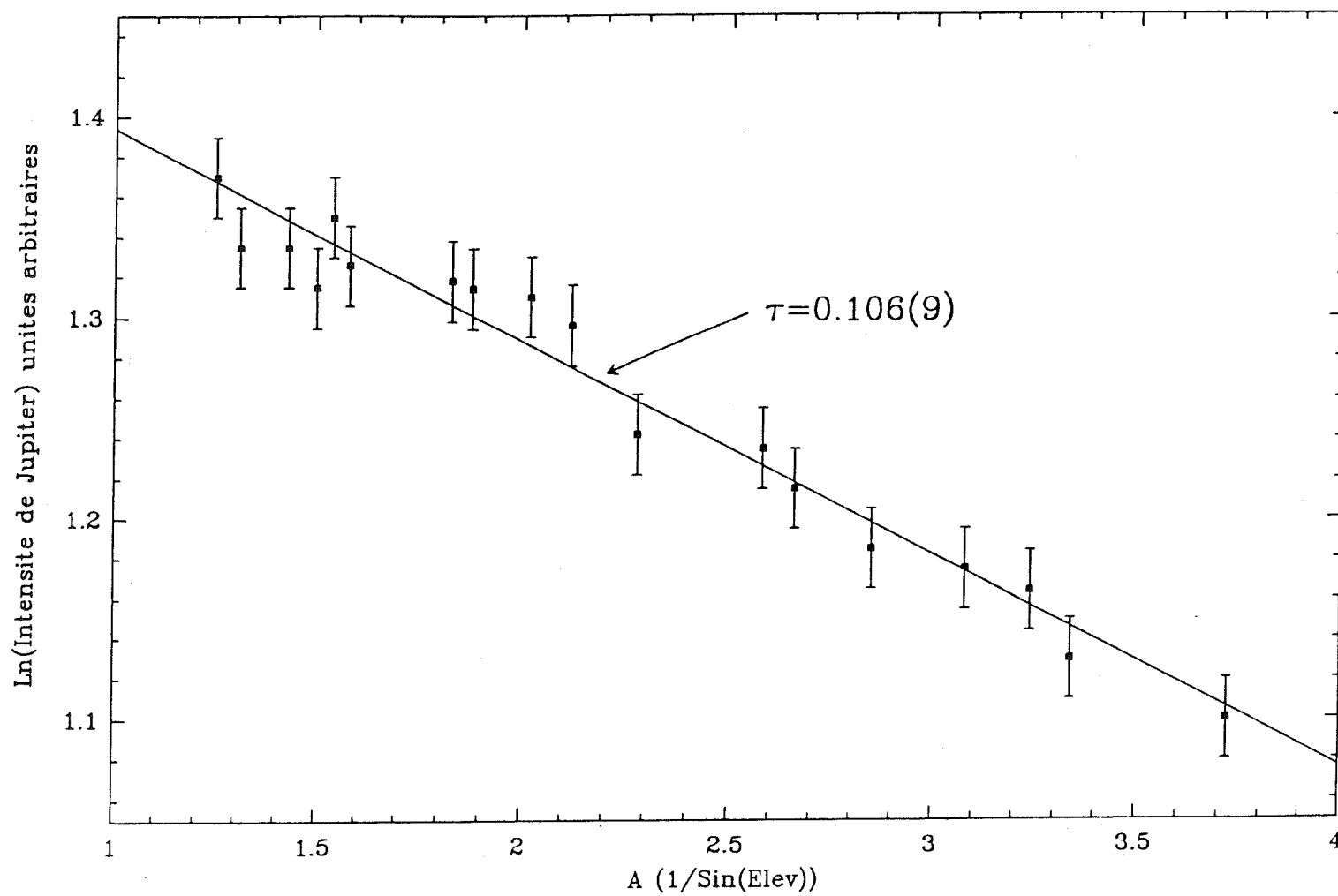

Logarithme de l'intensité de Jupiter, observée avec la première antenne de l'interféromètre du Plateau de Bure, en fonction de la masse d'air

sur le Plateau pendant les observations ($T_{amb}=280$ K, Humidité relative=50%, Pression atmosphérique = 744 mbar).

Le principal problème de la technique consistant à suivre une source à travers le ciel est sa durée, de l'ordre de quelques heures, au cours de laquelle l'atmosphère peut changer. L'échelle temporelle de variation de la distribution du principal absorbant atmosphérique du rayonnement extérieur, la vapeur d'eau, est aussi de quelques heures. Il faut une méthode plus rapide pour mesurer τ d'une façon routinière.

III.02.B.1) Détermination de l'opacité à partir de deux mesures de l'émissivité atmosphérique

Le signal détecté quand l'antenne pointe vers le ciel avec une élévation H ($A=1/\sin(H)$) est proportionnel dans le cas général à

$$\begin{aligned} V(\text{ciel}, A) \propto & T_{\text{réc}} + T_{\text{amb}} \cdot (1 - n_1) + T_{\text{atm}} \cdot n_1 \cdot \\ & [G_s \cdot (1 - e^{-\tau A}) + G_i \cdot (1 - e^{-\tau A})] + \\ & T_{2.7} \cdot n_1 \cdot [G_s \cdot e^{-\tau A} + G_i \cdot e^{-\tau A}] \end{aligned} \quad (13)$$

et quand l'absorbant est devant le cornet le signal détecté sera proportionnel à

$$V(T_{\text{abs}}) \propto T_{\text{réc}} + G_s \cdot T_{\text{abs}} + G_i \cdot T_{\text{abs}} = 2 \cdot T_{\text{réc}} + T_{\text{abs}} \quad (14)$$

et la différence absorbant moins ciel est proportionnelle à

$$V(T_{abs}) - V(\text{ciel}, A) \propto T_{abs} - (1 - n_1) \cdot T_{amb} - n_1 \cdot T_{atm} + (T_{atm} - T_{2.7}) \cdot (G_s \cdot e^{-\tau A} + G_i \cdot e^{-\tau A}) \quad (15)$$

d'où si nous avons cette valeur pour deux élévations différentes nous aurons

$$\frac{[V(T_{abs}) - V(\text{ciel}, A_1)]}{[V(T_{abs}) - V(\text{ciel}, A_2)]} = \frac{F_{atm}(A_1)}{F_{atm}(A_2)} = Z \quad (16)$$

où

$$F_{atm}(A) = B + C \cdot (G_s \cdot e^{-\tau A} + G_i \cdot e^{-\tau A})$$

avec

$$\begin{aligned} B &= T_{abs} - T_{amb} + n_1 \cdot (T_{amb} - T_{atm}) \\ C &= n_1 \cdot (T_{atm} - T_{2.7}) \end{aligned} \quad (17)$$

Si T_{atm} , n_1 , τ_i , G_s et G_i sont connus alors on peut calculer τ_s à partir de (16).

Il est évident que si le récepteur est réglé en SSB, quelques paramètres inconnus tels que τ_i , G_s et G_i sont éliminés. Dans ce cas ($G_s=1$, $G_i=0$) nous pouvons écrire

$$F_{atm}(A) = B + C e^{-\tau A} = B + C \cdot x^A$$

et nous pourrions résoudre l'équation:

$$Z = \frac{(B + C \cdot x^{A_1})}{(B + C \cdot x^{A_2})} \quad (18)$$

avec $x = e^{-\tau}$ pour déterminer τ . Si notre récepteur est réglé en

FIGURE 2

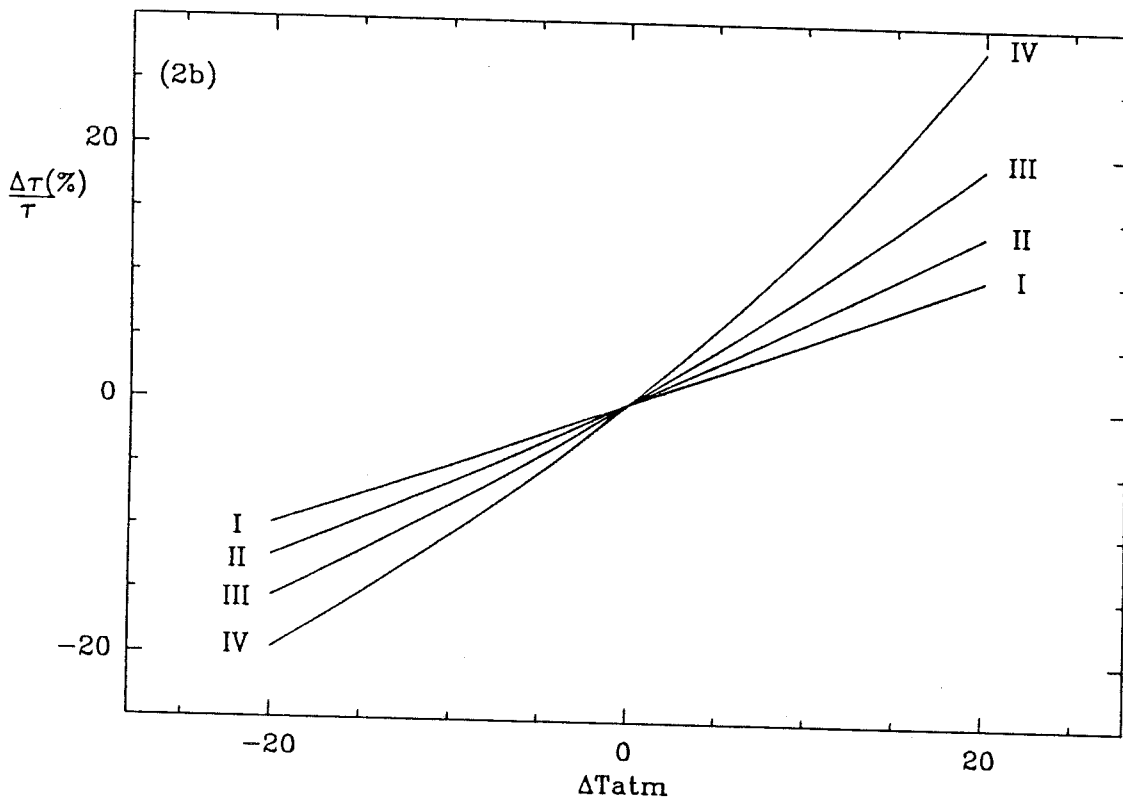
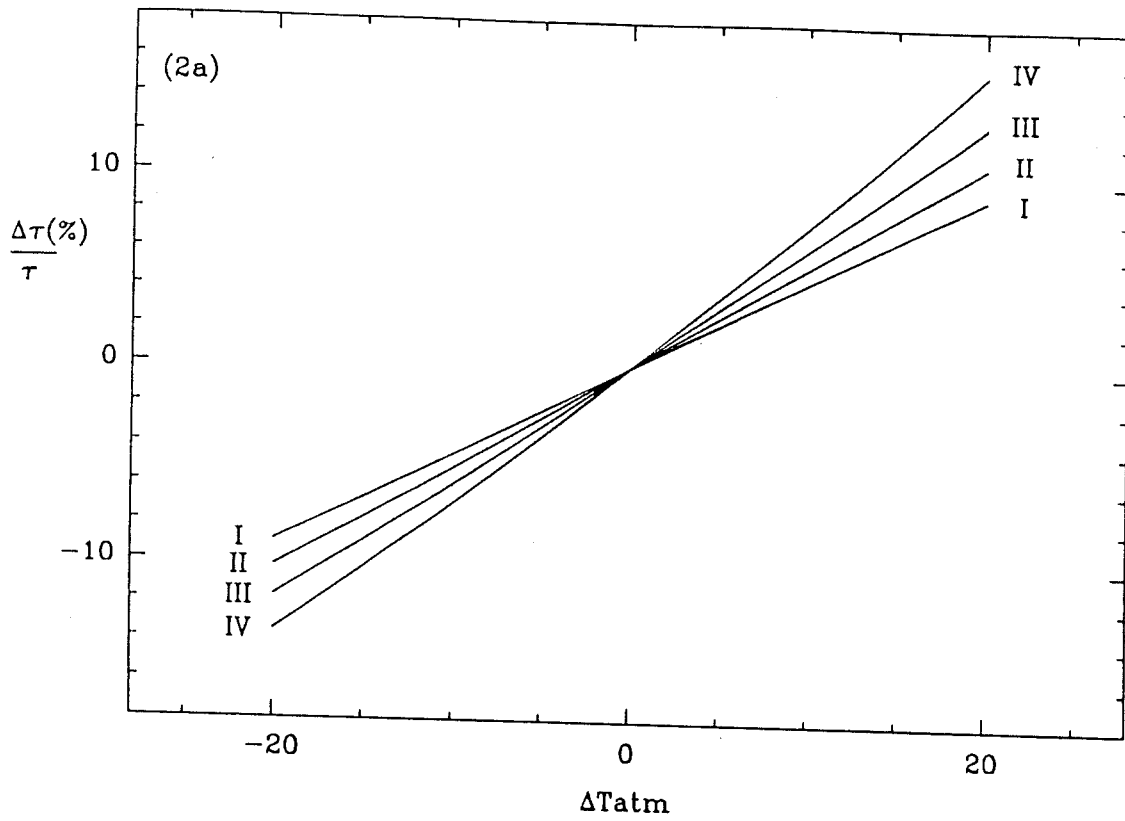

Erreur relative (en %) dans τ pour différentes opacités en fonction de ΔT_{atm} . Les courbes I, II, III, et IV correspondent à des opacités de 0.1, 0.2, 0.3 et 0.4 respectivement.

SSB la seule source d'erreur sera T_{atm} puisque les températures T_{abs} et T_{amb} sont bien connues et n_1 peut être mesuré. Dans la figure 2a nous montrons l'erreur sur l'opacité, déterminée à partir de (18), en fonction de ΔT_{atm} . Nous avons utilisé $T_{amb}=T_{abs}=280$ K, $T_{atm}(vrai)=260$ K, $n_1=0.9$, $G_i=0$, $A_2=2$, $A_1=1$. Z a été calculé à partir des valeurs vraies de B et C données par (17). Nous pouvons déduire de la figure 2a que l'opacité calculée à partir de deux mesures de l'émissivité atmosphérique aura une erreur $< 10\%$ pour des erreurs sur la température moyenne de l'atmosphère ≤ 20 K. La Figure 2b montre la même détermination quand $A_1=2$ et $A_2=3$; pour maintenir une erreur $\leq 10\%$ sur Z il faut dans ce cas que ΔT_{atm} soit ≤ 10 K. Si le récepteur est en DSB alors il faut supposer $G_s=G_i=0.5$ et que τ_i est connu pour pouvoir calculer τ_s (voir III.03). Le principal problème de cette méthode est lié à la stabilité du ciel pendant les observations et il est préférable de déterminer τ à partir de plusieurs mesures de l'émissivité de l'atmosphère.

III.02.B.2) Détermination de l'opacité atmosphérique à partir de plusieurs mesures de l'émissivité atmosphérique.

Cette technique, appelée "sky dip", est la plus utilisée pour déterminer τ . L'émissivité du ciel est mesurée à plusieurs élévations et la fonction $F_{atm}(A)$ donnée par (17) est ajustée par une méthode de moindres carrés non linéaire. Les paramètres à fitter sont B, C, et τ . Si le signal mesure n'est pas calibré on peut déterminer τ et du rapport B/C on peut, en supposant une valeur pour T_{atm} , déterminer n_1 . Si le

signal est calibré, alors on peut déterminer n_1 et T_{atm} . Cette technique permet de déterminer τ en quelques minutes. Elle peut aussi être utilisée pour déterminer n_1 d'une façon précise quand le récepteur est réglé en SSB. Si le récepteur est en DSB, alors il est nécessaire de déterminer la différence d'opacité entre la bande signal et image à l'aide d'un modèle d'atmosphère (voir III.03).

Finalement, si deux absorbants sont disponibles, et si T_{atm} , n_1 , et $\sigma\tau$ sont connus, alors il est possible de déterminer τ à partir d'une seule mesure de l'atmosphère, puisque l'émissivité atmosphérique pourra être mesurée directement en degrés Kelvin. C'est la technique normalement utilisée à Pico Veleta.

REFERENCES

- Davis, J.H., Vanden Bout, P.:1973, *Astrophys. Letters*, 15, 43.
Kutner, M.L.:1978, *Astrophys. Letters*, 19, 81
Penzias, A.A, Burrus, C.A.:1973, *Annual Review of Astronomy and Astrophysics*, Vol. 11, pag. 51.
Ulich, R.L., Hass, R.W.:1978, *Ap. J. Suppl.*, 30, 247.
Ulich, R.L.:1980, *Astrophys. Letters*, 21, 21.

**III.03) DETERMINATION DE L'OPACITE ATMOSPHERIQUE A PARTIR D'UN
MODELE D'ATMOSPHERE**

III.03) DETERMINATION DE L'OPACITE ATMOSPHERIQUE A PARTIR D'UN MODELE D'ATMOSPHERE

Ce chapitre est dédié à la détermination de l'opacité atmosphérique à partir d'un modèle numérique de l'atmosphère, c'est-à-dire, en tenant compte de la variation des paramètres physiques et chimiques de l'atmosphère terrestre avec l'altitude et des données spectroscopiques de ses principaux composants moléculaires. Les résultats fournis par le programme ATM sont en très bon accord avec les observations effectuées dans différents observatoires et le programme lui même est utilisé dans les observatoires de Pico Veleta, Bordeaux, et Plateau de Bure pour calibrer les observations.

IRAM INTERNAL REPORT. 15-APRIL-1985

J. Cernicharo

ATM: A PROGRAM TO COMPUTE THEORETICAL ATMOSPHERIC OPACITY
FOR FREQUENCIES <1000 GHz

Observing at millimeter wavelengths, atmospheric attenuation is the main source of spectral calibration uncertainties. ATM is a program to derive atmospheric emissivity and opacity for frequencies lower than 1000 GHz. He uses a atmospheric model (U.S. 1962 Standard Atmosphere for 45 N of latitude) and the equation of radiative transfer to compute the total absorption and thermal emission by water vapor and oxygen through the atmosphere. In the following sections I will follow the treatment of Waters, 1976.(Waters J.W.:1976;"Absorption and emission by Atmospheric Gases", in Methods of experimental Physics: Astrophysics-Radiotelescopes, Ed. by M.L. Meeks, Academic Press). The ATM routines are used for line calibration by the on-line data acquisition programs of the 30 m. IRAM telescope.

WATER VAPOR ABSORPTION

For millimeter wavelengths, absorption by H₂O is mainly due to rotational transitions of water vapor. The total absorption

coefficient of water vapor at any frequency, assuming no overlap in the wings of the H₂O lines, is given by

$$K_v(T, P, \rho) = \sum [K_{v,ul}(T, P, \rho)]_{ul}$$

where the sum extends over all the water rotational transitions. T, P and ρ are atmospheric temperature, pressure and water vapor density. These parameters vary with the altitude. The general expression for the absorption coefficient $(K_v)_{ul}$ between states u and l is given by

$$(K_v)_{ul} = 8\pi^3 N v_{ul}^2 g_l \phi_{ul}^2 f(v, v_{ul}) [\exp(-E_l/kT) - \exp(-E_u/kT)] / 3hcQ$$

where N is the number of absorbing molecules per unit volume, μ the dipole moment, g_l the statistical weight of the lower state, ϕ_{ul} the transition matrix element, Q is the partition function ($Q = 172.4 \cdot (T/293)^{3/2}$), and $f(v, v_{ul})$ is the function describing the line shape.

Two line shape are currently used, the Van Vleck and Weisskopf line profile given by

$$f(v, v_{ul}) = (v \Delta v / \pi v_{ul}) \{ [1 / (\Delta v^2 + (v - v_{ul})^2)] + [1 / (\Delta v^2 + (v + v_{ul})^2)] \}$$

and the Gross, Zhevakin and Naumov line profile (also called "kinetic line shape") given by

$$f(v, v_{ul}) = 4 v v_{ul} \Delta v / [\pi (4 v^2 \Delta v^2 + (v_{ul}^2 - v^2)]$$

where Δv is the collisional linewidth parameter which is a function of temperature and pressure. It seems that the kinetic line shape fits better the experimental results. For H₂O we can write (see Waters)

$$\Delta v_{ul} = \Delta v_{ul}^0 (P/1013) (T/300)^{-x} [1 - 0.00046 \rho T P^{-1} (1 - \Delta v_{ul}(\text{H}_2\text{O}) / \Delta v_{ul}^0)]$$

where ρ is the water vapor density in gr/m³, P is the total

pressure in mbar and $\bar{\Delta v}_{ul}^0$, $\bar{\Delta v}_{ul}(H_2O)$ and x are given in table 1, which also gives the line frequencies, quantum numbers, statistical weights, energy of lower molecular states of H_2O used by ATM.

In addition to the absorption by rotational lines it is necessary to add an empirical term to the water absorption given by (see Waters)

$$\Delta K_v = 1.08 \cdot 10^{-11} \rho (300/T)^{2.1} (P/1000.) v^2 \text{ cm}^{-1}$$

Figure 1 shows the total water vapor absorption coefficient for $T=273 \text{ K}$, $P=1013 \text{ mbar}$ and $\rho=1 \text{ gr/m}^3$.

TABLE 1
SPECTRAL LINE PARAMETERS OF H_2O

J_{KK-1}	$J_{K'K'-1}$	FRE(GHz)	g_1	ϕ_{ul}^2	$E(\text{cm}^{-1})$	$\bar{\Delta v}_{ul}$	$\bar{\Delta v}_{ul}$	x
6 1 6	5 2 3	22.2351	3	0.057	446.56	2.85	13.68	0.626
3 1 3	2 2 0	183.3101	1	0.102	136.16	2.68	14.49	0.649
10 2 9	9 3 6	321.2256	3	0.089	1283.02	2.30	12.04	0.420
5 1 5	4 2 2	325.1529	1	0.091	315.78	3.03	15.21	0.619
4 1 4	3 2 1	380.1974	3	0.123	212.16	3.19	15.84	0.630
10 3 7	11 2 10	390.1400	1	0.068	1525.31	2.11	11.42	0.330
7 5 3	6 6 0	437.3467	1	0.088	1045.03	1.50	7.94	0.290
6 4 3	5 5 0	439.1508	3	0.010	742.11	1.94	10.44	0.360
7 5 2	6 6 1	443.0183	3	0.088	1045.11	1.51	8.13	0.332
4 2 3	3 3 0	448.0011	3	0.132	285.42	2.47	14.24	0.510
6 4 2	5 5 1	470.8889	1	0.102	742.07	1.89	10.56	0.380
5 3 3	4 4 0	474.6891	1	0.118	488.14	2.07	11.95	0.380
6 2 4	7 1 7	488.4911	1	0.036	586.48	2.58	14.77	0.570
1 1 0	1 0 1	556.9360	3	1.500	23.79	3.33	14.66	0.645
5 3 2	4 4 1	620.7008	3	0.122	488.11	2.28	12.78	0.600
2 1 1	2 0 2	752.0332	1	2.073	70.09	3.13	13.93	0.690
4 2 2	3 3 1	916.6200	1	0.161	285.22	2.59	14.06	0.676
5 2 4	4 3 1	970.3100	1	0.262	383.84	2.48	14.16	0.560
2 0 2	1 1 1	987.9400	1	0.756	37.14	3.09	15.20	0.660

$\bar{\Delta v}_{ul}^0$ and $\bar{\Delta v}_{ul}(H_2O)$ are in GHz.

WATER VAPOR ATMOSPHERIC DISTRIBUTION

Below 15 Km ATM assumes a exponential distribution with a default value for the scale height of 2 Km (it is possible to change this value using the command WLEN). Above 15 Km of altitude ATM assumes a water vapor distribution with a constant mixing ratio of 2 ppm. Atmospheric temperature, pressure and density are given by the US standard atmosphere.

Water vapor density from humidity and temperature

In order to compute total atmospheric opacity it is necessary to input to ATM the water vapor amount above the telescope. To do that the information we can use is given by hygrometer data, i.e., temperature and relative humidity. Note however, that the total water vapor amount in mm above telescope site can be directly entered using the command WH20.

The saturation water vapor pressure at temperature T is given by

$$e_s(T) = 6.105 \cdot \exp[25.22 \cdot (T-273)/T - 5.31 \cdot \ln(T/273)]$$

and the partial water vapor pressure by

$$e = e_s(T) \cdot U / 100 / [1 - (1 - U/100) \cdot e_s(T)/P]$$

where

e_s is the saturation water vapor pressure (mbar)
 T is the temperature in kelvin (at telescope altit.)
 P is the total atmospheric pressure (mbar at telescope site)
 e is the partial water vapor pressure (mbar)
 U is the relative water vapor humidity (in %)

The water vapor density at telescope site is given by

$$\rho(\text{gr}/\text{m}^3) = 216.502 \cdot e(\text{mbar})/T(\text{K})$$

The water vapor density at sea level is given by

$$\rho_0(\text{gr}/\text{m}^3) = \rho(\text{gr}/\text{m}^3) \cdot \exp(H/H_0)$$

where H is the telescope altitude and H_0 is water vapor scale height.

The water vapor amount in mm. at sea level is given by

$$W_0(\text{mm}) = \rho_0(\text{gr/m}^3) \cdot H_0(\text{Km})$$

and at altitude H by

$$W(\text{mm}) = W_0(\text{mm}) \cdot \exp(-H/H_0)$$

Table 2 gives the total water vapor amount above 2.9 Km (30m. IRAM telescope) for different values of the atmospheric temperature and relative water vapor humidity for a atmospheric pressure of 700 mbar. Assumed water vapor scale height is 2 Km. Fig 2. is a plot of the total amount of H_2O above 2.9 Km as a function of relative humidity and temperature.

TABLE 2

TOTAL H₂O AMOUNT (mm) ABOVE 2.9 Km. H₂O SCALE HEIGHT = 2 Km

				TEMPERATURE (C)									
				-20	-16	-12	-8	-4	0	4	8	12	16
R	I	5.0	I	0.1	0.1	0.2	0.3	0.4	0.5	0.6	0.8	1.1	1.4
E	I	10.0	I	0.2	0.3	0.4	0.5	0.7	1.0	1.3	1.7	2.2	2.8
L	I	15.0	I	0.3	0.4	0.6	0.8	1.1	1.5	1.9	2.5	3.3	4.2
A	I	20.0	I	0.4	0.6	0.8	1.1	1.5	2.0	2.6	3.4	4.3	5.6
T	I	25.0	I	0.5	0.7	1.0	1.4	1.8	2.4	3.2	4.2	5.4	7.0
I	I	30.0	I	0.6	0.9	1.2	1.6	2.2	2.9	3.8	5.0	6.5	8.3
V	I	35.0	I	0.7	1.0	1.4	1.9	2.6	3.4	4.5	5.8	7.6	9.7
E	I	40.0	I	0.9	1.2	1.6	2.2	2.9	3.9	5.1	6.7	8.6	11.1
	I	45.0	I	1.0	1.3	1.8	2.5	3.3	4.4	5.8	7.5	9.7	12.5
H	I	50.0	I	1.1	1.5	2.0	2.7	3.7	4.9	6.4	8.3	10.8	13.8
U	I	55.0	I	1.2	1.6	2.2	3.0	4.0	5.3	7.0	9.2	11.8	15.2
M	I	60.0	I	1.3	1.8	2.4	3.3	4.4	5.8	7.7	10.0	12.9	16.6
I	I	65.0	I	1.4	1.9	2.6	3.6	4.8	6.3	8.3	10.8	14.0	17.9
D	I	70.0	I	1.5	2.1	2.8	3.8	5.1	6.8	8.9	11.6	15.0	19.3
I	I	75.0	I	1.6	2.2	3.0	4.1	5.5	7.3	9.6	12.5	16.1	20.6
T	I	80.0	I	1.7	2.4	3.2	4.4	5.9	7.8	10.2	13.3	17.1	22.0
Y	I	85.0	I	1.8	2.5	3.4	4.6	6.2	8.2	10.8	14.1	18.2	23.3
	I	90.0	I	1.9	2.7	3.6	4.9	6.6	8.7	11.5	14.9	19.2	24.6
	I	95.0	I	2.0	2.8	3.8	5.2	6.9	9.2	12.1	15.7	20.3	26.0
	I	100.0	I	2.1	2.9	4.0	5.5	7.3	9.7	12.7	16.5	21.3	27.3

OXYGEN ABSORPTION

The ground electronic state of the oxygen molecule is $3\Sigma_g^-$. Due to the symmetry of the oxygen molecule its electric dipole moment is zero. However, the two unpaired electrons of O_2 produce a magnetic dipole moment allowing a band of spin-rotation lines near 60 GHz and a single line at 118 GHz. The O_2 magnetic dipole value is $\mu = 1.85 \cdot 10^{-20}$ erg/G.

The rotational quantum number N for O_2 must be odd in order to satisfy the overall symmetry requirements of the wave functions. The electronic spin is $S=1$ and consequently each rotational level will be split into three sublevels of $J=N-1$, N and $N+1$. Selection rules for J are $\Delta J=0, \pm 1$.

The rotational function for O_2 can be written as $Q=3kT/2hB=0.725 \cdot T$ and the energy of the rotational state N is $E_N=hBN(N+1)$. The matrix elements, including the degeneracy factor g_J , are

$$\begin{aligned} \Delta J = -1 & \quad g_{N-} \cdot I \phi_{N-} I^2 = (N+1)(2N-1)/N \\ \Delta J = +1 & \quad g_{N+} \cdot I \phi_{N+} I^2 = N(2N+3)/(N+1) \\ \Delta J = 0 & \quad g_{N0} \cdot I \phi_{N0} I^2 = 2(N^2+N+1)(2N+1)/N(N+1) \end{aligned}$$

where the last matrix element corresponds to the nonresonant absorption by O_2 . The line profile for nonresonant absorption is given by

$$F(\nu) = 2\nu\Delta\nu / \pi(\nu^2 + \Delta\nu^2)$$

(Van Vleck. :1947, Pys. Rev. 71,413). The total O_2 absorption coefficient at frequency ν is given by

$$K_\nu = 1.44 \cdot 10^{-5} P T^{-3} \nu \exp(-E_N/kT) \cdot \{ g_{N+} I \phi_{N+} I^2 \nu_{N+} f(\nu, \nu_{N+}) + g_{N-} I \phi_{N-} I^2 \nu_{N-} f(\nu, \nu_{N-}) + g_{N0} I \phi_{N0} I^2 \nu_{N0} F(\nu) \}$$

where the sum extends over all transitions and where the O_2 density

has been replaced by the total atmospheric pressure using the O_2 mixing ratio of 0.21. In the last expression p is in mbars, T in Kelvin and ν in GHz. Table 3 gives the frequencies (GHz) of the O_2 $\Delta N=0$, $\Delta J=\pm 1$ lines used by ATM.

In addition to these spin-rotation lines ATM takes into account all the O_2 lines with $\Delta N=2$ and frequencies below 1000 GHz. Fig. 1 shows the O_2 absorption coefficient for $\nu < 1000$ GHz, $T=273$ K and $p=1013$ mbar.

For O_2 ATM uses the empirical linewidth of Reber (J. Geophys. Res. 77, 3831, 1972) which gives good agreement between observed and calculated O_2 opacities in the 48-72 GHz frequency range.

TABLE 3

O_2 SPIN-ROTATION LINES

<u>N</u>	<u>ν_{N-}</u>	<u>ν_{N+}</u>
1	118.7503	56.26477
3	62.48626	58.44658
5	60.30605	59.59098
7	59.16422	60.43478
9	58.32389	61.15057
11	57.61249	61.80017
13	56.96818	62.41122
15	56.36339	62.99799
17	55.78382	63.56852
19	55.22137	64.12778
21	54.67115	64.67892
23	54.13020	65.22412
25	53.59590	65.76475
27	53.06690	66.30206
29	52.54240	66.83677
31	52.02140	67.36951
33	51.50302	67.90073
35	50.98730	68.43080
37	50.47360	68.96010
39	49.96180	69.48870

TOTAL ATMOSPHERIC OPACITY

The total atmospheric optical depth at altitude H will be given by

$$K_{\nu}(\text{Total}) = K_{\nu}(\text{H}_2\text{O}) + K_{\nu}(\text{O}_2)$$

In order to compute the total atmospheric optical depth we must solve the radiative transfer equation. In the case of gaseous atmospheric absorption at microwave frequencies we can consider that the atmosphere is in thermal equilibrium and that it is without scattering and without refraction. In this condition the radiative transfer equation takes the form

$$I_{\nu}(H) = I_{\nu}(0) \cdot e^{-\tau(0,H)} + \int_0^H B_{\nu}(T) \cdot K_{\nu}(H') e^{-\tau(H',H)} \cdot dH'$$

(Chandrasekhar, "Radiative Transfer", Dover, New York, 1960). $I_{\nu}(H)$ is the intensity of radiation at frequency ν and position H, $B_{\nu}(T)$ the Planck function giving the intensity of radiation at frequency ν from a blackbody at temperature T, $K_{\nu}(H')$ the volume absorption coefficient at frequency ν and position H' , and

$$\tau_{\nu}(H', H) = \int_{H'}^H K_{\nu}(H'') \cdot dH''$$

is the optical depth between points H and H' . The integrals are taken along the path of observation (See Waters).

ATM assumes a plane-parallel atmosphere and integrates over a 60 Km atmospheric path above the site with steps

between 0-10 Km	step = 100 m.
between 10-20 Km	step = 500 m.
above 20 Km	step = 1000 m.

For an air mass different of 1 ATM integrates over a $60 \cdot A$ Km atmospheric path, where A is the air mass (COMMAND AIRM).

Figure 3 shows total atmospheric opacity at zenith, as derived by ATM, for frequencies between 1 and 360 GHz and for four

different values of the total water vapor amount -1,2,3 and 6 mm-, above 2.9 Km (The altitude of the 30m. IRAM telescope). Pressure, temperature and density distributions are given by US January 45° of latitude standard atmosphere (pressure[2.9 Km] = 703 mbar, temperature[2.9 Km] = -11 C); these distributions are scaled to pressure and temperature at site values. Figures 4 and 5 show atmospheric transmission and sky emissivity at zenith for the same conditions. Figure 6 shows the total atmospheric opacity, the opacity due to H₂O for 3 mm of water vapor (above 2.9 Km) and the opacity due to molecular oxygen for the same atmospheric profile. It can be seen that at frequencies > 200 GHz, the contribution of the molecular oxygen to the total atmospheric opacity is negligible; the total atmospheric absorption can thus be written, in the region between 200 and 300 GHz, as

$$\tau_{\nu > 200} = \tau_{\nu}(\text{H}_2\text{O}) = \{1.236 - 0.011 \cdot T[\text{C}]\} \cdot 10^{-6} \cdot \nu^2 \cdot W(\text{mm})$$

(after integration of the water vapor empirical term). Note that the contribution of molecular oxygen to the total atmospheric opacity between 200 and 300 GHz is as small as ≈ 0.005 .

For frequencies $70 < \nu$ (GHz) < 116 the contribution of molecular oxygen is important and a reduced formula cannot be derived. However, in practice and outside the line centers where ground based observations are not possible, it is possible to write

$$\tau_{\nu}(\text{total}) = A_{\nu}(T) + B_{\nu}(T) \cdot W(\text{mm})$$

where $A_{\nu}(T)$ is the contribution of molecular oxygen and $B_{\nu}(T)$ the contribution of water vapor. Table 4 gives the values of A and B for temperatures of -20 C (winter), 0 C (Spring) and 20 C (Summer) and for frequencies between 70 and 116 GHz. These values corresponds to the altitude of the 30 m telescope.

The mean atmospheric temperature given by ATM is an

effective one, i. e., it was derived from the calculated total atmospheric emissivity and the relation

$$\text{Emissivity} = T_{\text{atm}} \cdot (1 - e^{-\tau})$$

which is generally used from calibration purposes.

The contribution of O_3 , and O_2 and H_2O isotopes to the total atmospheric opacity is very low at the frequencies considered here. However, for sites at a few Km of altitude, the contribution of O_3 to the atmospheric opacity can be important, and for some frequencies $\tau(O_3)$ can be comparable to $\tau(H_2O)$. A new program including these minor atmospheric components is actually in progress.

TABLE 4

Contribution of O₂ and H₂O to total atmospheric opacity in function of temperature (T): $\tau_v = A_v(T) + B_v(T) \cdot W(\text{mm})$.

F (GHz)	TEMPERATURE (C)					
	-20		0		20	
	A _v	B _v	A _v	B _v	A _v	B _v
70.0	0.237	0.0064	0.201	0.0056	0.174	0.0050
71.0	0.194	0.0066	0.164	0.0056	0.141	0.0048
72.0	0.162	0.0066	0.137	0.0056	0.117	0.0050
73.0	0.139	0.0068	0.117	0.0058	0.100	0.0050
74.0	0.121	0.0070	0.101	0.0060	0.086	0.0052
75.0	0.106	0.0072	0.089	0.0062	0.076	0.0052
76.0	0.095	0.0074	0.079	0.0062	0.067	0.0054
77.0	0.085	0.0076	0.071	0.0064	0.060	0.0056
78.0	0.077	0.0078	0.064	0.0066	0.055	0.0056
79.0	0.070	0.0080	0.059	0.0068	0.050	0.0058
80.0	0.065	0.0082	0.054	0.0070	0.046	0.0060
81.0	0.060	0.0084	0.050	0.0072	0.042	0.0062
82.0	0.055	0.0086	0.046	0.0074	0.039	0.0062
83.0	0.052	0.0088	0.043	0.0074	0.037	0.0064
84.0	0.049	0.0090	0.040	0.0076	0.034	0.0066
85.0	0.046	0.0094	0.038	0.0078	0.032	0.0068
86.0	0.043	0.0096	0.036	0.0080	0.030	0.0068
87.0	0.041	0.0098	0.034	0.0082	0.029	0.0070
88.0	0.039	0.0100	0.033	0.0084	0.028	0.0072
89.0	0.038	0.0102	0.031	0.0086	0.026	0.0074
90.0	0.036	0.0104	0.030	0.0088	0.025	0.0076
91.0	0.035	0.0108	0.029	0.0090	0.024	0.0078
92.0	0.034	0.0110	0.028	0.0092	0.023	0.0080
93.0	0.033	0.0112	0.027	0.0094	0.023	0.0080
94.0	0.032	0.0114	0.026	0.0096	0.022	0.0082
95.0	0.031	0.0118	0.026	0.0098	0.021	0.0084
96.0	0.031	0.0120	0.025	0.0100	0.021	0.0086
97.0	0.030	0.0122	0.025	0.0104	0.021	0.0088
98.0	0.030	0.0124	0.024	0.0106	0.020	0.0090
99.0	0.030	0.0128	0.024	0.0108	0.020	0.0092
100.0	0.030	0.0130	0.024	0.0110	0.020	0.0094
101.0	0.030	0.0132	0.024	0.0112	0.020	0.0096
102.0	0.031	0.0136	0.025	0.0114	0.021	0.0098
103.0	0.031	0.0138	0.025	0.0116	0.021	0.0100
104.0	0.032	0.0142	0.026	0.0120	0.022	0.0102
105.0	0.034	0.0144	0.027	0.0122	0.022	0.0104
106.0	0.036	0.0148	0.029	0.0124	0.024	0.0106
107.0	0.039	0.0150	0.031	0.0126	0.025	0.0108
108.0	0.043	0.0154	0.034	0.0130	0.027	0.0110
109.0	0.048	0.0156	0.038	0.0132	0.031	0.0112
110.0	0.055	0.0160	0.043	0.0134	0.035	0.0114
111.0	0.066	0.0162	0.051	0.0136	0.041	0.0116
112.0	0.081	0.0166	0.063	0.0140	0.051	0.0120
113.0	0.106	0.0168	0.082	0.0142	0.065	0.0122
114.0	0.148	0.0172	0.114	0.0144	0.091	0.0124
115.0	0.226	0.0176	0.175	0.0148	0.138	0.0126
116.0	0.395	0.0178	0.307	0.0150	0.243	0.0128

COMPARISON BETWEEN EXPERIMENTAL RESULTS AND THEORETICAL CALCULATIONS

The values of the total atmospheric opacity at 86.2 GHz obtained from sky-dips with the 30m. telescope in clear days during last winter were ≈ 0.05 for some very cold days and 0.08 for more typically days. For these days, the hygrometric data indicates a water vapor content of 1 and 4 mm respectively. For $W=1$ mm ATM gives $\tau=0.053$ and for $W=4$ mm $\tau=0.083$ in excellent agreement with the sky dip results. At 230 GHz the only sky dip measure made on 13-APRIL-1985 yield, assuming equal opacity in the two receiver bandes, $\tau=0.17\pm 0.02$. From hygrometric data I derive $W=2.9$ mm and $\tau=0.197$ for the signal side bande and $\tau=0.186$ for the image side bande in good agreement with the skydip result. From the same sky-dip I can derive for the 230 GHz MPI receiver at the Naschmith focus of the 30 m. $\eta_1(230.5\text{GHz})=0.88\pm 0.05$, where η_1 is the coupling coefficient of the antenna with the sky (2π).

ATM was also checked at other sites and frequencies to give opacities in good agreement with sky-dips results. For example between 80 and 115 GHz the measured opacity in clear days at the Bordeaux Observatory agree within 30% with the ATM predictions from hygrometer data (see Cernicharo, Ph. D., 1985). At other frequencies ATM's predictions are also in good agreement with measured opacities :

FREQ.	OBSERVED	ATM
15 GHz(1)	$0.013+0.0010 \cdot \rho(\text{gr}/\text{m}^3)$	$0.012+0.0015 \cdot \rho(\text{gr}/\text{m}^3)$
22.2 GHz(2)	$0.025+0.0111 \cdot \rho(\text{gr}/\text{m}^3)$	$0.017+0.0134 \cdot \rho(\text{gr}/\text{m}^3)$
22.2 GHz(3)	$0.023+0.0168 \cdot \rho(\text{gr}/\text{m}^3)$	"
35 GHz(1)	$0.039+0.0030 \cdot \rho(\text{gr}/\text{m}^3)$	$0.039+0.0045 \cdot \rho(\text{gr}/\text{m}^3)$
90 GHz(4)	$0.064+0.0140 \cdot \rho(\text{gr}/\text{m}^3)$	$0.059+0.0240 \cdot \rho(\text{gr}/\text{m}^3)$
95 GHz(3)	$0.042+0.0222 \cdot \rho(\text{gr}/\text{m}^3)$	$0.050+0.0280 \cdot \rho(\text{gr}/\text{m}^3)$
110 GHz(3)	$0.096+0.0214 \cdot \rho(\text{gr}/\text{m}^3)$	$0.086+0.0380 \cdot \rho(\text{gr}/\text{m}^3)$
123 GHz(3)	$0.362+0.0367 \cdot \rho(\text{gr}/\text{m}^3)$	$0.287+0.0480 \cdot \rho(\text{gr}/\text{m}^3)$

150	GHz(3)	?	$0.0710 \cdot \rho (\text{gr/m}^3)$	$0.022 + 0.0790 \cdot \rho (\text{gr/m}^3)$
230	GHz(5)		$0.0120 \cdot \rho (\text{gr/m}^3)$	$0.010 + 0.0160 \cdot \rho (\text{gr/m}^3)$
270	GHz(6)		0.100	0.102
345	GHz(6)		0.237	0.238
405	GHz(6)		0.475	0.438
675	GHz(6)		1.170	1.250
880	GHz(6)		1.170	1.130

REFERENCES :

- (1) : Altshuler E.E., Falcone V.J., Jr., Wulfsberg, K.N.:1968, IEEE Spectrum 5,83.
- (2) : Waters, J.W.:1970, Ph. D., MIT.
- (3) : Gibbins, C.J., Wrench, C.L., Croom, D.L.:1984, Int. Journal of Infrared and Mill. Waves, No. 5, 1443.
(For 95 GHz their correlation coefficient is 0.4. At 150 GHz the oxygen contribution to atmospheric attenuation is bad determined 0.03 ± 0.34)
- (4) : Shimabukuro, F.I.:1966, IEEE Trans. on antennas and propagation, Vol AP-14, No. 2, 228.
- (5) : Plambeck, R.L.:1978, IEEE Trans. on antennas and propagation, Vol AP-26, No. 5, 737.
- (6) : Data from Hills et al. 1978, Infrared Physics. Vol 18., p 819; ATM results for these frequencies where obtained assuming $\rho = 0.5 \text{ gr/m}^3$.

For the above calculations the physical parameters (altitude, temperature, ...) given in the references were used to calculate the atmospheric opacity. The calculations are for the US 45° N standard atmosphere. Best agreements should be obtained if ad hoc atmospheric models are introduced for each site. The difference

between observed atmospheric attenuation in references 2 and 3 at the same frequency is larger than the expected uncertainties and it can be due to the difference in geographical site and climatologic conditions.

FIGURE CAPTIONS

FIGURE 1

Absorption coefficient for H₂O and O₂. Temperature is 273 C, pressure is 1013 mbar and $\rho(\text{gr}/\text{m}^3)=1$. Note that outside the lines themselves absorption coefficient for water vapor is dominated by the empirical term, proportional to the square of the frequency. The units of the absorption coefficient are cm^{-1} . In addition to the lines of water vapor and O₂ of tables 1 and 3, some weak lines of H₂O and two triplets of O₂ at high frequencies, have been added.

FIGURE 2a and 2b

Total water vapor amount (in mm) above 2.9 Km as a function of temperature and relative humidity at telescope site. A water vapor scale height of 2 Km is assumed. Note that the total water vapor amount is lower than 3 mm for typical clear sky winter conditions (i., e., $T < -5$ C and relative humidity $< 50\%$).

FIGURE 3a, 3b and 3c

Total atmospheric opacity at zenith for water vapor amounts of 1,2,3, and 6 mm during winter conditions for a telescope at 2.9 Km of altitude.

FIGURE 4

Atmospheric transmission at zenith for the same conditions that in fig. 3

FIGURE 5

Atmospheric emissivity at zenith for same conditions that fig. 3 and 4.

FIGURE 6

Water vapor, molecular oxygen and total atmospheric opacities for 3 mm of water vapor above 2.9 Km. Note that water vapor dominates the atmospheric absorption above 140 GHz.

FIGURE 7

Total atmospheric opacity between 1 and 300 GHz for altitudes of 0, 1, 2 and 3 Km. Water vapor amount is calculated on the basis of 3 mm at 3 Km of altitude (13.5, 8.2, and 5 mm at 0, 1, and 2 Km respectively). Pressure, temperature and density distributions are given by US January 45° N Standard Atmosphere. Water vapor distribution is exponential with a scale height of 2 Km. Note that the atmospheric opacity at 2 Km of altitude is 50% larger than at 3 Km; for example at 100 GHz $\tau(2 \text{ Km})=0.093$, $\tau(3 \text{ Km})=0.063$, and at 230 GHz $\tau(2 \text{ Km})=0.36$, $\tau(3 \text{ Km}) = 0.22$.

LOG(ABSORPTION COEFFICIENT)

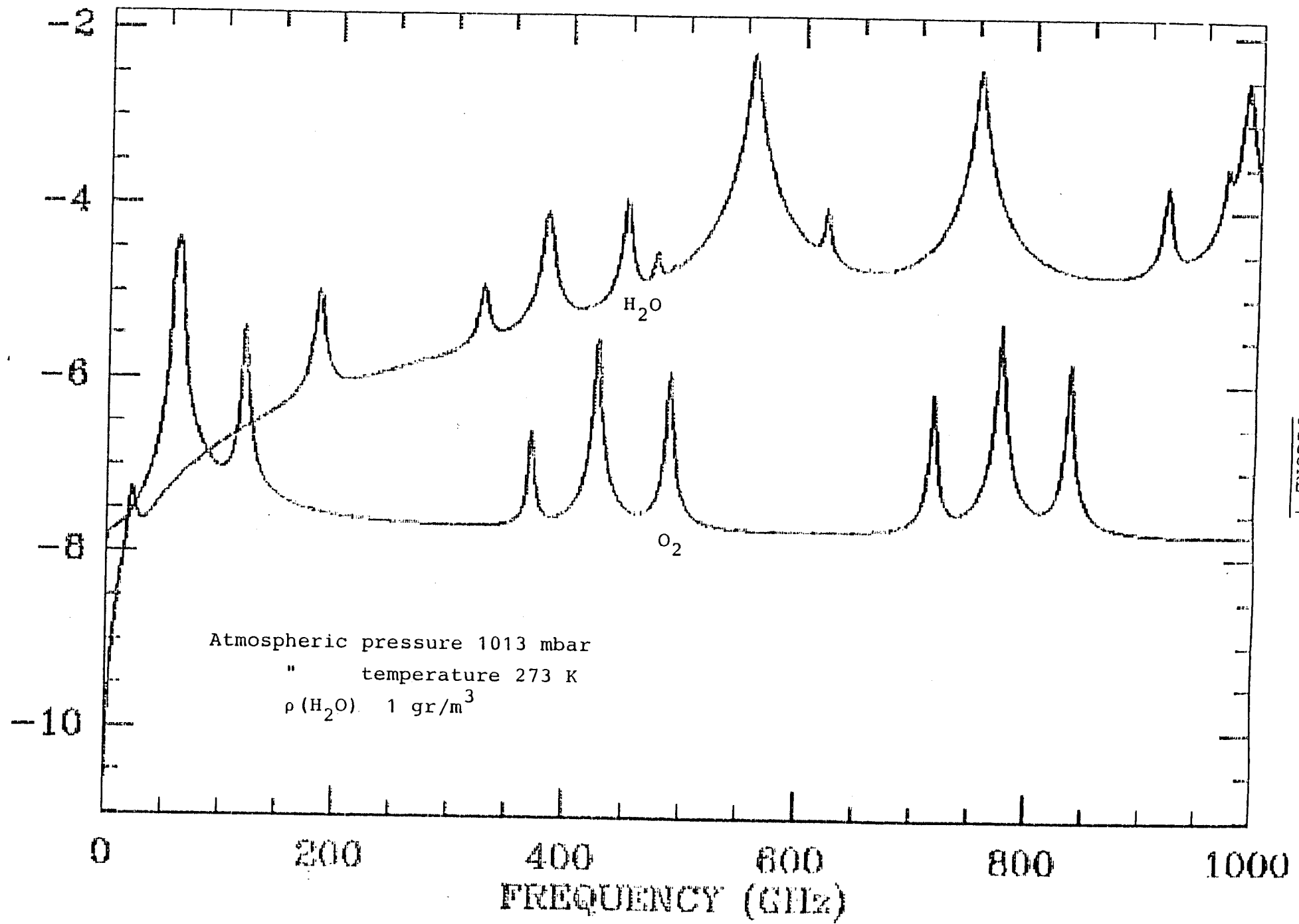

-472-
FIGURE 1

WATER VAPOR SCALE HEIGHT = 2 km

WATER VAPOR AMOUNT IN MM ABOVE 2.9 KM

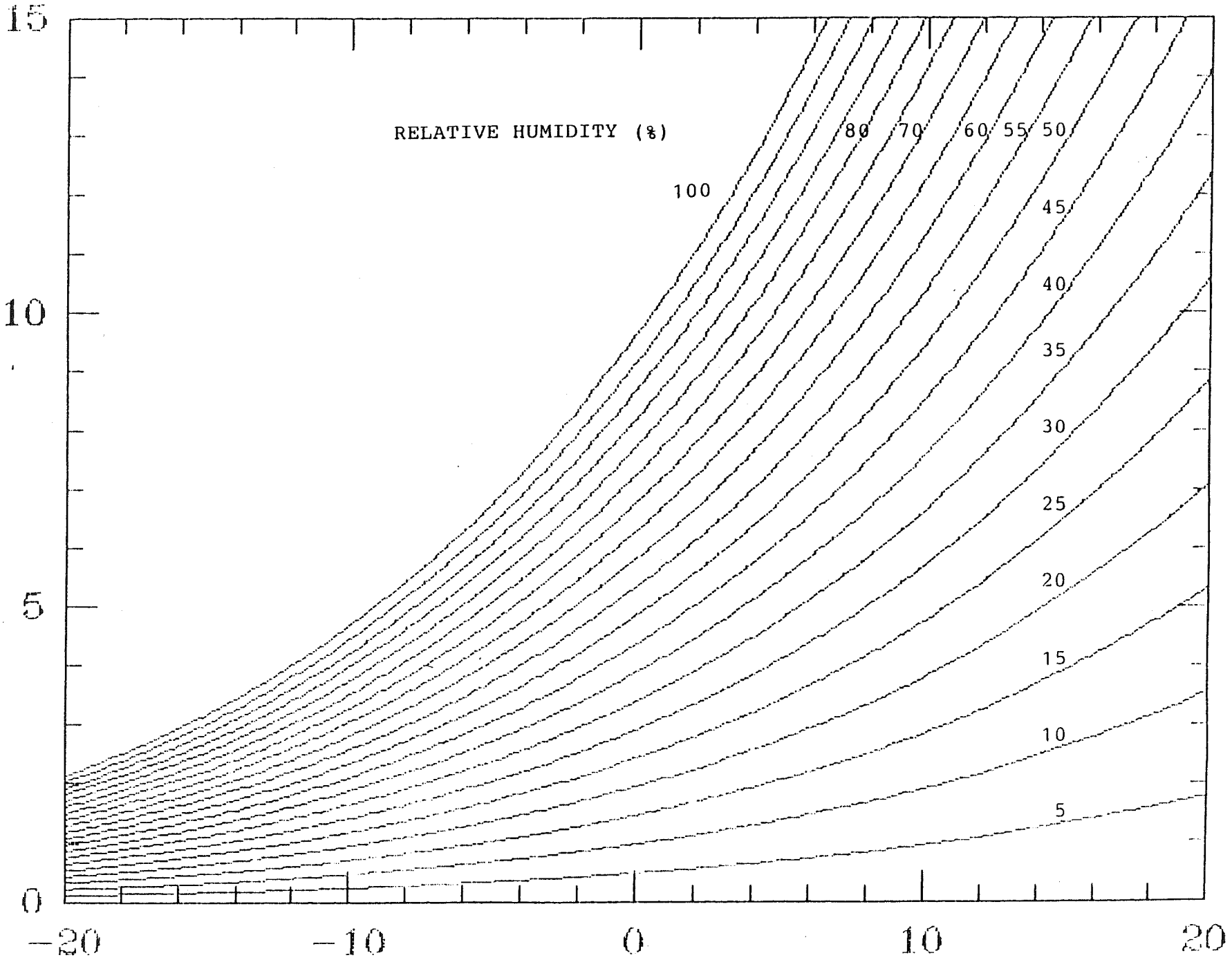

FIGURE 2a

WATER VAPOR AMOUNT IN MM ABOVE 2.8 KM

WATER VAPOR SCALE HEIGHT = 2 km

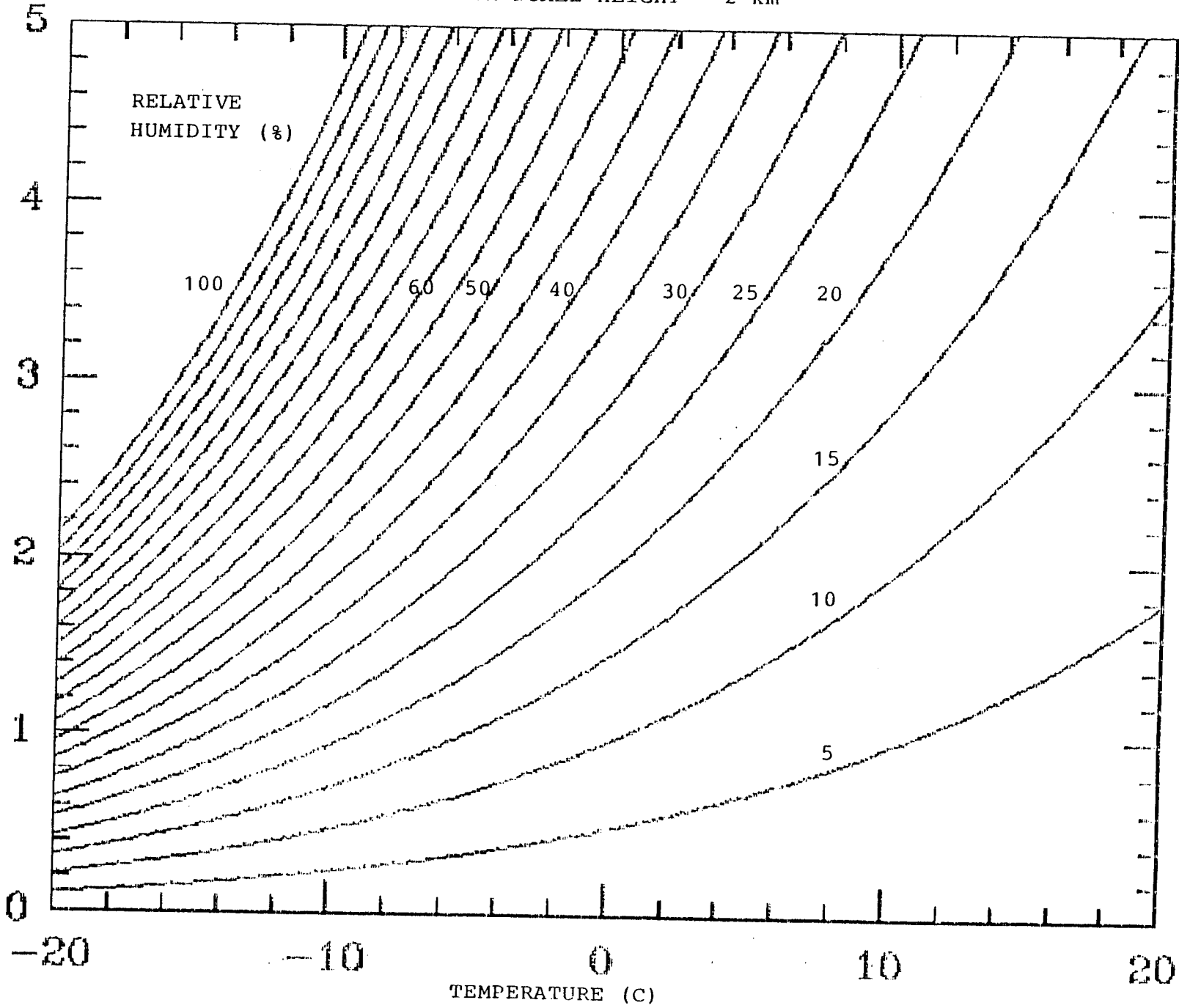

FIGURE 2b

ZENITH OPACITY (2.9 Km). WINTER. W = 1, 2, 3, 6 mm

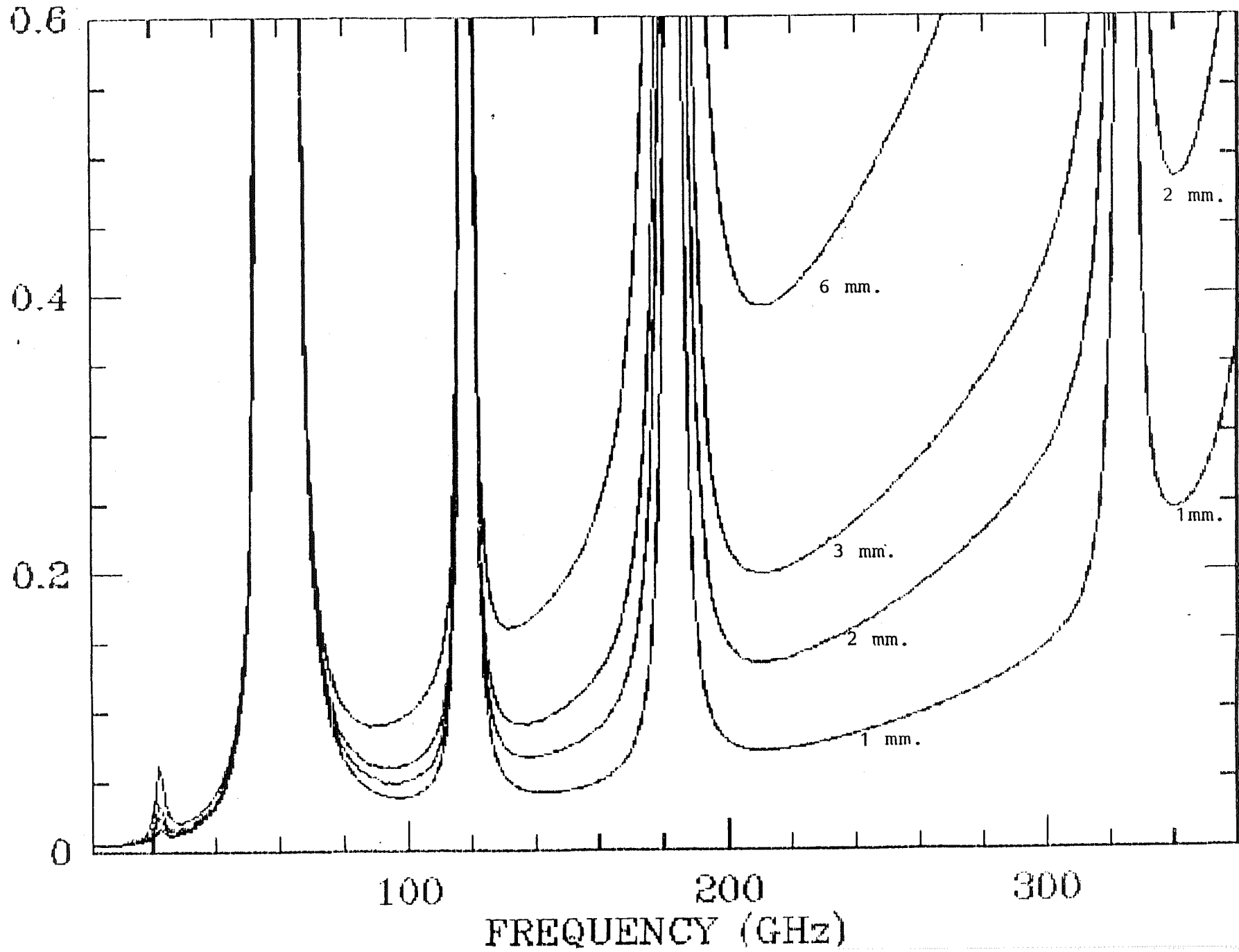

FIGURE 3a

ZENITH OPACITY (2.9 Km). WINTER. W = 1, 2, 3, 6 mm

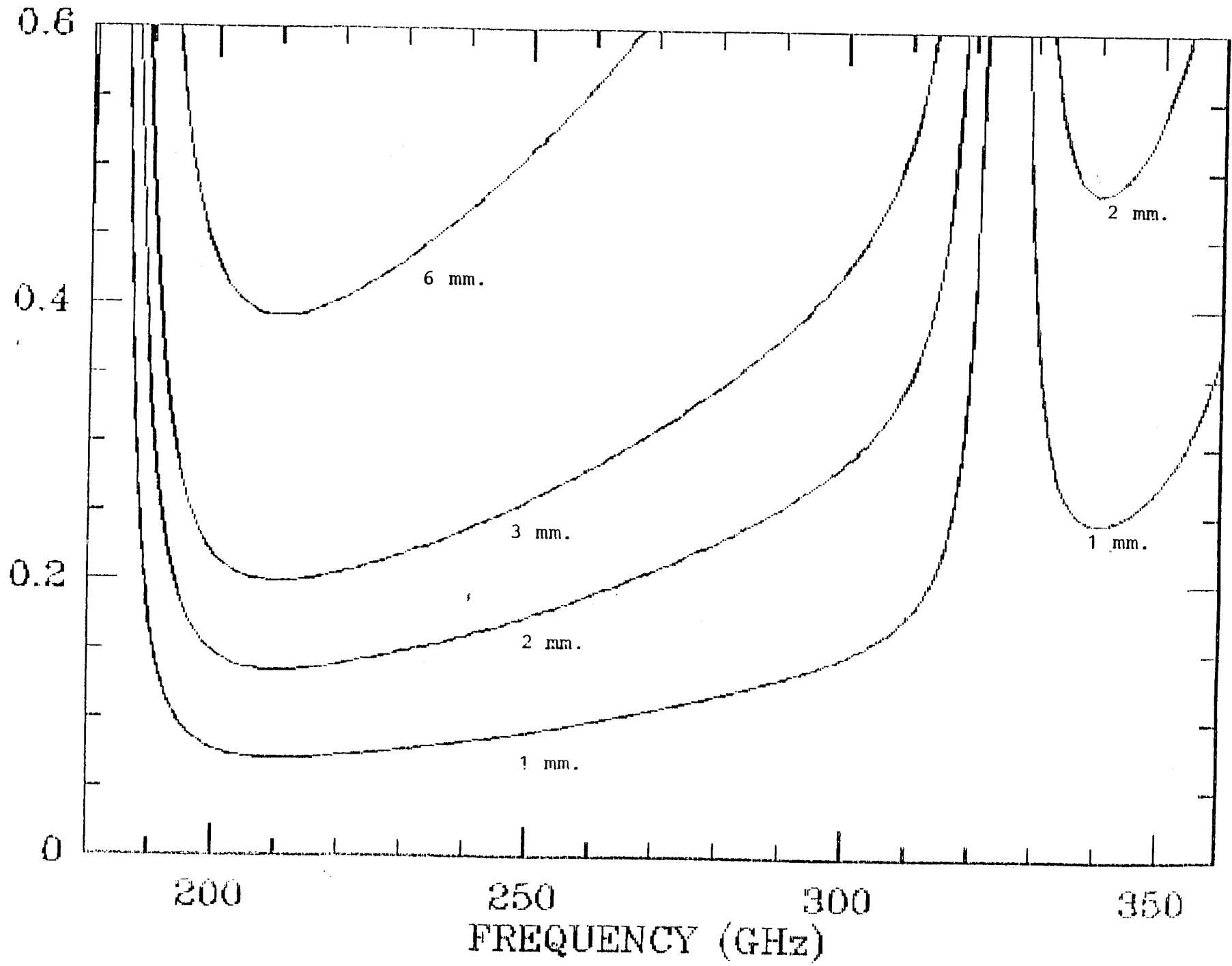

FIGURE 3C

ZENITH OPACITY (2.9 Km), WINTER. W = 1, 2, 3, 6 mm.

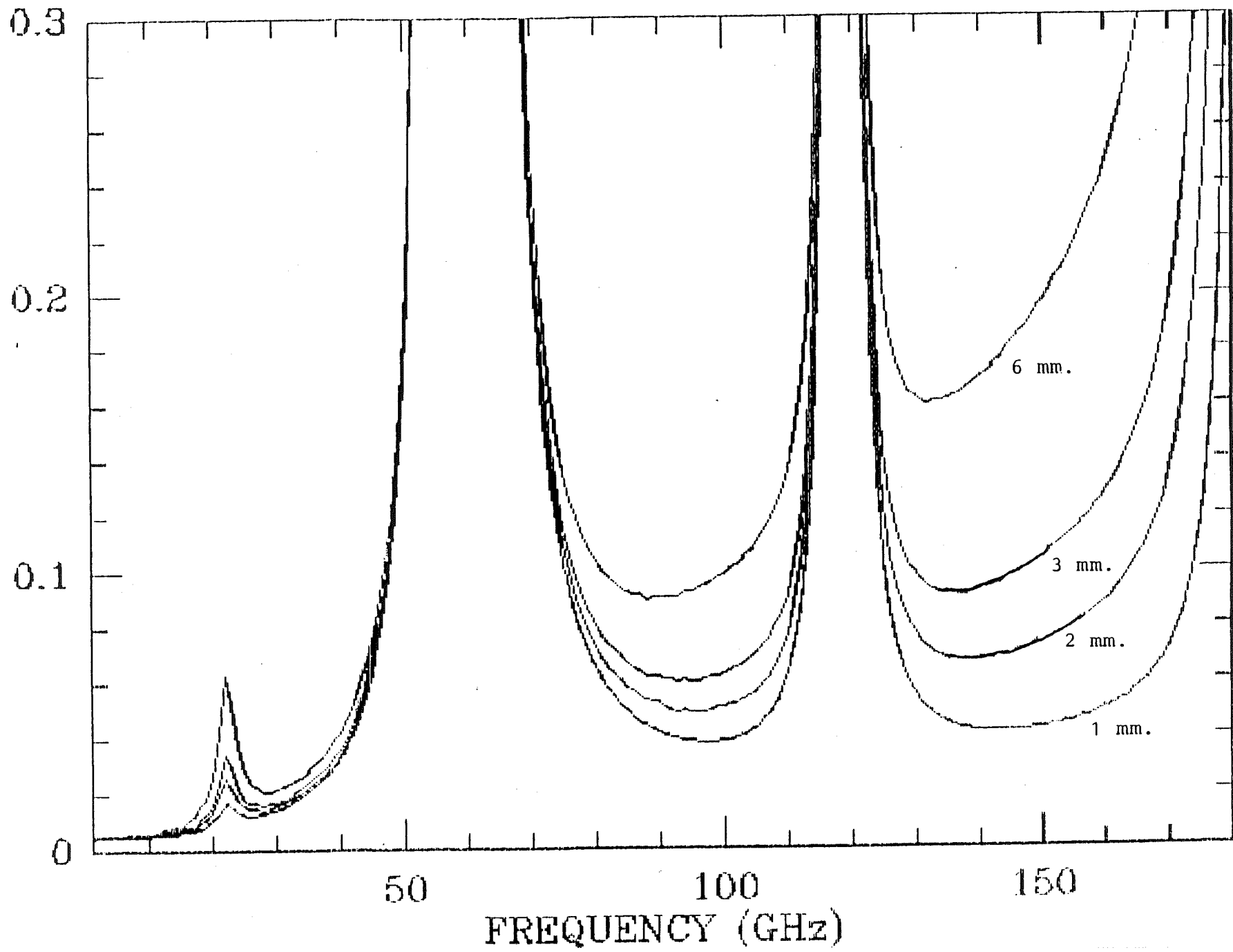

FIGURE 3b

ATMOS. TRANSM. (2.9 Km), WINTER, $W=1, 2, 3, 6$ mm

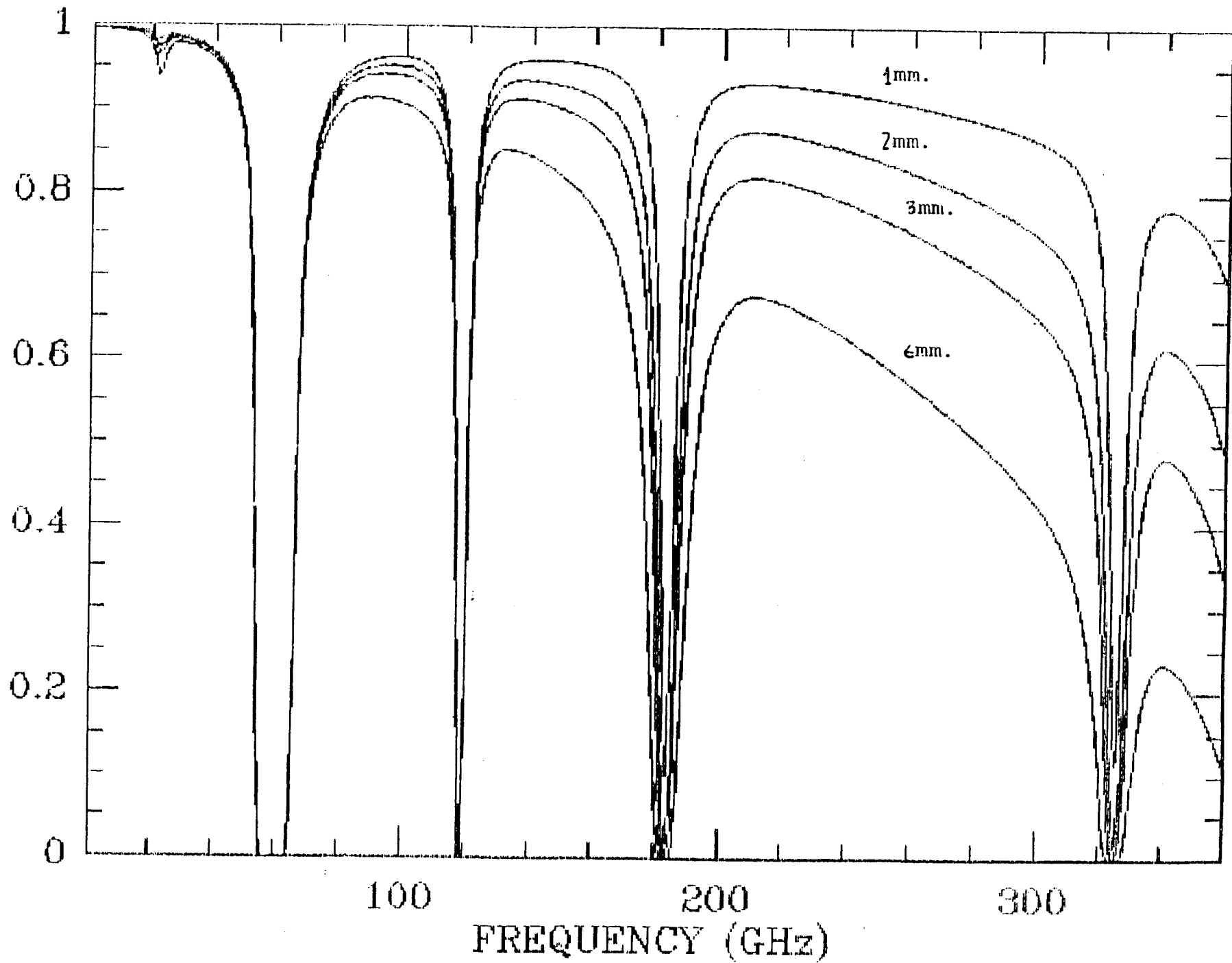

FIGURE 4

SKY EMISSIVITY. WINTER. W=1,2,3,6 mm

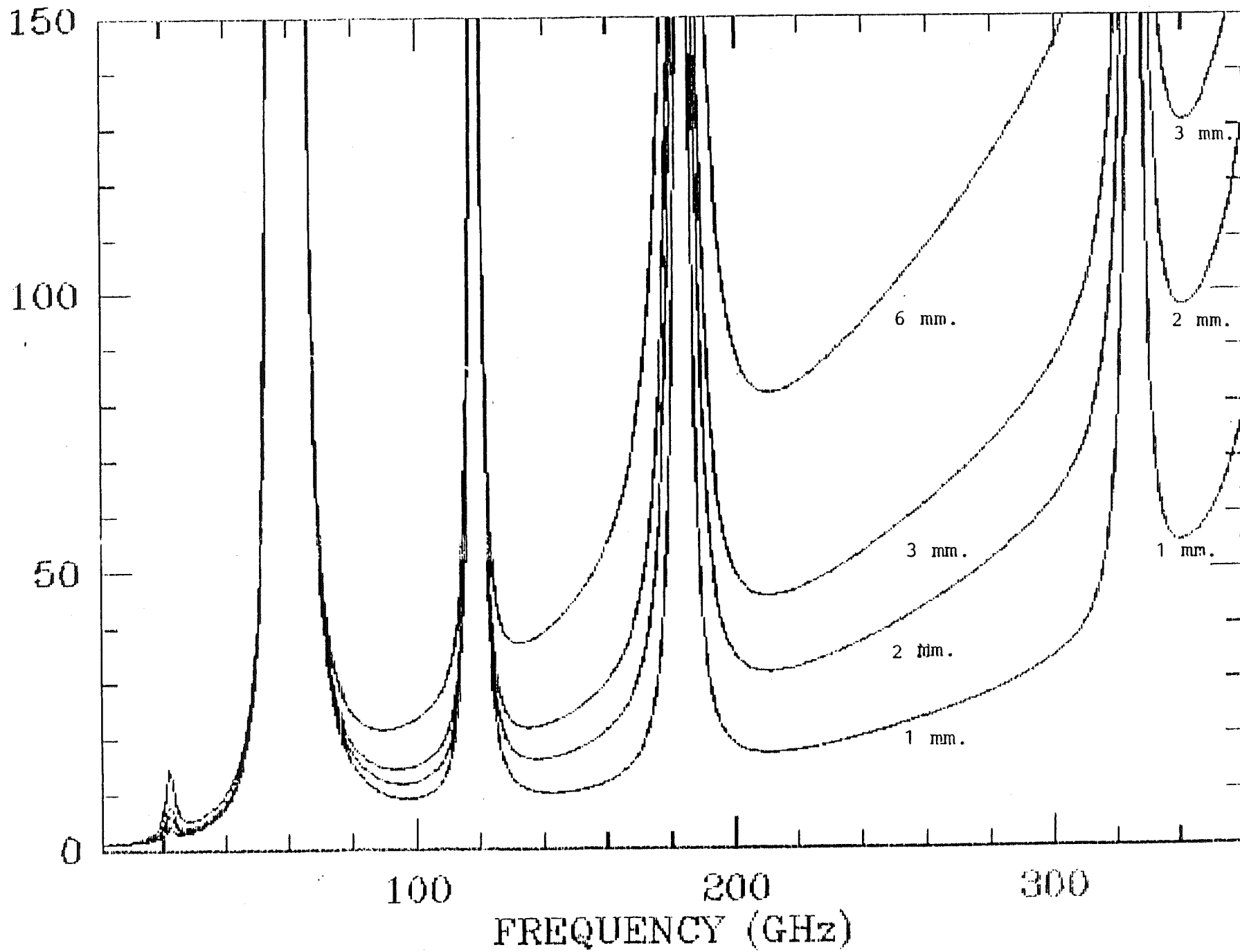

FIGURE 5

ZENITH OPACITY (2.9 Km), W=3 mm. WINTER

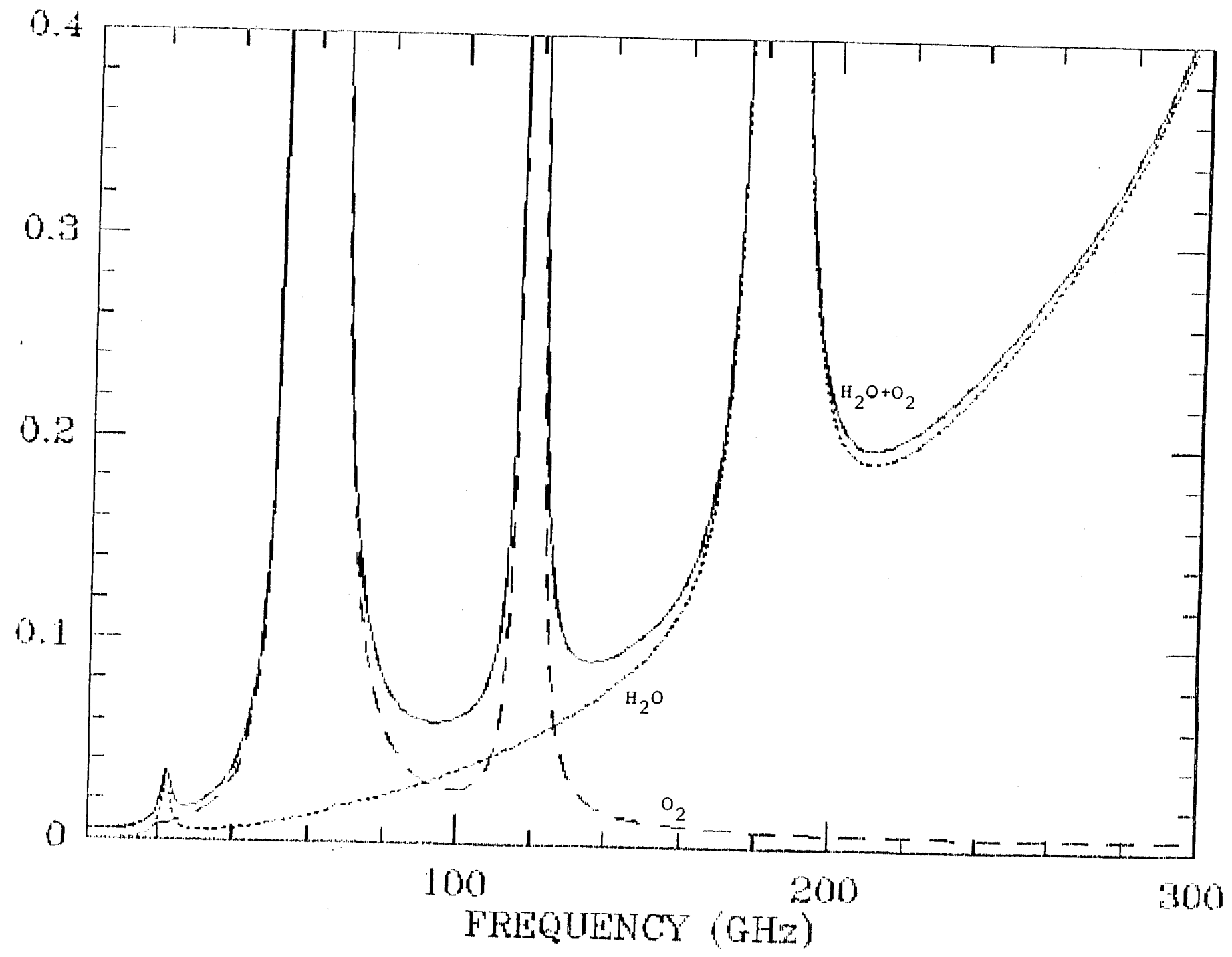

FIGURE 6

ZENITH OPACITY. WINTER. ALT=0,1,2,3.9 Km. $W(2.9) = 3\pi$

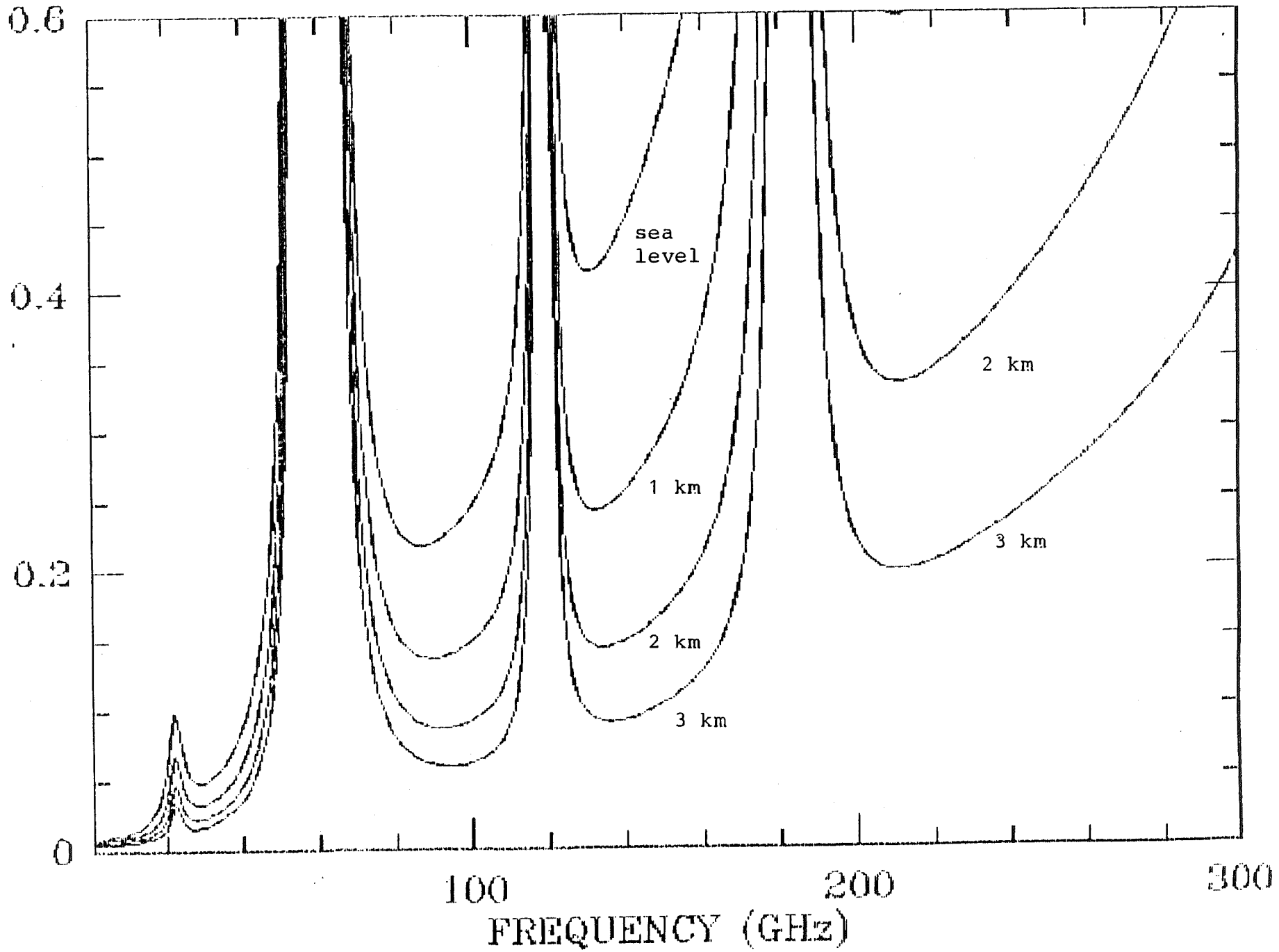

FIGURE 7

ATM PROGRAM :

ATM program (Cernicharo, Version 1.1) can be used in two ways :

MODE 1

Determination of the atmospheric opacity and emissivity for a given frequency and its corresponding image frequency (i. e., $\pm 2 \cdot \nu_{IF}$; $\nu_{IF}(30m)=3.932$ GHz). The US standard atmosphere is scaled by the actual pressure and temperature at telescope site. In this mode ATM is a useful tool for line calibration.

ATM COMMANDS :

The commands for ATM are formed by 4 alphanumeric characters followed (or not) by a real number (the new value it must assumes). Example

ALTI, 3.

WH20 1

TEMP -10.

(the separator between command and data may be any ascii character)

List of parameters

WINT	= Select winter atmosphere (default)
SUMM	= Select summer atmosphere
SPRI	= Select spring atmosphere
FALL	= Select fall atmosphere
	Spring and Fall atmosphere are average of Winter and Summer US standard atmosphere
AIRM	= Select air mass (Default 1.)
PROK	= Select kinetic line profile (Default)
PROV	= Select Van Vleck & Weisskopf profile.
DCL	= Transfer control to Digital command language.
HELP	= Help
WLEN	= Select water vapor scale height (default = 2

Km)
UNITS = Km.
WH20 = Input total water vapor amount above the
telescope
in mm. (default = 3 mm.)
UNITS = mm.
ALTI = Select site altitude (default = 2.9 Km)
UNITS = Km.
TEMP = Temperature at telescope site
UNITS = Celsius
HUMR = Water vapor relative humidity
UNITS = Percent (example HUMR 45.)
LSB = Select line in lower side bande
USB = Select line in upper side bande (default)
VIF = Intermediate frequency (default 3.932 GHz)
UNITS = GHz
PRES = Input atmospheric pressure at telescope site.
(Default = 700 mbar).
UNITS = mbar.

The selection of parametrs is followed by the command
COMP which actives the MODE 1.

COMP = Compute total atmospheric opacity, water vapor
opacity, oxygen opacity, atmospheric
emissivity
and transmission in the image and signal side
bandes.

If WH20 is not used then ATM computes it from
temperature and relative water vapor humidity at site.

MODE 2 :

In this mode ATM compute the atmospheric emissivity
and opacity step by step, between two frequencies. The
parameters to define are the same that for mode 1 to which are
added :

FRE1 = Initial frequency in GHz (default 1. GHz)
FRE2 = Final frequency in GHz. Must be <1000 GHz
(default value = 300 GHz)
STEP = In GHz (default 1.)

The command SPEC initialises the computation of the spectrum

SPEC = Compute spectra. Data output for mode 2 are written on the screen and on file SKY. SPE. This file can be used with GREG (see Greg documentation) to plot emissivity, attenuation, transmission, etc.

SKY. SPE FORMAT :

Column 1 of SKY. SPE is the frequency in GHz
Column 2 is the water vapor opacity
Column 3 is the oxygen opacity
Column 4 is the total atmospheric opacity
Column 5 is the total atmospheric emissivity
Column 6 is the average atmospheric temperature
Column 7 is the total atmospheric transmission.

EXAMPLE OF ATM IN MODE 1

\$@DRCO:ATM
ATM>PRES 706
ATM>TEMP -5.
ATM>HUMR 30.
ATM>FREQ 115.2
ATM>COMP

altitude = 2.9 Km atmospheric pressure = 706.0 mbar
water vapor scale height = 2.0 Km
TOTAL WATER VAPOR AMOUNT ABOVE TELESCOPE SITE= 2.0 mm
TOTAL WATER VAPOR AMOUNT ABOVE SEA LEVEL = 8.7 mm
input data was temperature and relative humidity ::
temperature = -5.0 C; relative humidity = 30.0 %
air mass = 1.00
atmospheric temperature and pressure at telescope altitude
given by winter us standard atmosphere are = -11.0 C 702.8
US standard atmosphere has been scaled to input data.

ATM RESULTS (KINETIC PROF.)	SIGNAL SIDE BANDE	IMAGE SIDE BANDE
-----	-----	-----
frequency (GHz)	= 115.200	107.336
water vapor opacity	= 0.032	0.027
oxygen opacity	= 0.199	0.033
total atmospheric opacity	= 0.230	0.060
atmospheric emissivity	= 51.230	14.660
mean atmospheric temperature	= 248.859	252.045

III.04) LE TELESCOPE MILLIMETRIQUE DU PLATEAU DE BURE

III.04) LE TELESCOPE MILLIMETRIQUE DU PLATEAU DE BURE

Ce chapitre est dédié à la Nouvelle Petite Opération Millimétrique (POM version 2.0). Le radiotélescope jumeau de POM I a été installé dans le Plateau de Bure, à 2550 mètres d'altitude. Le télescope est équipé d'un récepteur Schottky refroidi à 20 K et d'un autocorrelateur de 256 canaux et 80 MHz de bande. Nous faisons une description du télescope et nous montrons les premiers résultats astronomiques.

The 2.5-m millimeter telescope on Plateau de Bure

A. Castets¹, R. Lucas¹, B. Lazareff¹, J. Cernicharo¹, A. Omont¹, G. Duvert¹, B. Fouilleux¹, T. Forveille¹, L. Pagani², G. Beaudin², A. Deschamps², P. Encrenaz², S. Lebourg², H. Gheudin², H. Pérault², G. Ruffié², B. Clavelier, J. Lacroix³, R. Lauqué³, G. Montignac³, A. Baudry³, and M. Champion⁴

¹ Groupe d'Astrophysique, U.A. 708 du CNRS, Observatoire de Grenoble, Université Scientifique Technologique et Médicale de Grenoble, CERMO. B.P. 68, F-38402 St. Martin D'Hères Cedex, France

² DEMIRM, Observatoire de Meudon, U.A. 336 du CNRS, F-92190 Meudon, France

³ Observatoire de Bordeaux, U.A. 352 du CNRS, BP 21, F-33270 Floirac, France

⁴ Station de Radioastronomie de Nançay, F-18330 Neuvy-sur-Barangeon, France

Received July 23, accepted September 28, 1987

Summary. A 2.5 meter millimetre-wave telescope (POM-2) is now operating on the Plateau de Bure (France) for astronomical observations of the $J=2-1$ lines of CO and its isotopes, at ≈ 1.3 mm wavelength. The front-end used is a cooled Schottky-diode receiver; the back-end is a digital 256-channel autocorrelator with 80 MHz sampling rate. The system components are described and the first astronomical results are presented.

Key words: millimeter lines – radio telescopes

1. Introduction

Since astronomy in the millimetre-wave range started 15 years ago a steady increase in the size of the largest telescopes has occurred: 14 and 20 m telescopes have been operating for several years; still larger telescopes (30 and 45 m) just came into operation, giving resolutions down to $10''$, and interferometers are now approaching $1''$ resolution. In the same time a few smaller telescopes have been built: a 1.2-m telescope has been in use for 10 years at Columbia University in New-York, and duplicated in Chile; a 2.5-m telescope at Bordeaux observatory (POM-1, Baudry et al., 1980); a 3-m telescope at Cologne (recently moved to Gornegrat, see Winnewisser et al., 1986); a 4-m telescope at Nagoya university in Japan (Kawabata et al., 1985). These telescopes are particularly adapted to large-scale mapping of molecular clouds, which have typical sizes of several degrees: among other projects, the POM-1 telescope has been extensively used to study the nearby Taurus and Perseus clouds in the $J=1-0$ transitions of CO, HCO⁺ and their isotopically substituted species. We decided to go one step further in this direction by installing a 2.5-m telescope on a good mountain site for operation in the 1-mm atmospheric window. We chose the site of the Plateau de Bure (2550 m altitude), in the French Southern Alps, where the IRAM millimetre interferometer is now under construction. The instrument (POM-2) has been completed in July 1986 and is now used for astronomical observations in the $J=2-1$ lines of CO and its isotopes. We describe here this instrument and display the first results obtained during the testing period.

Send offprint requests to: A. Castets

2. The telescope

The antenna used to be the western antenna of the Bordeaux millimetre-wave interferometer (Baudry et al., 1975); it is identical to the eastern one, currently in use at 3 mm (POM-1). The telescope is now installed inside a 4 m diameter astrodome on the roof of a small building housing the electronics, the control room and living quarters (Fig. 1). The dish is 2.5 m in diameter, with a focal ratio of 0.4; the telescope surface was accurately measured before shipping to the Plateau de Bure, and the r.m.s. deviation from the best fitting paraboloid was found to be $48 \mu\text{m}$. The drive system was modified to withstand stronger winds during observation, by installing new reduction gears. The slew rate is 1.3 degree/second on both axes. A new subreflector (196 mm in diameter) was designed to provide a focal ratio of 9 at the secondary focus (magnification factor $M = 22.5$), suitable for the use of quasi-optical devices for local oscillator injection and calibration. The central part of the subreflector (image of its own shadow on the main reflector) was shaped to minimize the reflection coefficient for a spherical wave centered on the secondary focus, in order to improve spectral baselines, in the wavelength range 1.2–1.4 mm.

Absolute pointing is $15''$ (r.m.s.); a 14-term pointing model is used to correct for mount misalignments and encoder errors. The pointing model coefficients were determined by observing bright stars through a small optical telescope which can be attached to the reflector. The absolute pointing accuracy is also checked by observing the Sun, Venus and Jupiter in radio continuum. The tracking accuracy is typically $20''$.

3. The receiver

Schematics of the whole receiver assembly are given in Fig. 2. A Schottky diode mixer cooled to 15 K is used. The GaAs diodes come from University of Cork, Ireland, or from University of Virginia (USA). The diode is in a reduced height rectangular waveguide, connected to the lens-horn combination by a transformer. As the mixer frequency range has been chosen to be rather narrow (210–240 GHz), a fixed backshort could be used with success. The IF signal is centered on 1.6 GHz, and is amplified by a low-noise three-stage cooled FET amplifier.

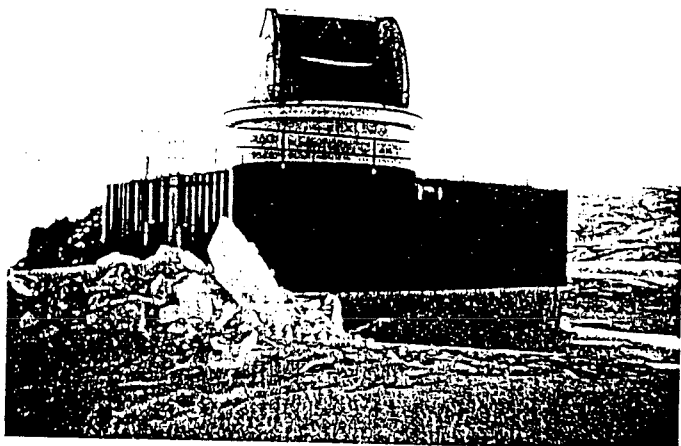

Fig. 1. The 2.5 m telescope on Plateau de Bure under its protective dome, on top of the small building housing receiving equipment, control room and living quarters

The local oscillator power is obtained from a 76 GHz Gunn diode oscillator followed by a GaAs varactor diode tripler. The Gunn oscillator is phase-locked to a 8 GHz reference, itself phase locked to a computer-controlled frequency synthesiser.

Calibration and local oscillator injection are obtained using Gaussian beam optics to minimize losses. A flat mirror at 45 degrees can be introduced in the beam to observe one of two calibration loads, at ambient temperature and at ≈ 70 K respec-

tively. The physical temperature of both loads is monitored. The receiver temperature and the atmosphere radiation temperature can thus be measured at any time. Local oscillator injection is achieved through a quasi-optical diplexer which has losses of 0.2 dB for both input ports (Fig. 2). A phase delay may be introduced at the output of the tripler, to correct the effect of possible mismatch between the local oscillator and the mixer.

The receiver noise temperature is at present typically 550 K (DSB) in the 600 MHz bandwidth, across the whole 30 GHz range.

All mechanical tuning and mirror displacements are remotely controlled by a microprocessor, which may be either directly commanded by a hexadecimal keyboard (for engineering tests) or by the central PDP 11/34 computer. A more extensive description of the receiver can be found in Pagani et al. (1985) or Pagani (1986).

4. The spectrometer

The spectrometer is an autocorrelator designed at the University of California at Berkeley (systems of the same type are used at Hat Creek, Arecibo, and at IRAM). Substantial improvements were made at Grenoble Observatory during the system assembly and tests. The IF power (100–500 MHz) is split and sent to four image-rejecting mixers (IRM). Each IRM is fed by a tunable (120–500 MHz) local oscillator (LO), and downconverts to baseband (0–40 MHz), two 40-MHz sidebands on each side of the LO frequency, with separate outputs for each sideband. The crosstalk between sidebands, 20 dB in the worst case, is adequate if not

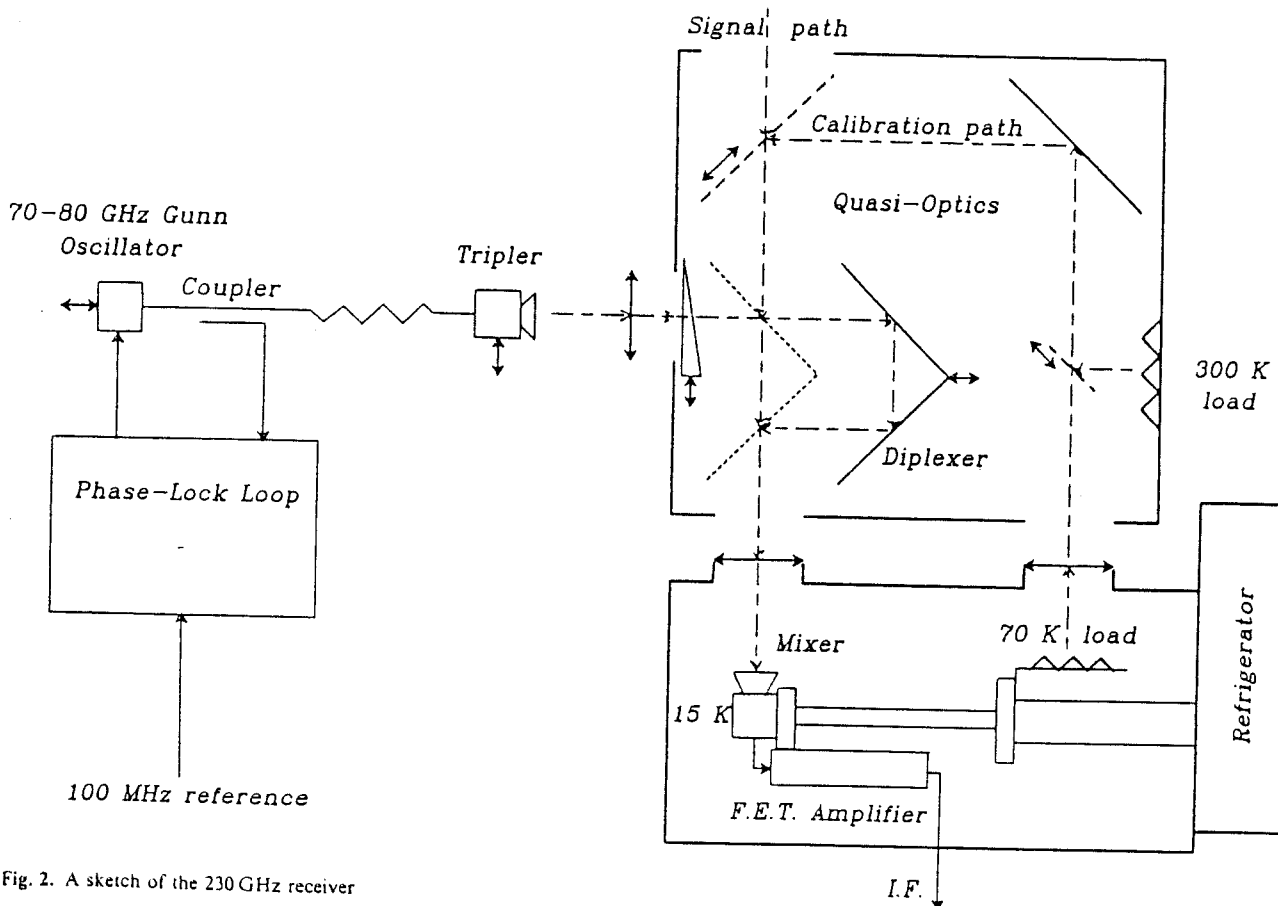

Fig. 2. A sketch of the 230 GHz receiver

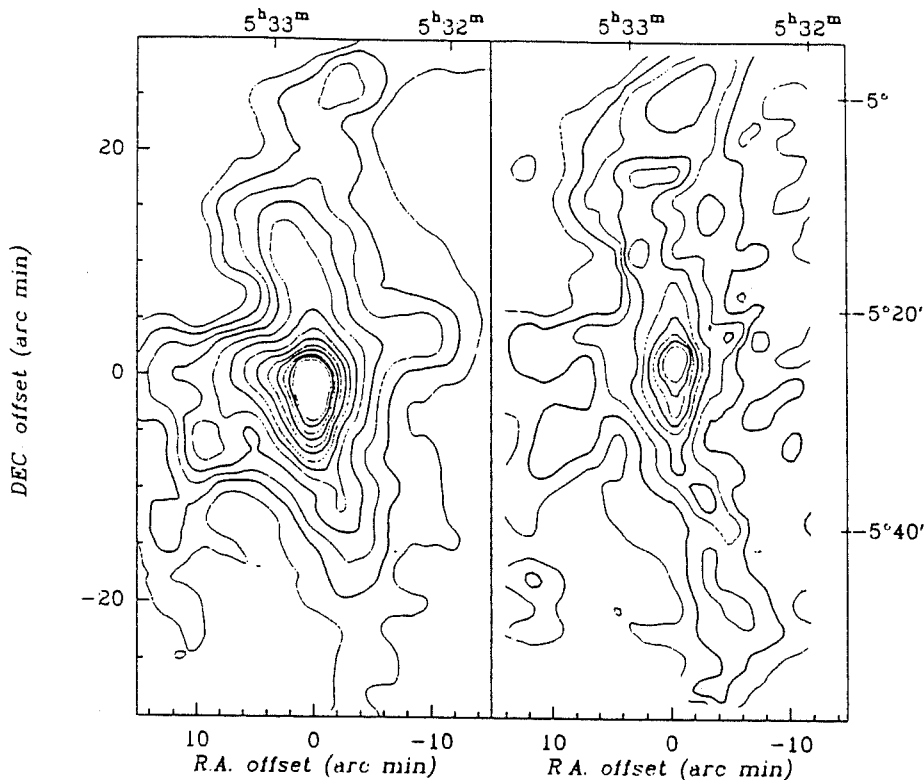

Fig. 3. Integrated intensity maps of:
 a) (left) ^{12}CO ($J=2-1$): contour levels range from 50 to 290 K km s^{-1} , spaced by 20 K km s^{-1} ;
 b) (right) ^{13}CO ($J=2-1$): contour levels range from 10 to 70 K km s^{-1} , spaced by 7.5 K km s^{-1} .
 Absolute position as well as offset (arc min) from the reference position ($\alpha_{1950} = 05^{\text{h}}32^{\text{m}}47^{\text{s}}$, $\delta_{1950} = -05^{\circ}24'30''$), are shown

outstanding. The bandwidth of each baseband can be repeatedly halved from 40 MHz down to 2.5 MHz. The eight baseband signals are sampled at a maximum clock rate of 80 MHz. 256 correlation channels are available (8 boards of 32 channels), and can be used in a fairly flexible way, with various tradeoffs between bandwidth and resolution, provided the Shannon criterion is observed for each baseband: $F_{\text{sample}} > 2 \times \text{Bandwidth}$. Maximum system bandwidth is 320 MHz, maximum resolution is 9.8 kHz (not simultaneously). Two different sampling rates can be used simultaneously, allowing, for instance, to "zoom" onto part of the spectrum while recording a wider bandwidth. Because the sampled signal is coded into only three values ($-1, 0, +1$), the signal-to-noise ratio is 82% of what a perfect analogue backend would provide. This penalty can be reduced by oversampling, i.e. by using a ratio of sampling frequency to bandwidth larger than 2.

5. System control

A central PDP 11/34A minicomputer drives the antenna, controls the receiver in connection with the built-in microprocessor, reads and stores the data from the correlator, and performs on-line and quick-look off-line data reduction. Interface with the observer is done via *OBS* commands as developed for the IRAM 30-m and 15-m telescopes by members of the Groupe d'Astrophysique (Forveille et al., 1987).

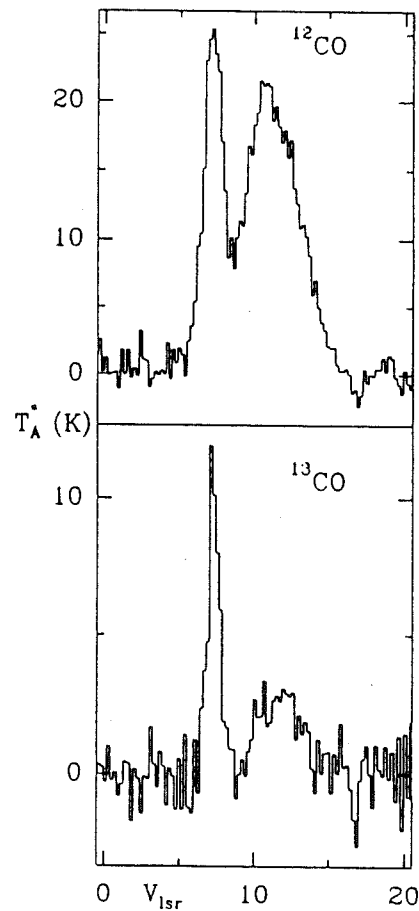

Fig. 4. Typical ^{12}CO and ^{13}CO spectra obtained by frequency switching by 20 MHz. Positions offsets are $(+10.0', -7.5')$ in R.A. and Dec. from reference position; integration times are 4 min and 10 min for ^{12}CO and ^{13}CO respectively

6. First observations

The ^{12}CO and ^{13}CO ($J=2-1$) observations reported here are the first since the completion of the data acquisition link, i.e., with the autocorrelator as backend.

The observations were carried out in several runs from September to December 1986. The receiver DSB temperature was typically 530 K for ^{12}CO observations and 580 K for ^{13}CO observations. The zenith opacity at 220 GHz was typically around 0.15, giving a system temperature of 2700 K. However, opacities as low as 0.06, i.e., nearly 1 mm of precipitable water in the atmosphere, were recorded on good nights. Calibration was done using the built-in ambient and cold loads; differential optical depth between side bands (low at the frequency in use) was estimated by using a standard atmosphere model.

In directions showing high-velocity wings, we observed ^{12}CO in a position switching mode. Other ^{12}CO and all ^{13}CO observations were done in a frequency switching mode (the switch amplitude was 10 MHz, so that the line could be observed in both phases in the 40 MHz bandwidth; spectra were folded off-line to increase the signal-to-noise ratio). The spectral resolution used was 156 kHz, giving a velocity resolution of 0.2 km s^{-1} . Typical ^{12}CO and ^{13}CO spectra are presented in Fig. 3.

The $J=2-1$ mapping of the central part of the Orion nebula was made with a 2.5 beam spacing in a $30' \times 1^\circ$ area centered on $\alpha = 05^{\text{h}}32^{\text{m}}47^{\text{s}}$, $\delta = -05^\circ24'30''$ (1950 coordinates). Figure 4

shows the integrated intensity maps of ^{12}CO and ^{13}CO respectively.

Analysis of this data, together with further observations, will be presented in a forthcoming paper.

References

- Baudry, A., Bocchia, R., Delannoy, J., Gérard, F., Lacroix, J., Montignac G., Poumeyrol, F., Robillot, J.M.: 1975, *L'Interféromètre Millimétrique de Bordeaux*, C.N.R.S., Paris
- Baudry, A., Brillet, J., Desbats, J.M., Lacroix, J., Montignac, G., Encrenaz, P., Lucas, R., Beaudin, G., Dierich, P., Germont, A., Landry, P., Rérat, G.: 1980, *J. Astrophys. Astron.* 1, 193
- Forveille, T., Guilloteau, S., Lucas, R.: 1987, *Observer's Guide to the IRAM 30-m Telescopes*, IRAM preprint No. 94
- Kawabata, K., Ogawa, H., Fukui, Y., Takano, T., Fujimoto, Y., Kawabe, R., Sugitani, K., Takaba, H.: 1985, *Astron. Astrophys.* 151, 1
- Pagani, L., Beaudin, G., Gheudin, M., Deschamps, A., Encrenaz, P.: 1985, *A 230 GHz low noise cooled receiver for radioastronomy applications*, 15th European Microwave Conference, Paris
- Pagani, L.: 1986, *Thèse*, Paris VII Univ.
- Winnewisser, G., Bester, M., Ewald, R., Hilberath, W., Jacobs, K., Krotz-Vogel, W., Miller, M., Olberg, M., Pauls, T., Pofahl, E., Rau, G., Schieder, R., Stubbush, H., Vorwinkel, B., Wieners, C., Zensen, W.: 1986, *Astron. Astrophys.* 167, 207

Te recuerdo como eras en el último otoño.
Eras la boina gris y el corazón en calma.
En tus ojos peleaban las llamas del crepúsculo.
Y las hojas caían en el agua de tu alma.

....

....

Cielo desde un navío. Campo desde los cerros:
Tu recuerdo es de luz, de humo, de estanque en calma!
Más allá de tus ojos ardían los crepúsculos
Hojas secas de otoño giraban en tu alma.

Pablo Neruda

A LA MEMORIA DE MI PADRE

$$3'' \rightarrow 10^{16} \rightarrow 8 \cdot 10^5$$
$$5 \cdot 10^{15} \quad 8$$

$$10^4 \rightarrow 2 \cdot 10^5 \text{ ans}$$

$$2 \cdot 10^5 \rightarrow 10^4 \text{ ans}$$

$$8 \cdot 10^5 \rightarrow 2500 \text{ ans}$$

$$\frac{10^{16}}{1.5 \cdot 10^6} = 6 \cdot 10^9 = 200 \text{ ans}$$

$$5 \cdot 10^{15} \rightarrow 900 \text{ ans}$$

