



HAL
open science

Algebraic approach for analysis of systems modeled by bond graph

Dapeng Yang

► **To cite this version:**

Dapeng Yang. Algebraic approach for analysis of systems modeled by bond graph. Other. Ecole Centrale de Lille, 2012. English. NNT : 2012ECLI0007 . tel-00735082

HAL Id: tel-00735082

<https://theses.hal.science/tel-00735082>

Submitted on 25 Sep 2012

HAL is a multi-disciplinary open access archive for the deposit and dissemination of scientific research documents, whether they are published or not. The documents may come from teaching and research institutions in France or abroad, or from public or private research centers.

L'archive ouverte pluridisciplinaire **HAL**, est destinée au dépôt et à la diffusion de documents scientifiques de niveau recherche, publiés ou non, émanant des établissements d'enseignement et de recherche français ou étrangers, des laboratoires publics ou privés.

N° d'ordre:

1	8	5
---	---	---

ÉCOLE CENTRALE DE LILLE

THÈSE

présentée en vue d'obtenir le grade de

DOCTORAT

en

Automatique, Génie Informatique, Traitement du Signal et Image

par

Dapeng YANG

DOCTORAT DELIVRE PAR L'ÉCOLE CENTRALE DE LILLE

Titre de la thèse :

**Approche Algébrique pour l'Analyse de Systèmes Modélisés par
Bond Graph**

**Algebraic Approach for Analysis of Systems Modeled by
Bond Graph**

Soutenue le 27 Juin 2012 devant le jury d'examen:

Président	Mme. Geneviève DAUPHIN-TANGUY	Professeur, École Centrale de Lille
Rapporteur	M. Abdellah EL MOUDNI	Professeur, UTBM
Rapporteur	M. Bernhard MASCHKE	Professeur, Université Lyon 1
Membre	M. Anand VAZ	Professeur, NIT
Directeur de thèse	M. Christophe SUEUR	Professeur, École Centrale de Lille

Thèse préparée dans le Laboratoire d'Automatique, Génie Informatique et Signal

L.A.G.I.S., CNRS UMR 8219 - École Centrale de Lille

École Doctorale SPI 072

PRES Université Lille Nord-de-France

*À mes parents,
à toute ma famille,
à mes professeurs,
et à mes chère(s) ami(e)s.*

Acknowledgements

This research work has been realized in École Centrale de Lille, in “Laboratoire d’Automatique, Génie Informatique et Signal (LAGIS)”, with the research team “Méthodes & Outils pour la Conception Intégrée de Systèmes (MOCIS)”.

First and foremost I offer my sincerest gratitude to my supervisor, Mr. Christophe Sueur, who has provided his supervision, advices, and guidance as well as given me extraordinary experiences through out the work. With his enormous helps, I have obtained some research experiences not only in Bond Graph method but also algebraic theory. Mr. Sueur has provided an oasis of ideas for this report by a lot of discussions with me and my colleagues. I am indebted to him more than he knows.

Mr. Abdellah EL MOUDNI and Mr. Bernhard Maschke used their precious times to review this PhD report before publication and gave various critical comments for shaping the final version of this report. They helped me refine the more delicate issues and present them from a more comprehensive perspective.

Mr. Anand Vaz was also accepted to take part in the jury of the PhD defense. We had some interesting discussions about bond graph modeling and analyse during my PhD research and the defense of my thesis.

I also would like to express my reconnaissance to Mrs. Geneviève Dauphin-Tanguy who supported me enormously, especially financed the end of my PhD study. During the three years, she was always close to us and encouraged us with enthusiasm for our research. I am grateful to her noble characters. I would like to thank Mr. Belkacem Ould Bouamama, the team leader of MOCIS, who organized many scientific workshops helping us to exchange ideas.

For the "Accueil à la française", I would like to thank Christine Yvoz, Daniel Rivière, Patrick Gallais, Régine Duplouich, Tram Nguyen, Vanessa Fleury and Virginie Leclercq who helped us with the administrative matters. I am also grate-

ACKNOWLEDGEMENTS

ful to all my PhD students colleagues: Catalin Chera, Catalin Dimon, Eugene Tarassov, Guillaume Camp, Guoguang Wen, Hui Liu, Huarong Wang, Jian Liu, Jinlin Gong, Jin Zhao, Lamine Chalal, Mei Wang, Naima Hadji, Nicolas Palitzyne, Roberto Sanchez, Samir Benmoussa, Wenjuan Jiang, Yang Qian, Yang Tian, Yifeng Li, Zhaoxia Peng, etc.

All my gratitude goes to Ms. H el ene Catsiapis who showed us the French language and culture. She made possible all those interesting and unforgettable voyages in France. My knowledge and interest in the French culture is inspired by her work and enthusiasm, she managed to open our appetite for art, history and cuisine/wine.

My PhD study was supported by the cooperation between the China Scholarship Council (CSC) and the  coles-Centrales Intergroup. So I would like to thank all of the people who have built this relationship and contributed to select candidates for interesting research projects. I am extremely grateful to CSC and  cole Centrale de Lille who financed me.

In the end, I convey special acknowledgement to my family, especially my mother, Qiuhua Wang, for supporting and encouraging me to pursue this degree. Also, I am indebted to my family who from China provided the link to my roots and kept a close contact during these three years.

Villeneuve d'Ascq, France
February, 2012

Dapeng YANG

Résumé en français

Ce travail de thèse a pour objet principal l'analyse des systèmes linéaires modélisés par bond graph avec les approches algébrique et graphiques. Deux types de modèles sont étudiés: les modèles linéaires à paramètres constants (LTI) et les modèles linéaires à paramètres dépendant du temps (LTV: Linear Time Varying models). Cette étape d'analyse est fondamentale puisqu'elle se situe en amont de la phase de conception et synthèse de lois de commande dans une démarche classique de conception intégrée.

La synthèse de la commande des systèmes physiques est une tâche complexe car elle nécessite la connaissance d'un "bon modèle" et en fonction du choix d'un modèle (linéaire, non linéaire, *etc.*), certains outils spécifiques doivent être développés. Ces outils, principalement développés à partir d'un point de vue mathématique et théorique, doivent être utilisés de l'étape d'analyse (analyse des propriétés du modèle) à l'étape de synthèse de commande. Il est bien connu que dans de nombreuses approches, les propriétés des systèmes pilotés peuvent être analysées à partir du modèle initial (système en boucle ouverte). Pour des modèles linéaires, il existe des représentations différentes, telles que: la matrice de transfert, l'espace d'état [Kalman \(1959\)](#), la représentation de [Rosenbrock \(1970\)](#) et la représentation du module de type fini [Fliess \(1990\)](#).

Si le système est modélisé avec une représentation entrée-sortie ou avec une représentation espace d'état, deux types d'information sont souvent soulignés: la structure externe (structure à l'infini) et la structure interne (structure finie). La première est souvent liée à l'existence de certaines stratégies de contrôle (découplage entrée-sortie, rejet de perturbation, détection de faute, observateur à l'entrée inconnue, *etc.*) et la seconde concerne la propriété de stabilité du système contrôlé. Cette thèse est structurée en suivant cette démarche: étude de

RÉSUMÉ EN FRANÇAIS

la structure finie des modèles LTI et LTV (en particulier la structure des zéros invariants), et en application la conception d'observateurs de différents types en utilisant les informations sur la structure des zéros, élément clé dans l'élaboration d'observateurs.

Dans ce rapport, l'accent a été mis sur l'étude des zéros invariants des modèles bond graph dans le contexte des modèles LTV. Les systèmes LTV ont reçu beaucoup d'attention ces dernières années en raison de leurs propriétés particulières nécessitant des traitements mathématiques particuliers. Les systèmes physiques sont souvent représentés par des modèles LTV ou non linéaires. Les systèmes LTV apparaissent dans de nombreux domaines, par exemple, dans le contrôle des avions modernes et moteurs spatiaux, où les accélérations et les vitesses accrues induisent des variations des paramètres. Dans l'industrie électronique, pour les amplificateurs paramétriques et émetteurs de microphone, il existe des composants avec des paramètres variant dans le temps. Un autre intérêt des modèles LTV est qu'un modèle non linéaire peut être considéré comme un modèle LTV après la procédure de simplification.

L'approche algébrique a été utilisée et développée par [Kalman \(1965\)](#), [Fliess \(1990\)](#) et [Bourlès & Marinescu \(2011\)](#) dans le domaine automatique. Cette approche est intrinsèque, un système linéaire est considéré comme un module de type fini sur un anneau d'opérateurs. Elle était essentielle parce que, même si le problème est déjà résolu pour les modèles LTI, l'extension aux modèles LTV n'est pas si facile. L'utilisation simultanée des approches algébrique et graphique a prouvé son efficacité pour résoudre ce problème.

Le problème des pôles et zéros des systèmes LTV a été étudié dans ce rapport. D'un point de vue algébrique, certains concepts utilisés pour les modèles LTI peuvent être étendus aux modèles LTV, mais par exemple le concept de racines de polynômes n'est pas si facile à définir et à expliquer d'un point de vue physique. Dans ce travail, certaines notions mathématiques sont utilisées, mais surtout pour comprendre le concept de racines de certains polynômes (zéros invariants), et des formes canoniques (Smith/Jacobson formes) à partir de laquelle les racines peuvent être définies et calculées.

Ce rapport est structuré en six parties, y compris l'introduction et la conclusion. Tout d'abord, certains outils de l'approche algébrique introduits par

Fliess (1999), Bourlès (2005) et Zerz (2006) *etc.* ont été rappelés dans le premier chapitre. Plus précisément, les systèmes linéaires qui peuvent être décrits comme un module de type fini sur un anneau d'opérateurs sont présentés. Les structures finie et à l'infini des modèles linéaires avec l'approche bond graph ont été étudiées dans Sueur & Dauphin-Tanguy (1991) pour les modèles LTI et Chalh *et al.* (2007) et Andaloussi *et al.* (2006) pour les modèles LTV. Les résultats connus pour l'étude des zéros invariants des modèles bond graphs dans le cas LTI ont été rappelés dans le chapitre deux. De nouveaux développements sont proposés dans le chapitre trois. Deux problèmes principaux sont étudiés: la structure des zéros invariants des modèles bond graphs dans les cas carré et non carré et le problème de l'annulation des variables de sortie avec la connaissance des zéros invariants. Des applications physiques concluent ce travail avec le problème d'étude d'observateur à entrées inconnues dans le chapitre quatre. Certains observateurs classiques sont développés et de nouvelles formes d'observateurs ont été proposées.

Pour l'étude des propriétés structurelles des systèmes linéaires, telles que la commandabilité, l'observabilité, la structure finie et à l'infini, la théorie des modules s'avère être un outil efficace. Les modèles LTI et LTV sont définis comme des modules sur des anneaux d'opérateurs. À la lumière de l'approche algébrique, les pôles et zéros des systèmes linéaires sont étudiés avec des sous-modules correspondants. La méthode classique pour définir des zéros et des pôles est d'utiliser certaines formes canoniques des matrices polynomiales ou rationnelles sur les anneaux. Un procédé plus intrinsèque consiste à examiner les propriétés de sous-modules, en particulier des modules de torsion. Les sous-modules de torsion sont liés à des parties non commandables dans un module, il s'agit d'une question essentielle, et ce principe a été utilisé tout au long du rapport. L'analyse de la propriété de commandabilité a été bien développée pour les modèles bond graphs dans les cas LTI et LTV avec une combinaison de l'utilisation de certains outils algébriques liés à la théorie des modules et certaines applications de la causalité. Le présent travail consiste à développer ces aspects, avec une analyse particulière des zéros invariants des modèles de LTV.

L'obtention des formes canoniques définissant la structure des zéros invariants (associées aux sous modules torsions) et ensuite le calcul des racines des polynômes invariants ainsi obtenus, sont des tâches complexes dans le cas LTV.

RÉSUMÉ EN FRANÇAIS

Dans le rapport, l'approche graphique a été utilisée pour détecter cette structure en combinant les approches algébrique et formelle. Trois types de causalité ont été utilisés pour analyser les propriétés des modèles, tels que: la causalité intégrale, dérivée et la bicausalité. Classiquement, le nombre des zéros invariants est étudié à partir de modèles bond graph en causalité intégrale (modèles BGI), et le nombre des zéros invariants nuls est obtenu à partir de modèles bond graph en causalité dérivée (modèles BGD). La principale différence entre les cas LTI et LTV se situe au niveau du calcul des zéros avec modèles l'application de la bicausalité (modèles BGB). Les zéros des systèmes étant des pôles des systèmes inverses, l'inversibilité est une notion fondamentale. Pour les modèles bond graphs, cette propriété est étroitement liée à la structure à l'infini des modèles et est donc associée aux chemins causaux entrées-sorties. La propriété d'inversibilité peut également être étudiée à partir des modèles bond graphs avec la bicausalité. Dans ce contexte, les procédures bond graph avec l'application de la bicausalité ont été étendues aux modèles linéaires carrés et non carrés. Dans les modèles BGB, les éléments dynamiques avec une causalité intégrale permettent le calcul des équations de torsion associées aux zéros invariants. Pour étudier la structure des zéros invariants de sous-modèles en lignes, les modèles BGB n'existent pas car la bicausalité ne peut être appliquée qu'à des modèles carrés. De nouvelles techniques ont été proposées, fondées sur la notion des modules de torsion "communs" entre chaque sous-modèle (sous-espaces non commandables en commun). Lorsque le nombre de détecteurs de sortie est supérieur au nombre d'actionneurs d'entrée, la notion des modules communs non observables a été nécessaire. Comme la propriété d'observabilité n'est pas directement liée à des modules facilement mis en évidence à partir d'un modèle bond graph, le concept des modèles bond graphs duals a été utilisé, la propriété d'observabilité étant duale de celle de la commandabilité.

Le problème de l'annulation des variables de sortie a également été étudié en parallèle avec l'analyse de la structure des zéros invariants parce que ces deux problèmes sont étroitement liés. Tout d'abord, des modèles LTI monovariables ont été pris en considération. Dans ce cas, la variable de sortie peut être nulle avec une condition initiale quelconque des variables d'état et pour une variable d'entrée de commande directement liée à un zéro invariant (constant pour un zéro invariant nul). Ce problème a été partiellement étendu au cas LTV. La proposition a été expliquée d'un point de vue algébrique lorsque les variables

de sortie ont été fixées à zéro. Pour illustrer l'étude des zéros invariants et le problème de l'annulation des sorties, des logiciels MapleTM et 20-sim[®] ont été utilisés sur certains exemples physiques.

Dans le dernier chapitre, le problème de synthèse d'observateur avec une entrée inconnue a été considéré. Une forme générale de UIO a été proposée par l'utilisation des propriétés de la structure à l'infini et de l'inversibilité des systèmes SISO dans le cas LTI. Basée sur l'estimation des variables d'état, une forme générale de l'estimation des entrées inconnues a été introduite avec des matrices inverses généralisées. Le problème de l'estimation de l'état et des variables d'entrée inconnues a été examiné avec l'existence de variables d'entrée connues permettant d'effectuer une synthèse de commande. Trois types de UIO ont été étudiés : UIO avec l'approche algébrique, UIO avec des matrices inverses généralisées et UIO avec une méthode directe. Les conditions d'existence des UIO ont également été données. Un modèle physique a été étudié dans les cas LTI et LTV. Les résultats de simulation avec MATLAB[®] ont prouvé l'efficacité des UIOs proposés.

Comme l'analyse de la structure finie est une tâche cruciale pour l'étude de la propriété de la stabilité des systèmes pilotés (étape de contrôle, estimation, *etc.*), certains développements mathématiques sont encore nécessaires. Pour les systèmes non linéaires, étant donné que certaines procédures graphiques existent pour obtenir un modèle "variationnel" qui peut être considéré comme un modèle LTV, certaines propriétés locales des systèmes non linéaires modélisés par bond graph pourraient être étudiées avec nos procédures.

RÉSUMÉ EN FRANÇAIS

Contents

Acknowledgements	3
Résumé en français	5
Table of Contents	10
List of Figures	15
List of Tables	20
Abbreviations	22
Introduction	25
1 Linear Systems Modeling and Structure	29
1.1 Algebraic Representation of Linear Systems	30
1.1.1 Mathematical Background and Notions	31
1.1.1.1 Fields	31
1.1.1.2 Rings and Rings of Differential Operators	31
1.1.1.3 Factorization and Roots of Differential Polynomials	33
1.1.2 Modules and Linear Systems	36
1.1.2.1 Modules	36
1.1.2.2 Linear Systems Modeled as Modules over \mathbf{R}	38
1.1.2.3 Sequences of \mathbf{R} -modules	40
1.1.3 Different Descriptions of Linear Systems	41
1.2 System Structures	42
1.2.1 Polynomial and Rational Matrices	43

CONTENTS

1.2.1.1	Smith/Jacobson Form and Zeros of a Polynomial Matrix	45
1.2.2	Finite Structure	48
1.2.2.1	System Poles	50
1.2.2.2	Decoupling Zeros (Hidden Modes)	51
1.2.2.3	Invariant Zeros	55
1.2.2.4	Relationships between various Poles and Zeros	56
1.2.3	Structure at Infinity	57
1.2.3.1	Smith-McMillan Form at Infinity of Rational Matrices over \mathbf{L}	58
1.2.3.2	Modules over \mathbf{S}	59
1.2.3.3	State Space Approach	60
1.3	Unknown Input Observers	61
1.3.1	UIO with Matching Conditions	62
1.3.2	UIO with Algebraic Approach	66
1.4	Conclusion	68
2	Bond Graph Methodology	71
2.1	Graphical Representations of Linear Systems	72
2.1.1	Linear Structured Systems	72
2.1.2	Bond Graph Modeling	74
2.2	Structural Properties of Linear Systems	75
2.2.1	Structural State Matrix Rank	76
2.2.2	Controllability	77
2.2.2.1	Controllability of LTI Systems	77
2.2.2.2	Controllability of LTV Systems	81
2.2.3	Observability	86
2.2.3.1	Rank Condition of Observability	86
2.2.3.2	Bond Graph Procedure	88
2.2.4	Dual Bond Graph Model	91
2.3	Infinite and Finite Structures	97
2.3.1	Infinite Structure	97
2.3.2	Invertibility and BGB Models	99
2.3.3	Finite Structure	103
2.4	Conclusion	106

3	Invariant Zeros of Bond Graph Models	107
3.1	Finite Structure of Linear Models	108
3.1.1	Invariant Zeros	109
3.1.2	Several Approaches for the Study of Invariant Zeros	110
3.1.3	Output-Zeroing Problem and Invariant Zeros	115
3.2	Invariant Zeros of Linear Square Models	118
3.2.1	BGB Procedure for Invariant Zeros of Square Models	118
3.2.2	Invariant Zeros of SISO Models	121
3.2.2.1	Null Invariant Zeros: LTI and LTV Cases	122
3.2.2.2	Invariant Zeros and Solution Set of Input Variables	126
3.2.2.3	Simulations	130
3.2.3	Invariant Zeros of MIMO Models	137
3.2.3.1	LTI Models	139
3.2.3.2	LTV Models	150
3.2.4	Conclusion	159
3.3	Invariant Zeros of Linear Non-Square Models	160
3.3.1	BG Procedure for Invariant Zeros of Non-Square Models	160
3.3.2	Row Subsystems of Square MIMO Systems	161
3.3.2.1	The LTI Case	161
3.3.2.2	The LTV Case	167
3.3.3	Non-Square MIMO Models	169
3.3.3.1	Linear MIMO Models with $m > p$	170
3.3.3.2	Linear MIMO Models with $m < p$	176
3.4	Conclusion	183
4	Unknown Input Observer	187
4.1	Unknown Input Observer Design	188
4.1.1	UIO Deduced from the Infinite Structure	189
4.1.2	A General Form of Unknown Input Estimate	190
4.1.2.1	LTI Case	191
4.1.2.2	LTV Case	192
4.1.3	UIO with the Algebraic Approach	195
4.1.4	Bond Graph Procedure for Strong* Detectability	197
4.2	Numerical Examples and Simulations	199
4.2.1	Case with Matching Condition Satisfied	200

CONTENTS

4.2.1.1	UIO by Generalized Inverse Matrices	202
4.2.1.2	UIO by Algebraic Approach	203
4.2.2	Case without Matching Condition	205
4.2.3	UIO with Direct Method	207
4.2.4	LTV Case	213
4.3	Conclusion	219
	Conclusions and Perspectives	221
	References	225
A	Appendix	233
A.1	Bond Graph Standard Elements	233
A.2	Causality	238

List of Figures

1.1	Circuit of a third order system	49
2.1	A directed graph representation	73
2.2	A second order system	78
2.3	Bond graph with preferred integral causality	79
2.4	Bond graph with preferred derivative causality	79
2.5	Differential loop transformations for CBG models	82
2.6	The CBG model with preferred integral causality	83
2.7	The CBG model with preferred derivative causality	84
2.8	Procedure for detecting input decoupling zeros of a module modeled by bond graph models	86
2.9	Differential loop transformations for OBG	89
2.10	Dual elements of time-varying dynamical elements	92
2.11	Dual bond graph model of the system	92
2.12	BGI model of the system in Figure 1.1	93
2.13	BGD model of the LTI system in Figure 1.1	93
2.14	BGI dual model of the LTI system in Figure 1.1	94
2.15	BGD dual model of the LTI system in Figure 1.1	94
2.16	BGI dual model of the LTV system in Figure 1.1	94
2.17	BGD dual model of the LTV system in Figure 1.1	95
2.18	The principle of bicausal bonds	101
2.19	A bicausal junction	102
2.20	Bond graph model in integral causality (BGI)	103
2.21	Bicausal bond graph model (BGB)	103
2.22	Bond graph model in derivative causality (BGD)	105

LIST OF FIGURES

3.1	Bond graph and algebraic approaches for detecting invariant zeros and their relations	120
3.2	Bond graph procedure for detecting invariant zeros of linear square systems	122
3.3	Bond graph model with integral causality: BGI model	123
3.4	Bond graph model with derivative causality: BGD model	124
3.5	Bond graph model with bicausality : BGB model	124
3.6	The output curve of the LTI model with $u(t) = \Gamma(t)$, $x_{10} = 0$, $x_{20} = 0.5$	128
3.7	The output curve of the LTV model with $u(t) = (t + 2)\Gamma(t)$, $x_{10} = 0$, $x_{20} = 1$	129
3.8	The output Df curve with $I(t) = t^2 + 1$ and $u(t) = \Gamma(t)$	131
3.9	The output Df curve with $R(t) = t + 1$ and $u(t) = \Gamma(t)$	132
3.10	The output Df curve with $R(t) = t + 1$, $I(t) = t^2 + 1$ and $u(t) = \Gamma(t)$	132
3.11	The output Df curve with $m(t) = \frac{1}{t+1}$ and $u(t) = \Gamma(t)$	133
3.12	The output Df curve with $m(t) = u(t) = \frac{1}{t+1}$ and $x_{20} = 1$	133
3.13	The output Df curve with $m(t) = \sin(t) + 2$ and $u(t) = \Gamma(t)$	133
3.14	The output Df curve with $C(t) = t + 1$ and $u(t) = \Gamma(t)$	134
3.15	The output Df curve with $C(t) = t + 1$, $u(t) = \frac{2}{t+1}$ and $x_{20} = 1$	134
3.16	The output Df curve with $C(t) = m(t) = t^2 + 1$ and $u(t) = \Gamma(t)$	135
3.17	The output Df curve with $m(t) = t + 2$, $C(t) = t^2 + 1$ and $u(t) = \Gamma(t)$	135
3.18	The output Df curve with $m(t) = t + 2$, $C(t) = t^2 + 1$, $u(t) = \frac{t+2}{t^2+1}$ and $x_{20} = 1$	135
3.19	The output Df curve with $I(t) = t + 1$, $C(t) = t^2 + 1$ and $u(t) = \Gamma(t)$	136
3.20	The output Df curve with $I(t) = t + 1$, $C(t) = t^2 + 1$, $u(t) = \frac{2}{t^2+1}$ and $x_{20} = 1$	136
3.21	Bond graph model: BGI	138
3.22	Bond graph model: BGD	140
3.23	Bond graph model: BGB	141
3.24	Output variables curves of the LTI model with $mC_4 \neq C_6$	144
3.25	Output variables curves of the LTI model with $mC_4 = C_6$	145
3.26	BGI model of the square MIMO LTI system without R element	145
3.27	Bond graph model without R-element: BGD	146
3.28	Bond graph model without R-element: BGB	147

LIST OF FIGURES

3.29 Output variables curves with $C_6 \neq mC_4, u_1 = 2, u_2 = 4$	149
3.30 Output variables curves with $C_6 = mC_4, u_1 = 2, u_2 = 4$	150
3.31 Output variables curves with $C_6 = mC_4, u_1 = t + 2, u_2 = -1.5t + 2$	150
3.32 Output variables curves with $C_6 \neq mC_4, u_1 = t + 2, u_2 = -1.5t + 2$	151
3.33 The output variables curves of the LTV system with $m(t) = C_6(t) =$ $t + 2$	158
3.34 The output variables curves of the LTV system with $m(t) = C_6(t) =$ $t + 2$ and an initial condition of the state variables	159
3.35 Bond graph procedure for detecting invariant zeros of non square MIMO systems	162
3.36 BGBI submodel with output y_1 : case 1 (input u_1)	163
3.37 Reduced model of submodel with output y_1 : case 1 (input u_1) . .	164
3.38 BGB submodel with output y_2 : case 1 (input u_1)	165
3.39 BGB submodel with output y_1 : case 1 (input u_1)	165
3.40 BGB submodel with output y_1 : case 2 (input u_2)	166
3.41 BGD for the reduced submodel with y_1 : case 1	166
3.42 BGD for the reduced submodel with y_1 : case 2	167
3.43 BGI model with three input and two output variables	170
3.44 Curves of output variables of the LTI model	173
3.45 Curves of output variables of the LTV model	173
3.46 BGB submodel with inputs u_2, u_3 and outputs y_1, y_2	174
3.47 BGB submodel with selected inputs u_1, u_2 and outputs y_1, y_2 . . .	175
3.48 BGB submodel with inputs u_1, u_3 and outputs y_1, y_2	175
3.49 BGI model of a system with one input and two output variables .	176
3.50 BGBD model of the square subsystem with u and y_1	180
3.51 Reduced model of the square subsystem with output y_2	180
3.52 Dual model of the reduced model with output y_2	181
3.53 BGBD model of the square subsystem with u and y_2	181
3.54 Reduced model of the square subsystem with output y_1	182
3.55 The dual model of the reduced model with output y_1	182
3.56 The outputs y_1 and y_2 curves of the LTI system	183
4.1 Block diagram of the LTI observer with generalized inverse matrices	192
4.2 Schema block of the LTI observer with the algebraic approach . .	196
4.3 Strong detectability condition with bond graph approach	198

LIST OF FIGURES

4.4	BGI model of the DC moteur	199
4.5	BGD model of the DC moteur	201
4.6	BGB model of the DC moteur	201
4.7	Trajectories $e_{x_i} = \hat{x}_i - x_i, i = 1, 2$ of the LTI system 1 with generalized inverse matrix method	203
4.8	Trajectories d and d_e of the LTI system 1 with generalized inverse matrix method	203
4.9	Trajectories d and d_e of MUIO of the LTI system 1 with a noise signal	204
4.10	Trajectories $e_{x_i} = \hat{x}_i - x_i, i = 1, 2$ of system 1 with the algebraic approach	204
4.11	Trajectories $d(t)$ and d_{e1}, d_{e2} of system 1 with the algebraic approach	205
4.12	Trajectories d and d_{e_i} of AUIO of the LTI system 1 with a noise signal	206
4.13	BGI model of the DC motor with y in the second position	206
4.14	Trajectories $e_{x_i} = \hat{x}_i - x_i, i = 1, 2$ of the LTI system 2 with the algebraic approach	207
4.15	Trajectories d and $d_{e_i}, i = 1, 2$ of the LTI system 2 with the algebraic approach	208
4.16	Trajectories d and d_e of the LTI system 1 with the direct method	209
4.17	Trajectories $e_{x_i} = x_i - \hat{x}_i, i = 1, 2$ of the LTI system 1 with the direct method	210
4.18	Trajectories d and d_e of DUIO of the LTI system 1 with a noise signal	210
4.19	Trajectories d and d_e of the LTI system 2 with the direct method	211
4.20	Trajectories $e_{x_i} = x_i - \hat{x}_i, i = 1, 2$ of the LTI system 2 with the direct method	212
4.21	Trajectories d and d_e of DUIO of the LTI system 2 with a noise signal	212
4.22	Trajectories $e_{x_i} = \hat{x}_i - x_i, i = 1, 2$ of the LTV system with generalized inverse matrices	214
4.23	Trajectories $d_e(t)$ and $d(t)$ of the LTV system with generalized inverse matrices	214

LIST OF FIGURES

4.24 Trajectories d and d_e of MUIO of the LTV system 1 with a noise signal	215
4.25 Trajectories $e_{x_i} = \hat{x}_i - x_i, i = 1, 2$ of the LTV system with the algebraic approach	216
4.26 Trajectories $d_e(t)$ and $d(t)$ of the LTV system with the algebraic approach	216
4.27 Trajectories d and d_e of AUIO of the LTV system 1 with a noise signal	217
4.28 Trajectories $e_{x_i} = \hat{x}_i - x_i, i = 1, 2$ of the LTV system with the direct approach	218
4.29 Trajectories $d_e(t)$ and $d(t)$ of the LTV system with the direct approach	218
4.30 Trajectories d and d_e of DUIO of the LTV system 1 with a noise signal	219
A.1 Source bond graph element	234
A.2 Inertial bond graph element	234
A.3 Capacitive bond graph element	234
A.4 Resistive bond graph element	235
A.5 Detector bond graph element	235
A.6 Transformer bond graph element	236
A.7 Gyrator bond graph element	236
A.8 0-junction	237
A.9 1-junction	237
A.10 (i) Circuit of a second order system (ii) Causally completed bond graph model (iii) Block diagram model of the system	238
A.11 Causal assignment and its block diagram representation	239
A.12 A bond graph model with integral causality	240

LIST OF FIGURES

List of Tables

1.1	Differences and counterparts between modules and vector spaces	38
1.2	Observability property of the system in several cases	54
1.3	Modules and corresponding matrices of finite zeros and poles	57
2.1	Effort and flow variables in some physical domains	75
2.2	Causal patterns for the source-sensor element SS	102
2.3	Calculation of invariant zeros of linear square BG models	105
3.1	Applicable bond graph models and techniques for IZ identification	115
3.2	Numerical values of RLC circuit components	123
3.3	Components's numerical values of the square LTI model	144
3.4	Invariant factors of system matrices with R in the LTI case	155
3.5	Invariant factors of system matrices with R in the LTV case	155
3.6	Invariant factors of the system matrix in several cases	157
3.7	Invariant factors of the system matrix without R in several cases	169
3.8	Invariant factors of the system matrix with $m < p$ in several cases	179
4.1	Numerical values of system parameters	200
A.1	Elements gain in the causal path	240

LIST OF TABLES

Abbreviations

- \mathbb{R}, \mathbb{C} - Real, complex numbers
LTI - Linear time-invariant
LTV - Linear time-varying
 \mathbf{k} - Coefficient field \mathbb{R} or \mathbb{C} - coefficient field of linear time-invariant system
 \mathbf{K} - Ore domain $\mathbf{k}[t]$ of LTV systems coefficients
PMD - Polynomial matrix description
PID - Principal ideal domain
 $\mathbf{k}[\delta]$ - Differential ring over \mathbf{k}
 $\mathbf{k}(\delta)$ - Field of fractions of $\mathbf{k}[\delta]$
 R - Ring or differential polynomial ring over \mathbf{k}
 \mathbf{R} - Differential polynomial ring over \mathbf{K}
 \mathbf{Q} - Field of fractions of \mathbf{R}
 \mathbf{S} - Ring of integration operators over \mathbf{K}
 \mathbf{L} - Field of fractions of \mathbf{S}
 M - Module
 \mathcal{T} - Torsion module
 $\alpha(\mathcal{T})$ - A full set of Smith zeros of \mathcal{T}
GCRD - Greatest common right divisor
LCLM - Least common left multiple
 $P(\delta, t)$ - System matrices of linear systems
 $P_r(\delta, t)$ - Reduced system matrices of linear systems
BGI - Bond graph model with preferred integral causality
BGD - Bond graph model with preferred derivative causality
BGB - Bond graph model with preferred bicausal causality
BGBI - Bicausal bond graph model with preferred integral causality
BGBD - Bicausal bond graph model with preferred derivative causality

ABBREVIATIONS

SISO - Single-input and single-output

MIMO - Multiple-input and multiple-output

DEs - Dynamical elements in BG models

IZ - Sets of invariant zeros

M_{ei} - Modules of DEs with an integral causality in BGB models

UIO - Unknown input observability (observer)

SD - Strong detectability

SD* - Strong* detectability

MUIO - UIO derived from the generalized inverse matrix approach

AUIO - UIO derived from the algebraic approach

DUIO - UIO derived from the direct approach

Introduction

This dissertation is mainly focused on the analysis of linear time invariant LTI and linear time-varying LTV systems modelled by bond graph throughout algebraic and graphical approaches.

LTV systems have received much attention in recent years due to the time-varying properties, which have different mathematical treatments and special performances. Physical systems are often represented by time-varying or non-linear models. LTV systems appear in many fields, for example, in the control of modern aircrafts and space crafts where increased accelerations and velocities induce parameter variations. In electronics, for parametric amplifiers and microphone transmitters, there exist time-varying components.

The study of LTI multivariable models is now well defined in the context of control problems since the first work of [Kalman \(1969\)](#) or [Rosenbrock \(1970\)](#) for example. Many control problems can be solved either from a state space representation which requires matrix calculus or from symbolic representation (Laplace operator for example) which requires polynomial representations. In this context the concept of poles and zeros is well defined and a direct relation can be pointed out between these poles and zeros (roots of some polynomials) and the temporal behavior. For LTV models, mathematical background from algebraic theory is required and it is much more difficult to be used. From an algebraic point of view, some concepts used for LTI models can be extended to LTV models, but for example the concept of roots of skew polynomials is not so easy to be defined and explained from a physical point of view. Many references can be cited either for a purely mathematical point of view or for a control theoretic point of view [Ritt \(1950\)](#), [Malgrange \(1962\)](#), [Cohn \(1985\)](#), [Kolchin \(1986\)](#), [Adkins & Weintraub \(1992\)](#), [Van der Put & Singer \(2003\)](#), [Lam & Leroy \(2004\)](#) and [Bourlès & Marinescu \(2011\)](#). In this work, some mathematical

INTRODUCTION

backgrounds are useful, but mainly for understanding the concept of roots of some polynomials (invariant zeros), and some particular mathematical representations (Smith/Jacobson forms) from which roots can be derived.

This report is structured into six parts (4 chapters), including the introduction and the conclusion. The first chapter recalls some algebraic notions, and first the algebraic representation of linear systems. More precisely, linear systems which can be described as a finitely generated module over a ring of operators are presented. Some well known contributions in this field, mostly dedicated to a control point of view are recalled [Kalman \(1965\)](#) or [Fliess \(1990\)](#) who proposed different developments, where a linear system is regarded as a finitely presented module over a ring of operators. The module theoretic approach is also closely related to the behavioral approach proposed by [Willems \(1983\)](#), [Willems \(1991\)](#) and [Ilchmann & Mehrmann \(2006\)](#). In [Bourlès & Marinescu \(2011\)](#), linear systems are also defined by this intrinsic way which is different from some well known representations: transfer matrix or state-space forms [Kalman \(1969\)](#) or Rosenbrock representation by [Rosenbrock \(1970\)](#). Then, the infinite and finite structures are introduced, with the concept of poles and zeros related to some particular modules [Marinescu & Bourlès \(2009\)](#), and [Zerz \(2006\)](#). Some canonical forms of matrices over corresponding rings are used for detecting these poles and zeros. For the finite structure, well known properties are recalled, such as the controllability/observability properties and the concept of invariant zero which is the central problem studied in this work. Some illustrative examples are proposed. Since The Unknown Input Observer (UIO) Problem is proposed as an application in this work, some fundamental concepts are recalled in the first chapter.

The study of the finite and infinite structures of linear models with a bond graph approach received much attention for example in [Sueur & Dauphin-Tanguy \(1991\)](#) for LTI models and in [Chalh \(2007\)](#) and [Andaloussi *et al.* \(2006\)](#) for LTV models. In the second chapter, some tools dedicated to bond graph models are recalled. First the controllability/observability properties are presented with a graphical approach, mainly based on the concept of structural rank deduced from a causal approach. Relations between the non-controllable part of a model (orthogonal complement of a controllability matrix) and a torsion module are pointed out with some causal manipulations. Extensions to LTV models are mainly based on some extensions of the LTI case, and in order to extend these properties to the

observability case, the concept of dual bond graph model is recalled [Lichiardopol & Sueur \(2010\)](#) and [Rudolph \(1996\)](#) for some theoretical developments. Since the central problem studied in this work concerns the invariant zeros, the previous approaches dedicated to this problem are recalled, mainly with the concept of bicausality, usually used for the analysis of the inverse model.

In chapter three, some new developments are proposed, mainly in two related directions. First, since invariant zeros can be characterized from the poles of the inverse models, with some restrictions and assumptions, some theoretical algebraic based approaches are first recalled, mainly on the characterization of invariant zeros from some particular modules associated to the initial model [Bourlès & Marinescu \(2011\)](#) and then from modules associated to the inverse model. Some relations with the output zeroing problems [MacFarlane & Karcanias \(1976\)](#) are recalled and some extensions are proposed for the LTV case, for this last problem. Since the inverse model is directly drawn with application of bicausality on a bond graph model, we define new modules associated to invariant zeros directly from the bicausal bond graph model (BGB). In some cases, it is possible to conclude on the existence of invariant zeros, and the particular case where invariant zeros have a zero value received a particular attention, with the concept of bond graph model with a derivative causality assignment (BGD). The bicausality can be only applied on square models. In many control problems, models may be not square and even if they are square, structure of row and global models must be compared. One main contribution in this chapter is the extension of classical approaches to non square models and with a mathematical module theoretical approach associated to a graphical approach (bicausality).

The last chapter is addressed to the unknown input observer problem. The algebraic [H. L. Trentelman & Hautus \(2001\)](#), [Daafouz *et al.* \(2006\)](#) and generalized inverse matrix approaches [Darouach *et al.* \(1994\)](#), [Darouach \(2009\)](#) are used to design unknown input observers in several cases. Some extensions are proposed. First, some new observer designs in the LTI case are proposed, without study of stability (which must still be proved), and then some extensions of the cited approaches are proposed, mainly by using control input variables. Some extensions to the LTV case are proposed, and we prove the convergence of these observers on some physical examples. An important work is still necessary for proving the

INTRODUCTION

stability property of controlled systems with this kind of observer. In that way, it could be a direct application of the developments proposed in chapter 3.

Chapter 1

Linear Systems Modeling and Structure

Contents

1.1 Algebraic Representation of Linear Systems	30
1.1.1 Mathematical Background and Notions	31
1.1.2 Modules and Linear Systems	36
1.1.3 Different Descriptions of Linear Systems	41
1.2 System Structures	42
1.2.1 Polynomial and Rational Matrices	43
1.2.2 Finite Structure	48
1.2.3 Structure at Infinity	57
1.3 Unknown Input Observers	61
1.3.1 UIO with Matching Conditions	62
1.3.2 UIO with Algebraic Approach	66
1.4 Conclusion	68

Modelling, analysis and synthesis are a logical sequence when dealing with an integrated design approach of dynamical systems. According to the complexity of physical phenomena, the model can have different descriptions, such as: linear time-invariant (LTI), linear time-varying (LTV) or nonlinear (NL) models.

In order to study system structures, one should choose a model, firstly. The associated issues and problems of LTI systems have been studied for a long time.

1. LINEAR SYSTEMS MODELING AND STRUCTURE

There exist many kinds of methods to model, analyze and synthesize physical systems. [Kalman *et al.* \(1969\)](#) has established the state space analysis around 1960 and proposed that in the sense of mathematics, a linear system may be represented by the module. [Rosenbrock \(1970\)](#) has proposed the general description of a linear system named the Rosenbrock polynomial description. [Fliess \(1990\)](#) has introduced and developed the module theory in control domain which is different from the Kalman's idea. Module theoretic approach is also related to the behavioral approach proposed by [Willems \(1991\)](#). Algebraic methods are appropriated not only in linear cases but also for nonlinear ones. By this powerful tool, one can extend the results of the LTI approach to LTV systems. However, because of non-commutative properties, some differences between these two cases must be pointed out.

As the coefficients of the differential equations of LTV models are time-varying functions, the operator does not commute with the coefficients. In the first chapter, some algebraic concepts which are fundamental to construct linear time-varying models will be introduced, such as: principal ideal ring, module, etc. For more details, [Adkins & Weintraub \(1992\)](#), [Goodearl & Warfield \(2004\)](#), [Bourlès & Marinescu \(2011\)](#) and [Ilchmann & Mehrmann \(2006\)](#) are highly recommended.

In this chapter, an overview of structural properties of linear systems is provided. Roughly speaking, linear system structure is divided into two parts: the finite structure and the infinite structure. In the second section, the finite and infinite structure and some kinds of canonical forms of matrices which are useful to derive two structures are introduced. A number of examples will be given. Several poles and zeros are presented, which are important to analysis the system performances such as controllability, observability, stability, etc. In the last section, a classical control problem like the unknown input observer one will be introduced, as an application of analysis and control of linear systems.

1.1 Algebraic Representation of Linear Systems

In this section, some elementary notions derived from algebra will be firstly recalled, such as: fields, polynomials and rings. For more details, see [Bourbaki \(1970\)](#), [Cohn \(1985\)](#), [McConnell *et al.* \(2001\)](#) and [Bourlès & Marinescu \(2011\)](#), etc. Then, the module theoretical approach used for the study of linear systems

1.1 Algebraic Representation of Linear Systems

will be introduced. Furthermore, some examples will illustrate that linear systems are finitely generated modules over differential polynomial rings of differential operators. In the time-varying case, some differences with the time-invariant one will be shown. In the last part, different descriptions of linear systems, such as state-space description, polynomial matrix descriptions are recalled.

1.1.1 Mathematical Background and Notions

1.1.1.1 Fields

One-dimensional (1-D) LTI systems can be modeled by a number of ordinary differential equations with coefficients in \mathbb{R} (or \mathbb{C}). In the LTI case, $\mathbf{k} = \mathbb{R}$ (or \mathbb{C}) denotes the fields to which the systems's coefficients belong. *Coefficient fields* will be utilized to name this kind of fields. Let's firstly recall the notion of field.

A field $\mathbf{k}(+, \times)$ is an algebraic structure with notions of addition, multiplication, satisfying axioms for $a, b, c \in \mathbf{k}$:

- $a + b \in \mathbf{k}, ab \in \mathbf{k}$
- $a + (b + c) = (a + b) + c, a \cdot (b \cdot c) = (a \cdot b) \cdot c$
- $a + b = b + a, a \cdot b = b \cdot a$
- $a + 0 = a, a \cdot 1 = a$
- $a + (-a) = 0, a \cdot a^{-1} = 1$
- $a \cdot (b + c) = (a \cdot b) + (a \cdot c)$

1.1.1.2 Rings and Rings of Differential Operators

A ring $R(+, \times)$ is an algebraic structure with notions of addition, multiplication, satisfying axioms for $a, b, c \in R$:

- $a + b \in R, ab \in R$
- $(a + b) + c = a + (b + c), (a \cdot b) \cdot c = a \cdot (b \cdot c)$
- $0 + a = a + 0 = a, 1 \cdot a = a \cdot 1 = a$
- $a + b = b + a$

1. LINEAR SYSTEMS MODELING AND STRUCTURE

- $a \cdot (b + c) = (a \cdot b) + (a \cdot c), (a + b) \cdot c = (a \cdot c) + (b \cdot c)$

The ring $\mathbf{K} = \mathbf{k}[t]$ of polynomials of t with coefficients in $\mathbf{k} \in \mathbb{R}$ or \mathbb{C} is a commutative ring. For LTV systems, the coefficients of the differential equations of the systems are rational or meromorphic functions of time. These coefficients belong to the ring $\mathbf{K} = \mathbf{k}[t]$.

Rings of Differential Operators

Definition 1.1 *A ring of differential operators (or differential polynomial ring) is formed from a ring \mathbf{R} and a derivation $\delta : \mathbf{R} \rightarrow \mathbf{R}$. In addition, every element of the ring is a polynomial of δ with coefficients in \mathbf{K} . Then the multiplication is extended from the relation $\delta \cdot a = a \cdot \delta + \dot{a}, a \in \mathbf{R}$, which is also known as Leibniz rules. In the sequel, $(\dot{})$ denotes the derivation.*

In the following, a special differential polynomial ring will be defined as $\mathbf{R} := \mathbf{K}[\delta]$. The elements of \mathbf{R} are polynomials of the form (1.1).

$$P(\delta) = \sum_0^n a_i \delta^i, \quad a_i \in \mathbf{K} \quad (1.1)$$

A polynomial in (1.1) is named *a skew polynomial* or *a differential operator* when \mathbf{K} is not a field of constants. Additionally, a polynomial is called *monic* if $a_n = 1$. The ring \mathbf{R} is generally noncommutative. It is commutative iff \mathbf{K} is a differential field of constants. When elements of coefficient field are polynomials in one variable (*e.g.* t), the differential polynomial ring is called a *Weyl algebra*.

Cohn (1985) has defined the notation of *ring of differential operators* over \mathbf{K} in $\frac{d}{dt}$ as $\mathbf{R} := \mathbf{K}[\delta; id, \frac{d}{dt}]$, where ‘*id*’ denotes respectively a variable with the fixed value in the time-continuous and time-discrete cases. In this report, only time-continuous case is considered, then the ring is also denoted by $\mathbf{R} := \mathbf{K}[\delta]$. The set \mathbf{R} consists of all polynomial expressions in the variable δ with coefficients in \mathbf{K} . For the addition operation, it’s an abelian group. However, the multiplication is given by the rule $\delta a = a\delta + \frac{d}{dt}(a)$ for all $a \in \mathbf{K}$. \mathbf{R} becomes a non-commutative ring by the expanding of associativity and distributivity. Rings of the type of \mathbf{R} are also known as *skew polynomial rings* or *Ore polynomial rings*. The ring

1.1 Algebraic Representation of Linear Systems

$\mathbb{Q}(t)[\delta; id, \frac{d}{dt}]$ is a special case of differential rings where the coefficients's fields are the rational functions $\mathbb{Q}(t)$ in t .

In what follows, $\mathbf{X}^{m \times n}$ is used to represent the set of $m \times n$ matrices with entries in \mathbf{X} , \mathbf{X}^n for n-length row vectors and \mathbf{X}_m for m-length column vectors, where \mathbf{X} is an algebraic structure, such as: field, ring, etc.

A ring is called an *integral domain*, or a *domain*, if it is integral, i.e., without zero divisors. In another word, an integral domain is a ring with $1 \neq 0$ (i.e., the multiplicative identity is not equal to the additive identity) that has no zero divisor. This means that if $a, b \in R$ such that $ab = 0$, then $a = 0$ or $b = 0$. A *unit* of R is an invertible element. Two nonzero elements a and b of an integral domain R are said to be *associated* if there exist units v and ϑ such that $a = vb\vartheta$. If $v = 1$ (resp., $\vartheta = 1$), they are said to be *right* (resp., *left*) *associated*.

Proposition 1.2 *Bourlès (2005)* $\mathbf{R} = \mathbf{K}[\delta]$, even in the general case, is:

- (i) An Euclidean domain, thus a principal ideal domain which is an integral domain whose all ideals are principal;
- (ii) A simple ring, i.e., has no proper nonzero ideal.

Remark 1.3 In the sequel, without any additional specification, $R := \mathbf{k}[\delta]$ (resp., $\mathbf{R} := \mathbf{K}[\delta]$) is the ring over which is the LTI (resp., LTV) system as a module, where $\mathbf{k} = \mathbb{R}$ or \mathbb{C} (resp., $\mathbf{K} = \mathbf{k}[t]$ or $\mathbf{k}(t)$) is the coefficient field of the LTI (resp., LTV) system.

1.1.1.3 Factorization and Roots of Differential Polynomials

System poles and zeros are defined by some appropriate differential polynomials. In order to get the solution of polynomials, their factorizations are required. Van der Put & Singer (2003) have shown that a skew polynomial can be factorized as a product of *elementary factors* after a well-chosen field extension.

An n-th order differential equation related to a torsion module \mathcal{T} in one variable has the following polynomial form

$$P(\delta, t)\xi = 0, P(\delta, t) = \delta^n + \sum_{i=0}^{n-1} a_i \delta^i, a_i \in \mathbf{K} \quad (1.2)$$

Proposition 1.4 *Van der Put & Singer (2003)* For every monic polynomial $P(\delta, t) \in \mathbf{R}^\times$ ($\mathbf{R}^\times = (\mathbf{R} \cup \{0\}) \setminus \{0\}$) there exists an element $\gamma \in \mathbf{K}'$ (\mathbf{K}' is

1. LINEAR SYSTEMS MODELING AND STRUCTURE

an extension of \mathbf{K}) such that $P(\delta, t)$ has a factorization of the form $P(\delta, t) = P'(\delta, t)(\delta - \gamma)$. γ is called a (right) root of $P(\delta)$.

In (1.2), if $P(\delta, t)$ has a right factor, i.e., $P(\delta, t) = P'(\delta, t)(\delta - \gamma)$, then γ is a right root of $P(\delta, t)$ and $\xi(t) = e^{\int \gamma dt}$ is a solution of (1.2).

A decomposition of the initial differential polynomial into its elementary factors can be given by Proposition 1.4 over a suitable extended field ($\alpha_i \in \mathbf{K}'$) as equation (1.3).

$$P(\delta, t) = \prod_i (\delta - \alpha_i)^{d_i} \quad (1.3)$$

In this factorization form, only α_1 is a root (zero) of $P(\delta, t)$. For an element $\alpha \in \mathbf{K}$, there exists a class named *conjugacy class* $\Delta(\alpha)$ which has the form:

$$\Delta(\alpha) = \left\{ \alpha + \frac{dc}{dt}c^{-1}, c \neq 0 \in \mathbf{K} \right\} \quad (1.4)$$

Let $P(\delta, t) \in \mathbf{R}$ be a skew polynomial represented by (1.1), the (right-)evaluation of $P(\delta, t)$ in $\alpha \in \mathbf{K}$ denoted by $P(\alpha)$ is defined as follows:

$$P(\alpha) = \sum_{i=0}^n a_i N_i(\alpha) \quad (1.5)$$

where $N_0(\alpha) = 1$, $N_i(\alpha) = N_{i-1}(\alpha)\alpha + \frac{d}{dt}(N_{i-1}(\alpha))$.

Example 1.5 Consider $P(\delta, t)$ which is a skew polynomial with a factorization form, such as:

$$P(\delta, t) = (\delta - \alpha)(\delta - \beta), \quad \alpha, \beta \in \mathbf{K}$$

The polynomial can be extended in the form (1.1) based on Leibniz rules in definition (1.1). The polynomial is rewritten as:

$$P(\delta) = \delta^2 - (\alpha + \beta)\delta + \alpha\beta - \beta'$$

where $a_0 = \alpha\beta - \beta'$, $a_1 = -(\alpha + \beta)$, $a_2 = 1$. According to (1.5), the evaluation of $P(\delta)$ in $\alpha, \beta \in \mathbf{K}$ is done separately.

- Calculate the terms in (1.5) with the evaluation in α : $N_0 = 1$, $N_1 = \alpha$, $N_2 = \alpha^2 + \alpha'$. So $P(\alpha) = \alpha' - \beta'$, and α is not a zero of the polynomial $P(\delta)$.

1.1 Algebraic Representation of Linear Systems

- Calculate the terms in (1.5) with the evaluation in β : $N_0 = 1$, $N_1 = \beta$, $N_2 = \beta^2 + \beta'$. So $P(\beta) = 0$, and β is a zero of the polynomial $P(\delta, t)$.

The product formula of two monic skew polynomials $U(\delta), V(\delta) \in \mathbf{R}$ is given in (1.6), where $\alpha \in \mathbf{K}$.

$$\begin{cases} (U(\delta) V(\delta))(\alpha) = 0, \text{ if } V(\alpha) = 0 \\ U(\alpha^{V(\alpha)}) V(\alpha), \text{ if } V(\alpha) \neq 0 \end{cases} \quad (1.6)$$

The notion of *left least common multiple* (LCLM) denoted by $[P(\delta, t), P'(\delta, t)]_l$ is introduced here for two monic skew polynomials $P(\delta, t), P'(\delta, t) \in \mathbf{R}^\times$. $[P(\delta, t), P'(\delta, t)]_l$ is a monic polynomial, and the calculation in the case of a first order polynomial $P'(\delta, t)]_l = \delta - \alpha$ is defined as relation (1.7).

$$\begin{cases} [P(\delta, t), \delta - \alpha]_l = P(\delta, t), \text{ if } P(\alpha) = 0 \\ [P(\delta, t), \delta - \alpha]_l = (\delta - \alpha^{P(\alpha)}) U, \text{ if } P(\alpha) \neq 0 \end{cases} \quad (1.7)$$

For differential equations (1.2), there exist two notions, such as: *fundamental set of roots* of polynomial $P(\delta, t)$ and *fundamental set of solutions* of variable ξ . By evaluation with each element in the fundamental set of roots, polynomial $P(\delta, t)$ is equal to zero. Each element in fundamental set of solutions is a solution of equation (1.2) with a related element in fundamental set of roots.

Definition 1.6 *Marinescu & Bourlès (2009)* Let $P(\delta, t) \in \mathbf{R}^\times$ be a polynomial of degree n . A *fundamental set of roots* of $P(\delta, t)$ is a set $\Delta = \{\gamma_1, \dots, \gamma_n\}$ of right roots of $P(\delta, t)$ such that $P(\delta, t) = P_\Delta(\delta, t)$, where $P_\Delta(\delta, t) = [\delta - \gamma_i, i = 1, \dots, n]_l$.

For a polynomial with factorization form (1.3), the fundamental set of roots can be found from the elementary factors in an iterative way. Firstly, $\gamma_1 = \alpha_1$, then $\gamma_i, i > 1$ is derived from equation

$$\gamma_i^{\gamma_i - \gamma_{i-1}} = \alpha'_i, \alpha'_i = \begin{cases} \alpha_{i-1}, d_{i-1} > 1 \\ \alpha_i, d_{i-1} = 1 \end{cases}$$

which leads to the Riccati equation:

$$\frac{d\gamma_i}{dt} + \gamma_i^2 - (\alpha'_i + \gamma_{i-1}) \gamma_i - \frac{d\gamma_i}{dt} + \gamma_i \alpha'_i$$

1. LINEAR SYSTEMS MODELING AND STRUCTURE

A fundamental set of solutions of (1.2) can be derived from a fundamental set of roots of $P(\delta, t)$ by solving the *elementary equations*

$$(\delta - \gamma_i) \xi_i = 0 \Leftrightarrow \frac{d\xi_i}{dt} \xi_i^{-1} = \gamma_i, i = 1, \dots, n \quad (1.8)$$

Therefore, a fundamental set of solutions consist of $\xi_i(t) = e^{\int \gamma_i dt}, i = 1, \dots, n$.

Now another definition of *zeros* of a polynomial $P(\delta, t) \in \mathbf{R}^\times$ and the notion of *full set of zeros* of $P(\delta)$ are recalled.

Definition 1.7 *Bourlès & Marinescu (2011)* 1. Let $P(\delta, t) \in \mathbf{R}^\times$ and let $\hat{\mathbf{K}} \supseteq \mathbf{K}$ be a field extension of \mathbf{K} . If there exist polynomials $P'(\delta, t), P''(\delta, t) \in \hat{\mathbf{K}}[\delta]$ and $\alpha \in \hat{\mathbf{K}}$ such that $P(\delta, t) = P'(\delta, t) (\delta - \alpha) P''(\delta, t)$, then α is called a zero of $P(\delta, t)$. 2. If $P(\delta, t)$ has a factorization (1.3) into n linear factors $\delta - \alpha_i$ (not necessarily distinct), then $\{\alpha_1, \dots, \alpha_n\} \subseteq \hat{\mathbf{K}}$ is called a full set of zeros of $P(\delta, t)$.

1.1.2 Modules and Linear Systems

In this section, we will recall that linear continuous systems are modules over polynomial rings. This class of systems consists of differential-algebraic equations in *kernel* presentation. The ring is commutative (resp., non-) for linear time-invariant (resp., -varying) systems. Module theory provides a better mathematical way to characterize the inherent structural properties of linear systems. However, in the time-varying case, mathematical calculus are not easily implemented because of the non commutative property between operations.

Generally speaking, components's parameters of systems are time-varying. Linear time-invariant models are just approximations of time-varying systems. Moreover, variational models of nonlinear systems are LTV systems. Analysis and synthesis techniques for LTV systems can be applied to control nonlinear systems along trajectories and to design multi-rate filters in signal processing.

1.1.2.1 Modules

An abelian group $(M, +)$ is a (*left*) R -*module*^{*} if there is a binary operation $R \times M \rightarrow M$ sending $(r, a) \mapsto ra$ that satisfies the following properties for all

^{*}In everything that follows, all modules are *left modules*, it means that any element of a module can be represented by a product of a scalar and of an element of a module. The scalar appears on the left-hand side, and it belongs to a ring.

1.1 Algebraic Representation of Linear Systems

$r, r_1, r_2 \in R$ and $a, a_1, a_2 \in M$:

- $r(a_1 + a_2) = ra_1 + ra_2$
- $(r_1 + r_2)a = r_1a + r_2a$
- $(r_1r_2)a = r_1(r_2a)$
- $1a = a$

An \mathbf{R} -module M is said to be *generated* by a family $(e_i)_{i \in I}$, if every element $m \in M$ is an \mathbf{R} -linear combination of the elements e_i . That is to say there exists a family $(\lambda_i)_{i \in I}$ of elements of \mathbf{R} such that $m = \sum_{i \in I} \lambda_i e_i$ where all but a finite number of λ_i are zero. The left \mathbf{R} -module M is *finitely generated* iff there exist a_1, a_2, \dots, a_n in M such that for all $m \in M$, there exist $\lambda_1, \lambda_2, \dots, \lambda_n$ in \mathbf{R} with $m = \lambda_1 a_1 + \lambda_2 a_2 + \dots + \lambda_n a_n$. The set a_1, a_2, \dots, a_n is referred to as a generating set for M in this case. In the case where the module M is a vector space over a field \mathbf{k} , and the generating set is linearly independent, n is well-defined and is referred to as the dimension of M . A left ideal of \mathbf{R} is an \mathbf{R} -module.

The concept of module over a ring is an extension of the notion ‘vector space’ over a field. Let V be a k -vector space, $\lambda \neq 0$ be a scalar (i.e., an element of k) and v be a vector (i.e., an element of V). If $\lambda v = 0$, then $v = 0$.

A module M is a set similar to a vector space, but defined over a ring \mathbf{R} of scalars. If \mathbf{R} is a field, then an \mathbf{R} -module is a vector space. Much of the theory of modules consists of recovering desirable properties of vector spaces in the case of modules over certain rings.

Definition 1.8 *Bourlès & Marinescu (2011)*

An element $\tau \in M$ is said to be *torsion* if, and only if, there exists a polynomial $a \in \mathbf{R}$, $a \neq 0$, such that $a\tau = 0$. The set of all torsion elements of a \mathbf{R} -module M is a torsion submodule $\mathcal{T}(M)$. A \mathbf{R} -module is said to be *torsion-free* if $\mathcal{T}(M) = 0$.

The quotient module $M/\mathcal{T}(M)$ is torsion-free. A module M is said to be *torsion* if $M = \mathcal{T}(M)$. A finitely generated \mathbf{R} -module is said to be *free*, iff there exists a *basis*, i.e., the module is generated by a finite set $e = (e_1, e_2, \dots, e_m)$, and the elements of the family are \mathbf{R} -linearly independent. It means that every element $m \in M$ can be represented by a unique form: $m = \sum_i \lambda_i e_i$. The *rank*

1. LINEAR SYSTEMS MODELING AND STRUCTURE

of this free module is m . There are some differences and counterparts between modules and vector spaces in Table 1.1, where n_b is the number of elements of the base.

Table 1.1: Differences and counterparts between modules and vector spaces

Vector Spaces	always have a base	dimension(n_b)
Modules	just for free modules	rank(n_b)

1.1.2.2 Linear Systems Modeled as Modules over \mathbf{R}

The LTV systems are represented by ordinary linear differential equations with time-varying coefficients, their solutions are called time-varying linear systems or behaviors, from the system theoretic point of view. The obtained results show the analogy for multidimensional LTI systems. There exists one-to-one correspondence between LTV systems or behaviors and finitely generated modules M over a skew-polynomial ring \mathbf{R} of differential operators. In Fliess's theoretic approach, the linear systems are the modules* over differential rings. A module M over \mathbf{R} which is finitely generated by a family $e = (e_1, e_2, \dots, e_q)$ is denoted by $[e]_{\mathbf{R}}$. In this thesis, the coefficients of the linear ordinary differential equations of LTV systems are supposed to be rational or meromorphic functions of time. Ring $\mathbf{R} := \mathbf{K}[\delta]$, $\mathbf{K} := \mathbf{k}[t]$ over which are LTV systems as modules is a simple Dedekind domain (Ore ring where all left ideals are invertible) [Bourlès & Marinescu \(2011\)](#).

An LTV system is defined by a set of equations of the form[†] (1.9).

$$R(\delta, t)w = 0 \tag{1.9}$$

where $R(\delta, t) \in \mathbf{K}[\delta]^{g \times q} \cong \mathbf{K}^{g \times q}[\delta]$ is a polynomial matrix in the indeterminate δ with entries in \mathbf{R} over a certain ring or field of time-varying function and $w = [w_1, w_2, \dots, w_q]^T$. Equation (1.9) defines a module denoted by $M = [w]_{\mathbf{R}}$ or $M = \text{coker}(\bullet R)$. It is said to be defined by generators $w = [w_1, w_2, \dots, w_q]^T$ and the g equalities in the second equation of (1.9). Matrix $R(\delta, t) \in \mathbf{R}^{g \times q}$ in (1.9) is called to be a *matrix of definition* of the module $M = \text{coker}(\bullet R)$.

*In the sequel, a finitely generated module associated with a linear system can always be represented by $R(\delta)w = 0$, where $R(\delta) \in \mathbf{R}^{g \times q}$ with appropriate dimensions is called the definition matrix and w is the generator of the module.

†In what follows, a matrix with a time term t ($t \in [0, \infty)$) is related to an LTV system.

1.1 Algebraic Representation of Linear Systems

The solution set \mathcal{B} , in the signal module, of the linear system of differential equations $R(\delta, t)w = 0$ is represented in the form:

$$\mathcal{B} = \{w \in M^q \mid R(\delta, t)w = 0\}$$

where $R(\delta, t) \in \mathbf{R}^{g \times q}$ is called a representation of \mathcal{B} . Such solution sets are known as “behaviors” in system theory. The elements of \mathcal{B} are called trajectories.

Definition 1.9 *Bourlès & Fliess (1997)* A (linear) dynamics \mathcal{D} is a system in which a finite set $u = \{u_1, u_2, \dots, u_m\}$ of input variables is such that the quotient module $\mathcal{D}/[u]_{\mathbf{R}}$ is torsion. It means that any element in \mathcal{D} is R -linearly dependent on u , i.e. $\forall d \in \mathcal{D}, \exists a(\delta, t), b_i(\delta, t) \in \mathbf{R}$ with $a(\delta, t) \neq 0$ such that (1.10) is verified.

$$a(\delta, t)d + \sum_{i=1}^m b_i(\delta, t)u_i = 0 \quad (1.10)$$

An LTV system Σ is a finitely generated \mathbf{R} -module over a noncommutative ring $\mathbf{R} = \mathbf{K}[\delta]$. (Σ, u) denotes the dynamics Σ with the input u . The input u is said to be *independent* if $[u]_{\mathbf{R}}$ is free of rank m . It means that there are no differential equations relating the input components. In what follows, u is assumed to be independent. Then the rank of Σ is equal to m . By this way, a torsion module $\mathcal{T} \cong M/[u]_{\mathbf{R}}$ is gotten. System (1.9) can be put into the state-space form and the *autonomous system* obtained by forcing the inputs to zero has an equation of the form

$$\delta x = Ax \quad (1.11)$$

where A is a matrix with entries in \mathbf{K} Bourlès (2005). Stability can be studied on equation (1.11) which can be equivalently represented by a scalar differential equation (1.12),

$$P(\delta)\hat{y} = 0, \quad P(\delta) = \delta^n + \sum_{i=1}^n a_i \delta^{n-i} \quad (1.12)$$

where \hat{y} is a generator of torsion module $\mathcal{T} = M/[u]_{\mathbf{R}}$.

1. LINEAR SYSTEMS MODELING AND STRUCTURE

1.1.2.3 Sequences of \mathbf{R} -modules

A sequence of \mathbf{R} -modules and \mathbf{R} -linear maps

$$M \xrightarrow{f} N \xrightarrow{g} P$$

is called *exact* at N if $\text{im}(f)=\ker(g)$. For instance, to say $0 \longrightarrow N \xrightarrow{h} P$ is exact at N means h is injective, and to say $M \xrightarrow{h} N \longrightarrow 0$ is exact at N means h is surjective. The linear maps coming out of 0 or going to 0 are unique, so there is no need to label them.

Let M, N and P be left \mathbf{R} -modules, and let $f : M \longrightarrow N$ and $g : N \longrightarrow P$ be \mathbf{R} -linear maps. A *short exact sequence* of \mathbf{R} -modules is a sequence of \mathbf{R} -modules and \mathbf{R} -linear maps, i.e., left module homomorphisms

$$0 \longrightarrow M \xrightarrow{f} N \xrightarrow{g} P \longrightarrow 0$$

which is exact at N, M and P . That means that f is injective, g is surjective, and $\text{im}(f)=\ker(g)$.

As mentioned previously, \mathbf{R} is a principal ideal domain. Let $\mathbf{w} = \{w_1, \dots, w_q\}$ be a finite subset of a left \mathbf{R} -module M . w and $[\mathbf{w}]_{\mathbf{R}}$ denote respectively the column vector $[w_1, \dots, w_q]^T$ and the submodule spanned by \mathbf{w} . It is supposed that all modules considered here are finitely generated modules over left and right principal ideal domains which have the left and right Ore property. For every \mathbf{R} -module Σ , there exists a short exact sequence

$$0 \longrightarrow \mathcal{N} \xrightarrow{f} \mathcal{F} \xrightarrow{g} \Sigma \longrightarrow 0$$

where modules \mathcal{F} and \mathcal{N} are free. \mathcal{N} being called sometimes the *module of relations*. The sequence is called a *presentation* of Σ . Let $\theta = \{\theta_1, \dots, \theta_g\}$ and $\phi = \{\phi_1, \dots, \phi_q\}$ be bases of \mathcal{N} and \mathcal{F} , respectively. f is represented by a matrix called a *matrix of definition* of Σ . Set $\gamma_i = f(\theta_i)$, $i = 1, \dots, g$, so that $\gamma = R\phi$ and $w_i = g(\phi_i)$, $i = 1, \dots, q$; then, $M = [\mathbf{w}]_{\mathbf{R}} \cong [\phi]_{\mathbf{R}}/[\theta]_{\mathbf{R}}$.

$$R(\delta, t)w = 0$$

is called the equation of the module Σ in the chosen bases.

1.1 Algebraic Representation of Linear Systems

Example 1.10 Consider the system of equations defined as

$$\sum_{i=1}^{\mu} a_{li} w_i = 0$$

where $a_{li} \in \mathbf{K}[\delta]$, $l = 1, \dots, \nu$. w_1, \dots, w_{μ} are system variables. \mathcal{F} is a free module generated by f_1, \dots, f_{μ} . Let $\mathcal{N} \subseteq \mathcal{F}$ be the submodule generated by $\sum_{i=1}^{\mu} a_{li} f_i$. \mathcal{F}/\mathcal{N} is the module corresponding to the system.

1.1.3 Different Descriptions of Linear Systems

State Space Representations

For a linear time-varying dynamical system Σ , the classical state representation is given by the Kalman form (1.13),

$$\begin{cases} \dot{x}(t) = A(t)x(t) + B(t)u(t) \\ y(t) = C(t)x(t) + D(t)u(t) \end{cases} \quad (1.13)$$

where $x(t) \in \mathbb{R}^n$, $u(t) \in \mathbb{R}^m$, $y(t) \in \mathbb{R}^p$, and the matrices $A(t)$, $B(t)$, $C(t)$ and $D(t)$ are of compatible order and are differentiable a finite number ($\leq n$) of times; the entries of these matrices are real-valued functions of the real independent variable t . Let \mathcal{U} be the input function space over $[t_0, \infty)$ and \mathcal{Y} the corresponding output space. Elements of \mathcal{U} are assumed to be at least continuous. For each initial state $x_0 = x(t_0)$, Σ defines a mapping $H_{x_0} : \mathcal{U} \rightarrow \mathcal{Y}$. The invertibility of the mapping H_{x_0} and the existence of the inverse system representation are some fundamental problems for engineers.

Rosenbrock Representations

The state space representation is a very important contribution to the control domain due to Kalman (1959). But systems's equations are not always in a state space representation, and the general description of a linear system is the Rosenbrock polynomial description (1.14), Rosenbrock (1970). $D(\delta, t)$ is assumed to be *regular* (i.e., $\det(D(\delta, t)) \neq 0$). The operator δ represents the differential

1. LINEAR SYSTEMS MODELING AND STRUCTURE

operator for linear *continuous-time* systems. It could be replaced by the *shift-forward operator* D for linear *discrete-time* systems.

$$\begin{cases} D(\delta, t)\xi = N(\delta, t)u \\ y = Q(\delta, t)\xi + W(\delta, t)u \end{cases} \quad (1.14)$$

Now the system representation is recalled by utilizing the module theory. Let $\xi_i, i = 1, \dots, r$ satisfying $\Sigma = [\xi, u]_{\mathbf{R}}$ (where $[\xi, u]_{\mathbf{R}} = [\xi]_{\mathbf{R}} + [u]_{\mathbf{R}}$, i.e., $[\xi, u]_{\mathbf{R}}$ is the \mathbf{R} -module generated by the components of ξ and u). With $w = [\xi, u]^T$, (1.9) can be written as (1.15) Bourlès (2005), where $D(\delta, t) \in \mathbf{R}^{r \times r}$ and $N(\delta, t) \in \mathbf{R}^{r \times m}$.

$$\left[\begin{array}{c|c} D(\delta, t) & -N(\delta, t) \end{array} \right] \begin{bmatrix} \xi \\ u \end{bmatrix} = 0 \quad (1.15)$$

As $y_i \in [\xi, u]_{\mathbf{R}}$ ($i = 1, \dots, p$), there exist matrices $Q(\delta, t) \in \mathbf{R}^{p \times r}$ and $W(\delta, t) \in \mathbf{R}^{p \times m}$ such that

$$y = \left[\begin{array}{c|c} Q(\delta, t) & W(\delta, t) \end{array} \right] \begin{bmatrix} \xi \\ u \end{bmatrix} \quad (1.16)$$

Equations (1.15), (1.16) are called a *polynomial matrix description* (PMD) of the input-output system Σ . The finite sequence $\xi_i, i = 1, \dots, r$ is called a *pseudo-state* of Σ .

Willems (2007) pointed that in some cases, it may be misleading to distinguish between system variables. Set $w_1 = \xi, w_2 = u, w = [w_1, w_2]$. The system corresponding the module $[w] = [\xi, u]$ can be written as

$$R(\delta, t)w = 0$$

with the polynomial matrix $R(\delta, t) = [D(\delta, t) - N(\delta, t)]$. The time functions that are the solutions of the system on the real line \mathbb{R} (or on an open interval of \mathbb{R}) are called the *behavior* Willems (1991).

1.2 System Structures

System structures play an important role in our understanding of linear systems in a number of system representations. One can get a set of matrix canonical forms associated to the system by utilizing differential algebraic structure and differential operator factorizations. The structural canonical form representation

of linear systems not only reveals system structures but also facilitates the design of feedback satisfying various control objectives [Chen *et al.* \(2004\)](#). A system can be decomposed into several subsystems. Between them, there exist the interconnections, which show structures of the system.

System structures such as structure at infinity and finite structure are largely studied, [Commault *et al.* \(1986\)](#) for the LTI systems, [Silverman & Meadows \(1967\)](#), [Porter \(1969\)](#) for the LTV systems. They are recently studied in [Ilchmann \(1985\)](#), [Bourlès & Fliess \(1997\)](#), [Bourlès \(2005\)](#), [Bourlès \(2006\)](#). Structural properties do not depend on the numerical value of the parameters but only on the type of elements, and on the way they are interconnected.

Generally speaking, the infinite structure allows us to know whether a model can be decoupled by a regular static state feedback. The finite structure is useful for studying the stability property of the decoupled model. It means that, if the fixed modes are stable, the controlled model can be set stable. The aim of this section is to recall some studies of structures of linear systems which is based on *module theory*. The notions of polynomial matrix and rational matrix from which system structures can be derived will be introduced firstly. Then the infinite and finite structure of linear systems will be implemented.

1.2.1 Polynomial and Rational Matrices

In linear system theory, polynomial matrices are used as modeling tools. Polynomial matrices manipulation can settle control problems. A well-known example is the polynomial matrix spectral factorization, which has been applied in H2 and H1 control, see [Ephremidze *et al.* \(2007\)](#) for a new algorithm. Zeros of polynomial matrices naturally represent either poles or zeros of linear multivariable systems described by polynomial matrix fractions [Zúñiga & Henrion \(2003\)](#). It's useful for analyzing and/or designing linear systems or filters. Associated with the zeros are the finite and infinite structures of a polynomial matrix $P(\delta, t)$, defined from specific canonical forms under matrix equivalence: the *Smith/Jacobson form* for the finite structure and the *Smith-MacMillan form* at infinity for the infinite structure.

In this section, some necessary technics of matrices factorization for defining the notions of zeros and poles of rational and polynomial matrices are recalled. For calculating the zeros and poles, the notion of unimodular matrix is needed.

1. LINEAR SYSTEMS MODELING AND STRUCTURE

Two special matrices - the *system matrix* and the *transfer matrix* are introduced. From them, some structural properties of a system will be obtained.

Definition 1.11 *The system matrix associated to the system $\Sigma(C(t), A(t), B(t))$ is the polynomial matrix $P(\delta, t)$ defined by equation (1.17). If the system is represented by the PMD form, the corresponding system matrix is in (1.18).*

$$P(\delta, t) = \begin{bmatrix} I\delta - A(t) & -B(t) \\ C(t) & 0 \end{bmatrix} \quad (1.17)$$

$$P(\delta, t) = \begin{bmatrix} D(\delta, t) & -N(\delta, t) \\ Q(\delta, t) & 0 \end{bmatrix} \quad (1.18)$$

Definition 1.12 *Bourbaki (1970) Let $R' = R$ or \mathbf{R} . A polynomial matrix $P \in R^{n \times n}$ is called a **unit** (invertible or unimodular) in $R^{n \times n}$ if $\exists Q \in R^{n \times n}$ such that*

$$PQ = I_n$$

Clearly if P and Q are units, so is PQ . In the LTI case, a matrix $P \in R^{n \times n}$ is unimodular iff $\det P = c$, where $c \in \mathbb{R}$ and $c \neq 0$.

Matrices whose entries belong to the ring \mathbf{R} (or \mathbf{R}) of polynomials of δ , are called polynomial matrices. Similarly, a rational matrix has entries which are rational functions of δ . In general, the inverse of an invertible polynomial matrix is not a polynomial matrix since the inverse of a non constant polynomial is not a polynomial. The set of all unimodular matrices belonging to $\mathbf{R}^{n \times n}$ is a group (for the multiplication) denoted by $GL_n(\mathbf{R})$ and called the “general linear group” of $\mathbf{R}^{n \times n}$. Therefore, the subclass $GL_n(\mathbf{K}[\delta])$ of unimodular matrices, defined as the set of invertible square $n \times n$ polynomial matrices whose inverses are polynomial, or equivalently whose determinants are a constant, plays an important role.

In this subsection, only some fundamental definitions are introduced. The convention that $\mathbf{K}[\delta]$ is the set of polynomials and $\mathbf{K}(\delta)$ is the set of rational functions is recalled. Here, $\mathbf{K}[\delta]$ is denoted as \mathbf{R} and $\mathbf{K}(\delta)$ as \mathbf{Q} . It is supposed here that the ring $R = \mathbf{k}[\delta]$ is over a field \mathbf{k} of constants.

1.2.1.1 Smith/Jacobson Form and Zeros of a Polynomial Matrix

Let $R = k[\delta]$ be a ring of differential polynomials, the definition of Smith/Jacobson form of a polynomial matrix over R is recalled in Definition 1.14. Before defining the Smith/Jacobson form, let's firstly recall the notion of divisor for an element in R .

Definition 1.13 *Bourlès & Marinescu (2011)*

(1) Let $a, b \in R$; a is said to left-divide (resp., right-) b (or to be a left-divisor (resp., right-) of b), and b is said to be a right-multiple (resp., left-) of a , if there exists $c \in R, c \neq 0$ such that $b = ac$ (resp., $b = ca$).

(2) If a is both left- and right-divisor of b , it is said to be a divisor of b , written $a|b$, and b is said to be a multiple of a .

(3) a is said to be a total divisor of b (written $a \parallel b$) if there exists an invariant element (a unit when $R = k[\delta]$) c such that $a|c$ and $c|b$.

Definition 1.14 *Bourlès & Marinescu (2011)*

(i) A matrix $R(\delta) \in R^{q \times k}$ admits a diagonal reduction if

$$R(\delta) \equiv \text{diag}(d_1(\delta), \dots, d_r(\delta), 0, \dots, 0), d_i(\delta) \parallel d_{i+1}(\delta), d_r(\delta) \neq 0 \quad (1.19)$$

where \equiv denotes matrices equivalence, i.e., there exist matrices $U(\delta) \in GL_q(R)^*$ and $V(\delta) \in GL_k(R)$ such that (1.20).

$$U(\delta)R(\delta)V(\delta) = \text{diag}(d_1(\delta), \dots, d_r(\delta), 0, \dots, 0) \quad (1.20)$$

Let $M = \text{coker}_R(\bullet R(\delta))$; then $M = \mathcal{T}(M) \oplus \Phi$ where $\mathcal{T}(M)$, Φ are the torsion submodule and free submodule of M . Hence, $\text{rk } \Phi = \text{rk } M = r$ and

$$\mathcal{T}(M) \cong \bigoplus_{1 \leq i \leq r} R/R d_i \quad (1.21)$$

(ii) $\text{diag}(d_1(\delta), \dots, d_r(\delta), 0, \dots, 0)$ is called the Smith form of $R(\delta)$, and the elements d_i ($1 \leq i \leq r$) are called the invariant factors (or polynomials) of $R(\delta)$ or of M .

* $GL_q(R)$ is the general linear group of the square invertible matrices of order q over R

1. LINEAR SYSTEMS MODELING AND STRUCTURE

When \mathbf{R} is noncommutative, the Smith normal form is often called the *Jacobson-Teichmüller form*. When \mathbf{R} is simple, the Jacobson form is given in Definition 1.15. A proof may be found in Cohn (1985) (Chapter 8).

Definition 1.15 Let $P(\delta, t) \in \mathbf{R}^{m \times n}$ be a polynomial matrix of rank r . There always exist unimodular matrices $U(\delta, t) \in \mathbf{R}^{m \times m}$ and $V(\delta, t) \in \mathbf{R}^{n \times n}$ satisfying equations (1.22) and (1.23), where $\Lambda(\delta, t)$ is the Jacobson form of $P(\delta, t)$.

$$U(\delta, t) P(\delta, t) V(\delta, t) = \Lambda(\delta, t) \quad (1.22)$$

$$\Lambda(\delta, t) = \left[\begin{array}{ccc|c} 1 & & & \\ & \ddots & & \\ & & 1 & \\ \hline & & & d_r(\delta, t) \\ \hline & & & 0 \end{array} \right] \quad (1.23)$$

The polynomials $d_i(\delta, t)$ are called *invariant polynomials* (or *invariant factors*) of $P(\delta, t)$.

Let $R = \mathbf{k}[\delta]$, matrices $R(\delta) \in R^{q \times k}$ are the definition matrices of modules related to LTI systems. Similarly, matrices $R(\delta, t) \in \mathbf{R}^{q \times k}$ are the definition matrices of modules related to LTV systems when $\mathbf{R} = \mathbf{K}[\delta]$. As mentioned, the *Smith form* is used to calculate the Smith zeros of a polynomial matrix over R , and *Jacobson form* for matrices over \mathbf{R} .

Elementary Operations

For detecting the Smith/Jacobson form of a polynomial matrix, the elementary operations are needed. On account of noncommutative property in the LTV case, these operations are defined in Definition 1.16.

Definition 1.16 *Bourlès (2005)*

Because of the noncommutative property, elementary operations of a matrix over \mathbf{R} are different from the ones in the time-invariant case. The elementary row (resp., column) operations are defined as follows:

1. interchange two rows (resp., columns);

2. multiply a row (resp., column) on the left (resp., right) by a unit in \mathbf{R} ;
3. add a left (resp., right) multiple of one row (resp., column) to another.

Each of (1)-(3) in Definition 1.16 corresponds to the left (resp., right) multiplication by an *elementary matrix*. So the Smith/Jacobson form can be detected by the procedure defined in Definition 1.16. In addition, these forms can be derived from the method in Definition 1.15 by using elementary matrices.

GCD Approach

In the LTI case, the GCD approach can be used to detect the Smith form of a matrix over R . Let $P(\delta) \in R^{p \times q}$ and $\Delta_k(\delta)$ denotes the GCD (greatest common divisor) of all $k \times k$ minors of $P(\delta)$, where $1 \leq k \leq \min(p, q)$.

Property 1.17 For $1 \leq k \leq r$, where $r = \text{rank}(P(\delta, t))$, $\Delta_k(\delta, t) \neq 0$ for $1 \leq k \leq (r - 1)$ and $\Delta_k(\delta, t)$ divides $\Delta_{k+1}(\delta, t)$.

The next definition shows the link between the invariant polynomials and the zeros of a polynomial matrix.

Definition 1.18 The zeros of a polynomial matrix are the roots of its invariant polynomials.

It is not difficult to find that there are some similar properties between the invariant polynomials and the GCRD of minors. Then one can get the invariant polynomials without calculating the Jacobson form.

Remark 1.19 $\Delta_i(\delta, t)$ is the monic GCD of all the i -order minors of $P(\delta, t)$. The invariant polynomials of $P(\delta, t)$ are presented by relations (1.24) and (1.25):

$$d_i(\delta, t) = (\Delta_{i-1}(\delta, t))^{-1} \Delta_i(\delta, t) \tag{1.24}$$

$$\Delta_0 = 1 \tag{1.25}$$

Example 1.20 Let $P(\delta, t) \in \mathbf{R}^{2 \times 3}$

$$\begin{bmatrix} \delta + 1 & \delta^2 & t \\ \delta & \delta^2 & 0 \end{bmatrix}$$

1. LINEAR SYSTEMS MODELING AND STRUCTURE

Making the line and column elementary operations, the Jacobson form of $P(\delta, t)$ is gotten:

$$\begin{bmatrix} \delta + 1 & \delta^2 & t \\ \delta & \delta^2 & 0 \end{bmatrix} \xrightarrow[c_2 - c_1 * \delta, c_1 \sim c_3, c_2 \sim c_3]{c_3 * \frac{1}{t}, r_1 - r_2, c_1 - c_3} \begin{bmatrix} 1 & 0 & 0 \\ 0 & \delta & 0 \end{bmatrix}$$

obtained with

$$U = \begin{bmatrix} 1 & -1 \\ 0 & 1 \end{bmatrix}, \quad V = \begin{bmatrix} 0 & 1 & -\delta \\ 0 & 0 & 1 \\ \frac{1}{t} & -\frac{1}{t} & \frac{1}{t} * \delta \end{bmatrix}$$

and $\Delta_0 = 1, \Delta_1 = 1, \Delta_2 = \delta$ so relation (1.24) can be obtained. For matrix $U(\delta, t)$, $\det(U(\delta, t)) = 1 \in \mathbf{K}$ and its inverse is $U^{-1}(\delta, t) = \begin{bmatrix} 1 & 1 \\ 0 & 1 \end{bmatrix}$ where $\det(U^{-1}(\delta, t)) = 1, U(\delta, t) * U^{-1}(\delta, t) = I$. For matrix $V(\delta, t)$, $\det(V(\delta, t)) = \frac{1}{t} \in \mathbf{K}$ and its inverse is $V^{-1}(\delta, t) = \begin{bmatrix} 1 & 0 & t \\ 1 & \delta & 0 \\ 0 & 1 & 0 \end{bmatrix}$ where $\det(V^{-1}(\delta, t)) = t, V(\delta, t) * V^{-1}(\delta, t) = I$.

1.2.2 Finite Structure

Finite structure describes the internal properties of linear systems. There exist some objects regarding finite structure, such as invariant zeros (resp., poles), transmission zeros (resp., poles), controllable (resp., uncontrollable) poles, observable (resp., unobservable) poles, hidden modes and system zeros and poles, etc. These poles and zeros could be stable or unstable. They are important for studying the stability of linear systems. The system poles and transmission poles dominate, respectively, the internal stability and the transfer stability. The hidden modes are related to the properties of uncontrollability and unobservability of systems. The invariant zeros can be regarded as the system poles of the inverse system. The finite structure of an LTV system is given by the invariant polynomials of several polynomial matrices derived from system matrices. [Bourlès & Marinescu \(2011\)](#) defined the modules of various finite poles and zeros, these modules are recalled, firstly. In what follows, Σ is an input-output system with input u and output y .

Fliess (1990) defined linear system Σ as modules which can be represented as a direct sum (1.26),

$$\Sigma = T \oplus \Phi \quad (1.26)$$

where T is the torsion submodule and $\Phi \cong \Sigma/T$ is the free submodule. $rank(\Sigma)$ is the rank of Σ which is equal to the rank of the free submodule Φ and to the cardinality of any basis of Φ .

Example 1.21 An electrical system is shown in Figure 1.1. The finite poles and zeros of this system are studied with the module and the PMD approaches in the next part.

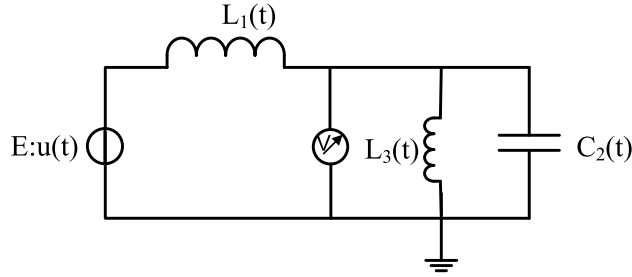

Figure 1.1: Circuit of a third order system

The state vector is $x = (p_{L_1}, q_{C_2}, p_{L_3})$, where p_{L_1} and p_{L_3} are the magnetic fluxes in the inductance elements and q_{C_2} is the charge in the capacitor.

The system equations are given in (1.27).

$$\dot{x}(t) = \begin{bmatrix} 0 & -\frac{1}{C_2(t)} & 0 \\ \frac{1}{L_1(t)} & 0 & -\frac{1}{L_3(t)} \\ 0 & \frac{1}{C_2(t)} & 0 \end{bmatrix} x(t) + \begin{bmatrix} 1 \\ 0 \\ 0 \end{bmatrix} u(t) \quad (1.27)$$

$$y(t) = \begin{bmatrix} 0 & \frac{1}{C_2(t)} & 0 \end{bmatrix} x(t)$$

From the PMD form, the system matrix $P(\delta, t)$ and the matrix $D(\delta, t)$, $N(\delta, t)$, $Q(\delta, t)$ are given in (1.28).

1. LINEAR SYSTEMS MODELING AND STRUCTURE

$$\begin{aligned}
 D(\delta, t) &= \begin{bmatrix} \delta & \frac{1}{C_2(t)} & 0 \\ -\frac{1}{L_1(t)} & \delta & \frac{1}{L_3(t)} \\ 0 & -\frac{1}{C_2(t)} & \delta \end{bmatrix} & N(\delta, t) &= \begin{bmatrix} 1 \\ 0 \\ 0 \end{bmatrix} \\
 Q(\delta, t) &= \begin{bmatrix} 0 & \frac{1}{C_2(t)} & 0 \end{bmatrix} & P(\delta, t) &= \begin{bmatrix} \delta & \frac{1}{C_2(t)} & 0 & -1 \\ -\frac{1}{L_1(t)} & \delta & \frac{1}{L_3(t)} & 0 \\ 0 & -\frac{1}{C_2(t)} & \delta & 0 \\ 0 & \frac{1}{C_2(t)} & 0 & 0 \end{bmatrix}
 \end{aligned} \tag{1.28}$$

1.2.2.1 System Poles

Definition 1.22 *Bourlès & Marinescu (2011)*

Let \mathcal{T} be a finitely generated torsion module and let $\text{diag}\{1, \dots, 1, P_T(\delta)\}$ be the Jacobson normal form of one of its matrices of definition. Let $\alpha \in \mathbf{K}$ be a zero of $P_T(\delta)$; α is called a Smith zero of \mathcal{T} . Let $\{\alpha_1, \dots, \alpha_m\}$ be a full set of zeros of $P_T(\delta)$, i.e. $P_T(\delta) = (\delta - \alpha_n) \dots (\delta - \alpha_1)$, $\{\alpha_1, \dots, \alpha_n\} \subseteq \widehat{\mathbf{K}} \supseteq \mathbf{K}$; $\{\alpha_1, \dots, \alpha_m\}$ is called a full set of Smith zeros of \mathcal{T} and noted $\alpha(\mathcal{T})$ in the sequel.

Definition 1.23 *The system poles of a linear system Σ are the Smith zeros of the module $\Sigma/[u]_{\mathbf{R}}$, which is called the module of system poles. Σ is called internal stable iff all of its system poles lie in the open left half-plane.*

If system Σ is given by the PMD form (1.14), its system poles can be derived from the Smith zeros of $D(\delta, t)$. They are the eigenvalues of the “state matrix” $A(t)$ in the state-space description (1.13). An equation of $\Sigma/[u]_{\mathbf{R}}$ is

$$D(\delta, t)\bar{\xi} = 0 \tag{1.29}$$

where $\bar{\xi}$ is the image of ξ by the epimorphism $\Sigma \rightarrow \Sigma/[u]_{\mathbf{R}}$ and $\Sigma/[u]_{\mathbf{R}} = [\bar{\xi}]_{\mathbf{R}}$

Example 1.24 *(continued)*

The module of system poles is defined by (1.29). According to Definition 1.16, the procedure for getting the Jacobson form of $D(\delta, t)$ in (1.28) is shown by equation (1.30).

$$\begin{aligned}
 & \left[\begin{array}{ccc} \delta & \frac{1}{C_2(t)} & 0 \\ -\frac{1}{L_1(t)} & \delta & \frac{1}{L_3(t)} \\ 0 & -\frac{1}{C_2(t)} & \delta \end{array} \right] \xrightarrow[\substack{-L_1(t) \times r_2, l_1 - \delta \times r_2, \\ c_2 + c_1 \times L_1(t) \delta, c_3 + c_1 \times \frac{L_1(t)}{L_3(t)}}]{} \\
 & \left[\begin{array}{ccc} 0 & \frac{1}{C_2(t)} + \delta L_1(t) \delta & \delta \frac{L_1(t)}{L_3(t)} \\ 1 & 0 & 0 \\ 0 & -\frac{1}{C_2(t)} & \delta \end{array} \right] \xrightarrow[\substack{-C_2(t) \times r_3, c_3 + c_2 \times C_2(t) \delta, \\ r_1 - \left(\frac{1}{C_2(t)} + \delta L_1(t) \delta\right) r_3, l_1 \leftrightarrow l_2, l_2 \leftrightarrow l_3}]{(1.30)} \\
 & \left[\begin{array}{ccc} 1 & 0 & 0 \\ 0 & 1 & 0 \\ 0 & 0 & \delta \frac{L_1(t)}{L_3(t)} + \delta + \delta L_1(t) \delta C_2(t) \delta \end{array} \right]
 \end{aligned}$$

From the last entry of the above matrix, the invariant polynomial of $D(\delta, t)$ is given by equation (1.31) with calculations according to Leibniz rules.

$$\begin{aligned}
 & \delta \frac{L_1(t)}{L_3(t)} + \delta + \delta L_1(t) \delta C_2(t) \delta \\
 & = \frac{L_1(t)}{L_3(t)} \delta + \left(\frac{L_1(t)}{L_3(t)} \right)' + \delta + (L_1(t) \delta + L_1'(t)) (C_2(t) \delta + C_2'(t) \delta) \\
 & = \frac{L_1(t)}{L_3(t)} \delta + \left(\frac{L_1(t)}{L_3(t)} \right)' + \delta + L_1(t) \delta C_2(t) \delta^2 + L_1(t) \delta C_2'(t) \delta \\
 & \quad + L_1'(t) C_2(t) \delta^2 + L_1'(t) C_2'(t) \delta \tag{1.31} \\
 & = L_1'(t) C_2(t) \delta^2 + \left(\frac{L_1(t)}{L_3(t)} + 1 + L_1'(t) C_2'(t) \right) \delta \\
 & \quad + L_1(t) C_2(t) \delta^3 + 2L_1(t) C_2'(t) \delta^2 + L_1(t) C_2''(t) \delta \\
 & = L_1(t) C_2(t) \delta^3 + (2L_1(t) C_2'(t) + L_1'(t) C_2(t)) \delta^2 \\
 & \quad + \left(L_1(t) C_2''(t) + L_1'(t) C_2'(t) + \frac{L_1(t)}{L_3(t)} + 1 \right) \delta + \left(\frac{L_1(t)}{L_3(t)} \right)'
 \end{aligned}$$

1.2.2.2 Decoupling Zeros (Hidden Modes)

The decoupling zeros are distinctly related to the system's controllability and observability property.

Input Decoupling Zeros and Controllability

1. LINEAR SYSTEMS MODELING AND STRUCTURE

The complex numbers $\{\delta_0\}$ which satisfy

$$rk[I\delta_0 - A(t) \ B(t)] < n$$

are called *input decoupling zeros* (i.d.z.). The i.d.z. number is equal to the *row rank defect* of the *controllability matrix* \mathcal{C} defined in (1.32).

$$\mathcal{C}(\delta, t) = [\ B(t) \ (A(t) - I\delta)B(t) \ \cdots \ (A(t) - I\delta)^{n-1}B(t) \] \quad (1.32)$$

The system Σ is said to be *controllable* iff there is no i.d.z.. If the system is given in the PMD form (1.14), Σ is controllable iff $D(\delta, t)$ and $N(\delta, t)$ are *left-coprime*. From the point of view of module theory, Σ is controllable iff Σ is a free \mathbf{R} -module.

Definition 1.25 *The input decoupling zeros of Σ are the Smith zeros of the module $T = \mathcal{T}(\Sigma)$, which is called the module of input decoupling zeros.*

If the system Σ is given by PMD (1.14), its i.d.z. are the Smith zeros of $[D(\delta, t) \ N(\delta, t)]$. If the system is defined by (1.9), its i.d.z. are the Smith zeros of $R(\delta, t)$.

Definition 1.26 *Σ is said to be stabilizable iff all the i.d.z. lies in the open left half-plane.*

Example 1.27 *(continued) The invariant polynomial of $[D(\delta, t) \ N(\delta, t)]$ is trivial. So there is no i.d.z. for Σ , i.e. the system is controllable in both LTI and LTV cases.*

Output Decoupling Zeros and Observability

The output decoupling zeros (o.d.z) related to the system observability property. The complex numbers $\{\delta_0\}$ which satisfy

$$rk \begin{bmatrix} I\delta_0 - A(t) \\ C(t) \end{bmatrix} < n$$

are called o.d.z.. The number of o.d.z. is equal to the column rank defect of the *observability matrix* \mathcal{O} is defined in (1.33).

$$\mathcal{O}(\delta, t) = [\ C^T(t) \ (A^T(t) + I\delta)C^T(t) \ \cdots \ (A^T(t) + I\delta)^{n-1}C^T(t) \] \quad (1.33)$$

The system is said to be observable iff there is no o.d.z.. If the system is given in the PMD form (1.14), Σ is observable iff $D(\delta, t)$ and $Q(\delta, t)$ are *right-coprime*. From the point of view of module theory, Σ is observable iff $\Sigma = [y, u]_{\mathbf{R}}$.

Definition 1.28 *The output decoupling zeros of Σ are the Smith zeros of the module $\Sigma/[y, u]_{\mathbf{R}}$, which is called the module of o.d.z..*

Assume that $R'(\delta, t)$ is a GCRD of $D(\delta, t)$ and $Q(\delta, t)$; i.e., $D(\delta, t) = {}^0D(\delta, t)R'(\delta, t)$, $Q(\delta, t) = {}^0Q(\delta, t)R'(\delta, t)$, where ${}^0D(\delta, t)$ and ${}^0Q(\delta, t)$ are right-coprime. An equation of $\Sigma/[y, u]_{\mathbf{R}}$ is

$$R'(\delta, t)\tilde{\xi} = 0$$

where $\tilde{\xi}$ is the image of ξ by the epimorphism $\Sigma \rightarrow \Sigma/[y, u]_{\mathbf{R}}$. If the matrix $R'(\delta, t)$ is unimodular, then $\Sigma/[y, u]_{\mathbf{R}} = 0 \rightarrow \Sigma = [y, u]_{\mathbf{R}}$, i.e., Σ is observable. The o.d.z. are the Smith zeros of $R'(\delta, t)$ or the Smith zeros of $[D^T(\delta, t) \ Q^T(\delta, t)]^T$.

Definition 1.29 *Σ is said to be detectable iff there is no o.d.z. which lie in the closed right half-plane.*

Example 1.30 (continued)

According to Definition 1.16, the procedure for getting the Jacobson form of $[D^T(\delta, t) \ Q^T(\delta, t)]^T$ is shown in (1.34). One will find the different results between the LTI case and the LTV case.

$$\begin{aligned} \begin{bmatrix} D(\delta, t) \\ Q(\delta, t) \end{bmatrix} &= \begin{bmatrix} \delta & \frac{1}{C_2(t)} & 0 \\ -\frac{1}{L_1(t)} & \delta & \frac{1}{L_3(t)} \\ 0 & -\frac{1}{C_2(t)} & \delta \\ 0 & \frac{1}{C_2(t)} & 0 \end{bmatrix} \xrightarrow{\begin{matrix} C_2 \times r_4, r_1 - \frac{1}{C_2(t)} \times r_4, \\ r_2 - \delta \times r_4, r_3 + \frac{1}{C_2(t)} \times r_4 \end{matrix}} \\ &\begin{bmatrix} \delta & 0 & 0 \\ -\frac{1}{L_1(t)} & 0 & \frac{1}{L_3(t)} \\ 0 & 0 & \delta \\ 0 & 1 & 0 \end{bmatrix} \xrightarrow{\begin{matrix} -L_1(t) \times r_2, r_1 - \delta \times r_2, \\ c_4 + c_1 \times \frac{L_1(t)}{L_3(t)} \end{matrix}} \begin{bmatrix} 0 & 0 & \delta \frac{L_1(t)}{L_3(t)} \\ 1 & 0 & 0 \\ 0 & 0 & \delta \\ 0 & 1 & 0 \end{bmatrix} \end{aligned} \quad (1.34)$$

In the LTI case, the last entry in the first line of the last matrix in (1.34) has the relation $\delta \frac{L_1}{L_3} = \frac{L_1}{L_3} \delta$. This entry is equal to zero when the elementary operation is executed as $l_1 - \frac{L_1}{L_3} \times l_3$. So the Smith form of $[D^T(\delta) \ Q^T(\delta)]^T$ is

1. LINEAR SYSTEMS MODELING AND STRUCTURE

$\Lambda(\delta) = \text{diag}\{1, 1, \delta\}$ where δ is the invariant polynomial. Therefore, there is an o.d.z such as $\delta = 0$ for Σ , i.e., the system is unobservable in the LTI case.

Because of the noncommutative property in the LTV case, one has the relation $\delta \frac{L_1(t)}{L_3(t)} = \frac{L_1(t)}{L_3(t)} \delta + \left(\frac{L_1(t)}{L_3(t)}\right)'$. If $L_1(t)$ and $L_3(t)$ are proportional by a constant $c \in \mathbb{C}$ as $L_1(t) = cL_3(t)$, i.e., $\left(\frac{L_1(t)}{L_3(t)}\right)' = 0$, the same elementary operations will be done as in the LTI case. So if $L_1(t) = cL_3(t)$, $c \in \mathbb{C}$, the system is unobservable. Another situation in LTV case is $\left(\frac{L_1(t)}{L_3(t)}\right)' \neq 0$. With new elementary operations on the last matrix in (1.34), one can get equation (1.35).

$$\left[\begin{array}{ccc} 0 & 0 & \frac{L_1(t)}{L_3(t)}\delta + \left(\frac{L_1(t)}{L_3(t)}\right)' \\ 1 & 0 & 0 \\ 0 & 0 & \delta \\ 0 & 1 & 0 \end{array} \right] \xrightarrow{\substack{r_1 - \frac{L_1(t)}{L_3(t)} \times r_3, \left(\left(\frac{L_1(t)}{L_3(t)}\right)'\right)^{-1} \times r_1, r_3 - \delta \times r_1, \\ c_4 + c_1 \times \frac{L_1(t)}{L_3(t)}, r_1 \leftrightarrow r_2, r_3 \leftrightarrow r_4, r_2 \leftrightarrow r_3}} \left[\begin{array}{ccc} 1 & 0 & 0 \\ 0 & 1 & 0 \\ 0 & 0 & 1 \\ 0 & 0 & 0 \end{array} \right] \quad (1.35)$$

So in the LTV case with $\left(\frac{L_1}{L_3}\right)' \neq 0$, the system is observable. Table 1.2 shows three situations of the observability property of the system in Figure 1.1.

Table 1.2: Observability property of the system in several cases

LTI case	LTV case	
	$\left(\frac{L_1(t)}{L_3(t)}\right)' = 0$	$\left(\frac{L_1(t)}{L_3(t)}\right)' \neq 0$
unobservable	unobservable	observable

Remark 1.31 From Example 1.30, the Smith form of matrix $[D^T(\delta) \ Q^T(\delta)]$ is unique. The LTI system is always unobservable because of the invariant polynomial δ , i.e. there always exists an o.d.z. such as: $\delta = 0$. But in the LTV case, the existence of $\{o.d.z.\}$ depends on the relation between parameters. These differences will be explained in Section 2.2.3 by the rank condition of the observability matrix, algebraic and bond graph approaches.

Let Σ_1 be the system obtained by removing $\{i.d.z\}$ from system Σ by the order reduction process described in Rosenbrock (1970). The set difference of $\{o.d.z.\}$ of Σ and of Σ_1 is called the set of input output decoupling zeros ($\{i.o.d.z.\}$) of Σ .

Definition 1.32 The $\{i.o.d.z.\}$ of Σ are the Smith zeros of the module $T/(T \cap [y, u]_{\mathbb{R}})$, which is called the module of input output decoupling zeros.

Since, the $\{i.o.d.z.\}$ corresponds the non-proper (uncontrollable and unobservable overlap) part of the system Σ . The set $\{i.o.d.z.\}$ is included in the intersection of the set $\{i.d.z.\}$ and of the set $\{o.d.z.\}$ such as:

$$\{i.o.d.z.\} \subset \{i.d.z.\} \cap \{o.d.z.\} \quad (1.36)$$

Definition 1.33 *The hidden modes are the Smith zeros of the module $\Sigma/(\Phi \cap [y, u]_{\mathbf{R}})$, which is called the hidden modes module.*

As to the hidden modes, relation (1.37) is written.

$$\{\text{hidden modes}\} = \{i.d.z.\} + \{o.d.z.\} - \{i.o.d.z.\} \quad (1.37)$$

Example 1.34 *(continued)*

According to (1.36) and (1.37), $\{i.o.d.z.\}$ is an empty set for the system in both LTI and LTV cases. In the LTI case, $\{\text{hidden modes}\}$ is equal to $\{0\}$. For the LTV system, $\{\text{hidden modes}\}$ is equal to $\{0\}$ when $(\frac{L_1(t)}{L_3(t)})' = 0$ is hold. If $(\frac{L_1(t)}{L_3(t)})' \neq 0$, the $\{\text{hidden modes}\}$ of the LTV system is $\{\emptyset\}$.

1.2.2.3 Invariant Zeros

Definition 1.35 *The module of invariant zeros is $M_{iz} = \mathcal{T}(\Sigma/[y]_{\mathbf{R}})$ which is the non controllable part of the reduced system $\Sigma/[y]_{\mathbf{R}}$. The invariant zeros of Σ are the conjugacy classes of the elements of a full set of Smith zeros of the module M_{iz} . The invariant zeros can also be derived from Smith zeros of invariant polynomials of system matrix (1.11).*

Let the system Σ be a proper state-space system (1.13). $u(t) = u_c(t) - K(t)x(t)$ is a feedback and Σ_c , $x_c(t)$, $y_c(t)$ denote the closed-loop system, the state and the output of Σ_c , respectively. One obtains the system equations

$$\begin{cases} \dot{x}_c(t) = (A(t) - B(t)K(t))x_c(t) + B(t)u_c(t) \\ y_c(t) = (C(t) - D(t)K(t))x_c(t) + D(t)u_c(t) \end{cases}$$

Property 1.36 *Bourlès (2005)*

The modules of invariant zeros of the system and its closed-loop system defined by state feedback are isomorphic $\mathcal{T}(\Sigma/[y]_{\mathbf{R}}) \cong \mathcal{T}(\Sigma_c/[y_c]_{\mathbf{R}})$. The invariant zeros of a proper state-space system are invariant by state feedback.

1. LINEAR SYSTEMS MODELING AND STRUCTURE

Consider an epimorphism $\Sigma \rightarrow \Sigma/[y]_{\mathbf{R}}$, and let $\hat{\xi}(t)$, $\hat{u}(t)$ denote the images of $\xi(t)$, $u(t)$. The equation of $\Sigma/[y]_{\mathbf{R}}$ is

$$P(\delta, t) \begin{bmatrix} \hat{\xi}(t) \\ \hat{u}(t) \end{bmatrix} = 0 \quad (1.38)$$

Hence, the Smith zeros of $P(\delta, t)$ are the invariant zeros of Σ . The invariant zeros can also be derived from the torsion differential equations in (1.38) with the form $f(\delta, t) \cdot g(\hat{\xi}(t), \hat{u}(t)) = 0$ related to $\mathcal{T}(\Sigma/[y]_{\mathbf{R}})$ where $f(\delta, t) \in \mathbf{R}$.

Procedure 1.37 *From the point of view of module theory, the invariant zero module $\mathcal{T}(\Sigma/[y]_{\mathbf{R}})$ is a torsion module. The invariant zeros are derived by using the following procedure:*

- *The output variables $y(t)$ are set equal to zero to get the module $\Sigma/[y]_{\mathbf{R}}$ (1.38),*
- *Torsion equations are derived from the torsion module $\mathcal{T}(\Sigma/[y]_{\mathbf{R}})$, (the Smith zeros of definition matrix of torsion equations are the invariant zeros)*

1.2.2.4 Relationships between various Poles and Zeros

Generally, the set of invariant zeros is a subset of the system zeros set. The set of invariant zeros and the set of system zeros coincide when $m = p$ and $\det(P(\delta, t)) \neq 0$.

Invariant zeros set contains the complete set of transmission zeros and some, but not necessarily all, of the decoupling zeros (all of the o.d.z. and some of i.d.z which are not i.o.d.z.). Generally, the sets of zeros for LTI models satisfy the following relationships [Bourlès & Fliess \(1997\)](#):

$$\begin{aligned} \{\text{system zeros}\} &= \{\text{transmission zeros}\} + \{\text{i.d.z}\} + \{\text{o.d.z}\} - \{\text{i.o.d.z}\} \\ \{\text{transmission zeros}\} + \{\text{i.o.d.z}\} &\subset \{\text{invariant zeros}\} \subset \{\text{system zeros}\} \end{aligned}$$

For finite poles, one has the relationships [Bourlès & Fliess \(1997\)](#):

$$\begin{aligned} \{\text{system poles}\} &= \begin{cases} = \{\text{i.d.z}\} + \{\text{controllable poles}\} \\ = \{\text{o.d.z}\} + \{\text{observable poles}\} \end{cases} \\ \{\text{observable poles}\} &= \{\text{transmission poles}\} + \{\text{i.d.z}\} - \{\text{i.o.d.z}\} \\ \{\text{controllable poles}\} &= \{\text{transmission poles}\} + \{\text{o.d.z}\} - \{\text{i.o.d.z}\} \\ \{\text{system poles}\} &= \{\text{transmission poles}\} + \{\text{hidden modes}\} \end{aligned}$$

In Table 1.3*, several kinds of finite zeros and poles are shown with their corresponding modules and matrices.

Table 1.3: Modules and corresponding matrices of finite zeros and poles

Zeros & Poles	Modules	Definition Matrices or Sets
M_{iz}	$\mathcal{T}(\Sigma/[y]_{\mathbf{R}})$	$P(\delta, t)$
M_{sp}	$\Sigma/[u]_{\mathbf{R}}$	$I\delta - A(t)$
M_{idz}	$T = \mathcal{T}(\Sigma)$	$L(\delta, t) = [I\delta - A(t) \ B(t)]$
M_{odz}	$\Sigma/[u, y]_{\mathbf{R}}$	$R(\delta, t) = [(I\delta - A^T(t)) \ C^T(t)]$
M_{iodz}	$T/(T \cap [u, y]_{\mathbf{R}})$	$\subset \{i.d.z.\} \cap \{o.d.z.\}$
M_{hm}	$\Sigma/(\Phi \cap [u, y]_{\mathbf{R}})$	$\{i.d.z.\} + \{o.d.z.\} - \{i.o.d.z.\}$

1.2.3 Structure at Infinity

The structure at infinity of linear time-invariant systems has been extensively studied since the end of the 70's (see, e.g., [Commault & Dion \(1981\)](#), [Ferreira \(1980\)](#)). The infinite poles are related to the impulsive motions arising in a system [Verghese & Kailath \(1979\)](#), [Bourles & Marinescu \(2007\)](#).

The system poles at infinity consist of the transmission poles at infinity and of the hidden modes at infinity. The first ones are related to the differentiation number between the input and the output. Another ones are related to the impulsive motions which can arise inside a system. The transmission zeros at infinity and the hidden modes at infinity form the structure of system zeros at infinity. The infinite transmission zeros are related to the number of integrators between the input and the output. In this section, our interest focus on the transmission zero at infinity which is called *infinite structure*. For other kinds of poles and zeros at infinity such as decoupling zero, hidden mode, invariant zero, system pole, controllable pole and observable pole at infinity; refer to [Bourlès & Marinescu \(1999\)](#), [Bourles & Marinescu \(2007\)](#), [Bourlès \(2006\)](#) and the references therein.

Ring of Integration Operators \mathbf{S} and it's Division Ring \mathbf{L}

For studying the poles and zeros at infinity of LTV systems, a new kind of non-commutative ring \mathbf{S} and its quotient field \mathbf{L} should be introduced. Set $\sigma = \delta^{-1}$

*All modules in the table are torsion modules.

1. LINEAR SYSTEMS MODELING AND STRUCTURE

(integration operator) and $\mathbf{S} := k[[\sigma]]$ denotes the ring of *formal power series* in σ which has the element form (1.39), and equipped with the commutation rule $\sigma a = a\sigma - \sigma \dot{a}\sigma$, $a \in k$.

$$a = \sum_{i=0}^{+\infty} a_i \sigma^i, \quad a_i \in k \quad (1.39)$$

The ring \mathbf{S} has the following properties [Bourlès \(2006\)](#):

1. An element a of \mathbf{S} is a unit (i.e., is invertible in \mathbf{S}), iff $a_0 \neq 0$.
2. Let a be a nonzero element of \mathbf{S} . The integer $w(a) = \min \{i | a_i \neq 0\}$ is called the *order* of a , and a takes the following form (1.40), where v and v' are units over \mathbf{S} .

$$a = v\sigma^{w(a)} = \sigma^{w(a)}v' \quad (1.40)$$

Similarly to ring \mathbf{R} , ring \mathbf{S} is also a principal ideal domain (PID), commutative iff k is a field of constants. Every nonzero ideal of \mathbf{S} has the form $\sigma^k \mathbf{S} = \mathbf{S}\sigma^k := (\sigma^k)$. Let a and b be two nonzero elements of \mathbf{S} , one has $a|b$ iff $w(a) \geq w(b)$. The quotient field of \mathbf{S} is defined as $\mathbf{L} := K((\sigma))$ of Laurent series in σ , which is of the form $\sum_{i \geq v} a_i \sigma^i, v \in \mathbb{Z}, a_v \neq 0$. Noticed that the quotient field \mathbf{Q} of \mathbf{R} can be embedded in \mathbf{L} , which means that every element of \mathbf{Q} can be regarded as an element of \mathbf{L} .

1.2.3.1 Smith-McMillan Form at Infinity of Rational Matrices over \mathbf{L}

For a rational matrix over \mathbf{L} , the Smith-McMillan form at infinity can give the order of the infinite poles and zeros. Suppose a transfer matrix $G(\delta, t) : U(\delta) \rightarrow Y(\delta)$ with entries in \mathbf{Q} , because \mathbf{Q} is embedded in \mathbf{L} , so that $G(\sigma^{-1}, t) = H(\sigma, t)$ is a matrix over \mathbf{L} .

Definition 1.38 [Bourlès & Marinescu \(2011\)](#) Let $H(\sigma, t) \in \mathbf{L}^{p \times m}$ be a r -rank rational matrix. There exist two unimodular matrices $U(\sigma, t) \in GL_p(\mathbf{S})$ and $V(\sigma, t) \in GL_m(\mathbf{S})$ over \mathbf{S} satisfying equations (1.41) and (1.42), where Φ is the Smith-McMillan form of $H(\sigma, t)$ at infinity.

$$U(\sigma, t)H(\sigma, t)V^{-1}(\sigma, t) = \Phi \quad (1.41)$$

$$\Phi = \begin{bmatrix} \sigma^{n_1} & & & & \\ & \ddots & & & \\ & & \sigma^{n_r} & & \\ \hline & & & & 0 \end{bmatrix} \quad (1.42)$$

The integers n_i which are possibly negative are such as: $n_i \leq n_{i+1}$, $i = 1, 2, \dots, r-1$. If n_i is negative (resp., positive), n_i is called the structural indices of the zero (resp., pole) at infinity. Infinite zero orders of the system are equal to the number of derivations of the output variables to let input variables appear explicitly and independently. The sum denoted by $z_\infty = \sum_{i=1}^k n_i$ with index k such that $n_i > 0$ for $i \leq k$ is called the McMillan degree at infinity, or number of zeros at infinity of $H(\sigma, t)$.

1.2.3.2 Modules over \mathbf{S}

An LTV system is given by the PMD form (1.14), it is assumed that $D(\delta, t)$ is of full rank over \mathbf{R} . Equation (1.14) can be written in a form similar to (1.9) as equation (1.43).

$$\underbrace{\begin{bmatrix} D(\delta, t) & -N(\delta, t) & 0 \\ Q(\delta, t) & W(\delta, t) & -I_p \end{bmatrix}}_{R(\delta, t)} \underbrace{\begin{bmatrix} \xi \\ u \\ y \end{bmatrix}}_w = 0 \quad (1.43)$$

The entries of the matrix $R(\delta, t)$ are over \mathbf{R} and $[\xi \ u \ y] \in M$. In the PMD or classical state representation, vectors ξ, u and y are considered as column vectors, and with the module representation, ξ, u and y are considered as row vectors because $[\xi \ u \ y]$ is considered as a list of variables belonging to the module M . M is a module over a ring. Consider some elementary operations for $R(\delta, t)$ which is now replaced by $R'(\delta, t)$ with

$$R'(\delta, t) = U(\delta, t)R(\delta, t)V(\delta, t)$$

where the matrices $U(\delta, t)$ and $V(\delta, t)$ are unimodular over \mathbf{R} . $R(\delta, t)$ and $R'(\delta, t)$ define the same linear system. The infinite structure of $R(\delta, t)$ is the same as that of $R'(\delta, t)$. These matrices correspond to the basis change which preserves the differentiation orders in (1.9). There exists a left-coprime factorization

1. LINEAR SYSTEMS MODELING AND STRUCTURE

$(A(\sigma, t), B(\sigma, t))$ of $R(1/\sigma, t)$ over \mathbf{S} defined as (1.44).

$$R(1/\sigma, t) = A^{-1}(\sigma, t)B(\sigma, t) \quad (1.44)$$

The matrix $B(\sigma, t)$ is a definition matrix of an \mathbf{S} -module Σ^+ which is determined by calculating $B(\sigma, t)$. An equation of the module is $B^T(\sigma, t)w^+ = 0$. All kinds of poles and zeros are derived from this module.

Definition 1.39 *Bourlès & Marinescu (1999)*

The orders of zero at infinity of a global LTV model are characterized by the Smith-McMillan matrix of the input-output relation $H(\sigma, t)$.

1.2.3.3 State Space Approach

Now the infinite structure such as zeros at infinity of LTV system is considered. The infinite zero structure of LTV multivariable models is made up of three sets:

- $\{n'_i\}$ the set of infinite zero orders of the global model $\Sigma(C(t), A(t), B(t))$
- $\{n_i\}$ the set of row infinite zero orders of the row sub-systems $\Sigma(c_i(t), A(t), B(t))$
- $\{n^j\}$ the set of column infinite zero orders of the column sub-systems $\Sigma(C(t), A(t), b^j(t))$

Property 1.40 *The global zero orders at infinity are equal to the minimum number of the derivation of the set of output to get the input variables appear explicitly and independently in the equations.*

One can also get the infinite structure by means of the temporal approach. The row infinite zero order for the row sub-system $\Sigma(c_i(t), A(t), B(t))$ associated to the i^{th} output y_i is denoted by n_i , which satisfies the relation:

$$n_i = \min \left\{ k | c_i(t)(A(t) - I\delta)^{k-1}B(t) \neq 0 \right\}$$

With reference to the column order n^j of zero at infinity associated to the j^{th} input variable u_j for the column sub-system $\Sigma(C(t), A(t), b^j(t))$, one has:

$$n^j = \min \left\{ k | C(t)(A(t) - I\delta)^{k-1}b^j(t) \neq 0 \right\}$$

Property 1.41 n_i (resp., n^j) is equal to the number of derivations (resp., integrations) of the output (resp., input) variable necessary for at least one input (resp., output) variable to appear explicitly.

1.3 Unknown Input Observers

The design of controllers requires the knowledge of many kinds of information often not available by measurement. When a state space approach is used, the state vector must be known (partially) and since systems are often subject to disturbances which can not be measured, an UIO (unknown input observer) must be designed. The UIO synthesis is achieved by following two steps: the first one which is dedicated to analysis (properties of the model must be known) and secondly UIO synthesis. In the first step, the concepts recalled previously must be used.

Constructive solutions based on generalized inverse matrices taking into account properties of invariant zeros are given in [Kudva *et al.* \(1980\)](#) and then in [Miller & Mukunden \(1982\)](#) and [Hou & Muller \(1992\)](#) with observability and detectability properties. Full order observers are then proposed in a similar way (based on generalized inverse matrices) in [Darouach *et al.* \(1994\)](#) and [Darouach \(2009\)](#), but with some restriction on the infinite structure of the model. The algebraic approach is proposed in [H. L. Trentelman & Hautus \(2001\)](#) and in [Daafouz *et al.* \(2006\)](#) for continuous and discrete time systems, without restriction on the infinite structure of the model. A graphical approach is in [T. Boukhobza. \(2007\)](#). The extension to the LTV case is not so easy, even if the problem formulations are similar to the LTI case.

In this section, two methods related to the UIO problem are recalled. One is based on generalized inverse matrices, another one is derived from algebraic theory which is intrinsic. Sufficient and necessary conditions of existence are recalled in each case.

1.3.1 UIO with Matching Conditions

The classical state representation, for an LTI system with unknown inputs, is given by the Kalman form (1.45)*, with $x(t) \in \mathbb{R}^n$ and $y(t) \in \mathbb{R}^p$. The input variables are divided into two sets $u(t) \in \mathbb{R}^m$ and $d(t) \in \mathbb{R}^q$ which represent known and unknown input variables respectively. It is supposed that input variables $u(t)$ and $d(t)$ are bounded and infinitely continuously derivable.

$$\begin{cases} \dot{x}(t) = Ax(t) + Bu(t) + Fd(t) \\ y(t) = Cx(t) \end{cases} \quad (1.45)$$

Models described in equation (1.45) without unknown inputs are denoted as $\Sigma(C, A, B)$ in the LTI case and $\Sigma(C(t), A(t), B(t))$ in the LTV case. Models are supposed to be invertible, with full matrix rank for matrices C , B and F .

Much attention has been paid to the algorithms to compute observers, but firstly existence conditions must be defined. The concepts of strong detectability, strong* detectability and strong observability have been proposed in Hautus (1983). These concepts are useful for solving the UIO problem.

System $\Sigma(C, A, F)$ (with only unknown input $d(t)$) is strongly detectable, if $y(t) = 0$ for $t > 0$ implies $x(t) \rightarrow 0$ with $(t \rightarrow \infty)$. It is strong* detectable if $y(t) = 0$ for $t \rightarrow \infty$ implies $x(t) \rightarrow 0$ with $(t \rightarrow \infty)$.

The strong detectability corresponds to the minimum-phase condition, directly related to the zeros of the system $\Sigma(C, A, F)$ (without input $u(t)$) defined as to be the values of $\delta \in \mathbb{C}$ (the complex plane) for which (1.46) is verified.

$$\text{rank} \begin{pmatrix} I\delta - A & -F \\ C & 0 \end{pmatrix} < n + \text{rank} \begin{pmatrix} -F \\ 0 \end{pmatrix} \quad (1.46)$$

Proposition 1.42 *Hautus (1983)* The system $\Sigma(C, A, F)$ in (1.45) is strongly detectable if and only if all its zeros δ satisfy $\text{Re}(\delta) < 0$ (minimum phase condition).

Proposition 1.43 *Hautus (1983)* The system $\Sigma(C, A, F)$ in (1.45) is strong* detectable if and only if it is strongly detectable and in addition

$$\text{rank}[CF] = \text{rank}[F] = q \quad (1.47)$$

*This system is also represented as $\Sigma(C, A, [B \ F])$. The subsystem with only known input $u(t)$ (unknown input $d(t)$) is represented by $\Sigma(C, A, B)$ ($\Sigma(C, A, F)$).

Proposition 1.44 *Hautus (1983)* The system $\Sigma(C, A, F)$ in (1.45) is strongly observable if and only if it has no zeros.

The condition in Proposition 1.43 is a necessary condition for the existence of some kinds of unknown input observers. It is used to be satisfied for robust state reconstruction. It is called *observer matching condition*, which is to be insensitive to matched perturbations.

An observer proposed by Darouach (2009) has the form

$$\begin{cases} \dot{\xi}(t) = N\xi(t) + Jy(t) + Hu(t) \\ \hat{x}(t) = \xi(t) - Ey(t) \end{cases} \quad (1.48)$$

where $\hat{x}(t) \in \mathbb{R}^n$ is the estimate of $x(t)$. Matrices N, J , and E with constant entries have appropriate dimensions.

Let $P = I + EC$, Proposition 1.45 gives the conditions for system (1.48) to be a full-order observer for system (1.45).

Proposition 1.45 *By the full-order observer (1.48), the state variables $x(t)$ in (1.45) will be estimated (asymptotically) if the following conditions hold*

1. N is a Hurwitz matrix (every eigenvalue of N has strictly negative real part)
2. $PA - NP - JC = 0$
3. $PF = 0$
4. $H = PB$

Derived from equations (1.45) and (1.48), the observer reconstruction error is

$$e = x - \hat{x} = Px - \xi \quad (1.49)$$

The dynamic of the estimation error is given by

$$\delta e = Ne + (PA - NP - JC)x + (PB - H)u + PFd \quad (1.50)$$

If conditions in Proposition 1.45 are satisfied, then $\lim_{t \rightarrow \infty} e(t) = 0$ for any $x(0), \hat{x}(0), d(t)$ and $u(t)$. Hence $\hat{x}(t)$ in (1.48) is an estimate of $x(t)$ in (1.45).

Equations 2-3 in Proposition 1.45 can be written as

1. LINEAR SYSTEMS MODELING AND STRUCTURE

$$N = A + \begin{bmatrix} E & K \end{bmatrix} \begin{bmatrix} CA \\ C \end{bmatrix} \quad (1.51)$$

$$\begin{bmatrix} E & K \end{bmatrix} \Sigma = -F \quad (1.52)$$

where $K = -J - NE$, $\Sigma = \begin{bmatrix} CF \\ 0 \end{bmatrix}$.

Lemma 1.46 *The necessary and sufficient condition for the existence of the solution of equation (1.52) is guaranteed by the matching condition in Proposition 1.43, i.e., $\text{rank}[CF] = \text{rank}[F] = q$.*

Under condition (1.47), the general solution of equation (1.52) is

$$\begin{bmatrix} E & K \end{bmatrix} = -F\Sigma^+ - Z(I - \Sigma\Sigma^+) \quad (1.53)$$

where Σ^+ is a generalized inverse matrix (Pringler & Rayner (1971)) of the matrix Σ which can be derived from

$$\Sigma^+ = (\Sigma^T \Sigma)^{-1} \Sigma^T \quad (1.54)$$

and Z is an arbitrary matrix with appropriate dimension.

After inserting (1.53) into (1.51), the matrix N has the form

$$N = A_1 - ZB_1 \quad (1.55)$$

where

$$A_1 = A - F\Sigma^+ \begin{bmatrix} CA \\ C \end{bmatrix} \quad (1.56)$$

and

$$B_1 = (I - \Sigma\Sigma^+) \begin{bmatrix} CA \\ C \end{bmatrix} \quad (1.57)$$

The matrix Z is used to guarantee the stability of the matrix N . The necessary and sufficient condition for the existence of the matrix Z such that N is Hurwitz is given by the following lemma.

Lemma 1.47 *There exists a matrix Z for assuring the stability of matrix N iff the system $\Sigma(C, A, F)$ is strong* detectable.*

The necessary and sufficient condition of existence of the observer (1.48) for the system (1.45) is given by the following theorem.

Theorem 1.48 *The full-order observer (1.48) will estimate (asymptotically) $x(t)$ in (1.45) if the system $\Sigma(C, A, F)$ is strong* detectable, i.e.,*

$$\begin{cases} \text{rank} \begin{bmatrix} I\delta - A & -F \\ C & 0 \end{bmatrix} = n + q, \forall \delta \in \mathbb{C}, \text{Re}(\delta) \geq 0 \\ \text{rank} [CF] = \text{rank} [F] = q \end{cases} \quad (1.58)$$

Theorem 1.49 *Darouach et al. (1994)*

Assume that $\text{rank}[CF] = \text{rank}[F] = q$ and $\text{rank}[P] = n - m$. Then the following conditions are equivalent

- *the pair (PA, C) is detectable (observable)*
- $\text{rank} \begin{bmatrix} P\delta - PA \\ C \end{bmatrix} = n, \forall \delta \in \mathbb{C}, \text{Re}(\delta) \geq 0 (\forall \delta \in \mathbb{C})$
- $\text{rank} \begin{bmatrix} I\delta - A & -F \\ C & 0 \end{bmatrix} = n + q, \forall \delta \in \mathbb{C}, \text{Re}(\delta) \geq 0 (\forall \delta \in \mathbb{C})$

A procedure for designing the observer (1.48) is given.

Procedure 1.50

1. *Verify the strong* detectability of the system $\Sigma(C, A, F)$.*
2. *Calculate matrices A_1, B_1 by equations in (1.56,1.57).*
3. *Determine matrix Z by pole placement of matrix N in (1.55).*
4. *Compute matrices E and K by (1.53), then $J = -K - NE$, $H = (I + EC)B$.*

The full order observer (1.48) proposed by Darouach for linear systems with unknown inputs is based on generalized inverse matrices. In Darouach (2009), the general form of observers was also given for linear systems with unknown inputs in both the state and the measurement equations ($y = Cx + Gd$). This kind of observer is convenient to realize, the calculations procedure is concise and easy to be implemented. But in many physical systems, the matching condition

1. LINEAR SYSTEMS MODELING AND STRUCTURE

$\text{rank}[CF] = \text{rank}[F]$ is not always satisfied. In view of this limit, many contributions have been given by algebraic method approach. [Barbot *et al.* \(2007\)](#) proposed an observer for linear systems with unknown inputs by using the sliding mode approach. In [Daafouz *et al.* \(2006\)](#), an intrinsic approach was used, but in that case, impulsive motions can arise due to some derivations used in their approach. In the next section, this method is recalled.

1.3.2 UIO with Algebraic Approach

In this section, an observer for SISO linear systems proposed in [Daafouz *et al.* \(2006\)](#) is recalled. Firstly, some fundamental algebraic notions are introduced.

As mentioned above, a linear system is a finitely generated module over a differential ring. Structural properties of the system depend on relations between certain submodules of the system. The notions of controllability, observability and invertibility have been introduced in previous sections. Here, the left invertibility and observability of systems with unknown inputs will be introduced by algebraic point of view.

Definition 1.51 *The input-output system Σ is left (resp., right) invertible iff its transfer matrix is left (resp., right) invertible. Equivalently, Σ is left invertible iff the quotient module $\Sigma/[y]_R$ is a torsion module. If the system is square, the two notions are equivalent. Then the system is called invertible.*

Without considering known input variables, the system (1.45) can be written as (1.59).

$$\begin{cases} \dot{x}(t) = Ax(t) + Fd(t) \\ y(t) = Cx(t) \end{cases} \quad (1.59)$$

In the following, notions of rapid and asymptotic observability of system (1.59) are introduced.

Definition 1.52 *The system 1.59 is said rapidly observable or observable in finite time for unknown inputs, iff*

$$x_i, d_j \in [y]_R, i = 1, \dots, n, j = 1, \dots, q \quad (1.60)$$

Property 1.53 *The system (1.59) is rapidly observable for unknown inputs iff the vector y is a generator of the system module Σ . Then, the system is observable and left invertible.*

System (1.59) is said *asymptotically observable* with unknown inputs iff all state variables can be divided into two groups:

- one group is represented by the output variables and their derivations.
- another group is represented by variables which tend to zero when $t \rightarrow \infty$.

Theorem 1.54 *The system (1.59) is asymptotically observable with unknown inputs iff it is left invertible, and has the minimal phase property.*

Property 1.55 *Assume the above theorem is true, the system (1.59) is rapidly observable with unknown inputs iff its zero dynamics is trivial.*

In the LTI monovariate case, the notion of *relative degree* r is the counterpart of infinite zero order introduced in Section 1.2.3.3. The relative degree r for system (1.59) is equal to the number of derivatives of the output to let the unknown input appears explicitly. r is defined by $CA^{r-1}F \neq 0$ and $CA^{i-1}F = 0, i < r$. Then one has $y^{(r)} = CA^r x + CA^{r-1}Fd$. In the multivariable case, the notion of relative order need to be defined.

An unknown input observer for system (1.59) in the SISO case has the form

$$\begin{cases} \dot{\hat{x}} = (PA - LC)\hat{x} + Qy^{(r)} + Ly \\ \hat{d} = (CA^{r-1}F)^{-1}(y^{(r)} - CA^r\hat{x}) \end{cases} \quad (1.61)$$

where \hat{d} is the estimate of the unknown input, and matrices Q, P verifies

$$Q = F(CA^{r-1}F)^{-1}, P = I - QCA^{r-1} \quad (1.62)$$

The dynamic of the estimation error of the state variables is given by

$$\delta e = \dot{x} - \dot{\hat{x}} = (PA - LC)(x - \hat{x}) \quad (1.63)$$

Then, one has $\lim_{t \rightarrow \infty} e(t) = 0$ for any $x(0), \hat{x}(0), d(t)$. Hence $\hat{x}(t)$ in (1.61) is an estimate of $x(t)$ in (1.59). The estimation error of the unknown input is

$$e_d = d - \hat{d} = (CA^{r-1}F)^{-1}CA^r(x - \hat{x}) \quad (1.64)$$

1. LINEAR SYSTEMS MODELING AND STRUCTURE

Since $\lim_{t \rightarrow \infty} (x - \hat{x}) = 0$, then $\lim_{t \rightarrow \infty} \hat{d} = d$.

The necessary and sufficient condition of existence of the observer (1.61) for the system (1.59) is given by the following theorem.

Theorem 1.56 *The full-order observer (1.61) will estimate (asymptotically) $x(t)$ in (1.59) if*

1. *system $\Sigma(C, A, F)$ is left invertible*
2. *system $\Sigma(C, A, F)$ is strongly detectable (minimal phase condition)*

The LTI system $\Sigma(C, A, F)$ in (1.59), supposed to be asymptotically observable with unknown input, is rapidly observable if, and only if, its zero dynamics is trivial.

Finally, a linear system is said to be observable with unknown inputs if, and only if, any system variable, a state variable or an input variable for instance, can be expressed as function of the output variables and their derivatives up to some finite order. In other words, an input-output system is observable with unknown inputs if, and only if, its zero dynamics is trivial and if moreover the system is square, it is flat.

The unknown input observer with the algebraic approach is intrinsic, and the complexity for computing matrices of the observer is smaller than the observer introduced in the above section. Even if the matching condition must not be satisfied, the utilization of high-order differentiator may cause a highly fluctuating or oscillatory impulsive phenomena. The low-pass filter with iterated time integrals is a solution. Furthermore, the derivatives of the output will be complicated in the LTV case. In the chapter 4, some numerical examples will be studied by these two observers. The results with two observers will be compared. It can be also noticed that in these observers, the control input is not considered, which is also another difficulty.

1.4 Conclusion

In this chapter, the focus is on the mathematical background for the study of linear systems and system structures. In the first part, the module theoretic method which is an intrinsic approach for the analysis and synthesis of linear

systems has been introduced. The algebraic notions such as differential field, ring of operators and differential module and their relations have been explained. The definition that a linear system is a left-module is fundamental to this dissertation.

Secondly, derived from the above algebraic objects, the polynomial matrices over some kinds of differential rings and the rational matrices over their quotient fields have been recalled. Then the Jacobson/Smith-McMillan forms of these matrices have been presented in the case of LTV systems. These forms are utilized to study the finite and the infinite structures of LTV systems. A number of submodules of a system module associated with the poles and zeros of finite and infinite structures were also given.

At last, the state and input observability analysis for linear systems with unknown inputs were recalled. The notion of observability is very useful for detecting the system faults. For the design of unknown input observers, the invariant zeros of systems play a fundamental role for the study of the stability property. Two kinds of unknown input observers are recalled, and the necessary and sufficient conditions of existence of observers are given. The first one is based on the generalized inverse matrices where a matching condition is required. For the second observer, some algebraic notions are needed but the existence conditions are less strict than the first one. The infinite structure related to the invertibility of systems is used to determine the observer. In the chapter 4, these two observers will be extended, and the LTV case will also be considered. Simultaneously, a number of numerical examples will be studied by various approaches.

1. LINEAR SYSTEMS MODELING AND STRUCTURE

Chapter 2

Bond Graph Methodology

Contents

2.1	Graphical Representations of Linear Systems	72
2.1.1	Linear Structured Systems	72
2.1.2	Bond Graph Modeling	74
2.2	Structural Properties of Linear Systems	75
2.2.1	Structural State Matrix Rank	76
2.2.2	Controllability	77
2.2.3	Observability	86
2.2.4	Dual Bond Graph Model	91
2.3	Infinite and Finite Structures	97
2.3.1	Infinite Structure	97
2.3.2	Invertibility and BGB Models	99
2.3.3	Finite Structure	103
2.4	Conclusion	106

In this chapter, the focus is on the graphical procedure to solve some control problems. Firstly, the elementary notions of the bond graph models are introduced. Being a powerful tool, the bond graph approach can be dedicated to the system modeling, the system analysis and synthesis. For a bond graph model, the notion of causal path and causal loop is fundamental. Secondly, some structural properties of the system such as: controllability, observability and invertibility

2. BOND GRAPH METHODOLOGY

are recalled. In the end, the graphical methods to determine the infinite structure and finite structure are given. A number of differential bond graph models are utilized to get the system zeros (finite/infinite). The bond graph model with integral causality (BGI) is mainly served to determine the invariant zeros. And the null invariant zeros can be determined by the bond graph model with derivative causality (BGD). The last part is also related to the bicausal bond graph model (BGB) which is useful to get the inverse system. It is as well used to get the invariant zero values by combining the notion of torsion module.

2.1 Graphical Representations of Linear Systems

The graphical approaches are powerful tools to solve the analysis and synthesis problems of control systems. Two graphical representations have been considered in this dissertation, such as: the directed graph and the bond graph approaches. Now let's introduce these two methods respectively.

2.1.1 Linear Structured Systems

From the middle of the last century, some kinds of system modeling methods are largely developed, for instance: state space models, transfer matrices, matrix pencils, polynomial representation, etc. By observing the different models, one can find that there exist several invariant properties of systems under some given transformation. The invariant properties are concerned tightly with the notion of zero (infinite or finite) which plays a fundamental role. [Dion et al. \(2003\)](#) has pointed out that the usual approaches of linear systems suffer from two main drawbacks. First, they do not consider available parametric information; and secondly, they often assume full knowledge of parameters. The notion of *structured system* is defined by the system matrices, like for instance in the quadruple (A, B, C, D) , where the entries of the matrices are either a fixed zero or is a free parameter. In that situation, only the structure of the model must be known.

Definition 2.1 [Dion et al. \(2003\)](#)

A structured real matrix A is a matrix with the coefficients among which are fixed to zero, and the remaining non-zero ones are supposed to be algebraically independent reals.

2.1 Graphical Representations of Linear Systems

Definition 2.2 A linear structured explicit system is defined by the following form:

$$\begin{cases} \dot{x}(t) = A_\lambda x(t) + B_\lambda u(t) \\ y(t) = C_\lambda x(t) \end{cases} \quad (2.1)$$

where $x \in \mathbb{R}^n$, $u \in \mathbb{R}^m$, $y \in \mathbb{R}^p$. Matrix in (2.2) denoting the system matrix of system in (2.1) is a structured matrix.

$$\begin{pmatrix} I\delta - A_\lambda & -B_\lambda \\ C_\lambda & 0 \end{pmatrix} \quad (2.2)$$

The fundamental idea of the proposition of “structured system” is that there exists only the zero/nonzero information in the matrices. This structure captures most of the structural information available from physical law and system decomposition. It allows the study of the system properties which depend only on the structure, almost independently of the value of the unknown parameters.

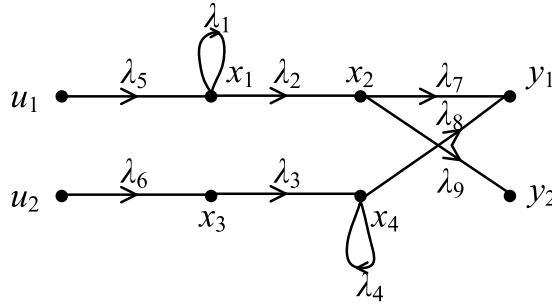

Figure 2.1: A directed graph representation

Given a system described by Figure 2.1, one has the following system equation:

$$\begin{aligned} A &= \begin{pmatrix} \lambda_1 & 0 & 0 & 0 \\ \lambda_2 & 0 & 0 & 0 \\ 0 & 0 & 0 & 0 \\ 0 & 0 & \lambda_3 & \lambda_4 \end{pmatrix}, & B &= \begin{pmatrix} \lambda_5 & 0 \\ 0 & 0 \\ 0 & \lambda_6 \\ 0 & 0 \end{pmatrix} \\ C &= \begin{pmatrix} 0 & \lambda_7 & 0 & \lambda_8 \\ 0 & \lambda_9 & 0 & 0 \end{pmatrix} \end{aligned} \quad (2.3)$$

where the λ_i 's are the new parameters. In the directed graph, the vertices correspond to the system variables (inputs, states, outputs) and the edges to the gains between variables. If one eliminates the edge gains, this (unweighed) graph

2. BOND GRAPH METHODOLOGY

contains the same information as the structured matrices (A, B, C) . Therefore, the system properties depend only on the zero/nonzero structure.

2.1.2 Bond Graph Modeling

In the 1940s and 1950s, H.M. Paynter worked on interdisciplinary engineering projects. He found that similar forms of equations are generated by dynamic systems in various domains. In 1959, he gave the revolutionary idea of portraying systems in terms of power bonds, connecting the elements of the physical system so called junction structures. Bond graphs offer a domain-neutral graphical technique for representing power flows in a physical system. Bond graphs have demonstrated to be very useful, not only for being a graphical modelization for dynamic physical systems, but also for being allowed to analyze systems structural properties and to generate the symbolic equations. Between the results, one can cite the notions of causal paths/loops which are useful for transfer function calculation [Chen & Satyanarayana \(1976\)](#), the calculation of characteristics polynomials [Dauphin-Tanguy \(2000\)](#), pole placement [Rahmani *et al.* \(1994\)](#) [Gawthrop & Ronco \(2002\)](#), controllability and observability matrices calculation. Some fundamental definitions of bond graph approach are introduced in the Appendix. One can find the introduction of bond graph standard elements in Appendix A.1. The notion of causality is recalled in Appendix A.2; one can find the notions of causal path and causal loop therein.

For a bond graph model, bonds connecting component energy ports specify the transfer of energy between system elements. The bond graph is composed of the “bonds” which link together “single port”, “double port” and “multi port” elements.

The bond graph language expresses general class of physical systems through power interactions. Power, the rate of energy transport between elements, is the universal currency of physical systems. Bonds exchange instantaneous energy at ports. A bond represents the flow of power, P , from one element of a physical system to another. There are two physical variables associated with each bond, an effort, $e(t)$, and a flow, $f(t)$. The product of these two variables is the instantaneous power flowing between two ports. For a physical system, two energy variables are given, such as the momentum $p(t) = \int e(t)dt$ and the displacement

2.2 Structural Properties of Linear Systems

$q(t) = \int f(t)dt$. Some power and energy variables of different physical domains are given in Table 2.1.

Table 2.1: Effort and flow variables in some physical domains

Systems	Electrical	Mechanical	Hydraulic
Effort $e(t)$	Force (F)	Voltage (V)	Pressure (P)
Flow $f(t)$	Torque (τ)	Velocity (v)	Volume flow rate (dQ/dt)
	Current (i)		
Momentum $p(t)$	Flux linkage (λ)	Angular velocity (ω)	Pressure
Displacement $q(t)$	Charge (q)	Momentum (p)	momentum (p_P)
		Angular momentum (h)	Volume (V)
		Displacement (x)	
		Angle (θ)	

2.2 Structural Properties of Linear Systems

A causally completed bond graph can provide many kinds of information before any equations are formulated. Between the structural properties, structural controllability and observability play an essential role in the context of control system design, which can be derived directly from the bond graph model. In this section, three approaches are used to detect controllability and observability properties of LTI and LTV systems, such as: formal (rank condition for controllability/observability matrix), bond graph and algebraic approaches.

In the LTI case, numerical criterion (rank conditions for the controllability and observability matrices) is a classical method to determine the structure studies. [Sueur & Dauphin-Tanguy \(1991\)](#) gave the bond graph criteria which are effective and intuitive to detect systems structural properties.

However, in the case of LTV systems, the bond graph approach for LTI systems mainly based on rank conditions is no more sufficient. So new rules are required in this case. [Silverman & Meadows \(1967\)](#) proposed the rank conditions for controllability and observability matrices in the LTV case. The module theory introduced by [Fliess \(1990\)](#) which is always valid for LTI/LTV systems is an intrinsic method to determine the structural properties. [Lichiardopol \(2007\)](#) proposed CBG (resp. OBG) models to detect the controllability (resp. observability) property of LTV system by bond graph approach. The conventional BGD

2. BOND GRAPH METHODOLOGY

models will be used with some algebraic criteria to determine the controllability property of LTV models. The observability property of LTV models will be studied by dual bond graph models by examining its controllability property. In this section, some differences between the structural properties procedures of LTI and of LTV systems are enumerated.

2.2.1 Structural State Matrix Rank

In the LTI case, the structural state matrix rank of the system Σ is associated to two integers determined by the bond graph model: the system order n and the number of structurally null modes p .

Suppose a linear bond graph model and its state representation defined in (2.4), where $x \in \mathbb{R}^n$, $u \in \mathbb{R}^m$, $y \in \mathbb{R}^p$.

$$\begin{cases} \dot{x}(t) = Ax(t) + Bu(t) \\ y(t) = Cx(t) \end{cases} \quad (2.4)$$

Then, the characteristic polynomial for the system (denominator of transfer functions) may be written as (2.5),

$$D(\delta) = |I\delta - A| = \delta^p (a_0 + a_1\delta + \dots + a_{q-1}\delta^{q-1} + \delta^q) \quad (2.5)$$

where $a_i \in \mathbb{R}$, $i = 0, \dots, q-1$, $p+q = n$ and p, q denote respectively the number of structurally null modes (null eigenvalues of A) and the structural rank of the state matrix. n is the order of the model.

Definition 2.3 *The order of a system is the number of initial conditions which are independent. In another word, it is equal to the number of independent state variables.*

Property 2.4 *The number p of structurally null modes is the number of storage elements to which derivative causality can not be assigned, when a preferred derivative causality assignment is chosen for the bond graph model.*

The structural rank of the model (rank of matrix A without parameter dependence) is pointed out by the following theorem.

Theorem 2.5 *Sueur & Dauphin-Tanguy (1991)*

The bond graph rank of matrix A is noted $bg_rk[A]$ and verifies (2.6).

$$bg_rk[A] = n - p \quad (2.6)$$

If the number of null modes p is zero, then the matrix A is said to be of *full rank*, which means that A is invertible. If every dynamical element can have a derivative causality assignment when a preferred derivative causality is assigned to the model, then the model is said to be of full rank. In this case, the mathematical representation associated to the bond graph model in derivative causality is given in (2.7).

$$\begin{cases} x(t) = A^{-1}\dot{x}(t) - A^{-1}Bu(t) \\ y(t) = C(t)A^{-1}\dot{x}(t) - CA^{-1}Bu(t) \end{cases} \quad (2.7)$$

2.2.2 Controllability

In Section 1.2.2.2, the notion of input decoupling zeros was introduced to detect controllability properties of LTI and LTV systems. Some differences between two cases were pointed out by mean of Jacobson forms of matrices $[I\delta - A \ B]$ and $[I\delta - A(t) \ B(t)]$. Here as mentioned, three approaches for detecting controllability property are introduced, such as: rank condition (formal approach), bond graph and algebraic approaches. Now, let's point out the difference between the controllability analysis of LTI and LTV systems by various methods.

2.2.2.1 Controllability of LTI Systems

Rank Condition for Controllability of LTI Models

From the structural point of view, the model is not structurally controllable if some linear relations can be written between the rows of matrix $[A \ B]$.

The numerical method to determine controllability of a system is to calculate the rank of the controllability matrix, such as:

$$\mathcal{C} = [B \ AB \ \dots \ A^{n-1}B] \quad (2.8)$$

2. BOND GRAPH METHODOLOGY

The rank of the controllability matrix depends on numerical values of the parameters. Hence, this method is parameter dependent and is not a robust measure of controllability.

Example 2.6 *A circuit with two inductance elements, one transformer and a dissipative element is shown in the Figure 2.2.*

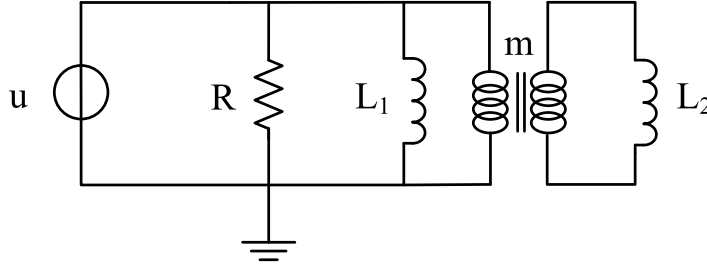

Figure 2.2: A second order system

In this example, the controllability matrix is $\mathcal{C} = \begin{bmatrix} R & -\frac{R^2}{L_1} - \frac{R^2}{m^2 L_2} \\ \frac{R}{m} & -\frac{R^2}{m L_1} - \frac{R^2}{m^3 L_2} \end{bmatrix}$. So the rank of the controllability matrix $rk(\mathcal{C}) = 1 < n$, it means that the system is not controllable.

Bond Graph Procedure for Controllability of LTI Systems

As mentioned above, the structural controllability property can be derived by using its bond graph model without calculating the rank of the controllability matrix. The controllability properties only depend on the causality assignment and the causal paths between various elements of the model, so this graphical approach is robust and parameter independent.

Let n be the number of elements with integral causality assignment in a BGI model. Before giving the procedure for determining the controllability properties of the system, some notions are now recalled.

Definition 2.7 *Sueur & Dauphin-Tanguy (1991)*

c is the number of dynamical elements keeping the integral causality after the following transformations:

- the preferred derivative causality is imposed on the bond graph model

2.2 Structural Properties of Linear Systems

- all the necessary dualisation of the control sources have been made to eliminate the integral causality assignment associated to the dynamical elements, without introducing unsolvable causal loops.

Note that causalities of independent sources, e.g. force due to gravity, are not considered for this analysis. Now an example is given to illustrate the procedure for determining c .

Example 2.8 (continued)

The bond graph model is shown in Figure 2.3.

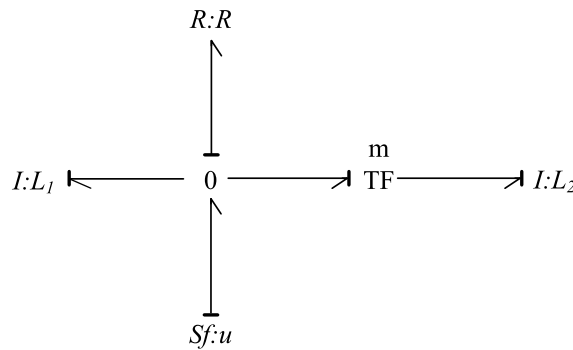

Figure 2.3: Bond graph with preferred integral causality

According to the procedure defined in Definition 2.7, the model with derivative causality is given in Figure 2.4. By comparing this two models, c is equal to 1.

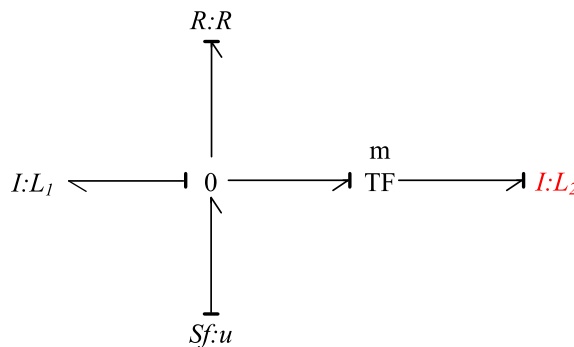

Figure 2.4: Bond graph with preferred derivative causality

Property 2.9 *Sueur & Dauphin-Tanguy (1991)*

2. BOND GRAPH METHODOLOGY

The bond graph rank of matrix $[A \ B]$ is noted $bg_rk[A \ B]$ and is calculated according to equation (2.9)

$$bg_rk[A \ B] = n - c \quad (2.9)$$

The controllability property of a bond graph model can be derived from Theorem 2.10.

Theorem 2.10 *Sueur & Dauphin-Tanguy (1991)*

A bond graph model is structurally controllable iff:

- *atteignability/reachability condition (necessary condition): there exists a causal path from one of the control sources to each dynamical element*
- *rank condition: $bg_rk[A \ B]=n$*

According to the Theorem 2.10, the bond graph in Example 2.8 is not structurally controllable.

Module Theoretic Approach for Bond Graph Models

Theorem 2.11 *Fliess (1990)* *A linear system is controllable iff it is a free \mathbf{R} -module, i.e. the torsion submodule is trivial $\mathcal{T}(\Sigma) = 0$.*

The module theoretic approach is an intrinsic method to study the controllability property of LTI and LTV systems. The dynamical elements with an integral causality in a BGD model are related to the uncontrollable part in the model. The differential equations of these elements define a module M_{ei} including the torsion module $\mathcal{T}(\Sigma)$. So one can get the torsion module $\mathcal{T}(\Sigma)$ from submodule M_{ei} of module Σ . The relation between modules is $\mathcal{T}(\Sigma) \subseteq M_{ei} \subseteq \Sigma$.

Definition 2.12 *For linear bond graph models, there exist a number of dynamical elements with an integral causality in BGD models. The equations related to these elements define modules M_{ei} . Because of the non controllable property of these elements, modules M_{ei} include torsion modules, i.e. the controllability property of bond graph models can be derived from modules M_{ei} .*

2.2 Structural Properties of Linear Systems

The non controllable parts of LTI models correspond to the dynamical elements with integral causality in BGD models. From the algebraic point of view, the non controllable submodule of these systems is torsion. Therefore, one can get the differential equations associated to the torsion submodule by using some information of elements equations with integral causality in BGD models.

Example 2.13 (continued) In Figure 2.3, the two state variables are x_{L_1} and x_{L_2} . In Figure 2.4, one dynamical element has an integral causality assignment, thus a mathematical relation can be written between state variables,

$$\dot{x}_{L_1} - m\dot{x}_{L_2} = 0 \quad (2.10)$$

(same relation obtained between the rows of matrix $[A \ B]$ when applying a structural approach). According to the properties of this equation, the controllability property can be pointed out. $\dot{x}_{L_1} - m\dot{x}_{L_2} = 0$ is equivalent to $\delta(x_{L_1} - mx_{L_2}) = 0$, which is the equation of a torsion submodule and in that case the model is not controllable.

Theorem 2.10 is a necessary and sufficient condition for the structural controllability property of LTI systems. In the LTV case, this theorem is no more valid. Rank condition, bond graph and module theoretical approaches are recalled in this case.

2.2.2.2 Controllability of LTV Systems

Rank Condition for Controllability of LTV models

As mentioned in Section 1.2.2, the controllability matrix of LTV systems differ from the one of LTI systems. In the LTV case, the second condition in Theorem 2.10 is not a necessary condition.

Definition 2.14 *Silverman & Meadows (1967)* The controllability matrix of LTV models can be written as the form:

$$\mathcal{C}(\delta, t) = [B(t), (A(t) - \delta I_n)B(t), \dots, (A(t) - \delta I_n)^{n-1}B(t)] \quad (2.11)$$

LTV systems are controllable iff $rk(\mathcal{C}(\delta, t)) = n$.

2. BOND GRAPH METHODOLOGY

Example 2.15 (continued) Let the transformer has a time varying parameter $m(t)$, according to Definition 2.14, the controllability matrix is:

$$\mathcal{C}(\delta, t) = \begin{bmatrix} B & (A - I\delta) B \end{bmatrix} = \begin{bmatrix} R & -\frac{R^2}{L_1} - R' - \frac{R^2}{m^2 L_2} \\ \frac{R}{m} & -\frac{R^2}{m L_1} - \frac{R^2}{m^3 L_2} - \frac{R'}{m} + \frac{Rm'}{m^2} \end{bmatrix}$$

The rank of controllability matrix is equal to 2. So the system is controllable but the corresponding LTI system is not. The algebraic method will illustrate the difference.

Bond Graph Procedure for Controllability study of LTV Systems

Some additional differential entries are added in the controllability matrix. Because there is no difference between the ordinary bond graph models of LTI and LTV systems, the procedure for the controllability study is no more valid for the LTV systems. Some changes are required in bond graph models in case of LTV systems. For solving this problem, Lichardopol (2007) has given modified bond graph models by using time-derivatives on the bond graph models.

Definition 2.16 Lichardopol (2007) A differential loop is the modification of a dynamical element on the BGI model shown in Figure 2.5, where the dissipative element has a value so that the differential loop gain is $\frac{d}{dt}$. C^* and I^* mean that the product of the gains which follow should be derived.

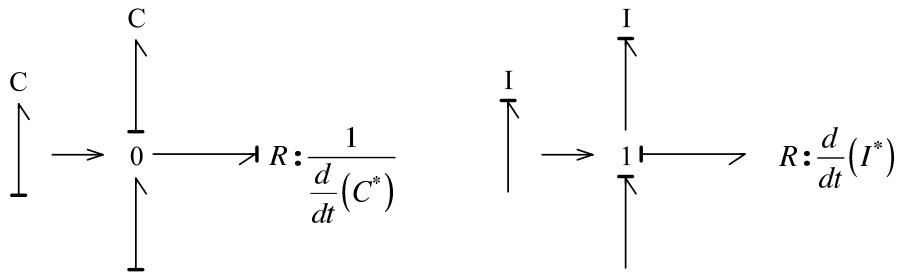

Figure 2.5: Differential loop transformations for CBG models

Definition 2.17 A CBG is a bond graph for the study of controllability property with a graphical approach. Some new differential loops are defined with Procedure 2.18.

2.2 Structural Properties of Linear Systems

Procedure 2.18

1. In BGI models, determine all the causal paths of length smaller than n which start from a source and end in a dynamical element with integral causality.
2. For each causal path determined in the previous step:
 - Check the first apparition of an element with a time varying gain along the causal path.
 - For every dynamical element following this element along the causal path, add a differential loop with the gain $\frac{d}{dt}$ (maximum one $\frac{d}{dt}$ for each dynamical element).

Property 2.19 *From the CBG model, an LTV system is controllable iff the two following conditions are satisfied:*

- *There is a causal path between each dynamical element and one of the input sources.*
- *Each dynamical element can have a derivative causality assignment in the CBG model with a derivative causality assignment (with a possible duality of input sources).*

Example 2.20 *(continued) The CBG model containing a time varying element $TF : m(t)$ with integral causality assignment (CBGI) from Figure 2.3 is presented in Figure 2.6. Figure 2.7 shows the CBG model with preferred derivative causality. According to Property 2.19, the LTV system is controllable.*

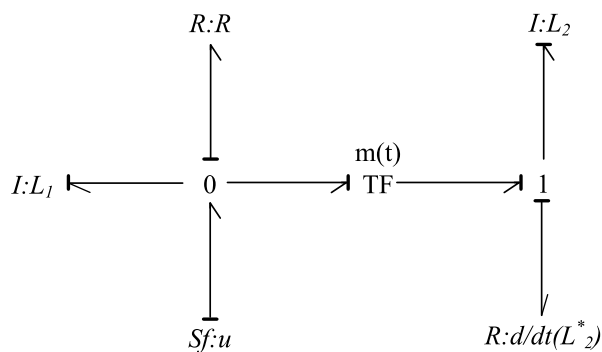

Figure 2.6: The CBG model with preferred integral causality

2. BOND GRAPH METHODOLOGY

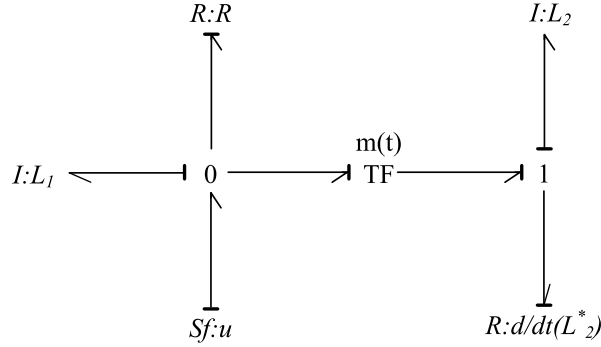

Figure 2.7: The CBG model with preferred derivative causality

Module Theoretic Method for Bond Graph Models

An LTV system (Σ, u, y) (or Σ) which is a \mathbf{R} -module can be represented in (2.12).

$$\begin{bmatrix} I\delta - A(t) & -B(t) & 0 \\ C(t) & 0 & -I_p \end{bmatrix} \begin{bmatrix} x \\ u \\ y \end{bmatrix} = 0 \quad (2.12)$$

The first matrix in (2.12) is a matrix of definition of module Σ .

The noncontrollable part of an LTV system is related to the torsion module $\mathcal{T}(\Sigma)$. There exist two methods to detect the controllability property of the system by means of the module theoretic approach. One is to use the Jacobson form of the first matrix in (2.12) to detect input decoupling zeros. As $\begin{bmatrix} I\delta - A(t) & -B(t) & 0 \\ C(t) & 0 & -I_p \end{bmatrix} \cong \begin{bmatrix} I\delta - A(t) & -B(t) \end{bmatrix}$, one can derive input decoupling zeros from the Jacobson form of the latter matrix $\begin{bmatrix} I\delta - A(t) & -B(t) \end{bmatrix}$. Another method is directly to detect torsion equations in (2.12) of which the torsion module $\mathcal{T}(\Sigma)$ consists. But, with this method it is difficult to find out torsion equations in some cases.

As mentioned, the controllability property is related to torsion submodules $\mathcal{T}(\Sigma)$. Because torsion modules $\mathcal{T}(\Sigma)$ are submodules of system modules Σ , it is not necessary to give all differential equations of systems elements. Through the bond graph tool, torsion modules can be derived from dynamical elements with an integral causality in BGD models. It means that torsion modules are included in modules M_{ei} defined by differential equations of these dynamical elements. For determining the controllability property of LTV bond graph models, one method

2.2 Structural Properties of Linear Systems

is to use the Jacobson form of definition matrices of these modules. Another method is to examine the existence of torsion equations in differential equations of dynamical elements with an integral causality in BGD models. Therefore, some differential equations can be written between state variables as for the LTI case from the bond graph model. If these equations define a torsion module, then the model is not controllable; otherwise it is controllable.

Let Σ be a linear system (module) and suppose that each dynamical element has an integral causality and there is a causal path between the set of input variables and each dynamical element in the BGI model of the system. The procedure for detecting the controllability property of Σ is given in Procedure 2.21. This procedure is also shown in Figure 2.8.

Procedure 2.21 *From the point of view of module theory, the controllability property can be derived from the input decoupling zeros of the module $\mathcal{T}(\Sigma)$. The input decoupling zeros are derived by using the following procedure.*

1. Draw the BGD model of module Σ .
2. Write the equations of the dynamical elements with an integral causality in the BGD model. These equations define a module M_{ei} , the definition equations of this module is: $P_{ei}x_{ei} = 0$.
3. The input decoupling zeros can be derived in parallel from the following methods:
 - Calculate the Jacobson form of matrix P_{ei} , then the conjugacy classes of the elements of a full set of Smith zeros of the invariant polynomials of this form are the input decoupling zeros.
 - Find out the torsion equations in $P_{ei}x_{ei} = 0$ which define the torsion module $\mathcal{T}(M_{ei})$. Then the conjugacy classes of the elements of a full set of Smith zeros of the definition polynomials of torsion module $\mathcal{T}(M_{ei})$ are the input decoupling zeros.

Example 2.22 *(continued) If $m = m(t)$, relation $\dot{x}_{L_1} - m(t)\dot{x}_{L_2} = 0$ between elements L_1 and L_2 is not associated to a torsion element. Thus, this model is controllable. This result is in accordance with the one from the bond graph approach.*

2. BOND GRAPH METHODOLOGY

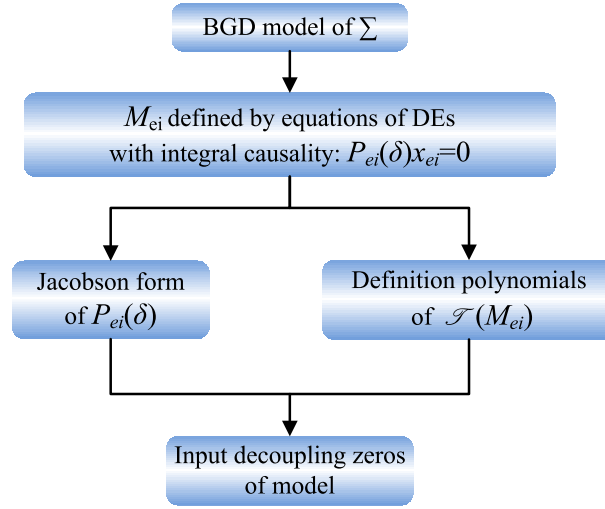

Figure 2.8: Procedure for detecting input decoupling zeros of a module modeled by bond graph models

2.2.3 Observability

Clearly, for a control system, its state variables $x(t)$ at a current time must be known. However, in general, not all state variables can be measured. Therefore, it is necessary to calculate the system state variables from the output variable measurements for a limited time period and the information of the input variables. This leads to the notion of *observability*. Just like the controllability property, there exist some differences for detecting the observability property of LTI systems and of LTV systems. Firstly, the rank conditions of observability of LTI and LTV systems are introduced separately. Then bond graph procedures for detecting the observability of two cases are recalled. Lastly, the module theoretic approach will be introduced for this structural property. Although the mathematical interpretation is clear by this approach, it is very difficult to find out the submodule $\Sigma/[u, y]_{\mathbf{R}}$ related to unobservable part of systems. In the next section, dual bond graph models will be used to get the controllability property of the dual bond graph models, which is equivalent to the observability property of initial bond graph models.

2.2.3.1 Rank Condition of Observability

Like the procedure for analyzing the controllability property, the observability one is firstly based on the rank criteria of the *observability matrix*. The observability

2.2 Structural Properties of Linear Systems

matrix \mathcal{O} is defined as (2.13) in the case of LTI systems.

$$\mathcal{O} = [C^T \ A^T C^T \ \dots \ A^{(n-1)T} C^T]^T \quad (2.13)$$

The observability matrix of LTV systems is defined in Definition 2.23, a particular attention is devoted to transposition.

Definition 2.23 *Silverman & Meadows (1967)* The controllability matrix of LTV systems is defined in (2.14). LTV systems are observable iff $\text{rank}(\mathcal{O}(\delta, t)) = n$.

$$\mathcal{O}(\delta, t) = \begin{bmatrix} C^T(t) & (A^T(t) + I\delta)C^T(t) & \dots & (A^T(t) + I\delta)^{n-1}C^T(t) \end{bmatrix} \quad (2.14)$$

Example 2.24 (continued from Example 1.21) Now rank condition of the observability matrix is used to study the observability property of the system in Example 1.21.

LTI and LTV cases are discussed separately, different results are shown between the two cases.

The LTI Case

Based on (2.13), the observability matrix of the LTI system is given in (2.15).

$$\mathcal{O}(\delta) = \begin{bmatrix} 0 & \frac{1}{C_2} & 0 \\ \frac{1}{C_2 L_1} & 0 & -\frac{1}{C_2 L_3} \\ 0 & -\frac{1}{C_2} \left(\frac{1}{C_2 L_1} + \frac{1}{C_2 L_3} \right) & 0 \end{bmatrix} \quad (2.15)$$

In (2.15), the first and the third columns are dependent. The rank of the observability matrix of the LTI system $\text{rank}(\mathcal{O}(\delta)) = 2 < 3$ means that the system is unobservable.

The LTV Case

According to Definition 2.23, the observability matrix of the LTV system is given in (2.16).

$$\mathcal{O}(\delta, t) = \begin{bmatrix} 0 & \frac{1}{C_2(t)} & 0 \\ \frac{1}{C_2(t)L_1(t)} & \frac{1}{C_2(t)}\delta & -\frac{1}{C_2(t)L_3(t)} \\ \frac{2}{C_2(t)L_1(t)}\delta + \frac{1}{C_2(t)}\left(\frac{1}{L_1(t)}\right)' & -\frac{1}{C_2^2(t)L_1(t)} + \frac{1}{C_2(t)}\delta^2 & -\frac{2}{C_2(t)L_3(t)}\delta - \frac{1}{C_2(t)}\left(\frac{1}{L_3(t)}\right)' \end{bmatrix} \quad (2.16)$$

2. BOND GRAPH METHODOLOGY

The observability property of the LTV system depends on the relation between parameters $L_1(t)$ and $L_3(t)$. In the first case, if $\left(\frac{L_1(t)}{L_3(t)}\right)' = 0$ i.e., $L_1(t) = cL_3(t)$, $c \in \mathbb{C}$, the first column is shown in (2.17) after substituting $L_1(t)$ by $L_3(t)$.

$$\left[0 \quad \frac{1}{cC_2(t)L_3(t)} \quad \frac{2}{cC_2(t)L_3(t)}\delta + \frac{1}{cC_2(t)}\left(\frac{1}{L_3(t)}\right)' \right]^T \quad (2.17)$$

From equation (2.17), the first and third columns of the matrix in (2.16) are dependent. According to Definition 2.23, the LTV system is unobservable with $L_1(t) = cL_3(t)$, $c \in \mathbb{C}$. In the second case, the dependent relation between the first and third columns does not exist any more. In this case, the LTV system becomes observable.

2.2.3.2 Bond Graph Procedure

Definition 2.25 *Sueur & Dauphin-Tanguy (1991)*

o is the number of dynamical elements which retain the integral causality after the following transformations:

- *the preferred derivative causality is imposed on the bond graph model*
- *all the necessary dualisation of the output detectors have been made to eliminate the integral causality assignment associated to the dynamical elements, without introducing unsolvable causal loops.*

Property 2.26 *Sueur & Dauphin-Tanguy (1991)*

The bond graph rank of matrix $[C^T A^T]^T$ denoted by $bg_rk[C^T A^T]^T$ verifies the following relation:

$$bg_rk[C^T A^T]^T = n - o \quad (2.18)$$

The observability of a bond graph model can be determined by Theorem 2.27.

Theorem 2.27 *Sueur & Dauphin-Tanguy (1991)*

A bond graph model is structurally observable iff:

- *reachability condition (necessary condition): for each dynamical element in integral causality, there exists a causal path from a detector to the dynamical elements*

2.2 Structural Properties of Linear Systems

- rank condition: $bg_rk[C^T A^T]^T = n$

Similar to CBG introduced in Section 2.2.2.2, the notion of the Observability Bond Graph (OBG) for the observability analysis of LTV models is recalled here.

Definition 2.28 *An OBG is a bond graph, with some new differential loops with the gain $\frac{d}{dt}$ defined with the following procedure. The dissipative elements are added which are similar to the ones designed for CBG, but with a negative gain (Figure 2.9).*

- Procedure 2.29**
1. For each dynamical element with an integral causality in a BGI models, determine all the causal paths with lengths smaller than $n-1$, which start from an output detector and end in that element.
 2. For each of the causal paths determined in the above step:
 - Check the first element with a time-varying gain along the causal path.
 - For each of the dynamical element following this time-varying element, add a differential loop with the gain $\frac{d}{dt}$ (maximum one $\frac{d}{dt}$ for each dynamical element).

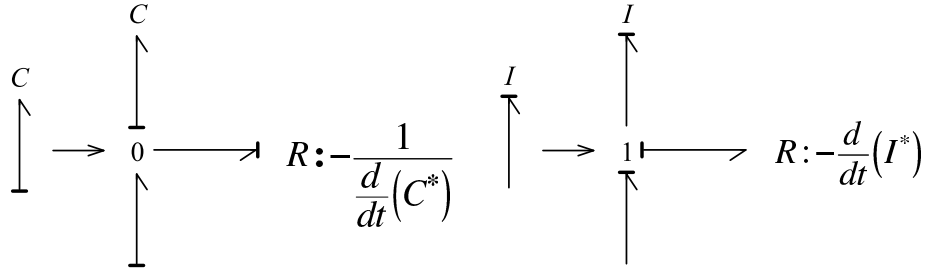

Figure 2.9: Differential loop transformations for OBG

Property 2.30 *From the OBG model, an LTV system is observable iff the two following conditions are satisfied:*

- There is a causal path between each dynamical element and one of the output detectors.
- Each dynamical element can have a derivative causality assignment in the OBG model with a derivative causality assignment (with a possible duality of output detectors).

2. BOND GRAPH METHODOLOGY

Module Theoretic Approach for LTV Bond Graph Models

The observability property of an LTV system in (2.12) is related to the quotient module $\Sigma/[u, y]_{\mathbf{R}}$ which is a torsion module. The equation of module $\Sigma/[u, y]_{\mathbf{R}}$ can be represented in (2.19),

$$\begin{bmatrix} I\delta - A(t) \\ C(t) \end{bmatrix} \bar{x} = 0 \quad (2.19)$$

where \bar{x} is the image of x in $\Sigma/[u, y]_{\mathbf{R}}$.

Property 2.31 *Fliess (1990)* A linear system is said to be observable iff the two modules Σ and $[u, y]_{\mathbf{R}}$ coincide, i.e. $\Sigma = [u, y]_{\mathbf{R}}$. It means that every element of Σ can be expressed as an \mathbf{R} -linear combination of the elements $u_i, i = 1, \dots, m$ and $y_j, j = 1, \dots, p$.

If $[u, y]_{\mathbf{R}}$ is strictly included in Σ , the system Σ is said to be *unobservable* with respect to the output $y(t)$. Observability is equivalent to stating that any element in Σ can be expressed as a \mathbf{K} -linear combination of the components of u, y and of a finite number of derivatives of them.

There exist two methods to get the observability property of LTV systems by means of the module theoretic approach. One is to use the Jacobson form of matrix $\begin{bmatrix} I\delta - A(t) \\ C(t) \end{bmatrix}$ in (2.19) to detect the output decoupling zeros of systems. Another one is to find out torsion equations in (2.12). These equations are related to unobservable parts in systems. But torsion equation in (2.12) are difficult to find out in a number of cases.

For analysis of observability property of LTV models, one solution is to use the OBG models based on the rank condition of observability matrices $\mathcal{O}(\delta, t)$. Another solution is based upon module theoretical approach. Uncontrollable parts of linear systems are related to dynamical elements with an integral causality of BGD models, which define torsion module. It means that torsion modules can be derived from equations of these dynamical elements. Even so, quotient modules $\Sigma = [u, y]_{\mathbf{R}}$ associated to unobservable parts are difficult to be derived from bond graph models. Because of the duality between controllability and observability properties, one solution is to examine controllability properties of dual bond graph models by module theoretic rules. Then observability properties

of initial bond graph models are identical with controllability properties of their dual bond graph models. In the next section, dual bond graph models of LTV bond graph models will be introduced. Some examples related to examinations of observability properties of LTV bond graph models will be given.

2.2.4 Dual Bond Graph Model

The concept of duality between the controllability and observability is well-known to the control system community. Rudolph (1996) has discussed the duality property for LTV systems from the point of view of module theory. A system is defined as a left module. The dual system is introduced by considering a corresponding right module. The module theoretic definitions are intrinsic. It means that they are valid not only for LTV systems but also for LTI systems. Now, this concept is recalled, firstly.

The duality associates to a control system another control system, the input of the former corresponds to the output of the latter and *vice-versa*. The dual system of a linear system (2.4) is defined via (2.20):

$$\begin{cases} \dot{\bar{x}} = -A^T(t)\bar{x} + C^T(t)\bar{u} \\ \bar{y} = -B^T(t)\bar{x} \end{cases} \quad (2.20)$$

Property 2.32 *Fliess (1990)* A linear system is observable (resp., controllable) iff its dual system is controllable (resp., observable).

Lichiardopol & Sueur (2010) have studied the duality between the controllability and observability by means of a bond graph approach. One can get the observability properties from the controllability properties of the dual system and vice versa.

Procedure 2.33 *The dual bond graph model of a bond graph model can be derived by:*

1. Substitute the sources by the detectors with a negative value, i.e. $\bar{y} = -y$;
2. Substitute the detectors by the sources;
3. Give a negative value to each R element, i.e. $R:(-R)$;

If there are time-varying dynamical elements, then

2. BOND GRAPH METHODOLOGY

4. Add a dissipative element with the gain $R : -\frac{1}{\frac{dC(t)}{dt}}$ for each $C(t)$ -element shown in Figure 2.10;
5. Add a dissipative element with the gain $R : -\frac{dI(t)}{dt}$ for each $I(t)$ -element shown in Figure 2.10.

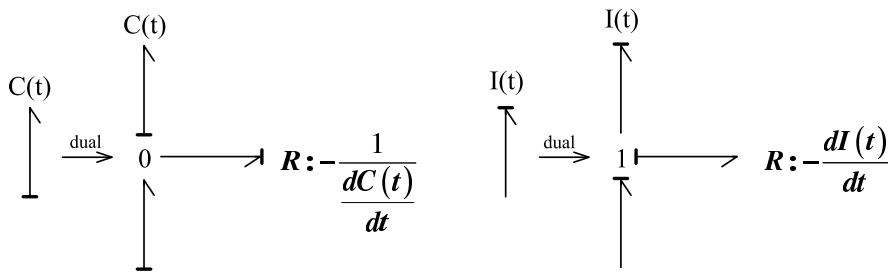

Figure 2.10: Dual elements of time-varying dynamical elements

Example 2.34 (continued) The dual bond graph model of system in Figure 2.3 with time-varying element $m(t)$ is shown in Figure 2.11 (if the current of L_2 is selected as the output for the initial system).

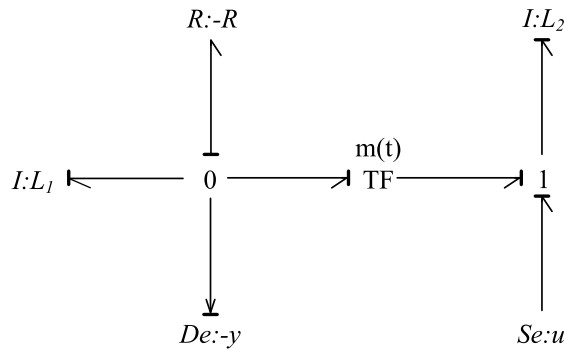

Figure 2.11: Dual bond graph model of the system

As mentioned, the observability property of a system is equivalent to the controllability property of its dual system. Now the method introduced in Procedure 2.33 is used to get the dual bond graph model of the LTI and LTV systems.

Example 2.35 The BGB model of the system in Example 1.21 is used to study the observability property of the system. The BGI model of the system is drawn in Figure 2.12. The LTI and LTV cases of the model are discussed; the differences between these two cases will be pointed out.

2.2 Structural Properties of Linear Systems

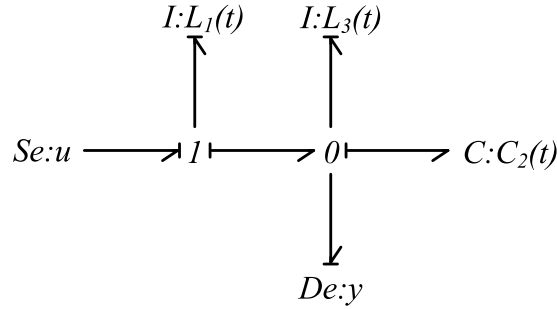

Figure 2.12: BGI model of the system in Figure 1.1

The LTI Case

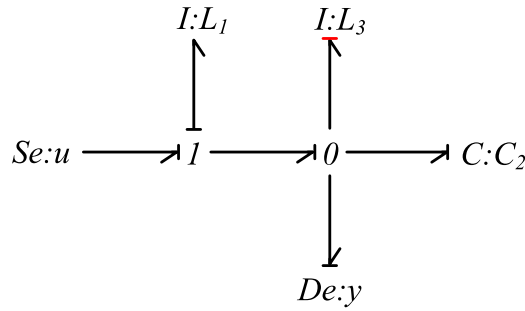

Figure 2.13: BGD model of the LTI system in Figure 1.1

Firstly, the classical method for studying the observability property with the BGD model is used. The BGD model of the LTI system is shown in Figure 2.13.

There exists a dynamical element L_3 with an integral causality. According to Theorem 2.27, the LTI system is unobservable.

Now the dual bond graph model is used to study the controllability property of the dual model. The dual bond graph model of the LTI system is drawn in Figure 2.14.

The BGD of the dual model is given in Figure 2.15. There exists a dynamical element L_3 with an integral causality. The mathematical equation between elements L_1 and L_3 is written as $\dot{x}_1 = \dot{x}_3$. This equation can be rewritten as $\delta(x_1 - x_3) = 0$ which corresponds to the torsion submodule. So the dual model of the LTI system is uncontrollable, which means that the LTI system is unobservable.

2. BOND GRAPH METHODOLOGY

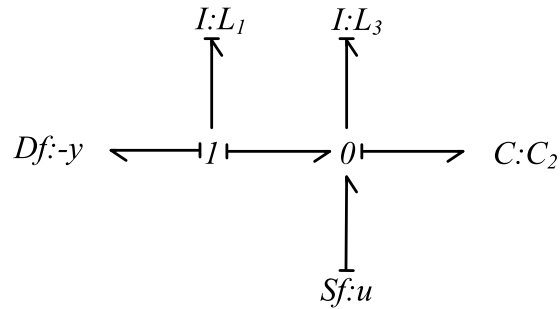

Figure 2.14: BGI dual model of the LTI system in Figure 1.1

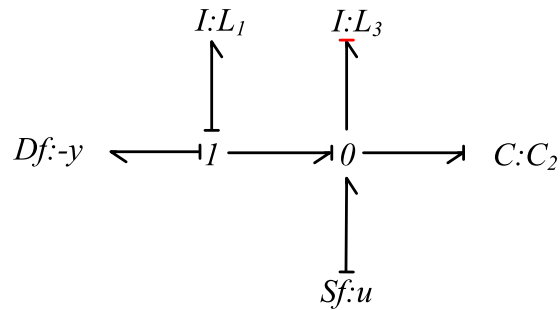

Figure 2.15: BGD dual model of the LTI system in Figure 1.1

The LTV Case

According to Procedure 2.33, the dual bond graph model of the LTV system is given in Figure 2.16.

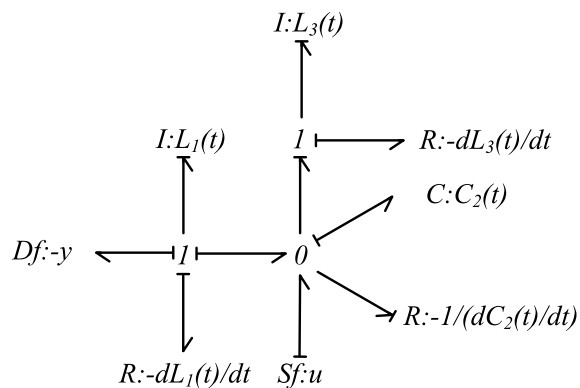

Figure 2.16: BGI dual model of the LTV system in Figure 1.1

Now the BGD dual model is used to detect the controllability property of the dual system. The BGD dual model is drawn in Figure 2.17.

2.2 Structural Properties of Linear Systems

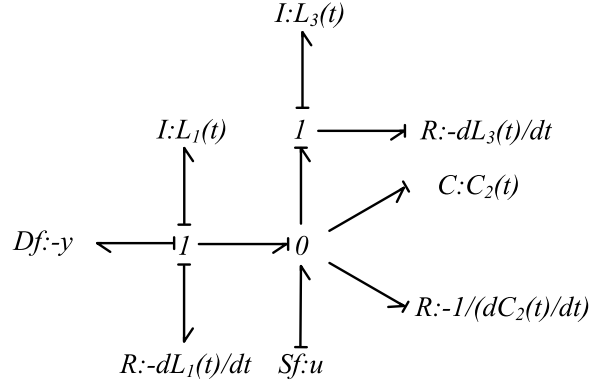

Figure 2.17: BGD dual model of the LTV system in Figure 1.1

In Figure 2.17, all dynamical elements have a derivative causality. Therefore, the dual model is structurally controllable and the LTV model is structurally observable.

From algebraic calculations, the particular case when a relation can be written between parameters $L_1(t)$ and $L_3(t)$ is retrieved. From Figure 2.17, the mathematical equation of element $L_3(t)$ is written in (2.21).

$$\dot{x}_1 - \frac{x_1}{L_1(t)} \frac{dL_1(t)}{dt} = -\dot{x}_3 + \frac{x_3}{L_3(t)} \frac{dL_3(t)}{dt} \quad (2.21)$$

If $L_1(t) = cL_3(t)$, $c \in \mathbb{C}$, equation (2.22) can be derived after substituting $L_1(t)$ by $L_3(t)$ in equation (2.21). Equation (2.21) is related to a torsion submodule. So the dual model is not controllable, which means the LTV system with $L_1(t) = cL_3(t)$, $c \in \mathbb{C}$ is unobservable. Otherwise, equation (2.21) is no more related to a torsion module, and the LTV system is observable.

$$\begin{cases} \dot{x}_1 - \frac{x_1}{L_3(t)} \frac{dL_3(t)}{dt} = -\dot{x}_3 + \frac{x_3}{L_3(t)} \frac{dL_3(t)}{dt} \\ \left(\delta - \frac{1}{L_3(t)} \frac{dL_3(t)}{dt} \right) (x_1 + x_3) = 0 \end{cases} \quad (2.22)$$

Remark 2.36 In Example 1.21, the observability properties of the LTI and LTV systems are studied by the existence of output decoupling zeros. These zeros can be derived by the Smith/Jacobson form of the matrix $[D^T(\delta, t) \quad Q^T(\delta, t)]$. By this method, the LTI system has been proven to be always unobservable. Nevertheless, in the LTV case, the observability of the system depends on the relation between parameters $L_1(t)$ and $L_3(t)$.

2. BOND GRAPH METHODOLOGY

In previous examples, the rank condition of the observability matrix, the bond graph and algebraic approaches are used to get the same results as in Example 1.21. Especially with the bond graph approach, the dual model was used to detect the controllability property of the dual system. The main idea for examining observability property of LTI and LTV systems is to determine if there exist torsion equations in dual bond graph models of systems. If dual models are not controllable with torsion equations, then initial models are not observable.

For LTI bond graph models, noncontrollable parts are related to dynamical elements with an integral causality in BGD models and numerical controllable is equivalent to structural controllability. In Figure 2.17, there is no element with an integral causality, but the model is not controllable when relation $L_1(t) = cL_3(t), c \in \mathbb{C}$ is verified. This result is different from the classical approach introduced in Theorem 2.10 for studying the controllability property from a numerical point of view. According to Property 2.19, this model is structurally controllable. Even so, from equation (2.22), this model is uncontrollable with relation $L_1(t) = cL_3(t), c \in \mathbb{C}$. So controllability and observability property of LTV systems are not very easy to be studied. The combined method with bond graph and algebraic approaches can be one of the solutions.

In this section, some structural properties of LTI and LTV models were recalled, such as: controllability and observability. In terms of these properties, there are some differences between LTI and LTV systems. Through a number of examples, these differences were shown. The controllability and observability matrices for each case were introduced. The CBG and OBG models with differential loops for LTV models were used to determine the structural properties by bond graph approach. As an intrinsic tool, the module theoretical approach is useful for verifying systems's properties. Therefore, the torsion submodules are not always easy to detect. Due to the notion of duality, the observability structure can be derived from the controllability property of the dual bond graph model. In the next section, infinite and finite structures of bond graph models will be recalled. Infinite zero orders related to lengths of input-output causal paths are used to determine the finite structure. The bond graph models with bicausality which are fundamental in the sequel to detect invariant zeros are introduced.

2.3 Infinite and Finite Structures

Bertrand *et al.* (1997) proposed that there exists a correspondence between the infinite structure of the bond graph model with a derivative causality assignment and the finite structure of the bond graph model with an integral causality assignment. Rahmani *et al.* (1996) combined the utilization of the infinite structure and the input-output causal paths concept to directly determine the solvability of the feedback decoupling and disturbance rejection problem for LTI systems. Andaloussi *et al.* (2006) studied the infinite structure of LTV by means of graphical methods. Chalh (2007) dealt with the characterization of invariant zeros of LTV systems using the bond graph methodology. This method is extended in terms of bicausality of bond graph models to get equations of modules of invariant zeros and the detail will be given in next chapter. Now the bond graph procedures which have been interpreted in the above-mentioned literatures are recalled.

2.3.1 Infinite Structure

For BGI models, the concept of infinite zero orders is related to the number of derivations of corresponding output variable(s) to make appear explicitly at least one of the entries. In the LTI case, if the system is represented by a state space equation, n_i is the i^{th} row infinite zero orders, associated with the i^{th} output variable y_i , it is the smallest integer such that (2.23) is verified. In that case,

$$y_i = c_i x \text{ and } y_i^{(n_i)} = c_i A^{n_i} x + c_i A^{(n_i-1)} B u \quad (2.23)$$

For an LTI bond graph model, the infinite structure can be determined graphically.

Property 2.37 *The row infinite zero order n_i of the subsystem $\Sigma(c_i, A, B)$ modeled by bond graph is equal to the length of the shortest input-output causal path between the output y_i and the set of source variables.*

The column infinite zero orders, similarly to the row one, is defined by the following property. The column infinite zero orders are equal to the number of integrations of the input variable u_j necessary for at least one output variable to appear explicitly.

2. BOND GRAPH METHODOLOGY

Property 2.38 *The column infinite zero orders n^j of the subsystem $\Sigma(C, A, B^j)$ modeled by bond graph is equal to the length of the shortest input-output causal path between the input source u_j and the set of output detectors.*

For the global system $\Sigma(C, A, B)$, the notion of disjoint input-output causal paths is significant.

Definition 2.39 *Two causal paths are called disjoint (or different) if there is no dynamical element in common in the two paths.*

Property 2.40 *The number of global infinite zeros of the system $\Sigma(C, A, B)$ is equal to the number of different input-output causal paths. The global infinite zero orders n'_i are given in equation (2.24) with possible change of the subscript of the output variable,*

$$\begin{cases} n'_1 = L_1 \\ n'_k = L_k - L_{k-1} \end{cases} \quad (2.24)$$

where L_k is the smallest sum of k disjoint input-output causal path lengths.

The BGD models are used to characterize the invariant zeros which are equal to zero. It is supposed that the state matrix A is invertible. The state representation of BGD models of LTI systems is in (2.25):

$$\begin{cases} \dot{x}(t) = A^{-1}\dot{x}(t) - A^{-1}Bu(t) \\ y(t) = CA^{-1}\dot{x}(t) - CA^{-1}Bu(t) \end{cases} \quad (2.25)$$

Analogously, several notions for BGD models are defined such as: the input-output causal paths and the infinite zero orders n_{id} .

If there exists dynamical elements in integral causality, the notion of *generalized causal path length* is defined: it is the number of the dynamical elements in derivative causality minus the number of the dynamical elements in integral causality.

Property 2.41 *The row infinite zero order n_{id} associated to the output variable y_i is equal to the length of the shortest causal path between y_i and the set of input variables in the BGD model.*

Property 2.42 *The global infinite zero orders $\{n'_{id}\}$ are determined by equations:*

$$\begin{cases} n'_{1d} = L_{1d} \\ n'_{kd} = L_{kd} - L_{(k-1)d} \end{cases} \quad (2.26)$$

where L_{kd} is equal to the smallest sum of k causal path lengths between k output detectors and k input sources in the BGD model.

Property 2.43 *The row zero orders at infinity of a BGD model are equal to the minimum number of the integration of the output variable to get the input variables appear explicitly and independently in the equations.*

The row infinite structure and the global infinite structure in the BGD model are denoted by two sets $\{n_{id}\}$ and $\{n'_{id}\}$. By the structural method, one can get the row infinite zero order n_{id} for the row sub-system $\Sigma(c_i, A, B)$ associated to output y_i , such as:

$$\sigma^{n_{id}} y_i = CA^{-n_{id}-1} \dot{x} - CA^{-n_{id}-1} Bu$$

where σ is the integral operator and $CA^{-n_{id}-1}B \neq 0, CA^{-k_{id}-1}B = 0, k < n_{id}$.

In case of the study of the infinite structure, there is no difference between procedures for LTI and LTV bond graph models. Hence, some extensions for LTV models should be considered. From the point view of the graphical method, infinite zero orders are determined by lengths of input-output causal paths. This structure depends on the structure of systems; it means that only non-zero terms in systems's matrices are related to infinite zero orders.

2.3.2 Invertibility and BGB Models

In this section, the invertibility criteria of a bond graph model is firstly introduced. For an LTV system, some conclusions obtained in the case of LTI systems are not valid due to the non commutative properties. The combination of algebraic and bond graph approaches is a solution for this problem. For bond graph models, the concept of bicausality is recalled, in order to get the inverse bond graph model. In the end, an example will be illustrated by pointing out the system equations of the inverse model.

2. BOND GRAPH METHODOLOGY

The invertibility property of the bond graph model is deduced from the bond graph model in integral causality, with the notion of disjoint input-output causal paths. In the LTI case, [Rahmani \(1993\)](#) proposed the necessary and sufficient condition for invertibility of square bond graph model.

Theorem 2.44 *Let Σ be a square system with $u \in \mathbb{R}^p$ and $y \in \mathbb{R}^p$. If there exist a unique choice of disjoint input-output causal paths, then the bond graph model is invertible.*

When there are several sets of disjoint input-output causal paths, the invertibility depends on the determinant of the system matrix $P(\delta)$.

Property 2.45 *Let $G(\delta)$ be the transfer matrix of the system $\Sigma(C, A, B)$. The system matrix $P(\delta)$ and the transfer matrix $G(\delta)$ associated to the system $\Sigma(C, A, B)$ satisfy equation (2.27).*

$$\det[P(\delta)] = \det[I\delta - A] \cdot \det[G(\delta)] \quad (2.27)$$

In order to ensure the invertibility of the transfer matrix $G(\delta)$, the determinant of the system matrix $P(\delta)$ should not be null.

Let Σ be an LTV system, its inverse system is obtained by the successive derivation of the output variable y until the input variable u appears explicitly. The expression of the n_i order derivation of y_i is represented by (2.28), where $n_i, i = 1, \dots, p$ is the i^{th} row infinite zero orders associated with the output variable y_i .

$$\delta^{n_i} y_i = [(A^T(t) + I\delta)^{n_i} c_i^T(t)]^T x + c_i(t) (A(t) - I\delta)^{n_i-1} B(t) u \quad (2.28)$$

For the output vector, one has:

$$\begin{bmatrix} \delta^{n_1} y_1 \\ \vdots \\ \delta^{n_i} y_i \\ \vdots \\ \delta^{n_p} y_p \end{bmatrix} = y^* = H(\delta, t) x + D(\delta, t) u$$

2.3 Infinite and Finite Structures

where $D(\delta, t) = \{D_i(\delta, t) = c_i(t)(A(t) - I\delta)^{n_i-1}B(t), i = 1, \dots, p\}$ and $H(\delta, t) = \{H_i(\delta, t) = [(A^T(t) + I\delta)^{n_i}c_i^T(t)]^T, i = 1, \dots, p\}$.

If the matrix $D(\delta, t)$ is invertible (system is decouplable), then the inverse system can be represented by equation (2.29).

$$\begin{cases} \delta x = (A - BD^{-1}H)x + BD^{-1}y^* \\ u = D^{-1}Hx + D^{-1}y^* \end{cases} \quad (2.29)$$

Theorem 2.46 *Andaloussi (2007)*

A square LTV system with p input variables and p output variables modeled by a bond graph model has the following properties:

- The system is structurally non-invertible if there is no set of p -disjoint input-output causal paths disjoint.
- The system is structurally invertible if there exists a unique set of p disjoint input-output causal paths.
- In the case of the existence of several sets of p -disjoint input-output causal paths, the determinant of Dieudonné of the system matrix is required, which is a difficulty.

When dealing with several control problems such as: system inversion, state estimation, parameter estimation and fault detection, the concept of *bicausality* proposed by Gawthrop (1997) can be used.

Figure 2.18 explains the principle of bicausal bonds. Comparing with the standard ones, one can get their mathematical relations.

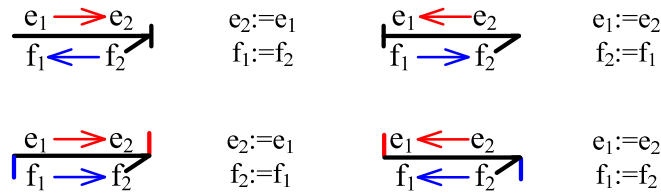

Figure 2.18: The principle of bicausal bonds

A new type of bond graph element - *source sensor* (SS) is shown in Table 2.2.

Gawthrop proposed that bicausality can be propagated through junctions, Figure 2.19 (i) shows a typical situation. The R element is supposed to be

2. BOND GRAPH METHODOLOGY

Table 2.2: Causal patterns for the source-sensor element SS

Causal pattern	Physical nature of SS element	actuator/detector
SS $\begin{array}{c} \longrightarrow \\ \nearrow \end{array}$	Effort source, flow sensor	Se element
SS $\begin{array}{c} \longleftarrow \\ \nearrow \end{array}$	Flow source, effort sensor	Sf element
SS $\begin{array}{c} \longleftarrow \\ \xrightarrow{f=0} \end{array}$	Zero flow source, effort sensor	De element: effort detector
SS $\begin{array}{c} \longleftarrow \\ \xrightarrow{e=0} \end{array}$	Zero effort source, flow sensor	Df element: flow detector
SS $\begin{array}{c} \longleftarrow \\ \nearrow \\ \color{red}\uparrow \end{array}$	Flow source, effort source	SeSf element
SS $\begin{array}{c} \longleftarrow \\ \nearrow \\ \color{red}\downarrow \end{array}$	Flow sensor, effort sensor	DeDf element

known. Flow f_1 impinges on the bond which forces causality of R . Effort e_2 can be represented by the combination of e_1 and of e_3 . Figure 2.19 (ii) shows a flow-carrying active bond interpreted as the ideal two-port unit gain flow amplifier which is a TF component. This component is described by the equations: $e_2 := \frac{1}{m}e_1, f_2 := mf_1$.

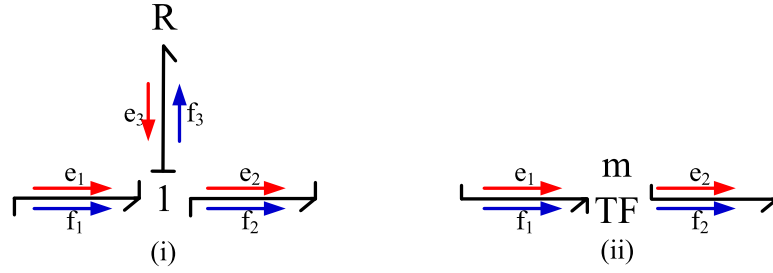

Figure 2.19: A bicausal junction

Example 2.47 Now an example is given to illustrate the procedure to get the inverse system by means of the notion of bicausality. Figure 2.20 shows a 3-order bond graph model in preferential integral causality (BGI). The disjoint input-output causal paths are: $u_1 \rightarrow I \rightarrow y_1$ and $u_2 \rightarrow C_2 \rightarrow y_2$. According to Theorem 2.46, the bond graph model is invertible.

To construct the inverse model, the bond graph model in bicausal assignment is defined in Figure 2.21. The assignment of bicausality to the bonds connected with input/output variables impinges on the bonds forcing a derivative causality on the I and C_2 elements. The state vector is $x = (x_1, x_2, x_3)^T = (p_I, q_{C_1}, q_{C_2})^T$.

The inverse model is directly obtained from the BGB model:

$$\begin{cases} u_1 = I\dot{y}_1 + \frac{1}{C_1}x_2 \\ u_2 = C_2\dot{y}_2 - \frac{x_2}{C_1R} + \frac{y_2}{R} \end{cases}$$

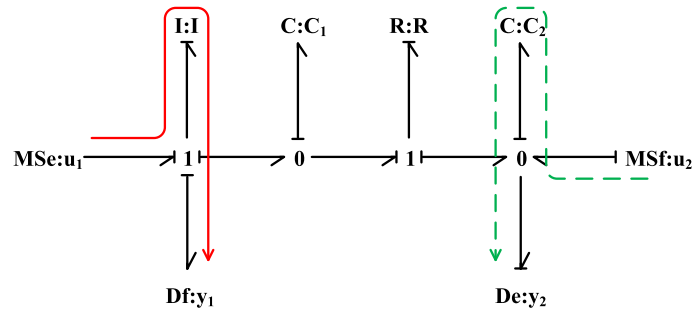

Figure 2.20: Bond graph model in integral causality (BGI)

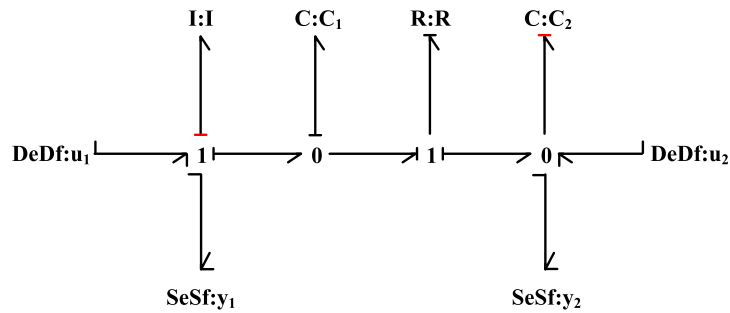

Figure 2.21: Bicausal bond graph model (BGB)

2.3.3 Finite Structure

Finite structure of linear systems was introduced in Section 1.2.2. Here the bond graph procedure for detecting invariant zeros is recalled. In line with the graphical approach, the infinite structure introduced above is fundamental to examine the numbers of invariant zeros and of null invariant zeros of square models without complex calculations. For the values of invariant zeros, the Jacobson form of system matrices or definition polynomials of torsion modules are useful. The invariant zeros structures of kinds of linear bond graph models are the principal issues of the next chapter.

For an LTI system, the invariant zeros are the system poles of the inverse system, and the set of system poles consists of the set of input decoupling zeros and the set of controllable poles. For a controllable and observable model, the invariant zeros are the non controllable poles of the model with output variables set to a zero value. The controllability property has been discussed in Section 2.2.2, now some properties of invariant zeros in the LTI case are recalled. The finite structure of LTV systems will be discussed in the next chapter.

2. BOND GRAPH METHODOLOGY

The algebraic approach for detecting invariant zeros structure is recalled. Let Σ be a linear system, the module of invariant zeros is the torsion module $\mathcal{T}(\Sigma/[y]_{\mathbf{R}})$. The invariant zeros are the Smith zeros of $\mathcal{T}(\Sigma/[y]_{\mathbf{R}})$.

Definition 2.48 *The invariant zeros of LTI/LTV systems Σ can be defined by the three following steps:*

- Give equations of module $\Sigma/[y]_{\mathbf{R}}$.
- Calculate equations of torsion module $\mathcal{T}(\Sigma/[y]_{\mathbf{R}})$.
- Factorize definition polynomial of torsion module $\mathcal{T}(\Sigma/[y]_{\mathbf{R}})$.

Although the algebraic interpretation is intrinsic, sometimes the torsion modules are difficult to find out. [Sueur & Dauphin-Tanguy \(1991\)](#), [Bertrand et al. \(1997\)](#) proposed the bond graph procedure which is intuitive and efficient for square LTI models is introduced.

Property 2.49 *[Sueur & Dauphin-Tanguy \(1991\)](#) Suppose an invertible, controllable and observable linear square model. The number of invariant zeros is*

$$n - \sum n'_i \quad (2.30)$$

where n is the order of the model and $\{n'_i\}$ is the set of global infinite zero orders.

Property 2.50 *The row infinite zero order n_{id} is equal to the number of null invariant zeros of the subsystem $\Sigma(c_i, A, B)$ in the BGD LTI model. $\sum n'_{id}$ is equal to the number of null invariant zeros of the global system $\Sigma(C, A, B)$ in BGD LTI model.*

After obtaining the numbers of invariant zeros, the BGB model is used to characterize invariant zeros with algebraic relations between variables associated to the torsion module in Definition 2.48. Therefore for an LTI system, there are three steps for determining the finite structure of the system:

- Determine the number of invariant zeros according to the infinite structure of the BGI model.
- Determine the number of null invariant zeros by using the infinite structure of the BGD model.

2.3 Infinite and Finite Structures

- Determine the values of invariant zeros, which are not equal to zero based on the torsion module in the BGB model.

The invariant zeros of linear square models can be derived from different kinds of bond graph models, which is shown in Table 2.3, where *IZ* denotes invariant zero and *IS* denotes infinite structure.

	IZ number	null IZ number	Non-null IZ value(s)
BG models	IS of BGI	IS of BGD	elements in integral causality of BGB
Calculate formula	$n - \Sigma n'_i$	$\Sigma n'_{id}$	Smith zeros of torsion module

Now Example 2.47 is used to illustrate the procedure for obtaining the finite structure of a bond graph model.

Example 2.51 *(continued)*

The global infinite zero orders of the bond graph model in Example 2.47 are $\{n'_i\} = \{1, 1\}$. In terms of equation (2.30), there exists $n - \Sigma n'_i = 3 - 2 = 1$ invariant zero.

Now the BGD model is used to obtain the number of the null invariant zero. Figure 2.22 shows the bond graph model in derivative causality. There exist two disjoint input-output causal paths such as: $y_1 \leftarrow u_2$ and $y_2 \leftarrow u_1$. Therefore, the set of global infinite zero orders of the BGD model is $\{n'_{id}\} = \{0, 0\}$. With Property 2.50, there is no null invariant zero in this system.

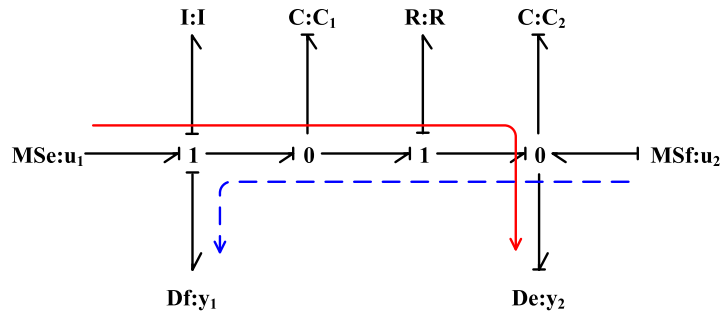

Figure 2.22: Bond graph model in derivative causality (BGD)

Figure 2.21 showed the BGB model of system. There exist one dynamical element C_1 in integral causality. Now, the causal path between C_1 and other

2. BOND GRAPH METHODOLOGY

components of the BGB model is used to get the equation of C_1 : $C_1 \rightarrow f_{C_1} : \dot{x}_2 = y_1 - f_R = -\frac{e_R}{R} = -\frac{e_{C_1} - y_2}{R} = -\frac{x_2}{C_1 R}$. Therefore, the equation corresponding to the torsion module is $(\delta + \frac{1}{C_1 R})x_2 = 0$, the invariant zero is equal to $-\frac{1}{C_1 R}$.

According to Property 2.49 and 2.50, the numbers of invariant zeros and of null invariant zeros can be detected. Therefore, the values of non-null invariant zeros are related to certain differential equations, which correspond to the module of invariant zeros. For linear square models, the bond graph models with bicausality which are inverse models of initial models are essential for getting the invariant zeros. The finite structure with bicausality will be widely studied in the next chapter. The module theoretical approach will highlight the invariant zeros structure for BGB models.

2.4 Conclusion

In this chapter, two graphical methods have been recalled to model linear systems such as: digraph and bond graph methods. From the graphical representation, one can find the system properties without calculating some complex mathematical relations.

Some structural properties have been studied for linear system by means of several approaches: formal, algebraic and graphical approaches. The controllability and observability of LTV systems have been redefined. Duality is a very important notion for studying these two notions. The difference between LTI and LTV systems have been pointed out by the combination of algebraic and bond graph methods.

Finally, the infinite and finite structure of linear systems modeled by bond graph have been introduced. The procedure for determining the infinite zero orders by bond graph model has been recalled. The determination procedure of invariant zeros of LTI bond graph models was introduced. Some criteria are no more valid for LTV systems; the next chapter will extend them in accord with LTV systems.

Chapter 3

Invariant Zeros of Bond Graph Models

Contents

3.1	Finite Structure of Linear Models	108
3.1.1	Invariant Zeros	109
3.1.2	Several Approaches for the Study of Invariant Zeros	110
3.1.3	Output-Zeroing Problem and Invariant Zeros	115
3.2	Invariant Zeros of Linear Square Models	118
3.2.1	BGB Procedure for Invariant Zeros of Square Models	118
3.2.2	Invariant Zeros of SISO Models	121
3.2.3	Invariant Zeros of MIMO Models	137
3.2.4	Conclusion	159
3.3	Invariant Zeros of Linear Non-Square Models	160
3.3.1	BG Procedure for Invariant Zeros of Non-Square Models	160
3.3.2	Row Subsystems of Square MIMO Systems	161
3.3.3	Non-Square MIMO Models	169
3.4	Conclusion	183

The topic of this chapter is the study of invariant zeros of linear bond graph models by combining several approaches. Before entering into details, basic facts on invariant zeros are firstly introduced and some approaches dealing with this issue are recalled.

3. INVARIANT ZEROS OF BOND GRAPH MODELS

In the second section, invariant zeros structure of linear square bond graph models is studied by means of bicausality. Two kinds of bond graph models are discussed. Firstly, the null invariant zeros structure is introduced by a linear SISO circuit from which the difference between LTI and LTV cases is pointed out. For explaining this difference, the combined method derived from graphical and algebraic approaches is required. Then an extension for invariant zeros of bond graph models of linear MIMO square systems is explained. Differential equations associated to the torsion module are given in the second subsection.

The aim of the third section is to discuss the invariant zeros structure of bond graph models of linear non-square systems. In accordance with the former section, the invariant zeros of row submodels of linear MIMO square systems are studied. Then non-square systems's invariant zeros structure is presented in two cases. In the first case, the number of input sources is greater than the one of output detectors, and the opposite situation is discussed in the second part. According to the module theoretic approach, the notion of common factors of non controllable/observable parts will be used.

3.1 Finite Structure of Linear Models

Numerous papers have been written on the study of poles and zeros of LTI systems. Fundamental contributions are due to [Kalman *et al.* \(1969\)](#) with the state space representation and a good survey is proposed in [Schrader & Sain \(1989\)](#). In order to calculate finite zeros well defined algorithms exist, [Kailath \(1980\)](#), but systems equations are not always in a state space representation and the general description of a linear system is the Rosenbrock polynomial description [\(1.14\)](#), [Rosenbrock \(1970\)](#). The entries of these matrices are elements of a ring denoted, in different equivalent ways, as $\mathbf{R} = k[\frac{d}{dt}] = k[\delta] = k[s]$. Mappings are morphisms of \mathbf{R} -modules and the spaces associated with them are \mathbf{R} -modules (instead of morphisms of \mathbb{R} -vectors space). This approach can be viewed as an extension of the Wonham approach who showed that instead of using matrices, it is more suitable to use linear mappings [Wonham \(1985\)](#). A discussion on this subject is proposed in [Bourlès & Fliess \(1997\)](#), with a nice intrinsic approach for the study of poles and zeros of linear systems. Their module theoretic approach is also

closely related to the behavioral approach proposed by [Willems \(1983\)](#), [Willems \(1991\)](#).

3.1.1 Invariant Zeros

Invariant zeros are important for the stability analysis of the controlled systems for several well-known control problems such as the disturbance rejection problem, the input-output decoupling problem and some other problems such as the conception of full order or reduced order observers.

The problems have been tackled under various resolution techniques, which are often similar, even if formulations are different. Among these techniques, the structural approach, the algebraic approach and the geometric approach which are popular in control theory, are appeared to be very effective. Different steps are sometimes proposed. The first step is mainly at an analysis level (study of the internal structure) and the last step deals with synthesis methods.

The study of finite poles and zeros of linear systems extended to LTV systems based on algebraic theory of differential rings and modules is proposed in [Bourlès & Fliess \(1997\)](#), [Marinescu & Bourlès \(2009\)](#), [Bourlès & Marinescu \(2011\)](#). From the point view of algebraic approach, a linear system is a finitely generated module over a non commutative polynomial ring of differential operator δ . With regard to the finite structure of LTV models, in terms of module theory, zeros are the Smith zeros of the torsion submodule of a specific quotient module, but even if this quotient module has a simple interpretation, its mathematical characterization is not so simple. Indeed, in that situation, polynomials are defined over skew fields, and roots can be obtained by choosing a good field extension. It is a mathematical problem, and many references can be found in [Van der Put & Singer \(2003\)](#), [Lam & Leroy \(2004\)](#). The issue about system poles/zeros is related to solving differential polynomial equations. In [Marinescu & Bourlès \(2009\)](#) it is shown that a skew polynomial can be written as a product of elementary factors $(\delta - \gamma_i)^{d_i}$. They used the same formalism as for the study of the infinite structure in [Bourlès & Marinescu \(1997\)](#), [Bourlès & Marinescu \(2007\)](#) and [Bourlès \(2006\)](#), by decomposing the initial module into a direct sum of left submodules and then they proposed a well-suited field extension for the characterization of polynomials roots. This allows one to give intrinsic definition of the poles and

3. INVARIANT ZEROS OF BOND GRAPH MODELS

zeros of LTV systems by the algebraic approach initiated by Malgrange (1962) and Fliess (1990).

For non linear models, variational models can be written with Kahler derivation. These new models are linear time-varying (LTV) models. Non linear bond graph models are transformed in LTV bond graph models with some graphical procedures proposed in Achir & Sueur (2005). One approach is proposed by Fliess (1990) for the study of linear systems and then extended to non linear systems with flatness analysis in Fliess *et al.* (1995).

From a bond graph point of view, different classical problems such as the controllability/observability analysis Chalh *et al.* (2007), Lichiardopol & Sueur (2010) or input-output decoupling problem Lichiardopol & Sueur (2006) are proposed as a direct extension of the LTI case due to some properties of the bond graph representation. This approach is a good solution for studying classical control problems with the stability property on bond graph models.

In what follows, the focus is on the invariant zeros structure of bond graph models. Some classical theoretical, mathematical and graphical procedures for the study of the invariant zeros structure of linear models are now recalled. Then a synthesis is proposed in two tables, and our main contribution is positioned in these tables.

3.1.2 Several Approaches for the Study of Invariant Zeros

In this section, several approaches for invariant zeros of bond graph models are recalled, such as: formal, algebraic and structural approaches. Assumption 3.1 is firstly given for bond graph models studied in the following.

Assumption 3.1 *It is supposed that linear bond graph models studied in this chapter are controllable, observable and invertible. The state matrices are invertible, and the model order is n . There exist at most one input source and/or one output detector connected to each junction, and a source (detector) is only connected to one junction.*

1. Formal Approach

For systems with state-representation (2.4), invariant zeros can be derived from the formal approach. This approach is based on the use of the Jacobson

3.1 Finite Structure of Linear Models

form of the system matrix $P(\delta, t)$ in (3.1) which was introduced in Section 1.2.2. It consists in getting this canonical form by using the *OreTools* library on Maple™ 13, for example. The algorithms are based on the Gauss pivot method by introducing the noncommutativity between operators. The rule $\delta a = a\delta + \dot{a}$ is used with euclidian divisions to reduce polynomials degrees until obtaining constant terms (zeros) with elementary row and column operations.

$$\begin{bmatrix} I\delta - A(t) & -B(t) \\ C(t) & 0 \end{bmatrix} \begin{bmatrix} x \\ u \end{bmatrix} = P(\delta, t) \begin{bmatrix} x \\ u \end{bmatrix} = 0 \quad (3.1)$$

The Jacobson normal form can also be derived from manual calculations with elementary operations introduced in Definition 1.16. Matrix $P(\delta, t)$ is singular when the differential operator is equal to the invariant zeros. The invariant factors of the Jacobson form of a system matrix over \mathbf{R} are the invariant zeros of the system.

In this chapter, the focus is on the invariant zeros structure of linear systems represented by bond graph models. From bond graph models, systems state-representations can be derived. Hence in system matrices, matrix $B(t)$ (resp., $C(t)$) is of full rank, its rows (resp., columns) are linear independent based on Assumption 3.1. After several fundamental operations for system matrices, matrices become new ones in (3.2),

$$\begin{bmatrix} & & b_{1,n+1} & & 0 \\ & [I\delta - A]' & & \ddots & \\ c_{n+1,1} & & 0 & & b_{n,n+m} \\ & \ddots & & & 0 \\ 0 & & c_{n+p,p} & & \end{bmatrix} \quad (3.2)$$

where $[I\delta - A]'$ is derived from matrix $[I\delta - A]$ after fundamental operations.

Because of the full rank assumption, one can eliminate rows and columns including elements $b_{i,n+i}, i = 1, \dots, m$ and $c_{n+j,j}, j = 1, \dots, p$ without changing rank of system matrices. After eliminations, new matrices are named as *reduced system matrices* denoted by $P_r(\delta, t)$. Reduced system matrices have the same Jacobson normal forms as original system matrices. In the sequel, Jacobson forms of reduced system matrices are calculated instead of system matrices by means

3. INVARIANT ZEROS OF BOND GRAPH MODELS

of a formal approach.

2. Algebraic Approach

The module of invariant zeros is written with the algebraic approach. This approach is defined in Definition 1.35 and with this approach the procedure can be found in Proposition 1.37. As this module is torsion, it is related to the non controllable part of the quotient module $\Sigma/[y]_{\mathbf{R}}$. The study of the controllability property for LTV systems has been introduced in Section 1.2.2 and Section 2.2.2. So the focus will be on the non controllable parts of such systems. Let's consider a LTV system $\Sigma(C(t), A(t), B(t))$ which is a finitely generated module over the ring $\mathbf{R} = \mathbf{K}[\delta]$. The module $\mathcal{T}(\Sigma/[y]_{\mathbf{R}})$ is torsion and is called the module of invariant zeros M_{iz} of Σ . Let z be a generator of $\mathcal{T}(\Sigma/[y]_{\mathbf{R}})$. There exists $Z(\delta) \in \mathbf{R}$ such that $Z(\delta)z = 0$ and let \bar{K} an extension of K over which a set of zeros of $Z(\delta)$ can be derived.

Definition 3.2 *Bourlès & Marinescu (2011)* $M_{iz} = \mathcal{T}(\Sigma/[y]_{\mathbf{R}})$ is the module of the invariant zeros of the LTV system. The invariant zeros of the LTV system are the conjugacy classes of the elements of a full set of Smith zeros of M_{iz} .

Definition 3.3 For the LTV system represented by equation (2.4), the submodule M_{iz} is defined by (3.3)

$$P(\delta, t) \begin{bmatrix} \hat{x} \\ \hat{u} \end{bmatrix} = 0 \quad (3.3)$$

$P(\delta, t)$ is the system matrix and \hat{x}, \hat{u} are the images of x, u in module M_{iz} . \hat{x}, \hat{u} are called the generators of M_{iz} and matrix $P(\delta, t)$ is the definition matrix of the module.

The torsion equations in (3.3) are related to the invariant zeros. The invariant zeros are the conjugacy classes of the full set of Smith zeros of the definition matrix of these equations.

Now, a procedure for detecting invariant zeros structure of LTI/LTV systems with state-representation is proposed in Procedure 3.4.

Procedure 3.4 According to Definition 3.2, there are two basic steps for detecting invariant zeros. In the first step, one should construct the torsion module

3.1 Finite Structure of Linear Models

$\mathcal{T}(\Sigma/[y]_{\mathbf{R}})$. Then, invariant zeros can be derived from the Jacobson normal form of the definition matrix of the torsion module in the second step. Now this procedure is explained as following:

1. Write the state space representation of the system.
2. Give equations (3.3) of module $\Sigma/[y]_{\mathbf{R}}$ with all output variables to be zero.
3. Find torsion equations in (3.3) and give the definition matrix of the torsion module $\mathcal{T}(\Sigma/[y]_{\mathbf{R}})$.
4. Calculate invariant zeros by two methods in parallel.

- 1). By elementary operations, calculate the Jacobson normal form of the definition matrix of the torsion module M_{iz} , the conjugacy classes of the elements of a full set of Smith zeros of M_{iz} are invariant zeros of LTV systems and the invariant factors of M_{iz} are invariant zeros of LTI systems.
- 2). Find out directly torsion equations in definition equations of M_{iz} , then definition polynomials of these torsion equations are identical with invariant polynomials of Jacobson forms of definition matrices of M_{iz} .

In Procedure 3.4 by algebraic method, the invariant zeros of a linear system Σ are derived from the Jacobson form of the definition matrix of the torsion module $\mathcal{T}(\Sigma/[y]_{\mathbf{R}})$. Equation (3.4) explains this procedure by a number of mappings and operations.

$$\Sigma \rightarrow \Sigma/[y]_{\mathbf{R}} \rightarrow \mathcal{T}(\Sigma/[y]_{\mathbf{R}}) \rightarrow \begin{cases} \text{invariant zeros (Jacobson form)} \\ \text{solutions set of } u \text{ (substitution by } u) \end{cases} \quad (3.4)$$

Sets of solutions of input variables for zeroing output variables are introduced in Section 3.1.3 by substituting variables in torsion modules by input variables.

3. Structural Approach

Because of non commutative properties and derivations of time-varying coefficients, the bond graph rules proposed in the LTI case in Chapter 2 for determining invariant zeros are not sufficient for the LTV case. Some complementary rules

3. INVARIANT ZEROS OF BOND GRAPH MODELS

must be added. The invariant zeros structure can be studied with an algebraic approach, but the algebraic calculations are often complex. By combining two methods, a simple procedure to determine the invariant zeros structure is pointed out. In this chapter, the study of null invariant zeros is one of crucial issues. From the point of view of module theory, a null zero corresponds to the factorization of the term $\delta^n (n \geq 0)$ related to *right roots* of torsion module polynomial representation.

Techniques for detecting the invariant zeros of bond graph square models and non-square models by the structural approach are different. For square systems, invariant zeros modules $\mathcal{T}(\Sigma/[y]_{\mathbf{R}})$ can be derived from system poles modules $\Sigma^{-1}/[\hat{u}]_{\mathbf{R}}$ of inverse systems, where \hat{u} denotes input variables of inverse systems. Two modules Σ and Σ^{-1} represent the same system and the variable y is identical to \hat{u} . Therefore, modules $\Sigma/[y]_{\mathbf{R}}$ and $\Sigma^{-1}/[\hat{u}]_{\mathbf{R}}$ are isomorphic, i.e., $\Sigma/[y]_{\mathbf{R}} \cong \Sigma^{-1}/[\hat{u}]_{\mathbf{R}}$. Consequently, invariant zeros of bond graph models can be derived from bond graph models with bicausality representing inverse systems. The structural procedure for bond graph square models is introduced in Section 3.2.1.

For non-square bond graph models, because the numbers of input sources and of output detectors are different, it is not possible to choose disjoint input-output causal paths. It means that BGB models for global models do not exist. However, submodels with the same number of input and output variables are square. So BGB models are valid for detecting uncontrollable parts in submodels. Common uncontrollable parts between submodels are used to deal with non-square systems. The structural procedure for bond graph non-square models is introduced in Section 3.3.1.

In this section, several approaches for detecting invariant zeros of bond graph models were recalled. The formal approach is valid for all kinds of linear bond graph models. The Jacobson form of the system matrices is of prime importance in this approach. One can get the invariant polynomial of system matrices or reduced system matrices after some fundamental operations or procedures of some softwares. Even so, for calculating the invariant zeros, factorizations of skew polynomials are needed, which lead to the utilization of the algebraic approach. By the algebraic approach, one can find out torsion equations in modules M_{iz} related to the invariant zeros. However, sometime torsion equations are difficult

3.1 Finite Structure of Linear Models

to detect. So the notion of a full set of Smith zeros of M_{iz} is used to calculate the invariant zeros. The structural approach is a direct and efficient method inspired from the two above approaches. In the square case, global BGB models consist in detecting uncontrollable parts of models, which are related to the invariant zeros. In non-square case, global BGB models do not exist. Hence, analysis of finite structure of square BGB submodels is required to discover the common factors of invariant zeros of each submodel. These common factors are related to invariant zeros of global non-square bond graph models. Several approaches and their techniques from which the invariant zeros structure of applicable bond graph models can be derived are shown in Table 3.1.

Table 3.1: Applicable bond graph models and techniques for IZ identification

Approaches	Formal	Algebraic	BGB global models	BGB submodels
Models	Square Non-square	Square Non-square	Square	Non-square
Techniques	$P_r(\delta)$	M_{iz}	M_{ei}	Submodels IZ Common factors

3.1.3 Output-Zeroing Problem and Invariant Zeros

The *output-zeroing problem* of a standard linear system is strictly connected with zeros of the system. These zeros are defined in many ways. MacFarlane & Karcnias (1976), Schrader & Sain (1989) gave a survey of these definitions. The most commonly used definition of zeros employs invariant zeros. All definitions consider zeros merely as complex numbers and for this reason may create certain difficulties in their dynamical interpretation. Each invariant zero is related to a set of the input variables which lead the output variable to be zero. Karcnias & Kouvaritakis (1979) studied the output problem and its relationship with the invariant zeros structure for continuous systems by a matrix pencil approach. In the case of discrete systems, this problem was well studied by Tokarzewski (2006) with the geometric approach.

The physical output-zeroing problem has been approached using zeros. It is to find all pairs $(x_0, u(t))$ consisting of initial states $x_0 \in \mathbb{R}^n$ and admissible inputs $u(t)$ such that the corresponding outputs $y(t)$ are identically zero (i.e.,

3. INVARIANT ZEROS OF BOND GRAPH MODELS

$y(t) \equiv 0, t \geq 0$). Any nontrivial pair (i.e., such that $x_0 \neq 0$ or $u(t)$ is not identically zero) will be called the *output-zeroing input*. The dynamics of LTI or LTV systems restricted to the set of initial conditions for zeroing output variables (if the set is well defined) is called the *zero dynamics*. x_0 (resp., $u_0(t)$) is used to denote the *state-zero direction* (resp., *input-zero direction*) and to denote the initial state (resp., input) in output-zeroing problem.

System matrices are singular for some $\delta = \alpha_i$ which are invariant zeros. Kailath (1980) proposed that, for an input $u(t) = u_0 e^{\alpha_i t}, t \geq 0$, there exists an initial state x_0 such that the output is zero: $y \equiv 0, t \geq 0$.

The conditions under which an exponential-type input signal vector leads to an identically zero output are first considered for proper systems. The key result required is given by Theorem 3.5.

Theorem 3.5 *MacFarlane & Karcanias (1976)* Suppose a system $\Sigma(A, B, C)$, an input is given in (3.5)

$$u(t) = g \exp(zt) \Gamma(t) \quad (3.5)$$

where z is an invariant zero of the system, g is a complex vector with appropriate dimension and $\Gamma(t)$ denotes the Heaviside unit step function. With an initial state vector x_0 , necessary and sufficient conditions for the existence of a set $\{z, x_0, g\}$ such that

$$y(t) = f(t, z, x_0, g) \equiv 0, t \geq 0 \quad (3.6)$$

are that $\{z, x_0, g\}$ satisfy

$$\begin{bmatrix} Iz - A & -B \\ C & 0 \end{bmatrix} \begin{bmatrix} x_0 \\ g \end{bmatrix} = 0 \quad (3.7)$$

The output zeroing problem is related to the initial state vector x_0 because the state-space motion corresponding to the solution of the problem is shown to be of the form

$$x(t) = x_0 \exp(zt), t \geq 0 \quad (3.8)$$

In the present report, the LTV case of the output-zeroing problem is also considered. Proposition 3.6 gives the solution for the output-zeroing problem of systems $\Sigma(C(t), A(t), B(t))$, which is similar to Theorem 3.5.

3.1 Finite Structure of Linear Models

Proposition 3.6 *Suppose z is one of invariant zeros of an LTV system $\Sigma(C(t), A(t), B(t))$, there exist an input vector*

$$u_i(t) = g_i(t) \exp(zt) \Gamma(t), i = 1, \dots, m \quad (3.9)$$

for zeroing the output variables with an initial state vector x_0 , where g_i is a time

function over \mathbb{R} . The vector x_0 and $g(t) = \begin{bmatrix} g_1(t) \\ \vdots \\ g_m(t) \end{bmatrix}$ can be derived from

$$\begin{bmatrix} Iz - A(t) & -B(t) \\ C(t) & 0 \end{bmatrix} \begin{bmatrix} x_0 \\ g(t) \end{bmatrix} = 0 \quad (3.10)$$

The solution of the vector x_0 is derived from equations of $x_{i0}, i = 1, \dots, n$ when the time variable is set to be zero ($t = 0$) in all matrices in (3.10). After getting x_0 , $g(t)$ is derived from (3.10) with time-varying parameters in the matrices.

In this chapter, the module theoretic approach is used to deal with the output-zeroing problem. It is supposed that all systems studied are controllable. It means that there exists a relation such as $\Sigma/[u]_{\mathbf{R}} = \emptyset$. Therefore, every element in module Σ can be represented by input variables and their derivations. After getting torsion equations related to $\mathcal{T}(\Sigma/[y]_{\mathbf{R}})$, one can substitute all variables in torsion equations by input variables. Then, several differential equations in input variables can be obtained. According to the method for solving differential equations introduced in Section 1.1.1.3, one can get a fundamental set of roots of differential polynomial and a fundamental set of solutions of input variables u . With elements of the fundamental set of roots α_i , for input variables $u_i(t) = u_{i0} e^{\alpha_i t}, t \geq 0, i = 1, \dots, m$, there exist initial state variables x_{i0} such that output variables are null: $y_i \equiv 0, t \geq 0, i = 1, \dots, p$.

Remark 3.7 *In what follows, two cases of the output-zeroing problem will be studied:*

1. *With consideration of initial conditions of state variables after detecting the invariant zeros, i.e., $x_0 \neq 0, u_0(t) \neq 0 \rightarrow y \equiv 0, t \geq 0$. Solutions of input variables and initial conditions of state variables are derived from Theorem 3.5 in the LTI case and from Proposition 3.6 in the LTV case for each invariant zero z_i .*

3. INVARIANT ZEROS OF BOND GRAPH MODELS

2. Without consideration of initial conditions of state variables, then output variables will asymptotically converge to zero, i.e., $\lim_{t \rightarrow \infty} y = 0, x_0 = 0$. Solutions of input variables are derived from $y = 0 \rightarrow \mathcal{T}(\Sigma/[y]_{\mathbf{R}}) \rightarrow U(\delta, t)u = 0$, where $\mathcal{T}(\Sigma/[y]_{\mathbf{R}})$ is the torsion submodule of the module M_{iz} , $U(\delta, t)u = 0$ is a differential polynomial of u after substituting variables in $\mathcal{T}(\Sigma/[y]_{\mathbf{R}})$ by u and its derivatives. In this case, the invariant zeros are not necessarily known.

3.2 Invariant Zeros of Linear Square Models

As mentioned, invariant zeros structure of square models can be derived from bond graph models with bicausality. In this section, the structural procedure for detecting invariant zeros of this kind of models is firstly introduced by means of BGB models. The relations between structural and algebraic approaches are interpreted. Then, invariant zeros structure of SISO models is discussed. Differences between LTI and LTV models are shown, and simulation results are given. An extension of the second kind of square models with multi-inputs and multi-outputs is introduced. Formal, algebraic and structural approaches are utilized to detect invariant zeros for every situation.

3.2.1 BGB Procedure for Invariant Zeros of Square Models

The invariant zeros structure of LTI bond graph models was introduced in Section 2.3.3. The numbers of invariant zeros and of null invariant zeros can be derived from infinite zero orders of BGI and BGD models by use of Property 2.49 and Property 2.50.

The calculations for BGB models give the values of non-null invariant zeros. The structural approach proposed here with bicausality is a unified method not only for LTI but also for LTV bond graph models. As introduced in Section 3.1.2, the invariant zeros can be obtained from the system poles of inverse bond graph models, i.e., BGB models.

For getting the invariant zeros structure, the definition equations of the module $\Sigma/[y]_{\mathbf{R}}$ are firstly needed. These equations are procured by using Procedure 3.8 for BGB models.

3.2 Invariant Zeros of Linear Square Models

Procedure 3.8 *Yang et al. (2010)* The study of the invariant zeros of a linear square bond graph model is related to the resolution of four sets of equations written in the BGB model from the following elements:

- Output detectors (variables are set to a zero value)
- Dynamical elements with a derivative causality
- Input sources
- Dynamical elements with an integral causality assignment

By bond graph method, every module in (3.4) can be represented by an appropriate bond graph model. In this procedure, the fundamental issue is to find out the torsion module $\mathcal{T}(\Sigma/[y]_{\mathbf{R}})$, i.e., the noncontrollable part of the module $\Sigma/[y]_{\mathbf{R}}$. Therefore, the focus is on the controllability property study of the bond graph model of the module $\Sigma/[y]_{\mathbf{R}}$. Similarly to Procedure 3.4, a procedure by bond graph approach for detecting invariant zeros of LTI/LTV systems is proposed in Procedure 3.9.

Firstly, the bond graph model of the module $\Sigma/[y]_{\mathbf{R}}$ is given by using bi-causality. The controllability property of this model can be derived from method introduced in Section 2.2.2. Then the procedure for getting the Jacobson normal form in Section 1.2.1.1 is served to detect invariant zeros structure. These steps are shown in detail in Figure 3.9 (i).

Procedure 3.9

1. Draw BGI model of modules Σ .
2. Construct the BGB model related to modules $\Sigma/[y]_{\mathbf{R}}$ with output variable $y \equiv 0$, then calculate equations (3.3) for each element (x, u) .
3. Find torsion equations in (3.3) and give the definition matrix of torsion module $\mathcal{T}(\Sigma/[y]_{\mathbf{R}})$.
4. Calculate invariant zeros and a set of solutions of u .
 - 1). Calculate the Jacobson normal form of the definition matrix of torsion module, the conjugacy classes of the elements of a full set of Smith zeros of this form are invariant zeros for an LTV model and the invariant factors

3. INVARIANT ZEROS OF BOND GRAPH MODELS

of this form are invariant zeros for an LTI model.

2). Substitute all variables in torsion equations by input variables, solve differential equations in u then get a fundamental set of solutions of u .

Relations between bond graph and algebraic approaches for detecting invariant zeros structure are shown in Figure 3.1.

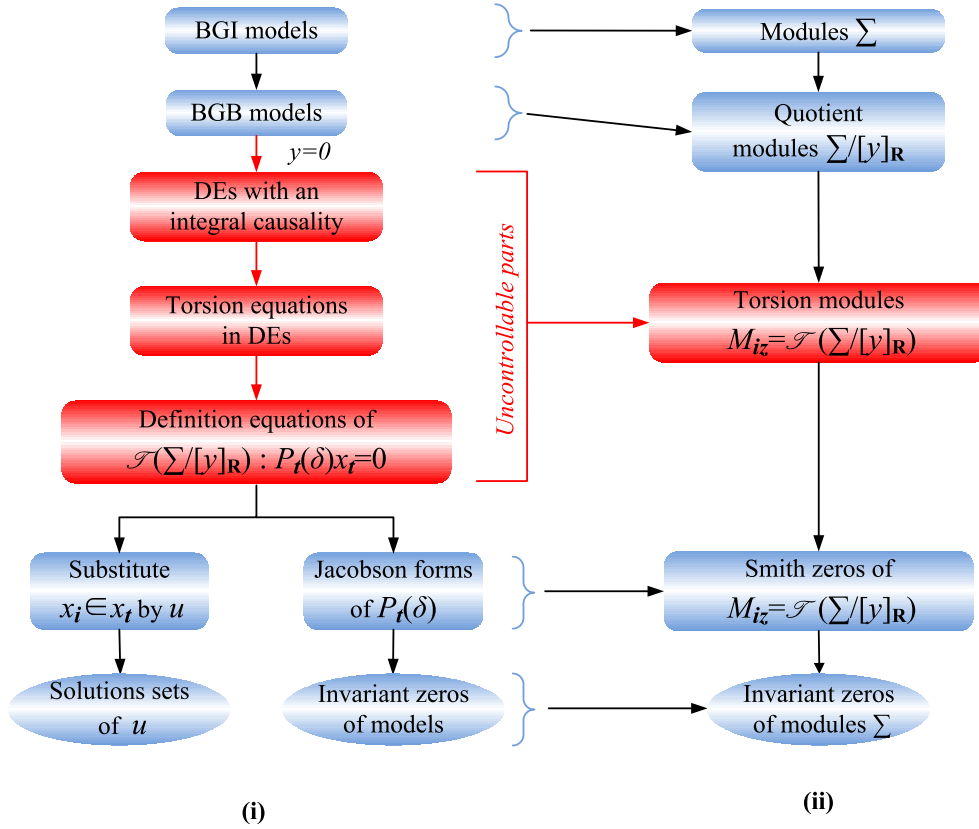

Figure 3.1: Bond graph and algebraic approaches for detecting invariant zeros and their relations

In the third step of Procedure 3.9, the torsion module is quite difficult to detect. Because of non controllable property of the module, the controllability property analysis will be used for bond graph models. For a linear square system, the bond graph model of the module $\Sigma/[y]_{\mathbf{R}}$ can be drawn by using bicausality. In the BGB model, the elements with an integral causality assignment are related to non controllable parts.

In reference to Property 2.49, the invariant zeros of LTI square models are related to dynamical elements which are not included in the shortest disjoint

3.2 Invariant Zeros of Linear Square Models

input-output causal paths in BGI models. Dynamical elements in these causal paths structurally have a derivative causality assignment in BGB models, then other dynamical elements may have an integral causality assignment. Equations of these elements forms a new module M_{ei} which is included in $\Sigma/[y]_{\mathbf{R}}$ and includes the module $\mathcal{T}(\Sigma/[y]_{\mathbf{R}})$, such as $\mathcal{T}(\Sigma/[y]_{\mathbf{R}}) \subseteq M_{ei} \subseteq \Sigma/[y]_{\mathbf{R}}$. So the definition matrices of these three modules have the same Jacobson normal form.

Definition 3.10 *For the BGB model of a linear square system, there exists a number of dynamical elements with an integral causality assignment. The equations related to these elements define a module M_{ei} . Because of the non controllable property of these elements, module M_{ei} includes the torsion module $\mathcal{T}(\Sigma/[y]_{\mathbf{R}})$, i.e. they have the same invariant zeros structure.*

The equations of modules M_{ei} are given in (3.11),

$$P_{ei}(\delta, t) x_{ei} = 0 \tag{3.11}$$

where matrices P_{ei} are definition matrices of M_{ei} and all state variable of dynamical elements with an integral causality assignment in BGB models are included in vector x_{ei} .

The procedure for detecting invariant zeros of linear square systems is shown in Figure 3.2, where DPs denotes definition polynomials.

3.2.2 Invariant Zeros of SISO Models

Linear SISO models are studied in this section. The main idea for solving the invariant zeros problem is to use the inverse model (BGB) with the null output variable to get invariant zeros and the input variable for zeroing the output variable. In the LTI case, these two issues have a tight relation. One can be easily derived from another. However, in the LTV case, this relation becomes indistinct. Invariant polynomials of system matrices of SISO systems are used to detect the invariant zeros structure. For an SISO system, there is one minor, which is the determinant of the system matrix. As to the bond graph model, a single input and a single output variables are considered for BGB model.

3. INVARIANT ZEROS OF BOND GRAPH MODELS

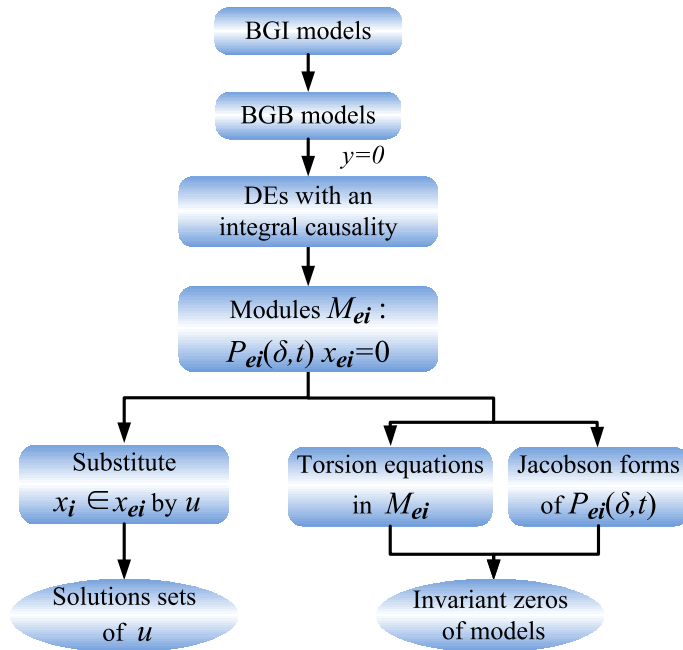

Figure 3.2: Bond graph procedure for detecting invariant zeros of linear square systems

3.2.2.1 Null Invariant Zeros: LTI and LTV Cases

In this section, the structure of null invariant zeros of a simple circuit studied in [Yang *et al.* \(2011\)](#) is discussed. For LTI models, the infinite structure of the BGD models is directly related to null invariant zeros. For LTV models, conditions are only sufficient and a quite similar extension to the study of the controllability/observability is proposed for the study of null invariant zeros. The bond graph procedures for detecting invariant zeros of LTI and LTV models have no difference. The crucial issue is to find out torsion equations after application of the bond graph procedure. Sometimes, torsion equations are evident; they can be found out by observation. Nevertheless, usually, it is necessary to use fundamental operations to get Jacobson forms of system matrices to determine torsion elements. In these operations, there may exist some differences of calculations between LTI and LTV cases. The difference between the invariant zeros structure of LTI and LTV cases is pointed out with an SISO electrical circuit. The results will be verified with simulations by the bond graph software 20-sim[®]*

*20-sim[®] is a registered trademark of the University of Twente, Drienerlolaan 5, 7522 NB Enschede, The Netherlands, <http://www.utwente.nl>

3.2 Invariant Zeros of Linear Square Models

This approach will be extended to MIMO LTV models for square and non square models in the next section.

The invariant zeros structure of the SISO LTV RLC circuit is studied by formal and bond graph approaches. The bond graph model of the circuit is shown by Figure 3.3. This model is controllable and observable. The order of the model is $n = 2$. The system equation is given in (3.12)

$$\begin{cases} \dot{x}_1 = -\frac{R(t)}{I(t)}x_1 - \frac{m(t)}{C(t)}x_2 + u \\ \dot{x}_2 = \frac{m(t)}{I(t)}x_1 \\ y = \frac{1}{I(t)}x_1 \end{cases} \quad (3.12)$$

where $x = (x_1, x_2)^T = (p_I, q_C)^T$ is the state vector, u and y are the input and output variables. Table 3.2 gives numerical values of the LTI system components.

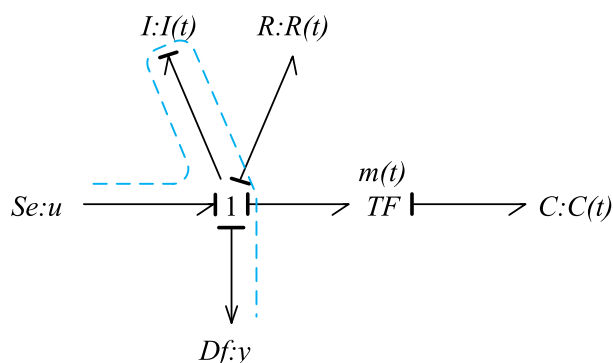

Figure 3.3: Bond graph model with integral causality: BGI model

Table 3.2: Numerical values of RLC circuit components						
Input u	element I	element R	element TF	element C		
1 V	1 H	1 Ω	2	1 F		

The infinite structure of the BGI model, Figure 3.3, is defined as $n' = 1$ (causal path $Df \rightarrow I(t) \rightarrow Se$). By Proposition 2.49, there exist one invariant zero ($n - n' = 2 - 1 = 1$).

Figure 3.4 gives the bond graph model with a derivative causality assignment, model BGD. There is an input-output causal path ($Df \rightarrow C(t) \rightarrow Se$). If the system is time invariant, there is a null invariant zero ($n_d = 1$) according to Property 2.50. With the BGD model, it is thus easy to conclude on the existence of a null invariant zero in this SISO example, but the extension to the MIMO

3. INVARIANT ZEROS OF BOND GRAPH MODELS

case is not so easy, and the characterization of the invariant module is not direct. The BGB model is a good alternative for solving these problems.

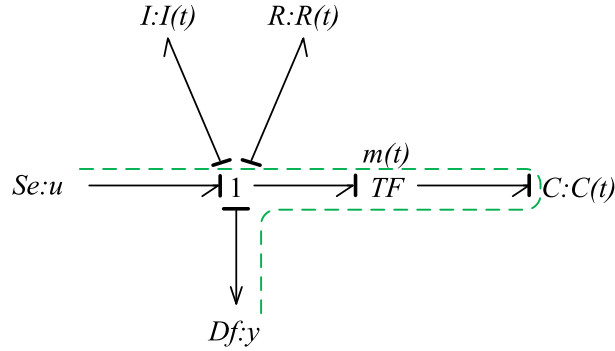

Figure 3.4: Bond graph model with derivative causality: BGB model

Torsion module with the bond graph model with bicausality (BGB) defined in [Yang *et al.* \(2010\)](#) is studied. It will prove the previous conclusion obtained from the study of the BGB model and it is a simple way for the study of torsion submodules associated to any kind of invariant zeros.

In [Figure 3.5](#), the bicausal path is drawn between the input source $Se : u$ and the output detector $Df : y$. In this simple example, the element $C(t)$ is associated to the torsion module $\mathcal{T}(\Sigma/[y]_{\mathbf{R}})$. The torsion module is the non controllable part of the inverse model. The element $C(t)$ (more precisely the state variable) is not controllable, because it is not reachable when the bicausal path is eliminated. Now the procedure for deriving the torsion module is given.

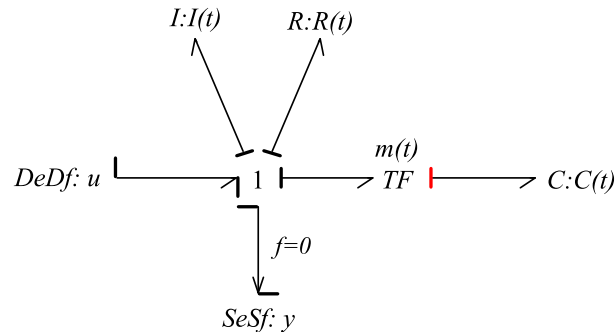

Figure 3.5: Bond graph model with bicausality : BGB model

Step 1: output variable

3.2 Invariant Zeros of Linear Square Models

For the output detector, the flow at the 1-junction is equal to zero. The equation of output variable is $y = \frac{1}{I(t)}x_1$. One relation is thus rewritten: $y = 0$, thus $x_1 = \dot{x}_1 = 0$.

Step 2: element with derivative causality

$$\text{Element } I : I(t) \longrightarrow f_I = \frac{pI}{I} = \frac{x_1}{I} = 0$$

Step 3: input source

$$\text{Source } Se : u \longrightarrow u = \dot{x}_1 + e_R + \frac{m(t)}{C(t)}x_2 = \frac{m(t)}{C(t)}x_2$$

Step 4: element with an integral causality assignment

$$\text{Element } C : C(t) \longrightarrow \dot{x}_2 = f_C = 0$$

The formal (Jacobson form) and module theoretic methods to get the set of invariant zeros are now used.

1. *Jacobson form*

The system matrix of the system is:

$$P(\delta, t) = \begin{bmatrix} \delta + \frac{R(t)}{I(t)} & \frac{m(t)}{C(t)} & -1 \\ -\frac{m(t)}{I(t)} & \delta & 0 \\ \frac{1}{I(t)} & 0 & 0 \end{bmatrix}$$

and it's Jacobson form is:

$$\Delta(\delta, t) = \begin{bmatrix} 1 & 0 & 0 \\ 0 & 1 & 0 \\ 0 & 0 & \delta \end{bmatrix} = U(\delta, t)P(\delta, t)V(\delta, t)$$

where

$$U(\delta, t) = \begin{bmatrix} 1 & 0 & 0 \\ 0 & 0 & I(t) \\ 0 & 1 & m(t) \end{bmatrix}, \quad V(\delta, t) = \begin{bmatrix} 0 & 1 & 0 \\ 0 & 0 & 1 \\ -1 & \delta + \frac{R(t)}{I(t)} & \frac{m(t)}{C(t)} \end{bmatrix}$$

So the invariant polynomial of the system matrix is δ , there is a null invariant zero for LTI model, and the invariant zero of LTV model is a conjugacy class:

3. INVARIANT ZEROS OF BOND GRAPH MODELS

$\Delta_{C(t)}(0)$. From the point of view of rank reduction, $\delta = 0$ can reduce the system matrix rank, which signifies the existence of the null invariant zero.

2. Module theoretic approach

With the algebraic method, the module of invariant zeros can be derived from (1.38), and the equations related to M_{iz} are such here

$$\begin{bmatrix} \delta + \frac{R(t)}{I(t)} & \frac{m(t)}{C(t)} & -1 \\ -\frac{m(t)}{I(t)} & \delta & 0 \\ \frac{1}{I(t)} & 0 & 0 \end{bmatrix} \begin{bmatrix} \hat{x} \\ \hat{u} \end{bmatrix} = 0 \quad (3.13)$$

where \hat{x}, \hat{u} are the images of x, u by the mapping $\Sigma \rightarrow \Sigma/[y]_{\mathbf{R}}$.

These mathematical relations are directly written for the unknown variables associated to elements of the BGB model (effort or flow variable depending on the causality assignment). From this set of mathematical relations, the torsion module can be highlighted, and the same result is obtained. A torsion equation has the form:

$$P(\delta)\xi = 0, \quad P(\delta) = \delta^n + \sum_{i=1}^n a_i \delta^{n-i}, \xi \neq 0 \quad (3.14)$$

where $P(\delta)$ is the *differential polynomial* and (3.14) is the definition equation of the torsion element. ξ is the generator of the torsion module. In (3.13), equation \hat{x}_2 is related to the torsion element. Therefore, there exist a null invariant zero for the LTI model and the invariant zero of LTV model is a conjugacy class: $\Delta_{C(t)}(0)$.

3.2.2.2 Invariant Zeros and Solution Set of Input Variables

The output-zeroing problem is considered here. For solving this problem, variables in torsion equations in M_{iz} need to be substituted by the input variable. Two equations can be derived from equation (3.13) or from the BGB model:

$$\begin{cases} \frac{m(t)}{C(t)} \hat{x}_2 = \hat{u} \\ \delta \hat{x}_2 = 0 \end{cases} \quad (3.15)$$

The second equation $\delta \hat{x}_2 = 0$ is a torsion element of M_{iz} . By taking account this relation in the first equation, one can get the torsion equation about \hat{u} such

3.2 Invariant Zeros of Linear Square Models

as:

$$\delta \frac{C(t)}{m(t)} \hat{u} = \left(\frac{C(t)}{m(t)} \delta + \left(\frac{C(t)}{m(t)} \right)' \right) \hat{u} = 0 \quad (3.16)$$

According to equation (3.15), the initial value of the input variable depends on the value of x_2 at $t = 0$. So the solution of the input variable for zeroing the output variable is shown in (3.17),

$$\begin{cases} u(t) = u_0 e^{\int \frac{C(t)m'(t) - C'(t)m(t)}{C(t)m(t)} dt} \\ u_0 = \frac{m(0)}{C(0)} x_{20} \end{cases} \quad (3.17)$$

where $u_0, x_{20}, m(0), C(0) \in \mathbb{R}$ are the values of variables $u(t), x_2(t), m(t), C(t)$ at $t = 0$. Equation (3.17) can also be derived from equation (3.7). After simplification in (3.17), the solution of the input for zeroing output problem is given in (3.18).

$$u(t) = \frac{m(t)}{C(t)} x_{20} \quad (3.18)$$

From equation (3.18), one can find that in the LTI case there is always a constant input for output zeroing which corresponds to the null invariant zero in the LTI case. However, in the LTV case, although the existence of the null invariant zero, solutions of the input variable have different forms in accordance with system parameters.

Solutions of the input variable for the output zeroing problem for SISO models can also be derived directly from bond graph models. There is a unique input-output causal path which means that the output variable can be represented by the input variable and its derivations. In this case, the input-output causal path gain is equal to $\frac{1}{m(t)} \delta \frac{C(t)}{m(t)}$, Achir *et al.* (2005). If the coefficient $\frac{C(t)}{m(t)}$ is a constant, i.e., $C(t)$ and $m(t)$ are proportional, there exists a right root of differential polynomial, which yields a constant input variable for zeroing the output variable.

In fact, the graphical procedure is closely related to the algebraic one proposed in Definition 2.48. The BGB model with the output variables $y \equiv 0$ is used to get the module $\Sigma/[y]_{\mathbf{R}}$. The dynamical elements with integral causality in BGBD model are associated the torsion module $\mathcal{T}(\Sigma/[y]_{\mathbf{R}})$. At last, the differential equations relative to these dynamical elements are solved to get the invariant zero and the set of the input variable.

3. INVARIANT ZEROS OF BOND GRAPH MODELS

Output-zeroing Problem with Initial Conditions of State Variables

For the previous example, the output variable converges to zero in a finite time. The output-zeroing problem where the output variable is equal to zero for all time range is considered here, i.e., $y \equiv 0, t \geq 0$. Theorem 3.5 gives the necessary and sufficient conditions for this issue. In what follows, LTI and LTV cases are considered.

The LTI Case

Consider the LTI model with parameters given in Table 3.2. As to the existence of the null zero, the input variable is $u(t) = g\Gamma(t)$. Equation (3.7) can be written as:

$$\begin{bmatrix} 1 & 2 & -1 \\ -2 & 0 & 0 \\ 1 & 0 & 0 \end{bmatrix} \begin{bmatrix} x_{10} \\ x_{20} \\ g \end{bmatrix} = 0 \quad (3.19)$$

Let $g = 1$, i.e., $u(t) = \Gamma(t)$. The solution set of $\{x_1, x_2\}$ is $\{0, \frac{1}{2}\}$. Hence, the input variable and initial condition of state variables for output-zeroing problem is shown in (3.20).

$$\begin{cases} x_{10} = 0 \\ x_{20} = \frac{1}{2} \\ u(t) = \Gamma(t) \end{cases} \quad (3.20)$$

The simulation result of the LTI model is indicated in Figure 3.6.

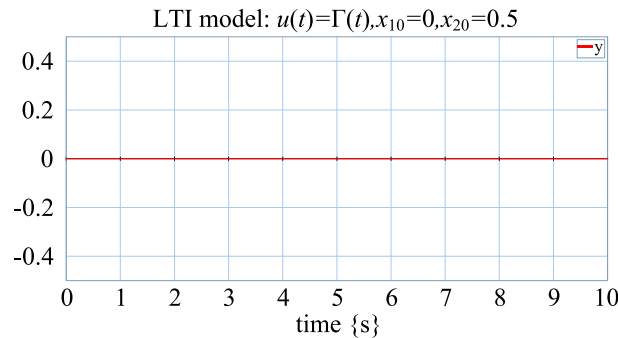

Figure 3.6: The output curve of the LTI model with $u(t) = \Gamma(t), x_{10} = 0, x_{20} = 0.5$

3.2 Invariant Zeros of Linear Square Models

The LTV Case

Let $m = t + 2$, the model becomes time-varying. There still exist a null invariant zero. Even so, the input variable is no more a constant, which was written in equation (3.18). Theorem 3.5 supposes that g is a complex vector. However, in the LTV case, this vector is proved to be a function of time. With the null invariant zero, equation (3.7) is written as:

$$\begin{bmatrix} 1 & t+2 & -1 \\ -t-2 & 0 & 0 \\ 1 & 0 & 0 \end{bmatrix} \begin{bmatrix} x_{10} \\ x_{20} \\ g(t) \end{bmatrix} = 0 \quad (3.21)$$

After solving equation (3.21), the input variable and the initial condition of the state variables are given in (3.22).

$$\begin{cases} x_{10} = 0 \\ x_{20} = c \\ u(t) = c(t+2)\Gamma(t) \end{cases} \quad (3.22)$$

where $c \neq 0, c \in \mathbb{R}^+$. Let $x_{20} = 1$, then $g(t) = t + 2$ which is a time function. The input variable derived from Theorem 3.5 is identical with the one in equation (3.17).

Figure 3.7 shows the simulation result of the LTV model according to equation (3.22).

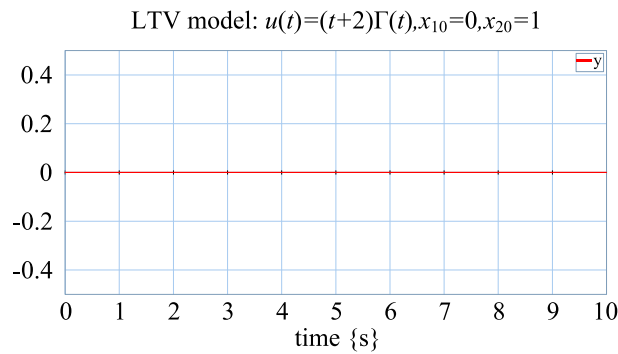

Figure 3.7: The output curve of the LTV model with $u(t) = (t + 2)\Gamma(t)$, $x_{10} = 0$, $x_{20} = 1$

The solutions of the input variable in the LTI (3.20) and LTV (3.22) cases are identical with the solution derived from the algebraic equation (3.18).

3. INVARIANT ZEROS OF BOND GRAPH MODELS

For solutions of input variables of LTV SISO models for the output-zeroing problem, Proposition 3.11 is given. It is supposed that Assumption 3.1 hold, and the BGD model has an input-output causal path length equal to 1, then there is a null invariant zero.

Proposition 3.11 *There exist an input variable such as $u(t) = c\Gamma(t)$, $c \in \mathbb{R}$ with $n_d = 1$, which yields $y \equiv 0, t \geq 0$ with an appropriate initial condition of x_0 if there is no time-varying component in the causal path or if the following situation is verified. The differential polynomial equation of the torsion module $\mathcal{T}(\Sigma/[y]_{\mathbf{R}})$ has the form: $G(\delta)u = 0 \rightarrow G'(\delta)\delta u = 0$, where $G'(\delta)$ is a polynomial of δ and δ is the right factor of $G(\delta)$. $G'(\delta) \in \mathbf{R}$ has the form $\sum_{i=0}^n a_i \delta^i$, $a_i \in K$, where $a_0 \neq 0$.*

3.2.2.3 Simulations

In this section, the output-zeroing problem is verified by a number of simulation results. The focus is on if there is always a constant input variable for zeroing the output variable in the LTV case with a null invariant zero. Without specification, the initial condition of the state variables is not considered, i.e. $x_{i0} = 0, i = 1, 2, \lim_{t \rightarrow \infty} y = 0$. In the LTI case, the input variable is constant for zeroing the output if there is a null invariant zero. Several cases related to different time-varying parameters of the studied system are considered.

At first, the case without time-varying element in the input-output causal path of the BGD model is studied. Simulation results show that there is no influence for the existence of constant input variable for zeroing the output. Then, with time-varying elements in the causal path, three situations are proposed. Firstly, there exists only one time-varying element $C(t)$ or $m(t)$ in the causal path, then parameters $C(t)$ and $m(t)$ are simultaneously time-varying and proportional with a time-invariant modulus. Secondly, parameters $C(t)$ and $m(t)$ are simultaneously time-varying but not proportional. Finally, the case with one time-varying element $I(t)$ outside the causal path and one time-varying element $C(t)$ in the path will be studied. In each case, the solution of the input variable for the output-zeroing problem is given. Without special declaration, the initial condition of state variables is null.

BGD without Time-varying Elements in the Input-output Causal Path

3.2 Invariant Zeros of Linear Square Models

If there is no time-varying elements in the input-output causal path of the BGD model, a constant input variable can zero the output. Elements I and R with time-varying parameters are considered respectively.

a). Inertial Element I is Time-Varying

Let $I(t) = t^2 + 1$, the solution of the input variable of the model is u_0 according to equation (3.17). The curve of the output variable Df with the constant input $u(t) = \Gamma(t)$ is drawn in Figure 3.8 and the output variable is equal to 0 in the steady state part.

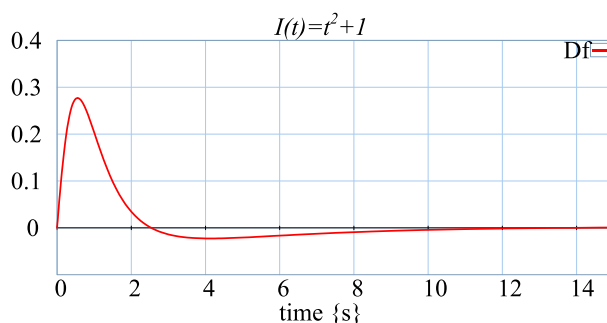

Figure 3.8: The output Df curve with $I(t) = t^2 + 1$ and $u(t) = \Gamma(t)$

b). Resistive Element R is Time-Varying

Let $R(t) = t + 1$, the solution of the input variable of the model is u_0 according to equation (3.17). The curve of the output variable Df with the constant input $u(t) = \Gamma(t)$ is shown in Figure 3.9.

c). Two Elements I and R are Simultaneously Time-Varying

Let $I(t) = t^2 + 1$ and $R(t) = t + 1$, the solution of the input variable of system is u_0 according to equation (3.17). The curve of the output variable Df with the constant input $u(t) = \Gamma(t)$ is displayed in Figure 3.10.

From these three situations, one can verify Proposition 3.11: if there is no element with time-varying parameter in the causal path of the BGD model, the LTV model has constant input variable for zeroing the output variable.

3. INVARIANT ZEROS OF BOND GRAPH MODELS

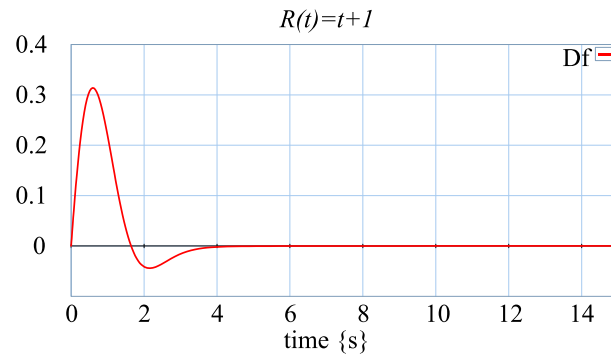

Figure 3.9: The output Df curve with $R(t) = t + 1$ and $u(t) = \Gamma(t)$

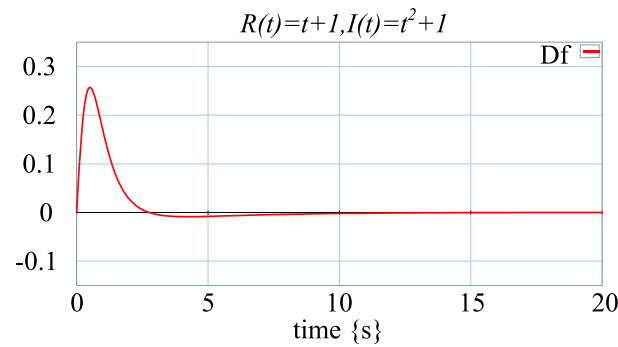

Figure 3.10: The output Df curve with $R(t) = t + 1$, $I(t) = t^2 + 1$ and $u(t) = \Gamma(t)$

Time-Varying Elements in the Causal Path

There are two elements C and TF in the input-output causal path of the BGD model. Four situations are considered here.

a). The Transformer Element TF is Time-Varying

Let $m(t) = \frac{1}{t+1}$, the input variable solution of system is $\frac{1}{t+1}u_0$ according to equation (3.17). The curve in Figure 3.11 gives the response of the output Df with the constant input $u(t) = \Gamma(t)$.

By (3.18), let $u(t) = \frac{1}{t+1}$, $x_{10} = 0$, $x_{20} = 1$, Figure 3.12 gives the response of the output Df .

If $m(t) = \sin(t) + 2$, the curve of output Df with the constant input $u(t) = \Gamma(t)$ in Figure 3.13 is not stable. As for the instability of the curve, one should calculate if there is (are) unstable pole(s) of the system. From algebraic approach,

3.2 Invariant Zeros of Linear Square Models

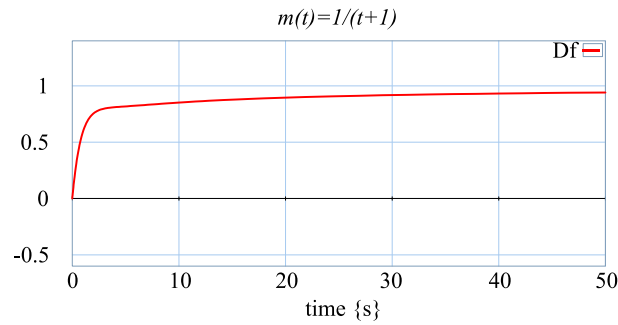

Figure 3.11: The output Df curve with $m(t) = \frac{1}{t+1}$ and $u(t) = \Gamma(t)$

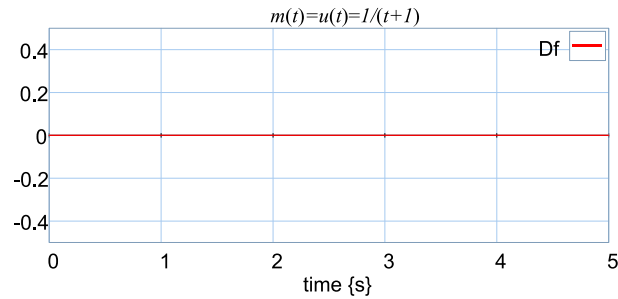

Figure 3.12: The output Df curve with $m(t) = u(t) = \frac{1}{t+1}$ and $x_{20} = 1$

poles are related to the module $\Sigma/[u]_{\mathbf{R}}$. Poles of the system can be derived from the Jacobson form of matrix $D(\delta) = (I\delta - A)$. For poles and stability property of LTV systems, [Marinescu & Bourlès \(2009\)](#) is recommended.

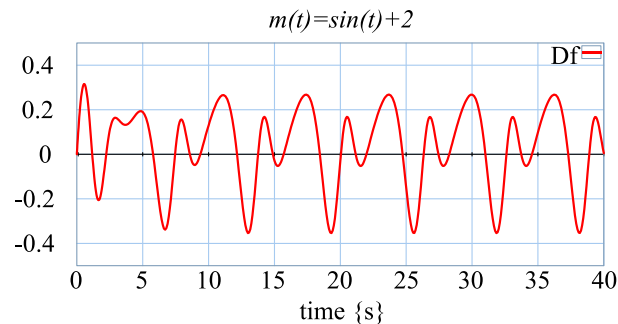

Figure 3.13: The output Df curve with $m(t) = \sin(t) + 2$ and $u(t) = \Gamma(t)$

b). *The Element C is Time-Varying*

Let $C(t) = t+1$, the solution of the input variable of system is $\frac{1}{t+1}u_0$ according

3. INVARIANT ZEROS OF BOND GRAPH MODELS

to equation (3.17). The curve of output Df with the constant input $u(t) = \Gamma(t)$ is plotted in Figure 3.14.

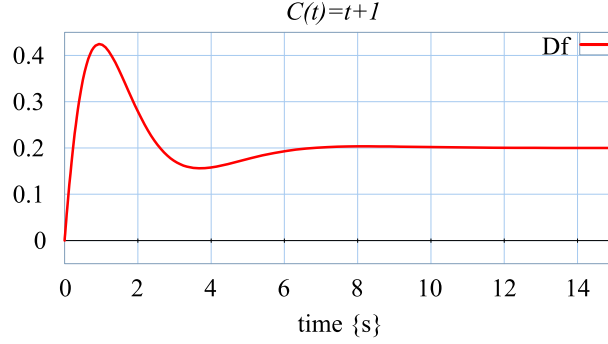

Figure 3.14: The output Df curve with $C(t) = t + 1$ and $u(t) = \Gamma(t)$

By (3.18), let $u(t) = \frac{2}{t+1}$, $x_{10} = 0$, $x_{20} = 1$, Figure 3.15 gives the response of the output Df .

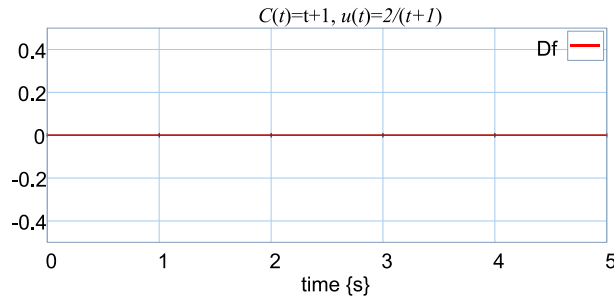

Figure 3.15: The output Df curve with $C(t) = t + 1$, $u(t) = \frac{2}{t+1}$ and $x_{20} = 1$

c). Two Elements TF and C are Time-Varying and Proportional

Let $C(t) = m(t) = t^2 + 1$, the solution of the input variable of system is u_0 according to equation (3.17). The curve of output Df with the constant input $u(t) = \Gamma(t)$ is shown in Figure 3.16.

d). Two Elements TF and C are Time-Varying and Nonproportional

Let $m(t) = t + 2$, $C(t) = t^2 + 1$, the solution of the input variable of system is $u(t) = \frac{t+2}{t^2+1}u_{20}$ according to equation (3.17). The curve of output Df with the constant input $u(t) = \Gamma(t)$ is indicated in Figure 3.17.

3.2 Invariant Zeros of Linear Square Models

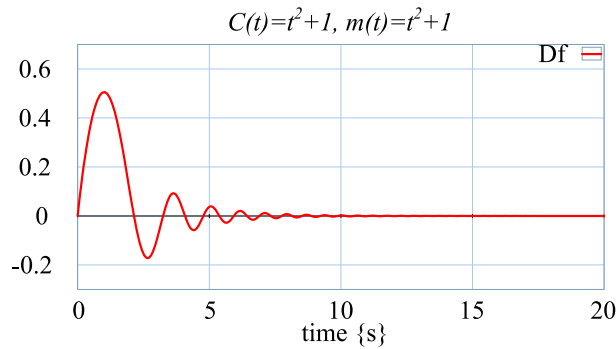

Figure 3.16: The output Df curve with $C(t) = m(t) = t^2 + 1$ and $u(t) = \Gamma(t)$

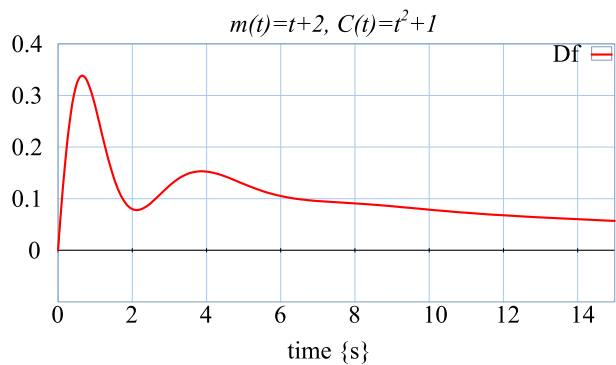

Figure 3.17: The output Df curve with $m(t) = t + 2, C(t) = t^2 + 1$ and $u(t) = \Gamma(t)$

By (3.18), let $u(t) = \frac{t+2}{t^2+1}, x_{10} = 0, x_{20} = 1$, Figure 3.18 gives the response of the output Df .

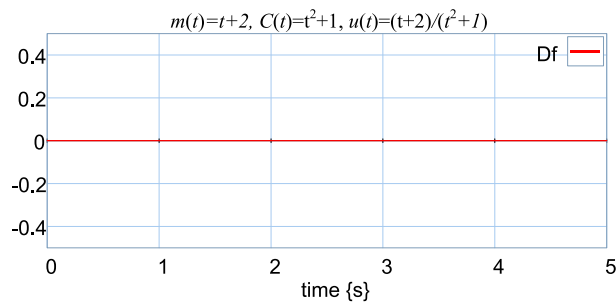

Figure 3.18: The output Df curve with $m(t) = t + 2, C(t) = t^2 + 1, u(t) = \frac{t+2}{t^2+1}$ and $x_{20} = 1$

From these four aforementioned examples, one can find that there exists a constant input variable for zeroing the output variable in spite of the existence of time-varying elements in the causal path of BGD model. It means that the

3. INVARIANT ZEROS OF BOND GRAPH MODELS

rule to determine the constant input variable from the BGD model must be completed with a study of the BGD model and an algebraic criterion. The invariant polynomials of system matrices give the intrinsic implementation of the existence of constant input variable.

e). *With Time-Varying Elements $C(t)$ and $I(t)$*

The model with two time-varying elements I and C is considered here. Let $I(t) = t + 1, C(t) = t^2 + 1$, the solution of the input variable of the system is $u(t) = \frac{2}{t^2+1}u_{20}$ according to equation (3.17). Figure 3.19 shows the output Df curve with the constant input $u(t) = \Gamma(t)$.

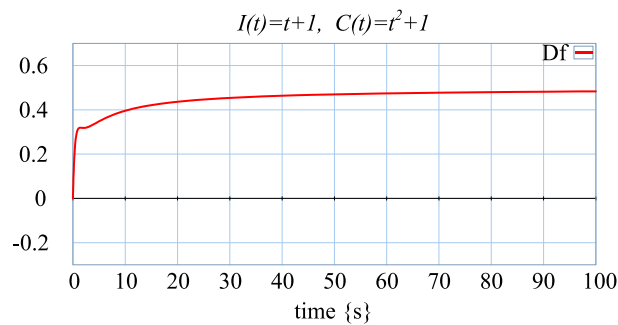

Figure 3.19: The output Df curve with $I(t) = t + 1, C(t) = t^2 + 1$ and $u(t) = \Gamma(t)$

By (3.18), let $u(t) = \frac{2}{t^2+1}, x_{10} = 0, x_{20} = 1$, Figure 3.20 gives the response of the output Df .

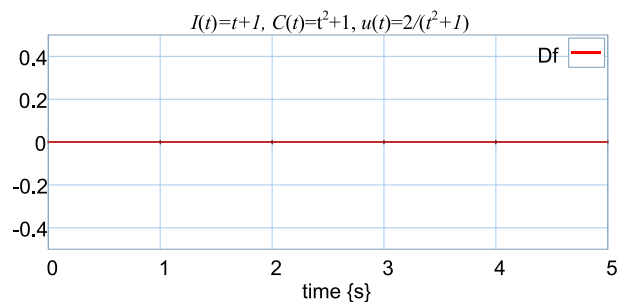

Figure 3.20: The output Df curve with $I(t) = t + 1, C(t) = t^2 + 1, u(t) = \frac{2}{t^2+1}$ and $x_{20} = 1$

As mentioned, the SISO system has a null invariant zero in LTI and LTV cases. In the LTI case, the null invariant zero is always related to a constant

3.2 Invariant Zeros of Linear Square Models

input variable for zeroing the output variable. However, the conclusion is no more valid for the LTV system. According to the simulation results of aforementioned cases, one can find that the input variable for zeroing the output variable has different forms according to system parameters. When elements $C(t)$ and $m(t)$ are time-varying separately or simultaneously but nonproportional, a constant input variable does not exist for the output-zeroing problem. It is because these time-varying parameters $C(t)$ and $m(t)$ are contained in the input-output causal path gain of the BGD model. In other cases, there is always a constant input variable for the problem. These results are confirmed by the algebraic procedure. An extension is now proposed for MIMO models.

3.2.3 Invariant Zeros of MIMO Models

In case of LTV models, the controllability/observability matrices are quite difficult to derive. From the algebraic point of view, the bond graph approach is simple if the algebraic and graphical approaches are combined (see previous sections). In the SISO case, there is only one choice for input-output causal path, and the non controllable part for BGB model is not very difficult to find out. But in the square MIMO case, the notion of disjoint input-output causal paths will be utilized to draw BGB models. For classical control problems, invariant zeros must be studied for global models (all input and output variables) and also for row submodels (only one output variable). In [Yang *et al.* \(2010\)](#), it is proven that some uncontrollable parts of the BGB models must be compared from an algebraic point of view (torsion submodules). An illustrative example is proposed all along this section and sets of invariant zeros of global MIMO square systems are pointed out. Therefore, sets of row invariant zeros of square systems are derived from the row subsystems which are not square, this issue and the non-square global systems will be discussed in [Section 3.3](#).

Some procedures are now illustrated on a bond graph model, and then the general methodology will be exposed. Firstly, the bond graph model is supposed to be associated to an LTI model (with and without an R-element), after that extended to the LTV case. In the LTV case, the graphical approach is exactly the same, but the algebraic relations written from different bond graph models allow us to conclude with the right property. According to [Definition 1.35](#), invariant zeros are related to Smith/Jacobson zeros of the module M_{iz} . The procedure for

3. INVARIANT ZEROS OF BOND GRAPH MODELS

detecting invariant zeros of linear MIMO square systems is defined in Procedure 3.9.

This procedure can be simplified for square models. According to Definition 3.2, invariant zeros of linear systems are related to torsion modules $\mathcal{T}(\Sigma/[y]_{\mathbf{R}})$. For an LTI/LTV square system, module $\Sigma/[y]_{\mathbf{R}}$ can be derived from the BGB model of the system. As mentioned, modules M_{ei} defined by equations of dynamical elements with an integral causality assignment in BGB models are related to non controllable parts in systems. As to the non controllable property of torsion module, modules M_{ei} have the same invariant zeros structures with torsion modules.

Proposition 3.12 *The invariant zeros of an LTI/LTV square system are related to dynamical elements with an integral causality assignment in the BGB model. The invariant zeros of the system are the conjugacy classes of the elements of a full set of Smith zeros of the module M_{ei} .*

In this section, a linear square bond graph model is studied with several situations. The bond graph model is shown in Figure 3.21. This bond graph model is studied in different cases: the element R is removed or not and parameters of the model are supposed to be constant or depending on time, in that case it is an LTV model. The method for detecting the invariant zeros of LTI and LTV models by the structural approach is quite the same except calculation procedures with torsion modules. These different configurations allow us to highlight the methodology.

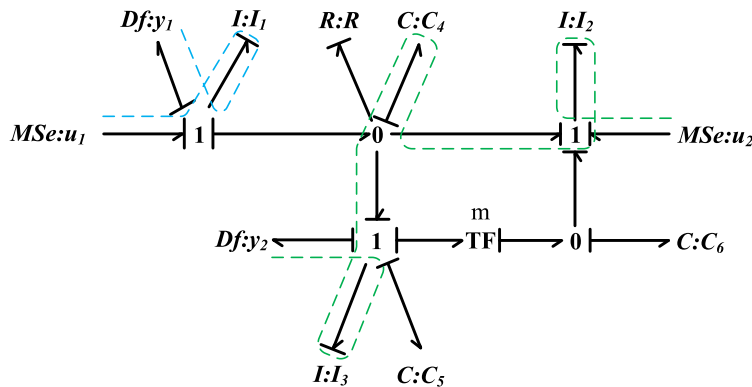

Figure 3.21: Bond graph model: BGI

3.2 Invariant Zeros of Linear Square Models

This bond graph model is structurally controllable, observable; a derivative causality can be assigned to each dynamical element in Figure 3.22 and it is invertible (the model has two different input-output causal paths). The rank of the state matrix is equal to 6. $x = (x_1, \dots, x_6)^t = (p_{I_1}, p_{I_2}, p_{I_3}, q_{C_4}, q_{C_5}, q_{C_6})^t$ is the state vector. These properties are true for each study (LTI, LTV, with and without the R-element). The study is proposed in a second step without the R-element, because some interesting properties can be illustrated with a nice graphical approach due to the bond graph representation.

The row infinite structure of the BGI model is defined as $n_1 = 1$ (causal path $Df : y_1 - I_1 - MSe : u_1$), $n_2 = 3$ (causal path $Df : y_2 - I_3 - C_4 - I_2 - MSe : u_2$). The global infinite structure is $n'_1 = L_1 = 1$ and $n'_2 = L_2 - L_1 = 3$ (the two previous input-output causal paths are different). It is concluded that the model has two invariant zeros.

3.2.3.1 LTI Models

In the LTI case, calculations are much simpler than ones in the LTV case. A new proposition for detecting invariant zeros of LTI square systems is given in Proposition 3.13.

Proposition 3.13 *Invariant zeros of LTI square systems can be derived from modules M_{ei} . Roots of invariant factors of Smith forms of definition matrices of M_{ei} are invariant zeros of systems. Invariant zeros of systems can also be derived from zeros of definition polynomials of torsion equations in M_{ei} .*

Invariant Zeros of the Global System with R Element

By use of Maple™ programs, the invariant polynomial of the Smith form of the system matrix is $\delta(R(mC_4 - C_6)\delta + m)$. The invariant zeros are the roots of this polynomial. Hence, there are two invariant zeros: $\delta_1 = 0$ and $\delta_2 = \frac{m}{R(C_6 - mC_4)}$ when $C_6 \neq mC_4$. There exist only one invariant zero, which is null $\delta = 0$ with $C_6 = mC_4$. It is indicated that this polynomial is directly deduced from the bond graph model, in different ways.

The row infinite structure of the BGD model, Figure 3.22, is defined as $n_{1d} = 0$ (causal path $Df : y_1 - R - MSe : u_1$) and $n_{2d} = 1$ (causal path $Df : y_2 - C_5 - TF(m) - MSe : u_2$) and the global infinite structure is $n'_{1d} = L_{1d} = 0$ and

3. INVARIANT ZEROS OF BOND GRAPH MODELS

$n'_{2d} = L_{2d} - L_{1d} = 1$ (two previous paths are different). It is concluded that the second row subsystems has a null invariant zero and that the global model has one invariant zero at $\delta = 0$.

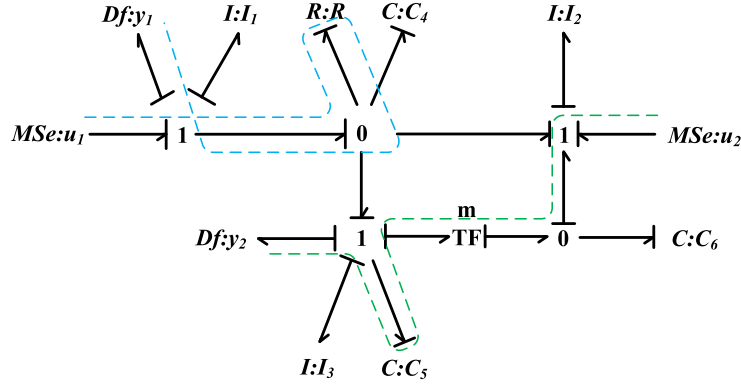

Figure 3.22: Bond graph model: BGD

Now, an algebraic characterization of the invariant zero at $\delta = 0$ for the global model is proposed with the BGD and in the next section with the BGB. Invariant zeros are defined when output variables are set to a zero value, thus $x_1 = x_3 = 0$. Two mathematical relations are directly written following causal path in the BGD from the output detectors. Equations of the output variables are shown in (3.23).

$$\begin{cases} y_1 = \dot{x}_4 - \dot{x}_6 + m\dot{x}_5 + \dot{x}_5 + \frac{1}{R}u_1 - \frac{1}{R}\dot{x}_1 \\ y_2 = \dot{x}_5 \end{cases} \quad (3.23)$$

From these two equations, if $y_1 = y_2 = 0$ it immediately follows $\dot{x}_5 = 0$ which is the algebraic relation directly related to the invariant zero at $\delta = 0$ for the global model, since the relation $\delta x_5 = 0$ can be written, which is associated to a torsion module.

The set of invariant zeros is algebraically characterized with the BGB model, drawn in Figure 3.23. Now the bond graph procedure introduced in Procedure 3.8 is used to detect the invariant zeros structure of the system. There are four steps in which mathematical relations are written for the unknown variables associated to elements of the BGB model (effort or flow variable depending on the causality assignment):

Step 1: output variables

For the two output detectors, the flow at the 1-junction is equal to zero. Two relations are thus written: $y_1 = y_2 = 0$, thereby $x_1 = \dot{x}_1 = x_3 = \dot{x}_3 = 0$. These

3.2 Invariant Zeros of Linear Square Models

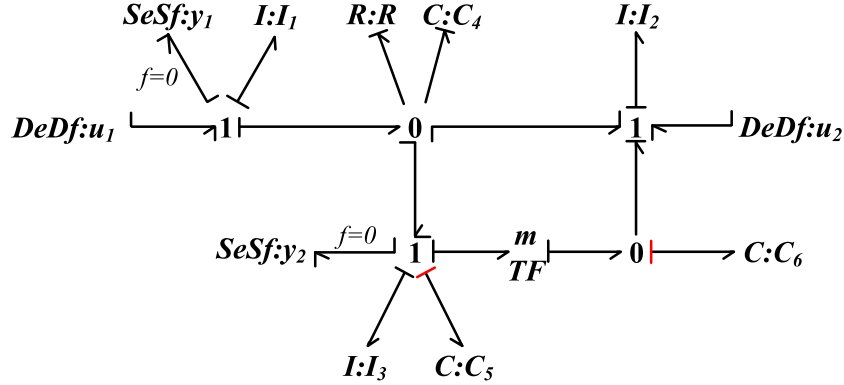

Figure 3.23: Bond graph model: BGB

relations are directly taking into account in the following.

Step 2: elements with a derivative causality

Element $I : I_1 \longrightarrow f_{I_1} = \frac{p_{I_1}}{I_1} = \frac{x_1}{I_1} = 0$

Element $I : I_3 \longrightarrow f_{I_3} = \frac{p_{I_3}}{I_3} = \frac{x_3}{I_3} = 0$

Element $I : I_2 \longrightarrow f_{I_2} = \frac{p_{I_2}}{I_2} = \frac{x_2}{I_2} = -f_{C_4} - f_R = -\dot{x}_4 - \frac{1}{R}e_R = -\dot{x}_4 - \frac{1}{R}(\dot{x}_3 + \frac{x_5}{C_5} + m\frac{x_6}{C_6})$, then $\frac{x_2}{I_2} = -\dot{x}_4 - \frac{1}{R}(\frac{x_5}{C_5} + m\frac{x_6}{C_6})$

Element $C : C_4 \longrightarrow e_{C_4} = \frac{q_{C_4}}{C_4} = \frac{x_4}{C_4} = \frac{x_5}{C_5} + m\frac{x_6}{C_6}$

In this second step, there are 2 mathematical relations.

Step 3: input sources

Source $MSe : u_1 \longrightarrow u_1 = \frac{x_5}{C_5} + m\frac{x_6}{C_6}$

Source $MSe : u_2 \longrightarrow u_2 = \dot{x}_2 - (\frac{x_5}{C_5} + m\frac{x_6}{C_6}) - \frac{x_6}{C_6}$

Step 4: elements with an integral causality assignment

Element $C : C_5 \longrightarrow \dot{x}_5 = f_{C_5} = 0$

Element $C : C_6 \longrightarrow \dot{x}_6 = f_{C_6} = \dot{x}_4 + \frac{1}{R}(\frac{x_5}{C_5} + m\frac{x_6}{C_6})$

In the LTI case, equation associated to element $C : C_4$ is rewritten with a derivation $\frac{\dot{x}_4}{C_4} = m\frac{\dot{x}_6}{C_6}$, and by taking into account this relation in step 4, two equations are immediately derived:

$$\begin{cases} \dot{x}_5 = 0 \\ (\frac{C_6 - mC_4}{m})\dot{x}_4 - \frac{1}{R}x_4 = 0 \end{cases} \quad (3.24)$$

Equations (3.24) are the equations of the torsion submodule associated to the invariant zeros. In the LTI case, it is thus easy to derive the invariant zeros. In

3. INVARIANT ZEROS OF BOND GRAPH MODELS

(3.24), there are two torsion equations with $mC_4 \neq C_6$ and one torsion equation with $mC_4 = C_6$. According to Proposition 3.13, the invariant zeros of the LTI system with $mC_4 \neq C_6$ are 0 and $\frac{m}{R(C_6 - mC_4)}$. When $mC_4 = C_6$, the LTI system has only a null invariant zero. The invariant zeros of the system are given in (3.25).

$$\begin{cases} \delta_1 = 0, \delta_2 = \frac{m}{R(C_6 - mC_4)}, C_6 \neq mC_4 \\ \delta = 0, C_6 = mC_4 \end{cases} \quad (3.25)$$

In this case, module M_{ei} is related to dynamical elements with an integral causality assignment in the BGB model, *i.e.*, elements C_5, C_6 . The definition equation of M_{ei} is given in 3.26.

$$\begin{cases} \frac{x_4}{C_4} = \frac{x_5}{C_5} + m\frac{x_6}{C_6} \\ \dot{x}_5 = 0 \\ \dot{x}_6 = \dot{x}_4 + \frac{1}{R}\left(\frac{x_5}{C_5} + m\frac{x_6}{C_6}\right) \end{cases} \quad (3.26)$$

The Smith form of the definition matrix of M_{ei} is $\delta(R(mC_4 - C_6)\delta + m)$ which is the same as the smith form of the system matrix.

Now the module theoretic procedure is executed to get the module M_{iz} . According to Definition 3.3, the equation of M_{iz} is:

$$\begin{bmatrix} \delta & 0 & 0 & \frac{1}{C_4} & 0 & 0 & -1 & 0 \\ 0 & \delta & 0 & -\frac{1}{C_4} & 0 & -\frac{1}{C_6} & 0 & -1 \\ 0 & 0 & \delta & -\frac{1}{C_4} & \frac{1}{C_5} & \frac{m}{C_6} & 0 & 0 \\ -\frac{1}{I_1} & \frac{1}{I_2} & \frac{1}{I_3} & \delta + \frac{1}{C_4 R} & 0 & 0 & 0 & 0 \\ 0 & 0 & -\frac{1}{I_3} & 0 & \delta & 0 & 0 & 0 \\ 0 & \frac{1}{I_2} & -\frac{m}{I_3} & 0 & 0 & \delta & 0 & 0 \\ \frac{1}{I_1} & 0 & 0 & 0 & 0 & 0 & 0 & 0 \\ 0 & 0 & \frac{1}{I_3} & 0 & 0 & 0 & 0 & 0 \end{bmatrix} \begin{bmatrix} \hat{x} \\ \hat{u} \end{bmatrix} = 0 \quad (3.27)$$

This equation is identical with the one derived from the BGB model in Figure 3.23 with the procedure in Proposition 3.8. Finally, one can get the torsion equations from (3.27) which are the same as (3.24).

Solutions of Input Variables for the Output-Zeroing Problem

3.2 Invariant Zeros of Linear Square Models

Now the procedure proposed in Proposition 1.37 is implemented to get differential equations with input variables. As mentioned, in a controllable model, all system variables can be represented by input variables and their derivations because of the relation $\Sigma = [u]_{\mathbf{R}}$. First of all, the representations of all state variables will be given in (3.28) by using the relations between them in four steps.

$$\begin{cases} x_2 = \left(-I_2 C_4 \delta - \frac{I_2}{R}\right) u_1 \\ x_4 = C_4 u_1 \\ x_5 = \left(m I_2 C_4 C_5 \delta^2 + \frac{m I_2 C_5}{R} \delta + (m+1) C_5\right) u_1 + m C_5 u_2 \\ x_6 = -\left(I_2 C_4 C_6 \delta^2 + \frac{I_2 C_6}{R} \delta + C_6\right) u_1 - C_6 u_2 \end{cases} \quad (3.28)$$

When $mC_4 \neq C_6$, one can substitute the state variables in equation (3.24) by input variables. The equation represented by input variables related to the torsion modules is given in (3.29).

$$\begin{cases} \left(\frac{m^2 I_2 C_6}{R^2 (C_6 - mC_4)^2} + m + 1\right) \delta u_1 + m \delta u_2 = 0 \\ \left(\delta - \frac{m}{R(C_6 - mC_4)}\right) u_1 = 0 \end{cases} \quad (3.29)$$

From equation (3.29), two invariant zeros can be derived, such as: $\delta_1 = 0, \delta_2 = \frac{m}{R(C_6 - mC_4)}$. The solution set of input variables is given in (3.30).

$$\begin{cases} u_1 = u_{10} e^{\frac{m}{R(C_6 - mC_4)} t} \\ u_2 = \frac{c}{m} - \left(\frac{m I_2 C_6}{R^2 (C_6 - mC_4)^2} + 1 + \frac{1}{m}\right) u_{10} e^{\frac{m}{R(C_6 - mC_4)} t} \end{cases} \quad (3.30)$$

where $c, u_{10} \in \mathbb{C}$ and u_{10} is the numerical value of input variable u_1 at $t = 0$.

When $mC_4 = C_6$, one can obtain the relation $x_4 = 0$ from the second equation in (3.24) which is no more a torsion element. Then the relation $u_1 = 0$ is derived from equation (3.28). Substitute x_5 in the first equation of (3.24) by the equation of x_5 in (3.28). The differential equation of u_2 is: $\delta u_2 = 0$. Therefore, the solutions of input variables u_1, u_2 are given by equation (3.31).

$$\begin{cases} u_1 = 0 \\ u_2 = u_{20} \end{cases} \quad (3.31)$$

where u_{20} is the value of u_2 at $t = 0$.

Example 3.14 Consider the system in Figure 3.21, the numerical values of the system components are given in Table 3.3.

3. INVARIANT ZEROS OF BOND GRAPH MODELS

Table 3.3: Components's numerical values of the square LTI model

element I_1	element I_2	element I_3	element R
1 H	1 H	1 H	1 Ω
element TF	element C_4	element C_5	element C_6
2	1 F	1 F	1 F

As $mC_4 \neq C_6$, the solution set of the input variables of this model is shown in (3.32) with arbitrary choices of $c, u_{10} \in \mathbb{C}$ such as $c = 2, u_{10} = 2$.

$$\begin{cases} u_1 = 2e^{-2t} \\ u_2 = 1 - 4e^{-2t} \end{cases} \quad (3.32)$$

With these input variables values, Figure 3.24 shows the simulation result where all output variables are null.

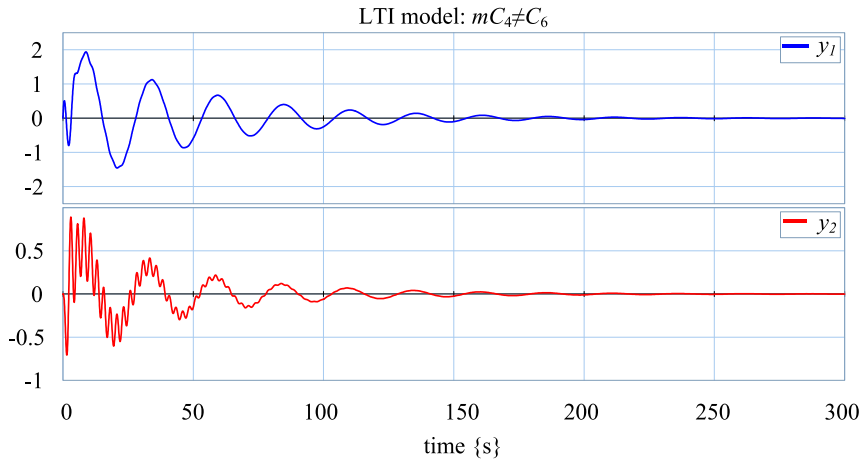

Figure 3.24: Output variables curves of the LTI model with $mC_4 \neq C_6$

Let $C_6 = 2F$ in Table 3.3, one has the relation $mC_4 = C_6$. Therefore, the set of solutions of input variables u_1, u_2 is given in (3.31). Let $u_2 = 2$, the simulation result of output variables curves with $u_1 = 0, u_2 = 2$ is shown in Figure 3.25.

Invariant Zeros of the Global System without R Element

The same study is proposed with the bond graph model without the R element in Figure 3.26. The previous procedures are still applied but with straight results. It is shown that in case of LTV models, results are different.

3.2 Invariant Zeros of Linear Square Models

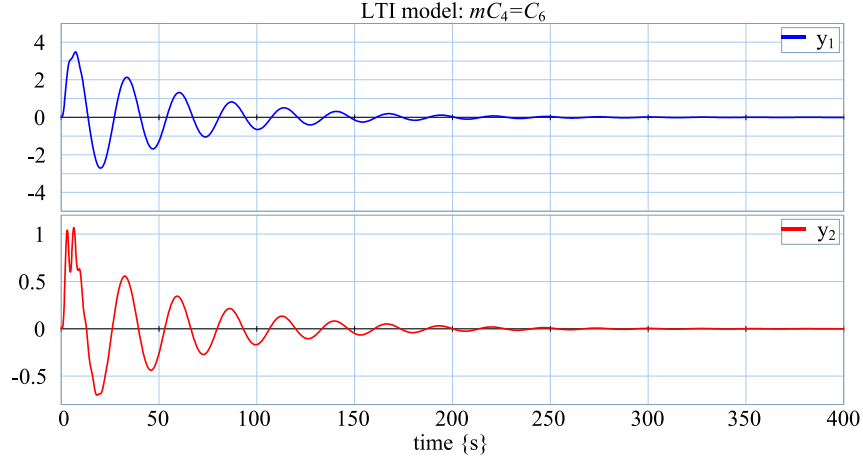

Figure 3.25: Output variables curves of the LTI model with $mC_4 = C_6$

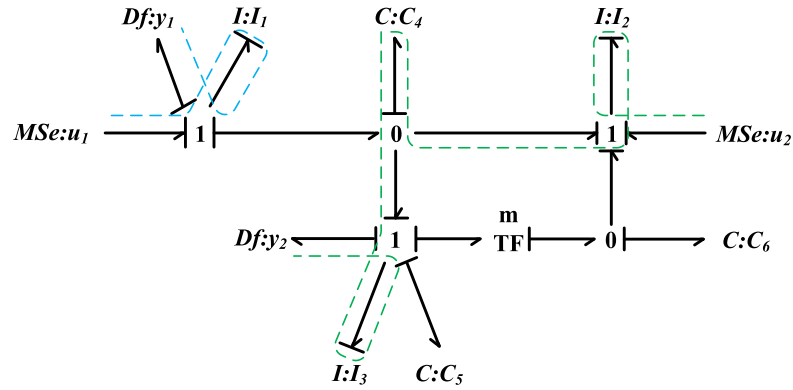

Figure 3.26: BGI model of the square MIMO LTI system without R element

By use of Maple™ programs, the invariant polynomials of the Smith form of the system matrix are $(mC_4 - C_6)\delta$ and δ . The invariant zeros are the roots of these polynomials. Therefore, the model has two null invariant zeros when $mC_4 \neq C_6$. There exists one null invariant zero when $mC_4 = C_6$. This polynomial is directly deduced from the bond graph model, in different ways.

The row infinite structure of the BGD model in Figure 3.27 is defined as $n_{1d} = 1$ (causal path $Df : y_1 - C_4 - MSe : u_1$) and $n_{2d} = 1$ (causal path $Df : y_2 - C_5 - TF(m) - MSe : u_2$) and the global infinite structure is $n'_{1d} = L_{1d} = 1$ and $n'_{2d} = L_{2d} - L_{1d} = 1$ (two previous paths are different). It is concluded that each row subsystems has one null invariant zero and that the global model has two invariant zeros at $\delta = 0$.

Now, an algebraic characterization of the invariant zero at $\delta = 0$ for the

3. INVARIANT ZEROS OF BOND GRAPH MODELS

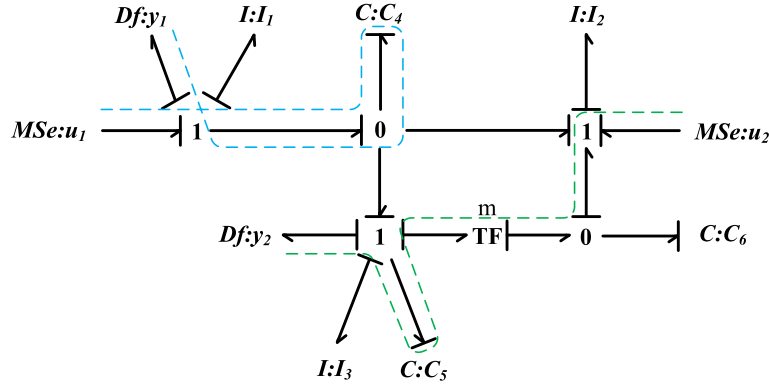

Figure 3.27: Bond graph model without R-element: BGD

global model is proposed with the BGD model and then with the BGB model. Two mathematical relations are directly written following causal paths from the output detectors. The equations are:

$$\begin{cases} y_1 = \dot{x}_4 - \dot{x}_6 + m\dot{x}_5 + \dot{x}_5 \\ y_2 = \dot{x}_5 \end{cases} \quad (3.33)$$

Invariant zeros are defined when output variables are set to a zero value, thus $y_1 = y_2 = 0$. If the input variables do not appear explicitly in these expressions, thus they can be considered as a mathematical expression of a torsion submodule associated to some invariant zeros equal to zeros. By integration, other null invariant zeros can be characterized. From the previous equations, it immediately follows $\dot{x}_5 = 0$ and $\dot{x}_4 - \dot{x}_6 = 0$ which are the algebraic relations directly related to the invariant zeros at $\delta = 0$ for the global model.

Now the set of invariant zeros is algebraically characterized on the BGB model, drawn on Figure 3.28, following the previous procedure. Given that the example is similar to the first one, the mathematical equations are directly written:

$$\text{Output detectors } y_1 = y_2 = 0 \longrightarrow x_1 = \dot{x}_1 = x_3 = \dot{x}_3 = 0$$

$$\text{Element } I : I_1 \longrightarrow f_{I_1} = \frac{pI_1}{I_1} = \frac{x_1}{I_1} = 0$$

$$\text{Element } I : I_3 \longrightarrow f_{I_3} = \frac{pI_3}{I_3} = \frac{x_3}{I_3} = 0$$

$$\text{Element } I : I_2 \longrightarrow f_{I_2} = \frac{pI_2}{I_2} = \frac{x_2}{I_2} = -f_{C_4} = -\dot{x}_4$$

$$\text{Element } C : C_4 \longrightarrow e_{C_4} = \frac{qC_4}{C_4} = \frac{x_4}{C_4} = \frac{x_5}{C_5} + m\frac{x_6}{C_6}$$

$$\text{Source } MSe : u_1 \longrightarrow u_1 = \frac{x_5}{C_5} + m\frac{x_6}{C_6}$$

$$\text{Source } MSe : u_2 \longrightarrow u_2 = \dot{x}_2 - \left(\frac{x_5}{C_5} + m\frac{x_6}{C_6}\right) - \frac{x_6}{C_6}$$

$$\text{Element } C : C_5 \longrightarrow \dot{x}_5 = 0$$

3.2 Invariant Zeros of Linear Square Models

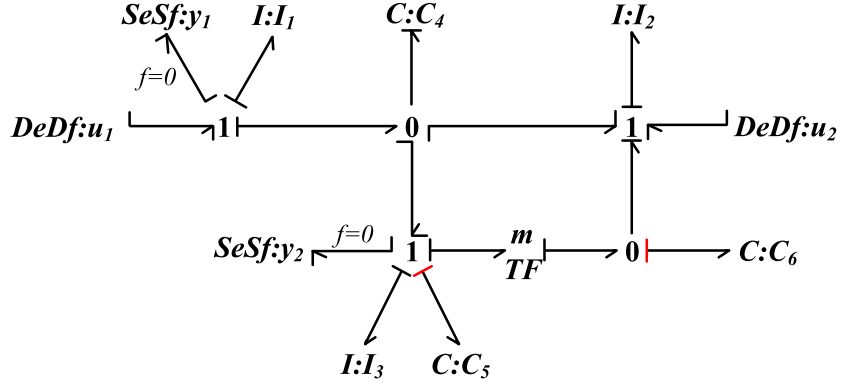

Figure 3.28: Bond graph model without R-element: BGB

Element $C : C_6 \longrightarrow \dot{x}_6 = f_{C_6} = \dot{x}_4$

Three equations are immediately derived, (3 mathematical relations written from C elements):

$$\begin{cases} \frac{x_4}{C_4} = \frac{x_5}{C_5} + m \frac{x_6}{C_6} \\ \dot{x}_5 = 0 \\ \dot{x}_6 = \dot{x}_4 \end{cases} \quad (3.34)$$

In the LTI case, for the first equation in (3.34), a new relation is written $x_4 = \frac{C_4}{C_5} x_5 + \frac{mC_4}{C_6} x_6$. Then equations in (3.34) can be written in (3.35). These equations are also written when reducing the Smith matrix by elementary operations on rows and columns. They are the equations of the torsion submodule associated to the invariant zeros. From equation (3.35), there exist two null invariant zeros when $mC_4 \neq C_6$. There is a null invariant zero when $mC_4 = C_6$.

$$\begin{cases} \delta x_5 = 0 \\ \delta \left(\frac{C_6 - mC_4}{C_6} \right) x_6 = 0 \end{cases} \quad (3.35)$$

Equation (3.34) is also the definition equation of the module M_{ei} in the BGB model. The invariant zeros can be deduced from the Smith form of the definition matrix of M_{ei} .

Solutions of Input Variables for Output-Zeroing Problem

Now the procedure introduced in Proposition 1.37 is used to get differential

3. INVARIANT ZEROS OF BOND GRAPH MODELS

equations of input variables. Then the solution set of input variables will be detected. From above steps, all state variables are derived from input variables and their derivations. These representations are given in (3.36).

$$\begin{cases} x_2 = -I_2 C_4 \delta u_1 \\ x_4 = C_4 u_1 \\ x_5 = (m I_2 C_4 C_5 \delta^2 + (m+1) C_5) u_1 + m C_5 u_2 \\ x_6 = (-I_2 C_4 C_6 \delta^2 - C_6) u_1 - C_6 u_2 \end{cases} \quad (3.36)$$

Substitute the state variables in (3.35) by input variables, differential equation in input variables can be derived. Then the equations of torsion submodule $\Sigma/[y]_{\mathbf{R}}$ in input variables are shown in equation (3.37).

$$\begin{cases} \delta u_1 = 0 \\ \delta u_2 = 0 \end{cases} \quad (3.37)$$

From (3.37), there are two null invariant zeros for the system. The solution set of input variables can be derived, which is shown in (3.38).

$$\begin{cases} u_1 = u_{10} \\ u_2 = u_{20} \end{cases} \quad (3.38)$$

where $u_{10}, u_{20} \in \mathbb{C}$ are the numerical values of u_1, u_2 at $t = 0$.

When $C_6 = mC_4$, equation (3.34) related to the torsion submodule $\mathcal{T}(\Sigma/[y]_{\mathbf{R}})$ is equivalent to equation (3.39).

$$\begin{cases} \dot{x}_5 = 0 \\ \dot{x}_4 = \dot{x}_6 \end{cases} \quad (3.39)$$

Substitute all state variables in (3.39) by using equations in (3.36), differential equations of input variables are shown in (3.40).

$$\begin{cases} \frac{C_6 - mC_4}{C_6} \delta u_1 = 0 \\ -\delta u_2 = \left(I_2 C_4 \delta^3 + \left(\frac{C_6 + C_4}{C_6} \right) \delta \right) u_1 \end{cases} \quad (3.40)$$

Because of $C_6 = mC_4$, the first equation in (3.40) is no more related to the torsion submodule. It means that input variable u_1 can be any arbitrary element in the coefficient differential ring \mathbf{K} . The second equation in (3.40) is the definition equation of the torsion submodule. This equation is rewritten in (3.41) which verifies that there is one null invariant zero. If input variable u_1 's form is fixed, so is the input variable u_2 according to the second equation in (3.40).

3.2 Invariant Zeros of Linear Square Models

$$\delta \left(\left(I_2 C_4 \delta^2 + \left(\frac{C_6 + C_4}{C_6} \right) \right) u_1 + u_2 \right) = 0 \quad (3.41)$$

Example 3.15 Now the simulation results of 20-sim[®] are used to verify solution sets of the input variables in two cases. In the first case, elements C_4 and C_6 have the relation $C_6 \neq mC_4$. Elements C_4 and C_6 have the relation $C_6 = mC_4$ in the second case.

Because the asymptotic stability property of this system is not guaranteed, a resistance element R ($R=1 \Omega$) is added in the 1-junction connected with dynamical element I_1 . Because BGD and BGB models have the same properties, this new model is used for simulation in order to guarantee the stability of the open loop simulation.

1. In the Case $C_6 \neq mC_4$

The studied system has two null invariant zeros, and the simulation result with 20-sim[®] is given in Figure 3.29. The same numerical values of system elements are used as in Table 3.3, and the two input variables are set to be constant such as $u_1 = 2, u_2 = 4$. This result verifies the existence of two null invariant zeros.

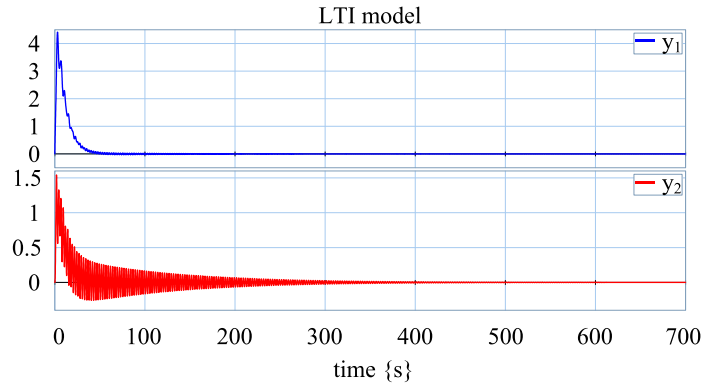

Figure 3.29: Output variables curves with $C_6 \neq mC_4, u_1 = 2, u_2 = 4$

2. In the Case $C_6 = mC_4$

In this case, $u_1 = 2, u_2 = 4$ is still the solution set of the input variables in (3.40). The simulation result is shown in Figure 3.30 with $C_6 = mC_4, u_1 = 2, u_2 = 4$.

3. INVARIANT ZEROS OF BOND GRAPH MODELS

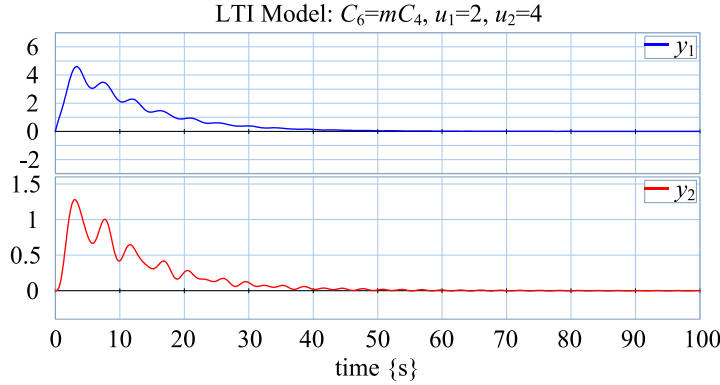

Figure 3.30: Output variables curves with $C_6 = mC_4, u_1 = 2, u_2 = 4$

As mentioned, input variable u_1 can be arbitrarily selected in \mathbf{K} . Let $u_1 = t + 2$, then $u_2 = -1.5t + c, c \in \mathbb{C}$ according to equation (3.40). Let $c = 2$ and $u_2 = -1.5t + 2$, the numerical value of C_6 is changed, such as $C_6 = 2$ in Table 3.3. The simulation result in Figure 3.31 shows that $u_1 = t + 2, u_2 = -1.5t + 2$ is the solution set of equation (3.40). With these values of the input variables, output variables y_1, y_2 are equal to zero.

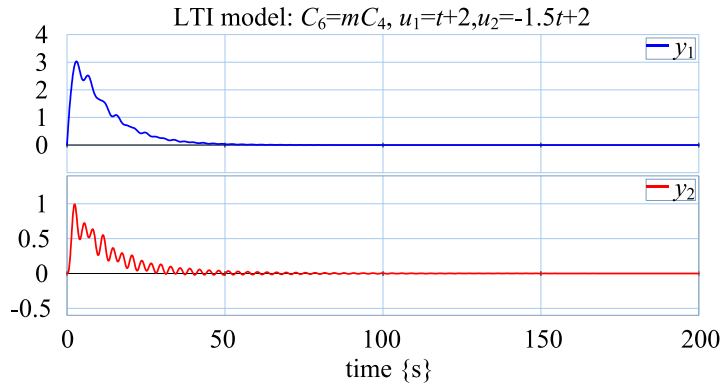

Figure 3.31: Output variables curves with $C_6 = mC_4, u_1 = t + 2, u_2 = -1.5t + 2$

If $C_6 = 1$, then $u_1 = t + 2, u_2 = -1.5t + 2$ is no more solution set of equation (3.40). It is verified by simulation in Figure 3.32.

3.2.3.2 LTV Models

Consider again the previous bond graph model in Figure 3.21, but in this case with time-varying parameters in $\mathbb{C}(t)$ (field of rational functions of t with coefficients in \mathbb{C}). It comes immediately that all the previous mathematical relations directly

3.2 Invariant Zeros of Linear Square Models

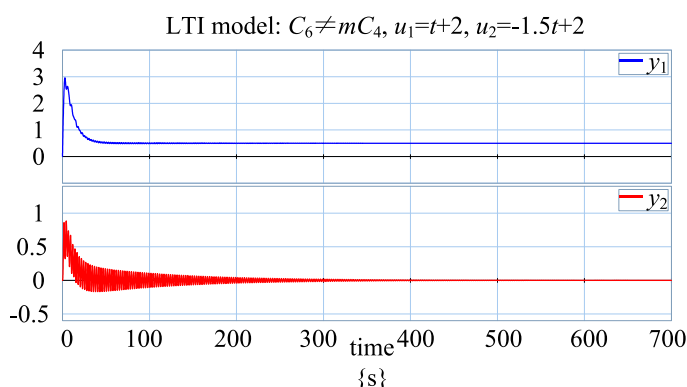

Figure 3.32: Output variables curves with $C_6 \neq mC_4, u_1 = t + 2, u_2 = -1.5t + 2$

derived from the bond graph models can be written. However, the differential equations cannot be in some cases associated to a torsion submodule; for example, some coefficients are depending on time. It is not always easy to point out torsion submodule and thus the invariant zeros. Two approaches are possible: first by considering derivations in the temporal domain, secondly by considering formal calculus in the non commutative ring.

In this section, the Jacobson form of system matrices is used to calculate invariant zeros of linear systems. Invariant zeros structures of LTI/LTV systems are detected in the same way, such as: Jacobson form of system matrices $P(\delta, t)$ in (3.1). Roughly speaking, the LTI case is a special class of the LTV case. The procedure for calculating the Jacobson normal form* is also valid in the LTI case. The case of LTI systems with the simplification that each conjugacy class of an element of a full set of zeros or a fundamental set of poles is a singleton (only one element in conjugacy classes). Now the two previous examples are reconsidered, but in LTV case.

As mentioned, for square LTV bond graph models, the invariant zeros are related to dynamical elements with an integral causality assignment in BGBs. These elements related to module M_{ei} in BGB models are the same as dynamical elements which are not included in the shortest disjoint input-output causal paths in BGI models. The invariant zeros of LTV models are the conjugacy classes of the elements of a full set of Smith zeros of M_{ei} . In line with Property 2.49, a

*When doing elementary operations, pay attention to the terms, with possible null values in matrices, which may change the rank of matrices.

3. INVARIANT ZEROS OF BOND GRAPH MODELS

new property for invariant zeros of square LTV bond graph models is given by Property 3.16.

Property 3.16 *Suppose a right invertible, controllable and observable LTV model. The invariant zeros are the conjugacy classes of which the number is less or equal to $n - \sum n'_i$ where n is the order of the model and $\{n'_i\}$ is the set of global infinite zero orders. The invariant zeros of the LTV model are the conjugacy classes of the elements of a full set of Smith zeros of M_{ei} .*

LTV System with R Element related to C_4 Element

Consider the bond graph model in Figure 3.21 with time-varying parameters. The system matrix is the same as the one of the LTI system in (3.27) except time-varying properties. As mentioned above, the Jacobson form of this matrix can be derived from its reduced matrix, which is given in (3.42).

$$\begin{bmatrix} 0 & -\frac{1}{C_4(t)} & \frac{1}{C_5(t)} & \frac{m}{C_6(t)} \\ \frac{1}{I_2(t)} & \delta + \frac{1}{C_4(t)R(t)} & 0 & 0 \\ 0 & 0 & \delta & 0 \\ \frac{1}{I_2(t)} & 0 & 0 & \delta \end{bmatrix} \quad (3.42)$$

The procedure for getting the Jacobson form of the matrix in (3.42) is shown in (3.43) on the basis of elementary operations defined in Definition 1.16.

$$\begin{aligned} & \begin{bmatrix} 0 & -\frac{1}{C_4(t)} & \frac{1}{C_5(t)} & \frac{m(t)}{C_6(t)} \\ \frac{1}{I_2(t)} & \delta + \frac{1}{C_4(t)R(t)} & 0 & 0 \\ 0 & 0 & \delta & 0 \\ \frac{1}{I_2(t)} & 0 & 0 & \delta \end{bmatrix} \xrightarrow[\text{eliminate } c_1, r_4]{r_2 - r_4} \begin{bmatrix} -\frac{1}{C_4(t)} & \frac{1}{C_5(t)} & \frac{m}{C_6(t)} \\ \delta + \frac{1}{C_4(t)R(t)} & 0 & -\delta \\ 0 & \delta & 0 \end{bmatrix} \\ & \xrightarrow[c_2 - c_1 \times \frac{m(t)C_4(t)}{C_6(t)}, c_2 - \left(\delta + \frac{1}{C_4(t)R(t)}\right) \times c_1, \text{eliminate } r_1, c_1]{C_4(t) \times r_1, c_2 - c_1 \times \frac{C_4(t)}{C_5(t)}, c_2 - c_1 \times \frac{m(t)C_4(t)}{C_6(t)}} \begin{bmatrix} \delta \frac{C_4(t)}{C_5(t)} + \frac{1}{C_5(t)R(t)} & \delta \frac{m(t)C_4(t) - C_6(t)}{C_6(t)} + \frac{m(t)}{C_6(t)R(t)} \\ \delta & 0 \end{bmatrix} \\ & \xrightarrow[r_1 - \frac{C_4(t)}{C_5(t)} \times r_2]{c_2 - c_1 \times \frac{m(t)C_4(t)}{C_6(t)}, c_2 - \left(\delta + \frac{1}{C_4(t)R(t)}\right) \times c_1, \text{eliminate } r_1, c_1} \begin{bmatrix} \left(\frac{C_4(t)}{C_5(t)}\right)' + \frac{1}{C_5(t)R(t)} & \delta \frac{m(t)C_4(t) - C_6(t)}{C_6(t)} + \frac{m(t)}{C_6(t)R(t)} \\ \delta & 0 \end{bmatrix} \end{aligned} \quad (3.43)$$

The second matrix in (3.43) is the definition matrix of module M_{ei} . From above calculations, one can find that modules M_{ei} and $\mathcal{T}(\Sigma/[y]_{\mathbf{R}})$ have the same Jacobson normal form. So one can derive invariant zeros from Jacobson normal

3.2 Invariant Zeros of Linear Square Models

forms of definition matrices of modules M_{ei} according to Proposition 3.13. The first term $\left(\frac{C_4(t)}{C_5(t)}\right)' + \frac{1}{C_5(t)R(t)}$ in the last matrix may has a null value. So, two situations based on its value are studied.

$$1. \text{ System with } \left(\frac{C_4(t)}{C_5(t)}\right)' + \frac{1}{C_5(t)R(t)} = 0$$

In this case, the last matrix in (3.43) becomes matrix in (3.44). There exists a term δ in the matrix which means there is a null invariant zero. For the term $\delta \frac{m(t)C_4(t)-C_6(t)}{C_6(t)} + \frac{m(t)}{C_6(t)R(t)}$, its relation with a torsion element depends on the value of $m(t)C_4(t) - C_6(t)$.

If $m(t)C_4(t) = C_6(t)$, this term is equal to zero and the invariant factor of the Jacobson form is δ , and the invariant zero of the system is a conjugacy class $\Delta_{C(t)}(0)$.

$$\begin{bmatrix} 0 & \delta \frac{m(t)C_4(t)-C_6(t)}{C_6(t)} + \frac{m(t)}{C_6(t)R(t)} \\ \delta & 0 \end{bmatrix} \quad (3.44)$$

If $m(t)C_4(t) \neq C_6(t)$, the procedure for getting the Jacobson form of matrix in (3.44) is shown in (3.45),

$$\begin{bmatrix} 0 & \delta \frac{m(t)C_4(t)-C_6(t)}{C_6(t)} + \frac{m(t)}{C_6(t)R(t)} \\ \delta & 0 \end{bmatrix} \xrightarrow{b^{-1} \times r_2} \begin{bmatrix} 0 & \delta + \frac{b'+c}{b} \\ \delta & 0 \end{bmatrix} \quad (3.45)$$

where $b = \frac{m(t)C_4(t)-C_6(t)}{C_6(t)}$, $c = \frac{m(t)}{R(t)C_6(t)}$. The invariant zeros of LTV system with $m(t)C_4(t) \neq C_6(t)$ are conjugacy classes $\Delta_{C(t)}(0)$ and $\Delta_{C(t)}\left(\frac{C_6(t)\left(\frac{m(t)C_4(t)-C_6(t)}{C_6(t)}\right)' + \frac{m(t)}{R(t)}}{C_6(t)-m(t)C_4(t)}\right)$.

The above calculations are also valid for the LTI case. In this case, one has relations such as $\left(\frac{C_4(t)}{C_5(t)}\right)' + \frac{1}{C_5(t)R(t)} = 0$ and $b' = 0$. Therefore, there exist one null invariant for LTI system with $mC_4 = C_6$.

δ and $\delta + \frac{m}{R(mC_4-C_6)}$ are invariant factors of system matrix of LTI system with $mC_4 \neq C_6$. So there are two invariant zeros, such as 0 and $\frac{m}{R(C_6-mC_4)}$ for the system. These results for LTI system are in accordance with the results by bond graph method in Section 3.2.3.1.

$$2. \text{ System with } \left(\frac{C_4(t)}{C_5(t)}\right)' + \frac{1}{C_5(t)R(t)} \neq 0$$

3. INVARIANT ZEROS OF BOND GRAPH MODELS

In this case, the procedure of elementary operations for the last matrix in (3.43) is shown in (3.46).

$$\begin{array}{c}
 \left[\begin{array}{cc} \left(\frac{C_4(t)}{C_5(t)} \right)' + \frac{1}{C_5(t)R(t)} & \delta \frac{m(t)C_4(t) - C_6(t)}{C_6(t)} + \frac{m(t)}{C_6(t)R(t)} \\ \delta & 0 \end{array} \right] \\
 \xrightarrow{\left(\left(\frac{C_4(t)}{C_5(t)} \right)' + \frac{1}{C_5(t)R(t)} \right)^{-1} \times r_1, r_2 - \delta r_1,} \\
 c_2 - c_1 \times \left(\left(\frac{C_4(t)}{C_5(t)} \right)' + \frac{1}{C_5(t)R(t)} \right)^{-1} \left(\delta \frac{m(t)C_4(t) - C_6(t)}{C_6(t)} + \frac{m(t)}{C_6(t)R(t)} \right), (-1) \times r_2 \\
 \left[\begin{array}{cc} 1 & 0 \\ 0 & \delta a(\delta b + c) \end{array} \right]
 \end{array} \quad (3.46)$$

Hence, the invariant polynomial of system matrix is given in (3.47),

$$\delta a(\delta b + c) \quad (3.47)$$

where $a = \left(\left(\frac{C_4(t)}{C_5(t)} \right)' + \frac{1}{R(t)C_5(t)} \right)^{-1}$, $b = \frac{m(t)C_4(t) - C_6(t)}{C_6(t)}$, $c = \frac{m(t)}{R(t)C_6(t)}$. According to above calculations, the value of variable $b = \frac{m(t)C_4(t) - C_6(t)}{C_6(t)}$ may influence the invariant zeros structure of the system.

If $m(t)C_4(t) = C_6(t)$, the invariant polynomial becomes δac . One can continue a column elementary operation, i.e., $\delta ac \times (ac)^{-1} = \delta$. Consequently, the invariant zero of the system is a conjugacy class, such as $\Delta_{C(t)}(0)$.

Otherwise, for getting the invariant zeros of the system, one should factorize this 2-order differential polynomial into the form with two 1-order polynomials, such as $(\delta - \alpha_1)(\delta - \alpha_2)$. Factorizations of differential polynomials in the LTV case are very complicated. In this case, one can get this form by using a special technic which is shown in (3.48).

$$\begin{aligned}
 \delta a(\delta b + c) &= (a\delta + a')(\delta b + c) = a \left(\delta + \frac{a'}{a} \right) \left(\delta + \frac{c}{b} \right) b = \Delta \\
 &\xrightarrow[\Delta \times b^{-1}]{a^{-1} \times \Delta} \left(\delta + \frac{a'}{a} \right) \left(\delta + \frac{c}{b} \right)
 \end{aligned} \quad (3.48)$$

So the invariant zeros of the system are conjugacy class $\Delta_{C(t)} \left(\frac{\left(\frac{C_4(t)}{C_5(t)} \right)'' + \left(\frac{1}{R(t)C_5(t)} \right)'}{\left(\frac{C_4(t)}{C_5(t)} \right)' + \frac{1}{R(t)C_5(t)}} \right)$
and $\Delta_{C(t)} \left(\frac{m(t)}{R(t)(C_6(t) - m(t)C_4(t))} \right)$.

3.2 Invariant Zeros of Linear Square Models

The invariant factors of the system matrices of the LTI system in two cases are shown in Table 3.4.

Table 3.4: Invariant factors of system matrices with R in the LTI case

LTI case	
$mC_4 = C_6$	$mC_4 \neq C_6$
δ	$\delta(\delta + \frac{m}{R(mC_4 - C_6)})$

Table 3.5 gives the invariant factors of the system matrices of the LTV system in several cases.

Table 3.5: Invariant factors of system matrices with R in the LTV case

LTV case			
$(\frac{C_4(t)}{C_5(t)})' = -\frac{1}{R(t)C_5(t)}$		$(\frac{C_4(t)}{C_5(t)})' \neq -\frac{1}{R(t)C_5(t)}$	
$m(t)C_4(t) = C_6(t)$	$m(t)C_4(t) \neq C_6(t)$	$m(t)C_4(t) = C_6(t)$	$m(t)C_4(t) \neq C_6(t)$
δ	$\delta, \delta + \frac{b'+c}{b}$	δ	$(\delta + \frac{a'}{a})(\delta + \frac{c}{b})$

LTV System with R Element related to I_1 Element

The study is proposed for the second bond graph model, i.e., the bond graph model with the resistive element R related to I_1 Element. It is shown that Property 2.50 is no more valid.

According to Proposition 3.12, the invariant zeros can be derived from the module M_{ei} . The equations of the module are given in (3.34). So the definition matrix of the module is shown in (3.49).

$$\begin{bmatrix} -\frac{1}{C_4(t)} & \frac{1}{C_5(t)} & \frac{m(t)}{C_6(t)} \\ 0 & \delta & 0 \\ \delta & 0 & -\delta \end{bmatrix} \quad (3.49)$$

The procedure for getting the Jacobson form for this matrix is show in (3.50).

$$\begin{bmatrix} -\frac{1}{C_4(t)} & \frac{1}{C_5(t)} & \frac{m(t)}{C_6(t)} \\ 0 & \delta & 0 \\ \delta & 0 & -\delta \end{bmatrix} \xrightarrow{c_1+c_3} \begin{bmatrix} \frac{m(t)}{C_6(t)} - \frac{1}{C_4(t)} & \frac{1}{C_5(t)} & \frac{m(t)}{C_6(t)} \\ 0 & \delta & 0 \\ 0 & 0 & -\delta \end{bmatrix} \quad (3.50)$$

3. INVARIANT ZEROS OF BOND GRAPH MODELS

Term $\frac{m(t)}{C_6(t)} - \frac{1}{C_4(t)}$ of the second matrix in (3.50) may has a null value. So, two cases must be studied.

1. System with $C_6(t) = m(t)C_4(t)$

The second matrix in (3.50) and the first matrix in (3.51) have the same Jacobson form. Equation (3.51) gives the procedure for getting the Jacobson form.

$$\begin{aligned} & \begin{bmatrix} \frac{1}{C_5(t)} & \frac{1}{C_4(t)} \\ \delta & 0 \\ 0 & -\delta \end{bmatrix} \xrightarrow[\text{eliminate } r_1, c_1]{C_5(t) \times r_1, r_2 - \delta \times r_1, -1 \times r_3} \begin{bmatrix} \frac{C_5(t)}{C_4(t)}\delta + \left(\frac{C_5(t)}{C_4(t)}\right)' \\ \delta \end{bmatrix} \\ & \xrightarrow{r_1 - \frac{C_5(t)}{C_4(t)} \times r_2} \begin{bmatrix} \left(\frac{C_5(t)}{C_4(t)}\right)' \\ \delta \end{bmatrix} \end{aligned} \quad (3.51)$$

Term $\left(\frac{C_5(t)}{C_4(t)}\right)'$ of the last matrix in (3.51) may has a null value.

If $\left(\frac{C_5(t)}{C_4(t)}\right)' = 0$, the invariant factor of the last matrix in (3.51) is δ . Therefore, the LTI system with $C_6 = mC_4$ has one null invariant zero. The invariant zero of the LTV system with $C_6(t) = m(t)C_4(t)$ and $\left(\frac{C_5(t)}{C_4(t)}\right)' = 0$ is the conjugacy class $\Delta_{C(t)}(0)$.

If $\left(\frac{C_5(t)}{C_4(t)}\right)' \neq 0$, term δ can be eliminated by the elementary operation $r_2 - \delta \left(\left(\frac{C_5(t)}{C_4(t)}\right)'\right)^{-1} \times r_1$. Hence, the LTV system with $C_6(t) = m(t)C_4(t)$ and $\left(\frac{C_5(t)}{C_4(t)}\right)' \neq 0$ has no invariant zero.

2. System with $C_6(t) \neq m(t)C_4(t)$

In this case, the second matrix in (3.50) becomes matrix in (3.52) by eliminating the first row and column of the previous matrix.

$$\begin{bmatrix} \delta & 0 \\ 0 & \delta \end{bmatrix} \quad (3.52)$$

Hence, the LTI system with $C_6 \neq mC_4$ has two null invariant zeros. The LTV system with $C_6(t) \neq m(t)C_4(t)$ has two identical conjugacy classes, such as

3.2 Invariant Zeros of Linear Square Models

$\Delta_{C(t)}(0)$.

The invariant factors of system matrices of the linear system in several cases are shown in Table 3.6.

Table 3.6: Invariant factors of the system matrix in several cases

LTI case		LTV case	
$mC_4 \neq C_6$	$mC_4 = C_6$	$m(t)C_4(t) \neq C_6(t)$	$m(t)C_4(t) = C_6(t)$
δ, δ	δ	δ, δ	$\left(\frac{C_4}{C_5}\right)' \neq 0$
			$\left(\frac{C_4}{C_5}\right)' = 0$
			\emptyset
			δ

Solutions of Input Variables for Output-Zeroing Problem

Now the set of solutions of input variables u_1, u_2 of the system with R ($R=10\Omega$) element related to element I_1 is studied here. Let $m(t) = C_6(t) = t + 2$ and the other elements's parameters are shown in Table 3.3. As $m(t)C_4 = C_6(t)$ and $\left(\frac{C_4}{C_5}\right)' = 0$, there is a null invariant zero according to Table 3.6.

In this case, equation (3.34) can be rewritten as in (3.53).

$$\begin{cases} x_4 = x_5 + x_6 \\ \dot{x}_5 = 0 \\ \dot{x}_4 = \dot{x}_6 \end{cases} \quad (3.53)$$

The third equation can be derived from the other equations, so it represents the same torsion element as the second equation. One can substitute x_5 by the differential polynomial equations of u_1, u_2 for getting the differential equations of the input variables. The relation between x_5 and u_1, u_2 was given in (3.36) in the LTI case. The similar relation can be calculated in this case. x_5 is represented in (3.54).

$$x_5 = ((t + 2)\delta^2 + t + 3)u_1 + (t + 2)u_2 \quad (3.54)$$

By use of equation $\dot{x}_5 = 0$ in (3.53), the differential equation of input variables u_1, u_2 is shown in (3.55).

$$\delta \left(((t + 2)\delta^2 + t + 3)u_1 + (t + 2)u_2 \right) = 0 \quad (3.55)$$

Finally, the above equation can be written as equation (3.56),

3. INVARIANT ZEROS OF BOND GRAPH MODELS

$$((t+2)\delta^2 + t+3)u_1 + (t+2)u_2 = c \quad (3.56)$$

where $c \neq 0 \in \mathbb{C}$. Let $u_1 = t+2$ and $c = 2$, then the set of solutions of u_1, u_2 is given in (3.57).

$$\begin{cases} u_1 = t+2 \\ u_2 = -t-3 + \frac{2}{t+2} \end{cases} \quad (3.57)$$

Figure 3.33 gives the curves of the output variables y_1, y_2 with solutions of u_1, u_2 (3.57) for $y_1 = y_2 \equiv 0$.

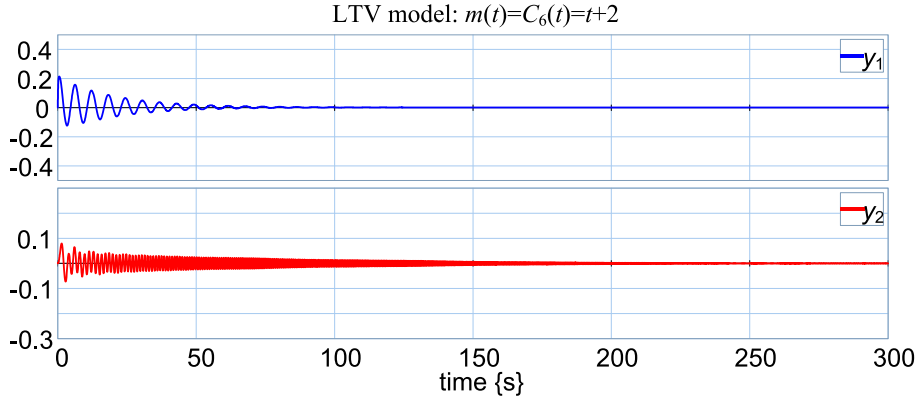

Figure 3.33: The output variables curves of the LTV system with $m(t) = C_6(t) = t+2$

With consideration of an initial condition of the state variables, according to Proposition 3.6, the solution of the input variables for zeroing the output variables is $u_1(t) = g_1, u_2(t) = g_2(t)$, where $g_i, x_{j0}, i = 1, 2, j = 1, \dots, 6$ can be derived from equation (3.58).

$$\begin{cases} x_{10} = x_{20} = x_{30} = 0 \\ \frac{x_{40}}{C_4} = \frac{x_{50}}{C_5} + \frac{m(t)x_{60}}{C_6(t)} \\ g_1 = \frac{x_{40}}{C_4} \\ g_2(t) = -\frac{x_{40}}{C_4} - \frac{x_{60}}{C_6(t)} \end{cases} \quad (3.58)$$

In (3.58), let $x_{40} = x_{60} = 1$ then $x_{50} = 0$, the solution of the input variables is $u_1(t) = 1, u_2(t) = -1 - \frac{1}{t+2}$. Figure 3.34 gives the simulation result of the output variables with the initial condition of the state variables and the input variables.

3.2 Invariant Zeros of Linear Square Models

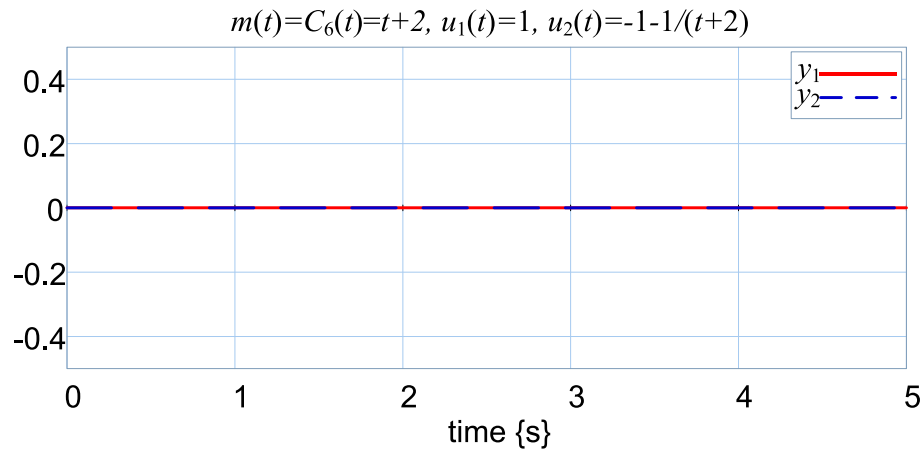

Figure 3.34: The output variables curves of the LTV system with $m(t) = C_6(t) = t + 2$ and an initial condition of the state variables

3.2.4 Conclusion

In this section, the structure of invariant zeros of square bond graph models is studied by several approaches, such as: the formal, module theoretical and graphical approaches. Especially, the structural approach for LTI models is extended to the LTV case. At first, the bond graph procedure for invariant zeros of square models is proposed by means of the bicausality. It is proven that the invariant zeros are related to torsion module of certain bond graph models. For getting torsion modules, the controllability property needs to be studied. Invariant zeros of SISO models with LTI and LTV cases are studied, and the simulations results verify the correctness and efficiency of the BGB method. Then, the BGB approach is extended to detect invariant zeros of MIMO models. By use of the module theoretical approach, the difference between LTI and LTV cases is pointed out by determining torsion modules. After obtaining invariant zeros, the solution of input variables and of initial conditions of state variables for the output-zeroing problem is considered. In the next section, the structure of invariant zeros of linear non-square models is taken into account. The main idea is to find out the common factors of noncontrollable modules between reduced subsystems.

3.3 Invariant Zeros of Linear Non-Square Models

In this dissertation, three approaches are used to detect the invariant zeros structure of bond graph models. In above sections, square models were studied. The formal and algebraic approaches are still valid for non-square models. From the point view of the structural approach, the main idea to detect the invariant zeros structure of linear systems is to use BGB models to get equation (3.3). Then some differential equations which are related to torsion elements in M_{iz} will be derived. For verifying the existence of torsion elements, the controllability property of BGB model is studied. Nevertheless, for non-square models, BGB models do not exist. In order to implement the previous procedures, some extensions for non-square models need to be developed. In view of the inequality of input and output variables number, there exist a number of square submodels, which are related to BGB models. For studying the controllability of models, the notion of *reduced models* will be utilized.

3.3.1 BG Procedure for Invariant Zeros of Non-Square Models

Definition 3.17 *For a linear bond graph non-square model, one can get the BGB models of submodels after determining the p ($m > p$) or m ($m < p$) shortest disjoint input-output causal paths. In these paths, all output ($m > p$) or input ($m < p$) variables are included. Then one removes all the elements in these paths. The rest of a BGB model represents a system which is called here the reduced model.*

There are two sets of dynamical elements in a BGB model. The first one is the set of elements in the input-output causal paths drawn in BGB model. The causality assignments for these elements are fixed. For other elements two causality assignment can be chosen. For the controllability study, a classical procedure can be used with a derivative causality assignment. For each choice of a set of input-output bicausal paths, the procedure must be applied.

Proposition 3.18 *The invariant zeros of a non-square model with $m > p$ are derived from the torsion equations of M_{iz} . These torsion elements are the common factors of definition polynomials of torsion equations in the different square BGB submodels. In each BGB model, the torsion equations are related to noncontrollable dynamical elements.*

3.3 Invariant Zeros of Linear Non-Square Models

In the case of $m < p$, the notion of common non controllable parts in the greatest-order subsystems does not exist. Therefore, the notion of common non observable parts in these subsystems will be used. Because the observability of a system is equivalent to the controllability of its dual system, the observability of reduced systems of square subsystems will be studied by detecting the controllability property of their dual systems.

The bond graph procedure for detecting the invariant zeros of non-square models is shown in Figure 3.35.

3.3.2 Row Subsystems of Square MIMO Systems

A row submodel is written if only one output variable is considered. For square MIMO systems, it is often necessary to compare the set of global invariant zeros to the sets of row invariant zeros. For stability requirement, in the input-output decoupling problem for example. The goal of this section is to propose new procedures for the study of row invariant zeros with a bicausal approach. Row invariant zeros are the roots of Smith polynomials obtained from the Smith matrix with one output, in that case the Smith matrix is not square and graphical approaches have not been proposed in the literature with the bicausal concept. As to the non-square property, BGB models of row submodels do not exist. The notion of common noncontrollable parts of all row submodels with the output set to be zero is used. Firstly, LTI row submodels are investigated by implementing the formal, algebraic and structural approaches for examining invariant zeros. Then the LTV case is studied by same approaches; therefore, some differences between two cases are pointed out by the point of view of the module theoretic approach.

3.3.2.1 The LTI Case

A new graphical procedure is proposed for LTI row submodels. Because of the algebraic consideration, this procedure is also valid for the LTV case. In order to verify the correctness and efficiency of the procedure, formal calculations are implemented for studying the invariant zeros structure.

The invariant zeros are the non controllable zeros of the row subsystems when the output variable is equal to zero. From a bond graph approach, a bicausal bond graph is drawn for each input variable (a bicausal path between the output

3. INVARIANT ZEROS OF BOND GRAPH MODELS

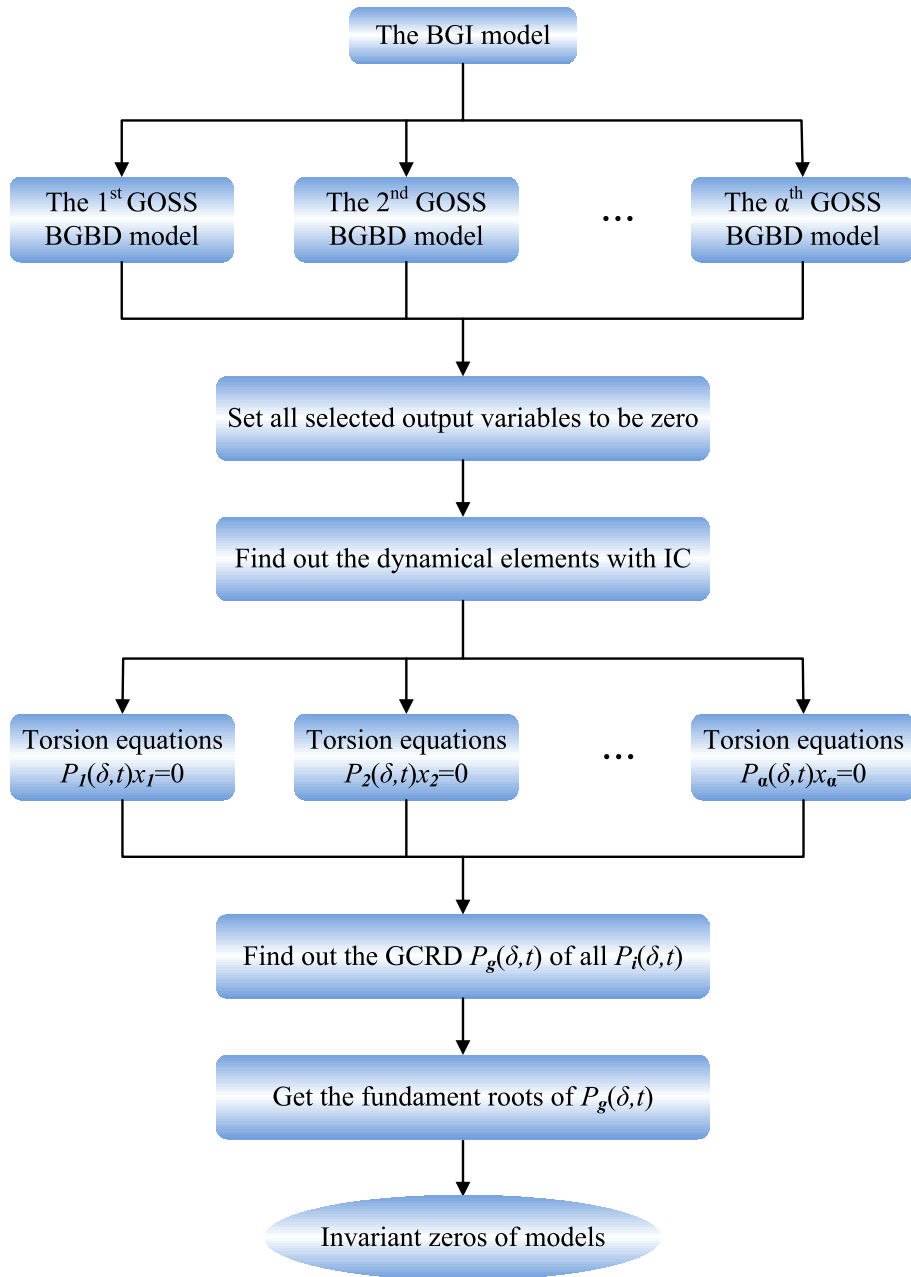

Figure 3.35: Bond graph procedure for detecting invariant zeros of non square MIMO systems

detector and one of the input sources) and if a common non controllable sub model is pointed in each case then it is associated to the invariant submodule.

The procedure is decomposed into four steps in which first a graphical study is proposed, then an algebraic correspondence is proposed (mathematical relations

3.3 Invariant Zeros of Linear Non-Square Models

are written).

Procedure 3.19 *Invariant zeros of row subsystems can be deduced from the following steps.*

For each row subsystem:

- Draw an input-output bicausal path for each input source;
- Study the controllability property for dynamical elements which still have an integral causality assignment;
- Point out the common non controllable part between each previous submodel;
- Calculate invariant zeros or find out the torsion submodule $\mathcal{T}(\Sigma/[y_i]_{\mathbf{R}})$.

a). Invariant Zeros of Row Subsystems with R Element

The formal and graphical approaches are proposed with the two previous examples. The first submodel of the model in Figure 3.21 is studied (output variable y_1). According to the infinite structure of the submodel, there is no null invariant zero. The system matrix of the row submodel is presented in (3.27) after eliminating the last row in the matrix. After implementing the Maple™ program, there is no invariant polynomial. Therefore, the row submodel does not have any invariant zero.

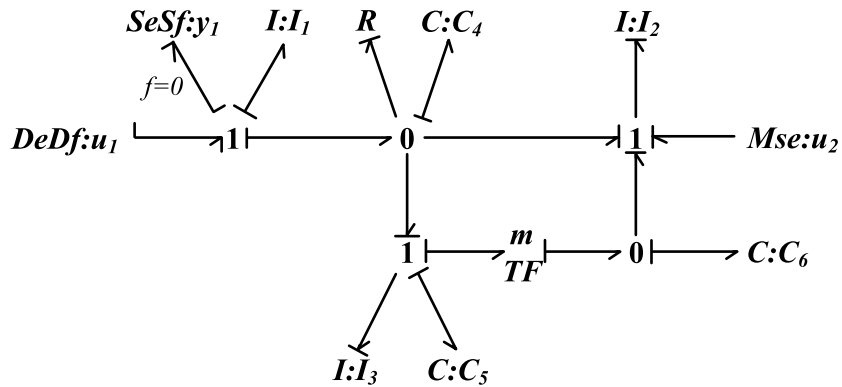

Figure 3.36: BGBI submodel with output y_1 : case 1 (input u_1)

3. INVARIANT ZEROS OF BOND GRAPH MODELS

Procedure 3.19 is used to get the same conclusion. The model has two input sources, thus two bicausal submodels are drawn. In Figure 3.36, the bicausal path is drawn between the input source u_1 and the output detector y_1 . The controllability property is studied for the bond graph model with input source u_2 and dynamical elements with an integral causality assignment. The classical procedure is used (derivative causality assignment). The reduced model shown in Figure 3.37 is controllable (it is possible to assign a derivative causality), thus the study of the second bicausal bond graph model is not useful because the common non controllable part must be pointed out, and in this first study, all modes are controllable.

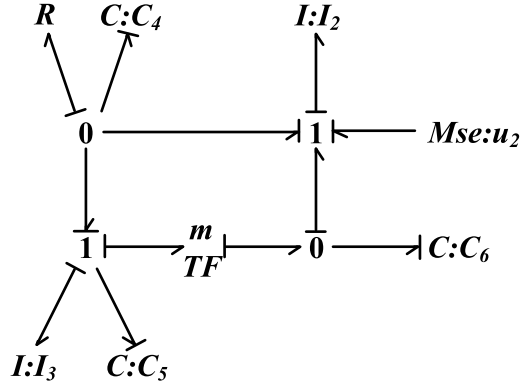

Figure 3.37: Reduced model of submodel with output y_1 : case 1 (input u_1)

The second submodel is studied (output variable y_2). Based on the infinite structure, there exist a null invariant zero. Furthermore, the result of the Maple™ programme indicates that the invariant polynomial is δ , i.e., a null invariant zero exists in the submodel. The model has two input sources, thus two bicausal submodels are drawn. In Figure 3.38, the bicausal path is drawn between the input source u_1 and the output detector y_2 . The dynamical element $C : C_5$ is not controllable, because when removing the bicausal path between the input source u_1 and the output detector y_2 , it is no more reachable. It is also true with a bicausal path between the input source u_2 and the output detector y_2 , as a result, a common non controllable mode (equal to 0) is pointed out.

In the LTI case, this bond graph model has two invariant zeros and one submodel has a null invariant zero (It is well known that the union of the sets of row invariant zeros is included in the set of invariant zeros of the global model).

3.3 Invariant Zeros of Linear Non-Square Models

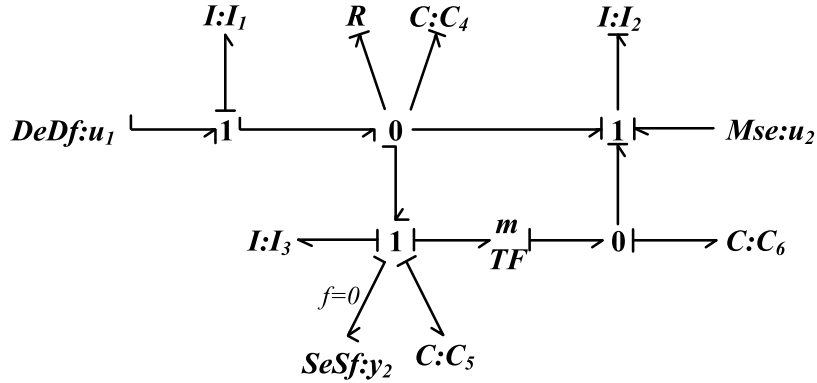

Figure 3.38: BGB submodel with output y_2 : case 1 (input u_1)

b). Invariant Zeros of Row Subsystems without R Element

The second example is now studied. Since the row infinite structure of the BGD models is $n_{1d} = 1$ and $n_{2d} = 1$, the two row subsystems have a null invariant zero, and in the LTI case, the set of global invariant zeros and the union set of row invariant zeros are equal. This property is retrieved with the bicausality approach. In light of the Maple™ program, it is concluded there is one invariant zero which is null for each submodel.

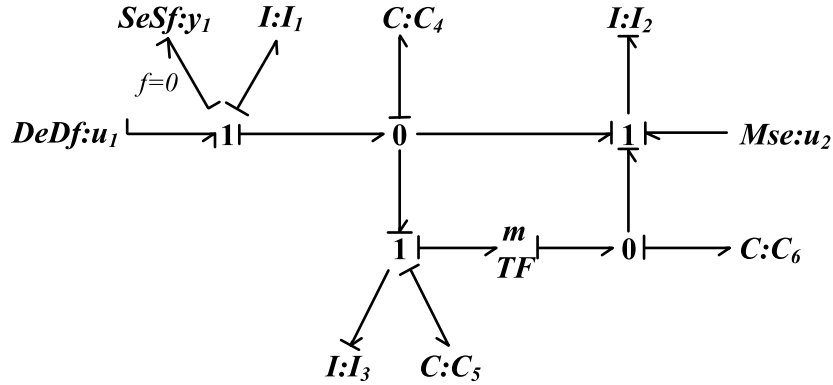

Figure 3.39: BGB submodel with output y_1 : case 1 (input u_1)

The first submodel with output y_1 is studied. The row invariant zeros for the subsystem are the common non controllable modes for the two row bond graph models with output y_1 and with the two input sources, first with a bicausal path between u_1 and y_1 , and secondly between u_2 and y_1 . Two row bond graph models are drawn, Figure 3.39 and 3.40. Now, the controllability property is studied for elements with an integral causality assignment and with input source u_2 . The

3. INVARIANT ZEROS OF BOND GRAPH MODELS

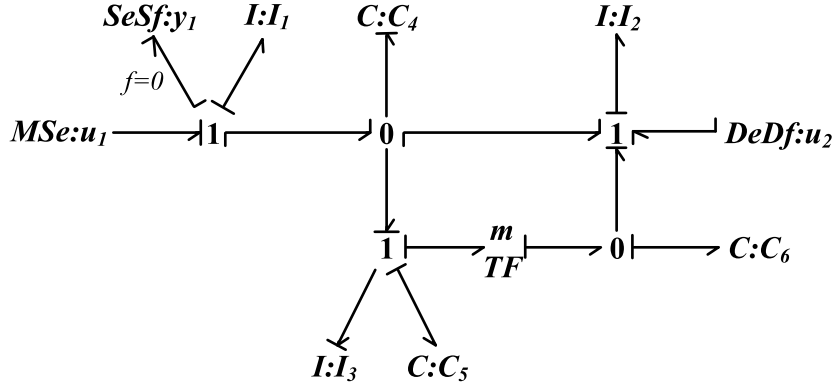

Figure 3.40: BGB submodel with output y_1 : case 2 (input u_2)

reduced submodel drawn in Figure 3.41 is not controllable, because one dynamical element has an integral causality assignment when applying a derivative causality assignment (Theorem 2.10). The mathematical relation $\dot{x}_6 = (m + 1)\dot{x}_5 + \dot{x}_4$ associated to a torsion module can be written.

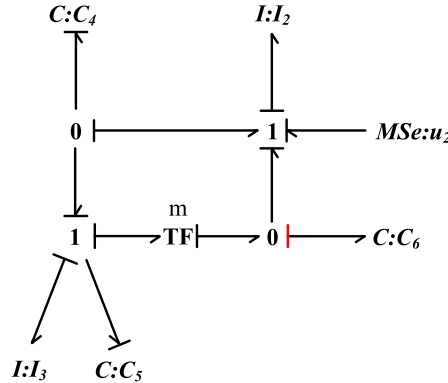

Figure 3.41: BGD for the reduced submodel with y_1 : case 1

In Figure 3.42, the controllability property is studied for the second reduced submodel with input source u_1 . The model is not controllable, because one dynamical element has an integral causality assignment when applying a derivative causality assignment. The mathematical relation $\dot{x}_6 = m\dot{x}_5$ associated to a torsion module can be written. In the two cases, the non controllable mode is equal to 0, thus the row invariant zero is equal to 0.

For the second submodel with output y_2 , the conclusions are exactly the same as for the bond graph model with an R-element. This submodel has a row invariant zero at $\delta = 0$.

3.3 Invariant Zeros of Linear Non-Square Models

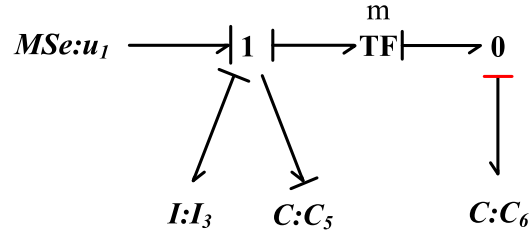

Figure 3.42: BGD for the reduced submodel with y_1 : case 2

3.3.2.2 The LTV Case

As indicated during the controllability analysis of LTV models, the controllability property can be influenced by time-varying parameters of models. Because of the relation between noncontrollable parts and torsion modules, torsion modules sometimes become free in time-varying cases. The main idea in this dissertation is to examine the invariant zeros structure by studying the controllability property of various bond graph models. Here the row subsystems of the system without R element in the LTV case are considered. Firstly, the formal approach is applied for detecting the invariant zeros structure of each subsystem. It can be found that even in the LTI case, some special relations between dynamical elements can induce different results. Therefore, invariant zeros derived from Maple™ program and graphical methods are called to be *generic* without considering these special situations. Then Procedure 3.19 is used to derive the invariant zeros. The graphical procedure is almost the same as the one used in previous examples except the determination of torsion modules with time-varying parameters.

1. The Formal Approach

Referring to the matrix in (3.27), the reduced system matrix of the first submodel is indicated in (3.59).

$$\begin{bmatrix} 0 & \delta & -\frac{1}{C_4} & \frac{1}{C_5} & \frac{m}{C_6} \\ \frac{1}{I_2} & \frac{1}{I_3} & \delta & 0 & 0 \\ 0 & -\frac{1}{I_3} & 0 & \delta & 0 \\ \frac{1}{I_2} & -\frac{m}{I_3} & 0 & 0 & \delta \end{bmatrix} \quad (3.59)$$

After several elementary operations, the matrix can be written as

3. INVARIANT ZEROS OF BOND GRAPH MODELS

$$\begin{bmatrix} \delta & \frac{m}{C_6} - \frac{1}{C_4} & \frac{1}{C_5} & \frac{m}{C_6} \\ -\frac{1}{I_3} & 0 & \delta & 0 \\ -\frac{m+1}{I_3} & 0 & 0 & \delta \end{bmatrix} \quad (3.60)$$

If $C_6 = mC_4$, the rank of the matrix is changed. In the LTI case, the invariant zeros of the model is related to the invariant polynomial, such as: $I_3C_5\delta^3 + \frac{(m+1)C_5+C_4}{C_4}\delta$. Therefore, there are three invariant zeros, and one of them is null. The invariant polynomial of the system matrix of the LTV model is $\delta\frac{C_5}{C_4} + \frac{1}{m+1}\delta + \delta C_5\delta\frac{I_3}{m+1}\delta$. Because of the term $\delta\frac{C_5}{C_4}$, there exists a constant in the polynomial, such as $(\frac{C_5}{C_4})' \neq 0$. So there are three conjugacy classes related to invariant zeros. When $(\frac{C_5}{C_4}) = 0$, a conjugacy class of zero exists because there is a right factor in the polynomial, i.e., δ .

Now, the more generic situation is taken account with $C_6 \neq mC_4$. Continuing to implement elementary operations; finally, the matrix in (3.60) is equivalent to the matrix in (3.61).

$$\begin{bmatrix} (m+1)\delta & \delta \end{bmatrix} \quad (3.61)$$

If m is a constant, the invariant polynomial of the above matrix is δ . Hence, there is a null invariant zero in the LTI model. However, in the LTV case, the invariant polynomial is null, i.e., there is no invariant zero in LTV model.

The second subsystem is studied by the formal approach. The reduced system matrix is

$$\begin{bmatrix} 0 & 0 & -\frac{1}{C_4} & \frac{1}{C_5} & \frac{m}{C_6} \\ -\frac{1}{I_1} & \frac{1}{I_2} & \delta & 0 & 0 \\ 0 & 0 & 0 & \delta & 0 \\ 0 & \frac{1}{I_2} & 0 & 0 & \delta \end{bmatrix} \quad (3.62)$$

Examining the matrix by elementary operations, there is always a null invariant zero, which does not depend on system parameters.

Through elementary operations on system matrices, the invariant zeros structure of two row subsystems is displayed in Table 3.7.

2. The Structural Approach

Here, only the general case $C_6 = mC_4$ is considered with the structural approach. The graphical procedure implemented in the preceding example in the

3.3 Invariant Zeros of Linear Non-Square Models

Table 3.7: Invariant factors of the system matrix without R in several cases

Subsystem	y_1		y_2
	$mC_4 \neq C_6$	$mC_4 = C_6$	
LTI	δ	$\delta^3 + \frac{(m+1)C_5+C_4}{I_3C_4C_5}\delta$	δ
LTV	\emptyset	$\delta \frac{C_5}{C_4} + \frac{1}{m+1}\delta + \delta C_5 \delta \frac{I_3}{m+1}\delta$	δ

LTI case is still valid for LTV subsystems. However, the criterion for the determination of torsion modules should be used on considering time-varying parameters.

The controllability property of each reduced model of two submodels is needed to be examined. Firstly, the submodel with output variable y_1 is studied, with the first reduced model in Figure 3.41. A differential equation related to the dynamical element with an integral causality assignment is written, such as $\dot{x}_6 = (m(t) + 1)\dot{x}_5 + \dot{x}_4$. In the LTI case, this equation is related to a torsion module. However, as to the time-varying parameter $m(t)$, it is no more related to a torsion module. It means that the reduced model is controllable. Consequently, it is not necessary to study the second reduced model. It is concluded there is no invariant zero in the submodel with y_1 . This conclusion is in accordance with the calculation result by the formal approach shown in Table 3.7.

For the second row subsystem with the output variable y_2 , there is always a differential equation $\dot{x}_5 = 0$ with $y_2 = 0$. This equation is related to a torsion module. Therefore, time-varying parameters do not influent the invariant zero structure for this model.

3.3.3 Non-Square MIMO Models

In this section, invariant zeros of non-square systems are studied by use of formal and bond graph approaches. By the formal approach, Jacobson forms of reduced system matrices are used to get invariant zeros. The invariant zeros of a non-square MIMO system can also be derived by mean of the bond graph approach which is similar to the procedure for row submodels of square models. One should study all square submodels and find the torsion elements related to elements with an integral causality assignment in every BGB model of the submodels. Finally, the common right factors of the definition polynomials of the torsion modules will be detected, which are related to systems invariant zeros. In this section, two

3. INVARIANT ZEROS OF BOND GRAPH MODELS

kinds of linear non-square MIMO systems will be studied with different sizes and relations of input and output variables.

3.3.3.1 Linear MIMO Models with $m > p$

Let's consider a linear system represented in Figure 3.43 with three input sources u_1, u_2, u_3 and two output detectors y_1, y_2 . Firstly, the formal approach is utilized to detect the invariant zeros structure of the system in LTI and LTV cases. Then the output-zeroing problem is studied with the obtained invariant zero. Secondly, the graphical procedure is implemented to derive the invariant zero from three 2-order square subsystems in the system. The idea of this approach is to study the torsion elements in each subsystem, separately.

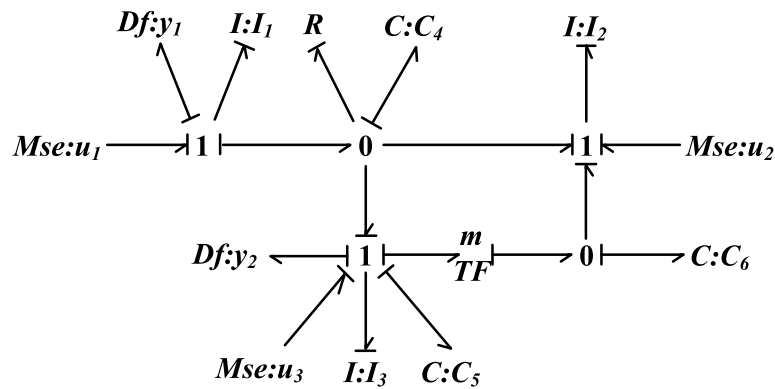

Figure 3.43: BGI model with three input and two output variables

1. Formal Approach for BG Models

1). Invariant Zeros

Now the Jacobson form of the system matrix is used to detect the invariant

3.3 Invariant Zeros of Linear Non-Square Models

zeros of the model. System matrix $P(\delta)$ is shown in (3.63).

$$P(\delta) = \begin{bmatrix} \delta & 0 & 0 & \frac{1}{C_4} & 0 & 0 & 1 & 0 & 0 \\ 0 & \delta & 0 & -\frac{1}{C_4} & 0 & -\frac{1}{C_6} & 0 & 1 & 0 \\ 0 & 0 & \delta & -\frac{1}{C_4} & \frac{1}{C_5} & \frac{m}{C_6} & 0 & 0 & 1 \\ -\frac{1}{I_1} & \frac{1}{I_2} & \frac{1}{I_3} & \delta + \frac{1}{C_4 R} & 0 & 0 & 0 & 0 & 0 \\ 0 & 0 & -\frac{1}{I_3} & 0 & \delta & 0 & 0 & 0 & 0 \\ 0 & \frac{1}{I_2} & -\frac{m}{I_3} & 0 & 0 & \delta & 0 & 0 & 0 \\ \frac{1}{I_1} & 0 & 0 & 0 & 0 & 0 & 0 & 0 & 0 \\ 0 & 0 & \frac{1}{I_3} & 0 & 0 & 0 & 0 & 0 & 0 \end{bmatrix} \quad (3.63)$$

The Jacobson form of system matrix $P(\delta)$ in (3.63) is identical to the Jacobson form of matrix $P_r(\delta)$ in (3.64) after eliminating r_1, r_2, r_3, r_7, r_8 and c_1, c_3, c_7, c_8, c_9 in $P(\delta)$.

$$P_r(\delta) = \begin{bmatrix} \frac{1}{I_2} & \delta + \frac{1}{C_4 R} & 0 & 0 \\ 0 & 0 & \delta & 0 \\ \frac{1}{I_2} & 0 & 0 & \delta \end{bmatrix} \quad (3.64)$$

The procedure by elementary operations for obtaining the Jacobson form of $P_r(\delta)$ is shown in (3.65).

$$\begin{aligned} P_r(\delta) &\xrightarrow[\text{eliminate } c_1, r_3]{r_1 - r_3} \begin{bmatrix} \delta + \frac{1}{C_4 R} & 0 & -\delta \\ 0 & \delta & 0 \end{bmatrix} \\ &\xrightarrow[\text{c}_3 + c_1 \times \delta, \text{eliminate } r_1, c_1]{c_1 + c_3, c_1 \times C_4 R} \begin{bmatrix} \delta & 0 \end{bmatrix} \end{aligned} \quad (3.65)$$

The invariant polynomial of the Jacobson form of matrix $P_r(\delta)$ is δ . Therefore, there is a null invariant zero for the LTI non-square system.

Now the algebraic procedure is used to get the torsion module $\mathcal{T}(\Sigma/[y]_{\mathbf{R}})$. The definition equations of module $\Sigma/[y]_{\mathbf{R}}$ are defined as (3.3), from which several differential equations are written

$$\begin{cases} x_1 = 0 \\ x_3 = 0 \\ -\frac{x_4}{C_4} + u_1 = 0 \\ \dot{x}_2 = \frac{x_4}{C_4} + \frac{x_6}{C_6} + u_2 \\ \frac{x_4}{C_4} - \frac{x_5}{C_5} - \frac{m x_6}{C_6} = -u_3 \\ \dot{x}_4 = -\frac{x_2}{I_2} - \frac{x_4}{C_4 R} \\ \dot{x}_5 = 0 \\ \dot{x}_6 = -\frac{x_2}{I_2} \end{cases} \quad (3.66)$$

3. INVARIANT ZEROS OF BOND GRAPH MODELS

The torsion equation related to (3.66) is $\dot{x}_5 = 0$. So there is one null invariant zero in the system. The proceeding calculations are also valid in the LTV case. Therefore, the system has always a null invariant zero $\delta = 0$ in LTI and LTV cases.

2). The Output-Zeroing Problem

The output-zeroing problem with initial conditions of state variables is considered here. On account of the null invariant zero, values of the input variables and initial conditions of state variables can be derived according to Theorem 3.5. The problem is studied in both LTI and LTV cases. Some differences are pointed out.

a. The LTI Case

The system parameters are indicated in Table 3.3. For solving the output-zeroing problem, the input variables need to be $u_i = g_i\Gamma(t)$, $i = 1, \dots, 3$ according to the null invariant zero, where g_i is a constant and $\Gamma(t)$ is the Heaviside unit step function. Referring to the system matrix in (3.63) and Theorem 3.5, equations related to variables $x_{i0}, g_j, i = 1, \dots, 6, j = 1, \dots, 3$ are shown in (3.67).

$$\left\{ \begin{array}{l} x_{10} = 0 \\ x_{20} = 0 \\ x_{30} = 0 \\ x_{40} = 0 \\ g_1 = 0 \\ g_2 = -x_{60} \\ g_3 = x_{50} + 2x_{60} \end{array} \right. \quad (3.67)$$

Let $x_{50} = 2, x_{60} = 1$, then $g_2 = -1, g_3 = 4$. Furthermore, the input variables for this problem are $u_1 = 0, u_2 = -\Gamma(t), u_3 = 4\Gamma(t)$. The simulation result is plotted in Figure 3.44 with these parameters.

b. The LTV Case

Consider the LTV model with a time-varying parameter $m(t) = t + 1$. Some similar equations to ones in (3.68) can be deduced in (3.68).

3.3 Invariant Zeros of Linear Non-Square Models

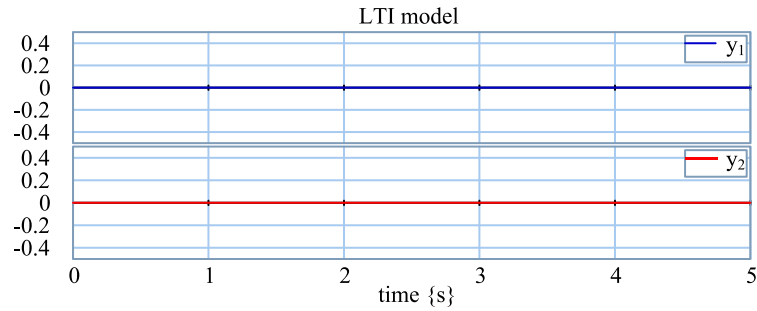

Figure 3.44: Curves of output variables of the LTI model

$$\begin{cases} x_{10} = 0 \\ x_{20} = 0 \\ x_{30} = 0 \\ x_{40} = 0 \\ g_1 = 0 \\ g_2 = -x_{60} \\ g_3(t) = x_{50} + m(t)x_{60} \end{cases} \quad (3.68)$$

In these equations, $g_3(t)$ is a time function, which is a constant in the LTI case. Let $x_{50} = x_{60} = 1$, finally, the parameters for the problem are $x_{i0} = 0, i = 1, \dots, 4$, and $u_1 = 0, u_2 = -\Gamma(t), u_3 = (t + 2)\Gamma(t)$. Figure 3.45 displays the simulation result of the LTV system.

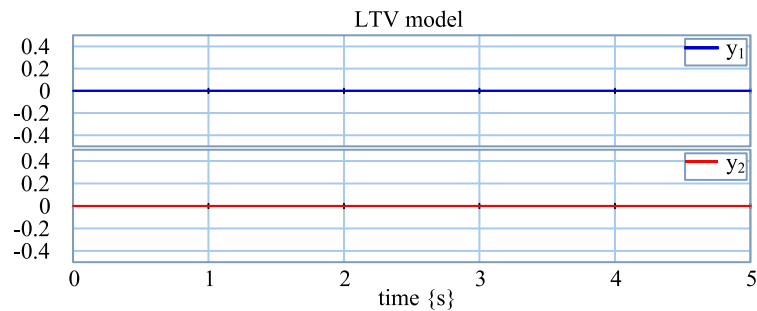

Figure 3.45: Curves of output variables of the LTV model

2. Bond Graph Approach for Invariant Zeros

Now, the graphical approach is executed to detect the invariant zero structure of the model. As mentioned, there are three 2-order square subsystems in the system. Let's study the torsion elements in each subsystem, separately. Then the

3. INVARIANT ZEROS OF BOND GRAPH MODELS

common factor of the definition polynomial of torsion elements in the subsystems is related to the invariant zero.

Subsystem with Bicausal Paths between Inputs u_2, u_3 and Outputs y_1, y_2

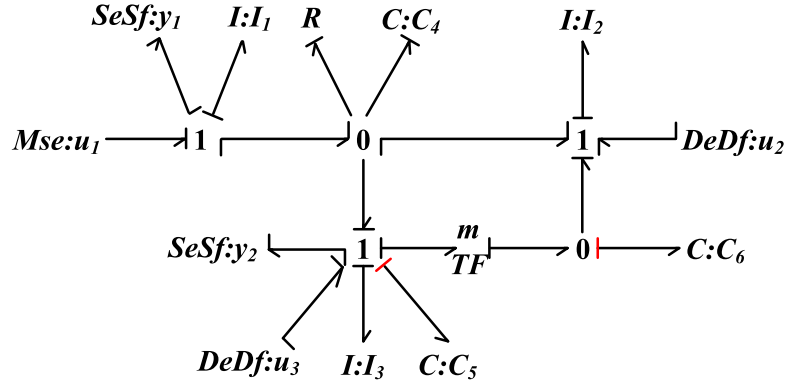

Figure 3.46: BGB submodel with inputs u_2, u_3 and outputs y_1, y_2

The BGB model of the first subsystem concerned with bicausal paths between input sources u_2, u_3 and output detectors y_1, y_2 is shown in Figure 3.46. There are two dynamical elements C_5, C_6 with integral causality. They are not controllable because there is not any causal path between these dynamical elements and the input source $MSe : u_1$ (not reachable). One can get the differential equation related to these elements:

$$\begin{cases} \dot{x}_5 = 0 \\ \dot{x}_6 = -\dot{x}_4 - \frac{x_4}{C_4 R} \\ \frac{x_4}{C_4} = \frac{x_5}{C_5} + \frac{m x_6}{C_6} \end{cases} \quad (3.69)$$

In the LTI case, with equation associated to element C_4 , a new relation can be written by doing derivation for two sides $\frac{\dot{x}_4}{C_4} = \frac{m \dot{x}_6}{C_6}$. Then two equations are derived from (3.69).

$$\begin{cases} \dot{x}_5 = 0 \\ \left(\frac{C_6 - m C_4}{m} \right) \dot{x}_4 - \frac{1}{R} x_4 = 0 \end{cases} \quad (3.70)$$

Equation (3.70) are the equations of the torsion submodule in this 2-order square subsystem. One can get the definition polynomials of this torsion module, such as: δ and $\frac{(C_6 - m C_4)}{m} \delta - \frac{1}{R}$.

3.3 Invariant Zeros of Linear Non-Square Models

Subsystem with Selected Inputs u_1, u_2 and Outputs y_1, y_2

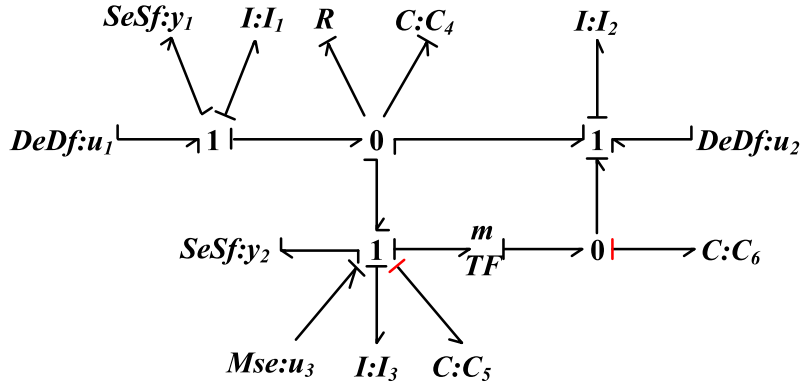

Figure 3.47: BGB submodel with selected inputs u_1, u_2 and outputs y_1, y_2

Figure 3.47 gives the BGB submodel with selected input sources u_1, u_2 and output detectors y_1, y_2 , for the two disjoint input-output causal paths, such as: $y_1 \rightarrow I_1 \rightarrow u_1$ and $y_2 \rightarrow I_3 \rightarrow C_4 \rightarrow I_2 \rightarrow u_2$. With the preferred derivative causality assignment, there are two dynamical elements C_5, C_6 with integral causality. In the LTI case, one can get the same differential equation related to these elements in (3.70). So one can get the definition polynomials of this torsion module, such as: δ and $\frac{(C_6 - mC_4)}{m}\delta - \frac{1}{R}$.

Subsystem with Selected Inputs u_1, u_3 and Outputs y_1, y_2

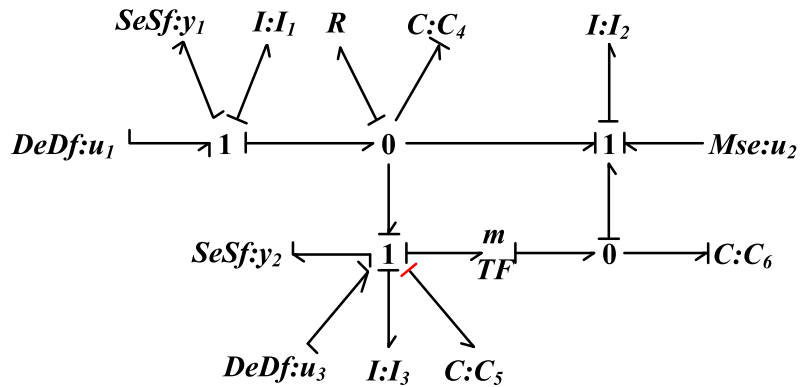

Figure 3.48: BGB submodel with inputs u_1, u_3 and outputs y_1, y_2

The BGB submodel with the selected input sources u_1, u_3 and the output

3. INVARIANT ZEROS OF BOND GRAPH MODELS

detectors y_1, y_2 is shown in Figure 3.48, for the two disjoint input-output causal paths in Figure, such as: $y_1 \rightarrow I_1 \rightarrow u_1$ and $y_2 \rightarrow I_3 \rightarrow u_3$. With the two selected input sources u_1 and u_3 , a third order bond graph model must be studied with dynamical elements I_2, C_4, C_5 and C_6 . In that case, this model is reachable with input source u_2 , except for element C_5 . If a derivative causality assignment is chosen, i.e., BGB model in Figure 3.48, only one dynamical element C_5 keep on integral causality assignment. One can get the differential equation related to these elements:

$$\dot{x}_5 = 0 \quad (3.71)$$

Equation (3.71) is the equation of the torsion module in the subsystem. The definition polynomial of this torsion module is δ . Comparing (3.71) with (3.70), δ is the common factor of the definition polynomials of the torsion submodules in three square subsystems. According to Proposition 3.18, there is a null invariant zero for the system in Figure 3.43.

3.3.3.2 Linear MIMO Models with $m < p$

A system with one input variable and two output variables is considered here. The system BGI model is drawn in Figure 3.49. One can find there are two input-output causal paths in the figure: $y_1 \rightarrow I_2 \rightarrow C_4 \rightarrow I_1 \rightarrow u$ and $y_2 \rightarrow I_3 \rightarrow C_4 \rightarrow I_1 \rightarrow u$. There exist two square subsystems $\Sigma_1(c_1, A, B)$ and $\Sigma_2(c_2, A, B)$. The common torsion elements in these two subsystems will be pointed out for determining the system invariant zeros.

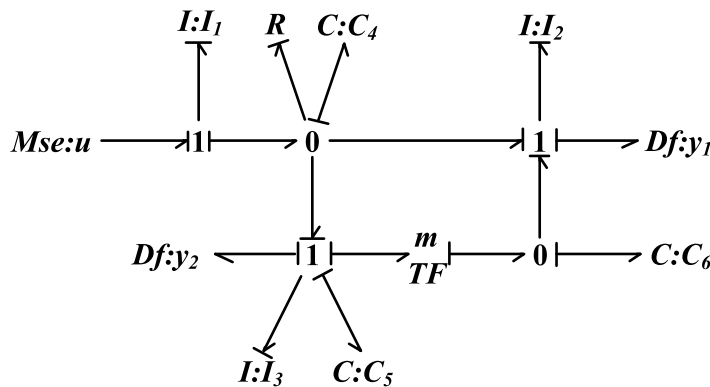

Figure 3.49: BGI model of a system with one input and two output variables

3.3 Invariant Zeros of Linear Non-Square Models

Formal and Algebraic Approaches for BG Models

Here, the structure of invariant zeros of bond graph models in LTI and LTV cases is studied by the formal and algebraic approaches. Calculations by elementary operations are implemented, the difference between the two cases is pointed out. Then the output-zeroing problem is considered in LTI and LTV cases.

From the BGI model, the system matrix is indicated in (3.72).

$$P(\delta) = \begin{bmatrix} \delta & 0 & 0 & \frac{1}{C_4} & 0 & 0 & -1 \\ 0 & \delta & 0 & -\frac{1}{C_4} & 0 & -\frac{1}{C_6} & 0 \\ 0 & 0 & \delta & -\frac{1}{C_4} & \frac{1}{C_5} & \frac{m}{C_6} & 0 \\ -\frac{1}{I_1} & \frac{1}{I_2} & \frac{1}{I_3} & \delta + \frac{1}{C_4 R} & 0 & 0 & 0 \\ 0 & 0 & -\frac{1}{I_3} & 0 & \delta & 0 & 0 \\ 0 & \frac{1}{I_2} & -\frac{m}{I_3} & 0 & 0 & \delta & 0 \\ 0 & \frac{1}{I_2} & 0 & 0 & 0 & 0 & 0 \\ 0 & 0 & \frac{1}{I_3} & 0 & 0 & 0 & 0 \end{bmatrix} \quad (3.72)$$

After eliminating rows and columns related to input and output matrices, the reduced system matrix is given in (3.73).

$$P_r(\delta) = \begin{bmatrix} 0 & -\frac{1}{C_4} & 0 & -\frac{1}{C_6} \\ 0 & -\frac{1}{C_4} & \frac{1}{C_5} & \frac{m}{C_6} \\ -\frac{1}{I_1} & \delta + \frac{1}{C_4 R} & 0 & 0 \\ 0 & 0 & \delta & 0 \\ 0 & 0 & 0 & \delta \end{bmatrix} \quad (3.73)$$

The above calculations are valid in both LTI and LTV cases. However, because of the non-commutative property, two situations are considered, separately.

a. The LTI Case

By implementing the Maple™ program, the Jacobson form of the system matrix is shown in (3.74).

$$\Delta(\delta) = U(\delta) P(\delta) V(\delta) = \begin{bmatrix} \text{diag}\{1, \dots, 1, \delta\} \\ 0 \end{bmatrix}_{8 \times 7} \quad (3.74)$$

So the invariant polynomial is δ which means there is a null invariant zero.

3. INVARIANT ZEROS OF BOND GRAPH MODELS

Now the algebraic procedure is used to get the module M_{iz} . The definition equations of M_{iz} are defined as (3.3), from which several differential equations are given in (3.75).

$$\begin{cases} x_2 = 0 \\ x_3 = 0 \\ \dot{x}_1 = -\frac{x_4}{C_4} + u \\ \frac{x_4}{C_4} + \frac{x_6}{C_6} = 0 \\ \frac{x_4}{C_4} - \frac{x_5}{C_5} - \frac{mx_6}{C_6} = 0 \\ \dot{x}_4 = \frac{x_1}{I_1} - \frac{x_4}{C_4 R} \\ \dot{x}_5 = 0 \\ \dot{x}_6 = 0 \end{cases} \quad (3.75)$$

The equations related to the torsion module are shown in (3.76).

$$\begin{cases} \dot{x}_5 = 0 \\ \dot{x}_6 = 0 \\ \frac{x_5}{C_5} + \frac{(m+1)x_6}{C_6} = 0 \end{cases} \quad (3.76)$$

In the LTI case, the second equation in (3.76) can be derived from the others equations in (3.76). It means that $\dot{x}_5 = 0$ is a definition equation of the torsion module M_{iz} , and δ is the definition polynomial of the module. Therefore, the LTI system has a null invariant zero.

b. The LTV Case

For getting the structure of invariant zeros of LTV system, the Jacobson form of the matrix in (3.73) with time-varying parameters is required. The calculations procedure is indicated in (3.77).

$$\begin{aligned} P_r(\delta, t) &\xrightarrow[c_1, r_3]{\text{eliminate}} \begin{bmatrix} -\frac{1}{C_4(t)} & 0 & -\frac{1}{C_6(t)} \\ -\frac{1}{C_4(t)} & \frac{1}{C_5(t)} & \frac{m(t)}{C_6(t)} \\ 0 & \delta & 0 \\ 0 & 0 & \delta \end{bmatrix} \xrightarrow[\text{eliminate } r_1, c_1]{r_2 - r_1, C_5 \times r_2} \\ &\begin{bmatrix} 1 & \frac{(m(t)+1)C_5(t)}{C_6(t)} \\ \delta & 0 \\ 0 & \delta \end{bmatrix} \xrightarrow[\text{eliminate } r_1, c_1]{r_2 - \delta \times r_1} \begin{bmatrix} -\delta \frac{(m(t)+1)C_5(t)}{C_6(t)} \\ \delta \end{bmatrix} \end{aligned} \quad (3.77)$$

Because of the non-commutative property, the first entry in the matrix needs to be discussed in two situations. If $\frac{(m(t)+1)C_5(t)}{C_6(t)}$ is a constant, it can be commu-

3.3 Invariant Zeros of Linear Non-Square Models

tative with δ . Hence, the first entry can be eliminated by the second entry. It means that there is a null invariant zero in the LTV system. Conversely, if this coefficient is time-varying, elementary operations for the last matrix in (3.77) is shown in (3.78). Obviously, there is no invariant zero in the LTV system.

$$\begin{aligned}
 & \begin{bmatrix} -\delta \frac{(m(t)+1)C_5(t)}{C_6(t)} \\ \delta \end{bmatrix} \rightarrow \begin{bmatrix} -\frac{(m(t)+1)C_5(t)}{C_6(t)}\delta - \left(\frac{(m(t)+1)C_5(t)}{C_6(t)}\right)' \\ \delta \end{bmatrix} \\
 & \xrightarrow[r_1 + \frac{(m(t)+1)C_5(t)}{C_6(t)} \times r_2]{-\left(\left(\frac{(m(t)+1)C_5(t)}{C_6(t)}\right)'\right)^{-1} \times r_1, r_2 - \delta \times r_1} \begin{bmatrix} 1 \\ 0 \end{bmatrix}
 \end{aligned} \tag{3.78}$$

Now, the algebraic approach is used to detect torsion equations in (3.76) with time-varying parameters. The third equation in (3.76) can be written as $x_5 = -\frac{(m(t)+1)C_5(t)}{C_6(t)}x_6$. If $\frac{(m(t)+1)C_5(t)}{C_6(t)}$ is a constant, the second equation can be derived from two others. However, if this coefficient is time-varying, a relation can be written in (3.79) from the third equation in (3.76) after a derivation.

$$\dot{x}_5 = -\frac{(m(t)+1)C_5(t)}{C_6(t)}\dot{x}_6 - \left(\frac{(m(t)+1)C_5(t)}{C_6(t)}\right)'x_6 \tag{3.79}$$

For getting the second equation in (3.76), a relation is needed, such as: $x_6 = 0$ which yields $x_5 = 0$ from the third equation in (3.76). Therefore, the equations in (3.76) are not related to a torsion module. Finally, there is no invariant zero in this situation. The invariant zeros structure of the model in several cases is shown in Table 3.8, where $a = \left(\frac{(m(t)+1)C_5(t)}{C_6(t)}\right)'$.

Table 3.8: Invariant factors of the system matrix with $m < p$ in several cases

System	LTI	LTV	
		$a = 0$	$a \neq 0$
	δ	δ	\emptyset

Bond Graph Approach for Invariant Zeros

1. Subsystem with Bicausal Path between u and y_1

The BGBD model of the first 1-order square subsystem is given by Figure 3.50. The bicausal path is drawn between the input source u and the output detector y_1 .

3. INVARIANT ZEROS OF BOND GRAPH MODELS

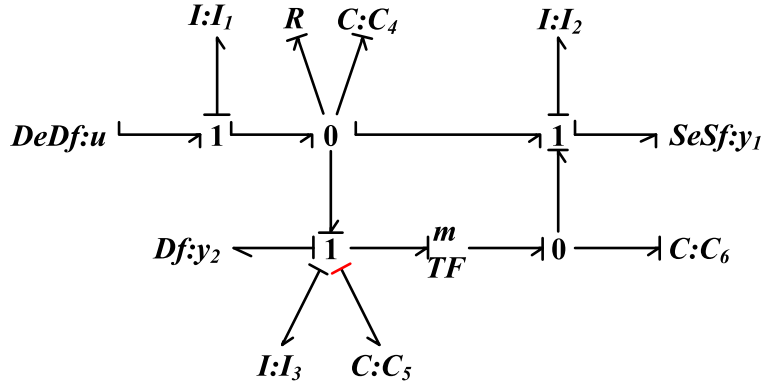

Figure 3.50: BGBD model of the square subsystem with u and y_1

With the preferred derivative causality assignment, there is a dynamical element C_5 with integral causality. So the torsion element of this submodel is related to C_5 . One can get the equation of the torsion element, such as:

$$m\dot{x}_5 - \dot{x}_6 = 0 \quad (3.80)$$

Equation (3.80) is related to a torsion element with the form $\delta(mx_5 - x_6)$ when m is time-invariant. The definition polynomial of the torsion module is δ .

The reduced submodel with output y_1 is shown in Figure 3.51.

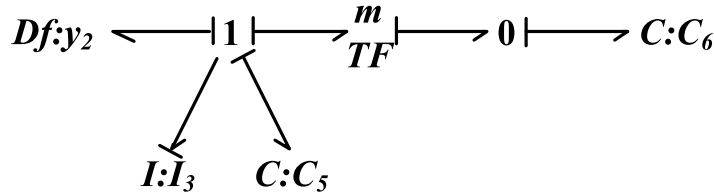

Figure 3.51: Reduced model of the square subsystem with output y_2

For studying the observability property, the dual model of the reduced model is needed. Figure 3.52 gives the dual model of the reduced system with output y_2 . The preferred derivative causality is assigned, there is a dynamical element C_5 with an integral causality assignment related to the torsion submodule. The definition equation of this torsion submodule is defined as: $m\dot{x}_5 = \dot{x}_6$, and the definition polynomial of the torsion module is δ in the LTI case. But if m is time-varying, this bond graph model will become controllable because the previous equation is no more related to a torsion module.

3.3 Invariant Zeros of Linear Non-Square Models

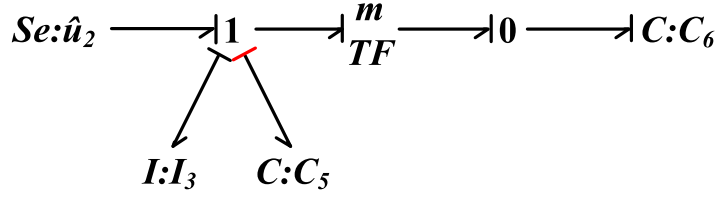

Figure 3.52: Dual model of the reduced model with output y_2

2. Subsystem with Bicausal Path between u and y_2

Figure 3.53 give the BGBD model of the second 1-order square subsystem. The causal path is drawn between the input source u and the output detector y_2 . In this case, the torsion element of this submodel is related to the dynamical element with integral causality, such as C_5 . One can get the equation of the torsion element, such as:

$$\dot{x}_5 = 0 \tag{3.81}$$

Equation (3.81) is related to a torsion element with the form δx_5 . It means that δ is the definition polynomial of the torsion module. This result is consistent with Table 3.8.

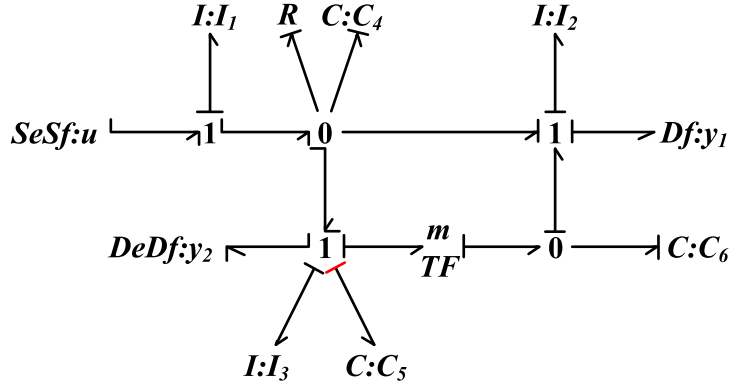

Figure 3.53: BGBD model of the square subsystem with u and y_2

The common factor of definition polynomials of torsion modules in two subsystem is δ by comparing equation (3.80) and (3.81). So there is one null invariant zero of the LTI system.

The reduced model with output y_1 is shown in Figure 3.54. For studying the observability property, the dual model of the reduced model is needed. Figure 3.55 gives the dual model of the reduced system with output y_2 . The preferred

3. INVARIANT ZEROS OF BOND GRAPH MODELS

integral causality is assigned in the figure, there is a dynamical element C_5 with an derivative causality. This element is not reachable. So the equation related to C_5 can be derived: $\dot{x}_5 = 0$, and this equation is related to a torsion submodule. Then the definition polynomial of the torsion module is δ in the LTI case.

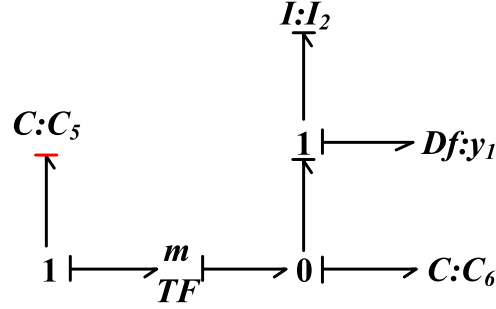

Figure 3.54: Reduced model of the square subsystem with output y_1

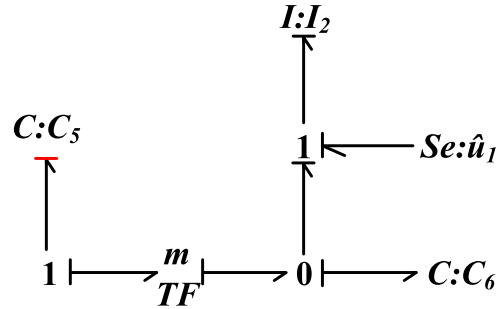

Figure 3.55: The dual model of the reduced model with output y_1

Compare Figure 3.52 with Figure 3.55, the common factor of the definition polynomials of the non observable submodules of the reduced systems is δ . So there is one null invariant zero in the system shown in Figure 3.49.

Figure 3.56 shows the simulation result with 20-sim[®] in the LTI case, which verifies there is a null invariant zero. Numerical values of the system elements parameters are given in Table 3.3 with $u = \Gamma(t)$.

In the LTV case, *e.g.* $m(t) = \mathbb{C}(t)$, equation (3.80) is no more related to a torsion module. Hence, there is no invariant zero, which corresponds to Table 3.8. Consider the submodel with the input source u and output detector y_1 in Figure 3.49 (eliminate the output y_2). The BGI model has an input-output causal path: $y \rightarrow I_2 \rightarrow C_4 \rightarrow I_1 \rightarrow u$, so there are three invariant zeros. $y \rightarrow C_6 \rightarrow u$ is an input-output causal path in BGD model. In the LTI case, there is a null

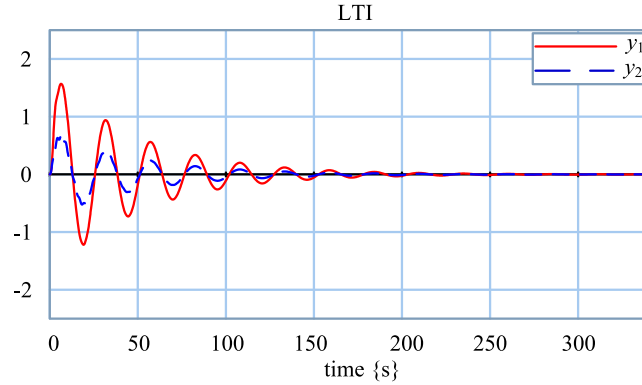

Figure 3.56: The outputs y_1 and y_2 curves of the LTI system

invariant zero because of $n'_d = 1$. But in the LTV case, after formal calculations, the invariant polynomial of the system matrix is $m(t)\delta + \delta \frac{C_6(t)}{C_5(t)(m(t)+1)} + \delta^2 I_3(t)\delta$. If the term $\frac{C_6(t)}{C_5(t)(m(t)+1)} = 0$, δ is a right root of the polynomial, i.e., a null invariant zero exists. Otherwise, there is no null invariant zero in LTV models.

Remark 3.20 *In LTV models, the condition that infinite zero orders of BGD models do not equal to zero, i.e. $n'_{id} \neq 0$, is not sufficient to ensure the existence of null invariant zeros. Algebraic calculations are necessary to deduce torsion submodules of M_{iz} , only right roots of definition polynomials of torsion modules which equal to zero are related to null invariant zeros.*

3.4 Conclusion

The focus of this third chapter was on the invariant zeros structure of LTI/LTV bond graph models. Firstly, several approaches were recalled, which are fundamental to determine the invariant zeros, such as: structural, graphical and algebraic approaches. Then new bond graph procedures using some BGB models were proposed.

Square models were discussed according to two situations. In the first one, the invariant zero structure of SISO systems was studied in LTI and LTV cases. From an algebraic point of view, results can be different in the context of LTI and LTV models because torsion modules associated to invariants zeros can have a complex description and invariant polynomials are not easy to be written. In the context of a bond graph approach, thanks to bicausality, a reduced bond graph model

3. INVARIANT ZEROS OF BOND GRAPH MODELS

can be drawn and some simplified equations can be written in the two cases. The last step allowing a right description of the torsion module is nevertheless also difficult to implement. For invariant zeros equal to zero, some particular analysis have been proposed in the context of zeroing the output. When a null invariant zero exists either in the LTI or LTV case, the solutions of the input variable for zeroing the output are different. Being different from a constant input variable in the LTI case, the input variable depends on the input-output causal gain in the BGD. For the second situation, a square MIMO system is studied with two input sources and two output detectors. It can be easily extended to systems with m input sources and m output detectors. The BGB models were used to detect the torsion elements in the bond graph model.

For square models (SISO or MIMO), in the BGB models, dynamical elements contained in the input-output bicausal paths have a derivative causality assignment. Other elements have an integral causality assignment and since these BGB models do not contain any other input source (in the BGB output detectors and input sources become Source-Sensor); the reduced bond graph model associated to these dynamical elements with an integral causality assignment is no more controllable. The associated torsion module can be used to define the module of the invariant zeros. This approach is used in the non-square case studied in the third part.

In many control problems, properties of row subsystems (one output variable) are often compared to properties of the global system (input-output decoupling problem, etc.). In that case, row submodels of a square MIMO model can be regarded as non-square MIMO submodels. The common non controllable parts of these square submodels were studied to get the invariant zeros. For non-square global MIMO systems, according to the number relation between input sources and output detectors, there are two kinds of systems.

When the number of input sources is greater than the one of output detectors, the bond graph procedure is similar to the procedure for row submodels of square models. When the number of output detectors is greater than the one of input sources, the common non observable parts in submodels were used to detect the invariant zeros structure of global models. This property must be studied from the controllability property of dual models because for LTV models modules associated to invariant zeros can be only written in this context. Results of the

invariant zeros study are considered in the context of the unknown input observer problem as an application in chapter 4.

3. INVARIANT ZEROS OF BOND GRAPH MODELS

Chapter 4

Unknown Input Observer

Contents

4.1	Unknown Input Observer Design	188
4.1.1	UIO Deduced from the Infinite Structure	189
4.1.2	A General Form of Unknown Input Estimate	190
4.1.3	UIO with the Algebraic Approach	195
4.1.4	Bond Graph Procedure for Strong* Detectability	197
4.2	Numerical Examples and Simulations	199
4.2.1	Case with Matching Condition Satisfied	200
4.2.2	Case without Matching Condition	205
4.2.3	UIO with Direct Method	207
4.2.4	LTV Case	213
4.3	Conclusion	219

In Section 1.3, several kinds of unknown input observers have been introduced. The sufficient and necessary conditions for existence of these observers were recalled. In this chapter, some extensions will be done with different approaches, such as: generalized inverse matrix, algebraic and bond graph approaches. First, new procedures for developing observers are given. A general form of UIO is proposed by using the infinite structure property of SISO systems $\Sigma(C, A, F)$. This form is shown to be accurate on a physical example, but some proofs on stability property and pole placement should still be derived. Then a general form of the unknown input estimate is proposed by using of the generalized inverse matrix

4. UNKNOWN INPUT OBSERVER

of the disturbance input matrix of systems $\Sigma(C, A, [B \ F])$. Then the observer proposed by Darouach (2009) will be extended into the LTV case. The algebraic approach for designing observers is developed when the control variable $u(t)$ is considered. By the algebraic point of view, procedures for designing observers for LTI and LTV cases will be explained. In this context, it is shown that the bond graph approach is convenient for detecting zeros and poles, and for verifying the detectability of system $\Sigma(C, A, F)$.

In the second part, some physical examples with a DC motor will be studied. The procedures will be implemented for the design of observers. A system satisfying the matching condition in the LTI case is studied, with the design of different observers. When the matching condition is not satisfied, the algebraic approach is used. A direct method is also proposed by using flatness property. The LTV case of systems with different situations is considered, some unknown input observers are designed.

Note that the stability property of observers is a crucial issue. Some of the poles can be chosen, but some of them which are a part of the invariant zeros cannot be freely chosen. In the LTI case, this problem is well defined, which is not the case for LTV models. Some solutions are proposed.

4.1 Unknown Input Observer Design

In this section, observers introduced in Section 1.3 are extended. A new form of UIO and of unknown input estimate is proposed. The observer is based on generalized inverse matrices which can estimate simultaneously state and disturbance variables of system $\Sigma(C, A, [B \ F])$. Most of previous works are proved to be accurate for estimation of disturbance state but without taking into account the control input. We propose new forms which take into account the control input. This solution must be improved by following two goals: stability study and pole placement. In this context, bond graph procedures are used for detectability analysis of systems and matching condition evaluation. For each observer, the LTV case is also considered.

4.1.1 UIO Deduced from the Infinite Structure

A new UIO based on the infinite structure of LTI SISO systems $\Sigma(C, A, F)$ is proposed here. The invertibility property between the unknown input d and the output y is studied for designing this UIO. Being different with conventional UIO, the UIO proposed here firstly estimate the unknown input d . After that, the estimate of the state variable x can be deduced.

Consider model (4.1) with Assumption 4.1.

$$\begin{cases} \dot{x} = Ax + Bu + Fd \\ y = Cx \end{cases} \quad (4.1)$$

Assumption 4.1 For LTI systems in (4.1), it is supposed that matrices B, F have full column rank, and matrix C has full row rank. The known and unknown input u, d are bounded.

The relative degree r is equal to the infinite zero order between the unknown input d and the output y . The r -order derivation of the output y can let the unknown input appears explicitly, such as:

$$\delta^r y = CA^r x + CA^{r-1} Fd + \sum_{i=0}^{r-1} CA^i Bu^{(r-1-i)} \quad (4.2)$$

where $CA^{r-1}F \neq 0, CA^{i-1}F = 0, i < r$.

The first equation in (4.1) can be written as:

$$x = (I\delta - A)^{-1} (Bu + Fd) \quad (4.3)$$

Inserting (4.3) into (4.2) yields

$$\delta^r y = CA^{r-1} (A(I\delta - A)^{-1} + I) Fd + \sum_{i=0}^{r-1} CA^i Bu^{(r-1-i)} + CA^r (I\delta - A)^{-1} Bu \quad (4.4)$$

Since $CA^{r-1}F \neq 0$, it can be shown that $CA^{r-1} (A(I\delta - A)^{-1} + I) Fd \neq 0$. Hence, equation (4.4) can be written as (4.5),

$$d = D(\delta) y^{(r)} - D(\delta) U(\delta) u \quad (4.5)$$

4. UNKNOWN INPUT OBSERVER

where

$$D(\delta) = (CA^{r-1}(A(I\delta - A)^{-1} + I)F)^{-1} \quad (4.6)$$

and

$$U(\delta) = \sum_{i=0}^{r-1} CA^i B \delta^{(r-1-i)} + CA^r (I\delta - A)^{-1} B \quad (4.7)$$

After inserting (4.5) into (4.3), an unknown input observer based on the infinite structure of $\Sigma(C, A, F)$ is proposed in (4.8).

$$\begin{cases} \hat{d} = D(\delta) \delta^{(r)} y - D(\delta) U(\delta) u \\ \hat{x} = (I\delta - A)^{-1} (Bu + F\hat{d}) \end{cases} \quad (4.8)$$

where matrices $D(\delta)$ and $U(\delta)$ are given in (4.6) and (4.7). The UIO in (4.8) can also be used in the LTV case. But the difficulty is related to calculations of inverses of matrices over a noncommutative differential ring. The UIO in (4.8) is derived from formal calculations of the initial system in (4.1). Different property must still be proved: the accuracy of this observer, pole placement and stability according to invariant zero property.

4.1.2 A General Form of Unknown Input Estimate

Systems (4.1) are considered in the LTI and LTV cases with Assumption 4.1. A new procedure for the design of the disturbance estimation is proposed with the pseudo-inverse of matrix F , which is an alternative of the UIO proposed in Darouach (2009).

A pseudoinverse A^+ of a matrix A is a generalization of the inverse matrix. Here, the generalized inverse matrices with two special cases are introduced.

1. If the columns of a matrix $A^{m \times n}$ are linearly independent (so that $m \geq n$), then $A^T A$ is invertible. In this case, an explicit formula is: $A^+ = (A^T A)^{-1} A^T$. It follows that A^+ is then a left inverse of A : $A^+ A = I_n$.
2. If the rows of a matrix $A^{m \times n}$ are linearly independent (so that $m \leq n$), then AA^T is invertible. In this case, an explicit formula is: $A^+ = A^T (AA^T)^{-1}$. It follows that A^+ is then a right inverse of A : $AA^+ = I_m$.

4.1.2.1 LTI Case

According to Assumption 4.1, the columns of the matrix F in the state equation of a system with unknown input in (4.1) are linearly independent. So it has a left inverse F^+ , such as $F^+F = I_q$. Suppose that \hat{x} is the estimate of x in (4.1), i.e.,

$$\lim_{t \rightarrow \infty} e_x(t) = \lim_{t \rightarrow \infty} (x(t) - \hat{x}(t)) = 0 \quad (4.9)$$

The first equation in (4.1) can be written as:

$$d(t) = F^+ (\dot{x}(t) - Ax(t) - Bu(t)) \quad (4.10)$$

Replace $x(t)$ by $\hat{x}(t)$, equation (4.10) is written as:

$$\hat{d}(t) = F^+ (\dot{\hat{x}}(t) - A\hat{x}(t) - Bu(t)) \quad (4.11)$$

where $\hat{x}(t)$ (resp., $\hat{d}(t)$) is the estimate of $x(t)$ (resp., $d(t)$) in (4.1).

The unknown input error is

$$e_d = d - \hat{d} = F^+ (\dot{x} - \dot{\hat{x}} - A(x - \hat{x})) = F^+ (\dot{e}_x - Ae_x) = F^+(N - A)e_x \quad (4.12)$$

Because of (4.9), the unknown input error converges asymptotically to zero, i.e., $\lim_{t \rightarrow \infty} e_d = 0$. Hence, $\hat{d}(t)$ in (4.11).

The observer in (1.48) with generalized inverse matrix approach is then rewritten as (4.13),

$$\begin{cases} \dot{\xi}(t) = N\xi(t) + Jy(t) + Hu(t) \\ \hat{x}(t) = \xi(t) - Ey(t) \\ \hat{d}(t) = F^+ (\dot{\hat{x}}(t) - A\hat{x}(t) - Bu(t)) \end{cases} \quad (4.13)$$

where matrices N, J, H, E and F^+ can be derived from procedures in Section 1.3.1.

The block diagram of observer in (4.13) is shown in Figure 4.1.

4. UNKNOWN INPUT OBSERVER

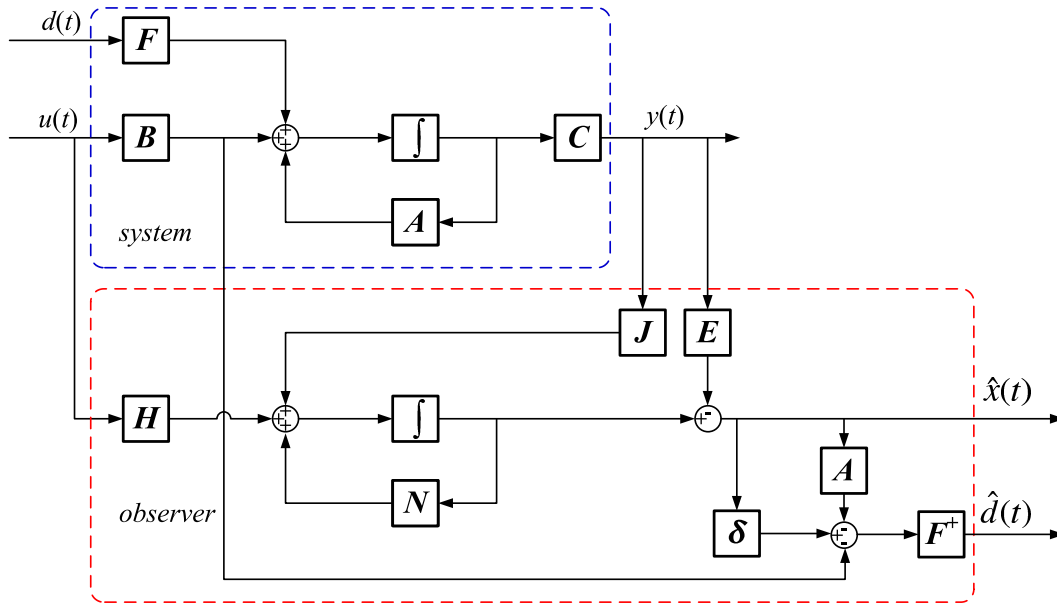

Figure 4.1: Block diagram of the LTI observer with generalized inverse matrices

4.1.2.2 LTV Case

In this section, the LTV systems which satisfy the matching condition are considered. Consider system (4.14) where matrices $A(t)$, $B(t)$, $C(t)$ and $F(t)$ have time-varying entries with appropriate dimensions.

$$\begin{cases} \dot{x}(t) = A(t)x(t) + B(t)u(t) + F(t)d(t) \\ y(t) = C(t)x(t) \end{cases} \quad (4.14)$$

The unknown input observer proposed by Darouach (2009) is extended to the LTV case. The UIO introduced in (4.13) is extended to the LTV UIO (4.15),

$$\begin{cases} \dot{\xi}(t) = N(t)\xi(t) + J(t)y(t) + H(t)u(t) \\ \hat{x}(t) = \xi(t) - E(t)y(t) \\ \hat{d}(t) = F^+(t) \left(\dot{\hat{x}}(t) - A(t)\hat{x}(t) - B(t)u(t) \right) \end{cases} \quad (4.15)$$

where $\hat{x}(t) \in \mathbb{R}^n$ (resp., $\hat{d}(t) \in \mathbb{R}^q$) is the estimate of $x(t)$ (resp., $d(t)$). Matrices $N(t)$, $J(t)$, and $E(t)$ with time-varying entries have appropriate dimensions.

Let $P(t) = I + E(t)C(t)$, Proposition 4.2 gives the conditions for system (4.15) to be a full-order observer for system (4.14).

Proposition 4.2 *By the full-order observer (4.15), the state and disturbance*

4.1 Unknown Input Observer Design

variables $x(t)$ and $d(t)$ in (4.14) will be asymptotically estimated if the following conditions hold.

1. $N(t)$ is a Hurwitz matrix
2. $\dot{P}(t) + P(t)A(t) - N(t)P(t) - J(t)C(t) = 0$
3. $P(t)F(t) = 0$
4. $H(t) = P(t)B(t)$

Derived from equations (4.14) and (4.15), the observer reconstruction error is

$$e_x = x - \hat{x} = P(t)x - \xi \quad (4.16)$$

The dynamic of the estimation error is given by

$$\begin{aligned} \dot{e}_x = N(t)e_x + \left(\dot{P}(t) + P(t)A(t) - N(t)P(t) - J(t)C(t) \right) x \\ + (P(t)B(t) - H(t))u + P(t)F(t)d(t) \end{aligned} \quad (4.17)$$

If conditions in Proposition 4.2 are satisfied, then $\lim_{t \rightarrow \infty} e(t) = 0$ for any $x(0), \hat{x}(0), d(t)$ and $u(t)$. Hence $\hat{x}(t)$ (resp., $\hat{d}(t)$) in (4.15) is an estimate of $x(t)$ (resp., $d(t)$) in (4.14).

Equations 2-3 in Proposition 4.2 can be written as

$$N(t) = A(t) + \begin{bmatrix} E(t) & K(t) \end{bmatrix} \begin{bmatrix} C(t)A(t) \\ C(t) \end{bmatrix} + \dot{P}(t) \quad (4.18)$$

$$\begin{bmatrix} E(t) & K(t) \end{bmatrix} \Sigma(t) = -F(t) \quad (4.19)$$

where $K(t) = -J(t) - N(t)E(t)$, $\Sigma(t) = \begin{bmatrix} C(t)F(t) \\ 0 \end{bmatrix}$.

Under condition $\text{rank}[C(t)F(t)] = \text{rank}[F(t)]$, the general solution of equation (4.19) is

$$\begin{bmatrix} E(t) & K(t) \end{bmatrix} = -F(t)\Sigma^+(t) - Z(t) (I - \Sigma(t)\Sigma^+(t)) \quad (4.20)$$

where $\Sigma^+(t)$ is a generalized inverse matrix of $\Sigma(t)$ and $Z(t)$ is an arbitrary matrix with appropriate dimension.

After inserting (4.20) into (4.18), the matrix $N(t)$ has the form

$$N(t) = A_1(t) - Z(t)B_1(t) + \dot{P}(t) \quad (4.21)$$

4. UNKNOWN INPUT OBSERVER

where

$$A_1(t) = A(t) - F(t)\Sigma^+(t) \begin{bmatrix} C(t)A(t) \\ C(t) \end{bmatrix} \quad (4.22)$$

and

$$B_1(t) = (I - \Sigma(t)\Sigma^+(t)) \begin{bmatrix} C(t)A(t) \\ C(t) \end{bmatrix} \quad (4.23)$$

The matrix $Z(t)$ is used to guarantee the stability of the matrix $N(t)$. There exists a matrix $Z(t)$ for assuring the stability of matrix $N(t)$ iff the system $\Sigma(C(t), A(t), F(t))$ is strong* detectable. Because the matrix $N(t)$ has time-varying entries, the calculation of its poles can be derived from the procedure introduced in Section 1.2.2.1.

The necessary and sufficient condition of existence of the observer (4.15) for the system (4.14) is given by the following theorem.

Theorem 4.3 *The full-order observer (4.15) will estimate (asymptotically) $x(t)$ in (4.14) if the system $\Sigma(C(t), A(t), F(t))$ is strong* detectable, i.e.*

$$\begin{cases} \text{rank} \begin{bmatrix} I\delta - A(t) & -F(t) \\ C(t) & 0 \end{bmatrix} = n + q, \forall \delta \in \mathbb{C}(t), \text{Re}(\delta) \geq 0 \\ \text{rank} [C(t)F(t)] = \text{rank} [F(t)] = q \end{cases} \quad (4.24)$$

A procedure for designing the observer (4.15) is given.

Procedure 4.4

1. Verify the strong* detectability of the system $\Sigma(C(t), A(t), F(t))$.
2. Calculate matrices $A_1(t), B_1(t)$ in equations (4.22) and (4.23).
3. Determine matrix $Z(t)$ by pole placement of matrix $N(t)$ in (4.21).
4. Compute matrices $E(t)$ and $K(t)$ by (4.20), then $J(t) = -K(t) - N(t)E(t)$, $H(t) = (I + E(t)C(t))B(t)$.
5. Calculate matrix $F^+(t)$ for the estimate of $d(t)$.

4.1.3 UIO with the Algebraic Approach

As mentioned above, the matching condition for the existence of observers is often required (see [Kudva *et al.* \(1980\)](#); [Darouach *et al.* \(1994\)](#)): $\text{rank } CF = \text{rank } F = q$. However, this condition is not always satisfied. [Floquet & Barbot \(2006\)](#) proposed unknown input sliding mode observers after implementing a procedure to get a canonical observable form of systems. This method can also be extended in the nonlinear case. [Daafouz *et al.* \(2006\)](#) gave an intrinsic explanation of the UIO problem by the algebraic approach for systems in (1.59). A general structure of UIOs for estimating state and unknown variables was proposed with the necessary and sufficient conditions: system $\Sigma(C, A, F)$ is left invertible and minimum phase. The first condition is equivalent to $\text{rank } C(I\delta - A)^{-1}F = q$.

Most of the previous works do not take into account the control input. An extension is proposed here with these input variables. The unknown input observer for an SISO model with control input is written in (4.25). Two estimates of the disturbance variables are proposed, the first one \hat{d}_1 is an extension of the one proposed in [Daafouz *et al.* \(2006\)](#), the second one \hat{d}_2 is the estimate proposed in (4.10).

$$\begin{cases} \dot{\hat{x}} = (PA - LC)\hat{x} + Q(y^{(r)} - U) + Ly + Bu \\ \hat{d}_1 = (CA^{r-1}F)^{-1}(y^{(r)} - CA^r\hat{x} - U) \\ \hat{d}_2 = F^+(\dot{\hat{x}} - A\hat{x} - Bu) \end{cases} \quad (4.25)$$

Matrices Q and P satisfy (4.26) and (4.27),

$$Q = F(CA^{r-1}F)^{-1}, \quad P = I_n - QCA^{r-1} \quad (4.26)$$

and U is a differential polynomials matrix of the input variable u , such as:

$$U = \sum_{i=0}^{r-1} CA^i B u^{(r-1-i)} \quad (4.27)$$

r is the infinite zero order between the unknown input $d(t)$ and the output $y(t)$.

The block diagram of observer (4.25) is shown in Figure 4.2, where $P1 = PA - LC$, $Y(\delta) = Q\delta^r + L$ and $U(\delta) = B - Q \sum_{i=0}^{r-1} CA^i B \delta^{(r-1-i)}$.

The main idea of the method is to implement derivations on the output variable $y(t)$ to let the unknown input variable $d(t)$ appears explicitly. The r -order

4. UNKNOWN INPUT OBSERVER

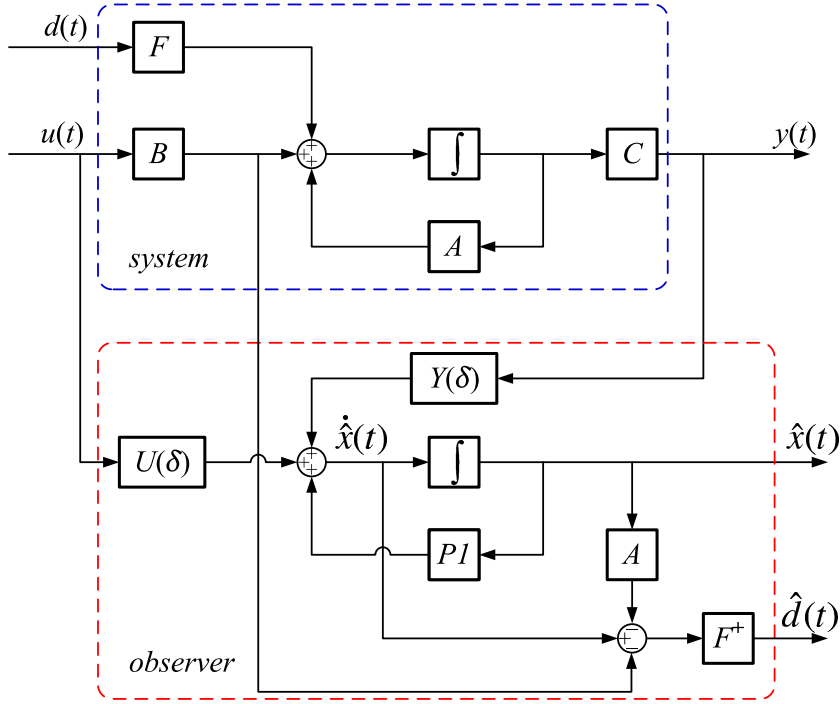

Figure 4.2: Schema block of the LTI observer with the algebraic approach

derivation of output variable is given in (4.2). Note that the control input must be derivable ($r - 1$ times) which is possible for example with a flat control approach. For MIMO models, the extension of the procedure was proposed by Floquet & Barbot (2006).

The dynamic of the estimation error of state variables is

$$\dot{e}_x = \dot{x} - \dot{\hat{x}} = (PA - LC)(x - \hat{x}) \quad (4.28)$$

One has $\lim_{t \rightarrow \infty} e_x(t) = 0$ for any $x(0)$, $\hat{x}(0)$, $d(t)$ and $u(t)$. The disturbance estimate \hat{d}_1 can be written as

$$\hat{d}_1 = (CA^{r-1}F)^{-1}CA^r(x - \hat{x}) + d \quad (4.29)$$

As $\lim_{t \rightarrow \infty} e_x(t) = 0$, then $\lim_{t \rightarrow \infty} \hat{d}_1(t) = d(t)$.

The observer (4.25) can be obtained by Procedure 4.5.

Procedure 4.5 *Yang & Sueur (2012)* If the following steps are implemented, the variables $x(t)$ and $d(t)$ will be asymptotically estimated.

1. Verify the minimum phase property of systems $\Sigma(C, A, F)$.

2. Compute the relative degree r and the inverse of $CA^{r-1}F$.
3. Compute Q , P and U and then L for pole placement.

The procedure for designing unknown input observers in the LTV case is similar to the LTI procedure. The main difference is that derivations of matrices with time-varying entries should be taken into account. The relative degree of the system $\Sigma(C(t), A(t), F(t))$ is not easy to calculate with the procedure, but it can be easily derived from the infinite structure of the bond graph model. In case of LTV models, a similar approach can be proposed.

4.1.4 Bond Graph Procedure for Strong* Detectability

According to Procedure 4.4, the first step is to verify the strong* detectability of the system $\Sigma(C, A, F)$. This step can be divided into two parts: the matching condition $\text{rank}[CF] = \text{rank}[F]$, and strong detectability of the system $\Sigma(C, A, F)$. For a bond graph model, these two conditions can be easily implemented with a graphical approach. The matching condition is related to the length of the causal path between the output y and the unknown input d . The strong detectability is related to the zeros structure of the system $\Sigma(C, A, F)$. The zeros structure of systems can be derived from bond graph models as proposed in chapter 3.

The matching condition for an LTI bond graph model with a single unknown input and a single output can be verified by Proposition 4.6.

Proposition 4.6 *In the bond graph model of an SISO system $\Sigma(C, A, F)$, the relative degree is equal to the length of the causal path between the unknown input and the output. If the input-output causal path is equal to one, i.e. there is only one dynamic element in the path, the matching condition is satisfied. One has $CF \neq 0$ and $\text{rank}[CF] = \text{rank}[F] = 1$.*

The strong detectability is related to the invariant zeros of systems. The invariant zeros must be stable for systems $\Sigma(C, A, F)$. In the LTI case, the existence of null zeros can be easily derived from bond graph models. The existence of null zeros do not satisfy the strong detectability condition. Then for a bond graph model, the first step is to verify the existence of null invariant zeros in the model. Now, a bond graph procedure for verifying the strong detectability of the system $\Sigma(C, A, F)$ is proposed.

4. UNKNOWN INPUT OBSERVER

Procedure 4.7 Based on the bond graph approach, the strong detectability of systems $\Sigma(C, A, F)$ is verified by the following steps.

- Verify the number of IZ of the system $\Sigma(C, A, F)$ by its BGI model. If there is no IZ, stop the procedure, the strong detectability condition is satisfied.
- Verify the existence of null zeros of the system $\Sigma(C, A, F)$ by its BGD model. If there are null zeros, stop the procedure, it is not possible to design the observer.
- Calculate values of IZ by its BGB model. If all real part of invariant zeros are negative (resp., positive), the strong detectability condition is satisfied (resp., unsatisfied).

This procedure is represented in Figure 4.3.

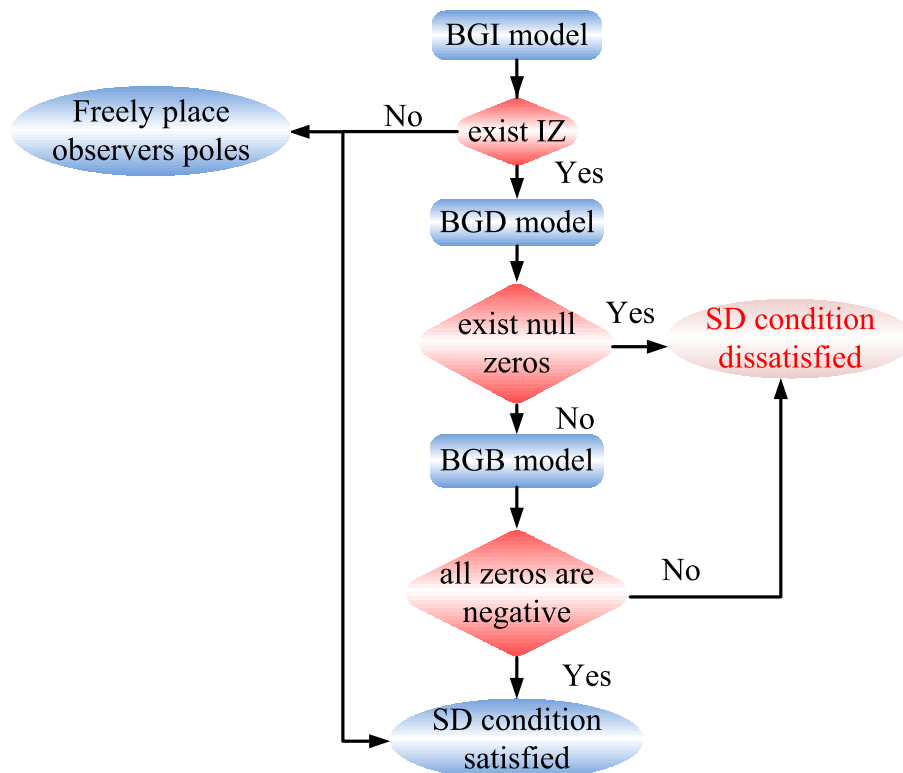

Figure 4.3: Strong detectability condition with bond graph approach

Procedure 4.8 The strong* detectability of the system $\Sigma(C, A, F)$ can be verified by the following steps.

1. Verify the matching condition by Proposition 4.6.
2. Examine the strong detectability by Procedure 4.7.

Since the same (or equivalent) conditions must be verified for design of other UIO, these procedures are not proposed here.

4.2 Numerical Examples and Simulations

In this section, an example of a DC motor as a physical example for the design of UIOs. The different UIOs proposed in the previous section are implemented. The LTI and LTV cases are considered here. The existence condition of observers will be verified by the bond graph approach introduced above. The graphic approach is used to detect invariant zeros and poles of bond graph models.

The BGI model of the system with a disturbance signal is given in Figure 4.4, and the state-space equations are presented in (4.30), with $x = (p_L, p_J)^t = (x_1, x_2)^t$ the state vector, y the measured output variable, u the control input variable and d the disturbance input variable. Here the disturbance input is supposed to be $d(t) = 20 \sin(t)$, and the input $u(t)$ is the Heaviside unit step function, i.e., $u(t) = 30\Gamma(t)$.

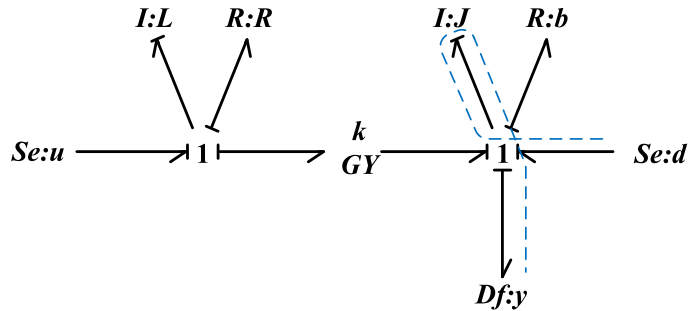

Figure 4.4: BGI model of the DC moteur

$$\begin{cases} \dot{x}_1 = -\frac{R}{L}x_1 - \frac{k}{J}x_2 + u \\ \dot{x}_2 = \frac{k}{L}x_1 - \frac{b}{J}x_2 + d \\ y = \frac{1}{J}x_2 \end{cases} \quad (4.30)$$

The bond graph model is controllable and observable (a derivative causality can be assigned). The numerical values of system parameters are shown in Table

4. UNKNOWN INPUT OBSERVER

4.1. From structural calculation, condition $\text{rank } CF = \text{rank } F = q$ is satisfied, hence the observer proposed in Darouach (2009) can be used.

Table 4.1: Numerical values of system parameters

L	R	k	J	b	$d(t)$	$u(t)$
$5 \times 10^{-4} \text{ H}$	$0.25 \text{ } \Omega$	1	5 kgm^2	0.2 Nm/Wb	$20 \sin(t)$	$30\Gamma(t)$

It is noticed that the matching condition is not satisfied if the output $y(t)$ is placed at the 1-junction related to the element $I : L$. In the following sections, the first case with the matching condition is considered in the LTI case. The generalized inverse matrix and algebraic approaches are implemented to design observers for the system. For the second case, the approach with generalized inverse matrices is no more available. Hence, the algebraic approach will be used to estimate the state and unknown input variables. Lastly, for each case, the LTV extension will be made by various approaches. It should be known that the study of poles and zeros of systems derived from bond graph and formal approaches is an essential issue for designing UIOs.

Remark 4.9 *In the simulation process, impulsive motions often arise because of some variables which appear with derivatives. Some filters are used in the simulation process for reducing non described phenomena. However, these filters can reduce the accuracy of the estimates of state and unknown input variables. The initial condition of state variables and the poles of observers also affect the simulation results.*

4.2.1 Case with Matching Condition Satisfied

The system in Figure 4.4 is studied in this section. First, the bond graph procedure is used to verify the matching condition of system $\Sigma(C, A, F)$. The input-output causal path between the input d and the output y is: $Df : y \rightarrow I : J \rightarrow Se : d$. According to Procedure 4.6, the matching condition is satisfied, i.e., $\text{rank}[CF] = \text{rank}[F] = 1$. After calculation, matrix CF is equal to $\frac{1}{j}$ with the causal path $Df : y \rightarrow I : J \rightarrow Se : d$. The strong detectability of system $\Sigma(C, A, F)$ is required. This property is related to the invariant zeros study of the system. Now, Procedure 4.7 is used to detect the invariant zeros of system $\Sigma(C, A, F)$. Firstly, the number of invariant zeros is determined by the infinite

4.2 Numerical Examples and Simulations

structure of the BGI model. The causal path length between the output detector $Df : y$ and the disturbance input $Se : d$ is equal to 1, thus there is an invariant zero in the system $\Sigma(C, A, F)$ and $r = 1$.

If there exist null zeros in system $\Sigma(C, A, F)$, it is no possible to design UIOs. The null zeros can be examined by BGD model of the system. This model is given in Figure 4.5. The causal path length between the output detector $Df : y$ and the disturbance input $Se : d$ is equal to 0, path $Df : y \rightarrow R : b \rightarrow Se : d$, thus there is no null invariant zero in the system $\Sigma(C, A, F)$.

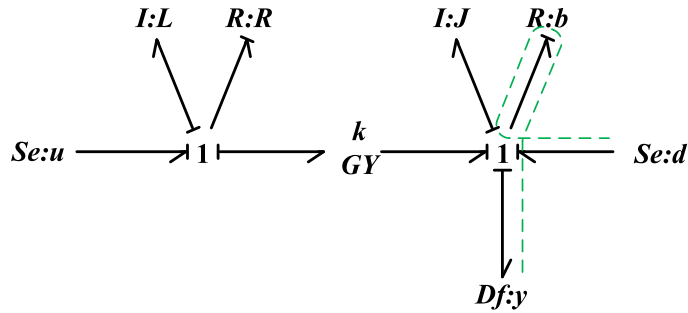

Figure 4.5: BGD model of the DC moteur

The BGB model of system $\Sigma(C, A, F)$ shown in Figure 4.6 is used to calculate the invariant zero.

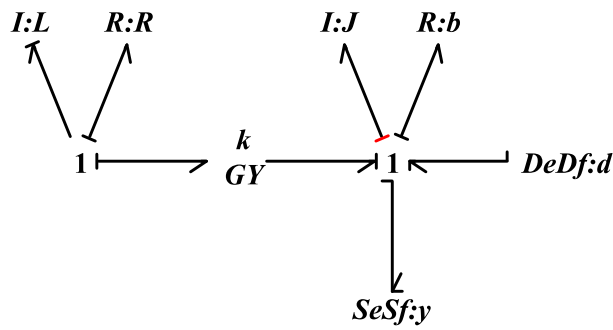

Figure 4.6: BGB model of the DC moteur

If the causal path $Df : y \rightarrow I : J \rightarrow Se : d$ is removed, the reduced bond graph model has no input variable. The mathematical relation $\dot{x}_1 + \frac{R}{L}x_1 = (\delta + \frac{R}{L})x_1 = 0$ associated to a torsion module can be written. Hence, the invariant zero of system $\Sigma(C, A, F)$ is $\delta = -\frac{R}{L} = -500$ which verifies the minimum phase condition.

4. UNKNOWN INPUT OBSERVER

4.2.1.1 UIO by Generalized Inverse Matrices

As mentioned above, the system $\Sigma(C, A, F)$ satisfies the matching condition and the strong detectability. Hence, the observer in (4.13) can be used. The calculations of matrices in Procedure 4.4 are implemented for designing the observer in (4.13).

The matrix Σ is derived from equation (1.52), such as $\Sigma = \begin{bmatrix} CF \\ 0 \end{bmatrix} = \begin{bmatrix} 0.2 \\ 0 \end{bmatrix}$. Based on equation (1.54), one has $\Sigma^+ = \begin{bmatrix} 5 & 0 \end{bmatrix}$. According to (1.56) and (1.57), matrices A_1 and B_1 are $A_1 = \begin{bmatrix} -500 & -0.2 \\ 0 & 0 \end{bmatrix}$, $B_1 = \begin{bmatrix} 0 & 0 \\ 0 & 0.2 \end{bmatrix}$. Let the matrix $Z = \begin{bmatrix} z_1 & z_2 \\ z_3 & z_4 \end{bmatrix}$, after inserting matrices A_1, B_1 and Z into (1.55), the matrix N has the form $N = \begin{bmatrix} -500 & -0.2 - 0.2z_2 \\ 0 & -0.2z_4 \end{bmatrix}$. The matrix Z is used to place the poles of the observer. The poles are the invariant factors of the Smith form of $I\delta - N$. In this case, the invariant polynomial of the Smith form of $I\delta - N$ is $(\delta + 500)(\delta + 0.2z_4)$. The pole $\delta = -500$ is equal to the invariant zero of system $\Sigma(C, A, F)$. Let $z_1 = z_2 = z_3 = 0$ and $z_4 = 100$, then the poles of the observer are $\delta_1 = -500, \delta_2 = -20$ which assure the stability of the observer. Finally, the matrix N has the form $N = \begin{bmatrix} -500 & -0.2 \\ 0 & -20 \end{bmatrix}$.

By computing the matrices E and K in (1.53), one has $E = \begin{bmatrix} 0 \\ -5 \end{bmatrix}$ and $K = \begin{bmatrix} 0 \\ -100 \end{bmatrix}$. After that, the matrices J and H can be deduced, such as: $J = \begin{bmatrix} -1 \\ 0 \end{bmatrix}$, $H = \begin{bmatrix} 1 \\ 0 \end{bmatrix}$. Since $F = \begin{bmatrix} 0 \\ 1 \end{bmatrix}$, one has $F^+ = \begin{bmatrix} 0 & 1 \end{bmatrix}$ which is used to estimate the unknown input.

After calculations of matrices, simulations are implemented with models of the system and the observer in MATLAB[®]/Simulink[®]. With an initial condition $x(0) = \begin{bmatrix} 0.1 \\ 2 \end{bmatrix}$ for the system $\Sigma(C, A, \begin{bmatrix} B & F \end{bmatrix})$, the estimate errors of the state variables are shown in Figure 4.7.

The unknown input d and its estimate d_e^* are displayed in Figure 4.8.

Suppose a noise signal $\mu(t)$ of random number with variance of 1 is added to the unknown input, i.e., $d(t) = \sin(t) + \mu(t)$. The unknown input d and its

*In what follows, because of a symbol display problem in MATLAB[®], the estimate of d is denoted by d_e in place of \hat{d} .

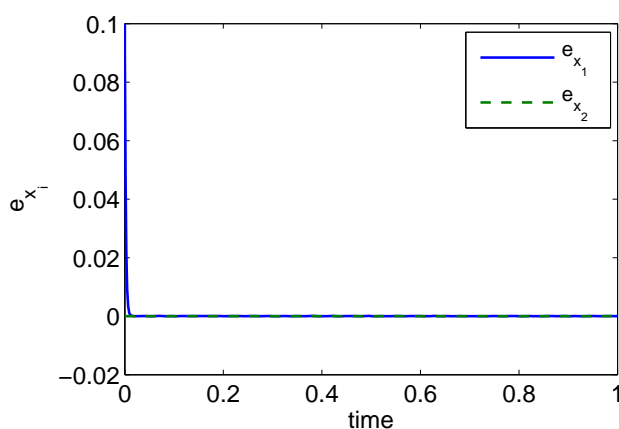

Figure 4.7: Trajectories $e_{x_i} = \hat{x}_i - x_i$, $i = 1, 2$ of the LTI system 1 with generalized inverse matrix method

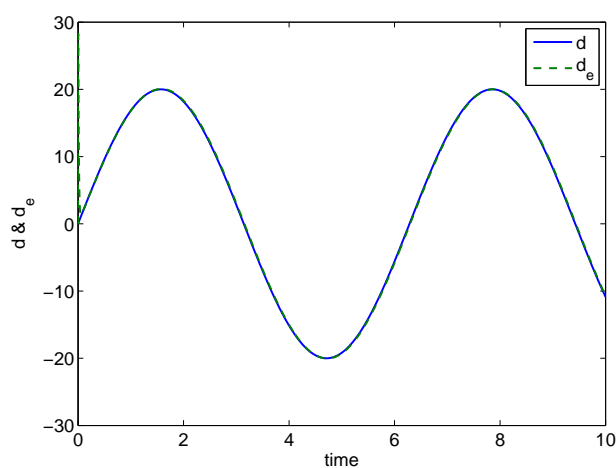

Figure 4.8: Trajectories d and d_e of the LTI system 1 with generalized inverse matrix method

estimate d_e are displayed in Figure 4.9. d_e can rapidly estimate the unknown input d with the noise signal.

Note that this noise signal will be used in the following simulations.

4.2.1.2 UIO by Algebraic Approach

Now, the UIO in (4.25) is used to estimate the state and unknown input variables. Matrix L is used to place the poles of the observer. One pole is fixed (invariant zero of system $\Sigma(C, A, F)$: $\delta_1 = -500$), another is placed at $\delta_2 = -20$. Through

4. UNKNOWN INPUT OBSERVER

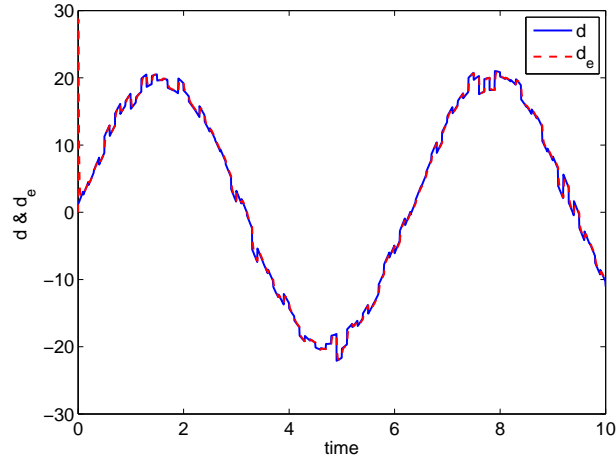

Figure 4.9: Trajectories d and d_e of MUIO of the LTI system 1 with a noise signal

the procedure proposed in Section 4.1.3, the matrices of the observer are

$$\begin{aligned} Q &= \begin{bmatrix} 0 \\ 5 \end{bmatrix} & PA - LC &= \begin{bmatrix} -500 & -0.4 \\ 0 & -20 \end{bmatrix} \\ L &= \begin{bmatrix} 1 \\ 100 \end{bmatrix} & U &= 0 \end{aligned} \quad (4.31)$$

The estimation errors of the two state variables with an initial condition $x(0) = \begin{bmatrix} 0.1 \\ 2 \end{bmatrix}$ are displayed in Figure 4.10.

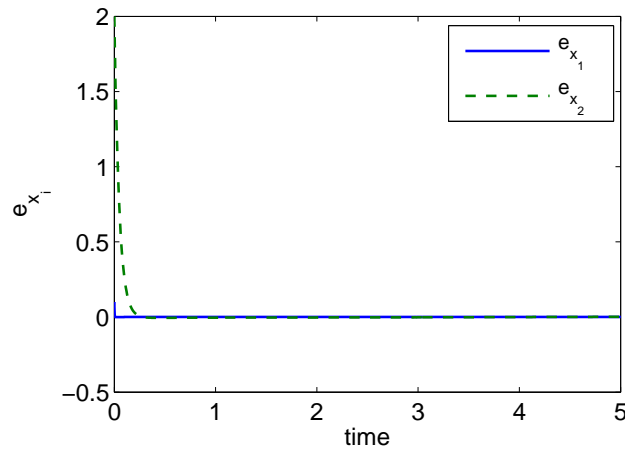

Figure 4.10: Trajectories $e_{x_i} = \hat{x}_i - x_i, i = 1, 2$ of system 1 with the algebraic approach

4.2 Numerical Examples and Simulations

The estimation \hat{d}_1 of d in (4.25) is

$$\hat{d}_1 = 5(y - [400 \quad -0.008] \hat{x}) \quad (4.32)$$

The comparison of the estimation of the unknown input $d_{ei}, i = 1, 2$ and itself d is shown in Figure 4.11, where d_{e1} (resp., d_{e2}) is \hat{d}_1 (resp., \hat{d}_2) in (4.25).

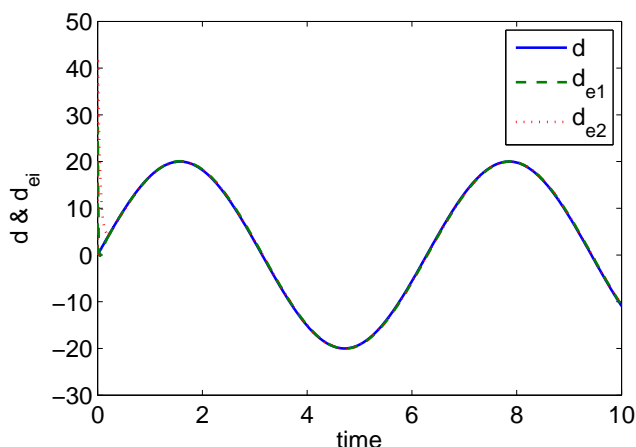

Figure 4.11: Trajectories $d(t)$ and d_{e1}, d_{e2} of system 1 with the algebraic approach

With $d(t) = \sin(t) + \mu(t)$, the unknown input d and its estimate d_{ei} are displayed in Figure 4.12. d_{ei} can still rapidly estimate the unknown input d with the noise signal.

4.2.2 Case without Matching Condition

Now the output $y(t)$ is placed at the 1-Junction related to the element $I : L$, i.e., the output matrix is $C = [\frac{1}{L} \ 0]$. The bond graph model is controllable and observable. The BGI model of the system is shown in Figure 4.13. The causal path length between the output detector $Df : y$ and the disturbance input $Se : d$ is equal to 2, i.e., $r = 2$, path $Df : y \rightarrow I : L \rightarrow GY \rightarrow I : J \rightarrow Se : d$, thus there is not any invariant zero. It means that poles of the observer can be freely assigned. According to Proposition 4.6, the matching condition is not satisfied. Here, one has $\text{rank}[CF] = 0$ and $\text{rank}[F] = 1$. So the observer with generalized inverse matrices in (4.13) can not be derived.

Because there is no invariant zero in the system $\Sigma(C, A, F)$, the minimum phase condition is satisfied. The system $\Sigma(C, A, F)$ is invertible. According to

4. UNKNOWN INPUT OBSERVER

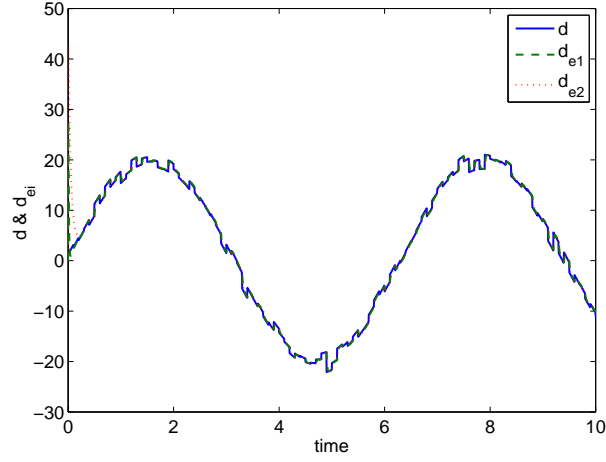

Figure 4.12: Trajectories d and d_{ei} of AUIO of the LTI system 1 with a noise signal

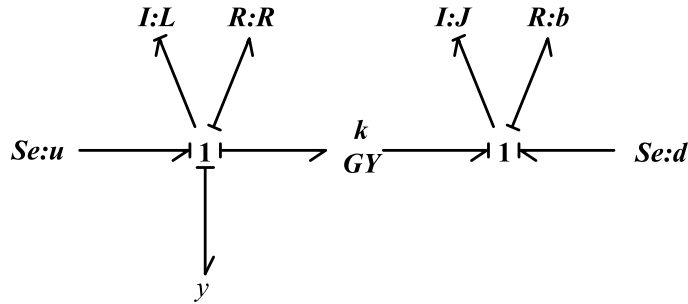

Figure 4.13: BGI model of the DC motor with y in the second position

Theorem 1.56, an observer in (4.25) can be designed. As $r = 2$, the unknown input can be represented by a 2-order differential polynomial of the output $y(t)$, such as $\ddot{y} = CA^2x + CABu + CAFd + CB\dot{u}$. One has $CF = 0, CAF = -400$. The matrices of the observer are:

$$\begin{aligned} Q &= \begin{bmatrix} 0 \\ -0.0025 \end{bmatrix} & PA - LC &= \begin{bmatrix} -900 & -0.2 \\ 2.45 \times 10^6 & 500 \end{bmatrix} \\ L &= \begin{bmatrix} 0.2 \\ -600 \end{bmatrix} & U &= 2000\dot{u} - 1 \times 10^6 u \end{aligned} \quad (4.33)$$

The poles of the observer are arbitrarily placed by the matrix L , here $\delta_{1,2} = -200$. Figure 4.14 shows the estimation errors of two state variables of the second system with an initial condition $x(0) = \begin{bmatrix} 0.1 \\ 2 \end{bmatrix}$.

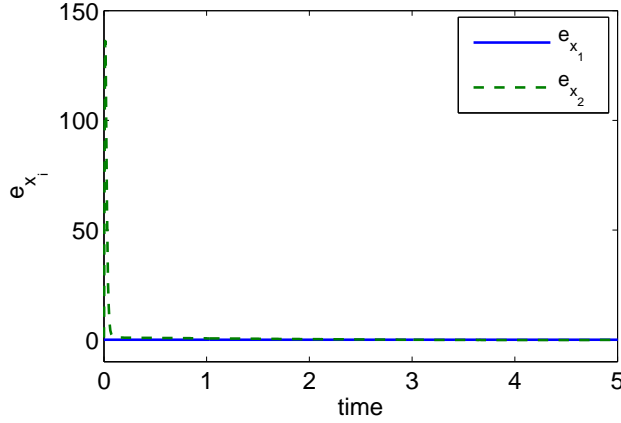

Figure 4.14: Trajectories $e_{x_i} = \hat{x}_i - x_i, i = 1, 2$ of the LTI system 2 with the algebraic approach

The estimation \hat{d}_1 and \hat{d}_2 in (4.25) are

$$\begin{cases} \hat{d}_1 = -0.0025(y^{(2)} + 1 \times 10^6 u - 2000\dot{u} - [4.992 \times 10^8 \quad 200016] \hat{x}) \\ \hat{d}_2 = \dot{\hat{x}}_2 - 2000\hat{x}_1 + 0.04\hat{x}_2 \end{cases} \quad (4.34)$$

Trajectories of the estimation $\hat{d}_i(t), i = 1, 2$ of the unknown input $d(t)$ are shown in Figure 4.15, where d_{e1} (resp., d_{e2}) is \hat{d}_1 (resp., \hat{d}_2) in (4.25). Because of the derivatives of the input variable $u(t)$ in (4.34) for estimating the unknown input $d(t)$, the impulsive motion in the curve of d_{e1} is much more violent than in the curve of d_{e2} .

4.2.3 UIO with Direct Method

The two examples are studied with the new UIO proposed in Section 4.1.1.

Example: case 1

For the system in Figure 4.4, without considering the unknown input d in (4.30), the system state space equation can be written as:

$$\begin{cases} \dot{x}_1 = -\frac{R}{L}x_1 - \frac{k}{J}x_2 + u \\ \dot{x}_2 = \frac{k}{L}x_1 - \frac{b}{J}x_2 \\ y = \frac{1}{J}x_2 \end{cases} \quad (4.35)$$

4. UNKNOWN INPUT OBSERVER

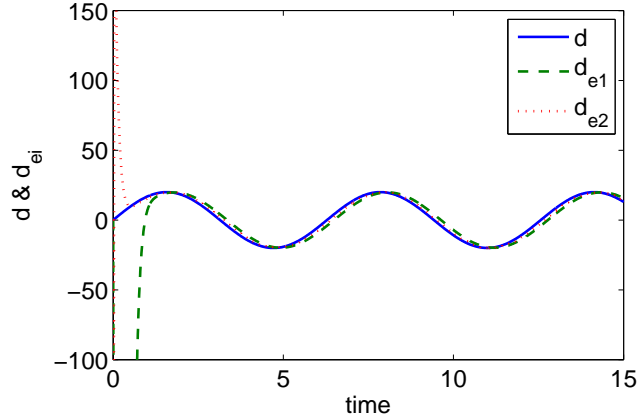

Figure 4.15: Trajectories d and $d_{ei}, i = 1, 2$ of the LTI system 2 with the algebraic approach

In Figure 4.4, the causal path between the output $Df : y$ and the input u is $Df : y \rightarrow I : J \rightarrow GY \rightarrow I : L \rightarrow Se : u$. So there is no invariant zero in the system $\Sigma(C, A, B)$. This system is a flat system [Barbot *et al.* \(2007\)](#), and the output y is the flat output. It means that all the variables of the system can be represented by the flat output and its derivatives. Hence, equation (4.35) can be written as:

$$\begin{cases} x_1 = \frac{LJ}{k}\dot{y} + \frac{Lb}{k}y \\ x_2 = Jy \\ u = \frac{LJ}{k}\ddot{y} + \frac{Lb+RJ}{k}\dot{y} + \frac{Rb+k^2}{k}y \end{cases} \quad (4.36)$$

Let's reconsider the system $\Sigma(C, A, [B \ F])$ in (4.30). Like the form in (4.35), all system variables can be represented by vectors y, d and their derivatives, such as:

$$\begin{cases} x_1 = \frac{LJ\delta+Lb}{k}y - \frac{L}{k}d \\ x_2 = Jy \\ u = \frac{LJ\delta^2+(Lb+RJ)\delta+bR+k^2}{k}y - \frac{L\delta+R}{k}d \end{cases} \quad (4.37)$$

Here, the unknown input d is estimated without estimating the state variables.

In (4.30), the second equation can be written as:

$$d = J\dot{y} + by - \frac{k}{L}x_1 \quad (4.38)$$

combined with the first equation in (4.30). One can get an estimate of the un-

4.2 Numerical Examples and Simulations

known input d :

$$\hat{d} = \left(J\delta + b + \frac{k^2}{L\delta + R} \right) y - \frac{k}{L\delta + R} u \quad (4.39)$$

After inserting (4.39) into (4.30) (or with equation (4.37)), an observer in (4.8) with the direct method is shown in (4.40).

$$\begin{cases} \hat{d} = \left(J\delta + b + \frac{k^2}{L\delta + R} \right) y - \frac{k}{L\delta + R} u \\ \hat{x}_1 = \frac{L}{k} \left(J\dot{y} + by - \hat{d} \right) \\ \hat{x}_2 = Jy \end{cases} \quad (4.40)$$

The curves of the unknown input d and its estimate d_e are displayed in Figure 4.16.

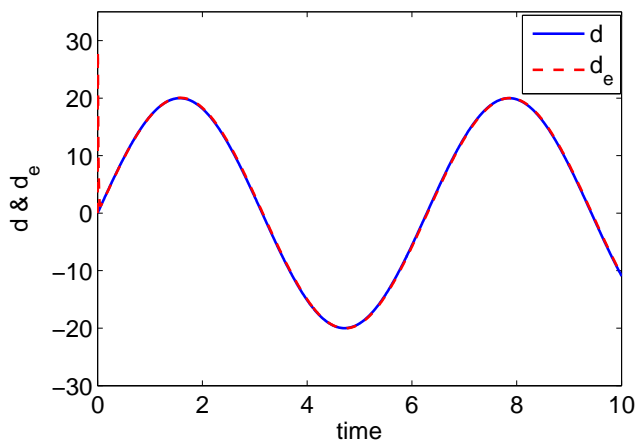

Figure 4.16: Trajectories d and d_e of the LTI system 1 with the direct method

Figure 4.17 shows the estimate errors of two state variables of the system in (4.30) with an initial condition $x(0) = \begin{bmatrix} 0.1 \\ 2 \end{bmatrix}$.

With $d(t) = \sin(t) + \mu(t)$, the unknown input d and its estimate d_e are displayed in Figure 4.18.

4. UNKNOWN INPUT OBSERVER

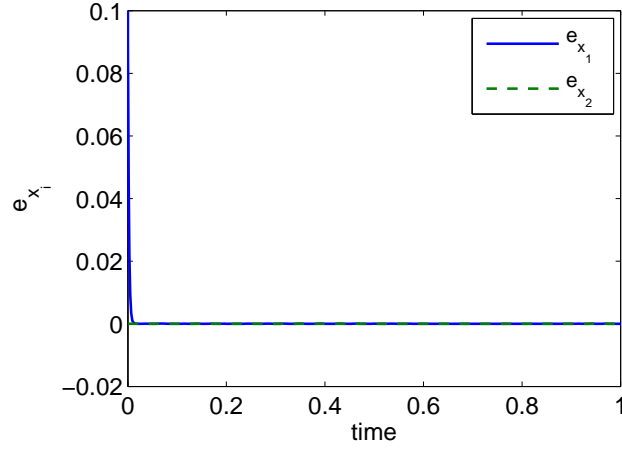

Figure 4.17: Trajectories $e_{x_i} = x_i - \hat{x}_i, i = 1, 2$ of the LTI system 1 with the direct method

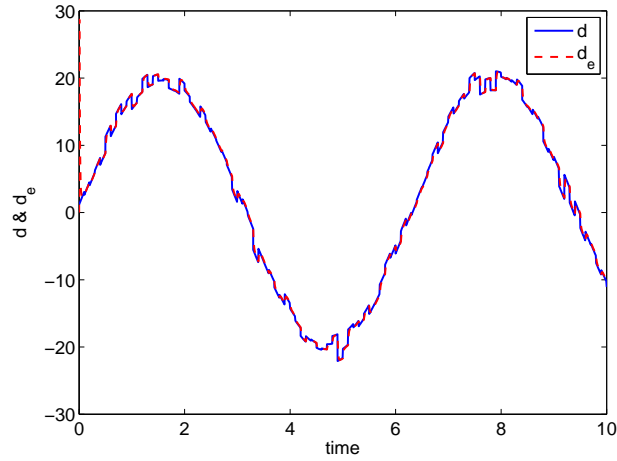

Figure 4.18: Trajectories d and d_e of DUIO of the LTI system 1 with a noise signal

Example: case 2

Similarly to the procedure for detecting the UIO in (4.40), the UIO of the system in Figure 4.13 is given in (4.41).

$$\begin{cases} \hat{d} = -\frac{1}{k} (JL\delta^2 + (JR + bL)\delta + bR + k^2) y + \frac{1}{k} (J\delta + b) u \\ \hat{x}_1 = Ly \\ \hat{x}_2 = \frac{J}{J\delta + b} (ky + \hat{d}) \end{cases} \quad (4.41)$$

4.2 Numerical Examples and Simulations

Remark that since in the first case, the model is flat (between control input and output detector). State variables estimates are derived as function of the input variable, the output variable and the disturbance variable estimation and their derivatives. In the second case, the model is flat but by considering the disturbance input and the output detector. In that case, the disturbance variable estimation is defined as a function of the output variable the input variable and their derivatives.

The curves of the unknown input d and its estimate d_e are displayed in Figure 4.19.

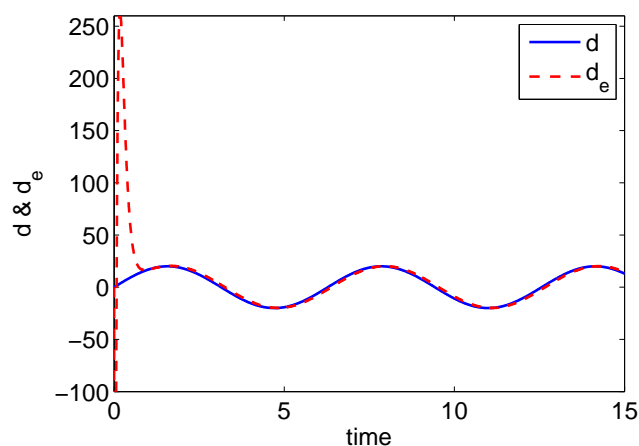

Figure 4.19: Trajectories d and d_e of the LTI system 2 with the direct method

Figure 4.20 shows the estimate errors of two state variables of the system with an initial condition $x(0) = \begin{bmatrix} 0.1 \\ 2 \end{bmatrix}$.

With $d(t) = \sin(t) + \mu(t)$, the unknown input d and its estimate d_e are displayed in Figure 4.21. Because of the use of filters, the estimate d_e can not rapidly estimate the unknown input d . This problem can also occur for the UIO in (4.25) of the second system. The algebraic and direct approaches for designing UIOs require two-order derivative of the output y , which leads impulsive motions. The filters are used to reduced these motions, but they may influence the accuracy of estimations.

In this section, the synthesis of UIO observers is proposed for a DC motor with different approaches. The disturbance variable has been estimated from the estimate of the sate vector, or directly from the input and output variables and

4. UNKNOWN INPUT OBSERVER

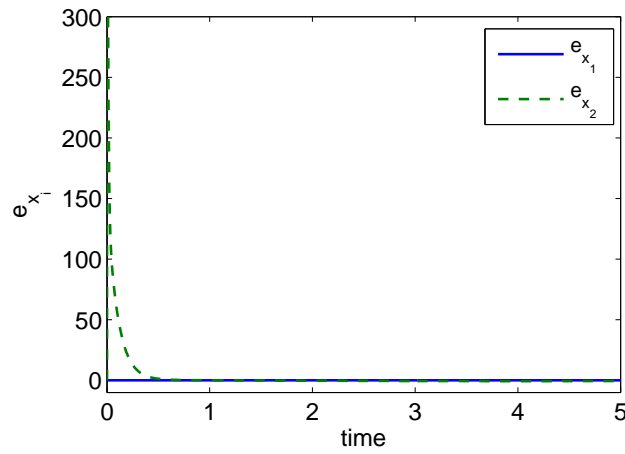

Figure 4.20: Trajectories $e_{x_i} = x_i - \hat{x}_i, i = 1, 2$ of the LTI system 2 with the direct method

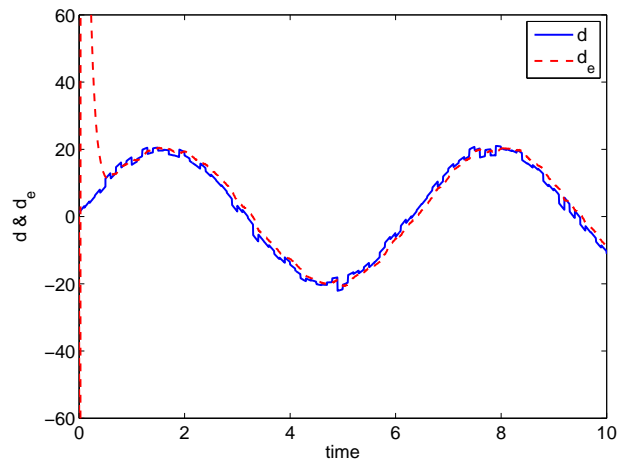

Figure 4.21: Trajectories d and d_e of DUIO of the LTI system 2 with a noise signal

their derivatives, or with some filters. According to the property of the model and of the estimations, different solutions can be proposed. In each case, the proposed solutions are sufficiently accurate. A deeper comparison could be proposed and an extension to the MIMO case could be easily achieved. In the following, an extension to the LTV case is proposed.

4.2.4 LTV Case

In this section, the LTI system described by equation (4.30) is extended to the LTV case. Let $k = \cos(t) + 1.2$, so the matrix A has time-varying entries, i.e., $A(t)$. Three approaches will be used to design UIOs for the LTV system, such as: generalized inverse matrix, algebraic and direct approaches. The main difficulty is related to pole placement due to the definition of a pole in the LTV case. The proposed example is rather simple because it is a second order model and the invariant zero in the first case is constant real value.

UIO with Generalized Inverse Matrices

With the generalized inverse matrix approach, the UIO proposed in (4.15) can be derived for estimating the state vector and the unknown input of the LTV system. From the formal calculation, the invariant zero of the LTV system $\Sigma(C, A(t), F)$ is $\delta = -500$. According to Procedure 4.4, the matrices of the UIO in (4.15) are given in (4.42).

$$\begin{aligned} N(t) &= \begin{bmatrix} -500 & -0.24 \\ 0 & -20 \end{bmatrix} & J(t) &= \begin{bmatrix} -\cos(t) - 1.2 \\ 0 \end{bmatrix} \\ H(t) &= \begin{bmatrix} 1 \\ 0 \end{bmatrix} & E(t) &= \begin{bmatrix} 0 \\ -5 \end{bmatrix} \end{aligned} \quad (4.42)$$

The matrix $Z(t)$ in (4.21) is used to place poles of the observer. Let $Z(t) = \begin{bmatrix} z_1(t) & z_2(t) \\ z_3(t) & z_4(t) \end{bmatrix}$, then the matrix $N(t)$ has the form

$$N(t) = \begin{bmatrix} -500 & -0.2k - 0.2z_2(t) \\ 0 & -0.2z_4(t) \end{bmatrix}$$

The poles of the observer can be derived from the Smith form of the matrix $I\delta - N(t)$. Let $Z(t) = \begin{bmatrix} 0 & -\cos(t) \\ 0 & 100 \end{bmatrix}$, then $N(t)$ become a matrix with time-invariant entries. The poles of the observer are $\delta_1 = -500, \delta_2 = -20$.

The estimation errors of two state variables with an initial condition $x(0) = \begin{bmatrix} 0.1 \\ 2 \end{bmatrix}$ are displayed in Figure 4.22.

The comparison between the estimation of the unknown input $d_e(t)$ and $d(t)$ is shown in Figure 4.23.

4. UNKNOWN INPUT OBSERVER

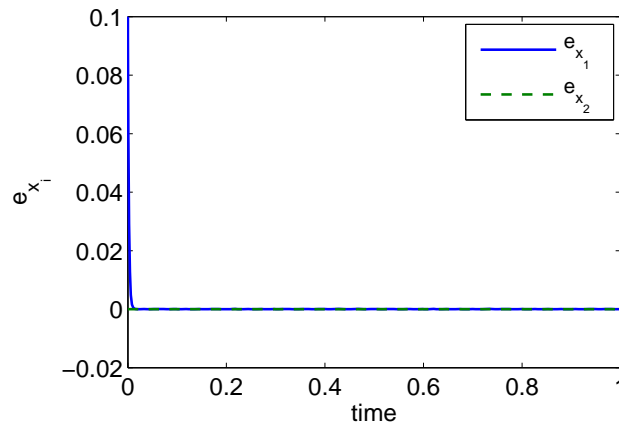

Figure 4.22: Trajectories $e_{x_i} = \hat{x}_i - x_i, i = 1, 2$ of the LTV system with generalized inverse matrices

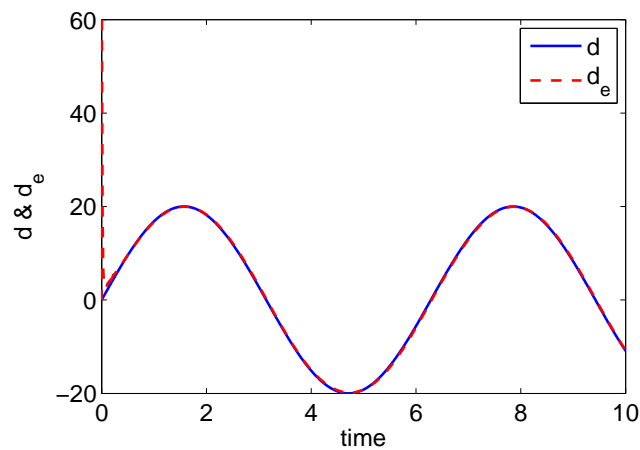

Figure 4.23: Trajectories $d_e(t)$ and $d(t)$ of the LTV system with generalized inverse matrices

With $d(t) = \sin(t) + \mu(t)$, the unknown input d and its estimate d_e are displayed in Figure 4.24. d_e can rapidly estimate the unknown input d .

UIO with the Algebraic Approach

In the LTV case, the design of the observer defined in (4.25) must be redefined, except for the part dealing with the structural analysis with the bond graph approach. An UIO is directly proposed on the following example, with a particular attention to the problem of poles and zeros.

The conclusions for structural analysis in the LTI case are still valid for the

4.2 Numerical Examples and Simulations

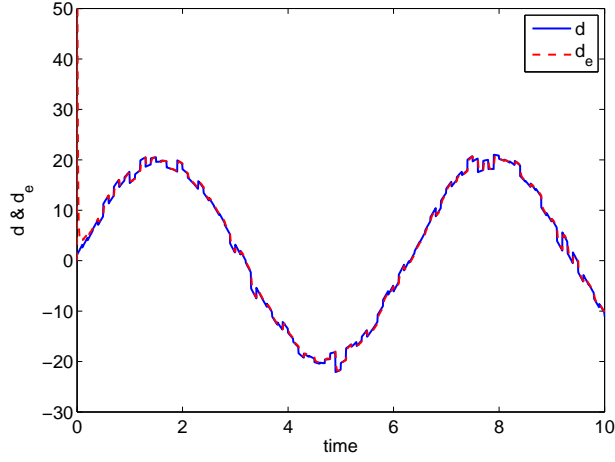

Figure 4.24: Trajectories d and d_e of MUIO of the LTV system 1 with a noise signal

LTV system. However, one should pay attention to calculation with time-varying parameters in matrices over the noncommutative ring of differential operators. System $\Sigma(C(t), A(t), F(t))$ contains one invariant zero, which is $\delta = -500$. So the minimum phase condition is satisfied. Procedures for UIO design are similar to the LTI case. As to $r = 1$, the 1-order derivation of the output is $\dot{y} = CA(t)x + CFd + CBu$. The matrices of the observer are

$$\begin{aligned} Q &= \begin{bmatrix} 0 \\ 5 \end{bmatrix} & PA(t) - L(t)C &= \begin{bmatrix} -500 & -0.24 \\ 0 & -1 \end{bmatrix} \\ L(t) &= \begin{bmatrix} -\cos(t) \\ 5 \end{bmatrix} & U &= 0 \end{aligned} \quad (4.43)$$

In the LTV case, the finite structure may be influenced by time-varying parameters in system matrices as shown by [Yang *et al.* \(2011\)](#). Invariant zeros and poles of systems can be derived from Smith form of matrices over differential rings. Let $L(t) = [l_1(t) \ l_2(t)]^T$ be the time varying matrix chosen for pole placement of the observer. The definition matrix of poles of the observer is $[I\delta - PA + LC]$. The invariant polynomial of this matrix in case of the example is $(\delta + 0.2l_2(t))(\cos(t) + 1.2 + l_1(t))^{-1}(\delta + 500)$. So there are two poles, one of which is $\delta = -500$ being the invariant zero of the system $\Sigma(C, A(t), F)$. As term $(\cos(t) + 1.2 + l_1(t))^{-1}$ is time varying, it cannot be commuted with the term $(\delta + 0.2l_2(t))$. Because only right factors of polynomials in LTV cases are roots of

4. UNKNOWN INPUT OBSERVER

polynomials, it is difficult to compute poles. If $l_1(t) = -\cos(t)$, the polynomial becomes $2(\delta + 0.2l_2(t))(\delta + 500)$. Let $l_2(t) = 500$, the observer has two negative poles $\delta_1 = -500, \delta_2 = -100$.

The estimation errors of two state variable with an initial condition $x(0) = \begin{bmatrix} 0.1 \\ 2 \end{bmatrix}$ are displayed in Figure 4.25.

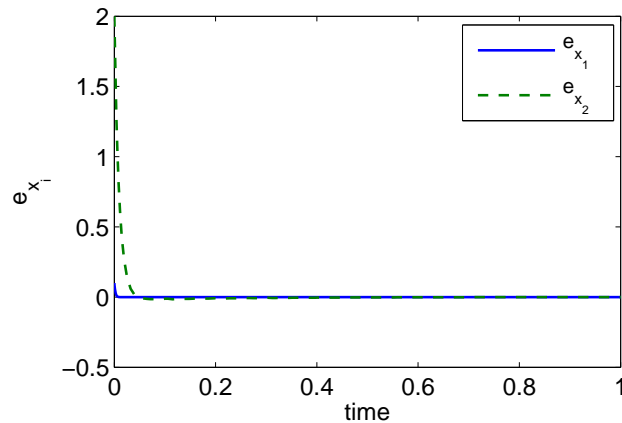

Figure 4.25: Trajectories $e_{x_i} = \hat{x}_i - x_i, i = 1, 2$ of the LTV system with the algebraic approach

The estimation of d is $\hat{d} = 5(\dot{y} - [0.4(\cos(t) + 1.2) \quad -0.008] \hat{x})$. The comparison of the estimation of the unknown input $d_e(t)$ and $d(t)$ is shown in Figure 4.26.

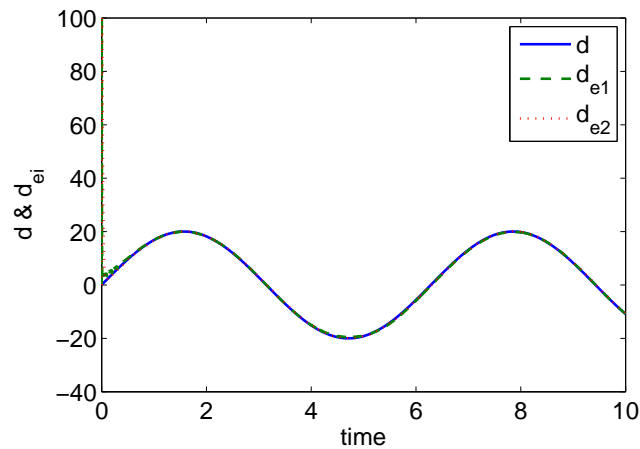

Figure 4.26: Trajectories $d_e(t)$ and $d(t)$ of the LTV system with the algebraic approach

4.2 Numerical Examples and Simulations

With $d(t) = \sin(t) + \mu(t)$, the unknown input d and its estimate d_e are displayed in Figure 4.27.

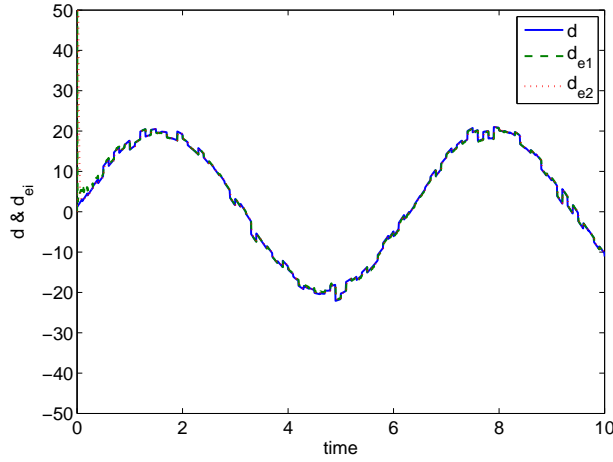

Figure 4.27: Trajectories d and d_e of AUIO of the LTV system 1 with a noise signal

The designed observer is stable and rebuilds correctly real states and the unknown input which is a time function. In the LTV case, the proposed observer (4.25) is still valid but matrices in (4.25) must be redesigned, for example with symbolic calculation. The second case (with detector on $I : L$) is more complex, because two time varying poles must be placed (not studied here). Finally, with the known input which are rarely kept on in cited works, the observer (4.25) is a good extension of the observer in Daafouz *et al.* (2006), but derivations of the control input are necessary. The flatness approach could be a good solution, with a flat output to be controlled.

UIO with the Direct Approach

The UIO with the direct approach introduced in Section 4.2.3 is valid in the LTV case. The UIO has the form

$$\begin{cases} \hat{d} = \left(J\delta + b + \frac{k^2(t)}{L\delta + R} \right) y - \frac{k(t)}{L\delta + R} u \\ \hat{x}_1 = \frac{L}{k(t)} \left(J\dot{y} + by - \hat{d} \right) \\ \hat{x}_2 = Jy \end{cases} \quad (4.44)$$

4. UNKNOWN INPUT OBSERVER

The estimation errors of two state variable with an initial condition $x(0) = \begin{bmatrix} 0.1 \\ 2 \end{bmatrix}$ are displayed in Figure 4.28.

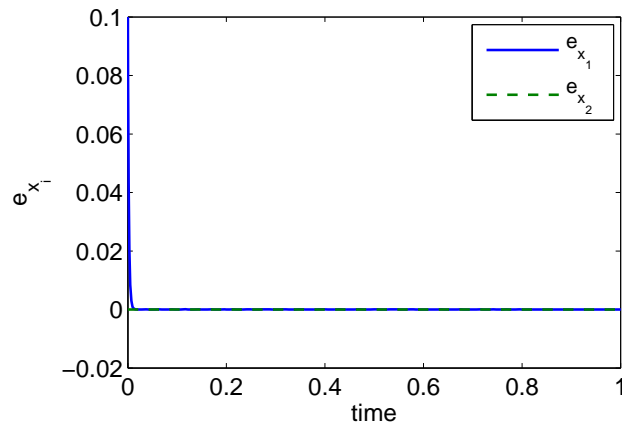

Figure 4.28: Trajectories $e_{x_i} = \hat{x}_i - x_i, i = 1, 2$ of the LTV system with the direct approach

The comparison of the estimation of the unknown input $d_e(t)$ and itself $d(t)$ is shown in Figure 4.29. With $d(t) = \sin(t) + \mu(t)$, the unknown input d and its estimate d_e are displayed in Figure 4.30.

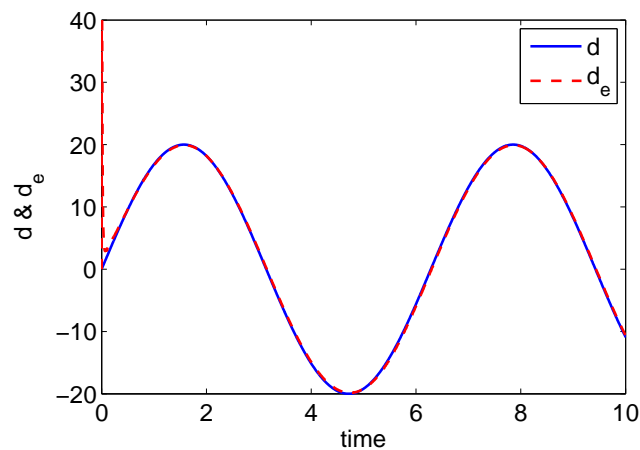

Figure 4.29: Trajectories $d_e(t)$ and $d(t)$ of the LTV system with the direct approach

By the direct method, unknown input and state variables of LTV systems can be estimated. This method is based on formal calculations on initial systems, it is not necessary to compute zeros and poles of LTV systems. The direct approach

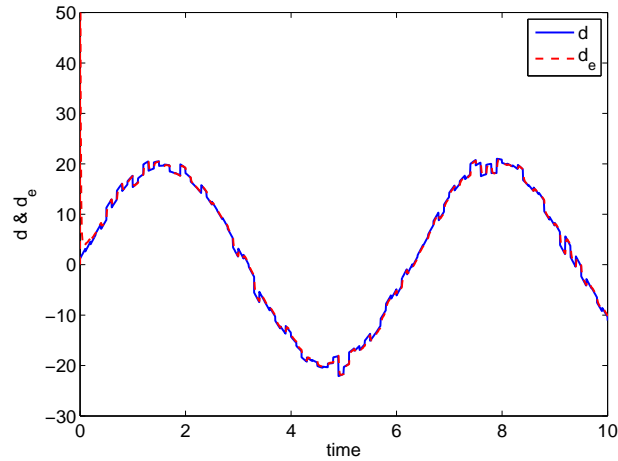

Figure 4.30: Trajectories d and d_e of DUIO of the LTV system 1 with a noise signal

is derived from derivatives of the output variable of LTV systems. Except the complexity of formal calculus, this approach is similar to the LTI case.

4.3 Conclusion

In this chapter, several unknown input observers were proposed. The observers recalled in chapter 1 were extended for LTI and LTV models with different situations. A general form of UIO of SISO systems was proposed by studying the infinite structure of systems $\Sigma(C, A, F)$. For this UIO, the unknown input can be estimated independently. This method does not need to calculate poles of observers and some algebraic notions are required to design observers. If the estimate of the state variable is constructed, a general form for the estimate of the unknown input was proposed by using generalized inverse matrices. The observer derived from the invertibility of systems $\Sigma(C, A, F)$ was extended to the case of systems with control variables, which is much more close to the real problems.

In the second part, a DC motor with a step input signal as the known input and a sinusoidal signal as the unknown input was studied by different approaches. Firstly, the system with the matching condition was studied, and simulation results prove the efficiency of different UIOs. Secondly, the system with the output detector in a new position was studied (the matching condition not satisfied).

4. UNKNOWN INPUT OBSERVER

The general form of UIOs were used to estimate the unknown input and state variables. At last, the LTV case was considered. With estimates of the unknown input and state variables, some synthesis problems can be resolved, *e.g.* the motion planing problem.

Conclusions and Perspectives

The control synthesis of physical systems is a complex task because it requires the knowledge of a "good model" and according to the choice of a model (linear, non linear...), some specific tools must be developed. These tools, mainly developed from a mathematical and theoretical point of view, must be used from the analysis step (analysis of model properties) to the control synthesis step. It is well-known that in many approaches, the properties of the controlled systems can be analyzed from the initial model (open loop system). If the system is described with an input-output representation or with a state space representation, two kinds of information are often pointed out: the external structure (infinite structure) and the internal structure (finite structure). The first one is often related to the existence of some control strategies (input-output decoupling, disturbance decoupling...) and the second one gives some focuses on the stability property of the controlled system.

In this report, the focus has been on the study of invariant zeros of bond graph models in the context of LTV models. The algebraic approach was essential because, even if the problem is already solved for LTI bond graph models, the extension to LTV models is not so easy. The simultaneous use of algebraic and graphical approaches has been proven to be effective and convenient to solve this problem. First, some tools from the algebraic approach have been recalled in chapter one and results for the study of invariant zeros of LTI bond graph models recalled in chapter two. Some new developments are proposed in chapter three and some applications for the unknown input observer problem with some physical applications concludes this work in chapter four.

For detecting structural properties of linear systems, such as controllability, observability, finite structure and infinite structure, the module theoretic approach is necessary. LTI and LTV models are defined as modules over rings of

CONCLUSIONS AND PERSPECTIVES

operators. In light of the module theoretic approach, the poles and zeros structures of linear systems have been studied with some corresponding submodules. The classical method for defining zeros and poles is to use some canonical forms of polynomial or rational matrices over rings. A more intrinsic method is to examine properties of submodules, especially torsion modules. Torsion submodules are related to noncontrollable parts in a module, this is an essential issue, and it has been used throughout the whole report. Since the controllability property has been well developed for LTI and LTV bond graph models with a combined use of some algebraic tools related to the module theory and some applications of causality in the graphical representation, the present work is dedicated to the analysis of invariant zeros of LTV models which are shown to be directly associated to some specific torsion submodules.

As to the complexity to get the canonical forms and roots of invariant polynomials of canonical forms of matrices, the invariant zeros structure is not easy to be pointed out in the LTV case. In the present report, the graphical approach has been used to detect this structure by combining the algebraic and formal approaches. Three kinds of causality were used to derive models properties, such as: integral causality, derivative causality and bicausality assignments. Conventionally, the number of invariant zeros is related to BGI models, and the number of null invariant zeros is derived from BGD models. The main difference between the LTI and LTV cases was the calculation procedure of zeros values with BGB models. Because zeros of systems are poles of inverse systems, the invertibility is a fundamental notion to get zeros when the output detectors are set to be zero. In conventional bond graph models, this property is tightly related to the infinite structure of bond graph models and thus associated to input-output causal paths. The invertibility property can also be studied from bond graph models with bicausality. In this context, bond graph procedures with application of bicausality were extended to the linear square and non square MIMO models. In BGB models, the dynamical elements with an integral causality are used to compute torsion equations. For studying the invariant zeros structure of row sub models, BGB models do not exist because the bicausality can only be assigned for bond graph models with the same number of input sources and output detectors. Some new technics were used, which are based on the notion "common" torsion modules between each sub model (common non controllable subspace). When the number

CONCLUSIONS AND PERSPECTIVES

of output detectors is greater than the number of input actuators the notion of common non observable modules was required. Since the observability property is not directly related to some simple modules, the concept of dual bond graph model was used.

The output-zeroing problem was also studied in parallel with the structure of invariant zeros because these two problems are closed. First, monovariable LTI models were considered. In that case, the output variable can be null with some well chosen initial conditions for the state vector and for a control input variable directly related to the invariant zero (constant for a null invariant zero). This problem has been partially extended for the LTV case. The proposition has been explained by the algebraic point of view with the formal presentation of the input variable when the output variables were set to be zero.

For the invariant zeros and output-zeroing problems study, softwares Maple[™] and 20-sim[®] were used on some physical examples.

In the last chapter, the unknown input observer problem has been considered. A general form of UIO was proposed by use of the infinite structure and invertibility of LTI SISO systems. Based on the estimate of the state variables, a general form of estimate of unknown inputs was introduced with generalized inverse matrices. The problem of estimation of state and unknown input variables was considered with the existence of known input variables. Three kinds of UIO were designed, such as: UIO with the algebraic approach, UIO with generalized inverse matrices and UIO with a direct method. The existence conditions of UIOs were also given. A physical model was studied in the LTI and LTV cases with or without the matching condition. The UIOs proposed have weaker conditions of existence than conventional UIOs. The simulation results of MATLAB[®] proved the efficiency of the proposed UIOs.

In this work, some new procedures were developed for the study of the invariant zeros structure of LTV bond graph models. We show that the extension from the LTI to the LTV case is not simple from a theoretical point of view, many proofs must still be achieved. Nevertheless, from a graphical point of view, some procedures developed in the LTI case can be used due to the linear structure of bond graph models. Causal analysis (with different assignments, integral, derivative, bicausal...) is similar for these two cases. Since the finite structure analysis is a crucial task for studying the stability property of controlled systems (control

CONCLUSIONS AND PERSPECTIVES

step, estimation...), some mathematical developments are still needed. Another interesting point is the application to non linear models. Since some graphical procedures yet exist to get a "variational" model which can be considered as an LTV model, some local properties of non linear systems modelled with bond graph could be studied with our procedures.

Bibliography

- ACHIR, A. & SUEUR, C. (2005). Non commutative ring bond graphs application to flatness. *ICBGM*, **37**, 59–64. [110](#)
- ACHIR, A., ANDALOUSSI, C. & SUEUR, C. (2005). Flatness based control of linear time-varying bond graphs. *Proceedings of IFAC World Congress, Prague*. [127](#)
- ADKINS, W. & WEINTRAUB, S. (1992). *Algebra: an approach via module theory*. Springer. [25](#), [30](#)
- ANDALOUSSI, C. (2007). *Propriétés structurelles des systèmes linéaires à paramètres variant dans le temps: approche bond-graph*. Ph.D. thesis, Ecole Centrale de Lille. [101](#)
- ANDALOUSSI, C., CHALH, Z. & SUEUR, C. (2006). Infinite zero of linear time-varying bond graph models: graphical rules. *Proceedings of the 2006 IEEE ICCA, Munich*, 2962–2967. [7](#), [26](#), [97](#)
- BARBOT, J.P., FLIESS, M. & FLOQUET, T. (2007). An algebraic framework for the design of nonlinear observers with unknown inputs. *Proceedings of the 46th IEEE CDC, New Orleans, USA, Dec. 12-14*. [66](#), [208](#)
- BERTRAND, J.M., SUEUR, C. & DAUPHIN-TANGUY, G. (1997). Bond graph for modeling and control: structural analysis tools for the design of input-output decoupling state feedbacks. *Proceedings of International Conference on Bond Graph Modeling and Simulation, Phoenix*, 103–108. [97](#), [104](#)
- BORUTZKY, W. (2010). *Bond Graph Methodology: Development and Analysis of Multidisciplinary Dynamic System Models*. Springer Verlag. [237](#)

BIBLIOGRAPHY

- BOURBAKI, N. (1970). *Algèbre, chapitres 1 à 3*. Hermann. [30](#), [44](#)
- BOURLÈS, H. (2005). 6 Structural Properties of Discrete and Continuous Linear Time-Varying Systems: A Unified Approach. *Advanced Topics in Control Systems Theory*, 225–280. [7](#), [33](#), [39](#), [42](#), [43](#), [46](#), [55](#)
- BOURLÈS, H. (2006). 7 structural properties of linear systems part ii: Structure at infinity. In *Advanced Topics in Control Systems Theory*, vol. 328, 259–284, Springer Berlin / Heidelberg. [43](#), [57](#), [58](#), [109](#)
- BOURLÈS, H. & FLIESS, M. (1997). Finite poles and zeros of linear systems: an intrinsic approach. *International Journal of Control*, **48(4)**, 897–922. [39](#), [43](#), [56](#), [108](#), [109](#)
- BOURLÈS, H. & MARINESCU, B. (1999). Poles and zeros at infinity of linear time-varying systems. *IEEE Transactions on Automatic Control*, **44**, 1981–1985. [57](#), [60](#)
- BOURLÈS, H. & MARINESCU, B. (2007). Infinite Poles and Zeros of Linear Time-Varying Systems: Computation Rules. In *Proc. 4th European Control Conf., Brussels, Belgium*, 1–4. [57](#), [109](#)
- BOURLÈS, H. & MARINESCU, B. (2011). *Linear Time-Varying Systems: Algebraic-Analytic Approach*, vol. 410. Springer. [6](#), [25](#), [26](#), [27](#), [30](#), [36](#), [37](#), [38](#), [45](#), [48](#), [50](#), [58](#), [109](#), [112](#)
- BOURLÈS, H. & MARINESCU, B. (1997). Infinite poles and zeros of linear time varying systems : computation rules. in *Proc. 4th European Control Conf. Brussels, Belgium*. [109](#)
- CHALH, A.A.S.C., Z. (2007). A bond graph approach for direct characterization of invariant zeros of linear time varying systems. vol. 3, Btazil. [26](#), [97](#)
- CHALH, Z., ANDALOUSSI, C. & SUEUR, C. (2007). Structural properties of bond graph rings. *ICBGM*, **38**, 20–26. [7](#), [110](#)
- CHEN, B., LIN, Z. & SHAMASH, Y. (2004). *Linear systems theory: a structural decomposition approach*. Birkhauser. [43](#)

- CHEN, W. & SATYANARAYANA, C. (1976). *Applied graph theory: graphs and electrical networks*. New York:American Elsevier. [74](#)
- COHN, P.M. (1985). *Free Rings and their Relations*. Academic Press, London, 2nd edition edn. [25](#), [30](#), [32](#), [46](#)
- COMMAULT, C. & DION, J.M. (1981). Structure at infinity of linear multivariable systems a geometric approach. vol. 20, 112–117. [57](#)
- COMMAULT, C., DESCUSSE, J., DION, J., LAFAY, J. & MALABRE, M. (1986). New decoupling invariants: the essential orders. *International Journal of Control*, **44**, 689–700. [43](#)
- DAAFOUZ, J., FLIESS, M. & MILLERIOUX, G. (2006). Une approche intrinsèque des observateurs linéaires à entrées inconnues. *CIFA 2006*. [27](#), [61](#), [66](#), [195](#), [217](#)
- DAROUACH, M. (2009). Complements to full order observer design for linear systems with unknown inputs. *Applied Mathematics Letters*, **22**, 1107–1111. [27](#), [61](#), [63](#), [65](#), [188](#), [190](#), [192](#), [200](#)
- DAROUACH, M., ZAZADINSKI, M. & XU, S. (1994). Full-order observers for linear systems with unknown inputs. *IEEE Transactions on Automatic Control*, **39**, 606–609. [27](#), [61](#), [65](#), [195](#)
- DAUPHIN-TANGUY, G. (2000). *Les Bond Graphs*. Hermes Science, Paris. [74](#)
- DIJK, J. & GOLO, G. (1994). *On the role of bond graph causality in modelling mechatronic systems*. Ph.D. thesis, University of Twente. [240](#)
- DION, J., COMMAULT, C. & VAN DER WOUDE, J. (2003). Generic properties and control of linear structured systems: a survey* 1. *Automatica*, **39**, 1125–1144. [72](#)
- EPHREMIDZE, L., JANASHIA, G. & LAGVILAVA, E. (2007). A new efficient matrix spectral factorization algorithm. 20–23. [43](#)
- FERREIRA, P. (1980). Infinite system zeros. *International Journal of Control*, **32**, 731–735. [57](#)

BIBLIOGRAPHY

- FLISS, M. (1990). Some basic structural properties of generalized linear systems. *Systems & Control Letters*, **15**, 391–396. [5](#), [6](#), [26](#), [30](#), [48](#), [75](#), [80](#), [90](#), [91](#), [110](#)
- FLISS, M. (1999). Some new interpretations of controllability and their practical implications* 1. *Annual reviews in Control*, **23**, 197–206. [7](#)
- FLISS, M., LÉVINE, J., MARTIN, P. & ROUCHON, P. (1995). Flatness and defect of nonlinear systems: introductory theory and examples. *Int. Journal Control*, **61**, 1327–1361. [110](#)
- FLOQUET, T. & BARBOT, J. (2006). *Advances in variable structure and sliding mode control*, chap. A canonical form for the design of unknown input sliding mode observers, 271–292. Springer. [195](#), [196](#)
- GAWTHROP, G. (1997). Control system configuration: inversion and bicausal bond graphs. *Proceedings of International Conference on Bond Graph Modeling and Simulation, Phoenix*, 97–102. [101](#)
- GAWTHROP, P. & RONCO, E. (2002). Predictive pole-placement control with linear models* 1. *Automatica*, **38**, 421–432. [74](#)
- GOODEARL, K. & WARFIELD, R. (2004). *An introduction to noncommutative Noetherian rings*. Cambridge Univ Pr. [30](#)
- H. L. TRENTelman, A.A. & HAUTUS, M. (2001). *Control theory for linear systems*. London, UK: Springer. [27](#), [61](#)
- HAUTUS, M.L.J. (1983). Strong detectability and observers. *Linear Algebra and its Applications*, **50**, 353–368. [62](#), [63](#)
- HOU, M. & MULLER, P. (1992). Design of observers for linear systems with unknown inputs. *IEEE Trans. Automat. Control*, **37**, 871–875. [61](#)
- ILCHMANN, A. (1985). Time-varying linear systems and invariants of system equivalence. *International Journal of Control*, **42**, 759–790. [43](#)
- ILCHMANN, A. & MEHRMANN, V. (2006). A behavioral approach to time-varying linear systems. Part 1: General theory. *SIAM journal on control and optimization*, **44**, 1725–1747. [26](#), [30](#)

- KAILATH, T. (1980). *Linear Systems*. Prentice Hall, Englewood-Cliff, N.J. [108](#), [116](#)
- KALMAN, R. (1959). On the general theory of control systems. *Automatic Control, IRE Transactions on*, **4**, 110. [5](#), [41](#)
- KALMAN, R. (1965). Algebraic structure of linear dynamical systems, i. the module of σ . *Proceedings of the National Academy of Sciences of the United States of America*, **54**, 1503. [6](#), [26](#)
- KALMAN, R.E. (1969). *Advanced theory of linear systems*. Topics in Mathematical System Theory : edited by R. E. Kalman, P. L. Falb and M. A. Arbib, McGraw-Hill, New York, Chap. 10, 245-339. [25](#), [26](#)
- KALMAN, R.E., FALB, P.L. & ARBIB, M.A. (1969). *Topics in Mathematical System Theory*. McGraw-Hill, New York. [30](#), [108](#)
- KARCANIAS, N. & KOUVARITAKIS, B. (1979). The output zeroing problem and its relationship to the invariant zero structure: a matrix pencil approach. *International Journal of Control*, **30**, 395–415. [115](#)
- KOLCHIN, E. (1986). Differential algebraic groups. *Group Theory, Beijing 1984*, 155–174. [25](#)
- KUDVA, P., VISWANADHAM, N. & RAMAKRISHNA, A. (1980). Observers for linear systems with unknown inputs. *IEEE Trans. Automat. Control*, **25**, 113–115. [61](#), [195](#)
- LAM, T.Y. & LEROY, A. (2004). Wedderburn polynomials over division rings. *Journal of Pure and Applied Algebra*, **186**, 43–76. [25](#), [109](#)
- LICHIARDOPOL, S. (2007). *Étude de la dualité des modèles bond graphs. Application à la commande*. Ph.D. thesis, L'École Centrale de Lille. [75](#), [82](#)
- LICHIARDOPOL, S. & SUEUR, C. (2006). Decoupling of linear time-varying systems with a bond graph approach. *ECMS 2006, Bonn, Germany*. [110](#)
- LICHIARDOPOL, S. & SUEUR, C. (2010). Duality in system analysis for bond graph models. *Journal of the Franklin Institute*, **347**, 377 – 414. [27](#), [91](#), [110](#)

BIBLIOGRAPHY

- MACFARLANE, A. & KARCANIAS, N. (1976). Poles and zeros of linear multi-variable systems: a survey of the algebraic, geometric and complex-variable theory. *International Journal of Control*, **24**, 33–74. [27](#), [115](#), [116](#)
- MALGRANGE, B. (1962). Systemes différentiels à coefficients constants. *Séminaire Bourbaki*, **246**, 63. [25](#), [110](#)
- MARINESCU, B. & BOURLÈS, H. (2009). An intrinsic algebraic setting for poles and zeros of linear time-varying systems. *Systems and Control Letters*, **58**, 248 – 253. [26](#), [35](#), [109](#), [133](#)
- MCCONNELL, J., ROBSON, J. & SMALL, L. (2001). *Noncommutative noetherian rings*, vol. 30. Amer Mathematical Society. [30](#)
- MILLER, B. & MUKUNDEN, R. (1982). On designing reduced-order observers for linear time-invariant systems subject to unknown inputs. *Internat. J. Control*, **35**, 183–188. [61](#)
- PORTER, W. (1969). Decoupling of and inverses for time-varying linear systems. *IEEE Transactions on Automatic Control*, **14**, 378–380. [43](#)
- PRINGLER, R. & RAYNER, A. (1971). *Generalized inverse matrices*. Griffin, London, England. [64](#)
- RAHMANI, A. (1993). *Etude structurelles des systèmes linéaires par l'approche bond-graph..* Ph.D. thesis, Université Lille 1. [100](#)
- RAHMANI, A., SUEUR, C. & DAUPHIN-TANGUY, G. (1994). Pole assignment for systems modelled by bond graph. *Journal of the Franklin Institute*, **331**, 299–312. [74](#)
- RAHMANI, A., SUEUR, C. & DAUPHIN-TANGUY, G. (1996). On the infinite structure of systems modelled by bond graph: feedback decoupling. In *Systems, Man, and Cybernetics, 1996., IEEE International Conference on*, vol. 3, 1617 –1622 vol.3. [97](#)
- RITT, J.F. (1950). *Differential Algebra*. American Mathematical Society, New York. [25](#)

- ROSENBROCK, H. (1970). *State space and multivariable theory*. Nelson, London, England. [5](#), [25](#), [26](#), [30](#), [41](#), [54](#), [108](#)
- RUDOLPH, J. (1996). Duality in time-varying linear systems: A module theoretic approach. *Linear Algebra and its Applications*, **245**, 83–106. [27](#), [91](#)
- SCHRADER, C.B. & SAIN, M.K. (1989). Research on systems zeros: a survey. *International Journal of control*, **50**, 1407–1433. [108](#), [115](#)
- SILVERMAN, L. & MEADOWS, H. (1967). Controllability and observability in time-variable linear systems. *SIAM Journal on Control*, **5**, 64. [43](#), [75](#), [81](#), [87](#)
- SUEUR, C. & DAUPHIN-TANGUY, G. (1991). Bond-graph approach for structural analysis of mimo linear systems. *Journal of the Franklin Institute*, **328**, 55–70. [7](#), [26](#), [75](#), [77](#), [78](#), [79](#), [80](#), [88](#), [104](#)
- T. BOUKHOBZA., S.M.M., F. HAMELIN (2007). State and input observability for structured linear systems: A graph-theoretic approach. *Automatica*, **43**, 1204–1210. [61](#)
- TOKARZEWSKI, J. (2006). *Finite Zeros in Discrete Time Control Systems*. Lecture Notes in Control and Information Sciences, Springer Berlin / Heidelberg. [115](#)
- VAN DER PUT, M. & SINGER, M. (2003). *Galois theory of linear differential equations*. Springer Verlag. [25](#), [33](#), [109](#)
- VERGHESE, G.C. & KAILATH, T. (1979). Rational matrix structure. vol. 18, 1008–1012. [57](#)
- WILLEMS, J. (2007). The behavioral approach to open and interconnected systems. *Control Systems Magazine, IEEE*, **27**, 46–99. [42](#)
- WILLEMS, J.C. (1983). Input-output and state space representations of finite dimensional linear time invariant systems. *Linear Algebra and its Applications*. [26](#), [109](#)
- WILLEMS, J.C. (1991). Paradigms and puzzles in the theory of dynamical systems. *IEEE Trans. Aut. Contr.* [26](#), [30](#), [42](#), [109](#)

BIBLIOGRAPHY

- WONHAM, W.M. (1985). *Linear Multivariable Control*. Springer, Berlin. [108](#)
- YANG, D. & SUEUR, C. (2012). Input and state observability for ltv bond graph models. *7th Vienna International Conference on Mathematical Modelling, Vienna, Austria, February 15-17, 2012*. [196](#)
- YANG, D., PALITZYNE, N. & SUEUR, C. (2010). Finite structure of ltv systems modelled by bond graph: an algebraic approach. *4th IFAC Symposium on System Structure and Control, Ancona, Italy, October 15-17, 2010*. [119](#), [124](#), [137](#)
- YANG, D., SUEUR, C. & DAUPHIN-TANGUY, G. (2011). Algebraic characterization of the invariant zeros structure of ltv bond graph models. *The 5th International Conference on Integrated Modeling and Analysis in Applied Control and Automation, Rome, Italy, September 12-14, 2011*. [122](#), [215](#)
- ZERZ, E. (2006). An algebraic analysis approach to linear time-varying systems. *IMA Journal of Mathematical Control and Information*, **23**, 113–126. [7](#), [26](#)
- ZÚNIGA, J. & HENRION, D. (2003). Comparison of algorithms for computing infinite structural indices of polynomial matrices. In *European Control Conference, Cambridge, UK*, Citeseer. [43](#)

A

Appendix

A.1 Bond Graph Standard Elements

A bond graph model consists of elements linked together by half arrows, which represent power bonds. Two variables such as effort $e(t)$ and flow $f(t)$ are related to each bond. The two conjugate variables at a bond is always bi-directional. A little line called a *causal stroke* is drawn orthogonally to one end of a bond where the effort serves as an output of the bond. Several kinds of elements and their possible causal stroke positions are introduced in this section.

Single Energy Port Elements

1. *Source Element*

The source elements impose the effort or the flow to the system. The causality assignments associated with source elements are fixed. The effort source Se and the flow source Sf are external variables for a system. Se (resp. Sf) determines the effort (resp. flow) in the bond connected with it. So the causal stroke for the effort (resp. flow) source must be away (resp. closed) from the source. Voltage supply, pressure supply, gravity can be regard as effort sources and current supply, pump as flow sources. The causalities are assigned for tow sources in Figure [A.1](#).

2. *Inertial Element I*

A. APPENDIX



Figure A.1: Source bond graph element

This element is defined in terms of a mass in mechanics. It allows modeling some energy storages. Depending on the causality assignment, effort-flow relations in Figure A.2 are defined. Electrical inductance, mass, inertia can be regarded as inertial elements.

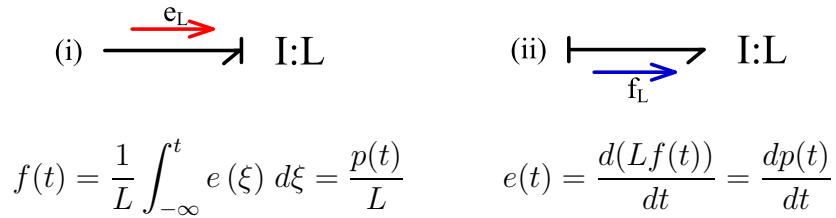

Figure A.2: Inertial bond graph element

3. Capacitive Element C

A bond graph element C can model the energy storage. Effort-flow relations are written in Figure A.3. Electrical capacitor, mechanical spring, torsion bar, tank, accumulator are identified as capacitive elements.

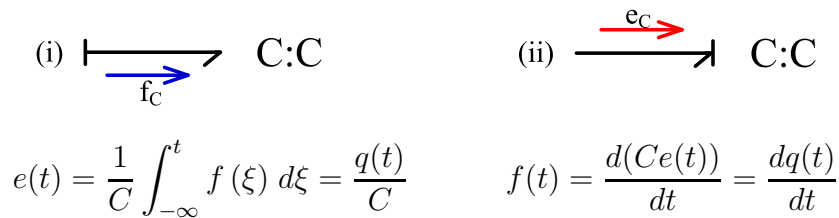

Figure A.3: Capacitive bond graph element

4. Resistive Element

Unlike I and C elements where an integration form exists between the effort and flow variables, resistive elements involve no integration and have a direct relation between the effort and flow variables. An R element is a passive element

A.1 Bond Graph Standard Elements

which is associated to the energy dissipation. Regarding the causality assigned to the element, the effort-flow relations are shown in Figure A.4. On the contrary, *conductive* causality for element caused case. Electrical resistor, mechanical damper, dashpot, friction, hydraulic restriction are resistive elements.

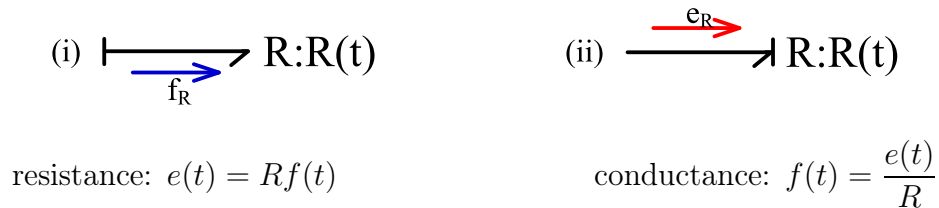

Figure A.4: Resistive bond graph element

5. Detector Element

The detectors also called sensors, are supposed to be ideal (no power dissipation and storage). The effort detector is symbolized as De , voltmeter, force sensor, pressure sensor belong to this category. The flow detector is used to detect the flow represented by symbol Df , such as: flow rate sensor, tachometer. Figure A.5 gives the fixed causality to each type of detector.



Figure A.5: Detector bond graph element

Two Energy Port Elements

1. Transformer TF

The transformer does not store or dissipate energy (power conservation). A transformer relates flow to flow and effort to effort. The bond graph transformer can represent an ideal electrical transformer, a massless lever, a gear pair, an hydraulic ram, etc. The possible causality assignments and the effort-effort or flow-flow relations are given in Figure A.6.

2. Gyration GY

A. APPENDIX

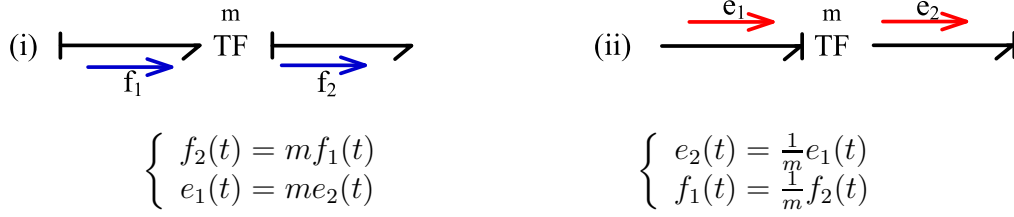

Figure A.6: Transformer bond graph element

In contrast with the transformer, a gyrator establishes relationship between flow to effort and effort to flow. It transmits also the power factors without storing or dissipating energy. The possible causality assignment and the effort-flow relations are given in Figure A.7, where r denotes the *gyrator modulus*. The bond graph gyrator can represent mechanical gyroscope, hall effect sensor, voice coil, DC motor, etc.

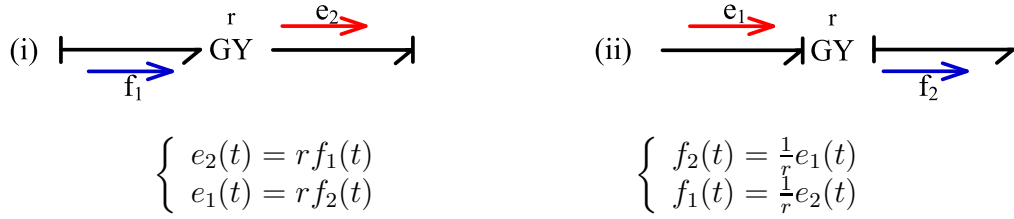

Figure A.7: Gyrator bond graph element

Junction Elements

The junction element is not a material point. It does not generate, dissipate or store energy. In other words, the algebraic sum of powers at a junction is zero. It is just utilized to connect elements and transmit the energy.

1. 0-Junction

The efforts on the bonds connected to a *0-junction* are identical and the flows algebraic sum is zero. The half-arrow directions determine the signs in the algebraic sum. The bond graph symbol and algebraic relations are given in Figure A.8.

2. 1-Junction

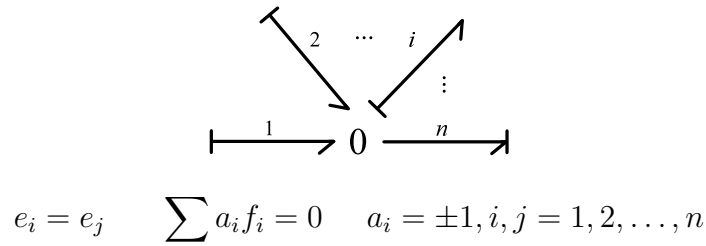

Figure A.8: 0-junction

Similarly, the flows on the bonds attached to a 1-junction are equal and the algebraic sum of the efforts is zero. The half arrow directions determine the signs in the algebraic sum. The bond graph symbol and algebraic relation are presented in Figure A.9.

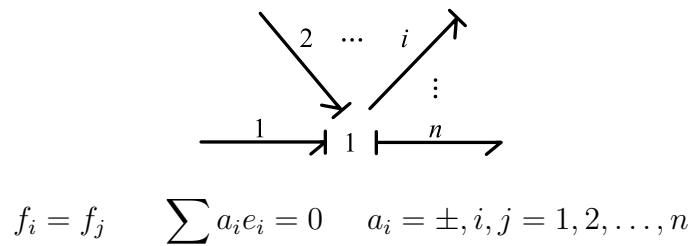

Figure A.9: 1-junction

Example A.1 *A bond graph model reflects the physical structure of a system. Block diagrams display which variables must be known in order to compute others, they represent the structure of the mathematical model - the computational structure. However, a connection between two blocks represents only one signal. In the bond graph representation, each bond represents two conjugate power variables. The causality structure of bond graphs could be confirmed by adding the causal strokes. Such a causally completed bond graph can be systematically transformed into a block diagram. Figure A.10 (i) gives a circuit of a second order system. The bond graph model of the system with causality assignments is shown in Figure A.10 (ii). The block diagram corresponding to the system is shown in Figure A.10 (iii). Nevertheless, not every block diagram can be transformed into a bond graph Borutzky (2010).*

A. APPENDIX

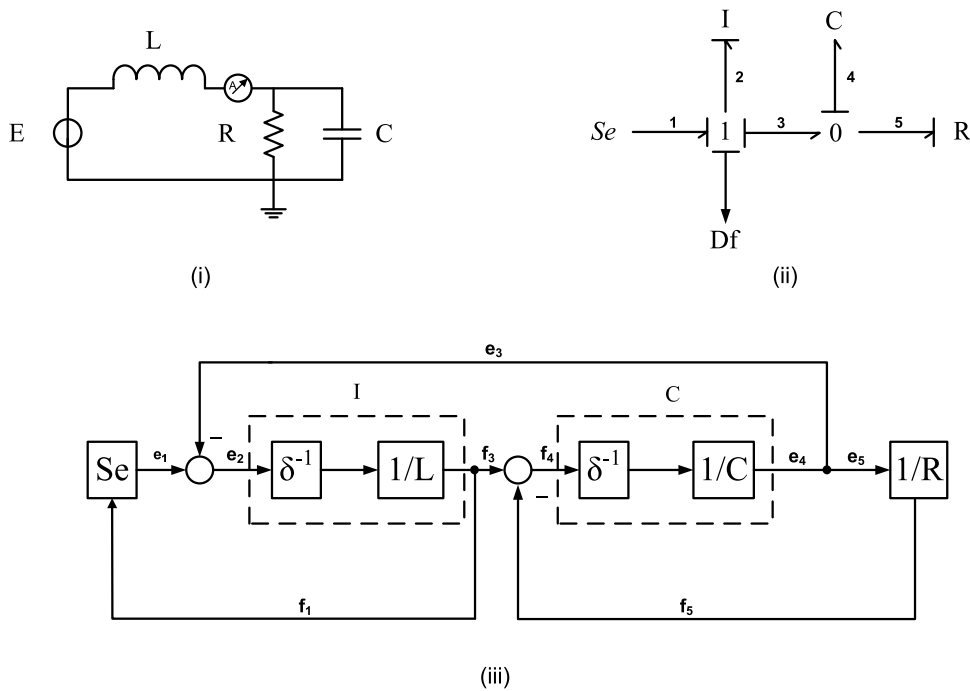

Figure A.10: (i) Circuit of a second order system (ii) Causally completed bond graph model (iii) Block diagram model of the system

A.2 Causality

Before talking about the causality, note that a bond in a bond graph model represents power exchange between elements or junctions. Bonds may be subjected to systematic analysis to build the system mathematical model which predicts its dynamical behavior. To achieve this purpose, another exchange is required in a bond - exchange of information. Paynter told that energy and information flow across a bond. The bond graph causality analysis provides many system characteristics. Because there exist two variables for an energetic interaction function, there are two possible choices for the input and output of each element (or subsystem). One variable is assigned as the role of cause (or input) and the other as the role of effect (or output), so this choice is referred to *causality assignment*. A *causal stroke* is put at one end of the bond to represent this choice. The causal assignment representation and the equivalent block diagram are shown in Figure A.11.

Several notions of causality are recalled here, such as causal paths/loops are useful in calculating the transfer function, the state space representation, poles

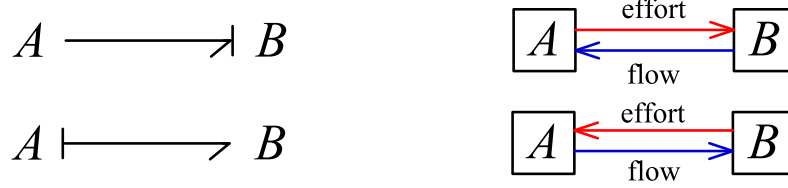

Figure A.11: Causal assignment and its block diagram representation

placement and the calculation of controllability/observability matrices, etc. A special kind of causality - bicausality is useful for system inverse analysis.

Causal Path

Definition A.2 Given two sets J_1 and J_2 , such as $J_1 = \{C, I, R, Se, Sf\}$ and $J_2 = \{C, I, R, De, Df\}$, a causal path between two elements in the previous two sets is a series of interconnected bonds, junctions and elements with complete and correct causality assignment; two bonds connected to the same node (element) have opposed causalities.

Definition A.3 For calculating the causal path length, the preferential integral causality is required. There exist two situations:

(i) Every element has the integral causality. The causal path length between two elements is equal to the number of dynamical elements met in the path.

(ii) There exist several dynamical elements with the derivative causality assignment, the generalized causal path length is equal to the difference between the number of dynamic elements in integral causality and the number of dynamic elements in derivative causality.

A causal path is characterized by its *gain* and its *length* which are devoted to determine system properties, for example: the transfer function, state space representation, system structure, etc.

Definition A.4 The causal path gain is defined as being the quotient of the last bond output variable divided by the first bond input variable in the path. The gain of the causal path is calculated by the equation (A.1) following the direction from the end to the beginning.

$$T_i = (-1)^{n_0+n_1} \prod_i m_i^{k_i}(t) \prod_j r_j^{l_j} \prod_e g_e(t) \quad (\text{A.1})$$

A. APPENDIX

where:

- n_0 , (resp. n_1): number of orientation switches in 0 (resp. 1) junction when the flow (resp. effort) variable is followed;
- $m_i^k(t)$ (resp. $r_i^l(t)$): is time varying modulus, gain of the transformer (resp. gyrator) along the causal path, with $k_i = \pm 1$, according to the elements causality.
- $g_i(t)$: gain of the R, I and C elements along the causal path.

Example A.5 A bond graph model with integral causality is shown in Figure A.12. There exist a causal path between the input S_e and the output D_e . Every element of model is met in the path.

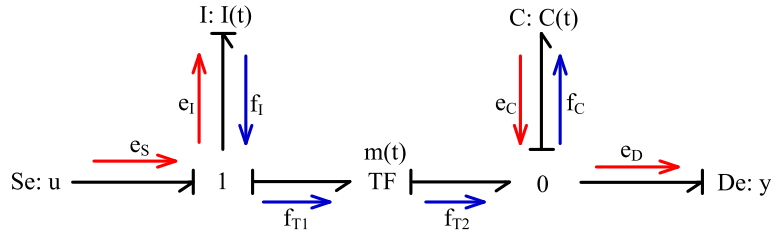

Figure A.12: A bond graph model with integral causality

By applying the causal path gain equation (A.1), elements gains are shown in the Table A.1 with $n_0 = 1$ and $n_1 = 1$.

Elements	Inertial I $I(t)$	Compliant C $C(t)$	Transformer TF $m(t)$
Gain	$\frac{1}{I(t)\delta}$	$\frac{1}{C(t)\delta}$	$m(t)$

Causal Loop

Definition A.6 A causal loop is a closed causal path between two elements in the set $\{C, I, R\}$. This path starts from the output variable of a bond and ends by the input variable of the same bond with passing through any bond only one time, following the same variable. When a causal loop does not contain any element in previous set, it is called a causal mesh *Dijk & Golo (1994)*. Furthermore, a causal mesh is as well as one kind of algebraic loops.

Definition A.7 *The gain of the causal loop between two elements in the set $\{C, I, R\}$ is given in equation (A.2).*

$$B_i = (-1)^{n_0+n_1} \prod_i m_i^{2k_i}(t) \prod_j r_j^{2l_j} \prod_e g_e(t) \quad (\text{A.2})$$

where: n_0 , n_1 , $m_i^{k_i}(t)$, $r_j^{l_j}$ and $g_e(t)$ are defined as in (A.1).

Approche Algébrique pour l'Analyse de Systèmes Modélisés par Bond Graph

Résumé: La commande de systèmes physiques s'avère être une tâche difficile en général. En fonction du modèle choisi, les outils mathématiques pour l'analyse et la conception de lois de commande peuvent changer. Pour les systèmes décrits par une représentation entrée-sortie, type transfert, ou par une équation de type état, les principales informations exploitées lors de la phase d'analyse concernent la structure interne du modèle (structure finie) et la structure externe (structure à l'infini) qui permettent avant la phase de synthèse de connaître, sur le modèle en boucle ouverte, les propriétés des lois de commande envisagées ainsi que les propriétés du système piloté (stabilité...).

Le travail porte principalement sur l'étude des zéros invariants des systèmes physiques représentés par bond graph, en particulier dans un contexte de modèle type LTV. L'approche algébrique est essentielle dans ce contexte car même si les aspects graphiques restent très proches du cas linéaire classique, l'extension aux modèles LTV reste très complexe d'un point de vue mathématique, en particulier pour le calcul de racines de polynômes. De nouvelles techniques d'analyse des zéros invariants utilisant conjointement l'approche bond graph (exploitation de la causalité) et l'approche algébriques ont permis de mettre en perspective certains modules associés à ces zéros invariants et de clarifier le problème d'annulation des grandeurs de sortie. L'application aux problèmes d'observateurs à entrées inconnues a permis d'illustrer nos propos sur des exemples physiques, avec certaines extensions, problèmes pour lesquels les zéros invariants apparaissent aussi comme éléments essentiels.

Mots-clés: Bond graph, Module, Approche algébrique, Modèles LTV, Zéros invariants, Causalité, Observateur à entrée inconnue

Algebraic Approach for Analysis of Systems Modeled by Bond Graph

Abstract: The control synthesis of physical systems is a complex task because it requires the knowledge of a "good model" and according to the choice of a model some specific tools must be developed. These tools, mainly developed from a mathematical and theoretical point of view, must be used from the analysis step (analysis of model properties) to the control synthesis step. It is well-known that in many approaches, the properties of the controlled systems can be analyzed from the initial model. If the system is described with an input-output representation or with a state space representation, two kinds of information are often pointed out: the external structure (infinite structure) and the internal structure (finite structure). The first one is often related to the existence of some control strategies (input-output decoupling, disturbance decoupling...) and the second one gives some focus on the stability property of the controlled system.

In this report, the focus has been on the study of invariant zeros of bond graph models in the context of LTV models. The algebraic approach was essential because, even if the problem is already solved for LTI bond graph models, the extension to LTV models is not so easy. The simultaneous use of algebraic and graphical approaches has been proven to be effective and convenient to solve this problem. First, some tools from the algebraic approach have been recalled in chapter one and results for the study of invariant zeros of LTI bond graph models recalled in chapter two. Some new developments are proposed in chapter three and some applications for the unknown input observer problem with some physical applications conclude this work.

Keywords: Bond graph, Module, Algebraic approach, LTV models, Invariant zeros, Causality, Unknown input observer