



HAL
open science

Etude de l'impact de la variabilité génétique de la protéine NS5A du virus de l'hépatite C dans la pathogenèse et la réplication virale

Muhammad Ahmad Maqbool

► **To cite this version:**

Muhammad Ahmad Maqbool. Etude de l'impact de la variabilité génétique de la protéine NS5A du virus de l'hépatite C dans la pathogenèse et la réplication virale. Sciences agricoles. Université Paris-Est, 2012. Français. NNT : 2012PEST0026 . tel-00742729

HAL Id: tel-00742729

<https://theses.hal.science/tel-00742729>

Submitted on 17 Oct 2012

HAL is a multi-disciplinary open access archive for the deposit and dissemination of scientific research documents, whether they are published or not. The documents may come from teaching and research institutions in France or abroad, or from public or private research centers.

L'archive ouverte pluridisciplinaire **HAL**, est destinée au dépôt et à la diffusion de documents scientifiques de niveau recherche, publiés ou non, émanant des établissements d'enseignement et de recherche français ou étrangers, des laboratoires publics ou privés.



UNIVERSITÉ
PARIS-EST CRÉTEIL
VAL DE MARNE

Thèse présentée pour obtenir le grade de
Docteur de l'Université Paris Est-Créteil

Spécialité : Aspects Moléculaires et Cellulaires de la Biologie

par Muhammad Ahmad MAQBOOL

Impact of Hepatitis C Virus NS5A Genetic Variability on Liver Pathogenesis and Viral Replication

**Etude de l'impact de la variabilité génétique de la protéine NS5A du virus de
l'hépatite C dans la pathogenèse et la réplication virale.**

Présentée et soutenue publiquement le 06 Janvier 2012

Membre de jury :

Rapporteur	:	Pr. François PENIN, Université Lyon 1
Rapporteur	:	Pr. Philippe ROINGEARD, Université François Rabelais, Tours
Examineur	:	Pr. Jean-Daniel LELIEVRE, Faculté de Médecine, Créteil
Examineur	:	Dr. Nicole PAVIO, ENVA, Maisons-Alfort
Directeur de thèse	:	Pr. Jean-Michel PAWLOTSKY, Hôpital Mondor, Créteil
Encadrant de thèse	:	Dr. Hervé LERAT, IMRB, Université Paris Est, Créteil

Dedication

I would like to dedicate this thesis to my late father who spared no effort and faced all hardships to support me throughout my life. Although he left us just a few months before the achievement of this milestone in my life, he will live forever in my heart.

Acknowledgments

I would like to thank Pr. Jean Michel PAWLOTSKY and Dr. Hervé LERAT for giving me an opportunity to undertake a PhD in their lab and for their technical expertise, guidance and assistance throughout my PhD. I especially appreciate Hervé for his ceaseless efforts to educate me as a scientist.

I would also like to specially thank Dr. Martin HIGGS as well as Dr. Philippe CHOUTEAU and Dr. Hakim BELKACEM for their scientific advice and support. I am extremely thankful to all past and current colleagues of my lab, too numerous to mention, for their technical assistance and support.

Last but by no means least; I am very thankful to my family, especially my mother for her love and support throughout my life. The most precious help during my PhD came from my beloved wife Mehwish. She gave me endless help throughout all frustrations, difficulties and worries during PhD. I would not have gotten this far without her help.

Summary

Hepatitis C virus (HCV) causes a chronic infection in the majority of infected patients, ultimately leading to liver cirrhosis and hepatocellular carcinoma (HCC). Although the roles of the HCV proteins in the viral life cycle are increasingly understood, the precise function of the HCV NS5A protein has yet to be elucidated. To date, the only putative direct function attributed to NS5A is its transcriptional transactivation properties. Our group has previously shown that quasispecies variants of NS5A isolated from the serum samples of the same patient bear different transactivating properties according to their amino acid sequence. Based on these observations, we performed preliminary phylogenetic and functional analysis of NS5A variants isolated from liver tissue of individuals infected with HCV of genotype 1b. This analysis revealed genetic and functional compartmentation of NS5A variants in tumoral and adjacent non-tumoral tissue. We hypothesized that the natural variability of NS5A may impact its proposed transactivation properties. We also hypothesized that NS5A's putative transactivation properties could play a role in HCV replication and in liver pathogenesis. The aim of the study presented in this thesis was to investigate the role of NS5A transactivation properties in the development of HCV-induced liver pathogenesis as well as in viral replication.

To study the role of NS5A transcriptional activation properties in liver pathogenesis, we developed lentiviral vectors for the expression of selected NS5A variants bearing different transactivation potentials in cultured primary human hepatocytes. We now intend to extend these preparations using RNAseq technology to analyse the transcriptome of primary hepatocytes transduced with lentiviral vectors encoding strongly and weakly transactivating NS5A variants to identify the cellular pathways targeted by NS5A, allowing us to decipher the role of NS5A mediated host gene regulation in development of HCV induced pathogenesis. For *in vivo* studies, we have begun the development of transgenic mice allowing liver-specific conditional expression of NS5A variants with high and low transactivation potentials. These transgenic mice will be used to study the possible role of NS5A transactivation properties in development of HCC.

To study the role of NS5A transcriptional activation properties in HCV RNA replication, we used the sub-genomic replicon system expressing previously characterized NS5A sequences.. Using this system, we have demonstrated that a subset of NS5A protein can translocate to the nucleus and is recruited to cellular promoters of host cell genes known to be required for efficient replication of HCV replicon RNA as well as those implicated in pathogenesis. Moreover, we have shown that NS5A directly regulate the expression of these genes. Consequently, it was observed that replicons encoding NS5A variants with different transactivation potentials exhibited different replication capacities, and that this correlated with the transactivation potential of the corresponding NS5A variant. In agreement with these observations, inhibition of nuclear translocation of NS5A resulted in the inhibition of replication of the HCV subgenomic replicon, further confirming the role of NS5A transactivation properties in viral RNA replication.

In conclusion, we have demonstrated that NS5A-mediated transcriptional regulation of cellular genes is required for HCV replication. Such NS5A-mediated modulation of cellular genes may also constitute one of the mechanisms involved in HCV-related liver pathogenesis and development of HCC, an aspect which is currently under investigation using the tools developed during this project. This study will contribute towards deciphering the role of NS5A in viral replication as well as providing insight into its role in HCV-induced liver pathogenesis. Furthermore, these data might open new anti-HCV drug developments based on inhibition of NS5A nuclear translocation.

Résumé

Le virus de l'Hépatite C (VHC), de la famille *Flaviviridae*, est à l'origine d'une pandémie mondiale. L'infection par le VHC provoque le développement d'hépatites chroniques, de cirrhoses et de carcinomes hépatocellulaires (CHC). Les fonctions de la majorité des protéines virales sont connues, mis à part pour NS5A dont la seule fonction directe attribuée à ce jour, équivaut à celle d'un facteur d'activation transcriptionnelle. Notre laboratoire a montré précédemment que les variants de quasi-espèce de NS5A isolés à partir du sérum d'un même patient présentaient des différences significatives dans leurs propriétés intrinsèques de transactivation. Fort de ces résultats, nous avons analysé des variants de NS5A isolés à partir de tissu hépatique d'un patient chroniquement infecté par le VHC de génotype 1b. Ces analyses ont révélé une compartimentation génétique et fonctionnelle des variants de NS5A entre le tissu tumoral et le tissu non-tumoral adjacent. Nous avons donc émis l'hypothèse que les propriétés transactivatrices de NS5A pourraient jouer un rôle dans la pathogenèse ainsi que dans la réplication virale, et que la variabilité naturelle de NS5A pourrait influencer ses propriétés transactivatrices. L'objectif de ce travail de thèse était d'analyser le rôle des propriétés transactivatrices de NS5A dans la pathogenèse hépatique viro-induite ainsi que dans la réplication virale.

Pour étudier le rôle des propriétés de transactivation de NS5A dans la pathogenèse hépatique, nous avons développé des vecteurs lentiviraux pour exprimer dans les hépatocytes primaires humains les variants choisis de NS5A portant différents potentiels de transactivation. En utilisant la technologie RNA-Seq d'Illumina, l'analyse des transcriptomes d'hépatocytes transduits exprimant les variants transactivateurs fort et faible de NS5A, sera utilisée pour identifier les voies cellulaires ciblées par les propriétés transactivatrices de NS5A. Pour les études *in vivo*, nous avons lancé le développement des souris transgéniques permettant l'activation conditionnelle de l'expression des variants de NS5A avec fort et faible potentiel de transactivation, spécifiquement dans le foie. Ces souris transgéniques seront utilisées pour étudier le rôle potentiel des propriétés transactivatrices dans la pathogenèse VHC induite et plus particulièrement dans le développement des cancers.

Pour étudier le rôle des propriétés de transactivation de NS5A dans la réplication virale, nous avons utilisé le système de réplicon subgénomique de VHC exprimant les variants de NS5A précédemment caractérisés. Pour exercer ses propriétés transactivatrices, NS5A doit être localisée au moins partiellement dans le noyau. Nous avons démontré qu'une partie de NS5A se retrouve dans le noyau et est recrutée sur des promoteurs cellulaires, modulant ainsi directement l'expression de gènes cellulaires essentiels pour la réplication de l'ARN viral. Nous avons observé que les variants de NS5A avec différents potentiels de transactivation, confèrent différentes capacités de réplication au réplicon subgénomique, et corrélaient avec le potentiel de transactivation de variant correspondant. En accord avec ces observations, l'inhibition de translocation nucléaire de NS5A entraîne une inhibition de la réplication virale, suggérant un rôle potentiel des propriétés transactivatrices de NS5A dans la réplication de l'ARN viral.

En conclusion, nous avons démontré que l'activation transcriptionnelle des gènes cellulaires par la NS5A est essentielle pour la réplication de l'ARN du VHC. Cette modulation des gènes cellulaires pourrait également être impliquée dans les mécanismes de la pathogenèse viro-induite. Nous confirmerons cette hypothèse grâce aux souris NS5A. Par ailleurs, ces résultats pourraient contribuer au développement de nouvelles thérapies anti-VHC, basées sur l'inhibition de translocation nucléaire de NS5A.

Table of Contents

List of Illustrations	IX
Principle Abbreviations	XI
1. INTRODUCTION	1
1.1. The Hepatitis C	2
1.1.1. Discovery of the Pathogen	2
1.1.2. Epidemiology and Transmission	2
1.1.3. Natural History and Physiopathology of HCV infection	4
1.2. Therapeutic Treatment of HCV Infection	5
1.3. The Hepatitis C Virus	7
1.3.1. Classification and Genomic Variability of HCV	7
1.3.2. Virion Morphology	9
1.3.3. Genome Structure	10
1.3.3.1. Non-translated Regions	10
1.3.3.2. HCV Proteins	12
1.3.3.3. Core Protein	12
1.3.3.4. Envelope Glycoproteins E1 and E2	13
1.3.3.5. p7	14
1.3.3.6. Non-structural protein 2 (NS2)	14
1.3.3.7. Non-structural protein 3 and 4 (NS3/4A)	14
1.3.3.8. Non-structural protein 4B (NS4B)	15
1.3.3.9. Non-structural protein 5B (NS5B)	16
1.4. Model Systems to Study HCV Life Cycle and Pathogenesis	16
1.4.1. <i>In vitro</i> infections	16
1.4.2. Pseudo-Particle model	17
1.4.3. HCV infectious clones.	18
1.4.3.1. JFH-1 Infectious Clone	19
1.4.4. HCV replicon model	19
1.4.5. Animal Models	21
1.4.6. Viral Vectors for HCV protein expression	23
1.4.6.1. Adenoviral Vectors	23
1.4.6.2. Lentiviral Vector	24
1.5. HCV Life Cycle	25
1.5.1. Virion Attachment and Entry	26
1.5.2. RNA Translation and Polyprotein Processing	29
1.5.3. RNA Replication, Virion Assembly and Release	30
1.5.4. Regulation of HCV replication by host factors.	32
1.6. Non-Structural Protein 5A (NS5A)	33
1.6.1. NS5A Structural Features	33
1.6.2. Role of NS5A in the viral life cycle.	35
1.6.2.1. NS5A phosphorylations modulate its functions	35
1.6.3. Interactions of NS5A with key actors of host cell pathways	36

1.6.4.	Transcriptional activation of host cell genes by NS5A.	39
1.7.	Aims of the Study	42
1.8.	Experimental design	43
2.	MATERIALS AND METHODS	44
2.1.	Genetic and phylogenetic analysis of NS5A	45
2.2.	Cell Culture	45
2.2.1.	Human Primary Hepatocyte Culture	45
2.2.2.	NG and 293FT Cell Culture	46
2.3.	RNA Isolation	46
2.3.1.	RNA Isolation from Liver Tissue	46
2.3.2.	RNA Isolation from Cultured Cells	46
2.4.	Complementary DNA (cDNA) Synthesis	46
2.5.	Molecular Cloning	47
2.5.1.	Restriction Enzyme Digests	47
2.5.2.	Ligation Reactions	47
2.5.3.	TOPO Cloning	47
2.5.4.	Transformation of competent bacteria	47
2.5.5.	Colony Screening	48
2.5.6.	Nucleotide Sequencing	48
2.5.7.	Plasmid DNA Isolations	48
2.5.7.1.	Small Scale Isolation	48
2.5.7.2.	Large Scale Isolation	49
2.5.8.	Yeast One-Hybrid Assay	49
2.5.9.	Mammalian Expression Vector	50
2.5.10.	Subgenomic Replicon Shuttle Vector	51
2.5.11.	Lentiviral NS5A Expression Vector	52
2.5.12.	Functional analysis of Acid Rich 2 region of NS5A	53
2.5.13.	Site-Directed Mutagenesis	54
2.6.	Construction of an Adenoviral NS5A Vector	55
2.6.1.	Construction of the Entry Vector	55
2.6.2.	Construction of the Destination Vector	56
2.6.3.	Generation of an NS5A Expression Cassette by LR Recombination	56
2.6.4.	Production of Recombinant Adenoviral Particles	57
2.7.	Injection of Recombinant Adenoviruses into Mice	57
2.8.	<i>In vitro</i> Transcription and Purification of Replicon RNA	58
2.8.1.	Plasmid Linearization	58
2.8.2.	<i>In vitro</i> Transcription	58
2.8.3.	Purification and Quantification of <i>In vitro</i> Transcribed RNA	59
2.9.	Generation and Titration of Lentiviral Particles	59
2.9.1.	Transfection of 293FT Cells	59
2.9.2.	Harvest and Concentration of Lentiviral Particles	59
2.9.3.	Titration of Lentiviral Stock	60
2.9.4.	Transduction of Cultured Cells	60
2.9.4.1.	Transduction of Primary Hepatocytes	60

2.9.4.2.	Transduction of Huh7.5 Cells	60
2.10.	Cell Transfections	61
2.10.1.	Transient DNA Transfections	61
2.10.2.	RNA Transfections	61
2.11.	Inhibition of Cellular Caspases	61
2.12.	Immunofluorescence Analysis	62
2.13.	Real Time Quantitative Gene Expression Profiling	62
2.14.	Chromatin Immunoprecipitation Assays	63
2.14.1.	Antibody coating of Protein A Mag Sepharose Beads	63
2.14.2.	Cross-linking and preparation of Chromatin	63
2.14.3.	Immunoprecipitation, Washes and Elution of Immune Complexes	64
2.14.4.	Reverse cross-linking and DNA purification	64
2.14.5.	PCR Analysis	64
2.15.	Protein Analysis	65
2.15.1.	Protein Quantification	65
2.15.2.	Western Blotting	65
2.15.2.1.	Denaturing Polyacrylamide Gel Electrophoresis (SDS-PAGE)	65
2.15.2.2.	Immunoblotting of Polyacrylamide Gels	66
2.16.	Yeast One-Hybrid Assay	66
2.17.	Luciferase Reporter Activity Assay	67
3.	RESULTS	68
3.1.	Phylogenetic and functional analysis of NS5A Quasispecies variants	69
3.1.1.	Genetic Compartmentalization of NS5A Quasispecies Variants	69
3.1.2.	Functional Compartmentalization of NS5A Quasispecies Variants	70
3.2.	Role of NS5A transactivational properties in HCV induced liver pathogenesis	74
3.2.1.	Construction of NS5A Adenoviral Vector	74
3.2.1.1.	Construction of NS5A expression cassette	74
3.2.1.1.1.	Construction of entry vector	76
3.2.1.1.2.	Construction of destination vector	80
3.2.1.1.3.	Generation of complete NS5A expression cassette	81
3.2.1.2.	Production of recombinant adenoviral particles	83
3.2.2.	Transduction of Murine Livers with NS5A Adenoviral Vectors	84
3.2.3.	Alternative Strategy: Development of Lentiviral Vector for NS5A Expression and Transgenic Mice Expressing NS5A in Liver Tissue	87
3.2.3.1.	Construction of Lentiviral Vector for the <i>in vitro</i> study of NS5A transactivation properties and their role in pathogenesis	87
3.2.3.1.1.	Cloning of NS5A into lentiviral vector genome	87
3.2.3.1.2.	Production and characterization of recombinant lentiviral particles	89
3.2.3.1.3.	Effect of NS5A transactivation properties on host cell gene expression	90
3.2.3.2.	Transgenic mice for <i>in vivo</i> studies	91
3.2.4.	Conclusions	92

3.3.	Article: Regulation of Hepatitis C Virus Replication by Nuclear Translocation of Nonstructural 5A Protein and Transcriptional Activation of Host Genes.	94
3.4.	The AR2 Region of NS5A bears the transactivation potential of NS5A	144
4.	DISCUSSION	147
5.	REFERENCES	154
6.	APPENDIX - OLIGONUCLEOTIDES	182

List of Illustrations

Figure 1.1	The estimated global prevalence of HCV in 2010 by country	3
Figure 1.2	The estimated prevalence of HCV in France in 2005	3
Figure 1.3	Sources of HCV infection in USA	4
Figure 1.4	The various outcomes of HCV infection	5
Figure 1.5	HCV genotype diversity	8
Figure 1.6	Global distribution of HCV genotypes	8
Figure 1.7	HCV Virion Morphology	9
Figure 1.8	HCV 5' and 3' NTRs, Genome organization and Polyprotein processing	11
Figure 1.9	Production of HCV pseudo particles	18
Figure 1.10	A schematic representation of HCV Replicon System.	20
Figure 1.11	A schematic diagram of Helper dependent Adenoviral vector (HdAd) genome	24
Figure 1.12	HCV Life Cycle	26
Figure 1.13	Schematic diagram of role of HCV IRES in assembly of ribosomal complex and translation initiation	29
Figure 1.14	Assembly of HCV particles	31
Figure 1.15	Schematic diagram of NS5A representing the major structural and functional features	34
Figure 1.16	Schematic representation of transcriptional activation domain of NS5A	40
Figure 2.1	Cloning of NS5A transcriptional activation domain into pGBT9 plasmid	50
Figure 2.2	Vector map of pHM6-NS5A	51
Figure 2.3	The Subgenomic replicon shuttle vector	52
Figure 2.4	Vector map of pLenti6.3-NS5A	53
Figure 2.5	Schematic representation of PCR based strategy to produce chimeric NS5A	54
Figure 2.6	Schematic representation of helper dependent adenoviral particle production	57
Figure 3.1	The complexity of NS5A transcriptional activation domain quasispecies variants in non-tumoural and tumoural liver.	70
Figure 3.2	Schematic representation of yeast one-hybrid constructs encoding NS5A variants	71
Figure 3.3	Transcriptional activation potential of NS5A variants	72
Figure 3.4	Functional compartmentation of NS5A variants	73
Figure 3.5	NS5A expression cassette for adenoviral vector	75
Figure 3.6	Construction of entry vector: Schematic representation of T2A sequence cloning.	77
Figure 3.7	Construction of entry vector: Removal of <i>AscI</i> restriction site	78
Figure 3.8	Construction of entry vector: Cloning of NS5A into Entry Vector	79
Figure 3.9	Construction of destination vector: Strategy for the removal of stop codons	80
Figure 3.10	Construction of destination vector: Generation of Destination Vector	81
Figure 3.11	Generation of complete NS5A expression cassette	82
Figure 3.12	Imunoblotting for NS5A expression in transfected cells	83

Figure 3.13	Immunoblotting for FIX and NS5A proteins in transduced mice	85
Figure 3.14	ELISA for FIX protein in the plasma of adenovirus transduced mice	86
Figure 3.15	Schematic representation of NS5A cloning into lentiviral vector	88
Figure 3.16	Characterization of lentiviral vector stocks: Titration	89
Figure 3.17	Characterization of lentiviral vector stocks: Immunoblotting	90
Figure 3.18	Role of AR2 in transactivational properties of NS5A	145
Figure 3.19	Role of AR2 in NS5A transactivation and HCV RNA replication	146

Principle Abbreviations

Apo	Apolipoprotein
bp	Base pair(s)
BSA	Bovine Serum Albumin
BVDV	Bovine Viral Diarrhoea Virus
cDNA	Complementary DNA
cfu	Colony forming unit
CLDN	Claudin
DMEM	Dulbecco's Modified Eagles Media
DMSO	Dimethyl Sulphoxide
<i>E.coli</i>	Escherichia coli
EDTA	Ethylenediaminetetra-Acetic Acid
EMCV	Encephalomyocarditis Virus
ER	Endoplasmic Reticulum
FBS	Foetal Bovine Serum
FITC	Fluorescein Isothiocyanate
g	Gram(s)
GFP	Green Fluorescent Protein
HBV	Hepatitis B Virus
HCC	Hepatocellular Carcinoma
HCV	Hepatitis C Virus
HCVcc	HCV cell culture-derived virus
HCVpp	HCV Pseudoparticles
HDL	High-Density Lipoprotein
HIV	Human Immunodeficiency Virus
HL	Hydrophobic Loop
HRP	Horseradish Peroxidase
HVR	Hypervariable Region
IF	Immunofluorescence
IFN	Interferon
IRES	Internal Ribosome Entry Site
ISG	IFN-Stimulated Gene
JFH	Japanese Fulminant Hepatitis
kb	Kilobase(s)
kDa	Kilodalton(s)
LD	Lipid Droplet
LDL	Low-Density Lipoprotein
LEL	Large Extracellular Loop
M	Molar
MOI	Multiplicity of Infection
mRNA	Messenger RNA
NANBH	Non-A, non-B Hepatitis
NEAA	Non-Essential Amino Acids
Neo/G418	Neomycin Phosphotransferase

NTP	Nucleoside Triphosphate
NTR	Non-Translated Region
OCLN	Occludin
ORF	Open Reading Frame
PAGE	Polyacrylamide Gel Electrophoresis
PBS	Phosphate-Buffered Saline
PCR	Polymerase Chain Reaction
PFA	Paraformaldehyde
pH	Potential of Hydrogen
PI	Protease Inhibitor
PKR	Protein kinase R
PMSF	Phenylmethanesulfonylfluoride
qRT-PCR	Quantitative real time PCR
RdRp	RNA-dependent RNA polymerase
RIG-I	Retinoic-acid-Inducible Gene I
RLU	Relative light unit(s)
RNA	Ribonucleic acid
RNAi	RNA interference
rpm	Revolutions per minute
RT-PCR	Reverse Transcriptase PCR
SDS	Sodium Dodecyl Sulphate
SEL	Small Extracellular Loop
SEM	Standard Error of Mean
SGR	Subgenomic Replicon
siRNA	Small inhibitory RNA
SR-BI	Scavenger Receptor class B member I
TMD	Transmembrane Domain
UTR	Untranslated Region
VLDL	Very-Low Density Lipoprotein
vp	Viral Particles

1 - INTRODUCTION

1.1. Hepatitis C

1.1.1. Discovery of the Pathogen

Before the discovery of hepatitis C virus (HCV), two viral pathogens were known to cause hepatitis: hepatitis A (HAV) and B (HBV) viruses. However, many patients with hepatitis did not harbor HAV or HBV infection, and their disease was thus referred to as non-A non-B hepatitis (NANBH). NANBH was demonstrated to be infectious and could be transmitted by blood transfusion, suggesting the involvement of a viral factor (Bradley *et al.*, 1986). Research efforts using novel molecular biology techniques resulted in identification of a new RNA virus, renamed hepatitis C virus (HCV), in sequence libraries made from the serum of a chimpanzee suffering from chronic NANBH (Choo *et al.*, 1989). It is now estimated that 170 million people worldwide are chronically infected by hepatitis C virus (WHO, 2000). Even two decades after the discovery of pathogen, no vaccine is available against HCV and to date; all treatments against HCV are only partially efficient.

1.1.2. Epidemiology and Transmission

Hepatitis C virus is a pandemic infection and is a major public health problem. Industrialized countries of North America and Western Europe have the lowest prevalence rates (below 2%) whereas HCV infects more than 10% of people in Mongolia, Bolivia and Egypt, the latter having the highest prevalence rate (22% , Figure 1.1) (Lavanchy 2011). Use of contaminated syringes in nationwide schistosomiasis treatments during the 1970s is considered to be the cause of such a high seroprevalence of HCV in Egypt (Frank *et al.*, 2000). France has a 0.84% seroprevalence, with an estimated 367,055 people having antibodies to HCV (Figure 1.2) (INVS, 2005).

HCV is primarily transmitted through exposure to infected blood. Blood from unscreened donors was a major factor in its transmission before the development of systematic blood screening methods in the early 1990s (Huber *et al.*, 1996). Currently, injecting drug abuse has become the predominant mode of transmission of HCV in industrialized countries whereas contaminated blood transfusions and therapeutic injections are still the most frequent modes of transmission in the developing world (Figure 1.3) (Shepard *et al.*, 2005). In children, mother-to-infant vertical transmission is the most frequent mode of transmission of HCV (Alter 2007). Although significant, sexual transmission of HCV is far less frequent than other sexually transmitted viruses (Alter 2007).

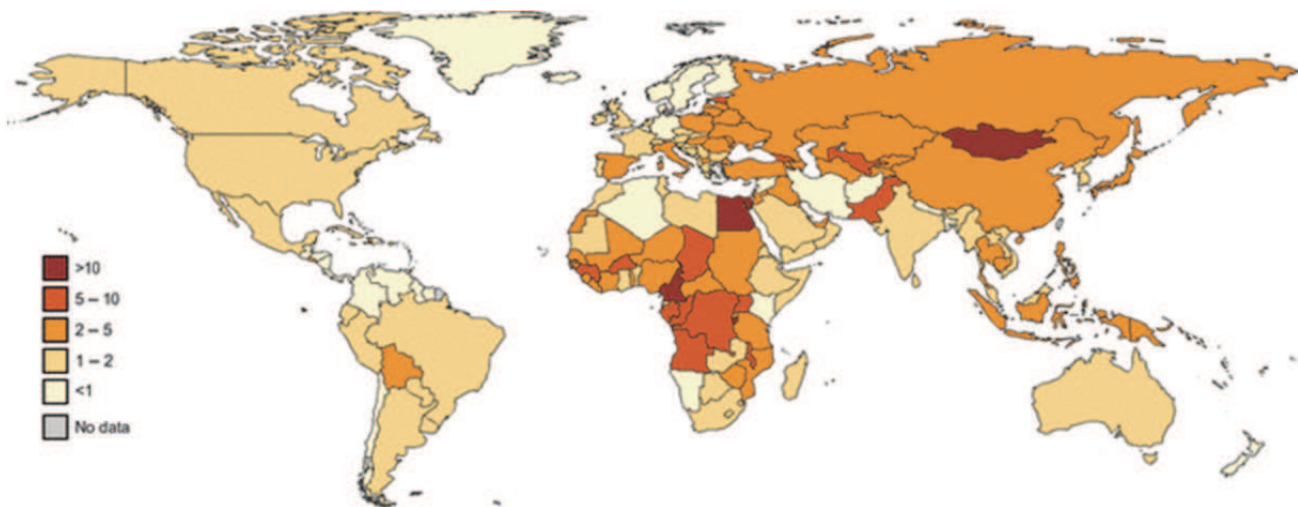

Figure 1.1: The estimated global prevalence of HCV infection in 2010 (% population infected) (Lavanchy 2011).

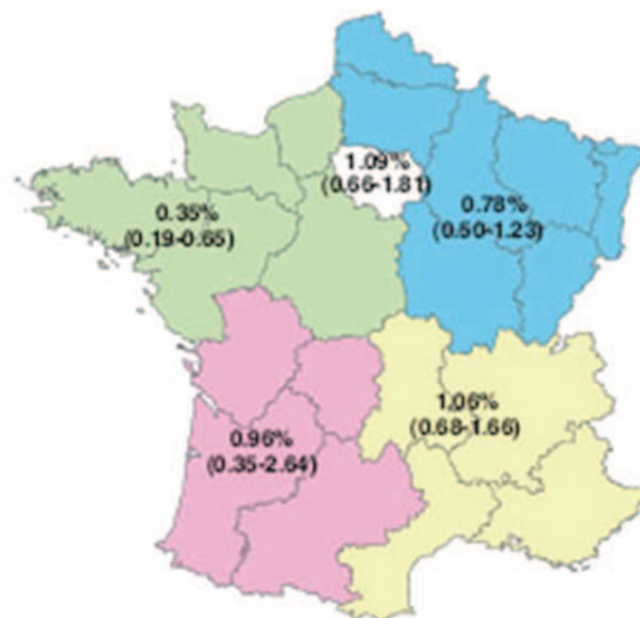

Figure 1.2: The estimated prevalence of HCV in France (Source: INVS 2005).

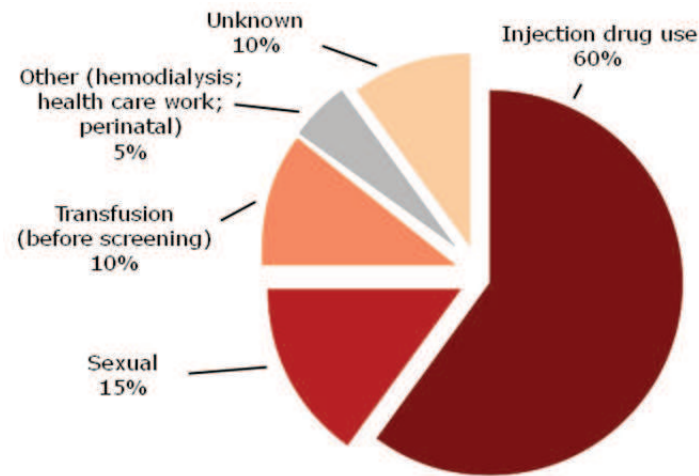

Figure 1.3: Sources of HCV infection in the USA (Source: CDC 2009)

1.1.3. Natural History and Physiopathology of HCV infection

In majority of cases, acute HCV infection is asymptomatic, although approximately 20-30 % of acutely infected patients may develop typical hepatitis symptoms such as weakness, anorexia and jaundice 3 to 12 weeks after infection (Alter *et al.*, 2000). HCV RNA can be detected in patient serum within 1-2 weeks of exposure to the virus (Thimme *et al.*, 2001). In some cases, symptoms of acute infection may be severe, and rapid fulminant hepatitis have been reported (Farci *et al.*, 1996).

Although acute infection is self-limiting in 15-25 % of patients, in the majority of cases HCV escapes the immune response and infection persists over six months, leading to chronic hepatitis (Shimotohno 2000). The majority of chronically-infected patients develop chronic hepatitis with symptoms such as lobular injury and portal inflammation (Di Bisceglie 1998). The transition to chronic HCV infection is influenced by a wide range of factors such as sex, age, co-infection with HIV or HBV and some genes of major histocompatibility complex (Lavanchy 2009). Approximately 20 % of chronically-infected patients develop liver cirrhosis within 15-20 years post-infection (Yano *et al.*, 1996). Males aged over 50 and consumers of alcohol are more prone to cirrhosis development (Lavanchy 2009). Recent data have shown that HCV-induced liver injury is responsible for 40-50% of orthotopic liver transplantations in the USA (Figure 1.4) (Brown 2005).

It is estimated that every year 1-4% of HCV infected cirrhotic patients develop primary liver cancer or hepatocellular carcinoma (HCC) (Di Bisceglie 1998; Gordon *et al.*, 1998). Chronic HCV infection has become the principal cause of primary liver cancer in Japan as 80-90 % of HCC patients are carriers of HCV. Moreover, modeling of ongoing epidemics predicts a similar trend in Europe (Aizawa *et al.*, 2000; Kiyosawa *et al.*, 2004; El-Serag *et al.*, 2007). In Western Europe, HCV infection is prevalent in the majority of HCC patients, ranging from 44-66 % in Italy, 27-58 % in France and 60-75 % in Spain (El-Serag *et al.*, 2007). It has been estimated that HCV infection increases HCC risk by 17 fold as compared to non-infected subjects (Donato *et al.*, 2002). The mean time to develop HCC in HCV infected patients has been estimated to be 28+/-11 years post infection (Tong *et al.*, 1995). In industrialized countries, liver transplantation has become the principal long term treatment for severe HCV-induced cirrhosis or HCC (Charlton 2001).

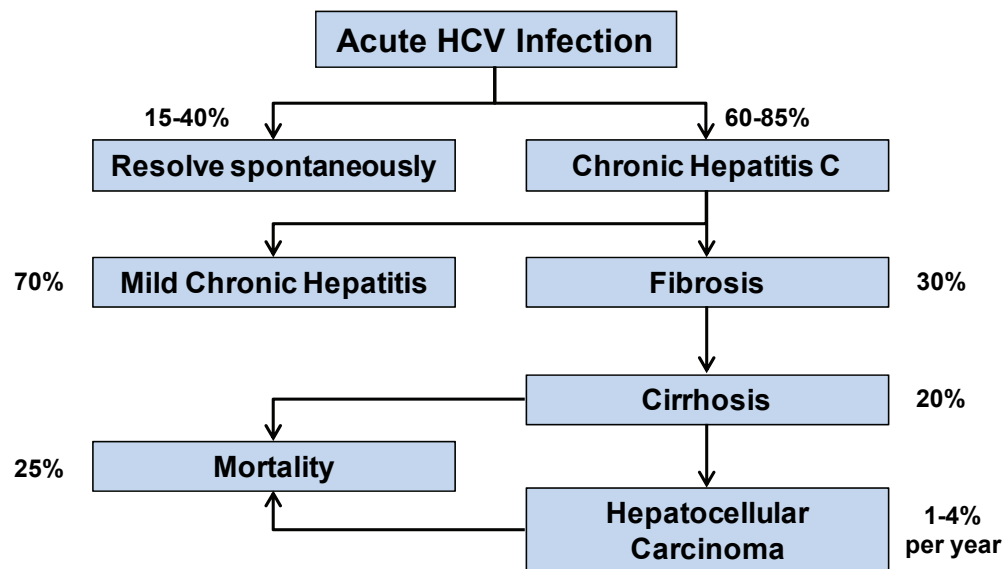

Figure 1.4: The various outcomes of HCV infection (Adapted from (Patel *et al.*, 2006))

1.2. Therapeutic Treatment of HCV Infection

Interferon- α treatment was noticed to be beneficial to NANBH patients long before the discovery of HCV itself (Hoofnagle *et al.*, 1986). It was demonstrated that interferon- α induces an anti-viral state by inducing *interferon stimulated genes* (ISGs) within infected and neighboring cells (Sen 2001). This antiviral state leads to a rapid decline in HCV RNA levels

in serum (Lau *et al.*, 1998). However, only 16-20 % of HCV-infected patients showed a sustained anti-viral response when treated with interferon- α (Di Bisceglie *et al.*, 2002). The number of patients eliciting such a response was increased by two fold with the use of the broad spectrum anti-viral drug Ribavirin in combination with interferon- α therapy (McHutchison *et al.*, 1999). Ribavirin is a guanosine analogue that has been shown to have anti-viral activity against several DNA and RNA viruses such respiratory syncytial virus, bovine viral diarrhea virus, and GB virus B. (Lau *et al.*, 1999; Lanford *et al.*, 2001). Despite detailed studies, the exact mechanism(s) of action of ribavirin still remains elusive. Incorporation of ribavirin by the HCV RNA-dependent RNA polymerase results in chain termination, leading to inhibition of viral replication (Maag *et al.*, 2001). It has also been suggested that ribavirin causes lethal mutagenesis mediated by RNA-dependent-RNA-polymerase (Cameron *et al.*, 2001). However, the study of viral kinetics in ribavirin-treated patients showed that chain termination events induced by ribavirin is not the only mechanism of action of ribavirin in combination therapy (Pawlotsky *et al.*, 2004). It has also been suggested that ribavirin may exert its anti-viral activity by modulating the immune system and interferon signaling pathways (Tam *et al.*, 1999; Feld *et al.*, 2005). Today, interferon- α has been replaced by Pegylated interferon- α that has a longer half-life and achieves a better virological response (Glue *et al.*, 2000; Bailon *et al.*, 2001).

Currently, combination therapy with pegylated interferon- α and Ribavirin has become the standard-of-care for HCV infection. However, only 40-50% patients infected with genotype 1 and up to 80% patients with genotypes 2 and 3 can achieve a sustained virological response with this therapy (reviewed in (Pawlotsky 2011a)). However, the high rate of non-responders, especially in genotype 1 infected patients, and the adverse side effects of the standard treatment regimen have necessitated the development of new treatments against HCV. Recently, research efforts have focused on the development of direct acting antivirals (DAAs) such as inhibitors of viral enzymes and nucleic acid based agents to destroy viral RNA such as antisense oligonucleotides and siRNAs (reviewed in (De Francesco *et al.*, 2005)). These efforts have resulted in the development of many promising DAAs that are in early or late stages of clinical trials, or that are now licensed for use in clinical settings such as telaprevir (Kwong *et al.*, 2011) and boceprevir (Poordad *et al.*, 2011).

However it has been demonstrated that DAAs may lead to selection of resistant viruses and that they must not be used alone (Tarik 2011; Pawlotsky 2011a). Keeping in mind the

possible selection of resistant viruses by DAAs, efforts are underway to develop inhibitors of host cell proteins important for viral replication, such as inhibitors of cyclophilins (Goto *et al.*, 2006; Paeshuyse *et al.*, 2006). Besides DAAs and cyclophilin inhibitors, synthetic immunomodulatory agents such as agonists of toll-like receptors (TLRs) 7 and 9 have shown promising potential to control HCV infection (De Francesco *et al.*, 2005).

1.3. Hepatitis C Virus

1.3.1. Classification and Genomic Variability of HCV

Early analysis of the HCV genome classified it as a member of *Flaviviridae* family, at that time consisting of two genera: the *Flaviviruses* (Dengue Virus, West Nile Virus, Yellow Fever Virus etc.) and the *Pestiviruses* (such as Bovine Viral Diarrhea Virus). Similar to *Flaviviruses* and *Pestiviruses*, the HCV genome consists of single strand RNA of positive polarity and codes for a single polyprotein. However due to low sequence homology with these viruses, HCV was classified as the sole member of a novel genus *Hepacivirus* (Miller *et al.*, 1990; Choo *et al.*, 1991; Houghton *et al.*, 1991).

Analysis of a large number of sequences of HCV from all over the world demonstrated that HCV could be divided into six genotypes that differ by 30-35% in nucleotide homology (Figure 1.5) (Simmonds 2004). Similarly, each genotype has been subdivided into several subtypes; differing by 20-25% nucleotide sequence homology (Simmonds 2004). HCV genotypes and subtypes are heterogeneously distributed in the world. Genotypes 1a and 1b are more frequent in America and Europe whereas genotype 3 is dominant in South East Asia. Genotype 4 is predominant in Egypt whereas genotype 5 is predominant and almost completely limited to South Africa. Similarly, genotype 6 is mainly found in East Asia (Figure 1.6) (Zein 2000).

The RNA-dependent RNA polymerase of HCV lacks 5'-3' exonuclease proofreading activity, which leads to the introduction of frequent mutations in viral genomic RNA. Since the rate of mutation is very high, HCV evolves at an astonishing rate (Okamoto *et al.*, 1992). This high mutation rate leads to significant variability not only between viral populations amongst different patients, but also between viruses in a single infected patient, giving rise to quasispecies. Viral quasispecies are composed of a dynamic and complex mixture of

genetically distinct but closely related variants (Pawlotsky 2006). Quasispecies confer a greater adaptability to HCV and may have important implications in viral persistence, treatment response and pathogenicity. (Forns *et al.*, 1999; Lyra *et al.*, 2004; Lerat *et al.*, 2008).

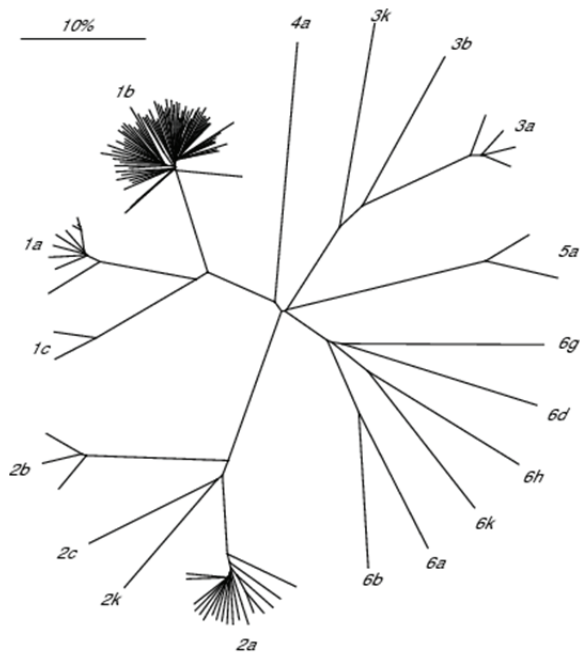

Figure 1.5: HCV genotype diversity: Neighbor-joining tree of the complete genome sequences that formed the basis for the plot of the complete genome distances (Source: HCV Sequence Database)

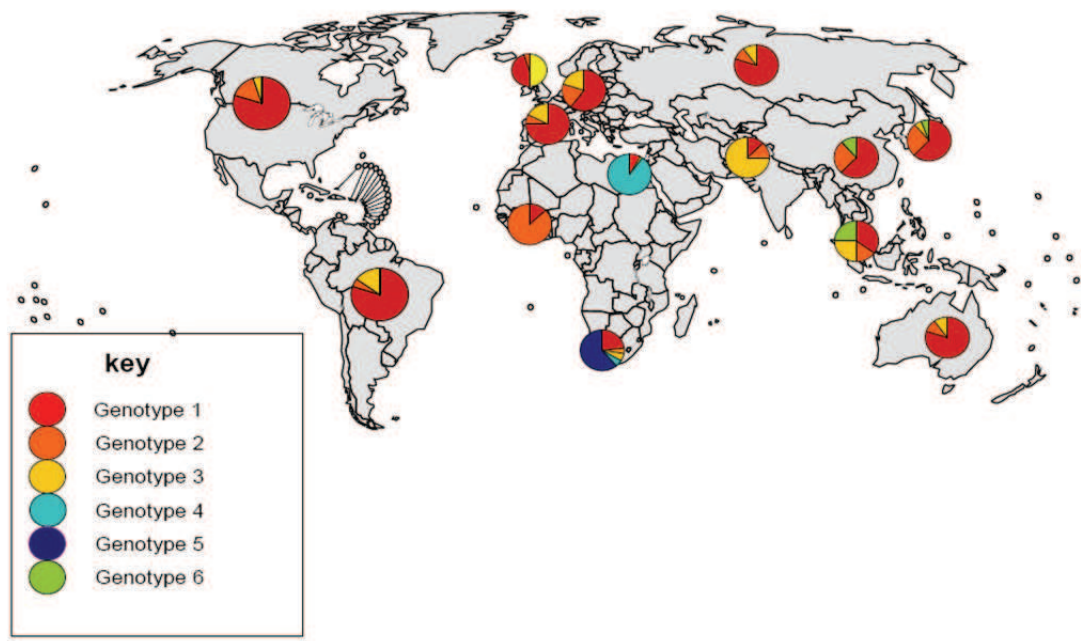

Figure 1.6: Global distribution of HCV genotypes (Source: WHO 2009)

1.3.2. Virion Morphology

Electron microscopy studies have indicated that *in vitro*-produced HCV virions have a diameter of 50-60 nm, consisting of a nucleocapsid of 30-35 nm and an envelope containing viral glycoproteins E1 and E2 (Wakita *et al.*, 2005) (Figure 1.7). This is similar to virions produced *in vivo* and secreted into the serum of infected humans or chimpanzees (Kaito *et al.*, 1994; Shimizu *et al.*, 1996). HCV virions found in patients' sera are attached to lipoproteins of low or very-low density (LDLs or VLDLs) (Andre *et al.*, 2002). It has also been demonstrated that buoyant density of secreted virions (1.03-1.16 g/ml) is lower than that of intracellular virions (1.15-1.20 g/ml) (Gastaminza *et al.*, 2006). These observations suggested that virions acquire these lipoproteins during the secretion process. Recently, it has been demonstrated that *in vitro* secretion of HCV particles by infected hepatocytes is tightly dependent on the secretion of VLDLs (Gastaminza *et al.*, 2008). It has been further demonstrated that, even in the absence of other viral proteins, secreted E1 and E2 proteins are associated with lipoproteins (Icard *et al.*, 2009).

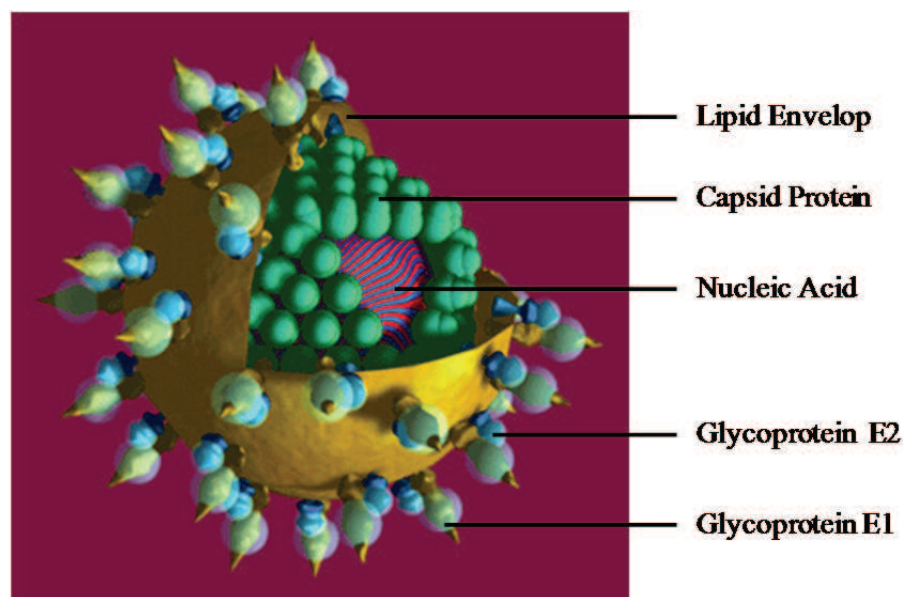

Figure 1.7: HCV Virion Morphology (Image from Louis E. Henderson (Frederick Cancer Research Center))

1.3.3. Genome Structure

The HCV genome comprises of a positive sense single stranded 9.6 kbp RNA molecule containing a single open reading frame (ORF), encoding a polyprotein of about 3000 amino acids, depending on the genotype. This ORF is flanked by highly conserved 5' and 3' non-translated regions (NTRs) of 341 and 230 bp respectively (Penin *et al.*, 2004a) (Figure 1.8a).

1.3.3.1. Non-translated Regions

The highly conserved 5' NTR is essential for genome translation and replication. It is highly structured and contains four major secondary structure domains known as domains I, II, III and IV. The 5' NTR contains an internal ribosome entry site (IRES) that is comprised of domains II, III and IV along with the first 30 nucleotides of the ORF, which, in the absence of a 5' cap, ensures translation of the HCV genome (*reviewed in* (Lindenbach *et al.*, 2005). Besides its important role in genome translation, many studies have demonstrated that 5'NTR is also crucial for efficient replication of viral RNA (Friebe *et al.*, 2001; Kim *et al.*, 2002; Appel *et al.*, 2006). It has been demonstrated that binding of the host cell-encoded microRNA (miR-122) to the 5'NTR is essential for viral replication (Jopling *et al.*, 2005). However these observations are not supported by *in vivo* data, as recently it has been demonstrated that mir-122 levels are reduced in HCV infected patients poorly responding to interferon therapy (Sarasin-Filipowicz *et al.*, 2009).

The length of the 3' NTR varies between different genotypes. It has a tripartite structure differentiated into three regions: a highly variable region of 30-40 nucleotides, a poly-uracil/pyrimidine tract of variable length and a conserved sequence of 98 nucleotides that is organized into three stem-loop structures termed SL1, SL2 and SL3 (*reviewed in* (Chevaliez *et al.*, 2006)). The variable region is not essential for HCV RNA replication in cell culture models, whereas the poly-uracil/pyrimidine region contains a segment of uridine and cytidine residues that must be longer than 25 nucleotides to allow viral RNA replication (Friebe *et al.*, 2002). The conserved region containing SL1, SL2 and SL3 has been demonstrated to be indispensable for HCV replication and infectivity (Yanagi *et al.*, 1999; Yi *et al.*, 2003).

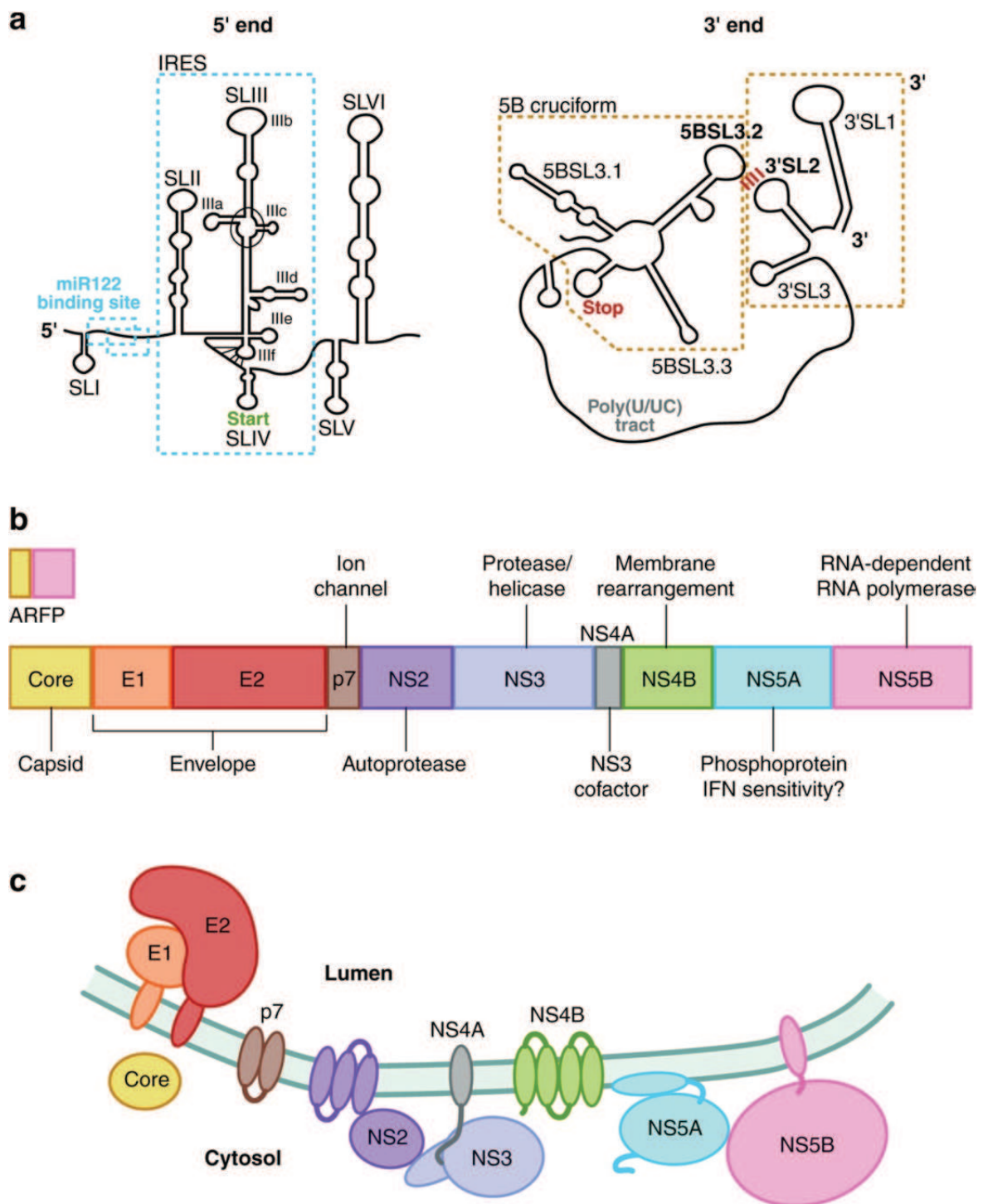

Figure 1.8: HCV 5' and 3' NTRs, Genome organization and Polyprotein processing. (*adapted from* (Dustin *et al.*, 2007)) **a)** RNA secondary structures in 5' and 3' UTRs. **b)** HCV genome translation produces polyprotein precursor. ARFP denotes alternative reading frame protein also termed “F” protein **c)** Polyprotein precursor is processed into mature structural and non-structural proteins.

1.3.3.2. HCV Proteins

The translation of the HCV ORF produces a large polyprotein precursor which is processed by viral and cellular proteases to produce eleven viral proteins that make up viral particles (structural) or viral replication complex (non-structural) (Figure 1.8b). Host cell proteases such as endoplasmic reticulum signal peptidase, first cleave the polyprotein to liberate structural proteins, followed by further processing of non-structural proteins by viral proteases NS2-3 and NS3-4A (Chevaliez *et al.*, 2006). The amino terminal proteins core and glycoproteins E1 and E2 are virion structural proteins whereas a small protein p7 has been suggested to function as ion channel (Griffin *et al.*, 2003; Pavlović *et al.*, 2003; Griffin *et al.*, 2004). The non-structural proteins NS2, NS3, NS4A, NS4B, NS5A and NS5B are intracellular coordinators of the viral life cycle (Lindenbach *et al.*, 2005).

1.3.3.3. Core Protein

The core protein is the first protein encoded by the HCV genome. It is a highly basic, RNA binding protein and the putative construction unit of viral nucleocapsid that encapsulates the viral genome (Hijikata *et al.*, 1991). After cleavage from the polyprotein, the immature form (21-23kDa) of core undergoes another round of cleavage to produce the 19kDa mature form of core (Santolini *et al.*, 1994; Hussy *et al.*, 1996). The mature core protein is organized into two domains termed domains 1 (D1) and 2 (D2). D1 is rich in acidic amino acids and interacts with the 5' end of the viral genome to initiate its encapsidation (Boulant *et al.*, 2005). The hydrophobic domain 2 of the core protein is essential for its localization on the ER membrane as well as its trafficking to lipid droplets (Hope *et al.*, 2000; Suzuki *et al.*, 2005). Core protein is essential for viral particle assembly and mutations that disrupt its trafficking to LDs result in a significant loss of production of infectious viral particles (Boulant *et al.*, 2007; Miyanari *et al.*, 2007; Murray *et al.*, 2007). Although not absolutely indispensable for HCV RNA replication, it has been suggested that core protein plays an important role in recruiting viral replication complexes to lipid droplet-associated membranes (Miyanari *et al.*, 2007). More recently, core has been reported to induce redistribution of lipid droplets in the cell through its interaction with microtubules, bringing them in close contact with membranes bearing viral replication complexes, possibly to initiate viral assembly in infected cells (Boulant *et al.*, 2008; Roohvand *et al.*, 2009). These observations clearly suggest that core protein plays an essential role in viral particle assembly and is essential for infectious virion production.

Besides being a part of viral capsid, core protein has been shown to interact with host cell pathways, possibly contributing to HCV-associated pathogenesis. Transgenic mice expressing core protein demonstrate reduced activity of microsomal triglyceride transfer protein (MTP) resulting in reduced secretion of VLDL (Perlemuter *et al.*, 2002). In addition, some studies have suggested that core protein may stimulate lipogenesis and play a role in liver steatosis in HCV infected patients (Piodi *et al.*, 2008; Roingeard *et al.*, 2008). It is interesting to notice that HCV might perturb the production of lipids and lipid droplets which are essential for HCV life cycle, although no clear relation has been shown so far between steatosis and HCV replication.

Although still controversial, it has also been reported that core protein transcriptionally regulates host cell proto-oncogenes and bear transforming properties resulting in transformation of rat primary hepatocytes (Ray *et al.*, 1996a; Ray *et al.*, 1996b). Another study has demonstrated that hepatic expression of core protein induces the development of hepatocellular carcinoma in core transgenic mice (Moriya *et al.*, 1998). However these findings have been negated by other investigators who have reported no transforming or cytopathic effects of core protein on livers of transgenic mice expressing core protein (Pasquinelli *et al.*, 1997).

Although core protein has been shown to carry a nuclear localization signal and translocate to the nucleus, no precise nuclear function has been ascribed (Suzuki *et al.*, 2005). Core has been reported to induce cell growth (Fukutomi *et al.*, 2005) and has also been shown to have controversial effects on cell apoptosis (Kountouras *et al.*, 2003; Meyer *et al.*, 2005). More recently it has been demonstrated that core protein plays an important role in the development of liver fibrosis via interaction with TLR2 (Coenen *et al.*, 2011; Feng *et al.*, 2011).

1.3.3.4. Envelope Glycoproteins E1 and E2

Glycoproteins E1 and E2 are components of the viral envelope and are essential for viral entry into the host cells (Nielsen *et al.*, 2004). Depending on the genotype, E1 and E2 are 33-35 kDa and 70-72 kDa respectively (Deleersnyder *et al.*, 1997). E1 and E2 form stable non-covalent heterodimers anchored into the endoplasmic reticulum membrane (Ralston *et al.*, 1993; Dubuisson *et al.*, 1994; Deleersnyder *et al.*, 1997; Michalak *et al.*, 1997). Both E1 and

E2 contain hyper variable regions (HVR) that are highly immunogenic and thought to be responsible for viral escape from host immune system (Weiner *et al.*, 1991).

1.3.3.5. p7

p7 is a small hydrophobic polypeptide of 63 amino acids (Lin *et al.*, 1994) and is an integral membrane protein (Carrere-Kremer *et al.*, 2002). Classified as a member of viroporin family of proteins, p7 has been shown to function as cation channel (Griffin *et al.*, 2003; Griffin *et al.*, 2004; Steinmann *et al.*, 2007). Although not required for viral RNA replication, p7 is essential for release of virions and *in vivo* infectivity in chimpanzee (Sakai *et al.*, 2003) and thus represents a promising target for development of antiviral HCV drugs (Griffin 2010). It has been demonstrated that it is essential for infectious virus production and adaptive mutations enhance virus production *in vitro* (Steinmann *et al.*, 2007; Russell *et al.*, 2008). Very recently it has been demonstrated that p7 plays an essential role in targeting of NS2 to viral replication complexes, and in its interaction with NS5A (Tedbury *et al.*, 2011).

1.3.3.6. Non-structural protein 2 (NS2)

NS2 is a 23kDa non-glycosylated trans-membrane protein that localizes to the ER membrane (Santolini *et al.*, 1995). Cleavage of NS2 from the polyprotein is achieved by both cellular and viral proteases. NS2 is cleaved from the polyprotein by a host signal peptidase at its N-terminus, whereas its C-terminus is auto-proteolytically cleaved by the NS2-3 metalloprotease on (Lin *et al.*, 1994). Once cleaved from polyprotein, it has a very short half-life and is degraded by the proteasome (Franck *et al.*, 2005). NS2 is not required for viral RNA replication but it is indispensable for infectious virus production. Recently it has been demonstrated that NS2 plays a vital role in organization of virion assembly (Jirasko *et al.*, 2010).

1.3.3.7. Non-structural protein 3 and 4 (NS3/4A)

NS3 is a 70 kDa multifunctional protein that carries a serine protease activity in its N-terminus and a helicase/NTPase activity in C-terminal region (*reviewed in* (Chevaliez *et al.*, 2006)). NS3 interacts with NS4A as its co-factor (Lin *et al.*, 1994; Failla *et al.*, 1995). NS3 serine protease activity is required for polyprotein cleavage at the junctions of NS2/3, NS3/NS4A, NS4A/4B, NS4B/5A and NS5A/5B (Grakoui *et al.*, 1993; Kolykhalov *et al.*, 1994). The NTPase domain of NS3 helicase- binds to RNA, hydrolyses NTPs and uses this

energy to travel along the nucleic acid polymer, removing both the complementary strand and bound proteins. NS3-NS4A has also been shown to prevent dsRNA detection and the subsequent interferon response to viral infection by interfering with toll like receptor 3 (TLR3) and interferon regulatory factor 3 (IRF3) signaling pathways (Foy *et al.*, 2003; Li *et al.*, 2005).

Because it plays a pivotal role in viral life cycle, NS3/4A has been identified as an important target for anti-HCV therapy. Two potent inhibitors of NS3 protease activity; Telaprevir and Boceprevir have recently been licensed for therapy against HCV (Kwong *et al.*, 2011; Poordad *et al.*, 2011; Vermehren *et al.*, 2011).

1.3.3.8. Non-structural protein 4B (NS4B)

NS4B is a 261aa, 27 kDa highly hydrophobic protein that localizes to the endoplasmic reticulum. It induces the formation of a specific membrane structure designated the membranous web, although the exact mechanisms are still unknown,. This membranous web has been shown to serve as a scaffold for HCV RNA replication complex formation (Egger *et al.*, 2002; Konan *et al.*, 2003). Besides functioning as a membrane anchor for viral replication complexes, NS4B also plays an important role in viral assembly (Jones *et al.*, 2009).

NS4B also plays a role in the pathogenesis of hepatitis C by several mechanisms. It has been demonstrated that NS4B induces activation of endoplasmic reticulum stress pathways (Tardif *et al.*, 2002). Some studies have suggested that NS4B upregulates fatty acid synthesis and play a role in steatosis in chronically infected patients (Waris *et al.*, 2007; Park *et al.*, 2009). NS4B has also been reported to transform NIH-3T3 cells when co-expressed with Ha-*Ras* as well as being shown to modulate cellular genes involved in tumor suppression, oncogenesis and cellular stress, suggesting that NS4B possesses transforming properties and may play a role in carcinogenesis (Park *et al.*, 2000; Zheng *et al.*, 2005). Although the mechanisms involved in NS4B-mediated cellular transformation are still not clear, it has been demonstrated that GTPase activity of NS4B nucleotide binding motif is essential for its transformation activity (Einav *et al.*, 2008).

The non-structural 5A (NS5A) protein, subject of the work presented in this thesis, will be described in further detail in Section 1.6.

1.3.3.9. Non-Structural Protein 5B (NS5B)

NS5B is a 68 kDa membrane associated protein that functions as an RNA dependent RNA polymerase. It is anchored to the ER through an α -helical transmembrane domain in its C-terminal region (Moradpour *et al.*, 2004). It possesses typical features of a polymerase such as “fingers, palm and thumb” structure and Gly-Asp-Asp (GDD) motif (Poch *et al.*, 1989; Ago *et al.*, 1999; Bressanelli *et al.*, 1999). The ‘finger’ and ‘thumb’ comprise the template RNA binding channel, whereas the ‘palm’ carries the catalytically active GDD motif (Penin *et al.*, 2004a). Since NS5B is catalytic machinery responsible for viral genome synthesis and replication, it has become a very important target for antiviral therapy (Pawlotsky 2006a; Koch *et al.*, 2007).

Both viral and cellular proteins interact with NS5B and modulate its activity. NS3 and NS5A have both been reported to modulate the activity of NS5B (Piccininni *et al.*, 2002; Shirota *et al.*, 2002). Similarly, a cellular protein, cyclophilin B (CypB) has been reported to interact with NS5B and modulate its RNA binding capacity, thus modulating viral replication (Watashi *et al.*, 2005).

1.4. Model Systems to Study HCV Life Cycle and Pathogenesis

The discovery of the causative agent for non-A non-B hepatitis helped to diagnose and prevent new infections, especially in blood receivers through detection of HCV specific antibodies in the serum of potentially infected blood donors. However, the lack of robust cell culture and small animal models initially made it the study of the viral life cycle and host-pathogen interactions extremely difficult. However, over the last fifteen years several models have been developed and successfully used to study different steps of viral life cycle and to identify novel drug targets. Some of the most relevant models have been reviewed in the following sections.

1.4.1. *In vitro* infections

Initially all research related to HCV was conducted almost exclusively by epidemiological and serological studies. Cultured cell lines were not susceptible to HCV infection, whilst cultured primary hepatocytes isolated from chronically infected patients harbored a very low level of viral replication. Many efforts were made to infect *in vitro* cultured primary

hepatocytes by using sera from HCV-infected patients; however, these efforts were hampered by low level of HCV replication (Ito *et al.*, 1996; Fournier *et al.*, 1998). Despite low level of HCV replication, such experiments have allowed the study of several host cell receptors required for HCV infection, as well as the analysis of anti-viral therapies (Castet *et al.*, 2002; Molina *et al.*, 2007; Molina *et al.*, 2008). Similarly, *in vitro* cultured primary hepatocytes from *Tupaia belangeri* were also shown to be infectable by sera from HCV-infected individuals (Zhao *et al.*, 2002). However such *in vitro* infection models are hampered by problems with low reproducibility. In addition, the infectivity of patients' sera differs greatly, despite having similar HCV RNA titers. Moreover, viral replication must be estimated by negative strand-specific methods, which have several problems including the detection of very low levels of negative strand RNA, contamination and false positives due to self-priming of viral RNA (Gunji *et al.*, 1994; Lanford *et al.*, 1994; Takyar *et al.*, 2000). Alternatively, another group demonstrated that hepatocytes cultured in a 3-D radial flow bioreactor could produce infectious viral particles after inoculation with HCV-infected sera (Aizaki *et al.*, 2003). However, the complexity and cost of this system are major obstacles in its widespread use.

1.4.2. Pseudo-Particle Model

HCV pseudo-particles (HCVpp) are chimeric virus particles that are produced by incorporation of HCV glycoproteins E1 and E2 into murine leukemia virus (MLV) or human immune deficiency virus (HIV) viral capsids containing either GFP or Luciferase reporter genes (Hsu *et al.*, 2003; Bartosch *et al.*, 2003a) (Figure 1.9). This model has allowed the identification of several cellular receptors that are essential for HCV entry into cells, such as LDLR, DC-SIGN, L-SIGN, Claudin-1, Claudin-6, Claudin-9 and most recently Occludin (von Hahn *et al.*, 2008; Ploss *et al.*, 2009a). This model is limited to the study of HCV entry into cells or to the study of antibodies directed against the HCV envelope proteins (Bartosch *et al.*, 2005; Lavillette *et al.*, 2005).

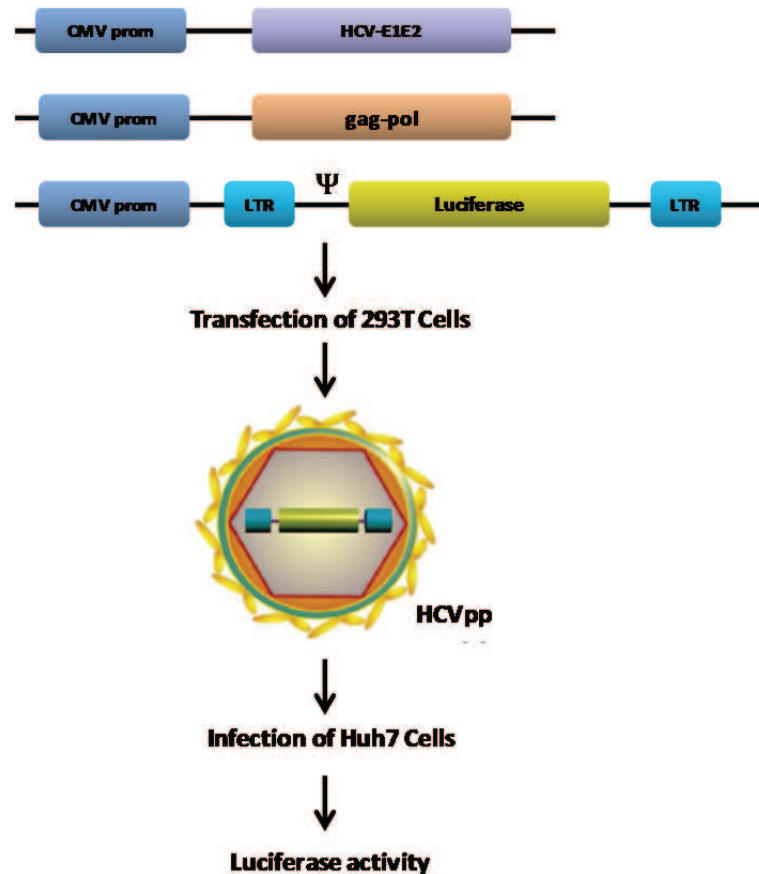

Figure 1.9: Production of HCV pseudo particles (adapted from (Voisset *et al.*, 2004). Ψ indicates the retroviral packaging signal, LTR indicates Lateral Terminal Repeats.

1.4.3. HCV infectious clones.

The genomic amino acid sequence of HCV has been obtained from multiple PCR amplifications of HCV infected sera. In the late 1980s, PCR techniques lacked efficient proofreading polymerases and amplified HCV fragments contained many mutations, which impaired HCV protein functions and lead to non-replicable clones. Based on this assumption, different groups tried to repair these mutations to generate a consensus HCV clone which would be fully replicative in chimpanzees. Several groups reported the successful infection of chimpanzees by intrahepatic inoculation of infectious HCV RNA transcribed from consensus cDNAs constructed by comparison with several full-length clones (Kolykhalov *et al.*, 1997; Beard *et al.*, 1999; Lanford *et al.*, 2001). Inoculation of these constructs made the animals seropositive for HCV, although these transcripts could not replicate in cell culture (Kolykhalov *et al.*, 1997).

1.4.3.1. JFH-1 Infectious Clone

A serious drawback of replicon system had been the failure to produce viral particles and the ability to passage the infection to naïve cells. A major breakthrough came when a full-length replicon was constructed using the JFH-1 clone (Figure 1.10), a genotype 2a HCV genome isolated from a Japanese patient suffering from fulminant hepatitis. This replicon efficiently replicated in cell culture without the need of any adaptive mutations and produced viral infectious particles (Lindenbach *et al.*, 2005; Wakita *et al.*, 2005). These viral particles could be isolated by sucrose gradient centrifugation and could be visualized by immuno-electron microscopy. Such particles could infect naïve Huh7 cells in culture, and were also infectious *in vivo* when injected in chimpanzees (Wakita *et al.*, 2005; Lindenbach *et al.*, 2006). The replication and virion production capacities of JFH-1 replicon were improved by constructing a chimeric replicon of JFH-1 that contained structural proteins from another 2a isolate termed J6 (Pietschmann *et al.*, 2006). The development of JFH-1 has allowed the study of the complete viral life cycle *in vitro*, including steps that were previously inaccessible such as viral particle assembly and infectious particle secretion.

1.4.4. HCV Replicon Model

In 1999 Lohmann *et al.*, made a major breakthrough in HCV research when they reported the development of the HCV replicon system (Lohmann *et al.*, 1999). It was hypothesized that the HCV genome should adapt to the particular environment of cancer-derived hepatocytes in culture to form infectious clones. In order to achieve stable autonomous replication of subgenomic HCV RNA, this new replicon system contained a Neomycin selection marker (Lohmann *et al.*, 1999). The coding sequence of the structural proteins and NS2 of the Con1 consensus sequence was replaced by Neomycin Phosphotransferase (a selectable antibiotic resistance marker) together with the EMCV IRES to produce a bicistronic replicon (Figure 1.10). When this subgenomic replicon was transfected into HuH7 cells, neomycin sulphate-resistant colonies were obtained that contained autonomously replicating replicon RNAs (Lohmann *et al.*, 1999). Several mutations (now termed as cell culture adaptive mutations) were identified in these autonomously replicating RNAs and it was demonstrated that these mutations significantly enhanced the replication of the replicon RNAs (Krieger *et al.*, 2001; Lohmann *et al.*, 2001). A major cluster of such mutations was found in NS5A, that increased the RNA replication by almost 10,000 fold, along with some mutations present in NS3 and

NS5B (Blight *et al.*, 2000; Lohmann *et al.*, 2001). Although some of these mutations have been shown to alter the phosphorylation status of NS5A, the exact mechanisms are largely unknown (Evans *et al.*, 2004). In 2002 Pietschmann *et al.* modified the subgenomic replicon and generated a selectable full-length replicon containing the entire genome of HCV (Pietschmann *et al.*, 2002). This replicon clone could autonomously replicate *in vitro*, although it did not produce any viral particles. Pietschmann *et al.* hypothesized that Huh7 cells may lack certain factors that are indispensable for virion production; however this theory was disproved by production of viral particles in the same cells by infection with the JFH-1 clone (Wakita *et al.*, 2005). However, due to the expression of functional viral enzymes, the HCV replicon system has proved to be the model of choice for study of viral RNA replication, host-pathogen protein interactions and antiviral drug design.

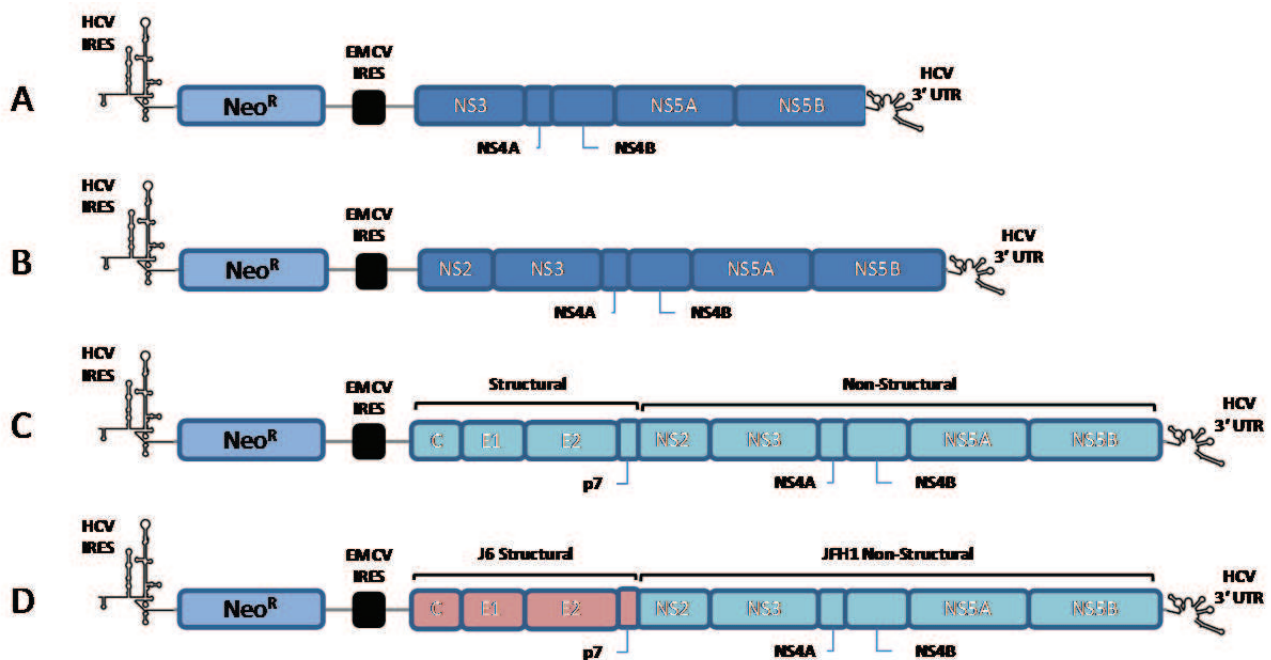

Figure 1.10: Schematic representation of the HCV Replicon System. A) sub-genomic replicon, B) sub-genomic replicon with all non-structural proteins, C) JFH1 full-length replicon, D) JFH1-J6 hybrid full-length replicon. Neomycin resistance gene (Neo^R) can be replaced by a reporter gene such as Luciferase or Secreted Alkaline Phosphatase (SEAP) to produce replicon constructs that can be used in transient replication assays.

1.4.5. Animal Models

A small animal model is very important to understand the mechanisms that underlie viral pathogenesis and would expedite the development of new therapies against HCV infection (Ploss *et al.*, 2009b). However HCV has a very limited natural species tropism for humans and chimpanzees. Even before the discovery of HCV, infectious studies revealed that the chimpanzee (*Pan troglodytes*) was susceptible to infection by the then-unknown causative agent of non-A non-B hepatitis (Alter *et al.*, 1978). Many early studies of NANBH used the chimpanzee model. Indeed, the first isolation of HCV was performed in NANBH-infected chimpanzee (Choo *et al.*, 1989; Bradley *et al.*, 1991). HCV infection in chimpanzees follows a similar course to that observed in humans. Viral RNA is detectable in the plasma within a few days after infection, followed by acute hepatitis characterized by a rise in serum aminotransferase levels within 2-12 weeks of infection and development of HCV-specific antibodies. Although the chimpanzee model has proved to be a relevant model for study of functional viral genomics, monoclonal infections, host immune responses and liver gene expression (*reviewed in* (Couto *et al.*, 2006)), its use as an experimental model for HCV research is limited for several reasons: firstly, there is a low rate of chronic infection; a lack of fibrosis; a limited availability of animals; their protected species status; ethical constraints and high cost of experimentation. The *Tupaia belangeri* is another primate model of HCV infection; however, in a manner similar to chimpanzees, acute infection is quickly resolved and these animals rarely develop chronic infection (Xie *et al.*, 1998). No other non-human primate has been shown to be permissive to HCV infection.

Perhaps the most promising animal models in the study of HCV are murine models. Several groups have developed transgenic mice expressing either one or more HCV proteins (Moriya *et al.*, 1997; Pasquinelli *et al.*, 1997) or the complete ORF of HCV (Lerat *et al.*, 2002). Although transgenic mouse models have been very useful in study of virally-induced pathogenesis, a major drawback of such models is the absence of an immune response against these viral proteins. To overcome this limitation, conditional transgenic mice have been developed by using Cre/loxP system, in which transgene expression is activated only after infection with an adenoviral vector that expresses Cre recombinase (Wakita *et al.*, 2000). However, a major flaw of this model is the fact that adenovirus alone has been shown to cause hepatitis, hence it remains unclear whether the pathogenic effects observed were caused by HCV proteins or by adenoviral proteins.

Another murine model is that of xenografted chimeric liver mice, in which human hepatocytes, which are permissive for HCV infection, are transplanted into mice. In one such model, immunodeficient SCID mice are used which contain a lethal transgene encoding urokinase type plasminogen activator (uPA) under the control of a liver specific promoter, leading to the targeted destruction of hepatocytes (Mercer *et al.*, 2001; Meuleman *et al.*, 2005). These depleted hepatocytes are then replaced by a graft of human hepatocytes. These mice have been shown to develop a prolonged HCV infection and produce infectious virus after inoculation with infected patient's serum (Mercer *et al.*, 2001) Similarly JFH1 infectious viral particles have also been shown to be infective in these mice (Lindenbach *et al.*, 2006; Kaul *et al.*, 2007). A similar model was developed by re-colonizing murine liver with human hepatocytes in normal mice whose hematopoietic system was reconstituted by using the bone marrow of SCID mice after full body irradiation (Ilan *et al.*, 2002). Use of uPA lethal transgene makes these mice very difficult to handle because of early hepatotoxicity. Recently another similar mouse model, termed the FRG model, has been developed, which unlike uPA-SCID mice, the FRG model allows the prevention of very early hepatotoxic effects via the use of 2-(2-nitro-4-trifluoromethylbenzyl)-cyclohexane-1,3-dione (NTBC), thus making the mice easier to handle (Azuma *et al.*, 2007). Despite the fact that these models allow researchers to bypass the species barrier of HCV infection, these models have a single major drawback: the absence of an immune response. To overcome this flaw, several groups have developed parallel xenograft mouse models in which the murine immune system is replaced by a functional human immune system by injecting human hematopoietic stem cells. In one example, after reconstitution of the immune system, the murine liver cells are destroyed by the expression of activated caspase 8 under the control of an inducible liver-specific promoter. The murine liver is then re-colonized by human hepatocyte progenitor cells (Washburn *et al.*, 2011).

As well as being susceptible to HCV infection, these chimeric xenograft mouse models have been successfully used in several investigations to test antiviral compounds (Kneteman *et al.*, 2006; Bissig *et al.*, 2010). Although these models exhibit symptoms of acute HCV infection, the development of pathologies associated with chronic infection such as cirrhosis and HCC have not yet been reported, indicating that these models are of limited interest for the study of chronic HCV associated pathologies (Lerat *et al.*, 2011). In addition, these models require human hepatocytes as well as specialized surgical skills, making them technically complex models that are therefore not widely available.

1.4.6. Viral Vectors for HCV protein expression

HCV subgenomic and full-length replicon systems have been extensively used to study viral replication, pathogenesis and protein properties. However, to study the functions and pathogenic properties of a particular protein, it may be necessary to analyze that protein out of context of other viral proteins or in context of only a few selected viral proteins. Often transfection of naked plasmid DNA encoding the gene of interest is used to express a particular protein in cultured cells. However, this approach has several drawbacks. Certain cell types, particularly primary cells, are resistant to transfection (Gardmo *et al.*, 2005). In addition, transfections performed by electroporation or by using transfection reagents affect the viability of the transfected cells. Moreover, naked DNA transfections cannot be used to deliver transgenes *in vivo*. Therefore, viral vectors have been developed to as an alternative to transfections for delivery of expression vectors into cells. Viral vectors have several advantages over transfections: a high transduction efficiency can be achieved without causing serious harm to cells, and viral vectors can be used to express transgenes *in vivo*. However, the construction of viral vectors is relatively laborious, hence naked DNA transfections are still a method of choice for certain applications.

Hepatoma cells, which are required for efficient culture of HCV *in vitro*, harbor multiple genomic mutations and deletions which impact several cell signaling pathways involved in carcinogenesis, therefore impairing any related studies. Therefore, primary cultures of human or murine hepatocytes are considered to be the most relevant tools for *in vitro* studies for HCV-induced liver pathogenesis. However, such cells are difficult to transfect by traditional methods (as mentioned above). Many studies have reported that viral vectors can be used for efficient delivery of transgenes into *in vitro* cultured primary hepatocytes (Ohashi *et al.*, 2002; Seppen *et al.*, 2002), including adeno-associated viral vectors (Snyder *et al.*, 1999; Palmer *et al.*, 2005) and baculovirus-derived viral vectors (McCormick *et al.*, 2004), although the latter have proved to be less efficient than adenoviral and lentiviral vectors.

1.4.6.1. Adenoviral Vectors

Adenoviruses are dsDNA viruses of 60-90nm diameter. The main targets of adenoviruses are epithelial cells and they cause mild infections of the upper respiratory and gastrointestinal tracts. Most infections are self-limiting and asymptomatic, and to date no association between adenoviral infections and neoplastic disease has been reported. When injected intravenously,

adenoviruses show efficient infection of liver endothelial cells and hepatocytes (Chan 1995). This has made modified adenoviruses a promising vehicle for transgene delivery (Benihoud *et al.*, 1999). The last-generation adenoviral vector, also called ‘Helper dependent Adenoviral vector (HdAd)’ or “gutless adenoviral vector”, has become a vector of choice for *in vivo* transgene delivery (Palmer *et al.*, 2003; Jozkowicz *et al.*, 2005). HdAd are developed by deleting all coding sequences from the viral genome and leaving only the inverted terminal repeats (ITRs) and a packaging signal ψ (Figure 1.17) (Palmer *et al.*, 2003). The deleted viral genes are replaced with a transgene expression cassette and “stuffer” sequence (Kochanek *et al.*, 1996). Besides making HdAd safer, the removal of coding sequences also allows the use of larger transgene cassettes (Segura *et al.*, 2008). The recombinant adenoviral particles are then produced by co-transfection of helper adenovirus genomes into producer cells to obtain high titer HdAd vector preparations (Palmer *et al.*, 2003; Sakhuja *et al.*, 2003). These vectors have demonstrated an enormous potential as hepatic transgene delivery vehicle without causing any chronic inflammation (Brunetti-Pierri *et al.*, 2004; Palmer *et al.*, 2005). Besides the high efficacy of transduction, these vectors have been also used for long term transgene expression with a single injection of recombinant adenovirus particles (Kim *et al.*, 2001). Another important advantage of adenoviral vector is that it is not integration competent and has not been associated with any malignant transformations following transduction (Palmer *et al.*, 2005).

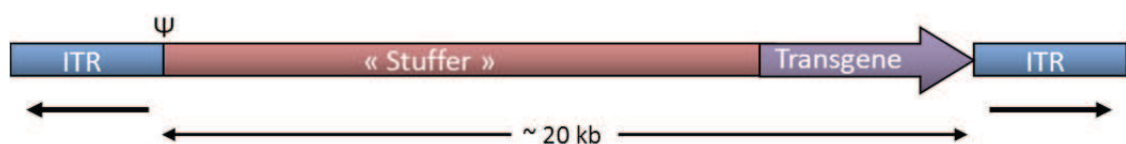

Figure 1.11: A schematic diagram of the Helper dependent Adenoviral vector (HdAd) genome. The transgene cassette and Stuffer DNA is flanked by inverted terminal repeats (ITR) along with a packaging signal (Ψ).

1.4.6.2. Lentiviral Vectors

Lentiviral vectors (LVs) developed from Moloney Murine Leukemia Virus (MoMLV) or Human Immunodeficiency Virus 1 (HIV-1) have a broad tropism and can stably transduce hard-to-transfect quiescent cells (such as neurons and cultured primary hepatocytes) (Lewis *et al.*, 1994; Zufferey *et al.*, 1998). Upon entry into the host cell, the ssRNA genome of LVs is

reverse transcribed into dsDNA that is actively transported to the host cell nucleus without the need of cell division as is required for other retroviruses (Bukrinsky *et al.*, 1993; Naldini 1998). Once in the nucleus, viral dsDNA genome is integrated into the host cell DNA hence stably transducing the target cell. These characteristics have made LVs an attractive vehicle for transgene delivery into mammalian cells. The last generation LVs are replication deficient and also lack the accessory genes *vpr*, *vif*, *nef* and *vpu* hence improving vector safety. Despite being replication deficient, LVs are integration competent and have a tendency to integrate into transcriptionally active regions (Schroder *et al.*, 2002). This leads to insertional mutagenesis and has been reported to cause malignant transformations (Hacein-Bey-Abina *et al.*, 2008). The carcinogenetic potential of LVs has created complications for their use as gene therapy vectors, although they remain very attractive transgene delivery vehicles for *in vitro* cultured cells (Naldini 1998; Williams 2009).

1.5. HCV Life Cycle

Although the liver has been identified as the primary site for HCV replication, some studies have suggested the existence of extra-hepatic sites of viral replication. Studies using highly specific methods for detection of HCV negative strand RNA have demonstrated that peripheral blood mononuclear cells (PBMCs) are permissive for very low levels of HCV replication (Cribier *et al.*, 1995; Lerat *et al.*, 1996). It has been further reported that the presence of HCV RNA negative strand in PBMCs was higher for genotype 1-infected patients as compared to other genotypes and that negative strand RNA could be detected in polymorphonuclear leukocytes, monocytes and B lymphocytes but not in T lymphocytes (Lerat *et al.*, 1998). Another study has reported the detection of negative strand viral RNA in brain tissue of patients with recurrent HCV infection after liver transplantation (Vargas *et al.*, 2002). However, the existence of extra hepatic reservoirs of HCV is still disputed and role of such HCV replication in pathogenesis is yet to be studied. The majority of studies on HCV have therefore focused on its hepatic life cycle.

The development of *in vitro* models capable of sustaining HCV replication and producing infectious HCV virions (Lohmann *et al.*, 1999; Wakita *et al.*, 2005); described in detail in Section 1.4), have allowed an understanding of viral entry and RNA replication, although the

relatively recent discovery of the JFH-1 infectious clone of HCV means that HCV assembly and release remain poorly understood (Figure 1.12).

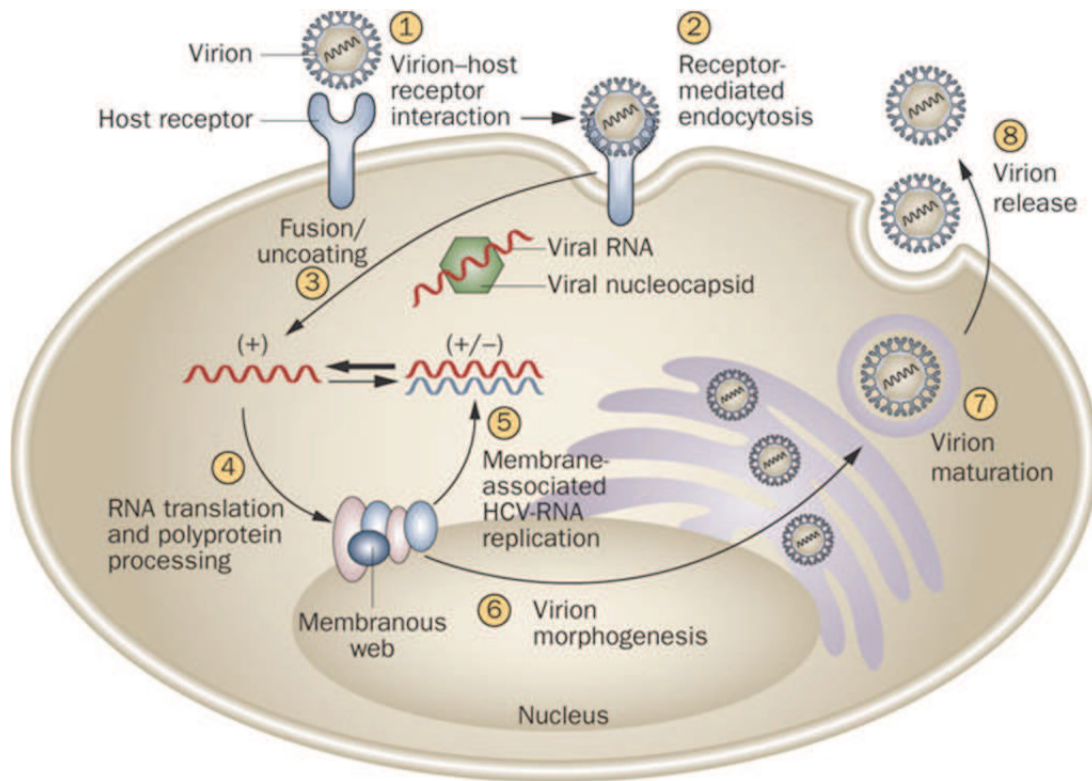

Figure 1.12: The HCV Life Cycle (from (Pereira *et al.*, 2009))

The viral particles attach to the cell surface by interacting with receptors. Following endocytosis-mediated internalization (1, 2), capsids are disintegrated leading to release of genomic RNA into the cytoplasm (3). Genomic RNA is used as an mRNA to translate viral proteins (4). Translated viral proteins use the genomic RNA to produce negative strand RNA which is then used as template to synthesize new genomic RNA strands (5). The new virions are assembled from translated proteins (6) and newly-synthesised RNA and exported to the cell surface (7).

1.5.1. Virion Attachment and Entry

The viral life cycle starts with virion attachment and subsequent entry into the host cell. Initial attachment of the virus to a host cell is believed to be random and nonspecific. It is well established that viral particles circulating in the blood of an infected patient are associated with LDLs or VLDLs (Nielsen *et al.*, 2006). It has been demonstrated that antibodies against

LDL-R or the apo-E and apo-B lipoproteins can inhibit HCV infection in a dose-dependent manner, suggesting that HCV targets host cells via interaction with the LDL receptor LDL-R (Bartosch *et al.*, 2003b; Chang *et al.*, 2007; Molina *et al.*, 2007). Glycosaminoglycans (GAGs) have been shown to play an essential but undefined role in HCV virion attachment and thus entry into target cells (Barth *et al.*, 2003; Koutsoudakis *et al.*, 2006). It has also been reported that two molecules of the C-Type Lectin family; L-SIGN and DC-SIGN, like LDL-R and GAGs, help to capture and concentrate circulating viral particles, although they are not involved in viral entry (Lai *et al.*, 2006).

Following nonspecific receptors mediated attachment of viral particles to the cell surface; virions interact with specific receptors to promote entry into the host cell (reviewed in (Dubuisson *et al.*, 2008)). Several studies have identified four different specific receptors. CD81 was the first molecule to be identified as an HCV-specific receptor (Pileri *et al.*, 1998). The viral E2 protein has been shown to interact with large extracellular loop (LEL) of CD81 via four conserved residues L162, I182, N184 and F186 (Drummer *et al.*, 2002; Owsianka *et al.*, 2006; Helle *et al.*, 2008). Several studies have confirmed that CD81 is essential for viral entry in target cells both in HCVpp and HCVcc models (Bartosch *et al.*, 2003b; Cormier *et al.*, 2004; Kapadia *et al.*, 2007). Recently a study has identified certain mutations in envelope glycoproteins E1 and E2 that increase their interaction with murine CD81 and enhance viral entry into murine hepatocytes by more than 100 fold in the absence of human entry factors (Bitzegeio *et al.*, 2010). Although CD81 binding is essential, it is not sufficient for viral entry (Zhang *et al.*, 2004; Owsianka *et al.*, 2006).

Another specific viral receptor; the scavenger receptor class B type 1 (SR-B1) is a cell surface glycoprotein comprised of two transmembrane domains, one large extracellular loop and two short intracellular domains. Inhibition of SR-B1 expression or anti-SR-B1 antibodies have been shown to inhibit HCVpp and HCVcc internalization (Voisset *et al.*, 2005; Catanese *et al.*, 2007) whereas its over-expression has been shown to increase viral internalization (Schwarz *et al.*, 2009). Recently a study has confirmed that SR-B1 plays a specific and direct role in HCV penetration into target cells (Catanese *et al.*, 2010).

CD81 and SR-B1 are required but not sufficient for viral entry into target cells. Attempts made to identify cellular genes that can render non-permissive cells susceptible to HCV infection resulted in identification of Claudin-1 (CLDN1) as an essential viral entry receptor

(Evans *et al.*, 2007). CLDN1 is a member of tetraspanin tight junction protein superfamily which have play an important role in maintenance of cell permeability and polarity in epithelial and endothelial tissues (Lal-Nag *et al.*, 2009). It has been proposed that CLDN1 is involved in later stages of viral penetration into target cells, after HCV interaction with CD81 (Evans *et al.*, 2007). Very recently it has been demonstrated that monoclonal anti-claudin1 antibodies inhibit HCV infection in cultured primary human hepatocytes (Fofana *et al.*, 2010). Although knock-down of CLDN1 expression in cultured hepatocytes makes them less permissive, overexpression of CLDN1 does not increase permissiveness to viral entry (Evans *et al.*, 2007; Schwarz *et al.*, 2009).

Recently another study has identified another tight junction protein, Occludin (OCLN); as a cofactor required for HCV entry (Liu *et al.*, 2009; Ploss *et al.*, 2009a). As for CD81 and SR-B1, OCLN directly interacts with glycoprotein E2 and functions at late stages of viral entry in a similar fashion to CLDN1 (Benedicto *et al.*, 2009; Liu *et al.*, 2009).

When the above described four receptors of human origin (CD81, SR-B1, CLDN1 and OCLN) are overexpressed in non-permissive murine or hamster cells (CHO and NIH3T3) these cells become infectable by HCVpp suggesting that these four receptors are sufficient for viral entry into target cells (Ploss *et al.*, 2009a). These observations gave rise to hopes that a murine model permissive to HCV infection was feasible. However it has been reported that transgenic mice expressing all four receptors of human origin were not permissive to infection by HCV from patients' sera nor to entry of HCVpp into hepatocytes (Hikosaka *et al.*, 2011). Interestingly, it has been reported very recently that expression of the minimal human factors CD81 and occludin is sufficient to allow HCV infection of fully immunocompetent mice (Dorner *et al.*, 2011).

It has been suggested that after receptor binding, HCV virions internalized by clathrin-mediated endocytosis (Hsu *et al.*, 2003; Blanchard *et al.*, 2006; Meertens *et al.*, 2006). After endocytosis, viral glycoproteins fuse with the endosomal membrane and release the viral genome into cytoplasm (Hsu *et al.*, 2003; Koutsoudakis *et al.*, 2006; Meertens *et al.*, 2006). However the detailed mechanisms involved in the fusion and release of viral genetic material are still elusive, and require further study.

1.5.2. RNA Translation and Polyprotein Processing

Like other single-stranded positive sense RNA viruses, genomic HCV RNA is directly translated upon release of the viral genome into the cytoplasm. Host cell ribosomal machinery is used to translate the viral genome into the viral polyprotein precursor. Contrary to cellular mRNAs, genomic HCV RNA translation is not cap-dependent. Instead, translation occurs after binding of the ribosomal 40S subunit to domain II of the IRES, allowing the recruitment of eukaryotic initiation factor eIF3 and the subsequent assembly of a complete ribosomal complex that translates the viral genome into a polyprotein precursor (Figure 1.13) (Fraser *et al.*, 2007) (Tsukiyama-Kohara *et al.*, 1992). This polyprotein precursor is then cleaved by viral and cellular proteases to produce ten viral proteins (Grakoui *et al.*, 1993) (for details please refer to section 1.3.3.2).

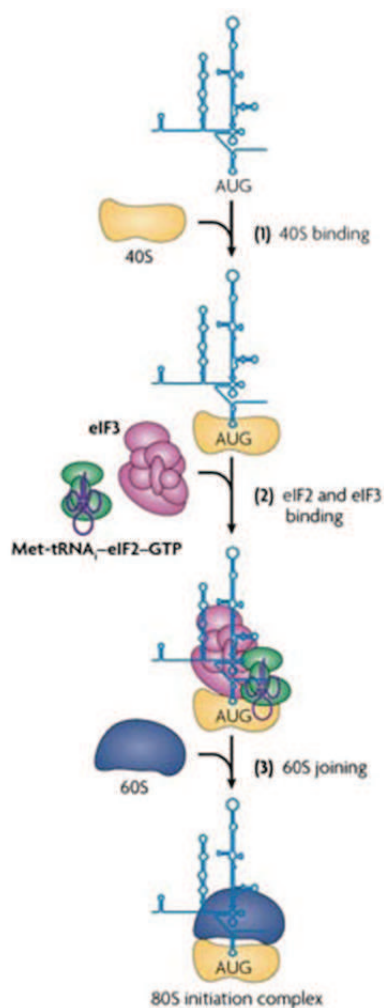

Figure 1.13: Schematic diagram of the role of the HCV IRES in the assembly of ribosomal complexes and translation initiation (*adapted from* (Fraser *et al.*, 2007).

1.5.3. RNA Replication, Virion Assembly and Release

HCV genome translation and polyprotein processing leads the release of the HCV proteins, and the initiation of viral replication complex formation. The viral replication complex (RC) is thought to be formed in modified endoplasmic membrane structures called membranous webs (Gosert *et al.*, 2003; Shi *et al.*, 2003). The formation of membranous webs is thought to be mediated by NS4B, and it has been demonstrated that NS4B alone can induce such structures (Egger *et al.*, 2002). RCs formed inside the membranous web contain the complete cellular machinery needed for viral RNA replication (Egger *et al.*, 2002; Waris *et al.*, 2004). In a manner similar to other positive strand RNA viruses, the viral genome is transcribed into an intermediate RNA of negative polarity which serves as template for the synthesis of multiple viral genomic RNAs of positive polarity (Fong *et al.*, 1991; Lohmann *et al.*, 1999). Recently it has been demonstrated that negative and positive strand RNAs form a double-stranded RNA intermediate which undergoes strand displacement to produce nascent strands (Targett-Adams *et al.*, 2008). Synthesis of negative polarity RNA as well as positive polarity RNA is catalyzed by the viral RNA dependent RNA polymerase (RdRp) NS5B (for detailed description of NS5B, please refer to section 1.3.3.9). NS5B has the potential to synthesize long RNA molecules without any need of other viral or host cell factors; however, it lacks template specificity (Lohmann *et al.*, 1997). It has been propose that other factors (viral and cellular) present in the replication complex may play a role to ensure the template specificity of the viral RdRp.

The mechanisms surrounding the later steps in viral production are still unclear. It has been demonstrated that core protein is found on lipid droplets (LDs) that colocalize with replication complexes (Miyanari *et al.*, 2007) and that disruption of interaction between lipid droplets and core protein, reduces the production of infective viral progeny (Boulant *et al.*, 2007). Newly synthesized viral RNAs destined to serve as genomes for new virions interact with LD-associated core protein, inducing its oligomerization and leading to the formation of nucleocapsids, which then acquire an envelope derived from host cell membranes carrying viral glycoproteins (Figure 1.14) (Tanaka *et al.*, 2000; Nakai *et al.*, 2006; Suzuki 2011). Besides the structural proteins, non-structural proteins also play an important role in viral assembly. Certain mutations in NS5A that abolish the interaction between NS5A and LDs have been shown to reduce the production of infectious particles (Miyanari *et al.*, 2007). Other studies have demonstrated important interactions between NS5A and core protein that

are essential for viral assembly (Appel *et al.*, 2008; Masaki *et al.*, 2008; Tellinghuisen *et al.*, 2008). Similarly, several publications have reported the implication of NS2 and NS3 in viral assembly (Ma *et al.*, 2008; Dentzer *et al.*, 2009).

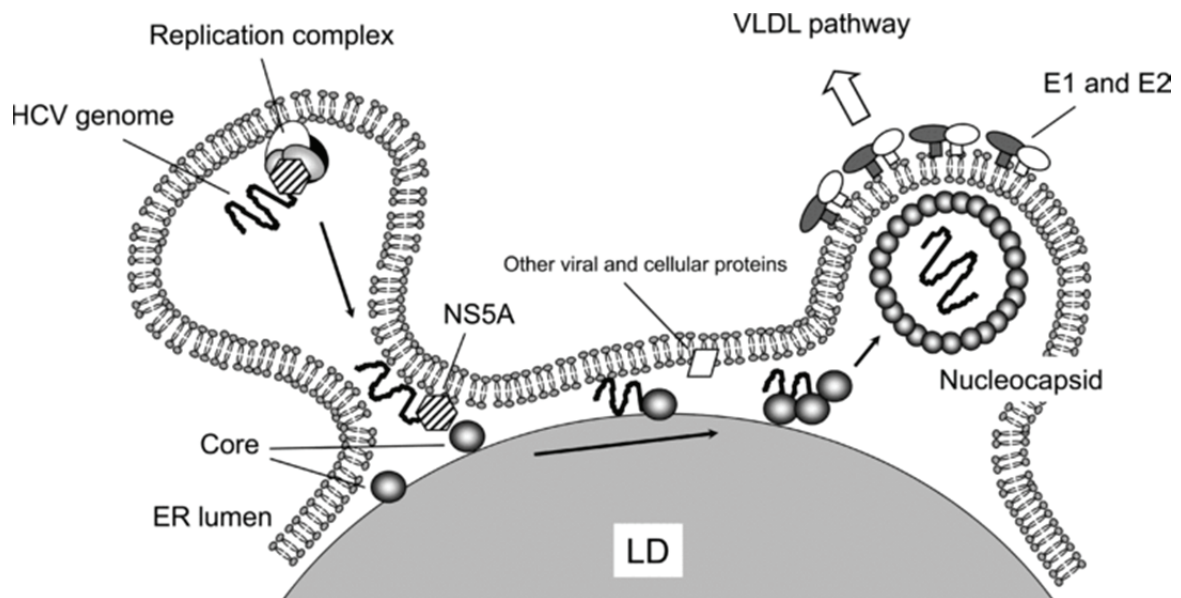

Figure 1.14: Assembly of HCV particles. Newly synthesized genomic RNAs (left) come into contact with LD-associated Core protein, possibly via an interaction between NS5A and Core. This interaction of genomic RNA with Core protein ultimately leads to its encapsidation and nucleocapsid formation (right). Then, through still unknown mechanisms, E1 and E2 are added to the nucleocapsid and virions are then exported to the cell surface.

Newly synthesized virions are then exported to the cell surface via an as-yet-unknown mechanism and released into extracellular medium. Not much is known about the further maturation and export of virions after nucleocapsid assembly and acquiring of their envelope. Some studies have suggested that HCV may exploit LDL/VLDL synthesis and secretion pathways to transport progeny virions into the extracellular medium. Another study has suggested that, besides secretion, the VLDL secretion pathway may well be important during virion assembly (Chang *et al.*, 2007). It has been observed that inhibition of VLDL synthesis by inhibitor molecules or by siRNAs targeting apoB reduces the production of infectious virions (Huang *et al.*, 2007b; McLauchlan 2009b).

1.5.4. Regulation of HCV replication by host factors.

Besides the viral proteins, many host proteins have also been reported to directly or indirectly participate in viral replication. HCV RCs appear to be transported to lipid rafts, where HCV RNA replication may take place, and it has been demonstrated that HCV replication is closely tied to host lipid metabolism (Aizaki *et al.*, 2004). Accordingly, it has been demonstrated that apolipoprotein E (apoE) is indispensable for both production and infectivity of virions (Chang *et al.*, 2007). More recent studies have reported that the lipid kinase PI4KIII α is a key factor in HCV RNA replication. It has been demonstrated that NS5A plays a role in the activation of PI4KIII α via a direct interaction, and that this interaction is critical for the stability of the membranous compartment surrounding the viral RNA replication complex (Borawski *et al.*, 2009; Vaillancourt *et al.*, 2009; Reiss *et al.*, 2011).

Several host proteins have been reported to directly or indirectly interact with viral proteins involved in replication. Cyclophilin B has been shown to directly interact with NS5B, regulating its association with viral RNA, and inhibitors of cyclophilin B have been shown to reduce viral replication (Watashi *et al.*, 2005). Similarly, cyclophilin A has been reported to be essential for HCV replication and suggested to play a role in polyprotein cleavage (Kaul *et al.*, 2009). Furthermore, yet other studies have reported that FKBP9, hsp90 and hVAP-B proteins interact with NS5A and this interaction is indispensable for viral replication (Hamamoto *et al.*, 2005; Okamoto *et al.*, 2006).

Many efforts are currently being made to identify host proteins involved in viral replication. Several studies using high-throughput RNAi based screening methods have reported the identification of several cellular proteins that are essential for HCV replication (Ng *et al.*, 2007; Randall *et al.*, 2007; Supekova *et al.*, 2008; Borawski *et al.*, 2009). Although the exact mechanisms are not known, these studies have identified several host factors (for example TBXA2R, TRAF2, SNARK and PI4KIII α) whose expression is necessary for efficient HCV replication *in vitro* (Ng *et al.*, 2007). Another study found several host nuclear proteins that are essential for viral replication, suggesting that host proteins may also indirectly regulate viral replication, possibly via the activation of host cell pathways which impact on HCV RNA replication (Li *et al.*, 2009).

The high mutation rate of HCV results in the emergence of viral mutants that are resistant to antiviral therapies that target viral proteins. Moreover, current antiviral treatment consisting of interferon and ribavirin is not equally efficient across different genotypes. Although our knowledge about host proteins involved in HCV replication is still very limited, targeting interactions between viral and host proteins has been suggested to be a promising approach for future design drugs with a greater barrier of resistance as well complementing currently available antiviral therapies (Flisiak *et al.*, 2008; Pawlotsky 2011a).

1.6. Non-Structural Protein 5A (NS5A)

NS5A is a 446aa proline rich phosphoprotein of 49kDa calculated mass but exists in two phosphorylated isoforms: a basal (56kDa) and a hyperphosphorylated (58kDa) form (Tanji *et al.*, 1995; Reed *et al.*, 1997). NS5A is a predominantly hydrophilic protein anchored to the ER membrane through an amphipathic α -helix present in its N-terminal (Brass *et al.*, 2002; Penin *et al.*, 2004b). Despite being essential to viral replication, no precise enzymatic activity has been ascribed to it and it is hypothesized that it plays a role in viral replication through its interaction with both viral and cellular proteins.

1.6.1. NS5A Structural Features

NS5A is organized into three domains called Domain I (residues 27-213), Domain II (residues 250-342) and Domain III (residues 356-447) (Figure 1.15) (Tellinghuisen *et al.*, 2004). These domains are separated by two linkers known as Low Complexity Sequences (Tellinghuisen *et al.*, 2004). The N-terminal region of NS5A carries a highly conserved hydrophobic amphipathic alpha helix (residues 1-26) which serves as an ER membrane anchor for NS5A (Brass *et al.*, 2002). It has also been suggested that NS5A is a zinc-metalloprotein and can form dimers that contain a potential RNA binding groove (Tellinghuisen *et al.*, 2004), a suggestion further confirmed by X-ray crystallography studies of NS5A showing that Domain I is a zinc binding domain with potential RNA-binding activity (Huang *et al.*, 2005). Recently it has been reported that Domain I can also adopt an alternative structure that may be required for RNA replication or viral particle assembly (Love *et al.*, 2009). Although the precise enzymatic function of Domain I remains elusive, it has proved to be a promising target for anti-HCV drugs (Gao *et al.*, 2010). In contrast, Domains II and III are natively unfolded (Tellinghuisen *et al.*, 2004; Liang *et al.*, 2007; Hanouille *et al.*, 2009a; Hanouille *et al.*, 2010).

Although some parts of Domain II can be deleted without any effects, it is indispensable for viral RNA replication (Appel *et al.*, 2008; Tellinghuisen *et al.*, 2008; Yang *et al.*, 2010). A recent study has demonstrated that Domain II is a substrate for the Peptidyl-prolyl cis/trans Isomerase (PPIase) Activity of Cyclophilins A and B (Hanouille *et al.*, 2009b). Domain III has been shown to be not required for viral RNA replication but is essential for viral particle assembly in the JFH1 model (Appel *et al.*, 2008; Tellinghuisen *et al.*, 2008).

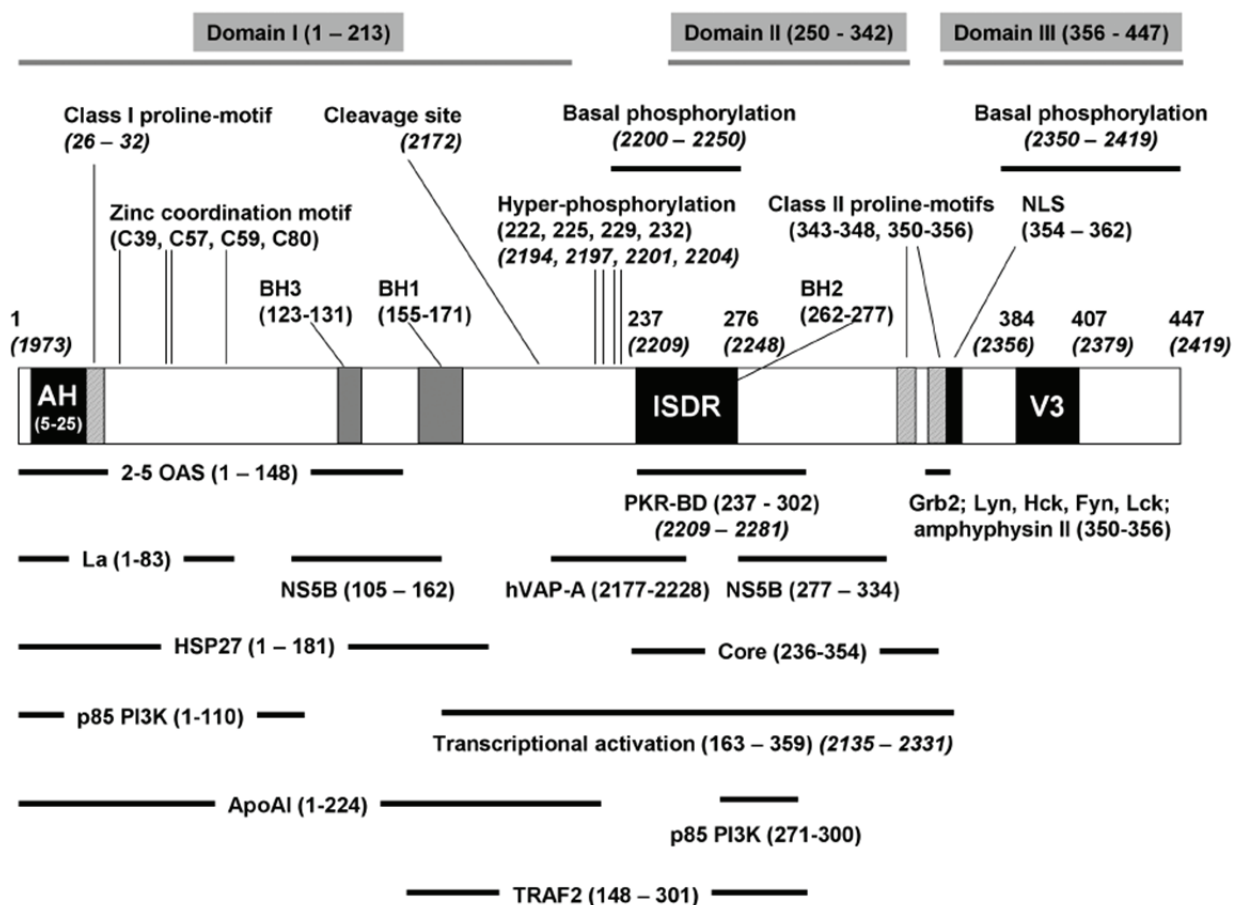

Figure 1.15: Schematic diagram of NS5A representing the major structural and functional features. NS5A is divided into three domains; Domain I (aa 1- 213), Domain II (aa 250-342) and Domain III (aa 356-447) (*adapted from (He et al., 2006).*

1.6.2. Role of NS5A in the viral life cycle

Although no precise enzymatic function is currently known for NS5A, it is an absolutely essential component of the HCV replication complex. As described previously, NS5A is a zinc binding metalloprotein that is organized into three distinct structural domains (Tellinghuisen *et al.*, 2004). The N-terminal Domain I of NS5A has been shown to be involved in the homodimerization of NS5A. This dimerization results in the formation of a basic cleft that shows a high affinity for pyrimidine rich sequences in the untranslated regions of HCV genomic RNA (Huang *et al.*, 2005; Tellinghuisen *et al.*, 2005; Love *et al.*, 2009). Interaction of NS5A with viral genomic RNA is thought to be critical for viral replication (Huang *et al.*, 2005). Recently, it has been suggested that NS5A homodimers may come together in large oligomer arrays that may transport viral RNA within the cell (Gao *et al.*, 2010). A drug (BMS-790052) that is thought to disrupt such NS5A oligomers has proved to be a potent inhibitor of HCV replication and is in early clinical trials for anti-HCV therapy (Gao *et al.*, 2010).

Domain I of NS5A is essential for its interaction with lipid droplets and hence critical for virus production (Miyazari *et al.*, 2007). Similarly, Domain III has been shown to play an essential role in viral particle assembly (Appel *et al.*, 2008; Tellinghuisen *et al.*, 2008). Current data show that there is an inverse correlation between NS5A adaptive mutations that facilitate RNA replication and particle assembly (Appel *et al.*, 2005a; Tellinghuisen *et al.*, 2008). A recent study has reported that phosphorylation of serine 457 in JFH1 replicon system regulates viral particle production (Tellinghuisen *et al.*, 2008).

1.6.2.1. NS5A phosphorylation modulates its functions.

NS5A is phosphorylated by several cellular kinases such as casein kinase I- α (CKI- α), casein kinase II (CKII), Mitogen activated protein kinase (MAPK), Protein Kinase B (Akt), Mitogen-activated protein kinase kinase 6 (MKK6), Glycogen synthase kinase 3 (GSK3) and protein kinase alpha (PKA) (Ide *et al.*, 1997; Reed *et al.*, 1997; Kim *et al.*, 1999; Coito *et al.*, 2004). However, only CKI- α has been shown to be involved in its hyperphosphorylation (Quintavalle *et al.*, 2007). NS5A carries three conserved serine clusters in its central and C-terminal region. These clusters serve as phosphorylation sites; however, only cluster I is thought to be responsible for hyperphosphorylation (Quintavalle *et al.*, 2006). It has been reported that NS5A phosphorylation occurs after its cleavage from polyprotein precursor and

depends upon proper conformation of the protein. Besides cleavage and conformation, NS5A phosphorylation also depends on interactions with other viral proteins, for example, hyperphosphorylation of NS5A requires the presence of NS3, NS4A and NS4B (*reviewed in* (Huang *et al.*, 2007a)). Although phosphorylation of NS5A does not affect its subcellular localization (Tanji *et al.*, 1995), the half-life of NS5A appears to be inversely correlated to its degree of phosphorylation (Pietschmann *et al.*, 2001). Cell culture-adaptive mutations observed with the subgenomic replicon system which lead to loss of NS5A hyperphosphorylation have been reported to enhance viral RNA replication (Blight *et al.*, 2000; Appel *et al.*, 2005a). Similarly, inhibition of NS5A hyperphosphorylation by using small molecule kinase inhibitors enhanced replicon RNA replication (Neddermann *et al.*, 2004). Moreover, only basally phosphorylated form of NS5A (p56) is found in the membranous web along with other viral proteins that make the replication complex (Waris *et al.*, 2004). These observations suggest that only the hypo-phosphorylated p56 isoform of NS5A is required for HCV RNA replication. As the phosphorylation state of NS5A does affect its binding capacity to NS5B RdRp, it was hypothesized that NS5A phosphorylation mediates RNA replication through indirect mechanisms. In agreement, it was reported that hyperphosphorylation of NS5A inhibits its interaction with human vesicle-associated membrane protein-associated protein (hVAP-33) which is involved in intracellular vesicular trafficking. This results in a disruption of replication complex formation and an inhibition of viral RNA replication (Evans *et al.*, 2004; Gao *et al.*, 2004). More recently it has been demonstrated that NS5A phosphorylation may also play direct role in inhibition of viral RNA replication by modulating the binding of NS5B to the RNA template (Ivanov *et al.*, 2009).

Taken together, these observations suggest that NS5A may function as a molecular switch between viral RNA replication and particle assembly, depending on its phosphorylation state.

1.6.3. Interactions of NS5A with key actors of host cell pathways

Many of the HCV viral proteins interact with host cell signal pathways to modulate them in a targeted manner. HCV NS5A has been reported interact with numerous host cell proteins. It can be envisaged that both differences in phosphorylation, and the natively unfolded nature of Domains II and III, gives NS5A the ability to adopt different conformations and thus interact with many different host proteins (Hanouille *et al.*, 2009a; Hanouille *et al.*, 2010). Numerous studies have demonstrated that NS5A is involved in the modulation of host immune responses

as well as control of the cell cycle and programmed cell death (Gale *et al.*, 1997; Tan *et al.*, 2001; Macdonald *et al.*, 2005; Verdegem *et al.*, 2011).

NS5A has been implicated in the modulation of host immune responses, especially in the inhibition of interferon induced antiviral response through its interaction with the dsRNA-activated protein kinase (PKR) through its PKR binding region (residues 237-302) (Gale *et al.*, 1997). PKR is well known to be involved in the interferon-mediated cellular response to viral infections (Hovanessian 1989). However, different studies have shown conflicting results regarding the consequences of the interaction between NS5A and PKR. It has been reported that NS5A prevents PKR dimerization and thus inhibits interferon antiviral activity (Gale *et al.*, 1997; Gale *et al.*, 1998). On the other hand, some studies have suggested that NS5A does not interact with PKR and that NS5A-induced inhibition of interferon signaling is independent of PKR (Ezelle *et al.*, 2001; Podevin *et al.*, 2001). It has been suggested that, besides direct inhibition of the interferon response through interaction with PKR, NS5A may also indirectly disrupt interferon response via its interaction with the MAPK signaling pathway (He *et al.*, 2002). Furthermore, NS5A has been shown to up-regulate interleukin8 (IL8, also termed CXCL8) expression, which is known to reduce the antiviral activity of interferon, resulting in a weakening of the host antiviral response (Khabar *et al.*, 1997; Polyak *et al.*, 2001b).

Evasion of apoptosis and maintenance of cell survival are very important strategies adopted by viruses to ensure persistence of infection. NS5A is able to modulate apoptosis and cell growth by interfering with several cellular pathways. Recently it has been described that NS5A interacts with FK506-binding protein 38 (FKBP38) and impairs its interaction with mammalian target of rapamycin (mTOR) resulting in activation of the mTOR pathway leading to inhibition of apoptosis (Peng *et al.*, 2010). Similarly, interactions between NS5A and Growth receptor binding protein 2 (Grb2) results in reduced activity of extracellular signal regulated kinase (ERK) and MAPK signal transduction pathways resulting in inhibition of apoptosis (Chang *et al.*, 2001; He *et al.*, 2002; Georgopoulou *et al.*, 2003). In addition, it has been reported that NS5A can interact with the cellular tumor suppressor p53 to cause its retention in cytoplasm and reduction of nuclear p53 leading to inhibition of apoptosis (Lan *et al.*, 2002). p53 is a transcription factor that induces the transcription of several pro-apoptotic genes while inhibiting the transcription of anti-apoptotic genes. Survivin, an anti-apoptotic protein that is highly expressed in tumors and often associated with metastasis, is negatively regulated by p53 (Muchmore *et al.*, 2000; Sah *et al.*, 2006). A recent study has reported that

NS5A activates survivin via the enhanced degradation and interference of nuclear translocation of p53, thus contributing to the inhibition of apoptosis in NS5A-expressing hepatocytes (Jiang *et al.*, 2011). NS5A has also been reported to interfere with the PI3K-Akt cell survival pathway thus providing protection against apoptosis in NS5A expressing cells or replicon transfected cells (Street *et al.*, 2004; Macdonald *et al.*, 2005). These studies have demonstrated that NS5A can directly activate PI3K through its interaction with p85 regulatory subunit and p110 catalytic subunit of PI3K (He *et al.*, 2002). NS5A has also been shown to inhibit TNF-dependent apoptosis. It has been demonstrated that NS5A interacts with TNF-R1 associated death domain (TRADD) and interrupts the TRADD-FADD signaling pathway (Majumder *et al.*, 2002; Park *et al.*, 2002; Miyasaka *et al.*, 2003). In addition, another study has suggested that NS5A may interact with Bcl2 family proteins to block apoptosis (Chung *et al.*, 2003). However these studies have been conducted using either over-expressed or purified NS5A and must be interpreted carefully.

Besides preventing programmed cell death by apoptosis, NS5A also induces cell proliferation by interfering with cell cycle regulatory pathways. Some studies have suggested that NS5A perturbs cell growth by interacting with Grb2 via its C-terminal proline rich region (Tan *et al.*, 1999; He *et al.*, 2002). NS5A-mediated repression of the Grb2 pathway results in inhibition of downstream ERK and MAPK activation (Georgopoulou *et al.*, 2003). Among many other activities, the MAPK signaling pathway is known to regulate cell proliferation, suggesting that, by interfering with Grb2 and downstream MAPK pathways, NS5A may influence the cell cycle. Cyclin dependent kinases (Cdks) are cell cycle regulatory proteins that control the cell cycle progression. The Cdks are in turn regulated by inhibitory proteins such as p15, p19 and p21^{Waf1/cip1}. Several studies have demonstrated that p21^{Waf1/cip1} is down-regulated by NS5A, resulting in increased cell proliferation (Majumder *et al.*, 2001; Qadri *et al.*, 2002). It has been demonstrated that this down regulation of p21^{Waf1/cip1} by NS5A is dependent on p53, where cytoplasmic sequestration inhibition of transcriptional activity of p53 by NS5A results in inhibition of p21^{Waf1/cip1} (Majumder *et al.*, 2001; Gong *et al.*, 2004). However these results have never been reproduced *in vivo* or in replicon models that do not use over-expressed NS5A. Another study has demonstrated that NS5A forms a heterotrimeric complex with TATA box binding protein (TBP) and p53 thus preventing their function as transcription factors (Qadri *et al.*, 2002). Although NS5A interactions with cell cycle regulatory proteins have been demonstrated, the precise effects of these interactions still remain elusive and need further study.

Besides above stated pathways, NS5A has been reported to interact with several other cellular proteins such as Src-family kinases (Lyn, Lck, Fyn, Hck) (Macdonald *et al.*, 2004), amphiphysin II (Zech *et al.*, 2003), karyopherin β 3 (Chung *et al.*, 2000) and many others for whom exact physiological role remains to be studied. Indeed, some studies have reported that inhibition of interaction between a cellular geranylgeranylated protein FBL2 and NS5A significantly reduces HCV RNA replication, although the mechanisms underlying these observations remain to be determined (Ye *et al.*, 2003; Wang *et al.*, 2005).

Taken together, these reports suggest that NS5A perturbs the regulation of both apoptosis and cell cycle, and therefore may be involved in the initiating events of liver carcinogenesis.

1.6.4. Transcriptional activation of host cell genes by NS5A

The central region of NS5A contains two acidic rich (AR) regions: AR1: residues 2143-2184 and AR2: residues 2220-2273, and one proline rich region (residues 2282-2328) (Figure 1.16) (Tanimoto *et al.*, 1997; Tan *et al.*, 1999). These structural characteristics are a typical feature of many viral and eukaryotic transcription factors (Hope *et al.*, 1988; Lillie *et al.*, 1989). It has been demonstrated that, for transcriptional activation by the HIV-Tat and c-Jun transcriptional activators, both acidic and proline-rich regions are essential (Subramanian *et al.*, 1994). In accordance with these observations, the central region (residues 163-359) of NS5A has been shown to carry transcriptional activation properties and is termed the 'transcriptional activation region' (Chung *et al.*, 1997; Kato *et al.*, 1997; Tanimoto *et al.*, 1997; Fukuma *et al.*, 1998). This region is able to transactivate the transcription of the Gal4-lacZ fusion protein in yeast simple hybrid experiments. Moreover, it was demonstrated by our group that NS5A quasispecies variants isolated from the serum of the same patient, possess different levels of transcriptional activation potential in this yeast simple hybrid system (Pellerin *et al.*, 2004). The proline rich region of NS5A may play a role in transcriptional activation by providing a potential SH3 binding site (Tan *et al.*, 1999; Macdonald *et al.*, 2004). Moreover NS5A also carries a putative functional Nuclear Localization Signal (NLS: PPRKKRTVV, residues 354-362) immediately downstream of the transcriptional activation region. Although the precise role of this NLS is unknown, its presence suggesting that NS5A could be translocated to the

nucleus where it may utilize its transcriptional activation properties (Figure 1.13) (Ide *et al.*, 1996).

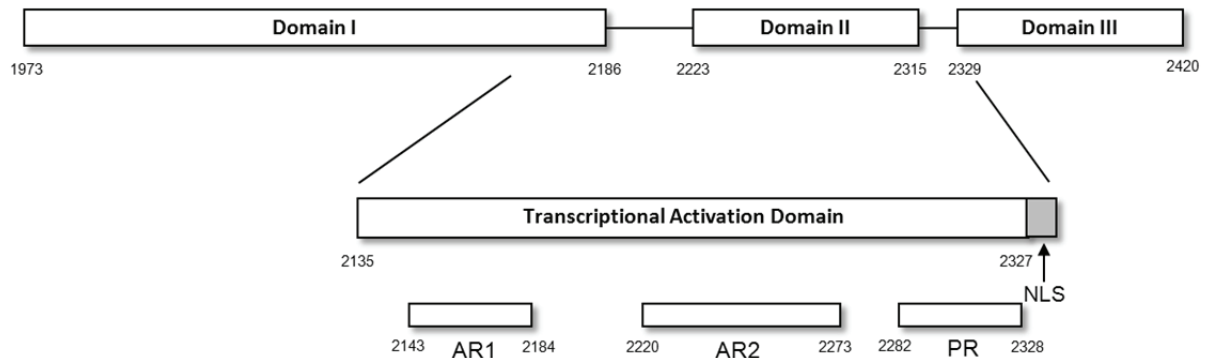

Figure 1.16: Schematic representation of the transcriptional activation domain of NS5A.

Although NS5A carries a functional NLS, NS5A is localized predominantly in perinuclear region (Ide *et al.*, 1996) as it has been demonstrated that the 27 N-terminal amino acids of NS5A constitute a small amphipathic alpha-helix that serves as an ER-membrane retention signal (Brass *et al.*, 2002). Accordingly, N-terminal deletion mutants of NS5A almost exclusively localize to the nucleus, whereas this 27aa alpha helix is sufficient to retain a nuclear protein in the cytoplasm (Satoh *et al.*, 2000; Brass *et al.*, 2002). These findings suggest that for the NLS to induce nuclear localization, NS5A must first be liberated from its N-terminal region anchored into the ER membrane. Accordingly, several studies have reported that NS5A is indeed cleaved by both cellular caspases and calpain-like enzymes to produce shorter isoforms of NS5A, and that this proteolytic processing of NS5A could be inhibited by universal caspase inhibitor zVAD-fmk (Satoh *et al.*, 2000; Goh *et al.*, 2001; Kalamvoki *et al.*, 2004). In addition, a recent study has demonstrated that caspase-cleaved isoforms of NS5A can translocate to the nucleus (Sauter *et al.*, 2009).

These observations suggest that N-terminally truncated forms of NS5A can translocate to the nucleus, where they may play a role in the transcriptional activation of host cell genes. Transcriptional activation of host genes by viral proteins may be one of the mechanisms adopted by the viral pathogen to interfere with the host immune response and cell cycle and to activate the expression of host factors required for viral replication. Such transactivation by

viral proteins may also have important consequences in pathogenesis. For example, chronic HCV infection is associated with increased serum IL8 levels that may play an important role in interferon resistance (Khabar *et al.*, 1997; Polyak *et al.*, 2001a). IL8 is known to reduce the antiviral activity of interferon, thus weakening the host cell response against viral pathogens (Khabar *et al.*, 1997). It has been demonstrated that by its transactivation activity, NS5A can directly enhance activity of the IL8 promoter in reporter construct assays (Polyak *et al.*, 2001b; Girard *et al.*, 2002).

As mentioned in section 1.1.3, chronic infection by HCV often leads to the development of liver cirrhosis and primary hepatocellular carcinoma (HCC). Although cirrhosis is an important factor in development of HCC in HCV infected patients, it is likely that the viral proteins also play a direct role in the carcinogenesis, although this role is still unclear. As previously mentioned, NS5A has been shown to interact with cellular proteins such as p53 to modulate the expression of host genes involved in apoptosis and cell cycle regulation. It is also possible that the transactivational activity of NS5A may also play a direct role in the development of these pathologies. As described above, NS5A can transactivate the IL8 promoter (Polyak *et al.*, 2001b). Besides inhibiting IFN response, aberrant levels of IL8 are also known to induce angiogenesis, an important factor in development of tumors (Lin *et al.*, 2004). Similarly, it has been shown that NS5A can transactivate the NS5ATP9 protein (Shi *et al.*, 2008). NS5ATP9, also called p15PAF, has been shown to be over-expressed in many tumoral tissues including esophageal tumor tissue (Yu *et al.*, 2001), pancreatic cancer cells (Hosokawa *et al.*, 2007) and thyroid carcinoma cells (Mizutani *et al.*, 2005), suggesting that NS5A mediated activation of NS5ATP9 may play a role in tumorigenesis.

Taken together, these observations suggest that cleavage and translocation of NS5A to the nucleus could result in transcriptional activation or inhibition of certain cellular genes, including those linked with oncogenesis. Indeed, many viral oncogenic proteins have transcriptional regulation activity and can regulate host cell gene expression (Yoshida 1994; Kovelman *et al.*, 1996; Van Tine *et al.*, 2004). This hypothesis is further supported by the fact that NS5A is the only nonstructural protein of HCV that can be trans-complemented, suggesting that NS5A plays a key role in viral replication independent from its role in replication complex (Appel *et al.*, 2005b). However, no experimental proof currently exists which demonstrates a direct role of NS5A in transcriptional regulation of cellular genes. One of the major focuses of research described in this thesis has been to study the direct role of

NS5A in transcriptional regulation of cellular genes. As described in the Results section of this thesis, I have successfully demonstrated that NS5A is recruited to host gene promoter sequences and can control their transcription to enhance HCV RNA replication.

1.7. Aims of the Study

As is evident from the above review regarding the functions of the NS5A protein, we are still lacking a comprehensive understanding of the complex mechanisms of HCV replication and HCV pathogenesis involving NS5A. Although indispensable for HCV replication, no clear direct NS5A function have been described so far.

As stated above, HCV is a highly variable virus: in an infected individual, it exists in the form of a quasispecies; a complex, unstable mixture of genetically distinct but closely-related variants arising from the same inoculum. We propose that the random introduction of mutations in the HCV genome may confer novel or enhanced functions to the various HCV proteins. This may happen in any given hepatocyte and as a consequence, may trigger 1) the initiation of mechanisms leading to the development of liver pathologies such as hepatocellular carcinoma and 2) may confer different replication advantages to the corresponding virus. In agreement with this hypothesis, it has been previously demonstrated in our laboratory that the transcriptional activation potential differs significantly between different NS5A quasispecies variants isolated from serum of an HCV infected patient (Pellerin *et al.*, 2004).

Based on these findings, we hypothesized that: (i) similar differences in terms of transcriptional activation potential may exist among naturally occurring NS5A quasispecies variants isolated from the liver tissue of an HCV infected patient; (ii) that NS5A variants with high transcriptional activation properties might interfere with cellular mechanisms thus exerting transforming effects on hepatocytes and may result in development of HCC; (iii) and that NS5A variants with high transcriptional activation potentials might give replication advantages to the corresponding virus in the tumoral environment.

In this context, the initial aims of this project were to develop a novel murine model in which patient-isolated NS5A sequences were to be chronically expressed in a liver specific fashion

by using a last generation helper dependent adenoviral vector (HdAd). Such a vector would also be used for the transduction of difficult-to-transfect primary cell cultures. Then, this new model was to be used to understand the impact of the natural variability of NS5A on both the replication of viral RNA and on viral pathogenesis.

Experimental design:

NS5A variants were first isolated from a patient chronically infected with genotype 1b HCV. For the study of the role of NS5A transactivation properties in the development of liver pathology, different NS5A variants were screened according to their transactivation properties tested in the yeast one-hybrid model. Selected clones were then cloned into a helper dependent adenoviral vector, with a view to inducing a lifelong transgene expression in transduced mice to enable the study of HCV-related liver pathologies. However, due to insurmountable technical difficulties with this system, alternative viral vectors were developed. These permitted the pangenomic analysis of cell transcriptomes from NS5A-expressing primary hepatocytes to identify host cell pathways targeted by NS5A transactivation function. In parallel, a sub-genomic HCV replicon model was used to study the role of NS5A transactivation properties in viral RNA replication.

2 - MATERIALS AND METHODS

2.1. Genetic and phylogenetic analysis of NS5A transcriptional activation domain quasispecies compartmentalization

Nucleotide and amino acid sequences were aligned with the Clustal X program, version 1.8. Distances between pairs of sequences were calculated using the DNADIST and PROTDIST modules of the PHYLIP package, version 3.572. The calculation was based on a Kimura two-parameter distance matrix with a transition-to-transversion ratio of 4.0 (Smith *et al.*, 1997). The mean \pm SEM within-sample genetic distances were calculated for each sample, as well as the mean \pm SEM between-sample genetic distances (i.e. the genetic distances between different compartments from the same patient). To determine whether or not the viral quasispecies isolated from different compartment in the same patient were genetically different, the mean within-sample and between-sample genetic distances were compared by means of the t test. The average number of synonymous substitutions per synonymous site was compared to the average number of nonsynonymous substitutions per nonsynonymous site within and between each sample, after calculation by means of the Jukes-Cantor correction for multiple substitutions (Nei *et al.*, 1986) with the program MEGA [S. Kumar, K. Tamura, M. Nei, Molecular Evolutionary Genetics Analysis (MEGA) version 1.02, Institute of Molecular Evolutionary Genetics, Pennsylvania State University].

For phylogenetic analysis, the median branch lengths were calculated by means of a Kimura two-parameter distance matrix to create a neighbor-joining tree using the NEIGHBOR program in PHYLIP (Felsenstein, J., *Cladistics* 1989). Bootstrap support was determined by 1000 resamplings of the sequences. Phylogenetic trees were constructed with both nucleotide and amino acid sequences

2.2. Cell Culture

2.2.1. Human Primary Hepatocyte Culture

Cryopreserved primary human hepatocytes were purchased from ZenBio Inc, NC, USA. Hepatocytes were thawed according to supplier's instructions. After thawing, hepatocytes were centrifuged for 10 minutes at 4 °C and 100 g, on a PBS-buffered 25% Percoll (Sigma Aldrich, St. Louis, MO, USA) gradient prepared in Hepatocyte Plating Medium (ZenBio Inc.). Supernatant was discarded and the hepatocyte pellet was resuspended in cold Plating Medium. The number and viability of resuspended hepatocytes was analysed using Trypan blue (Sigma Aldrich) and a haemocytometer. After counting, cells were resuspended in warm Plating Medium and were plated into six-well Primaria Culture Plates (BD Bioscience, MA,

USA) at 7.5×10^5 cells/well. Seeded hepatocytes were maintained at 37 °C with 5% CO₂ throughout the experiment. Eight hours post-plating, Plating Medium was replaced with 2mL Hepatocyte Maintenance Medium (ZenBio Inc.).

2.2.2. NG and 293FT Cells Culture

Hepatoma (NG; Abbott Laboratories, IL, USA) cells were maintained in Dulbecco's Modified Eagle's Medium (DMEM) supplemented with 10% Fetal Calf Serum (FCS), 100 units/ml Penicillin and 100µg/ml Streptomycin (Invitrogen Life Technologies, CA, USA). Human kidney cells (293FT; Invitrogen, CA, USA) cells were cultivated in identical media supplemented with 1X Non-Essential Amino Acids (Invitrogen).

2.3. RNA Isolation

2.3.1. RNA Isolation from Liver Tissue

Liver tissue samples were obtained from patients infected with HCV of genotype 1b. Total RNA was isolated from hepatic tissue using a PARIS kit (Ambion, TX, USA) according to the manufacturer's protocol. The quantity and quality of RNA were determined by NanoDrop and Agilent Bioanalyser analyses respectively (Agilent Technologies, CA, USA). Only the RNA samples with RNA integrity (RIN) > 8 were retained for downstream experiments. RNA was stored at -80°C until use.

2.3.2. RNA Isolation from Cultured Cells

RNA was isolated from cultured cells using a PARIS kit, and the quantity and quality of the resulting RNA was analysed as described above (section 2.2.1).

2.4. Complementary DNA (cDNA) Synthesis

Total RNA (2µg) isolated from liver tissues or cultured cells was used as a template to synthesize complementary DNA using a High Capacity cDNA Reverse Transcription Kit (Applied Biosystems, CA, USA) according to the manufacturer's protocol and stored at -20°C.

2.5. Molecular Cloning

2.5.1. Restriction Enzymes Digests

Typically, two micrograms of DNA were digested with 10-15 U of the respective restriction enzyme (Promega Corporation, Madison, WI, USA; New England BioLabs, Ipswich, MA, USA) in a total volume of 50µl using the manufacturer's recommended buffer. Digestion reactions were incubated at 37 °C for 1 hour. After digestion, DNA was treated with 1µl SAP (Promega Corporation) which was then inactivated by incubation at 85 °C for 10 minutes. Digested DNA samples were electrophoresed on 1% agarose gels, and bands corresponding to the expected size(s) were excised and purified with a QIAQuick Gel Extraction Kit (Qiagen, Hilden, Germany) according to the manufacturer's protocol. Purified DNA was eluted in 20µl Elution Buffer and stored at -20 °C.

2.5.2. Ligation Reactions

Ligation reactions were performed with the Rapid DNA Ligation Kit (Roche Applied Science, Indianapolis, IN, USA) according to the manufacturer's instructions. Fifty nanograms of digested and dephosphorylated vector DNA was used for each ligation reaction, with a 1:3 molar ratio of vector: insert. Ligation reactions were incubated for 10 minutes at room temperature and then kept on ice.

2.5.3. TOPO Cloning

For all TOPO cloning reactions, 1 µl of purified PCR product was mixed with 1µl TOPO Vector (Invitrogen), 1 µl of Salt Solution (Invitrogen) and 3 µl of DNase-free water. Reactions were incubated at room temperature for 5 minutes and then kept on ice.

2.5.4. Transformation of competent bacteria

For each transformation reaction, 25 µl Top10 One Shot competent *E. coli* (Invitrogen) were thawed on ice. Two microliters of ligation mixture was mixed with competent cells and incubated on ice for 15 minutes, followed by heat shocking at 42 °C for 30 seconds in a water bath. Cells were again incubated on ice for 2 minutes followed by the addition of 250 µl pre-warmed SOC medium without antibiotics (Invitrogen) and incubated at 37 °C for 1 hour in

shaker incubator at 200 rpm. Cells were then spread on BHI-agar plates containing the appropriate antibiotics and plates were incubated at 37 °C overnight.

2.5.5. Colony Screening

Colony screening was performed by PCR analysis. The appropriate PCR primers flanking the insertion site in the vector were used to amplify the insert. Selected colonies were picked with sterile inoculation loops (Sarstedt, France) and resuspended in 25 µl sterile nuclease free water in 96-well plates. Five microliters of this suspension was used as a template for screening PCR, and a further 5µl was used to inoculate 4 mL of liquid BHI medium (BD Bioscience) containing the appropriate antibiotics to make stock cultures for subsequent plasmid DNA isolations.

Amplified PCR products were analyzed on 1 % agarose gels, and colonies that produced appropriately sized fragments were considered positive. The amplification products from these positive colonies were sequenced to confirm the orientation and integrity of the insert.

2.5.6. Nucleotide Sequencing

To identify quasispecies variants, to determine orientation of insert or to confirm the integrity of cloned constructs, DNA was sequenced by the dye termination method in an ABI 377 DNA Sequencer (Applied Biosystems) with the ABI PRISM BigDye Terminator v3.0 Cycle Sequencing Kit (Applied Biosystems) according to the manufacturer's instructions. The sequence data obtained were analyzed using BioEdit and Vector NTI (Invitrogen) software.

2.5.7. Plasmid DNA Purification

2.5.7.1. Small Scale DNA Purification

Plasmid minipreps were performed by alkaline lysis method using a PureLink HQ Plasmid Miniprep Kit (Invitrogen) according to manufacturer's protocol. Plasmid DNA was eluted with 75µl TE buffer and quantified with a spectrophotometer using 260 nm wavelength. DNA purity was evaluated by ratio of optical density at 260 nm over 280 nm. Only the samples that showed 260/280 ratio greater than 1.6, were used in downstream applications. Purified DNA was stored at -20°C.

2.5.7.2. Large Scale Isolation

Plasmid maxipreps were performed by alkaline lysis method using PureLink HiPure Maxiprep Kit (Invitrogen) according to manufacturer's protocol. After elution, DNA was precipitated with isopropanol after centrifugation at 10000 xg for 45 minutes at 4 °C. After centrifugation, supernatant was discarded and DNA pellet was air dried and resuspended in 300µl nuclease free water. DNA was quantified using a spectrophotometer as described previously (section 2.4.7.1). DNA concentration was adjusted to 1 µg/µl and stored at -20 °C.

2.5.8. Yeast One-Hybrid Assays

To create yeast one-hybrid vectors, the transcriptional activation domain of isolated NS5A sequences (aa 163-359) were cloned into yeast expression vector pGBT9 (Clontech, Takara Bio Inc. Shiga, Japan) (Figure 2.1). The NS5A transcriptional activation domain sequences were amplified using NS5A-tr-*EcoRI* and NS5A-tr-*BamHI* primers. Amplified PCR products were purified by a Microcon PCR Purification Column (Millipore, MA, USA). Two micrograms of purified DNA and 2µg pGBT9 vector DNA was digested with *EcoRI* and *BamHI* and ligated to obtain pGBT9-NS5Atr (Figure 2.1). Ligation products were transformed into competent cells and colonies were screened as described in sections 2.4.4 and 2.4.5 respectively.

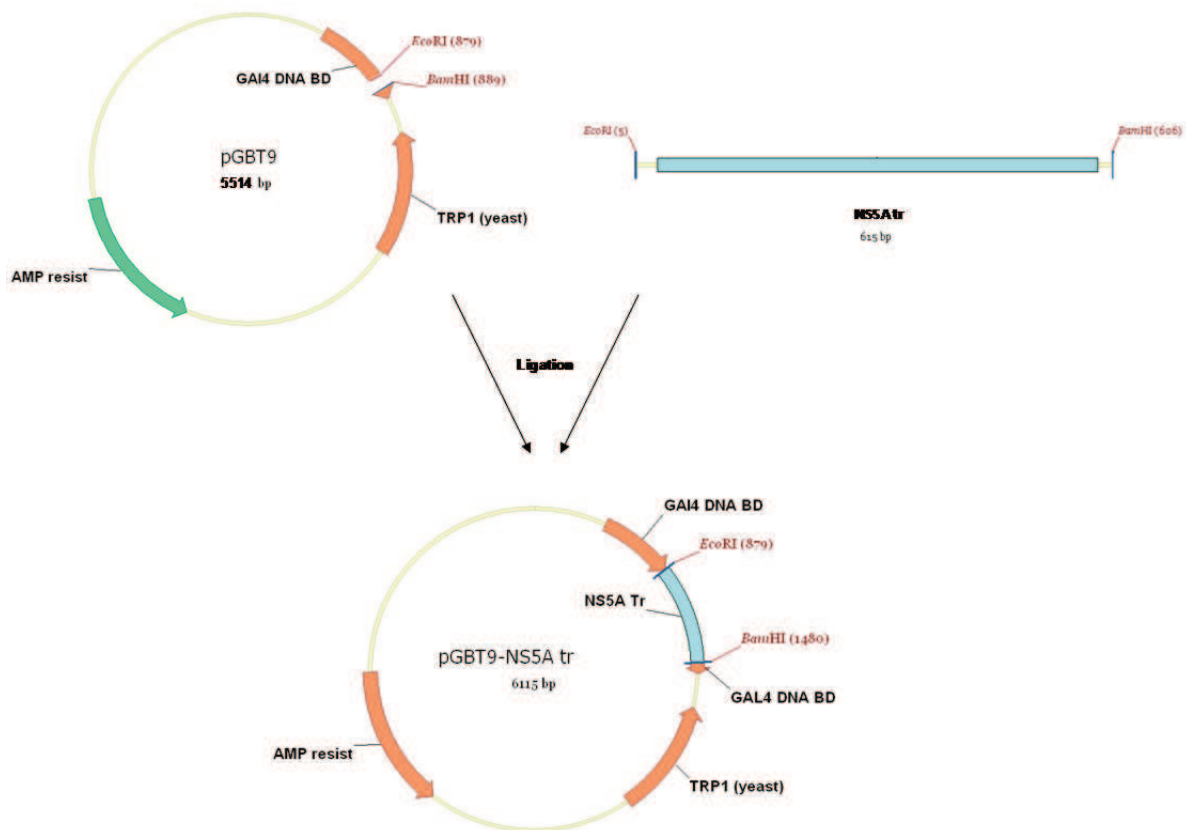

Figure 2.1: Cloning of NS5A transcriptional activation domain into pGBT9. pGBT9 plasmid DNA and amplified NS5A transcriptional activation domains were digested with *EcoRI* and *BamHI* enzymes and ligated to produce pGBT9-NS5Atr.

2.5.9. Mammalian Expression Vector

For expression of NS5A in cultured cells, HCV quasispecies variants were cloned into the pHM6 vector (Roche Life Science). For this purpose, full-length NS5A sequences were PCR amplified with NS5A-*HindIII* and NS5A-*BamHI* primers. Amplified DNA and vector DNA was digested with the appropriate restriction enzymes and then ligated as described in sections 2.4.1 and 2.4.2 respectively to give pHM6-NS5A (Figure 2.2). Ligation products were transformed into competent cells and colonies were screened for the correct inserts as described in sections 2.4.4 and 2.4.5 respectively.

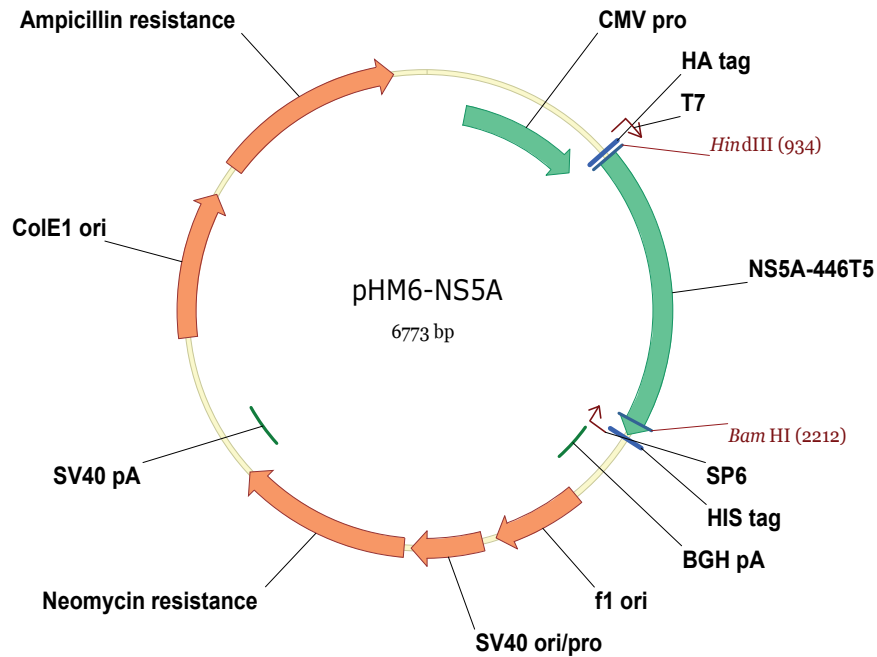

Figure 2.2: Vector map of pHM6-NS5A. NS5A was cloned into pHM6 using the *HindIII* and *BamHI* restriction sites. Expression of NS5A in eukaryotic cells is driven by the CMV promoter.

2.5.10. Subgenomic Replicon Shuttle Vector

A shuttle Vector (p1071) for the subgenomic HCV replicon (genotype 1b) was obtained from the Global Research and Development Center (Abbott Laboratories, IL, USA). This replicon shuttle vector carries *NotI* and *PacI* restriction sites in the 3' regions of NS4B and NS5A respectively (Figure 2.3). However, as the *NotI* restriction site is present in NS4B at 97 bases upstream of NS5A, this site could not be used to clone already isolated full-length NS5A quasispecies variant sequences not containing downstream 97 bases of NS4B. To enable the cloning of already isolated NS5A quasispecies variants, a silent mutation encoding a restriction site for *SacII* was introduced in both the shuttle vector and in patient derived NS5A inserts by site directed mutagenesis 88 bp into NS5A. Subsequently, the region between the *NotI* and *PacI* restriction sites encoding NS4B and the N-terminus of NS5A was PCR-amplified from p1071 and cloned into pCR2.1-TOPO. The *SacII-PacI* fragment (encompassing nucleotides 89-1328 of NS5A) in pCR2.1-TOPO was then replaced with the *SacII-PacI* fragment of patient isolated NS5A sequences. Finally the *NotI-PacI* fragment from intermediate vector containing patient derived NS5A, was cloned into replicon shuttle vector (Figure 2.3). In addition, the in vitro fitness mutation S2204I (REF) was introduced by site

directed mutagenesis into all NS5A sequences before being cloned into replicon shuttle vector.

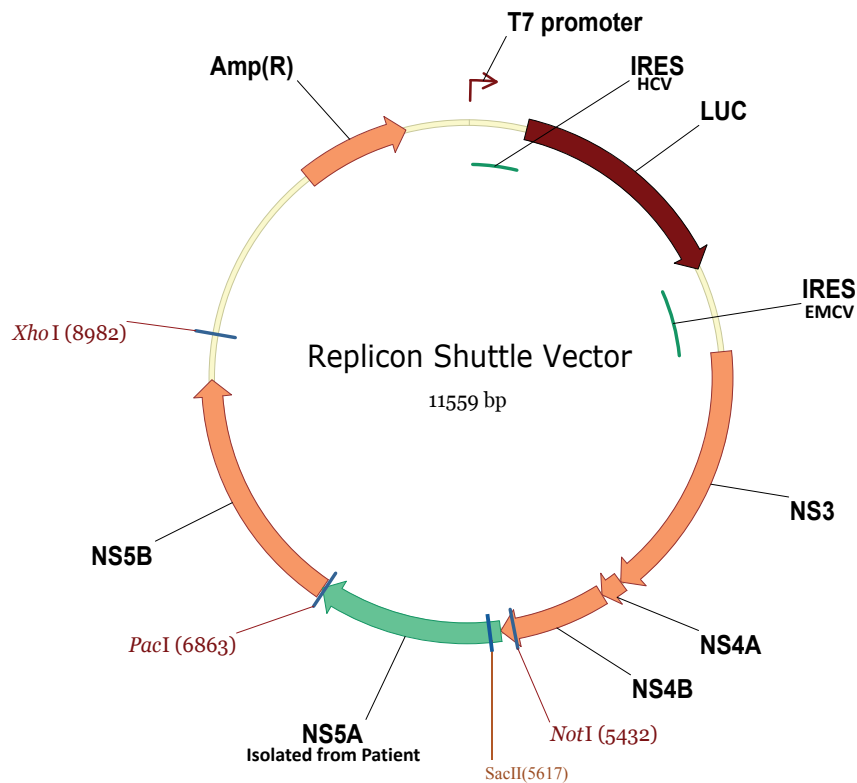

Figure 2.3: The subgenomic replicon shuttle vector. Patient isolated NS5A sequences were cloned using *NotI* and *PacI* restriction sites.

2.5.11. Lentiviral NS5A Expression Vector

For cloning into a Lentiviral expression vector, full-length NS5A sequences were amplified by PCR using NS5A-kozak-S containing a modified kozak sequence followed by a start codon and NS5A-stop-AS containing two stop codons. Amplification was performed with Advantage 2 Polymerase Mix (Clontech) and following cycle:

95°C	5 min	} 35 cycles
95°C	20 sec	
58°C	20 sec	
70°C	90 sec	
4°C	Hold	

Amplified NS5A fragments were cloned into pLenti6.3/V5-TOPO Vector (Invitrogen) as described in section 2.4.3 and ligation products were transformed into Stb13 competent cells (Invitrogen) as described in section 2.4.4. Colonies were screened and the inserts were sequenced to verify their integrity, as described in section 2.4.5. The pLenti6.3/V5-TOPO vectors containing cloned transgene sequences were used to produce Lentiviral particles (described in section 2.7).

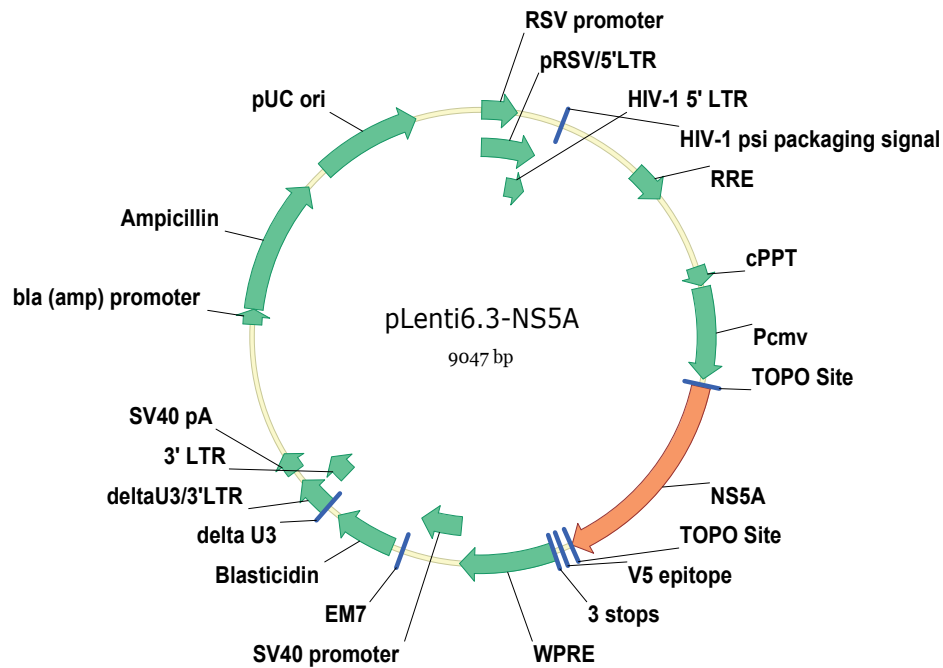

Figure 2.4: Vector map of pLenti6.3/V5-TOPO-NS5A. After amplification with NS5A-kozak-S and NS5A-stop-AS primers, TOPO-TA cloning (section 2.4.3) was used to clone NS5A inserts into this vector.

2.5.12. Functional analysis of Acid Rich 2 region of NS5A

To study the role of naturally occurring mutations present in Acid Rich 2 region (AR2) of NS5A, AR2 regions from strong and weak transactivating NS5A variants were swapped using a PCR based swapping strategy adapted from (Deminie *et al.*, 1993) as illustrated in Figure 2.5. Briefly, AR2 amplification primers B-NS5A-swap and C-NS5A-swap were designed such that their 5' ends were complementary to the 'receiving' NS5A sequence whereas their 3' ends were complementary to the 'donor' NS5A. Primers A (NS5A-NotI primer) and D (NS5A-HindIII primer) were entirely complementary to the receiving NS5A sequence. In the first step, NS5A fragments that flank the AR2 sequence were amplified from receiving NS5A

by primer sets AB and CD, whereas the AR2 sequence was amplified from donor NS5A using primer set BC. In the second step, these three fragments were mixed and PCR was performed by primer set AD to amplify full-length chimeric NS5A sequences.

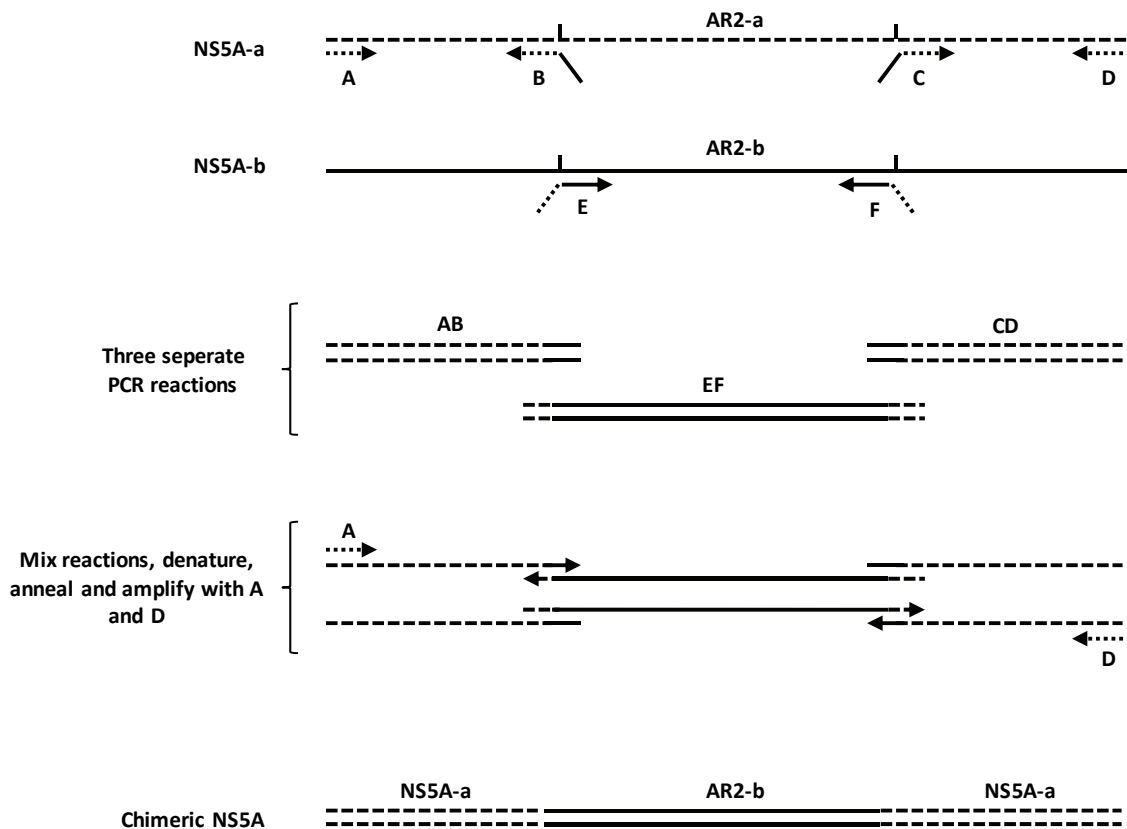

Figure 2.5: Schematic representation of PCR based strategy to produce chimeric NS5A by exchanging AR2 sequence from another NS5A variant. The dashed lines represent the variant NS5A-a while solid lines represent the NS5A-b variant. Straight arrows (labeled A, B, C, D, E and F) represent oligonucleotides while bent arrows indicate that oligonucleotide is homologous to NS5A-a in one half and to NS5A-b in other half. AB, CD and EF represent three amplification products. Adapted from (Deminie *et al.*, 1993).

2.5.13. Site-Directed Mutagenesis

To introduce point mutations in cloned sequences, PCR based site-directed mutagenesis was performed using the QuickChange II XL Site-Directed Mutagenesis Kit (Agilent Technologies). Primers for mutagenesis were designed with QuickChange Primer Design Tool (Agilent Technologies) according to the manufacturer’s guidelines. Mutagenesis PCR

reaction was performed according to the manufacturer's protocol using 50 ng of template DNA.

2.6. Construction of an NS5A Adenoviral Vector

To clone patient-isolated NS5A sequences into the helper dependent adenoviral vector, we developed a strategy that uses two intermediate plasmids that can be easily recombined by Gateway LR recombination to produce the complete NS5A expression cassette. Gateway LR recombination uses the specific recombination sites of bacteriophage λ and allows quick and efficient insertion of a DNA sequence into a plasmid without any restriction digestion. The two intermediate plasmids are termed as the Entry and Destination Vectors. The Entry Vector contains patient-isolated NS5A sequence that is transferred to the Destination Vector after recombination. The Destination vector contains the rest of the sequences required for liver-specific expression of NS5A (notable: the PEPCK promoter, human factor IX, huGHpA and polyadenylation signal). Construction of these vectors and recombination are described in following sections.

2.6.1. Construction of the Entry Vector

The construction of the entry vector was carried out in following steps:

1) The T2A chisel sequence was synthesized by PCR using two complementary primers that also introduced *SrfI* and *BglII* restriction sites at the 5' and 3' ends of the T2A sequence respectively. The PCR-generated T2A sequence was cloned into pCR2.1-TOPO vector (Invitrogen) to produce pCR2.1-TOPO-T2A-*SrfI*-*BglII*. Then the sequence between *SrfI* and *XhoI* sites (125bp) was PCR amplified from pCR2.1-TOPO-T2A-*SrfI*-*BglII* using CACC-*SrfI*-T2A-S and TopoT2A-*XhoI*-AS primers. This fragment was cloned into pENTR/D-TOPO (Invitrogen) between the attL1 and attL2 sites. This plasmid, pENTR-T2A-*XhoI*, contained a *BglII* restriction site immediately downstream of the T2A sequence.

2) As the *AscI* restriction sites of pENTR-T2A-*XhoI* were to be used to clone the complete expression cassette into adenoviral genome, the elimination of an extra *AscI* restriction site in pENTR-T2A-*XhoI* was necessary. To remove this restriction site, pENTR-T2A-*XhoI* was digested with *AscI* and then treated with the Klenow fragment of Polymerase I (Invitrogen) to

fill-in the sticky ends. The blunt ends obtained were ligated with Rapid DNA Ligation Kit (Roche Lifescience) to obtain pENTR-T2A-*XhoI*- Δ AscI.

3) Patient-isolated NS5A sequences were amplified with *BglI*-NS5Apop28-S and NS5A-Stop-*XhoI*-AS primers containing *BglI* and *XhoI* restriction sites respectively. NS5A-Stop-*XhoI*-AS primer also introduced a stop codon at the 3' end of NS5A. NS5A sequences were cloned into the *BglI* and *XhoI* restriction sites of pENTR-T2A-*XhoI*- Δ AscI, and the resulting vector was termed pENTR-T2A-NS5A.

2.6.2. Construction of the Destination Vector

A plasmid (pPEPCK-FIX) containing all the sequences required for liver-specific expression of the target gene (NS5A) was kindly provided by Dr. Nicola Brunetti-Pieri at Department of Molecular and Human Genetics, Baylor College of Medicine, Houston, USA. Two stop codons immediately downstream of human Factor IX (FIX) sequence in pPEPCK-FIX plasmid were removed by site-directed mutagenesis using QuickChange Mutagenesis Kit (Agilent Technologies). After deleting the two stop codons, pPEPCK-FIX was converted into a Gateway Destination Vector using the Gateway Vector Conversion System (Invitrogen). This kit allows the insertion of an LR recombination cassette into any plasmid to convert it to a Destination Vector. This kit also allows the insertion of recombination cassette in any of the three reading frames to allow continued translation from upstream sequences. We inserted the recombination cassette for Reading Frame A (RFA). For this purpose, pPEPCK-FIX was digested with *SrfI* and RFA cassette was ligated into pPEPCK-FIX vector to produce pPEPCK-FIX-Dest (Figure 2.10). The ligation products were transformed into *ccdB* Survival Cells (Invitrogen). The RFA gateway conversion cassette encodes a gene conveying Chloramphenicol Resistance (Cm^{R}) as transformation selection marker as well as the *ccdB* gene that functions as negative selection lethal gene after homologous recombination (Figure 2.10). The insertion sites were sequenced to confirm insertion and integrity of the correct reading frame.

2.6.3. Generation of an NS5A Expression cassette by LR Recombination

The Entry Vector (pENTR-T2A-NS5A) and Destination Vector were recombined to obtain a final expression clone (pPEPCK-FIX-T2A-NS5A (Figure 2.11)) containing patient-isolated

NS5A sequences as well as all sequences required for their liver-specific expression. This recombination was performed using LR Clonase II Enzyme (Invitrogen) according to manufacturer's instructions. Recombination results in the production of a complete expression clone and another byproduct plasmid that contains the *ccdB* lethal gene. After transformation of bacteria, expression of *ccdB* lethal gene results in elimination of all cells that contain the byproduct plasmid thus resulting in the survival of only those colonies that contain pPEPCK-FIX-T2A-NS5A.

2.6.4. Production of Recombinant Adenoviral Particles

Recombinant helper-dependent adenoviral particles were produced in collaboration with Dr. Nicola Brunetti-Pieri as described in (Palmer *et al.*, 2003). Briefly, the complete NS5A expression cassette (pPEPCK-FIX-T2A-NS5A) was cloned into the *AscI* restriction sites of the helper-dependent adenoviral genome. Recombinant helper-dependent viral genomes was transfected into 293Cre cells along with the helper virus AdNG163 . Recombinant viral particles were characterized as previously described (Palmer *et al.*, 2003).

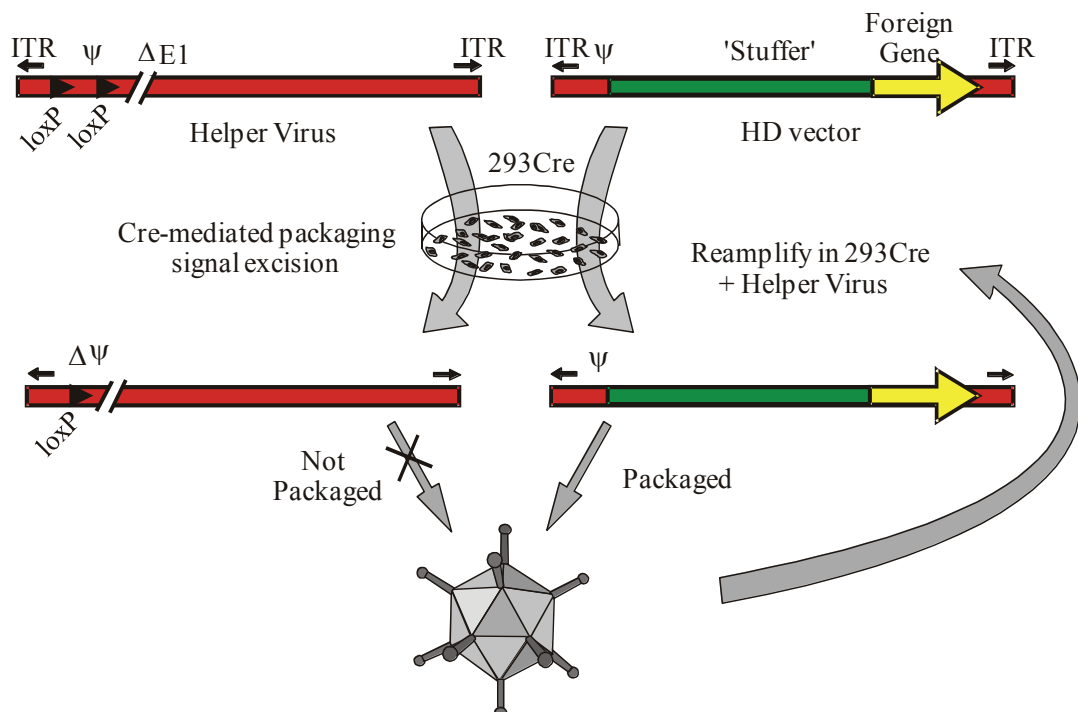

Figure 2.6: Schematic representation of helper-dependent adenoviral particle production. Ψ indicates the viral genome packaging signal whereas ΔΨ indicates non-functional packaging signal. ITR = inverted terminal repeats. Red color indicates the adenoviral sequence. Green color indicates stuffer DNA sequence while yellow color indicates our transgene expression cassette (Adapted from (Palmer *et al.*, 2003)).

2.7. Injection of Recombinant Adenoviruses into Mice

Four month old C57Bl6 male mice were transduced with 5×10^5 vp/Kg recombinant adenoviruses encoding NS5A or hFIX. Mice were anaesthetized with intra-peritoneal injections of 40 mg/Kg body weight sodium pentobarbital (Sigma Aldrich). A fine catheter was surgically inserted into the jugular vein and a 20 μ l suspension of viral particles in sterile isotonic saline solution was administered into jugular vein through the catheter. After administration of the viral particles, the catheter was retrieved, the open area was sutured and mice were kept in aseptic cages. Blood samples were collected by tail vein incision. Sacrifice took place by CO₂ euthanasia to collect blood, liver, spleen and kidney tissue samples.

2.8. *In vitro* Transcription and Purification of Replicon RNA

2.8.1. Plasmid Linearization

Twenty-five micrograms of replicon plasmid DNA was linearized by *Xho*I digestion in a final reaction volume of 200 μ l. After *Xho*I digest, plasmid DNA was purified by Phenol:Chloroform extraction. For this, 200 μ l Phenol: Chloroform: Isoamyl alcohol (25:24:1) (Invitrogen) was mixed with the digested DNA and the sample was transferred to a microfuge tube containing PhaseLock Heavy Gel (5Prime). The sample was centrifuged at 10000 g for 5 minutes to separate the phases, and the aqueous phase was transferred to a new microfuge tube. Then 1/10 volume of 3M NaOAc and 2.5 volumes of 100% ethanol were added, and the mixture incubated at -20 °C for 1 hour. Samples were centrifuged at 14000 g for 20 minutes, the supernatant discarded and the DNA pellet was washed with ice cold 70% ethanol. The resulting pellet was air dried and resuspended in 30 μ l of nuclease free water. Linearized replicon plasmid DNA was analyzed on a 0.8% agarose gel along with 0.5 μ g 1kb DNA Ladder Plus (Fermentas). DNA concentration was determined using GeneTools software (SynGene).

2.8.2. *In vitro* Transcription

Replicon RNA was transcribed from the linearized replicon plasmid DNA using T7 MegaScript Kit (Ambion) according to the manufacturer's instructions.

2.8.3. Purification and Quantification of *in vitro* Transcribed RNA

In vitro transcribed RNA was purified using the RNeasy Mini Kit (Qiagen) according to the RNA Cleanup Protocol provided by the manufacturer. Purified RNA was quantified with a spectrophotometer and the final RNA concentration was adjusted to 1 µg/µl. The RNA sample was divided into 2 µl single use aliquots and stored at -80°C.

2.9. Generation and Titration of Lentiviral Particles

pLenti6.3/V5-TOPO vectors containing cloned NS5A sequences (section 2.4.11) were used to produce lentiviral particles using the ViraPower HiPerform Lentiviral Expression System (Invitrogen) according to the following protocol:

2.9.1. Transfection of 293FT Cells

The day before transfection, 5×10^6 293FT cells (Invitrogen) were plated in 10 cm tissue culture plates. The next day, culture medium was replaced with 5 mL of Opti-MEM I Medium (Invitrogen) supplemented with 10% fetal calf serum and NEAA. In a sterile 15 mL tube, 9 µg of ViraPower Packaging Mix and 3 µg of pLenti expression plasmid were mixed with 36 µl Lipofectamine 2000 in 3 mL Opti-MEM I Medium without serum. The mix was incubated at room temperature for 20 minutes to allow the DNA-Lipofectamine 2000 complexes to form. After incubation, the complexes were added drop-wise to the monolayer of 293FT cells. The plates were then incubated at 37 °C in a humidified incubator with 5% CO₂. Six hours after transfection, the medium was replaced with 10 mL fresh culture medium without antibiotics (DMEM supplemented with 10% serum). Transfected 293FT cells were then left for 72 hours before harvesting of the infected media.

2.9.2. Harvest and Concentration of Lentiviral Particles

Seventy-two hours after transfection, virus-containing culture medium was transferred to a 15 mL falcon tube and centrifuged at 2000 x g for 15 minutes at 4°C to pellet cellular debris. After centrifugation, virus-containing supernatant from three replicate transfections was pooled into a fresh 50 mL tube. The cleared supernatant was mixed with 10mL of 4X LentiX Concentrator (Clontech) and incubated at 4 °C for 2 hours, before being centrifuged at 1500 x g for 45 minutes at 4°C. After centrifugation, the supernatant was discarded and the virus-

containing pellet was re-suspended in 3 mL DMEM. The viral suspension was divided into single use aliquots containing 1×10^6 cfu and stored at -80°C .

2.9.3. Titration of Lentiviral Stock

For the titration of lentiviral stocks, 1×10^5 Huh7.5 cells/well were plated in 6-well cell culture plates (Day 0). The next day, the culture medium was replaced with 1 mL of 10-fold serial dilutions (10^{-1} , 10^{-2} , 10^{-3} , 10^{-4} , 10^{-5} and –ve Control) of lentiviral stocks prepared in complete culture medium (DMEM supplemented with 10% fetal calf serum and antibiotics) (Day 1). The following day, the culture media was replaced with fresh complete culture media (Day 2). On day 3, the selection antibiotic Blasticidin (Invitrogen) was added to the culture media to a final concentration of $4\mu\text{g/mL}$. The culture media was replaced every three days with fresh culture medium containing $4\mu\text{g/mL}$ Blasticidin. On day ~13, when no living cells were evident in non-transduced control wells, the cells were fixed with 1 % paraformaldehyde in PBS and stained with 0.1 % Crystal Violet in 10 % ethanol. The number of colonies was counted in each well and the viral titer was calculated for each well using the following formula. The average viral titer for all wells was considered as the viral titer of the stock.

$$\frac{\text{No. of Colonies}}{D \times V} = \text{cfu/mL} \quad \begin{array}{l} D = \text{Dilution Factor} \\ V = \text{Volume of diluted virus added to the well} \end{array}$$

2.9.4. Transduction of Cultured Cells

2.9.4.1. Transduction of Primary Hepatocytes

Primary human hepatocytes (1×10^6 cells/well) were plated in 6-well culture plates as described in section 2.1.1. Eight hours after plating, Plating Medium was replaced with 1 mL Maintenance Medium. Aliquots of lentiviral stocks were thawed at 37°C in a water bath, and 3×10^6 cfu (an MOI of 3) was added to each well of primary hepatocytes. The next day, the medium was replaced with 2 mL of fresh Maintenance Medium.

2.9.4.2. Transduction of Huh7.5 Cells

Huh7.5 cells (2×10^5 cells/well) were plated in 6-well culture plates as described in section 2.1.2. Six hours after plating, aliquots of lentiviral stocks were thawed at 37°C in a water

bath and 2×10^5 c.f.u (an MOI of 1) were added to each well. The following day, the culture medium containing lentiviral particles was replaced with 2 mL of fresh complete medium.

2.10. Cell Transfections

2.10.1. Transient DNA Transfections

Transient DNA transfections were carried out using Lipofectamine LTX (Invitrogen) and Plus Reagent (Invitrogen). Briefly, NG cells were seeded at 1.5×10^5 cells/well in 6-well culture plates in complete culture medium. The next day, liposome complexes containing 2 μ g of plasmid DNA were prepared according to the manufacturer's instructions, and incubated at room temperature for 30 minutes to allow the formation of DNA-liposome complexes. During incubation, the culture medium of cells was replaced with 1.5 mL DMEM supplemented with 5 % fetal bovine serum. After incubation, 500 μ l of the DNA-liposome mix was added drop wise to each monolayer and incubated at 37 °C in a humidified incubator with 5 % CO₂. After 6 hours, the culture media was replaced with 2 mL fresh culture medium.

2.10.2. RNA Transfections

Transient RNA transfections were carried out using a TransIT mRNA Kit (Mirus Bio LLC, WI, USA). Huh7.5 cells were seeded at 2×10^4 cells/well in 48-well culture plates in complete culture medium. The next day, 250 ng RNA was diluted in 25 μ l Opti-MEM I Medium (Invitrogen), and 0.25 μ l of RNA Boost Reagent was added. Then, 0.5 μ l TransIT mRNA Reagent was added, mixed well and RNA-liposome complexes incubated at room temperature for 5 minutes. During incubation, the culture medium of cells was replaced with 100 μ l Opti-MEM I supplemented with 5 % fetal bovine serum. After incubation, 25 μ l of RNA-liposome mix was added drop wise to the monolayers, which were then incubated at 37 °C in a humidified incubator with 5 % CO₂. After 4 hours, the culture media was replaced with 200 μ l fresh culture medium.

2.11. Inhibition of Cellular Caspases

To inhibit the activity of cellular caspases, the pan-caspase inhibitor z-VAD-fmk (R&D Systems, MN, USA) was added to the culture medium at a final concentration of 20 μ M. If

the cultured cells were to be kept more than 24 hours, fresh z-VAD-fmk was added every 24 hours.

2.12. Immunofluorescence Analysis

Monolayers of cells were grown on 4-chamber Labtek Chamber Slides (Thermo Scientific). The following day, the media was removed and the monolayers were washed twice with PBS. Cells were then fixed with -20 °C 100 % Methanol at room temperature for 10 minutes. After three further rinses in PBS, cells were incubated with the appropriate primary antibodies in PBS for 90 minutes. Cells were again washed three times with PBS, and incubated for one hour at room temperature with the appropriate fluorophore-coupled secondary antibodies. Cells were then washed twice with PBS and incubated for five minutes at room temperature with 1 nM of To-Pro-3 Stain (Invitrogen). Finally, cells were washed two times with PBS and once with distilled water and air dried for two minutes before being mounted mounted with VectaShield Mounting Medium (Vector Laboratories Inc., CA, USA).

Cells were observed with confocal laser scanning microscope (Leica DMRE-7/TCSSP2, Wetzlar, Germany) in conjunction with 62X and 40X objectives using 488 nm argon and 633 nm He-Ne lasers. Image acquisition and analysis was performed with Leica TCS SP Software (Leica Microsystems), and reconstruction of 3D image projections from confocal z-stacks was done using Imaris Software (Bitplane AG, Zurich).

2.13. Real Time Quantitative Gene Expression Profiling

The expression of cellular genes was analyzed using custom designed TaqMan Gene Expression Array plates (Applied Biosystems) according to the manufacturer's guidelines. In brief, 20 ng of cDNA was used per well (reverse transcribed from total RNA as described in section 2.3) and reactions were performed with an Applied Biosystems 7300 Thermal Cycler.

2.14. Chromatin Immunoprecipitation Assay

Chromatin Immunoprecipitation (ChIP) assays were performed as described below:

2.14.1. Antibody coating of Protein A Mag Sepharose Beads

Ten microliters of Protein A Mag Sepharose beads (GE Life Sciences, Chalfont St-Giles, UK) were resuspended in 1 mL PBS containing 5% bovine serum albumin (Sigma) and 1X Protease Inhibitor Cocktail (Roche Life Science). After incubation at 4°C for 3 hours on a rotator, an appropriate amount of beads were isolated for use as a Bead Only Control (BOC), and 8 µl anti-NS5A sheep serum was added to the remainder. Both tubes were then incubated at 4°C overnight on a rotator. The following day, 200 µl aliquots of antibody-coated beads were transferred to fresh 1.5 mL microfuge tubes and kept on ice until use.

2.14.2. Cross-linking and preparation of Chromatin

Transduced Huh7.5 cells or primary human hepatocytes (described in section 2.7.4) were harvested after 72 hours post-transduction. Briefly, the culture medium from cells was removed and 2.7 mL fresh DMEM containing 10% FCS was added. Then cells were crosslinked by the addition of 0.3 mL 10% formaldehyde solution for 10 minutes at RT. To stop cross-linking, 0.3 mL 1.375M Glycine solution was added. Plates were transferred to ice and washed three times with cold PBS containing 0.5 mM PMSF. Monolayers were scraped and the cells transferred to a fresh 1.5mL microfuge tube, with cells from duplicate wells being pooled into a single tube. After centrifugation at 1500 g to pellet the cells, the supernatant was discarded and cell pellets were resuspended in 300 µl ChIP Lysis Buffer (10 mM HEPES, 1.5 mM MgCl₂, 10 mM KCl, 0.5 mM DTT, 0.1% NP-40, 1X Protease Inhibitor Cocktail). After incubation on ice for 20 minutes, tubes were centrifuged at 5000 g for 5 minutes at 4 °C to isolate nuclei. The supernatant was discarded and nuclei were resuspended in 400 µl Nuclei Lysis Buffer (50 mM Tris-HCl pH 8, 10 mM EDTA, 1% SDS, 1X Protease Inhibitor Cocktail). After 30 minutes incubation on ice, each sample was sonicated with a VibraCell 75115 Sonicator (BioBlock) for 7 cycles of 20 seconds each at 25% amplification with 60 seconds interval on ice after each cycle. After sonication, lysates were centrifuged at 10000 g for 10 minutes at 4 °C and the resulting chromatin was transferred to a fresh tube. The upper lipid layer was discarded. Chromatin was pre-cleared with 5 µl Protein A Mag Sepharose beads, and the pre-cleared chromatin was transferred to fresh microfuge tubes and

kept on ice. A 50 µl aliquot of pre-cleared chromatin was transferred to another tube and stored at -80°C for preparation of Input DNA.

2.14.3. Immunoprecipitation, Washes and Elution of Immune Complexes

For immunoprecipitation, the supernatant of antibody-coated beads (section 2.12.1) was removed and 300 µl of pre-cleared chromatin was added. Tubes were incubated at 4 °C overnight on a rotator. The next day, tubes were placed on a magnetic rack and supernatant was discarded. Beads were then washed three times with 300 µl ChIP Lysis Buffer and transferred to fresh microfuge tubes. Immune complexes were eluted by adding 50µl ChIP Elution Buffer (20 mM Tris-HCl pH 8, 5 mM EDTA, 1% SDS, 50 mM NaCl, 50µg/ml proteinase K) and incubating at 68 °C for 15 minutes in a water bath. This step was repeated twice and the two elutes were pooled together. In parallel, input DNA samples were thawed and 100µl Elution buffer was added.

2.14.4. Reverse cross-linking and DNA purification

Both Input DNA samples and eluted immune complexes were incubated at 68 °C for 6 hours to reverse cross-linking. The volume of each sample was brought to 300 µl with nuclease free water and 300 µl Phenol/Chloroform/Isoamyl alcohol (25:24:1) was added to each sample. Tubes were vortexed and samples were centrifuged at 10000 g for 5 minutes at 4 °C. The resulting aqueous phases were transferred to fresh tubes and 1.5 µl GenElute-LPA DNA carrier (Sigma) was added to each sample. DNA was precipitated by adding 0.1 volumes of 3M NaOAc and 2.5 volumes of cold 100% ethanol. Following incubation for 30 minutes at -20 °C, tubes were centrifuged at 15000 g for 15 minutes at 4 °C. The supernatant was discarded and DNA pellets were rinsed with 70 % ethanol before air drying. The purified DNA pellets were resuspended in 20 µl nuclease free water and stored at -20 °C until analysis.

2.14.5. PCR Analysis

PCR was used to detect the presence of specific promoter DNA sequences in ChIP samples. One microliter of ChIP DNA was used in each PCR reaction using the primers described in Table 2.1 (sequences in Appendix: Primers). PCR was performed with Advantage Polymerase in a Mastercycler Ep thermocycler (Eppendorf). PCR conditions were as follows: 95°C for 5

minutes; then 35 cycles of 95°C for 20 seconds, annealing temperature (Table 2.1) for 30 seconds, 70°C for 45 seconds; followed by 70°C for 10 minutes. Amplification products were analyzed on a 1.5 % agarose gel.

Gene	Primers	Annealing temperature	Expected Product Size
Interleukin 8 (IL8)	IL8-prom3-S IL8-prom3-AS	60 °C	252 bp
Lymphotoxin β (LTB)	LTB-prom1-S LTB-prom1-AS	58 °C	155 bp
NUAK2	NUAK2-prom1-S NUAK2-prom1-AS	58 °C	175 bp
TRAF2	TRAF2-prom-S TRAF2-prom-AS	59 °C	249 bp
MAP2K7	MAP2K7-prom-S MAP2K7-prom-AS	57 °C	231 bp
FBXL2	FBXL2-prom-S FBXL2-prom-AS	57 °C	200 bp

Table 2.1: List of primers used for ChIP Assays (sequences detailed in Appendix: Primers).

2.15. Protein Analysis

2.15.1. Protein Quantification

The protein content of cellular lysates was quantified using the Dc Protein Assay (BioRad) according to manufacturer's instructions. Briefly, 2 µl sample aliquots of samples were analyzed by a modified Lowry assay, and the resulting absorbance at 690nm was measured. Protein concentrations were calculated with reference to the absorptions of protein standards, and were expressed as µg/µl total protein.

2.15.2. Western Blotting

2.15.2.1. Denaturing Polyacrylamide Gel Electrophoresis (SDS-PAGE)

Thirty micrograms of protein were combined with XT Sample Buffer (BioRad) and XT Reducing Agent (BioRad) at final concentrations of 1X in a total volume of 30 ul. Polypeptides were denatured by incubation for 10 minutes at 95 °C and then kept on ice. Twenty micrograms denatured samples were loaded on 4-12% Bis-Tris Criterion XT Precast

Gels (BioRad) and electrophoresed in XT-MOPS Buffer (BioRad, CA, USA) using Criterion Electrophoresis Cells (BioRad) according to manufacturer's instructions.

2.15.2.2. Immunoblotting of Polyacrylamide Gels

After electrophoresis, separated proteins were transferred to a Hybond-ECL Nitrocellulose Membrane (GE Lifescience) in Transfer Buffer (25 mM Tris, 192 mM glycine, 20% methanol). for 1 hour at 100 V. After transfer, membranes were stained with Ponceau S Solution (BioRad) to confirm protein transfer. After saturation for 1 hour in 5 % milk powder in TBS containing 0.1% Tween-20 (Sigma), membranes were incubated overnight with primary antibodies diluted in 5% fat-free milk in TBST at 4°C on a tube roller. The following day, membranes were washed three times with TBS containing 0.1% Tween-20 (TBST) and then incubated for 1 hour with the appropriate HRP conjugated secondary antibody diluted in 5% fat-free milk in TBST. Membranes were again washed three times with TBST, and bound antibody was detected with ECL Advance (GE Lifescience) according to manufacturer's instructions. Bands were visualized using a ImageQuant LAS 4000 Mini System (GE Lifescience).

2.16. Yeast One-Hybrid Assay

For yeast one hybrid assays, *S. cerevisiae* reporter strain Y187 (MATa, ura3-52, his3-200, ade2-101, trp1-901, leu2-3, 112, met-, gal4D, gal80D, URA3::GAL1UAS-GAL1TATA-lacZ ; Clontech) was used (Clontech). Y187 contains a stably integrated LacZ reporter gene regulated by a wild-type GAL1 promoter. Yeast were transformed with plasmids encoding the transcriptional activation domains of isolated NS5A (section 2.4.8) by the lithium acetate method following the manufacturer's recommended protocol provided with the YeastMaker Yeast Transformation System (Clontech). pCL1 plasmid (Clontech), encoding wild-type GAL4, was used as a positive control for transformation. Transformants were grown on tryptophan-deficient synthetic dropout (SD) (trp-) media plates for 3 days at 30 °C.

Reporter gene β -galactosidase activity was measured by a quantitative luminescent assay using the Galacto Star kit (Tropix, Perkin Elmer) according to the manufacturer's protocol. Briefly, well-isolated transformed yeast colonies were grown overnight in trp- SD medium for

plasmid maintenance. When the optical density (OD₆₀₀) reached 1.5, 2 ml of this culture was then used to inoculate 8 ml of YPD medium (1% bacto-yeast extract, 2% bacto-peptone, 2% dextrose) and grown in a shaking incubator at 30 °C up to mid-log phase (OD₆₀₀ : 0.4 to 0.6). A 1.5 mL aliquot was used to prepare cell extracts. For this, the culture was centrifuged and the yeast pellet was resuspended in 300 µl of Z lysis buffer provided in the Galacto Star kit. A 100 µl aliquot was subjected to 2 freeze-thaw cycles, and 20 µl was mixed with 300 µl of reaction buffer containing the Galacto Star substrate. After incubation for 20 min at room temperature, light emission was measured using Mithras LB940 Luminometer (Berthold Technologies). All assays were repeated in triplicate using three independent transformants for each construct. The β-galactosidase activity was calculated as a relative value over that of vector pGBT9 alone.

2.17. Luciferase Reporter Activity Assay

Cells transfected with subgenomic HCV replicons containing the luciferase reporter gene were washed with PBS and lysed with Cell Culture Lysis Buffer (Promega). Fifty microliters of the lysate was mixed with 25µl Luciferin solution (Promega) and luciferase activity was measured with a Mithras LB940 Luminometer (Berthold Technologies). All luciferase activity measurements were performed in triplicate.

3.- RESULTS

Phylogenetic and functional analysis of NS5A quasispecies variants**3.1.1. Genetic Compartmentalization of NS5A Quasispecies Variants**

In order to investigate the quasispecies sequence variability in the liver tissues, total RNA was isolated from tumoral and adjacent non-tumoral liver tissues from six patients infected with genotype 1b HCV, and the NS5A sequences amplified by RT-PCR and cloned into pCR2.1-TOPO vector. For each sample, 30 randomly generated colonies were selected and the corresponding NS5A transcriptional activation domain was sequenced. A total of 358 sequences were generated. Phylogenetic analysis of these sequences allowed the characterization of NS5A quasispecies variants in both tumoral and non-tumoral adjacent tissue in terms of both quasispecies complexity (Figure 3.1-A) and genetic distance (Figure 3.1-B). Such analyses revealed that there was lower quasispecies complexity within tumoral tissue (lower Shannon Entropy). Moreover, for 3 out of 6 patients, we observed a higher genetic distance between quasispecies variants isolated from tumoral tissue versus those isolated from non-tumoral adjacent tissue.

[A]

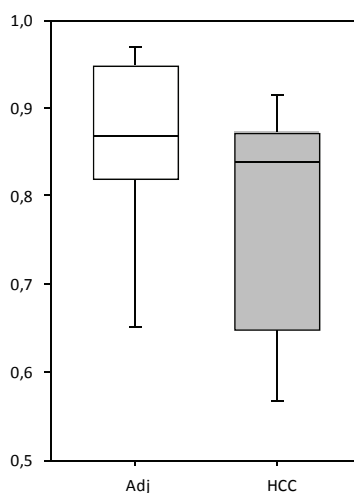

[B]

Patients	Amino acid distances +/- SD			t test p value
	Inter N versus T	Intra N	Intra T	N versus T
1	0.020	0.018	0.020	NS
2	0.017	0.017	0.015	0.001
3	0.010	0.007	0.011	0.001
4	0.030	0.023	0.022	NS
5	0.044	0.019	0.032	0.001
6	0.023	0.018	0.018	NS

Figure 3.1: The complexity of NS5A transcriptional activation domain quasispecies variants in non-tumoural and tumoural liver. [A] A: Normalized Shannon's entropy was calculated for NS5A transcriptional activation domain quasispecies variants (amino acid sequences) isolated from tumoral and non-tumoral adjacent tissues from all 6 patients. Shannon's entropy value is 0 when there is no difference i.e., only one variant whereas it is 1 when all variants differ from each other and are equally represented. [B] To calculate genetic distances, CLUSTAL W program was used to align amino acid sequences. Distances between pairs of amino acid sequences were calculated by using the PROTDIST module in the PHYLIP package version 3.572. Calculation was based on a Kimura two-parameter distance matrix with a transition-transversion ratio of 4.0. The mean +/-standard deviation within-sample genetic distances were calculated for each tissue.

3.1.2. Functional Compartmentalization of NS5A Quasispecies Variants

As described above, phylogenetic analyses showed a genetic compartmentalization of NS5A quasispecies variants in tumoral and non-tumoral adjacent tissues. I next hypothesized that the genetic compartmentalization was linked to a functional compartmentalization of NS5A

quasispecies variants. As described in section 3.1, our group has previously demonstrated that there is a significant difference of transcriptional activation potential among NS5A quasispecies variants isolated from serum of an HCV infected patient (Pellerin *et al.*, 2004). Therefore, to investigate this hypothesis, I studied the transcriptional activation potential of NS5A quasispecies variants.

For this purpose, I cloned the transcriptional activation domains of the isolated NS5A quasispecies variants into the yeast one hybrid vector pGBT9 (Figure 3.2) and performed yeast one-hybrid assay to analyse the ability of different variants to transactivate the yeast GAL4 promoter.

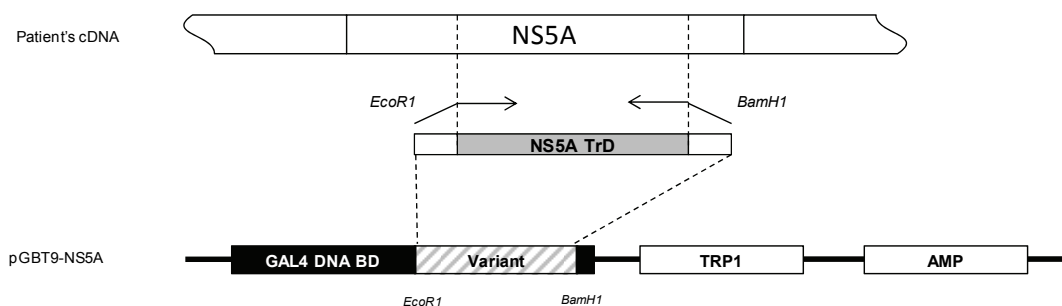

Figure 3.2: Schematic representation of yeast one-hybrid constructs encoding NS5A variants. The NS5A transcriptional activation domains (NS5A TrD) were amplified from patient's cDNA and cloned into pGBT9, giving fusions of the Gal4 DNA binding domain (BD) with the respective NS5A transactivation domains for each variant.

In agreement with previous results (Pellerin *et al.*, 2004), the results of these analyses demonstrated that the isolated quasispecies variants of NS5A possessed significantly different transcriptional activities irrespective of the compartment (non-tumoral vs tumoral) studied (Figure 3.3).

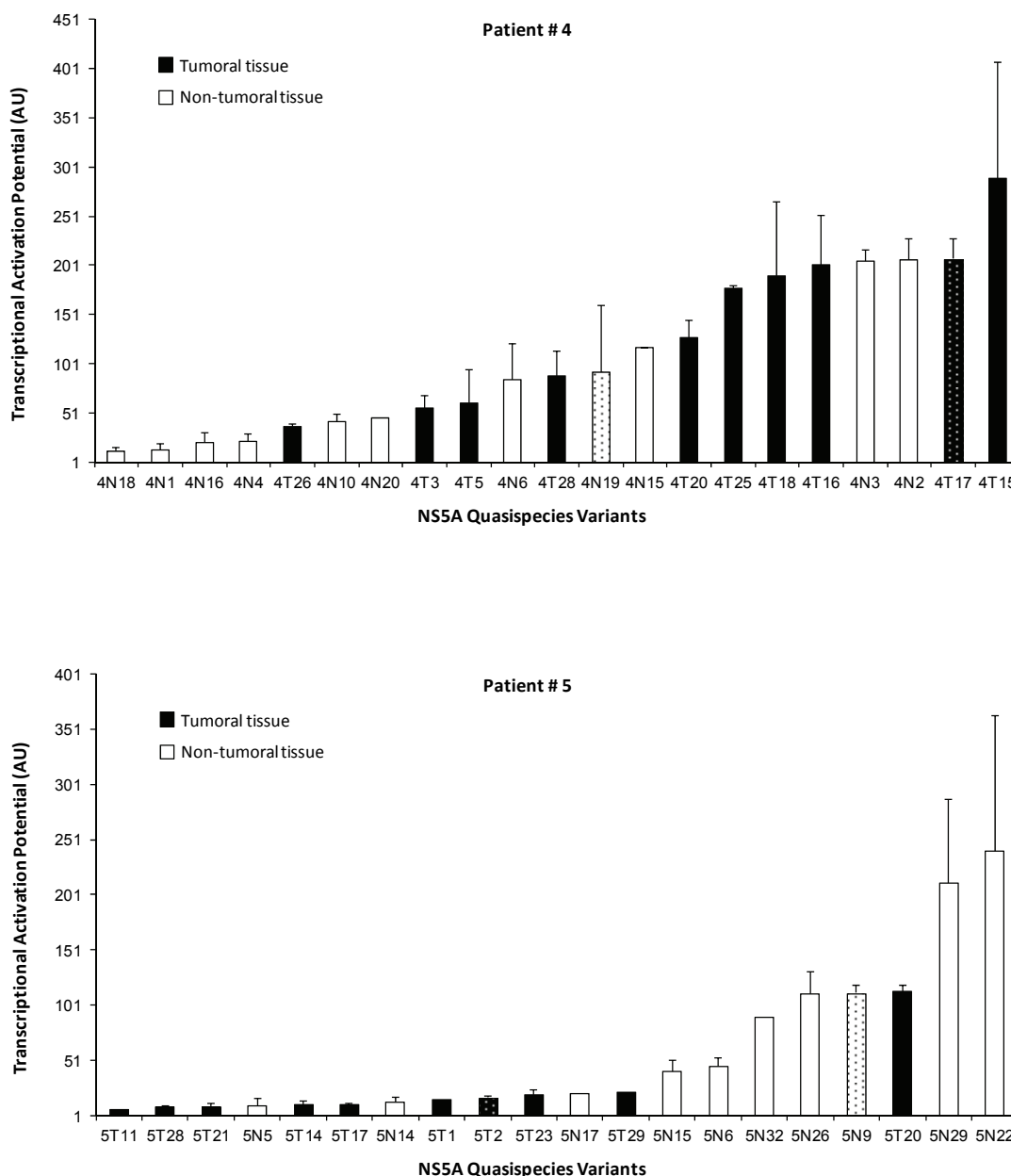

Figure 3.3: Transcriptional activation potential of NS5A variants. The transcriptional activation domains of NS5A quasispecies variants isolated from the patients were cloned into yeast one-hybrid vector pGBT9 as described in figure 3.3. Yeast one hybrid vectors expressing NS5A TrD – GAL4 DNA BD fusion proteins were transfected into yeast. The potential of the hybrid proteins to activate transcription of *LacZ* gene was analyzed by quantification of β -galactosidase activity. Results obtained from the variants isolated from two of the six patients are expressed as mean \pm SEM transactivation levels obtained from at least three independent experiments. Dotted bars represent major variants. AU = arbitrary units.

Interestingly, statistical analysis of the distribution of variants according to their transactivation potential and tissue origin demonstrated a significant functional

compartmentalization of variants for 4 out of 6 patients (patients 3, 4, 5, 6; Figure 3.4). Among these 4 patients, 3 (patients 3, 4 and 6) exhibited a trend whereby variants with highest transactivation properties were in tumoral tissue, while one patient (patient 5) displayed the opposite trend. Interestingly, of the six patients, the two which developed cirrhosis were the two which displayed no functional compartmentalization of NS5A variants.

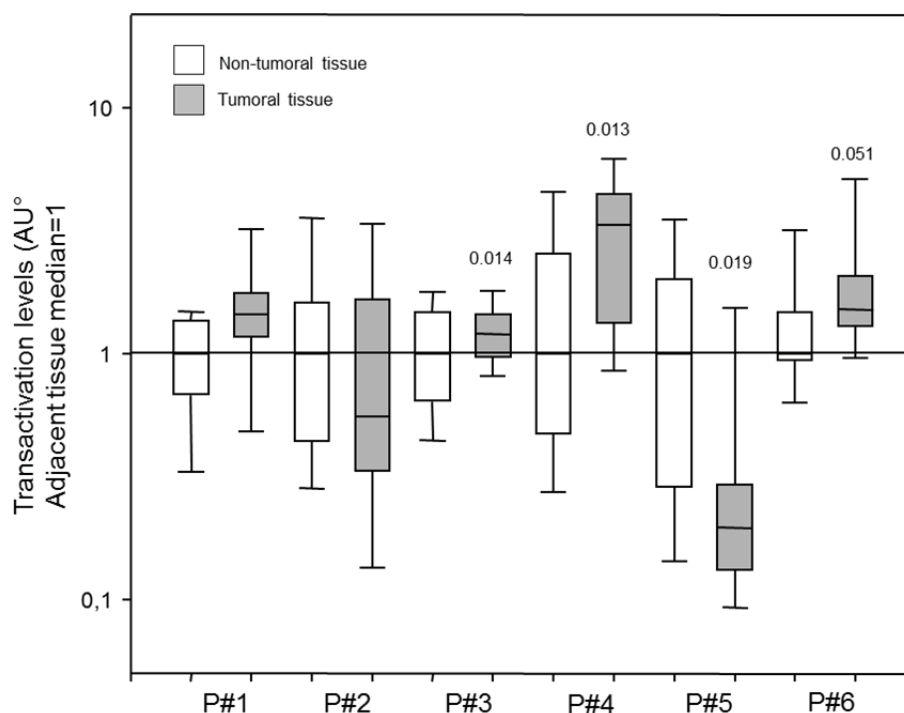

Figure 3.4: Functional compartmentalization of NS5A variants. To analyze the functional compartmentalisation of NS5A quasispecies variants, the transactivation potential of variants isolated from tumoral and non-tumoral adjacent tissues was statistically analyzed using a Mann Whitney Rank Sum test. Results are illustrated as box plots, with the median transactivation potential of all NS5A variants isolated from tumoral or non-tumoral adjacent tissues of each patient depicted. Empty and shaded boxes represent non-tumoral adjacent tissues and tumoral tissues respectively.

Two hypotheses could be drawn from these observations: i) That quasispecies variants with high transcriptional activation potentials were involved in the onset or development of HCC by transactivating genes involved in carcinogenesis, and viruses bearing these variants had since replicated in the tumors; ii) that variants with high transcriptional activation potentials were better adapted to the selective tumoral environment (e.g. highly replicating hepatocytes) and were selected for at the expense of others. We investigated both hypotheses, and the

results are dealt with in section 3.2 (the first hypothesis) and section 3.3 (the second hypothesis)

3.2. Role of NS5A transactivational properties in HCV-induced liver pathogenesis

In order to study the role of NS5A variants in cellular transformation and development of HCC, we required an expression vector that could be used for long-term expression of NS5A variants *in vivo* in murine livers, as well as for *in vitro* transient expression in cultured primary hepatocytes. We chose to use an adenoviral vector as, on one hand, it can be used to transduce mice for long term *in vivo* expression of transgene, and on the other hand it can be used to transduce *in vitro* cultured primary human or murine hepatocytes for transient transgene expression. To study the role of naturally occurring NS5A quasispecies variants in transformation of hepatocytes *in vivo* and development of hepatocellular carcinoma, we selected two NS5A variants from those isolated from tumoral tissues based on their transactivation potential and cloned them into a helper dependent adenoviral transgene expression vector.

3.2.1. Construction of NS5A Adenoviral Vector

Two NS5A variants isolated from patient 4 bearing high and low transactivation potentials were selected for the construction of adenoviral vectors for *in vivo* and *in vitro* expression of NS5A. These variants, renamed from 4T17 and 4T26 to NS5A-V1 and NS5A-V5 respectively, were selected because they respectively showed the highest and lowest transactivation potentials in yeast one-hybrid assays (Figure 3.3). Construction of recombinant adenoviral vectors was performed in two major steps; i) Construction of NS5A expression cassettes and ii) cloning of NS5A expression cassettes into helper-dependent adenoviral genomes and production of recombinant adenoviral particles.

3.2.1.1. Construction of NS5A expression cassette

NS5A expression cassettes were designed as bicistronic constructs for the hepatic expression of NS5A concomitantly with the expression of human factor IX as a reporter gene (Figure 3.5). We used the PEPCK promoter to drive liver-specific transgene expression. Human factor IX was chosen as reporter gene due to its easy detection by ELISA in the plasma of

transduced animals, to the absence of interference with murine hepatocyte functions and its non-immunogenicity in mice.

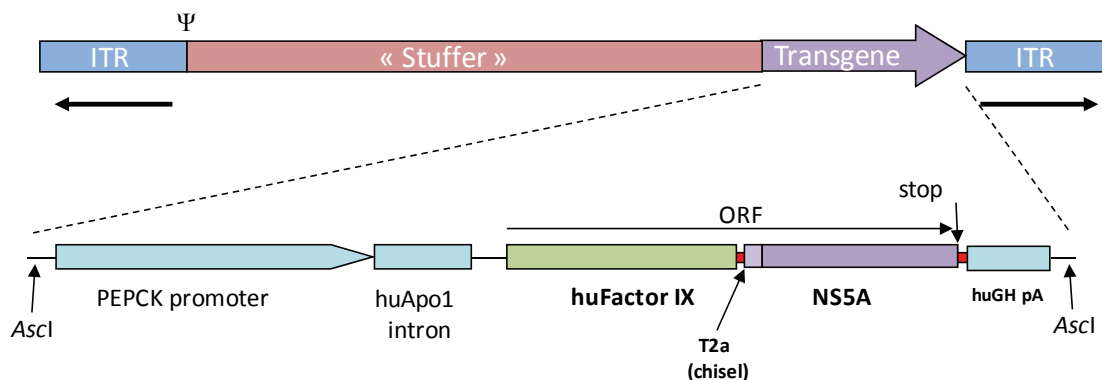

Figure 3.5: NS5A expression cassette for adenoviral vector development. The bicistronic expression cassette for NS5A, containing the PEPCK promoter and human Apo1 intron sequences located upstream of an open reading frame (ORF) consisting of human factor IX, T2A chisel and NS5A sequences, in turn followed by the polyadenylation signal from human growth hormone was cloned into a helper-dependent adenoviral vector using *AscI* restriction sites. The recombinant adenoviral genome was then used to produce adenoviral particles carrying NS5A expression cassettes in their genome.

The construction of NS5A expression cassette necessitated a strategy to easily clone patient-isolated NS5A sequences. To achieve this, the NS5A expression cassette was constructed by Gateway homologous recombination which consists of a recombination of two plasmids termed Entry and Destination vectors. The entry vector (pENTR-T2A-NS5A) contained T2A Chisel and NS5A variant sequences flanked by the homologous recombination sites attL1 and attL2. The 2A-like peptide from the insect virus *Thosea asigna* (TaV), abbreviated as T2A peptide, is a small polypeptide of 19 residues (Donnelly *et al.*, 2001a). All 2A-like peptides have a rare consensus motif associated with a novel cleavage mechanism. This cleavage does not occur by classical proteolytic mechanism, but rather by inducing a “ribosomal skip” that impairs normal peptide bond formation between two amino acids without affecting the continuity of downstream translation (Donnelly *et al.*, 2001b). We used the T2A sequence in place of an IRES in our bicistronic transgene expression cassette since the use of 2A peptides has been demonstrated to produce equal quantities of all genes in a multicistronic transgene cassette. Moreover, the relatively small sequence length of 2A peptides (57 bases compared to > 300 bases for IRES) can help reduce expression cassette size.

The destination vector (pPEPCK-FIX-DEST) contained factors needed for efficient expression of NS5A including the PEPCK promoter, the human ApoA intron, human factor IX, a polyA signal and a homologous recombination cassette inserted between human factor IX and the polyA signal. Phosphoenolpyruvate Carboxykinase (PEPCK) is a key enzyme in glucose synthesis pathway and is specifically expressed in liver and to a very small extent in kidney cells (Hanson *et al.*, 1997). Thanks to the liver-specific expression of PEPCK, the PEPCK promoter sequence has become one of the promoters of choice for use in *in vivo* long-term liver specific transgene expression (Perales *et al.*, 1994; Kiang *et al.*, 2006). The PEPCK promoter is not as strong a promoter as some other liver specific promoters such as hAAT and Albumin; indeed it has been demonstrated that PEPCK promoter is ~20 fold weaker than albumin promoter, and is hence better adapted to achieve physiologically relevant levels of transgene expression for which strong expression is not desired such as viral pathogen proteins (Hafenrichter *et al.*, 1994). Human factor IX (FIX) is a blood coagulation factor of 54 KDa consisting of 415 residues. It has been observed that human FIX is not immunogenic in C57BL/6 mice and can be expressed in immunocompetent mice without provoking an immune reaction (Herzog *et al.*, 1997). Human FIX is secreted into blood plasma and can be easily quantified by ELISA, and can thus be used as a heterologous reporter gene for *in vivo* transgene expression studies in C57BL/6 mice.

3.2.1.1.1. Construction of entry vector

The entry vector was constructed in two steps: i) cloning of T2A sequence into pENTR/D-TOPO to produce pENTR-T2A-XhoI and ii) cloning of NS5A variants into pENTR-T2A-XhoI. In the first step, the T2A sequence and downstream *Bgl*I and *Xho*I restriction sites was amplified by PCR, and cloned into pENTR/D-TOPO by TOPO-TA cloning. (strategy outlined in Figure 3.6).

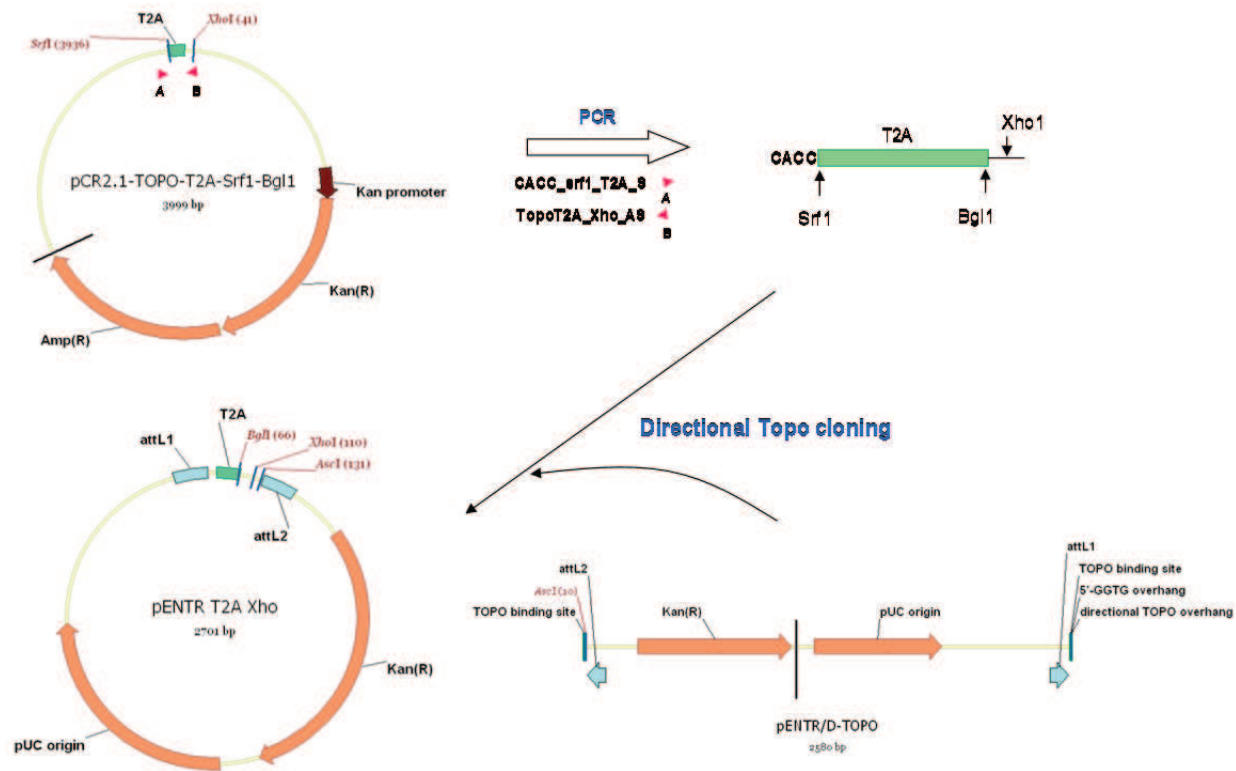

Figure 3.6: Construction of entry vector: Schematic representation of T2A sequence cloning. The T2A sequence was PCR amplified and cloned in pENTR/D-TOPO using Directional TOPO cloning. The resulting plasmid was termed as pENTR-T2A-XhoI.

An undesirable *AscI* restriction site in pENTR/D-TOPO was removed by *AscI* digestion of plasmid DNA followed by filling in sticky ends using Klenow fragment of DNA polymerase I. Upon relegation, the plasmid was now termed pENTR-T2A-XhoI- Δ *AscI* (Figure 3.7).

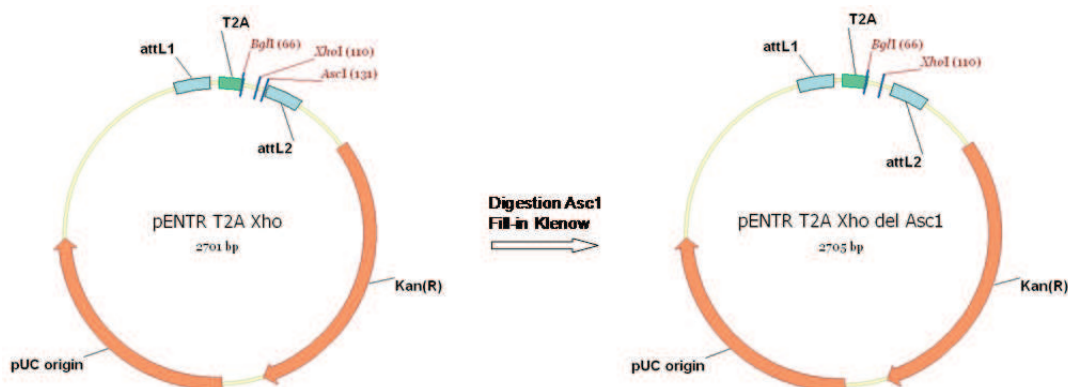

Figure 3.7: Construction of entry vector: Removal of *AscI* restriction site. To remove the unwanted *AscI* restriction site present in pENTR-T2A-XhoI, plasmid DNA was digested with *AscI*, then treated with Klenow fragment of Polymerase I to fill-in the sticky ends before religation.

In the second step, patient-derived NS5A sequences were amplified and cloned into pENTR-T2A-XhoI- Δ *AscI* to give pENTR-T2A-NS5A (Figure 3.8A). Successful cloning was confirmed by *BglII* and *XhoI* digestion of plasmid DNA isolated from several colonies. Agarose gel electrophoresis analysis of digested DNA revealed two bands corresponding to expected fragments of 1343bp and 2661bp (Figure 3.8B). Integrity of the insert was verified by nucleotide sequencing.

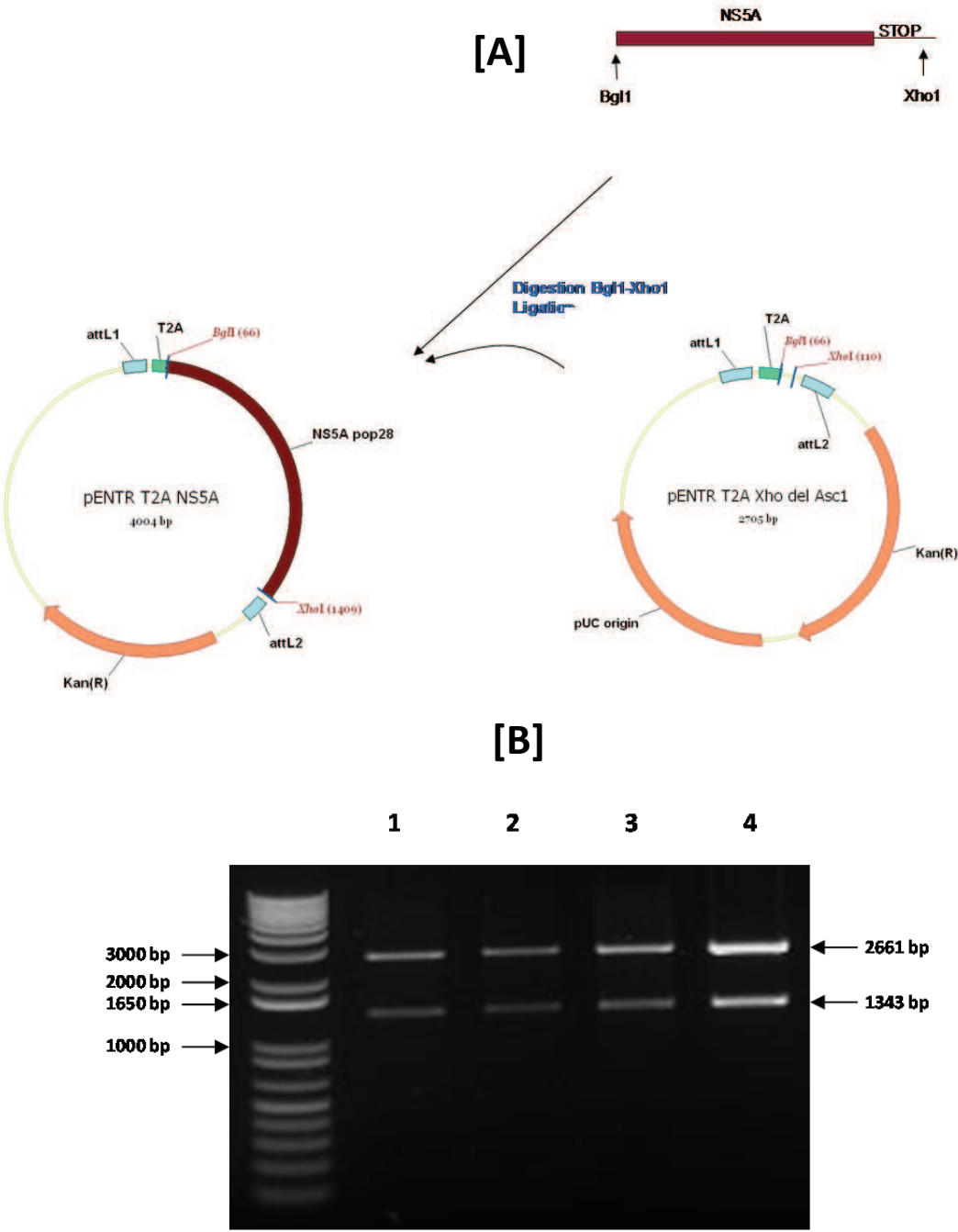

Figure 3.8: Construction of entry vector: Cloning of NS5A into Entry Vector. [A]. NS5A was PCR amplified using primers containing *BglI* and *XhoI* restriction sites. The amplified NS5A was cloned between these sites in pENTR-T2A-*XhoI*-Δ*AscI* to obtain pENTR-T2A-NS5A. [B] Insertion of NS5A into pENTR-T2A-*XhoI*-Δ*AscI* vector was confirmed by digestion of plasmid DNA with *BglI* and *XhoI*, revealing bands of the expected sizes.

3.2.1.1.2. Construction of destination vector

The plasmid pPEPCK-FIX containing all sequences required for liver-specific expression of NS5A was kindly provided by Dr. Nicola Brunetti-Pierri (Baylor College of Medicine, Houston, TX). As described in Materials and Methods, two stop codons present immediately downstream of human Factor IX (FIX) were first removed by site directed mutagenesis (Figure 3.9).

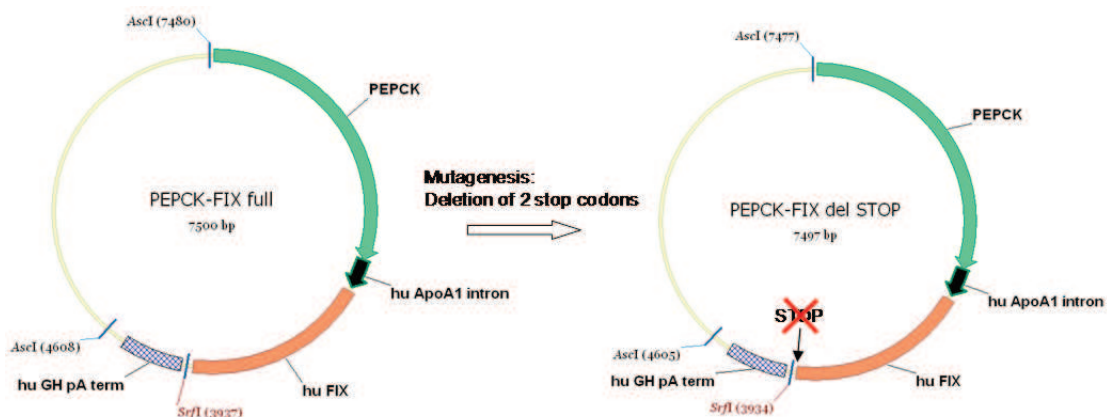

Figure 3.9: Construction of destination vector: Strategy for the removal of stop codons. To allow continued expression of downstream sequences, two stop codons present at the end of FIX sequence in pPEPCK-FIX plasmid were removed by site directed mutagenesis.

pPEPCK-FIX was next converted into a Gateway Destination Vector (Figure 3.10A). A Cm^R resistance marker in the conversion cassette allowed the selection of colonies that contained the gateway conversion cassette insert. Restriction analysis of plasmid DNA isolated from several colonies by digestion with *AscI* enzyme revealing the two fragments of expected sizes corresponding to 2872bp and 6339bp, confirming the conversion of the plasmid into a Gateway Destination Vector (Figure 3.10B). Finally the plasmid DNA was sequenced to confirm the integrity and orientation of the insert.

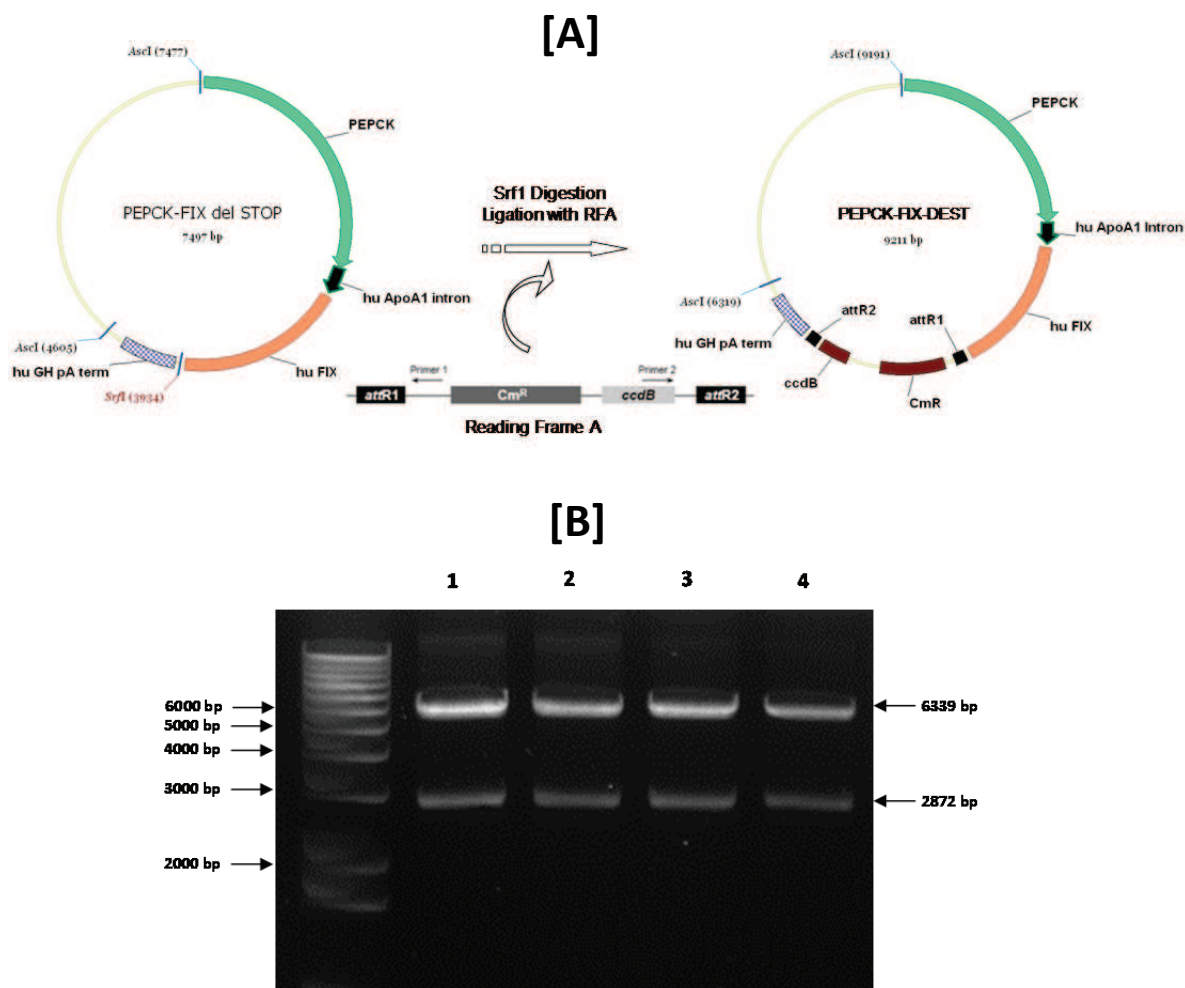

Figure 3.10: Construction of destination vector: Generation of Destination Vector [A] To convert the vector pPEPCK-FIX-delStop to a gateway cloning compatible destination vector, Reading Frame A (RFA) conversion cassette was ligated into blunt ends of *SrfI* digested plasmid pPEPCK-FIX-delStop. The complete destination vector was termed pPEPCK-FIX-DEST. **[B]** *AscI* restriction analysis of plasmid DNA isolated from several colonies to confirm the insertion of RFA conversion cassette.

3.2.1.1.3. Generation of complete NS5A expression cassette

The Entry (pENTR-T2A-NS5A) and Destination (pPEPCK-FIX-Dest) vectors were recombined to obtain pPEPCK-FIX-T2A-NS5A plasmid that carried a complete NS5A expression cassette along with the PEPCK promoter, human Factor IX, human ApoA1 intron, T2A, NS5A and human GH pA term sequences (Figure 3.11A). A byproduct plasmid produced during recombination was eliminated by antibiotic resistance selection of bacteria transformed with the recombination products. Insertion of the T2A and NS5A sequences was confirmed by *AscI* restriction analysis of plasmid DNA isolated from transformed colonies

(Figure 3.11B). The integrity of inserted sequence, continuity of the reading frame and correct orientation of the insert were analyzed by nucleotide sequencing of the resulting vector.

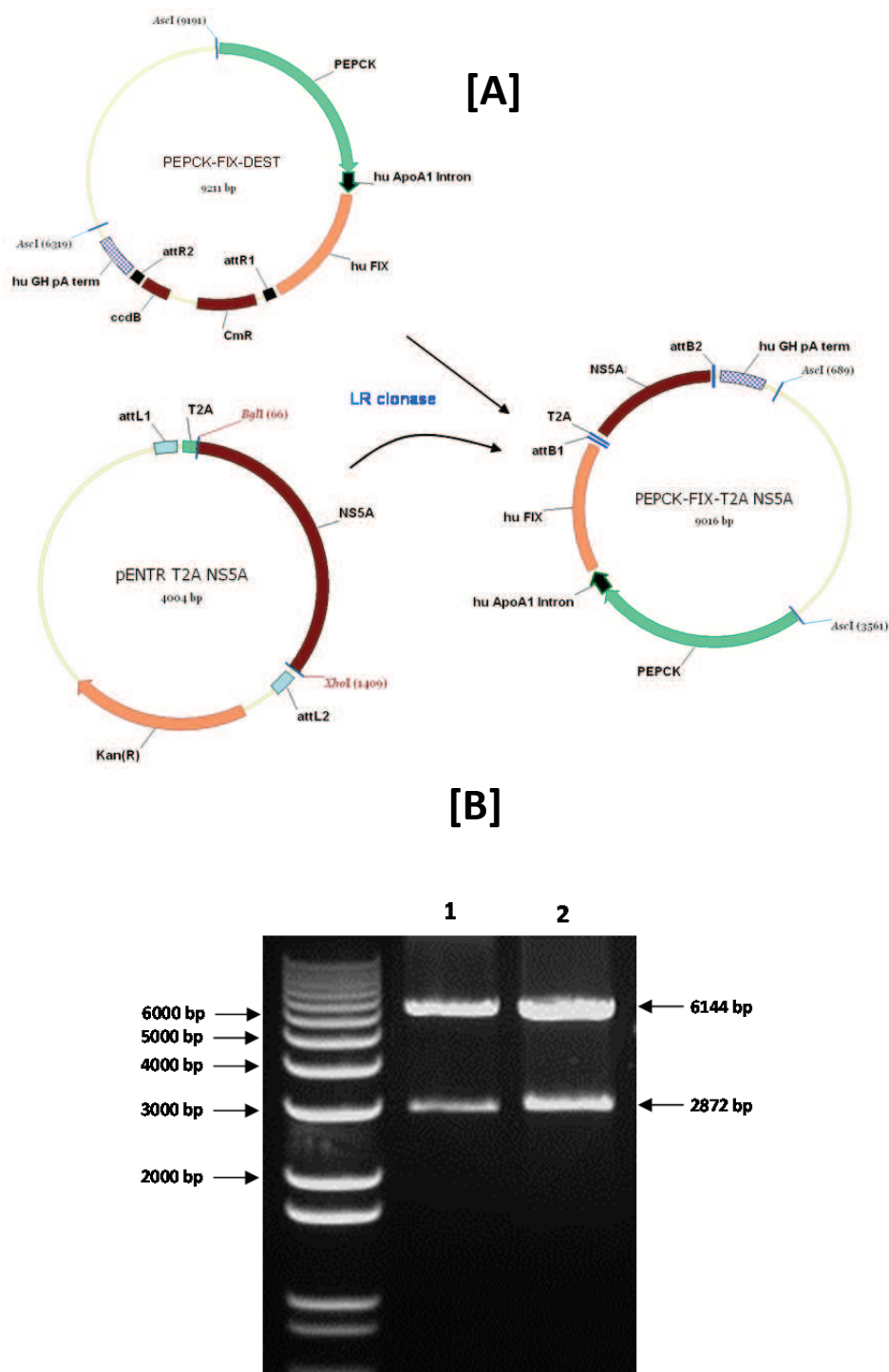

Figure 3.11: Generation of complete NS5A expression cassette. [A] Entry and destination vectors were recombined to generate the plasmid that carried the complete NS5A expression cassette. This plasmid was termed pPEPCK-FIX-T2A-NS5A and contained NS5A and T2A sequences fused in frame with human factor IX reporter gene sequence. **[B]** *AsclI* restriction analysis of pPEPCK-FIX-T2A-NS5A-v1 (Lane 1) and pPEPCK-FIX-T2A-NS5A-v5 (Lane 2) plasmid DNA.

3.2.1.2. Production of recombinant adenoviral particles

Before proceeding to the production of adenoviral vector particle stocks, pPEPCK-FIX-T2A-NS5A carrying complete expression cassettes for NS5A variants v1 or v2 were transfected into Huh7 cells and NS5A expression was analyzed 48 hours after transfection by western blot. As demonstrated in figure 3.12, no NS5A could be detected in transfected cells, suggesting that the vectors did not express NS5A *in vitro*.

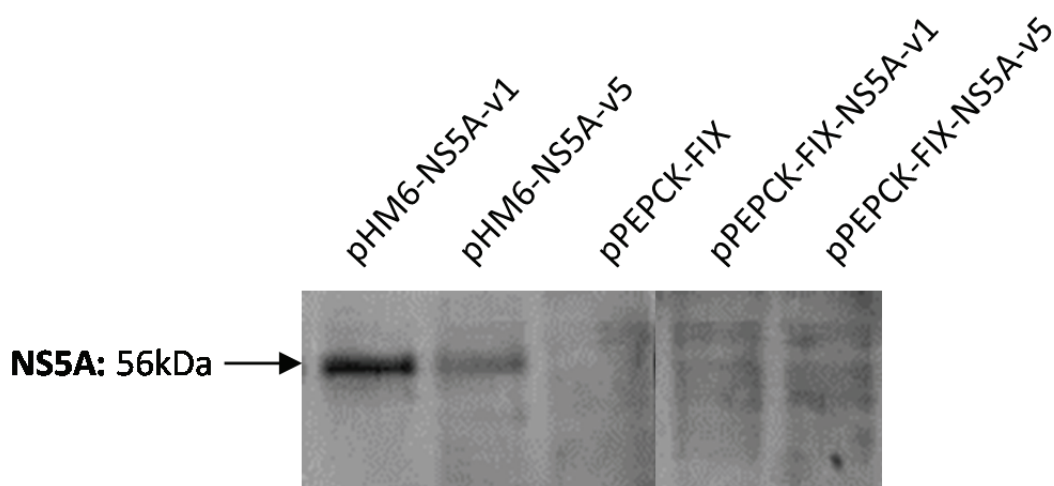

Figure 3.12: Immunoblotting for NS5A expression in transfected cells. Protein extracts from cells transfected with indicated plasmids were analyzed by western blotting to detect NS5A. Polyclonal sheep anti-NS5A serum was used at 1/500 dilution to detect NS5A. HRP conjugated rabbit anti-sheep antibody at 1/10000 dilution was used as secondary antibody. Western blot was revealed with ECL Advance reagent. Cells transfected with plasmids pHM6-NS5A-V1 and pHM6-NS5A-V5 were used as positive control for NS5A expression.

During the course of these experiments, a literature search revealed that the PEPCK promoter is strongly suppressed by glucose and insulin, both of which are present at high concentrations in cell culture medium (Quinn *et al.*, 2005). This suggested that, although the adenoviral vector construct may be functional, the expression of NS5A in transfected cells may have been suppressed in cell culture, although this may not have been the case *in vivo*. Following this, we decided to continue with the production of adenoviral particle stocks. Plasmids encoding complete expression cassettes for NS5A variants v1 and v2 were sent to Dr. Nicola Brunetti-Pierri's laboratory where further cloning of NS5A expression cassettes into helper dependent adenoviral vector genome and production of infectious adenoviral particles was performed. A plasmid carrying expression cassette encoding human FIX was

used to produce adenoviral particles to be used as a negative control for adenoviral vector based experiments. These cloning and adenoviral production procedures were performed as published previously (Palmer *et al.*, 2003). Adenoviral particle stocks were produced for NS5A-v1, NS5A-v2 and human FIX and termed as Ad-NS5A-v1, Ad-NS5A-v5 and Ad-FIX respectively. Viral titers of these stocks were determined to be 1.27×10^{13} vp/mL, 5.15×10^{12} vp/mL and 9.7×10^{12} vp/mL respectively.

3.2.2. Transduction of Murine Livers with NS5A Adenoviral Vectors

Adenoviral vector particles were used to infect mice to induce hepatic expression of the various NS5A variants. To study the contribution of NS5A transactivation properties in development of HCC, it was important to express equal quantities of both NS5A variants. This necessitated the injection of precisely the same number of infectious adenoviral particles for each recombinant virus. The tail vein is often used for intravenous injections in mice: however, this vein is very fragile and not suitable for the precise injection of small volumes (20-30 μ l) since a non-quantifiable loss of viral particles into tail tissues cannot be excluded. Therefore we chose to inject the viral particles through the jugular vein, after prior insertion of a fine catheter by minor surgery. This technique allows the delivery of precise small volume doses (20-30 μ l) without any loss into surrounding tissues. Three C57Bl6 mice per clone were injected with recombinant adenoviruses Ad-NS5A-v1, Ad-NS5A-v5 and Ad-FIX as described in section 2.6. Blood samples were collected at day 0 (D0; before injection), D1, D3, D5, D7, D14 and D21. . As the PEPCCK promoter is involved in gluconeogenesis and its maximum activation is achieved during fasting, mice were fasted for 12 hours before being sacrificed. Sacrifice took place at D3, D7 and D21 by CO₂ euthanasia to collect blood, liver, spleen and kidney tissue samples. Hepatic protein extracts of sacrificed mice were separated on 12 % SDS-PAGE gels, and western blotting was performed to detect NS5A or human FIX proteins. Protein extracts from NG cells transfected with pHM6-NS5A plasmid, and human serum, were used as positive controls for NS5A and human FIX respectively. Such analyses revealed that only mice infected with Ad-FIX expressed human factor IX in their livers. Specific bands for neither FIX reporter protein nor NS5A could be detected in Ad-NS5A-v1- and Ad-NS5A-v5-transduced mice (Figure 3.13 A and B). GAPDH was used as loading control.

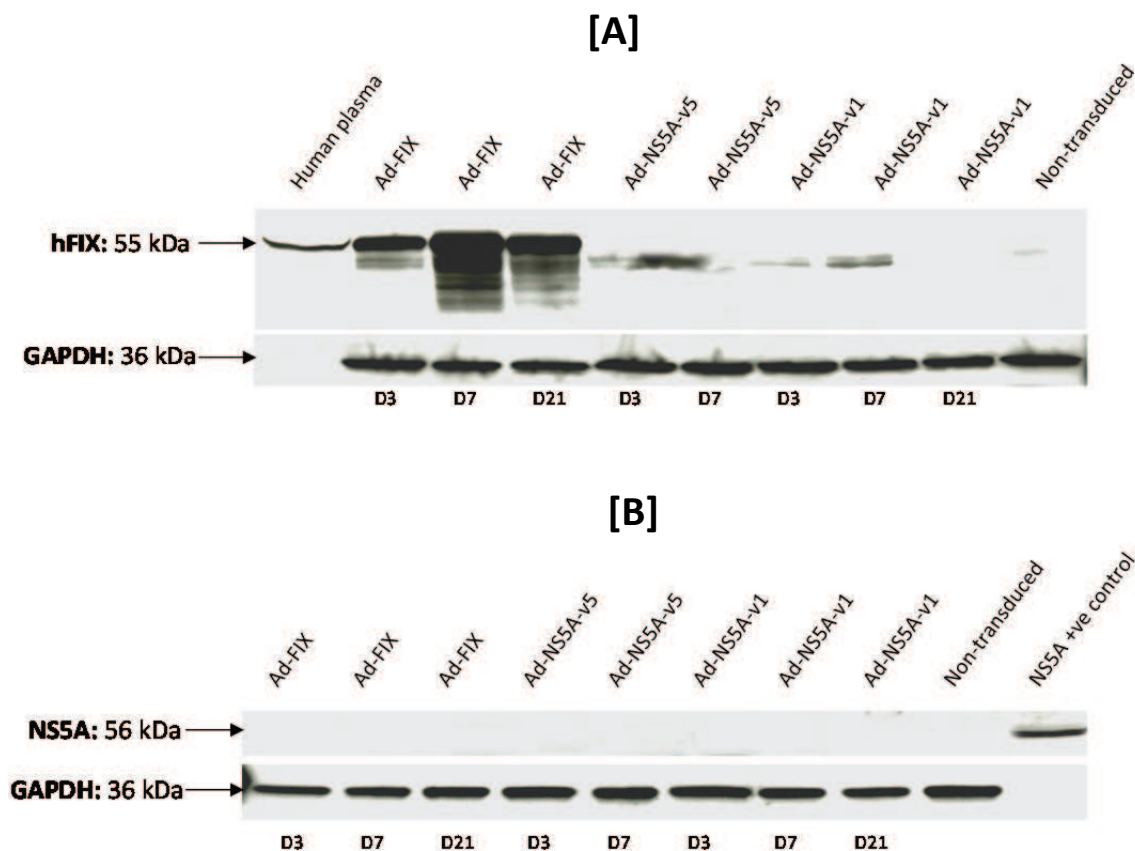

Figure 3.13: Immunoblotting for FIX and NS5A proteins in transduced mice. Protein extracts from the liver tissues of HdAd-infected mice were analyzed by western blotting to detect reporter gene human factor IX **[A]** and NS5A **[B]**. Pooled human plasma was used as a positive control for human FIX western blotting, whereas proteins from liver tissue of a non-transduced mouse served as a negative control. Similarly, proteins from NG cells transfected with pHM6-NS5A were used as a positive control for NS5A western blotting whereas proteins from liver tissue of a non-transduced mouse served as negative control. GAPDH was used as endogenous loading control. Bands corresponding to 55kDa human FIX, 56kDa NS5A and 36kDa GAPDH are indicated. Data are representative of two independent experiments.

Serum samples from injected mice were assayed by ELISA to detect the presence of secreted human FIX. Pooled human serum was used as a positive control. These experiments confirmed the presence of secreted human factor IX in plasma of Ad-FIX transduced mice, whereas it was absent from the plasma of Ad-NS5A-v1 and Ad-NS5A-v5 transduced mice (Figure 3.14).

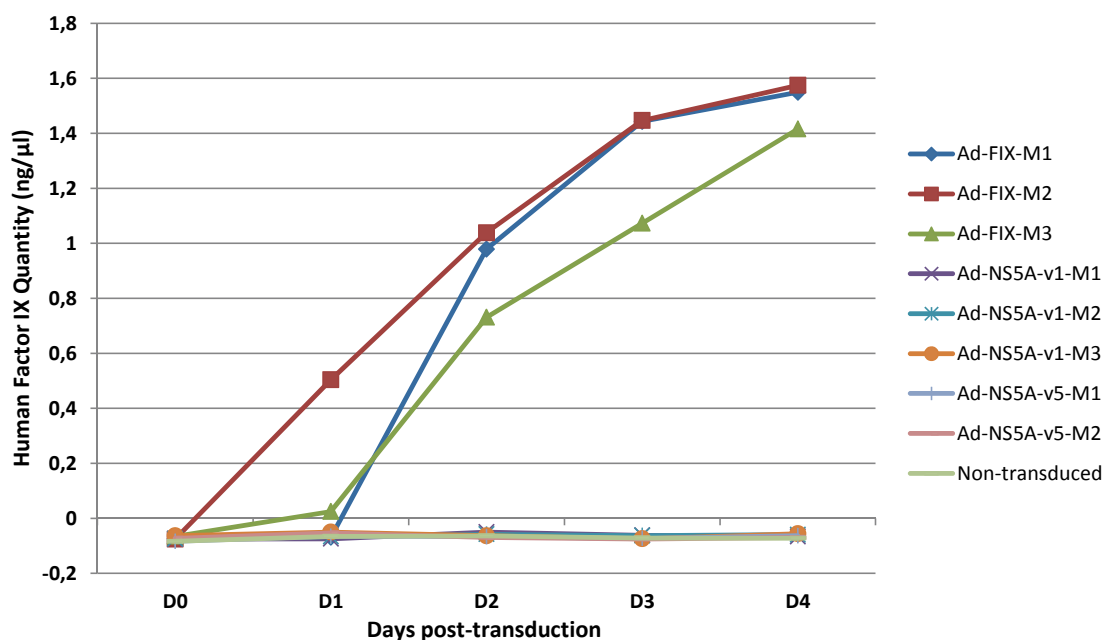

Figure 3.14: ELISA for FIX protein secretion in the plasma of adenovirus-transduced mice. Expression of secreted human factor IX reporter protein was analyzed by ELISA in plasma of mice transduced with indicated adenoviruses at the indicated time intervals. Pooled plasma from non-transduced mice served as negative control.

Taken together, these results suggested that mice infected with adenoviruses encoding NS5A (Ad-NS5A-v1 and Ad-NS5A-v5) failed to express both the reporter gene and NS5A transgene in transduced mice. One of the possible reasons for these observations may be the low number of adenoviral particles used to transduce the mice. To investigate this hypothesis, we repeated the above experiment using three times higher doses of adenoviral particles i.e., 1.5×10^6 vp / Kg. However the use of higher doses of adenoviral vector particles resulted in the death of injected mice within 24 hours, suggesting a strong acute immune reaction to the higher dose of adenoviral vector particles injected intravenously. For these mice, we were not able to harvest any blood or tissue samples.

3.2.3. Alternative Strategy: Development of Lentiviral Vector for NS5A Expression and Transgenic Mice Expressing NS5A in Liver Tissue

As described in the previous section, we failed to efficiently express NS5A variants *in vivo* using adenoviral vectors. Besides adenoviral vectors, two other viral vectors are appropriate for efficient transgene delivery: retroviral and lentiviral vectors. Two serious drawbacks of retroviral vectors are their inability to transduce non-dividing cells such as cultured primary hepatocytes, and the random insertion of the viral genome into the host cell DNA. In contrast, lentiviral vectors can efficiently transduce non-dividing cells, and thus were chosen as an alternative approach to express NS5A variants in cultured hepatocytes, in order to study the role of these variants in transactivating host genes. However, as for retroviral vectors, the lentiviral vector genome is integration competent, and its use as an *in vivo* transgene delivery vehicle is often associated with cellular transformations leading to development of carcinoma. Because of this oncogenic potential, the lentiviral vector system cannot be used for long-term *in vivo* liver transduction, and therefore not for the study of role of NS5A in liver carcinogenesis. As an alternative solution for the long-term *in vivo* expression of NS5A variants, we decided to produce transgenic mice expressing strong and weak transactivating NS5A variants (detailed in section 3.1.2).

3.2.3.1. Construction of Lentiviral Vector for the *in vitro* study of NS5A transactivation properties and their role in pathogenesis

Lentiviral vectors were constructed in two steps: i) the cloning of NS5A into the lentiviral vector genome, and ii) the production and characterization of recombinant lentiviral particles.

3.2.3.1.1. Cloning of NS5A into lentiviral vector genome

To clone high- and low-transactivating NS5A variants into the lentiviral vector genome, NS5A variants v1 and v5 were amplified by PCR (Figure 3.15A) as described in section 2.4.11. The amplified NS5A fragments were cloned into pLenti6.3/V5-TOPO by TOPO-TA cloning and plasmid DNA from the resulting colonies was restriction digested with *Bam*HI and analyzed by agarose gel analysis to confirm the insertion of NS5A into the vector (Figure 3.15D). pLenti6.3-NS5A-v1 and pLenti6.3-NS5A-v5 (Lanes 1 and 3 of Figure 3.15D) exhibited a band corresponding to the expected size of 9047 bp, while empty control vector (Lane 2) did not. Moreover the plasmid DNA was sequenced to confirm the integrity and orientation of NS5A fragments. The resulting plasmids were termed pLenti6.3-NS5A-v1 and pLenti6.3-NS5A-v5

(Figure 3.15 B and C). A similar plasmid expressing β -Galactosidase (pLenti6.3- β Gal) instead of NS5A was used as a negative control.

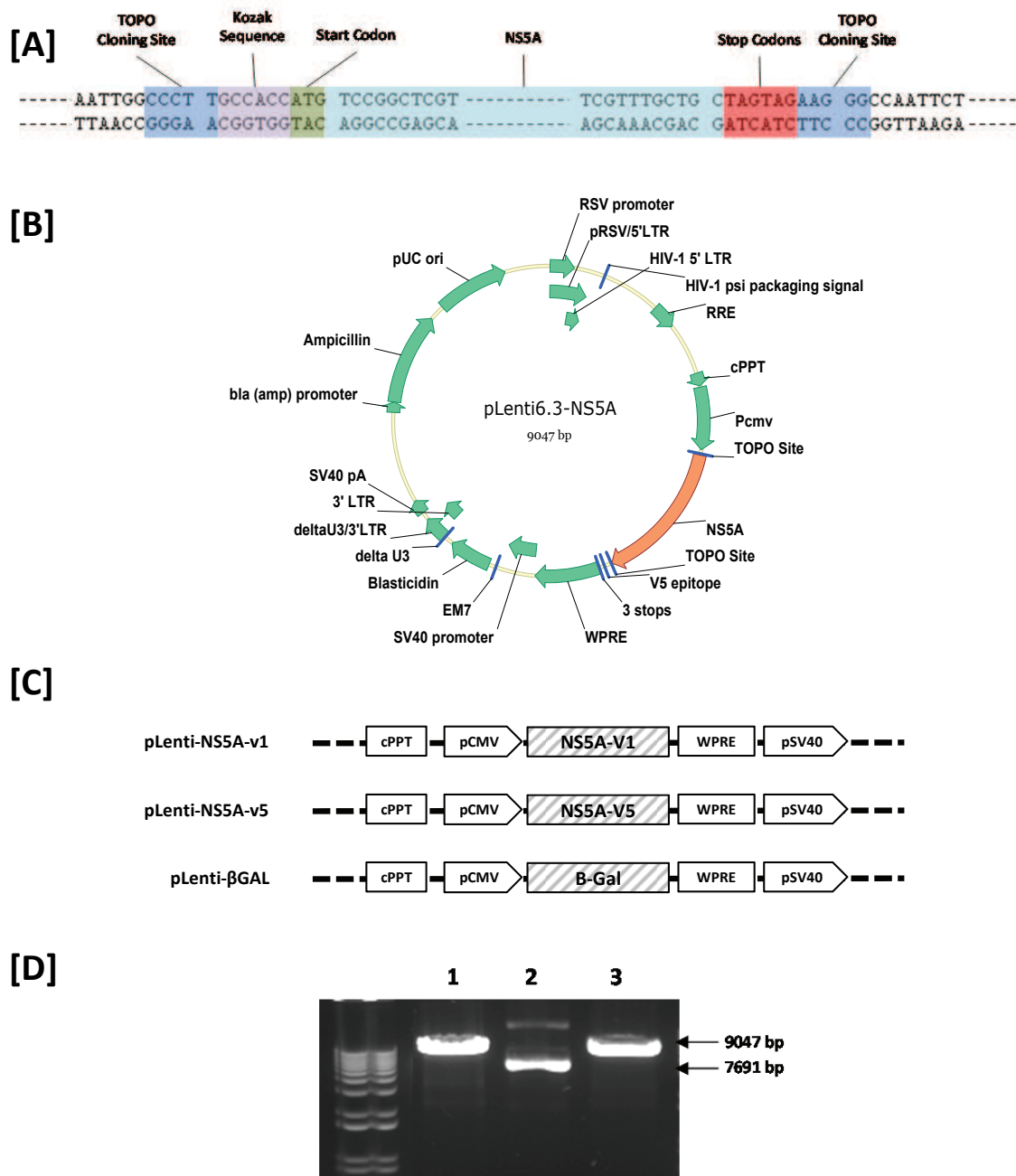

Figure 3.15: Schematic representation of NS5A cloning into lentiviral vector. [A] NS5A sequences were amplified using the NS5A-kozak-S and NS5A-stop-AS primers. The amplified NS5A sequences were then cloned between TOPO cloning sites in the pLenti6.5/V5-TOPO vector. Dotted lines depict continued sequences. A complete plasmid map of pLenti6.3-NS5A vector is presented in panel [B]. [C] Schematic representation of lentiviral vectors containing indicated NS5A variants or β -galactosidase gene. [D] Vector DNA was linearized by digestion with *Bam*HI and electrophoresed on 0.8% agarose gel.

3.2.3.1.2. Production and characterization of recombinant lentiviral particles

To produce recombinant lentiviral particles encoding NS5A variant sequences, pLenti6.3-NS5A was transfected into 293FT cells along with ViraPower Packaging Mix as described in section 2.7. Lentiviral particles were harvested from the culture supernatant and titrated using NG cells as described in section 2.7.3. The titrations of Lenti-NS5A-v1 and Lenti-NS5A-v5 are represented in figures 3.16 A and B respectively. Viral titers were determined to be 1.59×10^6 cfu/mL and 6×10^6 cfu/mL for NS5A-v1 and NS5A-v5 respectively.

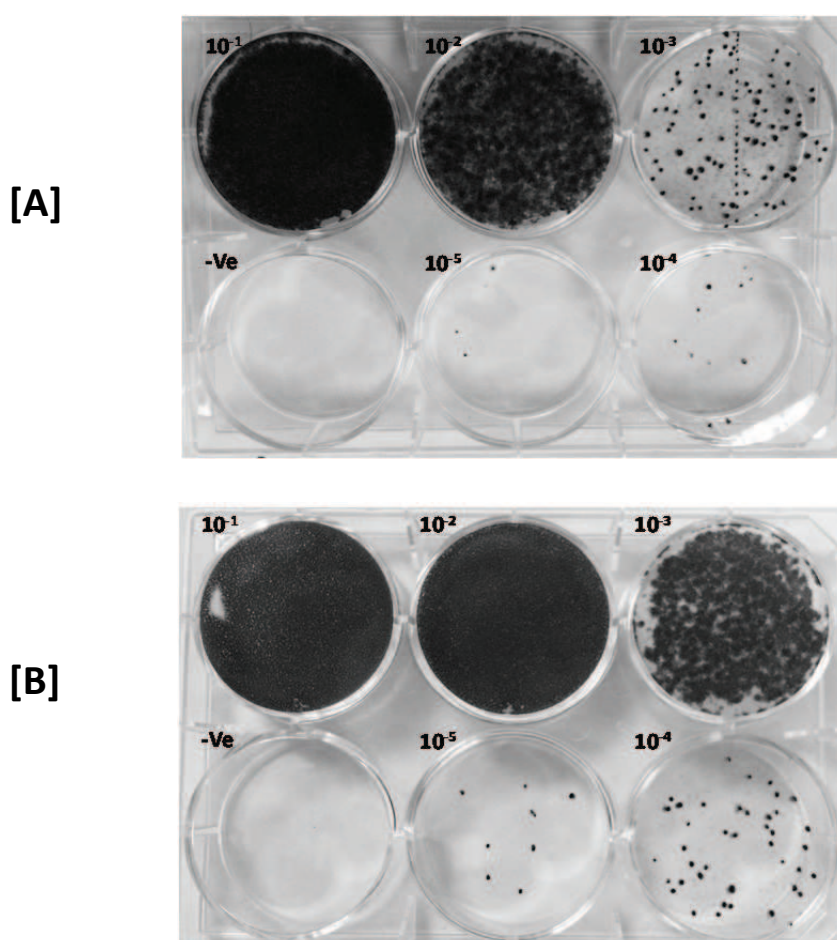

Figure 3.16: Characterization of lentiviral vector stocks: Titration [A] and [B] NG cells monolayers in 6-well culture plates were transduced with indicated 10 fold serial dilutions of lentiviral particle stocks Lenti-NS5A-v1 or Lenti-NS5A-v5 respectively. Colonies of transduced cells were selected against blasticidin resistance and revealed as Crystal Violet stained colonies.

To characterize the NS5A expression in hepatocytes transduced with these lentiviruses, cultured human primary hepatocytes were transduced with Lenti-NS5A-v1, Lenti-NS5A-v5 and Lenti- β Gal stocks at an MOI of 3. Extracts of transduced cells were prepared at 72 hours post-transduction and examined by western blot analysis (Figure 3.17). NS5A was expressed in both Lenti-NS5A-v1 and Lenti-NS5A-v5 transduced cell extracts, but not in Lenti- β Gal transduced cell extracts. These results demonstrated that lentiviral vector particles for NS5A expression could efficiently transduce primary hepatocytes and express the NS5A variants encoded.

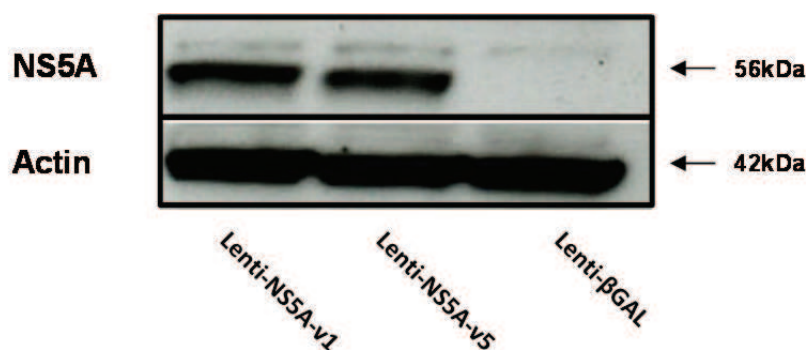

Figure 3.17: Characterization of lentiviral vector stocks: Immunoblotting. NS5A expression in lentivirus transduced cells. Protein extracts of primary human hepatocytes transduced with indicated lentiviruses was analyzed by immuno-blotting at 72 hours post transduction. Actin was used as endogenous loading control. Specific bands for 56kDa NS5A and 42kDa actin are indicated.

3.2.3.1.3. Effect of NS5A transactivation properties on global host cell gene expression

We hypothesized that the transactivation properties of NS5A could interfere with host cell mechanisms and have a transforming effect on liver cells. In order to investigate this hypothesis, we studied the impact of naturally-occurring NS5A variants with high and low transactivation potentials on host cell gene expression. For this, cultured primary human hepatocytes (from commercially available batches) were transduced with Lenti-NS5A-v1, Lenti-NS5A-v2 or Lenti- β Gal stocks at an MOI of 3. At 72 hours post-transduction cells were harvested and total RNA was extracted. RNA from two independent experiments was pooled and subjected to RNAseq analysis using Illumina deep sequencing in collaboration with GenoScreen Laboratories in Lille, France. This collaboration is ongoing, and the results of these analyses are not yet available.

3.2.3.2. Transgenic mice for *in vivo* studies

As described above, the *in vivo* study of the role of NS5A transactivation properties in liver pathogenesis requires the stable expression of patient-isolated NS5A variants in the hepatic tissues of mice. However our first attempt to achieve this goal by using helper-dependent adenoviral vectors was unsuccessful, as mice transduced with these vectors failed to express NS5A. As an alternative approach, we chose to develop transgenic mice for conditional expression of patient-isolated NS5A variants. Traditional methods of transgenesis are based on the injection of foreign DNA into the male pronucleus, leading to the random insertion of transgene DNA into the host genome. However, such random insertion presents several problems, notably the mutation or inactivation of host genes affected by transgene insertion. Another problem associated with random insertion is the high variability of transgene expression dependent upon the integration site. Therefore, to develop our transgenic mouse models, we chose a recently developed technique termed as “Quick knock-in”. This technique allows the targeted insertion of transgene DNA into the Rosa26 locus, a neutral locus situated in euchromatin. This targeted transgenesis bypasses the risk of host gene mutations and the variable expression levels of transgenes.

Using Quick knock-in, we have started the development of two transgenic mouse lines expressing NS5A-v1 and NS5A-v5, the highly and weakly transactivating NS5A variants respectively. This targeted transgenesis will be combined with a strategy for the conditional activation of transgene expression by inserting a loxP-flanked STOP codon between the ubiquitous promoter and NS5A transgene sequences. Thus, the activation of NS5A expression can be controlled by the expression of the Cre recombinase enzyme, which will be introduced by crossing the NS5A transgenic mice with Alb-Cre transgenic mice in which the expression of Cre recombinase is controlled by the Albumin promoter. This strategy therefore limits the expression of NS5A transgene to the hepatic tissues.

These transgenic mice are being currently developed in collaboration with genOway, a company that specializes in transgenesis. The mice are expected to be generated and validated within 12 months, at which point studies on the modification of cellular pathways leading to cellular transformation and carcinogenesis by NS5A can begin. The data collected from the studies will hopefully allow us to demonstrate a direct role of NS5A transactivation properties

in the modulation of genes linked to carcinogenesis and the development of hepatocellular carcinoma.

3.2.4. Conclusions:

During the course of the studies presented in this thesis, NS5A quasispecies variants isolated from HCV 1b infected individuals were characterized in terms of their transactivation potentials, and their impact on HCV-induced pathogenesis and in the HCV life cycle was studied.

Our results revealed for some patients a genetic compartmentalization of NS5A variants between tumoral and adjacent non-tumoral hepatic tissues, suggesting for these patients the existence of a selective environment in tumoral or non-tumoral tissues which results in this genetic compartmentalization within the same infected organ at a single time point. It was further revealed that NS5A quasispecies variants isolated from the liver tissue of HCV-infected individuals possess different transcriptional activation properties. The high variability of the results between patients, and the small number of patients in our cohort did not allow us to draw general conclusions on a specific tissue compartment harboring particular NS5A transactivation levels during HCV infection in a liver tumor bearing patient. However, a functional compartmentalization of quasispecies was demonstrated in a few patients of our cohort, for which tumoral tissues were harboring NS5A variants with the highest transactivation potential.

Altogether, these observations led to two hypotheses: i) that quasispecies variants with higher transactivation potentials were involved in the onset or development of hepatocellular carcinogenesis and ii) such variants were better adapted to the selective tumoral environment (e.g. highly replicating hepatocytes, oxidative stress, vascularization etc.) and were selected for. We investigated these hypotheses by studying the role of NS5A transactivation properties in pathogenesis using murine-based models, and by examining the role of NS5A transactivation properties in HCV RNA replication using a subgenomic replicon model.

To study the role of NS5A transactivation properties of NS5A in the perturbation of pathways implicated in liver carcinogenesis, an adenoviral vector for NS5A protein expression was developed. This adenoviral vector consisted of a last generation helper-dependent adenoviral vector (HdAd) in which the transgene expression cassette is inserted in a viral genome that is devoid of all coding sequences except inverted terminal repeat sequences and a packaging

signal. We successfully constructed NS5A transgene expression cassettes which were inserted in HdAd. Recombinant viral stocks were thus produced and used to transduce mice with the aim of inducing long-term stable hepatic expression of NS5A. However, our adenoviral vector failed to express both the NS5A transgene and the selected reporter gene. As an alternative strategy, we chose two complimentary approaches for *in vivo* and *in vitro* studies. For *in vivo* studies of the role of NS5A transactivation properties in liver pathogenesis, we have begun the development of two transgenic mouse lines expressing NS5A proteins with high or low transactivation properties. For *in vitro* studies on NS5A transactivation properties, we have successfully developed lentiviral vectors to express NS5A proteins in cultured primary human hepatocytes. To study the effect of these NS5A proteins on host-cell gene expression, we are currently performing global transcriptome analyses on primary hepatocytes transduced with these lentiviral vectors. This genome-wide approach is being performed by deep-sequencing RNAseq technology by Illumina.

3.3. Article: Regulation of Hepatitis C Virus Replication by Nuclear Translocation of Nonstructural 5A Protein and Transcriptional Activation of Host Genes

As described in previous sections, we have demonstrated that NS5A possesses transcriptional activation properties. Furthermore, we have demonstrated that quasispecies variants of NS5A possess significantly different potentials of transactivation. However, the physiological relevance of these observations is still not clear. Several studies have suggested that transactivation potential of viral proteins could play an important role in the replication of the corresponding viruses (Tang *et al.*, 2005; Althaus *et al.*, 2010). Therefore we hypothesized that the transactivational properties of NS5A may play a role in HCV replication. To test our hypotheses we used the sub-genomic replicon model of HCV to study the effect of NS5A transactivation capacity on HCV RNA replication. This study has been submitted to the Journal of Virology and is presented here in the submitted article form.

Title:

Regulation of Hepatitis C Virus Replication by Nuclear Translocation of Nonstructural 5A Protein and Transcriptional Activation of Host Genes

Muhammad Ahmad Maqbool¹, Martin Higgs¹, Sophie Carmouse¹, Jean-Michel Pawlotsky^{1,2}, Hervé Lerat^{1,*}

Running title : (54 c) : Regulation of HCV replication by NS5A transactivation

Authors affiliation : ¹ Institut National de la Santé et de la Recherche Médicale (INSERM) U955, Université Paris Est, Créteil, France ; ² French National Reference Center for Viral Hepatitis B, C and delta, Department of Virology, Hôpital Henri Mondor, Créteil, France

***Correspondent Footnote:** Hervé Lerat, Institut Mondor de Recherche Biomédicale, Inserm U955, University of Paris-Est (UPEC), 54 avenue du Maréchal de Lattre de Tassigny, 94010 Créteil, France. Fax : +33 1 498 14844 ; phone : +33 1 498 14711. Email : herve.lerat@inserm.fr

Acknowledgments: We thank Dr. Rakesh L Tripathi and Dr Akhteruzzaman Molla from Abbott Laboratories for kindly providing us with the p1071 plasmid. We thank Pr. Mark Harris from the University of Leeds (UK) for the gift of the sheep anti-NS5A antibody.

Word count (Abstract) : 209

Word count (Text) : 4859

ABSTRACT

Hepatitis C virus (HCV) non-structural protein 5A (NS5A) is involved in regulating viral replication through its direct interaction with the HCV RNA-dependent RNA polymerase. NS5A also alters infected cell metabolism through complex interactions with numerous host cell proteins. NS5A has been suggested to act as a transcriptional activator, although the impact on viral replication is unclear.

To study this, HCV NS5A variants were amplified from hepatic tissue from an HCV-infected patient, and their abilities to activate gene transcription were analyzed in a single hybrid yeast model. Strikingly, different variants isolated from the same patient displayed different transactivational activities. When these variants were inserted into the HCV subgenomic replicon system, they demonstrated varying levels of RNA replication. Moreover, the replication of these replicons correlated with their transactivational activities. We showed that the C-terminal fragment of NS5A was localized to the nucleus, and that a functional NS5A NLS and cellular caspase activity were required for this process. Furthermore, nuclear localization of NS5A was necessary for viral replication. Finally, we demonstrate that nuclear NS5A binds to host-cell promoters of several genes previously identified as important for efficient HCV RNA replication, inducing their transcription. Taken together, these results demonstrate a new mechanism by which HCV modulates its cellular environment, thereby enhancing viral replication.

INTRODUCTION

Hepatitis C Virus (HCV) infection is characterized by its high frequency of chronicity leading to about 130 million carriers, e.g. 2.2% of the worldwide population (27).

Chronic HCV infection is a major risk factor in the development of chronic hepatitis, cirrhosis. It is responsible for development of hepatocellular carcinoma (HCC) or primary liver cancer at a rate of 1-4% of cirrhotic patients per year (11, 16). It has become the principal cause of primary liver cancer in Japan and modeling of the ongoing epidemics predicts a similar trend in Europe (2, 25).

HCV proteins evolved in their sequence and functions to adapt the fitness of its replication in response to the immune and cellular environments. In that matter, the non-structural HCV proteins 5A (NS5A) precise enzymatic function remains largely unclear. However it has been shown to be a pleiotropic serine phosphoprotein, involved in many aspects of viral replication as well as interactions with host cell mechanisms (28). NS5A is an essential component of the HCV replication complex and plays a key role in viral RNA replication (34, 55). Many studies have suggested the potential role of NS5A protein in chronicity of HCV infection and subsequent carcinogenesis (32).

HCV NS5A is localized predominantly in the cytoplasm and perinuclear regions despite the presence of a functional nuclear localization signal (NLS) in its C-terminal region (21, 23). Studies have shown that a small amphipathic α -helix in N-terminus of NS5A acts as an ER membrane retention signal (8). Accordingly, the NS5A mutants lacking N-terminus region, are almost exclusively localized in the nucleus. It has also been demonstrated that cellular caspases cleave the full-length NS5A to produce N-

terminally deleted products that could translocate to the nucleus and may function as transcription factors (15, 23, 42). A recent study using the infectious HCV clone JFH1, has demonstrated that N-terminally truncated forms of NS5A are produced during viral infection and that these fragments of NS5A translocate to the nucleus (43). However physiological relevance of caspase mediated cleavage and nuclear localization of NS5A remains elusive.

In this study we demonstrate that HCV NS5A protein nuclear localization is essential for *in vitro* viral RNA replication and that replication capacity is significantly impaired when caspase-mediated cleavage of NS5A and its release from endoplasmic reticulum is inhibited. We also demonstrate that NS5A transcriptional regulation capacity correlates with HCV RNA replication capacity *in vitro*.

MATERIALS AND METHODS

Cells

NG cells, highly permissive to HCV RNA replication, were obtained from Abbott Laboratories (Abbott Park, IL). This cell line was derived by treatment with interferon- α from Huh-7 cells carrying a stably-maintained replicon as described previously (31). These cells were maintained in Dulbecco's modified Eagle's medium (DMEM) supplemented with 10% fetal calf serum, 100 IU/ml penicillin and 100 μ g/mL streptomycin.

Plasmid construction

HCV subgenomic replicon shuttle vector. A subgenomic replicon shuttle vector (genotype 1b, strain Con1) was obtained from Abbott Laboratories (50, 58). This shuttle vector contains two unique restriction sites to facilitate the cloning of patient-derived NS5A sequences: a single *NotI* site present within NS4B, 97 nt upstream of NS5A, and a *PacI* site present within NS5A, 18 nt upstream of NS5B. NS5A originating from pHCV-N (genotype 1b, acc. number #AF139594) was cloned into this vector to create SGR-Nim. Cloning of NS5A sequences isolated from patients were performed as described (50).

Isolation and cloning of quasispecies variants. Total hepatic RNA was isolated from a single liver biopsy from a patient infected with HCV genotype 1b using a PARIS kit (Ambion, Austin, TX) according to the manufacturer's protocol. Complementary DNA was synthesized from isolated RNA using a Superscript III Reverse transcription Kit (Life Technologies, Carlsbad, CA). Five NS5A quasispecies variants were amplified from patient cDNA using a nested PCR technique as described previously (50). Flanking restriction sites *NotI* and *PacI*, together with the adaptive mutation S2204I were introduced into all amplified NS5A sequences by PCR. Variants were cloned into the *NotI-PacI* site of the subgenomic replicon shuttle vector, and verified by sequencing.

Site-directed mutagenesis. Site directed mutagenesis was performed using a QuickChange II XL kit (Agilent Technologies, Santa Clara, CA) according to the manufacturer's instructions. NS5A Nuclear Localization Signal (NLS) was invalidated by mutagenesis as previously described by Yeh *et al.*, 2005 (57) using the following primers: CCCCTCCAATACCACCTCCAGGGGGAATGGGGACGGTTGTCCTAACAG (forward) and

CTGTTAGGACAACCGTCCCCATTCCCCCTGGAGGTGGTATTGGAGGGG

(reverse). Using this approach, the nuclear localization signal was mutated from PPPRRKRTVVLTESTL to PPPGGMGTVVLTESTL. Similarly, site-directed mutagenesis was performed to introduce a D154E mutation to invalidate a caspase cleavage site in NS5A, as described by Kalamvoki *et al.* (22). The following primers, adapted to the HCV 1b sequence, were used: ATTCTTCACAGAGGTGGAAGGGGTGCGGC (forward) and TAAGAAGTGTCTCCACCTTCCCCACGCCG (reverse).

Lentiviral vector production

NS5A variants were cloned into pLenti6.3/V5-TOPO (Life Technologies, Carlsbad, CA), and the nucleotide sequence of all constructs was verified by DNA sequencing. Recombinant lentiviral vector particles were synthesized by using the ViraPower HiPerform Lentiviral Expression System (Life Technologies) according to the manufacturer's instructions. Briefly, lentiviral vector particles were produced by transient transfection of 5×10^6 293FT cells with pLenti vectors containing different NS5A sequences and the ViraPower packaging mix using lipofectamin 2000 (Life Technologies). The particles produced were used to transduce 2×10^5 Huh7.5 cells in 6-well culture plates to determine viral titer according to the manufacturer's instructions.

Transient replication assay

Replicon shuttle vector DNA was linearized and purified by phenol-chloroform extraction. One microgram of purified DNA was used as a template for RNA synthesis using the T7 Megascript Kit (Life Technologies) according to the

manufacturer's instructions. Synthesized RNA was purified using RNeasy Mini Kit (Qiagen, Hilden, Germany).

Monolayers of NG cells seeded in 48-well plates (2×10^4 cells/well) were transfected with 0.25 μg RNA/well using TransIT-mRNA reagent (Mirus Bio LLC, Madison, WI) in Opti-MEM reduced serum medium (Life Technologies) containing 5% fetal calf serum (Life Technologies). Transfected cells (6 wells per construct) were divided into two equal samples: three wells harvested at 4 h post-transfection, and three wells harvested at 96 h post-transfection. Cells were washed, lysed in Cell Culture Lysis Buffer (Promega Corporation, Madison, WI), and the resultant luciferase activity was measured with a Mithras LB940 luminometer (Berthold Technologies, Bad Wildbad, Germany) in conjunction with luciferin substrate (Promega Corporation). All luciferase activity measurements were done in triplicate. Replication efficiency for each replicon clone was calculated as described previously (50).

Yeast simple hybrid assay

Nucleotide sequences encoding the NS5A transactivation domain (nt 6405-6981 of the subgenomic replicon) of selected variants was amplified by PCR as described previously by Pellerin *et al.* (38) and cloned into the *Bam*HI-*Eco*RI sites of the yeast expression vector pGBT9 (Clontech, Takara Bio Inc. Shiga, Japan) to generate a fusion protein consisting of the NS5A transcriptional activation domain and the GAL4 DNA-binding domain. The resulting plasmids were transformed into Y187 yeast using a Yeast Maker yeast transformation kit (Clontech). Transformants were grown on tryptophan-deficient (Trp^-) synthetic dropout plates for 3 days at 30 °C, and screened by PCR.

Transcriptional activation of NS5A-GAL4 fusions were measured by a quantitative luminescent β -galactosidase assay based on the Galacto Star kit (Tropix, Bedford, MA) according to the manufacturer's protocol using an automated Mithras LB940 luminometer. All assays were repeated with three independent transformants for each construct, each analysed in duplicate.

Immunofluorescence

For immunofluorescence studies, NG cells (0.5×10^5 cells/well) cultured in LabTek 4-chamber slides (Thermo Fisher Scientific Inc., Waltham, MA) were transduced with lentivirus particles at multiplicity of infection (MOI) of 1.5. Forty-eight hours post-transduction, cells were fixed with ice-cold 100% methanol at room temperature for five minutes, washed with PBS and incubated for 2 hours at room temperature with rabbit anti-NS5A polyclonal antibody (9). Bound antibody was detected with anti-rabbit FITC-conjugated secondary antibody (Sigma Aldrich, St. Louis, MO), and cellular DNA marked with 1 μ M of To-Pro-3 DNA stain (Life Technologies). Samples were analyzed with a confocal laser scanning microscope (Leica DMRE-7/TCSSP2, Wetzlar, Germany) in conjunction with a 63X oil immersion objective and 633 HeNe and 488nm argon lasers. Confocal image z-stacks were obtained using optical slice intervals of 0.2 μ m from the bottom to top of the cell, with three scans made per slice. The mean of the signal was recorded, and Imaris software (Bitplane AG, Zurich, Switzerland) was used to reconstruct 3D image projections.

Immunoblotting

Cells were lysed with Cell Culture Lysis Reagent (Promega), separated by SDS-PAGE, and immobilized onto Hybond ECL Nitrocellulose membrane (GE Healthcare,

Chalfont St-Giles, UK). Bound polypeptides were detected using sheep anti-NS5A antibody (kindly provided by Pr Mark Harris, University of Leeds, UK), rabbit anti-GAPDH (Abcam, Cambridge, UK), or mouse anti-actin antibody (Sigma Aldrich, St. Louis, MO). Immunodetection was achieved by enhanced chemiluminescence (GE Healthcare) in conjunction with horse-radish peroxidase conjugated anti-sheep (Sigma Aldrich) or anti-mouse (Sigma Aldrich) antibodies. Chemiluminescent signals were detected and quantified using an Image Quant Las 4000 Mini scanner and Image Quant software (GE Healthcare).

Caspase inhibition assays

NG cells were treated with the pan-caspase inhibitor z-VAD-fmk (R&D Systems Inc., Minneapolis, MN) at 10 μ M or 20 μ M final concentrations, two hours prior to transfection with replicon RNA. Four hours post-transfection, culture medium was changed and fresh z-VAD-fmk was added at the appropriate concentrations.

Real-time quantitative gene expression assay

Total RNA was extracted from NG cells transduced with the appropriate lentiviral expression vector particles (72 hours post-transduction) using a PARIS RNA Isolation Kit (Ambion). RNA quality and quantity were determined using a 2100 Bioanalyser and RNA Nano Chips (Agilent Technologies, Santa Clara, CA). RNA integrity number was calculated using the Agilent software, and samples displaying an RNA integrity number below 6 were discarded.

Complementary DNA was synthesized using a High Capacity cDNA Synthesis Kit (Applied Biosystems, Life Technologies). Quantitative PCR was performed on pooled cDNA from two independent experiments using Applied Biosystems 7300 Thermal

Cycler and Taqman reagents (Applied Biosystems; see table 1 for primer information).

Chromatin Immunoprecipitation

NG cells were transduced with lentiviral vector particles at an MOI of 1.5. Forty-eight hours post-transduction, cells were fixed with 1% formaldehyde, lysed in 10 mM HEPES, 1.5 mM MgCl₂, 10 mM KCl, 0.5 mM DTT, 0.1% NP-40 and protease inhibitors cocktail (Roche Applied Science, Indianapolis, IN), and nuclei were recovered and lysed in 50 mM Tris-HCl pH 8, 10 mM EDTA, 1% SDS, and protease inhibitors, and DNA sheared by sonication. Sheared chromatin was pre-cleared by incubation with Protein G Mag Sepharose beads (GE Healthcare) and incubated with rabbit-anti NS5A antibody. The precipitated DNA was purified by phenol/chloroform extraction and amplified by PCR using the following primers: IL8 5'-GTTGTAGTATGCCCTAAGAG-3' (forward) and 5'-CTCAGGGCAAACCTGAGTCATC-3' (reverse); LTB 5'-TACGGGCCTCTCTGGTACAC-3' (forward) and 5'-ATATTCCCTCACCCCACCAT-3' (reverse); NUA2 5'-CCTGAAGTTGCTGCTGTGAA-3' (forward) and 5'-CCTGAAGGCCTAGAGAACA-3' (reverse); MAP2K7 5'-AACGAGGTTCCAGGAATGC-3' (forward) and 5'-GAAGGATGACGCCACCTAGA-3' (reverse); TRAF2 5'-GGGAAGGGACCCAATTAGC-3' (forward) and 5'-CAGCCCTCAGGAAGCTGTAG-3' (reverse); FBXL2 5'-TGGGGTGAGTGTCGTTTTATC-3' (forward) and 5'-CGTATCTGGTCCATCCTCTCA-3' (reverse). DNA immunoprecipitated from cells not expressing NS5A was used as a negative control.

Statistics

Statistical comparisons of the data were performed using a Mann-Whitney test where appropriate. *P* values of less than 0.05 were considered statistically significant. All error bars indicate standard error of the mean.

RESULTS

Naturally occurring NS5A variants are associated with different transcriptional activation capacities *in vitro*

The sequence of the five NS5A full length variants amplified from an HCV-infected patient's liver extract is shown in Figure 1. Amino acid differences were observed over the full NS5A sequence, but were more frequent between amino acids 210 and 450, a region which encompasses the NS5A transactivation domain. In order to verify our previous findings that naturally occurring NS5A variants are associated with different transcriptional activation capacities *in vitro* (38), the NS5A transactivation domain (underlined in Figure 1) was amplified by PCR. The amplified domains, which were confirmed to be identical in sequence to the full-length variants, were subsequently cloned into the pGBT9 yeast expression vector to generate fusion proteins consisting of the NS5A transcriptional activation domain fused to the GAL4 DNA-binding domain (Figure 2A). The capacity of each fusion protein to activate *lacZ* transcription (and thus β -galactosidase expression) was assayed in yeast. As shown in Figure 2B the five tested variants (v1 to v5) exhibited markedly different transcriptional activities *in vitro*, with the weakest activator (NS5A-v5) exhibiting transcriptional activities approximately 1 log below the activity of the strongest activator (NS5A-v1).

Naturally occurring NS5A variants are associated with different HCV RNA replication efficiencies *in vitro*

To test the hypothesis that NS5A mutations naturally occurring *in vivo* could be associated with different replication capacities of the corresponding variants, the five distinct NS5A variants isolated from the liver of a patient infected with HCV genotype 1b (variants v1 to v5) were cloned into a subgenomic replicon shuttle vector (50) containing a luciferase reporter gene and the replication capacity of the corresponding replicons was measured (Figure 3A). Western blotting analysis revealed that the five variants expressed NS5A at the same level 4 hours post-transfection, i.e. in the timeframe of translation of the transfected RNA (Figure 3B, top panel). In contrast, at 96 hours post-transfection, the different constructs exhibited different levels of NS5A expression, suggesting that different NS5A variants could be associated with different replication capacities of the corresponding replicons (Figure 3B, lower panel).

To assess the replication efficiencies of replicons harboring the different NS5A variant sequences, we quantified the luciferase activity from replicon-transfected cell extracts (Figure 3C). Different replication levels were observed, including higher (v1), nearly identical (v2 and v3) and lower replication efficiencies as compared to the wt subgenomic replicon (Figure 3C). In the latter, the replication level was close to that of a replicon containing a deficient RNA polymerase. Together, these results demonstrate that naturally occurring NS5A variants are associated with different RNA replication efficiencies *in vitro*.

HCV RNA replication efficiency *in vitro* correlates with NS5A variant transcriptional activation capacity

As shown in Figure 3D, we found a statistically significant correlation ($R^2=0.9801$, $p<0.01$) between the transactivation capacities of NS5A variants *in vitro* and the *in vitro* replication efficiency of the corresponding replicons. This result suggests that HCV RNA replication efficiency is, at least partly, related to the transcriptional activation properties of NS5A.

NS5A nuclear localization is dependent upon NLS-driven nuclear import and cellular caspase activity.

The transcriptional activation function of NS5A requires that at least a subset of this protein be translocated into the nucleus. In order to determine whether NS5A relocates to the nucleus, we performed immunofluorescence analysis of cells harboring the stable subgenomic replicon I389-neo/NS3-3'/5.1 (1), by means of confocal microscopy and 3D-reconstruction. A proportion of NS5A localized to the nucleus of cells stably harboring I389-neo/NS3-3'/5.1 (Figure 4A). To confirm these results in the absence of viral replication, we cloned NS5A-v1 or NS5A-v5 into a lentivirus vector (Figure 4B), and verified the expression of NS5A in cell transduced with these viruses (Figure 4C). Moreover, cells transduced with these lentiviruses also demonstrated a proportion of NS5A localized to the nucleus (Figure 4D).

To confirm the role of the NS5A NLS in this process, we invalidated the NLS by site-directed mutagenesis as previously described (57) (Figure 5A). After verifying that the constructs expressed similar amounts of NS5A (Figure 5B), immunofluorescence analyses were performed. As shown in Figure 5C (upper panel), abolition of the NLS

drastically reduced, but did not abolish, NS5A translocation to the nucleus. Taken together, these results indicate that the NLS of NS5A is functional and plays an important role in NS5A translocation to the nucleus. However, passive nuclear translocation of NS5A could also occur in this system.

As NS5A is released from the ER membrane by caspase-mediated cleavage (20, 42), we assessed in parallel whether caspase-mediated cleavage of NS5A is necessary for nuclear localization of NS5A. Mutation of the putative caspase recognition site at position 154 of the N-terminus of NS5A (D154E, Figure 5A) completely abolished nuclear translocation of NS5A (Figure 5C, lower image), demonstrating the importance of caspase cleavage in the release of NS5A from the ER before its subsequent translocation to the nucleus.

HCV RNA replication efficiency *in vitro* is dependent upon nuclear translocation of NS5A

To investigate whether NLS-mediated NS5A nuclear localization is important in HCV RNA replication, we analyzed the impact of NS5A NLS invalidation on replication of the sub-genomic replicons. Replicons encoding two different NS5A variants associated with high replication levels (v1 and v2) in which the NLS of NS5A was mutated (Figure 6A) exhibited reduced NS5A expression after 96h post-transfection (Figure 6B, lower panel), despite a similar expression at 4h (Figure 6B, upper panel), and a corresponding reduction in replicon replication *in vitro* (Figure 6C). These results demonstrate the importance of a functional NS5A NLS for efficient replication of the HCV subgenomic replicon. However, invalidation of the NLS did not completely abolish replication, in line with our findings that a proportion of NS5A translocates to the nucleus in the absence of a functional NLS (Figure 5C, upper panel).

In order to investigate the importance of caspase cleavage of NS5A in HCV replication, cells harboring sub-genomic replicons were treated with the pan-caspase inhibitor z-VAD-fmk and replication capacity was analyzed. As shown in Figure 6D, inhibition of cellular caspase activity substantially reduced, but did not abrogate, replicon replication. To verify that this result was not due to a non-specific effect of caspase activity inhibition, we analyzed the replicative capacity of an SGR mutated in the putative N-terminal caspase cleavage site (D154E) of NS5A (Figure 6D, inset). This mutation resulted in the complete loss of subgenomic replicon replication (Figure 6D).

Taken together, these results demonstrate that caspase-mediated cleavage of NS5A, its release from the endoplasmic reticulum, and its subsequent localization to the nucleus is essential for the replication of the subgenomic HCV replicons. They are in line with the correlation between HCV replication efficiency and the NS5A transcriptional activation capacities.

Different NS5A transcriptional activation properties are associated with differential expression of host cell genes essential for HCV RNA replication

To better understand the mechanisms involved in regulation of HCV replication by NS5A transcriptional activation, the expression of 28 cellular genes previously shown to be essential for replication (listed in table 1) was analyzed in cells harboring replicons carrying an NS5A variant with high transcriptional and replication capacity (v1) and with low transcriptional and replication capacities (v5). When RTqPCR screening was used on cells harboring SGR-NS5A-v1 or SGR-NS5A-v5, no significant difference in gene expression profiles was observed (data not shown). Because the large number of untransfected cells in these transient assays could

have masked any differences, we made use of our lentivirus vectors expressing NS5A-v1 or NS5A-v5 (Figure 4B), allowing the transduction of a high proportion of cells and thus increasing signal-to-noise ratios. Analysis of host-cell gene expression in lentivirus-transduced cells revealed significant differences in the expression of five of the 28 genes analyzed. As shown in Figure 7, the genes of *interleukin 8* (IL-8), *lymphotoxin beta* (LTB) and *SNF-like kinase 2* (NUAK2) were significantly up-regulated by Lenti-NS5A-v1, whereas they were either weakly up-regulated (IL-8 and NUAK2) or down-regulated (LTB) by Lenti-NS5A-v5. Expression of β -galactosidase using an identical lentiviral backbone had no impact on the expression of these genes, indicating that our observations were specifically due to expression of NS5A. In addition, MAP2K7 and TRAF2 genes were down-regulated by Lenti-NS5A-v5, whereas their levels were not significantly changed by Lenti-NS5A-v1. Together, these results suggest that NS5A variants with different transcriptional activation properties differentially regulate transcription of host-cell genes previously shown as required for viral replication and that this may impact HCV RNA replication.

NS5A is recruited to host-cell promoters

The deregulation of host-cell gene expression observed above might be due either to a direct interaction of NS5A with the promoter sequence of these genes, or to an indirect regulation involving NS5A-protein interactions. To investigate whether NS5A was capable of binding to the promoters of the genes identified above, we performed chromatin immunoprecipitation assays (ChIP) on nuclear extracts from cells transduced with lentiviruses encoding NS5A-v1 or NS5A-v5. Such experiments revealed that both NS5A-v1 and NS5A-v5 were able to bind specifically to the promoters of IL-8, LTB and NUAK2, but were absent from the promoters of MAP2K7,

TRAF2 and FBXL2 (Figure 8). The latter gene was included as a negative control, as its expression was unaltered by NS5A in previous experiments (data not shown). These data suggest that the regulation of MAP2K7 and TRAF2 by NS5A occurs via indirect mechanisms, which do not require the presence of NS5A on their respective promoters. Taken together, these results strongly suggest that NS5A directly interacts with the promoters of IL8, LTB and NUAK2, and that regulation of their expression through its intrinsic transactivation properties is important in modulating HCV replication.

DISCUSSION:

It is well established that in an infected individual, HCV exists as a quasispecies; a complex mixture of genetically distinct but closely related variants (33, 56). Using a functional analysis in a yeast single hybrid model, we have demonstrated that NS5A is able to transactivate the GAL4 minimum promoter. This is in agreement with previous reports in yeast and mammalian cells (10, 24, 44, 49). Moreover, quasispecies variants isolated from the liver tissue of an HCV-infected patient possessed different transactivation potentials. These data are in agreement with our previous observations of variants isolated from serum samples of HCV infected patients (38).

We studied the effect of NS5A transactivation potential on HCV RNA replication using a subgenomic HCV replicon model in an Huh-7 derived cell line (50). Significantly different replication capacities were observed for replicons bearing NS5A variants with different transactivation potentials, despite similar levels of NS5A expression at 4 hours post-transfection. Moreover, we observed a significant correlation between NS5A transactivation potential and the replication capacity of the

subgenomic HCV replicon, indicating that NS5A transactivation could play a role in viral replication. It has previously been demonstrated that certain adaptive mutations in NS5A significantly increase the replication capacity of replicons by as yet unknown mechanisms (3, 6). Although none of our NS5A variants carried any of these previously identified mutations, our results suggested that the mutations carried by these variants played a similar role. Since this domain of NS5A is not well structured (18), any mutations in this area in our variants are unlikely to perturb the structural integrity of NS5A. As we suggested in our previous work (38), only a global change of the physical properties of this domain (e.g.: charge) might be involved in the modulation of its transactivation properties.

Native NS5A is retained to the endoplasmic reticulum via trans-membrane sequences in domain 1, whereas to be able to directly exert its transcriptional activation functions, NS5A must translocate to the nucleus. Immunofluorescence confocal microscopy and 3D reconstruction analysis in cells harboring a stable subgenomic HCV replicon revealed a proportion of nuclear NS5A, demonstrating that NS5A could translocate to the nucleus. This was further confirmed by similar analyses of cells transduced with lentiviral vectors expressing NS5A-v1 and NS5A-v5. We found that, both NS5A variants could translocate to the nucleus regardless of their transactivation potential, suggesting that the difference in transactivation properties between these variants was not due to their ability to translocate to the nucleus.

Some studies have previously suggested that NS5A carries a functional NLS in its C-terminal region and that N-terminally truncated forms of NS5A could translocate to

the nucleus (24, 46). In agreement with these findings, we observed that invalidation of the NS5A NLS provoked a significant reduction in the quantity of nuclear NS5A. However, a small proportion of NS5A was able to localize to the nucleus in the absence of a functional NLS, probably via passive diffusion. Previous studies have demonstrated that proteins up to 60kDa can passively diffuse through the nuclear pores even in the absence of active nuclear import (36, 45, 54). This suggested that, although not absolutely required, the NLS of NS5A plays an important role in its active nuclear translocation. In parallel, we found a significant reduction in the replication capacity of replicon whose NS5A NLS was invalidated, highlighting the importance of a functional NS5A NLS for HCV RNA replication. However, the replication capacity of these modified replicons was not completely abolished, in line with our observations that a proportion of NS5A could still translocate to the nucleus by passive diffusion in the absence of a functional NLS. It is probable that passively diffused NS5A may exert a role in the nucleus which may suffice for reduced viral replication.

As previously mentioned, NS5A carries a small amphipathic α -helix in its N terminus that functions as an ER membrane retention signal (8). To be able to translocate into the nucleus, NS5A must be released from this anchor. Some studies have demonstrated that NS5A can be cleaved by cellular caspases to produce N-terminally truncated fragments, which may represent a mechanism to release NS5A from the ER to allow its nuclear translocation and exert its transactivational function (15, 42). We inhibited this cleavage using either a pan-caspase inhibitor or a mutation in the putative N-terminal caspase cleavage site of NS5A. The former partially inhibited NS5A re-localization into the nucleus, while the latter resulted in a complete loss of nuclear NS5A, both without influencing its expression level. These

data strongly suggest that caspase-mediated release of NS5A from its N-terminal ER membrane anchor is indispensable for its translocation into the nucleus. More importantly, mutation of the conserved caspase cleavage site of NS5A resulted in complete loss of replication of the corresponding subgenomic replicon. These results are in contrast to those of Sauter *et al.* (43) who observed an inhibition of JFH1 replication in Huh-7.5 cells over-expressing N-terminal truncated NS5A. These discrepancies may be due to the amount of nuclear NS5A produced in this system and the absence of characterization of the transactivation potential of NS5A in their model.

NS5A has previously been demonstrated to modulate cellular responses to viral infection through interaction with several proteins involved in host cell signaling pathways related to interferon response, cell cycle and apoptosis etc. (4, 12, 13). We hypothesized that direct regulation of host gene transcription by NS5A represents another mechanism employed by HCV to achieve similar goals, providing a possible explanation for the correlation between HCV replication and NS5A transactivation properties observed. We therefore analyzed the expression of a subset of cellular genes whose expression has been previously described to be required for efficient HCV RNA replication (7, 14, 17, 35, 41, 47, 48, 51, 53). Our results indicated a significant difference in the expression of several of these genes between cells expressing NS5A-v1 and -v5. The mRNAs of *interleukin 8* (IL8; also called CXCL-8), *lymphotoxin beta* (LT β) and *SNF like kinase 2* (NUAK2; also called SNARK) were significantly more abundant in cells expressing NS5A-v1 compared to NS5A-v5-transduced cells. Furthermore, we demonstrated a direct interaction between NS5A and the promoters of these cellular genes. Modulation of IL-8 expression via NS5A

transactivation is in keeping with previously published results (39). In addition, JFH1 infection stimulates the expression of this proinflammatory cytokines (5, 26) and high level of IL-8 are found in chronically infected patients (40). HCV RNA synthesis in replicon harboring cells was inhibited by IL-8 siRNA knockdown. IL-8 protein levels correlated positively with HCV RNA levels in subgenomic and genomic replicon lines. However, IL-8 may have opposing antiviral and proviral effects depending on the level of HCV replication, the cellular context, and whether the infection is acute or chronic (26). Moreover, HCV infection triggers dsRNA signaling pathways that induce IL-8 expression via transcriptional activation, and mutations of the interferon-stimulated response element (ISRE) and NF-kappaB binding sites of this IL-8 promoter reduced and abrogated IL-8 transcription (52). Overall, the regulation of IL-8 gene transcription by HCV might involve multiple pathways, including a direct transactivatory effect of NS5A, leading to the inhibition of the antiviral actions of IFN, thus enhancing HCV replication.

Knock-down of the membrane protein LT β and the kinase NIAK2 in Huh-7 derived cells containing a subgenomic replicon identical to the one used in our study correlated with a 60 to 80% decrease in HCV replication (35). Our data suggest that NS5A directly activates the transcription of both these genes. LT β is a member of the TNF superfamily which controls cell survival. Similarly to IL-8, this signaling pathway leads to the activation of NF-kappaB. In contrast, very little is known about the link between NIAK2 and HCV replication, although it is interesting to note that NIAK2 might be an NF-kappaB-regulated anti-apoptotic gene (29). Interestingly, HCV infections have been described to increase the hepatic expression of LTB (30) whose

sustained expression in turn has been shown to represent an important pathway in HCV induced primary liver tumors (19).

Although we found that NS5A-v5 decreased the abundance of TRAF2 mRNA, we observed no direct interaction between NS5A and the TRAF2 promoter. It has been previously reported that TRAF2 and NS5A directly interact which results in an inhibition of NF- κ B activation (37). Taken together, it is likely that NS5A modulates TNF-receptor signaling through direct interaction with its signaling complex rather than through repression of TRAF2 gene expression.

In conclusion, we have demonstrated a novel mechanism by which HCV regulates host-cell gene expression. We observed that the ability of NS5A to transactivate a cellular promoter was correlated with the replication efficiency of HCV replicons. Furthermore, efficient replication of HCV RNA is dependent upon the caspase-mediated release of NS5A and its subsequent NLS-mediated translocation to the nucleus. Finally, we provide compelling evidence that NS5A binds directly to cell promoters, thus modulating their activity. These data present a new mechanism by which HCV modulates its cellular environment, thereby enhancing viral replication.

FIGURE LEGENDS:

Figure 1. Amino acid sequence alignment of isolated NS5A variants. Amino acid sequences of NS5A quasispecies variants (V1 to V5) isolated from the liver of a patient infected with HCV genotype 1b aligned with the SGR-Nim NS5A sequence used as a reference sequence. Numbers represent amino acid positions within NS5A. The underlined sequence represents the NS5A transactivation domain. * denotes mutations not conserved between all 5 variants. ~ indicates a deletion.

Figure 2. Analysis of the transactivation properties of NS5A variants.

(A) Schematic representation of yeast one-hybrid constructs encoding NS5A variants V1 to V5. The NS5A transcriptional activation domains (NS5A TrD) were amplified from patient cDNA and cloned into plasmid pGBT9, giving fusions of the GAL4 DNA binding domain (BD) with the respective NS5A transactivation domains of each variant (pGBT9-NS5A-v1 to v5).

(B) Yeast one-hybrid vectors pGBT9-NS5A-v1 to v5 (described above) were transfected into yeast strain Y187. The potential of the hybrid proteins to activate transcription of the *LacZ* gene was analyzed by quantification of β -galactosidase activity, and the results are expressed as mean \pm SEM transactivation levels obtained from at least three independent experiments. AU = arbitrary units.

Figure 3. Impact of HCV NS5A transactivation properties on replication efficiency of subgenomic HCV replicons harboring different NS5A quasispecies variants. (A) Schematic representation of sub-genomic replicon constructs encoding NS5A variants V1 to V5. NS5A variant sequences were cloned

into a sub-genomic replicon shuttle vector. Filled triangles indicate the introduction of cell culture adaptive mutation S2204I. An open triangle indicates the introduction of the GDD to GND mutation in the NS5B polymerase. SGR-NS5A-vX is the subgenomic replicon carrying NS5A variant sequence vX; SGR-Nim is the wt replicon (50); SGR-GND is the nonreplicative control replicon. (B) NS5A protein expression in NG cells transfected with subgenomic replicons encoding different NS5A variants as analyzed by western blotting at 4 and 96 hours post-transfection. Actin expression was used as a loading control. Bands corresponding to 56 kDa NS5A or 42 kDa actin are indicated. (C) Replication efficiency of HCV sub-genomic replicons carrying different NS5A variants was analyzed in the cell lysates detailed in (B). Luciferase activities were assayed in transfected cells, and the replication efficiency was calculated as a percentage of that obtained with replicon SGR-Nim (represented by the dashed line). Data is indicative of mean \pm SEM replication efficiencies obtained from 7 independent experiments carried out in triplicate. (D) Relationship between the transcriptional activation capacities of NS5A variants and the replication efficiencies of the corresponding subgenomic replicons. Data points represent the mean transactivational capacities and replication efficiencies for each variant.

Figure 4. Subcellular localization of NS5A.

(A) Cells harboring the subgenomic replicon I389-neo/NS3-3'/5.1 were analyzed by confocal microscopy using anti-NS5A antibody in conjunction with anti-rabbit FITC-conjugated secondary antibody. Nuclei were stained with To-Pro-3. Three-dimensional representations were reconstructed from image z-stacks. Scale bar = 10 μ m. * denotes non-replicon harboring cells. (B) Schematic representations of lentivirus vectors carrying NS5A variants V1 and V5 and β -galactosidase. Filled

triangles indicate the presence of cell culture adaptive mutation S2204I. (C) Immunoblotting analysis of NS5A expression in cells transduced for 72 hours with the lentiviruses described in (B). Bands corresponding to 56 kDa NS5A or 42 kDa actin are indicated. (D) Confocal analysis of cells transduced with lenti-NS5A-v1 or -v5 was carried out as described in (A). Scale bar = 10 μ m. * denotes non-transduced cells.

Figure 5. Analysis of mechanisms surrounding NS5A nuclear localization.

(A) Schematic representations of lentivirus vectors carrying mutated NS5A-v1. An open triangle denotes invalidation of the NS5A NLS, a closed triangle indicates mutation of the caspase recognition site at amino acid position 154. (B) Western blotting analysis of NS5A expression in cells transduced for 72 hours with the mutated and non-mutated NS5A-v1 lentiviruses. Bands corresponding to 56 kDa NS5A or 39 kDa GAPDH are indicated. (C) Confocal analysis of cells transduced with the mutated and non-mutated NS5A-v1 lentiviruses was carried out as described in figure 4. Scale bar = 10 μ m. * denotes non-transduced cells.

Figure 6. The contribution of nuclear NS5A localization to HCV RNA replication.

(A) Schematic representation of sub-genomic replicons encoding NS5A-v1 or v2 containing mutated NLS. An open triangle denotes invalidation of the NS5A NLS, and a closed triangle indicates the presence of the cell culture adaptive mutation S2204I. (B) Western blotting analysis of NS5A expression in cells transfected with NLS-mutated and non-mutated v1 and v2 replicons at 4 and 96 hours post-transfection. Actin expression was used as a loading control. Bands corresponding to 56 kDa NS5A or 42 kDa actin are indicated. (C) Replication efficiency of HCV sub-genomic

replicons carrying NS5A variants encoding mutated NLS was analyzed in the cell lysates 96h post-transduction. The replication efficiencies were calculated as described in the legend to Figure 3C. Data is indicative of the mean \pm SEM replication efficiencies obtained from 7 independent experiments carried out in triplicate. The statistical significance of these data was analyzed using a Mann-Whitney test. (D) The effect of caspase cleavage of NS5A on HCV replicon replication. (*Upper panel*) Schematic representation of a sub-genomic replicon encoding NS5A-v1 with a mutated caspase cleavage site. An open triangle denotes mutation of the caspase recognition site at amino acid position 154, and a closed triangle indicates the presence of the cell culture adaptive mutation S2204I. (*Lower panel*) Replication efficiency of the indicated subgenomic replicons was analyzed in the presence or absence of the caspase inhibitor z-VAD-fmk at the indicated concentrations. Data represents the mean \pm SEM replication efficiencies obtained from 3 independent experiments carried out in triplicate.

Figure 7. Gene expression analyses of cells expressing NS5A variants.

mRNA expression in NG cell cultures transduced with Lenti-NS5A-v1 and Lenti-NS5A-v5. The expression levels of the indicated genes were determined by quantitative real-time PCR from the pooled RNA of three independent experiments. The results were normalized to expression of GAPDH, and the mean \pm SEM mRNA quantities are expressed in relation to control cells transduced with Lenti- β -gal.

Figure 8. Chromatin immunoprecipitation analyses of cells expressing NS5A-V1 and -V5

Chromatin was immunoprecipitated using an anti-NS5A antibody from NG cells transduced with lentiviruses expressing NS5A-V1 or NS5A-V5. Immunoprecipitated chromatin and input DNA were amplified using primers spanning the promoters of the indicated genes. The PCR products were analyzed by agarose gel electrophoresis. Cells transduced with Lenti- β -gal were used as a control. The promoter of FBXL2 was amplified as a negative control. Numbers on the left indicate sizes in bp of the DNA ladder.

Table 1: RTqPCR Taqman probes for gene expression analysis.

Primers	Gene Acc. No.	Assay ID	Gene Name
GAPDH	NM_002046.3	Hs99999905_m1	Glyceraldehyde-3-phosphate dehydrogenase
CDC42	NM_001791.3	Hs03044122_g1	Cell division cycle 42 (GTP binding protein, 25kDa)
COPZ1	NM_016057.1	Hs00255433_m1	Coatomer protein complex, subunit zeta 1
CSK	NM_001127190.1	Hs01062579_g1	c-src tyrosine kinase
CYP1A1	NM_000499.3	Hs01054797_g1	Cytochrome P450, family 1, subfamily A, polypeptide 1
DDX3X	NM_001356.3	Hs00606179_m1	DEAD (Asp-Glu-Ala-Asp) box polypeptide 3, X-linked
DICER1	NM_030621.3	Hs00998582_g1	Dicer 1, ribonuclease type III
EIF2S3	NM_001415.3	Hs00831673_gH	Eukaryotic translation initiation factor 2, subunit 3 gamma, 52kDa
FBXL2	NM_012157.3	Hs00247211_m1	F-box and leucine-rich repeat protein 2
HAMP	NM_021175.2	Hs01057160_g1	Hepcidin antimicrobial peptide
JAK1	NM_002227.2	Hs01026996_m1	Janus kinase 1
LTB	NM_009588.1	Hs00242739_m1	Lymphotoxin beta (TNF superfamily, member 3)
MAP2K7	NM_145185.2	Hs00178198_m1	Mitogen-activated protein kinase kinase 7
NFKB2	NM_001077493.1	Hs00174517_m1	Nuclear factor of kappa light polypeptide gene enhancer in B-cells 2 (p49/p100)
NUAK2	NM_030952.1	Hs00388292_m1	NUAK family, SNF1-like kinase, 2
PI4KA	NM_058004.2	Hs00176931_m1	Phosphatidylinositol 4-kinase
PI4KB	NM_002651.1	Hs00356327_m1	Phosphatidylinositol 4-kinase, catalytic, beta
PPIA	NM_021130.3	Hs99999904_m1	Peptidylprolyl isomerase A (cyclophilin A)
RELA	NM_001145138.1	Hs00153294_m1	v-rel reticuloendotheliosis viral oncogene homolog A
SLC12A4	NM_001145961.1	Hs00957122_m1	Solute carrier family 12 (potassium/chloride transporters), member 4
SLC12A5	NM_001134771.1	Hs00221168_m1	Solute carrier family 12 (potassium-chloride transporter), member 5
TBXA2R	NM_201636.2	Hs00169054_m1	Thromboxane A2 receptor
TRAF2	NM_021138.3	Hs00184186_m1	TNF receptor-associated factor 2
TXNIP	NM_006472.3	Hs01006900_g1	Thioredoxin interacting protein
VAPA	NM_194434.2	Hs00427749_m1	VAMP (vesicle-associated membrane protein)-associated protein A, 33kDa
VAPB	NM_004738.3	Hs00191003_m1	VAMP (vesicle-associated membrane protein)-associated protein B and C
VRK1	NM_003384.2	Hs00177470_m1	Vaccinia related kinase 1
IL8	NM_000584.2	Hs99999034_m1	Interleukin 8

PLK1

NM_005030.3

Hs00983233_g1 Polo-like kinase 1

REFERENCES:

1. Ahmed-Belkacem, A., N. Ahnou, L. Barbotte, C. Wychowski, C. Pallier, R. Brillet, R. T. Pohl, and J. M. Pawlotsky. 2010. Silibinin and related compounds are direct inhibitors of hepatitis C virus RNA-dependent RNA polymerase. *Gastroenterology* 138:1112-1122.
2. Aizawa, Y., Y. Shibamoto, I. Takagi, M. Zeniya, and G. Toda. 2000. Analysis of factors affecting the appearance of hepatocellular carcinoma in patients with chronic hepatitis C. *Cancer* 89:53-59.
3. Appel, N., T. Pietschmann, and R. Bartenschlager. 2005a. Mutational analysis of hepatitis C virus nonstructural protein 5A: Potential role of differential phosphorylation in RNA replication and identification of a genetically flexible domain. *Journal of Virology* 79:3187-3194.
4. Arima, N., C.-Y. Kao, T. Licht, R. Padmanabhan, Y. Sasaguri, and R. Padmanabhan. 2001. Modulation of Cell Growth by the Hepatitis C Virus Nonstructural Protein NS5A. *Journal of Biological Chemistry* 276:12675-12684.
5. Blackham, S., A. Baillie, F. Al-Hababi, K. Remlinger, S. You, R. Hamatake, and M. J. McGarvey. 2010. Gene expression profiling indicates the roles of host oxidative stress, apoptosis, lipid metabolism, and intracellular transport genes in the replication of hepatitis C virus. *Journal of Virology* 84:5404-5414.
6. Blight, K. J., A. A. Kolykhalov, and C. M. Rice. 2000. Efficient initiation of HCV RNA replication in cell culture. *Science* 290:1972-1974.

7. Borawski, J., P. Troke, X. L. Puyang, V. Gibaja, S. C. Zhao, C. Micanin, J. Leighton-Davies, C. J. Wilson, V. Myer, I. CornellaTaracido, J. Baryza, J. Tallarico, G. Joberty, M. Bantscheff, M. Schirle, T. Bouwmeester, J. E. Mathy, K. Lin, T. Compton, M. Labow, B. Wiedmann, and L. A. Gaither. 2009. Class III Phosphatidylinositol 4-Kinase Alpha and Beta Are Novel Host Factor Regulators of Hepatitis C Virus Replication. *Journal of Virology* 83:10058-10074.
8. Brass, V., E. Bieck, R. Montserret, B. Wolk, J. A. Hellings, H. E. Blum, F. Penin, and D. Moradpour. 2002. An amino-terminal amphipathic alpha-helix mediates membrane association of the hepatitis C virus nonstructural protein 5A. *J Biol Chem* 277:8130-8139.
9. Bürckstümmer, T., M. Kriegs, J. Lupberger, E. K. Pauli, S. Schmittel, and E. Hildt. 2006. Raf-1 kinase associates with Hepatitis C virus NS5A and regulates viral replication. *FEBS Letters* 580:575-580.
10. Chung, K. M., O. K. Song, and S. K. Jang. 1997. Hepatitis C virus nonstructural protein 5A contains potential transcriptional activator domains. *Mol Cells* 7:661-667.
11. Di Bisceglie, A. M. 1998. Hepatitis C. *The Lancet* 351:351-355.
12. Gale, M., Jr., B. Kwieciszewski, M. Dossett, H. Nakao, and M. G. Katze. 1999. Antiapoptotic and oncogenic potentials of hepatitis C virus are linked to interferon resistance by viral repression of the PKR protein kinase. *Journal of Virology* 73:6506-6516.
13. Gale, M. J., M. J. Korth, N. M. Tang, S. L. Tan, D. A. Hopkins, T. E. Dever, S. J. Polyak, D. R. Gretch, and M. G. Katze. 1997. Evidence that hepatitis C virus

- resistance to interferon is mediated through repression of the PKR protein kinase by the nonstructural 5A protein. *Virology* 230:217-227.
14. Gao, L., H. Aizaki, J. W. He, and M. M. Lai. 2004. Interactions between viral nonstructural proteins and host protein hVAP-33 mediate the formation of hepatitis C virus RNA replication complex on lipid raft. *J Virol* 78:3480-3488.
 15. Goh, P.-Y., Y.-J. Tan, S. P. Lim, S. G. Lim, Y. H. Tan, and W. J. Hong. 2001. The Hepatitis C Virus Core Protein Interacts with NS5A and Activates Its Caspase-Mediated Proteolytic Cleavage. *Virology* 290:224-236.
 16. Gordon, S. C., N. Bayati, and A. L. Silverman. 1998. Clinical outcome of hepatitis C as a function of mode of transmission. *Hepatology* 28:562-567.
 17. Hamamoto, I., Y. Nishimura, T. Okamoto, H. Aizaki, M. Liu, Y. Mori, T. Abe, T. Suzuki, M. M. Lai, T. Miyamura, K. Moriishi, and Y. Matsuura. 2005. Human VAP-B is involved in hepatitis C virus replication through interaction with NS5A and NS5B. *Journal of Virology* 79:13473-13482.
 18. Hanouille, X., A. Badillo, D. Verdegem, F. Penin, and G. Lippens. 2010. The Domain 2 of the HCV NS5A Protein Is Intrinsically Unstructured. *Protein Pept. Lett.* 17:1012-1018.
 19. Haybaeck, J., N. Zeller, M. J. Wolf, A. Weber, U. Wagner, M. O. Kurrer, J. Bremer, G. Iezzi, R. Graf, P. A. Clavien, R. Thimme, H. Blum, S. A. Nedospasov, K. Zatloukal, M. Ramzan, S. Ciesek, T. Pietschmann, P. N. Marche, M. Karin, M. Kopf, J. L. Browning, A. Aguzzi, and M. Heikenwalder. 2009. A Lymphotoxin-Driven Pathway to Hepatocellular Carcinoma. *Cancer Cell* 16:295-308.
 20. Hidajat, R., M. Nagano-Fujii, L. Deng, and H. Hotta. 2004. Cleavage of the hepatitis C virus NS5A protein by caspase-3 in the interferon sensitivity-

- determining region in a sequence-dependent manner. *Kobe J Med Sci* 50:153-166.
21. Ide, Y., L. Zhang, M. Chen, G. Inchauspe, C. Bahl, Y. Sasaguri, and R. Padmanabhan. 1996. Characterization of the nuclear localization signal and subcellular distribution of hepatitis C virus nonstructural protein NS5A. *Gene* 182:203-211.
 22. Kalamvoki, M., U. Georgopoulou, and P. Mavromara. 2006. The NS5A Protein of the Hepatitis C Virus Genotype 1a Is Cleaved by Caspases to Produce C-terminal-truncated Forms of the Protein That Reside Mainly in the Cytosol. *Journal of Biological Chemistry* 281:13449-13462.
 23. Kalamvoki, M., and P. Mavromara. 2004. Calcium-dependent calpain proteases are implicated in processing of the hepatitis C virus NS5A protein. *Journal of Virology* 78:11865-11878.
 24. Kato, N., K. H. Lan, S. K. OnoNita, Y. Shiratori, and M. Omata. 1997. Hepatitis C virus nonstructural region 5A protein is a potent transcriptional activator. *Journal of Virology* 71:8856-8859.
 25. Kiyosawa, K., T. Umemura, T. Ichijo, A. Matsumoto, K. Yoshizawa, A. Gad, and E. Tanaka. 2004. Hepatocellular carcinoma: Recent trends in Japan. *Gastroenterology* 127:S17-S26.
 26. Koo, B. C., P. McPoland, J. P. Wagoner, O. J. Kane, V. Lohmann, and S. J. Polyak. 2006. Relationships between hepatitis C virus replication and IL-8 production in vitro. *Journal of Virology* 80:7885-7893.
 27. Lavanchy, D. 2011. Evolving epidemiology of hepatitis C virus. *Clinical Microbiology and Infection* 17:107-115.

28. Le Guillou-Guillemette, H., S. Vallet, C. Gaudy-Graffin, C. Payan, A. Pivert, A. Goudeau, and F. Lunel-Fabiani. 2007. Genetic diversity of the hepatitis C virus: Impact and issues in the antiviral therapy. *World Journal of Gastroenterology* 13:2416-2426.
29. Legembre, P., R. Schickel, B. C. Barnhart, and M. E. Peter. 2004. Identification of SNF1/AMP kinase-related kinase as an NF-kappaB-regulated anti-apoptotic kinase involved in CD95-induced motility and invasiveness. *The Journal of biological chemistry* 279:46742-46747.
30. Lowes, K. N., E. J. Croager, L. J. Abraham, J. K. Olynyk, and G. C. Yeoh. 2003. Upregulation of lymphotoxin beta expression in liver progenitor (oval) cells in chronic hepatitis C. *Gut* 52:1327-1332.
31. Lu, L., T. J. Pilot-Matias, K. D. Stewart, J. T. Randolph, R. Pithawalla, W. He, P. P. Huang, L. L. Klein, H. Mo, and A. Molla. 2004. Mutations conferring resistance to a potent hepatitis C virus serine protease inhibitor in vitro. *Antimicrob Agents Chemother* 48:2260-2266.
32. Macdonald, A., and M. Harris. 2004. Hepatitis C virus NS5A: tales of a promiscuous protein. *Journal of General Virology* 85:2485-2502.
33. Martell, M., J. I. Esteban, J. Quer, J. Genesca, A. Weiner, R. Esteban, J. Guardia, and J. Gomez. 1992. Hepatitis-C virus (HCV) circulates as a population of different but closely related genomes - quasi-species nature of HCV genome distribution. *Journal of Virology* 66:3225-3229.
34. Mottola, G., G. Cardinali, A. Ceccacci, C. Trozzi, L. Bartholomew, M. R. Torrisi, E. Pedrazzini, S. Bonatti, and G. Migliaccio. 2002. Hepatitis C Virus Nonstructural Proteins Are Localized in a Modified Endoplasmic Reticulum of Cells Expressing Viral Subgenomic Replicons. *Virology* 293:31-43.

35. Ng, T. I., H. Mo, T. Pilot-Matias, Y. He, G. Koev, P. Krishnan, R. Mondal, R. Pithawalla, W. He, T. Dekhtyar, J. Packer, M. Schurdak, and A. Molla. 2007. Identification of host genes involved in hepatitis C virus replication by small interfering RNA technology. *Hepatology* 45:1413-1421.
36. Nigg, E. A. 1997. Nucleocytoplasmic transport: signals, mechanisms and regulation. *Nature* 386:779-787.
37. Park, K. J., S. H. Choi, S. Y. Lee, S. B. Hwang, and M. M. Lai. 2002. Nonstructural 5A protein of hepatitis C virus modulates tumor necrosis factor alpha-stimulated nuclear factor kappa B activation. *J Biol Chem* 277:13122-13128.
38. Pellerin, M., Y. Lopez-Aguirre, F. Penin, D. Dhumeaux, and J.-M. Pawlotsky. 2004. Hepatitis C virus quasispecies variability modulates nonstructural protein 5A transcriptional activation, pointing to cellular compartmentalization of virus-host interactions. *Journal of Virology* 78:4617-4627.
39. Polyak, S. J., K. S. A. Khabar, D. M. Paschal, H. J. Ezelle, G. Duverlie, G. N. Barber, D. E. Levy, N. Mukaida, and D. R. Gretch. 2001b. Hepatitis C virus nonstructural 5A protein induces interleukin-8, leading to partial inhibition of the interferon-induced antiviral response. *Journal of Virology* 75:6095-6106.
40. Polyak, S. J., K. S. A. Khabar, M. Rezeiq, and D. R. Gretch. 2001a. Elevated levels of interleukin-8 in serum are associated with hepatitis C virus infection and resistance to interferon therapy. *Journal of Virology* 75:6209-6211.
41. Randall, G., M. Panis, J. D. Cooper, T. L. Tellinghuisen, K. E. Sukhodolets, S. Pfeffer, M. Landthaler, P. Landgraf, S. Kan, B. D. Lindenbach, M. Chien, D. B. Weir, J. J. Russo, J. Ju, M. J. Brownstein, R. Sheridan, C. Sander, M. Zavolan, T. Tuschl, and C. M. Rice. 2007. Cellular cofactors affecting hepatitis

- C virus infection and replication. Proceedings of the National Academy of Sciences of the United States of America 104:12884-12889.
42. Satoh, S., M. Hirota, T. Noguchi, M. Hijikata, H. Handa, and K. Shimotohno. 2000. Cleavage of hepatitis C virus nonstructural protein 5A by a caspase-like protease(s) in mammalian cells. *Virology* 270:476-487.
 43. Sauter, D., K. Himmelsbach, M. Kriegs, M. Carvajal Yepes, and E. Hildt. 2009. Localization determines function: N-terminally truncated NS5A fragments accumulate in the nucleus and impair HCV replication. *Journal of Hepatology* 50:861-871.
 44. Shi, L., S.-l. Zhang, K. Li, Y. Hong, Q. Wang, Y. Li, J. Guo, W.-h. Fan, L. Zhang, and J. Cheng. 2008. NS5ATP9, a gene up-regulated by HCV NS5A protein. *Cancer Letters* 259:192-197.
 45. Silver, P. A. 1991. How proteins enter the nucleus. *Cell* 64:489-497.
 46. Song, J., M. Nagano-Fujii, F. Wang, R. Florese, T. Fujita, S. Ishido, and H. Hotta. 2000. Nuclear localization and intramolecular cleavage of N-terminally deleted NS5A protein of hepatitis C virus. *Virus Research* 69:109-117.
 47. Supekova, L., F. Supek, J. Lee, S. Chen, N. Gray, J. P. Pezacki, A. Schlapbach, and P. G. Schultz. 2008. Identification of human kinases involved in hepatitis C virus replication by small interference RNA library screening. *Journal of Biological Chemistry* 283:29-36.
 48. Tai, A. W., Y. Benita, L. F. Peng, S. S. Kim, N. Sakamoto, R. J. Xavier, and R. T. Chung. 2009. A functional genomic screen identifies cellular cofactors of hepatitis C virus replication. *Cell Host & Microbe* 5:298-307.
 49. Tanimoto, A., Y. Ide, N. Arima, Y. Sasaguri, and R. Padmanabhan. 1997. The amino terminal deletion mutants of hepatitis C virus nonstructural protein

- NS5A function as transcriptional activators in yeast. *Biochemical and Biophysical Research Communications* 236:360-364.
50. Tripathi, R. L., P. Krishnan, Y. He, T. Middleton, T. Pilot-Matias, C.-M. Chen, D. T. Y. Lau, S. M. Lemon, H. Mo, W. Kati, and A. Molla. 2007. Replication efficiency of chimeric replicon containing NS5A-5B genes derived from HCV-infected patient sera. *Antiviral Research* 73:40-49.
 51. Vaillancourt, F. H., L. Pilote, M. Cartier, J. Lippens, M. Liuzzi, R. C. Bethell, M. G. Cordingley, and G. Kukulj. 2009. Identification of a lipid kinase as a host factor involved in hepatitis C virus RNA replication. *Virology* 387:5-10.
 52. Wagoner, J., M. Austin, J. Green, T. Imaizumi, A. Casola, A. Brasier, K. S. Khabar, T. Wakita, M. Gale, Jr., and S. J. Polyak. 2007. Regulation of IL-8 (interleukin-8) induction by double-stranded RNA signaling pathways during hepatitis C virus infection. *Journal of Virology* 81:309-318.
 53. Wang, C. F., M. Gale, B. C. Keller, H. Huang, M. S. Brown, J. L. Goldstein, and J. Ye. 2005. Identification of FBL2 as a geranylgeranylated required for hepatitis C cellular protein virus RNA replication. *Molecular Cell* 18:425-434.
 54. Wang, R., and M. G. Brattain. 2007. The maximal size of protein to diffuse through the nuclear pore is larger than 60kDa. *FEBS Letters* 581:3164-3170.
 55. WARIS, G., S. SARKER, and A. SIDDIQUI. 2004. Two-step affinity purification of the hepatitis C virus ribonucleoprotein complex. *RNA* 10:321-329.
 56. Weiner, A. J., M. J. Brauer, J. Rosenblatt, K. H. Richman, J. Tung, K. Crawford, F. Bonino, G. Saracco, Q. L. Choo, M. Houghton, and J. H. Han. 1991. Variable and hypervariable domains are found in the regions of HCV corresponding to the flavivirus envelope and NS1 proteins and the pestivirus envelope glycoproteins. *Virology* 180:842-848.

57. Yeh, C.-T., M.-H. Chang, W.-C. Shyu, M.-L. Chang, P.-Y. Yang, M.-L. Tsao, and H.-Y. Lai. 2005. Characterization of a HCV NS5A protein derived from a patient with hepatoma. *Biochemical and Biophysical Research Communications* 327:516-522.
58. Yi, M., F. Bodola, and S. M. Lemon. 2002. Subgenomic hepatitis C virus replicons inducing expression of a secreted enzymatic reporter protein. *Virology* 304:197-210.

Figure 1

```

      10      20      30      40      50      60      70      80      90     100
Nim    |.....|.....|.....|.....|.....|.....|.....|.....|.....|.....|
SGSWLRD|VWVDVCTV|LSDFK|TWLQSK|LLPRLP|GVVFLS|CQGRYK|GVWRGD|GIMHTT|CPCGAQ|IAGHV|KNGSM|RIIGPK|TCSNT|WHTF|FPIN|AYTTG|PCTP
V1     |.....|.....|.....|.....|.....|.....|.....|.....|.....|.....|
V2     |.....|.....|.....|.....|.....|.....|.....|.....|.....|.....|
V3     |.....|.....|.....|.....|.....|.....|.....|.....|.....|.....|
V4     |.....|.....|.....|.....|.....|.....|.....|.....|.....|.....|
V5     |.....|.....|.....|.....|.....|.....|.....|.....|.....|.....|

      110     120     130     140     150     160     170     180     190     200
Nim    |.....|.....|.....|.....|.....|.....|.....|.....|.....|.....|
SPAPNYS|KALMWRVA|EEYVEV|TRVGDH|FYVTG|ITTENV|KPCQV|PAPPEFF|TEVDGV|RLHRYA|PVCKP|LLRDEV|VFOVGL|NQYLV|GSQLP|CEPEP|DVAVLT
V1     |.....|.....|.....|.....|.....|.....|.....|.....|.....|.....|
V2     |.....|.....|.....|.....|.....|.....|.....|.....|.....|.....|
V3     |.....|.....|.....|.....|.....|.....|.....|.....|.....|.....|
V4     |.....|.....|.....|.....|.....|.....|.....|.....|.....|.....|
V5     |.....|.....|.....|.....|.....|.....|.....|.....|.....|.....|

      210     220     230     240     250     260     270     280     290     300
Nim    |.....|.....|.....|.....|.....|.....|.....|.....|.....|.....|
SMLTDP|SHITAE|AAKRR|LARGSP|PPLAS|SSAIQ|LSAPL|RATCT|THSSY|NLDSP|VDLIE|ANLLW|ROEMG|GNITR|VESEN|KVVVL|DSFE|PLR|AEGDENEI
V1     |.....|.....|.....|.....|.....|.....|.....|.....|.....|.....|
V2     |.....|.....|.....|.....|.....|.....|.....|.....|.....|.....|
V3     |.....|.....|.....|.....|.....|.....|.....|.....|.....|.....|
V4     |.....|.....|.....|.....|.....|.....|.....|.....|.....|.....|
V5     |.....|.....|.....|.....|.....|.....|.....|.....|.....|.....|

      310     320     330     340     350     360     370     380     390     400
Nim    |.....|.....|.....|.....|.....|.....|.....|.....|.....|.....|
SIAAEI|LRKSKK|FPAIPI|NARPDY|NPPLES|WKNPDY|VPPV|VHGCC|PLPPV|KAPPIP|PPPRR|KRTV|VLTDS|TVSSV|LAE|LATK|TFG|SSEL|SAA|DSGT|ATAP
V1     |.....|.....|.....|.....|.....|.....|.....|.....|.....|.....|
V2     |.....|.....|.....|.....|.....|.....|.....|.....|.....|.....|
V3     |.....|.....|.....|.....|.....|.....|.....|.....|.....|.....|
V4     |.....|.....|.....|.....|.....|.....|.....|.....|.....|.....|
V57    |.....|.....|.....|.....|.....|.....|.....|.....|.....|.....|

      410     420     430     440     450
Nim    |.....|.....|.....|.....|.....|
PDQTS|DNGGK|SDAES|CSMPP|LEGE|PGDP|DLS|DGSW|STVSE|ELIKR|VVOC
V1     |.....|.....|.....|.....|.....|
V2     |.....|.....|.....|.....|.....|
V3     |.....|.....|.....|.....|.....|
V4     |.....|.....|.....|.....|.....|
V5     |.....|.....|.....|.....|.....|
    
```

Figure 2A

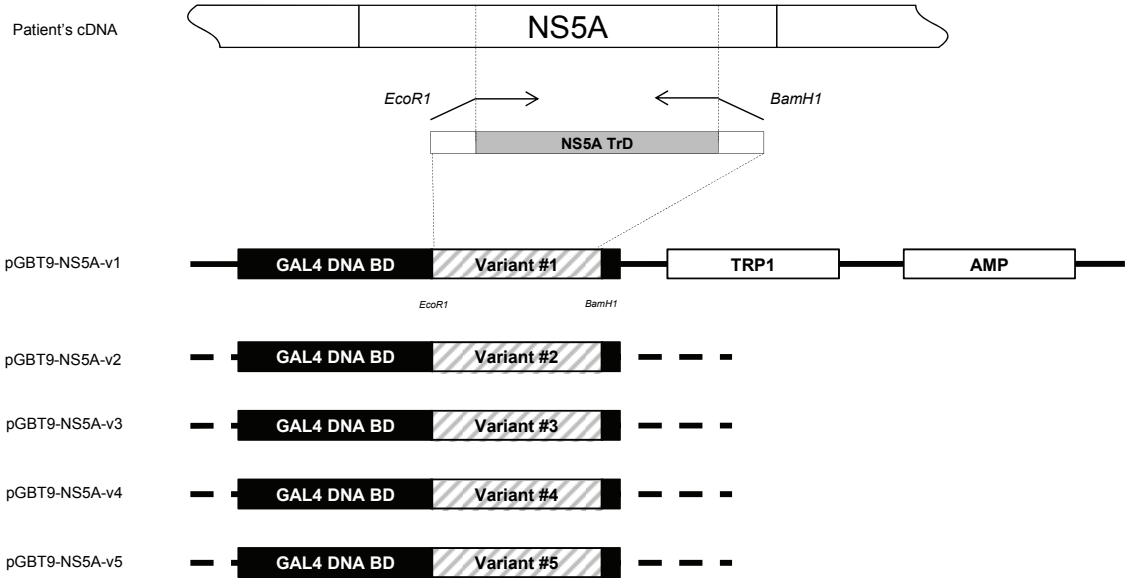

Figure 2B

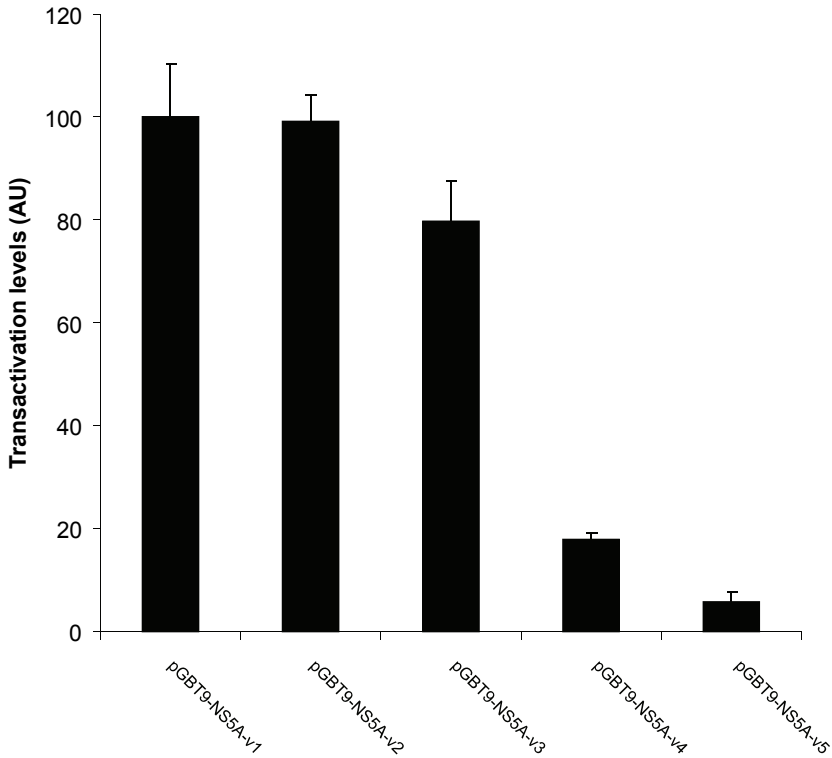

Figure 3A

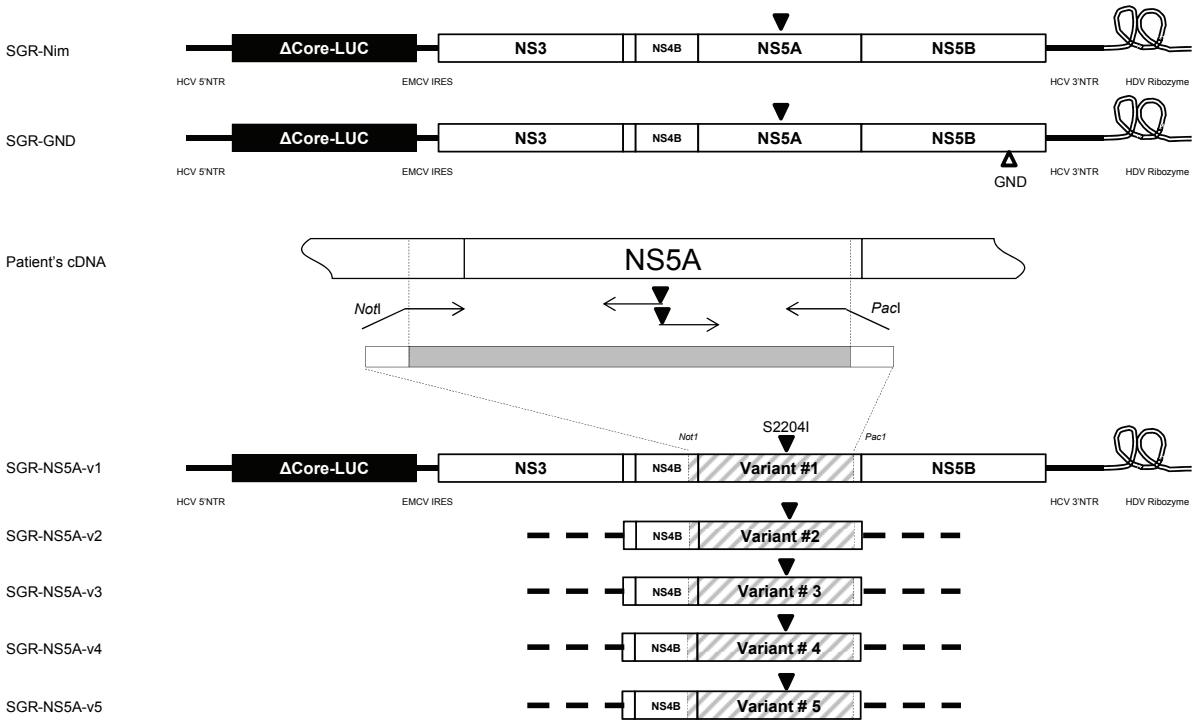

Figure 3B

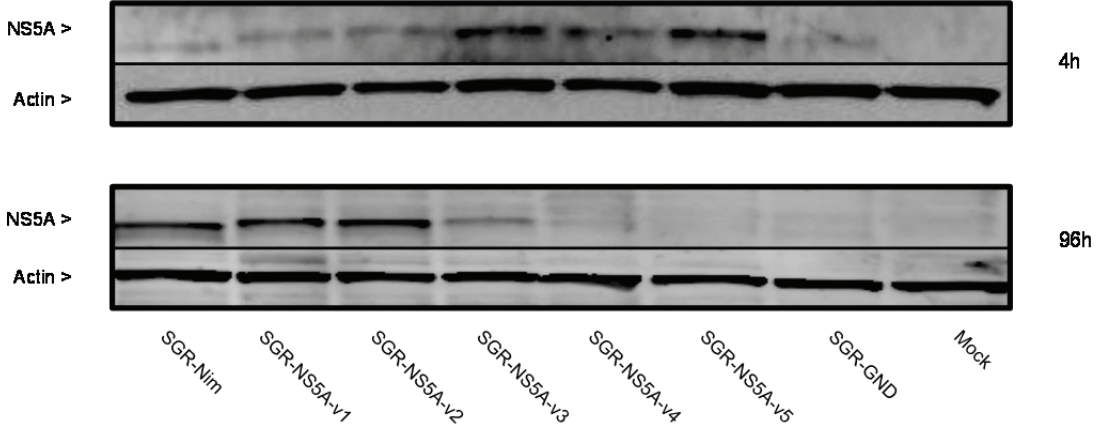

Figure 3C

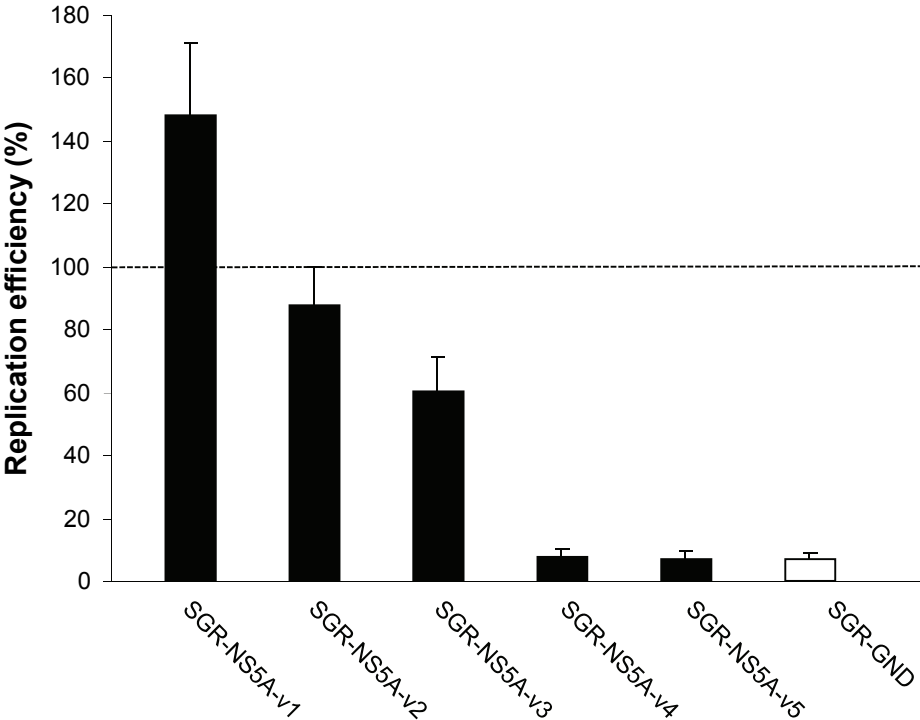

Figure 3D

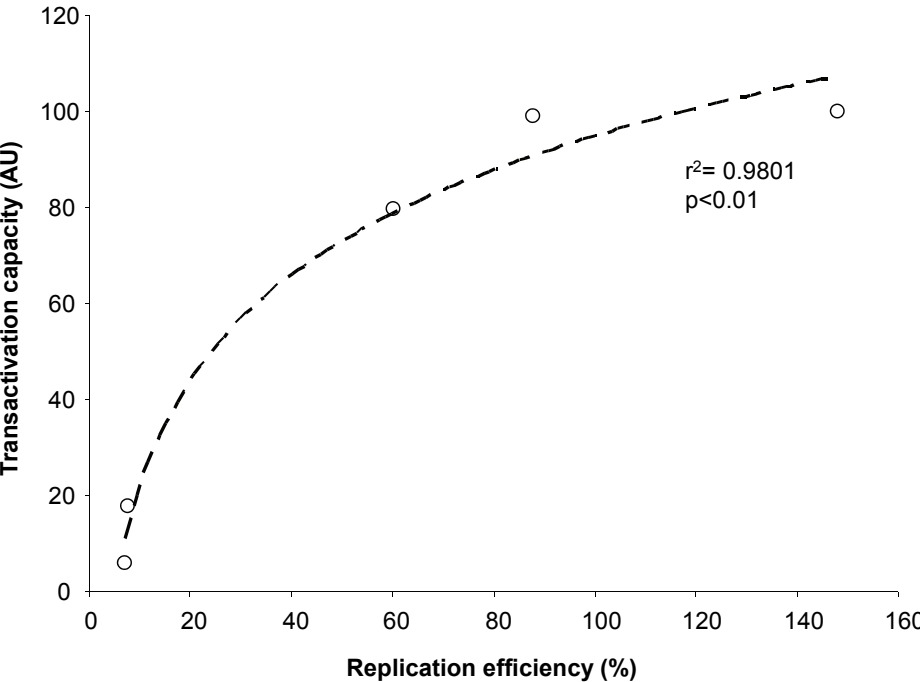

Figure 4A

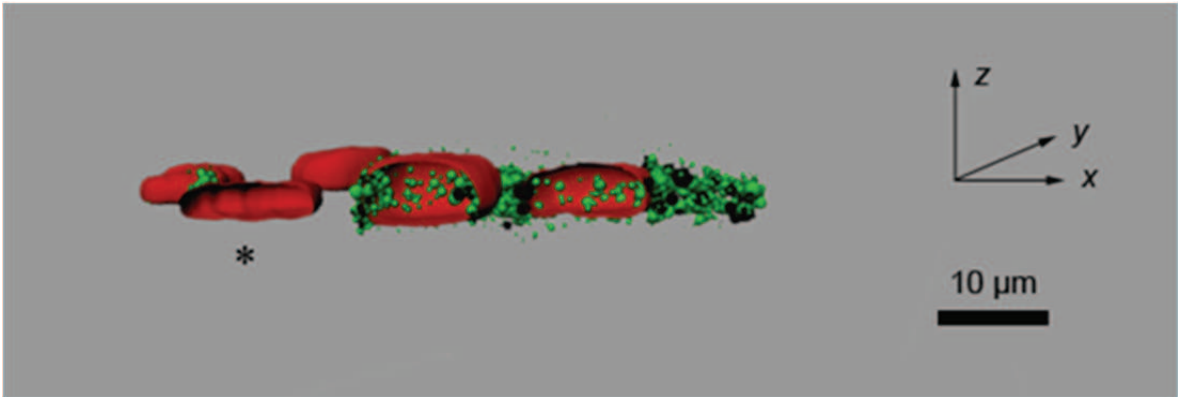

Figure 4B

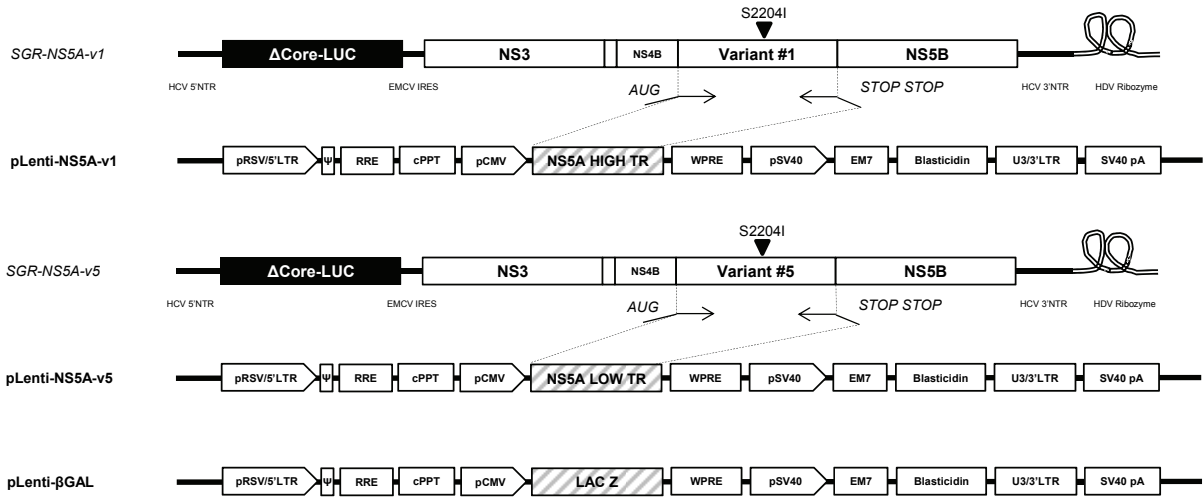

Figure 4C

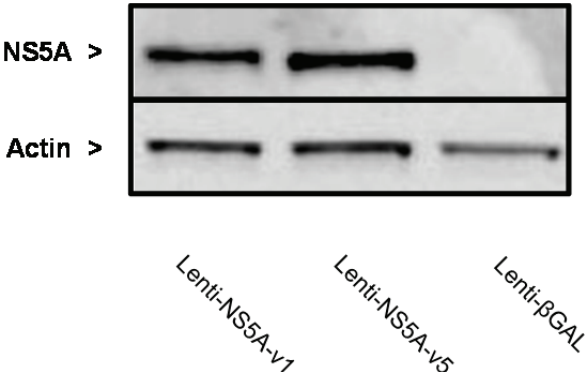

Figure 4D

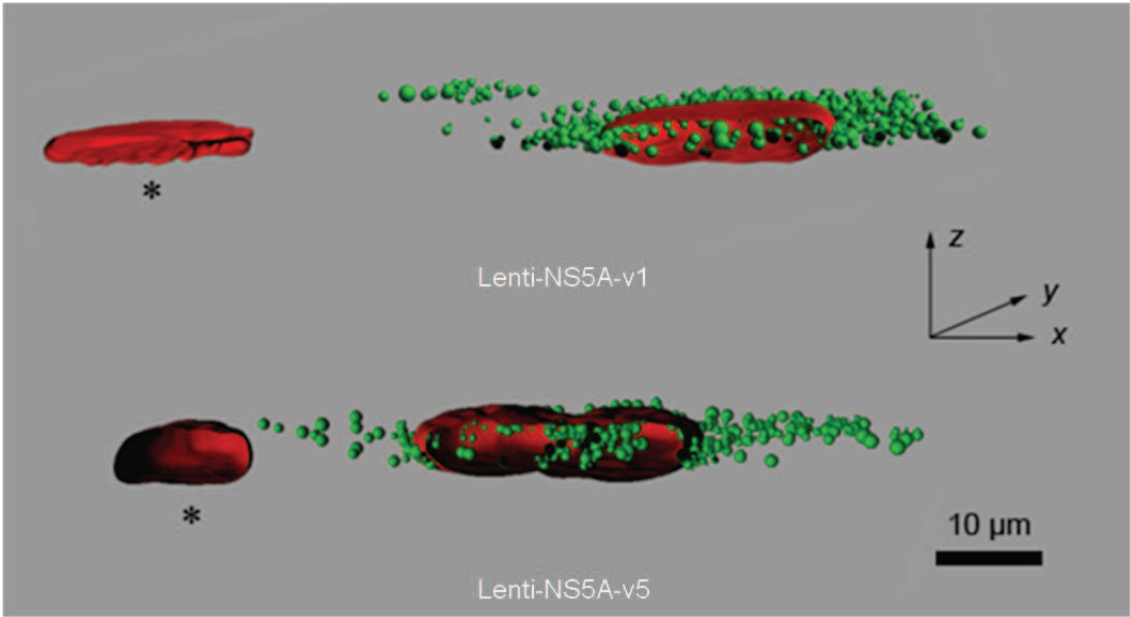

Figure 5A

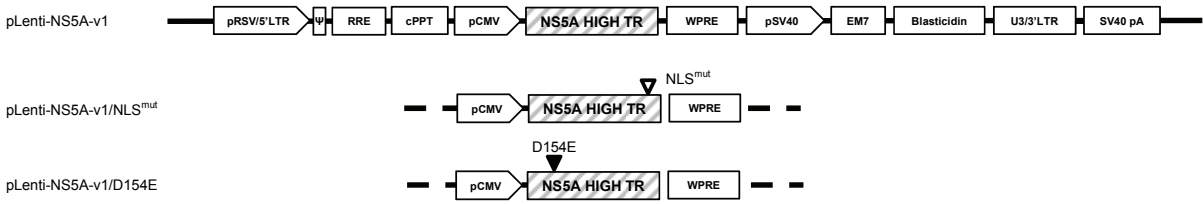

Figure 5B

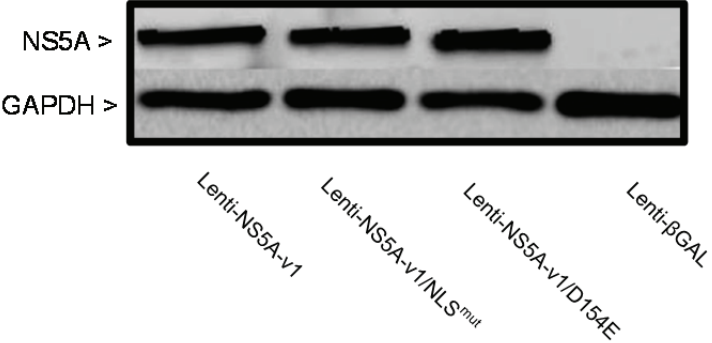

Figure 5C

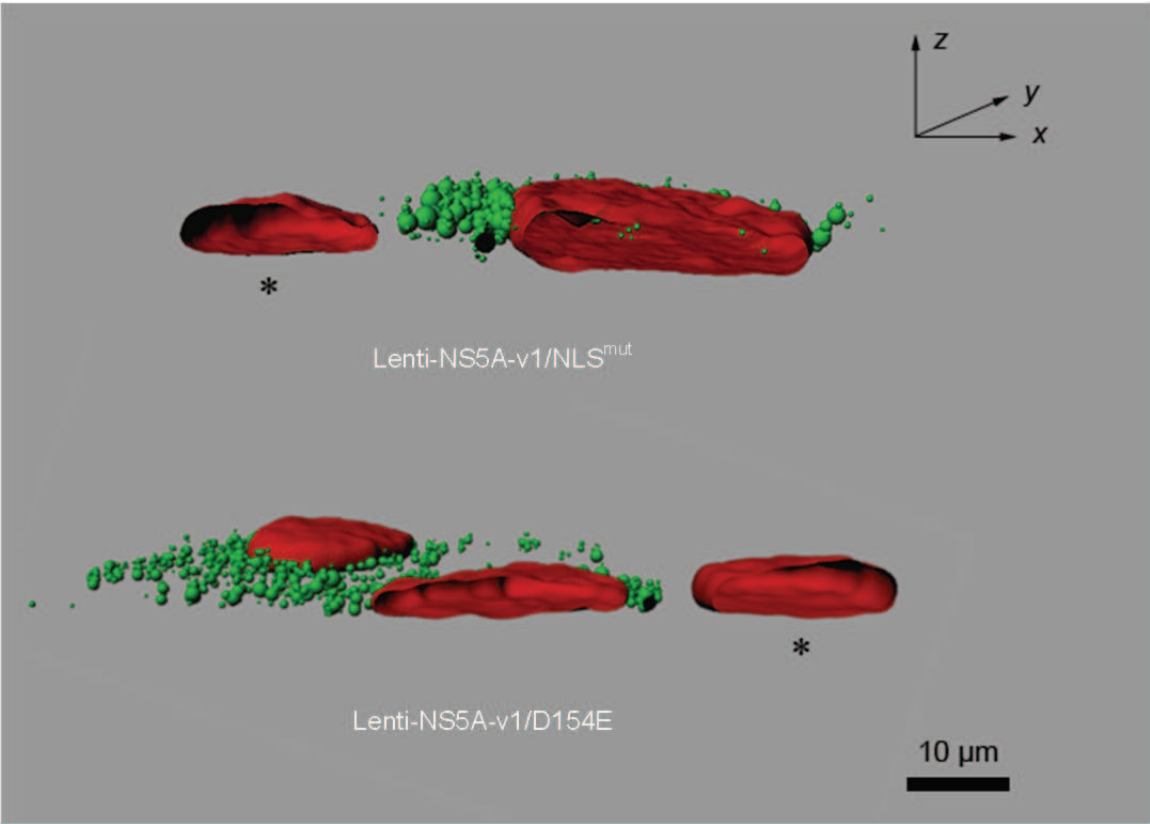

Figure 6A

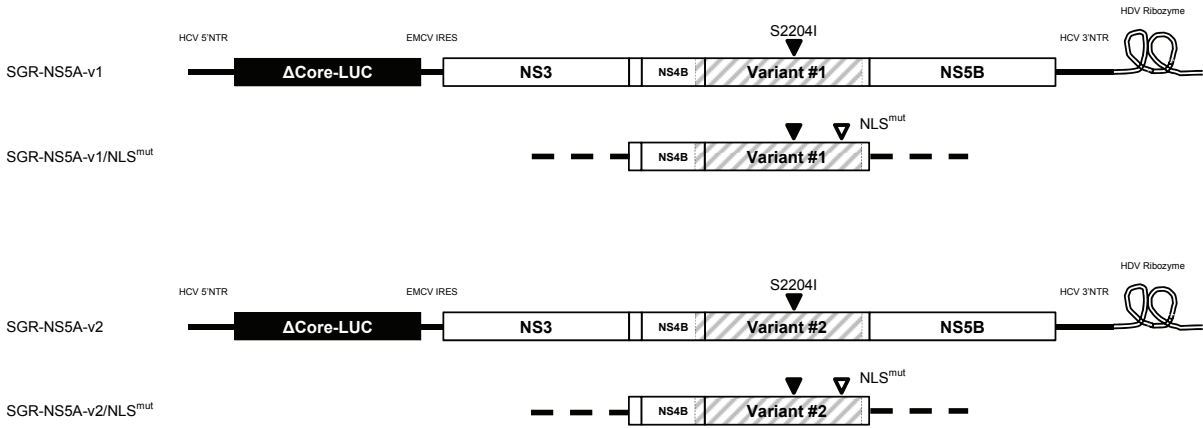

Figure 6B

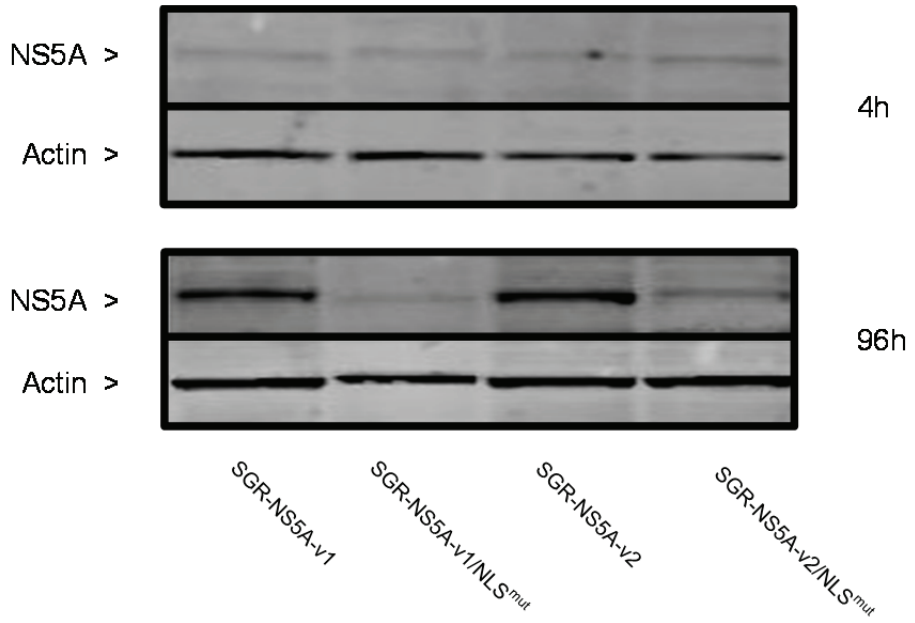

Figure 6C

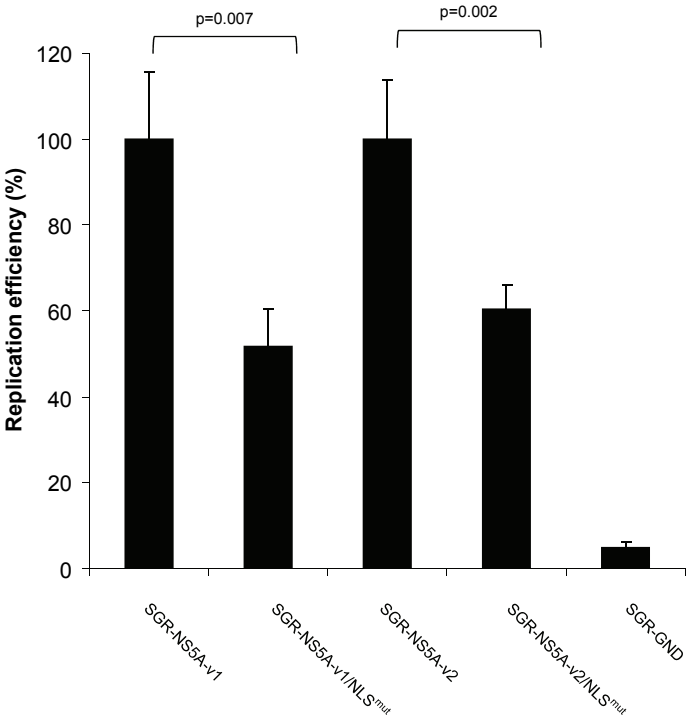

Figure 6D

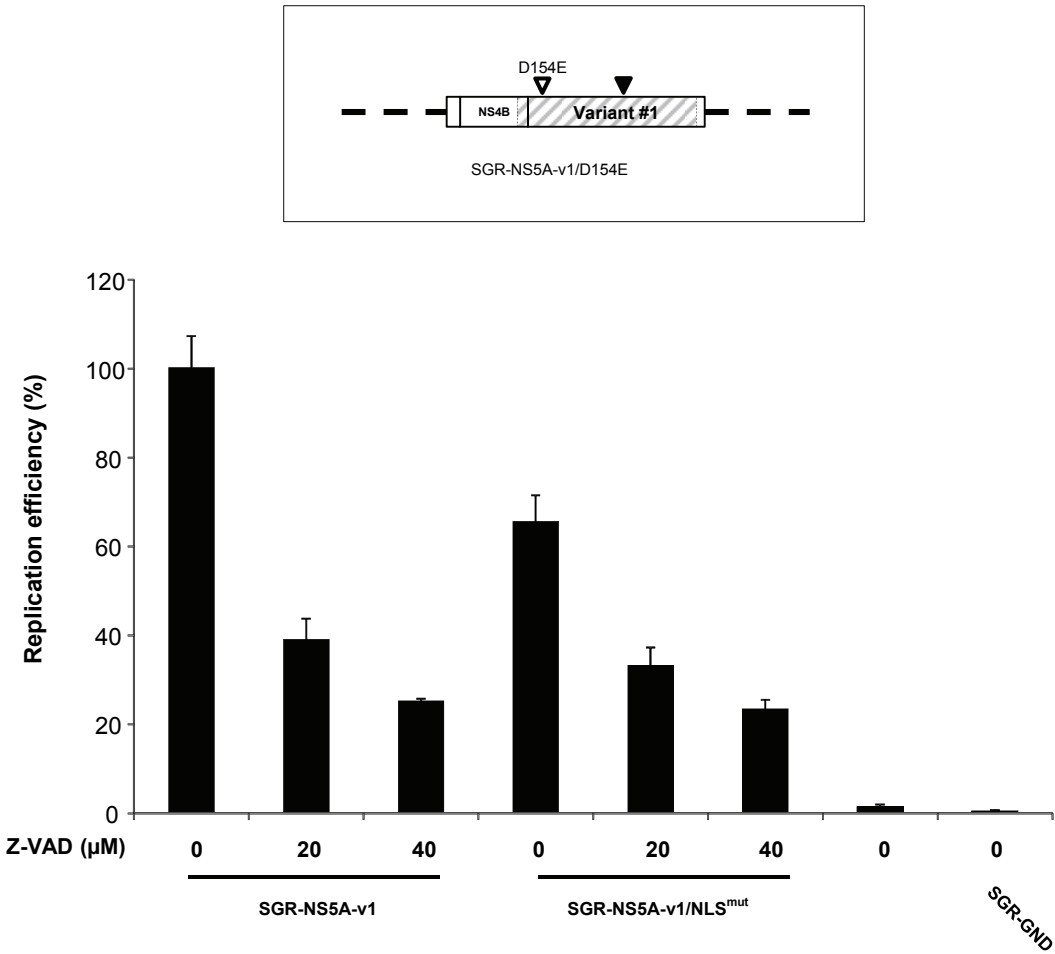

Figure 7

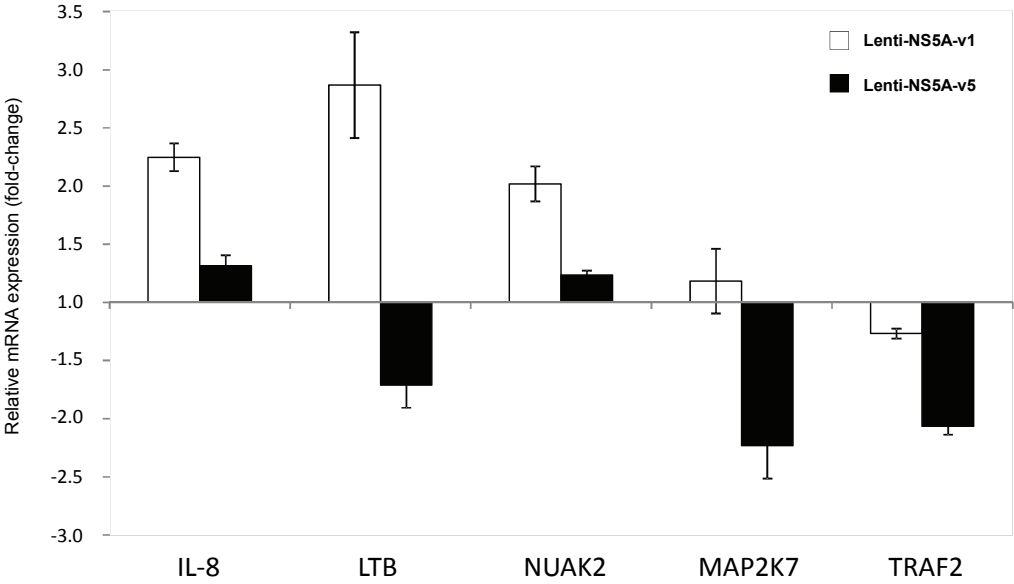
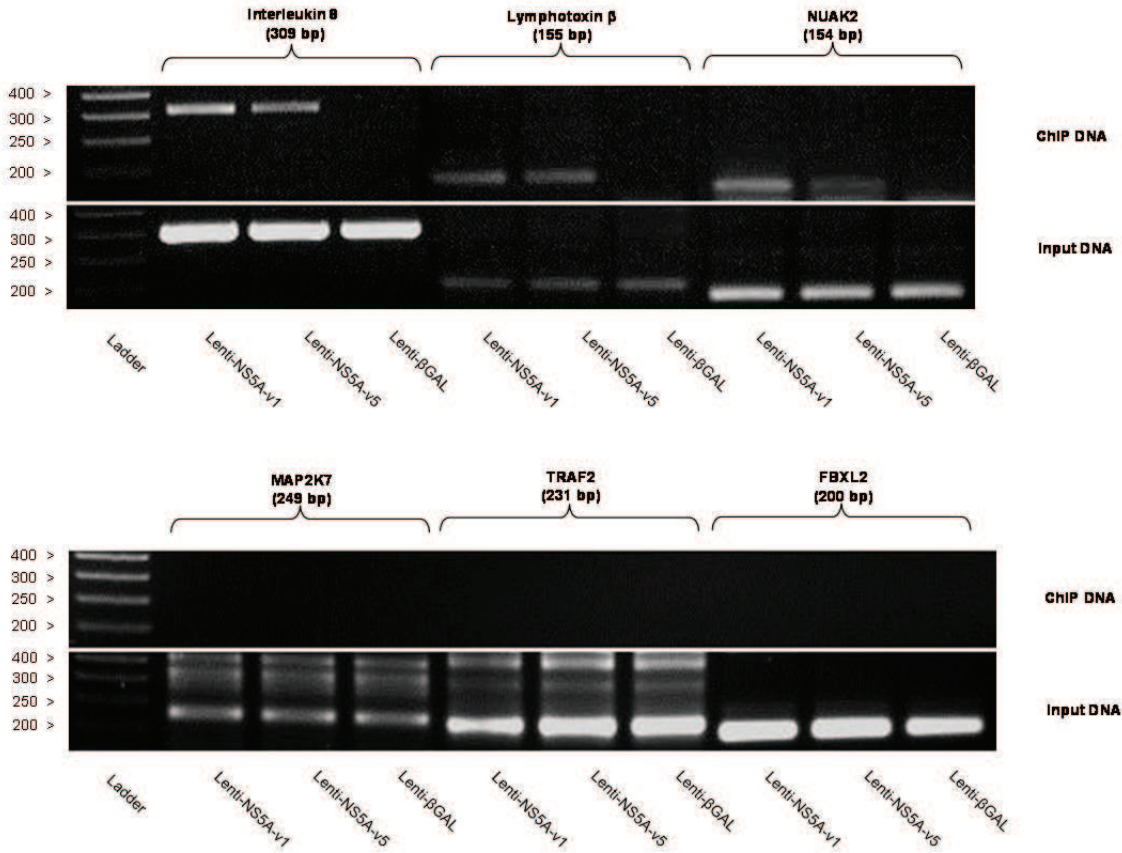

Figure 8



3.4. The AR2 Region of NS5A bears the transactivation potential of NS5A (Additional data not included in the J Virol paper.)

As described above, NS5A quasispecies variants isolated from the hepatic tissue of an HCV-infected individual demonstrated significantly different transactivation potentials. Sequence analysis of the transactivation domains of these variants demonstrated no correlation between specific amino acid residues and the transactivation potential of a variant (Figure 1 of the submitted article). These observations suggested that the transactivation potential of an NS5A variant may depend on the global physical properties of the region. Previously our group has reported that the calculation of hydrophobicity and the prediction of secondary structures by various methods reveal very close values and conformational differences amongst variants (Pellerin *et al.*, 2004). In addition, in the same study it was suggested that amino acid substitutions among variants may affect the global charge of the polypeptide and may thus influence NS5A interactions and functions. To investigate this hypothesis, we correlated the global charge of each NS5A transactivation domain with the transactivation potential of the corresponding variant. Our results indicated a significant correlation between the global charge of the transactivation domain and its transactivation potential (Figure 3.18B). The transcriptional activation domain of HCV NS5A has been shown to contain two regions rich in acidic amino acids termed AR1 and AR2 (Figure 3.18A) (Tanimoto *et al.*, 1997). To investigate whether one or both of these regions play a role in transactivation, we studied the correlation between the global charges of these acid-rich regions and the transactivation potential of the corresponding variant. For this, all isolated NS5A variants were divided into three categories based on their transactivation potential i.e., strong, average and weak transactivators. The global charge of polypeptides corresponding to the transactivation domain, AR1 or AR2 regions of variants in these categories were plotted. We observed a significant correlation between the global charge of AR2 and transactivation potential of the variant, although no such correlation was observed for AR1 (Figure 3.18B). These observations suggested that AR2 could play a major role in the transactivation properties of NS5A.

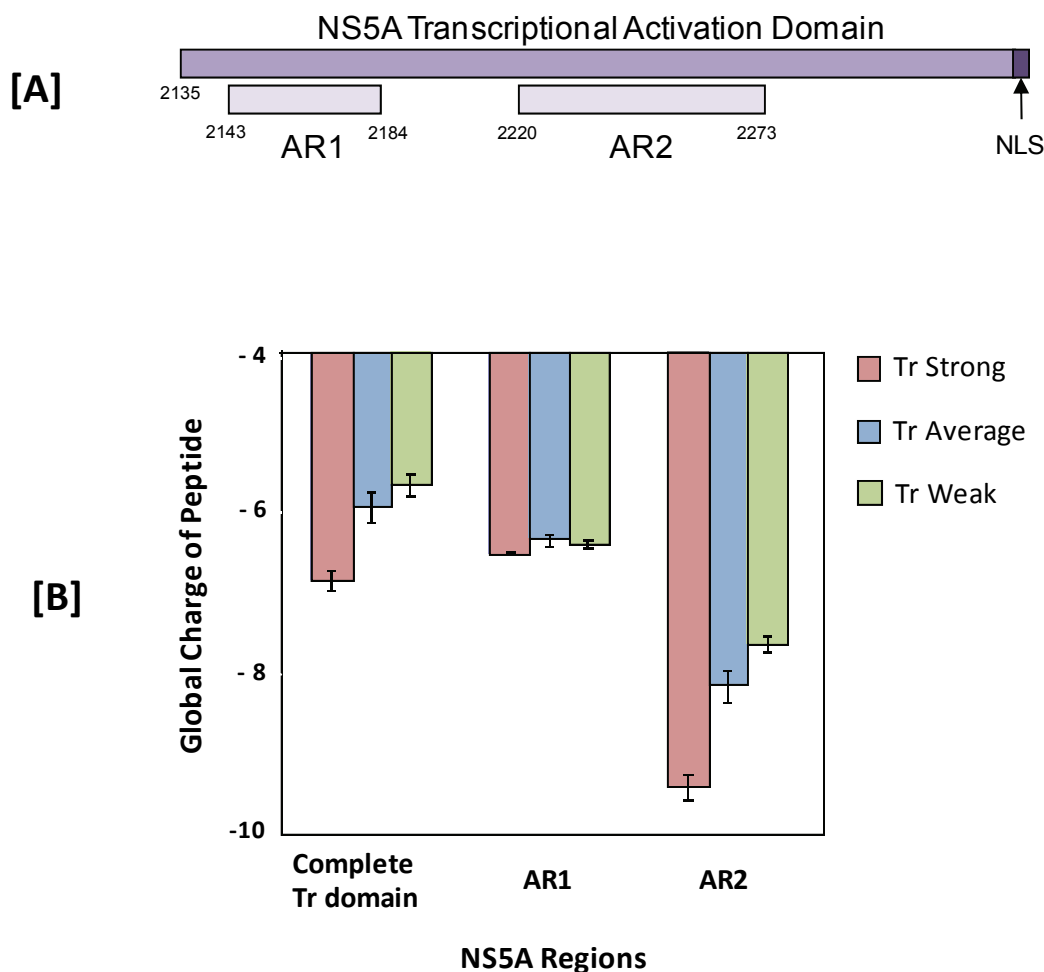

Figure 3.18: Role of AR2 in the transactivational properties of NS5A. [A] Schematic representation of acid rich regions AR1 and AR2 of the NS5A transactivation domain. [B] Correlation between the global charge of NS5A transcriptional activation domain, AR1 or AR2 and the transactivation potential of NS5A variants. Each bar represents the mean global charge of the indicated polypeptide region of all NS5A variants in the indicated group.

To experimentally confirm these observations, we exchanged the AR2 region sequences between strong and weak transactivating NS5A variants (v1 and v5) as described in section 2.4.12. We then cloned these chimeric variants into our yeast one-hybrid and sub-genomic replicon systems to study the subsequent effect NS5A transactivation properties and HCV RNA replication capacity.

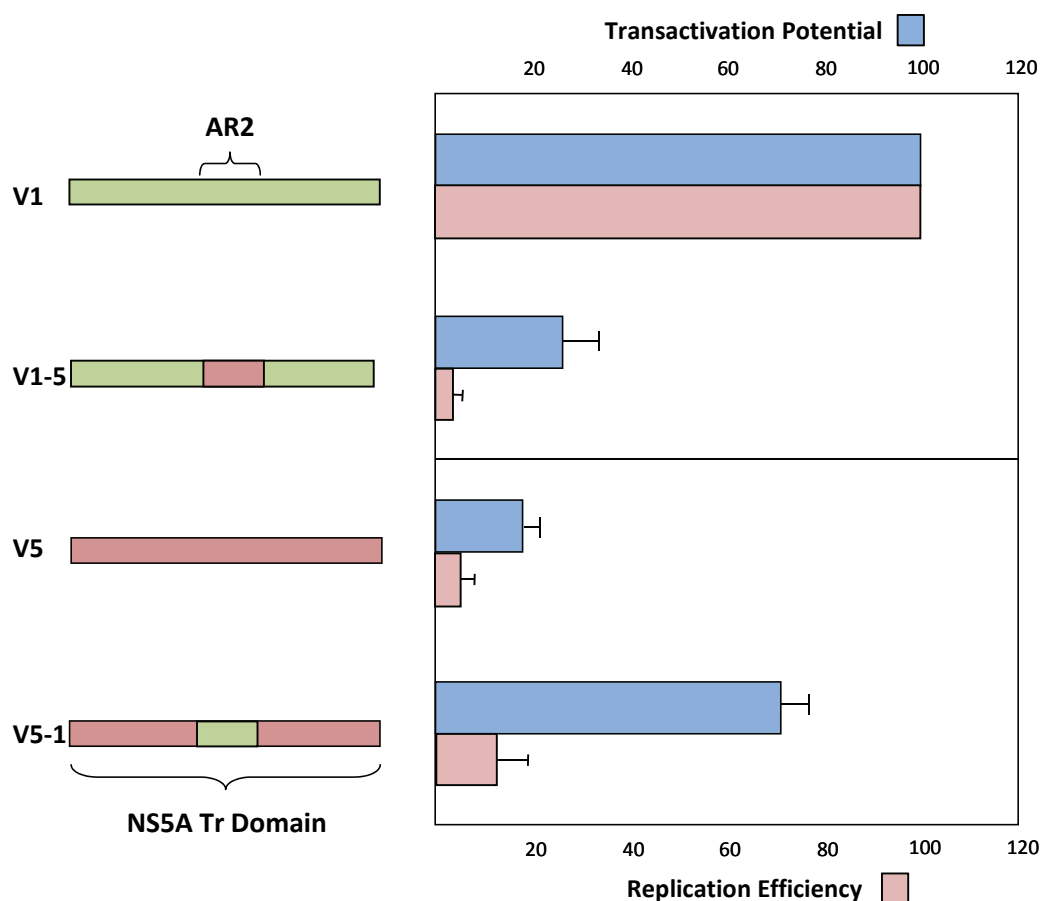

Figure 3.19: Role of AR2 in NS5A transactivation and HCV RNA replication. The AR2 region of the NS5A transactivation domain of strongly (NS5A-v1) and weakly (NS5A-v5) transactivating NS5A variants were swapped with each other (left). The effect of this exchange on NS5A transactivation properties and HCV RNA replication was studied in yeast one-hybrid (blue) and subgenomic replicon models (red) respectively. Error bars indicate SEM. These results are indicative of three independent experiments.

The results shown in figure 3.19 demonstrate that both the transactivation potential of the variant and the HCV RNA replication capacity of a replicon bearing such a variant were strongly reduced when the AR2 region of a strongly transactivating variant was replaced with that of a weakly transactivating variant. On the other hand, whilst the transactivation potential of a weakly transactivating variant increased significantly when the AR2 domain was replaced with that of a strongly transactivating variant, the corresponding replication capacity was nearly unaffected. Together these observations suggest that the AR2 region of NS5A is necessary but not sufficient for its transcriptional activity and its effect on HCV RNA replication.

4 - Discussion

With more than 170 million carriers around the world, HCV represents a serious public health problem. HCV infection becomes chronic in more than 80% of the patients and is often associated with liver steatosis, fibrosis, cirrhosis, and is a major risk factor for the development of hepatocellular carcinoma. Little is known about the mechanisms surrounding HCV-induced pathogenesis and it is unclear what, if any, role the direct HCV proteins play in these processes remains to be defined. In this context, we have investigated the role of the HCV NS5A protein, especially its transactivation properties, on viral replication and in liver pathogenesis.

NS5A is a nonstructural protein and is an essential component of HCV replication complex, although no precise enzymatic function has been attributed to it. Some studies have suggested that N-terminal deletion mutants of HCV NS5A possess transcriptional activation properties, although the exact mechanisms involved are unclear (Kato *et al.*, 1997; Tanimoto *et al.*, 1997; Pellerin *et al.*, 2004). It is well established that in an infected individual, HCV exists as a quasispecies; a complex mixture of genetically distinct but closely-related variants (Weiner *et al.*, 1991; Martell *et al.*, 1992). Using phylogenetic and functional analyses we demonstrated that hepatic quasispecies variants of NS5A possessed different levels of transactivation potential, suggesting that the accumulation of genetic mutations randomly generates viral protein variants with quantitatively different functional properties in infected cells. These data extend previous observations made using quasispecies variants isolated from serum samples (Pellerin *et al.*, 2004). Moreover, our analysis of NS5A sequence distributions within a given patient revealed a genetic compartmentalization between tumoral and adjacent non-tumoral hepatic tissues. However, this finding was not observed in all patients from our cohort. This genetic compartmentalization was most evident in patients with non-cirrhotic liver tissues, although it is difficult to draw a valid conclusion from such a small group (n=4). Both decreased Shannon entropy of NS5A quasispecies and lower virus titers (HL, personal data) were observed in the tumoral tissue of these patients, indicating restrictions on virus genetic diversity in the tumoral environment. One possible explanation is that reduced genetic diversities and viral titers were due to a more recent infection of the tumoral tissues by HCV from the adjacent tissues. Similar virus diversity was proposed in the case of lymphoid and central nervous system tissues infection by neuropathogenic SIVsmmFGb. (Reeve *et al.*, 2009; Reeve *et al.*, 2010). These studies also pinpointed that such compartmentalization evolved over the time of infection, therefore complicating any conclusions that may be drawn from such analyses.

A study has reported that HCV core protein sequences isolated from tumoral tissue could interact with the cellular transcription factor Smad3 and inhibit the TGF- β pathway, but that variants isolated from adjacent non-tumoral tissues could not (Pavio *et al.*, 2005), thus demonstrating a functional compartmentalization of core protein. In our study, due to high variability between patients, we were unable to conclude that a specific tissue compartment was harboring particular NS5A transactivation levels.

We found that the transactivation properties of a given NS5A variant and the amino-acid sequence of its transactivating domain were related, with certain regions exclusively mutated in variants with high transactivatory potentials. However, we did not observe any correlation between specific amino acid residues and transactivation properties, suggesting that the transactivation potential of a variant may rather depend on global physical properties of the polypeptide. Indeed, analysis of the variants revealed a significant correlation between their global charge and transactivation potential, confirming hypotheses posed by Pellerin *et al.* (2004). The central region of NS5A contains two domains rich in acidic amino acids and one proline rich region ((Tanimoto *et al.*, 1997; Tan *et al.*, 1999). Interestingly these structural characteristics are a typical feature of many viral and eukaryotic transcription factors such as HIV Tat, HSV VP16 and c-Jun (Hope *et al.*, 1988; Lillie *et al.*, 1989; Kamine *et al.*, 1991; Tiley *et al.*, 1992; Subramanian *et al.*, 1994). We were able to pinpoint the domain AR2 as essential for NS5A transactivation properties.

Although it has previously been suggested that NS5A protein may possess transactivation properties, the impact of such activity was not known. Here, we showed that NS5A transactivation potentials positively correlated with viral replication capacity. Thus, one possibility is that HCV NS5A may act in a manner analogous to HIV Tat and HSV-1 VP16 during viral replication. Tat and VP16 are viral transactivators shown to be essential for viral replication as they are required for efficient transcription of viral genomes (Arya *et al.*, 1985; Fisher *et al.*, 1986; Tal-Singer *et al.*, 1999).

We have further shown that that NS5A transactivational activity plays an important role in viral replication by modulation of the host cell genes required for efficient replication of HCV. Indeed, other viral transactivators such as HIV Tat have also been shown to regulate HIV replication and chronicity by transactivating cellular genes (Buonaguro *et al.*, 1992). Although NS5A has previously been shown to play a role in viral regulation by modulating the cellular responses through interactions with several proteins involved in host cell signaling

pathways related to interferon response, cell cycle and apoptosis (Gale *et al.*, 1997; Gale *et al.*, 1999; Arima *et al.*, 2001), we have demonstrated that direct regulation of host gene transcription by NS5A represents another mechanism employed by HCV to achieve similar goals, providing a possible explanation for the correlation between HCV replication and NS5A transactivation properties observed.

The translocation of a protein to the nucleus is essential for it to exert any putative transactivational activity. In line with this, we demonstrated that that caspase-mediated release of NS5A from its ER retention signal and its translocation to the nucleus is essential for HCV RNA replication *in vitro*. Although our study does not provide any data about the mechanisms by which NS5A may function as transcriptional activator, the use of formaldehyde in our ChIP experiments demonstrate that NS5A closely interacts with the cellular gene promoters. It is well known that different transcription factors function as transcriptional regulators by interacting with specific DNA elements (Kang *et al.*, 2010). However as NS5A amino acid sequence does not contain any known DNA binding motif, it is less likely that it may interact directly with DNA. Interestingly, it has been demonstrated that NS5A colocalizes with Snf2-related CREBBP activator protein (SRCAP), a cellular transcription factor, suggesting that NS5A may interact with cellular transcription factors to modulate their activity (Ghosh *et al.*, 2000b). Other viral transactivators that modulate host cell gene expression, such as Tat, have been shown to target protein kinases involved in the phosphorylation of polymerase II C-terminal domain thus influencing the transcription initiation as well as elongation (Herrmann *et al.*, 1996; Gold *et al.*, 1998). Recently, it has been suggested that viral transactivators such as VP16 may also function by enhancing the polyadenylation of targeted precursor mRNAs (Nagaike *et al.*, 2011). It is possible that NS5A may act in a manner similar to these viral transactivators, although further work remains to be performed on the exact manner(s) in which NS5A exerts its transactivational activities.

To completely understand the mechanisms of NS5A transactivation, it will be critical to characterize the cellular promoters bound by NS5A. Chromatin immunoprecipitation coupled with last-generation genome-wide deep sequencing (ChIP-seq) represents a powerful strategy to analyze the possible targets of transactivation by viral proteins (Kennedy *et al.*, 2010). We are currently performing ChIP-seq analysis on primary human hepatocytes expressing weakly and strongly transactivating NS5A variants. Such analysis, coupled with transcriptome analysis of these cells, will allow us to define the complement of cellular genes transactivated

by NS5A. Using these data, we may be able to suggest a DNA motif necessary for NS5A DNA binding or transcription factors targeted by NS5A.

Apart from enhancing HCV replication, NS5A mediated modulation of host cell gene expression may represent a mechanism by which HCV can override cellular control mechanisms such as the interferon response, cell cycle progression and apoptosis, contributing to persistent infection. We have demonstrated that NS5A can directly modulate the expression of several cellular proteins such as CXCL8, LTB, NUA2. In agreement with our observations, it has been previously demonstrated that NS5A induces the activity of CXCL8 promoter in reporter gene assays (Polyak *et al.*, 2001b). Moreover it has been demonstrated that CXCL8 is induced to high levels by replicons with high replicative capacity (Koo *et al.*, 2006). Interestingly our results demonstrated that NS5A variant with higher transactivation potential, induced higher levels of CXCL8 as well as conferred higher replication to corresponding replicon, suggesting that NS5A transactivation of CXCL8 may play an important role in enhancing the replication of HCV. NS5A transactivation of CXCL8 may also represent one of the mechanisms involved in HCV induced pathogenesis. It has been demonstrated that increased expression of CXCL8 in HCV infected patients is associated to inhibition of antiviral effects of interferon (Polyak *et al.*, 2001a). HCV has been suggested to increase levels of LT β in liver tissues (Lowe *et al.*, 2003) whose sustained expression represents an important factor in liver inflammation and HCV-induced HCC (Lowe *et al.*, 2003; Haybaeck *et al.*, 2009). We observed a strong upregulation of LT β by strongly transactivating NS5A variant, suggesting that NS5A mediated transcriptional activation may account for at least a partial increase in liver LT β levels thus inducing liver inflammation. Similarly, NUA2 is a potent anti-apoptotic kinase involved in increased death resistance and invasiveness of tumor cells (Legembre *et al.*, 2004; Kim *et al.*, 2008). No direct link between HCV and NUA2 is known. However, it is a very important cell cycle regulator, therefore its modulation by NS5A might be one of the mechanisms by which HCV regulates the cell cycle thus play a role in HCV-induced pathogenesis.

To study the role of NS5A transactivation in HCV induced pathogenesis *in vivo*, we tried to develop an adenoviral vector system to express well-characterized NS5A variants in murine hepatic tissues. However, our adenoviral vector system failed to efficiently express the NS5A transgene *in vivo*. We therefore decided to use two complementary approaches to study our hypotheses that the natural variability of NS5A may impact its proposed transactivation properties and that NS5A's putative transactivation properties could play a role in liver

pathogenesis. Our alternative strategy was to use a lentiviral vector for *in vitro* studies, whereas for *in vivo* studies we developed transgenic mice expressing the patient-isolated NS5A variants we previously characterized. In order to investigate the role of NS5A transactivation in host gene regulation, we performed genome wide RNA-seq differential transcriptome analysis on *in vitro* cultured primary human hepatocytes transduced with lentiviral vectors encoding weakly and strongly transactivating NS5A variants. Such primary human cells were chosen because we assumed that major cellular pathways in these cells were closer to those found in patients than those of hepatoma cells (Huh-7 and derived clones). The data obtained will allow us to identify the host cell molecular pathways differentially regulated by NS5A variants. The role of NS5A variants in differential regulation of identified pathways and eventually the potential mechanisms of pathogenesis will be the subject of future studies. As with our previous approach, this approach is also based on expression of NS5A alone. This might represent a caveat in this study since during HCV lifecycle, NS5A is part of a multiprotein replication complex, absent from our models. The results obtained from this approach should then be confirmed using other models harboring the full HCV protein repertoire. Such full-length or infectious HCV replicon systems bear numerous other caveats, mainly concerning the cell types used. A better approach might involve recently developed *in vivo* infectious model in humanized mice (Mercer *et al.*, 2001; Strick-Marchand *et al.*, 2004; Meuleman *et al.*, 2005).

As described above, we are developing transgenic mice expressing NS5A variant proteins. Making use of advanced targeted transgenesis techniques, in which the transgene is inserted into a neutral locus, and is able to be conditionally expressed in a liver- and time-specific fashion, we have begun the development of transgenic mice expressing NS5A variants v1 and v2. We expect to obtain the first mice in March 2012. The double transgenic mice for both hepatic *Cre* recombinase and NS5A variants will be followed for 18 months to study the incidence of both spontaneous and chemically-induced HCC as a function of transactivation properties of NS5A variants, using *Cre*-negative littermates as negative controls. The absence of other viral proteins may be one of the limiting factors in the development of HCC: to overcome this problem, the Alb-*Cre*/NS5A mice will also be crossed with FL-N/35 mice (Lerat *et al.*, 2002) that express the entire protein complement of HCV. Host cell pathways identified as potential targets of NS5A-mediated transcriptional regulation in *in vitro* RNAseq studies will be studied in these transgenic mice and their implication in HCV-induced pathogenesis will be defined.

In conclusion, the work presented in this thesis demonstrates that quasispecies nature of HCV gives rise to a large number of variant proteins with different functional properties. The difference of functional and biological properties among quasispecies variant proteins might play an important role in the development of HCV-induced liver pathogenesis. We have demonstrated a novel mechanism by which HCV regulates host-cell gene expression to facilitate HCV replication. We have further provided compelling evidence that NS5A directly interacts with cell promoters, thus modulating their activity. As a result, host genes involved in cell multiplication, apoptosis or other pathways key for cell fate are modulated by NS5A and might lead to perturbations of host cell functions, liver functions and the common pathologies observed in HCV-induced chronic hepatitis. It will be difficult, but interesting, to understand the origins of the modulation of the HCV cellular environment: are they collateral damages due to properties of HCV proteins originally involved in viral genome replication, or virus-targeted modulations of the host cell?

5 - References

- Ago, H., T. Adachi, et al. (1999). "Crystal structure of the RNA-dependent RNA polymerase of hepatitis C virus." Structure **7**(11): 1417-1426.
- Aizaki, H., K. J. Lee, et al. (2004). "Characterization of the hepatitis C virus RNA replication complex associated with lipid rafts." Virology **324**(2): 450-461.
- Aizaki, H., S. Nagamori, et al. (2003). "Production and release of infectious hepatitis C virus from human liver cell cultures in the three-dimensional radial-flow bioreactor." Virology **314**(1): 16-25.
- Aizawa, Y., Y. Shibamoto, et al. (2000). "Analysis of factors affecting the appearance of hepatocellular carcinoma in patients with chronic hepatitis C." Cancer **89**(1): 53-59.
- Alter, H. J., P. V. Holland, et al. (1978). "TRANSMISSIBLE AGENT IN NON-A, NON-B HEPATITIS." Lancet **1**(8062): 459-463.
- Alter, H. J. and L. B. Seeff (2000). "Recovery, persistence, and sequelae in hepatitis C virus infection: A perspective on long-term outcome." Seminars in Liver Disease **20**(1): 17-35.
- Alter, M. J. (2007). "Epidemiology of hepatitis C virus infection." World Journal of Gastroenterology **13**(17): 2436-2441.
- Althaus, C. L. and R. J. De Boer (2010). "Intracellular transactivation of HIV can account for the decelerating decay of virus load during drug therapy." Molecular Systems Biology **6**.
- Andre, P., F. Komurian-Pradel, et al. (2002). "Characterization of low- and very-low-density hepatitis C virus RNA-containing particles." Journal of Virology **76**(14): 6919-6928.
- Appel, N., U. Herian, et al. (2005b). "Efficient rescue of hepatitis C virus RNA replication by trans-complementation with nonstructural protein 5A." Journal of Virology **79**(2): 896-909.
- Appel, N., T. Pietschmann, et al. (2005a). "Mutational analysis of hepatitis C virus nonstructural protein 5A: Potential role of differential phosphorylation in RNA replication and identification of a genetically flexible domain." Journal of Virology **79**(5): 3187-3194.
- Appel, N., T. Schaller, et al. (2006). "From structure to function: New insights into hepatitis C virus RNA replication." Journal of Biological Chemistry **281**(15): 9833-9836.
- Appel, N., M. Zayas, et al. (2008). "Essential role of domain III of nonstructural protein 5A for hepatitis C virus infectious particle assembly." Plos Pathogens **4**(3).
- Arima, N., C.-Y. Kao, et al. (2001). "Modulation of Cell Growth by the Hepatitis C Virus Nonstructural Protein NS5A." Journal of Biological Chemistry **276**(16): 12675-12684.
- Arya, S. K., C. Guo, et al. (1985). "Trans-activator gene of human T-lymphotropic virus type III (HTLV-III)." Science **229**(4708): 69-73.

- Azuma, H., N. Paulk, et al. (2007). "Robust expansion of human hepatocytes in Fah(-/-)/Rag2(-/-)/Il2rg(-/-) mice." Nature Biotechnology **25**(8): 903-910.
- Bailon, P., A. Palleroni, et al. (2001). "Rational Design of a Potent, Long-Lasting Form of Interferon: A 40 kDa Branched Polyethylene Glycol-Conjugated Interferon α -2a for the Treatment of Hepatitis C." Bioconjugate Chemistry **12**(2): 195-202.
- Barth, H., C. Schafer, et al. (2003). "Cellular binding of hepatitis C virus envelope glycoprotein E2 requires cell surface heparan sulfate." Journal of Biological Chemistry **278**(42): 41003-41012.
- Bartosch, B., J. Dubuisson, et al. (2003a). "Infectious hepatitis C virus pseudo-particles containing functional E1-E2 envelope protein complexes." Journal of Experimental Medicine **197**(5): 633-642.
- Bartosch, B., G. Verney, et al. (2005). "An interplay between hypervariable region 1 of the Hepatitis C Virus E2 glycoprotein, the scavenger receptor BI, and high-density lipoprotein promotes both enhancement of infection and protection against neutralizing antibodies." Journal of Virology **79**(13): 8217-8229.
- Bartosch, B., A. Vitelli, et al. (2003b). "Cell entry of hepatitis C virus requires a set of co-receptors that include the CD81 tetraspanin and the SR-B1 scavenger receptor." Journal of Biological Chemistry **278**(43): 41624-41630.
- Beard, M. R., G. Abell, et al. (1999). "An infectious molecular clone of a Japanese genotype 1b hepatitis C virus." Hepatology **30**(1): 316-324.
- Benedicto, I., F. Molina-Jimenez, et al. (2009). "The Tight Junction-Associated Protein Occludin Is Required for a Postbinding Step in Hepatitis C Virus Entry and Infection." Journal of Virology **83**(16): 8012-8020.
- Benihoud, K., P. Yeh, et al. (1999). "Adenovirus vectors for gene delivery." Curr Opin Biotechnol **10**(5): 440-447.
- Bissig, K. D., S. F. Wieland, et al. (2010). "Human liver chimeric mice provide a model for hepatitis B and C virus infection and treatment." Journal of Clinical Investigation **120**(3): 924-930.
- Bitzegeio, J., D. Bankwitz, et al. (2010). "Adaptation of Hepatitis C Virus to Mouse CD81 Permits Infection of Mouse Cells in the Absence of Human Entry Factors." PLoS Pathog **6**(7): e1000978.
- Blanchard, E., S. Belouzard, et al. (2006). "Hepatitis C virus entry depends on clathrin-mediated endocytosis." Journal of Virology **80**(14): 6964-6972.
- Blight, K. J., A. A. Kolykhalov, et al. (2000). "Efficient initiation of HCV RNA replication in cell culture." Science **290**(5498): 1972-1974.
- Borawski, J., P. Troke, et al. (2009). "Class III Phosphatidylinositol 4-Kinase Alpha and Beta Are Novel Host Factor Regulators of Hepatitis C Virus Replication." Journal of Virology **83**(19): 10058-10074.

- Boulant, S., M. W. Douglas, et al. (2008). "Hepatitis C virus core protein induces lipid droplet redistribution in a microtubule- and dynein-dependent manner." Traffic **9**(8): 1268-1282.
- Boulant, S., P. Targett-Adams, et al. (2007). "Disrupting the association of hepatitis C virus core protein with lipid droplets correlates with a loss in production of infectious virus." J Gen Virol **88**(Pt 8): 2204-2213.
- Boulant, S., C. Vanbelle, et al. (2005). "Hepatitis C virus core protein is a dimeric alpha-helical protein exhibiting membrane protein features." Journal of Virology **79**(17): 11353-11365.
- Bradley, D., K. McCaustland, et al. (1991). "Hepatitis-C virus - Buoyant density of the factor -VIII-derived isolate in sucrose." Journal of Medical Virology **34**(3): 206-208.
- Bradley, D. W. and J. E. Maynard (1986). "Etiology and Natural History of Post-Transfusion and Enterically-Transmitted Non-A, Non-B Hepatitis." Semin Liver Dis **6**(01): 56,66.
- Brass, V., E. Bieck, et al. (2002). "An amino-terminal amphipathic alpha-helix mediates membrane association of the hepatitis C virus nonstructural protein 5A." J Biol Chem **277**(10): 8130-8139.
- Bressanelli, S., L. Tomei, et al. (1999). "Crystal structure of the RNA-dependent RNA polymerase of hepatitis C virus." Proceedings of the National Academy of Sciences **96**(23): 13034-13039.
- Brown, R. S. (2005). "Hepatitis C and liver transplantation." Nature **436**(7053): 973-978.
- Brunetti-Pierri, N., V. Mane, et al. (2004). "Hydrodynamic injection of helper dependent adenoviral vectors increases liver transduction efficiency and decreases acute inflammatory response." Molecular Therapy **9**: 789.
- Bukrinsky, M. I., S. Haggerty, et al. (1993). "A nuclear localization signal within HIV-1 matrix protein that governs infection of non-dividing cells." Nature **365**(6447): 666-669.
- Buonaguro, L., G. Barillari, et al. (1992). "Effects of the human immunodeficiency virus type 1 Tat protein on the expression of inflammatory cytokines." Journal of Virology **66**(12): 7159-7167.
- Cameron, C. E. and C. Castro (2001). "The mechanism of action of ribavirin: lethal mutagenesis of RNA virus genomes mediated by the viral RNA-dependent RNA polymerase." Current opinion in infectious diseases **14**(6): 757-764.
- Carrere-Kremer, S., C. Montpellier-Pala, et al. (2002). "Subcellular Localization and Topology of the p7 Polypeptide of Hepatitis C Virus." J. Virol. **76**(8): 3720-3730.
- Castet, V., C. Fournier, et al. (2002). "Alpha interferon inhibits hepatitis C virus replication in primary human hepatocytes infected in vitro." Journal of Virology **76**(16): 8189-8199.
- Catanese, M. T., H. Ansuini, et al. (2010). "Role of scavenger receptor class B type I in hepatitis C virus entry: kinetics and molecular determinants." J Virol **84**(1): 34-43.

- Catanese, M. T., R. Graziani, et al. (2007). "High-avidity monoclonal antibodies against the human scavenger class B type I receptor efficiently block hepatitis C virus infection in the presence of high-density lipoprotein." Journal of Virology **81**(15): 8063-8071.
- Chan, L. (1995). "Use of somatic gene transfer to study lipoprotein metabolism in experimental animals in vivo." Curr Opin Lipidol **6**(5): 335-340.
- Chang, K. S., J. Y. Jiang, et al. (2007). "Human apolipoprotein E is required for infectivity and production of hepatitis C virus in cell culture." Journal of Virology **81**(24): 13783-13793.
- Chang, L. F. and M. Karin (2001). "Mammalian MAP kinase signalling cascades." Nature **410**(6824): 37-40.
- Charlton, M. (2001). "Hepatitis C Infection in Liver Transplantation." American Journal of Transplantation **1**(3): 197-203.
- Chevaliez, S. and J.-M. Pawlotsky (2006). HCV Genome and Lifecycle. Hepatitis C Viruses: Genomes and Molecular Biology. S.-L. Tan. Norfolk (UK), Horizon Bioscience: 5-47.
- Choo, Q. L., J. Han, et al. (1991). Hepatitis-c virus is a distant relative of the flaviviruses and pestiviruses. Viral Hepatitis C, D and E. N. Shikata, R. H. Purcell and T. Uchida. **895**: 47-52.
- Choo, Q. L., G. Kuo, et al. (1989). "Isolation of a cDNA clone derived from a blood-borne non-A, non-B viral-hepatitis genome." Science **244**(4902): 359-362.
- Chung, K. M., J. Lee, et al. (2000). "Nonstructural protein 5A of hepatitis C virus inhibits the function of karyopherin beta3." J Virol **74**(11): 5233-5241.
- Chung, K. M., O. K. Song, et al. (1997). "Hepatitis C virus nonstructural protein 5A contains potential transcriptional activator domains." Mol Cells **7**(5): 661-667.
- Chung, Y. L., M. L. Sheu, et al. (2003). "Hepatitis C virus NS5A as a potential viral Bcl-2 homologue interacts with Bax and inhibits apoptosis in hepatocellular carcinoma." Int J Cancer **107**(1): 65-73.
- Coenen, M., H. D. Nischalke, et al. (2011). "Hepatitis C virus core protein induces fibrogenic actions of hepatic stellate cells via toll-like receptor 2." Lab Invest.
- Coito, C., D. L. Diamond, et al. (2004). "High-throughput screening of the yeast kinome: Identification of human serine/threonine protein kinases that phosphorylate the hepatitis C virus NS5A protein." Journal of Virology **78**(7): 3502-3513.
- Cormier, E. G., R. J. Durso, et al. (2004). "L-SIGN (CD209L) and DC-SIGN (0209) mediate transinfection of liver cells by hepatitis C virus." Proceedings of the National Academy of Sciences of the United States of America **101**(39): 14067-14072.
- Couto, L. B. and A. A. Kolykhalov (2006). "Animal Models for HCV Study."

- Cribier, B., C. Schmitt, et al. (1995). "IN-VITRO INFECTION OF PERIPHERAL-BLOOD MONONUCLEAR-CELLS BY HEPATITIS-C VIRUS." Journal of General Virology **76**: 2485-2491.
- De Francesco, R. and G. Migliaccio (2005). "Challenges and successes in developing new therapies for hepatitis C." Nature **436**(7053): 953-960.
- Deleersnyder, V., A. Pillez, et al. (1997). "Formation of native hepatitis C virus glycoprotein complexes." Journal of Virology **71**(1): 697-704.
- Deminie, C. A. and M. Emerman (1993). "INCORPORATION OF HUMAN-IMMUNODEFICIENCY-VIRUS TYPE-1 GAG PROTEINS INTO MURINE LEUKEMIA-VIRUS VIRIONS." Journal of Virology **67**(11): 6499-6506.
- Dentzer, T. G., I. C. Lorenz, et al. (2009). "Determinants of the Hepatitis C Virus Nonstructural Protein 2 Protease Domain Required for Production of Infectious Virus." J. Virol. **83**(24): 12702-12713.
- Di Bisceglie, A. M. (1998). "Hepatitis C." The Lancet **351**(9099): 351-355.
- Di Bisceglie, A. M. and J. H. Hoofnagle (2002). "Optimal therapy of hepatitis C." Hepatology **36**(5): S121-S127.
- Donato, F., A. Tagger, et al. (2002). "Alcohol and Hepatocellular Carcinoma: The Effect of Lifetime Intake and Hepatitis Virus Infections in Men and Women." American Journal of Epidemiology **155**(4): 323-331.
- Donnelly, M. L., L. E. Hughes, et al. (2001a). "The 'cleavage' activities of foot-and-mouth disease virus 2A site-directed mutants and naturally occurring '2A-like' sequences." J Gen Virol **82**(Pt 5): 1027-1041.
- Donnelly, M. L., G. Luke, et al. (2001b). "Analysis of the aphthovirus 2A/2B polyprotein 'cleavage' mechanism indicates not a proteolytic reaction, but a novel translational effect: a putative ribosomal 'skip'." J Gen Virol **82**(Pt 5): 1013-1025.
- Dorner, M., J. A. Horwitz, et al. (2011). "A genetically humanized mouse model for hepatitis C virus infection." Nature **474**(7350): 208-211.
- Drummer, H. E., K. A. Wilson, et al. (2002). "Identification of the hepatitis C virus E2 glycoprotein binding site on the large extracellular loop of CD81." Journal of Virology **76**(21): 11143-11147.
- Dubuisson, J., F. Helle, et al. (2008). "Early steps of the hepatitis C virus life cycle." Cellular Microbiology **10**(4): 821-827.
- Dubuisson, J., H. H. Hsu, et al. (1994). "FORMATION AND INTRACELLULAR-LOCALIZATION OF HEPATITIS-C VIRUS ENVELOPE GLYCOPROTEIN COMPLEXES EXPRESSED BY RECOMBINANT VACCINIA AND SINDBIS VIRUSES." Journal of Virology **68**(10): 6147-6160.
- Dustin, L. B. and C. M. Rice (2007). "Flying Under the Radar: The Immunobiology of Hepatitis C." Annual Review of Immunology **25**(1): 71-99.

- Egger, D., B. Wolk, et al. (2002). "Expression of hepatitis C virus proteins induces distinct membrane alterations including a candidate viral replication complex." Journal of Virology **76**(12): 5974-5984.
- Einav, S., E. H. Sklan, et al. (2008). "The nucleotide binding motif of hepatitis C virus NS4B can mediate cellular transformation and tumor formation without ha-ras co-transfection." Hepatology **47**(3): 827-835.
- El-Serag, H. B. and K. L. Rudolph (2007). "Hepatocellular Carcinoma: Epidemiology and Molecular Carcinogenesis." Gastroenterology **132**(7): 2557-2576.
- Evans, M. J., C. M. Rice, et al. (2004). "Phosphorylation of hepatitis C virus nonstructural protein 5A modulates its protein interactions and viral RNA replication." Proc Natl Acad Sci U S A **101**(35): 13038-13043.
- Evans, M. J., T. von Hahn, et al. (2007). "Claudin-1 is a hepatitis C virus co-receptor required for a late step in entry." Nature **446**(7137): 801-805.
- Ezelle, H. J., S. Balachandran, et al. (2001). "Analyzing the mechanisms of interferon-induced apoptosis using CrmA and hepatitis C virus NS5A." Virology **281**(1): 124-137.
- Failla, C., L. Tomei, et al. (1995). "AN AMINO-TERMINAL DOMAIN OF THE HEPATITIS-C VIRUS NS3 PROTEASE IS ESSENTIAL FOR INTERACTION WITH NS4A." Journal of Virology **69**(3): 1769-1777.
- Farci, P., H. J. Alter, et al. (1996). "Hepatitis C Virus-Associated Fulminant Hepatic Failure." New England Journal of Medicine **335**(9): 631-634.
- Feld, J. J. and J. H. Hoofnagle (2005). "Mechanism of action of interferon and ribavirin in treatment of hepatitis C." Nature **436**(7053): 967-972.
- Feng, X., B. Xiu, et al. (2011). "Hepatitis C virus core protein promotes the migration and invasion of hepatocyte via activating transcription of extracellular matrix metalloproteinase inducer." Virus Research **In Press, Corrected Proof**.
- Fisher, A. G., M. B. Feinberg, et al. (1986). "The trans-activator gene of HTLV-III is essential for virus replication." Nature **320**(6060): 367-371.
- Flisiak, R., A. Horban, et al. (2008). "The cyclophilin inhibitor Debio-025 shows potent anti-hepatitis C effect in patients coinfecting with hepatitis C and human immunodeficiency virus." Hepatology **47**(3): 817-826.
- Fofana, I., S. E. Krieger, et al. (2010). "Monoclonal anti-claudin 1 antibodies prevent hepatitis C virus infection of primary human hepatocytes." Gastroenterology **139**(3): 953-964, 964 e951-954.
- Fong, T. L., M. Shindo, et al. (1991). "DETECTION OF REPLICATIVE INTERMEDIATES OF HEPATITIS-C VIRAL-RNA IN LIVER AND SERUM OF PATIENTS WITH CHRONIC HEPATITIS-C." Journal of Clinical Investigation **88**(3): 1058-1060.
- Forns, X., R. H. Purcell, et al. (1999). "Quasispecies in viral persistence and pathogenesis of hepatitis C virus." Trends in Microbiology **7**(10): 402-410.

- Fournier, C., C. Sureau, et al. (1998). "In vitro infection of adult normal human hepatocytes in primary culture by hepatitis C virus." Journal of General Virology **79**: 2367-2374.
- Foy, E., K. Li, et al. (2003). "Regulation of Interferon Regulatory Factor-3 by the Hepatitis C Virus Serine Protease." Science **300**(5622): 1145-1148.
- Franck, N., J. Le Seyec, et al. (2005). "Hepatitis C Virus NS2 Protein Is Phosphorylated by the Protein Kinase CK2 and Targeted for Degradation to the Proteasome." J. Virol. **79**(5): 2700-2708.
- Frank, C., M. K. Mohamed, et al. (2000). "The role of parenteral antischistosomal therapy in the spread of hepatitis C virus in Egypt." The Lancet **355**(9207): 887-891.
- Fraser, C. S. and J. A. Doudna (2007). "Structural and mechanistic insights into hepatitis C viral translation initiation." Nature Reviews Microbiology **5**(1): 29-38.
- Friebe, P. and R. Bartenschlager (2002). "Genetic analysis of sequences in the 3' nontranslated region of hepatitis C virus that are important for RNA replication." Journal of Virology **76**(11): 5326-5338.
- Friebe, P., V. Lohmann, et al. (2001). "Sequences in the 5' nontranslated region of hepatitis C virus required for RNA replication." Journal of Virology **75**(24): 12047-12057.
- Fukuma, T., N. Enomoto, et al. (1998). "Mutations in the interferon-sensitivity determining region of hepatitis C virus and transcriptional activity of the nonstructural region 5A protein." Hepatology **28**(4): 1147-1153.
- Fukutomi, T., Y. Zhou, et al. (2005). "Hepatitis C virus core protein stimulates hepatocyte growth: Correlation with upregulation of wnt-1 expression." Hepatology **41**(5): 1096-1105.
- Gale, M., C. M. Blakely, et al. (1998). "Control of PKR protein kinase by hepatitis C virus nonstructural 5A protein: Molecular mechanisms of kinase regulation." Molecular and Cellular Biology **18**(9): 5208-5218.
- Gale, M., Jr., B. Kwieciszewski, et al. (1999). "Antiapoptotic and oncogenic potentials of hepatitis C virus are linked to interferon resistance by viral repression of the PKR protein kinase." Journal of Virology **73**(8): 6506-6516.
- Gale, M. J., M. J. Korth, et al. (1997). "Evidence that hepatitis C virus resistance to interferon is mediated through repression of the PKR protein kinase by the nonstructural 5A protein." Virology **230**(2): 217-227.
- Gao, L., H. Aizaki, et al. (2004). "Interactions between viral nonstructural proteins and host protein hVAP-33 mediate the formation of hepatitis C virus RNA replication complex on lipid raft." J Virol **78**(7): 3480-3488.
- Gao, M., R. E. Nettles, et al. (2010). "Chemical genetics strategy identifies an HCV NS5A inhibitor with a potent clinical effect." Nature **465**(7294): 96-U108.
- Gardmo, C., P. Kotakorpi, et al. (2005). "Transfection of adult primary rat hepatocytes in culture." Biochemical pharmacology **69**(12): 1805-1813.

- Gastaminza, P., G. F. Cheng, et al. (2008). "Cellular determinants of hepatitis C virus assembly, maturation, degradation, and secretion." Journal of Virology **82**(5): 2120-2129.
- Gastaminza, P., S. B. Kapadia, et al. (2006). "Differential biophysical properties of infectious intracellular and secreted hepatitis C virus particles." Journal of Virology **80**(22): 11074-11081.
- Georgopoulou, U., K. Caravokiri, et al. (2003). "Suppression of the ERK1/2 signaling pathway from HCV NS5A protein expressed by herpes simplex recombinant viruses." Arch Virol **148**(2): 237-251.
- Ghosh, A. K., M. Majumder, et al. (2000b). "Hepatitis C Virus NS5A Protein Modulates Transcription through a Novel Cellular Transcription Factor SRCAP." Journal of Biological Chemistry **275**(10): 7184-7188.
- Girard, S., P. Shalhoub, et al. (2002). "An altered cellular response to interferon and up-regulation of interleukin-8 induced by the hepatitis C viral protein NS5A uncovered by microarray analysis." Virology **295**(2): 272-283.
- Glue, P., J. W. S. Fang, et al. (2000). "Pegylated interferon-[alpha]2b: Pharmacokinetics, pharmacodynamics, safety, and preliminary efficacy data[ast]." Clin Pharmacol Ther **68**(5): 556-567.
- Goh, P.-Y., Y.-J. Tan, et al. (2001). "The Hepatitis C Virus Core Protein Interacts with NS5A and Activates Its Caspase-Mediated Proteolytic Cleavage." Virology **290**(2): 224-236.
- Gold, M. O., X. Z. Yang, et al. (1998). "PITALRE, the catalytic subunit of TAK, is required for human immunodeficiency virus tat transactivation in vivo." Journal of Virology **72**(5): 4448-4453.
- Gong, G. Z., Y. F. Jiang, et al. (2004). "HCV NS5A abrogates p53 protein function by interfering with p53-DNA binding." World J Gastroenterol **10**(15): 2223-2227.
- Gordon, S. C., N. Bayati, et al. (1998). "Clinical outcome of hepatitis C as a function of mode of transmission." Hepatology **28**(2): 562-567.
- Gosert, R., D. Egger, et al. (2003). "Identification of the hepatitis C virus RNA replication complex in Huh-7 cells harboring subgenomic replicons." Journal of Virology **77**(9): 5487-5492.
- Goto, K., K. Watashi, et al. (2006). "Evaluation of the anti-hepatitis C virus effects of cyclophilin inhibitors, cyclosporin A, and NIM811." Biochemical and Biophysical Research Communications **343**(3): 879-884.
- Grakoui, A., D. W. McCourt, et al. (1993). "Characterization of the hepatitis C virus-encoded serine proteinase: determination of proteinase-dependent polyprotein cleavage sites." J. Virol. **67**(5): 2832-2843.
- Griffin, S. (2010). "Inhibition of HCV p7 as a therapeutic target." Current opinion in investigational drugs **11**(2): 175-181.

- Griffin, S. D., L. P. Beales, et al. (2003). "The p7 protein of hepatitis C virus forms an ion channel that is blocked by the antiviral drug, Amantadine." FEBS Letters **535**(1-3): 34-38.
- Griffin, S. D., R. Harvey, et al. (2004). "A conserved basic loop in hepatitis C virus p7 protein is required for amantadine-sensitive ion channel activity in mammalian cells but is dispensable for localization to mitochondria." J Gen Virol **85**(Pt 2): 451-461.
- Gunji, T., N. Kato, et al. (1994). "SPECIFIC DETECTION OF POSITIVE AND NEGATIVE STRANDED HEPATITIS-C VIRAL-RNA USING CHEMICAL RNA MODIFICATION." Archives of Virology **134**(3-4): 293-302.
- Hacein-Bey-Abina, S., A. Garrigue, et al. (2008). "Insertional oncogenesis in 4 patients after retrovirus-mediated gene therapy of SCID-X1." J Clin Invest **118**(9): 3132-3142.
- Hafenrichter, D., X. Wu, et al. (1994). "Quantitative evaluation of liver-specific promoters from retroviral vectors after in vivo transduction of hepatocytes." Blood **84**(10): 3394-3404.
- Hamamoto, I., Y. Nishimura, et al. (2005). "Human VAP-B is involved in hepatitis C virus replication through interaction with NS5A and NS5B." Journal of Virology **79**(21): 13473-13482.
- Hanouille, X., A. Badillo, et al. (2010). "The Domain 2 of the HCV NS5A Protein Is Intrinsically Unstructured." Protein and Peptide Letters **17**(8): 1012-1018.
- Hanouille, X., A. Badillo, et al. (2009b). "Hepatitis C Virus NS5A Protein Is a Substrate for the Peptidyl-prolyl cis/trans Isomerase Activity of Cyclophilins A and B." Journal of Biological Chemistry **284**(20): 13589-13601.
- Hanouille, X., D. Verdegem, et al. (2009a). "Domain 3 of non-structural protein 5A from hepatitis C virus is natively unfolded." Biochemical and Biophysical Research Communications **381**(4): 634-638.
- Hanson, R. W. and L. Reshef (1997). "Regulation of phosphoenolpyruvate carboxykinase (GTP) gene expression." Annu Rev Biochem **66**: 581-611.
- Haybaeck, J., N. Zeller, et al. (2009). "A Lymphotoxin-Driven Pathway to Hepatocellular Carcinoma." Cancer Cell **16**(4): 295-308.
- He, Y., H. Nakao, et al. (2002). "Subversion of cell signaling pathways by hepatitis C virus nonstructural 5A protein via interaction with Grb2 and P85 phosphatidylinositol 3-kinase." J Virol **76**(18): 9207-9217.
- He, Y., K. A. Staschke, et al. (2006). "HCV NS5A: A Multifunctional Regulator of Cellular Pathways and Virus Replication."
- Helle, F. and J. Dubuisson (2008). "Hepatitis C virus entry into host cells." Cellular and Molecular Life Sciences **65**(1): 100-112.

- Herrmann, C. H., M. O. Gold, et al. (1996). "Viral transactivators specifically target distinct cellular protein kinases that phosphorylate the RNA polymerase II C-terminal domain." Nucleic Acids Research **24**(3): 501-508.
- Herzog, R. W., J. N. Hagstrom, et al. (1997). "Stable gene transfer and expression of human blood coagulation factor IX after intramuscular injection of recombinant adeno-associated virus." Proceedings of the National Academy of Sciences of the United States of America **94**(11): 5804-5809.
- Hijikata, M., N. Kato, et al. (1991). "GENE-MAPPING OF THE PUTATIVE STRUCTURAL REGION OF THE HEPATITIS-C VIRUS GENOME BY INVITRO PROCESSING ANALYSIS." Proceedings of the National Academy of Sciences of the United States of America **88**(13): 5547-5551.
- Hikosaka, K., H. Noritake, et al. (2011). "Expression of human factors CD81, claudin-1, scavenger receptor, and occludin in mouse hepatocytes does not confer susceptibility to HCV entry." Biomed Res **32**(2): 143-150.
- Hoofnagle, J. H., K. D. Mullen, et al. (1986). "Treatment of Chronic Non-A, Non-B Hepatitis with Recombinant Human Alpha Interferon." New England Journal of Medicine **315**(25): 1575-1578.
- Hope, I. A., S. Mahadevan, et al. (1988). "STRUCTURAL AND FUNCTIONAL-CHARACTERIZATION OF THE SHORT ACIDIC TRANSCRIPTIONAL ACTIVATION REGION OF YEAST GCN4-PROTEIN." Nature **333**(6174): 635-640.
- Hope, R. G. and J. McLauchlan (2000). "Sequence motifs required for lipid droplet association and protein stability are unique to the hepatitis C virus core protein." Journal of General Virology **81**: 1913-1925.
- Hosokawa, M., A. Takehara, et al. (2007). "Oncogenic role of KIAA0101 interacting with proliferating cell nuclear antigen in pancreatic cancer." Cancer Research **67**(6): 2568-2576.
- Houghton, M., K. Richman, et al. (1991). HEPATITIS-C VIRUS (HCV) - A RELATIVE OF THE PESTIVIRUSES AND FLAVIVIRUSES.
- Hovanessian, A. G. (1989). "THE DOUBLE-STRANDED RNA-ACTIVATED PROTEIN-KINASE INDUCED BY INTERFERON - DSRNA-PK." Journal of Interferon Research **9**(6): 641-647.
- Hsu, M., J. Zhang, et al. (2003). "Hepatitis C virus glycoproteins mediate pH-dependent cell entry of pseudotyped retroviral particles." Proceedings of the National Academy of Sciences of the United States of America **100**(12): 7271-7276.
- Huang, H., F. Sun, et al. (2007b). "Hepatitis C virus production by human hepatocytes dependent on assembly and secretion of very low-density lipoproteins." Proceedings of the National Academy of Sciences of the United States of America **104**(14): 5848-5853.
- Huang, L., J. Hwang, et al. (2005). "Hepatitis C Virus Nonstructural Protein 5A (NS5A) Is an RNA-binding Protein." Journal of Biological Chemistry **280**(43): 36417-36428.

- Huang, Y., K. Staschke, et al. (2007a). "Phosphorylation of hepatitis C virus NS5A nonstructural protein: A new paradigm for phosphorylation-dependent viral RNA replication?" *Virology* **364**(1): 1-9.
- Huber, K. R., C. Sebesta, et al. (1996). "Detection of common hepatitis C virus subtypes with a third-generation enzyme immunoassay." *Hepatology* **24**(3): 471-473.
- Hussy, P., H. Langen, et al. (1996). "Hepatitis C virus core protein: Carboxy-terminal boundaries of two processed species suggest cleavage by a signal peptide peptidase." *Virology* **224**(1): 93-104.
- Icard, V., O. Diaz, et al. (2009). "Secretion of Hepatitis C Virus Envelope Glycoproteins Depends on Assembly of Apolipoprotein B Positive Lipoproteins." *Plos One* **4**(1).
- Ide, Y., A. Tanimoto, et al. (1997). "Hepatitis C virus NS5A protein is phosphorylated in vitro by a stably bound protein kinase from HeLa cells and by cAMP-dependent protein kinase A-alpha catalytic subunit." *Gene* **201**(1-2): 151-158.
- Ide, Y., L. Zhang, et al. (1996). "Characterization of the nuclear localization signal and subcellular distribution of hepatitis C virus nonstructural protein NS5A." *Gene* **182**(1-2): 203-211.
- Ilan, E., J. Arazi, et al. (2002). "The hepatitis C virus (HCV)-Trimera mouse: a model for evaluation of agents against HCV." *J Infect Dis* **185**(2): 153-161.
- Ito, T., J. Mukaigawa, et al. (1996). "Cultivation of hepatitis C virus in primary hepatocyte culture from patients with chronic hepatitis C results in release of high titre infectious virus." *Journal of General Virology* **77**: 1043-1054.
- Ivanov, A. V., V. L. Tunitskaya, et al. (2009). "Hepatitis C virus NS5A protein modulates template selection by the RNA polymerase in in vitro system." *FEBS Letters* **583**(2): 277-280.
- Jiang, Y., B. He, et al. (2011). "The oncogenic role of NS5A of hepatitis C virus is mediated by up-regulation of survivin gene expression in the Hepatocellular cell through p53 and NF-KappaB pathways." *Cell biology international*.
- Jirasko, V., R. Montserret, et al. (2010). "Structural and Functional Studies of Nonstructural Protein 2 of the Hepatitis C Virus Reveal Its Key Role as Organizer of Virion Assembly." *PLoS Pathog* **6**(12): e1001233.
- Jones, D. M., A. H. Patel, et al. (2009). "The Hepatitis C Virus NS4B Protein Can trans-Complement Viral RNA Replication and Modulates Production of Infectious Virus." *Journal of Virology* **83**(5): 2163-2177.
- Jopling, C. L., M. K. Yi, et al. (2005). "Modulation of hepatitis C virus RNA abundance by a liver-specific microRNA." *Science* **309**(5740): 1577-1581.
- Jozkowicz, A. and J. Dulak (2005). "Helper-dependent adenoviral vectors in experimental gene therapy." *Acta Biochim Pol* **52**(3): 589-599.

- Kaito, M., S. Watanabe, et al. (1994). "HEPATITIS-C VIRUS PARTICLE DETECTED BY IMMUNOELECTRON MICROSCOPIC STUDY." Journal of General Virology **75**: 1755-1760.
- Kalamvoki, M. and P. Mavromara (2004). "Calcium-dependent calpain proteases are implicated in processing of the hepatitis C virus NS5A protein." Journal of Virology **78**(21): 11865-11878.
- Kamine, J., T. Subramanian, et al. (1991). "SP1-DEPENDENT ACTIVATION OF A SYNTHETIC PROMOTER BY HUMAN-IMMUNODEFICIENCY-VIRUS TYPE-1 TAT PROTEIN." Proceedings of the National Academy of Sciences of the United States of America **88**(19): 8510-8514.
- Kang, H. S., G. ZeRuth, et al. (2010). "Gli-similar (Glis) Kruppel-like zinc finger proteins: insights into their physiological functions and critical roles in neonatal diabetes and cystic renal disease." Histology and histopathology **25**(11): 1481-1496.
- Kapadia, S. B., H. Barth, et al. (2007). "Initiation of hepatitis C virus infection is dependent on cholesterol and cooperativity between CD81 and scavenger receptor B type I." J Virol **81**(1): 374-383.
- Kato, N., K. H. Lan, et al. (1997). "Hepatitis C virus nonstructural region 5A protein is a potent transcriptional activator." Journal of Virology **71**(11): 8856-8859.
- Kaul, A., S. Stauffer, et al. (2009). "Essential Role of Cyclophilin A for Hepatitis C Virus Replication and Virus Production and Possible Link to Polyprotein Cleavage Kinetics." Plos Pathogens **5**(8).
- Kaul, A., I. Woerz, et al. (2007). "Cell culture adaptation of hepatitis C virus and in vivo viability of an adapted variant." J Virol **81**(23): 13168-13179.
- Kennedy, P. G. and R. J. Cohrs (2010). "Varicella-zoster virus human ganglionic latency: a current summary." Journal of neurovirology **16**(6): 411-418.
- Khabar, K. S. A., F. AlZoghaibi, et al. (1997). "The alpha chemokine, interleukin 8, inhibits the antiviral action of interferon alpha." Journal of Experimental Medicine **186**(7): 1077-1085.
- Kiang, A., Z. C. Hartman, et al. (2006). "Fully Deleted Adenovirus Persistently Expressing GAA Accomplishes Long-Term Skeletal Muscle Glycogen Correction in Tolerant and Nontolerant GSD-II Mice." Mol Ther **13**(1): 127-134.
- Kim, I. H., A. Jozkowicz, et al. (2001). "Lifetime correction of genetic deficiency in mice with a single injection of helper-dependent adenoviral vector." Proceedings of the National Academy of Sciences of the United States of America **98**(23): 13282-13287.
- Kim, J., D. Lee, et al. (1999). "Hepatitis C virus NS5A protein is phosphorylated by casein kinase II." Biochemical and Biophysical Research Communications **257**(3): 777-781.
- Kim, J. H., W. S. Kim, et al. (2008). "SNARK, a novel downstream molecule of EBV latent membrane protein 1, is associated with resistance to cancer cell death." Leukemia & lymphoma **49**(7): 1392-1398.

- Kim, Y. K., C. S. Kim, et al. (2002). "Domains I and II in the 5' nontranslated region of the HCV genome are required for RNA replication." Biochemical and Biophysical Research Communications **290**(1): 105-112.
- Kiyosawa, K., T. Umemura, et al. (2004). "Hepatocellular carcinoma: Recent trends in Japan." Gastroenterology **127**(5, Supplement 1): S17-S26.
- Kneteman, N. M., A. J. Weiner, et al. (2006). "Anti-HCV therapies in chimeric scid-Alb/uPA mice parallel outcomes in human clinical application." Hepatology **43**(6): 1346-1353.
- Koch, U. and F. Narjes (2007). "Recent progress in the development of inhibitors of the hepatitis C virus RNA-dependent RNA polymerase." Curr Top Med Chem **7**(13): 1302-1329.
- Kochanek, S., P. R. Clemens, et al. (1996). "A new adenoviral vector: Replacement of all viral coding sequences with 28 kb of DNA independently expressing both full-length dystrophin and beta-galactosidase." Proc Natl Acad Sci U S A **93**(12): 5731-5736.
- Kolykhalov, A. A., E. V. Agapov, et al. (1997). "Transmission of Hepatitis C by Intrahepatic Inoculation with Transcribed RNA." Science **277**(5325): 570-574.
- Kolykhalov, A. A., E. V. Agapov, et al. (1994). "SPECIFICITY OF THE HEPATITIS-C VIRUS NS3 SERINE-PROTEASE - EFFECTS OF SUBSTITUTIONS AT THE 3/4A, 4A/4B, 4B/5A, AND 5A/5B CLEAVAGE SITES ON POLYPROTEIN PROCESSING." Journal of Virology **68**(11): 7525-7533.
- Konan, K. V., T. H. Giddings, et al. (2003). "Nonstructural protein precursor NS4A/B from hepatitis C virus alters function and ultrastructure of host secretory apparatus." Journal of Virology **77**(14): 7843-7855.
- Koo, B. C., P. McPoland, et al. (2006). "Relationships between hepatitis C virus replication and CXCL-8 production in vitro." Journal of Virology **80**(16): 7885-7893.
- Kountouras, J., C. Zavos, et al. (2003). "Apoptosis in hepatitis C." Journal of Viral Hepatitis **10**(5): 335-342.
- Koutsoudakis, G., A. Kaul, et al. (2006). "Characterization of the early steps of hepatitis C virus infection by using luciferase reporter viruses." Journal of Virology **80**(11): 5308-5320.
- Kovelman, R., G. K. Bilter, et al. (1996). "Enhanced transcriptional activation by E2 proteins from the oncogenic human papillomaviruses." J Virol **70**(11): 7549-7560.
- Krieger, N., V. Lohmann, et al. (2001). "Enhancement of hepatitis C virus RNA replication by cell culture-adaptive mutations." Journal of Virology **75**(10): 4614-4624.
- Kwong, A. D., R. S. Kauffman, et al. (2011). "Discovery and development of telaprevir: an NS3-4A protease inhibitor for treating genotype 1 chronic hepatitis C virus." Nature Biotechnology **29**(11): 993-1003.

- Lai, W. K., P. J. Sun, et al. (2006). "Expression of DC-SIGN and DC-SIGNR on human sinusoidal endothelium - A role for capturing hepatitis C virus particles." American Journal of Pathology **169**(1): 200-208.
- Lal-Nag, M. and P. J. Morin (2009). "The claudins." Genome Biology **10**(8).
- Lan, K.-H., M.-L. Sheu, et al. (2002). "HCV NS5A interacts with p53 and inhibits p53-mediated apoptosis." Oncogene **21**: 4801-4811.
- Lanford, R. E., D. Chavez, et al. (2001). "Ribavirin induces error-prone replication of GB virus B in primary tamarin hepatocytes." Journal of Virology **75**(17): 8074-8081.
- Lanford, R. E., H. Lee, et al. (2001). "Infectious cDNA clone of the hepatitis C virus genotype 1 prototype sequence." Journal of General Virology **82**(6): 1291-1297.
- Lanford, R. E., C. Sureau, et al. (1994). "DEMONSTRATION OF IN-VITRO INFECTION OF CHIMPANZEE HEPATOCYTES WITH HEPATITIS-C VIRUS USING STRAND-SPECIFIC RT/PCR." Virology **202**(2): 606-614.
- Lau, D. T., D. E. Kleiner, et al. (1998). "10-year follow-up after interferon- α therapy for chronic hepatitis C." Hepatology **28**(4): 1121-1127.
- Lau, J., P. Ingravallo, et al. (1999). "Synergistic antiviral activity of interferon-alpha 2b and ribavirin against a surrogate virus of hepatitis C." Hepatology **30**(4): 117.
- Lavanchy, D. (2009). "The global burden of hepatitis C." Liver International **29**: 74-81.
- Lavanchy, D. (2011). "Evolving epidemiology of hepatitis C virus." Clinical Microbiology and Infection **17**(2): 107-115.
- Lavillette, D., Y. Morice, et al. (2005). "Human serum facilitates hepatitis C virus infection, and neutralizing responses inversely correlate with viral replication kinetics at the acute phase of hepatitis C virus infection." Journal of Virology **79**(10): 6023-6034.
- Legembre, P., R. Schickel, et al. (2004). "Identification of SNF1/AMP kinase-related kinase as an NF-kappaB-regulated anti-apoptotic kinase involved in CD95-induced motility and invasiveness." The Journal of biological chemistry **279**(45): 46742-46747.
- Lerat, H., F. Berby, et al. (1996). "Specific detection of hepatitis C virus minus strand RNA in hematopoietic cells." Journal of Clinical Investigation **97**(3): 845-851.
- Lerat, H., S. Carmouse, et al. (2008). "FUNCTIONAL COMPARTMENTALIZATION OF HEPATITIS C VIRUS NS5A QUASISPECIES VARIANTS IN THE LIVER OF PATIENTS WITH CHRONIC HEPATITIS C AND HEPATOCELLULAR CARCINOMA." Hepatology **48**(4): 1063.
- Lerat, H., M. Higgs, et al. (2011). "Animal models in the study of hepatitis C virus-associated liver pathologies." Expert review of gastroenterology & hepatology **5**(3): 341-352.
- Lerat, H., M. Honda, et al. (2002). "Steatosis and liver cancer in transgenic mice expressing the structural and nonstructural proteins of hepatitis C virus." Gastroenterology **122**(2): 352-365.

- Lerat, H., S. Rumin, et al. (1998). "In vivo tropism of hepatitis C virus genomic sequences in hematopoietic cells: Influence of viral load, viral genotype, and cell phenotype." Blood **91**(10): 3841-3849.
- Lewis, P. F. and M. Emerman (1994). "Passage through mitosis is required for oncoretroviruses but not for the human immunodeficiency virus." J Virol **68**(1): 510-516.
- Li, K., E. Foy, et al. (2005). "Immune evasion by hepatitis C virus NS3/4A protease-mediated cleavage of the Toll-like receptor 3 adaptor protein TRIF." Proceedings of the National Academy of Sciences of the United States of America **102**(8): 2992-2997.
- Li, Q., A. L. Brass, et al. (2009). "A genome-wide genetic screen for host factors required for hepatitis C virus propagation." Proceedings of the National Academy of Sciences **106**(38): 16410-16415.
- Liang, Y., H. Ye, et al. (2007). "Domain 2 of Nonstructural Protein 5A (NS5A) of Hepatitis C Virus Is Natively Unfolded†." Biochemistry **46**(41): 11550-11558.
- Lillie, J. W. and M. R. Green (1989). "GENE-TRANSCRIPTION - ACTIVATORS TARGET IN SIGHT." Nature **341**(6240): 279-280.
- Lin, C., B. D. Lindenbach, et al. (1994). "PROCESSING IN THE HEPATITIS-C VIRUS E2-NS2 REGION - IDENTIFICATION OF P7 AND 2 DISTINCT E2-SPECIFIC PRODUCTS WITH DIFFERENT C-TERMINI." Journal of Virology **68**(8): 5063-5073.
- Lin, C., B. M. Pragai, et al. (1994). "HEPATITIS-C VIRUS NS3 SERINE PROTEINASE - TRANS-CLEAVAGE REQUIREMENTS AND PROCESSING KINETICS." Journal of Virology **68**(12): 8147-8157.
- Lin, Y., R. C. Huang, et al. (2004). "Identification of interleukin-8 as estrogen receptor-regulated factor involved in breast cancer invasion and angiogenesis by protein arrays." International Journal of Cancer **109**(4): 507-515.
- Lindenbach, B. D., M. J. Evans, et al. (2005). "Complete replication of hepatitis C virus in cell culture." Science **309**(5734): 623-626.
- Lindenbach, B. D., P. Meuleman, et al. (2006). "Cell culture-grown hepatitis C virus is infectious in vivo and can be recultured in vitro." Proceedings of the National Academy of Sciences of the United States of America **103**(10): 3805-3809.
- Lindenbach, B. D. and C. M. Rice (2005). "Unravelling hepatitis C virus replication from genome to function." Nature **436**(7053): 933-938.
- Liu, S. F., W. Yang, et al. (2009). "Tight Junction Proteins Claudin-1 and Occludin Control Hepatitis C Virus Entry and Are Downregulated during Infection To Prevent Superinfection." Journal of Virology **83**(4): 2011-2014.
- Lohmann, V., F. Korner, et al. (2001). "Mutations in hepatitis C virus RNAs conferring cell culture adaptation." Journal of Virology **75**(3): 1437-1449.

- Lohmann, V., F. Korner, et al. (1997). "Biochemical properties of hepatitis C virus NS5B RNA-dependent RNA polymerase and identification of amino acid sequence motifs essential for enzymatic activity." Journal of Virology **71**(11): 8416-8428.
- Lohmann, V., F. Korner, et al. (1999). "Replication of subgenomic hepatitis C virus RNAs in a hepatoma cell line." Science **285**(5424): 110-113.
- Love, R. A., O. Brodsky, et al. (2009). "Crystal Structure of a Novel Dimeric Form of NS5A Domain I Protein from Hepatitis C Virus." Journal of Virology **83**(9): 4395-4403.
- Lowes, K. N., E. J. Croager, et al. (2003). "Upregulation of lymphotoxin beta expression in liver progenitor (oval) cells in chronic hepatitis C." Gut **52**(9): 1327-1332.
- Lyra, A. C., X. Fan, et al. (2004). "Molecular biology and clinical implication of hepatitis C virus." Brazilian Journal of Medical and Biological Research **37**: 691-695.
- Ma, Y., J. Yates, et al. (2008). "NS3 helicase domains involved in infectious intracellular hepatitis C virus particle assembly." J Virol **82**(15): 7624-7639.
- Maag, D., C. Castro, et al. (2001). "Hepatitis C virus RNA-dependent RNA polymerase (NS5B) as a mediator of the antiviral activity of ribavirin." Journal of Biological Chemistry **276**(49): 46094-46098.
- Macdonald, A., J. K. Chan, et al. (2005). "Perturbation of epidermal growth factor receptor complex formation and Ras signalling in cells harbouring the hepatitis C virus subgenomic replicon." J Gen Virol **86**(Pt 4): 1027-1033.
- Macdonald, A., K. Crowder, et al. (2004). "The hepatitis C virus NS5A protein binds to members of the Src family of tyrosine kinases and regulates kinase activity." Journal of General Virology **85**: 721-729.
- Majumder, M., A. K. Ghosh, et al. (2001). "Hepatitis C virus NS5A physically associates with p53 and regulates p21/waf1 gene expression in a p53-dependent manner." Journal of Virology **75**(3): 1401-1407.
- Majumder, M., A. K. Ghosh, et al. (2002). "Hepatitis C virus NS5A protein impairs TNF-mediated hepatic apoptosis, but not by an anti-FAS Antibody, in transgenic mice." Virology **294**(1): 94-105.
- Martell, M., J. I. Esteban, et al. (1992). "HEPATITIS-C VIRUS (HCV) CIRCULATES AS A POPULATION OF DIFFERENT BUT CLOSELY RELATED GENOMES - QUASI-SPECIES NATURE OF HCV GENOME DISTRIBUTION." Journal of Virology **66**(5): 3225-3229.
- Masaki, T., R. Suzuki, et al. (2008). "Interaction of hepatitis C virus nonstructural protein 5A with core protein is critical for the production of infectious virus particles." J Virol **82**(16): 7964-7976.
- McCormick, C. J., L. Challinor, et al. (2004). "Introduction of replication-competent hepatitis C virus transcripts using a tetracycline-regulable baculovirus delivery system." Journal of General Virology **85**(2): 429-439.

- McHutchison, J. G. and T. Poynard (1999). "Combination therapy with interferon plus ribavirin for the initial treatment of chronic hepatitis C (vol 19, pg 57, 1999)." Seminars in Liver Disease **19**(3): 353-353.
- McLauchlan, J. (2009b). "Lipid droplets and hepatitis C virus infection." Biochimica Et Biophysica Acta-Molecular and Cell Biology of Lipids **1791**(6): 552-559.
- Meertens, L., C. Bertaux, et al. (2006). "Hepatitis C virus entry requires a critical postinternalization step and delivery to early endosomes via clathrin-coated vesicles." Journal of Virology **80**(23): 11571-11578.
- Mercer, D. F., D. E. Schiller, et al. (2001). "Hepatitis C virus replication in mice with chimeric human livers." Nature Medicine **7**(8): 927-933.
- Meuleman, P., L. Libbrecht, et al. (2005). "Morphological and biochemical characterization of a human liver in a uPA-SCID mouse chimera." Hepatology **41**(4): 847-856.
- Meyer, K., A. Basu, et al. (2005). "Inhibition of hepatitis C virus core protein expression in immortalized human hepatocytes induces cytochrome c-independent increase in Apaf-1 and caspase-9 activation for cell death." Virology **336**(2): 198-207.
- Michalak, J. P., C. Wychowski, et al. (1997). "Characterization of truncated forms of hepatitis C virus glycoproteins." Journal of General Virology **78**: 2299-2306.
- Miller, R. H. and R. H. Purcell (1990). "HEPATITIS-C VIRUS SHARES AMINO-ACID-SEQUENCE SIMILARITY WITH PESTIVIRUSES AND FLAVIVIRUSES AS WELL AS MEMBERS OF 2 PLANT-VIRUS SUPERGROUPS." Proceedings of the National Academy of Sciences of the United States of America **87**(6): 2057-2061.
- Miyanari, Y., K. Atsuzawa, et al. (2007). "The lipid droplet is an important organelle for hepatitis C virus production." Nat Cell Biol **9**(9): 1089-1097.
- Miyasaka, Y., N. Enomoto, et al. (2003). "Hepatitis C virus nonstructural protein 5A inhibits tumor necrosis factor-alpha-mediated apoptosis in Huh7 cells." J Infect Dis **188**(10): 1537-1544.
- Mizutani, K., M. Onda, et al. (2005). "Overexpressed in anaplastic thyroid carcinoma-1 (OEATC-1) as a novel gene responsible for anaplastic thyroid carcinoma." Cancer **103**(9): 1785-1790.
- Molina, S., V. Castet, et al. (2007). "The low-density lipoprotein receptor plays a role in the infection of primary human hepatocytes by hepatitis C virus." Journal of Hepatology **46**(3): 411-419.
- Molina, S., V. Castet, et al. (2008). "Serum-derived hepatitis C virus infection of primary human hepatocytes is tetraspanin CD81 dependent." Journal of Virology **82**(1): 569-574.
- Moradpour, D., V. Brass, et al. (2004). "Membrane Association of the RNA-Dependent RNA Polymerase Is Essential for Hepatitis C Virus RNA Replication." J. Virol. **78**(23): 13278-13284.

- Moriya, K., H. Fujie, et al. (1998). "The core protein of hepatitis C virus induces hepatocellular carcinoma in transgenic mice." Nature Medicine **4**(9): 1065-1067.
- Moriya, K., H. Yotsuyanagi, et al. (1997). "Hepatitis C virus core protein induces hepatic steatosis in transgenic mice." J Gen Virol **78** (Pt 7): 1527-1531.
- Muchmore, S. W., J. Chen, et al. (2000). "Crystal structure and mutagenic analysis of the inhibitor-of-apoptosis protein survivin." Molecular Cell **6**(1): 173-182.
- Murray, C. L., C. T. Jones, et al. (2007). "Alanine scanning of the hepatitis C virus core protein reveals numerous residues essential for production of infectious virus." Journal of Virology **81**: 10220-10231.
- Nagaike, T., C. Logan, et al. (2011). "Transcriptional Activators Enhance Polyadenylation of mRNA Precursors." Molecular Cell **41**(4): 409-418.
- Nakai, K., T. Okamoto, et al. (2006). "Oligomerization of Hepatitis C Virus Core Protein Is Crucial for Interaction with the Cytoplasmic Domain of E1 Envelope Protein." J. Virol. **80**(22): 11265-11273.
- Naldini, L. (1998). "Lentiviruses as gene transfer agents for delivery to non-dividing cells." Current Opinion in Biotechnology **9**(5): 457-463.
- Neddermann, P., M. Quintavalle, et al. (2004). "Reduction of hepatitis C virus NS5A hyperphosphorylation by selective inhibition of cellular kinases activates viral RNA replication in cell culture." Journal of Virology **78**(23): 13306-13314.
- Nei, M. and T. Gojobori (1986). "Simple methods for estimating the numbers of synonymous and nonsynonymous nucleotide substitutions." Molecular biology and evolution **3**(5): 418-426.
- Ng, T. I., H. Mo, et al. (2007). "Identification of host genes involved in hepatitis C virus replication by small interfering RNA technology." Hepatology **45**(6): 1413-1421.
- Nielsen, S. U., M. F. Bassendine, et al. (2004). "Characterization of the genome and structural proteins of hepatitis C virus resolved from infected human liver." J Gen Virol **85**(6): 1497-1507.
- Nielsen, S. U., M. F. Bassendine, et al. (2006). "Association between hepatitis C virus and very-low-density lipoprotein (VLDL)/LDL analyzed in iodixanol density gradients." Journal of Virology **80**(5): 2418-2428.
- Ohashi, K., F. Park, et al. (2002). "Efficient gene transduction to cultured hepatocytes by HIV-1 derived lentiviral vector." Transplantation proceedings **34**(5): 1431-1433.
- Okamoto, H., M. Kojima, et al. (1992). "GENETIC DRIFT OF HEPATITIS-C VIRUS DURING AN 8.2-YEAR INFECTION IN A CHIMPANZEE - VARIABILITY AND STABILITY." Virology **190**(2): 894-899.
- Okamoto, T., Y. Nishimura, et al. (2006). "Hepatitis C virus RNA replication is regulated by FKBP8 and Hsp90." The EMBO journal **25**(20): 5015-5025.

- Owsianka, A. M., J. M. Timms, et al. (2006). "Identification of conserved residues in the E2 envelope glycoprotein of the hepatitis C virus that are critical for CD81 binding." Journal of Virology **80**(17): 8695-8704.
- Paeshuyse, J., L. Coelmont, et al. (2006). "The cyclophilin inhibitor DEBIO-025 is a potent inhibitor of hepatitis C virus replication in vitro." Hepatology **44**(4): 416.
- Palmer, D. and P. Ng (2003). "Improved system for helper-dependent adenoviral vector production." Molecular Therapy **8**(5): 846-852.
- Palmer, D. J. and P. Ng (2005). "Helper-dependent adenoviral vectors for gene therapy." Human Gene Therapy **16**(1): 1-16.
- Park, C. Y., H. J. Jun, et al. (2009). "Hepatitis C Virus Nonstructural 4B Protein Modulates Sterol Regulatory Element-binding Protein Signaling via the AKT Pathway." Journal of Biological Chemistry **284**(14): 9237-9246.
- Park, J. S., J. M. Yang, et al. (2000). "Hepatitis C virus nonstructural protein NS4B transforms NIH3T3 cells in cooperation with the Ha-ras oncogene." Biochemical and Biophysical Research Communications **267**(2): 581-587.
- Park, K. J., S. H. Choi, et al. (2002). "Nonstructural 5A protein of hepatitis C virus modulates tumor necrosis factor alpha-stimulated nuclear factor kappa B activation." J Biol Chem **277**(15): 13122-13128.
- Pasquinelli, C., J. M. Shoenberger, et al. (1997). "Hepatitis C virus core and E2 protein expression in transgenic mice." Hepatology **25**(3): 719-727.
- Patel, K., A. J. Muir, et al. (2006). "Diagnosis and treatment of chronic hepatitis C infection." BMJ **332**(7548): 1013-1017.
- Pavio, N., S. Battaglia, et al. (2005). "Hepatitis C virus core variants isolated from liver tumor but not from adjacent non-tumor tissue interact with Smad3 and inhibit the TGF-beta pathway." Oncogene **24**(40): 6119-6132.
- Pavlović, D., D. C. A. Neville, et al. (2003). "The hepatitis C virus p7 protein forms an ion channel that is inhibited by long-alkyl-chain iminosugar derivatives." Proceedings of the National Academy of Sciences **100**(10): 6104-6108.
- Pawlotsky, J.-M. (2006a). "Therapy of hepatitis C: From empiricism to eradication." Hepatology **43**(S1): S207-S220.
- Pawlotsky, J.-M. (2011a). "Treatment failure and resistance with direct-acting antiviral drugs against hepatitis C virus." Hepatology **53**(5): 1742-1751.
- Pawlotsky, J.-M., H. Dahari, et al. (2004). "Antiviral action of ribavirin in chronic hepatitis C." Gastroenterology **126**(3): 703-714.
- Pawlotsky, J. M. (2006). Hepatitis C virus population dynamics during infection. Quasispecies: Concept and Implications for Virology. **299**: 261-284.

- Pellerin, M., Y. Lopez-Aguirre, et al. (2004). "Hepatitis C virus quasispecies variability modulates nonstructural protein 5A transcriptional activation, pointing to cellular compartmentalization of virus-host interactions." Journal of Virology **78**(9): 4617-4627.
- Peng, L., D. Liang, et al. (2010). "Hepatitis C virus NS5A activates the mammalian target of rapamycin (mTOR) pathway, contributing to cell survival by disrupting the interaction between FK506-binding protein 38 (FKBP38) and mTOR." J Biol Chem **285**(27): 20870-20881.
- Penin, F., V. Brass, et al. (2004b). "Structure and function of the membrane anchor domain of hepatitis C virus nonstructural protein 5A." Journal of Biological Chemistry **279**(39): 40835-40843.
- Penin, F., J. Dubuisson, et al. (2004a). "Structural biology of hepatitis C virus." Hepatology **39**(1): 5-19.
- Perales, J. C., T. Ferkol, et al. (1994). "Gene transfer in vivo: sustained expression and regulation of genes introduced into the liver by receptor-targeted uptake." Proceedings of the National Academy of Sciences **91**(9): 4086-4090.
- Pereira, A. A. and I. M. Jacobson (2009). "New and experimental therapies for HCV." Nature Reviews Gastroenterology & Hepatology **6**(7): 403-411.
- Perlemuter, G., A. Sabile, et al. (2002). "Hepatitis C virus core protein inhibits microsomal triglyceride transfer protein activity and very low density lipoprotein secretion: a model of viral-related steatosis." Faseb Journal **16**(2): 185-194.
- Piccininni, S., A. Varaklioti, et al. (2002). "Modulation of the hepatitis C virus RNA-dependent RNA polymerase activity by the non-structural (NS) 3 helicase and the NS4B membrane protein." Journal of Biological Chemistry **277**(47): 45670-45679.
- Pietschmann, T., A. Kaul, et al. (2006). "Construction and characterization of infectious intragenotypic and intergenotypic hepatitis C virus chimeras." Proceedings of the National Academy of Sciences of the United States of America **103**(19): 7408-7413.
- Pietschmann, T., V. Lohmann, et al. (2002). "Persistent and transient replication of full-length hepatitis C virus genomes in cell culture." Journal of Virology **76**(8): 4008-4021.
- Pietschmann, T., V. Lohmann, et al. (2001). "Characterization of cell lines carrying self-replicating hepatitis C virus RNAs." Journal of Virology **75**(3): 1252-1264.
- Pileri, P., Y. Uematsu, et al. (1998). "Binding of hepatitis C virus to CD81." Science **282**(5390): 938-941.
- Piodi, A., P. Chouteau, et al. (2008). "Morphological changes in intracellular lipid droplets induced by different hepatitis C virus genotype core sequences and relationship with steatosis." Hepatology **48**(1): 16-27.
- Ploss, A., M. J. Evans, et al. (2009a). "Human occludin is a hepatitis C virus entry factor required for infection of mouse cells." Nature **457**(7231): 882-886.

- Ploss, A. and C. M. Rice (2009b). "Towards a small animal model for hepatitis C." EMBO Rep **10**(11): 1220-1227.
- Poch, O., I. Sauvaget, et al. (1989). "IDENTIFICATION OF 4 CONSERVED MOTIFS AMONG THE RNA-DEPENDENT POLYMERASE ENCODING ELEMENTS." Embo Journal **8**(12): 3867-3874.
- Podevin, P., A. Sabile, et al. (2001). "Expression of hepatitis C virus NS5A natural mutants in a hepatocytic cell line inhibits the antiviral effect of interferon in a PKR-independent manner." Hepatology **33**(6): 1503-1511.
- Polyak, S. J., K. S. A. Khabar, et al. (2001b). "Hepatitis C virus nonstructural 5A protein induces interleukin-8, leading to partial inhibition of the interferon-induced antiviral response." Journal of Virology **75**(13): 6095-6106.
- Polyak, S. J., K. S. A. Khabar, et al. (2001a). "Elevated levels of interleukin-8 in serum are associated with hepatitis C virus infection and resistance to interferon therapy." Journal of Virology **75**(13): 6209-6211.
- Poordad, F., J. McCone, et al. (2011). "Boceprevir for Untreated Chronic HCV Genotype 1 Infection." New England Journal of Medicine **364**(13): 1195-1206.
- Qadri, I., M. Iwahashi, et al. (2002). "Hepatitis C virus NS5A protein binds TBP and p53, inhibiting their DNA binding and p53 interactions with TBP and ERCC3." Biochimica et biophysica acta **1592**(2): 193-204.
- Quinn, P. G. and D. Yeagley (2005). "Insulin regulation of PEPCK gene expression: a model for rapid and reversible modulation." Current drug targets. Immune, endocrine and metabolic disorders **5**(4): 423-437.
- Quintavalle, M., S. Sambucini, et al. (2006). "The alpha isoform of protein kinase CKI is responsible for hepatitis C virus NS5A hyperphosphorylation." Journal of Virology **80**(22): 11305-11312.
- Quintavalle, M., S. Sambucini, et al. (2007). "Hepatitis C virus NS5A is a direct substrate of casein kinase I-alpha, a cellular kinase identified by inhibitor affinity chromatography using specific NS5A hyperphosphorylation inhibitors." Journal of Biological Chemistry **282**(8): 5536-5544.
- Ralston, R., K. Thudium, et al. (1993). "CHARACTERIZATION OF HEPATITIS-C VIRUS ENVELOPE GLYCOPROTEIN COMPLEXES EXPRESSED BY RECOMBINANT VACCINIA VIRUSES." Journal of Virology **67**(11): 6753-6761.
- Randall, G., M. Panis, et al. (2007). "Cellular cofactors affecting hepatitis C virus infection and replication." Proceedings of the National Academy of Sciences of the United States of America **104**(31): 12884-12889.
- Ray, R. B., L. M. Lagging, et al. (1996a). "Hepatitis C virus core protein cooperates with ras and transforms primary rat embryo fibroblasts to tumorigenic phenotype." Journal of Virology **70**(7): 4438-4443.

- Ray, R. B., K. Meyer, et al. (1996b). "Suppression of apoptotic cell death by hepatitis C virus core protein." Virology **226**(2): 176-182.
- Reed, K. E., J. Xu, et al. (1997). "Phosphorylation of the hepatitis C virus NS5A protein in vitro and in vivo: Properties of the NS5A-associated kinase." Journal of Virology **71**(10): 7187-7197.
- Reeve, A. B., K. Patel, et al. (2009). "Reduced genetic diversity in lymphoid and central nervous system tissues and selection-induced tissue-specific compartmentalization of neuropathogenic SIVsmmFGb during acute infection." AIDS research and human retroviruses **25**(6): 583-601.
- Reeve, A. B., N. C. Pearce, et al. (2010). "Neuropathogenic SIVsmmFGb genetic diversity and selection-induced tissue-specific compartmentalization during chronic infection and temporal evolution of viral genes in lymphoid tissues and regions of the central nervous system." AIDS research and human retroviruses **26**(6): 663-679.
- Reiss, S., I. Rebhan, et al. (2011). "Recruitment and Activation of a Lipid Kinase by Hepatitis C Virus NS5A Is Essential for Integrity of the Membranous Replication Compartment." Cell Host & Microbe **9**(1): 32-45.
- Roingard, P. and C. Hourieux (2008). "Hepatitis C virus core protein, lipid droplets and steatosis." Journal of Viral Hepatitis **15**(3): 157-164.
- Roohvand, F., P. Maillard, et al. (2009). "Initiation of Hepatitis C Virus Infection Requires the Dynamic Microtubule Network ROLE OF THE VIRAL NUCLEOCAPSID PROTEIN." Journal of Biological Chemistry **284**(20): 13778-13791.
- Russell, R. S., J. C. Meunier, et al. (2008). "Advantages of a single-crystal production assay to study cell culture-adaptive mutations of hepatitis C virus." Proceedings of the National Academy of Sciences of the United States of America **105**(11): 4370-4375.
- Sah, N. K., Z. Khan, et al. (2006). "Structural, functional and therapeutic biology of survivin." Cancer Letters **244**(2): 164-171.
- Sakai, A., M. S. Claire, et al. (2003). "The p7 polypeptide of hepatitis C virus is critical for infectivity and contains functionally important genotype-specific sequences." Proceedings of the National Academy of Sciences **100**(20): 11646-11651.
- Sakhuja, K., P. S. Reddy, et al. (2003). "Optimization of the generation and propagation of gutless adenoviral vectors." Hum Gene Ther **14**(3): 243-254.
- Santolini, E., G. Migliaccio, et al. (1994). "BIOSYNTHESIS AND BIOCHEMICAL-PROPERTIES OF THE HEPATITIS-C VIRUS CORE PROTEIN." Journal of Virology **68**(6): 3631-3641.
- Santolini, E., L. Pacini, et al. (1995). "THE NS2 PROTEIN OF HEPATITIS-C VIRUS IS A TRANSMEMBRANE POLYPEPTIDE." Journal of Virology **69**(12): 7461-7471.
- Sarasin-Filipowicz, M., J. Krol, et al. (2009). "Decreased levels of microRNA miR-122 in individuals with hepatitis C responding poorly to interferon therapy." Nature Medicine **15**(1): 31-33.

- Satoh, S., M. Hirota, et al. (2000). "Cleavage of hepatitis C virus nonstructural protein 5A by a caspase-like protease(s) in mammalian cells." Virology **270**(2): 476-487.
- Sauter, D., K. Himmelsbach, et al. (2009). "Localization determines function: N-terminally truncated NS5A fragments accumulate in the nucleus and impair HCV replication." Journal of Hepatology **50**(5): 861-871.
- Schroder, A. R., P. Shinn, et al. (2002). "HIV-1 integration in the human genome favors active genes and local hotspots." Cell **110**(4): 521-529.
- Schwarz, A. K., J. Grove, et al. (2009). "Hepatoma Cell Density Promotes Claudin-1 and Scavenger Receptor BI Expression and Hepatitis C Virus Internalization." Journal of Virology **83**(23): 12407-12414.
- Segura, M. M., R. Alba, et al. (2008). "Advances in helper-dependent adenoviral vector research." Curr Gene Ther **8**(4): 222-235.
- Sen, G. C. (2001). "Viruses and interferons." Annual Review of Microbiology **55**: 255-281.
- Seppen, J., M. Rijnberg, et al. (2002). "Lentiviral vectors for efficient transduction of isolated primary quiescent hepatocytes." Journal of Hepatology **36**(4): 459-465.
- Shepard, C. W., L. Finelli, et al. (2005). "Global epidemiology of hepatitis C virus infection." Lancet Infectious Diseases **5**(9): 558-567.
- Shi, L., S. I. Zhang, et al. (2008). "NS5A^{ATP9}, a gene up-regulated by HCVNS5A protein." Cancer Letters **259**(2): 192-197.
- Shi, S. T., K. J. Lee, et al. (2003). "Hepatitis C virus RNA replication occurs on a detergent-resistant membrane that cofractionates with caveolin-2." Journal of Virology **77**(7): 4160-4168.
- Shimizu, Y. K., S. M. Feinstone, et al. (1996). "Hepatitis C virus: Detection of intracellular virus particles by electron microscopy." Hepatology **23**(2): 205-209.
- Shimotohno, K. (2000). "Hepatitis C virus and its pathogenesis." Seminars in Cancer Biology **10**(3): 233-240.
- Shirota, Y., H. Luo, et al. (2002). "Hepatitis C virus (HCV) NS5A binds RNA-dependent RNA polymerase (RdRP) NS5B and modulates RNA-dependent RNA polymerase activity." Journal of Biological Chemistry **277**(13): 11149-11155.
- Simmonds, P. (2004). "Genetic diversity and evolution of hepatitis C virus - 15 years on." Journal of General Virology **85**: 3173-3188.
- Smith, D. B. and P. Simmonds (1997). "Characteristics of Nucleotide Substitution in the Hepatitis C Virus Genome: Constraints on Sequence Change in Coding Regions at Both Ends of the Genome." Journal of Molecular Evolution **45**(3): 238-246.
- Snyder, R. O., C. Miao, et al. (1999). "Correction of hemophilia B in canine and murine models using recombinant adeno-associated viral vectors." Nature Medicine **5**(1): 64-70.

- Steinmann, E., F. Penin, et al. (2007). "Hepatitis C virus p7 protein is crucial for assembly and release of infectious virions." *Plos Pathogens* **3**(7): 962-971.
- Street, A., A. Macdonald, et al. (2004). "The Hepatitis C virus NS5A protein activates a phosphoinositide 3-kinase-dependent survival signaling cascade." *Journal of Biological Chemistry* **279**(13): 12232-12241.
- Strick-Marchand, H., S. Morosan, et al. (2004). "Bipotential mouse embryonic liver stem cell lines contribute to liver regeneration and differentiate as bile ducts and hepatocytes." *Proceedings of the National Academy of Sciences of the United States of America* **101**(22): 8360-8365.
- Subramanian, T., C. Dsaiepper, et al. (1994). "THE ACTIVATION REGION OF THE TAT PROTEIN OF HUMAN-IMMUNODEFICIENCY-VIRUS TYPE-1 FUNCTIONS IN YEAST." *Nucleic Acids Research* **22**(8): 1496-1499.
- Supekova, L., F. Supek, et al. (2008). "Identification of human kinases involved in hepatitis C virus replication by small interference RNA library screening." *Journal of Biological Chemistry* **283**(1): 29-36.
- Suzuki, R., S. Sakamoto, et al. (2005). "Molecular Determinants for Subcellular Localization of Hepatitis C Virus Core Protein." *J. Virol.* **79**(2): 1271-1281.
- Suzuki, T. (2011). "Assembly of hepatitis C virus particles." *Microbiology and Immunology* **55**(1): 12-18.
- Takyar, S. T., D. S. Li, et al. (2000). "Specific detection of minus-strand hepatitis C virus RNA by reverse-transcription polymerase chain reaction on PolyA(+)-purified RNA." *Hepatology* **32**(2): 382-387.
- Tal-Singer, R., R. Pichyangkura, et al. (1999). "The Transcriptional Activation Domain of VP16 Is Required for Efficient Infection and Establishment of Latency by HSV-1 in the Murine Peripheral and Central Nervous Systems." *Virology* **259**(1): 20-33.
- Tam, R. C., B. Pai, et al. (1999). "Ribavirin polarizes human T cell responses towards a Type 1 cytokine profile." *Journal of Hepatology* **30**(3): 376-382.
- Tan, S. L. and M. G. Katze (2001). "How hepatitis C virus counteracts the interferon response: the jury is still out on NS5A." *Virology* **284**(1): 1-12.
- Tan, S. L., H. Nakao, et al. (1999). "NS5A, a nonstructural protein of hepatitis C virus, binds growth factor receptor-bound protein 2 adaptor protein in a Src homology 3 domain/ligand-dependent manner and perturbs mitogenic signaling." *Proceedings of the National Academy of Sciences of the United States of America* **96**(10): 5533-5538.
- Tanaka, Y., T. Shimoike, et al. (2000). "Selective binding of hepatitis C virus core protein to synthetic oligonucleotides corresponding to the 5' untranslated region of the viral genome." *Virology* **270**(1): 229-236.
- Tang, H., L. Delgermaa, et al. (2005). "The Transcriptional Transactivation Function of HBx Protein Is Important for Its Augmentation Role in Hepatitis B Virus Replication." *J. Virol.* **79**(9): 5548-5556.

- Tanimoto, A., Y. Ide, et al. (1997). "The amino terminal deletion mutants of hepatitis C virus nonstructural protein NS5A function as transcriptional activators in yeast." Biochemical and Biophysical Research Communications **236**(2): 360-364.
- Tanji, Y., T. Kaneko, et al. (1995). "PHOSPHORYLATION OF HEPATITIS-C VIRUS-ENCODED NONSTRUCTURAL PROTEIN NS5A." Journal of Virology **69**(7): 3980-3986.
- Tardif, K. D., K. Mori, et al. (2002). "Hepatitis C virus subgenomic replicons induce endoplasmic reticulum stress activating an intracellular signaling pathway." Journal of Virology **76**(15): 7453-7459.
- Targett-Adams, P., S. Boulant, et al. (2008). "Visualization of double-stranded RNA in cells supporting hepatitis C virus RNA replication." Journal of Virology **82**(5): 2182-2195.
- Tarik, A. (2011). "A sprint to increase response to HCV treatment: Expectancies but caution." Journal of Hepatology **55**(5): 1154-1158.
- Tedbury, P., S. Welbourn, et al. (2011). "The subcellular localization of the hepatitis C virus non-structural protein NS2 is regulated by an ion channel-independent function of the p7 protein." J Gen Virol **92**(4): 819-830.
- Tellinghuisen, T. L. and K. L. Foss (2008). "Regulation of hepatitis C virion production via phosphorylation of the NS5A protein." Plos Pathogens **4**(3).
- Tellinghuisen, T. L., K. L. Foss, et al. (2008). "Identification of residues required for RNA replication in domains II and III of the hepatitis C virus NS5A protein." Journal of Virology **82**(3): 1073-1083.
- Tellinghuisen, T. L., J. Marcotrigiano, et al. (2004). "The NS5A Protein of Hepatitis C Virus Is a Zinc Metalloprotein." Journal of Biological Chemistry **279**(47): 48576-48587.
- Tellinghuisen, T. L., J. Marcotrigiano, et al. (2005). "Structure of the zinc-binding domain of an essential component of the hepatitis C virus replicase." Nature **435**(7040): 374-379.
- Thimme, R., D. Oldach, et al. (2001). "Determinants of Viral Clearance and Persistence during Acute Hepatitis C Virus Infection." The Journal of Experimental Medicine **194**(10): 1395-1406.
- Tiley, L. S., S. J. Madore, et al. (1992). "THE VP16 TRANSCRIPTION ACTIVATION DOMAIN IS FUNCTIONAL WHEN TARGETED TO A PROMOTER-PROXIMAL RNA SEQUENCE." Genes & development **6**(11): 2077-2087.
- Tong, M. J., N. S. El-Farra, et al. (1995). "Clinical Outcomes after Transfusion-Associated Hepatitis C." New England Journal of Medicine **332**(22): 1463-1466.
- Tsukiyama-Kohara, K., N. Iizuka, et al. (1992). "Internal ribosome entry site within hepatitis C virus RNA." J Virol **66**(3): 1476-1483.
- Vaillancourt, F. H., L. Pilote, et al. (2009). "Identification of a lipid kinase as a host factor involved in hepatitis C virus RNA replication." Virology **387**(1): 5-10.

- Van Tine, B. A., J. C. Kappes, et al. (2004). "Clonal Selection for Transcriptionally Active Viral Oncogenes during Progression to Cancer." J. Virol. **78**(20): 11172-11186.
- Vargas, H. E., T. Laskus, et al. (2002). "Detection of hepatitis C virus sequences in brain tissue obtained in recurrent hepatitis C after liver transplantation." Liver Transplantation **8**(11): 1014-1019.
- Verdegem, D., A. Badillo, et al. (2011). "Domain 3 of NS5A protein from the hepatitis C virus has intrinsic α -helical propensity and is a substrate of Cyclophilin A." Journal of Biological Chemistry.
- Vermehren, J. and C. Sarrazin (2011). "New HCV therapies on the horizon." Clinical Microbiology and Infection **17**(2): 122-134.
- Voisset, C., N. Callens, et al. (2005). "High density lipoproteins facilitate hepatitis C virus entry through the scavenger receptor class B type I." Journal of Biological Chemistry **280**(9): 7793-7799.
- Voisset, C. and J. Dubuisson (2004). "Functional hepatitis C virus envelope glycoproteins." Biol. Cell **96**(6): 413-420.
- von Hahn, T. and C. M. Rice (2008). "Hepatitis C virus entry." Journal of Biological Chemistry **283**(7): 3689-3693.
- Wakita, T., A. Katsume, et al. (2000). "Possible role of cytotoxic T cells in acute liver injury in hepatitis C virus cDNA transgenic mice mediated by Cre/loxP system." J Med Virol **62**(3): 308-317.
- Wakita, T., T. Pietschmann, et al. (2005). "Production of infectious hepatitis C virus in tissue culture from a cloned viral genome." Nature Medicine **11**(7): 791-796.
- Wang, C. F., M. Gale, et al. (2005). "Identification of FBL2 as a geranylgeranylated required for hepatitis C cellular protein virus RNA replication." Molecular Cell **18**(4): 425-434.
- Waris, G., D. J. Felmlee, et al. (2007). "Hepatitis C virus induces proteolytic cleavage of sterol regulatory element binding proteins and stimulates their phosphorylation via oxidative stress." Journal of Virology **81**(15): 8122-8130.
- Waris, G., S. Sarker, et al. (2004). "Two-step affinity purification of the hepatitis C virus ribonucleoprotein complex." Rna-a Publication of the Rna Society **10**(2): 321-329.
- Washburn, M. L., M. T. Bility, et al. (2011). "A Humanized Mouse Model to Study Hepatitis C Virus Infection, Immune Response, and Liver Disease." Gastroenterology **140**(4): 1334-1344.
- Watashi, K., N. Ishii, et al. (2005). "Cyclophilin B is a functional regulator of hepatitis C virus RNA polymerase." Mol Cell **19**(1): 111-122.
- Weiner, A. J., M. J. Brauer, et al. (1991). "VARIABLE AND HYPERVARIABLE DOMAINS ARE FOUND IN THE REGIONS OF HCV CORRESPONDING TO THE FLAVIVIRUS ENVELOPE AND NS1 PROTEINS AND THE PESTIVIRUS ENVELOPE GLYCOPROTEINS." Virology **180**(2): 842-848.

- Williams, D. A. (2009). "Gene therapy continues to mature and to face challenges." Mol Ther **17**(8): 1305-1306.
- Xie, Z. C., J. I. Riezu-Boj, et al. (1998). "Transmission of hepatitis C virus infection to tree shrews." Virology **244**(2): 513-520.
- Yanagi, M., M. St Claire, et al. (1999). "In vivo analysis of the 3' untranslated region of the hepatitis C virus after in vitro mutagenesis of an infectious cDNA clone." Proceedings of the National Academy of Sciences of the United States of America **96**(5): 2291-2295.
- Yang, F., J. M. Robotham, et al. (2010). "A Major Determinant of Cyclophilin Dependence and Cyclosporine Susceptibility of Hepatitis C Virus Identified by a Genetic Approach." Plos Pathogens **6**(9).
- Yano, M., H. Yatsunami, et al. (1996). "Epidemiology of acute hepatitis in Japan." Hepatology **23**(1): P273-P273.
- Ye, J., C. F. Wang, et al. (2003). "Disruption of hepatitis C virus RNA replication through inhibition of host protein geranylgeranylation." Proceedings of the National Academy of Sciences of the United States of America **100**(26): 15865-15870.
- Yi, M. K. and S. M. Lemon (2003). "3' Nontranslated RNA signals required for replication of hepatitis C virus RNA." Journal of Virology **77**(6): 3557-3568.
- Yoshida, M. (1994). "Mechanism of transcriptional activation of viral and cellular genes by oncogenic protein of HTLV-1." Leukemia **8 Suppl 1**: S51-53.
- Yu, P. W., B. Huang, et al. (2001). "p15(PAF), a novel PCNA associated factor with increased expression in tumor tissues." Oncogene **20**(4): 484-489.
- Zech, B., A. Kurtenbach, et al. (2003). "Identification and characterization of amphiphysin II as a novel cellular interaction partner of the hepatitis C virus NS5A protein." J Gen Virol **84**(Pt 3): 555-560.
- Zein, N. N. (2000). "Clinical significance of hepatitis C virus genotypes." Clinical Microbiology Reviews **13**(2): 223-+.
- Zhang, J., G. Randall, et al. (2004). "CD81 is required for hepatitis C virus glycoprotein-mediated viral infection." Journal of Virology **78**(3): 1448-1455.
- Zhao, X. P., Z. Y. Tang, et al. (2002). "Primary hepatocytes of *Tupaia belangeri* as a potential model for hepatitis C virus infection." Journal of Clinical Investigation **109**(2): 221-232.
- Zheng, Y., L. B. Ye, et al. (2005). "Gene expression profiles of HeLa cells impacted by hepatitis C virus non-structural protein NS4B." Journal of Biochemistry and Molecular Biology **38**(2): 151-160.
- Zufferey, R., T. Dull, et al. (1998). "Self-inactivating lentivirus vector for safe and efficient in vivo gene delivery." Journal of Virology **72**(12): 9873-9880.

Appendix-Oligonucleotides

Primer Name	Primer Sequence (5'-3')
<i>Bgl</i> I_NS5Apop28_S	GCAGCCCATCCGGCTCGTGGCTGAGGGA
B-NS5A-swap	CAAAGAAGGCGCAGACAACTGGCTAGC
CACC- <i>Srf</i> I-T2A-S	CACCTGCCCCGGGCGA GGGCAGAGG
C-NS5A-swap	TTCCCCCAGCGATGCCCATATGG
E-NS5A-swap	GCTATCCAGTTGTCTGCGCCTTCTTGT
FBXL2-prom-AS	CGTATCTGGTCCATCCTCTCA
FBXL2-prom-S	TGGGGTGAGTGTCGTTTTATC
F-NS5A-swap	CCCATATGGGCATCGCTGGGGGGA
IL8-Prom3-AS	CTCAGGGCAAACCTGAGTCATC
IL8-Prom3-S	GTTGTAGTATGCCCTAAGAG
LTB-prom1-AS	ATATTCCTCACCCACCAT
LTB-prom1-S	TACGGGCCTCTCTGGTACAC
MAP2K7-prom-AS	GAAGGATGACGCCACCTAGA
MAP2K7-prom-S	AACGAGGTTCCAGGAATGC
NS5A_Stop_ <i>Xho</i> I_AS	GTCCTCGAGTCAGCAGCAGGGCAGCGTTCTC
NS5A-c1167a-AS	CTTAGCAGCCGGCAGCTTTCGCCGTGC
NS5A-c1167a-S	GAATCGTCGGCCGTCGAAAGCGGCACG
NS5A- <i>Hind</i> III	GGAAGCTTGTCCGGCTCGTGGCTAAGG
NS5A-kozak-S	GCCACCATGTCCGGCTCGTGGCTA
NS5A- <i>Not</i> I-S	TAGCGGCCGGGAGCAGCAAACGACGTCCTC
NS5A- <i>Pac</i> I-AS	CCTCTTAATTAACCTCGCTCACGGTAGACCAAGACCC
NS5A-stop-AS	CTACTAGCAGCAAACGACGTCCTC
NS5A-t462a-AS	TAAGAAGTGTCTCCACCTTCCCCACGCCG
NS5A-t462a-S	ATTCTTCACAGAGGTGGAAGGGGTGCGGC
NUAK2-prom1-AS	CCTGAAGGCCTAGAGAACACA
NUAK2-prom1-S	CCTGAAGTTGCTGCTGTGAA
p1071-NLSmut-AS	CTGTTAGGACAACCGTCCCCATTCCCCC TGGAGGTGGTATTGGAGGGG
p1071-NLSmut-S	CCCCTCCAATACCACCTCCAGGGGGAAT GGGGACGGTTGTCCTAACAG
TopoT2A- <i>Xho</i> I-AS	ATGCATGCTCGAGCGGCCGC

TRAF2-prom-AS		CAGCCCTCAGGAAGCTGTAG
TRAF2-prom-S		GGGAAGGGACCCAATTAGC

Notes

Notes

Notes

Summary

Hepatitis C virus (HCV) causes a chronic infection in the majority of infected patients, ultimately leading to liver cirrhosis and hepatocellular carcinoma (HCC). Although the roles of the HCV proteins in the viral life cycle are increasingly understood, the precise function of the HCV NS5A protein has yet to be elucidated. To date, the only putative direct function attributed to NS5A is its transcriptional transactivation properties. Our group has previously shown that quasispecies variants of NS5A isolated from the serum samples of the same patient bear different transactivating properties according to their amino acid sequence. Based on these observations, we performed preliminary phylogenetic and functional analysis of NS5A variants isolated from liver tissue of individuals infected with HCV of genotype 1b. This analysis revealed genetic and functional compartmentation of NS5A variants in tumoral and adjacent non-tumoral tissue. We hypothesized that the natural variability of NS5A may impact its proposed transactivation properties. We also hypothesized that NS5A's putative transactivation properties could play a role in HCV replication and in liver pathogenesis. The aim of the study presented in this thesis was to investigate the role of NS5A transactivation properties in the development of HCV-induced liver pathogenesis as well as in viral replication.

To study the role of NS5A transcriptional activation properties in liver pathogenesis, we developed lentiviral vectors for the expression of selected NS5A variants bearing different transactivation potentials in cultured primary human hepatocytes. We now intend to extend these preparations using RNAseq technology to analyse the transcriptome of primary hepatocytes transduced with lentiviral vectors encoding strongly and weakly transactivating NS5A variants to identify the cellular pathways targeted by NS5A, allowing us to decipher the role of NS5A mediated host gene regulation in development of HCV induced pathogenesis. For *in vivo* studies, we have begun the development of transgenic mice allowing liver-specific conditional expression of NS5A variants with high and low transactivation potentials. These transgenic mice will be used to study the possible role of NS5A transactivation properties in development of HCC.

To study the role of NS5A transcriptional activation properties in HCV RNA replication, we used the sub-genomic replicon system expressing previously characterized NS5A sequences.. Using this system, we have demonstrated that a subset of NS5A protein can translocate to the nucleus and is recruited to cellular promoters of host cell genes known to be required for efficient replication of HCV replicon RNA as well as those implicated in pathogenesis. Moreover, we have shown that NS5A directly regulate the expression of these genes. Consequently, it was observed that replicons encoding NS5A variants with different transactivation potentials exhibited different replication capacities, and that this correlated with the transactivation potential of the corresponding NS5A variant. In agreement with these observations, inhibition of nuclear translocation of NS5A resulted in the inhibition of replication of the HCV subgenomic replicon, further confirming the role of NS5A transactivation properties in viral RNA replication.

In conclusion, we have demonstrated that NS5A-mediated transcriptional regulation of cellular genes is required for HCV replication. Such NS5A-mediated modulation of cellular genes may also constitute one of the mechanisms involved in HCV-related liver pathogenesis and development of HCC, an aspect which is currently under investigation using the tools developed during this project. This study will contribute towards deciphering the role of NS5A in viral replication as well as providing insight into its role in HCV-induced liver pathogenesis. Furthermore, these data might open new anti-HCV drug developments based on inhibition of NS5A nuclear translocation.