



HAL
open science

Histoire de la pollution en métaux lourds de l'atmosphère de l'hémisphère nord au cours des deux derniers siècles retracée dans les neiges du Groenland central: thèse soutenue sur un ensemble de travaux

Jean Pierre Candelone

► **To cite this version:**

Jean Pierre Candelone. Histoire de la pollution en métaux lourds de l'atmosphère de l'hémisphère nord au cours des deux derniers siècles retracée dans les neiges du Groenland central: thèse soutenue sur un ensemble de travaux. Glaciologie. Université Joseph-Fourier - Grenoble I, 1994. Français. NNT: . tel-00760048

HAL Id: tel-00760048

<https://theses.hal.science/tel-00760048>

Submitted on 3 Dec 2012

HAL is a multi-disciplinary open access archive for the deposit and dissemination of scientific research documents, whether they are published or not. The documents may come from teaching and research institutions in France or abroad, or from public or private research centers.

L'archive ouverte pluridisciplinaire **HAL**, est destinée au dépôt et à la diffusion de documents scientifiques de niveau recherche, publiés ou non, émanant des établissements d'enseignement et de recherche français ou étrangers, des laboratoires publics ou privés.

TS 94/GRE1/0146
double

TS 94/GRE1/0146
DOUBLE

88
CS

CENTRE NATIONAL DE LA RECHERCHE SCIENTIFIQUE



**LABORATOIRE
DE GLACIOLOGIE
ET GEOPHYSIQUE
DE L'ENVIRONNEMENT**

Associé à l'Université Joseph Fourier
de Grenoble

THESE
PRESENTEE PAR

Jean-Pierre CANDELONE

Pour obtenir le titre de Docteur de l'Université Joseph Fourier - Grenoble 1
(ARRETES MINISTERIELS DU 5 JUILLET 1984 ET DU 30 MARS 1992)

SPECIALITE : PHYSIQUE

**HISTOIRE DE LA POLLUTION EN METAUX LOURDS DE L'ATMOSPHERE DE
L'HEMISPHERE NORD AU COURS DES DEUX DERNIERS SIECLES RETRACEE
DANS LES NEIGES DU GROENLAND CENTRAL**

Présentée le 28 Octobre 1994 devant la commission d'examen :

MM.	Laurent CHARLET	Président
	Claude BOUTRON	Directeur de thèse
	Patrick BUAT-MENARD	
	Alain LAMOTTE	
	Eric WOLFF	

Rapporteurs : MM. Kevin ROSMAN et Eric WOLFF

54 Rue MOLIERE, Domaine Universitaire BP 96 38402 SAINT MARTIN D'HERES CEDEX (FRANCE)
Telephone : 76 82 42 00 ; Telefax : 76 82 42 01





CENTRE NATIONAL DE LA RECHERCHE SCIENTIFIQUE

**LABORATOIRE
DE GLACIOLOGIE
ET GEOPHYSIQUE
DE L'ENVIRONNEMENT**

Associé à l'Université Joseph Fourier
de Grenoble

THESE
PRESENTEE PAR

Jean-Pierre CANDELONE

Pour obtenir le titre de Docteur de l'Université Joseph Fourier - Grenoble 1
(ARRETES MINISTERIELS DU 5 JUILLET 1984 ET DU 30 MARS 1992)

SPECIALITE : PHYSIQUE

**HISTOIRE DE LA POLLUTION EN METAUX LOURDS DE L'ATMOSPHERE DE
L'HEMISPHERE NORD AU COURS DES DEUX DERNIERS SIECLES RETRACEE
DANS LES NEIGES DU GROENLAND CENTRAL**

Présentée le 28 Octobre 1994 devant la commission d'examen :

MM.	Laurent CHARLET	Président
	Claude BOUTRON	Directeur de thèse
	Patrick BUAT-MENARD	
	Alain LAMOTTE	
	Eric WOLFF	

Rapporteurs : MM. Kevin ROSMAN et Eric WOLFF

54 Rue MOLIERE, Domaine Universitaire BP 96 38402 SAINT MARTIN D'HERES CEDEX (FRANCE)
Telephone : 76 82 42 00 ; Telefax : 76 82 42 01



Remerciements

Ce travail s'inscrit dans le programme Eurocore cofinancé par la commission des Communautés Européennes et la Suisse dans le cadre du Cost 611. Ce programme a été financé également par le Ministère français de l'Environnement (bourse N°92295), l'Institut National des Sciences de l'Univers et l'Université de Grenoble.

Je tiens à remercier tout particulièrement Claude Rado et François Maupetit de m'avoir procuré la carotte de 70 m de névé qui a constitué le coeur de ce travail.

Robert Delmas m'a accueilli au laboratoire de Glaciologie dont il assure la direction ; je l'associe doublement à ces remerciements : pour avoir activement participé au carottage avec Claude et François et pour ses nombreuses remarques constructives apportées à ce travail.

Ma gratitude à Jean Luc Jaffrezo pour les fructueuses séries d'échantillons prélevés pour notre groupe au cours de ses campagnes au Groenland et son aide à la rédaction de ce mémoire.

Je remercie Martine de Angelis et Michel Legrand pour leurs multiples conseils.

Merci également aux personnes du Laboratoire qui m'ont témoigné leur sympathie.

Mes remerciements pour MM Laurent Charlet qui me fait l'honneur de présider la commission d'examen de cette thèse, Patrick Buat-Ménard et Alain Lamotte qui ont accepté de participer au jury. Kevin Rosman et Eric Wolff ont été rapporteurs de ces travaux : je les en remercie vivement

A Claude Boutron, mon directeur de thèse, de m'avoir supporté durant ces quatre années...

A mon ami Sungmin pour son dévouement et sa fidélité.

A toute ma Famille.

A l'Eternel Dieu, Créateur de toute chose
et aux hommes de bonne volonté qui accompliront la Sienne.

Table des Matières

Remerciements	2
Table des Matières	3
Introduction	5
Chapitre I : An improved method for decontaminating polar snow or ice cores for heavy metal analysis.....	21
Chapitre II : Post industrial revolution changes in large scale atmospheric pollution of the northern hemisphere for heavy metals as documented in central Greenland snow and ice.....	48
Chapitre III : Seasonal variations in heavy metals concentrations in present day Greenland snows.....	87
Chapitre IV : Determiation of bismuth down to the sub pg/g level in Green- -land snow by Laser Atomic Fluorescence Spectrometry.....	124
Chapitre V : Bi in recent snow from central Greenland : Preliminary results....	133
Conclusion :.....	158
Annexe I : "Determiation of bismuth down to the sub pg/g level in Green- -land snow by Laser Atomic Fluorescence Spectrometry". Article publié dans le " journal de Physique".....	165

- Annexe II** : "Isotopic evidence for the source of lead in greenland snows since the late 1960s."
Article publié dans la revue "Nature"170
- Annexe III** : "Isotopic evidence to account for changes in the concentrations of lead in Greenland snow between 1960 and 1988"
Article publié dans "Geochimica et Cosmochimica Acta"173
- Annexe IV** : "Speciation analysis of organolead compounds in Greenland snow at the fg/g level by capillary gas chromatography / atomic emission spectrometry".
Article publié dans "Analytical Chemistry"179
- Annexe V** : "Present century snow core record of organolead pollution in Greenland".
Article publié dans "Environmental Science & Technology"186

INTRODUCTION

Ce mémoire présente les mesures des concentrations en métaux lourds obtenues par diverses techniques analytiques dans des échantillons de névé et de glace prélevés au Groenland central.

Âges de cuivre, de bronze et de fer: les qualificatifs attribués aux différentes périodes caractéristiques de l'humanité nous rappellent que la production des métaux est indissociable de l'histoire des civilisations.

Invisibles au quotidien dans l'environnement, leur omniprésence concerne de façon directe l'être humain. A l'état de traces, le cuivre et le zinc sont essentiels au métabolisme cellulaire, le zinc notamment intervient dans la synthèse protéinique; à plus forte dose, ils deviennent toxiques (C. G. Elinder, 1984). D'autres métaux comme le plomb, le cadmium, le bismuth et le mercure sont déjà toxiques à très faible dose. La toxicité de certains d'entre eux est connue depuis l'antiquité. Le poète grec Lucretius décrit le travail dans les mines et souligne la nocivité des émissions sur la santé des mineurs. L'auteur romain Pline décrit le déperissement de la faune au voisinage des fonderies de métaux et selon une thèse récente, (J.O.Nriagu, 1983), la chute de l'Empire Romain, liée à la décadence de l'élite patricienne serait la conséquence d'un saturnisme progressif: l'utilisation domestique de couverts et d'ustensiles de cuisine en plomb était généralisée parmi la classe dirigeante de la société romaine.

Les métaux accèdent principalement à l'organisme par voie digestive et par voie respiratoire (C.C. Patterson, 1983; C. G. Elinder, 1984). Leur évacuation de l'organisme dépend de leur nature et de leur forme chimique (organique ou minérale), mais elle est presque toujours

incomplète et selon leur affinité ils peuvent s'accumuler dans l'organisme. Aussi, leur temps de résidence dans chaque milieu constituant le corps humain présente une variabilité importante: une particule de plomb inorganique réside en moyenne 35 jours dans le sang mais 70 ans dans le squelette une fois fixée (M.B. Rabinowitz et al., 1973). Cette particularité n'est pas propre à l'espèce humaine mais s'étend de façon générale au monde vivant.

Ainsi, même présents en faibles quantités dans un écosystème, les processus biologiques conduisent souvent à l'enrichissement des métaux par eutrophisme direct : nombre d'entre eux comme le cadmium, le plomb et le mercure s'accumulent dans les tissus vivants par eutrophie et; ils peuvent alors atteindre pour un prédateur en fin de chaîne alimentaire, tel l'homme, des niveaux directement toxiques (D.A. Wright et al., 1993).

Divers cas d'empoisonnement au cadmium (maladie de Itai-Itai) et au mercure (maladie de Minamata) ont été répertoriés au Japon (K. Nogawa, 1984 ; F.M. D'Itri, 1991). De tels cas d'intoxications aiguës restent localisés et facilement identifiables. Aux USA, des études ont montré qu'une plombémie pré et post natale élevée semblait induire une baisse sur le Q.I. des enfants de 6 à 18 mois et s'accompagnerait en outre, chez les nouveaux-nés, d'une plus grande fréquence de malformations mineures (J.M. Davis & D.J. Svendsgaard, 1987). D'autre part, Ward & Bryce-Smith (1993) ont révélé l'incidence sur le fœtus d'un effet tératogène lié au plomb et au cadmium. D'autres études soutiennent que l'exposition permanente à de faibles concentrations de métaux pourrait à long terme entraîner l'intoxication massive de populations à l'échelle d'un continent. L'évolution lente et pandémique du syndrome, masquant son caractère pathologique le rendrait ainsi difficilement détectable.

La répartition générale des métaux dans l'écosystème global de notre planète apparaît ainsi comme un sujet majeur d'étude dans une fin de siècle où les préoccupations liées à

l'environnement connaissent une importance croissante (J.O. Nriagu, 1990a).

Historiquement, leur redistribution à grande échelle à la surface de la Terre débuta au milieu du 18^{ème} siècle consécutivement à l'essor parallèle des techniques d'exploitation des mines et de la métallurgie. A partir de cette époque, les flux anthropiques de métaux vers les trois écosystèmes planétaires : l'atmosphère, la biosphère et l'hydrosphère ont rapidement et très largement dépassé les flux estimés d'origine naturelle. La portée d'un tel bouleversement sur les cycles biogéochimiques naturels est jusqu'à présent encore incomplètement appréciée à l'échelle globale (J.O. Nriagu, 1990b).

Bien qu'en constante diminution depuis les années 1970, les flux anthropiques de métaux lourds vers l'atmosphère sont actuellement toujours très nettement supérieurs aux flux naturels (J.O. Nriagu & J.M. Pacyna, 1989). La voie aérienne favorise par excellence la délocalisation des métaux et leur répartition à l'échelle globale : il est reconnu que les 4/5^{ème} du plomb dans l'atmosphère de l'Antarctique, continent pourtant protégé de la circulation atmosphérique générale par son propre courant circumpolaire, ont une origine industrielle. Pour beaucoup de régions voisines des sources, l'atmosphère est devenue la voie majeure d'apports en métaux lourds : 30 à 50% des flux totaux de Pb, Cd, Zn et Cu entrant dans la mer Baltique suivraient la voie aérienne (J.M. Pacyna, 1993). En l'absence de sources naturelles locales, l'atmosphère est souvent le principal vecteur de propagation et de redistribution des métaux lourds vers les régions les plus éloignées des zones sources (A.R. Flegal & C.C. Patterson, 1983 ; J.O. Nriagu & J.M. Pacyna, 1988).

Cependant l'atmosphère est très sensible aux sollicitations extérieures et les fluctuations d'une source où d'un puit s'y repercutent rapidement ; en effet, mis à part le mercure qui, sous forme élémentaire gazeuse (98% de la spéciation de cet élément - J.P. Kim & W.F. Fitzgerald, 1986) y demeure un an en moyenne, le temps de résidence des autres métaux dans la troposphère (dont

la spéciation favorise très majoritairement la forme particulière inorganique) dépasse exceptionnellement la dizaine de jours (de 3 à 6 jours habituellement?)

Cette particularité de l'atmosphère lui confère un intérêt certain lorsqu'on étudie les variations à court terme des flux globaux de métaux.

Bien que faisant l'objet d'une recherche assidue depuis plus d'une décade, les mécanismes responsables de la déposition des aérosols métalliques par voie sèche où humide en surface des calottes polaires demeurent encore mal connus (C.I. Davidson et al, 1981 ; D.A. Peel & E.W. Wolff, 1982 ; M.H. Bergin et al, 1994). En glaciologie, les recherches paléoenvironnementales s'appuient sur la certitude, confirmée par l'expérience que les couches de neige déposées à la surface du manteau nival conservent l'empreinte physico-chimique des masses d'air à l'origine de la précipitation.

La circulation atmosphérique du Groenland présente d'importantes variations annuelles conduites par les mouvements de descente du front polaire vers l'équateur pendant l'hivers et de son retrait vers les hautes latitudes pendant l'été (W.E. Raatz, 1991). L'interaction des différents systèmes anticycloniques d'Amérique du Nord et d' Europe avec les centres de basses pression arctiques où sibériens régit le déplacement de masses d'air d'origine changeante en direction du Groenland (P. Putnins, 1970). Géographiquement isolées des régions continentales sources de métaux, les parties centrales de la calotte Groenlandaise, d'altitudes élevées, reçoivent les précipitations originaires des hautes couches de la troposphère représentatives des processus météorologiques globaux.

Au cours du temps, l'accumulation de ces dépôts a constitué pour l'hémisphère nord de véritables archives du contenu en métaux des atmosphères passées. Ces archives, obtenues par carottages, se présentent sous la forme cylindres -carottes- de glace, de névé pour les couches superficielles

moins denses .

Les très faibles concentrations des microparticules métalliques présentes dans ces archives polaires classent les métaux lourds dans la catégorie des ultratrace et l'unité de mesure utilisée pour quantifier leurs concentrations est le picogramme par gramme. La mesure fiable d'éléments sous forme atomique ou de certains de leurs composés chimiques à de si faibles niveaux représente une gageure analytique où l'utilisation d'une technique performante de mesure (Spectrophotométrie d'Absorption Atomique à Four Graphite -GFAAS- (C.F. Boutron et al, 1991), Spectrométrie de Masse par Dilution Isotopique -IDMS- (K.J.R. Rosman et al, 1993) Spectrophotométrie de Fluorescence Atomique par Excitation Laser -LEAFS- (M.A. Bolshov et al, in press), Spectrométrie d'Emission Atomique Plasma induit par Micro-Ondes en Chromatographie Gazeuse à Colonne Capillaire -CCGC-MIP-AES- (R. Lobinski et al, 1993)), ne constitue que l'étape finale d'une procédure particulièrement complexe qui débute avant les prélèvements par un travail intensif de laboratoire. Au centre du Groenland, l'environnement est comparable à celui d'une salle blanche : l'opérateur et les matériels qui l'accompagnent sont alors les seules sources de particules étrangères à l'atmosphère du lieu et constituent ainsi une importante source potentielle de contamination des échantillons. L'opérateur doit être revêtu d'habits anti-émitifs de particules, ses déplacements et le choix du site de prélèvement doivent tenir compte de la direction du vent. Les conteneurs d'échantillons et les divers outils utilisés sur le terrain, sélectionnés en matériaux synthétiques (polyéthylène et teflons) dont les teneurs en métaux sont les plus faibles (en l'occurrence le polyéthylène basse densité (PE), le fluoro éthylène propylène (FEP), le perfluoro alkoxy (PFA)) doivent au préalable avoir été décontaminés. Ce traitement chimique a pour résultat de désorber de ces matériels les éventuelles inclusions de particules métalliques qui peuvent se trouver adsorbées au niveau des parois au cours de leur fabrication. Cette étape de décontamination se déroule en salle blanche de laboratoire ; les

procédures impliquées incluent l'usage intensif d'eau et d'acides ultrapurs notamment pour des immersions prolongées dans des bains d'acide chauffés (C.F. Boutron, 1990).

Dans le domaine de la glaciologie polaire, les seuls travaux fiables publiés directement à la suite des premières grandes campagnes de carottage au Groenland du début des années 60 sont ceux de Murozumi et al, (1969).

Ces premiers travaux concernent la mesure des concentrations en plomb dans 17 échantillons de glace prélevés dans la paroi d'une tranchée creusée dans un site voisin de Camp Century, base cotière au Nord Ouest du Groenland. Seize de ces échantillons intègrent un dépôt de glace correspondant à plusieurs années d'accumulation dont l'âge moyen est régulièrement espacé entre 1753 et 1965. Un échantillon âgé de 800 ans avant notre ère a servi de référence naturelle pour quantifier les variations observées dans les niveaux plus récents. La concentration en plomb mesurée pour l'échantillon de 1753 s'avera déjà 10 fois supérieure, au niveau naturel (~ 0.8 pg/g), révélant que les concentrations mesurées pour les années 1850, 1950 et 1965 étant respectivement 40, 120, et 230 fois plus élevées. L'augmentation rapide de ces concentrations depuis 1930 fût attribuée à l'introduction dans l'essence de composés alkylés au plomb à partir de 1923, puis à la consommation massive de ces additifs dans les années qui suivirent. L'accélération marquée de l'augmentation des concentrations en plomb à partir de la fin de la seconde guerre mondiale a été expliquée par l'essor des pays industrialisés pendant la période 1950-1965 (J.O. Nriagu, 1989b). Les résultats de ces travaux, menés sous l'égide de Clair C. Patterson montraient pour la première fois que les activités humaines liées au développement économique avaient pollué la planète dans son ensemble : Les flux des retombées en plomb au Groenland se révélant 200 fois supérieurs aux flux naturels. Cette découverte incita plusieurs gouvernements, ceux du Japon et des Etats Unis d'Amérique notamment, à prendre des mesures visant à réduire les émissions de plomb vers l'atmosphère. Elles consistèrent d'une part en une

diminution du taux de composés alkylés introduits dans l'essence et d'autre part à commercialiser un carburant dépourvu d'additifs au plomb d'autre part.

Cependant une polémique divisa la classe scientifique: cette découverte fut controversée par les résultats obtenus subséquemment par la totalité des autres équipes de chercheurs du domaine des sciences environnementales.

Cette situation perdura jusqu'en 1981 où Ng & Patterson confirmèrent la valeur de référence naturelle pour l'Holocène en mesurant des concentrations de plomb inférieures à 0.5 pg/g dans trois échantillons de glace du Groenland âgé de 2700 à 5500 ans. Toutes les autres valeurs de plomb mais aussi des autres métaux lourds publiées auparavant se révélèrent fausses, souvent de plusieurs ordres de grandeur (R.A. Carr & P.E. Wilkniss, 1973 ; J.H. Cragin et al 1975 ; M.M. Herron et al 1977 ; H.V. Weiss et al, 1978). Ceci s'avéra être la conséquence directe du non respect des protocoles opératoires évoqués précédemment ; les problèmes de contamination des échantillons avaient été sous- estimés voire même incompris.

Le premier objectif fixé au commencement du travail présenté dans ce mémoire est de dupliquer pour la première fois la la tendance temporelle observée pour le plomb par Murozumi et al. (1969) il y a 25 ans et de prolonger cette étude aux autres métaux lourds (Cd, Zn, Cu) qui, pareillement au plomb sont émis en quantités massives par les activités industrielles (J.O. Nriagu et J.M. Pacyna, 1988, J.M. Pacyna, 1991), mais dont les flux, contrairement au plomb, ne proviennent pas de façon majoritaire d'une même source .

A cette fin, nous avons utilisé une carotte prélevée à Summit, au centre du Groenland durant l'été 1989. Longue de 70m, cette carotte, contient en continu l'archivage des précipitations sur la période 1772-1989. Les résultats présentés dans ce mémoire font référence aux données obtenues précédemment par Boutron et al (1991) pour une carotte de 10.70 m couvrant la période 1967-1989 : ces dernières données montrent que les concentrations en métaux lourds, mesurées dans les

neiges de Summit ont diminué d'un facteur 7.5 pour le plomb, 2.5 pour le cadmium et le zinc mais n'ont significativement pas changé pour le cuivre durant cette période. Ces résultats, ont constitué la base de départ de ce travail. La carotte de 70 m a été recarottée en tenant compte de ces premiers résultats afin d'obtenir en réunissant l'ensemble des données un profil temporel sans chevauchement ; la technique de recarottage utilisée étant en tout point identique. Cette technique, décrite en détail par Görlach & Boutron (1992), consiste à prélever les parties centrales des carottes en y enfonçant des tubes parallèlement au grand axe de la carotte au travers de sections transversales vierges obtenues par fracture du tronçon selon un plan perpendiculaire à son axe. La résistance croissante du névé à la pénétration des tubes a rendu cette technique inopérante pour les profondeurs supérieures à 20 m, correspondant aux années antérieures à 1946. Nous avons alors développé une approche différente basée sur les travaux de Ng & Patterson (1981) et de Boutron & Patterson (1986) ; cette nouvelle technique fait l'objet d'une publication intitulée "An improved method for decontaminating polar snow or ice cores for heavy metal analysis", en cours de parution à Analytica Chimica Acta (Candelone J.P., Hong S., Boutron C., 1994). Dix tronçons de cette carotte intégrant chacun 1 ou 2 ans d'accumulation pendant la période 1773-1940 ont été ainsi recarottés.

Les résultats sont présentés dans un second article, intitulé "Post industrial revolution changes in large scale atmospheric pollution of the northern hemisphere for heavy metals as documented in central Greenland snow and ice" soumis à publication dans la revue "Journal of Geophysical Research" (Candelone J.P., Hong S., Pellone C., Boutron C., 1995). Ils révèlent l'émergence de la source anthropique pour les autres métaux lourds (Cd, Zn et Cu) et montrent que leurs concentrations présentent des variations temporelles globalement similaires pendant la période étudiée. Cela confirme que pour l'ensemble des métaux (Pb, Cd, Zn et Cu), les émissions anthropiques ont complètement éclipsé les sources naturelles sur un rythme croissant du milieu

du 18^{ème} siècle au début des années 1960. Pour le plomb toutefois, les concentrations mesurées dans les plus anciens échantillons montrent que les émissions anthropiques occultaient déjà les émissions naturelles.

La contribution de chacune des sources naturelles inventoriées demeure cependant mal connue: les plus récentes estimations donnent au mieux pour les émissions correspondantes des fourchettes d'un ordre de grandeur d'amplitude (17 pour Cd, 22 pour Zn, 24 pour Pb et Cu - J.O. Nriagu, 1989).

La source volcanique a fait l'objet de nombreuses investigations (G. Lambert et al, 1988). Par manque de traceur direct, la contribution de l'activité volcanique aux concentrations de métaux lourds dans la précipitation du Groenland était jusqu'à présent calculée à partir des rapports moyens métal/soufre mesurés dans les panaches et fumeroles volcaniques et de la fraction de sulfates imputée à la source volcanique dans les niveaux naturels. Il a en effet été montré que les flux anthropiques de soufre ont concurrencé les flux naturels dès la fin du 19^{ème} siècle et qu'ils demeurent majoritaires dans le bilan actuel du cycle atmosphérique du soufre ; respectivement 150 et 100 Tg S / an (M.O. Andreae, 1986, C.F. Cullis & M.M. Hirschler, 1980).

Le bismuth est un métal dont le cycle atmosphérique est gouverné par le volcanisme. L'idée de l'utiliser comme traceur de cette source est toutefois récente (C.C. Patterson & D.M. Settle 1987). Les concentrations de Bi sont cependant si faibles (de l'ordre de quelques dizaines de fg/g) qu'elles mettent ce métal hors de portée des moyens usuels de détection. Les récents développements analytiques en spectrométrie laser ont rendu possible la mesure directe du bismuth à très faible niveaux, tels ceux trouvés dans les échantillons de neiges et glaces polaires. Ces avancées techniques sont reportées dans un troisième article intitulé "Determination of bismuth down to sub pg/g level in Greenland snow by Laser Atomic Fluorescence Spectrometry"

paru dans le Journal de Physique (Candelone J.P., Bolshov M.A., Rudniev S.N., Hong S., Boutron C.F., 1994). Divers échantillons de neige fraîche et de la carotte de 10.70 m ont été préparés au Laboratoire de Glaciologie et analysés en bismuth par LEAFS à l'Institut de Spectroscopy de l'Académie des Sciences de Russie à Troitzk (Région de Moscou). Nous avons ainsi obtenu les premières valeurs de bismuth mesurées dans les neiges du Groenland. Ces résultats font l'objet d'une quatrième publication intitulée "Bi in recent snow from central Greenland : preliminary results" soumise à Atmospheric Environment (Candelone J.P., Bolshov M.A., Rudniev S.N., Hong S., Boutron C.F.). Ces résultats ont été exploités en confrontation avec l'approche habituelle basée sur le soufre pour l'estimation de la source volcanique dans une série de 36 échantillons prélevés dans un puit creusé à Summit en Juillet 92.

L'étude des variations saisonnières des métaux lourds dans ces échantillons de puit déposés entre le printemps 90 et l'été 92 constitue le troisième volet du travail présenté dans ce mémoire. Historiquement, l'idée d'une variabilité temporelle du dépôt des métaux est due à Murozumi et al. (1969): outre leur série temporelle, ces chercheurs mesurèrent les concentrations en plomb dans 5 échantillons de névé intégrant chacun des couches de neige successivement déposées au cours de l'année 1964. La variation observée leur suggéra que les conditions météorologiques rythment l'arrivée des masses d'air polluées au Groenland selon un cycle saisonnier, favorisant l'hivers comme période de dépôt maximal.

Cette hypothèse a été confirmée à plusieurs reprises. Tout d'abord, des prélèvements d'aérosols selon des sites cotiers ont montré d'importantes variations de concentrations en métaux en cours d'année dans l'aérosol de basse altitude (N.Z. Heidam, 1986). Plus tard, une série d'échantillons de neige recouvrant l'année 1983 ont révélé qu'au niveau de la calotte, au site de Dye3 (Sud Est du Groenland), une arrivée importante de métaux dans la déposition se produit en fin d'hivers et au début du printemps (E.W. Wolff & D.A. Peel, 1988). Ensuite, d'autres séries saisonnières

provenant de puits de la région de Summit ont permis de mieux appréhender le phénomène (J. Savarino et al. 1994, E.A. Boyle et al., 1994).

Interprétées en terme de sources et de transport, nos données forment un cinquième article soumis à Earth and Planetary Science Letters sous le titre "Seasonal variations in heavy metals concentrations in present day Greenland snows" (Candelone J.P., Hong S., Pellone C., Boutron C.F., 1995). Dans ces échantillons, les concentrations totales sont voisines de celles observées pour les années 1900-1920 ; par rapport à des échantillons plus anciens (ceux des années 1960 ou 1970), la proportion de la contribution des sources naturelles est donc plus importante. Nous nous sommes attachés à donner des estimations des contributions relatives de chacune des sources naturelles repertoriées. L'absence des trajectographies des masses d'air à l'origine de la précipitation à Summit rend l'interprétation en termes de sources assez délicate.

La dernière partie de ce mémoire se focalise plus particulièrement sur la spéciation du plomb dans des échantillons de Summit, et présente les résultats obtenus conjointement avec d'autres groupes de recherche à l'étranger. La préparation et le conditionnement des échantillons se sont déroulés sous notre contrôle au LGGE, les mesures, par contre, ont été effectuées par nos collègues des laboratoires avec lesquels nous collaborons, sans toutefois que y participions d'une façon directe.

D'une part, ces résultats concernent la composition isotopique du plomb mesurée par IDMS au département de Physique de l'Université Curtin de Perth (Australie). Ils se présentent sous forme d'une première série de deux articles intitulés "Isotopic evidence for the source of lead in Greenland snows since the late 1960s" (Rosman K.J.R., Chisolm W., Boutron C.F., Candelone J.P. and Görlach U., 1993) et "Isotopic evidence to account for changes in the concentrations of lead in Greenland snow between 1960 and 1988" (Rosman K.J.R., Chisolm W., Boutron C.F., Candelone J.P., Hong S., 1994), publiés respectivement dans les revues Nature et Géochimica

et Cosmochimica Acta.

D'autre part, ces résultats présentent, dans une seconde série de deux autres articles, les analyses des différents composés d'alkyles de plomb mesurés par CCGC-MIP-AES au département de Chimie de l'Université d'Anvers (Belgique). Le premier, de titre "Speciation analysis of organolead compounds in Greenland snows at the fg/g by capillary gas chromatography /atomic emission spectrometry" (Lobinski R., Boutron C.F., Candelone J.P., Hong S., Szpunar-Lobinska J., Adams F.C., 1993) explicite la méthode analytique développée pour ces analyses ; le second, intitulé "Present Century Snow Core Record of Organolead Pollution in Greenland" (Lobinski R., Boutron C.F., Candelone J.P., Hong S., Szpunar-Lobinska J., Adams F.C., 1994). montre l'évolution des concentrations des alkyles de plomb depuis leur production dans les années 1920 à nos jours. Ces deux articles ont été respectivement publiés dans les revues Analytical Chemistry et Environmental Science Technology.

REFERENCES

- Andreae M.O., The ocean as a source of atmospheric sulfur compounds, in *The role of air-sea exchange in Geochemical Cycling*, P. Buat-Menard Ed., 331-362, 1986.
- Bergin M.H., J.L. Jaffrezo, C.I. Davidson, R.Caldow, J. Dibb, Fluxes of chemical species to the Greenland ice sheet at Summit by fog and dry deposition, *Geochim. Cosmochim. Acta* 1994.
- Bolshov M.A., S.N. Rudniev, J.P. Candelone, S. Hong and C.F. Boutron, Ultratrace determination of Bi by Laser Atomic Fluorescence Spectrometry, *Spectrochim. Acta B*, in press.
- Boutron C.F. and C.C. Patterson, lead concentration changes in Antarctic ice during the Wisconsin/Holocene transition, *Nature* 323, 222-225, 1986.
- Boutron C.F., A clean laboratory for ultralow concentration heavy metal analysis, *Fresenius' Z. Anal. Chem.* 337, 482-491, 1990.
- Boutron C.F., U. Görlach, J.P. Candelone, M.A. Bolshov and R.J. Delmas, Decrease of anthropogenic lead, cadmium and zinc in Greenland snows since the late 1960s, *Nature* 353, 153-156, 1991.
- Boyle E.A., R.M. Sherrell and M.P. Bacon, Lead variability in the western North Atlantic ocean and central Greenland ice : implications for the search for decadal trends in anthropogenic emissions, *Geochim. Cosmochim. Acta*, 58, 3227-3238, 1994.
- Carr R.A. and P.E. Wilkniss, Mercury in the Greenland ice sheet : further data, *Science* 181, 843-844, 1973.
- Cragin J.H., M.M. Herron and C.C. Jr. Langway , *The chemistry of 700 years of precipitation at Dye 3, Greenland*. U.S. Army Cold Regions research and Engineering Laboratory (USA CRREL) research report 341, 1975.
- Cullis C.F. and M.M. Hirschler, Atmospheric sulfur : natural and man-made sources, *Atm. Environ.* 14, ?, 1263-1278, 1980.

- Davidson C.I., T.C. L. Chu, T.C. Grimm, M.A. Nasta and M.P. Qamoos, Wet and dry deposition of trace elements onto the Greenland ice Sheet, *Atm. Environ.* 15, 8, 1429-1437, 1981.
- Davis J.M. and D.J. Svendsgaard, Lead and child development, *Nature* 329, 297-300, 1987.
- D'Itri F.M. Mercury contamination What we have learned since Minamata, *Env. Monitor. and Assess.* 19, 165-182, Kluwer Acad. Publ., 1991.
- Elinder C.G., Metabolism and toxicity of metals in Changing metal cycles and human health , Ed. J.O. Nriagu, 265-274, Dalhem Konferenzen, Springer-Verlag, Berlin, 1984.
- Flegal A.R. & C.C. Patterson, Vertical concentration profiles of lead in the Central Pacific at 15°N and 20°S, *Earth Planet Sci. Lett.* 64, 19-32, 1983.
- Görlach U. and C.F. Boutron, Changes in heavy metals concentrations in Antarctic snows from 1940 to 1980, *J. Atmos. Chem.* 14, 205-222, 1992.
- Heidam N.Z., The Greenland aerosol : elemental composition, seasonal variations and likely sources, in: *Arctic Air Pollution*, B. Stonehouse, Ed., 37-52 , Cambridge University press, Cambridge, 1986.
- Herron M.M., C.C. Jr. Langway, H. V. Weiss, J.H. Cragin, Atmospheric trace metals and sulfate in the Greenland ice sheet, *Geochim. Cosmochim. Acta* 41, 915-920, 1977.
- Kim J.P. and W.F. Fitzgerald, Sea-air partitioning of mercury over the equatorial Pacific ocean, *Science* 231, 1131-1133, 1986.
- Lambert G., M.F. Le Cloarec and M. Pennisi, Volcanic output of SO₂ and trace metals : a new approach, *Geochim. Cosmochim. Acta* 52, 39-42, 1988.
- Lobinski R., C.F. Boutron, J.P. Candelone, S. Hong, J. Szpunar-Lobinska and F. Adams, Speciation analysis of organolead compounds in Greenland snow at the fg/g level by capillary gas chromatography/atomic emission spectrometry, *Anal. Chem.* 65, 2510-2515, 1993.
- Murozumi M., T.J. Chow and C.C. Patterson, Chemical concentrations of pollutant lead aerosols, terrestrial dusts and sea salts in Greenland and Antarctic snow strata, *Geochim. Cosmochim.*

- Acta 33, 1247-1294, 1969.
- Ng A. and C.C. Patterson, Natural concentrations of Lead in ancient Arctic and Antarctic ice, *Geochim. Cosmochim. Acta* 45, 2109-2121, 1981.
- Nogawa K., Cadmium in Changing metal cycles and human health, J.O. Nriagu Ed., *Dalhem Konferenzen*, Springer-Verlag, Berlin, 275-284, 1984.
- Nriagu J.O., Global inventory of natural and anthropogenic emissions of trace metals to the atmosphere, *Nature* 279, 409-411, 1979.
- Nriagu J.O., Lead and Lead poisoning in antiquity, J. Wiley & Sons Eds., New-york, 437 p., 1983.
- Nriagu J.O. and J.M. Pacyna, Quantitative assessment of worldwide contamination of air, water and soils by trace metals, *Nature* 333, 134-139, 1988.
- Nriagu J.O., A global assessment of natural sources of atmospheric trace metals, *Nature* 338, 47-49, 1989.
- Nriagu J.O., The history of leaded gasoline, Geneva, Switzerland, 12-18 September, J.P. Vernet Ed., 361-366, Page Bros., Norwich, U.K., 1989.
- Nriagu J.O., Global metal pollution : Poisoning the biosphere?, *Environment*, 32, 7, 1990a.
- Nriagu J.O., Human influence on the global cycling of trace metals, *Palaeogeography, Palaeo-climatology, Palaeoecology (Global and Planetary Change Section)* 82, 113-120, 1990b.
- Pacyna J.M., Emission Factors of Atmospheric Cd, Pb and Zn for Major Source Categories in Europe in 1950 through 1985, Report OR 30/91, Norwegian Institute for Air Research, Lillestrom, Norway, 1991.
- Pacyna J.M., Atmospheric deposition, of heavy metals to the Baltic sea, Toronto, Canada, 12-16 September, R.J. Allan and J.O. Nriagu Eds., 93-96, Page Bros, Norwich, U.K., 1993.
- Patterson C.C., British mega exposures to industrial lead in *Lead Versus Health*, M. Rutter and R. Russel Jones Eds., 17-32, J. Wiley & Sons, New-York, 1983.

- Patterson C.C. and D.M. Settle, Magnitude of lead flux to the atmosphere from volcanoes, *Geochim. Cosmochim. Acta* 51, 675-681, 1987.
- Peel D.A., E.W. Wolff, Recent variations in heavy metal concentrations in firn and air from the Antarctic peninsula, *Ann. Glac.* 3, 255-259, 1982.
- Putnins P., The climate of Greenland, in *Climates of the polar regions, world survey of climatology*, S. Orvig Ed., 3-128, Elsevier, New-York, 1970.
- Raatz W.E., The climatology and meteorology of Arctic air pollution, in: *Pollution of the Arctic atmosphere*, W.T. Sturges Ed., 13-42, Elsevier, London, 1991.
- Rabinowitz M.B., G.W. Wetherhill and J.D. Koppler, *Science* 182, 725, 1973.
- Rosman K.J.R., W. Chisholm, C.F. Boutron, J.P. Candelone and U. Görlach, Isotopic evidence for the source of lead in Greenland snow since the late 1960s, *Nature* 362, 333-335, 1993.
- Savarino J., C.F. Boutron and J.L. Jaffrezo, Short-term variations of Pb, Cd, Zn and Cu in recent Greenland snow, *Atm. Environ.* 28, 11, 1731-1737, 1994.
- Ward N.I. and D. Bryce-Smith, Lead Cadmium and zinc levels in relation to fetal development and abnormalities (stillbirths, spina bifida and hydrocephalus), Toronto, Canada, 12-16 September, R.J. Allan and J.O. Nriagu Eds., 93-96, Page Bros, Norwich, U.K., 1993.
- Weiss H.V., M. Koide and E.D. Goldberg, Mercury in the Greenland ice sheet : evidence of recent input by man, *Science* 174, 692-694, 1971.
- Wolff E.W. and D.A. Peel, Concentrations of cadmium, copper, lead and zinc in snow from near Dye 3 in South Greenland, *Ann. Glaciol.* 10, 193-197, 1988.
- Wright D.A., K.I. Adare, S.M. Lingard and P.M. Welbourn, Bioaccumulation of mercury by Crayfish in a field transplant experiment, Toronto, Canada, 12-16 September, R.J. Allan and J.O. Nriagu Eds., 93-96, Page Bros, Norwich, U.K., 1993.

**AN IMPROVED METHOD FOR DECONTAMINATING POLAR SNOW OR ICE CORES
FOR HEAVY METAL ANALYSIS**

Jean-Pierre CANDELONE, Sungmin HONG and Claude F. BOUTRON

*Submitted to Analytica Chimica Acta, May 17, 1994
in press.*

**AN IMPROVED METHOD FOR DECONTAMINATING POLAR SNOW OR ICE CORES
FOR HEAVY METAL ANALYSIS**

Jean-Pierre CANDELONE¹, Sungmin HONG¹ and Claude F. BOUTRON^{1,2*}

¹ *Laboratoire de Glaciologie et Géophysique de l'Environnement du CNRS, 54, rue Molière,
Domaine Universitaire, B.P. 96, 38402 St Martin d'Hères (France)*

² *UFR de Mécanique, Université Joseph Fourier de Grenoble, Domaine Universitaire, B.P. 68, 38041
Grenoble, France*

** Author to whom correspondence and reprints requests should be addressed
Phone : (33) 76 82 42 00 - Fax : (33) 76 82 42 01*

*Submitted to Analytica Chimica Acta, May 17, 1994
in press.*

ABSTRACT

An improved method has been developed for the decontamination of Greenland and Antarctic snow or ice cores for heavy metal analysis. The investigated core sections are chiselled while being held horizontal in a polyethylene lathe inside a laminar flow clean bench in a cold room. Each veneer layer and the final inner core are then analysed for Pb, Cd, Zn and Cu by Graphite Furnace Atomic Absorption Spectrometry in clean room conditions.

The procedural blank was found to range from 0.015 pg/g for Cd up to 0.25 pg/g for Cu. The quality of the decontamination was checked by studying changes in heavy metals concentrations from the outside to the center of each core section. In most cases, good plateaus of concentrations were observed in the central parts, then indicating that contamination present on the outside of the cores was not transferred to these central parts. Various Greenland and Antarctic cores were decontaminated, giving new insights into the past and recent occurrence of heavy metals in the atmosphere of both hemispheres.

KEY WORDS : heavy metals, lead, cadmium, zinc, copper, snow, ice, Greenland, Antarctica, global pollution

1. INTRODUCTION

The successive well preserved snow and ice layers deposited in the large Antarctic and Greenland ice sheets are unique archives of the past and recent changes in the atmospheric concentrations of heavy metals. Deciphering these archives for heavy metals has unfortunately proved to be very difficult mainly because the concentrations to be measured are extremely low, down to the sub pg/g level.

A key point to obtain reliable data is in the cleanliness of the available samples. For near surface snow, clean samples can be obtained from the walls of clean hand dug pits [1, 2] or trenches [3], or by using specially designed clean augers [4]. But deeper layers can only be reached by using large size electromechanical [5] or thermal [6] drills. Such drills provide us with snow/ice cores whose diameters range from about 3 to 5 inches (7.5 to 13 cm), the most frequent diameter being 4 inches (10.2 cm).

A major problem is that the cores are always more or less contaminated on their outside. This contamination originates from various contributions. The main one is the wall retaining fluid (amongst the fluid used are kerosene and freon [7] and n butyl acetate [8]) when such a fluid is required to prevent the closing of the drilling hole at great depths. But other contributions can also originate from the body of the drill, the cable and the handling, packing and storage of the core.

To obtain reliable heavy metals data from such cores, it is therefore essential to be able to decontaminate them by removing the outside contamination without transferring it to the most central parts and to check the efficiency of the procedure.

Although this problem has already been tackled by a few investigators [9-12], none of them has until now developed a fully satisfying method, i.e. a method which is ultraclean, suitable both for snow or ice cores, not too much time consuming and which allows to check the efficiency of the procedure.

We present here an improved ultraclean mechanical decontamination procedure for snow or ice cores. It has been successfully used for the decontamination of various sections of several snow and ice cores from Greenland and Antarctica.

2. EXPERIMENTAL

The experimental procedure requires two operators. It consists in chiselling successive layers of snow or ice from the outside to the central part of the core using ultraclean stainless steel chisels. The core is kept horizontal, its extremities tightly secured in Low Density Polyethylene (LDPE) tumblers.

2.1. Laminar flow clean bench in a cold room

The whole decontamination procedure takes place in a laminar flow clean bench located inside a cold room at - 15°C. The inside of the bench is entirely made out of plastics. Moreover, the working area is covered with a thin LDPE film which is changed regularly. The bench is fitted with a special High Efficiency Particulate Air (HEPA) filter (99.999 % efficiency at 0.5 µm) with particulate board frames and plastic separators. It has no rubber or polyurethane compressible gasket : the seal between the HEPA filter frame and the ceiling of the bench is made with silicone cement [13]. The operators wear full clean room garb over their warm clothing. Over their isothermic gloves, they also wear shoulder length LDPE gloves and wrist length LDPE gloves over these. These last gloves are changed as often

as required.

2.2. Polyethylene lathe

A major improvement is the fact that during the chiselling, the core is not held with the hands of the operator and is not laying on any working surface. Instead, it remains horizontal about 20 cm above the plastic working surface as its extremities are pinched in two LDPE tumblers (Fig. 1). The lathe is designed so that it can be used in order to decontaminate snow or ice cores whose lengths range from 25 to 65 cm. Also, it is suitable not only for cylindrical cores with full section but also for cores for which only part of the cross section is available. This last situation occurs frequently for ice cores obtained as part of international programmes : a given core section is indeed cut into several parts used for different kinds of measurements (Fig. 2). At both extremities, the core is fastened in the tumblers using 3 to 6 home made LDPE screws which are screwed, perpendiculary to the axis of the core, through threaded holes made in the lateral side of the tumblers, Fig. 1. Depending on the available cross section, several sets of screws of different lengths can be used.

2.3. Chisels

It would have been preferable to make the chisels out of plastics such as LDPE, Fluorinated Ethylene Propylene (FEP) or Perfluoroalkoxy (PFA) Teflon. Unfortunately, such plastics are too soft for high density snow and for ice. Therefore, the chisels chosen are similar to those used by Ng and Patterson [9] and Boutron and Patterson [10, 11], Fig. 3. They are made out of a single piece of 2 mm thick plate of stainless steel (ref 316 L). The cutting edge is 3 cm wide and 4 cm long. It is sharpened to a single

acute bevel with an angle of 30°.

Before use, the chisels, cleaned as described in 2.5, are kept horizontal inside a LDPE box, each of them fitted separately in a display rack which prevents any contact between the chisels and allows the cutting edges not to touch the walls of the box.

2.4. Description of the procedure

The core section to be decontaminated is taken out from the LDPE bag inside which it was transported frozen from Antarctica or Greenland back to France. After changing their outer wrist-length LDPE gloves, the two operators introduce the core inside the laminar flow clean bench and put it in the lathe (Fig. 1). The core is then firmly secured between the two tumblers with the LDPE screws, Fig. 1.

A first veneer layer 5 to 10 mm thick is then chiselled as follows. A shallow chord shaving is first made from one end of the core to the other parallel to its axis, the snow or ice chips being allowed to fall directly into a specially designed LDPE tray held by the second investigator. Using the crank, the cut is rotated upward about 30° and another shallow chord shaving is made. The procedure is then repeated until the whole exposed outside surface has been chiselled. The chips obtained from this first layer are then transferred from the tray into an ultraclean 1 L wide mouth LDPE bottle and kept frozen until analysis.

The operators then put on new fresh pairs of LDPE gloves and a second layer is chiselled using another chisel and a new fresh tray. Depending on the initial cross section of the core, this procedure is repeated

up to 4 times then giving a maximum of 4 successive layers from the outside towards the center.

The remaining inner core (whose diameter ranges from 2 to 4.5 cm) is then recovered as follows : the first operator holds it firmly with all LDPE home made tongs while the other operator breaks the right end with the last chisel. The right hand pillar of the lathe (part 4 in Fig. 1) is then moved away. An ultraclean [13] 1 L wide mouth LDPE bottle is pushed onto the inner core until about half of it is introduced into the bottle. The inner core is broken in its middle with the chisel and its second half is introduced into a second 1 L bottle. Then the left edge of the inner core is broken with the chisel.

The bottles containing the chips from the successive veneer layers and the two parts of the inner core are then packed into double sealed acid cleaned LDPE bags and brought to the main clean laboratory at 20°C [13].

2.5. Cleaning procedures

They are similar to those described in full details elsewhere [13]. For the various small size items such as the tumblers, the screws, the trays and the 1 L bottles, the initial cleaning before the first use involved degreasing with CHCl_3 , then soaking 1 month in a first acid bath at 50°C (25% Merck "Suprapur" HNO_3 diluted in ultrapure water [13]), 1 month in a second acid bath at 50°C (0.1% ultrapure HNO_3 from US National Institute of Standards and Technology (NIST) [14] diluted in ultrapure water [13]), and finally 1 month in a third 0.1% ultrapure NIST HNO_3 bath at 50°C. Transfers from one bath to the next one are made using home made LDPE tongs.

The cleaning between each core decontamination is similar except that soaking is for only 2 hours in the first bath and for 3 days in the other ones.

For the very large size items such as the basement of the lathe, a simplified procedure was used. It however also involved extensive cleaning with HNO_3 .

Finally, the cleaning procedure for the chisels involved degreasing with ether, then overnight soaking in 60% HNO_3 bath (Merck "Suprapur" diluted in purest water) and finally soaking in a series of two 0.1% NIST HNO_3 baths for one week (for the initial cleaning, immersions were for a much longer time period).

2.6. Analytical procedures

Inside the clean laboratory [13], each veneer layer and the inner core are melted separately in the 1 L wide mouth LDPE bottle in which they were kept. Various aliquots are then taken in 15 ml or 60 ml ultraclean [13] LDPE bottles. A 5 ml aliquot is first taken for the direct measurement of Zn, Al and Na by Graphite Furnace Atomic Absorption Spectrometry (GFAAS) without preconcentration using a Perkin Elmer 2380 spectrometer and HGA 500 graphite furnace (pyrolytically coated

graphite tubes) [15]. A 50 ml aliquot is then taken for the determination of Pb, Cd and Cu by GFAAS after preconcentration (x 50) by non boiling evaporation [15].

If necessary, additional aliquots are also made for subsequent analysis of Pb isotopes [16], organo Pb compounds [17], Hg [18] and Bi [19, 20]. These last measurements will not be discussed in the present paper.

3. RESULTS AND DISCUSSION

3.1. Determination of the procedural blank

Such determination is essential to obtain fully reliable data. The procedural blank was determined by processing an artificial ice core made out by freezing ultrapure water [13] whose composition, Table 1, was known beforehand. This core was prepared by freezing 2 L of ultrapure water inside a 2 L LDPE ultraclean bottle. The inside diameter of the bottle was about 11.2 cm, then allowing to prepare an artificial ice core whose diameter was similar to that of real Greenland or Antarctic cores.

The bottle was cut using an acid cleaned stainless steel scalpel and the artificial ice core (length about 20 cm) so obtained was chiselled using exactly the same procedure as previously described in 2.4. Three layers were chiselled before getting the final inner core. Each layer and the inner core were analysed separately.

As shown in Table 1, heavy metals concentrations are found to be slightly higher in the last veneer layer

and in the inner core than in the reference water used to prepare the core. The differences so observed, listed in Table 2, represent the procedural blank. This procedural blank will then be used for the correction of all the values obtained for Greenland and Antarctic real cores. For the inner core, the blank values are found to range from 0.015 pg/g for Cd up to 0.25 pg/g for Cu (these values include the blank of the non boiling evaporation procedure, which represents a rather small contribution to the total blank). For recent Greenland snow cores in which the concentrations are relatively high due to very significant anthropogenic contribution, this procedure blank contribution is extremely small, it represents less than a few percents of the measured concentrations. For ancient Greenland or Antarctic ice, on the other hand, it can be very significant (up to about 30% for Cu, 25% for Pb, and 10% for Cd and for Zn) since heavy metals concentrations in such ancient ice are much lower.

It is interesting to mention that the concentrations measured in the veneer layers are significantly higher for all four metals than those observed in the inner core, Table 2. This was expected since the veneer layers are subject to more handling than the inner core : the contact with the chisel is much more extensive ; the chips do contact the inner tray ; and they are also exposed to the air flow in the clean bench for a much longer time.

The precision of these procedural blanks is difficult to assess, since the artificial core chiselling experiment was done only once because it is very time consuming. It is however interesting to mention that the concentrations measured in the 2nd and 3rd veneer layers of the artificial core were very similar, then suggesting that the precision on the blanks is probably rather good (concentrations measured in the 1st layer were on the other hand found to be significantly higher because of the handling of the core prior to its chiselling).

It is important to emphasize that this artificial core was ice, not snow. We have however used the blank values for Greenland and Antarctic snow cores. It would indeed be extremely difficult to prepare an artificial snow core of known composition. Moreover, it is our feeling that the blank contributions for such a snow core would not be significantly different. If this is not the case, however, it is expected that the blank for the ice might rather be an upper limit of the blank for the snow : this would result into a slight over correction of the snow core data.

3.2. Outside - inside concentration profiles

For each decontaminated core section and each investigated heavy metal, it is essential to study in full details changes in the concentrations from the outside to the inner part of the core. If a clear plateau of concentration is observed in at least two consecutive layers in the central part of the core, it shows that contamination present on the outside has not penetrated to the central part of the core : the plateau value then represents the original concentration in the Antarctic or Greenland snow or ice. If, on the other hand, a continuous decrease of concentration is observed towards the center, it evidences that outside contamination has penetrated to the very center of the core : the concentration measured in the inner part will only represent an upper limit of the real concentration in the original snow or ice.

Very contrasting situations have been obtained for the different snow or ice cores which we have decontaminated in this work. Typical outside - inside profiles are discussed in the following sections.

3.3. Shallow electromechanical snow core from central Greenland

In July 1989, a 70.3 m long snow core covering the years 1772 - 1989 has been drilled at Summit (72° 58'N, 37° 64'W elevation 3,238 m a.s.l., mean annual temperature -32°C) in central Greenland as part

of the european "Eurocore" programme. It was obtained using a 4 inches in diameter electromechanical drill [21]. Such a drill is known to bring significant contamination on the outside of the core sections mainly because of the contact with the knives (2% C and 11.5% Cr steel) and the framework (stainless steel with Teflon coating) of the drill, and the contact of the galvanized steel cable with the walls of the drilling hole. Concentrations measured in the outermost layer of the core sections were indeed found to range from 10 to 100 pg/g for Cd, 100 to 500 pg/g for Pb and Cu, and 1000 to 5000 pg/g for Zn. It must however be emphasized that these values are for the first 1 cm or so from the outside of the core : the actual contamination present on the very outside of the core was then probably much higher. Also, it is interesting to notice that it is for Zn that the contamination is the most pronounced. This suggests that the cable does contribute a significant fraction of the contamination.

Typical outside - inside concentration profiles are shown in Figs. 4, 5 and 6. In most cases, good plateaus of concentrations are obtained as illustrated in Fig. 4 for Pb in the 70 m section and for Cu in the 21.5 m section. This is also the case for the two profiles shown in Fig. 5 : for these last two profiles the slight difference observed between the inner core and the next to last layer is indeed within the experimental errors. The fact that good plateaus were observed in most cases was not easy to foretell. It was indeed to be feared that outside contamination could penetrate deeply into such porous snow, which was finally not the case.

In a few cases however, we observed a continuous decrease of concentrations from the outside to the very center of the core as illustrated in Fig. 6 for Zn and Cu in the 52 m section. For these last cases, the concentrations obtained in the inner core must then be considered as upper limits of the original concentrations in the snow. The actual reasons for these few cases are not known, they could however

be linked to difficulties encountered in the field during drilling operations and/or core handling.

Fig. 7 shows changes in the concentrations of Zn and Cd measured in the inner core as a function of the age of the snow from 1773 to 1965. It can be seen that the concentrations of these two metals have significantly increased from the 1770's, i.e the Industrial Revolution period, to the 1960's. The increase factor is about 5 for Cd and Zn [22]. The causes for these increases are discussed in full details elsewhere [22]. They are linked to the increasing emissions of these two metals to the atmosphere of the Northern Hemisphere by human activities during this period (fossil fuels burning, mining, non ferrous metal industry and refuse incineration [23, 24]).

3.4. Deep electromechanical ice core from central Greenland

At the same location in central Greenland, a 3,028.8 m long ice core was recovered by electromechanical drilling in 1990 - 1992 as part of the joint european Greenland Ice Core Project ("GRIP"). This core covers the last 250,000 years [5].

The electromechanical drill is described in details in Ref. [25]. Because the depth to be reached was very important, the drilling hole was filled with a wall retaining fluid. The main constituent of the fluid was kerosene. We have decontaminated various sections of this deep ice core. Because many other programmes of investigations were conducted on the same core sections, only a limited part of the core cross section (see Fig. 2 b, c) was available.

Significant contamination was found to be present in the outermost layer of the sections. This

contamination probably originates at least partially from the fluid. Good plateaus of concentrations were however obtained in most cases as illustrated in Fig. 8 for Pb in the 1,286 m section (age : 7,760 years BP) and for Zn in the same section. This evidences that the ice acted as a good barrier against transfer of contamination from the outside towards the center of the core, at least for the investigated core sections which were chosen because no visible cracks were seen in them.

Pb concentration, 0.55 pg/g, measured in the inner core of the 1,286 m core section represents the natural concentration level of Pb in Greenland ice before the Greco-Roman times when man started to significantly contaminate the atmosphere of the Northern Hemisphere because of silver-lead mining and smelting [26, 27]. As discussed in [27], it mainly originated from rock and soil dust.

3.5. Deep thermal ice core from central Antarctica

In 1977, 1978 a 905 m ice core was thermally drilled at Dome C (77° 39'S, 124° 10'E ; elevation 3,240 m a.s.l. ; mean annual temperature : - 53.5°C) as part of a french-american cooperation. It was thermally drilled in a dry hole which was not filled with a wall retaining fluid [28]. This core covers the past 40,000 years [29] i.e. the whole Holocene interglacial period (the past 10,000 years or so) and part of the last Ice Age. Fig. 9 displays the variations of Pb and Cd concentrations from the outside to the center of the 515 m core section (age : 14,500 years BP). Despite the fact that the core was obtained in a dry hole without fluid, pronounced contamination is present on the outside of the section. This contamination is found to have significantly penetrated to the second layer. Fortunately, a good plateau of concentration is obtained beyond this second layer, Fig. 9.

Pb and Cd concentrations observed in the central part of this core section, 7.8 pg/g and 0.5 pg/g,

respectively, are typical for Antarctic ice from the Last Glacial Maximum (LGM) i.e the very cold terminal stage of the last Ice Age. They are mainly originating from soil and rock dust : the atmospheric cycles of these two metals were indeed dominated by rock and soil dust during the LGM when the climatic conditions led to increased aridity, stronger winds and enhanced meridional circulations [11, 30].

ACKNOWLEDGEMENTS

This work was supported by the French Ministry of the Environment (Grant nb 92295), the Institut National des Sciences de l'Univers and the University of Grenoble. The Greenland samples were collected as part of the Eurocore and GRIP programmes which were funded by the Commission of European Communities and national funding agencies and organizations in Belgium, Denmark, France, Germany, Iceland, Italy, Switzerland and the United Kingdom. The Antarctic samples were collected as part of a french - american collaboration which was funded by the Expéditions Polaires Françaises, the Terres Australes et Antarctiques Françaises and the Division of Polar Programmes of the US National Science Foundation. We thank C. Rado, R.J. Delmas and F. Maupetit for their participation in the Eurocore field sampling.

REFERENCES

1. E.W. Wolff and E.D. Suttie, *Geophys. Res. Lett.* **21** (1994) 781.
2. E.D. Suttie and E.W. Wolff, *Tellus* **44B** (1992) 351.
3. M. Murozumi, T.J. Chow and C.C. Patterson, *Geochim. Cosmochim. Acta* **33** (1969) 1247.
4. C.F. Boutron, U. Görlach, J.P. Candelone, M.A. Bolshov, R.J. Delmas, *Nature* **353** (1991) 153.
5. W. Dansgaard, S.J. Johnsen, H.B. Clausen, D. Dahl-Jensen, N.S. Gundestrup, C.U. Hammer, C.S. Hvidberg, J.P. Steffensen, A.E. Sveinbjörnsdottir, J. Jouzel and G. Bond, *Nature* **364** (1993) 218.
6. J. Jouzel, C. Lorius, J.R. Petit, C. Genthon, N.I. Barkov, V.M. Kotlyakov and V.N. Petrov, *Nature* **329** (1987) 403.
7. B.B. Kudryashov, V.K. Chistyakov, V.M. Pashkevich and V.N. Petrov in G. Holdsworth, K. C. Kuivinen and J.H. Rand (Eds), Proceedings of the Second International Symposium on Ice Drilling Technology, Calgary, Canada, 30 - 31 August 1982, *US Army Cold Regions Research and Engineering Laboratory, Special Report 84 - 34*, Hanover, New Hampshire (1984) 137.
8. T.A. Gosink, J.T. Kelley, B.R. Koci, T.W. Burton and M.A. Tumeo, *J. Glaciol.* **37** (1991) 170.
9. A. Ng and C.C. Patterson, *Geochim. Cosmochim. Acta* **45** (1981) 2109.
10. C.F. Boutron and C.C. Patterson, *Geochim. Cosmochim. Acta* **47** (1983) 1355.
11. C.F. Boutron and C.C. Patterson, *Nature* **323** (1986) 222.
12. E.W. Wolff and D.A. Peel, *Ann. Glaciol.* **7** (1985) 61.
13. C.F. Boutron, *Fresenius Z. Anal. Chem.* **337** (1990) 482.
14. P.J. Paulsen, E.S. Beary, D.S. Bushee and J.R. Moody, *Anal. Chem.* **60** (1988) 971.

15. U. Görlach and C.F. Boutron, *Anal. Chim. Acta* **236** (1990) 391.
16. K.J.R. Rosman, W. Chisholm, C.F. Boutron, J.P. Candelone, U. Görlach, *Nature* **362** (1993) 333.
17. R. Lobinski, C.F. Boutron, J.P. Candelone, S. Hong, J. Szpunar-Lobinska and F.C. Adams, *Anal. Chem.* **65** (1993) 2510.
18. G.M. Vandal, W.F. Fitzgerald, C.F. Boutron and J.P. Candelone, *Nature* **362** (1993) 621.
19. M.A. Bolshov, S.N. Rudniev, J.P. Candelone, S. Hong, C.F. Boutron, *Spectrochim. Acta B*, in press.
20. J.P. Candelone, M.A. Bolshov, S.N. Rudniev, S. Hong and C.F. Boutron, *J. Phys.*, **C4** (1994) 661.
21. F. Gillet, D. Donnou, C. Girard, A. Manouvrier, C. Rado and G. Ricou, in G. Holdsworth, K.C. Kuivinen and J.H. Rand (Eds.), Proceedings of the Second International Symposium on Ice Drilling Technology, Calgary, Canada, 30 - 31 August 1982, *US Army Cold Regions Research and Engineering Laboratory, Special Report 84 - 34*, Hanover, New Hampshire (1984) 73.
22. J.P. Candelone, S. Hong, C.F. Boutron, *J. Geophys. Res.*, submitted.
23. J.O. Nriagu, *Nature* **209** (1979) 409.
24. J.O. Nriagu and J.M. Pacyna, *Nature* **323** (1988) 134.
25. N.S. Gundestrup and S.J. Johnsen in C.C. Langway Jr., H. Oeschger and W. Dansgaard (Eds), *Greenland Ice Cores : Geophysics, Geochemistry and the Environment*, Geophysical Monograph (American Geophysical Union) **33** (1985) 19.
26. C.C. Patterson and D.M. Settle, *Science* **207** (1980) 1167.
27. S. Hong, J.P. Candelone, C.C. Patterson and C.F. Boutron, *Science* **265** (1994) 1841.
28. C. Lorius, L. Merlivat, J. Jouzel and M. Pourchet, *Nature* **280** (1979) 644.

29. J. Jouzel, G. Raisbeck, J.P. Benoist, F. Yiou, C. Lorius, D. Raynaud, J.R. Petit, N.I. Barkov, Y.S. Korotkevich and V.M. Kotlyakov, *Quat. Res.* **31** (1989) 135.
30. C.F. Boutron, S.N. Rudniev, M.A. Bolshov, V.G. Koloshnikov, C.C. Patterson and N.I. Barkov, *Earth Planet. Sci. Lett.* **117** (1993) 431.

	Pb	Cd	Cu	Zn
	Measured concentration (pg/g)			
Reference water used to make the core	0.25	0.01	0.2	0.3
Veneer layer adjacent to the inner core	0.42	0.033	0.8	1.25
Inner core	0.36	0.025	0.45	0.5

Table 1. *Comparative determination of heavy metals in the water used to make the artificial ice core, in the last veneer layer and in the inner core of this artificial core.*

	Pb	Cd	Cu	Zn
	Procedural blank (pg/g)			
Veneer layer	0.17	0.023	0.6	0.95
Inner core	0.11	0.015	0.25	0.2

Table 2. *Procedural blank obtained from the analysis of the artificial ice core.*

FIGURES CAPTIONS

Fig. 1. Schematic diagram of the Low Density Polyethylene (LDPE) lathe used for the decontamination of the snow or ice cores. (1) : snow or ice core (length : up to 65cm); (2) : LDPE tumblers ; (3) : fixed LDPE pillar ; (4) : movable LDPE pillar which can be slid along the guide rail ; (5) : LDPE guide rail ; (6) : LDPE crank used to rotate the core ; (7) : LDPE heavy base plate of the lathe ; (8) ; LDPE screw.

Fig. 2. Greenland and Antarctic snow or ice cores : schematic view of different typical cross sections available for heavy metals investigations.

Fig. 3. Stainless steel chisel used for the chiselling of the successive veneer layers.

Fig. 4. Changes in Pb and Cu concentrations from the outside to the inside in two sections (depths : 69.88 - 70.22 and 21.10 - 21.45 m) of a 70.3 m snow core electromechanically drilled at Summit, central Greenland.

Fig. 5. Changes in Zn and Cd concentrations from the outside to the inside in two sections (depths : 29.77 - 30.13 and 43.87 - 44.45 m) of a 70.3 m core electromechanically drilled at Summit, central Greenland.

Fig. 6. Changes in Zn and Cu concentrations from the outside to the inside in one section (depth : 51.76 - 52.23 m) of a 70.3 m snow core electromechanically drilled at Summit, central Greenland.

Fig. 7. Summit, central Greenland : observed changes in Cd and Zn concentrations in snow from 1773 to 1965. Each data point integrates one or two years of snow accumulation.

Fig. 8. Measured Pb and Zn concentrations as a function of radius in one section (depth : 1,285.90 - 1,286.45 m ; estimated age 7,760 years BP) of the 3,028 m GRIP deep ice core electromechanically drilled at Summit, central Greenland, in a hole filled with a wall retaining fluid.

Fig. 9. Measured Pb and Cd concentrations as a function of radius in one section (depth : 514.89 - 515.07 m ; estimated age : 14,500 years BP) of the 905 m deep ice core thermally drilled at Dome C, East Antarctica.

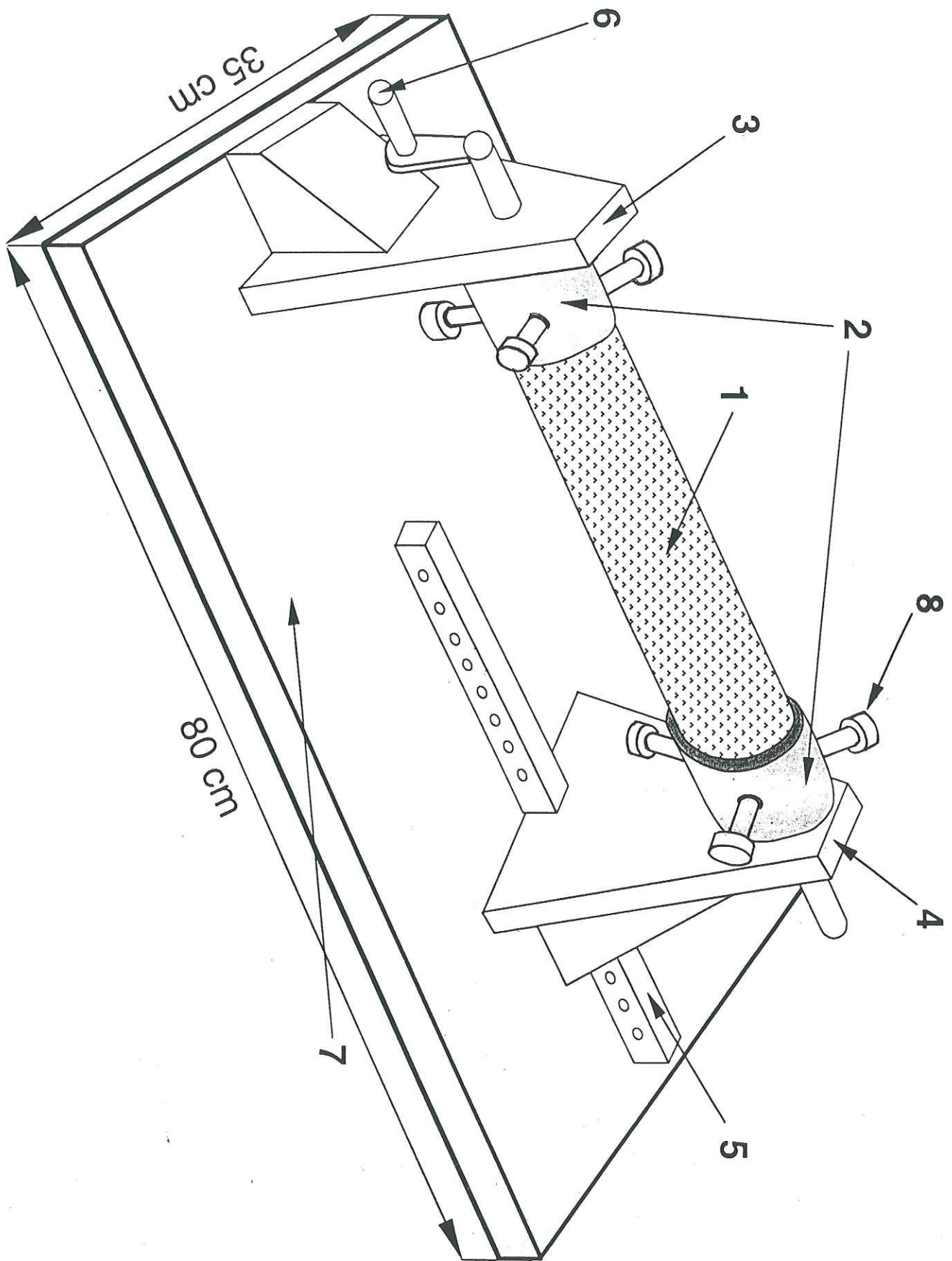

Figure 1

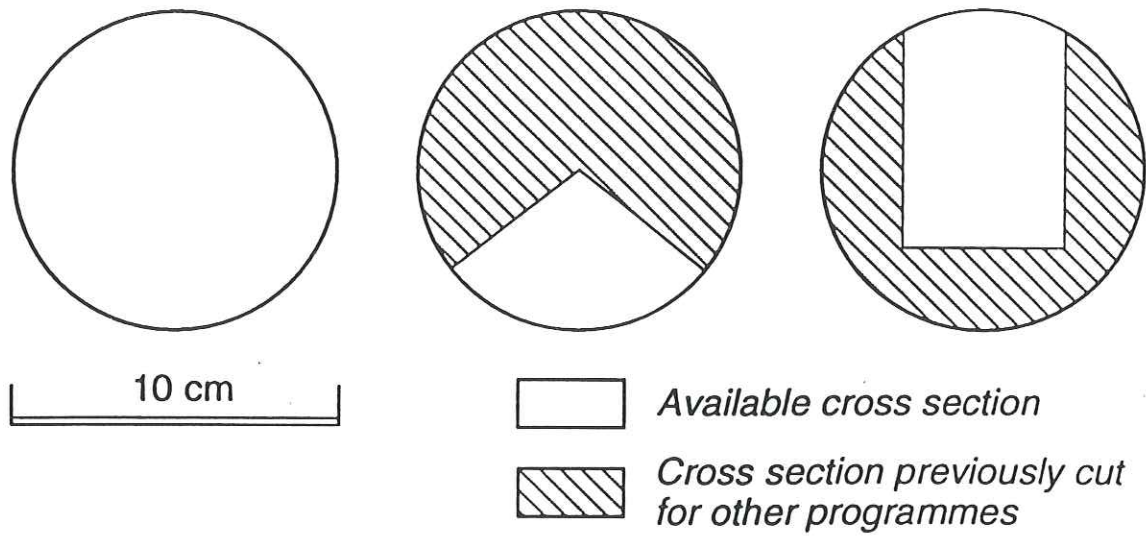

Figure 2

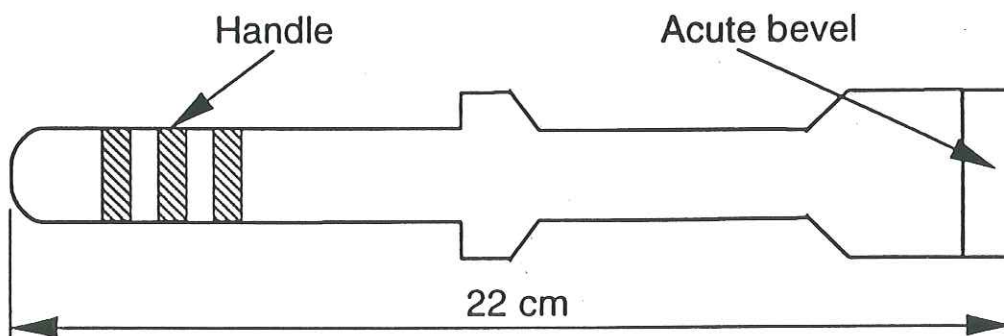

Figure 3

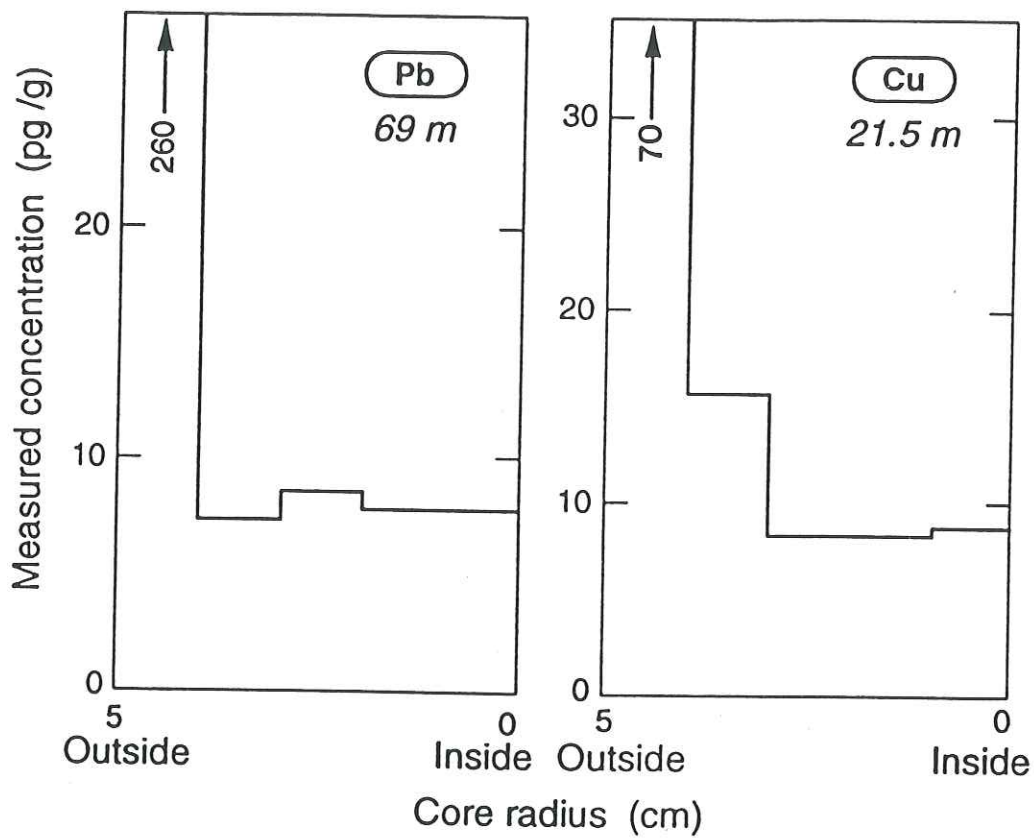

Figure 4

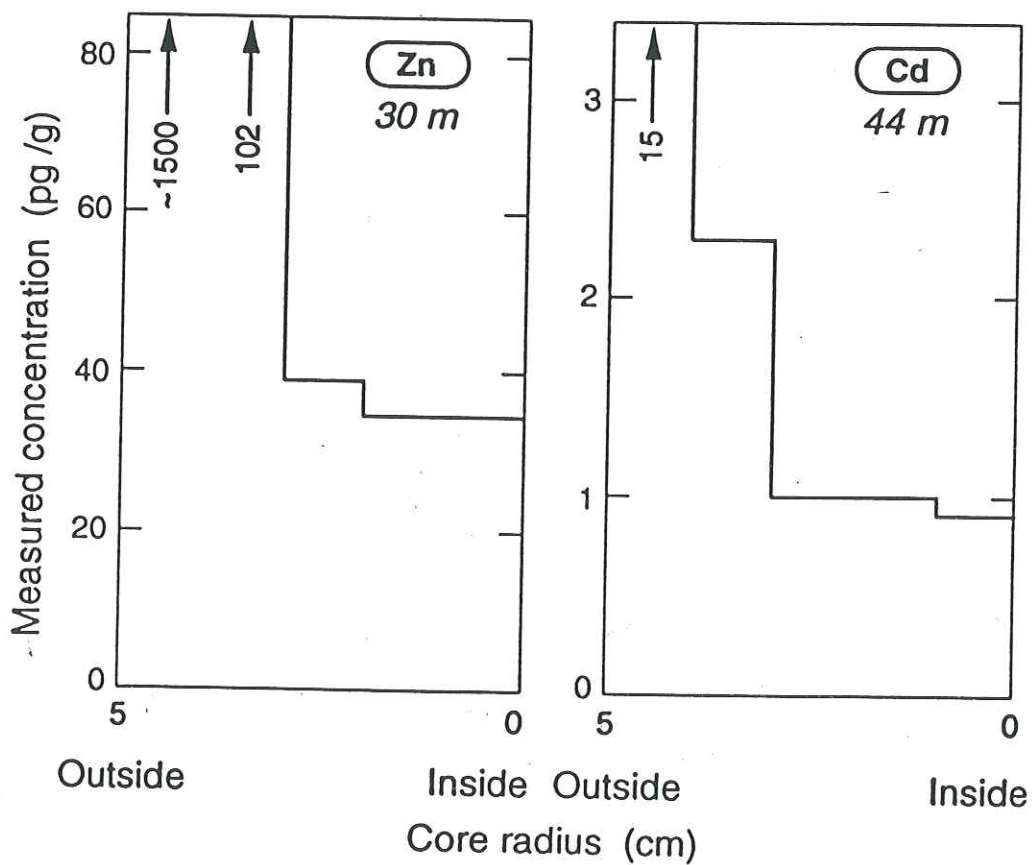

Figure 5

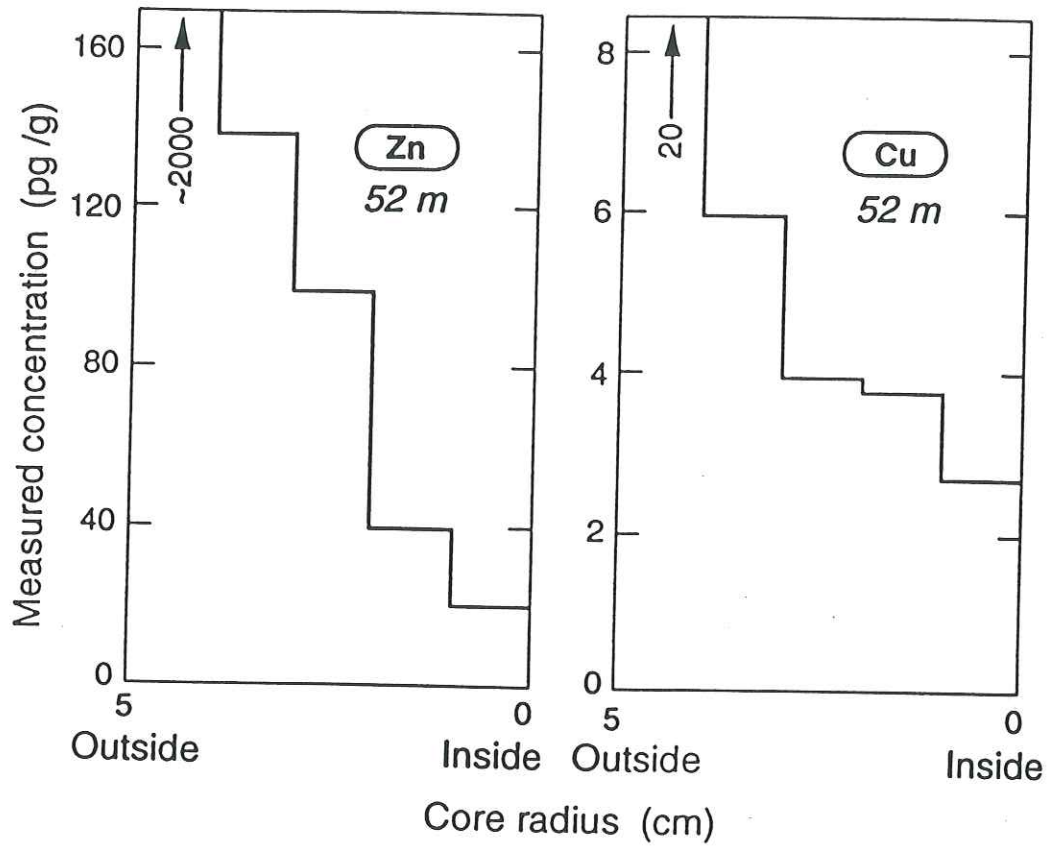

Figure 6

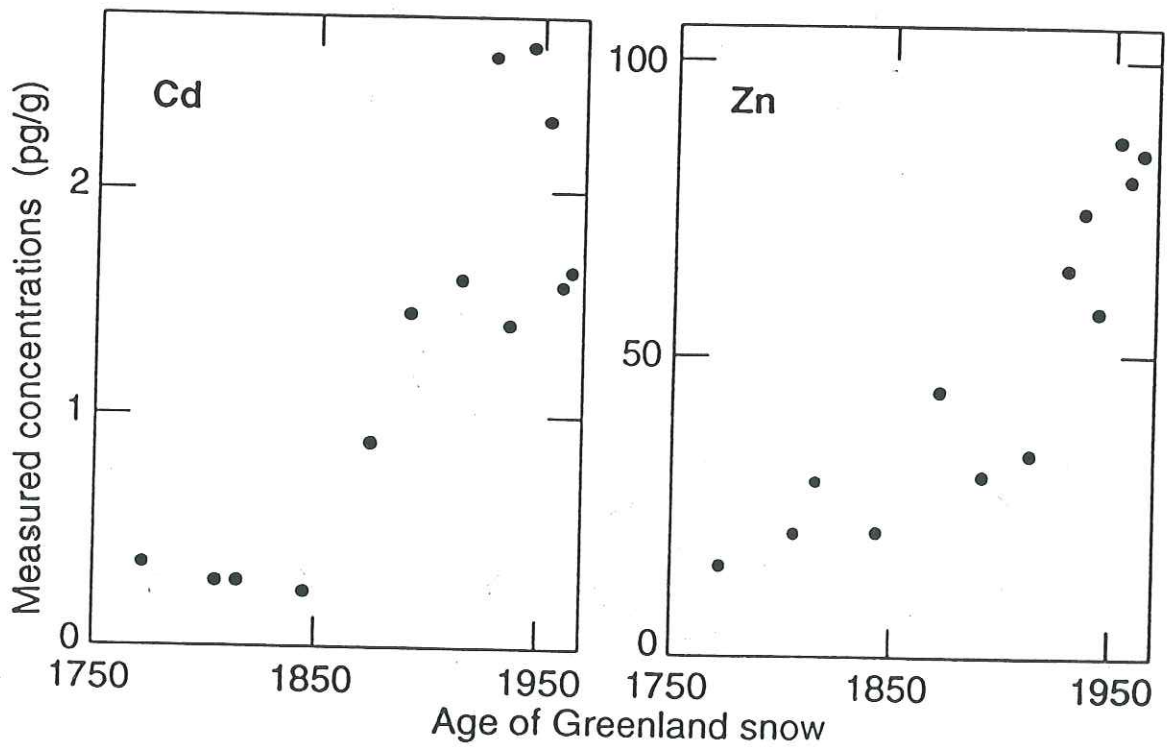

Figure 7

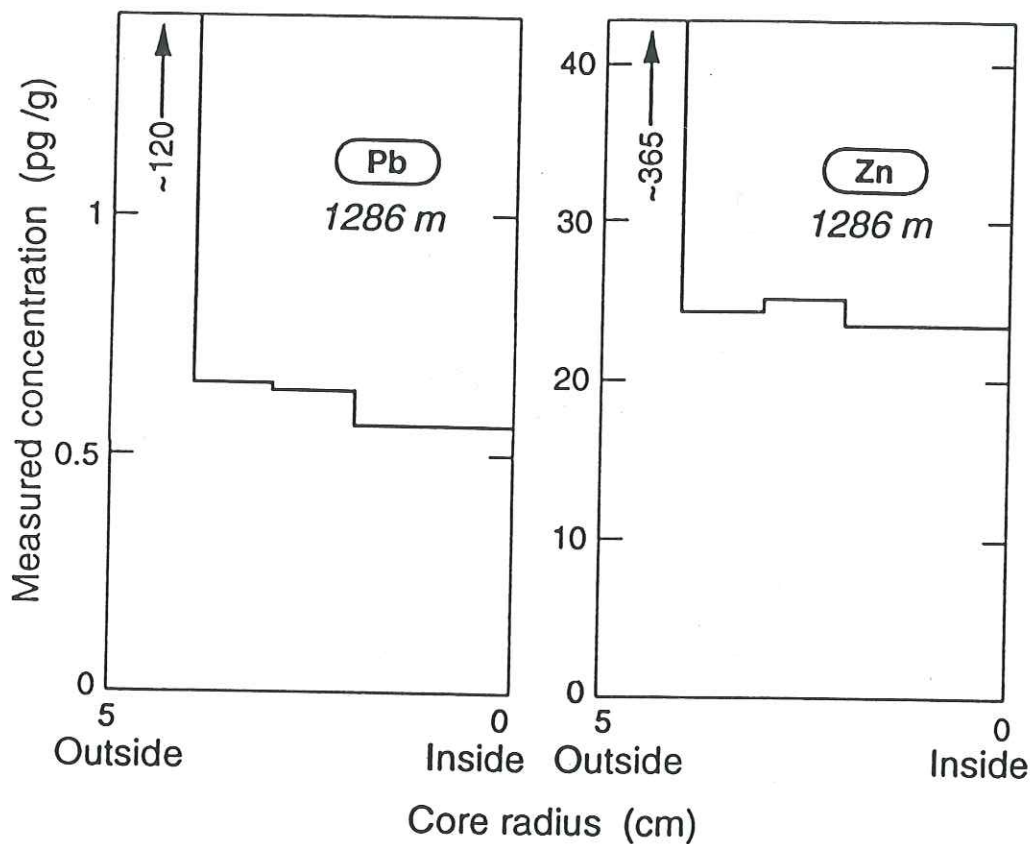

Figure 8

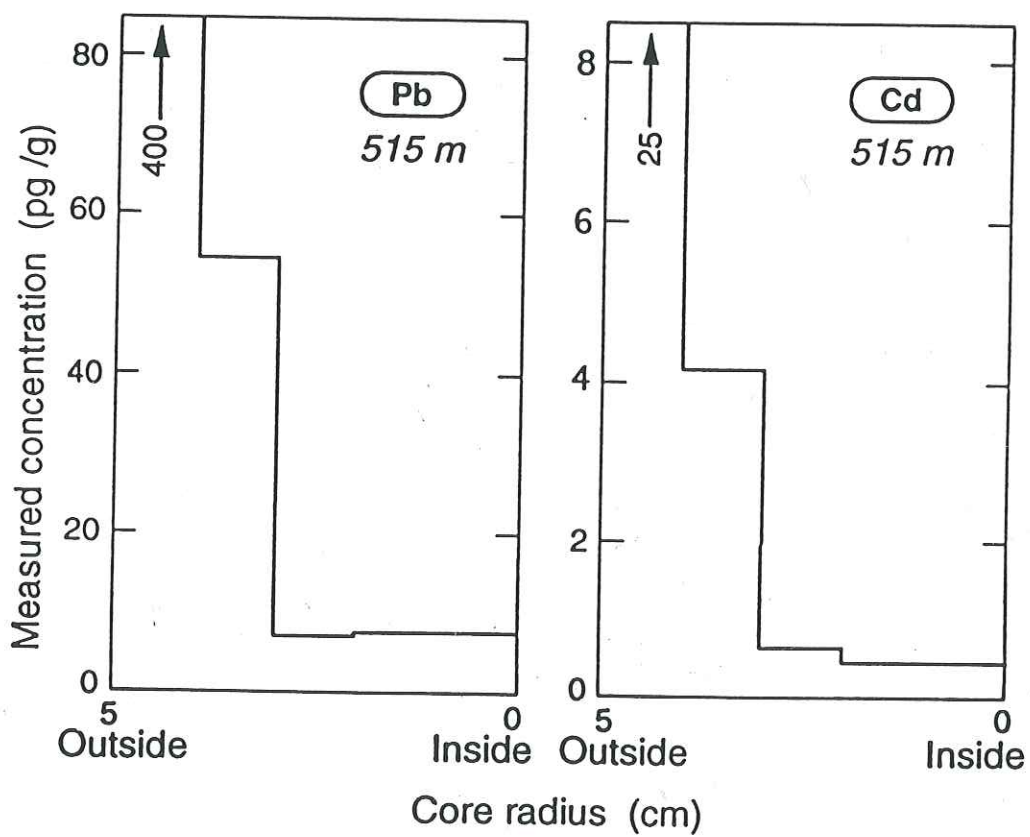

Figure 9

**POST INDUSTRIAL REVOLUTION CHANGES IN LARGE SCALE
ATMOSPHERIC POLLUTION OF THE NORTHERN HEMISPHERE FOR HEAVY
METALS AS DOCUMENTED IN CENTRAL GREENLAND SNOW AND ICE**

Jean-Pierre CANDELONE, Sungmin HONG, Christian PELLONE
and Claude F. BOUTRON

Submitted to "*Journal of Geophysical Research*", September 16, 1994

**POST INDUSTRIAL REVOLUTION CHANGES IN LARGE SCALE
ATMOSPHERIC POLLUTION OF THE NORTHERN HEMISPHERE FOR HEAVY
METALS AS DOCUMENTED IN CENTRAL GREENLAND SNOW AND ICE**

Jean-Pierre CANDELONE¹, Sungmin HONG¹, Christian PELLONE²
and Claude F. BOUTRON^{1,3*}

¹*Laboratoire de Glaciologie et Géophysique de l'Environnement du CNRS, 54, rue Molière,
Domaine Universitaire, B.P. 96, 38402 Saint Martin d'Hères, France*

²*Centre de Recherche et d'Essais des Machines Hydrauliques de Grenoble, Domaine
Universitaire, B.P. 95 X, 38402 Saint Martin d'Hères, France*

³*UFR de Mécanique, Université Joseph Fourier de Grenoble, Domaine Universitaire, B.P.
68, 38041 Grenoble, France*

** Author to whom correspondence and reprints requests should be addressed*

Submitted to "*Journal of Geophysical Research*", September 16, 1994

ABSTRACT

Pb, Zn, Cd, and Cu have been measured using ultraclean procedures in various sections of a 70.3m snow/ice core covering the past 220 years (including the Industrial Revolution) drilled at Summit, central Greenland. These time series are the first reliable ones ever published for Zn, Cd, and Cu; for Pb, they are the first verification of the pioneering data published more than two decades ago by C. Patterson and his co-workers. For all four heavy metals, concentrations are found to have markedly increased up until the 1960s-1970s, before decreasing significantly during the following few decades. The timing and the amplitude of the observed changes differ significantly however from one metal to another. Comparison with concentration values obtained by analysing ancient Holocene ice dated 7760 years BP, that is, before humans started to impact on the atmosphere, show that no increase occurred for Zn, Cd, and Cu before the Industrial Revolution. On the other hand, Pb concentrations were already one order of magnitude above natural values in late 18th century ice. Cumulative deposition of heavy metals to the whole Greenland ice cap since the Industrial Revolution ranges from 3200 tonnes for Pb to 60 tonnes for Cd.

1. INTRODUCTION

Investigating the occurrence of heavy metals in the well preserved dated snow and ice layers deposited in the large Greenland ice sheet during the last few centuries offers a unique way to reconstruct the history of the large scale pollution of the atmosphere of the Northern Hemisphere for these toxic metals especially since the Industrial Revolution [Wolff and Peel, 1985; Peel, 1989; Wolff, 1990; Boutron *et al.*, 1994 a, b].

This was first illustrated by C. Patterson and his co-workers in a pioneering paper published twenty five years ago [Murozumi *et al.*, 1969]. Using revolutionary ultraclean sampling and laboratory techniques [Patterson and Settle, 1976], they obtained the first reliable time series for Pb concentration in Greenland snow and ice for the 1753-1965 time period from the analysis of large size snow blocks collected from the walls of shafts or trenches at two locations in north-west Greenland: Camp Century (77°10'N, 61°08'W, elevation 1866m a.s.l.) and the "virgin trench site" (76°46'N, 58°52'W, elevation 1800m a.s.l.) ~ 80 km from Camp Century. In addition, they also obtained the first estimate of natural Pb concentrations in Greenland Holocene ice by analysing a single block of blue ice dated ~ 2800 years BP collected at Camp Tuto (76°25'N, 68°20'W). They found that the Pb concentration was exceedingly low, ~ 0.8 pg/g, 2800 years BP before man started to impact significantly on the atmosphere, and that this natural Pb could be explained simply by a soil and rock dust contribution. In the 1750s, Pb concentration was found to be ~ 10 pg/g, i.e., one order of magnitude higher than the value for 2800 years BP: it clearly evidenced for the first time that the Arctic atmosphere was already strongly contaminated in Pb before the onset of the Industrial Revolution. From the 1750s to 1965, a further continuous ~ 20 fold increase was observed, the increase being especially rapid after the 1930s as a response to the introduction and subsequent massive use of Pb alkyl additives [Nriagu, 1990] in automobile gasoline. On the whole, Pb concentrations appeared to have massively increased by about 200 fold from several thousand years ago to the 1960s in Greenland snow and ice, providing the first clear evidence of massive large scale pollution of

the atmosphere of the Northern Hemisphere for this toxic metal. And it is at least partially because of this landmark work that the USA and various other countries severely limited the use of Pb alkyl additives in gasoline from the early 1970s.

During the following two and half decades, various other investigators tried to emulate this pioneering work, not only for Pb but also for several other heavy metals such as Cd, Hg, Cu and Zn (see for instance [Weiss *et al.*, 1971 a,b, 1975; Carr and Wilkniss, 1973; Cragin *et al.*, 1975; Herron *et al.*, 1977; Appelquist *et al.*, 1978]). None of them succeeded in producing reliable time series for the past few centuries, mainly because they were unable to fully control contamination problems during field sampling, laboratory analysis or both.

The only reliable data which became available during these twenty-five years were either for ancient ice or for recent (post 1965) snow. C. Patterson and his co-workers were able to successfully meet the very difficult requirements of decontaminating deep Greenland ice cores for heavy metals analysis [Ng and Patterson, 1981]. It allowed them to analyse, for Pb, a few sections of the Camp Century 1387m ice core whose age ranged from 2700 to 5500 years BP, and to confirm that the natural Pb concentration in Greenland Holocene ice was really at the pg/g level as previously claimed by Murozumi *et al.* [1969] from the analysis of their single block of blue ice. For recent snow, various reliable data were published from the analysis of shallow samples collected in southern or central Greenland either from the walls of hand dug pits [Wolff and Peel, 1988; Boyle *et al.*, 1994; Savarino *et al.*, 1994; Candelone *et al.*, 1995] or using specially designed acid cleaned all-plastic augers [Boutron *et al.*, 1991]. These last data show that Pb concentrations have decreased by a factor of 7.5 since the mid 1960s in central Greenland as a consequence of the reduction in the use of Pb alkyl additives especially in the USA. During the same period, Cd and Zn concentrations were found to have decreased by a factor of 2.5 in response to the increasing efforts made in various countries of the Northern Hemisphere to reduce the emissions of these metals to the atmosphere from the combustion of fossil fuels, metal processing activities, and refuse incineration. They also revealed that there

are pronounced intra-annual (seasonal) variations in heavy metals concentrations in recent Greenland snow.

Confronted with the lack of confirmation of the Pb time series of *Murozumi et al.* [1969] and with the lack of time series for other metals for the past few centuries, we decided to collect and analyse for Pb, Zn, Cd, and Cu new samples covering the post Industrial Revolution period, i.e., the past ~ 220 years, using improved ultraclean procedures. The results are interpreted and discussed in the light of available data on anthropogenic emissions of these metals to the atmosphere.

2. EXPERIMENTAL

2.1 Field sampling

The samples were collected in July 1989 at Summit (72°34'N, 37°37'N, elevation 3238m a.s.l., mean annual temperature - 32°C, mean annual snow accumulation rate 23g cm⁻² yr⁻¹) as part of the European "Eurocore" programme. They consisted of a snow/ice core 9.8 cm in diameter and 70.3m deep which was electromechanically drilled only for our heavy metals measurements. To minimise local contamination problems, the exact sampling site was selected about 500 metres from the Eurocore camp. In order to minimise contamination brought to the outside of the core during drilling operations, we used a stainless steel drill [*Gillet et al.*, 1984] which was coated with Polytetrafluoroethylene (PTFE).

Core handling was kept to a strict minimum. Each core section was handled by operators wearing full clean room clothing and shoulder length polyethylene gloves, using specially designed acid cleaned Low Density Polyethylene (LDPE) pistons (to push the core section out of the drill if necessary), brushes (to remove the cutting chips from the outside of the core),

gutters (to keep the core sections before packing), and saws.

Each core section (about 1 metre long) was packed inside double sealed LDPE bags and transported frozen to Grenoble, France.

2.2 Decontamination of the core sections

Despite the great precautions which were taken in the field to minimise contamination brought to the outside of the core, significant contamination was found to be present on the outside of the core sections. This contamination was especially pronounced for Zn: for this metal, measured concentrations in the first centimetre or so from the outside ranged indeed from about 1000 to 5000 pg/g, i.e., concentrations higher by up to two orders of magnitude than the original Zn concentration in the snow. This Zn contamination was thought to originate at least partially from the galvanised steel cable of the electromechanical drill.

Each of the analysed core sections was therefore mechanically decontaminated before analysis, using ultraclean procedures, in order to remove the contaminated outside veneer layers and get the uncontaminated innermost part of the core. The decontamination took place inside a laminar flow clean bench located in a -15°C cold room.

For low-medium density snow sections (depth down to ~ 20m), the decontamination procedure was similar to that described by *Boutron et al.* [1991] and *Görlach and Boutron* [1992]. It involved breaking the core sections with a sharp-edged LDPE splitting wedge in order to obtain 20 or 15 centimetre long sections with fresh untouched surfaces at both extremities, then extracting the central part (diameter: 4cm) of these 20 or 15 centimetre sections by hammering a home-made cylindrical LDPE beaker into the centre of one of the untouched surfaces parallel to the core axis. Additional sub-samples were also obtained at increasing distances from the axis using smaller diameter LDPE beakers.

Below ~ 20 metres, with the higher density of the snow, it was no longer possible to use this

procedure and a new improved procedure, described in detail by *Candelone et al.* [1994], was employed. It involved supporting the core section horizontally in a LDPE home-made lathe [*Candelone et al.*, 1994], then chiselling successive veneers of snow (or ice for the deepest sections) in progression from the outside towards the centre, using the same stainless steel chisels used by C. Patterson and his co-workers on their Antarctic ice cores work [*Boutron and Patterson*, 1986]. The two extremities of the inner core (diameter: ~ 4 cm), obtained when the procedure was completed, were then broken using chisels while firmly held with all LDPE homemade tongs. A distinct advantage of this improved procedure is that it allowed to handle sections of variable length and obtain inner cores whose length can be adjusted in order to integrate a given time period, for instance an exact full year of snow or ice accumulation.

The procedural blank for the chiselling procedure was accurately determined by processing an artificial ice core [*Candelone et al.*, 1994] made by freezing ultrapure water [*Boutron*, 1990] whose heavy metals content was known beforehand. It ranged from 0.015 pg/g for Cd up to 0.25 pg/g for Cu [*Candelone et al.*, 1994], i.e., contributions which are extremely small compared to heavy metals concentrations in post Industrial Revolution Greenland snow and ice.

2.3 Checking the efficiency of the decontamination procedure

As previously emphasised by various authors [*Ng and Patterson*, 1981; *Boutron and Patterson*, 1986; *Peel*, 1989; *Wolff*, 1990; *Boutron et al.*, 1994 a, b], it is essential to determine changes in the concentrations of each heavy metal from the outside to the inside of each analysed core section to make certain that concentrations measured in the central part, obtained after the decontamination is completed, do represent the original concentration in the snow or ice. If a clear plateau of concentration is obtained in the central part, it indicates that external contamination has not penetrated to this central part: the plateau concentration will then represent the original concentration in the snow or ice, providing an appropriate blank correction

is made for the whole analytical procedure. If, on the other hand, a continuous decrease of concentration is observed to the most central parts, this indicates that external contamination has probably reached the centre of the core: the corresponding concentration value then gives only an upper limit of the original concentration in the snow or ice.

Outside-inside concentration profiles have been obtained for all four heavy metals for each of the investigated core sections. In most cases, good plateaus of concentrations were observed, as illustrated in Fig.1 for Cu and Zn in the 61.56-61.85m section. A continuous decrease of concentrations from the outside to the centre was observed in a few cases only, as shown in Fig.2 for Cu in the 69.93-70.17 in section and Zn in the 51.76-52.23m section.

2.4 Analytical procedures

Each veneer layer and inner core were analysed separately using ultraclean procedures [Boutron, 1990]. Pb, Cd, and Cu were determined by Graphite Furnace Atomic Absorption Spectrometry (GFAAS) after preconcentration ($\sim x 50$) by non boiling evaporation [Görlach and Boutron, 1990]. Zn, Al, and Na were measured by GFAAS without preconcentration. The GFAAS measurements were performed with a Perkin Elmer 2380 Spectrometer and HGA 500 Graphite Furnace, using Electrodeless Discharge Lamps for Pb, Cd, and Zn. Pyrolytically coated graphite tubes from Applied Optics were used. The precision of the data is estimated to be $\pm 10\%$.

Various 0.1% HNO₃ (ultrapure twice distilled HNO₃ from US National Institute of Standards and Technology [Paulsen *et al.* 1988]) aliquots were also taken for subsequent determination of Pb by Isotope Dilution Mass Spectrometry (IDMS) [Rosman *et al.*, 1993, 1994], Pb isotopes by Thermal Ionisation Mass Spectrometry (TIMS) [Rosman *et al.*, 1993, 1994], ethyl and methyl Pb compounds by Capillary Gas Chromatography with Microwave Induced Plasma Atomic Emission Spectrometry (CGC-MIP-AES) [Lobinski *et al.*, 1993, 1994], and Hg by Cold Vapour

Atomic Fluorescence Spectrometry (CVAFS) [Vandal *et al.*, 1993].

Comparative determination of Pb by GFAAS after preconcentration and IDMS indicated that the IDMS values were systematically slightly lower, by ~ 20%, than the GFAAS values when these last values were corrected using the slope (0.82) of the calibration line of the preconcentration procedure given in *Görlach and Boutron* [1990]. They were on the other hand in excellent agreement if this correction was not made. Taking into account the fact that IDMS is essentially an absolute technique, we have then decided no longer to apply a correction for the preconcentration procedure not only for Pb, but also for Cd, Cu and Zn (for these last metals, this results in decreasing the values by 24%, 11%, and 15% respectively). It must however be emphasised that these very small differences are, in any case, of no importance at all for the geochemical interpretation of the snow and ice data.

2.5 Dating of the samples

The dating of the core was based on detailed continuous oxygen isotopes data obtained in a nearby parallel core [*H. Clausen*, personal communication]. It indicates that the bottom of the core (70.3m) corresponds to the year 1772, i.e., slightly before the beginning of the first Industrial Revolution. The whole core then covers continuously a 217 year time period. The precision of the dating is estimated to be about ± 2 years at the bottom of the core.

3. RESULTS AND DISCUSSION

3.1 Presentation of the data

Since comprehensive heavy metals data had already been obtained for the 1967-1989 period

from the analysis of a 10.7m snow core drilled at a nearby location [Boutron *et al.*, 1991], we mainly analysed the part of the 70.3m core corresponding to the pre-1966 period. Special attention was moreover given to the 1945-1966 period (depth interval 20-11 m), which was expected to correspond to a rapid increase of Pb concentrations in response to the massive use of Pb alkyl additives in gasoline after World War II.

Table 1 displays Pb, Cd, Zn and Cu concentrations measured in the central part of each of the 26 investigated core sections. For the core sections which were decontaminated using the stainless steel chisels, see 2.2, i.e., the sections whose depth was greater than 20m, the chiselling procedure was conducted so that the length of the inner core obtained after the decontamination was completed integrated exactly one or two years of snow or ice accumulation at the corresponding depth (estimated from the detailed oxygen isotopes profiles). For these sections, each data point given in Table 1 then exactly corresponds to a one or two year time interval. It is then not influenced by intra-annual (seasonal) variations of the concentrations [Wolff and Peel, 1988; Boyle and Sherrell, 1994; Savarino *et al.*, 1994; Candelone *et al.*, 1995].

For the core sections which were decontaminated using the earlier procedure (see 2.2) of Boutron *et al.* [1991] and Görlach and Boutron [1992], i.e., the sections whose depth was smaller than 20m, the situation is more complicated. The depth interval associated with each data point often does not correspond exactly to one year of snow accumulation, since it was determined by the cumulative length of the LDPE beakers hammered into the core. It can be seen in Table 1 that the corresponding depth interval was often ~ 30 to 65 cm, which represents slightly less than one year of snow accumulation at these depths (at 15m for instance, one year of snow accumulation is approximately equal to 40 cm). Because these samples do not represent exactly one year of accumulation, the corresponding data points are probably influenced by seasonal variations in concentrations: this will result into a larger scatter in the data points, as it will be seen in the time series discussed in 3.2. and 3.3.

3.2. Changes in Zn, Cd and Cu concentrations from 1773 to 1992

Changes in the concentrations of these three metals from 1773 to 1992 are shown in Fig.3 as documented by combining the data obtained in this work from the analysis of the 70.3m core with the data given in *Boutron et al.* [1991] for the 1967-1989 period (averaged so that each data point corresponds approximately to one year of snow accumulation) and with the mean yearly values for the years 1990, 1991, and 1992 recently obtained by *Candelone et al.* [1995]. This is the first reliable time series ever published for these three metals, since previously published data [*Weiss et al.*, 1975; *Herron et al.*, 1977] were plagued by major contamination problems, which is clear from the comparison of published data in Table 2. For an example, Table 2 compares the concentrations we observe in our sample dated on 1805 with those obtained in the earlier studies for samples from the early 19th century: the very large differences, especially for Cd and Cu, cannot be explained by geographical variations between the different sites. They are due to extensive uncontrolled contamination of the samples in the earlier studies.

A common feature of the three time series shown in Fig.3 is the existence of a clear increasing trend until the 1960-1970s, followed by a significant decreasing trend afterwards. But a detailed examination of the profiles reveals pronounced differences for the three metals.

First of all, the timing of the observed increase is not the same. For Zn, our data indicate that the increase started as early as the 1770s. It was however fairly slow until the ~ 1900s, then became more rapid during the first half of the 20th century. For Cd and Cu, on the other hand, the increase did not start until the 1850s (the maximum shown by the spline function around the 1800s for Cu is probably not significant since it is due only to a single data point). Its rate was moreover fairly stable during the following one century or so.

Another difference is with the amplitude of the observed increases. Cd shows the greatest increase (~ x 8), followed by Zn (~ x 5) and Cu (~ x 4).

Also, the time when the maximum is observed is not the same. The spline smoothed curves shown in Fig.3 suggest that the maximum was reached earlier for Zn (around ~ 1961) than for

Cd and Cu (around ~ 1972 and 1969 respectively).

Finally, the amplitude of the recent decrease differs from one metal to another. Cd is found to have decreased by a factor of ~ 2.3 during the past two decades down to 1992 values which are similar to those around the 1870s. For Zn, the decrease appears to be smaller (factor of ~ 1.7), with the 1992 values similar to those in the 1920s. The decrease for Cu appears to be hardly significant (factor of ~ 1.2), with the 1992 values close to those observed in the 1930s.

These changes cannot be linked with changes in emissions from natural sources to the atmosphere such as rock and soil dust, sea salt spray, and volcanoes [*Nriagu*, 1989]. The corresponding emissions have indeed not significantly changed since the 18th century, as evidenced, for instance, for the rock and soil dust and sea salt spray contributions by the fact that no time trend is observed since the 1770s for Al and sea salt Na, Table 3. They are then, without doubt, the result of major changes in the large scale anthropogenic emissions of these metals to the atmosphere of the Northern Hemisphere.

There is a wealth of data available on the world production of Cd, Cu, and Zn during the past century or so, for instance, in extremely detailed publications of the UK government [*Anonymous*, 1913-1920, 1920-1944, 1945-1951, 1952-1970, and 1970-1990] and the US Bureau of Mines [*Anonymous*, various years] or in specialised books devoted to given metals (see for instance *Nriagu* [1978, 1979 a,b,c]). Although the past trends in metals production have often been used as surrogates for trends in past metals emissions to the atmosphere (see for instance *Wolff and Suttie*, [1994]), they however do not satisfyingly represent these trends.

On the other hand, the available data on world emissions (which originate mainly from non ferrous metals production and also from coal combustion, steel and iron manufacturing, and refuse incineration) are much sparser. Even for recent years the best available estimates [*Nriagu and Pacyna*, 1988; *Pacyna*, 1994] remain rather uncertain. For instance, the ranges for the estimates of worldwide emissions for Zn, Cd, and Cu for the year 1983, given in *Nriagu and Pacyna* [1988], are (in tonnes/year) 70000-194000, 3100-12000 and 19900-50900 respectively,

that is, uncertainties by up to a factor of four. The few data on historical changes in these emission fluxes (see for instance *Nriagu* [1979d]) are even sparser.

Table 4 compares the mean ratios of total emissions (anthropogenic plus natural, 1983 values)/natural emissions given in *Nriagu* [1989] with the enhancement factors which we observe in Summit snow and ice from 1773 to 1983 (that is, not the enhancement factors discussed above which were for the time period from 1773 to the time when the maximum is reached). It must be noted that this comparison relies upon the fact that concentrations measured in the ice in 1773 are entirely natural, which is indeed the case as will be discussed in 3.4. It can be seen in Table 4 that the increase factors are in remarkable agreement with the mean ratios, which show that the historical changes in Zn, Cd, and Cu deposition in Greenland are consistent with the estimates of emissions.

Finally, the decrease trend which we observe from the early 1960s for Zn and from the early 1970s for Cd and possibly Cu appears to be consistent with the very significant reported decrease in the emissions in the Northern Hemisphere as a consequence of the abatement measures which were taken in various countries of the Northern Hemisphere during the past decades [*Pacyna*, 1989, 1991; *Pacyna et al.*, 1993; *Thomas and Spiro*, 1994]. For instance, *Pacyna* [1991] estimated that emissions of Cd and Zn from Europe, which are likely to be a significant contribution to Cd and Zn deposited in Greenland, peaked in the 1970s, and that the 1980 emissions were about three times lower than the pre mid-1970 ones. His estimates were obtained from a comprehensive review of changes in emission factors for these two metals in Europe from the 1950s up to 1985 for major source categories such as non-ferrous metal production and combustion of fuels [*Pacyna*, 1991]. In addition to the impact of these abatement measures, it is also likely that a significant reduction of the emissions also resulted from the very strong economic recession which has affected the States of the former Soviet Union during the past few years. These reductions are thought to have been especially important for the highly polluting non-ferrous metal production activities in the Russian Arctic, for instance, in the Kola

Peninsula [Jaffee, 1994].

3.3. Changes in Pb concentrations from 1773 to 1992

Changes in Pb concentrations from 1773 to 1992 are shown in Fig.4. This time series is the first verification and extension of the pioneering data published twenty five years ago by *Murozumi et al.* [1969] for the years 1753-1965, which are also shown in Fig.4.

For the time period covered by both time series, the general trends obtained from both sets of data are similar: our data confirm the very large increase in concentration from the middle of the 18th century to the 1960s seen in the earlier work. However, our data appear to be systematically lower than those of *Murozumi et al.* [1969]. A possible explanation for this discrepancy is that it would be linked with the different geographical characteristics of the sampling sites. The samples of *Murozumi et al.* [1969] were indeed collected at a much lower altitude than our samples (1800 instead of 3238m a.s.l.): the high altitude-free troposphere of Summit is likely to be less contaminated. Moreover, the sampling sites of *Murozumi et al.* [1969] were located in north-west Greenland, that is, an area which is more affected by the Arctic haze phenomenon [Barrie, 1986] than central Greenland. An alternative explanation could however be that the data of *Murozumi et al.* [1969], although of outstanding quality at the time when they were obtained, suffered slight but, however, significant contamination. They were indeed not meeting all standards of quality by which heavy metals work is now judged, especially regarding the necessity of taking outside-inside profiles across the samples. Such profiles, which were first proposed by *Ng and Patterson* [1981], were not studied for the snow blocks analysed by *Murozumi et al.* [1969].

A more detailed examination of the data in Fig.4 indicates that there are different growth regimes between 1773 and 1992. From 1773 to the ~ 1890s, first, a rather slow increase (~ 6.3 fold in ~ 130 years) is observed. It is attributed to the progressive increase in Pb emissions to

the atmosphere of the Northern Hemisphere, linked with the anthropogenic sources which were dominant at that time when Pb alkyl additives in gasoline were still not used. The most important of these sources were non-ferrous metals production (Pb, Cu-Ni, and Zn-Cd), iron and steel manufacturing and coal and wood combustion [Nriagu, 1978, 1979d; Patterson, 1980; Nriagu and Pacyna, 1988; Wolff and Suttie, 1994].

The spline smoothed curve shown in Fig.4 suggests that this ~ 130 year period was followed by a few decades around the 1920s-1930s during which Pb concentrations seem to have slightly decreased. From our data points, it is difficult to determine whether this decrease is significant or not: more data points would obviously be needed, especially for the 1880s-1920s. It is however interesting to see that such a decline around the 1920s-1930s was also suggested by the data of Murozumi *et al.* [1969], Fig.4. If real, it could indicate that Pb emissions to the atmosphere declined during the big economic recession, as already documented for other pollutants such as SO₂ (see for instance Möller, 1984).

Starting from the ~ 1930s, a large and rapid increase is then observed until ~ 1970 (~ 3.4 fold in ~ 40 years). Although the contribution from other sources such as non-ferrous metals production certainly remained very significant during that period, and probably played a role in the observed increase, there is little doubt that this rapid increase was largely caused by the introduction (in 1923) and massive increase in the use of Pb alkyl additives in automobile and aviation gasoline [Nriagu, 1990]. The consumption of additives massively increased from 1923 to 1970, reaching a peak value of ~ 400000 tonnes of lead per year in the early 1970s. It is estimated that ~ 70% of the lead content in the additives was emitted to the atmosphere via the exhaust pipes of the engines. The largest part of these emissions occurred in the Northern Hemisphere, where there are most cars (95% in 1948; 93% now, Wolff and Suttie [1994]).

Further unambiguous evidence of the key role played by Pb alkyl additives in the rapid increase of concentrations from the 1930s to ~ 1970 was recently obtained thanks to the direct measurement of organo-Pb compounds (Et₃ Pb⁺ and Et₂ Pb⁺⁺) in aliquots of part of the post-

1923 samples analysed in this work [Lobinski *et al.*, 1994]. These compounds, which have no natural origin and are unique tracers of gasoline-related pollution [Granjean, 1983; Van Cleuvenbergen and Adams, 1990] were indeed found to be present above detection limit (10 fg/g, Lobinski *et al.* [1993]) in our samples from the 1930s, with a marked increasing trend to the 1970s. Additional evidence was also provided by the determination of the isotopic pattern of Pb (Pb^{204} , Pb^{206} , Pb^{207} , and Pb^{208}), in other aliquots [Rosman *et al.*, 1994, 1995].

After this final increase, a clear maximum of Pb concentrations is observed in ~ 1970, Fig.4, followed by a pronounced decrease from ~ 1970 to 1992 (~ 6.5 fold in two decades) which brings the 1992 values back down to the concentrations observed in the mid-19th century, Fig.4. If part of this decrease can probably be accounted for by reduction in emissions from non-ferrous metal production, steel and iron manufacturing, thanks to abatement measures [Pacyna, 1989, 1991; Pacyna *et al.*, 1993], the largest part undoubtedly originates from the massive fall in the use of Pb alkyl additives in gasoline from the early 1970s [Nriagu, 1990]. This is illustrated in Fig.5, which shows the striking parallelism between the observed changes in Pb concentration in Summit snow from 1955 to 1986 and the reported world (in fact mostly Northern Hemisphere) consumption of additives during the same period [Larbey and Bain, 1988]. Both curves do peak nearly at the same time (~ 1970). Moreover, the relative changes are very similar (decrease by a factor of ~ 4 from 1970 to 1986).

This fall was due both to the pioneering work of Murozumi *et al.* [1969] and to the generalisation of catalytic exhaust pipes (these pipes cannot work when using leaded gasoline). It included two aspects. Firstly, the increasing use of unleaded gasoline, which now represents virtually 100% of the gasoline sold in the United States and in Canada [Loranger and Zayed, 1994], and an ever increasing percentage of gasoline sold in European countries (48% in France in 1994). Secondly, the very pronounced decline in the Pb content of leaded gasoline: in France, for instance, it is now almost 4 fold lower (0.15 g/l since June 1991) than it was fifteen years ago (0.55 g/l in April 1976, with intermediate steps in January 1979 (0.50 g/l), January 1981 (0.40

g/l), and March 1989 (0.25 g/l)).

3.4. Comparison with concentrations in pre-human activities ancient Holocene ice

Table 5 compares Pb, Zn, Cd, and Cu concentrations observed in our oldest samples dated on 1773 with those measured in Greenland ice 7760 years old, that is, Holocene ice deposited before man started to impact significantly on the atmosphere. These last data were obtained from the analysis of a 1286.5m deep section of the 3028.8m GRIP deep ice core drilled in 1990-1992 at Summit [*Hong et al.*, 1994; *S. Hong*, personal communication].

For Zn, Cd, and Cu, concentrations in 1773 appear to be very similar to these 7760 years ago, which shows that in the second half of the 18th century the troposphere of the remote Arctic areas of the Northern Hemisphere was still uncontaminated for these three metals. At that time, Zn, Cd, and Cu were still entirely derived from natural sources, mainly rock and soil dust [*Hong et al.*, 1994; *S Hong*, personal communication]. When combined with the time series shown in Fig.3, the overall picture is then that the large scale pollution of the troposphere of the Northern Hemisphere started from ~ the 1770s for Zn and from the ~ 1850s for Cd and Cu.

For Pb on the other hand, the situation is very different: concentrations measured in 1773 are found to be more than one order of magnitude higher than in ancient Holocene ice, Table 5. This clearly confirms for the first time the claim made long ago by C. Patterson and his co-workers [*Murozumi et al.*, 1969; *Patterson*, 1980] that the troposphere of the remote areas of the Northern Hemisphere was already heavily contaminated with this toxic metal long before the onset of the Industrial Revolution. Actually, this large scale pollution started as early as ~ 3000 years ago. This was recently evidenced by *Hong et al.* [1994] from the analysis of various sections of the 3028.8m GRIP deep ice core whose age ranged from 3000 to 470 years BP (depths: 619.3 to 129.3m). It was evident from ~ 2500 to 1700 years BP; that is, during the flourishing of the Greco-Roman civilisation, as a consequence of anthropogenic Pb emissions

to the atmosphere linked with the extensive Greek and Roman Pb/Ag mining and smelting activities. During that period, Pb concentrations in Greenland ice reached values of ~ 3 pg/g [Hong *et al.*, 1994], which is ~ 6 fold above natural values and only 2.5 fold lower than the 1773 concentration value. After the fall of the Roman Empire, it declined down to values close to the natural ones. Finally, it started to increase again progressively from 1500 to 470 years ago, that is, during the Medieval and Renaissance times [Hong *et al.*, 1994]. Pb concentration 470 years ago (i.e., in 1524) was close to 4 pg/g, that is ~ 2 times lower than in 1773.

The overall picture is then that the history of the large scale pollution of the troposphere of the Northern Hemisphere during the past three millennia has been rather lively, with a succession of increases and decreases, Fig.6. Two maxima are observed, Fig.6: the first one around 2000 years ago at the peak of Roman power and influence; the second one around 1970 at the peak of the use of alkyl Pb additives in gasoline. The amplitude of these changes is much larger than for any other pollutant species: the Pb concentration measured in Greenland snow in 1970 (~ 110 pg/g, Fig.4) is about 200 times higher than in pre-human activities Holocene ice (0.55 pg/g, Table 5).

3.5. Past and present day atmospheric deposition fluxes to the Greenland ice sheet

The past and present day atmospheric deposition fluxes of Pb, Zn, Cd, and Cu at Summit can be estimated by combining the heavy metals concentrations measured in the snow or ice with the snow/ice accumulation rate of $23\text{g H}_2\text{O cm}^{-2}\text{ yr}^{-1}$ at Summit (a value which has remained essentially unchanged during the past few thousand years). We have made the calculations for different times, Table 6: 7760 years BP, which gives the pre-human activity Holocene fluxes; 1773, which corresponds to the onset of the first Industrial Revolution; 1850, which is the time when Cd and Cu concentrations started to increase; and 1992. In addition, Table 6 also presents the deposition fluxes for the 1960s-1970s when the concentrations reached their maximum. The

fluxes so calculated range from $0.06 \times 10^{-10} \text{ g cm}^{-2} \text{ yr}^{-1}$ (Cd until 1850) to $25 \times 10^{-10} \text{ g cm}^{-2} \text{ yr}^{-1}$ (Pb in the early 1970s).

Extrapolation to the whole Greenland ice cap (surface of $1.4 \times 10^6 \text{ km}^2$; mean accumulation rate of $34.5 \text{ g H}_2\text{O cm}^{-2} \text{ yr}^{-1}$) would require that the deposition patterns are known for the different areas of the ice cap, which is not the case. Besides the Summit data, there are indeed only very few reliable heavy metals data for other locations in Greenland, which, moreover, are not for the same time periods [Murozumi *et al.*, 1969; Wolff and Peel, 1988]. We have then assumed that the deposition patterns for heavy metals to the Greenland ice cap are similar to those for non sea salt sulfate (nss sulfate) [Legrand, 1994]. For this compound, extensive data are now available for various areas of Greenland [Legrand, 1994]. They show that the nss sulfate deposition fluxes are correlated with the snow/ice accumulation rates. The mean annual deposition flux of nss sulfate to the Greenland ice cap was found to be $\sim 1.04 \times 10^{-6} \text{ g cm}^{-2} \text{ yr}^{-1}$, that is, ~ 1.3 times the value for Summit ($0.8 \times 10^{-6} \text{ g cm}^{-2} \text{ yr}^{-1}$). The heavy metals deposition fluxes so obtained are given in Table 7. They range from 0.11 tonnes yr^{-1} (Cd before 1850) up to 46 tonnes yr^{-1} (Pb in the early 1970s).

Finally, it is interesting to evaluate the cumulative anthropogenic deposition flux of heavy metals to the Greenland ice cap from 1773 to 1992, that is, from the onset of the first Industrial Revolution to present. The calculations were made from the spline-smoothed curves shown in Figs. 3 and 4 after subtracting the natural contribution estimated from the 7760 years BP sample. The cumulative deposition flux during this 220 year period is found to be ~ 3200 tonnes for Pb, which is one order of magnitude higher than the deposition (400 tonnes) documented for the Greco-Roman times [Hong *et al.*, 1994]. For Zn, Cd, and Cu the fluxes are ~ 2500 , 60, and 200 tonnes respectively.

ACKNOWLEDGEMENTS

This work is a contribution of the Eurocore programme funded by the Commission of European Communities and Switzerland within the framework of Cost 611. It was supported by the French Ministry of the Environment (grant nb 92295), the Institut National des Sciences de l'Univers, and the University Joseph Fourier of Grenoble. We thank C. Rado, R .J. Delmas, and F. Maupetit for their participation in field sampling.

REFERENCES

- Anonymous, *The Mineral Industry of the British Empire and Foreign Countries. Statistical Summary (Production, Imports and Exports)*, vols 1913-1920, Imperial Mineral Resources Bureau, His Majesty's Stationery Office, London, U.K.
- Anonymous, *The Mineral Industry of the British Empire and Foreign Countries. Statistical Summary (Production, Imports and Exports)*, vols 1920-1944, Imperial Institute, His Majesty's Stationery Office, London, U.K.
- Anonymous, *Statistical Summary of the Mineral Industry. (Production, Imports and Exports)*, vols 1945-1951, Colonial Geological Surveys, Mineral Resources Division, Her Majesty's Stationery Office, London, U.K.
- Anonymous, *Statistical Summary of the Mineral Industry. World Production, Imports and Exports*, vols 1952-1970, National Environmental Research Council, Institute of Geological Sciences, Mineral Resources Division, Her Majesty's Stationery Office, London, U.K.
- Anonymous, *World Mineral Statistics. Production: Exports, Imports*, vols 1970-1990, Natural Environmental Research Council, Institute of Geological Sciences, Mineral Statistics and Economics Unit, Her Majesty's Stationery Office, London, U.K.
- Anonymous, *Mineral Yearbooks*, vols 1930-1990, U.S. Bureau of Mines, Washington D.C., USA.
- Appelquist, H., K.O. Jensen, T. Sevel and C. Hammer, Mercury in the Greenland ice sheet, *Nature*, 273, 657-659, 1978.
- Barrie, L.A., Arctic air pollution: an overview of current knowledge, *Atmos Environ.*, 20, 643-663, 1986.
- Boutron, C.F. and C.C. Patterson, Lead concentration changes in Antarctic ice during the Wisconsin/Holocene transition, *Nature*, 323, 222-225, 1986.
- Boutron, C.F., U. Görlach, J.P. Candelone, M.A. Bolshov and R.J. Delmas, Decrease in

- anthropogenic lead, cadmium and zinc in Greenland snows since the late 1960s, *Nature*, 353, 153-156, 1991.
- Boutron, C.F., J.P. Candelone and S. Hong, Past and recent changes in the large scale tropospheric cycles of lead and other heavy metals as documented in Antarctic and Greenland snow and ice: a review, *Geochim. Cosmochim. Acta*, in press, 1994a.
- Boutron, C.F., J.P. Candelone and S. Hong, Greenland snow and ice cores: unique archives of the large scale pollution of the troposphere of the Northern Hemisphere for lead and other heavy metals, *Sci. Tot. Environ.*, in press, 1994b.
- Boyle, E.A. and R.M. Sherrell, Temporal variability of anthropogenic lead in the oceans and ice cores, *Geochim. Cosmochim. Acta*, in press, 1994.
- Candelone, J.P., S. Hong and C.F. Boutron, An improved method for decontaminating polar snow or ice cores for heavy metal analysis, *Anal. Chim. Acta*, in press, 1994.
- Candelone, J.P., J.L. Jaffrezo, S. Hong, C. Pellone, C.I. Davidson and C.F. Boutron, Seasonal variations in heavy metal concentrations in present day Greenland snow, *Earth Planet. Sci. Lett*, submitted, 1995.
- Carr, R.A. and P.E. Wilkniss, Mercury in the Greenland ice sheet: further data, *Science*, 181, 843-844, 1973.
- Cragin, J.H., M.M. Herron and C.C. Langway, Jr., The chemistry of 700 years of precipitation at Dye 3, Greenland, *U.S. Army Cold Regions Res. Eng. Lab. Res. Rept.* 341, 1975.
- Gillet, F., D. Donnou, C. Girard, A. Manouvrier, C. Rado and G. Ricou, Ice core quality in electro-mechanical drilling, in *Ice Drilling Technology*, edited by G. Holdsworth, K.C. Kuivinen and J.H. Rand, *U.S. Army Cold Regions Res. Eng. Lab. Spec. Res. Rept* 84-34, 1984.
- Görlach, U. and C.F. Boutron, Preconcentration of lead, cadmium, copper and zinc in water at the pg/g level by non-boiling evaporation, *Anal. Chim. Acta*, 236, 391-388, 1990.
- Görlach, U. and C.F. Boutron, Changes in heavy metals concentrations in Antarctic snows from

- 1940 to 1980, *J. Atmos. Chem.* 14, 205-222, 1992.
- Granjean, P., Health significance of organolead compounds, in *Lead versus Health*, edited by M. Rutter and R. Russell Jones, Wiley, New York, pp 179-189, 1983.
- Herron, M.M., C.C. Langway, Jr., H.V. Weiss and J.H. Cragin, Atmospheric trace metals and sulfate in the Greenland ice sheet, *Geochim. Cosmochim. Acta*, 41, 915-920, 1977.
- Hong, S., J.P. Candelone, C.C. Patterson and C.F. Boutron, Greenland ice evidence of hemispheric pollution for lead two millennia ago by Greek and Roman civilizations, *Science*, in press, 1994.
- Jaffee, D. Deposition of sulfate and heavy metals in the Kola peninsula, *Sci. Tot. Environ.*, in press, 1994.
- Larbey R.J. and J.R. Bain, Trends in the use of lead as a gasoline antiknock additive, in "*Proceedings of the International Lead and Zinc Conference*", October 5-7, 1988, London, U.K.
- Legrand, M., Sulphur-derived species in polar ice, in: *Ice Core Studies of Global Biogeochemical Cycles*, edited by R.J. Delmas, C. Hammer, D. Kley, and P. Mayewski, NATO-ARW Series, Kluwer, Dordrecht, in press, 1994.
- Lobinski, R., C.F. Boutron, J.P. Candelone, S. Hong, J. Szpunar-Lobinska and F.C. Adams, Speciation analysis of organolead compounds in Greenland snow at the femtogram-per-gram level by capillary gas chromatography/atomic emission spectrometry, *Anal. Chem.*, 65, 2510-2515, 1993.
- Lokinski, R., C.F. Boutron, J.P. Candelone, S. Hong, J. Szpunar-Lobinska and F.C. Adams, Present century snow core record of organolead pollution in Greenland, *Env. Sci. Technol.*, 28, 1467-1471, 1994.
- Loranger, S. and J. Zayed, Manganese and lead concentrations in ambient air and emission rates from unleaded and leaded gasoline between 1981 and 1992 in Canada: a comparative study, *Atmos. Environ.* 28, 1645-1651, 1994.

- Möller, D., Estimation of the global man-made sulphur emission, *Atmos. Environ.* 18, 19-27, 1984.
- Murozumi, M., T.J. Chow and C.C. Patterson, Chemical concentrations of pollutant lead aerosols, terrestrial dusts and sea salts in Greenland and Antarctic snow strata, *Geochim. Cosmochim. Acta*, 33, 1247-1294, 1969.
- Ng, A. and C.C. Patterson, Natural concentrations of lead in ancient Arctic and Antarctic ice, *Geochim. Cosmochim. Acta*, 45, 2109-2121, 1981.
- Nriagu, J.O. (ed.), *Biogeochemistry of Lead in the Environment*, Elsevier, Amsterdam, The Netherlands, 1978.
- Nriagu, J.O. (ed.), *Zinc in the Environment*, Wiley, New York, USA, 1979a.
- Nriagu, J.O. (ed.), *Cadmium in the Environment*, Wiley, New York, USA, 1979b.
- Nriagu, J.O. (ed.), *Copper in the Environment*, Wiley, New York, USA, 1979c.
- Nriagu, J.O., Global inventory of natural and anthropogenic emissions of trace metals to the atmosphere, *Nature*, 279, 409-411, 1979d.
- Nriagu, J.O., A global assessment of natural sources of atmospheric trace metals, *Nature*, 338, 47-49, 1989.
- Nriagu, J.O., The rise and fall of leaded gasoline, *Sci. Tot. Environ.* 92, 13-28, 1990.
- Nriagu, J.O. and J.M. Pacyna, Quantitative assessment of worldwide contamination of air, water and soils by trace metals, *Nature*, 323, 134-139, 1988.
- Pacyna, J.M., Technological parameters affecting atmospheric emissions of trace elements from major anthropogenic sources, in *Control and Fate of Atmospheric Trace Metals*, edited by J.M. Pacyna and B. Ottar, pp. 15-31, Kluwer, Dordrecht, 1989.
- Pacyna, J.M., *Emission Factors of Atmospheric Cd, Pb and Zn for Major Source Categories in Europe in 1950 through 1985*, Norwegian Institute for Air Research Rept OR 30-91, 1991.
- Pacyna, J.M., Emissions of pollutants and their control, in *Topics in Atmospheric and*

Interstellar Physics and Chemistry, edited by C.F. Boutron, Les Editions de Physique, Paris, in press, 1994.

Pacyna, J.M., E. Voldner, G.J. Keeler and G. Evans, *Proceedings of the 1st Workshop on Emissions and Modelling of Atmospheric Transport of Persistent Organic Pollutants and Heavy Metals*, May 6-7, 1993, Durham, NC, U.S.A.

Patterson, C.C., An alternative perspective - Lead pollution in the human environment: origin, extent and significance, in *Lead in the Human Environment*, pp 265-349, National Academy of Sciences, Washington D.C., USA, 1980.

Patterson, C.C. and D.M. Settle, The reduction of orders of magnitude errors in lead analysis of biological materials and natural waters by evaluating and controlling the extent and sources of industrial lead contamination introduced during sample collection and analysis, in: *Accuracy in Trace Analysis*, edited by P. La Fleur, *Natl. Bur. Stand. Spec. Publ.* 422, 321-351, 1976.

Paulsen, P.J., E.S. Beary, D.S. Bushee and J.R. Moody, Inductively coupled plasma mass spectrometric analysis of ultrapure acids, *Anal. Chem.*, 60, 971-975, 1988.

Peel, D.A., Trace metals and soot in ice cores, in *The Environmental Record in Glaciers and Ice Sheets (Dahlem Konferenzen)*, edited by H. Oeschger and C.C. Langway, Jr., pp. 207-223, Wiley, New York, 1989.

Rosman, K.J.R., W. Chisholm, C.F. Boutron, J.P. Candelone and U. Görlach, Isotopic evidence for the sources of lead in Greenland snows since the late 1960s, *Nature*, 362, 333-335, 1993.

Rosman, K.J.R., W. Chisholm, C.F. Boutron, J.P. Candelone and S. Hong, Isotopic evidence to account for changes in the concentration of lead in Greenland snow between 1960 and 1988, *Geochim. Cosmochim. Acta*, 58, 3265-3269, 1994.

Rosman, K.J.R., W. Chisholm, C.F. Boutron, J.P. Candelone and S. Hong, The changing isotopic composition of lead in snow deposited in central Greenland since the 18th

- century, *Earth Planet. Sci. Lett.*, submitted 1995.
- Savarino, J., C.F. Boutron and J.L. Jaffrezo, Short-term variations of Pb, Cd, Zn and Cu in recent Greenland snow, *Atmos. Environ.* 28, 1731-1737, 1994.
- Taylor, S.R. and S.M. McLennan, *The Continental Crust: its composition and evolution*, Blackwell, Oxford, 1985.
- Thomas, V. and T.G. Spiro, Emissions and exposure to metals: cadmium and lead, in *Industrial Ecology and Global Change*, Cambridge University Press, 1994.
- Van Cleuvenbergen, R.J.A. and F.C. Adams, Organolead compounds, in *Handbook of Environmental Chemistry*, edited by O. Hutzinger, Springer, Berlin, 1990.
- Vandal, G.M., W.F. Fitzgerald, C.F. Boutron and J.P. Candelone, Variations in mercury deposition to Antarctica over the past 34000 years, *Nature*, 362, 621-623, 1993.
- Weiss, H.V., M. Koide and E.D. Goldberg, Mercury in the Greenland ice sheet: evidence of recent input by man, *Science*, 174, 692-694, 1971a.
- Weiss, H.V., M. Koide and E.D. Goldberg, Selenium and sulfur in a Greenland ice sheet: relation to fossil fuel combustion, *Science*, 172, 261-263, 1971b.
- Weiss, H.V., K. Bertine, M. Koide and E.D. Goldberg, The chemical composition of a Greenland glacier, *Geochim. Cosmochim. Acta*, 39, 1-10, 1975.
- Wolff, E.W., Signals of atmospheric pollution in polar snow and ice, *Antarctic Sci.*, 2, 189-205, 1990.
- Wolff, E.W. and D.A. Peel, The record of global pollution in polar snow and ice, *Nature*, 313, 535-540, 1985.
- Wolff, E.W. and D.A. Peel, Concentrations of cadmium, copper, lead and zinc in snow from near Dye 3 in south Greenland, *Ann. Glaciol.*, 10, 193-197, 1988.
- Wolff, E.W. and E.D. Suttie, Antarctic snow record of southern hemisphere lead pollution, *Geophys. Res. Lett.*, 21, 781-784, 1994.

Table 1. Summit, central Greenland: heavy metals concentrations measured in the central part of various sections of a 70.3m snow/ice core.

Depth Interval ¹ (m)	Age ² (Calendar Year)	Measured Concentration (pg/g)			
		Pb	Zn	Cd	Cu
7.48-7.93	1974.5	84	60	1.7	7.6
9.79-10.11	1969.6	109	46	1.5	3.2
10.92-11.25	1965.4	99	60	1.3	8.3
11.44-11.77	1964.1	88	129	1.5	9
11.96-12.25	1963	90	75	1.3	7.9
12.54-12.86	1961.6	65	72	0.85	13
12.98-13.27	1960.4	60	49	0.78	4
13.37-13.67	1959.2	126	155	2.2	15
13.74-14.17	1958.2	59	54	0.82	3.2
14.38-14.69	1956.9	90	74	1.2	6.4
15.17-15.62	1954.7	67	75	1.2	7.5
15.80-16.17	1953.2	81	134	3.3	17
16.69-16.97	1951.2	67	67	1.4	7.3
17.30-17.58	1949.7	88	71	2.9	7.1
18.08-18.54	1948	49	79	2.1	6.8
18.66-19.11	1946.6	31	42	1.2	4.9
21.10-21.45	1940	41	75	1.1	8.6
23.64-24.08	1933	18	90	1.1	9.3
25.48-25.92	1928	45	65	2.0	6.9
29.77-30.13	1915	34	34	1.2	5.2
37.27-37.60	1891	63	30	1.1	4.9
43.90-44.45	1869-1870	18	44	0.68	2.7
51.76-52.23	1841-1842	17	22	0.15	2.4
58.20-58.50	1817	4.4	29	0.23	3.5
61.56-61.85	1805	12	20	0.21	6.1
69.93-70.17	1773	7.6	16	0.27	2.8

¹ Surface: July 1989

² Estimated age for the middle of the corresponding core section

Table 2. Comparative determination of Zn, Cd, and Cu in snow/ice deposited in Greenland in the early 19th century.

Reference	Location	Age of Snow/Ice (Calendar Year)	Measured Concentration (pg/g)		
			Zn	Cd	Cu
<i>Weiss et al.</i> [1975]	• Camp Century (77°10'N, 61°08'W)	1815	-	7	445
	• Dye 3 (65°11'N, 43°50'W)	1807	180	<2	153 ¹
<i>Herron et al.</i> (1977)	Milcent (70°18'N, 44°35'W)	1804/5	38	12 ²	-
<i>This work</i>	Summit (72°34'N, 37°37'W)	1805	20	0.28	6.8

¹ Value for the sample dated 1900 (oldest sample in the series which was analysed for Cu)

² Value for the sample dated 1785/86 (the 1804/05 sample was not analysed for Cd)

Table 3. Measured Al and sea salt Na (Na_{ss}) concentrations in typical samples whose age ranges from 1773 to 1992. Na_{ss} was calculated by correcting measured Na concentrations for the crustal component evaluated from Al concentrations using the Na/Al abundance ratio in the mean crustal material [Taylor and McLennan, 1985].

Years	Measured Concentration (ng/g)	
	Al	Na_{ss}
1773	4.3	2.4
1817	5.6	4.4
1870	7.6	4.1
1915	5.0	2.3
1940	8.6	0.7
1968	3.7	0.9
1992 ¹	5.6	3.2

¹ From Candelone et al. [1995]

Table 4. Zn, Cd and Cu: comparison of the mean ratio of total world emissions (anthropogenic plus natural, 1983 values)/natural world emissions [*Nriagu and Pacyna, 1988*] with the enhancement factor in Summit, central Greenland, snow and ice from 1773 to 1983.

	Zn	Cd	Cu
Total/natural world emissions (1983 values)	3.9	6.9	2.3
Enhancement factor in Greenland snow from 1773 to 1983	3.4	6.3	2.6

Table 5. Summit, central Greenland: comparison of heavy metals concentrations measured in ice dated for 1773 (second half of the 18th century, this work) and in pre-human activities Holocene ice dated for 7760 years BP (from *Hong et al. [1994]* and *S. Hong*, personal communication).

Age of the Ice		Measured Concentrations (pg/g)			
Calendar	Years BP	Pb	Zn	Cd	Cu
1773 AD	222	7.6	16	0.27	≤2.8
5766 BC	7760	0.55	23	0.25	1.7

Table 6. Heavy metals deposition fluxes at Summit, central Greenland.

Year	Deposition Flux at Summit ($10^{-10}\text{g cm}^{-2}\text{ yr}^{-1}$)			
	Pb	Zn	Cd	Cu
7760 BP ¹	0.13	5.3	0.06	0.39
1773	1.8	3.7	0.06	$\leq 0.64^3$
1850 ²	3.5	7.0	0.06	0.53
1992 ²	3.9	12	0.18	1.7
1960s-1970s maximum	25	20	0.41	2.2

1 Concentration values given in *Hong et al* [1994] and *S. Hong*, personal communication

2 For 1850 and 1992, the concentration values used for the calculations are those given by the spline-smoothed curves shown in Figs. 3, 4

3 No satisfying plateau of concentration was obtained for Cu in the 1773 sample

Table 7. Past and present day deposition fluxes of heavy metals to the Greenland ice cap.

Year	Deposition Flux to the Greenland Ice Sheet (tonnes yr^{-1})			
	Pb	Zn	Cd	Cu
7760 BP	0.24	9.8	0.11	0.72
1773	3.3	6.8	0.11	≤ 1.2
1850	6.5	13	0.11	1.0
1992	7.2	22	0.33	3.1
1960s-1970s maximum	46	37	0.75	4.1

FIGURE CAPTIONS

- Figure 1.** Measured Zn and Cu concentrations as a function of radius in the 61.56-61.85 section of the 70.3m snow/ice core electromechanically drilled at Summit, central Greenland. Good plateaus of concentrations are obtained in the central part of the core section.
- Figure 2.** Measured heavy metals concentrations as a function of radius in two sections of the 70.3m snow/ice core electromechanically drilled at Summit, central Greenland. (A): Cu in the 69.93-70.17m section (year 1773); (B) Zn in the 51.76-52.23m section (years 1841-1842). No satisfying plateau of concentrations is obtained in the central part of the core section for these two cases.
- Figure 3.** Changes in Zn, Cd and Cu concentrations in snow/ice deposited at Summit, central Greenland, from 1773 to 1992. Full dots: this work (70.3m core); full triangles: averaged values from *Boutron et al.* [1991] (10.7m core); open triangles: mean yearly values for the years 1990, 1991 and 1992 from *Candelone et al.* [1995] (1.6m snow pit). The general time trends are shown with spline-smoothed curves.
- Figure 4.** Changes in Pb concentrations in snow/ice deposited at Summit, central Greenland, from 1773 to 1992. Full dots: this work (70.3m core); full triangles: averaged values from *Boutron et al.* [1991] (10.7m core); open triangles: mean yearly values for the years 1990, 1991 and 1992 from *Candelone et al.* [1995] (1.6m snow pit). The general time trend is shown with a spline-smoothed curve. Also shown with open circles are the original data of *Murozumi et al.* [1969] for the Camp Century area in north-west Greenland (the dotted line shown on the figure is the original one given in *Murozumi et al.* [1969]).

Figure 5. (A) Changes in Pb tonnage used to manufacture Pb alkyl antiknock additives for gasoline from 1955 to 1986 [*Larbey and Bain, 1988*]. It is estimated that ~ 70% of the amount of the lead content in the additive is emitted to the atmosphere through the exhaust pipe. (B) Changes in Pb concentration in snow/ice at Summit, central Greenland, during the same time period (spline-smoothed curve).

Figure 6. Changes in Pb concentrations in ice/snow at Summit, central Greenland, from 3000 years BP to 1992. Years 3000 - 470 BP: data from *Hong et al. [1994]*. 1773-1992: this work. Note the logarithmic scale on the vertical axis.

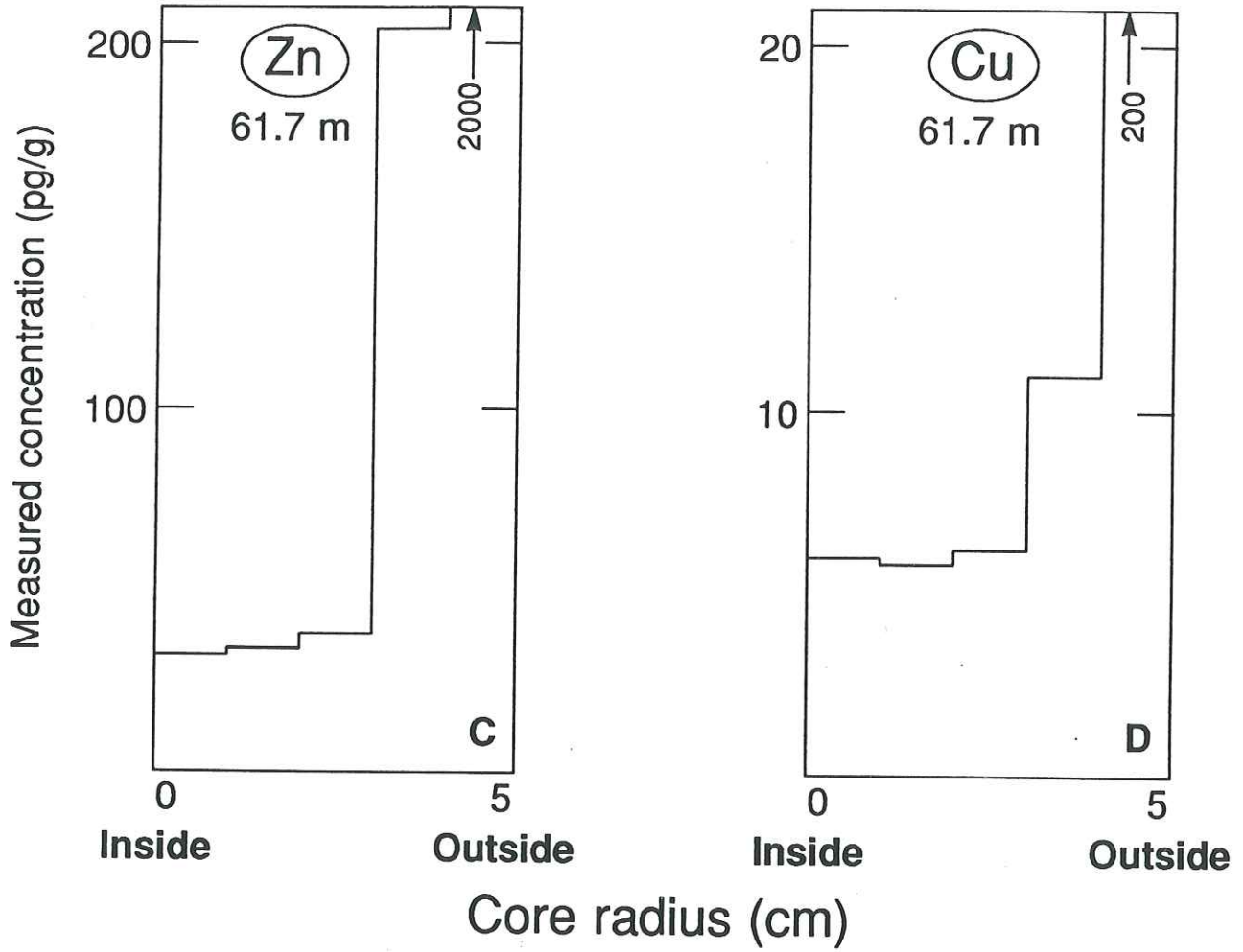

Figure 1

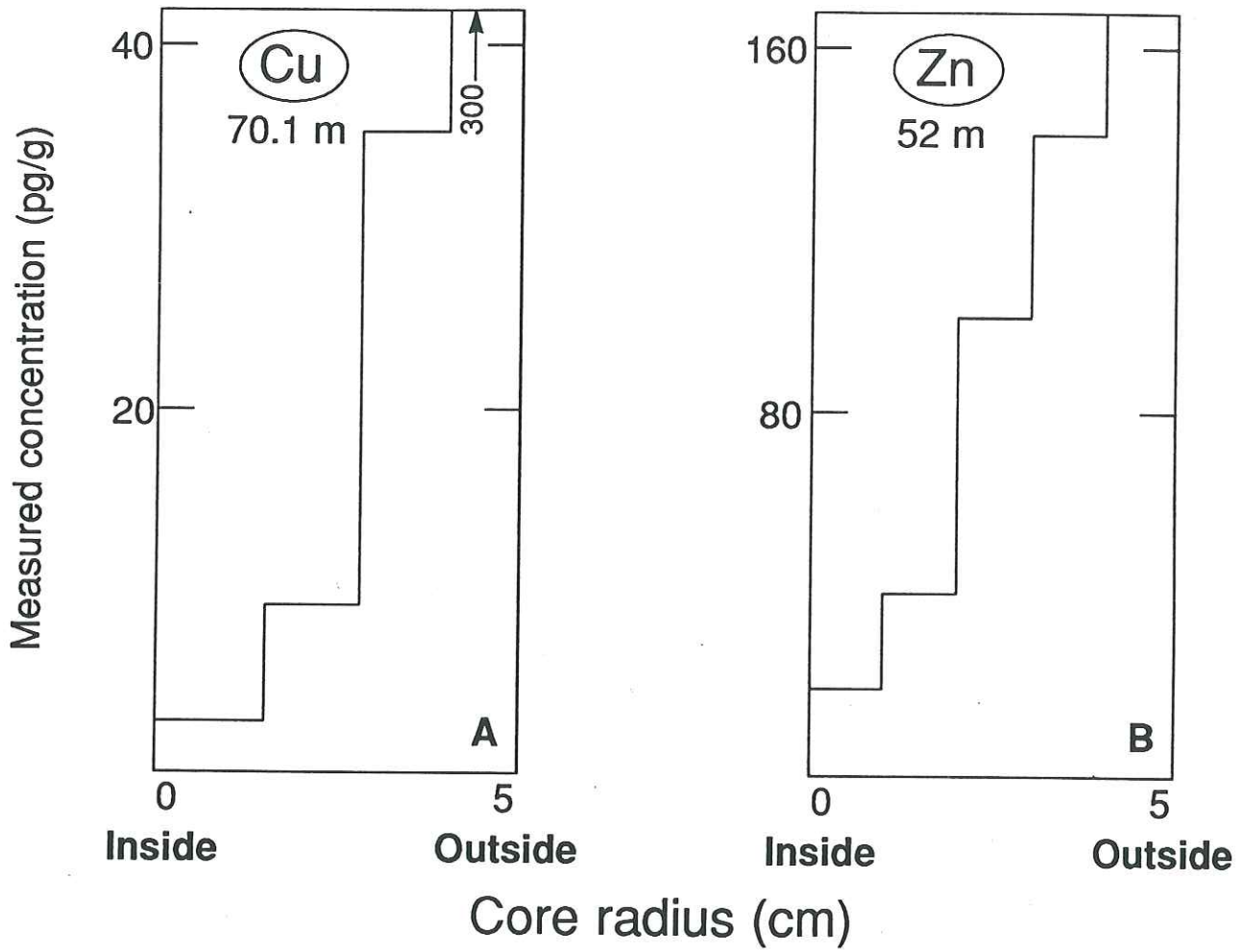

Figure 2

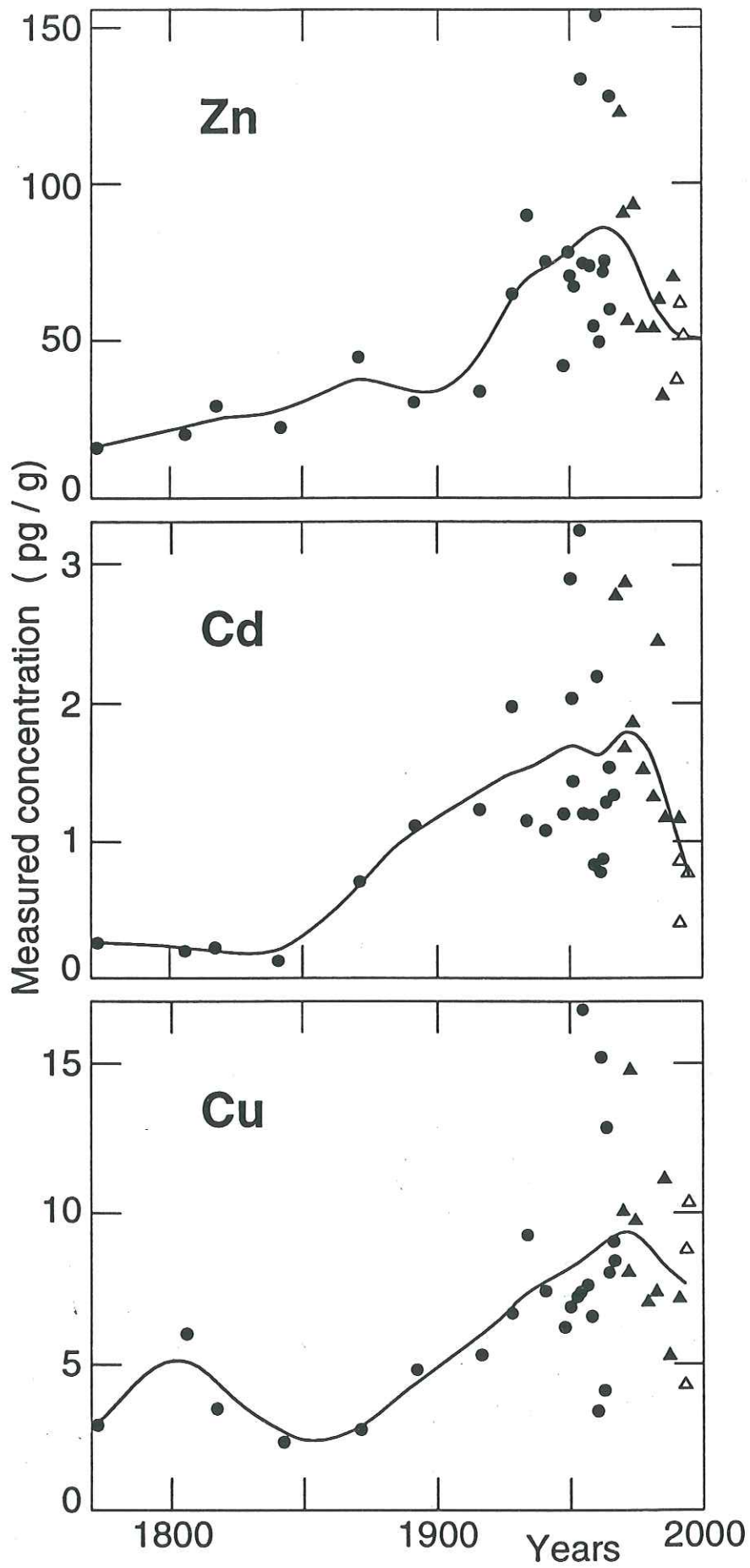

Figure 3

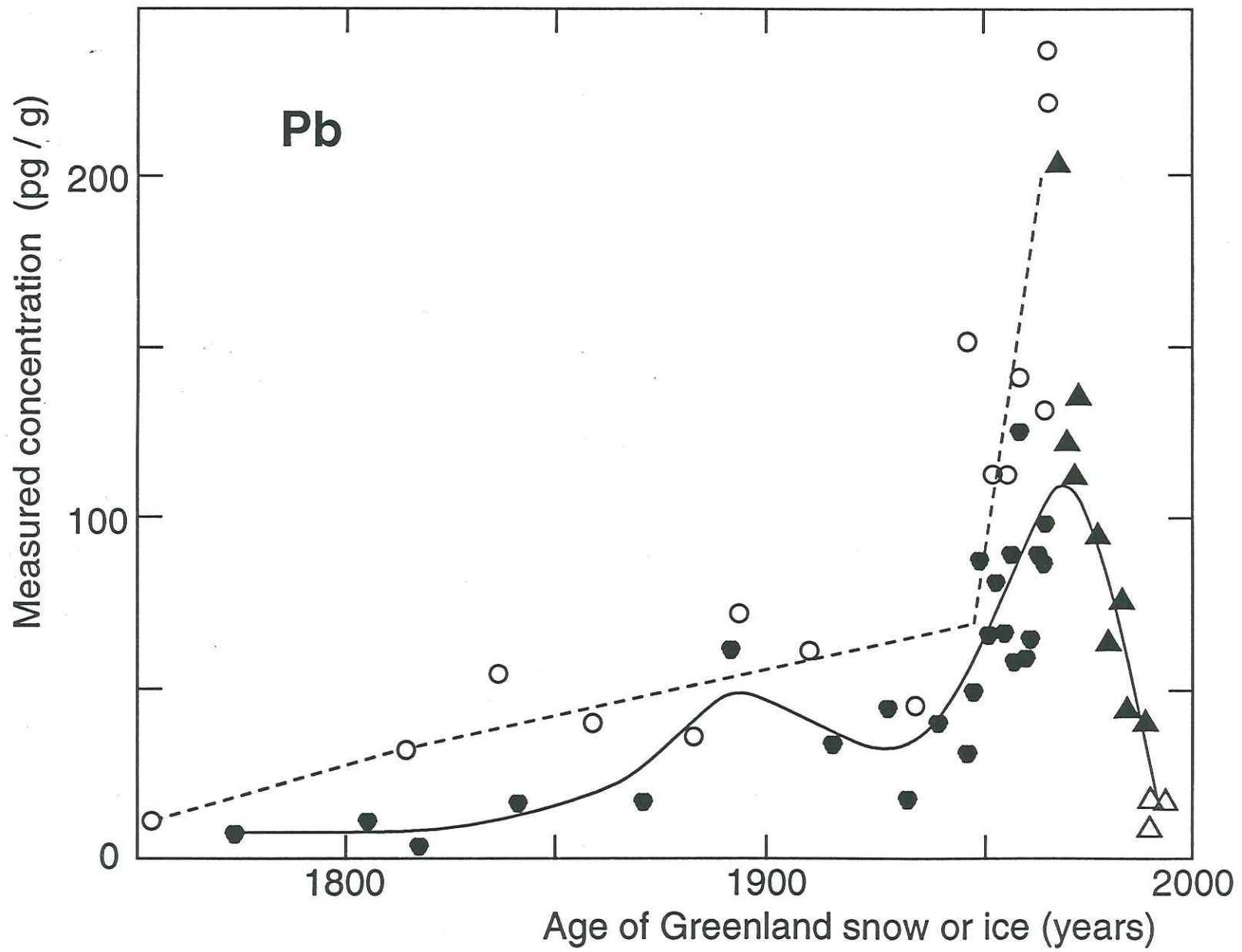

Figure 4

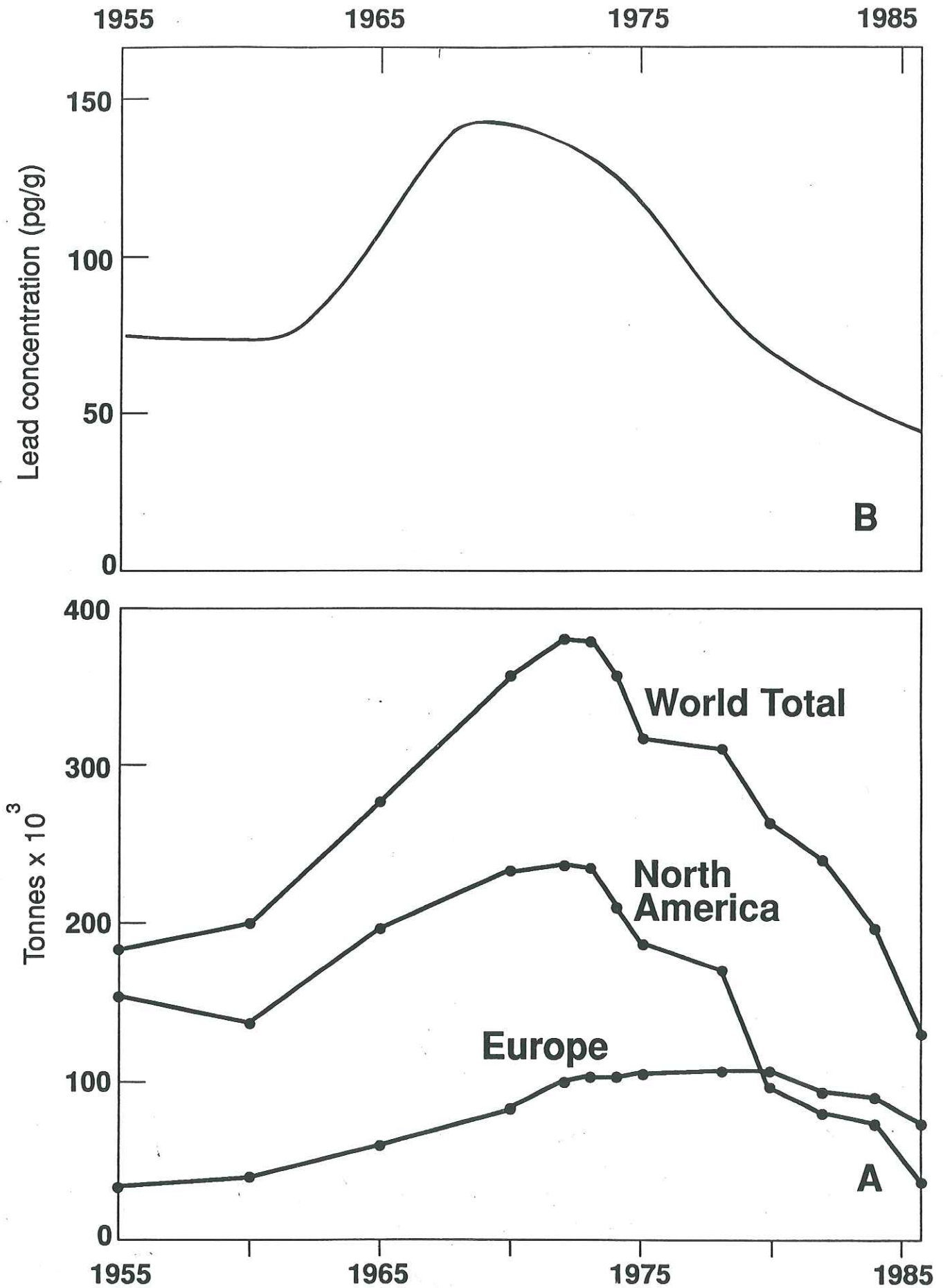

Figure 5

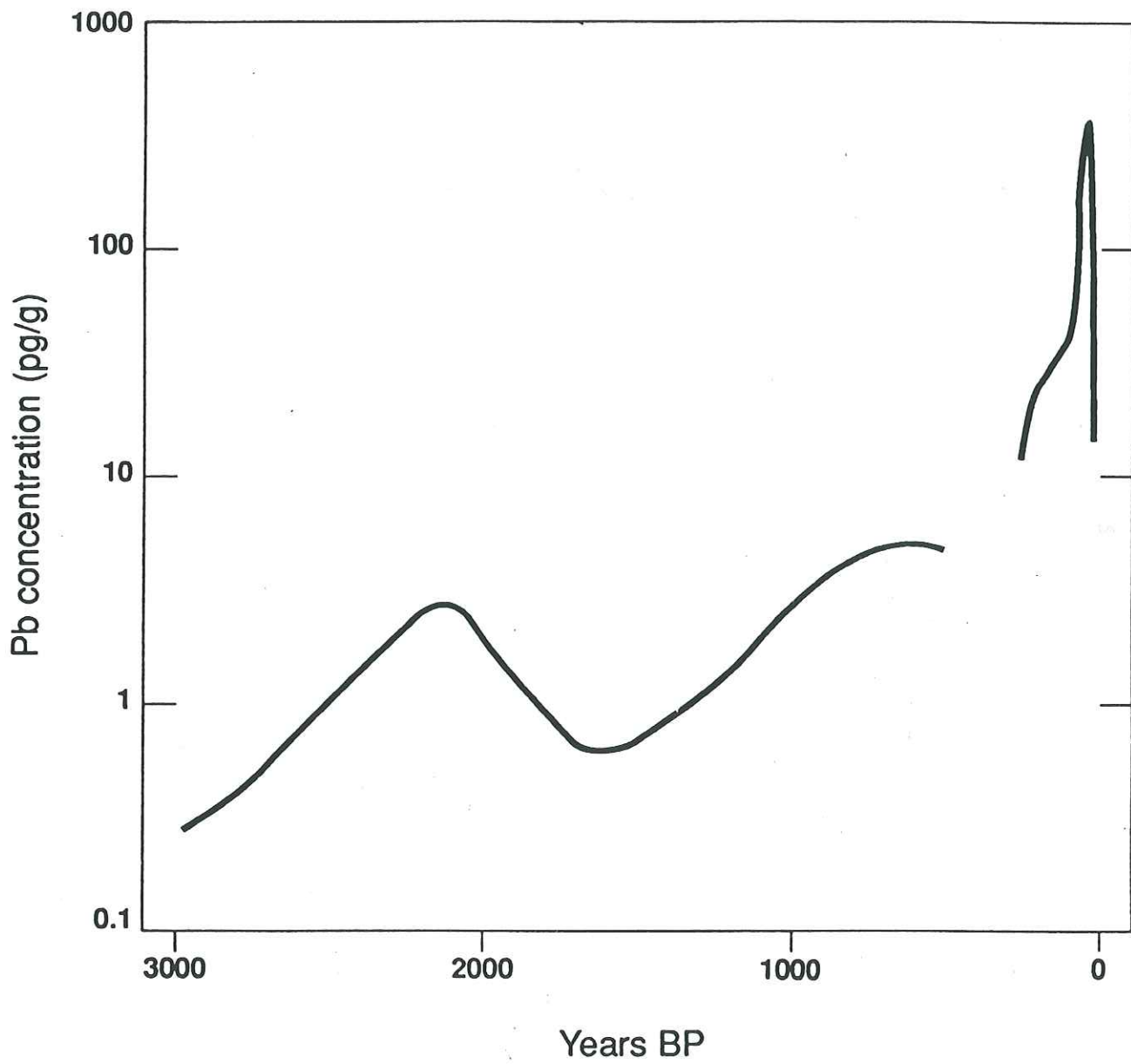

Figure 6

**SEASONAL VARIATIONS IN HEAVY METAL CONCENTRATIONS IN PRESENT
DAY GREENLAND SNOW**

Jean-Pierre CANDELONE, Jean-Luc JAFFREZO, Sungmin HONG, Christian PELLONE,
Cliff I. DAVIDSON and Claude F. BOUTRON

Submitted to Earth and Planetary Science Letters, October 25th, 1994

**SEASONAL VARIATIONS IN HEAVY METAL CONCENTRATIONS IN PRESENT
DAY GREENLAND SNOW**

Jean-Pierre CANDELONE¹, Jean-Luc JAFFREZO¹, Sungmin HONG¹, Christian PELLONE²,
Cliff I. DAVIDSON³ and Claude F. BOUTRON^{1,4,*}

¹Laboratoire de Glaciologie et Géophysique de l'Environnement du CNRS, 54, rue Molière, Domaine
Universitaire, B.P. 96, 38402 St Martin d'Hères, France

²Centre de Recherche et d'Essais des Machines Hydrauliques de Grenoble, B.P. 95 X, 38402 St
Martin d'Hères, France

³Department of Civil Engineering, Carnegie Mellon University, Pittsburgh, PA, 15213, USA

⁴UFR de Mécanique, Université Joseph Fourier de Grenoble, Domaine Universitaire, B.P. 68, 38041
Grenoble, France

*Author to whom correspondence and reprints requests should be addressed

Submitted to Earth and Planetary Science Letters, October 25th, 1994

ABSTRACT

Thirty six samples from a snow pit dug in central Greenland have been analysed for heavy metals giving detailed profiles of the seasonal variations in the concentrations of Pb, Cd, Zn and Cu. We date our sample set through comparisons between stable hydrogen isotopes, aluminium, sodium concentrations (measured in our samples) and also variations of SO_4^{2-} , MSA and H_2O_2 (measured in another serie of samples from the same pit). The set is found to integrate a period of two years of accumulation, most of the deposition occuring during spring and summer.

Crustal enrichment factors have been calculated based on the Al content in each sample and the average metal/Al ratio in the bulk earth crust. The heavy metals are found to derive mainly from anthropogenic sources: estimates of the contributions from the main known natural sources only represent 15% or less of the total Pb, Cd and Zn concentrations but 40% for Cu.

Polluted air masses from continental industrialized areas are found to reach central Greenland mostly in spring and early summer ; occasional incursions may also happen in winter. For spring, the origine of the air masses is attribute to the Canadian Arctic and Eurasia via transport over the pole. Arrivals from populated areas of eastern North America and western Europe seem to prevail later in the year.

I - INTRODUCTION

There are now comprehensive and reliable data on changes in heavy metal concentrations in central Greenland snow covering the past few centuries [1, 2], particularly for the period since the industrial revolution. These data for the first time show the large scale pollution of the troposphere of the northern hemisphere for Pb [1-4], Cd, Zn and Cu [3-4]. However there is still a lack of reliable data on short term (seasonal) variations of these metals in Greenland recent snow and ancient ice. Such data should provide valuable information about sources and long range transport of these metals from North American and Eurasian source areas to the Arctic troposphere. It is now clear that many of the few initial published data were indeed plagued by contamination problems during field sampling or laboratory analysis [5-6]. The only exceptions are a few data sets for Pb [1, 7, 8, 9] and short data sets for Cd, Cu and Zn [7-9]; these few data are for recent and rather short time periods only. There are presently no data at all for ancient ice.

We present here a new and rather comprehensive data set on seasonal variations in Greenland snow during the past few years. It includes data on Pb, Cd, Zn and Cu in snowpit samples collected near Summit, central Greenland. First, we present a quantitative evaluation of natural and anthropogenic sources. We then attempt to interpret the changes in concentrations and in the crustal enrichment factors in terms of changing sources and of associated transport pathways.

II - SAMPLING AND ANALYTICAL PROCEDURES

2.1. Samples collection

The samples were collected on July 15, 1992 at a remote site located 4 km east-south east of the US-European ATM sampling site [10] ($72^{\circ}20'N$; $38^{\circ}45'W$; elevation 3270 m, accumulation rate : $23 \text{ g H}_2\text{O/cm}^2\cdot\text{y}$) in central Greenland. The exact location of the sampling site was chosen in order to minimize local contamination problems which might result from the operations at the ATM camp.

A 1.60 m deep snow pit was hand dug by operators wearing full clean room clothing and shoulder length polyethylene gloves. The upwind vertical wall of the pit was then cut back to a distance of about 15 cm using acid cleaned polyethylene and polycarbonate scrapers. A continuous sequence of 36 samples was then collected from the shaved wall beginning from the surface down to the bottom of the pit. Each sample was taken by pushing an ultraclean Teflon corer (inside diameter 4.5 cm, length 40 cm) horizontally ; the snow was then transferred into an ultraclean 11 wide mouth polyethylene bottle. The bottles were packed inside double acid clean polyethylene bags and kept frozen until analysis.

2.2. Analytical procedures

Each sample was melted at room temperature inside the original bottle under the laminar air flow of a clean bench inside the clean laboratory of the Laboratoire de Glaciologie et Géophysique de l'Environnement de Grenoble. A 10 ml aliquot was first taken in a ultraclean [11] Low Density

Polyethylene (LDPE) bottle for direct determination of Zn, Al, Na by Graphite Furnace Atomic Absorption Spectrometry (GFAAS). A 30 ml aliquot was taken also in a 30 ml LDPE ultraclean bottle, for the determination of Pb, Cd and Cu by GFAAS after preconcentration (x 30) by non boiling evaporation [12]. A third aliquot was finally taken for the hydrogen isotopes measurements by Mass Spectrometry [13].

2.3. Dating

More detailed dating of the samples can be obtained by combining the Na, Al (Fig. 1) and hydrogen isotopes (M. Stievenard and J. Jouzel, personal communication) data obtained in this work with ancillary data obtained by other investigators from nearby samples collected in the same pit within 1 m from our series (sulfates and MSA [14] and H_2O_2 [15]). The seasonal pattern of the concentrations of these various species is rather well documented for the Summit area [16-18]. Summer depths are indeed characterized by decreasing trend and low marine Na (Na_m) values (Fig. 1a), high δD , and maxima in MSA [14] and H_2O_2 [15] concentrations. H_2O_2 is however subject to post deposition processes that may shift the maximum value within the upper layer of snow [15]. Spring (April-May) layers are characterized by pronounced aluminium and the crustal fraction of sodium peaks (Fig. 1a, b), transition from low to high values of δD [13], and increasing values for sulfate, MSA [14] and H_2O_2 [15].

High seasalt sodium, low aluminium and δD values associated with low MSA, sulfate and H_2O_2 values are ascribed to winter and fall periods. No direct observations of snow accumulation and chemistry are presently available for winter and fall in the Summit area. It is thus impossible to

distinguish between the two seasons in our data. Overall, it seems that the snow accumulation is not evenly distributed during the course of the calendar year as documented by several investigators [14, 17, 19]. Most of the snow accumulates during spring and summer while little occurs in winter.

Using these patterns, the following sequences can be deduced : two summer layers and their following winter layers are fully recorded (summer and winter 90 and 91), two spring layers are also identified (spring 91 and 92) ; the deepest samples are attributed to spring 90 and the top ones correspond to summer 92. These sequences are indicated by overlapping arrows on top of each graph (Figures 1,2 and 5).

III - RESULTS AND DISCUSSION

3.1. Presentation of our data

Figure 2 shows the change in Cd, Pb, Zn and Cu concentrations in Summit snow from spring/summer 1990 to summer 1992 as observed in our samples. Pronounced seasonal variations are seen for the four heavy metals, with concentrations varying by factors of 31, 75, 22 and 48 for Cd, Pb, Zn and Cu, respectively. Spring and summer layers present much higher concentrations than winter/fall layers. Pb and Cd concentration profiles display a similar pattern associated with very significant correlation coefficients (Table 1). A good correlation also links Pb and Cu, while a slightly lower (but still significant) correlation associates Cd with Zn and Cu on one hand, Pb and Al on the other. No correlation is observed between Na and any heavy metal. The averages, ranges and extreme concentration values in our samples are given in Table 2.

3.2. Comparison with data of other investigators

We can compare our data for Pb with those covering a 10 year period (1980-1990) collected from a snow pit located within 3 km of our sampling site [8]. The observed seasonal variations are in very good agreement, although the ratio between highest and lowest values is lower than in our study (ratio of 35 for respective minima and maxima values of about 5 and 160 pg/g). This may be due to the less precise temporal resolution in this last study (an average of 11-12 samples/year instead of 16 in our study). A peak in lead concentration attributed to late winter/early spring is however evident, which is in fairly good agreement with our observations. This pattern was initially described some 25 years ago, with a very limited sample series covering one year of snow deposited in northwest Greenland, near Camp Century (5 samples only, dated from August 1964 to August 1965) [1].

Our data can be directly compared for all four metals with a more recent work [9]. This data set, with 19 samples, was collected close location to our sampling pit, on 08/20/90 ; the dating puts the deepest sample back to winter 89. The data obtained in this preliminary work are in general agreement with ours as can be seen in Table 2.

Reliable heavy metal data from other Greenland snow-pits are not common ; we can only mention previous results obtained at Dye 3 (southern Greenland, 800 km from Summit, [7]). This data set was constituted of 12 samples integrating the year 1983-84. Interestingly, a clear peak occurring in spring was also evidenced for all metals (Pb, Zn, Cu) but Cd. The authors initially suggested a different source or input mechanism for this last metal.

3.3. Principal components Factor Analysis (PCFA)

It had previously been demonstrated that PCFA can provide valuable information for the identification of the different heavy metal sources in Arctic aerosol [20] and Antarctic and Greenland snow and ice [21-22]. Results of a PCFA on our data set are shown with Table 1 (correlation matrix) and Figure 3 (two dimensional plots of the 6 measured elements (Pb, Cd, Zn, Cu, Al and Na_m) for the first three eigenvectors). The percentage of variance explained by each of these first three eigenvectors is respectively 62.6, 20.2 and 7.2 %. It must be noted that no rotation was performed on the factors since such operation do not ease, in our case, the interpretation of the results. The first two dimensional plot using factors F1 and F2 (Fig. 3a) clearly separate Na_m on one side and all the other elements on the other side : this was anticipated since the correlation coefficients between Na_m and the other elements are not significant. The second two dimensional plot, using factors F2 and F3 (Fig. 3b) clearly separates 3 groups. Group 1 (Na_m) represents the marine (seasalt) source. Group 2 (Al) represents the rock and soil dust source. The elements of group 3 (Pb, Cd, Zn and Cu) clearly appear not to be derived from these two sources : they are probably mostly anthropogenic. This first attempt is however insufficient to make distinctions between in the origin of the heavy metals. The result suggests that further insight can be gained after having identified the different sources.

3.4. Natural and anthropogenic components

Contributions to each metal from continental biogenic, biomass burning, seasalt, volcanic plumes and rock and soil dust are tentatively estimated below. The emission factors and the source intensities are very poorly known : the annual fluxes reported in the current literature are given with

confidence intervals of one order in magnitude in a few cases, but two generally. Then we also attempt to precise the contributions of the main anthropogenic sources.

3.4.1. Natural emissions involving biomass material

We indirectly assess the flux of metals emitted by biogenic processes and biomass burning events using some existing carbon data. Particulate carbon measured in ice from Summit site revealed a background concentration of 10 ng/g [23]. In the atmospheric aerosol burden, particulate carbon may be separated in two classes : soot carbon, which came from combustion processes and organic carbon that originates from both combustion and exudates of the vegetation ; they represent respectively 17 and 83 % of the total particulate carbon [23].

The particulate organic carbon (POC) concentration averages 8.3 ng/g in Summit old ice [23]. Assessing the totality of the POC derived from forest evasion to particulate organic matter (POM), using a ratio of 2.2 to relate the POM to the POC [26] and using the average POM content in heavy metal given by Nriagu [24] yield to contributions of 0.047 pg/g for Pb, 0.011 pg/g for Cd, 0.12 pg/g for Zn and 0.10 pg/g for Cu or 0.3, 0.9, 0.23 and 1.3 % of the average concentration for each metal, repectively.

The metal flux from wild forest fires may be estimated if we consider that they were the unique source for atmospheric soot carbon in pre-industrial times. We then can use data for soot carbon in old Summit ice (1.7 ng/g) [23] and multiply it by the average heavy metal content in trees and foliage ashes (respectively 450, 8, 1450 and 200 μ g/g for Pb, Cd, Zn and Cu) given in [25]. It leads

to contributions of 0.77 pg/g for Pb, 0.014 pg/g for Cd, 2.47 pg/g for Zn and 0.34 pg/g for Cu, corresponding to 5.1, 2.1, 4.8 and 4.4 % of the average concentrations observed in our samples, respectively. This natural background level may apply to our data set since ammonium does not reveal high biomass burning inputs of specific events for the time period covered by our samples (M. Legrand, personal communication). The actual figures may be slightly different, since the ratio of metals to soot carbon is not well known for boreal biomass burning, while it is probable that only emissions from high latitude forests may influence Greenland (M. Legrand, personal communication).

3.4.2. Natural emissions from inorganic processes

The marine contribution can be estimated from Na_m using the mean metal/Na ratio for bulk seawater [26], multiplied with the few available enrichment factors for sea derived aerosols relative to bulk seawater taken in [27]. This contribution is found to be negligible for all four metals (with less than 0.05 % of the concentrations).

Volcanic emissions of sulfur have been estimated to represent 13 % of the non seasalt sulfate [28] present in the global atmosphere. We multiply the average metal/S ratio given for volcanic plumes [24] with the average sulfur content in snow from volcanic origin (taking into account a natural level of 40 ng/g for sulfate in Summit ice [29]). We obtain amounts of 0.13, 0.03, 0.34 and 0.35 pg/g for Pb, Cd, Zn and Cu that correspond to 0.9, 4.9, 0.7, and 4.5 % of the total respective concentrations. Volcanic contribution can now be estimated using bismuth as a more specific tracer, (the volcanic source largely dominates the Bi budget for background atmosphere [28,30]), with newly obtained

data for surface and shallow depth snow core samples from Summit [31,32]. In those samples, Bi is found to range from 0.05 (detection limit) to 0.66 pg/g (0.25 on average). The metal/Bi ratio we use for our estimates came from the most recent literature [26, 33, 34]. The calculated contributions using the average Bi value (0.25 pg/g) are ~5 fold higher than results based on sulfur (0.55, 0.14, 1.6 and 1.58 pg/g). On the other hand, the contributions obtained from the lower Bi value (0.05 pg/g) are very similar to estimates as calculated with average sulfur content from volcanic origin in Summit snows (1.7 ng/g), as can be seen with Table 3.

Rock and soil dust contribution to the measured heavy metal concentrations can be estimated from the measured Al concentrations and metal/Al ratios in mean crustal material. For Pb, we used the mean bulk continental crust ratio given in [35]. For Cd, Zn and Cu we used the mean ratios given in [36]. Data recently obtained for Greenland ancient Holocene ice have indeed indicated that these reference ratios are giving an adequate representation of rock and soil dust inputs to central Greenland, with calculated crustal enrichment (EF_{crust}) factors in these old ice samples close to unity ([37] and S. Hong, unpublished data).

The calculated crustal contribution is always small for Pb and Cd : from 0.8 up to 12 % in a few cases for Pb (3.1 % on average) and from 0.65 to 16.5 % for Cd (3.6 % on average). It is also small for Zn in 35 % of the samples (less than 5 %), but it can be significant (above 25 % in several cases, and 9.2 % on average). Finally, for Cu, the crustal contribution can be highly significant (from 7 up to 82 %, 27 % on average). The corresponding average amounts are 0.47, 0.024, 4.7 and 2.1 pg/g for Pb, Cd, Zn and Cu respectively.

For Pb and Cu, despite the broad confidence interval given for the emission factors used for the

calculations, the total amount from the precited natural sources (summerized in Table 4) are in good agreement with Pb and Cu contents in Holocene ancient ice 4 to 9 millenia old. Opposately, for Cd and Zn the total amounts are respectively 4 to 10 and 3 to 4 fold lower, when compared to the same reference ([37] and S. Hong, unpublished data). Such results indicate that either the lead and copper, the average emission factors and ratios we used, fairly represent the natural processes or they are individually wrong and the inaccuracies compensate each other.

As a conclusion, the prevailing natural component originate from rock and soil dust. This contribution was calculated for each individual sample, for each heavy metal and was then substracted from the corresponding initial concentration. The values obtained in this way are indeed more representative of the anthropogenic component. The set of data (Al and Na_m values were not modified) was then run through PCFA again. The correlations coefficients have not change significantly from those displayed in Table 1, and the percentage of variance the three first vectors is unchanged. Fig. 4 displays the two dimensional plots obtained using factors F2 and F3 (the graph based on F1 and F2 is identical to Fig. 3a and so not represented). Contrasting with Fig. 3b, a separation occurred in the group of the heavy metals. Cadmium and lead are still closely grouped but clearly separated from copper and zinc. We now detail the contributions to each metal from the major different anthropogenic sources to help for the interpretation of Fig. 4.

3.4.3. Emissions from anthropogenic sources

The most recent heavy metal emissions from anthropogenic sources, reported the metal (Zn-Cd and Cu-Ni) production as the main source of atmospheric Cd, Zn and Cu in 1983 [38]. It



represented 72, 55 and 67% of the total atmospheric fluxes of Cd, Zn and Cu, respectively. From 1983 to 1990, the production of refined Cd, Zn and Cu increased by 20, 17 and 8.2 % [39, 40] respectively

(we are currently not aware of the trends for the other sources for the same period). The emission factors relate the atmospheric emissions with metal production, but they directly depend on the control emission equipment [41]. To our knowledge, no inventory has assessed the extent to which such changes in production have modified the global atmospheric flux of metal from 1983 to 1992. However, it seems a reasonable assumption that it has affected all of the major anthropogenic sources [41] at roughly the same rate. It is thus reasonable to estimate that, in 1992 as in 1983, metal production of Zn-Cd was the main source of Zn and Cu-Ni production was the main source of Cu. For atmospheric Cd, they were also the main sources of equal importance.

In 1983, metal production of Pb was 15%, compared with 75% for the leaded gasoline contribution of the global atmospheric flux. The total world trend of lead consumed with gasoline for the period 1955 - 1986 [42] illustrates the progressive phasing out of alkyllead additives initiated in the 1970's. Out of 65 kT of Pb consumed for this purpose in 1992, 45 kT were released to the atmosphere. In comparison, the non ferrous metal production of Pb averaged 50 kT in 1983 [38]. Using the same hypothesis for Pb as for the other three metals, we may consider the 1992 atmospheric Pb flux to be equally divided in two main sources which are both decreasing : lead gasoline and metal production.

Thus Figure 4 may be interpreted as due to two main metal production sources : Cu-Ni represented by Cu and Zn-Cd represented by Zn. The intermediate position of Cd and Pb reflects the mix between the two sources; however the specific gasoline contribution for Pb has apparently no effect

on the relative position of Pb and Cd on the plot ; it may be tentatively interpreted as the intervention of a similar mechanism of transport for both metals linked with a similar range of size for the emitted particules. In 1983, Zn was also emitted in large quantities (45 % of the total) by other anthropogenic sources than non ferrous metal production (steel manufacturing, phosphate fertilizers, coal combustion [38]) ; this partition in several sources is to be considered for the separation of the plots in Fig. 4.

The partition of these sources is reflected in the timing of the arrival of the elements in Greenland.

3.5. Timing of the elements

The patterns in Figures 2a-d reflect a complexity of processes that ultimately result in the trace metals reaching the Ice Sheet. After emissions from those sources discussed in the previous section, the metals are transported over the Greenland Ice Sheet. Most of this transport takes place in the free troposphere. In some cases, the metal-containing particles are carried to the Arctic in cloud droplets or ice crystals, or the particles may undergo physical or chemical changes in other cases, they may remain essentially intact as they are carried by winds.

Upon reaching the Ice Sheet, meteorological conditions may be such that the free troposphere is isolated from the surface by strong temperature inversions. This can prevent the particles from reaching the surface. When the atmosphere is unstable, in contrast, there can be efficient mixing; particles in the free troposphere can then reach the surface easily. Inversions are most prevalent in the winter when the Ice Sheet is subject to a negative radiation balance [43], and hence

concentrations in surface air and in the snow are expected to be smaller during that period of the year. Efficient mixing is most common during spring and fall when the meteorological conditions undergo seasonal transitions.

Upon reaching the surface, the contaminants can deposit by one of several mechanisms [44]. Metals in precipitating clouds can deposit by snowfall. Others are scavenged by fog which develops locally at the site, and reach the surface as the supercooled fog droplets or ice crystals settle. In the absence of water, the particles can deposit by dry deposition. Because all of these processes depend on particles size, shape, and chemical composition, the relative concentrations in the snow can be different from those in the atmosphere. Nevertheless, the overall seasonal variations have been documented as similar in both air and snow in Greenland.

We can interpret the patterns in Figures 2a-d by noting the timing of the peaks. Previous work [45] has shown that trace metals in fresh snow at Dye3, 800 km to the South, have strong peaks in April-June, in particular Pb, Cu, Zn and Al have strong peaks in April and again in June, while Cd has smaller but still noticeable peaks in April with strong peaks in June. No snowfall was sampled in May during these experiments. Other chemical species such as SO_4^{2-} and ^7Be show similar patterns during these Dye3 experiments [46,47]. The patterns agree with aerosol data that show peaks in April and again in late May. Furthermore, Jaffrezo et al.(1994) have shown that strong SO_4^{2-} peaks occur in springtime layers in snowpit at Summit.

The peaks in Figures 2a-d are consistent with these previous Dye3 and Summit data. We can obtain a calibration by noting that peak p and g correspond to maxima in H_2O_2 concentrations that are an

indicator of solar intensity. Therefore, we would expect these two peaks to coincide with midsummer 1990 and 1991 respectively.

We hypothesize the following timing of the sequence of peaks in these figures. Peaks o and p indicate roughly June-July 1990 while the space between o and l corresponds to winter and early spring 1991. Peaks l through g correspond to spring and early summer (April-June 1991). Peaks x and f represent the fall-winter period. Finally, peaks d through b correspond once again to spring and early summer (April-June 1992).

This timing is consistent with the Na plot. The thick line in the figure, which represents marine Na shows two major clusters of peaks: the first is just prior to the April 1991 peak k-l, with slight overlap, while the second is prior to the April 1992 peak d. Marine influence is known to have an annual peak in Dye3 snow in midwinter, attributed to increased storm activity over the North Atlantic [48]. The proximity of the Na midwinter peak to the April peaks in the other metals indicates low accumulation in the winter months.

There are slight differences in the timing of the spring peaks among Al and the four anthropogenic metals. In 1990, Al peaks just before the anthropogenic metals (strong Al peak just right of p), while in 1991, Al peaks at or slightly after the anthropogenic metals (k is the dominant Al peak). In 1992, Al and the anthropogenic metals have coinciding peaks at d. These patterns can be easily seen by noting the heavy line in Figure 2d, which represent the crustal Cu and is therefore proportional to Al. Overall, this shows that there are some consistencies in the patterns among these elements, suggesting similar source regions and transport pathways at certain times, but there are differences at other times.

To help understand these differences, the data have been used to calculate crustal enrichment factors based on Al (Figures 5a-d). EF's are high during the fall and winter months when Al concentrations are minimum. Concentrations of Al and all four anthropogenic metals increase significantly in April, but the increase in Al is greatest and hence EF's for Cd, Pb, Zn, and Cu decrease. Al concentrations decrease throughout the summer and thus EF's increase: note the large EF's for peak g in midsummer. It should be pointed out that many of the enrichments in Figures 5a-d are not as high as those observed in airborne trace metals in Greenland; previous work has shown that enrichment in snow are generally smaller than those in air. This is due to a combination of factors, including fractionation processes as airborne material integrated over time periods of high and low concentration [49]. The lack of snowfall during some episodes of high airborne concentration may also be a factor.

Although no backward airmass trajectories are available for Summit, the similarity between seasonal patterns at Dye3 and at Summit suggests that trajectories for Dye 3 may apply at least roughly to the present data. These trajectories offer evidence that both the Canadian Arctic to the west and European sources to the east can contribute contaminants to Greenland in spring when concentrations reach annual maxima; the Canadian Arctic is part of the "Arctic Haze" region where pollutants from Eurasia have been transported over the Pole. Sources in populated regions of eastern U.S. and Canada become more important as summer progresses, although short transport distances may limit the amount of contaminants reaching Greenland. Longer transport from North America is prevalent in fall. Finally, the source regions become increasingly higher in latitude with the arrival of winter, moving into central Canada and eventually the Canadian Arctic [50].

We hypothesize that the April-June peaks in Figures 2a-d represent material from both North America and Europe. The earlier peaks in April of each year, during the Arctic Haze season, possibly represent material from Eurasia transported over the Pole into the Canadian Arctic and eventually to Greenland. Late spring/early summer peaks are more likely to reflect material from populated regions of eastern North America and western Europe. The fall-winter peaks are also likely to originate from these populated regions.

REFERENCES

1. M. Murozumi, T.J. Chow and C.C. Patterson, Chemical concentrations of pollutant lead aerosols, terrestrial dusts and sea salts in Greenland and Antarctic snow strata, *Geochim. Cosmochim. Acta* 33, 1247-1294, 1969.
2. A. Ng and C.C. Patterson, Natural concentrations of Lead in ancient Arctic and Antarctic ice, *Geochim. Cosmochim. Acta* 45, 2109-2121, 1981.
3. J.P. Candelone, S. Hong and C.F. Boutron, Post industrial revolution changes in large scale atmospheric pollution for heavy metals, *J. Geophys. Res.*, submitted.
4. C.F. Boutron, U. Görlach, J.P. Candelone, M.A. Bolshov and R.J. Delmas, Decrease in anthropogenic lead, cadmium and zinc in Greenland snows since the late 1960's, *Nature* 353, 153-156, 1991.
5. M.M. Herron, C.C. Jr. Langway, H. V. Weiss, J.H. Cragin, Atmospheric trace metals and sulfate in the Greenland ice sheet, *Geochim. Cosmochim. Acta* 41, 915-920, 1977.
6. J.H. Cragin, M.M. Herron and C.C. Jr. Langway, The chemistry of 700 years of precipitation at Dye 3, Greenland. U.S. Army Cold Regions research and Engineering Laboratory (USA CRREL) research report 341, 1975.
7. E.W. Wolff and D.A. Peel, Concentrations of cadmium, copper, lead and zinc in snow from near Dye 3 in South Greenland, *Ann. Glaciol.* 10, 193-197, 1988.
8. E.A. Boyle, R.M. Sherrell and M.P. Bacon, Lead variability in the western North Atlantic ocean and central Greenland ice : implications for the search for decadal trends in anthropogenic emissions, *Geochim. Cosmochim. Acta*, 58, 3227-3238, 1994.
9. J. Savarino, C.F. Boutron and J.L. Jaffrezo, Short-term variations of Pb, Cd, Zn and Cu in recent Greenland snow, *Atm. Environ.* 28, 11, 1731-1737, 1994.
10. J.L. Jaffrezo, J.E. Dibb and C.I. Davidson, GISP2 studies of the atmosphere and surface

- snow at Summit, Greenland, EOS Trans. AGU 72, 250-251, 1991.
11. C.F. Boutron, A clean laboratory for ultralow concentration heavy metal analysis, Fresenius' Z. Anal. Chem. 337, 482-491, 1990.
 12. U. Görlach and C.F. Boutron, Preconcentration of lead, cadmium, copper and zinc in water at $\mu\text{g l}^{-1}$ level by non-boiling evaporation, Anal. Chim. Acta 236, 391-398, 1990.
 13. M. Stievenard, M. Delmotte and J. Jouzel, Spectrometrie de masse automatisée pour l'analyse des isotopes stables de l'oxygène et de l'hydrogène dans les neiges et glaces : application à la reconstitution des climats du passé, Anal. Chim. Acta, in press.
 14. J.L. Jaffrezo, C.I. Davidson, M. Legrand and J.E. Dibb, Sulfate and MSA in the air and snow on the Greenland ice sheet, J. Geophys. Res. 99, 1241-1253, 1994.
 15. A. Neftel, R.C. Bales and D.J. Jacob, H_2O_2 and HCHO in polar snow and their relation to atmospheric chemistry, in: Ice core studies of global biogeochemical cycles, NATO ARW, Annecy 1993, in press.
 16. P.A. Mayewski, M.J. Spencer, M.S. Twickler and S. Whitlow, A glaciological survey of the Summit region, Greenland, Ann. Glaciol. 14, 51-54, 1990.
 17. S. Whitlow, P.A. Mayewski and J.E. Dibb, A comparison of major chemical species seasonal concentration and accumulation at the South Pole and Summit, Greenland, Atm. Environ. 26A, 11, 2045-2054, 1992.
 18. J.L. Colin, B. Lim, E. Herms, F. Genet, J.L. Jaffrezo and C.I. Davidson, Air to snow mineral transfer : crustal elements in aerosols, fresh snow and snowpits on the Greenland ice sheet. In preparation.
 19. J.E. Dibb, J.L. Jaffrezo and M.L. Legrand, Initial findings of recent investigations of air-snow relationships in the Summit region of the Greenland ice sheet, J. Atm. Chem. 14, 167-180, 1992.
 20. N.Z. Heidam, The Greenland aerosol : elemental composition, seasonal variations and likely

- sources, in: Arctic Air Pollution, B. Stonehouse, ed., pp. 37-52, Cambridge University press, Cambridge, 1986.
21. C. Boutron and S. Martin, Sources of twelve trace metal elements in Antarctic snows determined by principal component analysis, *J. Geophys. Res.* 85, C10, 5631-5638, 1980.
 22. C. Boutron, Trace element content of Greenland snows along an east-west transect, *Geochim. Cosmochim. Acta* 43, 1253-1258, 1979.
 23. J. Ducret-Blein, Incorporation du carbone particulaire aux retombées humides : implications géochimiques, PhD thesis, 249 pp., Université de Paris VII., 1993.
 24. J.O. Nriagu, A global assessment of natural sources of atmospheric trace metals, *Nature* 338, 47-49, 1989.
 25. J.O. Nriagu, Global inventory of natural and anthropogenic emissions of trace metals to the atmosphere, *Nature* 279, 409-411, 1979.
 26. R.A. Duce, R. Arimoto, B.J. Ray, C.K. Unni and P.J. Harder, Atmospheric trace elements at Enewetak Atoll, 1, concentrations, sources and temporal variability, *J. Geophys. Res.* 88, 5321-5342, 1983.
 27. F. Batifol, C. F. Boutron and M. de Angelis, Changes in copper, zinc and cadmium concentration in Antarctic ice during the past 40,000 years, *Nature*, 337, 544-546, 1989.
 28. C.C. Patterson and D.M. Settle, Magnitude of lead flux to the atmosphere from volcanoes, *Geochim. Cosmochim. Acta* 51, 675-681, 1987.
 29. M. De Angelis and M. Legrand, Origins and variations of fluoride in Greenland precipitation, *J. Geophys. Res.* 99, 1157-1172, 1994.
 30. M.F. Le Cloarec, P. Allard, B. Ardouin, W.F. Giggenbach, D.S. Sheppard, Radioactive isotopes and trace elements in gaseous emissions from White Island, New Zealand, *Earth Planet. Sci. Lett.* 108, 19-28, 1992.

31. J.P. Candelone, M.A. Bolshov, S.N. Rudniev, S. Hong and C.F. Boutron, Determination of bismuth down to sub pg/g level in Greenland snow by laser excited atomic fluorescence spectrometry, *J. de Phys. IV*, 661-664, 1994.
32. M.A. Bolshov, S.N. Rudniev, J.P. Candelone, S. Hong and C.F. Boutron, Ultratrace determination of Bi by Laser Atomic Fluorescence Spectrometry, *Spectrochim. Acta B*, in press.
33. G. Lambert, M.F. Le Cloarec and M. Pennisi, Volcanic output of SO₂ and trace metals : a new approach, *Geochim. Cosmochim. Acta* 52, 39-42, 1988.
34. M.F. Le Cloarec and B. Marty, Volatile fluxes from volcanoes, *Terra Nova* 3, 17-27, 1991.
35. S.R. Taylor and S.M. McLennan, *The continental crust : its composition and evolution, an examination of the geochemical record preserved in sedimentary rocks*, 312 pp., Blackwell Scientific Publications, Oxford, 1985.
36. H.J.M. Bowen, *Environmental chemistry of the elements*, 333 pp., Academic Press, New York, 1979.
37. S. Hong, J.P. Candelone, C.C. Patterson and C.F. Boutron, Greenland ice evidence of hemispheric lead pollution two millenia ago by greek and roman civilizations, *Science*, in press.
38. J.O. Nriagu and J.M. Pacyna, Quantitative assessment of worldwide contamination of air, water and soils by trace metals, *Nature* 333, 134-139, 1988.
39. G.J. Lofty, J.A. Hillier, E.M. Burton, D.C. Mitchell, S.A. Cooke, K.A. Linley and C.D.G. Black, *World mineral statistics 1983-87*, pp. 45-290, Keyworth, Nottingham British Geological Survey, 1989.
40. G.J. Lofty, J.A. Hillier, S.A. Cooke, K.A. Linley, H.S.R. Singh and C.D.G. Black, *World mineral statistics 1986-90*, pp. 28-196, Keyworth, Nottingham British Geological Survey, 1992.

41. J.M. Pacyna, Emission Factors of Atmospheric Cd, Pb and Zn for Major Source Categories in Europe in 1950 through 1985, Report OR 30/91, Norwegian Institute for Air Research, Lillestrom, Norway, 1991.
42. R.J. Larbey and J.R. Bain, Trends in the use of lead as a gasoline antiknock additive, International lead and zinc conference, October 5-7, 1988, London, U.K.
43. W.E. Raatz, The climatology and meteorology of Arctic air pollution, in: Pollution of the Arctic atmosphere, W.T. Sturges, ed., pp. 13-42, Elsevier, London, 1991.
44. M.H. Bergin, J.L. Jaffrezo, C.I. Davidson, R.Caldow, J. Dibb, Fluxes of chemical species to the Greenland ice sheet at Summit by fog and dry deposition, *Geochim. Cosmochim. Acta* 1994.
45. C.F. Boutron, F.M. Ducroz, U. Görlach, J.L. Jaffrezo, C.I. Davidson, M.A. Bolshov, variations in heavy metal concentrations in Greenland snow from January to August 1989, *Atm. Environ.*, 27A, 2773-2779, 1993.
46. J.E. Dibb and J.L. Jaffrezo, Beryllium - 7 and Lead - 210 in aerosol and snow in the Dye3 Gas Aerosol and Snow Sampling Program, *Atmos. Environ.* 27A, 2751-2760, 1993.
47. C.I. Davidson, J.L. Jaffrezo, B.W. Mosher, J.E. Dibb, R.D. Borys, B.A. Bodhaine, C.F. Boutron, U. Görlach, H. Cachier, J. Ducret, J.L. Colin, N.Z. Heidam, K. Kemp, R. Hillamo, Chemical constituents in the air and snow at Dye3, Greenland: I Seasonal variations, *Atmos. Environ.*, 27A, 2709-2722, 1993.
48. C.I. Davidson, J.R. Harrington, M.J. Stephenson, M.J. Small, F.P. Boscoe, R.E. Gandley, Seasonal variations in sulfate, nitrate and chloride in the Greenland Ice Sheet: relation to atmospheric concentrations, *Atmos. Environ.*, 23, 2483-2493, 1989.
49. C.I. Davidson, S. Santhanam, R.C. Fortmann, M.P. Olson, Atmospheric transport and deposition of trace elements onto the Greenland ice sheet. *Atmos. Environ.* 19, 2065 - 2081, 1985.

50. C.I. Davidson, J.L. Jaffrezo, M.J. Small, P.W. Summers, M.P. Olson and R.D. Borys, Trajectory analysis of source regions influencing the South Greenland ice sheet during the Dye3 Gas and Aerosol Sampling Program, *Atmos. Environ.* 27 A, 2739-2749, 1993.

	Pb	Cd	Zn	Cu	Na _m	Al
Pb	1.00					
Cd	<u>0.90</u>	1.00				
Zn	<u>0.66</u>	<u>0.71</u>	1.00			
Cu	<u>0.83</u>	<u>0.72</u>	<u>0.48</u>	1.00		
Na _m	0.08	0.07	- 0.23	0.32	1.00	
Al	<u>0.70</u>	<u>0.65</u>	<u>0.54</u>	<u>0.63</u>	0.05	1.00

Table 1. Summit, central Greenland : correlation matrix for a series of 36 snow samples covering a 2 years time period. Na_m : marine Sodium. The correlation coefficients significant for 99 % confidence limits are underlined.

		Pb	Cd	Zn	Cu
Average concentration	A	15.1	0.67	51.2	7.7
	B	17.7	1.00	35.3	9.5
Factor of range	A	75	31	22	48
	B	19	12	70	26
Minima and Maxima	A	0.6 - 44	0.08 - 2.45	9-193.5	0.5-24
	B	2.5-47	< 0.23-2.8	1.7-122	1.8-47

Table 2. Summit, central Greenland : comparative values (pg/g) from snow pit samples .
 A : this work (n=36)
 B : Savarino et al. [9] (n=19).

		Pb	Cd	Zn	Cu
Sulfate	A	0.2	0.05	0.7	0.6
Sulfate	P	1.3 (1-1.6)	7.5 (5.6-9.3)	1.4 (1-1.7)	7.8 (5.8-9.75)
Bismuth	A	0.42	0.17	0.83	2.5
Bismuth	P	2.8 (0.56-7.3)	25 (3.3-66)	1.6 (0.3-4.3)	32 (6.5-86)

Table 3. comparison of the heavy metals inputs from volcanic activities to central Greenland snows as calculated from Sulfate and Bismuth concentrations.

A : Average concentration (pg/g)

P : Percentage of the total average concentration and range (calculated using the minimum and maximum values of Bi [31] and the mean concentrations of Pb, Cd, Zn and Cu from this work). For sulfate the range is given by the range of concentrations for background conditions (30 to 50 ng/g). We used the mean metal/S ratio given in [24].

FIGURES CAPTIONS

Fig. 1. Profiles of changes in Na, Al, H_2O_2 , δD , SO_4^{2-} concentrations with depth of a 1.6 m snow pit at Summit, central Greenland. Fig.1.a: thin line: total sodium concentrations. Thick line: marine Na (Na_m) concentrations (calculated from the Al concentrations in the samples and the mean Na/Al ratio in bulk seawater).

Fig. 2. Profiles of changes in Cd, Pb, Zn and Cu concentrations with depth in a 1.6 m snow pit at Summit, central Greenland. Fig. 2.d: Thin line: total Cu concentrations. Thick line: rock and soil dust contribution (calculated from the Al concentrations in the samples and the mean Cu/Al ratio in the bulk crust of the earth [36]).

Fig. 3. Factor analysis: two-dimensional plots using eigenvectors F1, F2 (Fig 3A) and F2, F3 (Fig. 3B).

Fig. 4. Factor analysis : two-dimensional plot using eigenvectors F2 and F3. (Prior calculations, the concentrations for each heavy metal was corrected from the crustal contribution, see text).

Fig. 5. Profiles of changes in the crustal enrichment factor (see text for details) of Cd, Pb, Zn and Cu as calculated in a 1.6 m snow pit at Summit, central Greenland.

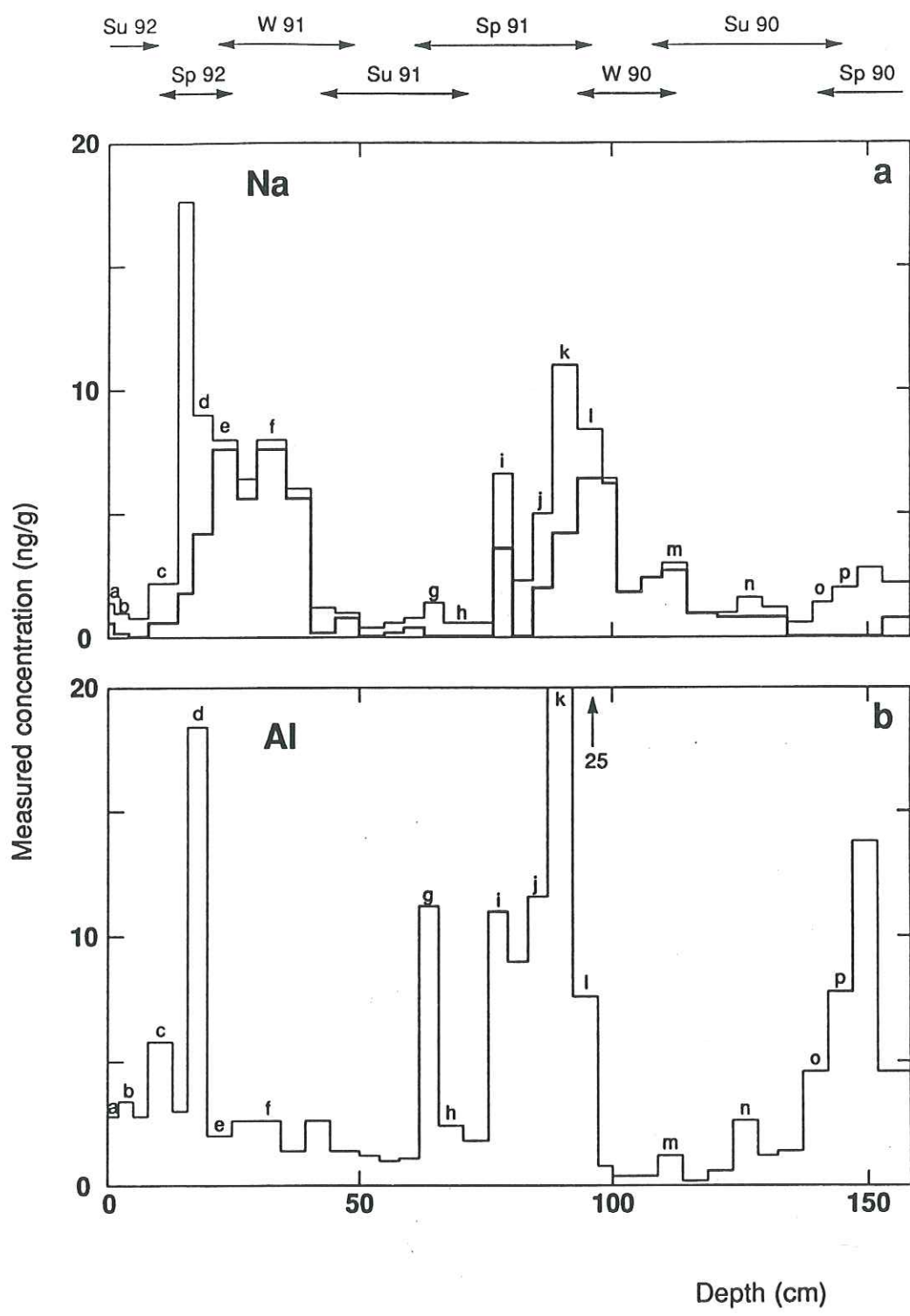

Figure 1

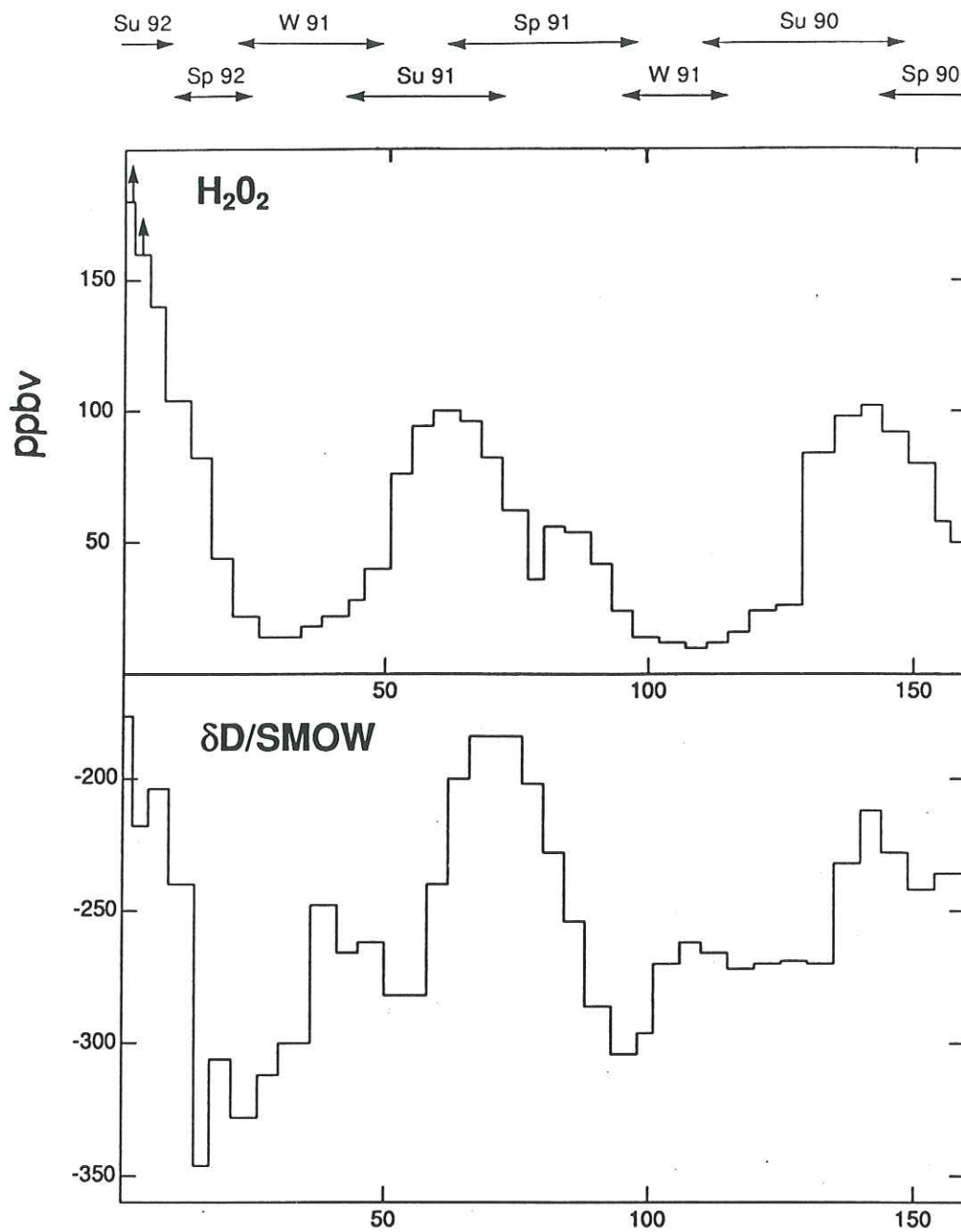

Figure 1 bis

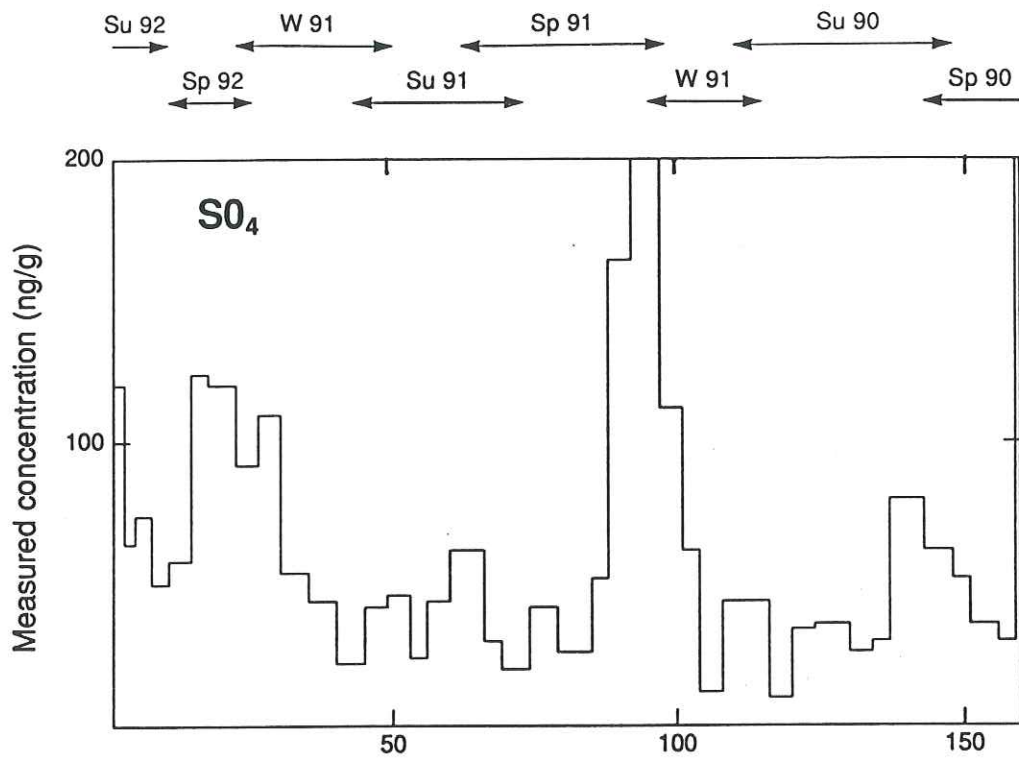

Figure 1 ter

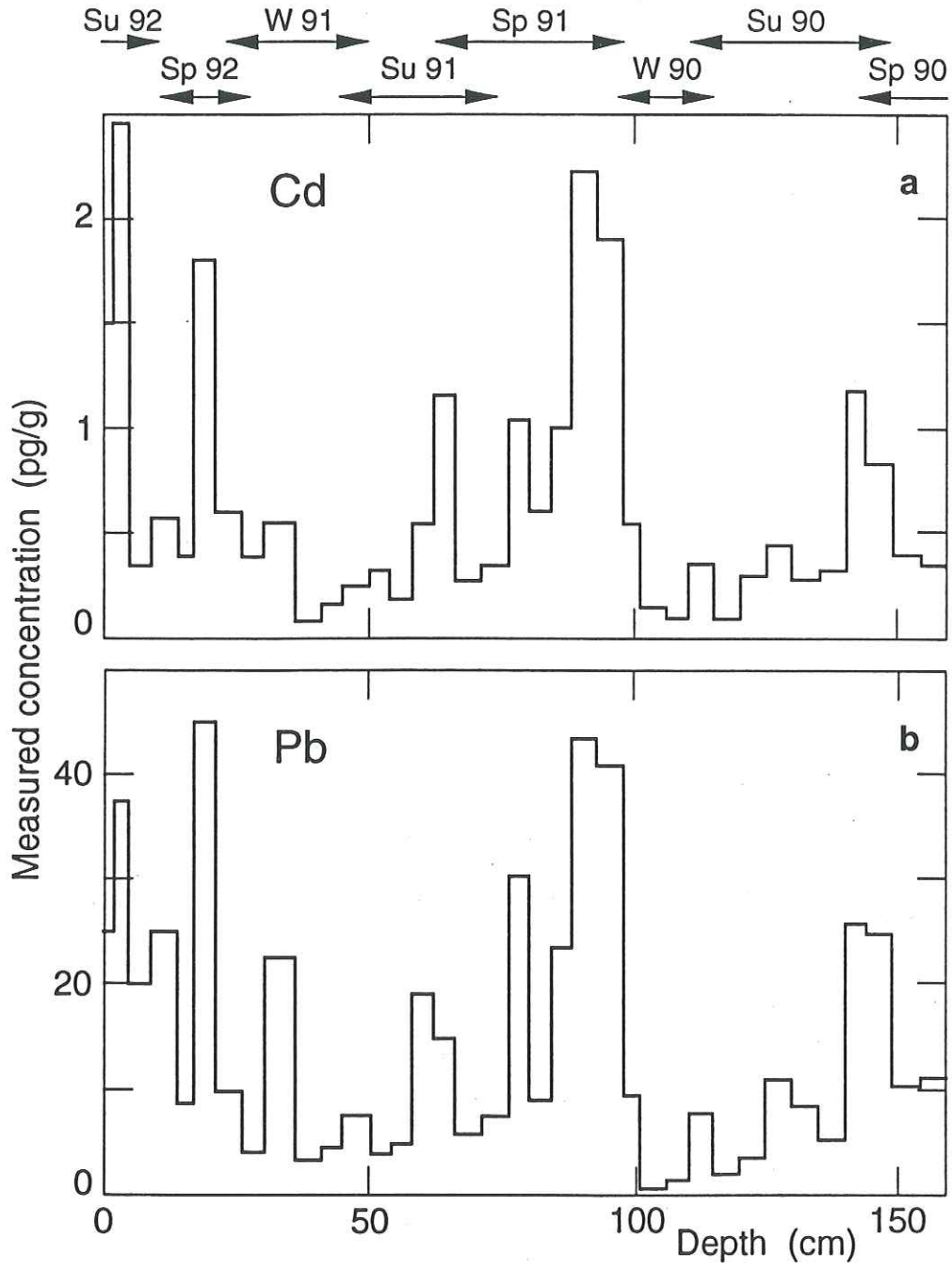

Figure 2

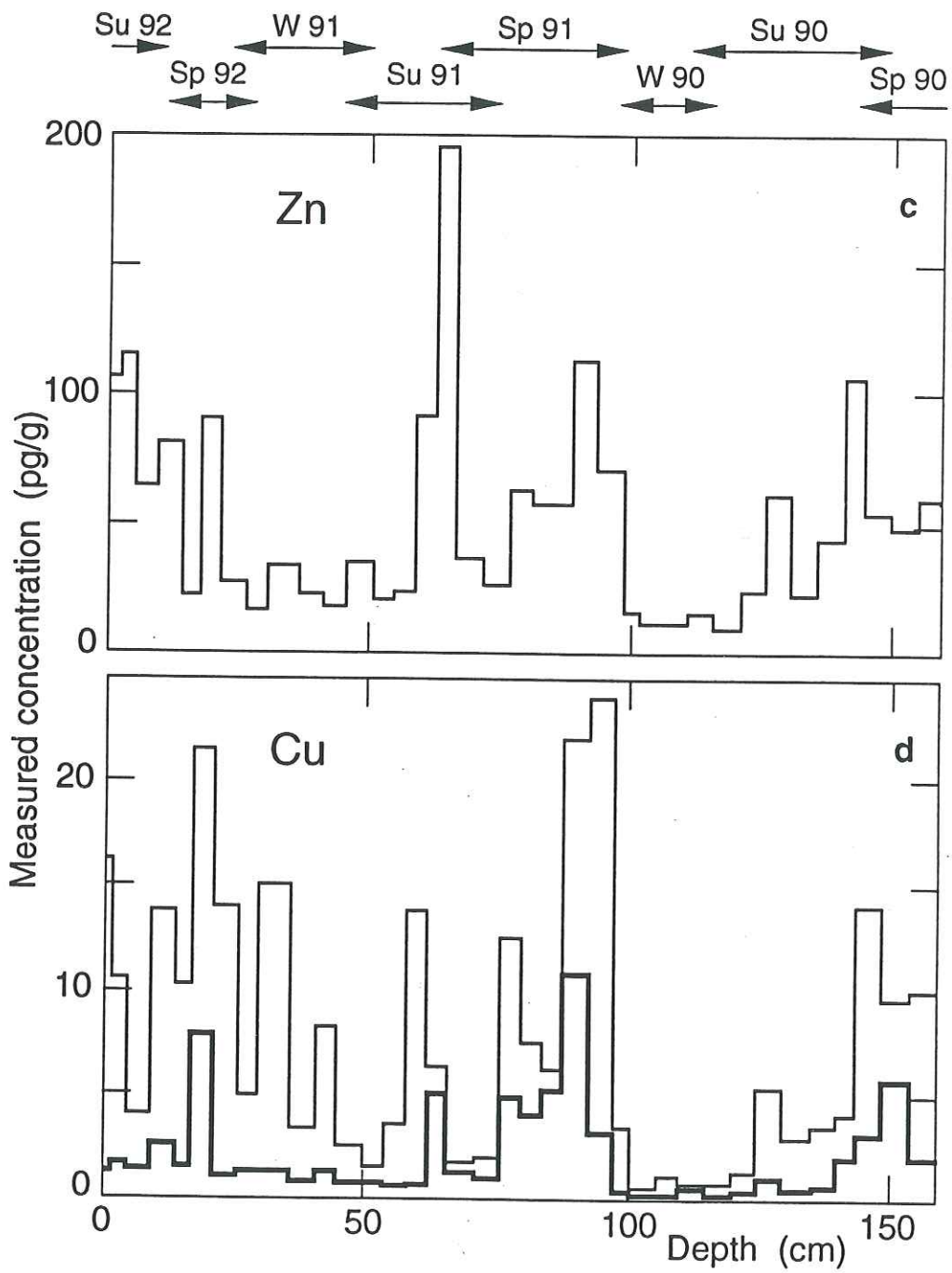
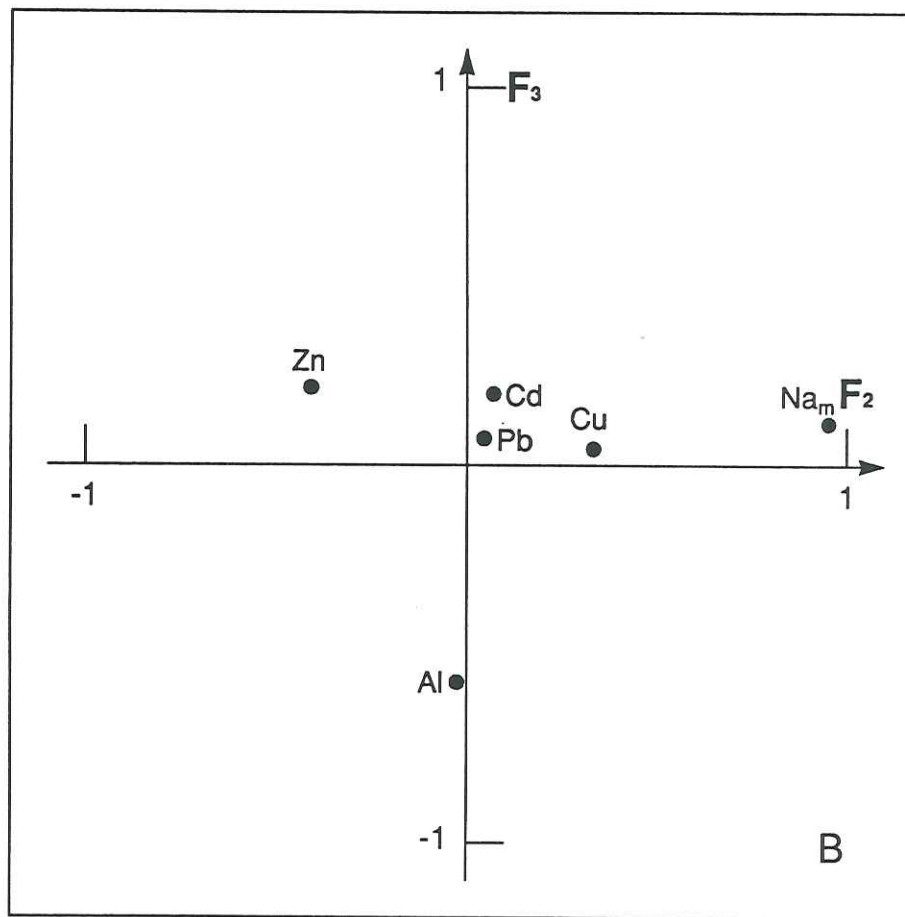
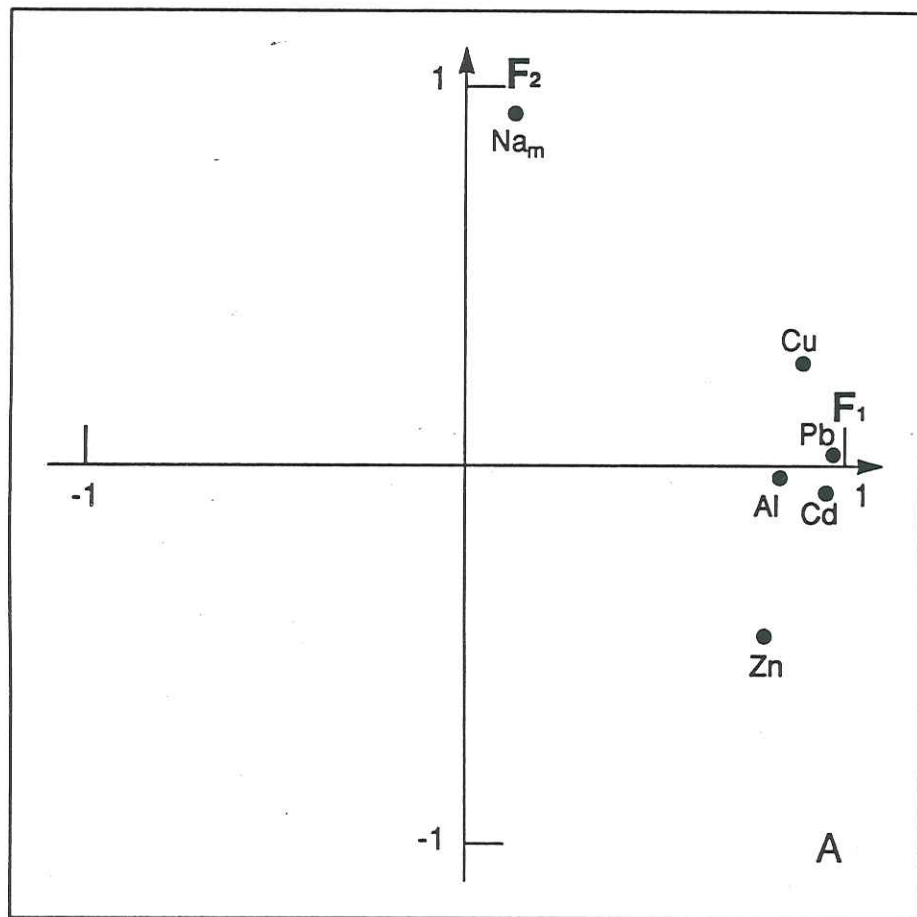
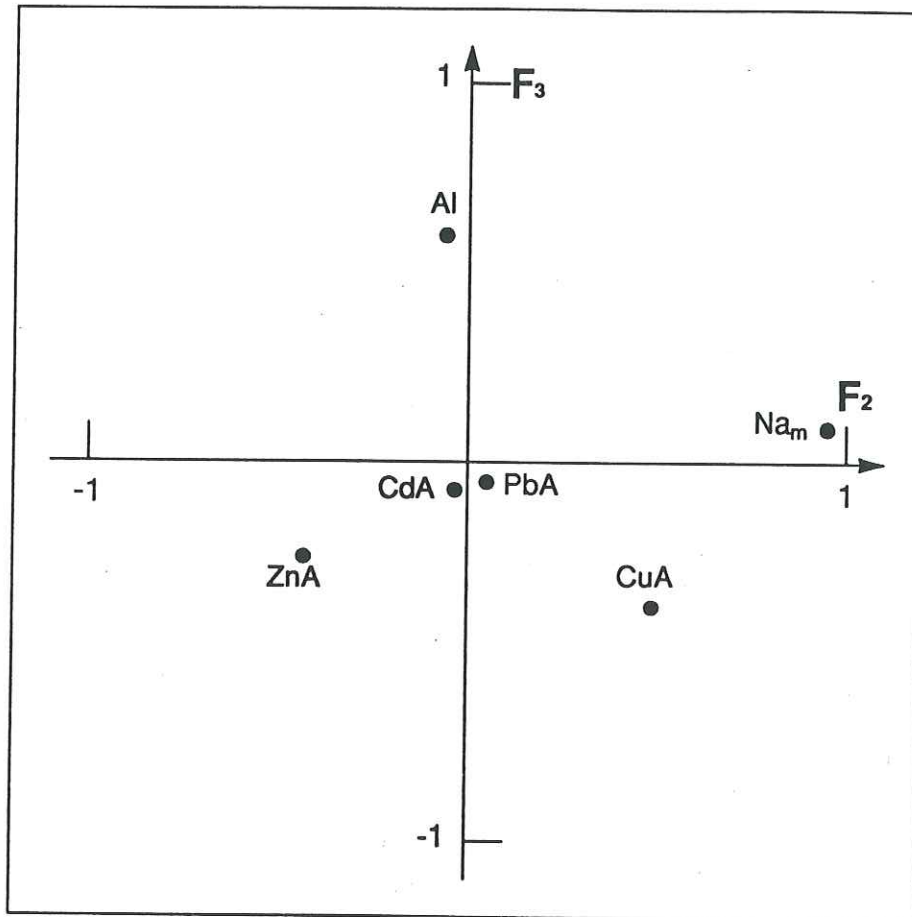

Figure 2 bis



PCF
Factor Matrix

Figure 3



PCF
Factor Matrix

Figure 4

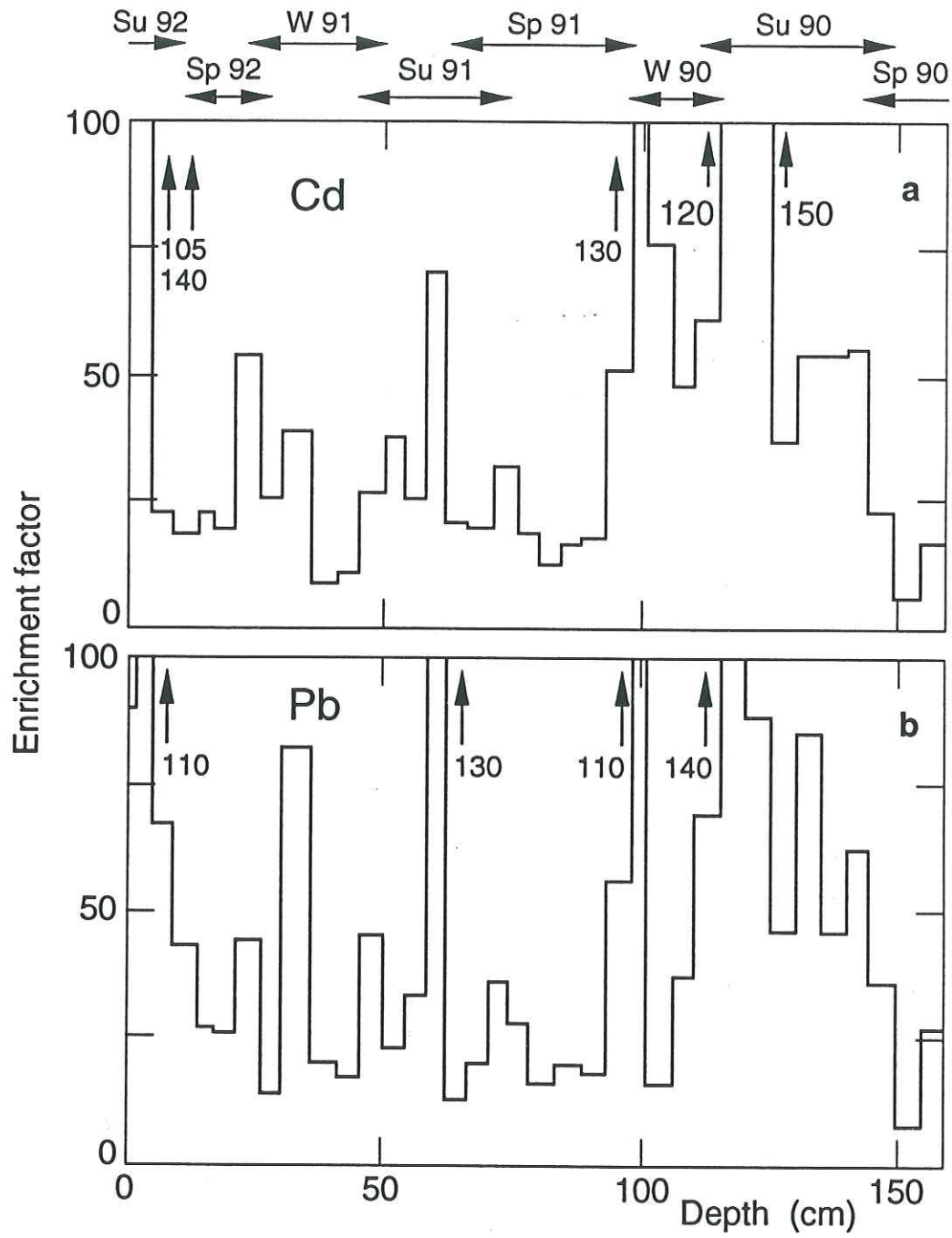

Figure 5

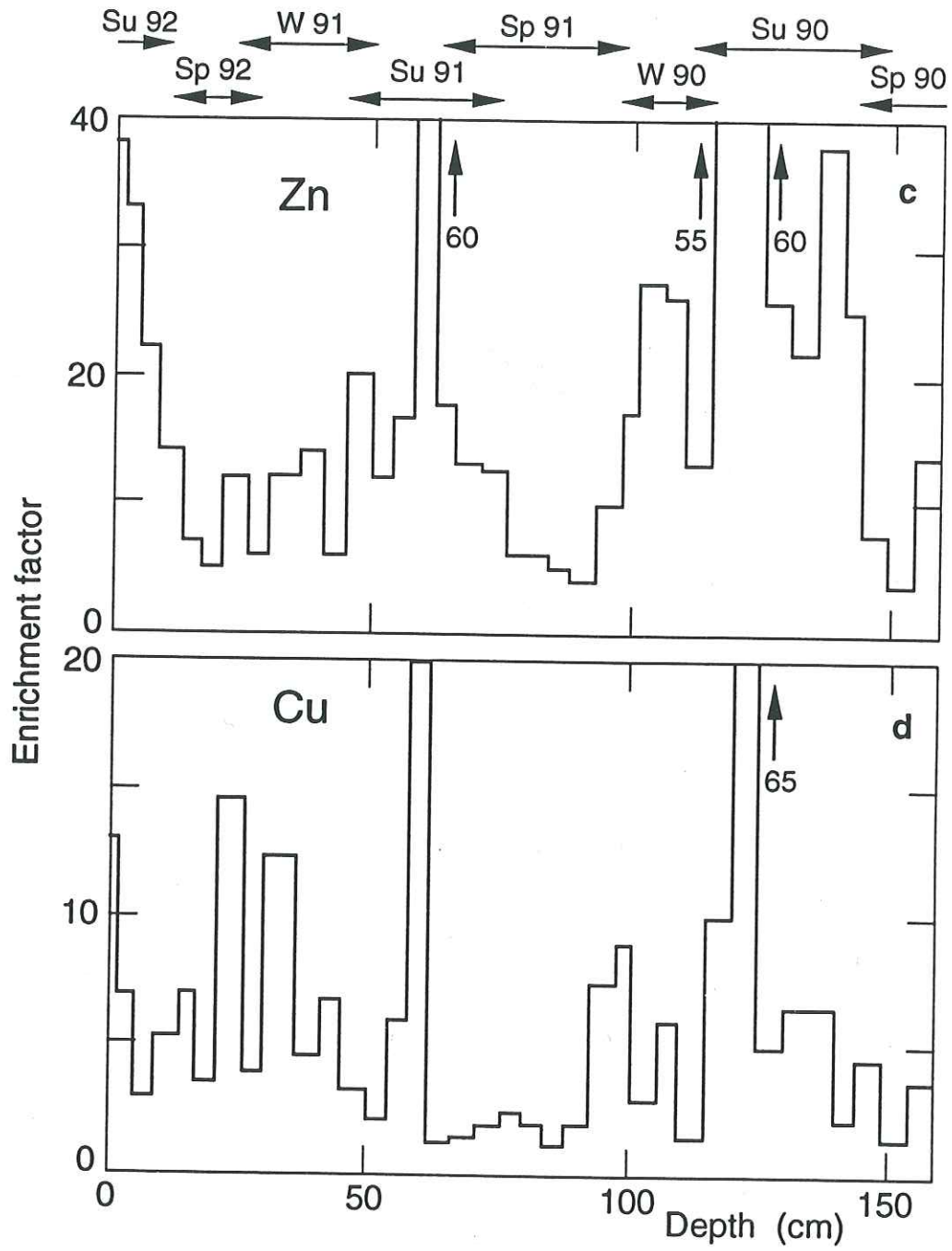

Figure 5 bis

**DETERMINATION OF BISMUTH DOWN TO SUB PG/G LEVEL IN GREENLAND SNOW
BY LASER EXCITED ATOMIC FLUORESCENCE SPECTROMETRY**

Jean-Pierre CANDELONE, Michael A. BOLSHOV,
Sergei N. RUDNIEV, Sungmin HONG and Claude F. BOUTRON*

J. Phys., C4, 661-664, 1994.

**DETERMINATION OF BISMUTH DOWN TO SUB PG/G LEVEL IN GREENLAND SNOW
BY LASER EXCITED ATOMIC FLUORESCENCE SPECTROMETRY**

Jean-Pierre CANDELONE¹, Michael A. BOLSHOV²,
Sergei N. RUDNIEV², Sungmin HONG¹ and Claude F. BOUTRON^{1,3,*}

¹Laboratoire de Glaciologie et Géophysique de l'Environnement du CNRS, 54, rue Molière,
Domaine Universitaire, BP 96, 38402 St Martin d'Hères, France.
Phone: 76.82.42.00 - Fax: 76.82.42.01.

²Institute of Spectroscopy, Russia Academy of Sciences, Troitzk, 142092 Moscow Region, Russia.

³UFR de Mécanique, Université Joseph Fourier de Grenoble, Domaine Universitaire, BP 68,
38041 Grenoble, France.

*Author to whom correspondence and reprints requests should be addressed.

Abstract. We present here preliminary data on the first direct determination of Bi in Greenland recent snow down to the sub pg/g level by Laser Excited Atomic Fluorescence (LEAF) spectrometry in clean room conditions. Calibration of the spectrometer was achieved using ultralow concentration Bi standards (concentration range 0.05 - 50 pg/g). The limit of detection was found to be 2.5 fg Bi. Various Greenland samples were analysed, giving Bi concentration values in good agreement with these anticipated from the available volcanic emissions data.

1. Introduction

The investigation of the occurrence of heavy metals in the dated ice and snow layers accumulated in Antarctica and Greenland has proven to be an outstanding way to understand the past natural large scale atmospheric cycles of these metals and to evaluate their present alteration by man /1,2/. This has been beautifully illustrated during the past few years in a series of comprehensive studies for various metals /3-8/.

Such studies however represent a formidable analytical challenge. This is mainly because heavy metals are present in polar ice and snow at extremely low concentration levels, down to the sub pg/g level. Reliable data can then be obtained only if stringent control of contamination is achieved from field sampling to laboratory analysis and if ultrasensitive spectrometric techniques are used.

Main attention has until now been given to the metals - Pb, Hg, Cd and Zn - which are the most influenced by human

activities /9,10/. On the other hand, little attention has been paid to the metals whose atmospheric cycles are likely to be still undisturbed by man, although such metals can be extremely interesting tracers of specific natural sources and of atmospheric transport pathways. Among these last metals is Bismuth (Bi).

Although the available data on the occurrence of this heavy metal in the atmosphere and more generally in the environment are scarce, it is indeed likely that Bi is an excellent tracer of volcanic emissions to the atmosphere, since emissions from other natural sources are very limited /11-13/. Investigating the occurrence of this metal in the frozen atmospheric archives stored in the Antarctic and Greenland ice caps could then provide with very valuable time series of volcanic activity in both hemispheres and with pertinent data on the transport patterns of volcanic aerosols in the atmosphere.

Despite this interest, there are presently no data at all on Bi in Antarctic and Greenland ice and snow. This is especially because Bi concentrations in polar ice and snow were anticipated to be so low, at the sub pg/g level, that no sensitive enough analytical technique was available. We present here preliminary results on the determination of Bi in Greenland recent snow using the ultrasensitive Laser Excited Atomic Fluorescence (LEAF) technique.

2. Experimental conditions

The Bi measurements were performed using the LAFAS-1 automated LEAF spectrometer developed at the Institute of Spectroscopy /14/. The radiation source is a tunable dye laser pumped by an excimer XeCl laser. Radiation of the dye laser is frequency doubled in a KDP or KB5 non-linear crystal. The melted snow sample (50 μ l) is introduced into a Ringsdorff pyrolytically coated graphite cup inside the electro-thermal atomizer (ETA). The fluorescence radiation is collected through a monochromator onto a photomultiplier whose output signal is digitized using an A/D converter. To minimize contamination problems, the whole spectrometer is located inside a specially designed room supplied with filtered air. In addition, the electro-thermal atomizer and the bench onto which the samples and standards are handled, are placed inside a clean chamber flushed with a laminar flow of air filtered through high efficiency particulate air filters /14/.

Extensive investigations were conducted to determine the best analytical schemes for effective excitation and detection of Bi atomic fluorescence /15/. The best sensitivity was achieved with excitation at $\lambda_1 = 223.061$ nm and fluorescence detection at $\lambda_2 = 299.334$ nm. The working conditions for the electro-thermal atomizer were also optimized to reduce the severe spectral and matrix interferences problems which were faced for the Greenland snow samples /15/. The best conditions were found to be as follows: after being introduced into the graphite cup of the atomizer with an Eppendorf micropipette, the sample (50 μ l) was first evaporated (95° C for 120 s) and charred (300° C for 8 s) with the atomizer being filled with air at atmospheric pressure. The chamber of the atomizer was then closed, evacuated and filled with Argon. The sample was charred again at a slightly higher temperature (400° C for 4 s) and then atomized (1200° C for 4 s) /15/.

3. Calibration of the spectrometer down to sub pg/g level

The calibration of the spectrometer for Bi was performed using ultralow concentration aqueous standards. Bi concentrations in these standards ranged from 0.05 to 50 pg Bi/g.

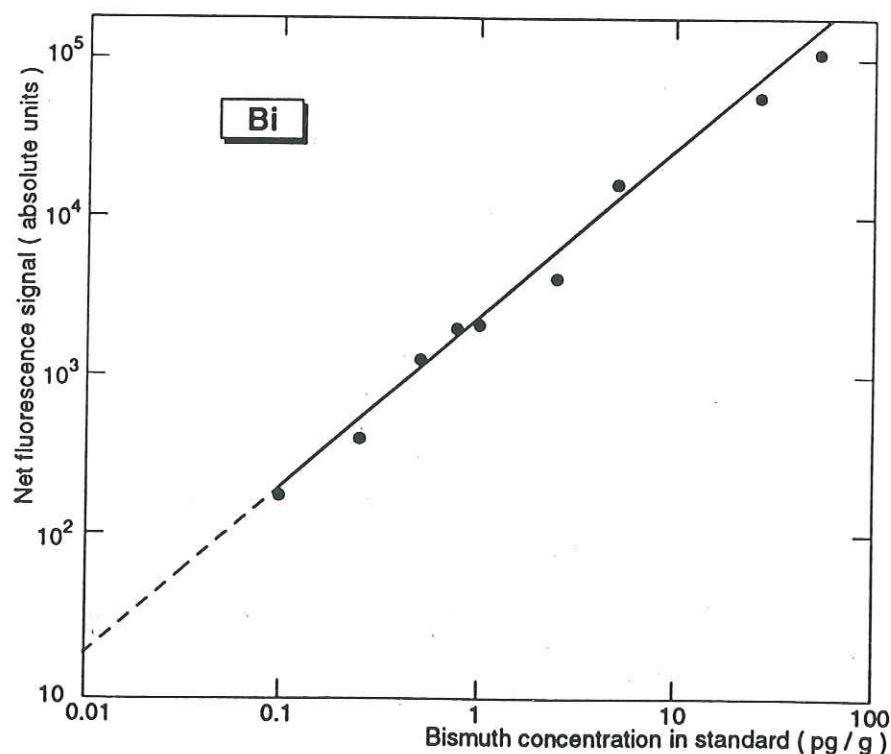

Figure 1. Calibration of the LAFAS-1 spectrometer for Bi using ultralow concentration 0.1 % HNO₃ aqueous standards.

They were prepared in the clean laboratory /16/ of the Laboratoire de Glaciologie et Géophysique de l'Environnement by successive dilutions of a 1000 ppm Bi certified atomic absorption standard with ultrapure water /16/ using ultraclean procedures. The standards were immediately acidified to make 0.1 % HNO₃ solutions using high purity double distilled HNO₃ from US National Institute of Standards and Technology (N.I.S.T.) /17/. They were transferred into ultraclean /16/ conventional polyethylene (CPE) bottles and immediately frozen. They were then transported frozen to the Institute of Spectroscopy, packed inside sealed acid cleaned polyethylene bags. They were kept frozen until use in order to minimize possible exchanges (losses or additions) with the walls of the CPE bottles.

The Bi standards (and the samples) were allowed to melt only when really needed for the analyses. Although they remained in liquid state during limited time periods only, there was concern that Bi concentrations might be affected by significant exchanges, especially losses, with the walls of the CPE bottles. In order to quantitatively assess these possible exchanges, several aliquots of the 1 pg Bi/g standard were analysed after being left melted during periods of time ranging from thirty minutes to one week. Bi concentrations were found not to deviate significantly from the initial 1 pg Bi/g value, then confirming the stability of our ultralow concentration Bi standards.

The calibration curve so obtained is shown in Fig. 1. The limit of detection (LOD) was found to be 0.05 pg Bi/g (for 50 µl injections), which corresponds to 2.5 fg Bi. This is by far the lowest LOD ever reported by Bi: it is indeed several orders of magnitude lower than the LODs reported for other analytical techniques.

4. Analysis of Greenland snow samples

Two series of Greenland snow samples have been analysed. The first series was surface snow (first 5 cm or so from the surface) collected in May 1987 at two locations in central Greenland /18/ by pushing ultraclean wide mouth 1 l CPE bottles horizontally into the snow. A few typical results are shown in Table

1.

Bi concentrations are found to range from <0.05 pg/g to 0.66 pg/g, i.e. values in good agreement with what was anticipated from the few available data on Bi emissions from volcanoes on a global scale /11-13/. All the measurements were performed using 50 µl injections, without any preliminary preconcentration or chemical treatment. All samples were 0.1 % NIST HNO₃ /17/.

Reference of the sample	Sampling location	Sampling date	Bi (pg/g)
56	72° 21' N	May 13, 1987	0.38
57	40° 13' W	id.	0.66
109		id.	0.27
58	72° 59' N	May 28, 1987	<0.05
53	37° 42' W	id.	<0.05
110		id.	0.12

Table 1. Bi concentrations measured in a few samples of surface snow collected in central Greenland in May 1987.

The samples in the second series were various section of a 10.7 m snow core drilled in July 1989 at Summit (72° 35' N, 37° 38' W, elevation 3230 m) in central Greenland as part of the european Eurocore programme. This core covered a continuous sequence of 22 years (1967-1989). It was hand drilled by operators wearing full clean room clothing using a specially designed all plastic acid cleaned mechanical auger /5/. Despite the exceptional cleanliness of this drilling procedure, it could not be excluded that slight heavy metals contamination might be present on the outside of the core sections. Each section was then mechanically decontaminated in the laboratory using ultraclean methods /5,16/, allowing to keep for Bi analyses only the most central part of each core section. Bi data obtained for a few typical sections are shown in Table 2. Analysis of various additional snow or ice samples covering much longer time periods

is planned in the near future. Before such comprehensive analyses are undertaken, it will however be necessary to further improve the LOD, for instance by using a two-step scheme for the excitation.

Reference of the sample	Depth (m)	Age	Bi (pg/g)
EU3H	2.41-2.56	1985	<0.05
EU5H	4.47-4.56	1981	0.3
EU5B	4.56-4.72	1980	0.07
EU7H	6.00-6.16	1978	0.2
EU12H	9.58-9.74	1969	0.4

Table 2. *Bi concentrations measured in various sections of a 10.7 snow core drilled at Summit, central Greenland.*

Acknowledgements

We thank P. Mayewski, C. Rado and R. Delmas for their participation in field sampling, and V. Koloshnikov, G. Turk, J. Brust and F. Hartmann for their continuous interest and stimulating discussions. This work was supported by the Commission of European Communities and Switzerland within the framework of Cost 611 as part of the Eurocore programme, the Division of Polar Programmes of the US National Science Foundation, the Ministere de l'Environnement, the Institut National des Sciences de l'Univers, the University of Grenoble, and the Markon Ltd company.

References

1. Wolff, EW, *Antarct Sci* 2 (1990) 189.
2. Boutron, CF, Candelone, JP, Hong, S, *Geochim Cosmochim Acta*, in press.
3. Boutron, CF, Patterson, CC, *Nature* 323 (1986) 222.
4. Boutron, CF, Patterson, CC, Barkov, NI, *Earth Planet Sci Lett* 101 (1990) 248.
5. Boutron, CF, Görlach, U, Candelone, JP, Bolshov, MA, Delmas, RJ, *Nature* 353 (1991) 153.
6. Vandal, GM, Fitzgerald, WF, Boutron, CF, Candelone, JP, *Nature* 362 (1993) 621.
7. Rosman, KJR, Chisholm, W, Boutron, CF, Candelone, JP, Görlach, U, *Nature* 362 (1993) 333.
8. Boutron, CF, Rudniev, SN, Bolshov, MA, Koloshnikov, VG, Patterson, CC, Barkov, NI, *Earth Planet Sci Lett* 117 (1993) 431.
9. Nriagu, JO, Pacyna, JM, *Nature* 323 (1988) 134.
10. Nriagu, JO, *Nature* 338 (1989) 47.
11. Patterson, CC, Settle, DM, *Geochim Cosmochim Acta* 51 (1987) 675.
12. Lambert, G, Le Cloarec, MF, Pennisi, M, *Geochim Cosmochim Acta* 52 (1988) 39.
13. Le Cloarec, MF, Allard, P, Ardouin, B, Giggenbach, WF, Sheppard, DS, *Earth Planet Sci Lett* 108 (1992) 19.
14. Apatin, VM, Arkhangelskii, BV, Bolshov, MA, Ermolov, VV, Koloshnikov, VG, Kompanetz, ON, Kutznetsov, NI, Mikhailov, EL, Shishkovskii, VS, Boutron, CF, *Spectrochim Acta* 44B (1989) 253.
15. Bolshov, MA, Rudniev, SN, Candelone, JP, Hong, S, Boutron, CF, *Spectrochim Acta B*, in press.
16. Boutron, CF, *Fresenius Z Anal Chem* 337 (1990) 482.
17. Paulsen, PJ, Beary, ES, Bushee, DS, Moody, JR, *Anal Chem* 60 (1988) 971.
18. Görlach, U, Boutron, CF, *Proceed 7th Int Conf on Heavy Metals in the Environ*, Vernet, JP, Ed, Page Bros, Norwich, England (1989) 24.

**BISMUTH IN RECENT SNOW FROM CENTRAL GREENLAND:
PRELIMINARY RESULTS**

Jean Pierre CANDELONE, Michael A. BOLSHOV
Sergei N. RUDNIEV, Sungmin HONG and Claude F. BOUTRON

Submitted to "Atmospheric Environment", September 9, 1994.

**BISMUTH IN RECENT SNOW FROM CENTRAL GREENLAND:
PRELIMINARY RESULTS**

Jean Pierre CANDELONE¹, Michael A. BOLSHOV²
Sergei N. RUDNIEV², Sungmin HONG¹ and Claude F. BOUTRON^{1,3,*}

¹*Laboratoire de Glaciologie et Geophysique de l'Environnement du CNRS, 54 rue
Moliere Domaine Universitaire, BP 96, 38402 Saint-Martin-d'Herès, France*

²*Institute of Spectroscopy, Russia Academy of Sciences, Troitzk, 142092 Moscow
Region, Russia.*

³*UFR de Mecanique, Université Joseph Fourier de Grenoble, Domaine Universitaire,
BP68, 38041 Grenoble, France.*

**Author to whom correspondence and reprints requests should be addressed.*

Submitted to "Atmospheric Environment", September 9, 1994.

ABSTRACT

We present here the first data on the occurrence of Bismuth (Bi) in recent snow from central Greenland. They were obtained by analysing surface snow and a shallow snow core covering the past twenty years, using the new ultrasensitive Laser Excited Atomic Fluorescence Spectrometry technique. Measured concentrations range from 0.66 to <0.05 pg/g. These are the lowest concentrations ever reported for precipitation. No significant time trend is observed during the past two decades. Bi appears to be probably mainly derived from volcanic emissions to the atmosphere, opening the way to obtaining time series of the past global volcanic activity through the analysis of this heavy metal in deep Greenland or Antarctic ice cores.

KEW WORDS: Bismuth, Snow, Greenland, Atmosphere, Volcanoes, Laser Atomic Fluorescence.

INTRODUCTION

Great efforts have recently been devoted to the investigation of the occurrence of heavy metals in Greenland snow and ice in order to reconstruct past and recent changes in the large scale atmospheric cycles of these toxic metals (Peel, 1989; Wolff, 1990; Boutron et al., 1994 a,b). Until now, most investigations have however focused on metals whose cycles have been strongly modified by human activities, especially Pb and to a lesser extent Cd, Zn and Cu (Murozumi et al., 1969; Wolff and Peel, 1988; Boutron et al., 1991; Hong et al., 1994; Candelone et al., 1995a). In the mean time, very little effort has been devoted to other heavy metals for which the anthropogenic contribution is very limited although such metals could be very valuable atmospheric tracers.

Amongst these last metals is Bismuth (Bi). Although the available data on the environmental occurrence of this heavy metal which is recognized to be toxic and accessible to the biota (Craig, 1980) are rather sparse, there are some indications that its atmospheric cycle might be dominated by emissions from volcanoes (Patterson and Settle, 1987; Buat Menard, 1990). Bi could then be a very interesting tracer of volcanic emissions to the global atmosphere, and its investigation in the well preserved dated snow and ice layers stored in the central areas of the Greenland ice cap is likely to provide a valuable historical record of the past global volcanic activity in the Northern Hemisphere.

Despite this high potential interest, there are presently no data at all on the occurrence of Bi in Greenland (and Antarctic) snow and ice. This is mainly due to the fact that concentrations of Bi which are likely to be observed in polar snow and ice are exceedingly low, below the pg/g level. This is beyond the detection limit of the analytical techniques which are currently

available.

We present here preliminary data on the occurrence of Bi in central Greenland recent snow. They were obtained using the new ultrasensitive Laser Excited Atomic Fluorescence Spectrometry (LEAFS) technique together with ultraclean sampling and sample preparation procedures.

2.EXPERIMENTAL

2.1 Field sampling

Two series of samples were collected in central Greenland. The first series consisted of a 10.7m snow core drilled in July 1989 near Summit (72°34'N, 37°37'W, elevation 3238m, mean annual air temperature -32°C, mean annual snow accumulation rate 23g H₂O cm⁻²yr⁻¹), at the top of the Greenland ice sheet, Fig. 1. The second one consisted of surface snow samples collected in May 1987 at two sites (site A : 72° 21'N, 40°13'W; site B : 72°59'N, 37°42'W) located about 85 km WSW and 50km N, respectively, of the Summit site where the core was obtained, Fig. 1.

The 10.7 m snow core (diameter : 10.2cm) was hand drilled on 19-24 July 1989 as part of the European Eurocore program using a specially designed all-plastic mechanical auger made of polycarbonate (Boutron et al., 1991). The whole auger, including the extension rods, had been extensively cleaned with high purity acids and water inside the clean laboratory (Boutron, 1990) of the Laboratoire de Glaciologie et Geophysique de l'Environnement (LGGE). It was handled by operators wearing full clean-room clothing and shoulder length polyethylene gloves. Each core section was directly transferred into acid cleaned Low Density Polyethylene (LDPE) tubes

with screwed caps packed inside LDPE sealed bags, and transported frozen to LGGE.

The surface snow samples were collected on 13 May (site B) and 28 May (site A) 1987, respectively (Görlach and Boutron, 1989). Four samples were collected at each site by pushing ultraclean wide mouth LDPE bottles horizontally into the snow. This made it possible to collect the first ~3cm or so from the surface. As above, the operators wore full clean room clothing and shoulder length polyethylene gloves. The bottles had been extensively cleaned with ultrapure acids and water as described in details in Boutron (1990). They were brought back frozen to LGGE packed inside multiple acid-cleaned LDPE sealed bags.

2.2 Sample preparation

Despite the outstanding cleanliness of the drilling procedure, we could not discard the possibility that significant Bi contamination might be present on the outside surface of the snow core. Each core section was therefore subsampled inside a laminar flow clean bench inside a cold room, in order to get its innermost part (diameter : 5cm), using ultraclean procedures which have been described in detail elsewhere (Boutron et al., 1991; Görlach and Boutron, 1992). Each inner core so obtained was allowed to melt at room temperature in the LGGE clean laboratory (Boutron, 1990), and a 2ml aliquot was taken in an ultra clean 15ml LDPE bottle for Bi measurements. It was immediately acidified to make a 0.1% HNO₃ solution using ultrapure twice-distilled HNO₃ from US National Institute of Standards and Technology (Paulsen et al., 1988), frozen, and transported frozen to the Institute of Spectroscopy (ISAN) in Troitzk. It was allowed to melt only just prior to measurement by LEAFS. Separate aliquots were also taken for ancillary measurements of Al, Na and several other heavy metals by Graphite Furnace Atomic Absorption Spectrometry (Boutron et al., 1991).

The surface snow samples were melted at room temperature directly in the original wide mouth 11 LDPE bottles inside which they were collected. They were then aliquoted as above.

2.3 LEAFS determination of Bi

Bi was directly determined by LEAFS, without any preliminary preconcentration or extraction step, with 50 μ l sample volumes, using the LAFAS-1 spectrometer of ISAN. This spectrometer has been described in detail by Apatin et al. (1989). The radiation source is a tunable dye laser pumped by a XeCl excimer laser. It is frequency doubled in a KDP or KB5 non-linear crystal, spectrally filtered, and directed by an optical system just above the brim of the pyrolytically coated cup of an electrothermal atomizer. The fluorescence radiation is focussed onto the entrance slit of a monochromator and detected with a photomultiplier. The whole spectrometer is located inside a special room over-pressured with filtered air. In addition, the atomizer and the bench onto which the bottles containing the snow samples and the standards are handled are located inside a clean chamber flushed with a downward laminar flow of air filtered by high efficiency particulate air filters (Apatin et al., 1989).

Extensive investigations were made to obtain the best analytical conditions for effective excitation and detection of Bi atomic fluorescence (Bolshov et al., 1994 a, b; Candelone et al, 1994). Amongst the various excitation-detection schemes which were tested, the best one was found to be with excitation at 223.061nm and fluorescence detection at 299.334nm. The working conditions for the graphite cup atomizer had also to be carefully chosen to minimize the severe spectral and matrix interferences problems (Bolshov et al., 1994 a,b). The best conditions were as follows: after being introduced into the cup, the sample of melted snow (50 μ l) was evaporated (95°C for 120s) and charred (300°C for 8s) with the cell of the atomizer filled with ambient air

at atmospheric pressure. The cell was then evacuated, and filled with Ar. The sample was then charred again at 400°C for 4s, and finally atomized (1200°C for 4s).

The calibration of the LAFAS-1 spectrometer for Bi was achieved using ultralow concentration 0.1% HNO₃, aqueous standards (concentration range : 0.05 - 50 pg/g) prepared in the LGGE clean laboratory. The calibration curve so obtained is shown in Fig. 2. The limit of detection (LOD) was found to be 0.05 pg/g for 50µl sample volumes, which corresponds to 2.5 fg Bi.

3. RESULTS AND DISCUSSION

3.1 Presentation of the data

The preliminary results obtained in this work are shown in Table 1 (10.7m snow core) and Table 2 (surface snow collected at sites A and B). Also shown are the Al and Na concentration values previously obtained for all these samples. The quoted precision for Bi (95% confidence level) was estimated from the precision of the calibration curve and the dispersion of parallel determinations (Bolshov et al., 1991). The confidence intervals are rather large because most measurements were very close to the LOD. Moreover, the LAFAS 1 spectrometer was only available for a limited time, thus permitting only a very small number of parallel determinations for each sample.

Bi was detected in 5 of the 8 analysed sections of the 10.7 m core, Table 1. The measured concentrations in these 5 sections ranged from 0.07 to 0.38 pg/g. In 3 sections, Bi

concentration was found to be below the LOD (0.05 pg/g). It was detected in 6 of the 8 surface snow samples, with concentrations ranging from 0.12 to 0.66 pg/g. In two surface snow samples, Bi was below the LOD (0.05 pg/g). These data are the first obtained for polar precipitation. They are several orders of magnitude lower than those obtained for precipitation in remote temperate areas (see for instance Berg et al. (1994a)).

3.2 Character of the data

As shown in Table 1, our data do not allow any clear time trend for Bi to be identified in central Greenland snow from 1969 to 1985. Significant changes seem however to be observed from one sample to another. They could be due to short term (seasonal) variations in Bi concentrations in snow at Summit, since the time period integrated by each individual sample listed in Table 1 is rather short (it ranges from ~2 to 5 months). Such short term variations have already been documented in Greenland snow for Pb, Zn, Cd and Cu (Wolff and Peel, 1988; Savarino et al., 1994; Candelone et al., 1995b), with pronounced maxima of concentrations in late spring-early summer. Although the precision of the dating of the snow core sections is not good enough to determine to which part of the year each sample corresponds to, it might then be the case that the highest concentrations we obtain are for spring-summer layers while the lowest ones (below the LOD) could correspond to autumn-winter layers. This will of course need to be confirmed by analysing comprehensive series of samples covering a few years with sub-seasonal definition.

The Bi values we obtain for the surface snow samples are generally slightly higher than those in the snow core. Surface snow sampling took place in the middle (site A) and at the end (site B) of May. Although we do not know when the precipitation events occurred during the

time period before the sampling dates, it is then likely that the snow samples do correspond to spring snow. The fact that the Bi concentrations in them are rather high might then tentatively indicate that, as previously observed for other heavy metals, Bi concentrations in Greenland snow might be high during spring time because of inputs of aging and well-mixed air masses from the Arctic Basin to the Greenland ice sheet at this time.

3.3 Contribution from natural sources

Contribution to the measured Bi concentrations from rock and soil dust can be estimated from Al concentrations measured in the snow (Tables 1 and 2) and the mean Bi/Al concentration ratios in continental material. Published data on Bi concentrations in bulk continental crust range from 48 to 170 ng/g (Taylor, 1964; Bowen, 1979; Taylor and McLennan, 1985). For soils, the mean value given in Bowen (1979) is 200 ng/g (range 100-13000). These soils values might however include some anthropogenic contribution since most of them are for populated areas in Europe and North America, and probably do not reflect natural rock and soil dust contribution. If we take the value given by Taylor and McLennan (1985), which is 60 ng/g, this gives a Bi/Al ratio of $\sim 0.84 \times 10^{-6}$. When combined with the Al values listed in Tables 1 and 2, it gives a rock and soil dust contribution for Bi ranging from ~ 0.0018 pg/g (sample EU7B, Table 1) to ~ 0.02 pg/g (sample 111, Table 2). For the snow core, this represents ~ 1 to 3% of the measured Bi concentrations, except for the three samples for which Bi was below the LOD (EU3H, EU7B, EU12B, Table 1): for these last samples, it could represent up to more than 10%. Regarding now the surface snow samples (spring snow), it represents 1.5 to 10% for the samples in which Bi was detected and could represent up to more than 20% in the two samples below the LOD. A general conclusion is that the rock and soils dust contribution is probably not more than a few percent in most cases, but might be significantly higher in some cases especially for spring snow.

Contribution from sea salt can be evaluated from the mean Bi/Na concentration ratio in sea water and the concentrations of sea derived Na (Na_m) in our samples. These last concentrations are calculated from measured Na concentrations in the snow (Tables 1 and 2) by subtracting the rock and soil dust contribution estimated from the mean Na/Al ratio, 0.27, in crustal material (Taylor and McLennan, 1985). Recent data on Bi concentrations in present day surface sea water indicate values in the 0.02 - 0.1 pg/g range (Lee, 1982; Lee et al., 1986), i.e. values several orders of magnitude lower than the earlier ones, ranging from 15 to 42 pg/g, listed in Arhens and Erlank (1978) and Bowen (1979). If we assume a value of 0.05 pg/g, it gives a Bi/Na ratio in sea water of 5×10^{-12} . The sea salt contribution to Bi in our samples so obtained is found to be totally negligible (less than 6×10^{-8} pg/g, that is six orders of magnitude lower than our lowest Bi values). And it would remain negligible even if sea derived aerosols were enriched for Bi with respect to bulk sea water as documented for various other heavy metals (Weisel et al., 1984; Arimoto et al., 1985). Such data are unfortunately currently not available.

Emissions from volcanoes have been suggested by various authors to probably account for most of the global atmospheric reservoir of Bi (Lee et al., 1986; Patterson and Settle, 1987). The flux of volcanic Bi to the global atmosphere has been evaluated to be about 1200-1700 tonnes/yr (Patterson and Settle, 1987 and erratum 1988; Lambert et al., 1988; Le Cloarec and Marty, 1991; Le Cloarec et al., 1992), that is about 30 - 40 fold the estimated flux of ~ 40 tonnes Bi/yr from rock and soil dust (Patterson and Settle, 1987). Volcanic contribution to Bi in our samples can be tentatively estimated from the mean Bi/S concentration ratio for volcanic emissions and natural concentrations of non sea salt (nss) sulfate at Summit, assuming that a given fraction (~13%, Zehnder and Zinder, 1980) of nss sulfate originates from volcanoes on a global basis.

We have used the tentative Bi/S ratio, $\sim 1 \times 10^{-4}$, given by Patterson and Settle (1987 and erratum 1988). Present day sulfate concentrations measured in part of our samples cannot be used since they include a large anthropogenic component. We have then used the mean nss sulfate concentration values, $\sim 25-40$ ng/g, in pre-industrial revolution Summit Holocene ice (De Angelis et al., 1994; Zielinski et al, 1994). The volcanic Bi contribution so obtained is about 0.13-0.20 pg Bi/g, which is rather close to the measured Bi concentration in the snow (Tables 1 and 2), taking into account the very large uncertainty in the Bi/S ratio in volcanic emissions. Our preliminary data appear then to be compatible with the claim by Lee et al. (1986) and Patterson and Settle (1987) that volcanoes probably contribute a large fraction of atmospheric Bi.

3.4 Contribution from anthropogenic sources

We are not aware of any recent comprehensive inventory of anthropogenic emissions of Bi to the global atmosphere. The most recent detailed inventories of worldwide emissions of heavy metals to the atmosphere from anthropogenic sources indeed unfortunately do not include Bi (Nriagu and Pacyna, 1988; Nriagu, 1989). There are however some data on emissions of Bi to the atmosphere due to oil and coal combustion, which were obtained earlier using the amounts of fuels and the elemental composition of typical fuels (Bowen, 1979). For Bi, it gives a flux of ~ 15 tonnes/yr (1975 value), which would make it very minor when compared with the volcanic flux ($\sim 1200 - 1700$ tonnes/yr) quoted in section 3.3. This would be in good agreement for instance with the estimates given by Cass and McRae (1986) of emissions (1975 values) of particulate Bi in the highly polluted Los Angeles area : 0.1 Kg Bi/day only (0.04 tonnes/yr), which is five orders of magnitude less than Pb emissions in the same area (~ 9000 Kg Pb/day). It should however be mentioned that significant local pollution for Bi was for instance recently documented in Norway in the vicinity of Aluminium and Ferro-Manganese plants and in the Oslo area (Berg

et al., 1994b).

Our data do not allow us to confirm this small anthropogenic contribution. This will require a comparison of Bi concentrations in recent Greenland snow with that in ancient ice deposited several thousand years ago before man started to impact significantly on the atmosphere. The fact that the volcanic contribution estimated in section 3.3 matches Bi concentrations observed in recent Greenland snow reasonably well suggests that the anthropogenic contribution will probably be found to be very small, contrary to what is observed for other heavy metals such as Pb, Zn, Cd and Cu (Candelone et al., 1995a).

3.5 Fallout flux of Bi to the Greenland ice sheet

Present day Bi fallout flux can be estimated by combining the mean Bi concentration in the snow with the snow accumulation rate, $23 \text{ g H}_2\text{O cm}^{-2}\text{yr}^{-1}$, at Summit. If we assume a mean concentration of $\sim 0.2 \text{ pg Bi/g}$ in present day Greenland snow, it gives a fallout flux of $\sim 4.6 \times 10^{-12} \text{ g Bi cm}^{-2} \text{ yr}^{-1}$. For the whole Greenland ice cap (surface of $1.4 \times 10^6 \text{ km}^2$, mean accumulation rate of $34 \text{ g H}_2\text{O cm}^{-2} \text{ yr}^{-1}$), it represents about 95 kg Bi/yr.

4. CONCLUSIONS

This preliminary work has provided us with the first data on the occurrence of Bi in recent Greenland snow, by combining the unrivalled sensitivity of the newly developed LEAFS technique with stringent ultraclean sampling procedures. These preliminary data seem to confirm that volcanoes are likely to be the main source of atmospheric Bi on a global scale.

Despite the outstanding sensitivity of LEAFS, Bi concentrations in part of the samples however remained below the actual LOD of 0.05 pg/g (50 μ l samples). Further improvements of this LOD are expected to be achieved in the near future by using a two-step scheme of fluorescence excitation. Once achieved, priority will be given to the determination of Bi in Greenland snow and ice cores covering much longer time periods in order to confirm that the anthropogenic contribution to this heavy metal is indeed negligible and obtain time series of the past global volcanic activity. It will of course also be very interesting to get data on the occurrence of this metal in the Antarctic ice cap.

ACKNOWLEDGEMENTS

This work was supported by the Commission of European Communities and Switzerland within the framework of Cost 611 as part of the Eurocore programme, the Division of Polar Programmes of the US National Science Foundation, the Ministère de l'Environnement, the Institut National des Sciences de l'Univers, the Ministère de l'Enseignement Supérieur et de la Recherche, the Ministère des Affaires Etrangères, the University of Grenoble, the Academy of Sciences of Russia and the Markon Ltd company. We thank R. Delmas, C. Rado and P. Mayewski and his colleagues for their participation in field sampling, and V. Koloshnikov, G. Turk and F. Hartmann for their continuous interest and stimulating discussions.

REFERENCES

- Apatin V.M., Arkhangeskii B.V., Bolshov M.A., Ermolov V.V., Koloshnikov V.G., Kompanetz O.N., Kuznetsov N.I., Mikhailov E.L., Shishkovskii V.S. and Boutron C.F. (1989) Automated laser excited atomic fluorescence spectrometer for determination of trace concentrations of elements. *Spectrochim. Acta* **44B**, 253-262.
- Arhens L.H., and Erlank A.J. (1978) Bismuth. In *Handbook of Geochemistry II.5* (edited by Wedepohl K.H.), pp 83C1-83O3, Springer, Berlin.
- Arimoto R., Duce R.A., Ray B.J. and Unni C.K. (1985) Atmospheric trace elements at Enewetak Atoll, 2. Transport to the ocean by wet and dry deposition. *J. Geophys. Res.* **90**, 2391-2408.
- Berg T., Røyset O. and Steinnes E. (1994a) 27 trace elements in atmospheric precipitations at six background stations in Norway 1989-1990. *Atmos. Environ.*, submitted.
- Berg T., Royset O., Steinnes E. and Vadset O. (1994b) A survey of atmospheric trace element deposition based on ICP-MS analysis of mosses. *Environ. Poll.*, in press.
- Bolshov M.A., Boutron C.F., Ducroz F.M., Görlach U., Kompanetz O.N., Rudniev S.N. and Hutch B. (1991) Direct ultratrace determination of cadmium in Antarctic and Greenland snow and ice by laser atomic fluorescence spectrometry *Analytica Chim. Acta* **251**, 169-175.

- Bolshov M.A., Rudniev S.N. and Brust J. (1994a) Direct determination of bismuth traces by laser excited atomic fluorescence spectrometry. *Spectrochim. Acta B*, in press.
- Bolshov M.A., Rudniev S.N., Candelone J.P., Boutron C.F. and Hong S. (1994b) Ultratrace determination of Bi in Greenland snow by laser atomic fluorescence spectrometry. *Spectrochim. Acta B*, in press.
- Boutron C.F. (1990) A clean laboratory for ultralow concentration heavy metal analysis. *Fresenius Z. Anal. Chem.* **337**, 482-491.
- Boutron C.F., Görlach U., Candelone J.P., Bolshov M.A. and Delmas R.J. (1991) Decrease in anthropogenic lead, cadmium and zinc in Greenland snows since the late 1960's. *Nature* **353**, 153-156.
- Boutron C.F., Candelone J.P. and Hong S. (1994a) Past and recent changes in the large scale tropospheric cycles of lead and other heavy metals as documented in Antarctic and Greenland snow and ice : A review. *Geochim, Cosmochim. Acta*, in press.
- Boutron C.F., Candelone J.P. and Hong S. (1994b) Greenland snow and ice cores : unique archives of the large scale pollution of the troposphere of the Northern Hemisphere for lead and other heavy metals. *Sci. Tot. Environ.*, in press.
- Bowen H.J.M. (1979) *Environmental Chemistry of the Elements*. Academic Press, London.
- Buat Menard P. (1990) Global source strength and long-range atmospheric transport of trace

elements emitted by volcanic activity. In *The Long-Range Atmospheric Transport of Natural and Contaminant Substances* (edited by Knap A.H.), NATO-ASI Series vol C297, pp 163-175, Kluwer Academic, Dordrecht.

Candelone J.P., Bolshov M.A., Rudniev S.N., Hong S. and Boutron C.F. (1994) Determination of bismuth down to sub pg/g level in Greenland snow by laser excited atomic fluorescence spectrometry. *J. Phys. C4*, 661-664.

Candelone J.P., Hong S., Pellone C. and Boutron C.F. (1995a) Post industrial revolution changes in large scale atmospheric pollution of the Northern Hemisphere for heavy metals as documented in central Greenland snow and ice. *J. Geophys. Res.*, submitted.

Candelone J.P., Jaffrezo J.L., Hong S., Pellone C., Davidson C.I. and Boutron C.F. (1995b) Seasonal variations in heavy metal concentrations in present day Greenland snow. *Earth. Planet. Sci. Lett.*, submitted.

Cass G.R. and McRae G.J. (1986) Emissions and air quality relationships for atmospheric trace metals. In *Toxic Metals in the Atmosphere* (edited by Nriagu J.O. and Davidson C.I.) Wiley, New York.

Craig P.J. (1980) Metal cycles and biological methylation. In *The Natural Environment and The Biogeochemical Cycles*, pp 169-227, Springer, Berlin.

De Angelis M. and Legrand M. (1994) Origins and variations of fluoride in Greenland precipitation. *J. Geophys. Res.* **99**, 1157-1172.

Görlach U. and Boutron C.F. (1989) Heavy metal concentrations in surface snow from central Greenland. In *Proceedings of the 7th International Conference on Heavy Metals in the Environment* (edited by Vernet J.P.) pp 24-27, Page Bros, Norwich.

Görlach U. and Boutron C.F. (1992) Changes in heavy metals concentrations in Antarctic snows from 1940 to 1980. *J. Atmosph. Chem.* **14**, 205-222.

Hong S., Candelone J.P., Patterson C.C. and Boutron C.F. (1994) Greenland ice evidence of hemispheric lead pollution two millennia ago by Greek and Roman civilizations. *Science*, in press.

Lambert G., Le Cloarec M.F. and Pennisi M. (1988) Volcanic output of SO₂ and trace metals : a new approach. *Geochim. Cosmochim. Acta* **52**, 39-42.

Le Cloarec M.F. and Marty B. (1991) Volatile fluxes from volcanoes. *Terra Nova* **3**, 17-27.

Le Cloarec M.F., Allard P., Ardouin B., Giggenbach W.F. and Sheppard D.S. (1992) Radioactive isotopes and trace elements in gaseous emissions from White Island, New Zealand. *Earth Planet. Sci. Lett.* **108**, 19-28.

Lee D.S. (1982) Determination of bismuth in environmental samples by flameless atomic absorption spectrometry with hydride generation. *Anal. Chem.* **54**, 1682-1686.

Lee D.S., Edmond J.M. and Bruland K.W. (1986) Bismuth in the Atlantic and North Pacific : a

natural analogue to plutonium and lead? *Earth. Planet. Sci. Lett.* **76**, 254-262.

Murozumi M., Chow T.J. and Patterson C.C. (1969) Chemical concentrations of pollutant lead aerosols, terrestrial dusts and sea salts in Greenland and Antarctic snow strata. *Geochim. Cosmochim. Acta* **33**, 1247-1294.

Nriagu J.O. (1989) A global assessment of natural sources of atmospheric trace metals. *Nature* **338**, 47-49.

Nriagu J.O. and Pacyna J.M. (1988) Quantitative assessment of worldwide contamination of air, water and soils by trace metals. *Nature* **323**, 134-139.

Patterson C.C. and Settle D.M. (1987) Magnitude of lead flux to the atmosphere from volcanoes. *Geochim. Cosmochim. Acta* **51**, 675-681. Erratum in *Geochim. Cosmochim. Acta* **52**, 245 (1988).

Paulsen P.J., Beary E.S., Bushee D.S. and Moody J.R. (1988) Inductive coupled plasma mass spectrometric analysis of ultrapure acids. *Anal. Chem.* **60**, 971-975.

Peel D.A. (1989) Trace metals and soot in ice cores. In *The Environmental Record in Glaciers and Ice Sheets (Dahlem Konferenzen)* (edited by Oeschger H. and Langway C.C. Jr), pp 207-223, Wiley, New York.

Savarino J., Boutron C.F. and Jaffrezo J.L. (1994) Short-term variations of Pb, Cd, Zn and Cu in recent Greenland snow. *Atmosph. Environ.* **28**, 1731-1737.

- Taylor S.R. (1964) Abundance of chemical elements in the continental crust : a new table. *Geochim. Cosmochim. Acta* **28**, 1273-1285.
- Taylor S.R. and McLennan S.M. (1985) *The Continental Crust : its Composition and Evolution*, Blackwell, Oxford.
- Weisel C.P., Duce R.A., Fashing J.L. and Heaton R.W. (1984) Estimates of transport of trace metals from the ocean to the atmosphere. *J. Geophys. Res.* **89**, 11607-11618.
- Wolff E.W. (1990) Signals of atmospheric pollution in polar snow and ice. *Antarctic Sci.* **2**, 189-205.
- Wolff E.W. and Peel D.A. (1988) Concentrations of cadmium, copper, lead and zinc in snow from near Dye 3 in South Greenland. *Ann. Glaciol.* **10**, 193-197.
- Zehnder A. and Zinder S. (1980) In *The Handbook of Environmental Chemistry* (edited by Hüttinger O.) **Vol 1, Part A**, pp 105-145, Springer, New York.
- Zielinski G.A., Mayewski P.A., Meeker LD., Whitlow S., Twickler M.S., Morrison M., Meese D.A., Gow A.J. and Alley R.B. (1994) Record of volcanism since 7000 B.C. from the GISP 2 Greenland ice core and implications for the volcano - climate system. *Science* **264**, 948 - 952.

Sample reference	Depth (m)	Age ¹	Measured concentration		
			Bi (pg/g)	Al ² (ng/g)	Na ² (ng/g)
EU 3H	2.41 - 2.56	1984.7	<0.05	5.3	11.3
EU 3B	2.56 - 2.72	1984.5	0.18 ± 0.08	3.0	5.5
EU 5H	4.47 - 4.56	1981.0	0.32 ± 0.13	7.0	3.2
EU 5B	4.56 - 4.72	1980.6	0.07 ± 0.05	3.2	9.7
EU 7H	6.00 - 6.16	1977.6	0.23 ± 0.1	5.5	7.5
EU 7B	6.16 - 6.31	1977.2	<0.05	2.2	2.2
EU 12H	9.58 - 9.74	1969.7	0.38 ± 0.15	12.7	9.1
EU 12B	9.74 - 9.90	1969.4	<0.05	7.8	1.7

¹Estimated age for the middle of the sample ²From Boutron et al. (1991).

Table 1. 10.7 snow core drilled near Summit, central Greenland : measured concentrations of Bi, Al and Na in the inner part of 8 sections whose depth range from 2.4 to 9.9 m (years 1984 - 1969).

Sample reference	Sampling site	Sampling date	Measured concentrations		
			Bi (pg/g)	Al ¹ (ng/g)	Na ¹ (ng/g)
56	A	13 May 1987	0.38 ± 0.15	10	2.4
57	A	13 May 1987	0.66 ± 0.40	13	3.4
109	A	13 May 1987	0.27 ± 0.17	22	5.0
112	A	13 May 1987	0.43 ± 0.33	17	8.1
58	B	28 May 1987	<0.05	7	1.9
53	B	28 May 1987	<0.05	15	15.2
110	B	28 May 1987	0.12 ± 0.10	17	3.7
111	B	28 May 1987	0.46 ± 0.34	25	6.8

¹From Görlach and Boutron (1989).

Table 2. Surface snow collected at two different sites located about 85 km WSW (SiteA) and 50 km (site B) of Summit, central Greenland : measured concentrations of Bi, Al and Na.

FIGURES LEGEND

Figure 1 : (A) General map of Greenland showing Summit ; (B) Enlarged view of the Summit area showing the three sampling sites.

Figure 2 : Calibration of the LAFAS-1 spectrometer for Bi using ultralow concentration 0.1% HNO₃ aqueous standards (volume introduced into the graphite cup of the atomizer : 50 µl).

A

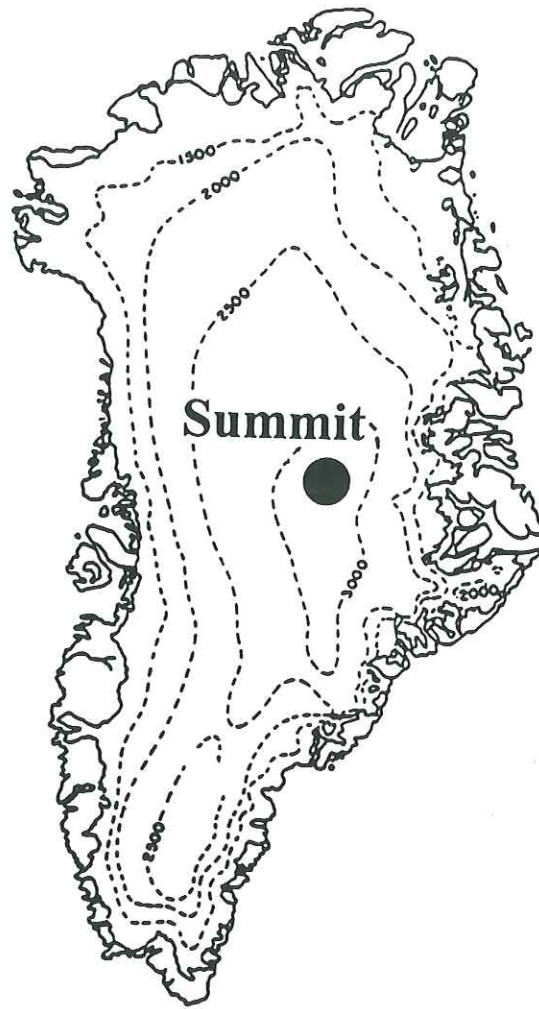
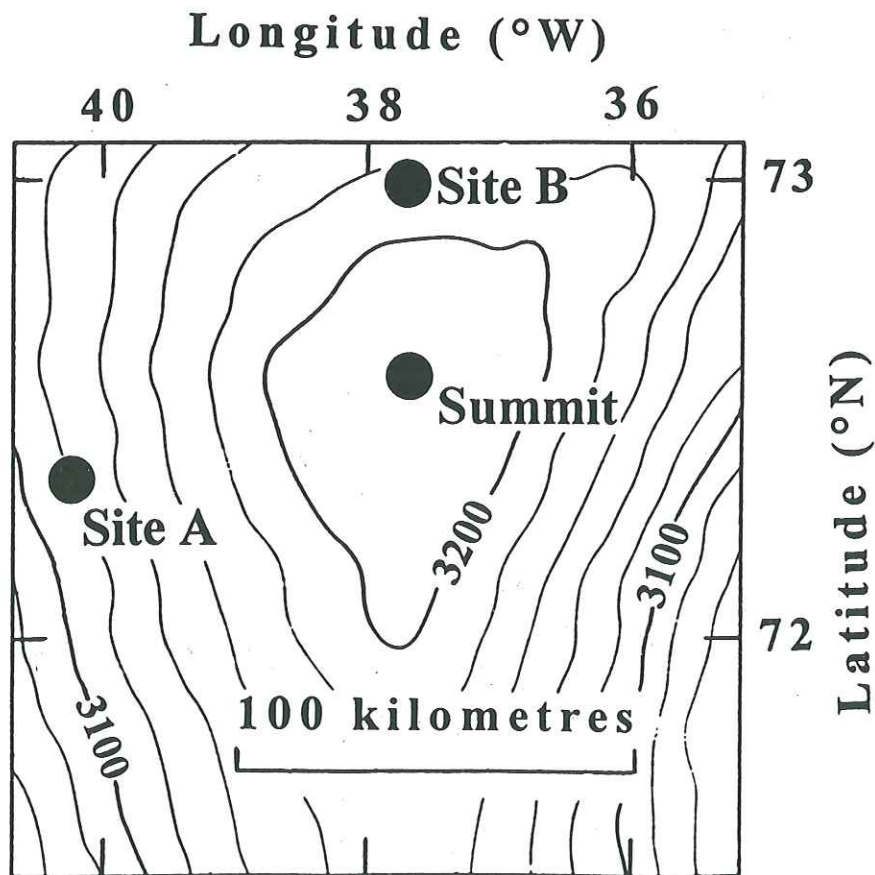

Figure 2

B



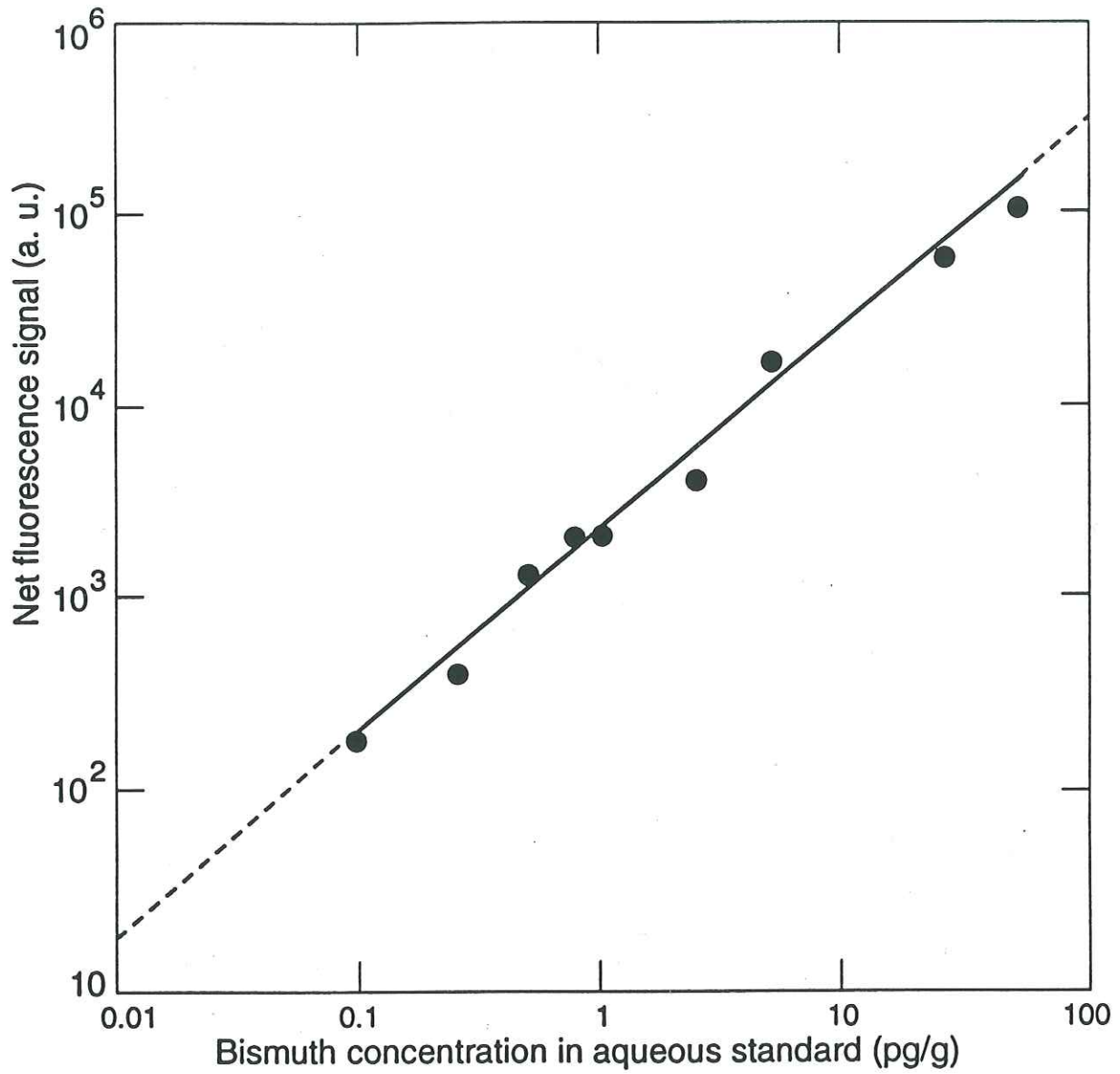

Figure 2

CONCLUSION

CONCLUSION

L'originalité des travaux présentés dans ce mémoire réside dans leur unicité : ils viennent en effet combler un quart de siècle d'absence quasi générale en données fiables. Ils démontrent ainsi que le domaine de l'analyse des éléments à l'état d'ultratraces suit une logique d'approche hors normes des protocoles usuels de laboratoire, rigoureuse dans son application, du prélèvement initial de l'échantillon sur le site, tout au long de sa préparation en laboratoire, jusqu'à sa mesure par la technique analytique appropriée.

Les résultats de nos travaux révèlent l'ampleur de l'impact à long terme des activités humaines sur les cycles biogéochimiques des métaux en présentant un profil temporel recouvrant la période comprise entre le début de l'ère industrielle à nos jours (1773-1992). Ils révèlent aussi l'impact à court terme de ces activités dans les variations saisonnières des concentrations en métaux d'une série d'échantillons prélevés dans un puit.

Nos résultats confirment pour le site central de Summit, le profil temporel précédemment publié par C. Patterson et ses collègues en 1969 retraçant pour la période 1750-1965 les variations des concentrations en plomb dans des échantillons de glace du Nord Ouest du Groenland. Ils confirment aussi le facteur 200 d'augmentation des concentrations observé pour les précipitations du milieu des années 1960 par rapport aux niveaux naturels (il y a plusieurs milliers d'années). Ils confirment encore que les teneurs en plomb dans la précipitation pré-industrielle dépassaient de plus d'un ordre de grandeur les concentrations de la précipitation

naturelle ce qui conduit tout un chacun à penser que la pollution globale de l'atmosphère de notre hémisphère par le plomb est une histoire ancienne

En détaillant le rythme des variations des concentrations du profil temporel, nous voyons une croissance particulièrement marquée à partir des années 1930. Cette croissance avait été initialement attribuée, aux composés organiques du plomb, ajoutés à l'essence dès 1924 puis à leur consommation massive dans les années qui suivirent (maximale vers 1972). Cette hypothèse vient d'être confirmée par la mesure des organo-plombs (principalement plomb di et tri-Ethyl), espèces qui n'ont pas de sources naturelles reconnues et qui sont, par conséquence, des traceurs uniques des émissions des moteurs à explosion. Le profil temporel des concentrations totales de ces composés est par ailleurs très semblable à celui obtenu pour le plomb total.

La composition isotopique du plomb introduit dans l'essence étant différente aux USA et en Europe, des renseignements précieux sur l'origine géographique de la déposition ont pu être obtenus en déterminant les différents rapports isotopiques (Pb^{206}/Pb^{207} principalement) dans les échantillons de notre série temporelle. La contribution des USA apparait majoritaire, pour les années 1970, la tendance s'inversant progressivement en défaveur du vieux continent pour la fin des années 1980. Cette inversion s'explique par la politique de réduction du taux de plomb ajouté à l'essence et de la commercialisation d'un carburant sans additifs appliquée plus tôt en Amérique qu'en Europe. Cependant, une très notable diminution des concentrations totales de plomb a été observée pour les deux dernières décennies (facteur 6.3), les niveaux actuels retrouvant des valeurs correspondantes aux années 1930.

Pour cette année justement, notre profil semble indiquer une inflexion de la croissance des concentrations en plomb qui serait liée à la recession économique. Les estimations des flux de soufre (polluant fréquemment associé aux métaux) présentent une diminution pour cette période.

Nous pensons que cette suggestion mérite certainement d'être vérifiée par une étude plus approfondie.

Les profils temporels présentés par le cadmium, le zinc et le cuivre explicitent quant à eux une philosophie identique à celle du plomb avec toutefois des différences de chronologie et d'ampleur. En 1770, la déposition de ces trois métaux à la surface de la calotte polaire est uniquement due aux sources naturelles (poussières de roches et de sols, aérosols marins et volcaniques, etc...), mais nos résultats montrent qu'à partir de cette date, les émissions anthropiques de zinc commencent à affecter de façon lentement croissante mais régulière le bilan atmosphérique de ce métal jusqu'en 1900 où s'amorce alors une accélération des émissions ; le maximum est obtenu pour le début des années 1960 (1961). Pour le cadmium et le cuivre, l'influence humaine débute plus tardivement, vers 1850 et les croisances des concentrations de ces deux métaux sont alors rapides jusqu'aux maxima atteints respectivement en 1972 et 1969. Les taux d'augmentation de ces trois métaux sont de 800% (Cd), 500% (Zn) et 400% (Cu). Ces augmentations révèlent pour la première fois l'étendue de la pollution de l'atmosphère de l'hémisphère nord par les émissions industrielles : en proportion avec les niveaux naturels des métaux dans la glace ancienne, la pollution de la troposphère globale de notre hémisphère est tout à fait unique par son ampleur. D'après les bilans globaux des flux anthropiques de métaux lourds vers l'atmosphère, les principales émissions proviennent des installations minières et des industries de transformation des métaux non ferreux, de l'usage domestique où privé de combustibles fossiles, de la sidérurgie et de l'incinération des déchets.

Comme pour le plomb, les concentrations de cadmium et de zinc décroissent de façon importante après leur maximum (facteurs respectifs 2.3 et 1.7) ; pour le cuivre, cette diminution est beaucoup moins significative (facteur 1.2). Ce résultat encourageant reflète à la fois les

conséquences de la modernisation des technologies de production des métaux non ferreux et des autres sources ainsi que de l'efficacité des mesures visant à réduire les émissions de ces différentes sources (précipitateurs électrostatiques, filtres, laveurs de fumées...)

L'étude des métaux dans notre série temporellement détaillée, a permis de poser l'accent sur les estimations des contributions naturelles. Pour nos échantillons, nous avons utilisé les concentrations d'aluminium et de sodium marin pour estimer les sources naturelles "classiques": les poussières d'origine crustale et les aérosols marins. La contribution de l'activité océanique est toujours négligeable devant celle des poussières terrigènes dans nos échantillons ; la contribution crustale, par contre, représente jusqu'à 80% de celle du cuivre, jusqu'à 25% de celle du zinc, jusqu'à 16.5 % de celle du cadmium et jusqu'à 12% de celle du plomb.

La source volcanique a été conjointement approchée à partir des niveaux pré-industriels de sulfates d'origine volcanique associés aux rapports moyens métal/soufre dans les panaches volcaniques d'une part et des toutes premières valeurs de concentrations en bismuth dans divers échantillons de carotte récemment mesurées par spectrométrie de fluorescence laser d'autre part. Il convient de souligner que les concentrations de ce métal repertorié comme étant un bon traceur de la source volcanique, demeurent à des niveaux sub pg/g qui placent la mesure directe du bismuth hors de portée des techniques classiques de detection. Les dernières améliorations techniques dans ce domaine dont nous avons bénéficié pour notre étude permettent d'atteindre directement de tels niveaux. Malgré les différences d'approche sur lesquelles elles reposent, ces deux méthodes d'estimation de la source volcanique donnent des résultats convergents. Cette contribution est ainsi évaluée à 1% pour Pb et Zn et à 5% pour Cd et Cu.

Les autres sources naturelles telles que les feux de forêt et l'évasion de matière organique particulaire par la couverture végétale continentale ont fait l'objet d'une tentative d'estimation

à partir de récentes données en teneurs de carbone particulaire dans les neiges de Summit. Les contributions n'apparaissent significatives que pour les feux de forêts (5% pour Pb, Zn, Cu, 2% pour Cd).

Pour ces quatre métaux, nos résultats montrent la prédominance de la source anthropique; le cuivre présentant cependant une composante crustale élevée (en moyenne, un quart de la concentration de chaque échantillon).

D'autre part, les concentrations en cadmium et en plomb sont fortement corrélées dans nos échantillons, ce qui laisserait penser pour ces deux éléments à des mécanismes voisins de transport.

Identiquement à ce qui avait été observé antérieurement au site de Dye3 (Sud Est de la calotte), l'arrivée maximale des métaux se produit au printemps et en été ; des concentrations nettement plus basses sont enregistrées pendant l'automne et l'hivers. Malgré l'absence de trajectographies sur l'origine des masses d'air pour l'interprétation directe de nos résultats en termes de sources, les ressemblances entre les chronologies des arrivées des métaux pour les deux sites suggèrent que les schémas des régions sources influençant Dye3 sont en partie applicables à Summit. Dans cette hypothèse, l'Arctique canadien, en tant que réservoir d'aérosols eurasiatiques transportés au dessus du pôle, et l'Europe sont des régions sources potentielles au printemps, le Canada et l'Est des Etats Unis jouant un rôle plus important en été.

Les résultats que nous avons obtenus ne permettent cependant pas d'éclaircir les questions soulevées par les mécanismes d'incorporation des aérosols métalliques dans la précipitation et l'importance des autres voies de déposition; voie sèche où par brouillard. ces phénomènes sont cependant importants car un fractionnement différent des aérosols selon leur nature (spectre de taille différent) pourrait induire un biais dans le calcul des flux globaux de retombées.

La similitude des concentrations en plomb observées entre le profil de C. Patterson et le notre, obtenus pourtant en des sites éloignés l'un de l'autre, d'altitude et latitude différents, suggèrent à priori un taux de déposition comparable sur une grande partie du Groenland ; nous pouvons toutefois remarquer que les sites de moyenne altitude doivent être davantage influencés par effet du brouillard arctique (Arctic haze) selon les latitudes croissantes. Un échantillonnage composé de carottes de faible profondeur (couvrant les cinq dernières années) en différents sites de la calotte permettrait de préciser d'éventuelles variations géographiques dans la distribution des flux de métaux retombant sur la calotte polaire.

De même, l'analyse des isotopes du plomb dans ces échantillons devrait pouvoir aider à cartographier les zones favorisant les retombées d'origine européenne ou américaine.

Il nous semble à priori intéressant d'étudier les variations saisonnières des métaux dans des échantillons pour les époques pré et post industrielle afin de vérifier si, comme pour les sulfates (autre indicateur de l'activité humaine), l'émergence de la source anthropique a induit de façon indirecte des modifications dans le cycle d'arrivée des métaux au Groenland.

Enfin, nous disposons maintenant des moyens analytiques pour la mesure du bismuth, bon traceur de la source volcanique ; son utilisation future, en association avec les autres métaux devrait permettre de préciser l'influence de l'activité volcanique de "bruit de fond" dans des carottes pré et post révolution industrielle et également de mieux cerner l'impact des événements volcaniques majeurs répertoriés dans les niveaux pré-industriels. Là encore, la signature isotopique du plomb peut éventuellement permettre de singulariser certains événements.

JOURNAL DE PHYSIQUE IV

Colloque C4, Supplément au Journal de Physique III, Volume 4, avril 1994

C4-661,664

**Determination of bismuth down to sub-pg/g level in Greenland snow by Laser
Excited Atomic Fluorescence Spectrometry.**

J-P. CANDELONE, M.A. BOLSHOV, S.N. RUDNIEV, S. HONG & C.F. BOUTRON.

Determination of bismuth down to sub PG/G level in Greenland snow by laser excited atomic fluorescence spectrometry

J.-P. CANDELONE*, M.A. BOLSHOV**, S.N. RUDNIEV**, S. HONG* and C.F. BOUTRON***

* *Laboratoire de Glaciologie et Géophysique de l'Environnement du CNRS, 54 rue Molière, Domaine Universitaire, BP. 96, 38402 St Martin d'Hères, France*

** *Institute of Spectroscopy, Russia Academy of Sciences, Troitzk 142092, Moscow Region, Russia*

*** *UFR de Mécanique, Université Joseph Fourier de Grenoble, Domaine Universitaire, BP. 68, 38041 Grenoble, France*

Abstract. We present here preliminary data on the first direct determination of Bi in Greenland recent snow down to the sub pg/g level by Laser Excited Atomic Fluorescence (LEAF) spectrometry in clean room conditions. Calibration of the spectrometer was achieved using ultralow concentration Bi standards (concentration range 0.05 - 50 pg/g). The limit of detection was found to be 2.5 fg Bi. Various Greenland samples were analysed, giving Bi concentration values in good agreement with these anticipated from the available volcanic emissions data.

1. Introduction

The investigation of the occurrence of heavy metals in the dated ice and snow layers accumulated in Antarctica and Greenland has proven to be an outstanding way to understand the past natural large scale atmospheric cycles of these metals and to evaluate their present alteration by man /1,2/. This has been beautifully illustrated during the past few years in a series of comprehensive studies for various metals /3-8/.

Such studies however represent a formidable analytical challenge. This is mainly because heavy metals are present in polar ice and snow at extremely low concentration levels, down to the sub pg/g level. Reliable data can then be obtained only if stringent control of contamination is achieved from field sampling to laboratory analysis and if ultrasensitive spectrometric techniques are used.

Main attention has until now been given to the metals - Pb, Hg, Cd and Zn - which are the most influenced by human activities /9,10/. On the other hand, little attention has been paid to the metals whose atmospheric cycles are likely to be still undisturbed by man, although such metals can be extremely interesting tracers of specific natural sources and of atmospheric transport pathways. Among these last metals is Bismuth (Bi). Although the available data on the occurrence of this heavy metal in the atmosphere and more generally in the environment are scarce, it is indeed likely that Bi is an excellent tracer of volcanic emissions to the atmosphere, since emissions from other natural sources are very limited /11-13/. Investigating the occurrence of this metal in the frozen atmospheric archives stored in the Antarctic and Greenland ice caps could then provide with very valuable time series of volcanic activity in both hemispheres and with pertinent data on the transport patterns of volcanic aerosols in the atmosphere.

Despite this interest, there are presently no data at all on Bi in Antarctic and Greenland ice and snow. This is especially because Bi concentrations in polar ice and snow were anticipated to be so low, at the sub pg/g level, that no sensitive enough analytical technique was available. We present here preliminary results on the determination of Bi in Greenland recent snow using the ultrasensitive Laser Excited Atomic Fluorescence (LEAF) technique.

2. Experimental conditions

The Bi measurements were performed using the LAFAS-1 automated LEAF spectrometer developed at the Institute of Spectroscopy /14/. The radiation source is a tunable dye laser pumped by an excimer XeCl laser. Radiation of the dye laser is frequency doubled in a KDP or KB5 non-linear crystal. The melted snow sample (50 μ l) is introduced into a Ringsdorff pyrolytically coated graphite cup inside the electro-thermal atomizer (ETA). The fluorescence radiation is collected through a monochromator onto a photomultiplier whose output signal is digitized using an A/D converter. To minimize contamination problems, the whole spectrometer is located inside a specially designed room supplied with filtered air. In addition, the electro-thermal atomizer and the bench onto which the samples and standards are handled, are placed inside a clean chamber flushed with a laminar flow of air filtered through high efficiency particulate air filters /14/.

Extensive investigations were conducted to determine the best analytical schemes for effective excitation and detection of Bi atomic fluorescence /15/. The best sensitivity was achieved with excitation at $\lambda_1 = 223.061$ nm and fluorescence detection at $\lambda_2 = 299.334$ nm. The working conditions for the electro-thermal atomizer were also optimized to reduce the severe spectral and matrix interferences problems which were faced for the Greenland snow samples /15/. The best conditions were found to be as follows: after being introduced into the graphite cup of the atomizer with an Eppendorf micropipette, the sample (50 μ l) was first evaporated (95° C for 120 s) and charred (300° C for 8 s) with the atomizer being filled with air at atmospheric pressure. The chamber of the atomizer was then closed, evacuated and filled with Argon. The sample was charred again at a slightly higher temperature (400° C for 4 s) and then atomized (1200° C for 4 s) /15/.

3. Calibration of the spectrometer down to sub pg/g level

The calibration of the spectrometer for Bi was performed using ultralow concentration aqueous standards. Bi concentrations in these standards ranged from 0.05 to 50 pg Bi/g. They were prepared in the clean laboratory /16/ of the Laboratoire de Glaciologie et Géophysique de l'Environnement by successive dilutions of a 1000 ppm Bi certified atomic absorption standard with ultrapure water /16/ using ultraclean procedures. The standards were immediately acidified to make 0.1 % HNO₃ solutions using high purity double distilled HNO₃ from US National

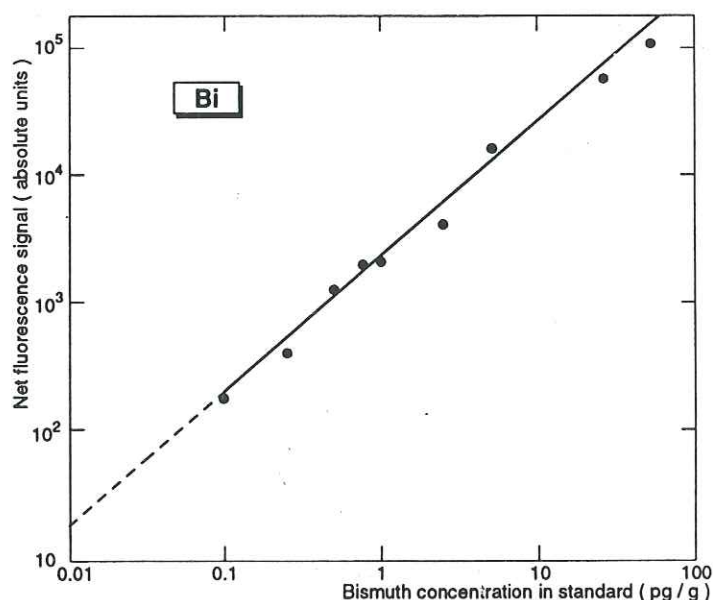

Figure 1. Calibration of the LAFAS-1 spectrometer for Bi using ultralow concentration 0.1 % HNO₃ aqueous standards.

Institute of Standards and Technology (N.I.S.T.) /17/. They were transferred into ultraclean /16/ conventional polyethylene (CPE) bottles and immediately frozen. They were then transported frozen to the Institute of Spectroscopy, packed inside sealed acid cleaned polyethylene bags. They were kept frozen until use in order to minimize possible exchanges (losses or additions) with the walls of the CPE bottles.

The Bi standards (and the samples) were allowed to melt only when really needed for the analyses. Although they remained in liquid state during limited time periods only, there was concern that Bi concentrations might be affected by significant exchanges, especially losses, with the walls of the CPE bottles. In order to quantitatively assess these possible exchanges, several aliquots of the 1 pg Bi/g standard were analysed after being left melted during periods of time ranging from thirty minutes to one week. Bi concentrations were found not to deviate significantly from the initial 1 pg Bi/g value, then confirming the stability of our ultralow concentration Bi standards.

The calibration curve so obtained is shown in Fig. 1. The limit of detection (LOD) was found to be 0.05 pg Bi/g (for 50 µl injections), which corresponds to 2.5 fg Bi. This is by far the lowest LOD ever reported by Bi: it is indeed several orders of magnitude lower than the LODs reported for other analytical techniques.

4. Analysis of Greenland snow samples

Two series of Greenland snow samples have been analysed. The first series was surface snow (first 5 cm or so from the surface) collected in May 1987 at two locations in central Greenland /18/ by pushing ultraclean wide mouth 1 l CPE bottles horizontally into the snow. A few typical results are shown in Table 1.

Reference of the sample	Sampling location	Sampling date	Bi (pg/g)
56	72° 21' N	May 13, 1987	0.38
57	40° 13' W	id.	0.66
109		id.	0.27
58	72° 59' N	May 28, 1987	<0.05
53	37° 42' W	id.	<0.05
110		id.	0.12

Table 1. Bi concentrations measured in a few samples of surface snow collected in central Greenland in May 1987.

Bi concentrations are found to range from <0.05 pg/g to 0.66 pg/g, i.e. values in good agreement with what was anticipated from the few available data on Bi emissions from volcanoes on a global scale /11-13/. All the measurements were performed using 50 µl injections, without any preliminary preconcentration or chemical treatment. All samples were 0.1 % NIST HNO₃ /17/.

The samples in the second series were various section of a 10.7 m snow core drilled in July 1989 at Summit (72° 35' N, 37° 38' W, elevation 3230 m) in central Greenland as part of the European Eurocore programme. This core covered a continuous sequence of 22 years (1967-1989). It was hand drilled by operators wearing full clean room clothing using a specially designed all plastic acid cleaned mechanical auger /5/. Despite the exceptional cleanliness of this drilling procedure, it could not be excluded that slight heavy metals contamination might be present on the outside of the core sections. Each section was then mechanically decontaminated in the laboratory using ultraclean methods /5,16/, allowing to keep for Bi analyses only the most central part of each core section. Bi data obtained for a few typical sections are shown in Table 2. Analysis of various additional snow or ice samples covering much longer time periods is planned in the near future. Before such comprehensive analyses are undertaken, it will however be necessary to further improve the LOD, for instance by using a two-step scheme for the excitation.

Reference of the sample	Depth (m)	Age	Bi (pg/g)
EU3H	2.41-2.56	1985	<0.05
EU5H	4.47-4.56	1981	0.3
EU5B	4.56-4.72	1980	0.07
EU7H	6.00-6.16	1978	0.2
EU12H	9.58-9.74	1969	0.4

Table 2. Bi concentrations measured in various sections of a 10.7 snow core drilled at Summit, central Greenland.

Acknowledgements

We thank P. Mayewski, C. Rado and R. Delmas for their participation in field sampling, and V. Koloshnikov, G. Turk, J. Brust and F. Hartmann for their continuous interest and stimulating discussions. This work was supported by the Commission of European Communities and Switzerland within the framework of Cost 611 as part of the Eurocore programme, the Division of Polar Programmes of the US National Science Foundation, the Ministère de l'Environnement, the Institut National des Sciences de l'Univers, the University of Grenoble, and the Markon Ltd company.

References

1. Wolff, EW, *Antarct Sci* 2 (1990) 189.
2. Boutron, CF, Candelone, JP, Hong, S, *Geochim Cosmochim Acta*, in press.
3. Boutron, CF, Patterson, CC, *Nature* 323 (1986) 222.
4. Boutron, CF, Patterson, CC, Barkov, NI, *Earth Planet Sci Lett* 101 (1990) 248.
5. Boutron, CF, Görlach, U, Candelone, JP, Bolshov, MA, Delmas, RJ, *Nature* 353 (1991) 153.
6. Vandal, GM, Fitzgerald, WF, Boutron, CF, Candelone, JP, *Nature* 362 (1993) 621.
7. Rosman, KJR, Chisholm, W, Boutron, CF, Candelone, JP, Görlach, U, *Nature* 362 (1993) 333.
8. Boutron, CF, Rudniev, SN, Bolshov, MA, Koloshnikov, VG, Patterson, CC, Barkov, NI, *Earth Planet Sci Lett* 117 (1993) 431.
9. Nriagu, JO, Pacyna, JM, *Nature* 323 (1988) 134.
10. Nriagu, JO, *Nature* 338 (1989) 47.
11. Patterson, CC, Settle, DM, *Geochim Cosmochim Acta* 51 (1987) 675.
12. Lambert, G, Le Cloarec, MF, Pennisi, M, *Geochim Cosmochim Acta* 52 (1988) 39.
13. Le Cloarec, MF, Allard, P, Ardouin, B, Giggenbach, WF, Sheppard, DS, *Earth Planet Sci Lett* 108 (1992) 19.
14. Apatin, VM, Arkhangelskii, BV, Bolshov, MA, Ermolov, VV, Koloshnikov, VG, Kompanetz, ON, Kutznetsov, NI, Mikhailov, EL, Shishkovskii, VS, Boutron, CF, *Spectrochim Acta* 44B (1989) 253.
15. Bolshov, MA, Rudniev, SN, Candelone, JP, Hong, S, Boutron, CF, *Spectrochim Acta B*, in press.
16. Boutron, CF, *Fresenius Z Anal Chem* 337 (1990) 482.
17. Paulsen, PJ, Beary, ES, Bushee, DS, Moody, JR, *Anal Chem* 60 (1988) 971.
18. Görlach, U, Boutron, CF, *Proceed 7th Int Conf on Heavy Metals in the Environ*, Vernet, JP, Ed, Page Bros, Norwich, England (1989) 24.

NATURE, Vol 362, 25 March, 333-334, 1993.

Isotopic evidence for the source of lead in Greenland snows since the late 1960s.

K.J. R. ROSMAN, W. CHISOLM, C.F. BOUTRON, J.P. CANDELONE & U. GÖRLACH.

Isotopic evidence for the source of lead in Greenland snows since the late 1960s

K. J. R. Rosman*, W. Chisholm*, C. F. Boutron†‡, J. P. Candelone† & U. Görlach†

* Department of Applied Physics, Curtin University of Technology, Bentley 6102, Western Australia, Australia

† Laboratoire de Glaciologie et Géophysique de l'Environnement du CNRS, 54 rue Molière, Domaine Universitaire, BP 96, 38402 St Martin d'Hères Cedex, France

‡ UFR de Mécanique, Université Joseph Fourier de Grenoble, Domaine Universitaire, BP 69, 38401, Cedex, France

IN 1969, Murozumi *et al.*¹ demonstrated that the concentration of lead in Greenland snow had increased by a factor of 200 since ancient times, and concluded that most of this increase was a result of the use of alkyl-lead petrol. Partly because of these findings, the United States and other western countries limited the use of lead additives in petrol from about 1970. Recently, Boutron *et al.*² showed that the lead concentration in Greenland snow had decreased by a factor of ~7.5 over the past 20 years, and suggested that this was a result of the decline in use of leaded petrol. We present here measurements of the ²⁰⁶Pb/²⁰⁷Pb ratio of the lead contained in the samples studied by Boutron *et al.* Because aerosols from the atmosphere above the United States are more radiogenic than those from Eurasia, we can trace the relative contributions of these two sources in the Greenland lead over the period analysed by Boutron *et al.* We find that the United States was a significant source of lead in the 1970s, but it has since declined considerably in relative importance. This decline mirrors the decrease in use of leaded petrol in the United States, confirming the earlier hypothesis.

We analysed aliquots of the samples collected by Boutron *et al.*², who collected snow to a depth of 10.7 m at Summit (72° 35' N, 37° 38' W) in central Greenland using a hand-operated auger made of polycarbonate. Details of the elaborate low-contamination procedures used to drill, collect, process and store these samples are given in ref. 2. These samples were taken at an elevation of ~3.23 km and give a more representative sample of tropospheric aerosols than those collected at sea level. This 10.7-m core provided a continuous record of snow deposited between 1967 and 1989, which includes the period when the consumption of leaded gasoline peaked in the Northern Hemisphere.

Lead has four naturally occurring stable isotopes, three of which are the end products of radioactive decay chains: ²³⁸U → ²⁰⁶Pb, ²³⁵U → ²⁰⁷Pb and ²³²Th → ²⁰⁸Pb. Consequently, industrial lead will vary in isotopic composition depending on the primary source. In principle, it is therefore possible to identify the source of atmospheric lead if the isotopic history of the potential source regions is well documented.

Aliquots of decontaminated bulk samples² were transferred to acid-cleaned³ bottles (made of low-density conventional polythene), frozen, then transported to Curtin University of Technology in Western Australia where they were analysed. The samples were processed inside a HEPA-filtered clean-air laboratory using ultra-clean conditions and procedures. Each sample was evaporated under a filtered stream of nitrogen in a PFA beaker together with HNO₃, H₃PO₄ and a ²⁰⁵Pb spike. By adding a ²⁰⁵Pb tracer it was possible to measure simultaneously the concentration and isotopic composition of the lead sample.

The sample was transferred together with H₃PO₄ and silica gel to the rhenium filament of a thermal ion source, then analysed in a VG354 mass spectrometer using a Daly collector operating in analog mode. The average procedural blank for an isotopic analysis amounted to ~3% of the sample analysed. A correction

TABLE 1 Estimates of lead concentrations in Greenland snow

	1968	1972	1976	1980	1984	1988
²⁰⁶ Pb/ ²⁰⁷ Pb ratios						
Greenland snow*	1.159	1.18	1.182	1.182	1.164	1.155
US aerosols†	1.18	1.20	1.21	1.22	1.21	1.20
Eurasia & Canada‡	1.14	1.14	1.14	1.14	1.14	1.14
Concentration of Pb in Greenland snow (pg g ⁻¹)						
Greenland (total)	135.5	118.4	94.2	63.3	55.3	33.7
US	64.2	78.8	56.8	32.9	19.1	8.4
Eurasia & Canada	71.3	39.6	37.4	30.4	36.2	25.3
Range‡	±16.0	±13.1	±8.1	±4.1	±2.7	±2.2

Estimates are based on the measured isotope ratios and those in the principal contributing sources.

* These ratios are a weighted average of the data shown in Fig. 1. Groups of points adjacent to the tabulated date have been averaged using $R = \sum w_i R_i / \sum w_i$, where w_i is the mass of Pb with ratio R_i .

† Estimated by averaging values given in cited literature (see text). The relatively small differences shown between the signatures of the two source regions and Greenland snow in 1968 makes the computed concentrations particularly sensitive to the ratios used.

‡ This range applies to both sources and was determined by allowing a change of ±0.01 in the US isotopic ratio.

was made to the isotopic composition of the sample for this contribution, although the changes generally amounted to less than 0.3% of the ²⁰⁶Pb/²⁰⁷Pb ratio. The accuracy of the mass spectrometer was monitored by analysing ~100 pg amounts of the lead isotopic standard SRM981 at regular intervals. After making a correction of 0.31% per mass unit for isotopic fractionation, the ²⁰⁶Pb/²⁰⁷Pb ratios agreed with the certified values to within ~0.4% (95% confidence limits).

The samples were dated using the seasonal variations of methanesulphonic acid (M. Legrand, personal communication). The lead concentrations were measured by isotope dilution mass spectrometry to an accuracy of better than 20% (95% confidence limit). These concentrations were slightly lower than the values given by Boutron *et al.*² on aliquots of the same bulk sample, but within errors, indicating that they were not contaminated by the storage containers or during the transfer process. To demonstrate that the coring device has not contaminated the sample, one normally measures the lead concentration profile of each core^{2,4}. We measured one core and found no increase in concentration on the outside, but we did detect an increase of 0.5% in the ²⁰⁶Pb/²⁰⁷Pb ratio. As the outside is the most contaminated part of the core, the effect on the inner samples can be expected to be negligible. We ruled out the possibility

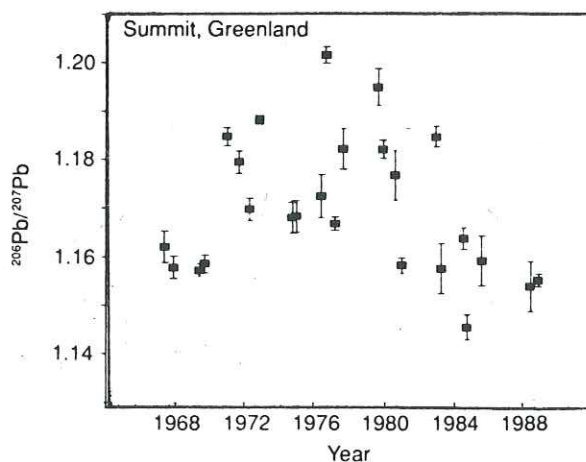

FIG. 1 Changes in the ²⁰⁶Pb/²⁰⁷Pb ratio in Greenland snow between 1967 and 1988. The uncertainties given are 95% confidence intervals. The crescent-shaped trend is mainly due to combined changes in both the isotopic composition and the consumption of leaded gasoline in the United States.

that lead contamination had occurred during subsampling by analysing ultra-pure water which had been allowed to stand in the subsampling tubes.

The results of measuring the isotopic composition of the lead in 25 snow core sections covering the last two decades are shown in Fig. 1 as a plot of the $^{206}\text{Pb}/^{207}\text{Pb}$ ratio against time. There has been a general trend upward since 1967 reaching a maximum between 1975 and 1980, then a fall back to the 1967 values, and even lower, by 1986. The $^{208}\text{Pb}/^{207}\text{Pb}$ and $^{206}\text{Pb}/^{204}\text{Pb}$ ratios, which were also measured, were highly correlated with the $^{206}\text{Pb}/^{207}\text{Pb}$ ratios and therefore showed a similar trend with time. A complete set of isotope ratios will be published elsewhere.

The United States, Eurasia and Canada are considered to be the main sources of polluted air reaching Greenland⁵. To assess the contribution from each of these sources, we need to know the isotopic signatures of the atmospheric aerosols from each of these areas. For US aerosols, the most comprehensive isotope data available between 1967 and 1974 (ref. 6) that the $^{206}\text{Pb}/^{207}\text{Pb}$ ratio changed from 1.151 to 1.211 over this period. This change was attributed to the shift to the more radiogenic Mississippi Valley lead in alkyl-Pb additives used in US gasoline. Later values have remained fairly constant: 1.22 for 1980 (ref. 7); an average of 1.213 in 1982–84 (eastern US) and 1.221 in 1986 (US mid-west; both from ref. 8); 1.18–1.22 by 1989 (R. Flegal, personal communication) when the Summit snow core was taken. Canadian aerosols give a lower and fairly constant value: 1.165 in 1979 (in Vancouver⁹) and 1.148 in 1980 (in Victoria⁹); typical values of 1.15 ± 0.01 between 1982 and 1986 (ref. 8). Church *et al.*¹⁰, however, report values of ~ 1.20 by late 1988 in air originating in Canada, but collected over the Atlantic Ocean. Eurasian lead emissions are much greater than Canadian and the $^{206}\text{Pb}/^{207}\text{Pb}$ ratio is poorly documented. Hopper *et al.*¹¹ have indicated a value of 1.156 for year 1988. Other data for the period 1965 to 1988 indicate an average value of 1.14 although there is wide scatter^{12–17}. In summary, the isotopic signature of US lead changed from 1.15 in 1964 to 1.20 by 1974 and remained between 1.20 and 1.22 for the following two decades. Neither Eurasia nor Canada appears to have substantially altered its average signature (1.15 and 1.14, respectively) since the late 1960s, although Canadian lead may have risen to ~ 1.20 after 1986.

On the basis of the above region signatures, a simple two-component linear model was constructed to derive the contributions of these components in the Greenland snow. US aerosol lead and a mixture of Eurasian and Canadian lead were used for the two isotopic signatures. A value of 1.14 was chosen for the latter. The results presented in Table 1 and Fig. 2 show that after 1972 there was a declining concentration in US lead and an almost constant concentration of the second (Eurasian/Canadian) component. Increasing the isotopic ratio of the second component to accommodate a significant proportion of Canadian lead does not alter the general shape of the concentration profiles. This establishes the US as a significant source of lead in the atmosphere during this period. This pattern also corresponds closely with that expected from leaded gasoline consumption figures (R. Fiat, personal communication).

The steep increase in the $^{206}\text{Pb}/^{207}\text{Pb}$ ratio between 1967 and 1975 (Fig. 1) can be attributed to the influence of US lead emissions which were increasing both in quantity and isotopic

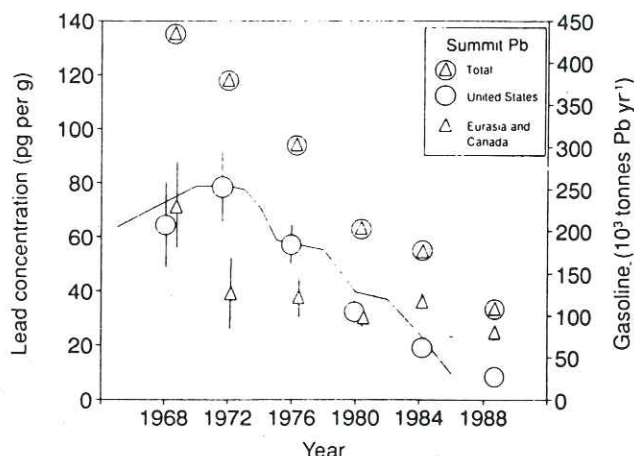

FIG. 2 Concentrations of the lead in Greenland snow (left-hand scale) from the principal source regions as a function of time. The data are taken from Table 1, and the uncertainty bars show the effect of altering the US $^{206}\text{Pb}/^{207}\text{Pb}$ ratio by ± 0.01 . (The use of a higher $^{206}\text{Pb}/^{207}\text{Pb}$ ratio for the Eurasian/Canadian component will lower the US and raise the Eurasian/Canadian concentrations, but the shapes of the two profiles do not change significantly.) The solid curve, showing US lead consumption in gasoline (right-hand scale), agrees well with the concentration profile at Summit.

ratio. The marked decrease after 1976 can be attributed to a decrease in the amount of US lead, whereas other major contributors in the Northern Hemisphere, such as Eurasia and Canada, maintained a lower but constant output.

Figure 1 also displays large variations in the $^{206}\text{Pb}/^{207}\text{Pb}$ ratio between adjacent core sections which integrate 3–8 months of snow. These show that there are occasions when air masses from different source regions have fairly direct access to Summit. For example, two adjacent samples collected in 1976 had $^{206}\text{Pb}/^{207}\text{Pb}$ ratios of 1.172 and 1.201, whereas two in 1979 had values of 1.185 and 1.158. The samples with the high ratios are clearly dominated by US lead, whereas the other samples contain a substantial component of less-radiogenic lead, probably from Eurasia or Canada. □

Received 6 November 1992; accepted 26 January 1993.

- Murozumi, M., Chow, T. J. & Patterson, C. C. *Geochim. cosmochim. Acta* **33**, 1247–1294 (1969).
- Boutron, C. F., Görlich, U., Candelone, J. P., Bolshov, M. A. & Delmas, R. J. *Nature* **353**, 153–156 (1991).
- Boutron, C. F. *Fresenius Z. analyt. Chem.* **337**, 482–491 (1990).
- Ng, A. & Patterson, C. *Geochim. cosmochim. Acta* **45**, 2109–2121 (1981).
- Wolff, E. W. *Antarct. Sci.* **2**, 189–205 (1990).
- Chow, T. J., Snyder, C. B. & Earl, J. L. *Proc. Conf. IAEA-191/4*, 95–108 (IAEA, Vienna, 1975).
- Shirahata, H., Elias, R. W. & Patterson, C. C. *Geochim. cosmochim. Acta* **44**, 149–162 (1980).
- Sturges, W. T. & Barrie, L. A. *Nature* **329**, 144–146 (1987).
- Stukas, V. J. & Wong, C. S. *Science* **211**, 1424–1427 (1981).
- Church, T. M. *et al. Global biogeochem. Cycles* **4**, 431–443 (1990).
- Hopper, J. F., Ross, H. B., Sturges, W. T. & Barrie, L. A. *Tellus B* **43**, 45–60 (1991).
- Hamilton, E. I. & Clifton, R. J. *Estuar. Coast. mar. Sci.* **8**, 271–278 (1979).
- Maring, M., Settle, D. M., Buat-Ménard, P., Dulac, F. & Patterson, C. C. *Nature* **330**, 154–156 (1987).
- Facchetti, S. *et al. Isotopic Lead Experiment* (Commission of the European Communities, US EPA 1982).
- Petit, D., Mennessier, J. P. & Lamberts, L. *Atmos. Environ.* **18**, 1189–1193 (1984).
- Elbaz-Poulichet, F., Hollinger, P., Huang, W. W. & Martin, J.-M. *Nature* **308**, 409–413 (1984).
- Kenonen, M. *Sci. tot. Environ.* **113**, 251–268 (1992).

ACKNOWLEDGEMENTS. We thank C. Rado and R. Delmas for the field sampling and our colleagues in the Curtin University Isotope Science Group for discussions. This work was supported by the French Ministry of the Environment, the University of Grenoble, and the Commission of the European Communities and Switzerland as part of the EUROCORE program.

GEOCHIMICA ET COSMOCHIMICA ACTA, Vol 58, N°15, 3265-3269, 1994.

Isotopic evidence to account for changes in the concentrations of lead in Greenland snow between 1960 and 1988.

K.J.R. ROSMAN, W. CHISOLM, C.F. BOUTRON, J.P. CANDELONE & S. HONG.



0016-7037(94)00122-7

Isotopic evidence to account for changes in the concentration of lead in Greenland snow between 1960 and 1988*

K. J. R. ROSMAN,¹ W. CHISHOLM,¹ C. F. BOUTRON,^{2,3} J. P. CANDELONE,² and S. HONG²

¹Department of Applied Physics, Curtin University of Technology, Bentley 6102, W.A., Australia

²Laboratoire de Glaciologie et Géophysique de l'Environnement du CNRS, 54 rue Molière, Domaine Universitaire, BP 96, 38402 St Martin d'Hères Cedex, France

³UFR de Mécanique, Université Joseph Fourier de Grenoble, Domaine Universitaire, BP 68, 38401 Grenoble Cedex, France

(Received June 15, 1993; accepted in revised form April 8, 1994)

Abstract—Preserved layers of snow deposited between 1960 and 1988, taken from 10.7 m and 70 m snow cores drilled at Summit in central Greenland in 1989, were analyzed for lead isotopes ($^{206}\text{Pb}/^{207}\text{Pb}$, $^{208}\text{Pb}/^{207}\text{Pb}$, and $^{206}\text{Pb}/^{204}\text{Pb}$). The lead has an isotopic composition consistent with a mixture of USA and Eurasian origins. Although the $^{206}\text{Pb}/^{207}\text{Pb}$ ratio fluctuates, presumably due to seasonal changes in the weather patterns, there is a clear trend in values from about 1.16 in the early 1960s to 1.18 by 1976, then back to the initial value by the mid 1980s. The initial trend upwards reflects the progressive introduction of relatively radiogenic Mississippi Valley-type lead into USA gasoline during the 1960s, while the return to lower values indicates a decreased contribution from this source due to the switch to unleaded gasoline for motor vehicles. Eurasian lead, assumed to be the second component of the mixture, appears to have a relatively constant $^{206}\text{Pb}/^{207}\text{Pb}$ ratio over this period.

INTRODUCTION

LEAD POLLUTION OF THE polar regions was first demonstrated by MUROZUMI et al. (1969) who, in an extraordinary study, measured the concentration of lead in layers of Greenland snow and ice extending back to 800 BC. They showed that the concentration of lead had increased two hundredfold since ancient times. The difficulty of making these measurements was not fully appreciated at the time, and in the following decade a number of unsuccessful attempts were made to confirm the results (WOLFF and PEEL, 1985; BOUTRON, 1986). Verification only came when NG and PATTERSON (1981), in a second landmark experiment, measured lead concentrations in Greenland ice taken from a drill core at Camp Century. The innovative techniques developed in this study provided a foundation for subsequent measurements of heavy metals in Antarctic and Greenland ice and snow (BOUTRON and PATTERSON, 1986, 1987; BOUTRON et al., 1987, 1991).

Measurements of lead deposition in Greenland snow between 1967 and 1989 by BOUTRON et al. (1991), completed the historical exposure record and indicated that the lead concentration decreased by a factor of 7.5 over this period. This was tentatively ascribed to the reduction in the use of lead additives in gasoline in the USA after 1970. Subsequent measurements of lead isotope abundance measurements in these samples have confirmed this hypothesis (ROSMAN et al., 1993).

Although ROSMAN et al. (1993) reported only $^{206}\text{Pb}/^{207}\text{Pb}$ ratios, HOPPER et al. (1991) have shown that $^{208}\text{Pb}/^{207}\text{Pb}$ is also important for characterising Eurasian aerosol source regions. In this paper we report the $^{208}\text{Pb}/^{207}\text{Pb}$ and $^{206}\text{Pb}/^{204}\text{Pb}$

ratios in the Greenland snow samples analysed previously for $^{206}\text{Pb}/^{207}\text{Pb}$, and also extend the isotope record back to 1960.

EXPERIMENTAL

Only a brief account of the techniques used will be given here since the details have already been published (BOUTRON, 1990; BOUTRON et al., 1991; GÖRLACH and BOUTRON, 1992; ROSMAN et al., 1993) or are to be published elsewhere.

Samples

The samples analysed were taken from two 10.5-cm diameter snow cores drilled at Summit, central Greenland, in 1989 (72°35'N, 37°38'W, mean annual accumulation rate 21.5 g cm⁻² a⁻¹). Taken at an elevation of ~3.23 km these samples should give a representative sample of free tropospheric aerosols which can differ from those collected at sea level.

The first core was drilled to a depth of 10.7 m using a specially constructed, hand-operated, polycarbonate auger. This core provides a record of snow deposited between 1967 and 1989, which included the period when the USA switched to unleaded gasoline for motor vehicles. Twenty-five sections, representing approximately half the length of the core, were analysed in this study. The remaining sections were set aside for other studies. Annual changes in the concentration of methanesulphonic acid were used to date the snow to a precision of better than 0.5 years (M. Legrand, pers. commun.).

The second core was drilled to 70 m with an electromechanical drill. The core sections were packed in double sealed polyethylene bags and transported frozen to France. Only the results of measurements on the 8–13 m section of the core, corresponding to the period 1960–1975, are reported here. The core was dated using a comprehensive oxygen isotope profile (H. Clausen, pers. commun.) giving precisions of 1 year. The mean deposition dates of snow sampled are shown in Table 1.

Decontamination

The samples were decontaminated in a cold room, under a HEPA-filtered air-stream, at the Laboratoire de Glaciologie et Géophysique de l'Environnement in Grenoble, France. The extent to which contaminant lead had penetrated the samples was determined by

* Paper presented at the symposium "Topics in Global Geochemistry" in honor of Clair C. Patterson on 3–4 December 1993 in Pasadena, California, USA.

TABLE 1. The details of Summit snow core samples analysed, including mean age of snow, isotopic composition, and lead concentration.

Year ¹	206/207 ²	208/207 ²	206/204 ²	Concentration (pg/g) ³
70m Core				
1960	1.1573 ± 0.0018	2.4287 ± 0.0034	17.936 ± 0.090	62
1960.7	1.1605 ± 0.0013	2.4303 ± 0.0024	18.055 ± 0.034	83
1961.3	1.1699 ± 0.0013	2.4385 ± 0.0019	18.292 ± 0.084	101
1961.9	1.1569 ± 0.0017	2.4257 ± 0.0022	17.944 ± 0.078	57
1962.8	1.1634 ± 0.0012	2.4346 ± 0.0033	18.092 ± 0.061	77
1963.3	1.1624 ± 0.0011	2.4317 ± 0.0025	18.060 ± 0.023	141
1963.8	1.1486 ± 0.0011	2.4180 ± 0.0016	17.835 ± 0.031	78
1964.4	1.1670 ± 0.0055	2.4350 ± 0.013	18.15 ± 0.12	135
1965	1.1625 ± 0.0015	2.4303 ± 0.0024	18.042 ± 0.057	158
1965.8	1.1631 ± 0.0019	2.4375 ± 0.0019	18.153 ± 0.060	85
1968.4	1.1407 ± 0.0011	2.4146 ± 0.0028	17.711 ± 0.036	61
1968.8	1.1844 ± 0.0010	2.4387 ± 0.0017	18.451 ± 0.029	117
1973.5	1.1715 ± 0.0028	2.4333 ± 0.0035	18.249 ± 0.053	83
1974.5	1.1803 ± 0.0012	2.4399 ± 0.0021	18.404 ± 0.049	50
11m Core				
1967.4	1.1621 ± 0.0032	2.4328 ± 0.0066	17.94 ± 0.20	178
1967.9	1.1578 ± 0.0023	2.4300 ± 0.0032	18.00 ± 0.09	318
1969.4	1.1573 ± 0.0014	2.4291 ± 0.0042	18.01 ± 0.14	162
1969.7	1.1585 ± 0.0019	2.4263 ± 0.0031	17.95 ± 0.09	137
1971.0	1.1847 ± 0.0019	2.4413 ± 0.0043	18.40 ± 0.10	66
1971.7	1.1794 ± 0.0023	2.4377 ± 0.0039	18.36 ± 0.10	210
1972.3	1.1698 ± 0.0023	2.4414 ± 0.0038	18.46 ± 0.15	159
1972.9	1.1881 ± 0.0009	2.4416 ± 0.0020	18.60 ± 0.04	175
1974.8	1.1680 ± 0.0032	2.4390 ± 0.0033	18.40 ± 0.40	134
1975.0	1.1682 ± 0.0032	2.4258 ± 0.0039	18.12 ± 0.20	166
1976.4	1.1725 ± 0.0044	2.4390 ± 0.0071	18.17 ± 0.21	99
1976.7	1.2015 ± 0.0017	2.4545 ± 0.0033	18.71 ± 0.11	278
1977.2	1.1668 ± 0.0014	2.4310 ± 0.0036	18.17 ± 0.09	35
1977.6	1.1821 ± 0.0042	2.4402 ± 0.0056	18.49 ± 0.11	52
1979.6	1.1949 ± 0.0039	2.4450 ± 0.0046	18.81 ± 0.29	74
1979.9	1.1820 ± 0.0019	2.4408 ± 0.0049	18.35 ± 0.08	128
1980.6	1.1767 ± 0.0051	2.4335 ± 0.0103	18.39 ± 0.80	39
1981.0	1.1581 ± 0.0015	2.4273 ± 0.0033	18.01 ± 0.11	69
1982.9	1.1846 ± 0.0022	2.4457 ± 0.0034	18.61 ± 0.48	92
1983.2	1.1575 ± 0.0051	2.4263 ± 0.0075	17.99 ± 0.20	93
1984.5	1.1637 ± 0.0022	2.4219 ± 0.0040	18.11 ± 0.11	51
1984.7	1.1455 ± 0.0026	2.4151 ± 0.0046	17.74 ± 0.07	58
1985.6	1.1591 ± 0.0051	2.4234 ± 0.0103	17.85 ± 0.11	48
1988.4	1.1538 ± 0.0051	2.4171 ± 0.0103	17.80 ± 0.30	14
1988.9	1.1552 ± 0.0013	2.4415 ± 0.0028	18.01 ± 0.14	84

¹ Mean date of the deposition, showing the decimal part of a year, ±0.5 years.

² 95% confidence interval for mean of about 6-10 sets of 10 ratios.

³ Method GFAAS: '11m core' from Boutron et al. (1991), '70m core' this work., ±20%.

measuring a lead concentration profile across selected core sections. This was performed using 1 cm diameter tubes for the outer regions and a 4 cm diameter tube for the central region, as described by GÖRLACH and BOUTRON (1992).

Processing

The frozen bulk samples, analysed previously by BOUTRON et al. (1991), were melted in a clean-air laboratory and 10-15 mL aliquots were transferred to 30 mL low density conventional polyethylene bottles. These bottles were extensively cleaned in a series of heated baths containing diluted high purity HNO₃ (BOUTRON, 1990). They were sealed in acid-washed polyethylene bags, frozen, then transported frozen to Curtin University of Technology, Perth, Western Australia. The procedure was continued inside a HEPA-filtered, dust-free laboratory using ultra-clean conditions and procedures. Samples were evaporated together with HNO₃, H₃PO₄, and a ²⁰⁵Pb-enriched tracer, inside a PFA beaker, under a filtered stream of nitrogen. During the study the use of nitrogen was found to be unnecessary and was phased out in favour of evaporation inside an isolated Teflon chamber.

Isotope Dilution Mass Spectrometry (IDMS)

By adding a ²⁰⁵Pb-enriched tracer (half-life 1.5 × 10⁷ a), which is not naturally present in the lead mass spectrum, to each sample it was possible to simultaneously measure both the concentration and isotopic composition of the lead. Although the principal objective of the study was to measure isotopic composition with a minimum lead blank, IDMS measurements (Curtin) in general showed excellent correlation with the GFAAS values (Grenoble); however, the former tend to be lower and there is sometimes evidence of elemental het-

erogeneity in the sample solutions. Each beaker was checked for blank immediately prior to use by processing an equivalent volume of high purity water (~0.03 pg Pb g⁻¹). The lead blank amounted to less than 3% of the sample analysed.

Mass Spectrometry

Isotopic analyses were made using a VG354 isotope-ratio mass spectrometer (FISONS Instruments). This instrument has a 90° magnetic sector field and is fitted with a thermal ion source and a Daly collector which operates in analogue mode. Sixteen samples can be mounted together in the turret ion source.

The sample was transferred together with H₃PO₄ and silica gel to the central rhenium filament of a thermal ion source, then briefly taken to red heat in air before mounting in the mass spectrometer. Although fully automated operation was feasible it was normal practice to manually increase the temperature of the sample and focus the ion beam. Ion currents of ~1 × 10⁻¹⁴ A were typically produced from 100 pg samples. Between 6 and 10 blocks, each containing ten ²⁰⁶Pb/²⁰⁴Pb, ²⁰⁶Pb/²⁰⁷Pb, and ²⁰⁸Pb/²⁰⁷Pb ratios, were collected. Corrections were made to the isotopic ratios for isotopic fractionation and the analytical blank, with the latter amounting to less than ~0.3% of the ²⁰⁶Pb/²⁰⁷Pb ratio.

The accuracy of the mass spectrometer for isotope ratio determinations was monitored by analysing 100 pg amounts of the Standard Reference Material 981 (National Institute for Standards and Technology) with each batch of samples. After making a correction of ~0.3% per mass unit for isotopic fractionation, the ²⁰⁶Pb/²⁰⁴Pb, ²⁰⁶Pb/²⁰⁷Pb, and ²⁰⁸Pb/²⁰⁷Pb ratios agreed with the certified values to within the precision of the measurements (95% confidence limits) which were 4%, 0.4%, and 0.4%, respectively. The standards that were measured with the "70 m core" samples displayed significantly better precision, particularly in the ²⁰⁶Pb/²⁰⁴Pb ratio, reflecting improvements in the mass spectrometric technique during the study.

RESULTS AND DISCUSSION

The results of measurements on twenty-five core sections from the "10.7 m core" and fourteen core sections from the "70 m core" are shown in Table 1. Included are the ²⁰⁶Pb/²⁰⁷Pb, ²⁰⁸Pb/²⁰⁷Pb, and ²⁰⁶Pb/²⁰⁴Pb ratios as well as the concentration of lead in each sample.

Contamination of Snow Cores

The extent to which the snow core was contaminated by the polycarbonate auger, by exposure to air and by contact with the storage container, was demonstrated by measuring the lateral change in lead concentration from the outside to the centre of core sections. No significant surface lead contamination was detected in any of the core sections analysed (BOUTRON et al., 1991). A ²⁰⁶Pb/²⁰⁷Pb ratio profile measured on sample 1984.5 (11 m core) gave values of 1.1695 ± 0.0016, 1.1686 ± 0.0012, and 1.1637 ± 0.0022 from the outer layer to the central region which represents an extreme difference between layers of 0.5%. This difference, even if due to surface contamination, will result in a negligible effect on the isotopic ratio of the central region compared with the precision of the measurements.

An isotopic ratio profile was also measured on the surface sample 1988.9 to confirm an unusually high ²⁰⁸Pb abundance in this sample. In this case the ²⁰⁸Pb/²⁰⁷Pb ratios from outside to centre were 2.4402 ± 0.0043, 2.4391 ± 0.0025, and 2.4415 ± 0.0028, indicating that surface contamination was not the source of the unusual lead.

Lead Isotope Systematics

The use of all four lead isotopes to identify the source of lead found in the Summit snow is severely limited by the small amount of published data on ^{208}Pb and ^{204}Pb abundances. The data available for the USA are those by CHOW et al. (1975), RABINOWITZ and WETHERILL (1972), and HIRO and PATTERSON (1974) for the years 1964 to 1975 and by A. R. Flegal (pers. commun., 1993) for 1989. Data for the Eurasian region are also few. The largest datasets are those reported by CHOW et al. (1975) for gasoline collected in 1966 and 1967 from a number of European countries, and by HOPPER et al. (1991) for Eurasian aerosols and gasoline collected in 1988. Smaller datasets have been reported by JAAKKOLA et al. (1983) for Finland, ELBAZ-POULICHET et al. (1984) for France, HAMILTON and CLIFTON (1979) for the United Kingdom, and HORN et al. (1987) for Germany.

In Fig. 1 the Summit data is compared with published data for aerosols of USA and Eurasian origin. Only data corresponding to period 1971–1990 have been plotted since during this period the USA and Eurasian isotopic signatures appear to have been relatively constant, although the published data are few and cover quite limited time periods. Fields shown for Western Europe (WE), Eastern Europe (EE), East (E, former USSR, Finland), and Northwest (NW, Sweden, Norway) uniquely characterise the source regions of lead aerosols collected by HOPPER et al. (1991) in 1988. This work clearly shows the importance of reporting the ^{208}Pb abundance data. The points p and h represent aerosols collected by ELBAZ-POULICHET et al. (1984) in Paris during 1981 and by JAAKKOLA et al. (1983) in Helsinki during 1972/1973. The Summit snow data taken over the same period are consistent with published data for the proposed source regions for the lead. The point marked 88.9, which corresponds to the surface snow sample, deviates from the other Summit data, but is similar to Eurasian aerosol data reported by HOPPER et al. (1991) but not shown in the Fig. 1. It is of interest to note

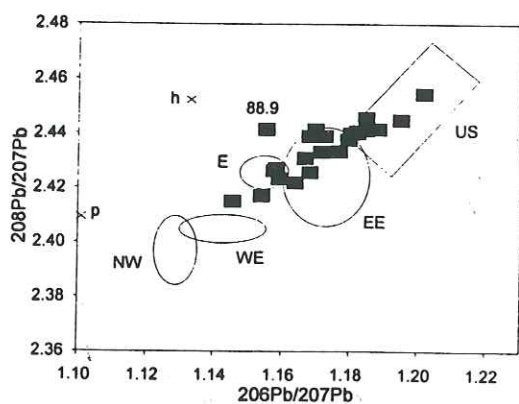

FIG. 1. The isotopic composition of lead in Summit snow, and USA and Eurasian aerosols for the years 1971–1989. The regions enclosed by lines are characteristic of aerosols emitted from Eurasia: EE—Eastern Europe, E—East (former USSR, Finland), WE—Western Europe, NW—Northwest (Sweden, Norway) reported by HOPPER et al. (1991) for 1989, p—Paris by ELBAZ-POULICHET et al. (1984), h—Helsinki by JAAKKOLA et al. (1983); and from the USA: HIRO and PATTERSON (1974), CHOW et al. (1975), and A. R. Flegal (1992, pers. commun.). See text for details.

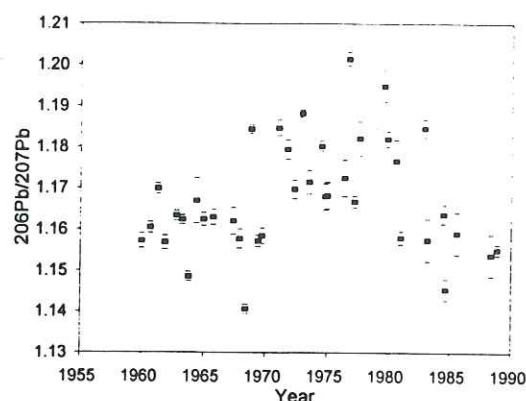

FIG. 2. The isotopic composition of the lead in Summit snow showing the change in the $^{206}\text{Pb}/^{207}\text{Pb}$ ratio with time. The plot includes data from ROSMAN et al. (1993). Uncertainties shown are 95% confidence intervals.

that this point agrees closely with the composition of an average of eighteen small ore deposits from central/southern former USSR (HOPPER et al., 1991) and probably identifies the primary source of the lead.

Time Dependent Variation in the Isotopic Ratios

The $^{206}\text{Pb}/^{207}\text{Pb}$ ratios for the Summit snow samples are plotted against the deposition date in Fig. 2. Two significant features are displayed in this plot. These are firstly a slowly changing ratio which increases to maximum value by about 1976 then falls back to the initial ratio by the mid 1980s.

Superimposed upon the longer term trend are short-term (2–4 month) fluctuations. The changes in isotopic ratio are abrupt with the $^{206}\text{Pb}/^{207}\text{Pb}$ ratio in adjacent parts of the same core section changing for instance from 1.1725 (sample 1976.4) to 1.2015 (sample 1976.7). These changes probably relate to seasonal changes in the weather patterns transporting aerosols to Summit from different source regions, although the dating technique was not sufficiently accurate to resolve the seasons.

The long-term trend is attributed to the change in both the isotopic composition and consumption of leaded gasoline in the USA over this period. Figure 3 shows the $^{206}\text{Pb}/^{207}\text{Pb}$ ratios in USA gasoline and aerosols between 1964 and 1990 which characterises the USA isotopic signature (CHOW et al., 1975; CHOW and JOHNSTONE, 1965; STURGES and BARRIE, 1989; SHIRAHATA et al., 1980; STUKAS and WONG, 1981; RABINOWITZ and WETHERILL, 1972; HIRO and PATTERSON, 1974; TERA et al., 1985; A. R. Flegal, 1992, pers. commun.). The increase after about 1964 resulted from the use of an increasing proportion of the more radiogenic Mississippi Valley-type lead (CHOW et al., 1975; DOE, 1970). The other principal source region believed to contribute lead to Greenland is Eurasia which includes western and eastern Europe, and the former Soviet Union. Figure 4 shows the available data for Eurasian lead, but also includes Canadian data (ELBAZ-POULICHET et al., 1984; CHOW et al., 1975; PETIT et al., 1984; JAAKKOLA et al., 1983; HAMILTON and CLIFTON, 1979; FACCHETTI and GIESS, 1982; HOPPER et al., 1991; KEINONEN, 1992; M. Keinonen and T. Jaakola, 1985, pers. commun.;

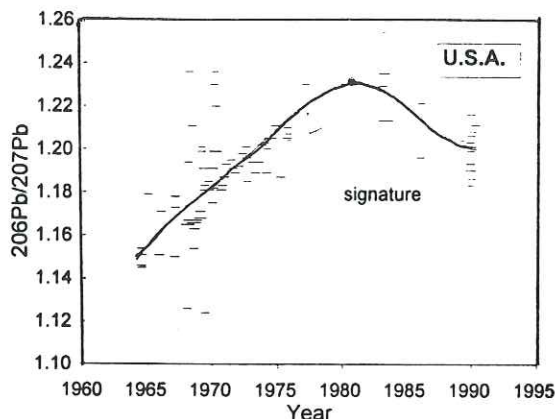

FIG. 3. A plot of published $^{206}\text{Pb}/^{207}\text{Pb}$ ratios for USA lead measured in aerosols and gasoline. These data have been used to establish the USA lead signature, shown as a line. The line is a least squares fit to the data using a polynomial.

STURGES and BARRIE, 1987, 1989; STUKAS and WONG, 1981). The data are widely scattered; hence, in the absence of further data, we have represented the Eurasia-Canada signature by a constant $^{206}\text{Pb}/^{207}\text{Pb}$ ratio for the years 1960 to 1988.

The decrease in the $^{206}\text{Pb}/^{207}\text{Pb}$ ratio in the Summit snow after 1976 can be attributed to the reduced consumption of leaded gasoline in the USA during this period. By the late 1980s the lead in the snow was largely of Eurasian origin.

Leaded gasoline consumption figures (R. Fiat, pers. commun.) indicate that Canadian plus Mexican consumption was about 20–25% of the European value over the period of interest to this study. On a population basis the Canadian contribution would contribute less than half this amount. Since we are unable to distinguish the Eurasian and Canadian isotopic source signatures both data are included in Fig. 4. There is, however, an indication that the Canadian $^{206}\text{Pb}/^{207}\text{Pb}$ ratio may have increased to ~ 1.2 by the late 1980s due to a switch to more radiogenic lead following the cessation of production of lead additives in Canada (CHURCH et al., 1990).

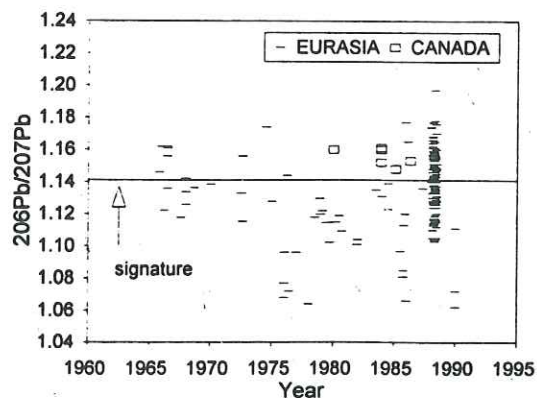

FIG. 4. A plot of published $^{206}\text{Pb}/^{207}\text{Pb}$ ratios for Eurasian and Canadian aerosols and petrol. The signature for these regions has been taken as the mean of all the data and is indicated by the line corresponding to a value of 1.14. References used to construct the plot are listed in the text.

Mixing Model for Contributing Source Regions

Although lead isotopic data needed for the interpretation of the isotopic record in the Summit snow are few and rather scattered, enough $^{206}\text{Pb}/^{207}\text{Pb}$ data are available to allow regional signatures for the USA and Eurasia to be identified, and their contributions to be broadly estimated.

The measured isotopic abundance data (Table 1), taken together with the source signatures (Figs. 3, 4), allows the proportion of USA lead in the snow to be determined. A two-component mixing model was constructed, taking the USA as one source and the combined Eurasian-Canadian component as the other. The values used for the USA component were taken from a polynomial least squares fit to the USA data, shown as a line in Fig. 3. The second component (Eurasian-Canadian) was averaged to give a value of 1.14. The contributions of each component to the lead concentration in the snow at Summit are shown in Fig. 5. The USA contribution has decreased significantly since ~ 1970 whereas the Eurasian-Canadian component shows no significant trend. This decrease correlates with the reduction in use of lead additives in USA fuel over this period. Although the choice of a constant $^{206}\text{Pb}/^{207}\text{Pb}$ ratio for the Eurasian-Canadian signature is somewhat arbitrary, the choice of values between 1.12 and 1.16 leads to a dominant, but decreasing contribution by USA lead to the Summit snow from the early 1970s as shown in Fig. 6.

The occurrence of large peaks in the concentration of USA lead in the Summit snow during the 1970s presumably reflects the influence of weather systems favouring a highly efficient transfer of USA aerosols at certain times of the year.

CONCLUSIONS

The measurement of lead isotopes in snow and ice samples provides a powerful tool for identifying the source regions which are contributing pollutants to remote locations. Also this approach allows the relative contributions from each source to be established independent of fluctuations in the quantity of lead deposited.

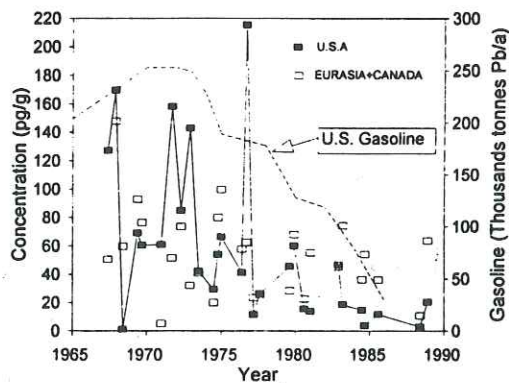

FIG. 5. The concentration of USA and Eurasian-Canadian lead in the Summit snow. These concentrations have been determined using the proportional contribution from each source, calculated from the measured $^{206}\text{Pb}/^{207}\text{Pb}$ ratios in the Summit snow and the source signatures defined by Figs. 3 and 4. Proportions were converted to concentrations using the concentrations shown in Table 1. The lead consumption in USA gasoline over the period is shown for comparison (R. Fiat, pers. commun.).

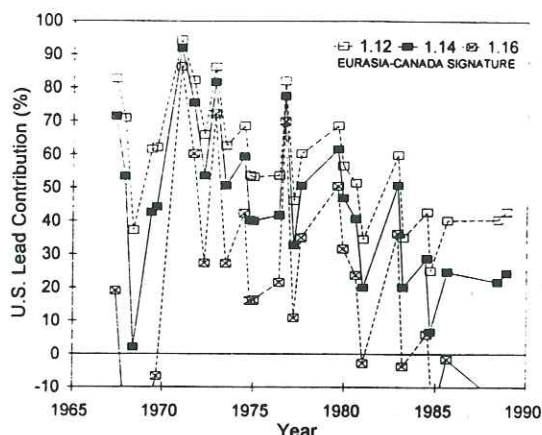

FIG. 6. The contribution of USA lead in the Summit snow samples, showing the effect of choosing different values of $^{206}\text{Pb}/^{207}\text{Pb}$ ratio for the Eurasian-Canadian component. Only the $^{206}\text{Pb}/^{207}\text{Pb}$ ratios measured in the Summit snow and the two isotopic signatures were used to determine the proportions.

In this study techniques were developed which allowed the isotopic composition of lead to be measured in a few milliliters of melted Arctic snow. Between 1960 and 1988 the isotopic composition of lead in Greenland snow changed, reflecting the unique signature of USA lead and its changing concentration in the snow. The results of this study, which are based on isotopic measurements, provide indisputable support for the conclusions reached by BOUTRON et al. (1991) who attributed the reduction in the concentration of lead in Greenland snow since the mid 1970s to the switch to the use of unleaded gasoline for motor vehicles in the United States.

Acknowledgments—We thank C. Rado and R. Delmas for participation in the field sampling and useful discussions. Colleagues and students of Curtin University's Isotope Science Group provided helpful discussion. This work was supported by the Australian Research Council, the Commission of the European Communities, and Switzerland as part of the EUROCORE program, the French Ministry of the Environment, and the University of Grenoble.

Editorial handling: T. M. Church

REFERENCES

- BOUTRON C. F. (1986) Atmospheric toxic metals and metalloids in the snow and ice layers deposited in Greenland and Antarctica from prehistoric times to the present. In *Toxic Metals in the Atmosphere. Advances in Environmental Science and Technology Series* (ed. J. O. NRIAGU and C. I. DAVIDSON), pp. 467–505. Wiley.
- BOUTRON C. F. (1990) A clean laboratory for ultralow concentration heavy metal analysis. *Fresenius Analyt. Chem.* **337**, 482–491.
- BOUTRON C. F. and PATTERSON C. C. (1986) Lead concentration changes in Antarctic ice during the Wisconsin/Holocene transition. *Nature* **323**, 222–225.
- BOUTRON C. F. and PATTERSON C. C. (1987) Relative levels of natural and anthropogenic lead in recent Antarctic snow. *J. Geophys. Res.* **92**, 8454–8464.
- BOUTRON C. F., PATTERSON C. C., PETROV V. N., and BARKOV N. I. (1987) Preliminary data on changes of Pb concentrations in Antarctic ice from 155 k.y. to 26 k.y. BP. *Atmos. Environ.* **21**, 1197–1202.
- BOUTRON C. F., GÖRLACH U., CANDELONE J., BOLSHOV M. A., and DELMAS R. J. (1991) Decrease in anthropogenic lead, cadmium and zinc in Greenland snows since the late 1960s. *Nature* **353**, 153–156.
- CHOW T. J. and JOHNSTONE M. S. (1965) Lead isotopes in gasoline and aerosols of Los Angeles basin, California. *Science* **147**, 502–503.
- CHOW T. J., SNYDER C. B., and EARL J. L. (1975) Isotope ratios of lead as pollutant source indicators. *United Nations FAO and International Atomic Energy Association Symposium, Vienna, Austria. (IAEA-SM-191/4) Proceedings*, pp. 95–108.
- CHURCH T. M., VÉRON A., PATTERSON C. C., SETTLE D., EREL Y., MARING H. R., and FLEGAL A. R. (1990) Trace elements in the North Atlantic troposphere: Shipboard results of precipitation and aerosols. *Global Biogeochem. Cycles* **4**, 431–443.
- DOE B. R. (1970) *Lead Isotopes*. Springer-Verlag.
- ELBAZ-POULICHET F., HOLLINGER P., HUANG W. W., and MARTIN J.-M. (1984) Lead cycling in estuaries, illustrated by the Gironde estuary, France. *Nature* **308**, 409–413.
- GÖRLACH U. and BOUTRON C. F. (1992) Variations in heavy metals concentrations in Antarctic snows from 1940 to 1980. *J. Atmos. Chem.* **14**, 205–222.
- FACCHETTI S. and GIESS F. (1982) Isotopic lead experiment. Report EUR 8352 EN. Commission of the European Communities, Joint Research Centre, Ispra Establishment.
- HAMILTON E. I. and CLIFTON R. (1979) Isotopic abundances of lead in estuarine sediments, Swansea bay, Bristol channel. *Estuarine Coast. Mar. Sci.* **8**, 271–278.
- HIRO Y. and PATTERSON C. C. (1974) Lead aerosol pollution in the high Sierra overrides natural mechanisms which exclude lead from a food chain. *Science* **184**, 989–992.
- HOPPER J. F., ROSS H. B., STURGES W. T., and BARRIE L. A. (1991) Regional source discrimination of atmospheric aerosols in Europe using the isotopic composition of lead. *Tellus* **43B**, 45–60.
- HORN P., MICHLER G., and TODT W. (1987) Die anthropogene Blei-Belastung im Raum München, ermittelt aus Pb-isotopenmessungen von Wasser und Sedimentproben. *Mitteilungen der Geographischen Gesellschaft in München* **72**, 105–117.
- KEINONEN M. (1992) The isotopic composition of lead in man and the environment in Finland 1966–1987: Isotope ratios of lead as indicators of pollution source. *Sci. Tot. Environ.* **113**, 252–268.
- JAKKOLA T., HEINONEN O. J., KEINONEN M., SALMI A., and MIETTINEN J. K. (1983) Use of $^{206}\text{Pb}/^{204}\text{Pb}$ isotope ratio in lichen, air filter, incinerator ash and gasoline samples as pollution source indicator. *Int. J. Mass Spectrom. Ion Proc.* **48**, 347–350.
- MUROZUMI M., CHOW T. J., and PATTERSON C. C. (1969) Chemical concentrations of pollutant aerosols, terrestrial dusts and sea salts in Greenland and Antarctic snow strata. *Geochim. Cosmochim. Acta* **33**, 1247–1294.
- NG A. and PATTERSON C. C. (1981) Natural concentrations of lead in ancient Arctic and Antarctic ice. *Geochim. Cosmochim. Acta* **45**, 2109–2121.
- PETIT D., MENNESSIER J. P., and LAMBERTS L. (1984) Stable lead isotopes in pond sediments as tracers of past and present atmospheric lead pollution in Belgium. *Atmos. Environ.* **18**, 1189–1193.
- RABINOWITZ M. B. and WETHERILL G. W. (1972) Identifying sources of lead contamination by stable isotope techniques. *Environ. Sci. Technol.* **6**, 705–709.
- ROSMAN K. J. R., CHISHOLM W., BOUTRON C. F., CANDELONE J. P., and GÖRLACH U. (1993) Isotopic evidence for the source of lead in Greenland snows since the late 1960s. *Nature* **362**, 333–335.
- SHIRAHATA H., ELIAS R. W., and PATTERSON C. C. (1980) Chronological variations in concentrations and isotopic compositions of anthropogenic atmospheric lead in sediments of a remote sub-alpine pond. *Geochim. Cosmochim. Acta* **44**, 149–162.
- STUKAS V. J. and WONG C. S. (1981) Stable lead isotopes as a tracer in coastal waters. *Science* **211**, 1424–1427.
- STURGES W. T. and BARRIE L. A. (1987) Lead 206/207 isotope ratios in the atmosphere of North America as tracers of US and Canadian emissions. *Nature* **329**, 144–146.
- STURGES W. T. and BARRIE L. A. (1989) Stable lead isotope ratios in Arctic aerosols: evidence for the origin of Arctic air pollution. *Atmos. Environ.* **23**, 2513–2519.
- TERA O., SCHWARTZMAN D. W., and WATKINS T. R. (1985) Identification of gasoline lead in children's blood using isotopic analysis. *Arch. Environ. Health* **40**, 120–123.
- WOLFF E. W. and PEEL D. A. (1985) The record of global pollution in polar snow and ice. *Nature* **313**, 535–540.

ANALYTICAL CHEMISTRY, Vol 65, 2510-2515, 1993.

Speciation analysis of organolead compounds in Greenland snow at the femtogram-per-gram level by Capillary Gas Chromatography:Atomic Emission Spectrometry.

R. LOBINSKI, C.F. BOUTRON, J-P. CANDELONE, S. HONG, J. SZPUNAR-LOBINSKA & F.C. ADAMS.

Speciation Analysis of Organolead Compounds in Greenland Snow at the Femtogram-per-Gram Level by Capillary Gas Chromatography/Atomic Emission Spectrometry

Ryszard Łobiński,[†] Claude F. Boutron,^{‡,§} Jean-Pierre Candelone,[‡] Sungmin Hong,[‡] Joanna Szpunar-Łobińska,[†] and Freddy C. Adams^{†,¶}

Department of Chemistry, University of Antwerp (U.I.A.), Universiteitsplein 1, 2610-Wilrijk (Antwerpen), Belgium, Laboratoire de Glaciologie et Géophysique de l'Environnement du CNRS, 54, rue Molière, Domaine Universitaire, B.P. 96, 38402 St. Martin d'Hères, France, and UFR de Mécanique, Université Joseph Fourier de Grenoble, Domaine Universitaire, B.P. 68, 38041 Grenoble, France

A method for comprehensive speciation analysis of organolead compounds in polar snow at levels down to femtograms per gram is developed. The analytes are preconcentrated (250:1) in a single-step extraction, derivatized by propylation using a Grignard reagent, and analyzed by capillary gas chromatography with microwave-induced plasma atomic emission detection (GC-MIP AED) after further *on-line* preconcentration (50:1). Extraction and derivatization efficiencies of organolead species at subpicogram per gram levels and sources of the blank are extensively discussed. A number of snow samples collected at different locations in Greenland are analyzed, providing the first data on organolead levels in polar snow. Tri- and diethyllead species are the only compounds found in the majority of the samples.

INTRODUCTION

The well-preserved and dated successive snow and ice layers deposited in the Greenland ice cap have proved to contain a unique record of past and present changes in the large-scale atmospheric pollution of the Northern Hemisphere by heavy metals, especially lead.¹⁻⁴ These frozen archives can be accessed by means of high-performance analytical chemistry as shown by Patterson et al.^{1,2} and Boutron et al.^{3,4} They observed that the concentration of lead in the Greenland troposphere reached maximum in the mid-1960s (at a level 200 times exceeding that in the ancient times) and has been decreasing since then. This phenomenon was tentatively related to the use of alkyllead compounds as antiknock agents in gasoline, but a deeper insight is necessary for unambiguous and geographically more precise identification of the origin of the pollution. For lead, such information may be obtained by determining the isotopic⁵ or speciation pattern⁶ of lead emitted by a given source and subsequently recognizing it in the snow investigated.

Alkyllead compounds are characteristic to gasoline, which makes them a unique indicator of automotive and aircraft pollution. In addition, they offer some interesting features for the climatologist such as a different composition of North American and European emissions with respect to the use of methyl- or ethyllead compounds, a year-to-year variable and known output since 1923, and different transport mechanisms of ionic (partly alkylated) and nonpolar (fully alkylated) species.

The potential of organolead compounds as tracers in atmospheric chemistry of the remote environment is to a large degree unexplored, mainly due to the lack of sufficiently simple and sensitive methods for comprehensive speciation analysis at ultratrace levels.⁶ Indeed, considering the total lead concentrations in Greenland snow (1-300 pg/g) and the fraction of organolead assumed on the basis of earlier environmental studies (0.1-0.5%, split into a variety of species),⁷⁻⁹ the need for a method for the determination of organolead compounds down to the low femtogram per gram level becomes evident. Another problem is the limited amount of sample available: typically only 50-100 g as only a small-diameter central part of the snow core is free enough of contamination to be analyzed.

Gas chromatography with spectrometric detection is a universally accepted approach to speciation analysis of organolead compounds.^{10,11} Electrothermal atomic absorption spectrometry, using either quartz furnace¹²⁻¹⁵ or graphite furnace,¹⁶ is the dominant detection technique but the sensitivity is insufficient to cope with the organolead levels in polar samples. Lower detection limits (0.03-0.2 pg) are offered by MIP-AES, which is at present the most sensitive detection technique for organolead in a GC effluent.^{17,18} However, a well-tailored sample preparation procedure

(7) Allen, A. G.; Radojević, M.; Harrison, R. *Environ. Sci. Technol.* 1988, 22, 517-522.

(8) Van Cleuvenbergen, R. J. A.; Adams, F. C. Organolead Compounds. In *Handbook of Environmental Chemistry*; Hutzinger, O., Ed.; Springer: Berlin, 1990; Vol. 3E.

(9) Van Cleuvenbergen, R. J. A.; Adams, F. C. *Environ. Sci. Technol.* 1992, 26, 1354-1360.

(10) Radojević, M. Lead. In *Environmental Analysis Using Chromatography Interfaced with Atomic Spectroscopy*; Harrison, R. M., Rapsomanikis, S., Eds.; Horwood; Chichester, England, 1989.

(11) Łobiński, R.; Dirks, W. M. R.; Szpunar-Łobińska, J.; Adams, F. C. *Anal. Chim. Acta*, in press.

(12) Chakraborti, D.; De Jonghe, W. R. A.; Van Mol, W. E.; Van Cleuvenbergen, R. J. A.; Adams, F. C. *Anal. Chem.* 1984, 56, 2692-2697.

(13) Forsyth, D. S.; Marshall, W. D. *Anal. Chem.* 1985, 57, 1299-1305.

(14) Forsyth, D. S. *Anal. Chem.* 1987, 59, 1742-1744.

(15) Radojević, M.; Allen, A.; Rapsomanikis, S.; Harrison, R. M. *Anal. Chem.* 1986, 58, 658-661.

(16) Nygren, O. J. *Anal. At. Spectrom.* 1987, 2, 801-803.

(17) Estes, S. A.; Uden, P. C.; Barnes, R. M. *Anal. Chem.* 1981, 53, 1829-1837.

(18) Łobiński, R.; Adams, F. C. *Anal. Chim. Acta* 1992, 262, 285-297.

[†] University of Antwerp.

[‡] Laboratoire de Glaciologie et Géophysique de l'Environnement du CNRS.

[§] Université Joseph Fourier de Grenoble.

(1) Patterson, C. C.; Chow, T. J.; Murozumi, M. *Geochim. Cosmochim. Acta* 1969, 33, 1247-1294.

(2) Ng, A.; Patterson, C. C. *Geochim. Cosmochim. Acta* 1981, 45, 2109-2121.

(3) Boutron, C. F.; Candelone, J. P.; Görlach, U. *Analyst* 1992, 20, M24-M27.

(4) Boutron, C. F.; Görlach, U.; Candelone, J. P.; Bolshov, M. A.; Delmas, R. J. *Nature* 1991, 353, 153-156.

(5) Roaman, K. J. R.; Chisholm, W.; Boutron, C. F.; Candelone, J. P.; Görlach, U. *Nature* 1993, 62, 333-335.

(6) Łobiński, R.; Adams, F. C. *Analyst* 1992, 20, M28-M31.

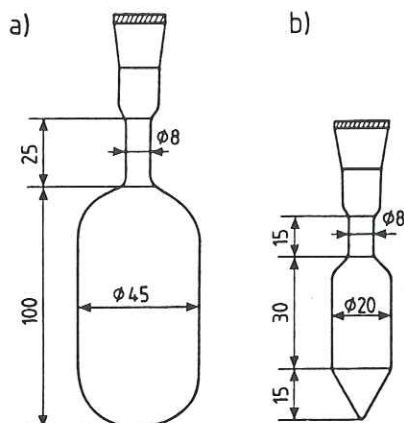

Figure 1. Design of the glassware used in sample preparation procedure: (a) extraction vessel; (b) derivatization vessel.

involving preconcentration and derivatization of the analytes is necessary.

The lowest reported experimental detection limit in comprehensive speciation analysis of water for organolead was 0.1 pg/g on the basis of a 100-g sample.¹⁹ These detection characteristics are still insufficient for the analysis of less contaminated polar snow samples. In this paper, a much more sensitive method is developed and applied to the analysis of recent Greenland snow.

EXPERIMENTAL SECTION

Apparatus. Propylated ionic alkyllead species were separated on a capillary column (HP-1, 25 m \times 0.32 mm \times 0.17 μ m) using an HP Model 5890 Series II gas chromatograph (Hewlett-Packard, Avondale, PA) and detected by means of an HP Model 5921A atomic emission spectrometer. Samples were introduced using a Gerstel Model KAS 3 temperature-programmed cool injection system (Gerstel, Mülheim, Germany). Deactivated glass vaporization tubes (93 mm long \times 1.25 mm i.d. \times 2 mm o.d.) containing a 20-mm plug of Tenax (80–100 mesh) were used. Injections were made manually using a 50- μ L Hamilton 701RN syringe equipped with a special needle (0.64 mm o.d.) with a polished finish to fit the septumless injection head (Gerstel).

Extraction and derivatization of alkyllead compounds were performed in custom-designed borosilicate glass vessels shown in Figure 1.

The sample preparation was done in a class 100 clean bench (Holten, Denmark) at a temperature of 18 °C in a thermostated room.

Reagents. The chemicals used were of analytical grade and were purchased from Merck (Darmstadt, Germany) except for Grignard reagents (Aldrich, Milwaukee, WI) and sodium tetrabutylborate (NaBEt₄) (Strem, Bischeim, France).

Ammonia/Citrate Buffer Solution (pH 8.5). A 20.6-g sample of citric acid monohydrate was dissolved in 950 mL of water. pH was adjusted to 8.5 with concentrated ammonia and then the solution was made to 1 L with water.

Integrated Extraction Reagent (IER). A 7.44-g sample of the disodium salt of ethylenediamine/tetraacetic acid (EDTA) was dissolved in 95 mL of the buffer solution. The pH of the solution thus obtained was adjusted to 8.5 with concentrated ammonia and 2.25 g of sodium diethyldithiocarbamate trihydrate (NaD-DTC) was added. The solution was purified by shaking it with two consecutive 5-mL portions of hexane. The reagent was prepared daily.

The preparation, quantification, and purity checking of the standards were described elsewhere.¹⁸ Water deionized and further purified in a Milli-Q apparatus (Millipore) was used throughout. Prior to the first use the glassware was cleaned with a common detergent, thoroughly rinsed with water, soaked in hot concentrated HNO₃ for a few hours, and finally rinsed with water. In-between the analyses of samples the glassware were

soaked in concentrated HNO₃ and rinsed with water. The pipet tips were rinsed with concentrated HNO₃ and water.

Samples Analyzed. Several surface and deep snow samples collected in Southern and Central Greenland were analyzed. The surface snow batch included three samples (I–III) collected on a precipitation event basis in 1989 at Dye 3 (65°11' N, 43°50' W)²⁰ and three aged snow samples (IV–VI) collected in May 1987 at two different sites (72°21' N, 40°13' W and 72°59' N, 37°42' W) near Summit.²¹ These samples were collected in 1-L wide-open conventional polyethylene (CPE) bottles by immersing them horizontally into the surface snow. The second batch of samples included three sections (VII–IX) of a 0–10.7-m snow core⁴ covering the years 1967–1989, obtained by drilling with a custom-designed all-plastic auger in July 1989 at the Summit site (72°35' N, 37°38' W), and three sections (X–XII) of a 7.5–18.6-m snow core²² covering the years 1948–1975 obtained there by drilling with an electromechanical auger. The samples were brought frozen to the laboratory in Grenoble.

Procedures. Initial Sample Preparation. The auger and sampling bottles used were previously extensively acid cleaned as described in detail elsewhere.²³ Samples were prepared under clean room conditions²³ according to the ultraclean procedure described in full detail earlier.^{4,21,23} The aliquots for organolead analyses were transferred into 120-mL acid-cleaned CPE bottles²³ which were sealed in multiple acid cleaned PE bags. They were transported frozen to the University of Antwerp and kept frozen (–20 °C) until analysis.

Speciation Analysis of Organolead Compounds. A sample (75–120 g) was thawed in the CPE bottle used for storage by warming it in a water bath at 18 °C and transferred into an extraction vessel. IER (2 mL) was added. If necessary, concentrated ammonia was added dropwise to adjust the pH (8.4 \pm 0.2), which was controlled by putting a drop of the sample solution on an indicator paper. Hexane (400 μ L) was added, and the flask was shaken for 5 min. Then some water was added to let the organic phase pass into the neck of the vessel, and the mixture was set off for 5 min for the separation of the phases. A 250- μ L aliquot of the organic phase was transferred into a derivatization vessel, and 25 μ L of the propylmagnesium chloride was added. The mixture was homogenized by ultrasonic treatment during several seconds and set off for 10 min. Then enough 0.1 M sulfuric acid was added to let the organic phase enter the neck of the vessel. The latter was shaken for 1 min and set off to let the phases separate. The organic phase was transferred to a small conical vial containing some anhydrous Na₂SO₄ and analyzed by GC-AES in triplicate.

GC-AED Conditions. The optimum settings of the injector, gas chromatograph, and detector are listed in Table I. The liner was packed as follows. A plug of glass wool was placed in the liner. Tenax was poured to form a 2–3-mm plug which was tightly packed by means of a syringe plunger. This procedure had been repeated until a Tenax plug of 20 mm was formed. The liner was heated at 260 °C for 2 min. The helium flow rate measured at the split vent should then be the same regardless of the position of the purge valve. The liner was conditioned by injecting a solution of 10 pg each of organolead compounds in hexane until two subsequent responses did not differ by more than 3%. *Note:* A 1–2-mL sample of the Grignard reagent was taken daily from the SureSeal bottle into a small glass vial using an all-glass syringe. The reagent was stored at –15 °C in a freezer and added by means of an Eppendorf pipet. The derivatization vessels were kept in a refrigerator before use.

RESULTS AND DISCUSSION

Extraction Conditions. Effect of pH. Sodium diethyldithiocarbamate (NaDDTC) is a well-established reagent for extraction separation of ionic organolead com-

(20) Boutron, C. F.; Ducroz, F. M.; Görlach, U.; Jaffrezou, J. L.; Davidson, C. I.; Bolshov, M. A. *Atmos. Environ.*, in press.

(21) Görlach, U.; Boutron, C. F. *Proceedings of the 7th International Conference on Heavy Metals in the Environment*, Geneva, Switzerland, 1989.

(22) Boutron, C. F., unpublished.

(23) Boutron, C. F. *Fresenius' Z. Anal. Chem.* 1990, 337, 482–491.

(19) Łobiński, R.; Adams, F. C. *J. Anal. At. Spectrom.* 1992, 7, 987–992.

Table I. Operating GC-AED Conditions

GC parameters	
injection temperature program	5 °C (2 min), 12 °C/s, 250 °C (1 min)
injection volume program	25 µL (1 min)
column head pressure	130 kPa
oven program	45 °C (3 min), 20 °C/min, 200 °C (0.5 min)
purge valve time program	on (1.9 min) → off (1.6 min) → on
interface parameters	
transfer line	HP-1 column
transfer line temperature	250 °C
AED parameters	
wavelength	405.783 nm
helium make-up flow	300 mL/min ^a
H ₂ pressure	90 psi
O ₂ pressure	20 psi
spectrometer purge flow	2 L/min nitrogen
solvent vent-off program	on (3.9 min) → off (3.8 min) → on
cavity temperature	250 °C

^a Measured at the cavity vent.

pounds.^{10,12,15,24,25} However, the dependence of the recovery on pH has hitherto been studied only at levels about 3 orders of magnitude higher than those of interest in this study.¹² In addition, controversy exists about the optimum pH value and the extraction yield. Therefore it was necessary to study the extraction yield as a function of pH from very dilute solutions (0.2 µg/mL) in more detail.

Figure 2 shows that, in contrast to the extraction of organolead with pentane,¹² the optimum pH range is fairly narrow for all the species except Et₃Pb⁺. For the latter, the direct transfer to the organic phase contributes to the extraction yield. A fall of the recovery of other species at pH > 8.5 indicates that the hydroxyl group acts as the competitive ligand. This drop is the most dramatic for Me₃Pb⁺, which forms a hydrophilic compound, PbMe₃OH. For dialkyllead species, a second maximum occurs at very high pH (~12) probably due to formation of a hydrophobic product of unknown structure.

At pH values 4–7 the precision of the method and the recovery are lower due to the decomposition of DDTc and instability of the organolead DDTc complexes. The peaks observed in the chromatograms of the derivatized extracts obtained at still lower pH values showed the retention times slightly shifted with respect to those of the standards and could not be unequivocally attributed to organolead compounds.

To match the optimum ranges for individual analytes, a pH of 8.4 ± 0.2 was chosen. It was adjusted with a buffer (pH 8.5).

Reagent Concentrations. A minimum concentration of DDTc of 1.5 mM is required for all the compounds. Et₃Pb⁺ was reported to be quantitatively extracted even in the absence of the complexing agent,²⁶ but for the very dilute solutions studied in this work, a recovery of only 40% was observed. As the samples analyzed were well characterized with respect to other metal concentrations, only a small excess of DDTc was used to cover for losses during the purification of the reagent and those due to the coextraction of other metals. EDTA, which was added to eliminate the metallic coextractives including Pb²⁺, was found not to affect the extraction recovery of organolead up to a concentration of 0.1 M. The addition of NaCl reported by some authors^{15,24,25} was not found

to bring any improvement in the recovery. For convenience, an integrated reagent containing DDTc and EDTA in the buffer was used. In this way, the adjustment of pH after addition of EDTA to the sample was avoided and the purification of the reagent added was easier.

Extraction Time. Extraction times from 2 to 30 min were reported to be necessary for the maximum recovery of organolead species.^{10,12,15,25,27} It was found in this work that 2-min shaking was sufficient for the extraction of ionic species while 5 min was necessary for tetraalkylated species.

Preconcentration Factor. A linear increase in the response was observed with amounts of the extraction solvent decreasing to 250 µL for 100 mL of the sample. The use of smaller volumes of hexane for extraction resulted in difficulties with recuperation of a sufficiently large aliquot of the extract required for derivatization; 400 µL of hexane was used in the routine analysis.

Derivatization Conditions. Choice of Reagent. The reagent chosen should produce stable and well-separated derivatives as well as ensure complete and artifact-free derivatization. Propyl-,¹⁵ butyl-,^{12,14,16,24} and phenylmagnesium chloride²⁷ were proposed. The large volume of the derivatized extract injected and the very high instrumental sensitivity set strong requirements with respect to the Grignard reagent purity. A stable flat baseline is the prerequisite for ultrasensitive analysis. Also, the Grignard reagent used must be free from traces of analytes due to practical impossibility of purification.

Chromatograms obtained for a sample of hexane derivatized with the same concentration of different Grignard reagents (propyl-, butyl-, pentyl-, and phenylmagnesium chloride/bromide) show propylmagnesium chloride to be the best choice with respect to both chromatographic purity and baseline stability. The latter is negatively affected by the prolonged contact of the reagent with air and moisture. Therefore, fresh portions of the reagent should be taken daily from the Sureseal bottle.

Reaction Conditions. The effect of the reagent concentration on the efficiency of derivatization is shown in Figure 3. Trialkyllead compounds are derivatized easier than dialkylleads, but a concentration of 120 mM of the derivatizing reagent is sufficient to get a quantitative yield for all the species. As the level of the blank is the function of the amount of Grignard reagent added, the minimum concentration should be chosen. Derivatization times from 15 s to 15 min were investigated. Quantitative recovery of organolead species is observed after 2 min. However, as artifacts due to intermediate products of the derivatization of Pb²⁺ occasionally led to a noisy baseline, 10 min was chosen.

Drying of the extract recommended by some workers¹² was not found necessary to obtain the quantitative recovery. In addition, drying reduces the extract volume which is available for derivatization. It is important, however, that droplets of water be avoided as they decompose the Grignard reagent.

Design of the Glassware. A special vessel (Figure 1a) was designed to enable easy recovery of the extract after only a few minutes' waiting time without the need for centrifugation. Improvements were also necessary in the design of the glassware used for the derivatization. It was observed that handling small volumes of hexane during derivatization in large size glassware¹² and transfers to other vessels for the decomposition of the Grignard reagent introduced a hazard of uncontrolled evaporation losses negatively affecting the precision of analysis. To avoid these effects a novel derivatization vessel was designed (Figure 1b). The derivatization is carried out in the 300-µL cone while homogenization is carried out by ultrasonification and not swirling. This prevents the mixture from forming a large surface thin layer

(24) Chau, Y. K.; Wong, P. T. S.; Kramar, O. *Anal. Chim. Acta* 1983, 146, 211–217.

(25) Mikić, N.; Branica, M. *Anal. Chim. Acta* 1992, 264, 249–258.

(26) De Jonghe, W. R. A.; Van Mol, W. E.; Adams, F. C. *Anal. Chem.* 1983, 55, 1050–1054.

(27) Blais, J. S.; Marshall, W. D. *J. Environ. Qual.* 1986, 15, 255–260.

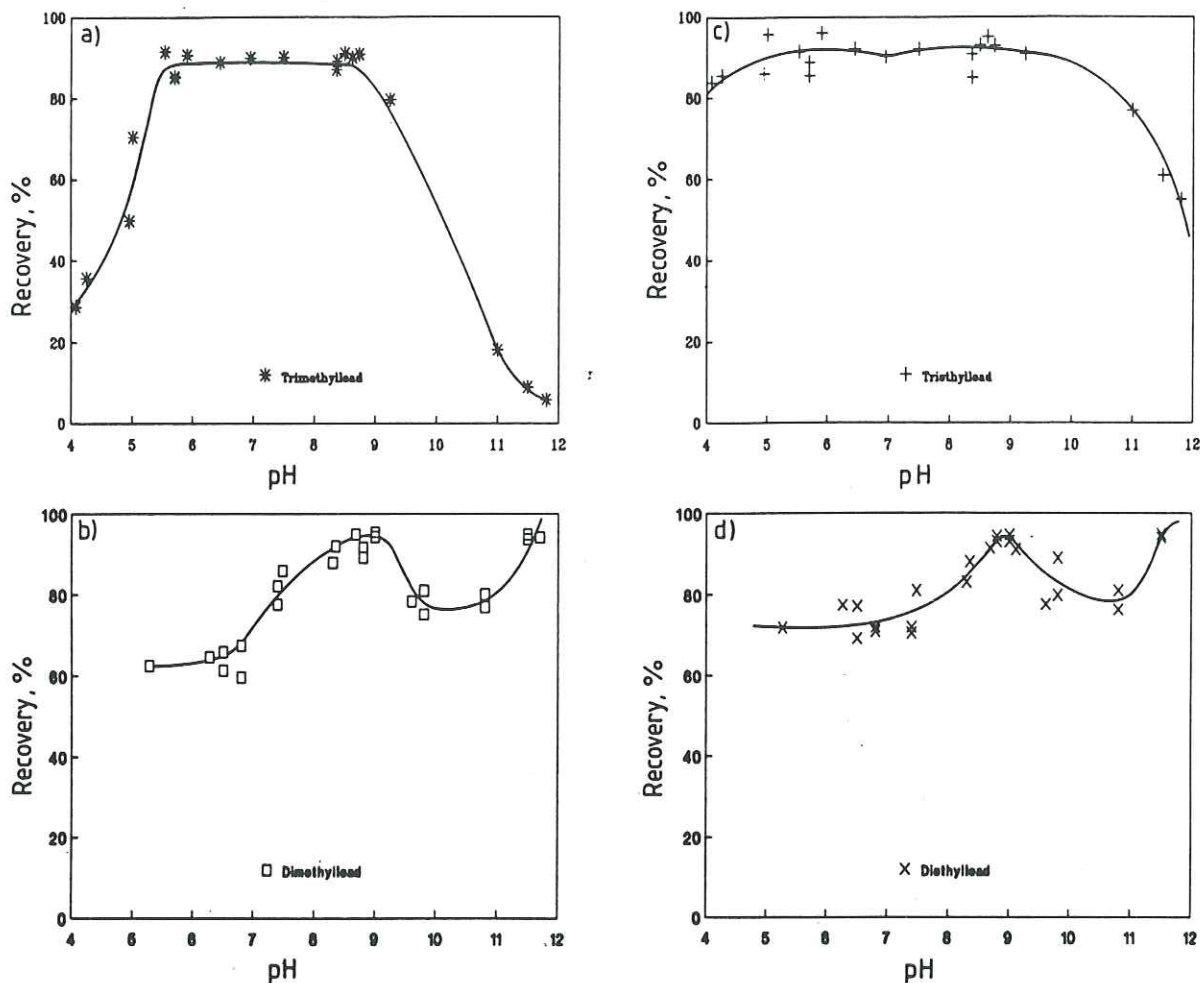

Figure 2. Effect of pH on the determination of (a) PbMe_3^+ , (b) PbEt_3^+ , (c) PbMe_2^{2+} , and (d) PbEt_2^{2+} in water (0.2 ng/L each).

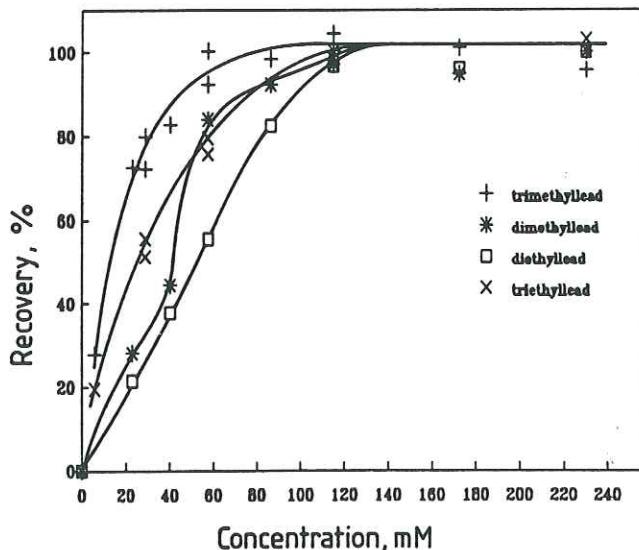

Figure 3. Effect of the PrMgCl concentration on the efficiency of derivatization of ionic organolead compounds in hexane.

sticking to the vessel wall from which hexane could easily evaporate. After shaking and separation of the phases, the solution of analytes in a microvolume of hexane finds its way to the narrow neck of the vessel from which it can be recovered. Thus, all operations are carried out in one flask, eliminating sample transfers. Compared to the separatory funnel designed earlier¹² the compact size vessel was also more convenient to use and could be cleaned easier, e.g., in boiling acid.

GC-AED Conditions. The derivatized analytes were preconcentrated *on-line* using the *in-liner* solvent-venting

technique developed earlier.¹⁹ However, some modifications were introduced. As injection of volumes larger than 25 μL did not result in increase in the signal, the conditions were optimized for *on-line* preconcentration by multiple injection. For injections of 25 μL at 1-min intervals at 5 °C a linear increase in the signal was observed up to 150 μL for all the species except Me_3PbPr , where losses of 10–15% were observed. In these conditions the blank also increases and a compromise in the injected volume is necessary. A 2×25 μL injection was chosen.

As it turned out that various liners differed with respect to the optimum solvent venting temperature and the lifetime, a more reproducible packing procedure was developed. Fresh prepared liners needed to be conditioned, which was done by injecting the same standard solution until the subsequent responses differed by less than 3%. One injection was sufficient to obtain a regular peak shape while two or three were required to get the response stable. For a liner packed and conditioned as described under Procedures, 25 μL of hexane could be removed at 5 °C during 1 min. It was observed that when the injected samples were not dried the packing of the liner deteriorated more rapidly, leading to losses of Me_3Pb^+ , a loss in sensitivity, and peak shape distortion. Liners were exchanged after ca. 100 injections.

Gas chromatography and AED conditions optimized earlier^{18,19} were adapted.

Contamination Danger. The need for special precautions to avoid the blank value in the speciation analysis for organolead has hardly ever been emphasized. However, with organolead compounds ubiquitously present in urban air, the absence of this problem must have been due to the relatively low sensitivity of the procedures used. In our former work¹⁹ a blank contribution of 0.2 pg/g $\text{Et}_2\text{Pb}^{2+}$ was observed while

Table II. Evaluation of the Blank Contribution (fg/g) from Various Sources with (B) and without (A) Extra Precautions Taken

source	Me ₃ Pb ⁺		Me ₂ Pb ²⁺		Et ₃ Pb ⁺		Et ₂ Pb ²⁺	
	A	B	A	B	A	B	A	B
1. integrated extraction reagent	20				3		8	
2. glassware	10				10		20	
3. Grignard reagent			4	4	4	4	5	5
4. air	20				30	6	45	10
total	50	<DL	≤DL	≤DL	47	10	78	15

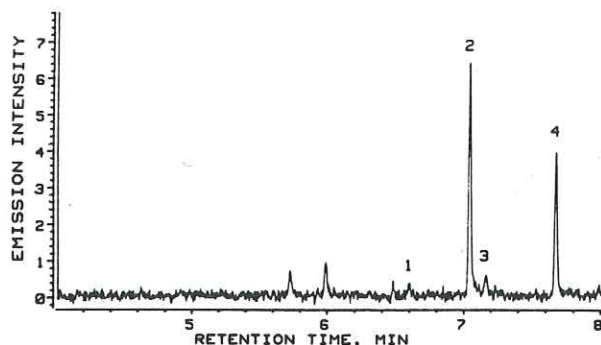

Figure 4. Chromatogram of the blank value: (1) PbEt₃⁺; (2, 4) unidentified; (3) PbEt₂²⁺ (50 μL injected).

smaller signals from Me₃Pb⁺ were occasionally measured. With the experimental detection limits of the present procedure 20 times lower, much more serious blank limitations appeared.

Table II shows a quantitative evaluation of the blank contribution from various sources. They included the IER, water, glassware, Grignard reagent, hexane, and atmosphere. The IER solution was analyzed undiluted according to the Procedures. A considerable signal from Me₃Pb⁺ and much lower ones from Et₃Pb⁺ and Et₂Pb²⁺ were measured. The contaminants were efficiently eliminated by twice preextracting the IER solution with hexane. The water used was checked for the presence of organolead by analyzing different volumes. The presence of analytes (principally Me₃Pb⁺ and Et₂Pb²⁺) was occasionally observed. Therefore, water purified by extraction with DDTC into hexane was used further to prepare blanks used to control for airborne contamination during sample preparation. Analyses performed in glassware exposed to the atmosphere showed an elevated level of Et₂Pb²⁺ in comparison with glassware pretreated with concentrated HNO₃. To evaluate the fraction of the blank contribution originating from the Grignard reagent separately from that due to hexane, the same volumes of the latter were derivatized at varying concentrations of PrMgCl (>120 mM). Et₃Pb⁺ and Et₂Pb²⁺ were the contaminants identified. The dependence of signal height vs the Grignard reagent concentration was a straight line passing through the origin of the coordinates, enabling us to relate the impurities to the Grignard reagent.

Despite purifying the IER and the glassware, the blank of the procedure was still higher than it should have been if it were due only to the impurities in the Grignard reagent, indicating an airborne contamination. As organolead concentrations in the laboratory air could be elevated due to earlier activities, the analyses were moved to a separate room while concentrated standards were still handled in the main part of the laboratory. However, this only partly solved the problem. Further improvement was achieved by handling the samples in a clean bench class 100.

Figure 4 shows a chromatogram of the blank in the optimized procedure. The presence of Et₃Pb⁺ and Et₂Pb²⁺ at levels of about 0.01 and 0.015 pg/g, respectively, is

Table III. Results of the Analysis of the Inner (core), Intermediate (int), and Outer (ext) Part of the Core

sample no.	Et ₃ Pb ⁺ , fg/g			Et ₂ Pb ²⁺ , fg/g		
	core	int	ext	core	int	ext
IX	21.1	19.1	17.0	24.7	23.8	37.3
X	42.3	44.9	122	25.6	21.7	45.9
XI	35.5	38.4	163	20.0	25.0	96.7
XII	40.3	37.0	57.3	25.5	30.5	91.5

reproducible within the level of the baseline noise. The numerous unidentified peaks are present but they are well separated from the analytes and do not interfere with the determination. As they increase proportionally to the inorganic lead concentration it is reasonable to assign them to products of the derivatization of Pb²⁺ by some impurities of *n*-propylmagnesium chloride. It was found that the purity of *n*-PrMgCl with respect to the analytes could differ by up to 30% depending on the batch even when purchased from the same manufacturer. The interbatch variations in the heights of the nonanalyte signals, however, could amount to a factor of 5.

Rigorous control of contamination during sampling, transport, and storage of samples is a prerequisite for valid analysis. Once appearing at the surface of the core the contaminants may penetrate into the interior, probably along the cracks.² Therefore a record of variations of the analyte concentration from the exterior toward the interior of the core showing whether and how far superficial contamination has penetrated toward the center of a sample is necessary.²⁴ Such a record was obtained in this work for four sections of the core by mechanically chiseling off two successive layers of snow progressing from the outside to the central part of the core and analyzing the sections chiseled off and the remaining core for organolead. Ultraclean decontamination procedures developed by Boutron²³ were used. The results of the analysis of the inner, intermediate, and outer parts of the core are summarized in Table III. Note that because of the very small amounts of samples available (15–40 mL) the precision of these results may be as low as 25–30% as some measurements were carried out virtually at the detection limit. For these samples, extraction was performed with 250 μL of hexane in vessels of a design similar to that in Figure 1a but of smaller size.

Table III shows that for most samples roughly equal values were obtained for the inner and intermediate layers while in some cases much higher values were measured for the outer layer. It confirms the assumption that superficial contamination may occur either during sampling or during storage of the core. However, the levels of organolead concentrations at fixed values along successive radial positions clearly indicate that the interiors were not contaminated. Virtually no sample shows a continuous decrease in lead concentrations with no plateau, which would have indicated that lead contamination from the exterior has penetrated to the center of the core.

No similar record could be obtained for surface snow. However, sampling bottle cleaning protocols applied in ultratrace analysis for metals are also valid for organolead. The probability of atmospheric contamination via diffusion through PE storage bags and bottles is considered very small since methyllead species present in the atmosphere of Grenoble and Antwerp are usually not found in Greenland snow samples. In parallel to the preparation of aliquots of snow samples, several blanks were included which accompanied the samples batch during transport to Antwerp and further storage. A chromatogram for such a sample did not differ from that of a MilliQ-water blank.

Characteristics of the Method. Owing to the very effective preconcentration and considerable reduction of the blank value, the experimental detection limit of the method (3 times standard deviation of blank) is at the 0.010 pg/g level

Table IV. Mean Results of the Determination of Organolead Compounds Spiked on Water at Different Concentration Levels^a

analyte	added, fg/g	found \pm confid limit, ^b fg/g	RSD, %
Me ₃ Pb ⁺	80	75.6 \pm 11.8	12.6
	160	152 \pm 13.6	7.2
	240	247 \pm 10.8	3.5
Et ₃ Pb ⁺	120	128 \pm 15.6	9.8
	240	227 \pm 19.5	6.9
	360	375 \pm 23.3	5.0
Me ₂ Pb ²⁺	50	52 \pm 7.8	12.1
	100	105 \pm 11.1	8.5
	150	147 \pm 12.4	6.8
Et ₂ Pb ²⁺	100	95 \pm 13.9	11.8
	200	208 \pm 17.3	6.7
	300	287 \pm 18.5	5.2

^a Five measurements each. ^b $\alpha = 0.95$.

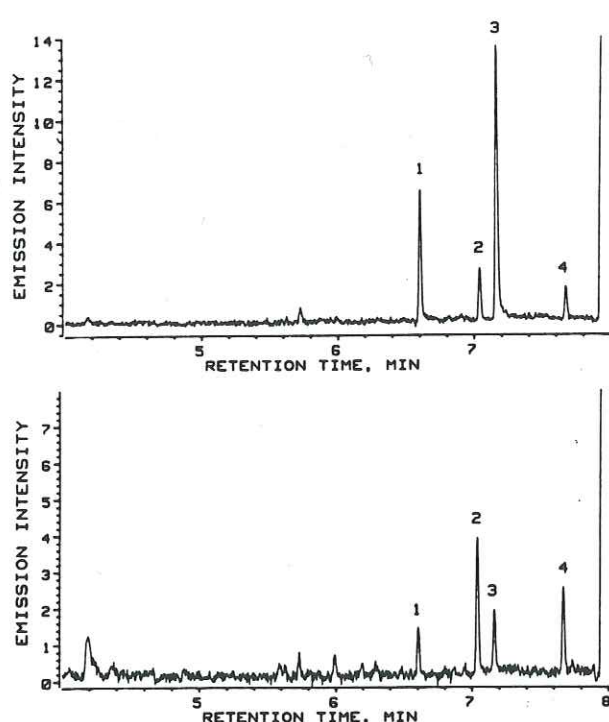

Figure 5. Typical chromatograms of Greenland snow: (a, top) sample V (25 μ L injected) and (b, bottom) sample VII (50 μ L injected); (1) PbEt₃⁺, (2, 4) unidentified, and (3) PbEt₂²⁺.

(as Pb) for a 100-g sample and is by a factor of 10 lower than ever reported. The precision and accuracy of the method were evaluated by analyzing a synthetic solution of the analytes at three concentration levels. The results summarized in Table IV show that at the levels typical for the polar snow analyzed a precision below 10% can be obtained.

Analysis of Greenland Snow. Typical chromatograms for Greenland snow samples are shown in Figure 5. Owing to the small available volume of the sample, only a single analysis was possible. Blanks were run before and after the sample; the latter blank was followed by the standards. Forty- (2 \times 20) and 50- (2 \times 25) μ L aliquots of the derivatized extract were injected to verify the response linearity each time. Results of the analysis of the snow samples are shown in Table V. Concentrations of the total lead measured for the same samples earlier^{4,20} served to calculate the ratio of organolead to inorganic lead.

The snow samples analyzed were well characterized with respect to the heavy metal and organic compound concen-

Table V. Concentrations of Organolead Compounds in Greenland Snow Samples (Expressed as pg of Pb/g)

sample no.	depth, m	Et ₃ Pb ⁺	Et ₂ Pb ²⁺	Me ₃ Pb ⁺	Me ₂ Pb ²⁺	organolead/ total Pb, %
I	surface	0.158	0.145	0.030	0.054	0.99
II	surface	0.042	0.038	nf ^a	0.018	0.29
III	surface	0.022	0.026	nf	nf	0.37
IV	surface	0.045	0.21	nf	nf	0.41
V	surface	0.25	0.53	nf	nf	2.36
VI	surface	0.077	0.48	nf	nf	1.40
VII	2.0	0.023	0.024	nf	nf	0.10
VIII	6.5	0.13	0.23	nf	nf	0.36
IX	9.8	0.021	0.025	nf	nf	0.29
X	11.0	0.042	0.026	nf	nf	0.08
XI	12.0	0.035	0.020	nf	nf	0.04
XII	13.5	0.040	0.025	nf	nf	0.04

^a nf, not found, below 10 fg/g.

trations, which were at the nanogram per gram level or below. The probability of sample-related interferences stimulating formation of derivatization artifacts is thus very small. Independent confirmation of accuracy of the method developed is very difficult as no method has been hitherto reported to determine lead at such low levels based on such small amounts of sample. Nevertheless, in some samples available in larger amounts, the absence of methyllead (<50 fg/g) was confirmed by a modified method of Rapsomanikis et al.²⁸ Me₃Pb⁺ and Me₂Pb²⁺ were in-situ ethylated using NaBEt₄ and extracted with hexane.

A further concern regarding the validity of the data obtained is the stability of organolead in snow and ice deposits. It seems, however, that once fallen, organolead compounds remain stable due to very low temperatures and the virtual absence of biological life and UV radiation. This assumption is supported by the low Et₂Pb²⁺/Et₃Pb⁺ ratios found in the deep (old) snow.²⁹ They are observed despite the higher thermodynamic stability of Et₂Pb²⁺ compared to its predecessor in the degradation scheme, Et₃Pb⁺.

CONCLUSIONS

This work has brought the speciation analysis of organolead down to the low femtogram per gram levels by a combination of a state-of-the-art instrumental technique with a classic wet chemical procedure. The study provides the first data on the levels of organolead compounds in the remote environment free from direct automotive emissions. The occurrence of organolead compounds in ancient and fresh snow supports the theory of the global character of lead pollution related to the development of the automobile industry. The concentrations of organolead compounds measured in Greenland snow and ice show strong seasonal and long-term variations while the distribution patterns generally differ from those obtained in all the European studies.^{8,30} These, interpreted in terms of atmospheric chemistry, meteorology, and source emissions, should contribute to the elucidation of the transport mechanisms of gaseous and fine particulate matter into the remote environment as well as of the global biogeochemical cycle of organolead.

ACKNOWLEDGMENT

This work was financially supported by the Commission of European Communities and Switzerland as part of the Eurocore program, by the Belgian government as part of the Global Change program, the French Ministry of the Environment, and the U.S. National Science Foundation. We thank P. Mayewski, C. Rado, and R. Delmas for their participation in field sampling.

(28) Rapsomanikis, S.; Donard, O. F. X.; Weber, J. H. *Anal. Chem.* 1986, 58, 35-38.

(29) Łobiński, R., unpublished.

(30) Radojević, M.; Harrison, R. M. *Sci. Total Environ.* 1987, 59, 157-180.

ENVIRONMENTAL SCIENCE & TECHNOLOGY, Vol 28, N°8, 1467-1471, 1994.

Present Century snow core record of organolead pollution in Greenland

R. LOBINSKI, C.F. BOUTRON, J-P. CANDELONE, S. HONG, J. SZPUNAR-LOBINSKA &
F.C. ADAMS.

Present Century Snow Core Record of Organolead Pollution in Greenland

Ryszard Lobiński,^{*†} Claude F. Boutron,^{‡,§} Jean-Pierre Candelone,[‡] Sungmin Hong,[‡] Joanna Szpunar-Lobińska,[†] and Freddy C. Adams[†]

Department of Chemistry, Micro- and Trace Analysis Centre, University of Antwerp, Universiteitsplein 1, 2610 Wilrijk, Belgium, Laboratoire de Glaciologie et Géophysique de l'Environnement du CNRS (LGGE), 54 rue Molière, Domaine Universitaire, B.P. 96, 38402 St. Martin d'Hères, France, and UFR de Mécanique, Université Joseph Fourier de Grenoble, Domaine Universitaire, B.P. 68, 38041 Grenoble, France

Ionic alkyllead species have been determined in precisely dated consecutive layers of a 25-m-deep snow core obtained by drilling at the Summit site, relying on ultraclean sampling, high-resolution separation of individual species, and ultrasensitive determination procedures. Ethylleads were the only species found in the concentration ratio varying from 5 to 400 fg/g. The concentrations found show an increasing trend since the early 1970s until the late 1980s that is slightly blurred by seasonal variations. The results are correlated with the data on the distribution of organolead species in gasoline, the consumption levels of leaded gasoline in Europe and the United States, and the concentrations and isotopic compositions of total lead in particular samples. Unambiguous evidence of the gasoline-related sources of lead in aged Greenland snow and ice during the past 70 years are provided. In contrast to Pb(II), no dramatic drop in the northern hemispheric pollution by organic lead in the 1970s is observed.

Introduction

The potential health hazard associated with lead (used principally as an antiknock additive to gasoline) has given rise to a 25-year-long argument about to what extent the development of automobile transport has modified the lead level in the entire terrestrial atmosphere (1-4).

A glaciological approach to this question consists of following the changes of Pb concentration in polar snow during the past few hundred years. It is based on the assumption that the concentration of lead in successive layers of precisely dated snow and ice is proportional to that existing in the polar troposphere at the time of precipitation. A unique record of changes in Arctic lead pollution levels over time is thus available which extends back to times when there was no human activity. The central plateau of the Greenland ice sheet is a valuable resource for extracting glacial record samples for studies of atmospheric chemistry, long-range transport, and global change. It is an integral component of the zonal circulation of the high northern latitudes (North America and Eurasia), and at the same time, it is remote from local influences of soil dust and sea spray.

The background value for total lead of about 1 pg/g in a few thousands year-old Greenland ice (3, 4) is consistent with the level resulting from the known natural contributions of Pb to crustal dusts, sea salts, and volcanic debris trapped in the ice. This concentration was reported to increase by a factor of 50 as a consequence of the Industrial Revolution at the end of the 18th century and remained

fairly stable until 1930 (1). Then a rapid increase (by a factor of 5) within 40 years was observed, tentatively assigned to the introduction of organolead compounds as antiknock additives to gasoline (1). The accuracy of the highest values was confirmed by Boutron *et al.* (5), who analyzed snow cores sampled at a different location. He and co-workers showed that since the late 1960s the concentration of lead in Greenland snow has decreased back to the 30 pg/g level confirmed by Wolff and Peel (6).

The evidence for the automotive origin of lead is, up to now, based exclusively on the correlation of changes in Pb concentration in polar ice with the rate of increase or decrease in the world gasoline production. Measurement of the total lead in Greenland snow seems to be a too simplified approach to enable a precise source identification especially as the acquisition of pure lead needed for the production of gasoline must have resulted in a proportional increase in lead smelting operations and thus related emissions. The same factor of increase (1930-1970) and decrease (1970-1989) in the Pb concentration in snow is striking taking into account that the use of leaded gasoline is still considerable in Europe. It must also be remembered that the period 1930-1970 coincides with intensive development of high-temperature industrial processes such as the smelting of minerals and the burning of fossil fuels in the northern Soviet Union, while the 1980s are characterized by the strong environmental protection measures introduced in the Western World. Glacial records indicate a marked increase in Arctic air pollution since the mid 1950s parallel to an increase in SO₂ and NO_x emissions in Europe (7), which are not necessarily linked to the consumption of leaded gasoline.

Unambiguous evidence for human impact can be obtained from studies of pollutant species which have no natural origin. Source assignment may be done by determining the isotopic (8) or speciation pattern (9) of lead emitted by a given source and subsequently recognizing it in the snow investigated. The gasoline-related emissions can be unequivocally accounted for by considering alkyllead species determined as a function of depth and, hence, age in the ice sheet.

The objective of this work was to study the evolution of the northern hemispheric gasoline-related pollution during the present century by investigating organolead concentrations in a snow core drilled in central Greenland and to account for the possible sources.

Materials and Methods

Sampling. Twenty-three sections of a snow core (0-10.7 m) were obtained by drilling at the Summit site (72°35' N, 37°38' W), elevation 3230 m, and mean annual snow accumulation rate 21.5 g/cm² year in July 1989 (EURO-CORE Project). The samples covered a continuous sequence of 22 years (1967-1989). They consisted of a

* E-mail address: Lobinski@schs.uia.ac.be.

† University of Antwerp.

‡ Domaine Universitaire, St. Martin d'Hères.

§ Domaine Universitaire, Grenoble.

snow core 10.5-cm in diameter and 10.7 m long, which was drilled only for the heavy metal measurements. To minimize local contamination, the sampling site was selected several kilometres north of the camp, in a clean area to which access was limited. The core was hand-drilled by operators wearing full clean-room clothing and shoulder-length polyethylene gloves, using a custom-designed all-plastic mechanical auger made of polycarbonate. The cutting blades, the extension rods, and the T-shaped arm used to rotate the auger were also made of polycarbonate. Before being sent to Greenland, the auger, extension rods, and all other items (also made of plastic) used during drilling operations had been extensively cleaned in the LGGE laboratory (10) by successive immersions in a series of 25% and 0.1% HNO₃ baths, the last two washes being ultrapure 0.1% HNO₃ (from the U.S. National Institute of Standards and Technology) diluted with ultrapure water. The core sections (length ~50 cm) were directly transferred by gravity into specially designed conventional polyethylene tubes with threaded caps, which had also been extensively cleaned in the clean laboratory and were packed in multiple sealed acid-cleaned polyethylene bags. All samples were brought back frozen to the LGGE.

Eighteen sections of a snow core (7.6–18.8 m) were obtained in July 1989 by drilling at the Summit site using an electromechanic auger. They were processed further as described in the previous section. The samples covered a continuous sequence of 28 years (1948–1975) with the caveat of gaps resulting from the inavailability (for this study) of samples in some periods. In addition, several deeper snow core sections dated from 1841, 1869, 1915, 1928, 1933, and 1940 were analyzed.

Sample Handling and Analysis. Each core section investigated was subsampled through freshly prepared untouched surfaces, inside a laminar flow clean bench located inside a cold room, following a procedure similar to that described by Boutron (5). From each section of initial length ~50 cm, two ~20-cm-long core sections were obtained, with fresh untouched surfaces at both extremities, by breaking the original core section with a sharp-edged polyethylene splitting wedge (used only to initiate the crack) and a polyethylene hammer. The central part of each of these two sections was then extracted by hammering a home-made cylindrical polyethylene beaker (5 cm diameter, 20 cm long) into the center of these untouched surfaces in parallel to the axis of the core. Additional subsamples are also taken in parallel to the axis at increasing distances from the center of each section using narrower (1 cm diameter, 20 cm long) conventional polyethylene beakers. All items used during subsampling were extensively cleaned following the procedure described elsewhere (5). Nine of the ~20-cm-long sections subsampled in this way were later analyzed.

The samples (surface snow or snow/ice core) were allowed to thaw inside the Grenoble ultraclean laboratory, and aliquots of the samples were prepared and refrozen for organolead analysis. Blanks of MQ water were prepared by exposure to the lab atmosphere during the preparation of aliquots. Upon freezing they were transported together with the sample aliquots packed in triple CPE bags in an air-tight box to the MiTAC laboratory in Antwerp and stored at -20 °C prior to analysis. Samples and blanks were handled further under class 100 clean-bench conditions.

Table 1. Results of Analysis of Inner (CORE), Intermediate (INT), and Outer (EXT) Part of the Core

sample no.	Et ₃ Pb ⁺ (fg/g)			Et ₂ Pb ²⁺ (fg/g)		
	CORE	INT	EXT	CORE	INT	EXT
1	34	28	36	20	22	43
2	82	76	137	151	162	140
3	51	52	50	47	42	47
4	21	19	17	25	24	37
5	32	32	43	22	23	39
6	40	37	57	26	31	91
7	100	95	123	67	110	69
8	42	45	122	26	22	46
9	36	38	163	20	25	97

Organolead compounds were determined using capillary gas chromatography with a microwave-induced plasma atomic emission spectrometric detection according to the procedure described in detail elsewhere (11). The method allowed quantification of organolead in Greenland snow down to the 10 fg/g level on the basis of 50 g of sample. The procedure blank was at the level of ca. 10 fg/g.

Results and Discussion

Contamination Control. Rigorous control of contamination during sampling, transport, and storage of samples is a prerequisite for valid analysis. Despite exceptional cleanliness of the field collection procedure, the possibility that some organolead contamination might occur on the outside layer of the snow core must be taken into account. The same applies to transport and storage especially as, contrary to metal ions, tetraalkyllead (TAL) compounds were reportedly capable of diffusing through polyethylene (12). Once that occurred at the surface of the core, the contaminants may penetrate into the interior probably along the cracks (2). Therefore, a record of variations of the analyte concentration from the exterior toward the interior of the core showing whether and how far superficial contamination has penetrated toward the center of a sample is necessary (2, 5). Such a record was obtained in this work for nine sections of the core by mechanically chiseling off two successive layers of snow progressing from the outside to the central part of the core and analyzing the sections chiseled off and the remaining core for organolead. Ultraclean decontamination procedures developed by Boutron *et al.* (5, 10) and described briefly in the previous section were used. The results of the analysis of the inner, intermediate, and outer part of the core are summarized in Table 1. Note that because of the very small amounts of samples available (15–40 mL) the precision of these results may be as low as 25–30% as some measurements are carried out virtually at the detection limit.

Table 1 shows that, for most samples, roughly equal values were obtained for the inner and intermediate layer while in some cases much higher values were measured for the outer layer. It confirms the assumption that superficial contamination may occur either during sampling or during storage of the core. However, the levels of organolead concentrations at fixed values along successive radial positions clearly indicate that the interiors were not contaminated. Virtually no sample shows a continuous decrease in lead concentrations with no plateau, which would have indicated that lead contamination from the exterior has penetrated to the center of the core.

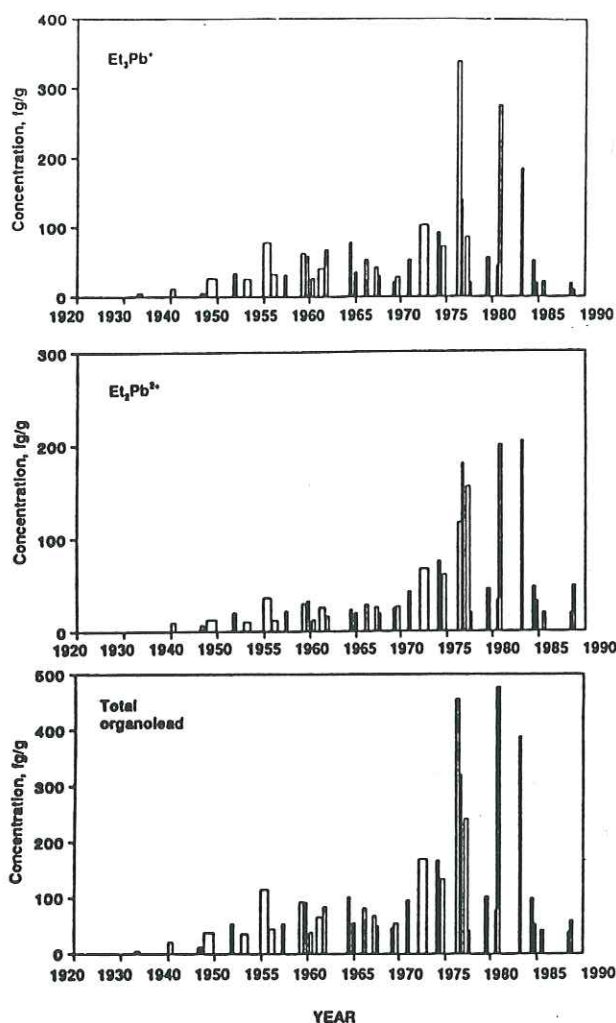

Figure 1. In-depth profiles for Et_3Pb^+ (A, top) $\text{Et}_2\text{Pb}^{2+}$ (B, middle) and total organolead (C, bottom) found for a snow core from the Summit site.

A valuable proof of the cleanliness of all the procedures was the absence of the organolead signal in old snow samples (from 1841, 1869, and 1915), i.e., before organolead compounds were first synthesized.

Organolead Concentration Profile in Snow Core. Historical changes in the organolead pollution at Summit

were investigated by analyzing two snow cores overall covering a period of 45 years and some older samples. In-depth profiles for Et_3Pb^+ and $\text{Et}_2\text{Pb}^{2+}$ and total organolead are shown in Figure 1A, B, and C, respectively. Some surface snow samples from Summit (from 1987 and 1989) were analyzed in the preceding paper (13). Mean values for each of the sampling dates were taken when more than a single result was available.

An increasing trend in concentration of the total organolead is seen since 1970 and apparently continues until mid-1980s. This coincides with the increased consumption of leaded gasoline in Europe while that in the United States was starting slowly to drop (Figure 2). This trend is blurred, however, by strong differences between the adjacent sections of the core, indicating seasonal variations. Taking into account the error associated with the dating of the core (± 0.5 year), it is not possible to state unequivocally which sample corresponds to which season. Individual samples cover a period of 4–6 months.

Seasonal Variations of Organolead Compounds. A deeper insight in the seasonal variations in terms of possible sources can be gained by comparing values for organolead with those for the $^{206}\text{Pb}/^{207}\text{Pb}$ isotopic ratio. Figure 3 compares the timing of fluctuations of the $^{206}\text{Pb}/^{207}\text{Pb}$ isotopic ratio (δ) with that of organolead concentrations for years 1975–1985, which are particularly interesting as the European emissions matched the American ones. It is striking that low total organolead values correspond to high $^{206}\text{Pb}/^{207}\text{Pb}$ ratios and vice versa. This confirms the observation of Rosman *et al.* (8) that variations between the adjacent core sections reflect the fact that air masses from different source regions have a fairly direct access to Summit. The more radiogenic snow (less charged with organolead) contains mostly U.S. emissions while the less radiogenic snow (more charged with organolead) contains Eurasian or Canadian pollution. The statistical correlation for all data in Figure 3 is fairly weak ($r = 0.45$) but considerably improves ($r = 0.8$) if only samples from 1977, 1979, 1981, and 1983 are considered. A similar correlation was not found for total Pb.

Samples from the years 1950–1970, which exhibit low concentrations of ethyllead, are likely to represent North American emissions. Indeed, by this time the European

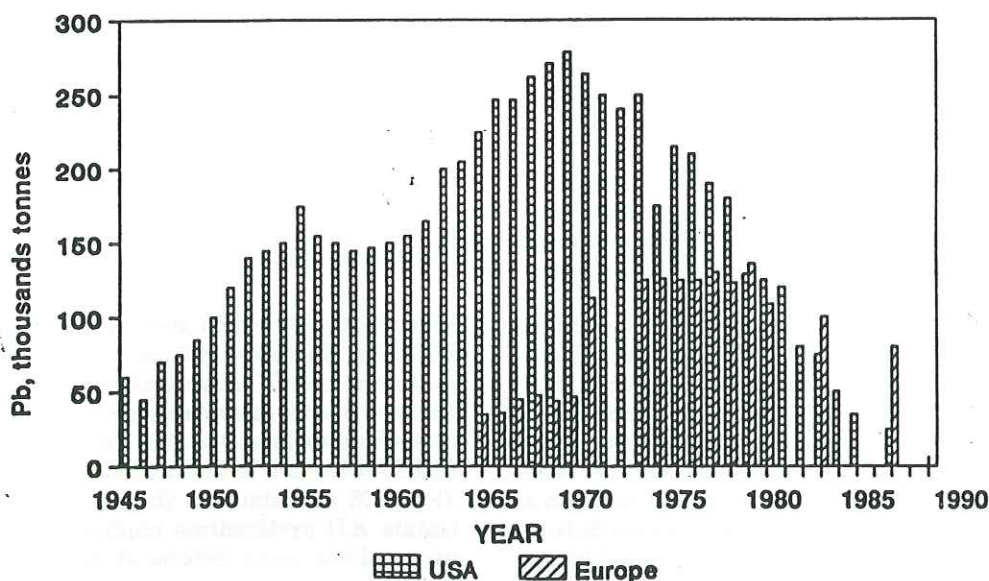

Figure 2. Approximate trends in consumption of leaded gasoline in the Western World. Compiled from refs 8 and 22.

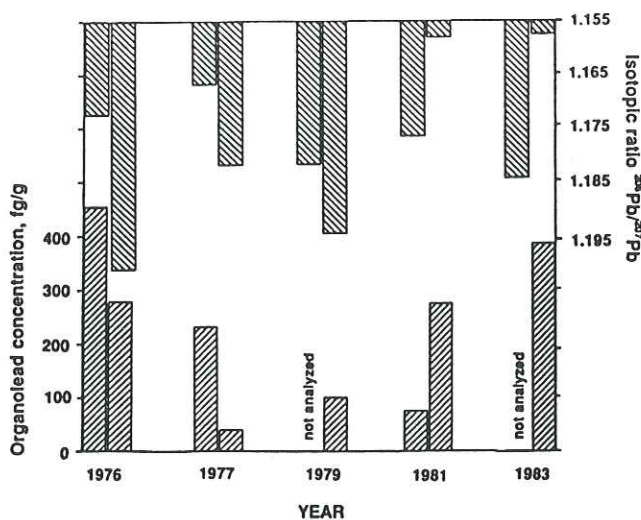

Figure 3. Comparison of fluctuations of the $^{206}\text{Pb}/^{207}\text{Pb}$ isotopic ratio (δ) with organolead concentration found in a snow core from the Summit site.

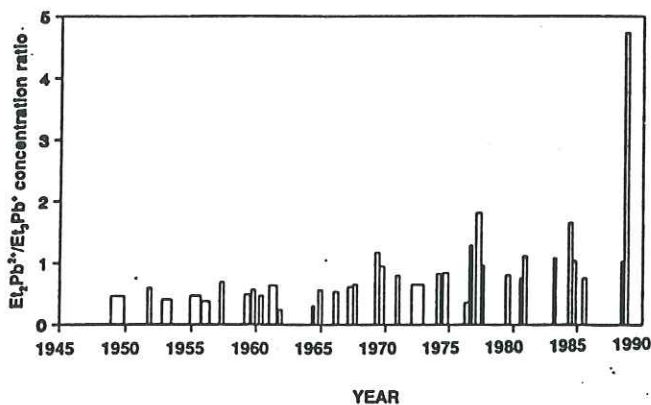

Figure 4. Concentration ratio $\text{Et}_2\text{Pb}^{2+}/\text{Et}_3\text{Pb}^+$ found in a snow core from the Summit site.

source emissions were only 20–30% of the American ones. This also could account for the fact that no seasonal variations are observed clearly before 1970. The U.S. origin of lead present in the same snow dated between 1967 and 1972 was suggested by Rosman on the basis of the increase in the $^{206}\text{Pb}/^{207}\text{Pb}$ ratio reflecting the increase in both gasoline consumption and isotopic ratio of lead added to gasoline in the United States at these times. The American origin of emissions before 1970 is also reflected by the low ratio $\text{Et}_2\text{Pb}^{2+}/\text{Et}_3\text{Pb}^+$ (<0.5) compared with 0.8–2 measured later (Figure 4). The latter is similar to that observed at Dye 3 (13) in the summer when American emissions influence this site. Air mass trajectories usually show the longer residence time over the ocean with the enrichment of Et_3Pb^+ due to its less aerosolphilic character than $\text{Et}_2\text{Pb}^{2+}$.

In the second half of the 1980s, high–low variations are observed for organolead but not for the isotopic ratio. This may be due to the relative increase in Canadian vs U.S. contribution to the North American share of the Greenland lead pollution. Indeed, in 1982 the Canadian production of leaded gasoline accounted for 20% of that in the United States, while in 1986 it already accounted for 80% (14). Considering that the fraction northeastern U.S. states/total U.S. consumption is smaller than southeastern Canada/total Canada, the dominant contribution of

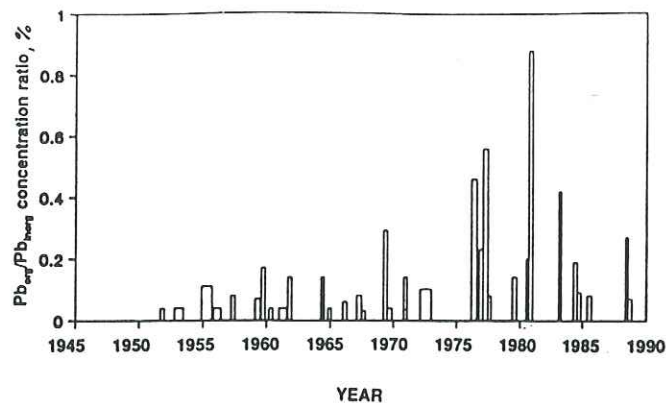

Figure 5. Concentration ratio $\text{Pb}_{\text{org}}/\text{Pb}_{\text{inorg}}$ found in a snow core from the Summit site.

Canadian emissions vs American emissions appears. Canadian emissions are less charged with organolead than the European ones but the isotopic $^{206}\text{Pb}/^{207}\text{Pb}$ ratio is similar in Canada and in Europe.

The shape of the dependence of organolead/inorganic lead ($\text{Pb}_{\text{org}}/\text{Pb}_{\text{inorg}}$) concentration ratio vs sampling depth is shown in Figure 5. A background at a $\text{Pb}_{\text{org}}/\text{Pb}_{\text{inorg}}$ concentration ratio of $0.1 \pm 0.05\%$ is clearly seen, which roughly corresponds to the average values obtained for atmospheric deposits in Europe (15) and Canada (16). In some samples, the $\text{Pb}_{\text{org}}/\text{Pb}_{\text{inorg}}$ concentration ratio is 2–7 times higher than this value. This relative enrichment is observed in the samples with elevated ethyllead concentrations and is likely to reflect emissions from the Arctic Basin similarly as for Dye 3 (13).

Methyllead species were not detected in any of the ancient EUROCORE snow samples. Tetramethyllead (TML), which is beneficial for the combustion of fuels with an increased fraction of aromatic constituents, was introduced only in 1960 and ever since then constituted in the United States only a small fraction of the total alkyllead added. This may explain the absence of methyllead in the snow deposits containing a large fraction of the U.S. emitted lead. Another possible explanation for the absence of methyllead in the Summit snow is that the more charged winter precipitation may not be well preserved in the record (17). Indeed, the average winter snow accumulation is smaller, and winter is known to be the period of maximum surface winds. The poor preservation of winter snow or little winter precipitation at Summit is also indicated by the absence of a winter peak in sea-salt species similar to that at Dye 3 (18).

Recently, Boutron *et al.* (5) reported a decrease in Greenland snow lead concentration since 1970 and attributed it to the consequence of legislative measures to reduce the gasoline lead content. The latter were also demonstrated to be reflected rapidly in the total lead burden of the atmosphere and atmospheric depositions on the local (19, 20). Indeed, the consumption of leaded gasoline consumed in the United States has declined sharply since 1975 while that in Europe declined somewhat later. However, there appears to be no indication of a rapid beneficial effect of the more stringent regulations on the organolead atmospheric burden on a local scale (21). A sound explanation for this unexpected absence of a response fails as yet. The intermediate decomposition products of anthropogenic TAL, in particular trialkylleads, are probably much more persistent in the atmosphere than the inorganic lead aerosol and are scavenged less efficiently

from the atmosphere than inorganic lead, which might explain at least partly a slower response of the former. In particular, organolead compounds proved to be more stable under Arctic conditions than in the ambient continental air. Gas-phase organolead in the stratosphere seems to be more stable due to much smaller concentrations of hydroxyl radicals. The relative proportion of organolead to total lead will increase with time and distance away from emission sources. Also, there is an indication of the increase in the use of lead additives in eastern Europe where no regulatory measures exist. Unfortunately, the many gaps in the data set in the late 1980s and the strong seasonal variations leave any hypothesis as being rather speculative.

The issues of possible volatilization or decomposition of organolead in the deep snow need to be considered. Volatilization may be the reason for the absence of methyllead provided that Me_4Pb was the compound actually transported and deposited. On the other hand, the ionic alkyllead species are unlikely to volatilize because of high boiling points and larger polarity. A significant degradation of organolead compounds in deep snow sheets seems to be unlikely because of the fairly high organolead to total lead ratio observed. In addition, a domination of Et_3Pb^+ in the oldest samples is observed, which compound is less thermodynamically stable than the direct product of its degradation— $\text{Et}_2\text{Pb}^{2+}$. A partial decomposition of organolead cannot, of course, be excluded.

Acknowledgments

This work was financially supported by the Commission of European Communities and Switzerland as part of the EUROCORE Program (STEP-CT90-0064-C/DSCN/), by the Belgian government as part of the Global Change Program (GC/06/006), by the French Ministry of the Environment, and by the University of Grenoble. We thank P. C. Rado and R. Delmas for their participation in field sampling.

Literature Cited

- (1) Murozumi, M.; Chow, T. J.; Patterson, C. C. *Geochim. Cosmochim. Acta* 1969, 33, 1247-1294.
- (2) Ng, A.; Patterson, C. C. *Geochim. Cosmochim. Acta* 1981, 45, 2109-2121.
- (3) Peel, D. A. In *The environmental record in glaciers and ice sheets*; Oeschger, H.; Langway, Jr., C. C., Eds.; Wiley: New York, 1989; pp 207-223.
- (4) Boutron, C. F. *La Recherche* 1988, 19, 446-455.
- (5) Boutron, C. F.; Görlach, U.; Candelone, J. P.; Bolshov, M. A.; Delmas, R. J. *Nature* 1991, 353, 153-156.
- (6) Wolff, E. W.; Peel, D. A. *Ann. Glaciol.* 1988, 10, 193-197.
- (7) Barrie, L. *Atmos. Environ.* 1986, 20, 643-663.
- (8) Rosman, K. J. R.; Chisholm, W.; Boutron, C. F.; Candelone, J. P.; Görlach, U. *Nature* 1993, 362, 333-335.
- (9) Lobiński, R.; Adams, F. C. *Analysis* 1992, 20, M28-M31.
- (10) Boutron, C. F. *Fresenius' Z. Anal. Chem.* 1990, 337, 482-491.
- (11) Lobiński, R.; Boutron, C. F.; Candelone, J. P.; Hong, S.; Szpunar-Lobińska, J.; Adams, F. C. *Anal. Chem.* 1993, 65, 2510-2515.
- (12) Colombini, M. P.; Corbini, G.; Fuoco, R.; Papoff, P. *Ann. Chim. (Rome)* 1981, 71, 609-629.
- (13) Lobiński, R.; Boutron, C. F.; Candelone, J. P.; Hong, S.; Szpunar-Lobińska, J.; Adams, F. C. *Environ. Sci. Technol.* 1994, preceding paper in this issue.
- (14) Fiat, R. Société Octel, Paris, Personal communication, 1992.
- (15) Allen, A. G.; Radojevic, M.; Harrison, R. M. *Environ. Sci. Technol.* 1988, 22, 517-522.
- (16) Forsyth, D. Ph.D. Thesis, McGill University, Montreal, 1985.
- (17) Putnis, P. *World Survey of Climatology*; Elsevier: Amsterdam, 1970; Vol. 12, pp 3-128.
- (18) Whitlow, S.; Mayewski, P. A.; Dibb, J. E. *Atmos. Environ.* 1992, 26A, 2045-2054.
- (19) Eisenreich, S. J.; Metzger, N. A.; Urban, N. R. *Environ. Sci. Technol.* 1986, 20, 171-174.
- (20) Rohbock, E.; Georgii, H. W.; Müller, J. *Atmos. Environ.* 1980, 14, 89-98.
- (21) Van Cleuvenbergen, R. J. A.; Adams, F. C. *Environ. Sci. Technol.* 1992, 26, 1354-1360.
- (22) Nriagu, J. O. *Sci. Total Environ.* 1990, 92, 13-28.

Received for review October 8, 1993. Revised manuscript received March 24, 1994. Accepted April 11, 1994.*

* Abstract published in *Advance ACS Abstracts*, May 15, 1994.





Grenoble, novembre 1994

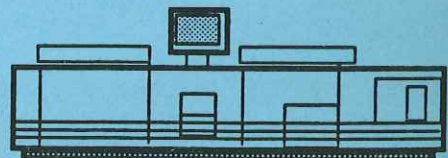

Impression et finition réalisées sur Rank Xerox 5090,
au Service Reprographie du CNRS.