



**HAL**  
open science

# Intégrale de Kontsevich elliptique et enchevêtrements en genre supérieur

Philippe Humbert

► **To cite this version:**

Philippe Humbert. Intégrale de Kontsevich elliptique et enchevêtrements en genre supérieur. Algèbres quantiques [math.QA]. Université de Strasbourg, 2012. Français. NNT : . tel-00762209v1

**HAL Id: tel-00762209**

**<https://theses.hal.science/tel-00762209v1>**

Submitted on 7 Dec 2012 (v1), last revised 2 Oct 2013 (v2)

**HAL** is a multi-disciplinary open access archive for the deposit and dissemination of scientific research documents, whether they are published or not. The documents may come from teaching and research institutions in France or abroad, or from public or private research centers.

L'archive ouverte pluridisciplinaire **HAL**, est destinée au dépôt et à la diffusion de documents scientifiques de niveau recherche, publiés ou non, émanant des établissements d'enseignement et de recherche français ou étrangers, des laboratoires publics ou privés.

# Thèse

INSTITUT DE  
RECHERCHE  
MATHÉMATIQUE  
AVANCÉE

UMR 7501

Strasbourg

présentée pour obtenir le grade de docteur de  
l'Université de Strasbourg  
Spécialité MATHÉMATIQUES

**Philippe Humbert**

**Intégrale de Kontsevich elliptique  
et enchevêtrements en genre supérieur**

Soutenue le 11 décembre 2012  
devant la commission d'examen

Benjamin Enriquez, directeur de thèse  
Gwénaél Massuyeau, co-encadrant  
Dror Bar-Natan, rapporteur  
Christine Lescop, rapporteur  
Christian Kassel, examinateur  
Pierre Lochak, examinateur  
Alexis Virelizier, examinateur  
Pierre Vogel, examinateur  
Leila Schneps, invité

[www-irma.u-strasbg.fr](http://www-irma.u-strasbg.fr)



Dans cette thèse, on définit un invariant fonctoriel d'enchevêtrements dans le tore épaissi qui généralise l'intégrale de Kontsevich. Cet invariant est tout d'abord construit analytiquement à partir d'une version universelle de la connexion de Knizhnik–Zamolodchikov–Bernard elliptique. On donne ensuite une version combinatoire de sa construction, basée sur la notion d'« associéur elliptique » introduite par Enriquez. L'outil principal de cette dernière construction est un théorème qui caractérise la catégorie des enchevêtrements en genre quelconque par une propriété universelle exprimée dans le langage des catégories tensorielles.

**INSTITUT DE RECHERCHE MATHÉMATIQUE AVANCÉE**  
**UMR 7501**  
 Université de Strasbourg et CNRS  
 7 Rue René Descartes  
 67 084 STRASBOURG CEDEX

Tél. 03 68 85 01 29  
 Fax 03 68 85 03 28  
[www-irma.u-strasbg.fr](http://www-irma.u-strasbg.fr)  
[irma@math.unistra.fr](mailto:irma@math.unistra.fr)

**IRMA**  
 Institut de Recherche  
 Mathématique Avancée

ISSN 0755-3390  
<http://tel.archives-ouvertes.fr/tel-00762209>

IRMA 2012/012

Intégrale de Kontsevich elliptique  
et enchevêtrements en genre supérieur

Philippe Humbert  
Institut de Recherche Mathématiques Avancée (IRMA),  
Strasbourg

11 décembre 2012



# Remerciements

Parce que je suis tombé entre de bonnes mains...

Je fais tout d'abord référence à mon directeur de thèse, Benjamin Enriquez, à qui je souhaite exprimer toute ma gratitude. Outre le fait que cette thèse soit très largement basée sur ses travaux, je dois avouer que sans ses efforts répétés de planification, agenda à la main, elle aurait sans doute fini par s'évaporer après d'innombrables refontes... Et quand bien même l'objectif d'une rédaction satisfaisante serait inatteignable, je peux du moins, au contact de la bienveillance et de l'enthousiasme de Benjamin, entrevoir l'idée d'un « Sisyphes heureux » [Cam].

Pendant ma thèse, j'ai eu la chance de bénéficier d'une expérience et d'un point de vue mathématique complémentaires grâce à l'expertise de mon co-encadrant Gwénaél Massuyeau. La réalisation de ce travail doit beaucoup à ses nombreuses lectures attentives, toujours assorties de remarques pertinentes. Merci infiniment, Gwénaél, pour ton suivi rigoureux et ton encadrement sans faille.

J'aimerais ensuite témoigner ma sincère reconnaissance aux rapporteurs qui ont bien voulu accorder du temps à la lecture détaillée de cette thèse : merci beaucoup à Christine Lescop pour ses nombreux commentaires utiles, ainsi qu'à Dror Bar-Natan pour l'intérêt qu'il porte à ce travail.

Merci également à Christian Kassel, Alexis Virelizier et Pierre Vogel, qui me font l'honneur de participer au jury de cette thèse, sans oublier Leila Schneps, qui a accepté de se joindre à eux en tant que membre invité.

Ils ponctuent le quotidien du mathématicien, distillant tout au long de son parcours leurs mystérieux effets stimulants : je parle des colloques, séminaires, écoles et autres rencontres... Merci entre autres à Paolo Belleri, Olivier Elchinger et Jean-Baptiste Meilhan pour l'opportunité qu'ils m'ont offerte d'exposer mes travaux, ainsi qu'à tous mes collègues doctorants de Paris, Grenoble et d'ailleurs que je retrouve à chaque épisode avec le même plaisir.

Ma deuxième année de doctorat fut agrémentée d'un séjour à Kyoto dans le cadre du « Programme d'été » de la JSPS. À ce titre, je souhaite vivement remercier Kazuo Habiro pour son accueil au RIMS, ainsi que Toshitake Kohno pour son invitation à l'université de Tokyo. Compte tenu des épreuves que traversait alors le Japon, l'édition 2011 du « Programme d'été » fut teinté d'un sentiment particulier. Le travail fourni par les organisateurs, suivant leur décision honorable de maintenir l'événement, mérite toute ma reconnaissance.

C'est l'existence du Magistère de mathématiques qui m'a conduit à Strasbourg. Merci à Claudine Mitschi, la responsable de cette filière, ainsi qu'à tous ceux qui ont contribué d'une façon ou d'une autre à m'orienter dans la voie de la recherche. Je pense en particulier à Vincent Blanlœil et Kimihiko Motegi, grâce à qui j'ai découvert la théorie des nœuds à l'occasion d'un stage de Master à Tokyo. Mes premiers pas en topologie remontent quant à eux à un mémoire de Licence effectué sous la direction de François Costantino, que je remercie (ainsi que pour le suivant). J'en profite pour saluer au passage tout le reste de la famille Quantique...

A ce stade, il serait impardonnable d'omettre de mentionner Adrien Brochier, un « grand frère mathématique » hors pair, toujours prêt à répondre à mes questions et à partager ses points de vue, mathématiques ou non, avec joie et amitié.

Comme il est d'usage, je réserve le petit espace restant à tous les proches, collègues ou amis qui n'ont pas forcément de rapport direct avec les mathématiques qui suivent, mais sans qui mes années de doctorat auraient été bien moins savoureuses...

Qu'il me soit donc permis de saluer ici mes anciens ou actuels cobureaux Mickaël, Arnaud et Yacouba, ainsi que les doctorants de l'IRMA, passés et présents, que j'ai pu côtoyer : Alex, Antoine, Auguste, Aurélien, Aurore, Camille, Camille, Cédric, Enrica, Fabien, Jean, Jean-Stefan, Nicolas, Romain, et tout le reste de la troupe.

Merci à mes joyeux compères Ambroise et Olivier pour plein de bonnes raisons – souvent prolongées au-delà des intentions initiales ; merci à Christophe et Pierre pour les foulées requinquantes, à Paul Hochon alias Jean Bombeur, et à Gilles pour les impitoyables duels à la Winchester.

Merci à Anaïs d'avoir été présente à mes côtés, émaillant ces six années strasbourgeoises d'une quantité incalculable de bons souvenirs. D'autres ont, entretemps, quitté l'Alsace ; mais c'est toujours un grand plaisir de retrouver mes profs de math parisiens préférés : Adrien, Claire, et Médéric...

Je n'oublie pas mes chers coloc's Claire, Franzi, Ivan et Sebastian, ni Laurent pour le go, ni Kuri pour le japonais. M'autorisant à creuser jusqu'au terreau Franc-Comtois : merci à Léa(h), JB Regaz', JB Midz', JLouc, Valérie, Mehdi, et autres Pasteuriens et Hugoliens de la même espèce...

Enfin, j'embrasse toute ma famille : mes parents, que je remercie tant pour le regard d'amour qu'ils me portent que pour leur regard sur le monde qu'ils me font partager, mes sœurs Lucie et Cécile, mes grands-parents Suzanne, Laurent, – accompagné par le souvenir affectueux de la Lulu et d'Antoine.

# Contents

<b>Introduction</b>	<b>v</b>
<b>1 The Kontsevich integral</b>	<b>1</b>
1.1 Formal connections . . . . .	1
1.1.1 Chen's iterated integrals . . . . .	1
1.1.2 Formal connections and parallel transport . . . . .	2
1.2 The KZ connection . . . . .	3
1.3 Tangles and bd-tangles . . . . .	4
1.3.1 Geometric braids . . . . .	4
1.3.2 Bd-tangles . . . . .	5
1.3.3 Moves of bd-tangles . . . . .	6
1.3.4 Tangles . . . . .	7
1.3.5 Hump insertion . . . . .	8
1.4 Jacobi diagrams . . . . .	9
1.5 The Kontsevich integral of bd-tangles . . . . .	13
1.5.1 Complex iterated integrals . . . . .	13
1.5.2 Construction of $Z^{\text{bd}}$ . . . . .	14
1.5.3 Invariance of $Z^{\text{bd}}$ . . . . .	16
1.5.4 The normalization . . . . .	18
<b>2 An elliptic Kontsevich integral</b>	<b>21</b>
2.1 The Lie algebra $\mathfrak{t}_{1,n}$ . . . . .	21
2.2 A universal elliptic KZB connection . . . . .	22
2.3 Elliptic braids and tangles . . . . .	24
2.4 Elliptic Jacobi diagrams . . . . .	25
2.5 Construction of $Z_{\tau}^{\text{bd}}$ . . . . .	30
2.6 Invariance of $Z_{\tau}^{\text{bd}}$ . . . . .	34
2.7 Relation between $Z_{\tau}^{\text{bd}}$ and $Z^{\text{bd}}$ . . . . .	34
2.8 The normalization . . . . .	35
<b>3 The combinatorial Kontsevich invariant</b>	<b>37</b>
3.1 Framed tangles . . . . .	37
3.2 Ribbon categories . . . . .	38
3.3 The non-strict case . . . . .	41
3.4 Infinitesimal braidings . . . . .	42
3.5 Drinfeld associators . . . . .	43
3.6 The KZ associator . . . . .	44



3.7	Regularizing factors and relation between $Z_{KZ}$ and $Z$ . . . . .	45
<b>4</b>	<b>Beak diagrams and RST moves</b>	<b>47</b>
4.1	Surface tangles . . . . .	47
4.2	Beak diagrams . . . . .	47
4.3	Fatgraphs and their markings . . . . .	50
4.4	RST Moves . . . . .	55
4.4.1	The main theorem . . . . .	55
4.4.2	A combed version of the $S_2$ -moves . . . . .	60
4.4.3	Doubling a beak strand . . . . .	62
4.5	Proof of Theorem 4.4.3 . . . . .	62
<b>5</b>	<b>A universal property for surface tangles</b>	<b>71</b>
5.1	Ribbon markings . . . . .	71
5.2	Genus $g$ structure on a ribbon category . . . . .	75
5.3	Genus $g$ structures as compatible families of ribbon markings . . . . .	78
5.4	The non-strict case . . . . .	81
5.5	The elliptic case . . . . .	83
<b>6</b>	<b>The combinatorial invariants <math>Z_{e(\tau)}</math>.</b>	<b>85</b>
6.1	Infinitesimal elliptic structures and formal integration . . . . .	85
6.2	The elliptic associators $e(\Phi) = (X_\Phi, Y_\Phi)$ . . . . .	88
6.3	The elliptic associators $e(\tau) = (X_\tau, Y_\tau)$ . . . . .	89
6.4	The variation of $Z_{e(\tau)}$ with respect to the elliptic parameter $\tau$ . . . . .	91
6.4.1	The variation of $e(\tau)$ . . . . .	91
6.4.2	An action of $\mathfrak{sl}_2$ by derivations of $\mathbf{A}_1(2)$ . . . . .	92
6.4.3	Implementation of the derivations $\delta_{2k}$ in $\mathbf{A}_1(2)$ . . . . .	94
6.4.4	The Lie algebra $\mathfrak{sl}_2 \ltimes \mathfrak{L}$ . . . . .	98
6.4.5	Variation of $Z_{e(\tau)}$ with respect to $\tau$ . . . . .	98

# Introduction

L'objet principal de cette thèse est une étude combinatoire des noeuds – et, plus généralement, de la catégorie des enchevêtrements – plongés dans une surface fermée de genre  $g$  épaissie  $S_g \times I$ . Dans le cas du genre  $g = 1$ , les résultats obtenus nous permettent en particulier de construire une version elliptique de l'intégrale de Kontsevich, à partir de la notion d'associateur elliptique introduite dans [Enr].

Mais avant d'en détailler davantage le contenu, rappelons tout d'abord en quelques lignes le contexte général dans lequel s'inscrit ce travail.

Pour distinguer les noeuds, les outils classiques de la topologie algébrique s'avèrent assez limités. Dans les années 1920, Reidemeister montre que l'étude topologique des noeuds peut alternativement se réduire à un problème de nature combinatoire, en identifiant les classes d'isotopies de noeuds à des diagrammes planaires considérés modulo trois types de mouvements locaux. Une soixantaine d'années plus tard, la découverte du polynôme de Jones relie ce modèle combinatoire à de nouvelles perspectives algébriques, qui vont conduire au "boom" des invariants quantiques.

Parallèlement à ces développements, Goussarov et Vassiliev définissent indépendamment à la fin des années 1980 la notion d'invariant de type fini, à partir de transformations chirurgicales associées aux noeuds singuliers. Tous les invariants quantiques se trouvent englobés dans cet espace d'invariants, qui est par ailleurs filtré ; un invariant de type  $d$  pouvant, en un certain sens, être compris comme un invariant dont la "dérivée d'ordre  $d + 1$ " s'annule [BN95]. La théorie des invariants de type fini conduit à s'intéresser aux diagrammes de Jacobi, qui sont des objets purement combinatoires dont la structure uni-trivalente illustre un lien profond avec les algèbres de Lie.

En 1993, Kontsevich [Kon93] construit un invariant de noeuds  $Z$  à valeurs dans l'espace des diagrammes de Jacobi qui factorise tous les invariants de type fini, et donc en particulier les invariants quantiques. L'invariant  $Z$  est dérivé d'une version universelle de l'équation de Knizhnik–Zamolodchikov (KZ), et prend originalement la forme d'intégrales itérées difficiles à calculer explicitement.

L'invariant universel de Kontsevich, aussi bien que l'ensemble des invariants quantiques, trouvent sans doute leur expression la plus aboutie dans le langage des *catégories tensorielles*. Considérons l'espace ambiant tridimensionnel comme le produit  $\mathbb{R}^2 \times \mathbb{R}$  du plan par une droite que l'on pense comme une coordonnée temporelle. Dans un intervalle de temps  $I$ , une "tranche" générique de noeud est un *enchevêtrement* formé de brins reliant entre eux des points-bases de  $\mathbb{R}^2 \times \partial I$ . Les enchevêtrements parallélisés (*framed tangles*) sont munis d'une structure de catégorie tensorielle stricte notée  $\mathbf{T}$  dont les objets sont les suites finies de signes  $\{+, -\}$ ,

la composition est définie par empilement, et le produit tensoriel est obtenu par adjonction côte à côte. La catégorie  $\tilde{\mathbf{T}}$  possède en outre une dualité et un twist qui lui confèrent une structure de *catégorie enrubannée*. Le théorème de cohérence de Reshetikhin–Turaev–Shum [Tur10, Shu94], que l’on abrégera ici en "théorème RTS", affirme que  $\tilde{\mathbf{T}}$  peut en fait être vue comme la catégorie enrubannée libre engendrée par un seul objet. Plus précisément, pour toute catégorie enrubannée stricte  $\mathcal{C}$  munie d’un objet  $V$ , il existe un unique foncteur  $F : \tilde{\mathbf{T}} \rightarrow \mathcal{C}$  préservant la structure enrubannée et tel que  $F(+)=V$ . Ce point de vue peut être considéré comme un ultime raffinement du théorème de Reidemeister : à partir d’objets de nature topologique (les enchevêtrements), on passe à une version combinatoire (leurs diagrammes), puis enfin à une caractérisation purement algébrique.

Des catégories enrubannées non triviales peuvent être construites explicitement à partir des groupes quantiques, conduisant ainsi à retrouver le polynôme de Jones, et plus généralement tous les invariants quantiques.

D’un autre côté, l’intégrale de Kontsevich possède également une expression combinatoire [BN97, LM96] qui met en jeu la structure de catégorie enrubannée (non stricte) des enchevêtrements parallélisés et parenthésés, notée  $\mathbf{q}\tilde{\mathbf{T}}$ . Cette construction généralise le traitement algébrique de la monodromie de l’équation KZ par Drinfeld, dont l’ingrédient principal est la notion d’associateur, et peut être formulée de la façon suivante: on observe que la donnée d’un associateur de Drinfeld  $\Phi$  permet de munir la catégorie  $\mathbf{A}$  des diagrammes de Jacobi d’une structure enrubannée [Car93, KT98]. L’existence de l’intégrale de Kontsevich combinatoire  $Z_\Phi : \mathbf{q}\tilde{\mathbf{T}} \rightarrow \mathbf{A}$  comme foncteur enrubanné devient alors une conséquence du théorème RTS.

L’intégrale de Kontsevich s’étend assez naturellement aux graphes trivalents [MO97, Lie08, Dan10, BND, CL07]. Par ailleurs, la notion d’invariant de type fini se généralise aux objets noués dans une variété de dimension trois quelconque. Des invariants universels ont ainsi été définis, entre autres, pour les entrelacs dans une surface à bord épaissie [AMR98, Lie04] ainsi que pour les tresses dans une surface fermée [GMP04]. Contrairement à l’intégrale de Kontsevich classique, on sait en revanche [BF04] que de tels invariants ne peuvent pas être construits d’une façon fonctorielle pour la composition des enchevêtrements.

L’invariant elliptique auquel on s’intéresse ici est de nature différente. Il possède par construction la propriété de fonctorialité, puisqu’il étend une représentation de monodromie des tresses elliptiques. On s’attend à ce que cet invariant soit universel pour une filtration moins fine que celle de Goussarov–Vassiliev (pouvant être définie à partir du langage des claspers [Hab00]), et qui généralise en un certain sens la filtration des tresses par les puissances de l’idéal d’augmentation.

Les connexions de Knizhnik–Zamolodchikov–Bernard (KZB) sont des généralisations de la connexion KZ à des surfaces de Riemann de genre supérieur. Ces connexions sont définies sur l’espace de modules de  $n$  points sur une surface de genre  $g$ , qui contient donc à la fois la position des points marqués et la structure complexe de la surface elle-même.

En 2007, Calaque, Enriquez et Etingof [CEE10] ont introduit une version universelle de la connexion KZB dans le cas elliptique ( $g=1$ ). En fixant un paramètre elliptique  $\tau$  dans le demi-plan de Poincaré, celle-ci se restreint à une connexion plate

sur l'espace de configuration  $\mathbb{E}_n$  de  $n$  points sur la courbe elliptique  $\mathbb{E} := \mathbb{C}/(\mathbb{Z} + \tau\mathbb{Z})$ , à valeurs dans une algèbre de Lie graduée  $\mathfrak{t}_{1,n}$ . Son transport parallèle donne lieu à une représentation  $T_\tau$  du groupe fondamental de  $\mathbb{E}_n$  basé en un point  $p$  fixé, qui s'identifie au groupe  $PB_{1,n}$  des tresses pures à  $n$  brins dans le tore :

$$T_\tau : PB_{1,n} \cong \pi_1(\mathbb{E}_n, p) \rightarrow \exp(\widehat{\mathfrak{t}}_{1,n}).$$

Du côté algébrique, la notion d'*associateur elliptique* introduite dans [Enr] permet de construire combinatoirement un invariant de tresses elliptiques parenthésées à valeurs dans  $\exp(\widehat{\mathfrak{t}}_{1,n})$ . Un associateur elliptique est un triplet  $e = (\Phi, X, Y)$  où  $\Phi$  est un associateur de Drinfeld et  $X, Y$  sont des séries à deux variables non commutatives satisfaisant certains axiomes reliés à la structure des tresses elliptiques parallélisées. On peut définir, pour tout paramètre  $\tau$ , un associateur elliptique  $e(\tau) = (\Phi_{KZ}, X_\tau, Y_\tau)$  au-dessus de l'associateur KZ en comparant deux solutions particulières de l'équation KZB réduite.

### Les résultats

Comme dans le cas de l'intégrale de Kontsevich usuelle, on montre l'extension suivante.

**Théorème 1.** *Il est possible d'étendre la représentation  $T_\tau$  des tresses elliptiques à un invariant d'enchevêtrements  $Z_\tau$ , grâce à une formule d'intégrales itérées.*

Cet invariant  $Z_\tau$  prend ses valeurs dans une catégorie  $\mathbf{A}_1$  de diagrammes de Jacobi dits "elliptiques", comportant des sommets externes linéairement ordonnés et coloriés par des éléments du premier groupe d'homologie du tore  $H_1 := H_1(\mathbb{E}; \mathbb{C})$  (voir Figure 1). Outre la relation STU, ces diagrammes sont considérés modulo une relation "STU-like", qui contrôle la façon dont deux sommets externes commutent, ainsi qu'une relation non locale qui reflète le fait que la surface  $\mathbb{E}$  est fermée.

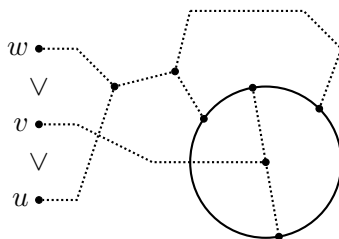

Figure 1: Un diagramme de Jacobi elliptique pour  $u, v, w \in H_1$ .

La preuve de l'invariance de l'intégrale  $Z_\tau(\gamma)$  par isotopie de  $\gamma$  est essentiellement la même que dans le cas usuel, malgré quelques points de vérification supplémentaires. L'invariant elliptique  $Z_\tau$  contient l'intégrale de Kontsevich  $Z$  au sens suivant: si  $\gamma$  est un entrelacs elliptique contenu dans une boule, alors  $Z_\tau(\gamma)$  coïncide avec  $Z(\gamma)$ .

On s'intéresse ensuite à une version combinatoire de l'invariant elliptique. D'après [Enr], un associateur elliptique  $e = (\Phi, X, Y)$  fournit déjà un invariant combinatoire des tresses elliptiques parenthésées. Celui-ci peut être naïvement étendu aux

enchevêtrements à partir de l'invariant combinatoire  $Z_\Phi$ , en observant que tout enchevêtrement elliptique peut être obtenu comme une composition d'enchevêtrements dans le disque et de tresses elliptiques. En notant  $\tilde{\mathbf{T}}_1$  (respectivement  $\mathbf{q}\tilde{\mathbf{T}}_1$ ) la catégorie des enchevêtrements elliptiques parallélisés (parenthésés), on a le théorème suivant.

**Théorème 2.** *Pour tout associateur elliptique  $e = (\Phi, X, Y)$ , il existe un unique foncteur  $Z_e : \mathbf{q}\tilde{\mathbf{T}}_1 \rightarrow \mathbf{A}_1$  qui généralise l'invariant des tresses elliptiques construit à partir de  $e$ , et qui coïncide avec l'intégrale de Kontsevich  $Z_\Phi$  sur  $\mathbf{q}\tilde{\mathbf{T}}$ .*

En particulier, on peut associer à chaque paramètre elliptique  $\tau$  un invariant combinatoire  $Z_{e(\tau)} : \mathbf{q}\tilde{\mathbf{T}}_1 \rightarrow \mathbf{A}_1$  construit à partir de l'associateur elliptique  $e(\tau)$ . En se basant sur un résultat de [Enr], on montre que la dépendance en  $\tau$  de l'invariant  $Z_{e(\tau)}$  appliqué aux entrelacs est gouvernée par l'action de  $SL_2(\mathbb{C})$  sur  $H_1 \cong \mathbb{C}^2$ . Dans le cas d'un enchevêtrement général, cette action se conjugue à une opération intérieure réalisée par certains diagrammes elliptiques non horizontaux.

Pour démontrer le théorème 2 en s'assurant que l'invariant  $Z_e$  ainsi construit est bien défini, il nous faut disposer d'une description combinatoire, par générateurs et relations, de la catégorie  $\tilde{\mathbf{T}}_1$ . On cherche à formuler cette description dans le langage des catégories enrubannées.

La deuxième partie de la thèse atteint cet objectif dans le contexte général d'une surface fermée  $S_g$  de genre  $g \geq 0$  quelconque. On caractérise la catégorie  $\tilde{\mathbf{T}}_g$  des enchevêtrements parallélisés dans  $S_g \times I$  par une propriété universelle, à la manière du théorème RTS.

La première étape consiste en un théorème de type Reidemeister, qui nous permet de voir un enchevêtrement de  $\tilde{\mathbf{T}}_g$  comme un diagramme planaire modulo une relation d'équivalence engendrée par un nombre fini de mouvements. On introduit à cet effet une catégorie de diagrammes plans appelés "diagrammes à becs", dont un exemple se trouve en Figure 2.

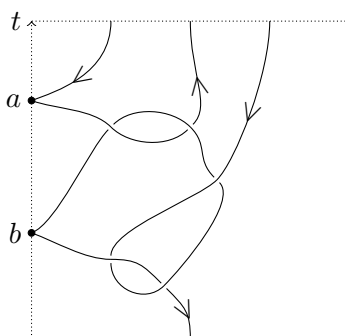

Figure 2: Un diagramme à becs pour  $a, b \in \pi_1$ .

Les becs du diagramme sont coloriés par une famille de générateurs du groupe fondamental  $\pi_1$  de la surface privée d'un disque (notée  $S_{g,1}$ ), qui indiquent le fait que le brin effectue une boucle dans la surface suivant la classe d'homotopie correspondante. Il apparaît que certaines familles de générateurs bien choisies permettent de traduire plus simplement que d'autres l'isotopie des noeuds par des mouvements

d'équivalence simples entre les diagrammes à becs correspondants. Ces "bonnes familles" sont combinatoirement codées par des graphes de genre  $g$  épaissis appelés *fatgraphs*. On peut en effet associer des générateurs de  $\pi_1$  à tout fatgraph plongé dans la surface  $S_{g,1}$  en considérant les arcs "duaux" aux arêtes du graphe. Pour tout fatgraph  $\Gamma$ , on définit donc une catégorie  $\mathbf{D}(\Gamma)$  de diagrammes à becs coloriés par les arêtes de  $\Gamma$ , ainsi qu'une relation d'équivalence  $\tilde{RST}(\Gamma)$  engendrée par:

- les mouvements de Reidemeister  $\tilde{R}$ ,
- d'autres mouvements locaux  $S$ , qui contrôlent en particulier la façon dont deux becs peuvent se croiser,
- des mouvements  $T$  qui reflètent une présentation du groupe fondamental de la surface  $S_g$ .

On démontre ensuite le théorème suivant.

**Théorème 3.** *Pour tout fatgraph  $\Gamma$  de genre  $g$ , les catégories  $\tilde{\mathbf{T}}_g$  et  $\mathbf{D}(\Gamma)/\tilde{RST}(\Gamma)$  sont isomorphes.*

L'isomorphisme en question dépend d'un plongement du fatgraph dans la surface.

Dans une deuxième partie, on définit la notion de *structure de genre  $g$*  sur une catégorie enrubannée  $\mathcal{C}$ . Il s'agit d'un foncteur  $\mathcal{C} \rightarrow \mathcal{C}_g$  vérifiant certains axiomes qui sont inspirés d'une version raffinée "en tranches" du théorème 3, et qui dépendent en particulier du choix d'un fatgraph  $\Gamma$ . Le choix d'un plongement  $f$  de  $\Gamma$  dans la surface  $S_g$  détermine une structure de genre  $g$  relative au foncteur  $\tilde{\mathbf{T}} \rightarrow \tilde{\mathbf{T}}_g$ . On établit le théorème suivant.

**Théorème 4.** *Soit  $\mathcal{C}$  une catégorie enrubannée stricte munie d'un objet  $V$ . Pour toute structure de genre  $g$  relative à  $\mathcal{C} \rightarrow \mathcal{C}_g$ , il existe un unique foncteur  $F_f : \tilde{\mathbf{T}}_g \rightarrow \mathcal{C}_g$  respectant la structure et tel que le diagramme suivant commute (où  $F$  est le foncteur du théorème RTS):*

$$\begin{array}{ccc} \tilde{\mathbf{T}} & \xrightarrow{F} & \mathcal{C} \\ \downarrow & & \downarrow \\ \tilde{\mathbf{T}}_g & \xrightarrow{F_f} & \mathcal{C}_g \end{array}$$

On montre à partir du Theorème 4 que les notions de structures de genre  $g$  issues de différents choix de fatgraphs sont équivalentes.

Enfin, il est à noter que les axiomes définissant une structure de genre  $g$  ne font pas intervenir la dualité de  $\mathcal{C}$ . C'est à partir de cette remarque que l'on déduit aisément, dans le cas du genre  $g = 1$ , que les associateurs elliptiques munissent  $\mathbf{A}_1$  d'une structure de genre 1, ce qui conduit au théorème 2.

## Plan de la thèse

On rappelle dans le Chapitre 1 la construction sous forme intégrale de l'invariant  $Z$  de Kontsevich ; c'est un modèle que l'on suit dans le Chapitre 2, en l'adaptant au cas elliptique (théorème 1). Le Chapitre 3 est un rappel de la version combinatoire de  $Z$  : on y présente les deux ingrédients principaux que sont la notion d'associateur de Drinfeld et la description algébrique des enchevêtrements formalisée par le théorème RTS. Les deux chapitres suivants s'attachent à généraliser cette description en genre quelconque, et aboutissent ainsi aux théorèmes 3 et 4. Enfin, on croise ces résultats avec la notion d'associateur elliptique dans le Chapitre 6 pour obtenir une version combinatoire de l'invariant elliptique (théorème 2).

# Chapter 1

## The Kontsevich integral

In this chapter, we recall the analytic construction of the Kontsevich integral as defined in [BN95] from Kontsevich's original paper [Kon93]. Our exposition is inspired from [BN95, CDM12, Les99].

The chapter is organized as follows. Chen's iterated integrals (Section 1.1) provide an explicit formula for the braid invariant derived from the universal KZ connection (Section 1.2). In Section 1.5, this formula is extended to an invariant of *bd-tangles* (defined in Section 1.3) with values in a category of Jacobi diagrams (defined in Section 1.4). A genuine tangle invariant is finally obtained after a suitable renormalization (Section 1.5.4).

### 1.1 Formal connections

We first review some general facts about formal connections and the expression of their parallel transport in terms of iterated integrals.

#### 1.1.1 Chen's iterated integrals

Let  $A$  be a completed graded algebra. By this, we mean the product  $A = \prod_{k \geq 0} A_k$  of *finite*-dimensional complex vector spaces, equipped with the product topology (for which convergence in  $A$  means convergence in each component  $A_k$ ), and endowed with an algebra structure such that  $A_k A_l \subseteq A_{k+l}$  for any  $k, l \geq 0$ . For  $p \geq 0$ , we denote by  $A_{\geq p}$  the ideal  $\prod_{k \geq p} A_k$ . The applications  $\exp : A_{\geq 1} \rightarrow 1 + A_{\geq 1}$  and  $\log : 1 + A_{\geq 1} \rightarrow A_{\geq 1}$  are defined by their usual power series expansions.

Let  $a : I \rightarrow A$  be a piecewise continuous function whose image lies in  $A_{\geq 1}$ . Following the terminology of [Che61], we consider the *formal differential equation*

$$\frac{d}{dt} f(t) = a(t)f(t), \quad f(0) = 1. \quad (1.1.1)$$

In his work, Chen observes that the (continuous) solution of (1.1.1) can be expressed in terms of iterated integrals, as a formal analogue of Picard approximation method.

**Theorem 1.1.1.** [Che61] *Equation (1.1.1) has a unique continuous solution  $f(t)$  which can be written in the form*

$$f(t) = \sum_{m=0}^{\infty} Q_m(t) \quad \text{for all } t \in I, \quad (1.1.2)$$



where the  $Q_m(t)$  are defined inductively by  $Q_0(t) = 1$  and

$$Q_{m+1}(t) = \int_0^t a(s)Q_m(s)ds.$$

Note that the above sum converges in  $A$ , since the fact that  $a(t) \in A_{\geq 1}$  implies that  $Q_m(t) \in A_{\geq m}$ . The iterated integrals formula (1.1.2) may be thought of as a generalization of  $\exp(\int a)$  to the non-commutative case. Following this idea, we have:

**Theorem 1.1.2.** *Let  $H \subset A$  be a Lie subalgebra with respect to the commutator bracket, such that  $H = \prod_{k \geq 1} (H \cap A_k)$ . If  $a(t) \in H$  for all  $t \in I$ , then  $\log f(t) \in H$  for all  $t \in I$ .*

This result is well known. A proof can be found in [Che61, Theorem 2.1] in the case where  $a(t) \in H \cap A_1$ . We reprove it in the general case, from its following generalization in the language of Hopf algebras:

**Proposition 1.1.3.** *If  $A$  has a Hopf algebra structure such that  $a(t)$  is primitive for all  $t \in I$ , then  $f(t)$  is group-like for all  $t \in I$ .*

*Proof.* On the one hand,

$$\frac{d}{dt}(\Delta f(t)) = \Delta\left(\frac{d}{dt}f(t)\right) = \Delta(a(t)f(t)) = \Delta a(t)\Delta f(t).$$

On the other hand,

$$\begin{aligned} \frac{d}{dt}(f(t) \otimes f(t)) &= \frac{d}{dt}f(t) \otimes f(t) + f(t) \otimes \frac{d}{dt}f(t) \\ &= a(t)f(t) \otimes f(t) + f(t) \otimes a(t)f(t) \\ &= (a(t) \otimes 1 + 1 \otimes a(t))(f(t) \otimes f(t)) \\ &= \Delta a(t)(f(t) \otimes f(t)). \end{aligned}$$

Since  $\Delta f(t)$  and  $f(t) \otimes f(t)$  are solutions of the same differential equation and coincide at  $t = 0$ , they coincide for all  $t \in I$ .  $\square$

Theorem 1.1.2 then follows by considering the Hopf structure of the enveloping algebra  $U(H)$ . If  $a(t) \in H$ , the solution  $f_U(t)$  of Equation (1.1.1) in  $U(H)$  is group-like. Recall that the logarithm of a group-like element  $x$  is primitive (since  $\Delta \log(x) = \log(\Delta x) = \log(x \otimes x) = \log((x \otimes 1)(1 \otimes x)) = \log(x) \otimes 1 + 1 \otimes \log(x)$  as  $x \otimes 1$  and  $1 \otimes x$  commute), and that the Lie algebra of primitive elements of  $U(H)$  coincides with  $H$  [Bou72]. Hence  $\log f_U(t) \in H$ , and through the morphism  $U(H) \rightarrow A$  induced by  $H \subset A$ , we get  $\log f(t) \in H$ .

### 1.1.2 Formal connections and parallel transport

Let  $M$  be a connected complex manifold. In the following, all the paths in  $M$  and all the path homotopies are assumed to be piecewise smooth. We denote by  $\Pi_1(M)$  the fundamental groupoid of  $M$ . In our convention, the source and target of a path  $\alpha$  are  $\alpha(0)$  and  $\alpha(1)$  respectively. It follows that the composition in  $\Pi_1(M)$  is the

opposite of the usual product of paths: we have  $\alpha_2\alpha_1 := \alpha_1 * \alpha_2$ , where  $*$  denotes the usual concatenation of paths.

We consider a 1-form  $\Omega$  on  $M$  with values in  $A_{\geq 1}$ , which we think of as a "formal connection" on the trivial  $A$ -bundle over  $M$ . (If  $A$  is the algebra of power series in non-commutative variables  $\mathbb{C}\langle\langle x_1, \dots, x_n \rangle\rangle$ , we recover Chen's notion of "formal power series connection" [Che77], see also [Lin97].)

**Definition 1.1.4.** In this setting, the *parallel transport*  $T_\Omega(\alpha)$  of  $\Omega$  along a path  $\alpha : I \rightarrow M$  is defined by  $T_\Omega(\alpha) := f_\alpha(1)$  where  $f_\alpha : I \rightarrow A$  is the continuous solution of the formal differential equation

$$\frac{d}{dt}f_\alpha(t) = \Omega(\alpha'(t))f_\alpha(t), \quad f_\alpha(0) = 1. \quad (1.1.3)$$

From Theorem 1.1.1,  $T_\Omega(\alpha)$  can be expressed in terms of iterated integrals. Moreover,  $T_\Omega$  enjoys the following properties.

**Lemma 1.1.5.** (i) *The parallel transport  $T_\Omega(\alpha)$  does not depend on the parametrization of the path  $\alpha$ .*

(ii) *If  $\alpha_1$  and  $\alpha_2$  are two composable paths, then  $T_\Omega(\alpha_2\alpha_1) = T_\Omega(\alpha_2)T_\Omega(\alpha_1)$  (where (i) ensures that the left-hand term is well-defined).*

*Proof.* (i) If  $u : I \rightarrow I$  is a positive diffeomorphism,  $f_{\alpha \circ u}$  and  $f_\alpha \circ u$  satisfy the same differential equation, hence  $T_\Omega(\alpha \circ u) = T_\Omega(\alpha)$ . (ii) We have  $T_\Omega(\alpha_2\alpha_1) = \tilde{f}_{\alpha_2}(1)$ , where  $\tilde{f}_{\alpha_2}$  is the solution of the differential equation (1.1.3) with  $\tilde{f}_{\alpha_2}(0) = T_\Omega(\alpha_1)$ . Two solutions of (1.1.3) with distinct values at  $t = 0$  differ by a constant term on the right. Hence  $\tilde{f}_{\alpha_2}(t) = f_{\alpha_2}(t)T_\Omega(\alpha_1)$ , and  $T_\Omega(\alpha_2\alpha_1) = T_\Omega(\alpha_2)T_\Omega(\alpha_1)$ .  $\square$

The homotopy invariance of  $T_\Omega$  is equivalent to an "integrability condition" for the formal connection  $\Omega$ , as stated in Theorem 1.1.6 below. This standard fact of differential geometry (see [KN96]) still holds in our formal context; a direct proof can be found in [Oht02, Proposition 5.2].

**Theorem 1.1.6.** *The parallel transport  $T_\Omega$  is invariant under path homotopy if and only if  $\Omega$  satisfies  $d\Omega - \Omega \wedge \Omega = 0$ .*

In this case, the formal connection  $\Omega$  is said to be *flat*. It follows from Theorem 1.1.6 and Lemma 1.1.5 that the parallel transport of a flat connection  $\Omega$  valued in  $A_{\geq 1}$  induces a functor

$$T_\Omega : \Pi_1(M) \rightarrow 1 + A_{\geq 1},$$

where the group  $1 + A_{\geq 1}$  is seen as a category with a single object.

## 1.2 The KZ connection

The Knizhnik–Zamolodchikov (KZ) connection appears in the Wess–Zumino–Witten model of conformal field theory [KZ84]. We recall here its formal version. As a flat connection on the configuration space of  $n$  points in the plane, it gives rise to a representation of its fundamental groupoid, which we call here the braid groupoid.

**Definition 1.2.1.** We denote by  $\mathbb{C}_n$  the configuration space of  $n$  ordered distinct points on  $\mathbb{C}$

$$\mathbb{C}_n := \{(z_1, \dots, z_n) \in \mathbb{C}^n \mid i \neq j \Rightarrow z_i \neq z_j\},$$

and we define the *braid groupoid*  $\mathcal{B}_n$  as the fundamental groupoid of  $\mathbb{C}_n$ .

**Definition 1.2.2.** Let  $\mathfrak{t}_n$  be the graded Lie algebra generated in degree one by the variables  $t_{ij}$  for  $1 \leq i \neq j \leq n$ , subject to the relations  $t_{ij} = t_{ji}$  and Kohno's *infinitesimal pure braid relations* [Koh87]:

$$[t_{ij}, t_{ik} + t_{kj}] = 0, \quad [t_{ij}, t_{kl}] = 0 \quad \text{for } i, j, k, l \text{ all distincts.} \quad (1.2.1)$$

The formal KZ connection  $\Omega_{KZ}$  is given by the following 1-form on  $\mathbb{C}_n$  with values in the graded completion<sup>1</sup> of the enveloping algebra  $\widehat{U}(\mathfrak{t}_n)$ :

$$\Omega_{KZ} = \frac{1}{2\pi i} \sum_{1 \leq i < j \leq n} d \log(z_i - z_j) t_{ij}. \quad (1.2.2)$$

The relations (1.2.1) imply:

**Lemma 1.2.3.** (See for example [Kas95, Proposition XIX.2.1]) *The connection  $\Omega_{KZ}$  is flat.*

The KZ connection thus gives rise to a parallel transport functor

$$T_{KZ} : \mathcal{B}_n = \Pi_1(\mathbb{C}_n) \rightarrow \exp(\widehat{\mathfrak{t}_n}) \subset \widehat{U}(\mathfrak{t}_n).$$

## 1.3 Tangles and bd-tangles

In this section, we introduce the notion of bd-tangle as a natural generalization of a braid. Bd-tangles are implicitly considered in [Kon93] and are very similar to Morse tangles [MS03] (the two corresponding categories are in fact isomorphic). We show that the equivalence of bd-tangles is generated by some kinds of elementary moves (Proposition 1.3.8), and relate bd-tangles to usual tangles (Proposition 1.3.11).

### 1.3.1 Geometric braids

Let us consider a path  $\beta = (\beta_1, \dots, \beta_n) : I \rightarrow \mathbb{C}_n$  representing an element of the  $n$ -th braid groupoid  $\mathcal{B}_n$ . From a physical point of view,  $\beta$  is seen as the movie of  $n$  particles (labeled from 1 to  $n$ ) evolving on  $\mathbb{C}$ , from the time  $t = 0$  to  $t = 1$ . Such a movie can be recorded in the cylinder  $\mathbb{C} \times I$ , where the vertical coordinate  $t \in I$  corresponds to the time evolution. More precisely, for all  $i \in \{1, \dots, n\}$ , the path of the  $i$ -th particle parametrizes an arc  $(\beta_i(t), t)_{t \in I}$  in  $\mathbb{C} \times I$  that is called the  $i$ -th *strand* of  $\beta$ . The whole recording is then the (ordered) union of the strands. Slightly abusing notation, it shall also be denoted by  $\beta \subset \mathbb{C} \times I$  and referred to as the *geometric braid* associated with the path  $\beta$ .

Two paths in  $\mathbb{C}_n$  are homotopic if and only if their corresponding geometric braids are related by an isotopy<sup>2</sup> of  $\mathbb{C} \times I$  that fixes the boundary pointwise and

<sup>1</sup>Here and in the following, for a graded vector space  $V$ , we denote by  $\widehat{V}$  its degree completion.

<sup>2</sup>Here and in the following, we may implicitly turn isotopies of embeddings into ambient isotopy, making use of the isotopy extension theorem ([Hir76], Chapter 8).

$$\begin{array}{c}
t = 1 \uparrow \\
\left| \right. \\
t = 0
\end{array}
\quad
\boxed{\beta_2} \cdot \boxed{\beta_1} = \boxed{\begin{array}{c} \beta_2 \\ \beta_1 \end{array}}$$

Figure 1.1: The composition of geometric braids and (bd)-tangles.

preserves the horizontal planes  $\mathbb{C} \times \{t\}$ . (In fact the last "horizontality" requirement is not necessary [Art47].) The fundamental groupoid  $\mathcal{B}_n$  can thus be alternatively seen as the category of geometric braids modulo isotopy, where the composition  $\beta_2\beta_1$  is obtained by gluing  $\beta_2$  above  $\beta_1$  and rescaling the result in  $\mathbb{C} \times I$ , as depicted in Figure 1.1.

### 1.3.2 Bd-tangles

The notion of bd-tangle (where "b" and "d" stand for "birth" and "death") arise from a natural generalization of the above physical picture of a braid. Let us consider a finite number of particles evolving on the plane, no longer ordered, and labeled with a sign  $+$  or  $-$ . At some time, two dual particles  $+$  and  $-$  may collide and annihilate, or conversely, may appear at the same point and split. A bd-tangle corresponds to the recording of such a movie.

**Definition 1.3.1.** A *bd-tangle*  $\gamma \subset \mathbb{C} \times I$  is a properly embedded compact one-manifold that satisfies the following conditions:

1.  $\gamma$  is piecewise smooth in the sense that it is decomposed into a finite number of smooth oriented arcs joining boundary or inner vertices, such that two adjacent arcs are not tangent to each other,
2. the arcs of  $\gamma$  are transverse to the horizontal planes  $\mathbb{C} \times \{t\}$ ,  $t \in I$ .

As in the case of braids, the arcs of  $\gamma$  shall be referred to as the *strands* of  $\gamma$ . It follows from the definition that the set of local extrema of the height function  $\gamma \rightarrow I$  is included in the set of vertices of  $\gamma$ . The inner vertices of  $\gamma$  corresponding to such local extrema are the *bd-vertices* of  $\gamma$ . A bd-vertex is a *b-vertex* if it is a local minimum and a *d-vertex* if it is a local maximum of the height function. Two bd-tangles are *bd-equivalent* if there is a piecewise-smooth isotopy of  $\mathbb{C} \times I$  that takes one to the other within the class of bd-tangles, keeping the boundary vertices fixed.

The bd-tangles form a category  $\mathcal{T}^{\text{bd}}$  in the usual way: the objects are the finite sets of distinct signed points of  $\mathbb{C}$ , and the morphisms are bd-equivalence classes of bd-tangles. The source and target of a bd-tangle  $\gamma$  are its set of *bottom endpoints*  $\gamma \cap (\mathbb{C} \times \{0\})$  and *top endpoints*  $\gamma \cap (\mathbb{C} \times \{1\})$  respectively, where an endpoint is assigned a  $+$  if its neighboring strand is oriented upwards, and a  $-$  else. As in the case of geometric braids, the composition  $\gamma_2\gamma_1$  is obtained by gluing  $\gamma_2$  above  $\gamma_1$ .

There is a functor  $\mathcal{B}_n \rightarrow \mathcal{T}^{\text{bd}}$ , which consists in seeing a geometric braid as a bd-tangle with no bd-vertex by orienting its strands upwards and forgetting their order.

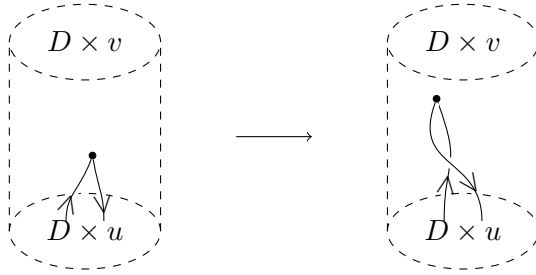

Figure 1.2: A move of type d.

### 1.3.3 Moves of bd-tangles

In this subsection, we show that bd-equivalence is generated by two kinds of moves of bd-tangles: "horizontal deformations" and "bd-moves" (Proposition 1.3.8). This statement appears (at least implicitly) in [BN95, CDM12] in the context of Morse tangles.

**Definition 1.3.2.** Let  $\gamma$  be a bd-tangle. Take  $u, v$  such that  $0 < u < v < 1$ , and  $D \subset \mathbb{C}$  a disc. If  $D \times \{u, v\}$  contains no vertex of  $\gamma$  and  $\partial D \times [u, v]$  does not intersect  $\gamma$ , then the restriction  $\gamma \cap (D \times [u, v])$  is denoted by  $\gamma|_{D, u, v}$  and is called a *bd-subtangle* of  $\gamma$ . A *strand* of  $\gamma|_{D, u, v}$  is the intersection of a strand of  $\gamma$  with the cylinder  $D \times [u, v]$ .

Let us introduce three types of elementary bd-subtangles.

**Definition 1.3.3.** A bd-subtangle  $\gamma|_{D, u, v}$  is of *type i* if  $\gamma|_{D, u, v}$  consists of one strand only. A bd-subtangle  $\gamma|_{D, u, v}$  is of *type b* (respectively, of *type d*) if  $\gamma|_{D, u, v}$  consists of two strands meeting at a b-vertex (respectively, d-vertex).

Each type of bd-subtangle leads to an elementary move of bd-tangles:

**Definition 1.3.4.** Two bd-tangles  $\gamma$  and  $\gamma'$  are related by an *x-move* (here replace  $x$  with i, b and d) if there exists a disc  $D \subset \mathbb{C}$  and two heights  $0 < u < v < 1$  such that:

- $\gamma$  and  $\gamma'$  are identical outside of  $D \times [u, v]$ ,
- $\gamma|_{D, u, v}$  and  $\gamma'|_{D, u, v}$  are both bd-subtangles of type  $x$ .

See Figure 1.2 for an example of d-move. A *bd-move* is a b-move or a d-move.

**Lemma 1.3.5.** *Two bd-tangles  $\gamma, \gamma'$  are bd-equivalent if and only if they are related by a finite sequence of bd-moves and of i-moves.*

*Proof.* We first show that any i-move and bd-move can be realized by a bd-equivalence. The i-move case is obvious. Let us deal with the case of a d-move (the b-move case being obtained similarly). Assume that  $\gamma|_{D, u, v}$  and  $\gamma'|_{D, u, v}$  are both bd-subtangles of type *d*. Since two strands cannot be tangent to each other when they meet at a death vertex (Definition 1.3.1),  $\gamma|_{D, u, v}$  and  $\gamma'|_{D, u, v}$  admit a "generic" projection  $\pi$  on a vertical plane, in the sense that  $\pi(\gamma|_{D, u, v})$  and  $\pi(\gamma'|_{D, u, v})$  have finitely many

singularities, all of which are double points where two strands cross transversally. If both  $\pi(\gamma|_{D,u,v})$  and  $\pi(\gamma'|_{D,u,v})$  have no crossings, it is immediate that  $\gamma$  and  $\gamma'$  are related by a bd-equivalence of support  $D \times [u, v]$ . Else, if  $\pi(\gamma|_{D,u,v})$  has one or more crossings, the height monotonicity of the strands implies that the highest crossing forms a twist at the top of  $\gamma|_{D,u,v}$  (as on the right part of Figure 1.2). The number of crossings can thus be reduced by one by "untwisting" the top of  $\gamma|_{D,u,v}$  through a local bd-equivalence. Iterating this process leads to a bd-subtangle which is bd-equivalent to  $\gamma|_{D,u,v}$  and whose projection has no crossings. It follows that any move of type  $d$  can be realized by a bd-equivalence.

Conversely, assume that  $\gamma$  and  $\gamma'$  are bd-equivalent, and let us show that they are related by a finite sequence of i-moves and bd-moves. Let  $(\gamma_s)_{s \in [0,1]}$  be a continuous family of bd-tangles with  $\gamma_0 = \gamma$  and  $\gamma_1 = \gamma'$ . Pick  $s_0 \in [0, 1]$ . There exists a finite open cover  $(U_j)$  of  $\gamma_{s_0}$ , where the  $U_j$ 's are the interiors of disc cylinders  $D_j \times [u_j, v_j]$ , such that for all  $j$ ,  $\gamma_{s_0}|_{D_j, u_j, v_j}$  is a bd-subtangle of type  $x_j$  (for  $x_j = i, b, d$ ). Then, there exists a neighborhood  $N(s_0)$  of  $s_0 \in I$  which is small enough so that for all  $s \in N(s_0)$ ,  $\gamma_s$  is still covered by the  $U_j$ 's, and for all  $j$ ,  $\gamma_s|_{D_j, u_j, v_j}$  is still a bd-subtangle of type  $x_j$ . It is a general fact (see for example [EK71, Corollary 1.3]) that the isotopy  $(\gamma_s)_{s \in N(s_0)}$  can be decomposed into a finite sequence of local isotopies, all of which being of support in one of the  $U_j$ 's. But such a local isotopy realizes by definition an  $x_j$ -move. Thus, the isotopy  $(\gamma_s)_{s \in N(s_0)}$  can be expressed as a finite sequence of i-moves and bd-moves, and by compactness of  $I$ , this is also true for the whole isotopy  $(\gamma_s)_{s \in [0,1]}$ .  $\square$

**Definition 1.3.6.** A *horizontal deformation* of a bd-tangle  $\gamma$  is an isotopy of  $\mathbb{C} \times I$  that is the identity outside  $\mathbb{C} \times [u, v]$ , where  $0 < u < v < 1$  are two heights such that  $\gamma$  has no bd-vertex in  $\mathbb{C} \times [u, v]$ , and that preserves the height function  $\mathbb{C} \times I \rightarrow I$  everywhere.

**Lemma 1.3.7.** *Any i-move can be realized as a sequence of horizontal deformations and of bd-moves.*

*Proof.* An i-move which is performed in the cylinder  $D \times [u, v]$  is a horizontal deformation unless  $\gamma$  has some bd-vertices whose heights are between  $u$  and  $v$ . In that case, a finite number of b-moves can be performed (in cylinders that do not intersect  $D \times [u, v]$ ) to drag the b-vertices below the height  $u$ , and similarly, d-vertices can be dragged above the height  $v$  by d-moves. The initial i-move is now a horizontal deformation. Finally, the bd-vertices can be moved back to their initial positions by performing the inverse bd-moves.  $\square$

Lemmas 1.3.5 and 1.3.7 imply:

**Proposition 1.3.8.** *Two bd-tangles are bd-equivalent if and only if they are related by a sequence of horizontal deformations and of bd-moves.*

### 1.3.4 Tangles

We now turn to the "standard" tangles, which are a smooth version of the bd-tangles, considered up to general isotopy with no height monotonicity condition.

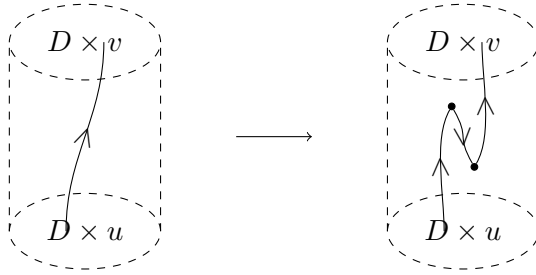

Figure 1.3: A hump insertion.

**Definition 1.3.9.** A *tangle*  $\gamma$  is a smooth properly embedded compact one-submanifold  $\gamma \subset \mathbb{C} \times I$  whose arcs coincide with vertical segments (of the form  $\{z\} \times I$ ) near the boundary  $\mathbb{C} \times \partial I$ . Two tangles are *isotopic* if they are ambient isotopic relative to a neighborhood of the boundary. Isotopy classes of tangles form a category  $\mathcal{T}$  in the same way as bd-tangles (the objects are finite sets of signed points of  $\mathbb{C}$ ).

There is a functor  $\mathcal{T}^{\text{bd}} \rightarrow \mathcal{T}$  which sends a bd-tangle  $\gamma$  to a smooth tangle that is piecewise smoothly isotopic to  $\gamma$  by "smoothing" its vertices and by "straightening" its endpoints. (Note that this functor is well defined since two piecewise smoothly isotopic smooth tangles are smoothly isotopic.)

### 1.3.5 Hump insertion

The functor  $\mathcal{T}^{\text{bd}} \rightarrow \mathcal{T}$  is surjective, but not injective. The first obstruction that prevents two isotopic bd-tangles from being bd-equivalent is the number of bd-vertices of each component, which is an obvious bd-equivalence invariant. But the isotopy class together with the number of bd-vertices is not sufficient to distinguish all the bd-tangles. It turns out that there exists two isotopic bd-knots having the same number of bd-vertices but which are not bd-equivalent (see [Bir76]). However, it seems intuitively clear that if one increases the number of bd-vertices of two isotopic bd-knots by inserting a sufficiently large number of "humps", they will become "flexible" enough to be bd-equivalent.

Let  $(\gamma, X)$  be a bd-tangle with a distinguished connected component  $X$ . We construct from this pair a new bd-tangle  $h_X(\gamma)$  in the following way.

Take a cylinder  $D \times [u, v]$  in the interior of  $\mathbb{C} \times I$ , such that  $\gamma|_{D, u, v}$  is a bd-subtangle of type  $i$  contained in the component  $X$ . Then  $h_X(\gamma)$  is obtained from  $\gamma$  by replacing  $\gamma|_{D, u, v}$  with a "hump" as depicted in Figure 1.3. More precisely, a "hump" means a connected bd-subtangle embedded in a rectangle  $[a, b] \times [u, v]$  (where  $[a, b]$  is a diameter of  $D$ ) that contains exactly one birth and one death vertex.

**Lemma 1.3.10.** *Up to bd-equivalence, the above construction of  $h_X(\gamma)$  depends only on  $(\gamma, X)$ .*

*Proof.* Up to bd-equivalence, a small hump can slide along a strand of a bd-tangle. Moreover, a hump can pass through a d-vertex by switching its height with the height of the d-vertex of the hump, as depicted in Figure 1.4. A hump can pass through a b-vertex in a similar way. Therefore, a small hump can slide everywhere along its connected component in  $\gamma$ , and thus  $h_X(\gamma)$  depends only of the component  $X$ .  $\square$

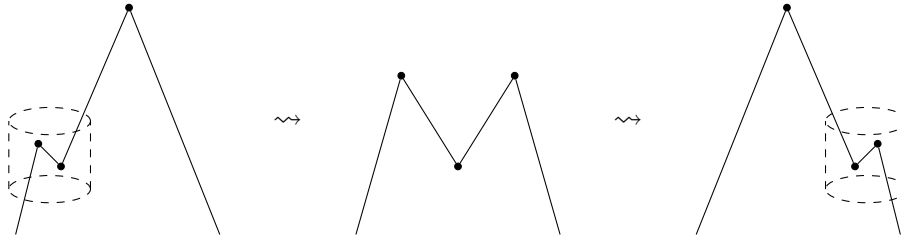

Figure 1.4: Passing a hump through a death vertex.

Since a hump is isotopic to a bd-subtangle of type i, any pair of bd-tangles related by a hump insertion are isotopic. Conversely, we have the following "stabilization" theorem:

**Proposition 1.3.11.** *Let  $\gamma$  and  $\gamma'$  be two isotopic bd-tangles. Then if  $X_1, \dots, X_r$  and  $X'_1, \dots, X'_r$  denote the isotopic components of  $\gamma$  and  $\gamma'$  respectively, there exists non-negative integers  $n_1, \dots, n_r$  and  $n'_1, \dots, n'_r$  such that  $h_{X_1}^{n_1} \cdots h_{X_r}^{n_r}(\gamma)$  is bd-equivalent to  $h_{X'_1}^{n'_1} \cdots h_{X'_r}^{n'_r}(\gamma')$ .*

We do not prove this fact. A sketch of proof can be found in [MS03, Lemma 3.2], in the context of Morse knots. Here, the same arguments can be used, replacing "Morse knot" by "bd-tangles".

## 1.4 Jacobi diagrams

In this section, we recall the definition and the basic properties of Jacobi diagrams which form the target of the Kontsevich invariant. These uni-trivalent diagrams play a central role in quantum topology as they are both related to the chord diagrams arising from the Vassiliev-Goussarov theory of finite-type invariants and to the commutator calculus of metrized Lie algebras [BN95].

We first define the category  $\mathbf{P}$  of patterns. Here, patterns are one-dimensional cobordisms which are thought of as the underlying skeletons of the tangles.

**Definition 1.4.1.** A *pattern* is a compact one-manifold  $P$  whose boundary  $\partial P$  is split into two linearly ordered sets  $\partial^- P$  and  $\partial^+ P$ . Patterns form a category denoted by  $\mathbf{P}$ . The objects are words in  $\{+, -\}$  and the morphisms are patterns. The source and target of  $P$  are  $-\partial^- P$  and  $\partial^+ P$  respectively, which are seen as words in  $\{+, -\}$  as sequences of oriented points (an endpoint is assigned a  $+$  if the orientation of  $P$  points towards this point). The composition  $P_2 P_1$  is obtained by gluing the  $i$ -th point of  $\partial^- P_2$  to the  $i$ -th point of  $\partial^+ P_1$  for each  $i$ .

**Definition 1.4.2.** A *Jacobi diagram* is a pattern  $P$  of  $\mathbf{P}$  equipped with a finite abstract graph  $D$  whose vertices are either univalent *and* attached to a point of the interior of  $P$ , or trivalent *and* oriented (that is, equipped with a cyclic ordering of its three adjacent half-edges). Moreover, each component of  $D$  is required to be attached to  $P$ . In the figures,  $D$  is represented by dashed lines, and the vertex orientation is always induced by the counterclockwise orientation of the sheet of paper. An edge



whose both extremities are attached to  $P$  is called a *chord*. The *degree* of a Jacobi diagram  $D$  is defined as:

$$\deg(D) := \frac{1}{2}(\text{number of vertices of } D) \in \mathbb{N}.$$

Let  $\mathbf{A}(P)$  be the graded vector space generated by the Jacobi diagrams of pattern  $P$ , up to the (homogeneous) relation STU depicted in Figure 1.5. We set  $(\mathbf{A}/FI)(P) := \mathbf{A}(P)/FI$ , where FI is the "framing independence" relation depicted in Figure 1.6.

*Remark 1.4.3.* Since each component of the graph of a Jacobi diagram is connected to its pattern, the STU relation implies the IHX and AS relations depicted in Figures 1.7-1.8 (see [BN95, Theorem 6]).

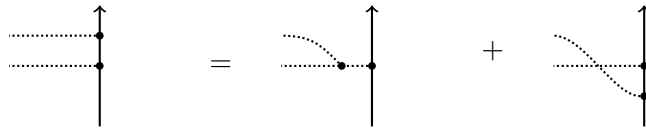

Figure 1.5: The STU relation.

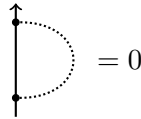

Figure 1.6: The FI relation.

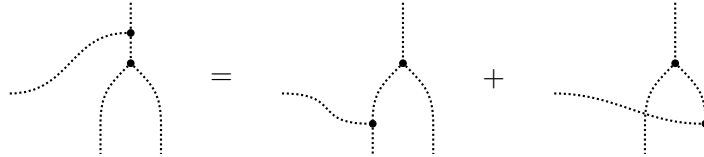

Figure 1.7: The IHX relation.

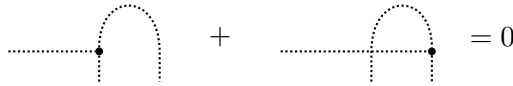

Figure 1.8: The AS relation.

Let us recall a standard notation. A Jacobi diagram of pattern  $P$  having an edge attached to a box which covers some strands of  $P$  is seen as an element of  $\mathbf{A}(P)$  as depicted in Figure 1.9. If the box covers no strands, the corresponding element is 0. We generalize this notation to the "mixed" case, where the box covers both strands of  $P$  and dashed edges of the diagram. If the  $i$ -th line is a (non oriented) dashed edge, we take  $\varepsilon_i = +1$ .

The STU, IHX and AS relations imply the following lemma, which is a straightforward generalization of [CDM12, Lemma 5.2.9] to the mixed case.

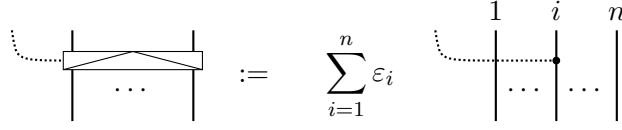
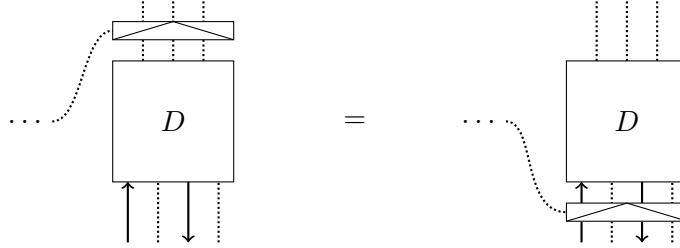

Figure 1.9: The box notation, where  $\varepsilon_i = +1$  if the orientation of the  $i$ -th strand agrees with the arrow inside the box (in this case, if the strand goes upwards) and  $\varepsilon_i = -1$  otherwise.

**Lemma 1.4.4.** *A box can slide over a part of a Jacobi diagram. For example, if  $D$  is any part of a Jacobi diagram, we have*



Using the box notation, we introduce two operations on Jacobi diagrams of  $\mathbf{A}(P)$ , which are relative to the choice of a union of connected components  $C$  of the pattern  $P$ .

**Definition 1.4.5.** The *coproduct*  $\Delta_C(D)$  is defined by doubling the components of  $C$  while replacing each univalent vertex that is attached to  $C$  with a box whose arrow follows the orientation of  $C$ . The *antipode*  $S_C(D)$  is defined by replacing each univalent vertex that is attached to  $C$  with a box whose arrow follows the orientation of  $C$ , and then by reversing the orientation of  $C$ .

Coproduct and antipode are well-defined modulo STU.

**Definition 1.4.6.** We define the category  $\mathbf{A}$  of Jacobi diagrams as follows. The objects are finite sequences of signs. A morphism of  $\mathbf{A}$  is an element of  $\mathbf{A}(P)$  for some pattern  $P$ , and the source and target of such a morphism are those of  $P$ . The *product* of two composable Jacobi diagrams is defined by taking the composition of their patterns together with the union of the two graphs, and the composition in the category  $\mathbf{A}$  is defined by extending the product of Jacobi diagrams linearly. We define the category  $\mathbf{A}/FI$  similarly by considering the quotient spaces  $\mathbf{A}(P)/FI$ .

We introduce the following definition to formalize the structure of  $\mathbf{A}$  relative to the category  $\mathbf{P}$  of patterns.

**Definition 1.4.7.** Let  $\mathbf{G}$  and  $\mathbf{C}$  be two categories with same objects.  $\mathbf{C}$  is said to be a  $\mathbf{G}$ -category if it is equipped with a functor  $F : \mathbf{C} \rightarrow \mathbf{G}$  which is the identity on objects. Moreover,  $\mathbf{C}$  is *linear* as a  $\mathbf{G}$ -category if

- for any morphism  $g$  of  $\mathbf{G}$ ,  $F^{-1}(g)$  is equipped with a structure of a vector space which we denote by  $\mathbf{C}(g)$ ,
- for any composable pair of morphisms  $(g_1, g_2)$  of  $\mathbf{G}$ , the restriction of the composition in  $\mathbf{C}$  to  $\mathbf{C}(g_1) \times \mathbf{C}(g_2) \rightarrow \mathbf{C}(g_2 g_1)$  is bilinear.

A linear  $\mathbf{G}$ -category  $\mathbf{C}$  is  $\mathbb{N}$ -graded if  $\mathbf{C}(g) = \bigoplus_{k \geq 0} \mathbf{C}(g)_k$  is  $\mathbb{N}$ -graded for any morphism  $g$  of  $\mathbf{G}$ , and the composition takes  $\mathbf{C}(g_1)_{k_1} \times \mathbf{C}(g_2)_{k_2}$  to  $\mathbf{C}(g_2 g_1)_{k_1+k_2}$ . In this case, the *degree completion*  $\widehat{\mathbf{C}}$  of  $\mathbf{C}$  is defined in the obvious way.

The category  $\mathbf{A}$  is a graded linear  $\mathbf{P}$ -category.

Let  $\uparrow^n$  be identity of  $(+, \dots, +)$  ( $n$  times) in  $\mathbf{P}$ ; that is, the pattern made of  $n$  "vertical" segments oriented upwards. We set  $\mathbf{A}(\uparrow^n) =: \mathbf{A}(n)$ . The composition of diagrams endows the vector space  $\mathbf{A}(n)$  with a structure of a graded algebra.

Just as tangles generalize braids, the category of Jacobi diagrams can be seen as an enlargement of the algebra  $\text{Ut}_n$ . More precisely, we have the following Lemma.

**Lemma 1.4.8.** *There is a unique graded algebra morphism  $\iota_n : \text{Ut}_n \rightarrow \mathbf{A}(n)$  sending  $t_{ij}$  to the Jacobi diagram made of a horizontal chord linking the  $i$ -th to the  $j$ -th segment for any  $i \neq j$ .*

$$t_{ij} \longmapsto \begin{array}{cccc} 1 & i & j & n \\ \uparrow & \uparrow & \uparrow & \uparrow \\ \vdots & \cdots & \cdots & \vdots \end{array}$$

*Proof.* We have to check that  $\iota_n$  factors through the relations  $[t_{ij}, t_{kl}] = 0$  and  $[t_{ij}, t_{ik} + t_{kj}] = 0$  where  $i, j, k, l$  are all distinct. The first relation is immediate,

$$\begin{array}{cccc} i & j & k & l \\ \uparrow & \uparrow & \uparrow & \uparrow \\ \cdots & \cdots & \cdots & \cdots \end{array} = \begin{array}{cccc} i & j & k & l \\ \uparrow & \uparrow & \uparrow & \uparrow \\ \cdots & \cdots & \cdots & \cdots \end{array}$$

and the second relation is a particular case of Lemma 1.4.4:

$$\begin{array}{ccc} i & j & k \\ \uparrow & \uparrow & \uparrow \\ \cdots & \cdots & \cdots \end{array} = \begin{array}{ccc} i & j & k \\ \uparrow & \uparrow & \uparrow \\ \cdots & \cdots & \cdots \end{array}$$

□

*Remark 1.4.9.* Although not obvious, it turns out that  $\iota_n : \text{Ut}_n \rightarrow \mathbf{A}(n)$  is injective (see [BN96, Corollary 4.4], or equivalently, [HM00, Theorem 16.1]).

In fact, the category  $\mathbf{A}$  will be considered in the algebraic context only (from Chapter 3). Here we introduce another version of patterns and Jacobi diagrams, whose endpoints are embedded in  $\mathbb{C}$  (just as tangles of  $\mathcal{T}$ ), to be used in the analytic approach (Chapters 1-2).

**Definition 1.4.10.** A *pattern* on  $\mathbb{C}$  is a compact one-manifold  $P$  equipped with an embedding  $\partial P \hookrightarrow \mathbb{C} \times \partial I$ . Pattern on  $\mathbb{C}$  form a category denoted by  $\mathcal{P}$  in the same way as tangles; that is, there exists a forgetful functor  $\mathcal{T} \rightarrow \mathcal{P}$  which sends a tangle  $\gamma$  to its underlying pattern (obtained by seeing  $\gamma$  as an abstract one-manifold and keeping track of the embedding of  $\partial\gamma$  in  $\mathbb{C} \times \partial I$  only).

**Definition 1.4.11.** We define the category  $\mathcal{A}$  of Jacobi diagram in the same way as  $\mathbf{A}/FI$  by replacing the category  $\mathbf{P}$  with  $\mathcal{P}$ . In particular,  $\mathcal{A}$  is a graded linear  $\mathcal{P}$ -category.

Of course, the distinction between  $\mathbf{A}/FI$  and  $\mathcal{A}$  is a matter of detail as they differ "at the level of objects" only. Let us introduce the following notation to formulate this idea more precisely.

**Definition 1.4.12.** For an algebra  $A$  and a set  $M$ , we denote by  $A\{M\}$  the category whose set of objects is  $M$  and whose morphisms are the triples  $(x_1, a, x_0) \in M \times A \times M$ , such that the source and target of  $(x_1, a, x_0)$  are  $x_0$  and  $x_1$  respectively, and the composition is given by  $(x_2, b, x_1)(x_1, a, x_0) = (x_2, ba, x_0)$ .

There is an obvious functor  $\mathbf{A}(n)\{\mathbb{C}_n\} \rightarrow \mathcal{A}$  which embeds the bottom and top endpoints of a diagram  $D \in \mathbf{A}(n)$  via the two associated configurations of  $\mathbb{C}_n$ . Further, the algebra morphism  $\iota_n : \mathbf{Ut}_n \rightarrow \mathbf{A}(n)$  gives rise to a functor  $\mathbf{Ut}_n\{\mathbb{C}_n\} \rightarrow \mathbf{A}(n)\{\mathbb{C}_n\}$ . By composition, we obtain a functor  $\mathbf{Ut}_n\{\mathbb{C}_n\} \rightarrow \mathcal{A}$ . Finally, observe that the parallel transport of the KZ connection can be seen as a functor  $T_{\text{KZ}} : \mathcal{B}_n \rightarrow \widehat{\mathbf{Ut}}_n\{\mathbb{C}_n\}$  by keeping track of the position of the endpoints of the braids.

## 1.5 The Kontsevich integral of bd-tangles

In this section, we recall the construction of the "preliminary" invariant  $Z^{\text{bd}} : \mathcal{T}^{\text{bd}} \rightarrow \mathcal{A}$  which extends the parallel transport of the KZ connection in the sense that the following diagram commutes.

$$\begin{array}{ccc}
 \mathcal{B}_n & \xrightarrow{T_{\text{KZ}}} & \widehat{\mathbf{Ut}}_n\{\mathbb{C}_n\} \\
 \downarrow & & \downarrow \\
 \mathcal{T}^{\text{bd}} & \xrightarrow{Z^{\text{bd}}} & \widehat{\mathcal{A}}
 \end{array} \tag{1.5.1}$$

We then recall how the Kontsevich integral  $Z : \mathcal{T} \rightarrow \widehat{\mathcal{A}}$  is obtained from  $Z^{\text{bd}}$ .

### 1.5.1 Complex iterated integrals

Let us first introduce some notation.

Given a collection  $f_1, \dots, f_m$  of piecewise-continuous complex functions defined on an open real interval  $]u, v[$ , we define the iterated integral  $\mathcal{I}_{(u,v)}^m(f_m, \dots, f_1)$  as the following integral over the open  $m$ -simplex

$$\begin{aligned}
 \Delta_{(u,v)}^m &= \{(t_1, \dots, t_m) \in \mathbb{R}^m \mid u < t_1 < \dots < t_m < v\}, \\
 \mathcal{I}_{(u,v)}^m(f_m, \dots, f_1) &:= \int_{\Delta_{(u,v)}^m} f_m(t_m) \cdots f_1(t_1) dt_1 \cdots dt_m.
 \end{aligned}$$

For  $m = 0$ , we set  $\mathcal{I}_{(u,v)}^0(\emptyset) = 1$  by convention. (We use this specific notation to make a distinction between these iterated integrals and those of Theorem 1.1.1. Here,  $\mathcal{I}_{(u,v)}^m(f_m, \dots, f_1)$  is complex valued and may not necessarily converge since the domain of integration is open.) Let us give a useful convergence criterium.

**Lemma 1.5.1.** *We use the notation  $f(\varepsilon) \sim g(\varepsilon)$  to mean that  $f(\varepsilon)$  and  $g(\varepsilon)$  are proportional near  $\varepsilon = 0$  (that is,  $f(\varepsilon)/g(\varepsilon)$  has a finite limit different from 0 as  $\varepsilon \rightarrow 0$ ). Assume that the functions  $f_1, \dots, f_m$  satisfy*

- $f_k(u + \varepsilon) \sim (1 \text{ or } 1/\varepsilon)$ ,  $f_k(v - \varepsilon) \sim (1 \text{ or } 1/\varepsilon)$  for any  $k$ ,
- $f_1(u + \varepsilon) \sim 1$ , and  $f_m(v - \varepsilon) \sim 1$ .

Then  $\mathcal{I}_{(u,v)}^m(f_m, \dots, f_1)$  converges.

*Proof.* Let us focus on the singularity near the boundary point  $u$  (the case of  $v$  is obtained similarly by symmetry of the situation). We show recursively that for any  $k$ ,  $\mathcal{I}_{(u,u+\varepsilon)}^k(f_k, \dots, f_1) \sim \varepsilon^p$  with  $p \geq 1$ . We have  $\mathcal{I}_{(u,u+\varepsilon)}^1(f_1) = \int_u^{u+\varepsilon} f_1(t) dt \sim \varepsilon$ . Assume  $\mathcal{I}_{(u,u+\varepsilon)}^k(f_k, \dots, f_1) \sim \varepsilon^p$ . Then

$$\begin{aligned} \mathcal{I}_{(u,u+\varepsilon)}^{k+1}(f_{k+1}, \dots, f_1) &= \int_u^{u+\varepsilon} f_{k+1}(t) \mathcal{I}_{(u,t)}^k(f_k, \dots, f_1) dt \\ &\sim \varepsilon^{p+1} \text{ if } f_{k+1}(u + \varepsilon) \sim 1 \\ &\sim \varepsilon^p \text{ if } f_{k+1}(u + \varepsilon) \sim 1/\varepsilon. \end{aligned}$$

□

Iterated integrals enjoy the following property.

**Lemma 1.5.2.** *For any  $u \leq t \leq v$ , we have*

$$\mathcal{I}_{(u,v)}^m(f_m, \dots, f_1) = \sum_{k=0}^m \mathcal{I}_{(t,v)}^{m-k}(f_m, \dots, f_{k+1}) \mathcal{I}_{(u,t)}^k(f_k, \dots, f_1)$$

if the integral on the right-hand side converges.

*Proof.* This follows from the decomposition  $\Delta_{(u,v)}^m = \bigcup_{k=0}^m \Delta_{(u,t)}^k \times \Delta_{(t,v)}^{m-k}$  (up to a measure zero set). □

## 1.5.2 Construction of $Z^{\text{bd}}$

Throughout this section,  $\gamma \subset \mathbb{C} \times I$  is a fixed bd-tangle. For simplicity, we assume that the bd-vertices of  $\gamma$  are of pairwise distinct heights. These heights are called the *special heights* of  $\gamma$  and are denoted by  $0 < v_1 < v_2 < \dots < v_r < 1$ . We set  $v_0 := 0$ ,  $v_{r+1} := 1$ . Between two successive heights  $v_j$  and  $v_{j+1}$ , each strand of  $\gamma$  is fully determined by a couple  $(z, \varepsilon)$  where  $z : ]v_j, v_{j+1}[ \rightarrow \mathbb{C}$  is the function such that  $\{(z(t), t) \mid t \in ]v_j, v_{j+1}[\}$  parametrizes the strand and  $\varepsilon = +1$  if the strand is oriented upwards,  $\varepsilon = -1$  otherwise.

**Definition 1.5.3.** Let  $m \geq 0$  be an integer. An  $m$ -configuration  $C$  on  $\gamma$  is the choice of

- a decomposition of  $m$  into  $r + 1$  nonnegative integers  $m = m_0 + m_1 + \dots + m_r$  (this decomposition leads to an identification

$$\{1, \dots, m\} \cong \{(j, k) \mid 0 \leq j \leq r, 1 \leq k \leq m_j\} =: L_C,$$

defined by the lexicographic order, where the elements  $(j, k)$  of  $L_C$  are called the *levels* of  $C$ ),

- for each level  $(j, k) \in L_C$ , an unordered pair of distinct strands  $(z_k^j, \varepsilon_k^j)$  and  $(\bar{z}_k^j, \bar{\varepsilon}_k^j)$  of  $\gamma$  of height in  $]v_j, v_{j+1}[$ .

To keep the notation light, we shall omit to write down the indices  $j, k$  unless necessary: it is left to the reader to replace  $z$  with  $z_k^j$ , and so on, in any sentence starting with "for each level  $(j, k)$ ".

The set of  $m$ -configurations on  $\gamma$  is finite, and denoted by  $\mathcal{C}_m(\gamma)$ .

We associate to any  $m$ -configuration  $C$  a "coefficient"  $Z_C(\gamma) \in \mathbb{C} \cup \infty$  as follows. For each level  $(j, k)$ , define  $f_k^j : ]v_j, v_{j+1}[ \rightarrow \mathbb{C}$  by

$$f_k^j(t) = \frac{\varepsilon \bar{\varepsilon}}{2\pi i} \frac{d}{dt} \log(z(t) - \bar{z}(t)), \quad (1.5.2)$$

and set

$$Z_C(\gamma) := \prod_{j=0}^r \mathcal{I}_{(v_j, v_{j+1})}^{m_j}(f_{m_j}^j, \dots, f_1^j). \quad (1.5.3)$$

We also associate to the configuration  $C$  a degree  $m$  Jacobi diagram  $D_C$  as follows. Pick  $m$  heights  $t = t_k^j$ , one for each level  $(j, k)$ , satisfying

$$v_j < t_1^j < t_2^j < \dots < t_{m_j}^j < v_{j+1}.$$

Then, for each level  $(j, k)$ , connect the two corresponding points  $(z(t), t)$  and  $(\bar{z}(t), t)$  of  $\gamma$  with a chord. The result is seen as a Jacobi diagram  $D_C \in \mathcal{A}(\gamma)$ . (Here and in the following, we slightly abuse notation and write  $\mathcal{A}(\gamma)$  for  $\mathcal{A}(P)$  where  $P$  is the pattern of  $\gamma$ .)

We finally define:

$$Z^{\text{bd}}(\gamma) := \sum_{m=0}^{\infty} \sum_{C \in \mathcal{C}_m(\gamma)} Z_C(\gamma) D_C \in \widehat{\mathcal{A}}(\gamma). \quad (1.5.4)$$

**Lemma 1.5.4.** *If  $C$  is a configuration on  $\gamma$  such that  $D_C$  does not vanish in  $\mathcal{A}(\gamma)$ , then the iterated integrals of  $Z_C(\gamma)$  converge, so that the formula (1.5.4) makes sense.*

*Proof.* Let  $C$  be a configuration such that  $D_C$  does not vanish in  $\mathcal{A}(\gamma)$ , and let  $j \in \{0, \dots, r\}$ . We show that the integral  $\mathcal{I}_{(v_j, v_{j+1})}^{m_j}(f_{m_j}^j, \dots, f_1^j)$  converges. Since the derivatives of the strands  $\frac{d}{dt} z_k^j(t)$  and  $\frac{d}{dt} \bar{z}_k^j(t)$  are bounded, the functions  $f_k^j$  have no singularity near the boundary, unless the strands  $z_k^j$  and  $\bar{z}_k^j$  meet at a b-vertex of height  $v_j$  or at a d-vertex of height  $v_{j+1}$ . In the first case (using the notation of Lemma 1.5.1),  $f_k^j(v^i + \varepsilon) \sim 1/\varepsilon$ . Observe that this situation cannot occur for  $k = 1$ , as the chord of the diagram  $D_C$  joining the strands  $z_1^j$  and  $\bar{z}_1^j$  would be an isolated chord, and  $D_C$  would vanish in  $\mathcal{A}(\gamma)$  due to the FI relation. In the second case,  $f_k^j(v_{j+1} - \varepsilon) \sim 1/\varepsilon$ . For the same reason as above, this cannot occur for  $k = m_j$ . We are left to the situation of Lemma 1.5.1, which implies that  $\mathcal{I}_{(v_j, t)}^{m_j}(f_{m_j}^j, \dots, f_1^j)$  converges.  $\square$

$Z^{\text{bd}}$  is invariant under height rescaling (as it corresponds to a change of variables in the integrals), and we have the following.

**Lemma 1.5.5.** *If  $(\gamma, \alpha)$  is a composable pair of tangles, then  $Z^{\text{bd}}(\gamma\alpha) = Z^{\text{bd}}(\gamma)Z^{\text{bd}}(\alpha)$ .*

*Proof.* Let  $C$  be an  $m$ -configuration on  $\gamma\alpha$ , and  $D_C$  the associated Jacobi diagram. Let  $u$  denote the highest special height of  $\alpha$  and  $v$  be the lowest special height of  $\gamma$ , so that  $u, v$  are two consecutive special heights of  $\gamma\alpha$ . A chord of  $D_C$  is said to be *undecided* if its height is between  $u$  and  $v$ . Let  $n$  denotes the number of undecided chords, and for any  $k = 0, \dots, n$ , define  $(D_{C'(k)}, D_{C''(n-k)}) \in \mathcal{A}(\gamma) \times \mathcal{A}(\alpha)$  as the pair of Jacobi diagrams obtained by splitting  $D_C$  while seeing the  $k$  highest undecided chords on  $\gamma$  and the  $n - k$  lowest ones on  $\alpha$ . By definition, we have for any  $k = 0, \dots, n$ ,

$$D_C = D_{C'(k)} D_{C''(n-k)}. \quad (1.5.5)$$

On the other hand, Lemma 1.5.2 implies

$$Z_C(\gamma\alpha) = \sum_{k=0}^n Z_{C'(k)}(\gamma) Z_{C''(n-k)}(\alpha). \quad (1.5.6)$$

Putting the identities (1.5.5) and (1.5.6) together leads to the result.  $\square$

**Lemma 1.5.6.** *The diagram (1.5.1) commutes. That is, if  $\beta$  is a braid,  $Z^{\text{bd}}(\beta)$  coincides with the parallel transport of the KZ connection  $T_{\text{KZ}}(\beta)$  seen in  $\mathcal{A}(\beta)$ .*

*Proof.* We briefly check that

$$\int_{0 \leq t_1 \leq \dots \leq t_m \leq 1} \Omega(\dot{\beta}(t_m)) \cdots \Omega(\dot{\beta}(t_1)) dt_1 \cdots dt_m = \sum_{C \in \mathcal{C}_m(\gamma)} \mathcal{I}_{(0,1)}^m(f_m, \dots, f_1) D_C,$$

where  $\Omega$  denotes the KZ connection, and the left-hand side of the equality is seen in  $\mathcal{A}(\beta)$ . Starting from the left-hand side, replace each  $\Omega(\dot{\beta}(t_k))$  with its defining formula (1.2.2) and develop the whole product: this leads to a sum over the set of  $m$ -configurations. For any configuration  $C$ , take the  $t_{ij}$ 's together out of the integral: this forms the diagram  $D_C$ . The associated complex integral coefficient coincides with  $\mathcal{I}_{(0,1)}^m(f_m, \dots, f_1)$ .  $\square$

**Lemma 1.5.7.** *Let  $\alpha \cup \gamma$  be a disjoint union of two bd-tangles, and let  $\bar{\alpha} \cup \gamma$  denote the bd-tangle obtained by reversing the orientation of  $\alpha$ . We then have*

$$Z^{\text{bd}}(\bar{\alpha} \cup \gamma) = S_\alpha Z^{\text{bd}}(\alpha \cup \gamma),$$

where  $S_\alpha$  is the antipode defined on the part  $\alpha$  of the pattern  $\alpha \cup \gamma$ .

*Proof.* This immediately follows from the definition of  $Z^{\text{bd}} = \sum Z_C D_C$ , according to which every vertex of  $D_C$  comes with a coefficient  $\varepsilon = \pm 1$  in  $Z_C$  which depends on the orientation of the strand the vertex is attached to.  $\square$

### 1.5.3 Invariance of $Z^{\text{bd}}$

In this section, we prove the following theorem.

**Theorem 1.5.8.**  *$Z^{\text{bd}}$  is invariant under bd-equivalence and thus defines a functor  $Z^{\text{bd}} : \mathcal{T}^{\text{bd}} \rightarrow \hat{\mathcal{A}}$ .*

Using Proposition 1.3.8, it is enough to show that  $Z^{\text{bd}}$  is invariant under horizontal deformations and bd-moves.

**Lemma 1.5.9.**  $Z^{\text{bd}}(\gamma)$  is invariant under horizontal deformation of  $\gamma$ .

*Proof.* Using Lemma 1.5.5, it is enough to show Lemma 1.5.9 in the case where  $\gamma$  has no bd-vertex. If  $\gamma$  is a geometric braid, the invariance of  $Z^{\text{bd}}(\gamma)$  under horizontal deformation is immediate from Lemma 1.5.6 together with the fact that  $T_{\text{KZ}}$  is a braid invariant. Otherwise,  $\gamma$  can be turned into a geometric braid by reversing the orientation of some of its strands, and the conclusion follows from Lemma 1.5.7.  $\square$

**Lemma 1.5.10.**  $Z^{\text{bd}}(\gamma)$  is invariant under bd-move of  $\gamma$ .

*Proof.* Let us consider the case of a b-move (the other case works in a similar way). Let  $\gamma$  and  $\gamma'$  be two bd-tangles which are related by a b-move in the cylinder  $D \times [u, v]$ . We denote by  $h, h' \in (u, v)$  the heights of the corresponding b-vertices of  $\gamma$  and  $\gamma'$ . Let us first assume that  $\gamma$  (and thus  $\gamma'$ ) has no other bd-vertices of height in  $[u, v]$ . Take  $w \in (u, v)$  such that  $w > h$  and  $w > h'$ .

For any  $\varepsilon > 0$ , one can assume, up to horizontal deformation of  $\gamma$  of support  $D \times [h + \varepsilon, v]$  and horizontal deformation of  $\gamma'$  of support  $D \times [h' + \varepsilon, v]$ , that  $\gamma$  and  $\gamma'$  are identical above the height  $w$ , that the two strands  $(z_+, +)$  and  $(z_-, -)$  of  $\gamma|_{D, u, v}$  satisfy, for any  $t \in [h + \varepsilon, w]$ ,

1.  $|z_+(t) - z_-(t)| \leq \varepsilon M$ ,
2.  $|\frac{d}{dt}(z_+(t) - z_-(t))| \leq M|z_+(t) - z_-(t)|$ ,

(for some fixed positive constant  $M$  that does not depend on  $\varepsilon$ ), and that the two strands  $(z'_\pm, \pm)$  of  $\gamma'|_{D, u, v}$  satisfy the same conditions (replacing  $h$  with  $h'$ ), as depicted below.

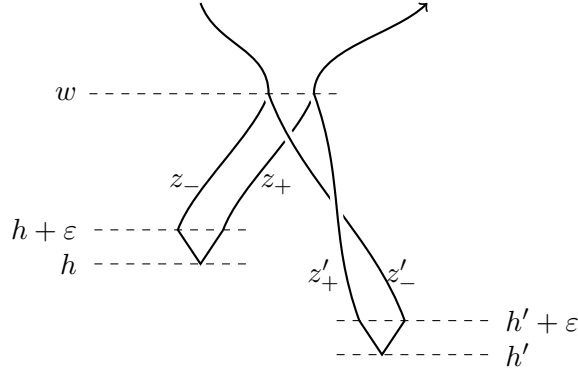

We consider a configuration  $C$  on  $\gamma$  such that  $D_C \neq 0$  and  $D_C$  has at least one chord attached to  $\gamma|_{D, u, v}$ . The lowest chord attached to  $\gamma|_{D, u, v}$ , say, of level  $(j, l)$ , does not connect the two strands  $z_+$  and  $z_-$  (otherwise, the chord would be isolated and  $D_C$  would vanish). It follows that such kind of configurations always come by pairs  $(C_+, C_-)$  where  $C_+$  and  $C_-$  are identical except at the level  $(j, l)$ , where the chord of  $D_{C_+}$  connects the strand  $z_+$  to another strand  $z$ , and the chord of  $D_{C_-}$  connects  $z_-$  to  $z$ . For any level  $(j, k)$ , we denote by  $(f_\pm)_k^j$  the functions associated to the configurations  $C_\pm$  (we have  $(f_+)_k^j = (f_-)_k^j := f_k^j$  except at the level  $(j, l)$ ). For any  $t \in (h, w]$ , the conditions 1 and 2 imply that  $|(f_+)_l^j(t) + (f_-)_l^j(t)| \rightarrow 0$  as  $\varepsilon \rightarrow 0$ . It follows that for any  $k \in \{l, \dots, m_j\}$ ,

$$\mathcal{S}_{(h, w)}^k(f_k^j, \dots, (f_+)_l^j + (f_-)_l^j, \dots, f_1^j) \rightarrow 0 \text{ as } \varepsilon \rightarrow 0.$$



Using Lemma 1.5.2, this means that the contribution of the bd-subtangle  $\gamma|_{D,u,w}$  to  $Z_{C_+}(\gamma) + Z_{C_-}(\gamma)$  tends to 0 as  $\varepsilon \rightarrow 0$ . Moreover, since  $D_{C_+} = D_{C_-}$ , we obtain that the contribution of  $\gamma|_{D,u,w}$  to  $Z^{\text{bd}}(\gamma)$  tends to 0 as  $\varepsilon \rightarrow 0$ . The same argument can be applied to  $\gamma'$ . Since  $Z^{\text{bd}}$  is invariant under horizontal deformation, we conclude that  $Z^{\text{bd}}(\gamma) = Z^{\text{bd}}(\gamma')$ .

In the case where  $\gamma$  has some other bd-vertices of height in  $[u, v]$ , a finite number of b-moves can be performed to drag the b-vertices below the height  $u$ , and similarly, d-vertices can be dragged above the height  $v$  by d-moves. Since these moves can be arbitrary "thin" (in the sense that the two moving strands can satisfy the conditions 1 and 2 for any  $\varepsilon$ ), this procedure keeps the Kontsevich integral of the new bd-tangle arbitrary close to its initial value. We are thus left to the assumption of the beginning of the proof. Finally, the bd-vertices can be moved back to their initial positions by performing the inverse bd-moves.  $\square$

#### 1.5.4 The normalization

Let  $S^1$  denote the pattern of made of an oriented circle. Recall that we have the following (see for example [Oht02, Proposition 6.3]; the proof consists essentially in checking that the product and action below are well-defined. This can be done using Lemma 1.4.4).

**Lemma 1.5.11.** *(i)  $\mathcal{A}(S^1)$  has a commutative algebra structure whose product is given by the connected sum of the two circles.*

*(ii) Let  $(P, X)$  be a (non empty) pattern equipped with a distinguished connected component  $X \subset P$ . We have an action  $\sharp_X$  of  $\mathcal{A}(S^1)$  on  $\mathcal{A}(P)$  by taking the connected sum of the circle to the component  $X$ .*

Up to bd-equivalence, there exists a unique bd-knot  $U \subset \mathbb{R} \times I \subset \mathbb{C} \times I$  with exactly two b-vertices, and hence two d-vertices (see Figure 1.10).

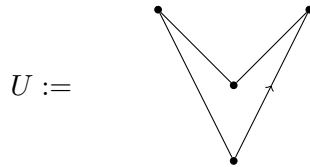

Figure 1.10: The bd-knot  $U$ .

We set  $H := Z(U) \in \widehat{\mathcal{A}}(S^1)$ .

**Lemma 1.5.12.** *For any bd-tangle  $\gamma$  with a component  $X$ , and using the notation of Section 1.3.5 for the hump insertion, we have*

$$Z^{\text{bd}}(h_X(\gamma)) = H \sharp_X Z^{\text{bd}}(\gamma).$$

*Proof.* The hump insertion is performed between two heights  $u < v$ . Up to bd-equivalence, we can assume that the strands of  $\gamma$  are vertical between the heights  $u$  and  $v$ . Then, the strands of the hump by which  $h_X(\gamma)$  differs from  $\gamma$  can be made "almost vertical". By this, we mean that their derivatives can be taken arbitrary close to zero up to bd-equivalence. By performing such a bd-equivalence, we see

that the coefficients of the chord diagrams of  $Z^{\text{bd}}(h_X(\gamma))$  having at least one "long chord" linking the hump to another vertical strand of  $\gamma$  tends to zero. The lemma follows by applying the same argument to one of the humps of the bd-knot  $U$ .  $\square$

As the degree zero part of  $H$  is the unit  $S^1$  of the complete algebra  $\widehat{\mathcal{A}}(S^1)$ ,  $H$  is invertible.

**Definition 1.5.13.** Let  $\gamma$  be a bd-tangle, and let  $X_1, \dots, X_r$  denote its connected components. Let  $p_i$  be the number of d-vertices of the component  $X_i$ . We define

$$Z(\gamma) := H^{-p_1} \#_{X_1} \cdots H^{-p_r} \#_{X_r} Z^{\text{bd}}(\gamma).$$

**Theorem 1.5.14.**  $Z$  defines a functor  $\mathcal{T} \rightarrow \widehat{\mathcal{A}}$ .

*Proof.* Let  $\gamma$  and  $\gamma'$  be two bd-tangles that are isotopic as smooth tangles, and denote by  $X_1, \dots, X_r$  their components. From Proposition 1.3.11, there exist  $n_1, \dots, n_r$  and  $n'_1, \dots, n'_r$  such that  $h_{X_1}^{n_1} \cdots h_{X_r}^{n_r}(\gamma)$  is bd-equivalent to  $h_{X_1}^{n'_1} \cdots h_{X_r}^{n'_r}(\gamma')$ . Moreover, since the number of d-vertices of a given component is invariant under bd-equivalence, we have  $n_i + p_i = n'_i + p'_i$  for any  $i$ . From Lemma 1.5.12,

$$H^{n_1} \#_{X_1} \cdots H^{n_r} \#_{X_r} Z^{\text{bd}}(\gamma) = H^{n'_1} \#_{X_1} \cdots H^{n'_r} \#_{X_r} Z^{\text{bd}}(\gamma').$$

By definition,

$$H^{n_1+p_1} \#_{X_1} \cdots H^{n_r+p_r} \#_{X_r} Z(\gamma) = H^{n'_1+p'_1} \#_{X_1} \cdots H^{n'_r+p'_r} \#_{X_r} Z(\gamma'),$$

hence  $Z(\gamma) = Z(\gamma')$  and  $Z$  is an invariant of tangles. Since the number of d-vertices of the product of two bd-tangles  $\gamma_2\gamma_1$  is the sum of the number of d-vertices of  $\gamma_1$  and  $\gamma_2$ , it is immediate that  $Z$  is a functor.  $\square$



## Chapter 2

# An elliptic Kontsevich integral

Here we develop here an "elliptic version" of Chapter 1, leading to the analytic construction of a Kontsevich-type invariant for tangles in the thickened torus. We first recall the universal elliptic Knizhnik–Zamolodchikov–Bernard (KZB) connection introduced in [CEE10]. This is a flat connection on the configuration space of  $n$  points on the elliptic curve  $\mathbb{E} := \mathbb{C}/(\mathbb{Z} + \tau\mathbb{Z})$  with values in the genus one analog  $\mathfrak{t}_{1,n}$  of the Lie algebra  $\mathfrak{t}_n$ . The parallel transport of this connection gives rise to a representation  $T_{KZB}$  of the elliptic braid groupoid  $\mathcal{B}_{1,n}$ . After defining the categories  $\mathcal{T}_1$ ,  $\mathcal{T}_1^{\text{bd}}$  and  $\mathbf{A}_1$ ,  $\mathcal{A}_1$  of elliptic (bd-)tangles and Jacobi diagrams, we give an integral formula extending  $T_{KZB}$  to an invariant  $Z_\tau^{\text{bd}}$  of elliptic bd-tangles with values in  $\mathcal{A}_1$ . As in the former case,  $Z_\tau^{\text{bd}}$  can be renormalized to produce an invariant  $Z_\tau$  of elliptic smooth tangles. If  $\gamma$  is an elliptic link which is contained in a ball, then the elliptic invariant  $Z_\tau(\gamma)$  coincides with the usual Kontsevich invariant  $Z(\gamma)$ .

Throughout this chapter, we fix an elliptic parameter  $\tau$  in the Poincaré upper half plane  $\mathfrak{H} = \{z \in \mathbb{C} \mid \Im(z) > 0\}$ . The corresponding lattice  $\Lambda := \mathbb{Z} + \mathbb{Z}\tau$  defines an elliptic curve  $\mathbb{E} := \mathbb{C}/\Lambda$ .

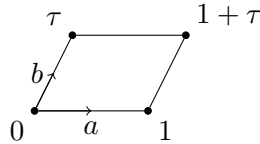

We define the loops  $a$  and  $b$  on  $\mathbb{E}$  as the projections of the oriented segments  $[0, 1]$  and  $[0, \tau]$  respectively. Let  $x := [a]$  and  $y := [b]$  be their homology classes, and  $H_1 \cong \mathbb{C}x \oplus \mathbb{C}y$  the first complex homology group of  $\mathbb{E}$ . The intersection pairing  $H_1 \otimes H_1 \rightarrow \mathbb{C}$ , for which  $x, y$  is a symplectic basis, is denoted by  $\langle \cdot, \cdot \rangle$ .

### 2.1 The Lie algebra $\mathfrak{t}_{1,n}$

We define the graded Lie algebra  $\mathfrak{t}_{1,n}$ , which has been introduced by Bezrukavnikov [Bez94] as the Lie algebra associated with the lower central series of the pure braid group of the torus.

**Definition 2.1.1.** Let  $\mathfrak{t}_{1,n}$  be the graded Lie algebra presented by the degree one generators  $v_i$  (for any  $v \in H_1$  and  $i \in \{1, \dots, n\}$ ), the degree two generators  $t_{ij}$  (for

any  $i \neq j \in \{1, \dots, n\}$ , the linearity relation  $(v + \lambda w)_i = v_i + \lambda w_i$  and the following relations (2.1.1-2.1.3) for any  $v, w \in H_1$  and any distinct  $i, j, k \in \{1, \dots, n\}$ .

$$[v_i, w_j] = \langle v, w \rangle t_{ij}, \quad (2.1.1)$$

$$[v_i, t_{jk}] = 0, \quad (2.1.2)$$

$$[x_i, y_i] = - \sum_{j \neq i} t_{ij}. \quad (2.1.3)$$

**Lemma 2.1.2.** *The relations of Definition 2.1.1 imply that  $\sum_{j=1}^n v_j$  is central in  $\mathfrak{t}_{1,n}$ , and*

$$t_{ij} = t_{ji}, \quad [v_i + v_j, t_{ij}] = 0,$$

as well as the infinitesimal pure braids relations

$$[t_{ij}, t_{kl}] = 0 \quad \text{and} \quad [t_{ij}, t_{ik} + t_{kj}] = 0.$$

In particular, there is a Lie algebra morphism  $\mathfrak{t}_n \rightarrow \mathfrak{t}_{1,n}$  sending  $t_{ij} \in \mathfrak{t}_n$  to  $t_{ij} \in \mathfrak{t}_{1,n}$ . This morphism multiplies the degree by two.

*Proof.* Relations (2.1.3) and (2.1.1) imply  $[x_i, \sum_{j=1}^n y_j] = 0$ , and from (2.1.1), we also have  $[y_i, \sum_{j=1}^n y_j] = 0$ . Since the  $x_i$ 's and the  $y_i$ 's generate  $\mathfrak{t}_{1,n}$ , it follows that  $\sum_{j=1}^n y_j$  is central. Similarly, we show that  $\sum_{j=1}^n x_j$  is central. Hence,  $\sum_{j=1}^n v_j$  is central for any  $v$ . The relation  $t_{ij} = t_{ji}$  follows from  $t_{ij} = [x_i, y_j] = -[y_j, x_i] = -\langle y, x \rangle t_{ji} = t_{ji}$ . Using (2.1.2), we have  $[v_i + v_j, t_{ij}] = [\sum_{s=1}^n v_s, t_{ij}] = 0$  and  $[t_{ij}, t_{kl}] = [t_{ij}, [x_k, y_l]] = 0$ . Last, we have  $[t_{ij}, t_{ik} + t_{kj}] = [t_{ij}, [x_i, y_k] + [x_j, y_k]] = [t_{ij}, [x_i + x_j, y_k]] = -[x_i + x_j, [y_k, t_{ij}]] - [y_k, [t_{ij}, x_i + x_j]] = 0$ .  $\square$

## 2.2 A universal elliptic KZB connection

Let  $\pi : \mathbb{C} \rightarrow \mathbb{E}$  be the projection, and  $\mathbb{C}_{n,\tau}$  be the *orbit configuration space*

$$\mathbb{C}_{n,\tau} = \{(z_1, \dots, z_n) \in \mathbb{C}^n \mid i \neq j \Rightarrow \pi(z_i) \neq \pi(z_j)\}.$$

In this section, we define the universal elliptic KZB connection as a  $\widehat{\mathfrak{t}}_{1,n}$ -valued formal connection on  $\mathbb{C}_{n,\tau}$  with some elliptic equivariance properties.

Let  $\theta_\tau$  denotes the classical Jacobi theta function

$$\theta_\tau(z) = \sum_{n \in \mathbb{Z}} e^{\pi i \tau (n + \frac{1}{2})^2} e^{2\pi i (n + \frac{1}{2})(z + \frac{1}{2})}, \quad z \in \mathbb{C}.$$

The function  $\theta_\tau$  is holomorphic on  $\mathbb{C}$ . Its set of zeros, which are all simple, coincides with the lattice  $\Lambda$ . Moreover,  $\theta_\tau$  satisfies the following elliptic properties:

$$\theta_\tau(z + 1) = -\theta_\tau(z) = \theta_\tau(-z) \quad \text{and} \quad \theta_\tau(z + \tau) = -e^{-\pi i \tau} e^{-2\pi i z} \theta_\tau(z). \quad (2.2.1)$$

From  $\theta_\tau$ , we define the following meromorphic function  $F_\tau$  in two complex variables (introduced by Kronecker [Kro81]).

$$F_\tau(z, x) = \frac{\theta'_\tau(0)\theta_\tau(z+x)}{\theta_\tau(z)\theta_\tau(x)}. \quad (2.2.2)$$

The functional equations (2.2.1) imply:

$$F_\tau(z+1, x) = F_\tau(z, x) \quad \text{and} \quad F_\tau(z+\tau, x) = e^{-2\pi i x} F_\tau(z, x). \quad (2.2.3)$$

It follows from (2.2.2) that  $F_\tau(z, x) - 1/z - 1/x$  is regular near  $(z, x) = (0, 0)$ . Therefore, we can define a family of meromorphic functions  $\Psi_k$ ,  $k \geq 0$ , on  $\mathbb{C}$  by the expansion:

$$F_\tau(z, x) - \frac{1}{z} - \frac{1}{x} = \sum_{k=0}^{\infty} \Psi_k(z) (2\pi i x)^k.$$

The poles of  $\Psi_k$  coincide with  $\Lambda$  for  $k = 0$  and with  $\Lambda \setminus \mathbb{Z}$  for  $k \geq 1$ .

We give an explicit formula for  $\Psi_k(z)$  in the domain  $|\Im(z)| < |\Im(\tau)|$ . Let us set  $\xi := e^{2\pi i z}$ ,  $\eta := e^{2\pi i x}$  and  $q := e^{2\pi i \tau}$ . As shown by Zagier [Zag91],  $F_\tau(z, x)$  can be expressed as the following double series<sup>1</sup> in the domain defined by  $|\Im(z)| < |\Im(\tau)|$  and  $|\Im(x)| < |\Im(\tau)|$ :

$$F_\tau(z, x) = (2\pi i) \left( 1 - \frac{1}{1-\xi} - \frac{1}{1-\eta} - \sum_{m,n=1}^{\infty} (\xi^m \eta^n - \xi^{-m} \eta^{-n}) q^{mn} \right).$$

For  $|\Im(z)| < |\Im(\tau)|$ , the functions  $\Psi_k$  can thus be expressed by:

$$\begin{aligned} \Psi_0(z) &= 2\pi i \left( \frac{1}{2} + \frac{1}{\xi-1} - \sum_{m,n \geq 1} (\xi^m - \xi^{-m}) q^{mn} \right), \text{ and} \\ \Psi_k(z) &= \frac{2\pi i}{k!} \left( \frac{B_{k+1}}{k+1} - \sum_{m,n \geq 1} n^k (\xi^m - (-1)^k \xi^{-m}) q^{mn} \right) \text{ for any } k \geq 1. \end{aligned}$$

Here,  $B_k$  stands for the  $k$ -th Bernoulli number defined by  $\frac{t}{e^t-1} = \sum_{k=0}^{\infty} B_k \frac{t^k}{k!}$ .

We consider the formal connection  $\Omega_\tau$  on  $\mathbb{C}_{n,\tau}$  with values in  $\widehat{\mathfrak{t}}_{1,n}$  given by:

$$\Omega_\tau = \sum_{i=1}^n x_i dz_i + \frac{1}{2\pi i} \sum_{\substack{i,j=1 \\ i < j}}^n \sum_{k=0}^{\infty} \Psi_k(z_{ij}) (\text{ady}_i)^k(t_{ij}) dz_{ij}, \quad (2.2.4)$$

where  $z_{ij} := z_i - z_j$ .

*Remark 2.2.1.* Let us check that the above defined  $\Omega_\tau$  coincides with the original<sup>2</sup> connection given in [CEE10, Section 1.2], by:

$$\sum_{i=1}^n \left( x_i + \frac{1}{2\pi i} \sum_{\substack{j=1 \\ j \neq i}}^n \sum_{k=0}^{\infty} \Psi_k(z_{ij}) (\text{ady}_i)^k(t_{ij}) \right) dz_i.$$

Since  $\theta_\tau(-z) = -\theta_\tau(z)$ , we have  $F_\tau(-z, -x) = -F_\tau(z, x)$ , hence  $\Psi_k(-z) = (-1)^{k+1} \Psi_k(z)$ . Moreover, it follows from the relations  $[y_i + y_j, t_{ij}] = 0$  and  $[y_i, y_j] = 0$  that

$$(\text{ady}_i)^k(t_{ij}) = (-1)^k (\text{ady}_j)^k(t_{ij}).$$

<sup>1</sup>We have set  $F_\tau(z, x) = 2\pi i F_\tau^{\text{Zag}}(2\pi i z, 2\pi i x)$  where  $F_\tau^{\text{Zag}}$  is the function introduced in [Zag91].

<sup>2</sup>After application of the automorphism of  $\mathfrak{t}_{1,n}$  given by  $x_i \mapsto \frac{y_i}{2\pi i}$  and  $y_i \mapsto -x_i$ .

Using these two identities:

$$\begin{aligned}
\Omega_\tau &= \sum_{i=1}^n x_i dz_i + \frac{1}{2\pi i} \sum_{\substack{i,j=1 \\ i < j}}^n \sum_{k=0}^{\infty} \Psi_k(z_{ij}) (\text{ady}_i)^k(t_{ij}) dz_{ij} \\
&= \sum_{i=1}^n x_i dz_i + \frac{1}{2\pi i} \sum_{\substack{i,j=1 \\ i < j}}^n \sum_{k=0}^{\infty} (\Psi_k(z_{ij}) (\text{ady}_i)^k(t_{ij}) dz_i + \Psi_k(z_{ji}) (\text{ady}_j)^k(t_{ij}) dz_j) \\
&= \sum_{i=1}^n x_i dz_i + \frac{1}{2\pi i} \sum_{\substack{i,j=1 \\ i \neq j}}^n \sum_{k=0}^{\infty} \Psi_k(z_{ij}) (\text{ady}_i)^k(t_{ij}) dz_i.
\end{aligned}$$

**Proposition 2.2.2.** [CEE10, Proposition 1.2] *The connection  $\Omega_\tau$  is flat.*

Let  $(\delta_i)_{1 \leq i \leq n}$  denote the canonical basis of  $\mathbb{C}^n$ . We define a morphism of  $\mathbb{Z}$ -modules  $\rho : \Lambda^n \rightarrow \mathfrak{t}_{1,n}$  by  $\rho(\delta_i) = 0$  and  $\rho(\tau\delta_i) = y_i$  for all  $i \in \{1, \dots, n\}$ .

The relations (2.2.3) imply the following.

**Lemma 2.2.3.** [CEE10, Lemma 1.1] *The connection  $\Omega_\tau$  is  $\Lambda^n$ -equivariant in the sense that  $\Omega_\tau(\mathbf{z} + \lambda) = e^{-\text{ad}(\rho(\lambda))} \Omega_\tau(\mathbf{z})$  for all  $\mathbf{z} \in \mathbb{C}_{n,\tau}$  and all  $\lambda \in \Lambda^n$ .*

## 2.3 Elliptic braids and tangles

Let  $E \subset \mathbb{E}$  be the complement of the two loops  $a \cup b$ , and  $B \subset \mathbb{C}$  the lift of  $E$  defined by  $B := \{r + s\tau \mid 0 < r < 1 \text{ and } 0 < s < 1\}$ . We denote by  $\mathbb{E}_n := (\pi \times \dots \times \pi)(\mathbb{C}_{n,\tau})$  the configuration space of  $n$  ordered points of  $\mathbb{E}$ , and we also set  $E_n := \mathbb{E}_n \cap E^n$ .

**Definition 2.3.1.** We define an *elliptic  $n$ -strand braid* as a path  $\beta : I \rightarrow \mathbb{E}_n$  whose endpoints  $\beta(0)$  and  $\beta(1)$  lie in  $E_n$ . The *elliptic  $n$ -strand braid groupoid*  $\mathcal{B}_{1,n}$  is then the groupoid consisting of the homotopy classes of elliptic  $n$ -strand braids.

Let  $\beta : I \rightarrow \mathbb{E}_n$  be an elliptic braid, and let  $\tilde{\beta} : I \rightarrow \mathbb{C}_{n,\tau}$  be a lift of  $\beta$ . Since the endpoints  $\beta(0)$  and  $\beta(1)$  lie in  $E_n$ , there is a unique pair  $\lambda_0, \lambda_1 \in \Lambda^n$  such that  $\tilde{\beta}(0) - \lambda_0$  and  $\tilde{\beta}(1) - \lambda_1$  are in  $B^n$ .

Let  $T_\tau(\tilde{\beta}) \in \exp(\widehat{\mathfrak{t}}_{1,n})$  denote the parallel transport of the flat connection  $\Omega_\tau$  along the path  $\tilde{\beta}$ .

**Lemma 2.3.2.**  $e^{\rho(\lambda_1)} T_\tau(\tilde{\beta}) e^{-\rho(\lambda_0)}$  is independent of the choice of the lift  $\tilde{\beta}$  of  $\beta$ .

*Proof.* Any lift of  $\beta$  is of the form  $\tilde{\beta} + \lambda$  where  $\lambda \in \Lambda^n$ . We have to show that  $T_\tau(\tilde{\beta}) = e^{\rho(\lambda)} T_\tau(\tilde{\beta} + \lambda) e^{-\rho(\lambda)}$ . By definition,  $T_\tau(\tilde{\beta}) = f_{\tilde{\beta}}(1)$  where  $f_{\tilde{\beta}}(0) = 1$  and

$$\frac{d}{dt} f_{\tilde{\beta}}(t) = \Omega_\tau(\dot{\tilde{\beta}}(t)) f_{\tilde{\beta}}(t),$$

and  $T_\tau(\tilde{\beta} + \lambda) = f_{\tilde{\beta} + \lambda}(1)$  where  $f_{\tilde{\beta} + \lambda}(0) = 1$  and

$$\begin{aligned}
\frac{d}{dt} f_{\tilde{\beta} + \lambda}(t) &= \Omega_\tau(\dot{\tilde{\beta}}(t) + \lambda) f_{\tilde{\beta} + \lambda}(t) \\
&= e^{-\text{ad}(\rho(\lambda))} \Omega_\tau(\dot{\tilde{\beta}}(t)) f_{\tilde{\beta} + \lambda}(t) \\
&= e^{-\rho(\lambda)} \Omega_\tau(\dot{\tilde{\beta}}(t)) e^{\rho(\lambda)} f_{\tilde{\beta} + \lambda}(t),
\end{aligned}$$

where the second equality follows from Lemma 2.2.3. Hence

$$\frac{d}{dt} e^{\rho(\lambda)} f_{\tilde{\beta}+\lambda}(t) = \Omega_\tau(\dot{\tilde{\beta}}(t)) e^{\rho(\lambda)} f_{\tilde{\beta}+\lambda}(t).$$

Since  $e^{\rho(\lambda)} f_{\tilde{\beta}+\lambda}$  and  $f_{\tilde{\beta}}$  satisfy the same formal differential equation, they differ by multiplication by a constant on the right:

$$f_{\tilde{\beta}+\lambda}(t) = e^{-\rho(\lambda)} f_{\tilde{\beta}}(t) e^{\rho(\lambda)}, \quad (2.3.1)$$

and the lemma follows.  $\square$

For an elliptic braid  $\beta$ , we define (slightly abusing notation)  $T_\tau(\beta) \in \exp(\widehat{\mathfrak{t}}_{1,n})$  by

$$T_\tau(\beta) := e^{\rho(\lambda_1)} T_\tau(\tilde{\beta}) e^{-\rho(\lambda_0)}.$$

$T_\tau(\beta)$  is well-defined from Lemma 2.3.2. The homotopy lifting property and the flatness of  $\Omega_\tau$  imply that  $T_\tau(\beta)$  is invariant under homotopy of  $\beta$ . One can easily check that we have thus defined a functor

$$T_\tau : \mathcal{B}_{1,n} \rightarrow \exp(\widehat{\mathfrak{t}}_{1,n}).$$

We end this section with the definition of the elliptic versions  $\mathcal{P}_1$ ,  $\mathcal{T}_1$  and  $\mathcal{T}_1^{\text{bd}}$  of the categories of patterns, tangles and bd-tangles.

**Definition 2.3.3.** The categories  $\mathcal{P}_1$ ,  $\mathcal{T}_1$  and  $\mathcal{T}_1^{\text{bd}}$  are defined as  $\mathcal{P}$ ,  $\mathcal{T}$  and  $\mathcal{T}^{\text{bd}}$  respectively by replacing the base surface  $\mathbb{C}$  with the elliptic curve  $\mathbb{E}$ , and (as in the case of elliptic braids) requiring the endpoints of any elliptic pattern, tangle or bd-tangle to lie in  $E \subset \mathbb{E}$  (so that the objects of  $\mathcal{P}_1$ ,  $\mathcal{T}_1$  and  $\mathcal{T}_1^{\text{bd}}$  are the finite sets of signed points of  $E$ ).

All the definitions and results of Sections 1.3.2, 1.3.3 and 1.3.5 can be directly transposed to the elliptic context.

## 2.4 Elliptic Jacobi diagrams

We define the category of *elliptic Jacobi diagrams* which form, as a "diagrammatic enlargement" of the completed enveloping algebra  $\widehat{\mathfrak{U}}_{\mathfrak{t}_{1,n}}$ , the target of the elliptic Kontsevich integral constructed in the next section. Elliptic Jacobi diagrams are similar to the genus one *symplectic Jacobi diagrams* introduced by Habiro in [Hab00] (see also [HM09]), except that our diagrams are attached to patterns.

**Definition 2.4.1.** An *elliptic Jacobi diagram* of pattern  $P \in \mathbf{P}$  is a finite graph  $D$  whose vertices are

- univalent and attached to a point of the interior of the pattern  $P$ ,
- or trivalent and oriented,
- or univalent and labeled with an element of  $H_1$ .



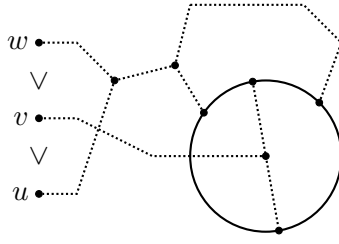

Figure 2.1: An elliptic Jacobi diagram where  $u, v, w \in H_1$ .

$$\begin{array}{c} v \bullet \text{-----} \\ \vee \\ w \bullet \text{-----} \end{array} - \begin{array}{c} w \bullet \text{-----} \\ \vee \\ v \bullet \text{-----} \end{array} = \langle v, w \rangle \begin{array}{c} \text{-----} \\ \text{-----} \end{array}$$

Figure 2.2: The STU-like relation.

In the third case, the vertex is said to be *external*. The other vertices are *internal*. The set of external vertices is linearly ordered. In the figures, this order is symbolized by  $<$  and is induced by the height  $t \in I$  (higher vertices being always greater than the lower ones). See Figure 2.1. Again, each connected component of  $D$  is required to be attached to the pattern  $P$ . The *degree* of an elliptic Jacobi diagram  $D$  is defined as:

$$\text{deg}(D) := \text{number of internal vertices of } D.$$

In what follows, we introduce the category  $\mathbf{A}_1$  of elliptic Jacobi diagrams as a quotient of a "preliminary" category  $\mathbf{A}_1^\partial$ .

**Definition 2.4.2.** Let  $\mathbf{A}_1^\partial(P)$  be the graded vector space generated by the elliptic Jacobi diagrams of pattern  $P$ , up to the (homogeneous) relations STU, STU-like (Figure 2.2), and to the multilinearity of labels. We define a category  $\mathbf{A}_1^\partial$  as follows. A morphism of  $\mathbf{A}_1^\partial$  is an element of  $\mathbf{A}_1^\partial(P)$  for some pattern  $P$ , and the source and target of such a morphism are those of  $P$ . The *product*  $D_2 D_1$  of two elliptic Jacobi diagrams of composable patterns is obtained by taking the composition of the patterns together with the union of the two graphs (the external vertices of  $D_2 D_1$  coming from  $D_2$  being considered greater than those coming from  $D_1$ ). The composition in  $\mathbf{A}_1^\partial$  is obtained by extending the product of Jacobi diagrams linearly.

The category  $\mathbf{A}_1^\partial$  is a graded linear  $\mathbf{P}$ -category in the sense of Definition 1.4.7.

As in [HM09], a diagram with ordered external vertices labeled by either an element of  $H_1$  or the symbol " $\omega$ " shall be seen as an elliptic Jacobi diagram according to the following rule:

$$\begin{array}{c} \vdots \\ \vee \\ \omega \bullet \text{-----} \\ \vee \\ \vdots \end{array} := \begin{array}{c} \vdots \\ \vee \\ x \bullet \text{-----} \\ \vee \\ y \bullet \text{-----} \\ \vee \\ \vdots \end{array}$$

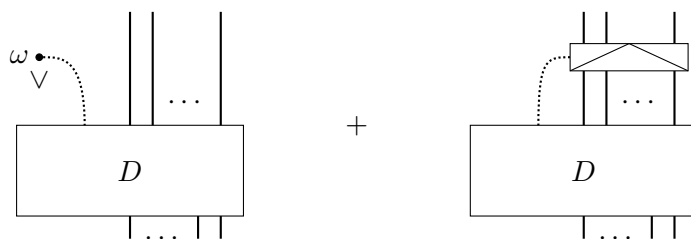

Figure 2.3: The generators of  $\mathbf{I}_1(P)$ . In this sum, the two diagrams are identical except on their top parts. See Figure 1.9 for the "box" notation.

**Definition 2.4.3.** Let  $\mathbf{I}_1(P) \subset \mathbf{A}_1^\partial(P)$  be the subspace generated by the sums depicted in Figure 2.3, for any part  $D$  of a Jacobi diagram of pattern  $P$ .

**Lemma 2.4.4.** *The collection of subspaces  $\mathbf{I}_1(P)$  defines a two-sided ideal  $\mathbf{I}_1$  of the linear  $\mathbf{P}$ -category  $\mathbf{A}_1^\partial$ , in the sense of the following definition.*

**Definition 2.4.5.** A two-sided ideal  $\mathbf{I}$  in a linear  $\mathbf{G}$ -category  $\mathbf{C}$  is a collection of subspaces  $\mathbf{I}(f) \subset \mathbf{C}(f)$  associated to any morphism  $f$  of  $\mathbf{G}$ , such that  $\mathbf{C}(f_2)\mathbf{I}(f_1) \subset \mathbf{I}(f_2f_1)$  and  $\mathbf{I}(f_2)\mathbf{C}(f_1) \subset \mathbf{I}(f_2f_1)$  for any pair of composable morphisms  $(f_1, f_2)$  of  $\mathbf{G}$ . If  $\mathbf{I}$  is a two-sided ideal of  $\mathbf{C}$ , the linear  $\mathbf{G}$ -category  $\mathbf{C}/\mathbf{I}$  is defined by  $(\mathbf{C}/\mathbf{I})(f) := \mathbf{C}(f)/\mathbf{I}(f)$  for any morphism  $f$  of  $\mathbf{G}$ , and the composition in  $\mathbf{C}/\mathbf{I}$  is induced by the composition in  $\mathbf{C}$ .

*Proof of Lemma 2.4.4.* By construction, we have  $\mathbf{I}_1(P_2)\mathbf{A}_1^\partial(P_1) \subset \mathbf{I}_1(P_2P_1)$ , since stacking a generator of  $\mathbf{I}_1(P_2)$  above an arbitrary diagram of  $\mathbf{A}_1^\partial(P_1)$  leads to a generator of  $\mathbf{I}_1(P_2P_1)$  (see Figure 2.3). Let us show that  $\mathbf{A}_1^\partial(P_2)\mathbf{I}_1(P_1) \subset \mathbf{I}_1(P_2P_1)$ . From two successive applications of the STU-like relation, we have (as stated in Lemma 7.1 of [HM09]):

$$\begin{array}{c} v \bullet \text{-----} \\ \vee \\ \omega \bullet \text{-----} \end{array} - \begin{array}{c} \omega \bullet \text{-----} \\ \vee \\ v \bullet \text{-----} \end{array} = -v \bullet \text{-----} \begin{array}{c} \diagup \\ \bullet \\ \diagdown \end{array}$$

Thus, on the one hand:

Recall that a box can be slid over a part  $D$  of a Jacobi diagram without external vertices (Lemma 1.4.4). Thus, on the other hand:

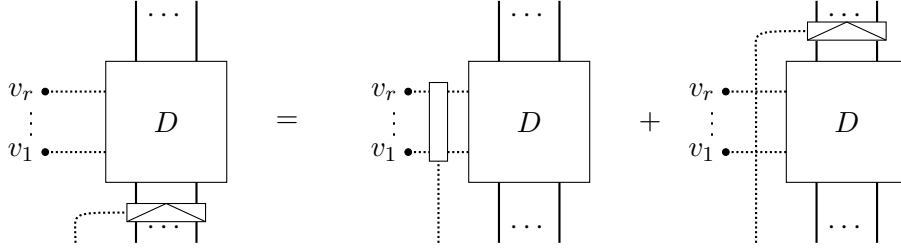

Finally, the sum of the left-hand sides of the two last equalities, which represents an arbitrary diagram  $D$  of  $\mathbf{A}_1^\partial$  stacked over an arbitrary generator of  $\mathbf{I}_1$ , lies in  $\mathbf{I}_1$ .  $\square$

**Definition 2.4.6.** We define the category  $\mathbf{A}_1$  as the quotient  $\mathbf{A}_1^\partial/\mathbf{I}_1$ . Again, the category  $\mathbf{A}_1/FI$  is defined by considering the morphisms of  $\mathbf{A}_1$  up to the FI relation of Figure 1.6.

There is a functor  $\mathbf{A} \rightarrow \mathbf{A}_1$  which consists in seeing a usual Jacobi diagram  $D$  as an elliptic Jacobi diagram with no external vertex. Note that this functor multiplies the degree by two. We do not know whether  $\mathbf{A} \rightarrow \mathbf{A}_1$  is injective, but at least we have the following.

**Lemma 2.4.7.** *Let  $P \in \mathbf{P}$  be a pattern whose source is empty or whose target is empty. Then  $\mathbf{A}(P) \rightarrow \mathbf{A}_1(P)$  is injective.*

*Proof.* The proof is inspired from [CHM08, Lemma 8.4]. We prove the lemma in the case where  $P$  is of empty target (the opposite case being obtained in a symmetric way). An *unordered elliptic Jacobi diagram*  $D$  is defined in the same way as an elliptic Jacobi diagram, except that the external vertices of  $D$  are labeled with  $x, y$  and are not ordered. The vector space spanned by unordered elliptic Jacobi diagrams on  $P$  modulo the STU relation is denoted by  $\mathbf{A}_{x,y}^\partial(P)$ . We define a linear map  $\varphi : \mathbf{A}_{x,y}^\partial(P) \rightarrow \mathbf{A}_1^\partial(P)$  where  $\varphi(D)$  is obtained from  $D$  by taking any  $x$ -vertex to be greater than any  $y$ -vertex. Using the multilinearity of labels and the STU-like relation, we see that  $\varphi$  is surjective. Conversely, we define a linear map  $\psi : \mathbf{A}_1^\partial(P) \rightarrow \mathbf{A}_{x,y}^\partial(P)$  as follows. Using the multilinearity of labels, it is enough to define  $\psi(D)$  in the case where  $D$  is labeled with  $x, y$  only. In this case,  $\psi(D)$  is the sum of all ways of connecting some  $x$ -vertices of  $D$  to some greater  $y$ -vertices. The map  $\psi$  factors through the STU-like relation, and  $\psi \circ \varphi$  is the identity. Hence  $\varphi$  and  $\psi$  are isomorphisms.

We have  $\mathbf{A}_{x,y}^\partial(P) \cong \mathbf{A}(P) \oplus \mathbf{A}'_{x,y}(P)$ , where  $\mathbf{A}'_{x,y}(P)$  is spanned by the unordered elliptic Jacobi diagrams having at least one external vertex. Through the isomorphism  $\psi$ , we get  $\mathbf{A}_1^\partial(P) \cong \mathbf{A}(P) \oplus \psi(\mathbf{A}'_{x,y}(P))$ . Moreover, since the target of  $P$  is empty, we have  $\mathbf{I}_1(P) \subset \psi(\mathbf{A}'_{x,y}(P))$ , and  $\mathbf{A}(P) \rightarrow \mathbf{A}_1(P) = \mathbf{A}_1^\partial(P)/\mathbf{I}_1(P)$  is injective.  $\square$

As previously, we set  $\mathbf{A}_1(n) := \mathbf{A}_1(\uparrow^n)$  and we see  $\mathbf{A}_1(n)$  as a graded algebra. In this context, Lemma 1.4.8 generalizes as follows.

**Lemma 2.4.8.** *There is a unique graded algebra morphism  $\iota_{1,n} : \text{Ut}_{1,n} \rightarrow \mathbf{A}_1(n)$  sending  $v_i$  (for any  $v \in H_1$ ,  $1 \leq i \leq n$ ) to the elliptic Jacobi diagram made of a single chord linking the  $i$ -th segment to an external  $v$ -vertex.*

$$v_i \xrightarrow{\iota_{1,n}} \begin{array}{c} | \quad | \quad | \\ \bullet \cdots \cdots \bullet \\ | \quad | \quad | \\ 1 \quad i \quad n \end{array}$$

Moreover, the following diagram commutes:

$$\begin{array}{ccc} \mathbf{Ut}_n & \xrightarrow{\iota_n} & \mathbf{A} \\ \downarrow & & \downarrow \\ \mathbf{Ut}_{1,n} & \xrightarrow{\iota_{1,n}} & \mathbf{A}_1 \end{array}$$

*Proof.* Let us check that the relations of Definition 2.1.1 are satisfied at the level of elliptic Jacobi diagrams. Relation (2.1.1):

$$\begin{array}{c} v \cdots \uparrow^i \uparrow^j \\ w \cdots \cdots \bullet \end{array} - \begin{array}{c} w \cdots \uparrow^i \uparrow^j \\ v \cdots \cdots \bullet \end{array} \stackrel{\text{STU-like}}{=} \langle v, w \rangle \begin{array}{c} \uparrow^i \uparrow^j \\ \cdots \bullet \end{array}$$

Relation (2.1.2):

$$\begin{array}{c} v \cdots \uparrow^i \uparrow^j \uparrow^k \\ \cdots \bullet \end{array} = \begin{array}{c} \uparrow^i \uparrow^j \uparrow^k \\ v \cdots \cdots \bullet \end{array}$$

Relation (2.1.3):

$$\begin{array}{c} x \cdots \uparrow^i \\ y \cdots \cdots \bullet \end{array} - \begin{array}{c} y \cdots \uparrow^i \\ x \cdots \cdots \bullet \end{array} \stackrel{\text{STU}}{=} \begin{array}{c} x \cdots \uparrow^i \\ y \cdots \cdots \bullet \end{array} + \begin{array}{c} x \cdots \uparrow^i \\ y \cdots \cdots \bullet \end{array} - \begin{array}{c} y \cdots \uparrow^i \\ x \cdots \cdots \bullet \end{array} \\ \stackrel{\text{STU-like}}{=} \begin{array}{c} x \cdots \uparrow^i \\ y \cdots \cdots \bullet \end{array} + \begin{array}{c} \uparrow^i \\ \cdots \bullet \end{array} \stackrel{\mathbf{I}_1}{=} - \sum_{\substack{j=1 \\ j \neq i}}^n \begin{array}{c} \uparrow^i \uparrow^j \\ \cdots \bullet \end{array}$$

□

We do not know whether  $\iota_{1,n}$  is injective.

As in Chapter 1, we introduce the "embedded endpoints" version of elliptic Jacobi diagrams.

**Definition 2.4.9.** We define the category  $\mathcal{A}_1$  in the same way as  $\mathbf{A}_1/FI$  by replacing the category  $\mathbf{P}$  with  $\mathcal{P}_1$ . In particular,  $\mathcal{A}_1$  is a graded linear  $\mathcal{P}_1$ -category.

As previously, we have functors

$$\mathbf{Ut}_{1,n}\{E_n\} \rightarrow \mathbf{A}_1(n)\{E_n\} \rightarrow \mathcal{A}_1,$$

where the first arrow is induced by the algebra morphism  $\iota_{1,n} : \mathbf{Ut}_{1,n} \rightarrow \mathbf{A}_1(n)$ . Again, we see the parallel transport  $T_\tau$  of the elliptic KZB connection as a functor  $\mathcal{B}_{1,n} \rightarrow \widehat{\mathbf{Ut}}_{1,n}\{E_n\}$  by keeping track of the position of the endpoints of the braids.

## 2.5 Construction of $Z_\tau^{\text{bd}}$

Our goal in this section is to extend the elliptic braid invariant  $T_\tau$  to an invariant of elliptic bd-tangles  $Z_\tau^{\text{bd}}$  in the sense that the following diagram commutes:

$$\begin{array}{ccc}
 \mathcal{B}_{1,n} & \xrightarrow{T_\tau} & \widehat{\text{U}}\mathfrak{t}_{1,n}\{E_n\} \\
 \downarrow & & \downarrow \\
 \mathcal{T}_1^{\text{bd}} & \xrightarrow{Z_\tau^{\text{bd}}} & \widehat{\mathcal{A}}_1
 \end{array} \tag{2.5.1}$$

Throughout this section,  $\gamma \subset \mathbb{E} \times I$  is a fixed elliptic bd-tangle. We define the *a-wall* of  $\mathbb{E} \times I$  as the annulus  $a \times I \subset \mathbb{E} \times I$ , and the *b-wall* as  $b \times I \subset \mathbb{E} \times I$ . A *wall-crossing point* of  $\gamma$  is a point where  $\gamma$  intersects a wall. Up to an arbitrary small perturbation of  $\gamma$  by bd-equivalence, we can assume that

- $\gamma$  does not intersect the segment  $0 \times I = (a \cap b) \times I$ ,
- $\gamma$  crosses the walls transversally,
- the wall-crossings points of  $\gamma$  (which are thus of finite number) are all distinct from the bd-vertices of  $\gamma$ ,
- the wall-crossings points together with the bd-vertices (which form the set of *special points* of  $\gamma$ ) are of distinct heights  $v_1 < v_2 < \dots < v_r$  (the *special heights* of  $\gamma$ ). We set  $v_0 := 0$ ,  $v_{r+1} := 1$ .

Between two consecutive special heights  $v_j$  and  $v_{j+1}$ , each strand of  $\gamma$  is fully determined by a pair  $(z, \varepsilon)$  where  $z : ]v_j, v_{j+1}[ \rightarrow B \subset \mathbb{C}$  is the function such that  $\{(z(t), t) \mid t \in ]v_j, v_{j+1}[\}$  parametrizes the strand (here we identify  $E = \mathbb{E} \setminus (a \cup b)$  with its lift  $B$ ), and  $\varepsilon = +1$  if the strand is oriented upwards,  $\varepsilon = -1$  otherwise.

**Definition 2.5.1.** An *m-configuration*  $C$  on  $\gamma$  is the choice of

- a decomposition of  $m$  into  $r + 1$  nonnegative integers  $m = m_0 + m_1 + \dots + m_r$  (recall that this leads to an identification

$$\{1, \dots, m\} \cong \{(j, k) \mid 0 \leq j \leq r, 1 \leq k \leq m_j\} := L_C,$$

where the elements  $(j, k)$  of  $L_C$  are the *levels* of  $C$ ),

- a partition of  $L_C$  into two subsets  $L_C = L_C^1 \cup L_C^2$ ,
- for each  $(j, k) \in L_C^1$ , a strand  $(z_k^j, \varepsilon_k^j)$  of  $\gamma$  of height  $]v_j, v_{j+1}[$ ,
- for each  $(j, k) \in L_C^2$ , an unordered pair of distinct strands  $(z_k^j, \varepsilon_k^j)$  and  $(\bar{z}_k^j, \bar{\varepsilon}_k^j)$  of  $\gamma$  of height  $]v_j, v_{j+1}[$ , together with an integer  $\eta_k^j \geq 0$ .

The (infinite) set of *m-configuration*s on  $\gamma$  is denoted by  $\mathcal{C}_m(\gamma)$ .

As previously, we do not specify the indices  $(j, k)$  of  $z$ ,  $\varepsilon$  and  $\eta$  as far as there is no fear of confusion.

To each  $m$ -configuration  $C$  on  $\gamma$ , we associate a "coefficient"  $Z_{\tau, C}(\gamma) \in \mathbb{C} \cup \infty$  as follows. For each level  $(j, k)$ , we define the function  $f_k^j : ]v_j, v_{j+1}[ \rightarrow \mathbb{C}$  by

$$f_k^j(t) = \varepsilon \frac{d}{dt} z(t) \quad \text{if } (j, k) \in L_C^1, \quad (2.5.2)$$

and

$$f_k^j(t) = \frac{\varepsilon \bar{\varepsilon}}{2\pi i} \Psi_\eta(z(t) - \bar{z}(t)) \frac{d}{dt} (z(t) - \bar{z}(t)) \quad \text{if } (j, k) \in L_C^2. \quad (2.5.3)$$

*Remark 2.5.2.* In the case where  $(j, k) \in L_C^2$  and  $\eta$  is odd, the function  $f_k^j$  is well-defined only up to sign. Indeed, recall that  $\Psi_k(-z) = (-1)^{k+1} \Psi_k(z)$ . Hence  $f_k^j$  depends up to sign on the choice of an ordering of the pairs of strands  $(z, \bar{z})$ , which are by definition non-ordered. Anyway, this ambiguity will soon disappear.

We set

$$Z_{\tau, C}(\gamma) := \prod_{j=0}^r \mathcal{G}_{(v_j, v_{j+1})}^{m_j}(f_{m_j}^j, \dots, f_1^j). \quad (2.5.4)$$

We also associate to the  $m$ -configuration  $C$  a series  $D_C \in \mathcal{A}_1(\gamma)_{\geq m}$  of elliptic Jacobi diagrams of degree at least  $m$  in the following way. Pick  $m$  heights  $t = t_k^j$ , one for each level  $(j, k)$ , satisfying

$$v_j < t_1^j < t_2^j < \dots < t_{m_j}^j < v_{j+1}.$$

Then,

- for each  $(j, k) \in L_C^1$ , link the point  $(z(t_k^j), t_k^j) \in \gamma$  to an  $x$ -vertex with a chord,
- for each  $(j, k) \in L_C^2$ , link the points  $(z(t_k^j), t_k^j)$  and  $(\bar{z}(t_k^j), t_k^j)$  with a chord, and attach a number  $\eta$  of  $y$ -vertices on it to form a "comb" as depicted in Figure 2.4,
- link each  $a$ -wall crossing point of  $\gamma$  to an external vertex (provisionally) colored with  $\exp(y)$  if  $\Im\left(\frac{d}{dt} z(t)\right) < 0$  (where  $z$  is the complex function that parametrizes the strand near the wall-crossing point), and with  $\exp(-y)$  in the opposite case,
- substitute:

$$\begin{array}{l} \exp(y) \bullet \cdots \uparrow \rightsquigarrow \uparrow + y \bullet \cdots \uparrow + \frac{1}{2} \begin{array}{c} y \bullet \cdots \uparrow \\ y \bullet \cdots \uparrow \end{array} + \dots \\ \exp(-y) \bullet \cdots \uparrow \rightsquigarrow \uparrow - y \bullet \cdots \uparrow + \frac{1}{2} \begin{array}{c} y \bullet \cdots \uparrow \\ y \bullet \cdots \uparrow \end{array} + \dots \end{array}$$

The external edges of  $D_C$  are ordered according to the heights of the points of  $\gamma$  they are attached to. Note that we do not need to specify any ordering among the bunch of  $y$ -vertices coming from the same comb: the STU-like relation says that any choice leads to the same result in  $\mathcal{A}_1(\gamma)$ .

*Remark 2.5.3.* The orientation of the trivalent vertices of Figure 2.4 depends on the choice of a specific order of the pairs  $(z, \bar{z})$ . Because of the AS relation, switching this order switches the sign of  $D_C$  if and only if  $\eta$  is odd. Therefore, the sign indetermination of  $Z_{\tau, C}(\gamma)$  (Remark 2.5.2) and of  $D_C$  annihilate when taking the product  $Z_{\tau, C}(\gamma)D_C$ .

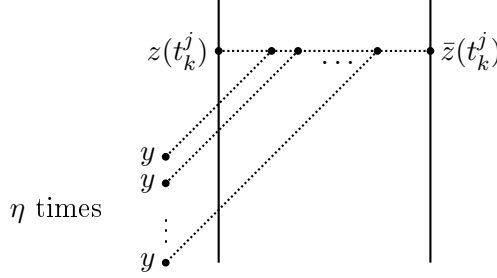

Figure 2.4: A "comb" linking  $z(t_k^j)$  to  $\bar{z}(t_k^j)$ . As depicted here, the orientation of the trivalent vertices of the comb is given by the following cyclic order "half-edge going to  $\bar{z}(t_k^j)$ "  $\rightarrow$  "half-edge going to  $z(t_k^j)$ "  $\rightarrow$  "half-edge going to the external  $y$ -vertex".

Finally, we set:

$$Z_{\tau}^{\text{bd}}(\gamma) := \sum_{m=0}^{\infty} \sum_{C \in \mathcal{C}_m(\gamma)} Z_{\tau, C}(\gamma) D_C \in \widehat{\mathcal{A}}_1(\gamma).$$

Note that for any degree  $d$ , the number of configurations  $C \in \cup_{m \geq 0} \mathcal{C}_m(\gamma)$  such that  $\deg(D_C) = d$  is finite. It remains to prove the following Lemma to verify that  $Z_{\tau}(\gamma)$  is well defined.

**Lemma 2.5.4.** *If  $C$  is a configuration such that  $D_C$  does not vanish as a morphism of  $\mathcal{A}_1$ , then the iterated integrals of  $Z_{\tau, C}(\gamma)$  converge.*

*Proof.* The proof goes essentially as for Lemma 1.5.4. Let  $C$  be a configuration such that  $D_C$  does not vanish in  $\mathcal{A}_1$ , and let  $j \in \{0, \dots, r\}$ . We show that the integral  $\mathcal{I}_{(v_j, v_{j+1})}^{m_j}(f_{m_j}^j, \dots, f_1^j)$  converges. Recall that:

- the derivatives of the strands  $\frac{d}{dt}z(t)$ ,  $\frac{d}{dt}\bar{z}(t)$  are bounded,
- the functions  $\Psi_s(z)$  are regular near  $z = 0$  for any  $s > 0$ ,
- the function  $\Psi_0$  has a simple pole at  $z = 0$ .

It follows that for any level  $(j, k)$ , the function  $f_k^j$  is bounded on  $(v_j, v_{j+1})$ , unless we are unlucky:  $(j, k)$  is in  $L_C^2$ ,  $\eta = 0$  and the strands  $z_k^j$  and  $\bar{z}_k^j$  meet at a b-vertex (in which case  $f_k^j(v_j + \varepsilon) \sim 1/\varepsilon$ ) or at a d-vertex (in which case  $f_k^j(v_{j+1} - \varepsilon) \sim 1/\varepsilon$ ). Nevertheless, the first situation cannot happen for  $k = 1$ , and the second situation cannot happen for  $k = m_j$ , because  $D_C$  would contain an isolated chord and thus would vanish. Lemma 1.5.1 allows us to conclude.  $\square$

As in the former case,  $Z_{\tau}^{\text{bd}}$  is invariant under height rescaling, and we have the following Lemma.

**Lemma 2.5.5.** *If  $(\gamma_1, \gamma_2)$  is a composable pair of elliptic bd-tangles, then  $Z_\tau^{\text{bd}}(\gamma_2\gamma_1) = Z_\tau^{\text{bd}}(\gamma_2)Z_\tau^{\text{bd}}(\gamma_1)$ .*

*Proof.* The proof goes exactly as in the case of  $Z^{\text{bd}}$  (Lemma 1.5.5). □

**Proposition 2.5.6.** *The diagram (2.5.1) is commutative; that is, if  $\beta$  is an elliptic braid, then  $Z_\tau^{\text{bd}}(\beta)$  coincides with the parallel transport of the KZB connection  $T_\tau(\beta)$  seen in  $\widehat{\mathcal{A}}_1$ .*

*Proof.* Let us first assume that  $\beta$ , when seen as a bd-tangle, has no wall-crossing point. In this case,  $T_\tau(\beta)$  is by definition the parallel transport of  $\Omega_\tau$  along the lift  $\tilde{\beta} : I \rightarrow B^n$  of  $\beta$ . It can then be checked that

$$\sum_{C \in \mathcal{C}_m(\beta)} \mathcal{I}_{(0,1)}^m(f_m, \dots, f_1) D_C = \int_{0 \leq t_1 \leq \dots \leq t_m \leq 1} \Omega_\tau(\tilde{\beta}(t_m)) \cdots \Omega_\tau(\tilde{\beta}(t_1)) dt_1 \cdots dt_m$$

(where the left-hand side of the equality is seen in  $\widehat{\mathcal{A}}_1$ ) in the same way as in the proof of Lemma 1.5.6, by observing that the "combs" of  $D_C$  correspond to the terms  $(\text{ady}_i)^k(t_{ij})$  in the expression of  $\Omega_\tau$ . Indeed, by  $k$  iterations of the STU relation, we have

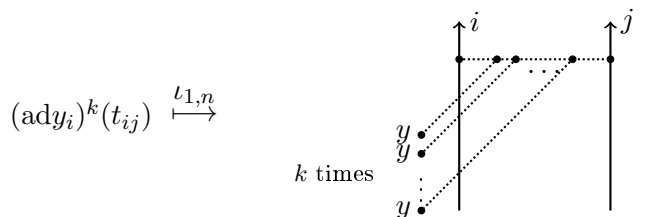

Now, assume that  $\beta$  has some wall-crossing points of distinct heights  $0 < w_1 < \dots < w_s < 1$ , and let  $\tilde{\beta} : I \rightarrow \mathbb{C}_{n,\tau}$  be a lift of  $\beta$ . Considering the decomposition  $I = [0, w_1] \cup [w_1, w_2] \cup \dots \cup [w_s, 1]$ , one can write  $\tilde{\beta}$  as a composition of paths  $\tilde{\beta} = (\tilde{\beta}_s + \lambda_s) \cdots (\tilde{\beta}_0 + \lambda_0)$  where for each  $i \in \{0, \dots, s\}$ ,  $\lambda_i \in \Lambda_\tau^n$  is the unique translation such that  $\tilde{\beta}_i$  is a path in  $B^n$ . By definition (see Section 2.3), we have:

$$T_\tau(\beta) = T_\tau(\tilde{\beta}_s) e^{\rho(\lambda_s - \lambda_{s-1})} T_\tau(\tilde{\beta}_{s-1}) \cdots T_\tau(\tilde{\beta}_1) e^{\rho(\lambda_1 - \lambda_0)} T_\tau(\tilde{\beta}_0).$$

It remains to notice that the insertion of the factors  $e^{\rho(\lambda_{i+1} - \lambda_i)}$  corresponds to the insertion of the vertex labeled with  $\exp(y)$  and  $\exp(-y)$  at the level of the  $\alpha$ -wall crossings points in the construction of the morphism  $D_C$ . □

We state the analog of Lemma 1.5.7.

**Lemma 2.5.7.** *Let  $\alpha \cup \gamma$  be a disjoint union of two elliptic bd-tangles, and let  $\bar{\alpha} \cup \gamma$  denote the bd-tangle obtained by reversing the orientation of  $\alpha$ . We then have*

$$Z_\tau^{\text{bd}}(\bar{\alpha} \cup \gamma) = S_\alpha Z_\tau^{\text{bd}}(\alpha \cup \gamma).$$

*Proof.* For any configuration  $C$ , each vertex of  $D_C$  which is attached to a given strand of the pattern comes either from a level  $(j, k)$  (and is associated with a coefficient  $\varepsilon = \pm 1$  in  $Z_C$  which depends on the orientation of this strand) or from a wall-crossing point (in which case the labeling with  $\exp(y)$  or  $\exp(-y)$  also depends on the orientation of the strand). □



## 2.6 Invariance of $Z_\tau^{\text{bd}}$

In this section we briefly check the following:

**Theorem 2.6.1.**  $Z_\tau^{\text{bd}}$  is invariant under bd-isotopy.

According to Proposition 1.3.8, the proof can be decomposed into two steps, namely the invariance under horizontal deformation and under bd-moves. The proofs are essentially the same as in the usual Kontsevich integral case.

**Lemma 2.6.2.**  $Z_\tau^{\text{bd}}(\gamma)$  is invariant under horizontal deformation of  $\gamma$ .

*Proof.* The proof is parallel to that of Lemma 1.5.9, using Lemma 2.5.5 and Lemma 2.5.7 in place of Lemma 1.5.5 and Lemma 1.5.7 respectively.  $\square$

To complete the proof of Theorem 2.6.1, it remains to show:

**Lemma 2.6.3.**  $Z_\tau^{\text{bd}}(\gamma)$  is invariant under bd-moves of  $\gamma$ .

*Proof.* Up to horizontal deformation, the bd-moves can be assumed to be arbitrary thin (as formulated in the proof of Lemma 1.5.10). If a bd-move is performed in a cylinder that is contained in  $E \times I$  or that crosses the b-wall only, then the proof goes essentially as in Lemma 1.5.10. If the bd-move crosses the a-wall, the only contribution of the move to  $Z_\tau^{\text{bd}}(\gamma)$  is the pair of external vertices labeled with  $\exp(y)$  and  $\exp(-y)$ . Since these two vertices are consecutive on the pattern, they can be simplified as depicted below.

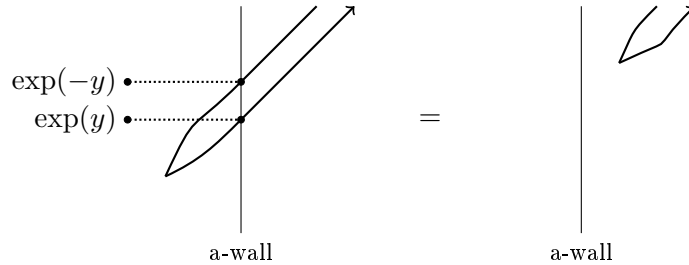

$\square$

## 2.7 Relation between $Z_\tau^{\text{bd}}$ and $Z^{\text{bd}}$

Let  $\gamma$  be an elliptic bd-link with no wall-crossing points; that is,  $\gamma$  lies in  $E \times I$ . By identifying  $E$  with its lift  $B \subset \mathbb{C}$ ,  $\gamma$  can also be seen as a bd-link in  $\mathbb{C} \times I$ . Therefore, both the usual and the elliptic Kontsevich integrals  $Z^{\text{bd}}(\gamma)$  and  $Z_\tau^{\text{bd}}(\gamma)$  make sense.

**Proposition 2.7.1.** If  $\gamma \subset E \times I$  is a bd-link, then  $Z_\tau^{\text{bd}}(\gamma) = Z^{\text{bd}}(\gamma)$ .

*Proof.* For any  $0 < \varepsilon \leq 1$ , let  $h_\varepsilon : B \rightarrow B$  be the homothety of ratio  $\varepsilon$  and center 0. We denote by  $\varepsilon\gamma := (h_\varepsilon \times \text{id}_I)(\gamma) \subset B \times I$  the corresponding "thin" bd-link. For any  $\varepsilon \in (0, 1]$ ,  $\gamma$  is obviously bd-equivalent to  $\varepsilon\gamma$ , Hence  $Z_\tau^{\text{bd}}(\gamma) = \lim_{\varepsilon \rightarrow 0} Z_\tau^{\text{bd}}(\varepsilon\gamma)$ . Let us show that  $\lim_{\varepsilon \rightarrow 0} Z_\tau^{\text{bd}}(\varepsilon\gamma) = Z^{\text{bd}}(\gamma)$ . Let  $C$  be a configuration on  $\gamma$ , which is seen as a family of configurations on  $\varepsilon\gamma$  for any  $0 < \varepsilon \leq 1$ . Let  $(j, k)$  be a level of the configuration  $C$ . If  $(j, k) \in L_C^1$ , then  $f_k^j \rightarrow 0$  as  $\varepsilon \rightarrow 0$ . If  $(j, k) \in L_C^2$  and  $\eta \geq 1$ ,

we still have  $f_k^j \rightarrow 0$  (since the functions  $\Psi_\eta$  are regular at  $z = 0$ ). Therefore, the coefficient  $Z_{\tau,C}(\varepsilon\gamma)$  tends to zero unless for any level  $(j, k)$  of  $C$ , we have  $(j, k) \in L_C^2$  and  $\eta = 0$ . In this case, since  $\Psi_0$  has a simple pole with residue 1 at  $z = 0$ , we see by comparing Formulae (1.5.2) and (2.5.3) that  $Z_{\tau,C}(\varepsilon\gamma)$  and  $Z_C(\varepsilon\gamma) = Z_C(\gamma)$  have the same limit as  $\varepsilon \rightarrow 0$ .  $\square$

*Remark 2.7.2.* In fact, the same proof still holds if  $\gamma \subset E \times I$  is a *bd-string-knot*; that is, a bd-tangle such that  $\partial\gamma = z_0 \times \partial I$  for some  $z_0 \in E$ . In the case of a general bd-tangle  $\gamma \subset E \times I$  of source  $X$  and target  $Y$ , the relation can be generalized as

$$Z_\tau^{\text{bd}}(\gamma) = c_Y Z^{\text{bd}}(\gamma) c_X^{-1},$$

with  $c_X := \lim_{\varepsilon \rightarrow 0} Z_\tau^{\text{bd}}(l_X^\varepsilon)^{-1} Z^{\text{bd}}(l_X^\varepsilon)$ , where for  $0 < \varepsilon \leq 1$ , we denote by  $l_X^\varepsilon$  the bd-tangle made of oriented segments linking each point of  $X \times 0$  on the bottom to the corresponding point of  $h_\varepsilon(X) \times 1$  on the top.

## 2.8 The normalization

Let us go back to the notations of Section 1.5.4.

One cannot *a priori* define an algebra structure on  $\mathcal{A}_1(S^1)$  in the same way as on  $\mathcal{A}(S^1)$ . However, we still have:

**Lemma 2.8.1.** *Let  $(P, X)$  be a (non empty) pattern equipped with a distinguished connected component  $X \subset P$ . We have an action  $\sharp_X$  of  $\mathcal{A}(S^1)$  on  $\mathcal{A}_1(P)$  by taking the connected sum of the circle to the component  $X$ .*

*Proof.* Just as in the case of Lemma 1.5.11, we see that this action is well-defined using the fact that "boxes can slide over a part of a Jacobi diagram without external vertices" (Lemma 1.4.4).  $\square$

Moreover, Lemma 1.5.12 still holds for the elliptic invariant  $Z_\tau^{\text{bd}}$ .

**Lemma 2.8.2.** *We have*

$$Z_\tau^{\text{bd}}(h_X(\gamma)) = H \sharp_X Z_\tau^{\text{bd}}(\gamma).$$

*Proof.* The proof is parallel to that of Lemma 1.5.12.  $\square$

**Definition 2.8.3.** Let  $\gamma$  be an elliptic bd-tangle, and let  $X_1, \dots, X_r$  denote its connected components. Let  $p_i$  be the number of d-vertices of the component  $X_i$ . We define

$$Z_\tau(\gamma) := H^{-p_1} \sharp_{X_1} \cdots H^{-p_r} \sharp_{X_r} Z_\tau^{\text{bd}}(\gamma).$$

In the same way as in Section 1.5.4, it follows from Lemma 2.8.2 that:

**Theorem 2.8.4.**  *$Z_\tau$  defines a functorial invariant of elliptic tangles  $\mathcal{T}_1 \rightarrow \widehat{\mathcal{A}}_1$ .*



## Chapter 3

# The combinatorial Kontsevich invariant

In this chapter, we recall the combinatorial construction of the Kontsevich invariant  $Z_\Phi$  depending on a Drinfeld associator  $\Phi$  (see [BN97, LM96]). The construction is formulated in the language of Drinfeld–Cartier’s quantization of infinitesimal categories [Car93] (see also [Kas95, KT98]), and goes in three steps. First, Reshetikhin–Turaev–Shum’s coherence Theorem [Tur10, Shu94], which asserts that  $\mathbf{q}\tilde{\mathbf{T}}$  can be seen as the free ribbon category generated by one object, allows us to turn the problem of finding tangle invariants into the problem of finding ribbon structures on monoidal categories (Section 3.2). On the diagrammatic side, the key properties of the category  $\mathbf{A}$  can be encoded by the notion of infinitesimal braiding (Section 3.4). Now, if we are given a Drinfeld associator  $\Phi$ , then we are able to produce a braiding from an infinitesimal one, and further, to endow  $\mathbf{A}$  with a ribbon structure. As an application of Shum’s Theorem, this gives rise to a functor  $Z_\Phi : \mathbf{q}\tilde{\mathbf{T}} \rightarrow \mathbf{A}$  (Section 3.5).

In Section 3.6, we recall Drinfeld’s construction of an associator  $\Phi_{KZ}$  from the KZ connection. We denote  $Z_{KZ} := Z_{\Phi_{KZ}}$ , and we relate the analytic invariant  $Z$  of Chapter 1 to  $Z_{KZ}$  in Section 3.7.

### 3.1 Framed tangles

In Chapter 1, we have defined a category of tangles  $\mathcal{T}$  whose objects are the finite sets of signed points of  $\mathbb{C}$ . For the combinatorial approach, we restrict ourselves to the unit disk  $D^2 \subset \mathbb{C}$  in which we use the real coordinates  $(x, y)$  (and the coordinates  $(x, y, t)$  for the cylinder  $D^2 \times I$ ). We also fix some base points on  $D^2$  to reduce the number of objects: for  $n \geq 1$ , we denote by  $b_n = \left(\frac{1-n}{n+1}, \frac{3-n}{n+1}, \dots, \frac{n-1}{n+1}\right)$  the sequence of  $n$  points uniformly distributed on the segment from  $(-1, 0)$  to  $(1, 0)$ , and  $b_0 := \emptyset$ .

**Definition 3.1.1.** Let  $\mathbf{T}$  be the full subcategory of  $\mathcal{T}$  made of tangles  $\gamma \subset D^2 \times I$  whose source and target are of support  $b_m$  and  $b_n$  for some  $m, n \geq 0$ . Since the base points of  $b_n$  are linearly ordered from left to right along the  $x$ -axis, the set of objects of  $\mathbf{T}$  are identified with the set of finite sequences of signs  $\{+, -\}$ .

We define the category  $\tilde{\mathbf{T}}$  of framed tangles.

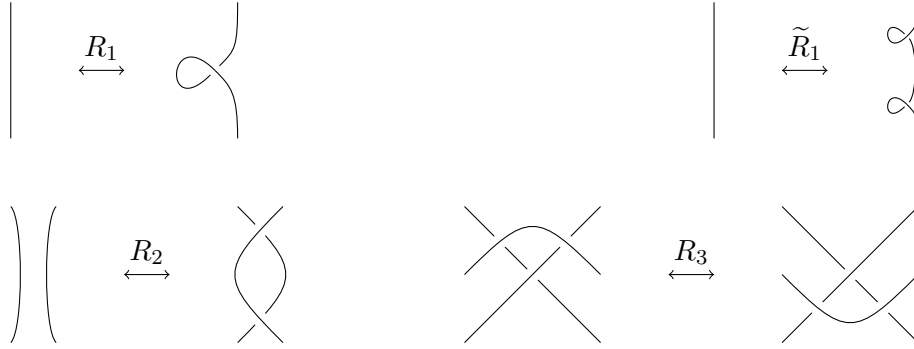

Figure 3.1: The Reidemeister moves, and the modified  $\tilde{R}_1$ .

**Definition 3.1.2.** If  $\gamma$  is a tangle of  $\mathbf{T}$ , a *framing* of  $\gamma$  is the homotopy class relative to the boundary of a nonzero normal vector field on  $\gamma \subset \mathbb{C} \times I$ , such that all the vectors based on  $\partial\gamma$  are of coordinate  $(x, y, t) = (0, -1, 0)$ . A *framed tangle*  $\tilde{\gamma}$  is a tangle  $\gamma$  equipped with a framing. Since the composition (as tangles) of two framed tangles is endowed with a framing, we can equip the set  $\tilde{\mathbf{T}}$  of framed tangles with a category structure such that there exists a forgetful functor  $\tilde{\mathbf{T}} \rightarrow \mathbf{T}$ .

As is well known, any equivalence class of tangles of  $\mathbf{T}$  admits a representative  $\gamma$  whose projection under  $\pi : (x, y, t) \mapsto (x, t)$  is generic in the sense that its only singularities are transverse crossings. A *tangle diagram* (as defined for instance in [Kas95], Chapter XII.3) is such a projection  $\pi(\gamma)$  equipped with the distinction between over and under strand at each crossing. Tangle diagrams up to planar isotopy form a category  $\mathbf{D}$  with same objects as  $\mathbf{T}$ . A surjective functor  $\varphi : \mathbf{D} \rightarrow \mathbf{T}$  is defined by seeing the diagram in  $D^2 \times I$  via  $(x, t) \mapsto (x, 0, t)$  and slightly pushing the under-strand "behind" the over-strand at each crossing. The kernel of  $\varphi$  is generated by the Reidemeister moves  $R_1$ ,  $R_2$  and  $R_3$  depicted in Figure 3.1. In the framed case, a surjective functor  $\tilde{\varphi} : \mathbf{D} \rightarrow \tilde{\mathbf{T}}$  is defined from  $\varphi$  by setting the normal vectors to be  $(0, -1, 0)$  everywhere on the tangle (according to the so-called "blackboard framing" convention). The kernel of  $\tilde{\varphi}$  is generated by the modified Reidemeister moves  $\tilde{R}_1$ ,  $R_2$  and  $R_3$ .

## 3.2 Ribbon categories

Let  $(\mathcal{C}, \otimes, \mathbf{1})$  be a monoidal category. At first, we assume that  $\mathcal{C}$  is strict; that is, the tensor product is associative:  $(U \otimes V) \otimes W = U \otimes (V \otimes W)$  for any triple of objects  $U, V, W$ . To shorten the notation, we shall simply write  $UV$  for the tensor product of objects  $U \otimes V$ .

In this setting, let us recall the notions of *duality*, *braiding* and *twist* leading to the definition of a ribbon category.

A *duality* on  $\mathcal{C}$  is a rule that associate to each object  $V$  an object  $V^*$  and two morphisms  $b_V : \mathbf{1} \rightarrow V \otimes V^*$  and  $d_V : V^* \otimes V \rightarrow \mathbf{1}$  satisfying

$$(\text{id}_V \otimes d_V)(b_V \otimes \text{id}_V) = \text{id}_V, \quad (3.2.1)$$

$$(d_V \otimes \text{id}_{V^*})(\text{id}_{V^*} \otimes b_V) = \text{id}_{V^*}. \quad (3.2.2)$$

A *braiding* on  $\mathcal{C}$  is a commutativity constraint  $c$  (that is, a family of isomorphisms  $c_{U,V} : UV \rightarrow VU$  for each pair of objects  $U, V$  which is natural in the sense that  $c_{U',V'}(f \otimes g) = (g \otimes f)c_{U,V}$  for any pair of morphisms  $f : U \rightarrow U'$  and  $g : V \rightarrow V'$ ) satisfying for any objects  $U, V, W$ :

$$c_{UV,W} = (c_{U,W} \otimes \text{id}_V)(\text{id}_U \otimes c_{V,W}), \quad (3.2.3)$$

$$c_{U,VW} = (\text{id}_V \otimes c_{U,W})(c_{U,V} \otimes \text{id}_W). \quad (3.2.4)$$

By convention, we set  $c_{U,V}^{-1} := (c_{V,U})^{-1}$ . A *braided monoidal category* is a monoidal category equipped with a braiding.

A *twist* on a braided monoidal category  $(\mathcal{C}, c)$  is a natural family of isomorphisms  $\theta_V : V \rightarrow V$  satisfying, for any objects  $U, V$ ,

$$\theta_{UV} = c_{V,U}c_{U,V}(\theta_U \otimes \theta_V). \quad (3.2.5)$$

**Definition 3.2.1.** A *ribbon category* is a braided monoidal category  $(\mathcal{C}, c)$  equipped with a twist  $\theta$  and a duality  $(*, b, d)$  compatible in the sense that for any object  $V$ ,

$$(\theta_V \otimes \text{id}_{V^*})b_V = (\text{id}_V \otimes \theta_{V^*})b_V. \quad (3.2.6)$$

There is a standard graphical calculus for ribbon categories (see for instance [Tur10]), where a morphism  $f : U_1 \otimes U_2 \otimes \dots \otimes U_m \rightarrow V_1 \otimes V_2 \otimes \dots \otimes V_n$  is represented by boxes of the form

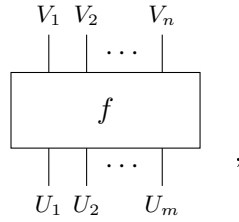

the composition  $gf$  is depicted by gluing  $g$  above  $f$ , and the tensor product  $f \otimes g$  by putting  $f$  and  $g$  side by side. The braiding, twist and duality morphisms are represented by

$$c_{U,V} = \begin{array}{c} \diagup \quad \diagdown \\ U \quad V \end{array} ; \quad c_{U,V}^{-1} = \begin{array}{c} \diagdown \quad \diagup \\ U \quad V \end{array} ; \quad \theta_V = \begin{array}{c} | \\ \downarrow \\ V \end{array} ; \quad \theta_V^{-1} = \begin{array}{c} \uparrow \\ | \\ V \end{array} ;$$

$$b_V = \begin{array}{c} V \quad V^* \\ \cup \end{array} ; \quad d_V = \begin{array}{c} \cap \\ V^* \quad V \end{array} .$$

As suggested by the graphical calculus, the category  $\tilde{\mathbf{T}}$  of framed tangles is endowed with a ribbon structure. The tensor product of two framed tangles  $\gamma_1 \otimes \gamma_2$  is defined by setting  $\gamma_1$  and  $\gamma_2$  side by side along the  $x$ -axis and rescaling the result to get back in  $D^2 \times I$ , as suggested in Figure 3.2. The dual of an object  $V = (\varepsilon_1, \dots, \varepsilon_k)$  of  $\tilde{\mathbf{T}}$  (where  $\varepsilon_i = \pm 1$ ) is  $V^* = (-\varepsilon_k, \dots, -\varepsilon_1)$ , and the morphisms  $b_V$ ,  $d_V$ , the braiding  $c_{U,V}$  and the twist  $\theta_V$  are the images under  $\tilde{\varphi}$  of the following planar diagrams:



### 3.3 The non-strict case

Let us now turn to the case of a non necessarily strict monoidal category  $\mathcal{C}$ . We denote by  $a_{X,Y,Z} : (XY)Z \rightarrow X(YZ)$  the associativity constraint which satisfies the pentagon relation:

$$\begin{array}{ccccc}
 & & (WX)(YZ) & & \\
 & \nearrow^{a_{WX,Y,Z}} & & \searrow_{a_{W,X,YZ}} & \\
 ((WX)Y)Z & & & & W(X(YZ)) \\
 & \searrow_{a_{W,X,Y} \otimes \text{id}_Z} & & \nearrow_{\text{id}_W \otimes a_{X,Y,Z}} & \\
 & & (W(XY))Z & \xrightarrow{a_{W,XY,Z}} & W((XY)Z)
 \end{array}$$

(For simplicity we still assume that  $\mathbf{1} \otimes V = V = V \otimes \mathbf{1}$  for any object  $V$ .) From MacLane coherence theorem [ML98], any two compositions of associativity constraints between the same source and target are identical. Therefore, the notions of braided category and ribbon category can be unambiguously generalized to the non strict case by inserting the appropriate associativity constraints in the axioms (3.2.1)-(3.2.6).

**Definition 3.3.1.** We define the categories  $\mathbf{qT}$  (and  $\mathbf{q\tilde{T}}$ ) of *quasi (framed) tangles*, or *parenthesized (framed) tangles*, as follows. The set of objects of  $\mathbf{qT}$  and  $\mathbf{q\tilde{T}}$  is the set of fully parenthesized words in  $\{+, -\}$ . For any pair of parenthesized words  $U, V$ , the sets of morphisms  $\mathbf{qT}(U, V)$  and  $\mathbf{q\tilde{T}}(U, V)$  are identified with  $\mathbf{T}(\bar{U}, \bar{V})$  and  $\tilde{\mathbf{T}}(\bar{U}, \bar{V})$  respectively, where  $\bar{U}$  and  $\bar{V}$  are obtained by forgetting the parentheses of  $U$  and  $V$ .

The category  $\mathbf{q\tilde{T}}$  of parenthesized framed tangles is endowed with a structure of non-strict ribbon category, where for any triple of parenthesized words  $U, V, W$ , the associativity morphism  $a_{U,V,W}$  is the quasi tangle of source  $(UV)W$  and target  $U(VW)$  that corresponds to the identity in  $\tilde{\mathbf{T}}$ .

$$a_{U,V,W} = \begin{array}{ccc} U & (V & W) \\ | & | & | \\ (U & V) & W \end{array}$$

Theorem 3.2.2 is generalized to the non-strict case as follows.

**Theorem 3.3.2.** *Let  $\mathcal{C}$  be a ribbon category equipped with an object  $V$ . There exists a unique monoidal functor  $qF : \mathbf{q\tilde{T}} \rightarrow \mathcal{C}$  preserving the associativity constraint, the braiding and the twist, and such that  $qF(+)=V$ ,  $qF(-)=V^*$ ,  $qF(b_{(+)})=b_V$  and  $qF(d_{(+)})=d_V$ .*

*Proof.* Modulo existence, the uniqueness of  $qF$  follows from its defining conditions (since any quasi-tangle can be written as a composition of tensor products of braiding, duality, associativity and identity morphisms). Let us construct  $qF$  explicitly from the functor  $F$  of Theorem 3.2.2.



Mac Lane coherence theorem asserts that one can construct, from the monoidal category  $\mathcal{C}$ , an equivalence of monoidal categories  $\eta : \mathcal{C}^{str} \rightarrow \mathcal{C}$  where  $\mathcal{C}^{str}$  is strict (see [Kas95, XI.5]). The objects of  $\mathcal{C}^{str}$  are the finite sequences  $S = (V_1, \dots, V_k)$  of objects of  $\mathcal{C}$ . If  $V$  and  $V'$  are objects of  $\mathcal{C}$  which are both obtained by parenthesizing the same sequence  $S$  in two different ways, we denote by  $a_{V \rightarrow V'} : V \rightarrow V'$  the unique morphism of  $\mathcal{C}$  that is written as a composition of associativity morphisms. We set  $\eta(S) = \eta(V_1, \dots, V_k) := (\dots((V_1 V_2) V_3) \dots) V_k$ , and  $\mathcal{C}^{str}(S, S') := \mathcal{C}(\eta(S), \eta(S'))$ . The tensor product of two objects  $S$  and  $T$  of  $\mathcal{C}^{str}$  is the concatenation  $ST$ , and the tensor product of two morphisms  $f : S \rightarrow S'$  and  $g : T \rightarrow T'$  of  $\mathcal{C}^{str}$  is

$$f \otimes g = a_{\eta(S')\eta(T') \rightarrow \eta(S'T')}(\eta(f) \otimes \eta(g))a_{\eta(ST) \rightarrow \eta(S)\eta(T)}.$$

The ribbon structure on  $\mathcal{C}$  induces a ribbon structure on  $\mathcal{C}^{str}$  by

$$c_{S,T} := a_{\eta(T)\eta(S) \rightarrow \eta(TS)}c_{\eta(S),\eta(T)}a_{\eta(ST) \rightarrow \eta(S)\eta(T)},$$

and so on.

Applying Theorem 3.2.2 to the strict ribbon category  $\mathcal{C}^{str}$  equipped with the object  $(V)$  seen as a sequence of length one, we obtain a functor  $F : \mathbf{T} \rightarrow \mathcal{C}^{str}$ . The composition

$$\mathbf{qT} \longrightarrow \mathbf{T} \xrightarrow{F} \mathcal{C}^{str} \xrightarrow{\eta} \mathcal{C}$$

is denoted by  $pF : \mathbf{qT} \rightarrow \mathcal{C}$ . For a parenthesized word  $X$ , we define  $qF(X)$  as the object of  $\mathcal{C}$  obtained from  $X$  by substituting  $V$  to  $+$  and  $V^*$  to  $-$ . For a quasi-tangle  $\gamma : X \rightarrow Y$ , we finally set

$$qF(\gamma) = a_{\eta(F(\bar{Y})) \rightarrow qF(Y)}pF(\gamma)a_{qF(X) \rightarrow \eta((F(\bar{X}))}.$$

$qF$  is a monoidal functor and satisfies the conditions of Theorem 3.3.2.  $\square$

### 3.4 Infinitesimal braidings

The notion of infinitesimal braiding is an "infinitesimal version" of a braiding in a monoidal category, and encodes the structure of the category  $\mathbf{A}$  of Jacobi diagrams. For more details, see [KT98].

**Definition 3.4.1.** Let  $\mathcal{S}$  be a strict monoidal category. A braiding  $\sigma_{U,V}$  in  $\mathcal{S}$  is a *symmetry* if it satisfies  $\sigma_{V,U}\sigma_{U,V} = \text{id}_{U,V}$  for any objects  $U, V$ . A *symmetric category* is a strict monoidal category equipped with a symmetry.

**Definition 3.4.2.** Let  $\mathcal{G}$  be a category and  $(\mathcal{S}, \sigma)$  be a symmetric graded linear  $\mathcal{G}$ -category with duality. An *infinitesimal braiding* in  $\mathcal{S}$  is a natural family of endomorphisms  $t_{U,V} : UV \rightarrow UV$  of  $\mathcal{S}$  such that  $t_{U,V}$  is of degree one in the vector space  $\mathcal{S}(\text{id}_{UV})$  and

$$\sigma_{U,V}t_{V,U}\sigma_{U,V} = t_{U,V}, \quad (3.4.1)$$

$$t_{UV,W} = \text{id}_U \otimes t_{V,W} + (\sigma_{V,U} \otimes \text{id}_W)(\text{id}_V \otimes t_{U,W})(\sigma_{U,V} \otimes \text{id}_W). \quad (3.4.2)$$

In the sequel, an *infinitesimal  $\mathcal{G}$ -category* will refer to a symmetric graded linear  $\mathcal{G}$ -category with duality equipped with an infinitesimal braiding.

Let  $\mathcal{S}$  be an infinitesimal category and let  $V$  be an object of  $\mathcal{S}$ . The *Casimir operator* of  $V$  is the endomorphism  $C_V$  of  $V$  defined by

$$C_V = -(\mathrm{id}_V \otimes d_V)(t_{V,V^*} \otimes \mathrm{id}_V)(b_V \otimes \mathrm{id}_V). \quad (3.4.3)$$

We then have

$$t_{U,V} = \frac{1}{2}(C_{UV} - C_U \otimes \mathrm{id}_V - \mathrm{id}_U \otimes C_V). \quad (3.4.4)$$

**Lemma 3.4.3.** [KT98, Corollary 5.3] *The category  $\mathbf{A}$  is endowed with a structure of an infinitesimal  $\mathbf{P}$ -category, with:*

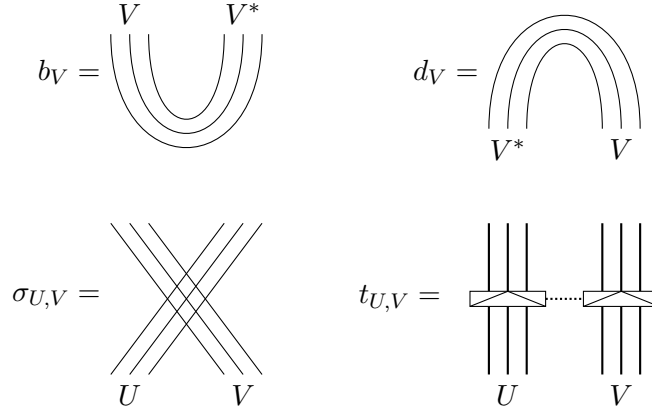

The naturality of  $t$  follows from the fact that boxes can slide over a part of a Jacobi diagram (Lemma 1.4.4).

In our setting, [KT98, Theorem 5.4] can be formulated as follows.

**Theorem 3.4.4.** *Let  $\mathcal{S}$  be an infinitesimal  $\mathcal{G}$ -category with a distinguished object  $V$ . There exists a unique monoidal functor  $G : \mathbf{A} \rightarrow \mathcal{S}$  preserving the symmetry, the infinitesimal braiding and such that  $G(+)=V$ ,  $G(-)=V^*$ ,  $G(b_{(+)})=b_V$  and  $G(d_{(+)})=d_V$ . Moreover, there is a functor  $\mathbf{P} \rightarrow \mathcal{G}$  such that the following diagram commutes.*

$$\begin{array}{ccc} \mathbf{A} & \xrightarrow{G} & \mathcal{S} \\ \downarrow & & \downarrow \\ \mathbf{P} & \longrightarrow & \mathcal{G} \end{array}$$

### 3.5 Drinfeld associators

A *Drinfeld associator* is a formal series  $\Phi(A, B) \in \exp(\widehat{\mathfrak{f}}(A, B))$  (where  $\widehat{\mathfrak{f}}(A, B)$  denote the degree completion of the free Lie algebra generated by  $A$  and  $B$ ) satisfying the pentagon equation in  $\exp(\widehat{\mathfrak{t}}_4)$ :

$$\Phi(t_{12}, t_{23} + t_{24})\Phi(t_{13} + t_{23}, t_{34}) = \Phi(t_{23}, t_{34})\Phi(t_{12} + t_{13}, t_{24} + t_{34})\Phi(t_{12}, t_{23})$$

and the hexagon equations in  $\exp(\widehat{\mathfrak{t}}_3)$ :

$$\exp((t_{13} + t_{23})/2) = \Phi(t_{13}, t_{12}) \exp(t_{13}/2) \Phi(t_{13}, t_{23})^{-1} \exp(t_{23}/2) \Phi(t_{12}, t_{23}),$$

$$\exp((t_{13} + t_{12})/2) = \Phi(t_{23}, t_{13})^{-1} \exp(t_{13}/2) \Phi(t_{12}, t_{13}) \exp(t_{12}/2) \Phi(t_{12}, t_{23})^{-1}.$$

*Remark 3.5.1.* As shown in [Fur10, BND12], the pentagon equation is enough if the coefficient of  $AB$  in  $\Phi(A, B)$  is  $\frac{1}{24}$ .

The data of a Drinfeld associator allows us to construct a ribbon category from an infinitesimal one.

**Theorem 3.5.2.** (see for instance [Car93]) *Let  $\mathcal{S}$  be an infinitesimal category whose duality morphisms are denoted by  $(b_V^0, d_V^0)$  for any object  $V$ . There exists a unique ribbon structure on the degree completion  $\widehat{\mathcal{S}}$  with:*

$$c_{X,Y} = \sigma_{X,Y} \exp(t_{X,Y}/2)$$

$$a_{X,Y,Z} = \Phi(t_{X,Y} \otimes \text{id}_Z, \text{id}_X \otimes t_{Y,Z})$$

$$\theta_X = \exp(C_X/2)$$

$$b_V = b_V^0 \quad \text{and} \quad d_V = d_V^0 \circ (\lambda_{V^*}^{-1} \otimes \text{id}_V)$$

where  $\lambda_{V^*}$  is the automorphism of  $V^*$  defined by

$$\lambda_{V^*} = (d_V^0 \otimes \text{id}_{V^*}) \circ \Phi^{-1}(t_{V^*,V} \otimes \text{id}_{V^*}, \text{id}_{V^*} \otimes t_{V,V^*}) \circ (\text{id}_{V^*} \otimes b_V^0).$$

Using this construction, we define a ribbon structure on the category  $\widehat{\mathbf{A}}$  of Jacobi diagrams. There is thus a unique functor

$$Z_\Phi : \mathbf{qT} \rightarrow \widehat{\mathbf{A}}$$

satisfying the conditions of Corollary 3.3.2. This functor is what we call the *combinatorial Kontsevich invariant*.

Moreover,  $Z_\Phi(\theta_{(+)}) = \exp(C_{(+)}/2)$  vanishes in  $\widehat{\mathbf{A}}/FI$  since the Casimir element  $C_{(+)}$  forms an isolated chord. Therefore,  $Z_\Phi$  induces an invariant of quasi-tangles (that we still denote by  $Z_\Phi$ )

$$Z_\Phi : \mathbf{qT} \rightarrow \widehat{\mathbf{A}}/FI.$$

### 3.6 The KZ associator

In this subsection, we briefly recall from [Dri89, Dri90] the definition of the KZ associator  $\Phi_{KZ}$  in terms of the solutions of the reduced KZ equation:

$$\frac{dG}{dz} = \left( \frac{\overline{A}}{z} + \frac{\overline{B}}{z-1} \right) G, \tag{3.6.1}$$

with values in the algebra of power series  $\mathbb{C}\langle\langle A, B \rangle\rangle$  in two non-commuting variables  $A$  and  $B$ , having set  $\overline{A} := A/2\pi i$ ,  $\overline{B} := B/2\pi i$ .

**Lemma 3.6.1.** [Dri89, Dri90] *There exist unique solutions  $G_0(z)$  and  $G_1(z)$  of Equation (3.6.1), analytic in the domain  $\{|z| < 1, |z-1| < 1\}$  and with the asymptotic behavior  $G_0(z) \sim z^{\overline{A}}$  as  $z \rightarrow 0$  and  $G_1(z) \sim (1-z)^{\overline{B}}$  as  $z \rightarrow 1$ .*

The KZ associator is the ratio  $\Phi_{KZ} := G_1(z)^{-1}G_0(z)$  of these two special solutions.  $\Phi_{KZ}(A, B)$  satisfies the axioms of a Drinfeld associator (Section 3.5), and therefore defines an invariant of tangles

$$Z_{KZ} := Z_{\Phi_{KZ}} : \mathbf{q}\tilde{\mathbf{T}} \rightarrow \mathbf{A}.$$

**Lemma 3.6.2.** (See for example [CDM12, Lemma 10.1.9].) We have

$$\Phi_{KZ} = \lim_{\varepsilon \rightarrow 0} \varepsilon^{-\bar{B}} G_\varepsilon(1 - \varepsilon) \varepsilon^{\bar{A}},$$

where  $G_\varepsilon(z)$  is the solution of (3.6.1) satisfying  $G_\varepsilon(\varepsilon) = 1$ .

In the next subsection, we give a generalization of the above lemma, relating the combinatorial invariant  $Z_{KZ}$  to the analytic invariant  $Z$ .

### 3.7 Regularizing factors and relation between $Z_{KZ}$ and $Z$

Let  $w$  be a parenthesized word of length  $n$ . For  $1 \leq i \neq j \leq n$ , we denote by  $w(i, j) = w(j, i) \in \{1, \dots, n\}$  the number of pair of parentheses in which both the  $i$ -th and the  $j$ -th symbol of  $w$  are included. For example, if  $w = (+((-+)-))$ , then  $w(1, 2) = 1$ ,  $w(2, 4) = 2$  and  $w(2, 3) = 3$ .

**Definition 3.7.1.** Let  $w$  be a parenthesized word of length  $n$ , and  $k \in \{1, \dots, n-1\}$ . We set

$$c_k(w) = \sum_{\substack{1 \leq i < j \leq n \\ w(i, j) = k}} t_{ij} \epsilon_i \epsilon_j \in \mathfrak{t}_n,$$

where  $\epsilon_i \in \{-1, +1\}$  is the  $i$ -th symbol of  $w$ . Note that if  $w(i, j) = k$  and  $w(j, j') > k$ , then  $w(i, j') = k$ . Therefore, it follows from the infinitesimal braid relations (1.2.1) that the  $c_k(w)$  commute with each other for all  $k$ . Let  $\varepsilon \in (0, 1]$ . We define

$$\rho_w(\varepsilon) := \prod_{k=1}^{n-1} \varepsilon^{k c_k(w)} \in \exp(\widehat{\mathfrak{t}}_n).$$

The element  $\rho_w(\varepsilon)$  is called the *regularizing factor* of  $w$ .

Let  $[a, b] \subset \mathbb{C}$  be an oriented segment. Let  $(z_1, \dots, z_n)$  be a sequence of  $n$  paths  $z_j : (0, 1] \rightarrow [a, b]$  such that for any  $0 < \varepsilon \leq 1$ , the points  $z_1(\varepsilon), \dots, z_n(\varepsilon)$  are distributed from  $a$  to  $b$  according to the order  $z_1 < \dots < z_n$ . We say that  $(z_1, \dots, z_n)$  is of *asymptotical behavior*  $w$  if  $|z_i(\varepsilon) - z_j(\varepsilon)| \sim \varepsilon^{w(i, j)-1}$  as  $\varepsilon \rightarrow 0$ .

Let  $\gamma \subset \mathbb{C} \times I$  be a tangle of  $\mathcal{T}$  whose bottom and top endpoints are on the segments  $[a, b] \times \partial I$ . We denote by  $s^0 = (s_1^0, \dots, s_n^0)$  and  $t^0 = (t_1^0, \dots, t_m^0)$  the sequences of bottom and top endpoints (ordered from  $a$  to  $b$ ). We fix a parenthesization on the sequences  $s$  and  $t$ , and we denote by  $\gamma_v^w$  the corresponding parenthesized tangle of  $\mathbf{q}\mathbf{T}$ , of source and target given by the parenthesized words  $v$  and  $w$  respectively. Let  $s = (s_1, \dots, s_n)$  and  $t = (t_1, \dots, t_m)$  be sequences of paths  $(0, 1] \rightarrow [a, b]$  with  $s_i(1) = s_i^0$ ,  $t_j(1) = t_j^0$  for all  $i, j$ , and of asymptotical behavior  $v$  and  $w$  respectively. We set:

$$\gamma_v^w(\varepsilon) := (t_{[\varepsilon, 1]})^{-1} \gamma_{s_{[\varepsilon, 1]}}$$

where  $t_{[\varepsilon, 1]}$  and  $s_{[\varepsilon, 1]}$  are seen as tangles.

**Theorem 3.7.2.** [CDM12, Theorem 10.3.7] We have

$$Z_{KZ}(\gamma_v^w) = \lim_{\varepsilon \rightarrow 0} \rho_w(\varepsilon)^{-1} Z(\gamma_v^w(\varepsilon)) \rho_v(\varepsilon),$$

where the right-hand side of the equality is seen as a morphism of  $\widehat{\mathbf{A}}/FI$  using the linear ordering of the endpoints along the segment  $[a, b]$ .

**Corollary 3.7.3.** If  $\gamma$  is a link,  $Z_{KZ}(\gamma) = Z(\gamma)$ .

## Chapter 4

# Beak diagrams and RST moves

This chapter is the first step of the combinatorial study of surface tangles. We show that surface (framed) tangles can be represented by some kinds of planar diagrams called *beak diagrams*. Beak diagrams are considered up to the *RST* (or  $\tilde{RST}$ ) equivalence relations, which contain the well-known Reidemeister moves.

### 4.1 Surface tangles

In Section 3.1, we have defined the categories of (framed) tangles  $\mathbf{T}$  and  $\tilde{\mathbf{T}}$ . These tangles lie in the unit disc cylinder  $D^2 \times I$ , and their bottom and top endpoints are uniformly distributed along the diameter  $[-1, 1] \times \{0\}$  of the disc.

In this chapter, we consider a closed surface  $S_g$  of genus  $g \geq 0$ , equipped with a fixed embedding of the disc  $D^2 \subset S_g$ . A *(framed) tangle on  $S_g$*  is the straightforward generalization of a (framed) tangle on  $D^2$  obtained by replacing  $D^2$  with  $S_g$ . Again, the bottom and top endpoints of such tangles are required to be uniformly distributed along the segment  $[-1, 1] \times \{0\} \subset D^2 \subset S_g$ .

Isotopy classes of tangles and framed tangles on  $S_g$  form the categories  $\mathbf{T}_g$  and  $\tilde{\mathbf{T}}_g$  respectively. Just as in the disc case, the objects of  $\mathbf{T}_g, \tilde{\mathbf{T}}_g$  are the finite sequences of signs, and  $\mathbf{T}_g, \tilde{\mathbf{T}}_g$  are  $\mathbf{P}$ -graded. Moreover, we have functors

$$\mathbf{T} \rightarrow \mathbf{T}_g \quad \text{and} \quad \tilde{\mathbf{T}} \rightarrow \tilde{\mathbf{T}}_g,$$

that consist in seeing a (framed) tangle on  $D^2$  as a (framed) tangle on  $S_g$  via the embedding  $D^2 \subset S_g$ .

### 4.2 Beak diagrams

Our goal is now to represent tangles on  $S_g$  as planar diagrams. One could imagine several ways to achieve this, using various kind of diagrams. The notion of *beak diagram* introduced in this section is well suited for our purpose.

**Definition 4.2.1.** Let  $X$  be a set. A *beak diagram* labeled with  $X$  is a planar diagram embedded in the rectangle  $\{(x, t) \mid x \in [-1, 1], t \in [0, 1]\}$  that looks like an ordinary tangle diagram except that its strands may coincide with the left border  $\{x = -1\}$  along short segments (see Figure 4.1). Such segments are called the *beaks*

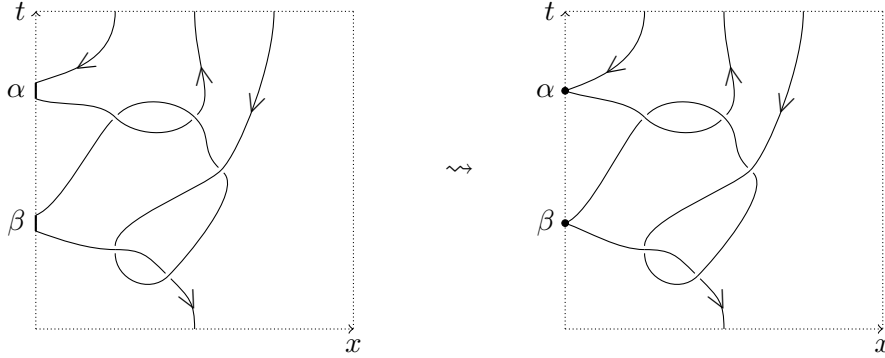

Figure 4.1: On the left, a genuine beak diagram for  $\alpha, \beta \in X$ . On the right, the way it may be drawn in the sequel.

of the diagram and are labeled with elements of  $X$ . Beak diagrams are considered up to planar isotopy. Here, "planar isotopy" means isotopy of the rectangle, fixing the top and bottom edges  $\{t = 1\}$  and  $\{t = 0\}$  pointwise.

It results that the left border  $\{x = -1\}$  is fixed, but not necessarily pointwise. In particular, the beaks may slide along the left border, but their heights cannot switch. In the following pictures, beaks may not appear as segments (unless it is relevant to keep in mind they actually are), but rather as points<sup>1</sup> which can be thought of as "microscopic" segments.

**Definition 4.2.2.** Beak diagrams labeled with  $X$  are endowed with a category structure in the obvious way: the objects are the finite sequences of signs, the morphisms are the planar isotopy classes of beak diagrams, and the composition  $d_2 d_1$  is obtained by gluing the bottom of  $d_2$  above the top of  $d_1$ , as in the case of tangles. This category is denoted by  $\mathbf{D}(X)$ .

For any set  $X$ , there is a functor  $\mathbf{D} \rightarrow \mathbf{D}(X)$  which consists in seeing an ordinary tangle diagram as a beak diagram without beaks. Moreover, any map  $X \rightarrow Y$  induces a functor  $\mathbf{D}(X) \rightarrow \mathbf{D}(Y)$ .

Let  $S_{g,1}$  be the surface with one boundary component obtained by removing the interior of  $D^2$  from  $S_g$ . We set  $p := (-1, 0) \in \partial D^2$ , and  $\pi_1 := \pi_1(S_{g,1}, p)$ . We denote by  $US_{g,1}$  the unit tangent bundle - made of non-vanishing tangent vectors on  $S_{g,1}$ . A path in  $US_{g,1}$  can be seen as a "framed path" of  $S_{g,1}$ . Set  $\tilde{\pi}_1 := \pi_1(US_{g,1}, p)$ , where the basepoint  $p$  is equipped with the tangent vector  $(0, -1)$ . We have the central extension

$$0 \rightarrow \mathbb{Z} \rightarrow \tilde{\pi}_1 \rightarrow \pi_1 \rightarrow 1, \quad (4.2.1)$$

where the image of  $\mathbb{Z}$  is generated by the *positive twist*

$$\theta \in \tilde{\pi}_1$$

defined by  $[0, 1] \ni t \mapsto \theta(t) = e^{2\pi i t} p$ . Any non-vanishing vector field  $S_{g,1} \rightarrow US_{g,1}$  gives rise to a section  $\pi_1 \rightarrow \tilde{\pi}_1$ . We also define

$$\partial \in \tilde{\pi}_1$$

---

<sup>1</sup>Hence the terminology "beak".

as the boundary loop  $\partial D^2$  oriented from the positive orientation of  $D^2$  and equipped with the constant framing  $(0, -1)$ .

Let us now construct two functors

$$\varphi_{\pi_1} : \mathbf{D}(\pi_1) \rightarrow \mathbf{T}_g \quad \text{and} \quad \varphi_{\tilde{\pi}_1} : \mathbf{D}(\tilde{\pi}_1) \rightarrow \tilde{\mathbf{T}}_g$$

such that the following diagram commutes (where  $\varphi, \tilde{\varphi}$  are defined in Section 3.1, and  $\mathbf{D}(\tilde{\pi}_1) \rightarrow \mathbf{D}(\pi_1)$  is induced by the canonical projection  $\tilde{\pi}_1 \rightarrow \pi_1$ ).

$$\begin{array}{ccccc}
 & & \varphi & & \\
 & & \curvearrowright & & \\
 \mathbf{D} & \xrightarrow{\tilde{\varphi}} & \tilde{\mathbf{T}} & \xrightarrow{\quad} & \mathbf{T} \\
 \downarrow & & \downarrow & & \downarrow \\
 \mathbf{D}(\tilde{\pi}_1) & \xrightarrow{\varphi_{\tilde{\pi}_1}} & \tilde{\mathbf{T}}_g & \xrightarrow{\quad} & \mathbf{T}_g \\
 \downarrow & & & & \uparrow \\
 \mathbf{D}(\pi_1) & & & \xrightarrow{\varphi_{\pi_1}} & 
 \end{array}$$

We define  $\varphi_{\pi_1}$  as follows. Start from a beak diagram  $d$  of  $\mathbf{D}(\pi_1)$ . The diagram  $d$  lies in the rectangle  $[-1, 1] \times I$ . Embed this rectangle in the cylinder  $D^2 \times I$  by  $(x, t) \mapsto (x, 0, t)$ . The beaks of  $d$  are now segments of the form  $\{p\} \times [u, v] \subset \partial D^2 \times I$ , where  $0 < u < v < 1$ . As in the usual case, separate the strands of  $d$  at each crossing by slightly pushing the under-strand "behind" - that is, in the positive  $y$ -coordinate area. Finally, replace each beak  $\{p\} \times [u, v]$  with an arc parametrized by  $[0, 1] \ni s \mapsto (\alpha(s), u + s(v - u)) \in S_{g,1} \times I$ , where  $\alpha : [0, 1] \rightarrow S_{g,1}$  is a loop whose homotopy class is the label of the beak, as depicted below.

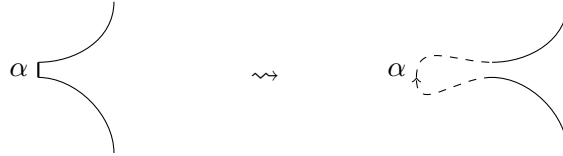

(Note that the parametrization of this arc, increasing from  $u$  to  $v$ , may not coincide with the orientation of the resulting tangle, which is as usual determined by the orientation of the beak diagram.) By choosing an appropriate representative loop  $\alpha$ , this produces a smooth tangle in  $S_g \times I$ , which we declare to be  $\varphi_{\pi_1}(d)$ .

For  $d$  in  $\mathbf{D}(\tilde{\pi}_1)$ , we construct  $\varphi_{\tilde{\pi}_1}(d)$  by taking  $\varphi_{\pi_1}(d)$  with the framing to be  $(0, -1, 0)$  inside  $D^2 \times I$  (according to the blackboard convention), and the framings of the arcs running outside of  $D^2 \times I$  to be determined by the labels  $\alpha \in \tilde{\pi}_1$  of their corresponding beaks.

We will see in Section 4.5 that the functors  $\varphi_{\pi_1}$  and  $\varphi_{\tilde{\pi}_1}$  are surjective. By construction,  $\varphi_{\pi_1}$  (respectively,  $\varphi_{\tilde{\pi}_1}$ ) factors through the three (modified) Reidemeister moves of Figure 3.1. Moreover,  $\varphi_{\tilde{\pi}_1}$  clearly factors through the following local moves involving the beaks,



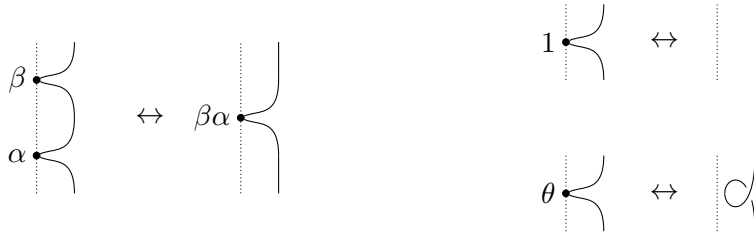

as well as the move



This last move is not local, but involves a whole horizontal slice of the diagram. On the right hand side, the strand coming from the beak  $\partial$  goes around all the other strands.

The rest of the chapter is aimed at describing the kernel of  $\varphi_{\tilde{\pi}_1}$  and  $\varphi_{\pi_1}$  with a set of equivalence moves on beak diagrams, generalizing the Reidemeister theorem. To do so, we first restrict ourselves to beak diagrams labeled with a finite family of generators of  $\tilde{\pi}_1$ . It turns out that certain well-chosen families lead to particularly easily definable sets of equivalence moves. These nice families are combinatorially encoded by *fatgraphs*.

### 4.3 Fatgraphs and their markings

The objects we call "fatgraphs" in the sequel are known as *once-bordered fatgraphs* in the literature. Once-bordered fatgraphs have been introduced in [BKP09] and [God07] to adapt constructions and results of Harer [Har86, Har88] and Penner [Pen87, Pen88] to the bordered case.

Let us start with defining once-bordered fatgraphs from a set-theoretical point of view.

**Definition 4.3.1.** A *once-bordered fatgraph*  $\Gamma$  is a finite linearly ordered set  $(\Gamma, \leq)$  equipped with a fixed-point free involution  $\mathbf{e} \rightarrow \bar{\mathbf{e}}$  that switches the first and the last elements of  $\Gamma$ .

The elements  $\mathbf{e} \in \Gamma$  are the *edges* of  $\Gamma$ . The first edge  $\min(\Gamma)$  is the *tail* of  $\Gamma$ , and is denoted by  $\mathbf{t}$ . We have  $\max(\Gamma) = \bar{\mathbf{t}}$  by definition. The predecessor and successor of an edge  $\mathbf{e}$  (if such elements exist) are denoted by  $\mathbf{e} - 1$  and  $\mathbf{e} + 1$  respectively. We define the permutation  $\sigma$  of  $\Gamma \setminus \{\mathbf{t}\}$  by

$$\sigma(\mathbf{e}) := \overline{\mathbf{e} - 1}.$$

The orbits of  $\sigma$  are the *vertices* of  $\Gamma$ . A vertex  $v$  is thus a cyclically ordered set; we write  $v = (\mathbf{e}_1, \dots, \mathbf{e}_k)$  for  $v = \{\mathbf{e}_1, \dots, \mathbf{e}_k\}$  and  $\sigma(\mathbf{e}_i) = \mathbf{e}_{i+1}$  ( $i \in \mathbb{Z}/k\mathbb{Z}$ ). The orbits  $\{\mathbf{e}, \bar{\mathbf{e}}\}$  of the involution are the *non-oriented edges* of  $\Gamma$ .

As suggested by the terminology, any once-bordered fatgraph  $\Gamma$  gives rise to a thickened graph  $S(\Gamma)$ , that is, an oriented surface equipped with a decomposition into disks and bands joining them. The construction is as shown in Figure 4.2:

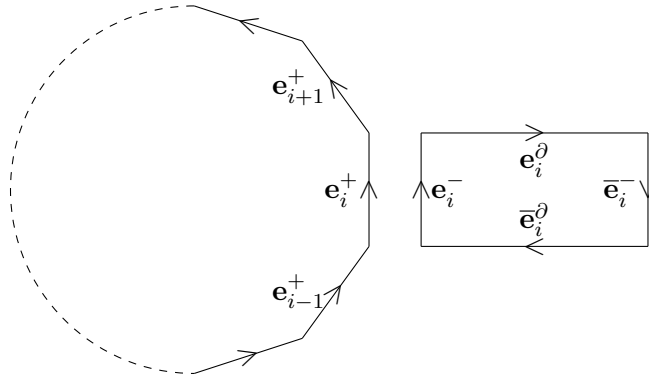

Figure 4.2: Construction of the thickened graph  $S(\Gamma)$ .

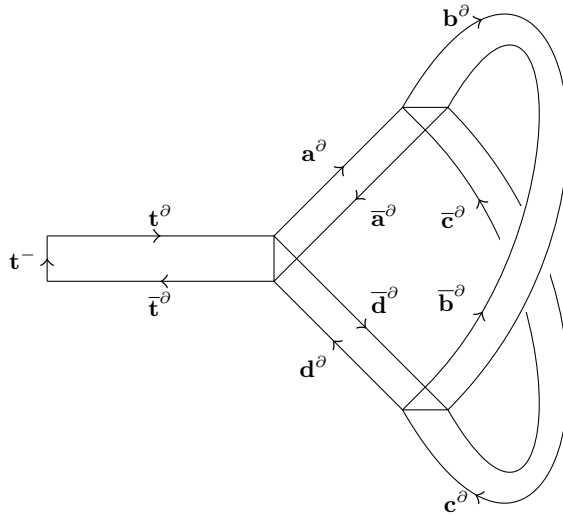

Figure 4.3: The genus one surface  $S(\Gamma)$  associated to the fatgraph  $\Gamma = \{\mathbf{t} < \mathbf{a} < \mathbf{b} < \bar{\mathbf{c}} < \bar{\mathbf{a}} < \bar{\mathbf{d}} < \bar{\mathbf{b}} < \mathbf{c} < \mathbf{d} < \bar{\mathbf{t}}\}$ .

- To each vertex  $v = (\mathbf{e}_1, \dots, \mathbf{e}_k)$ , associate a polygon with  $k$  oriented edges labeled with  $\mathbf{e}_1^+, \mathbf{e}_2^+, \dots, \mathbf{e}_k^+$  counterclockwise.
- To each non-oriented edge  $\{\mathbf{e}, \bar{\mathbf{e}}\}$ , associate a band with four oriented edges labeled with  $\mathbf{e}^-, \mathbf{e}^\partial, \bar{\mathbf{e}}^-, \bar{\mathbf{e}}^\partial$  clockwise.
- Finally, glue the edges  $\mathbf{e}^+$  and  $\mathbf{e}^-$  pairwise for all  $\mathbf{e} \neq \mathbf{t}$ , according to their orientations.

Observe that the linear order  $\leq$  on  $\Gamma$  is recovered by following the boundary of  $S(\Gamma)$  clockwise starting from the arc  $\mathbf{t}^-$  (see for example Figure 4.3). Therefore,  $S(\Gamma)$  is a surface with exactly one boundary component. Moreover, the genus  $g(\Gamma)$  of  $S(\Gamma)$  can be obtained combinatorially by the Euler formula:

$$-2g(\Gamma) = \left| \frac{\Gamma \setminus \{\mathbf{t}\}}{\sigma} \right| - \frac{|\Gamma|}{2}.$$

In the following, we restrict ourselves to genus  $g$  once-bordered fatgraphs. For short, "**fatgraph**" is understood as "**genus  $g$  once-bordered fatgraph**" from now on.

**Definition 4.3.2.** Let  $\Gamma$  be a fatgraph, and let  $G$  be a group equipped with a distinguished element  $h \in G$ . A  $(G, h)$ -marking of  $\Gamma$  is a map  $m : \Gamma \rightarrow G$  satisfying:

- (edge relations) for any oriented edge  $\mathbf{e} \in \Gamma$ ,

$$m(\mathbf{e})m(\bar{\mathbf{e}}) = h$$

- (vertex relations) for any vertex  $v = (\mathbf{e}_1, \dots, \mathbf{e}_k)$ ,

$$m(\mathbf{e}_k)m(\mathbf{e}_{k-1}) \cdots m(\mathbf{e}_1) = h.$$

In the particular case  $h = 1$ , the notion of  $(G, 1)$ -marking coincides with the notion of "abstract  $G$ -marking" introduced in [BKP09].

*Remark 4.3.3.* The edge relations imply that  $h$  commutes with  $m(\mathbf{e})$  for any edge  $\mathbf{e}$ :

$$hm(\mathbf{e}) = m(\mathbf{e})m(\bar{\mathbf{e}})m(\mathbf{e}) = m(\mathbf{e})h.$$

It follows that the vertex relation for  $v = (\mathbf{e}_1, \dots, \mathbf{e}_k)$  does not depend on the choice of a "first" edge  $\mathbf{e}_1$  in the cyclically ordered set  $v$ .

**Definition 4.3.4.** An *embedding* of a fatgraph  $\Gamma$  is an isotopy class of embeddings  $f : S(\Gamma) \hookrightarrow S_{g,1}$  such that  $f(S(\Gamma)) \cap \partial S_{g,1} = f(\mathbf{t}^-)$  and  $p \notin f(\mathbf{t}^-)$ . An *embedded fatgraph*  $(\Gamma, f)$  is a fatgraph together with an embedding.

In the sequel, we may identify  $S(\Gamma)$  with its image in  $S_{g,1}$  and omit to mention  $f$  explicitly when there is no fear of confusion. Figure 4.4 represents an embedded fatgraph in the genus one case, where the torus  $S_1$  has been cut along the arcs  $\mathbf{e}^\partial$ .

Observe that for any embedded fatgraph  $\Gamma$ , the complement  $S_{g,1} \setminus S(\Gamma)$  is contractible (since  $S(\Gamma)$  is of genus  $g$ ).

In [BKP09], a  $(\pi_1, 1)$ -marking of  $\gamma$  is associated to any embedding  $f$  of  $\Gamma$ . Here, we extend the construction to the framed case. For this, let us first introduce the notion of "simply framed path". Let  $P$  be a polygonal disc, and let  $p_0$  and  $p_1$  be two nonzero vectors that are tangent to the boundary  $\partial P$  and based at two distinct points of  $\partial P$ . A framed path  $\tilde{\alpha} : [0, 1] \rightarrow UP$  joining  $p_0$  to  $p_1$  is said to be *simply framed in  $P$*  if the underlying path  $\alpha : [0, 1] \rightarrow P$  is smooth, simple, and if the framing of  $\tilde{\alpha}$  is nowhere tangent to  $\alpha$ . One may think of a simply framed path in  $P$  as a path induced from the embedding of a ribbon  $r : [0, 1] \times [0, 1] \rightarrow P$ , with  $\tilde{\alpha}(t) = \frac{d}{ds}r(t, s)|_{s=0}$ . In the following, simply framed paths are depicted from this point of view, where  $r(t, 0)$  is drawn with a solid line and  $r(t, 1)$  with a dashed line (see Figure 4.4). Note that such a simply framed path  $\tilde{\alpha}$  exists if and only if the vectors  $p_0$  and  $p_1$  induce opposite orientations on  $\partial P$ , and in that case,  $\tilde{\alpha}$  is unique up to homotopy in  $UP$ .

Let  $(\Gamma, f)$  be an embedded fatgraph. For each edge  $\mathbf{e}$ , we fix a nonzero vector  $p(\mathbf{e})$  tangent to the arc  $\mathbf{e}^\partial \subset S_{g,1}$  and directed according to its orientation.

**Definition 4.3.5.** For any edge  $\mathbf{e}$ , we define  $\mu_f(\mathbf{e}) \in \tilde{\pi}_1$  as the composition of paths

$$\mu_f(\mathbf{e}) = (p \leftarrow p(\mathbf{e}) \leftarrow -p(\bar{\mathbf{e}}) \leftarrow -p \leftrightarrow p),$$

where:

- $-v \leftrightarrow v$  denotes the "half-twist"  $([0, 1] \ni t \mapsto e^{\pi i t} v)$ ,
- $v \leftarrow w$  is the unique simply framed path in a band of the thickened graph  $S(\Gamma)$ ,
- $v \leftarrow w$  is the unique simply framed path in the complement  $S_{g,1} \setminus \text{int}(S(\Gamma) \cup D^2)$ .

See Figure 4.4.

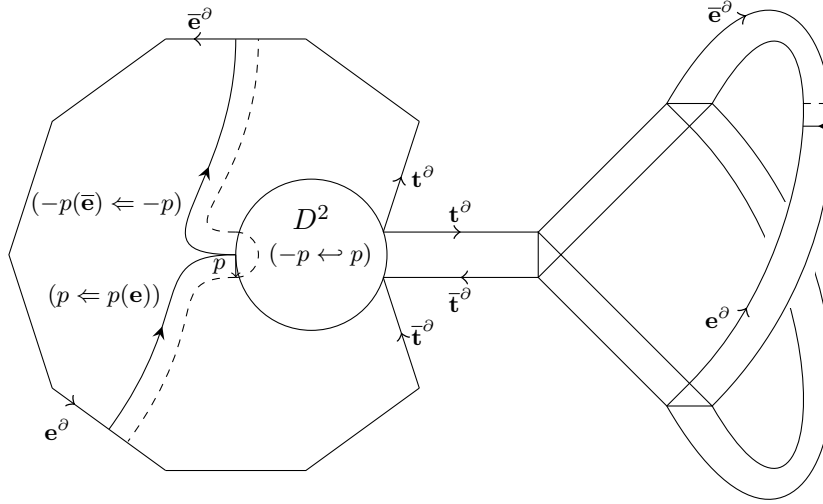

Figure 4.4: The framed path  $\mu_f(\mathbf{e})$  (here,  $\bar{\mathbf{e}} < \mathbf{e}$ ).

**Lemma 4.3.6.** The map  $\mu_f : \Gamma \rightarrow \tilde{\pi}_1$  is a  $(\tilde{\pi}_1, \theta)$ -marking. In other words, we have

$$\mu_f(\mathbf{e})\mu_f(\bar{\mathbf{e}}) = \theta \text{ for any edge } \mathbf{e}, \quad (4.3.1)$$

$$\mu_f(\mathbf{e}_k)\mu_f(\mathbf{e}_{k-1}) \cdots \mu_f(\mathbf{e}_1) = \theta \text{ for any vertex } v = (\mathbf{e}_1, \dots, \mathbf{e}_k). \quad (4.3.2)$$

Moreover, we have

$$\mu_f(\bar{\mathbf{t}}) = \theta^{-1}\partial^{-1}. \quad (4.3.3)$$

*Proof.* Let us show (4.3.1). We have

$$\mu_f(\mathbf{e})\mu_f(\bar{\mathbf{e}}) = (p \leftarrow p(\mathbf{e}) \leftarrow -p(\bar{\mathbf{e}}) \leftarrow -p \leftrightarrow p \leftarrow p(\bar{\mathbf{e}}) \leftarrow -p(\mathbf{e}) \leftarrow -p \leftrightarrow p).$$

Using the obvious general relations  $(w \leftarrow v \leftrightarrow -v) = (w \leftrightarrow -w \leftarrow -v)$  and  $(w \leftarrow v \leftrightarrow -v) = (w \leftrightarrow -w \leftarrow -v)$ , we obtain

$$\mu_f(\mathbf{e})\mu_f(\bar{\mathbf{e}}) = (p \leftarrow p(\mathbf{e}) \leftarrow -p(\bar{\mathbf{e}}) \leftarrow -p \leftarrow -p(\bar{\mathbf{e}}) \leftarrow p(\mathbf{e}) \leftarrow p \leftrightarrow -p \leftrightarrow p).$$

Since  $(v \leftarrow w \leftarrow v) = 1$  and  $(v \rightleftharpoons w \rightleftharpoons v) = 1$ , we finally get

$$\mu_f(\mathbf{e})\mu_f(\bar{\mathbf{e}}) = (p \rightleftharpoons -p \rightleftharpoons p) = \theta.$$

Let us now show (4.3.2). By definition of the vertex  $v = (\mathbf{e}_1, \dots, \mathbf{e}_k)$ , we have  $\bar{\mathbf{e}}_{i+1} = \mathbf{e}_i - 1$ . As depicted here,

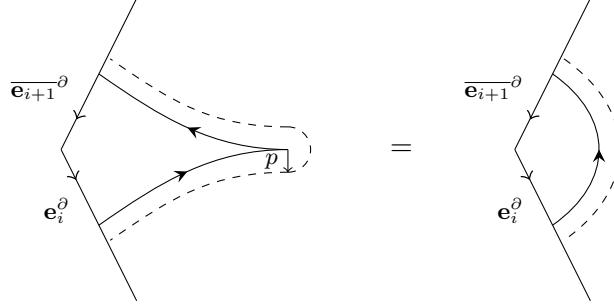

we have

$$(-p(\bar{\mathbf{e}}_{i+1}) \leftarrow -p \rightleftharpoons p \rightleftharpoons p(\mathbf{e}_i)) = (-p(\bar{\mathbf{e}}_{i+1}) \rightleftharpoons p(\mathbf{e}_i)).$$

It follows that

$$\begin{aligned} & \mu_f(\mathbf{e}_k)\mu_f(\mathbf{e}_{k-1}) \cdots \mu_f(\mathbf{e}_1) = \\ & p \rightleftharpoons p(\mathbf{e}_k) \leftarrow -p(\bar{\mathbf{e}}_k) \rightleftharpoons p(\mathbf{e}_{k-1}) \leftarrow -p(\bar{\mathbf{e}}_{k-1}) \quad \cdots \quad p(\mathbf{e}_1) \leftarrow -p(\bar{\mathbf{e}}_1) \rightleftharpoons -p \rightleftharpoons p. \end{aligned}$$

As shown by the following picture, this corresponds to the twist  $\theta$ .

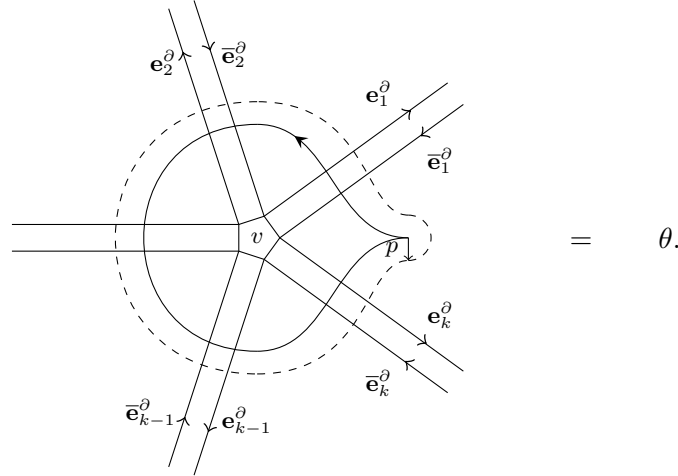

Finally, Relation (4.3.3) can be checked by looking at the following picture.

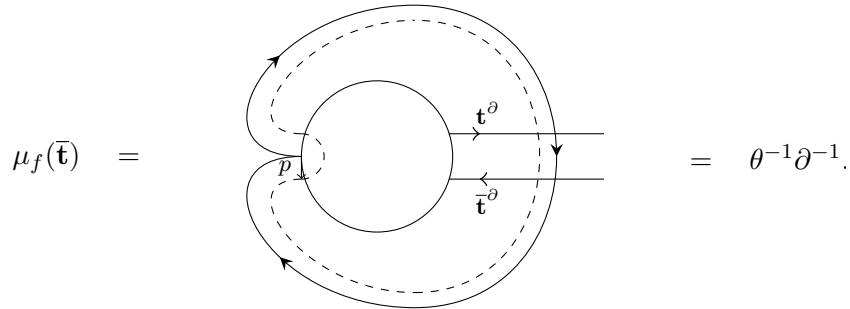

□

The next lemma says that the marking  $\mu_f$  is universal.

**Lemma 4.3.7.** *Let  $(\Gamma, f)$  be an embedded fatgraph. For any  $(G, h)$ -marking  $m$ , there is a unique morphism  $\rho : \tilde{\pi}_1 \rightarrow G$  sending  $\theta$  to  $h$  such that the following diagram commutes.*

$$\begin{array}{ccc}
 & \Gamma & \\
 \mu_f \swarrow & & \searrow m \\
 (\tilde{\pi}_1, \theta) & \xrightarrow{\rho} & (G, h)
 \end{array}$$

*Proof.* This amounts to say that  $\tilde{\pi}_1$  is presented by the generators  $\mu_f(\Gamma)$  and the edges and vertices relations (4.3.1) and (4.3.2). From Van Kampen theorem,  $\pi_1$  is presented by the unframed  $\mu_f(\Gamma)$  and the unframed relations (4.3.1) and (4.3.2). By considering the central extension (4.2.1), we see that  $\tilde{\pi}_1$  is presented by the generators  $\mu_f(\Gamma) \cup \{\theta\}$  and the relations (4.3.1) and (4.3.2) together with the centrality relations for  $\theta$ . Now, the edge condition (4.3.1) says that  $\theta$  is generated by  $\mu_f(\Gamma)$ , and implies the centrality relations for  $\theta$  (see Remark 4.3.3). □

Let  $\Gamma$  be a fatgraph. We consider the category  $\mathbf{D}(\Gamma)$  of beak diagrams labeled with the edges of  $\Gamma$ . Any embedding  $f$  of  $\Gamma$  gives rise to a marking  $\mu_f : \Gamma \rightarrow \tilde{\pi}_1$ , and thus induces a functor  $\mathbf{D}(\Gamma) \rightarrow \mathbf{D}(\tilde{\pi}_1)$ . Forgetting the framing leads to a functor  $\mathbf{D}(\Gamma) \rightarrow \mathbf{D}(\pi_1)$ . We define the functors

$$\tilde{\varphi}_f : \mathbf{D}(\Gamma) \rightarrow \tilde{\mathbf{T}}_g \quad \text{and} \quad \varphi_f : \mathbf{D}(\Gamma) \rightarrow \mathbf{T}_g$$

by composing the above arrows with  $\varphi_{\tilde{\pi}_1} : \mathbf{D}(\tilde{\pi}_1) \rightarrow \tilde{\mathbf{T}}_g$  and  $\varphi_{\pi_1} : \mathbf{D}(\pi_1) \rightarrow \mathbf{T}_g$  respectively, where  $\varphi_{\tilde{\pi}_1}$  and  $\varphi_{\pi_1}$  are defined in Section 4.2.

## 4.4 RST Moves

Throughout this section, we fix a fatgraph  $\Gamma$ . We introduce a set of equivalence moves on beak diagrams of  $\mathbf{D}(\Gamma)$ . These moves generate an equivalence relation  $\tilde{RST}(\Gamma)$ . We then state the main result of this chapter (Theorem 4.4.3), which asserts that  $\tilde{\varphi}_f$  induces an isomorphism  $\mathbf{D}(\Gamma)/\tilde{RST}(\Gamma) \rightarrow \tilde{\mathbf{T}}_g$ .

### 4.4.1 The main theorem

In order to be able to carry out several cases in a single formula, we introduce the following notation:

$$\text{For } \mathbf{x} \neq \mathbf{y} \in \Gamma, \quad \mathbf{xy} := \begin{cases} +1 & \text{if } \mathbf{x} < \mathbf{y}, \\ -1 & \text{if } \mathbf{y} < \mathbf{x}. \end{cases}$$

We also set the following graphical convention, which will appear at the level of crossings in beak diagrams:

$$\begin{array}{c} \text{---} \\ \diagup \quad \diagdown \\ \text{---} \\ \diamond \\ \text{---} \\ \diagdown \quad \diagup \\ \text{---} \end{array} := \begin{array}{c} \diagup \\ \diagdown \end{array} \quad ; \quad \begin{array}{c} \text{---} \\ \diagdown \quad \diagup \\ \text{---} \\ \diamond \\ \text{---} \\ \diagup \quad \diagdown \\ \text{---} \end{array} := \begin{array}{c} \diagdown \\ \diagup \end{array} .$$

Note that the position of the diamond symbol matters. For  $\varepsilon = \pm 1$ , we have

$$\begin{array}{c} \text{---} \\ \diagup \quad \diagdown \\ \text{---} \\ \diamond \\ \text{---} \\ \diagdown \quad \diagup \\ \text{---} \end{array} \varepsilon = \begin{array}{c} \text{---} \\ \diagdown \quad \diagup \\ \text{---} \\ \diamond \\ \text{---} \\ \diagup \quad \diagdown \\ \text{---} \end{array} -\varepsilon .$$

We define a family of moves called S-moves<sup>2</sup> on the beak diagrams labeled with  $\Gamma$ , as depicted in the Figures 4.5-4.7. (Here and in what follows, the orientation of the strands of the diagrams is not mentioned: this means that the moves hold for any arbitrary orientation.)

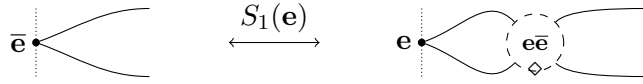

Figure 4.5: The move  $S_1(\mathbf{e})$  for any edge  $\mathbf{e}$ .

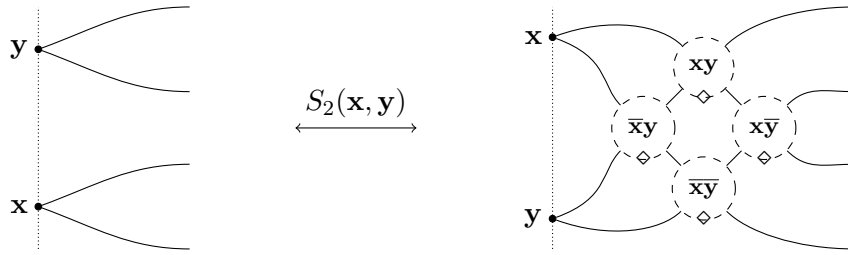

Figure 4.6: The move  $S_2(\mathbf{x}, \mathbf{y})$  for any edges  $\mathbf{x}, \mathbf{y}$  such that the non-oriented edges  $\{\mathbf{x}, \bar{\mathbf{x}}\}$  and  $\{\mathbf{y}, \bar{\mathbf{y}}\}$  are distinct.

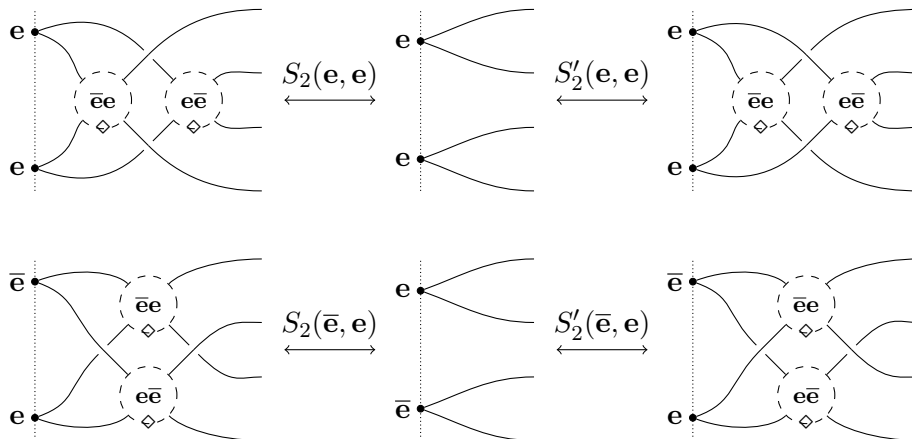

Figure 4.7: The moves  $S_2(\mathbf{e}, \mathbf{e})$ ,  $S'_2(\mathbf{e}, \mathbf{e})$ ,  $S_2(\bar{\mathbf{e}}, \mathbf{e})$  and  $S'_2(\bar{\mathbf{e}}, \mathbf{e})$  for any edge  $\mathbf{e}$ .

<sup>2</sup>S stands for "slide".

**Lemma 4.4.1.** Using the notation  $M_1 + \dots + M_k \Rightarrow N_1, \dots, N_l$  to mean that the moves  $N_1, \dots, N_l$  can be written as a sequence of moves  $M_1, \dots, M_k$ , we have:

(i)  $R_2 + S_1(\mathbf{e}) \Rightarrow S_1(\bar{\mathbf{e}})$ ,

(ii)  $R_2 + S_2(\mathbf{x}, \mathbf{y}) \Rightarrow S_2(\mathbf{y}, \mathbf{x})$ ,

(iii)  $R_2 + S_2(\mathbf{e}, \mathbf{e}) \Rightarrow S'_2(\mathbf{e}, \mathbf{e})$ ,

(iv)  $R_3 + S_1(\mathbf{x}) + S_2(\mathbf{x}, \mathbf{y}) \Rightarrow S_2(\bar{\mathbf{x}}, \mathbf{y})$ ,

(v)  $R_3 + S_1(\mathbf{e}) + S_2(\mathbf{e}, \mathbf{e}) \Rightarrow S'_2(\bar{\mathbf{e}}, \mathbf{e}), S_2(\mathbf{e}, \bar{\mathbf{e}}), S'_2(\bar{\mathbf{e}}, \bar{\mathbf{e}})$ ,

(vi)  $R_3 + S_1(\mathbf{e}) + S'_2(\mathbf{e}, \mathbf{e}) \Rightarrow S_2(\bar{\mathbf{e}}, \mathbf{e}), S'_2(\mathbf{e}, \bar{\mathbf{e}}), S_2(\bar{\mathbf{e}}, \bar{\mathbf{e}})$ .

*Proof.* (i) The move  $S_1(\bar{\mathbf{e}})$  can be obtained as a sequence of moves  $R_2$  and  $S_1(\mathbf{e})$ :

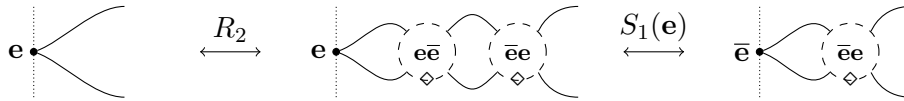

(ii) For  $\{\mathbf{x}, \bar{\mathbf{x}}\} \neq \{\mathbf{y}, \bar{\mathbf{y}}\}$ , the move  $S_2(\mathbf{y}, \mathbf{x})$  can be obtained as a sequence of moves  $R_2$  and  $S_2(\mathbf{x}, \mathbf{y})$ :

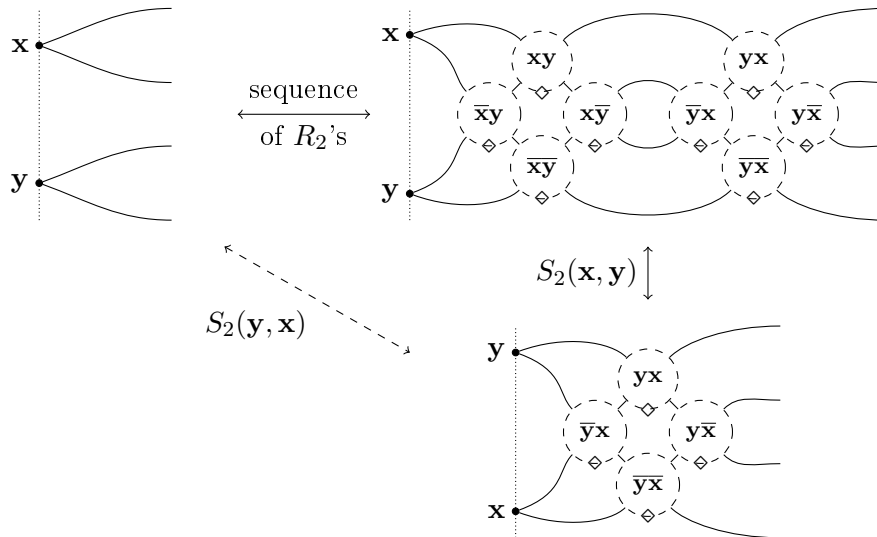

(iii) is obtained similarly. (iv) The move  $S_2(\bar{\mathbf{x}}, \mathbf{y})$  can be obtained from  $S_2(\mathbf{x}, \mathbf{y})$ , using  $R_3$  (here, the sequence of two moves  $R_3$  can be checked on a case by case basis) and  $S_1(\mathbf{x})$ :



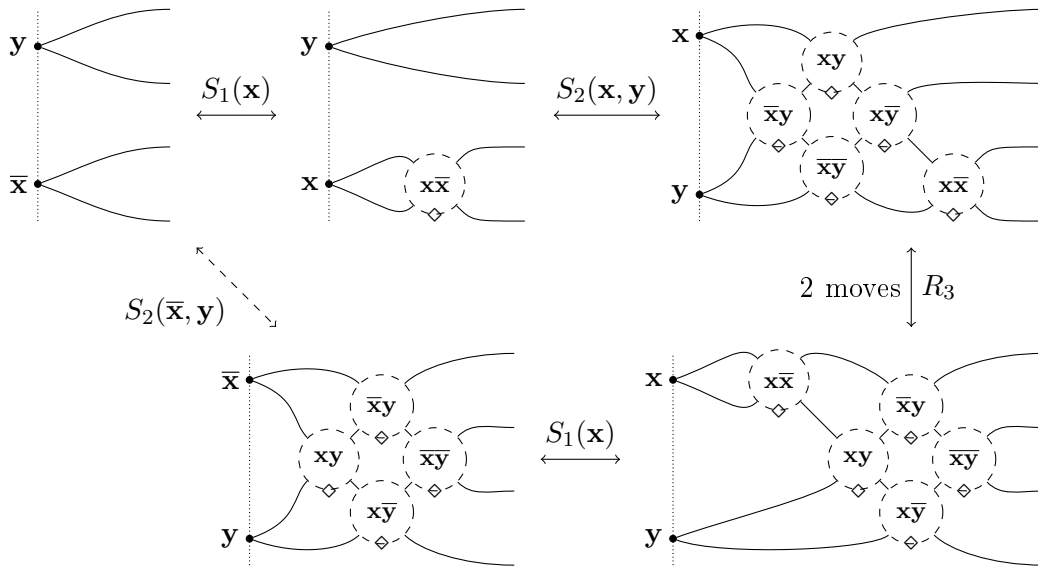

Assertions (v) and (vi) work in the same way. The three resulting moves are respectively obtained by performing  $S_1(\mathbf{e})$  on one of the beaks, on the other, and finally on both of them.  $\square$

We now define three kind of moves called T-moves<sup>3</sup> on the beak diagrams labeled with  $\Gamma$ , as depicted in the Figures 4.8-4.10. These T-moves are nothing but the diagrammatic versions of the three relations (4.3.1)-(4.3.3) of Lemma 4.3.6.

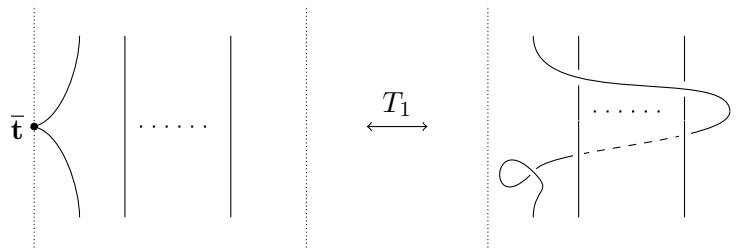

Figure 4.8: The move  $T_1$ . This move involves a whole horizontal slice of the diagram. There is a nonnegative number of vertical strands running in this slice. On the right-hand side, the solid line goes over all these strands, whereas the dashed line goes under.

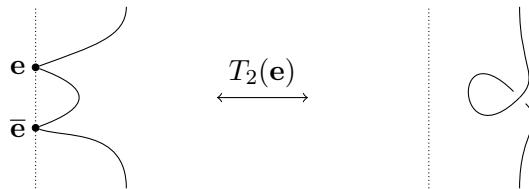

Figure 4.9: The move  $T_2(\mathbf{e})$  for any edge  $\mathbf{e}$ .

<sup>3</sup>T stands for "topology".

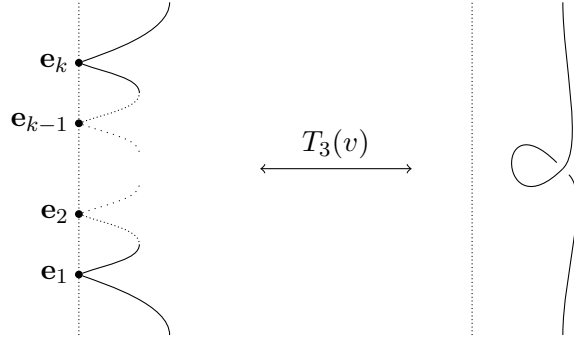

Figure 4.10: The move  $T_3(v)$  for any vertex  $v = (\mathbf{e}_1, \dots, \mathbf{e}_k)$ .

**Definition 4.4.2.** Seeing  $\mathbf{D}(\Gamma)$  as a set, let  $RST(\Gamma)$  (respectively  $\tilde{R}ST(\Gamma)$ ) be the equivalence relation on  $\mathbf{D}(\Gamma)$  generated by the Reidemeister moves (R-moves), the S-moves and the T-moves (respectively, by the modified Reidemeister  $\tilde{R}$ -moves, the S-moves and the T-moves).

Since the RST-moves are performed in local slices of the beak diagrams, the composition in  $\mathbf{D}(\Gamma)$  obviously induces a category structure on the quotient sets  $\mathbf{D}(\Gamma)/RST(\Gamma)$  and  $\mathbf{D}(\Gamma)/\tilde{R}ST(\Gamma)$ .

**Theorem 4.4.3.** *The functor  $\varphi_f : \mathbf{D}(\Gamma) \rightarrow \mathbf{T}_g$  factors through  $RST(\Gamma)$ , and induces an isomorphism of categories:*

$$\mathbf{D}(\Gamma)/RST(\Gamma) \xrightarrow{\cong} \mathbf{T}_g.$$

*The functor  $\tilde{\varphi}_f : \mathbf{D}(\Gamma) \rightarrow \tilde{\mathbf{T}}_g$  factors through  $\tilde{R}ST(\Gamma)$ , and induces an isomorphism of categories:*

$$\mathbf{D}(\Gamma)/\tilde{R}ST(\Gamma) \xrightarrow{\cong} \tilde{\mathbf{T}}_g.$$

Theorem 4.4.3 will be proved in Section 4.5.

*Remark 4.4.4.* As a diagrammatic analog of Remark 4.3.3, it follows from the move  $T_2$  that curls commute with beaks:

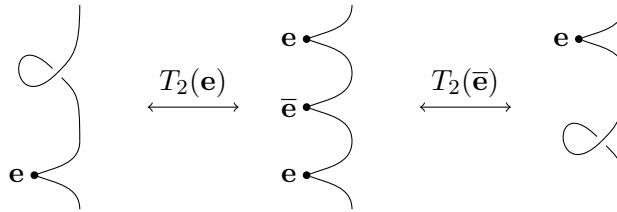

Therefore, the move  $T_3(v)$  does not depend (up to  $\tilde{R}_1$  and  $T_2$ ) on the choice of  $\mathbf{e}_1$  in the cyclically ordered set  $v = (\mathbf{e}_1, \dots, \mathbf{e}_k)$ .

*Remark 4.4.5.* The number of S-moves generating  $\tilde{R}ST(\Gamma)$  can be strongly reduced. For example, it is sufficient to restrict ourselves to the S-moves of the form  $S_1(\mathbf{e})$  for  $\bar{\mathbf{e}} < \mathbf{e}$ ,  $S_2(\mathbf{x}, \mathbf{y})$  for  $(\bar{\mathbf{x}} < \mathbf{x}, \bar{\mathbf{y}} < \mathbf{y}, \mathbf{x} < \mathbf{y})$ , and  $S_2(\mathbf{e}, \mathbf{e})$  for  $\bar{\mathbf{e}} < \mathbf{e}$ . Indeed, Lemma 4.4.1 says that together with the R-moves, this subset generates any S-move.

#### 4.4.2 A combed version of the $S_2$ -moves

Let  $\mathbf{FB}_{g,n}$  denote the group of framed braids of  $n$  strands on  $S_g$ . (By a *framed braid* on  $S_g$ , we mean a framed tangle on  $S_g$  whose underlying unframed tangle is a braid.) We define the framed braids  $\tau_i$  (for  $1 \leq i \leq n-1$ ),  $\theta_j$  (for  $1 \leq j \leq n$ ), and  $b(\mathbf{e})$  (for any edge  $\mathbf{e}$ ) as the images under  $\tilde{\varphi}_f$  of the following diagrams.

$$\tau_i := \begin{array}{c} | \cdots \diagdown \cdots | \\ 1 \quad i \quad n \end{array}; \quad \theta_j := \begin{array}{c} | \cdots \diagup \cdots | \\ 1 \quad j \quad n \end{array}; \quad b(\mathbf{e}) := \mathbf{e} \begin{array}{c} \diagdown \\ 1 \quad 2 \quad n \end{array}.$$

Up to planar isotopy, a beak diagram representing a framed braid can always be decomposed into a finite number of elementary "slices" of the form  $\tau_i$ ,  $\theta_j$  and  $b(\mathbf{e})$ . Therefore, all these elements form a set of generators for  $\mathbf{FB}_{g,n}$ . The T-moves can be rewritten as "local" relations between these generators:

$$\begin{aligned} T_1 &\rightsquigarrow b(\bar{\mathbf{t}}) = \theta_1^{-1} \tau_1^{-1} \cdots \tau_{n-1}^{-1} \tau_{n-1}^{-1} \cdots \tau_1^{-1} \\ T_2(\mathbf{e}) &\rightsquigarrow b(\mathbf{e})b(\bar{\mathbf{e}}) = \theta_1 \\ T_3(v) \text{ with } v = (\mathbf{e}_1, \dots, \mathbf{e}_k) &\rightsquigarrow b(\mathbf{e}_k) \cdots b(\mathbf{e}_1) = \theta_1 \end{aligned}$$

Moreover, the  $S_2$ -moves can also be "combed" as shown in Figure 4.11, that is, rewritten as local framed braid relations. For any  $\mathbf{x}, \mathbf{y}$  with  $\{\mathbf{x}, \bar{\mathbf{x}}\} \neq \{\mathbf{y}, \bar{\mathbf{y}}\}$ , the move  $S_2(\mathbf{x}, \mathbf{y})$  is equivalent to the move  $CS_2(\mathbf{x}, \mathbf{y})$  which locally gives

$$b(\mathbf{y})\tau_1^{\bar{\mathbf{y}}\mathbf{x}}b(\mathbf{x}) = \tau_1^{\mathbf{y}\bar{\mathbf{x}}}b(\mathbf{x})\tau_1^{\bar{\mathbf{x}}\mathbf{y}}b(\mathbf{y})\tau_1^{\bar{\mathbf{y}}\mathbf{x}}. \quad (4.4.1)$$

For any edge  $\mathbf{e}$ , the move  $S_2(\mathbf{e}, \mathbf{e})$  can be combed in a similar fashion, and locally gives

$$b(\mathbf{e})\tau_1^{\bar{\mathbf{e}}\mathbf{e}}b(\mathbf{e}) = \tau_1^{-1}b(\mathbf{e})\tau_1^{\bar{\mathbf{e}}\mathbf{e}}b(\mathbf{e})\tau_1. \quad (4.4.2)$$

In particular, if we take  $\Gamma$  to be the "symplectic" fatgraph  $\Gamma_g$  depicted in Figure 4.12, we obtain, combining the three types of T-moves, the relation

$$[b(\mathbf{y}_1), b(\mathbf{x}_1)] \cdots [b(\mathbf{y}_g), b(\mathbf{x}_g)] = \theta_1^{2-2g} \tau_1 \cdots \tau_{n-1} \tau_{n-1} \cdots \tau_1, \quad (4.4.3)$$

where  $[x, y] := xyx^{-1}y^{-1}$ . Moreover, the combed  $CS_2$  moves give the relations:

$$b(\mathbf{x}_i)\tau_1 b(\mathbf{x}_i) = \tau_1^{-1}b(\mathbf{x}_i)\tau_1 b(\mathbf{x}_i)\tau_1 \quad \text{for } 1 \leq i \leq g \quad (4.4.4)$$

$$b(\mathbf{y}_i)\tau_1^{-1}b(\mathbf{y}_i) = \tau_1^{-1}b(\mathbf{y}_i)\tau_1^{-1}b(\mathbf{y}_i)\tau_1 \quad \text{for } 1 \leq i \leq g \quad (4.4.5)$$

$$b(\mathbf{y}_i)\tau_1 b(\mathbf{x}_i) = \tau_1 b(\mathbf{x}_i)\tau_1^{-1}b(\mathbf{y}_i)\tau_1^{-1} \quad \text{for } 1 \leq i \leq g \quad (4.4.6)$$

$$b(\mathbf{u}_i)\tau_1 b(\mathbf{v}_j) = \tau_1 b(\mathbf{v}_j)\tau_1^{-1}b(\mathbf{u}_i)\tau_1 \quad \text{for } i < j, \{\mathbf{u}, \mathbf{v}\} \in \{\mathbf{x}, \mathbf{y}\}. \quad (4.4.7)$$

The relations (4.4.3)-(4.4.7) are compatible with the presentation of the framed braid group  $\mathbf{FB}_{g,n}$  given by Bellingeri and Gervais in [BG12, Theorem 13].

*Remark 4.4.6.* As for the  $S_1$ -moves, it can be observed that there is no way to "comb" them.

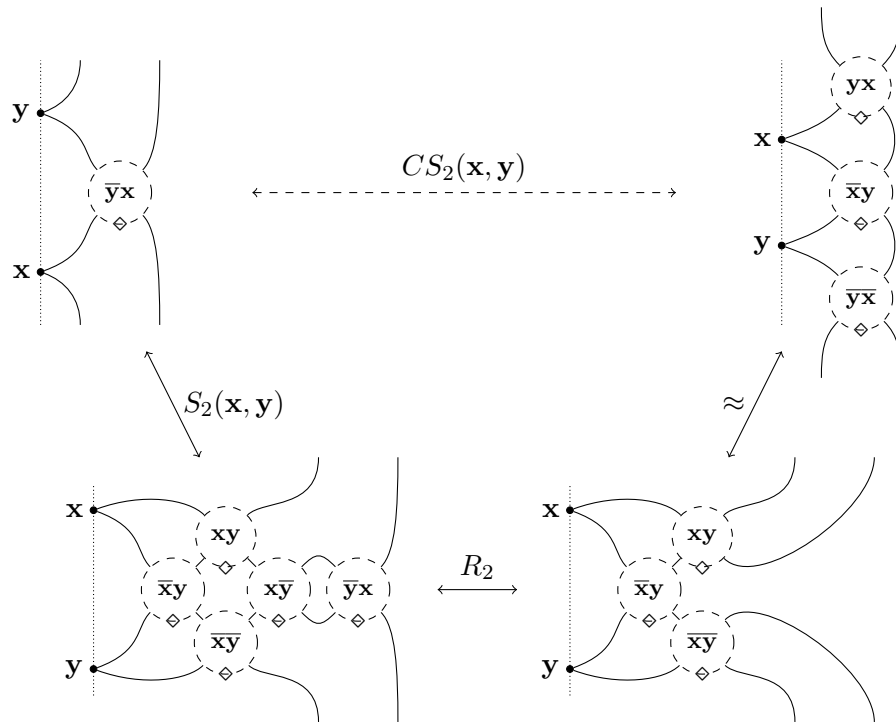

Figure 4.11: The combed  $S_2$  move  $CS_2(x, y)$  is obtained from  $S_2(x, y)$ , using  $R_2$  and planar isotopy  $\approx$ . Conversely,  $CS_2(x, y)$  implies  $S_2(x, y)$ , so the two moves are equivalent.

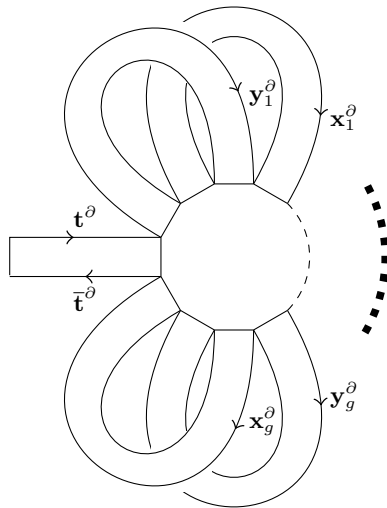

Figure 4.12: The symplectic fatgraph  $\Gamma_g$ .

### 4.4.3 Doubling a beak strand

We recall a standard *cabling operation* on framed tangles. Let  $k$  be a nonnegative integer,  $\gamma$  be a framed tangle and  $\alpha : M \rightarrow S_g \times I$  be a connected component of  $\gamma$ , whose framing is denoted by  $\tilde{\alpha}$ . The  $k$ -th *cabling* of  $\gamma$  along  $\alpha$  is the tangle  $\Delta_\alpha^k(\gamma)$  obtained by replacing the component  $\alpha$  with  $k$  parallel copies  $(\alpha_1, \dots, \alpha_k)$  in the following way. Extend  $\alpha : M \rightarrow S_g \times I$  to an embedding  $\hat{\alpha}$  of the ribbon  $M \times [0, 1]$  such that

- $\hat{\alpha}(\cdot, 0) = \alpha$ ,
- $\hat{\alpha}(M \times [0, 1])$  does not intersect the other components of  $\gamma$ ,
- $\hat{\alpha}(\partial M \times [0, 1])$  is on the  $x$ -axis of the disc  $D^2$ ,
- and  $(\tilde{\alpha}(r), \frac{d}{ds}\hat{\alpha}(r, s)|_{s=0}, \frac{d}{dr}\alpha(r))$  is positively oriented for any  $r \in M$ .

Set  $\alpha_i(r) = \hat{\alpha}(r, \frac{i}{k})$ . The framing of  $\tilde{\alpha}_i$  is taken such that  $(\tilde{\alpha}_i(r), \frac{d}{ds}\hat{\alpha}(r, s)|_{s=\frac{i}{k}}, \frac{d}{dr}\alpha_i(r))$  is positively oriented. Finally, rescale the endpoints of  $\Delta_\alpha^k(\gamma)$  along the  $x$ -axis to get a tangle in  $\tilde{\mathbf{T}}_g$ .

For  $k, l \geq 0$ , and for any  $1 \leq i \leq k$ , we have

$$\Delta_{\alpha_i}^l \Delta_\alpha^k(\gamma) = \Delta_\alpha^{k+l}(\gamma).$$

Moreover, if  $\alpha$  and  $\beta$  are two distinct components of  $\gamma$ ,

$$\Delta_\beta^l \Delta_\alpha^k(\gamma) = \Delta_\alpha^k \Delta_\beta^l(\gamma).$$

If  $X = (\varepsilon_1, \dots, \varepsilon_k)$  is a sequence of signs, we denote by  $\Delta_\alpha^X(\gamma)$  the tangle obtained from  $\Delta_\alpha^k(\gamma)$  by reversing the orientation of the strands  $\alpha_i$  if  $\varepsilon_i = -1$ .

**Lemma 4.4.7.** *At the level of beak diagrams, the 2-cabling of a strand containing a beak behaves as follows.*

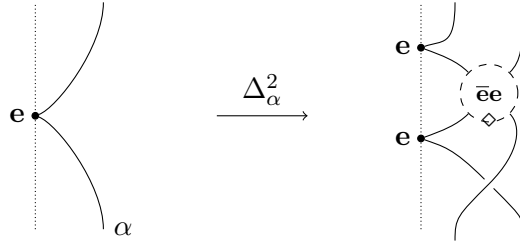

The proof of Lemma 4.4.7 is contained in Section 4.5.

## 4.5 Proof of Theorem 4.4.3

In this section,  $(\Gamma, f)$  is a fixed embedded fatgraph. The categories  $\mathbf{T}_g$ ,  $\tilde{\mathbf{T}}_g$  and  $\mathbf{D}(\Gamma)$  are seen as sets. Let us first prove the unframed case of Theorem 4.4.3. The framed case will follow.

We identify the complement  $S_g \setminus \text{int}(S(\Gamma))$  with the square  $R := [-1, 1]^2$  as depicted in Figure 4.13. This identification sends the arc  $\mathbf{t}^- \subset \partial S(\Gamma)$  (recall Definition 4.3.4) to the union of the three edges  $C \cup C' \cup C''$  of  $\partial R$ . We set  $P := (-1, 1) \in \partial C$ .

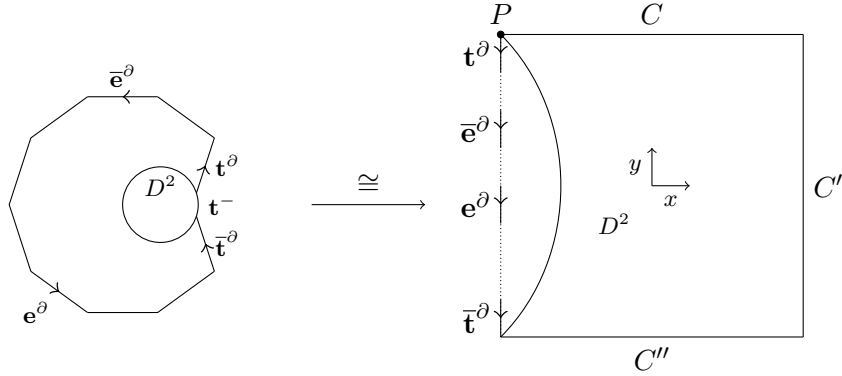

Figure 4.13: The square  $R$  on the right-hand side.

For a tangle  $\gamma \subset S_g \times I$ , we consider the decomposition  $\gamma = A(\gamma) \cup B(\gamma)$  where  $A(\gamma) := \gamma \cap (R \times I)$  and  $B(\gamma) = \gamma \cap (S(\Gamma) \times I)$ . The tangle  $\gamma$  is said to be in *generic position* if the following conditions are satisfied.

1.  $A(\gamma)$  is in generic position with respect to the projection  $pr : R \times I \rightarrow C \times I$  parallel to the  $y$  axis (that is, the only singularities are transverse double points),
2.  $B(\gamma)$  is made of a finite number of arcs that we call the *B-arcs* of  $\gamma$ . Each B-arc is contained in  $B_{\{\mathbf{e}, \bar{\mathbf{e}}\}} \times I$  where  $B_{\{\mathbf{e}, \bar{\mathbf{e}}\}}$  is the band of  $S(\Gamma)$  associated to a non-oriented edge  $\{\mathbf{e}, \bar{\mathbf{e}}\}$ , and joins the two walls  $\mathbf{e}^\partial \times I$  and  $\bar{\mathbf{e}}^\partial \times I$  by crossing them transversally,
3. the endpoints of any B-arc are of distinct height, which allows us to distinguish the *top endpoint* from the *bottom endpoint* of a B-arc.
4. the heights of the B-arcs are pairwise disjoint subsegments of  $I$ .

Let  $\mathcal{T}_g^{\text{gen}}$  denotes the set of tangles in generic position. As  $S(\Gamma)$  can be made arbitrary thin up to isotopy, it is clear that any tangle can be put in generic position up to small perturbation. Hence, we have a surjective map

$$\mathcal{T}_g^{\text{gen}} \rightarrow \mathbf{T}_g.$$

Let us define a surjective map

$$\pi : \mathcal{T}_g^{\text{gen}} \rightarrow \mathbf{D}(\Gamma).$$

Take  $\gamma \in \mathcal{T}_g^{\text{gen}}$ . The projection  $pr(A(\gamma)) \subset C \times I$  defines a usual tangle diagram by distinguishing, at the level of crossings, the over strand (which is far from  $C \times I$ , that is, whose  $y$  coordinate is smaller) from the under strand. This diagram may have endpoints on  $C \times \partial I$  (corresponding to the "genuine" endpoints of  $\gamma$ ) but also on the edge  $P \times I$  (corresponding to the endpoints of the B-arcs). From Conditions 3 and 4, these endpoints are pairwise distinct. Add to the diagram the subsegments of  $P \times I$  obtained by joining the bottom and top endpoints of the B-arcs. From Condition 4, these segments are pairwise disjoint. Last, label each segment with  $\mathbf{e}$  if

and only if its top endpoint corresponds to a point of  $\mathbf{e}^\partial \times I$  (see Figure 4.14). From Condition 2, this is equivalent to saying that its bottom endpoint corresponds to a point of  $\bar{\mathbf{e}}^\partial \times I$ . We thus obtain a beak diagram  $D$ . The map  $\pi : \mathcal{T}_g^{\text{gen}} \rightarrow \mathbf{D}(\Gamma)$  is defined by  $\pi(\gamma) = D$ .

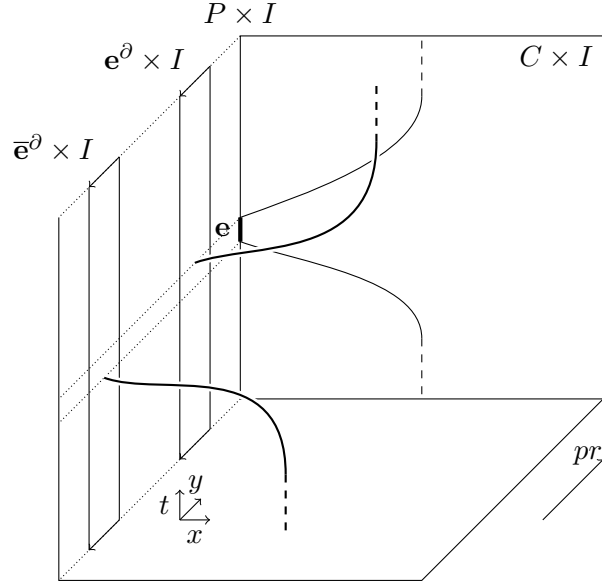

Figure 4.14: The tangle  $A(\gamma)$  (in bold lines) near a B-arc. The two strands are projected on the back side  $C \times I$ . In this case, the beak has to be labeled with  $\mathbf{e}$ .

The map  $\pi : \mathcal{T}_g^{\text{gen}} \rightarrow \mathbf{D}(\Gamma)$  is clearly surjective, and the following diagram commutes:

$$\begin{array}{ccc}
 & \mathcal{T}_g^{\text{gen}} & \\
 \pi \swarrow & & \searrow \\
 \mathbf{D}(\Gamma) & \xrightarrow{\varphi_f} & \mathbf{T}_g
 \end{array} \tag{4.5.1}$$

Since  $\mathcal{T}_g^{\text{gen}} \rightarrow \mathbf{T}_g$  is surjective,  $\varphi_f$  is also surjective.

The fact that  $\varphi_f$  factors through the Reidemeister moves is clear by construction. Moreover, Lemma 4.3.6 asserts that  $\varphi_f$  factors through the  $T$ -moves.

**Lemma 4.5.1.** *The map  $\varphi_f$  factors through the  $S$ -moves. More precisely, any  $S$ -move can be seen as the image under  $\pi$  of a local isotopy between two tangles  $\gamma_1$  and  $\gamma_2$  in generic position.*

*Proof.* The move  $S_1(\mathbf{e})$  corresponds to an isotopy in the neighborhood of a B-arc whose associated beak is labeled with  $\bar{\mathbf{e}}$ . This isotopy switches the bottom and top endpoints of the B-arc, as depicted below.

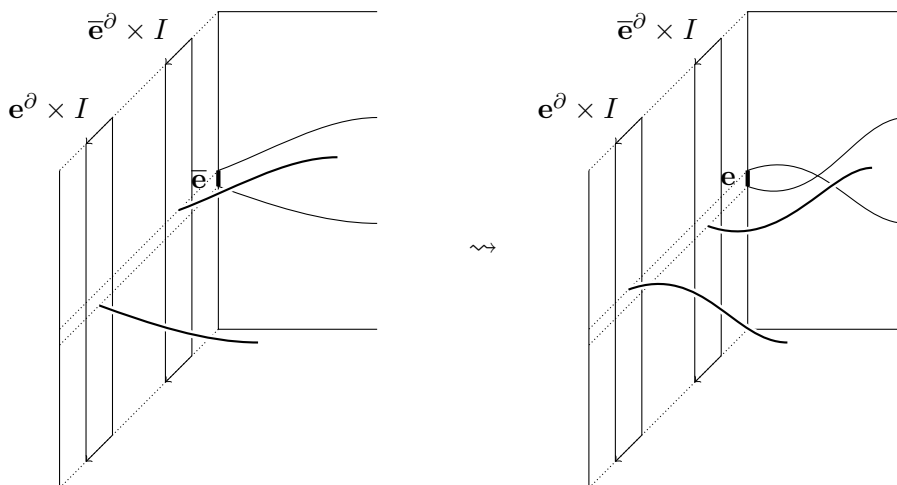

This switch creates a crossing which depends on the position of the walls  $\bar{\mathbf{e}}^\delta \times I$  and  $\mathbf{e}^\delta \times I$  with respect to the "projection screen"  $C \times I$ , that is, on the sign of  $\mathbf{e}\bar{\mathbf{e}}$ , as announced in Figure 4.5.

The move  $S_2(\mathbf{x}, \mathbf{y})$  (for  $\{\mathbf{x}, \bar{\mathbf{x}}\} \neq \{\mathbf{y}, \bar{\mathbf{y}}\}$ ) corresponds to an isotopy in the neighborhood of two B-arcs of consecutive heights, whose associated beaks are labeled with  $\mathbf{x}$  and  $\mathbf{y}$ . The B-arc associated to the beak  $\mathbf{x}$  slides up, and the other one slides down, so that their heights switch. One can easily check that the projection of this operation under  $\pi$  creates four crossings which behave as depicted in Figure 4.6.

The moves  $S_2(\mathbf{e}, \mathbf{e})$ ,  $S'_2(\mathbf{e}, \mathbf{e})$ ,  $S_2(\mathbf{e}, \bar{\mathbf{e}})$  and  $S'_2(\mathbf{e}, \bar{\mathbf{e}})$  correspond to isotopies of the same kind, in the case  $\{\mathbf{x}, \bar{\mathbf{x}}\} = \{\mathbf{y}, \bar{\mathbf{y}}\} = \{\mathbf{e}, \bar{\mathbf{e}}\}$ . In this case however, we have to take care of the fact that the two sliding B-arcs should not intersect. Therefore, if the height-increasing strand goes behind the height-decreasing strand near the wall  $\mathbf{e}^\delta \times I$ , the situation is necessarily the opposite near the wall  $\bar{\mathbf{e}}^\delta \times I$ . Observe that Figure 4.7 depicts any possible situation.  $\square$

The rest of the proof is as follows. We first show that two tangles of  $\mathcal{T}_g^{\text{gen}}$  are isotopic if and only if they are related by a sequence of "cellular moves" (Lemma 4.5.3). Then, from the commutative diagram (4.5.1), two beak diagrams lead to the same tangle under  $\varphi_f$  if and only if they are related by a sequence of projections of cellular moves under  $\pi$ . We conclude by showing that such a projection can always be decomposed into a sequence of *RST*-moves (Lemma 4.5.4).

**Definition 4.5.2.** Two tangles  $\gamma_1$  and  $\gamma_2$  are related by a *cellular move*  $(d, \alpha_1, \alpha_2)$  if  $d \subset S_g \times I$  is an embedded bigon of edges  $\alpha_1, \alpha_2$  such that  $\alpha_1 \subset \gamma_1$ ,  $\alpha_2 \subset \gamma_2$  and  $\gamma_2 = (\gamma_1 \setminus \alpha_1) \cup \alpha_2$ . See Figure 4.15. We write  $\gamma_1 \sim \gamma_2$  if and only if  $\gamma_1$  and  $\gamma_2$  are related by a sequence of cellular moves.

The following fact is well known.

**Lemma 4.5.3.** *Two tangles  $\gamma_1$  and  $\gamma_2$  are isotopic if and only if  $\gamma_1 \sim \gamma_2$ .*

In the case of links in  $\mathbb{R}^3$ , a self-contained proof can be found in [BZ85, Theorem 1.10] or [Kam02, Lemma 3.9]. Here, we adapt the main idea of these proofs to the general case of tangles in  $S_g \times I$  (we have not found any reference concerning tangles in the literature). Certain additional technicalities occur; in particular, we are led to



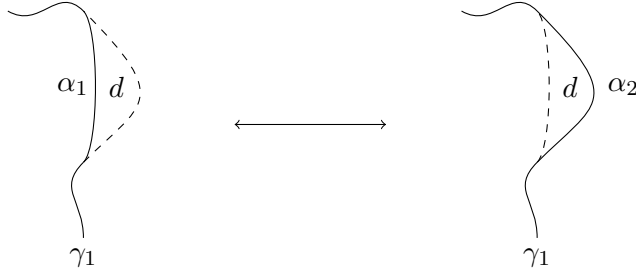

Figure 4.15: A cellular move

use the isotopy factorization [EK71, Corollary 1.3] that has already been mentioned in the proof of Lemma 1.3.5.

*Proof.* If  $\gamma_1 \sim \gamma_2$ , then  $\gamma_1$  and  $\gamma_2$  are isotopic. Let us prove the converse, and assume that  $\gamma_1$  and  $\gamma_2$  are (ambient) isotopic. Since the strands of the tangles are vertical near the endpoints, the ambient isotopy taking  $\gamma_1$  to  $\gamma_2$  can be assumed to fix a neighborhood of  $S_g \times \partial I$ . By isotopy factorization, it is thus sufficient to restrict ourselves to the case where there is an isotopy  $(f_t)_t$  whose support is contained in a 3-ball  $B \subset \text{int}(S_g \times I)$  such that  $f_0 = \text{id}$  and  $f_1(\gamma_1) = \gamma_2$ . For any  $r > 0$ , let  $B_r \subset \mathbb{R}^3$  denote the 3-ball of center 0 and radius  $r$ . There exist  $0 < r_1 < r_2 < r_3 < r_4 < r_5$  and an embedding  $B_{r_5} \hookrightarrow \text{int}(S_g \times I)$  such that  $B_{r_2} \cap \gamma_1 = \emptyset$  and  $B \subset B_{r_3}$ . Up to arbitrary small cellular moves of  $\gamma_1$ , it can be assumed that  $\gamma_1$  is nowhere tangent to the radii of  $B_{r_5}$ . Let  $g : [0, r_5] \rightarrow [0, r_5]$  be a diffeomorphism satisfying:

- $g(r) = r$  if  $r \leq r_1$  or  $r \geq r_4$ ,
- $g(r) > r$  otherwise,
- and  $g(r_2) = r_3$ .

Let  $(g_t)_t$  be the radial isotopy of support  $B_{r_5}$  defined by  $g_t(r) = r + t(g(r) - r)$ . Since  $\gamma_1$  is nowhere tangent to the radii of  $B_{r_5}$ , there exists an integer  $N$  such that for any  $0 \leq k \leq N - 1$ , the map  $(x, t) \mapsto g_t(x)$  defines an embedding  $e_k$  of  $(\gamma_1 \cap \text{int}(B_{r_4})) \times [\frac{k}{N}, \frac{k+1}{N}]$ . A decomposition of the image of  $e_k$  into bigons gives rise to a sequence of cellular moves between  $g_{\frac{k}{N}}(\gamma_1)$  and  $g_{\frac{k+1}{N}}(\gamma_1)$ . Therefore,  $\gamma_1 = g_0(\gamma_1) \sim g_1(\gamma_1)$ . The image under the diffeomorphism  $f_1$  of a sequence of cellular moves between  $\gamma_1$  and  $g_1(\gamma_1)$  is a sequence of cellular moves between  $f_1(\gamma_1) = \gamma_2$  and  $f_1(g_1(\gamma_1))$ . Notice that  $f_1(g_1(\gamma_1)) = g_1(\gamma_1)$ , since  $g_1$  takes  $\gamma_1$  outside of the support  $B$  of  $f_1$ . Therefore  $\gamma_2 \sim g_1(\gamma_1) \sim \gamma_1$ .  $\square$

We conclude the proof of the unframed case of Theorem 4.4.3 with the following lemma.

**Lemma 4.5.4.** *Let  $\gamma_1$  and  $\gamma_2$  be two isotopic tangles in  $\mathcal{T}_g^{\text{gen}}$ . Then the beak diagrams  $\pi(\gamma_1)$  and  $\pi(\gamma_2)$  can be related by a sequence of RST moves.*

*Proof.* From Lemma 4.5.3,  $\gamma_1$  and  $\gamma_2$  are related by a sequence of cellular moves along bigons. Let  $G(\Gamma) \subset S(\Gamma)$  be an embedded graph which forms the core of  $S(\Gamma)$ . Up to arbitrary small perturbations, the bigons can be assumed to be transverse to

$G(\Gamma) \times I$ . Under this assumption, and by taking  $S(\Gamma)$  sufficiently thin, any bigon  $d$  intersects  $S(\Gamma) \times I$  "generically" as depicted in Figure 4.16.

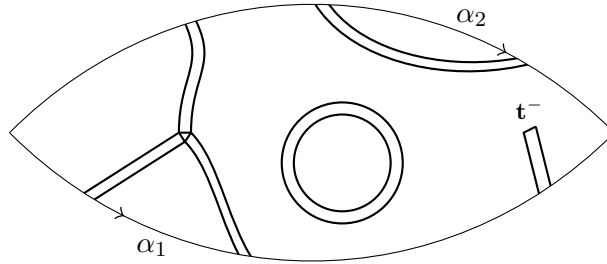
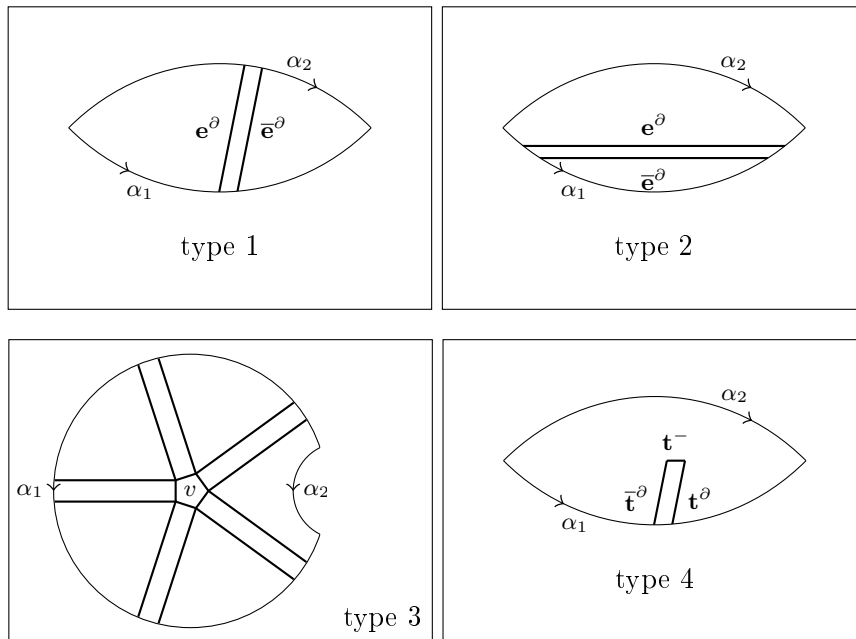

Figure 4.16: A generic intersection  $d \cap (S(\Gamma) \times I)$ .

Then, observe that  $d$  can be decomposed into a finite number of smaller bigons whose intersection with  $S(\Gamma) \times I$  are of types 0, 1, 2, 3 or 4. The types 1-4 cases are depicted below, and the type 0 case is defined by  $d \cap (S(\Gamma) \times I) = \emptyset$ . (There is also a type 2' case, similar to the type 2, but where  $\alpha_1$  and  $\alpha_2$  are switched. This case can be skipped without loss of generality by symmetry of the situation.)



The cellular move along  $d$  can thus be decomposed into a sequence of elementary cellular moves along such kinds of bigons. Moreover, it can be assumed that these moves relate tangles in generic position.

In the rest of the proof, we check that the projections of these elementary cellular moves under  $\pi$  can be written as sequences of  $RST$  moves.

**Type 0.** In this case,  $d \subset (R \times I)$ . Then  $A(\gamma_1)$  and  $A(\gamma_2)$  are isotopic relative to the boundary in  $R \times I$ . From Reidemeister Theorem,  $\pi(\gamma_1)$  and  $\pi(\gamma_2)$  are related by a sequence of  $R$ -moves.

**Type 1.** Up to cellular moves of type 0,  $d$  can be assumed to be arbitrary close to  $S(\Gamma) \times I$ . The cellular move along  $d$  amounts to sliding a strand near a B-arc. As seen in the proof of Lemma 4.5.1, its projection under  $\pi$  can thus be written as a sequence of  $S$ -moves.

**Types 2 and 3.** Up to cellular moves of types 0 and 1, we can assume that

- the heights of  $\alpha_1$  and  $\alpha_2$  are strictly increasing,
- $d$  is small enough so that the projections  $pr(\alpha_1 \cap (R \times I))$  and  $pr(\alpha_2 \cap (R \times I))$  do not cross any other strand of the beak diagram.

The projection under  $\pi$  of the cellular move of type 2 then corresponds to the move  $T_2(\mathbf{e})$ . The cellular move of type 3 projects to the move  $T_3(v)$ .

**Type 4.** Since  $\mathbf{t}^-$  is identified with  $C \cup C' \cup C''$  (see Figure 4.13), the projection  $pr(d \cap (R \times I))$  necessarily crosses the whole beak diagram from its left to its right-hand side. Up to cellular moves of types 0 and 1, we can assume that

- the heights of  $\alpha_1$  and  $\alpha_2$  are strictly increasing,
- $d$  is small enough so that in a whole horizontal slice of the beak diagram containing  $pr(d \cap (R \times I))$ , all the other strands of the diagram are vertical and do not intersect  $pr(\alpha_1 \cap (R \times I))$ .

The projection under  $\pi$  of the cellular move of type 2 then corresponds to the move  $T_1$ . □

This concludes the proof of the unframed case of Theorem 4.4.3.

*Proof of the framed case of Theorem 4.4.3.* The fact that  $\tilde{\varphi}_f$  factors through the  $T$ -moves follows from Lemma 4.3.6. Recall that the  $S$ -moves can be realized, at the level of tangles, by sliding a B-arc along the height coordinate  $t$ . By considering the framed version of such a local isotopy, we see that  $\tilde{\varphi}_f$  factors through the  $S$ -moves. Hence  $\tilde{\varphi}_f : \mathbf{D}(\Gamma)/\tilde{RST}(\Gamma) \rightarrow \tilde{\mathbf{T}}_g$  is well defined.

Since curls commute with beaks up to  $\tilde{RST}$  (Remark 4.4.4), they can slide everywhere along the components of the beak diagrams. Thus, the operation "adding a curl to a component of a beak diagram" is well-defined in  $\mathbf{D}(\Gamma)/\tilde{RST}(\Gamma)$ . Under  $\tilde{\varphi}_f$ , this operation becomes "adding a twist to the corresponding component of the tangle". As is well-known, two framings of the same tangle are related by a unique signed number of twists to add to each component. It follows that  $\tilde{\varphi}_f : \mathbf{D}(\Gamma)/\tilde{RST} \rightarrow \tilde{\mathbf{T}}_g$  is bijective. □

Before closing this chapter, let us finally prove Lemma 4.4.7.

*Proof of Lemma 4.4.7.* Figure 4.17 depicts the 2-cabling of a framed strand parametrized by the framed path  $\mu_f(\mathbf{e})$ . Compare with Figure 4.4. The first crossing on the bottom comes from the "half twist" ( $-p \leftrightarrow p$ ). Then, observe that the projection on  $C \times I$  has another crossing which depends on the sign of  $\bar{\mathbf{e}}\mathbf{e}$ , and thus behaves as depicted on the right-hand side of Lemma 4.4.7. □

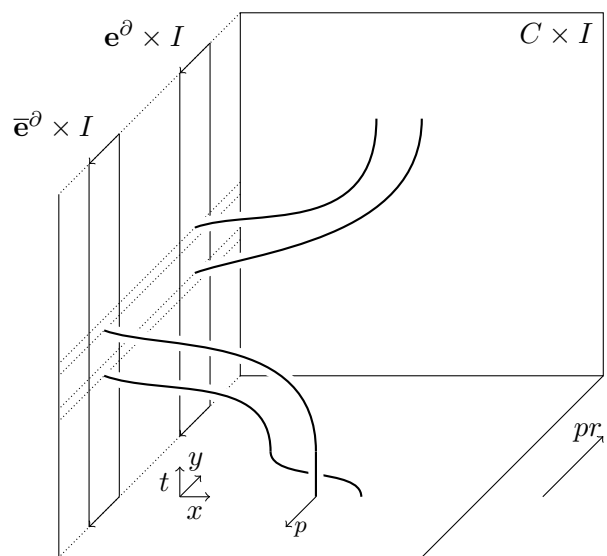

Figure 4.17: Doubling the framed path  $\mu_f(\mathbf{e})$ .



## Chapter 5

# A universal property for surface tangles

Let us now turn to the categorical step of our study of tangles on  $S_g$ . In this chapter, the notion of *genus  $g$  structure* on a ribbon category is introduced. This is the data of a functor  $\mathcal{C} \rightarrow \mathcal{C}_g$ , where  $\mathcal{C}$  is ribbon, endowed with an additional structure which is inspired by the beak diagrammatic description of the genus  $g$  tangles. The functor  $\tilde{\mathbf{T}} \rightarrow \tilde{\mathbf{T}}_g$  comes with a genus  $g$  structure, and the main result of the chapter is that this is, in some sense, the universal one.

A genus  $g$  structure depends on the choice of a fatgraph. However, we show that any fatgraph leads essentially to the "same" notion, by observing that one of the defining axioms of a genus  $g$  structure can be reinterpreted as a compatibility condition for these structures to evolve unambiguously under elementary moves of fatgraphs.

### 5.1 Ribbon markings

In this section,  $\mathcal{C}$  is a strict ribbon category, and  $\mathcal{C}_g$  is a category (with no extra structure) equipped with a functor

$$\{\cdot\} : \mathcal{C} \rightarrow \mathcal{C}_g.$$

**Definition 5.1.1.** Let  $\Gamma$  be a fatgraph. A *ribbon marking* of  $\Gamma$  relative to  $(\mathcal{C} \rightarrow \mathcal{C}_g)$  is a map that associates to any edge  $\mathbf{e} \in \Gamma$  a natural automorphism  $(\mathbf{e})$  of the functor

$$\{\cdot \otimes \cdot\} : \mathcal{C} \times \mathcal{C} \rightarrow \mathcal{C}_g,$$

(in other words, this is the data of an isomorphism  $(\mathbf{e})_{U,V} : \{UV\} \rightarrow \{UV\}$  of  $\mathcal{C}_g$  for any edge  $\mathbf{e}$  and any pair of objects  $U, V$  of  $\mathcal{C}$ , satisfying  $\{f \otimes g\}(\mathbf{e})_{U,V} = (\mathbf{e})_{U',V'} \{f \otimes g\}$  for any pair of morphisms  $f : U \rightarrow U'$  and  $g : V \rightarrow V'$  of  $\mathcal{C}$ ), such that:

- (edge conditions) for any edge  $\mathbf{e}$ ,

$$(\mathbf{e})_{U,V}(\bar{\mathbf{e}})_{U,V} = \{\theta_U \otimes \text{id}_V\}, \quad (5.1.1)$$

- (vertex conditions) for any vertex  $v = (\mathbf{e}_1, \dots, \mathbf{e}_k)$ ,

$$(\mathbf{e}_k)_{U,V} \cdots (\mathbf{e}_1)_{U,V} = \{\theta_U \otimes \text{id}_V\}, \quad (5.1.2)$$

- (tail condition)

$$(\bar{\mathbf{t}})_{U,V} = \{c_{V,U}^{-1}c_{U,V}^{-1}(\theta_U^{-1} \otimes \text{id}_V)\}, \quad (5.1.3)$$

- (doubling) for any edge  $\mathbf{e}$  such that  $\bar{\mathbf{e}} < \mathbf{e}$ ,

$$(\mathbf{e})_{UV,W} = (\mathbf{e})_{U,VW}\{c_{V,U} \otimes \text{id}_W\}(\mathbf{e})_{V,UW}\{c_{U,V} \otimes \text{id}_W\}. \quad (5.1.4)$$

We define a graphical calculus for  $\mathcal{C}_g$  by "transporting" the usual graphical calculus for  $\mathcal{C}$  via the functor  $\{\cdot\}$ . In other words, if  $f : U \rightarrow U'$  is a morphism of the category  $\mathcal{C}$ ,

$$\begin{array}{c} U' \\ \downarrow \\ \boxed{f} \\ \downarrow \\ U \end{array}$$

is now understood as the morphism  $\{f\} : \{U\} \rightarrow \{U'\}$  of  $\mathcal{C}_g$ . The isomorphisms  $(\mathbf{e})_{U,V} : \{UV\} \rightarrow \{UV\}$  are represented by

$$(\mathbf{e})_{U,V} = \mathbf{e} \begin{array}{c} \diagup \\ U \\ \diagdown \end{array} \begin{array}{c} | \\ V \end{array}, \quad (\mathbf{e})_{UV,W} = \mathbf{e} \begin{array}{c} \diagup \\ U \\ \diagdown \end{array} \begin{array}{c} \diagup \\ V \\ \diagdown \end{array} \begin{array}{c} | \\ W \end{array}, \quad \text{etc.}$$

In this setting, the naturality of  $(\mathbf{e})$  can be depicted

$$\begin{array}{c} U' \quad V' \\ \downarrow \quad \downarrow \\ \boxed{f} \quad \boxed{g} \\ \downarrow \quad \downarrow \\ \mathbf{e} \begin{array}{c} \diagup \\ U \\ \diagdown \end{array} \begin{array}{c} | \\ V \end{array} \end{array} = \begin{array}{c} U' \quad V' \\ \downarrow \quad \downarrow \\ \mathbf{e} \begin{array}{c} \diagup \\ U \\ \diagdown \end{array} \begin{array}{c} \diagup \\ V \\ \diagdown \end{array} \\ \downarrow \quad \downarrow \\ \boxed{f} \quad \boxed{g} \\ \downarrow \quad \downarrow \\ U \quad V \end{array},$$

and the doubling relation (5.1.4) reads

$$\begin{array}{c} \mathbf{e} \begin{array}{c} \diagup \\ U \\ \diagdown \end{array} \begin{array}{c} \diagup \\ V \\ \diagdown \end{array} \begin{array}{c} | \\ W \end{array} \end{array} = \begin{array}{c} \mathbf{e} \begin{array}{c} \diagup \\ U \\ \diagdown \end{array} \begin{array}{c} \diagup \\ V \\ \diagdown \end{array} \\ \mathbf{e} \begin{array}{c} \diagup \\ U \\ \diagdown \end{array} \begin{array}{c} \diagup \\ V \\ \diagdown \end{array} \\ \downarrow \\ \begin{array}{c} | \\ W \end{array} \end{array}.$$

As in the previous chapter, we introduce a graphical convention to cope with crossing indeterminacy: for  $\varepsilon = \pm 1$ , we set

$$c_{U,V}^\varepsilon = \varepsilon \begin{array}{c} \diagup \quad \diagdown \\ U \quad V \\ \diagdown \quad \diagup \end{array}.$$

**Proposition 5.1.2.** Any embedding  $f$  of  $\Gamma$  defines a ribbon marking of  $\Gamma$  relative to  $(\tilde{\mathbf{T}} \rightarrow \tilde{\mathbf{T}}_g)$ , denoted by  $\langle \mathbf{e} \rangle^f$ , with

$$\langle \mathbf{e} \rangle_{U,V}^f := \Delta_\alpha^U \Delta_\beta^V \left( \tilde{\varphi}_f \left( \mathbf{e} \begin{array}{c} \curvearrowright \\ \alpha \\ \beta \end{array} \right) \right),$$

where the right-hand side beak diagram is seen as a tangle through  $\tilde{\varphi}_f : \mathbf{D}(\Gamma) \rightarrow \tilde{\mathbf{T}}_g$ , and where the symbol  $\Delta$  denotes the cabling operation defined in Section 4.4.3.

*Proof.* The naturality of  $\langle \mathbf{e} \rangle^f$  is clear: it is a well-known feature of the cabling operation that tangles can slide along the parallel copies of strands. The edge, vertex and tail conditions immediately follow from the  $T$  moves of beak diagrams (compare these conditions to the relations of Lemma 4.3.6). The doubling condition follows from Lemma 4.4.7.  $\square$

We derive the following relations from the defining axioms of a ribbon marking.

**Lemma 5.1.3.** For any edge  $\mathbf{e}$ , we have

*Proof.* In the case  $\bar{\mathbf{e}} < \mathbf{e}$ , the first equality is the doubling condition. We show the second equality in the case  $\mathbf{e} < \bar{\mathbf{e}}$ . On the one hand,

$$(\mathbf{e})_{UV,W} (\bar{\mathbf{e}})_{UV,W} = \begin{array}{c} \mathbf{e} \\ \bar{\mathbf{e}} \end{array} \begin{array}{c} | \\ | \\ | \end{array} = \begin{array}{c} \curvearrowright \\ \curvearrowleft \end{array} \begin{array}{c} | \\ | \\ | \end{array} = \begin{array}{c} \text{crossing} \\ \text{crossing} \end{array} \begin{array}{c} | \\ | \\ | \end{array}$$

On the other hand, writing the inverse of the doubling condition for  $\bar{\mathbf{e}}$  and using the edge condition leads to

$$(\bar{\mathbf{e}})_{UV,W}^{-1} = \begin{array}{c} \text{crossing} \\ \text{crossing} \end{array} \begin{array}{c} | \\ | \\ | \end{array}. \quad \text{Thus, } (\mathbf{e})_{UV,W} = \begin{array}{c} \text{crossing} \\ \text{crossing} \end{array} \begin{array}{c} | \\ | \\ | \end{array} = \begin{array}{c} \mathbf{e} \\ \mathbf{e} \end{array} \begin{array}{c} | \\ | \\ | \end{array},$$



which is the second equality of the lemma in the case  $\mathbf{e} < \bar{\mathbf{e}}$ . Now, the equality between the right-hand and the left-hand terms (in the case  $\bar{\mathbf{e}} < \mathbf{e}$  as well as  $\mathbf{e} < \bar{\mathbf{e}}$ ) is obtained by naturality of  $(\mathbf{e})$ :

We have thus shown the two equalities of the lemma in any case.  $\square$

**Lemma 5.1.4.** *For any edge  $\mathbf{e}$ , we have  $(\mathbf{e})_{\mathbf{1},W} = \text{id}_W$ .*

*Proof.* By writing the doubling condition in the case  $U = V = \mathbf{1}$ , we get  $(\mathbf{e})_{\mathbf{1},W} = ((\mathbf{e})_{\mathbf{1},W})^2$ .  $\square$

**Lemma 5.1.5.** *For any edge  $\mathbf{e}$ , we have*

(5.1.5)

*Proof.* By naturality of  $(\mathbf{e})$ , and using Lemma 5.1.4, we have

Using Lemma 5.1.3 and the edge condition, we thus have

$\square$

*Remark 5.1.6.* In the particular case of tangles, the equality between the left and right-hand sides of Lemma 5.1.3 corresponds to the combed move  $CS_2(\mathbf{e}, \mathbf{e})$  of Section 4.4.2. The identity of Lemma 5.1.4 is obvious, and the relation (5.1.5) corresponds to the move  $S_1(\mathbf{e})$  (up to the Reidemeister move  $R_2$ ).

## 5.2 Genus $g$ structure on a ribbon category

In the last section, we have defined the notion of ribbon marking, whose defining axioms are algebraic formulations of the  $T$ -moves and the cabling of a beak. Lemmas 5.1.3 and 5.1.5, corresponding to some of the  $S$ -moves, have been obtained from these axioms. But so far, we are not able to derive the move  $S_2(\mathbf{x}, \mathbf{y})$  for  $\{\mathbf{x}, \bar{\mathbf{x}}\} \neq \{\mathbf{y}, \bar{\mathbf{y}}\}$  (in fact, this can be done in some cases, as shown in Section 5.3). This motivates the following definition.

**Definition 5.2.1.** A ribbon marking of  $\Gamma$  relative to  $(\mathcal{C} \rightarrow \mathcal{C}_g)$  is called a *genus  $g$  structure* on the strict ribbon category  $\mathcal{C}$  if it satisfies the additional condition  $cs_2(\mathbf{x}, \mathbf{y})$  depicted below

$$(5.2.1)$$

for any edges  $\mathbf{x}, \mathbf{y} \in \Gamma$  such that  $\{\mathbf{x}, \bar{\mathbf{x}}\} \neq \{\mathbf{y}, \bar{\mathbf{y}}\}$ .

*Remark 5.2.2.* As in the context of beak diagrams (Remark 4.4.5), it can be easily checked that the condition  $cs_2(\mathbf{x}, \mathbf{y})$  implies  $cs_2(\mathbf{y}, \mathbf{x})$ , and, using the edge condition, that  $cs_2(\mathbf{x}, \mathbf{y})$  also implies  $cs_2(\bar{\mathbf{x}}, \bar{\mathbf{y}})$ . The number of conditions  $cs_2$  needed to define a genus  $g$  structure can thus be divided by eight.

Since the conditions  $cs_2$  are satisfied in the case of tangles (they correspond to the combed version of the move  $S_2(\mathbf{x}, \mathbf{y})$ ), the ribbon marking  $\langle \mathbf{e} \rangle^f$  of  $\Gamma$  associated to any embedding  $f$  of  $\Gamma$  is a genus  $g$  structure. We can now state the main result of this chapter.

**Theorem 5.2.3.** *Let  $V$  be an object of  $\mathcal{C}$  and  $F : (\tilde{\mathbf{T}}, (+)) \rightarrow (\mathcal{C}, V)$  be the functor of Theorem 3.2.2. Assume that  $\mathcal{C} \rightarrow \mathcal{C}_g$  is endowed with a genus  $g$  structure for a fatgraph  $\Gamma$ . We have seen that an embedding  $f$  of  $\Gamma$  endows  $\tilde{\mathbf{T}} \rightarrow \tilde{\mathbf{T}}_g$  with a genus  $g$  structure. In this context, there exists a unique functor  $F_f : \tilde{\mathbf{T}}_g \rightarrow \mathcal{C}_g$  such that the following diagram commutes and  $(F, F_f)$  preserves the genus  $g$  structure.*

$$\begin{array}{ccc} \tilde{\mathbf{T}} & \xrightarrow{F} & \mathcal{C} \\ \downarrow & & \downarrow \\ \tilde{\mathbf{T}}_g & \xrightarrow{F_f} & \mathcal{C}_g \end{array}$$

In other words, any genus  $g$  structure for  $\Gamma$  gives rise to a functorial invariant of framed tangles on  $S_g$  (depending on the choice of an embedding of  $\Gamma$ ).

Theorem 5.2.3 is obtained as a corollary of the following lemma.

**Lemma 5.2.4.** *The category  $\tilde{\mathbf{T}}_g$  is presented by the generators  $\{\gamma\}$  (for any  $\gamma \in \tilde{\mathbf{T}}$ ),  $(\mathbf{e})_{\varepsilon, X}$  (for any edge  $\mathbf{e} \in \Gamma$ ,  $\varepsilon = \pm 1$ , and any sequence of signs  $X$ ) and the relations*

1. *for any composable pair  $(\gamma_1, \gamma_2)$  in  $\tilde{\mathbf{T}}$ ,  $\{\gamma_2\}\{\gamma_1\} = \{\gamma_2\gamma_1\}$ ,*

2. *for any sequence of signs  $X$ ,  $\{\text{id}_X\} = \text{id}_X$ ,*

3. *for any edge  $\mathbf{e}$ ,  $\varepsilon = \pm$  and any tangle  $\gamma : X \rightarrow Y$  in  $\tilde{\mathbf{T}}$ ,*

$$\{\text{id}_{(\varepsilon)} \otimes \gamma\}(\mathbf{e})_{\varepsilon, X} = (\mathbf{e})_{\varepsilon, Y} \{\text{id}_{(\varepsilon)} \otimes \gamma\},$$

4. *the relations (5.1.1)-(5.1.3) for  $U = \pm$  and any sequence of signs  $V$ ,*

5. *the relation between the left and the right-hand sides of Lemma 5.1.3 for  $U = \pm$ ,  $V = \pm$ , and any sequence of signs  $W$ ,*

6. *the relation (5.1.5) for  $V = \pm$  and any sequence of signs  $W$ ,*

7. *the relation (5.2.1) for  $U = \pm$ ,  $V = \pm$ , and any sequence of signs  $W$ .*

*Proof.* Let us define a *sliced beak diagram* to be a beak diagram which can be sliced by horizontal lines such that each domain between consecutive horizontal lines has either no beak or is the disjoint union of a single beak with vertical segments (see the left-hand side of Figure 5.1). The set of sliced beak diagrams considered up to vertical rescaling form a well-defined category (with same objects as  $\mathbf{D}(\Gamma)$  and the usual composition), which is denoted by  $\mathbf{sD}(\Gamma)$ . There is a forgetful functor  $\mathbf{sD}(\Gamma) \rightarrow \mathbf{D}(\Gamma)$  which considers the sliced beak diagrams up to planar isotopy.

Let  $\mathcal{F}$  be the category generated by the morphisms  $\{\gamma\}$  and  $(\mathbf{e})_{\varepsilon, X}$  up to the relations 1 and 2 of the Lemma. There is a functor  $\varsigma : \mathbf{sD}(\Gamma) \rightarrow \mathcal{F}$  which sends each slice  $D_i$  with no beak to the corresponding tangle  $\{\tilde{\varphi}(D_i)\}$ , and each slice  $B_j$  consisting of a beak labeled with  $\mathbf{e}$  (of source and target  $(\varepsilon) \otimes X$ ) to  $(\mathbf{e})_{\varepsilon, X}$ . Moreover, for any embedding  $f$  of  $\Gamma$ , the following diagram commutes, where  $\rho_f$  is defined by  $\rho_f(\{\gamma\}) = \gamma$  and  $\rho_f((\mathbf{e})_{\varepsilon, X}) = \langle \mathbf{e} \rangle_{(\varepsilon), X}^f$ .

$$\begin{array}{ccc} \mathbf{sD}(\Gamma) & \xrightarrow{\varsigma} & \mathcal{F} \\ \downarrow & & \downarrow \rho_f \\ \mathbf{D}(\Gamma) & \xrightarrow{\tilde{\varphi}_f} & \tilde{\mathbf{T}}_g \end{array}$$

Let us denote by  $\sim$  the equivalence relation on  $\mathcal{F}$  generated by the relations 3-7. To prove the lemma, it is sufficient to check that if  $A$  and  $B$  are two sliced diagrams whose underlying beak diagrams in  $\mathbf{D}(\Gamma)$  are equivalent up to  $\tilde{RST}(\Gamma)$ , then  $\varsigma(A) \sim \varsigma(B)$ .

First, assume that  $A$  and  $B$  are the same in  $\mathbf{D}(\Gamma)$ . That is,  $A$  and  $B$  are planar isotopic. We construct from  $A$  and  $B$  new sliced diagrams  $A'$  and  $B'$  by "lifting

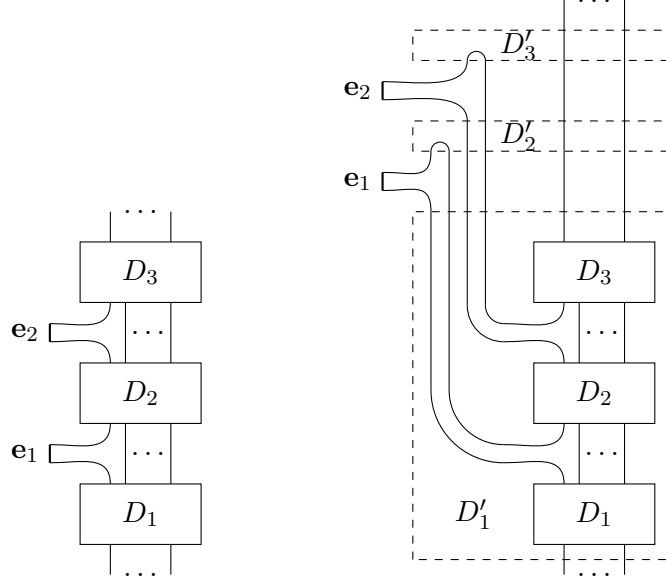

Figure 5.1: On the left: an example of sliced beak diagram  $A$ , where  $D_1$ ,  $D_2$  and  $D_3$  are three diagrams with no beaks, and  $\mathbf{e}_1, \mathbf{e}_2 \in \Gamma$ . On the right: the corresponding sliced beak diagram  $A'$  obtained by lifting the beaks.

the beaks" as depicted in Figure 5.1. The relation 3 implies  $\zeta(A) \sim \zeta(A')$  and  $\zeta(B) \sim \zeta(B')$ . Moreover, since  $A$  and  $B$  are planar isotopic, the "bottom slices" (corresponding to  $D'_1$  in Figure 5.1) of  $A'$  and  $B'$  are planar isotopic, and all the other slices coincide. We have thus  $\zeta(A') \sim \zeta(B')$ , hence  $\zeta(A) \sim \zeta(B)$ .

Now, assume that  $A$  and  $B$  are related by an  $\tilde{R}$ -move in  $\mathbf{D}(\Gamma)$ . Up to a planar isotopy, we can assume that this move is performed in a single slice  $D_i$  with no beak, outside of which all the other slices remain identical. Since  $\zeta(D_i)$  does not change under the  $\tilde{R}$ -move, we have  $\zeta(A) = \zeta(B)$ .

If  $A$  and  $B$  are related by a move  $S_1(\mathbf{e})$ , we can assume (up to planar isotopy and an  $R_2$ -move) that  $A$  and  $B$  are identical except in a sequence of consecutive slices where they differ by the relation 6. Hence  $\zeta(A) \sim \zeta(B)$ .

The rest of the proof is straightforward, using similar arguments. Recall that the  $S_2$ -moves are equivalent (up to  $R_2$ ) to their combed versions  $CS_2$ , which can be obtained from the relations 5 and 7. The  $T$ -moves are obtained from the relation 4.  $\square$

*Proof of Theorem 5.2.3.* The functor  $F_f$  is fully determined by the conditions

$$F_f(\gamma) = \{F(\gamma)\}$$

for any  $\gamma \in \tilde{\mathbf{T}}$  (commutativity of the square of the theorem) and

$$F_f(\langle \mathbf{e} \rangle_{\varepsilon, X}^f) = (\mathbf{e})_{F_f(\varepsilon), F_f(X)} = (\mathbf{e})_{\{F(\varepsilon)\}, \{F(X)\}}$$

( $F_g$  preserves the genus  $g$  structure). Moreover, we have seen that all the relations of Lemma 5.2.4 are satisfied in the general context of a ribbon structure relative to  $(\mathcal{C} \rightarrow \mathcal{C}_g)$ . Hence the existence and the uniqueness of  $F_f$ .  $\square$

### 5.3 Genus $g$ structures as compatible families of ribbon markings

Throughout this section, we assume that the objects of  $\mathcal{C}$  are identified with sequences of signs (the object  $V$  of Theorem 5.2.3 is now  $(+)$ ).

By definition, a genus  $g$  structure on a strict ribbon category  $\mathcal{C}$  depends on the choice of a fatgraph. In this section, we show that the genus  $g$  structures relative to two distinct fatgraphs  $\Gamma$  and  $\Gamma'$  are in one-to-one correspondence.

**Definition 5.3.1.** A fatgraph  $\Gamma'$  is obtained from  $\Gamma$  by an *edge collapse* (we write  $\Gamma \rightsquigarrow \Gamma'$ ) if there is an edge  $\mathbf{a}$  of  $\Gamma$  distinct from  $\mathbf{t}$  and  $\bar{\mathbf{t}}$ , such that  $\mathbf{a}$  and  $\bar{\mathbf{a}}$  belong to distinct vertices of  $\Gamma$ , and such that  $\Gamma'$  is identified with the set  $\Gamma \setminus \{\mathbf{a}, \bar{\mathbf{a}}\}$  endowed with the restriction of the linear order  $\leq$  and the involution  $\mathbf{e} \mapsto \bar{\mathbf{e}}$  of  $\Gamma$ .

If the thickened graph  $S(\Gamma)$  is embedded in  $S_{g,1}$ , and if  $\Gamma \rightsquigarrow \Gamma'$ , then  $S(\Gamma')$  comes with a well-defined embedding by "collapsing" the band of  $S(\Gamma)$  corresponding to the non-oriented edge  $\{\mathbf{a}, \bar{\mathbf{a}}\}$ , as depicted below:

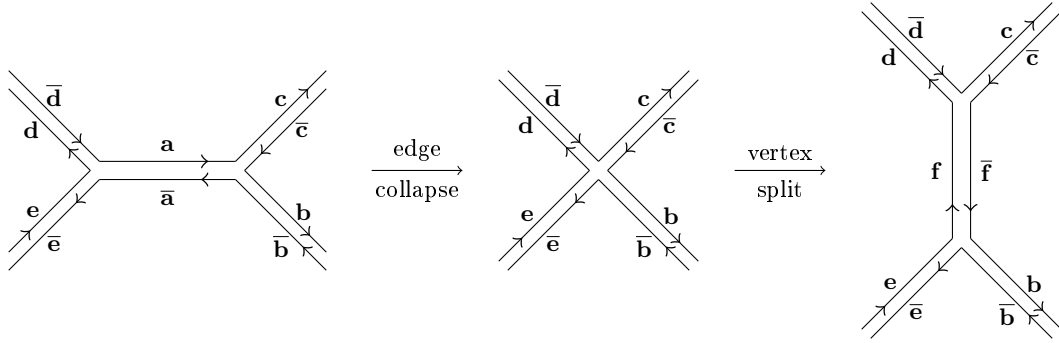

Thus, the edge collapse operation is also defined for embedded fatgraphs  $(\Gamma, f) \rightsquigarrow (\Gamma', f')$ . The inverse of an edge collapse is a *vertex split*, which can be defined for embedded fatgraphs as well.

In Section 4.3, we have defined a marking  $\mu_f : \Gamma \rightarrow \tilde{\pi}_1$  for any embedded fatgraph  $(\Gamma, f)$ . Observe that by construction, the family of markings  $(f \mapsto \mu_f)$  is compatible with edge collapse in the sense that if  $(\Gamma, f) \rightsquigarrow (\Gamma', f')$ , then  $\mu_{f'}(\mathbf{e}) = \mu_f(\mathbf{e})$  for any edge  $\mathbf{e}$  of  $\Gamma'$ .

In Section 5.1, we have defined a ribbon marking  $(\mathbf{e} \mapsto \langle \mathbf{e} \rangle^f)$  relative to  $(\tilde{\mathbf{T}} \rightarrow \tilde{\mathbf{T}}_g)$  for any embedded fatgraph  $(\Gamma, f)$ . (For short, we simply write  $\langle \mathbf{e} \rangle^f$  to refer to this ribbon marking.) Since  $(f \mapsto \mu_f)$  is compatible with edge collapse,  $(f \mapsto \langle \mathbf{e} \rangle^f)$  is also compatible. More precisely: if  $(\Gamma, f) \rightsquigarrow (\Gamma', f')$ , then  $\langle \mathbf{e} \rangle^{f'}_{U,V} = \langle \mathbf{e} \rangle^f_{U,V}$  for any edge  $\mathbf{e}$  of  $\Gamma'$  and any sequences of signs  $U, V$ .

This motivates the following definition.

**Definition 5.3.2.** A *compatible family of ribbon markings* relative to  $(\mathcal{C} \rightarrow \mathcal{C}_g)$  is the assignment<sup>1</sup> of a ribbon marking  $\langle \mathbf{e} \rangle^f$  of  $\Gamma$  to each embedded fatgraph  $(\Gamma, f)$ ,

<sup>1</sup>"Fatgraphs", "embedded fatgraphs" and "ribbon marked fatgraphs" are endowed with category structures whose morphisms are generated by edge collapse. In this setting, a compatible family of ribbon markings can alternatively be defined as a functor from "embedded fatgraphs" to "ribbon marked fatgraphs" whose projection on "fatgraphs" is the identity.

such that if  $(\Gamma, f) \rightsquigarrow (\Gamma', f')$ , then  $(\mathbf{e})_{U,V}^{f'} = (\mathbf{e})_{U,V}^f$  for any edge  $\mathbf{e}$  of  $\Gamma'$  and any objects  $U, V$ .

The above remark can be reformulated as follows.

**Lemma 5.3.3.** *The assignment  $(\Gamma, f) \mapsto \langle \mathbf{e} \rangle^f$  defines a compatible family of ribbon markings relative to  $(\tilde{\mathbf{T}} \rightarrow \tilde{\mathbf{T}}_g)$ .*

We are now able to state the main result of this section.

**Theorem 5.3.4.** *If  $\Gamma$  is a fatgraph, any embedding  $f$  of  $\Gamma$  gives rise to a one-to-one correspondence between the genus  $g$  structures relative to  $\Gamma$  and the compatible families of ribbon markings. In particular, the genus  $g$  structures relative to  $\Gamma$  are in one-to-one correspondence with the genus  $g$  structures relative to any other fatgraph  $\Gamma'$ .*

The rest of this section is devoted to proving Theorem 5.3.4.

**Lemma 5.3.5.** *Let  $\Gamma_0$  be a fatgraph, and  $(\mathbf{e})^0$  be a genus  $g$  structure for  $\Gamma_0$ . Then for any embedding  $f_0$  of  $\Gamma_0$ , there is a unique compatible family of ribbon markings  $(f \mapsto (\mathbf{e})^f)$  such that  $(\mathbf{e})^{f_0}$  coincides with  $(\mathbf{e})^0$ .*

*Proof.* From Theorem 5.2.3, the genus  $g$  structure  $(\mathbf{e})^0$  together with the embedding  $f_0$  of  $\Gamma_0$  gives rise to a functor  $F_{f_0} : \mathbf{T}_g \rightarrow \mathcal{C}_g$ . We consider the family of ribbon markings  $(f \mapsto (\mathbf{e})^f)$  defined by

$$(\mathbf{e})_{U,V}^f := F_{f_0} \left( \langle \mathbf{e} \rangle_{U,V}^f \right)$$

for any sequence of signs  $U, V$  (recall that in this section, the objects of  $\mathcal{C}$  are identified with sequences of signs). Since  $(f \mapsto \langle \mathbf{e} \rangle^f)$  is a compatible family (Lemma 5.3.3),  $(f \mapsto (\mathbf{e})^f)$  is also compatible. Moreover, by definition of  $F_{f_0}$  we have  $(\mathbf{e})^{f_0} = F_{f_0}(\langle \mathbf{e} \rangle^{f_0}) = (\mathbf{e})^0$ .

It is known [Har86, Pen87] that two embedded fatgraphs are always related by a sequence of edge collapse and vertex split. Moreover, the vertex condition implies that ribbon markings of a compatible family evolve unambiguously under vertex split. It follows that a compatible family of ribbon markings  $(f \mapsto (\mathbf{e})^f)$  satisfying  $(\mathbf{e})^{f_0} = (\mathbf{e})^0$  is unique.  $\square$

The following fact will be useful to prove the next lemma.

**Lemma 5.3.6.** *Let  $\Gamma$  be a fatgraph and  $\mathbf{x}$  and  $\mathbf{y}$  be two edges such that  $\bar{\mathbf{y}} < \mathbf{x}$  and  $(\bar{\mathbf{y}} < \mathbf{e} < \mathbf{x}) \Rightarrow (\mathbf{e} \neq \mathbf{y}, \bar{\mathbf{x}})$ . Then, there exists a sequence of edge collapses and vertex splits which takes  $\Gamma$  to a new fatgraph  $\Gamma'$  such that*

- *the relative ordering of the edges  $\mathbf{x}, \bar{\mathbf{x}}, \mathbf{y}, \bar{\mathbf{y}}$  is the same in  $\Gamma'$  as in  $\Gamma$ ,*
- *$\Gamma'$  has a vertex  $v = (\mathbf{x}, \mathbf{y}, \mathbf{z})$ .*

*Proof.* Up to a sequence of vertex splits, we can assume that any vertex of  $\Gamma$  is trivalent. Note that any edge  $\mathbf{e} \neq \mathbf{t}, \bar{\mathbf{t}}$  of a trivalent graph can be collapsed (since  $\mathbf{e}$  and  $\bar{\mathbf{e}}$  belong to distinct vertices). The result of an edge collapse on  $\mathbf{e}$  followed by the opposite vertex split is known as a *Whitehead move* on  $\mathbf{e}$ .

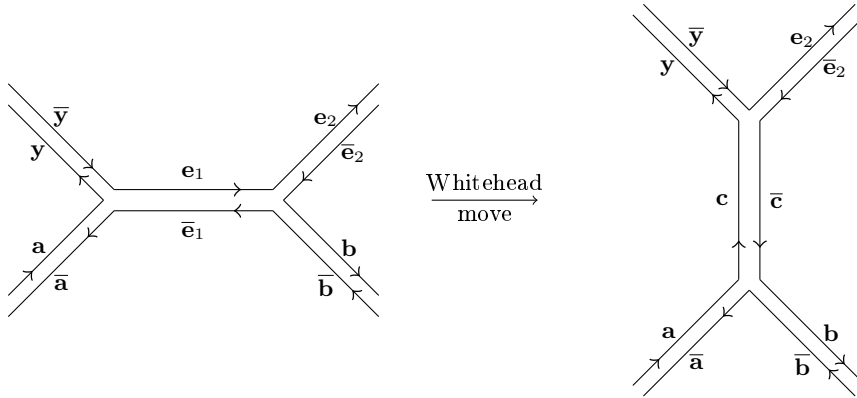

In the trivalent graph  $\Gamma$ , there is a sequence of consecutive edges  $\bar{y} < \mathbf{e}_1 < \dots < \mathbf{e}_m < \mathbf{x}$  such that  $\mathbf{e}_i \neq \mathbf{y}, \bar{\mathbf{x}}$  for any  $1 \leq i \leq m$ . We call these edges the *intermediate edges*. Let us show that a Whitehead move on  $\mathbf{e}_1$  followed by a Whitehead move on  $\mathbf{e}_2$  always decreases the number of intermediate edges by one or more (this is sufficient to prove the lemma since such moves do not change the relative order of the edges  $\mathbf{x}, \bar{\mathbf{x}}, \mathbf{y}, \bar{\mathbf{y}}$ ). We first consider the Whitehead move on  $\mathbf{e}_1$ . We say that the situation is *good* relative to  $\mathbf{e}_1$  if the Whitehead move decreases the number of intermediate edges. Since  $\mathbf{y}$  is not intermediate,  $\mathbf{c}$  cannot be intermediate. Therefore, we observe that the situation is good relative to  $\mathbf{e}_1$  unless  $\bar{\mathbf{c}}$  is intermediate and  $\bar{\mathbf{e}}_1$  is not. In this situation, the number of intermediate edges remains the same after performing the Whitehead move on  $\mathbf{e}_1$ . But in the next step, the situation becomes good relative to  $\mathbf{e}_2$  since the fact that  $\bar{\mathbf{c}}$  is intermediate implies that  $\bar{\mathbf{e}}_2$  is intermediate.

Here, we have not taken care of the fact that some of the edges of the above picture may coincide. In such a case, it can be easily checked that  $\mathbf{a} = \mathbf{e}_2$  or  $\bar{\mathbf{y}} = \mathbf{b}$ . If  $\mathbf{a} = \mathbf{e}_2$ , then  $\mathbf{x} = \mathbf{e}_1$  or  $\mathbf{e}_2$ , and the lemma follows. If  $\bar{\mathbf{y}} = \mathbf{b}$ , then  $\bar{\mathbf{c}}$  cannot be intermediate, and the situation is good relative to  $\mathbf{e}_1$ . The Lemma is now proven in any case.  $\square$

**Lemma 5.3.7.** *A ribbon marking taken from a compatible family is a genus  $g$  structure. In other words, if  $(f \mapsto (\mathbf{e})^f)$  is a compatible family of ribbon markings, and if  $(\Gamma_0, f_0)$  is an embedded fatgraph, then  $(\mathbf{e})^{f_0}$  satisfies the conditions  $cs_2$ .*

*Proof.* Let  $\mathbf{x}, \mathbf{y} \in \Gamma_0$  be two edges such that  $\bar{\mathbf{y}} < \mathbf{x}$  and  $(\bar{\mathbf{y}} < \mathbf{e} < \mathbf{x}) \Rightarrow (\mathbf{e} \neq \mathbf{y}, \bar{\mathbf{x}})$ . From Lemma 5.3.6, there exists a finite sequence of edge collapses and vertex splits taking  $(\Gamma_0, f_0)$  to an embedded fatgraph  $(\Gamma_1, f_1)$  having a vertex  $v = (\mathbf{x}, \mathbf{y}, \mathbf{z})$ . The following graphical calculus is understood with respect to the ribbon marking  $(\mathbf{e})^{f_1}$ . Using the vertex and edge condition, we have

$$\begin{array}{c} \mathbf{y} \bullet \\ \left. \begin{array}{l} \mathbf{y} \\ \mathbf{x} \end{array} \right\} \\ \left. \begin{array}{l} UV \\ W \end{array} \right| \end{array} = \begin{array}{c} \mathbf{z} \bullet \\ \left. \begin{array}{l} UV \\ W \end{array} \right\} \end{array} .$$

Thus, from Lemma 5.1.3, and then using the vertex condition again:

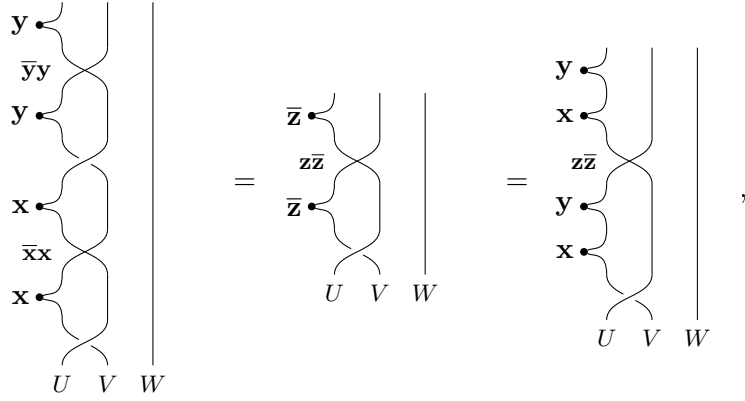

which can be simplified

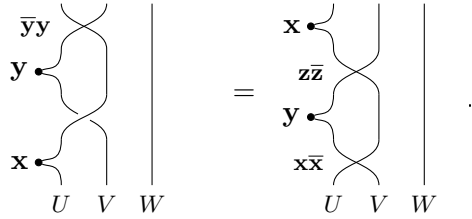

Since  $\bar{y} < \mathbf{x}$  are consecutive in  $\Gamma_1$ , we have

$$\mathbf{x}\bar{\mathbf{x}} = \bar{\mathbf{y}}\bar{\mathbf{x}}, 1 = \bar{\mathbf{y}}\mathbf{x}, \text{ and } \bar{\mathbf{y}}\mathbf{y} = \mathbf{x}\mathbf{y}.$$

Moreover, since  $\bar{\mathbf{z}} < \mathbf{y}$  and  $\bar{\mathbf{x}} < \mathbf{z}$  are consecutive in  $\Gamma_1$ , we have

$$\mathbf{z}\bar{\mathbf{z}} = \bar{\mathbf{x}}\mathbf{y}.$$

The last identity thus coincides with the relation  $cs_2(\mathbf{x}, \mathbf{y})$  for the ribbon marking  $(\mathbf{e})^{f_1}$ . By compatibility of the family of ribbon markings, and since the relative ordering of the edges  $\mathbf{x}, \bar{\mathbf{x}}, \mathbf{y}, \bar{\mathbf{y}}$  is the same in  $\Gamma'$  as in  $\Gamma$ , we obtain the relation  $cs_2(\mathbf{x}, \mathbf{y})$  for the ribbon marking  $(\mathbf{e})_{f_0}$ .

In the beginning of the proof, we have assumed that  $\bar{\mathbf{y}} < \mathbf{x}$ . Note that the relation  $cs_2(\mathbf{x}, \mathbf{y})$  can be deduced for any pair of edges  $\mathbf{x}, \mathbf{y}$  (see Remark 5.2.2).  $\square$

Theorem 5.3.4 is an immediate consequence of Lemmas 5.3.5 and 5.3.7.

## 5.4 The non-strict case

We generalize Theorem 5.2.3 to the case where the ribbon category  $\mathcal{C}$  is equipped with an associativity constraint  $a$  which is not necessarily trivial. Let  $\mathcal{C}_g$  be a category equipped with a functor  $\{.\} : \mathcal{C} \rightarrow \mathcal{C}_g$ , and let  $\Gamma$  be a fatgraph. The notion of ribbon marking of  $\Gamma$  relative to  $(\mathcal{C} \rightarrow \mathcal{C}_g)$  is adapted from Definition 5.1.1 in the obvious way. The doubling condition (5.1.4) becomes, for any edge  $\mathbf{e}$  such that  $\bar{\mathbf{e}} < \mathbf{e}$ ,

$$(\mathbf{e})_{UV,W} = (\mathbf{e})'_{U,V,W} \{c_{V,U} \otimes \text{id}_W\} (\mathbf{e})'_{V,U,W} \{c_{U,V} \otimes \text{id}_W\},$$

where  $(\mathbf{e})'_{U,V,W} := a_{U,V,W}^{-1} (\mathbf{e})_{U,V,W} a_{U,V,W}$ .



A genus  $g$  structure on  $\mathcal{C}$  is a ribbon marking of  $\Gamma$  that satisfies the additional condition: for any edges  $\mathbf{x}, \mathbf{y}$ ,

$$\begin{aligned} \{c_{V,U}^{\mathbf{xy}} \otimes \text{id}_W\}(\mathbf{y})'_{V,U,W} \{c_{U,V}^{\overline{\mathbf{yx}}} \otimes \text{id}_W\}(\mathbf{x})'_{U,V,W} \\ = (\mathbf{x})'_{U,V,W} \{c_{V,U}^{\overline{\mathbf{xy}}} \otimes \text{id}_W\}(\mathbf{y})'_{V,U,W} \{c_{U,V}^{\overline{\mathbf{yx}}} \otimes \text{id}_W\}. \end{aligned}$$

As one would expect, the categories of quasi (framed) tangles on  $S_g$ , denoted by  $\mathbf{qT}_g$  and  $\mathbf{q}\tilde{\mathbf{T}}_g$ , are defined in the same way as  $\mathbf{qT}$  and  $\mathbf{q}\tilde{\mathbf{T}}$  (Definition 3.3.1) by replacing  $\mathbf{T}$  with  $\mathbf{T}_g$  and  $\tilde{\mathbf{T}}$  with  $\tilde{\mathbf{T}}_g$  respectively. Again, the inclusion of the disc  $D^2$  in the surface  $S_g$  gives rise to a functor  $\mathbf{q}\tilde{\mathbf{T}} \rightarrow \mathbf{q}\tilde{\mathbf{T}}_g$ . An embedding  $f$  of  $\Gamma$  endows  $\mathbf{q}\tilde{\mathbf{T}} \rightarrow \mathbf{q}\tilde{\mathbf{T}}_g$  with a genus  $g$  structure denoted by  $\langle \mathbf{e} \rangle^f$ , which is defined as in the strict case except that for any parenthesized words  $U$  and  $V$ , the tangle  $\langle \mathbf{e} \rangle_{U,V}^f$  has a parenthesized source and target  $U \otimes V$ .

In this setting, Theorem 5.2.3 becomes:

**Theorem 5.4.1.** *Let  $V$  be an object of  $\mathcal{C}$  and  $qF : (\mathbf{q}\tilde{\mathbf{T}}, (+)) \rightarrow (\mathcal{C}, V)$  be the functor of Theorem 3.3.2. Assume that  $\mathcal{C} \rightarrow \mathcal{C}_g$  is endowed with a genus  $g$  structure for a fatgraph  $\Gamma$ . Then, there exists a unique functor  $qF_f : \mathbf{q}\tilde{\mathbf{T}}_g \rightarrow \mathcal{C}_g$  such that the following diagram commutes and  $(qF, qF_f)$  preserves the genus  $g$  structure.*

$$\begin{array}{ccc} \mathbf{q}\tilde{\mathbf{T}} & \xrightarrow{qF} & \mathcal{C} \\ \downarrow & & \downarrow \\ \mathbf{q}\tilde{\mathbf{T}}_g & \xrightarrow{qF_f} & \mathcal{C}_g \end{array}$$

In other words, any genus  $g$  structure for  $\Gamma$  gives rise to a functorial invariant of parenthesized framed tangles on  $S_g$  (depending on the choice of an embedding of  $\Gamma$ ).

*Proof.* Since any tangle in  $\mathbf{q}\tilde{\mathbf{T}}_g$  can be written as a composition of tangles in  $\mathbf{q}\tilde{\mathbf{T}}$  and of tangles of the form  $\langle \mathbf{e} \rangle_{U,V}^f$  for some parenthesized words  $U$  and  $V$ , the uniqueness of  $qF_f$  follows from its existence.

Let us construct the functor  $qF_f$  explicitly from Theorem 5.2.3. We come back to the notations of the proof of Theorem 3.3.2 and consider the equivalence of categories  $\eta : \mathcal{C}^{str} \rightarrow \mathcal{C}$ . Observe that the composition  $\mathcal{C}^{str} \rightarrow \mathcal{C} \rightarrow \mathcal{C}_g$  is endowed with a genus  $g$  structure with

$$(\mathbf{e})_{S,T} := \{a_{\eta(S)\eta(T) \rightarrow \eta(ST)}\}(\mathbf{e})_{\eta(S),\eta(T)} \{a_{\eta(ST) \rightarrow \eta(S)\eta(T)}\}.$$

From Theorem 5.2.3, there is a pair of functors  $(F, F_f) : (\tilde{\mathbf{T}}, \tilde{\mathbf{T}}_g) \rightarrow (\mathcal{C}^{str}, \mathcal{C}_g)$  such that the following diagram commutes:

$$\begin{array}{ccccc} \mathbf{q}\tilde{\mathbf{T}} & \longrightarrow & \tilde{\mathbf{T}} & \overset{F}{\dashrightarrow} & \mathcal{C}^{str} & \xrightarrow{\eta} & \mathcal{C} \\ \downarrow & & \downarrow & & & & \swarrow \\ \mathbf{q}\tilde{\mathbf{T}}_g & \longrightarrow & \tilde{\mathbf{T}}_g & \overset{F_f}{\dashrightarrow} & \mathcal{C}_g & & \end{array}$$

The composition

$$\mathbf{q}\tilde{\mathbf{T}}_g \longrightarrow \tilde{\mathbf{T}}_g \xrightarrow{F_f} \mathcal{C}_g$$

is denoted by  $pF_f : \mathbf{q}\tilde{\mathbf{T}}_g \rightarrow \mathcal{C}_g$ .

For a quasi-tangle  $\gamma : X \rightarrow Y$ , we set

$$qF_f(\gamma) = \{a_{\eta(F(\bar{Y})) \rightarrow qF(Y)}\} pF(\gamma) \{a_{qF(X) \rightarrow \eta(F(\bar{X}))}\},$$

where  $\bar{W}$  is obtained from  $W$  by forgetting the parentheses.  $qF_f$  is a functor and satisfies the conditions of the theorem.  $\square$

## 5.5 The elliptic case

We give here a particular version of the notion of genus one structure, which will be used in the next chapter to define the combinatorial elliptic invariant. We keep the notations of Section 5.4.

**Definition 5.5.1.** An *elliptic structure* relative to  $(\mathcal{C} \rightarrow \mathcal{C}_1)$  is a pair  $(X, Y)$  of natural automorphisms of the functor  $\{\cdot \otimes \cdot\} : \mathcal{C} \times \mathcal{C} \rightarrow \mathcal{C}_1$  satisfying the following identities for any objects  $U, V, W$  of  $\mathcal{C}$  (where for  $Z := X$  or  $Z := Y$ , we set  $Z'_{U,V,W} := a_{U,V,W}^{-1} Z_{U,V,W} a_{U,V,W}$ ).

$$X_{UV,W} = X'_{U,V,W} \{c_{V,U} \otimes \text{id}_W\} X'_{V,U,W} \{c_{U,V} \otimes \text{id}_W\}, \quad (5.5.1)$$

$$Y_{UV,W} = Y'_{U,V,W} \{c_{V,U}^{-1} \otimes \text{id}_W\} Y'_{V,U,W} \{c_{U,V}^{-1} \otimes \text{id}_W\}, \quad (5.5.2)$$

$$Y_{U,V} X_{U,V} Y_{U,V}^{-1} X_{U,V}^{-1} = \{c_{V,U} c_{U,V}\}, \quad (5.5.3)$$

$$Y'_{U,V,W} \{c_{V,U} \otimes \text{id}_W\} X'_{V,U,W} \{c_{U,V} \otimes \text{id}_W\} = \{c_{V,U} \otimes \text{id}_W\} X'_{V,U,W} \{c_{U,V}^{-1} \otimes \text{id}_W\} Y'_{U,V,W}. \quad (5.5.4)$$

**Lemma 5.5.2.** *Elliptic and genus 1 structures are equivalent notions. A correspondence is given, for the genus 1 fatgraph  $\Gamma_1 = \{\mathbf{t} < \mathbf{y} < \bar{\mathbf{x}} < \bar{\mathbf{y}} < \mathbf{x} < \bar{\mathbf{t}}\}$ , by  $X_{U,V} = (\mathbf{x})_{U,V}$  and  $Y_{U,V} = (\mathbf{y})_{U,V} \{\theta_U^{-1} \otimes \text{id}_V\}$ .*

The fatgraph  $\Gamma_1$  is the symplectic fatgraph  $\Gamma_g$  of Figure 4.12 in the case  $g = 1$ .

*Proof.* Let us first show that Relations (5.5.1)-(5.5.4) follow from the definition of a genus 1 structure for  $\Gamma_1$  with  $X_{U,V} = (\mathbf{x})_{U,V}$  and  $Y_{U,V} = (\mathbf{y})_{U,V} \{\theta_U^{-1} \otimes \text{id}_V\}$ . We do not give the detail of the computations, which can be immediately checked by graphical calculus. The (only) vertex condition for  $\Gamma_1$  is

$$(\mathbf{y})_{U,V} (\mathbf{x})_{U,V} (\bar{\mathbf{y}})_{U,V} (\bar{\mathbf{x}})_{U,V} (\bar{\mathbf{t}})_{U,V} = \{\theta_U \otimes \text{id}_V\}.$$

Using the tail condition,

$$(\mathbf{y})_{U,V} (\mathbf{x})_{U,V} (\bar{\mathbf{y}})_{U,V} (\bar{\mathbf{x}})_{U,V} = \{c_{V,U} c_{U,V} (\theta_U \otimes \text{id}_V)^2\}.$$

Using the edge conditions for  $\mathbf{x}$  and  $\mathbf{y}$ , we obtain Relation (5.5.3). Relation (5.5.1) is the doubling condition for  $\mathbf{x}$ . Relation (5.5.2) follows from Lemma 5.1.3 (in the

case  $\mathbf{e} = \mathbf{y}$ ) together with the fact that  $\theta_{UV} = c_{V,U}c_{U,V}(\theta_U \otimes \theta_V)$ . Finally, Relation (5.5.4) follows from the relation  $cs_2(\mathbf{x}, \mathbf{y})$ .

Conversely, the isomorphisms  $(\mathbf{e})_{U,V}$  can be expressed from  $X$  and  $Y$  for any edge  $\mathbf{e}$  of  $\Gamma_1$ , and it is straightforward to check that all the defining axioms of a genus 1 structure for  $\Gamma_1$  can be recovered from Relations (5.5.1)-(5.5.4).  $\square$

## Chapter 6

# The combinatorial invariants $Z_{e(\tau)}$ .

In this chapter, we define the notion of *infinitesimal elliptic structure*. The category of elliptic Jacobi diagrams  $\mathbf{A}_1$  is endowed with such a structure. Moreover, the notion of *elliptic associator* introduced in [Enr] allows us to construct an elliptic structure from an infinitesimal one. As a consequence of Theorem 5.4.1, any elliptic associator  $e$  produces a combinatorial invariant  $Z_e$  of framed parenthesized elliptic tangles.

The parallel transport of a reduced version of the KZB equation gives rise to an elliptic associator  $e(\tau)$  for any elliptic parameter  $\tau$ . In the last section, we study the dependence of the invariant  $Z_{e(\tau)}$  in this parameter.

### 6.1 Infinitesimal elliptic structures and formal integration

Let  $\mathcal{G}$  be a category and  $\mathcal{S}$  be an infinitesimal  $\mathcal{G}$ -category as defined in Section 3.4. We consider a graded linear  $\mathcal{G}$ -category  $\mathcal{S}_1$  equipped with a linear functor  $\{.\} : \mathcal{S} \rightarrow \mathcal{S}_1$  which is the identity on objects and which multiplies the degree by two.

**Definition 6.1.1.** An *infinitesimal elliptic structure* relative to  $(\mathcal{S} \rightarrow \mathcal{S}_1)$  is the data of two natural families of endomorphisms  $x_{U,V} : U \otimes V \rightarrow U \otimes V$  and  $y_{U,V} : U \otimes V \rightarrow U \otimes V$  such that for any triple of objects  $U, V, W$ ,  $x_{U,V}$  and  $y_{U,V}$  are of degree one in  $\mathcal{S}_1(\text{id}_{UV})$  and the following relations are satisfied (for  $z := x$  or  $z := y$ ).

$$z_{UV,W} = z_{U,VW} + \{\sigma_{V,U} \otimes \text{id}_W\} z_{V,UW} \{\sigma_{U,V} \otimes \text{id}_W\}, \quad (6.1.1)$$

$$\begin{aligned} z_{U,VW} \{\sigma_{V,U} \otimes \text{id}_W\} z_{V,UW} \{\sigma_{U,V} \otimes \text{id}_W\} \\ = \{\sigma_{V,U} \otimes \text{id}_W\} z_{V,UW} \{\sigma_{U,V} \otimes \text{id}_W\} z_{U,VW}, \end{aligned} \quad (6.1.2)$$

$$\begin{aligned} x_{U,VW} \{\sigma_{V,U} \otimes \text{id}_W\} y_{V,UW} \{\sigma_{U,V} \otimes \text{id}_W\} \\ - \{\sigma_{V,U} \otimes \text{id}_W\} y_{V,UW} \{\sigma_{U,V} \otimes \text{id}_W\} x_{U,VW} = \{t_{U,V} \otimes \text{id}_W\}, \end{aligned} \quad (6.1.3)$$

$$x_{U,V} y_{U,V} - y_{U,V} x_{U,V} = -\{t_{U,V}\}. \quad (6.1.4)$$



Instead of proving an elliptic analogue of Theorem 3.4.4, we state here a weaker version that is immediate and sufficient for our purpose.

Let  $\mathcal{S} \rightarrow \mathcal{S}_1$  be an infinitesimal elliptic structure. We consider a tensor product of objects  $V = V_1 \cdots V_n$ . The composition of the category  $\mathcal{S}_1$  endows the vector space  $\mathcal{S}_1(\text{id}_V)$  with a structure of a graded algebra.

**Lemma 6.1.3.** *There is a unique graded algebra morphism  $\Psi : \text{Ut}_{1,n} \rightarrow \mathcal{S}_1(\text{id}_V)$  such that (for  $z := x$  or  $z := y$ ),*

$$\Psi(z_i) = z_{V_i, V_1 \cdots V_{i-1} V_{i+1} \cdots V_n}.$$

Moreover, we have

$$\Psi(t_{ij}) = \{t_{V_i, V_j} \otimes \text{id}_{V_1 \cdots V_{i-1} V_{i+1} \cdots V_{j-1} V_{j+1} \cdots V_n}\}.$$

*Proof.* From Definition 2.1.1,  $\text{Ut}_{1,n}$  is presented by the generators  $x_i, y_i$  (for  $1 \leq i \leq n$ ),  $t_{ij} = t_{ji}$  (for  $1 \leq i \neq j \leq n$ ) and the following relations (for any distinct  $i, j, k$ )

$$[x_i, x_j] = [y_i, y_j] = 0, \quad (6.1.5)$$

$$[x_i, y_j] = t_{ij}, \quad (6.1.6)$$

$$[x_i, t_{jk}] = [y_i, t_{jk}] = 0, \quad (6.1.7)$$

$$[x_i, y_i] = - \sum_{l \neq i} t_{il}. \quad (6.1.8)$$

The fact that  $\Psi$  preserves the relations (6.1.5), (6.1.6) and (6.1.8) follows from the conditions (6.1.2), (6.1.3) and (6.1.4) respectively.  $\Psi$  preserves the relation (6.1.7) by naturality of  $z_{V_i, V_1 \cdots V_{i-1} V_{i+1} \cdots V_n}$  ( $z := x$  or  $z := y$ ).  $\square$

We give an elliptic analogue of Theorem 3.5.2, providing some sufficient conditions to produce an elliptic structure on a ribbon category from an infinitesimal one.

**Theorem 6.1.4.** *Let  $\mathcal{S} \rightarrow \mathcal{S}_1$  be an infinitesimal elliptic structure, and  $\widehat{\mathcal{S}}$  be the ribbon category obtained as in Theorem 3.5.2 from a Drinfeld associator  $\Phi$ . Let  $X(A, B)$  and  $Y(A, B) \in \exp(\mathfrak{f}(A, B))$  be two formal series in non-commuting variables  $A, B$  satisfying*

$$\left( Y(x_1, y_1), X(x_1, y_1) \right) = \exp(t_{12}) \quad (6.1.9)$$

in  $\exp(\widehat{\mathfrak{t}}_{1,2})$ , where  $(a, b) := aba^{-1}b^{-1}$  denotes the commutator, and

$$\begin{aligned} X(x_1 + x_2, y_1 + y_2) &= \Phi(t_{12}, t_{23})^{-1} X(x_1, y_1) \Phi(t_{12}, t_{23}) \exp(t_{12}/2) \\ &\quad \Phi(t_{12}, t_{13})^{-1} X(x_2, y_2) \Phi(t_{12}, t_{13}) \exp(t_{12}/2), \end{aligned} \quad (6.1.10)$$

$$\begin{aligned} Y(x_1 + x_2, y_1 + y_2) &= \Phi(t_{12}, t_{23})^{-1} Y(x_1, y_1) \Phi(t_{12}, t_{23}) \exp(-t_{12}/2) \\ &\quad \Phi(t_{12}, t_{13})^{-1} Y(x_2, y_2) \Phi(t_{12}, t_{13}) \exp(-t_{12}/2), \end{aligned} \quad (6.1.11)$$

$$\begin{aligned}
& \Phi(t_{12}, t_{23})^{-1} Y(x_1, y_1) \Phi(t_{12}, t_{23}) \exp(t_{12}/2) \\
& \quad \Phi(t_{12}, t_{13})^{-1} X(x_2, y_2) \Phi(t_{12}, t_{13}) \exp(t_{12}/2) \\
& = \exp(t_{12}/2) \Phi(t_{12}, t_{13})^{-1} X(x_2, y_2) \Phi(t_{12}, t_{13}) \\
& \quad \exp(-t_{12}/2) \Phi(t_{12}, t_{23})^{-1} Y(x_1, y_1) \Phi(t_{12}, t_{23}) \quad (6.1.12)
\end{aligned}$$

in  $\exp(\widehat{\mathfrak{t}}_{1,3})$ . Then the assignment

$$X_{U,V} := X(x_{U,V}, y_{U,V}) \quad \text{and} \quad Y_{U,V} := Y(x_{U,V}, y_{U,V})$$

defines an elliptic structure  $\widehat{\mathcal{S}} \rightarrow \widehat{\mathcal{S}}_1$ .

*Proof.* This assertion can easily be checked by comparing the relations (6.1.9)-(6.1.12) with the conditions (5.5.1)-(5.5.4). Let us show for instance that the assignment  $X_{U,V} := X(x_{U,V}, y_{U,V})$  satisfies the condition (5.5.1). The others conditions are obtained by similar arguments. Using 6.1.1, we have

$$\begin{aligned}
X_{UV,W} &= X(x_{UV,W}, y_{UV,W}) \\
&= X(x_{U,VW} + x_{V,UW}, y_{U,VW} + y_{V,UW}).
\end{aligned}$$

Therefore, it follows from (6.1.10) and Lemma 6.1.3 (in the case  $n = 3$ ) that

$$\begin{aligned}
X_{UV,W} &= \{\Phi(t_{U,V} \otimes \text{id}_W, \text{id}_U \otimes t_{V,W})^{-1}\} X(x_{U,VW}, y_{U,VW}) \\
& \{\Phi(t_{U,V} \otimes \text{id}_W, \text{id}_U \otimes t_{V,W})(\sigma_{V,U} \exp(t_{V,U}/2) \otimes \text{id}_W) \Phi(t_{V,U} \otimes \text{id}_W, \text{id}_V \otimes t_{U,W})^{-1}\} \\
& X(x_{V,UW}, y_{V,UW}) \{\Phi(t_{V,U} \otimes \text{id}_W, \text{id}_V \otimes t_{U,W})(\sigma_{U,V} \exp(t_{U,V}/2) \otimes \text{id}_W)\}. \quad (6.1.13)
\end{aligned}$$

Since the associativity constraint and the braiding of  $\widehat{\mathcal{S}}$  are

$$c_{X,Y} = \sigma_{X,Y} \exp(t_{X,Y}/2) \quad \text{and} \quad a_{X,Y,Z} = \Phi(t_{X,Y} \otimes \text{id}_Z, \text{id}_X \otimes t_{Y,Z}),$$

we see that (6.1.13) corresponds to the condition (5.5.1)

$$X_{UV,W} = X'_{U,V,W} \{c_{V,U} \otimes \text{id}_W\} X'_{V,U,W} \{c_{U,V} \otimes \text{id}_W\}.$$

□

In the two next sections, we recall the results of [CEE10, Enr] which provide two different kinds of solution for the equations (6.1.9)-(6.1.12).

## 6.2 The elliptic associators $e(\Phi) = (X_\Phi, Y_\Phi)$

In the completed free Lie algebra  $\widehat{\mathfrak{f}}(A, B)$  generated by the variables  $A$  and  $B$ , we set

$$\widetilde{A} := \frac{\text{ad}B}{e^{\text{ad}B} - 1}(A) = A - \frac{1}{2}[B, A] + \frac{1}{12}[B, [B, A]] + \dots,$$

and  $T := [B, A]$ .

**Definition 6.2.1.** To any Drinfeld associator  $\Phi(A, B) \in \exp(\widehat{\mathfrak{f}}(A, B))$ , we associate the pair  $e(\Phi) = (X_\Phi, Y_\Phi)$  with  $X_\Phi, Y_\Phi \in \exp(\widehat{\mathfrak{f}}(A, B))$  defined by:

$$X_\Phi(A, B) = \Phi(\widetilde{A}, T) \exp(\widetilde{A}) \Phi(\widetilde{A}, T)^{-1} \quad (6.2.1)$$

$$Y_\Phi(A, B) = \exp(T/2) \Phi(-\widetilde{A} - T, T) \exp(B) \Phi(\widetilde{A}, T)^{-1} \quad (6.2.2)$$

**Theorem 6.2.2.** [CEE10, Enr] *The above defined  $X_\Phi(A, B)$  and  $Y_\Phi(A, B)$  satisfy the relations (6.1.9)-(6.1.12).*

*Remark 6.2.3.* It follows from the proof of [Enr, Proposition 3.8] (see also [CEE10, Proposition 5.3]) that  $X_\Phi(A, B)$  and  $Y_\Phi(A, B)$  satisfy (6.1.9) in  $\exp(\widehat{\mathfrak{t}}_{1,2})$  and (6.1.10)-(6.1.12) in  $\exp(\widehat{\mathfrak{t}}_{1,3})$ , where  $\bar{\mathfrak{t}}_{1,n}$  is the quotient of  $\mathfrak{t}_{1,n}$  by the vector space generated by the central elements  $\sum_{i=1}^n v_i$  for any  $v \in H_1$ . Let us check that these relations still hold in  $\exp(\widehat{\mathfrak{t}}_{1,2})$  and  $\exp(\widehat{\mathfrak{t}}_{1,3})$ . There is a unique Lie algebra morphism  $f : \mathfrak{t}_{1,n} \rightarrow H_1 \cong \mathbb{C}^2$  (where  $H_1$  is seen as a commutative Lie algebra) with  $f(v_i) = 0$  if  $i < n$  and  $f(v_n) = v$  for any  $v \in H_1$ . Together with the projection  $\pi : \mathfrak{t}_{1,n} \rightarrow \bar{\mathfrak{t}}_{1,n}$ , it gives rise to an isomorphism  $\pi \oplus f : \mathfrak{t}_{1,n} \xrightarrow{\sim} \bar{\mathfrak{t}}_{1,n} \oplus \mathbb{C}^2$ . Since the image under  $f$  of the logarithms of the relations (6.1.9)-(6.1.12) in  $\widehat{\mathfrak{t}}_{1,2}$  and  $\widehat{\mathfrak{t}}_{1,3}$  is 0, they are satisfied in  $\exp(\widehat{\mathfrak{t}}_{1,2})$  and  $\exp(\widehat{\mathfrak{t}}_{1,3})$ .

From Theorem 6.2.2 and Theorem 6.1.4, the pair  $e(\Phi) = (X_\Phi, Y_\Phi)$  produces an elliptic structure  $\widehat{\mathbf{A}} \rightarrow \widehat{\mathbf{A}}_1$  from the infinitesimal elliptic structure  $\mathbf{A} \rightarrow \mathbf{A}_1$ . Using Lemma 5.5.2 and Theorem 5.4.1, this gives rise to a functorial invariant of parenthesized framed tangles in genus one  $Z_{e(\Phi)} : \mathbf{q}\widetilde{\mathbf{T}}_1 \rightarrow \widehat{\mathbf{A}}_1$ , such that the following diagram commutes:

$$\begin{array}{ccc} \mathbf{q}\widetilde{\mathbf{T}} & \xrightarrow{Z_\Phi} & \widehat{\mathbf{A}} \\ \downarrow & & \downarrow \\ \mathbf{q}\widetilde{\mathbf{T}}_1 & \xrightarrow{Z_{e(\Phi)}} & \widehat{\mathbf{A}}_1 \end{array}$$

As in the usual case,  $Z_{e(\Phi)}$  induces an invariant of unframed tangles  $Z_{e(\Phi)} : \mathbf{q}\mathbf{T}_1 \rightarrow \widehat{\mathbf{A}}_1/FI$ .

### 6.3 The elliptic associators $e(\tau) = (X_\tau, Y_\tau)$

We now turn to the elliptic analogue of Section 3.6, following [Enr, Section 5].

In  $\bar{\mathfrak{t}}_{1,2}$ , we denote  $x := x_1$ ,  $y := y_1$ , and  $t = -[x, y]/2\pi i = t_{12}/2\pi i$ . Note that  $\bar{\mathfrak{t}}_{1,2}$  is freely generated by  $x, y$ .

Let us consider the function

$$\kappa(z) := x + \left( \Psi_0(z) - \frac{1}{z} \right) t + \sum_{k=1}^{\infty} \Psi_k(z) (\text{ad } x)^k(t),$$

where the  $\Psi_k$  are the functions (depending on an elliptic parameter  $\tau$ ) defined in Section 2.2. The following "reduced" KZB equation is derived from the connection  $\Omega_\tau$  defined in Chapter 2 (for  $n = 2$ ,  $z_1 = z$  and  $z_2 = 0$ ):

$$\frac{dF}{dz} = \left( \frac{t}{z} + \kappa(z) \right) F \tag{6.3.1}$$

**Lemma 6.3.1.** *There exists a unique solution  $F_0(z)$  of Equation (6.3.1) in  $\exp(\widehat{\mathfrak{t}}_{1,2})$ , analytic in the domain  $B = \{a + b\tau, 0 < a < 1, 0 < b < 1\}$  and with the asymptotic behavior  $F_0(z) \sim z^t$  as  $z \rightarrow 0$ , which means that  $F_0(z) = f(z)z^t$  for some function  $f$  with  $f(0) = 1$ .*



*Proof.* By inserting the expression  $F_0(z) = f(z)z^t$  into (6.3.1), we get

$$f'(z)z^t + f(z)\frac{t}{z}z^t = \left(\frac{t}{z} + \kappa(z)\right) f(z)z^t.$$

Hence  $f(z)$  satisfies the differential equation

$$f'(z) - \frac{1}{z}[t, f(z)] = \kappa(z)f(z).$$

Let us write in power series  $f(z) = 1 + \sum_{k=1}^{\infty} f_k z^k$  and  $\kappa(z) = \sum_{k=0}^{\infty} \kappa_k z^k$  with coefficients  $f_k, \kappa_k \in \widehat{U}_{1,2}$ . We then obtain the following recurrence relation for the coefficient of  $z^{k-1}$

$$(k - \text{adt})f_k = \sum_{l=0}^{k-1} \kappa_{k-1-l} f_l.$$

The operator  $k - \text{adt}$  is invertible:

$$(k - \text{adt})^{-1} = \frac{1}{k} \sum_{s=0}^{\infty} \left(\frac{\text{adt}}{k}\right)^s.$$

(The above sum is well-defined since  $\text{adt}$  increases the grading.) Hence  $f(z)$  is uniquely determined by

$$f_k = (k - \text{adt})^{-1} \left( \sum_{l=0}^{k-1} \kappa_{k-1-l} f_l \right).$$

□

Let  $F_0(z)$  be the solution of (6.3.1) introduced in Lemma 6.3.1. From the equivariance of the KZB equation,  $z \mapsto F_0(z+1)$  and  $z \mapsto e^x F_0(z+\tau)$  are also solutions of (6.3.1) and hence are related to  $F_0(z)$  by multiplication by a constant on the right.

**Definition 6.3.2.** We set

$$X_\tau := F_0(z)^{-1} F_0(z+1) \quad \text{and} \quad Y_\tau := F_0(z)^{-1} e^x F_0(z+\tau).$$

**Lemma 6.3.3.** Let  $F_\varepsilon(z)$  be the solution of (6.3.1) such that  $F_\varepsilon(\varepsilon) = 1$ . Then

$$X_\tau = \lim_{\varepsilon \rightarrow 0} \varepsilon^{-t} F_\varepsilon(\varepsilon+1) \varepsilon^t,$$

and

$$Y_\tau = \lim_{\varepsilon \rightarrow 0} \varepsilon^{-t} e^x F_\varepsilon(\varepsilon+\tau) \varepsilon^t.$$

*Proof.* Since  $F_0(z+1)$  and  $F_\varepsilon(z+1)$  are both solutions of (6.3.1), they are related by a constant on the right:

$$\begin{aligned} F_\varepsilon(z+1) &= F_0(z+1) F_0(\varepsilon)^{-1} \\ &= F_0(z) X_\tau F_0(\varepsilon)^{-1} \end{aligned}$$

Taking  $z = \varepsilon$ , we get

$$X_\tau = F_0(\varepsilon)^{-1} F_\varepsilon(\varepsilon+1) F_0(\varepsilon).$$

Taking the limit  $\varepsilon \rightarrow 0$  and using the fact that  $F_0(\varepsilon) \sim \varepsilon^t$ , we obtain the first equality. The second one is obtained similarly. □

**Theorem 6.3.4.** *The pair  $e(\tau) := (X_\tau, Y_\tau)$  satisfies the relations (6.1.9)-(6.1.12) if  $\Phi$  is the KZ associator  $\Phi_{KZ}$  and via the identification  $\exp(\widehat{\mathfrak{t}}_{1,2}) \cong \exp(\widehat{\mathfrak{f}}(A, B))$  given by  $x \mapsto A$  and  $y \mapsto B$ .*

Theorem 6.3.4 follows from [Enr, Proposition 5.1] and from the same argument as in Remark 6.2.3.

As in the previous section, the map  $\tau \mapsto e(\tau)$  thus gives rise to a family (indexed by the upper-half plane  $\tau \in \mathfrak{H}$ ) of functorial invariants  $Z_{e(\tau)} : \mathbf{q}\widetilde{\mathbf{T}}_1 \rightarrow \widehat{\mathbf{A}}_1$ , such that the following diagram commutes:

$$\begin{array}{ccc} \mathbf{q}\widetilde{\mathbf{T}} & \xrightarrow{Z_{KZ}} & \widehat{\mathbf{A}} \\ \downarrow & & \downarrow \\ \mathbf{q}\widetilde{\mathbf{T}}_1 & \xrightarrow{Z_{e(\tau)}} & \widehat{\mathbf{A}}_1 \end{array}$$

Again,  $Z_{e(\tau)}$  induces an invariant of unframed tangles  $Z_{e(\tau)} : \mathbf{q}\mathbf{T}_1 \rightarrow \widehat{\mathbf{A}}_1/FI$ .

## 6.4 The variation of $Z_{e(\tau)}$ with respect to the elliptic parameter $\tau$

We first recall from [Enr] the construction of a Lie algebra  $\langle \mathfrak{sl}_2, (\delta_{2k}) \rangle$  of derivations of  $\bar{\mathfrak{t}}_{1,2}$  which controls the variation of  $e(\tau)$  with respect to the parameter  $\tau$  (Proposition 6.4.1). We then show (Proposition 6.4.5) that the positive degree derivations of  $\langle \mathfrak{sl}_2, (\delta_{2k}) \rangle$  can be implemented as inner derivations of  $\mathbf{A}_1(2)$ . Finally, we derive from this result Theorem 6.4.8 relating  $Z_{e(\tau)}$  to  $Z_{e(\tau_0)}$  for any  $\tau$  and  $\tau_0 \in \mathfrak{H}$ .

### 6.4.1 The variation of $e(\tau)$

As previously, we set  $x := x_1$ ,  $y := y_1$  and  $t = -[x, y] = t_{12}$  in  $\bar{\mathfrak{t}}_{1,2}$ . Recall that  $\bar{\mathfrak{t}}_{1,2}$  is freely generated by  $x, y$ . It is thus  $\mathbb{N}^2$ -graded with  $\deg(x) = (1, 0)$  and  $\deg(y) = (0, 1)$ . Let  $\text{Der}_*(\bar{\mathfrak{t}}_{1,2})$  denote the Lie algebra of derivations  $\delta$  of  $\bar{\mathfrak{t}}_{1,2}$  such that  $\delta(t) = 0$ . The Lie algebra  $\text{Der}_*(\bar{\mathfrak{t}}_{1,2})$  is  $\mathbb{Z}^2$ -graded, where  $\text{Der}_*(\bar{\mathfrak{t}}_{1,2})[p, q]$  consists of the derivations that increase the degree by  $(p, q) \in \mathbb{Z}^2$ .

The action of the Lie algebra  $\mathfrak{sl}_2$  on the degree one part of  $\bar{\mathfrak{t}}_{1,2}$  (the two-dimensional vector space spanned by  $x, y$ ) given by  $e_+(x) = 0$ ,  $e_+(y) = x$ ,  $e_-(x) = y$  and  $e_-(y) = 0$ , where

$$e_+ := \begin{pmatrix} 0 & 1 \\ 0 & 0 \end{pmatrix} \quad \text{and} \quad e_- := \begin{pmatrix} 0 & 0 \\ 1 & 0 \end{pmatrix},$$

extends uniquely to an action on  $\bar{\mathfrak{t}}_{1,2}$  by derivations:

$$\mathfrak{sl}_2 \rightarrow \text{Der}_*(\bar{\mathfrak{t}}_{1,2}).$$

For any  $k \geq 0$ , we define  $\delta_{2k} \in \text{Der}_*(\bar{\mathfrak{t}}_{1,2})$  by

$$\delta_{2k}(x) = \frac{1}{2} \sum_{p+q=2k+1} (-1)^q [(\text{ady})^p(x), (\text{ady})^q(x)] \quad \text{and} \quad \delta_{2k}(y) = -(\text{ady})^{2k+2}(x).$$

We have  $\deg(\delta_{2k}) = (1, 2k + 1)$ . Let  $\langle \mathfrak{sl}_2, (\delta_{2k}) \rangle \subset \text{Der}_*(\bar{\mathfrak{t}}_{1,2})$  denote the graded Lie subalgebra generated by  $\mathfrak{sl}_2$  and the  $\delta_{2k}$ 's. Then  $\langle \mathfrak{sl}_2, (\delta_{2k}) \rangle = \mathfrak{sl}_2 \rtimes \langle \mathfrak{sl}_2, (\delta_{2k}) \rangle^+$ , where  $\langle \mathfrak{sl}_2, (\delta_{2k}) \rangle^+$  is the positive degree part of  $\langle \mathfrak{sl}_2, (\delta_{2k}) \rangle$ .

**Proposition 6.4.1.** *[Enr] We have*

$$2\pi i \frac{\partial}{\partial \tau} X_\tau = \left( e_+ + \sum_{k \geq 0} (2k + 1) G_{2k+2}(\tau) \delta_{2k} \right) X_\tau,$$

$$2\pi i \frac{\partial}{\partial \tau} Y_\tau = \left( e_+ + \sum_{k \geq 0} (2k + 1) G_{2k+2}(\tau) \delta_{2k} \right) Y_\tau,$$

where  $G_{2k+2}(\tau)$  denotes the Eisenstein series of weight  $2k + 2$  defined for  $k \geq 1$  by

$$G_{2k+2}(\tau) := \sum_{p \in \Lambda'_\tau} \frac{1}{p^{2k+2}},$$

with  $\Lambda'_\tau := (\mathbb{Z} + \mathbb{Z}\tau) \setminus \{(0, 0)\}$ . For  $k = 0$ , the above series does not converge absolutely. We set

$$G_2(\tau) := \frac{\pi^2}{3} + \sum_{m \in \mathbb{Z} \setminus \{0\}} \left( \sum_{n \in \mathbb{Z}} \frac{1}{(n + m\tau)^2} \right).$$

We consider the morphism  $\bar{\mathfrak{t}}_{1,2} \rightarrow \mathbf{A}_1(2)$  sending  $x, y$  and  $t$  to the diagrams  $\mathfrak{x}, y$  and  $\mathfrak{t}$  where

$$\mathfrak{x} := x \bullet \cdots \uparrow \uparrow, \quad \mathfrak{y} := y \bullet \cdots \uparrow \uparrow, \quad \text{and } \mathfrak{t} := \uparrow \uparrow \cdots \uparrow \uparrow.$$

### 6.4.2 An action of $\mathfrak{sl}_2$ by derivations of $\mathbf{A}_1(2)$

For a symplectic Jacobi diagram  $D$ , we denote by  $V_x(D)$  the set of external vertices of  $D$  that are labeled with  $x$ . If  $v$  is an external vertex of  $D$ , let  $D_{(v \rightarrow x)}$  be the diagram obtained from  $D$  by replacing the label of  $v$  with  $x$ . We introduce the same notations for the label  $y$ . Let us define

$$\tilde{e}_+(D) := \sum_{v \in V_y(D)} D_{(v \rightarrow x)} \quad \text{and} \quad \tilde{e}_-(D) := \sum_{v \in V_x(D)} D_{(v \rightarrow y)}.$$

In particular, if  $D$  has no  $y$ -vertex (respectively, no  $x$ -vertex), then  $\tilde{e}_+(D) = 0$  (respectively,  $\tilde{e}_-(D) = 0$ ).

**Lemma 6.4.2.** *(i) The maps  $\tilde{e}_+$  and  $\tilde{e}_-$  define derivations of  $\mathbf{A}_1(2)$ .*

*(ii) We have a Lie algebra morphism  $\mathfrak{sl}_2 \rightarrow \text{Der}(\mathbf{A}_1(2))$  given by  $e_\pm \mapsto \tilde{e}_\pm$ .*

*(iii) The actions of  $\mathfrak{sl}_2$  on  $\bar{\mathfrak{t}}_{1,2}$  and  $\mathbf{A}_1(2)$  are compatible:*

$$\begin{array}{ccc}
\bar{\mathbf{t}}_{1,2} & \longrightarrow & \mathbf{A}_1(2) \\
e_{\pm} \downarrow & & \downarrow \tilde{e}_{\pm} \\
\bar{\mathbf{t}}_{1,2} & \longrightarrow & \mathbf{A}_1(2)
\end{array}$$

*Proof.* (i) We first check that the maps  $\tilde{e}_{\pm}$  defined from the above formula of  $\tilde{e}_{\pm}(D)$  on the vector space spanned by symplectic Jacobi diagrams factor through the STU-like and the relation  $\mathbf{I}_1$ , which are the only defining relations of  $\mathbf{A}_1$  that involve external vertices. We just give one example for the STU-like relation, all the other cases being obtained as easily.

$$\begin{array}{c}
\begin{array}{ccccccc}
x \bullet & \cdots & \boxed{D} & - & \begin{array}{c} y \bullet \\ \vee \\ x \bullet \end{array} & \cdots & \boxed{D} & - & \begin{array}{c} \bullet \\ \cdots \end{array} & \boxed{D} & = & 0 \\
y \bullet & \cdots & & & & & & & & & & & \\
\vee & & & & & & & & & & & & \\
y \bullet & \cdots & & & & & & & & & & & 
\end{array} \\
\downarrow \tilde{e}_+ \\
\begin{array}{ccccccc}
x \bullet & \cdots & \boxed{\tilde{e}_+(D)} & + & \begin{array}{c} x \bullet \\ \vee \\ x \bullet \end{array} & \cdots & \boxed{D} & - & \begin{array}{c} y \bullet \\ \vee \\ x \bullet \end{array} & \cdots & \boxed{\tilde{e}_+(D)} & - & \begin{array}{c} x \bullet \\ \vee \\ x \bullet \end{array} & \cdots & \boxed{D} & - & \begin{array}{c} \bullet \\ \cdots \end{array} & \boxed{\tilde{e}_+(D)} & = & 0 \\
y \bullet & \cdots & & & & & & & & & & & & & & & & & & & \\
\vee & \\
y \bullet & \cdots & & & & & & & & & & & & & & & & & & & 
\end{array}
\end{array}$$

It is immediate that the induced maps  $\mathbf{A}_1(2) \rightarrow \mathbf{A}_1(2)$  are derivations.

(ii) Let us set  $[\tilde{e}_+, \tilde{e}_-] = \tilde{h}$ . We show that  $[\tilde{h}, \tilde{e}_+] = 2\tilde{e}_+$  and  $[\tilde{h}, \tilde{e}_-] = -2\tilde{e}_-$ . We denote by  $\text{swit}(D)$  the sum of all the diagrams obtained by switching two  $x$  and  $y$  vertices. In particular if  $D$  has no  $x$ -vertices or no  $y$ -vertices, then  $\text{swit}(D) = 0$ . Observe that

$$\tilde{e}_+(\tilde{e}_-(D)) = \text{swit}(D) + |V_x(D)| \cdot D,$$

where  $|V_x(D)|$  is the number of  $x$ -vertices of  $D$ . Similarly,

$$\tilde{e}_-(\tilde{e}_+(D)) = \text{swit}(D) + |V_y(D)| \cdot D.$$

Hence,

$$\tilde{h}(D) = (|V_x(D)| - |V_y(D)|) \cdot D.$$

We thus have

$$\begin{aligned}
[\tilde{h}, \tilde{e}_+](D) &= \tilde{h}(\tilde{e}_+(D)) - \tilde{e}_+(\tilde{h}(D)) \\
&= (|V_x(\tilde{e}_+(D))| - |V_y(\tilde{e}_+(D))|) \cdot \tilde{e}_+(D) - (|V_x(D)| - |V_y(D)|) \cdot \tilde{e}_+(D) \\
&= 2\tilde{e}_+(D),
\end{aligned}$$

since  $|V_x(\tilde{e}_+(D))| = |V_x(D)| + 1$  and  $|V_y(\tilde{e}_+(D))| = |V_y(D)| - 1$ . The relation  $[\tilde{h}, \tilde{e}_-](D) = -2\tilde{e}_-(D)$  is obtained similarly.

Assertion (iii) is immediate.  $\square$

### 6.4.3 Implementation of the derivations $\delta_{2k}$ in $\mathbf{A}_1(2)$

We adopt the following graphical convention for any  $k \geq 0$ .

$$y \bullet \text{---} \boxed{k} \text{---} \begin{array}{c} \vdots \\ \vdots \\ \vdots \end{array} := (k \text{ times}) \begin{array}{c} y \bullet \text{---} \bullet \\ \vdots \\ y \bullet \text{---} \bullet \end{array} \begin{array}{c} \vdots \\ \vdots \\ \vdots \end{array}$$

*Remark 6.4.3.* (i) By  $k$  applications of the STU relation, we have

$$(\text{ad}(y))^k(\mathbf{t}) = y \bullet \text{---} \boxed{k} \begin{array}{c} \uparrow \\ \bullet \\ \vdots \\ \bullet \\ \uparrow \end{array}$$

(ii) It follows from  $k$  applications of the AS relation that

$$y \bullet \text{---} \begin{array}{c} \vdots \\ \vdots \\ \vdots \end{array} \boxed{k} = (-1)^k y \bullet \text{---} \boxed{k} \begin{array}{c} \vdots \\ \vdots \\ \vdots \end{array}$$

**Definition 6.4.4.** For  $k \geq 0$ , we define  $\mathbf{C}_{2k} \in \mathbf{A}_1(1)$  by

$$\mathbf{C}_{2k} := \frac{1}{2} y \bullet \text{---} \boxed{2k} \begin{array}{c} \uparrow \\ \bullet \\ \vdots \\ \bullet \\ \uparrow \end{array}$$

Note that  $\mathbf{C}_0$  corresponds to the half of the Casimir element  $C_+$ . Moreover,

$$\Delta \mathbf{C}_{2k} = \frac{1}{2} y \bullet \text{---} \boxed{2k} \begin{array}{c} \uparrow \uparrow \\ \bullet \\ \vdots \\ \bullet \\ \downarrow \downarrow \end{array}$$

From Remark 6.4.3, we have

$$\Delta \mathbf{C}_{2k} = \uparrow \otimes \mathbf{C}_{2k} + \mathbf{C}_{2k} \otimes \uparrow + (\text{ad}(y))^{2k}(\mathbf{t}), \quad (6.4.1)$$

where  $\uparrow \otimes \mathbf{C}_{2k}$  and  $\mathbf{C}_{2k} \otimes \uparrow$  are understood as the result of setting a vertical arrow  $\uparrow$  and *the representative* of  $\mathbf{C}_{2k}$  depicted in Definition 6.4.4 side by side (we have not defined any tensor product on  $\mathbf{A}_1$ ).

**Proposition 6.4.5.** *The derivations  $\delta_{2k}$  can be implemented as inner derivations of  $\mathbf{A}_1(2)$  by the elements  $\Delta \mathbf{C}_{2k}$ . That is, we have the following commutative square:*

$$\begin{array}{ccc} \bar{\mathbf{t}}_{1,2} & \longrightarrow & \mathbf{A}_1(2) \\ \delta_{2k} \downarrow & & \downarrow \text{ad}(\Delta \mathbf{C}_{2k}) \\ \bar{\mathbf{t}}_{1,2} & \longrightarrow & \mathbf{A}_1(2) \end{array}$$

Before proving this proposition, we first state a preliminary lemma.

**Lemma 6.4.6.** *For any  $p, q \geq 0$ , we have the relation*

*Proof.* First observe that

(6.4.2)

since by the IHX relation, the left and right-hand sides of (6.4.2) can be written in the form

respectively, and since these two expressions coincide by the STU-like relation. Now the relation of Lemma 6.4.6 that we would like to prove can be rewritten, using IHX, as

The first and last terms of this equation coincide (by  $p$  applications of relation (6.4.2)), and the two remaining terms coincide as well (by  $q$  iterations of (6.4.2)). The Lemma is thus proven.  $\square$

*Proof of Proposition 6.4.5.* It is sufficient to show that

$$[\Delta C_{2k}, \mathbf{x}] = \frac{1}{2} \sum_{p+q=2k+1} (-1)^q [(\text{ad}(y))^p(\mathbf{x}), (\text{ad}(y))^q(\mathbf{x})] \quad (6.4.3)$$

and

$$[\Delta C_{2k}, y] = -(\text{ad}(y))^{2k+2}(x). \quad (6.4.4)$$

Equation (6.4.3) can be rewritten

$$[\Delta C_{2k}, x] = \sum_{p+q=2k+1} (-1)^q (\text{ad}(y))^p(x) (\text{ad}(y))^q(x). \quad (6.4.5)$$

Let us first show (6.4.4). We have  $[\uparrow \otimes C_{2k}, y] = 0$  since by the STU-like relation

We have also  $[C_{2k} \otimes \uparrow, y] = 0$  since

From (6.4.1) we have thus

$$[\Delta C_{2k}, y] = [(\text{ad}(y))^{2k}(t), y] = [(\text{ad}(y))^{2k+1}(x), y] = -(\text{ad}(y))^{2k+2}(x),$$

which proves (6.4.4). Let us now show (6.4.5). For convenience we adopt the following summation convention: a diagram with the variables  $p'$  and  $q'$  shall be understood as the sum of the diagrams for  $p' \geq 0$ ,  $q' \geq 0$  and  $p' + q' = 2k - 1$ . We compute  $[\uparrow \otimes C_{2k}, x]$ . By  $2k$  applications of the STU-like and AS relations, we have

We now compute  $[C_{2k} \otimes \uparrow, x]$ . By sliding the  $x$ -leg downwards, we have:

By STU-like, the first term of the right-hand side of (6.4.7) is

$$\begin{array}{c} x \\ \bullet \\ \dots \\ y \\ \bullet \end{array} \begin{array}{c} \uparrow \\ \uparrow \end{array} \begin{array}{c} \boxed{2k} \\ \dots \\ \dots \end{array} = \begin{array}{c} y \\ \bullet \\ \dots \\ x \\ \bullet \end{array} \begin{array}{c} \uparrow \\ \uparrow \end{array} \begin{array}{c} \boxed{2k} \\ \dots \\ \dots \end{array} + \begin{array}{c} y \\ \bullet \\ \dots \\ y \\ \bullet \end{array} \begin{array}{c} \uparrow \\ \uparrow \end{array} \begin{array}{c} \boxed{p'} \\ \dots \\ \boxed{q'} \\ \dots \end{array}$$

By the closure relation, the second term of the right-hand side of (6.4.7) is

$$\begin{array}{c} \omega \\ \bullet \\ \dots \\ y \\ \bullet \\ \dots \\ y \\ \bullet \end{array} \begin{array}{c} \uparrow \\ \uparrow \end{array} \begin{array}{c} \boxed{p'} \\ \dots \\ \boxed{q'} \\ \dots \end{array} = - \begin{array}{c} y \\ \bullet \\ \dots \\ y \\ \bullet \end{array} \begin{array}{c} \uparrow \\ \uparrow \end{array} \begin{array}{c} \boxed{p'} \\ \dots \\ \boxed{q'} \\ \dots \end{array} + \begin{array}{c} y \\ \bullet \\ \dots \\ y \\ \bullet \end{array} \begin{array}{c} \uparrow \\ \uparrow \end{array} \begin{array}{c} \boxed{p'} \\ \dots \\ \boxed{q'} \\ \dots \end{array}$$

Putting the last three equalities together and using Lemma 6.4.6 leads to

$$\begin{array}{c} y \\ \bullet \\ \dots \\ x \\ \bullet \end{array} \begin{array}{c} \uparrow \\ \uparrow \end{array} \begin{array}{c} \boxed{2k} \\ \dots \\ \dots \end{array} - \begin{array}{c} x \\ \bullet \\ \dots \\ y \\ \bullet \end{array} \begin{array}{c} \uparrow \\ \uparrow \end{array} \begin{array}{c} \boxed{2k} \\ \dots \\ \dots \end{array} = - \begin{array}{c} y \\ \bullet \\ \dots \\ y \\ \bullet \end{array} \begin{array}{c} \uparrow \\ \uparrow \end{array} \begin{array}{c} \boxed{p'} \\ \dots \\ \boxed{q'} \\ \dots \end{array} \tag{6.4.8}$$

From (6.4.6) and (6.4.8), we then have

$$2[\uparrow \otimes C_{2k} + C_{2k} \otimes \uparrow, x] = \begin{array}{c} y \\ \bullet \\ \dots \\ y \\ \bullet \end{array} \begin{array}{c} \uparrow \\ \uparrow \end{array} \begin{array}{c} \boxed{p'} \\ \dots \\ \boxed{q'} \\ \dots \end{array} - \begin{array}{c} y \\ \bullet \\ \dots \\ y \\ \bullet \end{array} \begin{array}{c} \uparrow \\ \uparrow \end{array} \begin{array}{c} \boxed{p'} \\ \dots \\ \boxed{q'} \\ \dots \end{array}$$

By the STU relation, this equals

$$\begin{array}{c} y \\ \bullet \\ \dots \\ y \\ \bullet \end{array} \begin{array}{c} \uparrow \\ \uparrow \end{array} \begin{array}{c} \boxed{p'} \\ \dots \\ \boxed{q'} \\ \dots \end{array} - \begin{array}{c} y \\ \bullet \\ \dots \\ y \\ \bullet \end{array} \begin{array}{c} \uparrow \\ \uparrow \end{array} \begin{array}{c} \boxed{p'} \\ \dots \\ \boxed{q'} \\ \dots \end{array} - \begin{array}{c} y \\ \bullet \\ \dots \\ y \\ \bullet \end{array} \begin{array}{c} \uparrow \\ \uparrow \end{array} \begin{array}{c} \boxed{p'} \\ \dots \\ \boxed{q'} \\ \dots \end{array} + \begin{array}{c} y \\ \bullet \\ \dots \\ y \\ \bullet \end{array} \begin{array}{c} \uparrow \\ \uparrow \end{array} \begin{array}{c} \boxed{p'} \\ \dots \\ \boxed{q'} \\ \dots \end{array}$$

Note that the second and fourth terms of the above sum vanish: by exchanging  $p'$  and  $q'$ , we see that they are opposite. It follows from Remark 6.4.3, (ii) that the first



and third terms are identical, since  $p' + q' = 2k - 1$  implies that one of the variables  $p', q'$  is even and the other is odd. Therefore, we have

$$[\uparrow \otimes \mathbf{C}_{2k} + \mathbf{C}_{2k} \otimes \uparrow, \mathbf{x}] = \sum_{p'+q'=2k-1} (-1)^{p'} (\text{ad}(\mathbf{y}))^{p'}(\mathbf{t})(\text{ad}(\mathbf{y}))^{q'}(\mathbf{t}).$$

Hence,

$$\begin{aligned} [\Delta \mathbf{C}_{2k}, \mathbf{x}] &= [(\text{ad}(\mathbf{y}))^{2k}(\mathbf{t}), \mathbf{x}] + \sum_{p'+q'=2k-1} (-1)^{p'} (\text{ad}(\mathbf{y}))^{p'}(\mathbf{t})(\text{ad}(\mathbf{y}))^{q'}(\mathbf{t}) \\ &= [(\text{ad}(\mathbf{y}))^{2k+1}(\mathbf{x}), \mathbf{x}] + \sum_{p'+q'=2k-1} (-1)^{p'} (\text{ad}(\mathbf{y}))^{p'+1}(\mathbf{x})(\text{ad}(\mathbf{y}))^{q'+1}(\mathbf{x}) \\ &= \sum_{p+q=2k+1} (-1)^q (\text{ad}(\mathbf{y}))^p(\mathbf{x})(\text{ad}(\mathbf{y}))^q(\mathbf{x}), \end{aligned}$$

which proves (6.4.5).  $\square$

#### 6.4.4 The Lie algebra $\mathfrak{sl}_2 \ltimes \mathfrak{L}$

Let  $\mathfrak{L}$  be the free Lie algebra generated by  $\delta_{p,q}$  for  $p \geq 0, q \geq 0$  and  $p + q$  even.  $\mathfrak{L}$  is graded by  $\deg(\delta_{p,q}) = (p + 1, q + 1)$ . The Lie algebra  $\mathfrak{sl}_2$  acts by derivation on  $\mathfrak{L}$  by

$$e_+ \delta_{p,q} = (p + 1) \cdot \delta_{p+1,q-1} \quad \text{and} \quad e_- \delta_{p,q} = (q + 1) \cdot \delta_{p-1,q+1},$$

where  $\delta_{p,q} := 0$  if  $p \leq -1$  or  $q \leq -1$ . We denote by  $\mathfrak{sl}_2 \ltimes \mathfrak{L}$  the resulting semi-direct product (the Lie bracket of  $\mathfrak{sl}_2 \ltimes \mathfrak{L}$  being defined, for  $e, e' \in \mathfrak{sl}_2$  and  $\delta, \delta' \in \mathfrak{L}$ , by  $[e + \delta, e' + \delta'] := [e, e'] + [\delta, \delta'] + e\delta' - e'\delta$ ).

Let us define a Lie algebra morphism

$$\nu : \widehat{\mathfrak{L}} \rightarrow \mathbf{A}_1(1)$$

by  $\nu(\delta_{p,q}) = \mathbf{C}_{p,q}$ , where  $\mathbf{C}_{p,q}$  is the sum of all Jacobi diagrams obtained from  $\mathbf{C}_{p+q}$  by replacing  $p$   $y$ -labels with  $x$ -labels (in particular,  $\mathbf{C}_{0,2k} = \mathbf{C}_{2k}$ ).

**Lemma 6.4.7.** *The Lie algebra  $\mathfrak{sl}_2 \ltimes \mathfrak{L}$  acts by derivations on  $\mathbf{A}_1(2)$ . More precisely, we have a Lie algebra morphism  $\mathfrak{sl}_2 \ltimes \mathfrak{L} \rightarrow \text{Der}(\mathbf{A}_1(2))$  with  $e_{\pm} \mapsto \tilde{e}_{\pm}$  and  $\delta \in \mathfrak{L} \mapsto \text{ad}(\Delta \nu(\delta))$ .*

*Proof.* It suffices to prove that  $[\tilde{e}_+, \text{ad}(\Delta \mathbf{C}_{p,q})] = (p + 1) \cdot \text{ad}(\Delta \mathbf{C}_{p+1,q-1})$  and that  $[\tilde{e}_-, \text{ad}(\Delta \mathbf{C}_{p,q})] = (q + 1) \cdot \text{ad}(\Delta \mathbf{C}_{p-1,q+1})$ . We show the first identity, the second one being obtained in a similar way. Since  $[\tilde{e}_+, \text{ad}(\mathbf{C}_{p,q})] = \text{ad}(\tilde{e}_+(\mathbf{C}_{p,q}))$ , we have left to check  $\tilde{e}_+(\Delta \mathbf{C}_{p,q}) = (p + 1) \cdot \Delta \mathbf{C}_{p+1,q-1}$ , which easily follows from the definition of  $\mathbf{C}_{p,q}$  and  $\tilde{e}_+$ .  $\square$

#### 6.4.5 Variation of $Z_{e(\tau)}$ with respect to $\tau$

In this subsection, we fix  $\tau_0 \in \mathfrak{H}$ .

Since  $\mathfrak{L}$  is generated as a Lie algebra by the  $(2k + 1)$ -dimensional  $\mathfrak{sl}_2$ -submodules generated by  $\delta_{0,2k}$ ,  $\mathfrak{L}$  is a sum of finite dimensional  $\mathfrak{sl}_2$ -modules. The action of the

Lie algebra  $\mathfrak{sl}_2$  on  $\mathfrak{L}$  can thus be integrated to an action of the group  $SL_2(\mathbb{C})$ , and we can form the semi-direct product

$$\mathbf{G} := SL_2(\mathbb{C}) \ltimes \exp(\widehat{\mathfrak{L}}).$$

$\mathbf{G}$  acts on  $\mathbf{A}_1(2)$  by, for any  $\begin{pmatrix} a & b \\ c & d \end{pmatrix} \exp(\delta) \in \mathbf{G}$  and any diagram  $D \in \mathbf{A}_1(2)$ ,

$$\begin{pmatrix} a & b \\ c & d \end{pmatrix} \exp(\delta) \star D = \left( \exp(\Delta\nu(\delta)) D \exp(-\Delta\nu(\delta)) \right)_{\substack{(x \rightarrow ax+cy) \\ (y \rightarrow bx+dy)}},$$

where  $D_{\substack{(x \rightarrow ax+cy) \\ (y \rightarrow bx+dy)}}$  denotes the diagram obtained from  $D$  by replacing simultaneously all the labels  $x$  of  $D$  with  $ax + cy$  and all the labels  $y$  with  $bx + dy$ .

Let  $F(\tau) \in \mathbf{G}$  be the solution of

$$2\pi i \frac{\partial}{\partial \tau} F(\tau) = \left( e_+ + \sum_{k \geq 0} (2k+1) G_{2k+2}(\tau) \delta_{0,2k} \right) F(\tau), \quad F(\tau_0) = 1.$$

We have  $F(\tau) = \exp((\tau - \tau_0)e_+) \exp(f(\tau))$ , with  $f(\tau) \in \widehat{\mathfrak{L}}$ . We set  $\mathbf{C}_\tau := \nu(f(\tau)) \in \mathbf{A}_1(1)$ .

**Theorem 6.4.8.** *For any tangle  $\gamma$  of source  $S$  and target  $T$ , we have*

$$Z_{e(\tau)}(\gamma) = \left( \exp(\Delta^T \mathbf{C}_\tau) Z_{e(\tau_0)}(\gamma) \exp(-\Delta^S \mathbf{C}_\tau) \right)_{(y \rightarrow y + (\tau - \tau_0)x)}.$$

In the particular case where  $\gamma$  is a link,  $S$  and  $T$  are empty and we have the following corollary.

**Corollary 6.4.9.** *If  $\gamma$  is a link, then  $Z_{e(\tau)}(\gamma) = (Z_{e(\tau_0)}(\gamma))_{(y \rightarrow y + (\tau - \tau_0)x)}$ .*

*Proof.* The right-hand term of the equality is functorial with respect to  $\gamma$ . Therefore, we are reduced to proving the equality in the case where  $\gamma$  has no beak and in the case where  $\gamma = X_{U,V}$  or  $\gamma = Y_{U,V}$ .

If  $\gamma$  has no beak, then  $Z_{e(\tau)}(\gamma) = Z_{e(\tau_0)}(\gamma) = Z_{KZ}(\gamma)$ . Since  $Z_{KZ}(\gamma)$  has no external vertices, we have  $Z_{KZ}(\gamma) = \exp(\Delta^T C) Z_{KZ}(\gamma) \exp(-\Delta^S C)$  for any  $C \in \mathbf{A}_1(1)$  from Lemma 1.4.4, and the theorem is proved in this case.

If  $\gamma = X_{+,+}$ , then  $Z_{e(\tau)}(\gamma) = \mathbf{X}_\tau$ , where  $\mathbf{X}_\tau$  is the image of the elliptic associator  $X_\tau$  under  $\exp(\widehat{\mathfrak{t}}_{1,2}) \rightarrow \mathbf{A}_1(2)$ .

From Proposition 6.4.1, Proposition 6.4.5 and Lemma 6.4.2, we have

$$\begin{aligned} 2\pi i \frac{\partial}{\partial \tau} \mathbf{X}_\tau &= \left( \tilde{e}_+ + \sum_{k \geq 0} (2k+1) G_{2k+2}(\tau) \text{ad}(\Delta \mathbf{C}_{2k}) \right) \mathbf{X}_\tau \\ &= \left( e_+ + \sum_{k \geq 0} (2k+1) G_{2k+2}(\tau) \delta_{0,2k} \right) \cdot \mathbf{X}_\tau, \end{aligned}$$

where in the second line,  $\mathfrak{sl}_2 \ltimes \mathfrak{L}$  acts on  $\mathbf{A}_1(2)$  as stated in Lemma 6.4.7. Therefore,

$$\mathbf{X}_\tau = F(\tau) \star \mathbf{X}_{\tau_0} = \left( \exp(\Delta \mathbf{C}_\tau) \mathbf{X}_{\tau_0} \exp(-\Delta \mathbf{C}_\tau) \right)_{(y \rightarrow y + (\tau - \tau_0)x)}.$$

By applying the appropriate coproducts and antipodes, the latter equality immediately generalizes to the theorem in the case  $\gamma = X_{U,V}$  for any objects  $U, V$ . The case  $\gamma = Y_{U,V}$  is obtained similarly.  $\square$



# Bibliography

- [AMR98] Jørgen Ellegaard Andersen, Josef Mattes, and Nicolai Reshetikhin. Quantization of the algebra of chord diagrams. *Math. Proc. Cambridge Philos. Soc.*, 124(3):451–467, 1998.
- [Art47] E. Artin. Theory of braids. *Ann. of Math. (2)*, 48:101–126, 1947.
- [Bez94] R. Bezrukavnikov. Koszul DG-algebras arising from configuration spaces. *Geom. Funct. Anal.*, 4(2):119–135, 1994.
- [BF04] Paolo Bellingeri and Louis Funar. Braids on surfaces and finite type invariants. *C. R. Math. Acad. Sci. Paris*, 338(2):157–162, 2004.
- [BG12] Paolo Bellingeri and Sylvain Gervais. Surface framed braids. *Geom. Dedicata*, 159:51–69, 2012.
- [Bir76] Joan S. Birman. On the stable equivalence of plat representations of knots and links. *Canad. J. Math.*, 28(2):264–290, 1976.
- [BKP09] Alex James Bene, Nariya Kawazumi, and R. C. Penner. Canonical extensions of the Johnson homomorphisms to the Torelli groupoid. *Adv. Math.*, 221(2):627–659, 2009.
- [BN95] Dror Bar-Natan. On the Vassiliev knot invariants. *Topology*, 34(2):423–472, 1995.
- [BN96] Dror Bar-Natan. Vassiliev and quantum invariants of braids. In *The interface of knots and physics (San Francisco, CA, 1995)*, volume 51 of *Proc. Sympos. Appl. Math.*, pages 129–144. Amer. Math. Soc., Providence, RI, 1996.
- [BN97] Dror Bar-Natan. Non-associative tangles. In *Geometric topology (Athens, GA, 1993)*, volume 2 of *AMS/IP Stud. Adv. Math.*, pages 139–183. Amer. Math. Soc., Providence, RI, 1997.
- [BND] Dror Bar-Natan and Zsuzsanna Dancso. Homomorphic expansions for knotted trivalent graphs. Preprint arXiv:1103.1896.
- [BND12] Dror Bar-Natan and Zsuzsanna Dancso. Pentagon and hexagon equations following Furusho. *Proc. Amer. Math. Soc.*, 140(4):1243–1250, 2012.

- [Bou72] N. Bourbaki. *Éléments de mathématique. Fasc. XXXVII. Groupes et algèbres de Lie. Chapitre II: Algèbres de Lie libres. Chapitre III: Groupes de Lie.* Hermann, Paris, 1972. Actualités Scientifiques et Industrielles, No. 1349.
- [BZ85] Gerhard Burde and Heiner Zieschang. *Knots*, volume 5 of *de Gruyter Studies in Mathematics*. Walter de Gruyter & Co., Berlin, 1985.
- [Cam] Albert Camus. *Le mythe de Sisyphe*.
- [Car93] Pierre Cartier. Construction combinatoire des invariants de Vassiliev-Kontsevich des nœuds. *C. R. Acad. Sci. Paris Sér. I Math.*, 316(11):1205–1210, 1993.
- [CDM12] S. Chmutov, S. Duzhin, and J. Mostovoy. *Introduction to Vassiliev knot invariants*. Cambridge University Press, Cambridge, 2012.
- [CEE10] Damien Calaque, Benjamin Enriquez, and Pavel Etingof. Universal KZB equations: the elliptic case. In *Algebra, Arithmetic, and Geometry: Volume I: In Honor of Yu. I. Manin*, Progress in Mathematics. Birkhäuser Boston, 2010.
- [Che61] Kuo-tsai Chen. Formal differential equations. *Ann. of Math. (2)*, 73:110–133, 1961.
- [Che77] Kuo Tsai Chen. Iterated path integrals. *Bull. Amer. Math. Soc.*, 83(5):831–879, 1977.
- [CHM08] Dorin Cheptea, Kazuo Habiro, and Gwénaél Massuyeau. A functorial LMO invariant for Lagrangian cobordisms. *Geom. Topol.*, 12(2):1091–1170, 2008.
- [CL07] Dorin Cheptea and Thang T. Q. Le. A TQFT associated to the LMO invariant of three-dimensional manifolds. *Comm. Math. Phys.*, 272(3):601–634, 2007.
- [Dan10] Zsuzsanna Dancso. On the Kontsevich integral for knotted trivalent graphs. *Algebr. Geom. Topol.*, 10(3):1317–1365, 2010.
- [Dri89] V. G. Drinfeld. Quasi-Hopf algebras. *Algebra i Analiz*, 1(6):114–148, 1989.
- [Dri90] V. G. Drinfeld. On quasitriangular quasi-Hopf algebras and on a group that is closely connected with  $\text{Gal}(\overline{\mathbf{Q}}/\mathbf{Q})$ . *Algebra i Analiz*, 2(4):149–181, 1990.
- [EK71] Robert D. Edwards and Robion C. Kirby. Deformations of spaces of imbeddings. *Ann. Math. (2)*, 93:63–88, 1971.
- [Enr] Benjamin Enriquez. Elliptic associators. Preprint arXiv:1003.1012.
- [Fur10] Hidekazu Furusho. Pentagon and hexagon equations. *Ann. of Math. (2)*, 171(1):545–556, 2010.

- [GMP04] Juan González-Meneses and Luis Paris. Vassiliev invariants for braids on surfaces. *Trans. Amer. Math. Soc.*, 356(1):219–243 (electronic), 2004.
- [God07] Véronique Godin. The unstable integral homology of the mapping class groups of a surface with boundary. *Math. Ann.*, 337(1):15–60, 2007.
- [Hab00] Kazuo Habiro. Claspers and finite type invariants of links. *Geom. Topol.*, 4:1–83 (electronic), 2000.
- [Har86] John L. Harer. The virtual cohomological dimension of the mapping class group of an orientable surface. *Invent. Math.*, 84(1):157–176, 1986.
- [Har88] John L. Harer. The cohomology of the moduli space of curves. In *Theory of moduli (Montecatini Terme, 1985)*, volume 1337 of *Lecture Notes in Math.*, pages 138–221. Springer, Berlin, 1988.
- [Hir76] Morris W. Hirsch. *Differential topology*. Springer-Verlag, New York, 1976. Graduate Texts in Mathematics, No. 33.
- [HM00] Nathan Habegger and Gregor Masbaum. The Kontsevich integral and Milnor’s invariants. *Topology*, 39(6):1253–1289, 2000.
- [HM09] Kazuo Habiro and Gwénaél Massuyeau. Symplectic Jacobi diagrams and the Lie algebra of homology cylinders. *J. Topol.*, 2(3):527–569, 2009.
- [Kam02] Seiichi Kamada. *Braid and knot theory in dimension four*, volume 95 of *Mathematical Surveys and Monographs*. American Mathematical Society, Providence, RI, 2002.
- [Kas95] Christian Kassel. *Quantum groups*, volume 155 of *Graduate Texts in Mathematics*. Springer-Verlag, New York, 1995.
- [KN96] Shoshichi Kobayashi and Katsumi Nomizu. *Foundations of differential geometry*. Wiley Classics Library. John Wiley & Sons Inc., New York, 1996. Reprint of the 1963 original, A Wiley-Interscience Publication.
- [Koh87] Toshitake Kohno. Monodromy representations of braid groups and Yang-Baxter equations. *Ann. Inst. Fourier (Grenoble)*, 37(4):139–160, 1987.
- [Kon93] Maxim Kontsevich. Vassiliev’s knot invariants. In *I. M. Gelfand Seminar*, volume 16 of *Adv. Soviet Math.*, pages 137–150. Amer. Math. Soc., Providence, RI, 1993.
- [Kro81] Kronecker. Zur theorie der elliptischen funktionen. *Mathematische Werke*, IV:313–318, 1881.
- [KT98] Christian Kassel and Vladimir Turaev. Chord diagram invariants of tangles and graphs. *Duke Math. J.*, 92(3):497–552, 1998.
- [KZ84] V. G. Knizhnik and A. B. Zamolodchikov. Current algebra and Wess-Zumino model in two dimensions. *Nuclear Phys. B*, 247(1):83–103, 1984.

- [Les99] Christine Lescop. Introduction to the Kontsevich integral of framed tangles. *Lectures notes from "École d'été : Invariants de noeuds et de variétés de dimension 3"*, 1999.
- [Lie04] Jens Lieberum. Universal Vassiliev invariants of links in coverings of 3-manifolds. *J. Knot Theory Ramifications*, 13(4):515–555, 2004.
- [Lie08] Jens Lieberum. The Drinfeld associator of  $\mathfrak{gl}(1|1)$ . In *Quantum groups*, volume 12 of *IRMA Lect. Math. Theor. Phys.*, pages 39–80. Eur. Math. Soc., Zürich, 2008.
- [Lin97] Xiao-Song Lin. Power series expansions and invariants of links. In *Geometric topology (Athens, GA, 1993)*, volume 2 of *AMS/IP Stud. Adv. Math.*, pages 184–202. Amer. Math. Soc., Providence, RI, 1997.
- [LM96] Tu Quoc Thang Le and Jun Murakami. The universal Vassiliev-Kontsevich invariant for framed oriented links. *Compositio Math.*, 102(1):41–64, 1996.
- [ML98] Saunders Mac Lane. *Categories for the working mathematician*, volume 5 of *Graduate Texts in Mathematics*. Springer-Verlag, New York, second edition, 1998.
- [MO97] J. Murakami and T. Ohtsuki. Topological quantum field theory for the universal quantum invariant. *Comm. Math. Phys.*, 188(3):501–520, 1997.
- [MS03] Jacob Mostovoy and Theodore Stanford. On a map from pure braids to knots. *J. Knot Theory Ramifications*, 12(3):417–425, 2003.
- [Oht02] Tomotada Ohtsuki. *Quantum invariants*, volume 29 of *Series on Knots and Everything*. World Scientific Publishing Co. Inc., 2002. A study of knots, 3-manifolds, and their sets.
- [Pen87] R. C. Penner. The decorated Teichmüller space of punctured surfaces. *Comm. Math. Phys.*, 113(2):299–339, 1987.
- [Pen88] R. C. Penner. Perturbative series and the moduli space of Riemann surfaces. *J. Differential Geom.*, 27(1):35–53, 1988.
- [RT90] N. Y. Reshetikhin and V. G. Turaev. Ribbon graphs and their invariants derived from quantum groups. *Comm. Math. Phys.*, 127:1–26, 1990.
- [Shu94] Mei Chee Shum. Tortile tensor categories. *J. Pure Appl. Algebra*, 93(1):57–110, 1994.
- [Tur10] Vladimir G. Turaev. *Quantum invariants of knots and 3-manifolds*, volume 18 of *de Gruyter Studies in Mathematics*. Walter de Gruyter & Co., Berlin, revised edition, 2010.
- [Yet01] David N. Yetter. *Functorial knot theory*, volume 26 of *Series on Knots and Everything*. World Scientific Publishing Co. Inc., River Edge, NJ, 2001. Categories of tangles, coherence, categorical deformations, and topological invariants.

- [Zag91] Don Zagier. Periods of modular forms and Jacobi theta functions. *Invent. Math.*, 104(3):449–465, 1991.



# Index

- $\delta_{2k}$ , 91
- $\theta_\tau$ , 22
- $\iota_n$ , 12
- $\iota_{1,n}$ , 28
- $\Lambda$ , 21
- $\pi_1$ , 48
- $\tilde{\pi}_1$ , 48
- $\tau$ , 21
- $\Phi_{KZ}$ , 45
- $\Psi_k$ , 23
- $\Omega_{KZ}$ , 4
- $\Omega_\tau$ , 23
  
- A**, 11
- $\mathcal{A}$ , 13
- $\mathbf{A}_1$ , 28
- $\mathbf{A}_1^\partial$ , 26
- $\mathcal{A}_1$ , 29
- AS Relation, 10
  
- $\mathcal{B}_n$ , 4
- $\mathcal{B}_{1,n}$ , 24
  
- $\mathcal{C}_n$ , 4
- $\mathcal{C}_{n,\tau}$ , 22
- $\mathcal{C}_{2k}$ , 94
- $CS_2$  Move, 61
- $cs_2$ , 75
  
- D**, 38
- $\mathbf{D}(\Gamma)$ , 55
  
- E**, 21
- $\mathbb{E}_n$ , 24
- $E$ , 24
- $E_n$ , 24
- $e_+$ , 91
- $\tilde{e}_+$ , 92
- $e_-$ , 91
- $\tilde{e}_-$ , 92
- $e(\tau)$ , 91
  
- $e(\Phi)$ , 89
- $F_\tau$ , 22
- FI Relation, 10
  
- G**, 98
- $G_{2k+2}(\tau)$ , 92
  
- $H_1$ , 21
  
- $\mathbf{I}_1$ , 27
- IHX Relation, 10
  
- $\mathcal{L}$ , 98
  
- P**, 9
- $\mathcal{P}$ , 12
- $\mathcal{P}_1$ , 25
  
- $\mathbf{qT}$ , 41
- $\mathbf{q}\tilde{\mathbf{T}}$ , 41
- $\mathbf{qT}_g$ , 82
- $\mathbf{q}\tilde{\mathbf{T}}_g$ , 82
  
- $R_1, \tilde{R}_1, R_2$  and  $R_3$  Moves, 38
- $RST(\Gamma)$  and  $\tilde{RST}(\Gamma)$  Relations, 59
  
- $S_1, S_2$  and  $S'_2$  Moves, 56
- $S_g$ , 47
- $S_{g,1}$ , 48
- STU Relation, 10
- STU-like Relation, 26
  
- T**, 37
- $\tilde{\mathbf{T}}$ , 38
- $\mathcal{T}$ , 8
- $\mathcal{T}^{\text{bd}}$ , 5
- $\mathbf{T}_g$ , 47
- $\tilde{\mathbf{T}}_g$ , 47
- $\mathcal{T}_1$ , 25
- $\mathcal{T}_1^{\text{bd}}$ , 25
- $T_{KZ}$ , 4

$T_\tau$ , 25  
 $\mathfrak{t}_n$ , 4  
 $\mathfrak{t}_{1,n}$ , 21  
 $\bar{\mathfrak{t}}_{1,n}$ , 89  
 $T_1, T_2$  and  $T_3$  Moves, 58  
  
 $X_\tau$ , 90  
 $X_\Phi$ , 88  
  
 $Y_\tau$ , 90  
 $Y_\Phi$ , 88  
  
 $Z$ , 19  
 $Z^{\text{bd}}$ , 15  
 $Z_\Phi$ , 44  
 $Z_{KZ}$ , 45  
 $Z_\tau$ , 35  
 $Z_\tau^{\text{bd}}$ , 32  
 $Z_{e(\tau)}$ , 91  
 $Z_{e(\Phi)}$ , 89