



**HAL**  
open science

# Les métaux lourds dans la glace du Groenland datant de l'époque gréco-romaine et du dernier cycle climatique : contribution anthropique et naturelle

Sungmin Hong

► **To cite this version:**

Sungmin Hong. Les métaux lourds dans la glace du Groenland datant de l'époque gréco-romaine et du dernier cycle climatique : contribution anthropique et naturelle. Geochemistry. Université Joseph-Fourier - Grenoble I, 1995. English. NNT: . tel-00762345

**HAL Id: tel-00762345**

**<https://theses.hal.science/tel-00762345>**

Submitted on 7 Dec 2012

**HAL** is a multi-disciplinary open access archive for the deposit and dissemination of scientific research documents, whether they are published or not. The documents may come from teaching and research institutions in France or abroad, or from public or private research centers.

L'archive ouverte pluridisciplinaire **HAL**, est destinée au dépôt et à la diffusion de documents scientifiques de niveau recherche, publiés ou non, émanant des établissements d'enseignement et de recherche français ou étrangers, des laboratoires publics ou privés.

TS 95/GRE1/0149/D  
(double)

TS 95/GRE1 / 0 1 4 9

DOUBLE *SP*

CENTRE NATIONAL DE LA RECHERCHE SCIENTIFIQUE

*CS*  
*TS*  
*///*  
*///*  
*///*



**LABORATOIRE  
DE GLACIOLOGIE  
ET GEOPHYSIQUE  
DE L'ENVIRONNEMENT**

Associé à l'Université Joseph Fourier  
de Grenoble

THESE  
PRESENTEE PAR

Sungmin HONG

Pour obtenir le titre de Docteur de l'Université Joseph Fourier - Grenoble I  
(ARRETES MINISTERIELS DU 5 JUILLET 1984 ET DU 30 MARS 1992)

SPECIALITE : GEOPHYSIQUE ET GEOCHIMIE

---

**LES METAUX LOURDS DANS LA GLACE DU GROENLAND DATANT DE  
L'EPOQUE GRECO-ROMAINE ET DU DERNIER CYCLE CLIMATIQUE :  
CONTRIBUTION ANTHROPIQUE ET NATURELLE**

---

Présentée le 16 Octobre 1995 devant la commission d'examen :

|     |                   |                    |
|-----|-------------------|--------------------|
| MM. | Laurent CHARLET   | Président          |
|     | Freddy ADAMS      |                    |
|     | Claude BOUTRON    | Directeur de thèse |
|     | Jean-Luc JAFFREZO |                    |
|     | Remi LOSNO        |                    |

Rapporteurs : MM. Freddy ADAMS et Kevin ROSMAN

54 Rue MOLIERE, Domaine Universitaire BP 96 38402 SAINT MARTIN D'HERES CEDEX (FRANCE)  
Telephone : 76 82 42 00 ; Telefax : 76 82 42 01



CENTRE NATIONAL DE LA RECHERCHE SCIENTIFIQUE



**LABORATOIRE  
DE GLACIOLOGIE  
ET GEOPHYSIQUE  
DE L'ENVIRONNEMENT**

Associé à l'Université Joseph Fourier  
de Grenoble

THESE  
PRESENTEE PAR

Sungmin HONG

Pour obtenir le titre de Docteur de l'Université Joseph Fourier - Grenoble 1  
(ARRETES MINISTERIELS DU 5 JUILLET 1984 ET DU 30 MARS 1992)

SPECIALITE : GEOPHYSIQUE ET GEOCHIMIE

---

**LES METAUX LOURDS DANS LA GLACE DU GROENLAND DATANT DE  
L'EPOQUE GRECO-ROMAINE ET DU DERNIER CYCLE CLIMATIQUE :  
CONTRIBUTION ANTHROPIQUE ET NATURELLE**

---

Présentée le 16 Octobre 1995 devant la commission d'examen :

|                     |                    |
|---------------------|--------------------|
| MM. Laurent CHARLET | Président          |
| Freddy ADAMS        |                    |
| Claude BOUTRON      | Directeur de thèse |
| Jean-Luc JAFFREZO   |                    |
| Remi LOSNO          |                    |

Rapporteurs : MM. Freddy ADAMS et Kevin ROSMAN

S4 Rue MOLIERE, Domaine Universitaire BP 96 38402 SAINT MARTIN D'HERES CEDEX (FRANCE)  
Telephone : 76 82 42 00 ; Telefax : 76 82 42 01



## REMERCIEMENTS

Ce travail est une contribution du programme organisé par la Fondation Européenne pour la Science grâce aux contributions financières de différentes agences et des organismes en Belgique, au Danemark, en France, en Allemagne, en Islande, en Italie, en Suisse et au Royaume Uni et de la Direction générale de la Commission des Communautés Européennes. Ce travail a été financé par le Ministère de l'Environnement (contrats N° 92295 et 94074), l'Institut National des Sciences de l'Univers et l'Université de Grenoble. Je voudrais exprimer mes remerciements à B. Stauffer et J.P. Steffensen pour leur aides lors de la sélection des carottes glaciaires à Copenhague.

Je désire d'exprimer mes remerciements profonds à Robert Delmas pour son accueil au Laboratoire de Glaciologie et Géophysique de l'Environnement et ses attentions incessantes. Je témoigne de la gratitude à Michel Legrand et Martine de Angelis pour leur conseils et leur discussions. Merci également à Joël Savarino et François Ducroz pour leur aides au cours de ce travail et à Michel Soutif et Claude Domergue pour leur discussions considérables.

Je tiens à bien exprimer mes remerciements à MM. Laurent Charlet qui me fait l'honneur de présider la commission d'examen de cette thèse, Jean-Luc Jaffrezo et Remi Losno qui ont accepté de participer au jury. Mes remerciements très vivement à Freddy Adams et Kevin Rosman qui ont été les rapporteurs de cette thèse.

Un grand merci à fond à Claude Boutron, mon directeur de thèse, qui m'a guidé de réaliser ce travail avec dévouement au cours des derniers 4 ans.

A mon ami, Jean-Pierre Candelone, avec lequel j'ai partagé les peines et les joies depuis mon arrivée en France. A tous mes collègues du laboratoire pour leur aides morales.

Une partie de bonheur devant l'âme de mon ami qui était le plus intime avec moi.

Cette thèse est un fruit de support persistant de ma famille et de mon amie sincère.

## Table des Matières

|   |          |
|---|----------|
| <b>Remerciements</b>  | -----2   |
| <b>Table des Matières</b>   | -----3   |
| <b><u>Introduction</u></b>  | -----5   |
| <b>1.1 General</b>  | -----5   |
| <b>1.2 Field sampling</b>   | -----10  |
| <b>1.3 Presentation of each component</b>   | -----11  |
| <b>1.4 References</b>   | -----22  |
| <br>  |          |
| <b>Article I</b> : An improved method for decontaminating polar snow and ice for heavy metal analysis   | -----27  |
| <br>  |          |
| <b>Article II</b> : Greenland ice evidence of hemispheric lead pollution two millennia ago by Greek and Roman civilizations                               | -----58  |
| <br>  |          |
| <b>Article III</b> : Lead isotope record in ancient Greenland ice from 6000 B.C. to A.D.1500: preliminary data  | -----72  |
| <br>  |          |
| <b>Article IV</b> : A reconstruction of historical copper production and its relevance to copper emission to the atmosphere with ages                     | -----76  |
| <br>  |          |
| <b>Article V</b> : Greater cumulative large scale atmospheric pollution of the Northern Hemisphere for copper before than after the Industrial Revolution | -----104 |

|   |     |
|---|-----|
| <b>Article VI</b> : Deposition of atmospheric heavy metals to the Greenland ice sheet from the 1783-1784 volcanic eruption of Laki, Iceland -----   | 119 |
| <b>Article VII</b> : Changing occurrences of lead, copper, cadmium and zinc in central Greenland ice deposited during the Holocene -----  | 149 |
| <b>Article VIII</b> : Changes in natural lead, copper, zinc and cadmium concentrations in central Greenland ice from 8000 to 150,000 years B.P. - its association with climatic changes and resultant variation of dominant source contribution ----- | 193 |
| <b>Conclusion</b> -----   | 230 |
| <b>Annexe I</b> : An improved method for decontaminating polar snow and ice cores for heavy metal analysis -----  | 237 |
| <b>Annexe II</b> : Greenland ice evidence of hemispheric lead pollution two millennia ago by Greek and Roman civilizations -----  | 246 |

## 1. INTRODUCTION

### 1.1 General

It is now well recognized that the huge amounts of metal discharge from industrial emissions into the air, water and soils have no doubt resulted in the great impact on the regional and global cycling of trace metals since the Industrial Revolution [Nriagu, 1990]. To evaluate the impact of anthropogenic emissions on the natural cycles of toxic heavy metals, it is needed to understand a general historical trend in occurrence of these elements in the atmospheric system which is a main route of the transport of pollutant aerosols emitted from various anthropogenic sources.

The well preserved and dated snow and ice layers deposited in Greenland ice cap give us an unique way to investigate on a global basis the historical pollution of the atmosphere of the Northern Hemisphere for various toxic heavy metals stemming from the industrial activities [Wolff and Peel, 1985; Boutron, 1995; Boutron et al., 1995]. In fact, the study on the changing occurrences of heavy metals in this frozen archives was stimulated by a pioneering work performed by C. Patterson and his co-workers twenty six years ago [Murozumi et al., 1969]. They analysed the north-west Greenland snow and ice block samples collected from the walls of an inclined shaft at the Camp Century area (77° 10'N, 61° 08'W, elevation 1866m a.s.l.) and from a virgin trench site (76° 46'N, 58° 52'W, elevation 1800m a.s.l.) 80 km east by south-east of the Camp century. The estimated ages of the samples collected ranged from 1753 to 1965 AD. In addition, a single block of the Holocene ice dating back to about 2800 years B.P. was also

collected at Camp Tuto (76° 25'N, 68° 20'W) for the measurement of the Holocene natural Pb concentration level. From this splendid work, they obtained the first time series of Pb concentrations which showed that the Pb concentrations in 1753 AD was already elevated to about 10 pg/g with respect to that (< 1pg/g) of the Holocene natural one and that the continuous ~ 5 fold increase of Pb concentrations until the 1930s was followed by the subsequent rapid increase by a factor of ~ 4 during the time span of about 30 years. As a result, the Pb concentrations were found to increased by up to a factor of 20 during the last two centuries. At that time, they suggested an interpretation that the remote Arctic atmosphere was already polluted for Pb about 200 years ago by the uncontrolled Pb mining and smelting activities and an enormous increase of Pb concentrations after the 1930's had resulted from the introduction and subsequent massive use of Pb alkyl additives in automotive fuels.

Since then, many investigators made their efforts to reconstruct a historical trend of various heavy metals such as Hg [Weiss et al., 1971a; Carr and Wilkness, 1973; Appelquist et al., 1978], Se [Weiss et al., 1971b], and Cd, Cu and Zn as well as Pb [Weiss et al., 1975; Herron et al., 1977] for evaluating the dominant source contribution, using the same snow and ice samples as ones of Murozumi et al. or the samples recovered from the newly excavated snow pits and deep ice core drilled at the Dye-3 (65°N, 44° W) and Crete (71°N, 37°W) in Greenland. In these studies, they claimed that most of the heavy metals contents contained in modern and ancient Greenland snow and ice had originated not from the industrial emissions but from the natural sources such as the crustal dusts, volcanic emanations, biological volatilization, and the degassing processes of the earth's crust and, therefore, that man-made pollutants contribution was not responsible for the changing occurrences of heavy

metals during the time span comparable to that of previous Patterson and co-worker's investigation. Also they suggested that Pb concentrations presented by Murozumi et al. [1969] for the pre-1900 period was anomalously low.

However, this controversy was ended when Ng and Patterson [1981] analysed three ice core sections of the Camp Century Greenland deep ice core (77° 10'N, 61° 08'W, elevation 1885) whose ages ranged from 2700 to 5500 years B.P. They confirmed that the natural Pb concentrations free of a possible influence from the ancient Pb smelting activities (i.e., Roman and medieval German operations) was really at the pg/g level as previously claimed by Murozumi et al. [1969]. For this work, the mechanical decontamination by chiselling successive veneer layers of ice core section was for the first time used instead of the previous melting and washing procedures. It was, moreover, proposed that the penetration of the outside contamination towards the inner part of core section had to be checked by analysing separately each veneer layer in order to obtain a reliable data. Consequently, their confirmation led to a definitive conclusion that the previous investigations on various heavy metals present in Greenland snow and ice had suffered severe contamination problems during field sampling, laboratory analysis or both.

Owing to the revolutionary decontamination process executed by Ng and Patterson [1981], thereafter, the reliable time series of heavy metals could have been obtained by various investigators using the Vostok (78° 30'S, 106° 54'E) and Dome C (74° 39'S, 124° 10'E) deep ice cores of East Antarctica [Boutron and Patterson, 1986; Boutron et al., 1987; Batifol et al., 1989; Boutron et al., 1990,1993; Vandal et al., 1993]. Unfortunately, however, any reliable time series of various heavy metals was not

produced to evaluate a large scale pollution of the atmosphere of the Northern Hemisphere in human history from Greenland ice samples, although short-term (yearly or decadal) variations of heavy metals deposition flux over southern or central Greenland snow were measured by various investigators [Wolff and Peel, 1988; Boutron et al., 1991; Savarino et al., 1994]. Just recently, Candelone et al. [in press] obtained the reliable time series of Pb, Cu, Zn, and Cd covering the time period of the post Industrial Revolution, that is, about 220 years, using Eurocore samples collected at Summit (72° 34'N, 37° 37'W, elevation 3238m a.s.l., mean annual temperature - 32°C, mean annual snow accumulation rate 23g cm<sup>2</sup> yr<sup>-1</sup>) in central Greenland. This work was aimed to confirm the change of Pb concentrations level with time at one site over Greenland in comparison with that of Murozumi et al. [1969], for which they used the samples collected from various sites, and to assess human impact on the natural atmospheric cycles of other heavy metals such as Cu, Zn and Cd on an hemispheric scale. Candelone et al. [in press] found that the general trend of the temporal variations of Pb concentrations obtained from both Murozumi et al. [1969] and themselves are similar, although there is a slight discrepancy in concentration level, which is probably due to the differences in altitude and geographical area of the sampling sites and/or due to the unexpected contamination occurred in the previous analytical procedures. It was also observed that the concentration level determined in their snow and ice samples started to increase as early as the 1770s for Zn and from the 1850s for Cu and Zn and reached the maximum at the different time for each individual metal, that is, ~ 1961 for Zn, ~1972 and 1969 for Cd and Cu, respectively. Enhancement factor in concentration was found to amount to be ~ 8 for Cd, ~ 5 for Zn, and ~ 4 for Cu. They attributed these temporal variations to the changes of worldwide anthropogenic emission rates to the atmosphere of the Northern Hemisphere, assuming

that the Cu, Zn and Cd contents determined in the ice sample 220 years ago are entirely natural in origin, while the natural Pb loading in the atmosphere of the Northern Hemisphere was already perturbed on a significant scale by the anthropogenic Pb pollutant aerosols emitted from the extensive Pb mining and smelting processes at the time of the Industrial Revolution.

As mentioned above, much attention on the large scale heavy metal pollution in the atmosphere of the Northern Hemisphere have been paid to the limited time period, i.e., the past two centuries, because the industrial emissions of the contaminants to the atmosphere were regarded to have become significant on a global basis after the Industrial Revolution. However, Patterson et al. [1970] proposed that Pb production rate in Roman times was comparable to that at the onset of the Industrial Revolution and hence the amplitude of the anthropogenic pollution in the atmosphere of the Northern Hemisphere for Pb during the Roman times might be of the same order of magnitude as that for the Industrial Revolution, which was evidenced from the measurement of Pb contents in Greenland ancient ice sample. His proposition implied definitively that a reconstruction of the time variations in occurrence of heavy metals had to be extended in time to the long period enough to understand a full historical course of the anthropogenic pollution. This was a principal motive of the study for Pb presented in this thesis. In order to properly assess to what extent man gave rise to a large scale perturbation of natural atmospheric cycles of various heavy metals, on the other hand, it is indispensable to decipher the natural occurrences of those heavy metals in the atmosphere and their time-dependent modulation in accordance with the control factors. For this, the comprehensive time series have to be obtained for the last full glacial period as well as the Holocene, during which the climatic conditions have



changed to a great extent so that we could have a general picture of the control factors for the changes of natural source contributions to the atmospheric heavy metals burden. The above mentioned investigation was expected to yield a comprehensive understanding of the changing occurrences of heavy metals in Greenland snow and ice, for instance, the preceded investigation of Candelone et al. [in press]. Consequently, the study presented here was designed and carried out in order to extend our knowledge about the biogeochemical cycles of heavy metals in the atmosphere of the Northern Hemisphere from the past to present.

This thesis consists of eight components in the form of articles (I-VIII) which present all the analytical procedures and results obtained by analysing forty seven ice core sections from GRIP deep ice core. The purpose and basic background of each article is presented in section 1.3 in order to make the ultimate objective of this thesis clear.

### 1.2 Field sampling

In 1990-92, the multinational European Greenland Ice-core Project (GRIP) drilled an ice core at Summit (72° 58'N, 37° 64'W, elevation of 3238m above sea level, annual mean air temperature -32°C) in central Greenland (Fig. 1). The 3028.8-m-long core was recovered by an electromechanical drill, which covered the past 250 kyr according to the time scale given from Dansgaard et al. [1993]. The author analysed for Pb, Cu, Zn, and Cd forty seven ice core sections which cover the Holocene period (< 10,000 years B.P.) and the last full glacial cycle (10,000 - 150,000 years B.P.). As many other investigations were conducted on the same core sections, only a limited part of the core cross section was available for this study (see Article I). Each core section is 55cm long

and thus the time span of the accumulation of ice ranges from three years for the shallow depth to about 200 years for the deep one. This allows us to obtain an average concentration value of more than one year of accumulation of ice in each core section for eliminating a possible influence of seasonal variation in concentration. The time scale used here was established by counting annual layers back to 14.5 kyr B.P. and beyond that by ice flow modelling [Johnsen et al., 1992; Dansgaard et al., 1993].

### 1.3 Presentation of each component

#### Article I : An improved method for decontaminating polar snow or ice cores for heavy metal analysis

The outside of core sections to be analysed is generally contaminated by various metals originating mainly from the wall retaining fluid when such a fluid is required to prevent the closing of the drilling hole at great depths. The first requisite procedure to obtain reliable data is, therefore, to decontaminate them by removing the outside contamination in order to get the clean central part of the core section.

After Ng and Patterson [1981] developed the revolutionary decontamination techniques which involved the mechanical chiselling of successive veneer layers from ice core samples instead of melting-washing method used by the previous investigators, their method was widely used and improved by several investigators [Boutron and Patterson, 1986; Boutron et al., 1990; Boutron et al., 1993]. However, this method was not fully satisfying, because the ice samples had to be hold with the operator's hands so that the blank contribution was still high for the low concentration level of

heavy metals measured. For instance, the blank contribution was found to account for up to 50-75% for the heavy metal contents present in the Holocene ancient ice of the Antarctic [Boutron and Patterson, 1986; Boutron et al., 1990; Boutron et al., 1993]. Taken into account that the Holocene natural level of various heavy metals to be measured from GRIP ice core was presumed to be down to sub pg/g, it was mandatory to improve the decontamination procedures for obtaining reliable data.

All the core sections analysed for this thesis were decontaminated using an improved method : the core sections were drilled while being hold horizontal in a polyethylene lathe inside a laminar flow clean bench in a cold room. The whole procedural blank including the chiselling procedure was determined by using an artificial ice core made by freezing ultraclean water whose heavy metals contents were known beforehand. It was found to amount to 0.015 pg/g for Cd, 0.11 pg/g for Pb, 0.2 pg/g for Zn and 0.25 pg/g for Cu, respectively, for inner core. The blank contribution accounted for about 30% for Pb and Cu, 10% for Cd and insignificant for Zn (for the lowest concentration value obtained in this work). The heavy metals concentrations presented in this thesis represent the values corrected for blank contribution derived from the whole analytical procedures.

When all the analytical procedures are completed, it is essential to determine the full outside-inside profiles in concentrations for each ice core section and each heavy metal. If a clean plateau of concentration is observed in the central part of the core, it suggests that the outside contamination has not penetrated to the central part of the core : the value obtained in the most inner part represents the original concentration of the investigated core section. On the contrary, if a continuous decrease of concentration is

observed from the outside towards the central parts, it can be considered that the very center of the core was contaminated by the penetration of the outside contamination : the value of the most central part of the core represents only an upper limit of the original concentration in the ice. The full outside-inside concentration profiles were determined for all the investigated core sections.

**Article II : Greenland ice evidence of hemispheric lead pollution two millennia ago by Greek and Roman civilizations**

As mentioned before, Patterson et al. [1970] proposed that as the Romans produced and used a large amount of lead comparable to that at the onset of the Industrial Revolution, they might have significantly polluted the atmosphere of the Northern Hemisphere for lead. According to his estimate of lead production rates during the Roman period [Patterson, 1972; Settle and Patterson, 1980], the peak output of lead production amounted to about 80,000 tonnes per year two millennia ago.

In fact, lead has been a focus of attention as a tracer of the anthropogenic pollution resulting from the ancient industrial activities, because lead is believed to be the first metal to be won from its ores [Gale and Stos-Gale, 1981] and to be used in widespread commercial applications in ancient times [Nriagu, 1983a]. In prehistoric times, most of lead was produced as a by-product of silver production. It was only during the Roman times that lead became a base metal to have been actively sought for and exploited on its own right [Nriagu, 1983b]. The quantity of lead mined and produced between about 200 B.C. and 500 A.D. amounts roughly to 18 million tonnes, which accounts for about 50% of all the lead produced in ancient times [Nriagu, 1983a]. Interestingly, it is

estimated that the production of lead during the Roman Empire amounted to about 540 g per person per year, while the present-day consumption of lead in the United States reaches about 5500 g per person per year [Nriagu, 1983b]. Such a wide use of lead in ancient times, in particular the Roman period, gave rise to lead poisoning which is one of the earliest occupational diseases contracted by mankind [Nriagu, 1983b]. Patterson et al. [1987] found that lead level prevailing in Rome was about 1000 fold above natural level in humans. Furthermore, Gilfillan [1965] even claimed that the chronic lead poisoning in the Roman upper class, which stemmed mainly from drinking lead-contaminated wine, was a factor in the fall of Rome.

As mentioned above, lead was a principal metal familiar to ancient people. Therefore it has been regarded as the first contributor in the large scale anthropogenic pollution of the atmosphere of the Northern Hemisphere. When Patterson et al. [1970] suggested a possibility of this Roman pollution for lead, the experimental procedures and techniques were not good enough to measure lead in the ice samples corresponding to the Roman times. Indeed a large volume of melted samples (~ 50 l) was required to measure very low concentration level of lead at that time. Thanks to the continuous development of analytical techniques and decontamination procedures, which reduced the required sample volume (~ 50 to 100 ml instead of ~ 50 l), it was possible to analyse Pb in twenty two sections of GRIP deep ice core covering the period from 3000 to 500 years ago (the Greek, Roman, Medieval, and Renaissance times) and 7760 years ago (the Holocene natural level). The results showed that the middle troposphere of the Northern Hemisphere was already polluted by Pb on a hemispheric scale two millennia ago, long before the Industrial Revolution.

**Article III : Lead isotope record in ancient Greenland ice from 6000 B.C. to A.D. 1500**  
: preliminary data

Lead has four stable isotopes,  $Pb^{204}$ ,  $Pb^{206}$ ,  $Pb^{207}$  and  $Pb^{208}$ , which are present in nature in average proportions of 1 : 17 : 15 : 37. The first one is non-radiogenic, while the latter three are the end products of radioactive decay chains :  $^{238}U$   $^{206}Pb$ ,  $^{235}U$   $^{207}Pb$  and  $^{232}Th$   $^{208}Pb$ . Isotopic abundances of lead can significantly vary in different ore bodies in association with the parent uranium-thorium concentrations in the mother rock, their decay rates and geochemical cycling processes [Kersten et al., 1992]. Therefore, a characteristic lead isotope composition occurs in each natural lead deposit. This allows us to assess the relative source contribution to lead present in the atmosphere. If major sources of the industrial lead have their own characteristic isotopic signatures, it is possible to identify whether the main contributor for lead is natural or anthropogenic in origin. Moreover, the dominant source regions from where lead originated could be identified, if the isotopic compositions of the potential source regions differ significantly. Using lead isotopes, many investigators tried to identify the source of lead aerosols present in various environments [Petit et al., 1984; Flegal et al., 1993; Rosman et al., 1993].

Aliquots taken for Pb isotope measurement were transported frozen to Curtin University (Perth, Australia) where the isotopic composition and concentration of lead has been measured by Thermal Ionization Mass Spectrometry (TIMS) and Isotope Dilution Mass Spectrometry (IDMS), respectively [Rosman et al., 1993,1994]. The isotopic signatures showed that the elevated Pb concentrations from 3000 to 500 years B.P. have resulted from the anthropogenic Pb aerosols emitted from the ancient Ag/Pb

mining and smelting activities mainly in Spain, Britain and Germany as a function of the ages.

**Article IV : A reconstruction of historical copper production and its relevance to copper emission to the atmosphere with ages**

An assessment of historical atmospheric pollution requires an understanding of the history of metal production and associated metallurgical technologies which are linked to the emissions of metal pollutant aerosols to the atmosphere during metal mining, smelting and refining processes. In contrast to lead [Patterson, 1972; Nriagu, 1983], until now, the historical production of copper was not available.

In this work, the worldwide production rates of copper have been reconstructed for the past 5000 years from a review of the available fragmentary documents. The temporal changes of emission rates of copper aerosols from copper industrial sources to the atmosphere have also been estimated. Much attention is paid to the Roman (250 B.C. - A.D. 350) and Chinese Sung Dynasty (960-1279 A.D.) period, during which copper mining and extraction activities were so intense that they may have caused the large-scale anthropogenic pollution in the atmosphere of the Northern Hemisphere, long before the Industrial Revolution.

It should be noted that the estimated figures presented in this work are quite uncertain and are thus expected to be improved by further archaeological evidence.

**Article V : Greater cumulative large scale atmospheric pollution of the Northern Hemisphere for copper before than after the Industrial Revolution**

It is not too much to say that the evolution of human history in antiquity commenced with the use of metals such as gold, silver, lead and copper for ornamentation and various rituals. Copper was first used from native copper in the Old World around 7000 B.C. and after the development of smelting technology around 5000 B.C., copper production was gradually increased as a result of the simple reduction smelting of copper carbonate and oxide ores (i.e., cuprite, malachite, azurite) in many parts of the Near East [Patterson, 1971; Darling, 1990]. The beginning of bronze industry indeed stimulated the massive use of copper for both military and civil purposes, and led to rapid growth of the ancient civilizations. From about 2500 B.C. copper was mined and produced on a significant scale by smelting sulfide ores (i.e., chalcocite, chalcopyrite, bornite, conellite). Thereafter, the quantity of copper produced in the world fluctuated greatly with a growth and decline of the powerful ancient empires.

When considering that the mining and smelting processes for copper production were very wasteful and uncontrolled in ancient times, one can presume that a considerable amount of Cu aerosols emitted may have polluted on a regional or even large scale the atmosphere of the Northern Hemisphere. Therefore, it is needed to reconstruct an historical trend in concentrations of Cu present in Greenland ice for understanding the extent of the ancient anthropogenic pollution in the atmosphere.

The record of copper concentration found in Greenland ice samples indicates that the ancient Cu mining and smelting activities were so intense that the atmosphere of the

Northern Hemisphere was contaminated on a significant scale from the Greek and Roman to Medieval times.

**Article VI : Deposition of atmospheric heavy metals to the Greenland ice sheet from the 1783-1784 volcanic eruption of Laki, Iceland**

One of the major natural sources of heavy metal emissions to the atmosphere is volcanoes. According to the global inventory of natural heavy metal emissions proposed by Nriagu [1989], volcanic inputs can be responsible (median values) for about 30% for Pb, 35% for Cu, 20% for Zn and 65% for Cd, respectively, of the total natural emission rates. However, the volcanic contributions can only be order of magnitude estimates, based on scattered emission rates measured in volcanic plumes. In fact, emission rates of heavy metals differ from volcano to volcano and vary even for various stages of eruption of volcanoes [Buat-Ménard, 1988]. Furthermore, the volcanic impacts on the natural atmospheric cycles of heavy metals tend to be sporadic, depending on the cataclytic eruptions of volcanoes.

In order to properly evaluate volcanic contributions to the global atmospheric burden of heavy metals, it is necessary to investigate volcanic layers recorded in the polar ice sheets. Until now, no data on the volcanic contribution is available for the Greenland ice sheet.

Greenland ice from the 70.3-m-long Eurocore drilled at Summit, central Greenland, was chosen to investigate heavy metals contributed from the known volcano. The ice core section selected was found to contain the great 1783-1784 Laki eruption fallout

layer. In this ice layer, the well-defined volcanic heavy metals contribution is observed and thus discussed.

**Article VII : Changing occurrences of the heavy metals (Pb, Cu, Cd, Zn) in central Greenland ice deposited during the Holocene**

From the measurement of Pb and Cu in various core sections, it was revealed that man began to pollute on a hemispheric scale the atmosphere of the Northern Hemisphere two millennia ago, long before the Industrial Revolution. This indicates that the input strength of anthropogenic contaminants to the Arctic atmosphere became comparable to that from the natural sources. A proper assessment of the contribution from various natural sources such as the crustal particles, volcanoes, seasalt spray, biomass burning, and biogenic emissions, offers an opportunity to have a general picture on the historical change of the atmospheric cycles of heavy metals in the Northern Hemisphere.

The estimates of natural contributions have still remained uncertain because of variable emission rates from natural sources proposed in various studies [Nriagu, 1989]. Another reason is that there are few comprehensive investigations of the relative strengths of the different natural sources. Also there have been no reliable investigations of atmospheric heavy metals present in frozen archives of Greenland ice.

In this work, the natural input of heavy metals to Greenland during the Holocene is assessed in detail using the available data (Al, Na,  $\text{SO}_4^{2-}$ ,  $\text{NH}_4^+$ ). Also presented is the

first reliable time series of Zn and Cd documented in Greenland ice deposited from 8000 years ago onwards.

**Article VIII : Changes in natural lead, copper, zinc and cadmium concentrations in central Greenland ice from 8000 to 150,000 years B.P. - its association with climatic changes and resultant variation of dominant source contribution**

The first comprehensive time series of Pb, Cu, Zn and Cd are obtained in this work for the last full glacial period by the analysis of twenty four sections. The ages of the samples analysed cover the major climatic stages such as the next to last glacial age known as the Saale, the last interglacial age (Eemian), several stadial and interstadial ages during the last glaciation and the last deglaciation to Holocene transition period.

The concentration level of heavy metals determined is found to strongly fluctuate by a factor of about 320 for Pb, 100 for Cu, 36 for Zn and 13 for Cd, respectively. This evidences that the input strength of these metals into the high-latitude troposphere had been regulated in response to the changes of the large-scale atmospheric circulation and the areal extent of the source regions, as like that of the terrestrial and marine aerosol contents recorded at the same site [Mayewski et al., 1994]. From the measurement of various subsidiary elements (Al, Ca, Na,  $\text{SO}_4^{2-}$ ,  $\text{NH}_4^+$ ), the well-defined relationships between each individual heavy metal and subsidiary elements are observed and thus allow us to evaluate the relative strength of different source contributions linked to the climatic conditions. A remarkable variation of the major source contribution to each heavy metal is well documented in the samples corresponding to the preboreal to

Holocene transition period (12,000 - 8000 years B.P.). Taking into account the changes of Cd/Al and Zn/Al ratios determined, it is proposed that the continental biogenic emissions may have become the principal contributor for Cd and to a lesser extent for Zn aerosols contained in the Arctic troposphere during the given time period, which had resulted from the retreat of the massive land-ice sheet and the following northward expansion of vegetation area.

## REFERENCES

- Appelquist, H., K.O. Jensen, T. Sevel and C. Hammer, Mercury in the Greenland ice sheet, *Nature*, 273, 657-659, 1978.
- Batifol, F., C.F. Boutron and M. De Angelis, Changes in copper, zinc and cadmium concentrations in Antarctic ice during the past 40,000 years, *Nature*, 377, 544-546, 1989.
- Boutron, C.F., Historical reconstruction of the earth's past atmospheric environment from Greenland and Antarctic snow and ice cores, *Environ. Rev.*, 3, 1-28, 1995.
- Boutron, C.F. and C.C. Patterson, Lead concentration changes in Antarctic ice during the Wisconsin/Holocene transition, *Nature*, 323, 222-225, 1986.
- Boutron, C.F., C.C. Patterson and N.I. Barkov, The occurrence of zinc in Antarctic ancient ice and recent snow, *Earth Planet. Sci. Lett.*, 101, 248-259, 1990.
- Boutron, C.F., J.P. Candelone and S. Hong, Greenland snow and ice cores : unique archives of the large scale pollution of the troposphere of the Northern Hemisphere for lead and other heavy metals, *Sci. Total Environ.*, 160, 233-241, 1995.
- Boutron, C.F., C.C. Patterson, V.N. Petrov and N.I. Barkov, Preliminary data on changes of lead concentrations in Antarctic ice from 155,000 to 26,000 years B.P., *Atmos. Environ.*, 21, 1197-1202, 1987.
- Boutron, C.F., U. Görlach, J.P. Candelone, M.A. Bolshov and R.J. Delmas, Decrease in anthropogenic lead, cadmium and zinc in Greenland snows since the late 1960s, *Nature*, 353, 153-156, 1991.

- Boutron, C.F., S.N. Rudniev, M.A. Bolshov, V.G. Koloshnikov, C.C. Patterson and N.I. Barkov, Changes in cadmium concentrations in Antarctic ice and snow during the past 155,000 years, *Earth Planet. Sci. Lett.*, 117, 431-441, 1993.
- Buat-Ménard, P., Global source strength and long-range atmospheric transport of trace elements emitted by volcanic activities, in : *The Long-Range Atmospheric Transport of Natural and Contaminant Substances (NATO ASI Ser. Vol. C 297)*, edited by A.H. Knap, pp. 163-175, Kluwer, Dordrecht, 1990.
- Candelone, J.P., S. Hong, C. Pellone and C.F. Boutron, Post industrial revolution changes in large scale atmospheric pollution of the Northern Hemisphere by heavy metals as documented in central Greenland snow and ice, *J. Geophys. Res.*, in press.
- Carr, R.A. and P.E. Wilkiss, Mercury in the Greenland ice sheet : further data, *Science*, 181, 843-844, 1973.
- Dansgaard, W., S.I. Johnsen, H.B. Clausen, D. Dahl-Jensen, N.S. Gundestrup, C.U. Hammer, C.S. Hvidberg, J.P. Steffensen, A.E. Sveinbjörnsdottir, J. Jouzel and G. Bond, Evidence for general instability of past climate from a 250-kyr ice-core record, *Nature*, 364, 218-220, 1993.
- Darling, A.S., Non-ferrous metals, in : *An Encyclopaedia of the History of Technology*, pp. 45-145, Routledge, London, 1990.
- Flegal, A.R., H. Maring and S. Niemeier, Anthropogenic lead in Antarctic sea water, *Nature*, 365, 242-244, 1993.
- Gale, N.H. and Z. Stos-Gale, Lead and silver in the ancient Aegean, *Sci. Amer.*, 244, 176-192, 1981.
- Gilfillan, S.C., Lead poisoning and the fall of Rome, *J. Occup. Med.*, 7, 53-60, 1965.

- Herron, M.M., C.C. Langway, Jr., H.V. Weiss and J.H. Cragin, Atmospheric trace metals and sulfate in the Greenland ice sheet, *Geochim. Cosmochim. Acta*, 41, 915-920, 1977.
- Johnsen, S.J., H.B. Clausen, W. Dansgaard, K. Fuhrer, N. Gundestrup, C.U. Hammer, P. Iversen, J. Jouzel, B. Stauffer and J.P. Steffensen, Irregular glacial interstadials recorded in a new Greenland ice core, *Nature*, 359, 311-313, 1992.
- Kersten, M., U. Förstner, P. Krause, M. Kriews, W. Dannecker, C.D. Garbe-Schönberg, M. Höck, U. Terzenbach and H. Graß, Pollution source reconnaissance using stable isotope ratios ( $^{206/207}\text{Pb}$ ), in: *Impact of Heavy Metals on the Environment*, edited by J.-P. Vernet, pp. 311-324, Elsevier, Amsterdam, 1992.
- Mayewski, P.A., L.D. Meeker, S. Whitlow, M.S. Twickler, M.C. Morrison, P. Bloomfield, G.C. Bond, R.B. Alley, A.J. Gow, P.M. Grootes, D.A. Meese, M. Ram, K.C. Taylor and W. Wumkes, Changes in atmospheric circulation and ocean ice cover over the North Atlantic during the last 41,000 years, *Science*, 263, 1747-1751, 1994.
- Murozumi, M., T.J. Chow and C.C. Patterson, Chemical concentrations of pollutant lead aerosols, terrestrial dusts and sea salts in Greenland and Antarctic snow strata, *Geochim. Cosmochim. Acta*, 33, 1247-1294, 1969.
- Ng, A. and C.C. Patterson, Natural concentrations of lead in ancient Arctic and Antarctic ice, *Geochim. Cosmochim. Acta*, 45, 2109-2121, 1981.
- Nriagu, J.O., *Lead and lead poisoning in antiquity*, Wiley, New York, 1983a.
- Nriagu, J.O., Occupational exposure to lead in ancient times, *Sci. Total Environ.*, 31, 105-116, 1983b.

- Nriagu, J.O., A global assessment of natural sources of atmospheric trace metals, *Nature*, 338, 47-49, 1989.
- Nriagu, J.O., Global metal pollution poisoning the biosphere?, *Environment*, 32, 7-33, 1990.
- Patterson, C.C., Native copper, silver, and gold accessible to early metallurgists, *Am. Antiq.*, 36, 286-321, 1971.
- Patterson, C.C., Silver stocks and losses in ancient and medieval times, *Eco. Hist. Rev.* 2nd Ser., 25, 205-235, 1972.
- Patterson, C.C., T.J. Chow and M. Murozumi, The possibility of measuring variations in the intensity of worldwide lead smelting during medieval and ancient times using lead aerosol deposits in polar snow strata, in: *Scientific Methods in Medieval Archaeology*, edited by R. Berger, pp. 339-350, University of California, Berkeley, 1970.
- Patterson, C.C., H. Shirahata and J.E. Ericson, Lead in ancient human bones and its relevance to historical developments of social problems with lead, *Sci. Total Environ.*, 61, 167-200, 1987.
- Petit, D., J.P. Mennessier and L. Lamberts, Stable lead isotopes in pond sediments as tracer of past and present atmospheric lead pollution in Belgium, *Atmos. Environ.*, 18, 1189-1193, 1984.
- Rosman, K.J.R., W. Chisholm, C.F. Boutron, J.P. Candelone and U. Görlach, Isotopic evidence for the source of lead in Greenland snows since the late 1960s, *Nature*, 362, 333-334, 1993.
- Rosman, K.J.R., W. Chisholm, C.F. Boutron, J.P. Candelone and S. Hong, Isotopic evidence to account for changes in the concentration of lead in Greenland snow between 1960 and 1988, *Geochim. Cosmochim. Acta*, 58, 3265-3269, 1994.



- Savarino, J., C.F. Boutron and J.L. Jaffrezo, Short-term variations of Pb, Cd, Zn and Cu in recent Greenland snow, *Atmos. Environ.*, 28, 1731-1737, 1994.
- Settle, D.M. and C.C. Patterson, Lead in albacore : guide to lead pollution in Americans, *Science*, 207, 1167-1176, 1980.
- Vandal, G.M., W.F. Fitzgerald, C.F. Boutron and J.P. Candelone, Variation in mercury deposition to Antarctic over the past 34,000 years, *Nature*, 362, 621-623, 1993.
- Weiss, H.V., M. Koide and E.D. Goldberg, Mercury in the Greenland ice sheet : evidence of recent input by man, *Science*, 174, 692-694, 1971a.
- Weiss, H.V., M. Koide and E.D. Goldberg, Selenium and sulfur in a Greenland ice sheet : relation to fossil fuel combustion, *Science*, 172, 261-263, 1971b.
- Weiss, H.V., K. Bertine, M. Koide and E.D. Goldberg, The chemical composition of a Greenland glacier, *Geochim. Cosmochim. Acta*, 39, 1-10, 1975.
- Wolff, E.W. and D.A. Peel, The record of global pollution in polar snow and ice, *Nature*, 313, 535-540, 1985.
- Wolff, E.W. and D.A. Peel, Concentrations of cadmium, copper, lead and zinc in snow from near Dye 3 in south Greenland, *Ann. Glaciol.*, 10, 193-197, 1988.

AN IMPROVED METHOD FOR DECONTAMINATING POLAR SNOW OR ICE  
CORES FOR HEAVY METAL ANALYSIS

Jean-Pierre CANDELONE<sup>1</sup>, Sungmin HONG<sup>1</sup> and Claude F. BOUTRON<sup>1,2\*</sup>

<sup>1</sup> *Laboratoire de Glaciologie et Géophysique de l'Environnement du CNRS, 54, rue Molière, Domaine Universitaire, B.P. 96, 38402 St Martin d'Hères (France)*

<sup>2</sup> *UFR de Mécanique, Université Joseph Fourier de Grenoble, Domaine Universitaire, B.P. 68, 38041 Grenoble, France*

\* *Author to whom correspondence and reprints requests should be addressed*

*Phone : (33) 76 82 42 00 - Fax : (33) 76 82 42 01*

published in "Analytica Chimica Acta", 299, 1994.

**ABSTRACT**

An improved method has been developed for the decontamination of Greenland and Antarctic snow or ice cores for heavy metal analysis. The investigated core sections are chiselled while being held horizontal in a polyethylene lathe inside a laminar flow clean bench in a cold room. Each veneer layer and the final inner core are then analysed for Pb, Cd, Zn and Cu by Graphite Furnace Atomic Absorption Spectrometry in clean room conditions.

The procedural blank was found to range from 0.015 pg/g for Cd up to 0.25 pg/g for Cu. The quality of the decontamination was checked by studying changes in heavy metals concentrations from the outside to the center of each core section. In most cases, good plateaus of concentrations were observed in the central parts, then indicating that contamination present on the outside of the cores was not transferred to these central parts. Various Greenland and Antarctic cores were decontaminated, giving new insights into the past and recent occurrence of heavy metals in the atmosphere of both hemispheres.

**KEY WORDS** : heavy metals, lead, cadmium, zinc, copper, snow, ice, Greenland, Antarctica, global pollution

**1. INTRODUCTION**

The successive well preserved snow and ice layers deposited in the large Antarctic and Greenland ice sheets are unique archives of the past and recent changes in the atmospheric concentrations of heavy metals. Deciphering these archives for heavy metals has unfortunately proved to be very difficult mainly because the concentrations to be measured are extremely low, down to the sub pg/g level.

A key point to obtain reliable data is in the cleanliness of the available samples. For near surface snow, clean samples can be obtained from the walls of clean hand dug pits [1, 2] or trenches [3], or by using specially designed clean augers [4]. But deeper layers can only be reached by using large size electromechanical [5] or thermal [6] drills. Such drills provide us with snow/ice cores whose diameters range from about 3 to 5 inches (7.5 to 13 cm), the most frequent diameter being 4 inches (10.2 cm).

A major problem is that the cores are always more or less contaminated on their outside. This contamination originates from various contributions. The main one is the wall retaining fluid (amongst the fluid used are kerosene and freon [7] and n butyl acetate [8]) when such a fluid is required to prevent the closing of the drilling hole at great depths. But other contributions can also originate from the body of the drill, the cable and the handling, packing and storage of the core.

To obtain reliable heavy metals data from such cores, it is therefore essential to be able to decontaminate them by removing the outside contamination without transferring it to the most central parts and to check the efficiency of the procedure.

Although this problem has already been tackled by a few investigators [9-12], none of them has until now developed a fully satisfying method, i.e. a method which is ultraclean, suitable both for snow or ice cores, not too much time consuming and which allows to check the efficiency of the procedure.

We present here an improved ultraclean mechanical decontamination procedure for snow or ice cores. It has been successfully used for the decontamination of various sections of several snow and ice cores from Greenland and Antarctica.

## 2. EXPERIMENTAL

The experimental procedure requires two operators. It consists in chiselling successive layers of snow or ice from the outside to the central part of the core using ultraclean stainless steel chisels. The core is kept horizontal, its extremities tightly secured in Low Density Polyethylene (LDPE) tumblers.

### 2.1. Laminar flow clean bench in a cold room

The whole decontamination procedure takes place in a laminar flow clean bench located inside a cold room at - 15°C. The inside of the bench is entirely made out of plastics. Moreover, the working area is covered with a thin LDPE film which is changed regularly. The bench is fitted with a special High Efficiency Particulate Air (HEPA) filter (99.999 % efficiency at 0.5 µm) with particulate board frames and plastic separators. It has no rubber or polyurethane compressible gasket : the seal between the HEPA filter frame and the ceiling of the bench is made with silicone

cement [13]. The operators wear full clean room garb over their warm clothing. Over their isothermic gloves, they also wear shoulder length LDPE gloves and wrist length LDPE gloves over these. These last gloves are changed as often as required.

### 2.2. Polyethylene lathe

A major improvement is the fact that during the chiselling, the core is not held with the hands of the operator and is not laying on any working surface. Instead, it remains horizontal about 20 cm above the plastic working surface as its extremities are pinched in two LDPE tumblers (Fig. 1). The lathe is designed so that it can be used in order to decontaminate snow or ice cores whose lengths range from 25 to 65 cm. Also, it is suitable not only for cylindrical cores with full section but also for cores for which only part of the cross section is available. This last situation occurs frequently for ice cores obtained as part of international programmes : a given core section is indeed cut into several parts used for different kinds of measurements (Fig. 2). At both extremities, the core is fastened in the tumblers using 3 to 6 home made LDPE screws which are screwed, perpendiculary to the axis of the core, through threaded holes made in the lateral side of the tumblers, Fig. 1. Depending on the available cross section, several sets of screws of different lengths can be used.

### 2.3. Chisels

It would have been preferable to make the chisels out of plastics such as LDPE, Fluorinated Ethylene Propylene (FEP) or Perfluoroalkoxy (PFA) Teflon. Unfortunately, such plastics are too soft for high density snow and for ice. Therefore, the chisels chosen are similar to those used by Ng and

Patterson [9] and Boutron and Patterson [10, 11], Fig. 3. They are made out of a single piece of 2 mm thick plate of stainless steel (ref 316 L). The cutting edge is 3 cm wide and 4 cm long. It is sharpened to a single acute bevel with an angle of 30°.

Before use, the chisels, cleaned as described in 2.5, are kept horizontal inside a LDPE box, each of them fitted separately in a display rack which prevents any contact between the chisels and allows the cutting edges not to touch the walls of the box.

#### 2.4. Description of the procedure

The core section to be decontaminated is taken out from the LDPE bag inside which it was transported frozen from Antarctica or Greenland back to France. After changing their outer wrist-length LDPE gloves, the two operators introduce the core inside the laminar flow clean bench and put it in the lathe (Fig. 1). The core is then firmly secured between the two tumblers with the LDPE screws, Fig. 1.

A first veneer layer 5 to 10 mm thick is then chiselled as follows. A shallow chord shaving is first made from one end of the core to the other parallel to its axis, the snow or ice chips being allowed to fall directly into a specially designed LDPE tray held by the second investigator. Using the crank, the cut is rotated upward about 30° and another shallow chord shaving is made. The procedure is then repeated until the whole exposed outside surface has been chiselled. The chips obtained from this first layer are then transferred from the tray into an ultraclean 1 L wide mouth LDPE bottle and kept frozen until analysis.

The operators then put on new fresh pairs of LDPE gloves and a second layer is chiselled using another chisel and a new fresh tray. Depending on the initial cross section of the core, this procedure is repeated up to 4 times then giving a maximum of 4 successive layers from the outside towards the center.

The remaining inner core (whose diameter ranges from 2 to 4.5 cm) is then recovered as follows : the first operator holds it firmly with all LDPE home made tongs while the other operator breaks the right end with the last chisel. The right hand pillar of the lathe (part 4 in Fig. 1) is then moved away. An ultraclean [13] 1 L wide mouth LDPE bottle is pushed onto the inner core until about half of it is introduced into the bottle. The inner core is broken in its middle with the chisel and its second half is introduced into a second 1 L bottle. Then the left edge of the inner core is broken with the chisel.

The bottles containing the chips from the successive veneer layers and the two parts of the inner core are then packed into double sealed acid cleaned LDPE bags and brought to the main clean laboratory at 20°C [13].

#### 2.5. Cleaning procedures

They are similar to those described in full details elsewhere [13]. For the various small size items such as the tumblers, the screws, the trays and the 1 L bottles, the initial cleaning before the first use involved degreasing with  $\text{CHCl}_3$ , then soaking 1 month in a first acid bath at 50°C (25% Merck "Suprapur"  $\text{HNO}_3$  diluted in ultrapure water [13]), 1 month in a second acid bath at 50°C (0.1%

ultrapure  $\text{HNO}_3$  from US National Institute of Standards and Technology (NIST) [14] diluted in ultrapure water [13]), and finally 1 month in a third 0.1% ultrapure NIST  $\text{HNO}_3$  bath at 50°C. Transfers from one bath to the next one are made using home made LDPE tongs.

The cleaning between each core decontamination is similar except that soaking is for only 2 hours in the first bath and for 3 days in the other ones.

For the very large size items such as the basement of the lathe, a simplified procedure was used. It however also involved extensive cleaning with  $\text{HNO}_3$ .

Finally, the cleaning procedure for the chisels involved degreasing with ether, then overnight soaking in 60%  $\text{HNO}_3$  bath (Merck "Suprapur" diluted in purest water) and finally soaking in a series of two 0.1% NIST  $\text{HNO}_3$  baths for one week (for the initial cleaning, immersions were for a much longer time period).

## 2.6. Analytical procedures

Inside the clean laboratory [13], each veneer layer and the inner core are melted separately in the 1 L wide mouth LDPE bottle in which they were kept. Various aliquots are then taken in 15 ml or 60 ml ultraclean [13] LDPE bottles. A 5 ml aliquot is first taken for the direct measurement of Zn, Al and Na by Graphite Furnace Atomic Absorption Spectrometry (GFAAS) without preconcentration using a Perkin Elmer 2380 spectrometer and HGA 500 graphite furnace (pyrolitically coated

graphite tubes) [15]. A 50 ml aliquot is then taken for the determination of Pb, Cd and Cu by GFAAS after preconcentration ( $\times 50$ ) by non boiling evaporation [15].

If necessary, additional aliquots are also made for subsequent analysis of Pb isotopes [16], organo Pb compounds [17], Hg [18] and Bi [19, 20]. These last measurements will not be discussed in the present paper.

## 3. RESULTS AND DISCUSSION

### 3.1. Determination of the procedural blank

Such determination is essential to obtain fully reliable data. The procedural blank was determined by processing an artificial ice core made out by freezing ultrapure water [13] whose composition, Table 1, was known beforehand. This core was prepared by freezing 2 L of ultrapure water inside a 2 L LDPE ultraclean bottle. The inside diameter of the bottle was about 11.2 cm, then allowing to prepare an artificial ice core whose diameter was similar to that of real Greenland or Antarctic cores.

The bottle was cut using an acid cleaned stainless steel scalpel and the artificial ice core (length about 20 cm) so obtained was chiselled using exactly the same procedure as previously described in 2.4. Three layers were chiselled before getting the final inner core. Each layer and the inner core were analysed separately.

As shown in Table 1, heavy metals concentrations are found to be slightly higher in the last veneer layer and in the inner core than in the reference water used to prepare the core. The differences so observed, listed in Table 2, represent the procedural blank. This procedural blank will then be used for the correction of all the values obtained for Greenland and Antarctic real cores. For the inner core, the blank values are found to range from 0.015 pg/g for Cd up to 0.25 pg/g for Cu (these values include the blank of the non boiling evaporation procedure, which represents a rather small contribution to the total blank). For recent Greenland snow cores in which the concentrations are relatively high due to very significant anthropogenic contribution, this procedure blank contribution is extremely small, it represents less than a few percents of the measured concentrations. For ancient Greenland or Antarctic ice, on the other hand, it can be very significant (up to about 30% for Cu, 25% for Pb, and 10% for Cd and for Zn) since heavy metals concentrations in such ancient ice are much lower.

It is interesting to mention that the concentrations measured in the veneer layers are significantly higher for all four metals than those observed in the inner core, Table 2. This was expected since the veneer layers are subject to more handling than the inner core : the contact with the chisel is much more extensive ; the chips do contact the inner tray ; and they are also exposed to the air flow in the clean bench for a much longer time.

The precision of these procedural blanks is difficult to assess, since the artificial core chiselling experiment was done only once because it is very time consuming. It is however interesting to mention that the concentrations measured in the 2nd and 3rd veneer layers of the artificial core were very similar, then suggesting that the precision on the blanks is probably rather good (concentrations measured in the 1st layer were on the other hand found to be significantly higher

because of the handling of the core prior to its chiselling).

It is important to emphasize that this artificial core was ice, not snow. We have however used the blank values for Greenland and Antarctic snow cores. It would indeed be extremely difficult to prepare an artificial snow core of known composition. Moreover, it is our feeling that the blank contributions for such a snow core would not be significantly different. If this is not the case, however, it is expected that the blank for the ice might rather be an upper limit of the blank for the snow : this would result into a slight over correction of the snow core data.

### 3.2. Outside - inside concentration profiles

For each decontaminated core section and each investigated heavy metal, it is essential to study in full details changes in the concentrations from the outside to the inner part of the core. If a clear plateau of concentration is observed in at least two consecutive layers in the central part of the core, it shows that contamination present on the outside has not penetrated to the central part of the core : the plateau value then represents the original concentration in the Antarctic or Greenland snow or ice. If, on the other hand, a continuous decrease of concentration is observed towards the center, it evidences that outside contamination has penetrated to the very center of the core : the concentration measured in the inner part will only represent an upper limit of the real concentration in the original snow or ice.

Very contrasting situations have been obtained for the different snow or ice cores which we have decontaminated in this work. Typical outside - inside profiles are discussed in the following sections.

### 3.3. Shallow electromechanical snow core from central Greenland

In July 1989, a 70.3 m long snow core covering the years 1772 - 1989 has been drilled at Summit (72° 58'N, 37° 64'W elevation 3,238 m a.s.l., mean annual temperature -32°C) in central Greenland as part of the european "Eurocore" programme. It was obtained using a 4 inches in diameter electromechanical drill [21]. Such a drill is known to bring significant contamination on the outside of the core sections mainly because of the contact with the knives (2% C and 11.5% Cr steel) and the framework (stainless steel with Teflon coating) of the drill, and the contact of the galvanized steel cable with the walls of the drilling hole. Concentrations measured in the outermost layer of the core sections were indeed found to range from 10 to 100 pg/g for Cd, 100 to 500 pg/g for Pb and Cu, and 1000 to 5000 pg/g for Zn. It must however be emphasized that these values are for the first 1 cm or so from the outside of the core : the actual contamination present on the very outside of the core was then probably much higher. Also, it is interesting to notice that it is for Zn that the contamination is the most pronounced. This suggests that the cable does contribute a significant fraction of the contamination.

Typical outside - inside concentration profiles are shown in Figs. 4, 5 and 6. In most cases, good plateaus of concentrations are obtained as illustrated in Fig. 4 for Pb in the 70 m section and for Cu in the 21.5 m section. This is also the case for the two profiles shown in Fig. 5 : for these last two profiles the slight difference observed between the inner core and the next to last layer is indeed within the experimental errors. The fact that good plateaus were observed in most cases was not easy to foretell. It was indeed to be feared that outside contamination could penetrate deeply into such porous snow, which was finally not the case.

In a few cases however, we observed a continuous decrease of concentrations from the outside to the very center of the core as illustrated in Fig. 6 for Zn and Cu in the 52 m section. For these last cases, the concentrations obtained in the inner core must then be considered as upper limits of the original concentrations in the snow. The actual reasons for these few cases are not known, they could however be linked to difficulties encountered in the field during drilling operations and/or core handling.

Fig. 7 shows changes in the concentrations of Zn and Cd measured in the inner core as a function of the age of the snow from 1773 to 1965. It can be seen that the concentrations of these two metals have significantly increased from the 1770's, i.e the Industrial Revolution period, to the 1960's. The increase factor is about 5 for Cd and Zn [22]. The causes for these increases are discussed in full details elsewhere [22]. They are linked to the increasing emissions of these two metals to the atmosphere of the Northern Hemisphere by human activities during this period (fossil fuels burning, mining, non ferrous metal industry and refuse incineration [23, 24]).

### 3.4. Deep electromechanical ice core from central Greenland

At the same location in central Greenland, a 3,028.8 m long ice core was recovered by electromechanical drilling in 1990 - 1992 as part of the joint european Greenland Ice Core Project ("GRIP"). This core covers the last 250,000 years [5].

The electromechanical drill is described in details in Ref. [25]. Because the depth to be reached was very important, the drilling hole was filled with a wall retaining fluid. The main constituent of the

fluid was kerosene. We have decontaminated various sections of this deep ice core. Because many other programmes of investigations were conducted on the same core sections, only a limited part of the core cross section (see Fig. 2 b, c) was available.

Significant contamination was found to be present in the outermost layer of the sections. This contamination probably originates at least partially from the fluid. Good plateaus of concentrations were however obtained in most cases as illustrated in Fig. 8 for Pb in the 1,286 m section (age : 7,760 years BP) and for Zn in the same section. This evidences that the ice acted as a good barrier against transfer of contamination from the outside towards the center of the core, at least for the investigated core sections which were chosen because no visible cracks were seen in them.

Pb concentration, 0.55 pg/g, measured in the inner core of the 1,286 m core section represents the natural concentration level of Pb in Greenland ice before the Greco-Roman times when man started to significantly contaminate the atmosphere of the Northern Hemisphere because of silver-lead mining and smelting [26, 27]. As discussed in [27], it mainly originated from rock and soil dust.

### 3.5. Deep thermal ice core from central Antarctica

In 1977, 1978 a 905 m ice core was thermally drilled at Dome C (77° 39'S, 124° 10'E ; elevation 3,240 m a.s.l. ; mean annual temperature : - 53.5°C) as part of a french-american cooperation. It was thermally drilled in a dry hole which was not filled with a wall retaining fluid [28]. This core covers the past 40,000 years [29] i.e. the whole Holocene interglacial period (the past 10,000 years or so) and part of the last Ice Age. Fig. 9 displays the variations of Pb and Cd concentrations from the outside to the center of the 515 m core section (age : 14,500 years BP). Despite the fact that the

core was obtained in a dry hole without fluid, pronounced contamination is present on the outside of the section. This contamination is found to have significantly penetrated to the second layer. Fortunately, a good plateau of concentration is obtained beyond this second layer, Fig. 9.

Pb and Cd concentrations observed in the central part of this core section, 7.8 pg/g and 0.5 pg/g, respectively, are typical for Antarctic ice from the Last Glacial Maximum (LGM) i.e the very cold terminal stage of the last Ice Age. They are mainly originating from soil and rock dust : the atmospheric cycles of these two metals were indeed dominated by rock and soil dust during the LGM when the climatic conditions led to increased aridity, stronger winds and enhanced meridional circulations [11, 30].

### ACKNOWLEDGEMENTS

This work was supported by the French Ministry of the Environment (Grant nb 92295), the Institut National des Sciences de l'Univers and the University of Grenoble. The Greenland samples were collected as part of the Eurocore and GRIP programmes which were funded by the Commission of European Communities and national funding agencies and organizations in Belgium, Denmark, France, Germany, Iceland, Italy, Switzerland and the United Kingdom. The Antarctic samples were collected as part of a french - american collaboration which was funded by the Expéditions Polaires Françaises, the Terres Australes et Antarctiques Françaises and the Division of Polar Programmes of the US National Science Foundation. We thank C. Rado, R.J. Delmas and F. Maupetit for their participation in the Eurocore field sampling.



## REFERENCES

1. E.W. Wolff and E.D. Suttie, *Geophys. Res. Lett.* **21** (1994) 781.
2. E.D. Suttie and E.W. Wolff, *Tellus* **44B** (1992) 351.
3. M. Murozumi, T.J. Chow and C.C. Patterson, *Geochim. Cosmochim. Acta* **33** (1969) 1247.
4. C.F. Boutron, U. Görlach, J.P. Candelone, M.A. Bolshov, R.J. Delmas, *Nature* **353** (1991) 153.
5. W. Dansgaard, S.J. Johnsen, H.B. Clausen, D. Dahl-Jensen, N.S. Gundestrup, C.U. Hammer, C.S. Hvidberg, J.P. Steffensen, A.E. Sveinbjörnsdottir, J. Jouzel and G. Bond, *Nature* **364** (1993) 218.
6. J. Jouzel, C. Lorius, J.R. Petit, C. Genthon, N.I. Barkov, V.M. Kotlyakov and V.N. Petrov, *Nature* **329** (1987) 403.
7. B.B. Kudryashov, V.K. Chistyakov, V.M. Pashkevich and V.N. Petrov in G. Holdsworth, K.C. Kuivinen and J.H. Rand (Eds.), *Proceedings of the Second International Symposium on Ice Drilling Technology, Calgary, Canada, 30 - 31 August 1982, US Army Cold Regions Research and Engineering Laboratory, Special Report 84 - 34, Hanover, New Hampshire* (1984) 137.
8. T.A. Gosink, J.T. Kelley, B.R. Koci, T.W. Burton and M.A. Tumeo, *J. Glaciol.* **37** (1991) 170.
9. A. Ng and C.C. Patterson, *Geochim. Cosmochim. Acta* **45** (1981) 2109.
10. C.F. Boutron and C.C. Patterson, *Geochim. Cosmochim. Acta* **47** (1983) 1355.
11. C.F. Boutron and C.C. Patterson, *Nature* **323** (1986) 222.
12. E.W. Wolff and D.A. Peel, *Ann. Glaciol.* **7** (1985) 61.
13. C.F. Boutron, *Fresenius Z. Anal. Chem.* **337** (1990) 482.
14. P.J. Paulsen, E.S. Beary, D.S. Bushee and J.R. Moody, *Anal. Chem.* **60** (1988) 971.
15. U. Görlach and C.F. Boutron, *Anal. Chim. Acta* **236** (1990) 391.
16. K.J.R. Rosman, W. Chisholm, C.F. Boutron, J.P. Candelone, U. Görlach, *Nature* **362** (1993) 333.
17. R. Lobinski, C.F. Boutron, J.P. Candelone, S. Hong, J. Szpunar-Lobinska and F.C. Adams, *Anal. Chem.* **65** (1993) 2510.
18. G.M. Vandal, W.F. Fitzgerald, C.F. Boutron and J.P. Candelone, *Nature* **362** (1993) 621.
19. M.A. Bolshov, S.N. Rudniev, J.P. Candelone, S. Hong, C.F. Boutron, *Spectrochim. Acta B*, in press.
20. J.P. Candelone, M.A. Bolshov, S.N. Rudniev, S. Hong and C.F. Boutron, *J. Phys.*, **C4** (1994) 661.
21. F. Gillet, D. Donnou, C. Girard, A. Manouvrier, C. Rado and G. Ricou, in G. Holdsworth, K.C. Kuivinen and J.H. Rand (Eds.), *Proceedings of the Second International Symposium on Ice Drilling Technology, Calgary, Canada, 30 - 31 August 1982, US Army Cold Regions Research and Engineering Laboratory, Special Report 84 - 34, Hanover, New Hampshire* (1984) 73.
22. J.P. Candelone, S. Hong, C.F. Boutron, *Nature*, submitted.
23. J.O. Nriagu, *Nature* **209** (1979) 409.
24. J.O. Nriagu and J.M. Pacyna, *Nature* **323** (1988) 134.
25. N.S. Gundestrup and S.J. Johnsen in C.C. Langway Jr., H. Oeschger and W. Dansgaard (Eds), *Greenland Ice Cores : Geophysics, Geochemistry and the Environment*, Geophysical Monograph (American Geophysical Union) **33** (1985) 19.
26. C.C. Patterson and D.M. Settle, *Science* **207** (1980) 1167.
27. S. Hong, J.P. Candelone, C.C. Patterson and C.F. Boutron, *Science*, submitted.

28. C. Lorius, L. Merlivat, J. Jouzel and M. Pourchet, *Nature* **280** (1979) 644.
29. J. Jouzel, G. Raisbeck, J.P. Benoist, F. Yiou, C. Lorius, D. Raynaud, J.R. Petit, N.I. Barkov, Y.S. Korotkevich and V.M. Kotlyakov, *Quat. Res.* **31** (1989) 135.
30. C.F. Boutron, S.N. Rudniev, M.A. Bolshov, V.G. Koloshnikov, C.C. Patterson and N.I. Barkov, *Earth Planet. Sci. Lett.* **117** (1993) 431.

|   | Pb                            | Cd    | Cu   | Zn   |
|---|-------------------------------|-------|------|------|
|   | Measured concentration (pg/g) |       |      |      |
| Reference water used to make the core   | 0.25                          | 0.01  | 0.2  | 0.3  |
| Veneer layer adjacent to the inner core | 0.42                          | 0.033 | 0.8  | 1.25 |
| Inner core                              | 0.36                          | 0.025 | 0.45 | 0.5  |

**Table 1.** Comparative determination of heavy metals in the water used to make the artificial ice core, in the last veneer layer and in the inner core of this artificial core.

|              | Pb                      | Cd    | Cu   | Zn   |
|--------------|-------------------------|-------|------|------|
|              | Procedural blank (pg/g) |       |      |      |
| Veneer layer | 0.17                    | 0.023 | 0.6  | 0.95 |
| Inner core   | 0.11                    | 0.015 | 0.25 | 0.2  |

**Table 2.** Procedural blank obtained from the analysis of the artificial ice core.

### FIGURES CAPTIONS

- Fig. 1.** Schematic diagram of the Low Density Polyethylene (LDPE) lathe used for the decontamination of the snow or ice cores. (1) : snow or ice core (length : up to 65cm); (2) : LDPE tumblers ; (3) : fixed LDPE pillar ; (4) : movable LDPE pillar which can be slid along the guide rail ; (5) : LDPE guide rail ; (6) : LDPE crank used to rotate the core ; (7) : LDPE heavy base plate of the lathe ; (8) ; LDPE screw.
- Fig. 2.** Greenland and Antarctic snow or ice cores : schematic view of different typical cross sections available for heavy metals investigations.
- Fig. 3.** Stainless steel chisel used for the chiselling of the successive veneer layers.
- Fig. 4.** Changes in Pb and Cu concentrations from the outside to the inside in two sections (depths : 69.88 - 70.22 and 21.10 - 21.45 m) of a 70.3 m snow core electromechanically drilled at Summit, central Greenland.
- Fig. 5.** Changes in Zn and Cd concentrations from the outside to the inside in two sections (depths : 29.77 - 30.13 and 43.87 - 44.45 m) of a 70.3 m core electromechanically drilled at Summit, central Greenland.
- Fig. 6.** Changes in Zn and Cu concentrations from the outside to the inside in one section (depth : 51.76 - 52.23 m) of a 70.3 m snow core electromechanically drilled at Summit, central Greenland.

Fig. 7. Summit, central Greenland : observed changes in Cd and Zn concentrations in snow from 1773 to 1965. Each data point integrates one or two years of snow accumulation.

Fig. 8. Measured Pb and Zn concentrations as a function of radius in one section (depth : 1,285.90 - 1,286.45 m ; estimated age 7,760 years BP) of the 3,028 m GRIP deep ice core electromechanically drilled at Summit, central Greenland, in a hole filled with a wall retaining fluid.

Fig. 9. Measured Pb and Cd concentrations as a function of radius in one section (depth : 514.89 - 515.07 m ; estimated age : 14,500 years BP) of the 905 m deep ice core thermally drilled at Dome C, East Antarctica.

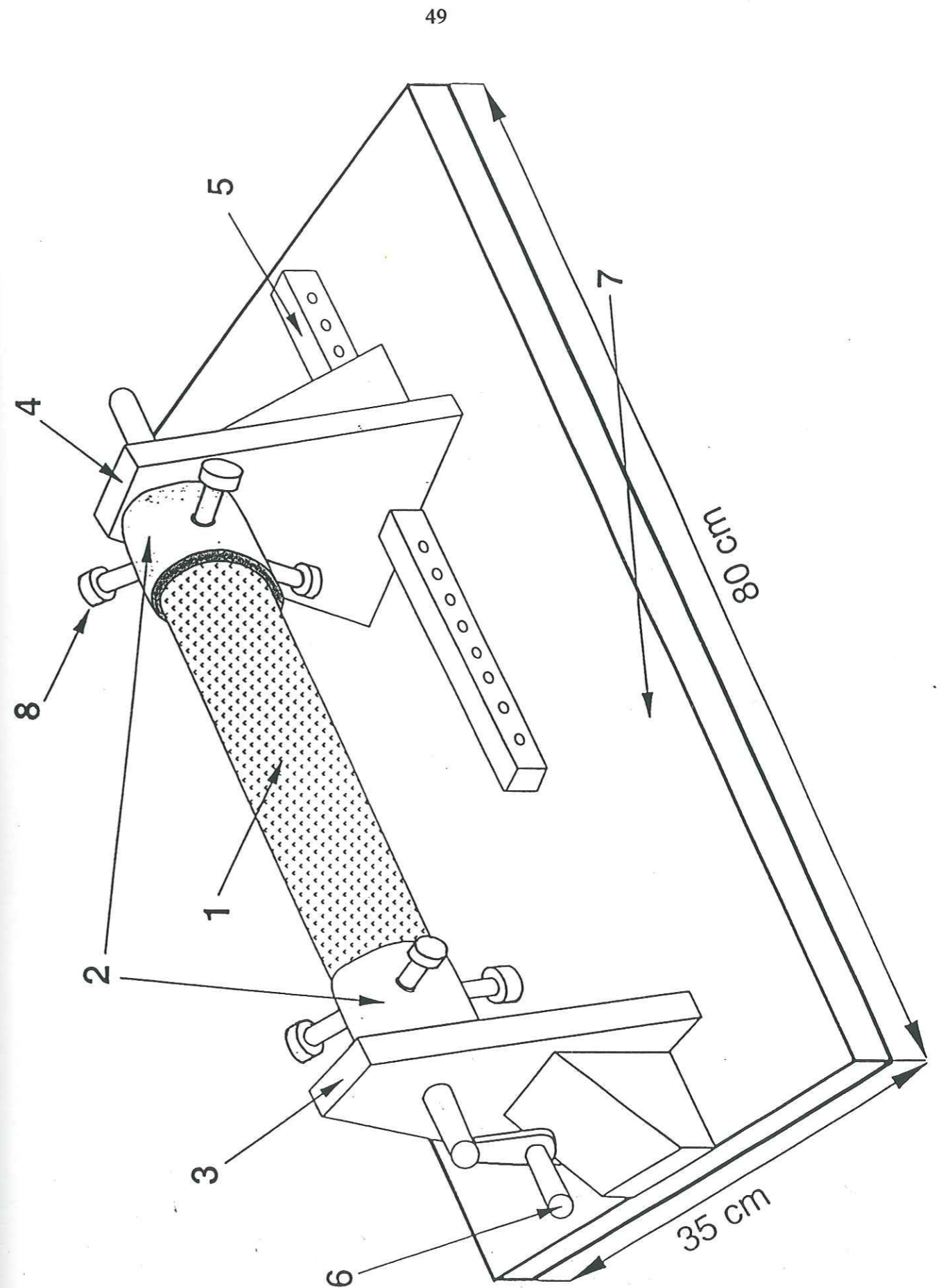

Fig. 1

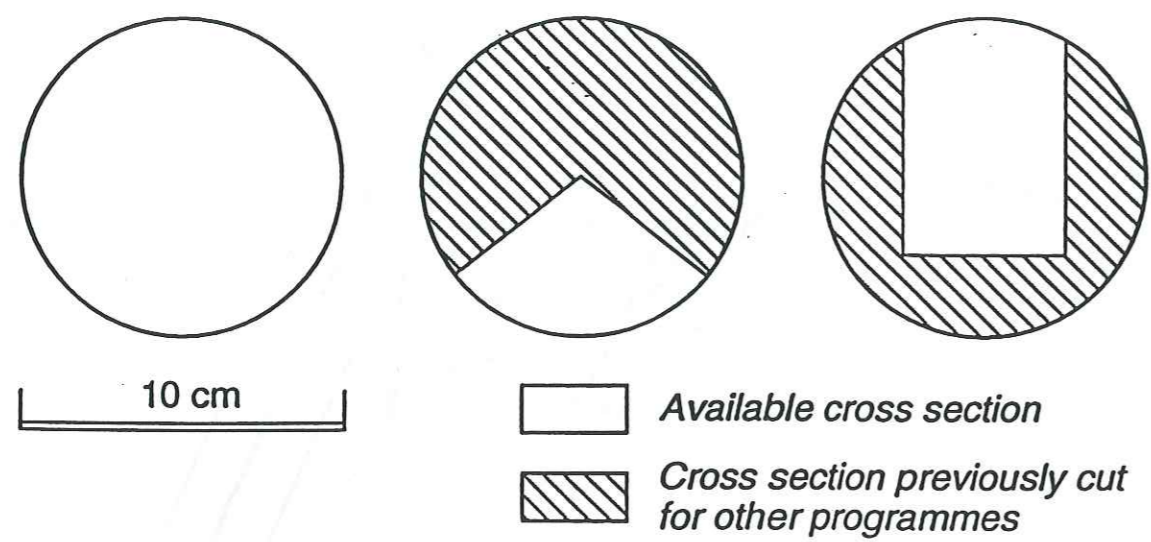

Fig. 2.

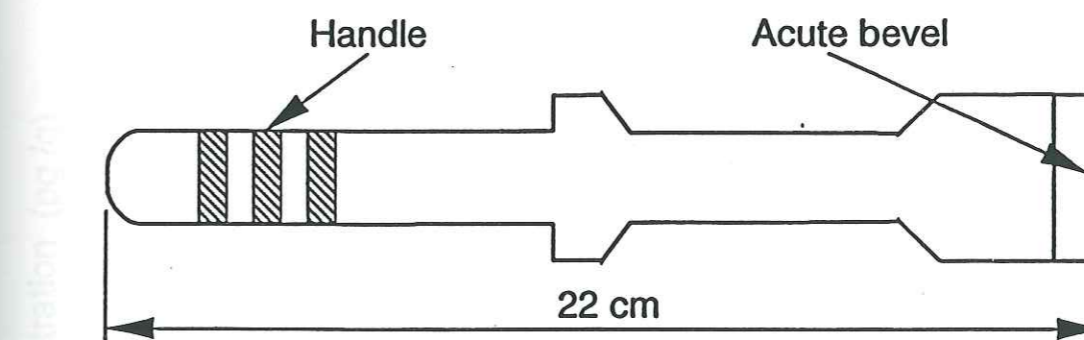

Fig. 3.

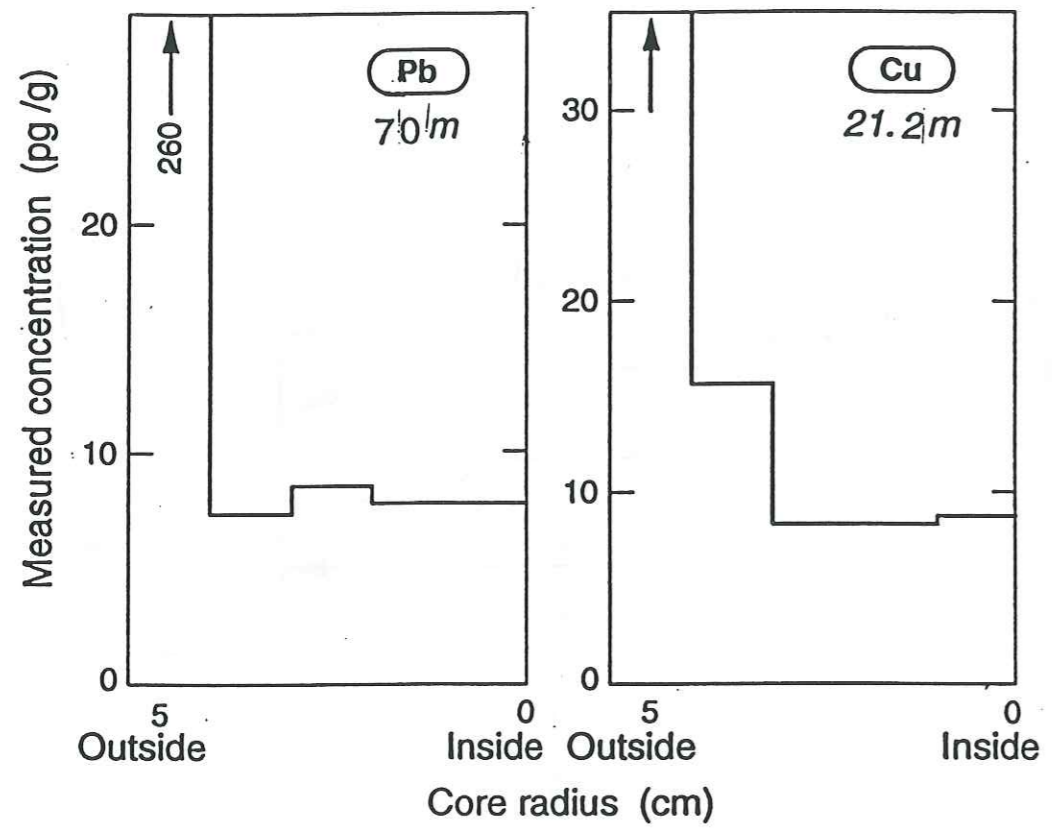

Fig. 4

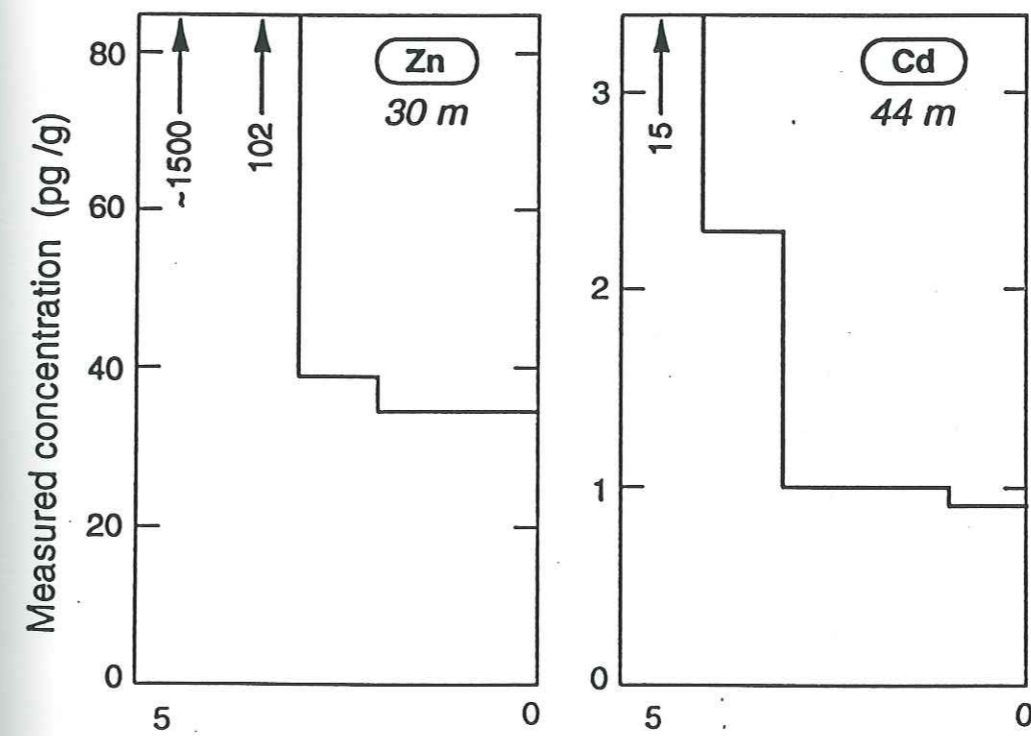

Fig. 5

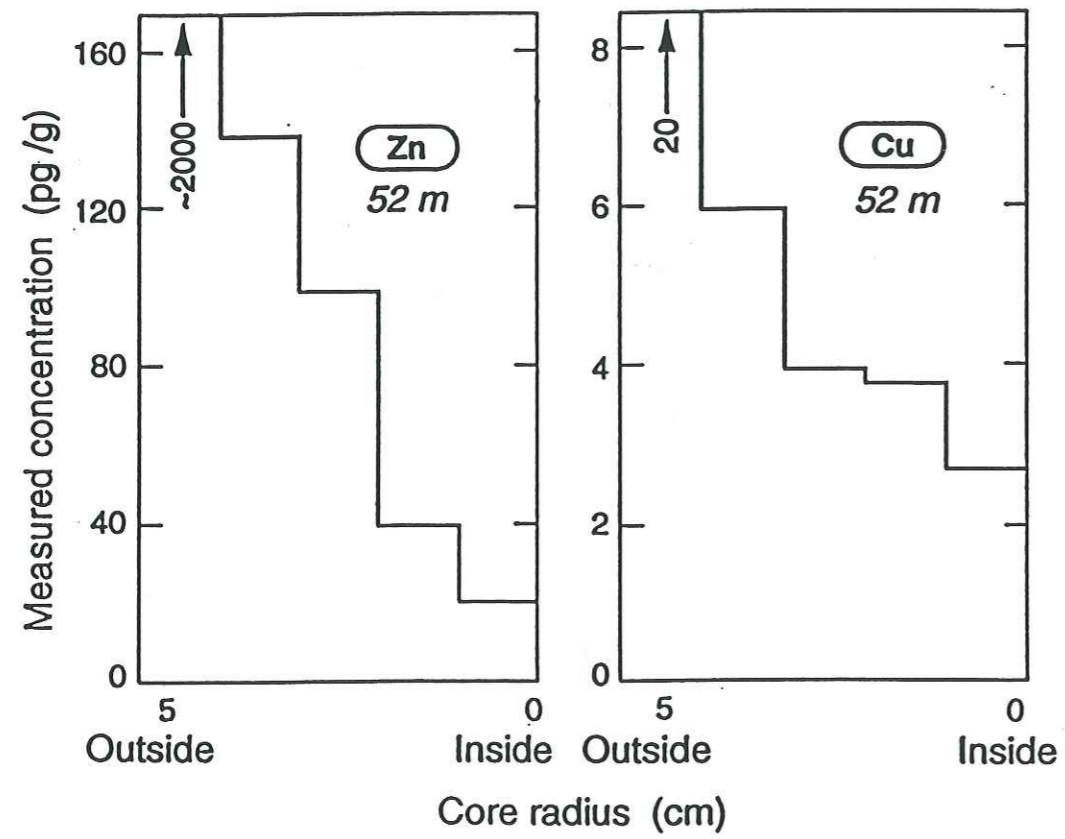

Fig. 6

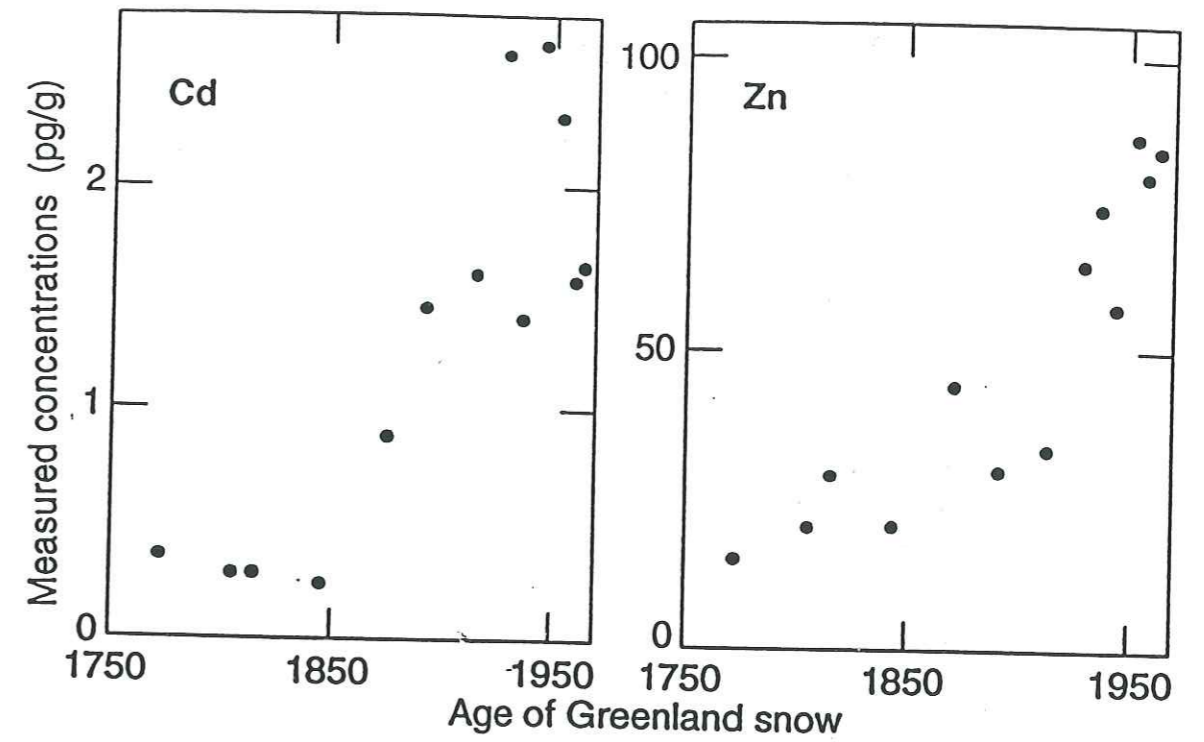

Fig. 7

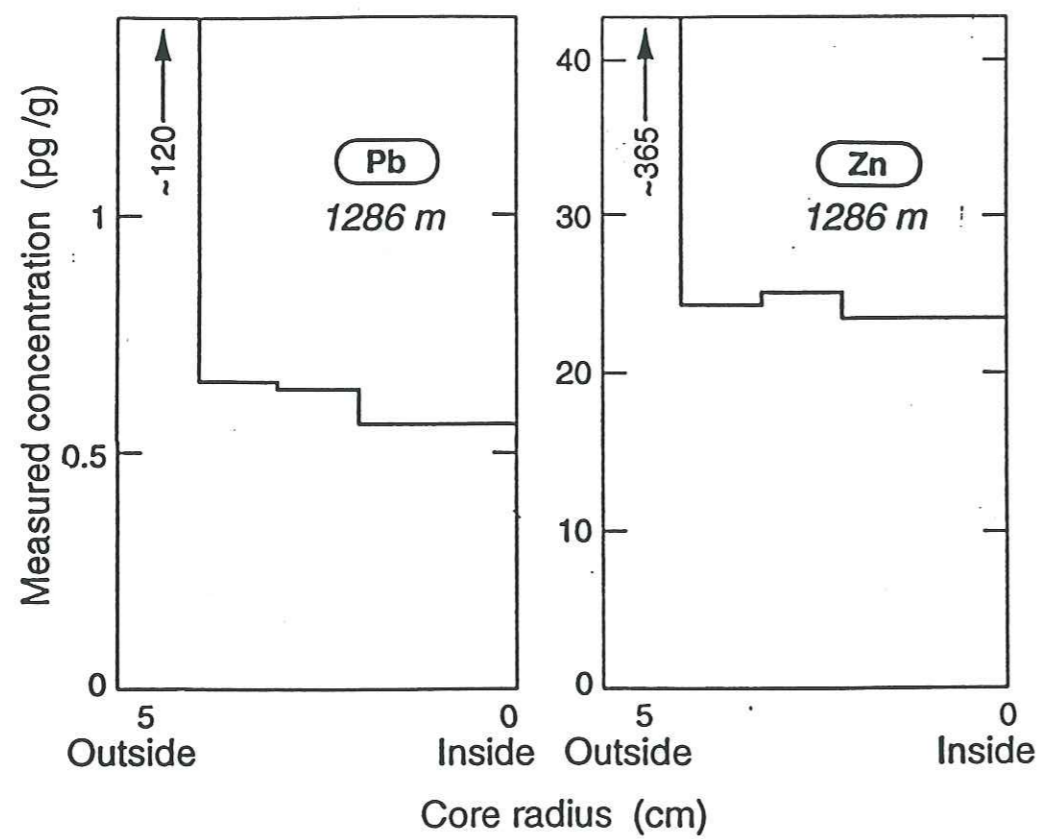

Fig. 8

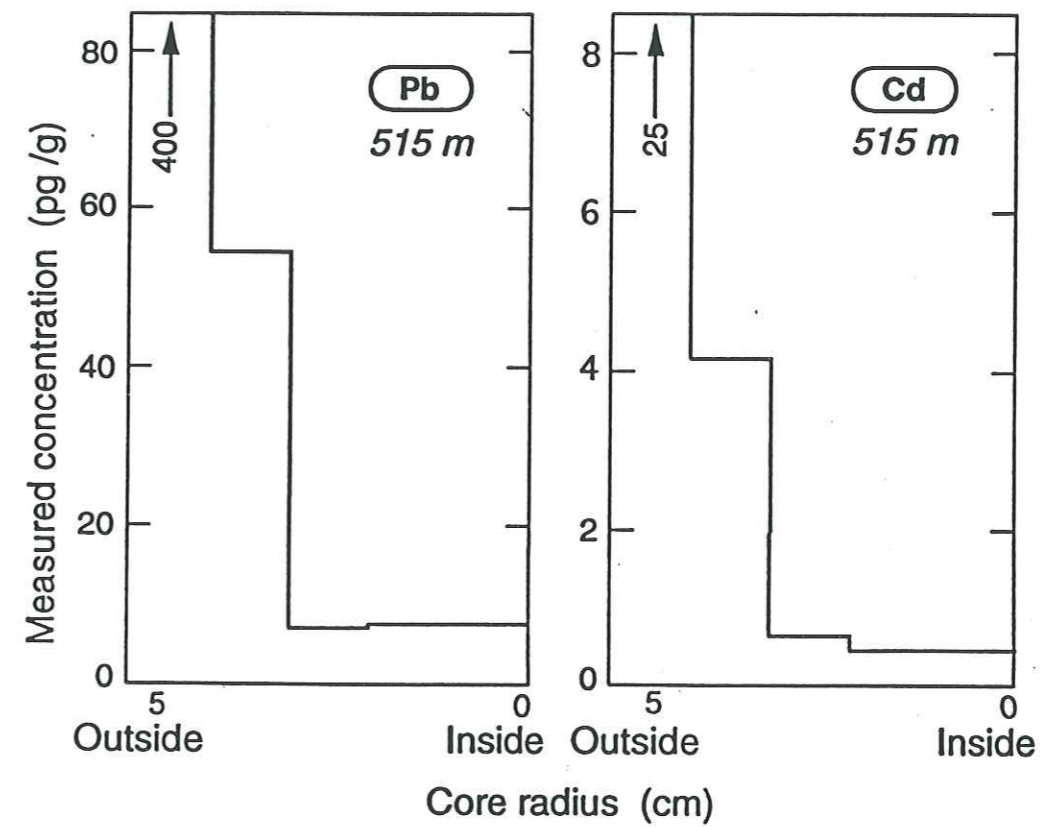

Fig. 9



**Greenland Ice Evidence of Hemispheric Lead Pollution  
Two Millenia Ago by Greek and Roman Civilizations**

Sungmin Hong, Jean-Pierre Candelone,  
Clair C. Patterson and Claude F. Boutron \*

S. Hong and J-P. Candelone, Laboratoire de Glaciologie et Géophysique de l'Environnement du CNRS, 54, rue Molière, Domaine Universitaire, B.P. 96, 38402 Grenoble/Saint Martin d'Hères, France.

C. C. Patterson, Division of Geological and Planetary Sciences 170-25, California Institute of Technology, Pasadena, California 91125, USA.

C. F. Boutron, Laboratoire de Glaciologie et Géophysique de l'Environnement du CNRS, 54, rue Molière, Domaine Universitaire, B.P. 96, 38402 Grenoble/Saint Martin d'Hères, and UFR de Mécanique, Université Joseph Fourier de Grenoble, Domaine Universitaire, B.P. 68, 38041 Grenoble, France.

\* *To whom correspondence should be addressed.*

published in "Science", 265, 1994.

Analysis of Greenland ice core covering the period from 3000 to 500 years ago, the Greek, Roman, Medieval and Renaissance times, shows that lead is present at levels four-fold above natural values from ~ 2500 to 1700 years ago (500 B.C. to 300 A.D.). These results establish that Greek and Roman lead-silver mining and smelting activities polluted the middle troposphere of the Northern Hemisphere on an hemispheric scale two millennia ago, long before the Industrial Revolution. Cumulative lead fallout to the Greenland ice sheet during these eight centuries was as high as 15 percent of that caused by the massive use of lead alkyl additives in gasoline since the 1930s. Pronounced lead pollution is also observed during Medieval and Renaissance times.

The history of world lead production, began about six millennia ago, Fig. 1A (1-7). Significant lead production started only about one millennium later with the discovery of new techniques for smelting lead-silver alloys from lead sulfide ores (galena) and cupelling silver from the alloys (1-7). Lead production then rose continuously during the Copper, Bronze and Iron ages (5, 6, 8), stimulated by the introduction of silver coinage (during those times lead was as much as a 300-to-1 by-product of silver production) and the development of the Greek civilization. A pronounced maximum of about 80,000 metric tons per year (approximately the value at the time of the Industrial Revolution) was reached during the flourishing of the Roman power and influence around two millennia ago, Fig. 1A. The use of lead was ubiquitous and most mining districts in the Old World were known and worked, especially those in Spain, the Balkans,

Greece and Asia

*Hong, Candelone, Patterson and Boutron*

Minor (5, 7). Lead production then decreased sharply during the decline of the Roman Empire, down to a minimum of only a few thousand tons per year during medieval times, before increasing again from A.D. 1000 with the discovery of the lead/silver mines of central Europe.

Lead poisoning from extensive lead production and use during the Roman times has been suggested to be one of the causes of the fall of Rome (5, 9, 10). Smelter emissions from these sources have also been documented to have resulted in significant local or even regional lead pollution in Europe as evidenced for instance by studies of peat deposits in Britain (11, 12) and lake sediments in Southern Sweden (13). We show here that it also resulted in significant contamination of the middle troposphere of the remote Arctic. This therefore indicates the oldest large scale hemispheric pollution ever reported long before the onset of the Industrial Revolution.

We analysed 22 sections of the 3028.8 m GRIP deep ice core electromechanically drilled in 1990 to 1992 at Summit (72°58'N, 37°64'W, elevation 3238 m above sea level, annual mean air temperature - 32°C) in central Greenland (14). Fourteen sections were selected from the period 2360 to 1775 years ago (depths of 511.0 to 349.3 m), that are the ~ 600 years corresponding to the flourishing of the Roman Republic and Empire. Two sections were selected from ice deposited 3000 to 2500 years ago (depths of 619.3 to 569.3 m), which includes the rise of the Greek civilization. Five sections were selected from ice deposited 1520 to 470 years ago (depths of 349.3 to 129.3 m), that is during the Medieval and Renaissance period. Finally, one

section was chosen in ice from pre-lead production period (7760 years ago, depth 1286.5 m) to serve as

a Holocene natural background sample. It was not possible to analyze samples deposited 3500

*Hong, Candelone, Patterson and Boutron*

to 7000 years ago, because this time period corresponds to the brittle-zone depth interval where the core quality is too poor to allow reliable measurements of heavy metals.

We mechanically decontaminated each core section (length of 55 cm) using an ultraclean procedure (17) derived from those developed by C. Patterson and his coworkers (15, 16). It involved the chiselling of successive veneers of ice from the outside to the central part of each section inside a laminar flow clean bench in a cold room while the core was held horizontally in an all-polyethylene lathe (17). Each veneer layer was analysed separately in a clean laboratory (18). Pb contents were determined with a precision of about  $\pm 10\%$  by graphite furnace atomic absorption spectrometry (GFAAS) after preconcentration by nonboiling evaporation (19). We also determined Al and Na contents by direct GFAAS and  $\text{SO}_4^-$  contents by ion chromatography. Blank determinations were performed for each step of the analytical procedure. They included an evaluation of the blank contributed by the chiselling procedure, which was determined (17) by processing an artificial ice core made by freezing ultrapure water (18) whose Pb content was known beforehand. This last blank contribution was found to be 0.11 pg/g for the inner most veneer layer and 0.17 pg/g for the other layers (17).

In order to check the cleanliness of the most central part of the cores obtained after the chiselling

was completed, we studied changes of Pb concentrations from the outside to the center of each of the 22 sections. Significant contamination was observed on the outside (first) layer of the sections, which confirms that they were significantly contaminated on their outside during drilling operations. Excellent plateaus of concentrations were on the other hand obtained from the second

*Hong, Candelone, Patterson and Boutron*

or third layers, as illustrated in Table 1, which is evidence that Pb concentrations measured in the most central part of the core sections do represent the original concentrations in Greenland ice.

The results (Fig. 1B) show that Pb concentration was low, 0.55 pg of Pb per g of ice, 7760 years ago before the beginning of lead production, when atmospheric Pb was still entirely originating from natural sources (24). The corresponding  $EF_{\text{crust}}$  value (19) of 0.8, that is close to unity, shows that virtually all this natural Pb was from soil and rock dust (sea-salt spray and volcanic contributions are minor as calculated (16) from the measured Na and  $SO_4^-$  concentrations). The Pb concentration at 2960 years ago that is about 5000 years later, was essentially identical showing that anthropogenic emissions of Pb to the atmosphere three thousand years ago were still negligible on a hemispheric scale compared with Pb originating from soil and rock dust (about 4000 metric tons per year for both hemispheres (24)). Then, record shows that Pb concentration started to increase markedly above this natural background, at 2500 years ago, up to about 2 pg/g ( $EF_{\text{crust}} : \sim 3$ ), that is an increase by a factor of  $\sim 4$ , and Pb concentration remained high from  $\sim 2,500$  to  $\sim 1,700$  years ago. This 800 years time period corresponds to the flourishing of the Greco-Roman civilizations as shown in Fig. 1A. Pb

concentration declined to low values (0.7 pg/g) around 1500 years ago, that is after the fall of the Roman Empire, and then increased continuously from 1500 to 500 years ago which is during the Medieval and Renaissance times.

The high ( $\sim 4$  fold above the natural level) Pb concentration and crustal enrichment factor observed in Greenland ice from  $\sim 2500$  to 1700 years ago cannot be explained by an increase in natural Pb emissions to the atmosphere : the measured Al, Na and  $SO_4^-$  concentrations in the ice

*Hong, Candelone, Patterson and Boutron*

do not change significantly during the whole period covered by our samples. We interpret the increase as a result of anthropogenic Pb emissions to the atmosphere from the large lead-silver production by Greeks and Romans (production in the other parts of the world such as Asia was minor and is unlikely to have made a significant contribution (5,6)). This production peaked at about 80,000 metric tons per year around 2000 years ago and it is estimated that approximately 5 % of the mined and smelted Pb was emitted to the atmosphere (25), which would have given a peak value of  $\sim 4000$  metric tons per year to the atmosphere. The data show that the resulting pollution was not only local (5, 6, 9-10) or regional (11-13) in scale, but reached the middle troposphere (Summit is located at a high elevation of 3238 m above sea level) of the remote Arctic region. It represents the oldest hemispheric scale atmospheric pollution ever reported, well before the Industrial Revolution.

The 4 fold increase during the Greco-Roman period for a middle troposphere location in central Greenland is in excellent agreement with that ( $\sim 5$  fold) which was hypothesized by H. Shirahata

et al. (25); it is lower than the one (~ 10) speculated by C. Patterson earlier (26).

During the Greco-Roman times, most Pb emitted to the atmosphere would have been due to lead-silver mining and smelting activities in Spain (which contributed about 40 % of the worldwide production during the Roman Empire), central Europe, Britain, the Balkans, Greece and Asia Minor (5, 6). The lead was produced in open air furnaces with no control on emission rates. Small Pb aerosol particles emitted during these activities could easily be transported from these regions to the Arctic through well-known pathways (27, 28). Differences in transport efficiencies

*Hong, Candelone, Patterson and Boutron*

between the different source regions and central Greenland cannot however be ruled out. Such differences could for instance explain why Pb levels in the ice during the Greek and Roman periods are similar, even though Pb production was several fold lower during Greek times. Alternative explanation could however be in differences in Pb emission rates for mining and smelting activities during the Greek and Roman times or in uncertainties in the historical data shown in Fig. 1A.

The cumulative anthropogenic Pb fallout over Greenland from ~ 2500 to 1700 years ago, estimated by combining a Pb excess value of ~ 1 pg Pb/g over the pre lead time value with a mean ice accumulation rate of 23 g H<sub>2</sub>O cm<sup>-2</sup> yr<sup>-1</sup>, is 23 x 10<sup>-12</sup> g Pb cm<sup>-2</sup> yr<sup>-1</sup>. Over 800 years, this represents 1.84 x 10<sup>-8</sup> g Pb cm<sup>-2</sup>. For the whole Greenland ice cap (surface of 1.4 x 10<sup>6</sup> km<sup>2</sup>; mean annual accumulation rate of 34 g of H<sub>2</sub>O cm<sup>-2</sup> yr<sup>-1</sup>), the net deposition is about 400 tons during

these 800 years. This is as much as ~ 15 % of the cumulative fallout of Pb to Greenland during the past 60 years linked to the massive use of Pb alkyl additives in gasoline calculated from a mean concentration of 100 pg Pb/g in 1930-1990 Greenland snow (29).

Further evidence of this hemispheric scale pollution by Greco-Roman civilization could be found in other archives such as sea sediments in the North Atlantic Ocean and in the Mediterranean Sea. Analyses of lead isotopes could fingerprint the relative contribution of the different Ancient mining districts to this pollution.

*Hong, Candelone, Patterson and Boutron*

#### References and Notes

1. C. C. Patterson, *Am. Antiq.* **36**, 286 (1971).
2. C. C. Patterson, *Econ. Hist. Rev.* 2nd ser. **25**, 205 (1972).
3. C. C. Patterson, "Lead in the Human Environment", Report prepared by the Committee on Lead in the Human Environment, *Nat. Acad. Sci. Wash. D.C.*, pp. 265-349 (1980).
4. C. C. Patterson and D. M. Settle, *Science* **207**, 1167 (1980).
5. J. O. Nriagu, *Lead and Lead Poisoning in Antiquity* (Wiley, New York, 1983).
6. J. O. Nriagu, *Sci. Tot. Environ.* **31**, 105 (1983).
7. C. C. Patterson, H. Shirahata, J. E. Ericson, *Sci. Tot. Environ.* **61**, 167 (1987).
8. R. J. Hopper, *Ann. British School Athens*, **63**, 293 (1968).

9. S. C. Gilfillan, *J. Occup. Med.* **7**, 53 (1965).
10. J. O. Nriagu, *N. Engl. J. Med.* **308**, 660 (1983).
11. J. A. Lee and J. H. Tallis, *Nature* **245**, 216 (1973).
12. M. H. Martin, P. J. Coughtrey, P. Ward, *Proc. Bristol Naturalists Soc.* **37**, 91 (1979).
13. I. Renberg, M. W. Persson, O. Emteryd, *Nature* **368**, 323 (1994).
14. W. Dansgaard et al., *Nature* **364**, 218 (1993).
15. A. Ng and C. C. Patterson, *Geochim. Cosmochim. Acta* **45**, 219 (1981).
16. C. F. Boutron and C. C. Patterson, *Nature* **323**, 222 (1986).
17. J. P. Candelone, S. Hong, C. F. Boutron, *Anal. Chim. Acta*, in press.
18. C. F. Boutron, *Fresenius Z. Anal. Chem.* **337**, 482 (1990).

*Hong, Candelone, Patterson and Boutron*

19. U. Görlach and C. F. Boutron, *Anal. Chim. Acta* **236**, 391 (1990).
20. Dating of the core sections has been performed by using known volcanic events and interpolation between these events with a glaciological model (S. Johnsen, personal communication, 1994).
21. Pb crustal enrichment factor is defined as  $EF_{\text{crust}}(\text{Pb}) = (\text{Pb}_{\text{ice}}/\text{Al}_{\text{ice}}) / (\text{Pb}/\text{Al})_{\text{mean crust}}$  where  $\text{Pb}_{\text{ice}}$  and  $\text{Al}_{\text{ice}}$  are the measured concentrations of Pb and Al in the ice and  $(\text{Pb}/\text{Al})_{\text{mean crust}}$  is the Pb/Al ratio in mean crustal material given by Taylor and McLennan (22). Such crustal reference material is appropriate to characterize the composition of soil and rock derived

- dust (23).
22. S. R. Taylor and S. M. McLennan, *The Continental Crust: its Composition and Evolution* (Blackwell, Oxford, 1985).
23. L. Schütz and K. A. Rahn, *Atmos. Environ.* **16**, 171 (1982).
24. J. O. Nriagu, *Nature* **338**, 47 (1989).
25. H. Shirahata, R. W. Elias, C. C. Patterson, *Geochim. Cosmochim. Acta* **44**, 149 (1980).
26. C. C. Patterson, in *Scientific Methods in Medieval Archeology*, R. Berger, Ed. (Univ. of California Press, Berkeley, 1970), pp. 339-350.
27. W. E. Raatz, in *Pollution of the Arctic Atmosphere*, W. T. Sturges, Ed. (Elsevier, London, 1991), pp. 13-42.
28. T. Iversen, in *The Tropospheric Chemistry of Ozone in the Polar Regions*, H. Niki and K. H. Becker, Eds. (Springer, Berlin, 1993), pp. 57-75.
29. C. F. Boutron, U. Görlach, J. P. Candelone, M. A. Bolshov, R. J. Delmas, *Nature* **353**, 153 (1991).

*Hong, Candelone, Patterson and Boutron*

30. This work is a contribution of the International Greenland Ice-core Project (GRIP) organized by the European Science Foundation. We thank the national funding agencies and organizations in Belgium, Denmark, France, Germany, Iceland, Italy, Switzerland and the United Kingdom, as well as the XII Directorate of CEC for financial support. This research was supported by the French Ministry of the Environment (Grant 92295), the Institut National des Sciences de l'Univers and the University of Grenoble. We thank B. Stauffer and

J.P. Steffensen for their very kind assistance in core selection, M. Legrand for the ion chromatography measurements, and R.J. Delmas for his continuous interest and helpful discussions.

**Table 1.** Pb concentrations measured in the 2nd and 3rd layers and in the final inner core for five typical GRIP ice core sections. For three of these sections (129.25 m, 399.3 m and 1286.45 m), the concentrations are virtually the same in all three sub samples : contamination was only present in the outside (1st) layer. For the 349.25 m and 510.95 m sections, the outside contamination did reach the 2nd layer, but the 3rd layer and the inner core remained free of contamination.

| Depth<br>(m) | Age<br>(years ago) | Measured Pb concentration (pg/g) |           |            |
|--------------|--------------------|----------------------------------|-----------|------------|
|              |                    | 2nd layer                        | 3rd layer | inner core |
| 129.25       | 470                | 4.77                             | 3.99      | 3.90       |
| 349.25       | 1520               | 1.79                             | 0.65      | 0.66       |
| 399.3        | 1775               | 1.06                             | 1.07      | 1.17       |
| 510.95       | 2360               | 43                               | 1.64      | 1.64       |
| 1286.45      | 7760               | 0.57                             | 0.56      | 0.55       |

Boutron

## Figure Caption

**Fig.1** (A) Changes in worldwide Pb production over the past 5500 yrs (redrawn from (3, 4)). (B) and (C) Changes in Pb concentration and Pb crustal enrichment factor (19) in central Greenland ice from 2960 to 470 years ago. Each data point was obtained from the analysis of a core length corresponding to exactly 2 years of ice accumulation (except one for which it was only 1 year because of poor core quality) in order to eliminate the influence of possible short term (seasonal) changes in Pb deposition.

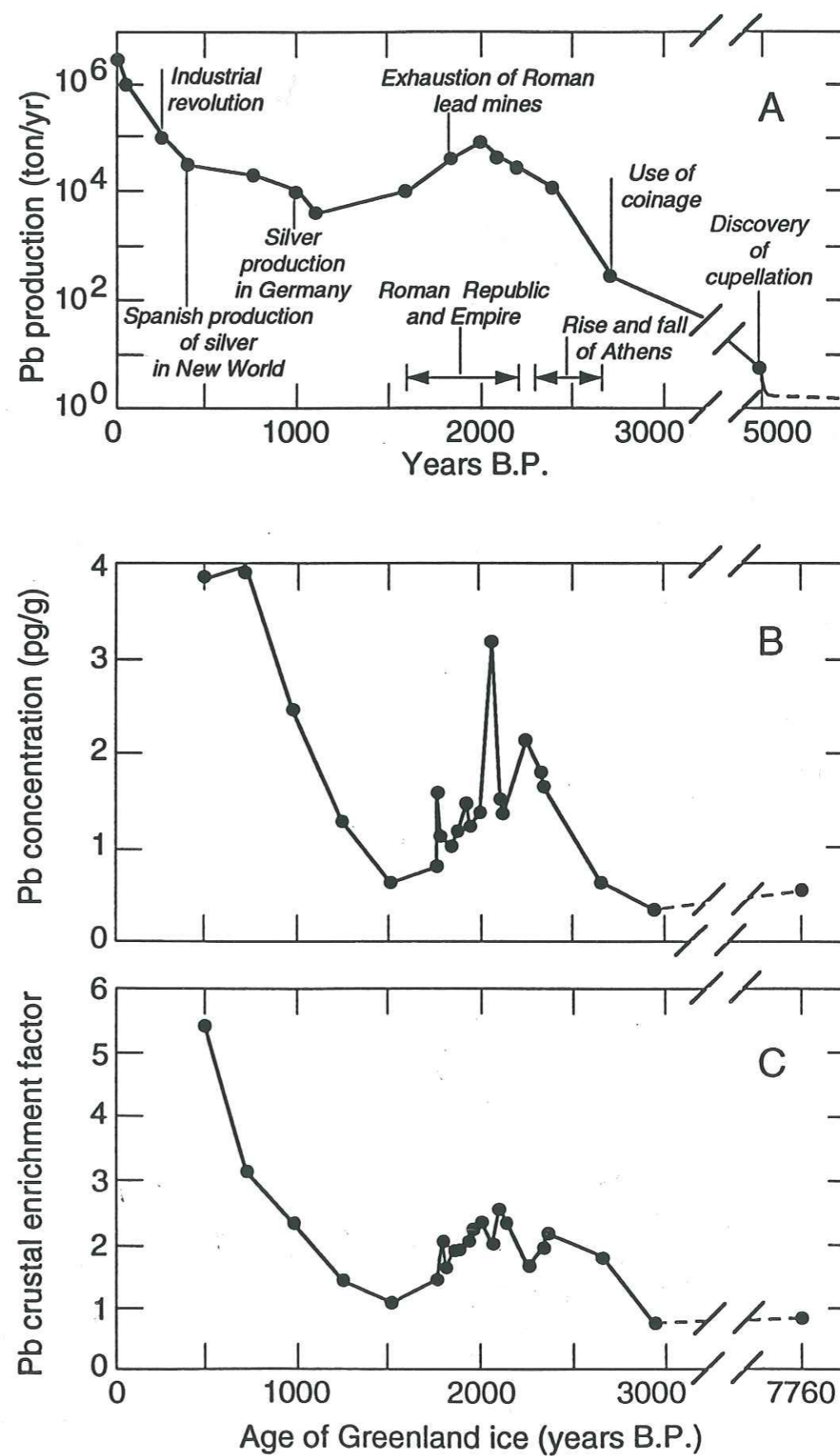

LEAD ISOTOPE RECORD IN ANCIENT GREENLAND ICE  
(A preliminary result)

Rosman, K.J.R.\*, Chisholm, W.\*, Hong, S.\*\*, Boutron, C.F.\*\* and Candelone, J.P.\*

\*Department of Applied Physics, Curtin University of Technology, Bentley 6102,  
W.A., Australia

\*\*Laboratoire de Glaciologie et Géophysique de l'Environnement du CNRS,  
54 rue Molière, Domaine Universitaire, BP 96, 38402 St Martin d'Hères Cedex, France

To be submitted to "Nature"

LEAD ISOTOPE RECORD IN ANCIENT GREENLAND ICE

K.J.R. Rosman<sup>1</sup>, W. Chisholm<sup>1</sup>, S. Hong<sup>2</sup>, C.F. Boutron<sup>2,3</sup> and J.P. Candelone<sup>2</sup>.

ABSTRACT

The isotopic composition and concentration of lead has been measured in samples of the GRIP ice core up to 150 ky old. The results show a significant depression in the  $^{206}\text{Pb}/^{207}\text{Pb}$  ratio near 2 ky BP reflecting anthropogenic emissions from industrial activity during Greek and Roman times. Between 12 ky and 150 ky BP the ratio varies within the range 1.20 - 1.23 which is similar to that found in sediments from the North Atlantic Ocean.

INTRODUCTION

The permanent ice caps of Greenland and Antarctica are an archive of the aerosols present in the atmosphere during the past ~ 0.5 My. The analysis of this ice can therefore provide a record of aerosol composition over this period. Older ice, > 5 ky BP, contains natural aerosols while younger ice also contains anthropogenic aerosols. Recently Hong et al. (ref 1) analysed the concentration of lead in ~2 ky old ice from the GRIP core and found that it was significantly above background. They attributed this enhancement to anthropogenic emissions from industrial activity associated with the Greek and Roman civilisations.

Measurement of the isotopic composition of this lead can conclusively demonstrate that this pollution was of human origin. We have therefore analysed lead isotopes in some of these same samples and report the results in this paper. In addition we report the isotopic composition of lead in ice up to 150 ky old.

EXPERIMENTAL TECHNIQUES

Samples were taken from the 3,029 m GRIP deep ice core electromechanically drilled in 1990-92 at Summit in central Greenland (ref 2). Core sections from depths of 239 to 2889 m corresponding to the period 1 ky - 150 ky were sampled for the present study.

The core sections were mechanically decontaminated using procedures described by Candelone et al. (ref 3). Each was held in a polyethylene lathe inside a laminar flow clean bench and successive layers were chiselled away leaving a central cylinder of ice. The chips obtained for each layer and the inner core were separately melted, then aliquots were transferred to LDPE bottles and kept frozen until analysis. Only results of measurements on the inner core samples are reported here.

Samples were transported frozen to Curtin University (Perth, Australia) where they were processed inside a dust-free laboratory using ultra clean procedures. These procedures have been described in detail by Chisholm et al. (ref 4). Processing involved evaporation with

<sup>1</sup> Department of Applied Physics, Curtin University of Technology, Bentley 6102, W.A., Australia.

<sup>2</sup> Laboratoire de Glaciologie et Géophysique de l'Environnement du CNRS, 54 rue Molière, Domaine Univ., BP 96, 38402 St Martin d'Hères Cedex, France.

<sup>3</sup> UFR de Mécanique, Université Joseph Fourier, Domaine Universitaire, BP 68, 38041 Grenoble Cedex, France.



HNO<sub>3</sub>, H<sub>3</sub>PO<sub>4</sub> and a <sup>205</sup>Pb-enriched tracer, inside a PFA beaker, isolated within a PTFE chamber. All plastic lab-ware which came into contact with the sample underwent rigorous cleaning successively in chloroform or dichloromethane, HCl and HNO<sub>3</sub> acids. Concentrated acids used for sample preparation were purified on site and contained <3 pg Pb/g while the laboratory water contained <0.03 pg Pb/g. The procedural blank for the determinations has decreased as the procedures have been improved, but for the measurements described here it was in the range 0.4 and 0.8 pg. It was possible to reduce the significance of this blank by increasing the volume of sample analysed. However the storage blank from the LDPE storage bottle became significant at low concentration which lead to relatively large uncertainties in the isotopic ratios for some samples.

Isotopic analyses were performed in a sector field, thermal ionisation, Isotope Ratio Mass Spectrometer (VG354: FISIONS, U.K.). Typically 20-100 pg of lead was loaded onto the rhenium filament of a modified thermal ion source using a silica gel-based activator. The ion currents of  $\sim 1 \times 10^{-14}$  A were measured on a Daly detector operating in analogue mode. All four lead isotopes were measured although only the <sup>206</sup>Pb/<sup>207</sup>Pb abundance ratios will be discussed in this paper. Corrections for isotope fractionation were made by reference to measurements of the Standard Reference Material 981 (National Institute of Standards and Technology).

The lead concentration of each sample was measured by Isotope Dilution Mass Spectrometry (IDMS). The choice of a <sup>205</sup>Pb-enriched lead ( $T_{1/2} = 1.5 \times 10^7$  a) for these measurements allowed both the quantity and isotopic composition to be determined in a single measurement.

## RESULTS AND DISCUSSION

The <sup>206</sup>Pb/<sup>207</sup>Pb isotopic ratios of lead deposited at Summit in central Greenland during the past 4 ky are shown in Figure 1. The corresponding lead concentrations determined by IDMS are also shown (95% confidence intervals for the uncertainties is  $\pm 20\%$ ). At the time of writing the Pb contribution to the samples from the LDPE bottles was still being established, but the trends displayed in the figure should not alter significantly.

The concentrations, represented as squares in the figure, follow a trend similar to that reported by Hong et al. (ref 1) although our concentrations appear to be slightly higher. The isotopic ratios progressively decrease from  $\sim 3$  ky to 1 ky BP, but show a significant depression of  $\sim 2\%$  near 2 ky BP indicating a contribution from lead with a lower isotopic ratio. We have also measured lead isotopes in ice extending back to 150 ky BP. Although the lead concentration between 9 ky and 150 ky varies widely ( $\sim 5$  to  $\sim 100$  pg/g) the <sup>206</sup>Pb/<sup>207</sup>Pb ratio falls between 1.20 and 1.23. The depression of the isotopic record at  $\sim 2$  ky BP must therefore be due anthropogenic lead introduced into the atmosphere during Greek and Roman times. Following the fall of the Roman Empire the isotopic ratio remained below background reflecting continuing anthropogenic emissions.

Using our measurement on 7758 y BP ice (<sup>206</sup>Pb/<sup>207</sup>Pb =  $1.216 \pm 0.018$  and 1.03 pg Pb/g) to represent the background yields a value of  $\sim 1.17$  for the added component in 2037 y BP ice (<sup>206</sup>Pb/<sup>207</sup>Pb =  $1.184 \pm 0.005$  and 3.85 pg Pb/g).

The <sup>206</sup>Pb/<sup>207</sup>Pb ratios (1.20 - 1.22) which we find in ice between 12 ky and 150 ky BP, is similar to that found in sediments from the North Atlantic Ocean (ref 5,6), but is slightly higher than ratios found further south. This variation of the isotopic ratio reflects different source regions or changes to contributions from regular source regions. These changes may result from seasonal effects or other factors related to the glacial cycle, such as changes in sea level, wind strength or changing atmospheric circulation patterns.

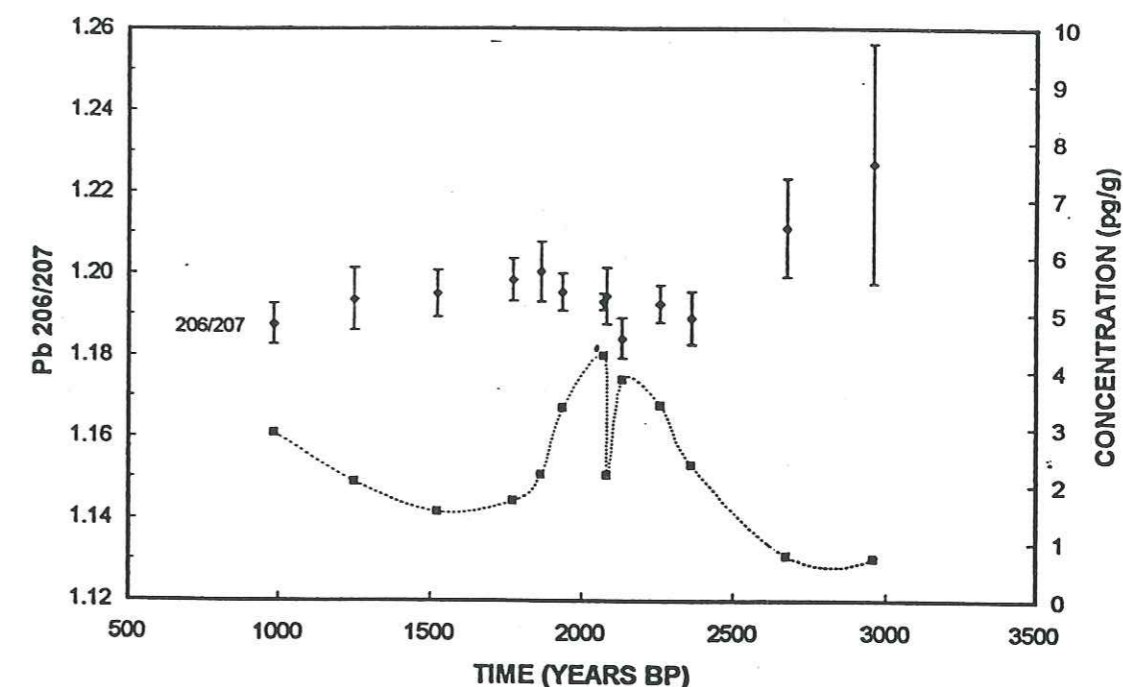

Figure 1. The <sup>206</sup>Pb/<sup>207</sup>Pb and concentration of lead in Greenland ice during the past 3.5 ky.

## ACKNOWLEDGMENTS

We thank colleagues and students of Curtin University's Isotope Science Research Centre who provided helpful discussion. This research was supported by research grants from the Australian Research Council. The collection and decontamination of the samples was supported by the Commission of the European Communities and Switzerland, the French Ministry of the Environment and the University of Grenoble.

## REFERENCES

1. S Hong, J-P Candelone, C C Patterson and C F Boutron, *Science* **265**, 1841 (1994)
2. W. Dansgaard, S J Johnsen, H B Clausen, D Dahl-Jensen, N S Gundestrup, C U Hammer, C S Hvidberg, J P Steffensen, A E Sveinbjöfnsson, J Jouzel, G. Bond, *Nature* **364**, 218 (1993)
3. J-P Candelone, S Hong and C F Boutron, *Anal. Chim. Acta* **299**, 9-16 (1994)
4. W Chisholm, K J R Rosman, C F Boutron, J-P Candelone and S Hong, *Anal. Chim. Acta* (1995) [IN PRESS]
5. T J Chow and C C Patterson, *Geochim. Cosmochim. Acta* **26**, 263 (1962)
6. B Hamelin, F Grousset and E R Sholkovitz, *Geochim. Cosmochim. Acta* **54**, 37 (1990)

**A reconstruction of historical copper production and its relevance to  
copper emission to the atmosphere with ages**

**Sungmin Hong<sup>a</sup>, Jean-Pierre Candelone<sup>c</sup>, Michel Soutif<sup>d</sup> and Claude F. Boutron<sup>\*a,b</sup>**

<sup>a</sup>Laboratoire de Glaciologie et Géophysique de l'Environnement du CNRS, 54, rue Molière, Domaine Universitaire, B.P. 96, 38402 Saint Martin d'Hères, France

<sup>b</sup>UFR de Mécanique, Université Joseph Fourier de Grenoble, Domaine Universitaire, B.P. 68, 38041 Grenoble, France

<sup>c</sup>Department of Applied Physics, Curtin University of Technology, GPO Box U 1987, Perth, WA 6001, Australia

<sup>d</sup>UFR de Sciences Humains, Université Pierre Mendès France, Domaine Universitaire, B.P. 68, 38041 Grenoble, France

\*To whom correspondence should be addressed

To be Submitted to "The Science of the Total Environment"

**ABSTRACT**

The historical copper production of the world since the early times had remarkably changed with the growth and decline of ancient civilizations. During the Roman period (200 B.C.-A.D. 350), Cu mining and smelting activities were very vigorous to supply a needed copper for monetary base-metal. An estimate of the total amount of copper produced in the Roman World reaches about 4 to 5 million tonnes which gives an average production rate of about 7,000 tonnes per year with a maximum yearly output of about 15,000 tonnes two millennia ago. The world's copper production, declined after the fall of the Roman Empire, rised up again in the Sung dynasty of China (A.D. 960-1279) at a peak of 14,000 tonnes per year in A.D. 1080's. From the Industrial Revolution onwards, during which the world's Cu production was of the order of about 10,000 tonnes per year, the amount of copper produced have increased exponentially. The emission rate of Cu aerosols from uncontrolled and wasteful mining and smelting activities to the atmosphere in the ancient times is assumed to have reached as much as about 15%. After the Industrial Revolution, the emission rates decreased gradually to about 1% in the begining of this century and then about 0.25% at present. The cumulative quantities of Cu emitted to the atmosphere came to about 600,000 tonnes during the Roman times, which corresponds to half of the total amount of Cu emitted since this century. It is of worth to note that the total amount of Cu aerosols released from the early times to the onset of the Industrial Revolution is estimated to be about 1.67 million tonnes. This figure is comparable to that of having been emitted since the Industrial Revolution until the present.

## 1. INTRODUCTION

The development of metallurgy since the ancient times had played a key role on the growth of the ancient civilizations. After the discovery of smelting processes around 7000 years ago, man began to mine and extract metals on a significant scale (Patterson, 1971; Darling, 1990). From this time onwards, the demand and supply for metals such as gold, silver, copper, and lead had increased with the progressive development of civilization. The large change of the amounts of metals produced appears to have followed to the growth and decline of the ancient Empires in history (Ch'en, 1965; Patterson, 1972). In fact, it is evident that from the onset of the Industrial Revolution the output of metals mined and smelted rised up enormously due to the great expansion of the world's economy. Since the twentieth century an exponential increase of metal production has been an important source of atmospheric pollution by toxic metals on a global scale, as evidenced by records of heavy metals in polar snow and ice (Wolff and Suttie, 1994; Candelone et al., 1995).

In general, it was assumed that ancient mining and smelting activities resulted in environmental contamination by toxic pollutants only on a local and/or regional scale (Nriagu, 1990). Recent study (Hong et al., 1994.) showed, however, that during the Greco-Roman times mining and smelting activities to produce silver and its by-product, lead, caused a large scale atmospheric pollution for lead two millennia ago, suggesting that their metallurgical operations were so extensive as to impact on global biogeochemical cycles of lead. Historically, copper was also one of the metals widely used in the ancient times. In order to study on its historical

aspect of global environmental cycle, one should certainly need to reconstruct the historical variation of copper production and resultant Cu emissions to the atmosphere.

The purpose of this study is to reconstruct historical change of copper production from documentary evidences and to assess the amount of this toxic pollutant aerosols emitted to the atmosphere with ages. It should be noticed that the world's production rates estimated in this paper are approximate, because a review of all the archaeological field would be beyond our scope and a paucity of historical record hampered to face up to the actual quantitative amount of copper produced in the whole world. For this, we present here a general historical trend with certain distinctive periods.

## 2. RECONSTRUCTION OF HISTORICAL COPPER PRODUCTION

### 2-1. From the Bronze Age to the Roman Empire

In antiquity, man began first to use native copper for ornamental and ritual purposes (Darling, 1990). As the pyrometallurgical methods were developed, copper was produced on a small scale by simple reduction of smelting carbonate and oxide ores found in weathered zone near the surface during the Copper Age (Patterson, 1971). The demand for copper continued to increase with the growing of the ancient civilizations during the Bronze Age. Since carbonate and oxide copper ores occurred in parts of confined areas and became more and more exhausted, the ancient metallurgists may have devoted their attentions to the enriched sulfide ores found just beneath the oxidized zone of the surface. At about 2500 B.C., the smelting

processes of sulfide ores, which involved repeated processes of alternative roasting and smelting sulfide ores, were developed by virtue of the advance of metallurgical techniques (Patterson, 1971; Tylecote, 1976). Thereafter, the Cu production had quantitatively increased in various regions such as the eastern Mediterranean, Asia Minor, Austria, Spain, and Ireland (Patterson, 1972; Tylecote, 1976; Gale and Stos-Gale, 1982; Tylecote, 1987). Patterson (1972) estimated that the total copper produced in these regions might have amounted to about 500,000 tonnes during the late Bronze Age (2000-700 B.C.). It gives an average production of 400 tonnes per year with an uncertainty due to his approximate estimate from a limited historical documents. In the Iron Age, the introduction of coinage at about 600 B.C. stimulated the exploitation of precious metals (gold and silver) and also copper for base-metal of coins (Patterson, 1972; Healy, 1978). The fundamental use of copper was for bronze coins, bronze cattle or bars for the basis of exchange, utensils, military uses, etc. During the period of 650-350 B.C., the total Cu production was estimated to be about 700,000 tonnes at an average rate of 2000 tonnes per year (Patterson, 1972). It was, however, not until the Roman period that the copper production was remarkably increased through the smelting of sulfide copper ores from Cyprus, central Europe, Britain, and mainly Spain (Forbes, 1956; Allan, 1970; Patterson, 1972; Healy, 1978; Tylecote, 1987; Darling, 1990). It is estimated that during the Roman times (250 B.C.-A.D. 350) the amount of copper produced reached about 4 to 5 million tonnes, which ranges about 10% of the total copper produced for the period pre-1900 A.D (Patterson, 1971, 1972; Nriagu, 1979a). The average production of Roman copper is found to be about 7000 tonnes per year. Of interest is very extensive exploitation and extraction of copper in the Huelva district of the south-west Spain. In this region alone, an enormous amount of slag

worked in the Roman period is estimated to be over 30 million tonnes (Forbes, 1956; Tylecote, 1987). The simple evaluation combining with a copper content of at least 8% in copper ores and a rate of recovery of 80% from it gives about 2 million tonnes of copper metal. On the contrary, we could not exclude any case of overestimate for production rate in Spain, based on an assumption that during the Roman times an annual copper production in the whole Iberian Peninsular might not have exceeded the order of 1000 tonnes (Allan, 1970). However, this estimate was made from the Roman copper slag of 750,000 tonnes at Rio Tinto alone, which seems to be extraordinarily small amount of slag, compared to the other evaluations for the amount of copper slag (Forbes, 1956; Tylecote, 1987). In other regions, Roman had produced about 500,000 tonnes of copper at an average rate of 1250 tonnes per year in Cyprus where was one of the vigorous mining regions since the antiquity (Allan, 1970).

When considering the huge amount of copper production in these two regions, the above estimate made for the whole Roman copper produced at that time is likely to be reasonable. The Romans utilized a vast amount of copper for coinage depending on their economic situation and exported copper and bronze to the rest of the Roman World. In addition, they introduced brass for a series of coin. As shown in Table 1, it was assumed that the maximum output might have reached an average production of about 15,000 tonnes around 2000 years ago (Patterson, 1972), in accordance with the highest Roman mining industries in the Augustan period (Del Mar, 1968). On the other hand, Darling (1990) suggested that the maximum output might have occurred between the second and third centuries AD. Anyway, it is believed that the output of all the metals including copper began to decrease with a reduction of the Roman Empire's power from the third century A.D. (Forbes, 1956; Aitchison, 1960).

As to Cu production in the East beyond the Roman World, it is certain that a sizable amount of copper had been produced in the South-east Asia and Far East since long ago (Gungwu, 1964; Solheim II, 1968). Considering that, when the Han dynasty of China was extending its influences even to the South-east Asia two millennia ago, an annual Cu production in China amounted to about 800 tonnes (Archaeometallurgy Group, 1978; Xia et al., 1980), the total quantity of copper produced in these regions may be of the order of 1000 tonnes by the beginning of the christian era. This represents that most of copper in the world was evidently obtained in the Roman World a few centuries before and after the beginning of Christian era.

#### 2-2. Declined metallurgical activities during the Dark Ages

We do not much know the historical information on non-ferrous metallurgy of the immediate post-Roman period when the barbarian Age commenced in Europe with the collapse of Roman Empire (Lombard, 1974; Tylecote, 1976). At this time, european peoples had been inferior to the peoples in near-eastern countries and even China in the metallurgical knowledge for mining and extraction of metals.

During the early part of the Medieval times, the world's copper production was at very low level like that of all the other metals. Copper was mined and produced in the Caucasus, central Asia, and Iran beyond the early Roman frontiers (Lombard, 1974). From the middle of Medieval Ages, the middle East, north Africa, the Caucasus, central Asia, and the Urals became main source regions for production of copper and copper-base metals in the Moslem World (8-11 centuries A.D.) (Lombard, 1974). On the other hand, increasing demand for bronze in the

growing ancient dynasties of China stimulated to produce copper on a large scale, which amounted to over 1000 tonnes per year at some time (Xia et al., 1980). In Europe, the German miners started to exploit the copper ores in central Europe before the 10th century (Tylecote, 1976; Darling, 1990). The Moors also revived copper mining activities in southern Spain by the 8th century (Aitchison, 1960; Lombard, 1974). It is probable that the yearly output of copper in the whole world may not have exceeded 2000 tonnes by the late 10th century.

#### 2-3. Flourishing copper industry in China

For the period of the middle Medieval times, we have to refer to the copper production in China where was one of the important regions of metallurgical development in the ancient civilization. The amount of copper produced in China fluctuated with the growing and decline of ancient civilizations like other parts of the world. Table 2 shows an average rate of copper production in different ancient dynasties of China. During the Western Han period (206 B.C.-A.D. 23), when the Bronze Age in China came to an end, bronze was replaced by iron in the production of superior weapons. From this time on, therefore, bronze was used primarily for coins and mirrors (Fong, 1980). The amount of copper used for minting coins for the period of 108 B.C.-A.D. 6 reached about 98,000 tonnes, which gives an annual Cu production of about 800 tonnes (Archaeometallurgy Group, 1978; Xia et al., 1980). A peak of copper production in China had occurred in the Northern Sung period (A.D.960-1127) (Table 2). At this time, copper mining and smelting activities were greatly expanded with relation to the use of their coins as a standard money for the international trade (Ch'en, 1965). The maximum production

of copper in 1080's amounted to about 13,000 tonnes a year, which is comparable to that of the peak of Cu production during the Roman period. Thereafter, copper supply declined and was at very low rate in the late Southern Sung period. Interestingly, in the 12th century, a portion of copper was produced by the copper extraction, using cementation processes with iron displacement from mine waters, caverns and mountain streames (Rostoker and Shen, 1984). In the following dynasties of Yuan (A.D.1279-1368) and Ming (A.D.1368-1644), we could not estimate the rates of copper production, but it is likely that the output of copper mined and smelted was deflated at a low level, since they had not minted a large number of coins because of insufficient supply of copper (Xia et al., 1980).

As shown in Table 3, the chinese copper began to be predominating in the worldwide Cu production from the mid-8th century and this dominance of chinese copper had lasted for 400 years up to the mid-12th century.

#### 2-4. Revival of Cu mining in Europe

After the Moors started to work the copper ores in southern Spain by the 8th century, the Cu mining activities in central Europe were revived by Frankish miners, extracting Cu in Fahlerz copper ores of the Saxon Ore mountains in Germany before the end of the 10th century (Aitchison, 1960; Lombard, 1974; Tylecote, 1976). Since then the German were active in mining and smelting Cu in the Hartz mountains, Bohemia and Slovakia. The famous Falun copper mine in Sweden was opened in A.D.1220. From this time onwards, the German and Swedish output of copper dominated the supply for european Cu consumption. In the early

16th century, for instance, copper produced in German and Slovakia was of the order of 3000 tonnes per year (Pounds, 1974). And the annual output of Swedish copper reached 3000 tonnes at its peak in A.D.1650 (Tylecote, 1976; Pounds, 1990).

For the whole Cu produced in the western World outside the East, it is difficult to know the actual total amount with a credit, because we know where the copper ores were worked, but not quantitative amount produced. To approximately estimate Cu production rate in these regions during the late Medieval times, we used the amount of tin produced in Europe (Tylecote, 1976) where most of tin consumed in the western part of the World was produced and supplied. An average composition of bronze in antiquity was aimed to 90% of copper and 10% of tin (Penhallurick, 1986) and this metallurgical aspect may not have changed until the Medieval times. The principal use of tin was to make bronze before the Medieval Ages, but to make pewter and bronze later (Pounds, 1990). We assume, therefore, that only one-third of tin produced was used to make bronze. As shown in Table 4, the approximate estimates of copper produced in the West and near-east countries so evaluated are found to amount to about 1000 tonnes in the beginning of the 14th century and to increase to about 5500 tonnes in A.D.1650. This may not be overestimated, because we do not include brass (Cu-Zn) and other copper alloys (Cu-Sn-Zn-Pb) to make an estimate. The total world's Cu production including those produced in the East, where the Malaya and China were tin producer, was derived from the assumption that production rate may be of the order of at least 1000 tonnes in the 14th century and increase steadily for the following 400 years, although the chinese copper was at a low ebb, as ascribed in the section 2-3.

## 2-5. From the Industrial Revolution to present

The demand for copper was increasing in Europe after the onset of the Industrial Revolution, as like all the other metals. A remarkable aspect is that the smelting center of south Wales became the largest center of Cu smelting in the world (Day and Tylecote, 1991). The rising output of copper in Britain from the early 18th century was at its zenith in the late 18th century at a rate of production of 80,000 tonnes (Tylecote, 1976). In the mid-19th century, three-fourth of the total Cu amount of the world was produced in Britain (Thornton and Abrahams, 1984). On the other hand, quantity of copper produced in China possessed still a great portion of the world's Cu production for the period of A.D.1750-1800 (Table 5).

The rounded figures of the world's Cu production show that quantitative amount of copper increased no more than three times for 100 years from the mid-18th century (Table 5). It is of interest that the world's Cu amount in A.D.1750 was lower than those of the peaks in the Roman times and Sung dynasty of China. A dramatical rise of copper consumption arised from the development of the electric industries in the late 19th and early 20th centuries (Biswas and Davenport, 1976) and, accordingly, the worldwide Cu production have exponentially increased to reach about 9 millions metric tonnes per year of present production rate.

### 3. CHANGE OF COPPER EMISSION RATES TO THE ATMOSPHERE AS A FUNCTION OF AGES

As mentioned before, the ancient mining and smelting activities were so extensive as to suffice increasing need for copper at any distinctive period. The smelting of sulfide ores which is often a mixture of copper and iron, is complicated to need repeated roasting and smelting processes for obtaining high purity of copper, while carbonate and oxide ores can be smelted by the simple reduction smelting with charcoal. Many successive stages of roasting and smelting of sulfide ores could accompany a lot of emission of toxic elements to the atmosphere, as evidenced by the fact that the environment near Cu smelter operated in modern ages was seriously devastated due to the highly elevated emissions of multi-toxic metals such Cu, As, Sb, Pb, and Zn as well as sulfur dioxide (Hutchinson, 1979). It is, therefore, no wonder that a large amount of Cu aerosols should be emitted to the atmosphere through uncontrolled and wasteful mining and smelting operations in ancient times.

We know the present-day emission rate from various studies (Nriagu, 1979b,c), but not the ancient one, because of no reliable historical records on a loss rate. Thus we estimate a loss rate to the atmosphere during the ancient times on the basis of Harkins and Swain's analysis (1907) of smelter smoke in the beginning of this century. They analysed the smoke expelled from the stack of the world's largest smelter at Anaconda, Montana of the United States and presented that an average amount of Cu aerosols released into the atmosphere from the stack of smelter amounted to 1966 kg per day. Combining the amount of sulfide ores smelted everyday (10,000 tonnes) and the average content of Cu (~ 2%) in ores mined in the United States at that time (Patterson, 1971; Bairoch, 1993), an approximate calculation of emission rate gives about 1%. In the great flues and stack, built to prevent all the Cu and As pollutants from being escaped from the furnaces, Cu emission rate was found to increase to about 8%, which would be much

more approaching the furnaces. In the case of ancient smelter, smelting operations were done in the open air, indicating that all the Cu aerosols emitted out of furnaces were escaped into the atmosphere. Moreover, the ancient technique of smelting processes was uncontrolled, very wasteful and less efficient, and more many operations of roasting and smelting were involved. Taking account of these points including rude mining works, we assume that emission rate of Cu pollutant aerosols emitted from mining and smelting activities to the atmosphere would reach not less than about 15%. The essential techniques and processes for copper smelting had not changed very much until the Industrial Revolution since the ancient times (Tylecote, 1976). From this time, the development of the furnaces and metallurgical technique prompted to improve efficiency of the extraction of copper and the processes of smelting operation were reduced to need only five stages by the mid-19th century (Tylecote, 1976). According to sustained development, it is proved that emission rates from smelting activities became decreased gradually to reach at about 1% in the beginning of the 20th century. An estimate of emission rate from Cu mining and smelting in the middle of 1970's accounted for about 0.25% (Nriagu, 1979b), which represents about 60-fold decrease of emission factor from the ancient times to present.

Table 6 shows the historical change of an annual amount, estimated by using production and emission rates with ages, of copper aerosols emitted from mining and smelting activities to the atmosphere. Surprisingly, it is found that global Cu emissions at the peak of the Roman and Sung dynasty periods were greater than that in A.D.1850 and lower by a factor of only about 10 than in A.D.1990. In addition, the cumulative Cu emissions for the Roman period came to about 600,000 tonnes, which account for about half of that for the twentieth century (Table 7).

It is, moreover, remarkable that the quantity of anthropogenic Cu aerosols emitted before the Industrial Revolution was comparable to that between the onset of Industrial Revolution and present.

## SUMMARY

After the development of smelting technique around 7000 years ago, copper was supplied by simple reduction smelting of carbonate and oxide copper ores. As the early metallurgist developed the smelting operations of sulfide ores at about 2500 B.C., a large quantity of copper was mined and smelted from sulfide ores on a significant scale in Bronze Age. The estimated amount of copper produced from 2000 to 700 B.C. was about 500,000 tonnes. For the period of 650-350 B.C., about 700,000 tonnes of copper appear to have been produced for base-metal of coins with the introduction of coinage at about 600 B.C. The rapid increase of copper production had taken place during the Roman period. It is estimated that total copper mined and produced amounted to 4 to 5 million tonnes and maximum output reached about 15,000 tonnes per year around two millennia ago with an average annual rate of 7000 tonnes.

After the fall of the Roman Empire, copper production declined and was at a low ebb by the 8th century. In the middle of the Medieval times, copper produced in China increased greatly due to the growth of the ancient dynasties of China and, consequently, dominated the world's Cu production from the mid-8th to mid 12th centuries. At the peak of Sung dynasty of China, an annual Cu production was about 13,000 tonnes in 1080's. As Sung dynasty declined, the world's Cu production became low at about 2000 tonnes in the 14th century. In Europe, the Cu



mining and smelting activities were revived in Germany by the end of the 10th century and then in Sweden in the 13th century. Since then, the quantity of copper produced in the world increased gradually until the Industrial Revolution. Thereafter, the world's production rate show an exponential rise from the 19th century. As a result, the historical Cu production shows a dramatical change with the development of powerful Empires in the world since the ancient times (Fig. 1).

We assume, here, that emission rate of Cu aerosols released from uncontrolled and wasteful mining and smelting activities to the atmosphere may have reached about 15% during the ancient times. In modern ages, emission rate decreased to about 1% and 0.25% in the beginning of this century and the present, respectively. Using the production and emission rates with ages, the historical trend of the annual amounts of Cu emitted to the atmosphere are found that at the peak of the Roman and Sung dynasty period, the amounts of Cu emission were greater than that estimated for the Industrial Revolution. Moreover, the total amount of Cu emitted before the Industrial Revolution is comparable to the estimate of post-Industrial Revolution, indicating that a vast amount of Cu aerosols emitted from the ancient Cu mining and smelting activities may have considerably polluted the atmosphere and disturbed the global cycle of copper in the environment.

Finally, it should be noticed that the reconstruction of historical Cu production and the estimate of Cu emission presented here came from the limited bibliographies, because a review of all the related documents is beyond our scope. We expect, therefore, that further detailed and available reconstruction of historical Cu production rate would be supplemented by other additional works.

### Acknowledgement

This work was supported by the French Ministry of the Environment (grant 92295), the Institut National des Sciences de l'Univers, and the University of Joseph Fourier of Grenoble.

We thank C. Domergue for his helpful discussion.

## REFERENCES

- Aitchison, L., 1960. *A History of Metals*. Macdonald, London. V. II, pp. 647.
- Allan, J.C., 1970. Considerations on the antiquity of mining in the Iberia Peninsular. Royal Anthropological Institute. *occa. Paper*, No. 27: 1-42.
- Archaeometallurgy Group, Beijing University of Iron and Steel Technology, 1978. *A Brief History of Metallurgy in China*. Science Press, Beijing.
- Bairoch, P., 1993. *Economics and World History*. Harvester, New York, pp. 184.
- Biswas, A.K. and W.G. Davenport, 1976. *Extractive Metallurgy of Copper*. Pergamon, Oxford, pp. 438.
- Candelone, J.-P., S. Hong, C. Pellone and C.F. Boutron, 1995. Post industrial revolution changes in large scale atmospheric pollution of the Northern Hemisphere by heavy metals as documented in central Greenland snow and ice. *J. Geophys. Res.*, in press.
- Ch'en, J., 1965. Sung bronze - An economic analysis. *J. Bull. of the School of Oriental and African*, 28: 613-626.
- Day, J. and R.F. Tylecote (Eds.), 1991. *The Industrial Revolution in Metals*. The Institute of Metals, London, pp. 318.
- Darling, A.S., 1990. Non-ferrous metals. In: I. Mcneil (Ed.), *An Encyclopaedia of the History of Technology*. Routledge, London, pp. 45-145.
- Del Mar, A., 1968. *A History of the Precious Metals from the Earliest Times to the Present*. Burt Franklin, New York. (2nd Ed.), pp. 479.
- Fong, W. (Ed.), 1980. *The Great Bronze Age of China*. Alfred, New York, pp. 386.

- Forbes, R.J., 1956. The Mediterranean civilization and the Middle Ages c. 700B.C. to c. A.D. 1500. In: C. Singer, E.J. Holmyard, A.R. Hall and T.I. Williams (Eds.), *A History of Technology*. V. II. Oxford, pp. 802.
- Gale, N.H. and Z.A. Stos-Gale, 1982. Bronze Age copper sources in the Mediterranean : A new approach. *Science*, 216: 11-19.
- Gungwu, W. (Ed.), 1964. *Malaysia : A survey*. Pall Mall, London, pp. 466.
- Harkins, W.D. and R.E. Swain, 1907. Papers on smelter smoke. I. The determination of Arsenic and other solid constituents of smelter smoke, with study of the effects of high stacks and large condensing flues. *J. Am. Chem. Soc.*, 29: 970-998.
- Healy, J.F., 1978. *Mining and metallurgy in the Greek and Roman World*. Thames and Hudson, London, pp. 316.
- Hong, S., J.-P. Candelone, C.C. Patterson and C.F. Boutron, 1994. Greenland ice evidence of hemispheric lead pollution two millennia ago by Greek and Roman civilizations. *Science*, 265: 1841-1843.
- Hutchinson, T.C., 1979. Copper contamination of ecosystem caused by smelter activities. In: J.O. Nriagu (Ed.), *Copper in the Environment*. Wiley, New York, pp. 451-502.
- Kerr, R., 1990. *Later Chinese Bronze*. Bamboo, London, pp. 115.
- Lombard, M., 1974. *Les Métaux dans l'Ancien Monde du V<sup>e</sup> au XI<sup>e</sup> siècle*. Mouton, Paris, pp.
- Mitchell, B.R., 1987. *European Historical Statistics 1750-1975*. Macmillan, London, (2nd ser.).
- Nriagu, J.O., 1979a. The global copper cycle. In: J.O. Nriagu (Ed.), *Copper in the Environment*. Wiley, New York, Part I: 1-17.

- Nriagu, J.O., 1979b. Copper in the atmosphere and precipitation. In: J.O. Nriagu (Ed.), *Copper in the Environment*. Wiley, New York, pp. 43-75.
- Nriagu, J.O., 1979c. Global inventory of natural and anthropogenic emissions of trace metals to the atmosphere. *Nature*, 279: 409-411.
- Nriagu, J.O., 1990. Human influence on the global cycling of trace metals. *Palaeogeogr. Palaeoclimatol. Palaeoecol.*, 82: 113-120.
- Patterson, C.C., 1971. Native copper, silver, and gold accessible to early metallurgists. *Am. Antiq.*, 36: 286-321.
- Patterson, C.C., 1972. Silver stocks and losses in ancient and Medieval times. *Econ. Hist. Rev.*, 25 (2nd ser.): 205-235.
- Penhallurick, R.D., 1986. *Tin in Antiquity*. The Institute of Metals, London, pp. 271.
- Pounds, N.J.G., 1974. *An Economic History of Medieval Europe*. Longman, New York, pp. 562.
- Pounds, N.J.G., 1990. *An Historical Geography of Europe*. Cambridge, London, pp. 484.
- Rostoker, W. and G. Shen, 1984. Copper sulphate as an ancient source of copper. *J. Historical Metallurgy Soc.*, 18: 13-20.
- Simonetti, J.-O., 1981. *Géographie des Matières Premières Minérales*. Masson, Paris, pp.
- Solheim II, W.G., 1968. Early bronze in northeastern Thailand. *Current Anthropol.*, 9: 59-62.
- Thornton, I. and P. Abrahams, 1984. Historical record of metal pollution in the environment. In: J.O. Nriagu (Ed.), *Changing Metal Cycles and Human Health*. Springer-Verlag, New York, pp. 7-25.
- Tylecote, R.F., 1976. *A History of Metallurgy*. Mid-County, London, pp. 182.

- Tylecote, R.F., 1987. *The Early History of Metallurgy in Europe*. Longman, London, pp. 379.
- Wolff, E.W. and E.D. Suttie, 1994. Antarctic snow record of Southern Hemisphere lead pollution. *Geophys. Res. Lett.*, 21: 781-784.
- Xia, X.R., Z.J. Li and G.Z. Wang, 1980. *A History of Ancient Chinese Exploitation of Mining Industry*. Geology Press, Beijing.

Table 1

Changing Cu production rate during the Roman period. These figures are derived from the estimates by Patterson (1972).

| Period           | Annual amount of copper produced<br>(tonnes/yr) |
|------------------|---|
| 350-250 B.C.     | 1,900   |
| 250-150 B.C.     | 4,500   |
| 150-50 B.C.      | 7,500   |
| 50 B.C.-A.D. 100 | 15,000  |
| A.D. 100-200     | 7,500   |
| A.D. 200-300     | 2,300   |
| A.D. 300-400     | 1,900   |

Table 2

Historical record of copper production in China.

| Period                    | Cu production (tonnes/yr) |        |
|---------------------------|---------------------------|--------|
| <b>Wesern Han Dynasty</b> |                           |        |
| (206 B.C.-A.D. 23)        | 118B.C.-A.D. 6            | 800    |
| <b>Tang Dynasty</b>       |                           |        |
| (A.D. 618-907)            | 742-756                   | 1,200  |
|                           | 806-820                   | 160    |
|                           | 847-859                   | 400    |
| <b>Sung Dynasty</b>       |                           |        |
| <b>northern Sung</b>      |                           |        |
| (A.D. 960-1127)           | 995-997                   | 2,500  |
|                           | 1017-1021                 | 1,600  |
|                           | 1049-1054                 | 3,100  |
|                           | 1064-1067                 | 4,200  |
|                           | 1078                      | 8,800  |
|                           | 1080's                    | 13,000 |
| <b>southern Sung</b>      |                           |        |
| (A.D. 1127-1279)          | 1127                      | 4,200  |
|                           | 1162                      | 4,200  |
|                           | 1166                      | 160    |
| <b>Qing Dynasty</b>       |                           |        |
| (A.D. 1644-1911)          | 1743-1802                 | 7,000  |
|                           | 1874                      | 500    |
|                           | 1874-1887                 | 288    |
|                           | 1888-1906                 | 813    |

Table 3

Increasing chinese output of copper and dominant aspect in the world's Cu production during the mid-Medieval times.

| Date (A.D.) | Total world production<br>(tonnes/yr) | Relative production rate |                       |
|-------------|---------------------------------------|--------------------------|-----------------------|
|             |                                       | China                    | The rest <sup>a</sup> |
| 1150        | 6,000                                 | 4,200                    | 1,800                 |
| 1080's      | 14,000                                | 13,000                   | 1,000                 |
| 1000        | 3,500                                 | 2,500                    | 1,000                 |
| 750         | 2,000                                 | 1,200                    | 800                   |

<sup>a</sup>These figures are estimated and rounded from the relationship between silver production rate and its relative value to copper as suggested by Patterson (1972).

Table 4

The estimated amount of copper produced in the late Medieval times.

| Date (A.D.) | Tin production<br>in Europe <sup>1</sup> | Cu produced in the rest<br>outside the East<br>(tonnes/yr) | Global<br>total <sup>2</sup> |
|-------------|--|--|------------------------------|
| 1650        | 1,850                                    | 5,500  | 6,500                        |
| 1500        | 1,600                                    | 4,800  | 5,500                        |
| 1300        | 400                                      | 1,200  | 2,000                        |

<sup>1</sup>From Tylecote (1976).

<sup>2</sup>For this, we assume that after the decline of Sung dynasty in China the amount of copper produced in the East decreased, but was still of the order of about 1000 tonnes per year, considering that Yunnan, one of chief copper-producing areas in China, began to be controlled under the chinese authorities from A.D. 1253 (Kerr, 1990).



Table 5

The world's copper production from 1750 to 1880 A.D.

| Date (A.D.) | Annual output (tonnes) | Main sources                             |
|-------------|------------------------|--|
| 1880        | 200,000 <sup>1</sup>   | Britain 80,000                           |
| 1850        | 30,000 <sup>2</sup>    | Britain 22,000                           |
| 1800        | 15,000                 | Europe 8,000<br>China 7,000 <sup>3</sup> |
| 1750        | 10,000                 | Europe 3,000<br>China 7,000 <sup>3</sup> |

<sup>1</sup>An estimate extrapolated from the 1900-Cu production, using the annual growth rate (5.5%) of the world's copper production between 1881 and 1914 A.D. (Bairoch, 1993).

<sup>2</sup>The pre-1850 figures are derived from Tylecote (1976), Thornton and Abrahams (1984), Mitchell (1987), and Day and Tylecote (1991).

<sup>3</sup>See Table 2.

Table 6

The estimated amount of copper emitted from Cu mining and smelting activities to the atmosphere with times.

| Date (A.D.) | Annual Cu emission<br>(x 10 <sup>3</sup> tonnes / yr) |
|-------------|---|
| 1990        | 22.5  |
| 1975        | 19.7  |
| 1950        | 16.2  |
| 1905        | 7.5   |
| 1850        | 1.5   |
| 1750        | 1.5   |
| 1500        | 0.8   |
| 1080's      | 2.1   |
| 750         | 0.3   |
| 0           | 2.3   |
| 500 B.C.    | 0.3   |

The pre-1750 figures are derived from the emission rate of ~15%. The post-1750 figures are estimated by assuming that the emission rates had decreased linearly to ~1 % in A.D. 1900 and again to ~0.25% in A.D. 1975, respectively.

Table 7

The cumulative amounts of Cu aerosols emitted from Cu mining and smelting activities to the atmosphere at any given periods.

| Period              | Cumulative Cu emission<br>(x 10 <sup>5</sup> tonnes / yr) |
|---------------------|---|
| A.D. 1900 - present | 12.5  |
| A.D. 1750 - 1900    | 4.0   |
| A.D. 1000 - 1750    | 6.6   |
| A.D. 350 - 1000     | 2.1   |
| 200 B.C. - A.D. 350 | 6.0   |
| 3000 - 200 B.C.     | 2.0   |
| <b>Total</b>        | <b>33.2</b>   |

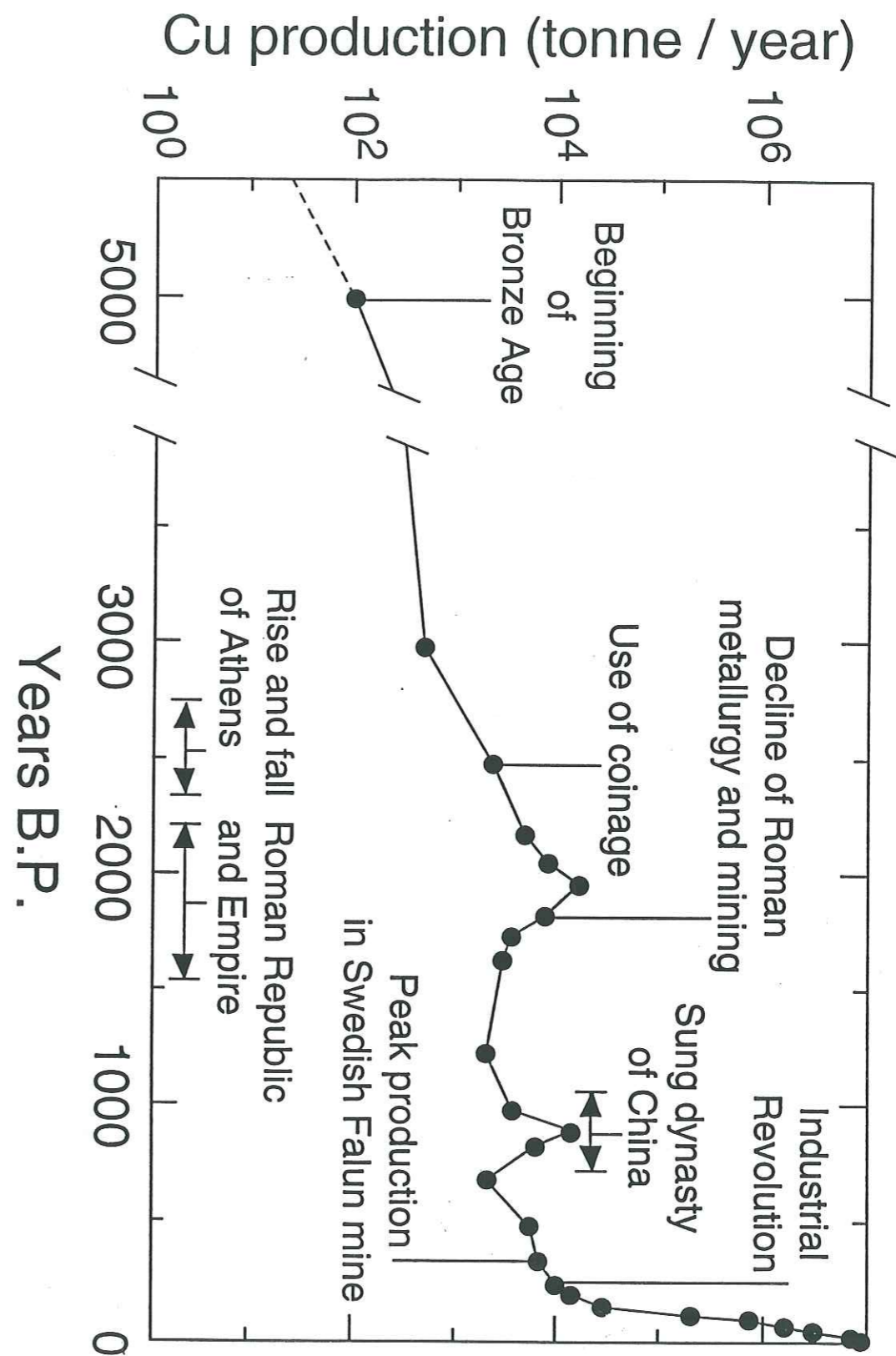

GREATER CUMULATIVE LARGE SCALE ATMOSPHERIC POLLUTION OF THE  
NORTHERN HEMISPHERE FOR COPPER BEFORE THAN AFTER THE  
INDUSTRIAL REVOLUTION

Sungmin Hong, Jean-Pierre Candelone, Clair C. Patterson and Claude F. Boutron\*

S. Hong, Laboratoire de Glaciologie et Géophysique de l'Environnement du CNRS, 54, rue Molière, Domaine Universitaire, B.P. 96, 38402 Saint Martin d'Hères, France

J.P. Candelone, Department of Applied Physics, Curtin University of Technology, GPO Box U 1987, Perth, WA 6001, Australia and Laboratoire de Glaciologie et Géophysique de l'Environnement du CNRS, 54, rue Molière, Domaine Universitaire, B.P. 96, 38402 St Martin d'Hères, France

C.C. Patterson, Division of Geological and Planetary Sciences, California Institute of Technology, Pasadena, California 91125, USA

C.F. Boutron\*, Laboratoire de Glaciologie et Géophysique de l'Environnement du CNRS, 54, rue Molière, Domaine Universitaire, B.P. 96, 38402 St Martin d'Hères, France and UFRs de Mécanique et de Physique, Université Joseph Fourier de Grenoble, Domaine Universitaire, B.P. 68, 38041 Grenoble, France

\*To whom correspondence should be addressed

*Submitted to "Science", September 15, 1995*

ABSTRACT

The first reliable determination of copper in Greenland ice dated from seven millennia ago onwards shows values in excess above natural levels from ~ 2500 years ago. This early large scale pollution of the atmosphere of the Northern Hemisphere for copper is attributed to emissions from the crude highly polluting smelting technologies used for copper production during Roman and Medieval times in various parts of the world, especially in Europe and China. Cumulative deposition of copper to the ice cap is found to be one order of magnitude higher from 2500 years ago to the Industrial Revolution than from the Industrial Revolution to present.

It is generally assumed that the bulk of the emissions of pollutant species to the global atmosphere of our planet occurred after the Industrial Revolution, driven by the combination of the unprecedented growth of the population of the earth and the massive technological and economical development. Time series of large scale atmospheric pollution stored in archives such as polar ice caps confirm that this is indeed the case for most investigated polluting species (1, 2): anthropogenically induced increasing trends are observed neither for greenhouse gases nor for sulfur or nitrogen compounds before the middle of the eighteenth century. The only exception reported so far is lead. For this heavy metal indeed, time series recently obtained from Greenland ice (3) and Swedish lake sediments (4) conclusively showed the existence of an early hemispheric scale atmospheric pollution during Greek and Roman times far before the onset of the Industrial Revolution. The importance of this early pollution for lead remained however relatively limited: cumulative lead deposition to the Greenland ice cap during the eight centuries of the flourishing of the Greek and Roman civilizations, ~ 400 metric tonnes, was indeed one order of magnitude lower than the post Industrial Revolution fallout flux to the ice cap, ~ 3200 metric tonnes (5). Here we report evidence that cumulative early atmospheric pollution for copper before the Industrial Revolution was one order of magnitude greater than that from the Industrial



revolution to Present.

We analysed for copper twenty three sections of the 3028.8 m GRIP deep ice core (6) recently drilled in central Greenland at Summit (72°34'N, 37°37'W, elevation of 3238 m above sea level) : twenty one were selected from ice dated from 2960 to 470 years ago (depths of 619.3 to 129.3 m) in order to cover the Greek and Roman civilizations, the Barbaric and Medieval times and the Renaissance. Two sections were chosen from ice dated Holocene copper concentrations during pre-copper production times. With the exception of the 7260 years BP sample, these are the same samples previously analysed for lead in (3). Already described, each core section was mechanically decontaminated using ultraclean procedures (7). A critical point for the accuracy of the data is with the efficiency of the decontamination procedure. It was systematically checked for all sections by investigating radial changes in copper concentrations from the outside to the center of each individual core section (8). Copper concentrations measured in the central parts of the twenty three sections are found to range from 0.8 to 6.4 pg/g. These are the first reliable copper data ever obtained for ancient Greenland ice.

Changes in copper over aluminum ratio (9) as a function of the age (10) of the ice from 7760 to 470 years ago are shown in Fig. 1. Also shown are representative mean values from (5) for the post Industrial Revolution period obtained from the analysis of a 70 m core drilled at the same location. Copper /aluminum ratio was about  $2 \times 10^{-4}$  seven millennia ago, before the beginning of the production of copper by man ~ 7000 years ago. Copper in the atmosphere was still totally natural and originated from sources such as rock and soil, the oceans, volcanoes, etc... (12, 13). It remained unchanged around 3000-2700 years ago. Starting from ~ 2400 years ago, the situation becomes different. From ~ 2400 to 1800 years ago, if the lowest values remain close to the natural level of  $\sim 2 \times 10^{-4}$ , higher values, up to  $\sim 6 \times 10^{-4}$ , are observed in part of the samples. Finally, from ~ 1800 years ago onwards, all values are above natural levels, with the lowest values being  $\sim 3 \times 10^{-4}$  and the highest being  $\sim 17 \times 10^{-4}$ .

These high values observed in part of the samples from ~ 2400 years ago onwards are not due to uncontrolled contamination of the corresponding core sections : the radial concentrations profiles for copper (and aluminum) in all but one (8) sections indeed show excellent plateaus of concentrations which confirms that transfer of outside contamination to the inner parts of the cores cannot be responsible for the observed high values. They cannot be explained by changes in contributions from natural sources. Ancillary measurements of aluminum, sodium, sulfate and ammonium (13) indeed conclusively indicate (15) that natural copper contribution from natural sources such as rock and soil dust, sea salt spray, volcanoes and biomass burning is not responsible for the observed high values. We think that they are due to early large scale copper pollution of the atmosphere of the Northern Hemisphere long before the Industrial Revolution.

We are not aware of any published comprehensive data on past changes in anthropogenic copper emissions to the atmosphere from prehistoric times to present. Both during ancient and recent times, these emissions mainly originated from copper mining and smelting activities, with only rather minor contributions from other human activities (production of iron and other non ferrous metals, wood combustion, ... (15). As a first step towards obtaining a time series of copper emissions to the atmosphere which can be used for the interpretation of our Greenland ice data, we have therefore reconstructed past changes in copper production, Fig. 2, from a comprehensive review (16) of available literature. It will be discussed here only briefly, with special emphasize on the pre-Renaissance times.

Copper was first produced from native copper ~ 7000 years ago (17). Its production became however significant only ~ 5000 years ago, after the development of techniques for smelting carbonate and oxide ores (18) and the introduction of tin-bronze which heralded the beginning of the real Bronze-Age. The production then continuously increased thanks to the development of new techniques for smelting sulfide ores ~ 4500 years ago (17-19). Cumulative production from ~ 4000 to 2700 years ago was ~ 500000 metric tonnes (20).

The Roman period marked the beginning of a sharp rise in the production of copper in response to the rapidly increasing use of copper alloys both for military and civilian purposes, especially for coinage (20, 23). Total production peaked at over ~ 15000 metric tonnes per year ~ 2000 years ago, Fig. 2, with the main production districts being located in Spain (which accounted for more than half of worldwide production during the Roman times), Cyprus and central Europe (18, 23). Cumulative production from ~ 2250 to 1650 years ago was ~ 5 millions metric tonnes.

After the fall of the Roman Empire, copper production strongly declined in Europe, and world production remained low at ~ 2000 metric tonnes per year until the ~ eighth century (19, 24). Then it increased again during Medieval times; In Europe, this increase was linked with the mining of new German ores from the ninth century and of Swedish ores (especially in the Falun area) from the thirteenth century (19, 24, 25). But during Medieval times, the largest part of the production originated from China (26, 27), especially during the Northern Sung period (tenth to twelfth century): during that period, the Chinese production reached a pronounced maximum of ~ 13000 metric tonnes per year ~ 900 years ago (26), which gives a worldwide production peak of ~ 15000 metric tonnes per year ~ 900 years ago comparable to the Roman peak ~ 2000 years ago, Fig. 2.

Production was then rather low again for several centuries (~2000 metric tonnes per year in the fourteenth century), before increasing massively from the Industrial Revolution to present, Fig. 2, strongly stimulated by the development of electrical industries. Present day production is ~ 9 millions metric tonnes per year.

Special attention must be given to estimating the emission factors for the release of copper to the atmosphere during copper production, especially the high temperature processes employed in smelters. From a comprehensive review (16) of available literature, it is clear that these emission factors have varied considerably during the past seven millennia, due to the big changes

in production technologies (19, 21). During ancient times, a reasonable estimate is that the emission factors were probably as high as ~ 15 % (16). These extremely high values were linked with the uncontrolled and wasteful smelting procedures which were used then. This was especially the case for the smelting of sulfide ores, which required numerous successive wasteful roasting, smelting, oxidizing and refining steps (22) performed in rude open furnaces without any control of emissions. This lack of control of emissions essentially remained until the Industrial Revolution (19), when highly improved furnaces and metallurgical techniques started to be developed and implemented. For instance, smelting procedures were greatly improved, requiring only five steps by the middle of the nineteenth century (19). These major improvements in copper production technologies resulted in a sharp decrease in emission factors, from the Industrial Revolution onwards, which were probably reduced to ~ 1 % at the beginning of the twentieth century. Further improvements were achieved since that, resulting in present day emission factors of ~ 0.25 % (29). This represents an enormous decrease in emission factors by a factor of ~ 60 from ancient times to present.

When combining these emission factors with the production data shown in Fig. 2, it appears that copper emissions to the atmosphere were as high as ~ 2100-2300 metric tonnes per year at the peaks of the Roman Empire ~ 2000 years ago and of the Northern Sung dynasty in China ~ 900 years ago, Table 1, that is values which are higher than those for the mid eighteenth and nineteenth century and represent as much as ~ 10 % of present day emissions.

We interpret the high copper/aluminum ratios observed in part of our ice samples dated from the Roman times onwards, Fig. 1, as a result of these early anthropogenic copper emissions to the atmosphere of the Northern Hemisphere, long before the Industrial Revolution. Our ice data suggest that these emissions were intense enough to result in an early significant copper pollution of the middle troposphere of the Arctic. Pollutant copper was probably emitted to the atmosphere in the form of small size aerosols during the high temperature steps of copper

production processes. These aerosols were easily transported from the mid-latitude areas where they were emitted (mainly the Mediterranean basin, especially Spain, during roman times, and China during Medieval times) to the Arctic through well documented general circulation features of the atmosphere of the Northern Hemisphere (30).

Changes in copper/aluminum ratio in Greenland ice during the past seven millennia appear to be in general agreement with the estimated changes in anthropogenic copper emissions to the atmosphere shown in Table 1. The Greenland ice data indeed show low (natural) values until ~ 2500 years ago, then medium values from the roman times to the Industrial revolution, and finally a sharp increase in recent times, Fig. 1. We have however not enough data points for the Medieval times to confirm the peak of emissions during the eleventh century (Table 1) and the low emissions periods which preceded and followed this peak. Of interest is the high variability of the data during the Roman period. It might be the consequence of the fact that during Roman times copper production strongly varied over short time periods such as decades along with pronounced changes in the need of copper especially for coinage. It is probably not due to large changes in atmospheric transport from mid-latitude to the Arctic since such a variability was not observed for lead (3) (lead production did not suffer such big short term changes).

Changes in fallout flux of copper at Summit during the past seven millennia can be obtained from copper concentrations measured in the ice and the mean local ice accumulation rate of 23 g of H<sub>2</sub>O cm<sup>-2</sup> year<sup>-1</sup>, Fig. 3. Fallout flux is found to range from ~ 0.17 x 10<sup>-10</sup> g of copper cm<sup>-2</sup> year<sup>-1</sup> (pre-Roman period ~ 3000 years ago) to ~ 2.2 x 10<sup>-10</sup> g of copper cm<sup>-2</sup> year<sup>-1</sup> (present day). Cumulative fallout of anthropogenic copper to the whole Greenland ice cap (surface of 1.4 x 10<sup>6</sup> km<sup>2</sup>, mean annual accumulation rate of 34 g of H<sub>2</sub>O cm<sup>-2</sup> year<sup>-1</sup>) can be calculated from Fig. 3 after correction for copper flux from natural sources (31). The net deposition of anthropogenic copper to the Greenland ice cap during the Roman period (~ 2500 to 1500 years ago) is found to be ~ 800 metric tonnes. From the fall of the Roman Empire to the Industrial Revolution (~ 1500

to 220 years ago), the deposition is ~ 2000 metric tonnes; The cumulative deposition from 2500 years ago to the Industrial Revolution is then ~ 2800 metric tonnes. These values are much higher than the cumulative deposition of copper to the Greenland ice cap from the Industrial Revolution to present, ~ 200 metric tonnes (5). It means that cumulative large scale pollution of the atmosphere of the Northern Hemisphere for copper was much larger before than after the Industrial Revolution, contrary to what was observed for lead (3). As discussed above, it is probably largely due to the wasteful and uncontrolled processes which were used for copper production during the Roman and Medieval times, which resulted in relatively large emissions of copper to the atmosphere.

#### References and notes

1. D. Raynaud, J. Jouzel, J.M. Barnola, J. Chappellaz, R.J. Delmas and C. Lorius, *Science* **259**, 26 (1993).
2. C.F. Boutron, *Environ. Rev.* **3**, 1 (1995).
3. S. Hong, J.P. Candelone, C.C. Patterson and C.F. Boutron, *Science* **265**, 1841 (1994).
4. I Renberg, M.W. Persson and O. Emteryd, *Nature* **368**, 323 (1994).
5. J.P. Candelone, S. Hong, C.I. Pellone and C.F. Boutron, *J. Geophys. Res.*, in press.
6. W. Dansgaard et al., *Nature* **364**, 218 (1993).
7. J.P. Candelone, S. Hong, C.F. Boutron, *Anal. Chim. Acta* **299**, 9 (1994).
8. Very significant copper contamination was found to be present in the most outside layer of the core sections. Concentrations then decrease to the second or third layers. Good plateaus of concentrations were then obtained from the second or third layers for all but one of the investigated core sections : it indicates that the plateau concentration value does represent the

original concentration in the ice. The only exception was the 294.25 m section (dated 1248 years ago). For this section, we used a value extrapolated from the radial profile which showed a continuous decrease from the outside to the inside.

9. Aluminum and sodium were measured by GFAAS with a precision of 10 %. Aluminum is used to normalize copper concentrations in order to compensate for year to year changes in parameters such as atmospheric transport or precipitation rates.
10. The age of the core sections was estimated from an improved unpublished time scale for the Holocene part of the GRIP core (S. Johnsen, personal communication, 1995). Compared with the earlier scale of Johnsen *et al.* (11), this improved time scale is based on a glaciological model constrained by all the time markers available for the Holocene (volcanic eruptions, isotopic event at 8200 years BP dated independently in the Dye 3 Greenland ice core).
11. S. Johnsen *et al.*, *Nature* 359, 311 (1992).
12. J.O. Nriagu, *Nature* 338, 47 (1989).
13. Sulfate and ammonium were measured by ion chromatography with a precision of 10 %.
14. S. Hong, J.P. Candelone and C.F. Boutron, *Earth Planet. Sci. Lett.* submitted.
15. J.O. Nriagu and J.M. Pacyna, *Nature* 333, 134 (1988).
16. S. Hong, J.P. Candelone, M. Soutif and C.F. Boutron, *Sci. Tot. Environ.*, submitted.
17. C.C. Patterson, *Am. Antiq.* 36, 286 (1971).
18. A.S. Darling, in *An Encyclopaedia of the History of Technology*, I. McNeil, Ed. (Routledge, London, 1990), pp. 47-145.
19. R.F. Tylecote, *A History of Metallurgy* (Mid-County, London, 1976).
20. C.C. Patterson, *Econ. Hist. Rev.* 25 (2nd ser.) 205 (1972).
21. R.F. Tylecote, *The Early History of Metallurgy in Europe* (Longman, London, 1987).
22. R.J. Forbes, in *A History of Technology*, Vol. II. C. Singer, E.J. Holmyard, A.R. Hall and T.I. Williams, Eds. (Clarendon Press, Oxford, 1956), pp. 48-80.

23. J.F. Healy, *Mining and Metallurgy in the Greek and Roman World* (Thames and Hudson, London, 1988).
24. M. Lombard, *Les Métaux dans l'Ancien Monde du Ve au XIe siècle* (Mouton, Paris, 1974).
25. N.J.G. Pounds, *An Historical Geography of Europe* (Cambridge, London, 1990).
26. Archaeometallurgy Group, Beijing University of Iron and Steel Technology, *A Brief History of Metallurgy in China* (Science Press, Beijing, 1978).
27. J. Ch'en, *Bull of the School of Oriental and African Studies*, 28, 613 (1965).
29. J.O. Nriagu, in *Copper in the Environment*, J.O. Nriagu, Ed. (Wiley, New-York, 1979), pp. 43-75.
30. W.E. Raatz, in *Pollution of the Arctic Atmosphere*, W.T. Sturges, Ed. (Elsevier, London, 1991), pp. 13-42.
31. Natural copper flux was calculated as the arithmetic mean of the fluxes obtained from the 7760, 7260, 2960 and 2670 data points. The value so obtained was  $0.25 \times 10^{-10}$  g of copper  $\text{cm}^{-2} \text{year}^{-1}$ .
32. This work is a contribution of the Greenland Ice Core Project organized by the European Science Foundation. We thank B. Stauffer and J.P. Steffensen for their very kind assistance, in ice core selection, and M. Soutif, R.J. Delmas, C. Domergue and for helpful discussions. We thank the national funding agencies and organizations in Belgium, Denmark, France, Germany, Iceland, Italy, Switzerland, and the United Kingdom as well as the XII Directorate of the Commission of European Communities for financial support. Supported by the French Ministry of the Environment (grants 92295 and 94 ), the Institut National des Sciences de l'Univers, and the University Joseph Fourier of Grenoble.

**Table 1.** Estimated copper emissions to the atmosphere linked with copper production. These estimates were derived (16) from the production data shown in Fig. 2 by assuming that copper emission factors were ~ 15 % before the Industrial Revolution, then declined linearly to ~ 1 % in 1900 and ~ 0.25 % for present (16).

| Date<br>(years before present (B.P.) or calendar<br>years | Estimated copper emission to the<br>atmosphere (metric tonnes per year) |
|---|---|
| 5000 B.P.   |   |
| 3000 B.P.   |   |
| 500 B.P.  | 300   |
| 0 <sup>1</sup>  | 2300  |
| 750   | 300   |
| 1080 <sup>2</sup>   | 2100  |
| 1500  | 800   |
| 1750  | 1500  |
| 1850  | 1500  |
| 1950  | 16000   |
| 1990  | 23000   |

<sup>1</sup>Peak of Roman copper production ~ two millennia ago <sup>2</sup>Peak of Chinese copper production during the Northern Sung dynasty ~ 900 years ago.

### Figure legends

**Fig. 1.** Changes in copper over aluminum ratio in ice from Summit, central Greenland, dated from 7760 to 470 years ago (black dots). An open symbol is used for the core section dated from 1248 years ago, since no plateau of concentration was obtained for copper in that section (8) : copper over aluminum ratio was calculated using the copper value extrapolated from the radial profile (8) and should therefore be considered as an upper limit of the original ratio in the ice. Also shown as triangles are representative mean values from (5) for ice and snow dated from the Industrial Revolution to Present collected at the same location.

**Fig. 2.** Variations in copper production rate from the time when copper was first produced from native copper (~ 7000 years ago) to present as reconstructed from an extensive review (16) of available literature.

**Fig. 3.** Summit, central Greenland : changes in copper deposition to the ice from 7760 to 470 years ago (black dots ; an open symbol is used for the data point for 1248 years ago which should be considered as an upper limit only (8)). Also represented as triangles are representative mean deposition values from (5) for the post Industrial Revolution period.

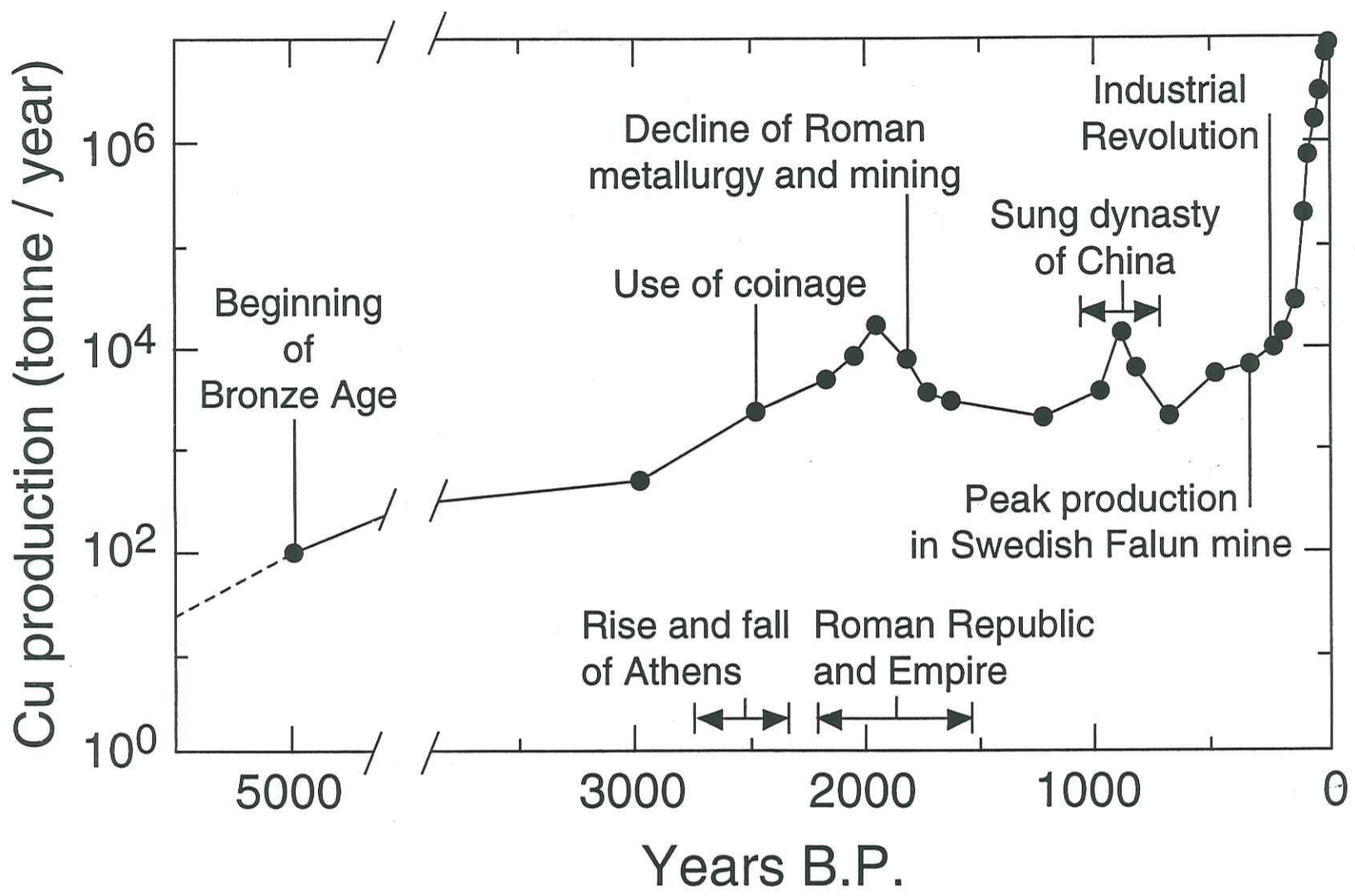

Fig. 2

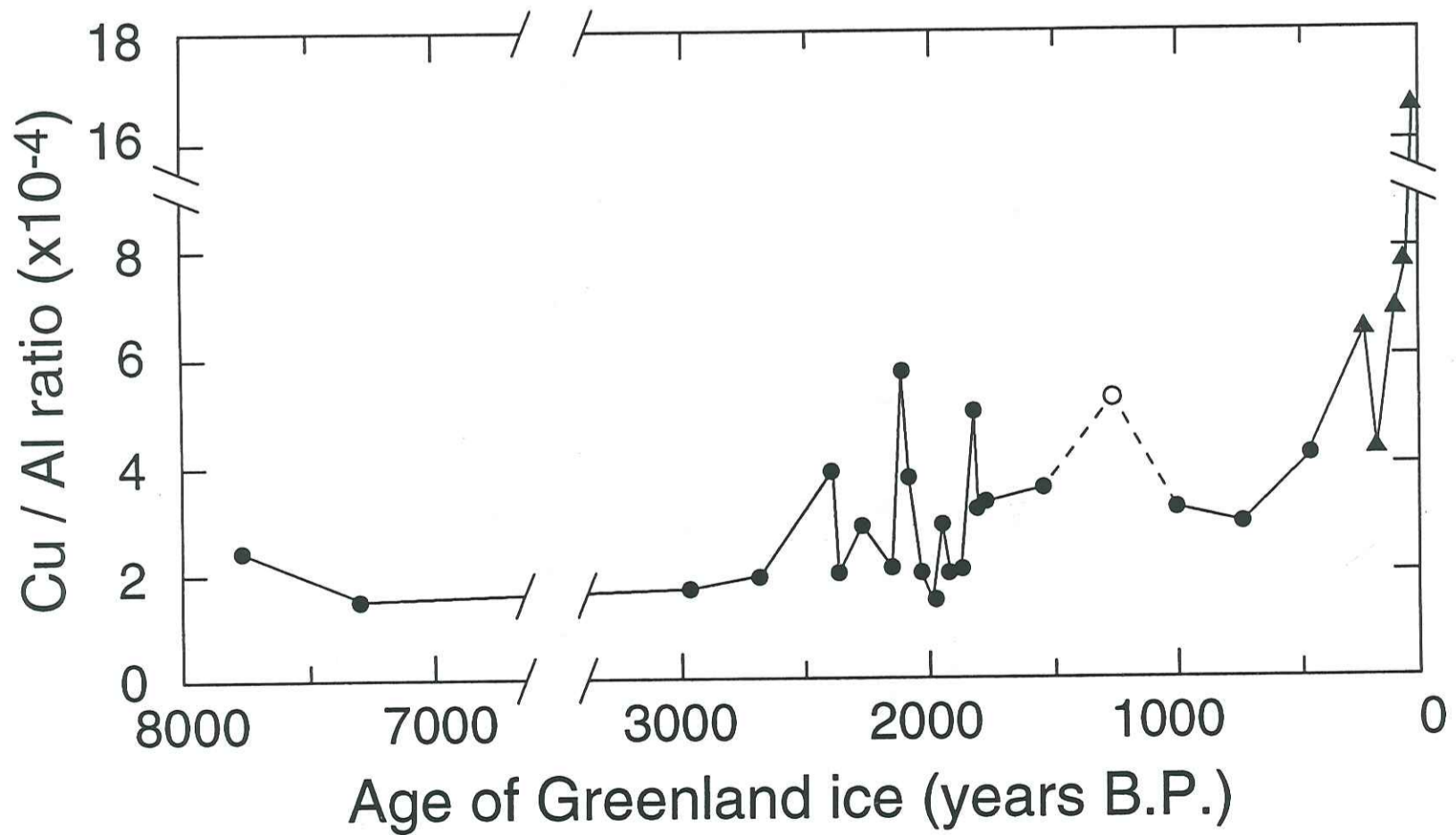

Fig. 1

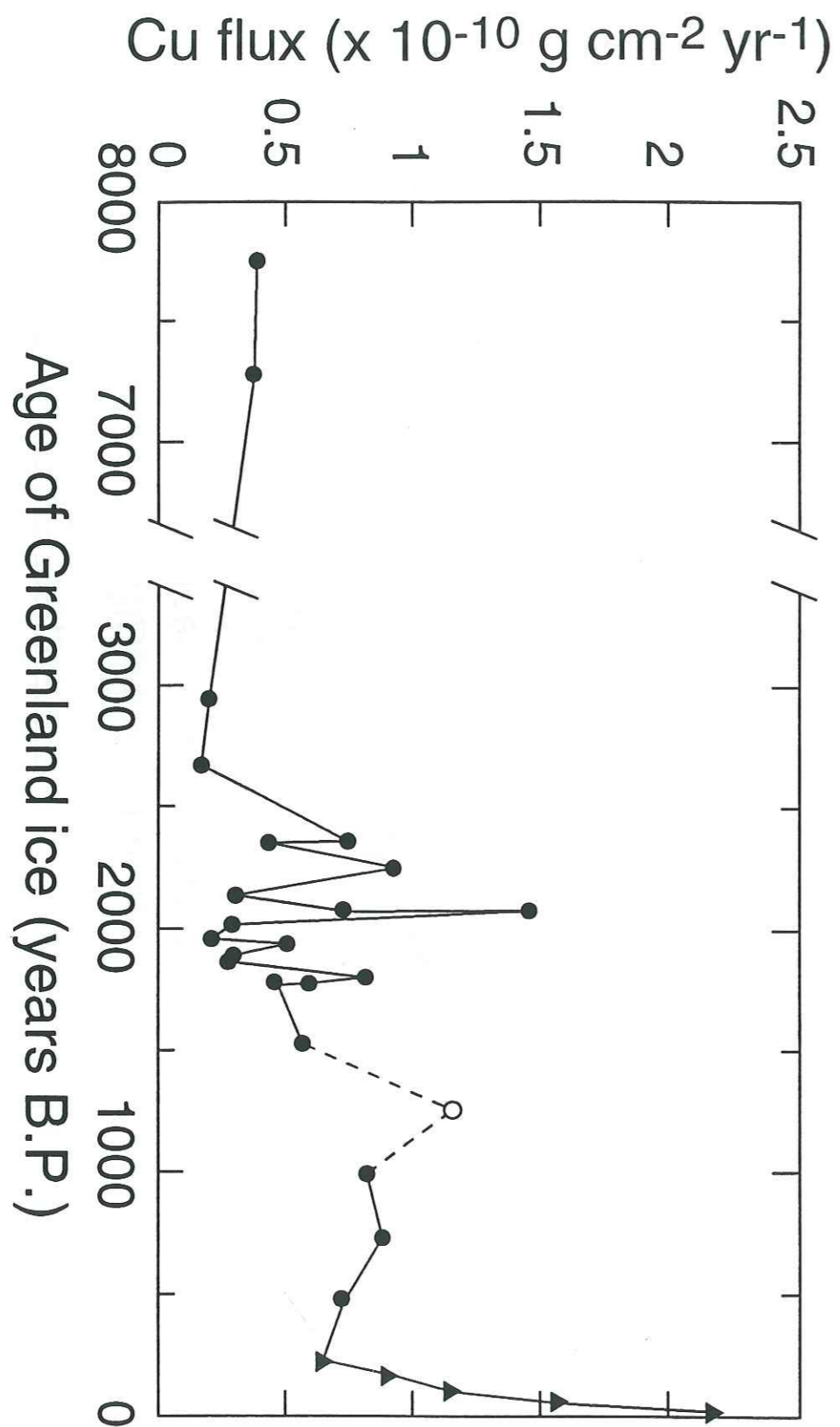

Fig. 3

DEPOSITION OF ATMOSPHERIC HEAVY METALS TO THE GREENLAND ICE SHEET  
FROM THE 1783-1784 VOLCANIC ERUPTION OF LAKI, ICELAND

Sungmin Hong<sup>a</sup>, Jean-Pierre Candelone<sup>b</sup>, and Claude F. Boutron<sup>a,c,1</sup>

<sup>a</sup>Laboratoire de Glaciologie et Géophysique de l'Environnement du CNRS, 54, rue Molière, Domaine Universitaire, B.P. 96, 38402 Saint Martin d'Hères, France

<sup>b</sup>Department of Applied Physics, Curtin University of Technology, GPO Box U 1987, Perth, Western Australia 6001, Australia

<sup>c</sup>UFR's de Mécanique et de Physique, Université Joseph Fourier de Grenoble, Domaine Universitaire, B.P. 68, 38041 Grenoble, France

<sup>1</sup>Author to whom correspondence and reprint requests should be addressed

Submitted to "Earth and Planetary Science Letters", September 29, 1995

**ABSTRACT**

In order to better assess the influence of major volcanic events on the large scale atmospheric cycles of heavy metals, Greenland ice dated from the time of fallouts from the great 1783-1784 eruption of Laki in Iceland has been analysed for Pb, Cd, Cu, Zn as well as for sulfate and other species. Concentrations of all four investigated heavy metals are found to be greatly enhanced in the ice layer which corresponds to the fallouts from the eruption, then confirming that such events do strongly modify the atmospheric cycles of heavy metals. Cumulative deposition of heavy metals to the whole Greenland ice cap from the 1783-1784 Laki eruption are found to range from 1 metric tonne for Pb and Cd to 40 metric tonnes for Zn. For Cd, Cu and Zn, it represents a few percents of total deposition since the Industrial Revolution.

**1. INTRODUCTION**

There are now numerous evidences that human activities have been responsible since many years for the emission of massive quantities of heavy metals such as Pb, Cd, Hg, Cu and Zn to the atmosphere of our planet [1, 2]. These emissions have resulted in pronounced pollution of various compartments of the environment and have then become major ecological and health problems [3]. Amongst the unique characteristics of this pollution is the fact that it is, by far, the oldest ever reported : recent investigation of Pb and Cu in Greenland ice dated from several millennia ago to present have indeed conclusively shown that it was already significant for Pb and Cu during Greek, Roman and Medieval times [4, 5], long before the Industrial Revolution, mainly because of early metals emissions to the atmosphere from Pb, Ag and Cu mining and smelting activities [4, 5]. It must also be emphasized that its amplitude is very high, especially for Pb. For this last metal, concentrations observed in Greenland ice dated from the late 1960s are indeed two orders of magnitude higher than those in ice dated from the pre-Greek times [6].

Any proper assessment of the importance of this pollution requires a good knowledge of natural emissions of heavy metals to the atmosphere. This is especially crucial when assessing early pollution during Antiquity [4, 5] : the amplitude of such early pollution remains indeed rather small, with limited enhancement factors above natural reference levels. It makes it essential to have a clear understanding of natural levels of heavy metals in the atmosphere before man impact started to be significant, and of the temporal variability of these levels.

These natural emissions are unfortunately difficult to evaluate from the available data on heavy metals emissions from the different natural sources (windborne soil and rock particles, seasalt spray, volcanoes, wild forest fires, continental and marine biogenic sources [7]). There is indeed a large dispersion in the estimates of the mass flux from individual sources and the emission factors. It results



in very large uncertainties in the estimated total emission of each heavy metal from any given source [7]. As an illustration, the range of estimates for Cu given in [7] is as large as 2300-54000 metric tonnes per year, that is an uncertainty by a factor of more than one order of magnitude.

These estimates indicate that emissions from volcanoes and fumaroles are likely to contribute a rather large fraction of natural atmospheric heavy metals [7, 8]. These emissions are however only poorly known because of the episodic nature of volcanic emissions, the very large number of volcanoes, and the extreme geographical and temporal variability in the metals content of volcanic plumes. Most attempts to evaluate volcanic emissions of heavy metals to the global atmosphere were based so far on the determination of heavy metals over sulfur ratios in plumes from selected volcanoes then deducing global volcanic heavy metals emissions by indexing these ratios to the global flux of volcanic sulfur [9, 10] or  $\text{Po}^{210}$  [11]. There are however major limitations to these approaches, especially because of the extreme dispersion of the measured ratios.

An alternative approach is to investigate heavy metals in specific layers of atmospheric archives such as polar snow and ice which are dated on the time when atmospheric fallouts from well identified volcanic events occurred. These layers can generally be clearly identified by means of solide conductivity, sulfate or acidity measurements (e.g. [12-14]). At least for the past few centuries and to a lesser extent since the Antiquity, they can often be related to known major volcanic eruptions [15]. To our knowledge, the only attempt to use this approach was that by Görlach and Boutron [16]. They measured Pb, Cd, Cu and Zn in a series of snow samples covering the years 1940-1980 collected in East Antarctica. Ancillary sulfate measurements performed on the samples showed that one sample corresponded to the fallouts from the eruption of Agung volcano in Indonesia on 17 March 1967. Heavy metals measurements on this particular sample were unfortunately inconclusive since they did not show evidence of any enhanced values above levels observed in adjacent samples [16]. Several possible explanations for this lack of heavy metals peak were proposed [16]. Also worth to be mentioned is the study carried out by Laj and Boutron [17] on a shallow snow/ice core

covering approximately two years of accumulation drilled on the small ice cap which covers the top of the active Nevado del Ruiz volcano in Colombia [17]. The interpretation of the heavy metals time series obtained from the analysis of this core, which covered both eruptive and fumarolic periods, was however made very uncertain because the Nevado del Ruiz ice cap is temperate despite its high elevation (5389 m above sea level (a.s.l.) at the top). It results in significant liquid water percolation during part of the year, which is likely to be responsible for major transfers of heavy metals (and other impurities) from one layer to another.

We present here comprehensive data on the occurrence of heavy metals and other chemical species in Greenland ice dated on the time of fallout from the great 1783-1784 eruption of Laki volcano in Iceland [18-22]. They were obtained from the analysis of selected sections of a 70.3 m snow/ice core drilled at Summit, central Greenland.

## 2. EXPERIMENTAL

### 2.1. Field sampling

The 70.3 m snow/ice core was electromechanically drilled in July 1989 at Summit (72°34'N, 37°37'W, elevation 3238 m a.s.l., mean annual temperature - 32°C, mean annual snow accumulation rate 23 g H<sub>2</sub>O cm<sup>-2</sup> yr<sup>-1</sup>) as part of the european "Eurocore" programme, using a drill whose inside was coated with polytetrafluoroethylene. As described in detail elsewhere [6], special handling procedures were used for core handling in order to minimize contamination brought to the outside of the core. Each core section (~ 1 m long, diameter 9,8 cm) was packed inside double sealed polyethylene bags and transported frozen to the laboratory.

## 2.2. Identifying the 1783-1784 Laki eruption fallout in the core

It was known beforehand from detailed dating and continuous solid electrical conductivity and sulfate measurements of nearby cores ([23], and M. Legrand, personal communication, 1995) that the 1783-1784 Laki eruption fallout layer was probably located in the ~ 67-68 m depth interval. This was confirmed by solid electrical conductivity measurements [24] along the 67.10-68.025 m section of the 70.3 m core, Fig. 1 : the Laki peak is clearly found to be in the depth interval 67.52-67.72 m. This ~ 0.20 m interval corresponds to ~ 9 months of accumulation according to a detailed continuous oxygen isotopes profiles obtained in a nearby core (H. Clausen, personal communication, 1993).

We have therefore decided to analyse in great detail for heavy metals the whole 67.10-68.025 m section, which covers a ~ 3.5 years time period from 1782 to 1785. It allowed to get data both for the Laki eruption fallout layer itself (67.52-67.72 m depth interval), but also for the pre and post eruption layers which can be used as reference levels to assess the Laki eruption impact.

## 2.3. Mechanical decontamination of the core

Previous measurement of heavy metals in other sections of the 70.3 m core had conclusively shown that significant contamination was present on the outside of the core sections despite the great precautions which were taken in the field. We have therefore decontaminated the 67.10-68.025 m section by mechanically chiselling successive veneers of ice from the outside toward the center, using ultraclean procedures which have been described in detail elsewhere [25].

It was however necessary to strongly modify the original procedure described in [25]. This was mainly because the present investigation required to have a good time resolution and therefore to divide the inner core obtained after the decontamination was completed into as many parts as

possible when considering the sample volume necessary for the analyses. This was also because the core was unfortunately broken into two parts (lengths : 0.53 and 0.39 m), with the fracture in the Laki peak interval.

Fig. 2 shows a schematic description of how the core was chiselled. Four or five layers were chiselled before obtaining the inner part of the core. The inner core so obtained was divided into nine different parts, Fig. 2, three of them (numbers 3, 4 and 5) corresponding to the Laki peak. It can be seen that the inner core was almost continuous, with only a loss of ~ 2 cm from 67.625 to 67.645 due to the ~ 1 cm shaving of the two sides of the fracture and a loss of ~ 1 cm from 67.305 to 67.315 m due to the fact that the polyethylene lathe used to support the core section horizontally during the decontamination cannot accommodate cores whose overall length is larger than 0.8 m.

## 2.4. Analytical procedures

Each veneer layer and inner core were analysed separately using ultraclean procedures [26]. Pb, Cd and Cu were determined by Graphite Furnace Atomic Absorption Spectrometry (GFAAS) after preconcentration ( $x \sim 50$ ) by non boiling evaporation [27]. Following the intercomparative determinations described in [5], no correction was applied for the preconcentration procedure. Zn, Al and Na were measured by GFAAS without preconcentration. Sulfate, chloride and fluoride ions were determined by Ion Chromatography [28]. All values were blank corrected. In most cases, the precision was ~  $\pm 10\%$ . For a few samples in which concentrations were particularly low, the precision was however only ~  $\pm 20\%$ .

Separate aliquots were also taken for subsequent determination of Pb by Isotope Dilution Mass Spectrometry (IDMS) [29], Pb isotopes by Thermal Ionization Mass Spectrometry (TIMS)

[29], Bi and Hg by Laser Excited Atomic Fluorescence Spectrometry (LEAFS) [30], and Hg by Cold Vapour Atomic Fluorescence Spectrometry (CVAFS) [31].

### 3. RESULTS AND DISCUSSION

#### 3.1. Character of the data

In order to be sure that concentrations measured in the inner part of the core obtained after the mechanical decontamination was completed (see Fig. 2) did represent the original concentration in the ice, we studied in full detail changes in concentrations of each investigated metal from the outside to the inside of the core. Due to sample volume requirements for the analyses and other experimental constraints, it was however not possible to draw such outside-inside radial profiles for each of the nine depths intervals corresponding to the nine successive parts (see Fig. 2) of the inner core. Radial profiles were obtained only for the 67.155-67.23 m, 67.315-67.51 m and 67.78-67.945 m depths intervals.

Very significant heavy metals contamination was found to be present on the outside (first ~ 5 mm or so) of the core. It ranges from 78 to 680 pg/g for Pb, 105 to 274 pg/g for Cd, 500 to 3200 pg/g for Cu, and 2820 to 3440 pg/g for Zn. This contamination probably mainly originates from the electromechanical drill itself, especially the galvanized steel cable [25, 6].

Outside-inside radial profiles show rather contrasting situations, depending on the investigated metal. For Pb and Cd, concentrations are found to decrease to the second or third layer, but then to level off in all cases at well established plateau values which then do represent the original concentration of these metals in the ice, Fig. 3. This is also the case for Cu in two out of the three profiles, Fig. 3. For Zn, on the other hand, a continuous decrease of concentration is observed from the outside to the inner core in all three cases, which indicates that for this metal significant amounts

of contamination have been transferred from the outside towards the center of the core. This transfer was however probably limited for the 67.315-67.51 m depth interval since for that interval, the concentration value for the inner core is only slightly lower than that for the next to last veneer layer.

When referring to the other parts of the core for which no outside-inside radial profiles were drawn, especially the 67.52-67.72 m depth interval which corresponds to the Laki eruption fallout, a reasonable conclusion of the above discussion is that the inner core values are likely to represent the original concentrations in the ice for Pb, Cd and probably Cu. For Zn on the other hand, the inner core values will probably represent only upper limits of the original concentrations in the ice, except for depth intervals for which Zn concentrations in the inner cores are found to be very high. This will be the case for one of the depths intervals in the Laki fallout layers, see. 3.2. : the 490 pg/g Zn value observed between 67.555 and 67.625 m is probably not significantly influenced by transfer from outside contamination since it is similar or even higher than the Zn values observed in the third or fourth veneer layers in the Zn radial profiles.

#### 3.2. Observed changes in measured concentrations during the 1782-1785 time period

Concentrations of Pb, Cd, Cu, Zn, Al, Na,  $\text{SO}_4^-$ ,  $\text{Cl}^-$  and  $\text{F}^-$  measured in the nine successive parts of the inner core are shown in Table 1.

The sulfate data shown in Table 1 clearly confirm that fallouts from the 1783-1784 Laki eruption [18-22] are found in the 0.26 m depth interval between 67.555 and 67.745 m, mainly in the 0.07 m depth interval between 67.555 and 67.625 m in which sulfate concentrations peak at ~ 1100 ng/g, that is a peak value which is as much as ~ 30 times above the sulfate level in nearby samples. This sulfate signal is in good agreement with that previously observed in other Greenland cores by various authors (see, e.g. [12, 21, 32-34]).

It is clear from Table 1 that this 0.07 m depth interval is characterized by greatly enhanced concentration values for all four investigated heavy metals. The enhancement factor with respect to

the values measured in the nearby samples are ~ 3 for Pb, 40 for Cd, 7 for Cu and 25 for Zn. It is tempting to attribute this concentration peak, observed for all four heavy metals exactly at the same time as the 1783-1784 Laki sulfate signal, to heavy metals fallout from that eruption. Before doing it, it is however necessary to discuss other possible explanations.

### 3.3. Natural contributions other than volcanoes to the measured concentrations

Natural contributions other than volcanoes are from rock and soil dust, seasalt spray, wild vegetation fires, and continental and marine biogenic sources [7]. We have estimated the rock and soil dust contribution from Al concentrations measured in each part of the inner core, Table 1, and mean estimated heavy metals/Al ratios in rock and soil dust. As discussed in detail in [35], we used for Pb the mean ratio,  $9.5 \times 10^{-5}$ , given in [36] for the bulk continental crust. For Cd, Cu and Zn, we used the mean ratios ( $4.9 \times 10^{-6}$ ,  $4.2 \times 10^{-4}$  and  $1.27 \times 10^{-3}$ , respectively) given in [37] for mean soils. The rock and soil dust contributions so calculated are found to range from 0.24 to 2.4 pg/g for Pb, 0.013 to 0.15 pg/g for Cd, 0.3 to 3 pg/g for Cu, and 3 to 32 pg/g for Zn. This represents only a very small contribution for the 67.655-67.625 m sample which corresponds to the Laki eruption fallout (less than 5 % of measured concentrations). But it represents a significant contribution for the other samples, especially for the 67.40-67.485 m, 67.315-67.40 m and 67.645-67.745 m samples in which Al concentrations are rather high.

For Cu, the rock and soil dust contribution so evaluated using the Cu/Al ratio given in [37] is found to be even higher than the concentrations measured in the ice for all samples but the Laki one. This is also the case when using Cu/Al ratios for rock and soil given by other authors. It could indicate that there is some fractionation between Cu and Al during long range atmospheric transport from source areas to central Greenland [35]. Taking into account the Cu and Al data obtained for Greenland ice dated from the early Holocene [35] and the last glacial period [38], we have then

calculated again the rock and soil contribution for Cu using a tentative Cu/Al ratio of  $1 \times 10^{-4}$  instead of  $4.2 \times 10^{-4}$ . The values so obtained, which range from 0.25 to 2.5 pg/g, were used below for the calculation of the "excess" residual component for Cu in all nine parts of the inner core. It must be emphasized that this uncertainty in the evaluation of the rock and soil dust contribution for Cu makes no difference for the interpretation of the Laki peak itself.

Contribution from seasalt spray can be estimated from Na concentrations measured in the samples, Table 1 (corrected for the contribution from rock and soil dust), using the mean heavy metal/Na concentration ratio in present day bulk seawater [39] combined with estimated heavy metals enrichment factors in sea-derived aerosols relative to bulk seawater [40, 41]. This contribution is found to be always extremely small (less than 1 % of measured concentrations).

Other possible natural contributions are from wild forest fires and biogenic sources. Quantitative estimates of these contributions would have required ancillary measurements of adequate tracers such as ammonium [42, 43] and carbon [44, 45] to be made in each of the nine parts of the inner core. This was not possible because of the very limited sample volumes. Comprehensive ammonium and carbon measurements have however been performed on various sections of the Holocene part of the GRIP and GISP2 ice cores (see, e.g., [35, 42-45]). For ammonium, measurements were also made on samples from the Laki fallout layer taken in a nearby core (M. Legrand, personal communication), showing no enhancement in ammonium values compared with mean Holocene values. As discussed in detail in [35], these data suggest that the contribution from wild forest fires and biogenic sources is probably very limited for Pb and Cu. We have then assumed that it was negligible for these two metals in all nine parts of the inner core.

For Cd and Zn, on the other hand, they suggest that contributions from wild forest fires and biogenic sources are probably responsible for a significant fraction of Cd and Zn in excess above the rock and soil dust component for periods without major volcanic events. For these two metals, we tentatively estimated these two contributions as follows. The wild vegetation (mainly forest) fires

contribution was evaluated from mean soot carbon concentration in Summit Holocene ice during pre-Industrial Revolution times, about 2 ng/g [45]. When combining this value with typical mean Cd and Zn concentrations in trees and foliage ashes (~ 8 and 200 µg/g, respectively [7]), it gives a contribution from wild vegetation fires of ~ 0.015 pg/g for Cd and 2.5 pg/g for Zn. This contribution is totally negligible for the 67.555-67.625 m layer which corresponds to the Laki eruption fallout, but represents up to ~ 40 % (Cd) and 20 % (Zn) of measured concentrations for the other parts of the inner core. The contribution from biogenic sources for Cd and Zn was tentatively estimated from mean particulate organic carbon concentrations in pre-Industrial Revolution Summit Holocene ice, ~ 8 ng/g [45] and average Cd and Zn concentrations in particulate organic matter [7]. The contribution so estimated (~ 0.011 pg/g for Cd and ~ 0.12 pg/g for Zn) is totally negligible for both metals for the 67.655-67.625 m Laki layer. This is also the case for Zn for the other parts of the inner core. For Cd on the other hand, it represents up to ~ 30 % for these other parts.

The total contribution calculated by combining these different natural contributions can be subtracted from the heavy metals concentrations given in Table 1. Changes in the "excess" heavy metals concentrations so obtained as a function of depth from 67.155 to 67.945 m are shown in Fig. 4.

#### 3.4. Anthropogenic contributions

The time series previously obtained for Summit ice and snow dated from seven millennia ago to present [4-6] indicate that the only two heavy metals for which anthropogenic contribution was already significant in the late eighteenth century are Pb, and, to a lesser extent, Cu. For these two metals indeed, large scale pollution of the atmosphere of the Northern Hemisphere became significant long before the Industrial Revolution [4, 5].

It is however difficult to quantitatively estimate this anthropogenic contribution for Pb and

Cu in each of the nine parts of the inner core from available data [5]. There is indeed only a single data point for the late eighteenth century in [5]: it indicates a value of 7.6 pg/g for Pb and  $\leq 2.8$  pg/g for Cu in Summit ice dated from 1773. These values are moreover mean yearly values obtained from the analysis of a core section which covered exactly one year of ice accumulation. They do not allow to evaluate the anthropogenic contribution for Pb and Cu in each of the nine parts of the inner core, since anthropogenic inputs to the Greenland ice sheet during the eighteenth century are likely to have been characterized by pronounced short term (seasonal) variations. Such variations have already been documented for recent snow (see, e.g. [46, 47]), but were probably different in earlier times. There are presently no data on these earlier short term variations.

Confronted with the lack of data to quantitatively assess this anthropogenic contribution, we have decided to make no correction for it. It will however need to be kept in mind for the interpretation of the Pb depth profile, since the anthropogenic contribution for this metal was probably rather large at the time of the Laki eruption. For Cu on the other hand, this lack of correction is probably of little importance, especially for the Laki peak itself.

#### 3.5. Heavy metals fallout from the 1783-1784 Laki eruption to the Greenland ice sheet

After correction for other natural contributions, the signal from the 1783-1784 Laki eruption appears very clearly for all four heavy metals, Fig. 4. This is the first direct evidence ever reported of the impact of a well identified volcanic eruption on the heavy metals content of Greenland (and Antarctic) ice. It confirms for the first time that the large scale atmospheric cycles of heavy metals are significantly influenced by major volcanic events.

The eruption of Laki began on 8 June 1783 and continued with dwindling intensity until February 1784 [20, 22]. It produced the largest terrestrial lava flow of the present millennium (a total of ~ 15 km<sup>3</sup> of magma was erupted [20]). It resulted in major consequences not only for Iceland

itself, but also for large parts of the Northern Hemisphere [22]. Immense plumes of ash, dust and aerosol-forming gases (especially  $\text{SO}_2$ ) were indeed released into the troposphere and were widely dispersed. Fine ash and dust was transported in the troposphere on much of the Northern Hemisphere, resulting in a long-lasting aerosol haze, resembling smoke. It was detected all over Europe, in middle Asia, North Africa, China and probably North America [22]. It probably laid primarily in the troposphere. Although it extended well above ground level (it was perceptible above 3000 m altitude in the Alps), it is now thought that there was probably no large stratospheric penetration [19, 22].

There are various data showing that heavy metals are emitted in large quantities to the atmosphere during volcanic eruptions (see, e.g. [8-11, 48-54]. Although there are of course no data on the emissions of heavy metals during the 1783-1784 Laki eruption (or subsequent eruptions of this volcano), our ice data conclusively show that such emissions did occur. The emissions were strong enough to give rise to a very strong signal in Greenland ice for all four investigated heavy metals at a free troposphere location (Summit is located at a high altitude of 3238 m a.s.l. above sea level, i.e. in the middle troposphere). As discussed above, they were probably transported to Summit in the troposphere rather than in the low stratosphere.

Such tropospheric transport is consistent with the fact that at least for Cd, Cu and Zn, the heavy metals deposition of excess heavy metals from the Laki eruption lasted only over a rather short time period. For these three metals, the Laki signal is indeed seen only in the 67.555-67.625 m sample, Fig. 4, that is a depth interval of 7 cm which corresponds to only about three months. If stratospheric transport had been important, the deposition to the Greenland ice cap would have lasted over much longer time periods, at least one or two years.

For Pb however, Fig. 4 indicates that enhanced concentrations are observed for a larger depth interval (~ 33 cm, which corresponds to about 18 months). This might indicate that the residence time for lead-enriched small size aerosols from the eruption was greater than that for the three other

investigated heavy metals. There are however no data on the size distribution for metals enriched aerosols emitted by volcanoes to support such hypothesis. An alternative explanation could however be with the anthropogenic contribution for this metal. Seasonal inputs of pollutant Pb from mid-latitude areas could indeed be superimposed, with the Laki signal itself. This will need to be checked by analysing these samples for Pb isotopes: the isotopic patterns should allow to clearly separate the anthropogenic and volcanic components.

Table 2 shows heavy metal/S ratios measured in the ice for the 67.555-67.625 m depth interval. The ratios range from  $0.30 \times 10^{-4}$  (Pb/S) to  $13 \times 10^{-4}$  (Zn/S). Also shown in Table 2 are the only other ratios previously measured in snow or ice layers corresponding to fallouts from other volcanoes. The ratios observed for the Laki layer are much lower, with the exception of Zn, than those measured in snow deposited ~ 2 km from the crater of the Nevado del Ruiz volcano in Colombia [17]. They are, on the other hand, higher than those observed at an East Antarctica plateau site for the layer corresponding to fallout from the 1963 Agung eruption in Indonesia [16]. These differences are probably linked with the very different transport patterns in the three cases: very short (few hours) transport over a few kilometres distance only for Nevado del Ruiz; mid-range tropospheric transport (days to weeks) from Laki to Greenland; long-range stratospheric transport (few years) from Agung to Antarctica. The observed differences in heavy metal/sulfur ratios could then reflect possible fractionation between heavy metals and sulfur during aging of volcanic aerosols during transport.

Heavy metals fallout flux from the 1783-1784 Laki eruption to Summit can be estimated from "excess" concentration profiles observed in the ice, Fig. 4. They range from 6.5 (Pb) to 2800 (Zn)  $\text{pg} \times \text{cm}^{-2}$ , Table 3. If we assume an evenly fallout over the whole Greenland ice cap (surface of  $1.4 \times 10^6 \text{ km}^2$ ), the deposition to the whole ice cap is found to range from 0.9 metric tonnes for Pb to 40 metric tonnes for Zn, Table 3). For Cd, Cu and Zn, this is comparable to yearly deposition in the 1960s-1970s resulting from man's activities [5]. For Pb, on the other hand, it remains much lower

than the yearly flux in the 1960-1970s which resulted from the massive use of Pb alkyl additives in gasoline [5].

#### ACKNOWLEDGEMENTS

This work is a contribution of the Eurocore programme funded by the Commission of European Communities and Switzerland within the framework of Cost 611. It was supported by the French Ministry of the Environment (grant 92295), the Institut National des Sciences de l'Univers, and the University Joseph Fourier of Grenoble. We thank C. Rado, R.J. Delmas and F. Maupetit for their participation in field sampling, and M. Legrand and J. Savarino for their participation in the ion chromatography measurements.

#### REFERENCES

1. J.O. Nriagu and J.M. Pacyna, Quantitative assessment of worldwide contamination of air, water and soils by trace metals, *Nature* 323, 134-139, 1988.
2. J.M. Pacyna, E. Voldner, T.F. Bidleman, G. Evans and G.J. Keeler, Emissions, atmospheric transport and deposition of heavy metals and persistent organic pollutants, in : *Proceedings of the First Workshop on Emissions and Modelling of Atmospheric Transport of Persistent Organic Pollutants and Heavy Metals*, J.M. Pacyna, E. Voldner, G.J. Keeler and G. Evans, eds., pp. 45-137, EMEP-CCC Rep. 7/93, Norwegian Inst. for Air Res., Lillestrom, Norway, 1993.
3. C.C. Patterson, An alternative perspective-Lead pollution in the human environment : origin, extent and significance, in : *Lead in the Human Environment*, pp 265-349, Natl. Acad. of Sci., Washington, D.C., USA, 1980.
4. S. Hong, J.P. Candelone, C.C. Patterson and C.F. Boutron, Greenland ice evidence of hemispheric lead pollution two millennia ago by Greek and Roman civilizations, *Science* 265, 1841-1843, 1994.
5. S. Hong, J.P. Candelone, C.C. Patterson and C.F. Boutron, Greater cumulative large scale atmospheric pollution of the northern hemisphere for copper before than after the industrial revolution, *Science*, submitted, 1995.
6. J.P. Candelone, S. Hong, C. Pellone and C.F. Boutron, Post-industrial revolution changes in large scale atmospheric pollution of the northern hemisphere by heavy metals as documented in central Greenland snow and ice, *J. Geophys. Res.*, in press, 1995.

7. J.O. Nriagu, A global assessment of natural sources of atmospheric trace metals, *Nature* 338, 47-49, 1989.
8. P. Buat-Menard, Global source strength and long-range atmospheric transport of trace elements emitted by volcanic activity, in : *The Long-Range Atmospheric Transport of Natural and Contaminant Substances*, A.H. Knap, ed., NATO-ASI Series vol. C 297, pp 163-175, Kluwer Academic, Dordrecht, 1990.
9. P. Buat-Menard and M. Arnold, The heavy-metal chemistry of atmospheric particulate matter emitted by Mount Etna volcano, *Geophys. Res. Lett.* 5, 245-248, 1978.
10. C.C. Patterson and D.M. Settle, Magnitude of lead flux to the atmosphere from volcanoes, *Geochim. Cosmochim. Acta* 51, 675-681, 1987 (and erratum 52, 245, 1988).
11. G. Lambert, M.F. Le Cloarec and M. Pennisi, Volcanic output of SO<sub>2</sub> and trace metals : a new approach, *Geochim. Cosmochim. Acta* 52, 39-42, 1988.
12. C. Hammer, Past volcanism revealed by Greenland ice sheet impurities, *Nature* 270, 482-486, 1977.
13. M. Legrand and R.J. Delmas, A 220-year continuous record of volcanic H<sub>2</sub>SO<sub>4</sub> in the Antarctic ice sheet, *Nature* 327, 671-676, 1987.
14. G.A. Zielinski, P.A. Mayewski, L.D. Meeker, S. Whitlow, M.S. Twickler, M. Morrison, D.A. Meese, A.J. Gow and R.B. Alley, Record of volcanism since 7000 B.C. from the GISP2 Greenland ice core and implications for the volcano-climate system, *Science* 264, 948-952, 1994.
15. C.G. Newhall and S. Self, The volcanic explosivity index : an estimate of explosive magnitude for historical volcanism, *J. Geophys. Res.* 87, 1231-1238, 1982.
16. U. Görlach and C.F. Boutron, Variations in heavy metals concentrations in Antarctic snows from 1940 to 1980, *J. Atmos. Chem.* 14, 205-222, 1992.

17. P. Laj and C.F. Boutron, Trace elements in snow deposited at Nevado del Ruiz volcano, Colombia, *J. Volcanol. Geotherm. Res.* 42, 89-100, 1990.
18. H. Sigurdsson, Volcanic pollution and climate : the 1783 Laki eruption, *EOS* 63, 601-602, 1982.
19. C.A. Wood, Climatic effects of the 1783 Laki eruption, in : *The Year Without a Summer ? World Climate in 1816*, C.R. Harington, ed., pp 58-77, Canadian Museum of Nature, Ottawa, Canada.
20. Thordarson and S. Self, The Laki (Skaftar Fires) and Grimsvötn eruptions in 1783-1785, *Bull. Volcanol.* 55, 233-263, 1993.
21. R.J. Fiacco, T. Thordarson, M.S. Germani, S. Self, J.M. Palais, S. Whitlow and P.M. Grootes, Atmospheric aerosol loading and transport due to the 1783-84 Laki eruption in Iceland, interpreted from ash particles and acidity in the GISP2 ice core, *Quaternary Res.* 42, 231-240, 1994.
22. R.B. Stothers, The great dry fog of 1783, *Climatic Change*, in press, 1995.
23. H.B. Clausen, C.U. Hammer, J. Christensen, C. Schott Hvidberg, D. Dahl-Jensen, M. Legrand and J.P. Steffensen, 1250 years of global volcanism as revealed in central Greenland ice cores, in : *Ice Core Studies of Global Biogeochemical Cycles*, R.J. Delmas, ed., NATO-ASI series Vol I 30, pp 175-194, Springer, Berlin, 1995.
24. M. Legrand, J.R. Petit and Y.S. Korotkevich, DC conductivity of Antarctic ice in relation to its chemistry, *J. de Phys.*, 48, 605-611, 1987.
25. J.P. Candelone, S. Hong and C.F. Boutron, An improved method for decontaminating polar snow and ice cores for heavy metals analysis, *Anal. Chim. Acta* 299, 1-16, 1994.
26. C.F. Boutron, A clean laboratory for ultralow concentration heavy metal analysis, *Fresenius Z. Anal. Chem.* 337, 482-491, 1990.



27. U. Görlach and C.F. Boutron, Preconcentration of lead, cadmium, copper and zinc in water at the  $\mu\text{g g}^{-1}$  level by non boiling evaporation, *Anal. Chim. Acta* 236, 391-398, 1990.
28. M. Legrand, M. De Angelis and F. Maupetit, Field investigation of major and minor ions along Summit (central Greenland) ice cores by ion chromatography, *J. Chromatography* 640, 251-258, 1993.
29. W. Chisholm, K.J.R. Rosman, C.F. Boutron, J.P. Candelone and S. Hong, The determination of lead isotopic ratios in Greenland and Antarctic snow and ice with picogram per gram concentrations, *Anal. Chim. Acta*, in press.
30. M.A. Bolshov, S.N. Rudniev, J.P. Candelone, C.F. Boutron and S. Hong, Ultratrace determination of Bi in Greenland snow by laser excited atomic fluorescence spectrometry, *Spectrochim. Acta* 49B, 1445-1452, 1994.
31. G.M. Vandal, W.F. Fitzgerald, C.F. Boutron and J.P. Candelone, Variations in mercury deposition to Antarctica over the past 34,000 years, *Nature* 362, 621-623, 1993.
32. H.B. Clausen and C.U. Hammer, The Laki and Tambora eruptions as revealed in Greenland ice cores from 11 locations, *Ann. Glaciol.* 10, 16-22, 1988.
33. P.A. Mayewski, W.B. Lyons, M.J. Spencer, M.S. Twickler, C.F. Buck and S. Whitlow, An ice core record of atmospheric response to anthropogenic sulphate and nitrate, *Nature* 346, 554-556, 1990.
34. P. Laj, S.M. Drummey, M.J. Spencer, J.M. Palais and H. Sigurdsson, Depletion of  $\text{H}_2\text{O}_2$  in a Greenland ice core : implications for oxidation of volcanic  $\text{SO}_2$ , *Nature* 346, 45-48, 1990.
35. S. Hong, J.P. Candelone and C.F. Boutron, Changing occurrence of heavy metals (Pb, Cu, Cd and Zn) in central Greenland ice deposited during the Holocene, *Geochim. Cosmochim. Acta*, submitted.
36. S.R. Taylor and S.M. McLennan, *The Continental Crust : its Composition and Evolution*, Blackwell Scientific, Oxford, 1985.

37. H.J.M. Bowen, *Environmental Chemistry of the Elements*, Academic Press, New York, 1979.
38. S. Hong, J.P. Candelone and C.F. Boutron, Changes in natural lead, copper, zinc and cadmium concentrations in central Greenland ice from 8000 to 150000 years B.P. : their association with climatic changes and resultant variation of dominant source contribution, *Earth Planet. Sci. Lett.*, submitted.
39. R.A. Duce, R. Arimoto, B.J. Ray, C.K. Unni and P.J. Harder, Atmospheric trace elements at Enewetak Atoll, 1 : concentrations, sources and temporal variability, *J. Geophys. Res.* 88, 5321-5342, 1983.
40. C.F. Boutron and C.C. Patterson, Lead concentration changes in Antarctic ice during the Wisconsin/Holocene transition, *Nature* 323, 222-225, 1986.
41. F. Batifol, C.F. Boutron and M. De Angelis, Changes in copper, zinc and cadmium concentrations in Antarctic ice during the past 40,000 years, *Nature* 337, 544-546, 1989.
42. M. Legrand, M. De Angelis, T. Staffelbach, A. Neftel and B. Stauffer, Large perturbations of ammonium and organic acids content in the Summit-Greenland ice core. Finger-print from forest fires ? *Geophys. Res. Lett.* 19, 473-475, 1992.
43. S. Whitlow, P. Mayewski, J. Dibb, G. Holdsworth and M. Twickler, An ice core based record of biomass burning in the Arctic and subArctic, 1750-1980, *Tellus* 46B, 234-242, 1994.
44. P. Chylek, B. Johnson, P.A. Damiano, K.C. Taylor and P. Clement, Biomass burning record and black carbon in the GISP2 ice core, *Geophys. Res. Lett.* 22, 89-92, 1995.
45. H. Cachier, Combustion carbonaceous aerosols in the atmosphere : implications for ice core studies, in : *Ice Core Studies of Global Biogeochemical Cycles*, R.J. Delmas, ed., NATO-ASI Series vol. I 30, pp 313-346, Springer, Berlin, 1995.
46. J. Savarino, C.F. Boutron and J.L. Jaffrezo, Short-term variations of Pb, Cd, Zn and Cu in recent Greenland snow, *Atmos. Environ.* 28A, 1731-1737, 1994.

47. E.A. Boyle, R.M. Sherrell and M.P. Bacon, Lead variability in the western North Atlantic Ocean and central Greenland ice : implications for the search for decadal trends in anthropogenic emissions, *Geochim. Cosmochim. Acta* 58, 3227-3238, 1994.48.
48. E.J. Mroz and W.H. Zoller, Composition of atmospheric particulate matter from the eruption of Heimaey, Iceland, *Science* 190, 461-464, 1975.
49. E.A. Lepel, M. Stefansson and W.H. Zoller, The enrichment of volatile elements in the atmosphere by volcanic activity : Augustine volcano 1976, *J. Geophys. Res.* 83, 6213-6220.
50. J.P. Quisefit, G. Bergametti, R. Vie le Sage, D. Martin, P. Zeltwoog, J. Carbonelle and R. Faivre Pierret, Nouvelle évaluation des flux particulières de l'Etna-1980, *C.R. Acad. Sci. Paris* 295, 943-945, 1982.
51. J.M. Phelan, D.L. Finnegan, D.S. Ballanstine, W.H. Zoller, M.A. Hart and J.L. Moyers, Airborne aerosol measurements in the quiescent plume of Mount St. Helens : September 1980, *Geophys. Res. Lett.* 9, 1093-1096, 1982.
52. J.M. Phelan Kotra, D.L. Finnegan, W.H. Zoller, M.A. Hart and J.L. Moyers, Le Chichon : composition of plume gases and particles, *Science* 222, 1018-1021, 1983.
53. W.H. Zoller, J.R. Parrington and J.M. Phelan-Kotra, Iridium enrichment in airborne particles from Kilauea volcano, January 1983, *Science* 222, 1118-1121, 1983.
54. R.B. Symonds, W.I. Rose, M.H. Reed, F.E. Lichte and D.L. Finnegan, Volatilization, transport and sublimation of metallic and non-metallic elements in high-temperature gases at Merapi volcano, Indonesia, *Geochim. Cosmochim. Acta* 51, 2083-2101, 1987.
55. W.I. Rose, G. Heiken, K. Wohletz, D. Eppler, S. Barr, T. Miller, R.L. Chuan and R.B. Symonds, Direct rate measurements of eruption plumes at Augustine volcano : a problem of scaling and uncontrolled variables, *J. Geophys. Res.* 93, 4485-4499, 1988.

## FIGURE CAPTIONS

Fig. 1. Changes in solid electrical conductivity along the 67.1 - 68.025 m section (years 1782-1785) of the 70.3 m snow/ice core drilled at Summit, central Greenland. (A) : fracture of the core.

Fig. 2. Schematic representation of how the 67.1-68.025 m core section was decontaminated by chiselling four or five successive veneers of ice from the outside to the center. The nine parts of the inner core so obtained are numbered from 1 to 9. It was not possible to use the two extremities of the core (shown as A and B) since they were fastened in the tumblers of the polyethylene lathe [25].

Fig. 3. Measured concentrations as a function of radius. For Pb, values are for the ~ 67.78-67.945 m depth interval, see Fig. 2. For Cd and Cu, values are for the 67.315-67.5 m depth interval, see Fig. 2.

Fig. 4. Changes in excess concentrations (inner core values) of heavy metals and in sulfate as a function of depth along the 67.1-68.025 m core section (years 1782-1785) of the 70.3 m snow/ice core drilled at Summit, central Greenland.

TABLE 1. Summit, central Greenland : concentrations measured in the ice (inner core values) in the 67.155 - 67.945 m depth interval (1782 - 1785).

| Depth interval (m) | Measured concentrations in the inner core |      |                  |     |        |     |                 |                 |                  |
|--------------------|---|------|------------------|-----|--------|-----|-----------------|-----------------|------------------|
|                    | Pb  | Cd   | Cu               | Zn  | Al     | Na  | SO <sub>4</sub> | Cl <sup>-</sup> | F <sup>-</sup>   |
|                    | (pg/g)                                    |      |                  |     | (ng/g) |     |                 |                 |                  |
| 67.155-67.23       | 1.8                                       | 0.04 | 0.46             | 35  | 2.5    | 2.7 | 6.8             | 6.3             | 3.6              |
| 67.23-67.305       | 2.6                                       | 0.11 | 1.6              | 26  | 4.5    | 2.6 | 28              | 6.8             | 5.4              |
| 67.315-67.40       | 7.9                                       | 0.39 | 2.9              | 42  | 15     | 2.6 | 46              | 12              | 0.34             |
| 67.40-67.485       | 11  | 0.19 | 6.4 <sup>a</sup> | 35  | 25     | 9.7 | 49              | 16              | 2.9              |
| 67.485-67.555      | 7.2                                       | 0.62 | 2.0              | 11  | 5.3    | 9.5 | 112             | 24              | LOD <sup>b</sup> |
| 67.555-67.625      | 13  | 12.6 | 20.5             | 490 | 5.9    | 3.3 | 1120            | 6.8             | LOD <sup>b</sup> |
| 67.645-67.745      | 4.5                                       | 0.22 | 3.2              | 21  | 12     | 10  | 230             | 17              | 0.56             |
| 67.745-67.845      | 1.5                                       | 0.21 | 1.2              | 24  | 2.7    | 1.5 | 40              | 5.4             | 0.23             |
| 67.845-67.945      | 2.7                                       | 0.26 | 1.3              | 198 | 6.1    | 1.6 | 22              | 5.9             | 0.52             |

<sup>a</sup>For this sample, the value measured in the inner core (18 pg/g) was larger than that for the last veneer (6.4 pg/g). We have then used this last value. <sup>b</sup>For these two samples, fluoride concentration was below the limit of detection of ng/g.

TABLE 2. Heavy metal/sulfur weight ratio measured in ice or snow layers corresponding to the fallout from known volcanic eruptions

|  | Metal/sulfur weight ratio (x10 <sup>-4</sup> ) |       |      |      |
|--|--|-------|------|------|
|  | Pb   | Cd    | Cu   | Zn   |
| Greenland ice, 1783-1781 Laki eruption (this work)       | 0.30   | 0.33  | 0.52 | 13   |
| Antarctic snow, 1963 Agung eruption [16]                 | <0.3   | <0.02 | <0.2 | <0.2 |
| Nevado del Ruiz (Colombia) snow, autumn 1985 period [17] | 26   | 1.2   | 9.8  | 20   |

TABLE 3. Heavy metals fallout from the 1783-1784 Laki eruption to the Greenland ice sheet

|  | Heavy metal     |     |     |      |
|--|-----------------|-----|-----|------|
|  | Pb              | Cd  | Cu  | Zn   |
| Fallout flux to Summit,<br>central Greenland ( $\text{pg} \times \text{cm}^{-2}$ ) | 65 <sup>a</sup> | 750 | 115 | 2800 |
| Fallout flux to the Greenland<br>ice sheet (metric tonnes)                         | 0.9             | 1.1 | 1.6 | 40   |

<sup>a</sup>Taking into account only the 67.555 - 67.625 m depth interval

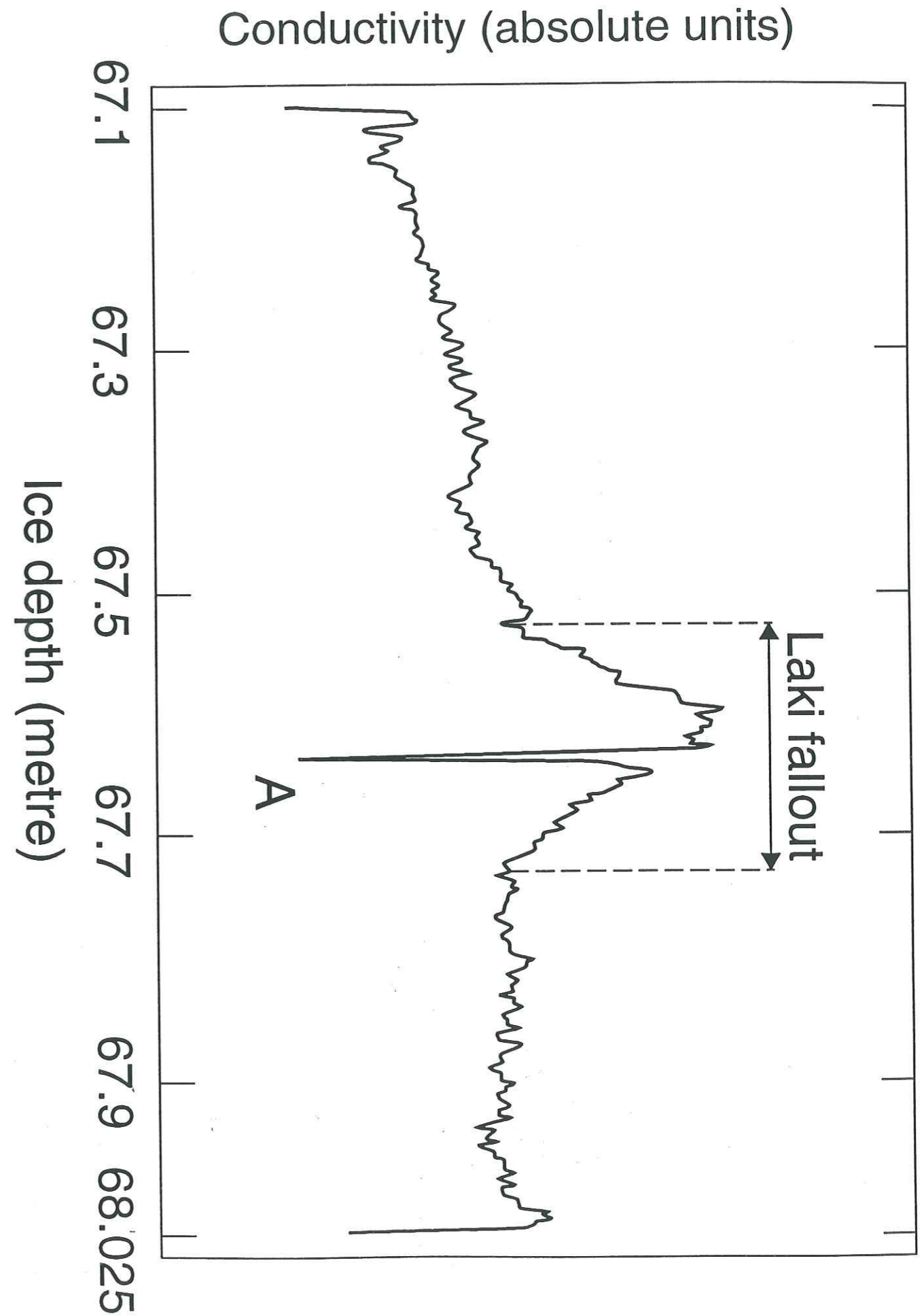

Fig. 1

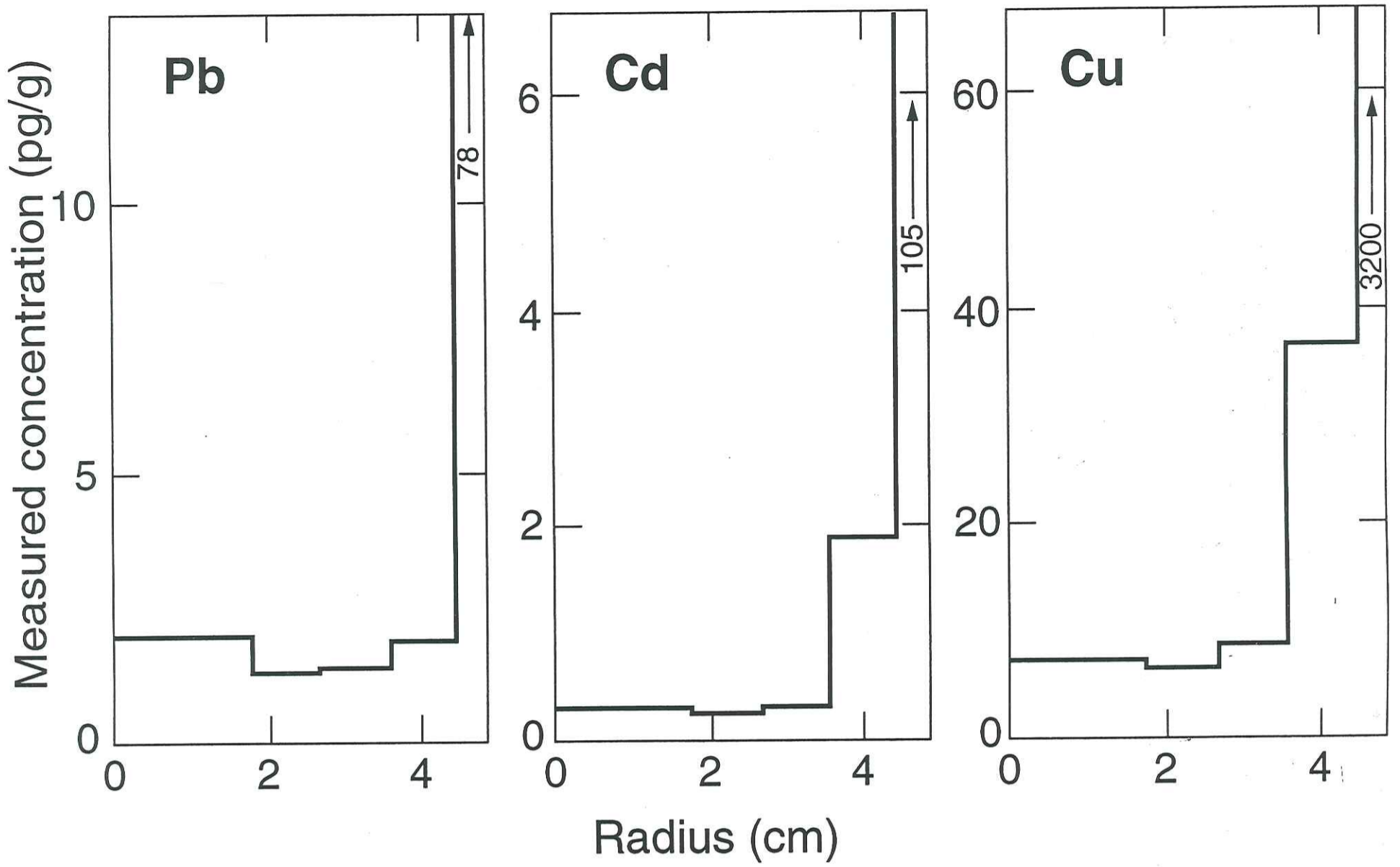

Fig. 3

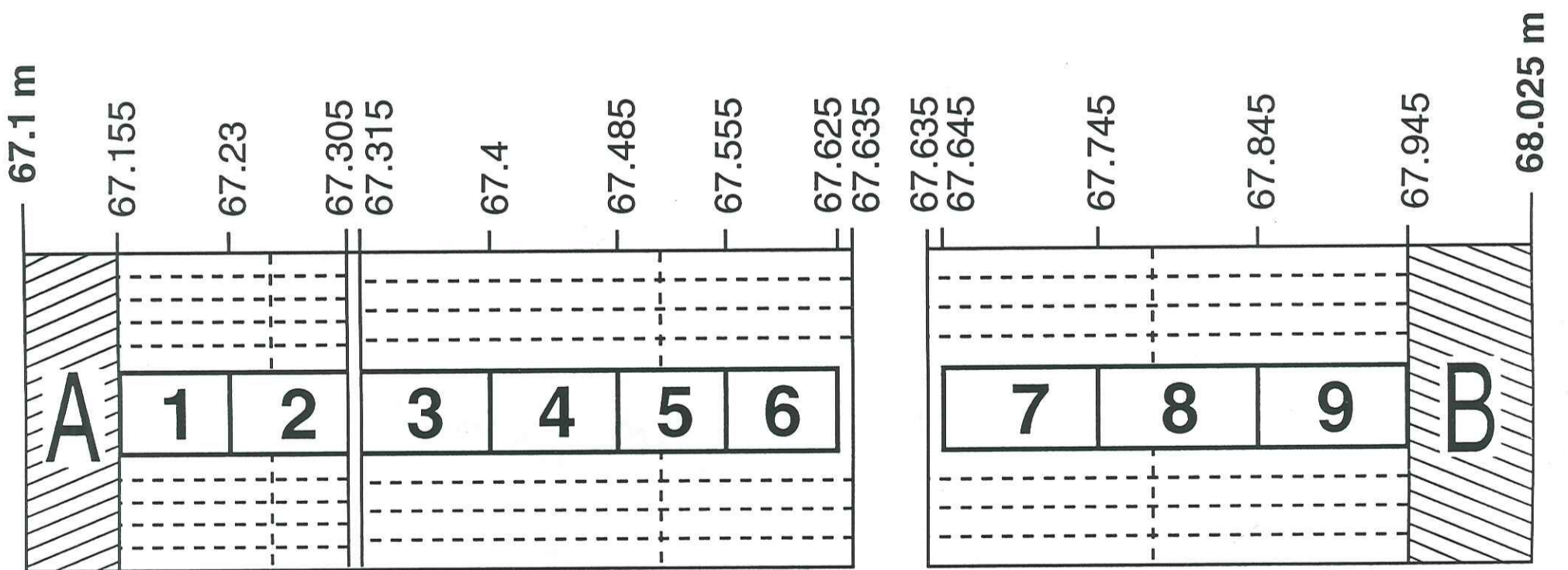

Fig. 2

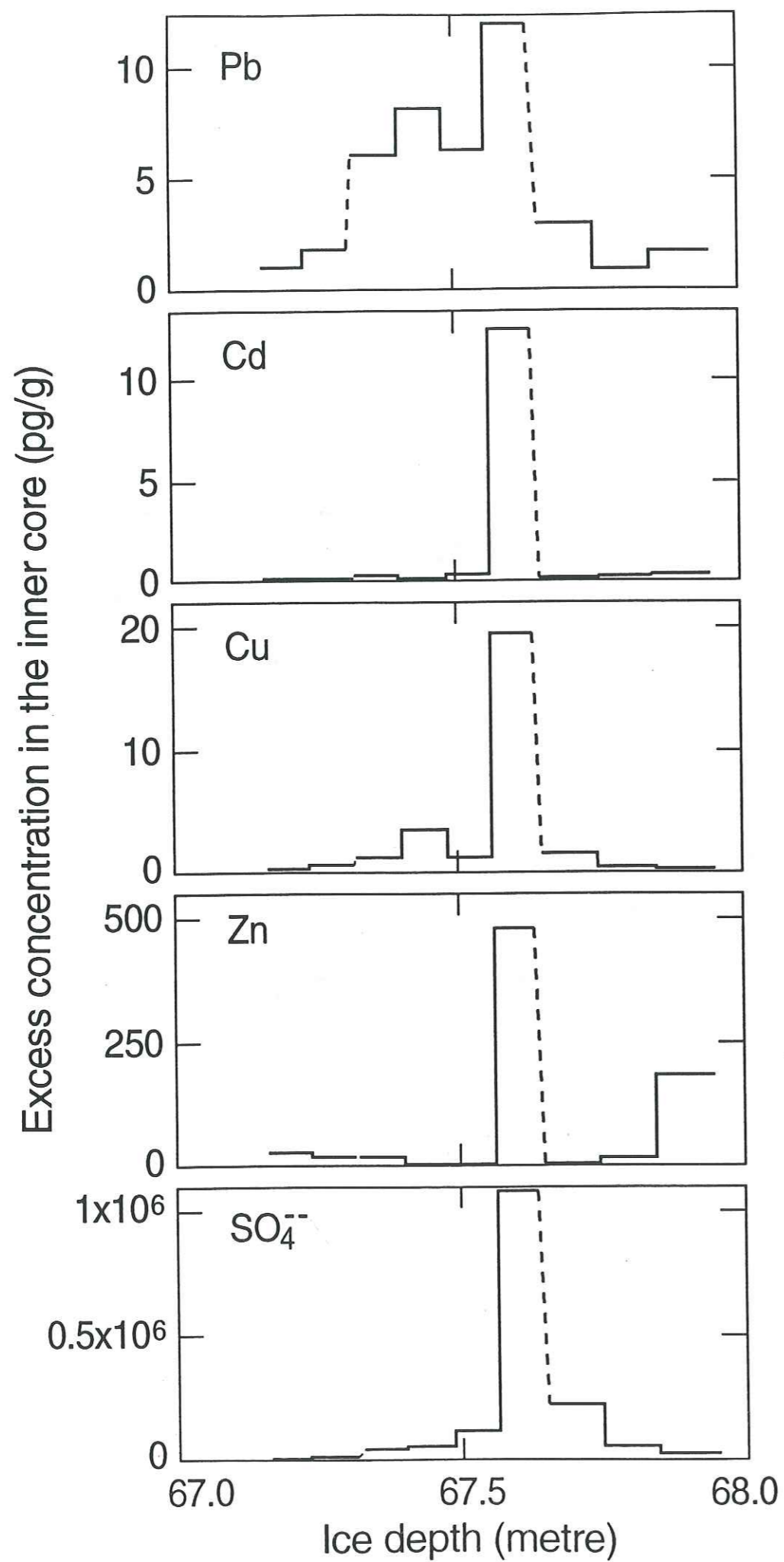

Fig. 4

CHANGING OCCURRENCES OF LEAD, COPPER, CADMIUM AND ZINC IN  
CENTRAL GREENLAND ICE DEPOSITED DURING THE HOLOCENE

Sungmin Hong<sup>1</sup>, Jean-Pierre Candelone<sup>1,3</sup> and Claude F. Boutron<sup>1,2\*</sup>

<sup>1</sup>Laboratoire de Glaciologie et Géophysique de l'environnement du CNRS, 54, rue Molière,  
Domaine Universitaire, B.P. 96, 38402 Saint Martin d'Hères, France

<sup>2</sup>UFR de Mécanique, Université Joseph Fourier de Grenoble, Domaine Universitaire, B.P.  
68, 38041 Grenoble, France

<sup>3</sup>Department of Applied Physics, Curtin University of Technology, GPO Box U 1987,  
Perth, WA 6001, Australia

\* To whom correspondence should be addressed

To be submitted to "Geochimica Cosmochimica Acta"

**ABSTRACT**

The contributions from various natural sources to the heavy metals (Pb, Cu, Cd and Zn) aerosols contained in the Arctic troposphere during the given Holocene periods (8000-7000 years B.P. and 3000-500 years B.P., respectively) have been investigated to evaluate human impact on their natural cycles by analysing the ice core sections selected from the Greenland deep ice core recovered at Summit, central Greenland. From the estimates of natural contribution, it is found that most of natural Holocene Pb and Cu originated from the wind-blown dusts and the whole contributions from natural sources such as wind-blown dusts, volcanoes, seasalt spray, wild forest fires and vegetation cannot be responsible for the observed Pb and Cu contents in ice covering the period of 3000-500 years B.P. This confirms our suggestions [9, 10] that during the past 3000 years anthropogenic Pb and Cu pollutant aerosols have perturbed on an hemispheric scale the natural atmospheric cycles of Pb and Cu. For Cd and Zn, the measured contents in our samples are estimated to be entirely natural in origin and, therefore, it is evidenced that the large scale anthropogenic pollution for these two metals in the Northern Hemisphere had not taken place until the last century as suggested in [7]. Continental biogenic emissions are regarded as a dominant source for Cd and Zn aerosols in the Arctic troposphere, accounting for about 80 % of the total Cd contents and 50 % of the total Zn at an average rate. In addition, wind-blown dusts are likely to account for most of the remaining Cd and Zn contents, although wild forest fires could sporadically release massive quantities of Cd and Zn aerosols to the atmosphere.

**1. Introduction**

AT PRESENT, IT IS well documented that greatly increased human activities since the past century have become a major factor in temporal and spacial changes of the biogeochemical cycles of various trace metals in the atmospheric environment (NRIAGU, 1979, 1989). In order to investigate to what extent they have impacted on the atmospheric natural burden of heavy metals, much attention has been given to the measurement of changing occurrences of heavy metals (especially Pb, Cu, Cd, and Zn due to their toxicities and characteristics as a tracer for the anthropogenic pollution) in Greenland and Antarctic recent snow and aged ice (MUROZUMI et al., 1969; BOUTRON et al., 1991; GÖRLACH and BOUTRON, 1992; WOLFF and SUTTIE, 1994; CANDELONE et al., in press). Until recently, the time period covered by most of these studies represented only the past decades or even few centuries, because it was supposed that significant large scale pollution by these metals had occurred during the industrial period. However, very recent measurement of Pb and Cu contained in Greenland ancient ice revealed that remarkable large scale pollution by man for these metals had occurred two millennia ago in the atmosphere of the Northern Hemisphere, due to the extensive mining and smelting activities of non-ferrous metals (HONG et al., 1994; HONG et al., submitted]. From these investigations, it is found that, when evaluating human influences on changes in the biogeochemical cycles of heavy metals in the global troposphere with human history, temporal changes must be reconstructed, using a time period long enough to show the natural level of these metals. In addition, estimates of metal contributions from various natural sources are important in understanding the origin of sources causing their actual changes in the ancient times.

The objective of this study is to examine in detail the natural and anthropogenic components of Pb and Cu observed by HONG et al. (1994, submitted). As well, we present, for the first

time, reliable time series of concentrations of Cd and Zn from the Holocene period which enable a proper assessment of biogeochemical cycles in the Arctic troposphere.

## 2. Experimental

### 2.1 Description of the samples

In 1990-1992, the 3028.8-m-long Greenland deep ice core was recovered by an electromechanical drill at Summit (72° 34'N, 37° 37'W, elevation of 3238 m above sea level, annual mean air temperature -32°C) in central Greenland, under the joint European Greenland Ice-core Project (GRIP). Twenty-three core sections of this Greenland deep ice core were selected. Twenty-one sections corresponded to the period 3000-471 years B.P. (before present) (depth : 511.0 m - 129.3 m) which encompasses Greek, Roman, Medieval and Renaissance periods. The other two sections corresponded to 7290 years B.P. (depth of 1230.4 m) and 7760 years B.P. (depth of 1286.5 m), and were chosen to investigate the Holocene natural background level for the measured heavy metals. The above mentioned samples are identical to the ones measured for Pb (except for one of 7290 years B.P.) and Cu (HONG et al., 1994, submitted). The age of the core sections was obtained using an improved unpublished time scale for the Holocene (JOHNSON, personal communication), which was performed by use of all available time markers such as the known volcanic eruptions and isotopic event at around 8200 years B.P. dated independently in the Dye 3 Greenland ice core and interpolation among these events. The uncertainty of the time scale is assumed to be negligible for the interpretation of our result, on the basis of the fact that the estimated error limits proposed in a preliminary time scale was much less than 1% for the Holocene (JOHNSON et al., 1992).

### 2.2 Decontamination of the samples

The superficial layer of the core sections recovered from a drilling operation is subject to heavy contamination from various metals. Decontamination of the core is therefore essential to obtain a reliable data. In our study, all the core sections were mechanically decontaminated using an improved ultraclean procedure to remove the contaminated outside veneer layer leaving the clean innermost part of the core, as described in detail elsewhere (CANDELONE et al., 1994). The whole procedure of decontamination was performed inside a laminar flow clean bench installed in a - 15°C cold room. This involved the chiselling of successive veneers of the core from the outside to the central part of each section while being held horizontal in a polyethylene lath specially designed (CANDELONE et al., 1994). In all cases, the inner cores obtained were broken into a length corresponding to exactly more than one year of ice accumulation, depending on the core quality, to eliminate any influence of seasonal variation.

As the blank contribution could be decisive for the measurement of extremely low heavy metal concentration, the procedural blank for the whole analytical procedure (including the chiselling step) was strictly checked using an artificial ice core made by freezing ultraclean water whose heavy metals contents were known beforehand (CANDELONE et al., 1994). It ranges from 0.015 pg/g for Cd to 0.25 pg/g for Cu. These contributions were found to account for about 30% for the lowest value of Pb and Cu, while about 10% for Cd and insignificant for Zn observed in our data.

### 2.3 Sample analysis

Each veneer layer, obtained after the decontamination operation, was analysed separately using ultraclean procedure in a clean laboratory (BOUTRON, 1990). After preconcentration by



non-boiling evaporation (GÖRLACH and BOUTRON, 1990), Pb, Cu and Cd contents were determined by Graphite Furnace Atomic Absorption Spectrometry (GFAAS), using a Perkin-Elmer 2380 Spectrometer with a Perkin-Elmer HGA 500 graphite furnace. Zn, Al and Na were measured directly by GFAAS without preconcentration. We also measured  $\text{SO}_4^{2-}$  and  $\text{NH}_4^+$  contents by ion chromatography. Multiple injections (up to 4 x 50 l) were used for Pb, Cu and Cd for part of the samples when the concentrations were close to the detection limits. The precision of the data was estimated to range from 5 to 15%, increasing as the concentrations approach the detection limits (GÖRLACH and BOUTRON, 1990). After all measurements were completed, the concentration values for heavy metals were corrected for blank contribution from the whole analytical procedures

### 3. Results and discussion

#### 3.1 Description of the measured concentrations

In order to confirm that the measured concentration values of each core section decontaminated are representative of the original ones in the ice, it is critical to determine the full outside-inside profiles in concentrations of each ice core section. As demonstrated in detail by various authors (see for instance NG and PATTERSON, 1981, BOUTRON and PATTERSON, 1986, BOUTRON et al., 1990, BOUTRON et al., 1993), if the outside contamination penetrated to the central part of the core, the measured concentrations in each layer should decrease gradually from the outside to the central part. The value of the most central part of the core must therefore be considered only an upper limit of the original concentration in the ice. If good concentration plateaus are observed in the central part, the corresponding values of the inner part of the core sections do represent the original values in the ice.

Typical profiles of changes in the measured concentrations from the outside to the inside of the core sections are shown in Fig. 1, 2. For Pb and Cu, good concentration plateaus were observed in the central part of all the core sections (Fig. 1) but one of 294.3m depth for Cu (HONG et al., 1994, submitted). For Cd and Zn, outside-inside profiles determined in our samples are also found to show clearly good plateaus, except for one of 457.1m depth, in which a continuous decrease of both Cd and Zn concentrations is observed in the same core section (Fig. 2). While most of the concentration values obtained in the most central parts of good plateau represent the original ones in the corresponding ice core sections, each Cu, Zn and Cd concentration measured in the sections of 294.3 and 457.1m depth, respectively, can serve only upper limit concentration values of these ice core sections because of no satisfying plateaus in the central parts. Considering that the core section available for this study was not full but thin one (CANDELONE et al., 1994), it is approved that the improved operation technique used here is excellent to decontaminate the contaminated ice core and also the quality of the investigated ice core sections was good enough to prevent the outmost contamination from penetrating to the inside of the core.

All the measured concentrations of heavy metals, Al,  $\text{SO}_4^{2-}$ , Na and  $\text{NH}_4^+$  are listed in Table 1. In the period of 7000 to 8000 years B.P., during which the atmospheric heavy metals originated wholly from the natural sources, the measured concentrations remained nearly constant. From around 3000 years B.P., changing occurrences of the measured heavy metals are observed. As already suggested by HONG et al. (1994, submitted), the time variations of the measured Pb and Cu were attributed to the atmospheric pollution by the human activities. Since the natural components of Pb and Cu are important for understanding their natural cycles in the Arctic troposphere, we will assess the Pb and Cu contribution from the natural sources in detail using the data available in our study. Furthermore, we discuss for the first time the

dominant sources for atmospheric Cd and Zn aerosols and their relative contributions to Cd and Zn deposition in the remote Arctic during the Holocene.

### 3.2 Assessment of the contribution from natural sources

The main natural sources of atmospheric trace metals on a global basis include wind-blown dusts, volcanoes, seasalt spray, wild forest fires, and biogenic activities (NRIAGU, 1979, 1989). According to global inventories of natural trace metal emissions by NRIAGU (1979, 1989), in which the total fluxes from various sources to the atmosphere are only order-of-magnitude estimates because of scattered emission factors from published data, the relative importance of individual source to different metals is considerably variable. Despite a wide range of uncertainties in an assessment of natural emission rates, the global inventory of natural metals fluxes to the atmosphere can be useful to have a picture of evaluating the relative significance of individual source for the measured heavy metals in our study. Therefore, we first evaluate the natural contribution from each potential source using the measured heavy metals for the period of 7000-8000 years B.P., because the atmospheric heavy metals were entirely derived from natural sources at that time and thus represent the Holocene natural background level. And an estimated contribution from each source is then compared with the global inventories of natural emissions proposed by NRIAGU (1979, 1989) for a proper assessment of the relative significance of various natural sources.

#### a) volcanoes

The volcanic impact can be evaluated from measured sulfate concentrations. In the Greenland and Antarctic snow and ice, signals of large eruptions of volcanoes are well recorded due to the highly elevated sulfur level in the atmosphere (HAMMER et al., 1980;

LEGRAND and DELMAS; 1987; ZIELINSKI et al., 1994). As shown in Table 1, the measured sulfate concentrations are close to the Holocene background level (30 ng/g). The sulfate value less than 50 ng/g in Greenland ice deposited during the Holocene could be regarded as being free of volcanic impact (DE ANGELIS and LEGRAND, 1994). It seems, therefore, most likely that the volcanic contribution to the measured heavy metals may have been negligible for the period of 7000-8000 years B.P. However, a small fraction of volcanic contribution resulting from either non-eruptive volcanic emissions or long residual stratospheric loading caused by a large eruption of volcanoes could not be dismissed. A tentative estimate of the volcanic contribution to the heavy metals measured in the Antarctic snow and ice has been estimated by several authors (BOUTRON and PATTERSON, 1986; BOUTRON et al., 1990; BOUTRON et al., 1993; BATIFOL et al., 1989), assuming that about 15% of excess sulfate is volcanic in origin on a global basis (ZEHNDER and ZINDER, 1980). In fact, it is difficult to estimate an average rate of volcanic sulfur emission in the global sulfur burden because of the sporadic volcanic activities resulting in a wide range of estimates (CULLIS and HIRSCHLER, 1980; MÖLLER, 1984). According to sulfur isotopic composition measurements (LI and BARRIE, 1993), most natural aerosol sulfate contained in the present-day Arctic atmosphere is of marine biogenic and seasalt origin for the period of little volcanism. When considering this observation, it is probable that over the Holocene period of little volcanism the volcanic portion of excess sulfate in the Arctic troposphere may have been much lesser than (~15%) proposed previously. In order to evaluate the contribution from volcanoes, therefore, we prefer to use an estimate that ~5% of excess sulfate at an average rate in the toposphere of the Northern Hemisphere may be attributed to the volcanic origin, based on the low limit of the estimates for the annual input of volcanic sulfur emissions (NEFTEL et al., 1985).

Other problems in evaluating volcanic contribution arise from the facts that the metal/S ratios in volcanic emission are widely scattered (Table 2) and were measured in volcanic plumes very

shortly after emission (BUAT-MENARD, 1990). Accordingly, the fractionation between sulfate and metals occurring in the aged volcanic aerosols during long-range transport is not understood. From Table 2, it seems that a difference in metal/S ratios could arise from aging of volcanic aerosols as indicated from Laki (short transport through the troposphere) and Agung (aged in the stratosphere). Since all the discrepancies mentioned above cannot be put together into a single explanation, the volcanic contribution has been tentatively estimated with a large uncertainty by using the metal/S ratios measured in the ice layers corresponding to Laki eruption (HONG et al., in preparation), assuming these ratios to be representative of the huge volcanic impact recorded in the Greenland snow and ice. The volcanic contributions so evaluated are found to account for ~2% of Pb and Cu, <4% of Zn, and <8% of Cd concentrations, respectively. This implies that volcanoes may have been a minor contributor for heavy metals during the Holocene period for which sporadic large volcanic activities were not documented.

#### b) wind-blown dusts

As described in various studies (HEIDAM, 1985; WOLFF and PEEL, 1988; PATTERSON and DUCE, 1991; HONG et al., 1994), the contribution from crustal-derived dusts to the measured heavy metals in the air or snow samples can be conveniently demonstrated by using the crustal enrichment factor ( $EF_{crust}$ ):

$$EF_{crust} = (X_m/Al_m) / (X/Al)_{rock, soil}$$

where  $X_m$  and  $Al_m$  represent the measured concentration of any element X and of aluminum in the air or snow samples, respectively, and  $(X/Al)_{rock, soil}$  is a mean composition in the bulk rock or soils. In general, it is suggested that values of  $EF_{crust}$  near one imply eroded crustal particles to be a dominant source. Elements enriched relative to crustal mean composition ( $EF_{crust} \gg 1$ ) are

likely to have predominantly non-crustal sources such as natural combustion (volcanism, forest fires), biological emissions, seasalt spray, and anthropogenic activities.

Until now, the  $EF_{crust}$  obtained in the snow or air samples of the Arctic region were calculated by preferentially using the mean composition of the bulk rock or soils given in Table 3a with an uncertainty of a factor of about 3, because the  $EF_{crust}$  for the prehistoric times, during which all the airborne trace metals were naturally-derived, were not available to select an appropriate mean composition for evaluating an enrichment factor of heavy metals compared to the Holocene natural background level. It is, of course, certain that highly enriched  $EF_{crust}$  values of heavy metals determined in the recent Arctic snow and air have resulted from anthropogenic pollutant aerosols derived from various human activities (HEIDAM, 1985; WOLFF and PEEL, 1988). Meanwhile, the interpretation for the slightly enriched  $EF_{crust}$  could be confused without knowing that of the Holocene natural level. For this, we discuss the  $EF_{crust}$  values shown in Table 3a with the global inventory of natural emissions to select a suitable mean composition for evaluating  $EF_{crust}$  in the remote Arctic region.

As shown in Table 3b, the  $EF_{crust}$  calculated by using each mean composition of the bulk rock or soils given in Table 3a vary by at least a factor of about 4 for Cd and 2 for Pb, Cu and Zn, respectively. For Pb and Cu, all the  $EF_{crust}$  calculated are lower than unit, indicating that all the given mean compositions could be used as an upper limit. However, it is found that most of Pb and Cu measured is likely to be crustal origin. This is in good agreement with the global trace metal fluxes from natural sources to the atmosphere proposed by NRIAGU (1979) as summarized in Table 4, in which volcanic contribution was eliminated because of little volcanism during the time period 7290 and 7760 years B.P. Based on this observation, a mean composition of the bulk crustal rock given by TAYLOR and MCLENNAN (1985) is found to be proper to appropriately calculate the  $EF_{crust}$  for Pb and the mean composition of the bulk soils given by BOWEN (1979) for that of Cu. On the other hand, the contribution from wind-blown

dusts to atmospheric Zn and Cd on a global basis is smaller than that for Pb and Cu, but represents a significant fraction, that is, about 30% for Cd and about 70% for Zn (Table 4). The  $EF_{\text{crust}}$  calculated using a mean composition given by BOWEN (1979) approach the estimated portions of crustal origin in the worldwide natural emissions and thus may be adequate for estimating the crustal contribution to the measured heavy metals with a certain uncertainty. From the  $EF_{\text{crust}}$  calculated for each element, we can conclude that for the Holocene natural level the crustal contribution can be attributed to most of the airborne Pb and Cu, while other natural sources such as wild forest fires, seasalt spray, and biogenic emission may also be important in the atmospheric Cd and Zn aerosols. The Holocene natural  $EF_{\text{crust}}$  determined above for each heavy metal can become useful criteria for investigating temporal changes of relative strength of natural and anthropogenic emissions to the past and present atmosphere.

c) seasalt spray

After correction for dust contribution using the Na/Al ratio (0.2867) in the mean crust composition (TAYLOR, 1964), the obtained seasalt Na concentrations provide an index for estimating heavy metals contribution from seasalt spray. This contribution can be estimated from the metal/Na ratios in present-day bulk seawater (DUCE et al., 1983) combined with the few available data on heavy metal enrichment factors with respect to bulk seawater to present-day sea-driven aerosols, about 100 for Pb, 1000 for Cu, 10,000 for Cd, and 50,000 for Zn, respectively (BOUTRON and PATTERSON, 1986; WEISEL et al., 1984; ARIMOTO et al., 1987; MARING and DUCE, 1989). It should be noted, however, that both the metal/Na ratios and the metal enrichment factors used here are probably high, since the present-day seawater contains significant metal pollutants originating from anthropogenic activities (BOUTRON et al., 1990;

BATIFOL et al., 1989). The estimated contribution from seasalt spray is found to be negligible, accounting for much less than 1% in all four metals. This corresponds to the estimate shown in Table 4.

d) other natural sources

Other possible natural contributions come from wild forest fires and continental or marine biogenic sources (NRIAGU, 1989). These contributions cannot be quantitatively estimated from our data, but the contribution from one of these sources, wild forest fires, can be evaluated with respect to its possible impact on the measured heavy metals concentrations by virtue of ammonium concentrations determined in our samples. As demonstrated in various studies (LEGRAND et al., 1992; WHITLOW, 1994; CHYLEK et al., 1995), the unusually high ammonium peaks recorded in ice cores from central Greenland are thought to originate from the aged plumes of high latitude forest fires reaching to the remote Arctic atmosphere. On a global basis, the atmospheric fluxes of trace metals emitted from wild forest fires were estimated to reach about 1900 tonnes for Pb, 3800 tonnes for Cu, 110 tonnes for Cd, and 7600 tonnes for Zn, respectively, which account for about 20% of the total natural emission for each element on a yearly median value (NRIAGU, 1989). Therefore, it is probable that the Arctic atmosphere could be sporadically perturbed by massive inputs of trace metals originating from high latitude forest fires.

The ammonium concentrations measured in our study are close to the Holocene natural background level as documented in the ice cores of central Greenland (LEGRAND et al., 1992; WHITLOW et al., 1994; CHYLEK et al., 1995). Therefore the contribution to heavy metal concentrations from wild forest fires over the studied period may have been insignificant.

Contributions from continental and marine biogenic sources cannot be estimated from our available data, but are assumed to explain a significant portion of the remaining (about 70-80% for Cd and 40-60% for Zn) obtained after subtracting the estimated wind-blown dusts, volcanic, and seasalt spray contribution from the measured heavy metals concentrations. This assumption is based on the assessment of global natural emissions of trace metals (NRIAGU, 1979, 1989).

### 3.3 Changing occurrences of heavy metals from 3000 B.C. to A.D. 1500

Over this period, atmospheric pollutant aerosols of anthropogenic origin became a major contributor to changes in natural cycles of heavy metals in the troposphere of the Northern Hemisphere. This is the case for Pb and Cu. As mentioned by HONG et al. (1994, submitted), the extensive Pb and Cu mining and smelting activities in ancient times had already resulted in a large scale atmospheric pollution for Pb and Cu two millennia ago. Thus natural biogeochemical cycles of Pb and Cu in the global atmospheric environment had been altered by anthropogenic aerosols.

Apart from Pb and Cu production in ancient times, Zn was also used to make brass (Cu-Zn alloy) in the pre-industrial period. Although the amount of zinc produced and consumed during the ancient times could not be quantitatively estimated at present, it is probable that a considerable amount of Zn may have been emitted to the atmosphere due to its high volatility from the Roman times, during which brass was produced on a large scale by the cementation process for the coinage (DARLING, 1990). The zinc metallurgy had also been developed in India and China as early as the fourteenth to sixteenth centuries A.D. (DARLING, 1990). However, it was after the Industrial Revolution that the metallic zinc began to be produced in comparable amounts to other non-ferrous metals such as copper, lead and tin. For instance,

average zinc production in Europe reached about 45,000 tonnes per year by the middle of the nineteenth century (CAMMAROTA, 1979). The total emissions of anthropogenic Zn to the atmosphere before 1850 A.D. was estimated to be about 2,800 thousands tonnes (NRIAGU, 1979). In the beginning of this century, the annual amount of anthropogenic Zn emissions was comparable to that emitted from natural sources (NRIAGU, 1979), which caused undoubtedly a large scale pollution in the atmosphere of the Northern Hemisphere as evidenced from the measurements of Greenland snow and ice (CANDELONE et al., in press).

For Cd, on the other hand, the case is quite different from Zn. Production of Cd commenced in 1859 A.D. after the discovery of cadmium in 1817 A.D. (NRIAGU, 1980). With increasing demand for paint pigments and other purposes, the production of Cd rose greatly from 1871 A.D. and exceeded 43,000 tonnes per year by 1910 A.D. (NRIAGU, 1980). However, anthropogenic Cd emissions to the atmosphere may have occurred long before its production, because cadmium occurs characteristically as an impurities in the sulfide ores of various metals, especially zinc, lead and copper (NRIAGU, 1980) and, therefore, non-ferrous metal production would have released a detectable amount of Cd to the atmosphere (HUTTON, 1983).

As mentioned above, for the period of 3000-1500 years B.P., a detailed evaluation of the contribution from natural and anthropogenic sources is necessary to understand an historical course of atmospheric pollution. Estimates of natural portions for the measured Pb and Cu will be presented to make sure of anthropogenic impact on the global atmospheric cycles of natural Pb and Cu. Also we discuss on the predominating sources for the measured Cd and Zn in order to observe a probable perturbation of natural atmospheric burden caused by the anthropogenic Zn and Cd aerosols emitted during the preindustrial times.

#### a) Pb and Cu

Pb contributions from wind-blown dusts evaluated from the measured Al concentrations (Table 1) are found to represent variable portions of the measured Pb concentrations, that is, from about 20 up to 75% except for two core sections of 349.3m (1521 B.P.) and 619.3m (2956 B.P.), for which all the Pb contents are crustal in origin. As shown in Table 5, the Pb concentrations are moderately correlated with Al, indicating that a significant portion of Pb originated not only from wind-blown dusts, but from other sources. The sulfate concentrations measured in our samples show values close to the Holocene natural background level, indicating little volcanic activity. However, one 509.3m core section (2351 B.P.) is suspected to have some volcanic input (Table 1) (DE ANGELIS and LEGRAND, 1994). Estimates of volcanic contribution from the nss-sulfate concentrations range from 0.008 to 0.019 pg Pb/g, accounting for less than about 3% of each Pb concentration. This implies that volcanoes make insignificant contribution to the measured Pb concentrations. The contribution from seasalt spray also constitutes a negligible portion (< 0.0001%) similar to the Holocene natural Pb. The correlations of Pb with ssNa and sulfate suggest a minor contribution (Table 5). As a result, it is observed that wind-blown dusts are still the main source of Pb contents in ice over the studied period. In Fig 3, the residual Pb, after subtracting the estimated contributions from wind-blown dusts, volcanoes and seasalt spray, appears to show very similar time variation to the total Pb concentrations measured.

For Cu, we cannot definitively estimate the contribution from wind-blown dusts, because the observed Cu/Al ratios for the Holocene natural Cu are found to be depleted with respect to each mean composition of the bulk rock or soils used to calculate the  $EF_{crust}$  (see section 3-1). This is probably because each mean composition could not explain the fractionation of Cu and Al concentrations occurring in air masses originating from source areas during long-range transport (SCHÜTZ and RAHN, 1982), and therefore causing unexpected Cu/Al ratio for the crustal aerosols in the remote Arctic atmosphere. For the period 3000-1500 years B.P., it can

be known only that a significant portion of the measured Cu is contributed from wind-blown dusts, based on the correlation between the measured Cu and Al (Table 5). The observed Cu contributions from volcanoes are found to be 0.018-0.048 pg Cu/g, representing less than 3% of all measured Cu. The seasalt contributions calculated also constitute a very small fraction (< ~2% ). As like Pb, wind-blown dusts but not volcanoes and seasalt spray contributed a significant portion of the measured Cu during the studied period. In order to obtain residual Cu, unexplained by the contribution from wind-blown dusts, volcanoes and seasalt spray, we used the mean value ( $0.2 \times 10^{-3}$ ) of the Holocene natural Cu/Al ratios, regarding that a portion corresponding to this natural ratio is of crustal origin in each measured Cu concentration. Therefore, residual Cu was calculated from the following equation :

$$[Cu]_{residual} = [Cu] \{ (Cu/Al) - 0.2 \} / (Cu/Al) - C_v - C_s$$

where [Cu] is the measured Cu concentration, (Cu/Al) represents Cu/Al ratio obtained from the Cu and Al concentrations measured in the same core section,  $C_v$  and  $C_s$  are the estimated portions for the volcanic and seasalt spray contributions, respectively. The residual Cu concentrations so calculated are shown in Fig. 4, where it can be seen that natural contributions from wind-blown dusts, volcanoes and seasalt spray are not responsible for the enrichment of observed Cu.

The ammonium concentrations in our data allow us to identify a potential contribution from forest fires. The mean value ( 7.49 ng/g) is within natural level of Holocene Greenland ice (LEGRAND et al., 1992; WHITLOW et al., 1994; CHYLEK et al., 1995). The high ammonium concentrations which are greater than the mean plus one standard deviation ( = 4.29) were detected in only three core sections (184.2m, 430.7m and 492.3m, respectively). This was not due to an influence of seasonal variation, because the values are yearly averages. Instead, they are suspected to record wild forest fire events. The Pb and Cu concentrations measured in

these core sections are found to be enriched with respect to the natural Pb and Cu for the period of 7000-8000 B.P. (Table 1). The fraction of Pb and Cu contributed from forest fires cannot be estimated, but it is probable that their contributions are small, since the residual Pb and Cu values corresponding to particularly high ammonium concentrations are not enriched with respect to others shown in Fig. 5a,b.

Finally, even though the contribution from biogenic sources could not be estimated from our data, an insight on the heavy metal associated with biogenic sources could be drawn from the relationship between heavy metal and ammonium concentrations measured in the same core sections. Now, it is well demonstrated that natural gaseous ammonia ( $\text{NH}_3$ ) originates from continental ecosystems and oceans as a product of biological activities and then ammonia is converted to ammonium ( $\text{NH}_4^+$ ), which is subject to long-range transport, in the boundary layer (DENTENER and CRUTZEN, 1994). Ammonia concentrations over the continent are typically on order of magnitude higher than over the oceans (DENTENER and CRUTZEN, 1994) and the continents of North America and Eurasia close to Greenland are important contributors having influence on aerosol compositions and concentrations in the air over Greenland (WHITLOW et al., 1992). Ammonium can be therefore considered as a tracer of biogenic components of continental air masses (MAYEWSKI et al., 1993). The observed correlations of Pb and Cu with  $\text{NH}_4^+$  are found to be negligible (Table 5), which suggests that the continental biogenic contribution to the measured Pb and Cu may not be significant. Furthermore, no relationship between the residual Pb and Cu and ammonium are observed (Fig. 5a,b), implying that the residual Pb and Cu may have arrived in central Greenland independent of the biogenic component input derived from continents surrounding Greenland.

As a whole, the contribution from various natural sources estimated from our data cannot be attributed to the historical variation of the measured Pb and Cu concentrations. This confirms the previous suggestion that enriched Pb and Cu in comparison with the Holocene natural

background level during the investigated time period have resulted from man-induced Pb and Cu pollutant aerosols having originated from ancient Pb and Cu mining and smelting activities (HONG et al., 1994, submitted).

#### b) Cd and Zn

The measured Cd and Zn concentrations, which are the first reliable time series for these metals, are found to be variable up to by a factor of about 5 over the investigated time period (Fig 6a,b) (0.14-0.59 pg/g for Cd and 11.0-50.4 pg/g for Zn, respectively) (Table 1). The particularly high concentrations of Cd and Zn are observed in three core sections of 184.2m (723 B.P.), 475.1m (2073 B.P.), and 492.3m depth (2260 B.P.), respectively. In these sections, Al concentrations determined are highly elevated, indicating more intensive meridional transport of crustal dust particles from source areas in mid-latitudes at that time.

In contrast to changes in Cd and Zn concentrations, on the other hand, Cd/Al and Zn/Al ratios (we prefer to use metal/Al ratio for evaluating enrichment of metals compared to the Holocene natural value, because the difference among each mean composition of the bulk rock or soils given by various authors (see section 3-1) could make erroneous uncertainties in estimating the  $\text{EF}_{\text{crust}}$ ) do not show any temporal enrichment with respect to those observed in the period of 7000-8000 B.P. (Fig. 7), for which all measured Cd and Zn are of natural origin. Only slight enrichments are shown for the time 2956 years B.P. for Cd and 2084 years B.P. for Zn. We cannot explain this enrichment for Cd and Zn with each one point, but it seems that Cd enrichment may be caused by analytical uncertainty due to proximity to the detection limit, although evaporated before analysis. The Zn enrichment may be due to either analytical uncertainty or anthropogenic influence as described before. Anyway, the overall picture implies that during the pre-industrial times all the Cd and Zn aerosols contained in the Arctic

troposphere may have been naturally-derived in origin and hence their natural geochemical cycles of the troposphere of the Northern Hemisphere may not have been perturbed on a global scale by the human activities. As a result, our time series of Cd and Zn confirms the previous suggestion by CANDELONE et al. (in press) that a large scale pollution of the Northern Hemisphere started from the mid-19th century for Cd and from the late 18th century for Zn corresponding to the enormously expanded global emissions of anthropogenic pollutants to the atmosphere [Fig. 6, 7].

As the measured Cd and Zn are found to have originated from various natural sources, it is interesting to estimate principal sources impacting on the Cd and Zn input over Greenland during the Holocene. The estimated contributions from wind-blown dusts for Cd are found to amount to 0.02 to 0.08pg Cd/g, which account for 10-25% at an average of about 15%. For Zn, their contributions are in the range of 5 to 20 pg Zn/g, representing 25-60% of the measured Zn with an average of about 45%. This association of the measured Cd and Zn with crustal contribution is supported from the correlations of Cd and Zn with respect to Al, which show that Zn is more significantly related to wind-blown dusts than Cd. The estimated volcanic contributions are slightly greater than those of Pb and Cu, accounting for an average of about 7% for Cd and 3% for Zn. Volcanoes were therefore only minor contributor compared to wind-blown dusts for Cd and Zn aerosols in the Arctic troposphere for the time period of little volcanic activities. Also the Cd and Zn contributions from seasalt spray are always negligible as less as 0.5% in concentration. Finally, as mentioned before, a possible influence from wild forest fires for the measured Cd and Zn contents can be inferred from ammonium spikes corresponding to the core depth of 184.2m (723 years B.P.), 430.7m (1936 years B.P.), and 492.3m (2260 years B.P.), respectively, (Table 1). In two core sections of 723 and 2260 years B.P., the concentrations of Cd and Zn measured appear to be enriched, but not the metal/Al ratios (Fig. 6, 7). As a strong enhancement of the aluminum level is observed in these core

sections, larger part of the enriched Cd and Zn contents originated from the increased input of wind-blown dusts to the Arctic caused by the favorable meteorological condition for their transport. In addition, a significant part of the remaining Cd and Zn after subtracting the crustal portion may have been derived from the forest fire. This suggests that wild forest fires could release sporadically a large amount of Cd and Zn aerosols to the atmosphere so as to perturb the atmospheric Cd and Zn cycles in the high latitudes troposphere. However, it must be noted that any affirmative presumption in our study cannot be given with only a few data points.

Taking into account natural contribution estimated above, a large fraction of the measured Cd and Zn cannot be explained by natural contributions from wind-blown dusts, volcanoes, seasalt spray, and wild forest fires. The remaining fractions amount to be about 80% for Cd and 50% for Zn at an average rate. On the basis of an assessment of the global natural emissions to the atmosphere (NRIAGU, 1979, 1989), it seems most likely that the contribution from biogenic sources may be assigned to the remaining Cd and Zn. The amount of biogenic Cd and Zn emissions from continental vegetation areas could reach about 200 tonnes for Cd and 9400 tonnes for Zn at a median value, which account for about 65% and 25% of the total natural emission rates for Cd and Zn, respectively, excluding volcanic emissions because of negligible volcanic influences in our samples (Table 1). In the light of a wide range of emission rates estimated, biogenic contributions could increase up to about 90% for Cd and 65% for Zn (NRIAGU, 1979). The large fraction of biogenic contribution can be evidenced from the observed correlations of Cd and Zn with  $\text{NH}_4^+$  (Table 5), which show that Cd and Zn are associated with ammonium, tracer of air masses arriving from continental biosphere, in statistical significance. Moreover, the residual Cd and Zn (after correction from the estimated wind-blown dusts, volcanic and seasalt spray portions) are found to show even more coherent relationship with  $\text{NH}_4^+$  (Fig. 7) in comparison with those between residual Pb and Cu and  $\text{NH}_4^+$  (Fig. 5A, B), for which both crustal and anthropogenic contributions are dominant. When



considering that the higher residual Cd and Zn concentrations seem to be linked to wild forest fires (elevated  $\text{NH}_4^+$  level in Fig. 7), it is probable that Cd and Zn aerosols emissions from continental vegetation may be facilitated by wild forest fires. Therefore, we propose that most of residual Cd and Zn contents in ice may have originated from continental biosphere by means of direct biological emissions or wild forest fires.

In addition, the strong correlation ( $r = 0.814$ ) between Cd and Zn in our samples is likely to indicate that the geochemical cycles of the atmospheric Cd and Zn aerosols are closely related each other by virtue of their co-occurrence in the Earth's crust (NRIAGU, 1980). The strength of Cd and Zn emissions to the atmosphere from various natural sources outside volcanoes can be estimated by the Zn/Cd ratios observed from our measurement. It gives an average Zn/Cd ratio of 93/23 with a standard deviation, which appears to be within a range of about 75 to 120 of Zn/Cd ratio in the global natural emissions, estimated by median values given by NRIAGU (1979, 1989), after subtracting volcanic emission. This agreement of the Zn/Cd ratios in our data with that of the worldwide natural Cd and Zn emission rates evidences again that the principal sources for the measured Cd and Zn may have been wind-blown dusts and continental biogenic emissions, because the contribution from other sources (volcanoes, seasalt spray, marine biogenic activities) are relatively insignificant in the global natural emission inventory of heavy metals, provided that the large eruptive volcanisms were absent at a given time. The temporal changes of the measured Cd and Zn concentrations together with their Zn/Cd ratios may, therefore, have occurred in accordance with any short-term variations of individual Cd and Zn emission strength from natural source areas on the continents surrounding Greenland and/or changes of the meteorological conditions influencing the meridional long-range transport favorable differently for Cd and Zn (RAATZ, 1991).

In summary, the measured Cd and Zn contents in our ice samples for the pre-industrial period are found to be naturally-driven in origin and to be variable in concentration due to changing

input of the atmospheric Cd and Zn from various natural sources to the Arctic troposphere. Without any large eruption of volcanoes, the dominant natural sources for Cd seem to be biogenic emissions from continental biosphere, accounting for about 80% of the total atmospheric Cd emission, and wind-blown dusts as a secondary natural source. On the other hand, about half of Zn may originate from wind-blown dusts and a remaining half from continental biogenic source. Based on the relationship between Cd and Zn concentrations and ammonium contents in ice, it is assumed that sporadic wild forest fires could release a large amount of Cd and Zn aerosols to the atmosphere so that the atmospheric burdens of Cd and Zn in the high-latitude troposphere may increase to a great extent. Finally, the close correlation between the measured Cd and Zn concentrations seems to indicate that natural geochemical cycling of Cd and Zn in the high latitudes troposphere may have similar in pathway of the transport and deposition.

#### ACKNOWLEDGEMENTS

This work is a contribution of GRIP organized by the European Science Foundation. Our thanks are due to M. Legrand for the ion chromatography measurements and to R.J. Delmass for his helpful discussion and also to F. Ducroz and J. Savarino for their assistance in the laboratory. We thank the national funding agencies and organizations in Belgium, Denmark, France, Germany, Iceland, Italy, Switzerland, and the United Kingdom as well as the XII Directorate of the Commission of European Communities for financial support. This work is also supported by the French Ministry of the Environment (grant 92295), the Institut National des Sciences de l'Univers, and the University of Grenoble.

## References

- ARIMOTO R., DUCE R.A., RAY B.J., HEWITT A.D., and WILLIAMS J. (1987) Trace elements in the atmosphere of American Samoa : concentrations and deposition to the tropical South Pacific. *J. Geophys. Res.* **92**, 8465-8479.
- BATIFOL F., BOUTRON C.F., and DE ANGELIS M. (1989) Changes in copper, zinc and cadmium concentrations in Antarctic ice during the past 40,000 years. *Nature* **337**, 544-546.
- BOUTRON C.F. (1990) A clean laboratory for ultralow concentration heavy metal analysis. *Fresenius Z. Anal. Chem.* **337**, 482-491.
- BOUTRON C.F., GÖRLACH U., CANDELONE J.P., BOLSHOV M.A., and DELMAS R.J. (1991) Decrease in anthropogenic lead, cadmium and zinc in Greenland snow since the late 1960s. *Nature* **353**, 153-156.
- BOUTRON C.F. and PATTERSON C.C. (1986) Lead concentration changes in Antarctic ice during the Wisconsin / Holocene transition. *Nature* **323**, 222-225.
- BOUTRON C.F., PATTERSON C.C., and BARKOV N.I. (1990) The occurrence of zinc in Antarctic ancient ice and recent snow. *Earth Planet. Sci. Lett.* **101**, 248-259.
- BOUTRON C.F., RUDNIEV S.N., BOLSHOV M.A., KOLOSHNIKOV V.G., PATTERSON C.C., and BARKOV N.I. (1993) Changes in cadmium concentrations in Antarctic ice and snow during the past 155,000 years. *Earth Planet. Sci. Lett.* **117**, 431-444.
- BOWEN H.J.M. (1979) *Environmental Chemistry of the Elements*. Academic Press.
- BUAT-MENARD P. (1990) Global source strength and long-range atmospheric transport of trace elements emitted by volcanic activity. In *The Long-range Atmospheric Transport of Natural and Contaminant Substances* (ed. A.H. KNAP) NATO ASI Ser. Vol. C 297, pp. 163-175. Kluwer, Dordrecht.

- CAMMAROTA V.A., JR. (1979) Production and uses of zinc. In *Zinc in the Environment* (ed. J.O. NRIAGU), pp. 1-38. Wiley.
- CANDELONE J.P., HONG S., and BOUTRON C.F. (1994) An improved method for decontaminating polar snow and ice cores for heavy metals analysis. *Anal. Chim. Acta* **229**, 9-16.
- CANDELONE J.P., HONG S., PELLONE C., and BOUTRON C.F. (in press) Post industrial revolution changes in large scale atmospheric pollution of the Northern Hemisphere by heavy metals as documented in central Greenland snow and ice. *J. Geophys. Res.*
- CH'YLEK P., JOHNSON B., DAMIANO P.A, TAYLOR K.C., and CLEMENT P. (1995) Biomass burning record and black carbon in the GISP2 ice core. *Geophys. Res. Lett.* **22**, 89-92.
- CULLIS C.F. and HIRSCHLER M.M. (1980) Atmospheric sulphur : natural and man-made sources. *Atmos. Environ.* **14**, 1263-1278.
- DARLING A.S. (1990) Non-ferrous metals. In *An Encyclopaedia of the History of Technology*. (ed. I. MCNEIL), pp. 47-145. Routledge.
- DE ANGELIS M. and LEGRAND M. (1994) Origins and variations of fluoride in Greenland precipitation. *J. Geophys. Res.* **99**, 1157-1172.
- DENTENER F.J. and CRUTZEN P.J. (1994) A three-dimensional model of the global ammonia cycle. *J. Atmos. Chem.* **19**, 331-369.
- DUCE R.A., ARIMOTO R., RAY B.J., UNNI C.K., and HARDER P.J. (1983) Atmospheric trace metals at Enewetak atoll : 1. concentrations, sources and temporal variability. *J. Geophys. Res.* **88**, 5321-5342.
- GÖRLACH U, and BOUTRON C.F. (1990) Preconcentration of lead, cadmium, copper and zinc in water at  $\mu\text{g}\cdot\text{g}^{-1}$  level by non-boiling evaporation. *Anal. Chim. Acta* **236**, 391-398.

- GÖRLACH U. and BOUTRON C.F. (1992) Variations in heavy metals concentrations in Antarctic snows from 1940 to 1980. *J. Atmos. Chem.* **14**, 205-222.
- HAMMER C.U., CLAUSEN H.B., and DANSGAARD W. (1980) Greenland ice sheet evidence of post-glacial volcanism and its climatic impact. *Nature* **288**, 230-235.
- HEIDAM N.Z. (1985) Crustal enrichments in the Arctic aerosol. *Atmos. Environ.* **19**, 2083-2097.
- HONG S., CANDELONE J.P., and BOUTRON C.F. (submitted) Deposition of atmospheric heavy metals to the Greenland ice sheet from the 1783-1784 volcanic eruption of Laki, Iceland. *Earth. Planet. Sci. Lett.*
- HONG S., CANDELONE J.P., PATTERSON C.C., and BOUTRON C.F. (1994) Greenland ice evidence of hemispheric scale pollution for lead two millennia ago by Greek and Roman civilizations. *Science* **265**, 1841-1843.
- HONG S., CANDELONE J.P., PATTERSON C.C., and BOUTRON C.F. (submitted) Greater large scale atmospheric pollution for copper during antiquity than in modern times. *Science*.
- HUTTON M. (1983) Sources of cadmium in the environment. *Ecotoxic. Environ. Safety* **7**, 9-24.
- JOHNSEN S.J., CLAUSEN H.B., DANSGAARD W., FUHRER K., GUNDESTRUP N., HAMMER C.U., IVERSEN P., JOUZEL J., STAUFFER B., and STEFFENSEN J.P. (1992) Irregular glacial interstadials recorded in a new Greenland ice core. *Nature* **359**, 311-313.
- LEGRAND M. and DE ANGELIS M., STAFFELBACH T., NEFTEL A., and STAUFFER B. (1992) Large perturbations of ammonium and organic acids content in the Summit-Greenland ice core. Fingerprint from forest fires?. *Geophys. Res. Lett.* **19**, 473-475.
- LEGRAND M. and DELMAS R.J. (1987) A 220-year continuous record of volcanic H<sub>2</sub>SO<sub>4</sub> in the Antarctic ice sheet. *Nature* **327**, 671-676.

- LI S.M. and BARRIE L.A. (1993) Biogenic sulfur aerosols in the Arctic troposphere : 1. Contribution to total sulfate. *J. Geophys. Res.* **98**, 20,613-20,622.
- MARING H.B. and DUCE R.A. (1989) The impact of atmospheric aerosols on trace metal chemistry in open ocean surface seawater. *J. Geophys. Res.* **94**, 1039-1045.
- MASON B. (1966) *Principles of Geochemistry*. 3rd Ed. Wiley.
- MAYEWSKI P.A., MEEKER L.D., MORRISON M.C., TWICKLER M.S., WHITLOW S.I., FERLAND K.K., MEESE D.A., LEGRAND M.R. and STEFFENSEN J.P. (1993) Greenland ice core "signal" characteristics : an expanded view of climate change. *J. Geophys. Res.* **98**, 12,839-12,847.
- MÖLLER D. (1984) On the global natural sulphur emission. *Atmos. Environ.* **18**, 29-39.
- MUROZUMI M., CHOW T.J., and PATTERSON C.C. (1969) Chemical concentrations of pollutant lead aerosols, terrestrial dusts and sea salt in Greenland and Antarctic snow strata. *Geochim. Cosmochim. Acta* **33**, 1247-1294.
- NEFTEL A., BEER J., OESCHGER H., ZÜRCHER F., and FINKEL R.C. (1985) Sulphate and nitrate concentrations in snow from South Greenland 1895-1978. *Nature* **314**, 611-613.
- NG A. and PATTERSON C.C. (1981) Natural concentrations of lead in ancient Arctic and Antarctic ice. *Geochim. Cosmochim. Acta* **45**, 2109-2121.
- NRIAGU J.O. (1979) Global inventory of natural and anthropogenic emissions of trace metals to the atmosphere. *Nature* **279**, 409-411.
- NRIAGU J.O. (1980) Production, uses, and properties of cadmium. In *Cadmium in the Environment. Part 1 : Ecological Cycling* (ed. J.O. NRIAGU), pp. 35-70. Wiley.
- NRIAGU J.O. (1989) A global assessment of natural sources of atmospheric trace metals. *Nature* **338**, 47-49.

- PATTERSON T.L. and DUCE R.A. (1991) The cycle of atmospheric cadmium over the North Pacific Ocean. *Tellus* **43B**, 12-29.
- RAATZ W.E. (1991) The climatology and meteorology of Arctic air pollution. In *Pollution of the Arctic atmosphere* (ed. W.T. STURGES), pp. 13-42. Elsevier.
- SCHÜTZ L. and RAHN K.A. (1982) Trace-element concentrations in erodible soils. *Atmos. Environ.* **16**, 171-176.
- TAYLOR S.R. (1964) Abundance of chemical elements in the continental crust : a new table. *Geochim. Cosmochim. Acta* **28**, 1273-1285.
- TAYLOR S.R. and MCLENNAN S.M. (1985) *The continental Crust : its composition and evolution*. Blackwells, Oxford.
- WEISEL C.P., DUCE R.A., FASCHING J.L., and HEATON R.W. (1984) Estimates of the transport of trace metals from the ocean to the atmosphere. *J. Geophys. Res.* **89**, 11607-11618.
- WHITLOW S., MAYEWSKI P.A., and DIBB J.E. (1992) A comparison of major chemical species seasonal concentration and accumulation at the South Pole and Summit, Greenland. *Atmos. Environ.* **26A**, 2045-2054.
- WHITLOW S., MAYEWSKI P., DIBB J., HOLDSWORTH G., and TWICKLER M. (1994) An ice-core-based record of biomass burning in the Arctic and Subarctic, 1750-1980. *Tellus* **46B**, 234-242.
- WOLFF E.W. and PEEL D.A. (1988) Concentrations of cadmium, copper, lead and zinc in snow from near Dye 3 in south Greenland. *Ann. Glaciol.* **10**, 193-197.
- WOLFF E.W. and SUTTIE E.D. (1994) Antarctic snow record of southern hemisphere lead pollution. *Geophys. Res. Lett.* **21**, 781-784.

- ZEHNDER A. and ZINDER S. (1980) In *The Handbook of Environmental Chemistry* (ed. O. HUTZINGER), Vol. 1, Pt. A, pp. 105-145. Springer.
- ZIELINSKI G.A., MAYEWSKI P.A., MEEKER L.D., WHITLOW S., TWICKLER M.S., MORRISON M., MEESE D.A., GOW A.J., and ALLEY R.B. (1994) Record of volcanism since 7000 B.C. from the GISP2 Greenland ice core and implications for the volcano-climate system. *Science* **264**, 948-952

TABLE 1

The concentration data of various elements (Pb, Cu, Cd, Zn, Al, Na, SO<sub>4</sub><sup>2-</sup>, and NH<sub>4</sub><sup>+</sup>) measured in the central parts of the investigated ice core sections, Summit, central Greenland.

| Depth<br>(m) | Age<br>(yrs B.P.) | Measured concentration |       |       |       |        |     |                               |                              |
|--------------|-------------------|------------------------|-------|-------|-------|--------|-----|-------------------------------|------------------------------|
|              |                   | Pb                     | Cu    | Cd    | Zn    | Al     | Na  | SO <sub>4</sub> <sup>2-</sup> | NH <sub>4</sub> <sup>+</sup> |
|              |                   | (pg/g)                 |       |       |       | (ng/g) |     |                               |                              |
| 129.3        | 471               | 3.90                   | 3.14  | 0.15  | 17.9  | 7.6    | 3.7 | 25.3                          | 4.2                          |
| 184.2        | 723               | 3.99                   | 3.83  | 0.59  | 50.4  | 13.4   | 5.3 | 26.6                          | 16.7                         |
| 239.3        | 985               | 2.46                   | 3.55  | 0.21  | 27.1  | 11.2   | 5.1 | 29.0                          | 4.8                          |
| 294.3        | 1248              | 1.29                   | 6.43* | 0.32  | 31.7  | 9.4    | 3.9 | 43.9                          | 4.9                          |
| 349.3        | 1521              | 0.66                   | 2.46  | 0.30  | 25.7  | 6.9    | 3.8 | 33.1                          | 9.2                          |
| 399.3        | 1774              | 0.80                   | 2.02  | 0.23  | 18.8  | 6.2    | 4.8 | 35.1                          | 4.8                          |
| 401.0        | 1783              | 1.57                   | 2.63  | 0.21  | 17.1  | 8.2    | 3.6 | 40.8                          | 5.5                          |
| 404.3        | 1801              | 1.12                   | 3.58  | 0.19  | 19.0  | 7.2    | 5.4 | 36.4                          | 5.8                          |
| 416.9        | 1866              | 1.02                   | 1.20  | 0.21  | 14.1  | 5.8    | 3.6 | 22.4                          | 3.2                          |
| 422.4        | 1894              | 1.17                   | 1.30  | 0.20  | 25.3  | 6.6    | 3.4 | 38.2                          | 10.3                         |
| 430.7        | 1936              | 1.45                   | 2.23  | 0.34  | 28.3  | 7.7    | 3.2 | 28.6                          | 15.8                         |
| 435.1        | 1958              | 1.23                   | 0.90  | 0.24  | 18.1  | 5.9    | 5.3 | 32.9                          | 7.0                          |
| 446.1        | 2015              | 1.37                   | 1.25  | 0.27  | 19.1  | 6.3    | 4.3 | 26.0                          | 6.2                          |
| 457.1        | 2073              | 3.19                   | 6.30  | 0.46* | 34.0* | 16.4   | 7.4 | 34.5                          | 9.5                          |
| 459.3        | 2084              | 1.48                   | 3.16  | 0.23  | 27.1  | 5.5    | 5.1 | 36.0                          | 5.1                          |
| 469.2        | 2137              | 1.36                   | 1.33  | 0.17  | 20.2  | 6.2    | 2.6 | 34.0                          | 9.7                          |
| 492.3        | 2260              | 2.13                   | 4.05  | 0.49  | 42.9  | 14.2   | 5.7 | 37.4                          | 19.2                         |
| 509.3        | 2351              | 1.79                   | 1.92  | 0.24  | 22.6  | 9.7    | 5.2 | 57.6                          | 5.9                          |
| 511.0        | 2360              | 1.64                   | 3.26  | 0.18  | 18.2  | 8.3    | 5.4 | 24.4                          | 5.1                          |
| 569.3        | 2674              | 0.64                   | 0.76  | 0.14  | 11.0  | 3.9    | 1.9 | 40.5                          | 3.2                          |
| 619.3        | 2956              | 0.35                   | 0.86  | 0.29  | 19.1  | 5.1    | 2.9 | 25.9                          | 6.8                          |
| 1230.4       | 7290              | 0.89                   | 1.62  | 0.24  | 22.5  | 10.5   | 4.0 | 34.3                          | 4.9                          |
| 1286.5       | 7760              | 0.55                   | 1.65  | 0.25  | 22.8  | 6.9    | 2.4 | 38.6                          | 6.7                          |

\* Value of an upper limit due to no good plateau of concentration (see text).

TABLE 2

A comparison of the metal/S weight ratio : for Laki (tropospheric transport) and Agung (stratospheric transport), the metal/S ratios were obtained in snow layers corresponding to the ages of their eruptions; a wide range of the metal/S ratios measured for various volcanic plumes are also shown.

| Volcanoes                         | Metal/sulfur ratio (x 10 <sup>-4</sup> ) |         |          |          |
|-----------------------------------|--|---------|----------|----------|
|                                   | Pb                                       | Cu      | Zn       | Cd       |
| Measured in snow layer            |  |         |          |          |
| Laki <sup>1</sup><br>(Greenland)  | 0.32                                     | 0.52    | 13       | 0.33     |
| Agung <sup>2</sup><br>(Antarctic) | < 0.3                                    | < 0.2   | < 0.2    | < 0.02   |
| Measured in volcanic plumes       |  |         |          |          |
| Range <sup>3</sup>                | 0.36-1.2                                 | 0.6-3.5 | 0.21-3.8 | 0.09-0.3 |
| Median value                      | 0.8                                      | 2       | 2        | 0.2      |

<sup>1</sup> From Hong et al. (in preparation).

<sup>2</sup> From Görlach and Boutron (1991).

<sup>3</sup> From Nriagu (1989).

TABLE 3

A) Mean composition of the bulk rock or soils given by various authors.

| Metal/Al ratio<br>( $\times 10^{-4}$ ) | Taylor<br>(1964) | Taylor<br>(1985) | Mason<br>(1966) | Bowen<br>(1979) |
|--|------------------|------------------|-----------------|-----------------|
| Pb/Al                                  | 1.52             | 0.95             | 1.60            | 1.70            |
| Cu/Al                                  | 6.68             | 8.92             | 6.77            | 4.20            |
| Cd/Al                                  | 0.024            | 0.012            | 0.025           | 0.049           |
| Zn/Al                                  | 8.51             | 9.51             | 8.61            | 1.27            |

B) The calculated  $EF_{\text{crust}}$  of each heavy metal for the 7290 and 7760 years B.P. core sections, using the metal/Al ratios given above.

| Years B.P.<br>Element | $EF_{\text{crust}}$ calculated |                  |                 |                 |
|-----------------------|--------------------------------|------------------|-----------------|-----------------|
|                       | Taylor<br>(1964)               | Taylor<br>(1985) | Mason<br>(1966) | Bowen<br>(1979) |
| 7290 years B.P.       |                                |                  |                 |                 |
| Pb                    | 0.6                            | 0.9              | 0.5             | 0.5             |
| Cu                    | 0.2                            | 0.2              | 0.2             | 0.4             |
| Zn                    | 2.5                            | 2.3              | 2.5             | 1.7             |
| Cd                    | 9.2                            | 20.0             | 9.2             | 4.7             |
| 7760 years B.P.       |                                |                  |                 |                 |
| Pb                    | 0.5                            | 0.8              | 0.5             | 0.5             |
| Cu                    | 0.4                            | 0.3              | 0.4             | 0.6             |
| Zn                    | 3.9                            | 3.5              | 3.8             | 2.6             |
| Cd                    | 14.7                           | 31.3             | 14.7            | 7.4             |

TABLE 4

The relative strength of various natural source contributions to the global heavy metals emissions to the atmosphere given by Nriagu (1979) : the summarized values come from the median values of the total amount of heavy metals emission fluxes ; all the values are rounded as a percentage.

| Sources*          | Relative % of the total global annual emissions |     |      |     |
|-------------------|---|-----|------|-----|
|                   | Pb  | Cu  | Zn   | Cd  |
| Wind-blown dusts  | 88  | 81  | 68   | 32  |
| Seasalt spray     | 0.1   | 0.5 | 0.03 | 0.3 |
| wild forest fires | 3   | 2   | 6    | 3.8 |
| vegetation        | 9   | 17  | 26   | 64  |

\* Volcanic contribution was eliminated due to little volcanisms during the investigated times (see text).

TABLE 5

The determined correlation coefficients between each element : Cd and Zn values obtained in ice core section of 2073 years B.P. were eliminated in determining correlation coefficient, because they represent only the values of an upper limit.

|                 | Pb | Cu    | Zn    | Cd    | Al    | NH <sub>4</sub> | ssNa  | SO <sub>4</sub> |
|-----------------|----|-------|-------|-------|-------|-----------------|-------|-----------------|
| Pb              | 1  | 0.304 | 0.320 | 0.199 | 0.446 | 0.117           | 0.014 | 0.039           |
| Cu              |    | 1     | 0.402 | 0.249 | 0.518 | 0.053           | 0.019 | 0.013           |
| Zn              |    |       | 1     | 0.814 | 0.598 | 0.644           | 0.012 | 0.001           |
| Cd              |    |       |       | 1     | 0.478 | 0.708           | 0.003 | 0.005           |
| Al              |    |       |       |       | 1     | 0.281           | 0.000 | 0.008           |
| NH <sub>4</sub> |    |       |       |       |       | 1               | 0.024 | 0.005           |
| ssNa            |    |       |       |       |       |                 | 1     | 0.006           |
| SO <sub>4</sub> |    |       |       |       |       |                 |       | 1               |

## FIGURE CAPTIONS

**Figure 1.** The outside-inside profiles of measured Pb and Cu concentrations in the core section of the 401.0m (1783 years B.P.) of the 3028.8m GRIP deep ice core drilled at Summit, central Greenland. Good plateaus of concentrations are obtained in the central part of the core section.

**Figure 2.** The outside-inside profiles of measured Zn and Cd concentrations in the core section of the 457.1m (2073 years B.P.) of the 3028.8m GRIP deep ice core. No good plateaus of concentrations in the central part of the core section are found that the Zn and Cd values obtained can be used only as an upper limit for the original ones in ice.

**Figure 3.** Changes of Pb concentrations measured in various ice core sections of the 3028.8m GRIP deep ice core (full dots) (from Hong et al., 1994) and residual Pb concentrations in the same core sections (full and open squares), obtained after correction from the estimated wind-blown dusts, seasalt spray and volcanic contributions, for the period of 3000 to 500 years B.P. Open squares represent the core sections suspected to have an influence of wild forest fires on the basis of the high contents of ammonium (> 15 ppb) in ice; full triangles are used when the estimated contributions from the wind-blown dusts, seasalt spray and volcanoes are responsible for the entire Pb concentrations measured.

**Figure 4.** Changes of Cu concentrations measured in the same core sections for Pb (full dots) (from Hong et al., submitted) and residual Cu concentrations after correction from the estimated wind-blown dusts, seasalt spray and volcanic contributions. Symbols (full and

open squares and full triangles) are used for the same cases as Pb in Fig. 3. Note that the concentration value of 1248 years B.P. is an upper limit (see text).

**Figure 5.** Residual Pb and Cu concentrations versus ammonium concentrations measured in the same core sections used in our work. Open dots are used for high ammonium concentrations ( $> 15$  ppb) which may be indicative of a signal of wild forest fires. No significant relationship between residual Pb and Cu concentrations and elevated ammonium contents in ice is found to imply that the contribution from wild forest fires could be regarded as negligible for the measured Pb and Cu concentrations corresponding to the high ammonium contents.

**Figure 6.** Changes in concentration of Cd and Zn measured in the same core sections used for Pb and Cu (Hong et al., 1994, submitted) from the 3028.8m GRIP deep ice core for the period of 8000 to 7000 years B.P. and 3000 to 500 years B.P.; open dots represent the core sections of high ammonium contents ( $> 15$  ppb). Also shown are changes of Cd and Zn concentrations from Candelone et al. (in press) (full triangles), covering the period from the Industrial Revolution to present; mean yearly values for the period of 1773 to 1940 and thereafter, decadal averaged values. Note that Zn and Cd concentrations measured in the core section of 457.1m depth are upper limit values (see text).

**Figure 7.** Changes of the Cd/Al and Zn/Al ratios determined from our work (full and open dots) and from Candelone et al. (in press) (full triangles). Open dots represent the core sections of high ammonium contents ( $> 15$  ppb) (see text).

**Figure 8.** Residual Zn (full dots) and Cd (cross) concentrations after correction from the estimated wind-blown dusts, seasalt spray and volcanic contributions are plotted with respect to the measured ammonium concentrations. A positive increasing trend of residual Zn and Cd with an increase of ammonium ones are shown.



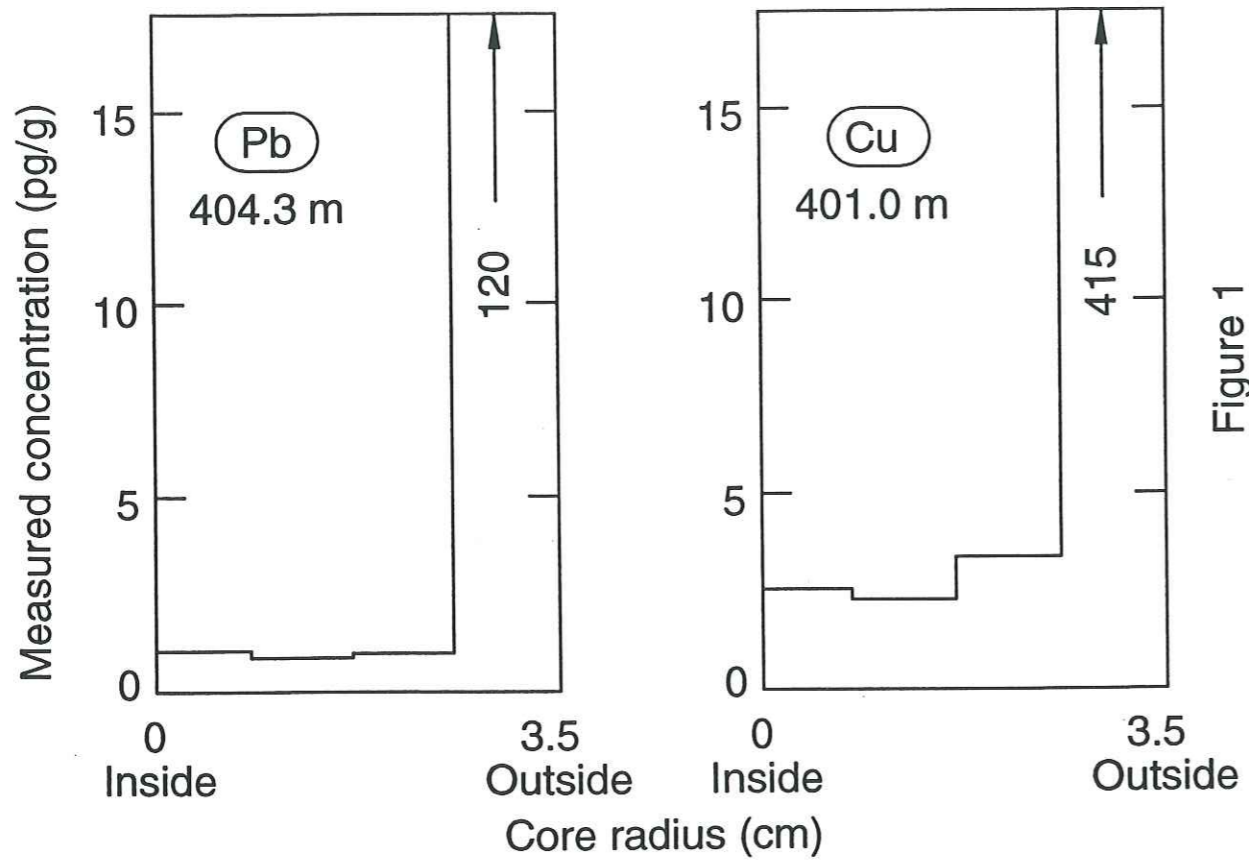

Figure 1

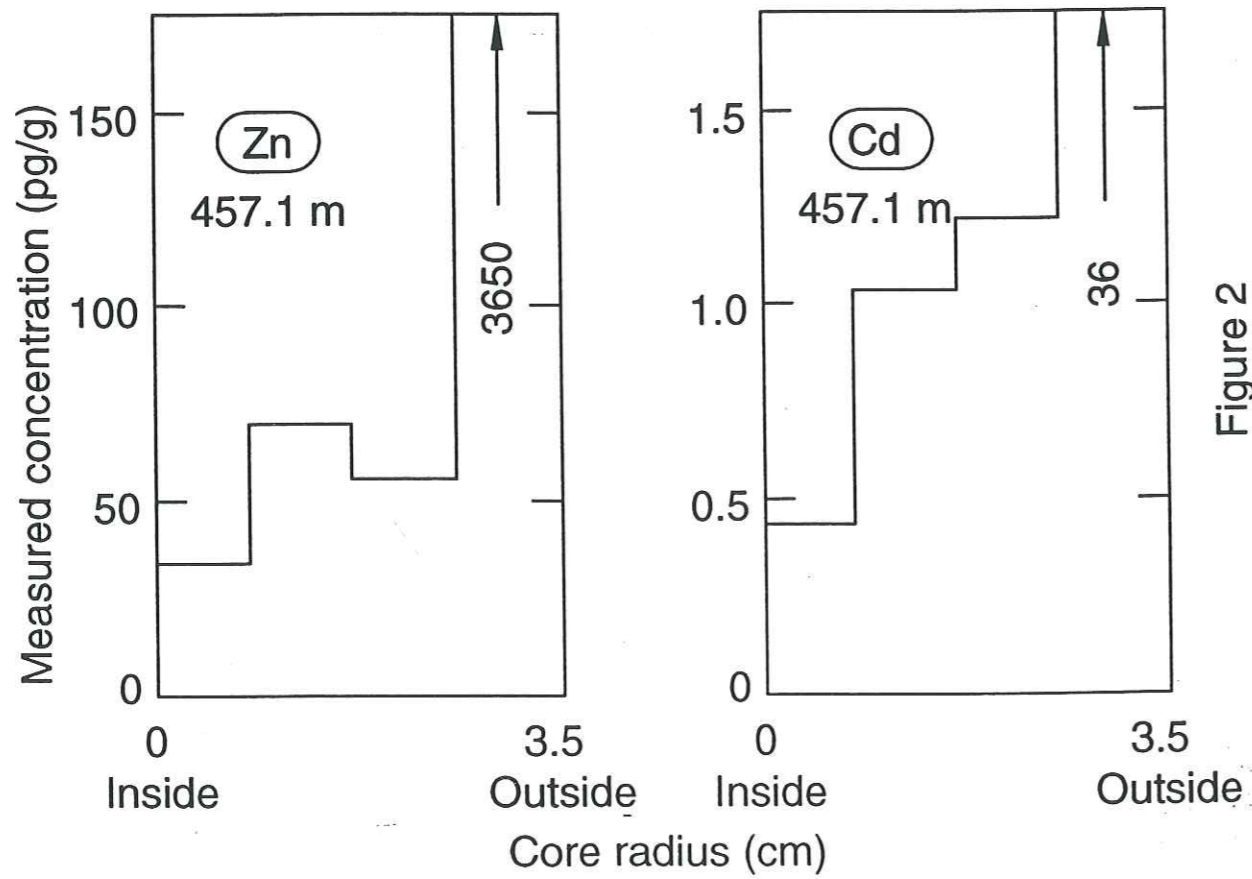

Figure 2

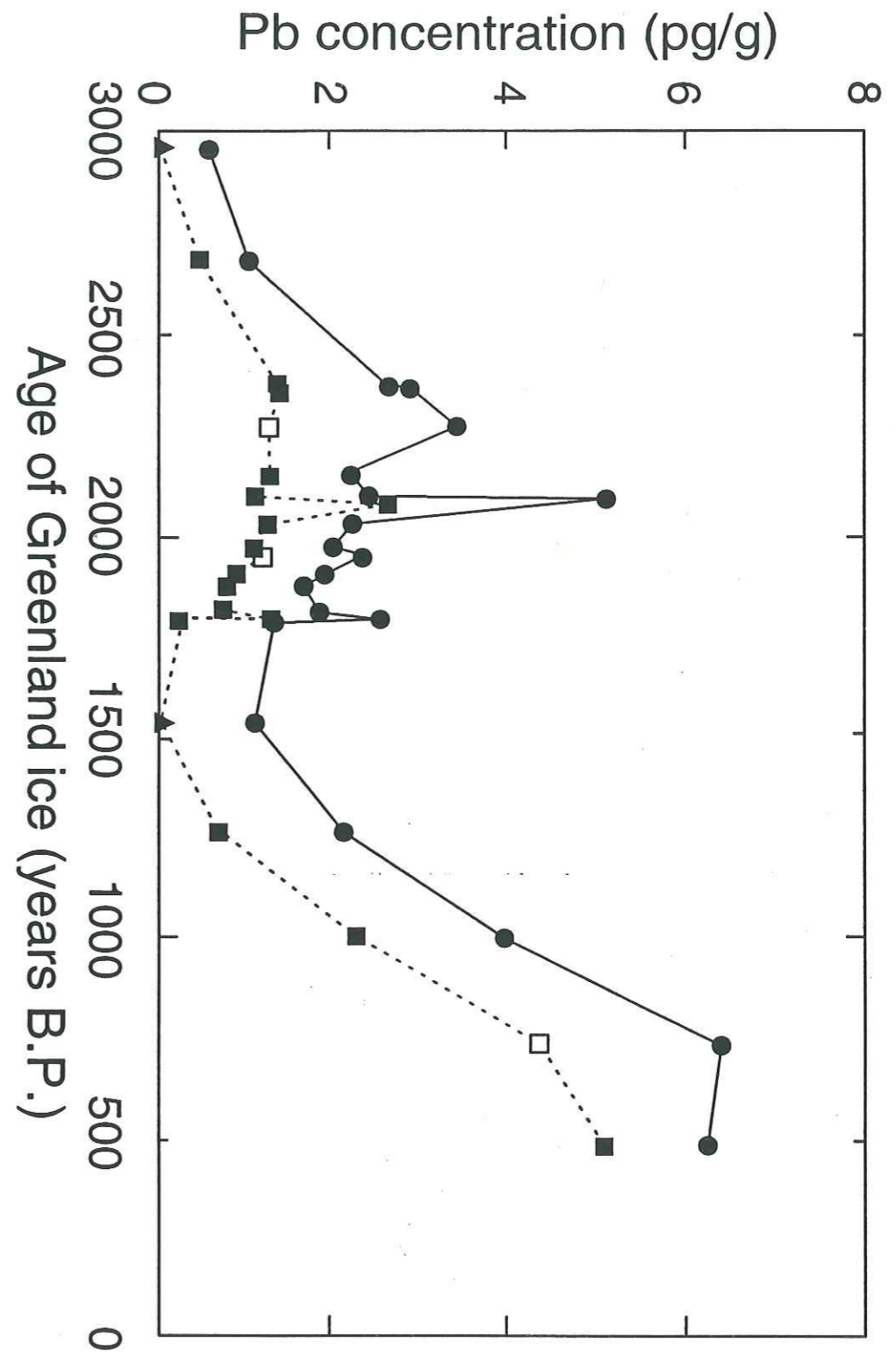

Fig. 3

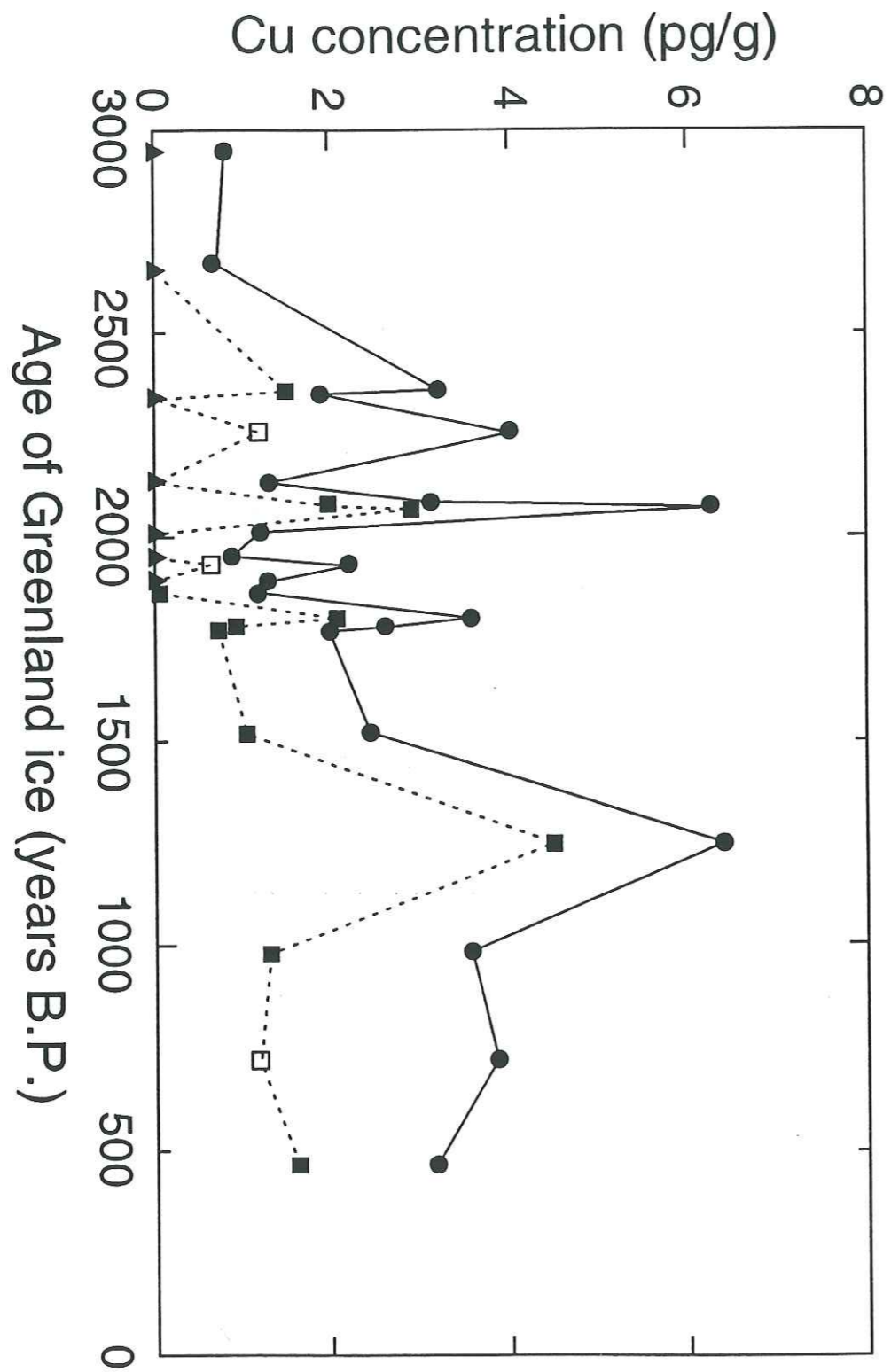

Fig. 4

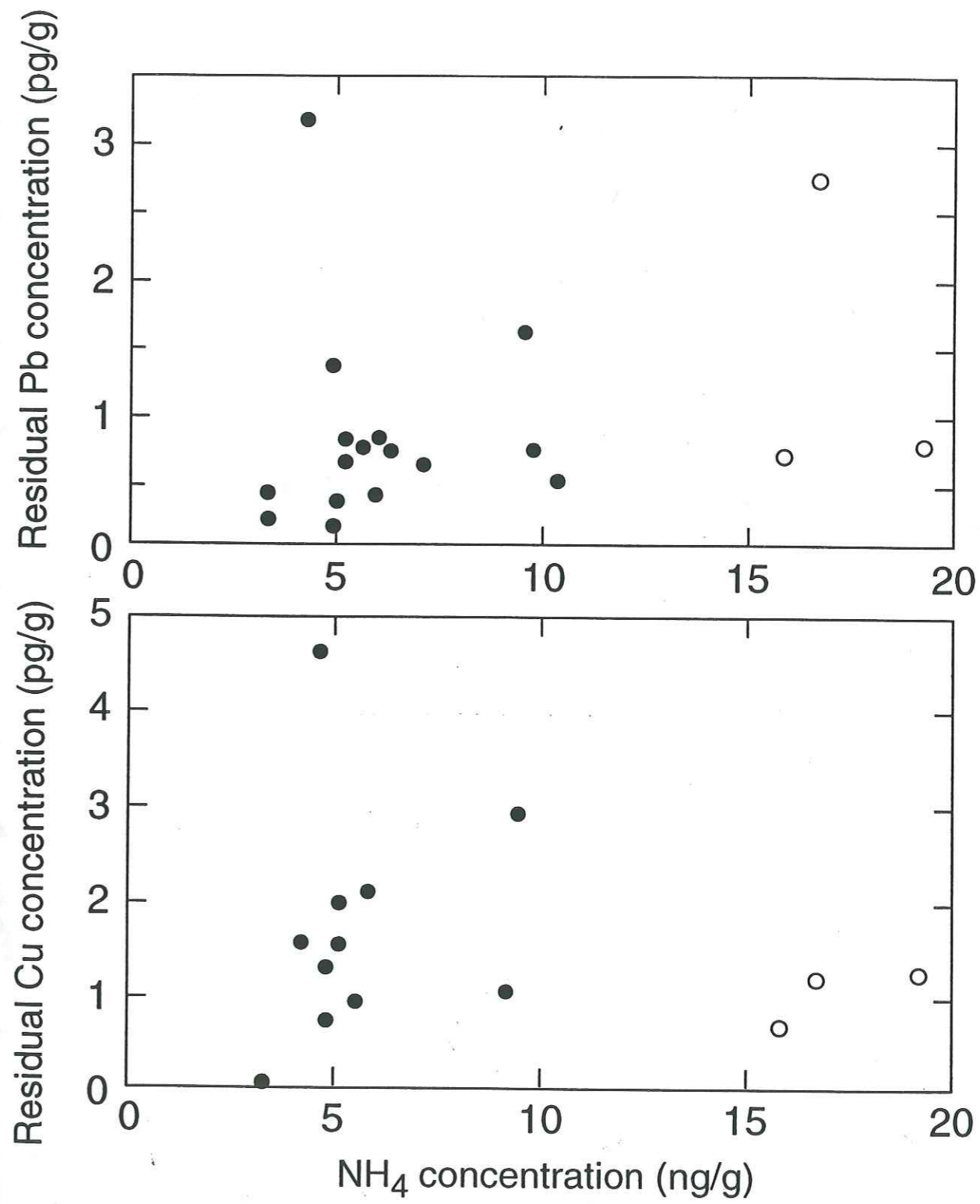

Fig. 5

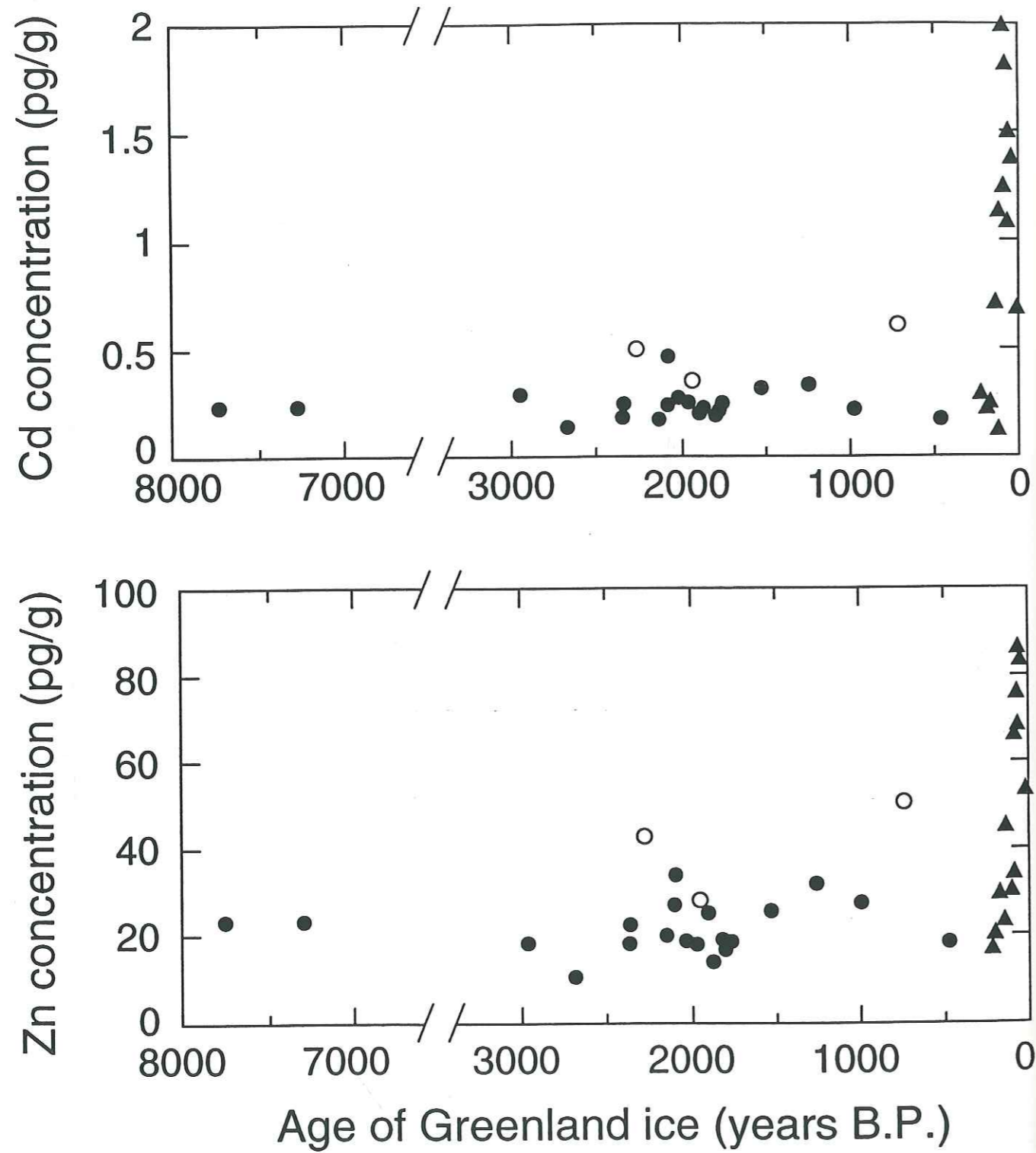

Fig. 6

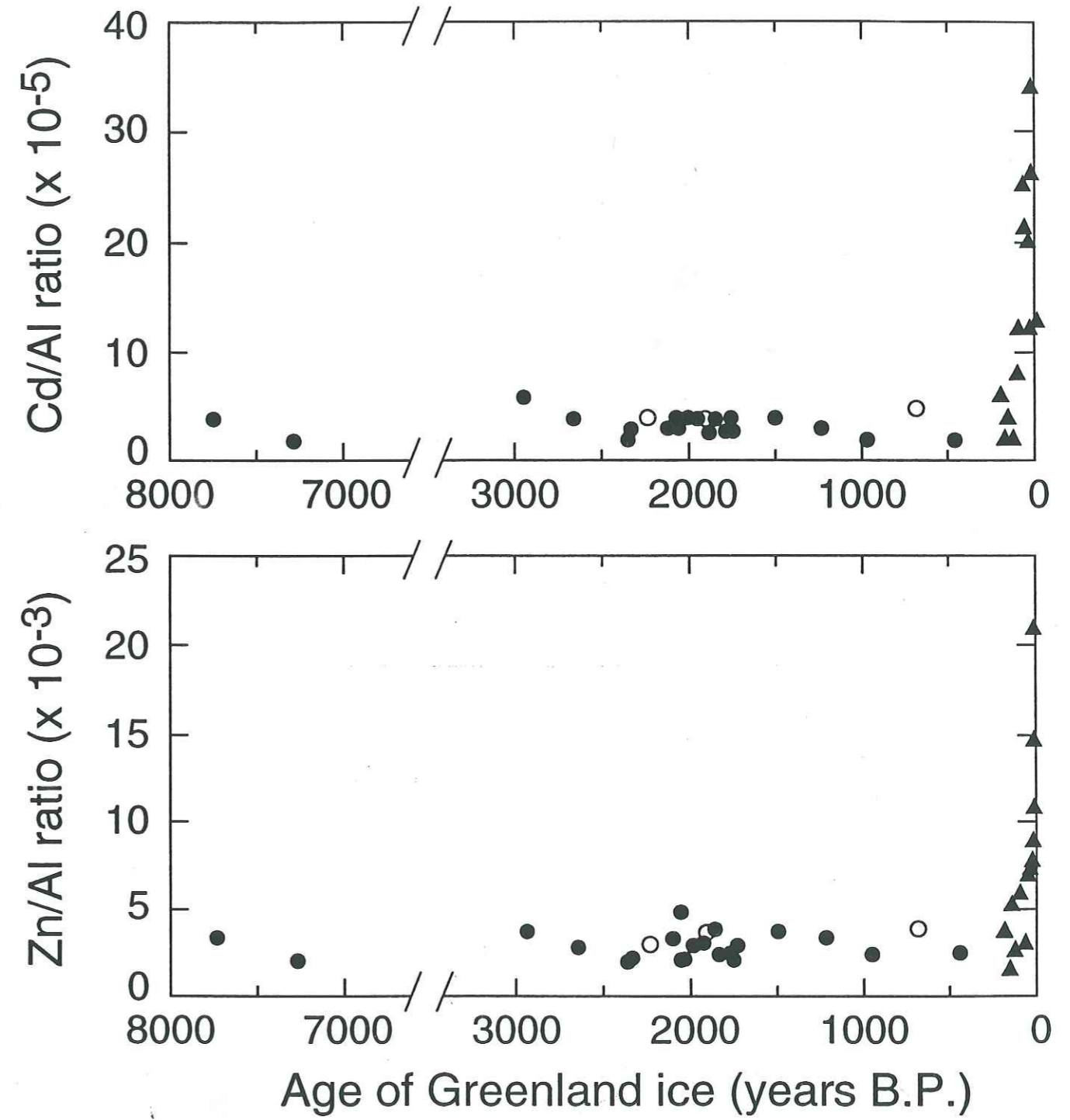

Fig. 7

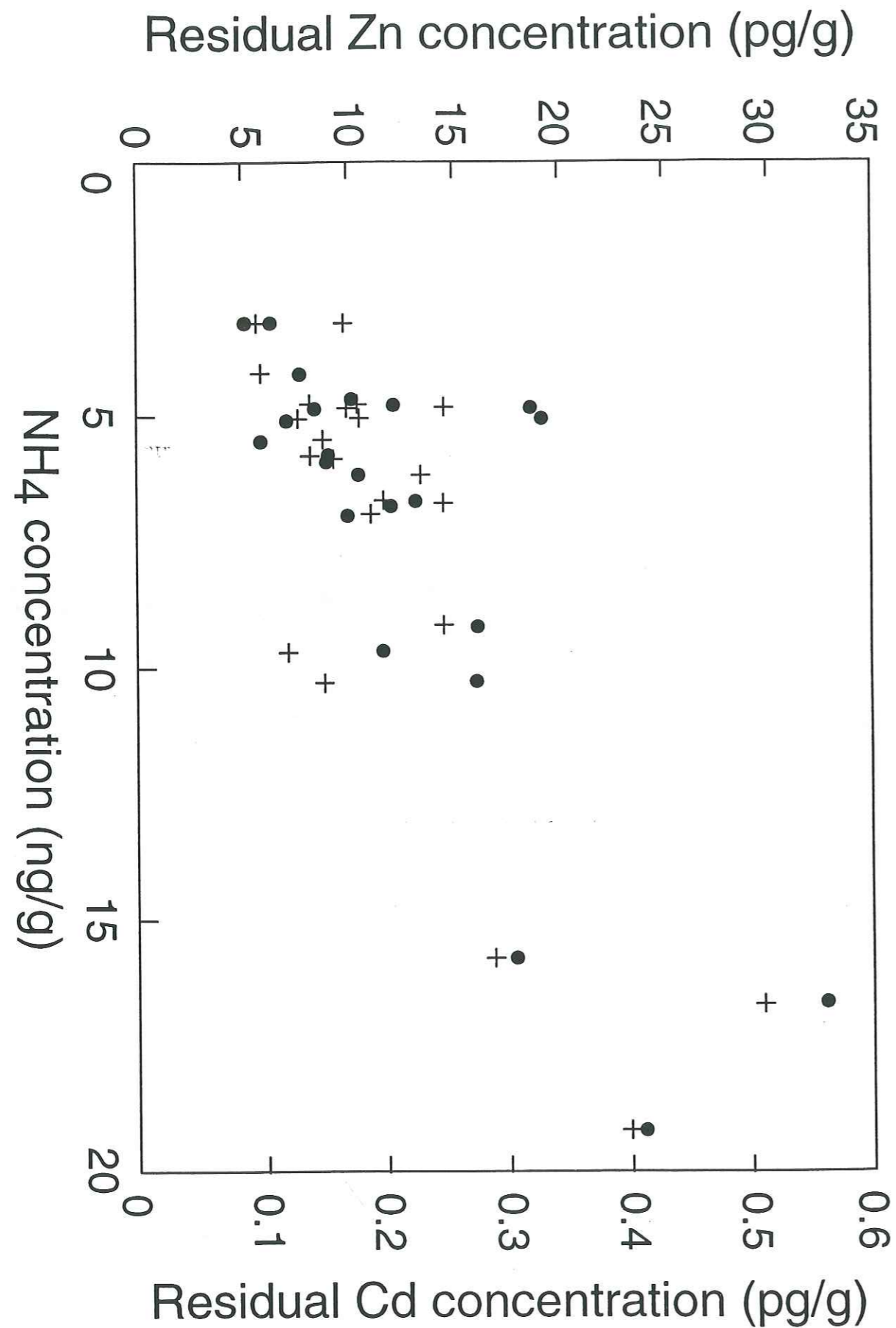

Fig. 8

CHANGES IN NATURAL LEAD, COPPER, ZINC AND CADMIUM  
CONCENTRATIONS IN CENTRAL GREENLAND ICE FROM 8000 TO 150,000  
YEARS B.P. : ITS ASSOCIATION WITH CLIMATIC CHANGES AND  
RESULTANT VARIATION OF DOMINANT SOURCE CONTRIBUTION

Sungmin Hong<sup>1</sup>, Jean-Pierre Candelone<sup>1,3</sup> and Claude F. Boutron<sup>1,2\*</sup>

<sup>1</sup>Laboratoire de Glaciologie et Géophysique de l'Environnement du CNRS, 54, rue Molière,  
Domaine Universitaire, B.P. 96, 38402 Saint Martin d'Hères, France

<sup>2</sup>UFR de Mécanique, Université Joseph Fourier de Grenoble, Domaine Universitaire, B.P.  
68, 38041 Grenoble, France

<sup>3</sup>Department of Applied Physics, Curtin University of Technology, GPO Box U 1987, Perth,  
WA 6001, Australia

\*To whom correspondence should be addressed

To be Submitted to "Earth and Planetary Science Letters"

## ABSTRACT

We have obtained for the first time the reliable comprehensive time series of Pb, Cu, Zn and Cd for the last full glacial period ranging from 8000 to 150,000 yrs B.P. by analysing various sections of GRIP deep ice core drilled at Summit in central Greenland. Our results show that the climatic changes have resulted in the strong variations in concentration level of natural Pb, Cu, Zn and Cd contained in the high-latitude troposphere of the Northern Hemisphere. The enhancement factors for concentration between the glacial and interglacial periods amount to about 320 for Pb, 100 for Cu, 36 for Zn, and 13 for Cd, respectively. Based on a good correlated relationship between each heavy metal and Al contents measured in our samples, most Pb and Cu is estimated to have originated from the wind-blown dusts for both the glacial and interglacial periods. On the other hand, continental biogenic emissions became important as a main source of Cd and to a lesser extent Zn aerosols contained in the Arctic troposphere during the warm Eemian and preboreal to-Holocene transition periods, whereas the wind-blown dusts were the only predominant source during the cold glacial climatic stages. This characteristic change of relative Cd and Zn contribution from different sources in contrast to that for Pb and Cu is well documented in our samples corresponding to the late deglaciation period between around 11,400 and 8000 yrs B.P. That is, after the Young Dryas event ended, a remarkable increase of Cd/Al and Zn/Al ratios is shown during the time period spanning from 11,400 to 9300 yrs B.P., which is consistent with progressive expansion of vegetation following the retreat of the massive land-ice sheet. The subsequent decrease of these ratios to the typical Holocene level can be explained by the stabilization of atmospheric circulation in the northern high-latitude regions, which have become similar to that for the Holocene stability

period, due to further advanced reduction of Laurentide ice sheet. Finally, the changes of metal/Al ratios determined indicate that the variable dust source regions in step with the climatic changes have altered a mean composition of the crustal particles transported to the Arctic for Pb and Cu, but not for Zn and Cd. This suggests that crustal portions, calculated by using a mean composition of the bulk rock or soils, of heavy metals measured in various polar ice cores during the glacial and interglacial periods can give only an approximate estimate of crustal contribution and, therefore, lead to an erroneous interpretation to the dominant natural source contributing to the measured heavy metal concentration level, depending on the large scale climatic changes.

## 1. Introduction

The well-preserved and dated snow and ice deposited in Greenland and Antarctic provide an unique way of assessing global changes in atmospheric cycles of various heavy metals in the past [1]. For this, many efforts have been devoted to reveal the changing occurrences of heavy metals recorded in these frozen archives, with focusing especially on the time period that human impact have become so great as to have resulted in a large-scale atmospheric pollution [2-6]. Therefore, it is now agreed in the conclusion that the highly enhanced concentration level of heavy metals observed in recent or aged snow and ice have resulted from a large amount of man-induced contaminants. In general, these conclusions were based on the historical changes of the quantitative emission rates of heavy metals to the atmosphere from human activities and the concomitant time variations of heavy metal contents measured in snow and ice deposited during the corresponding ages.

In order to confirm and evaluate the extent of anthropogenic contribution, however, a decisive evidence is required on a global basis. This is, of course, to reconstruct the temporal variations of naturally-derived heavy metals concentration level for the long period enough to understand the variables responsible for altering the concentration level and also dominant sources.

While the reliable time series of heavy metals such as Pb, Cu, Zn, Cd, and Hg were presented for the Antarctic ancient ice dating back to the Last Glacial Maximum (~ 40,000 years) or even to the next to last ice age (~ 160,000 years) [7-12], no data are as yet available for the Greenland ice. Very recently, the reliable time series for Pb, Cu, Zn, and Cd were obtained by analysing various ice core sections of GRIP deep ice core only for the Holocene period [13].

This is not so long a time span as to decipher any relationship between the changes of heavy metal contents and climatic changes in the Northern Hemisphere. When considering a prominent difference in geographical distribution of source regions and atmospheric circulation system in both hemisphere, one can expect that an aspect of the changing input strength of heavy metal aerosols with climatic changes in the Arctic troposphere may have been different from the Antarctic one.

For this reason, we have analysed for the first time various GRIP deep ice core sections covering the last full glacial period. Here the reliable time series of Pb, Cu, Zn, and Cd are presented and the temporal variations in concentration and predominating source for them are discussed in accordance with each characteristic climatic stages.

## 2. Experimental

### 2.1 Description of the samples

We have analysed for Pb, Cu, Zn, and Cd twenty four ice core sections of the 3028-m-long Greenland deep ice core, which was electromechanically drilled at Summit (72° 34'N, 37° 37'W, elevation of 3238m above sea level, annual mean air temperature -32°C) in central Greenland in 1990-1992, under the multinational European Greenland Ice-core Project (GRIP).

The depth and estimated age, given from [14], for each section (55cm in length) are listed in Table 1. Our samples cover the time span of the last full glacial cycle ranging from 8000 to 150,000 yrs B.P. (before present). Thus they include various climatic events such as the Saale

glacial and Eemian interglacial periods, the stadial and interstadial stages during the last glaciation period, and the preboreal to Holocene transition period.

## 2.2 Decontamination and analytical procedures

For obtaining a reliable data, all the core sections analysed in our study were strictly decontaminated using an improved ultraclean procedures as described in detail elsewhere [15]. This involved a mechanical chiselling of successive veneers of the core from the outside to the central part of each section inside a laminar flow clean bench installed in a  $-15^{\circ}\text{C}$  cold room so as to finally get a clean innermost part of the core. After the decontamination was completed, the obtained samples of each layer were brought to a clean laboratory and then melted at a room temperature ( $\sim 20^{\circ}\text{C}$ ). The inner core of each section represents variable ages of ice accumulation ranging from 4 years for the core section of 8250 yrs B.P. up to about 200 yrs for 150,000 yrs B.P.

Each veneer layer obtained was analysed separately using ultraclean procedure in a clean laboratory [16]. Pb, Cu and Cd contents were determined by Graphite Furnace Atomic Absorption Spectrometry (GFAAS), using a Perkin-Elmer 2380 Spectrometer with a Perkin-Elmer HGA 500 graphite furnace. When their concentrations were at a low level, preconcentration by non-boiling evaporation [17] was carried out before the measurement. In contrast, the high concentration level exhibited in ice deposited during the cold climatic ages was determined by direct injection. If necessary, multiple injection (up to  $4 \times 50$  l) was used for the measurement of Pb, Cu, and Cd after preconcentration or by direct injection when the concentration was close to the detection limit. For Zn and Al, their concentrations were

measured directly by GFAAS without preconcentration. We also measured Ca, Na,  $\text{SO}_4^{2-}$  and  $\text{NH}_4^+$  contents by ion chromatography. The precision of the data is estimated to range from 5 to 15% [17]. The concentration values of heavy metals determined were corrected for blank contribution derived from the whole analytical procedures [15].

As already mentioned in various studies [7-11,18], the full outside-inside profiles in concentration as a function of radius allow us to check the penetration of contaminants from the outer layer towards the central part of the core. For all the core sections, we examined the outside-inside profiles and observed good concentration plateaus in the central part of the core, indicating that the obtained value in the innermost part of each section represent the original one of the ice deposited at a given time.

## 3. Results and Discussion

### 3-1. Time variations of atmospheric heavy metals with the climatic changes during the last full glacial period

All the concentrations of four heavy metals measured in our samples are listed in Table 1. They cover the time span of the last full glacial cycle including the Saale glacial age which preceded the last interglacial (Eemian) period.

As shown in Fig. 1, the observed concentrations of four heavy metals are found to represent in a similar tendency a dramatic change with the climatic changes. They vary in antiphase with  $^{18}\text{O}$  as like the variations of terrestrial and marine aerosol contents in Greenland ice for the glacial period [19,21]. The highly enhanced level in concentration of each heavy metal in the

Saale glacial period (~ 150,000 yrs B.P.) decreased to very low level at around 127,800 yrs B.P. corresponding to the Eemian interglacial period. In this Eemian climatic stage, isotopically derived temperatures were at least as high as in the Holocene stability and hence a similar atmospheric circulation to the Holocene was prevailed as evidenced by a comparison of the observed concentrations of terrestrial and marine aerosols for the Eemian and Holocene [20]. For the heavy metals, the concentration values in our work are also coincident with those of the Holocene level (Table 2), indicating that the climatic conditions for the atmospheric burdens of the heavy metals may have been in a great measure similar in both periods. After the Eemian period, the heavy metal contents in ice show an oscillatory time variations between the stadial (cold) and interstadial (milder) stages over the last glacial period. Together with the beginning of the last deglaciation (~ 15,000 yrs B.P.), the concentration level of four heavy metals begun to decrease and then came to be close to the typical Holocene level through the preboreal period. Note that no data for the cold Younger Dryas event (11,550 to 12,700 yrs B.P.) are available in our samples.

Our results show that the measured concentrations fluctuated greatly by a factor of about 320 and 100 for Pb and Cu and to a lesser extent by a factor of 36 and 13 for Zn and Cd, respectively, during the glacial and interglacial ages. These variations cannot be accounted for by the changes of ice accumulation rates, because the accumulation rates at Summit, central Greenland, have presumably not varied by more than a factor of three during the period covered by our samples [22]. As demonstrated in various studies [19-21], the climatic changes had led to the concomitant variations of atmospheric aerosols, resulting from the changes of the large-scale atmospheric circulation. These climatic-dependent changes of four heavy metals were already presented for the Antarctic ice by several authors [7-11]. When compared the

highest concentration values of four heavy metals observed in our Greenland ice samples to the ones in the Antarctic (Table 3), it is revealed that the heavy metals aerosol loading in the high-latitude atmosphere of the Northern Hemisphere was much greater for Pb, Cu and Zn than in the Southern Hemisphere. For Cd, the maximum concentration value is found to be so similar in both sites. These observed facts could be explained by the dominating sources for the atmospheric heavy metal emission and the proximity to those source areas (see section later).

### 3.2 Assessment of the contribution from various natural sources

On a global basis, the wind-blown dusts, volcanoes, seasalt spray, wild forest fires, and marine and continental biogenic emissions are listed as the main natural sources for the heavy metal emissions to the atmosphere [23,24]. The relative strength of each source contributing to the heavy metal aerosol emissions would be modified in different climatic stages of the glacial-interglacial periods due to the the variations of ice-sheet size, sea-ice extent and vegetation. When considering that the atmospheric contents level of the terrestrial and marine aerosols have been enhanced by up to two orders of magnitude so as to have controled the Arctic atmospheric compositions [19,20], the wind-blown dusts and seasalt spray could be expected as the dominant sources for the heavy metal aerosols contained in the high-latitudes atmosphere during the glacial periods.

In our measurement, the measured concentrations of four heavy metals are correlated very well with Al contents in ice as shown in Fig. 2. A well-defined relationship between each heavy metal and Al content can be expressed as the followed equations with a correlation coefficient ( $r$ ):



$$[\text{Pb}] = 0.225 [\text{Al}] - 2.06 \quad (r = 0.98) \quad (1)$$

$$[\text{Cu}] = 0.357 [\text{Al}] + 0.75 \quad (r = 0.99) \quad (2)$$

$$[\text{Zn}] = 0.927 [\text{Al}] + 18.44 \quad (r = 0.98) \quad (3)$$

$$[\text{Cd}] = 0.0036 [\text{Al}] + 0.38 \quad (r = 0.90) \quad (4)$$

where [X] represents the concentration of element X (pg/g for Pb, Cu, Zn, and Cd and ng/g for Al). From the observed relationship, it is found that most of Pb and Cu aerosols are likely to have originated from the wind-blown dusts over the glacial-interglacial periods on the basis of their y intercepts (rather negative for Pb and slightly positive value for Cu in equation (1) and (2)). On the other hand, the situation is different for Zn and Cd. For Zn, the crustal inputs seem to be responsible for most of the measured contents in ice of the cold stages of the glacial period. For the warmer periods when Zn concentrations were at a low level, however, the value of the positive y intercept, 18.44 in equation (3), suggests that a significant fraction of the measured Zn could be contributed from different sources other than the wind-blown dusts. This is also the case for Cd. As shown in Fig. 3, the variations of Cd concentrations lower than 1 pg/g, for which the corresponding ages represent the interglacial (warm) or interstadial (mild) stages (Table 1), are not correlated to Al contents. The occurrence of Zn and Cd different from that for Pb and Cu (mainly crustal origin) during the warmer climatic stages could be explained by a difference of dominant sources for each element. For example, over the Holocene period, the continental biogenic emissions can account for about 70 % of Cd and 50 % of Zn contained in the Arctic troposphere in contrast to Pb and Cu that have originated principally from the crustal-derived particles, provided that the contributions from volcanoes and wild forest fires were insignificant at a given time [13]. Therefore, it is assumed that the observed Zn and Cd contents level, which are not to a great extent associated with Al contents for the warmer

climatic stages, could be attributed to the increasing input strength from other sources (mainly continental biogenic emissions) outside the wind-blown dusts. This characteristic aspect of the change of dominant sources are well documented in our samples covering the last deglaciation period and thus will be discussed in detail in the followed section.

As already demonstrated by several authors [7-11], the wind-blown dusts was estimated to have contributed most of the heavy metal contents measured in the Antarctic ice deposited during the coldest glacial periods. This estimate was tentatively made by using the metal/Al ratios of a mean composition of the bulk rock or soils given from [24,25]. The slopes of the regression lines presented in equation (1)- (4) are in good agreement with those given from [24,25] within a factor of two, indicating that the calculation of the crustal contribution using the metal/Al ratios of a mean composition of the bulk rock or soils may not lead to an erroneous estimate. However, the quantitative estimate of the crustal contribution to the observed heavy metals, using the above mentioned metal/Al ratios, may not be straightforward, if the climatic conditions were different in each investigated periods. The Pb/Al and Cu/Al ratios determined in our samples, Fig. 1, are found to have changed through the last glacial cycle including the Saale glacial and the Eemian interglacial ages, despite that they are estimated have originated mainly from the wind-blown dusts for both the glacial and interglacial periods. Since the contributions of other natural sources are regarded as insignificant for the given times (to be discussed in this section later), it is assumed that the Pb/Al and Cu/Al ratios may have been altered by the changes of the mineralogical composition of crustal particle aerosols transported to the Arctic troposphere in accordance with the climatic changes. This is supported by a tendency of decreasing Pb/Al and Cu/Al ratios well associated with a decrease of Al contents, as shown in Fig. 4. The possible explanations for the

observed changes of the Pb/Al and Cu/Al ratios with ages could, on one hand, be that the continental source regions producing the crustal aerosols have varied due to the climatic changes and that the newly exposed continental shelves were involved as a contributor of the crustal aerosol emissions as evidenced by the observation of changed composition of crustal aerosols recorded in Antarctic ice core [20,27,28]. On the other hand, stronger atmospheric circulation and the resultant shorter meridional transport time at the cold stages, compared to the warmer stages, could have caused a differentiated fractionation by the way of transport of crustal aerosols and an increase of particle size due to stronger wind velocity for the dust deflation could lead to a compositional ratio different from that of smaller size between heavy metal and Al content [29,30]. In contrast to Pb and Cu, the Zn/Al and Cd/Al ratios have sustained nearly constant during the glacial periods and are found to increase remarkably with a decrease of Al contents (Fig. 1,4). As the Al contents less than 100 ng/g are observed in the warm (interglacial) or mild (interstadial) climatic stages, the increase of Zn/Al and Cd/Al ratios is linked to the changing continental biogenic Zn and Cd emissions to the atmosphere as mentioned before (and see next section). The unvaried ratios during the cold stages (Fig. 1,4) may suggest that various factors of having caused the variations of Pb/Al and Cu/Al ratios with climatic changes have not influenced on the compositional ratio between Zn, Cd and Al content, but here we could not explain reasonably for this contrary phenomenon, because of no available data on the mineralogical fractionation during the long-range transport along with a difference in size of crustal aerosols.

Although most of four heavy metals contents measured in our samples is found to be crustal in origin, the contributions from other natural sources could be responsible for a portion of the measured heavy metals concentrations. The measured Na concentrations provide an index for

estimating heavy metals contribution from seasalt spray, assuming that most of the soluble Na, which ranges from 2.7 to 86.7 ng/g, determined in our samples by ion chromatography represents seasalt Na (M. Legrand, personal communication, 1995). This estimate was made from the metal/Na ratios in present-day bulk seawater [31], combined with the few available data on heavy metal enrichment factors with respect to bulk seawater to present-day sea-derived aerosols, about 100 for Pb, 1000 for Cu, 10,000 for Cd and 50,000 for Zn, respectively [7,32-34]. The contribution from seasalt spray so evaluated accounts for less than 1% for all measured four heavy metals contents and, therefore, is found to be negligible during the studied period as like that for the Holocene demonstrated in [13].

The volcanic contribution cannot be estimated from the measured sulfate concentrations in our study, although possible over the Holocene period [13], because during the glacial periods the volcanic signature in the sulfate contents determined cannot be identified due to highly elevated values corresponding to enhanced soil dust input as indicated by M. De Angelis and M. Legrand [35]. They proposed that relatively high sulfate content with respect to corresponding calcium (mainly derived from terrestrial dusts) content could be attributed to the volcanic input at that time. In Fig. 5, the relationship between the measured sulfate and calcium concentrations is well correlated with a slope value of 0.602 (correlation coefficient,  $r = 0.93$ ) and, moreover, the positive y intercept value, 32.1 ng/g, is very close to the Holocene background level of non-volcanism (i.e., 30 ng/g) [35], indicating that elevated sulfate contents ( $> 30$  ng/g) determined in our samples are associated with the enhanced terrestrial input. The contribution from volcanic emissions is, therefore, considered to be insignificant due to little volcanism during the investigated times. Nevertheless, we cannot rule out an intensive sporadic volcanic input which cannot be identified by sulfate contents determined in our

samples. That is, for example, the case of ice core section of 149100 B.P. (depth of 2887.5m). In this sample, the measured Cd concentration (denoted as a circle in Fig. 2) is particularly enhanced compared to the other ones with respect to Al contents of corresponding ice core sections. Since this Cd concentration represents a mean value of about 200 years (estimated from the length of inner core obtained after decontamination operation), the volcanic signature could be obscure from the measured sulfate content level. The measurement of metal/S ratios for various volcanic plumes revealed that the volatile Cd aerosols could be occasionally enriched in some volcanic plumes emitted during cataclysmic volcanic eruptions by up to two orders of magnitude relative to those from other volcanoes, whereas not for other heavy metals [36]. If this is indeed the case for the core section of 149100 yrs B.P., a difference in enrichment of each individual element may be a reason why Cd concentration alone is found to be enhanced in contrast to Pb, Cu, and Zn, for which the concentrations level observed in the same core section is well correlated with Al content. An alternative explanation may be that the enhancement factor in concentration during the cold glacial ages in comparison with the warmer interglacial ones comes to only about 13 for Cd which is much lower than those for Pb, Cu and Zn (Table 3). This may give rise to a difficulty for detection of the volcanic input of the high Pb, Cu, and Zn contents determined in the ice core of 149100 yrs B.P., although Cd concentration level may have been altered by an influence of volcanic input.

Finally, the measured ammonium contents in ice can give us a tentative evaluation of the impact of biomass burning on the heavy metals contents [37], granting that the interpretation of the ammonium concentration recorded in Greenland ice for the pre-Holocene period is not straightforward [20]. In our data, we detect only two ammonium peaks (24.8 and 15.3 ng/g for the depth of 2214.3 and 1669.3m, respectively) relative to other ammonium contents lower

than 10 ng/g. The concentrations of heavy metals in corresponding core sections do not represent any enhancement with respect to Al contents (Fig. 2), indicating that the contribution from biomass burning may have been negligible not to be identified.

### 3.3 Response to the last deglaciation in the atmospheric heavy metal cycles

The last deglaciation (from about 15,000 yrs B.P.) is one of the characteristic geological periods, because of the abrupt climatic change in contrast to the gradual increase of the associated solar radiation, reached at its maximum at around 11,000 yrs B.P. [38]. The prominent climatic events in this period involve the Bølling/Allerød as a warm period, an abrupt return to the glacial climate known as the Young Dryas (YD) cold event, and the preboreal period followed by the Holocene climatic stability [14]. A transition between each event was revealed to be extremely rapid, for example, 20 years in the ending of the YD [39].

The above mentioned climatic changes after the onset of the deglaciation must have changed the atmospheric burdens and cycles of heavy metals in the northern high-latitude regions. Since the gradual increase of ice accumulation rates at Summit during this period [22,39] could hinder a proper assessment of the change of atmospheric burden of heavy metals from the measured concentrations, we use here the fallout flux of each heavy metal instead of heavy metals contents in ice. As shown in Fig. 6, fallout flux of four heavy metals began to decrease rapidly from about 15,000 yrs B.P. and were very low at the period corresponding to the warm Bølling event. And they are found to have been slightly elevated at near the onset of the cold YD event (unfortunately, we have no available data for the full YD period). We assume that the heavy metal content level in the atmosphere of the YD event may have been as high as for

other cold climatic stages, on the basis of the increased level of other aerosols in this period [41]. From the end of the YD event, there is a marked difference in changes of fallout flux and metal/Al ratios observed for each heavy metal. Fallout flux of Pb, Cu, and Zn continued to decrease and then sustained low level (Fig. 6), indicating that the atmospheric Pb, Cu, and Zn burden in the high-latitude regions may have changed in phase with the weakened wind-blown dusts input from source areas in accordance with the climatic change. In contrast, fallout flux of Cd is found to increase up to by a factor of 3 at about 9300 yrs B.P. with respect to the Blling and Holocene level and thereafter decrease again to the typical Holocene level (denoted as full triangles) given from [13]. A different trend of each individual heavy metal in response to the climatic change is also shown in the observed metal/Al ratios. The metal/Al ratios for Pb and Cu show a slight change during the whole deglaciation period, finally approaching the typical Holocene value ( $\sim 0.8 \times 10^{-4}$  and  $\sim 2.0 \times 10^{-4}$ , respectively) [13]. On the other hand, both Cd/Al and Zn/Al ratios represent an increase by about 9300 yrs B.P. and the followed decrease to the mean Holocene value ( $\sim 3 \times 10^{-5}$  and  $\sim 3 \times 10^{-3}$ , respectively), the change being more dramatic for Cd. The above mentioned different pattern of each heavy metal can be, of course, explained by the climatic changes and a difference in dominant sources for each heavy metal.

The climatic changes, triggered by the increasing solar radiation at around 18,000 yrs B.P., have altered the large-scale atmospheric circulation and vegetation, resulting from the changes of ice-sheet size, sea-ice extent, and sea-surface temperature [38]. By 13,000 yrs B.P., the volume of the Northern Hemisphere ice sheet was diminished by 50% of its maximum extent at about 18,000 yrs B.P. and the responding northward advances of temperate forest were characterized [42]. The preboreal period had begun when summer insolation in the Northern

Hemisphere rised up to a maximum at 11,000 yrs B.P. These climatic changes were accompanied by the sustained retreat of the North Atlantic polar front [42,43], representing that the surface atmospheric circulation system to transport the aerosols derived from the mid-latitude source regions to the Arctic was weakened. Until the early Holocene, the vegetation continued to be expanded to the north together with the retreat of the land-ice sheet owing to 2° to 4°C higher temperature and wetter climatic conditions than it is at present in both Eurasia and western North America [38].

As most of Pb and Cu originated from the wind-blown dusts in both cold and warm climatic stages including the Holocene (see section 3.2 and ref. 13), the abruptly decreasing trend of fallout flux of Pb and Cu in the transition period of the early deglaciation can be explained by the weakness of wind intensity and the areal extent of the circulation system influencing meridional transport of the wind-blown dusts from the arid mid-latitude regions. The slight but continuous decrease during the preboreal period is likely to have resulted from the sustained change of the atmospheric circulation and the reduced areal extent of deserts and loess deposits. For this period, the contributions from volcanoes and biomass burning are estimated to be negligible to the measured Pb and Cu concentrations, because the measured sulfate and ammonium concentrations close to the Holocene natural background level is representative of the non-volcanism and non-biomass burning events [13]. When considering the small variation of the Pb/Al and Cu/Al ratios for the very early Holocene, although the measured Pb and Cu concentrations are similar to the typical Holocene value, it can be assumed that part of the wind-blown dusts contained in the Arctic troposphere may still have derived from different source areas other than those for the Holocene stability, during which the Chinese and Sahara deserts are likely to be predominating sources [44]. In the early Holocene, the north African-

Eurasian climate was wetter than it is at present, because of the strengthened summer monsoons to have increased rainfall [38]. Therefore, the areal extent of the Chinese and Sahara deserts was reduced at this time. In addition, it was suggested that the wind strength was considerably weakened over the Chinese desert and loess at around 9000 yrs B.P. as evidenced from the geological records in the loess stratigraphy [45]. All of these facts seem to prove that the contribution from the Chinese and Sahara deserts for the wind-blown dusts in the Arctic troposphere during the early Holocene may have been smaller than it is at present and hence their reduced contribution may have led to a different metal/Al ratio for Pb and Cu compared to those for the typical Holocene value.

As mentioned before, the changing occurrences of Cd and Zn are different from those of Pb and Cu. The Cd/Al ratios represent a dramatic increase up to by a factor of 11 at around 9300 yrs B.P. compared to that of the Belling event and show the followed decrease to the Holocene mean value, while the Zn/Al ratios are also found to increase by more than a factor of 3 (Fig. 6). On the other hand, the changes in fallout flux of Cd are different from those for Zn. In contrast to rather stable values of Zn fallout flux, that of Cd shows an increase until around 9300 yrs B.P. and then decrease to the Holocene value as like the Cd/Al ratios. These characteristic variations in fallout flux and metal/Al ratio is assumed to arise from a difference in dominant sources for Cd and Zn aerosols contained in the Arctic troposphere. An increase of the Cd/Al and Zn/Al ratios after the end of the YD event implies that the contribution from other natural sources outside the wind-blown dusts were increasing, because most of the Cd and Zn originated from the crustal eroded particles during the cold glacial periods (see section 3.2). From 11,400 to 7290 yrs B.P., the contributions from volcanoes and biomass burning to the measured Cd and Zn are likely to be insignificant as like for Pb and Cu, based on the

measured sulfate and ammonium concentrations, which do not represent any signal of the large volcanic eruption or wild forest fires. As the continental biogenic emissions are responsible for the greater portions of the total Cd and Zn fluxes emitted from natural sources to the atmosphere during the whole Holocene [13], the increased areal extent of the vegetation with the climatic changes may be a major factor to the observed variations of Cd/Al and Zn/Al ratios for the given period. As already mentioned above, the northward expansion of the vegetation had occurred in response to the retreat of the land-ice sheet according to the increasing solar radiation. With a progressive advance of the vegetation, the increased amount of the biogenic Cd and Zn aerosols emitted from the high-latitude continental biosphere may have begun to contribute to the Arctic background level of the atmospheric Cd and Zn from about 11,400 yrs B.P. (Fig. 6). The beginning time of the biogenic contribution to the measured Cd and Zn is in good agreement with that of carboxylic acid, formate, in Greenland, for which an increase of contents in Greenland precipitation (from 11,550 yrs B.P.) was mainly related to emissions from the high-latitude vegetation [46]. This agreement supports our observation that the biogenic Cd and Zn emissions from the high-latitude vegetation become important in the atmospheric cycles of Cd and Zn in the Arctic regions from the transition to the preboreal period.

Of much interest is it that, despite a continuous expansion of the vegetation until 6000 yrs B.P. [38], the contribution from continental vegetation for both Cd and Zn is found to decrease from about 9300 yrs B.P. (Fig. 6). This may have resulted from the change of regional atmospheric circulation in the high-latitudes from this time. The Laurentide ice sheet in the North America had been reduced in size to a much limited extent by about 9000 yrs B.P., but still influenced on the climate, that is, the atmospheric circulation in the North Atlantic regions

[38]. Therefore, it is probable that, as the influence of the Laurentide ice sheet on the regional climate was decreasing to a great extent after around 9000 yrs B.P., the prevailing atmospheric circulation around Greenland until the very early Holocene began to have changed to become less favorable for transport of the biogenic Cd and Zn aerosols emitted from the high-latitude vegetation over the Greenland. On the other hand, the sustained fallout flux of Zn at a low level since the preboreal, although the Zn contribution from the vegetations increased, suggest that the contribution from the vegetation for Zn was smaller relative to that for Cd but it was comparable to that from the wind-blown dusts, as expected from the averaged contribution from each natural source for the whole Holocene [13]. That is, while the Zn contribution from the wind-blown dusts decreased as like Pb and Cu with the climatic changes, the biogenic Zn aerosols was at the same time increased to give a relatively constant burden in the Zn atmospheric cycle for the investigated times.

In summary, Pb and Cu originating principally from the wind-blown dusts had changed in phase with the climatic changes, representing a continuous decrease from the last glacial period to the early Holocene. Based on the slight changes of the observed Pb/Al and Cu/Al ratios, it is likely that the wind-blown dusts were released from rather different source areas for the investigated period in comparison to the Holocene stability period. For Cd and Zn, the increasing biogenic emissions from the vegetation in the northern high-latitudes began to control the Arctic background level of the atmospheric Cd and Zn from about 11,400 yrs B.P. Their contribution continued to increase with the expansion of the vegetation owing to the increasing solar radiation in the Northern Hemisphere until about 9300 yrs B.P. and thereafter the change of the regional atmospheric circulation in the high-latitudes had led to a decrease of the contribution from the vegetation to the atmospheric Cd and Zn burdens in the Arctic,

establishing the typical Holocene cycle of the natural Cd and Zn aerosols by about 8000 yrs B.P.

#### Acknowledgements

This work is a contribution of GRIP organized by the European Science Foundation. We thank B. Stauffer and J.P. Steffensen for their very kind assistance in core selection. We thank G. Orombelli, W. Maggi and P. Laj for providing part of the core sections analysed in this work. Special thanks are due to M. Legrand for the ion chromatography measurement, F. Ducroz and J. Savarino for their assistance in the laboratory, and R.J. Delmas for his continuous interest and helpful discussions. We thank the national funding agencies and organizations in Belgium, Denmark, France, Germany, Iceland, Italy, Switzerland, and the United Kingdom as well as the XII Directorate of the Commission of European Communities for financial support. It was supported by the French Ministry of the Environment (grant 92295), the Institut National des Sciences de l'Univers, and the University of Grenoble.

## References

- 1 C.F. Boutron, Historical reconstruction of the earth's past atmospheric environment from Greenland and Antarctic snow and ice cores, *Environ. Rev.* 3, 1-28, 1995.
- 2 M. Murozumi, T.J. Chow, and C.C. Patterson, Chemical concentrations of pollutant lead aerosols, terrestrial dusts and sea-salt in Greenland and Antarctic snow strata, *Geochim. Cosmochim. Acta* 33, 1247-1294, 1969.
- 3 E.W. Wolff and E.D. Suttie, Antarctic snow record of southern hemisphere lead pollution, *Geophys. Res. Lett.* 21, 781-784, 1994.
- 4 S. Hong, J.P. Candelone, C.C. Patterson and C.F. Boutron, Greenland ice evidence of hemispheric scale pollution for lead two millennia ago by Greek and Roman civilization, *Science* 265, 1841-1843, 1994.
- 5 J.P. Candelone, S. Hong, C. Pellone and C.F. Boutron, Post industrial revolution changes in large scale atmospheric pollution of the Northern Hemisphere by heavy metals as documented in central Greenland snow and ice, *J. Geophys. Res.* in press.
- 6 S. Hong, J.P. Candelone, C.C. Patterson and C.F. Boutron, Greater large scale atmospheric pollution for copper during antiquity than in modern times, *Science*, submitted.
- 7 C.F. Boutron and C.C. Patterson, Lead concentration changes in Antarctic ice during the Wisconsin/Holocene transition, *Nature* 323, 222-225, 1986.
- 8 C.F. Boutron, C.C. Patterson, V.N. Petrov and N.I. Barkov, Preliminary data on changes of lead concentrations in Antarctic ice from 155,000 to 26,000 years BP, *Atmos. Environ.* 21, 1197-1202, 1987.
- 9 F. Batifol, C.F. Boutron and M. De Angelis, Changes in copper, zinc and cadmium concentrations in Antarctic ice during the past 40,000 years, *Nature* 377, 544-546, 1989.
- 10 C.F. Boutron, C.C. Patterson and N.I. Barkov, The occurrence of zinc in Antarctic ancient ice and recent snow, *Earth Planet. Sci. Lett.* 101, 248-259, 1990.
- 11 C.F. Boutron, S.N. Rudniev, M.A. Bolshov, V.G. Koloshnikov, C.C. Patterson and N.I. Barkov, Changes in cadmium concentrations in Antarctic ice and snow during the past 155,000 years, *Earth Planet. Sci. Lett.* 117, 431-441, 1993.
- 12 G.M. Vandal, W.F. Fitzgerald, C.F. Boutron and J.P. Candelone, Variation in mercury deposition to Antarctic over the past 34,000 years, *Nature* 362, 621-623, 1993.
- 13 S. Hong, J.P. Candelone and C.F. Boutron, Changing occurrence of the heavy metals (Pb, Cu, Zn and Cd) in central Greenland ice deposited during the Holocene, *Geochim. Cosmochim. Acta*, submitted.
- 14 W. Dansgaard, S.J. Johnsen, H.B. Clausen, D. Dahl-Jensen, N.S. Gundestrup, C.U. Hammer, C.S. Hvidberg, J.P. Steffensen, A.E. Sveinbjörnsdottir, J. Jouzel and G. Bond, Evidence for general instability of past climate from a 250-kyr ice-core record, *Nature* 364, 218-220, 1993.
- 15 J.P. Candelone, S. Hong and C.F. Boutron, An improved method for decontaminating polar snow and ice cores for heavy metals analysis, *Anal. Chim. Acta* 229, 9-16, 1994.
- 16 C.F. Boutron, A clean laboratory for ultralow concentration heavy metal analysis, *Fresenius Z. Anal. Chem.* 337, 482-491, 1990.
- 17 U. Görlach and C.F. Boutron, Preconcentration of lead, cadmium, copper and zinc in water at pg.g<sup>-1</sup> level by non-boiling evaporation, *Anal. Chim. Acta* 236, 391-398, 1990.

- 18 A. Ng and C.C. Patterson, Natural concentrations of lead in ancient Arctic and Antarctic ice, *Geochim. Cosmochim. Acta* 45, 2109-2121, 1981.
- 19 GRIP Members, Climatic instability during the last interglacial period recorded in the GRIP ice core, *Nature* 364, 203-207, 1993.
- 20 P.A. Mayewski, L.D. Meeker, S. Whitlow, M.S. Twickler, M.C. Morrison, P. Bloomfield, G.C. Bond, R.B. Alley, A.J. Gow, P.M. Grootes, D.A. Meese, M. Ram, K.C. Taylor and W. Wumkes, Changes in atmospheric circulation and ocean ice cover over the North Atlantic during the last 41,000 years, *Science* 263, 1747-1751, 1994.
- 21 K.C. Taylor, G.W. Lamorey, G.A. Doyle, R.B. Alley, P.M. Grootes, P.A. Mayewski, J.W.C. White and L.K. Barlow, The 'flickering switch' of late pleistocene climatic change, *Nature* 361, 432-436, 1993.
- 22 C. Schott, E.D. Waddington and C.F. Raymond, Predicted time-scale for GISP2 and GRIP boreholes at Summit, Greenland, *J. Glaciol.* 38, 162-168, 1992.
- 23 J.O. Nriagu, Global inventory of natural and anthropogenic emissions of trace metals to the atmosphere, *Nature* 279, 409-411, 1979.
- 24 J.O. Nriagu, A global assessment of natural sources of atmospheric trace metals, *Nature* 338, 47-49, 1989.
- 25 S.R. Taylor, Abundance of chemical elements in the continental crust : a new table, *Geochim. Cosmochim. Acta* 28, 1273-1285, 1964.
- 26 H.J.M. Bowen, *Environmental Chemistry of the Elements*, 333 pp., Academic Press, New York, 1979.
- 27 M. Sarnthein, Sand deserts during glacial maximum and climatic optimum, *Nature* 272, 43-46, 1978.

- 28 R.J. Delmas and J.R. Petit, Present Antarctic aerosol composition : A memory of ice age atmospheric dusts?, *Geophys. Res. Lett.* 21, 879-882, 1994.
- 29 J.R. Petit, M. Briat and A. Royer, Ice age aerosol content from East Antarctic ice core samples and past wind strength, *Nature* 293, 391-394, 1981.
- 30 L. Schütz and K.A. Rahn, Trace-element concentrations in erodible soils, *Atmos. Environ.* 16, 171-176, 1982.
- 31 R.A. Duce, R. Arimoto, B.J. Ray, C.K. Unni and P.J. Harder, Atmospheric trace metals at Enewetak atoll : 1. concentrations, sources and temporal variability, *J. Geophys. Res.* 88, 5321-5342, 1983.
- 32 C.P. Weisel, R.A. Duce, J.L. Fasching and R.W. Heaton, Estimates of the transport of trace metals from the ocean to the atmosphere, *J. Geophys. Res.* 89, 11607-11618, 1984.
- 33 R. Arimoto, R.A. Duce, B.J. Ray, A.D. Hewitt and J. Williams, Trace elements in the atmosphere of American Samoa : concentrations and deposition to the tropical South Pacific, *J. Geophys. Res.* 92, 8465-8479, 1987.
- 34 H.B. Maring and R.A. Duce, The impact of atmospheric aerosols on trace metal chemistry in open ocean surface seawater, *J. Geophys. Res.* 94, 1039-1045, 1989.
- 35 M. De Angelis and M. Legrand, Origins and variations of fluoride in Greenland precipitation, *J. Geophys. Res.* 99, 1157-1172, 1994.
- 36 P. Buat-Ménard, Global source strength and long-range atmospheric transport of trace elements emitted by volcanic activities, in: *The Long-Range Atmospheric Transport of Natural and Contaminant Substances (NATO ASI Ser. Vol. C 297)*, A.H. Knap, ed., pp 163-175, Kluwer, Dordrecht, 1990.



- 37 M. Legrand, M. De Angelis, T. Staffelbach, A. Neftel and B. Stauffer, Large perturbations of ammonium and organic acids content in the Summit-Greenland ice core. Fingerprint from forest fires?, *Geophys. Res. Lett.* 19, 473-475, 1992.
- 38 COHMAP Members, Climatic changes of the last 18,000 years : observations and model simulations, *Science* 241, 1043-1052, 1988.
- 39 R.B. Alley, D.A. Meese, C.A. Shuman, A.J. Gow, K.C. Taylor, P.M. Grootes, J.W.C. White, M. Ram, E.D. Waddington, P.A. Mayewski and G.A. Zielinski, Abrupt increase in Greenland snow accumulation at the end of Younger Dryas event, *Nature* 362, 527-529, 1993.
- 40 W. Dansgaard, J.W.C. White and S.J. Johnsen, The abrupt termination of the Young Dryas climatic event, *Nature* 339, 532-534, 1989.
- 41 P.A. Mayewski, L.D. Meeker, S. Whitlow, M.S. Twickler, M.C. Morrison, R.B. Alley, P. Bloomfield and K. Taylor, The atmosphere during the Young Dryas, *Science* 261, 195-197, 1993.
- 42 W.F. Ruddiman and A. McIntyre, The mode and mechanism of the last deglaciation : oceanic evidence, *Quat. Res.* 16, 125-134, 1981.
- 43 E. Bard, M. Arnold, P. Maurice, J. Duprat, J. Moyes and J.C. Duplessy, Retreat velocity of the North Atlantic polar front during the last deglaciation determined by  $^{14}\text{C}$  accelerator mass spectrometry, *Nature* 328, 791-794, 1987.
- 44 W.E. Ratz, The climatology and meteorology of Arctic air pollution, in: *Pollution of the Arctic Atmosphere*, W.T. Sturges, ed., pp 13-42, Elsevier, London, 1991.

- 45 J. Xiao, S.C. Porter, Z. An, H. Kumai and S. Yoshikawa, Grain size of quartz as an indicator of winter monsoon strength on the loess plateau of central China during the last 130,000 yr, *Quat. Res.* 43, 22-29, 1995.
- 46 M. Legrand and M. De Angelis, Origins and variations of light carboxylic acids in polar precipitation, *J. Geophys. Res.* 100, 1445-1462, 1995.

TABLE 1

Pb, Cu, Zn and Cd concentrations measured from the 3028-m-long Greenland deep ice core

| Depth<br>(m) | Estimated age*<br>(yrs B.P.) | Measured Concentration (pg/g) |      |      |      |
|--------------|------------------------------|-------------------------------|------|------|------|
|              |                              | Pb                            | Cu   | Zn   | Cd   |
| 1339.3       | 8250                         | 0.79                          | 2.00 | 29.7 | 0.57 |
| 1394.3       | 8775                         | 0.81                          | 1.62 | 18.6 | 0.50 |
| 1449.3       | 9310                         | 1.14                          | 1.65 | 28.7 | 0.69 |
| 1614.3       | 11400                        | 2.19                          | 4.54 | 30.7 | 0.45 |
| 1669.3       | 12800                        | 4.17                          | 14.9 | 57.8 | 0.37 |
| 1735.3       | 14165                        | 1.78                          | 5.62 | 32.2 | 0.23 |
| 1765.0       | 14795                        | 47.9                          | 77.4 | 196  | 1.13 |
| 1834.3       | 16920                        | 83.9                          | 141  | 340  | 1.58 |
| 1894.2       | 18910                        | 75.0                          | 112  | 248  | 1.12 |
| 1924.5       | 20220                        | 79.7                          | 150  | 404  | 1.63 |
| 1999.3       | 23850                        | 44.3                          | 100  | 256  | 1.29 |
| 2034.5       | 25590                        | 151                           | 238  | 563  | 2.89 |
| 2054.3       | 26560                        | 121                           | 202  | 559  | 2.17 |
| 2192.3       | 34430                        | 7.68                          | 13.7 | 52.3 | 0.23 |
| 2214.3       | 35880                        | 125                           | 210  | 526  | 1.90 |
| 2313.9       | 42720                        | 2.53                          | 7.27 | 75.3 | 0.31 |
| 2334.2       | 44200                        | 107                           | 157  | 352  | 2.20 |
| 2384.3       | 48340                        | 4.04                          | 10.5 | 30.9 | 0.54 |
| 2424.4       | 51400                        | 65.6                          | 157  | 384  | 1.31 |
| 2527.3       | 64100                        | 127                           | 231  | 844  | 3.01 |
| 2697.8       | 91900                        | 2.85                          | 14.4 | 45.5 | 0.68 |
| 2714.3       | 95800                        | 3.28                          | 11.7 | 40.5 | 0.72 |
| 2843.0       | 127800                       | 0.47                          | 2.40 | 17.7 | 0.29 |
| 2887.5       | 149100                       | 80.7                          | 138  | 422  | 2.44 |

\*From ref. [14]. Dating by counting annual layers back to 14.5 kyr B.P. and beyond that by ice flow modelling.

TABLE 2

Comparison of the measured various elements concentration level between the Holocene and Eemian interglacial periods from GRIP deep ice core

|                       | $^{18}\text{O}$ (‰) <sup>a</sup> | Pb   | Cu   | Zn   | Cd (pg/g) | Al  | Na (ng/g) |
|-----------------------|----------------------------------|------|------|------|-----------|-----|-----------|
| Holocene <sup>b</sup> | -34.8                            | 0.72 | 1.64 | 22.7 | 0.25      | 8.7 | 3.2       |
| Eemian                | -33.4                            | 0.47 | 2.40 | 17.7 | 0.29      | 6.0 | 4.0       |

<sup>a</sup>A mean value for each climatic period given from ref. [19].

<sup>b</sup>A mean concentration value for the period of 8000 to 7000 yrs B.P. given from ref. [13].

TABLE 3

The highest concentration value of Pb, Cu, Zn and Cd observed in Greenland and Antarctic ice deposited from the next to last ice age to the early Holocene

|                        | Pb  | Cu  | Zn  | Cd   | (pg/g) |
|------------------------|-----|-----|-----|------|--------|
| Greenland <sup>a</sup> | 151 | 238 | 634 | 3.01 |        |
| Antarctic <sup>b</sup> | 38  | 33  | 101 | 3.00 |        |

<sup>a</sup>From our work of GRIP deep ice core.

<sup>b</sup>From ref. [7,8,10,11] for Pb, Zn, and Cd and from ref. [9] for Cu, which covered only the past 40,000 years. The values presented were obtained from Vostok or Dome C Antarctic deep ice core.

## FIGURE CAPTIONS

**Figure 1.** Changes in concentration (full dots) and metal/Al ratio (open squares) of Pb, Cu, Zn and Cd measured in the 3028-m-long Greenland Ice Core Project (GRIP) core samples during the past 150,000 years. Continuous <sup>18</sup>O isotopic profile from ref. [14] is shown on the top, which includes the Saale glacial age (Saale), the Eemian interglacial age (Eem) and the warm Bølling/Allerød (B/A) (12,700 to 14,450 years B.P.) and cold Younger Dryas (YD) (11,500 to 12,700 years B.P.) events. The timescale is given from ref. [14].

**Figure 2.** Pb, Cu, Zn and Cd as a function of Al concentrations determined in the GRIP ice core samples. For Cd, the concentration value of the core depth of 2887.5m, which is suspected to have an influence of volcanic emissions, is denoted as a circle (see text).

**Figure 3.** Relationship of Cd below 1pg/g with respect to Al contents. Cd concentrations below 1pg/g were observed in our samples corresponding to the ages of interglacial of interstadial climatic stages of the GRIP ice core.

**Figure 4.** Changes of Pb/Al ( $\times 10^{-4}$ ) (full squares), Cu/Al ( $\times 10^4$ ) (full triangles), Zn/Al ( $\times 10^3$ ) (open triangles) and Cd/Al ( $\times 10^{-5}$ ) (open squares), respectively, with respect to Al contents determined in our GRIP ice core samples.

**Figure 5.** Sulfate as a function of calcium contents measured in our GRIP ice core samples.

**Figure 6.** Changes in fallout flux (full dots) and metal/Al ratio (open squares) of Pb, Cu, Zn and Cd measured in our GRIP ice core samples covering the time period of 8000 to 19,000 years B.P.; full and open triangles represent fallout flux and metal/Al ratios, respectively, given from ref. [13]. Continuous <sup>18</sup>O isotopic profile with the timescale from ref. [14] is also shown on the top.

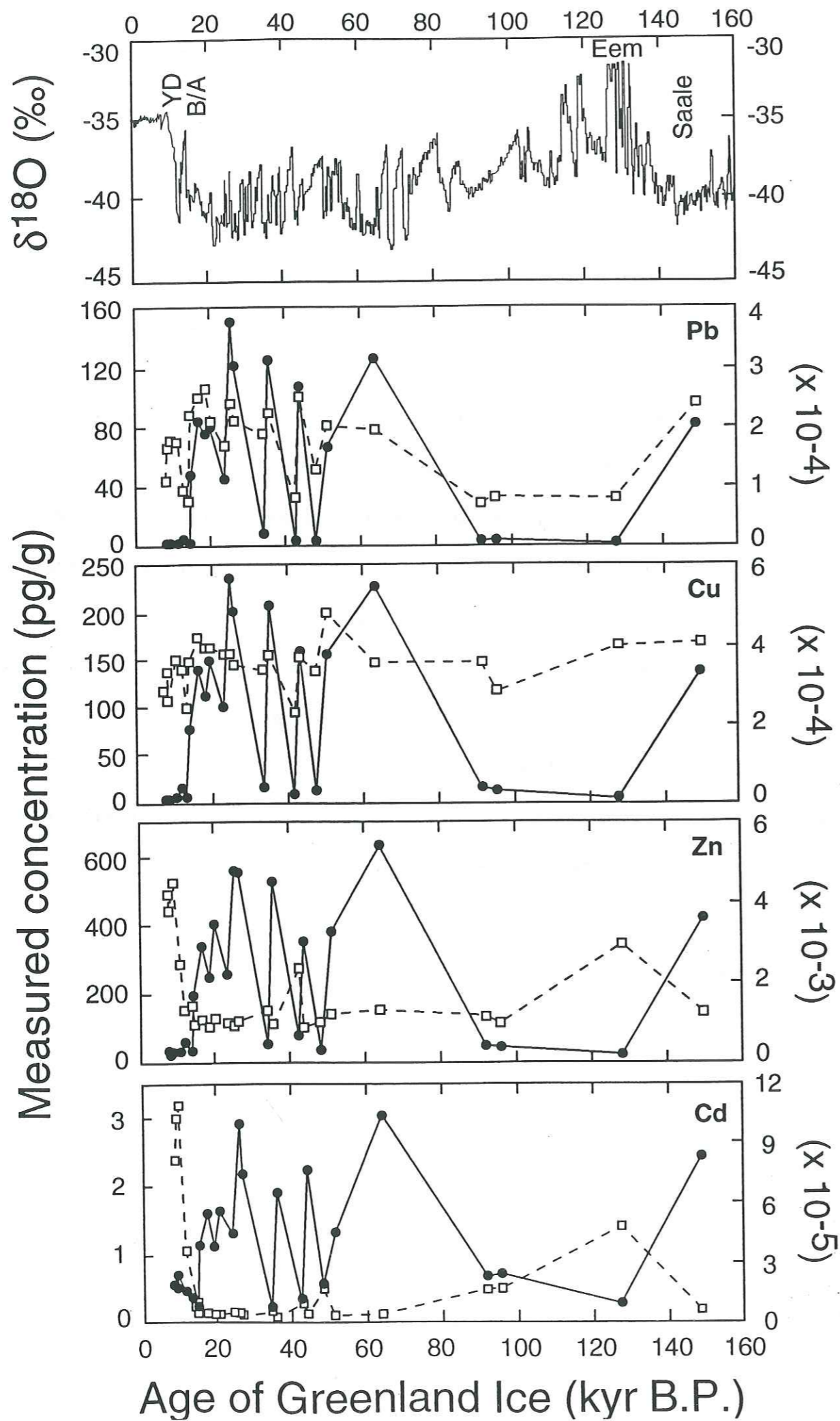

Metal/Al ratio

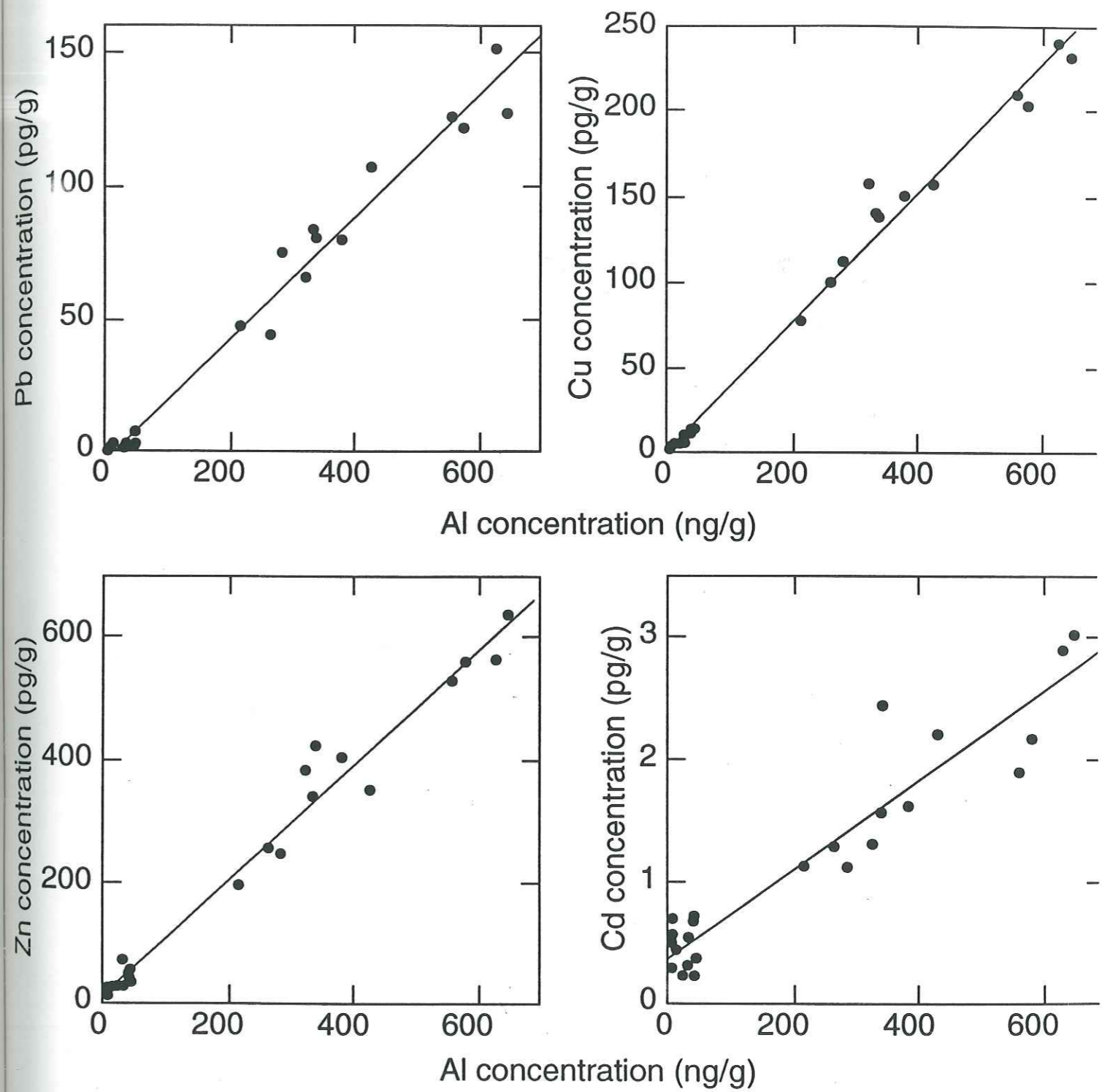

Fig. 2

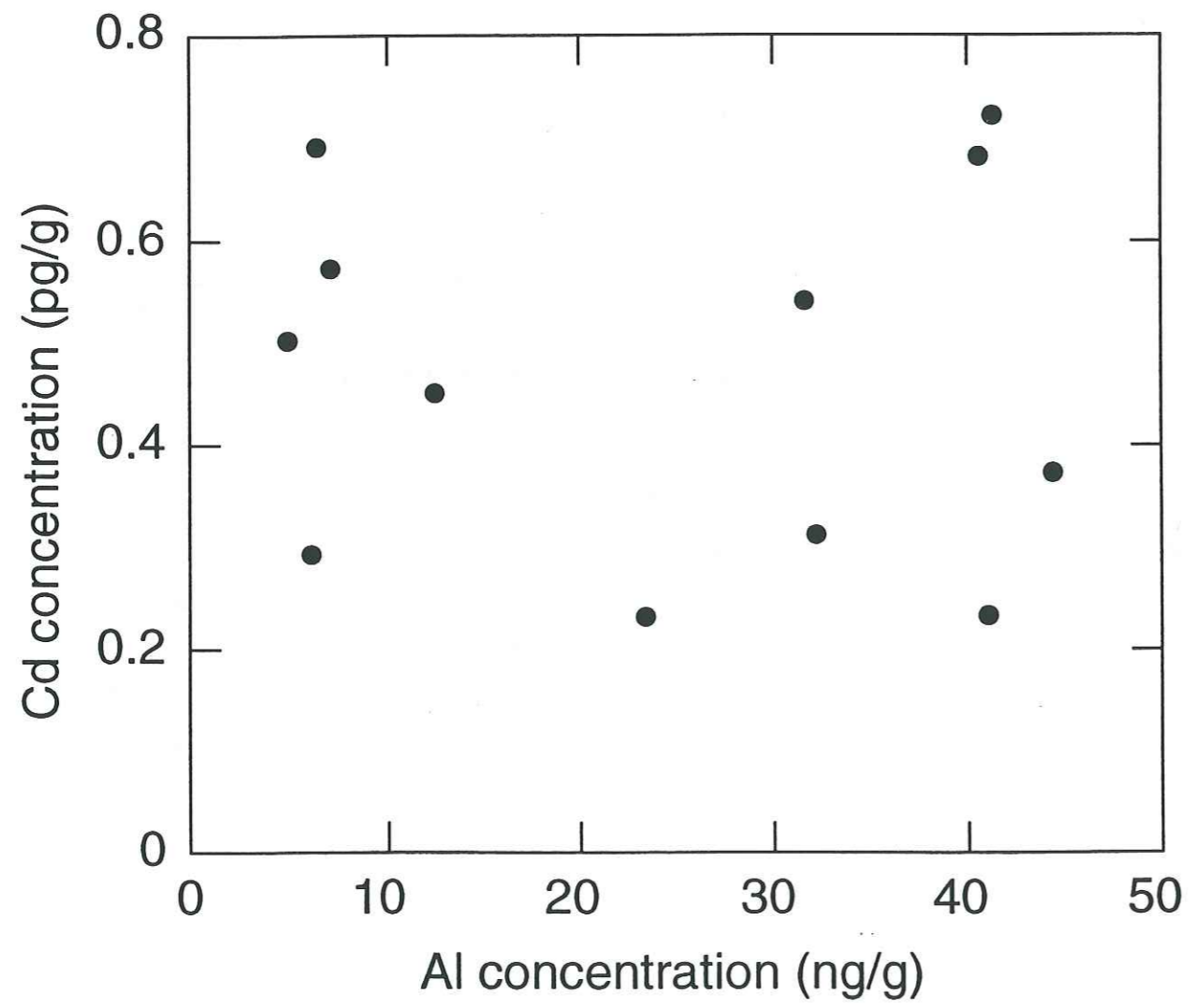

Fig. 3

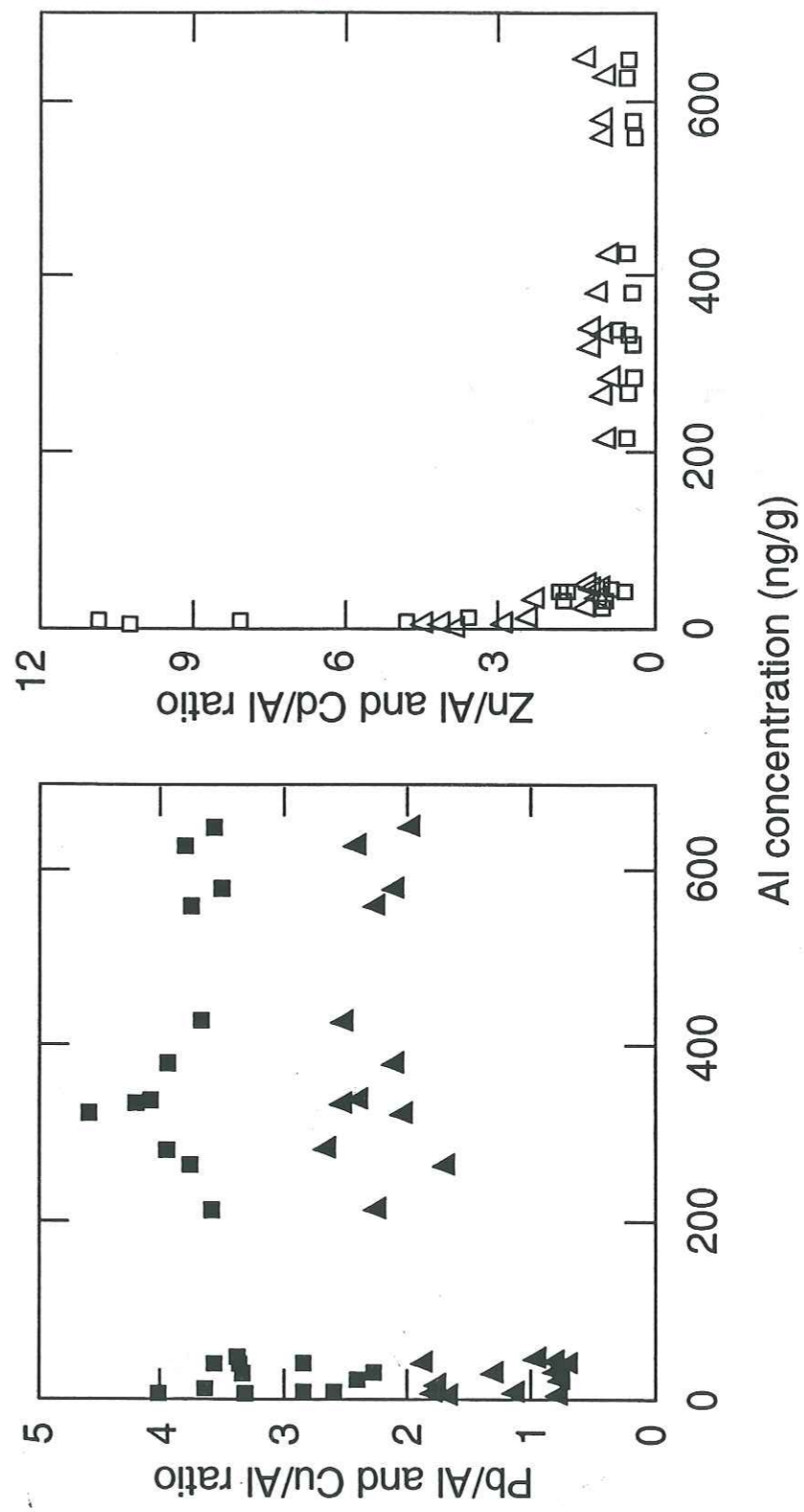

Fig. 4

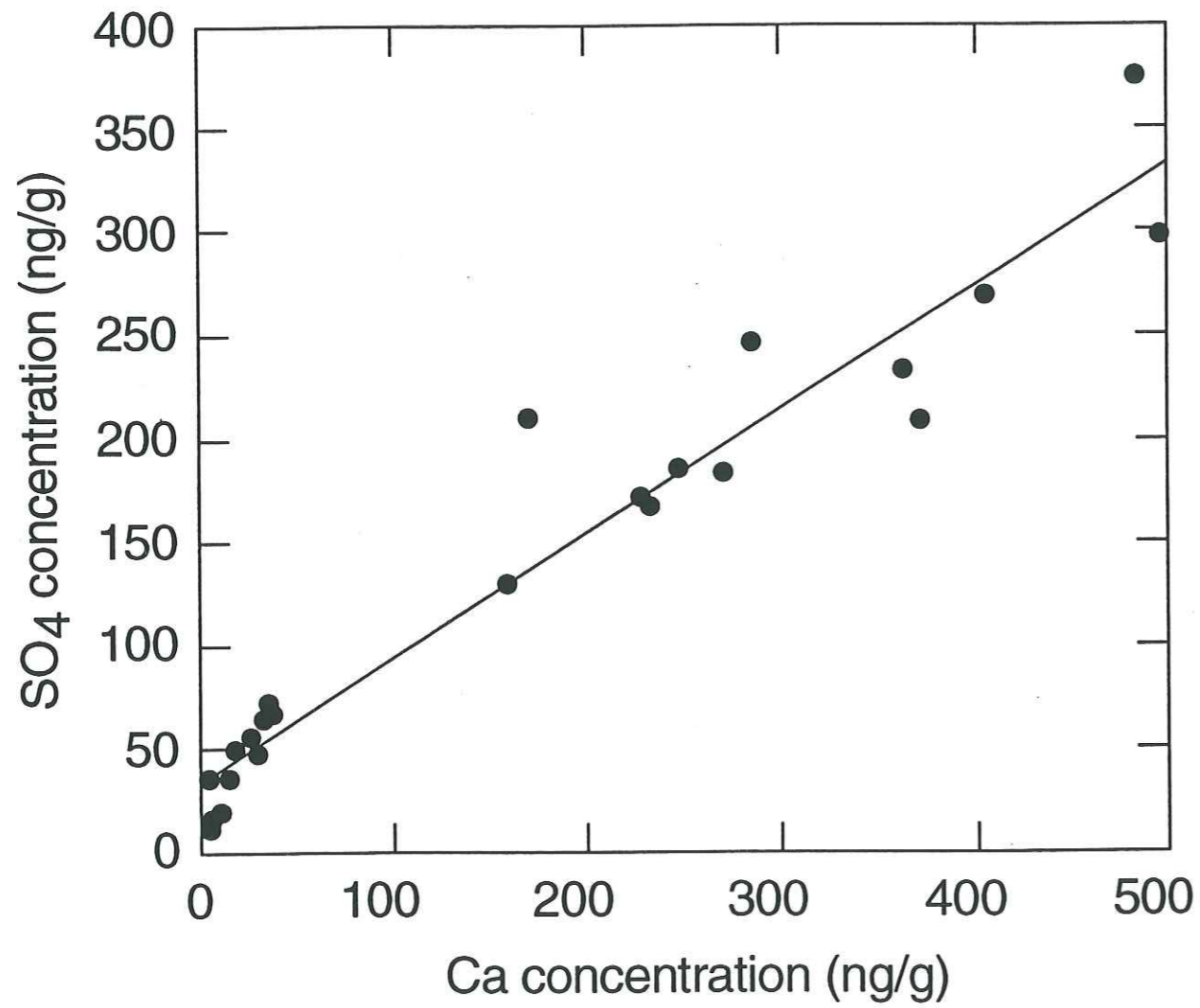
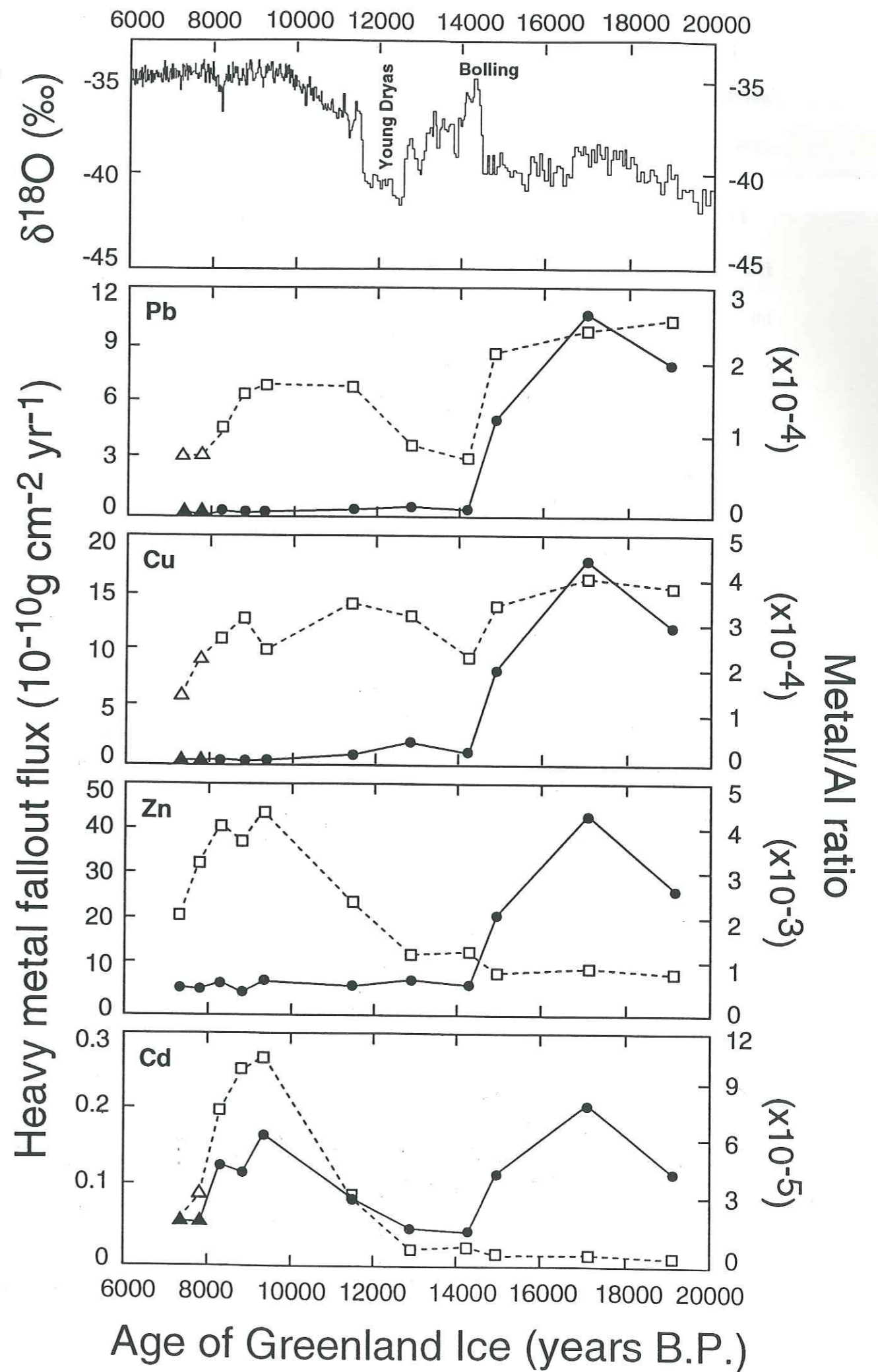

Fig. 5

Fig. 6



## CONCLUSION

Fourty seven core sections, which cover the time span of the past 150,000 years, from GRIP deep ice core were analysed for Pb, Cu, Zn and Cd : (1) to investigate the human impact on the atmospheric cycles of natural heavy metals aerosols contained in the Arctic troposphere during the pre-industrial period (1000 B.C. - A.D.1500), (2) to decipher the relative contribution strength from various natural sources to the atmospheric heavy metals deposition over the Greenland ice sheet as a function of the climatic conditions varied during the last full glacial period (from the next glacial age to the Holocene stability). All the investigated sections were decontaminated using an improved method of the previous ultraclean procedures involved the mechanical chiselling of successive each veneer layer of the core section. The strict check of the reliability of concentration values obtained in the inner core was carried out from the full outside-inside profile in concentrations of each ice core section. It is found that most of the heavy metals concentrations determined represents the original ones in the investigated ice samples, except for only three concentration values serving as an upper limit, despite the fact that the available core cross sections were not complete. This implies that an improved decontamination procedure used in this work was effective enough to be able to measure very low concentrations of heavy metals (down to sub pg/g).

As to changing occurrences of the measured heavy metals during the human history, the concentration values determined for each heavy metal are found to be variable up to by a factor of about 10 for Pb, 8 for Cu, 5 for Zn and 4 for Cd, respectively, during the

investigated time period (3000-500 years B.P.). These time variations in concentrations were compared to the Holocene natural level known from the analysis of core sections of 7290 and 7760 years B.P. and interpreted by using available data.

For Pb and Cu, first of all, most of natural Pb and Cu aerosols contained in the Arctic troposphere is likely to have originated from the wind-blown dusts during the Holocene. The estimates of the Pb and Cu contributions from other natural sources such as volcanoes, seasalt spray and biomass burning, which were made from the measured sulfate, sodium and ammonium concentrations, indicate that their contributions to the atmospheric Pb and Cu in the Arctic troposphere may have been insignificant, except when large volcanic eruptions occurred. Of these natural contributions, the volcanic contribution was based on the metal/sulfur ratios ( $0.30 \times 10^{-4}$  and  $0.33 \times 10^{-4}$  for Pb and Cu, respectively) determined from the measurement of heavy metals contents in the ice layer containing the volcanic aerosols emitted from the large 1783-1784 Laki eruption in Iceland. This allowed for the first time the direct determination of the episodic contribution of the heavy metal deposition fluxes to the Greenland ice sheet. The calculated Pb/Al and Cu/Al ratios are found to be enhanced up to four fold over the Holocene natural level from about 2500 years B.P., indicating that the unknown source contributions outside the wind-blown dusts have resulted in the enhancement of Pb and Cu aerosols input to the Arctic troposphere. Since the estimated contributions from other natural sources mentioned above could not explain the elevated concentration values and the ratios of Pb and Cu with respect to Al concentration, an alternative explanation is that the anthropogenic Pb and Cu pollutant aerosols emitted from the ancient mining and smelting activities may be responsible for the increase of the atmospheric Pb and Cu input to the Arctic troposphere. The time

variations of Pb and Cu fallout fluxes over the Greenland ice sheet are in good agreement with the reconstructed historical trends of Pb and Cu production rates since the ancient times. Therefore, it seems evident that man began to pollute on a hemispheric scale the atmosphere of the Northern Hemisphere for Pb and Cu from about 2500 years ago. This is the oldest large scale anthropogenic pollution ever reported, long before the Industrial Revolution.

It should be noted that there is a difference in general aspects of anthropogenic pollution between Pb and Cu. For Pb, the concentration began to increase from 2500 years ago and remained high (four times as great as natural values) during the Greek and Roman times (i.e., 500 B.C. to 300 A.D.). They declined then after the collapse of the Roman Empire and were at a low level (close to natural one) during the Medieval times. From the eighth century onwards, it is found that lead concentrations started to reincrease in accordance with the revival of silver/lead industries in Europe. Cumulative lead fallout to the Greenland ice sheet during the Greek and Roman period (~ 800 years) was as high as 15 percent (~ 400 tonnes) of that which resulted from the massive use of lead alkyl additives in automotive fuel since the 1930s. The Cu concentrations also exceed natural level from about 2500 years ago, and remained high until the late Medieval times, but exhibited large fluctuation. These fluctuations are attributed to the fact that copper production varied strongly over short time periods (decades) along with pronounced changes in the need for copper especially for coinage in Europe during the Greek and Roman times and in China during the Medieval times. Interestingly, the cumulative deposition of copper on the Greenland ice sheet was found to be one order of magnitude higher from 2500 years ago to the Industrial Revolution than from the Industrial Revolution to present. The above mentioned temporal changes

of anthropogenic lead and copper aerosol deposition documented in the Greenland ice cap could give us an historical picture on the growth and decline of lead and copper industries in ancient times, because the archaeological evidences have not been as yet comprehensible to evidently depict them.

In the case of Zn and Cd, the Zn/Al and Cd/Al ratios determined are found not to show any temporal variation during the whole Holocene period, whereas their concentrations are variable with time. This suggests that they are entirely natural in origin and the relative contributions from each dominant source had been constant, although the input strength of Zn and Cd aerosols to the Arctic troposphere had changed. The estimates of the contribution from natural sources revealed that the wind-blown dusts contribution accounts for about 45% and 15% of the Zn and Cd, respectively, while volcanic contribution is about 3% for Zn and 7% for Cd. Seasalt spray contribution was found to be negligible. Although one cannot evaluate quantitatively the biomass burning contribution, it is probable that Zn and Cd aerosol inputs to the Arctic troposphere may have been sporadically enhanced by the biomass burning in the high latitude regions, because highly enriched concentrations of residual Zn and Cd after correction from the wind-blown dusts, volcanoes and seasalt spray contributions are well-correlated with the ammonium peaks. Except these enriched Zn and Cd concentrations, about 50% of Zn and 80% of Cd cannot be explained by the natural contributions which were estimated using the available data. When considering that continental biogenic emissions are regarded to be the greater contributor to the atmospheric Cd and Zn aerosols on a global basis during the period of little volcanism, it is assumed that the residual Cd and Zn concentrations may have originated from continental biogenic contribution. Finally, A good relationship between the total Zn and



Cd concentrations suggests that their biogeochemical occurrences in nature and transport behaviors via the atmosphere may be similar.

From the measurement of twenty four core sections whose ages range from 8000 to 150,000 years B.P., it can be seen that atmospheric heavy metals burden was affected by climatic change. The concentration enhancement factor between the glacial and interglacial period is about 320 for Pb, 100 for Cu, 36 for Zn, and 13 for Cd, respectively. For Pb and Cu, it is clearly revealed that they have originated from the crustal particles through the glacial (cold) and interglacial (warmer) period, as evidenced by the excellent correlation of Pb and Cu with respect to Al (indicator of terrestrial input). Despite that, the Pb/Al and Cu/Al ratios are different in different climatic stages. This indicates a change of the mineralogical composition of the crustal aerosols with the climatic change. This mineralogical change may have been linked to the facts that the continental source regions producing the crustal aerosols varied due to the climatic changes and subsequent atmospheric circulations and that the newly exposed continental shelves were involved as a contributor of the crustal particle emissions. In addition, a differentiated fractionation during the transport of the crustal aerosols may have arisen from the changes of intensity and duration of meridional transport and the variation of crustal particle size caused by a change of surface wind velocity for the dust deflation. Consequently, the changes of the Pb/Al and Cu/Al ratios are related with the climatic changes and hence the use of the metal/Al ratios given from a mean crustal composition could lead to an ambiguous estimate of the crustal contribution for the different climatic period.

Finally, for Zn and Cd, it is found that they have also been derived from the wind-blown dusts during the cold climatic period. When the climatic conditions are similar to the Holocene ones, however, the situation is different. Based on the observation from 12,000 to 8000 years B.P., during which the characteristic changes of dominant source contributions are well documented in the investigated ice samples, it is proposed that continental biogenic emissions of Cd and Zn aerosols become the predominant source when the climate is warm causing land-ice sheet to retreat and subsequent northward expansion of the vegetated area. This fact is consistent with the prior suggestion that a continental biogenic source is the main contributor to the atmospheric Cd and Zn aerosols during the Holocene period.

In conclusion, this work shows the history of anthropogenic pollution by the heavy metals since the ancient times as well as the relative contributions from various natural sources in the troposphere of the Northern Hemisphere during the past 150,000 years.

As an additional remark, it should be emphasized that other heavy metals also have to be determined in the Greenland ice samples in order to extend our knowledge of the global changes of their biogeochemical cycles with time. Among these metals bismuth (Bi) is important as a tracer for evaluating a transport pathway of volcanic aerosols, because its atmospheric cycle may be dominated by volcanic emissions. Mercury (Hg), arsenic (As) and tin (Sn) also attract attention because of their high toxicities and potential for anthropogenic perturbation on their natural cycles in ancient times. In addition, silver (Ag) could be recommended as a good tracer of the historical industrial activities in the light of the fact that ancient people always exploited silver ores owing to its relevance to economic growth and resultant power of the ancient empires. It may

be possible to detect the anthropogenic contribution of Ag in the Greenland ice sheet, because its natural occurrence is extremely low.

Despite the interest in these elements, no data are yet available in the Greenland snow and ice. This is mainly due to the fact that their concentrations in the Greenland snow and ice are estimated to be extremely low, down to the pg/g level. However, much efforts have recently been made to determine their occurrences using the ultrasensitive analytical methods, for examples, Laser Excited Atomic Fluorescence Spectrometry (LEAFS) for Bi and Cold Vapour Atomic Fluorescence Spectrometry (CVAFS) for Hg. The high resolution Inductively Coupled Plasma Mass Spectrometry (ICP-MS) could be used to measure As, Sn and Ag contents. All these analytical techniques are now available to investigate the above mentioned elements. By virtue of collaboration between our laboratory (LGGE) and other laboratories specialized for those measurements in Russia, the United States and Italy, therefore, various reliable time series of these elements are expected to be obtained in the near future.

*Analytica Chimica Acta*, 299, 9-16, 1994.

**An improved method for decontaminating polar snow and ice cores  
for heavy metal analysis**

J.P. Candelone, S. Hong and C.F. Boutron



ELSEVIER

Analytica Chimica Acta 299 (1994) 9-16

ANALYTICA  
CHIMICA  
ACTA

## An improved method for decontaminating polar snow or ice cores for heavy metal analysis

Jean-Pierre Candelone<sup>a</sup>, Sungmin Hong<sup>a</sup>, Claude F. Boutron<sup>a,b,\*</sup>

<sup>a</sup> Laboratoire de Glaciologie et Géophysique de l'Environnement du CNRS, 54, rue Molière, Domaine Universitaire, B.P. 96, 38402 St. Martin d'Hères, France

<sup>b</sup> UFR de Mécanique, Université Joseph Fourier de Grenoble, Domaine Universitaire, B.P. 68, 38041 Grenoble, France

Received 23 May 1994; revised manuscript received 20 July 1994

### Abstract

An improved method has been developed for the decontamination of Greenland and Antarctic snow or ice cores for heavy metal analysis. The investigated core sections are chiselled while being held horizontal in a polyethylene lathe inside a laminar flow clean bench in a cold room. Each veneer layer and the final inner core are then analysed for Pb, Cd, Zn and Cu by graphite furnace atomic absorption spectrometry in clean room conditions. The procedural blank was found to range from 0.015 pg/g for Cd up to 0.25 pg/g for Cu. The quality of the decontamination was checked by studying changes in heavy metals concentrations from the outside to the center of each core section. In most cases, good plateaus of concentrations were observed in the central parts, then indicating that contamination present on the outside of the cores was not transferred to these central parts. Various Greenland and Antarctic cores were decontaminated, giving new insights into the past and recent occurrence of heavy metals in the atmosphere of both hemispheres.

**Keywords:** Atomic absorption spectrometry; Heavy metals; Lead; Cadmium; Zinc; Copper; Snow; Ice; Greenland; Antarctica; Global pollution

### 1. Introduction

The successive well preserved snow and ice layers deposited in the large Antarctic and Greenland ice sheets are unique archives of the past and recent changes in the atmospheric concentrations of heavy metals. Deciphering these archives for heavy metals has unfortunately proved to be very difficult mainly because the concentrations to be measured are extremely low, down to the sub pg/g level.

A key point to obtain reliable data is in the cleanliness of the available samples. For near surface snow, clean samples can be obtained from the walls of clean

hand dug pits [1,2] or trenches [3], or by using specially designed clean augers [4]. But deeper layers can only be reached by using large size electromechanical [5] or thermal [6] drills. Such drills provide us with snow/ice cores whose diameters range from about 3 to 5 inches (7.5 to 13 cm), the most frequent diameter being 4 inches (10.2 cm).

A major problem is that the cores are always more or less contaminated on their outside. This contamination originates from various contributions. The main one is the wall retaining fluid (amongst the fluid used are kerosene and freon [7] and *n*-butyl acetate [8]) when such a fluid is required to prevent the closing of the drilling hole at great depths. But other contributions can also originate from the body of the drill, the cable

\* Corresponding author.

and the handling, packing and storage of the core.

To obtain reliable heavy metals data from such cores, it is therefore essential to be able to decontaminate them by removing the outside contamination without transferring it to the most central parts and to check the efficiency of the procedure.

Although this problem has already been tackled by a few investigators [9-12], none of them has until now developed a fully satisfying method, i.e. a method which is ultraclean, suitable both for snow or ice cores, not too much time consuming and which allows to check the efficiency of the procedure.

We present here an improved ultraclean mechanical decontamination procedure for snow or ice cores. It has been successfully used for the decontamination of various sections of several snow and ice cores from Greenland and Antarctica.

## 2. Experimental

The experimental procedure requires two operators. It consists in chiselling successive layers of snow or ice from the outside to the central part of the core using ultraclean stainless steel chisels. The core is kept horizontal, its extremities tightly secured in low density polyethylene (LDPE) tumblers.

### 2.1. Laminar flow clean bench in a cold room

The whole decontamination procedure takes place in a laminar flow clean bench located inside a cold room at  $-15^{\circ}\text{C}$ . The inside of the bench is entirely made out of plastics. Moreover, the working area is covered with a thin LDPE film which is changed regularly. The bench is fitted with a special high efficiency particulate air (HEPA) filter (99.999% efficiency at  $0.5\ \mu\text{m}$ ) with particulate board frames and plastic separators. It has no rubber or polyurethane compressible gasket: the seal between the HEPA filter frame and the ceiling of the bench is made with silicone cement [13]. The operators wear full clean room garb over their warm clothing. Over their isothermic gloves, they also wear shoulder length LDPE gloves and wrist length LDPE gloves over these. These last gloves are changed as often as required.

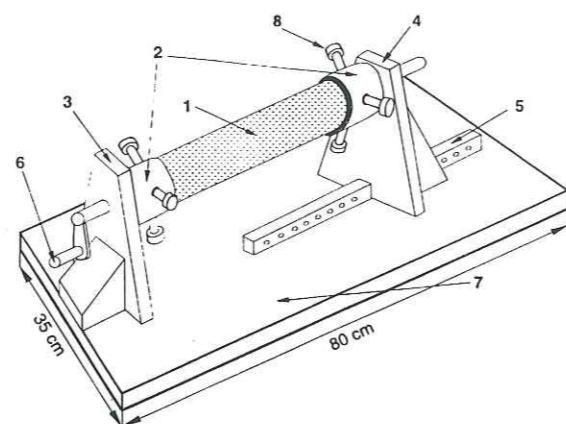

Fig. 1. Schematic diagram of the low density polyethylene (LDPE) lathe used for the decontamination of the snow or ice cores. (1) Snow or ice core (length up to 65 cm); (2) LDPE tumblers; (3) fixed LDPE pillar; (4) movable LDPE pillar which can be slid along the guide rail; (5) LDPE guide rail; (6) LDPE crank used to rotate the core; (7) LDPE heavy base plate of the lathe; (8) LDPE screw.

### 2.2. Polyethylene lathe

A major improvement is the fact that during the chiselling, the core is not held with the hands of the operator and is not laying on any working surface. Instead, it remains horizontal about 20 cm above the plastic working surface as its extremities are pinched in two LDPE tumblers (Fig. 1). The lathe is designed so that it can be used in order to decontaminate snow or ice cores whose lengths range from 25 to 65 cm. Also, it is suitable not only for cylindrical cores with full section but also for cores for which only part of the cross section is available. This last situation occurs frequently for ice cores obtained as part of international programmes: a given core section is indeed cut into several parts used for different kinds of measurements (Fig. 2). At both extremities, the core is fastened in the

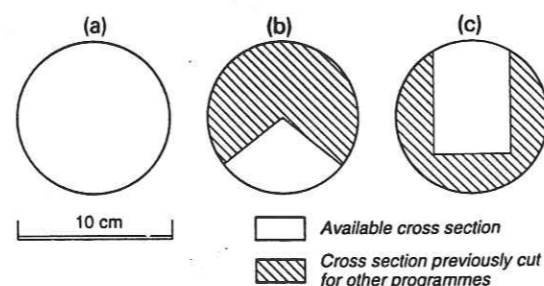

Fig. 2. Greenland and Antarctic snow or ice cores: schematic view of different typical cross sections available for heavy metals investigations.

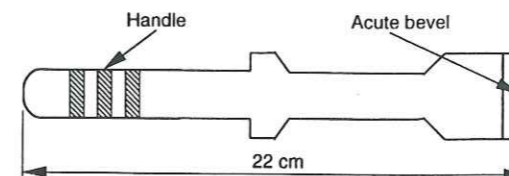

Fig. 3. Stainless steel chisel used for the chiselling of the successive veneer layers.

tumblers using 3 to 6 home made LDPE screws which are screwed, perpendicular to the axis of the core, through threaded holes made in the lateral side of the tumblers (Fig. 1). Depending on the available cross section, several sets of screws of different lengths can be used.

### 2.3. Chisels

It would have been preferable to make the chisels out of plastics such as LDPE, fluorinated ethylene propylene (FEP) or perfluoroalkoxy (PFA) Teflon. Unfortunately, such plastics are too soft for high density snow and for ice. Therefore, the chisels chosen are similar to those used by Ng and Patterson [9] and Boutron and Patterson [10,11] (Fig. 3). They are made out of a single piece of 2 mm thick plate of stainless steel (ref. 316 L). The cutting edge is 3 cm wide and 4 cm long. It is sharpened to a single acute bevel with an angle of  $30^{\circ}$ .

Before use, the chisels, cleaned as described in 2.5, are kept horizontal inside a LDPE box, each of them fitted separately in a display rack which prevents any contact between the chisels and allows the cutting edges not to touch the walls of the box.

### 2.4. Description of the procedure

The core section to be decontaminated is taken out from the LDPE bag inside which it was transported frozen from Antarctica or Greenland back to France. After changing their outer wrist-length LDPE gloves, the two operators introduce the core inside the laminar flow clean bench and put it in the lathe (Fig. 1). The core is then firmly secured between the two tumblers with the LDPE screws, Fig. 1.

A first veneer layer 5 to 10 mm thick is then chiselled as follows. A shallow chord shaving is first made from one end of the core to the other parallel to its axis, the snow or ice chips being allowed to fall directly into a

specially designed LDPE tray held by the second investigator. Using the crank, the cut is rotated upward about  $30^{\circ}$  and another shallow chord shaving is made. The procedure is then repeated until the whole exposed outside surface has been chiselled. The chips obtained from this first layer are then transferred from the tray into an ultraclean 1-l wide mouth LDPE bottle and kept frozen until analysis.

The operators then put on new fresh pairs of LDPE gloves and a second layer is chiselled using another chisel and a new fresh tray. Depending on the initial cross section of the core, this procedure is repeated up to 4 times then giving a maximum of 4 successive layers from the outside towards the center.

The remaining inner core (whose diameter ranges from 2 to 4.5 cm) is then recovered as follows: the first operator holds it firmly with all LDPE home made tongs while the other operator breaks the right end with the last chisel. The right hand pillar of the lathe (part 4 in Fig. 1) is then moved away. An ultraclean [13] 1-l wide mouth LDPE bottle is pushed onto the inner core until about half of it is introduced into the bottle. The inner core is broken in its middle with the chisel and its second half is introduced into a second 1-l bottle. Then the left edge of the inner core is broken with the chisel.

The bottles containing the chips from the successive veneer layers and the two parts of the inner core are then packed into double sealed acid cleaned LDPE bags and brought to the main clean laboratory at  $20^{\circ}\text{C}$  [13].

### 2.5. Cleaning procedures

They are similar to those described in full detail elsewhere [13]. For the various small size items such as the tumblers, the screws, the trays and the 1-l bottles, the initial cleaning before the first use involved degreasing with  $\text{CHCl}_3$ , then soaking one month in a first acid bath at  $50^{\circ}\text{C}$  (25% Merck "Suprapur"  $\text{HNO}_3$  diluted in ultrapure water [13]), one month in a second acid bath at  $50^{\circ}\text{C}$  (0.1% ultrapure  $\text{HNO}_3$  from US National Institute of Standards and Technology (NIST) [14] diluted in ultrapure water [13]), and finally one month in a third 0.1% ultrapure NIST  $\text{HNO}_3$  bath at  $50^{\circ}\text{C}$ . Transfers from one bath to the next one are made using home made LDPE tongs.

Table 1

Comparative determination of heavy metals in the water used to make the artificial ice core, in the last veneer layer and in the inner core of this artificial core

|   | Measured concentration (pg/g) |       |      |      |
|---|-------------------------------|-------|------|------|
|   | Pb                            | Cd    | Cu   | Zn   |
| Reference water used to make the core   | 0.25                          | 0.01  | 0.2  | 0.3  |
| Veneer layer adjacent to the inner core | 0.42                          | 0.033 | 0.8  | 1.25 |
| Inner core                              | 0.36                          | 0.025 | 0.45 | 0.5  |

The cleaning between each core decontamination is similar except that soaking is for only 2 h in the first bath and for 3 days in the other ones.

For the very large size items such as the basement of the lathe, a simplified procedure was used. It however also involved extensive cleaning with HNO<sub>3</sub>.

Finally, the cleaning procedure for the chisels involved degreasing with ether, then overnight soaking in 60% HNO<sub>3</sub> bath (Merck "Suprapur" diluted in purest water) and finally soaking in a series of two 0.1% NIST HNO<sub>3</sub> baths for one week (for the initial cleaning, immersions were for a much longer time period).

## 2.6. Analytical procedures

Inside the clean laboratory [13], each veneer layer and the inner core are melted separately in the 1-l wide mouth LDPE bottle in which they were kept. Various aliquots are then taken in 15- or 60-ml ultraclean [13] LDPE bottles. A 5-ml aliquot is first taken for the direct measurement of Zn, Al and Na by graphite furnace atomic absorption spectrometry (GFAAS) without preconcentration using a Perkin Elmer 2380 spectrometer and HGA 500 graphite furnace (pyrolytically coated graphite tubes) [15]. A 50-ml aliquot is then taken for the determination of Pb, Cd and Cu by GFAAS after preconcentration ( $\times 50$ ) by non boiling evaporation [15].

If necessary, additional aliquots are also made for subsequent analysis of Pb isotopes [16], organo Pb

Table 2

Procedural blank obtained from the analysis of the artificial ice core

|              | Pb   | Cd    | Cu   | Zn   |
|--------------|------|-------|------|------|
| Veneer layer | 0.17 | 0.023 | 0.6  | 0.95 |
| Inner core   | 0.11 | 0.015 | 0.25 | 0.2  |

compounds [17], Hg [18] and Bi [19,20]. These last measurements will not be discussed in the present paper.

## 3. Results and discussion

### 3.1. Determination of the procedural blank

Such determination is essential to obtain fully reliable data. The procedural blank was determined by processing an artificial ice core made out by freezing ultrapure water [13] whose composition (Table 1) was known beforehand. This core was prepared by freezing 2 l of ultrapure water inside a 2-l LDPE ultraclean bottle. The inside diameter of the bottle was about 11.2 cm, then allowing to prepare an artificial ice core whose diameter was similar to that of real Greenland or Antarctic cores.

The bottle was cut using an acid cleaned stainless steel scalpel and the artificial ice core (length about 20 cm) so obtained was chiselled using exactly the same procedure as previously described in 2.4. Three layers were chiselled before getting the final inner core. Each layer and the inner core were analysed separately.

As shown in Table 1, heavy metals concentrations are found to be slightly higher in the last veneer layer and in the inner core than in the reference water used to prepare the core. The differences so observed, listed in Table 2, represent the procedural blank. This procedural blank will then be used for the correction of all the values obtained for Greenland and Antarctic real cores. For the inner core, the blank values are found to range from 0.015 pg/g for Cd up to 0.25 pg/g for Cu (these values include the blank of the non boiling evaporation procedure, which represents a rather small contribution to the total blank). For recent Greenland snow

cores in which the concentrations are relatively high due to very significant anthropogenic contribution, this procedure blank contribution is extremely small, it represents less than a few percent of the measured concentrations. For ancient Greenland or Antarctic ice, on the other hand, it can be very significant (up to about 30% for Cu, 25% for Pb, and 10% for Cd and for Zn) since heavy metals concentrations in such ancient ice are much lower.

It is interesting to mention that the concentrations measured in the veneer layers are significantly higher for all four metals than those observed in the inner core (Table 2). This was expected since the veneer layers are subject to more handling than the inner core: the contact with the chisel is much more extensive; the chips do contact the inner tray; and they are also exposed to the air flow in the clean bench for a much longer time.

The precision of these procedural blanks is difficult to assess, since the artificial core chiselling experiment was done only once because it is very time consuming. It is however interesting to mention that the concentrations measured in the 2nd and 3rd veneer layers of the artificial core were very similar, then suggesting that the precision on the blanks is probably rather good (concentrations measured in the 1st layer were on the other hand found to be significantly higher because of the handling of the core prior to its chiselling).

It is important to emphasize that this artificial core was ice, not snow. We have however used the blank values for Greenland and Antarctic snow cores. It would indeed be extremely difficult to prepare an artificial snow core of known composition. Moreover, it is our feeling that the blank contributions for such a snow core would not be significantly different. If this is not the case, however, it is expected that the blank for the ice might rather be an upper limit of the blank for the snow: this would result into a slight over correction of the snow core data.

### 3.2. Outside-inside concentration profiles

For each decontaminated core section and each investigated heavy metal, it is essential to study in full details changes in the concentrations from the outside to the inner part of the core. If a clear plateau of concentration is observed in at least two consecutive layers in the central part of the core, it shows that contami-

nation present on the outside has not penetrated to the central part of the core: the plateau value then represents the original concentration in the Antarctic or Greenland snow or ice. If, on the other hand, a continuous decrease of concentration is observed towards the center, it evidences that outside contamination has penetrated to the very center of the core: the concentration measured in the inner part will only represent an upper limit of the real concentration in the original snow or ice.

Very contrasting situations have been obtained for the different snow or ice cores which we have decontaminated in this work. Typical outside-inside profiles are discussed in the following sections.

### 3.3. Shallow electromechanical snow core from central Greenland

In July 1989, a 70.3 m long snow core covering the years 1772-1989 has been drilled at Summit (72°58'N, 37°64'W elevation 3238 m a.s.l., mean annual temperature -32°C) in central Greenland as part of the European "Eurocore" programme. It was obtained using a 4 inches in diameter electromechanical drill [21]. Such a drill is known to bring significant contamination on the outside of the core sections mainly because of the contact with the knives (2% C and 11.5% Cr steel) and the framework (stainless steel with Teflon coating) of the drill, and the contact of the galvanized steel cable with the walls of the drilling hole. Concentrations

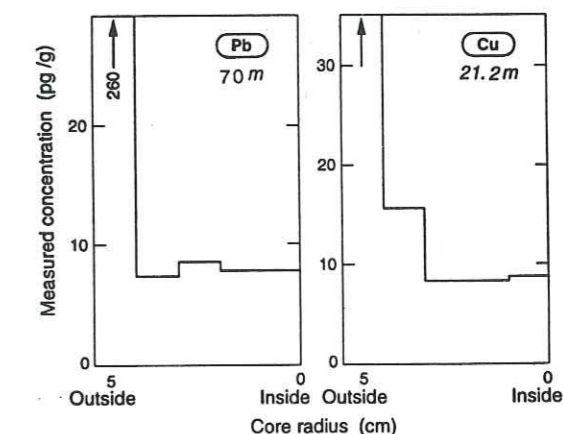

Fig. 4. Changes in Pb and Cu concentrations from the outside to the inside in two sections (depths: 69.88-70.22 and 21.10-21.45 m) of a 70.3-m snow core electromechanically drilled at Summit, central Greenland.

measured in the outermost layer of the core sections were indeed found to range from 10 to 100 pg/g for Cd, 100 to 500 pg/g for Pb and Cu, and 1000 to 5000 pg/g for Zn. It must however be emphasized that these values are for the first 1 cm or so from the outside of the core: the actual contamination present on the very outside of the core was then probably much higher. Also, it is interesting to notice that it is for Zn that the contamination is the most pronounced. This suggests that the cable does contribute a significant fraction of the contamination.

Typical outside-inside concentration profiles are shown in Figs. 4, 5 and 6. In most cases, good plateaus of concentrations are obtained as illustrated in Fig. 4 for Pb in the 70-m section and for Cu in the 21.5 m section. This is also the case for the two profiles shown in Fig. 5: for these last two profiles the slight difference observed between the inner core and the next to last layer is indeed within the experimental errors. The fact that good plateaus were observed in most cases was not easy to foretell. It was indeed to be feared that outside contamination could penetrate deeply into such porous snow, which was finally not the case.

In a few cases however, we observed a continuous decrease of concentrations from the outside to the very center of the core as illustrated in Fig. 6 for Zn and Cu in the 52 m section. For these last cases, the concentrations obtained in the inner core must then be considered as upper limits of the original concentrations in the snow. The actual reasons for these few cases are not known, they could however be linked to difficulties

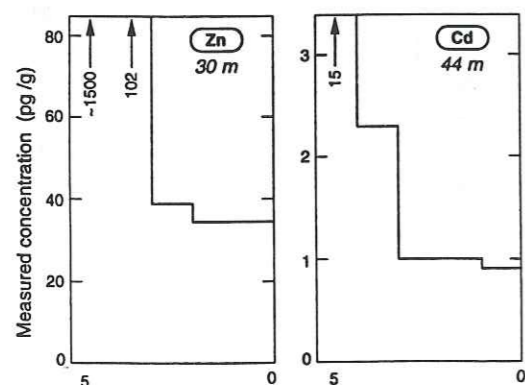

Fig. 5. Changes in Zn and Cd concentrations from the outside to the inside in two sections (depths: 29.77–30.13 and 43.87–44.45 m) of a 70.3-m core electromechanically drilled at Summit, central Greenland.

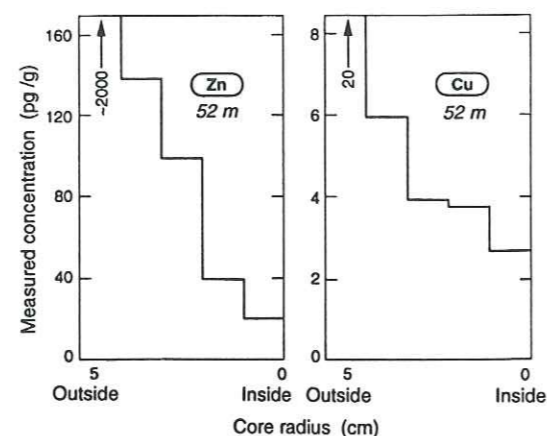

Fig. 6. Changes in Zn and Cu concentrations from the outside to the inside in one section (depth: 51.76–52.23 m) of a 70.3-m snow core electromechanically drilled at Summit, central Greenland.

encountered in the field during drilling operations and/or core handling.

Fig. 7 shows changes in the concentrations of Zn and Cd measured in the inner core as a function of the age of the snow from 1773 to 1965. It can be seen that the concentrations of these two metals have significantly increased from the 1770s, i.e. the Industrial Revolution period, to the 1960s. The increase factor is about 5 for Cd and Zn [22]. The causes for these increases are discussed in full detail elsewhere [22]. They are linked to the increasing emissions of these two metals to the atmosphere of the Northern Hemisphere by human activities during this period (fossil fuels burning, mining, non-ferrous metal industry and refuse incineration [23,24]).

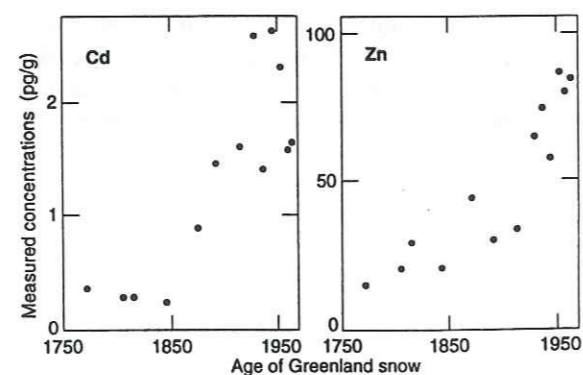

Fig. 7. Summit, central Greenland: observed changes in Cd and Zn concentrations in snow from 1773 to 1965. Each data point integrates one or two years of snow accumulation.

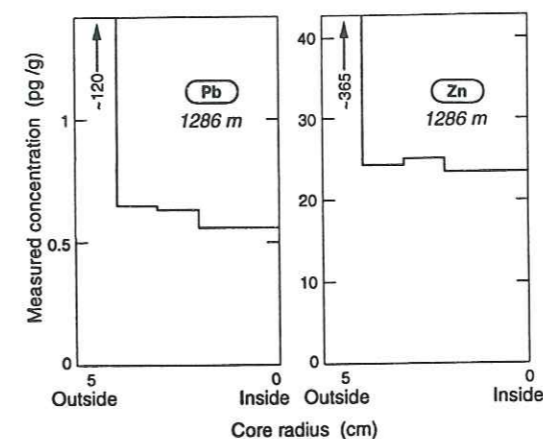

Fig. 8. Measured Pb and Zn concentrations as a function of radius in one section (depth: 1285.90–1286.45 m; estimated age 7760 years BP) of the 3028 m GRIP deep ice core electromechanically drilled at Summit, central Greenland, in a hole filled with a wall retaining fluid.

### 3.4. Deep electromechanical ice core from central Greenland

At the same location in central Greenland, a 3028.8 m long ice core was recovered by electromechanical drilling in 1990–1992 as part of the joint European Greenland Ice Core Project (“GRIP”). This core covers the last 250,000 years [5].

The electromechanical drill is described in detail in Ref. [25]. Because the depth to be reached was very important, the drilling hole was filled with a wall retaining fluid. The main constituent of the fluid was kerosene. We have decontaminated various sections of this deep ice core. Because many other programmes of investigations were conducted on the same core sections, only a limited part of the core cross section (see Fig. 2b and c) was available.

Significant contamination was found to be present in the outermost layer of the sections. This contamination probably originates at least partially from the fluid. Good plateaus of concentrations were however obtained in most cases as illustrated in Fig. 8 for Pb in the 1286 m section (age: 7760 years BP) and for Zn in the same section. This evidences that the ice acted as a good barrier against transfer of contamination from the outside towards the center of the core, at least for the investigated core sections which were chosen because no visible cracks were seen in them.

Pb concentration, 0.55 pg/g, measured in the inner core of the 1,286 m core section represents the natural

concentration level of Pb in Greenland ice before the Greco-Roman times when man started to significantly contaminate the atmosphere of the Northern Hemisphere because of silver-lead mining and smelting [26,27]. As discussed in [27], it mainly originated from rock and soil dust.

### 3.5. Deep thermal ice core from central Antarctica

In 1977, 1978 a 905-m ice core was thermally drilled at Dome C (77°39'S, 124°10'E; elevation 3240 m a.s.l.; mean annual temperature: -53.5°C) as part of a French-American cooperation. It was thermally drilled in a dry hole which was not filled with a wall retaining fluid [28]. This core covers the past 40,000 years [29] i.e. the whole Holocene interglacial period (the past 10,000 years or so) and part of the last Ice Age. Fig. 9 displays the variations of Pb and Cd concentrations from the outside to the center of the 515 m core section (age: 14,500 years BP). Despite the fact that the core was obtained in a dry hole without fluid, pronounced contamination is present on the outside of the section. This contamination is found to have significantly penetrated to the second layer. Fortunately, a good plateau of concentration is obtained beyond this second layer (Fig. 9).

Pb and Cd concentrations observed in the central part of this core section, 7.8 pg/g and 0.5 pg/g, respectively, are typical for Antarctic ice from the Last Glacial Maximum (LGM), i.e. the very cold terminal stage of

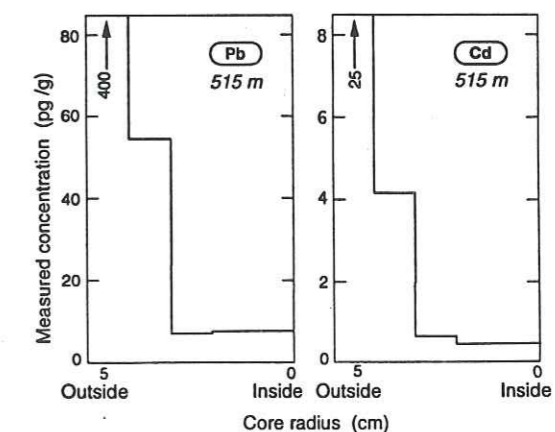

Fig. 9. Measured Pb and Cd concentrations as a function of radius in one section (depth: 514.89–515.07 m; estimated age 14,500 years BP) of the 905 m deep ice core thermally drilled at Dome C, East Antarctica.

the last Ice Age. They are mainly originating from soil and rock dust: the atmospheric cycles of these two metals were indeed dominated by rock and soil dust during the LGM when the climatic conditions led to increased aridity, stronger winds and enhanced meridional circulations [11,30].

#### Acknowledgements

This work was supported by the French Ministry of the Environment (Grant No. 92295), the Institut National des Sciences de l'Univers and the University of Grenoble. The Greenland samples were collected as part of the Eurocore and GRIP programmes which were funded by the Commission of European Communities and national funding agencies and organizations in Belgium, Denmark, France, Germany, Iceland, Italy, Switzerland and the United Kingdom. The Antarctic samples were collected as part of a French–American collaboration which was funded by the Expéditions Polaires Françaises, the Terres Australes et Antarctiques Françaises and the Division of Polar Programmes of the US National Science Foundation. We thank C. Rado, R.J. Delmas and F. Maupetit for their participation in the Eurocore field sampling.

#### References

- [1] E.W. Wolff and E.D. Suttie, *Geophys. Res. Lett.*, 21 (1994) 781.
- [2] E.D. Suttie and E.W. Wolff, *Tellus*, 44B (1992) 351.
- [3] M. Murozumi, T.J. Chow and C.C. Patterson, *Geochim. Cosmochim. Acta*, 33 (1969) 1247.
- [4] C.F. Boutron, U. Görlach, J.P. Candelone, M.A. Bolshov and R.J. Delmas, *Nature*, 353 (1991) 153.
- [5] W. Dansgaard, S.J. Johnsen, H.B. Clausen, D. Dahl-Jensen, N.S. Gundestrup, C.U. Hammer, C.S. Hvidberg, J.P. Steffensen, A.E. Sveinbjörnsdóttir, J. Jouzel and G. Bond, *Nature*, 364 (1993) 218.
- [6] J. Jouzel, C. Lorius, J.R. Petit, C. Genthon, N.I. Barkov, V.M. Kotlyakov and V.N. Petrov, *Nature*, 329 (1987) 403.
- [7] B.B. Kudryashov, V.K. Chistyakov, V.M. Pashkevich and V.N. Petrov, in G. Holdsworth, K.C. Kuivinen and J.H. Rand (Eds.), *Proceedings of the Second International Symposium on Ice Drilling Technology*, Calgary, Canada, 30–31 August 1982, US Army Cold Regions Research and Engineering Laboratory, Special Report 84-34, Hanover, New Hampshire, 1984, p. 137.
- [8] T.A. Gosink, J.T. Kelley, B.R. Koci, T.W. Burton and M.A. Tumeo, *J. Glaciol.*, 37 (1991) 170.
- [9] A. Ng and C.C. Patterson, *Geochim. Cosmochim. Acta*, 45 (1981) 2109.
- [10] C.F. Boutron and C.C. Patterson, *Geochim. Cosmochim. Acta*, 47 (1983) 1355.
- [11] C.F. Boutron and C.C. Patterson, *Nature*, 323 (1986) 222.
- [12] E.W. Wolff and D.A. Peel, *Ann. Glaciol.*, 7 (1985) 61.
- [13] C.F. Boutron, *Fresenius' Z. Anal. Chem.*, 337 (1990) 482.
- [14] P.J. Paulsen, E.S. Beary, D.S. Bushee and J.R. Moody, *Anal. Chem.*, 60 (1988) 971.
- [15] U. Görlach and C.F. Boutron, *Anal. Chim. Acta*, 236 (1990) 391.
- [16] K.J.R. Rosman, W. Chisholm, C.F. Boutron, J.P. Candelone and U. Görlach, *Nature*, 362 (1993) 333.
- [17] R. Lobinski, C.F. Boutron, J.P. Candelone, S. Hong, J. Szpunar-Lobinska and F.C. Adams, *Anal. Chem.*, 65 (1993) 2510.
- [18] G.M. Vandal, W.F. Fitzgerald, C.F. Boutron and J.P. Candelone, *Nature*, 362 (1993) 621.
- [19] M.A. Bolshov, S.N. Rudniev, J.P. Candelone, S. Hong and C.F. Boutron, *Spectrochim. Acta B*, in press.
- [20] J.P. Candelone, M.A. Bolshov, S.N. Rudniev, S. Hong and C.F. Boutron, *J. Phys.*, C4 (1994) 661.
- [21] F. Gillet, D. Donnou, C. Girard, A. Manouvrier, C. Rado and G. Ricou, in G. Holdsworth, K.C. Kuivinen and J.H. Rand (Eds.), *Proceedings of the Second International Symposium on Ice Drilling Technology*, Calgary, Canada, 30–31 August 1982, US Army Cold Regions Research and Engineering Laboratory, Special Report 84-34, Hanover, New Hampshire, 1984, p. 73.
- [22] J.P. Candelone, S. Hong and C.F. Boutron, *J. Geophys. Res.*, submitted
- [23] J.O. Nriagu, *Nature*, 209 (1979) 409.
- [24] J.O. Nriagu and J.M. Pacyna, *Nature*, 323 (1988) 134.
- [25] N.S. Gundestrup and S.J. Johnsen, in C.C. Langway Jr., H. Oeschger and W. Dansgaard (Eds.), *Greenland Ice Cores: Geophysics, Geochemistry and the Environment*, Geophysical Monograph (American Geophysical Union), 33 (1985) 19.
- [26] C.C. Patterson and D.M. Settle, *Science*, 207 (1980) 1167.
- [27] S. Hong, J.P. Candelone, C.C. Patterson and C.F. Boutron, *Science*, in press.
- [28] C. Lorius, L. Merlivat, J. Jouzel and M. Pourchet, *Nature*, 280 (1979) 644.
- [29] J. Jouzel, G. Raisbeck, J.P. Benoist, F. Yiou, C. Lorius, D. Raynaud, J.R. Petit, N.I. Barkov, Y.S. Korotkevich and V.M. Kotlyakov, *Quat. Res.*, 31 (1989) 135.
- [30] C.F. Boutron, S.N. Rudniev, M.A. Bolshov, V.G. Koloshnikov, C.C. Patterson and N.I. Barkov, *Earth Planet. Sci. Lett.*, 117 (1993) 431.

*Science*, 265, 1841–1843, 1994

### Greenland ice evidence of hemispheric lead pollution two millennia ago by Greek and Roman civilizations

S. Hong, J.P. Candelone, C.C. Patterson and C.F. Boutron

## Greenland Ice Evidence of Hemispheric Lead Pollution Two Millennia Ago by Greek and Roman Civilizations

Sungmin Hong, Jean-Pierre Candelone, Clair C. Patterson, Claude F. Boutron\*

Analysis of the Greenland ice core covering the period from 3000 to 500 years ago—the Greek, Roman, Medieval and Renaissance times—shows that lead is present at concentrations four times as great as natural values from about 2500 to 1700 years ago (500 B.C. to 300 A.D.). These results show that Greek and Roman lead and silver mining and smelting activities polluted the middle troposphere of the Northern Hemisphere on a hemispheric scale two millennia ago, long before the Industrial Revolution. Cumulative lead fallout to the Greenland Ice Sheet during these eight centuries was as high as 15 percent of that caused by the massive use of lead alkyl additives in gasoline since the 1930s. Pronounced lead pollution is also observed during Medieval and Renaissance times.

The history of human lead production began about six millennia ago (Fig. 1A) (1–7). Significant lead production started only

S. Hong and J.-P. Candelone, Laboratoire de Glaciologie et Géophysique de l'Environnement du CNRS, 54 rue Molière, Domaine Universitaire, B.P. 96, 38402 Grenoble/Saint Martin d'Hères, France.

C. C. Patterson, Division of Geological and Planetary Sciences 170-25, California Institute of Technology, Pasadena, CA 91125, USA.

C. F. Boutron, Laboratoire de Glaciologie et Géophysique de l'Environnement du CNRS, 54 rue Molière, Domaine Universitaire, B.P. 96, 38402 Grenoble/Saint Martin d'Hères, and UFR de Mécanique, Université Joseph Fourier de Grenoble, Domaine Universitaire, B.P. 68, 38041 Grenoble, France.

\*To whom correspondence should be addressed.

about one millennium later with the discovery of new techniques for smelting lead-silver alloys from lead sulfide ores (galena) and cupeling silver from the alloys (1–7). Lead production then rose continuously during the Copper, Bronze, and Iron ages (5, 6, 8), stimulated by the introduction of silver coinage (during those times, lead was as much as a 300-to-1 by-product of silver production) and the development of Greek civilization. A pronounced maximum of about 80,000 metric tons per year (approximately the rate at the time of the Industrial Revolution) was reached during the flourishing of Roman power and influence

around two millennia ago (Fig. 1A). The use of lead was ubiquitous, and most districts that were suitable for mining in the Old World were known and worked, especially those in Spain, the Balkans, Greece, and Asia Minor (5, 7). Lead production then decreased sharply during the decline of the Roman Empire, down to a minimum of only a few thousand tons per year during medieval times, before increasing again from A.D. 1000 with the discovery of the lead and silver mines of Central Europe.

Lead poisoning from extensive lead production and use during Roman times has been suggested as one of the causes of the fall of Rome (5, 9, 10). Smelter emissions from these sources have also been documented as resulting in significant local or even regional lead pollution in Europe, as evidenced, for instance, by studies of peat deposits in Britain (11, 12) and lake sediments in southern Sweden (13). We show here that smelter emissions also resulted in significant contamination of the middle troposphere of the remote Arctic. This occurrence marks the oldest large-scale hemispheric pollution ever reported, long before the onset of the Industrial Revolution.

We analyzed 22 sections of the 3028.8-m European Greenland Ice-Core Project (GRIP) deep ice core electromechanically drilled in 1990 to 1992 at Summit (72°34'N, 37°37'W, elevation of 3238 m above sea level, annual mean air temperature of -32°C) in central Greenland (14). Fourteen sections were selected from the period between 2360 and 1775 years ago (depths of 511.0 to 349.3 m), which are the ~600 years corresponding to the flourishing of the Roman Republic and Empire. Two sections were selected from ice deposited 3000 to 2500 years ago (depths of 619.3 to 569.3 m, respectively), a period that includes the rise of Greek civilization. Five sections were selected from ice deposited 1520 to 470 years ago (depths of 349.3 to 129.3 m, respectively), during the Medieval and Renaissance periods. Finally, one section was chosen in ice from the pre-lead production period (7760 years ago, depth of 1286.5 m) to serve as a Holocene natural background sample. It was not possible to analyze samples deposited 3500 to 7000 years ago because this period corresponds to the brittle-zone depth interval in which the core quality is too poor to allow reliable measurements of heavy metals.

We mechanically decontaminated each core section (length of 55 cm) using an ultraclean procedure (17) derived from those of Patterson and his co-workers (15, 16). It involved the chiseling of successive veneers of ice from the outside to the central part of each section inside a laminar-flow clean bench in a cold room while the core was held horizontally in an all-polyeth-



ylene lathe (17). Each veneer layer was analyzed separately in a clean laboratory (18). Lead contents were determined with a precision of about  $\pm 10\%$  by graphite furnace atomic absorption spectrometry (GFAAS) after preconcentration by non-boiling evaporation (19). We also determined Al and Na contents by direct GFAAS and  $\text{SO}_4^{2-}$  contents by ion chromatography. Blank determinations were performed for each step of the analytical procedure. They included an evaluation of the blank contributed by the chiseling procedure, which was determined (17) by processing an artificial ice core made by freezing ultrapure water (18) whose Pb content was known beforehand. This last blank contribution was found to be 0.11 pg per gram of ice (pg/g) for the innermost veneer layer and 0.17 pg/g for the other layers (17).

To check the cleanliness of the most central part of the cores obtained after the chiseling was completed, we studied changes of Pb concentrations from the outside to the center of each of the 22 sections. Significant contamination was observed on the outside (first) layer of the sections, which confirms that they were significantly contaminated on their outside during drilling

operations. On the other hand, excellent plateaus of concentrations were obtained from the second or third layers (Table 1). These plateaus serve as evidence that Pb concentrations measured in the most central part of the core sections do represent the original concentrations in Greenland ice.

The results (Fig. 1B) show that Pb concentration was low (0.55 pg/g, 7760 years ago) before the beginning of lead production, when atmospheric Pb still entirely originated from natural sources (24). The corresponding lead crustal enrichment factor ( $\text{EF}_{\text{crust}}$ ) (19) of 0.8, which is close to unity, shows that virtually all this natural Pb was from soil and rock dust [sea-salt spray and volcanic contributions are minor as calculated (16) from the measured Na and  $\text{SO}_4^{2-}$  concentrations]. The Pb concentration at 2960 years ago, about 5000 years later, was essentially identical to that at the beginning of Pb production, showing that anthropogenic emissions of Pb to the atmosphere 3000 years ago were still negligible on a hemispheric scale compared with Pb originating from soil and rock dust [about 4000 metric tons per year for both hemispheres (24)]. Then, at 2500 years ago our record shows that Pb concentration

started to increase markedly above this natural background up to about 2 pg/g ( $\text{EF}_{\text{crust}} \sim 3$ ), which is an increase by a factor of  $\sim 4$ , and Pb concentration remained high from  $\sim 2500$  to  $\sim 1700$  years ago. This 800-year period corresponds to the flourishing of the Greco-Roman civilizations (Fig. 1A). Lead concentration declined to low values (0.7 pg/g) around 1500 years ago (that is, after the fall of the Roman Empire) and then increased continuously from 1500 to 500 years ago, during the Medieval and Renaissance times.

The high (about fourfold the natural level) Pb concentration and  $\text{EF}_{\text{crust}}$  observed in Greenland ice from  $\sim 2500$  to  $\sim 1700$  years ago cannot be explained by an increase in natural Pb emissions to the atmosphere: The measured Al, Na, and  $\text{SO}_4^{2-}$  concentrations in the ice do not change significantly during the whole period covered by our samples. We interpret the increase as a result of anthropogenic Pb emissions to the atmosphere from the large lead-silver production by Greeks and Romans [production in the other parts of the world such as Asia was minor and is unlikely to have made a significant contribution (5, 6)]. This production peaked at about 80,000 metric tons per year around 2000 years ago, and it is estimated that  $\sim 5\%$  of the mined and smelted Pb was emitted to the atmosphere (25), which would have given a peak value of  $\sim 4000$  metric tons per year to the atmosphere. The data show that the resulting pollution was not only local (5, 6, 9-10) or regional (11-13) in scale but reached the middle troposphere (Summit is located at a high elevation of 3238 m above sea level) of the remote Arctic region. It represents the oldest hemispheric-scale atmospheric pollution ever reported, well before the Industrial Revolution.

The fourfold increase during the Greco-Roman period for a middle troposphere location in central Greenland is in excellent

**Fig. 1.** (A) Changes in worldwide Pb production over the past 5500 years [redrawn from (3, 4)]. (B and C) Changes in Pb concentration and Pb crustal enrichment factor (19) in central Greenland ice from 2960 to 470 years ago. Each data point was obtained from the analysis of a core length corresponding to exactly 2 years of ice accumulation (except one for which it was only 1 year because of poor core quality) to eliminate the influence of possible short-term (seasonal) changes in Pb deposition.

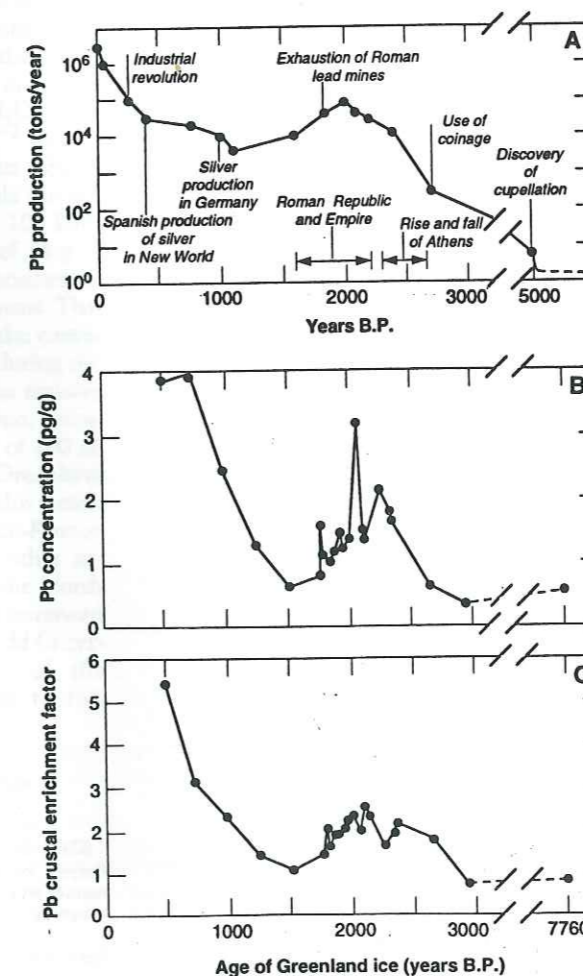

**Table 1.** Lead concentrations measured in the second and third layers and in the final inner core for five typical GRIP ice-core sections. For three of these sections (129.25, 399.3, and 1286.45 m), the concentrations are virtually the same in all three subsamples: Contamination was only present in the outside (first) layer. For the 349.25- and 510.95-m sections, the outside contamination reached the second layer but the third layer and the inner core remained free of contamination.

| Depth (m) | Age (years ago) | Measured Pb concentration (pg/g) |           |            |
|-----------|-----------------|----------------------------------|-----------|------------|
|           |                 | 2nd layer                        | 3rd layer | Inner core |
| 129.25    | 470             | 4.77                             | 3.99      | 3.90       |
| 349.25    | 1520            | 1.79                             | 0.65      | 0.66       |
| 399.3     | 1775            | 1.06                             | 1.07      | 1.17       |
| 510.95    | 2360            | 43                               | 1.64      | 1.64       |
| 1286.45   | 7760            | 0.57                             | 0.56      | 0.55       |

agreement with that (about fivefold) hypothesized by Shirahata and colleagues (25); it is lower than the increase (about tenfold) speculated by Patterson earlier (26). During the Greco-Roman times, most Pb emitted to the atmosphere would have been due to lead-silver mining and smelting in Spain (which represented ~40% of the worldwide Pb production during the Roman Empire), Central Europe, Britain, the Balkans, Greece, and Asia Minor (5, 6). The Pb was produced in open-air furnaces with no control on emission rates. Small Pb aerosol particles emitted during these activities could easily be transported from these regions to the Arctic through well-known pathways (27, 28). However, differences in transport efficiencies between the different source regions and central Greenland cannot be ruled out. Such differences could, for instance, help to explain why Pb levels in the ice during the Greek and Roman periods are similar, although Pb production was severalfold lower during Greek times. An alternative explanation could be the differences in Pb emission rates for mining and smelting activities between the Greek and Roman times or uncertainties in the historical data shown in Fig. 1A.

The cumulative anthropogenic Pb fallout over Greenland from ~2500 to 1700 years ago, estimated by combining a Pb excess value of ~1 pg/g over the value during the pre-Pb time with a mean ice accumulation rate of 23 g of H<sub>2</sub>O cm<sup>-2</sup> year<sup>-1</sup>, is 23 × 10<sup>-12</sup> g of Pb cm<sup>-2</sup> year<sup>-1</sup>. Over 800 years, this rate represents 1.84 × 10<sup>-8</sup> g of Pb cm<sup>-2</sup>. For the whole Greenland ice cap (surface of 1.4 × 10<sup>6</sup> km<sup>2</sup>, mean annual accumulation rate of 34 g of H<sub>2</sub>O cm<sup>-2</sup> year<sup>-1</sup>), the net deposition is about 400 tons during these 800 years. This estimate is as much as ~15% of the cumulative fallout of Pb to Greenland during the past 60 years that is linked to the massive use of Pb alkyl additives in gasoline, calculated from a mean concentration of 100 pg of Pb per gram in 1930 to 1990 Greenland snow (29). Further evidence of this hemispheric-scale pollution by Greco-Roman civilization might be found in other archives, such as sea sediments in the North Atlantic Ocean and in the Mediterranean Sea. Analyses of lead isotopes could fingerprint the relative contributions of the different ancient mining districts to this pollution.

#### REFERENCES AND NOTES

1. C. C. Patterson, *Am. Antiq.* **36**, 286 (1971).
2. ———, *Econ. Hist. Rev.* **25** (2nd ser.), 205 (1972).
3. ———, "Lead in the Human Environment," report prepared by the Committee on Lead in the Human Environment (National Academy of Sciences, Washington, DC, 1980), pp. 265–349.
4. D. M. Settle and C. C. Patterson, *Science* **207**, 1167 (1980).

5. J. O. Nriagu, *Lead and Lead Poisoning in Antiquity* (Wiley, New York, 1983).
6. ———, *Sci. Total Environ.* **31**, 105 (1983).
7. C. C. Patterson, H. Shirahata, J. E. Ericson, *ibid.* **61**, 167 (1987).
8. R. J. Hopper, *Ann. Br. School Athens* **63**, 293 (1968).
9. S. C. Gillfillan, *J. Occ. Med.* **7**, 53 (1965).
10. J. O. Nriagu, *N. Engl. J. Med.* **308**, 660 (1983).
11. J. A. Lee and J. H. Tallis, *Nature* **245**, 216 (1973).
12. M. H. Martin, P. J. Coughtrey, P. Ward, *Proc. Bristol Nat. Soc.* **37**, 91 (1979).
13. I. Renberg, M. W. Persson, O. Emteryd, *Nature* **368**, 323 (1994).
14. W. Dansgaard *et al.*, *ibid.* **364**, 218 (1993).
15. A. Ng and C. C. Patterson, *Geochim. Cosmochim. Acta* **45**, 219 (1981).
16. C. F. Boutron and C. C. Patterson, *Nature* **323**, 222 (1986).
17. J. P. Candelone, S. Hong, C. F. Boutron, *Anal. Chim. Acta*, in press.
18. C. F. Boutron, *Fresenius Z. Anal. Chem.* **337**, 482 (1990).
19. U. Görlich and C. F. Boutron, *Anal. Chim. Acta* **236**, 391 (1990).
20. Dating of the core sections has been performed by use of the known volcanic events and interpolation among these events with a glaciological model (S. Johnsen, personal communication, 1994).
21. The lead crustal enrichment factor is defined as
 
$$EF_{\text{crust}}(\text{Pb}) = (\text{Pb}_{\text{ice}}/\text{Al}_{\text{ice}})/(\text{Pb}/\text{Al})_{\text{mean crust}}$$
 where Pb<sub>ice</sub> and Al<sub>ice</sub> are the measured concentrations of Pb and Al in the ice, respectively, and (Pb/Al)<sub>mean crust</sub> is the Pb/Al ratio in mean crustal material given by Taylor and McLennan (22). Such crustal reference material is appropriate to characterize the composition of soil- and rock-derived dust (23).
22. S. R. Taylor and S. M. McLennan, *The Continental Crust: Its Composition and Evolution* (Blackwell, Oxford, 1985).
23. L. Schütz and K. A. Rahn, *Atmos. Environ.* **16**, 171 (1982).
24. J. O. Nriagu, *Nature* **338**, 47 (1989).
25. H. Shirahata, R. W. Elias, C. C. Patterson, *Geochim. Cosmochim. Acta* **44**, 149 (1980).
26. C. C. Patterson, in *Scientific Methods in Medieval Archaeology*, R. Berger, Ed. (Univ. of California Press, Berkeley, 1970), pp. 339–350.
27. W. E. Raatz, in *Pollution of the Arctic Atmosphere*, W. T. Sturges, Ed. (Elsevier, London, 1991), pp. 13–42.
28. T. Iversen, in *The Tropospheric Chemistry of Ozone in the Polar Regions*, H. Niki and K. H. Becker, Eds. (Springer, Berlin, 1993), pp. 57–75.
29. C. F. Boutron, U. Görlich, J. P. Candelone, M. A. Bolshov, R. J. Delmas, *Nature* **353**, 153 (1991).
30. This work is a contribution of GRIP organized by the European Science Foundation. We thank B. Stauffer and J. P. Steffensen for their very kind assistance in core selection, M. Legrand for the ion chromatography measurements, and R. J. Delmas for his continuous interest and helpful discussions. We thank the national funding agencies and organizations in Belgium, Denmark, France, Germany, Iceland, Italy, Switzerland, and the United Kingdom as well as the XII Directorate of the Commission of European Communities for financial support. Supported by the French Ministry of the Environment (grant 92295), the Institut National des Sciences de l'Univers, and the University of Grenoble.

20 May 1994; accepted 5 August 1994





*Grenoble, novembre 1995*

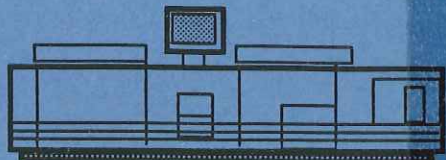

*Impression et finition réalisées sur Rank Xerox 5090,  
au Service Reprographie du CNRS.*