



HAL
open science

Microsphères résorbables pour embolisation et chimio embolisation

van Nga Nguyen

► **To cite this version:**

van Nga Nguyen. Microsphères résorbables pour embolisation et chimio embolisation. Autre. Université Paris Sud - Paris XI, 2012. Français. NNT : 2012PA114808 . tel-00763493

HAL Id: tel-00763493

<https://theses.hal.science/tel-00763493>

Submitted on 21 Jan 2013

HAL is a multi-disciplinary open access archive for the deposit and dissemination of scientific research documents, whether they are published or not. The documents may come from teaching and research institutions in France or abroad, or from public or private research centers.

L'archive ouverte pluridisciplinaire **HAL**, est destinée au dépôt et à la diffusion de documents scientifiques de niveau recherche, publiés ou non, émanant des établissements d'enseignement et de recherche français ou étrangers, des laboratoires publics ou privés.

UNIVERSITÉ PARIS-SUD 11

ECOLE DOCTORALE :

INNOVATION THÉRAPEUTIQUE : DU FONDAMENTAL A L'APPLIQUÉ
PÔLE : PHARMACOTECHNIE ET PHYSICO-CHIMIE PHARMACEUTIQUE

DISCIPLINE :

4100684 Pharmacotechnie et biopharmacie

ANNÉE 2011 - 2012

SÉRIE DOCTORAT N° 1138

THÈSE DE DOCTORAT

soutenue le 27/02/2012

par

Van Nga NGUYEN

Microsphères résorbables pour embolisation et chimio-embolisation

Directeur de thèse : Denis LABARRE, Professeur, (UMR CNRS 8612 - Univ Paris Sud)
Christine VAUTHIER DR CNRS (UMR CNRS 8612 - Univ Paris Sud)

Composition du jury :

Rapporteurs :	Sandrine CAMMAS-MARION	CR CNRS, HDR (UMR CNRS 6226 - ENSC Rennes)
	Yves FRERE	CR CNRS, HDR (UPR22-CNRS - ICS Strasbourg)
Examineurs :	Elias FATTAL	Professeur (UMR CNRS 8612 - Univ Paris Sud)
	Dominique HOURDET	Professeur (UMR CNRS 7615 - Univ Paris VI-ESPCI)
	Christine VAUTHIER	DR CNRS (UMR CNRS 8612 - Univ Paris Sud)

à mes parents,

à ma sœur et ma nièce,

à Nessim,

à mon grand père,

à mes oncles, tantes et cousins,

qui m'ont soutenue et encouragée sans réserves. Cette thèse est la leur !

Je tiens à adresser mes remerciements :

au Prof. Patrick Couvreur et au Prof. Elias Fattal pour m'avoir accueillie au sein du laboratoire UMR CNRS 8612 ainsi que pour leur soutien au cours de ce projet de collaboration ;

au Dr Sandrine Cammas-Marion et au Dr Yves Frère pour avoir accepté de juger ces travaux en tant que rapporteurs ;

au Prof. Dominique Hourdet pour avoir accepté de participer au jury de la thèse ;

à la société Occlugel, au Prof. Denis Labarre et au Dr Laurence Moine pour m'avoir permis de vivre cette aventure enrichissante et inoubliable ;

l'école doctorale ED 425 « Innovation thérapeutique » dirigée par le Prof. Marc Pallardy et le Prof. Catherine Dubernet pour son soutien ;

au Dr Christine Vauthier pour sa grande disponibilité et ses conseils scientifiques qui m'ont été précieux pour appréhender les différentes étapes du projet. Je lui suis également très reconnaissante pour sa gentillesse hors du commun, pour la confiance qu'elle m'a témoignée et pour ses encouragements grâce auxquels j'ai pu surmonter les moments les plus difficiles de cette thèse ;

au Dr Nicolas Huang, au Prof. Jean-Louis Grossiord et au Prof. Florence Agnely pour leur collaboration fructueuse en rhéologie, pour leurs conseils scientifiques, leur disponibilité et leur confiance ;

au Dr Ghazlene Mekhloufi pour sa disponibilité et son aide précieuse dans les mesures de granulométrie ;

au Dr Cinda Lepêtre et au Dr Didier Desmaële pour les discussions enrichissantes et leurs conseils en chimie organique ;

au Dr Christelle Zandanel et au Dr Emile Jubeli pour nos discussions scientifiques et culturelles passionnantes ainsi que pour leur amitié et leur soutien tout au long de la thèse ;

aux différents stagiaires qui ont participé à plusieurs parties de ce travail : Audrey Lams, Elisabeth Gaudron et Sabrina Hocine ;

aux personnels techniques et administratifs du laboratoire pour leur gentillesse et leur disponibilité : Sophie Haguenin, H  l  ne Chacun, Dr Claire Gueutin, Christine Van Ngoc Ty, Christine Bernard, Patricia Livet et Sylvie Zemmour ;

aux membres de l'  quipe « Sant   Publique et Risques Environnementaux » pour leur sympathie, leur amiti   et pour m  avoir permis d'utiliser certains mat  riels (notamment la centrifugeuse) : Prof. Yves Levi, Dr Sara Karolak, Dr Lucie Oziol, Emilie Bailly, Aurore Collin, Thomas Nefau, Maya Bimbot, Viviane Huteau et Tania Boyer ;

aux amis du laboratoire pour les agr  ables moments pass  s ensemble : Dr Mariane Lira, Dr Sajeesh Sankaranarayanan, Marisa Rendina, Guillaume Collin, Anne-Laure Ramon, Guillaume David, Dr Rachel Da Costa Martins, Claire Lageat, Dr Khelil Slimani, Odile Diou, Dr Perrine Pivette, Dr El  onore Jouanny, Olivier Cauchois, Kuniyuki Hidaka, Alexis Dupuy, Dr Ali Makky, Am  lie Dufay-Wojcicki, Dr Rime Skanji, Dr Rachel Diaz Lopez, Dr Donato Teutonico, Cong Tri Truong, Thu Hanh Pham, Dr Lucien Bildstein, Dr Benjamin Le Droumaguet, Dr Franceline Reynaud, H  l  ne Marie, Floriane Sequier, Silvia Mazzaferro, Davide Brambilla, Nad  ge Grabowski et Nathalie M  nard ;

   tous ceux que j'  ai c  toy  s au laboratoire UMR CNRS 8612, au CR2i et    la facult   (statuaires,   tudiants, stagiaires, personnels techniques et administratifs) ;

   mes amis aux quatre coins du monde qui me soutiennent et m'encouragent sans cesse

TABLE DES MATIERES

AVERTISSEMENT	1
INTRODUCTION GENERALE	4
ETUDE BIBLIOGRAPHIQUE	11
<u>Projet d'article de review « Biodegradable crosslinkers for hydrogels synthesis in biomedical applications »</u>	12
1. Introduction	14
2. General methods for the synthesis of covalently crosslinked hydrogels	18
3. Chemical nature of hydrolysable covalently crosslinked hydrogels	31
4. Formulation and applications of hydrolysable covalently crosslinked hydrogels in the biomedical field	58
5. Conclusion	67
6. References	68
TRAVAUX EXPERIMENTAUX	79
Introduction	80
Chapitre 1 - Synthèse de microsphères constituées d'un hydrogel hydrolysable	86
1. Introduction	87
2. Etude des conditions d'obtention de microsphères d'hydrogel résorbables par polymérisation en suspension directe	90
<u>Projet d'article 2 « A new class of biodegradable microspheres for therapeutic embolization »</u>	92

Abstract	93
Introduction	94
Materials and methods	96
Results and discussions	104
Conclusions	117
Acknowledgement	117
References	118
3. Etude des conditions d'obtention de microsphères d'hydrogel résorbables par polymérisation en suspension inverse	121
3.1. Matériels	122
3.2. Méthodes de synthèses	122
3.3. Résultats	125
4. Synthèse de microsphères d'hydrogel hydrolysables chargées en principe actif	130
4.1. Chargement des microsphères par une méthode de gonflement	131
4.2. Chargement des microsphères par copolymérisation d'une prodrogue d'un agent anti-inflammatoire	135
Bibliographie	141
Chapitre 2 - Développement de méthodes de caractérisation de la dégradation des microsphères hydrolysables	144
Introduction	145
<u>Projet d'article 3 « Rheology as a tool for characterisation of mechanical properties of chemically crosslinked microspheres and for monitoring their degradation »</u>	148
Abstract	149
Introduction	150
Materials and methods	152
Results and discussions	157
Conclusions	168
Acknowledgement	169
References	169
Chapitre 3 - Caractérisation de la dégradation des microsphères constituées d'un hydrogel hydrolysable	173
Introduction	174

<u>Projet d'article 4 « Rheology as a tool for characterisation of mechanical properties of chemically crosslinked microspheres and for monitoring their degradation »</u>	176
Abstract	177
Introduction	178
Materials and methods	179
Results	186
Discussions	196
Conclusions	200
Acknowledgement	201
References	201

DISCUSSION GENERALE	205
1. Synthèse des microsphères d'hydrogel	208
2. Synthèse de microsphères pour embolisation chargées en principes actifs	211
3. Caractérisation des microsphères	212
3.1. Développement d'une méthode de mesure des propriétés de résistance mécanique des microsphères basée sur un test de compression	213
3.2. Développement d'une méthode de mesure des propriétés rhéologiques des microsphères et application à la caractérisation de leur dégradation	216
3.3. Développement d'une méthode de mesure du gonflement des microsphères et application à la caractérisation de leur dégradation	218
3.4. Etude de la dégradation des microsphères	219
Bibliographie	223

CONCLUSIONS GENERALE ET PERSPECTIVES	224
---	------------

Table des abréviations

AAn	Acide Acrylique neutralisé à 75%
AIBN	Azobisisobutyronitrile
AP	Ammonium Peroxodisulfate
DCC	N,N'-dicyclohexylcarbodiimide
DMA	N-diméthyle acrylamide
DMAP	4-diméthyle aminopyridine
DSP	polymérisation en suspension directe
GMA	méthacrylate de glycidyle
HEMA	(2-hydroxyéthyle) méthacrylate
ISP	polymérisation en suspension inverse
MBA	N,N'-Méthylènebisacrylamide
MS	microsphères
PEG1500	poly(éthylène glycol) avec la masse moyenne de 1500 g/mol
PEGDMA	poly(éthylène glycol diméthacrylate)
PEGMA	Poly(éthylène glycol) méthacrylate
PEGMMA	Poly(ethylene glycol methyl éther methacrylate)
PLGA	Poly(acide lactique- <i>co</i> -glycolique)
PVA	poly(vinyl alcohol)
RMN	Résonance magnétique nucléaire
Rpm	Tour par minute
Sn(Oct) ₂	octoate d'étain
Span 80 [®]	Sorbitan oleate
TEA	triéthyleamine
TEMED	N, N, N', N'-tetramethylethylenediamine
TEG	tétra(éthylène glycol)
Tris	N-acryloyle tris(hydroxyméthyle) aminométhane

Avertissement

Le besoin de créer une microsphère résorbable pour l'embolisation a donné lieu en 2005 à une réflexion associant le Département de Neuroradiologie Interventionnelle de l'Hôpital Lariboisière APHP (Dr. A. Laurent) et le Laboratoire des biomatériaux de l'UMR CNRS 8612 et Paris XI (Prof. D. Labarre, Dr. L. Moine).

La solution technique imaginée alors pour répondre au besoin médical a été la synthèse de microsphères par polymérisation en suspension de macromonomères hydrolysables à base de PLGA en présence d'un comonomère de PEG.

Courant 2006-2007, des travaux de faisabilité ont montré la possibilité de synthétiser de telles molécules et de les introduire dans un procédé de polymérisation en suspension. Cela a abouti à une collaboration de trois ans (débutée le 15 octobre 2007) entre l'UMR CNRS 8612 et la société Occlugel, sous forme d'une thèse CIFRE réalisée par Melle Nguyen sous la responsabilité du Pr. D. Labarre, puis, après son départ en retraite, sous celle du Dr. C. Vauthier. Le Dr. L. Moine, collaboratrice proche du Pr. D. Labarre et spécialiste des polymères résorbables et des procédés de polymérisation en suspension, a étroitement collaboré aux différents travaux menés jusqu'en fin 2009.

Les différents procédés et applications ont fait l'objet du dépôt le 10 septembre 2009 :

- ✓ d'une demande de brevet provisoire américaine déposée à l'Office américain des brevets (USPTO) sous le n° 61/241 183 et intitulée « *Implantable bio-resorbable polymer* » et
- ✓ d'une demande de brevet européen EP 0930 5830 intitulée « *Implantable bio-resorbable polymer* », qui a été étendue par voie de PCT en septembre 2010. Son contenu a été porté à la connaissance de la communauté via publication en date du 16 mars 2011.

Les inventeurs de la technologie sont les personnes suivantes :

- Monsieur Alexandre LAURENT, MCU-PH, Service de Neuroradiologie de l'hôpital Lariboisière, AP-HP,
- Monsieur Denis LABARRE, PU, Laboratoire Biomatériaux et Polymères, UPS 11,
- Madame Laurence MOINE, CNRS,
- Monsieur Laurent BEDOUET, OCCLUGEL,
- Monsieur Michel WASSEF, MCU-PH, Service de Cytologie et Anatomie Pathologique de l'hôpital Lariboisière, AP-HP,
- Mademoiselle Van Nga NGUYEN, OCCLUGEL.

L'AP-HP, le CNRS, l'UPS 11, l'UPD 7 et OCCLUGEL sont copropriétaires du Brevet, de certaines inventions et découvertes relatives à des polymères gonflants et résorbables, chargeables pour implantation humaine ou animale.

Les quatre articles inclus dans le présent rapport de thèse sont à l'état de projet et n'ont pas encore été validés pour publication par la société OCCLUGEL.

Introduction générale

L'embolisation thérapeutique est devenue une méthode de choix pour le traitement des tumeurs hypervasculaires, des hémorragies ainsi que des malformations artériovéneuses [Hovsepian et al. 2004, Syed et al. 2007, Artinyan et al. 2008]. Le but de l'intervention est d'occlure de manière sélective les vaisseaux sanguins qui constituent ou qui nourrissent une lésion, ou de boucher une lésion portée par un ou plusieurs vaisseaux.

L'acte chirurgical est réalisé par un radiologue. L'agent embolisant est conduit jusqu'à l'endroit où il doit être injecté à l'aide d'un cathéter sans compromettre le flot sanguin dans le reste de la circulation. Le médecin observe en temps réel l'acheminement du cathéter dans le réseau vasculaire sous rayon X et à l'aide d'un agent de contraste pour l'amener jusqu'à la lésion à traiter. L'intervention est dite mini-invasive car elle ne nécessite qu'une ponction fémorale, évitant une ouverture importante comme dans les techniques chirurgicales classiques. Elle peut être réalisée sous une simple anesthésie locale et nécessite généralement une courte durée d'hospitalisation. Concernant l'agent d'embolisation, une définition en a été proposée par le Docteur Laurent dans un texte publié en 2006. Cette définition est reprise dans la citation suivante « On peut définir comme agent d'embolisation vasculaire tout produit sous une forme quelconque (solide/liquide) qui peut être largué dans un flux sanguin pour se bloquer dans le vaisseau où il détermine une occlusion temporaire ou durable » [Laurent 2006]. Dans la pratique, les agents d'embolisation se présentent sous forme de particules de forme et de taille plus ou moins calibrées, de spires métalliques (coils), de solutions gélifiantes ou de microsphères [<http://www.brainaneurysm.com/aneurysm-treatment.html>, <http://pennstatehershey.org/web/stroke/patientcare/services/onyx>, <http://www.ajronline.org/content/178/1/135.full>, www.biospheremed.com].

Parmi les particules d'embolisation, les microsphères calibrées constituent une classe d'agent d'embolisation vasculaire particulièrement bien adaptée pour cette application. Leur

forme sphérique et la maîtrise de leur taille offrent un avantage décisif par rapport aux autres particules pour le ciblage de l'occlusion. En effet, par le choix de leur taille, on peut prévoir le niveau de pénétration de l'embolie dans un tissu tumoral par exemple. Cet avantage peut être crucial dans le cas où la microsphère porte une charge de médicament anticancéreux destinée à une délivrance locale intra ou péri-tumorale.

En fonction de l'application thérapeutique, il peut être souhaitable l'embolisation soit permanente ou temporaire. Quelque soit la qualité de l'embolisation recherchée, les matériaux dégradables constituant les emboles s'avèrent plus adaptées [Schwarz et al. 2004; Zhang and Schwarz 2006; Moine et al. 2011; Weng et al. 2011]. Ces matériaux sont également intéressants pour d'autres applications qui nécessitent une implantation *in vivo*, comme pour la réparation et régénération tissulaire [Alsberg et al. 2003; Tan and Marra 2010], l'encapsulation de cellules [Temenoff et al. 2004; Nicodemus and Bryant 2008] ou la formulation de systèmes à libération contrôlée de principe actif [Park et al. 1993; Hatefi and Amsden 2002; Miyata et al. 2002; Hamidi et al. 2008].

Dans beaucoup de cas cliniques comme par exemple une hémorragie, des tumeurs bénignes (fibrome utérin) ou maligne (hépatocarcinome), un agent d'embolisation TEMPORAIRE pourrait être plus bénéfique sur le plan thérapeutique tout en apportant plus de confort aux patients. En effet, l'utilisation d'un agent d'embolisation non dégradable pourra entraîner des effets indésirables avec un risque d'inflammation importante. En outre, dans le cas du traitement par embolisation des tumeurs ischiémo-sensibles comme le fibrome utérin, il est inutile de prolonger l'occlusion vasculaire au-delà du temps nécessaire pour obtenir la nécrose de la tumeur. Une recanalisation rapide ne peut que profiter à l'organe pour l'aider à reprendre un fonctionnement physiologique normal et à éliminer les tumeurs nécrosées. Dans d'autres cas cliniques comme celui des tumeurs malignes hypervasculaires

(rencontrées dans l'hépatocarcinome), il est intéressant d'éliminer la tumeur en combinant l'occlusion vasculaire à la délivrance d'un principe actif chargé dans les microsphères. Cette technique, connue sous le nom de chimio-embolisation, permet de concentrer de manière considérable la charge médicamenteuse au niveau de la tumeur et donc de diminuer la concentration systémique et en même temps les effets indésirables. Au-delà du ciblage permettant la délivrance du principe actif à la tumeur, il est souhaitable d'obtenir une recanalisation des vaisseaux nourriciers pour éviter la destruction totale de l'organe atteint qui comporte encore du tissu sain et fonctionnel et pour permettre l'application de nouvelles cures de chimio-embolisation ou d'autres thérapies pour obtenir la destruction totale de la tumeur.

Actuellement, seuls deux produits commerciaux sont proposés pour réaliser des embolisations temporaires. Ce sont des éponges de gélatines (Gelfoam[®] de Pfizer, Spongel[®] de Sanofi-Aventis) et des microsphères à base d'amidon (Spherex[®] de Pharmacia, Embocept[®] de PharmaCept). L'agent biodégradable le plus utilisé est l'éponge hémostatique de gélatine. Ce produit, de faible coût, est commercialisé sous forme de plaques ou réglettes (destinées à être découpées, broyées ou grattées) ou bien sous forme de particules sèches tamisées. Malgré le tamisage, aucune calibration n'est possible due à leur forme irrégulière et à la tendance des particules à s'agglomérer. Les agrégats ainsi formés peuvent parfois conduire au blocage du cathéter. De plus, les éponges de gélatines seules ne produisent qu'une occlusion partielle [Laurent 2006] : l'embolisation totale n'est atteinte qu'après l'activation de la coagulation et la formation d'un caillot sanguin en complément du matériau d'embolisation. La dégradation de l'embolisation se produit suite à la réaction inflammatoire à corps étranger. Il est très difficile d'avoir des informations précises concernant le temps de recanalisation de la variabilité de la compacité de l'éponge, de l'ampleur de la réaction inflammatoire et de l'activité enzymatique du patient [Laurent 2006]. Les microsphères biodégradables calibrées seraient une réponse aux limites présentées par ces matériaux

d'embolisation de forme irrégulière et de tailles variables et permettraient une occlusion complète et mieux ciblée avec un bien meilleur contrôle du temps de dégradation. Des microsphères biodégradables à base d'amidon ont déjà fait l'objet de recherches pour des applications dans le domaine de l'embolisation [Hilger et al. 2008]. Ces microsphères ne sont disponibles que dans une gamme de taille d'un diamètre inférieur à 100 µm ce qui compromet leur application pour réaliser des embolisations nécessitant une occlusion des vaisseaux plus grands. Ces particules se dégradent très rapidement lorsqu'elles sont isolées : elles disparaissent en quelques dizaines de minutes [Pohlen et al. 2000], ce qui est généralement trop court pour réaliser une embolisation. A l'inverse, du fait de l'accumulation d'agrégats de plusieurs dizaines voire centaines de microsphères, La résorption est alors fortement ralentie (en fonction de la taille des amas) et il devient excessivement difficile de contrôler le temps de dégradation de l'embolie qui s'est réellement formé in situ. Il faut également souligner que la dégradation enzymatique de l'amidon dépend aussi fortement du site d'implantation et des conditions physiologiques du patient. L'ensemble de ces considérations montre clairement que la dégradation des emboles produits par ces microsphères n'est pas bien maîtrisée. A ce problème s'ajoute la difficulté d'obtenir un véritable ciblage de l'occlusion du fait de la formation d'agrégats.

Actuellement, il apparaît que le développement des techniques d'embolisation temporaire est considérablement freiné par le manque de matériaux d'embolisation adaptés à leur mise en œuvre. L'expérience acquise des techniques d'embolisation menées avec des matériaux non dégradables montre très clairement que la forme idéale des emboles est une forme sphérique. Pour lever la limite au développement de l'embolisation temporaire il paraît nécessaire de développer des emboles sphériques de taille calibrée dans un matériau dont la vitesse de dégradation est parfaitement maîtrisable. Les travaux réalisés sur des microsphères biodégradables d'amidon ont mis en évidence une limite à l'utilisation de matériaux dont la

dégradation dépend d'une activité enzymatique. Ils ont également mis en évidence qu'une taille de microsphère trop petite amenait des difficultés pour contrôler le ciblage de la localisation de l'embolisation. L'objectif de notre travail de thèse a été de rechercher un matériau dont la dégradation ne dépendrait pas d'une activité enzymatique et qui pourrait être transformé en microsphères résorbables de grande taille pour embolisation. Notre recherche de matériaux dégradables implantables *in vivo* s'est tournée vers les hydrogels. Les résultats de l'étude bibliographique présentés dans la première partie du mémoire de thèse a permis de sélectionner des types d'hydrogels hydrolysables répondants *a priori* aux critères recherchés. Le travail expérimental présenté dans la deuxième partie du mémoire de thèse rapporte les résultats des études ayant portées sur la synthèse des microsphères, sur le développement d'une méthode originale pour suivre leur dégradation *in vitro* et sur l'étude de leur dégradation.

Bibliographie

Alsberg E., H. J. Kong, et al. (2003). "Regulating Bone Formation via Controlled Scaffold Degradation." *Journal of Dental Research* 82(11): 903-908.

Artinyan A, Nelson R, Soriano P, Chung V, Retseck J, Reynolds J, Marx H, Kim J and Wagman L. (2008). "Treatment response to transcatheter arterial embolization and chemoembolization in primary and metastatic tumors of the liver." *HPB (Oxford)*. 10 (6): 396-404.

Hamidi M., A. Azadi, et al. (2008). "Hydrogel nanoparticles in drug delivery." *Advanced Drug Delivery Reviews* 60(15): 1638-1649.

Hatefi A. and B. Amsden (2002). "Biodegradable injectable in situ forming drug delivery systems." *Journal of Controlled Release* 80(1-3): 9-28.

Hilger R. A., Richly H., Grubert M., Libicher M., Strumberg D., Ebert J., Hecker D., Zähringer M. (2008). « Pharmacokinetics of intra-arterial applied liposomal encapsulated doxorubicin in liver metastases or hepatocellular carcinoma: A phase I study. » *J Clin Oncol* 26: 13523.

Hovsepian DM, Siskin GP, Bonn J, Cardella JF, Clark TW, Lampmann LE, Miller DL, Omary RA, Pelage JP, Rajan D, Schwartzberg MS, Towbin RB, Walker WJ, Sacks D. (2004). □Quality improvement guidelines for uterine artery embolization for symptomatic leiomyomata. □J Vasc Interv Radiol. 15(6): 535-41.

Laurent A. (2006). "Radio diagnostic - Principes et techniques d'imagerie - Agents d'embolisation." EMC (Elsevier Masson SAS, Paris); 35-140-A-20: 1-10.

Miyata, T., T. Uragami, et al. (2002). "Biomolecule-sensitive hydrogels." Advanced Drug Delivery Reviews 54(1): 79-98.

Moine L., L. Bedouet, et al. (2011). "IMPLANTABLE BIO-RESORBABLE POLYMER " WO/2011/029867.

Nicodemus G. D. and S. J. Bryant (2008). "Cell Encapsulation in Biodegradable Hydrogels for Tissue Engineering Applications." Tissue Engineering Part B: Reviews 14(2): 149-165.

Park, K., W. S. W. Shalaby, et al. (1993). Biodegradable hydrogels for drug delivery. Lancaster, PA, Technomic Pub.

Pohlen U., Berger G., Binnenhei M., Reszka R. and Buhr H. J. (2000). □Increased Carboplatin Concentration in Liver Tumors through Temporary Flow Retardation with Starch Microspheres (Spherex) and Gelatin Powder (Gelfoam): An Experimental Study in Liver Tumor-Bearing Rabbits. □Journal of Surgical Research 92: 165 □170.

Schwarz, A., H. Zhang, et al. (2004). "Transcatheter embolization using degradable crosslinked hydrogels." Biomaterials 25(21): 5209-5215.

Syed MI, Chaudhry N, Shaikh A, Morar K, Mukerjee K and Damallie E. (2007). □Catheter-directed middle hemorrhoidal artery embolization for life-threatening rectal bleeding. □Can J Gastroenterol. 21(2): 117 □123.

Tan, H. and K. G. Marra (2010). "Injectable, Biodegradable Hydrogels for Tissue Engineering Applications." Materials 3(3): 1746-1767.

Temenoff, J. S., H. Park, et al. (2004). "In vitro osteogenic differentiation of marrow stromal cells encapsulated in biodegradable hydrogels." Journal of Biomedical Materials Research Part A 70A(2): 235-244.

Weng, L., H. C. Le, et al. (2011). "Doxorubicin loading and eluting characteristics of bioresorbable hydrogel microspheres: In vitro study." International Journal of Pharmaceutics In Press, Corrected Proof.

Zhang, H. and A. Schwarz (2006). Degradable crosslinkers and degradable crosslinked hydrogels comprising them. U. S. Pat. 7135593 B2.

Etude bibliographique

**BIODEGRADABLE CROSSLINKERS FOR HYDROGELS SYNTHESIS
IN BIOMEDICAL APPLICATIONS**

V.N.Nguyen^{1,2}, C. Vauthier^{1,3*} L. Moine^{1,3} and D. Labarre^{1,3}

1. Univ Paris Sud, Physico-chimie, Pharmacotechnie and Biopharmacie, UMR 8612, Chatenay-Malabry, F 92296
2. Occlugel SARL, Paris BioTech, 24 Rue du Faubourg Saint-Jacques, Paris, F-75014
3. CNRS, Chatenay-Malabry, F-92296

Corresponding author:
Christine Vauthier
Physico-chimie, Pharmacotechnie and Biopharmacie
UMR CNRS 8612
University Paris Sud, Faculté de Pharmacie
92296 CHATENAY-MALABRY Cedex France
Fax : 33 1 46 83 53 12
E-mail: christine.vauthier@u-psud.fr

Abstract

Hydrogels have received increasing attentions for a wide range of biomedical applications including drug delivery and tissue engineering. Progresses in synthetic chemistry make biodegradable hydrogels a very dynamic topic with development potential of new materials resolving drawbacks found with non-degradable gels and improving comfort of patients by developing new techniques of therapeutics. They are versatile materials for which properties can be tuned by the chemistry to fit requirements identified for the desired application. In this review, we describe biodegradable hydrogels and present their potential use in biomedical applications. The review was focussed on synthetic hydrogels including hydrolysable crosslinks.

Key words: hydrogels, biodegradable crosslink, hydrolysis, biomedical applications

Contents:

- 1. INTRODUCTION**
- 2. General methods for the synthesis of covalently crosslinked hydrogels**
- 3. Chemical nature of hydrolysable covalently crosslinked hydrogels**
 - 3.1. Chemical nature of hydrolysable materials
 - 3.2. Design of crosslinkers with hydrolysable segments
- 4. Formulations and applications of hydrolysable covalently crosslinked hydrogels in the biomedical field**
- 5. CONCLUSIONS**
- 6. References**

1. Introduction

Hydrogels are three dimensional polymer networks which absorb and retain large amounts of water. They are universally found in Mother Nature as material of matrices of the living organisms including for instance the interstitial tissue and the cell cytoplasm.

Synthetic hydrogels were first introduced as biomaterial in 1960 by Wichterle and Lim (Wichterle and Lim 1960) as soft contact lenses. Since then, they continue to raise interests among biomaterial scientists because of their high potential of biocompatibility. Indeed, they are a class of materials with the most similar structure to the materials found in the nature.

The three dimensional polymer network which composes hydrogels swells in aqueous medium. It absorbs and retains large amount of water thanks to the high content in hydrophilic groups in the polymer structure (Ratner and Hoffman 1976, Peppas et al. 2000, Kopecek 2002). Thus, hydrogels were extensively studied as cell encapsulation matrices, drug delivery systems, biosensors and as matrix for tissue regeneration (Baldwin and Saltzman 1998, Rosiak and Yoshii 1999, Lee and Mooney 2001, Peppas et al. 2006, Ong et al. 2008, Caldorera-Moore and Peppas 2009). Non degradable hydrogels are, by far, the most abundant types of synthesized hydrogels. They are suitable for many applications such as encapsulation of bulky compounds including proteins and RNA (Monteiro et al. 2004; Leach and Schmidt 2005). However, degradable hydrogels have appeared to be more suitable in applications in which the material is directly implanted in the body and needs to be removed when its action is completed. Such applications include scaffolds for tissue regeneration (Alsberg et al. 2003; Tan and Marra 2010), cell encapsulation (Temenoff et al. 2004; Nicodemus and Bryant 2008), drug delivery systems with controlled released properties (Park et al. 1993; Hatefi and Amsden 2002; Miyata et al. 2002; Hamidi et al. 2008) and materials for temporary embolisation (Schwarz et al. 2004; Zhang and Schwarz 2006; Weng et al. 2010; Moine et al.

2011; Weng et al. 2011). The degradation time scale of the hydrogel materials used in these applications needs to be very precisely adjusted. This is a property of hydrogels which can be finely tuned by adapting various parameters of synthetic hydrogels. For instance, degradation rate can be controlled by the physical properties of the crosslinkers (e.g. length, rigidity), the chemical nature of the polymer composing the hydrogel and by the characteristics of the tridimensional polymer network, which establish the permeability of water inside the gel (West and Hubbell 1995). Moreover, the morphology of the hydrogels including their porosity, their size and their shape (slide, block, spherical particles, thread) influencing the surface/weight relation and the surface to volume ratio has shown to influence also the degradation rate especially when degradation occurs by hydrolysis (Wu and Ding 2004).

Although all types of hydrogels have a general structure based on a three dimensional polymer network swelled by a large amount of water, the polymer chains forming the network are hold together either by physical interactions including secondary forces such as ionic, H-bonding or hydrophobic forces or by covalent bonds in the case of covalently-crosslinked polymer networks. Hydrogels formed from physical interactions are called "physical" or "reversible" hydrogels. One advantage of these gels is that they can be formed without the need of chemical modification or chemical reaction. However, they can be dissolved by simple changes occurring in the physico-chemical conditions of the environment (Xu and Kopeček 2007; He et al. 2008). In comparison, covalently crosslinked hydrogels or "chemical" hydrogels would be more suitable for applications requiring materials with perfectly controllable degradation rates over time. Indeed, in theory, the degradation rate of these hydrogel can be finely tuned by adjusting many of the parameters characterizing the hydrogels. For instance, the chemical nature of the degradable segment can be used to define the mechanism by which the hydrogel will be degraded. Sedlář and collaborators have designed a hydrogel based on crosslinked synthetic poly(α -amino acid)s (Sedlář et al. 2011)

which degrades under the action of enzymes while the PLA-PEG-PLA crosslinked hydrogels proposed by Sawhney and collaborators are simply hydrolysed by water (Sawhney et al. 1993). Hydrogels composed of polyphosphoester can be degraded through both hydrolytic and enzymatic mechanisms (Iwasaki et al. 2004; Wang et al. 2005). As illustrated in these few examples, the nature of the degradable segment is another parameter which influences hydrogel degradation. This degradation depends on the enzyme activity and/or on the susceptibility to hydrolysis. The degree of crosslinking is another important parameter which influences the degradation rate (Kweon et al. 2003, Timmer et al. 2003 a,b, Bencherif et al, 2008, 2009, Wang et al. 2010). It controls the swelling of the hydrogel and the mesh size of the pores which influences the amount of water penetrating the hydrogel. The hydrophilicity of the hydrogel may also modulate the capacity of water absorption hence influence the degradation rate particularly in the case of hydrolysable hydrogels (Sawhney et al. 1993, Poon et al. 2009, Wang et al. 2010). Regarding applications that request a very high degree of degradation rate control, it seems that covalently crosslinked hydrogels degrading through a hydrolytic mechanism are the most suitable. Indeed, their degradation rate will only depend on the chemical structure and characteristics of the hydrogel and will be totally independent on the site of implantation in the body and on the physiology of the patient (Katti et al. 2002). Their degradation rate can theoretically be adjusted only from the manner the hydrogel was chemically designed and synthesized.

The present reviews aimed to summarize the different types of hydrolysable covalently crosslinked hydrogels developed so far. It first presents general methods that can be used to synthesise hydrogels. Then, it describes the chemical nature of the materials used to produce hydrolysable covalently crosslinked hydrogels. In this part, the different types of hydrolysable chemical compounds and the way they can be used to synthesize crosslinkers will be

described. The different forms that hydrogels can take and their applications in the biomedical field are considered in the last part of the paper.

Abbreviations and Commercial products

4EDMAB	ethyl-4- <i>N,N</i> -dimethylaminobenzoate
AIBN	aso-bis isobutyronitrile
AP	ammonium persulfate
BPO	benzoyl peroxide
CQ	camphorquinone
Darocur 2959	2-hydroxy-1-(4-(2-hydroxyethoxy)phenyl)-2-methyl-1-propanone
DEAP	diethoxyacetophenone
DMAEMA	di(methylamino ethyl methacrylate)
DMF	Dimethylformamide
DMPA	2,2-dimethoxy-2-phenylacetophenone
DMSO	Dimethyl sulfoxide
DMT	<i>N,N</i> -dimethyl- <i>p</i> -toluidine
EGDMA	ethylene glycol dimethacrylate
FAME	fumaric acid monoethyl ester
HEMA	hydroxyethyl methacrylate (
Irgacure 184	1-hydroxycyclohexyl phenyl ketone
Irgacure 819	phenyl bis(2,4,6-trimethyl benzoyl) phosphine oxide (BAPO)
Irgacure 2959	((4-(2-hydroxyethoxy)phenyl-(2-propyl)ketone
MACAH	methacryloyl hexane-1,6-diol cholanoate
MMA	Methyl methacrylate
NIPAM	<i>N</i> -isopropylacrylamide
NVP	<i>N</i> -vinylpyrrolidone
OCMCS	O-carboxymethylchitosan
PCL	Poly(ϵ -caprolactame)
PEG	poly(ethylene glycol)
PEGMMA	Poly(ethylene glycol) methacrylate
PGA	Poly(glycolic acid)
PLA	Poly(lactic acid)
PMA	poly(malic acid)
PPF	poly(propylene fumarate)
TED	<i>N,N,N,N</i> -tetraethyl thiuram disulfide
TEMED	<i>N,N,N,N</i> -Tetramethylethylene diamine
TMC	trimethylene carbonate
TMPTA	trimethylolpropanetriacrylate

2. General methods for the synthesis of covalently crosslinked hydrogels

Different methods can be used to synthesize polymers with three-dimensional network architecture by covalent linkage. This depends whether it is formed from monomer units or from the reticulation of preformed linear chains of polymer (Fig. 1).

In all cases, the nature of the building blocks and links created during assembly are keys to determine the biodegradable character of the resulting hydrogel. Building blocs are assembled together thanks to the presence of chemical functions that allow formation of a three-dimensional polymer network. Two families of chemical functions can be distinguished whether they contain unsaturated carbon-carbon bonds or they include in their structure chemical reactive functions consisting in alcohol, aldehyde, carboxylic acid, amine, hydrazide or thiol groups able to react with each other (Table I).

In the first family, the linkage between building blocs can occur by a simple reaction of polymerization resulting from the opening of the carbon-carbon double bond included in the molecule (Fig. 1C). Such reactions can be initiated by the formation of a radical that allows carbon-carbon double bonds to add to each other based on a chain type reaction (Fig. 2).

Many of the hydrogels developed for biomedical applications are synthesized by radical polymerizations which can be performed under mild conditions. Polymerization initiations is generally based on thermal, red-ox and photochemical methods. The obtaining of polymers with three dimensional network architecture requires that one building bloc named the crosslinking agent contains at least two carbon-carbon double bonds in their structure. Thus, preformed polymers containing a few carbon-carbon double bonds in their structure can be crosslinked by initiating a radical polymerization (Fig. 1B).

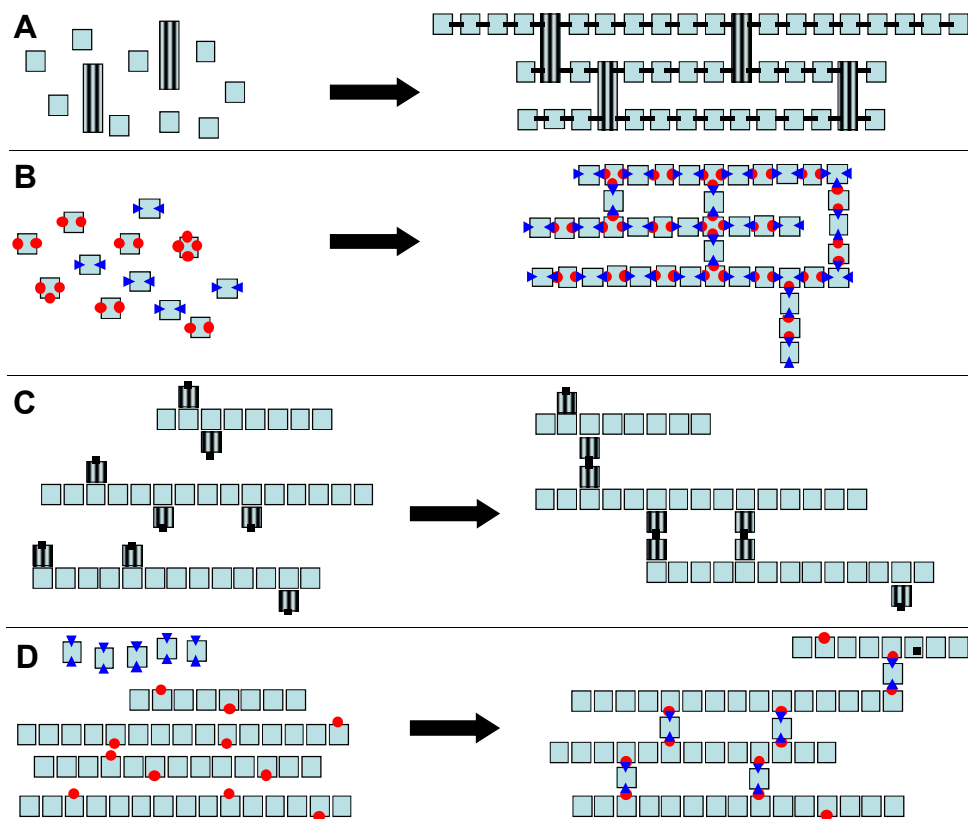
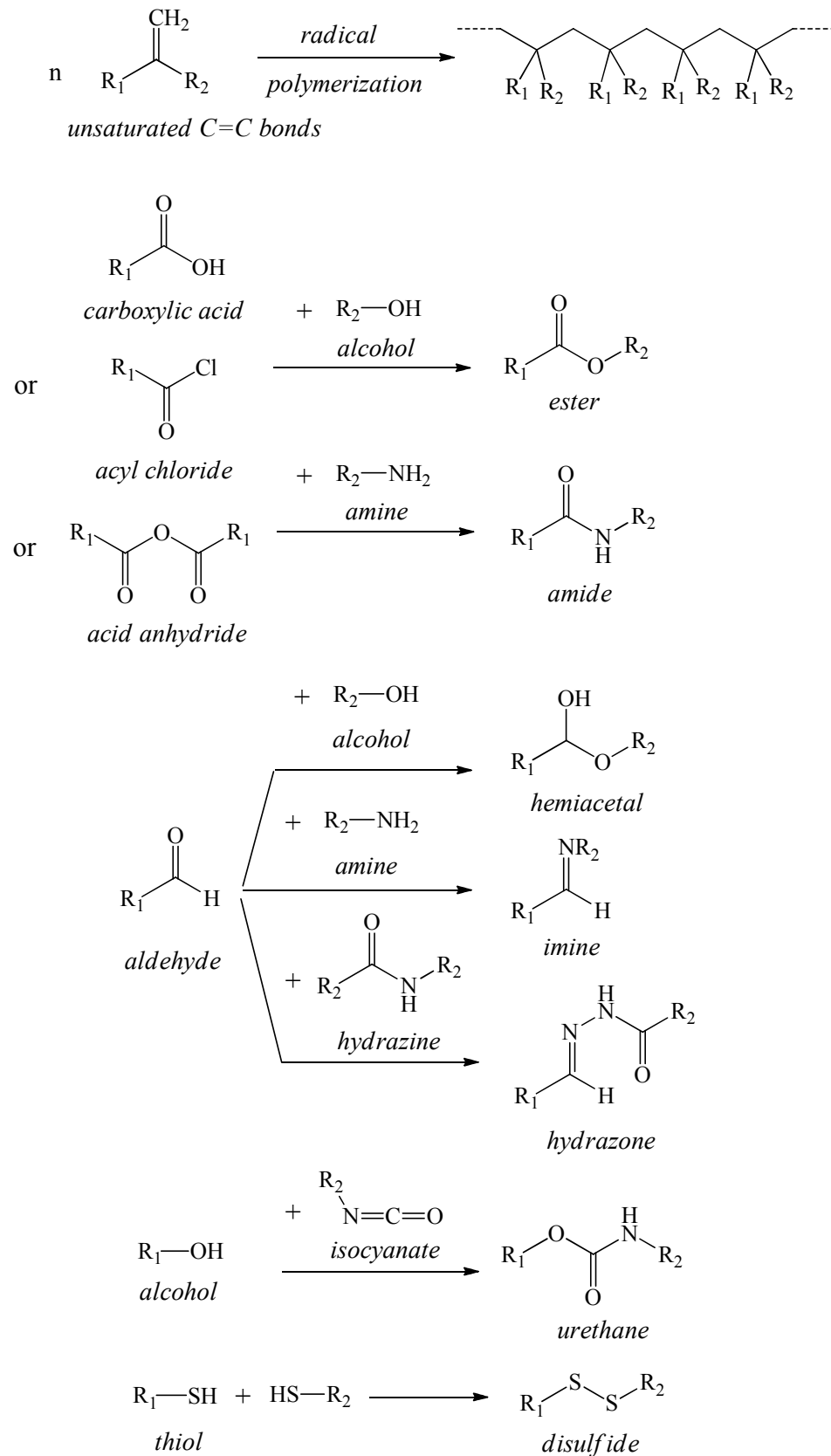

Figure 1. Scheme of the synthesis of polymer networks from monomer units (A, B) and from a blend of preformed functionalized polymer chains with crosslinking agents (C, D). A illustrates the formation of the polymer network from monomers containing unsaturated functions. Mono-unsaturated monomers are included in the linear parts while di-unsaturated monomers form the connections between chains. B illustrates the formation of the polymer network from monomer units containing complementary functions able to react together. Difunctional monomers are included in the linear segments of the polymer network while tri and tetrafunctional monomers form the connection between chains. C illustrates the formation of polymer network from a blend of polymer chains functionalized with unsaturated carbon carbon bonds. D illustrates formation of polymer network from a blend of polymer chains functionalized with chemical functions complementary to that of the difunctional monomers added as crosslinking agent.

Table I □ Chemical reactions of functional groups included on buiding blocks



Initiation

T or UV or
Oxydo-reduction reaction

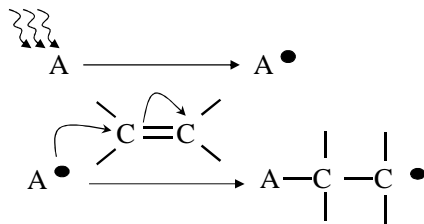

Propagation

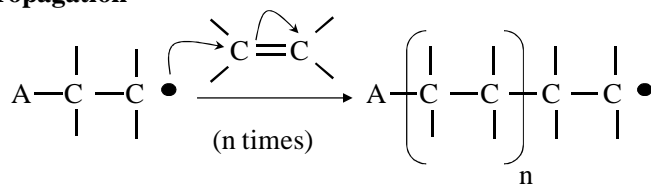

Termination

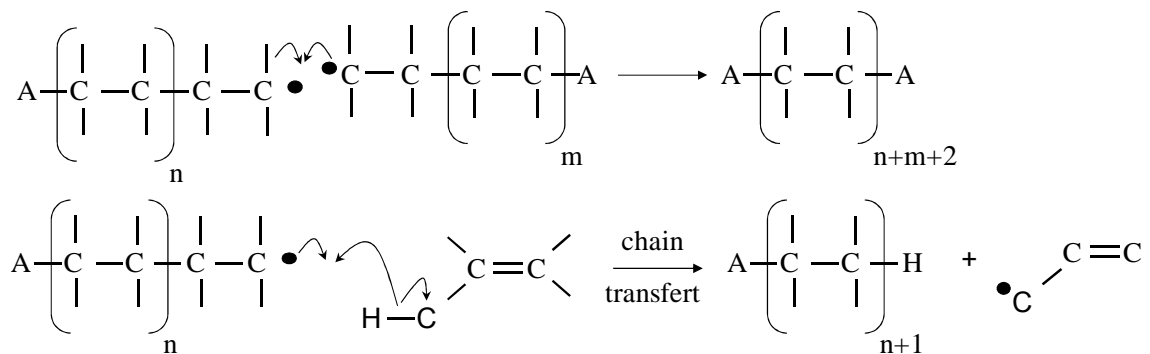

Figure 2. Scheme of the mechanism of radical polymerization.

The swelling characteristics of the hydrogels and their properties will depend on the length of the linear segment separating two connections between chains. In case hydrogels are synthesized from monomers, the polymerization is performed with two types of monomers.

One is mono-unsaturated and will be included in linear segments of the polymer network. A di- or pluri-unsaturated monomer is needed as crosslinking agent to form connections between chains making possible the obtaining of a three-dimensional polymer network (Fig. 1A). The composition in mono-unsaturated and di- or pluri-unsaturated monomers define the degree of reticulation of the polymer network and in turn the swelling properties and the mesh size of the hydrogel (Sawhney et al. 1993; Zhu et al. 2005). It is noteworthy that the first hydrogel synthesized for medical application was prepared according to this scheme by

radical copolymerization of HEMA as the mono-unsaturated monomer with EGDMA as a di-unsaturated monomer (Wichterle and Lim 1960). Although, this hydrogel is not biodegradable because of the nature of the monomers, degradable hydrogels can be obtained by introducing degradable segments in the structure of the building blocks as it will be further discussed in the following parts of this review (Tables II - VII). Many other properties can be incorporated in hydrogels by varying the nature of the building blocks. For instance, building blocks with pH and temperature sensitive properties were incorporated in the structure of hydrogels in order to design stimuli responsive devices (Bettini Colombo et al. 1995, Cıçek and Tuncel 1998). A polymerizable prodrug with a cleavable bond is another example of an interesting building block that we could incorporate in the hydrogel structure in order to design drug delivery systems in which the drug release is controlled by the hydrogel degradation rate (Table VI) (Liu and Rimmer 2002).

In the second family, the building blocs are chosen between chemicals containing functions which can react together and form of a covalent linkage between the parent molecules (Table I). The nature of the covalent bonds which crosslink the parent molecules depends on the nature of the chemical functions reacting together to form the polymer network. In turn, the nature of the linkage defines whether or not the hydrogel is degradable and the mechanism of degradation. Beside chemical reactions, hydrogels can be obtained using biochemical methods in which the crosslinking reaction is catalysed by enzymes. For instance, Sperinde and Griffith used transglutaminase to form peptide based hydrogels (Sperinde and Griffith 2000). It is noteworthy that radical polymerization of C=C double bond containing monomers and macromers is so far the most commonly used method to produce hydrogels for biomedical applications, since the design of suitable monomers is versatile and hydrogel can be formed in various conditions including *in vivo in situ* if needed.

TABLE II - POLYMERIZABLE POLYESTER-PEG CONTAINING CROSSLINKERS

<i>General structure of the degradable crosslinker</i>	<i>General principle of the method of preparation of the hydrogel</i>	<i>Form of the hydrogel/ Particularity of the polymerization</i>	<i>Degradation studies</i>	<i>Target applications</i>	<i>ref</i>
Poly(\square -hydroxyacid)-PEG ₁₀₀₀₋₂₀₀₀₀ - Poly(\square -hydroxyacid) diacrylate Poly(\square -hydroxyacid) were composed of PLA and/or PGA	UV irradiation (\square 365 nm) with DMPA. Copolymerization with NVP.	Solution photopolymerization, performed in molds to form disks or on a surface to form films	Degradation study in HEPES buffer saline pH 7.3, 37°C. Time of degradation vary from 1 to 120 days depending on PEG chain length and lactide and glycolide content	Drug delivery system for Macromolecules. Healing material.	Shawhney et al. 1993
PLA-PEG-PLA diacrylate PLA: 6 or 10 lactides units PEG: 2 or 6 ethylene glycol units.	bulk photopolymerization initiated by visible light (\square 450 nm) with CQ and 4EDMAB in the presence of cells or in molds	disks (1 x 5 mm) and porous scaffolds obtained by polymerization in molds. Polymerization can be performed in the presence of cells.	Degradation study in PBS pH 7.4, 37°C Time of degradation (30 to 60% mass loss) in 8 weeks depending on PEG-PLA content	Orthopaedia as scaffolds for bone tissue regenerating applications.	Burdick et al. 2001
Poly(\square -hydroxyacid)-PEG ₆₀₀₀₋₁₀₀₀₀ - Poly(\square -hydroxyacid) diacrylate Poly(\square -hydroxyacid) were PLA and PCL.	redox initiator system composed of AP and TEMED, 37°C	Solution polymerization in a bath.	Degradation study in PBS pH 7.4, 37°C. Total degradation was observed in 35 days.	Scaffold for tissue engineering and tissue regeneration.	Zhu and Ding 2006
PLA-PEG ₄₆₀₀ -PLA diacrylate	UV irradiation with Darocur 2959	Solution photopolymerization can be performed in the presence of cells.	Up to 50 % degradation in 3 weeks Encapsulation of cells from Rat brain Evaluation of compatibility with cell cultures and cell growth	Scaffold for tissue engineering and tissue regeneration. Suitable to be used as support for neural cell growth.	Benoit et al. 2006, Mahoney and Anseth 2007
PCL-PEG ₁₀₀₀ - PCL diacrylate	UV irradiation (\square 365 nm) initiated with DMPA dissolved in TMPTA.	Bulk polymerization in silicone rubber embossing molds. Formation of micro-patterned hydrogel films.	No degradation study <i>Adhesion tests to Fibroblasts</i> in cell culture	cell shape control scaffold for tissue-engineering.	Chan-Park et al 2006, Zhu et al. 2006

<i>General structure of the degradable crosslinker</i>	<i>General principle of the method of preparation of the hydrogel</i>	<i>Form of the hydrogel/ Particularity of the polymerization</i>	<i>Degradation studies</i>	<i>Target applications</i>	<i>ref</i>
<p>Poly(\square-hydroxyacid)- PEG₄₀₀₀- Poly(\square-hydroxyacid) diacrylate</p> <p>Poly(\square-hydroxyacid) were composed of PLA and PCL.</p>	UV irradiation (\square 365 nm) initiated with CQ and 4EDMAB.	<p>Bulk photopolymerization in molds</p> <p>Polymerization can be performed in the presence of cells</p>	<p>Degradation study on disks of hydrogels. About 10% mass loss after the first week. After 8 weeks, the mass loss of the faster degrading hydrogels (poly(2EG6LA), poly(2EG10LA)) ranged from 50 to 60% while the mass loss of the slowest degrading hydrogel (poly(8EG6LA)) was lower than 30%.</p> <p>Cell seeding experiment with primary rat calvarial osteoblasts</p> <p>Evaluation of neurite outgrowth from retina explant</p>	Scaffold for tissue regeneration. Implants for controlled drug delivery of neurotrophins to enhance regeneration of damage to the central nervous system	Davis et al. 2003, Burdick et al. 2006
PLA- PEG ₄₆₀₀ -PLA diacrylate	UV irradiation (\square 365 nm) initiated with Irgacure 2959.	Solution photopolymerization performed in molds	Compares the degradation of the macromer crosslinker in solution to that of the reticulated crosslinker : under the reticulated form, more sensitive degradation to fluctuations in macromer cross-linker composition and to the environment (water content, pH, ionic strength)	Drug delivery systems and Tissue engineering scaffold. potential stimuli-responsive materials	Shah et al. 2006
<p>PEG-PLA-PEG di-(meth)acrylate</p> <p><i>Biotin fonctionnalized hydrogels</i></p>	UV irradiation (\square 365 nm) initiated by Irgacure 184, Copolymerised with PEG-Biotin methacrylate	Solution photopolymerization performed in molds	<p>-with crosslinkers containing the larger number of lactide units (4 and 6) total degradation required > 3 months.</p> <p>- Degradation incomplete with the crosslinker containing the lower number of lactide units (2) in the structure.</p> <p>- Cell attachment test with preosteoblast human palatal mesenchymal cells</p>	<p>- Drug delivery system,</p> <p>- Biodegradable composite formulation</p> <p>- Scaffold for tissue engineering</p>	Clapper et al. 2007 Clapper et al. 2008
PGA- PEG ₄₀₀₀ -PGA diacrylate, dimethacrylate and di-urethane methacrylate.	UV irradiation (\square 365 nm) initiated by Irgacure-2959.	Solution photopolymerization performed in molds to prepare disk	Degradation between 1 to 27 days. Tuning achieved by controlling crosslinker chemistry which in turn make possible control of the hydrogel property.	Matrice for control release of drugs; Degradable scaffolds for tissue engineering.	Bencherif et al. 2009a,b

<i>General structure of the degradable crosslinker</i>	<i>General principle of the method of preparation of the hydrogel</i>	<i>Form of the hydrogel/ Particularity of the polymerization</i>	<i>Degradation studies</i>	<i>Target applications</i>	<i>ref</i>
PLA- PEG ₆₀₀₀ -PLA diacrylate co methacryloyl hexane	Polymerization initiated by UV irradiation by DMPA. MACAH as copolymer.	Solution polymerization	No degradation study Study of the morphology and swelling of the hydrogel.		Hao et al. 2009
Poly(\square -hydroxyacid)-PEO- PPO-PEO- Poly(\square -hydroxyacid) diacrylate Poly(\square -hydroxyacid) were composed of PLA and PCL.	Inverse suspension redox polymerization initiated by AP and TEMED.	Inverse suspension polymerization to prepare microspheres (~ 200 μ m).	No complete degradation was reached. Microspheres prepared with PLA containing crosslinker degrade faster (90-95% degradation after 56 days) than PCL containing ones (80% degradation after 56 days).	Thermo responsive and degradable hydrogel microspheres for controlled release of drug.	Zhu et al. 2005
PCL-PEO-PPO-PEO-PCL glycidyl methacrylate	UV irradiation initiated by DMPA Copolymerised with MMA, PEGMMA	Solution polymerization.	Degradation was monitored over 50 days. Weight loss varied from 25 to 50% over the 50 day period of time depending on pH of the incubation medium, composition of the crosslinker and degree of reticulation	Controlled release drug delivery system	Wang et al. 2010
PLGA-glycerol-PLGA diacrylate (star shaped)	initiated by AIBN under heating. Copolymerisation with <i>N</i> -vinyl pyrrolidone	Solution polymerization performed in molds to obtain films	no total degradation after 7 weeks incubation in PBS pH 7.4 at 37°C. Degradation proceeded in two steps: A slow steps occurring up to a mass loss of 25 to 30% over 5 to 7 weeks followed by a faster degradation reaching a maximum of 50% mass loss after 6 weeks for the samples which degraded the faster. Degradation rate depended on the composition and molecular weight of the crosslinking agent	Tissue engineering scaffolds Controlled release drug delivery system	Jiao et al. 2006
star-shaped polymeric precursors functionalized with FAME. The precursor polymers, was based on D,L lactide, caprolactone and TMC.	UV irradiation (\square 365 nm) with DMPA.	Bulk polymerization in molds to form films.	No degradation study Characterization of the morphology and of the thermal and physical properties of the networks.	Scaffold for engineering of cardiovascular tissues	Grijpma et al. 2005

TABLE III - POLYMERIZABLE PCL DIACRYLATE CROSSLINKERS

<i>General structure of the degradable crosslinker</i>	<i>General principle of the method of preparation of the hydrogel</i>	<i>Form of the hydrogel/ Particularity of the polymerization</i>	<i>Degradation studies</i>	<i>Target applications</i>	<i>ref</i>
PCL diacrylate	UV irradiation (\square 360 nm) with DMPA. Copolymerized with PCL macromer.	Solution polymerization, obtaining form as the reaction vessel.	Rate of weight loss depended on the rate of reticulation of the hydrogel but no more than 10% mass loss after 42 days in PBS (pH 7.4, 37°C). Cell proliferation test considering MG-63 osteoblasts	Scaffold for tissue engineering (bone repairing support material)	Kweon et al. 2003
PCL diacrylate	initiated by AP and TEMED. Copolymerisation with NIPAM and methacrylic acid.	Solution polymerization in DMF, performed in molds to provide with thick films	Total mass loss after 29 hours incubation at pH 12, 25°C when the hydrogel was soaked in acidified water (pH 2) prior to be dried and prior to the start of the experiment.	pH responsive controlled release drug delivery systems	París and Quijada-Garrido 2009
PCL diacrylate	UV irradiation (\square 365 nm) with DEAP or initiated by AIBN under heating. Copolymerised with NIPAM.	Solution polymerization in DMSO, performed in molds to obtain thick films.	Degradation in PBS pH 7.4 (0.2M) at 37°C in presence of lipase. Less than 20% mass loss after 50 days of incubation. Porous gels degraded more rapidly than non porous gels	Thermo-responsive degradable hydrogel for controlled release of drug and scaffold for tissue engineering	Lee and Cheng 2008
PCL diacrylate	UV irradiation with Irgacure 819. Copolymerised with PPF.	Solution polymerization in CH_2Cl_2 , performed in molds.	No degradation study. Cytotoxicity test with mouse MC3T3-E1 and rat SpL201 cells, Cell adhesion test and cell proliferation tests. Cell behaviour was found to depend on mechanical properties of the crosslinked matrices.	Scaffold for tissue engineering for bone and nerve regeneration	Cai and Wang 2010

TABLE IV - POLYMERIZABLE PMA BASED CROSSLINKERS

<i>General structure of the degradable crosslinker</i>	<i>General principle of the method of preparation of the hydrogel</i>	<i>Form of the hydrogel/ Particularity of the polymerization</i>	<i>Degradation studies</i>	<i>Target applications</i>	<i>ref</i>
PMA-PEG ₁₀₀₀ -PMA dimethacrylate	UV irradiation (□365 nm) with Irgacure 2959. Copolymerization with methacrylated OCMCS and PEG. Amount of crosslinker used: 7 to 20% of polymers.	Solution polymerization performed in molds.	Degradation rate depended on the length of the PMA chain. 80% weight loss max after 50 days incubation in PBS at 37°C. Evaluation of the compatibility with vascular smooth muscle cells: PMA improved cellular biocompatibility of the hydrogel. Cell proliferation was further improved by adding Arg-Gly-Asp (RGD) peptides on the hydrogel surface.	Potential materials for tissue engineering applications.	Poon et al. 2009
HEMA (4 to 12 mol %) grafted on PMA	UV irradiation (□365 nm) with Irgacure 2959.	Solution polymerization in water, obtaining form as the reaction vessel.	Degradation in PBS pH 7.4 at 37°C. Hydrogels were losing shape after 75 to 80% weight loss (after 2 to 5 days). Lower PMA content and lower amount of HEMA show shorter degradation times. Degradation occurred by both bulk and surface mechanism.	Scaffold for engineering tissue.	He et al. 2006

TABLE V - POLYMERIZABLE PPF BASED CROSSLINKERS

<i>General structure of the degradable crosslinker</i>	<i>General principle of the method of preparation of the hydrogel</i>	<i>Form of the hydrogel/ Particularity of the polymerization</i>	<i>Degradation studies</i>	<i>Target applications</i>	<i>ref</i>
(PPF) diacrylate Material with low water absorption capacity.	Redox polymerization initiated by BPO and DMT at 37°C. Copolymerised with PPF.	Bulk polymerization achieved in molds to provide cylinder and film shaped.	Total dissolution of the polymer network occurred in nearly 4 days in NaOH 1M, 70-80°C.	biomaterial scaffolds for orthopedic tissue engineering	He et al. 2001
(PPF) diacrylate Material with low water absorption capacity.	Polymerization initiated by visible irradiation (λ 470 nm) with Irgacure 819 (or BAPO). Copolymerised with PPF.	Bulk polymerization in molds of different shapes: rod, cylinder, dogbone shapes. Preparation of composite material by incorporating β -tricalcium phosphate (TCP) particles.	No total degradation in most formulations after 52 days incubation in PBS pH 7.5 and in citrate buffer (pH 5.0). Degradation occurred in bulk with minimal changes in mass and geometry prior to sudden fracture. Degradation rate was increased by reducing the crosslinking density and to a lower extent the pH. Degradation is delayed in composite materials incorporating TCP.	Orthopedic implants	Timmer et al. 2003a,b
poly(PEG fumarate) (OPF) modified with a bioactive peptide (GRGD)	UV irradiation with Irgacure 819 (or BAPO). Copolymerised with PPF.	Solution polymerization in CH ₂ Cl ₂ in mold to make films of 0.2mm thick.	No degradation study.	Functionalized Scaffolds for tissue regeneration and engineering.	Jo et al. 2001, Dadsetan et al. 2007
PPF-co-PCL	Initiated by BPO.	Solution polymerization in CH ₂ Cl ₂ .	No degradation study.	Injectable in situ polymerization material to be used in bone tissue regeneration.	Yan et al. 2011
PPF-PCL-PEG	Thermal polymerization with AP at 70°C Copolymerised with acrylamide and ascorbic acid.	Bulk polymerization.	Evaluation of fibroblast growth and adhesion.	Scaffold for tissue engineering	Krishna and Jayabalan 2009
oligo(PEG fumarate) (OPF)	Copolymerized with acrylated PEG-dithiothreitol (Ac PEG-DTT)	Solution polymerization in PBS.	Degradable hydrogels Degradation time can be tuned from a few days to >1 month by varying OPF and Ac PEG-DTT.	<i>In situ</i> tissue regeneration. Proof of concept evaluated as carrier for marrow stroma cells (MSC), for tendon overuse injuries repair	Qiu et al. 2011

TABLE VI - POLYMERIZABLE POLYCARBONATE BASED CROSSLINKERS

<i>General structure of the degradable crosslinker</i>	<i>General principle of the method of preparation of the hydrogel</i>	<i>Form of the hydrogel/ Particularity of the polymerization</i>	<i>Degradation studies</i>	<i>Target applications</i>	<i>ref</i>
Dicarbonate dimethacrylate	UV photopolymerization, DMPA. Copolymerised with NVP or with DMAEMA.	Bulk polymerization, performed in molds	<i>In vitro</i> and <i>in vivo</i> degradation study. Reproducible <i>in vitro</i> degradation. Degradation can be tuned during the synthesis by the choice of comonomer and composition in the crosslinking reagent. <i>In vivo</i> , rods can be fragmented in less than 2 days after implantation in the eye. No polymer remained after 2 months at the implantation site.	Potential use as drug delivery system in the vitreous body of the eye. Copolymer with NVP showed a good compatibility for applications in ophthalmology in contrast with copolymer with DMAEMA.	Bruining et al. 1999, 2000
5-Fluororacil dicarbonate dimethacrylate	Thermal polymerization with AIBN. Copolymerised with NVP.	Polymerization in solution (1,4-dioxane) performed in molds	<i>In vitro</i> degradation study performed by incubation in PBS pH 7.4 over 40 days through the release of the drug and the swelling of the gel. Degradation profiles showed two phases, one rapid at the beginning followed by a much slower process.	Drug delivery system. Drug release was controlled by the degradation of the device.	Liu and Rimmer 2002
Poly(hexa methylene carbonate)- <i>co</i> -polyfumarates, Poly(hexa methylene carbonate) diacrylate, Poly(hexa methylene carbonate)- <i>co</i> -polyethylene glycol- <i>co</i> -polyfumarates	Polymerization initiated with visible light in the blue region with camphorquinone (CQ). Copolymerised with NVP.	Bulk polymerization in molds	<i>In vitro</i> biocompatibility essai evaluating the cytotoxicity on L-929 fibroblasts cells from mice using the MTT test: no adverse cytotoxicity was found. No degradation study was provided.	Scaffold material for cell delivery, tissue engineering and drug delivery applications	Sharifi et al. 2008

TABLE VII - POLYMERIZABLE POLYANHYDRIDE BASED CROSSLINKERS

<i>General structure of the degradable crosslinker</i>	<i>General principle of the method of preparation of the hydrogel</i>	<i>Form of the hydrogel/ Particularity of the polymerization</i>	<i>Degradation studies</i>	<i>Target applications</i>	<i>ref</i>
Copolymers of sebacic acid dimethacrylate with 1,6-bis(carboxyphenoxy) hexane dimethacrylate	UV light (365 nm) and DMPA; or visible light (470-490 nm) and CQ and 4EDMAB.	Bulk polymerization in molds to provide disks Entrapment of DNA protected in alginate beads during polymerization	Degradation in PBS/HEPES at 37 °C. Total mass loss can be tuned from 6 to 42 days by varying the composition in hydrophobic comonomer in the composition of the polymer. Surface erosion mechanism and linear degradation throughout the study period.	Controlled released drug delivery system for genes (DNA must be protected to avoid damage during photoencapsulation)	Quick et al. 2004
Copolymers of sebacic dimethacrylate, Tricarballic dimethacrylate and Pyromellitylimido-alanine dimethacrylate	UV photopolymerization with DMPA. Copolymerised with methacrylic anhydride	Bulk polymerization in cuboid shape molds (4mm x 10mm x 1mm)	Degradation in PBS pH 7.4 at 37°C in 2 to 3 days, followed by monitoring weight and dimensional changes. Surface erosion mechanism.	Exploration for finding new potential degradable biocompatible material to be used in tissue engineering	Young et al. 2000
Copolymers of sebacic acid dimethacrylate, <i>bis</i> (<i>p</i> carboxyphenoxy) propane dimethacrylate and <i>bis</i> (<i>p</i> carboxyphenoxy) hexane dimethacrylate	325-400 nm initiated with TED and DMPA. Salt leaching method for construction of porous samples. Copolymerization with methacrylated cholesterol and methacrylated stearic acid	Bulk photopolymerization in molds Disks (d = 12 mm, t = 1.4 mm) Entrapment of living cells (osteoblasts prepared from neonatal rat calvaria) during polymerization	Degradation in PBS pH 7.4 at 37°C. Mass loss varied from 2 days to 1 year, depending on the hydrophobicity of the polymer network. Cell viability was preserved in the network throughout the polymerisation process	Orthopedic applications: cell seeded material to be used as allograft for bone tissue engineering	Burkoth et al. 2000
Crosslinked aminoacid-containing polyanhydrides: copolymers of Sebacic acid, N-trimellityl imido- α -alanine or N-trimellityl imido-glycine and 1,3,5-benzenetricarboxylic acid (crosslinker)	Melt polymerization at 180°C under vacuum ($< 4 \times 10^{-3}$ mbar)	The polymer was grounded in a mortar and sieved to isolate microparticles with diameter below 212 μ m. Disk shaped matrices were then prepared by compression (13 mm diameter, 1.2 mm thick)	Degradation in PBS pH 7.4 (0.1M) at 37°C. Experiments were stopped at 60% weight loss because of appearance of severe cracking on the discs. 60% mass loss reached in less than 3days. Drug release followed degradation of the matrice.	Controlled release drug delivery applications.	Cheng et al. 2004

3. Chemical nature of hydrolysable covalently crosslinked hydrogels

The degradation of hydrogels depends on the hydrolysable properties of the different building blocks. Therefore, the obtaining of hydrolysable hydrogels implies that at least one of the building blocs composing the three-dimensional polymer network must include hydrolysable bonds in their structure. Beside this requirement, there are several options that can be applied in designing hydrolysable hydrogels. The hydrolysable bonds may theoretically be included either in the structure of the crosslinking agent (Fig. 3A), into the linear segments of the three dimensional network (Fig. 3B) or in both parts of the three-dimensional network (Fig 3C). In all cases, it is required at first to identify which types of chemical compounds may be interesting to include in the hydrogel structure. In a second stage, it is interested to consider how these materials can be synthesized to be incorporated in a hydrolysable covalently crosslinked hydrogel. Thus, the following first paragraph reviews the different hydrolysable polymers and describes their methods of synthesis and their mechanisms of degradation. The next paragraph of this part of the paper discusses the different strategies that were developed to include hydrolysable polymer segments in designing crosslinkers to be included in chemically crosslinked hydrolysable hydrogels made on the model illustrated on Fig. 3A.

It is noteworthy that beside the hydrolysable building blocks, the hydrogel may also be formed from non degradable ones. This offers almost infinite possibilities in designing hydrogels. However some restrictions apply to hydrogels considered for biomedical applications. They must comply with all biocompatibility requirements. Additionally, when they are designed to be implanted in vivo, they must also be eliminated by the body. This needs to be taken into consideration when choosing the nature of building blocks which will be included in the non degradable parts of the polymer network of the hydrogels.

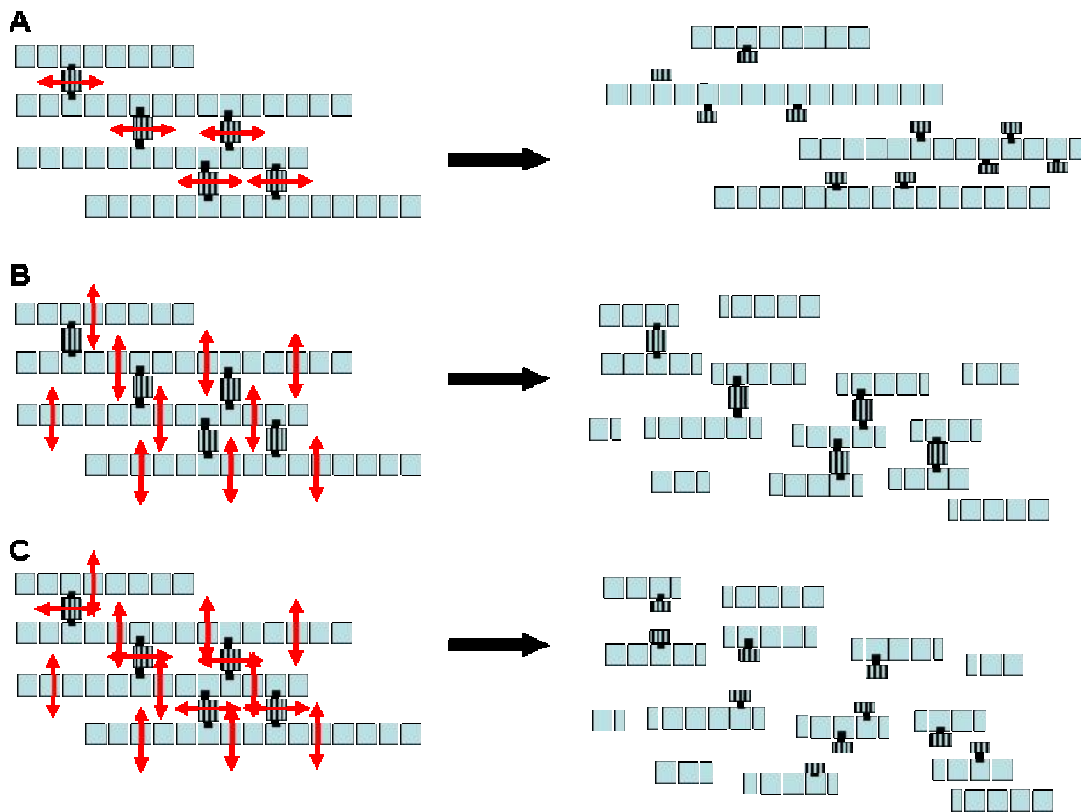
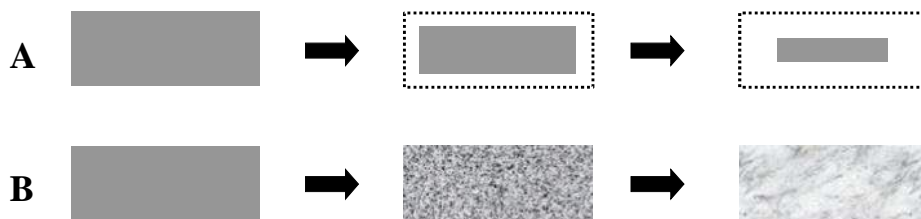

Figure 3. Scheme illustrating the different theoretical possibilities to incorporate hydrolysable segments in three dimensional structures forming polymer networks of hydrogels and the structures of the expected corresponding degradation products. The hydrolysable segment can be introduced in the crosslinker (A), in the linear part of the polymer network (B) or in both the crosslinker and the linear part (C).

3.1. Chemical nature of hydrolysable materials

In general, hydrolysable materials are synthetic polymers which contain at least one hydrolysable bond in the polymer backbone, meaning that they are cleaved in the presence of water. Examples of hydrolysable bonds include aliphatic esters, orthoesters, anhydrides, carbonates, amides, urethanes, ureas. It is noteworthy that, depending on the nature of the

polymer and on the properties of the backbone chains, the hydrolysis of materials composed of hydrolysable polymers occurs uniformly throughout the bulk of the materials or non uniformly following a surface erosion mechanism (Table VII) (Young et al. 2000, Davis and Anseth 2002). Bulk-degradation is promoted when the infiltration of water is faster than the inherent degradation kinetics (Wong and Bronzino 2007). Surface erosion occurs when the rate of penetration of water in the material is much slower than the hydrolysis reaction. In this case, the size of the material decreases continuously during the whole degradation process (Fig. 4A). The material can also degrade homogenously in the bulk where it can be seen that the pore size of the material increases throughout the whole degradation process until the material collapses (Fig. 4B).



(a) Fig. 4. Scheme illustrating the mechanisms of degradation of hydrogel through a surface erosion phenomenon (A) and through degradation in the bulk (B).

A competition between these two mechanisms is often observed, especially when we take into account the whole hydrogel network. Indeed, a hydrophobic material will have a surface erosion mechanism as water can not penetrate rapidly inside the network. However, in general, hydrogels contain hydrophilic groups which attract water into the matrix. Hence, a hydrophobic polymer which degrades by surface erosion mechanism may have either the two pathways or even only bulk degradation behaviour when it is incorporated into such hydrogel. Strength and structure of the material is greatly affected by the degradation process. In general, the strength of materials degrading through a surface erosion mechanism is better preserved while those having bulk degradation process is rapidly weakened (Young et al. 2000).

Therefore, the mechanism of degradation is an important parameter to consider when designing a hydrogel for a given application.

3.1.1. Aliphatic polyesters

Aliphatic polyesters, including poly(lactic acid) (PLA), poly(glycolic acid) (PGA), poly(ϵ -caprolactone) (PCL), polyhydroxybutyrate (PHB), poly(malic acid) (PMA) and their corresponding copolymers are so far the most investigated synthetic hydrolysable biomaterials. They are all degradable under simple hydrolysis of their ester functions. It is noteworthy that the hydrolysis of polyesters is an autocatalytic reaction. The cleavage of ester bonds produces acids which is a catalyst of the hydrolysis reaction. In general, degradation of material composed of aliphatic polyesters is uniform (bulk degradation) occurring in the whole volume of the material (Fig. 4B). During degradation process, the pore size of the material increases (Wong and Bronzino 2007).

Among different polyesters, homopolymers and copolymers of lactic acid and glycolic acid have been investigated over decades for tissue engineering and drug delivery applications (Södergård and Stolt 2002). In vivo, these polymers are degradable. Their degradation products, i.e. lactic acid and glycolic acid, are non toxic and bioresorbable as they are included in the metabolic route of the Krebs cycle (Holland et al. 1986). They comply with FDA regulations and were approved for in vivo applications as medical devices and as constituents of various implantable drug delivery systems occurring as microspheres (for instance Enontone[®], Decapeptyl[®]) and rods (Zoladex[®]).

Polymer		Synthesis by Ring Opening Polymerisation (ROP)
Polyesters	Poly(glycolide acid) PLA	<p>glycolide</p>
	Poly(lactide acid) PGA	<p>lactide</p>
	Poly(ϵ -caprolactone) PCL	<p>ϵ-caprolactone</p>
	Poly(hydroxybutyrate) PHB	
	Poly(ϵ -malic acid)	<p>ROOC R = protective group</p>
Poly(trimethylene carbonate)		

Figure 5. Chemical structure of cyclic monomers used in the synthesis of different hydrolysable polyesters and polycarbonates by Ring Opening Polymerisation (ROP).

Poly(ϵ -caprolactone) (PCL) is another polyester approved by the FDA for pharmaceutical applications. It has an excellent biocompatibility. Its degradation time is longer compared to that of PLA, PGA and PLGA (Dordunoo et al. 1997; Fialho et al. 2008). Thus, they are often used in the formulation of long time degradation systems or as component of copolymers with PLA and PGA.

Regarding the synthesis, the polymer chain of aliphatic polyesters is often formed by ring opening polymerisation (ROP) of cyclic forms including the monomer units. For instance, PLA is obtained from the ROP of lactide, PGA results from the ROP of glycolide, and PCL results from the ROP of ϵ -caprolactone which is a cyclic compound of the monomer unit found in the polymer chain (Fig. 5). Although ROP is the most frequently used method to synthesize these polyesters, a polycondensation reaction between corresponding acids (the lactic and the glycolic acid) can be an alternative route (Fig. 6).

Polymer	Synthesis by Polycondensation
Poly(glycolic acid)	$n \text{ HO-CH}_2\text{-COOH} \xrightarrow[\text{- } n \text{ H}_2\text{O}]{\text{polycondensation}} \left(\text{-O-CH}_2\text{-C(=O)-} \right)_n$ <p style="text-align: center;">glycolic acid</p>
Poly(lactic acid)	$n \text{ HO-CH(CH}_3\text{)-COOH} \xrightarrow[\text{- } n \text{ H}_2\text{O}]{\text{polycondensation}} \left(\text{-O-CH(CH}_3\text{)-C(=O)-} \right)_n$ <p style="text-align: center;">lactic acid</p>
Poly(malic acid)	$n \text{ HOOC-CH(OH)-CH}_2\text{-COOH} \xrightarrow[\text{- } n \text{ H}_2\text{O}]{\text{polycondensation}} \left(\text{-O-CH(OH)-C(=O)-} \right)_n \left(\text{-O-CH}_2\text{-C(=O)-COOH} \right)_n$ <p style="text-align: center;">malic acid</p> <p style="text-align: center;">α unit β unit</p>

Figure 6. Chemical structure of monomers used in the synthesis of different hydrolysable polyesters by a polycondensation reaction.

3.1.2. PMA

Poly(malic acid) (PMA) is a water-soluble, biodegradable and biocompatible polymer (Braud et al. 1985). The degradation of materials composed of PMA follows the scheme of a homogenous (or bulk) degradation over a short period of time (several days in general), as

indicated Table IV. It results in the production of malic acid which is metabolized in the Krebs cycle (Domurado et al. 2003; Kajiyama et al. 2004). This polymer has several other advantages which are interesting for biomedical applications. The pendant carboxylic group of each monomer residue included in the polymer structure can be used to attach different functional groups including drug molecules (Cammass-Marion and Guérin 2000). Polycondensation reactions can be used to synthesize PMA. They are simple one-step methods having the advantage to be performed by a "green" chemistry with no organic solvent and no catalysts (Kajiyama et al. 2003). In general, the polycondensation leads to PMA with low average molecular weight ($M_w < 3000$ g/mol and $M_n < 2000$ g/mol). Malic acid including an asymmetric carbon produces two isomers. Polymers synthesized by polycondensation are including both α and β type monomer units (see Fig. 6). PMA with longer polymer chain and selective α isomer can be obtained by anionic ROP of the corresponding lactone (Fig. 5). Poly(α -malic acid) can be also obtained by ROP. However, this method requires complex synthesis steps to form the cyclic starting monomer (Ouchi and Fujino 1989). Hence, the polycondensation is more frequently used thanks to the commercial availability of malic acid.

3.1.3. Poly(propylene fumarates)

Poly(propylene fumarates) (PPF) are unsaturated linear polyesters which contain two hydrolysable ester bonds per repeating unit (Fig. 7). The PPF polymeric network is well known to be biocompatible and biodegradable (Yaszemski et al. 1996, Suggs, West et al. 1999). The network degrades by simple hydrolysis of the ester bonds into non toxic products (propylene glycol and fumaric acid). In general, the degradation of PPF is homogenous following the scheme of a bulk degradation mechanism (Peter et al 1997). Their degradation rate depends intrinsically on the design of the network (Table V).

The synthesis of PPF was proposed by Peter et al. including a two-step reaction (Peter et al. 1999) (Fig. 7). The first step corresponds to an esterification reaction between propylene glycol and fumaryl chloride yielding di-(2-hydroxypropyl) fumarate which is then polymerized according to a transesterification reaction to form the desired PPF. Other derivative of fumarate can be used at the first step, such as diethyl fumarate (Wang et al. 2005), but the principle of the reaction remains the same. The double bonds which remain in the structure of PPF make the polymer attractive for crosslinking reactions. They allow the obtaining of three dimensional chemically crosslinked polymer networks from the linear chains. Furthermore, it is also possible to link different molecules (such as additional carbon-carbon double bond containing molecules or drugs) on the hydroxyl or ester groups present in the PPF.

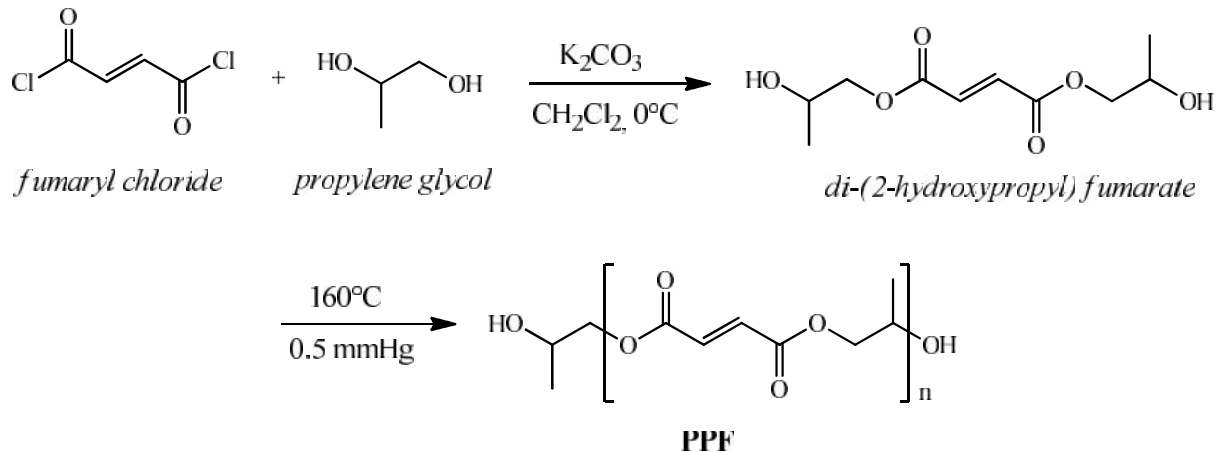

Figure 7. Scheme of the chemical structure of PPF and of its synthesis.

3.1.4. Polyphosphoester (PPE)

Polyphosphoesters (PPE) forms another family of hydrolysable polyesters which include degradable and biocompatible phosphorous containing polymers (Fig. 8). Traditional polymerization methods include ringopening, condensation, and addition polymerization can

be used to synthesize PPE. PEG segments were often introduced in PPE macromers to increase the absorption capacity of the polymer to absorb water. Moreover, the pentavalent phosphorus of PPE makes possible the incorporation of biologically active molecules or functional groups (Libiszowski et al. 1978; Xiao et al. 2006). This improves the biocompatibility of the resulting polymer and accelerates its degradation. The degradation of PEG-PPE macromers was described to occur by both chemical and enzymatic hydrolysis cleavage of the phosphate bonds. The released degradation products are phosphate, alcohol and diols (Iwasaki et al. 2004; Wang et al. 2005).

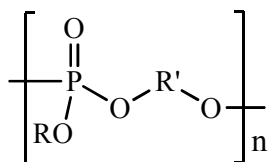

Figure 8. Scheme of the chemical structure of PPE

3.1.5. Polyorthoester (POE)

Polyorthoester was first developed in the early 70s in the group of Heller as an alternative to the only disponible poly(ε-esters) at the moment (Heller and Barr 2004). Since then, there are 4 families of POE which are all hydrophobic that prevents the absorption of water inside the matrix (Heller et al. 2002). Materials made of POE are hydrolysable by the surface erosion mechanism, especially in acidic environment (Fig. 4). The general scheme of synthesis of 4 families of POE (POE I, POE II, POE III, POE IV) and of their degradation are presented in Fig. 9. The first class POE I was obtained by transesterification of diethoxytetrahydrofuran and a diol (Choi and Heller 1979). POE from the second generation, POE II, was synthesized by polycondensation of diketene acetal with a diol (Heller et al. 1980). The polymer molecular weight can be controlled by modulating the stoichiometry. Appropriate chain flexibility of the diol can be chosen to adjust the mechanical and thermal properties of the

POE II. A crosslinked polymer may be produced by simple addition of a triol (or a higher functionality hydroxyl containing molecule) in the initial products. In general, POE II is extremely hydrophobic and appears quite stable in contact with water. The third generation of POE, POE III, was developed by introducing a very flexible backbone and reaction conditions making possible incorporation of drugs at the start of the synthesis without need of adding solvents. However, to obtain high molecular weight polymer, the synthesis requires a long reflux period with an ethanol azeotropic extraction (Heller et al. 1990). POE IV, corresponding to the fourth generation of POE, was designed to overcome the slow degradation rate shown by POE II. Hence, small chains of PLA, PGA or of their copolymer were introduced in the POE polymer (Ng et al. 1997) (Fig 9D). The degradation of the polyester chains produces acid compounds that can in turn catalyse the hydrolysis of the orthoester chains and accelerate their degradation.

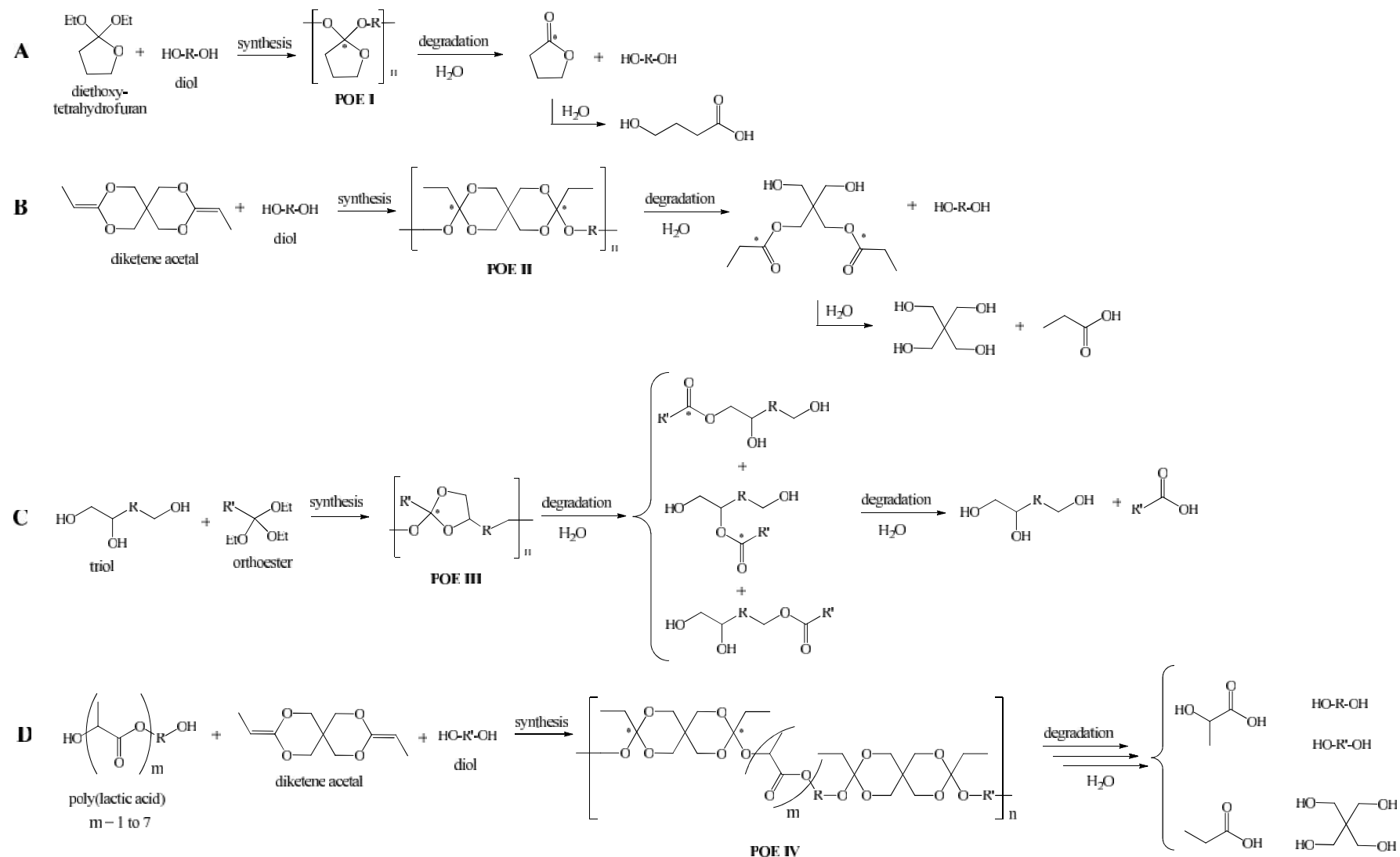

Figure 9. Synthesis and degradation routes of different classes of polyorthoester. (*) indicate position of the hydrolysable bonds

3.1.6. Polycarbonate

Crosslinkers containing polycarbonate were developed as alternative hydrolytic degradable materials to PLA, PGA or PLGA (Bruining et al. 1999). Similar to the ester function, carbonate group can be hydrolyzed into CO₂ and the corresponding diols (Fig. 10). However, due to the lack of acid formation which can catalyse the hydrolysis process, a polycarbonate does not have the auto-accelerated degradation process as it is found with corresponding polyesters (Bruining et al. 1999). Thus, in general, materials made of polycarbonate undergo surface degradation mechanism (Table VI) (Liu et al. 2006).

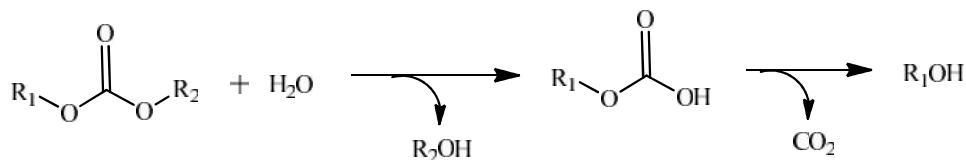

Figure 10. Scheme of the hydrolysis process of carbonate group.

Polycarbonate containing macromers show interesting visco-elastic properties, which are closed to those of hydrogels. These properties contribute to the high degree of biocompatibility of corresponding materials. The classical method of polycarbonate synthesis is transesterification from phosgene and a diol. Its application is limited in the medical field due to the toxicity of phosgene. To avoid this problem, polycarbonates used as biomaterials are often synthesized by esterification between an alcohol and an acyl chloride (Liu and Rimmer 2002; Sharifi et al. 2008). Bruining and collaborators have proposed the synthesis of their dicarbonate from a diol and another type of chlorine derivative (Bruining et al. 1999). This class of polymer can be also synthesized by ROP in the case of poly(trimethylene carbonate) (Figure 5). Polycondensation reaction can also be used to form polycarbonate from a dimethylcarbonate and a diol (Foy et al. 2009). Besides, double bond containing

polycarbonate can be synthesized by terpolymerization of carbon dioxide, propylene oxide and maleic anhydride (Liu et al. 2006, Song et al. 2008).

3.1.7. Polyanhydrides

Polyanhydrides, forming from non-toxic and low cost di-acid compounds, are well known to be biocompatible (Katti et al. 2002; Jain et al. 2005). The most common methods of polyanhydride synthesis are the melt condensation and the ROP, thanks to their simple one-step reaction without complex purifications. Other methods are also suitable to synthesize these polymers. They are based on interfacial condensation, dehydro-chlorination, and use of dehydrative coupling agents (Kumar et al. 2002). Degradation of polyanhydrides occurs by hydrolysis of the anhydride function. It is the inverse reaction of the formation of polyanhydride (Fig. 11). In general, the degradation occurs through a surface erosion mechanism over a predictable period, varying from 2 days to 1 year (Table VII) (Quick et al. 2004, Young et al. 2000, Cheng et al. 2004). Due to their easy synthesis, their surface degradation mechanism and their mechanical strength, polyanhydrides have been widely used (Kumar et al. 2002).

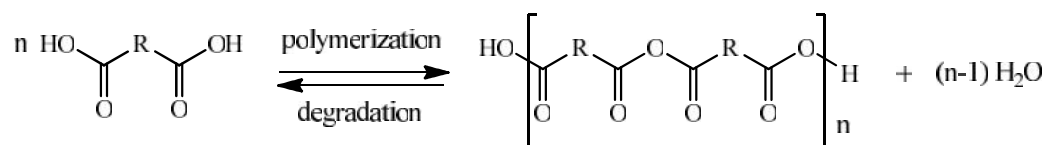

Figure 11. Scheme of the synthesis and degradation of polyanhydride.

It is possible to prepare unsaturated polyanhydrides by using initial diacids which contain carbon-carbon double bonds (Domb et al. 1996). Polyanhydrides with unsaturated groups are attractive. They can be used as hydrolysable crosslinkers to synthesize chemically crosslinked hydrogels for multiple applications (Kumar et al. 2002).

3.1.8. Polyphosphazene

Polyphosphazenes are the most well known biodegradable inorganic-organic hybrid polymers. They are synthesized by a two step reactions including a polymerization by thermal ROP of a tri(dichlorophosphazene) and a nucleophilic substitution of the chlorine groups (Fig. 12). The order of the two reactions can be inverted (Allcock 1992).

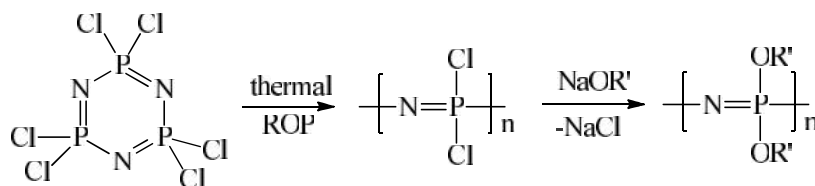

Figure 12. Scheme of the synthesis of Polyphosphazene. The order of the two reactions can be inverted.

Polyphosphazenes containing amino acid ester side groups are hydrolysable (Allcock et al. 1994). In contact with water, they can degrade by both bulk and surface erosion mechanism (Laurencin et al. 1992) into phosphates, ammonia, the corresponding amino acid and alcohol which can be processed and eliminated by the body (Krogman et al. 2007). It is possible to add different substituents on the polymer chain. Thus, this class of polymer is extremely versatile as side groups with various physical and chemical properties can be introduced in the polymer structure. The properties of the materials can be tuned to suit different application requirements (Huang et al. 2008). It can also be used to include biologically active compounds in the polymer structure by formation of a covalent linkage (Allcock et al. 1991).

3.1.9. N,O-dicarbonyl hydroxylamine

In general, biodegradable materials are polymers which contain multiple hydrolysable functions such as those described above including ester, anhydride and carbonate groups. However, it may occur that the degradable material only includes one degradable function. It

is the case of N,O-dicarbonyl hydroxylamine which structure is given in Fig. 13. Such components are special types of esters which are stable in acid solutions (aqueous buffers with pH < 5) but are susceptible to hydrolysis at physiological pH (7.4) (Ulbrich et al. 1995).

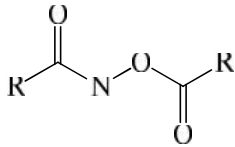

Figure 13. Chemical structure of the N,O-dicarbonyl hydroxylamine group that may be contained in biodegradable materials.

3.2. Design of crosslinkers with hydrolysable segments

As mentioned previously, radical polymerization of carbon-carbon double bond containing monomers and macromers is the most common method of synthesis of hydrogel used so far thanks to versatility of monomer design and possibility to form hydrogels *in situ* including *in vivo*. This part of the review reports works on the design of crosslinkers that are suitable hydrolysable building blocks to be introduced in the structure of degradable hydrogels by radical polymerization.

It is noteworthy that some of the degradable material presented in the previous part of the review include in their structures carbon-carbon double bonds that are readily available for radical polymerization and can be used as crosslinking agents. These are PPF, polyanhydrides and POEs. For all others, PLA, PGA, PLGA, PMA, polycarbonates, PPE, POE, chemical modifications are requested in order to add polymerizable residues. A large panel of hydrolysable crosslinkers was designed based on the incorporation of short segments of hydrolysable polymer on which polymerizable functions were added by chemical modifications. A minimal number of two polymerizable functions are incorporated in the

chemical structure as a requirement to obtain a crosslinker agent. In general, the polymerizable functions consist in carbon-carbon double bonds incorporated by addition of a residue of acrylic monomer. These crosslinkers are ready to be incorporated in a crosslinked polymer by radical polymerization. The larger family of crosslinker obtained following this principle of synthesis includes crosslinkers in which the hydrolysable segment is composed of polyesters (PLA, PGA, PLGA, and PCL). Their structure and methods of synthesis are described in the next paragraph. Other polymerizable functions can be added to degradable segments. They include chemical functions that may react with another to form covalent bonds between polymer chains (Table I) (Wise 1976; Belcheva et al. 1995; Yoncheva et al. 2001). In general, they are small molecules which contain several copies of the required chemical functions in their structure. An example is given by malic acid in which the two carboxylic acid groups are able to react with hydroxyl groups found on a polymer chain (Wise 1976). A few crosslinkers of this type which incorporate active molecules in their structure were found interesting to design hydrogels with high payload in drugs (Belcheva et al. 1995, Yoncheva et al. 2001). Although these crosslinkers are attractive to design performant drug delivery systems, they were not considered further in the present review paper.

3.2.1. Hydrolysable crosslinkers containing polyester segments

Acrylate or methacrylate were often used to introduce polymerizable functions at each extremities of hydrolysable polymer segments. Typical examples are diacrylates of PLA, PGA, PCL, PPF, saturated polyanhydride and their corresponding copolymers (Svaldi Muggli et al. 1998; He et al. 2001; Kweon et al. 2003; Chan-Park et al. 2004; Mespouille et al. 2008; Paris and Quijada-Garrido 2009; Cai and Wang 2010). The general structure of the resulted crosslinkers is illustrated in the example given in Fig. 14.

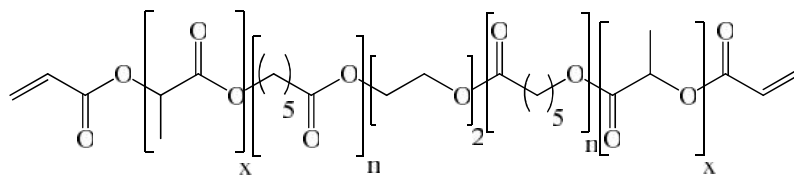

Figure 14. PLA-PCL-PLA diacrylated crosslinkers (Chan-Park et al. 2004)

It can be noted in this example that the crosslinker molecule also included PEG in its chemical structure. Although PEG is not biodegradable by itself, it can be eliminated from the body via kidney filtration with a molecular weight fragments lower than 30 kDa, (Yamaoka et al. 1994). Its incorporation in the chemical structure of degradable crosslinkers has numerous advantages. During the synthesis, PEG can be used as a ROP initiator to include PLA and/or PCL segments in the hydrolysable crosslinker prior to the addition of the acrylate residues at both ends of the molecule. Another interest is to increase the capacity of the final material to absorb water. This ensures that the material will degrade according to a bulk degradation mechanism (Deng et al. 1990). Regarding the physico-chemical property of the final material, the incorporation of PEG segments in the hydrogel structure increases the elasticity of the obtained hydrogel. Finally, in general, the surface of PEG containing materials displays valuable antifouling properties against proteins, bacteria and cell adhesion (Desai and Hubbell 1991). All of these advantages are combined with the fact that numerous PEG containing hydrogels are approved by the US Food and Drug Administration (FDA) for various clinical uses (Peppas et al. 2006). It can be considered that introducing PEG in the composition of the crosslinker was an important milestone in the development of degradable hydrogels for biomedical application, which emerged in the pioneer work of Sawhney et al. (Sawhney et al. 1993) (Fig. 15).

The chemical structure of the crosslinker developed by Sawhney et al. (Sawhney et al. 1993) served as model to the development of many types of crosslinker. This model can be modulated to suit different properties and further, to meet the different requirements found in

biomedical applications. The hydrolysable segment included at each end of the PEG segment can be modified as needed (PLA, PGA, PCL or mixtures) to tune both the physical properties and the degradation rate. Sawhney et al. have mainly worked with homopolymers of PLA and PGA (Sawhney et al. 1993) while Chan-Park et al. have introduced PCL segments into the chemical structure of the crosslinker (Chan-Park et al. 2004). A versatile choice is offered among the different hydrolysable materials.

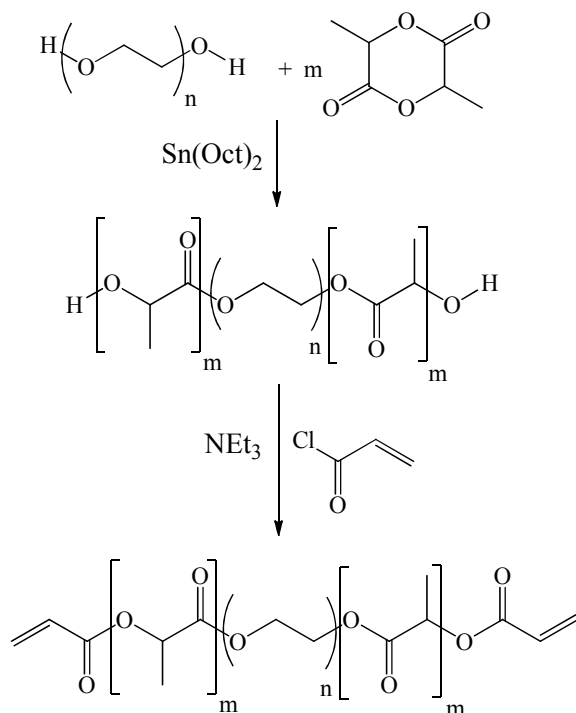

Figure 15. Synthesis of the triblock PLA-PEG-PLA diacrylate (Sawhney et al. 1993).

In addition to this, the model used for the synthesis of these materials has the advantage to also tailor the length of each hydrolysable segment composing the crosslinker (hydrolyable oligomer, PEG segment and either the double bond extremities). Thus, physical properties of polymer networks obtained with these crosslinkers can be finely tuned by changing the molecular weight, the composition and the architecture of the crosslinkers (Burdick et al. 2001, Jiao et al. 2006). Although acrylate was widely used to introduce polymerizable bonds in the structure of the crosslinker, other chemicals can be included such as methacrylate,

urethane methacrylate (Bencherif et al. 2009a,b), glycidyl methacrylate (Wang et al. 2010) or fumarate (Grijpma et al. 2005).

Zhu et al. have suggested replacing the PEG segments of the crosslinker by Pluronic® which is a triblock copolymer of PEG-PEO-PEG (Fig. 16) (Zhu et al. 2005). A new value was introduced in the hydrolysable crosslinker which gave thermosensitive properties to the final materials. Indeed, at low temperature, the hydrogel obtained with this crosslinker swells when it is placed in an aqueous solution but it shrinks at human body temperature. Such crosslinkers were designed with PLA (Zhu et al. 2005) and PCL (Wang et al. 2010) as hydrolysable segments.

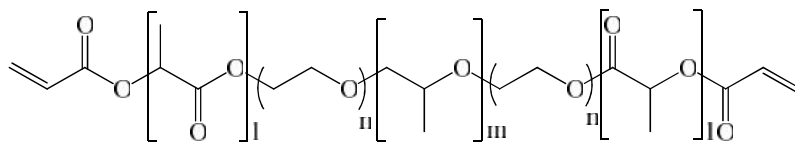

Figure 16. PLA-PEG-PPO-PEG-PLA diacrylate macromers (Zhu et al. 2005)

Replacing PEG by glycerol resulted in the synthesis of star shaped crosslinkers; as shown in Fig. 17 (Grijpma et al. 2005, Jiao et al. 2006). Indeed, the hydroxyl groups of glycerol can initiate the ROP with the different monomers which can be used to add the hydrolysable polymer segments to the crosslinker. By increasing the number of vinyl groups on the crosslinker structure, longer inhibition times for the mass loss was observed during degradation studies performed on corresponding hydrogels. It can be explained by the necessity to break more degradable units to release the crosslinking chain (Anseth et al. 2002).

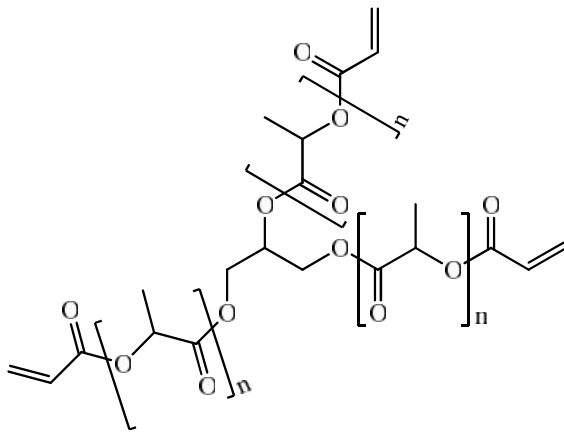

Figure 17. Chemical structure of PLA-glycerol-PLA triacrylate.

In complement to the series of triblock PLA-PEG-PLA diacrylate macromers, macromers with a reverse sequence arrangement were proposed by Clapper et al. (Clapper et al. 2007) in which PLA is the central block as illustrated in Fig. 18. The synthesis of this copolymer is more complicated than that of PLA-PEG-PLA macromers requiring multiples chemical modifications (Fig. 18).

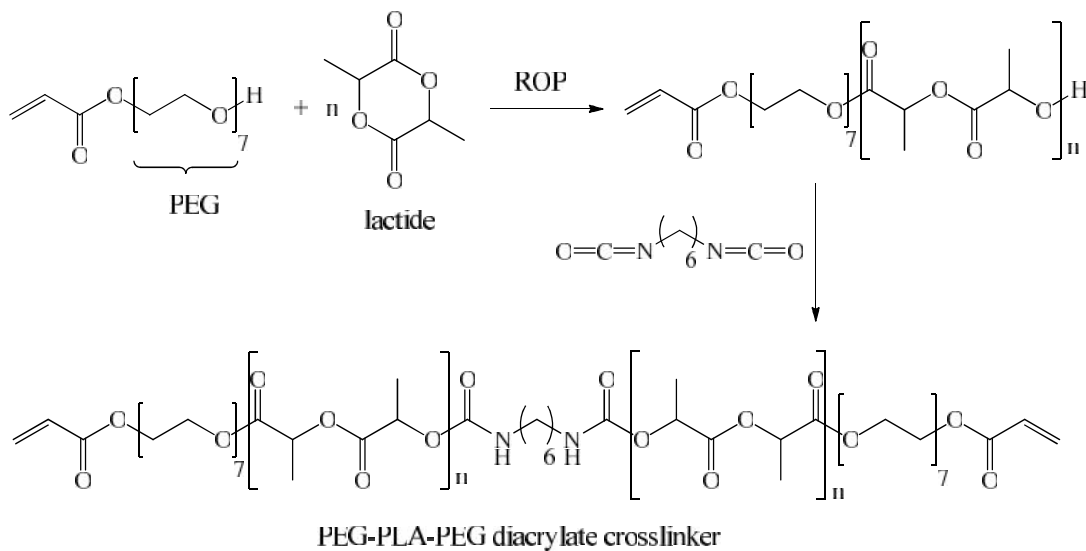

Figure 18. Chemical structure and scheme of the synthesis of PEG-PLA-PEG diacrylate crosslinker (Clapper et al. 2007).

In general, this crosslinking agent is formed with a block of PLA of low molecular weight ($MW < 2000$). It contains more PEG than the corresponding reverse sequence. It is well-known that the balance in the content of PLA and PEG in the crosslinking agent influences the swelling and degradation properties of hydrogels in which it is incorporated. Consequently, an increasing amount of PEG implies a faster degradation profile.

In the model of PEG-PLA-PEG crosslinker described previously, the polyester segments can be replaced by poly(malic acid) (PMA) to obtain a triblock PMA-PEG-PMA diacrylate crosslinker (Poon et al. 2009). However, this method required several synthesis steps to form the cyclic compound necessary for the ROP. A less complex method was developed via the addition of polymerizable double bonds on PMA obtained by polycondensation (Leboucher-Durand et al. 1996). In this case, chemical modifications are performed on the carboxylic pendant groups of the PMA chain. For example, this approach was used to graft HEMA residues on PMA chains to make possible the formation of crosslinked PMA (He et al. 2006).

3.2.2. Hydrolysable crosslinkers containing hydrolysable segments different from polyesters

Crosslinkers containing two hydrolysable carbonate groups were synthesised from the assembly of small molecules. In the synthesis suggested by Liu and Rimmer (Liu and Rimmer 2002), fluorouacil, which is an anticancer agent, was transformed in a dicarbonate containing crosslinker by coupling polymerizable acrylate residues on the substituents of the amino groups of the heterocycle (Fig. 19). The anti-tumour activity was preserved in the resulting

molecule which makes this crosslinker an interesting compounds to formulate implants with controlled released properties in fluorouracil.

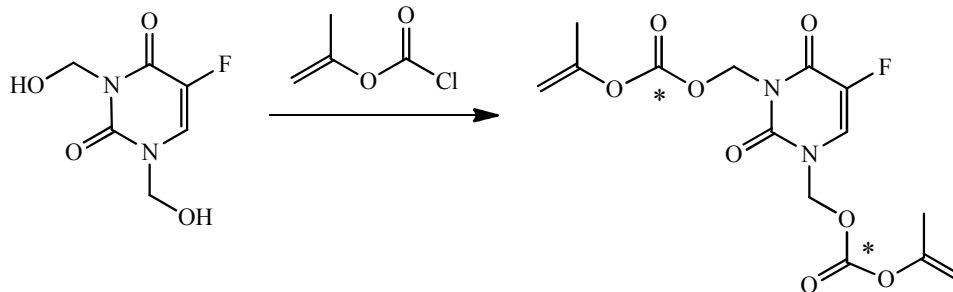

Figure 19. Synthesis and chemical structure of a polymerizable derivative of fluorouracil dicarbonate containing crosslinker. (The stars point out carbonate functions).

In another synthesis, a dicarbonate containing crosslinker was obtained from the combination of HEMA with triethylene glycol through a 2 steps reaction (Fig. 20) (Bruining et al. 1999, Bruining et al. 2000).

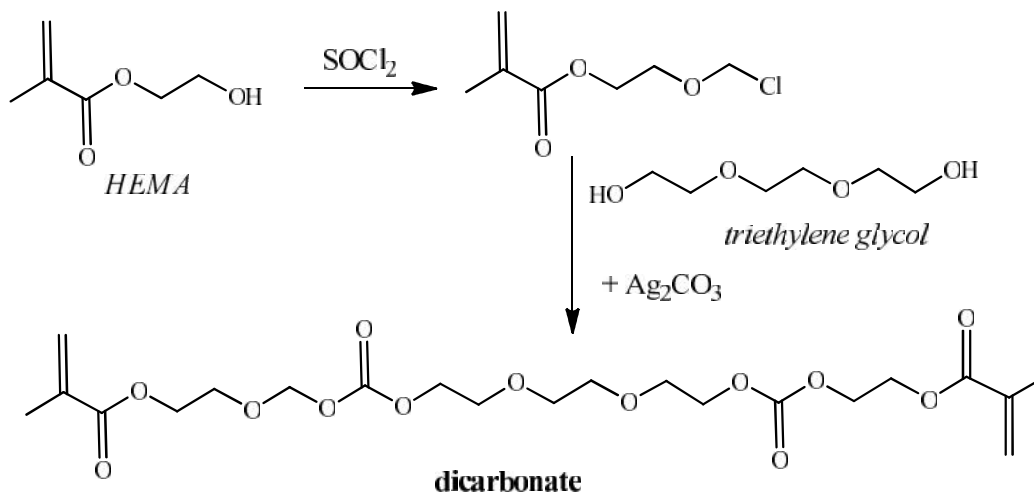

Figure 20. Scheme of the synthesis of polycarbonate based crosslinker designed by Bruining et al. (Bruining et al. 1999)

Keeping the carbonate group as the hydrolysable function in the crosslinker, Sharifi et al. (Sharifi et al. 2009) have introduced a new family of polycarbonate crosslinkers based on

poly(hexa methylene carbonate) (PHMC). Starting the synthesis of the crosslinker with this molecule has several advantages such as the possibility to modulate the nature of the compound providing with the double bonds. Indeed, this can come from acrylate residues or from fumarates. It is also possible to introduce PEG segments to obtain an amphiphilic macromer (Fig.21).

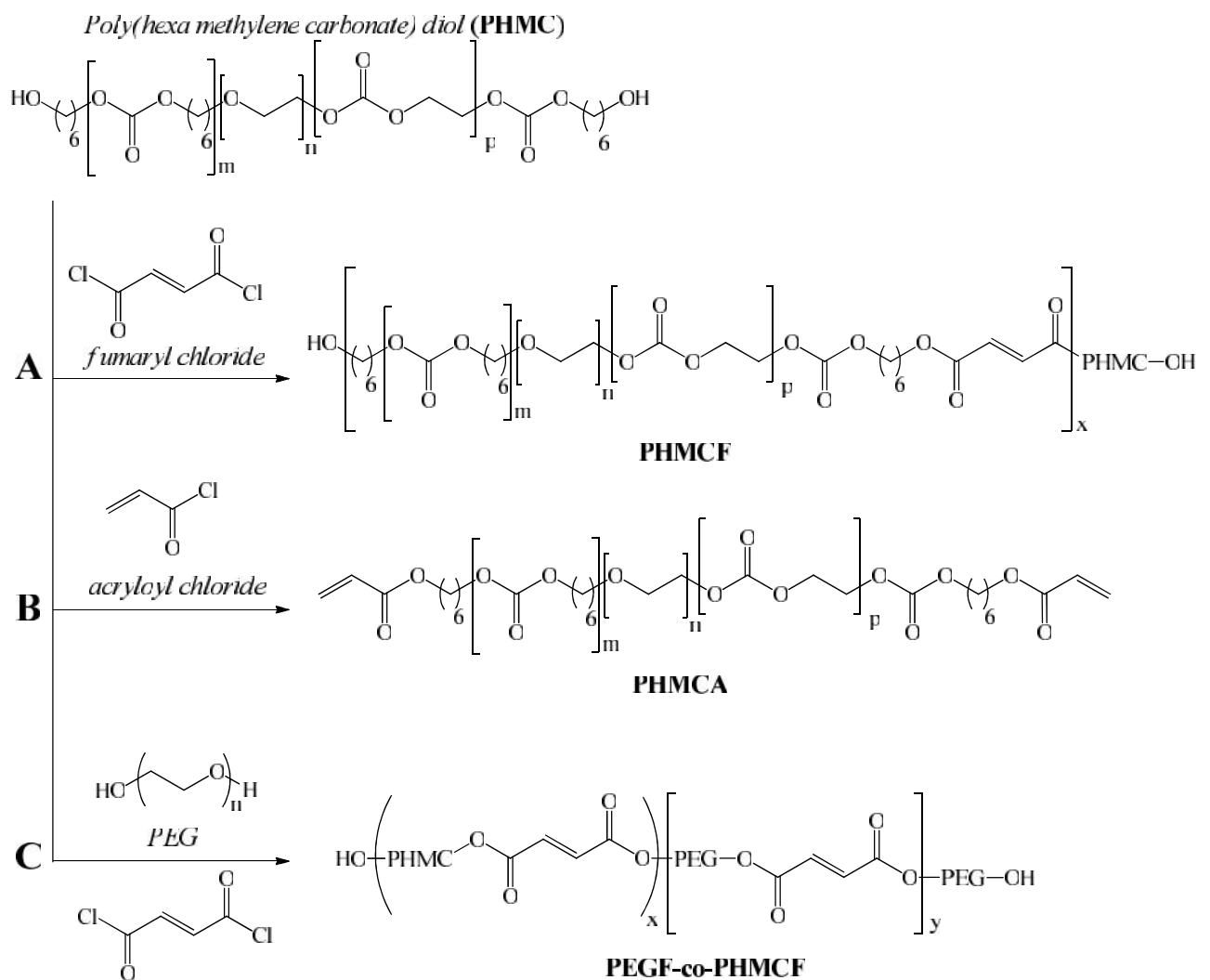

Figure 21. Scheme of the synthesis of polycarbonate containing hydrolysable crosslinkers from poly(hexamethylene carbonate) (PHMC). (A) poly(hexamethylene carbonate-fumarate) (PHMCF), (B) poly(hexamethylene carbonate) diacrylate (PHMCA) and (C) poly(ethylene glycol fumarate-co-hexamethylene carbonate fumarate) (PEGF-co-PHMCF) (Sharifi et al. 2009).

When hydrolysable segments are poly(phosphazene), the grafting of compounds containing a polymerizable double bond can be achieved by nucleophilic substitutions on the phosphorous atoms of the phosphazene molecular unit (Allcock et al. 1991). Following this scheme, numerous polyphosphazenes based crosslinker were synthesized by adding small molecules containing carbon-carbon double bond including for instance 2-butenoxy and 4-(allyl-oxyphenyl)phenoxy (Allcock and Ambrosio 1996). In another work, Grosse-Sommer and Prud'homme (Grosse-Sommer and Prud'homme 1996) have achieved the synthesis of a poly(phosphazene) containing degradable crosslinker with allylamine and imidazole substituents as illustrated in Fig. 22. The degradation rate of this crosslinker can be modulated by varying the ratio between the content of the two substituents.

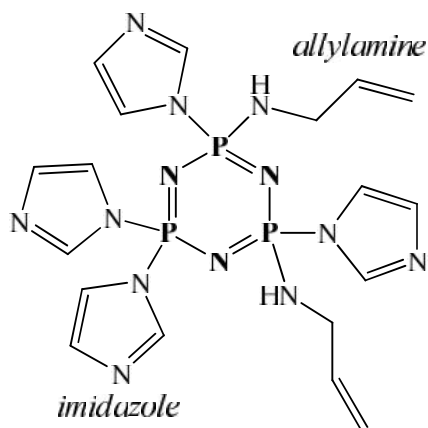

Figure 22. Chemical structure of trimeric phosphazene crosslinkers with allylamine and imidazole substituted (Grosse-Sommer and Prud'homme 1996).

In a more recent work, following the approach of Grosse-Sommer and Prud'homme, Allcock et al. have synthesized polyphosphazene containing crosslinkers with methoxyethoxyethoxy and cinnamyl groups as substituents (Allcock et al. 2006).

Considering polyanhydrides, these compounds may contain double bonds in their structure that are readily available for a radical polymerization. In general, polyanhydrides are

obtained from the copolymerization of unsaturated and saturated di-acids including fumaric acid and sebacic acid for instance (Domb et al. 1996). Their general structure is shown in Fig. 23. The double bond which remains intact after the polymerization of the diacids is available to achieve the crosslinking reaction between polymer chains. Several polyanhydride based crosslinkers were synthesized from fatty acids and amino acids (Kumar et al. 2002).

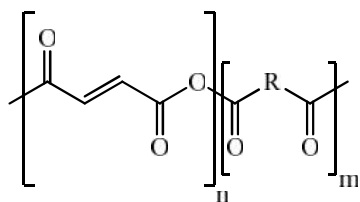
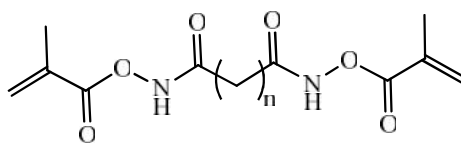

Figure 23. Chemical structure of the polyanhydride containing crosslinker model suggested by Domb et al. (Domb et al. 1996)

Similarly to polyanhydrides, double bonds are also readily available in poly(propylene fumarates) to achieved the crosslinking of polymers (Jo et al. 2001, Yan et al. 2011) (Fig. 7). It was observed that networks formed with these crosslinkers kept their degradability and hydrophilic/hydrophobic properties. The physico-chemical properties of the crosslinkers can be modulated by incorporation of polymeric segments of a different nature. For instance, PEG segments can be added to improve the water absorbance capacity of hydrogels obtained with these crosslinkers (Jo et al. 2001). In addition to a PPF and a PEG segment, the crosslinker can also include a PCL fragment. All the modifications can be considered to tune the properties of the crosslinker in such a way that the final material will have the desired properties in term of degradation rate, mechanical strength, softness and swelling capacity.

One of the main challenges found with the previously described hydrolysable crosslinkers is that they are extremely sensitive to the presence of moisture. This implies that they should be kept in a very dry environment during storage. Ulbrich et collaborators has developed the crosslinker *N,O*-dimethacryloyl hydroxylamine (Subr and Ulbrich 1992; Ulbrich et al. 1993,

linear aliphatic



linear aromatic

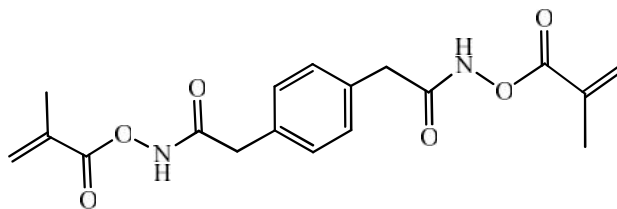

star shaped aromatic

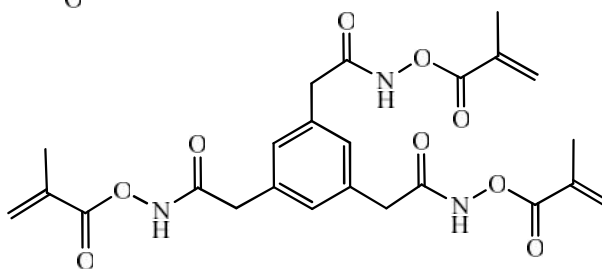

star shaped aliphatic

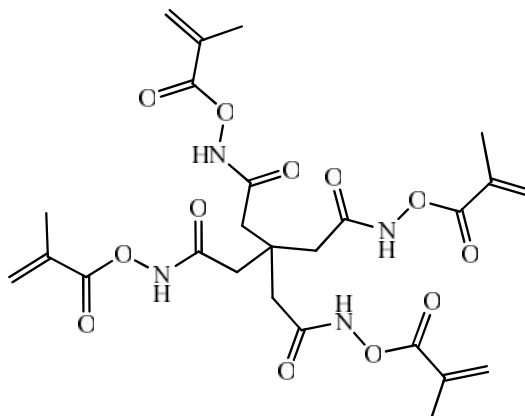

Figure 25. General structures of the panel of hydroxylamine containing crosslinkers proposed by Zhang et al. (Zhang and Schwarz 2006).

4. Formulation and applications of hydrolysable covalently crosslinked hydrogels in the biomedical field

Hydrogels in general and biodegradable hydrogels in particular may take many different forms to satisfy the different needs found in the biomedical field. They can be produced in molds to form solid matrices of different well define shapes (Burkoth et al. 2000, Young et al. 2000, Quick et al. 2004). For instance, biodegradable hydrogels can occur under the form of thin films serving as adhesion membranes or barriers (Bennett et al. 2003). Hydrogels can also take the form of rods or microparticles which were developed as matrixes for controlled releasing drug delivery systems (Zhu et al. 2005, Zhang et al. 2009). More interestingly, for a few applications, they can be formed *in vivo* in the exact location where their presence is required (Burkoth and Anseth 2000). In this case, they have no pre-defined shape, they take the shape of the empty space they are filling *in vivo*. They occur as injectable *in situ* forming gels or as glue-like hydrogels (West and Hubbell 1995; Bergman et al. 2009).

Properties of hydrogels can be tuned by varying the composition of the polymer matrix. The properties that may need to be adjusted are the rate of degradation, the visco-elastic properties including the mechanical strength of the hydrogel and the swelling ratio which define the amount of water able to penetrate in the polymeric network. Hydrogels can be made from the homopolymerization of only degradable crosslinkers. However, copolymerization with other monomers is widely used to further increase the versatility of properties that can be given to hydrogels. For instance, copolymerization of the PLA-PEG-PLA diacrylate macromer with acrylic acid led to gels with improved elasticity, higher swelling ratios and faster degradation

rate than those of the hydrogels resulted from the homopolymerization of the crosslinker (Sawhney et al. 1993). As a rather general rule, Jiao et al. (Jiao et al. 2006) demonstrated that the increasing ratio of co-monomer/crosslinker led to a diminution of crosslinking density of the hydrogels, hence contributed to increase the swelling ratios, the mechanical properties, and the rate of degradation measured *in vitro*. The nature of the end groups containing the polymerizable carbon-carbon double bond has significant effects on the mechanical, swelling and degradation as well properties of the hydrogel (Bencherif et al. 2009). More generally, it was demonstrated by different independent works that the degradation rate of hydrolysable hydrogels depended on the nature of the crosslinker and the general hydrophilicity of the hydrogel (Svaldi Muggli et al. 1999, Burkoth et al. 2000, Li et al. 2004). The degradation properties can be controlled by varying the crosslinker structure(s), their proportions, and the crosslink density (Grosse-Sommer and Prud'homme 1996, Eichenbaum et al. 2005). It was also reported that gels made from lower molecular weight precursors were more tightly crosslinked and thus degraded slowly than those made from higher molecular weight precursors (Sawhney et al. 1993; Han and Hubbell 1997). The following examples gives some degradation time regarding the nature of the crosslinker used to formulate hydrogels. Hydrogels obtained from polyester-PEG-polyester diacrylates have their degradation time which vary from 1 day to several months depending on the crosslinking density and on the type of polyester used as terminal blocks grafted (i.e. PLA, PGA, PLGA, PCL) on the central PEG segment (Sawhney et al. 1993, Zhu et al. 2005). Hydrogels obtained from the free radical copolymerization of a polyphosphazene based crosslinker and poly(acrylic acid) degraded over a period of one to two months in the presence of water (Grosse-Sommer and Prud'homme 1996). When *N,O*-dimethacryloylhydroxyl-amine was incorporated as the crosslinker in the hydrogel, the time required for a total hydrolysis of the gels varied from less than a day to nearly a week (Ulbrich et al. 1993). It was highlighted that the degradation rate

also depended on the size of the hydrogel device and on the pH of the micro-environment. Many of the experiments devoted to evaluate the degradation of hydrogels were performed *in vitro* using model solutions as degradation media. Only a few works report results from investigations carried out *in vivo*. In experiments performed in mice, Potta et al. have reported that the degradation rate of hydrogels can also be controlled by varying the ratios of different side groups composing the polymer matrice (Potta et al. 2009).

Other properties may be incorporated in the hydrogel by varying the nature of the comonomer. For instance, hydrogels can be thermo-sensitive by copolymerizing the PLA-PEG-PLA diacrylate crosslinker with N-isopropylarylamide (NIPAM) and acrylamide (Zhang et al. 2010).

Similarly to the degradation properties, initial mechanical and swelling properties of hydrogel can be tuned by choosing the chemical nature and structure of the polymer composing hydrogels. However, it is noteworthy that these properties are generally modified as soon as degradation starts. Effects are particularly dramatic in gels degrading in bulk in which the mechanical strength and the swelling ratios change notably during the whole process of degradation as the porosity of the polymer network increases. For instance, it was shown that the mechanical strength of the hydrogels composed of PLA-PEG-PLA diacrylate decreased exponentially with time while the volumetric swelling ratios increase exponentially (Metters, Anseth et al. 2000, Davis, Burdick et al. 2003). This can even be accompanied by an acceleration of the degradation rate as degradation proceeds (Davis, Burdick et al. 2003). For polymer degrading by a surface erosion mechanism, the mechanical strength of the bulk material remains unchanged while only the properties of the surface of the material are modified. The mechanical properties of the devise may be changes as the dimensions decrease as degradation proceeds.

Considering applications, hydrogels are synthetic materials with the most similar structure to natural livings. All of their properties including degradation can be finely tuned to fit with many applications of interest in the biomedical field. Thus, degradable hydrogels were widely considered as basic materials to produce matrices to be implanted *in vivo*. One typical application is the design of degradable hydrogels to achieve a controlled release of a drug (Belcheva et al. 1995, Allcock and Ambrosio 1996, Paris and Quijada-Garrido 2009). Devices such as microspheres were produced by polymerization in suspensions (Zhu et al. 2005) (Table II). Implantable drug eluting films, disks and rods were produced by copolymerizing the monomers in molds (Sawhney et al 1993, Bruinning et al. 1999, 2000, Liu and Rimmer 2002, Quick et al. 2004, Jiao et al. 2006, Shah et al. 2006) (Tables II, VI and VII). For the delivery of large molecules such as RNA, peptides, proteins and DNA, the release of the drug can be well controlled by the degradation of the hydrogel (Zhao and Harris 1998, Leach and Schmidt 2005, Bencherif et al. 2009). An equation which well correlated to experiments was established to predict the release profiles of the drug according to the degradation time (Mason et al. 2001). The volumetric swelling ratio, the network mesh size and the diffusivity of the entrapped drug were exponential to the evolution of the degradation. Bencherif et al. have investigated the influence of the crosslinker chemistry on the release kinetics of DNA from hydrogels made of triblock diacrylated PGA-PEG-PGA crosslinkers (Bencherif et al. 2009). The DNA was associated with the hydrogel during the preparation by photopolymerization. The released DNA kept its initial supercoiled form, which meanted that the integrity of the plasmid DNA was maintained after photo-encapsulation. The release of the plasmid DNA followed the degradation rate of the hydrogel, which can be controlled by varying the chemistry of the crosslinker at a given concentration of polymer in the hydrogel. Hydrogels obtained with high polymer concentrations (typically 20 weight % in D₂O) showed a release pattern with two bursts: the first occurred at the beginning of the experiment and was

attributed to the release of DNA near the surface of the device while the second burst occurred toward the end of the hydrogel degradation and was attributed to the release of the remaining DNA entrapped in the gel and released rapidly while the matrix loosened its integrity. When the hydrogel was formulated with a low concentration in polymer (typically 10 weight %), it exhibited only one-stage release profile of plasmid DNA which is linear over the period of degradation of the hydrogel. Other groups have also investigated the application of degradable hydrogels for DNA delivery. Quick et al. used hydrophobic polyanhydride based hydrogels to have a release of DNA controlled by the rate of erosion of the hydrogel matrix (Quick et al. 2004). Unfortunately, they have highlighted that the amount of supercoiled DNA released was decreased over time. Pre-encapsulation of the DNA in alginate microparticles before forming the polyanhydride matrix help in reducing denaturation of plasmid DNA during the preparation of the hydrogel matrix. To make *in situ* transfection, the authors have explored the co-encapsulation of plasmid DNA and cells (Quick and Anseth 2003). They observed that the released DNA could efficiently transfect plated and encapsulated cells indicating that it remained active. This result is interesting to further develop tissue mimicking the natural healing processes. The results showed a possibility of coupling drug delivery application with tissue engineering for a better treatment.

As an example of peptide, PLA-PEG-PLA crosslinked hydrogels formed via a photoinitiated polymerization were investigated for the delivery of neurotrophins, growth factors used to promote the regeneration of diseased or damaged tissues from the central nervous system) (Burdick et al. 2006). The network crosslinking density was shown to influence importantly the diffusion of the neurotrophin. This can be used to vary releasing time in a wide range (from weeks to several months).

Beside large molecules, degradable hydrogels were also considered to deliver different types of active compounds occurring as small molecules. Small drug molecules can be incorporated in hydrogel by simple entrapment or linked via a covalent linkage with the polymer composing the hydrogel. Drug released from a hydrolysable hydrogel composed of HEMA as copolymer can be controlled by either the degradation of the hydrogel or the diffusion of the drug molecule in the hydrogel or by a combination of both mechanisms. These mechanisms controlling the rate of release of the drug applied to both the free drug and the drug conjugated to the polymer (Ulbrich et al. 1995). In the work proposed by Liu and Rimmer (Liu and Rimmer 2002), the drug, the 5 fluorouracil, was incorporated in the structure of the hydrolysable crosslinker based on dicarbonate dimethacrylate. The hydrolysis of the dicarbonate functions released the parent 5 fluorouracil molecule. The release of the drug incorporated in the hydrogel structure was found to follow the rate of degradation of the hydrogel.

Degradable hydrogels were believed to constitute ideal matrices for cell growth. The rationale behind this choice was based on the fact that the general structure of hydrogel is very similar to that of matrices found in living organisms. Therefore, they were suggested to be used as scaffolds for cell culture in the 3 dimensional spaces to be applied in tissue engineering and regeneration purposes. At present, it is the hottest domain of investigations on degradable hydrogels which includes exiting applications and challenges. Demands in the biomedical field were identified in numerous areas where cell engineering may bring value to help recovery of injuries in damage tissues. This includes bone repair and cartilage regeneration, improvements of grafting methods of artificial hips in orthopedics and tooth in dentistry, regeneration of nerves or of impaired cardiac tissue and regeneration of damaged tissue of the central nervous system, engineering of artificial blood vessels. Several reports have already

proven the relevance of the approach. In some examples, cells were incorporated directly in hydrogels during the preparation of the matrices thanks to the application of gentle polymerization conditions (Burkoth et al. 2000, Burdick et al. 2001, 2006, Mahoney and Anseth 2006). These can further serve as reservoir of cells for tissue regeneration. When implanted *in vivo*, that can be achieved from a gel prepared either outside the body in a mold or inside the body. In other applications such as in orthopedics, the matrices can serve as temporary scaffolds for cell growth *in situ*. During tissue regeneration, it is expected that cells progressively colonize and produce new functioning tissue to heal injuries. For instance, this principle is applied to enhance bone and cartilage repair (Burkoth et al. 2000, Burdick et al. 2001, Kweon et al. 2003, Timmer et al. 2003a,b, Clapper et al. 2007,2008, Yan et al. 2011). Burdick and co-workers (Burdick et al. 2003) made an *in situ* forming porous PLA-PEG-PLA crosslinked hydrogels as an orthopaedic biomaterial under a particulate leaching technique previously developed by Mikos et al. (Mikos et al. 1994). Initially used to promote bone regeneration, these macromers also showed good potential applications for cartilage tissue engineering. (Anseth, Metters et al. 2002). The polymer matrix contained large amount of water and displayed elastic properties similar to those of the tissue. It can be used as a temporary scaffold for the growing cells until newborn cells can ensure the tissue function. To improve the functionality in tissue regeneration of the hydrogel, chondrocytes were seeded in a hydrogel scaffold (Bryant and Anseth 2002). The photoencapsulated chondrocytes produced similar biochemical contents as those obtained from newly synthesized cartilaginous tissue. However, it was suggested in another work that changes in the crosslinking density of the hydrogel scaffold might influence the level of deformation and heterogeneity of chondrocytes, which can in turn modify their function of cartilage producter (Bryant et al. 2004). More recently, other authors have developed oligo(PEG-fumarate) crosslinking hydrogel encapsulating chondrocytes as an orthopaedic tissue engineering material (Dadsetan et al.

2007). Photoencapsulated chondrocytes remained viable and produced cartilaginous matrix inside the hydrogel after 3 weeks. This result promised potential treatment for the joint diseases. Instead of chondrocytes which are differentiated cells, stem cells isolated from the marrow stroma were also successfully incorporated in a hydrogel scaffold to be used for the treatment of overused tendon injuries (Qiu et al. 2011). The synthesized hydrogels were cytocompatible (cell proliferations were found after 14 days). Moreover, cells delivery can be controlled by the degradation rate of the hydrogel.

Other applications are investigated in the intention to use degradable hydrogels as scaffolds for nerve and central nervous tissue regeneration (Mahoney and Anseth 2006, Burdick et al. 2006, Cai and Wang 2010). This is an extremely challenging application with considerable potential in case of success for making possible the reparation of nerves after accidental sectioning for instance. It is also believed that hydrogels may serve as candidates to support neural cell growth preserving the functionalities of the cells to make possible cell transplantation to the central nervous system (Mahoney and Anseth 2007). In their work, Mahoney and Anseth have incorporated neural cells in hydrogels crosslinked with PLA₂-PEG₄₆₀₀-PLA₂ in *in vitro* hydrogel culture tests. Promising results were observed including a good capacity of proliferation of the neural cells in the hydrogel scaffold. The proliferation could be tuned with the degradation rate of the hydrogel on a time-scale ranging from 1 to 3 weeks. The cells could differentiate into neurones and glia (Mahoney and Anseth 2006). The survival and growth of the neural cells was further enhanced by incorporating in the hydrogel collagen and beta FGF2 (Mahoney and Anseth 2007). These encouraging results may be used in the future to develop treatments for neurodegenerative diseases such as the Parkinson's disease.

Depending on the applications, hydrogels are intended to serve as support for cell growth until the damage tissue is sufficiently regenerated to be fully replaced by the newly grown cells. This is mostly the case in applications considering bone repair. In other situations, the hydrogel is used as cell reservoirs to provide the impaired tissue with healthy cells replacing the diseased cells. Typical applications interested by this technique are regeneration of cartilage, impaired cardiac tissue and of impaired or degenerative nervous tissues. Obviously, the characteristics of the scaffolds including its structure, mechanical strength and degradation time scale need to be adjusted very precisely as the function of the tissue to be regenerated. Beside the versatility of the hydrogels properties that can be adjusted by choosing the composition and chemical characteristics, another advantage is that hydrogels can be formed *in situ* including in *in vivo* conditions without causing damage on the surrounding tissue. In these latter conditions, the hydrogel takes the shape that is requested for an optimum contact with the impaired tissue providing an ideal situation to promote growth and implantation of the new tissue. In all cases, it was shown that the incorporation of growth factors in the hydrogels further enhances the efficacy of the technique.

Finally, a few attempts have been reported in the literature on the investigation of the use of degradable hydrogel films for cardiovascular tissue regeneration (Grijpma et al. 2005).

Apart from the main applications as controlled release drug delivery systems and for tissue engineering, degradable hydrogels were found interesting to be use in other biomedical applications. For instance, they were suggested to be used as material to produce emboles for temporary embolisation. In this case, the degradable hydrogel was formulated under the form of microspheres (Schwarz, Zhang et al. 2004, Wang et al. 2011, Moine et al. 2011). The microspheres can be loaded with a drug to be applied in chemo-embolization techniques (Moine et al. 2011). In another application, degradable hydrogel was found to be a suitable

material to create a temporary barrier *in vivo* to prevent post-surgical adhesion of tissue (Hill-West et al. 1994). The hydrogel was formed *in situ* directly on the surface of the tissue to be treated in assays performed in an animal model of post operative adhesions. An efficient conformational barrier was formed on the surface of the tissue preventing adhesion in the different post-operative situations created in the model with complete resorption of the hydrogel observed after 7 days (Hill-West et al. 1994). Finally, degradable hydrogels were also found as lubricants for coating medical devices (Kim, Hrkach et al. 2000).

5. CONCLUSIONS

Hydrolysable hydrogels obtained by the introduction of hydrolysable crosslinkers in the structure of the polymer during synthesis by polymerization is composed of a large family of materials. The chemistry behind the synthesis is so versatile that, in theory, such hydrogels can be obtained with almost infinite properties. They can be made biocompatible and appeared as materials of choice for various applications in the biomedical domain including highly demanding applications. They can be formed outside the body but also directly inside the body at the site of action. Their potential of application is so wide that there are still spaces available to design suitable degradable hydrogels for new applications.

6. References

Allcock H.R., Fitzpatrick R.J., Salvati L. (1991). "Functionalization of the surface of poly[bis(trifluoroethoxy)phosphazene] by reactions with alkoxide nucleophiles." *Chemistry of Materials* 3(3): 450-454.

Allcock, H. R. (1992). "Polyphosphazenes." *Journal of Inorganic and Organometallic Polymers* 2(2): 197-211.

Allcock H.R., Pucher S.R., Angelo G. (1994). "Poly[(Amino-Acid-Ester)Phosphazenes] - Synthesis, Crystallinity, and Hydrolytic Sensitivity in Solution and the Solid-State." *Macromolecules* 27(5): 1071-1075.

Allcock H.R. and Ambrosio A.M.A. (1996). "Synthesis and characterization of pH-sensitive poly(organophosphazene) hydrogels." *Biomaterials* 17(23): 2295-2302.

Allcock H.R., Phelps M.V.B. and Barrett E.W. (2006). "Ultraviolet photolithographic development of polyphosphazene hydrogel microstructures for potential use in microarray biosensors." *Chemistry of Materials* 18(3): 609-613.

Alsberg E., Kong H.J., Hirano Y., Smith M.K., Albeiruti A. and Mooney D.J. (2003). "Regulating Bone Formation via Controlled Scaffold Degradation." *Journal of Dental Research* 82(11): 903-908.

Anseth K.S., Metters A.T., Bryant S.J., Martens P.J., Elisseff J.H., Bowman C.N. (2002). "In situ forming degradable networks and their application in tissue engineering and drug delivery." *Journal of Controlled Release* 78(1-3): 199-209.

Baldwin S.P. and Saltzman W.M. (1998). "Materials for protein delivery in tissue engineering." *Advanced Drug Delivery Reviews* 33(1-2): 71-86.

Bergman, K., T. Engstrand, et al. (2009). "Injectable cell-free template for bone-tissue formation." *Journal of Biomedical Materials Research Part A* 91A(4): 1111-1118.

Belcheva, N., Smid J., Lambov N., Danchev N., Peikov P., Zlatkov A., Tsvetanov C. (1995). "Polymeric sustained release formulations of the bronchial dilator vephylline." *Journal of Controlled Release* 37(1-2): 43-48.

Bencherif S.A., Sheehan J.A., Hollinger J.O., Walker L.M., Matyjaszewski K., Washburn N. R. (2009A). □Influence of cross-linker chemistry on release kinetics of PEG-co-PGA hydrogels. □*J Biomed Mater Res* **90A**: 142 □53, 2009

Bencherif S.A., Srinivasan A., Sheehan J.A., Walker L.M., Gayathri C., Gil R., Hollinger J.O., Matyjaszewski K., Washburn N. R. (2009B). □End-group effects on the properties of PEG-co-PGA hydrogels. □*Acta Biomaterialia* **5**: 1872 □1883

Bennett S.L., Melanson D.A., Torchiana D.F., Wiseman D.M., Sawhney A.S. (2003) □Next-generation hydrogel films as tissue sealants and adhesion barriers. □*J Card Surg.* 18(6):494-9.

Benoit D.S.W., Durney A.R. and Anseth K.S (2006). □Manipulations in Hydrogel Degradation Behavior Enhance Osteoblast Function and Mineralized Tissue Formation. □*Tissue Engineering* 12(6): 1663-1673.

Bettini R., Colombo P. and Peppas N.A. (1995). "Solubility effects on drug transport through pH-sensitive, swelling-controlled release systems: Transport of theophylline and metoclopramide monohydrochloride." *Journal of Controlled Release* **37**(1-2): 105-111.

Braud C., Bunel C. and Vert M. (1985). "Poly(α -malic acid) : a new polymeric drug-carrier." *Polymer Bulletin* 13(4): 293-299.

Bruining M.J., Edelbroek-Hoogendoorn P.S., Blaauwgeers H.G., Mooy C.M., Hendrikse F.H., Koole L.H. (1999). "New biodegradable networks of poly(*N*-vinylpyrrolidinone) designed for controlled nonburst degradation in the vitreous body." *Journal of Biomedical Materials Research* 47(2): 189-197.

Bruining M.J., Blaauwgeers H.G., Kuijter R., Pels E., Nuijts R.M. Koole L.H. (2000). "Biodegradable three-dimensional networks of poly(dimethylamino ethyl methacrylate). Synthesis, characterization and in vitro studies of structural degradation and cytotoxicity." *Biomaterials* 21(6): 595-604.

Bryant S.J. and Anseth K.S. (2002). "Hydrogel properties influence ECM production by chondrocytes photoencapsulated in poly(ethylene glycol) hydrogels." *Journal of Biomedical Materials Research* 59(1): 63-72.

Bryant S.J., Chowdhury T.T., Anseth K.S., Lee D.A. and Bader D.L. (2004). α Crosslinking Density Influences the Morphology of Chondrocytes Photoencapsulated in PEG Hydrogels During the Application of Compressive Strain, α *Journal of Orthopaedic Research*, 22, 1143-49.

Burdick J.A., Philpott L.M., Anseth K.S. (2001). "Synthesis and characterization of tetrafunctional lactic acid oligomers: A potential *in situ* forming degradable orthopaedic biomaterial." *Journal of Polymer Science Part A: Polymer Chemistry* 39(5): 683-692.

Burdick, J. A., M. Ward, et al. (2006). "Stimulation of neurite outgrowth by neurotrophins delivered from degradable hydrogels." *Biomaterials* 27(3): 452-459.

Burkoth A.K. and Anseth K.S. (2000). "A review of photocrosslinked polyanhydrides: in situ forming degradable networks." *Biomaterials* 21(23): 2395-2404.

Burkoth A.K., Burdick J. and Anseth K.S. (2000). "Surface and bulk modifications to photocrosslinked polyanhydrides to control degradation behavior." *Journal of Biomedical Materials Research* 51(3): 352-359.

Cai L. and Wang S. (2010). "Poly(α -caprolactone) acrylates synthesized using a facile method for fabricating networks to achieve controllable physicochemical properties and tunable cell responses." *Polymer* 51(1): 164-177.

Caldorera-Moore M. and Peppas N.A. (2009). "Micro- and nanotechnologies for intelligent and responsive biomaterial-based medical systems." *Advanced Drug Delivery Reviews* 61(15): 1391-1401.

Chivukula, P., Dusek, K., Wang, D., Dusková-Smrcková, M., Kopecký, P., Kopeček, J., (2006). α Synthesis and characterization of novel aromatic azo bond-containing pH-sensitive and hydrolytically cleavable IPN hydrogels. α *Biomaterials* 27, 1140-1151.

Cammass-Marion, S. and P. Guérin (2000). "Design of malolactonic acid esters with a large spectrum of specified pendant groups in the engineering of biofunctional and hydrolyzable polyesters." *Macromolecular Symposia* 153(1): 167-186.

- Chan-Park M.B., Zhu A.P., Shen J.Y., Fan A.L. (2004).** "Novel photopolymerizable biodegradable triblock polymers for tissue engineering scaffolds: synthesis and characterization." *Macromolecular Bioscience* 4(7): 665-673.
- Cheng G., Aponte M.A., Ramírez C.A. (2004)** □Cross-linked amino acid-containing polyanhydrides for controlled drug release applications. □*Polymer* 45: 3157□3162.
- Choi N.S. and Heller J. (1979)** □Novel ortho ester polymers and poly(ortho esters) by the reaction of ketene acetals and orthocarbonate polymers. □U.S. Patent 4,180,646.
- Çiçek, H. and A. Tuncel (1998).** "Immobilization of &agr;-chymotrypsin in thermally reversible isopropylacrylamide-hydroxyethylmethacrylate copolymer gel." *Journal of Polymer Science Part A: Polymer Chemistry* 36(4): 543-552.
- Clapper J.D., Skeie J.M., Mullins R.F., Guymon C.A. (2007).** "Development and characterization of photopolymerizable biodegradable materials from PEG-PLA-PEG block macromonomers." *Polymer* 48(22): 6554-6564.
- Clapper J.D., Pearce M.E., Guymon C.A. and Salem A.K. (2008).** □Biotinylated Biodegradable Nanotemplated Hydrogel Networks for Cell Interactive Applications. □*Biomacromolecules* 9(4): 1188□1194.
- Dadsetan M., Szatkowski J.P., Yaszemski M.J. and Lu L. (2007).** □Characterization of Photo-Cross-Linked Oligo[poly(ethylene glycol) fumarate] Hydrogels for Cartilage Tissue Engineering. □*Biomacromolecules* 8(5): 1702-1709.
- Davis, K. A. and K. S. Anseth (2002).** "Controlled Release from Crosslinked Degradable Networks." *Crit Rev Ther Drug Carrier Syst* 19(4-5): 39.
- Davis K.A., Burdick J.A., Anseth K.S. (2003).** □Photoinitiated crosslinked degradable copolymer networks for tissue engineering applications. □*Biomaterials* 24: 2485□95.
- Deng X.M., Xiong C.D., Cheng L.M., Xu R.P. (1990).** "Synthesis and characterization of block copolymers from D, L-lactide and poly(ethylene glycol) with stannous chloride." *Journal of Polymer Science Part C: Polymer Letters* 28(13): 411-416.
- Desai, N. P. and J. A. Hubbell (1991).** "Biological responses to polyethylene oxide modified polyethylene terephthalate surfaces." *Journal of Biomedical Materials Research* 25(7): 829-843.
- Domb A J, Mathiowitz E, Ron E, Giannos S, Langer R. (1991)** □Polyanhydrides. IV. Unsaturated and crosslinked polyanhydrides. □*Journal of Polymer Science Part A: Polymer Chemistry* 29: 571□579.
- Domb, A. J., N. Manor, Elmalak O. (1996).** "Biodegradable bone cement compositions based on acrylate and epoxide terminated poly(propylene fumarate) oligomers and calcium salt compositions." *Biomaterials* 17(4): 411-417.
- Domurado, D., P. Fournie, Braud C., Vert M., Guérin P. and Sionnet F. (2003).** "In Vivo Fates of Degradable Poly(□Malic Acid) and of its Precursor, Malic Acid." *Journal of Bioactive and Compatible Polymers* 18(1): 23-32.

- Dordunoo S.K.; Oktaba A.M.C.; Hunter W.; Min W.; Cruz T.; Burt H.M. (1997).** "Release of taxol from poly(epsilon-caprolactone) pastes: effect of water-soluble additives." *Journal of Controlled Release* 44(1): 87-94.
- Eichenbaum K.D., Thomas A.A., Eichenbaum G.M., Gibney B.R., Needham D. and Kiser P.F. (2005).** "Oligo-epsilon-hydroxy Ester Cross-Linkers: Impact of Cross-Linker Structure on Biodegradable Hydrogel Networks." *Macromolecules* 38(26): 10757-10762.
- Fialho S.L., Behar-Cohen F. and Silva-Cunha A. (2008).** "Dexamethasone-loaded poly(epsilon-caprolactone) intravitreal implants: A pilot study." *European Journal of Pharmaceutics and Biopharmaceutics* 68(3): 637-646.
- Foy E., Farrell J.B., Higginbotham C.L. (2009).** epsilon-Synthesis of Linear Aliphatic Polycarbonate Macroglycols Using Dimethylcarbonate. *Journal of Applied Polymer Science*, 111: 217-227.
- Grijpma, D. W., Q. Hou, Feijen J. (2005).** "Preparation of biodegradable networks by photo-crosslinking lactide, epsilon-caprolactone and trimethylene carbonate-based oligomers functionalized with fumaric acid monoethyl ester." *Biomaterials* 26(16): 2795-2802.
- Grosse-Sommer A. and Prud'homme R.K. (1996).** "Degradable phosphazene-crosslinked hydrogels." *Journal of Controlled Release* 40(3): 261-267.
- Hamidi M., Azadi A., Raffei P. (2008).** "Hydrogel nanoparticles in drug delivery." *Advanced Drug Delivery Reviews* 60(15): 1638-1649.
- Han D.K. and Hubbell J.A. (1997).** "Synthesis of polymer network scaffolds from L-lactide and poly(ethylene glycol) and their interaction with cells." *Macromolecules* 30(20): 6077-6083.
- Hao J.Q., Li H. and Wo H.-G. (2009).** epsilon-Synthesis and Characterization of Cholic Acid-Containing Biodegradable Hydrogels by Photoinduced Copolymerization. *J Appl Polym Sci* 112: 2976-2980.
- Hatefi A. and Amsden B. (2002).** "Biodegradable injectable in situ forming drug delivery systems." *Journal of Controlled Release* 80(1-3): 9-28.
- He S., Timmer M. D., Yaszemski M.J, Yasko A.W, Engel P.S, Mikos A.G. (2001).** "Synthesis of biodegradable poly(propylene fumarate) networks with poly(propylene fumarate)-diacrylate macromers as crosslinking agents and characterization of their degradation products." *Polymer* 42(3): 1251-1260.
- He B., Wan E. and Chan-Park M.B. (2006).** "Synthesis and degradation of biodegradable photo-crosslinked poly(epsilon-epsilon-malic acid)-based hydrogel." *Chemistry of Materials* 18(17): 3946-3955.
- He C., Kim S.W., Lee D.S. (2008).** "In situ gelling stimuli-sensitive block copolymer hydrogels for drug delivery." *J Control Release* 127(3): 189-207.
- Heller J., Penhale D.W.H., Helwing R.F. (1980)** epsilon-Preparation of poly(ortho esters) by the reaction of ketene acetals and polyols. *J. Polym. Sci., Polym. Lett. Ed.* 18 82-83.

Heller J., Ng S. Y., Fritzinger B.K., Roskos K.V. (1990) □Controlled drug release from bioerodible hydrophobic ointments. □ *Biomaterials* 11 235□237.

Heller J, Barr J, Steven Y. Ng, Schwach Abdellauoi K, Gurny R. P (2002) □Poly(ortho esters): synthesis, characterization, properties and uses. □ *Advanced Drug Delivery Reviews* 54 1015□1039.

Heller J. and Barr J. (2004). □Poly(ortho esters) –From Concept to Reality□ *Biomacromolecules*, 5(5): 1625□1632

Hill-West J.L., Chowdhury S.M., Slepian M.J. and Hubbell J.A. (1994). "Inhibition of thrombosis and intimal thickening by in situ photopolymerization of thin hydrogel barriers." *Proceedings of the National Academy of Sciences of the United States of America* 91(13): 5967-5971.

Holland S.J., Tighe B.J. and Gould P.L. (1986). "Polymers for biodegradable medical devices. 1. The potential of polyesters as controlled macromolecular release systems." *Journal of Controlled Release* 4(3): 155-180.

Horak D. and Chaykivsky O., (2002). Poly(2-hydroxyethyl methacrylate-co-N,O-dimethacryloylhydroxylamine) particles by dispersion polymerization. *J. Polym. Sci. A* 40, 1625□1632.

Horák D., Kroupová J., Šlouf M., Dvořák P. (2004). Poly(2-hydroxyethyl methacrylate)-based slabs as amouse embryonic stem cell support. *Biomaterials* 25, 5249□5260.

Huang, Y., Y. Pan, Fu J., Huang X., Tang X. (2008). "Novel crosslinkable polyphosphazene with o-acetyl phenoxide as the pendant group. ." *e-Polymers*: no. 122.

Iwasaki Y., Nakagawa C., Ohtomi M., Ishihara K. and Akiyoshi K. (2004). □A Novel Biodegradable Polyphosphate Cross-Linker for Making Biocompatible Hydrogel. □ *Biomacromolecules*, 5(3): 1110-1115.

Jain, J. P., Modi S., Domb A.J., Kumar N. (2005). "Role of polyanhydrides as localized drug carriers." *Journal of Controlled Release* 103(3): 541-563.

Jiao, Y., Z. Liu, Ding S., Li L., Zhou C. (2006). "Preparation of biodegradable crosslinking agents and application in PVP hydrogel." *Journal of Applied Polymer Science* 101(3): 1515-1521.

Jo S., Shin H., Shung A.K, Fisher J.P. and Mikos A.G. (2001). "Synthesis and characterization of oligo(poly(ethylene glycol) fumarate) macromer." *Macromolecules* 34(9): 2839-2844.

Kajiyama T., Taguchi T., Kobayashi H., Kataoka K., Tanaka J. (2003). "Synthesis of high molecular weight poly(□□-malic acid) for biomedical use by direct polycondensation." *Polymer Degradation and Stability* 81(3): 525-530.

Katti D.S., Lakshmi S., Langer R. and Laurencin C.T. (2002). "Toxicity, biodegradation and elimination of polyanhydrides." *Advanced Drug Delivery Reviews* 54(7): 933-961.

Kim B.S., Hrkach J.S. and Langer R. (2000). "Biodegradable photo-crosslinked poly(ether-ester) networks for lubricious coatings." *Biomaterials* 21(3): 259-265.

- Kopecek, J. (2002).** "Polymer chemistry: swell gels." *Nature* 417(6887): 388-9, 391.
- Krishna L., Jayabalan M. (2009).** □Synthesis and characterization of biodegradable poly (ethylene glycol) and poly (caprolactone diol) end capped poly (propylene fumarate) cross linked amphiphilic hydrogel as tissue engineering scaffold material. □*J Mater Sci Mater Med.* 20 Suppl 1:S115-22.
- Kumar, N., Langer R.S., Domb A.J. (2002).** "Polyanhydrides: an overview." *Advanced Drug Delivery Reviews* 54(7): 889-910.
- Kweon H., Yoo M.K., Park I.K., Kim T.H., Lee H.C., Lee H.S., Oh J.S., Akaike T., Cho C.S. (2003).** "A novel degradable polycaprolactone networks for tissue engineering." *Biomaterials* 24(5): 801-808.
- Laurencin C.T., Morris C.D., Jacques H.P., Schwartz E.R., Keaton A.R., Zou L. (1992).** □Osteoblast culture on bioerodible polymers: studies of initial cell adhesion and spread. □*Polym. Adv. Tech.* 3: 359□364.
- Leach J. B. and Schmidt C. E. (2005).** "Characterization of protein release from photocrosslinkable hyaluronic acid-polyethylene glycol hydrogel tissue engineering scaffolds." *Biomaterials* 26(2): 125-135.
- Leboucher-Durand M.-A., Langlois V., Guérin P. (1996).** "Poly(□malic acid) derivatives with unsaturated lateral groups: epoxidation as model reaction of the double bonds reactivity." *Reactive and Functional Polymers* 31(1): 57-65.
- Lee, K. Y. and D. J. Mooney (2001).** "Hydrogels for Tissue Engineering." *Chemical Reviews* 101(7): 1869-1880.
- Lee W.-F., Cheng T.-S. (2008).** □Studies on preparation and properties of porous biodegradable poly(NIPAAm) hydrogels. □*J Appl Polym Sci* 109:1982□1992.
- Li, H.-Y., Chen Y.-F. and Xie Y.S. (2004).** "Nanocomposites of cross-linking polyanhydrides and hydroxyapatite needles: mechanical and degradable properties." *Materials Letters* 58(22-23): 2819-2823.
- Libiszowski J., Ka□ynski K., Penczek S. (1978).** "Polymerization of cyclic esters of phosphoric acid. VI. Poly(alkyl ethylene phosphates). Polymerization of 2-alkoxy-2-oxo-1,3,2-dioxaphospholans and structure of polymers." *Journal of Polymer Science: Polymer Chemistry Edition* 16(6): 1275-1283.
- Liu Z. and Rimmer S. (2002).** □Synthesis and release of 5-fluorouracil from poly(*N*-vinylpyrrolidinone) bearing 5-fluorouracil derivatives. □*Journal of Controlled Release* 81: 91□99.
- Liu Y., Huang K., Peng D., Wu H. (2006).** □Synthesis, characterization and hydrolysis of an aliphatic polycarbonate by terpolymerization of carbon dioxide, propylene oxide and maleic anhydride. □*Polymer* 47: 8453-8461.
- Mahoney MJ, Anseth KS (2006).** □Three-dimensional growth and function of neural tissue in degradable polyethylene glycol hydrogels. □*Biomaterials* 27(10): 2265-74

Mahoney, M. J. and K. S. Anseth (2007). "Contrasting effects of collagen and bFGF-2 on neural cell function in degradable synthetic PEG hydrogels." *Journal of Biomedical Materials Research Part A* 81A(2): 269-278.

Mason, M. N., A. T. Metters, et al. (2001). "Predicting Controlled-Release Behavior of Degradable PLA-*b*-PEG-*b*-PLA Hydrogels." *Macromolecules* 34(13): 4630-4635.

Mespouille L., Coulembier O., Paneva D., Degée P., Rashkov I., Dubois P. (2008). "Novel biodegradable adaptive hydrogels: controlled synthesis and full characterization of the amphiphilic co-networks." *Chemistry - A European Journal* 14(21): 6369-6378.

Metters, A. T., K. S. Anseth, Bowman C.N. (2000). "Fundamental studies of a novel, biodegradable PEG-*b*-PLA hydrogel." *Polymer* 41(11): 3993-4004.

Mikos A.G., Thorsen A.J., Czerwonka L.A, Bao Y., Langer R., Winslow D. N, Vacanti J.P (1994). "Preparation and characterization of poly(l-lactic acid) foams." *Polymer* 35(5): 1068-1077.

Miyata T, Uragami T, Nakamae K. (2002). "Biomolecule-sensitive hydrogels." *Advanced Drug Delivery Reviews* 54(1): 79-98.

Moine L., Bedouet L., Laurent A., Labarre D. Wassef M., and Nguyen V.N. (2011). "Implantable bio-resorbable polymer" WO/2011/029867.

Monteiro M.J., Hall G., Gee S. and Xie L. (2004). "Protein Transfer through Polyacrylamide Hydrogel Membranes Polymerized in Lyotropic Phases." *Biomacromolecules* 5(5): 1637-1641.

Ng S.Y., Vandamme T., Taylor M.S., Heller J. (1997). "Synthesis and erosion studies of self-catalyzed poly(ortho esters)." *Macromolecules* 30: 770-772.

Nicodemus G. D. and Bryant S. J. (2008). "Cell Encapsulation in Biodegradable Hydrogels for Tissue Engineering Applications." *Tissue Engineering Part B: Reviews* 14(2): 149-165.

Ong S.M., Zhang C., Toh Y.C., Kim S.H., Foo H.L., Tan C.H., van Noort D., Park S. and Yu H. (2008). "A gel-free 3D microfluidic cell culture system." *Biomaterials* 29(22): 3237-3244.

Ouchi T. and Fujino A. (1989) "Synthesis of poly(α -malic acid) and its hydrolysis behavior in vitro." *Die Makromol. Chem.* 190(7), 1523-1530.

Paris R. and Quijada-Garrido I. (2009). "Swelling and hydrolytic degradation behaviour of pH-responsive hydrogels of poly (N-isopropylacrylamide)-co-(methacrylic acid) crosslinked by biodegradable polycaprolactone chains." *Polymer International* 58(4): 362-367.

Park K., Shalaby W.S.W. and Park H. (1993). "Biodegradable hydrogels for drug delivery." Lancaster, PA, Technomic Pub.

Peppas N.A., Bures P., Leobandung W., Ichikawa H. (2000). "Hydrogels in pharmaceutical formulations." *European Journal of Pharmaceutics and Biopharmaceutics* 50(1): 27-46.

- Peppas, N.A., Hilt J.Z., Khademhosseini A. and Langer R. (2006).** "Hydrogels in Biology and Medicine: From Molecular Principles to Bionanotechnology." *Advanced Materials* 18(11): 1345-1360.
- Peter S.J., Nolley J.A., Widmer M.S., Merwin J.E., Yaszemski M.J., Yasko A.W., Engel P.S. and Mikos A.G. (1997).** □In vitro degradation of a poly(propylene fumarate)/beta-tricalcium phosphate composite orthopaedic scaffold.□*Tissue Eng* 3:207-215.
- Peter S.J., Suggs L.J., Yaszemski M.J., Engel P.S., Mikos A.G. (1999).** "Synthesis of poly(propylene fumarate) by acylation of propylene glycol in the presence of a proton scavenger." *Journal of Biomaterials Science-Polymer Edition* 10(3): 363-373.
- Poon Y.F., Cao Y., Zhu Y., Judeh Z.M. and Chan-Park M.B. (2009).** "Addition of beta-malic acid-containing poly(ethylene glycol) dimethacrylate to form biodegradable and biocompatible hydrogels." *Biomacromolecules* 10(8): 2043-2052.
- Potta, T., Chun C. and Song S.-C. (2009).** "Chemically crosslinkable thermosensitive polyphosphazene gels as injectable materials for biomedical applications." *Biomaterials* 30(31): 6178-6192.
- Průdny, M., Michálek, J., Lesný, P., Hejčí, J., Šlouf, M., Syková, E., (2006).** □Macroporous hydrogels based on 2-hydroxyethylmethacrylate, Part 5: hydrolytically degradable materials.□*J. Mater. Sci. Mater. Med.* 17, 1357-1364.
- Qiu Y., Lim J.J., Scott L.Jr, Adams R.C., Bui H.T., Temenoff J.S. (2011).** □PEG-based hydrogels with tunable degradation characteristics to control delivery of marrow stromal cells for tendon overuse injuries.□*Acta Biomater.* 7: 959-966.
- Quick D.J. and Anseth K.S. (2003).** □Gene Delivery in Tissue Engineering: A Photopolymer Platform to Co-encapsulate Cells and Plasmid DNA,□*Pharmaceutical Research*, 20, 1730-37.
- Quick D.J. and Anseth K.S. (2004).** □DNA delivery from photocrosslinked PEG hydrogels: encapsulation efficiency, release profiles, and DNA quality.□*Journal of Controlled Release* 96: 341-351.
- Quick D.J., Macdonald K.K. and Anseth K.S. (2004).** □Delivering DNA from Photocrosslinked, Surface-eroding Polyanhydrides,□*Journal of Controlled Release*, 97, 333-43.
- Ratner B.D. and Hoffman A.S. (1976).** □Synthetic Hydrogels for Biomedical Applications. Hydrogels for Medical and Related Applications.□*Washington D C - American Chemical Society* 1-36.
- Rosiak J. M. and Yoshii F. (1999).** "Hydrogels and their medical applications." *Nuclear Instruments and Methods in Physics Research Section B: Beam Interactions with Materials and Atoms* 151(1-4): 56-64.
- Shah N.M., Pool M.D. and Metters A.T. (2006).** □Influence of Network Structure on the Degradation of Photo-Cross-Linked PLA-b-PEG-b-PLA Hydrogels.□ *Biomacromolecules* 7(11): 3171-3177.

Sawhney A.S., Pathak C.P., Hubbell, J.A. (1993). "Bioerodible hydrogels based on photopolymerized poly(ethylene glycol)-co-poly(.alpha.-hydroxy acid) diacrylate macromers." *Macromolecules* 26(4): 581-587.

Scheler S, Kitzan M, Fahr A. (2011). □Cellular uptake and degradation behaviour of biodegradable poly(ethylene glycol-graft-methyl methacrylate) nanoparticles crosslinked with dimethacryloyl hydroxylamine. □*International Journal of Pharmaceutics* 403 207 □218.

Schwarz A., Zhang H., Metcalfe A., Salazkin I. and Raymond J. (2004). "Transcatheter embolization using degradable crosslinked hydrogels." *Biomaterials* 25(21): 5209-5215.

Sedlař T, Studenovsk H, Rypřek F. (2011). □Enzymatic degradation of the hydrogels based on synthetic poly(□-amino acid)s. □*J Mater Sci Mater Med.* 22(4):781-788.

Sharifi S., Imani M., Mirzadeh H., Atai M., Ziaee F., Bakhshi R. (2009). "Synthesis, characterization, and biocompatibility of novel injectable, biodegradable, and *in situ* crosslinkable polycarbonate-based macromers." *Journal of Biomedical Materials Research Part A* 90A(3): 830-843.

Smith M.H., South A.B., Gauldin J.C., Jyon L.A. (2010). □Monitoring the erosion of hydrolytically-degradable nanogels via multiangle light scattering coupled to asymmetrical flow field □flow fractionation. □*Anal. Chem.* 82, 523 □530.

Södergård, A. and M. Stolt (2002). "Properties of lactic acid based polymers and their correlation with composition." *Progress in Polymer Science* 27(6): 1123-1163.

Song P., Wang S., Xiao M., Du F., Gan L., Liu G., Meng Y. (2009). □Crosslinkable and thermally stable aliphatic polycarbonates derived from CO₂, propylene oxide and maleic anhydride. □*J Polym Res* 16:91 □97

Sperinde J.J. and Griffith L.G. (2000). □Control and Prediction of Gelation Kinetics in Enzymatically Crosslinked Poly(ethylene Glycol) Hydrogels. □*Macromolecules* 2000, 33, 5476-5480.

Subr V. and Ulbrich K. (1992). Hydrolytically degradable hydrophilic gels and the method for preparation thereof. . E. P. 0434438A2. U.S. Patent 5124421.

Suggs L.J., West J.L. and Mikos A.G. (1999). "Platelet adhesion on a bioresorbable poly(propylene fumarate-co-ethylene glycol) copolymer." *Biomaterials* 20(7): 683-690.

Svaldi Muggli, D., A. K. Burkoth, Keyser S.A., Lee H.R. and Anseth K.S. (1998). "Reaction Behavior of Biodegradable, Photo-Crosslinkable Polyanhydrides." *Macromolecules* 31(13): 4120-4125.

Syková E., Jendelová P., Urdžíková L., Lesný P., Hejčl J. (2006). □Bone marrow stem cells and polymer hydrogels □two strategies for spinal cord injury repair. □*Cell. Mol. Neurobiol* 26, 1111 □1127.

Tan H. and Marra K. G. (2010). "Injectable, Biodegradable Hydrogels for Tissue Engineering Applications." *Materials* 3(3): 1746-1767.

Temenoff J.S., Park H., Jabbari E., Sheffield T.L., LeBaron R.G., Ambrose C.G., Mikos A.G. (2004). "In vitro osteogenic differentiation of marrow stromal cells encapsulated in biodegradable hydrogels." *Journal of Biomedical Materials Research Part A* 70A(2): 235-244.

Timmer M.D., Ambrose C.G. and Mikos A.G. (2003). □In vitro degradation of polymeric networks of poly(propylene fumarate) and the crosslinking macromer poly(propylene fumarate)-diacrylate. □*Biomaterials* 24(4): 571-577.

Timmer M.D., Carter C., Ambrose C.G. and Mikos A.G. (2003). □Fabrication of poly(propylene fumarate)-based orthopaedic implants by photo-crosslinking through transparent silicone molds. □*Biomaterials*, 2003. 24(25): p. 4707-4714.

Ulbrich, K., V. Subr, Seymour L.W., Duncan R. (1993). "Novel biodegradable hydrogels prepared using the divinyllic crosslinking agent N,O-dimethacryloylhydroxylamine. 1. Synthesis and characterisation of rates of gel degradation, and rate of release of model drugs, in vitro and in vivo." *Journal of Controlled Release* 24(1-3): 181-190.

Ulbrich K., Subr V., Podperova P., Buresova M. (1995). □Synthesis of novel hydrolytically degradable hydrogels for controlled drug release. □*Journal of Controlled Release* 34 (1995): 155-165.

Xiao, C.-S., Y.-C. Wang, Du J.-Z., Chen X.-S. and Wang J. (2006). "Kinetics and Mechanism of 2-Ethoxy-2-oxo-1,3,2-dioxaphospholane Polymerization Initiated by Stannous Octoate." *Macromolecules* 39(20): 6825-6831.

Wang S. F., Lu L. C., Gruetzmacher J. A., Currier B. L. and Yaszemski M. J. (2005). □A Biodegradable and Crosslinkable Multiblock Copolymer Consisting of Poly(propylene fumarate) and Poly(□caprolactone): Synthesis, Characterization, and Physical Properties □*Macromolecules* 38, 7358.

Wang K., Xu X., Liu T.T., Fu S.Z., Guo G., Gu Y.C., Luo F., Zhao X., Wei Y.Q., Qian Z.Y. (2010). □Synthesis and characterization of biodegradable pH-sensitive hydrogel based on poly(ϵ -caprolactone), methacrylic acid, and Pluronic (L35). □*Carbohydrate Polymers* 79(3): 755-761.

Weng L., Le H.C., Talaie R., Golzarian J. (2011). " New bioresorbable hydrogel microspheres for therapeutic embolization: Development and in vitro evaluation." *Journal of Vascular and Interventional Radiology* *In Press*

Weng L., Le H.C., Lin J. and Golzarian J. (2011). "Doxorubicin loading and eluting characteristics of bioresorbable hydrogel microspheres: In vitro study." *International Journal of Pharmaceutics* 16;409(1-2):185-93.

West J.L. and Hubbell J.A. (1995). "Photopolymerized hydrogel materials for drug delivery applications. □*Reactive Polymers* 25(2-3): 139-147.

Wichterle O. and Lim D. (1960). "Hydrophilic Gels for Biological Use." *Nature* 185(4706): 117-118.

Wise D.L. 1976 □Sustained release of pharmaceuticals from polyester matrices. □US patent 3,978,203,

Wong J. Y. and Bronzino J.D. (2007). □Biomaterials.□Boca Raton, CRC Press.

Wu, L. and Ding J. (2004). "In vitro degradation of three-dimensional porous poly(-lactide-co-glycolide) scaffolds for tissue engineering." *Biomaterials* 25(27): 5821-5830.

Xu C. and Kopeček J. (2007). "Self-Assembling Hydrogels." *Polymer Bulletin* 58(1): 53-63.

Yamaoka T., Tabata Y., Ikada Y. (1994). "Distribution and tissue uptake of poly(ethylene glycol) with different molecular weights after intravenous administration to mice." *Journal of Pharmaceutical Sciences* 83(4): 601-606.

Yan J., Li J., Runge M.B., Dadsetan M., Chen Q., Lu L., Yaszemski M.J. (2011). "Crosslinking characteristics and mechanical properties of an injectable biomaterial composed of polypropylene fumarate and polycaprolactone co-polymer." *Journal of Biomaterials Science, Polymer Edition* 22: 489-504.

Yaszemski M.J., Payne R.G., Hayes W.C., Langer R. and Mikos A.G. (1996). "In vitro degradation of a poly(propylene fumarate)-based composite material." *Biomaterials* 17(22): 2127-2130.

Yoncheva, K., S. Miloshev, Belcheva N, Lambov N (2001). "Development and characterization of crosslinked poly(malate) microspheres with dipyrindamole." *International Journal of Pharmaceutics* 226(1-2): 31-37.

Young, J. S., K. D. Gonzales and Anseth K.S. (2000). "Photopolymers in orthopedics: characterization of novel crosslinked polyanhydrides." *Biomaterials* 21(11): 1181-1188.

Zhang H. and Schwarz A. (2006). Degradable crosslinkers and degradable crosslinked hydrogels comprising them. U. S. Pat. 7135593 B2.

Zhang, P., Huang X., Fu J., Huang Y., Zhu Y., Tang X. (2009). "A one-pot approach to novel crosslinked poly-phosphazene microspheres with active amino groups " *Macromol. Chem. Phys.* 210 792- 798.

Zhang, H., Zhong H., Zhang L., Chen S., Zhao Y., Zhua Y.-L., Wang J. (2010). "Modulate the phase transition temperature of hydrogels with both thermosensitivity and biodegradability." *Carbohydrate Polymers* 79(1): 131-136.

Zhao X., Harris J.M. (1998) □Novel degradable poly(ethylene glycol) hydrogels for controlled release of protein. □*J Pharm Sci* 87: 1450-1458.

Zhu W., Wang B., Zhang Y. and Ding J. (2005). "Preparation of a thermosensitive and biodegradable microgel via polymerization of macromonomers based on diacrylated Pluronic/oligoester copolymers." *European Polymer Journal* 41(9): 2161-2170.

Zhu W. and Ding J. (2006). □Synthesis and Characterization of a Redox-Initiated, Injectable, Biodegradable Hydrogel. □*J Appl Polym Sci* 99(5): 2375-2383.

Travaux expérimentaux

Introduction

L'objectif du travail était de concevoir des microsphères dégradables destinées à mettre en place un traitement de certaines anomalies vasculaires (comme l'hémorragie et les malformations artériovéneuses) ou des tumeurs hypervascularisées par une embolisation temporaire. Il était souhaité que l'embolie puisse être résorbée totalement in situ pour permettre une recanalisation des vaisseaux embolisés. Le temps nécessaire de cette recanalisation sera défini par la vitesse de résorption du matériau d'embolisation.

Le cahier des charges destiné à guider la conception des microsphères d'embolisation est le suivant :

Les microsphères doivent

- être constituées d'un matériau biocompatible et résorbable sur un temps court (de quelques jours à quelques semaines) pour permettre leur disparition complète de la lumière vasculaire avec une restitution de la lumière la plus fonctionnelle possible.
- être de grande taille (entre 100 et 1000 μm) avec une distribution en taille homogène
- être faciles à disperser dans un milieu injectable
- présenter des propriétés viscoélastiques appropriées pour permettre leur injection à travers un cathéter de très faible diamètre tout en assurant une occlusion totale après mise en place dans les vaisseaux.

La forme sphérique du matériau d'embolisation a été retenue pour ses bonnes capacités d'occlusion des vaisseaux dans le contexte d'une embolisation.

Un matériau constitutif de type hydrogel est apparu particulièrement adapté. Ces matériaux sont constitués d'un réseau de chaînes de polymère réticulées par voie chimique ou physique emprisonnant de grande quantité d'eau [Kopecek 2002, Lavik and Langer 2004]. Du fait de leur structure, de nombreux hydrogels sont déjà utilisés pour la conception de dispositifs

médicaux dans des applications les mettant en œuvre *in vivo* [Rosiak and Yoshii 1999, Lee K.Y. and Mooney 2001, Peppas et al. 2006]. Plus spécifiquement, des microsphères d'embolisation non dégradables constituées de gélatine et de N-acryloyle tris(hydroxyméthyle)aminométhane, commercialisées sous le nom d'Embosphere[®], sont utilisées en clinique [Vallée et al. 2003]. Dans le présent travail, il a été proposé de concevoir des microsphères d'embolisation résorbables par une méthode originale utilisant comme matériau constitutif un hydrogel résorbable. De telles microsphères n'existent pas encore sur le marché.

Pour concevoir de telles microsphères, notre choix s'est porté sur le développement d'un hydrogel chimique dans lequel les liaisons de réticulation sont covalentes et les chaînes de polymères séparant les nœuds de réticulation contiennent des segments hydrolysables. Le choix des liaisons de réticulation covalente a été retenu pour avoir un matériau dont les conditions de résorption seraient parfaitement contrôlées par la nature chimique du gel. En effet, contrairement aux gels physiques dans lesquels les liaisons de réticulation sont basées sur des interactions faibles et labiles sous l'effet d'un changement des conditions physico-chimiques rencontrées dans le milieu environnant, la résorption des gels chimiques peut théoriquement être entièrement contrôlée par la vitesse d'hydrolyse des segments hydrolysables incorporés dans la structure du réseau polymère. Dans la littérature, la plupart des travaux portant sur le développement d'hydrogels chimiques hydrolysables décrivent l'incorporation de chaînes d'oligomères d'acide lactique (PLA), d'acide glycolique (PGA) ou d'un mélange de ces deux constituants (PLGA) dans la structure d'un réseau de polymère comportant de courtes chaînes de PEG [Sawhney et al. 1993, Burdick et al. 2001, Davis et al. 2003, Chan-Park et al. 2004, Zhu et al. 2005, Grijpma et al. 2005, Jiao et al. 2006, Zhu and Ding 2006, Zhu et al. 2006, Burdick et al. 2006, Shah et al. 2006, Mahoney and Anseth 2007, Clapper et al. 2007, Clapper et al. 2008, Bencherif et al. 2009A, Bencherif et al. 2009B, Hao

et al. 2009, Wang et al. 2010] (Figure 1A). *In vivo*, ces réseaux de polymères se dégradent selon un mécanisme d'hydrolyse au simple contact de l'eau libérant de l'acide lactique et de l'acide glycolique comme produit de dégradation ultime et de courtes chaînes de PEG pouvant être éliminées par filtration rénale. Ce mécanisme de dégradation présente plusieurs avantages. La vitesse de dégradation peut être ajustée par un choix judicieux de la composition du polymère [Sawhney et al. 1993, Burdick et al. 2001, Jiao et al. 2006]. Elle est totalement indépendante d'une activité enzymatique. Sur la base de ce mécanisme de dégradation, il est attendu que la vitesse de dégradation de ces hydrogels soit identique dans les différents organes de l'organisme et qu'elle ne dépende pas de l'état physiopathologique du patient. Elle serait donc identique quelque soit le lieu d'implantation de l'hydrogel et quelque soit le patient. Ainsi, nos travaux se sont appuyés sur l'hypothèse que des microsphères constituées d'un tel hydrogel devraient être totalement résorbables *in vivo* par un mécanisme d'hydrolyse. Selon cette hypothèse, l'hydrolyse conduirait à la solubilisation et disparition complète des microsphères d'embolisation après hydrolyse des liaisons hydrolysables incorporées dans l'hydrogel (Figure 1B).

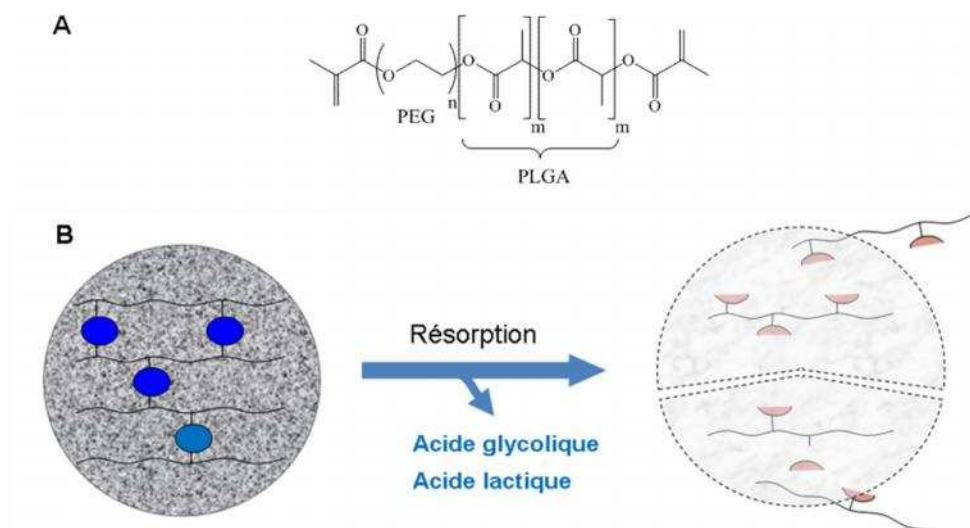

Figure 1. Structure chimique générale d'un agent de réticulation hydrolysable comportant une oligomère d'acide lactique et d'acide glycolique (A). Représentation schématique des

microsphères résorbables constituées d'un hydrogel synthétique à l'aide d'un tel agent réticulant et hypothèse sur leur mécanisme de résorption in vivo (B).

L'étude qui a été réalisée en vue de concevoir ces microsphères s'est déroulée en trois phases :

La première a été consacrée à la synthèse des agents réticulants et au développement d'une méthode de préparation de microsphères d'hydrogel.

La deuxième phase du travail a été consacrée au développement de méthodes destinées à caractériser les microsphères et plus particulièrement leur dégradation.

La troisième et dernière phase du travail a été consacrée à l'étude de la dégradation des microsphères dans des conditions d'hydrolyse menées in vitro.

Les résultats de l'ensemble des travaux réalisés dans le cadre de cette étude sont consignés respectivement dans les trois chapitres qui constituent la partie expérimentale de ce mémoire de thèse.

Bibliographie

Bencherif S.A., Sheehan J.A., Hollinger J.O., Walker L.M., Matyjaszewski K., Washburn N. R. (2009A). Influence of cross-linker chemistry on release kinetics of PEG-co-PGA hydrogels. *J Biomed Mater Res* **90A**: 142-153.

Bencherif S.A., Srinivasan A., Sheehan J.A., Walker L.M., Gayathri C., Gil R., Hollinger J.O., Matyjaszewski K., Washburn N. R. (2009B). End-group effects on the properties of PEG-co-PGA hydrogels. *Acta Biomaterialia* **5**: 1872-1883

Burdick, J. A., L. M. Philpott, et al. (2001). "Synthesis and characterization of tetrafunctional lactic acid oligomers: A potential in situ forming degradable orthopaedic biomaterial." *Journal of Polymer Science Part A: Polymer Chemistry* **39**(5): 683-692.

Burdick, J. A., M. Ward, et al. (2006). "Stimulation of neurite outgrowth by neurotrophins delivered from degradable hydrogels." *Biomaterials* **27**(3): 452-459.

Chan-Park, M. B., Zhu A. P. and , Gao J.X. (2004). "Novel Photopolymerizable Biodegradable Triblock Polymers for Tissue Engineering Scaffolds: Synthesis and Characterization." *Macromolecular Bioscience* **4**(7): 665-673.

Clapper, J. D., J. M. Skeie, et al. (2007). "Development and characterization of photopolymerizable biodegradable materials from PEG-PLA-PEG block macromonomers." *Polymer* **48**(22): 6554-6564.

Clapper J.D., Pearce M.E., Guymon C.A. and Salem A.K. (2008). "Biotinylated Biodegradable Nanotemplated Hydrogel Networks for Cell Interactive Applications." *Biomacromolecules* **9**(4): 1188-1194.

Davis K.A., Burdick J.A., Anseth K.S. (2003). "Photoinitiated crosslinked degradable copolymer networks for tissue engineering applications." *Biomaterials* **24**: 2485-2495.

Grijpma, D. W., Q. Hou, et al. (2005). "Preparation of biodegradable networks by photocrosslinking lactide, [epsilon]-caprolactone and trimethylene carbonate-based oligomers functionalized with fumaric acid monoethyl ester." *Biomaterials* **26**(16): 2795-2802.

Hao J.Q., Li H. and Wo H.-G. (2009). "Synthesis and Characterization of Cholic Acid-Containing Biodegradable Hydrogels by Photoinduced Copolymerization." *J Appl Polym Sci* **112**: 2976-2980.

Jiao, Y., Z. Liu, et al. (2006). "Preparation of biodegradable crosslinking agents and application in PVP hydrogel." *Journal of Applied Polymer Science* **101**(3): 1515-1521.

Kopecek, J. (2002). "Polymer chemistry: swell gels." *Nature* **417**(6887): 388-9, 391.

Lavik E. and Langer R. (2004). "Tissue engineering: current state and perspectives." *Applied Microbiology and Biotechnology* **65**(1): 1-8.

Lee K.Y. and Mooney D.J. (2001). "Hydrogels for Tissue Engineering." *Chemical Reviews* **101**(7): p. 1869-1880.

Mahoney M.J. and Anseth K.S. (2007). "Contrasting effects of collagen and bFGF-2 on neural cell function in degradable synthetic PEG hydrogels." *J Biomed Mater Res* **81A**(2): 269-278.

Peppas N.A., Hilt J. Z., Khademhosseini A. and Langer R. (2006) "Hydrogels in Biology and Medicine: From Molecular Principles to Bionanotechnology." *Advanced Materials* **18**(11): 1345-1360.

Rosiak J.M. and Yoshii F. (1999). "Hydrogels and their medical applications." *Nuclear Instruments and Methods in Physics Research Section B: Beam Interactions with Materials and Atoms* **151**(1-4): 56-64.

Sawhney A.S., Pathak C.P. and Hubbell J.A. (1993). "Bioerodible hydrogels based on photopolymerized poly(ethylene glycol)-co-poly(alpha-hydroxy acid) diacrylate macromers." *Macromolecules* **26**(4): 581-587.

Shah N.M., Pool M.D. and Metters A.T. (2006). □Influence of Network Structure on the Degradation of Photo-Cross-Linked PLA-b-PEG-b-PLA Hydrogels.□ *Biomacromolecules* **7**(11): 3171-3177.

Vallée J.N., Lo D., Guillevin R., Reb P., Adem C. and Chiras J. 2003. □In vitro study of the compatibility of tris-acryl gelatin microspheres with various chemotherapeutic agents.□ *Journal of Vascular and Interventional Radiology* **14**(5): 621-8.

Wang K., Xu X., Liu T.T., Fu S.Z., Guo G., Gu Y.C., Luo F., Zhao X., Wei Y.Q., Qian Z.Y. (2010). □Synthesis and characterization of biodegradable pH-sensitive hydrogel based on poly(ϵ -caprolactone), methacrylic acid, and Pluronic (L35).□ *Carbohydrate Polymers* **79**(3): 755-761.

Zhu W., Wang B., Zhang Y. and Ding J. (2005). "Preparation of a thermosensitive and biodegradable microgel via polymerization of macromonomers based on diacrylated Pluronic/oligoester copolymers." *European Polymer Journal* **41**(9): 2161-2170.

Zhu A.P., Chan-Park M.B., Gao J.X. (2006). □Foldable micropatterned hydrogel film made from biocompatible PCL-b-PEG-b-PCL diacrylate by UV embossing.□*Journal of Biomedical Materials Research Part B: Applied Biomaterials*, **6B**(1): 76-84

Zhu W. and Ding J. (2006). □Synthesis and Characterization of a Redox-Initiated, Injectable, Biodegradable Hydrogel.□*J Appl Polym Sci* **99**(5): 2375-2383.

Chapitre 1

Synthèse de microsphères constituées d'un hydrogel hydrolysable

1. Introduction

Notre choix de matériaux pour la conception des microsphères d'embolisation résorbables s'est tourné vers des hydrogels chimiques comportant des segments hydrolysables constitués d'oligomères d'acide lactique et d'acide glycolique. L'obtention de tels hydrogels est généralement décrite par polymérisation radicalaires de monomères conçus et synthétisés à façon en fonction des caractéristiques désirées pour l'hydrogel [Sawhney et al. 1993, Burdick et al. 2001, Davis et al. 2003, Chan-Park et al 2004, Zhu et al. 2005, Grijpma et al. 2005, Jiao et al. 2006, Zhu and Ding 2006, Zhu et al. 2006, Burdick et al. 2006, Shah et al. 2006, Mahoney and Anseth 2007, Clapper et al. 2007, Clapper et al. 2008, Bencherif et al. 2009A, Bencherif et al. 2009B, Hao et al. 2009, Wang et al. 2010, Moine et al. 2011]. L'originalité de notre travail a été de proposer des agents réticulants comportant des chaînons hydrolysables et de les mettre en œuvre dans une réaction de polymérisation permettant de synthétiser en une seule étape des microsphères de la taille recherchée. Les méthodes de polymérisation qui sont apparues les plus appropriées pour réaliser la synthèse de ces microsphères sont celles basées sur la polymérisation en suspension. Il existe deux types de méthodes de polymérisation en suspension, la méthode directe qui met en œuvre une suspension de type huile dans eau et la méthode inverse qui met en œuvre une suspension de type eau dans huile (Figure 2). Dans le cas de la polymérisation en suspension directe, les monomères sont hydrophobes pour pouvoir être solubilisés dans la phase organique alors que dans le cas de la méthode de polymérisation en suspension inverse, les monomères sont solubles dans la phase aqueuse.

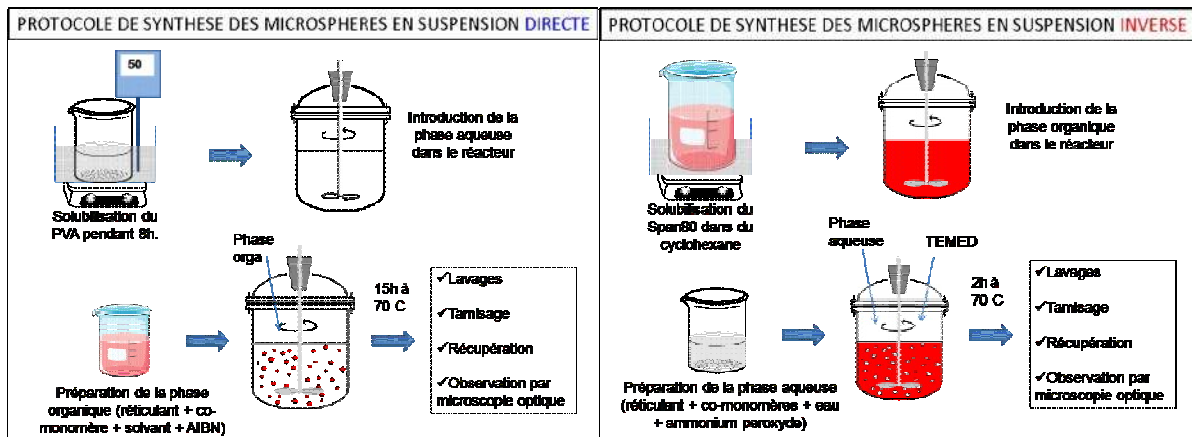

Figure 2. Schéma de principe de la synthèse des microsphères par polymérisation en suspension directe (schéma de gauche) et inverse (schéma de droite).

Dans les deux cas, la conception de l'hydrogel retenu a reposé sur la co-polymérisation d'un agent de réticulation et d'un ou plusieurs co-monomères (méth)acryliques. D'une part, au moins un des co-monomères apporte au réseau polymère des groupements lui permettant de gonfler après immersion dans un milieu aqueux (PEG du PEGMMA, -COOH de l'acide acrylique ou -OH du trisacrylamide). D'autre part, l'agent de réticulation comportant un ou deux segments hydrolysables constitués d'acide lactique et/ou d'acide glycolique qui permettent la dégradation des microsphères. (Figure 3).

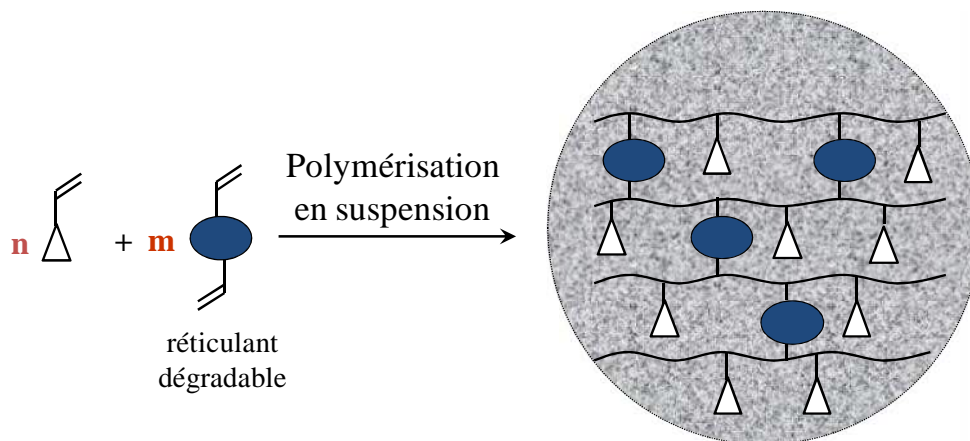

Figure 3. Schéma de principe de la synthèse des microsphères résorbables.

Dans la pratique, des agents réticulants comportant des segments hydrolysables ont été synthétisés en fonction des spécificités de solubilité requises pour chacune des deux méthodes

de polymérisation en suspension. Ces agents réticulants ont été caractérisés puis utilisés pour synthétiser des microsphères par les méthodes de polymérisation en suspension correspondantes. Les résultats de ces travaux sur chaque méthode de préparation des microsphères sont présentés dans les deux premières parties que comporte ce chapitre. La troisième partie rassemble des résultats consacrés à l'étude de l'incorporation de principes actifs dans les microsphères par deux méthodes de chargement.

2. Etude des conditions d'obtention de microsphères d'hydrogel résorbables par polymérisation en suspension directe

Introduction

La synthèse d'un hydrogel hydrolysable sous la forme de microsphères a été envisagée par deux méthodes de polymérisation en suspension. Dans cette partie, nous présentons le développement de la méthode de polymérisation en suspension directe.

Plusieurs agents réticulants comportant des oligomères d'acide lactique et d'acide glycolique hydrolysables et solubles dans les solvants organiques ont été synthétisés et caractérisés. Nous avons modifié les synthèses existantes dans la littérature afin d'obtenir des réticulants adaptés à nos méthodes de polymérisation en suspension. Plusieurs agents de réticulation hydrolysables ont été synthétisés. Ils diffèrent par la structure générale de la molécule (diblock asymétrique PLGA-PEG ou triblock symétrique PLGA-PEG-PLGA), par la longueur du segment PEG et par le nombre de segments d'oligomère d'acide lactique et/ou d'acide glycolique incorporés.

Pour former des hydrogels hydrolysables sous la forme de microsphères, les agents réticulants ont été copolymérisés avec le PEGMMA et l'acide méthacrylique. Les travaux réalisés ont permis d'identifier des conditions de polymérisation permettant de synthétiser des microsphères de grandes tailles tout en s'assurant que la formation d'agrégats de polymère reste limitée. Ces préparations fournissent après tamisage des microsphères dans les gammes de diamètre de 100 à 315 μm et de 315 à 500 μm . Les microsphères synthétisées gonflent de manière significative en présence d'eau et présentent une très bonne élasticité. En effet, leur valeur du déphasage delta mesuré par rhéologie indique que le matériau les constituant a une

élasticité quasi idéale (Δ inférieur à 10°). Leur capacité de gonflement et leur élasticité sont intrinsèquement dépendantes du taux de réticulation.

Il a également été constaté que l'incorporation d'un oligomère de PLGA plus long dans l'agent réticulant fournit des microsphères plus hydrophobes qui gonflent moins et sont plus rigides comme en témoigne les mesures du module élastique.

En conclusion, ce travail a permis de synthétiser des hydrogels sous une forme de microsphères selon une méthode originale. Plusieurs types de microsphères ont été synthétisés et sont constitués d'hydrogels comportant des segments hydrolysables. Ces microsphères présentent des propriétés qui diffèrent en fonction de la proportion d'agent de réticulation introduit lors de la synthèse par polymérisation et également en fonction de la nature de l'agent de réticulation.

Abstract

Therapeutic embolization is the method of choice for the treatment of hyper-vascular tumors, hemorrhage and arteriovenous malformations. In many clinical cases, a temporary agent of embolization is advantageous and more comfortable for the patient. However, there are nowadays no commercially available degradable microspheres which can ensure at the same time a total and distal occlusion with a predictable degradation rate. We have developed recently a new class of biodegradable microspheres based on PLGA and PEG for therapeutic embolization. Thanks to the hydrolysable property of PLGA, the obtained microspheres have their degradation rate totally site-to-site and patient-to-patient independent. Those hydrogel microspheres were formed by direct suspension polymerization between different types of degradable crosslinkers and PEGMMA Mw. 300. Methacrylic acid can be added as a comonomer, which may accelerate the hydrolysis process. First of all, different types of PLGA based crosslinker were synthesized. The nature of the crosslinker such as the length of PLGA chain or the length and the position of PEG can be tuned in order to form a large panel of materials. The suspension polymerization synthesizes provide microspheres with small size distribution and good yield. These microspheres, sieved from 100 to 315 μm and from 315 to 500 μm , were swellable and showed elastic properties. Their swelling capacity and their elasticity were demonstrated to be intrinsically dependant on the density of crosslinking. The longer the PLGA chain, the more hydrophobic, the less swellable and the more rigid were the synthesized microspheres. Their elasticity modulus indicated that low cross-linking microspheres (less than 6 molar %) can be suitable for injection through catheter.

Keywords: hydrogel, microsphere, hydrolysis, elasticity, degradable crosslink.

1. Introduction

Biodegradable hydrogels have been investigated in a wide range of medical applications, such as tissue engineering or drug delivery systems thanks to their remarkable biocompatibility and their capacity to be cleared from the body after their utility. Another specific implant application that biodegradable hydrogel can fulfill the requirement is microspheres for therapeutic embolization.

Therapeutic embolization is the method of choice for the treatment of hemorrhage, arteriovenous malformations or in certain types of tumors from benign like uterine fibroids to malign as hepatocellular carcinoma. In any of those cases, the purpose of this minimally invasive method is to locally inject an embolization agent by transcatheter that stop the blood flow at the target position. Thus, the hemorrhage and malformation can be blocked, the tumor can be isolated which lead to its shrinkage or even its total disappearance. The technique of embolization was developed since early 60s (Speakman 1964, Ishimori 1967), but it took up to the 90s to see a wide clinical application thanks to the appearance of non degradable microspheres (Embosphere®, Contour SE®, Bead Block™). These well spherical and calibrated particles allow a total occlusion of blood vessels at the targeting point (Laurent 2007). However, in various treatments such as for hemorrhage and tumor, a TEMPORARY embolization may be advantageous as the recanalization help the body to regain faster its normal physiological functioning. Moreover, in the case of embolization of chemo-sensitive tumors, a second chemotherapeutic injection at the same localization should be possible to ensure the elimination of the tumor. The only commercially available temporary agent for embolization is the gelatin sponge (Spongel®, Gelfoam®), existing in plates that can be manually cut or in dry powder (Katsumori and Kasahara 2006). The lack of calibration makes it difficult to predict the occlusion level and the degradation rate of particles. Furthermore,

catheter plugging was often observed with this type of agent. The dextran starch microspheres (Spherex®, Embocept®), still in the research process, have shown their limitation of too rapid degradation rate (several minutes to hours), that are not suitable for the application of embolization. Therefore, there is a need in the domain of degradable microspheres for embolization. They must be not only biocompatible, well calibrated with a small size distribution between 100 and 1000 μm and elastic enough to resist to an injection through catheter but also biodegradable from several days to weeks.

Our choice for biodegradable material is the family PLA, PGA, PLGA which have been used as implants for decades (Södergård and Stolt 2002) and were approved by the FDA. Their degradation products, i.e. lactic acid and glycolic acid, are non toxic and bioresorbable as they are included in the metabolic route of the Krebs cycle (Holland et al. 1986). In vivo, PLGA is also known to be degraded only by the hydrolysis mechanism (Hakkarainen et al. 1996). Therefore, the degradation rate is totally site-to-site and patient-to-patient independent. Hydrogels based on PLGA copolymerized with PEG were designed as microspheres for embolization in our group. Although PEG is not biodegradable by itself, it can be eliminated from the body via kidney filtration with a molecular weight fragments lower than 30 kDa (Yamaoka, Tabata et al. 1994). Numerous PEG containing hydrogels are approved by the US Food and Drug Administration (FDA) for various clinical uses (Peppas, Hilt et al. 2006). The incorporation of PEG in the chemical structure of hydrogels has numerous advantages. PEG helps the forming hydrogel to increase the capacity of water absorption which promotes the hydrolysis process. Moreover, PEG segments increase the elasticity of the obtained hydrogel. Finally, the surface of PEG containing materials displays valuable antifouling properties against proteins, bacteria and cell adhesion (Desai and Hubbell 1991) which ensure the

biocompatibility of the embolitic agent. Hence, hydrogel microspheres were designed by chemically crosslinked between PEG containing monomers and degradable crosslinkers in order to avoid dissolution of microspheres. Degradable materials are only present on the crosslinking, which allows controlling the degradation rate by tuning the nature and/or the amount of the crosslinking in the hydrogel. Crosslinkers were synthesized following well known methods developed previously by Sawhney et al. (Sawhney et al. 1993) and Lutz et al. (Lutz et al. 2004). Finally, the formation of microspheres was performed by direct suspension polymerization, the method of choice to obtain large diameter particles (Dowding and Vincent 2000).

2. Materials and methods

2.1. Materials

Lactide and glycolide were supplied by Biovalley. Triethylamine (TEA), tin 2-ethylhexanoate ($\text{Sn}(\text{Oct})_2$) and methacryloyl chloride were purchased from Fluka. Tetraethylene glycol (TEG), sodium chloride and 2,2'-azobisisobutyronitrile (AIBN) were obtained from Acros Organic (Belgium). Poly(ethylene glycol) methacrylate (PEGMA) of number-average molecular weight 360 g/mol, poly(ethylene glycol) methyl ether methacrylate (PEGMMA) of number-average molecular weight 300 g/mol, poly(ethylene glycol) dimethacrylate (PEGDMA) of number-average molecular weight 575 g/mol, poly(vinyl alcohol) (PVA) of number-average molecular weight 89,000-98,000 g/mol 99% pure were purchased from Sigma-Aldrich (France). Mass weight values are given by supplier. Analytical grade solvents

(acetone, cyclohexane, dichloromethane, chloroform, diethylether, petroleum ether, toluene, ethanol) were supplied by Carlo Erba (France). PEGMA Mw. 360 was purified by Ali and Stöver's method (Ali and Stöver 2004). The other chemical products were used without any further purification. Pure water was taken from MiliQ 185 supplier.

^1H NMR analyses were performed with a 300 MHz Bruker apparatus. Deuterium solvents are purchased from Carlo Erba.

2.2. Synthesis of degradable crosslinkers

Crosslinkers developed in our laboratory can be divided into 2 groups: di-block polymers PLGA-PEG and tri-block polymers PLGA-TEG-PLGA. Moreover, crosslinker can be formed with only lactide, only glycolide or their mixture to form a large panel of degradable materials.

2.2.1. Synthesis of the diblock crosslinkers

Several diblock crosslinkers have been synthesized by lactide and/or glycolide ring opening with HEMA or PEGMA as initiator (Fig.1).

In a dry round flask containing a magnetic stir bar, lactide (8 mmol, 1.152 g), glycolide (8 mmol, 0.929 g), PEGMA purified (4 mmol, 1.440 g) and $\text{Sn}(\text{Oct})_2$ (0.025 mmol, 10 mg) were dissolved in toluene (5 mL) under an argon atmosphere. After 20h at 90°C , chloroform (5 mL) was added to dilute the reaction mixture and the resulting polymer was purified by precipitating in a large volume of petroleum ether. The precipitate was then dried under vacuum. The polymerization degrees of lactic acid and of glycolic acid (respectively PD_L and PD_G) were determined from ^1H NMR spectra of obtained products. ^1H NMR (CDCl_3) δ (ppm): 6.13 (s, 1H, CHH=), 5.58 (s, 1H, CHH=), 5.27 (m, 1H x PD_L , PLA), 4.73 (m, 2H x

PD_G, PGA), 4.29 (m, 4H, PEG), 3.62-3.76 (m, n x CH₂, PEG), 1.95 (s, 3H, methacrylate), 1.59 (m, 3H x PD_L, PLA).

The dried polymer obtained from the first step was then subjected to an esterification on the hydroxyl group at the end of the PLGA chain by reacting with methacryloyl chloride. The total amount of the formed macromer (8 mmol of OH group) was dissolved in CH₂Cl₂ (30ml) under argon in a dry flask equipped with magnetic stir bar. The content of the flask was cooled to 0°C and TEA (12 mmol, 1.6 mL) was added. The solution was stirred and then methacryloyl chloride (12 mmol, 1.2 mL) was added drop wise to the solution during 30 min. The stirring was continued during 1h at 0°C and then 24h at room temperature. The salt was removed by filtration and the polymer was precipitated in a large volume of petroleum ether. The crude product was then separated, dried and kept in an argon atmosphere for further reactions. The methacrylate functionality \square of the macromonomer, the polymerization degree of lactic acid and of glycolic acid (respectively PD_L and PD_G) were determined from ¹H NMR spectra of obtained products. ¹H NMR (CDCl₃) \square (ppm): 6.22 (m, 1H x \square , CHH=), 6.12 (s, 1H, CHH=), 5.61 (m, 1H x \square , CHH=), 5.57 (s, 1H, CHH=), 5.27 (m, 1H x PD_L, PLA), 4.73 (m, 2H x PD_G, PGA), 4.29 (m, 4H, PEG), 3.62-3.76 (m, n x CH₂, PEG), 1.95 (m, 3H + 3H x \square , methacrylate), 1.59 (m, 3H x PD_L, PLA).

The obtained crosslinker was called PEGMA4L4G, which means that the initiator was PEGMA Mw. 360 and there were 4 units of lactic acid and 4 units of glycolic acid per chain. Other crosslinkers can be obtained with HEMA or PEGMA as initiators and the length of the degradable chain can be modulated by varying the quantity of lactide and glycolide. For example, HEMA12L12G crosslinker may be formed from HEMA and 12 units of lactic acid and 12 units of glycolic acid per chain.

2.2.2. Synthesis of the triblock crosslinkers

Triblock crosslinkers were synthesized by lactide and/or glycolide ring opening polymerization on the two hydroxyl extremities of TEG. Fig. 2 illustrates the synthesis of PLGA-TEG-PLGA crosslinker.

In a dry round flask containing a magnetic stir bar, TEG (5 mmol, 0.971 g) was reacted with lactide (10 mmol, 1.441 g), glycolide (10 mmol, 1.161 g) under an argon atmosphere in presence of $\text{Sn}(\text{Oct})_2$ (0.016 mmol, 6 mg) as catalyser. After 20h at 115°C, chloroform (10 mL) was added to dilute the reaction mixture and the resulting polymer was purified by precipitating in a large volume of petroleum ether. The precipitate was then dried under vacuum. The polymerization degrees of lactic acid and of glycolic acid (respectively PDL and PDG) were determined from ^1H NMR spectra of the obtained product. ^1H NMR (CDCl_3) \square (ppm): 5.18 (m, 1H x PDL, PLA), 4.82 (m, 2H x PDG, PGA), 4.31 (m, 4H, TEG), 3.64-3.70 (m, 12H, TEG), 1.53 (m, 3H x PDL, PLA).

The total amount of dried polymer obtained from the first step (10 mmol of OH group) was dissolved in CH_2Cl_2 (40ml) under argon in a dry flask equipped with magnetic stir bar. As the same principle, the content reacted with TEA (15 mmol, 2 mL) and methacryloyl chloride (15 mmol, 1.5 mL) for 1h at 0°C and then for 24h at room temperature. The salt was removed by filtration and the polymer was precipitated in a large volume of petroleum ether. The forming crosslinker was then separated from the supernatant, dried under vacuum and kept under argon for further use. The so-obtained crosslinker was named TEG4L4G.

The methacrylate functionality \square of the macromonomer, the polymerization degree of lactic acid and of glycolic acid (respectively PDL and PDG) were determined from ^1H NMR spectra of obtained products. ^1H NMR (CDCl_3) \square (ppm): 6.22 (m, 2H x \square , CHH=), 5.64 (m, 2H x \square ,

CHH=), 5.18 (m, 1H x PD_L, PLA), 4.82 (m, 2H x PD_G, PGA), 4.31 (m, 4H, TEG), 3.64-3.70 (m, 12H, TEG), 1.97 (m, 6H x □ methacrylate), 1.53 (m, 3H x PD_L, PLA).

2.3. *Synthesis of degradable microspheres*

Degradable microspheres were obtained by direct suspension polymerization. A PVA solution (300 mL at 0.75% wt./v. PVA) was introduced in a 500 mL reactor and was purged with nitrogen for 15 min. The dispersed phase was prepared by dissolving the degradable crosslinking agent and PEGMMA at various ratios in 12 mL of toluene. The amount of crosslinkers added to the polymerization system was expressed as a molar % of the total quantity of monomers. It was calculated taking into account the methacrylate functionality of the macromer obtained after the syntheses of crosslinkers. Then, the solution was purged with nitrogen for 15 min, and introduced into the aqueous phase at 30°C under agitation at 250 rpm. The initiator, AIBN (5 molar % of the total monomers) solubilized in 2 mL of toluene, was then introduced into the reactor. The temperature was raised to 70°C and the reaction was allowed to continue for 15 h under continuous stirring. Microspheres were washed with acetone and water. The obtained microspheres were then sieved to collect fractions with diameters ranging from 100 to 315 μm and diameters ranging from 315 to 500 μm. Immediately after sieving, microspheres were freeze dried and kept at -20°C until used to avoid hydrolysis.

2.4. Characterizations

2.4.1. Morphology observation

Microspheres obtained after synthesis were observed by optical microscopy. The optical microscope (OLYMPUS BH2 Microscope) was equipped with leitz PL2.5/0.08, Olympus Dplan 10 objectives and a Mightex camera. At least 25 micrographs were taken for each sample.

Morphology of microspheres was also observed by scanning electron microscopy using a LEO 9530, Gemini (France) at an accelerating voltage of 3kV (ICMPE, Thiais, France). Prior to observation, samples were mounted on metal stubs, using carbon-conductive double-sided adhesive tape, and coated with a 4 nm platinum/palladium layer under vacuum (Cressington 208 HR, Eloise, France).

2.4.2. Size measurements of microspheres

Particle size distribution was determined by laser diffraction on a Mastersizer S apparatus (Malvern Instrument Ltd.) at 25°C. Dry beads were dispersed in water and were allowed to swell for 15 min before measurement. They were then introduced in the QSpec small volume sample dispersion unit. Homogenous circulation between the latter and the measurement cell was performed by means of 1000 rpm magnetically stirring. The quantity of microspheres was added in order to obtain an obscuration between 5 and 10 %. Each injection was analyzed 3 times. Granulometry was analyzed using the Fraunhofer optical model. Results were presented in % volume distribution using the volume/mass moment mean diameter $D[4,3]$ (equation 1) and their size distribution expressed by the Span (equation 2):

$$D[4,3] = \frac{\sum n_i d_i^4}{\sum n_i d_i^3} \quad (1)$$

$$\text{Span} = \frac{D[v, 90] - D[v, 10]}{D[v, 50]} \quad (2)$$

where n_i represents the number of particles with a define diameter d_i .

$D[v, 90]$ is the volume diameter below which is included 90 % of the distribution.

$D[v, 50]$ is the volume diameter below which is included 50 % of the distribution.

$D[v, 10]$ is the volume diameter below which is included 10 % of the distribution.

2.4.3. Mass fraction measurements of microspheres

The mass fraction of the microspheres in concentrated suspensions obtained after sedimentation was determined as followed: A weighting boat was prepared with a pre-weighted piece of filter paper above which was placed a pre-weighted piece of organza. A sample of the concentrated suspension of microspheres obtained by sedimentation was placed over the organza. The mass measured, W_{sed} , corresponded to the weight of the wet microspheres (W_{WM}) and the weight of the surrounded liquid. As organza showed a mesh size much below the size of the smaller microspheres and it did not absorb water, it retained the microspheres while the surrounded liquid was absorbed by the filter paper placed below. By weighting separately the pre-weighted piece of organza with the microspheres and the pre-weighted piece of filter paper having absorbed the liquid surrounding the microspheres, it was possible to determine the weight of wet microspheres (W_{WM}) and that of the surrounding

liquid. The mass fraction of the microspheres (f_{WM}) expressed as a percentage can then be calculated from equation 3.

$$f_{WM} = \frac{W_{WM} \times 100}{W_{Sed}} \quad (\% \text{ wt.}) \quad (3)$$

2.4.4. Determination of the swelling ratio of microspheres

The same procedure as described above was used to evaluate the weight of the wet microspheres (W_{WM}). Then the isolated wet microspheres were freeze dried and weighted again after drying to measure their dried weight (W_{DM}). The mass swelling ratio was then calculated from equation 4:

$$Q_w = \frac{W_{WM} - W_{DM}}{W_{DM}} \quad (4)$$

2.4.5. Rheological characterisation of microsphere dispersion

The rheological behaviour of microsphere sediments was evaluated by a Haake controlled stress RS600 rheometer (Thermo Electron) equipped with a 35 mm plate-plate geometry. Measurements were performed at 25°C ($\pm 0.02^\circ\text{C}$) and regulated with a Peltier plate. A solvent trap placed on the geometry was used in order to prevent water evaporation during measurements. Microspheres were deposited on the plateau at a mass fraction which corresponds to the random close packing obtained after letting the suspension to settle in PBS pH 7.4 for 30 minutes. The method was previously developed and validated by our group (Nguyen et al. Submitted for validation to Occlugel 14 April 2011). Microspheres were characterized by oscillatory measurements in the linear regime. Frequency sweeps from 0.01 to 40 Hz were performed under a constant strain of 0.04%. The gap value was chosen as 200

μm for beads having diameter between 100-315 μm and as 300 μm for 315-500 μm beads. Three rheological parameters were registered on different aliquots of the same batch of microspheres at various hydrolysis times: the storage (or elastic) modulus G' , the loss (or viscous) modulus G'' and the phase angle δ (defined by $\tan \delta = G''/G'$). Rheological measurements were carried out in triplicate for each sample. Means and standard deviations of G' , G'' and δ were calculated.

3. Results and discussions

Hydrogel microspheres were prepared by radical crosslinking reaction between a degradable crosslinker containing two double bonds and comonomers (such as PEGMMA Mw. 300 and methacrylic acid). First of all, degradable crosslinkers were synthesized.

3.1. Biodegradable crosslinker synthesizes

Two structures of crosslinker were developed in this study: diblock and triblock.

The diblock system used a PEG containing initiator for ring-opening polymerization of lactide and/or glycolide in the presence of small amount of catalyst $\text{Sn}(\text{Oct})_2$ (Fig. 1). This step, inspired by the synthesis developed previously by Lutz et al. (Lutz et al. 2004), led to a high yield whatever the initiator used (> 95 %).

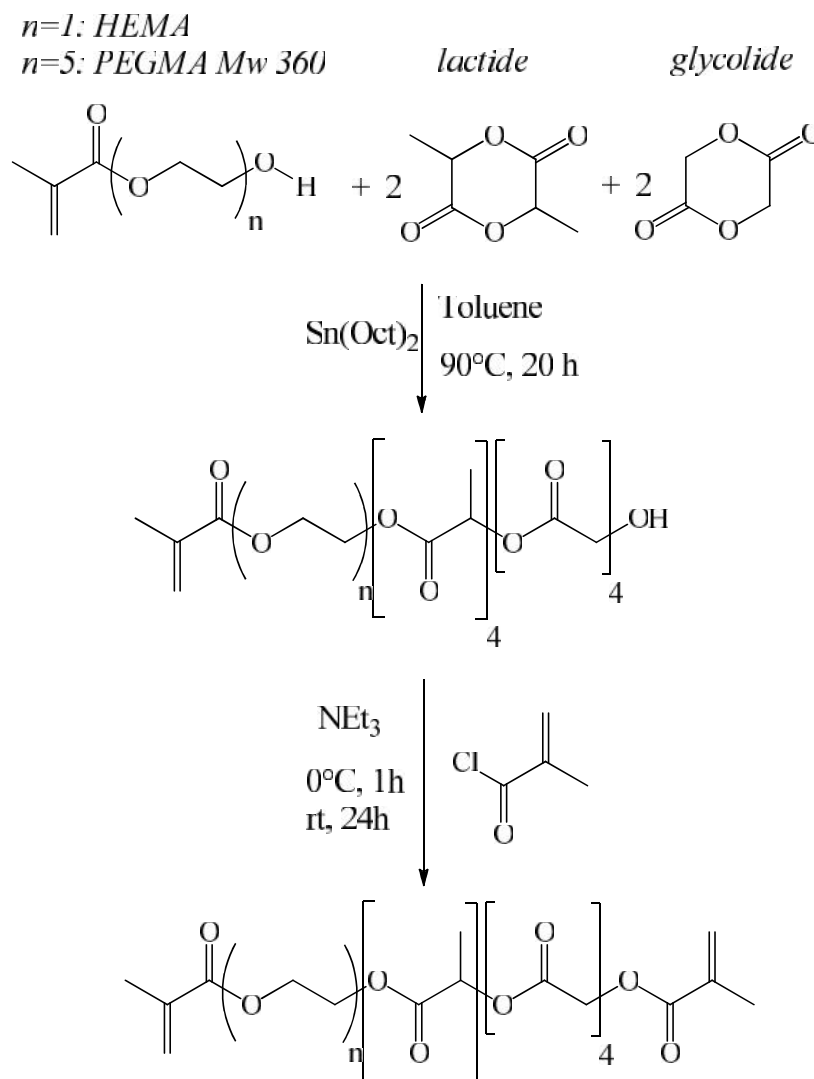

Figure 1. Synthesis of the diblock PEGMA4L4G crosslinker (asymmetric structure).

Appropriate quantity of lactide and/or glycolide (compared to the amount of initiator) can be introduced to form the desired length of PLGA chain as shown in Table I. The second double bond was then introduced at the PLGA extremity by a standard esterification of hydroxyl group in the presence of methacryloyl chloride. Characterization by ^1H NMR allowed to calculate the polymerization degree of lactide/glycolide (PD_L , PD_G) and the methacrylate functionality \square of the macromonomer (Table I). Figure 3 showed NMR spectra of different

crosslinkers where **a** represented the first double bond, introduced by the initiator (HEMA or PEGMA) and **b** the second double bond issued from the second step of the preparation.

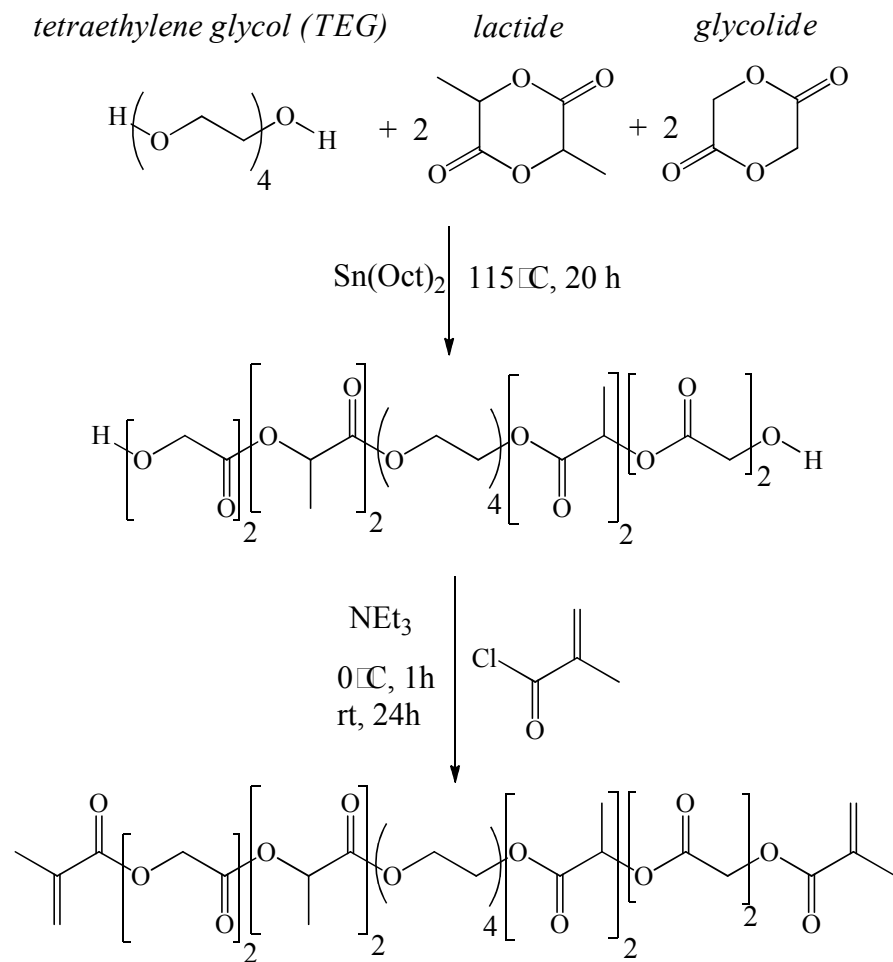

Figure 2. Synthesis of the triblock TEG4L4G crosslinker (symmetric system).

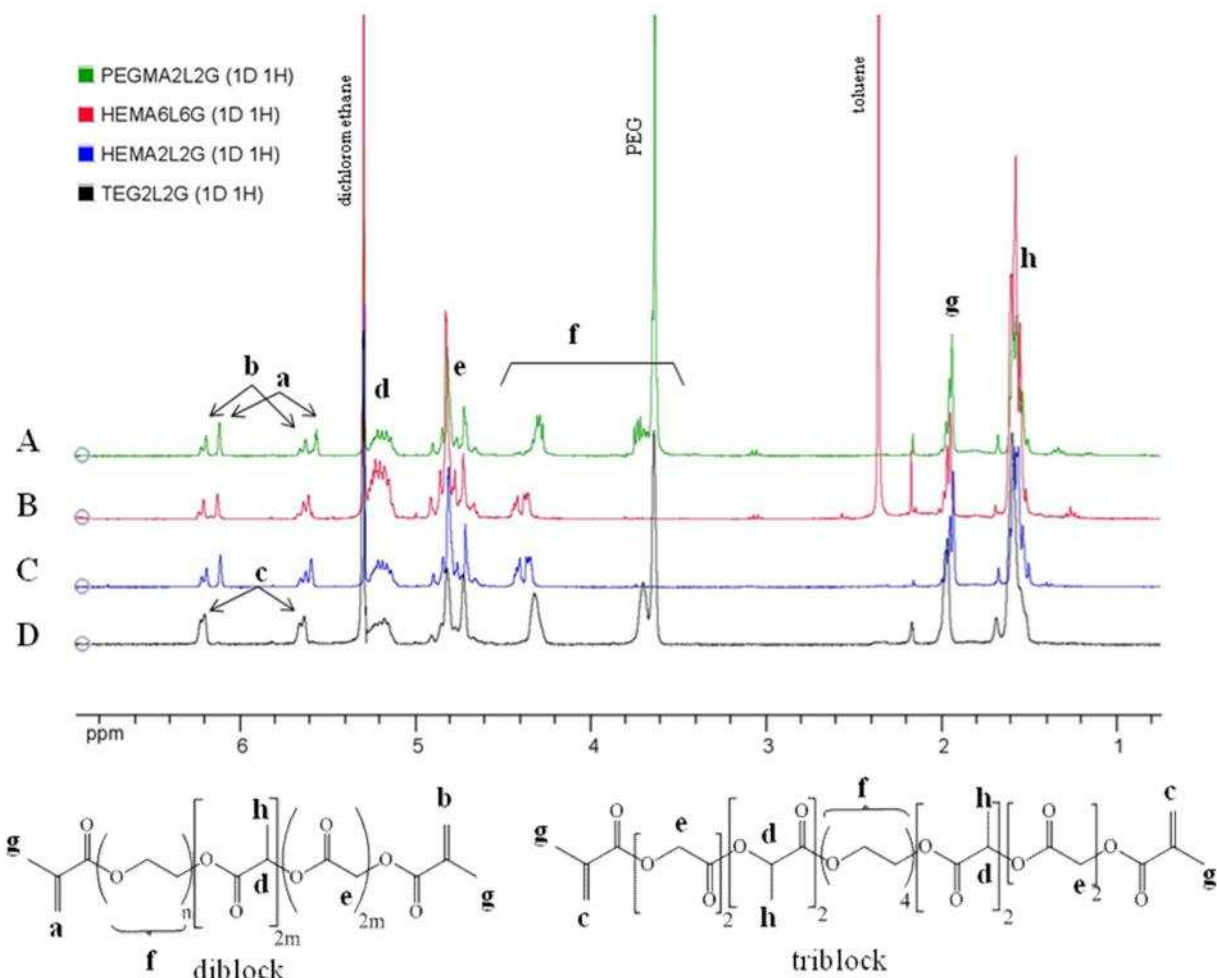

Figure 3. ^1H NMR spectra of degradable crosslinkers PEGMA4L4G (A), HEMA12L12G (B), HEMA4L4G (C) and TEG4L4G (D).

The triblock crosslinker was prepared according to a method first described by Sawhney et al. (Sawhney et al. 1983) using TEG as initiator and a mixture of lactide / glycolide to form the PLGA-TEG-PLGA crosslinker (Fig. 2). This method was widely used by many research groups for various medical applications (Burdick et al. 2001, Zhu and Ding 2006, Mahoney and Anseth 2006, Chan-Park et al 2006, Burdick et al. 2006, Shah et al. 2006, Clapper et al. 2008, Bencherif et al. 2008, Bencherif et al. 2009, Hao et al. 2009). As the synthesis of

diblock crosslinkers, the first step led to a total consumption of monomers. In the second step, esterification was performed on both extremities to form the symmetric triblock crosslinker.

For both types of synthesis, good methacrylate functionality \square of the macromonomer was obtained (Table I). Except for the HEMA5G crosslinker, the degree of the second double bond addition were high ($> 90\%$) whatever the length of either the initiator or the degradable PLA or PLGA chain (Table I). The small value of \square and reaction yield of HEMA5G crosslinker may be explained by a high crystallinity and low solubility of the macromer when only glycolide was used as degradable material.

TABLE I - Crosslinker characterizations by NMR analysis

Type of crosslinker		PD _L / PD _G	methacrylate functionality \square	Yield (%)
Diblock	HEMA5L	5 / 0	98	70
	HEMA5G	0 / 6	50	50
	HEMA4L4G	5 / 5	97	64
	HEMA12L12G	13 / 11	99	66
	PEGMA4L4G	5 / 5	90	68
Triblock	TEG4L4G	4 / 4	90	74

The two models with possibilities to modulate the PLGA and PEG length allow us to obtain a large range of crosslinkers. The major difference between them remained in the position of ethylene glycol (EG) groups: before the PLGA segment (asymmetric system) or in the middle of the PLGA segment (symmetric structure). This difference in the structure of the crosslinker may affect the swelling of the microsphere and in turn the degradation rate.

3.2. Biodegradable microspheres synthesizes

Direct suspension polymerization is a well known method, developed in the early 1900s by Hoffman and Delbruch (Hoffman and Delbruch 1909). This is the method of choice for the synthesis of microspheres with large diameter from small monomers containing double bonds, especially in the case of crosslinking polymerization (Dowding and Vincent 2000). The conditions of suspension polymerization (reactor geometry, stirrer, speed of agitation) were previously optimized in our group to promote the formation of large size microspheres ($> 300 \mu\text{m}$) and at the same time to minimize the amount of aggregates. PVA was chosen as the stabilizing agent as it is widely used in formulation of microspheres for biomedical applications, including for embolisation therapeutic (Spentlehauer et al. 1986). Salts were added to the dispersion to reduce solubility of the organic monomer in the aqueous phase. This decreased also the possible polymerization initiation in the continuous phase that would promote formation of aggregates.

PEGMMA Mw. 300 was chosen as the comonomer in our system in order to form biocompatible, elastic and swellable microspheres. In some preparations, methacrylic acid was added to introduce carboxylic acid functionality. The rationale behind this incorporation was that this hydrophilic group was expected to increase the swellability of the microspheres by attracting more water molecules in the hydrogel. It was believed that this may help to modulate the degradation rate of the microspheres. In addition, the carboxylic acid groups incorporated in the hydrogel structure may be available for drug loading by ionic interactions or covalently addition.

Different types of microspheres were prepared by copolymerization of the various synthesized crosslinkers (Table II). Less than 10% of aggregates were obtained for all batches. Whatever the crosslinker used, well spherical microspheres were obtained (Fig. 4).

Size distributions (before sieving) obtained from two different batches of same composition were found to be very similar (Table II). These results demonstrated a good reproducibility of the method of synthesis. Microspheres obtained from the different types of crosslinkers incorporated at the same ratio (3%) had similar diameters in water. When the molar percentage of the same crosslinker HEMA4L4G increased from 1 to 6%, a slight decrease of the diameter was observed from around 350 μ m to 290 μ m. Incorporation of methacrylic acid as comonomers (47%) did not modify the size of microspheres swelled in water and prepared with the same amount of crosslinker (3%). The neutral form of methacrylic acid seems not to influence on the microsphere size when they were dispersed in water. However, a different behavior may be expected if the microspheres are dispersed in a media containing ions.

It was reported in the literature that hydrogels including copolymers of PLGA in equal proportion of lactic acid and glycolic acid (50/50) were degraded more rapidly than pure PLA or PGA (Middleton and Tipton 2000). Since the aim of this work is to develop a rapid resorbable microsphere, only microspheres prepared by copolymerization of PEGMMA with crosslinkers included PLGA 50/50 were considered for further evaluation.

TABLE II □ Size distribution before sieving (in water) of different direct suspension polymerization batches prepared with various compositions in co-monomers and crosslinkers. The low percentage of aggregates found in dispersions indicated the good quality of the preparations.

Microspheres		Batch n° 1			Batch n° 2		
Comonomer	Crosslinker	D[4,3] (µm)	Span	aggregates (%)	D[4,3] (µm)	Span	aggregates (%)
PEGMMA Mw. 300	HEMA4L4G-1%	344	0.87	1	352	0.80	1
	HEMA4L4G - 3%	325	0.62	6	367	0.92	4
	HEMA4L4G - 6%	293	0.75	5	290	0.60	5
	HEMA12L12G- 3%	299	0.58	5	319	0.56	4
	PEGMA4L4G- 3%	330	0.71	12	335	0.68	11
	TEG4L4G-3%	315	0.58	3	306	0.60	2
PEGMMA Mw. 300 + methacrylic acid	HEMA4L4G - 3%	323	0.58	12	354	0.94	9

Fig. 4 showed an example of size measurement on a batch of microspheres HEMA4L4G-3% before and after sieving. All size distributions had a Gaussian form with a single peak. The obtaining results were in agreement with that expected after sieving in the range of 100-315 µm and 315-500 µm. Diameters of the sieved microspheres between 315 and 500 µm were listed in Table III.

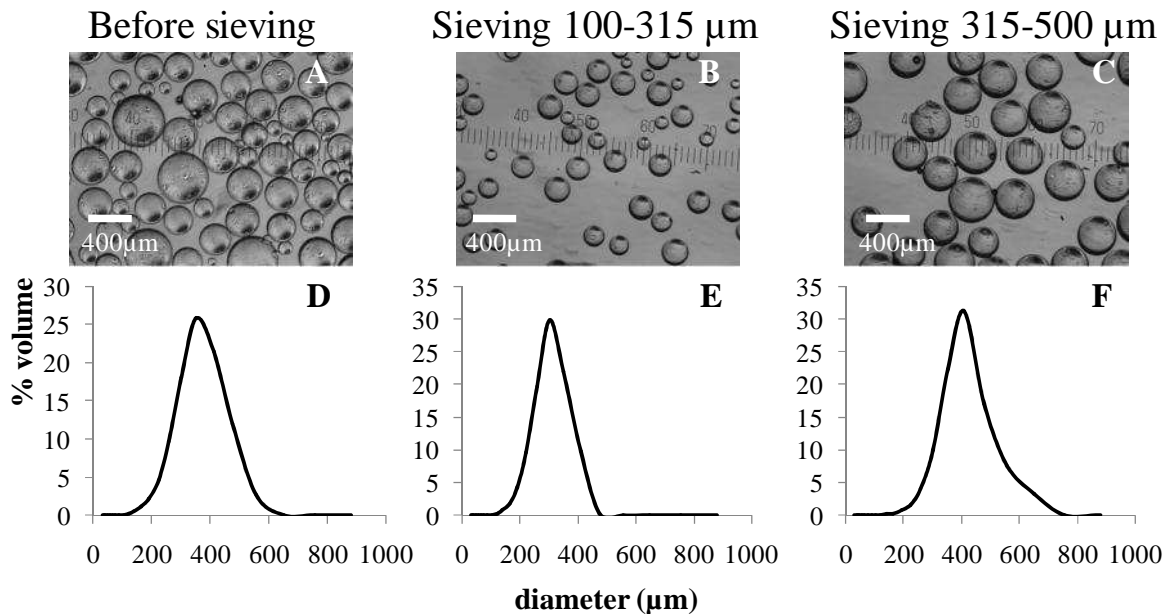

Figure 4. Micrographs of HEMA2L2G-3% microspheres before sieving (A), after sieving of 100-315 μm (B) and 315-500 μm (C) and their respective size distributions (D, E and F). Bar Scale = 400 μm.

The mass fraction of the random close packing microspheres is a key parameter of microspheres. It is necessary for further studies, especially in rheology where it is important to always perform measurements at the same concentration of microspheres as that greatly influences the obtained moduli (Taylor & Bagley 1975). Therefore, it is primary to quantify the mass fraction of various samples to make sure that they give a similar value. Mass fraction values of the different sieved microspheres were listed in Table III. No significant difference in mass fraction was found between measurements performed on swelled microspheres in water and in PBS, as shown in Fig. 5A and in Table III. This result indicated that all types of microspheres were packed similarly that the rheological measurements were assured to be studied at the same condition.

TABLE III - Characterizations of microspheres after sieving 100-315 μm and 315-500 μm .

Sieving (μm)	Microspheres	Size distribution		Mass fraction f_{WM} (%)		Mass swelling Q_{w0} (g/g)		Rheological results at 1 Hz	
		D[4,3] (μm)	Span	in water	in PBS pH 7.4	in water	in PBS pH 7.4	G_0 (10^3 Pa)	ϕ_0 ($^\circ$)
315-500	HEMA4L4G-1%	417	0.45	60.1 ± 0.8	57.9 ± 0.6	7.32 ± 0.20	5.96 ± 0.31	2.3 ± 0.2	4.0 ± 1.8
	HEMA4L4G -3%	393	0.60	69.4 ± 0.4	69.0 ± 0.5	3.91 ± 0.15	3.22 ± 0.18	4.3 ± 0.1	7.3 ± 0.5
	HEMA4L4G -6%	414	0.57	66.5 ± 0.2	64.7 ± 0.4	2.76 ± 0.06	2.04 ± 0.11	8.9 ± 1.3	9.1 ± 0.8
	HEMA12L12G-3%	342	0.54	69.1 ± 0.2	65.8 ± 1.1	3.19 ± 0.08	2.55 ± 0.06	7.2 ± 0.1	6.8 ± 0.2
	PEGMA4L4G-3%	368	0.60	62.5 ± 0.2		3.57 ± 0.03		7.3 ± 0.3	5.0 ± 1.6
	TEG4L4G-3%	390	0.61	68.4 ± 0.6		3.29 ± 0.07		5.6 ± 0.7	9.0 ± 1.6
100-315	HEMA4L4G -3%	277	0.66	65.6 ± 1.5		3.47 ± 0.11		9.8 ± 1.1	3.4 ± 0.2

The swelling behavior of the various microspheres was evaluated by mass swelling measurements in water and in PBS pH 7.4 (Table III and Fig. 5B). Measurement performed on microspheres with 1, 3 and 6 molar % of crosslinker HEMA4L4G showed that the higher the crosslinking ratio, the lower the obtained swelling capacity was, whatever the medium in water or in PBS (Fig. 5B). As also observed in Fig. 5B, at the same cross-linking percentage, microspheres swell more in water than in PBS. This can be explained by a salting out effect due to the presence of salts in PBS.

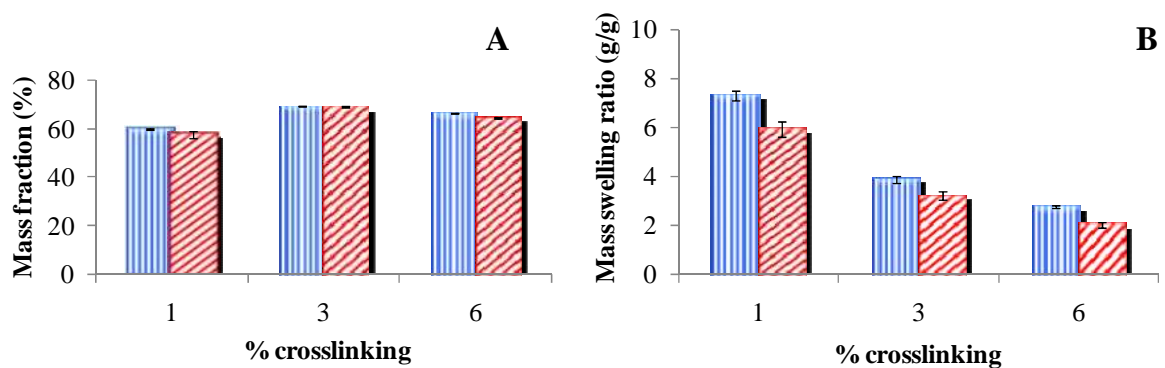



Figure 5. Mass fraction (A) and mass swelling behaviour (B) of HEMA2L2G-3% microspheres 315-500 μm in water  or in PBS pH 7.4 

It was also observed that almost no difference was obtained between microspheres formed from the different crosslinkers including 4L4G segments at the same crosslinking ratio (3 molar %) (Table III). Microspheres HEMA12L12G-3% swelled less than those formed from HEMA4L4G crosslinker at the same density. This is due to the hydrophobic character of the long PLGA crosslinking chain found in HEMA12L12G, which prevents microspheres from swelling. That explains also why HEMA12L12G-3% beads have a slightly smaller size than the others (Table II for microspheres before sieving and III for sieved ones). It is noteworthy that microspheres HEMA4L4G-3% of size class 100-315 μm swell slightly less than those

sieved from 315 to 500 μm . This can be explained by the difference in the ratio between the surface and the volume of the microspheres in the two ranges of size considered here.

Rheological measurements were performed on different microspheres in order to quantify their elasticity/rigidity (Table III). In fact, for their application in embolization, microspheres must pass through the catheter to reach the targeting point. Thus, they must be elastic enough to pass through the catheter without being broken. Moreover, they need to have enough rigidity to resist to blood pressure at the target site and therefore play their embolic role. All types of microspheres studied in rheology demonstrated a nearly pure elastic behaviour as indicated by the very low value of δ at a frequency above 1 Hz ($< 10^\circ$). The lower the ratio of crosslinking agent in the microspheres, the smaller the value of δ was (Fig. 6B). Moreover, it is noteworthy that an increase of crosslinking density of microspheres implied a higher rigidity, as shown from the elastic modulus G' of each microsphere presented in Fig. 6A.

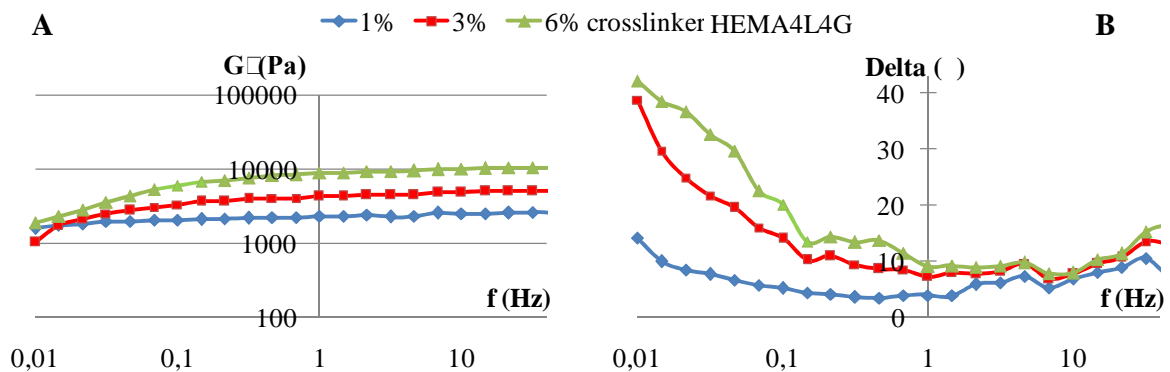

Figure 6. Elastic modulus G' (A) and delta (B) of 315-500 μm microspheres forming from 1%, 3% and 6% HEMA4L4G crosslinker

After the obtained results, the swelling and the rheological parameters of microspheres obtained with different crosslinking ratios were correlated. Rheological measurements give information on the balance rigidity/suppleness of microspheres. As microspheres are

hydrogels, they contain large amount of water and their suppleness also depends on the amount of water inside. Therefore, when the cross-linking density rises, the swelling capacity is lower and the elasticity of microspheres reduces significantly.

By comparing microspheres HEMA4L4G-3% (containing only 2 ethylene glycol(EG)), TEG4L4G-3% (having 4 EG) and PEGMA4L4 (containing 5EG) (Table III), it can be observed that the G' value was increased with the length of the PEG segment incorporated in the crosslinker while it has only marginal effect on the swelling properties of the microspheres. Thus, the balance PEG/PLGA in the crosslinker was also identified as a parameter influencing the rheological properties of microspheres with a lower extend compared to that of the crosslinking ratio. Although we do not have an explanation on these phenomena, it appeared from these results that the incorporation of longer PEG segments in the crosslinker did not improve the elastic properties of the microspheres as it was initially postulated.

Moreover, the rheological studies on microspheres HEMA4L4G-3% sieved between 100 and 315 μm showed a remarkable higher value (9.8 ± 1.1 kPa) compared to those sieved from 315 to 500 μm (4.3 ± 0.1 kPa). This phenomenon may be explained by the higher swelling ratio observed with the larger microspheres.

Comparing to a typical commercial non degradable microspheres used presently for embolization (Embospheres® 300-500 μm , $G' = 2730$ Pa), as measured in the same conditions, degradable microspheres proposed in this paper have elastic modulus higher or equal. It is therefore possible to conclude that low cross-linking microspheres (less than 6% molar) can be suitable for injection.

4. Conclusions

We have developed a panel of hydrolysable microspheres based on PLGA and PEG for therapeutic embolization. The variety of microspheres was created not only by modulating the molar % of the crosslinker but also by changing its nature (PLGA length, PEG length and the position of PEG chain). Moreover, methacrylic acid can be added as another comonomer which may accelerate the hydrolysis process. The suspension polymerization synthesizes provide microspheres with small size distribution and good yield. Synthesized microspheres, sieved from 100 to 315 μm and from 315 to 500 μm , were swellable and showed elastic properties. Their swelling capacity and their elasticity were demonstrated to be intrinsically dependant on the density of crosslinking. The longer the PLGA chain, the more hydrophobic, the less swellable and the more rigid microspheres obtained. Results suggested that easily deformable microspheres being suitable for embolization can be obtained with a maximum of 6% molar ratio of degradable crosslinker.

5. Acknowledgement

The authors would like to thank Dr. C Vauthier for her advices and investigations on the characterizations of microparticles; Dr. G. Mekhloufi for her helps in granulometric measurements. This work was financed by CNRS and Occlugel SARL.

6. References

Ali M.M., Stöver H.D.H. (2004). □Well-Defined Amphiphilic Thermosensitive Copolymers Based on Poly(ethylene glycol monomethacrylate) and Methyl Methacrylate Prepared by Atom Transfer Radical Polymerization. □Macromolecules 37: 5219-5227.

Bencherif, S. A., J. A. Sheehan, et al. (2009). "Influence of cross-linker chemistry on release kinetics of PEG-co-PGA hydrogels." Journal of Biomedical Materials Research Part A 90A(1): 142-153.

Bencherif, S. A., A. Srinivasan, et al. (2009). "End-group effects on the properties of PEG-co-PGA hydrogels." Acta Biomaterialia 5(6): 1872-1883.

Burdick, J. A., L. M. Philpott, et al. (2001). "Synthesis and characterization of tetrafunctional lactic acid oligomers: A potential *in situ* forming degradable orthopaedic biomaterial." Journal of Polymer Science Part A: Polymer Chemistry 39(5): 683-692.

Burdick, J. A., M. Ward, et al. (2006). "Stimulation of neurite outgrowth by neurotrophins delivered from degradable hydrogels." Biomaterials 27(3): 452-459.

Chan-Park M.B., Zhu A.P., et al. (2004). "Novel Photopolymerizable Biodegradable Triblock Polymers for Tissue Engineering Scaffolds: Synthesis and Characterization." Macromolecular Bioscience 4(7): 665-673.

Clapper J.D., Skeie J.M., et al. (2007). "Development and characterization of photopolymerizable biodegradable materials from PEG-PLA-PEG block macromonomers." Polymer 48(22): 6554-6564.

Desai N. P. and Hubbell J. A. (1991). "Biological responses to polyethylene oxide modified polyethylene terephthalate surfaces." Journal of Biomedical Materials Research 25(7): 829-843.

Dowding P.J. and Vincent B. (2000). □Suspension polymerisation to form polymer beads. □Colloids and Surfaces, A: Physicochemical and Engineering Aspects 161: 259-269.

Gomez C.G., Alvarez Igarzabal C.I., Strumia M.C. (2004). □Effect of the crosslinking agent on porous networks formation of hema-based copolymers.□Polymer 45: 6189□6194.

Hakkarainen M., Albetsson A.C., Karlsson S. (1996). □Weight losses and molecular weight changes correlated with the evolution of hydroxy-acids in simulated in vivo degradation of homo- and copolymers of PLA and PGA.□Polym. Deg. Stab., 52, 283-291.

Hao J.-Q., Li H., et al. (2009). "Synthesis and characterization of cholic acid-containing biodegradable hydrogels by photoinduced copolymerization." Journal of Applied Polymer Science 112(5): 2976-2980.

Hoffman F.and Delbruch K. (1909). German Patent 250,690

Holland S. J., Tighe B. J., et al. (1986). "Polymers for biodegradable medical devices. 1. The potential of polyesters as controlled macromolecular release systems." Journal of Controlled Release 4(3): 155-180.

Ishimori S., Hattori M., Shibata Y., Shizawa H., Fujinaga R. (1967). □Treatment of carotid-cavernous fistula by gelfoam embolization.□J Neurosurg.; 27(4): 315-9.

Katsumori T., Kasahara T. (2006). □The size of gelatin sponge particles: differences with preparation method.□Cardiovasc Intervent Radiol; 29(6): 1077-83.

Laurent A. (2007). □Microspheres and Nonspherical Particles for Embolization.□Tech Vasc Interventional Rad 10:248-256

Lutz J.F., Jahed N., Matyjaszewski K. (2004). □Preparation and Characterization of Graft Terpolymers with Controlled Molecular Structure.□J Polym Sci: PolymChem, 42: 1939□1952

Mahoney, M. J. and K. S. Anseth (2007). "Contrasting effects of collagen and bFGF-2 on neural cell function in degradable synthetic PEG hydrogels." Journal of Biomedical Materials Research Part A 81A(2): 269-278.

Middleton J. C., Tipton A. J. (2000). □Synthetic biodegradable polymers as orthopedic devices.□Biomaterials 21: 2335-2346.

Nguyen V.N., Huang N., Grossiord J.-L., Agnely F., Vauthier C. □Rheology as a tool for characterisation of mechanical properties of chemically crosslinked microspheres and for monitoring their degradation. □Submitted for validation to Occlugel 14 April 2011

Peppas N. A., Hilt J. Z., et al. (2006). "Hydrogels in Biology and Medicine: From Molecular Principles to Bionanotechnology." *Advanced Materials* 18(11): 1345-1360.

Shah N. M., M. D. Pool, et al. (2006). "Influence of network structure on the degradation of photo-cross-linked PLA-b-PEG-b-PLA hydrogels." *Biomacromolecules* 7(11): 3171-3177.

Sawhney A.S., Pathak C.P. et al. (1993). "Bioerodible hydrogels based on photopolymerized poly(ethylene glycol)-co-poly(.alpha.-hydroxy acid) diacrylate macromers." *Macromolecules* 26(4): 581-587.

Speakman T.J. (1964). □Internal Occlusion of a Carotid-Cavernous Fistula. □*J Neurosurg* 21: 303-5.

Spenlehauer G., Veillard M. and Benoît JP (1986). □Formation and characterization of cisplatin loaded poly(d,l-lactide) microspheres for chemoembolization. □*J Pharm Sci.* 75(8):750-5.

Södergård A. and Stolt M. (2002). "Properties of lactic acid based polymers and their correlation with composition." *Progress in Polymer Science* 27(6): 1123-1163.

Yamaoka T., Tabata Y., et al. (1994). "Distribution and tissue uptake of poly(ethylene glycol) with different molecular weights after intravenous administration to mice." *Journal of Pharmaceutical Sciences* 83(4): 601-606.

Zhu W. and Ding J. (2006). "Synthesis and characterization of a redox-initiated, injectable, biodegradable hydrogel." *Journal of Applied Polymer Science* 99(5): 2375-2383.

3. Etude des conditions d'obtention de microsphères d'hydrogel résorbables par polymérisation en suspension inverse

Dans le cas de la polymérisation en suspension inverse, les monomères sont solubilisés dans une phase aqueuse qui est dispersée dans un milieu organique. Le principe général de la polymérisation d'un agent de réticulation avec un ou plusieurs co-monomères (méth)acryliques utilisée dans ces travaux est similaire à la polymérisation en suspension directe présentée précédemment. Néanmoins, le choix des co-monomères et des agents amorceurs de la polymérisation radicalaire a dû être adapté pour permettre la solubilisation dans l'eau. Ainsi, la synthèse de l'agent réticulant a été réalisée sur le modèle de la synthèse proposé par Sawhney et collaborateurs [Sawhney et al. 1993] et la chaîne de PEG retenue pour ces synthèses était d'une longueur moyenne de 25 unités d'éthylène oxyde (Mw. 1500 g/mol) (Figure 4). Pour obtenir les microsphères, les amorceurs de la polymérisation radicalaire retenus ont été le persulfate d'ammonium et le N,N,N',N'-tétraméthyléthylène diamine (TEMED).

Une première étape de validation de la méthode de polymérisation a été réalisée en mettant en œuvre des monomères et agents de réticulation commerciaux conduisant à l'obtention d'un hydrogel non dégradé. L'agent de réticulation dégradé synthétisé au laboratoire pour préparer des microsphères résorbables par cette méthode a été mis en œuvre dans une deuxième étape.

3.1. Matériels

Le lactide et le glycolide ont été fournis par Biovalley. Les différents produits : Span 80[®], ammonium peroxodisulfate (AP), N,N,N',N'-tetramethylethylenediamine (TEMED), N-diméthyle acrylamide (DMA), polyéthylène glycol méthacrylate d'une masse molaire moyenne de 1100 g/mol (PEGMMA 1100), et le réticulant N,N'-Méthylènebisacrylamide (MBA) de pureté minimale à 99% ont été fournis par Sigma Aldrich (France). La triéthyleamine (TEA), l'octoate d'étain (Sn(Oct)₂) le polyéthylène glycol d'une masse moyenne de 1500 g/mol (PEG1500) et le chlorure d'acide méthacrylique ont été fournis par Fluka (France). N-acryloyle tris(hydroxyméthyle) aminométhane (Tris) a été offert par la société Biosphere Medical. L'acide acrylique, fourni par Sigma Aldrich, a été neutralisé à 75% (AAn) par une solution de NaOH 2,5 M en maintenant la température à 0°C. Les solvants (> 99 % de pureté) ont été utilisés sans aucune purification supplémentaire. L'eau pure a été distribuée par le système de purification miliQ 185. Les réactions de polymérisation en suspension ont été effectuées dans un réacteur d'une capacité maximale d'un litre. Le système d'agitation était également composé d'un moteur d'agitation IKA[®] Eurostar Digital. Les produits obtenus ont été caractérisés par spectrométrie RMN du proton (Bruker 300 MHz).

3.2. Méthodes de synthèses

+ Synthèse d'un agent réticulant hydrolysable soluble dans les milieux aqueux

Le Schéma de la réaction et les conditions de synthèse du réticulant à base de PEG1500L8G sont données dans la figure 4. La procédure de synthèse est identique à celle du TEG4L4G décrite dans la partie précédente (cf. page 97) en remplaçant le TEG (tétraéthylène glycol) par du PEG1500.

La fonctionnalisation en méthacrylate du macromonomère, le degré de polymérisation de l'acide lactique PD_L et celui de l'acide glycolique PD_G ont été déterminés à partir des spectres RMN du proton du produit synthétisé. ¹H NMR (acétone-d₆) (ppm): 6.16 (m, 2H x CHH=), 5.71 (m, 2H x CHH=), 5.22 (m, 1H x PD_L, PLA), 4.90 (m, 2H x PD_G, PGA), 4.28 (m, 4H, PEG), 3.58 (m, 2H x n, PEG), 1.94 (m, 6H x méthacrylate), 1.53 (m, 3H x PD_L, PLA).

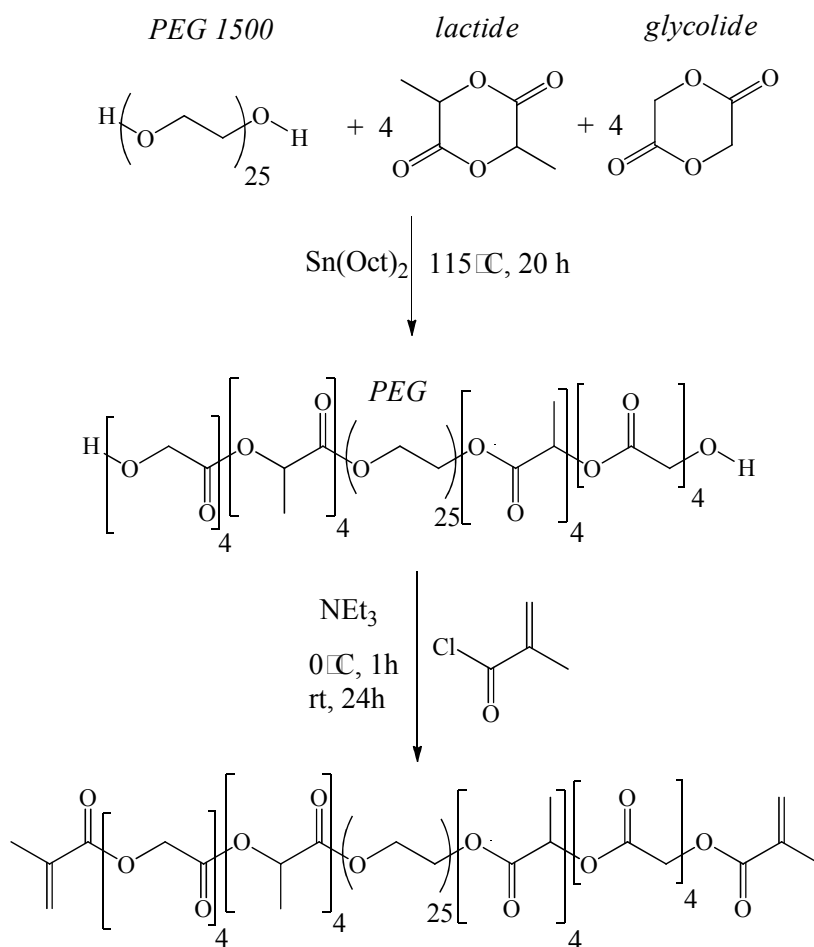

Figure 4. Synthèse de 1500PEG8L8G, agent de réticulation destiné à la préparation des microsphères dégradables par polymérisation en suspension inverse.

+ Synthèse de microsphères

Les études préliminaires sur les synthèses de microsphères par polymérisation en suspension inverse ont d'abord optimisées sur un réticulant non dégradé : MBA (figure 5) et en petite quantité (200 mL de phase continue).

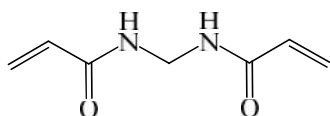

Figure 5. Le réticulant non dégradé hydrosoluble *N,N'*-Méthylènebisacrylamide (MBA).

Une solution de Span 80 à 1% w/w est préparée en utilisant 200 mL de cyclohexane puis elle est introduite dans le réacteur muni d'un système d'agitation mécanique. La solution est purgée avec de l'azote pendant 15 min. La phase aqueuse est ensuite préparée en dissolvant le réticulant MBA et les co-monomères (DMA, Tris, PEGMMA 1100, AAn) en quantités variables dans un volume total de 38 mL d'eau (Tableau I). Le persulfate d'ammonium (0,4 g) est ensuite ajouté au mélange de monomères puis la solution est purgée avec l'azote pendant 15 min. Cette solution aqueuse purgée est introduite dans le réacteur sous agitation mécanique (300 et 500 rpm). Une fois la suspension stabilisée, 2 mL de la solution de TEMED à 0,05 g/mL sont ajoutées dans le réacteur. Le système est maintenu sous agitation pendant 2h à 70°C. Les microsphères sont récupérées par filtration sur des tamis en inox puis lavées avec des quantités abondantes d'éthanol et d'eau.

Les microsphères obtenues ont été observées à l'aide d'un microscope optique (BH2 Olympus) équipé d'une caméra Mightex. Les diamètres des microsphères ont été évalués par granulométrie en suspension dans de l'eau en suivant le protocole décrit précédemment (page 99).

3.3. Résultats

+ Synthèse d'un agent réticulant hydrolysable soluble dans les milieux aqueux

L'analyse par RMN du proton a montré que le réticulant a bien été synthétisé. Le degré de polymérisation de l'acide lactique PD_L est proche de 6. La même valeur a été obtenue pour le degré de polymérisation de l'acide glycolique PD_G. Le degré de polymérisation est en théorie égal à 8 et cette différence s'explique par la présence de traces d'eau (provenant probablement du PEG) dans le milieu réactionnel ; l'eau a réagi avec une certaine quantité de lactide et de glycolide en les transformant en acides lactiques et glycoliques, bien moins réactifs que le lactide et le glycolide dans ces conditions réactionnelles. La fonctionnalisation en méthacrylate du macromonomère n'est que de 40%, comme le montre l'intégration des 2 doubles liaisons (Figure 6, pics a). Le faible taux de fonctionnalisation peut être expliqué par l'humidité résiduelle dans le PEG malgré la purification réalisée avant la réaction. Le réticulant 1500PEG8L8G synthétisé est symétrique (comme le TEG4L4G présenté précédemment). Les deux doubles liaisons apparaissant au même endroit sur le spectre RMN, il n'est pas possible de déterminer avec précision la quantité de réticulant dans le produit isolé à l'issue des 2 étapes de la synthèse. Nous ne pouvons seulement estimer que la proportion de réticulant dans le mélange varie entre 0 et 40% molaire. Il est donc nécessaire de trouver une méthode alternative efficace pour éliminer les traces d'eau présentes dans le PEG et ainsi augmenter la quantité de réticulant. Une fonctionnalisation en méthacrylate proche de 100% comme obtenu avec d'autres types d'amorceurs nous permettra d'obtenir une proportion de réticulant comprise dans une fourchette moins large et plus proche de 100%.

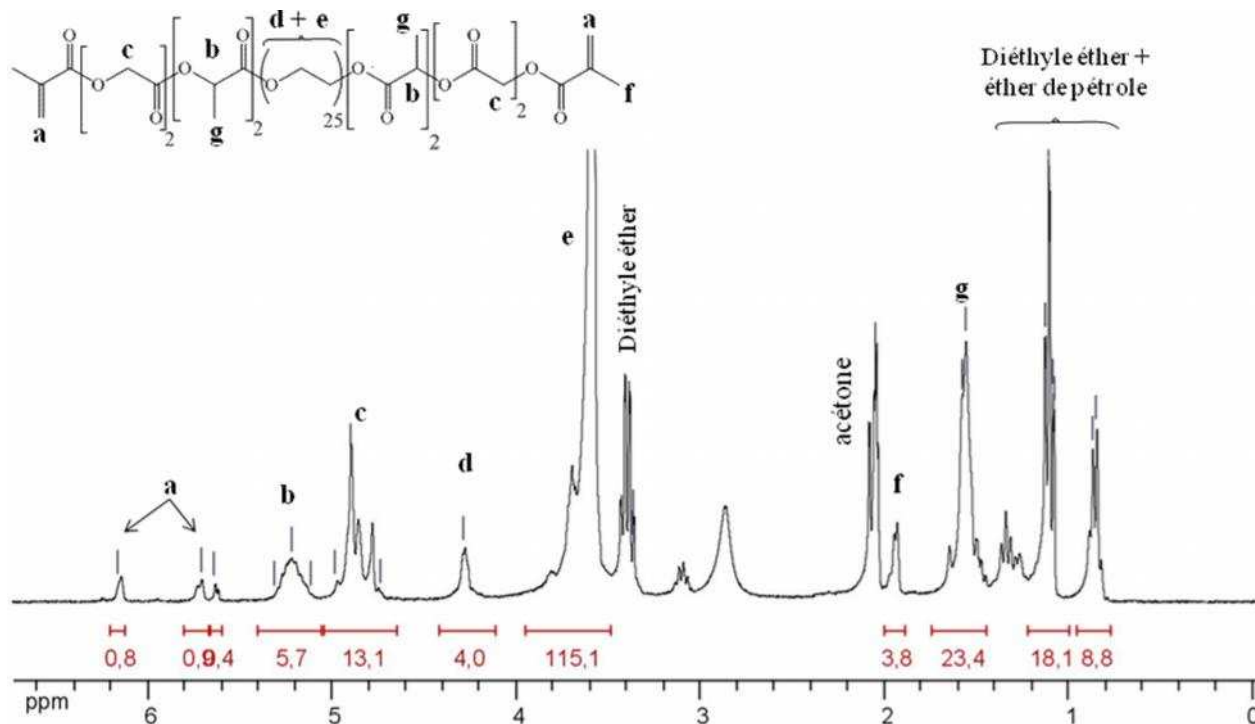

Figure 6. Spectre ¹H RMN du réticulant 1500PEG8L8G soluble dans l'eau.

+ Synthèse de microsphères

Les conditions de synthèse des microsphères d'hydrogel par la méthode de polymérisation en suspension inverse ont été explorées en réalisant des polymérisations avec une série de monomères solubles dans l'eau copolymérisés par voie de polymérisation radicalaire avec un agent réticulant non hydrolysable - le MBA (Tableau I).

Dans les conditions de polymérisation utilisées, les réactions de polymérisation ont conduit à des synthèses de microsphères avec un très bon rendement (dans la plupart des expériences citées, la quantité d'agrégats représente moins de 10% massique). L'observation des microsphères par microscopie optique démontre que les particules obtenues sont bien sphériques (Figure 7A).

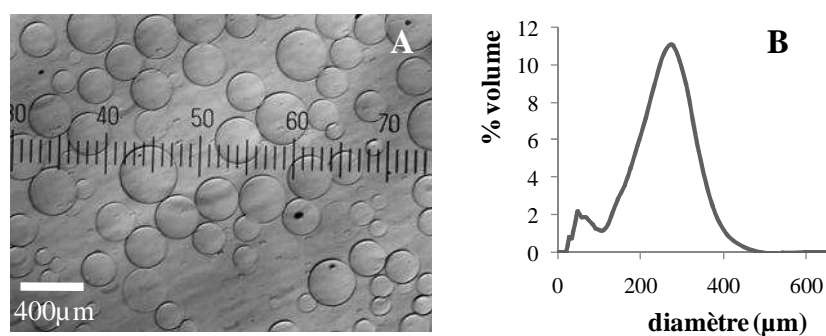

Figure 7. Microsphères non dégradables contenant 2% de réticulant MBA obtenues par polymérisation en suspension inverse observées par microscopie optique en suspension dans de l'eau (A) et allure de la courbe donnant leur distribution en taille (B) avant tamisage. L'échelle = 400 μm.

Tableau I - Conditions de polymérisation en suspension inverse permettant la préparation de microsphères

Réaction	réticulant nom	(%)	AAAn (%)	DMA (%)	Tris (%)	PEGMMA (%)	agitation (rpm)	Tailles des MS obtenues
ISP-ND1		2	44,3	53,7			400	100-315 μm
ISP-ND2		2	44,3	53,7			350	100-315 et 15-500 μm
ISP-ND3		2	44,3	53,7			300	100-315 et 15-500 μm
ISP-ND4	MBA (non dégrad- able)	2	44,3	40,3		13,4	400	100-315 μm
ISP-ND5		8,5			91,5		400	100-315 μm
ISP-ND6		4		47	49		450	100-315 μm + agrégats
ISP-ND7		4	29	18	49		450	100-315 μm
ISP-ND8		10	27	16	47		450	100-315 μm
ISP-ND9		12	32		56		450	100-315 μm
ISP-ND10		20	24	14	42		450	100-315 μm
ISP-D1	1500PEG	2	44,3	53,7			450	Agrégats
ISP-D2	8L8G	0,8	45	54,2			400	MS invisibles

Les mesures de taille des particules sont effectuées par granulométrie en suspension dans de l'eau. Par exemple, pour des microsphères ISP-ND1 formées avec 2 % molaire en réticulant, 53,6 % en DMA et 44,3 % en AAn sous une agitation de 400 rpm (Tableau I), nous avons obtenu des microsphères de tailles comprises entre 200 et 400 μm (Figure 7B). Les valeurs statistiques : $D[4,3] = 222 \mu\text{m}$, $\text{Span} = 1,27$.

Dans un deuxième temps, la méthode de polymérisation en suspension inverse a été appliquée à la synthèse de microsphères hydrolysable en substituant le réticulant non dégradable (MBA) par l'agent de réticulation hydrolysable synthétisé au laboratoire. L'obtention de microsphères dans ces nouvelles conditions expérimentales est apparue plus difficile. En effet, la masse importante du réticulant peut être l'origine d'une augmentation de la densité des gouttelettes. Il serait donc plus difficile de les maintenir en suspension dans les conditions d'agitation identiques. De ce fait, les microsphères formées auraient tendance à tomber au fond du réacteur et à former des agrégats. Une diminution du taux de réticulant a permis d'obtenir des microsphères. Ce résultat est cohérent avec l'hypothèse précédente puisqu'une diminution de la concentration du réticulant contribue à réduire la densité de la phase aqueuse. Néanmoins, ces microsphères obtenue en diminuant le taux de réticulant sont difficilement observables. En effet, compte tenu de leur faible taux de réticulation, elles présentent un très faible contraste lorsqu'elles sont en suspension dans de l'eau. Il n'a donc pas été possible d'obtenir de photo par microscopie optique des microsphères hydrolysables obtenues malgré l'utilisation d'un mode d'observation en contraste de phase. En outre, les mesures de tailles par granulométrie en voie liquide (dans de l'eau) sont également basées sur la différence d'indice de réfraction entre les particules et l'eau. La très faible différence de contraste entre les microsphères et le milieu de dispersion a également constitué un handicap pour réaliser ces mesures. Ceci est expliqué par un taux de gonflement très important de

l'hydrogel dont la composition se rapproche alors trop de celle du milieu de dispersion : leur indice de réfraction sont alors trop similaires pour les distinguer. Au total, sur les nombreux essais réalisés en modifiant la quantité d'agent réticulant, une seule condition de synthèse a conduit à l'obtention de microsphères avec un rendement supérieur à 50% calculé sur la base des agrégats isolés. Ces conditions sont résumées dans le tableau I.

4. Synthèse de microsphères d'hydrogel hydrolysables chargées en principe actif

Si l'objectif premier de ce travail de thèse est de développer des microsphères dégradables pour des applications en embolisation, nous avons exploré la possibilité de les charger en principes actifs. En effet, l'incorporation d'un principe actif au dispositif d'embolisation constitué par les microsphères pourrait apporter une valeur ajoutée en le transformant simultanément en système de libération contrôlée et locale d'une substance active une fois l'embolisation réalisée. L'incorporation de principes actifs dans des matériaux d'embolisation n'est pas nouvelle et présente notamment un intérêt en chimio-embolisation des tumeurs malignes comme par exemple pour le traitement de l'hépatocarcinome (HCC) [Ryder et al. 1996, Geschwind et al. 2003]. Elle permet de concentrer la charge médicamenteuse au niveau de la tumeur réduisant la distribution du principe actif dans les autres tissus et donc les effets indésirables et la dose totale de principe actif à administrer. Les principes actifs associés aux matériaux d'embolisation sont dans ce cas des anticancéreux comme la streptozocine. D'autres molécules actives pourraient être intéressantes d'associer aux embolies sont des molécules ayant un effet antalgique. Leur présence dans l'embolie et leur libération locale après positionnement de l'embolie pourraient contribuer au confort des patients en réduisant l'intensité des douleurs provoquées par une embolisation thérapeutique. En quittant le champ d'application de l'embolisation, les microsphères d'hydrogel résorbables chargées en principes actifs pourraient être intéressantes pour le traitement d'autres pathologies qui nécessitent un traitement local avec une action prolongée du principe actif. L'arthrose est un exemple pertinent de pathologie répondant à ces critères. Un traitement par anti-inflammatoires local et prolongé pourrait être proposé par injection des microsphères résorbables chargées en ibuprofène directement dans les articulations.

L'étude du chargement en principe actif des microsphères d'hydrogel hydrolysable a été réalisée par deux méthodes. L'une a été basée sur un chargement des microsphères par gonflement des microsphères lyophilisées dans un milieu contenant le principe actif, l'autre a été réalisée par copolymérisation d'un monomère correspondant à une prodrogue du principe actif retenu. Les travaux ont été menés sur deux molécules modèles :

- la streptozocine a été retenue pour ses applications potentielles en chimio-embolisation avec la technique de chargement par gonflement des microsphères lyophilisées.
- Une prodrogue de l'ibuprofène a été utilisée comme molécule modèle d'anti-inflammatoire. L'étude de son incorporation aux microsphères a été réalisée par la méthode de copolymérisation avec les autres monomères.

4.1. Chargement des microsphères par une méthode de gonflement

Le travail réalisé en vue de proposer des microsphères d'embolisation résorbables chargées en principe actif anticancéreux destinées à mettre en œuvre des traitements de tumeur par chimio-embolisation. Le principe de la méthode de chargement pour cette étude était basé sur le gonflement des microsphères lyophilisées dans une solution de principe actif (la streptozocine). La manipulation des molécules anticancéreuses étant contraintes à des risques toxicologiques importants, elle doit être réalisée dans des locaux spécialement aménagés et par du personnel formé à ces manipulations. Dans ce contexte, notre contribution à ce travail a été limitée à des expériences préliminaires mettant en œuvre des solutions tampons ne contenant pas la substance active. Elle avait pour objectif de préciser les conditions de réalisation du chargement des microsphères synthétisées par la technique du gonflement dans les conditions d'utilisation envisagées par les cliniciens. Nous avons donc mesuré avec

précision la quantité de microsphères sèches absorbant 1 mL de solution saline à 0.9% (Figure 8).



Figure 8. Observation macroscopique du gonflement des microsphères HEMA4L4G-3% (tamisées 315-500 μm) dans 1 mL de solution physiologique (0,9% NaCl). A. Microsphères sèches conditionnées dans un flacon à sertir. B. Microsphères gonflées dans 1 mL de solution physiologique.

Un exemple de l'étude du gonflement sur les microsphères HEMA4L4G-3% (tamisées 315-500 μm) suivi par microscopie optique est présenté en Figure 9. Nous pouvons remarquer tout d'abord que les particules lyophilisées gardent leur forme sphérique. Elles collent entre elles l'état sec mais en présence d'eau, elle gonfle de manière remarquable et se détachent totalement. Nous obtenons des microsphères identiques à celles avant le processus de lyophilisation.

Le travail a été réalisé sur plusieurs types de microsphères synthétisées (dégradables et non dégradables) par polymérisation en suspension directe ou en suspension inverse selon les méthodes décrites précédemment et sur deux fractions de tailles isolées par tamisage : 100-315 μm et 315-500 μm . Le tableau II donne les conditions de chargement des différentes microsphères identifiées au cours de ces travaux. Les différentes synthèses d'un même type de microsphères (HEMA4L4G-3%) ont fourni exactement le même taux de gonflement (donc la même quantité de produit absorbant 1 mL de solution saline). Ces résultats ont démontré

une bonne répétabilité de la synthèse. L'ajout de l'acide méthacrylique dans la formulation de microsphères en suspension directe les a permis de gonfler d'avantage. Cela explique une diminution de la quantité de microsphères nécessaires pour absorber 1 mL de solution saline. Dans les synthèses par polymérisation en suspension inverse, une augmentation en quantité d'acide acrylique neutralisé à 75% a fourni des microsphères avec une plus grande capacité de gonflement. En outre, comme il pouvait être attendu, plus le taux de réticulation est important (MBA 10%, MAB 20%), moins les microsphères gonflent.

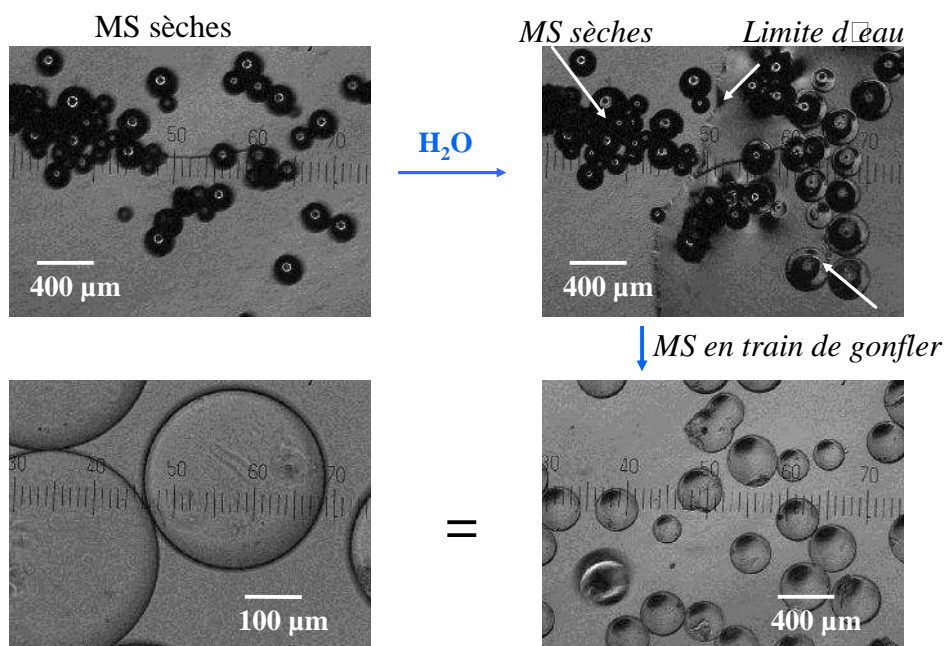

Figure 9. Observation du gonflement des microsphères HEMA4L4G-3% lyophilisées par microscopie optique.

Tableau II - Conditions de chargement des microsphères d'hydrogel par la méthode du gonflement. Détermination de la quantité de microsphères lyophilisées nécessaires pour absorber un volume total de 1 mL de solution saline à 0,9%.

Type de microsphères		Méthode de synthèse	Masse de microsphères absorbantes 1 mL de solution saline à 0,9 %	
Réticulant	Co-monomère(s)		Fraction 100-315 µm	Fraction 315-500 µm
HEMA4L4G 3%	PEGMMA Mw. 300 97% (1 ^{ère} lot)	Polymérisation en suspension directe		0,190 g
HEMA4L4G 3%	PEGMMA Mw. 300 97% (2 ^{ème} lot)			0,190 g
HEMA4L4G 3%	PEGMMA Mw. 300 49% + acide méthacrylique 48%			0,059 g
HEMA4L4G 3%	PEGMMA Mw. 300 49% + acide méthacrylique neutralisé 48%			0,037 g
HEMA4L4G 2%	PEGMMA Mw. 300 48% + PEGMA Mw. 360 50%			0,155 g
MBA 2%	AAn 44,3% + DMA 53,6%	Polymérisation en suspension inverse		0,039 g
MBA 3,5%	AAn 54,5% + PEGMMA Mw.1100 42%			0,056 g
MBA 4%	AAn 29% + DMA 18% + Tris 49%		0,070 g	
MBA 4%	DMA 47% + Tris 49%		0,078 g	
MBA 10%	AAn 27% + DMA 16% + Tris 47%		0,120 g	
MBA 10%	AAn 41% + DMA 49%		0,078 g	
MBA 20%	AAn 24% + DMA 14% + Tris 42%		0,200 g	

4.2. Chargement des microsphères par copolymérisation d'une prodrogue d'un agent anti-inflammatoire

Par ailleurs, le traitement d'embolisation entraîne en général une douleur liée à la nécrose tissulaire. Particulièrement pour le traitement des fibromes utérins, les patients peuvent subir des douleurs pelviennes sévères [Pron et al. 2003]. Ces douleurs apparaissent en deux temps : la première phase dans les heures qui suivent l'opération (liée à l'ischémie des tissus sains et aussi du fibrome) et la seconde au bout de 7 à 10 jours (principalement due à la nécrose du fibrome). Pour soulager les patients, une dose importante d'antalgique est souvent prescrite. Par exemple, pour l'ibuprofène, la dose est généralement de 600-800 mg par prise, 5 à 6 fois par jour pendant environ 1 semaine [Pron et al. 2003]. Dans la littérature, il existe déjà une méthode qui consiste à administrer localement de l'ibuprofène directement dans le cathéter avant l'embolisation mais elle ne peut soulager la douleur seulement jusqu'à quelques heures après l'opération [Pisco et al. 2008]. Le relargage ciblé et plus prolongé (jusqu'à plusieurs jours) de l'ibuprofène grâce à son association aux microsphères pour embolisation pourrait constituer un large bénéfice pour le confort du patient. Cela permettrait de cibler le principe actif au site de la douleur et par conséquent d'augmenter l'efficacité du traitement antalgique tout en réduisant de manière remarquable la dose nécessaire. Un autre avantage qui peut être relevé est d'ordre économique puisqu'il permettrait également de réduire le temps d'hospitalisation des patients.

Un chargement en ibuprofène de manière passive (simple absorption de l'ibuprofène aux microsphères déjà synthétisé) permet de diminuer la douleur dans les heures qui suivent. Pour traiter la deuxième phase de douleur, il a été proposé de réaliser une association covalente de l'ibuprofène : une prodrogue polymérisable de l'ibuprofène a été introduite directement dans le milieu de synthèse des microsphères pour être incorporée dans les chaînes de polymère formant le réseau tridimensionnel de l'hydrogel.

En préliminaire à la synthèse des microsphères chargées en ibuprofène, deux prodrogues d'ibuprofène (Figure 10) ont été synthétisées au laboratoire en adaptant deux protocoles décrits dans la littérature [McCoy et al. 2007, Babazadeh 2006, Babazadeh 2008]. Les schémas réactionnels sont présentés sur les Figures 10 et 11. Ces prodrogues ont été retenues car elles permettent une libération de la molécule de principe actif originale sous la simple action d'une hydrolyse aqueuse de la liaison ester incluse dans la structure de la molécule.

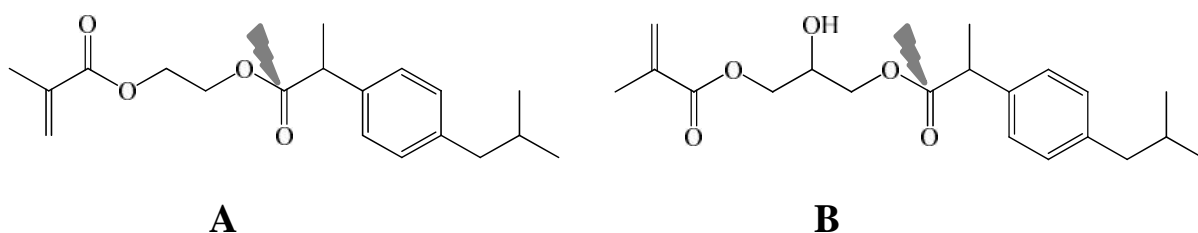

Figure 10. Structure chimique des 2 prodrogues HEMA-ibu (A) et GMA-ibu (B) d'ibuprofène polymérisables synthétisées au laboratoire. La flèche indique la liaison ester permettant de libérer l'ibuprofène par hydrolyse.

◆ Matériels

Méthacrylate de 2-hydroxyéthyle (HEMA) de pureté > 99 %, méthacrylate de glycidyle (GMA), N,N'-dicyclohexylcarbodiimide (DCC), 4-diméthyle aminopyridine (DMAP) et hydroquinone de pureté au moins 99% sont fournis par Sigma Aldrich (France). Ibuprofène est fourni par BASF Pharma (Allemagne). Les sels minéraux NaCl, NaHCO₃ et MgSO₄ sont fournis par Fluka (France). Les solvants (> 99 % de pureté) ont été utilisés sans aucune purification supplémentaire. L'eau pure est distribuée par le système de purification miliQ 185.

Les produits obtenus ont été caractérisés par spectrométrie RMN du proton (Bruker 300 MHz).

♦ Méthode de synthèse des prodrogues ibuprofènes

○ HEMA-ibu [McCoy et al. 2007]

Dans un ballon muni d'un agitateur magnétique, ibuprofène (1,65 mmol, 0,34 g) et DMAP (0,09 mmol, 0,01 g) sont solubilisés dans du CH₂Cl₂ (4 mL) sous atmosphère inerte (Argon). Le mélange d'HEMA (1,65 mmol, 0,21 g) et de DCC (1,65 mmol, 0,34 g) solubilisés dans du CH₂Cl₂ (2 mL) est ensuite ajouté dans le ballon réactionnel à 0°C. Après 24 h de réaction à 0°C, le mélange obtenu est filtré. Le produit brut est purifié par colonne chromatographique sur gel de silice avec un éluant cyclohexane/ acétate d'éthyle: 2/1 v/v. Rendement 86%.

¹H NMR (acétone-d₆) (ppm): 7,16 (dd, C₆H₄, ibuprofène), 5,59-5,98 (m, CH₂=C), 4,31 (m, CH₂-CH₂, HEMA), 3,75 (q, phenyl-CH-COO-, ibuprofène), 2,44 (d, CH₂-phenyl, ibuprofène), 1,85 (m, CH₃, methacrylate + CH, isopropyl, ibuprofène), 1,43 (d, CH₃-CH, ibuprofène), 0,88 (d, CH₃, isopropyl, ibuprofène).

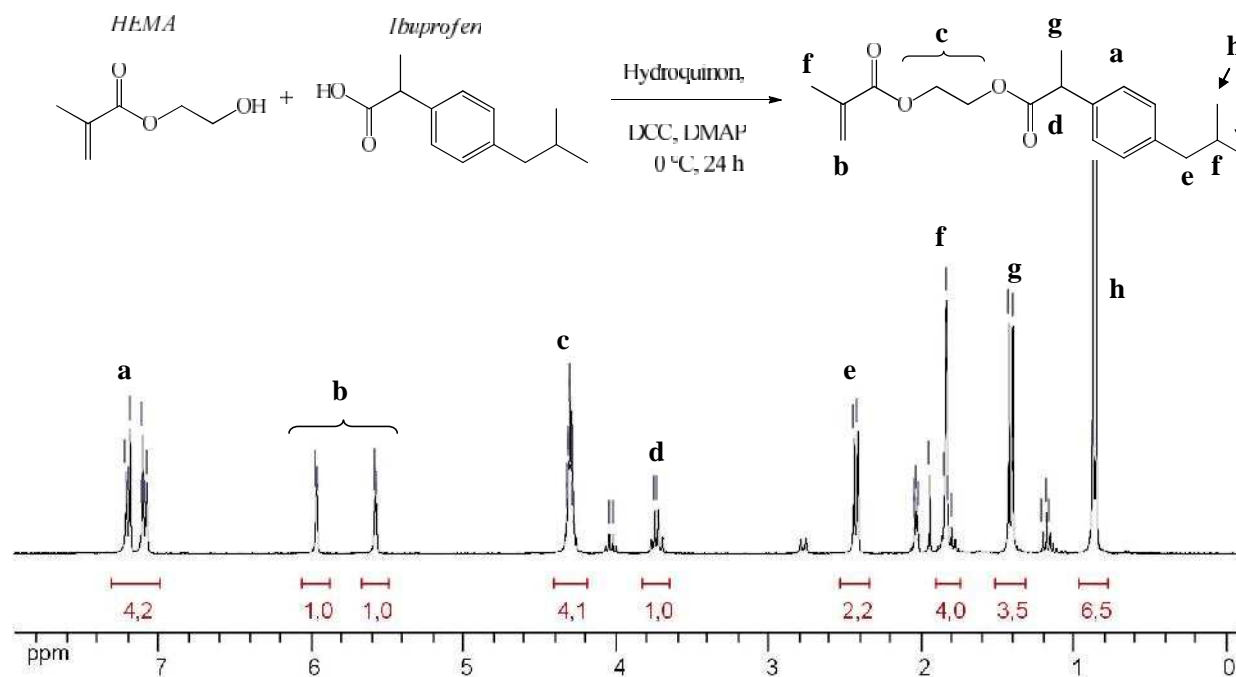

Figure 11. Schéma réactionnel de la synthèse et analyse RMN de la prodrogue HEMA-ibu.

- GMA-ibu [Babazadeh 2006, Babazadeh 2008]

Dans un ballon muni d'un agitateur magnétique, GMA (9,5 mmol, 1,348 g), ibuprofène (9,5 mmol, 1,955 g), hydroquinone (0,2 g) et pyridine (2 mL) sont solubilisés dans du DMF (5 mL), Après 6 h de réaction sous vide à 40°C, le mélange obtenu est neutralisé avec une solution saturée en NaHCO₃ (20 mL), La phase organique est extraite trois fois avec de l'acétate d'éthyle, puis lavée avec une solution saturée en NaCl et finalement séchée sur du MgSO₄, Le produit brut est en suite purifié par colonne chromatographie sur gel de silice avec un éluent cyclohexane/acétate d'éthyle: 5/1 v/v. Rendement 46%.

¹H NMR (CDCl₃) (ppm): 7,16 (dd, C₆H₄, ibuprofène), 5,60-6,12 (m, CH₂=C), 4,08-4,19 (m, CH₂-CH(OH)-CH₂, GMA), 3,75 (q, phenyl-CH-COO-, ibuprofène), 2,45 (d, CH₂-phenyl, ibuprofène), 1,94 (s, CH₃ méthacrylate, GMA), 1,85 (m, CH-iPr, ibuprofène), 1,51 (d, CH isopropyl, ibuprofène), 0,89 (d, CH₃, isopropyl, ibuprofène).

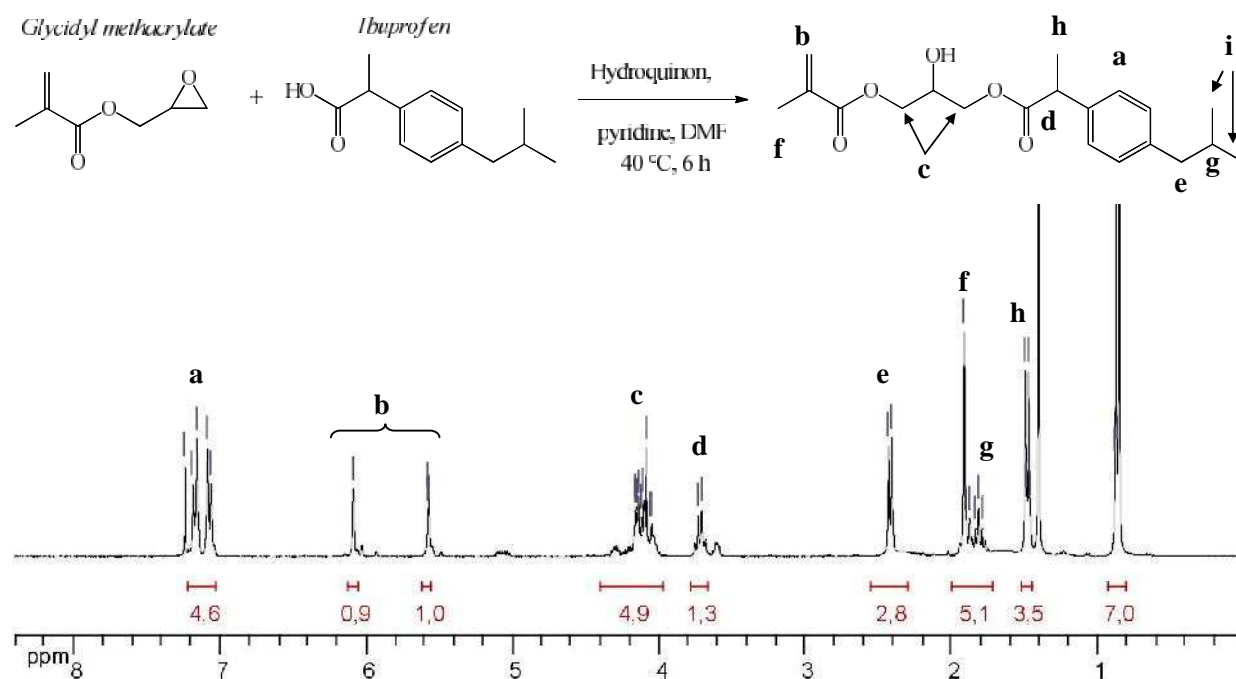

Figure 12. Schéma réactionnel de la synthèse et analyse RMN de la prodroge GMA-ibu.

Ensuite, les prodrogues ont été utilisées dans la réaction de polymérisation en suspension directe en tant qu'un co-monomère avec comme réticulant le PEGDMA (non dégradable), TEG4L4G ou le TEG8L8G (Tableau III) par la méthode précédemment décrite (cf. page 97). Différentes quantités de chargement en ibuprofène ont été effectuées (théoriquement entre 12 et 26 % massique en dose d'ibuprofène par rapport à la masse totale des microsphères sèches).

◆ Résultats

Les figures 11 & 12 montre les spectres RMN des deux prodrogues synthétisées. Les deux molécules ont été synthétisées avec de bon rendement après purification par chromatographie sur silice (86% pour le HEMA-ibu et 46% pour GMA-ibu).

Les microsphères contenant une des prodrogues synthétisées se révèlent plus hydrophobes que celles sans incorporation de l'ibuprofène. En effet, une partie de co-monomère PEG permettant le gonflement des microsphères a été remplacé par du monomère prodrogue. Par conséquent, elles gonflent moins dans l'eau et nous obtenons peu de microsphères de taille supérieure à 315 μm (Figure 13).

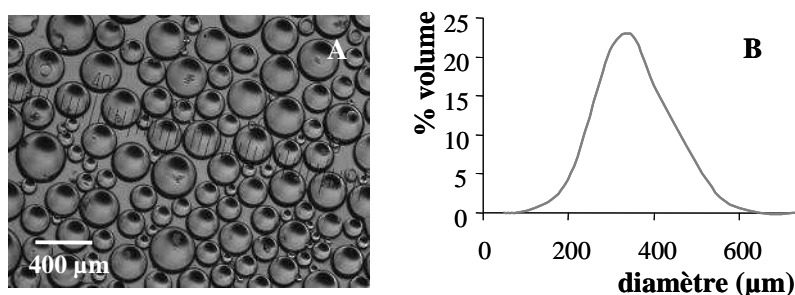

Figure 13. Microsphères HEMA4L4G-3% chargées en ibuprofène (théoriquement 6 mg d'ibuprofène dans 100 mg de microsphères) de manière covalente observées par microscopie optique en suspension dans de l'eau (A) et allure de la courbe donnant leur distribution en taille (B) avant tamisage. L'échelle = 400 μm .

Dans une deuxième étude, nous avons synthétisé des petites microsphères biodégradables (taille 40-100 μm) chargées en ibuprofène de manière covalente pour le traitement de l'arthrose. Notre contribution à ce travail a été d'étudier les conditions de synthèse de microsphères d'hydrogel hydrolysable incorporant de l'ibuprofène par une méthode de copolymérisation d'une prodrogue polymérisable de l'ibuprofène. Destinées à être implantées dans des articulations, les microsphères devant servir de forme à libération prolongée d'ibuprofène devaient être de très petite taille comparées à celles préparées pour les applications en embolisation. Les méthodes de synthèse des microsphères développées précédemment pour la synthèse de microsphères d'hydrogel hydrolysables pour embolisation ont été adaptées pour obtenir des microsphères de plus petit diamètre (compris entre 40 et 100 μm). Plus précisément, une augmentation de la vitesse d'agitation (de 250 rpm à 500 rpm) nous a permis de former des microsphères de la taille souhaitée (Figure 14).

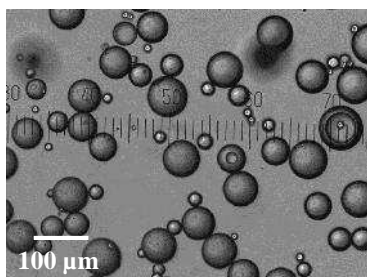

Figure 14. Microsphères TEG4L4G-3% chargées en ibuprofène (théoriquement 12 mg d'ibuprofène dans 100 mg de microsphères) de manière covalente, tamisées entre 40 et 100 μm , observées par microscopie optique en suspension dans de l'eau. L'échelle = 400 μm .

Le tableau III donne un résumé des conditions de synthèse des microsphères chargées en ibuprofène synthétisées par cette méthode.

Tableau III □ Synthèses des microsphères chargées en ibuprofène de manière covalente

Microsphères	Réticulant	Comonomère	Prodrogue	Chargement théorique
Référence 1 (dégradables non chargées)	TEG4L4G 3%	PEGMMA Mw.300	0	0
Référence 2 (non dégradables chargées)	PEGDMA 4%		HEMA-ibu	12 mg ibuprofène /100 mg MS
MS-ibu1	TEG4L4G 5,4%		HEMA-ibu	12 mg ibuprofène /100 mg MS
MS-ibu2	TEG8L8G 2,6%		HEMA-ibu	26 mg ibuprofène /100 mg MS
MS-ibu3	HEMA4L4G 3%		HEMA-ibu	6 mg ibuprofène /100 mg MS

Les microsphères chargées en ibuprofène et les microsphères de références (correspondantes non chargées en ibuprofène) ont été transmises pour analyse afin de mener des études de libération du principe actif *in vitro* et des études *in vivo* chez la brebis.

Bibliographie

Babazadeh M. (2006). □ Synthesis and study of controlled release of ibuprofen from the new acrylic type polymers. □ *International Journal of Pharmaceutics* **316**: 68-73.

Babazadeh M. (2006). □ Design, synthesis and *in vitro* evaluation of vinyl ether type polymeric prodrugs of ibuprofen, ketoprofen and naproxen. □ *International Journal of Pharmaceutics* **356**: 167-173.

Bencherif S.A., Sheehan J.A., Hollinger J.O., Walker L.M., Matyjaszewski K., Washburn N. R. (2009A). □ Influence of cross-linker chemistry on release kinetics of PEG-co-PGA hydrogels. □ *J Biomed Mater Res* **90A**: 142-153.

Bencherif S.A., Srinivasan A., Sheehan J.A., Walker L.M., Gayathri C., Gil R., Hollinger J.O., Matyjaszewski K., Washburn N. R. (2009B). □ End-group effects on the properties of PEG-co-PGA hydrogels. □ *Acta Biomaterialia* **5**: 1872-1883.

Burdick, J. A., L. M. Philpott, et al. (2001). "Synthesis and characterization of tetrafunctional lactic acid oligomers: A potential *in situ* forming degradable orthopaedic biomaterial." *Journal of Polymer Science Part A: Polymer Chemistry* **39**(5): 683-692.

- Burdick, J. A., M. Ward, et al. (2006). "Stimulation of neurite outgrowth by neurotrophins delivered from degradable hydrogels." *Biomaterials* **27**(3): 452-459.
- Chan-Park, M. B., Zhu A. P. and , Gao J.X. (2004). "Novel Photopolymerizable Biodegradable Triblock Polymers for Tissue Engineering Scaffolds: Synthesis and Characterization." *Macromolecular Bioscience* **4**(7): 665-673.
- Clapper, J. D., J. M. Skeie, et al. (2007). "Development and characterization of photopolymerizable biodegradable materials from PEG-PLA-PEG block macromonomers." *Polymer* **48**(22): 6554-6564.
- Clapper J.D., Pearce M.E., Guymon C.A. and Salem A.K. (2008). □Biotinylated Biodegradable Nanotemplated Hydrogel Networks for Cell Interactive Applications.□ *Biomacromolecules* **9**(4): 1188□1194.
- Davis K.A., Burdick J.A., Anseth K.S. (2003). □Photoinitiated crosslinked degradable copolymer networks for tissue engineering applications.□*Biomaterials* **24**: 2485□95.
- Geschwind, J.-F.H., Ramsey, D.E., Choti, M. A., Thuluvath, P.J. and Huncharek, M. S. (2003). □Chemoembolization of Hepatocellular Carcinoma: Results of a Metaanalysis.□ *American Journal of Clinical Oncology* **26**(4): 344-349.
- Grijpma, D. W., Q. Hou, et al. (2005). "Preparation of biodegradable networks by photocrosslinking lactide, [epsilon]-caprolactone and trimethylene carbonate-based oligomers functionalized with fumaric acid monoethyl ester." *Biomaterials* **26**(16): 2795-2802.
- Hao J.Q., Li H. and Wo H.-G. (2009). □Synthesis and Characterization of Cholic Acid-Containing Biodegradable Hydrogels by Photoinduced Copolymerization.□*J Appl Polym Sci* **112**: 2976□2980.
- Jiao, Y., Z. Liu, et al. (2006). "Preparation of biodegradable crosslinking agents and application in PVP hydrogel." *Journal of Applied Polymer Science* **101**(3): 1515-1521.
- Mahoney M.J. and Anseth K.S. (2007). □Contrasting effects of collagen and bFGF-2 on neural cell function in degradable synthetic PEG hydrogels.□*J Biomed Mater Res* **81A**(2): 269□278.
- McCoy C. P., Rooney C., Edwards C. R., Jones D. S., and Gorman S. P. (2007) □Light-Triggered Molecule-Scale Drug Dosing Devices.□*J. Am. Chem. Soc.* **129** (31), 9572-9573
- Moine L., Bedouet L., Laurent A., Labarre D., Wassef M., Nguyen V.N. « Implantable bioresorbable polymer□WO/2011/029867 published 16 March 2011.
- Pisco J.M., Bilhim T., Duarte M., Ferreira A., Santos D., Pires F.M. and Oliveira A.G. (2008) □Pelvic pain after uterine artery embolization: a prospective randomized study of polyvinyl alcohol particles mixed with ketoprofen versus bland polyvinyl alcohol particles.□*J Vasc Interv Radiol* **19**(11): 1537-42.
- Pron G., Mocarski E., Bennett J., Vilos G., Common A., Zaidi M., Sniderman K., Asch M., Kozak R., Simons M., Tran C. and Kachura J. (2003). □Tolerance, hospital stay, and recovery

after uterine artery embolization for fibroids: the Ontario Uterine Fibroid Embolization Trial. □ *J Vasc Interv Radiol.* **14**(10):1243-50.

Ryder S.D., Rizzi P.M., Metivier E., Karani J., Williams R. (1996). □ Chemoembolisation with lipiodol and doxorubicin: applicability in British patients with hepatocellular carcinoma. □ *Gut* **38**: 125-128.

Sawhney A.S., Pathak C.P. and Hubbell J.A. (1993). □ Bioerodible hydrogels based on photo-polymerized poly(ethylene glycol)-co-poly(.alpha.-hydroxy acid) diacrylate macromers. □ *Macromolecules* **26**(4): 581-587.

Shah N.M., Pool M.D. and Metters A.T. (2006). □ Influence of Network Structure on the Degradation of Photo-Cross-Linked PLA-b-PEG-b-PLA Hydrogels. □ *Biomacromolecules* **7**(11): 3171-3177.

Wang K., Xu X., Liu T.T., Fu S.Z., Guo G., Gu Y.C., Luo F., Zhao X., Wei Y.Q., Qian Z.Y. (2010). □ Synthesis and characterization of biodegradable pH-sensitive hydrogel based on poly(ϵ -caprolactone), methacrylic acid, and Pluronic (L35). □ *Carbohydrate Polymers* **79**(3): 755-761.

Zhu W., Wang B., Zhang Y. and Ding J. (2005). "Preparation of a thermosensitive and biodegradable microgel via polymerization of macromonomers based on diacrylated Pluronic/oligoester copolymers." *European Polymer Journal* **41**(9): 2161-2170.

Zhu W. and Ding J. (2006). □ Synthesis and Characterization of a Redox-Initiated, Injectable, Biodegradable Hydrogel. □ *J Appl Polym Sci* **99**(5): 2375-2383.

Zhu A.P., Chan-Park M.B., Gao J.X. (2006). □ Foldable micropatterned hydrogel film made from biocompatible PCL-b-PEG-b-PCL diacrylate by UV embossing. □ *Journal of Biomedical Materials Research Part B: Applied Biomaterials*, **6B**(1): 76-84

Chapitre 2

Développement de méthodes de caractérisation de la dégradation des microsphères hydrolysables

Introduction

Au cours de la première partie des travaux, une méthode originale de préparation d'hydrogels hydrolysables a été proposée. Elle a permis d'obtenir la synthèse de ces hydrogels sous la forme de microsphères en une seule étape. La structure du réseau de polymère constituant ces microsphères inclut un agent réticulant comportant des segments hydrolysables en milieu aqueux. Ces segments ont été incorporés pour permettre une résorption définie dans le temps après l'implantation des microsphères *in vivo* dans la lumière vasculaire par embolisation.

La deuxième partie du travail a été consacrée au développement de méthodes de caractérisation des microsphères et plus particulièrement de leur dégradation. Selon l'hypothèse qui a guidé le choix des composants utilisés pour synthétiser les microsphères, la dégradation de ces dernières devrait se faire par hydrolyse des ponts contenant l'agent de réticulation dans la structure du réseau de polymère. Cette dégradation s'accompagnerait d'une diminution du taux de réticulation de l'hydrogel ce qui se traduirait par une modification mesurable des propriétés de résistances mécaniques et des propriétés visco-élastiques des microsphères [Clapper et al. 2007, Bencherif et al. 2009, Payet 2010].

Dans la littérature, peu de méthodes sont décrites pour mesurer ces propriétés sur des microsphères et donc permettre d'évaluer les modifications découlant de la dégradation du réseau de polymère les constituant. Les seuls procédés connus consistent à mesurer le module de Young d'une seule microsphère par une méthode de compression [Hidaka et al. 2010]. Cette méthode présente plusieurs limites. Elle ne peut être appliquée que sur de grandes microsphères dont la taille est de l'ordre de plusieurs centaines de micromètres (en générale au dessus de 300 μm pour faciliter les manipulations). Par ailleurs, elle impose de réaliser un

grand nombre de mesures pour avoir un résultat statistique satisfaisant et exige de matériels sophistiqués. Confrontés à ces limites, notre démarche a été d'explorer le potentiel de méthodes rhéologiques couramment utilisées pour caractériser les propriétés visco-élastiques des hydrogels en les adaptant aux spécificités de notre population de microsphères hydrolysables.

Des conditions de mesure par une méthode de rhéologie ont été recherchées et la sensibilité de la méthode à des modifications du taux de réticulation a été explorée sur une série de microsphères non dégradables synthétisées avec des proportions molaire de réticulation variables compris entre 1 et 11% (par rapport à la totalité des monomères introduits dans le milieu de polymérisation). La méthode a été, dans une deuxième étape, testée sur des microsphères dégradables dans des conditions favorables à l'hydrolyse.

Les résultats de ce travail ont permis d'adapter les conditions de mesures pour caractériser les propriétés visco-élastiques d'un hydrogel sous la forme de microsphères. Les mesures peuvent ainsi être réalisées à l'aide d'une cellule de géométrie plateau-plateau entre lesquels une monocouche de microsphères homogène et continue est introduite. Les caractéristiques rhéologiques des microsphères ont été évaluées en balayage de fréquences sous une contrainte constante de 0,04%. Les microsphères étudiées ont démontré des propriétés quasi-élastiques (très faible valeur de δ). Nous avons également observé une relation intrinsèque entre leur module élastique G' et leur degré de réticulation. L'application de la méthode à un type de microsphères dégradables placées dans un milieu favorisant l'hydrolyse des segments hydrolysables incorporés dans la structure du polymère de hydrogel a permis de mettre en évidence une modification mesurable du module élastique au cours du temps. Cette modification mise en évidence est en accord avec une diminution du taux de réticulation de l'hydrogel constituant les microsphères et peut être attribuée à un phénomène

résultant de leur dégradation. Cette conclusion est renforcée par des mesures de pH visant à suivre la libération des produits de dégradation des microsphères. En effet, une bonne corrélation a été mise en évidence entre l'acidification du milieu d'incubation des microsphères et la diminution du module élastique de ces dernières, confirmant que les modifications des propriétés rhéologiques peuvent être directement liées à la dégradation des microsphères. Ces travaux ont permis de développer un outil pertinent de caractérisation des microsphères, qui est suffisamment sensible pour permettre en outre de suivre leur dégradation.

Bibliographie

Bencherif S.A., Sheehan J.A., Hollinger J.O., Walker L.M., Matyjaszewski K., Washburn N. R. (2009). □Influence of cross-linker chemistry on release kinetics of PEG-co-PGA hydrogels.□J Biomed Mater Res **90A**: 142□153.

Clapper, J. D., J. M. Skeie, et al. (2007). "Development and characterization of photopolymerizable biodegradable materials from PEG-PLA-PEG block macromonomers." Polymer **48**(22): 6554-6564.

Hidaka K., Nakamura M., Osuga K., Miyazaki H. and Wada S. (2010). □Elastic characteristics of microspherical embolic agents used for vascular interventional radiology .□Journal of the Mechanical behavior of Biomedical Materials **3**: 497-503.

Payet L, Ponton A, Grossiord JL, Agnely F. (2010). □Structural and rheological properties of chitosan semi-interpenetrated networks□The European Physical Journal E - Soft Matter and Biological Physics **32**: 109-118.

Rheology as a tool for characterisation of mechanical properties of chemically crosslinked microspheres and for monitoring their degradation

Journal of Applied Polymer Science (Wiley)

V.N. Nguyen^{1,2}, N. Huang^{1,3}, J.-L. Grossiord^{1,3}, L. Moine^{1,3}, F. Agnely^{1,3}, C. Vauthier^{1,3*}.

1. Univ Paris Sud, Physico-chimie, Pharmacotechnie and Biopharmacie, UMR 8612, Chatenay-Malabry, F 92296
2. Occlugel SARL, Paris BioTech, 24 Rue du Faubourg Saint-Jacques, Paris, F-75014
3. CNRS, Chatenay-Malabry, F-92296

Corresponding author:
Christine Vauthier
Physico-chimie, Pharmacotechnie and Biopharmacie
UMR CNRS 8612
University Paris Sud, Faculté de Pharmacie
92296 CHATENAY-MALABRY Cedex France
Fax : 33 1 46 83 53 12
E-mail: christine.vauthier@u-psud.fr

Abstract

This work aimed to develop a rheological method to characterize degradation of microspheres made of chemically crosslinked hydrogels. Conditions to measure rheological properties of microspheres remaining as individual microspheres during measurement were established. Relevant and reproducible measurements could be obtained with a rheometer equipped with a plate-plate measurement cell in which a homogenous and continuous monolayer of microspheres was inserted in the gap between the plates. Storage modulus of microspheres was determined under an imposed strain of 0.04% with an oscillatory measurement mode working at various frequencies. The microspheres showed almost pure elastic properties while their storage modulus was affected by the degree of crosslinking. In the second part of the work, the method was applied to investigate the degradation of microspheres made of a hydrolysable crosslinked hydrogel. The method was found suitable to monitor the degradation of the microspheres by measuring the storage modulus over time. A good correlation was highlighted between acidification of the incubation medium due to the release of degradation products and the decrease of the storage modulus of the microspheres indicating a reduction of the crosslinking of the hydrogel resulting from the degradation process.

Keywords: rheology, crosslink, hydrogels, microsphere, degradation

1. Introduction

Hydrogels are the synthetic biomaterial class the most similar to natural living material (Ratner and Hoffman 1976, Peppas et al. 2000). They consist of three-dimensional crosslinked macromolecular networks with a capacity of water absorbing up to thousand times their dry weight without dissolving (Kopecek 2002, Hoffman 2002). This unique property contributes to their soft consistency and biocompatibility. Therefore, they are receiving many attentions in developing biomaterials for medical applications including tissue engineering, cell encapsulation, drug delivery (Caldorera-Moore and Peppas 2009, Kopecek 2009). For many of the applications in biomedical field, properties of hydrogels need to fulfill appropriate mechanical properties. Rheology remains one of the most employed methods used to characterise gels from their formation to their intimate properties. Indeed, rheological properties are sensitive to the degree of crosslinking of the material and were widely used to follow the kinetic of crosslinking reaction used during formation of chemically crosslinked hydrogels (Vermonden et al. 2006, Moura et al. 2007, Neamtu et al. 2009, Payet et al. 2010). Various experimental conditions are suitable to study rheological properties of hydrogel. The most commonly used include time sweep at constant frequency and strain (Vermonden et al. 2006, Moura et al. 2007, Neamtu et al. 2009) or frequency sweep at constant shear stress amplitude (Payet et al. 2010). Forming hydrogels can be also characterized by different rheological methods i.e. frequency sweep, strain sweep or stress sweep mode (Khalid et al. 1999, Gevers et al. 2011). It is noteworthy that these methods were mainly applied to characterize bulk gels while their application to monitor degradation of hydrogels including chemical crosslinks remains marginal. This is contradictory to the fact that rheological properties of hydrogels are sensitive to the degree of crosslinking and are suitable to follow gel formation during crosslinking reaction. Thus, it can be assumed that it could also be used more systematically to monitor a decrease of the crosslinking ratio occurring during degradation of a

hydrolysable crosslinked hydrogel. Only a few studies have actually applied rheological methods to follow degradation of hydrogels made either from a biodegradable polymer network (Zustiak and Leach 2010, Potta et al. 2009) or by the association of opposite charged microspheres (Van Tomme et al. 2006). In all cases, it was demonstrated that the rheological properties of the gels were modified during degradation and that the methods were suitable to monitor the degradation of such materials. This is an advantage over all the other methods of characterisation of polymers such as GPC, DSC, ^1H NMR which can not be applied to characterize materials made of three dimensional polymer networks since they are not soluble in any solvent.

Although well applied for the characterization of bulk hydrogels, it is noteworthy that their application to the characterization of hydrogels under the form of nano- and microparticles has raised a very limited number of works so far (Raquois et al. 1995). The aim of our work was to develop a method based on rheological measurements that would be suitable to characterize hydrogels occurring as individual microspheres and to follow their degradation by hydrolysis of their crosslinking bonds. The first part of the work aimed to set up experimental conditions providing with reproducible measurement of the rheological characteristics of hydrogel microspheres with different degrees of reticulation. In the second part of the work, the rheological method was applied to monitor the degradation of hydrogel microspheres containing hydrolysable crosslinking bonds.

2. Materials and methods

2.1. Materials

Poly(ethylene glycol methyl ether methacrylate) (PEGMMA) of number-average molecular weight 300 g/mol, poly(ethylene glycol dimethacrylate) (PEGDMA) of number-average molecular weight 575 g/mol, poly(vinyl alcohol) (PVA) (MW_n 89,000-98,000 g/mol 99+% hydrolysed) were purchased from Sigma-Aldrich (St. Louis, USA). Molar mass values were given by supplier. Azobisisobutyronitrile (AIBN) used as polymerization initiator was obtained from Acros Organic (Geel, Belgium). Analytical grade solvents were supplied by Carlo Erba (Val de Rueil, France). All chemicals were used as purchased without further purification.

Phosphate buffer saline (PBS) (58 mM, 150 mM NaCl) at pH 7.4 was used as incubation medium for the microsphere degradation study.

Ethylene glycol-co-tetralactic-co-tetraglycolic dimethacrylate (HEMA4L4G) (Fig. 1) was synthesized according to the method previously described by Moine et al. 2011 (Moine et al. 2011).

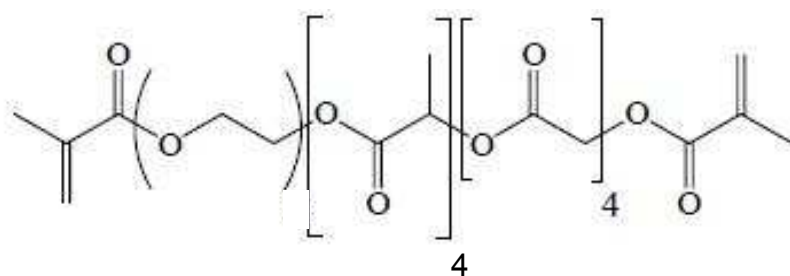

Figure 1 Chemical structure of the hydrolysable crosslinker Ethylene glycol-co-tetralactic-co-tetraglycolic dimethacrylate (HEMA4L4G) used in the synthesis of degradable microspheres.

2.2. Methods

2.2.1. Synthesis of crosslinked hydrogel microspheres

Microspheres were prepared by direct suspension polymerisation by the method described in Moine et al. 2011. A 0.75% solution of PVA (300 mL) was introduced into a 500 mL reactor and allowed to stand under a nitrogen atmosphere for 15 min. The dispersed phase containing the crosslinking agent and a co-monomer, PEGMMA, at various molar ratios were solubilized in 12 mL of toluene and degassed by bubbling nitrogen through the solution for 15 min. Non degradable microspheres were synthesised with PEGDMA as crosslinking agent at different molar ratios (expressed as percentage of the total monomers) ranging from 1 to 11 % (Table I). Degradable microspheres were synthesized using 3 % (in molar ratio regarding total amount of monomers) of HEMA4L4G as the crosslinking agent. Preparation of the microspheres was continued as followed in all cases. The dispersed phase containing the co-monomers dissolved in toluene was introduced into the aqueous phase at 30°C and agitated at 250 rpm. AIBN (0.3 g) was solubilized in 2 mL of toluene and was then added into the reactor. The temperature was increased to 70°C and the reaction was allowed to proceed under stirring for 15 h at 70°C. The microspheres were washed with acetone and water before they were sieved over the following series of sieves (Inox sieve with mesh size 630, 500, 315, 100, 40 µm) (Fisher scientific, Illkirch, France). Particles retained by the sieve with a mesh size of 315 µm corresponding to microspheres with diameter ranging from 315 to 500 µm were kept for the present study. They were immediately freeze dried after preparation and purification and stored at -20°C until use.

2.2.2. Degradation studies

Samples of dried microspheres (0.100 ± 0.002 g) were suspended in 15 mL of PBS pH 7.4 and incubated at 37°C under lateral stirring at 100 rpm (Incubator shaker KS4000i □ IKA).

Three essays were performed for each time point (0, 1, 3, 5, 10, 14 and 21 days). At the different incubation times, the supernatant and the microspheres were separated for pH and rheological measurements respectively.

2.2.3. Characterizations of microspheres

Morphology and size analysis

Microspheres obtained after synthesis or during the degradation process were observed by optical microscopy. The optical microscope (OLYMPUS BH2 Microscope) was equipped with leitz PL2.5/0.08 and Olympus Dplan 10 objectives and a Mightex camera. At less 25 micrographs were taken for each sample.

Particle size distribution was determined by laser diffraction on Mastersizer S apparatus (Malvern Instrument Ltd.) at 25°C. Dry beads were dispersed in water and were allowed to swell for 15 mins before measurement. They were then introduced in the QSpec small volume sample dispersion unit. Homogenous circulation between the latter and the measurement cell was performed by means of 1000 rpm magnetically stirring. The quantity of microspheres was added in order to obtain an obscuration between 5 and 10 %. Each injection was analyzed 3 times. Granulometry was analyzed using the Fraunhofer optical model. Results were presented in % volume distribution using the volume/mass moment mean diameter $D[4,3]$ (equation 1) and the span of their size distribution (equation 2)

$$D[4,3] = \frac{\sum n_i d_i^4}{\sum n_i d_i^3} \quad (1) \qquad \text{Span} = \frac{D[v, 90] - D[v, 10]}{D[v, 50]} \quad (2)$$

With « n_i » et « d_i » represented the number of particles with a define diameter

$D[v, 90]$ is the volume diameter above which it includes 90% of the distribution.

$D[v, 50]$ is the volume diameter above which it includes 50% of the distribution.

$D[v, 10]$ is the volume diameter above which it includes 10% of the distribution.

Mass fraction measurements of microspheres

The mass fraction of the microspheres in concentrated suspensions obtained after sedimentation was determined as followed. A weighting boat was prepared with a preweighted piece of filter paper above which was placed a preweighted piece of organza. A sample of the concentrated suspension of microspheres obtained by sedimentation was played over the organza. The mass measured, W_{sed} , corresponded to the weight of the wet microspheres (W_{WM}) and the weight of the surrounded liquid. As organza showed a mesh size much below the size of the smaller microspheres and it did not absorb water, it retained the microspheres while the surrounded liquid was absorbed by the filter paper placed below. By weighting separately the pre-weighted piece of organza with the microspheres and the pre-weighted piece of filter paper having absorbed the liquid surrounding the microspheres, it was possible to determine the weight of wet microspheres (W_{WM}) and that of the surrounding liquid. The mass fraction of the microspheres (f_{wm}) expressed as a percentage can then be calculated from equation 3.

$$f_{WM} = \frac{W_{WM} \times 100}{W_{Sed}} \quad (\% \text{ wt.}) \quad (3)$$

Determination of the Swelling ratio of the microspheres

The same procedure as described above was used to evaluate the weight of the wet microspheres (W_{WM}). Then the isolated wet microspheres were freeze dried and weighted again after drying to measure their dried weight (W_{DM}). The mass swelling ratio was then calculated from equation 4:

$$Q_w = \frac{W_{WM} - W_{DM}}{W_{DM}} \quad (4)$$

pH measurements

The pH of each supernatant obtained during degradation process was measured with a SevenMulti pH meter (Mettler Toledo) at 25°C.

Rheological measurements

The rheological properties of microspheres were evaluated by a Haake RheoStress 600 rheometer (Thermo Electron) equipped with a 35 mm plate-plate geometry. Measurements were performed at 25°C (± 0.02) and regulated with a Peltier plate. A solvent trap placed on the geometry was used to prevent water evaporation during measurements. Microspheres were allowed to sediment by gravity for 30 min prior sampling. The sediment with a mass fraction in microspheres of $65 \pm 3\%$ was deposited on the inferior plate of the measurement cell.

Rheological experiments were performed using the oscillatory modes with an imposed strain. The characterization of the microspheres included two steps that were carried out successively including a shear sweep and a frequency sweep. Three rheological parameters were monitored during each measurements which included the storage (or elastic) modulus G' , the loss (or viscous) modulus G'' and the phase angle δ (defined as $\tan \delta = G''/G'$).

At first, a shear sweep was performed to define the stable zone (plateau) of G' and G'' moduli as a function of the applied strain (from 0.0001 to 0.1) at a constant frequency of the oscillation (1 Hz). This experiment was performed on non degradable microspheres with a crosslinking ratio ranging between 1 and 11 %. It allowed choosing a strain value in the linear viscoelastic regime which was common for all systems.

Then G' , G'' moduli and phase angle δ were determined at different frequencies of the oscillation (0.01 - 100 Hz) for the different types of non degradable microspheres. In the case of the degradable microspheres, the three rheological parameters were recorded on different aliquots of the same batch of microspheres at various hydrolysis times.

All measurements were performed in triplicate for each sample. Results were given as the mean value and standard deviation of G' , G'' and η which were calculated from the three determinations.

3. Results and discussion

3.1. Microsphere syntheses

Degradable and non degradable microspheres were obtained with good production yield (>80%). Particles were spherical (Fig. 2) and their diameter and size distribution were comprised within the range of the size of particles (315-500 μm) expected from the sieve used to isolate the microspheres after synthesis (Table I).

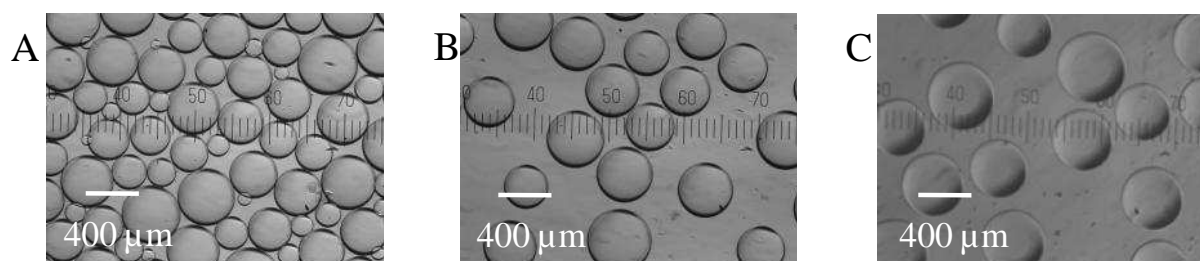

Figure 2 Morphological observations by optical microscopy of microspheres PEGDMA-1% in different stages of the study. A - Before sieving. B - After sieving 315-500 μm , before rheological study. C - After sieving 315-500 μm , after rheological study. Scale bar: 400 μm

Table I Characteristics of microspheres obtained after sieving between 315 and 500 μm .

Sample name	crosslink ratio %	nature of crosslink	D[4,3] (μm)	Span 10^{-1}	G'_{\square} at 10 Hz 10^3 (Pa)	\square at 10 Hz ($^{\circ}$)
PEGDMA-1%	1	PEGDMA (non degradable)	462 ± 2	3.5 ± 0.1	1.1 ± 0.1	7.9 ± 1.8
PEGDMA-2%	2		439 ± 2	4.0 ± 0.1	2.8 ± 0.1	5.6 ± 0.4
PEGDMA-2.5%	2.5		418 ± 3	5.0 ± 0.1	3.8 ± 0.2	4.2 ± 0.2
PEGDMA-3%	3		419 ± 1	4.6 ± 0.1	5.1 ± 0.7	4.3 ± 0.2
PEGDMA-4%	4		391 ± 2	2.1 ± 0.1	8.0 ± 0.4	3.6 ± 0.6
PEGDMA-5%	5		389 ± 4	2.3 ± 0.3	8.7 ± 0.1	4.4 ± 0.4
PEGDMA-6%	6		412 ± 2	4.8 ± 0.1	12 ± 1	4.1 ± 0.3
PEGDMA-7%	7		423 ± 1	5.0 ± 0.1	15 ± 1	3.0 ± 0.3
PEGDMA-9%	9		406 ± 2	5.8 ± 0.1	16 ± 1	3.8 ± 0.2
PEGDMA-11%	11		376 ± 1	2.7 ± 0.2	17 ± 1	4.7 ± 0.6
HEMA4L4G-3%	3	HEMA4L4G (hydrolysable)	379 ± 2	7.3 ± 0.1	4.8 ± 0.2	7.7 ± 0.7

Swelling measurements were carried out for non degradable microspheres with different crosslinking ratios. The swelling of the microspheres greatly depended on the crosslinking agent concentration used during the synthesis (Fig. 3). Highly crosslinked microspheres contained less amount of absorbed water while the lower the crosslinking the larger was the swelling. This result agreed with what is generally observed considering bulk hydrogels (Ibrahim et al. 2010, Wang et al. 2010).

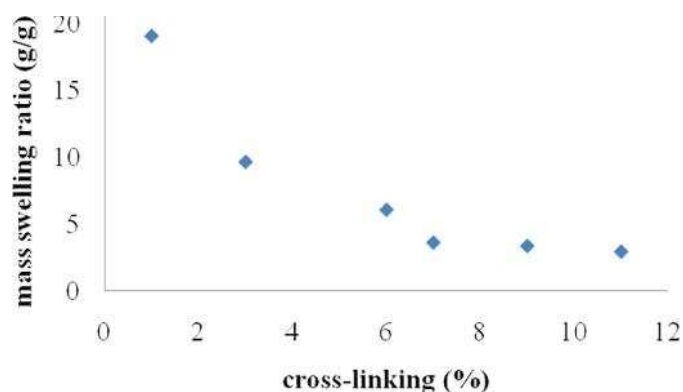

Figure 3 Swelling ratio of microspheres as the function of their crosslinking ratio.

3.2. Preliminary considerations to the development of the rheological method for the characterisation of the microspheres

The purpose of the work was to develop a rheological method to characterize mechanical properties of hydrogel microspheres while they remained under individual microspheres during the entire process of the measurement. This was in contrast with many works in which the properties of the hydrogel forming microspheres or nanospheres were approached by measuring the rheological properties of a bulk hydrogel of the same composition (Hu et al. 2008, Kumachev et al. 2011). Preliminary experiments included the determination of the concentration in microspheres of the suspensions used for rheological measurement and determination of the gap between the plates of the measurement cell that needed to be used to provide with relevant and reproducible experimental measurements.

3.2.1. Concentration in microspheres in the suspension:

The key parameter for rheological measurements of a suspension is that it must form a homogeneous medium. In physical studies in general and particularly in rheology, the volume fraction is frequently used to characterise the concentration of the dispersed phase in a suspension. It is an important factor which greatly influences the obtained moduli in rheological measurements (Taylor & Bagley 1975). This dependence is not only an issue for suspensions but also for bulk hydrogels (Raquois et al 1995, Baker et al. 2007). As a consequence, it was important to verify that all measurements were performed at the same concentration in microspheres in the suspension throughout the study to be able to obtain relevant comparable results. The volume fraction can be calculated by the ratio of the volumes of all the particles (particles without the liquid entrapped in the void spaces subsisting between microspheres) to the total volume of the suspension (particles plus dispersing liquid). However, volume fraction is sometimes difficult to determine as it requires to know the

density of the dispersed particles. This was the case with the hydrogel microspheres investigated in the present study. A related factor can be used in the case which corresponds to the mass fraction. This parameter can be measured from the determination of the weight of the wet microspheres contained in a define weight of sample. The mass fractions measured for all the suspensions used in this study at their maximal concentration obtained after sedimentation for 30 min were $65 \pm 3\%$. As the standard deviation was low between the different samples of microspheres, it was considered that rheological measurements were performed on suspensions at a constant mass fraction of the microspheres providing with results that could be compared in relevant conditions.

3.2.2. Choice of the gap between plates of the measurement cell.

Sedimentation occurring during measurement is another parameter influencing results from rheological evaluations performed on microsphere suspensions. To avoid sedimentation phenomenon with the large size hydrogel microspheres dispersed in PBS, we choose a gap between plates of the measurement cell in which only one layer of microspheres can fit in (i.e. 300 μm). The gap was then smaller than the mean size of the microspheres (microspheres sieved between 315 and 500 μm) assuming that the microspheres formed a reproducible homogenous monolayer of material between the plates of the cell measurement.

3.3. Rheological characterization of microspheres

3.3.1. Shear sweep studies:

First, experimental conditions needed to be identified to perform rheological measurements on microspheres in relevant conditions. It was then verified that the material deposited in the measurement cell underwent reversible deformation during shear solicitations. In general, this

condition is fulfilled in the linear regime which corresponds to plateau values of G' and G'' shear moduli as a function of the strain.

In a first set of experiments, rheological behaviours of non degradable microspheres were monitored under shear sweep to identify the range corresponding to the linear regime. Fig. 4 presents the results of the variation of G' and G'' shear moduli for two of the non degradable microspheres used in this study while the experiment was performed for all non degradable microspheres synthesized for this work (Fig. 4).

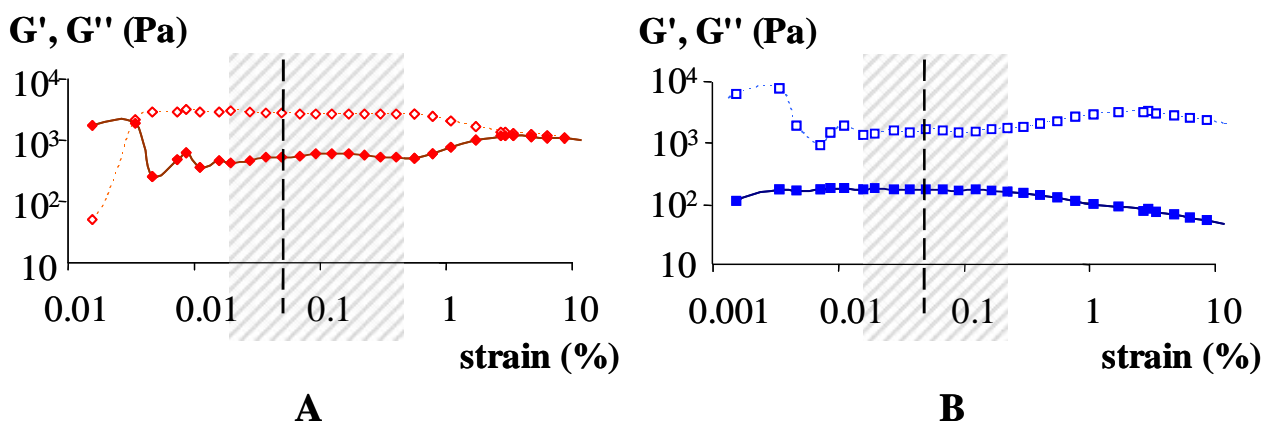

Figure 4 Determination of the range of the linear regime under controlled strain in experiment with non degradable microspheres with crosslinking ratio of 2% (A) and 6% (B). G' (open symbols) and G'' (closed symbols) moduli were monitored as a function of strain sweeping from 0.001 to 10%. The grey hashed zones correspond to the linear regime and the dotted lines indicate the positions of chosen controlled shear strain value (0.04%) for following experiments.

According to the results obtained from these experiments, G' and G'' moduli were stable between values of the strain ranging from 0.02 to 0.3% indicating the limits of the linear regime for all types of microspheres. The imposed strain, γ chosen for exploring the rheological behaviour of the microspheres in the oscillatory shear mode used in the next step of the development of the method was 0.04%. It is noteworthy that this value of controlled

strain is very low. It insured non destructive micro-shear preserving microspheres from being damaged during rheological measurements. This was confirmed by a systematic observation of the microspheres by optical microscopy after rheological measurements. This controlled observation performed on the different microspheres after rheological measurements showed that all types of microspheres remained well spherical and did not exhibited any fracture (All data not shown, See for an example Fig. 2 C).

3.3.2. Frequency sweep studies:

Controlled strain mode with a constant strain at 0.04% was applied to study the visco-elastic characteristics of the non degradable microspheres prepared with crosslinking ratios ranging between 1 and 11 %. Experiments repeated three times on the same sample of microspheres but by refilling the measurement cells with a new amount of sample always gave values in a low range interval (ranging between 5 to 8 %). An example of the curves obtained showing the mean value with standard deviation of the storage (G') and loss (G'') moduli as a function of frequency was plotted in Fig. 5A for the microspheres PEGDMA-1%. The two moduli G' and G'' were almost independent on the variation of frequency in the whole range of the frequency sweep. The rheological behaviour showed by the microspheres was typical of that of chemically crosslinked hydrogels. The ratio G''/G' was roughly in the order of 0.1 and appeared rather independent on the frequency. In agreement with this, the phase angle, δ was nearly constant over the range of frequencies comprised between 0.05 and 40 Hz (Fig. 5B). In those conditions, the value of the phase angle was around 8° indicating that the microspheres behaved like a gel material with nearly pure elastic properties.

As shown in Fig. 6, the storage modulus, G' , of the microspheres was almost independent on frequency whatever their crosslinking density was. The value of the storage modulus taken at a

frequency of 10 Hz increased with the degree of crosslinking of the microspheres (Table I, Fig. 7).

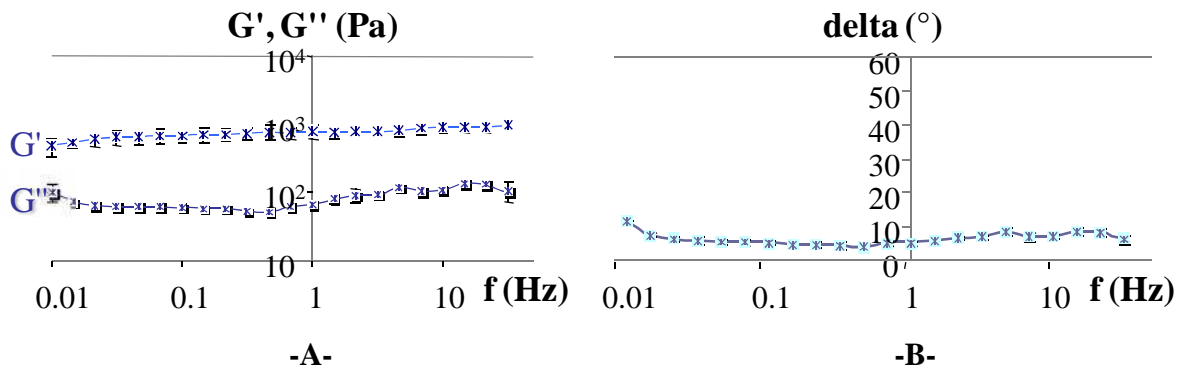

Figure 5 Influence of frequency on the rheological behaviour of the microspheres PEGDMA-1%. Measurements were performed with the imposed shear strain at 0.04%. A - The storage (G') and loss (G'') moduli ; B - Phase angle

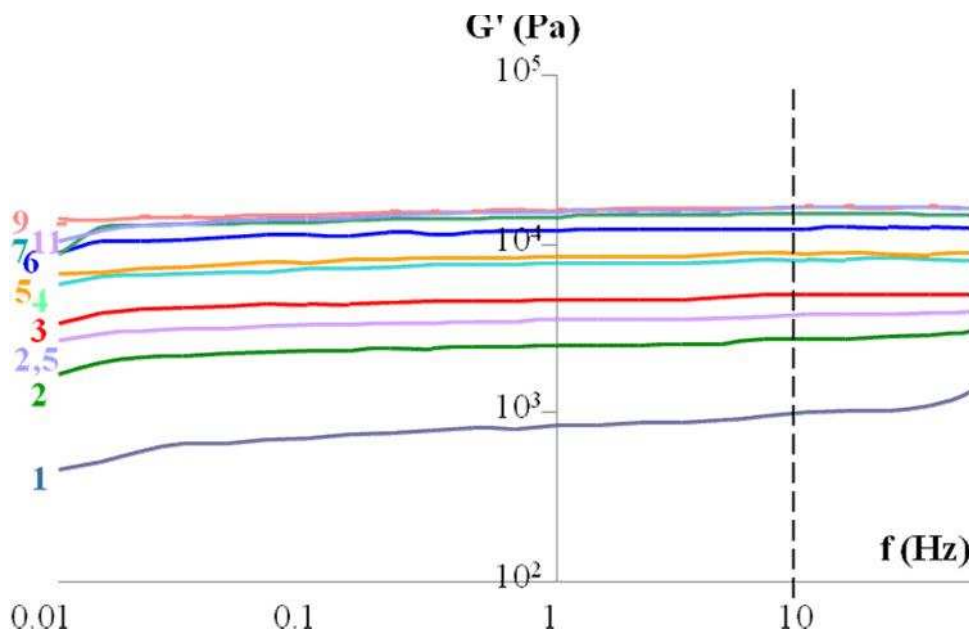

Figure 6 Determination of the storage modulus, G' , of non degradable microspheres with different crosslinking density (dark blue 1%, dark green 2%, light purple 2.5%, red 3%, cyan 4%, orange 5%, blue 6%, black 7%, pink 9%, dark purple 11%) at the oscillatory frequency of 10 Hz and under an imposed shear strain of 0.04%.

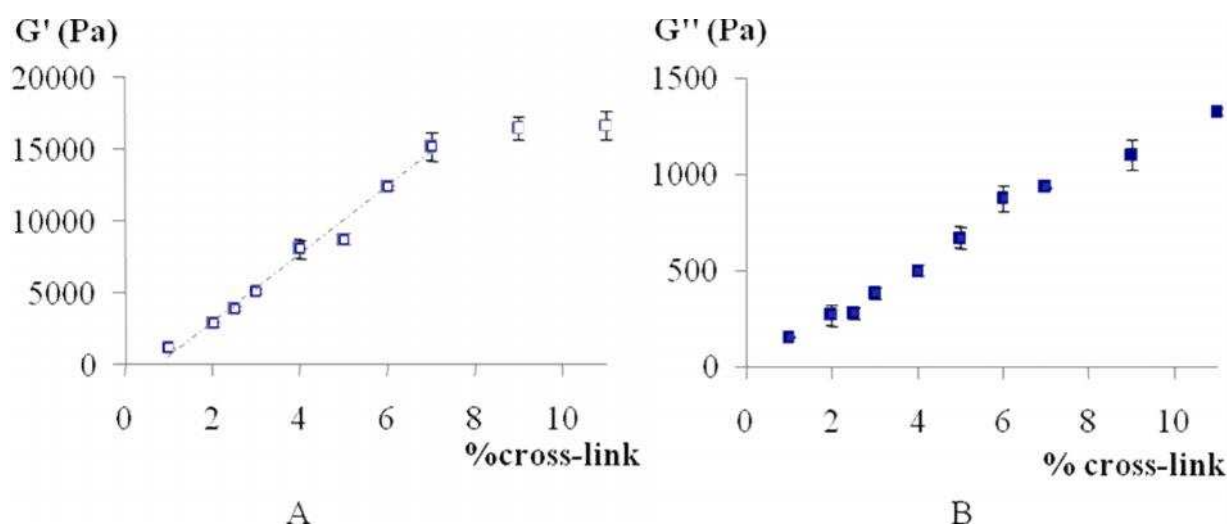

Figure 7 Storage modulus, G' (A), and loss modulus, G'' (B), of hydrogel microspheres with different crosslinking densities. Measurements were performed with an imposed shear strain at 0.04% and at an oscillation frequency of 10Hz. The line indicates is only a guide to highlight the linear domains of the curve between the storage modulus and the degree of crosslinking of the microspheres.

This was also the case considering the loss modulus, G'' (Fig. 7B). The phase angle deduced from these measurements ranged between 3 to 8° for the different microspheres (Table I). This indicated that all microspheres showed nearly pure elastic properties.

For both G' and G'' parameters, a clear dependency between the rheological properties of the microspheres and the degree of crosslinking appeared up to a crosslinking ratio of 7% while above this degree of crosslinking the values of both moduli reached a plateau value. The results obtained here can be discussed considering the theory of the rubber elasticity proposed by Flory (Flory 1953) in which the storage modulus, G' depends directly on the number of crosslink per elastically active chain, ν_e , and on a constant characterizing the polymer solvent

system, χ . The relation appearing between these parameters and the storage modulus is given in equation 5.

$$G' = \frac{\chi_e RT}{\chi} \quad (5)$$

where R is the universal gas constant and T the temperature.

The two parameters χ and χ_e are related to the characteristics of a given hydrogel. According to the Flory theory, they represent the swelling capacity of the gel. As a consequence, the above-relation demonstrates the dependence between rheological moduli and swelling ratio of hydrogels. It can be pointed out that the Flory theory applied well with the microspheres considered in the present study. Both the storage modulus, G' and the swelling ratio of microspheres with degrees of crosslinking below 7% varied a lot (Fig. 3). In contrast, with highly crosslinked microspheres (crosslinked density above 7%), very little differences in swelling capacities were observed and the storage modulus reached a plateau value. According to the above results the storage modulus of microspheres varied a lot with crosslinking degree only with microspheres crosslinked at a maximum ratio of 7%. Considering these microspheres, an almost linear relation was found between the two parameters (Fig. 7A). This suggested that degradation of microspheres through hydrolysis of the crosslink bonds can be monitored by measuring the loss modulus of the microspheres during degradation experiments performed on microspheres with an initial crosslinking degree below 7%.

3.4. Application of the rheological method to the characterization of the degradation of hydrolysable microspheres

Degradable microspheres were synthesized using a hydrolysable crosslinker. The degradation of these microspheres was believed to take place by hydrolysis of the crosslinking bonds including lactic and glycolic acid segments. Thus, it was expected that the crosslinking density

of the microspheres will be reduced during the degradation process which in turn could be monitored by measuring the storage modulus of the microspheres over time. It was also expected that the hydrolysis of the microspheres would be accompanied by the release of carboxylic acids in the incubation medium coming from the hydrolysis of the ester bonds included in the lactic and glycolic acid containing segments of the crosslinker. This effect can be monitored by measuring the pH of the incubation medium. Thus, an acidification of the incubation medium would signify that the microspheres degraded through the expected hydrolytic mechanism while a decrease of the storage modulus would indicate a loss of crosslinking bonds in the hydrogel structure of the microsphere.

Rheological measurements were performed in conditions established above on microspheres incubated in PBS. In agreement with the work presented in the first part of this paper, microspheres with a low initial crosslinking density (3%) were selected for this study.

Fig. 8 presents the results of the evolution of the pH of the incubation medium of microspheres HEMA4L4G-3% monitored during the experiment. It shows a significant decrease in pH value of the dispersing medium occurring from the start of the experiment up to the 10th day of the incubation time. The decrease of pH monitored over the first 10 days of the incubation indicated that the microspheres released acidic compounds in the incubation medium. This was in agreement with the hydrolytic mechanism expected from the chemical nature of the hydrogel composing the microspheres. After 10 days, the pH of the incubation medium remained constant indicating that the degradation of the microspheres was stopped.

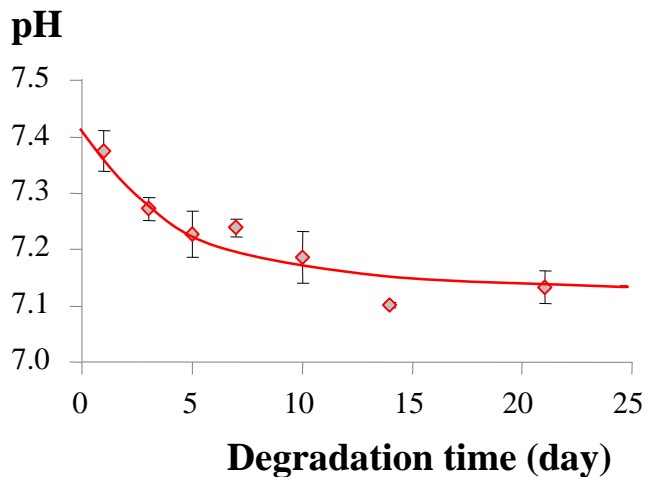

Figure 8 Variation of pH of the incubation medium during incubation of the microspheres in PBS at 37°C.

Fig. 9 presents the results obtained from the measurement of storage modulus, G' , of the degradable microspheres HEMA4L4G-3% incubated in PBS over a period of time of 21 days. A clear decrease of G' was monitored between the start of the experiment (day 0) and day 10 where G' reached a plateau value. The loss modulus, G'' , followed exactly the same tendency over the same period of time. The value of the phase angle, δ , remained constant and close to 8° during the whole period of time of the experiments indicating that the hydrogel remained as an almost purely elastic material.

The fact that the storage modulus of the microspheres was decreased with time during the incubation of the microspheres in PBS was in favour with a decrease of the crosslinking density of the hydrogel forming the microspheres. The time scale in which the modification of the rheological properties of the microspheres occurred correlated well with the time scale during which the pH of the incubation medium dropped down. This last result suggested that the modification of the rheological properties monitored during the incubation of the

microspheres in PBS resulted from the degradation of the hydrogel through the hydrolysis of the crosslinking bonds.

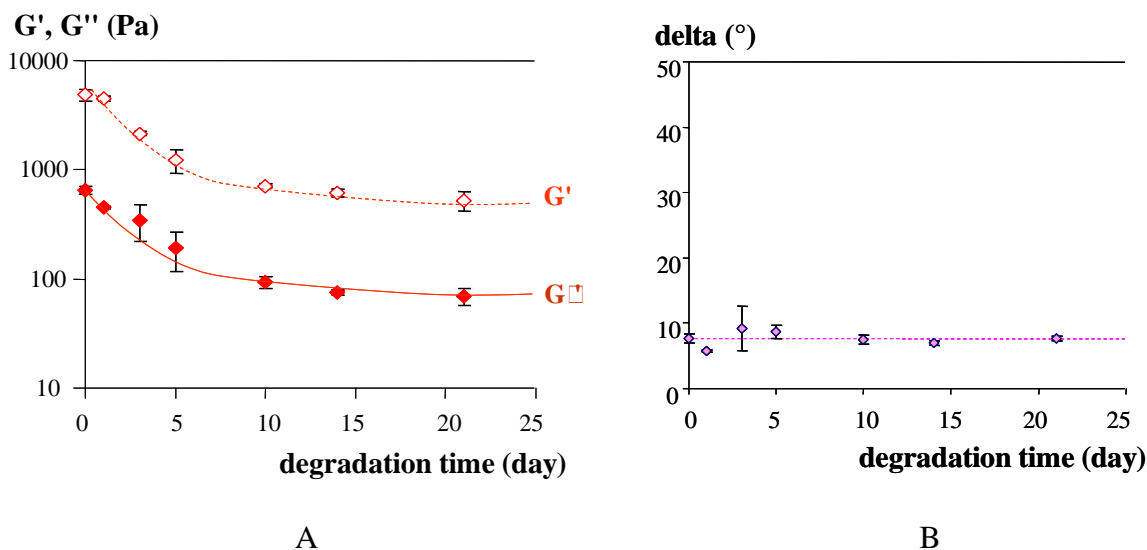

Figure 9 Evolution of rheological properties of microspheres HEMA4L4G-3% during incubation in PBS at 37°C. A - Storage (G' , open symbols) and loss (G'' , closed symbols) moduli. B - Phase angle δ . The lines were drawn to serve as guides for the eyes.

4. Conclusions

Conditions to measure rheological properties of microspheres made of a chemically crosslinked hydrogel and remaining as individual microspheres were established. It was determined that relevant and reproducible measurements could be obtained with a rheometer equipped with a plate-plate measurement cell in which a homogenous and continuous monolayer of microspheres is inserted in the gap between the plates. The storage moduli of the microspheres followed the theory of rubber elasticity suggested by Flory. It was affected by the degree of crosslinking of the hydrogel forming the microspheres in the same crosslinking density range than that affected the swelling ratio of the microspheres. Results from this work also showed that degradation of hydrolysable crosslinked microspheres can be monitored by

measuring their storage modulus over time by applying the rheological method of characterization of microspheres developed in this work.

5. Acknowledgement

The authors would like to thank CNRS and Occlugel SARL for their funding to this work. The authors would also like to thank G. MEKHLOUFI for her help in performing and analysing the size of the microspheres.

6. References

Baker, B.; Murff, R.; Milam, V. T. "Effects of volume fraction and composition on the rheological properties of polyacrylic acid/polyacrylamide hydrogels." *Mater Res Soc Symp Proc* 2007, 975, #0975-DD06-06.

Caldorera-Moore, M.; Peppas N.A. "Micro- and nanotechnologies for intelligent and responsive biomaterial-based medical systems." *Adv Drug Deliv Rev* 2009, 61, 1391-1401.

Flory; P. J. "Principle of polymer chemistry" Cornell University Press, Ithaca, New York, 1953.

Gever, L. M.; Lyons, J. G.; Higginbotham, C. L. "Photopolymerisation and characterisation of negative temperature sensitive hydrogels based on N,N-diethylacrylamide." *J Mater Sci* 2001, 46, 509-517.

Hoffman, A. S. "Hydrogels for biomedical applications." *Adv Drug Deliv Rev* 2002, 54, 3-12.

Hu, X.; Zhou, J.; Zhang, N.; Tan, H.; Gao, C. Preparation and properties of an injectable scaffold of poly(lactic-co-glycolic acid) microparticles/chitosan hydrogel. *J Mech Behav Biomed Mater.* 2008, 1, 352-359.

Ibrahim, S.; Kang, Q. K.; Ramamurthi A. □The impact of hyaluronic acid oligomer content on physical, mechanical, and biologic properties of divinyl sulfone-crosslinked hyaluronic acid hydrogels. □*Journal of Biomedical Materials Research Part A*, 2010, 94A, 355-370.

Khalid, M.N.; Ho, L.; Agnely, F.; Grossiord, J.L.; Couarraze G. □Swelling properties and mechanical characterization of a semi-interpenetrating chitosan/polyethylene oxide network. Comparison with a chitosan reference gel □*S.T.P. Pharma Sci* 1999, 9, 359-364.

Kopecek, J. "Polymer chemistry: swell gels. □*Nature* 2002, 417, 388-389, 391.

Kopecek, J. □Hydrogels: From soft contact lenses and implants to self-assembled nanomaterials. □*J. Applied Polym Sci Part A; Polym Chem* 2009, 47, 5929-5946.

Kumachev, A.; Greener, J.; Tumarkin, E.; Eiser, E.; Zandstra, P. W.; Kumacheva, E. High-throughput generation of hydrogel microbeads with varying elasticity for cell encapsulation. *Biomaterials* 2011, 32, 1477-1483.

Moura, M. J., Figueiredo, M. M.; Gil, M. H. □Rheological Study of Genipin Crosslinked Chitosan Hydrogels. □*Biomacromolecules* 2007, 8, 3823-3829.

Moine, L. ; Bedouet, L. ; Laurent, A. ; Labarre, D. ; Wassef, M. ; Nguyen, V. N. « Implantable bio-resorbable polymer □WO/2011/029867 published 16 March 2011.

Neamtu, I.; Nita, L. E.; Bercea, M.; Chiriac, A. P. □The rheological behaviour of chemically crosslinked hydrogels based on poly(acrylamide). □*Polymer* 2009, 54, 795-800.

Payet, L.; Ponton, A.; Grossiord, J.-L.; Agnely, F. □Structural and rheological properties of chitosan semi-interpenetrated networks□Eur Phys J 2010, E 32, 109-118.

Peppas, N. A.; Bures, P.; Leobandung, W.; Ichikawa, H. □Hydrogels in pharmaceutical formulations.□Eur J Pharm Biopharm 2000, 50, 27-46.

Potta, T.; Chun, C.J.; Song, S-C. □Chemically crosslinkable thermosensitive polyphosphazene gels as injectable materials for biomedical applications.□Biomaterials 2009, 30, 6178□6192

Raquois, C.; Tassin, J. F.; Rezaiguia, S.; Gindre, A. V. □Microgels in coating technology: structure and rheological properties.□Prog Organic Coating 1995, 26, 239-250.

Ratner, B. D.; Hoffman, A.S. (1976). □Synthetic Hydrogels for Biomedical Applications. Hydrogels for Medical and Related Applications. □ WASHINGTON, D. C., AMERICAN CHEMICAL SOCIETY: 1-36.

Taylor, K. W.; Bagley, E. B. □Rheology of Dispersions of Swollen Gel Particles.□J Polym. Sci. Polym. Phys. Ed. 1975, 13, 1133-1144

Vanderhooft, J. L.; Alcoutlabi, M.; Magda, J. J.; Prestwich G. D. □Rheological Properties of Crosslinked Hyaluronan-Gelatin Hydrogels for Tissue Engineering□Macromol. Biosci 2009, 9, 20-28.

Van Tomme, S. R.; van Nostrum, C. F.; de Smedt, S. C.; Hennick, W. E. □Degradation behaviour of dextran hydrogels composed of positively and negatively charged microspheres.□Biomaterials 2006, 27, 4141-4148.

Vermonden, T.; Besseling, N. A. M.; van Steenberg, M. J.; Hennick, W. E. □Rheological Studies of Thermosensitive Triblock Copolymer Hydrogels.□Langmuir 2006, 22, 10180-10184.

Wang, K.; Xu, X.; Liu, T. T.; Fu, S. Z.; Guo, G.; Gu, Y. C.; Luo, F.; Zhao, X. Wei, Y.Q.; Qian, Z. Y. □Synthesis and characterization of biodegradable pH-sensitive hydrogel based on poly(ϵ -caprolactone), methacrylic acid, and Pluronic (L35) □Carbohydrate Polymers 2010, 79, 755-761.

Zustiak, S. P.; Leach, J. B. □Hydrolytically Degradable Poly(Ethylene Glycol) Hydrogel Scaffolds with Tunable Degradation and Mechanical Properties. □Biomacromolecules 2010, 11, 1348-1357.

Chapitre 3

Caractérisation de la dégradation des microsphères constituées d'un hydrogel hydrolysable

Introduction

La dernière partie de ce travail a été consacrée à l'évaluation de la dégradation des microsphères synthétisées avec les agents de réticulation hydrolysables par la méthode de polymérisation en suspension directe. Ces travaux ont été réalisés *in vitro* par incubation des microsphères dans un milieu d'hydrolyse modeste et par l'évaluation des modifications des propriétés visco-élastique des microsphères par la méthode de rhéologie précédemment développée. Les études rhéologiques ont été complétées par le suivi de l'acidification du milieu d'incubation résultant de la libération de produits de dégradation acide du polymère constituant l'hydrogel des microsphères et du gonflement des microsphères lié à la diminution de la réticulation de l'hydrogel. Le suivi a été réalisé sur des microsphères préparées avec différents taux de réticulation et différents agents de réticulation hydrolysables sur une période de 60 jours. Les résultats de cette étude ont montré que les microsphères se dégradent seulement partiellement par hydrolyse. Le temps nécessaire pour rompre tous les ponts dégradables varie entre 7 et 49 jours en modulant la composition des microsphères notamment leur taux de réticulation ou la nature de l'agent réticulant. À l'issue de l'hydrolyse, les particules subsistent et conservent une forme bien sphérique. Leurs caractéristiques viscoélastiques ne sont plus modifiées et restent constantes jusqu'à la fin de l'expérience qui a été réalisée sur 60 jours. Les microsphères hydrolysées sont dans un état très gonflé et leur module élastique est très faible (allant de 172 à 830 Pa) comparé à celui du départ. Les résultats obtenus au cours de cette étude suggèrent que l'hydrogel formant les microsphères se hydrolyse mais que l'hydrolyse seule ne permet pas une résorption complète des microsphères. Ceci suggère que l'hydrogel constituant les microsphères est constitué de segments hydrolysables mais qu'il contient également des liaisons de réticulation non hydrolysables empêchant la dégradation totale et la dissolution des microsphères. La

formation de ces liaisons de réticulation non hydrolysables a pu être attribuée à une réaction secondaire qui a été décrite dans la littérature dans le cas de la polymérisation radicalaire du PEGMA, comonomère utilisé dans la synthèse des microsphères faisant l'objet de la présente étude. Concernant la partie hydrolysable de l'hydrogel, ce travail permet de mettre en évidence l'influence du taux de réticulation et de la nature des agents de réticulation sur la vitesse de dégradation de l'hydrogel constituant les microsphères et de dégager une échelle de temps sur lequel se produit cette dégradation.

Projet de publication à soumettre dans Acta Biomaterialia

Degradation of hydrolysable hydrogel microspheres

V.N. Nguyen^{1,2}, C. Vauthier^{1,3*}, N. Huang^{1,3}, J.-L. Grossiord^{1,3}, L. Moine^{1,3}, F. Agnely^{1,3}

1. Univ Paris Sud, Physico-chimie, Pharmacotechnie and Biopharmacie, UMR 8612, Chatenay-Malabry, F 92296
2. Occlugel SARL, Paris BioTech, 24 Rue du Faubourg Saint-Jacques, Paris, F-75014
3. CNRS, Chatenay-Malabry, F-92296

Corresponding author:
Christine Vauthier
Physico-chimie, Pharmacotechnie and Biopharmacie
UMR CNRS 8612
University Paris Sud, Faculté de Pharmacie
92296 CHATENAY-MALABRY Cedex France
Fax : 33 1 46 83 53 12
E-mail: christine.vauthier@u-psud.fr

Abstract

This work aims to monitor the hydrolysis of microspheres made of hydrogels synthesized with different biodegradable crosslinkers. Methods used to monitor the hydrolysis evaluated modifications of swelling and of rheological properties of the microspheres and variation of the pH of the degradation medium. Degradation was studied over a period of 60 days and results showed that all microspheres were only partially degraded through a hydrolytic mechanism. Time for total hydrolytic degradation varied from 7 to 49 days and could be finely tuned by modulating the composition of the microspheres in term of the degree of degradable crosslinkings introduced in the hydrogel and the nature and structure of the degradable crosslinker included in the hydrogel structure. After complete hydrolysis, microspheres were still present but their characteristics were very different from those of the starting material. They were highly swollen with a low elastic modulus (ranging from 172 to 830 Pa) and an almost ideal elasticity ($\nu = 0.5$). This suggested that the hydrogel forming the microspheres included also non hydrolysable crosslinking bonds. This hampers total degradation and dissolution of the microspheres after degradation of the hydrolysable crosslinks. Insignificant change in swelling capacity was found with crosslinking containing a longer PEG chain. However, the longer PLGA chain of the crosslinker increased the elastic modulus of microspheres.

Keywords: hydrogel, microsphere, hydrolysis, rheology, elasticity, degradable crosslink

1. Introduction

Over the last decade, biodegradable hydrogels have been widely investigated for medical applications including drug delivery, tissue engineering and cell encapsulation [Gombotz and Pettit 1995, Alsberg et al. 2003, Nicodemus and Bryant 2008]. Because of their high water content, hydrogels are considered as the synthetic biomaterials the most similar to natural living [Ratner and Hoffman 1976, Peppas et al. 2000]. They were applied as delivery systems for macromolecules such as proteins, peptides and RNA. In the field of tissue engineering, biodegradable hydrogels form suitable scaffolds for the development of tissue and cells [Ishaug-Riley et al. 1998]. When implanted *in vivo*, their *in situ* degradation is a tremendous advantage because it avoids post-surgical interventions aiming to remove the implant [Nair and Laurencin 2007]. However, the rate of degradation is a critical issue which needs to be finely tuned according to the final application. This can be achieved by choosing appropriate monomers and crosslinkers while designing the implantable device.

Recently, Moine et al. [Moine et al. 2011] have designed hydrogel microspheres including hydrolysable crosslinks to be used as biomaterial for temporary embolisation. This technique consists in the selective transcatheter occlusion of blood vessels and is interesting to apply to stop hemorrhage or to treat arteriovenous malformation and tumors requiring a temporary occlusion of the feed blood vessels. In these specific applications, re-canalisation is of primary importance to help the organ recovery of its normal physiological functioning. It can be made possible by using biomaterials with resorption time tuned according to the exact time required for the duration of the occlusion.

The microspheres developed by Moine et al. were composed of a hydrogel obtained from the polymerization of a poly(ethylene glycol) macromer of methylmethacrylate (PEGMMA) including hydrolysable crosslinkers. The general structure of the crosslinkers was based on

the model initially proposed by Shawhney et al. [Shawhney et al. 1993]. Such crosslinkers are known to be cleaved by a simple hydrolysis occurring in aqueous media [Metters et al. 2000, Metters et al. 2001]. Thus it is expected that degradation rate of such microspheres would be only defined by the chemical composition of the biomaterial while it will remain insensitive to the site of implantation in the patient and to the physiopathology of the patient. By varying the chemical composition and the molar ratio of the crosslinking agent added to the principal monomer PEGMMA different types of microspheres were synthesized. The present study aimed to evaluate the degradation of these microspheres and to identify parameters that can be adjusted to tune their degradation time in order to make them a suitable biomaterial device to be used for temporary embolisation in the corresponding clinical indications.

2. Materials and methods

2.1. Materials

Poly(ethylene glycol) methyl ether methacrylate (PEGMMA) (number-average molecular weight (Mn) 300 g/mol), poly(ethylene glycol) dimethacrylate (PEGDMA) (Mn 575 g/mol), poly(vinyl alcohol) (PVA) (Mn 89,000-98,000 g/mol 99% pure) were purchased from Sigma-Aldrich (St. Louis, USA). Mn of the different compounds were given by the supplier. 2,2'-azobisisobutyronitrile (AIBN) was obtained from Acros Organic (Belgium). Analytical grade solvents were supplied by Carlo Erba (France). All chemical products were used as received. Phosphate buffer saline (PBS) (58 mM, 150 mM NaCl) at pH 7.4 was used as the incubation medium for the microsphere degradation study. The PBS solutions were prepared following the protocol previously described [Höglund et al. 2007].

2.2. *Synthesis of degradable microspheres*

Four degradable crosslinking agents were synthesized as described elsewhere [Moine et al. 2011]. They were: Ethylene glycol-*co*-tetralactic-*co*-tetraglycolic dimethacrylate (HEMA4L4G), ethylene glycol-*co*-dodecalactic-*co*-dodecaglycolic dimethacrylate (HEMA12L12G), tetra(ethylene glycol)-*co*-tetralactic-*co*-tetraglycolic dimethacrylate (TEG4L4G) and poly(ethylene glycol)-*co*-tetralactic-*co*-tetraglycolic dimethacrylate (PEGMA4L4G) (see chemical formulas in Table I).

Degradable microspheres were obtained by direct suspension polymerisation. A PVA solution (300 mL at 0.75% wt./v. PVA, NaCl 0.1M) was introduced in a 500 mL reactor and was purged with nitrogen for 15 min. The dispersed phase was prepared by dissolving the two comonomers (13g) including the degradable crosslinking agent and PEGMMA in various molar ratios (1/99, 3/97, 6/94%) in 12 mL of toluene. The solution was also purged with nitrogen for 15 min. Then, the dispersed phase was introduced into the aqueous phase at 30°C under agitation at 250 rpm. The initiator, 0.3 g AIBN solubilized in 2 mL of toluene, was then introduced into the reactor. The temperature was raised to 70°C and the reaction was allowed to continue for 15 h under continuous stirring. Microspheres were washed with acetone and water. The obtained microspheres were then sieved to collect fractions with a homogenous size distribution ranging from 100 to 315 µm and from 315 to 500 µm. After sieving, microspheres were immediately freeze-dried and kept at -20°C until used to preserve them from hydrolysis.

TABLE I □ Crosslinking agents used for preparing different types of degradable microspheres

Crosslinker	Chemical formula
HEMA4L4G	
HEMA12L12G	
PEG4L4G	
TEG4L4G	

2.3. *Degradation study*

Dried microspheres (0.100 ± 0.002 g) were suspended in 15 mL of PBS pH 7.4 and incubated at 37°C under lateral stirring at 100 rpm (Incubator shaker KS4000i □ IKA). At different time points (0, 1, 3, 7, 14, 21, 28, 42 and 60 days) and for each type of microspheres, the supernatant and microspheres were separated and characterized by various methods to evaluate changes in microsphere morphology (observation by microscopes), physical properties (rheology studies) and release of degradation products (pH measurements of the supernatants). Each time point was performed in triplicate.

2.4. *Methods of Characterisations*

2.4.1. *Observation of the microsphere morphology*

Microspheres obtained after synthesis or during the degradation process were observed by optical microscopy. The optical microscope (OLYMPUS BH2 Microscope) was equipped with leitz PL2.5/0.08, Olympus Dplan 10 objectives and a Mightex camera. At least 25 micrographs were taken for each sample.

Morphology of microspheres was also observed by scanning electron microscopy using a LEO 9530, Gemini (France) at an accelerating voltage of 3kV (ICMPE, Thiais, France). Prior to observations, samples were mounted on metal stubs, using carbon-conductive double-sided adhesive tape, and coated with a 4 nm platinum/palladium layer under vacuum (Cressington 208 HR, Eloise, France).

2.4.2. *Size measurements of microspheres*

Particle size distribution was determined by laser diffraction on a Mastersizer S apparatus (Malvern Instrument Ltd.) at 25°C. Dry beads were dispersed in water and were allowed to swell for 15 min before measurement. They were then introduced in the QSpec small volume

sample dispersion unit. Homogenous circulation between the latter and the measurement cell was performed by means of 1000 rpm magnetically stirring. The quantity of microspheres was added in order to obtain an obscuration between 5 and 10%. Each injection was analyzed 3 times. Granulometry was analyzed using the Fraunhofer optical model. Results were presented in % volume distribution using the volume/mass moment mean diameter $D[4,3]$ (equation 1) and the span of their size distribution (equation 2)

$$D[4,3] = \frac{\sum n_i d_i^4}{\sum n_i d_i^3} \quad (1)$$

$$\text{Span} = \frac{D[v, 90] - D[v, 10]}{D[v, 50]} \quad (2)$$

where n_i represents the number of particles with a define diameter d_i .

$D[v, 90]$ is the volume diameter below which is included 90% of the distribution.

$D[v, 50]$ is the volume diameter below which is included 50% of the distribution.

$D[v, 10]$ is the volume diameter below which is included 10% of the distribution.

2.4.3. Determination of the swelling ratio of microspheres before degradation

A well defined weight of dried microspheres (0.0100 ± 0.0002 g) was introduced in a 1 mL graduated test tube containing 1 mL of PBS, pH 7.4. The test tube was sealed to avoid evaporation of water and placed in an incubator at 37°C under orbital agitation (100 rpm). All experiments were performed in triplicate.

The initial swelling ratio of the microspheres, Q_{v0} , was taken as the volume of the wet microspheres at t_0 (V_{WM0}), evaluated 15 min after dispersion in PBS at 37°C over the weight of dried microspheres (W_{DM}), introduced in the test tube:

$$Q_{v0} = V_{WM0} / W_{DM} \quad (3).$$

In our experiments, $W_{DM} = 0.01$ g.

V_{WM} was determined from the sediment volume (V_{Sed}), measured in the graduated test tube after sedimentation of the microspheres. This corresponded to the sum of the volume of the wet microspheres and of the volume of PBS entrapped in the void spaces subsisting between microspheres, V_{void} . Thus V_{WM} can be deduced from equation 4 as followed:

$$V_{WM} = V_{Sed} - V_{void} \quad (4)$$

In turn, V_{void} can be estimated from the mass fraction of the free liquid surrounding the microspheres assuming that its density was equal to 1. It was previously demonstrated that

$$V_{void} = 0.35 \times V_{Sed} \quad (5)$$

[Nguyen et al. Submitted for validation to Occlugel 14 April 2011] by weighing the free liquid part of a known amount of sediment after separation of the microspheres. Thus, V_{WM} can be deduced from equation 5:

$$V_{WM} = V_{Sed} (1 - 0.35) = 0.65 \times V_{Sed} \quad (6)$$

Thus, from equations (3), (4) and (6), the volume swelling ratio of microspheres

$$Q_v = 65 \times V_{sed} \text{ (mL/g)} \quad (7).$$

2.4.4. Swelling kinetic of microspheres during degradation experiment (volume swelling measurements)

In a 1 mL graduated test tube, 0.010 g (± 0.0002 g) of dried microspheres was dispersed in 1 mL of PBS pH 7.4. The test tube was then sealed to avoid evaporation of water. Modification of the swelling of the microspheres during degradation was followed by measuring V_{sed} at different time intervals over a period of 60 days. Although the microspheres were maintained at 37°C under orbital agitation for the whole duration of the study, the agitation was stopped 30 min prior to the measurement to allow sedimentation of the microspheres before direct

reading of the volume of the sediment, V_{sed} , on the graduations of the graduated tube. All readings were done in triplicate on each graduated tube and pictures of the tubes were also taken for records. The volume swelling ratio Q_v of the microspheres was calculated from the value of V_{sed} read on the test tube using equation 7.

2.4.5. Measurement of the pH of the degradation medium

At defined incubation times, samples were let to sediment and their supernatants were collected for pH measurements. The pH of each supernatant was measured with a SevenMulti pH meter (Mettler Toledo) at 25°C.

2.4.6. Rheological characterisation of microsphere dispersion

Rheological properties of the microspheres were evaluated at different incubation time according to a method recently developed in our group [Nguyen et al. Submitted for validation to Occlugel 14 April 2011]. Measurements were performed using a Haake controlled stress RS600 rheometer (Thermo Electron) equipped with a 35 mm plate-plate geometry maintained at constant temperature, $25 \pm 0.02^\circ\text{C}$, with a Peltier plate. A solvent trap placed on the geometry was used in order to prevent water evaporation during measurements. Microspheres were deposited on the plateau at a mass fraction which corresponds to the random close packing obtained after letting the suspension to settle in the incubation medium for 30 minutes. Rheological properties of the microspheres were characterized by oscillatory measurements in the linear regime. Frequency sweeps from 0.01 to 40 Hz were performed under a constant strain of 0.04%. The gap between plates was chosen as 200 μm for beads having diameters ranging between 100 and 315 μm and as 300 μm for microspheres with diameter ranging from 315 to 500 μm beads. Rheological parameters monitored on each microsphere samples and at each time point were: the storage (or elastic) modulus G' the loss

(or viscous) modulus G'' and the phase angle δ (defined by $\tan \delta = G''/G'$). Rheological measurements were performed in triplicate at each time point. Means and standard deviations of G' , G'' and δ were calculated.

3. Results

3.1. Characterisation of the microspheres:

Degradable microspheres were obtained with a good production yield (>80%). Particles appeared spherical with a homogenous size distribution shown by a single peak with a Gaussian shape (Fig.1). The mean diameter and size distribution of the different microspheres are listed in table II. Results agreed with size distribution expected from the size fraction selected during the sieving which was applied during the preparation of the microspheres (i.e. either 315-500 μm or 315-500 μm). The initial swelling ratio of the microspheres crosslinked at 3% were roughly the same indicating that it was not influenced by the nature of the crosslinking agent. However, the initial swelling ratio varied a lot with the degree of crosslinking, in agreement with general observations made on hydrogels [Ibrahim et al. 2010, Wang et al. 2010].

Rheological measurements performed on the microspheres showed that G' varied with the degree of crosslinking for a given crosslinker, the size of the microspheres and the chemical nature of the crosslinker. The evaluation of the elastic properties revealed that all microspheres behaved like nearly pure elastic material under the measurement conditions as indicated by the very low value of δ (< 10°).

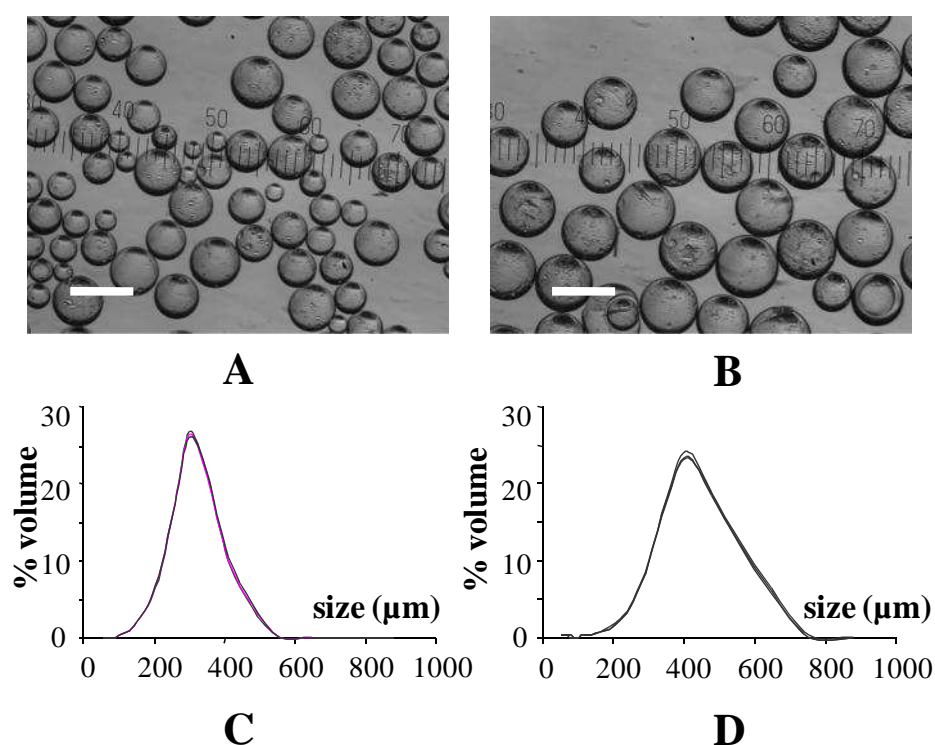

Figure 1 Optical micrographs of microspheres HEMA4L4G-3% obtained after sieving on 100-315 μm (A) and 315-500 μm (B) and their respective size distributions as evaluated by laser light diffraction with a Mastersizer S (C) and (D). Bar Scale = 400 μm .

TABLE II Initial characteristics of the microspheres prepared for the degradation studies.

Microspheres	Sieving (μm)	D[4,3] (μm)	Span $\times 10^{-1}$	Q_{v0} (mL/g)	G' at 10 Hz (10^3 Pa)	δ at 10 Hz ($^\circ$)
HEMA2L2G-1%		417	4.5	8.6	2.5 ± 0.4	7.0 ± 0.5
HEMA2L2G-3%		379	7.3	3.6	4.8 ± 0.2	7.7 ± 0.7
HEMA2L2G-6%	315-500	414	5.7	2.0	11 ± 0.7	8.0 ± 0.7
HEMA6L6G-3%		342	5.4	3.6	8.4 ± 0.6	8.0 ± 0.2
TFG2L2G-3%		368	6.0	3.0	6.5 ± 0.7	7.7 ± 1.4
PEGMA2L2G-3%		390	6.1	3.0	8.1 ± 0.4	4.8 ± 0.8
HEMA2L2G-3%	100-315	277	6.6	3.0	11 ± 1	4.2 ± 0.2

3.2. *Monitoring of the microsphere degradation*

Degradation of the microspheres was expected to take place through the hydrolysis of the PLGA segment introduced in the structure of the crosslinking agent used to synthesize the hydrogel microspheres. Such hydrolysis would transform ester groups in the PLGA chain into acid functions, which in turn would decrease the pH of the incubation medium [Grizzi et al. 1995]. Thus, a first method of monitoring the microsphere degradation was based on the measurement of the pH of the incubation medium over a period of 60 days. In parallel, the degree of crosslinking of the hydrogel microspheres was assumed to decrease as a consequence of the hydrolysis of the PLGA segments of the crosslinking bonds. This was expected to modify rheological and swelling properties of the microspheres as these properties are generally highly sensitive to the degree of crosslinking of hydrogels [Clapper et al. 2007, Bencherif et al. 2009, Payet et al. 2010, Nguyen et al. submitted for validation to Occlugel 14 April 2011]. Therefore, the swelling and the rheological behaviour of the microspheres were also evaluated during the course of the experiment. Finally, the morphology of the microspheres was observed using optical microscopy and SEM over the same period of time.

3.2.1. *Monitoring of the pH of the degradation medium*

The evolution of the pH of the incubation media of the different microspheres were plotted in Fig. 2. All curves showed a decrease of the pH, which indicated a release of acid compounds from the microspheres in agreement with the degradation of ester bonds included in the PLGA segments of the crosslinker. As shown in Fig. 2A, the higher the crosslinking percentage in the hydrogel, the larger the pH decreased. The comparison of the two classes of size distribution of the same microspheres did not reveal differences in pH variation during degradation process (Fig. 2B). Microspheres prepared with a crosslinker having a long PLGA

chain (HEMA12L12G) have produced a bigger pH decrease than those obtained with the HEMA4L4G crosslinker in which the PLGA segment was shorter (Fig. 2C). This agreed with the fact that the content in lactic acid and glycolic acid in the microspheres HEMA12L12G-3% was higher than that of the microspheres HEMA4L4G-3%. Microspheres with different PEG chains in the structure of the crosslinker were also compared: microspheres HEMA4L4G-3% with only one ethylene glycol unit, microspheres TEG4L4G-3% with 4 ethylene glycol units in the middle of the chain and microspheres PEGMA4L4G-3% with ethylene glycol units at one extremity. The total pH variation was the same for all types of microspheres. This indicated that the hydrophilic/hydrophobic balance of the crosslinker did not influence significantly the production of acid compounds resulted from the hydrolysis of the hydrogel (Fig. 2D).

3.2.2. Evolution of the morphology of microspheres during incubation

Microspheres were observed by optical microscopy and scanning electron microscopy (SEM) at different times during the degradation experiment. As an example, Fig. 3 shows the morphology evolution of microspheres TEG4L4G-3%. Both optical microscopy and SEM showed that the microspheres remained spherical during the whole duration of the experiment (i.e. 60 days). By optical microscopy, an obvious swelling of the microspheres can be observed up to day 14 while, at longer incubation times, the microspheres became less visible because of a progressive contrast match of the refractive index of the microspheres on that of the surrounding medium. This effect can easily be explained by the combination of two effects. During microsphere degradation, the amount of crosslinking decreased hence the concentration in polymer in the microspheres. As the second effect, the swelling of the microspheres tended to increase the amount of surrounding medium composing the hydrogel.

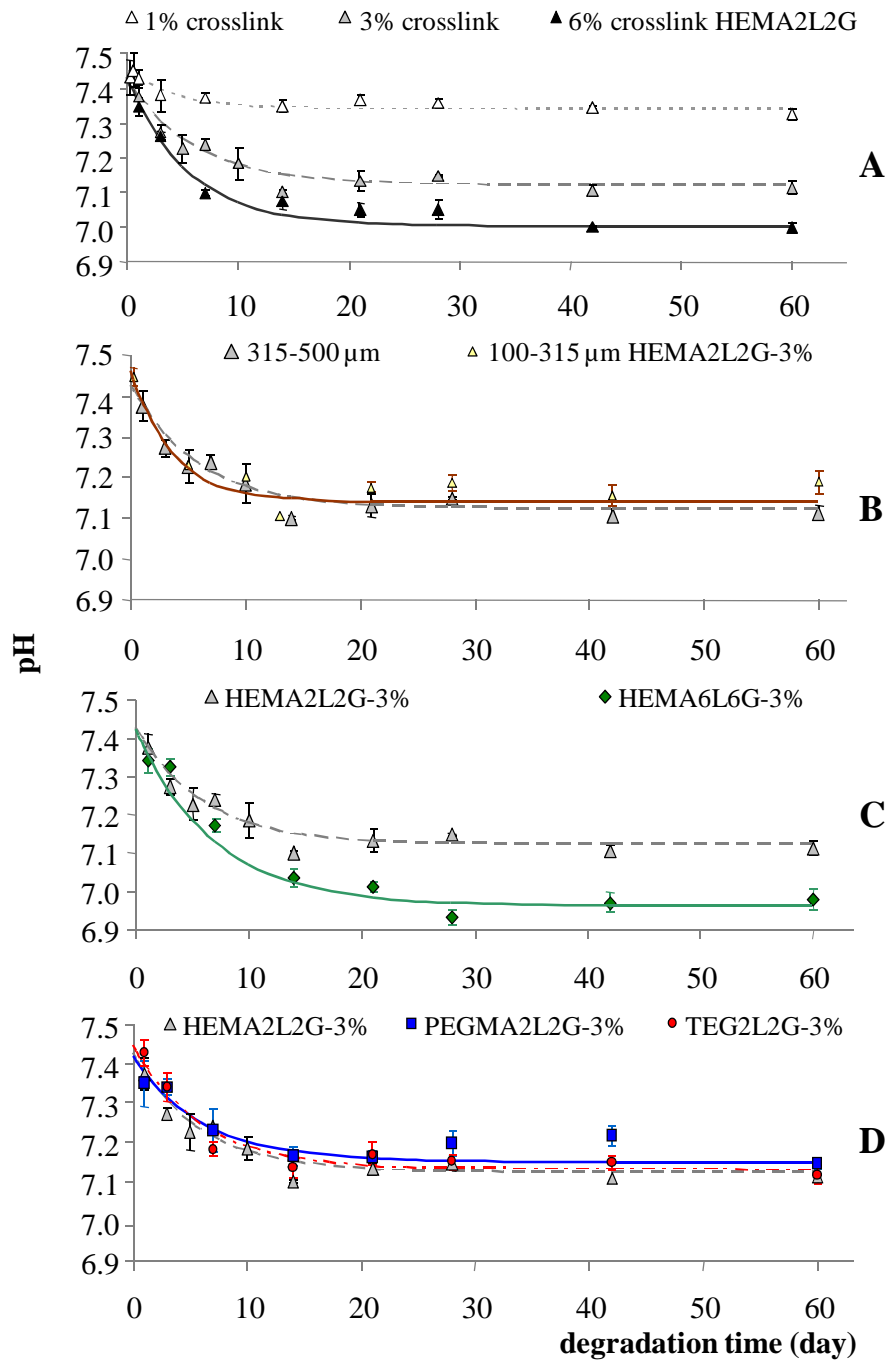

Figure 2. Effect of crosslinking density (A), of microsphere size (B), of crosslinker PLGA segment length (C) and of the PEG/PLGA balance in the crosslinker (D) on the variation of the pH of the incubation medium. Lines were exponential curve fits.

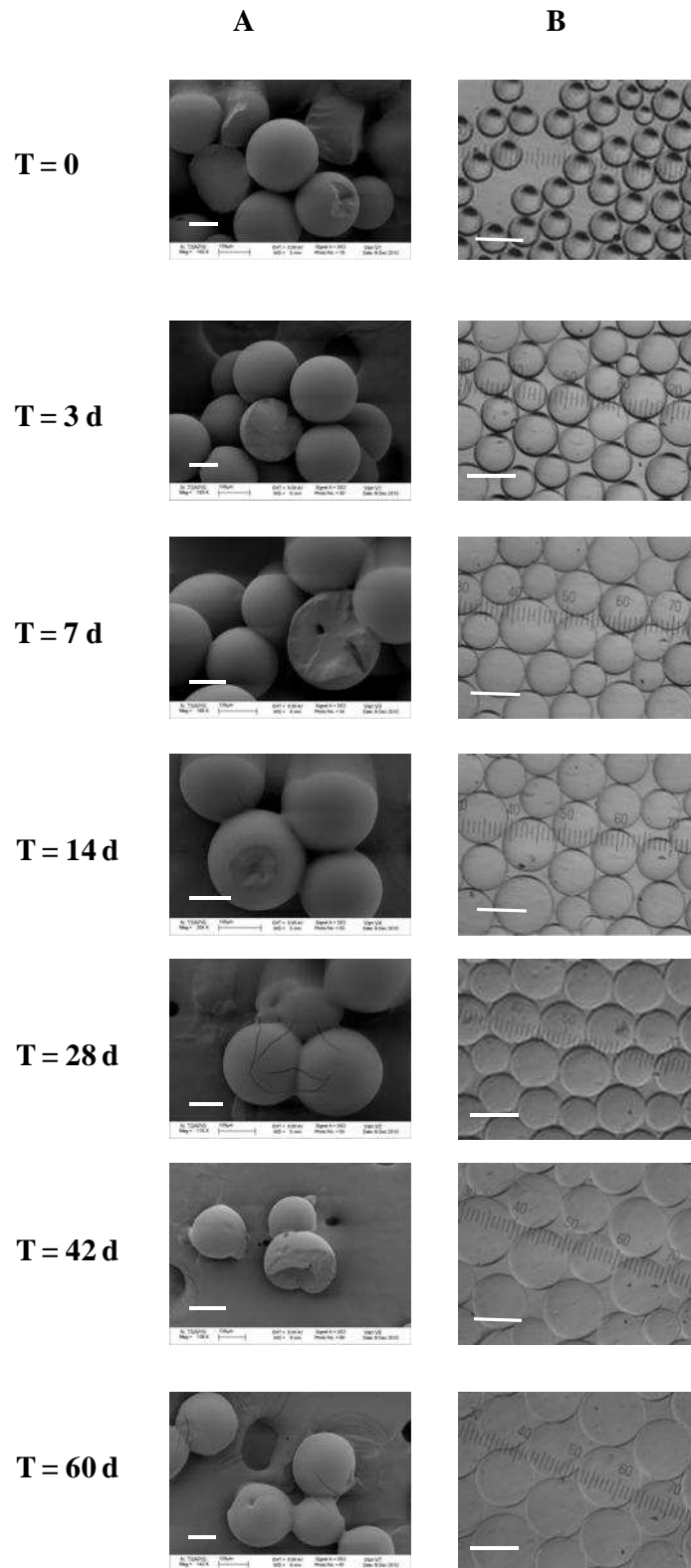

Figure 3. Evolution of the morphology of TEG4L4G-3% microspheres during incubation in PBS pH 7.4 at 37°C. Column A: SEM micrographs, scale bar 100 μm. Column B: Optical micrographs, scale bar 400 μm.

Thus the composition of the microspheres tended to reach that of the dispersion medium as the degradation proceeded. It is noteworthy that even after 60 days of incubation of the microspheres in a hydrolytic medium, there were still microspheres remaining indicating that they were not fully degraded. Observations described in detail for the microspheres TEG4L4G-3% were also observed with all the other microspheres studied in the present work.

3.2.3. Swelling behaviour of microspheres during the degradation

The volume taken by a defined amount of swelled microspheres in the incubation medium was measured at different time intervals. Results are reported in Fig. 4. In agreement with optical microscopy observations, the volume taken by the microspheres increased during incubation in PBS. The curves showed two parts. The first part corresponded to an increase of the volume occupied by the microspheres over several days before reaching a plateau value (the second part of the curve). Almost microspheres crosslinked at 3% had the same volume swelling ratio independently on their size and on the nature of the crosslinking agent (Fig. 4B and 4D). Only the microspheres obtained with the more hydrophobic crosslinker HEMA12L12G displayed a lower swelling during the incubation (Fig. 4C). Nevertheless, the degree of crosslinking of microspheres affected a lot their swelling ratio. (Fig. 4A). The more crosslinked microspheres, the smaller the initial volume swelling ratio (at $t=0$). The 3 different microsphere types (formed with 3 different crosslinkers) swelled and have followed a parallel evolution so that the differences between them remained roughly unchanged over the degradation process.

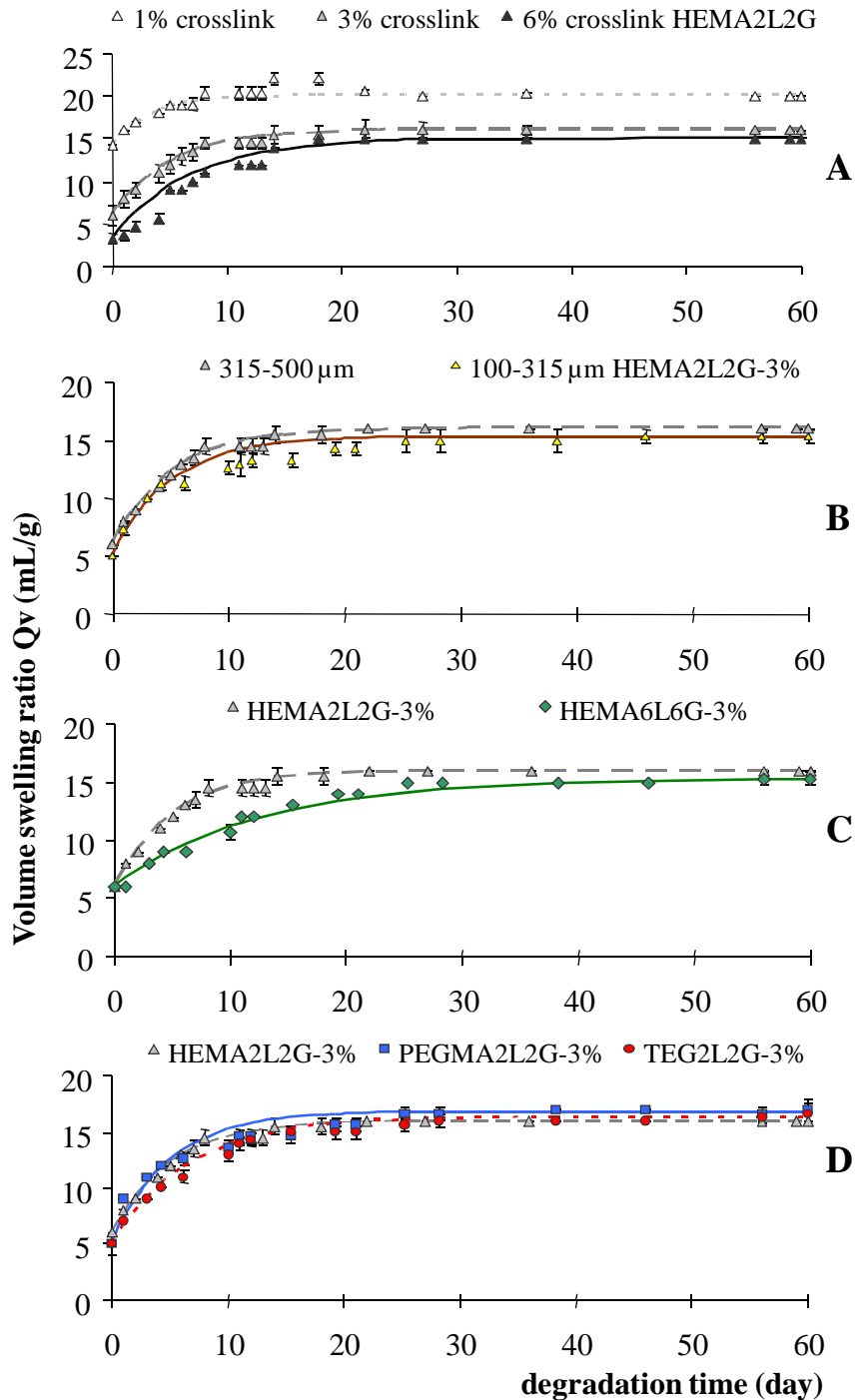

Figure 4: Monitoring of the swelling of the microspheres during the incubation in PBS. Microspheres differing from their crosslinking density (A), their size (B), the length of the hydrophobic segment in the crosslinker length (C) and the PEG/PLGA balance in the crosslinker (D). Lines were exponential curve fits.

3.2.4. *Monitoring the rheological properties of the microspheres during the degradation*

Results from the monitoring of the rheological properties of the microspheres during degradation are plotted in fig. 5. As mentioned above, G' of microspheres varied with their degree of crosslinking, the nature of the crosslinker and the size fraction. The initial values for the microspheres considered in the degradation study ranged from 2500 to 11000 Pa (Table II). During the incubation in PBS, a dramatic decrease of G' was monitored with all types of microspheres whatever the initial value was. The curves showed two distinct parts similarly to those monitoring the swelling of the microspheres during degradation. The decay showed in the first part of the curve was more pronounced for the most crosslinked microspheres (Fig 5 A) and the smaller microspheres (Fig 5 B). In contrast, decay of the first part of the curves appeared very similar between microspheres obtained with crosslinkers of different nature and composition (Fig 5 C, D). The decrease in G' was monitored until it reached a plateau value which ranged between 150 and 800 Pa. This plateau corresponded to the second part of the curve. This indicated that the hydrogels composing the microspheres were not fully degraded. These results were in agreement with previous observations showing that microspheres still remained at the end of the incubation time. The time at which the G' reached the plateau value depended on the degree of crosslinking (Fig. 5 A) and on the length of the hydrolysable PLGA segment in the crosslinker (Fig.5 C). It was rather not dependant on the size range of the microspheres and on the nature of the crosslinker (comparing crosslinkers with the same content in PLGA in their structure). The difference between initial G' and G' at the plateau greatly depended on the type of microspheres. This agreed with the fact that the initial G' of the microspheres varied over a wide range of values (2500 \square 11000 Pa) while it was comprised in a quite narrow range at the plateau value (200-800 Pa) obtained during incubation of the microspheres in PBS. Finally, it can be pointed out that the hydrogel microspheres which

showed almost ideal elastic properties at the beginning of the experiment ($\alpha < 10^\circ$) kept their elasticity properties all along the duration of the incubation time (data not shown).

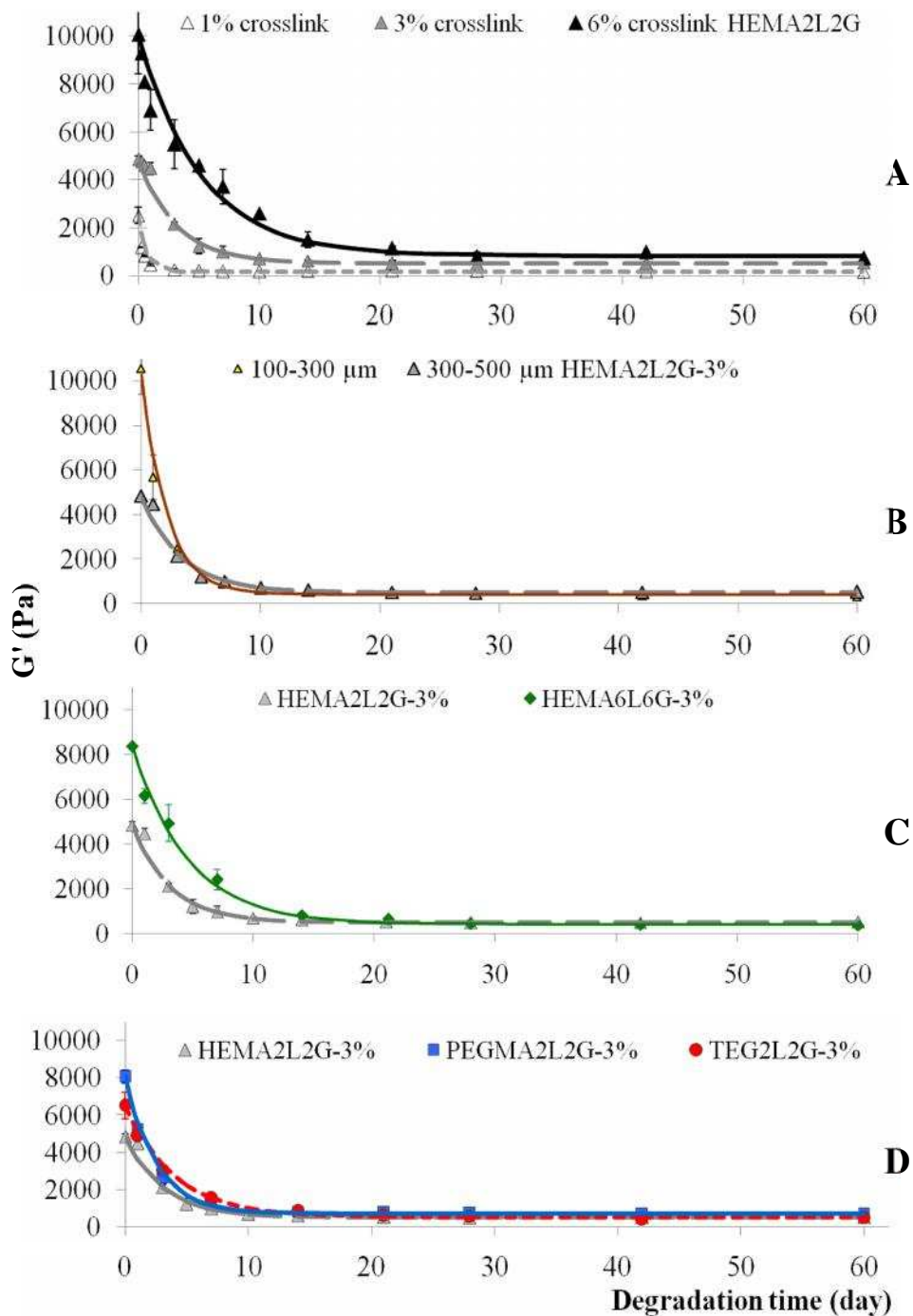

Figure 5: Monitoring of the variation of G' of the microspheres during incubation in PBS. Microspheres differing from their crosslinking density (A), their size (B), the length of the hydrophobic segment in the crosslinker (C) and the PEG/PLGA balance in the crosslinker (D). Lines were exponential curve fits.

4. Discussion

Hydrogel microspheres were synthesized with different hydrolysable crosslinkers and degrees of crosslinking and were sieved to obtain fractions with homogenous size distribution ranging from 100 to 315 μm and from 315 to 500 μm . The initial swelling and rheological behaviour of the different microspheres were evaluated prior to the degradation. The evolution of the swelling and the rheological properties observed with different degrees of crosslinking and with different crosslinker was in agreement with what is generally observed with other hydrogels independently of the nature and the shape of the device. [Zhu et al. 2005, Bencherif et al. 2009].

Once the microspheres were incubated in PBS they started swelling and their rheological properties were greatly modified. The G' decreased dramatically and the swelling proceeded until a steady state was reached. In parallel to these modifications of the microsphere properties, the pH of the degradation medium decreased, which indicated that there was a release of acid compounds. This was in agreement with the expected degradation mechanism of the hydrogels composing the microspheres. Indeed, during the degradation, the diminution of the pH of the incubation medium could correspond to the release of carboxylic acid containing components resulted from the hydrolysis of the ester bonds of the oligo(lactic and glycolic acid) segments included in the structure of the crosslinkers. Based on this hypothesis and on results reported in the literature, the decrease of pH expected should depend on the composition of the crosslinker in lactic and glycolic acid residues [Ponn et al. 2009]. The higher the amount of lactic and glycolic acid in the microspheres, the more quantity of carboxylic acid containing compounds may be released hence the higher the decrease in pH of the incubation medium [Grizzi et al. 1995]. Results from the experiments (Fig. 2) agreed well with what was expected from the degradation mechanism. Thus, the modification of the swelling and the rheological properties of the microspheres occurring after the start of the

incubation in PBS can be correlated with a hydrolytic degradation of the hydrogel. Due to the hydrolysis, the G' of the microspheres decreased as the density of the crosslink reduced implying a higher swelling [Flory 1953]. This is also in agreement with the assumed chemical structure of the hydrogel and with data reported in the literature on similar types of hydrogels [Bencherif et al. 2009]. However, it is noteworthy that, contrarily to what was expected, none of the microspheres were totally degraded. All curves showed a first part in which the studied parameters varied, that can be attributed to modifications of the microspheres properties due to the hydrolysis of the crosslinking bonds. Then, while no more variation of pH were recorded in the incubation medium, the swelling of the microspheres and their G' value stopped also to vary and remained constant until the end of the experiments. This was in contrast with the exponential increase of the swelling curves followed by a sudden drop attributed to the dissolution of the hydrogel reported with fully hydrolysable hydrogels [Clapper et al. 2007]. Samples having reached the plateau values were observed by optical microscopy and SEM revealing that highly swollen microspheres were there with quite spherical shape. This indicated that they were still composed of a crosslinked hydrogel that was strong enough to hold the material together within the shape of microspheres. In the work of Clapper et al. [Clapper et al. 2007], a similar result was reported with one of the hydrogels. The authors assumed that it included a very low fraction of non hydrolysable crosslinkings due to an incomplete modification of the PEG during the synthesis of the hydrolysable PEG macromer. As it was reported that very low non degrading crosslinkings may induce the formation of relatively permanent hydrogel networks, this hypothesis should be considered to explain the only partial degradation of the microspheres observed here. The method used for the synthesis of the microspheres was based on a radical co-polymerization of PEGMA with the hydrolysable crosslinker. It was reported in the literature that the monomer PEGMA can be reticulated during a radical polymerization even when the reaction is performed in the total

absence of crosslinking agents [Gramain and Frere 1986, Frere et al. 1992]. According to the authors, the crosslinking occurred through a chain transfer or a coupling reaction which follows the formation of reactive functions (radicals, hydroxyle and aldehyde groups) due to the degradation of the PEG segment of the macromer by a radical. The occurrence of such a crosslinking side reaction during microsphere preparation was confirmed by performing a polymerization of PEGMA in the same conditions than those used to prepare the microspheres of this study but without adding crosslinking agent in the polymerization medium. This polymerization allowed obtaining well spherical particles. The microspheres were totally insoluble in many common solvents for polymers (i.e. chloroform, THF, DMSO, DMF, acetone, ethanol, water) indicating that they were composed of a crosslinked polymer. Their rheological characteristics ($G \approx 100$ Pa) and swelling properties ($Q_{v0} = 28$ mL/g) suggested that the crosslinking rate was very low but sufficient to form a hydrogel of a well define spherical shape. This supported the assumption that that microspheres remaining after complete hydrolysis of the hydrolysable bonds were formed by a non degradable hydrogel. The permanent crosslinks of the hydrogels resulted from a non desirable side reaction occurring during the synthesis of the microspheres by radical polymerization of PEGMA. The obtaining of fully degradable microspheres required that this crosslinking reaction should be completely avoided.

It was possible to quantify the degradation rate of the hydrolysis of the microspheres by fitting the experimental data plotted in figures 2, 4 and 5 with an exponential equation (equation 8)

$$Y = A + B \exp(-t/\tau) \quad (8)$$

Where A was the value at the plateau, $A + B = C$ was the initial value at time 0, t was the time and τ the characteristic time of the rate of degradation. A small value of τ indicated a slow degradation while a high value of τ indicated a fast degradation. The same exponential trend

was previously observed during the degradation of bulk hydrogels obtained from similar crosslinking agents [Metters et al. 2000, Metters et al. 2001]. Parameters of the equation fitted the results of the variation of G' with the incubation time are given in table III for the different microspheres considered in this study. Results from the variation of G' were taken for this analysis because of the high sensitivity of this parameter monitoring microsphere degradation compared with other methods used in this study. The analysis revealed that the degradation rate of microspheres depended on their degree of crosslinking, on the composition of the crosslinking agents and, to a lesser extent, on their size. Results were in agreement with the literature considering hydrogels made with similar crosslinkers independently of their shape [Sawhney et al. 1993, Burdick et al. 2001]. Interestingly, the equation 8 could be used to calculate the time needed to reach completeness of the hydrolysis. It was defined as t_{99} , the time at which the decrease of G' have reached 99% of the total variation monitored between the initial value ($t=0$) and that of the plateau. This calculation revealed that the time required hydrolyzing the hydrogels composing the microspheres ranged from 7 to 49 days. Microspheres showing the shortest time of hydrolysis was the less reticulated while the microspheres with the highest degree of crosslinking showed the longest hydrolysis time.

The hydrolysis time was also greatly affected by the structure of the hydrolysable crosslinker as suggested by the comparison between the microspheres prepared with the two asymmetric crosslinkers PEGMA4L4G-3% and HEMA4L4G-3% ($t_{99} = 24$ and 28 days respectively) and those prepared with a crosslinker having the same composition in lactic and glycolic acid unit but symmetrically arranged at both ends of a tetra(ethyleneglycol) (TEG) segment (TEG4L4G-3%, $t_{99} = 37$ days). The increase in the length of the oligo(lactic-co-glycolic acid) segment also increased the time required for complete hydrolysis of the hydrogel. This can be explained by a higher hydrophobicity of the crosslinker [Clapper et al 2007]. The hydrolysis

time of the hydrogel composing the microspheres can be tuned by adjusting the degree of crosslinking as well as the nature and structure of the hydrolysable crosslinker.

TABLE III- Parameters of the exponential equation (8) obtained by fitting the experimental curves monitoring the variation of G' of the microspheres during their incubation in PBS.

sieving (μm)	Degradable microspheres	fit equation of G' (Pa)			t_{99} (days)
		A	B	α	
315-500	HEMA4L4G-1%	172	2340	0.7	7
	HEMA4L4G-3%	511	4334	3.1	28
	HEMA4L4G-6%	830	9248	5.3	49
	HEMA12L12G-3%	423	7945	4.6	45
	TEG4L4G-3%	533	5980	4.0	37
	PEGMA4L4G-3%	724	7340	2.5	24
100-315	HEMA4L4G-3%	418	9980	2.1	21

5. Conclusion

This study revealed that microspheres composed of a hydrogel of PEGMA crosslinked with hydrolysable crosslinkers were only partially degraded when they were incubated in PBS. The degradation occurred through the expected hydrolysis mechanism. The time window for complete degradation of hydrolysable bonds can be tuned by the chemical composition and

structure of the hydrolysable crosslinker and the degree of crosslinking of the hydrogel. Although this time window is satisfying and can be finely adjusted to comply with what is required for temporary embolisation, the microspheres, which did not completely dissolve after the hydrolysis, are not suitable for such an application. As the remaining non degradable crosslinking bonds of the hydrogel were identified to come from a side reaction of the radical polymerization of the PEG containing monomer, it will be necessary to further investigate the conditions of the polymerization to eliminate this side reaction. This would be the condition to obtain fully degradable microspheres.

6. Acknowledgement

The authors would like to thank Dr. G. Mekhloufi for her helps in granulometric measurements, Dr. N. Tsapis and Ms. M.-F. Trichet for MEB images captures. This work was financed by CNRS and Occlugel SARL.

7. References

- [Alsberg et al. 2003] Alsberg E, Kong HJ, Hirano Y, Smith MK, Albeiruti A, Mooney DJ. Regulating Bone Formation via Controlled Scaffold Degradation. *J Dent Res* 82:903-908, 2003.
- [Bencherif et al. 2009] Bencherif SA, Sheehan JA, Hollinger JO, Walker LM, Matyjaszewski K, Washburn NR. Influence of cross-linker chemistry on release kinetics of PEG-co-PGA hydrogels. *J Biomed Mater Res* 90A: 142–153, 2009.

[Burdick et al. 2001] Burdick JA, Philpott JM, Anseth KS. Synthesis and characterization of tetrafunctional lactic acid oligomers: A potential *in situ* forming degradable orthopaedic biomaterial. J Polym Sci Part A: Polymer Chem 39: 683-692, 2001.

[Clapper et al. 2007] Clapper JD, Skeie JM, Mullins RF, Guymon CA. Development and characterization of photopolymerizable biodegradable materials from PEG-PLA-PEG block macromers. Polymer 48: 6554-6564, 2007.

[Flory 1953] Flory P. □Principles in polymer chemistry□ Cornell Univ. Press. Ithaca. NY (1953).

[Frere et al 1992] Frere Y, Guilbert Y, Gramain P. Gel effect and subsequent degradation process in radical polymerisation of poly(ethylene oxide) acrylate and methacrylate macromers. New Polymeric Mater 3:175-186, 1992.

[Gombotz and Pettit 1995] Gombotz WR, Pettit K. Biodegradable Polymers for Protein and Peptide Drug Delivery. Bioconjugate Chem. 6:332-351,1995.

[Gramain and Frere 1986] Gramain P, Frere Y. Preparation of monomethoxy- poly(ethylene oxide) acrylate and methacrylate and its polymerisation: self gelling polymers. Polymer Comm. 27:16-18, 1986

[Grizzi et al. 1995] Grizzi I, Garreau H, Li S, Vert M. Hydrolytic degradation of devices based on poly(DL-lactic acid) size-dependence. Biomaterials 16:305-311,1995.

[Höglund et al. 2007] Höglund A, Odelius K, Hakkarainen M, Albertsson AC. Controllable degradation product migration from crosslinked biomedical polyester-ethers through predetermined alterations in copolymer composition. Biomacromolecules 8:2025-2032, 2007.

[Ibrahim et al. 2010] Ibrahim S, Kang QK, Ramamurthi A. The impact of hyaluronic acid oligomer content on physical, mechanical, and biologic properties of divinyl sulfone-crosslinked hyaluronic acid hydrogels. *J Biomed Mater Res* 94A:355–370, 2010.

[Ishaug-Riley et al. 1998] Ishaug-Riley SL, Crane-Kruger GM, Yaszemskib MJ, Mikos AG. Three-dimensional culture of rat calvarial osteoblasts in porous biodegradable polymers. *Biomaterials* 19(15):1405-1412, 1998.

[Moine et al. 2011] Moine L, Bedouet L, Laurent A, Labarre D, Wassef M, Nguyen VN. Implantable bio-resorbable polymer. EP2295480 (A1) published 16 March 2011.

[Metters et al 2000] Metters AT, Anseth KS, Bowman CN. Fundamental studies of a novel, biodegradable PEG-*b*-PLA hydrogel. *Polymer* 41:3993-4004, 2000.

[Metters et al 2001] Metters AT, Anseth KS, Bowman CN. Verification of scaling laws for degrading PLA-*b*-PEG-*b*-PLA hydrogels. *AIChE Journal* 47:1432-1437,2001.

[Nair and Laurencin 2007] Nair LS, Laurencin CT. Biodegradable polymers as biomaterials. *Prog Polymer Sci* 32(8-9): 762-798, 2007.

[Nguyen et al. Submitted for validation to Occlugel 14 April 2011] Nguyen VN, Huang N, Grossiord JL, Agnely F, Vauthier C. Rheology as a tool for characterisation of mechanical properties of chemically crosslinked microspheres and for monitoring their degradation
Submitted for validation to Occlugel 14 April 2011

[Nicodemus and Bryant 2008] Nicodemus GD, Bryant SJ. Cell Encapsulation in Biodegradable Hydrogels for Tissue Engineering Applications. *Tissue Eng Part B: Rev.* 2008; 14(2):149-165.

[Payet et al. 2010] Payet L, Ponton A, Grossiord JL, Agnely F. □Structural and rheological properties of chitosan semi-interpenetrated networks□The European Physical Journal E - Soft Matter and Biological Physics 32, 109-118, 2010.

[Peppas and Bures 2000] Peppas NA, Bures P, Leobandunga W, Ichikawa H. Hydrogels in pharmaceutical formulations. Eur J Pharm Biopharm 2000; 50(1):27-46.

[Poon et al 2009] Poon YF, Cao Y, Zhu Y, Judeh ZMA, Chan-Park MBAddition of □Malic Acid-Containing Poly(ethylene glycol) Dimethacrylate To Form Biodegradable and Biocompatible Hydrogels. Biomacromolecules 10: 2043□2052, 2009

[Sawhney et al. 1993] Sawhney AS, Pathak CP, Hubbell JA. Bioerodible hydrogels based on photopolymerized poly(ethylene glycol)-co-poly(.alpha.-hydroxy acid) diacrylate macromers. Macromolecules 26(4): 581-587, 1993.

[Taylor and Bagley 1975] Taylor KW, Bagley EB. Rheology of Dispersions of Swollen Gel Particles. J Polym Sci :Polymer Phys Ed. 13:1133-1144, 1975.

[Vanderhooft et al. 2009] Vanderhooft JL, Alcoutlabi M, Magda JJ, Prestwich GD. Rheological Properties of Crosslinked Hyaluronan-Gelatin Hydrogels for Tissue Engineering. Macromol Biosci 9:20-28, 2009.

[Wang et al. 2010] Wang K, Xu X, Liu TT, Fu SZ, Guo G, Gu YC, Luo F, Zhao X, Wei YQ, Qian ZY. Synthesis and characteri sation of biodegradable pH-sensitive hydrogel based on poly(e-caprolactone), methacrylic acid, and Pluronic (L35). Carbohydrate Polymers 79:755□761, 2010.

[Zhu et al. 2005] Zhu W, Wang B, Zhang Y, Ding J. Preparation of a thermosensitive and biodegradable microgel via polymerization of macromonomers based on diacrylated Pluronic/oligoester copolymers. Eur Polymer J 41: 2161□2170, 2005.

Discussion générale

L'objectif de ce travail était de développer des microsphères pour embolisation constituées d'un matériau dégradable. Les hydrogels, par leur grande flexibilité constituent une classe de matériaux bien adaptés à la conception de microsphères. Leur structure ressemble à une éponge gonflée d'eau dans laquelle le squelette est constitué par les chaînes d'un polymère réticulé formant un réseau tridimensionnel. Leur composition et leur structure sont proches de celles des milieux rencontrés dans le monde vivant ce qui en font des matériaux de choix pour développer des dispositifs relevant du domaine biomédical. Plus spécifiquement, ces matériaux présentent un très grand intérêt pour toutes les applications visant à développer des systèmes implantables *in vivo*. Un autre avantage présenté par les hydrogels est la possibilité d'avoir des matériaux très élastiques. Cette propriété était considérée comme importante pour permettre l'injectabilité des microsphères à travers un cathéter de faible diamètre utilisé lors de la mise en place de l'embolie dans les vaisseaux sanguins à obstruer chez le patient. Par ailleurs, les indications thérapeutiques pour lesquelles ces microsphères d'embolisation devaient être développées requièrent une embolisation temporaire allant de quelques jours à quelques semaines. Il était donc nécessaire de développer un polymère dégradable qui permettrait une recanalisation du vaisseau embolisé par disparition de l'embolie *in situ* sur l'échelle de temps souhaitée.

L'étude des travaux publiés dans la littérature a permis de mettre en évidence l'existence de nombreux hydrogels dégradables. Les hydrogels se dégradant selon un mécanisme d'hydrolyse sont apparus les plus adaptés pour constituer la matrice polymérique des microsphères d'embolisation à développer. En effet, une dégradation par hydrolyse est reproductible et indépendante du site d'implantation du matériau ou des conditions physiologiques du patient. Parmi les matériaux hydrolysables, il a été choisi de travailler avec la famille des poly(acide lactique), poly(acide glycolique) et leur copolymères. Ils sont bien connus dans le domaine biomédical pour leur biocompatibilité et ont été largement employés

depuis plus de vingt ans pour concevoir des implants biodégradables [Cutright et al. 1971, Miller et al. 1977, Agrawal et al. 1995, Athanasiou et al. 1998, Maurus P.B. and Kaeding 2004]. Ces matériaux présentent deux inconvénients en vue de leur utilisation pour la fabrication de microsphères d'embolisation. Ils sont hydrophobes et les implants obtenus ont une très faible élasticité. Pour contourner cette limitation et répondre au cahier des charges fixé par le cadre de l'application, nous nous sommes tournés vers les hydrogels formés par copolymérisation radicalaire entre un réticulant biodégradable à base de PLGA et des copolymères qui permettent une meilleure absorption d'eau (notamment le PEGMMA, l'acide méthacrylique ou l'acide acrylique). Par ailleurs, ce choix a également été fait en vue de favoriser la dégradation de l'hydrogel constituant les microsphères d'embolisation.

Dans la littérature, la synthèse d'hydrogels avec les composés identifiés est bien décrite pour obtenir des films, des objets préparés dans des moules ou pour combler des tissus endommagés in vivo par des méthodes de polymérisation in situ. Néanmoins, il n'y avait pas de méthode décrite pour synthétiser des hydrogels dégradables à base de réticulant PEG-PLGA sous la forme de microsphères pour répondre aux objectifs de ce projet. L'originalité de notre travail a donc été de développer une telle méthode. D'autres méthodes ont été développées pour permettre la caractérisation des microsphères synthétisées notamment mesurer leurs propriétés visco-élastiques et évaluer leur vitesse de dégradation. Pour un type de microsphères synthétisées, une étude préliminaire de la biocompatibilité a été réalisée dans des conditions d'embolisation chez l'animal. Au cours de ce travail, il a également été envisagé de charger les microsphères avec des principes actifs, l'un anticancéreux pour développer des applications en chimio-embolisation et l'autre antalgique pour soulager les fortes douleurs produites par l'embolisation. Cette partie du mémoire de thèse discute des résultats obtenus au cours des différentes étapes des travaux expérimentaux réalisés.

1. Synthèse des microsphères d'hydrogel

Préalablement à la synthèse des microsphères, plusieurs agents de réticulation ont été synthétisés par voie chimique. Suivant l'amorceur permettant l'incorporation du matériau hydrolysable (HEMA, PEGMA, TEG ou PEG) utilisé, la structure de la molécule résultante présente ou non une symétrie par rapport au segment PEG incorporé dans la structure. Les synthèses ont été réalisées en 2 étapes : l'insertion du matériau dégradable PLGA suivi par le greffage de la (des) double(s) liaison(s) afin d'obtenir un réticulant contenant deux groupements C=C. Tous les produits synthétisés incluant les agents de réticulation et leurs intermédiaires de synthèse ont été caractérisés par RMN. Les rendements de synthèse se sont révélés acceptables (> 60%) et la pureté du réticulant dans le produit final isolé et purifié avoisine les 100% sauf dans le cas du PLGA-PEG1500-PLGA. Il peut être avancé que dans le cas de ce dernier composant, les faibles rendements de synthèse pourraient être liés à une humidité importante du PEG Mw. 1500 qu'il a été difficile de sécher.

Les méthodes qui permettent la synthèse de particules de polymères de forme sphériques sont nombreuses. Elles comprennent les méthodes de polymérisation par précipitation, polymérisation en dispersion, en suspension ou en émulsion. La taille finale des microsphères dépend de la méthode mise en œuvre et du mécanisme de stabilisation des gouttelettes. Le choix de la méthode de polymérisation s'est tourné vers la polymérisation en suspension qui paraissait la mieux adaptée pour synthétiser des microsphères de taille adaptée pour servir d'agent d'embolisation (typiquement entre 100 μ m et 1mm).

Deux voies de polymérisation en suspension ont été étudiées dans le but de fournir des microsphères constituées d'une large gamme de choix de matériaux :

-Dans le cas de la polymérisation en suspension directe (huile dans eau), les agents de réticulation synthétisés ont été copolymérisés avec du PEGMMA Mw. 300 pour obtenir le

polymère devant former la matrice de l'hydrogel. Les monomères ont été dissous dans du toluène et le mélange formé a été dispersé dans une phase aqueuse à faible teneur de chlorure de sodium en présence de PVA utilisé comme agent de stabilisation des microsphères. La polymérisation, effectuée en réacteur de 1L, a été amorcée par l'AIBN, amorceur de polymérisation radicalaire soluble en milieu organique, et a été réalisée en 15 h à 70°C.

- Dans le cas de la polymérisation en suspension inverse (eau dans huile), le réticulant est copolymérisé avec de l'acide acrylique neutralisé à 75%, du DMA et du Tris ajoutés en différentes proportions. Les monomères ont été solubilisés dans de l'eau puis l'ensemble de la phase aqueuse a été suspendue dans du cyclohexane contenant du Span80 comme agent tensioactif. La réaction a été réalisée en 2 h à 70°C. La méthode de polymérisation en suspension directe a permis d'obtenir des microsphères constituées d'un hydrogel dans lequel les agents de réticulation hydrolysables synthétisés ont été incorporés.

Concernant la polymérisation en suspension inverse, cette méthode a été appliquée avec succès à la synthèse de microsphères non dégradables. Elle a en fait été optimisée dans le but de limiter la formation d'agrégats à l'aide d'un réticulant non dégradable. L'application de cette méthode à la fabrication de microsphères dégradables par copolymérisation du réticulant hydrolysable synthétisé (1500PEG8L8G) a échoué conduisant à la formation d'agrégats à cause de la densité trop élevée du réticulant. Une forte réduction de la quantité de réticulant (0.75%) 1500PEG8L8G a permis d'obtenir des microsphères. Cependant celles-ci ne sont pas visibles car elles ont absorbé une grande quantité d'eau (du à leur faible taux de réticulation) et ne présentaient pratiquement pas de différence de contraste avec le milieu aqueux. Il serait toutefois intéressant de refaire des essais avec l'agent de réticulation dégradable et d'optimiser les conditions de réaction pour obtenir par cette méthode des microsphères dégradables.

Dans les conditions de polymérisation permettant d'obtenir des microsphères, il a pu être montré qu'en fonction de la vitesse d'agitation et de la concentration en agent stabilisant (PVA ou Span 80), les microsphères obtenues ont une distribution de taille variables comprise entre quelque dizaine de micromètre à plus de 500 μm . En général, dans les conditions de synthèses optimisées, peu d'agrégats sont formés et la majorité du polymère obtenu se présente sous la forme sphérique souhaitée. Il a été observé que la répartition en taille des préparations diffère selon la nature de l'agent de réticulation et surtout selon le degré de réticulation de l'hydrogel. Pour l'application envisagée en embolisation, deux fractions de taille des microsphères ont été retenues après tamisage, la fraction contenant les microsphères de diamètre compris entre 100 et 315 μm et celle de diamètre compris entre 315 et 500 μm . Pour éviter toute dégradation, les microsphères ont été immédiatement congelées puis lyophilisées après lavage à l'eau et tamisage pour permettre leur conservation entre le moment de leur synthèse et celui des caractérisations ultérieures. Le rendement de production des microsphères a été évalué via la quantité d'agrégats obtenue après la synthèse. Les réactions effectuées ont toutes donné des quantités d'agrégats négligeables (5-10 % de la masse totale théorique). Ces résultats nous permettent de conclure que les conditions de synthèse ont bien été optimisées.

2. Synthèse de microsphères pour embolisation chargées en principes actifs

Deux méthodes d'incorporation de principes actifs dans les microsphères ont été proposées au cours de travaux menés en collaboration avec deux laboratoires. Dans un premier travail, les conditions d'imprégnations des microsphères par un médicament contenant un agent anticancéreux (Streptozocine) ont été optimisées. Dans ce cas, le principe de chargement des microsphères était basé sur une simple absorption de la solution par les microsphères lyophilisées au cours du phénomène de gonflement accompagnant leur rehydratation. Dans le deuxième travail, un antalgique, l'ibuprofène, a été introduit dans les microsphères dégradables sous la forme d'une prodrogue polymérisable au cours de la synthèse des microsphères. La prodrogue a été synthétisée avec une liaison ester facilement clivable pour permettre la libération de l'ibuprofène lors de la dégradation de l'embolo au cours de l'embolisation. Elle a pu être incorporée avec succès dans les microsphères dégradables étudiées au cours de ce travail par copolymérisation en suspension directe avec les monomères utilisés précédemment.

3. Caractérisation des microsphères

La caractérisation des microsphères isolées résultant de la synthèse a été réalisée par diverses méthodes. Dans un premier temps, des méthodes standard ont permis de caractériser la taille et la morphologie des microsphères. Il a ainsi pu être vérifié que les microsphères avaient une forme bien sphérique par microscopie optique et par microscopie électronique à balayage, que leur surface était lisse par microscopie électronique à balayage et que leur diamètre et répartition granulométrique correspondait à celle de la fraction de taille isolée lors du fractionnement sur les tamis.

L'évaluation des propriétés de l'hydrogel telles que la capacité de gonflement et la mesure des propriétés visco-élastiques et de résistance mécanique a nécessité le développement de méthodes de mesure adaptées aux microsphères. Par ailleurs, la dégradation de l'hydrogel se réalise par hydrolyse des ponts de réticulation du polymère ce qui suggère que les propriétés mécaniques et visco-élastiques et les capacités de gonflement des microsphères seraient affectées au cours de la dégradation. Les méthodes de caractérisation développées devaient également permettre de suivre l'évolution des propriétés de l'hydrogel résultant de sa dégradation et ainsi permettre d'évaluer la vitesse de dégradation.

3.1. Développement d'une méthode de mesure des propriétés de résistance mécanique des microsphères basée sur un test de compression

Une première méthode d'étude des caractéristiques des hydrogels a été destinée à évaluer les propriétés de résistance mécanique des microsphères (Figure 15A).

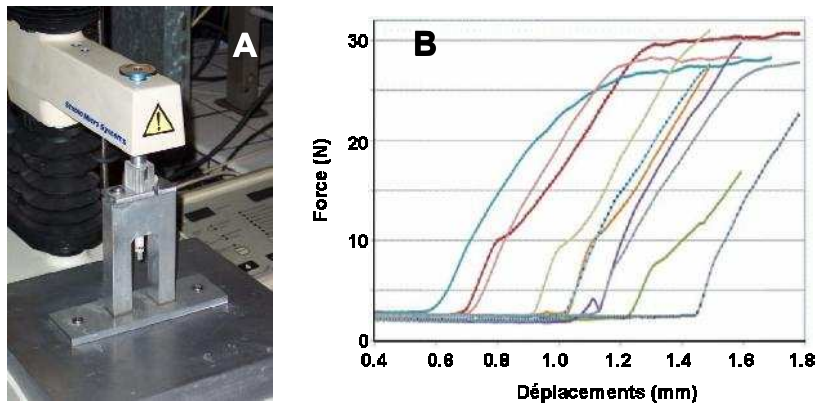

Figure 15. (A) - L'analyseur de texture TAXT2 et le montage adapté au système seringue-piston conçu dans notre laboratoire. (B) - L'analyse par compression des microsphères en vue d'en déterminer la limite d'élasticité. Résultat type montrant les courbes de compressions obtenues pour 12 expériences de compressions menées sur les microsphères HEMA4L4G-6%. On peut noter une grande variabilité de l'allure des courbes traduisant un manque de reproductibilité évident des mesures.

La méthode a été conçue sur la base d'un essai de compression réalisé sur plusieurs lits de microsphères pour en analyser la limite d'élasticité. Elle a été développée à l'aide d'un analyseur de texture TAXT2 qui permet d'enregistrer la force exercée au cours d'un test de compression. Pour ce faire, il a été proposé de placer les microsphères dans une cellule de mesure qui permettrait au liquide de s'échapper alors que les microsphères seraient retenues dans la cellule. De telles cellules de mesure n'existent pas et notre premier travail a été de s'entreprendre la conception d'une telle cellule. En outre, pour éviter qu'il ne soit pollué par des échantillons précédents, il est apparu que ce dispositif de mesure devait être renouvelé à chaque nouvelle mesure. C'est ainsi que le choix s'est porté sur un tube à usage unique en

plastique dont une extrémité était obstruée par une pastille de fritté. De tels tubes sont accessibles en grande quantité chez les fournisseurs et sont commercialisés comme tube de séparation en phase solide (SPE) à usage unique (Figure 16A). Pour compléter le dispositif, un piston a été réalisé sur mesure au laboratoire et l'ensemble a été adapté pour être monté sur l'analyseur de texture et permettre la réalisation de mesures.

La figure 15B donne les courbes obtenues lors de l'analyse réalisée sur une préparation de microsphères de type HEMA4L4G-6%, au cours de 12 expériences de compression effectuées avec l'analyseur de texture. Il apparaît que l'allure générale de ces courbes n'est pas reproductible. Par ailleurs, les changements de pente qui apparaissent sur certaines courbes ne fournissent pas non plus de données reproductibles.

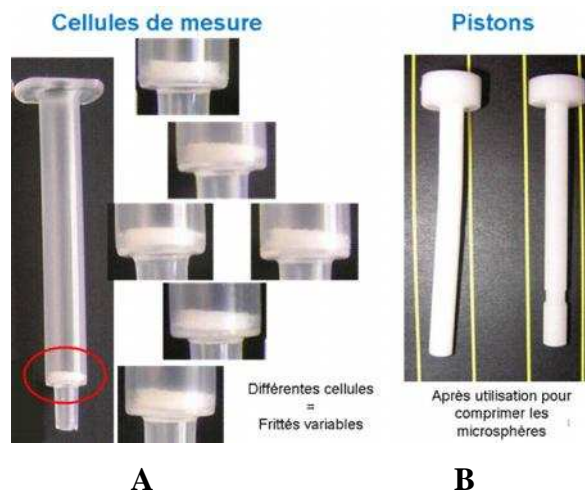

Figure 16. (A) - Photos des cellules de mesure neuves à usage unique telles que celles utilisées dans les tests de compression des microsphères. Il peut être noté une grande variabilité de la qualité des frittés dans les cellules tant au niveau de l'épaisseur que de la planéité de la surface. (B) - Les pistons après utilisation dans les tests de compression menés sur des microsphères. Les pistons apparaissent déformés suite à leurs utilisations.

Une analyse des facteurs expérimentaux pouvant être à l'origine de la forte variabilité des mesures a été conduite. Le premier facteur mis en évidence pouvant amener cette variabilité importante a été le remplissage des cellules. Les microsphères étant en suspension

dans un excès de liquide rendent particulièrement difficile un remplissage précis et reproductible que ce soit par un opérateur donné ou par plusieurs opérateurs. Egalement, un autre facteur clé pour obtenir des mesures reproductibles est lié à la qualité des cellules de mesures. Comme indiqué plus haut, les cellules de mesures sont constituées d'un ensemble de deux pièces : le tube comportant le fritté à une extrémité et un piston en teflon usiné sur mesure. Concernant le tube, son application dans le test de compression a été détournée de son application initiale puisqu'il est commercialisé pour être utilisé comme un support de colonne de séparation de solide à usage unique. Un examen visuel rapide de la qualité de ces tubes suggère qu'ils ne présentent pas les exigences requises pour réaliser les mesures de compression dans de bonnes conditions. En effet, l'épaisseur des frittés, leur rugosité macroscopique et leur positionnement dans le tube plastique de chromatographie est très largement variable d'une pièce à l'autre. (Figure 16A). Par ailleurs, une observation des pistons récupérés à l'issue de quelques expériences de compression montre qu'ils ont subi une déformation importante lors des expériences de compression des microsphères (Figure 16B). Il semblerait qu'ils ne sont donc pas adaptés pour réaliser les mesures souhaitées. Dans cette analyse, il apparaît que la cellule de mesure utilisée pour réaliser ces essais présente un certain nombre de défauts rédhibitoires qui pourraient être à l'origine du manque de reproductibilité relevé lors des essais réalisés avec les microsphères. La conception de cellules calibrées de très haute qualité et spécialement conçues pour cette analyse pourrait permettre d'apporter une réelle amélioration de la qualité des mesures et de leur reproductibilité. Ce problème résolu, le remplissage des cellules avec les microsphères devra être optimisé. Des études complémentaires seront encore nécessaires pour valider la méthode dans le but de caractériser les propriétés de résistance mécanique des microsphères pour en déduire la limite d'élasticité de l'hydrogel les constituant.

3.2. Développement d'une méthode de mesure des propriétés rhéologiques des microsphères et application à la caractérisation de leur dégradation

Suite aux difficultés rencontrées avec la méthode basée sur les tests de compression, une évaluation des propriétés viscoélastiques de l'hydrogel constituant les microsphères a été proposée en se basant sur des méthodes rhéologiques couramment employées pour la caractérisation des hydrogels. A notre connaissance, très peu d'études se sont intéressées à la caractérisation des propriétés viscoélastiques des microsphères, plus spécifiquement, les mesures ne sont généralement pas réalisées sur les microsphères mais sur des films constitués du même matériau que ces dernières [Hu et al. 2008, Kumachev et al. 2011]. Dans notre travail, nous souhaitons utiliser ces mesures pour suivre l'évolution des modifications des paramètres viscoélastiques des microsphères au cours de leur dégradation. La forme d'un matériau et sa taille influençant de manière importante les cinétiques de dégradation, il apparaissait indispensable de déterminer des conditions expérimentales permettant de réaliser les mesures pertinentes directement sur les microsphères. Le choix de l'appareil de mesure s'est porté sur un rhéomètre Haake RheoStress 600 équipé d'une cellule de mesure de type plateau-plateau d'un diamètre de 35 mm thermostaté à 25°C. Pour définir les conditions expérimentales des mesures viscoélastiques, l'hypothèse a été faite que l'espace compris entre les deux plateaux de la cellule de mesure serait totalement occupé par une monocouche de microsphères. Un premier travail visant à optimiser les conditions de remplissage de la cellule de mesure a permis de montrer que seules ces conditions permettaient effectivement d'obtenir des mesures stables avec un coefficient de variation inférieur à 5% en comparant des séries de 3 mesures réalisées sur une même préparation de microsphères ayant fait l'objet d'autant de répétitions que de mesures. Ces conditions expérimentales ont alors été appliquées à l'étude des propriétés viscoélastiques d'une série de microsphères constitués d'hydrogels non dégradables

de degrés de réticulation variant de 1 à 11% (exprimé en rapport molaire agent de réticulation/monomères totaux). Cette étude a permis de confirmer que les mesures étaient reproductibles dans les conditions expérimentales précisées lors des expériences précédentes et a surtout permis de montrer qu'elles étaient sensibles aux caractéristiques de réticulation de l'hydrogel constituant des microsphères. Ces deux études ont permis de valider une méthode originale de suivi des propriétés viscoélastiques d'un hydrogel sous la forme de microparticules. La méthode a ensuite été appliquée à la caractérisation des microsphères après leur synthèse. D'une manière générale, les résultats des mesures montrent que les microsphères ont un comportement très élastique : elles peuvent subir de fortes déformations et reprendre leur forme initiale. En particulier, l'observation des microsphères avant et après l'application du stress de cisaillement imposé dans la cellule de mesure permet de confirmer la bonne tenue morphologique des microsphères à l'issue d'une déformation. Des mesures ont été réalisées sur des microsphères préparées avec différentes compositions d'hydrogel. La nature de l'agent de réticulation utilisé lors de la synthèse des microsphères influence peu les propriétés viscoélastiques pour un même taux de réticulation. En revanche, le degré de réticulation de l'hydrogel influence de manière importante leur élasticité.

Par ailleurs, les microsphères ont été conçues de telle sorte qu'elles se dégradent seulement au niveau de leurs ponts de réticulation. Par conséquent, au cours de leur dégradation, nous attendons une diminution de leur degré de réticulation. Les mesures rhéologiques étant sensibles au taux de réticulation, il apparaissait possible de caractériser la dégradation des microsphères au cours du temps. Les études ont été réalisées sur une durée totale de 60 jours sur différents types de microsphères.

3.3. Développement d'une méthode de mesure du gonflement des microsphères et application à la caractérisation de leur dégradation

Une propriété très spécifique des hydrogels est celle d'être capable d'absorber de très grandes quantités d'eau. Ainsi, la masse d'eau contenue dans un hydrogel représente généralement une fraction massique très importante (pouvant atteindre 90%). Inversement, la fraction massique du polymère constituant l'hydrogel est très faible. Généralement, le gonflement d'un hydrogel est peu influencé par la nature du réticulant mais est fortement dépendant du degré de réticulation de la matrice polymérique. La mesure du gonflement des microsphères est apparue comme une deuxième méthode pertinente pour la caractérisation des microsphères. Le phénomène de dégradation par hydrolyse des ponts de réticulation engendrant une diminution du degré de réticulation, le suivi du gonflement des microsphères au cours de leur incubation dans un milieu d'hydrolyse permettrait d'évaluer le phénomène de dégradation. Notre travail a consisté à mettre en évidence si un tel phénomène pouvait être mesuré et utilisé pour suivre la dégradation des microsphères.

Il a été mis en place un dispositif permettant de quantifier le volume sédimenté de microsphères gonflées correspondant à 0,1 g de microsphères sèches mises en suspension dans 1 mL de PBS pH 7,4 à 37°C. L'étude de la dégradation sur une période de 60 jours a porté sur différents types de microsphères. Chaque mesure a été répétée 3 fois pour s'assurer de leur reproductibilité. Un exemple du dispositif de mesure et de la modification du volume du sédiment des microsphères au cours de la période d'incubation sur 60 jours est donné dans la figure 17. Une nette augmentation du volume des microsphères a été observée au cours des dix premiers jours. Cette augmentation correspond au gonflement des microsphères suite aux coupures des ponts de réticulation. La stabilisation du gonflement est caractéristique de la fin de la dégradation. Similairement aux caractérisations rhéologiques, il a été observé une

corrélation entre le degré de réticulation et l'évolution du gonflement des microsphères. Une augmentation du taux de réticulation des microsphères entraîne une diminution de leur capacité de gonflement. Le réticulant contenant une chaîne PLGA plus longue gonfle moins rapidement mais atteint le même plateau. En revanche, la taille des microsphères et la nature de la chaîne PEG incluse dans le réticulant utilisé lors de la synthèse des microsphères influencent peu le gonflement.

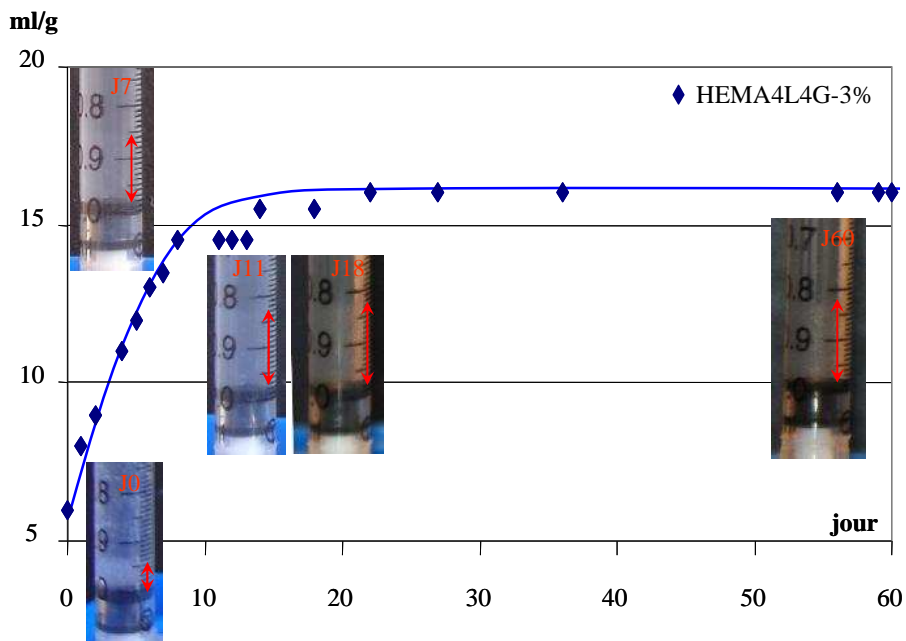

Figure 17. Suivi du gonflement des microsphères HEMA4L4G-3% tamisées entre 315 et 500 μ m au cours de la période d'incubation de 0.1g (poids sec) de microsphères mises en suspension dans 1mL de tampon PBS à 37°C.

3.4. Etude de la dégradation des microsphères

La conception de l'hydrogel constituant les microsphères synthétisés a été réalisée sur la base d'un polymère réticulé obtenu par incorporation d'agents de réticulation hydrolysables au cours de la synthèse. Les différents paramètres pouvant être utilisés pour suivre cette dégradation sont soit liés à la mise en évidence des produits de dégradation qui pourraient être

relargués par le gel soit liés aux modifications des propriétés physico-chimiques des microsphères au cours de la dégradation.

D'un point de vue chimique, les produits de dégradation issus de l'hydrolyse du gel (des fonctions esters) contiennent des groupements d'acides carboxyliques. L'hydrolyse conduit donc à l'acidification du milieu de libération et cette acidification peut être suivie par la mesure du pH du milieu d'incubation. Les mesures de pH appliquées au cours des études de dégradation ont effectivement confirmé une acidification du milieu d'incubation qui s'arrête après quelques jours d'incubation dans le milieu d'hydrolyse : Il s'agit du moment à partir duquel le pH se stabilise et cet instant dépend de la nature de l'agent de réticulation de l'hydrogel. L'amplitude de la variation de pH (correspondant à la différence entre le pH initial et le pH atteint au plateau) dépend du degré de réticulation des microsphères et de la composition en acide lactique et glycolique du réticulant. Toutefois, cette amplitude reste limitée en accord avec le fait que le polymère représente une faible part dans la composition des microsphères. Pour cette même raison, les mesures de pertes de masse habituellement appliquées dans des études de dégradation des hydrogels n'ont pas été appliquées dans le cadre de cette étude. En effet, ces mesures sont apparues trop peu sensibles d'autant plus que les échantillons mis en œuvre dans notre étude sont de petite taille. Sur le plan des méthodes physico-chimiques, la mesure de la variation des taux de gonflement des hydrogels a permis d'observer une augmentation du volume occupé par les microsphères au cours du temps pendant les premiers jours d'incubation puis le volume occupé par les microsphères s'est stabilisé. L'augmentation du volume occupé par les microsphères est compatible avec un mécanisme de dégradation de l'hydrogel par hydrolyse des ponts de réticulation conduisant à une diminution de degré de réticulation. La variation du volume des microsphères a coïncidé avec la variation du pH lors de l'expérience décrite précédemment. Ces deux résultats combinés sont en accord avec le mécanisme de dégradation attendu pour ces microsphères.

Toutes les méthodes citées précédemment sont apparues beaucoup moins sensibles que celle basée sur la mise en évidence et l'évaluation des variations de propriétés viscoélastiques des microsphères. En effet, les propriétés rhéologiques sont extrêmement sensibles aux modifications liées à la réticulation de l'hydrogel et permettent une analyse fine et précise de la dégradation des différentes microparticules par hydrolyse du pont de réticulation.

Les résultats des travaux montrent que la dégradation est rapide sur une période de temps de quelques jours puis les propriétés viscoélastiques des microsphères deviennent constantes dans le temps. Les courbes obtenues sont parallèles à celles de la variation du gonflement et de l'acidification du milieu d'incubation. L'ensemble des résultats est cohérent et suggère que le phénomène de dégradation s'arrête alors que l'hydrogel composant les microsphères n'est pas complètement disloqué. En effet, même après 60 jours alors que tous les paramètres faisant l'objet de mesures sont stables, il subsiste des microsphères parfaitement observables en microscopie optique et en microscopie électronique à balayage. Par ailleurs ces objets présentent des propriétés viscoélastiques témoignant de la subsistance d'un réseau de polymère présentant une élasticité quasi-parfaite qui leur permet de résister à des sollicitations comme les forces de cisaillements appliquées lors des mesures rhéologiques ou de compression lors des manipulations. La rémanence partielle de ces MS même après 60 jours d'incubation dans un milieu propice à leur dégradation par hydrolyse a constitué un résultat inattendu. Cependant, ils sont très importants par rapport à l'application envisagée pour ces microsphères. En effet, leur utilisation dans le cas de la mise en œuvre de techniques thérapeutiques d'embolisation temporaire requiert une disparition totale de l'embolie dans un temps donné pour permettre la recanalisation des vaisseaux sanguins embolisés. Les travaux de Gramain et Frère [Gramain and Frère 1986, Frère et al. 1992] ont montré l'existence d'un processus de réticulation du monomère PEGMMA même en l'absence de tout agent de réticulation. Ce monomère étant mis en œuvre lors de la synthèse de l'hydrogel constituant les

microsphères, on peut faire l'hypothèse que la dégradation partielle des microsphères résulte de la formation de ponts de réticulation non dégradables dans l'hydrogel selon un schéma de réaction qui pourrait suivre celui décrit dans les travaux menés sur le PEGMMA mentionné plus haut. Pour vérifier cette hypothèse, la méthode de synthèse des microsphères a été appliquée en utilisant comme seul monomère le PEGMMA. L'essai a fourni des microsphères que nous pouvons facilement observer par microscopie optique (Figure 18). Il était impossible de solubiliser ces particules dans les solvants classiques (acétone, éthanol, CH_2Cl_2 , THF, DMF, DMSO). De plus, ces microsphères présentaient des propriétés de gonflement et viscoélastiques proches de celles des microsphères réticulées avec l'agent de réticulation hydrolysables ayant été incubées 60 jours dans le milieu d'hydrolyse. Dans les conditions expérimentales décrites ci-avant, limitées à six types de microsphères et ne faisant varier que le pourcentage et la nature du réticulant, les microsphères ne se sont que partiellement dégradées. D'après les travaux de Gramain et Frère [Gramain and Frère 1986, Frère et al. 1992], la réaction de réticulation se produisant avec le monomère de PEGMMA, cette réaction ne peut pas être évitée. Cependant, les auteurs de ces travaux montrent que certaines conditions expérimentales de polymérisation permettent d'en limiter l'importance.

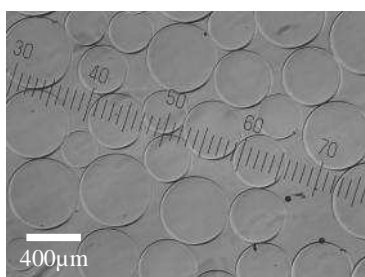

Figure 18. Microsphères obtenues seulement avec 100% du monomère PEGMMA Mw.300 observées par microscopie optique en suspension dans de l'eau. L'échelle = 400 µm.

Bibliographie

Agrawal C M, Niederauer G G, Athanasiou K A. (1995) Fabrication and Characterization of PLA-PGA Orthopedic Implants. *Tissue Engineering* 1(3) : 241-252.

Athanasiou K.A., Agrawal C.M., Barber F.A. and Burkhart S.S. (1998). □Orthopaedic applications for PLA-PGA biodegradable polymers.□ *Arthroscopy: The Journal of Arthroscopic and Related Surgery* 14 (7) : 726-737.

Cutright D.E., Beasley J.D. and Perez B. (1971). □Histologic comparison of polylactic and polyglycolic acid sutures.□*Oral Surgery, Oral Medicine, Oral Pathology.* 32(1) : 165-173.

Frère Y, Guilbert Y, Gramain P. (1992). □Gel effect and subsequent degradation process in radical polymerisation of poly(ethylene oxide) acrylate and methacrylate macromers.□*New Polymeric Mater.* 3:175-186.

Gramain P, Frère Y. (1986). □Preparation of monomethoxy- poly(ethylene oxide) acrylate and methacrylate and its polymerisation: self gelling polymers.□*Polymer Comm.* 27:16-18.

Hu, X.; Zhou, J.; Zhang, N.; Tan, H.; Gao, C. (2008). □Preparation and properties of an injectable scaffold of poly(lactic-co-glycolic acid) microparticles/chitosan hydrogel.□*J Mech Behav Biomed Mater.* 1: 352-359.

Kumachev, A.; Greener, J.; Tumarkin, E.; Eiser, E.; Zandstra, P. W.; Kumacheva, E. (2011). □High-throughput generation of hydrogel microbeads with varying elasticity for cell encapsulation.□*Biomaterials* 32 : 1477-1483.

Maurus P.B. and Kaeding C. C. (2004). □Bioabsorbable implant material review.□*Operative Techniques in Sports Medicine*12 (3): 158-160.

Miller R.A., Brady J.M., Cutright D. E. (1977). □Degradation rates of oral resorbable implants (polylactates and polyglycolates): Rate modification with changes in PLA/PGA copolymer ratios.□*Journal of Biomedical Materials Research* 11(5) : 711 □719.

Conclusion générale et perspectives

Les travaux réalisés dans le cadre de cette thèse ont permis de développer des nouveaux matériaux d'embolisation sous forme de microsphères d'hydrogel résorbables dont nous avons caractérisé les propriétés de dégradation et le potentiel pour être appliquées dans des techniques d'embolisation *in vivo*. Au cours de ce travail, plusieurs voies de synthèse ont été explorées et plusieurs méthodes de caractérisation ont été mises en œuvre permettant l'évaluation des propriétés initiales ainsi que la dégradation du matériau composant les microsphères. Nous avons également participé à des études de chargement en principes actifs par simple absorption ou par liaison covalente aux microsphères. Une preuve de concept de l'applicabilité de ces matériaux dans des conditions d'embolisation a été apportée au cours d'un essai réalisé *in vivo* chez la brebis.

Ces travaux ouvrent des perspectives intéressantes pour la conception de matériaux d'embolisation temporaire. Les paramètres influençant les vitesses de dégradation des hydrogels ont été identifiés, ce qui permettra d'ajuster les compositions des hydrogels en fonction des caractéristiques de dégradation des microsphères recherchées. Les méthodes de caractérisation développées pour étudier la dégradation sont simples à mettre en œuvre, rapides et précises.

A l'issue de ce travail, il subsiste un problème à résoudre qui est apparu au cours des études de dégradation des microsphères. En effet, dans les conditions expérimentales particulières décrites ci-avant, les microsphères ne se dégradaient que partiellement même après deux mois d'incubation dans un milieu propice à l'hydrolyse de l'hydrogel. D'après la littérature, la formation de ponts de réticulation non dégradables dans l'hydrogel a pour origine la polymérisation du PEGMMA et son ampleur peut être modulée par les conditions de polymérisation. Plusieurs solutions sont envisageables. Dans la poursuite de ce travail, une optimisation des conditions de polymérisation s'avère donc nécessaire pour réduire la

formation de ces ponts de réticulation et permettre d'obtenir des microsphères totalement dégradables pour les utiliser comme matériaux d'embolisation temporaire dans des applications thérapeutiques chez l'homme.

L'embolisation thérapeutique est devenu le traitement de choix pour l'hémorragie, les malformations artériovéneuses ou certains types de cancer. Parmi différents agents d'embolisation, les microsphères non dégradables (Embozene[®], Bead Block[™],...) sont les plus utilisées. Leur forme bien sphérique et leur taille calibrée permettent un meilleur ciblage dans les vaisseaux et une bonne qualité de l'occlusion. Dans certains cas cliniques, l'embolisation temporaire, envisageable avec l'utilisation des microsphères résorbables peut être bénéfique pour les patients. Le but du travail réalisé au cours de cette thèse a été le développement de microsphères résorbables satisfaisant les différents critères pour être employées comme matériaux d'embolisation (taille calibrée, biocompatibles, élastique pour être injectée au travers des cathéters mais suffisamment rigide pour résister à la pression sanguine). Dans cet objectif, nous avons développé une méthode de synthèse de microsphères constituées d'hydrogels hydrolysables par polymérisation en suspension. Une large gamme de microsphères ont été synthétisées en modulant la nature du réticulant et/ou la composition des milieux de polymérisation. Les expériences *in vitro* ont démontré que les microsphères obtenues sont satisfaisantes pour permettre leur injection au travers des cathéters. La dégradation rapide des ponts de réticulation a été confirmée à travers la diminution du module élastique G' et du pH du surnageant, accompagnée d'une augmentation du taux de gonflement.

Malgré une dégradation partielle des microsphères (due à une réaction secondaire formant des liaisons de réticulation non dégradables), le temps de l'hydrolyse a répondu parfaitement au cahier de charges (entre 7 et 49 jours). Des études complémentaires pour optimiser la réaction de polymérisation vont permettre le développement de microsphères totalement dégradables.

◆ Mots clés : hydrogel, microsphère, polymérisation en suspension, réticulation, PLGA, dégradation, embolisation, élasticité.

Therapeutic embolization is nowadays a first line treatment for haemorrhage, arteriovenous malformation or tumors. Among different embolization agents, non degradable microspheres (Embozene[®], Bead Block[™],...) are the most employed thanks to their well calibrated spherical shape which allows good occlusion. In some cases including treatment of uterine fibroids or chemo-sensitive tumors, it may be interesting to achieve a temporary embolization to avoid definitive destruction of the tissue. Temporary embolization would be possible using biodegradable microspheres. The aim of our work was to develop degradable microspheres having all required characteristics to be used as embolization material (well calibrated in size, biocompatible, rigid enough to resist blood pressure but elastic enough to remain intact during injection through catheter). To this purpose, we have developed hydrolysable hydrogel based microspheres by suspension polymerization. A wide range of microspheres was synthesized by varying the type of crosslinker and composition of the polymerization medium. In vitro test showed that the microspheres have suitable characteristics to pass through catheter. Degradation studies revealed a rapid diminution of G' modulus and the pH of the supernatants, accompanied by an increase of swelling ratio due to the hydrolysis of the crosslinkings. Although microspheres were not totally degradable as expected (since a side reaction had created non degradable crosslinking during the polymerisation), characterisations showed promising results that the degradation did occur within a suitable time scale requirements for temporal embolization.

◆ Keywords: hydrogel, microsphere, suspension polymerization, crosslink, degradable, embolisation, elasticity.

◆ Laboratoire de rattachement : Physico-chimie, Pharmacotechnie et Biopharmacie UMR CNRS 8612

PÔLE : PHARMACOTECHNIE ET PHYSICO-CHIMIE PHARMACEUTIQUE

UNIVERSITÉ PARIS-SUD 11

UFR «FACULTÉ DE PHARMACIE DE CHATENAY-MALABRY »

5, rue Jean Baptiste Clément

92296 CHÂTENAY-MALABRY Cedex