

*Soutenance de thèse*

**Alexandre Delga**



**Du phénomène quantique au dispositif macroscopique,  
transport électronique dans les détecteurs inter-sousbandes**

***Jury***

*Vincent Berger*

*Mathieu Carras*

*Philippe Christol*

*Laetitia Doyennette*

*Jean-Yves Duboz*

*Robson Ferreira*

*Emmanuel Rosencher*

*Angela Vasanelli*

*Virginie Trinité*

*Directeur de thèse*

*Encadrant*

*Rapporteur*

*Invitée*

*Rapporteur*

*Examineur*

*Président*

*Examinatrice*

*Invitée*

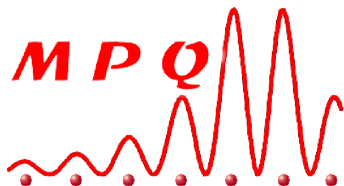

# Infrared

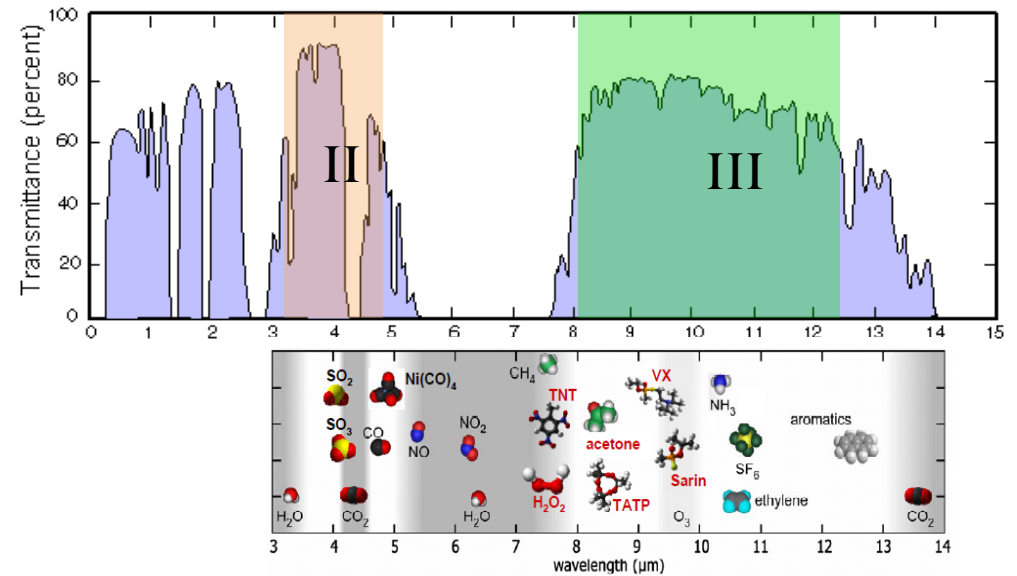
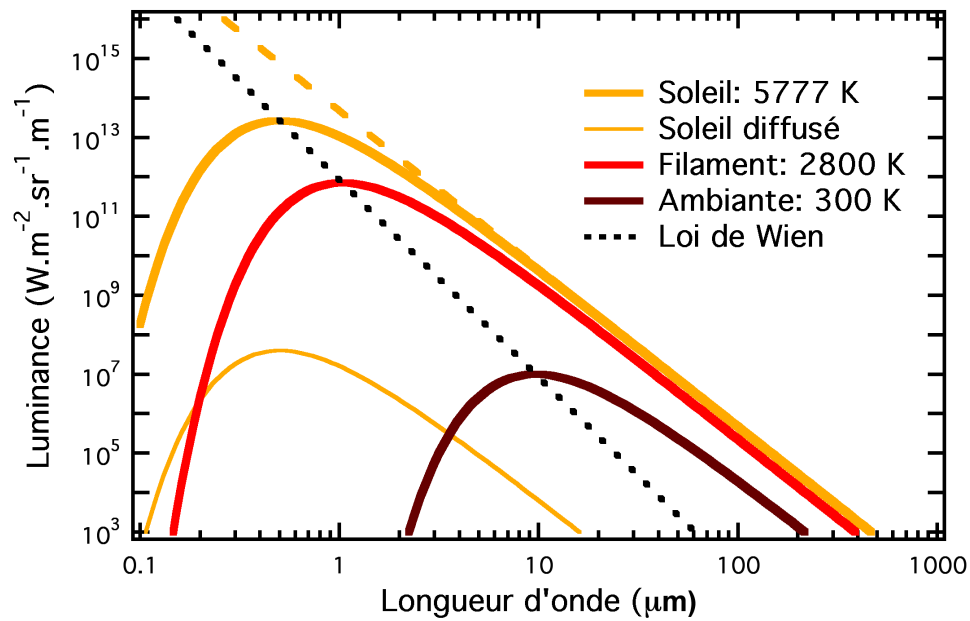
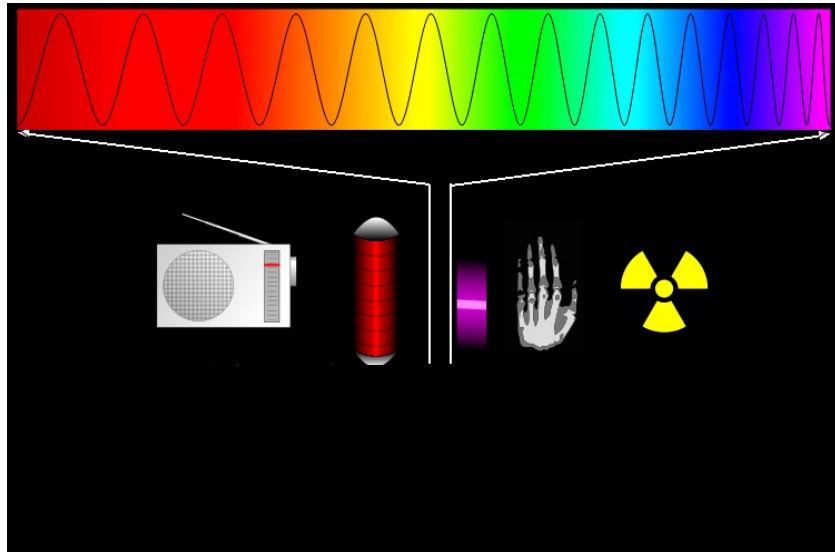

# Technological motivations

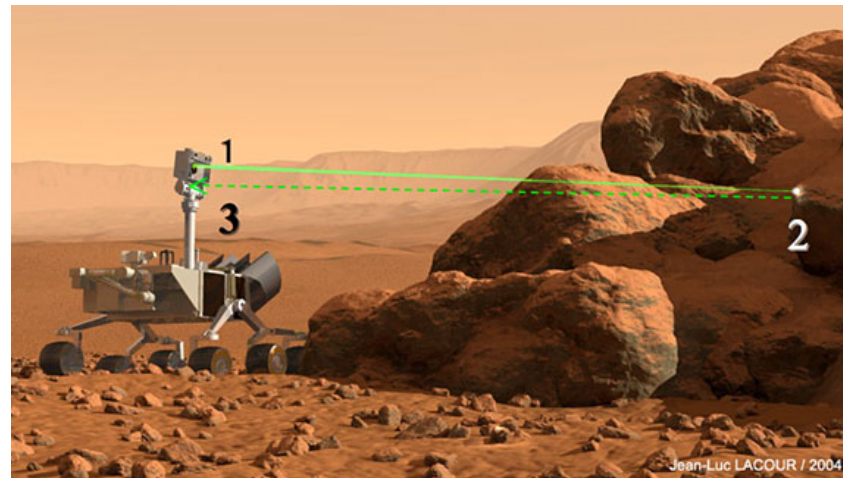
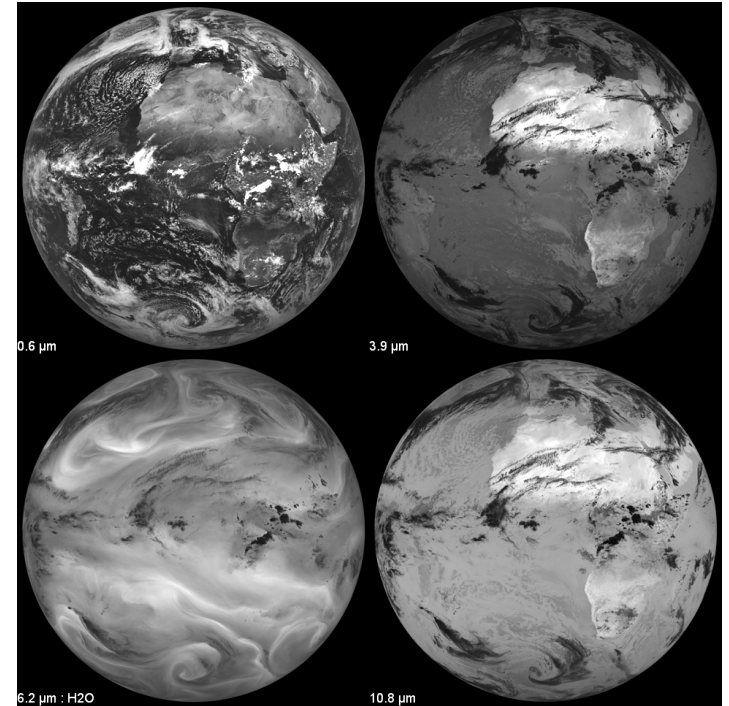

# Detection System

Photonics

Electronics

Active Layers



Catherine XP

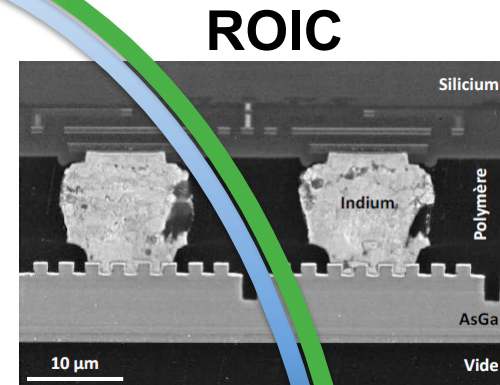
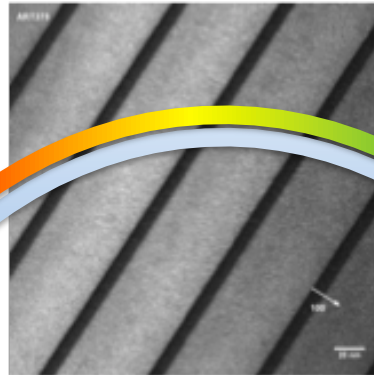
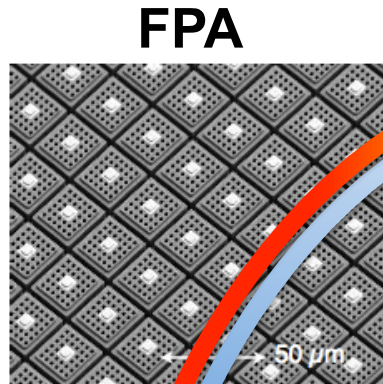

Optics



Scene



Cryogenics

A/D

Physics

Engineering

# State of the art

## Quantum Detectors

Thermal detectors

$h\nu \rightarrow \text{heat} \rightarrow e^-$   
**Cheap, Room T**  
**Limited Perf, slow**

**3D**

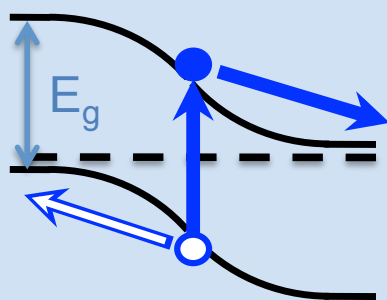

InSb, InGaAs

**Maturity**  
**Sensitivity**  
**Spectral Range**

**MCT**

**Maturity, HOT**  
**Sensitivity**  
**Stability**  
**Uniformity**

**quasi-3D**

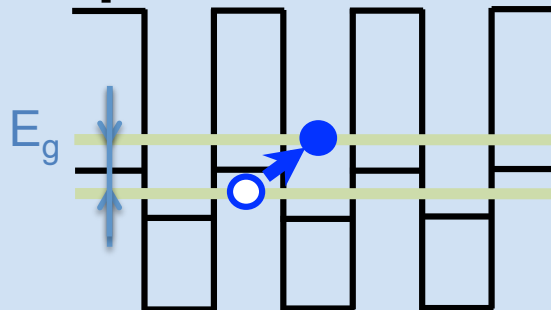

Type II Superlattices

**Sensitivity**  
**Tunability, HOT**  
**Technological issues**

**1D** Nanowires  
 Nanotubes

**2D**

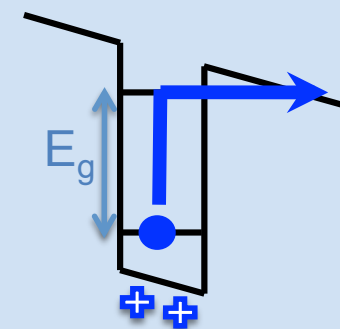

QWIP, QCD

**Speed**  
**Stability**  
**Maturity**  
**Sensitivity**

**0D** QDIPs  
 DWELLs

# Quantum Wells Detectors: QWIP

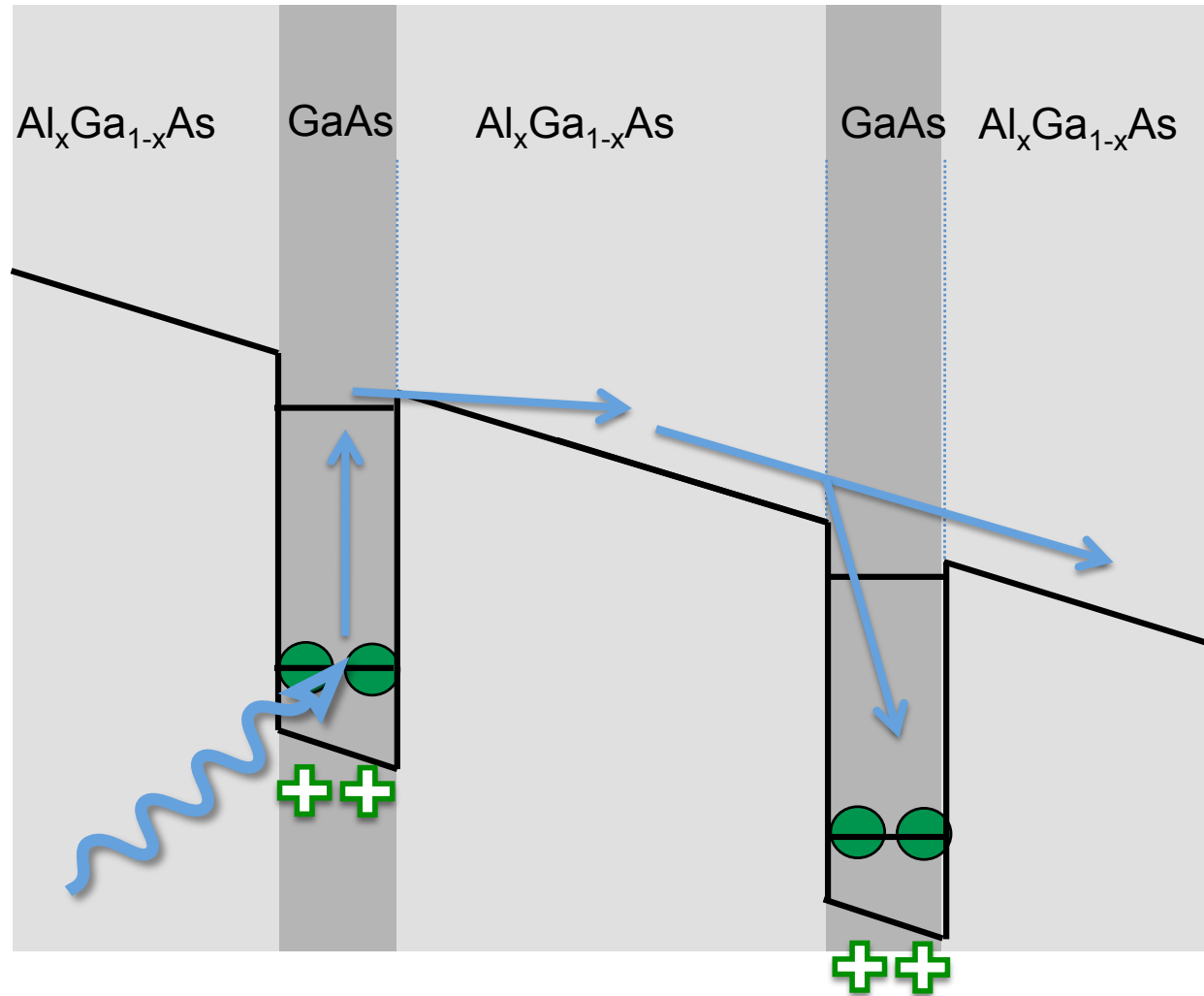
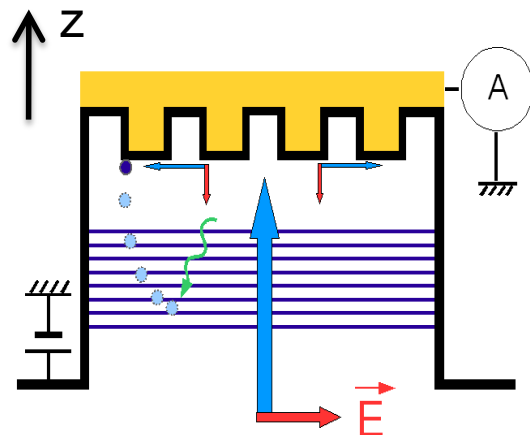
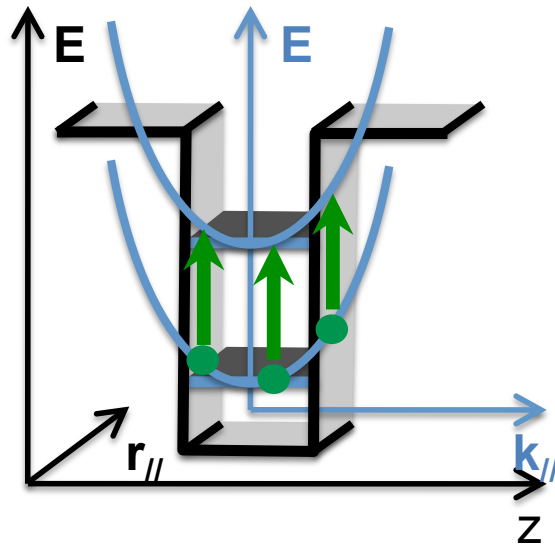

# Quantum Wells Detectors: QCD

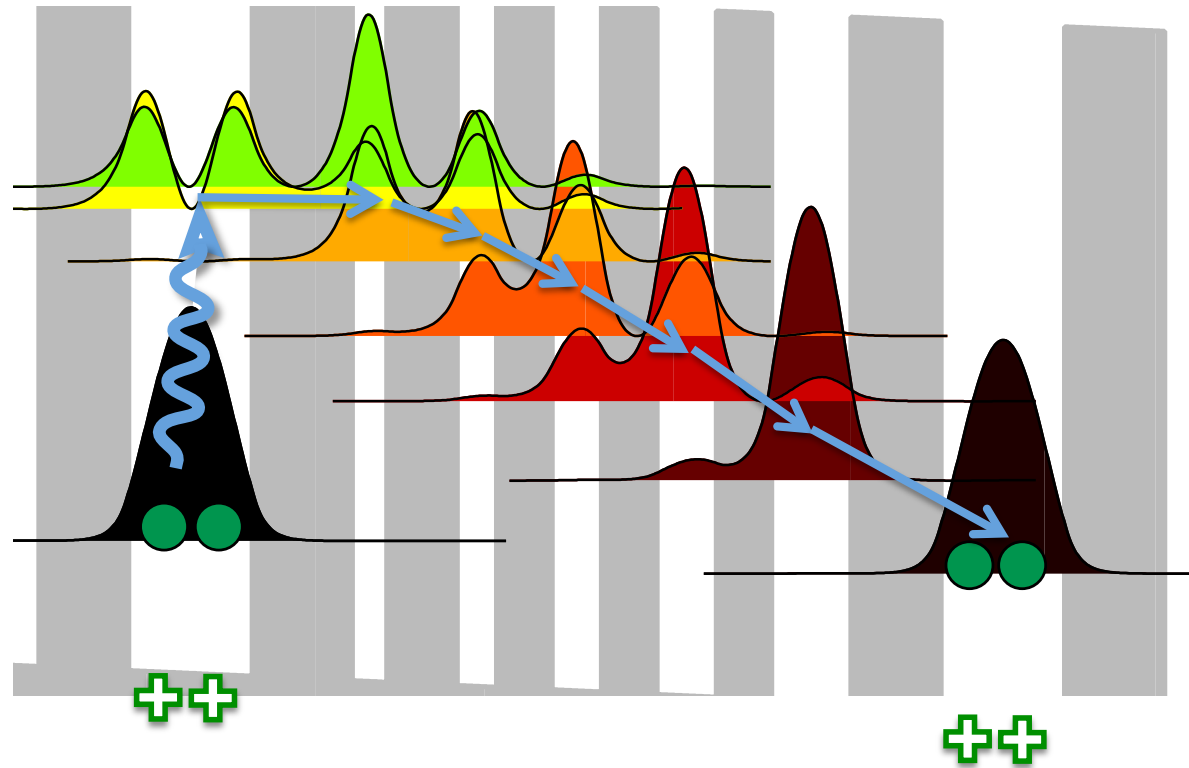
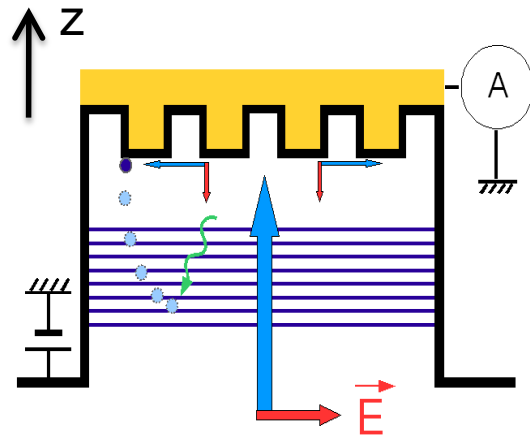
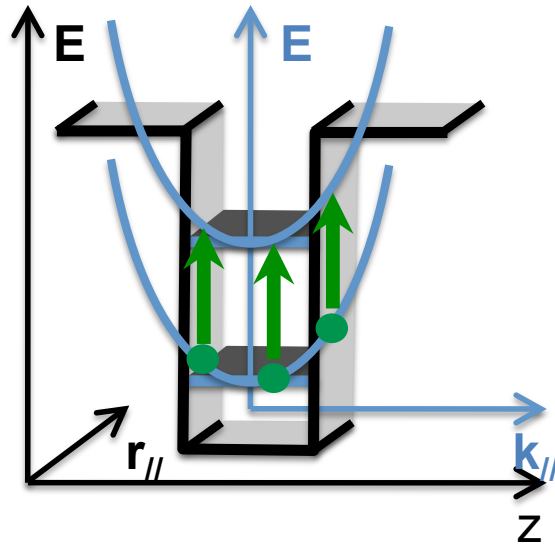

# From microscopic to macroscopic

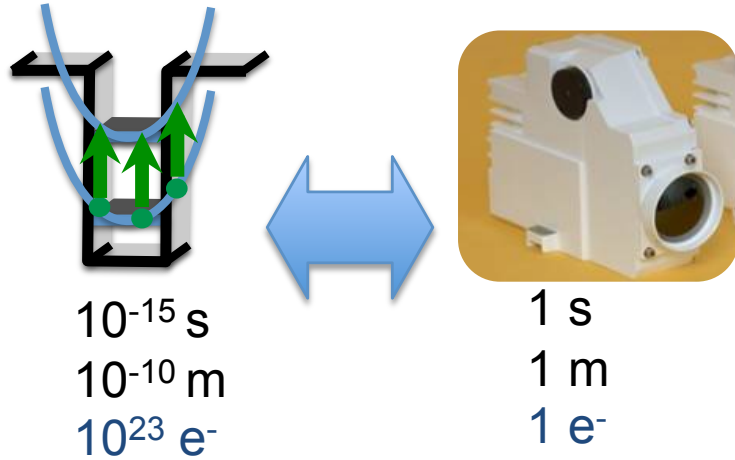

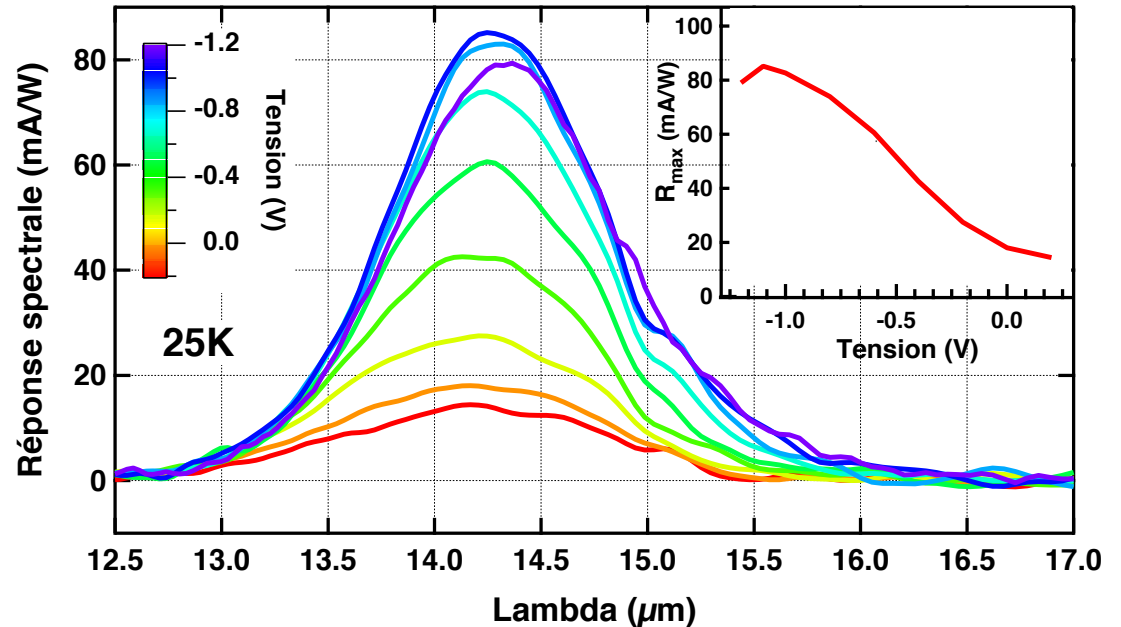
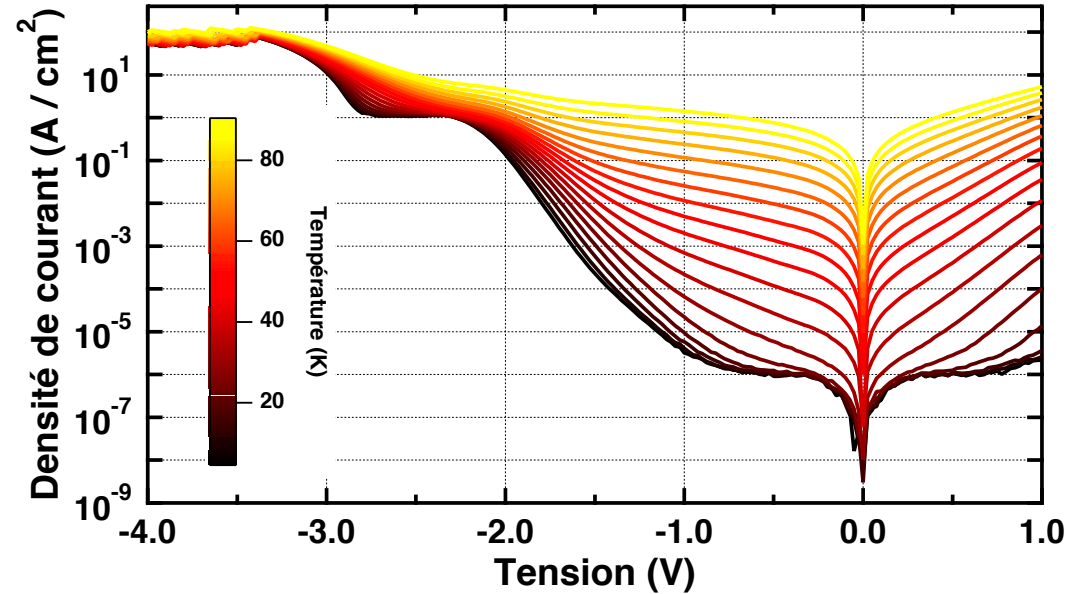

- Introduction
- Signal
- Noise
- Perspectives





# Transport models hierarchy

$$\rho_{ij} \Rightarrow \tau_{ij}$$

$$\vec{k} \Rightarrow n, p, w, T_e$$

$$p, w \Rightarrow \mu, D$$

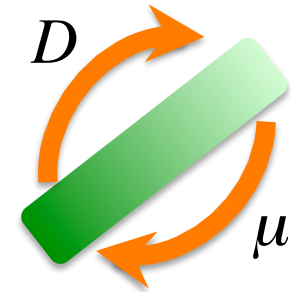
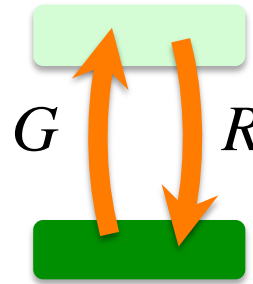
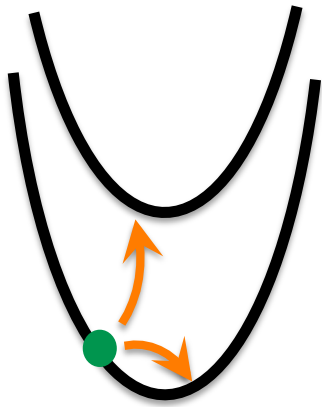

**Density matrix**  
Coherences

**Boltzmann equation**  
Diffusions

**Hydrodynamics**  
Local equilibrium

**Drift-diffusion**  
Global equilibrium

**z ?**

**Intra-subband thermalisation**

$$\tau_z \gg \tau_{||}$$

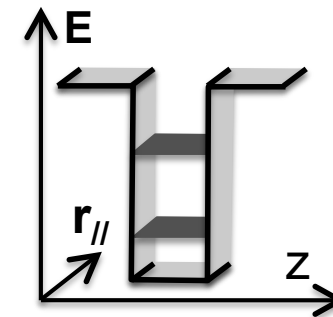

# Hamiltonian

$$H_z = \underbrace{\frac{p_z^2}{2m^*}}_{\text{Kinetic Energy}} + \underbrace{H_{het}}_{\text{Heterostructure Potential}} + \underbrace{eFz}_{\text{Electric Field}}$$

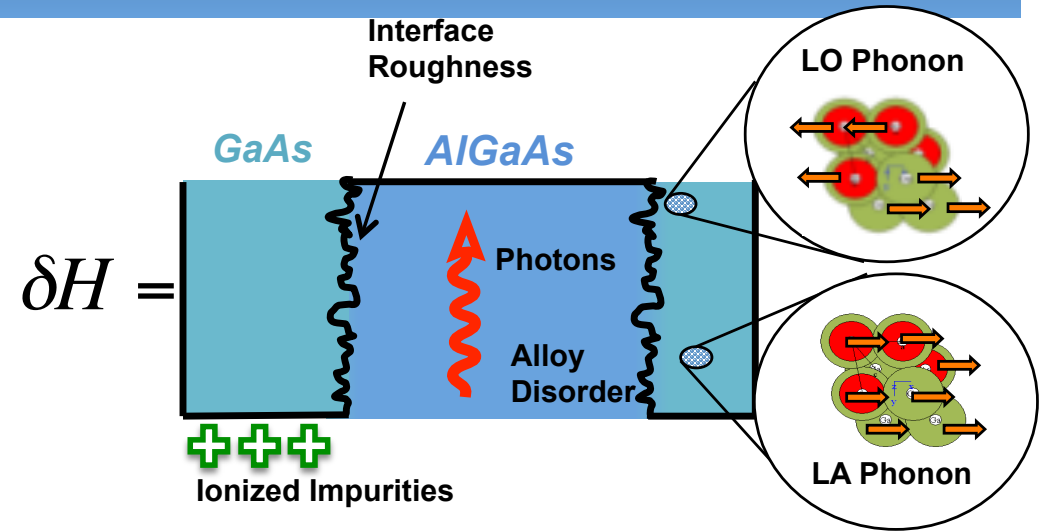
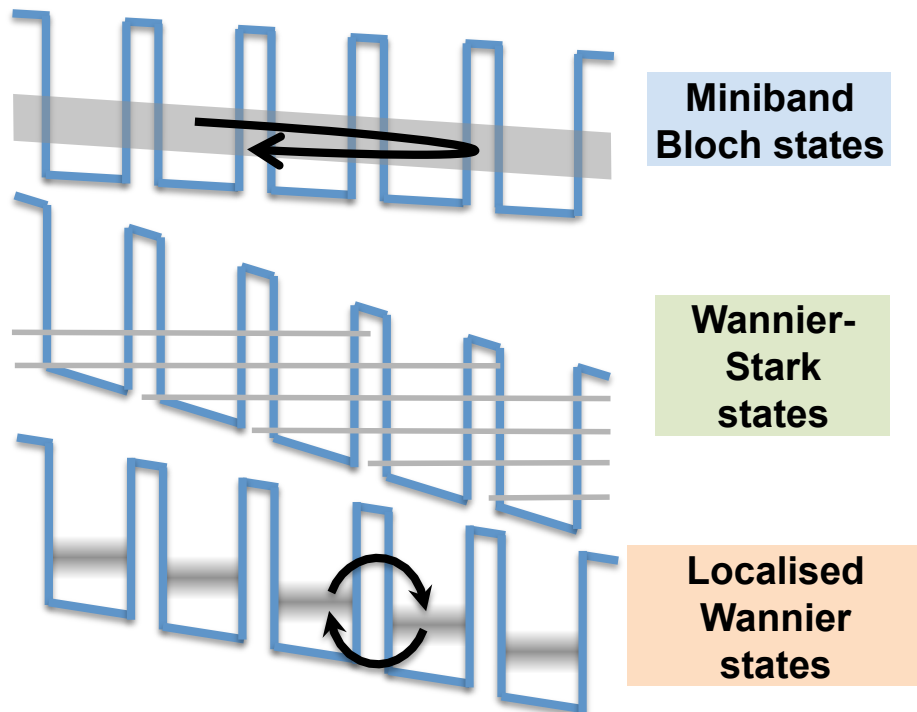

$$\delta H =$$

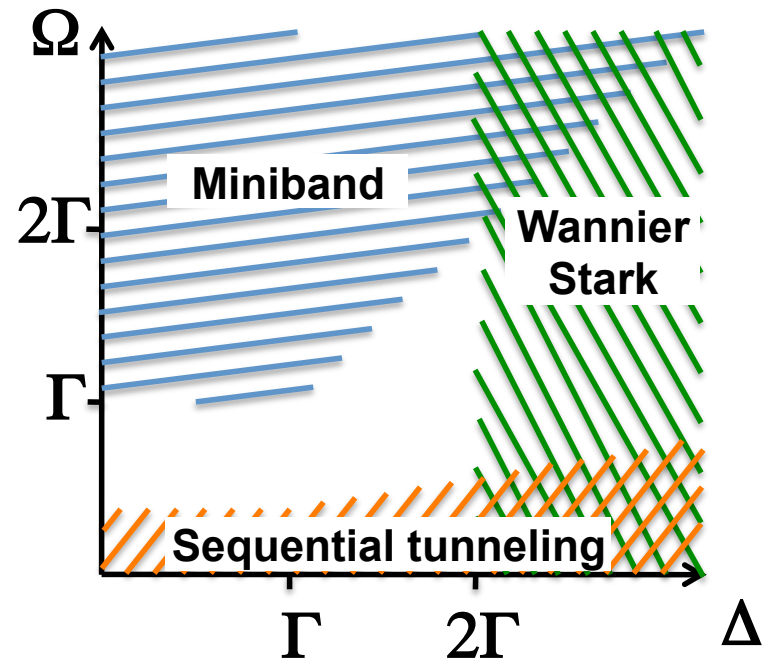

# Wannier-Stark hopping: states

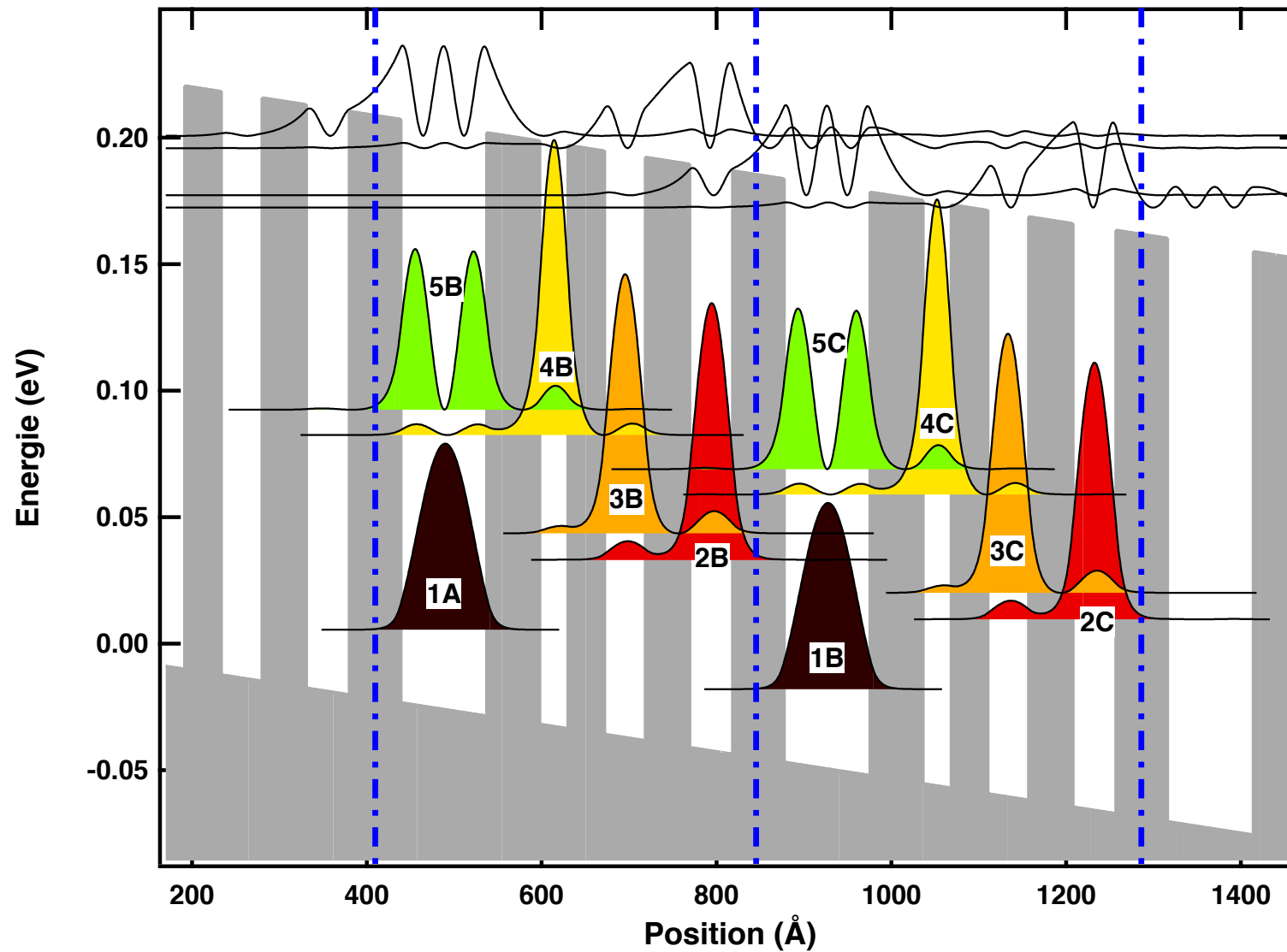

# W-S hopping: diffusion

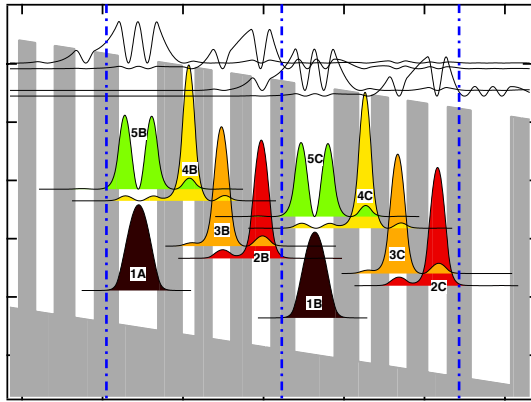

Inter-subband scattering

$$\frac{dn_i}{dt} = -\frac{n_i}{\tau_i} + \sum_{j \neq i} \frac{n_j}{\tau_{ji}}$$

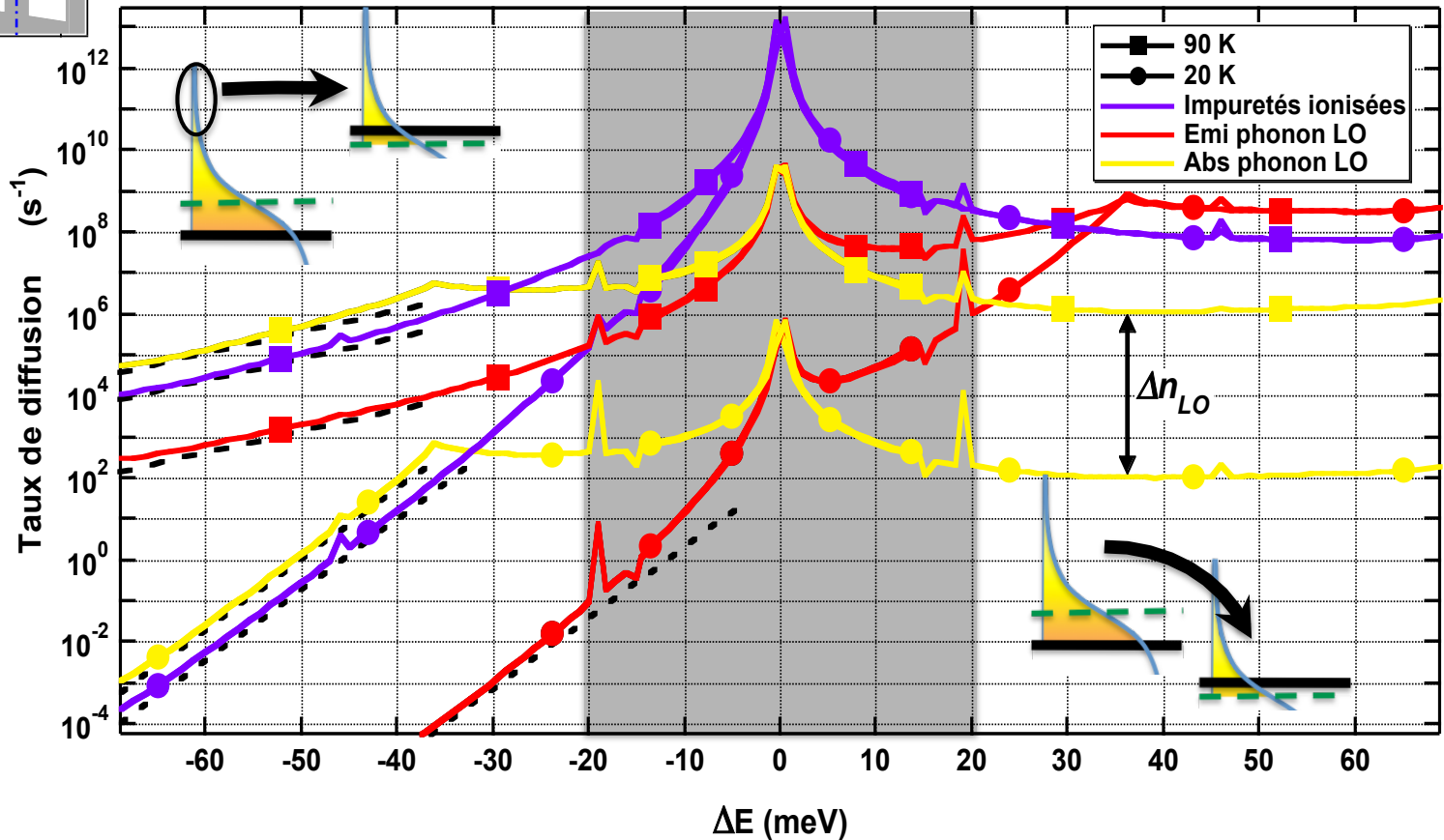
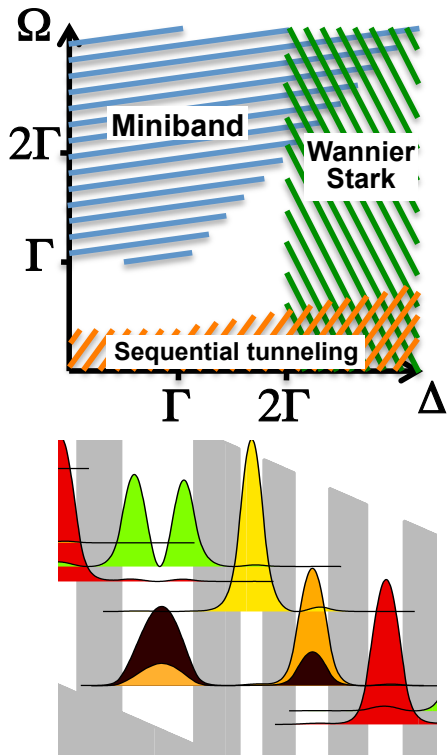
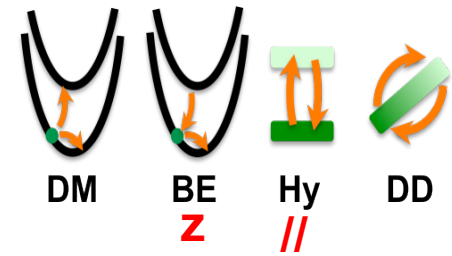

# W-S hopping: current

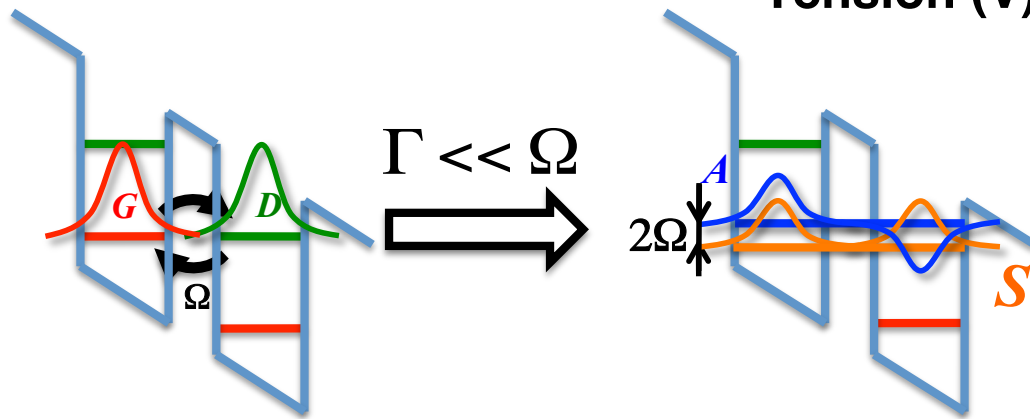
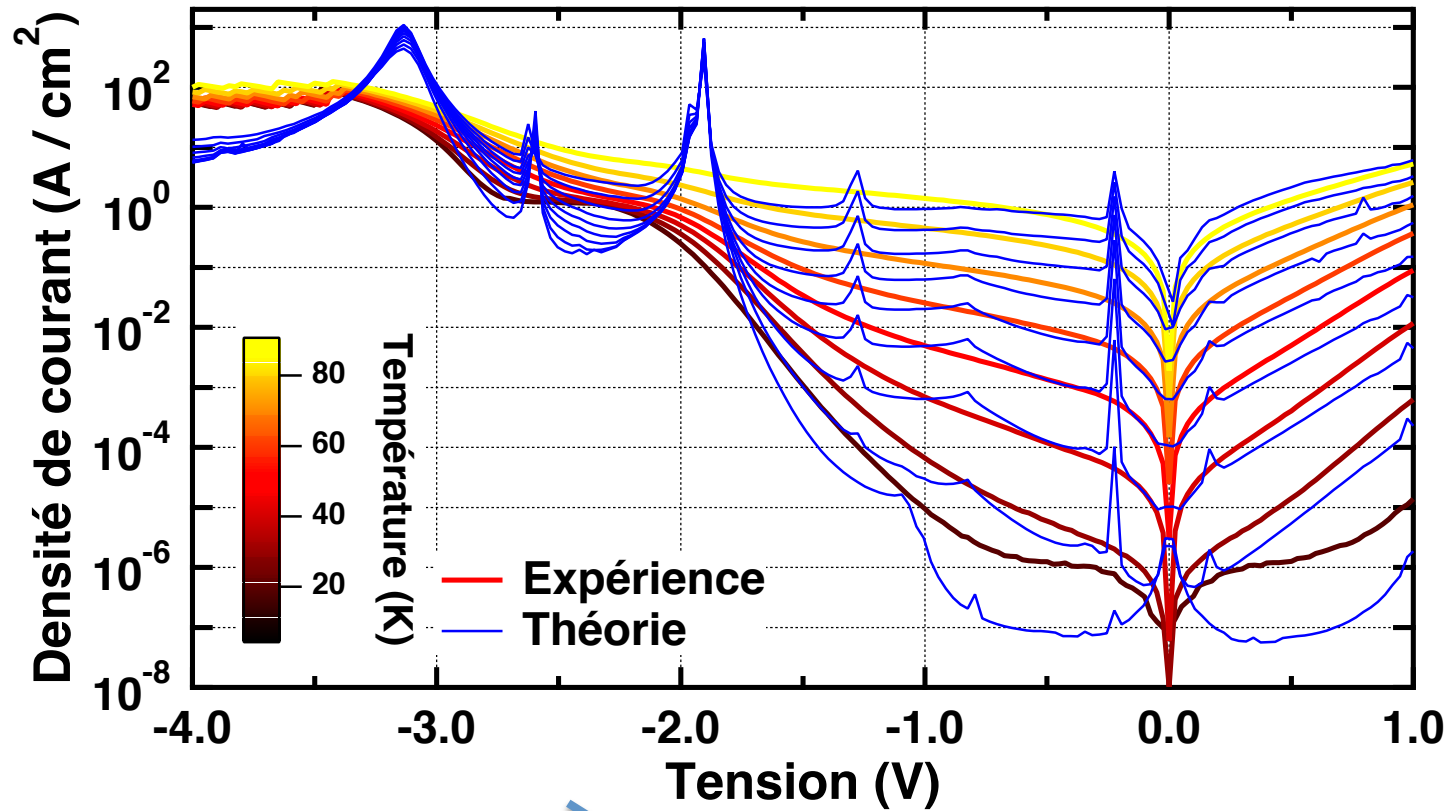

$$\Gamma \approx 1 - 10 \text{ meV}$$

$$\Omega \approx 1 - 5 \text{ meV}$$

*shielded when  $2\Gamma < \Delta$*

# W-S hopping: responsivity

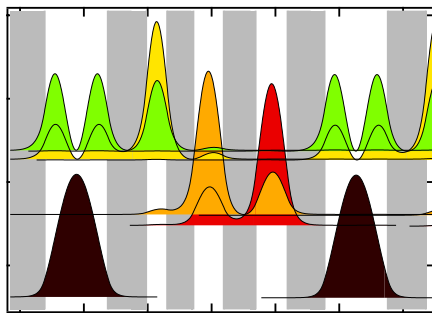
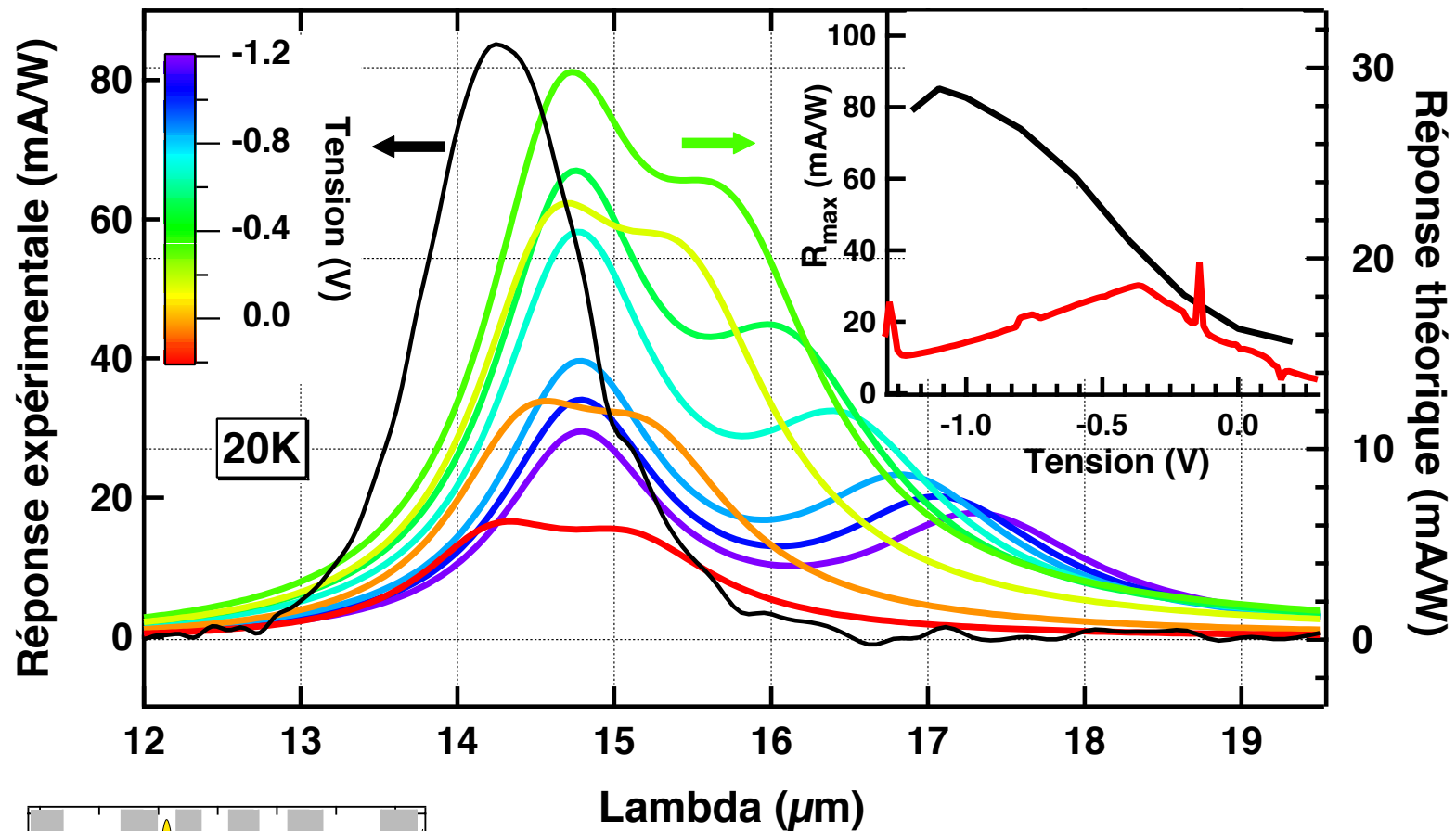

- No sense of absolute value
- Bad spectral shape
- Bad behavior with bias

# Hybrid model: principle

- **2<sup>nd</sup> order tunneling and absorption between *pairs of localized states***
  - Generalization of Kazarinov and Suris formalism with energy conserved
  - Induces an effective “*tunnel diffusion time*”
  - Rabi coupling calculated as 1<sup>st</sup> order perturbation

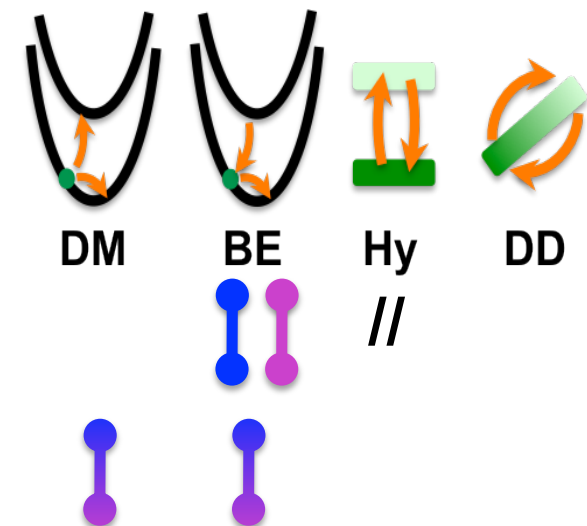
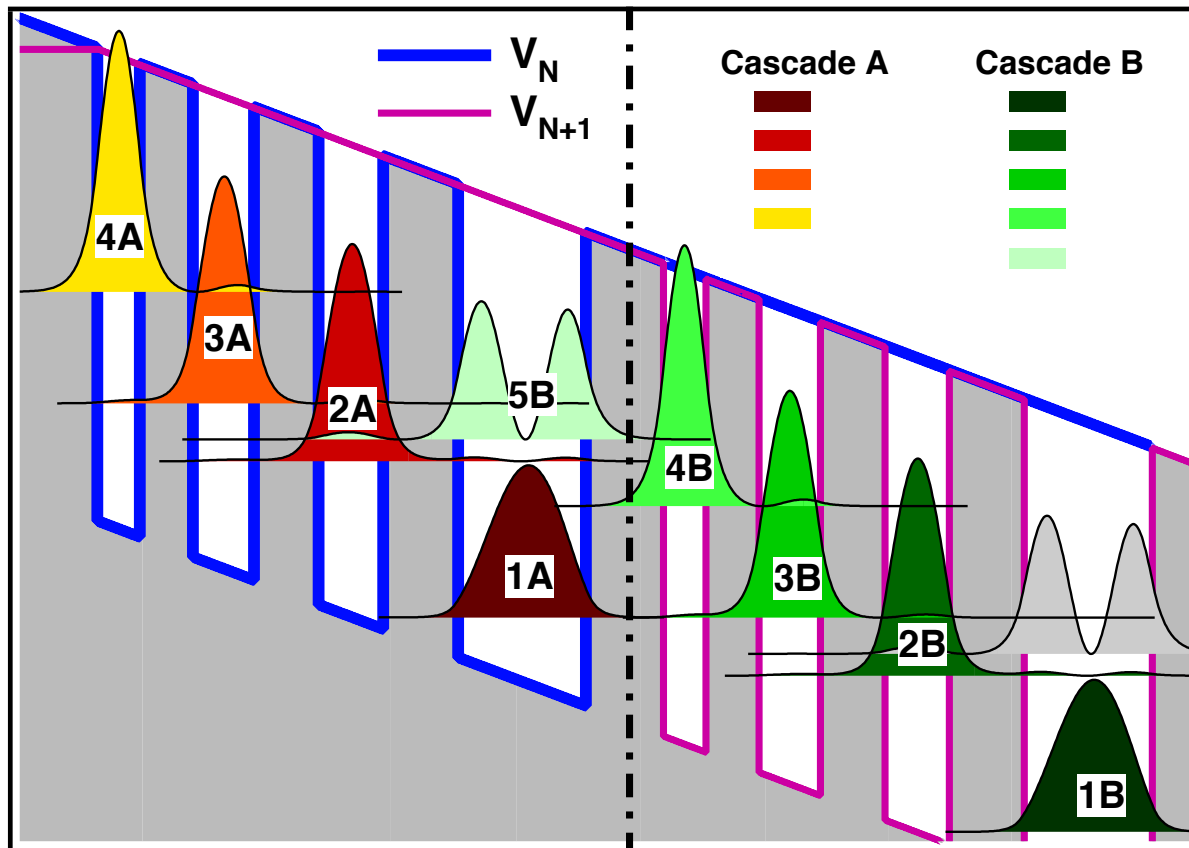

# Hybrid model: results

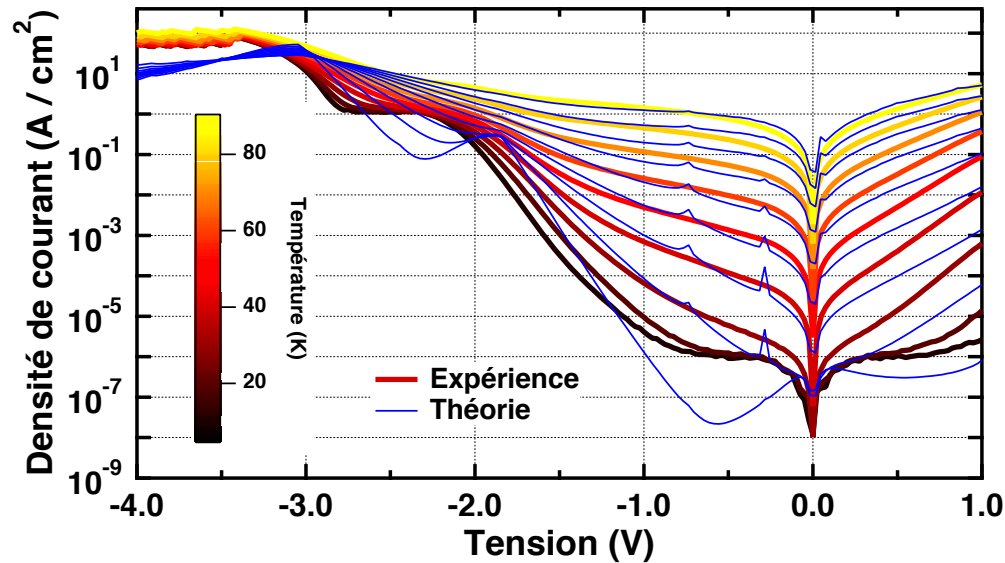

Wannier Stark hopping

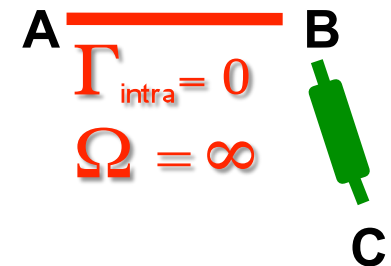

Sequential tunneling

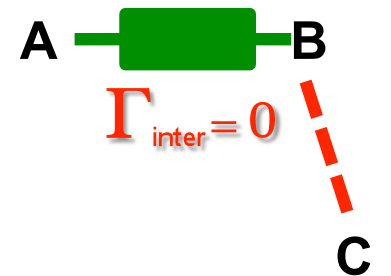

Hybrid Model

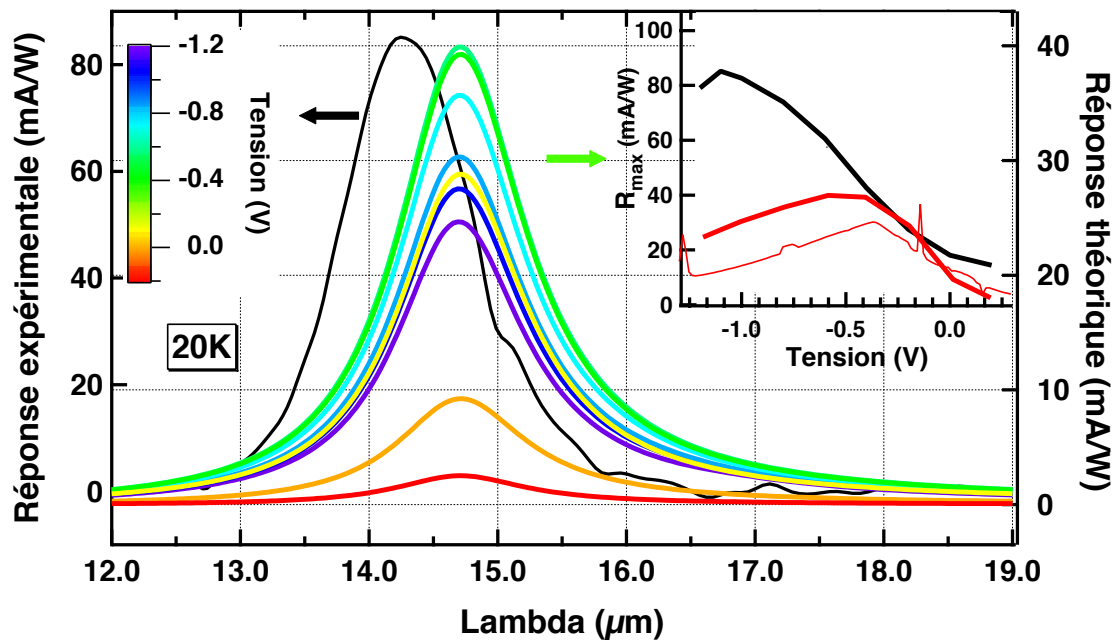
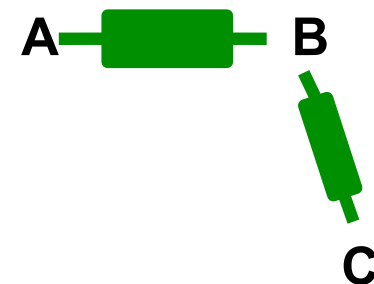



# From microscopic to macroscopic

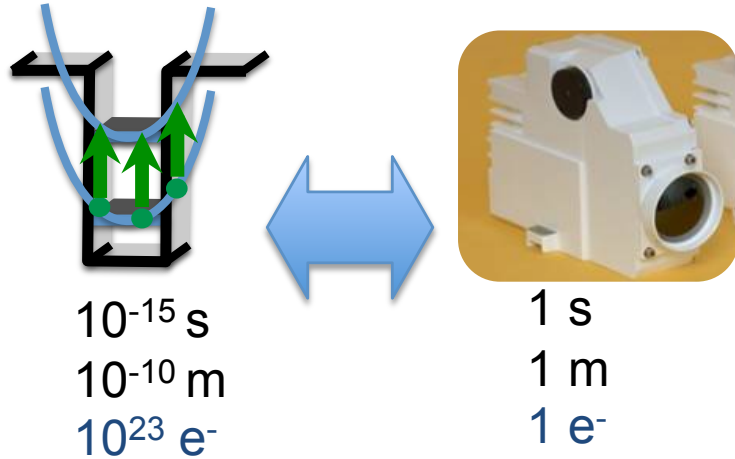

- Introduction
- Signal
- Noise
- Perspectives

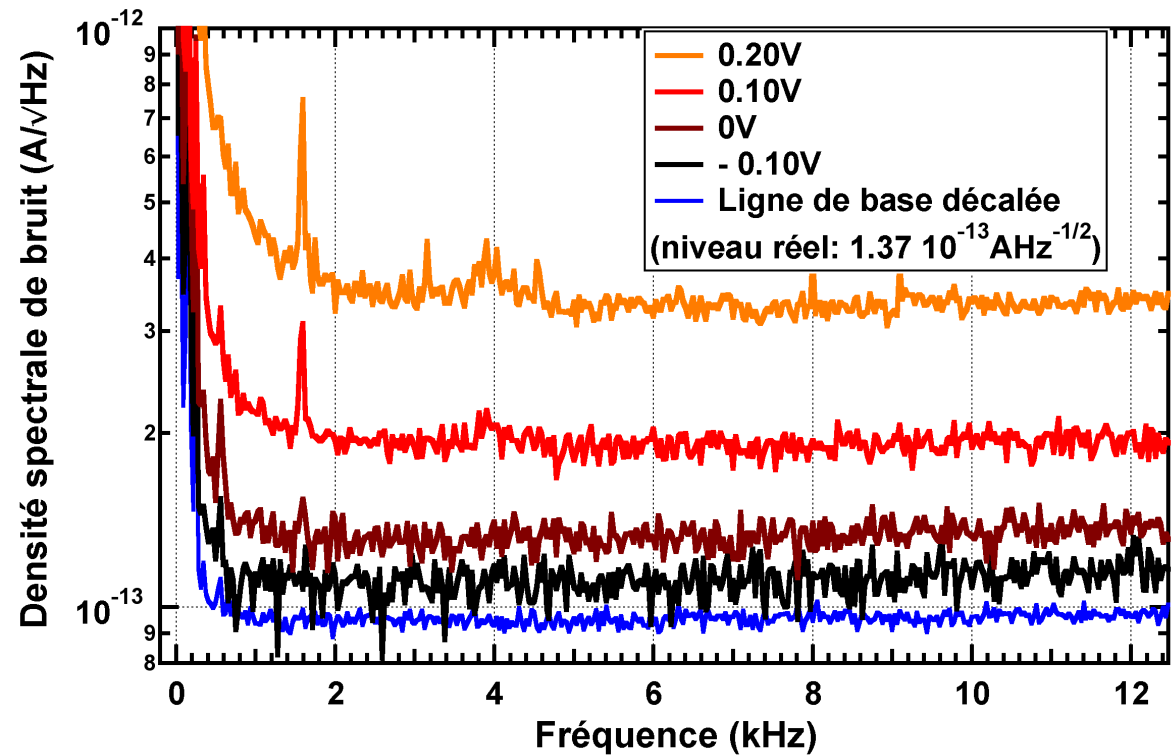

# Noise in QWIPs: issues

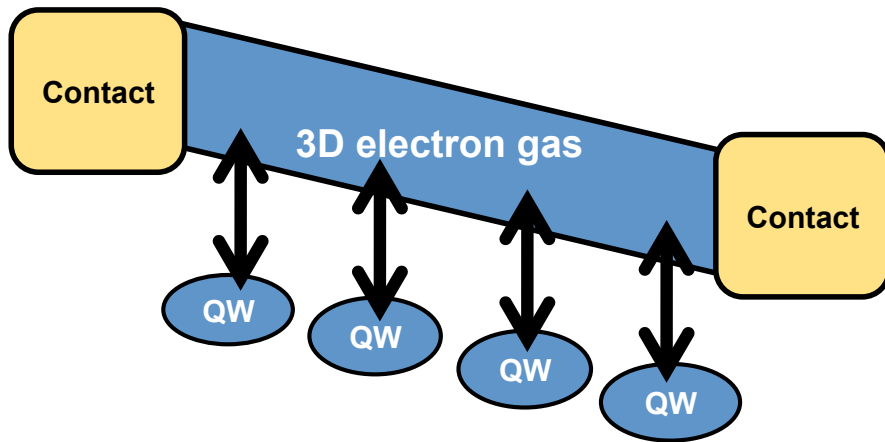

- Gain and capture probability derivation
- Static or dynamic resistance?
- Macro independence without micro
- Adequate transport model & scale?

$$I = env$$

$$S_I = 4egI + \frac{4k_B T}{R}$$

“Excess” shot noise      Johnson noise

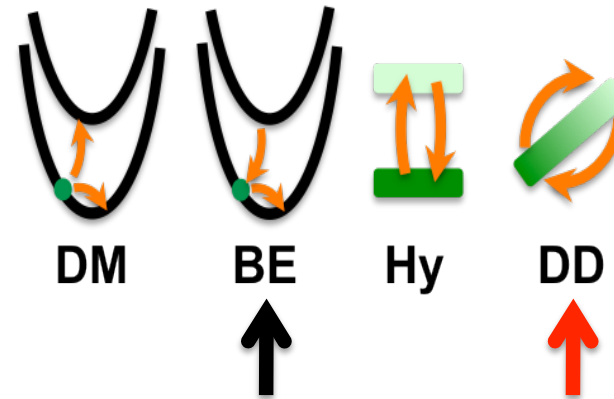

Johnson << Shot & gain adjustable

Noise: measured quantity

# Near equilibrium?

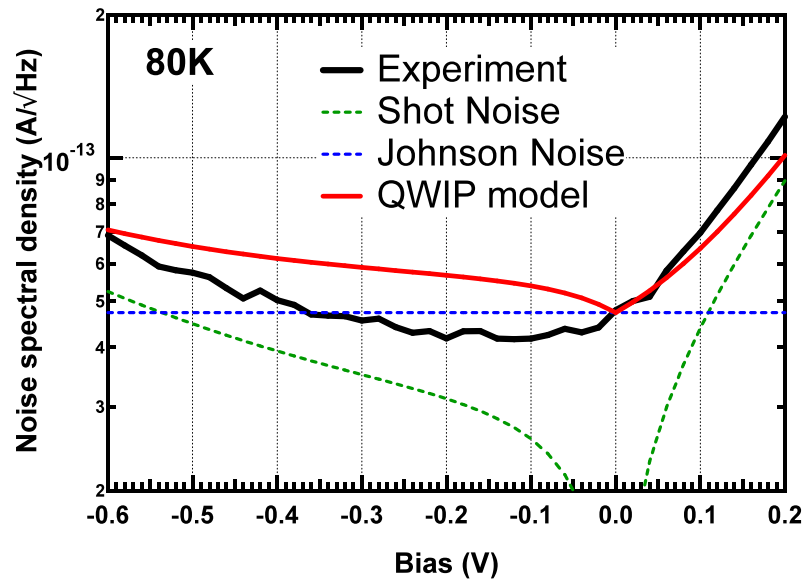

$$S_I = 4e g I + \frac{4k_B T}{R}$$

R. Landauer PRB 47, 16427 (1993)

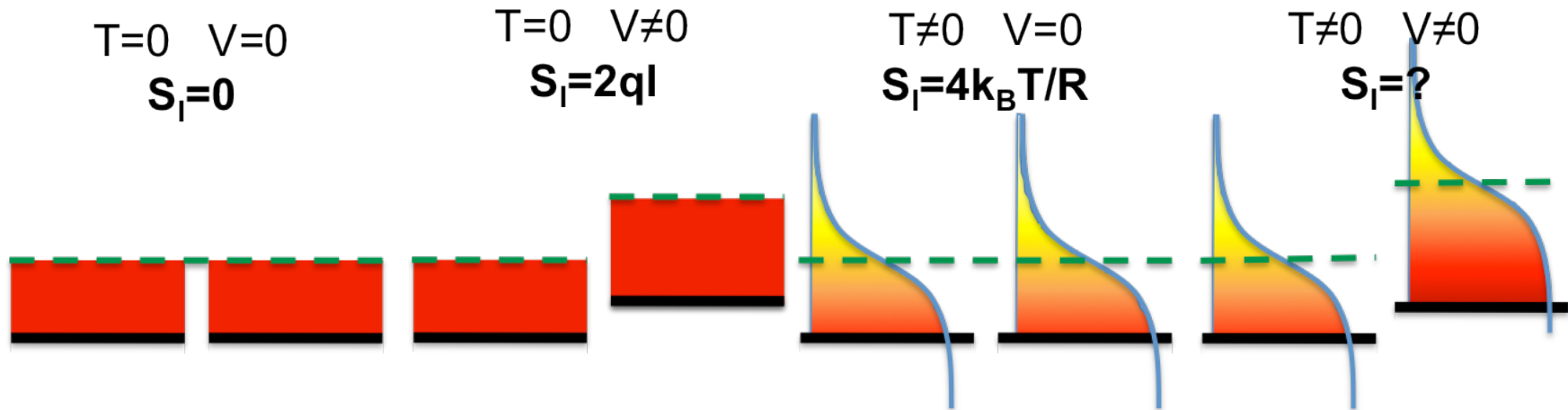

# Reintroduce fluctuation: master equation

## Intersubband scattering

$$\frac{dn_i}{dt} = -\frac{n_i}{\tau_i} + \sum_{j \neq i} \frac{n_j}{\tau_{ji}}$$

$$0 = L\underline{n}$$

$$\underline{n} = (n_1, n_2, n_3, n_4, n_5)$$

## Stochastic process

$$p(\underline{n}, t)$$

## Intrasubband relaxation

→ Markov process

$$\frac{dp(\underline{n}, t)}{dt} = -\Gamma_{\underline{n}} p(\underline{n}, t) + \int d\underline{n}' w_{\underline{n}', \underline{n}} p(\underline{n}', t)$$

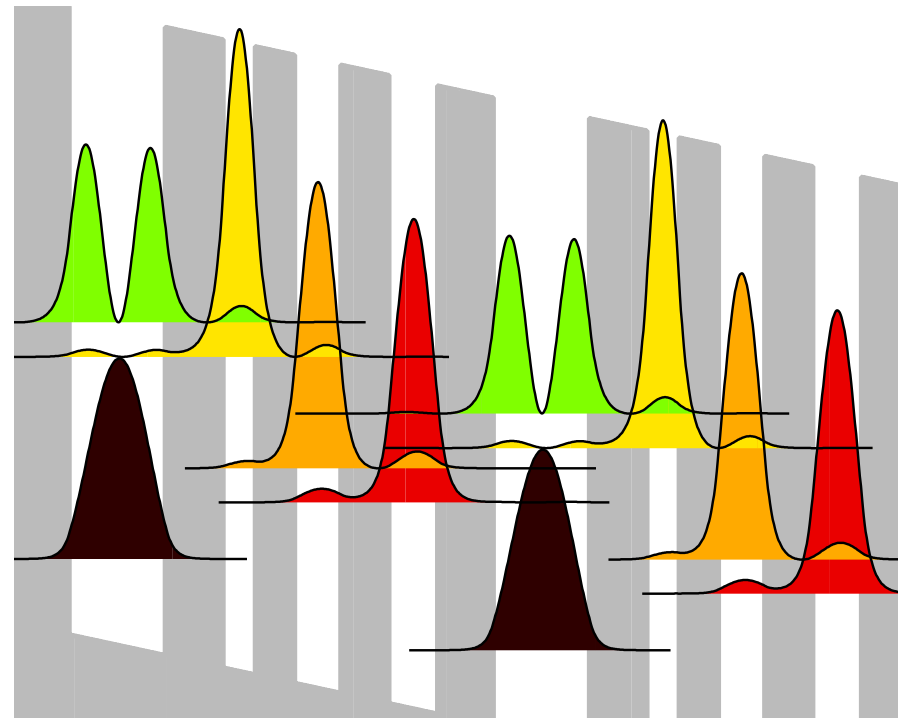

1<sup>st</sup> moment : mean values  
signal

2<sup>nd</sup> moment : correlations  
noise

# Micro-macro link: Ramo-Shockley theorem

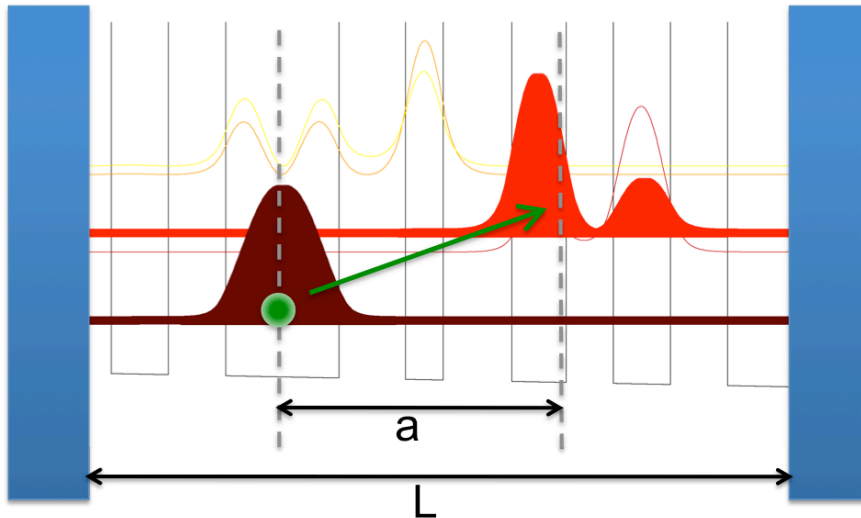

**Current = sum of hops**

**Noise = hop correlations**  $\longrightarrow$

**Population correlations**

$$S_I(\omega) = 2e^2 \sum_{i,j,k,l} \alpha_{ij} \alpha_{kl} \langle w_{kl} \rangle_0 \left[ \delta_{ij,kl} - \Gamma_{ij} \sum_s M_{is}(\omega) \left( \frac{\langle n_s \rangle_0}{N} - \delta_{ls} \right) \right]$$

Grandissement factor
Microscopic source
Conservation of carriers

# Results

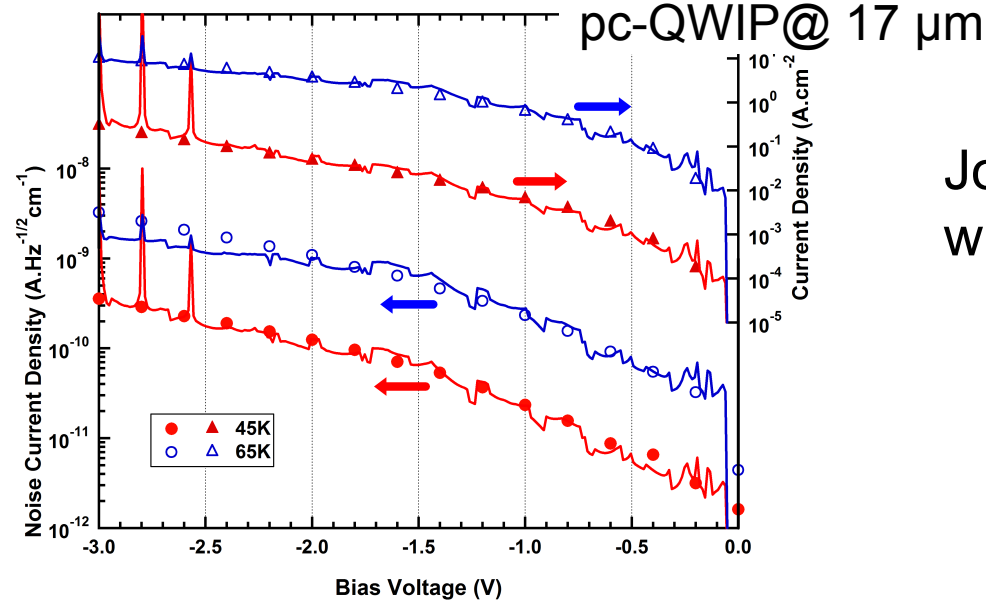
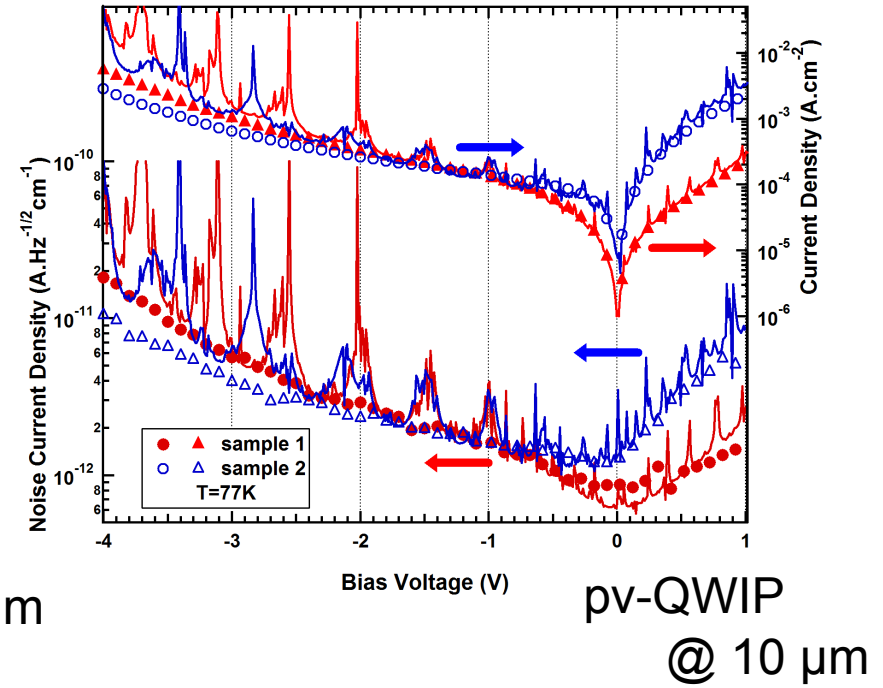
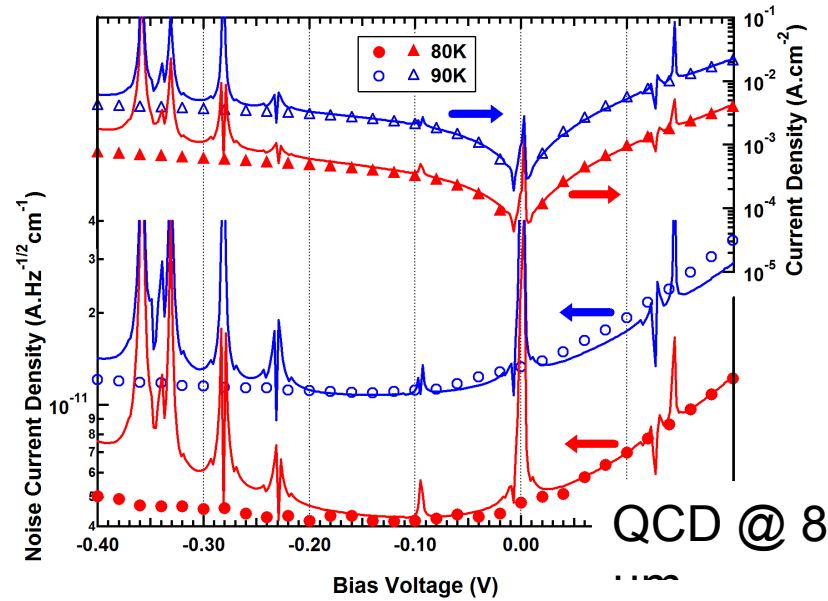

Johnson and shot noises  
within single description

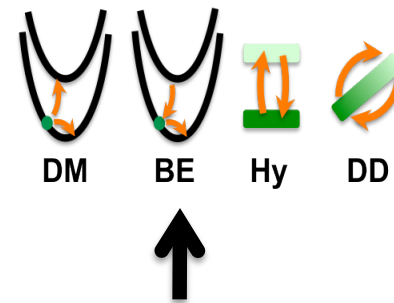

# Circuit theory

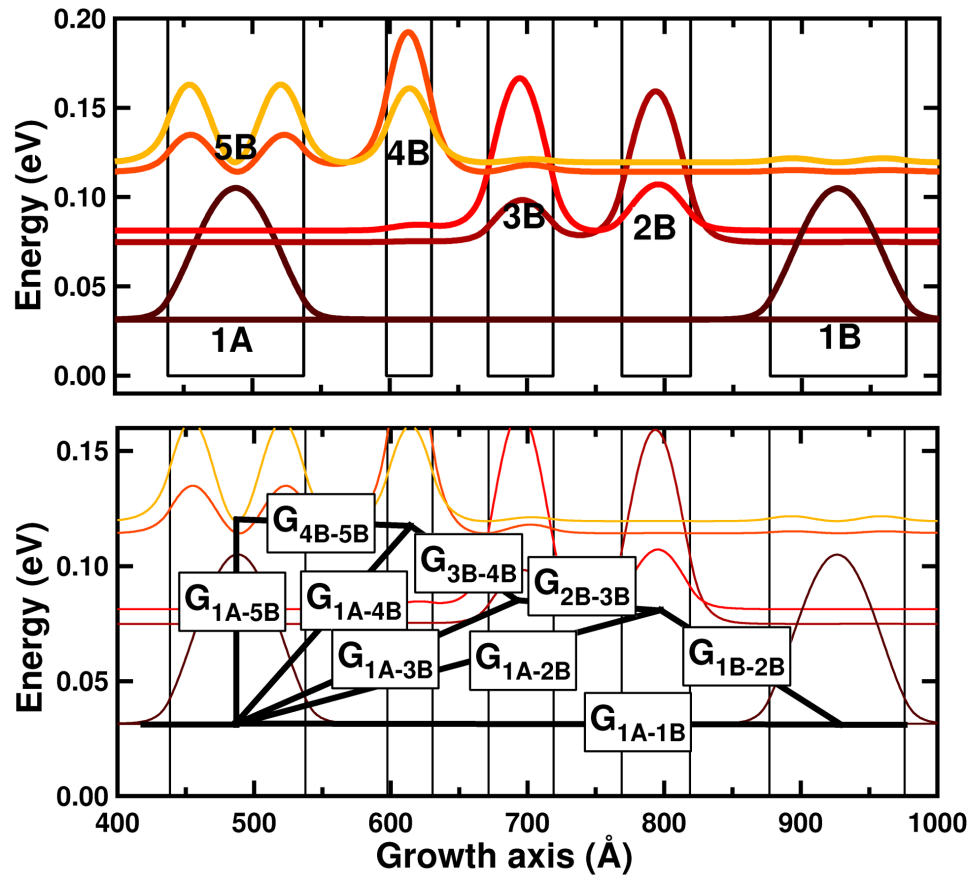

Intersubband transitions:  
vacuum diodes

$$G_{ij} = \frac{2q \left( \left| \langle i_{i \rightarrow j} \rangle_0 \right| + \left| \langle i_{j \rightarrow i} \rangle_0 \right| \right)}{4k_B T}$$

Noise equivalent circuit

Contacts : QCDs QWIPS

$$S_I = 4k_B T G_{eq}$$

# Results

QCD @ 8  $\mu\text{m}$

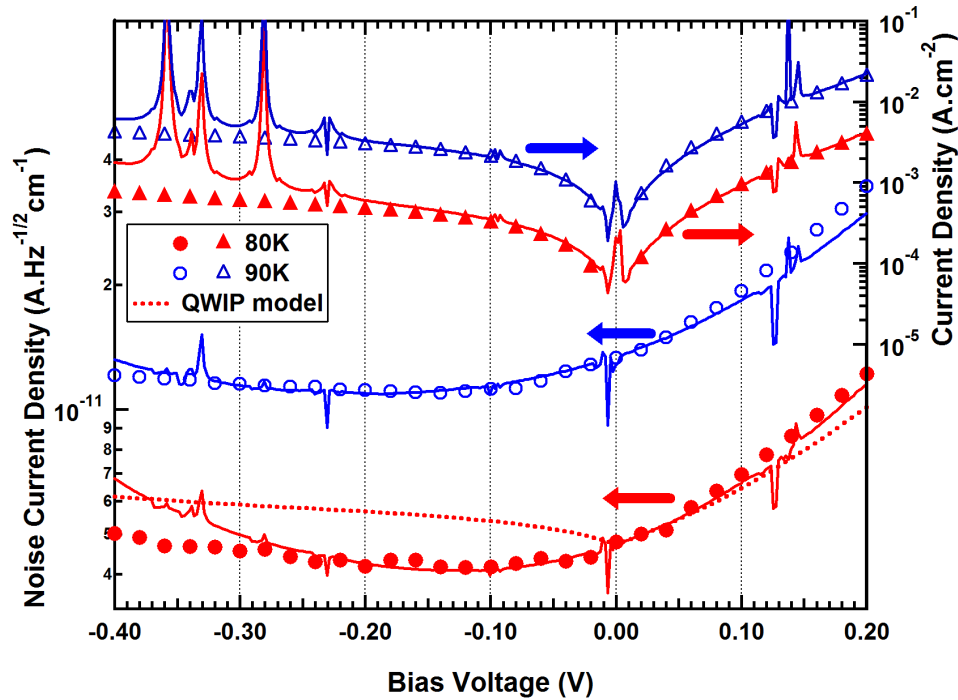

QCD @ 15  $\mu\text{m}$

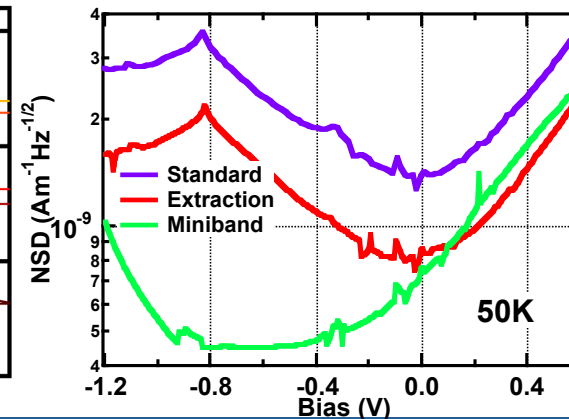
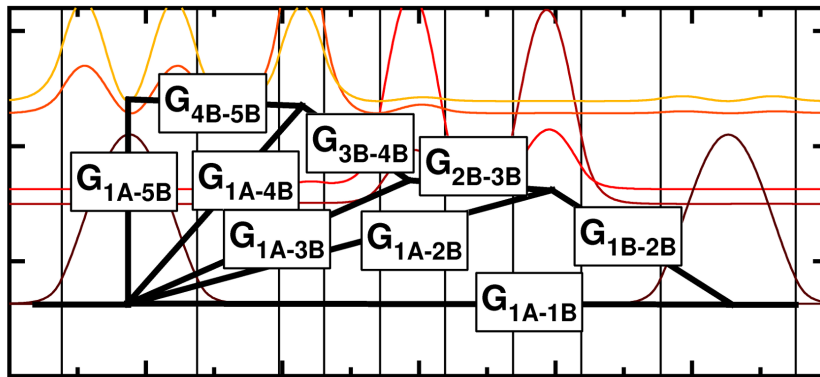
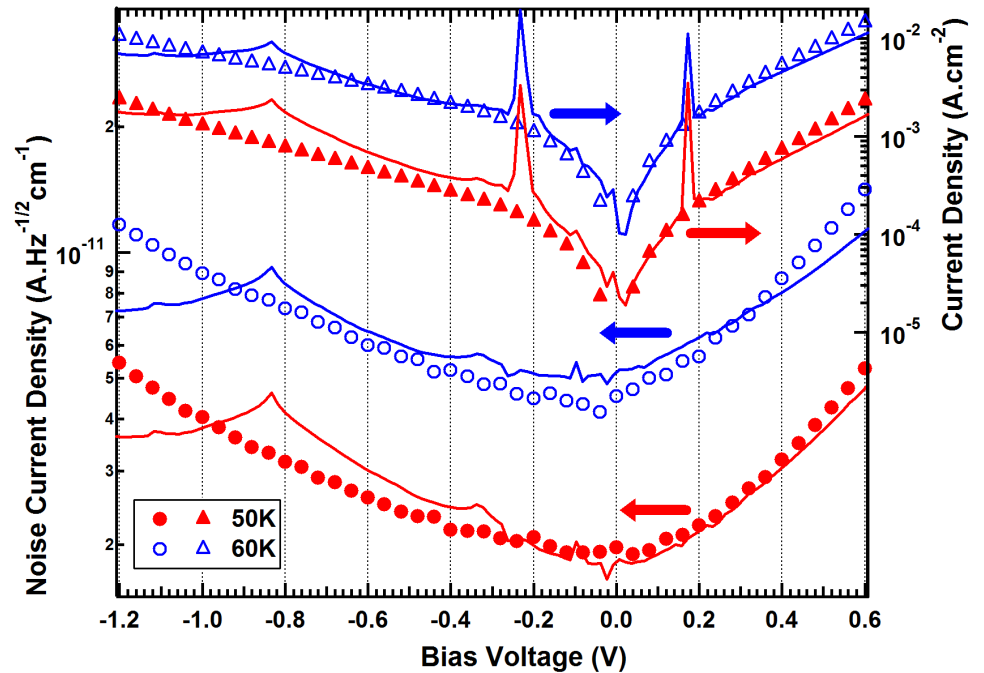



# What for?

- **Introduction**
- **Signal**
- **Noise**
- **Perspectives**