



HAL
open science

Sélection d'anticorps recombinants dirigés contre des matériaux inorganiques pour des applications en nanosciences

Purvi Jain

► **To cite this version:**

Purvi Jain. Sélection d'anticorps recombinants dirigés contre des matériaux inorganiques pour des applications en nanosciences. Autre [cond-mat.other]. Université de Grenoble, 2012. Français. NNT : 2012GRENY040 . tel-00772913

HAL Id: tel-00772913

<https://theses.hal.science/tel-00772913v1>

Submitted on 11 Jan 2013

HAL is a multi-disciplinary open access archive for the deposit and dissemination of scientific research documents, whether they are published or not. The documents may come from teaching and research institutions in France or abroad, or from public or private research centers.

L'archive ouverte pluridisciplinaire **HAL**, est destinée au dépôt et à la diffusion de documents scientifiques de niveau recherche, publiés ou non, émanant des établissements d'enseignement et de recherche français ou étrangers, des laboratoires publics ou privés.

UNIVERSITÉ DE GRENOBLE

THÈSE

Pour obtenir le grade de

DOCTEUR DE L'UNIVERSITÉ DE GRENOBLE

Spécialité : **Physique pour les sciences du vivant**

Arrêté ministériel : 7 août 2006

Présentée par

Purvi Jain

Thèse dirigée par **Dr Avraham Halperin**

codirigée par **Dr Clément Nizak**

Laboratoire Interdisciplinaire de Physique, LIPhy

École Doctorale de physique

**Sélection d'anticorps recombinants dirigés
contre des matériaux inorganiques pour
des applications en nanosciences**

Thèse soutenue publiquement le **27/09/12**,

devant le jury composé de :

Prof Franz Bruckert

Professeur INP Grenoble, Président

Prof Pierre Cosson

Professeur, Centre Médical Universitaire de Genève, Rapporteur

Prof Phillipe Minard

Professeur, Université Paris Sud 11, Rapporteur

Dr Erik Dujardin

Directeur de recherches CNRS, CEMES Toulouse, Examineur

Dr Avraham Halperin

Directeur de recherches CNRS, LIPhy Grenoble, Directeur de thèse

Dr Clément Nizak

Chargé de recherches CNRS, LIPhy Grenoble, Co-directeur de thèse



Acknowledgment

Thanking people in just few words makes these pages the hardest and most incomplete part of this thesis. First of all, I would like to thank my thesis supervisor, Clément Nizak to give me opportunity to work on such an interesting project. The project presented interesting questions during entire three years, which kept me amazed. Most of the questions attempted to answer in this thesis are new with no prior knowledge. Thus experience of finding new results which sometimes contradict my earlier assumptions was truly thrilling part of this thesis. Major contribution to maintain this voyage as fun goes to my supervisor, Clément Nizak. He continuously guided me and never allowed me to feel lost in the subject. He not only guided me scientifically but also helped me in dealing with frustrations caused by inevitable failure of experiments and helped me seeing light at the other end of the tunnel. He has so many things to be learned as a scientist as well as a human being. Working with him, made my PhD training an unforgettable learning platform.

Thank you to all jury members for your time and attention to review my work and also for constructive criticism.

I would take opportunity to thank nanoscience foundation for funding my project. I would also like to thank to the collaborators of different projects of this thesis – S.Moutel, F.Perez at Institute Curie, Paris and Benoit Dubertret at ESCPI, Paris.

It was amazing to work with talented peers working on very diverse areas at BIOP (LiPhy). Your suggestions, comments and criticisms along the way have been most helpful. In particular Jan Bednar, Avraham Helperin and Anand Shushi always provided their extended and constructive comments on my work.

I would like to offer special thanks to Noël and Mathilde, whose constant efforts make the laboratory very organised place to work. Your efforts with everything from ordering chemicals to occasional helping during experiment are very much appreciated. Special thanks to Jessi, without her I might be probably lost in dealing with administrative work. She is an (very) essential part of the lab in making any foreign students feel home.

Thanks to many people in the lab, who created an atmosphere which makes the laboratory a joy to work. Thanks to people at third floor for watching cricket world cup 2011 with great enthusiasm and cheering with me for glorious victory of India. Edith for being my translator in the lab as well as outside the lab, for all pause de café, giving me training for French bisous, and being my first gateway to learn French culture and Grenoble mountains, above all a good friend, list will go long. Thanks to Darja for being coolest colleague on the planet earth (I doubted her origin from earth in first few encounters). She has magic tricks to lighten up the environment. Thanks to Marc Joyeux for providing me quiet place in his office for thesis writing and creating nice musical environment. Thanks to Pierre-yves for his bottomless bag of incredible questions counterbalanced by Levan's calmness, Olivier Vincent for solving my physics related doubts, Michael for his friendship and lending his ears whenever needed. Luca, Jawani and Valentina for giving Italian touch to the

environment and also occasionally to our taste buds, Madhu for being new Indian entry and source of 4 pm Indian sweets, Catherine Quilliet for occasional chick talks, Prem Prabhakaran for nano talks, and Nathalie for her cat talks.

This section would be incomplete without thanking very talented colleagues I met during my stay at Indian Institute of Science (IISc), Bangalore. A special thanks to Amartya Sanyal, his positive attitude towards research is infectious and it really helped me to shape my interest in research at the very beginning of my career. Richa Tyagi, who set up an example to balance research life, by doing excel in science and never missing any opportune moment of fun which life offers. And also by pursuing personal interests without any excuse of busy research schedule. I feel lucky to meet you all as colleagues and now friends.

Life is rarely complete without friends, who directly or otherwise help achieve one's goals. My friends must be brave, for they put up with me. I cannot thank them enough, and will only name them here - Shubhra for being great buddy, Vivien as coolest flatmate, who believed that I do some science fiction sort of research in the lab, it gave me funny but great feeling when I was back at home. Friends whom I met in Grenoble – Tarun, Mahesh, Nirmal, Pallavi, Krutika, and Nivs, life would not be same here without all those parties, midnight b'day cakes, movies, and shopping together. Tarun's ice cream break helped me a lot to melt all sorts of worries. Special thanks to Sylvana, François, Jeremy, Lucky and Jack (Lucky and Jack being THE cats!) for their unconditional love and affection, I call them extended French family.

Thanks to papa, for setting an example of how to love one's job passionately. Thanks to mummy for much needed dose of encouraging words. Your lessons about being calm in hardest situations, and accepting all challenges with smile on the face, actually paid off during this thesis. I have never appeared in any exam from my school days to the college without talking to mummy-papa. PhD was for sure was toughest of all, It would have been impossible for me to complete it without your constant support. My elder sister actually share equal credit for all my degrees up till now, she was left with no choice than being awake all night, specially for my mathematics and physics tests. Now I am studying something out of her expertise, so she cannot help me directly, but thanks for helping me able to reach this level and also for spoiling me a bit with lots of pocket money during my student life. Having elder sister like you is one of the best things of my life. Thanks for your blessings nani (grand-mother), I will miss you throughout my life.

Very special thanks to Rohan, knowing you as a friend then boy friend and now as fiance is the next best thing happened to me. Ever since I met you, you are laughing on all my problems and actually you make them appear small, then I start wondering why I was worried about them. At the same time, even on small success, you make me feel like great achiever. Sometimes I am able to accomplish tasks just because you believe in my strength. It was your joyful spirit, which provided boost to enjoy my research work more.

An interesting project, nice supervisor, loving family, and trusted friends have always kept me motivated during this voyage of my career.

Sélection d'anticorps recombinants dirigés contre des matériaux inorganiques pour des applications nanoscientifiques

Résumé

Les matériaux inorganiques ont des propriétés uniques à l'échelle nanométrique. Ces propriétés ont généré beaucoup d'intérêt pour fabriquer des nouveaux matériaux utilisant des nano-objets comme unité de construction. Nous avons suivi une approche biomimétique pour la fabrication de dispositifs à base de nanoparticules afin d'améliorer les méthodes actuelles de fabrication top-down et bottom-up. Certaines protéines naturelles se lient en effet spécifiquement à des matériaux inorganiques, et déclenchent notamment la croissance de cristaux inorganiques. Une première étape dans cette approche biomimétique est de comprendre comment des protéines se lient spécifiquement à des nanomatériaux inorganiques. Nous avons exploré ce mécanisme de reconnaissance en sélectionnant des anticorps (les protéines de notre système immunitaire spécialisées dans les interactions avec de nombreuses cibles) contre des matériaux inorganiques par la méthode combinatoire biotechnologique appelée "phage display". Cette technique permet d'obtenir la séquence génétique codante des anticorps sélectionnés se liant à leur cible à partir d'une banque aléatoire d'anticorps. L'analyse statistique des séquences des anticorps sélectionnés fournit de nouvelles informations sur les interactions protéines/matériaux inorganiques. Notre principale conclusion est l'identification de l'acide aminé arginine en tant que contributeur majeur dans les interactions protéine/or. L'ingénierie génétique des anticorps permet de fonctionnaliser ces nouvelles sondes de matériaux inorganiques en vue de leur utilisation pour des applications dans le domaine des nanomatériaux. Les anticorps recombinants sélectionnés et leurs dérivés fonctionnalisés peuvent être exprimés par sécrétion à l'aide d'un hôte eucaryote (*Dictyostelium discoideum*) mis au point au cours de cette thèse.

Mots-clés: biomimétisme, nanoparticules, anticorps, Phage display, or, arginine, *Dictyostelium discoideum*.

Selection of recombinant antibodies against inorganic materials for applications in nanosciences

Abstract

Inorganic materials have unique properties at the nanometer scale. These properties have generated a lot of interest among researchers to fabricate novel materials using nano objects as building units. In this PhD thesis, we have attempted to mimic nature in the fabrication of nanoparticle based devices in order to improve upon current top-down and bottom-up nanomaterial fabrication methods. Proteins can specifically bind inorganic materials and trigger crystal growth and thus are considered as the main building units for a biomimetic approach of fabrication. The first step towards mimicking nature is to explore how proteins bind specifically to nanomaterials. We have explored this recognition mechanism by selecting antibodies (the protein binders of our immune system) against inorganic nanomaterials using the combinatorial biotechnology method of phage display. This technique provides us with the genetic sequence of selected antibodies from a random antibody library exposed against a target. Statistical analysis of selected antibody sequences provides new information on proteins/inorganics interactions. Our main finding in this regard is the identification of the amino acid arginine as a major contributor to protein/gold interactions. Additional functionality to these new binders of inorganic materials is obtained by antibody engineering, allowing for their value added use in nanomaterial science applications. Selected recombinant antibodies and their engineered derivatives along with other recombinant protein can be expressed and secreted using a eukaryotic expression platform (*Dictyostelium discoideum*) developed during this thesis.

Keywords: biomimetics, nanoparticles, antibody, phage display, gold, arginine, *Dictyostelium discoideum*.

CONTENTS

Abbreviations and Acronyms	7
Synopsis	8
Synopsis en français	167
1. Introduction	11
1.1 <i>An Introduction to antibodies</i>	12
1.1.1 Structure	12
1.1.2 Function	13
1.1.3 Applications of antibodies as probes	14
1.1.4 Development of antibody technologies	14
1.1.5 Single chain fragment variable (ScFv)	15
1.2 <i>An introduction to display techniques</i>	18
1.2.1 Antibody phage display technique	18
1.2.2 The link between genotype and phenotype: bacteriophage	19
1.2.3 Phage display cloning vector: phagemids	20
1.2.4 Antibody display libraries	22
1.2.5 <i>In vitro</i> selection of binders in controlled conditions	23
1.3 <i>Antibody engineering</i>	27
1.3.1 Engineering IgGs into small fragments	27
1.3.2 Engineering the valency of antibody molecules	28
1.3.3 Bispecific antibodies	29
1.3.4 Fusion with other molecules	31
1.3.5 Back to IgG like structure	31
1.3.6 Antibody class switch	32
1.4 <i>Production of recombinant antibodies</i>	34
1.4.1 Challenges faced by expression systems for production of recombinant antibodies	34
1.4.2 Expression systems for recombinant antibody production	35
1.4.2.1 <i>E. coli</i>	35
1.4.2.2 Yeast	36
1.4.2.3 Mammalian cells	38
1.4.2.4 <i>Dictyostelium discoideum</i>	39
1.4.3 Tool box to regulate recombinant antibody expression level in <i>Dd</i> by secretion	41
1.4.3.1 Genetic toolbox	42
1.4.3.2 Miscellaneous toolbox	42
1.4.4 Overview of glycosylation and its importance	43
1.4.5 Glycosylation profile of antibodies	44
1.4.6 Glycosylation in <i>Dd</i>	45
1.5 <i>Selection of biological binder (scFvs) for inorganic materials</i>	49
1.5.1 Introduction to nanoscience	49
1.5.2 Historical background and birth of modern nanoscience	50
1.5.3 Example of inorganic nanomaterials	51
1.5.3.1 Gold nanoparticles	51
1.5.3.2 Semiconductor QDs	53
1.5.4 Synthesis of nanomaterials	54
1.5.5 Stabilisation, functionalisation and self-assembly of nanoparticles: By surface modifications	55
1.5.6 Current strategies for surface modifications of nanoparticles and their limitations	57
1.5.7 Biomimetic approach to self assembly of nanoparticles	58
1.5.8 Motivation for surface modification by biological ligands	60
1.5.9 Selection of protein based binders (potential ligands) for nanoparticles	61
1.5.9.1 Selection of peptides or antibodies using combinatorial techniques	61
1.5.9.2 Comparison of protein based ligands: peptides vs antibodies	64
1.5.9.3 DNA based binder for inorganic materials	65
1.5.10 characterization of the clones selected by phage display	66
1.5.11 Potential use of inorganic material-binding proteins	68

2. Results	70
2.1 selection of antibody fragments (scFvs) binding to inorganic materials	70
2.1.1 Surface treated CdS QDs and gold nanoparticles	71
2.1.2 Screen against micron size particles (ZnS, CdS, CdSe, gold particles)	75
A) ZnS powder	78
B) CdSe powder	79
C) CdS powder	81
D) Gold powder	87
2.2 Engineering of antibodies and their production in <i>Dd</i>	96
2.2.1 Construction of expression vector	97
2.2.2 Cloning of the antibody sequences in <i>Dd</i> expression vector	98
2.2.2.1 Cloning of scFv sequences	98
2.2.2.2 Cloning of engineered scFv fragments	99
2.2.3 Transformation and selection of antibody fragments and engineered antibodies in <i>Dd</i> cells	102
2.2.4 Expression of antibody fragments and engineered antibodies in <i>Dd</i> cells	103
2.2.5 Large scale production and purification of antibodies from <i>Dd</i> supernatant	105
2.2.6 Enzymes involved in glycosylation in <i>Dd</i> genome	106
2.2.7 Analysis of glycosylation pattern in <i>Dd</i> secreted antibody	107
3 Discussion	110
3.1 Towards finding protein based binders (potential ligands) for inorganic materials	110
3.1.1 ScFvs as surface ligands for inorganic nanoparticles	110
3.1.2 Possibility of using other protein scaffolds as surface ligands for inorganic nanoparticles	111
3.1.3 Selection of positive binders (scFvs) using one large library: Searching a needle in haystack	111
3.1.4 Perspectives and consequences of using current display library	113
3.1.5 Failure of selection of binders for CdS QDs and gold nanoparticles	115
3.1.6 Failure of selection against micron sized CdS, CdSe, and ZnS semiconductor materials	116
3.1.7 Success of selection of binders for gold powder (a proof of concept)	116
3.1.8 Potential implications of arginine binding to gold	121
3.1.9 Potential application of gold binding scFv for surface modification of gold nanoparticles	121
3.1.10 From bench to bedside	122
3.2 Production of recombinant antibodies and their engineered constructs in <i>Dd</i>	123
3.2.1 <i>Dd</i> as an alternate eukaryotic expression system	123
3.2.2 Further improvements to establish <i>Dd</i> as better expression system	124
3.2.3 Probable reasons of non-expression of scFv::streptavidine and bispecific antibody constructs	125
3.2.4 Glycosylation pattern in <i>Dd</i>	126
3.2.5 Absence of universal expression system for production of recombinant proteins	127
4. Bibliography	128
Appendix A: Chemicals, biologicals and vector used in phage display experimen	139
Appendix B: Phage display protocols	142
Appendix C: Alignment of anti-gold scFv sequences	148
Appendix D: Chemicals, biologicals and vector used in production of recombinant antibody in <i>Dd</i>	151
Appendix E: Design of <i>Dd</i> expression vector and cloning strategy of engineered fragments in <i>Dd</i> expression vector.	152
Appendix F: Generation and characterisation of <i>Dd</i> cell lines expressing recombinant antibodies	162
Appendix G: Purification of <i>Dd</i> expressed antibodies	164
Appendix H: Glycosylation	165

Abbreviations and Acronyms

ADCC	Antibody-Dependent Cell-Mediated Cytotoxicity
CDC	complement-dependent cytotoxicity
CDR	complementarity determining regions
<i>Dd</i>	<i>Dictyostelium discoideum</i>
DHLA-SB	dihydrolipoic acid-sulfobetaine
ELISA	Enzyme linked immunosorbent assay
Fab	Antigen binding region
Fc	Fragment crystallisable
GFP	Green fluorescent protein
IF	Immunofluorescence
mAb	monoclonal antibody
NP	Nanoparticle
PEG	polyethylene glycol
PTM	Post translational modifications
QD	Quantum dot
scFv	Single chain fragment variable
SEM	Surface electron micrograph
SPR	surface Plasmon resonance
V _H	Variable heavy chain
V _L	Variable light chain

Synopsis

Inorganic materials at the nanoscale level (1 - 100 nano metre) exhibit different optical, electrical, photo-electrical, magnetic, mechanical, chemical and biological properties in contrast to the bulk material that can have application in medical, energy, environment, production, and various other fields. In the context of this thesis, we have focused on two potential applications of nanomaterials; the use of metal and semiconductor nanoparticles as probes in bio-imaging and the production of self-assembled structures/devices based on nanoparticles. Both applications require a better control on nanoparticle surface chemistry. The objective of this thesis is to propose a new strategy for improving surface chemistry of nanoparticles by using proteins, more precisely antibodies, as ligands/probes for inorganic nanomaterials, thus altering the surface chemistry. To achieve this goal, it is of primary importance to understand how proteins specifically bind to inorganic materials.

To understand protein/inorganics interaction we have used the combinatorial technique called phage display of antibodies. In this technique, a combinatorial random library of recombinant antibodies mimicking the immune repertoire is screened *in vitro* for selection of antibodies binding to a target of interest. This technique allows one to isolate specifically bound antibodies and their encoding genetic sequences. The technique has the major advantage of selecting protein binders under *in vitro* controlled conditions. One can tune the physical and chemical environment to create a selection pressure. Another major advantage of this technique is that there is no requirement for prior characterisation of the targets. In the case of inorganic surface targets, this is a crucial advantage over classical methods based on the rational design of inorganic surface ligands (molecular dynamics simulations, for instance).

In this thesis, multiple inorganic materials were used as a target. We propose this technique to prove the concept that, in principle, any material (organic/inorganic) can be used as a target and thus specific antibodies (proteins) targeting the material of interest can be identified. So far, by screening a library containing 10^8 random antibody sequences, we have successfully identified 32 sequences of selected antibodies that specifically bind to micron-sized gold particles. The statistical analysis of the 32 gold-binding antibodies sequences has allowed us to identify particular amino acids that were strongly selected at the random positions of antibody sequences. Arginine was predominantly selected at many positions in gold binding antibodies. This finding is in agreement with the observation of other groups using sophisticated and dedicated strategies such as molecular dynamics simulations. This result supports our strategy based on relatively simpler technique of

phage display for material science studies. We have then tried to use our gold-binding antibodies as ligands for improving the surface chemistry of gold nanoparticles (size - 20 nm). Preliminary results indicate the plausibility of the concept. The reasons for the inability to select antibodies against other inorganic targets used during thesis are partially identified. These challenges can be addressed by simply optimising the protocols for the other inorganic targets.

As a next step, the sequence of selected antibodies can be modified by using recombinant antibody engineering. Antibodies can be engineered to acquire a new chemical function. Sequences of two scFvs can be fused in order to produce adapters called bispecific antibodies capable of binding simultaneously to two targets. All the applications based on antibodies acting as probes to modify the surface chemistry of nanoparticles require the production of selected and/or engineered antibodies. Antibody production is a challenge due to their sophisticated structure and large size. This challenge is addressed in this thesis by the development of a new recombinant antibody production system based on the eukaryotic organism *Dictyostelium discoideum*. So far, this system has allowed us to produce two forms of engineered antibodies. In addition, we have started to explore the benefits of using this system for the production of therapeutic antibodies.

This thesis is divided into subparts; following is a brief description about the content of each subpart.

Section 1.1 is a general introduction to antibodies and the development of antibody technology; their structure, function, and applications as binders and probes.

Section 1.2 presents the combinatorial biotechnology technique of phage display and its application to select *in vitro* recombinant antibodies as binders of various biological and non-biological targets from random antibody libraries.

Section 1.3 describes the engineering of antibodies to produce antibodies fused to other biological and chemical moieties, including other antibodies.

Section 1.4 describes expression systems for the production of recombinant antibodies and their engineered forms. It also describes the new eukaryotic expression system that we have set up for this purpose (*Dictyostelium discoideum*).

Section 1.5 illustrates the biomimetic approach for inorganic nanomaterials fabrication and functionalisation, with a focus on using protein-based binders for inorganics to generate new materials.

Section 2 covers our results. This section is divided into two parts. **Section 2.1** describes the selection of recombinant antibodies binding inorganic materials using phage display and the possible use of antibodies as inorganic nanoparticle ligands. **Section 2.2** is about our setting up of the expression and production of recombinant antibodies and their engineered derivatives in *Dictyostelium discoideum*.

Section 3 covers the discussion which is divided into two parts: **section 3.1**- the successful selection of recombinant antibodies against gold, its potential applications in understanding interactions of proteins with inorganics and potential applications in biomimetic-inspired nanosciences and **Section 3.2**- the potential of *Dictyostelium* as a production system for recombinant antibodies and engineered constructs based on antibodies for therapeutical and nanoscience applications.

The process of scientific discovery is, in effect, a continual flight from wonder
- Albert Einstein

1. Introduction

The immune system response inside the body relies on antibodies that bind specifically to foreign molecules. This recognition has been exploited for many applications. In this thesis, we have applied it in our biomimetic approach to select inorganics-binding antibodies that could be used to fabricate novel materials with inorganic nano components.

1.1 An Introduction to antibodies

Antibodies are proteins produced by the immune system. They are secreted inside the body in response to harmful substances known as antigens. The production of antibodies is a major function of the humoral immune system and is carried out by plasma cells (a type of white blood cells). Antibodies have the remarkable ability to bind to antigens. Binding triggers signals that induce targeted immune response. Antibodies show a strong binding specificity towards antigens, often compared with a lock and key model. Antibodies are categorised under the superfamily of immunoglobulins, source- Kuby immunology, part II, (Kindt, Goldsby, & Osborne, 2006).

The aim of this thesis is to exploit the properties of antibodies and use them as versatile, specific binders of inorganic material targets for applications in nano-material science.

1.1.1 Structure

IgG antibodies are large molecules with molecular weight of approximately 150 kDa. They are composed of two different kinds of polypeptide chains. The classic structure of an IgG consists of two identical light chains (25 kDa) and two identical heavy chains (50 kDa) covalently linked by a disulphide bridge between the two heavy chains and between heavy and light chains.

Based on structural difference in heavy chains, different kinds of antibodies exist that are grouped into isotypes. Five different antibody isotypes are known in mammals, which perform different roles in the immune system. These isotypes are named with an "Ig" prefix that stands for immunoglobulin, e.g. IgM, IgD, IgG IgA and IgE .Some of the isotypes are further divided into subclasses — for e.g., there are four IgG subclasses and two IgA subclasses. IgGs are the most relevant class of antibodies for pharmaceutical applications.

Antibody molecules are roughly Y-shaped molecules (see figure 1.1a). The arms of the Y contain the sites that can bind antigens. This region of the antibody is called the Fab (fragment, antigen binding) region. It is composed of one constant and one variable domain

from each heavy and light chain of the antibody respectively. The variable domain is referred to as the Fv region and is the most important region for binding to antigens. More precisely, variable loops of β -strands, three each on the light (V_L) and heavy (V_H) chains are responsible for binding to the antigen. These loops are referred to as the complementarity determining regions (CDRs). The base of the Y shaped molecule is known as Fc (Fragment crystallisable or constant) region. This region is mostly constant in any antibody structure.

source- Kuby immunology, part II, (Kindt, Goldsby, & Osborne, 2006).

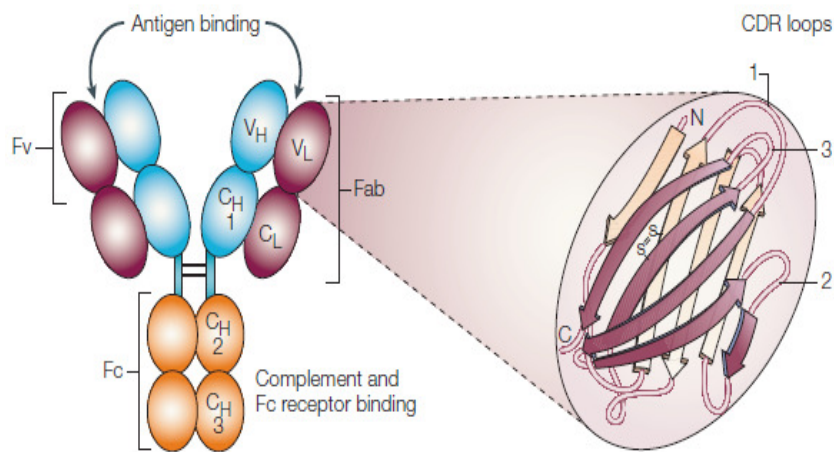

Figure 1.1a: Modular structure of an IgG molecule. All immunoglobulin monomeric units are made up of two identical light (L) chains and two identical heavy (H) chains. Light chains include one constant domain (C_L) and one variable domain (V_L), whereas heavy chains include three constant domains (C_{H1} , C_{H2} and C_{H3}) and one variable domain (V_H). The variable domains of both the heavy and light chains make the antigen-binding part of the molecule, termed as Fv. In the zoomed structure of Fv, three variable loops are depicted; these are called complementarity-determining regions (CDRs) 1, 2, and 3. Source- (Brekke & Sandlie, 2003)

1.1.2 Function

Antibodies recognize and bind foreign substances, such as bacteria or viruses, and alert other immune cells of body that can destroy them and flush them out of the body.

Antibody molecules can perform two different functions that are carried out by different parts present in the antibody structure. First, antibodies have the unique ability to recognize and bind to substances that cause disease. This primary function is performed by antigen binding site of antibody (Fab). Binding of an antibody to an antigen has no direct biological effect. The significant biological effects are carried by secondary "effector functions" of antibodies that are carried by sequence in the Fc region of antibodies. The common effector

functions are complement-dependent cytotoxicity (CDC), phagocytosis and antibody-dependent cellular cytotoxicity (ADCC) (Lucas & Oakland, 2001).

1.1.3 Applications of antibodies as probes

Antibodies can specifically bind to almost any target molecule. These target molecules do not necessarily need to be called antigens, it can be any molecule. Sometimes these targets are parts of proteins that are the important components of living cells or it can be non biological targets (such as inorganic materials in light of this thesis). Antibodies are, therefore, ideal sensors for detecting tiny amounts of a particular target molecule.

Antibodies are used daily as tools or reagents by research laboratories and clinic. For clinical purposes, antibodies can be used as a diagnosis reagent or as a drug for therapeutics. Fluorescence microscopy is a routinely used scientific technique that uses antibodies to visualize particular protein in cells or even in whole tissues (immunohistochemistry). Antibodies are used in many routine laboratory works for many standard assays like ELISA, western blot, flow cytometry etc. All methods of research in biotechnology and medicine are based on an understanding of the fundamental biological processes and their inter connections. For instance, which structure in the cells of organisms carries out which function? How do these functional structures communicate with each other? What are the consequences when they stop working? Antibodies are used in various laboratory techniques that address these questions. They are powerful tools in basic research because they recognize their antigens with outstanding specificity. This allows researchers to identify molecules and draw conclusions about the function of proteins of interest. Antibodies are also used in environmental analysis to provide evidence of contamination or the presence of harmful chemical substances (Killard, Smyth, Grennan, Micheli, & Palleschi, 2000). Last but not the least, we have tried to explore the applicability of this versatile molecule in nanomaterial fabrication and functionalisation.

1.1.4 Development of antibody technologies

Development of antibody technology is largely driven by the desire to use antibody as therapeutics. The mouse hybridoma technology described by Köhler and Milstein was an important step in the development of antibody technology and paved the way for the use of monoclonal antibody as therapeutics (Köhler & Milstein, 1975). However, antibodies derived from mouse are not suitable as therapeutic agent in humans. Strong immune response to non-human antibodies in humans had put end to this achievement in pharmaceutical sectors. Later developments in this field had again raised hope to use antibody as potential therapeutics. In an attempt to reduce the immunogenicity of mouse antibodies, genetic

engineering was used to generate chimeric antibodies. Further minimization of the mouse component of antibodies was achieved through CDR (complementarity determining region) and grafting (Bendig & Jones, 1996). Finally two major developments made antibodies completely independent from the animal immune system. These include development of selection by display technology and production of antibodies as recombinant proteins. The demonstration of displaying antibody fragments by phage and the functional expression of antibody fragments in bacterial periplasm are the pioneer experiments which provided strong platform for further development in the selection of antibodies by display techniques (Skerra & Plückthun, 1988) (McCafferty, Griffiths, Winter, & Chiswell, 1990). This selection is performed *in vitro* using library which contain many antibody fragment variants of human origin. Now the selection of fully human variable domain has become extremely simplified by the use of display technique (see section 1.2 for detailed technique of phage display). The initial product of display screen may be a fragment of antibody “ScFv” (see next paragraph). Small fragment can be further engineered to get full antibody construct (see section 1.3 for antibody engineering). Further development in antibody technology lead to explore various expression systems to produce antibodies and its engineered derivatives (see section 1.4 for production of recombinant antibodies).

1.1.5 Single chain fragment variable (ScFv)

Fv fragment (shown in figure 1.1a) is one of the smallest units of immunoglobulin molecule that can mediate function of antigen binding. However, Fv fragment did not show stability under *in vitro* conditions. This fragment is not a very stable structure because the interaction energy between two variable regions present in this structure is low. Varieties of approaches have been taken to build a functional and stable complex of V_H and V_L . As a solution to this problem, new structure was generated by using a soluble and flexible 15-20 amino acid peptide linker to connect the V regions in order to build “ScFv” fragment (Bird et al., 1988) (see figure 1.1b). The resulting scFv exhibits substantial antigen-binding activity compared to the monoclonal antibodies whose V_H and V_L sequences were used. Progress in phage display has opened the opportunity of *in vitro* selection of scFv from a large library of variable domains (McCafferty, Griffiths, Winter, & Chiswell, 1990). ScFv molecule can be easily expressed in functional form using *E. coli* (Skerra & Plückthun, 1988). The genetic sequence can be further engineered using this small fragment as building units. Small dimensions, elevated stability and capability to recognise antigens that are difficult to access by conventional antibodies make this fragment an interesting tool for several research and biotechnological applications (de Marco, 2011).

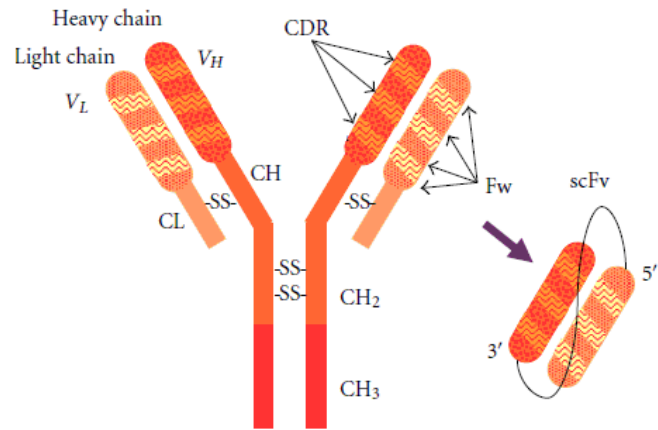

Figure 1.1b: Antibody model showing different domains along the polypeptide chains. Single-chain fragment variable (scFv) antibody is shown in shaded area.(CDR- complementarity determining region, FW- framework) Source (Ahmad et al., 2012)

Phage display is the presentation of (poly) peptides on the surface of bacteriophage (bacterial virus). The gene encoding the protein product will be found inside the virus particle while the function encoded in the gene (such as the binding properties of an antibody) will be displayed on the surface of the virus. Year 2012 marks the 27th anniversary of the invention of this powerful technique. It has allowed rapid, specific, controlled *in vitro* selection of proteins/peptides as binders for various targets.

1.2 An introduction to display techniques

Display technique is a family of molecular biology techniques that allow for the *in vitro* selection of protein/peptide binders from random protein/peptide libraries for many kinds of targets. The concept of display technology is based on physical linkage between the genotype and the phenotype. A protein with the desired binding ability is selected; simultaneously the genetic sequence corresponding to this protein is co-selected. This concept was successfully applied to small peptides by G P Smith by using phage as display system (Smith, 1985). Display of functional folded protein required several methodological improvements, which were initially done by groups at the MRC laboratory of molecular biology with Winter and McCafferty and the Scripps Research Institute with Lerner and Barbas for display of functional proteins such as antibodies. Later display method also extended to various forms such as ribosome display, mRNA display, cell surface display on bacteria and yeast. In this thesis we have used phage display of antibodies for screening against inorganic targets.

1.2.1 Antibody phage display technique

Antibody phage display technique empowers display of many antibody molecules on surface of small bacterial virus (bacteriophage). Collection of these displayed molecules is known as library. Initially phage display of antibodies was demonstrated by using small fragment of antibody molecules (scFv). ScFv fragment was displayed as a fusion protein on the surface of bacteriophage (see figure 1.2a) (McCafferty et al., 1990). Now this technology has been adapted for other antibody molecules including Fab fragment (Wieland, Orzáez, Lammers, Parmentier, & Schots, 2006), diabody (Takemura et al., 2000).

Library of phages displaying different antibodies can be used to rapidly identify antibodies that bind with high specificity and affinity to any desirable target molecule. This is possible because of presence of random antigen binding region.

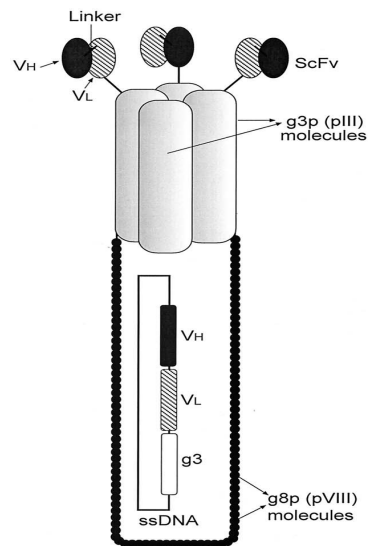

Figure 1.2a: Diagram of filamentous phage displaying scFv molecules. The phage consists of circular ssDNA surrounded by coat protein. p8 is major coat protein and p3 (on tip of the phage) is one of the minor coat proteins. The genes encoding variable domains of scFv are fused to gene3 (g3) in the genome of the filamentous phage, as a result scFv is displayed as a fusion to p3 protein at the tip of the phage. Source - (Azzazy & Highsmith, 2002)

1.2.2 The link between genotype and phenotype: bacteriophage

The display concept is based on the link between the phenotype and the genotype and this link is provided by the bacteriophages or simply phages. The link is created by a foreign protein in frame with the coat protein gene of the phages. The filamentous phages are most widely used for phage display systems, among them M13 is most commonly used. The M13 phages can infect a variety of gram-negative bacteria using their pilus as receptors (Carmen & Jermutus, 2002). The filamentous phages do not produce lytic infection in *E. coli*. After infection, they replicate inside *E. coli* and make them phage production factory. The bacteria, which are infected, do not lyse, but undergo reduced growth due to stress of phage production.

The phages are cylindrical shaped particles, which are approximately 7 nm wide and 900 to 2000 nm in length. The M13 phage has 6.4-kb genome, which contains circular, single-stranded DNA. The phage genome codes for 11 phage proteins. Five of these proteins are coat proteins. The major coat protein (p8) is present in approximately 2,700 copies and protects the genome in a cylindrical manner. The minor coat proteins p7 and p9 are necessary for efficient particle assembly, while other minor coat proteins p3 and p6 are necessary for particle stability and infectivity. The p3 protein mediates the binding of the phage to the F pilus and is necessary for viral uncoating and phage DNA transfer to the

cytoplasm of the bacterium. Host enzymes then convert the ssDNA into supercoiled dsDNA, known as the replicative form (RF) (source- chapter 1, phage display of peptide and protein, Winter, McCafferty et al.). The RF is essential to the phage display system because it can be purified and manipulated just like a plasmid. Through the manipulation of the RF of M13, some of the earliest cloning vectors were created. (Messing, 1991) (See next paragraph for phage display cloning vector).

The minor coat protein 3 (p3) and the major coat protein 8 (p8) are the most common proteins used for fusions. The Phage display system that uses the p3 and the p8 proteins has different advantages. Use of p8 protein as the fusion protein enables high copy display of the recombinant protein because there are over 2,700 copies of the p8 protein on the surface of the phages. However, the p8 protein can only display small size peptides. When p8 protein displays large size particles, the function of the coat protein becomes compromised and the number of infectious particles gets decreased (larger size peptide fusion become possible by use of phagemid vector, described in next paragraph). The p3 protein is present in 5 copies at the tip of bacteriophage. A recombinant fusion of larger peptide is possible using the p3 protein. Potential disadvantage is possibility of less infection due to sterical hindrance by displayed peptides. This can be better described as polyvalent display and this problem was solved by use of the phagemid vectors. (Source-book chapter 1, Introduction to phage biology, and phage display, Marjorie Russel et al.)

1.2.3 Phage display cloning vector: phagemids

Phagemids are cloning vector created by combining best features of plasmids and phages. They are designed to have origin of replication for both M13 phages and *E. coli*. The important difference between phage based vector and phagemid vector is phagemids code for only fusion gene protein and not for other phage proteins. This feature was gained in the phagemid vectors by fusion of displayed protein gene under control of weak promoter which led to monovalent display of fusion proteins. However, monovalency is possible only for p3 fusion, p8 fusion still remains polyvalent. The valency of display can be an important factor as monovalency lead to selection of strong binders.

The phagemids vector alone can not generate complete phage particles because they do not code for other structural proteins. The other structural and functional proteins necessary to accomplish life cycle of phagemid are provided by the helper phages (e.g. M13KO7 or VCSM13) as co infection to *E. coli* cells harbouring phagemids. The helper phages have slightly defected origin of replication that causes less effective replication than phagemids. This process is termed as “phage rescue”. In addition, other elements such as molecular tags and selective markers are introduced into the phagemids to facilitate the subsequent

operations, such as gene manipulation and protein purification. (Source- book chapter 1, Introduction to phage biology, and phage display, Marjorie Russel et al.)

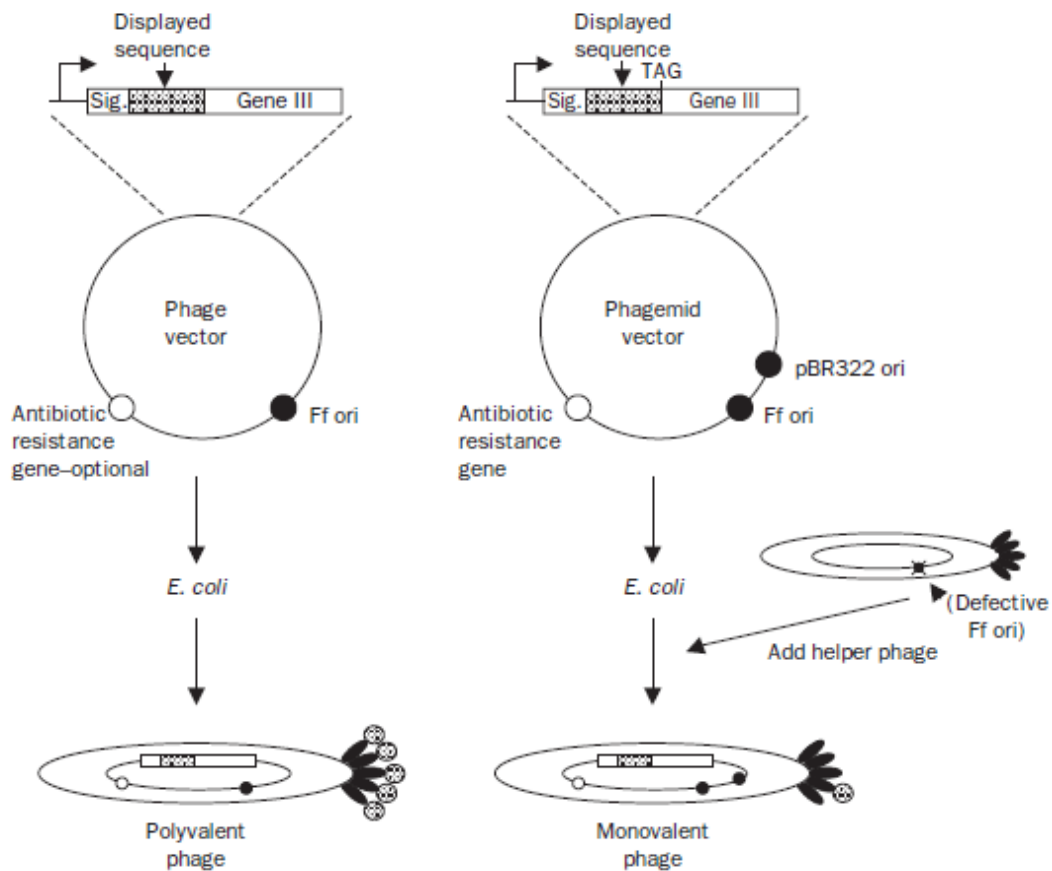

Figure 1.2b: General scheme for phage display using phage and phagemid vectors. The difference in both vectors is illustrated by using p3 fusion protein as an example. The sequences of display proteins are introduced in the vector between the signal peptide and the gene3. Both vector carry Ff origin of replication, which allow them to replicate as M13 phages. The phagemid vectors also carry origin of replication in *E. coli* (pBR322 in this figure) and an antibiotic selection marker, which allows them to replicate as plasmids in *E. coli*. In the phagemid vectors an amber stop codon (TAG) is introduced between the display protein gene and the gene3, which facilitates soluble protein expression by transforming phagemids in a *non-supE* suppressor strains. Source- book chapter 1, Introduction to phage biology, and phage display, Marjorie Russel et al.

The phages and the phagemids are the most common vectors used in phage display systems, while the phagemids are more widely used than the phages due to the following reasons. The smaller genome of the phagemids in comparison to the phages might facilitate efficient transformation. The phagemid vectors have wider choices of restriction sites. The phagemids are generally genetically more stable than the recombinant phages (Qi, Lu, Qiu, Petrenko, & Liu, 2012). The phagemids are more desirable if the monovalent display is preferred (in case of p3). The polyvalent display of larger peptides can be achieved by using

the phagemid p8 display system. The expression level of fusion proteins can be controlled easily in the phagemid vectors.

1.2.4 Antibody display libraries

It is possible to create a large library in which the proteins displayed on each phage are slightly different from each other; the process is called as library construction. Total number of different phage/phagemid particles displaying unique antibody fragments in the library defines the size of the library, which is a critical parameter for the success of the antibody phage technology. The larger size of a library increases chances of finding antibodies that bind to any given target with higher affinities. The second parameter that defines library performance is the number and location of variable positions. As in the immune system, the antibodies have a common framework, while diversity is present in the CDR loops that determine the specificity of binding. CDR3 loops represents the antibody region in which diversity is mainly concentrated in naturally occurring antibodies. Therefore, also for synthetic libraries, the amino-acid diversity is generally localized in the CDR3 residues (Griffiths et al., 1994). The other important parameters for library construction are: antibody gene should be well expressed, design of library should allow easy engineering of antibodies and finally overall handling of library should be easy (Kretzschmar & Von Rüden, 2002).

There are different ways to create diversity while building an antibody phage display libraries. On the basis of the strategy followed to obtain diversities, it can be classified in “Immune repertoires” (antigen-biased), and “Singlepot” libraries (antigen-unbiased). Both kinds of libraries are explained in the following paragraph.

Immune antibody phage display libraries

This type of libraries takes advantage of diversity created *in vivo* by the immune system. The source of variable immunoglobulin gene in this case is the B cells from immunised animal or immune patient (for human origin B cell) (Clackson, Hoogenboom, Griffiths, & Winter, 1991). This library needs custom preparation for each antigen, which slims its scope for universal use. Another limitation with this library is the requirement of an antigen to be immunogenic to provoke immune response. This feature makes use of such library less convenient for targets like inorganic materials used during this thesis, for which the immune responses are not yet fully known.

Single-pot libraries

The single-pot libraries contain virtually all possible binding specificities and are not biased for a particular antigen (Pini & Bracci, 2000). This type of library is suited for our application to find binders for various inorganic materials.

The single-pot libraries can be classified as naïve or synthetic. In the **naïve library**, variable genes are isolated from unimmunized animals or human donors and are assembled to create large diversity of antibodies. It is theoretically possible to select antibody against any target (antigen) by using this library. The major disadvantage is the requirement of very large library size to isolate high affinity binders as a consequence library has many unknown and uncontrolled contents. In the next step of artificial affinity maturation, these unknown contents need to be sequenced and that require preparation of customised primers.

In the **synthetic library**, diversity is entirely created outside the natural host. To construct a synthetic antibody library, germ line variable region is isolated from source and amplified; subsequently CDR region is randomised, and assembled (Griffiths et al., 1994). The source of germ line gene could be any organism. To mimic natural antibodies, generally V_H CDR3 region is chosen to insert maximum diversities. In the synthetic library, contents are well defined: antibody structure, knowledge of the antibody regions that are randomized and those that are kept constant. This library is not biased against self antigens. Main disadvantage of this library is that it needs to be highly diverse to obtain high affinity binders and while increasing the diversity of library, the chances of accumulating nonviable antibodies sequences also increase (Carmen & Jeremutus, 2002), (Pini & Bracci, 2000). We have used Tomlinson (I+J) library for screening of inorganic materials. The Tomlinson library is single pot, synthetic library comprised of approximately 1×10^8 random phagemids derived from non-immunized human donors (see appendix A for details).

1.2.5 *In vitro* selection of binders in controlled conditions

The phage display of antibodies provides selection of the binders against desired target under *in vitro* controlled conditions. Selection process can be divided into five main steps: 1) preparation of antigen/target 2) blocking 3) incubation of phage with antigen 4) washing to remove nonspecific phage and 5) elution. We can have great control during each step of selection, which are described in the following paragraph.

During the *in vitro* incubation step of the library with the target, physical (e.g. temperature), chemical (e.g. buffer composition, salt concentration, pH) and other parameters such as the

time of incubation (typically 1h) and the amount of target can be controlled to select antibodies which are able to bind the antigen under these defined conditions. Any molecule that remains stable in aqueous buffer for 1h can be used as a target. All these features make this technique applicable beyond biological targets. By playing with these selection conditions, it is possible to isolate binders (antibodies) with controlled affinity (nanomolar concentrations of the target will select for subnanomolar affinity), pH-dependence (selection at low pH and elution at high pH will select for pH-sensitive binders) etc.

1) There are many possibilities to prepare antigen/ target for screening: antigen/ target can be directly mixed (like in figure 1.2c (box2), for e.g. polycrystalline inorganic material is directly mixed with library of phages), or can be immobilized by direct adsorption to a plastic surface or can be used in solution (by using biotinylated antigen).

2) Blocking is done to avoid nonspecific binding which are mostly hydrophobic interactions with target entity. Generally, the target and the incubation device are immersed in buffer containing milk, BSA (Bovine Serum Albumin) or casein.

3) The mixture of library and target can be shaken or agitated for improving chances for phages to bind to the target. Phages which show affinity for target through displayed scFvs remain bound and those which do not show any affinity, either remain in solution or may bind non specifically (as shown in figure 1.2c (box 2)).

4) Washing step can remove non-specific and unbound phages (see figure 1.2c (box 3)). Washing is done by quick rinsing using appropriate buffer containing mild detergent. Washing step can also be performed under controlled condition by increasing or decreasing stringency of washes (usually by using different concentration of mild detergent or by increasing or decreasing number of washes or combination of both).

5) Elution is done to isolate target specific clones (see figure 1.2c (box 4)). There is enough choices for elution conditions - one can choose pH dependent reagents (triethylamine, glycine/HCl), or enzymatic reagents (trypsin, chymotrypsin) or competitive elution with soluble antigen. After elution phages are infected to *E. coli* to amplify population of target specific clone, (see figure 1.2c (box 5)). Subsequently, the phagemid bearing *E. coli* are infected with a helper-phage to produce new phage particles that can be used for further selection rounds until a significant enrichment of the target specific clones is achieved.

At the end of screen (typically 10th day), bacterial colonies can be randomly picked (these colonies appear as result of infection of phages from last round of selection). Each bacterium is capable of secreting scFv, which should be ideally specifically bind to target.

ScFv can be purified using bacterial strain (see appendix B). Genetic sequence of scFv can be obtained (by plasmid DNA purification) and analysed using various bioinformatics tools. Additionally target specific clones can be modified by using various methods of affinity maturation.

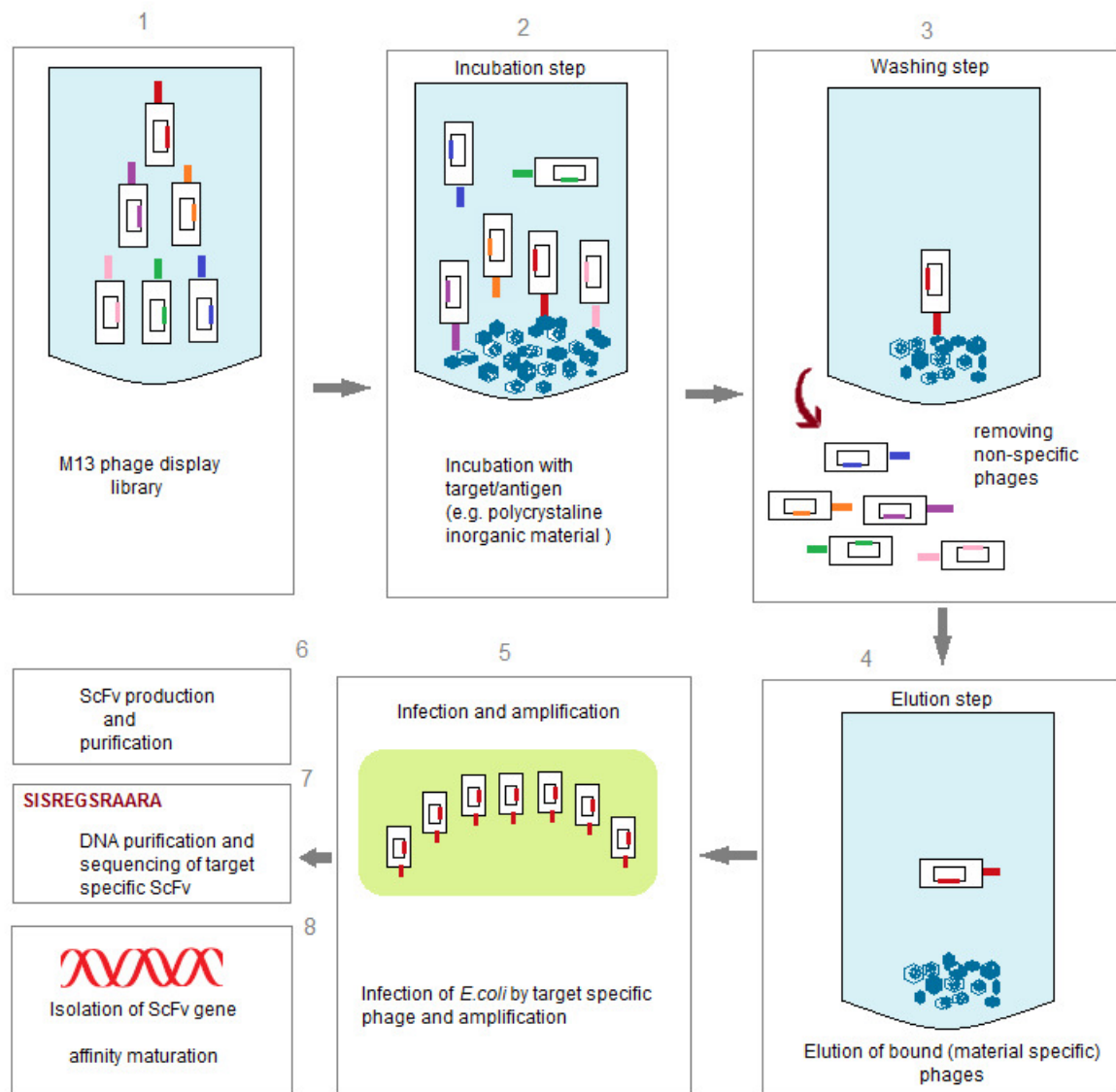

Figure 1.2c: Different steps of phage display technique and selection of scFv specific for target. screening box1-phage library, box2- incubation with target, box3 – washing step, box4- elution step, box5- infection and amplification in bacteria, box 6,7,8 – further choices after obtaining target specific scFv.

With advanced genetic engineering it is possible to remove or add any key protein domain or any other entity in order to create engineered antibodies.

1.3 Antibody engineering

The modular structure of antibodies allows a wide array of domain rearrangements by performing antibody engineering. The antibody engineering can provide more value to applications in nanoscience based on antibody fragments as inorganic binders. Engineering of this molecule allows us to modify an original antibody fragment (scFv) selected by phage display for controlled valency, geometry and many other functionalities (refer section 1.1.5 for structural details of scFv molecule).

Engineered antibody constructs are not only useful for applications in nanoscience but also in providing effective pharmacokinetic properties to therapeutic antibodies. Some of the engineered constructs have already been taken to the clinic to serve the purpose as better therapeutics (Jain, Kamal, & Batra, 2007).

** There are many ways to engineer antibody molecules, the examples given here are more based on the work done during this thesis.*

1.3.1 Engineering IgGs into small fragments

The large size of IgG can slim its scope for use as a small size binder for nanomaterials and as a therapeutic tool in few cases. Few limitations of using IgG are inefficiency to produce full size antibody, inefficiency to use IgG for display technique, increased circulation time in blood that affects its therapeutic applications and high background in imaging (Jain, Kamal, & Batra, 2007). These limitations have encouraged development of small antibody fragments. Initial attempts to make smaller fragments were based on digestion of intact IgGs by proteolytic enzymes (pepsin or papain).

With the advancement in various displays system and recombinant DNA technology, it is very easy to generate small antibody fragments. One of the smallest fragments of antibody that can recognise antigen was identified as "Fv" fragment. Due to instability of this unit it was engineered to more stable structure called scFv (explained earlier in section 1.1.5). Small size of scFv is a favourable characteristic for our aim to use scFv as small sized ligand for surface modification of nanoparticles. Due to small size, most scFvs have short serum half life (<10 min) compared to the intact IgG, which makes it useful for some diagnostic application such as imaging (Colcher, Batra et al., 2002). ScFv is a very interesting molecule for various research purposes.

Another popular fragment is Fab, where V_H and V_L regions are held together by C_{H1} and C_L domains as well as by inter chain disulphide bond. These four regions including the inter-

chain disulphide bond comprise of a Fab fragment. A Fab fragment is more stable than Fv or scFv fragment but this stability comes with relatively high molecular weight.

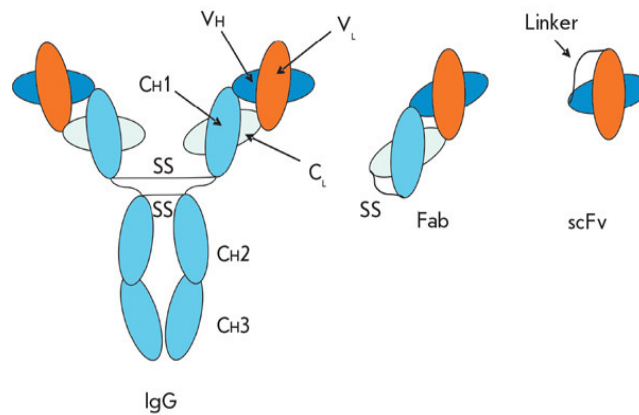

Figure 1.3a: Intact immunoglobulin molecules and its antigen binding fragments. Dark blue color fragment is V_H domain, orange color is V_L domain. In the structure of a Fab, V_H and V_L regions are held together by C_H1 and C_L domains as well as by inter chain disulphide bond. In the structure of an scFv, peptide linker of 15-20 amino acids is used to link V_H and V_L . Source (Tikunova & Morozova, 2009)

1.3.2 Engineering the valency of antibody molecules

The Fab and scFv fragments derived from phage display antibody library are monovalent, whereas in many *in vitro* and *in vivo* conditions, multivalency of Antibody molecule is preferred.

ScFv expression vector is designed in such a way that the cDNA, which encode for V_H and V_L chain of an antibody are assembled by a sequence that codes for a peptide linker. The most common linker has 15-20 amino acid residues. Holliger et al have demonstrated that if the peptide linker length is reduced to 5 amino acid, V_H and V_L of scFv are not able to bind to each other (Holliger, Prospero, & Winter, 1993). The small size of linker causes a displacement in the equilibrium and as a result, scFv dimer is formed (this structure is called diabody, shown in figure 1.3b). The dissociation rate of diabody is lower than its parental scFv. Diabodies are rigid structures and can be expressed in bacteria. Further reduction in linker length to just one residue results in tetrabody formation. scFv tends to form a tribody in absence of a linker (Le Gall, Kipriyanov, Moldenhauer, & Little, 1999). Another approach to create multivalency in antibody fragment is the fusion of C_H3 domain to a scFv or Fab fragment and the resulting molecule is called minibody.

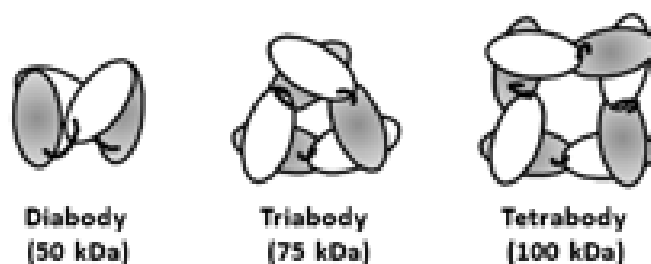

Figure 1.3b: Presentation of diabody, tribody and tetrabody with their molecular masses. Source- (Olafsen et al., 2010)

To develop artificial antibody with multiple valencies, in one report, scFv sequence is fused to core streptavidine (Kipriyanov et al., 1996). Resulting fusion protein was termed as scFv::streptavidine. Streptavidine is a stable tetrameric protein and it has high affinity for biotin. This fusion protein was expressed in periplasmic inclusion body of *E. coli*. After purification, tetrameric complex scFv::streptavidine demonstrated binding with both antigen and biotin. This complex was found stable over wide range of pH and at high temperature. However, expression level of streptavidine fused protein was observed to be low.

In designing strategies for multimerisation of antibody fragments, several issues need to be addressed like stability, resistance to proteolytic cleavage during *in vivo* assembly, efficient production of preferably soluble protein, easy gene engineering steps, efficient expression level, sufficient activity and specificity maintenance, thermal stability etc. Among these issues related to multimerisation of antibody fragments, we have attempted to address the issues of easy gene engineering steps by our antibody engineering platform and efficient expression level by using a new expression system (explained in section 1.4).

1.3.3 Bispecific antibodies

Naturally occurring antibodies are directed against a single antigen: they are monospecific. Advances in antibody engineering have made it possible to combine the specificities of two antibodies into a single molecule - this combined molecule is known as a bispecific antibody. Bispecific antibodies do not occur in nature, it is a man-made construct. Initially, bispecific antibody was designed for therapeutic purposes. The initial use of bispecific antibody was based on the design in which one arm is specific for the tumor cell surface antigen and the other arm recognizes and activates the signalling receptor on the effector cells (Dafne M,RE Kontermann,2010). The combination results in using patient's own

immune effector cells to target tumor cells which ultimately resulted in the killing of the tumor cells.

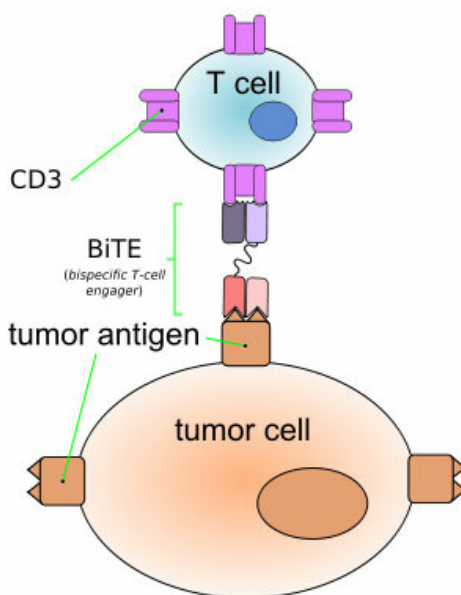

Figure 1.3c: Concept of BiTE constructs, Two scFvs having different specificity (one for tumor cell, other for T cell activation) joined together by a linker. This construct can use patient's own killer cell to eliminate tumor cell. Source - Wikipedia

This particular subset of bispecific antibody, which engages T cell receptor is also known as BiTE construct (Bi-specific T-cell engagers). Concept of BiTE is shown in figure 1.3d. These engineered bispecific molecules also caught the attention of material scientists for building bio-inspired or biomimetic material (explained in details in section 1.5).

There are some technical hindrances related to the construction and production of bispecific antibodies in terms of quantity and quality. Earliest bispecific antibodies were made by fusion of two hybridomas producing antibodies of two desired specificities. This construct had issues related to yield and purity because pairing between heavy and light chains was a random event with this technique. Over the years, many advanced construction and production techniques of bispecific antibody have come up. One of the recent techniques consist of using scFv from phage display selection and engineering them to make bispecific antibody. This engineering can be done by joining V_H or V_L of one scFv with V_H or V_L of another antibody by flexible linker. In this thesis we have attempted to make such bispecific antibody construct, using flexible linker. One bispecific antibody having therapeutical importance has already entered into the market and many others are in the clinical phase (www.f-star.com). Recently, Macrogenics and Boehringer Ingelheim have inked a deal of

\$2.2 billion for development of a bispecific antibody. Another important collaboration is between f-star and the German pharmaceutical worth \$1.7 billion (Moran, 2011).

1.3.4 Fusion with other molecules

Antibody fragments can be fused with other proteins or protein fragments. This fusion gives additional properties to the antibody fragments. Antibody fragments can be fused with other agents (e.g. radioisotopes) by chemical conjugation. Most widely engineered products in this category belongs to immunotoxins (scFv specific to tumor and toxin capable of killing target cells) (Kreitman, 2006).

There is also one report on the production of biotinylated antibody fragments by utilising the activity of *E. coli* biotin ligase BirA (Saviranta, Haavisto, Rappu, Karp, & Lövgren, 1998). The 13-residue sequence, recognised by enzyme BirA, was fused with antibody fragment and later purified fragment was incubated with enzyme that allowed addition of biotin to the sequence. This method of biotinylation is advantageous over chemical modification as the resulting biotinylated molecule is homogeneous, fully active and can be tetramerised by interaction with streptavidine.

Conjugation of antibody with GFP can be used as an important tool to study cellular mechanism. One such example is intracellular expression of GFP + scFV construct that allows study of dynamics of endogenous target protein within living cells (Nizak et al., 2003). Traditionally, GFP fusion is done by *in vitro* chemical conjugation of organic fluorophores. This procedure requires large quantity of purified protein and optimization for level of conjugation. But fusion of GFP with antibody fragments and ability to produce functional protein has lead to the use of GFP fused antibodies for a wide range of biotechnological applications. Functional production of GFP fused protein is questionable because GFP is a cytoplasmic protein. Attempt has been made to produce it functionally in our new expression system.

1.3.5 Back to IgG like structure

For some applications described above, scFv or other small fragments are the desired format but monovalent binding and lack of Fc mediated effector function of the scFv make it less viable for therapeutic purpose. There is a possibility to fuse scFv (selected by antibody phage library) to Fc region (shown in figure 1.3b). This construct has potency similar to a full length antibody. This fusion might improve the stability of the antibody. It may lead to the increase in the serum half-life of the antibody (increased half-life is important for *in vivo* antigen neutralisation). It may also add effector mediated functions to a molecule by ADCC

and CDC (Powers et al., 2001). One such example of re-engineering back to IgG like structure for therapeutic antibody is adalimumab (Humira), an FDA approved TNF α antibody. This antibody was selected using human Fab library and later engineered into IgG1 (Teillaud, 2005).

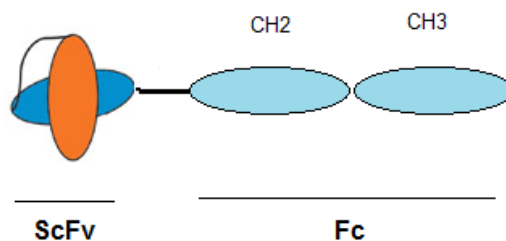

Figure 1.3d: ScFv (selected by phage display technique) is fused with Fc to construct scFv+Fc.

Another example is fusion of a multispecies (rabbit, mouse, human) Fc with scFv selected by phage display (Moutel et al., 2009). This work presented many multiplexing options and gave additional value to scFv by making antibody free from its species-specificity reaction. These multispecies Fc fusion scFvs were also tested for their applicability as a tool for western blotting and immunofluorescence. In future, scFv+ Fc conjugation can be used as a multifunctional and more stable probe for inorganic targets.

1.3.6 Antibody class switch

Immunoglobulin class switching (or isotype switch) is a biological mechanism that changes B cell's production of antibody from one class to another, for example, IgM to IgG. During this process, the constant region of the antibody heavy chain is replaced with different chains, but the variable region of the heavy chain remains same. Since the variable region does not change, class switching does not affect specificity on the antibody. It retains the same affinity for a given antigen but this different molecule can mediate different effector functions. From the five main immunoglobulin classes (IgG, IgD, IgA, IgE and IgM), IgG1 has been mostly used for engineering therapeutic antibodies. More recently, IgG2 and IgG4 have been used for better effector functions. IgG1 shows the most predominant effector function because of its unique Fc portion. Fc portion of IgG1 can be fused to therapeutic antibodies to enhance effector-mediated functions of immunoglobulins (Filpula, 2007). So far, such isoform switching seems to benefit only therapeutic antibodies; it may have null effect on improving probes for inorganic molecules.

The production of recombinant antibodies and their engineered forms is performed in both prokaryotic and eukaryotic expression systems, each having its own pros and cons. In this section, we have compared three common expression systems and have introduced a new eukaryotic expression system, *Dictyostelium discoideum*.

1.4 Production of recombinant antibodies

The practical realisation of all the possible applications (nanoscience and therapeutics) based on antibodies and their engineered derivatives may not be possible in absence of production of recombinant antibodies in their active form. The production of antibodies in large amounts is a challenge because of the sophisticated structure of immunoglobulin (see figure 1.1a) and the large size of engineered constructs. The production of antibodies using recombinant DNA technology was a great achievement to fulfil these demands. The recombinant DNA technology has also opened doors for using various expression systems for the production of recombinant antibodies. Three of the currently used expression systems along with a new system developed during this thesis for the production of recombinant antibodies and their engineered constructs are described in this section.

It could be interesting to learn about the current economic status of recombinant antibodies as this is one of the key motivations to develop new expression system for production of antibodies. Recombinant antibody production is a big market and monoclonal antibodies (mAbs) are the best selling class of biologics, Sales of mAbs constitute ~36% of the total biologics market (Aggarwal, 2011). The major pharmaceutical industries which were focusing only on traditional monoclonal antibody (mAb) therapies until now are looking for the next generation of therapeutics—conjugates, fragments or other derivatives such as bispecific antibody (Moran, 2011).

1.4.1 Challenges faced by expression systems for production of recombinant antibodies

Most of the expression systems could not provide the optimal conditions for the production of a full size IgG molecule. In general, the yield and the biological activity of any recombinant molecules depend on factors such as solubility, stability and size (Dingermann, 2008).

Size limitations can be overcome by the use of scFv (antibody fragment). Small antibody fragments can be produced even in bacteria in high amounts (Dübel, Breitling, Klewinghaus, & Little, 1992). However, production of large size constructs is often suffered from insufficient yield in most of the expression systems. This can be one of the major limiting factors for the applicability of antibody engineering technology as engineering may be achieved by increased size of antibodies. Apart from size, every protein imposes unique problems in its expression because of its unique amino acid composition (Verma, Boleti, & George, 1998).

In some therapeutic applications, only binding with antigen is not sufficient, further Fc mediated effector functions are required. In such conditions, scFv can be fused with Fc region. Fc region of an antibody molecule bear conserved N-linked glycosylation (Nezlin & Ghetie, 2004). Prokaryotic expression systems are not the most appropriate choice for the production of glycosylated proteins as they lack the machinery required for post translational modifications.

The antibody based proteins have been produced in *E. coli*, yeast, filamentous fungi, insect cells, mammalian cells, transgenic plants and transgenic animals. Currently around 20% of biopharmaceutical proteins are produced in yeast, 30% in *E. coli* and 50% in higher eukaryotic cells, mainly mammalian cells (Ferrer-Miralles, Domingo-Espín, Corchero, Vázquez, & Villaverde, 2009). Despite the several advantages offered by microorganisms, a large number of therapeutic antibodies are produced in mammalian cells. Microbial cells are more convenient for production of recombinant antibodies in terms of handling (Graumann & Premstaller, 2006). Improved microbial production platform can benefit industrial production of recombinant antibodies. In this thesis, a eukaryotic expression system *Dictyostelium discoideum* (commonly known as slime mold) is described for the first time as a production system for recombinant antibodies.

1.4.2 Expression systems for recombinant antibody production

There are various expression systems that can be used for the production of whole antibodies and antibody fragments. The choice of system is partially dependent on intended use of antibodies. In this section, we are restricting ourselves to the production of antibody fragments and their large size engineered constructs along with the production of therapeutically important antibodies. Both requirements are benefitted if the yield of protein is better which, in turn, influences the cost of production. Below is the description of three commonly used expression systems on industrial scale along with a newly established eukaryotic system (*Dictyostelium discoideum*).

1.4.2.1 *E. coli*

E. coli is the most widely used organism for expression and production of recombinant proteins. It is a well-studied organism with adequate knowledge about its genetics and physiology. It offers several advantages for production of any recombinant protein (including antibody fragments). Some of these advantages are as follows: (a) it can grow very fast and reach high cell density (b) medium requirement is simple and inexpensive (c) it is suitable for large scale fermentation (d) recombinant protein produced by *E. coli* can be purified by simple and well established downstream processes.

Some major challenges for producing recombinant protein in *E. coli* include - native disulfide bond formation, lack of post translational machinery and secretion of active proteins. Protein produced in *E. coli* often precipitates as insoluble aggregates in cytoplasm and form inclusion bodies that require tedious process of renaturation (Sahdev, Khattar, & Saini, 2008). Lysis to recover the cytoplasmic proteins often results in the release of endotoxins that must be removed from the final product. Only heavily engineered cysteine free mutant of scFvs were successfully produced in cytoplasm of *E. coli* that did not require refolding (Proba, Wörn, Honegger, & Plückthun, 1998).

Major challenges that *E. coli* expression system can face in order to produce antibodies are: the secretory nature of the antibodies and the requirement of an oxidising environment for proper folding. In *E. coli*, periplasm is the only site that provides an oxidising environment that favors stable disulfide bond formation. There are many folding modulators present in the periplasm. However, such scheme works only for small fragments. The production of full length IgG in *E. coli* has been reported after fine adjustment of translation strength of IgG sequence and mutation in leader sequence to achieve optimal periplasmic transport (Simmons et al., 2002). There are many strategies for directing secretion of proteins into the periplasmic space. Some protein having periplasmic leader sequence may seep out protein in the extra cellular medium (Neumann-Haefelin, Schäfer, Müller, & Koch, 2000).

The most serious disadvantage of using bacteria includes problems in post-translational modifications of proteins. It is widely believed that bacteria cannot glycosylate its protein but cellular processing of some oligosaccharides might take place in the periplasm. One such example of N linked glycosylation was recently reported in gram-negative bacteria *Campylobacter jejuni* (Weerapana & Imperiali, 2006). However, bacterial glycans are chemically very different from human ones. Proteins that do not undergo glycosylation in their native form like insulin or growth hormone can still be produced in bacteria (Graumann & Premstaller, 2006). Antibody production in *E. coli* is also related to host toxicity, which result in low yield of antibody (Schirrmann et al., 2010).

1.4.2.2 Yeast

Yeast is an attractive system for production of recombinant proteins/antibodies. It is a eukaryotic organism and hence can provide glycosylation to eukaryotic proteins. However, the capacity to generate human glycosylation varies in different expression systems (see detailed explanation in the following section). There are many advantages that yeast offers for production of recombinant proteins/antibodies. For e.g. (a) Short generation time, which allows it to grow rapidly and reach high cell density (b) ease of genetic manipulation, (c)

simple medium requirement, (d) high compatibility with fermentation, (e) post translational modification, (f) low number of secreted proteins that helps higher recovery of secreted heterologous protein at significantly lower costs (g) many yeast strains have GRAS (**G**enerally **R**ecognized **A**s **S**afe) status and they do not produce endotoxins. This can favour their approval for therapeutic use.

Many strains of yeast have been used for the production of recombinant antibodies. Particularly, *Saccharomyces cerevisiae* and *Pichia pastoris* have been studied for recombinant antibody production. The first expression of a scFv fragment in *P. pastoris* was demonstrated by Ridder et al (Ridder, Schmitz, Legay, & Gram, 1995) and later very high yield (upto 1.2 gm/L) of scFv was reported in *P. pastoris* under optimized fermentation conditions (Freyre et al., 2000). The yield of scFv+Fc fusion product has been reported to be 10-30mg/L using fermentor (Liu et al., 2003). Another scFv+Fc fusion protein product that was able to mediate antibody dependant cellular cytotoxicity against tumor cells was also produced in *P. pastoris* (Powers et al., 2001). Secretion of tetravalent scFv (15-20 mg/L) has also been reported in *this strain* (Goel et al., 2000).

Some reported disadvantages of yeast as an expression system are: lower transformation frequencies than *E. coli*, failure to express AT-rich genes due to premature transcriptional termination, proteolysis of secreted proteins during high cell density fermentation and inappropriate glycosylation of human glycoproteins (Schirrmann, Al-halabi, Dübel, & Hust, 2010). Even though yeasts are able to perform many post-translational modifications such as O-linked glycosylation, phosphorylation, acetylation and acylation, the main disadvantage of this expression system is related to its ability to perform N-linked glycosylation. The patterns of N linked glycosylation in yeast is different from higher eukaryotes (Ferrer-Miralles et al., 2009). Yeasts are reported to hyperglycosylate heterologous proteins even at positions not glycosylated in the native protein. They are also reported to add many mannose residues to glycoproteins. Hypermannosylation of the glycoprotein might affect pharmacokinetic properties of therapeutic antibodies (Sethuraman & Stadheim, 2006). However, *P. pastoris* mediates comparatively lesser hyperglycosylation than *S. cerevisiae*.

The strain *P. pastoris* has been reported to exhibit N-linked carbohydrate structures similar to the mammalian high-mannose core unit Man5-6GlcNAc2. Recently, production of human IgG showing humanised N linked glycosylation in *P. pastoris* has been reported (Li et al., 2006). Some yeast strains have been used for production of FDA-approved therapeutic proteins such as hormones (insulin, insulin analogues, non glycosylated human growth hormone, somatotropin, glucagon) and vaccines (hepatitis B virus surface antigen) (Ferrer-Miralles et al., 2009). Several groups of researchers have investigated the possibility of

reprogramming glycosylation pathways in yeast by substituting yeast enzymes with the human ones. This strategy presents good opportunity for the production of complex glycoprotein in yeasts.

1.4.2.3 Mammalian cells

Most of the proteins for therapeutic use and all currently approved therapeutic antibodies are produced in a mammalian cell lines (Chadd & Chamow, 2001). The success and popularity of the mammalian production system is due to its favourable features such as advanced folding and ability to perform post translational modifications. These features lead to the production of antibodies that are structurally very close to those produced in the human body. Another advantage of this system is that the recombinant protein is secreted into the media in natural form which makes purification of proteins/antibodies easier.

Major disadvantages of mammalian system are: (a) expression techniques in mammalian cells are time consuming and difficult to scale up, (b) large-scale antibody production requires stability of antibody gene that can only be achieved by chromosomal integration of antibody genes into the host cell genome, (c) clonal selection in the mammalian cell lines is time consuming (Schirrmann et al., 2010). (d) mammalian cells grow slowly, (e) They require complex medium including animal sera that are very expensive, they increase the overall cost of production, (f) the yield of recombinant proteins are also lower than other expression systems, (g) mammalian cell lines are under critical observation for viral contaminations (Taylor et al., 2001) and release of factors with oncogenic or pathogenic potential.

For recombinant protein production, chinese hamster ovary cells (CHO) cells, mouse myeloma NSO cells, baby hamster kidney (BHK) cells and a few other cell lines have gained regulatory approval. It should, however, be noted that oligosaccharide processing is species and cell type dependent among mammalian cells. Differences in glycosylation pattern are reported in rodent cell lines and human cell lines. Glycosylation is cell system dependent activity and this activity changes during differentiation, development and under different physiological and cell culture conditions. So secreted protein may not always be homogenous (Brooks, 2004). It may contain modified protein with different glycans and pharmaco-kinetic properties.

1.4.2.4 *Dictyostelium discoideum*

Dictyostelium discoideum (*Dd*) is recommended as a model organism by the National Institute of Health as part of its model organism initiative. The genome of this organism is of 34Mb, which contains many genes, homologous to higher eukaryotes. Genomic complexity of *Dd* is greater than yeast but simpler than plant or animals (Eichinger et al., 2005). Main areas of studies for *Dd* are functional analysis of gene, cytokinesis, cell motility, phagocytosis, chemotaxis, signal transduction and cell differentiation during development (Annesley & Fisher, 2009). In this thesis we have tried to study a new prospect for this organism- as a production system for secreted recombinant antibodies. The advantages of using this organism as an expression system are as follows.

Short life cycle

Life cycle is divided into two phases- vegetative growth phase and developmental phase. Growth phase is accomplished during favourable growth condition (presence of food) (dictybase.org). During its life cycle, the organism produces spores that can be used to start fresh culture leading to high cell density in a few days. The generation time in liquid culture is approximately 10 hours, suggesting much faster growth rate compared to the mammalian cells. During our experiment of recombinant protein production, we have only utilised growth phase of *Dd*.

The main advantage of *Dd* as an expression system is its relatively simple growth condition in contrast to other tissue cultures (mammalian or insect cells). *Dd* can be cultured axenically in growth medium. It can be easily grown upto a volume of 1 L in a shaking flask with control on gene expression. Growth mediums for *Dd* are simple and inexpensive. *Dd* can also be grown in **synthetically defined medium** (e.g. FM, SIH etc). These media do not require any protein of animal origin (commonly used axenic media HL5 contain yeast extract). So far, *Dd* is not known to have adventitious agents like viruses (discussion in Francodicty meeting, 2012).

Long-term storage

Dd cell lines do not required to be maintained for long time as cell lines can be stored in liquid nitrogen. Alternate option is storing spores. *Dd* cells produce spores that are highly resistant to desiccation, oxidising agent, and solvents. These properties of spores can be utilised for storing inocula. Spores do not loose their viability on silica gel for years and fresh culture can be started from spores (dictybase.com).

Informatics and Genetics

Information regarding all aspects of *Dd* is available on the internet. Dictybase provides news of research development in this field. Information on vectors, promoter, gene sequences, codon usage table and mutants are also available on dictybase. *Dd* is an **extensively studied** model organism. Because of its attractive biology this organism has been studied for various purposes that have resulted in the availability of powerful molecular techniques. These techniques provide a strong platform to explore *Dd* as an expression system. Most importantly, the **genome** of *Dd* is now known to us (Eichinger et al., 2005).

Most of the strains of *Dd* are grown at 22^oc. *Dd* cannot grow above 28^oc. Therefore, the organism itself might be **non-pathogenic** to humans (MB Slade, KR Emslia, KL Williams,1997).

Transformation can be done by electroporation. Selection of mutants takes less time than CHO cells as transformant cells start to be seen after 4 days of electroporation in *Dd*, whereas, in CHO cell, transformants can be seen after 2 weeks.

Economic

For recombinant protein expression at larger scale, the cost of production plays an important role. A expression system should be able to produce good amounts of protein in a cost effective manner. *Dd* has advantages over some other eukaryotic expression systems. As mentioned above, culture condition and medium requirement are simple. The medium is not expensive unlike mammalian culture medium. *Dd* culture does not need any animal-based additional expensive serum for growth. *Dd* can secrete recombinant protein/antibody in the culture medium. This can make downstream processing easy and less expensive. A group of researchers have systematically compared protein yield from *Dd* and mammalian cells using 100 ml culture and have observed 20 to 60 fold increase in yield in *Dd* (R. Arya, Aslam, Gupta, et al., 2008).

Codon usage

For efficient protein production the codon bias should be taken into consideration. The codon bias refers to the observation that all organisms do not use all the codons for one amino acid at the same frequency. AT content of *Dd* is 77.57%(Eichinger et al., 2005). *Dd* promoters are even 90% AT rich. In contrast, AT content of human is less than *Dd* (60%), which results in a different codon usage. The optimization of expression of human proteins in *Dd* would therefore, *a priori*, require codon usage adaptation. This is now easily done by

gene synthesis. It is possible to order a synthetic DNA sequence with the desired codon usage bias encoding any protein of interest.

Presence of extra chromosomal plasmid

Plasmids are traditionally associated with bacteria. Plasmids in bacteria are important tools specially for production of recombinant protein production. The presence of extra chromosomal circular plasmid is relatively rare for eukaryotic organisms. The availability of extra chromosomal plasmid in *Dd* raises the hope to produce therapeutic protein in good amounts. Many different extra chromosomal plasmids have been described in *Dictyostelium* species; they all differ in size (1.3-27kb) and copy number (50-300 copies per cell) (Farrar & Williams, 1988). Ddp1 and Ddp2 based plasmids have been used to construct recombinant vectors. Studies have suggested that Ddp1 and Ddp2 plasmids have nuclear origin. Experiments have confirmed their location in nucleosomes (Ashktorab & Welker, 1988). Extra chromosomal vectors have high transformation efficiency and can circumvent the need for clonal selection. However, extrachromosomal vectors based on *Dictyostelium* plasmid Ddp1 are often big, therefore more difficult to clone, whereas those based on Ddp2 are small but required to be co-transfected with a second vector in order to maintain extrachromosomal replication. These plasmids serve as excellent starting points for the construction of recombinant expression vectors.

Post translational modification

Eukaryotic proteins bear post translational modifications, specially glycosylation. *Dd* being a eukaryotic organism possesses the machinery to perform glycosylation. For therapeutic purposes, it is desirable to get human-like glycosylation pattern in proteins. There is no clear view about glycosylation pattern in *Dd* (see details in section 1.4.6). So far, *Dd* is not found to hyperglycosylate proteins like yeast cells do.

1.4.3 Tool box to regulate recombinant antibody expression level in *Dd* by secretion

There could be many possible uses of recombinant antibodies expressed in *Dd*. One is for functional studies, which do not require high amount of proteins. Another is therapeutic purpose, which requires high level of correctly folded protein. Production of engineered antibodies is also required in high amounts. All these aspects can be fulfilled by the use of an appropriate *Dd* expression vector. *Dd* expression vector and its expression cassette (promoter, translational start site, signal peptide, multiple cloning site, affinity purification tag and termination signal) are described in genetic toolbox. Other parameters such as culture conditions are described in miscellaneous toolbox.

1.4.3.1 Genetic toolbox

The presence of extra chromosomal plasmid in *Dd* allows the expression of recombinant proteins in *Dd*. One can choose low to high copy number vectors. Low copy number vectors are suitable for functional studies whereas high copy number plasmids are preferred for high level production of proteins. Ddp1 and Ddp2 based plasmids are characterised for recombinant protein expression (Manstein DJ, Schuster HP et. Al ,1995). Gene expression in *Dd* has been studied under natural conditions but increased expression level of recombinant proteins requires more regulation over gene expression. A better expression cassette in vector can introduce such regulation. Promoters can be chosen for best possible activity during axenic growth. Most of promoters available in the *Dd* are induced during different growth phase of its life cycle (MB Slade, KR Emslia, KL Williams,1997).

During axenic growth condition, the actin 15 promoter is observed to be active during the entire growth. Strength of actin15 promoter is suggested by poly (dT) sequence containing 45 dT residues adjacent to TATA box (Hori and Firtel,1994). Then next level is start codon. The start codon ATG in *Dd* is generally preceded by several A residues. This sequence performs the same function as mammalian kozak sequence (GCCRCCATGG). Difference between mammalian kozak sequence and *Dd* sequence is the absence of several "A" residues in mammalian Kozak sequence. Absence of initial A residue in the sequences of mammalian genes may not provide an optimal environment in *Dd* for translation initiation, therefore, mammalian genes expressed in *Dd* can be modified to *Dd* kozak like sequence (AAAAATG). There is one study which has reported increased level (~1.5-fold) of expression of hCG in *Dd* due to *Dd* kozak like sequence adaptation (Vervoort et al., 2000). For secreted protein, it is necessary to introduce signal peptide at the N terminus. Introduction or replacement of start codon and secretion signal peptide can also remove rare codon from the beginning of the gene and might partially optimise codon in *Dd* for secretion of human protein. Multiple cloning sites give wide options to insert foreign genes at different restriction sites. Histidine tag or any other tag (e.g. MBP, TAP) can be used for affinity purification. There are suggestions regarding the importance of transcription termination signal for increased level of expressions (Dingermann et al,1989). In one report where stop codon UAG was replaced with *Dd* stop codon UAA for expression of malarial parasite protein (CSP), increased level of expression of desired protein was observed (Fasel et al., 1992).

1.4.3.2 Miscellaneous toolbox

Culture conditions can greatly influence the final yield of recombinant protein. If *Dd* cells are grown axenically then the medium composition can become an important factor for the

growth of cells. Initial condition and concentration of inocula also influence proper growth. Apart from these, temperature, culture condition (shaking flask vs adhering cells), incubation time and selection marker can play determining roles for expression level.

1.4.4 Overview of glycosylation and its importance

Although glycosylation was not a focus of this thesis initially, it became a part of central theme when we started to develop a new eukaryotic expression system for the production of antibodies and their engineered forms. Apart from our aim to use engineered antibodies in materials science, the most important application of antibodies is in the therapeutics industry. As described in the details below, post translational modifications (PTMs) and in particular, the glycosylation profile of antibodies is of crucial importance for the latter application. The potential impact on the industrial terms of such results justified our focus on this secondary topic.

Proteins can be modified pre-translationally, co-translationally or post-translationally. All protein modifications are generally referred to as PTMs because a majority of them occur post-translationally i.e. after the protein is folded. Proteins can display many types of post translational modifications (PTM). Currently only one subset of PTM is mainly characterised for therapeutic proteins. This subset is glycosylation as it is one of the common and least well-understood PTM of proteins.

Glycosylation is an enzymatic process that attaches glycan (carbohydrate) to proteins. This process is a co-ordinated activity of enzymes present in the endoplasmic reticulum and golgi apparatus. Glycosylation types are classified according to the identity of the atom of the amino acid which binds the carbohydrate chain, i.e. C-linked, N-linked or O-linked (see appendix H for detailed description of glycosylation). Glycosylation is cell system dependent activity and this activity changes during differentiation, development and under different physiological and cell culture conditions (Brooks, 2004). The cells of non human species do not glycosylate their protein in the same way as human cells do (Demain & Vaishnav, 2009).

Glycosylation is the most common and the most complex PTM associated with therapeutic proteins. This PTM can have several potential effects on proteins. It is estimated that up to 50% of all native human proteins are glycosylated and between 1 to 2% of the human genome encodes proteins that contribute to glycosylation (Walsh & Jefferis, 2006). The glycosylation pattern can influence many significant properties of proteins that are described below:

a) Glycosylation can help in correct protein folding ,b) it can participate in targeting protein to its final destination, c) the glycan part can play a direct role in triggering the immune response – for example the carbohydrate moiety present at Fc portion of antibody helps in triggering immune effector cells, which ultimately leads to compliment activation d) sugar side chains can also stabilize glycoprotein in multiple ways like enhancing its solubility, shielding hydrophobic patches on its surface and protecting from proteolysis. e) It can also regulate protein half-life f) some glycoforms can be immunogenic to human. (Walsh & Jefferis, 2006)

Most of the FDA approved biopharmaceuticals (specially antibodies) are glycoproteins (Jenkins, 2007). Glycosylation can add considerable heterogeneity in glycoproteins. In order to decrease heterogeneity in glycoforms owing to its significance in protein function (as explained above), most therapeutic glycoproteins are produced in eukaryotic organisms, specially in mammalian cell lines (CHO, BHK etc). Biochemical differences between the therapeutic proteins and their natural homologues are often considered as technical or biological limitations. Such variations may not necessarily affect the therapeutic value. (See discussion, section 3.2 for details). So the therapeutic potential and value should not be determined by the resemblance between therapeutic proteins and naturally occurring human proteins.

1.4.5 Glycosylation profile of antibodies

Antibody molecules (IgG class), have two Fab regions and one Fc region. The Fc region is a homodimer which contains hinge regions, C_H2 and C_H3 domains. The C_H2 region has conserved N linked glycosylated regions. It is glycosylated through covalent attachment of oligosaccharide at Asn297 (Nezlin & Ghetie, 2004). The oligosaccharide is important to the Fc structure and is essential for the generation of Fc mediated effector function. This glycosylation is highly heterogeneous. Recombinant Monoclonal antibodies produced in currently used cell systems (CHO, NSO etc) typically contain up to 30 different types of glycans at Fc N-glycosylation sites (Fernandes, 2005). The Fc glycosylation can significantly modify Fc effector functions such as Fc receptor binding and complement activation. It has been demonstrated that the success of several antibody therapeutics in oncology depends on their ability to mediate ADCC (Jefferis, 2005). Many studies have demonstrated that the ability to mediate ADCC can vary greatly between different antibody glycoforms.

In addition to Fc glycosylation, some human IgG molecules may bear N-linked oligosaccharides within the Fab region. Sometimes both V_H and V_L chains may bear

oligosaccharides (Jefferis, 2005). For example, Cetuximab (Erbix) contains an N-glycan at Asn 88 of the V_H region. Such glycosylation can greatly influence antigen-binding affinity.

Because of the diversity in Fc glycosylation and Fab glycosylation many glycoforms may exist. Variations in culture condition or different expression system can greatly influence the heterogeneity of IgG oligosaccharide. This variation can also affect the biological activity of a therapeutic antibody.

1.4.6 Glycosylation in *Dd*

Dd is able to produce both N and O linked glycosylation. But it may produce modified glycosylated structures. In this section, the existence of different glycosylation patterns in *Dd* has been explained.

There is no evidence of hypermannosylation (either N or O linked) in *Dd*. This is in contrast with yeast cells that tend to add many mannose residues to their glycoforms.

In an attempt to produce human insulin-like growth factor binding protein 6 (hIGFBP6 in *Dd*), protein size was observed to be larger than the predicted protein size from peptide on SDS gel. However, this size was smaller than the same protein produced in CHO cell. The difference in size not only indicates that the protein was glycosylated, but also that there were differences in the glycosylation structure compared to those found in mammalian cells (Asgari et al., 2001). Similar observation was found while producing human erythropoietin (EPO) (Vats & Padh, 2007). Human gonadotropin hCG and human antithrombin III, secreted in *Dd* showed lower biological activity than the protein produced in CHO cells. This could be due to small differences in the glycosylation patterns (T Dingermann, Troidl, Bröker, & Nerke, 1991) (Heikoop et al., 1998).

It has been reported that *Dd* does not have the ability to add galactose, N-acetyl galactosamine or sialic acid, that has been observed in mammalian N linked glycosylation. But the basic structure of N-linked glycosylation in *Dd* is predominantly Man₉GlcNAc₂, similar to the mammalian high mannose structure (Sharkey & Kornfeld, 1991) This result was published before detailed analysis of *Dd* genome. Therefore, it is needed to be confirmed again. We have analyzed the *Dd* genome for the presence of glycosylation enzymes (see section 2.2).

N linked glycosylation has been studied in many organisms but O linked glycosylation of secreted protein has been studied only in few organisms. O linked glycosylation is more varied throughout eukaryotic evolution than N linked glycosylation. The work of Jung et al is

among the few that has detailed the characterisation of O-linked glycosylation in mammalian proteins expressed in *Dd*. A group of researchers has conducted in vivo studies on mucin MUC1 and MUC2 repeats and has demonstrated that one class of O-glycosylation in *Dd* involves the addition of a single *N*-acetylglucosamine residue to Ser and Thr residues, on secreted or membrane-bound proteins, at an early stage of development (Jung, Gooley, Packer, Karuso, & Williams, 1998). The *Dd* glycosylation apparatus incorporates GlcNAc residues into peptide sequences similar to those reported for the addition of GalNAc residues in mammalian tissues.

Most recent studies have been done on the production of human phosphodiesterase (PDEs) in *Dd*. PDE4B2 and PDE7A1 have been successfully expressed and purified in *Dd* (R. Arya, Gupta, et al., 2008)(R. Arya, Aslam, Gupta, et al., 2008). PDE4B2 expressed in *Dd* is very similar to the mammalian expressed hPDE4B2, specifically in its apparent molecular mass, predominant intracellular localization and interaction with substrate and various inhibitors.

Glycosylation pattern of human antibody produced in *Dd* is not known yet. Our result will provide the first report on glycosylation of antibodies in *Dd*.

Table 1.4a: Comparison of expression systems for the production of recombinant antibodies

Features	<i>E. coli</i>	yeast	<i>Dd</i>	mammalian
Secretion yield per L of culture	Up to 10 mg scFv, no or low secretion of engineered scFv	10-30mg/L using fermentor (Liu et al., 2003)	1mg/L for scFv+Fc (our results)	1mg/L for scFv+Fc (our results)
Cost per L (medium + antibiotics)	(LB + Ampicillin) 3\$	(1L YPD + 500mg G418) 65\$	(1L HL5 + 10mg G418) 15\$	(1L DMEM + 10% FBS + 400 mg G418) 130\$
Time from transformation to 1L production	3 days	6 days	15-20 days	45 days
Glycosylation	Few reports of glycosylation in periplasm of gram negative bacteria.(Szymanski et al., 2003)	Hyper-mannosylation	Both N and O linked glycosylation present, exact pattern is to be discovered (one of the goals of this thesis)	Human-like

* Cost of production is estimated from current price list at SIGMA, ForMedium™ and Gibco®.

Small world

When we get to the very, very small world – say circuits of seven atoms – we have a lot of new things that would happen that represent completely new opportunities for design. Atoms on a small scale behave like *nothing* on a large scale, for they satisfy the laws of quantum mechanics. So, as we go down and fiddle around with the atoms down there, we are working with different laws, and we can expect to do different things. We can manufacture in different ways. We can use, not just circuits, but some system involving the quantized energy levels, or the interactions of quantized spins, etc. - Richard Feynman (1959 talk at annual meeting of American Physical Society)

1.5 Selection of biological binder (scFvs) for inorganic materials

The main goal of this thesis is to select recombinant antibodies (scFvs) against inorganic materials by using random antibody library displaying antibodies on phage surface. Such antibodies could enable new applications in inorganic nanoparticles by optimising their surface chemistry. We begin this section with the general introduction to nanoscience, description of inorganic nano materials used during this thesis and their scope in nanoscience applications, current strategies to modify surface chemistry of these materials and their limitations, our strategy to use protein based ligand (antibody fragment) as an alternate strategy to modify surface of inorganic materials and further examples of potential applications of using protein based ligand.

1.5.1 Introduction to nanoscience

Nanotechnology has come of the age in the last few years, mostly because of advances in precise measurements and precise manufacturing methods at the nanometer scale. Any material that has at least one dimension less than 100 nm can be classified as nanomaterial. These nanomaterials exhibit different electrical, thermal and spectral properties as compared to their corresponding bulk material (Source -book “nanostructures and Nanomaterials” chapter-1, Guozhong Cao). The differences in these properties can be attributed to their small size. At the nanometer size, all particles have high surface area to volume ratios (refer table 1.5a). Such nanostructures have dominated surface effect as at nanoscale size, the ratio of the number of surface atoms to the number of interior atoms increases.

Nanosphere Diameter (nm)	Surface area (nm ²)	Volume (nm ³)	Ratio Surface Area:Volume
10	314	523	0.60
20	1260	4190	0.30
30	2830	14100	0.20
40	5030	33500	0.15
50	7850	65500	0.12
60	11300	113000	0.10
70	15400	180000	0.09
80	20100	268000	0.08
90	25400	382000	0.07
100	31400	523600	0.06

Table 1.5a Particles of different size (10 - 100nm), and their corresponding surface area: volume ratio.
Source- nanocomposix.com.

The high surface area to volume ratios of nanoparticles is attributed for interesting properties of nanomaterial. For example, unique optical properties of gold particles at nano size and fluorescent properties of quantum dots are due to the high ratio (explained in details in section 1.5.3).

1.5.2 Historical background and birth of modern nanoscience

Solutions of liquid gold were first mentioned by Egyptian and Chinese scholars around the 5th century BC. Ancient people used to believe in their metaphysical and healing powers. Colloidal gold was used during ancient Roman times for colouring glass of intense shades of yellow, red, or mauve (most likely resulting from different sizes of gold particles). A fine example is the famous Lycurgus cup in the British Museum, dated 4th century AD (www.britishmuseum.com). The cup exhibits different colours depending upon the direction of illumination. Michael Faraday did the first “scientific” study of metal nanoparticles in 1850. Faraday was the first to recognise that the red colour of gold colloid was due to the small size of the gold particles and red coloured solution of gold nanoparticles can be turned blue by adding salt to it (Faraday, 1857).

Many other synthetic (physical and chemical) methods for production of colloidal metal particles were developed in the early 20th century including the fundamental work of Turkevitch in 1951 (Turkevitch, Stevenson, & Hillier, 1951). Turkevitch used transmission electron microscopy (TEM) analysis to optimise the preparative conditions for various methods of synthesis for gold nanoparticles. The resulting method is known as Turkevitch method.

Currently, nanoparticles can be made from a variety of materials such as metals, metal chalcogenides (zinc oxide, iron oxide, zinc sulfide, cadmium selenide etc.), silicate or silicon oxide. Modern nanoscience is in its third decade; its impact is increasing in the fields of life science, energy, environmental science, and electronics (Mazzola, 2003). The birth of modern nanoscience can be traced to the invention of the so called building blocks of nanoscience “Quantum dots (QDs)”. QDs were literally invented as they are a completely human construct. Colloidal QDs were prepared in the mid 1980s in Bell laboratory by Louis Brus and his two post docs Alivisatos and Mike Steigerwald. Later, Maung Bawendi joined the team of Louis Brus and this team developed many key concepts of photophysics and material synthesis that ultimately led to the birth of building block of modern nanoscience (Alivisatos, 2008). The methods and approach developed by this team to grow colloidal QDs in flasks are widely adapted and they are now standard fabrication methods in laboratories.

The icon of modern nanoscience - a picture of vials containing colloidal QDs of different size, showing different colors when illuminated under UV lamp - has its origin from Bell's lab.



Lycurgus cup, example of gold nanoparticle from 4th century, it exhibits different colours depending on direction of illuminated light.

Source - www.britishmuseum.com

Icon of modern nanoscience, emission wavelength of QD can be tuned on the basis of particle size. Source - (Alivisatos, 2008)

Figure 1.5a: Example of nanoparticle (4th centuries – modern age)

1.5.3 Example of inorganic nanomaterials

There are many examples of inorganic nanoparticles. Here, in this thesis we have used gold nanoparticles and semiconductor QDs. Following is the explanation for why these nanoparticles are important. In particular, we address what are the unique properties of these materials at nanoscale and what could be their potential areas of application.

1.5.3.1 Gold nanoparticles

Gold has been considered as a precious metal for ages. In contrast to nanoscience which is a recent branch of science, gold nanoparticles have a rich and fascinating history. Ancient people exploited the optical property of gold particles thousand years ago without knowing science behind it (as mentioned in section 1.5.2). To the extension of the old proverb “everything that glitters is not gold” gold nanoparticles do not glitter but their future is bright and glittery.

Gold nanoparticles exhibit unique optical properties due to surface plasmon resonance (SPR) and thus gold nanoparticles are often called as plasmonic nanoparticles. SPR is a phenomenon of collective oscillation of conduction electron when a specific wavelength of light incident on surface of nanomaterial (see figure 1.5b). This phenomenon is more prominent in metal nanoparticles.

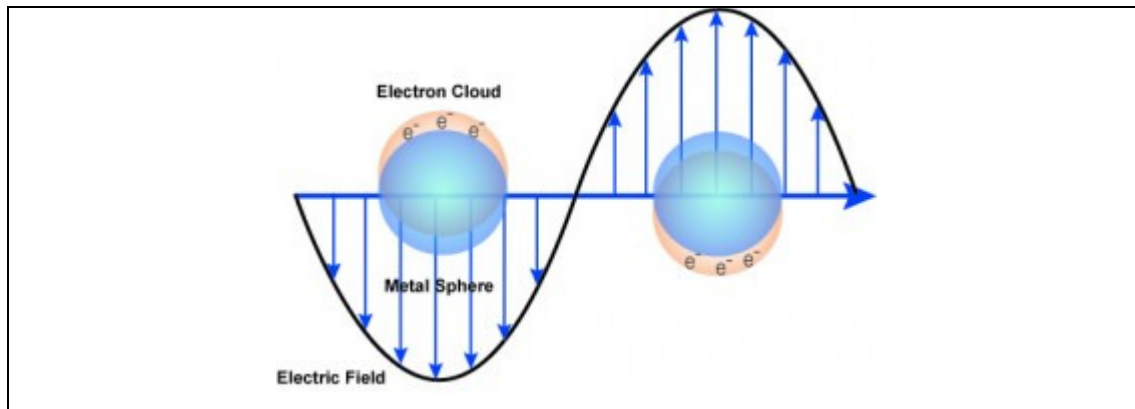

Figure 1.5b Presentation of surface plasmonic resonance (SPR), the free conduction electrons at the surface of gold nanoparticles are driven into oscillation due to strong coupling with incident light. Source- Wikipedia

The optical properties of gold nanoparticles can be tuned by changing their size and shape. For example, the extinction spectrums of 15 sizes of gold nanoparticles are displayed in the figure 1.5c. The reason for this size dependent shift is that smaller nanoparticles absorb light and have peaks near 520 nm. The larger spheres exhibit red shifting i.e. the absorption peaks shift towards longer wavelengths (nanocomposix.com).

The brightness and tunability of gold nanoparticle's optical properties make them desirable for numerous applications including molecular detection and solar energy materials. Furthermore, gold nanoparticles also exhibit high chemical stability as well as photo-stability. Unusual optical properties and the stability of gold nanoparticles make them robust materials for imaging and diagnostic applications. There are already few gold nanoparticles based diagnostic products commercially available – a pregnancy testing kit that has specific DNA sequence bound to gold nanoparticles (marketed by Church and Dwight), a kit for detection of food borne pathogens (currently being developed by Merck). Gold nanoparticles can also be used to enhance contrast and resolution in cellular samples examined under electron microscopes (Pissuwan, Cortie, & Valenzuela, 2007). The US based company Cytimmune is exploiting biocompatible properties of gold to deliver therapeutic drug directly to the cancerous tissue.

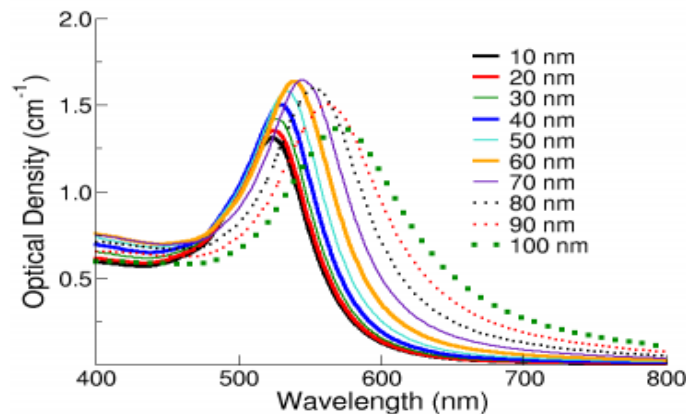

Figure 1.5c: Extinction (the sum of scattering and adsorption) spectra of gold nanoparticles with diameters ranging from 10 to 100 nm. The mass concentration for all the particles is 0.02 mg/ml. Source- nanocomposix.com

1.5.3.2 Semiconductor QDs

Quantum dots are tiny particles, or “nanoparticles”, of a semiconductor material. Usually they are metal chalcogenides (selenides or sulfides) such as cadmium selenide or zinc sulfide (source - nanocotechnologies.com). Semiconductor QDs exhibit size and shape-dependent fluorescent properties (Biju, Itoh, Anas, Sujith, & Ishikawa, 2008).

The fluorescent properties of the quantum dots are a result of their size which in turn affects the band gap energy. Band gap refers to the energy differences between the top of the valence band and the bottom of the conduction band (figure 1.5d). This gap is equal to the energy required to free an outer shell electron from its orbit. Thus, when a QD has a high band gap, higher energy is required to move the electron from valence band to conduction band. And when the movement of electron from valence band to conduction band takes place, it is called as an electron hole pair creation (or exciton) that emits a photon. The distance between an electron and hole is known as an exciton bohr radius (source - Wikipedia). When the size of QD is of the same order of exciton bohr radius, continuous band gap energy turns into discrete energy levels (source- physics.schooltool.nl/quantumoptics). Thus, the band gap becomes dependent on the size of the QD and in fact, as the size of QD decreases, the band gap increases leading to blue shift in optical illumination. Thus, we can control the fluorescent properties of QDs by controlling the size of particle which is best described in iconic figure of nanoscience (see figure 1.5a). This property can be used to make an array of QDs (same chemical composition) which shows different fundamental properties depending on the size of the individual crystal.

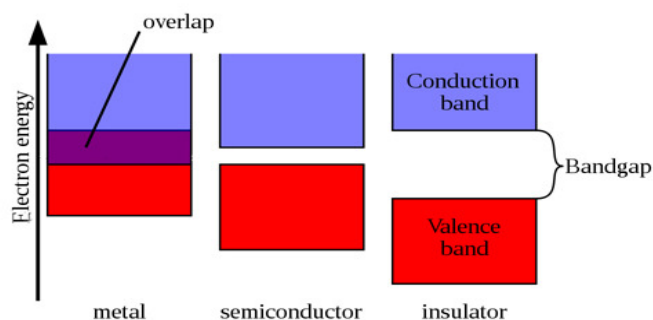

Figure 1.5d: Band gap diagram for insulator, metal and semiconductor. In metals, conduction band valence band overlap. In semiconductors, conduction band and valence band are spaced. In insulators, conduction band and valence band are widely separated. Source – miniphysics.com

QDs are gaining major attention for their unique optical properties, which clearly distinguish them from organic fluorophores. Organic fluorophores were conventionally used for tagging nucleotides and proteins for visual analysis. But these molecules have several limitations because of their poor photo stability, narrow excitation bandwidth, and cross talking in multiplexed experiments (Arya et al., 2005). Several efforts are being made to make ideal fluorophores that can have large extinction co-efficient, high photo stability, and pH inertness. QDs can probably meet all these demands as they are bright, have excellent resistance to photo bleaching and can be observed over long periods of time with standard fluorescence microscopy.

1.5.4 Synthesis of nanomaterials

Synthesis of nanostructures with fewer defects is the key for further advances in nanoscience, specially for manufacture of higher ordered assembled products which hold promise to revolutionise the nanotechnology industry. Major techniques for synthesis of nanoparticles can be classified as 1) vapour condensation 2) chemical synthesis 3) solid state synthesis (chapter-1, book “nanostructures and Nanomaterials”, Guozhong Cao). Apart from these, there are couple of recent reports of biological synthesis of nanoparticles (Krumov et al., 2009). There have been several advances in the synthesis of homogenous size and shape of nano objects. Please note that synthesis of nanoparticles is not studied during this thesis.

Two distinct approaches have been used to manufacture nanomaterial objects — ‘top-down’ and ‘bottom-up’. Both approaches play important roles in the modern science and industry of nanotechnology. There are advantages and disadvantages in both approaches.

The top-down development of materials is accomplished by fabrication tools. This is the classical approach where the bulk material is refined by cutting or modified by other physical or chemical methods to provide new functions. Techniques of lithography, embossing and contact printing are used to create micron or nanometer scale materials. The biggest problem with top-down approaches is the imperfection of the resulting surface structure. It is well known that conventional top-down approaches such as lithography can cause some crystallographic defects. Such imperfections can have significant impact on physical properties and surface chemistry of the nanostructure. In addition to surface defects, this technique can also introduce internal stress and contamination to the end product.

A bottom-up approach refers to the building-up of materials from the bottom: atom by atom, molecule by molecule or cluster by cluster. This approach is not new; many examples of this approach can be seen in nature. Bone structures are made up of several small elements. It is a very rigid structure that can absorb several shocks under the activities of daily life. Bottom up approaches promise a better chance to obtain nano-structures with less defects and more homogenous chemical composition. (Source - chapter-1, book “nanostructures and Nanomaterials”, Guozhong Cao). Complexities in making higher ordered structure using nanoparticles as building block arise from difficulty in controlling the shape, size, crystalline structure and functional integration of assembled structures (Hiroshi et al, 2010).

Once the desired size of the nanoparticles is achieved, the focus shifts towards making the nanoparticles stable, functional and self-assemble into higher order structure. These characteristics of nanoparticles can be achieved by surface modification which is described in detail in the following section.

1.5.5 Stabilisation, functionalisation and self-assembly of nanoparticles: By surface modifications

In this section we have explained importance of stabilisation, functionalisation and self-assembly of nanoparticles for making them suitable for their potential applications. The surface of nanoparticles play an important role for their solubility, reactivity and stability (Burda, Chen, Narayanan, & El-Sayed, 2005).

Stabilisation

During growth of the nanoparticles, stabilizing agents are added to prevent nanoparticle aggregating and precipitating, these agents are also called capping agents. When aggregates are formed, particles are assumed to loss their nanoscale-related properties.

Thus, surface modification of nanoparticles is an important field of study. Various capping agents (organic and inorganic materials) have been used through covalent or ionic interactions on the surface of nanoparticles (Heights, 2000). These capping agents can stabilise nanoparticles in solution. Apart from stabilisation these agent can also protect electrical and optical properties of bare nanoparticles, they also play a role as the connecting link of the nanoparticles to the outside world. For instance, in nanoparticle based drug delivery, capping agent can connect the nanoparticles to the therapeutic agents (Berry & Curtis, 2003).

One well known example of stabilisation of nanoparticles is by use of citrate as a capping agent for gold nanoparticles. The citrate layer weakly associates with the nanoparticle's surface, and provide long term stability. It is important to note that surface of most nanoparticles is strongly influenced by the local environment. Different conditions can affect the nanoparticles in different way. For example high salt environment can destabilise citrate layer on gold nanoparticles and can cause aggregation of these particles.

Functionalisation

Different applications of nanoparticles require further functionalisation of the surface. For example, application in bio imaging requires nanoparticles to be photostable, bio-compatible, small, specific, and water soluble. All these properties can be gained with some further surface modifications of nanoparticles. The surface chemistry of nanoparticles is modified in order to functionalise them and make them biocompatible for use as molecular probes in bio imaging. This kind of functionalisation can be achieved by completely or partially substitution of capping agent by another tighter binding ligand. Coming again to example of gold nanoparticles - the citrate layer can be easily displaced by a range of other molecules including thiols, amines, polymers, antibodies, and proteins. Gold nanoparticles used in biological applications are commonly coated with polyethylene glycol (PEG), bovine serum albumin (BSA), or numerous other proteins, peptides, and oligonucleotides (source-nanocomposix.com) . The surface chemistry of gold nanoparticles provides possibility of controlled attachment and detachment of organic molecules from the gold particles surface due to stable thiol-gold bonds (Pissuwan et al., 2007). Due to this 'simple' surface chemistry, opportunities for engineering controlled structure in gold nanoparticles have increased. Current chemotherapeutic and hypothermal therapeutic treatment regimes for tumour are also exploiting unique property of gold nanoparticles. There are reports of using paclitaxel (anti tumor drug) attached to functionalised gold nanoparticles (Gibson, Khanal, & Zubarev, 2007) for targeting tumor.

Self-assembly

Other promising method of incorporating nanoparticles into functional structures is through self-assembly. The self-assembly of nanoparticles can result into unusual functionality and many potential applications (Grzelczak, Vermant, Furst, & Liz-Marzán, 2010). Microelectronics processing techniques (e.g. lithography) are excellent for creating small features. Alternate method of obtaining self assembled structures could be use of a ligand/binder. Self-assembly by using biological ligand/binders seems to be a sound strategy for creating materials and devices cheaply, while keeping molecular recognition, and thermodynamic stability as the main consideration in the construction. Biological molecules can be used for controlled placement and assembly of various practically important materials (Hiroshi et al, 2010). This organic-inorganic hybrid structure will be able to fabricate complex, sophisticated electronic and medical devices. Inspiration for such kind of assembly can be taken by looking at examples existing in nature and mimicking them, such biological examples are explained in section 1.5.7.

1.5.6 Current strategies for surface modifications of nanoparticles and their limitations

During the past few years, there are many developments in studies related to the surface chemistry of nanomaterials owing to their wide spread utility. Several strategies have been applied for achieving water solubility of nanoparticles to make them compatible with biological environments. These strategies can essentially be divided in two main categories: encapsulation (scheme A in figure 1.5e) and ligand-exchange (scheme B in figure 1.5e) (Medintz, Uyeda, Goldman, & Mattoussi, 2005).

When nanoparticles are chemically synthesized, they are coated with hydrophobic ligand. These ligands prevent nanoparticles from aggregation. For specialised applications, surface of nanoparticles need to be modified further. One such scheme is by encapsulation, it is done by amphiphilic molecules such as block copolymer or phospholipid micelles, whose hydrophobic units selectively interact and interdigitate with the hydrophobic ligands present on surface of nanoparticles (Dubertret et al., 2002). Water solubility of the nanoparticles results from the presence of charged groups and/or polyethylene glycol (PEG). Apart from solubilisation, this additional layers very well protect the optical and electrical properties of the nanoparticle. However, main limitation of this scheme is that the resulting nanoparticles are much larger than the bare ones, specially PEGylation results in increased hydrodynamic radius. In spite of above mentioned limitations, PEG chemical surface treatment is still the main one in use, particularly for commercially available quantum dots. The mixture of PEGylated nanoparticles is very viscous, which makes injection into biological host difficult

(Targeting of these nanoparticles is often achieved through its conjugation with antibodies, and they are introduced into a biological host via injection. Reference - during discussion with researchers using PEG treated nanoparticles, at ESF summer school, 2011).

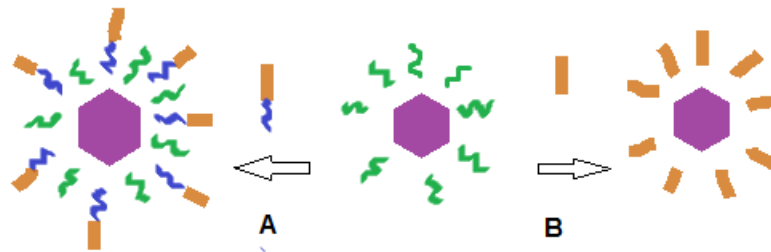

Figure 1.5e: Scheme to make NP soluble, scheme A- encapsulation of nanoparticle, scheme B- ligand exchange. (purple colored rigid structure – nanoparticle, green colored surface – hydrophobic ligand bound to NP, in (scheme A) additional structure – encapsulating material, in (scheme B) additional structure – ligand exchange material)

The ligand exchange method involves the replacement of the original hydrophobic surface ligands (capping agent) with bi and/or multifunctional hydrophilic ligands (Uyeda, Medintz, Jaiswal, Simon, & Mattoussi, 2005). These multifunctional hydrophilic ligands can be attached to inorganic nanoparticles surface by a linker group (typically a thio group). Another layer of hydrophilic ligand can be coated by polyethylene glycol or zwitter ions. Ligand exchange with several multifunctional groups such as di-thiol, multi-thiol and mixtures of thiols and amines have been performed during the past decade, because ligands with one functional group are not stable. Moreover, if the ligand is too strong, it may slowly erodes the nanoparticle, while a too weak ligand get detached from nanoparticle surface. Ligand exchange by multifunctional ligands seem to be a better solution for unfavourable surface of nanoparticle. However, later multifunctionality of nanoparticles depend on various conditions (salt/pH/temperature). It has left us with questions such as what is the best ligand, and how should it be designed for different nanoparticle surface chemistry? These questions do not have clear answer yet. Apart from the stability approach, the ligand exchange approach still necessitates functionalisation for targeting.

1.5.7 Biomimetic approach to self assembly of nanoparticles

Promising solution to many technological and manufacturing problems can be learned from biology, and can be applied to nonbiological materials. Such approaches are called biomimetic approaches. This kind of approach is particularly appreciated for designing self assembled structures (M Boncheva, GM Whiteside, 2004). Most of the macroscopic

biological materials are fabricated at the nano scale; this fabrication is mainly done in a hierarchical manner. Most of these structures show unique and specialised functions. If we analyse the mechanisms of formation of these unique objects, we would see that these structures are highly mineralised (the process through which an organic substance becomes impregnated by inorganic substances). The majority of them are made up of inorganic crystals and biomolecules. The interaction between inorganic crystals and biomolecules is very specific. This specificity has been developed during several years of evolution through many cycles of mutation and selection. It is important to note that such biological processing or fabrication is accomplished at ambient conditions - aqueous medium, neutral pH and ambient temperature (Gilbert, 2005). Below are some examples of materials found in nature - these materials are fabricated at the nanoscale via specific interactions between inorganic materials and biomolecules (see figure 1.5f).

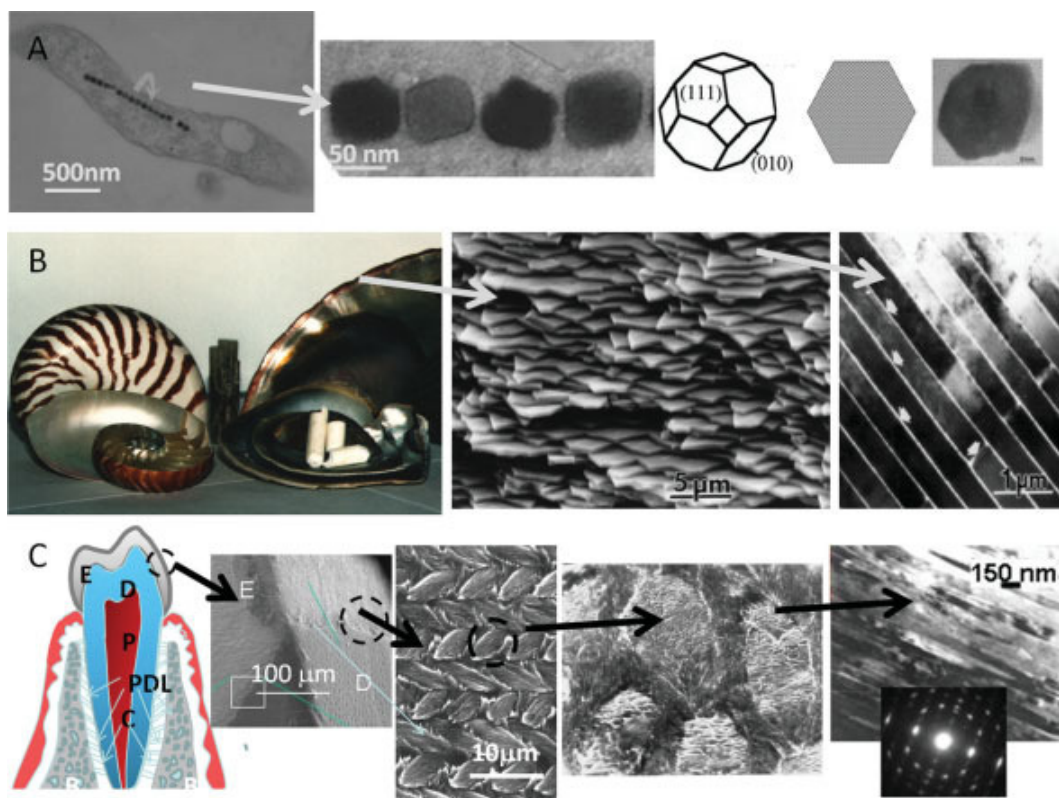

Figure 1.5f: Examples of biological materials fabricated at nanoscale (A) Magnetotactic bacteria, e.g., *Aquaspirillum magnetotacticum*, (B) Nacre, mother-of-pearl is (C) Mammalian tooth ,Source-(Tamerler et al., 2010) Details of this figure are described in the text follows.

Nature provides an abundance of examples of materials which show excellent correlation between function and structure. A few examples are shown in figure 1.5b – (A) single celled organisms (*Aquaspirillum magnetotacticum*) that can sense earth’s magnetic field (0.5 Gauss) and orient itself accordingly. This property is achieved through presence of special organells called magnetosome in the cytoplasm of this bacterium. When the bacteria ingest iron, proteins inside their bodies interact with it to produce tiny crystals of the mineral called as

magnetite (Fe_3O_4 , the most magnetic mineral on earth). It is present as perfect cubo-octahedral single crystal (50nm diameter). Particles are crystallographically and morphologically aligned with respect to each other to maximize magnetic field sensing. Figure B shows a classic biomimetic example: the mother-of pearl of seashells, the natural armor of mollusks. The interior portion of the shell is layered and segmented hybrid composite of aragonite (orthorhombic CaCO_3) and biopolymer mixture, which provide toughness to the shells. Figure C is an example of mammalian tooth. It has several layers with enamel as the top most layer. It is the hardest and most highly mineralised material in the human body. It provides protection to the tooth. Hierarchical structure of the enamel is fabricated by many proteins that control the formation of ordered woven fibers of 3 micro meter-diameter enamel rods, each consisting of thousands of 30 nm-diameters, crystallographically-aligned elongated hydroxyapatite (crystalline calcium phosphate) crystallites. This unique architecture provides good resistance to stresses.

Some of the properties of the natural designs in above examples are rarely seen in man-made engineered systems. Mimicking of the biological process for nanoscale device formation is not very straightforward. For making higher ordered structure through self-assembly, it is important to choose building blocks carefully and one must ensure that the resulting system is thermodynamically stable. Biomimetic growth of nanomaterials in aqueous solution is significant as the resulting assembled structures, when applied to therapeutic imaging specially *in vivo*, need to be dispersed in the body (Hiroshi et al, 2010). One fine example of biological building unit is antibodies. Antibodies are protein based molecules and known for its specific interaction with antigens. We can adapt this kind of specificity for selecting binder of inorganic materials. Our methodology to select such antibody based binder is explained in section 1.2. Proposed methodology allows us to mimic natural selection of antibodies under forced laboratory evolution conditions.

1.5.8 Motivation for surface modification by biological ligands

The limitations of currently used methodology for surface modification for nanoparticles (mentioned in 1.5.6) motivates to find alternative strategy. One such strategy is finding specific biological binder and further use them as ligand for nanoparticle's surface modification.

In the examples shown in figure 1.5f, the common binder present in all structures is proteins. Proteins are synthesisers, they can direct nucleation, growth, and assembly of a variety of biological tissues with precise control. In addition to their role in mineralization, proteins play various important roles in living organism: as enzymatic catalysts, as transport and storage

molecules, in immune protection and cell differentiation. Proteins participate in virtually every possible process within cells. Proteins, therefore, could be the key molecules in developing biomimetic approaches for inorganic material based fabrication.

In this thesis, we are proposing to use protein-based binder for surface modification of inorganic nanomaterials. There are many ways to find proteins, which can bind to nanoparticles or any inorganic material: 1) computational methods of molecular level description for protein-surface interaction (Makrodimitris, Masica, Kim, & Gray, 2007), 2) extraction of biomineralising proteins from hard tissue: by isolation, purification and then cloning, 3) combinatorial technique to find protein that can show specificity to inorganic materials. In this approach, a large, random library of protein based binders with the same number of amino acids, but varying compositions, is screened to identify specific sequences that strongly bind to an inorganic material of practical interest, this approach is described in section 1.5.9. Apart from protein, there is possibility to use DNA based binder for same applications, explained in details in the following text.

1.5.9 Selection of protein based binders (potential ligands) for nanoparticles

In an attempt to mimick nature for selecting binder/ligand in laboratory environment, we propose use of display techniques, which can allow *in vitro* controlled selection of binders. The three most common approaches used for display techniques are: phage display, cell surface display (e.g. yeast surface), and ribosome display. All technologies are based on the common theme of linking phenotype and genotype. Attempts have been made to select peptides and proteins through combinatorial technique like cell surface display and phage display methods. Following is the brief description of the concept and few pioneer works accomplished in the area.

1.5.9.1 Selection of peptides or antibodies using combinatorial techniques

Selection of peptide/antibodies is done by phage display methods. Random peptide/antibodies are displayed on the surface of phages (see section 1.2 for detailed method). Refer fig 1.5g for the pictorial presentation for selection of peptide/antibodies specific to inorganic materials. Gene3 and gene 8 in phage genome are mostly utilised for selection against inorganic materials. Depending on choice of insert gene position, peptide/antibodies can be displayed either on the tip (with gene 3) or on entire surface (with gene 8) of phages. Inserted gene sequence could be of small polypeptides or of any functional proteins (e.g. Antibodies).

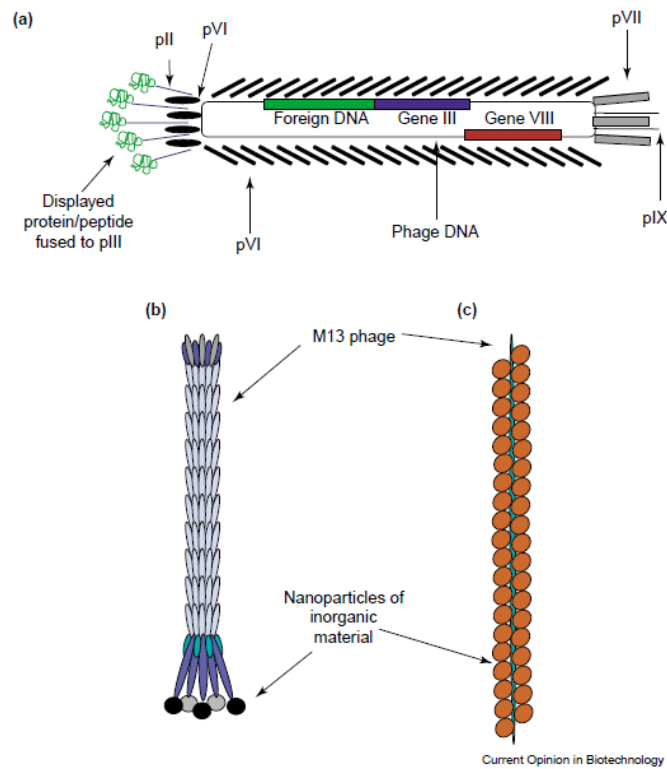

Figure 1.5g: Display and selection of peptide/antibodies using phage display technique (a) M13 Phage with all phage protein, phage coat protein p3 is modified to display fusion protein on the tip (b) Representation of M13 phage with nanoparticles (black spheres) nucleated onto p3 (dark blue) (c) Schematic of M13 phage used as a template for the construction of one-dimensional structures. In this case, a metal or semiconductor-binding peptide is displayed on coat protein p8 and it can be used to nucleate nanoparticles (red spheres). Source (Kriplani & Kay, 2005)

By using display methods many peptides have been identified which can bind to metals, metal oxides, metal alloys, semiconductors, carbon materials. Pioneer work in identifying peptide against solid surface was done by Brown. First few targets against which peptides were generated were iron oxide and gold (Brown, 1997) (Brown, 1992). Later this work has been extensively extended by A. Belcher (MIT), and M. Sarikaya (U. Washington). Work by these two groups resulted in catalogue of various materials including semiconductor QD binding peptides. List of peptides showing specificity to metal and semiconductors is mentioned in table 1.5b.

	Materials	Selected peptide sequence
Metal binding peptides	Au	LKAHLPPSRLPS ¹ TGTSVLIATPYV ²
	Ag	AYSSGAPPMPFF ³ WSWRSPTPHVVT ⁴
	Al	YPSSGPQDTRTT ⁵ YSPDPRPWSSRY ⁶
	Pd	QQSWPIS ⁷ NFMSLPRLGHMH ⁸
Semiconductor binding peptides	ZnS	CNNPMHQNC ⁹
	GaAs	AQNPSDNNTHTH ¹⁰
	CdS	CTYSRLHLC ¹¹

Table 1.5.b List of selected peptide binder against metals and semiconductors

Source ,1- (Nam et al., 2006), 2 - (Kim et al., 2010), 3 - (Rajesh R Naik, Stringer, Agarwal, Jones, & Stone, 2002), 4 - (R R Naik et al., 2004), (5, 6) - (Zuo, Ornek, & Wood, 2005), (7, 8) - (Chiu, Li, & Huang, 2010), 9 - (Flynn et al., 2003), 10 - (Whaley, English, Hu, Barbara, & Belcher, 2000), 11 - (Flynn et al., 2003)

Another example of protein-based binder is antibody fragment (scFv). ScFv is more sophisticated molecule than peptide. It can also serve as strong binder for inorganic materials. There are just two examples of selection of scFv against any material : one is against gold, selected by Kumagai group in Japan (Watanabe, Nakanishi, Umetsu, &

Kumagai, 2008), and other is against GaAs, selected by research group in Israel (Schnirman, Zahavi, Yeger, & Rosenfeld, 2006). In both reports selection is done by using phage display technique.

Apart from peptide and antibodies, other scaffold of proteins like protein cages, are also gaining interest (Flenniken et al., 2009). Container like protein architectures such as viral capsids and ferritin are examples of such biological templates. But two biological entities (peptides and antibodies) selected by phage display are currently considered to add information about interface between biology and inorganic material. Comparison of peptide and antibody based binder for inorganic material is mentioned in following paragraph.

1.5.9.2 Comparison of protein based ligands: peptides vs antibodies

Both peptides and antibodies recognise the interfacial surface with high affinity and selectivity because of their multiple point interaction by hydrogen bond, salt bridges and other surface complementarities (Hattori et al., 2010). Many peptides that can bind to materials like metal, metal oxide, metal alloys, and semiconductors have been identified. This peptide can be useful tool for further bottom-up fabrication of novel nanomaterials, functionalisation of nanoparticle and synthesis of unique crystal structure.

In comparison to peptide there are very few reports on the selection of antibodies for inorganic surfaces. Two groups who have published their result for antibodies against inorganic material using phage display are Kumagai lab from Japan (antibody against gold)(Watanabe et al., 2008) and research group from Israel (antibody against GaAs)(Schnirman et al., 2006). Interestingly an antibody raised against GaAs can differentiate between different crystalline facets in terms of binding affinity. These results demonstrate a very high specificity of antibody against inorganic solid surfaces. However, there are fewer antibodies than peptide against inorganic material. The reason for this discrepancy can be attributed to the factors: a) less sensitivity of human immune system to inorganic material, b) selection of antibodies against solid surface as target is more difficult than soluble antigen, c) less diversity of clones in case of antibody library, d) may be other groups are just focusing on use of peptide without considering antibodies as substitute. However, we think that antibodies are novel tool as material binder as it posses better affinity and specificity than peptide.

Peptides against metallic gold were first time identified by Brown and each polypeptide had repetition of identical units (14 or 28 amino acid long). One gold binding polypeptide showed difference in binding depending on number of repeats present in sequence. Reduction in

repeating unit showed less binding with gold. We can assume that polymerization of monomer unit change the properties, it can attain rigid structure with certain conformation. Researchers of Seker and Sarikaya groups also tried to observe difference in binding behaviour of single peptide, and its multiple repeats (selected by display technique for different materials) in order to check the hypothesis of improved binding with repeating units (Seker, Wilson, Sahin, & Tamerler, 2009). Their result suggested that use of multiple repeats of a given peptide sequence did not have a uniform effect in binding behaviour of all peptides, as in some cases it increased the binding affinity and in other cases the affinity was reduced. However, this result also suggests that protein in three dimensional conformations may acquire different binding ability.

Repetition of binding peptides can be introduced in several ways (tandem, with linker etc). With correct knowledge of binding behaviour due to multiple contact points, one can fine-tune the binding behaviour of peptides or any other protein conformation. Other researchers have also studied a peptide sequence, which binds to platinum in two conformations (linear and constrained) and observed higher binding by constrained form. For us it will be interesting to compare binding capacity of peptide and antibody, though it will be difficult to comment based on current knowledge. Kumagai group in Japan has identified material binding antibody which shows higher affinity than peptides (Hattori et al., 2010). They grafted material binding peptide (ZnO) into appropriate loop of CDR of camel type single variable (V_{HH}) antibody fragment. Then this structure is promoted for affinity maturation by combinatorial technique. Their result suggested higher binding ability of grafted peptide antibody than selected antibody and peptide. This study clearly provides hint of the potential of antibody scaffold for creating high affinity building block. Further assay described in this article, provide additional hints in favour of antibody as better probes: intact binding affinity shown by V_{HH} during competitive assay between V_{HH} and peptide, synergistic effect of CDR1 and CDR3 of VHH fragment in binding with target. Based on above-mentioned results, we can assume that antibody is more sophisticated tool than peptide and it has better binding affinity than peptide.

1.5.9.3 DNA based binder for inorganic materials

Biology is no longer the only branch of science which is benefitted by technology based on DNA, Remarkable structural features of DNA are now fascinating material scientists who construct 2D or 3D nanoscale constructs. The dimensions of DNA are inherently on the nanoscale: The diameter of the double helix is about 2 nm, and the helical pitch is about 3.5 nm; hence, construction involving DNA is fundamentally an exercise in nanotechnology. Apart from nanometer scale other features which provide programmability of hybrid

structures are-1) complementarity of DNA (2) ability of complementary strands to hybridize (3) programmability of intermolecular affinity (4) structural predictability of both sticky-ended cohesion products (6) specially designed branching DNA motifs. There are already few report on different structures based on DNA templates- unscaffold structure, DNA origami, two dimensional structures, three dimensional structures etc. There is recent report on DNA origami based nanoscale structure which yield higher production of plasmonic structure(Kuzyk et al., 2012). DNA origami has recently been used as a self-assembling agent to direct the organization of nanoparticles with successful diagnosis applications. Single stranded DNA or RNA can also be selected *in vitro* by using combinatorial technique called SELEX ("Systematic Evolution of Ligands by Exponential Enrichment") (Stoltenburg, Reinemann, & Strehlitz, 2007).

Nucleic acids are made of a phosphate-pentose backbone and the chemical diversity of nucleic acids is limited to purine and pyrimidine bases, while proteins have a very stable and neutral polyamide backbone and benefit from the entire amino-acid side chain diversity. Therefore, there is little chance that the DNA approach can be applied to the specific recognition of the inorganic interfaces.

1.5.10 characterization of the clones selected by phage display

Phage display and cell surface display techniques were adapted for selection of binder in material science. Further characterization of selected binders selected by display system is not very convenient. There are many methods to determine protein-protein, protein-carbohydrate interactions, but these methods can not be directly applied to study protein binding on inorganic material. Similarly there are reports on the adsorption of proteins on solid surfaces (Gray, 2004). But most of solid binding experiments are bulk experiment. Most preferred methods are fluorescence microscopy, ELISA assay, Competition binding assay, Atomic force microscopy. However, these methods provide semi quantitative measurement for binding. More advance techniques include surface plasmon resonance (SPR) and quartz crystal microbalance (QCM), solid state NMR etc.

Computational analysis of selected sequence with material is also possible with molecular dynamics studies(Oren, Tamerler, & Sarikaya, 2005), such studies could be good start point, but they are done in simple environment .

There are several known peptides against different materials, but quantitative affinity, binding kinetics, molecular recognition of these peptides are not fully understood. Primary characterisation of displayed peptide is possible by fluorescence microscopy when they are

displayed on the cell surface. Very few investigation is been done to know binding property by quartz crystal microbalance (QCM) ,surface plasmon resonance spectroscopy (SPR),and fluorometric peptide assays (Tamerler, Oren, Duman, Venkatasubramanian, & Sarikaya, 2006). Few reports showed possible mechanisms of molecular binding due to secondary structure change by NMR or mutational analysis, One interesting example is characterisation of titanium binding peptide (selected by phage display)(Sano & Shiba, 2003).They conducted alanine scan on selected sequence and measured affinity for each mutant phage with titanium surface. Mutational studies were done by changing position of amino acid. By changing charged side chain of few polar amino acids, they observed great variation in binding, and suggested for electrostatic binding of peptide to the target. Additional information is also provided by same group, which suggest amphoteric nature of Titanium, in biological environment surface of metallic Ti is covered by titanium oxide, which display many oxygen atom and get negatively charged. It was been observed that lysine (positively charged) as well as negatively charged amino acid aspartic acid gets accumulated at the surface of titanium oxide, which suggests amphoteric nature of oxide film . The same Titanium binding peptide was utilised recently, and revealed that peptide and target interaction is not primarily initiated by electrostatic attraction but by ability of amino acid to sense the molecular solvent structure at the solid/liquid interface with precision(Schneider & Ciacchi, 2012). Electrostatic attraction is described for other materials like gold, semiconductors (CdS, CdSe, ZnS, ZnSe) (Peelle, Krauland, Wittrup, & Belcher, 2005) , Aluminium, Silicon nitride, Silicon oxide (Willett, Baldwin, West, & Pfeiffer, 2005), Polystyrene(Kumada, Kuroki, Yasui, Ohse, & Kishimoto, 2010). However, this rule can not be generalised for all conditions. Primary or secondary structure of protein can also play role in binding, beautiful work is done by using different conformation of gold binding peptide(Hnilova et al., 2008).So there are many unanswered questions about how genetically selected peptides or antibodies bind to target material and not to other material. There are many possible ways to find answers to these questions: identification of amino acid showing specificity towards any given target, conformation of protein, correlation with experimental condition and selection of particular amino acid (pH of experiment, overall net charge on target during selection process etc). In studies where binding is shown on phage particle, overall charge of the virus should be taken into consideration as virus have pH-dependent surface charge in polar media (e.g. water) (Michen & Graule, 2010) .For practical applicability of these biological binders more knowledge of their material specificity is required.

1.5.11 Potential use of inorganic material-binding proteins

Phage display method has allowed evolution of protein based binder/ligand in laboratory condition to create new generation of materials with new functionality. There are few remarkable example of use of protein-based binders for advance level functions.

The future of nanoscale device fabrication can benefit diverse applications including electronics, tissue engineering, biomedical imaging, drug delivery, catalysis, and photonics. Specific binding and ability to self assemble are the core properties for nanomaterial based fabrications. Protein based binder can functionalise nano material or can provide template for assembly for fabrication on bio-inspired materials. Few examples are mentioned below which show potential utilization of engineered proteins.

1) Use of phage display selected peptide in controlling size and functionality of nanoparticles

A Pd-binding peptide was selected by phage display technique. Further minor modifications were made in the peptide sequence, and this modified peptide was able to control the size and functionality of nanoparticles by modulating peptide/Pd surface binding capabilities (Coppage et al., 2012). This result suggests that peptides can be used as unique ligands for the controlled morphogenesis of nanoparticles.

2) Use of a bispecific antibody for the immobilization of a biomolecule on gold surfaces

Bispecific antibodies are attractive molecules for therapeutic purposes. The design of this molecule has inspired researchers from the Kumagai group for nanomaterials purposes. They fused a gold-binding antibody with an antibody binding the enzyme lysozyme (Watanabe et al., 2011). In figure 1.5g the construct binds tightly both the gold surface and lysozyme. They observed that this bispecific construct could work as interface molecule between lysozyme and gold. They also observed that none of the ScFv lost any substantial antigen binding activity. This construct can be a promising candidate for biosensing molecules and building blocks for nanoscale fabrication.

This group has selected recombinant antibodies to gold. This result was published (in 2008) when we had barely started our project and confirmed the feasibility of our approach. The bispecific format is very promising for applications in nanodevice design as interface/adapter between two nano-objects. We are interested in making this construct showing specificity to

two nano-objects. This group has obtained the construct by purifying after refolding from bacterial inclusion bodies. We describe the development of a new eukaryotic host for production of such antibodies with more efficacy than in current production host.

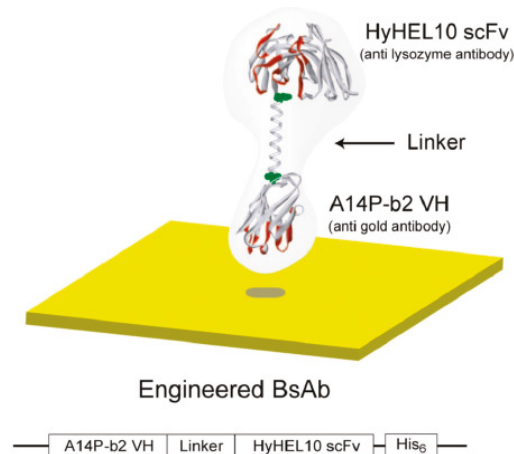

Figure 1.5h: Schematic representation of an engineered bispecific antibody (BsAb) with a modular structure. C-terminal end of A14P-b2, and the N-terminal end of HyHEL10 scFv are shown in green. Complementarity-determining regions of antibodies are shown in red. Source - (Watanabe et al., 2011)

3) A transistor based on an antibody, gold nano particles and a quantum dot

One of the encouraging examples of nanodevice fabrication based on inorganic-binding antibodies is the following. Y-shaped IgG antibody binding to gold was put to use to bind simultaneously two gold nano-electrodes through its two antigen-binding arms. The base of the Y-shaped IgG (the Fc portion, see section 1.1) is covalently linked to a QD. By illuminating the QD at the proper wavelength, the researchers from National Chiao Tung University observed a transistor-like behaviour of the IgG nano-structure, with the nano-electrodes as drain and source and the QD as gate (Chen, Hong, & Huang, 2012).

This study was however limited by the use of polyclonal IgGs purified from rabbit serum. Each device will be different from the others because many IgG molecules are present, questioning the reproducibility of such approach. Monoclonal antibody would offer a much better control over the molecular structure of the device, and recombinant ones would offer even greater control through genetic engineering.

2. Results

2.1 selection of antibody fragments (scFvs) binding to inorganic materials

(In collaboration with B. Dubetret at UMR 8213 CNRS/ESPCI Paristech)

We screened a phage display antibody library against various inorganic material targets (nano to micro sized). All screenings were performed under controlled *in vitro* conditions. Our goal was to select antibody fragments (scFvs) that have high binding affinity and specificity against inorganic materials. The selected antibody fragments (scFvs), then, can be used as a ligand to modify unfavourable surface chemistry of inorganic nanomaterials (refer section 1.5). In context of this thesis, we expect the use such modified nanoparticles for two potential applications - using nanoparticle as a probe for bioimaging and making self-assembled structures. Apart from this, genetic sequences of the selected antibody fragments (scFvs) can provide important information about protein/inorganic interaction. Such information can be utilised for further improvement of antibody fragment based ligands, as explained in section 1.5.11 by an example of phage display selected peptide sequence.

We used various inorganic materials as targets (see list in appendix A). We selected specific antibody fragments (scFvs) against the targets using the Tomlinson I+J library (see appendix A for a description). We screened these targets by applying the strategy, mentioned in section 1.2.5. The phage display method is mostly used for biological targets; inorganic targets used in this study were unusual targets for this technique. Moreover, inorganic targets were obtained in different physical states (suspension, powder etc); therefore protocol was adapted according to the target materials (see appendix B for the customised protocols). We performed three rounds of selections for each target to enrich the population of target specific binders (antibodies specific towards the inorganic materials). The phage recovery yield increased in the expected manner from round 1 to round 3 for most of the targets, which is a good indication of an effective selection. For few targets, we did not observe the expected pattern of enrichment during three rounds of selection, so we did not continue further experiments in those cases.

The targets which showed enrichment of specific binders were processed further. After the third round of selection, we infected *E. coli* with the selected phages (as standard protocol), and after infection, we randomly chose 94 bacterial colonies (infected with phage) which appeared on the agar plate with a selection marker. Each bacterial clone can secrete scFv, which may vary from each - other. We performed ELISA (enzyme-linked immunosorbent assay) to check the binding of secreted scFv with the corresponding target. Based on the

ELISA result for each target, we obtained a set of scFvs that showed strong, weak and no binding with the target. We discriminated strong binders and weak binders as positive binders and categorised rest as negative binders. We purified the plasmid DNA of all positive binders and sent them for sequencing and then analysed the sequences of each scFvs using bioinformatics tools. Then, we created sequence logo using MATLAB software. We used the sequences as a tool for analysis of the recognition mechanism of the scFv and the inorganic material. Following are the results obtained by screening of various inorganic targets.

2.1.1 Surface treated CdS QDs and gold nanoparticles

Before screening our library on bare inorganic surfaces directly, we tried to screen it against *a priori* easier target: nanoparticles coated with a known ligand. This ligand is a small organic molecule and would be in principle antigenic, whereas the antigenicity of inorganics is much less characterised.

Samples were provided by our collaborator, B. Dubetret (ESPCI, Paris). CdS QDs were capped with a novel a DHLA-SB (dihydrolipoic acid-sulfobetaine) ligand. DHLA provides a stable and compact surface to the QDs. This layer is further coated with a zwitterionic group (sulfobetaine) to limit nonspecific electrostatic interactions in biological environment. QDs capped with DHLA-SB are small, exhibit stability with time, pH and salt concentration (Muro, Pons, Lequeux, Fragola, & Sanson, 2010). The above modification of surface chemistry of QDs enabled them for use as probes in many biological imaging applications (long term single molecule tracking, simultaneous multicolor imaging etc). Similarly, gold nanoparticles were also capped with DHLA, and this layer was further coated with PEG. For functionalisation of gold nanoparticles and CdS QDs, surface of these particles can be treated with biotin or streptavidine. We received biotinylated DHLA-SB capped CdS QDs and biotinylated DHLA-PEG capped gold nano particles.

We used classical biotin-streptavidine binding affinity to select antibodies against these materials. First we incubated the biotinylated targets with streptavidine coated paramagnetic beads and later used these magnetic beads (having immobilised targets on their surfaces) for interaction with an antibody phage library. We took precaution to avoid nonspecific selection, by incubation of the antibody phage library with streptavidine coated paramagnetic beads (no immobilised target this time). Further we separated the antibody library and incubated with magnetic beads (having immobilised targets). We used magnetic bar for separation of selected phages. Please refer appendix B for detailed protocol.

The screening results for (DHLA-SB) capped and biotinylated CdS QDs are presented in figure 2.1.1a. The screening results for (DHLA-PEG) capped and biotinylated gold nanoparticles are presented in figure 2.1.1b. Both screenings showed significant increase of target specific binders. Later we performed ELISA experiment to check specificity of selected binders for the targets. The guidelines for analysing the screening results are explained in box 2.1a.

Box 2.1a

1) Graphical bar presents yield during each round of selection - This graph represents the yield at each round of selection. The yield is more precisely defined as the ratio of the number of selected phages over the number of input phages. This ratio is obtained by indirect method of counting number of bacterial colonies obtained after infection of the selected phages from each round of selection and number of bacterial colonies obtained after infection of input phages. We have performed three rounds of selection for all targets. In these graphs, the Y axis represents the yield (ratio of number of selected phages over the number of input phages), whereas the X axis represents the rounds of selection performed.

2) ELISA result - ELISA is a sensitive test that is routinely used in molecular and cell biology laboratories to check antigen – antibody interaction. This assay provides specific color signals in the presence of specific antigen-antibody interaction. If an antibody is not specific to antigen/target, it gives no color response.

Assay results are shown in the 96 well plates. The yellow color intensity increases with increasing binding affinity (i.e. dark yellow indicates a strong binder, light yellow indicates a weak binder, no color indicates no binder). In most of the results, wells A1 and H12 are control group (i.e. no scFv clone, only culture medium).

2.1.1a Screening result for (DHLA-SB) capped and biotinylated CdS QDs

The screening results against DHLA-SB capped and biotinylated CdS QDs as target showed significant enrichment of the target specific antibodies (fig. 2.1.1a). Therefore, we selected 94 random bacterial clones appeared after infection of selected phages from the third round of screening for the target. Further, we performed ELISA experiment to find specificity of these clones for the target (see ELISA result in fig. 2.1.1a). We immobilised the biotinylated targets on streptavidine coated 96 well ELISA plate. We used streptavidine coated ELISA plate for control experiment as well (absence of immobilised targets) to check non-specific selection against streptavidine surface.

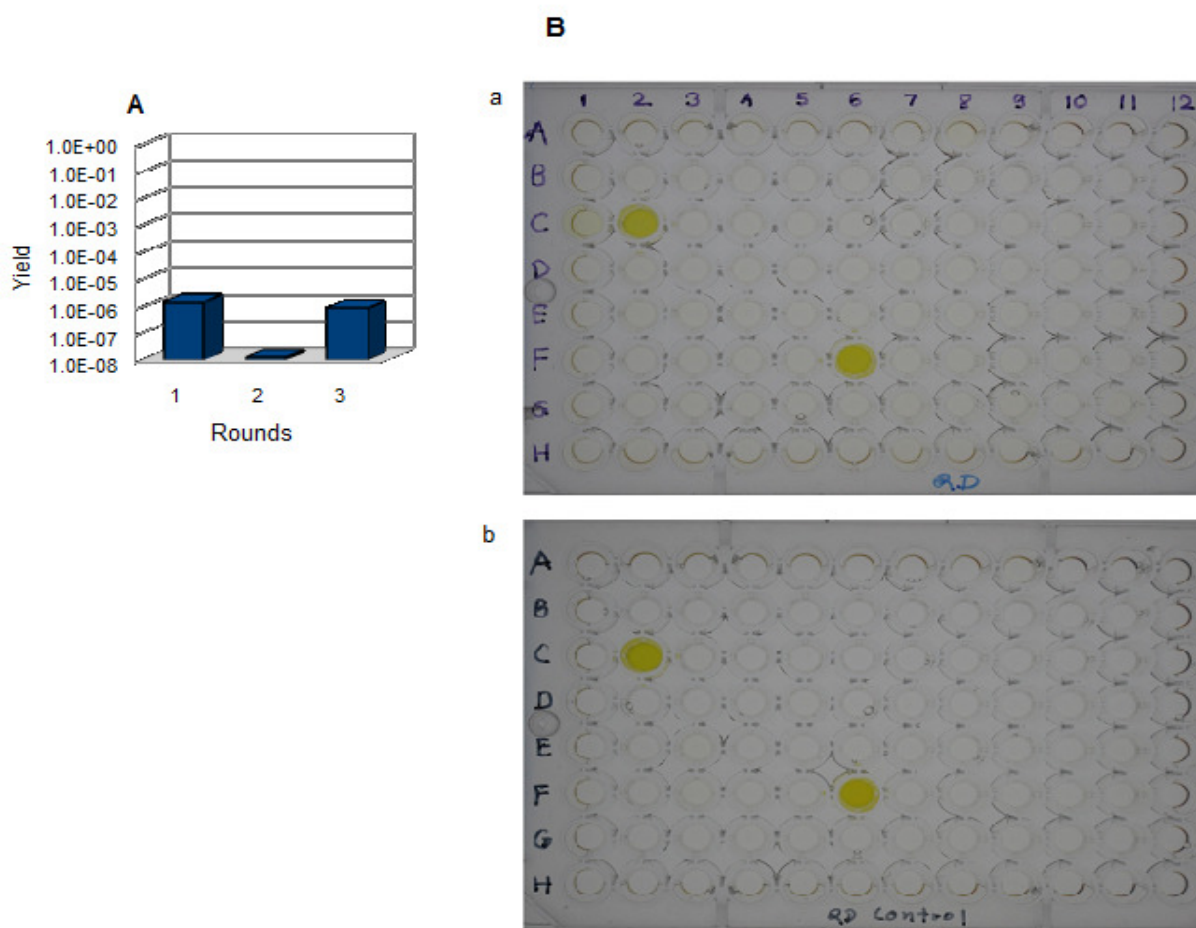

Figure 2.1.1a: (A) yield during three rounds of selection for (DHLA-SB) capped and biotinylated CdS QDs. (B) ELISA result (performed in streptavidine coated 96 well plate) a) Experimental plate, streptavidine surface was coated with biotinylated target, b) control plate, uncoated streptavidine surface (absence of target). Wells A1 and H12 represent the control group i.e. no bacterial clone is used, only culture medium.

2.1.1b Screening result for (DHHLA-PEG) capped and biotinylated gold nano particles

The screening results against DHHLA- PEG capped and biotinylated gold nanoparticles as target showed significant enrichment of the target specific antibodies (fig. 2.1.1b). Therefore, we selected 94 random bacterial clones appeared after infection of selected phages from the third round of screening for the target. Further, we performed ELISA experiment to find specificity of these clones for the target (see ELISA result in fig. 2.1.1b). We immobilised the biotinylated targets on streptavidine coated 96 well ELISA plate. We used streptavidine coated ELISA plate for control experiment as well (absence of immobilised targets) to check non-specific selection against streptavidine surface.

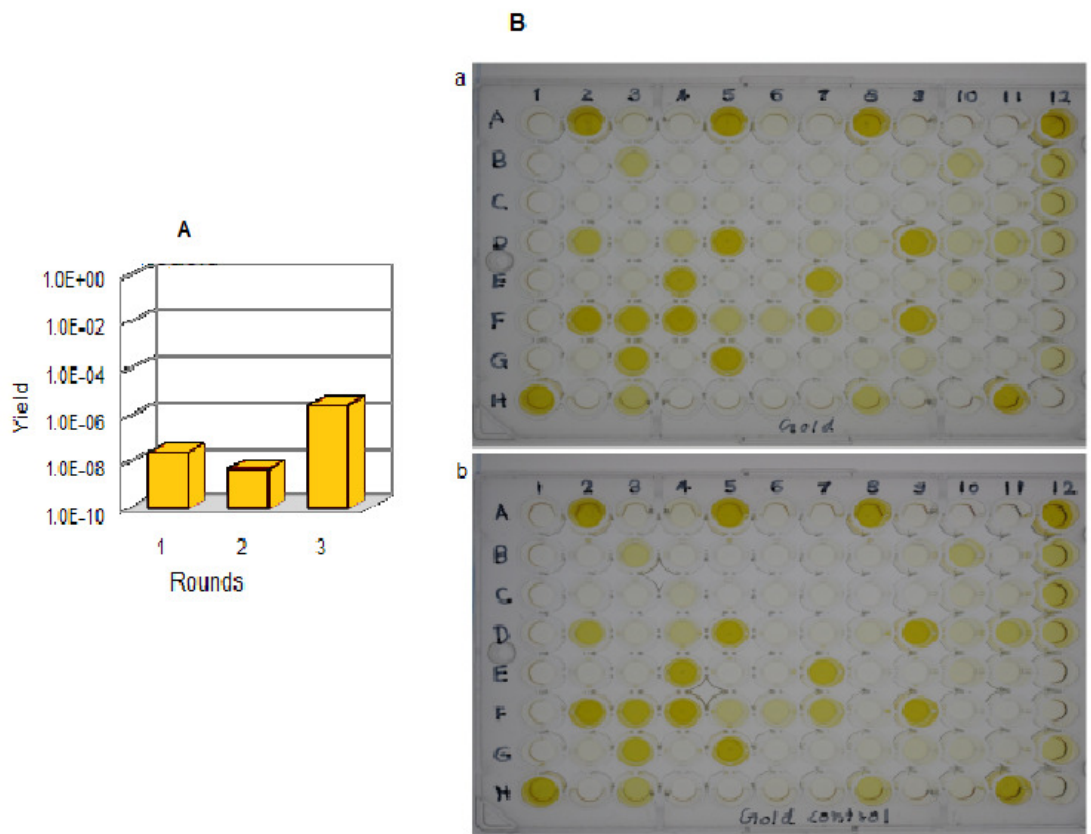

Figure 2.1.1b: (A) yield during three rounds of selection for (DHHLA+ PEG) capped and biotinylated gold nanoparticles. (B) ELISA result (performed in streptavidine coated 96 well plate), a) Experimental plate, streptavidine surface was coated with biotinylated target, b) control plate, uncoated streptavidine surface (absence of target). Wells A1 and H12 represent control groups i.e. no bacterial clone is used, only culture medium.

Interpretation of ELISA results of surface treated CdS QDs and gold nanoparticles

ELISA results for both targets showed binding of scFvs in both, the experimental as well as the control plates. The results indicate non-specific selection, thus failure of screens against these targets. The potential explanation for these failures is as follows-

We used streptavidine coated magnetic beads in these screens for immobilisation of biotinylated targets (inorganic nanoparticles). Magnetic beads are micron size beads and they are covalently coated with streptavidine all over their surface. The biotinylated targets are expected to bind streptavidine coated magnetic beads. If biotinylated target fail to bind streptavidine coated magnetic beads, we may raise antibodies against streptavidine coated surface of magnetic beads and we actually ended up in this way. The selection of antibodies against streptavidine surface can be confirmed by their binding in control ELISA plate (control plate used in ELISA experiment is streptavidine coated). THE ELISA result showed that all clones were selected against streptavidine target instead of biotinylated CdS QDs and biotinylated gold nanoparticles.

A possible reason for the failure of immobilisation of biotinylated targets on streptavidine coated paramagnetic beads may be inefficient biotinylation of target surfaces. Unfortunately, we did not check the biotin-coating of the inorganic nanoparticle targets used in this study. However, on the other extreme if targets are over biotinylated, we might have ended up with selection of anti-biotin antibodies.

Results from these screen pondered more emphasis on sufficient biotinylation of targets. This might not be efficient in the case of inorganic nanoparticles. So overall this approach is not safe due to increased chances of selection of non-specific antibodies. It motivated us to use the bare surface of semiconductor materials and metal surfaces, which are not stabilised by any surfactants.

2.1.2 Screen against micron size particles (ZnS, CdS, CdSe, gold particles)

The micron size particles of ZnS, CdS, CdSe, and gold were bought from sigma Aldrich (for details, see the list in appendix A). Selection of binders (scFvs) against bare surface of the semiconductor materials and the metal was the primary goal of this thesis, but first we attempted to select binders against these materials coated with some organic ligand which did not result into any specific binders. The absence of surfactant or ligand on the surface allows selection of antibodies that can bind directly to the inorganic surfaces and infact the selected antibodies itself can act as ligand. Micron size particles came in powder (solid) form.

The physical state of these particles facilitated easy screening procedure during the selection and washing steps as these powders get settled by centrifuging for few seconds.

The next step was to test the specificity of the antibodies selected against micron size particles to the nano size materials of same object. The selected antibodies might show the same, reduced or no affinity to nano size materials. The possibility of reduced or no binding affinities of antibodies towards nanoparticles can be explained by a fact that nanosize particles possess high curvature which produces highly corrugated surface at the atomic level. In the case of micron size crystals, the surface is flat as compared to the nanosize particles. Thus, the antibodies which are selected against relatively flat surface of micron size crystals may not recognise corrugated surface of the nano particles. If we observe reduced or no affinity then we would use alternate plan. This plan requires expertise technical platform of our collaborator at ESPCI, Paris. We can treat the micron size crystals with chemical methods in order to obtain similar corrugated surface as the nanoparticles and expect higher affinity of the antibodies for nano objects.

Before the screening experiment by phage display method, it is advisable to characterise inorganic materials using a surface analysis tool. This analysis was performed at Benoit Dubertet's lab at ESPCI, Paris. Electron micrographs after the analysis are shown in figure 2.1.2a. Screening results of each target are explained in following text.

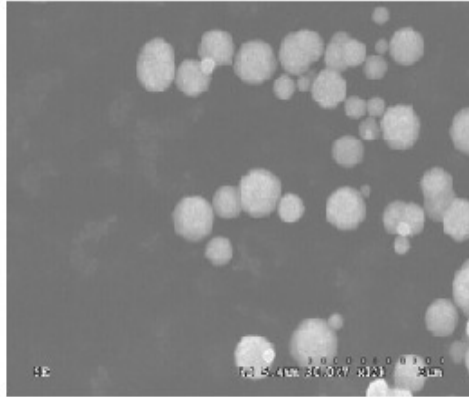
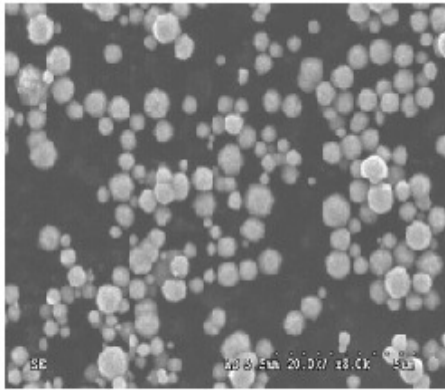

SEM image of gold powder

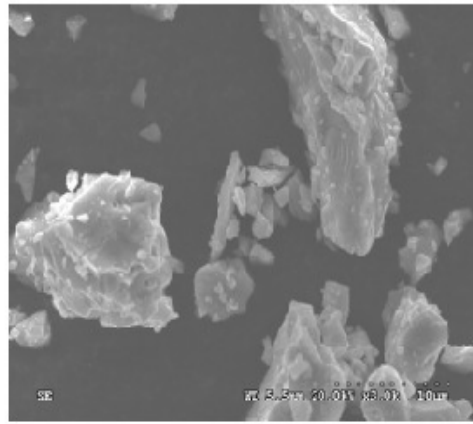
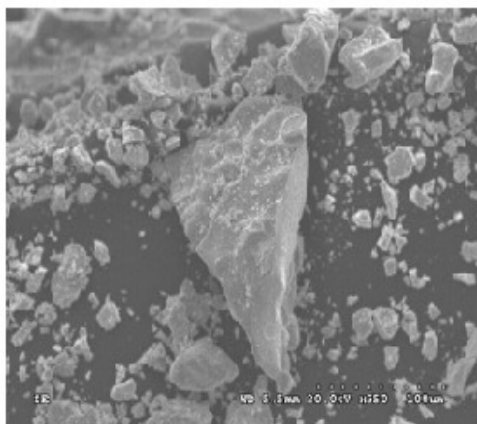

SEM images of CdSe powder

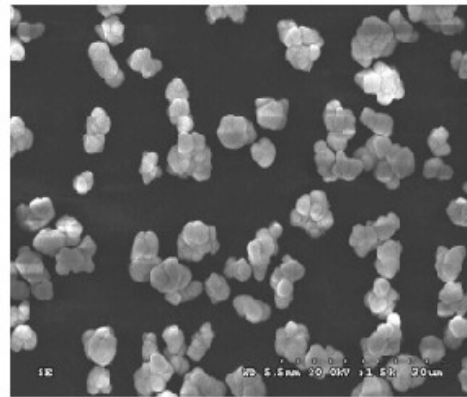
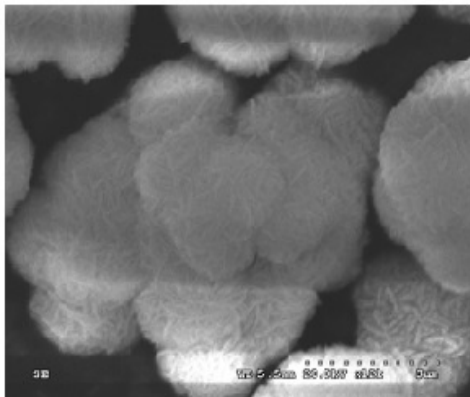

SEM image of ZnS powder

Figure 2.1.2a: SEM images of micron size particles. The gold powder contains 5 micron diameter quasi-spherical particles. The ZnS powder contains similarly micron-sized particles, of more irregular shape. CdSe particles are much more heterogeneous in size and shape.

A) ZnS powder

Zinc sulfide (ZnS) is an inorganic, semiconductor compound. It is one of the first semiconductors discovered. It has shown versatile properties and a promises for novel diverse applications, including light-emitting diodes (LEDs), electroluminescence, flat panel displays, infrared windows, sensors, lasers, and biodevices, etc (Fang et al., 2011).

ZnS is most often used as shell material of QDs. QDs are made up of core and shell that may consist of different materials. The shell of QDs plays an important role: it provides protection against environmental changes, photo-oxidative degradation. The shell material should be transparent, should have higher band gap, and should have structure similar to the core material (H. Arya et al., 2005). Coating with ZnS shell reduces the photochemical bleaching and dramatically increases the quantum yield (Hines & Guyot-Sionnest, 1996). Such combination is typically presented as CdS/ZnS, CdSe/ZnS (core/shell). We have used ZnS semiconductor powder as target for screening antibodies against it. The screening result with the ZnS particles is shown in figure A1.

Interpretation of Figure A1

The screening of antibodies against ZnS particles did not show any encouraging result, it might be a failure screen. The yield of antibodies specific to ZnS did not show any enrichment during the three subsequent rounds of selections. We are unable to provide any reason for such results except one argument that either ZnS material is not immunogenic or antibodies which can bind to this material were absent in pool of the Tomlinson library used for screening. We performed ELISA experiment for the few ZnS clones (total 6). We did not observe any binding with the ZnS target (data is not shown here as there were no color signal indicating binding with target). The results with other targets showed significant increase in yield, so we decided to focus on further characterisation of those clones first. Therefore we did not perform any further experiment with clones generated for ZnS target.

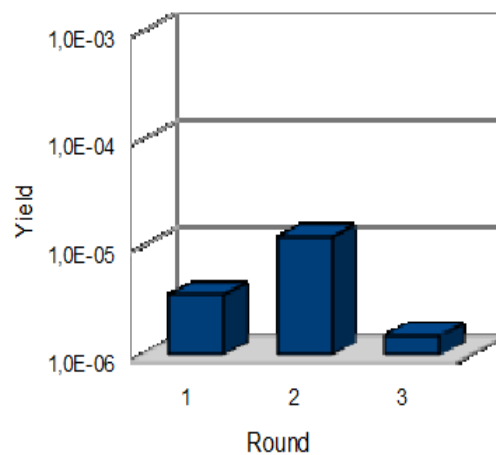

Figure A1: Yield for three rounds of selection for ZnS crystals . The Y axis represent indirect number of the phages by counting infected bacterial colonies as yield (ratio of output/input phages), whereas the X axis represent different rounds of selection performed.

B) CdSe powder

CdSe is an inorganic, semiconductor material. It has size dependent fluorescence spectrum. This property of CdSe can be utilised in making probe for imaging. Our collaborator (ESPCI, Paris) has already demonstrated live cell imaging by using CdSe QDs capped with appropriated ligand (Muro, Pons, Lequeux, Fragola, & Sanson, 2010). The screening results using the CdSe particles as target are presented in figure B1.

Interpretation of Figure B1

The screening of antibodies against CdSe particles did not show any encouraging results, it might be a failure screen. The yield of antibodies specific to CdSe did not show any enrichment during the three subsequent rounds of selections. We repeated the screening against CdSe particles, but we obtained similar results. We are unable to provide any reason for such results except the same argument mentioned for the ZnS crystals. We wanted to characterize clones for those targets which had shown significant increase in the yield, so we did not perform any further characterisation experiment with clones generated for CdSe target.

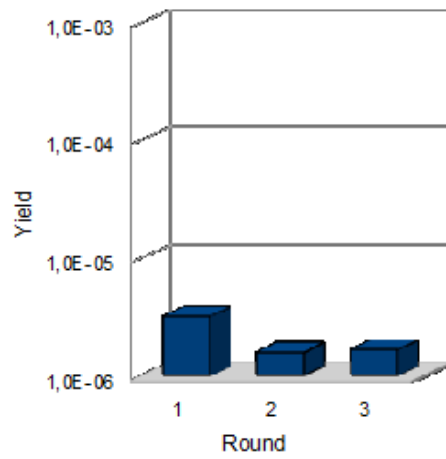

Figure B1: Yield during three rounds of selection for CdSe. The Y axis represent indirect number of the phages by counting infected bacterial colonies as yield (ratio of output/input phages), whereas the X axis represent different rounds of selection performed.

C) CdS powder

CdS is an inorganic, semiconductor compound. It is mainly used in pigment and in manufacturing of photoresistor (light dependent resistors) sensitive to visible and near infrared light (source- Wikipedia). It has excellent properties that can be utilised as a flurophore. Our collaborator (ESPCI, Paris) has already demonstrated live cell imaging by using CdS QDs capped with appropriated ligand (Muro, Pons, Lequeux, Fragola, & Sanson, 2010). The screening results using CdS powder as target are presented in figure C1.

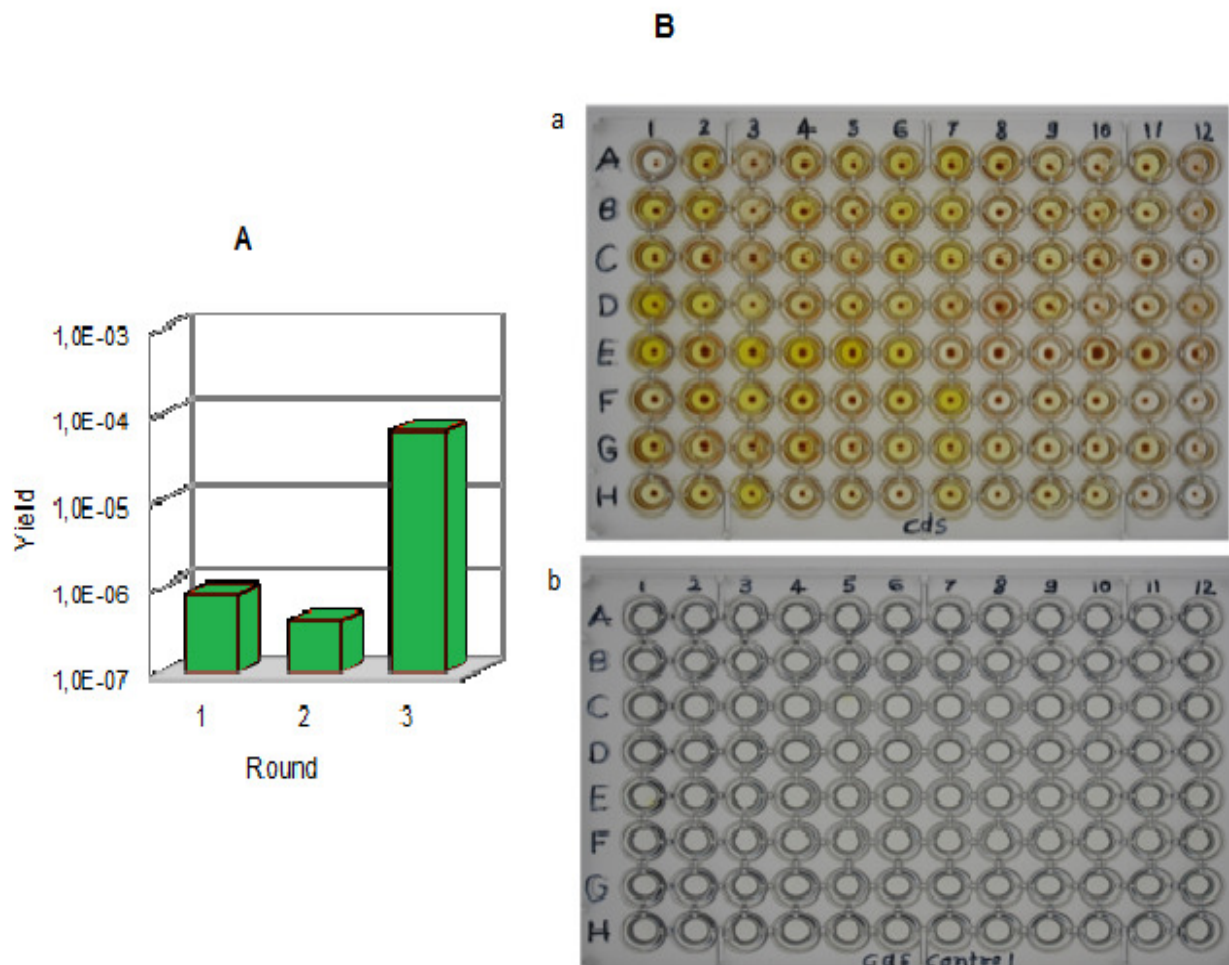

Figure C1: (A) yield during three rounds of selection for CdS crystals, (B) ELISA result, a) experimental plate, in presence of target (brown color dots are CdS powder), b) control plate, absence of target. Wells A1 and H12 represent control groups i.e. no bacterial clone is used, only culture medium.

Interpretation of Figure C1

The screening results against CdS powder as target showed significant enrichment of the target specific antibodies (fig. C1, A). Therefore, we selected 94 random bacterial clones appeared after infection of selected phages from the third round of screening for the target. Further, we performed ELISA experiment to find specificity of these clones for the CdS target (see fig. B). The ELISA experiment showed many positive binders for the CdS target. In order to confirm this result, we repeated the ELISA experiment using same clones in duplicate, the result is shown in figure C2. Unfortunately we did not get reproducible result this time.

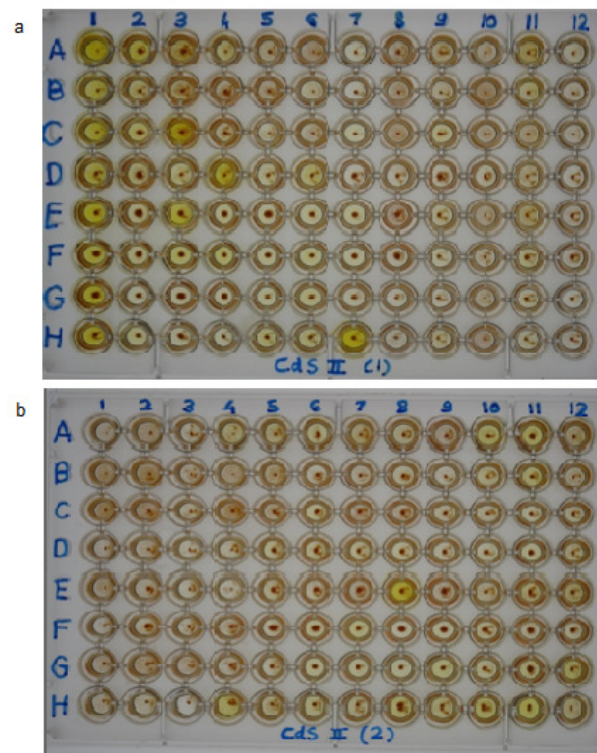

Figure C2: Repeated ELISA experiment for CdS clones a) clone no 1 to 48 in duplicate, b) clone 49 to 96 in duplicate. Controle plate not shown here, it came out clean

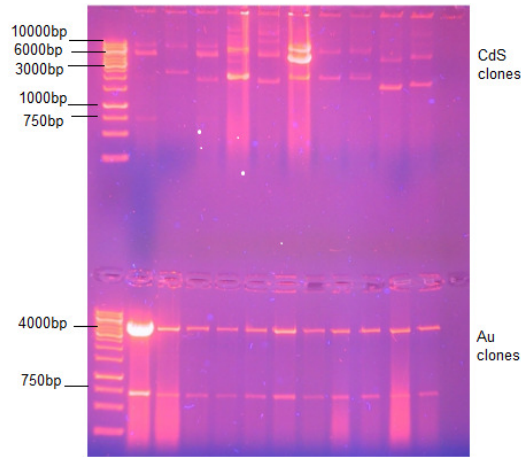

Figure C3: Restriction digestion with Nco I - Not I enzymes of 10 random clones of CdS target (above panel), Gold (below). Clones selected for CdS target showed strange patterns of inserts whereas clones selected for gold (Au) as target showed insert pattern of full length scFv sequence, i.e. 750bp.

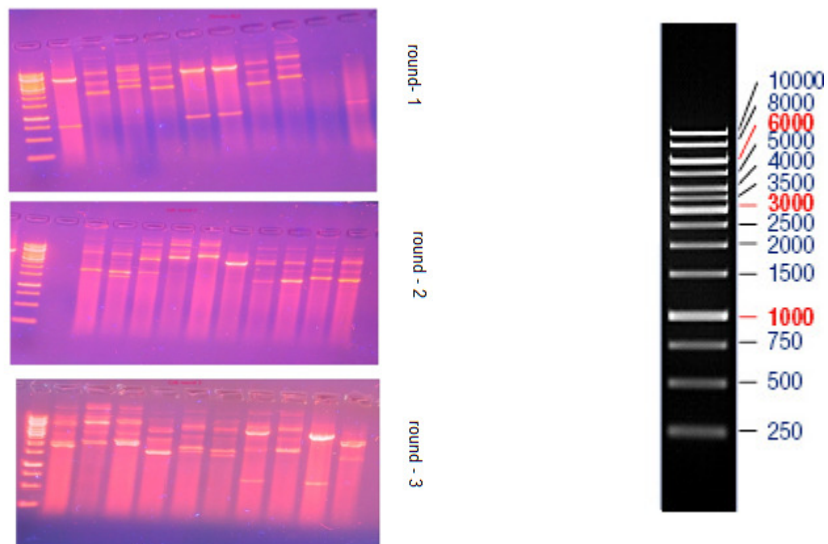

Figure C4: Restriction digestion with Nco I – Not I of 10 random clones from each round of selection for CdS target, 1kb DNA marker is shown on side. In case of selection of full length scFv, size of insert is 750bp, which is very rare in all the selections.

Interpretation of Figure C2, Figure C3 and Figure C4

In the repeated ELISA experiment for CdS, unfortunately we did not get reproducible results. At the point, we thought about two potential reasons for this failure of experiment –

- An error in ELISA experiment as washing of the powdered form of the target in ELISA plate is difficult.
- An error during screening process.

To find out the exact reason, first we checked pattern of selected antibody fragments (scFvs) against CdS target. The Tomlinson library, which we used for screening, was designed in such a way that all scFv sequences are present between Nco I – Not I restriction sites. As a result if we digest selected clones using Nco I – Not I restriction enzymes, we can expect three possibilities of patterns: 1) no insert, which is shown by no insert band on gel. 2) ScFv insert, which can be seen as 750 bp band on gel. 3) Half scFv clones, seen rarely (unpublished data of PVP screening in the lab).

We chose 10 random clones from the third round of selection for CdS target. We extracted plasmid DNA, performed digestion with Nco I and Not I restriction enzymes, ran DNA gel to check insert patterns. We also performed screening against gold powder in parallel with the screening against CdS powder. We chose 10 random clones from third round of selection of the gold powder. DNA gel is shown in figure C3. We observed unusual and random pattern of inserts in case of CdS clones whereas in the control experiment of the gold clones, insert patterns corresponded to full length scFv sequences i.e. 750 bp. The insert patterns between Nco I and Not I site for CdS clones were very different in gel picture (shown in figure C3) as compared to anything present in the library. This was the first time we observed this unusual insert pattern when using the Tomlinson phage antibody library. The reason for the non-reproducible ELISA result was attributed to an experimental error during the screening process. Further, we wanted to find the origin of error, so we chose 10 random clones from each round of selection for CdS and checked the insert patterns by restriction digestion (see figure C4). We again observed an unusual and random pattern of inserts in all rounds of selections. We concluded that, there is some experimental error, which has occurred during the first round of selection and we have amplified this error in the following rounds. Further, we repeated screening with CdS target in order to rectify our assumed error.

Repeated screen with CdS

The screening for CdS target was repeated. The yield obtained during the three rounds of selection was encouraging (see figure C5). Before going for ELISA experiment, we chose five random clones from the third round of selection for CdS target. We were surprised to see the same unusual and random patterns of inserts, which we observed during the previous experiment.

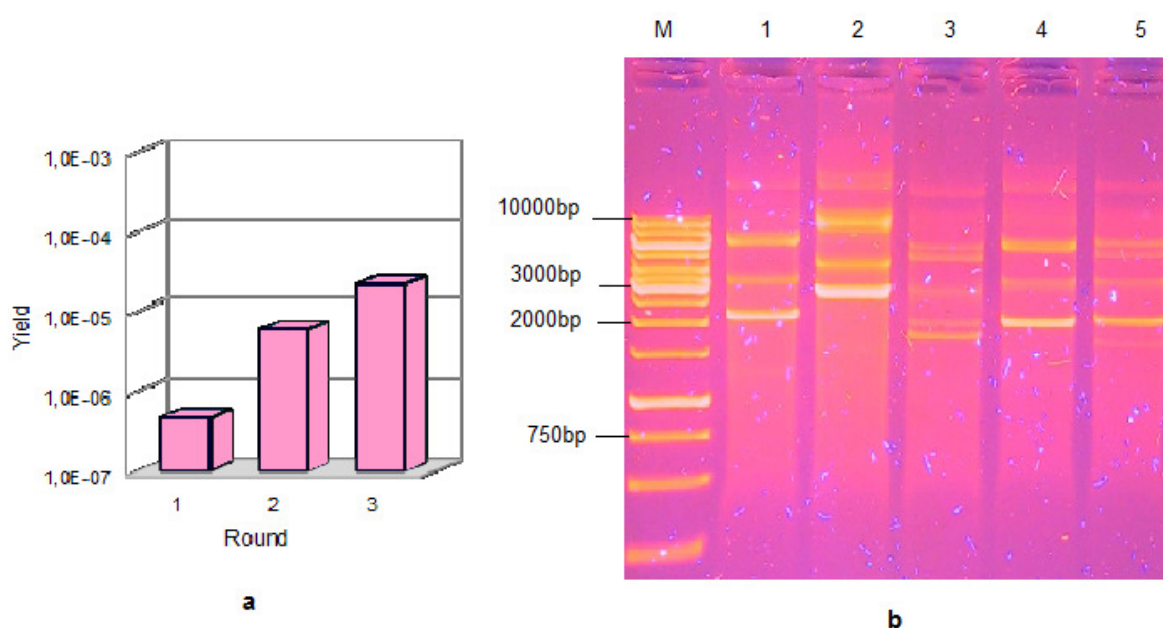

Figure C5: (a) yield during three rounds of selection for repeated CdS target, (b) restriction digestion with Nco I – Not I of 5 random clones from the third round of selection for CdS target, clones selected during repeated experiment with CdS target again showed unusual patterns of inserts.

Unusual insert patterns of scFvs selected against cadmium based semiconductor powders

We picked five random clones from the third round of selection of CdSe and ZnS targets. We extracted DNA and performed restriction digestion with Nco I and Not I enzymes and ran DNA gel, see figure C6. We observed the same unusual and random pattern of inserts in case of the CdSe clones, while Insert pattern of ZnS clone was normal. Most of the ZnS clones showed expected insert pattern of full-length scFv (750bp). From our semiconductor QDs target screens, on three occasion we obtained unusual patterns of inserts while using cadmium based semiconductors as target - CdS twice (figure C3, C5) , CdSe (figure C6. A)

and normal pattern with ZnS target (figure C6. B). This is a strong indication for cadmium generated toxicity. Potential reasons are mentioned in the discussion (section 3.1).

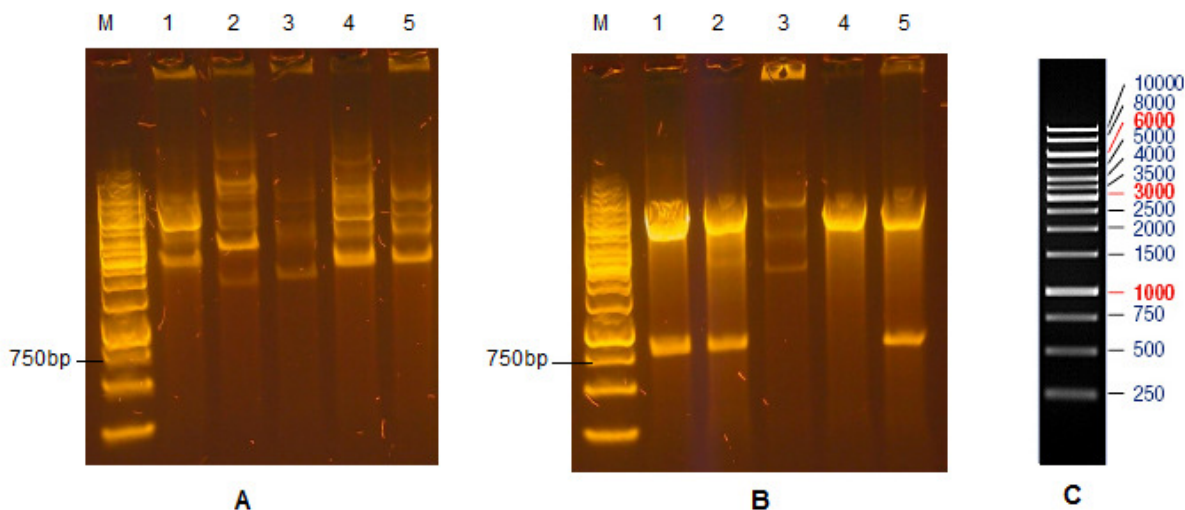

Figure C6: (A) five random clones from screening of CdSe target ,M- DNA marker, lane 1-5 CdSe clones, digested with Nco I- Not I, (B) five random clones from screening of ZnS target, M – DNA marker, lane 1-5 ZnS clones, digested with Nco I- Not I, (C) 1 kb DNA marker.

Conclusion to screening results obtained for CdS targets

We have failed to generate specific antibodies against CdS target. The antibodies clones raised against CdS target have unusual insert pattern of scFvs. The failure of selection of CdS specific antibodies might be due to the possible toxicity of cadmium based semiconductor on library plasmid DNA inserts. The toxicity could have generated either due to release of cadmium metal or generation of reactive oxygen species (see section 3.1 for detailed explanation).

To the solution to this problem, selection conditions can be altered to avoid direct contact of CdS powder and the bacteria (used for infection of selected phages). We can not avoid contact of CdS powder with phages, so we can alter the condition by using less amount of CdS target for the screening (we have used 21mg of CdS target for current screening). To circumvent the possible reason of generation of reactive oxygen species, we could try using some anti oxidant reagents while incubating of CdS powder with phages.

D) Gold powder

Gold is member of group 11 in periodic table, which contains the transition metals. The unique properties of gold are already explained in section 1.5. One of the areas where gold nanoparticles have been extensively used as a contrast agent is in biological electronic microscopy.

In this thesis, we performed screening using gold powder as target. The yield during the three rounds of selection for gold powder was encouraging (see figure D1). Thus, we proceeded for characterisation of gold binding clones by ELISA method. Here, we performed ELISA experiment for gold target in tubes. The reason for choosing tube ELISA over 96 well plate ELISA were based on the previous experience of using 96 well plate ELISA for CdS powder as target. The major problem occurred because target in powdered form can not be immobilised into the well and washing steps were performed by centrifuging the 96 well plates. While use of 96 well plate increased the difficulty of handling and moreover the method did not provide reproducible results in case of CdS target (before we suspected the toxicity issue). Therefore we performed the ELISA tests for all clones selected for gold targets (total 96) in 1.5 ml polypropylene tubes. ELISA experiment was performed in duplicate for all the clones, and we obtained reliable and reproducible results. The only drawback was tube ELISA took several days (around 2 weeks) instead of one day in 96 well plates. The ELISA results are presented in figure D2.

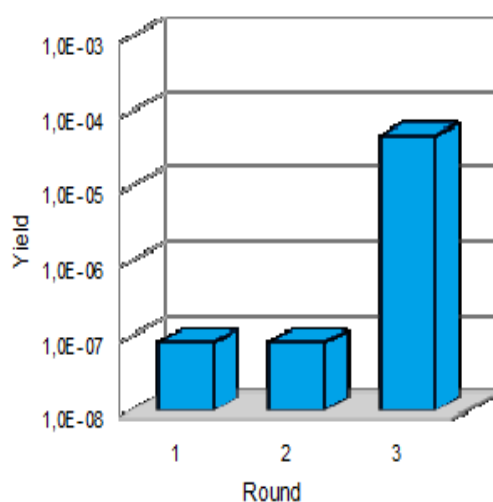

Figure D1: Yield for three rounds of selections for Au (gold) powder, Y axis represent indirect number of phages by counting infected bacterial colonies as yield, X axis represent number of rounds of selection performed.

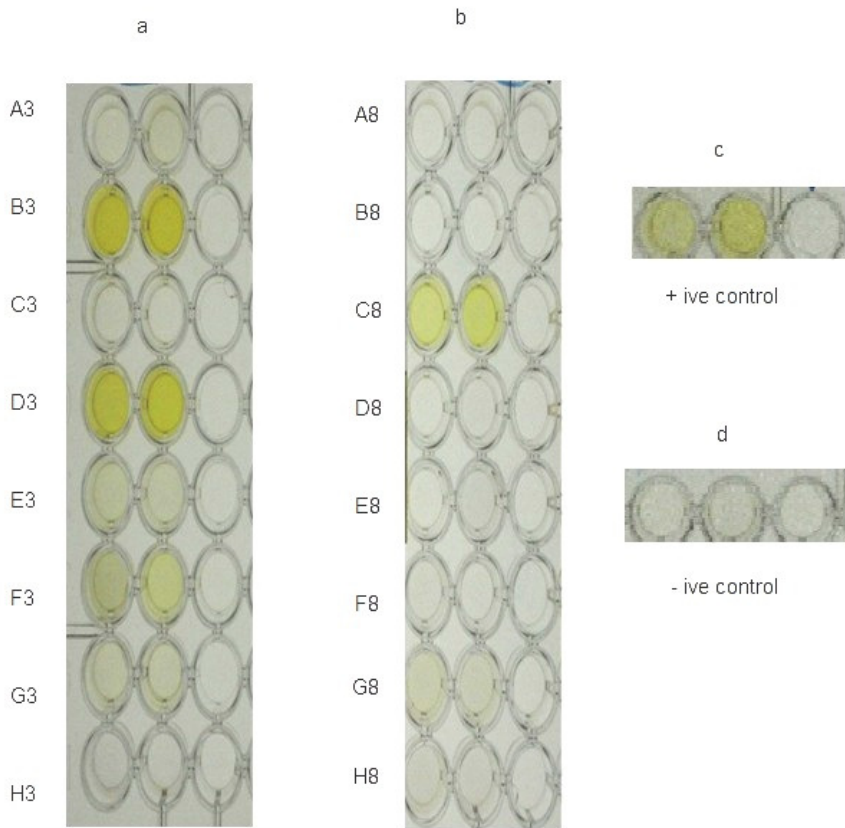

Figure D2: Tube ELISA result for gold, a) Clone A3 to H3, first two wells are showing results in duplicate, last well is the control (with no target) b) Clone A8 to H8, first two wells are showing results in duplicate, last well is the control (with no target) c) Positive control with gold binding clone (performed during every ELISA experiment), d) Negative control A1(no bacteria),performed during every ELISA experiment. All clones (96) have been done in duplicate and with control. The data are not shown for all cases.

Interpretation of figure D1 and D2

The screening results of using gold powder as target showed significant enrichment of the target specific antibodies (fig. D1). Therefore, we selected 94 random bacterial clones appeared after infection of selected phages from the third round of screening for the target. Further, we performed ELISA experiment to find specificity of these clones for the gold powder target. The ELISA experiment showed many positive binders for the gold powder target (fig. D2). Total 45 clones showed binding with gold target (either strong or weak) out of 94 randomly selected clones. The ELISA result showed that we have successfully selected nearly 50% positive clones, which indicate great success of screening against gold powder target.

Control experiments for gold binding scFv

We performed different control experiments for ensuring specificity of selected antibodies against the gold target. We used PVP binding antibodies against gold target. We also used different targets such as ZnS, silver during control experiments. Results of control experiments are shown in figure D3. All the control experiments ensured specificity of selected antibodies against the gold target.

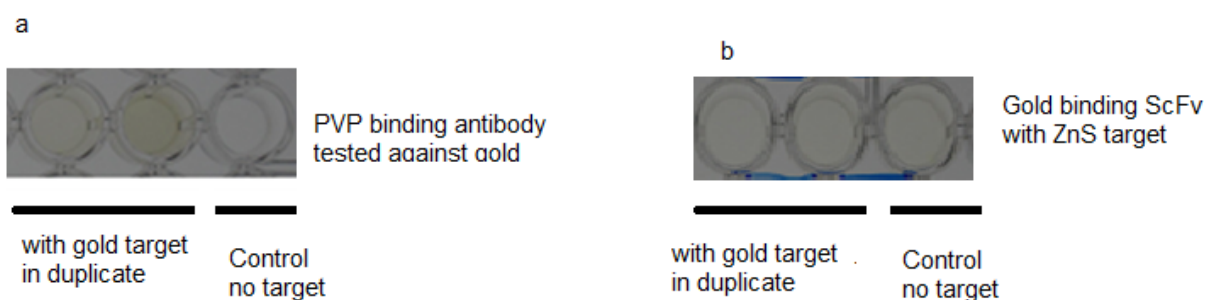

Figure D3: Control experiments for ensuring specificity of gold clones. a) PVP binding antibody with gold target, PVP binding ScFv did not show any binding with gold target. b) Gold binding scFv tested against another inorganic target ZnS, gold binding scFv did not show binding with ZnS. The gold binding antibody was also tested against silver, It did not show any binding with silver either (data not shown here).

Interpretation of Figure D3

Binding specificity was checked in many ways (fig. D3). In figure D3a, we showed that the antibody selected from the same library which strongly bind to another non-biological target (PVP synthetic polymer), do not show binding to the gold target. It is important to note that PVP binding antibodies share 75% sequence similarity with the gold binding antibodies. In figure D3b, we showed that the gold-binding antibody do not bind to other targets (ZnS or silver). This binding specificity reinforces the success of the screen.

Sequencing of positive binders (scFvs showing binding with gold targets) and their analysis

After ensuring the specificity of selected clones against gold target, we extracted the plasmid DNA corresponding to all positive clones and sent for sequencing. In total 45 clones were sent for sequencing, out of them 32 distinct sequences were identified. This is a large

number of sequence (in general) selected using the Tomlinson library. We did not expect such high number of distinct scFv sequences because usually the biological targets provide maximum 10 different antibody sequences (2-3 more commonly). Thus, the result of gold powder binding antibodies is even more successful than what we anticipated earlier. Also, this result is a major improvement over previous similar work on anti gold human antibody (Watanabe et al., 2008) which was based on only one sequence whose subparts (V_H and V_L) were selected from separate libraries.

The large number of different antibody sequences allowed us to perform statistical analysis. We found that some sequences are repeated several times, all unique sequences with their frequencies of appearance are shown in appendix C. The distinct DNA sequences were further aligned by using multiple sequence alignment tools. The sequence logo was created using MATLAB software, which is shown in figure D4. The guideline used to analyse the sequence logo is shown in Box 3.1b.

Box 3.1b

The sequence logo presented in figure D4 is a graphical presentation of the amino acids. Each letter represents one amino acid. The sequence logo is created from conserved multiple sequence alignment. It shows how well an amino acid is conserved at a particular position. If an amino acid is present more frequently at a particular position, It is depicted by a larger letter (e.g. in figure D4, letter R which is code for arginine, is shown in relatively larger letter at position 11). Source - Wikipedia

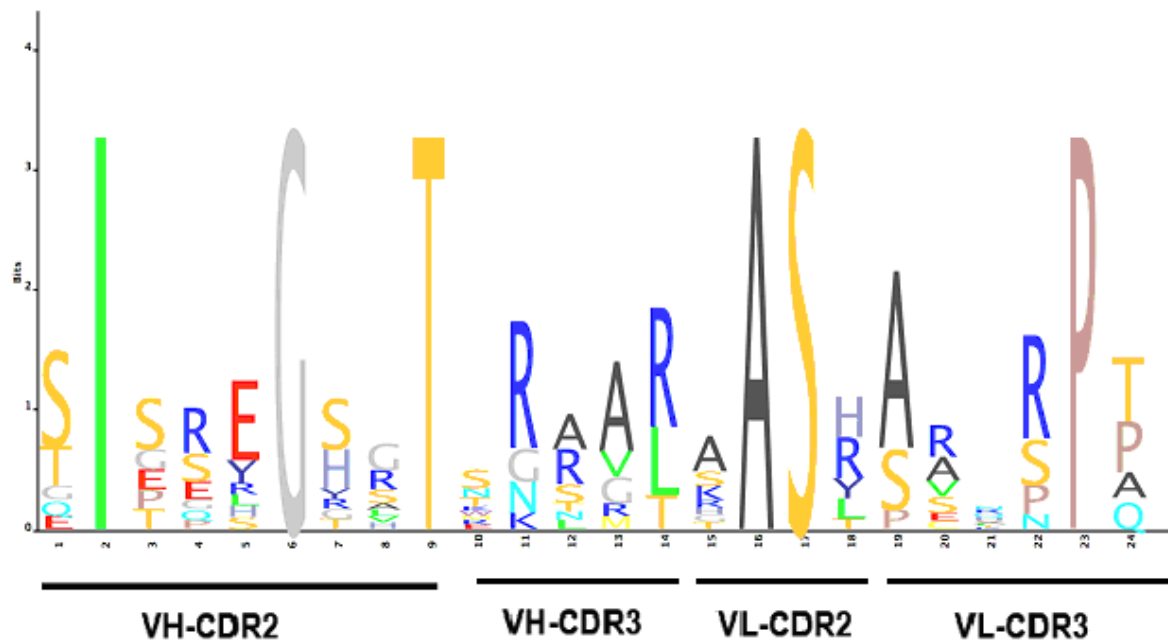

Figure D4 Sequence logo of amino acid in CDR region for gold-binding scFvs. The sequence of scFvs from the Tomlinson library sequence has 200 amino acid including 18 randomized positions. The figure represents 24 positions in the CDR region, 18 positions are variable (represented by several letters, each represent one amino acid), whereas 6 positions are fixed (represented by one large later at different positions, which are 2->I, 6->G, 9->T, 16->A, 17->S, 23->P). When there is a large letter on top at variable position, it indicates that particular amino acid is strongly selected at this position. For example letter R is represented by relatively bigger letter than rest of the letters at position 11, which indicate strong selection of arginine amino acid at position 11 in VH- CDR3.

Interpretation of sequence logo

There is clear a selection of arginine at many positions in particular at the V_H and V_L CDR3 regions. These regions are the most variable and are directly involved in contacting the target antigens. The large number of sequences showing strong selection for arginine amino acid clearly indicate role of arginine amino acid for gold binding. Detailed explanation for selection of arginine is mentioned in section 3.1 of the discussion.

ELISA experiment of gold binding clones using 96 well plate instead of polypropylene tube

The ELISA experiment when performed in tubes took several days as compared to one day when performed in 96 well plate. Though the ELISA experiment when carried out in 96 well plate for CdS target had handling problems, we decided to try ELISA experiment for gold powder target using improved protocol in 96 well plate to save time. In order to check the

reproducibility of ELISA experiment in 96 well plate, we chose all the gold binding clones for which positive and negative binders were already identified by use of tube ELISA. Also, we managed to improve ELISA conditions by centrifuging the ELISA plate for 1 minute at high speed instead of a few seconds in earlier experiment (with CdS powder as target) during washing steps and removing the last drag of remaining liquid very carefully (washing buffer, primary and secondary antibody solutions). ELISA experiment was done with gold binding clones no. 49 to 96 in duplicate (selected randomly as we can perform experiment in duplicate for only 48 clones in 96 well plate) and control experiment was done without gold powder target (results are shown in figure D5).

The ELISA result in experimental 96 well plate produced same result for positive and negative binders as we obtained in tube ELISA. However, the results were surprising as the gold binding antibodies also showed binding in control plate where gold target was absent. Such results were not expected as we already confirmed specificity of gold binding antibodies while using gold as target and also in many control experiments when ELISA was performed in polypropylene tube. The reason for such unexpected result is explained in following paragraph.

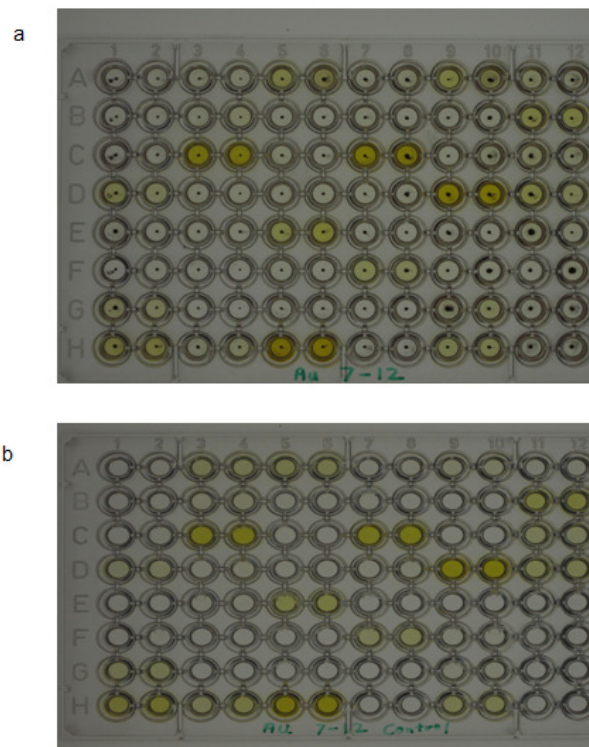

Figure D5: ELISA results of clones selected against gold target, performed in 96 well plates
a) Experimental plate in presence of gold target, clone no 49 to 96 in duplicate. The brown color dot is gold powder. b) Control plate, in absence of target. H12 is control with no bacterial clone.

Why gold binding antibodies showed binding in control ELISA plate

The ELISA result shown in figure D5 is very interesting as the figure shows the binding of positive binders in control 96 well plate in absence of gold powder target. However, the same positive binders did not bind in any control polypropylene tubes during tube ELISA. The result suggest the possibility of interaction between positive binders and material of the 96 well plate, polystyrene in this case and thus demanded a more careful look at the possibility of this interaction. We already know that the sequences of our gold binding scFvs (positive binders) have arginine amino acid in abundance (see figure D4). Later upon consulting of the literature, we found that arginine is also involved in polystyrene binding. Many researchers take advantage of this fact in designing polystyrene binding peptides. The polystyrene binding peptides are utilised in immobilising proteins on the polystyrene plate. Few example of polystyrene peptide tags are PS19-6 (RIIIRRIIRR) and PS19-6L (RLLLRRLRR) (Kumada et al., 2010) (Kumada, Shiritani, Hamasaki, Ohse, & Kishimoto, 2009). Thus, this all suggest the possible interaction of arginine residue present in positive binders and polystrene material of 96 well plate. This interaction also explains binding of the postive binders in 96 well control plate even in absence of gold powder target. It is important to note that this interesting result is not an artifact of selection this time, like with streptavidine beads (section 2.1.1). It is a sheer coincidence that we selected target (gold powder) and used 96 well plate (polystrene material) that showed binding affinity towards arginine. However, it is important to note that selection of gold binding scFvs was performed in polypropylene tube where we do not see any binders in control tubes.

Confirmation of binding of gold binding antibodies to polystyrene material

To confirm the reason summarised in above paragraph, we carried out a control ELISA experiment using tubes made up of polypropylene (PP) and polystyrene (PS) materials. In this experiment, we tested binding behaviour of one gold binding scFv (11D) in presence and absence of gold powder in polypropylene tubes and in absence of gold powder in polystyrene tube. The results are shown in figure D6. We observed that 11D (gold binding clone) showed binding with gold (gold powder in PP tube) and polystyrene tube (absence of gold powder) but no binding with polypropylene tube (absence of gold powder). However, intensity of binding correlated with yellow color is relatively less for polystyrene tubes than what we have observed previously in control polystyrene 96 well plates. This discrepancy can be accounted by difference in polystyrene composition of PS tube and PS 96 well plate.

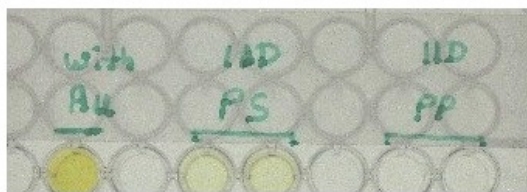

Figure D6: Control ELISA experiment using polystyrene (PS) and polypropylene (PP) tubes. Gold binding clone, 11D showing binding with gold target, little binding with polystyrene tube (PS), and no binding with polypropylene tube (PP).

Applications of antibodies selected against micro-particles for the surface chemistry of nanoparticles

Finally, we started testing the possibility of using our anti-gold powder scFvs as ligands to gold nanoparticles, which was one of our original aims. We tested one gold powder (micro size) binding scFv against citrate stabilised gold nanoparticles (20nm). The citrate stabilised gold nanoparticles are known to be sensitive to salt. At higher concentrations of salt, their citrate layer becomes destabilised and nanoparticles start to precipitate. This phenomenon can be visualised by the turning of the pink color solution to transparent. We have observed that in presence of gold powder (micro size) binding scFv, gold nanoparticles remain stabilised even at high NaCl concentration of 50mM. At the same NaCl concentration of 50mM but without scFv, gold nanoparticles becomes destabilised, which can be observed by the disappearance of pink color. This experiment is still in progress. See preliminary result in figure D7.

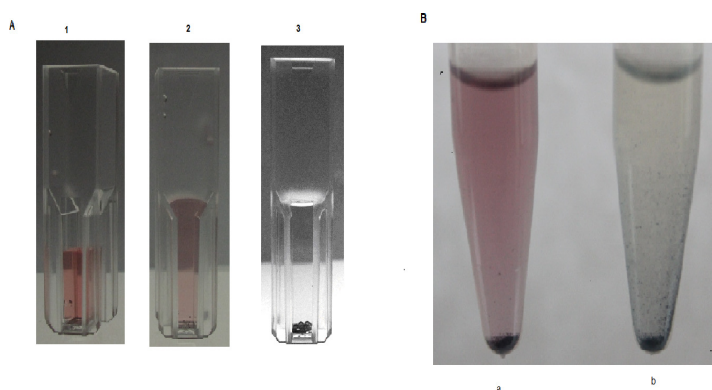

Figure D7: (A) tube 1- citrate stabilised gold nanoparticles (pink color is due to Plasmon resonance), tube 2 and 3- gold nanoparticles + buffer containing 50mM NaCl. Tube 2 is freshly prepared mixture while tube 3 is the same mixture after 18 hours of incubation. (Salt concentration is known to destabilise citrate, which results in aggregation of gold nanoparticle, ultimately the pink color disappears). (B) Tube a- citrate stabilised gold nanoparticle + gold binding scFv in culture medium, tube b- citrate stabilised gold nanoparticle + culture medium without scFv (NaCl concentration, 50mM). Salt concentration has destabilised gold nanoparticles in absence of scFv.

Conclusion

Although the results with most targets (nano and micro sized) did not appear as we expected, we have tried to identify the reason behind it. We need to adapt our protocols further to make the selection of antibodies possible for these targets. We achieved success in identifying many gold binding antibodies. The gold binding clones are proof of concept for our method to select antibodies (binders) for inorganic materials. The screen against gold target resulted in 32 distinct sequences of scFvs, which is a huge number in comparison to the selection of antibodies against any biological target. The sequence analysis of gold binding clones enabled us to identify key amino acid (arginine) that has potential role in gold binding.

Our goal was to test binding of antibodies generated against micro size particles to the nano size objects. Preliminary results confirm that antibodies selected against micron-sized gold particles can be used as ligands for surface modification of gold nanoparticles.

Result 2.2

2.2 Engineering of antibodies and their production in *Dd*

(In collaboration with S. Moutel & F. Perez at UMR 144 CNRS/Institute Curie)

Recent advances in antibody selection process led to an increase in the number of targeted antibodies. In section 2.1, we have explained generation of antibody fragments (scFvs) using phage display method against inorganic targets. These scFvs can be used as a building unit to build engineered antibody constructs. However, production and detailed characterisation of different antibodies and their engineered products are facilitated by their heterologous expression and purification. Applications of the engineered antibodies are limited due to the lack of efficient production platform for large size antibodies. Thus, a potential solution to the above problem is a better choice of an expression system that would result in sufficient yield of large size antibodies and low cost of production.

A variety of expression systems have been developed ranging from prokaryotic system of bacterial cells to eukaryotic expression systems (yeast, fungi, plant cells, insect cells and mammalian cells) for production of antibodies. Advantages and disadvantages of the above mentioned expression systems are described in section 1.4. We have exploited a new eukaryotic expression system: *Dictyostelium discoideum* (*Dd*) for the production of scFvs and engineered antibodies. The new expression system offers many advantages such as fast growth and easy genetic manipulations. Being a eukaryotic organism, it has a secretory pathway leading to correct protein processing and post-translational modifications. However, glycosylation pattern of antibodies expressed in *Dd* may differ from antibodies produced in humans. This could have an effect on use of antibodies produced in *Dd* for therapeutic purposes.

In this thesis, we have attempted to express variety of scFvs and engineered constructs such as scFv+Fc, scFv::streptavidine and bispecific antibodies in *Dictyostelium discoideum*. These antibodies were scFvs raised against biological target. The engineered constructs (scFv+Fc, scFv::streptavidine and bispecific antibodies) were generated using the scFvs as building blocks raised against biological targets. We can apply similar methodology to modify and express scFvs and their engineered constructs generated against inorganic materials.

All the scFv and scFv+Fc constructs were expressed functionally in *Dd* cells and secreted into the culture medium. However, the scFv::streptavidine constructs and the bispecific antibody constructs were not expressed in *Dd* cells. The specificity of secreted antibodies

was determined by immunofluorescence analysis. The secreted scFvs were purified from the culture supernatant using ion affinity chromatography. Furthermore, one scFv + human Fc (engineered antibody) secreted by *Dd* was purified using protein A and sent for glycosylation analysis.

2.2.1 Construction of expression vector

Contrary to the mammalian systems, there are no commercial vectors available for protein expression in *Dd* (Veltman, Akar, Bosgraaf, & Van Haastert, 2009). For the construction of *Dd* vector, we have taken advantage of the presence of extrachromosomal plasmids in *Dd* cells. The extrachromosomal plasmids are capable of producing recombinant proteins in *Dd* in large quantities. The extrachromosomal vectors have high transformation efficiency and they eliminate the need for clonal selection. Despite the substantially larger size (approx. 11kb), we decided to use Ddp1 based plasmid system. This plasmid eliminates the need for co-transfection and reduces the cell-to-cell variation of expression. pTX vector was used as a backbone for expression vector construction. The resulting vector is named as pUX vector. Detailed method of constructing pUX vector is mentioned in appendix E. The modular map for pUX vector is shown in figure 2.1.1a. We have combined favourable features (listed below) to construct *Dd* expression vector (pUX) that can allow secretion of recombinant antibodies and their engineered constructs in the culture medium. Following are the desired features that we have included in *Dd* expression vector-

- 1) Origin of replication for *E. coli* and *Dd*
- 2) Resistance marker for *E. coli* (amp) and *Dd* (G418)
- 3) Expression cassette - a) Promoter – actin 15 promoter, to ensure active translation during axenic growth b) Start codon - ATG c) Signal peptide- N terminal secretion signal peptide of *celA* to ensure efficient secretion of antibodies.
- 4) Wide choices of cloning sites (MCS) - particularly *NcoI/NotI* sites where one can subclone any *NcoI/NotI* excised scFv antibody fragments (this is the common format of all of the phage display vectors and vectors used for scFv subcloning in our study), *NotI/NheI* restriction sites (immediate downstream of the scFv fragment) that allow for the C terminal fusion of scFv with other protein or purification tags.
- 5) A terminator followed by a stop codon.
- 6) Tag for purification- His₆ tag for efficient purification

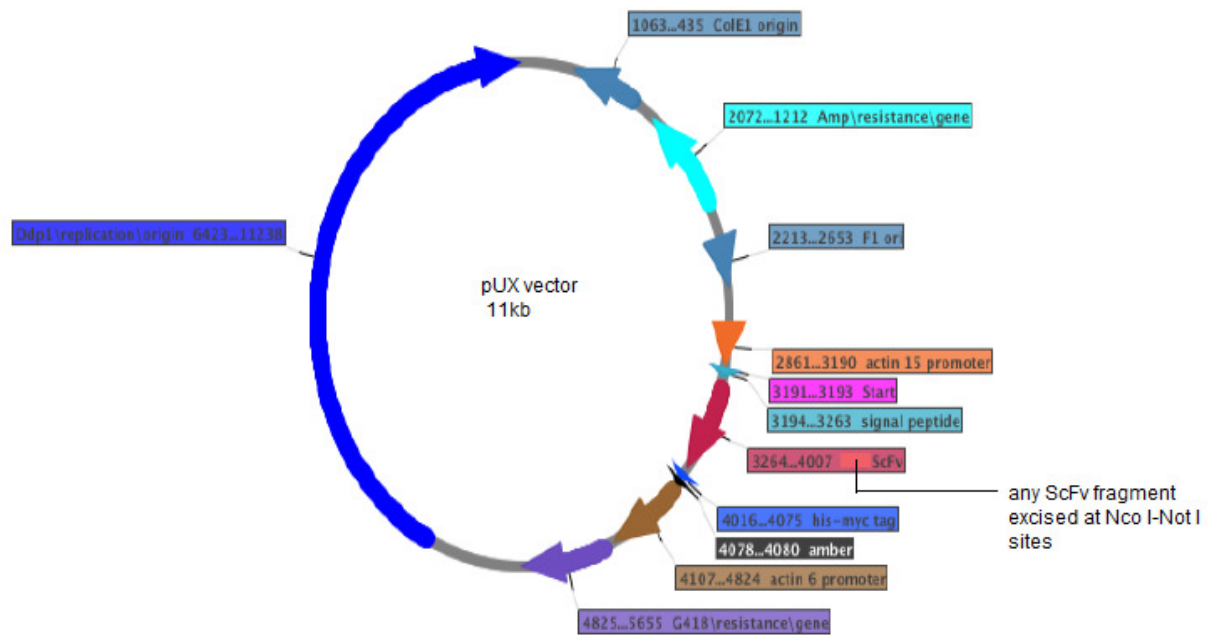

Figure 2.1.1a Modular map of pUX vector, any antibody fragment can be inserted at position Nco I - Not I, just downstream to this site, Not I - Nhe I site is present, which facilitate C terminal fusion of any other protein or purification tag to scFv sequence.

2.2.2 Cloning of the antibody sequences in *Dd* expression vector

After constructing the suitable expression vector, the next step was to clone antibody genes of interest. The pUX expression vector provides multiple cloning sites for easy cloning of the antibody genes. All scFv genes and engineered antibody genes were cloned in pUX vector. After cloning, plasmids were transformed into *E.coli*. All constructs were analysed for correct insert size of scFv and engineered antibodies. The plasmids DNA of positive clones were transformed into the *Dd* cells. Following is the description of cloning of scFvs and their engineered constructs in *Dd* expression vector.

2.2.2.1 Cloning of scFv sequences

We chose few scFv sequences - anti-alpha tubulin scFv (F2C), anti-giantin scFv (TA10), anti-myosin IIA scFv (SF9) [all generated by C.Nizak, (Nizak et al., 2003)] and conformation specific anti tubulin scFv (MB11) (Dimitrov et al., 2008). These sequences were excised from their original vectors and subcloned into the pUX vector at Nco I – Not I sites (see appendix E for the cloning strategy). The pUX plasmids containing these scFv sequences were transformed in the *Dd* cells. We obtained stable transformed *Dd* cells in two weeks. The transformed cells were able to secrete all scFvs in active form in the culture medium (detected by Immunofluorescence studies). The cloning of scFv gene was done N terminal to

affinity purification tag. As a result, we were able to purify these scFvs from culture supernatants (see section 2.2.3, 2.2.4 and 2.2.5 for detailed results).

2.2.2.2 Cloning of engineered scFv fragments

We constructed several engineered antibodies by using scFv sequences mentioned in sub section A. Engineering and cloning of these engineered antibodies have been explained in this sub-section.

(A) ScFv +Fc constructs

Traditional antibodies have two principal regions: A variable region (Fv) and a constant region (Fc). The variable region is a part of the binding domain. It is unique to each antibody and recognises a specific target antigen. The constant region (Fc) of the antibody is largely the same in all antibodies. The function of the Fc-region is to activate effector cells of the immune system. Thus, together these two regions work to bind specifically to a target antigen as well as to attract the immune system effector cells to eliminate the target antigen.

The scFv+Fc constructs were generated by fusion of Fc regions at Not I – Nhe I sites in the same scFv clones generated in sub section A. Not I – Nhe I site is present just downstream of scFv sequence cloned into the pUX vector. We went one-step further and fused multispecies Fc regions with scFvs. The multispecies fusion made these constructs free from species barrier and made them more valuable for various routine analyses in the laboratory. All scFv + Fc constructs are depicted in figure 2.2.2a (see appendix E for cloning strategy of scFv + Fc constructs).

All of the pUX plasmids containing scFv+Fc sequences (total 16) were transformed in the *Dd* cells. We obtained stable transformed *Dd* cells for all scFv+Fc constructs. All constructs were able to secrete active scFv+Fc antibodies into the culture medium of *Dd* cells (detected by Immunofluorescence studies). See section 2.2.3 and 2.2.4 for further results.

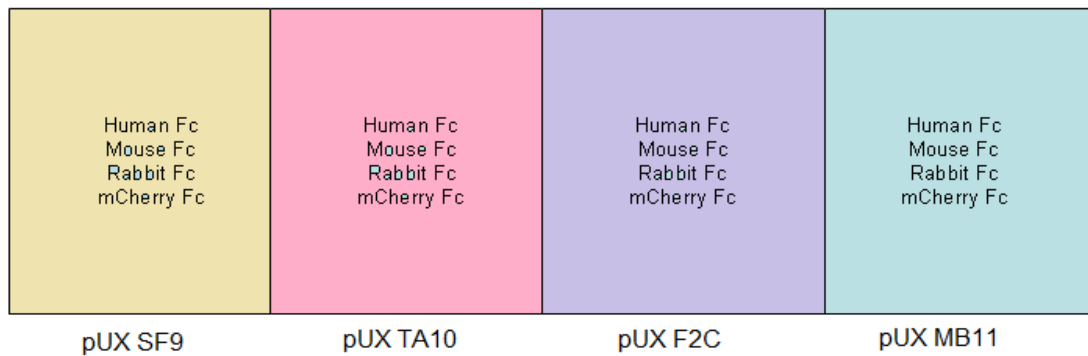

Figure 2.2.2a: ScFvs – SF9, TA10, F2C, and MB11 have been fused with multispecies (human, rabbit, mouse, m cherry) Fc regions.

(B) ScFv:: Streptavidine constructs

ScFv is a monovalent molecule and sometimes multivalency is preferred for the antibody molecules. To achieve multivalency, we fused streptavidine gene at Not I – Nhe I site just downstream to scFv sequence already cloned into the pUX vector. Streptavidine is a stable tetrameric protein. Pictorial presentation of tetrameric form of scFv :: streptavidine constructs are shown in figure 2.2.2b. Different cloning steps performed during construction of scFv:: streptavidine constructs are shown in appendix E. All of these constructs were transformed in the *Dd* cells. Our aim was to produce this tetrameric construct in *Dd*. We were able to obtain stable transformed *Dd* cells for all of the streptavidine fusion constructs. However, we could not achieve any expression of scFv::streptavidine fusion constructs (see section 2.2.3 and 2.2.4 for explanation).

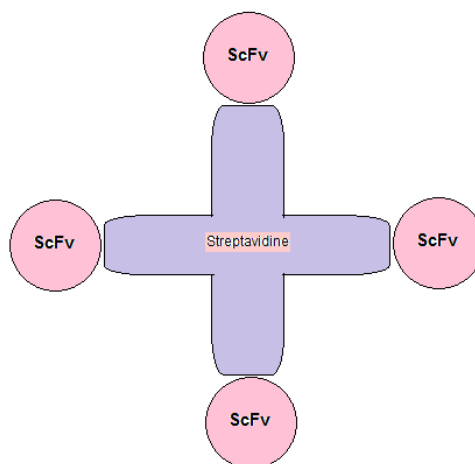

Figure 2.2.2b: ScFv:: streptavidine construct (ScFv- SF9, TA10, F2C, PVP binding scFv-A2,B1,C11,F1)

(C) Bispecific constructs

The bispecific antibodies do not naturally occur in nature. The concept of bispecific antibodies first emerged for therapeutic purposes (see section 1.3 for details). Apart from the therapeutic use, the bispecific antibodies can be utilised in various applications such as a bispecific antibody that has specificity towards two materials. They can be used for many materials science or sensing applications. The bispecific antibodies can also be used for cross linking two cell surface receptors, which can be used as novel cell biology tools. With the bispecific antibodies we can explore many new target combinations. Engineering bispecific construct requires good skills in molecular biology and genetic engineering. Most of the techniques described in literature are based on using primers, which need to be designed for each bispecific construct and additionally such strategies increase the cost of construction.

Our technique is more general, we can fuse any two antibodies of different specificities, using a linker sequence. The main strength of our technique is the use of universal linker. We set up a strategy to fuse any two NcoI/NotI excised scFv fragments resulting in a combined fragment flanked by NcoI/NotI sites. The design of the linker was inspired from the synthetic linker used in BiTE construct.

The Linker has (Gly₄ Ser)₃ sequence flanked by Eag I and Pag I at extremes. Eag I and Pag I sites share common overhang with Not I and Nco I sites respectively. Due to this engineering design, internal Nco I and Not I sites get killed. Final bispecific construct still posses Nco I-Not I sites, which makes it feasible to subclone into any of our scFv phage display or *Dd* expression vectors (see appendix E for details).

We constructed one bispecific antibody using TA10 and F2C scFvs, later we used the same method to make another construct for our project in collaboration with Yamuna Krishna at National centre for biological sciences (NCBS), Bangalore, India. There is little literature about different arrangement of variable domain chains and its effect on function. To explore this area, we made two types of bispecific constructs using one set of two scFvs. For example scFv A has V_H - V_L arrangement, scFv B has V_H - V_L arrangement, which provides opportunities to make two kinds of bispecific antibodies as shown in figure 2.2.2c. After making the bispecific constructs, sequences are confirmed by sequencing. The transformation of pUX vectors containing bispecific constructs (scFv A + linker + scFv B) was done in *Dd* cells. We were able to obtain stable transformed *Dd* cells for all of the bispecific constructs. However, we could not achieve any expression of bispecific antibodies (details is explained in section 2.2.3 and 2.2.4).

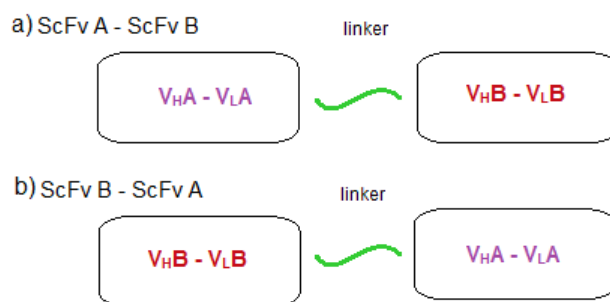

Figure 2.2.2c: Possibility of two arrangements of any Bispecific antibody , in construct (a), V_L of scFv “A” is in contact with V_H of “B”. Whereas in construct (b), V_L of scFv “B” is in contact with V_H of “B”.

2.2.3 Transformation and selection of antibody fragments and engineered antibodies in *Dd* cells

Plasmid DNA of all positive constructs (scFv and engineered antibodies) cloned in *Dd* expression vector (pUX) was extracted. All the constructs were transformed in AX3 strain of *Dd* cells. Transformation was done by electroporation. Transformed cells were subjected to increasing concentration of G418 antibiotic selection from 5 ug/ml to 20 ug/ml. The stable cells were propagated in HL5 medium containing 20ug/ml G418.

We were able to transform and obtain stable transformed cells for all scFvs and engineered antibody constructs. The selection of cells transformed with scFv was started with 5 ug/ml concentration of G418. We were able to achieve stable scFv transformed cells within two weeks. However, engineered antibodies constructs (scFv+Fc, scFv::streptavidine and bispecific constructs) took longer time (nearly three weeks) to obtain stable transformed *Dd* cells. Moreover, we did not observe any transformed cells for few scFv+Fc constructs when selection was started at 5 ug/ml concentration of G418. Therefore, we altered the selection condition by reducing the initial amount of G418. The selection was started at 2.5 ug/ml concentration of G418. Under this selection condition, we obtained stable transformed cells with scFv+Fc constructs. Further, we adapted similar selection conditions for all engineered antibody constructs owing to their larger size than the scFv alone. The possible reasons for slower transformation of engineered antibody constructs and absence of transformed cells under selection at high G418 concentration (5ug/ml) might be apparent toxicity of these constructs to *Dd* cells or bigger size of the constructs, which made them costly for *Dd* cells to replicate. After obtaining stable transformed *Dd* cells, we tested expression of antibodies in *Dd* supernatant (see the following section).

2.2.4 Expression of antibody fragments and engineered antibodies in *Dd* cells

Transformed cells were grown in axenic medium (HL5) with 20ug/ml G418. The expression of scFv and scFv+Fc constructs in AX3 transformants were studied by Immunofluorescence. The supernatant of transformed *Dd* cells were collected and Immunofluorescence studies were made using HeLa cell lines. Bright fluorescence signals were observed by supernatant of transformed *Dd* cells confirming the secretion of biologically active antibodies. The immunofluorescence (IF) images for actively secreted scFvs are shown in figure 2.2.4a, IF images for actively secreted scFv + Fc constructs are shown in figure 2.2.4b.

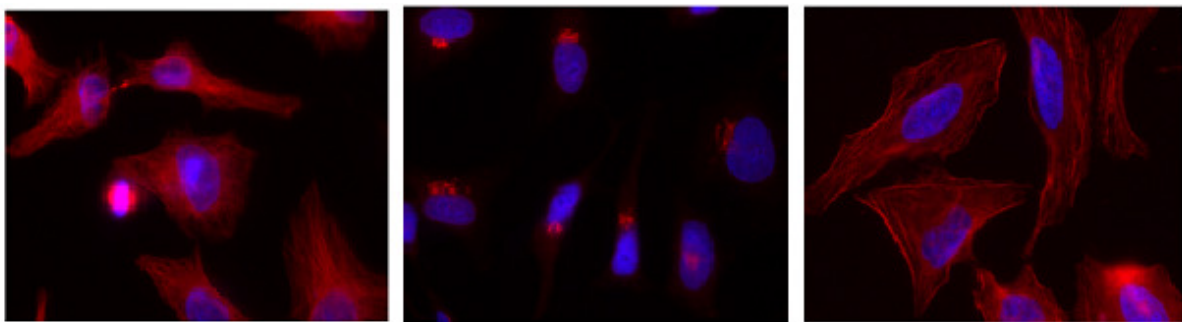

F2C ScFv (anti alpha tubulin)

TA10 ScFv (anti giantin)

SF9 ScFv (anti myosin)

Figure 2.2.4a: IF images of secreted scFvs using HeLa cells. Fixed HeLa cells were stained using the supernatant of *Dd* culture secreting respectively an anti-alpha tubulin ScFv (left, F2C), an anti-giantin scFv (middle, TA10), and an anti-myosin IIA scFv (right, SF9). ScFv staining is shown in red (detected via anti-His6 and secondary antibodies), DNA is stained by DAPI, shown in blue. ScFv staining intensity corresponds to the one usually obtained with the same scFv prepared from CHO cells.

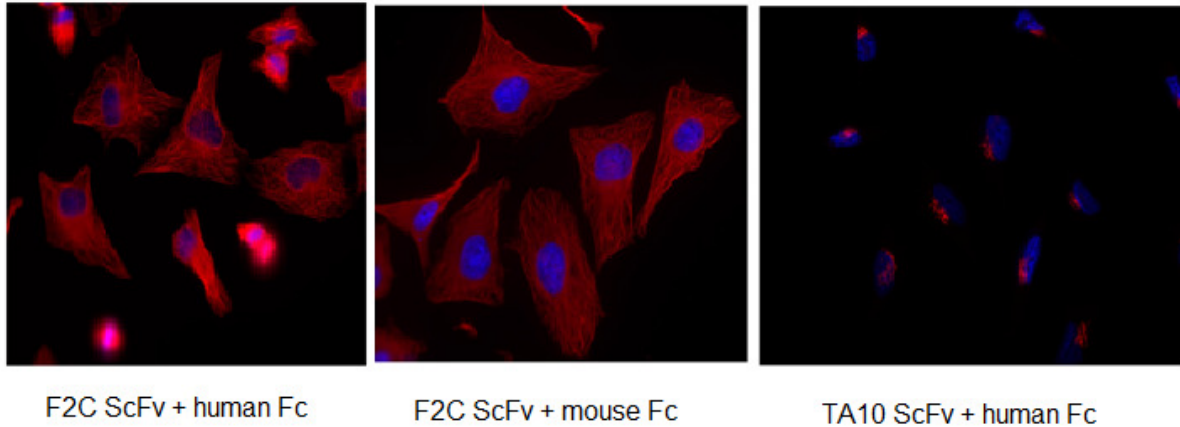

Figure 2.2.4b: IF images of secreted scFv + Fc constructs using HeLa cells. Fixed HeLa cells were stained using the supernatant of *Dd* culture. anti-alpha tubulin scFv +human Fc (left, F2C+ hFc), an anti-alpha tubulin scFv + mouse Fc (middle, F2C+ mFc), and an anti-giantin scFv+ human Fc (right, TA10+hFc). ScFv+Fc staining is shown in red (detected via secondary antibodies e.g.anti human, anti mouse), DNA is stained by DAPI, shown in blue. ScFv+Fc staining corresponds to the one usually obtained with the same scFv+Fc prepared from CHO cells. All scFv + Fc constructs were secreted in active form in *Dd* cells, other images are not shown here.

With the positive expression of scFvs and scFv+ Fc constructs we expected to obtain positive expression of scFv::streptavidine and bispecific constructs. But these two constructs did not show any expression after stable transformation in *Dd* cells. We tried to purify these constructs using ion affinity chromatography (cobalt resin for histidine tag proteins). We did not see any band on SDS PAGE. We tried to detect presence of purified protein using silver staining but could not see any band of purified protein. Instead of directly purifying these constructs we could have tried to detect presence of expressed antibody constructs directly in the supernatant of *Dd* cells by western blot analysis. The western blot analysis could have ensured us for correct expression of these constructs even if they were expressed at low level.

If expression of these constructs is really hindered in *Dd* cells, the potential reasons can be larger size of constructs, which make them costly for *Dd* cells to replicate. However, the non-expression of scFv::streptavidine and bispecific constructs due to their large sizes can be discounted as we were able to functionally express scFv+Fc construct whose size was comparable to bispecific construct.

The other reason for non expression of scFv::streptavidine and bispecific constructs might be the sequence of these constructs that can stop their transcription in *Dd* cells. The bispecific construct is made up of GC rich linker [(Gly₄ Ser)₃] joining two scFvs. It may be possible that *Dd* cells could not express the bispecific constructs due to the codon bias specially at the

linker region (*Dd* genome is AT rich, and not optimised to express GC rich protein) see section 3.2 for detailed explanation. Similarly the streptavidine sequence of scFv::streptavidine fusion constructs has high GC content, with the stretches of glycine and serine amino acids. So this constructs might have also faced problem of codon bias in *Dd* cells. The expression of the bispecific construct and the streptavidine fusion construct can be checked after codon optimisation of their sequences for *Dd* cells.

2.2.5 Large scale production and purification of antibodies from *Dd* supernatant

The large scale production of scFv was carried out in shake flask culture. Transformed *Dd* cells were inoculated in 100 ml of HL5 medium under presence of G418 20ug/ml. This culture was incubated in shaking incubator at 22° C till culture reached adequate cell density. The *Dd* cells were checked for their viability under the microscope, this culture was transferred to **500 ml** HL5 medium containing 20ug/ml G418. The culture was incubated for 72 hours at 22° C (shaking incubator). At the end of incubation period, the culture was harvested. The cells were removed by centrifugation and supernatant processed for purification. Cobalt ion affinity chromatography method was used to purify “His tagged” protein. Protein was purified using 150 mM imidazol. Purified protein was collected in separate aliquots, **25ul** of each aliquot were analysed by SDS-PAGE (figure 2.2.5a). Flow chart of complete procedure of expression of scFv in *Dd* is shown in figure 2.2.5b.

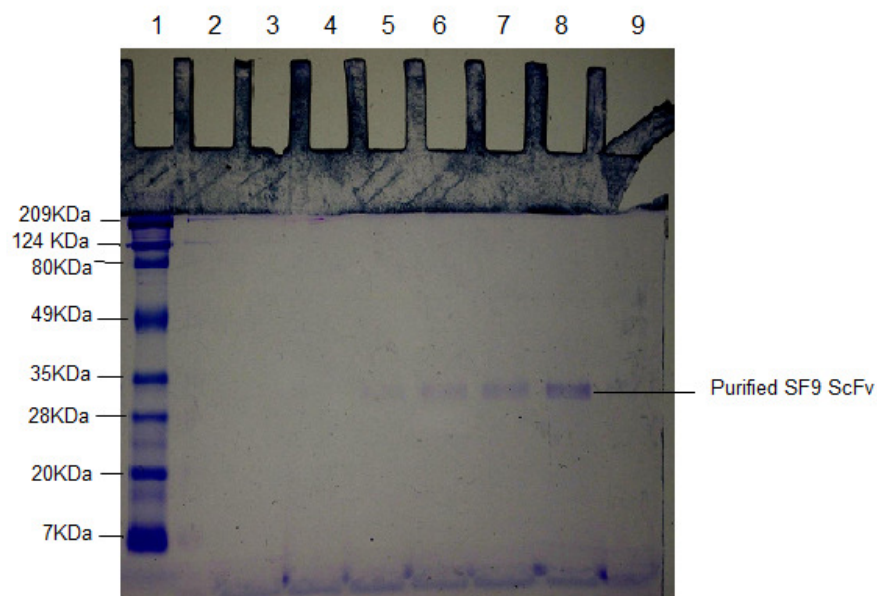

Figure 2.2.5a: SDS-PAGE image of purified scFv (SF9), lane 1- protein molecular weight marker, lane 2- 9 different aliquots of purified SF9 scFv eluted with 150mM imidazol, 25ul of each aliquot is loaded, expected size of purified scFv is 35KDa, single band is visible in lane 6,7,8.

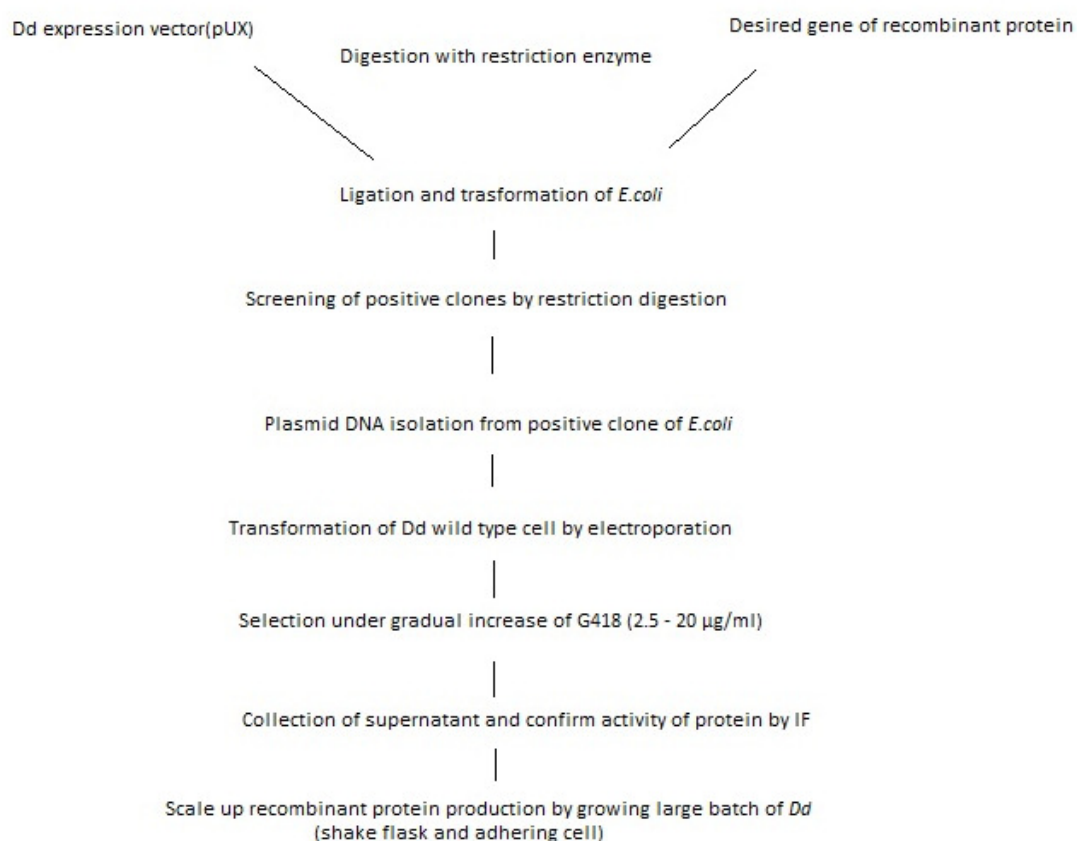

Figure 2.2.5b: Flowchart of production of recombinant proteins in *Dd*

2.2.6 Enzymes involved in glycosylation in *Dd* genome

We have compiled a list of glycosylation enzymes identified in the *Dd* genome database. Many enzymes involved in glycosylation functions are homologous to the human glycosylation enzymes which are involved in the antibody post translational modifications. This increased the motivation to develop *Dd* as an expression system for antibody production. All activities in the synthesis of N linked glycan are performed by glycosidase and glycosyltransferase enzymes present in endoplasmic reticulum and Golgi. The exact profile of such enzymes present in any cell can largely dictate the composition and structure of the final oligosaccharide side chains (Walsh & Jefferis, 2006). The presence of such enzymes also increased the potential impact of *Dd* as an expression system for therapeutical antibody production. (See table 2.2.6)

2.2.7 Analysis of glycosylation pattern in *Dd* secreted antibody

We performed a 1L scale production of a particular human scFv-Fc (Tn + human Fc) construct in *Dd* in order to compare its glycosylation profile with that of a CHO preparation of the same construct. Tn antibody (scFv) is generated against certain type of antigens which appear on tumor cell surface. We have received this scFv from Institute Curie, Paris. Later we have fused human Fc to Tn scFv and cloned into pUX *Dd* expression vector. This construction displays the classical glycosylation site in the Fc region (Asn297), as well as another glycosylation site in the Fv region. We have performed large scale production of the Tn scFv+ human Fc according to the protocols we have developed (appendix F). Our collaborators have produced the same scFv+Fc in CHO cells and proceeded for protein purification of both *Dd* and CHO produced constructs. The SDS PAGE image of purified antibodies is shown in figure 2.2.8. In the image, samples look partially degraded (probably due to proteolysis). But antibodies were still functional due to the intact disulfide bonds. The band intensities of CHO and *Dd* purified antibodies are comparable. The yield was comparable between CHO and *Dd* cells, of the order of 1-2mg per L of culture. The purified samples of scFv+Fc construct produced in CHO and *Dd* cells were sent for glycosylation analysis to our technical platform at Centre de Biophysique Moléculaire, Orléans. The glycosylation analysis process is currently under progress.

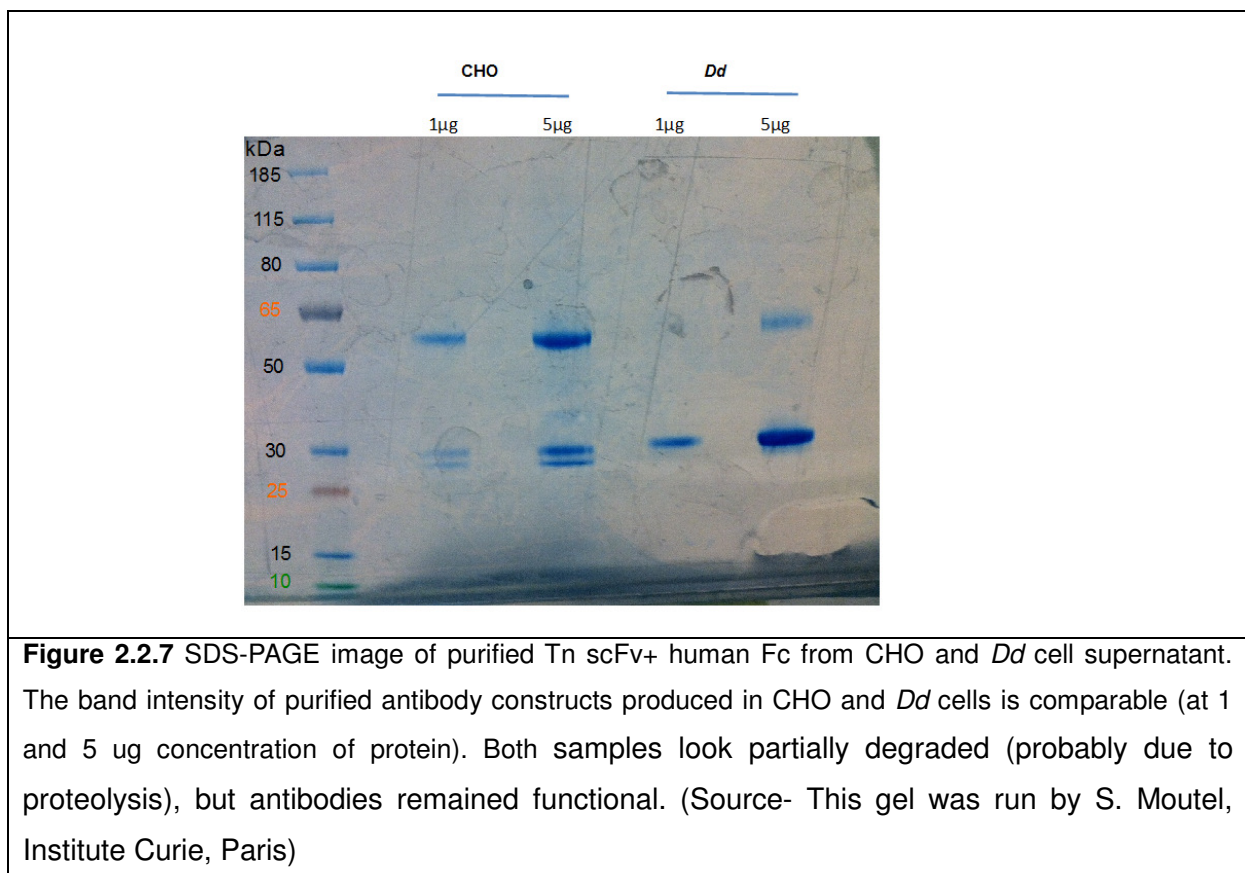

Conclusion

We have successfully developed an antibody production platform based on the *Dd* as an expression system. This system has shown functional secretion of various scFvs. The system was able to secrete functionally active large size antibody constructs at low cost (we have shown functional secretion of scFv+Fc constructs). The scFvs and scFv-Fc constructs were expressed at levels comparable to the mammalian expression system (CHO cells) at a much lower cost. However, we could not show the expression of scFv::streptavidine constructs and bispecific constructs. We have mentioned the probable reasons for non-expression of these constructs; much research is required to narrow down the true reason and to optimise the conditions for their expression. Another challenge of antibody production is the production of antibodies with correct post translational modifications. Among the various post translational modifications, glycosylation is the most crucial modification for therapeutically important antibodies. *Dictyostelium* being a eukaryotic expression system is expected to perform correct glycosylation of eukaryotic proteins (e.g. antibodies). We have attempted to find a potential of this expression system to produce therapeutically significant antibodies.

Table. 2.2.6: *Dd* glycosylation enzymes identified in the *Dd* genome annotation database. Source: dictybase.

Gene ID	Gene name	Gene product	Gene description
DDB_G0283965	<i>pigA</i>	GlcNAc transferase	CAZy family GT4; subunit of the transferase that catalyzes the transfer of N-acetylglucosamine (GlcNAc) from UDP-N-acetylglucosamine to phosphatidylinositol (PI)
DDB_G0271120		protein kinase C substrate	Very similar to the mammalian glucosidase II subunit beta also known as protein kinase C substrate 80K-H, which catalyzes the sequential removal of two alpha-1,3-linked glucose residues in the second step of N-linked oligosaccharide processing; also similar to yeast GTB1; defects in human PRKCSH are a cause of polycystic liver disease (PCLD)
DDB_G0283005	<i>agtA</i>	Alpha-galactosyletransferase	likely catalyzes the alpha addition of galactose to Fuc-Gal-Nac_Hypro143-Skp1 (FpaA/FpaB)
DDB_G0293896	<i>manA_ps</i>	pseudogene	Putative pseudogene; alpha-mannosidase family protein
DDB_G0277051 DDB_G0284395 DDB_G0268754 DDB_G0284393 DDB_G0284391 DDB_G0292918		1,2-alpha-mannosidase	Catalyzes the hydrolysis of the terminal 1,2-linked alpha-D-mannose residues in the oligo-mannose oligosaccharide Man9(GlcNAc)2; some members of this family are responsible for protein N-linked glycosylation, while other participate in the degradation of misfolded glycoproteins in the endoplasmic reticulum

3 Discussion

3.1 Towards finding protein based binders (potential ligands) for inorganic materials

In the thesis, we have described unique properties of inorganic materials at nanoscale and their potential uses in improving various devices such as electronics, sensing devices, bio-imaging and many more. We also addressed the limitations of current fabrication techniques specially for assembly of nanoparticles, and core issues concerning unfavourable surface chemistry of nanoparticles (see section 1.5). Full potential of nanomaterial-based products are far from being realised because of the above-mentioned challenges. We have suggested a potential solution by use of an antibody fragment (scFv) for surface modification of nanoparticles. The proposed surface modification can be utilized in making given inorganic nanomaterials biocompatible for imaging, and in triggering self-assembly of nanoparticles.

Peptides and antibodies (scFv) are two main protein based binders. Proteins are polymers of amino acids that can spontaneously fold into uniquely organised, tightly packed structures that self organise thousands of atoms. Such self organised atoms manifest a wide range of functional properties. However, among peptides and antibodies (scFvs), it is difficult to comment which one of them is a better binder (see section 1.5.9 for details).

3.1.1 ScFvs as surface ligands for inorganic nanoparticles

ScFvs are one of the smallest, stable units of immunoglobulin molecule that can mediate function of antigen binding. We have utilised specificity of this small antibody fragment for selecting binder against inorganic materials. At the length we intended to use the specific scFvs as ligand for modifying surface of inorganic nanoparticles. Here we have summarised few advantages offered by scFvs as inorganic nanoparticle surface ligand.

Further molecular engineering of selected scFv

ScFv is a favourable molecule for genetic engineering because of easy access to its domain rearrangement. We can use the antibody-engineering platform developed during this thesis to generate artificial antibody constructs such as bispecific antibody constructs using scFv as building units. One such example of a bispecific antibody construct is shown in section 1.5.11 for material science applications. Multivalent molecules can also be created by generation of streptavidin fusion construct (explained in section 1.3).

Functional expression of scFv

E. coli is an inexpensive expression system to obtain a high yield of protein. Thus, another advantage of scFv is its functional and high expression level in *E. coli*. There are many improved vectors available that can facilitate secretion of scFv in soluble form. Many polypeptides cannot be produced efficiently in *E. coli* because of improper folding or aggregation in bacterial cytoplasm; however, this is not the case with the scFvs.

3.1.2 Possibility of using other protein scaffolds as surface ligands for inorganic nanoparticles

It is possible to use other scaffolds of protein that show specificity with inorganic materials. Protein frames, which have structural stability and precise binding affinity for inorganics, can replace most commonly used peptide scaffold. Choices of other protein frames is limitless as long as gene sequence is known (Werkmeister & Ramshaw, 2012). Easy cloning of the target gene and its sufficient expression and further easy purification are the main requirements for using any other protein frame. However, depending on application such as biomedical purpose, it is important to choose a protein frame that is compatible in the biological environment.

3.1.3 Selection of positive binders (scFvs) using one large library: Searching a needle in haystack

Phage display technology is a powerful molecular biology tool. The power of this technique lies in its ability to efficiently and rapidly identify positive binders in the form of antibody fragment. The technique allows us to find specific binder for targets from large population of phages displaying various antibody fragments. We have used the Tomlinson (I+J) library of scFv for screening against non-biological, inorganic materials. This library has been successfully used for many biological targets so far. We have extended application of the library for non-biological targets. In this thesis, we have used this library for selecting binders against non-biological targets - gold, CdS, CdSe and ZnS powders.

In our laboratory, another colleague has used the same library against synthetic polymer (PVP). The screen against gold powder and PVP target resulted in identifying many positive clones (more than 40 out of 94 randomly selected clones). Such a high number of positive binders allowed us to statistically analyse different selections of amino acids. We used sequence data to create sequence logo. The sequence logo obtained from selection of positive binders for both non -biological targets are shown in figure 3.1a. Difference in

selection of clones against these two targets is very clear. There is a strong bias towards selection of tyrosine, glycine, asparagine and aspartic acid in the V_H-CDR3 region of PVP-binding clones, whereas, in most of the CDR regions of gold-binding scFv (more concentrated in V_H-CDR3) there is a strong bias towards selection of arginine. These results are extremely motivating for several reasons. First, it validated our approach to use the same antibody library of 10⁸ clonal diversity for selecting binders/ligands to a diverse range of targets: protein targets as well as non-biological targets such as synthetic neutral polymers and metallic surfaces. It also supports our strategy of using this method (binder selection by phage display) to modify the surface of inorganic particles (refer figure D7 of section 2.1). It is important to note that the chemical modification of a surface of every type of inorganic nanoparticle requires a dedicated strategy. On the other hand, our strategy of selecting binders using phage display is expected to be a general strategy, which can be utilised for various targets in the future.

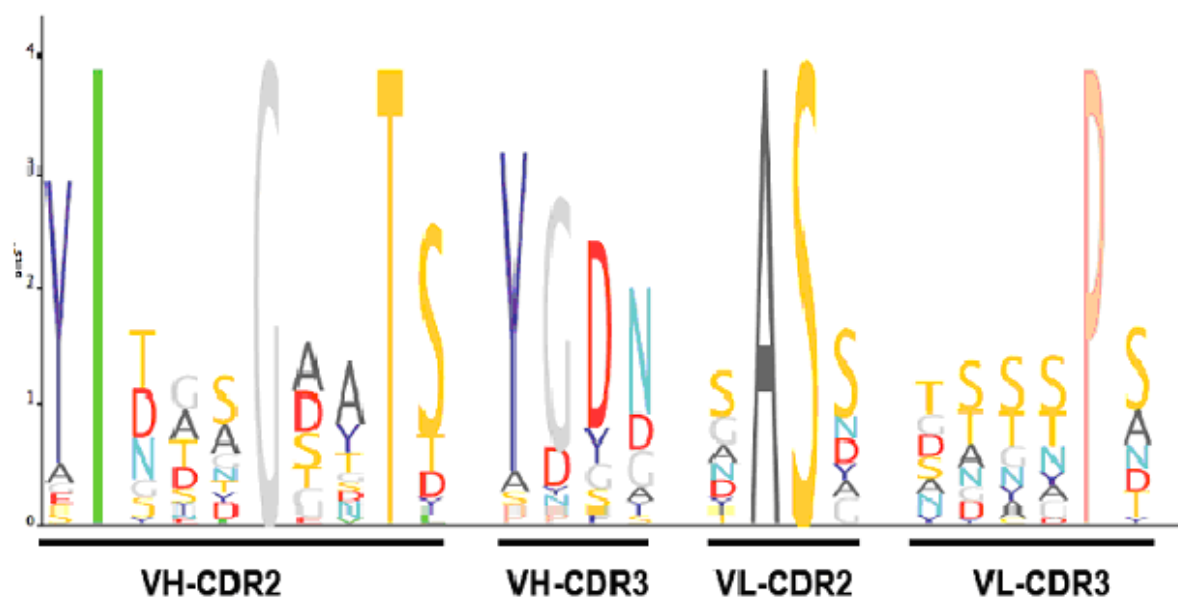

Sequence logo for PVP (Screen against PVP was performed by a colleague in the lab)

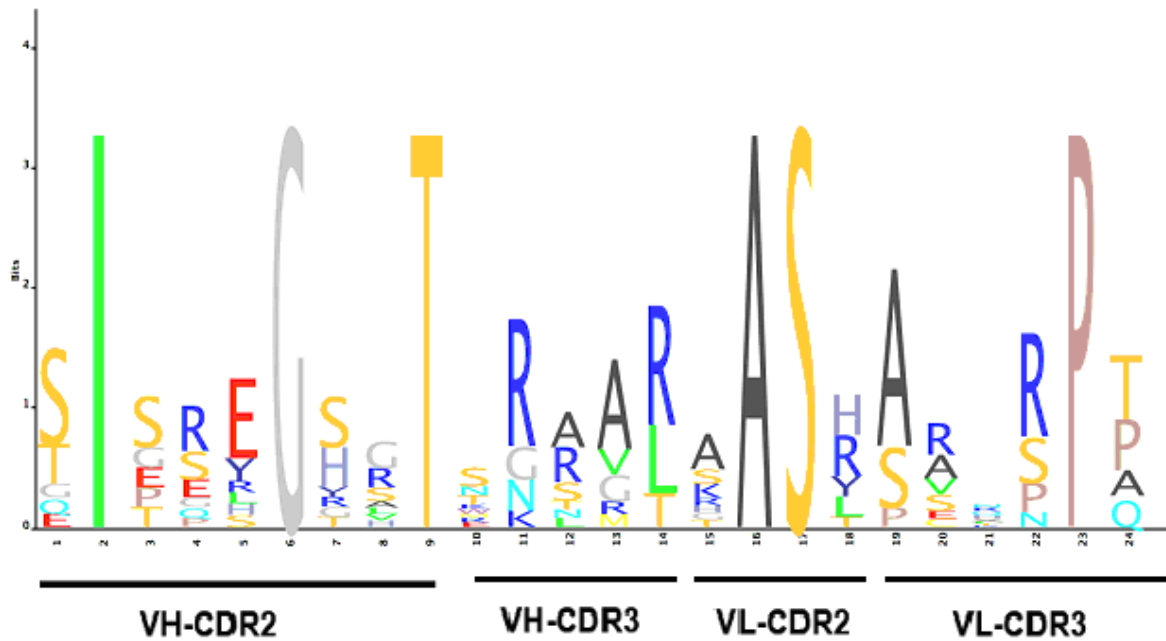

Sequence logo for Gold

Figure 3.1a: Sequence logo representing selection of amino acid at CDR regions of scFvs selected against the polymer PVP (top) and gold (bottom). Both screens were performed using the same scFv library [Tomlinson (I+J)] and both resulted in nearly 40 positive clones. Sequence logos are showing clear differences in selection at the variable positions (they are obviously identical at the fixed positions; 2->I, 6->G, 9->T, 16->A, 17->S, 23->P). There is a strong selection for tyrosine, glycine, asparagine and aspartic acid in the V_H-CDR3 region of PVP-binding clones. Whereas, there is a strong selection for arginine at most of the CDR regions of gold-binding scFv (more concentrated in V_H-CDR3).

3.1.4 Perspectives and consequences of using current display library

Less complexity of binders: an advantage

We know that all libraries (display libraries) exhibit some degree of compositional, positional and expressional bias, so in such conditions relying on limited number of validated methodology for selection is convenient so that we can compare our results.

If a polypeptide is less complex in terms of variability of amino acid and structure, it can provide comparative data for different targets. Low complexity of polypeptide also provides enough opportunity to manipulate structure for improved binding. Antibodies have more complex structure than peptide but antibody fragments of the Tomlinson library have fixed variable position (18 out of total 200 amino acids). Because of fixed variable positions, we

can compare screening results of very different targets using one library having 10^8 clonal diversity as we did for PVP and gold targets (see fig. 3.1b).

No need for prior surface characterisation of inorganic materials

In most of the screens, it is highly recommended to prepare target carefully. There are recommendations for characterisation of target material with surface analysis tool such as X-ray photon emission spectroscopy, X-ray diffraction spectroscopy, scanning electron microscopy and transmission electron microscopy (Seker & Demir, 2011). Methods to find binders for inorganic materials such as molecular dynamics study and rationally designed ligand require prior surface characterisation. However, method applied in this thesis using phage display, does not require prior characterisation of target, in fact screening result can provide fundamental information about how proteins specifically bind to inorganic materials.

Exploring the interface between biologics and inorganics

Selected scFvs against any target materials provide us primary information about how these biological molecules (scFvs) recognise inorganic materials. By analysing selected scFv sequences, we can identify particular amino acid which has appeared more frequently for given inorganic materials (like we did for gold binding clones). Such information can help us to explore fundamental recognition process between biologics and inorganics. Apart from this, it can guide further to design new molecule with improved specificity for the target (as shown in one example of potential application, in section 1.5.12)

Single strategy to modify surface chemistry of all types of nanoparticles

Nanoparticles have rough surface, as a result they have high surface energies. Therefore nanoparticles need to be stabilised by surface ligands (explained in details in section 1.5). The choice of ligands is specific to chemical nature of the nanoparticles. This kind of surface modification is crucial to the eventual application of nanoparticles. Most of the chemical modifications of a surface of inorganic nanoparticle require a dedicated strategy. On the other hand, the strategy of using ligands selected by phage display is general; we can apply it to any inorganic/organic targets. We have achieved success in selecting many positive binders for gold particles, which can also used as surface ligand. However, failure in selecting binder (potential ligand) for other materials (CdS, CdSe, and ZnS) can be attributed due to other reasons, which we have explained in section 3.1.4.

Consequences while using the library

Coming to the consequence faced while using the library for selection of binders against inorganic surfaces - Each screen produces many binders. Selection of many positive binders allows us to perform statistical analysis and identify over or under represented amino acid at variable positions. However, characterisation of all binders is not possible. In such a condition, we have to restrict ourselves by choosing one or a few positive binders. While choosing one best sequence for further characterisation, we may choose sequence, which may provide less information about the interface (inorganics/biologics) than other sequences. Thus, analysing large number of binders and selective study of a particular binder for its specificity are two major area of study and both should be done in parallel.

Another consequences of using the library (for that matter any other library) comes due to non-homogeneity of inorganic material target. Sometimes inorganic targets lack homogeneity both compositionally and structurally. Because of heterogeneity of the targets, final isolation of positive binders “elution step” becomes difficult (refer section 1.2 for phage display standard protocol). All positive clones can not be isolated using same elution conditions; as a consequence we may miss the best binders. In addition, no prior knowledge about surface charge of the target can also affect the selection of binders. Moreover, oxidation film may develop when inorganic material is immersed in any buffer, so careful attention must be paid while preparing incubation buffer (Seker & Demir, 2011). To the best of our knowledge, the Tomlinson library has never been used for inorganic targets, so there is no established protocol to follow. However, inspiration can be taken from screening done for biological targets and protocol can be tuned according to the target materials. In this thesis, we have described a few adaptations of protocols for screening of inorganic materials using the Tomlinson library.

3.1.5 Failure of selection of binders for CdS QDs and gold nanoparticles

We could not select any binder for the nanoparticles. The most probable reason for failure of these results was inefficient biotinylation of their surface. As a consequence we selected antibodies against streptavidine surface (refer result section 2.1.1 for details). On the other hand if nanoparticles were biotinylated in excess, we might have ended up with selection of anti-biotin antibodies. So overall this approach is not safe, due to increased chances of selection of non-specific antibodies.

3.1.6 Failure of selection against micron sized CdS, CdSe, and ZnS semiconductor materials

We could not select any binder for CdS, CdSe, and ZnS semiconductor materials. The screening against CdS and CdSe semiconductor materials resulted into selection of mutated, damaged scFv binders (refer result section 2.1.2, C). Whereas the screening against ZnS semiconductor material could not provide any positive binder but selected scFv sequences were not mutated or damaged.

We did not observe enrichment of positive clones during three rounds of selections for ZnS and CdSe semiconductor materials [refer result section 2.1.2 (A and B)] ; this might be due to less immunogenic profile of these targets or absence of binders (scFvs) against these targets in the pool of the Tomlinson library.

The appearance of damaged or mutated scFv sequences for CdS and CdSe semiconductor materials may be addressed due to toxicity generated by cadmium based semiconductor materials. It is hard to find a straight answer to these results. There are reports supporting plausible toxic effect of cadmium-based semiconductors. The reasons could be release of toxic metal from core of nanoparticle or generation of reactive oxygen species (ROS) or both. A single free radical can break deoxyribose unit. In one communication, plasmid DNA damage is reported on incubation with CdSe quantum dots (Green & Howman, 2005). Another evidence for cell damage due to reactive oxygen species is reported by Dusica et al by showing reduction in CdTe induced cytotoxicity by adding millimolar concentration of antioxidant chemical (Lovrić et al., 2005). This group also reported that cytotoxicity was partially dependent on size of nanoparticles. Another group has reported that if CdSe QD is well protected by polymer or protein, it exerts little harm on cells in comparison to bare QD (Derfus, Chan, & Bhatia, 2004). However, there is no concrete evidence to provide definitive answer therefore to circumvent the apparent toxicity or mutagenic effects of Cd; we propose to modify our screening protocol by avoiding contact between Cd based materials and bacteria during phage recovery, or by reducing the amount of CdS or CdSe powder used for screening or by using some anti oxidant reagents (to circumvent suspect due to generation of ROS) while incubating of these powders with phages.

3.1.7 Success of selection of binders for gold powder (a proof of concept)

The screening result of selecting positive binders against gold powder resulted in great success; we obtained nearly 50% of positive clones (refer result section 2.1.2, D). Many control experiments ensured the specificity of gold binding antibodies (binders). After

sequencing, we identified 32 distinct sequences which showed binding with gold surface (this is a huge number in comparison to number of binders obtained against biological targets, they result in maximum 10 different clones, usually 2 or 3).The gold binding scFvs are proof of concept for our ability to select biological binder for inorganic entities.

The selection of many positive binders provided us data to do statistical analysis. We observed clear selection of arginine (R) at many positions. In particular at the V_H and V_L CDR3 regions (see figure 3.1a). These regions are the most variable and are directly involved in contacting the target antigens. The selection of Arg by many positive binders, clearly indicate role of this amino acid for gold binding. This predominant selection made us explore about specific interaction of arginine with gold surface (similar evidences are mentioned in the following text).

Interestingly we were not aware of the specificity of Arg for gold surface before our phage display screen. We started our screen with unbiased library of phage displaying scFvs. Our result showing abundance of arginine in gold binding antibody agrees to studies performed by other group using sophisticated tools. The result of selecting binders against gold powder strongly supports our case of using the strategy for other inorganic target, whose surface characteristics are unknown.

Evidence of Arginine showing affinity for gold surface

The Amino acid sequence of CDR in gold binding antibody reported by Kumagai group (Watanabe et al., 2008) is shown below.

Variable light chain (V _L)		Variable heavy chain (V _H)	
CDR1	RSSQSISTYLN	CDR1	SYWIN
CDR2	AASSLQS	CDR2	MIYPADSDTRYSPSPQGH
CDR3	QQSYRTPIT	CDR3	IGGRYMSR

Arginine is present in the V_H CDR3 and V_L CDR3, as well as at two other CDRs in their anti gold antibody. But they did not draw any conclusion for role of Arginine for gold binding because they had only one antibody sequence; so they do not have statistics to support role of arginine in gold binding.

Sarikaya group studied absorption behaviour of gold binding peptide (Hnilova, Oren, Seker, Wilson, Collino, Evans, Tamerler, & Sarikaya, 2008b). They compared the amino acid composition of strong, moderate, and weak binder (peptide) for gold selected using FliTrx random peptide display library. They calculated the relative abundances of amino acids among them (see figure 3.1b).

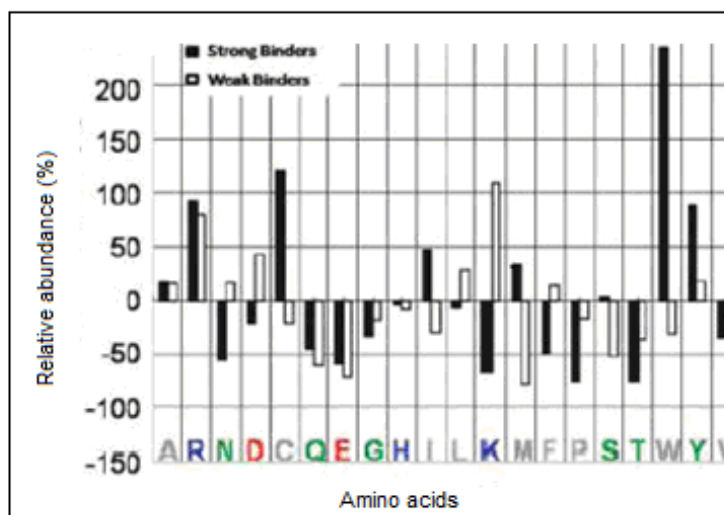

Figure 3.1b: Relative abundance of amino acids in strong- and weak binding groups of gold-binding peptides. The residues are coloured as blue (basic), red (acidic), green (hydrogen-bonding donor/acceptor), and grey (nonpolar). Source - (Hnilova, Oren, Seker, Wilson, Collino, Evans, Tamerler, & Sarikaya, 2008b)

Their result suggested that amino acids, Arg, Cys, Trp, and Tyr were over represented and Asn, Lys, Pro, and Thr under represented among strong binder sequences for gold. Arg was over represented not only among the strong gold-binding peptides but also among the weak-binding peptides.

Simulations carried out by Martin Hoefling and his group (Hoefling, Iori, Corni, & Gottschalk, 2010) on adsorption behaviour of 20 amino acids on gold surface (111) using molecular dynamics showed strong dependence for the binding affinities on the chemical character of the amino acids. Interaction free energy in KJ/mol of non covalent association of amino acids with gold surface (111) shown in table 3.1c.

Ala	Arg	Asn	Asp	Cys	Gln	Glu	Gly	His	Ile	Leu	Lys	Met	Phe	Pro	Ser	Thr	Trp	Tyr	Val
21.9	36.3	26.1	25.5	37.7	28.6	17.5	23.6	34.0	25.1	25.4	30.0	39.3	43.6	26.0	23.1	28.9	40.2	44.2	24.8

Table 3.1c: Interaction free energy in KJ/mol of non covalent association of amino acid with gold surface (111) Source - (Hoefling et al., 2010)

The detailed insight of the energy landscape of the amino acids shown in above table provide hints for their behavior when they are in contact with gold surface. During their simulation, they observed that Arg made one of the first contacts, due to length of its side chain. This observation leads them to conclude that Arg may be important for adsorption of protein on gold. However, cooperative effect of all amino acids in particular conformation might lead to other conclusion.

In extension to the above mentioned question, Hoefling et al showed interaction of polypeptides with a gold surface (111) using molecular dynamics simulations (Hoefling, Monti, Corni, & Gottschalk, 2011). This study was performed in polarisable gold model in explicit water. They used two kinds of polypeptides: peptide having beta sheet conformation and biologically important protein having two beta sheet domains. They summarised their result as adsorption occur in stepwise mechanism for both kind of polypeptides. The initial contact formation is initiated by positive charged amino acid Arginine (Arg), while overall charge on polypeptide was neutral. These results also open one debate on selectivity of any peptide on gold due to charge on gold surface as electrostatic interaction could be one reason for strong affinity of peptide to any inorganic surface. Recently group of Sarikaya explored this question (Donatan, Sarikaya, Tamerler, & Urgan, 2012), and their finding suggests that under each charged condition, binding behaviour of gold binding peptide demonstrated quantitative differences in terms of adsorbed peptide amount, surface coverage ratio. This finding can be used as a potential tuning parameter of peptide adsorption.

Another article published in soft matter in 2010, where they studied adsorption mechanism of single amino acid and other surfactant molecules (which are essential for stabilisation of gold nanoparticles) on gold surface (111) in aqueous solution. Their result also favored role of arginine for gold binding (Feng et al., 2011). The amino acid and surfactant molecule which were most attracted by gold surface were large molecules and with planar sp^2 hybridized group (e.g. Arg, Trp, Gln, Met, Asn, and PPh_3), whereas short aliphatic molecule with sp^3 hybridized group exhibit weak attraction (see figure 3.1d).

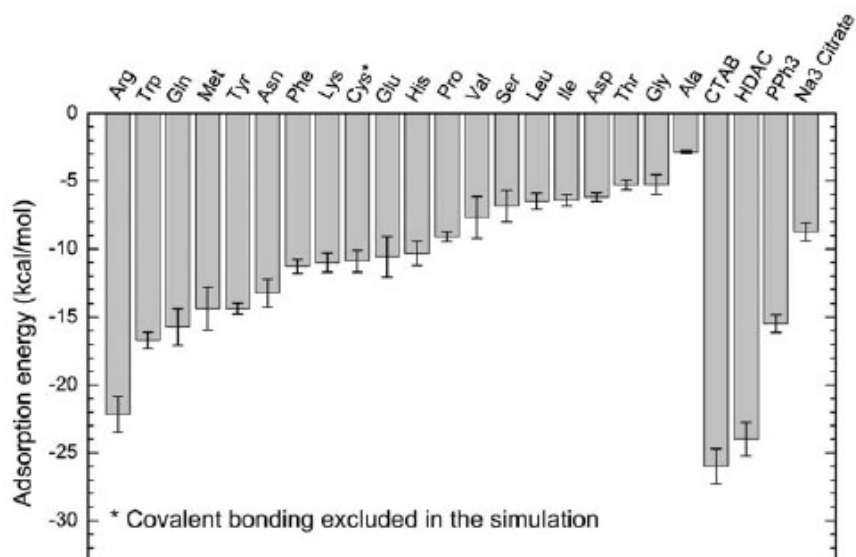

Figure 3.1d: Computed (free) energy of adsorption of single amino acids and single surfactant molecules on an even Au {111} surface in dilute aqueous solution at pH $\frac{1}{4}$ 7 using the CHARMM–METAL force field. Large molecules with planar sp²-hybridized groups show stronger adsorption and short aliphatic molecules with sp³-hybridized groups exhibit weaker adsorption. HDAC - hexadecylammonium chloride, CTAB - hexadecyltrimethylammonium bromide. Source - (Feng et al., 2011)

Insight of how Arginine might favor gold binding

Work of Feng et al suggested that strong affinity of arginine for gold can be attributed to guanidium group present in arginine structure. Strongly binding amino acids moved by a hopping mechanism in which surface attached group (guanidinium group of Arg), moved from one favorable coordination pattern on the surface to another in intervals on the order of one hundred picoseconds (Feng et al., 2011). Favorable binding condition of Guanidinium group of Arg with gold is shown in figure 3.1e.

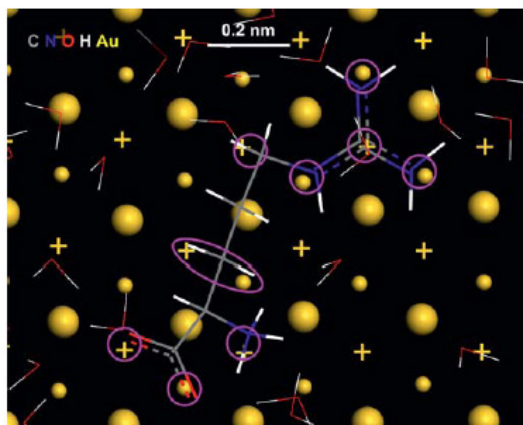

Figure 3.1e: Representative snapshot of Arg on the Au {111} surface. The guanidinium group is found most of the time in a favorable coordination pattern with numerous epitaxial sites which leads to strong adsorption (pink highlights). Diffusion on the surface occurs by stepwise hopping of the guanidinium group to similar epitaxial environments. Source - (Feng et al., 2011)

3.1.8 Potential implications of arginine binding to gold

The above mentioned information on arginine showing affinity for gold surface can be used to design proteins which can be adsorbed on to gold with a specific orientation and also provide possibilities to rationally control the binding of protein on gold. Knowledge of this specific interaction can be used to improve biosensors. Immunoassay measure of antigen-antibody interaction is mostly done on solid support such as gold, glass or polymer based surfaces. Many techniques have been developed for efficient binding of antibody on gold surface but most of them suffer from random orientation and denaturation of attached antibody. Simple ways to construct a well-oriented layer of antibody binding proteins are still missing. Cystein mediated protein immobilisation is widely used method in the construction of many biosensors (Lee et al., 2007). Arginine could be another candidate for inducing oriented interaction between antibody or any protein and the gold surface.

3.1.9 Potential application of gold binding scFv for surface modification of gold nanoparticles

We have also tested our gold powder (micron size) binding scFvs against gold nanoparticles (size 20 nm) stabilised by citrate. The citrate layer on gold particles is sensitive to salt concentration in environment, at high salt concentration it get destabilised and cause gold nanoparticle aggregation. We observed such destabilisation and aggregation of citrate stabilised gold nanoparticles at 50mM NaCl concentration. However, when these gold

nanoparticles were incubated with gold powder (micron size) binding scFv and 50 mM NaCl concentration, the gold nanoparticles were found to be much more stable (see figure D7 in result section 2.1). After further characterisation, it will be interesting to use gold binding scFv as ligand for surface modification of gold nanoparticles. ScFv as ligand is expected to provide photostable, bio-compatible, small, specific, and water soluble surface to gold nanoparticles. Such surface modified gold nanoparticles can be used as probe in bio-imaging.

3.1.10 From bench to bedside

There is a significant increase in the number of publications on nanotechnology and that has led to better understanding of the fundamentals. Nearly every economic centre has shown interest in development of nanotechnology and some have already made huge commitment towards research in field of nanotechnology (Mazzola, 2003). Nanotechnology research promises a lot of potential in fields encompassing energy, environment and health sectors. However, caution must be taken to avoid claim revolutionising the field of application with every single piece of nanotechnology research. On the other hand to suspect potential of every research achievement in nanotechnology should also be avoided. To this point, there are few nanotechnological products available for consumers. Most of the nanotechnology concepts including ours remain at a concept level and research is required to transform this concept into a viable products. Further, once the technical capabilities are established, the products have to go through safety regulations for reaching the markets and public acceptance. It would be a mistake to underestimate the impact of public acceptance as we can see present scenario with genetically modified crops, stem cell research etc.

There are ongoing public debates on environmental and toxicological effects of nanoparticles. Risk assessment of these effects is difficult as the field of nanotechnology is too diverse and thus the data are non-comparable. For a solution to this problem interpretation of the terms “nanobiotechnology”, “nanomedicine” and “nanotechnology” should be very clear. This interpretation is nicely discussed in an excellent review by Duncan and Gasper (Duncan & Gaspar, 2011), and also during discussion at European Science Foundation conference with authors of this review.

3.2 Production of recombinant antibodies and their engineered constructs in *Dd*

3.2.1 *Dd* as an alternate eukaryotic expression system

Dictyostelium discoideum (*Dd*) can be used as a promising eukaryotic alternative expression system for production of recombinant proteins that are big in size and require post translational modifications. Major advantages of using *Dd* as an expression system are adequate genomic knowledge, fast growth, easy maintenance, relatively cheaper medium than other eukaryotic systems (e.g. mammalian system), post translational modifications, and secretory pathway that may lead to easy and cost effective downstream processing.

Our study has validated *Dd* as an expression system for production of antibody fragments (scFvs). We have expressed biologically active recombinant antibody fragments (scFvs) in secreted form using *Dd* cells and purified it. However, antibody fragment (scFv) is comparatively small molecule, and in many cases it is not glycosylated. Thus, the expression of scFv does not impose many challenges in *Dd* (*E. coli* is also good option for expression of scFvs which are not glycosylated). However, expression of engineered antibodies (scFv+Fc, scFv::streptavidine and bispecific constructs) is expected to be challenging in any expression system due to their bigger size. We attempted to express big size antibody constructs (in comparison to 30-35 KDa scFv) such as scFv+ Fc, scFv::streptavidine and bispecific constructs in *Dd* cells. We achieved success in expression of scFv+Fc constructs in *Dd* cells. The same scFv+Fc antibody construct was produced using CHO cells and expression yield of this antibody construct was compared between CHO cells and *Dd* cells. The data suggest comparable expression yield in both systems (nearly 1-2mg/ L). If we compare cost and time to produce any recombinant protein in CHO and *Dd* cell, then there is a big difference (refer table 1.4a in section 1.4). To obtain a stable cell line in CHO, it takes more than a month, whereas in *Dd*, stable (transformed) cells were obtained within 2 to 3 weeks for all constructs. There is large difference in cost of production in both systems. However we could not express scFv::streptavidine and bispecific antibody constructs in *Dd* cells.

Another challenge for any expression system is to provide correct glycosylation pattern to the expressed recombinant proteins (or recombinant antibodies). Glycosylation is an important modification of protein, particularly for therapeutic recombinant antibodies. Glycosylation affect potency of any therapeutic candidate (glycans can have a marked influence on antibody Fc mediated effector functions). We have attempted to study glycosylation pattern of one scFv+Fc construct, this work is still under progress at our technical platform (Centre de Biophysique Moléculaire, Orléans). In the antibody molecule, Fc region bear conserved N

linked glycosylation. Apart from the Fc region, sometimes the antigen binding domain (Fab) may also bear glycan. If this awaited result can prove correct glycosylation pattern of antibody molecule produced in *Dd* cells, then *Dd* can be established as a very attractive alternate eukaryotic expression system for recombinant proteins or antibodies.

Although *Dd* certainly possesses many attractive features as a eukaryotic expression system, there is a lot of research needed to improve this system. For instance, we could not successfully express a few engineered antibody constructs (scFv::streptavidin and bispecific antibody constructs). We have tried to find potential reasons for these failures and a few solutions are mentioned to troubleshoot this problem in section 3.2.3. Apart from this, there are many possible ways to improve this system for better expression of recombinant proteins (in terms of yield and quality).

3.2.2 Further improvements to establish *Dd* as a better expression system

Optimisation of culture conditions

So far, we have not tried optimised culture conditions for culture of *Dd* cells. We expect that with optimised culture parameters, one can obtain a better yield of recombinant proteins/antibodies. We have used HL5 medium for culturing *Dd* cells. HL5 medium is a non-defined complex medium, main components of this medium are peptone, tryptone, and yeast extract. As an alternate, synthetically defined medium such as FM and SIH mediums are also available for *Dd* cells. FM and SIH mediums have a well-defined composition of mineral salts, vitamins and amino acids. FM medium can support growth of most of the strains which can grow in HL5 medium, SIH medium is a modified version of FM medium (source- Formedium). We expect that these synthetically defined mediums can also provide optimum growth conditions to the *Dd* cells. Additionally, these synthetically defined mediums do not contain any protein of animal origin, so it can eliminate chances of infection due to use of protein of other animal origin. Many mutant strains of *Dd* are available which can be grown using axenic media. We have exploited only AX3 strain, but other strains can also be used as an expression system. So far, we have grown *Dd* cells in shake flask, optimising culture conditions for using a fermentor for *Dd* cells might dramatically increase the final yield.

Optimisation of *Dd* expression vector

We have constructed a new *Dd* expression vector (pUX vector). In our study, the pUX vector has allowed successful transformation and secretion of recombinant antibodies. However, certainly this vector can be improved in many ways for better expression of recombinant

antibodies. The size of pUX vector is quite big (approx 11kb), hence this vector can be replaced by any small size vector that can provide sufficient expression level. In addition, expression cassette of existing vector can be optimised for better expression yield. We have utilised Histidine tag for purification of recombinant antibodies, we could try another tag system which can benefit purification of eukaryotic recombinant antibodies in better way. Last but not the least, different promoter and signal sequences can be used to obtain better expression yield.

Codon optimisation

We already know from the genomic analysis that *Dd* has different codon preference than humans, AT content of *Dd* genome is 77.59% whereas AT content of humans is 60%. The correlation between codon usage and the expression level is not very clear. There are few biased reports for *E. coli* on correlation between codon usage and expression level, same concept was used by Sharp and Devine to study codon usage in *Dd* for expression. Their study suggests that highly expressed gene do prefer optimal codon (Sharp & Devine, 1989). This idea was partly studied at Groningen university (Vervoort et al., 2000), where they studied importance of 5' codon adaptation for heterologous expression in *Dd*. They also optimised start codon of *Dd* with kozak sequence of vertebrates to evaluate expression level of human chorionic gonadotropin hormone (*Dd* do not share same kozak sequence with vertebrates). Their data suggest that first 10-15 codon optimisation is sufficient to show increased expression level. The Kozak sequence adaptation resulted in 1.5 fold increases in the expression of hCG. Therefore, codon optimisation could be one area of improvement for establishing *Dd* as better expression system. This could help in expression of GC rich protein.

3.2.3 Probable reasons of non-expression of scFv::streptavidine and bispecific antibody constructs

There could be two possible constraints for failure of production of scFv::streptavidine constructs and bispecific antibody constructs: bigger size or sequence itself. The first constraint cannot be justified as we have already shown active secretion of big construct in *Dd*; plasmid size of scFv+ Fc is 11.8 Kb, one of the Fc fusion construct (scFv+ mCherry Fc, 12.7 Kb) was even bigger than bispecific construct (12 Kb). Second constraint of sequence can be partially justified. We made bispecific construct with F2C and TA10 scFvs, we already shown active secretion of these individual scFvs. Nevertheless, in bispecific construct we have introduced linker sequence (Gly₄Ser)₃, which is rich in glycine and serine. Similarly streptavidine gene sequence of scFv::streptavidine constructs also possess' glycine and

serine in continuous stretches. As mentioned in the above paragraph, higher GC content of any sequence might impose problem in *Dd* cells for expression of protein. Probably higher GC content in the bispecific constructs and scFv::streptavidine constructs is the reason for inability to express them in *Dd* cells. Several attempts were made to purify bispecific antibody from *Dd* supernatant but we never achieved any yield.

3.2.4 Glycosylation pattern in *Dd*

Major concern with this expression system is its ability to perform correct glycosylation. Glycosylation pattern is not studied in details in *Dd* system; this pattern might be similar or different from native human protein. Our results for glycosylation pattern of recombinant antibodies secreted by *Dd* cells are still pending. Correct glycosylation pattern may establish *Dd* system as an important eukaryotic expression system for production of therapeutic proteins/antibodies. However, therapeutic antibodies expressed in *Dd* cell might still face hurdles for FDA approval. There is no report till date of any protein produced in *Dd* at any stage of clinical development (R. Arya, Bhattacharya, & Saini, 2008). Also, glycosylation pattern of antibodies produced in *Dd* and for that matter in any expression system has to be viewed holistically to draw any conclusion on antibodies' suitability for therapeutic use. The details are discussed in the following paragraphs.

Is glycosylation pattern variation a problem for therapeutic candidate?

In section 1.4, we have described the importance of glycosylation for therapeutic proteins and antibodies. We have also described the existence of different glycoforms. Source of different glycoforms for any one kind of recombinant protein is not just restricted to its production in different organisms, sometimes different cell of same organism can also produce different glycoforms. The variation can also arise from downstream processing (selective purification of particular glycoform). Debate is whether to consider different glycosylation pattern in proteins or antibodies as a possible cause of concern or not? There are concerns of immunogenicity for all recombinant proteins used as drugs. However, a few examples have shown to have no effect on functionality in spite of having different glycosylation pattern than native human one.

For example, recombinant factor VIII is a protein approved for treatment of haemophilia A. This protein is available in market with different brand name by different pharmaceutical company; Kogenate (by Bayer, Germany) and Bioclata (by AventisPasteur, PA, USA). Kogenate is produced in baby hamster kidney (BHK) cells and purified by several chromatographic steps. On the other hand, Bioclata is produced in CHO cells and is purified

using a monoclonal affinity chromatography. These products have difference in their glycosylation profile, yet both have proved to be safe and effective. This example highlight that variation in glycosylation might not hinder the efficacy and safety of therapeutic proteins in all cases (Walsh & Jefferis, 2006).

With currently available expression systems and downstream process, we are still far from producing recombinant protein exactly the same way as human body produce them. However, there is a scope of introducing structural changes in proteins/antibodies for improving their pharmacokinetics as done in second generation fast acting insulins (Theo Dingermann, 2008). This can be done regardless of production platform. However, precaution must be taken against immunogenicity while altering the protein/antibody structures. Hence, while evaluating a potential recombinant protein as drug candidate, emphasis must be given to functional and safety parameter of different variants, rather than structural authenticity of recombinant protein with natural one. The actual concern related to different glycoform should be judged by clinical studies. This is further encouragement for development of *Dd* as expression system for therapeutic antibodies.

3.2.5 Absence of universal expression system for production of recombinant proteins

There is general view about recombinant proteins that one expression system cannot produce all kind of recombinant proteins. Each set of amino acid in recombinant protein challenge expression system in different way. So accordingly, one should choose the best system for each particular protein. In this thesis, *Dd* is described as an alternate eukaryotic system that offers several benefits over currently existing expression systems. With further research, we can address some challenges faced by this expression system and hope to produce many recombinant proteins/antibodies in this expression system.

4. Bibliography

- Aggarwal, S. (2011). What's fueling the biotech engine--2010 to 2011. *Nature biotechnology*, 29(12), 1083-9. Nature Publishing Group. doi:10.1038/nbt.2060
- Ahmad, Z. A., Yeap, S. K., Ali, A. M., Ho, W. Y., Alitheen, N. B. M., & Hamid, M. (2012). scFv Antibody: Principles and Clinical Application. *Clinical and Developmental Immunology*, 2012, 1-15. doi:10.1155/2012/980250
- Alivisatos, A. P. (2008). Birth of a Nanoscience Building Block, 2(8), 1514-1516.
- Annesley, S. J., & Fisher, P. R. (2009). Dictyostelium discoideum--a model for many reasons. *Molecular and cellular biochemistry*, 329(1-2), 73-91. doi:10.1007/s11010-009-0111-8
- Arya, H., Kaul, Z., Wadhwa, R., Taira, K., Hirano, T., & Kaul, S. C. (2005). Quantum dots in bio-imaging: Revolution by the small. *Biochemical and biophysical research communications*, 329(4), 1173-7. doi:10.1016/j.bbrc.2005.02.043
- Arya, R., Aslam, S., Gupta, S., Bora, R. S., Vijayakrishnan, L., Gulati, P., Naithani, S., et al. (2008). Production and characterization of pharmacologically active recombinant human phosphodiesterase 4B in Dictyostelium discoideum. *Biotechnology journal*, 3(7), 938-47. doi:10.1002/biot.200700256
- Arya, R., Gupta, S., Aslam, S., Kaur, N. J., Seth, A., Eapen, M. S., Malik, R., et al. (2008). Purification of recombinant human phosphodiesterase 7A expressed in Dictyostelium discoideum. *Protein expression and purification*, 61(2), 149-54. doi:10.1016/j.pep.2008.05.002
- Asgari, S., Arun, S., Slade, M. B., Marshall, J., Williams, K. L., & Wheldrake, J. F. (2001). Expression of growth factors in Dictyostelium discoideum. *Journal of molecular microbiology and biotechnology*, 3(3), 491-7.
- Ashktorab, H., & Welker, D. L. (1988). Establishment of the nuclear location of Dictyostelium discoideum plasmids. *Gene*, 65(1), 41-49.
- Azzazy, H. M. E., & Highsmith, W. E. (2002). Phage display technology: clinical applications and recent innovations. *Clinical biochemistry*, 35(6), 425-45.
- Bendig, M. M., & Jones, S. T. (1996). Rodent to Human antibodies by CDR grafting. (J. McCafferty, H. R. Hoogenboom, & D. J. Chiswell, Eds.) *Antibody Engineering*. Oxford University Press.
- Bird, R. E., Hardman, K. D., Jacobson, J. W., Johnson, S., Kaufman, B. M., Lee, S. M., Lee, T., et al. (1988). Single-chain antigen-binding proteins. *Science*, 242(4877), 423-6. doi:10.1126/science.3140379
- Biju, V., Itoh, T., Anas, A., Sujith, A., & Ishikawa, M. (2008). Semiconductor quantum dots and metal nanoparticles: syntheses, optical properties, and biological applications. *Analytical and bioanalytical chemistry*, 391(7), 2469-95. doi:10.1007/s00216-008-2185-7

- Burda, C., Chen, X., Narayanan, R., & El-Sayed, M. a. (2005). *Chemistry and properties of nanocrystals of different shapes. Chemical reviews* (Vol. 105, pp. 1025-102).
doi:10.1021/cr030063a
- Berry, C. C., & Curtis, A. S. G. (2003). Functionalisation of magnetic nanoparticles for applications in biomedicine, *36*.
- Brekke, O. H., & Sandlie, I. (2003). Therapeutic antibodies for human diseases at the dawn of the twenty-first century. *Nature reviews. Drug discovery*, *2*(1), 52-62. doi:10.1038/nrd984
- Brooks, S. A. (2004). Appropriate glycosylation of Recombinant Proteins for Human Use, Implications of Choice of Expression System, *Molecular biotechnology*.
- Brown, S. Metal-recognition by repeating polypeptides. *Nat. Biotechnol.* **1997**, *15*, 269-272.
- Brown, S. Engineered iron oxide-adhesion mutants of the Escherichia coli phage lambda receptor. *Proc. Natl. Acad. Sci. USA* **1992**, *89*, 8651-8655)
- Carmen, S., & Jermutus, L. (2002). Concepts in antibody phage display. *Briefings in functional genomics & proteomics*, *1*(2), 189-203.
- Colcher D, Batra S K, Maneesh Jain , Uwe A Wittel , Subhash C Chauhan (2002) Pharmacokinetics and biodistribution of genetically engineered antibodies, *Current Opinion in Biotechnology*,
doi:10.1016/S0958-1669(02)00352-X
- Chadd, H. E., & Chamow, S. M. (2001). Therapeutic antibody expression technology. *Current opinion in biotechnology*, *12*(2), 188-94.
- Chen, Y.-S., Hong, M.-Y., & Huang, G. S. (2012). A protein transistor made of an antibody molecule and two gold nanoparticles. *Nature Nanotechnology*, *7*(3), 197-203. Nature Publishing Group. doi:10.1038/nnano.2012.7
- Chiu, C.-Y., Li, Y., & Huang, Y. (2010). Size-controlled synthesis of Pd nanocrystals using a specific multifunctional peptide. *Nanoscale*, *2*(6), 927-930. The Royal Society of Chemistry.
- Clackson, T., Hoogenboom, H. R., Griffiths, A. D., & Winter, G. (1991). Making antibody fragments using phage display libraries. *Nature*, *352*(6336), 624-628.
- Coppage, R., Slocik, J. M., Briggs, B. D., Frenkel, A. I., Naik, R. R., & Knecht, M. R. (2012). Determining Peptide Sequence Effects That Control the Size , Structure , and Function of Nanoparticles, *(2)*, 1625-1636.
- Dafne M,R E Kontermann, 2010, Bispecific antibodies for cancer immunotherapies, Review, Biodrug.
- Derfus, A. M., Chan, W. C. W., & Bhatia, S. N. (2004). Probing the Cytotoxicity of Semiconductor Quantum Dots. *Nano Letters*, *4*(1), 11-18. American Chemical Society. doi:10.1021/nl0347334
- de Marco, A. (2011). Biotechnological applications of recombinant single-domain antibody fragments. *Microbial cell factories*, *10*(1), 44. BioMed Central Ltd. doi:10.1186/1475-2859-10-44

- de Wildt, R. M., Mundy, C. R., Gorick, B. D., & Tomlinson, I. M. (2000). Antibody arrays for high-throughput screening of antibody-antigen interactions. *Nature biotechnology*, *18*(9), 989-94. doi:10.1038/79494
- Demain, A. L., & Vaishnav, P. (2009). Production of recombinant proteins by microbes and higher organisms. *Biotechnology advances*, *27*(3), 297-306. Elsevier Inc. doi:10.1016/j.biotechadv.2009.01.008
- Dingermann, T, Troidl, E. M., Bröker, M., & Nerke, K. (1991). Expression of human antithrombin III in the cellular slime mould *Dictyostelium discoideum*. *Applied microbiology and biotechnology*, *35*(4), 496-503.
- Dingermann, Theo. (2008). Recombinant therapeutic proteins: production platforms and challenges. *Biotechnology journal*, *3*(1), 90-7. doi:10.1002/biot.200700214
- Donatan, S., Sarikaya, M., Tamerler, C., & Urgan, M. (2012). Effect of solid surface charge on the binding behaviour of a metal-binding peptide. *Journal of the Royal Society, Interface / the Royal Society*, (April). doi:10.1098/rsif.2012.0060
- Dubertret, B., Skourides, P., Norris, D. J., Noireaux, V., Brivanlou, A. H., & Libchaber, A. (2002). In vivo imaging of quantum dots encapsulated in phospholipid micelles. *Science*, *298*(5599), 1759-1762. AAAS.
- Duncan, R., & Gaspar, R. (2011). Nanomedicine (s) under the Microscope. *Review ,Molecular pharmaceutics,dx.doi.org/10.1021/mp200394t*
- Dübel, S., Breitling, F., Klewinghaus, I., & Little, M. (1992). Regulated secretion and purification of recombinant antibodies in *E. coli*. *Cell Biophysics*, *21*(1-3), 69-79.
- Dimitrov, A., Quesnoit, M., Moutel, S., Cantaloube, I., Poüs, C., & Perez, F. (2008). Detection of GTP-tubulin conformation in vivo reveals a role for GTP remnants in microtubule rescues. *Science*, *322*(5906), 1353-6. doi:10.1126/science.1165401
- Empedocles, S.A., D.J. Norris, and M.G. Bawendi, Physical Review Letters, 1996. **77**(18): p. 3873-3876.
- Eichinger, L., Pachebat, J. a, Glöckner, G., Rajandream, M.-a, Sucgang, R., Berriman, M., Song, J., et al. (2005). The genome of the social amoeba *Dictyostelium discoideum*. *Nature*, *435*(7038), 43-57. doi:10.1038/nature03481
- Faraday, M. (1857). The Bakerian Lecture: Experimental Relations of Gold (and Other Metals) to Light. *Philosophical Transactions of the Royal Society of London*, *147*, 145-181. doi:10.1098/rstl.1857.0011
- Farrar, N. A., & Williams, K. L. (1988). review Nuclear plasmids in t h e simple eukaryotes *Saccharomyces cerevisiae* and *Dictyostelium discoideum*, *TIG,Dec,1988,vol4/12*.
- Fasel, N., Begdadi-Rais, C., Bernard, M., Bron, C., Corradin, G., & Reymond, C. D. (1992). *Dictyostelium discoideum* as an expression host for the circumsporozoite protein of *Plasmodium falciparum*. *Gene*, *111*(2), 157-163.

- Feng, J., Pandey, R. B., Berry, R. J., Farmer, B. L., Naik, R. R., & Heinz, H. (2011). Adsorption mechanism of single amino acid and surfactant molecules to Au {111} surfaces in aqueous solution: design rules for metal-binding molecules. *Soft Matter*, 7(5), 2113. doi:10.1039/c0sm01118e
- Fang, X., Zhai, T., Gautam, U. K., Li, L., Wu, L., Bando, Y., & Golberg, D. (2011). ZnS nanostructures: From synthesis to applications. *Progress in Materials Science*, 56(2), 175-287. Elsevier Ltd. doi:10.1016/j.pmatsci.2010.10.001
- Fernandes, B. D. (2005). Demonstrating Comparability of Antibody Glycosylation during Biomanufacturing ,Review, European Biopharmaceutical.
- Ferrer-Miralles, N., Domingo-Espín, J., Corchero, J. L., Vázquez, E., & Villaverde, A. (2009). Microbial factories for recombinant pharmaceuticals. *Microbial Cell Factories*, 8(1), 17. BioMed Central.
- Filpula, D. (2007). Antibody engineering and modification technologies. *Biomolecular engineering*, 24(2), 201-15. doi:10.1016/j.bioeng.2007.03.004
- Flenniken, M. L., Uchida, M., Liepold, L. O., Kang, S., Young, M. J., & Douglas, T. (2009). A library of protein cage architectures as nanomaterials. (M. Manchester & N. F. Steinmetz, Eds.)*Current Topics in Microbiology and Immunology*, 327, 71-93. Springer-Verlag.
- Flynn, C. E., Mao, C. B., Hayhurst, A., Williams, J. L., Georgiou, G., Iverson, B., & Belcher, A. M. (2003). Synthesis and organization of nanoscale II-VI semiconductor materials using evolved peptide specificity and viral capsid assembly. *Journal of Materials Chemistry*, 13(10), 2414-2421.
- Freyre, F. M., Vázquez, J. E., Ayala, M., Canaán-Haden, L., Bell, H., Rodríguez, I., González, A., et al. (2000). Very high expression of an anti-carcinoembryonic antigen single chain Fv antibody fragment in the yeast *Pichia pastoris*. *Journal of Biotechnology*, 76(2-3), 157-163.
- Gilbert, P. U. P. A. (2005). The Organic-Mineral Interface in Biominerals. *Reviews in Mineralogy and Geochemistry*, 59(1), 157-185. Mineral Soc America. doi:10.2138/rmg.2005.59.7
- Goel, A., Colcher, D., Baranowska-Kortylewicz, J., Augustine, S., Booth, B. J., Pavlinkova, G., & Batra, S. K. (2000). Genetically engineered tetravalent single-chain Fv of the pancarcinoma monoclonal antibody CC49: improved biodistribution and potential for therapeutic application. *Cancer Research*, 60(24), 6964-6971.
- Graumann, K., & Premstaller, A. (2006). Manufacturing of recombinant therapeutic proteins in microbial systems. *Biotechnology journal*, 1(2), 164-86. doi:10.1002/biot.200500051
- Gray, J. J. (2004). The interaction of proteins with solid surfaces. *Current opinion in structural biology*, 14(1), 110-5. doi:10.1016/j.sbi.2003.12.001
- Green, M., & Howman, E. (2005). Semiconductor quantum dots and free radical induced DNA nicking. *Chemical communications*, (1), 121-3. doi:10.1039/b413175d
- Griffiths, A. D., Williams, S. C., Hartley, O., Tomlinson, I. M., Crosby, W. L., Kontermann, E., Jones, P. T., et al. (1994). Isolation of high affinity human antibodies directly from large synthetic repertoires, 13(14), 3245-3260.

- Grzelczak, M., Vermant, J., Furst, E. M., & Liz-Marzán, L. M. (2010). Directed self-assembly of nanoparticles. *ACS nano*, *4*(7), 3591-605. doi:10.1021/nn100869j
- Hattori, T., Umetsu, M., Nakanishi, T., Togashi, T., Yokoo, N., Abe, H., Ohara, S., et al. (2010). High affinity anti-inorganic material antibody generation by integrating graft and evolution technologies: potential of antibodies as biointerface molecules. *The Journal of biological chemistry*, *285*(10), 7784-93. doi:10.1074/jbc.M109.020156
- Heikoop, J. C., Grootenhuis, P. D., Blaauw, M., Veldema, J. S., Van Haastert, P. J., & Linskens, M. H. (1998). Expression of a bioactive, single-chain choriogonadotropin in *Dictyostelium discoideum*. *European journal of biochemistry / FEBS*, *256*(2), 359-63.
- Heights, Y. (2000). Synthesis and characterisation of monodisperse nanocrystals and close packed nanocrystal assembly ,545-610.
- Hiroshi Matsui, Roberto de la Rica, (2010) Applications of peptide and protein-based materials in bionanotechnology, *Chem. Soc. Rev.*, 2010, 39, 3499-3509 DOI: 10.1039/B917574C
- Hnilova, M., Oren, E. E., Seker, U. O. S., Wilson, B. R., Collino, S., Evans, J. S., Tamerler, C., & Sarikaya, M. (2008b). Effect of molecular conformations on the adsorption behavior of gold-binding peptides. *Langmuir: the ACS journal of surfaces and colloids*, *24*(21), 12440-5. doi:10.1021/la801468c
- Hoefling, M., Iori, F., Corni, S., & Gottschalk, K.-E. (2010). Interaction of amino acids with the Au(111) surface: adsorption free energies from molecular dynamics simulations. *Langmuir: the ACS journal of surfaces and colloids*, *26*(11), 8347-51. doi:10.1021/la904765u
- Hoefling, M., Monti, S., Corni, S., & Gottschalk, K. E. (2011). Interaction of β -sheet folds with a gold surface. *PLoS one*, *6*(6), e20925. doi:10.1371/journal.pone.0020925
- Holliger, P., Prospero, T., & Winter, G. (1993). "Diabodies": small bivalent and bispecific antibody fragments. *Proceedings of the National Academy of Sciences of the United States of America*, *90*(14), 6444-6448.
- Jain, M., Kamal, N., & Batra, S. K. (2007). Engineering antibodies for clinical applications. *Trends in biotechnology*, *25*(7), 307-16. doi:10.1016/j.tibtech.2007.05.001
- Jefferis, R. (2005). Glycosylation of Recombinant Antibody Therapeutics, Review ,*Biotechnol. Prog.*, *21*,11-16.
- Jenkins, N. (2007). Modifications of therapeutic proteins: challenges and prospects. *Cytotechnology*, *53*(1-3), 121-5. doi:10.1007/s10616-007-9075-2
- Jung, E., Gooley, a a, Packer, N. H., Karuso, P., & Williams, K. L. (1998). Rules for the addition of O-linked N-acetylglucosamine to secreted proteins in *Dictyostelium discoideum*--in vivo studies on glycosylation of mucin MUC1 and MUC2 repeats. *European journal of biochemistry / FEBS*, *253*(2), 517-24.
- Killard, A. J., Smyth, M. R., Grennan, K., Micheli, L., & Palleschi, G. (2000). Rapid antibody biosensor assays for environmental analysis. *Biochemical Society Transactions*, *28*(2), 81-84.

- Kim, J., Rheem, Y., Yoo, B., Chong, Y., Bozhilov, K. N., Kim, D., Sadowsky, M. J., et al. (2010). Peptide-mediated shape- and size-tunable synthesis of gold nanostructures. *Acta Biomaterialia*, 6(7), 2681-9. Acta Materialia Inc. doi:10.1016/j.actbio.2010.01.019
- Kipriyanov, S. M., Little, M., Kropshofer, H., Breittling, F., Gotter, S., & Dübel, S. (1996). Affinity enhancement of a recombinant antibody: formation of complexes with multiple valency by a single-chain Fv fragment-core streptavidin fusion. *Protein Engineering*, 9(2), 203-211.
- Kreitman, R. J. (2006). Immunotoxins for targeted cancer therapy. *The AAPS journal*, 8(3), E532-E551. Springer-Verlag.
- Kretzschmar, T., & Von Rüden, T. (2002). Antibody discovery: phage display. *Current Opinion in Biotechnology*, 13(6), 598-602. doi:10.1016/S0958-1669(02)00380-4
- Kriplani, U., & Kay, B. K. (2005). Selecting peptides for use in nanoscale materials using phage-displayed combinatorial peptide libraries. *Current opinion in biotechnology*, 16(4), 470-5. doi:10.1016/j.copbio.2005.07.001
- Krumov, N., Perner-Nochta, I., Oder, S., Gotcheva, V., Angelov, a., & Posten, C. (2009). Production of Inorganic Nanoparticles by Microorganisms. *Chemical Engineering & Technology*, 32(7), 1026-1035. doi:10.1002/ceat.200900046
- Kumada, Y., Kuroki, D., Yasui, H., Ohse, T., & Kishimoto, M. (2010). Characterization of polystyrene-binding peptides (PS-tags) for site-specific immobilization of proteins. *Journal of bioscience and bioengineering*, 109(6), 583-7. The Society for Biotechnology, Japan. doi:10.1016/j.jbiosc.2009.11.005
- Kumada, Y., Shiritani, Y., Hamasaki, K., Ohse, T., & Kishimoto, M. (2009). High biological activity of a recombinant protein immobilized onto polystyrene. *Biotechnology Journal*, 4(8), 1178-1189.
- Kuzyk, A., Schreiber, R., Fan, Z., Pardatscher, G., Roller, E.-M., Högele, A., Simmel, F. C., et al. (2012). DNA-based self-assembly of chiral plasmonic nanostructures with tailored optical response. *Nature*, 483(7389), 311-314. doi:10.1038/nature10889
- Köhler, G., & Milstein, C. (1975). Continuous cultures of fused cells secreting antibody of predefined specificity. *Nature*, 256(5517), 495-497.
- Le Gall, F., Kipriyanov, S. M., Moldenhauer, G., & Little, M. (1999). Di-, tri- and tetrameric single chain Fv antibody fragments against human CD19: effect of valency on cell binding. *FEBS Letters*, 453(1-2), 164-168.
- Lee, J. M., Park, H. K., Jung, Y., Kim, J. K., Jung, S. O., & Chung, B. H. (2007). Direct immobilization of protein g variants with various numbers of cysteine residues on a gold surface. *Analytical chemistry*, 79(7), 2680-7. doi:10.1021/ac0619231
- Li, H., Sethuraman, N., Stadheim, T. A., Zha, D., Prinz, B., Ballew, N., Bobrowicz, P., et al. (2006). Optimization of humanized IgGs in glycoengineered *Pichia pastoris*. *Nature Biotechnology*, 24(2), 210-215.

- Liu, J., Wei, D., Qian, F., Zhou, Y., Wang, J., Ma, Y., & Han, Z. (2003). pPIC9-Fc: a vector system for the production of single-chain Fv-Fc fusions in *Pichia pastoris* as detection reagents in vitro. *Journal of Biochemistry*, *134*(6), 911-917.
- Lovrić, J., Bazzi, H. S., Cuie, Y., Fortin, G. R. a, Winnik, F. M., & Maysinger, D. (2005). Differences in subcellular distribution and toxicity of green and red emitting CdTe quantum dots. *Journal of molecular medicine (Berlin, Germany)*, *83*(5), 377-85. doi:10.1007/s00109-004-0629-x
- Lucas, A. H., & Oakland, H. (2001). Antibody Function. *Life Sciences*, dx.doi.org/10.1038/npg.els.0000907
- Makrodimitris, K., Masica, D. L., Kim, E. T., & Gray, J. J. (2007). Structure prediction of protein-solid surface interactions reveals a molecular recognition motif of statherin for hydroxyapatite. *Journal of the American Chemical Society*, *129*(44), 13713-22. doi:10.1021/ja074602v
- M B Slade, K R Emdlie, K L Williams (1997) Expression of recombinant glycoprotein in the simple eukaryotic *Dictyostelium discoideum*, *Biotechnology and genetic engineering review*
- Mila Boncheva, George M. Whitesides, (2004) Biomimetic Approaches to the Design of Functional, Self-Assembling Systems, DOI: 10.1081/E-ENN 120018352
- Manstein, D. J., Schuster, H. P., Morandini, P., and Hunt, D. M. (1995) Cloning vectors for the production of proteins in *Dictyostelium discoideum*. *Gene* *162*, 129–134
- Mazzola, L. (2003). Nature Feature, Commercializing nanotechnology, *October*, *21*(10), 1137-1143.
- McCafferty, J., Griffiths, A. D., Winter, G., & Chiswell, D. J. (1990). Phage antibodies: filamentous phage displaying antibody variable domains. *Nature*, *348*(6301), 552-4. Nature Publishing Group. doi:10.1038/348552a0
- Medintz, I. L., Uyeda, H. T., Goldman, E. R., & Mattoussi, H. (2005). Quantum dot bioconjugates for imaging, labelling and sensing. *Nature Materials*, *4*(6), 435-446. Nature Publishing Group. doi:10.1038/nmat1390
- Messing, J. (1991). Cloning in M13 phage or how to use biology at its best. *Gene*, *100*, 3-12.
- Michen, B., & Graule, T. (2010). Isoelectric points of viruses. *Journal of applied microbiology*, *109*(2), 388-97. doi:10.1111/j.1365-2672.2010.04663.x
- Moran, N. (2011). Boehringer splashes out on bispecific antibody platforms. *Nature biotechnology*, *29*(1), 5-6. Nature Publishing Group. doi:10.1038/nbt0111-5
- Moutel, S., El Marjou, A., Vielemeyer, O., Nizak, C., Benaroch, P., Dübel, S., & Perez, F. (2009). A multi-Fc-species system for recombinant antibody production. *BMC biotechnology*, *9*, 14. doi:10.1186/1472-6750-9-14
- Muro, E., Pons, T., Lequeux, N., Fragola, A., & Sanson, N. (2010). Small and Stable Sulfobetaine Zwitterionic Quantum Dots for Functional Live-Cell Imaging, 4556-4557.
- Naik, R R, Jones, S. E., Murray, C. J., McAuliffe, J. C., Vaia, R. a, & Stone, M. O. (2004). Peptide Templates for Nanoparticle Synthesis Derived from Polymerase Chain Reaction-Driven Phage

- Display. *Advanced Functional Materials*, 14(1), 25-30. WILEY-VCH Verlag. doi:10.1002/adfm.200304501
- Naik, Rajesh R, Stringer, S. J., Agarwal, G., Jones, S. E., & Stone, M. O. (2002). Biomimetic synthesis and patterning of silver nanoparticles. *Nature Materials*, 1(3), 169-172.
- Nam, K. T., Kim, D.-W., Yoo, P. J., Chiang, C.-Y., Meethong, N., Hammond, P. T., Chiang, Y.-M., et al. (2006). Virus-enabled synthesis and assembly of nanowires for lithium ion battery electrodes. *Science*, 312(5775), 885-888. AAAS.
- Neumann-Haefelin, C., Schäfer, U., Müller, M., & Koch, H.-G. (2000). SRP-dependent co-translational targeting and SecA-dependent translocation analyzed as individual steps in the export of a bacterial protein. *the The European Molecular Biology Organization Journal*, 19(23), 6419-6426. Oxford University Press.
- Nezlin, R., & Ghetie, V. (2004). Interactions of immunoglobulins outside the antigen-combining site. *Advances in Immunology*, 82, 155-215.
- N. Lequeux² and B. Dubertret (2005), Quantum Dots in Nanobiotechnology, *NanoBiotechnology*, DOI: 10.1385/Nano:1:3:279
- Nizak, C., Martin-Lluesma, S., Moutel, S., Roux, A., Kreis, T. E., Goud, B., & Perez, F. (2003). Recombinant antibodies against subcellular fractions used to track endogenous Golgi protein dynamics in vivo. *Traffic*, 4(11), 739-53.
- Olafsen, T., Sirk, S. J., Betting, D. J., Kenanova, V. E., Bauer, K. B., Ladno, W., Raubitschek, A. A., et al. (2010). ImmunoPET imaging of B-cell lymphoma using 124I-anti-CD20 scFv dimers (diabodies). *Protein engineering design selection PEDS*, 23(4), 243-249.
- Oren, E. E., Tamerler, C., & Sarikaya, M. (2005). Metal Recognition of Septapeptides via Polypod Molecular Architecture. *Nano Letters*, 5(3), 415-419. doi:10.1021/nl048425x
- Peelle, B. R., Krauland, E. M., Wittrup, K. D., & Belcher, A. M. (2005). Design criteria for engineering inorganic material-specific peptides. *Langmuir: the ACS journal of surfaces and colloids*, 21(15), 6929-33. doi:10.1021/la050261s
- Pini, a, & Bracci, L. (2000). Phage display of antibody fragments. *Current protein & peptide science*, 1(2), 155-69.
- Pissuwan, D., Cortie, C. H., & Valenzuela, S. M. (2007). Gold Nanosphere- Antibody Conjugates for Hyperthermal Therapeutic Applications. *Technology*, 121-129.
- Powers, D. B., Amersdorfer, P., Poul, M., Nielsen, U. B., Shalaby, M. R., Adams, G. P., Weiner, L. M., et al. (2001). Expression of single-chain Fv-Fc fusions in *Pichia pastoris*. *Journal of immunological methods*, 251(1-2), 123-35.
- Proba, K., Wörn, A., Honegger, A., & Plückthun, A. (1998). Antibody scFv fragments without disulfide bonds made by molecular evolution. *Journal of Molecular Biology*, 275(2), 245-253.

- Qi, H., Lu, H., Qiu, H.-J., Petrenko, V., & Liu, A. (2012). Phagemid vectors for phage display: properties, characteristics and construction. *Journal of molecular biology*, 417(3), 129-43. Elsevier Ltd. doi:10.1016/j.jmb.2012.01.038
- Ridder, R., Schmitz, R., Legay, F., & Gram, H. (1995). Generation of rabbit monoclonal antibody fragments from a combinatorial phage display library and their production in the yeast *Pichia pastoris*. *Biotechnology Nature*, 13(3), 255-260.
- Sahdev, S., Khattar, S. K., & Saini, K. S. (2008). Production of active eukaryotic proteins through bacterial expression systems: a review of the existing biotechnology strategies. *Molecular and cellular biochemistry*, 307(1-2), 249-64. doi:10.1007/s11010-007-9603-6
- Sano, K.-ichi, & Shiba, K. (2003). A Hexapeptide Motif that Electrostatically Binds to the Surface of Titanium, 14234-14235.
- Saviranta, P., Haavisto, T., Rappu, P., Karp, M., & Lövgren, T. (1998). In vitro enzymatic biotinylation of recombinant fab fragments through a peptide acceptor tail. *Bioconjugate Chemistry*, 9(6), 725-735.
- Schirrmann, T., Al-halabi, L., Dübel, S., & Hust, M. (2010). [Frontiers in Bioscience 4576-4594, May 1, 2008] Production systems for recombinant antibodies . 2010(6), 4576-4594.
- Schneider, J., & Ciacchi, L. C. (2012). Specific Material Recognition by Small Peptides Mediated by the Interfacial Solvent Structure.
- Schnirman, A. A., Zahavi, E., Yeger, H., & Rosenfeld, R. (2006). Antibody Molecules Discriminate between Crystalline Facets of a Gallium Arsenide Semiconductor. *Nano*.
- Seker, U. O. S., & Demir, H. V. (2011). Material binding peptides for nanotechnology. *Molecules (Basel, Switzerland)*, 16(2), 1426-51. doi:10.3390/molecules16021426
- Seker, U. O. S., Wilson, B., Sahin, D., & Tamerler, C. (2009). Quantitative Affinity of Genetically Engineered Repeating Polypeptides to Inorganic Surfaces, 250-257.
- Sethuraman, N., & Stadheim, T. A. (2006). Challenges in therapeutic glycoprotein production. *Current Opinion in Biotechnology*, 17(4), 341-346.
- Sharkey, D. J., & Kornfeld, R. (1991). Developmental regulation of asparagine-linked oligosaccharide synthesis in *Dictyostelium discoideum*. *Journal of Biological Chemistry*, 266, 18485-18497.
- Sharp, P. M., & Devine, K. M. (1989) Nucleic Acids , Codone usage and gene expression level in *Dictyostelium discoideum*: highly expressed genes do prefer optimal codon. 11; 17(13): 5029–5039
- Skerra, a, & Plückthun, a. (1988). Assembly of a functional immunoglobulin Fv fragment in *Escherichia coli*. *Science*, 240(4855), 1038-41.
- Smith, G. P. (1985). Filamentous fusion phage: novel expression vectors that display cloned antigens on the virion surface. *Science*, 228(4705), 1315-7.

- Stoltenburg, R., Reinemann, C., & Strehlitz, B. (2007). SELEX--a (r)evolutionary method to generate high-affinity nucleic acid ligands. *Biomolecular engineering*, *24*(4), 381-403. doi:10.1016/j.bioeng.2007.06.001
- Szymanski, C. M., Michael, F. S., Jarrell, H. C., Li, J., Gilbert, M., Larocque, S., Vinogradov, E., et al. (2003). Detection of conserved N-linked glycans and phase-variable lipooligosaccharides and capsules from campylobacter cells by mass spectrometry and high resolution magic angle spinning NMR spectroscopy. *The Journal of biological chemistry*, *278*(27), 24509-20. doi:10.1074/jbc.M301273200
- Takemura, S., Asano, R., Tsumoto, K., Ebara, S., Sakurai, N., Katayose, Y., Kodama, H., et al. (2000). Construction of a diabody (small recombinant bispecific antibody) using a refolding system. *Protein Engineering*, *13*(8), 583-588.
- Tamerler, C., Khatayevich, D., Gungormus, M., Kacar, T., Oren, E. E., Hnilova, M., & Sarikaya, M. (2010). Molecular biomimetics: GEPI-based biological routes to technology. *Biopolymers*, *94*(1), 78-94. doi:10.1002/bip.21368
- Tamerler, C., Oren, E. E., Duman, M., Venkatasubramanian, E., & Sarikaya, M. (2006). Adsorption kinetics of an engineered gold binding Peptide by surface plasmon resonance spectroscopy and a quartz crystal microbalance. *Langmuir : the ACS journal of surfaces and colloids*, *22*(18), 7712-8. doi:10.1021/la0606897
- Taylor, F. R., Ferrant, J. L., Foley, S. F., Zeng, C., Sernatinger, J., Juffras, R., & Pepinsky, R. B. (2001). Biochemical analysis of retroviral structural proteins to identify and quantify retrovirus expressed by an NS0 murine myeloma cell line. *Journal of Biotechnology*, *84*(1), 33-43.
- Teillaud, J.-L. (2005). Engineering of monoclonal antibodies and antibody-based fusion proteins: successes and challenges. *Expert opinion on biological therapy*, *5 Suppl 1*, S15-27. doi:10.1517/14712598.5.1.S15
- Tikunova, N. V., & Morozova, V. V. (2009). Phage display on the base of filamentous bacteriophages: application for recombinant antibodies selection. *Acta naturae*, *1*(3), 20-8.
- Turkevich, J., Stevenson, P. C., & Hillier, J. (1951). A study of the nucleation and growth processes in the synthesis of colloidal gold. *Discussions Of The Faraday Society*, *11*(c), 55. The Royal Society of Chemistry. doi:10.1039/df9511100055
- Uyeda, H. T., Medintz, I. L., Jaiswal, J. K., Simon, S. M., & Mattoussi, H. (2005). Synthesis of compact multidentate ligands to prepare stable hydrophilic quantum dot fluorophores. *Journal of the American Chemical Society*, *127*(11), 3870-3878. ACS Publications.
- Vats, B., & Padh, H. (2007). Development of soil amoeba Dictyostelium discoideum as an expression system for recombinant human erythropoietin. *World Journal of Microbiology and Biotechnology*, *23*(11), 1511-1518. doi:10.1007/s11274-007-9395-6
- Veltman, D. M., Akar, G., Bosgraaf, L., & Van Haastert, P. J. M. (2009). A new set of small, extrachromosomal expression vectors for Dictyostelium discoideum. *Plasmid*, *61*(2), 110-8. Elsevier Inc. doi:10.1016/j.plasmid.2008.11.003

- Verma, R., Boleti, E., & George, A. J. T. (1998). Antibody engineering : Comparison of bacterial , yeast , insect and mammalian expression systems. *Journal of Immunological Methods*.
- Vervoort, E. B., van Ravestein, a, van Peij, N. N., Heikoop, J. C., van Haastert, P. J., Verheijden, G. F., & Linskens, M. H. (2000). Optimizing heterologous expression in dictyostelium: importance of 5' codon adaptation. *Nucleic acids research*, 28(10), 2069-74.
- Walsh, G., & Jefferis, R. (2006). Post-translational modifications in the context of therapeutic proteins. *Nature biotechnology*, 24(10), 1241-52. doi:10.1038/nbt1252
- Watanabe, H., Kanazaki, K., Nakanishi, T., Shiotsuka, H., Hatakeyama, S., Kaieda, M., Imamura, T., et al. (2011). Biomimetic engineering of modular bispecific antibodies for biomolecule immobilization. *Langmuir: the ACS journal of surfaces and colloids*, 27(16), 9656-61. doi:10.1021/la2006259
- Watanabe, H., Nakanishi, T., Umetsu, M., & Kumagai, I. (2008). Human anti-gold antibodies: bifunctionalization of gold nanoparticles and surfaces with anti-gold antibodies. *The Journal of biological chemistry*, 283(51), 36031-8. doi:10.1074/jbc.M805547200
- Weerapana, E., & Imperiali, B. (2006). Asparagine-linked protein glycosylation: from eukaryotic to prokaryotic systems. *Glycobiology*, 16(6), 91R-101R. doi:10.1093/glycob/cwj099
- Werkmeister, J. A., & Ramshaw, J. A. M. (2012). Recombinant protein scaffolds for tissue engineering. *Biomedical materials Bristol England*, 7(1), 012002. doi:10.1088/1748-6041/7/1/012002
- Whaley, S. R., English, D. S., Hu, E. L., Barbara, P. F., & Belcher, A. M. (2000). Selection of peptides with semiconductor binding specificity for directed nanocrystal assembly. *Nature*, 405(6787), 665-668.
- Wieland, W. H., Orzáez, D., Lammers, A., Parmentier, H. K., & Schots, A. (2006). Display and selection of chicken IgA Fab fragments. *Veterinary Immunology and Immunopathology*, 110(1-2), 129-140.
- Willett, R. L., Baldwin, K. W., West, K. W., & Pfeiffer, L. N. (2005). Differential adhesion of amino acids to inorganic surfaces. *Proceedings of the National Academy of Sciences of the United States of America*, 102(22), 7817-22. doi:10.1073/pnas.0408565102
- Zuo, R., Ornek, D., & Wood, T. K. (2005). Aluminum- and mild steel-binding peptides from phage display. *Applied Microbiology and Biotechnology*, 68(4), 505-509.

{Bibliography}

Books-

- Introduction to phage biology, and phage display, Marjorie Russel
- Nanostructures and Nanomaterials” chapter-1, Guozhong Cao
- Phage display of peptide and protein, chapter 1, Winter, McCafferty et al.
- Kuby Immunology, Kindt, T. J., Goldsby, R. A., & Osborne, B. A. (2006).

Appendix A: Chemicals, biologicals and vector used in phage display experiment

A) Chemicals

PBS (5.84 g NaCl, 4.72 g Na₂HPO₄ and 2.64 g NaH₂PO₄·2H₂O, pH 7.2, in 1 litre), 2xTY medium (16g Tryptone, 10g Yeast Extract and 5g NaCl in 1 litre), M9 medium ,Glycerol, tween-20, 'Marvel' dried skimmed milk powder, magnetic beads (M280 streptavidine dynabead), TMB (3,3',5,5'-tetramethylbenzidine ,Sigma), H₂O₂ (sigma), Glucose, IPTG (Sigma), TEA- Triethylamine, PEG-8000

B) Materials and antibodies

Magnet, falcon tube, 1.5 ml polypropylene tube, 96 well plate (2ml deep well), ELISA plate (normal and streptavidine coated, Nunc), Large and small petri dishes, anti His antibody, anti mouse HRP

C) Bacterial strains and vector, display library

TG1 *E.coli* stock (grown in nonsupplemented thiamin containing M9 medium to maintain selection on the F' pilus), M13KO7 helper phage (GE- Healthcare), pIT2 vector, Tomlinson (I+J) library (see details on next page)

D) Phage display targets

Inorganic material	Physical state	Size	Source
DHLA- SB capped CdS QD (biotinylated)	Suspension	10-10.5 nm, hydrodynamic radius	ESPCI, Paris
DHLA- PEG capped gold nanoparticles (biotinylated)	Suspension		ESPCI, Paris
ZnS	Powder	10 µm	SigmaAldrich, 244627
CdS	Powder		Sigma Aldrich, 208183
CdSe	Powder	~10 µm	SigmaAldrich, 244600
gold	Powder	<10 µm	Sigma Aldrich, 326585

Tomlinson (I+J) library

We used Tomlinson I+J library during all screens done in this thesis. This is a single pot, synthetic library. Success of using this library can be traced by generation of scFv against many targets (mostly biological). (Tomlinson I and J) libraries are distributed by BioScience LifeSciences. Antibody fragments are displayed on M13 filamentous phage. 18 different amino acid positions in the antigen-binding sites are mutated to introduce diversity in library. Two different mutation strategies result in library sizes of 1.47×10^8 (Library I) and 1.37×10^8 (Library J). These clones are present in ampicillin resistant phagemid vector, which is transformed into TG1 cells. Both libraries are based on a single human framework for V_H (V3-23/DP-47 and JH4b) and V_k (O12/O2/DPK9 and Jk1) with side chain diversity at fixed position in antigen binding site. 18 variable positions are ; (H50, H52, H52a, H53, H55, H56, H58, H95, H96, H97, H98, L50, L53, L91, L92, L93, L94 and L96). The CDR3 of the heavy chain was designed to be as short as possible yet still able to form an antigen binding surface. The scFv-phage in Tomlinson I + J libraries is monomeric, which in practice means that only one copy of scFv is attached on each phage (de Wildt, Mundy, Gorick, & Tomlinson, 2000).

Phagemid vector (pIT2)

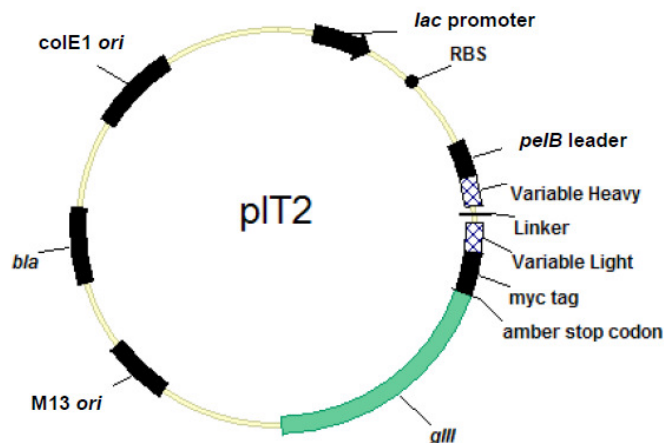

Vector map of pIT2 phagemid vector from the Tomlinson scFv library. RBS - ribosome binding site. pelB leader peptide sequence promotes export of the scFv protein. Variable Heavy and Variable Light peptide sequences are fused together by a glycine-serine linker. An amber stop codon is at the junction of the c-myc tag and the g3 gene to enable conditional expression of the scFv-p3 fusion in an amber suppressor strain. The M13 origin of replication enables packaging into M13 phage particles, the bla gene encodes ampicillin resistance, and the colE1 origin of replication enables maintenance as a plasmid in *E. coli*.

Helper phage

Helper phage is used to produce phagemid particles. There are many variations of helper phages, we have used M13KO7. It is a derivative of M13 that has a couple of differences including a kanamycin resistance gene and the P15A origin of replication, which allows the genome to be replicated as a plasmid in *E. coli*. Helper phages supply all of the genes necessary for production of phagemid particles.

Appendix B: Phage display protocols

We performed three successive rounds of selection for each target, during each round we monitored output/input phage ratio by systematic titration of phages by infecting them in *E.coli* and counting bacterial colonies appeared on selection plate. Protocol is adapted from the Tomlinson (I+J) library user's manual with some modification according to the targets properties.

Step 1: Preparation of input

- 1) An aliquot of the library in TG1 is diluted at OD= 0.05 and incubated at 37⁰c in 2xTY+ amp+ 1% glucose until it reached OD=0.5.
- 2) 25 ml of above culture with exponentially growing bacteria were mixed with 20x excess of helper phage. Mixing was done gently to prevent breaking of bacterial pili (essential for M13 infection). Mixture was quickly put in water bath incubation (standing) at 37⁰c for 30 min.
- 3) Cells were centrifuged at 3300xg for 20 min, infected bacteria are resuspended in 500ml of 2xTY+amp+kan and incubated at 30⁰c overnight. (Kanamycin is used for selection of positively infected bacteria, low temperature (30⁰c) is maintained to help scFv folding).
- 4) Phages are separated from overnight culture by mixing one fifth volume of PEG 8000/NaCl to culture supernatant and then followed by ice incubation for 1 hr. Later mixture was centrifuged at 10,800xg for 10 min. Pellet was resuspended in 40 ml H₂O + 8 ml PEG/NaCl followed by second incubation on ice for 20 min. Pellet was again centrifuged to remove last drop of PEG/NaCl. Finally pellet was resuspended in 1ml PBS and centrifuged at 11,600xg for 10 min to remove bacterial debris. Supernatant is input phage solution. It can be mixed with 15% glycerol for long term storage at -70⁰c.

Step 2: selection of specific binders (scFvs) against different targets

The targets used during this thesis are unusual for phage display methods. The Tomlinson library has been used more frequently for biological targets. Therefore, method of screening is well described for biological targets. In our experiment we adapted several techniques on need to use basis, of course inspiration was taken from well described methods of selection against biological targets. Preparation of target is important step in display technology. In screening against biological target, target/antigen is adsorbed onto plastic surfaces like immunotubes or ELISA plates. Alternate approach is using antigen/ target in solution. Antigen/target can be labelled with biotin, and then phage antibody can be selected against biotinylated antigen. After selection phages bound to labelled antigen can be recovered with avidin or streptavidine coated paramagnetic beads. One disadvantage of this technique is

the possibility of selection of anti streptavidine antibodies. Inorganic materials can be obtained in powder form, crushed sheet, single crystal, or polycrystalline form. Nanoparticles are generally stabilised by some chemical agent. Surface chemistry and crystal structure can play important role in antibody selection. One research group in Israel has demonstrated the specificity of antibody for a crystalline facet of GaAs semiconductor (Schnirman, Zahavi, Yeger, & Rosenfeld, 2006). Depending on the physical state of the target material used in screen, we adapted different strategy to prepare target.

Step 2.1: Selection protocol for surface modified and biotinylated nanoparticle

Surface modified and biotinylated targets (CdS QDs and gold nanoparticles) were immobilised on streptavidine coated paramagnetic beads. Magnetic beads having the target immobilised on their surface were used for interaction with antibody phage library. To avoid nonspecific selection we incubated antibody phage library with streptavidine coated paramagnetic beads prior to its incubation with target. Detailed protocol is as followed-

1) To remove potential nonspecific binder, equal amount of Tomlinson I and Tomlinson J library in (total 1 ml) was taken in low protein bind eppendorf tube and 250ul of MPBST (PBS + 0.1% tween-20 + 2% milk) was also added. 50 ul of streptavidine M280 dynabeads were washed twice with PBST and mixed with phage mixture and incubated of 90 min on small rotator. At the end of incubation, phages were aspirated carefully and mixed with target (as explained in next step).

2) Magnetic beads were washed twice with PBST (PBS+ 0.1% tween) and mixed with biotinylated targets. Mixture was incubated for 30 min in standing position and occasional tapping of tube. (25 ul of biotinylated CdS QD + 50 ul of magnetic beads) (125 ul of biotinylated gold nanoparticles + 50 ul of magnetic beads). At the end of incubation, targets were aspirated out, and beads were washed twice with PBST and mixed with phages (preabsorbed with magnetic beads).

3) Mixture of phages and immobilised target on beads were incubated for 90 min on rotator and 30 min in standing position. At the end of incubation, buffer was taken out carefully (with the help of magnet). Beads were mixed with 1ml PBST and transferred to falcon tube containing 7 ml PBST.

4) Beads were washed rapidly with 8 ml PBST (10 times for first round of selection) in subsequent rounds of selection washing was performed 20 times.

There is good chance to miss important clone during first round of panning, as each clone is present in 10^4 to 10^5 copies, which determine selection co-efficient of specific binder as 10^{-4} , this is one reason to keep selection stringency low during first round of selection. It is more likely that during third round of selection, specific clones are enriched and become major part of population.

5) After last wash, elution step was performed. 1 ml of freshly prepared TEA (140ul of TEA in 10 ml H₂O) was added to beads, and mixture was incubated for 10 min by gentle agitation on rotor. After 10 min, 500 ul of TEA was recovered (on the magnet) and neutralised in 500 ul of 1M Tris, pH 7, after additional 10 min incubation, the remaining 500 ul of TEA was recovered and neutralised in same tube containing Tris. The beads were also neutralised with 200 ul Tris, and kept separately.

6) The rescue and amplification of selected phages were achieved by infecting TG1 bacteria. 10 ml of exponentially growing TG1 bacteria (OD=0.5) were mixed with 750 ul of neutralised eluted phages. 4 ml TG1 culture was added to neutralised beads. Both mixtures were incubated in water bath at 37⁰c for 30 min. Rest of unused neutralised phages were also saved and stored at -4⁰c. at the end of incubation both mixtures were pooled (100ul of this mixture is saved for titration of eluted phages), and centrifuged at 3300xg for 10 min. Pellet was resuspended with appropriate amount of 2xTY medium to spread infected bacteria on 3x 15 cm 2xTY +amp+ 1% glucose plates.

7) 10^{-10} dilution of input phages solution was infected with exponentially growing TG1 cells, infected TG1 cells were also spread on 2XTY amp 1%Glu plates for input titration (10^{-1} , 10^{-2} , 10^{-3} dilutions).

8) Eluted phages saved during step 6 were also infected with exponentially growing TG1 cells, infected TG1 cells were also spread on 2XTY+ amp +1%Glu plates for output titration (10^{-1} , 10^{-2} , 10^{-3} dilutions). Negative controls were done by spreading 2xTY medium, TG1 on amp and kanamycin plates. All the plates were incubated at 37⁰c overnight.

9) Next day, all colonies appeared on input and output plates were counted to determine yield.

10) Large plates were scraped with 6 ml 2xTY + 30% glycerol and stored in separate aliquots. Next round of selection was started by dilution of this culture to OD=0.05 in 100 ml 2xTY+amp+1%glu, culture was incubated at 37⁰c until OD=0.5.

11) 20-fold excess of helper phages were added to 10 ml of this culture and mixed gently and incubated in water bath at 37⁰c for 30 min. After incubation, the culture was centrifuged and resuspended in 50ml 2xTY+amp+kan (no glucose)and incubated at 30⁰c overnight to produce phages for another round of selection. Phage solution was prepared exactly same as explained in step1 (preparation of input).

12) Random 94 bacterial colonies were picked from titration plates obtained for output of last (third) round of selection. Alternatively, it can be performed later by spreading glycerol stock of last round output, n picking clones. Each colony was transferred to 2 ml deep well (in 96 well plate) containing 500 ul 2xTY+amp+ 1% glu, and incubated overnight at 37⁰c. Next day storing solution prepared by adding 50% glycerol and 50% 2xTY medium was added into each well (500ul each) to make glycerol stock. Well no A1 and H12 were kept as control (no bacterial colony). This plate was the master plate, other replica plates were prepared for further experiments.

Step 2.2: Selection protocol for powder form targets

Micron size particles (ZnS, CdS, CdSE and gold) came in powder form. Physical state of these crystals facilitated ease in screening as these powders get sediment in few Seconds by centrifuging for few seconds. Quantity of target used for screening was 21 mg CdS, 21 mg gold, 30 mg ZnS and 30 mg CdSe powder. Most of the steps performed for selection were same as mentioned for biotinylated target, except, preparation of target, washing and elution steps. Powdered form targets were directly mixed with library of phages, washing and elution steps were performed by centrifuging the tube containing target for few second using table centrifuge. After last round of selection, 94 random clones were picked for each target.

Step 3: Identification of positive clones

ELISA (enzyme linked immunosorbent assay) was performed to identify positive (target specific) clones. The protocol for ELISA was also adapted according to the physical state of target. Biotinylated targets were immobilised on streptavidine coated ELISA plate (Nunc), after that ELISA experiment was performed as mentioned in next paragraph. Powder form of target imposed problem in ELISA experiment because they can not be immobilised on plate, which make washing step technically difficult (washing is done by quick rinsing and then by inverting and tapping the plate, for powder form target inverting was not possible, rinsing each well without loosing target was difficult task). Therefore, ELISA was performed using 1.5 ml polypropylene tubes. Each clone was tested in tube ELISA, which took several days instead of one day in ELISA plate. ELISA was performed with bacterial supernatant

containing secreted scFvs. Supernatants were obtained by systematic induction of each clone as explained below-

All clones were replicated from glycerol stock of randomly picked clones in 2xTY+amp+1%glucose in 96 well plate (2ml deep well). Cultures were started by inoculating 10 ul of each clone in 1 ml 2xTY+amp+ 0.1% glucose followed by incubation at 37⁰c until OD reached 0.5 (*Glucose level was reduced to 0.1% for scFv expression*). At this stage, cultures were induced by 1mM IPTG and transferred to 30⁰c incubator for overnight. Next day 96 well plate was centrifuged at 5000xg for 10 min. Supernatants of each clones were used for ELISA experiment.

ELISA in 96 well plate

ELISA experiment for biotinylated target was performed in 96 well streptavidine coated plate. Plate was rinsed quickly with PBST (1xPBS+ 0.05% tween) and coated with targets, targets were mixed with PBST and distributed equally in each well. [25ul of CdS QD+ 10.5 ml PBST (1xPBS+ 0.05%tween), 100 ul of gold nanoparticles +10.5 ml PBST]. 100 ul of each target sample was coated in 96 wells of plate. Coating was done by 1 hr incubation at room temperature on table rocker. Plates were rinsed quickly 2 times with PBST (1xPBS+ 0.05% tween). Plate was blocked by using blocking buffer (2% milk+ 1xPBS+ 0.1% tween) for 1 hour. Later blocking buffer was removed by inverting and tapping the plate. 100 ul scFv culture supernatant was added in each well; plate was covered and incubated for 1 hr at rocker. After incubation supernatants were discarded and plate was washed with PBST (1xPBS+ 0.1% tween). Primary antibody (anti His antibody) is diluted 1:1000 times in blocking buffer and added into each well (100ul/well) and incubated for 1 hr. After incubation, primary antibody was discarded, and plate was washed three time using PBST. Plate was incubated with secondary antibody (anti mouse HRP, 1:3000 dilutions) for 1 hr. After incubation secondary antibody solution was discarded and plate was washed. Later 100 ul of developing solution (70 ml acetate buffer pH 6+ 15ul H₂O₂ +7 mg TMB+ 700 ul DMSO) was added in each well, plate was incubated in dark for 10 min. In presence of specific antigen/antibody interaction color signal appeared. Reaction was stopped by using 1M HCl (50 ul/well), which turned positive color signal (blue) into yellow color.

ELISA in tubes

Tube ELISA was performed in 1.5 ml polypropylene tube. Targets (powder) and tubes used for ELISA were blocked by using blocking buffer (2% milk+ 1xPBS+ 0.1% tween) for 1 hour. Later blocking buffer was removed by centrifuging the tubes. Targets were equally distributed

in each tube (approx 1 mg/tube). 100 ul scFv culture supernatant was added in each tube, and incubated for 1 hr at rocker. After incubation supernatants were discarded and targets in tube were washed with PBST (1xPBS+ 0.1% tween) by mixing and then by centrifuging. Primary antibody (anti His antibody) is diluted 1:1000 times in blocking buffer and added into each tube (100ul/tube) and incubated for 1 hr. After incubation, primary antibody was discarded, and tubes were washed three time using PBST. Targets in tube were incubated with secondary antibody (anti mouse HRP, 1:3000 dilutions) for 1 hr. After incubation secondary antibody solution was discarded and targets were washed. Later 100 ul of developing solution (70 ml acetate buffer pH 6+ 15ul H₂O₂ +7 mg TMB+ 700 ul DMSO) was added in each tube, followed by incubation in dark for 10 min. In presence of specific antigen/antibody interaction color signal appeared. Reaction was stopped by using 1M HCl (50 ul/well), which turned positive color signal (blue) into yellow color. Colored solutions were taken into 96 well plate for taking picture on ELISA result.

Step 4: Production of soluble scFv antibodies in *E. coli*

Phagemids can allow either soluble expression of recombinant protein (antibody fragment) in bacteria, or the production of the fusion protein encapsulated on the phage tip (thus forming the phage antibody). This is possible because an AMBER stop codon with TAG sequence, which is placed between the foreign protein (scFv) gene and g3. In some *E. coli* strains (as HB2151), the TAG codon can be read as a stop signal thus determining soluble expression of the recombinant protein. These bacteria are termed “non-suppressor”. On the contrary, in “suppressor” *E. coli* strains such as TG1, TAG codon is read as glutamic acid so that transcription is not stopped and foreign protein-p3 fusion protein is synthesized. The phagemid is also designed to have polyhistidine tag fused to express scFv, which allows purification of antibodies by using metal affinity chromatography. Depending on clone and bacterial strain, one can obtain soluble antibodies in culture supernatant, periplasm or inside the bacterial cell, (we obtain most of the scFvs secreted in culture medium in sufficient amount).

Appendix C: Alignment of anti-gold scFv sequences

We had identified 45 clones showing binding to gold target, DNA of these clones was extracted and sent to sequencing company. Sequence of some clones were repeated, we identified 32 unique sequences. Unique 32 sequences with symbol are presented below.

	VH CDR 1 ↔	VH CDR 2 ↔	
7A_++	AEVQLLES	GGGLVQ	59
4E_L	AEVQLLES	GGGLVQ	58
3F_L	AEVQLLES	GGGLVQ	60
5D_+	AEVQLLES	GGGLVQ	59
6E_L	AEVQLLES	GGGLVQ	59
11G_L	AEVQLLES	GGGLVQ	59
2G_++	AEVQLLES	GGGLVQ	59
4H_++	AEVQLLES	GGGLVQ	59
7B_L	AEVQLLES	GGGLVQ	59
5F_L	AEVQLLES	GGGLVQ	59
11A_++	AEVQLLES	GGGLVQ	60
2B_+	AEVQLLES	GGGLVQ	59
9H_8++	AEVQLLES	GGGLVQ	59
4D_L	AEVQLLES	GGGLVQ	59
2A_2++	AEVQLLES	GGGLVQ	59
7H_++	AEVQLLES	GGGLVQ	58
12B_+	AEVQLLES	GGGLVQ	59
8G_L	AEVQLLES	GGGLVQ	59
9E_+	AEVQLLES	GGGLVQ	59
11C_L	AEVQLLES	GGGLVQ	59
11H_2L	AEVQLLES	GGGLVQ	59
4A_L	AEVQLLES	GGGLVQ	59
12D_++	AEVQLLES	GGGLVQ	59
3D_++	AEVQLLES	GGGLVQ	59
11D_++	AEVQLLES	GGGLVQ	60
4C_++	AEVQLLES	GGGLVQ	59
10F_+	AEVQLLES	GGGLVQ	59
2D_++	AEVQLLES	GGGLVQ	59
9A_2+	AEVQLLES	GGGLVQ	59
↔ VH CDR 3 ↔			
7A_++	YADSVKGRFTISRDSSKNTLYLQMN	SLRAEDTAVYYCAK	119
4E_L	YADSVKGRFTISRDSSKNTLYLQMN	SLRAEDTAVYYCAK	118
3F_L	YADSVKGRFTISRDNSKNTLYLQMN	SLRAEDTAVYYCAK	120
5D_+	YADSVKGRFTISRDNSKNTLYLQMN	SLRAEDTAVYYCAK	119
6E_L	YADSVKGRFTISRDNSKNTLYLQMN	SLRAEDTAVYYCAK	119
11G_L	YADSVKGRFTISRDNSKNTLYLQMN	SLRAEDTAVYYCAK	119
2G_++	YADSVKGRFTISRDNSKNTLYLQMN	SLRAEDTAVYYCAK	119
4H_++	YADSVKGRFTISRDNSKNTLYLQMN	SLRAEDTAVYYCAK	119
7B_L	YADSVKGRFTISRDNSKNTLYLQMN	SLRAEDTAVYYCAK	119
5F_L	YADSVKGRFTISRDNSKNTLYLQMN	SLRAEDTAVYYCAK	119
11A_++	YADSVKGRFTISRDNSKNTLYLQMN	SLRAEDTAVYYCAK	120
2B_+	YADSVKGRFTISRDNSKNTLYLQMN	SLRAEDTAVYYCAK	119
9H_8++	YADSVKGRFTISRDNSKNTLYLQMN	SLRAEDTAVYYCAK	119
4D_L	YADSVKGRFTISRDNSKNTLYLQMN	SLRAEDTAVYYCAK	119
2A_2++	YADSVKGRFTISRDNSKNTLYLQMN	SLRAEDTAVYYCAK	119
7H_++	YADSVKGRFTISRDNSKNTLYLQMN	SLRAEDTAVYYCAK	118
12B_+	YADSVKGRFTISRDNSKNTLYLQMN	SLRAEDTAVYYCAK	119
8G_L	YADSVKGRFTISRDNSKNTLYLQMN	SLRAEDTAVYYCAK	119
9E_+	YADSVKGRFTISRDNSKNTLYLQMN	SLRAEDTAVYYCAK	119
11C_L	YADSVKGRFTISRDNSKNTLYLQMN	SLRAEDTAVYYCAK	119
11H_2L	YADSVKGRFTISRDNSKNTLYLQMN	SLRAEDTAVYYCAK	119
4A_L	YADSVKGRFTISRDNSKNTLYLQMN	SLRAEDTAVYYCAK	119
12D_++	YADSVKGRFTISRDNSKNTLYLQMN	SLRAEDTAVYYCAK	119
3D_++	YADSVKGRFTISRDNSKNTLYLQMN	SLRAEDTAVYYCAK	119
11D_++	YADSVKGRFTISRDNSKNTLYLQMN	SLRAEDTAVYYCAK	120
4C_++	YADSVKGRFTISRDNSKNTLYLQMN	SLRAEDTAVYYCAK	119
10F_+	YADSVKGRFTISRDNSKNTLYLQMN	SLRAEDTAVYYCAK	119
2D_++	YADSVKGRFTISRDNSKNTLYLQMN	SLRAEDTAVYYCAK	119
9A_2+	YADSVKGRFTISRDNSKNTLYLQMN	SLRAEDTAVYYCAK	119

VL CDR 1

↔

```

7A_++ GSGGGSGGGSTNIQMTQSPSSLSASVGDRVITCRASQSISSYLNWYQQKPGKAPKLL 179
4E_L GSGGGSGGGSTNIQMTQSPSSLSASVGDRVITCRASQSISSYLNWYQQKPGKAPKLL 178
3F_L GSGGGSGGGSTDIQMTQSPSSLSASVGDRVITCRASQSISSYLNWYQQKPGKAPKLL 180
5D_+ GSGGGSGGGSTDIQMTQSPSSLSASVGDRVITCRASQSISSYLNWYQQKPGKAPKLL 179
6E_L GSGGGSGGGSTDIQMTQSPSSLSASVGDRVITCRASQSISSYLNWYQQKPGKAPKLL 179
11G_L GSGGGSGGGSTDIQMTQSPSSLSASVGDRVITCRASQSISSYLNWYQQKPGKAPKLL 179
2G_++ GSGGGSGGGSTDIQMTQSPSSLSASVGDRVITCRASQSISSYLNWYQQKPGKAPKLL 179
4H_++ GSGGGSGGGSTDIQMTQSPSSLSASVGDRVITCRASQSISSYLNWYQQKPGKAPKLL 179
7B_L GSGGGSGGGSTDIQMTQSPSSLSASVGDRVITCRASQSISSYLNWYQQKPGKAPKLL 179
5F_L GSGGGSGGGSTDIQMTQSPSSLSASVGDRVITCRASQSISSYLNWYQQKPGKAPKLL 179
11A_++ GSGGGSGGGSTDIQMTQSPSSLSASVGDRVITCRASQSISSYLNWYQQKPGKAPKLL 180
2B_+ GSGGGSGGGSTDIQMTQSPSSLSASVGDRVITCRASQSISSYLNWYQQKPGKAPKLL 179
9H_8++ GSGGGSGGGSTDIQMTQSPSSLSASVGDRVITCRASQSISSYLNWYQQKPGKAPKLL 179
4D_L GSGGGSGGGSTDIQMTQSPSSLSASVGDRVITCRASQSISSYLNWYQQKPGKAPKLL 179
2A_2++ GSGGGSGGGSTDIQMTQSPSSLSASVGDRVITCRASQSISSYLNWYQQKPGKAPKLL 179
7H_++ GSGGGSGGGSTDIQMTQSPSSLSASVGDRVITCRASQSISSYLNWYQQKPGKAPKLL 178
12B_+ GSGGGSGGGSTDIQMTQSPSSLSASVGDRVITCRASQSISSYLNWYQQKPGKAPKLL 179
8G_L GSGGGSGGGSTDIQMTQSPSSLSASVGDRVITCRASQSISSYLNWYQQKPGKAPKLL 179
9E_+ GSGGGSGGGSTDIQMTQSPSSLSASVGDRVITCRASQSISSYLNWYQQKPGKAPKLL 179
11C_L GSGGGSGGGSTDIQMTQSPSSLSASVGDRVITCRASQSISSYLNWYQQKPGKAPKLL 179
11H_2L GSGGGSGGGSTDIQMTQSPSSLSASVGDRVITCRASQSISSYLNWYQQKPGKAPKLL 179
4A_L GSGGGSGGGSTDIQMTQSPSSLSASVGDRVITCRASQSISSYLNWYQQKPGKAPKLL 179
12D_++ GSGGGSGGGSTDIQMTQSPSSLSASVGDRVITCRASQSISSYLNWYQQKPGKAPKLL 179
3D_++ GSGGGSGGGSTDIQMTQSPSSLSASVGDRVITCRASQSISSYLNWYQQKPGKAPKLL 179
11D_++ GSGGGSGGGSTDIQMTQSPSSLSASVGDRVITCRASQSISSYLNWYQQKPGKAPKLL 180
4C_++ GSGGGSGGGSTDIQMTQSPSSLSASVGDRVITCRASQSISSYLNWYQQKPGKAPKLL 179
10F_++ GSGGGSGGGSTDIQMTQSPSSLSASVGDRVITCRASQSISSYLNWYQQKPGKAPKLL 179
2D_++ GSGGGSGGGSTDIQMTQSPSSLSASVGDRVITCRASQSISSYLNWYHQKPGKAPKLL 179
9A_2+ GSGGGSGGGSTDIQMTQSPSSLSASVGDRVITCRASQSISSYLNWYQQKPGKAPKLL 179

```

VL CDR 2

VL CDR 3

↔

```

7A_++ IYRASHLQSGVPSRFSGSGSDTDFLLTISLQPEDFATYYCQQRRRQRPRTFFGQGTKVEIK 239
4E_L IYRASHLQSGVPSRFSGSGSDTDFLLTISLQPEDFATYYCQQRRRQRPRTFFGQGTKVEIK 238
3F_L IYRASRLQSGVPSRFSGSGSDTDFLLTISLQPEDFATYYCQQRYRKRPRTFFGQGTKVEIK 240
5D_+ IYRASRLQSGVPSRFSGSGSDTDFLLTISLQPEDFATYYCQQRHGKRPRTFFGQGTKVEIK 239
6E_L IYMAASHLQSGVPSRFSGSGSDTDFLLTISLQPEDFATYYCQQRKTGPRTFFGQGTKVEIK 239
11G_L IYGASRLQSGVPSRFSGSGSDTDFLLTISLQPEDFATYYCQQRNRPRTFFGQGTKVEIK 239
2G_++ IYQASRLQSGVPSRFSGSGSDTDFLLTISLQPEDFATYYCQQRRAKRPRTFFGQGTKVEIK 239
4H_++ IYKASRLQSGVPSRFSGSGSDTDFLLTISLQPEDFATYYCQQRAKQPSTFFGQGTKVEIK 239
7B_L IYRASRLQSGVPSRFSGSGSDTDFLLTISLQPEDFATYYCQQRYLKPGTFFGQGTKVEIK 239
5F_L IYAAASRLQSGVPSRFSGSGSDTDFLLTISLQPEDFATYYCQQRTAYPRTFFGQGTKVEIK 239
11A_++ IYRASLLQSGVPSRFSGSGSDTDFLLTISLQPEDFATYYCQQRPELNPPRTFFGQGTKVEIK 240
2B_+ IYDASLLQSGVPSRFSGSGSDTDFLLTISLQPEDFATYYCQQRIPLLPRTFFGQGTKVEIK 239
9H_8++ IYAAASYLQSGVPSRFSGSGSDTDFLLTISLQPEDFATYYCQQRASRRPRTFFGQGTKVEIK 239
4D_L IYASASYLQSGVPSRFSGSGSDTDFLLTISLQPEDFATYYCQQRGSTAPRTFFGQGTKVEIK 239
2A_2++ IYASASRLQSGVPSRFSGSGSDTDFLLTISLQPEDFATYYCQQRAAAKPRTFFGQGTKVEIK 239
7H_++ IYASASRLQSGVPSRFSGSGSDTDFLLTISLQPEDFATYYCQQRAAHKPTFFGQGTKVEIK 238
12B_+ IYASASHLQSGVPSRFSGSGSDTDFLLTISLQPEDFATYYCQQRARHPPRTFFGQGTKVEIK 239
8G_L IYAAASRLQSGVPSRFSGSGSDTDFLLTISLQPEDFATYYCQQRARHPPITFFGQGTKVEIK 239
9E_+ IYAAASHLQSGVPSRFSGSGSDTDFLLTISLQPEDFATYYCQQRAVQSPQRTFFGQGTKVEIK 239
11C_L IYAAASHLQSGVPSRFSGSGSDTDFLLTISLQPEDFATYYCQQRAVQSPQRTFFGQGTKVEIK 239
11H_2L IYTASRLQSGVPSRFSGSGSDTDFLLTISLQPEDFATYYCQQRAAARPATFFGQGTKMEIK 239
4A_L IYTASRLQSGVPSRFSGSGSDTDFLLTISLQPEDFATYYCQQRAAARPPTFFGQGTKMEIK 239
12D_++ IYAAASRLQSGVPSRFSGSGSDTDFLLTISLQPEDFATYYCQQRAARPATFFGQGTKMEIK 239
3D_++ IYTASRLQSGVPSRFSGSGSDTDFLLTISLQPEDFATYYCQQRAAARPATFFGQGTKMEIK 239
11D_++ IYHASTLQSGVPSRFSGSGSDTDFLLTISLQPEDFATYYCQQRAKSPPTFFGQGTKVEIK 240
4C_++ IYKASNLQSGVPSRFSGSGSDTDFLLTISLQPEDFATYYCQQRRKTPPTFFGQGTKVEIK 239
10F_+ IYKASRLQSGVPSRFSGSGSDTDFLLTISLQPEDFATYYCQQRSTRPPTFFGQGTKVEIK 239

```

2D_++ IYRASHLQSGVPSRFSGSGSGTDFTLTISSLQPEDFATYYCQQSAHRPPTFGQGTKVEIK 239
 9A_2+ IYKASLLQSGVPSRFSGSGSGTDFTLTIGSLQPEDFATYYCQQAANRPPTFGQGTKVEIK 239

7A_++ RAAK 243
 4E_L RAAK 242
 3F_L RAAK 244
 5D_+ RAAK 243
 6E_L RAAK 243
 11G_L RAAK 243
 2G_++ RAAK 243
 4H_++ RAAK 243
 7B_L RAAK 243
 5F_L RAAK 243
 11A_++ RAAK 244
 2B_+ RAAK 243
 9H_8++ RAAK 243
 4D_L RAAK 243
 2A_2++ RAAK 243
 7H_++ RAAK 242
 12B_+ RAAK 243
 8G_L RAAK 243
 9E_+ RAAK 243
 11C_L RAAK 243
 11H_2L RAAK 243
 4A_L RAAK 243
 12D_++ RAAK 243
 3D_++ RAAK 243
 11D_++ RAAK 244
 4C_++ RAAK 243
 10F_+ RAAK 243
 2D_++ RAAK 243
 9A_2+ RAAK 243

Symbol-

digit- no of repeated sequence

(++) - Very strong binder

(+) - good binder

L - light/weak binder

Appendix D: Chemicals, biologicals and vector used in production of recombinant antibody in *Dd*

A) Chemicals/ media

HL5 medium (peptone 5 gm, tryptone 5 gm, yeast extract 5 gm, KH₂PO₄ 0.35 gm, Na₂HPO₄ 0.35gm, glucose 10 gm for 1 L), 2XTY medium, G418, ampicilline , cobalt resin (Thermo scientific), imidazol (sigma), enzymes (Fermentas, fast digest), electroporation buffer (50 mM Sucrose, 10 mM NaPO₄, pH 6.1)

B) *Dd* strain and vector

AX3 *Dd* strain, pTX-GFP vector, pUX vector, pUC vector, DH10B bacterial strains

C) ScFv sequences

NCBI accession no- (TA10 - AY348549.1), (SF9 - AY348548.1), (F2C- AY348545.1), (MB11-AA842745.1)

Appendix E: Design of *Dd* expression vector and cloning strategy of engineered fragments in *Dd* expression vector.

A) *Dd* vector cloning

Ddp1 plasmid based pTX-GFP vector was used as backbone. The vector plasmid already carries cassette for G418 selection in *Dd* under actin 6 promoter, amp resistance marker for *E. coli*, *Dd* origin of replication, and *E.coli* origin of replication, actin 15 promoter sequences. Our collaborator at Curie institute ordered a sequence from gene synthesis Company, this sequence contains actin 15 promoters sequence, start codon sequence, Cel- A signal peptide sequence of *Dd* origin, few additional sequences for multiple cloning site. We received the synthesized sequence cloned into pUC-57 vector. The sequence was PCR amplified from pUC 57 vector and further digested with Xba I and Sal I restriction enzymes, and gel purified. pTX –GFP vector was digested with Sal I – Xba I enzymes, resulting in removal of original actin 15 promoter sequence and MCS sequence. Backbone of pTX–GFP vector and synthesized gene sequence were ligated using ligation enzyme. The ligated product was transformed into competent DH10B strain of *E.coli*. The positive clone was confirmed by extraction of plasmid DNA of few selected *E.coli* transformed colonies appeared on selection plate and further, checking the correct insert size by digestion with Sal I and Xba I restriction enzymes. Design of *Dd* Expression vector construction and different cloning steps are shown in figure E1.

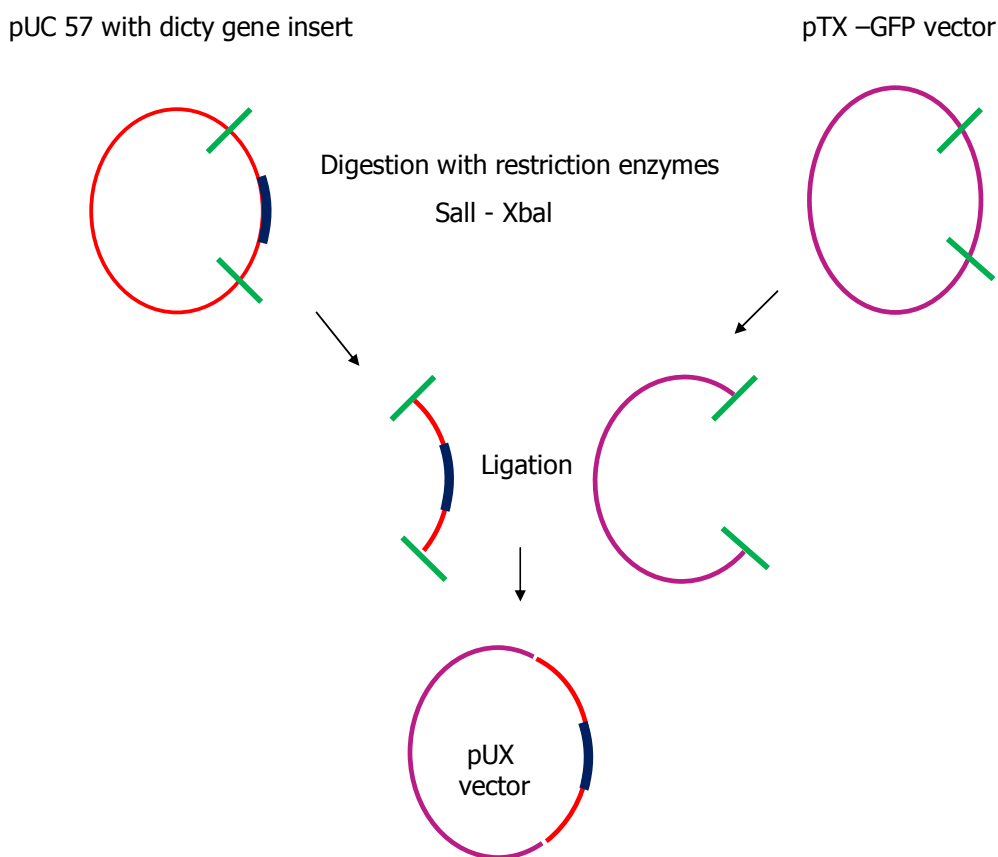

design of expression vector(pUX)

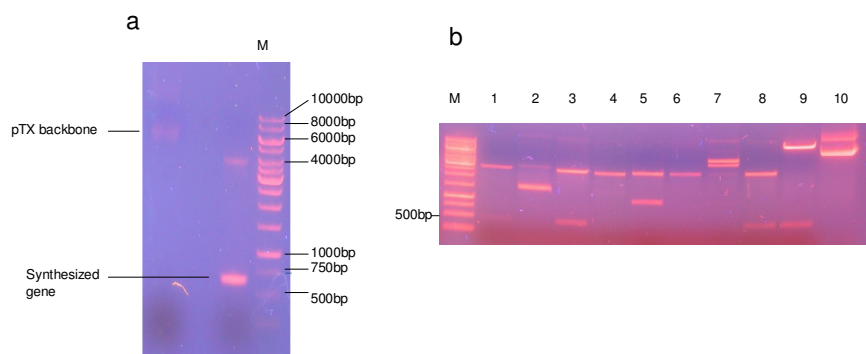

Figure E1: Construction of pUX vector, a) before ligation pTX and synthesized gene (Sal I-Xba I cut), b) confirmation of positive clone by restriction digestion (expected insert size 500bp) M-DNA marker, lane 1-10 transformants of ligated product (synthesized gene+ pTX backbone), digested with Sal I and Xba I, clone no 9 is positive clone with the insert size nearly 500bp.

B) Cloning of scFv in *Dd* expression vector

cDNA correspond to scFvs -SF9, TA10, F2C, MB11 were excised from phen vector and then subcloned into *Dd* expression vector (pUX) between Nco I and Not I restriction sites. The

ligated product was transformed into competent DH10B strain of *E.coli*. The positive clone was confirmed by extraction of plasmid DNA of few selected *E.coli* transformed colonies appeared on selection plate and further, by checking the correct insert size by digestion with Nco I –Not I restriction enzymes. Design of scFv cloning in *Dd* expression vector and different cloning steps are shown in figure E2. The plasmid DNA of positive clone was transformed in *Dd* cells (see appendix F). Vector map of pUX- scFv is shown in figure E3.

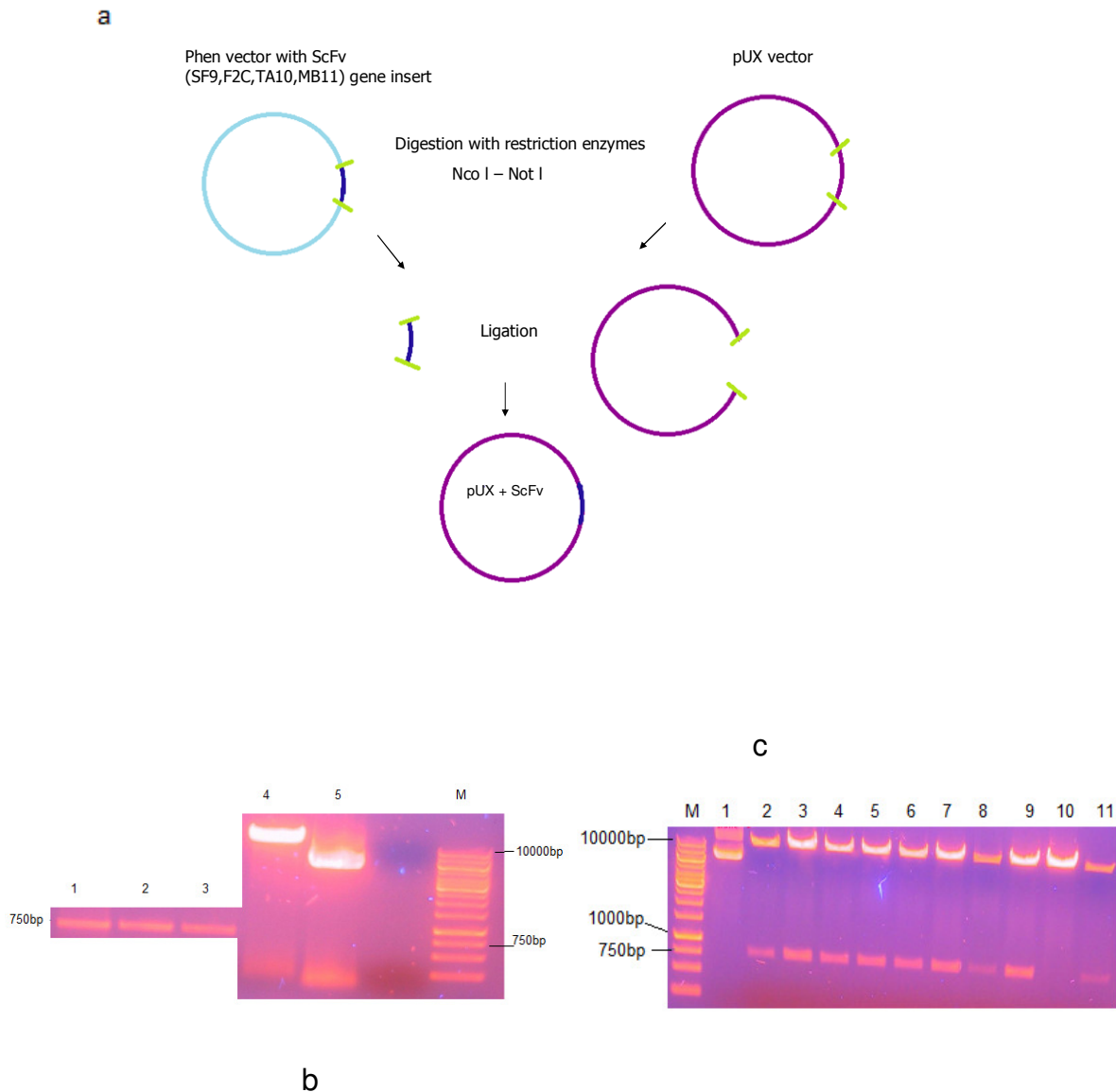

Figure E2: (a) design of pUX - scFv construct, (b) before ligation of scFv insert into pUX vector, 1- SF9, 2- TA10, 3 – F2C, 4- pUX vector uncut, 5 – pUX vector digested with Nco I – Not I, M – DNA marker, (c) Screening of positive clone by restriction digestion (Nco I – Not I), M- DNA marker, 1 – pUX- F2C transformed clone (uncut), lane 2 to 11 – pUX-F2C transformed clones digested with Nco I – Not I. expected insert size 750 bp, all clones are positive except clone 10. Similarly, we obtained positive clones with SF9, TA10, MB11 cloning, data not shown here.

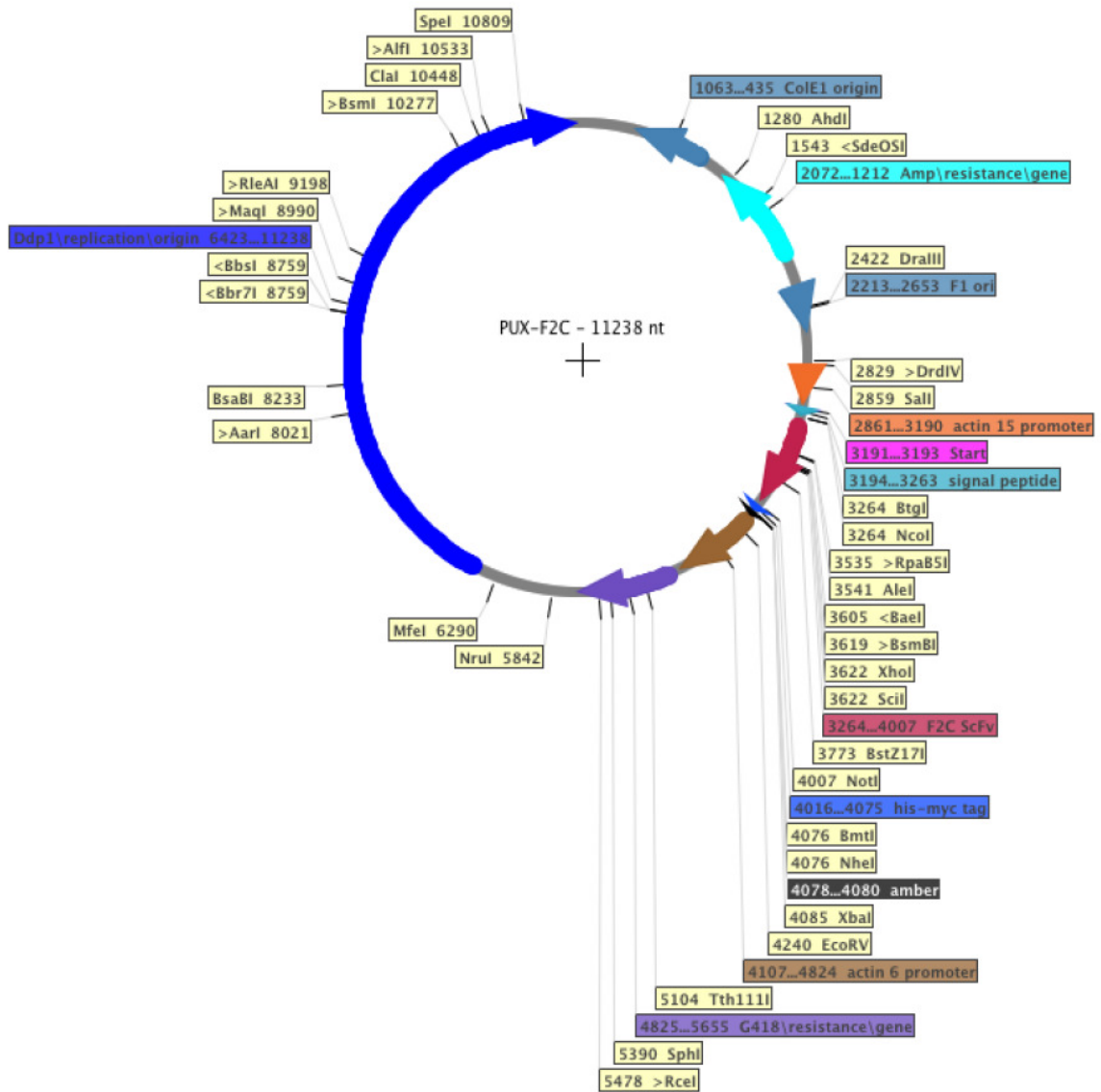

Figure E3: pUX - F2C scFv vector map

C) Cloning of scFv+Fc constructs in *Dd* expression vector

This cloning was done in one step by using previously generated pUX-scFv constructs. We have fused multispecies Fc regions with various scFvs. This work has given additional value to antibody fragment by making it free from species specificity barrier. Multispecies Fc (human, rabbit, mouse) and mCherry Fc are extracted from phen vector by restriction

digestion with Not I – Nhe I. All Fc fragments were ligated in pUX vector at Not I – Nhe I sites, just downstream to scFv sequence in pUX vector. The ligated product was transformed into competent DH10B strain of *E.coli*. The positive clone was confirmed by extraction of plasmid DNA of few selected *E.coli* transformed colonies appeared on selection plate and further, checking the correct insert size of Fc region by digestion with Not I- Nhe I restriction enzymes. Design of scFv+Fc cloning in *Dd* expression vector and different cloning steps are shown in figure E4. The plasmid DNA of positive clone was transformed in *Dd* cells (see appendix F). Vector map of pUX- scFv+Fc is shown in figure E5.

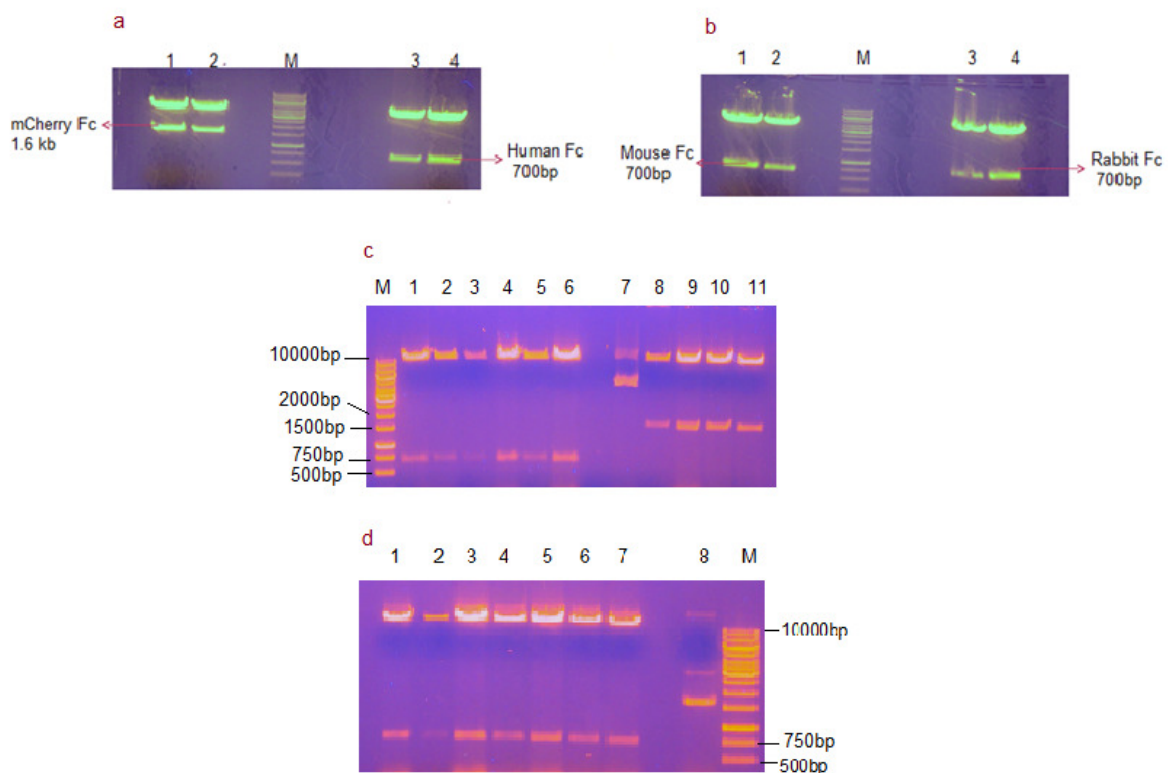

Figure E4: (a,b) isolation of multispecies Fc from phen vector by digesting with Not I - Nhe I restriction enzymes, (c) Screening of clones by restriction digestion using Not I - Nhe I, M – DNA marker, lane 1-6 (pUX TA10+ Mouse Fc) expected insert 700 bp. Lane 8- 11 (pUX TA10+ mCherry Fc) expected insert 1.6kb, (d) Screening of clones by restriction digestion using Not I - Nhe I, lane 1-4 (pUX TA10 + Human Fc) expected insert size 700bp, lane 5-7 (pUX TA10 + Rabbit Fc) expected insert size 700bp. The screening results and vector map are shown for only one scFv (TA10). Positive constructs were obtained with other scFvs – SF9, F2C, MB11, data not shown here.

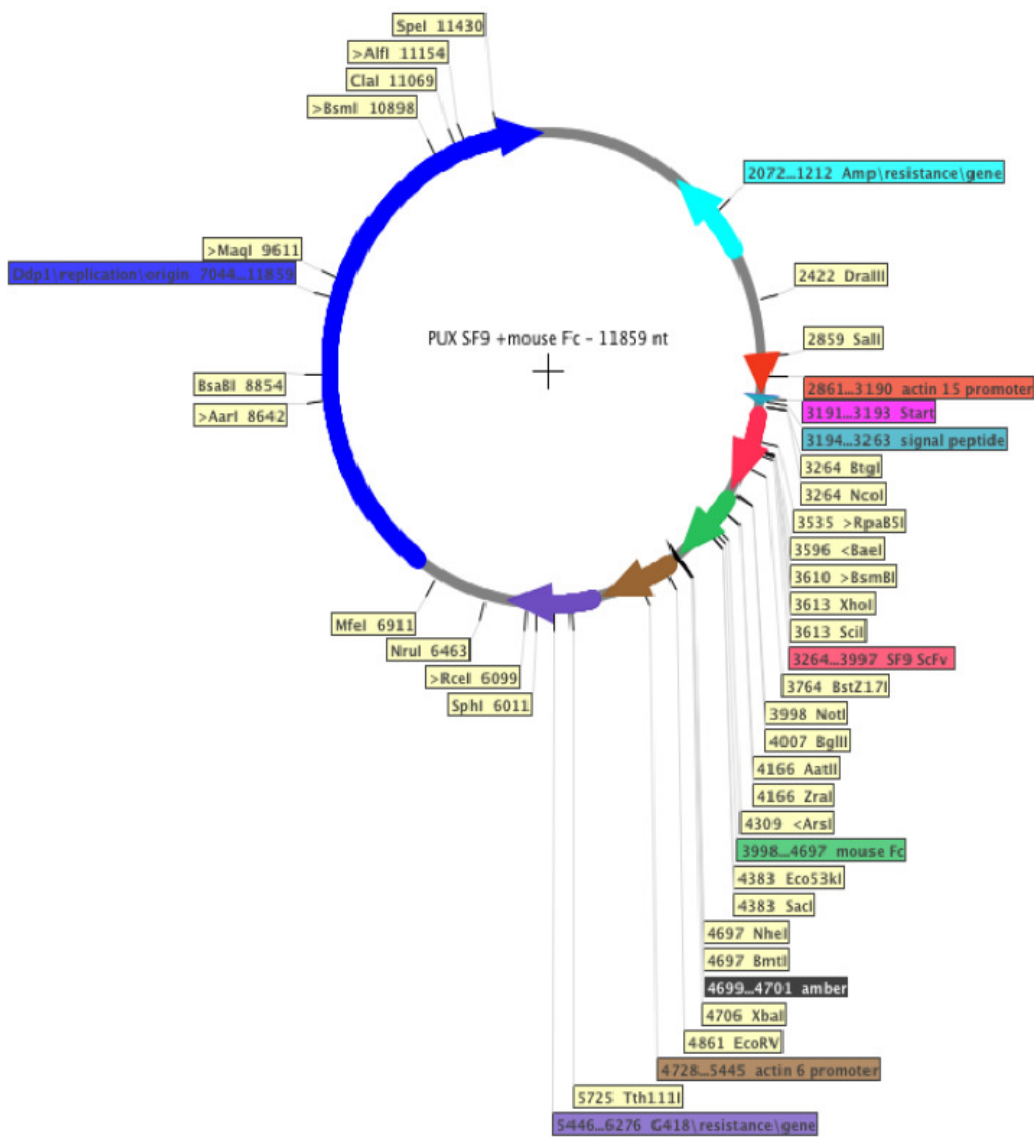

Figure E5: pUX SF9 + mouse Fc vector map

D) Cloning of scFv:: streptavidine construct in *Dd* expression vector

In order to get tetrameric construct, streptavidine gene was fused with scFv sequence. The streptavidine gene was isolated from PSTE2 vector by digestion with Not I- Nhe I restriction enzymes (fig.E6). DNA of pUX scFvs (scFv- F2C, TA10, SF9) were digested with Not I- Nhe I restriction enzymes and dephosphorylated. The streptavidine gene was ligated at Not I - Nhe I sites , just downstream to scFv in pUX vector. The ligated product was transformed into competent DH10B strain of *E.coli*. The positive clone was confirmed by extraction of plasmid DNA of few selected *E.coli* transformed colonies appeared on selection plate and further, checking the correct insert size by digestion with Not I- Nhe I restriction enzymes. Different cloning steps are shown in figure E7. The plasmid DNA of positive clone was

transformed in *Dd* cells (see appendix F). Vector map of pUX- scFv::streptavidine is shown in figure E9.

PVP binding scFvs were also fused with streptavidine, this cloning was done by replacing scFv construct which were already fused with streptavidine, replacement was done at Nco I-Not I site. The ligated product was transformed into competent DH10B strain of *E.coli*. The positive clone was confirmed as described above but this time we checked the insert pattern of scFvs by digesting construct with Nco I – Not I enzymes. Different cloning steps are shown in figure E8. The plasmid DNA of positive clone was transformed in *Dd* cells (see appendix F).

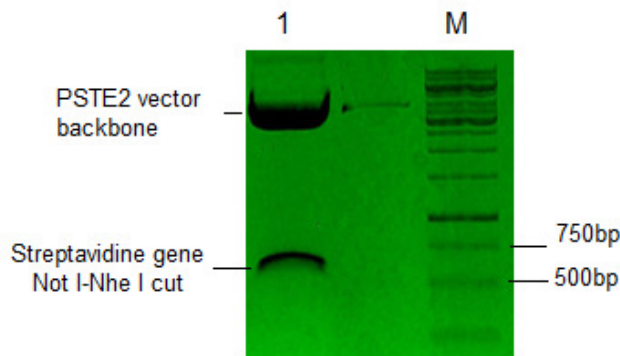

Figure E6: Cloning of streptavidine gene, M – DNA marker, lane 1- PSTE2 vector digested with Not I-Nhe I (size of streptavidine insert 500bp)

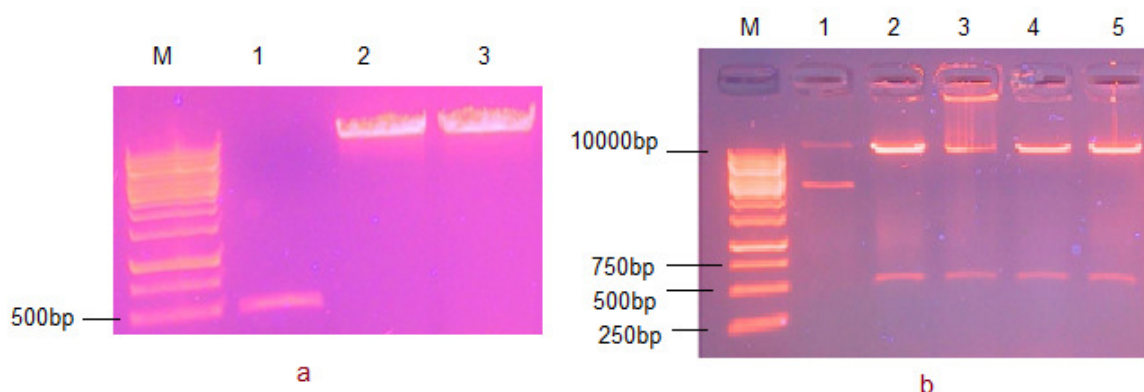

Figure E7: ScFv:: streptavidine cloning (a) Before ligation of streptavidine gene, M – DNA marker, lane 1- PSTE2 (Not I- Nhe I cut), Lane 2, 3- pUX TA10,pUX F2C respectively (Not I-Nhe I digested, dephosphorylated) (b) Screening of positive clone for pUX F2C :: streptavidine clones, M – DNA marker, lane 1-5 pUX F2C:: streptavidine clones digested with Not I-Nhe I restriction enzymes, expected insert size (500bp). We obtained positive streptavidine fusion constructs with other scFvs, results are not shown here.

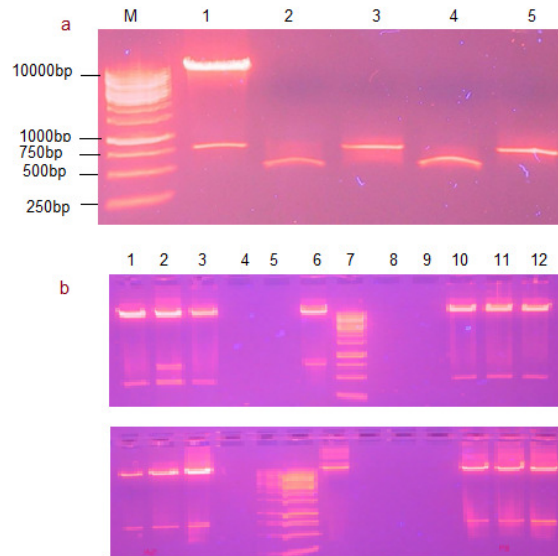

Figure E8: PVP binding scFv:: streptavidine (a) Before ligation of streptavidine gene and PVP ScFv, M- DNA marker, 1- pUX SF9 :: streptavidine clone (Nco I- Not I digested, dephosphorylated) expected insert (10kb and 750bp), lane 2- B1 scFV (expected size 500bp), lane 3- A2 ScFv(750bp), lane 4- C11 ScFv (500bp), lane 5- F1 ScFv (750bp) (b) Screening of positive clones for PVP ScFv:: streptavidine, digestion with Nco I- Not I

Lane 1,2,3 (upper gel) pUX B1::streptavidine (expected insert size, 500bp)

Lane 6 (upper gel) - control (no insert DNA), Lane 7 (upper gel)- DNA marker,

lane 10,11,12 (upper gel) pUX C11::streptavidine (expected insert size ,500bp)

lane 1,2,3 (lower gel) pUX A2:: streptavidine (expected insert size, 750bp)

lane 6 (lower gel) DNA marker, 7 (lower gel) – control,

lane 10,11,12 (lower gel) pUX F1:: streptavidine (expected insert size 750bp)

E) Cloning of bispecific antibody constructs in *Dd* expression vector

We have set up a strategy to fuse any two NcoI/NotI excised scFv fragments, resulting in a combined fragment flanked by NcoI/NotI sites. We used one flexible linker to attach two scFvs.

Design of linker

In bispecific construct, two scFvs are separated by a linker. We suspected that linker should not interfere with binding activity of both scFvs. Therefore, naturally occurring flexible linker sequence was chosen, which was highly rich in glycine and serine. Primers were ordered for linker sequence. Linker has $(G_4 S)_3$ sequence in middle flanking by Eag I at 5' end and Pag I at 3' end. These extreme ends were introduced in order to design linker to facilitate joining of any two scFvs having Nco I and Not I sites at the extremes. Eag I share same overhanging

region with Not I site. Pag I share same overhanging region with Nco I site. Primers were annealed by boiling at 95°C for 15 min, and by cooling overnight. Size of annealed fragment is small, so digestion with Eag I and Pag I enzymes was performed separately.

Construction of bispecific antibody

The pUX vector backbone was used for construction of bispecific antibody constructs. Advantage was taken from earlier cloning of scFv in pUX vector. In pUX-scFv construct, scFv is present at Nco I and Not I sites. (General scheme is described for two scFvs, where two scFvs are denoted with A and B, please refer figure E10) pUX scFv A was digested with Not I and Nhe I restriction enzymes and dephosphorylated, this was used as backbone. scFv B was extracted from pUX vector from site Nco I – Xba I, and dephosphorylated. Digested fragment of scFv B was ligated with linker.

Pag I site and Nco I site share same overhang as mentioned in above paragraph. Pag I end of linker and Nco I end of scFv B were ligated. Resulting ligated product had Eag I and Xba I sites. Newly ligated product had one end phosphorylated (Eag I) and other end dephosphorylated (Xba I). For ligation reaction one end required to be phosphorylated and other end dephosphorylated. For last ligation in backbone with scFv A, which has Not I and Nhe I sites (dephosphorylated), compatible ends were prepared in ligated product. scFv B+ linker is digested with Nhe I enzyme, resulting fragment has Eag I and Nhe I sites, which were compatible for ligation with backbone having scFv A (Eag I and Not I share same overhang). Ligation resulted in bispecific construct, present at Nco I and Nhe I. Screening was done by transformation into DH10B strain of *E.coli*. Few transformed clones were selected, their plasmid DNA were isolation and digested with restriction enzymes Nco I and Nhe I, to check correct insert size (which should be 1.5Kb). See figure E 11 for screening result. Later sequence of bispecific construct was confirmed by sequence analysis. Transformation of pUX vector containing bispecific construct (ScFv A + linker + ScFv B) was done in *Dd* cells. We did not observe expression of this construct in *Dd*. Potential reason is mentioned in discussion ,section 3.2.

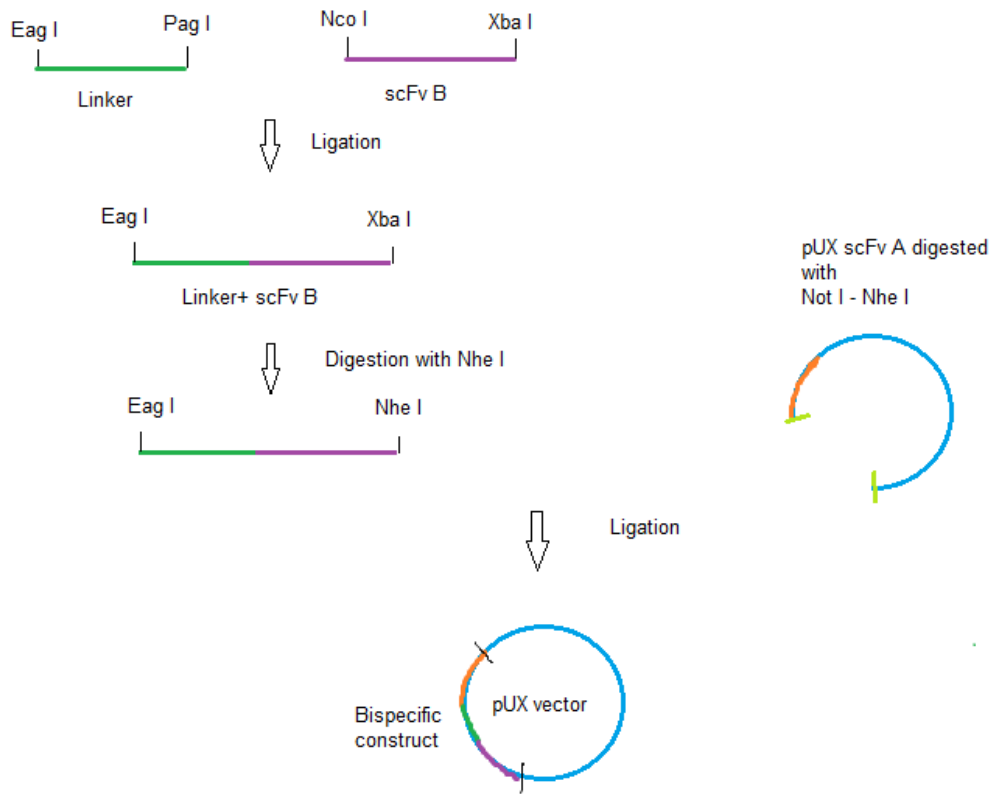

Figure E10 Scheme of bispecific construct design

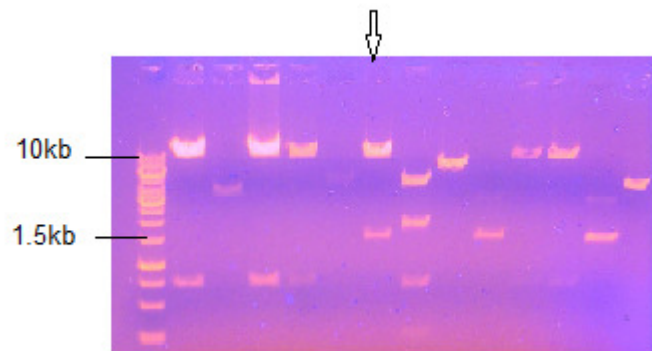

Figure E11, Screening for bispecific construct by digestion with Nco I- Not I
 This cloning was difficult, only one clone out of many clones was positive. Correct size of bispecific insert is 1.5 kb, positive clone is shown with the arrow.

Appendix F: Generation and characterisation of *Dd* cell lines expressing recombinant antibodies

Expression and purification of scFv and engineered scFv fragment in *Dd*

A) Transformation of AX3 cells by electroporation

The expression vector used in this case was named as pUX that harbors the G418 resistance marker. The convenient feature of the vector is the fact that the gene of interest can be inserted using Nco I – Not I restriction sites in the multiple cloning sites under the actin 15 promoter which allows high level of recombinant gene expression. A signal sequence (Cel A) is present downstream of the actin 15 promoter which enables efficient secretion of the recombinant antibodies into the medium. The vector also contains sequences required for selection and propagation of the plasmid in the bacterial system.

The recombinant plasmid was purified using Nucleo Spin (Macherey nagel) kit. Transformation was carried out using electroporation method recommended by the Bioered micro pulser with some modifications. Briefly, *AX3 cell* was grown in (T75 tissue culture flask) HL5 medium at 22°C incubator. When cells reached exponential state, they were harvested (scrapped) and incubated on ice for 30 min. later centrifugation at 500×g for 5 minutes at 4°C was performed. Supernatant was discarded and cells were resuspended in 850 ul of electroporation buffer (50 mM Sucrose, 10 mM NaPO₄, pH 6.1). An aliquot (850 µl) of the resuspended competent cells was transferred to a 4mm gap electroporation cuvette (Molecular Bio Products) for transformation. Cuvette was already incubated for 10 min on ice with 30 ug of plasmid DNA (*Dd* expression vector) to be transformed. DNA and competent cells were mixed, cells were subjected to electroporation in a Gene PulserR electroporator (BioRad Laboratories, Hercules, CA, USA) using a charging voltage of, 1KV; resistance, 200Ω; capacitance, 25µF for about one milliseconds (2 pulses, 3 second apart). Immediately after electroporation, contents of cuvette were transferred to T 75 tissue culture flask containing HL5 medium. Flask was incubated at 22°C in incubator for 14-15 hours for recovery. After recovery period medium was changed, successive dose of G418 was added.

B) Screening of the *Dd* transformants

Dd transformants were obtained after successive increased dose of G418. Dose was increased from 5 ug/ml to 20 ug/ml. Few transformants could not tolerate initial dose of 5 ug/ml, so we restarted transformation with dose 2.5 ug/ml. Cells were screened for their ability to secrete scFv and other engineered scFv products in medium (HL5) under selection

of G418. After getting confluent at 20 ug of G418, The supernatants of the transformed cells was analysed by immunofluorescence. The clone secreting scFv was used for scaling up the production in shake flask culture.

C) Immunofluorescence assay

Immunofluorescence labelling was performed on HeLa cells. Cells were fixed in 3% paraformaldehyde and permeabilized with PBS and 0.1% saponin for 4 min at -20°C. scFv and engineered scFv containing supernatants were used at different dilution from 1/20 to 1/1000 times and incubated for 1 hr on cells(along with primary antibody anti-His₆ in PBS and+saponin). Cells were then rinsed twice with PBS and incubated with secondary antibodies for 30 min. After two short rinsing steps, cover slips were mounted onto slides in mowiol. (Immunofluorescence assay were performed at Institute Curie, Paris)

D) Large scale expression of the antibody in *Dd* cells

Expression of scFv was scaled up in shake flask culture. Selected clones were first grown in tissue culture flask (T75, nunc) at 22^oc incubator in HL5 medium and 20ug/ml G418. After attaining certain growth, cells were scrapped and transferred into flask containing 100ml HL5 medium and 20 ug/ml. Flask was incubated at 22^oc shaking incubator. After two days when cells grow in density from initial inoculums, culture is transferred into bigger flask with 500ml HL5 medium and G418 (20ug/ml). Cells were grown until 72 hours. At this stage cells were harvested and centrifuged at 8000 RPM for 30 min at 4^oc (Sigma centrifuge). Supernatant was collected and further processed for purification.

Appendix G: Purification of *Dd* expressed antibodies

500ml *Dd* supernatant was used to purify scFv. Column was prepared with cobalt resin (2 ml bed volume), column was previously equilibrated with phosphate buffer (5.84 g NaCl, 4.72 g Na₂HPO₄ and 2.64 g NaH₂PO₄·2H₂O, pH 7.2, in 1 litre). Column was again washed 2 times with 20ml phosphate buffer. Dictyostelium culture supernatant was applied to column, flow through was collected. Purification procedure was performed at 4^oc. Flow through was again applied on column and collected. Column was washed with 2x20 ml volume of phosphate buffer. Elution was carried out with 150mM imidazole. Different elution fractions were analysed by SDS-PAGE. One of scFv+ Fc construct was purified by S. Moutel at Institute Curie by using protein A, this sample was later sent for glycosylation analysis.

SDS-PAGE analysis

The purified proteins (25ul of each fraction) were analyzed on 10% SDS-PAGE under reducing conditions, followed by coomassie brilliant blue staining and subsequent destaining. For SDS-PAGE, all the chemicals were purchased from bioered.

Appendix H: Glycosylation

The glycans synthesized by human cells are composed of seven monosaccharide units:

1. glucose(Glc)
2. galactose (Gal)
3. mannose (Man)
4. fucose (Fuc)
5. *N*-acetylglucosamine (GlcNAc)
6. *N*-acetylgalactosamine (GalNAc)
7. Sialic or neuraminic acids (SA).

These units can be joined in linear or branching manner of two and many hundreds monosaccharide units. The monosaccharide may be linked together by either α - or β -linkages, and bonds can be formed between the hydroxyl groups associated with different carbon atoms of the molecules. This gives a range of possible linkages, including 1→3, 1→6 and 2→3 linkages. This combination of seven monosaccharide, different linkages between them, and the potential for linear or branching chains of different lengths gives a large number of possible glycan structures(Brooks, 2004). All of these structures actually do not occur in nature, but naturally occurring glycans are still extremely varied and heterogeneous. Glycosylation types are classified according to the identity of the atom of the amino acid which binds the carbohydrate chain, i.e. C-linked, N-linked or O-linked. (adaptation-<http://www.uniprot.org>)

1. N-linked glycosylation

N-linked glycosylation refers to the attachment of oligosaccharides to a nitrogen atom, usually the N4 of asparagine residues. The consensus sequence for N-glycosylation is Asn-Xaa-Ser/Thr (where Xaa is amino acid except Pro) N-glycosylation occurs on secreted or membrane bound proteins, mainly in eukaryotes and archaea – most bacteria do not carry out this modification.

2. O-linked glycosylation

O-linked glycosylation of secreted and membrane bound proteins is a post-translational event that takes place in the cis-Golgi compartment after N-glycosylation and folding of the protein. It refers to the attachment of glycans to serine and threonine, and, to a lesser extent, to hydroxyproline and hydroxylysine.

3. C-linked glycosylation

C-linked glycosylation refers to the covalent attachment of a mannose residue to a tryptophan residue within an extracellular protein.

4. Glycation

Glycation refers to the non-enzymatic attachment of reducing sugars to the nitrogen atoms of proteins (both to the N-terminus and to lysine and histidine side chains).

Biosynthesis of N linked glycosylation-

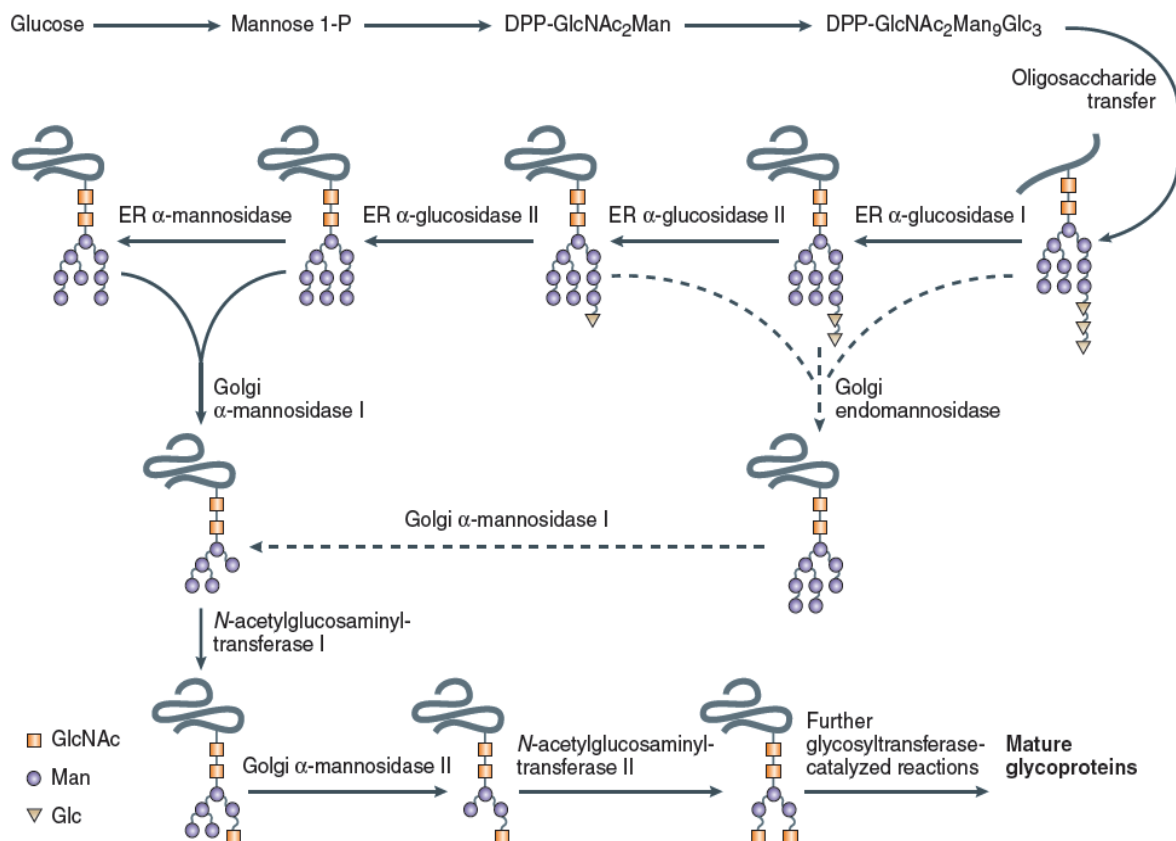

Figure G1: Overview of the biosynthesis of protein N-linked glycan side chains. The nascent glycoprotein enters the endoplasmic reticulum (ER), a preformed oligosaccharide, dolicol phosphate precursor (DPP) is attached cotranslationally to some asparagine residues that are part of the consensus sequence. All the activities in synthesis of N linked glycan are performed by glycosidases and glycosyltransferases enzymes present in endoplasmic reticulum and golgi. The exact profile of such enzymes present in the cell will largely dictate the composition and structure of the final oligosaccharide side chain(Walsh & Jefferis, 2006)

Synopsis en français

Sous forme agrégée, les matériaux inorganiques sont utilisés dans de nombreux domaines, tels que le domaine médical, énergétique, environnemental ou productique. Cependant à l'échelle nanométrique (1-100nm), leurs propriétés optiques, électriques, photo-électriques, magnétiques, mécaniques, chimiques, et biologiques diffèrent. Ils ne peuvent donc plus être exploités de la même manière.

Dans ces travaux, nous nous sommes intéressés à deux applications potentielles de ces nanomatériaux inorganiques : d'une part, l'utilisation de nanoparticules métalliques ou semi-conductrices comme sondes pour l'imagerie biologique ; d'autre part, la production de structures/systèmes autoassemblés basés sur les nanoparticules. Pour chacune de ces deux applications, la surface chimique des nanomatériaux doit être rigoureusement contrôlée. Dans ce but, nous proposons une nouvelle stratégie qui altère la surface des nanoparticules par le biais de ligands/sondes correspondant à des protéines, plus précisément des anticorps.

Pour réussir à ainsi améliorer la surface chimique des nanoparticules, il est primordial de bien comprendre les mécanismes de liaisons spécifiques des protéines aux matériaux inorganiques. Nous avons donc étudié les interactions protéine-matériaux inorganiques. Pour ce faire, nous avons utilisé une technique combinatoire : le phage display d'anticorps. Dans cette technique, une librairie combinatoire et aléatoire d'anticorps recombinants mime le répertoire immunitaire. Cette librairie est scannée in-vitro pour sélectionner les anticorps qui se lient à une cible d'intérêt : cela permet d'isoler les anticorps qui se lient spécifiquement, ainsi que la séquence génétique qui leur correspond.

A l'instar des méthodes conventionnelles, le phage display d'anticorps offre la possibilité de contrôler in-vitro les conditions utilisées pour sélectionner les ligands : l'environnement physique et chimique peut être ajusté par l'expérimentateur pour créer une pression de sélection. Par ailleurs, cette technique ne nécessite pas de caractériser préalablement la cible nanométrique. Dans le cas de cibles qui possèdent une surface inorganiques, ceci est particulièrement avantageux par rapport aux méthodes conventionnelles qui reposent sur un design rationnel de la surface inorganique des ligands (avec, par exemple, des simulations dynamiques moléculaires).

Dans cette thèse, les cibles utilisées sont des matériaux inorganiques, et elles sont diverses. Donc à priori, n'importe quel matériau (organique/inorganique) peut être ciblé.

Dans ces conditions, les anticorps spécifiques (protéines) qui visent le matériau d'intérêt peuvent être identifiés.

A ce jour, en scannant une librairie de 10^8 séquences aléatoires d'anticorps, nous avons réussi à identifier 32 séquences d'anticorps qui se lient spécifiquement aux particules d'or de taille micrométrique. Une analyse statistique de ces 32 séquences nous a permis d'identifier des amino acides particuliers qui sont fortement sélectionnés dans les positions aléatoires des séquences d'anticorps. L'Arginine a été sélectionnée de manière prédominante à plusieurs positions dans les anticorps qui se lient spécifiquement à l'or. Ce résultat est cohérent avec les observations de collègues qui utilisent des stratégies plus sophistiquées et méticuleuses, telles que les simulations dynamiques moléculaires. Cette cohérence conforte notre stratégie pour l'étude des matériaux, qui est elle, basée sur une technique relativement simple : le phage display.

Nous avons ensuite voulu utiliser nos anticorps spécifiques de l'or comme ligands, le but étant d'améliorer la surface chimique des nanoparticules d'or (de taille -20nm). Les résultats préliminaires sont encourageants : ils attestent de la faisabilité du concept.

Nous n'avons pas réussi à identifier des anticorps spécifiques d'autres cibles inorganiques. Toutefois, les raisons en ont été partiellement identifiées, et ce dernier déficit peut être relevé en optimisant simplement les protocoles pour les autres cibles inorganiques.

Dans une deuxième étape, nous avons attachés à modifier la séquence des anticorps sélectionnés en utilisant l'ingénierie de recombinaison d'anticorps. Les anticorps peuvent être construits pour acquérir de nouvelles fonctions. La séquence des deux scFvs peuvent être fusionnée dans le but de produire des adaptateurs : des anticorps spécifiques capables de se lier simultanément à deux cibles.

Toutes les applications qui visent à modifier la surface chimique des nanoparticules en se basant sur le système de sondes-anticorps nécessitent de produire les anticorps sélectionnées et/ou construits. Etant donnée la structure sophistiquée et la taille des anticorps, c'est un réel déficit ! Dans cette thèse, nous avons voulu relever ce déficit. Pour ce faire, nous avons développé un nouveau système de production d'anticorps recombinants dans l'organisme eucaryotique *Dictyostellium discoideum*. A ce jour, ce système nous a permis de produire deux formes d'anticorps artificiels. Nous avons commencé à étudier les avantages que procure ce système pour la production d'anticorps thérapeutiques.

Cette thèse est divisée en quatre parties, qui commencent chacune par une description brève de son contenu.

La **section 1.1** est une introduction générale sur les anticorps, leur structure, leur fonction, ainsi que sur le développement des technologies qui en découlent, avec notamment l'utilisation d'anticorps comme ligands et comme sondes.

Dans la **section 1.2** nous présentons la biotechnique combinatoire qu'est le phage display. Nous expliquons comment utiliser cette technique pour sélectionner in vitro, parmi une librairie aléatoire d'anticorps, les anticorps recombinants qui se lient à des cibles biologiques et non-biologiques.

Dans la **section 1.3**, nous détaillons les étapes de construction qui permettent d'aboutir à un anticorps capable de fusionner avec une autre moitié biologique et chimique, y compris avec un autre anticorps.

Dans la **section 1.4**, nous décrivons les systèmes d'expression utilisés pour produire ces anticorps recombinants, ainsi que la forme qui leur est octroyée. Nous présentons aussi le système eucaryotique hôte (*Dictyostelium discoideum*) que nous avons mis en place pour pouvoir construire ces anticorps .

La **section 1.5** illustre l'approche biomimétique généralement adoptée pour fabriquer et fonctionnaliser des nanomatériaux inorganiques, avec une attention plus particulière sur l'utilisation de ligands protéiques qui permettent aux nanoparticules inorganiques de générer de nouveaux matériaux.

Dans la **section 2**, nous présentons nos résultats en deux parties. La première partie (2.1) décrit la sélection par phage display d'anticorps capables de se recombiner à des matériaux inorganiques. Nous décrivons aussi l'utilisation probable de ces anticorps comme ligands de nanoparticules inorganiques. Dans la deuxième partie (2.2), nous présentons le système expérimental mis en place pour l'expression et la production dans *Dictyostelium discoideum* d'anticorps recombinants et de leurs constructions dérivées.

Enfin, dans la **section 3**, nous discutons nos résultats. Une première discussion (3.1) porte sur la sélection réussie d'anticorps recombinant contre l'or, et ses applications potentielles dans le domaine des nanosciences inspirée du biomimétisme. La deuxième partie (3.2) insiste sur le potentiel d'utiliser *Dictyostelium* comme système de production, que ce soit

pour les anticorps recombinants ou pour les constructions élaborées à partir d'anticorps à applications thérapeutiques ou dans le domaine des nanosciences.

