



HAL
open science

**La modélisation mathématique des réseaux logistiques :
procédés divergents et positionnement par anticipation.
Application à l'industrie du bois d'œuvre**

Didier Vila

► **To cite this version:**

Didier Vila. La modélisation mathématique des réseaux logistiques : procédés divergents et positionnement par anticipation. Application à l'industrie du bois d'œuvre. Gestion et management. Ecole Nationale Supérieure des Mines de Saint-Etienne; Université Laval, 2005. Français. NNT : . tel-00778631

HAL Id: tel-00778631

<https://theses.hal.science/tel-00778631v1>

Submitted on 22 Jan 2013

HAL is a multi-disciplinary open access archive for the deposit and dissemination of scientific research documents, whether they are published or not. The documents may come from teaching and research institutions in France or abroad, or from public or private research centers.

L'archive ouverte pluridisciplinaire **HAL**, est destinée au dépôt et à la diffusion de documents scientifiques de niveau recherche, publiés ou non, émanant des établissements d'enseignement et de recherche français ou étrangers, des laboratoires publics ou privés.

DIDIER VILA

**LA MODÉLISATION MATHÉMATIQUE DES
RÉSEAUX LOGISTIQUES :
PROCÉDÉS DIVERGENTS ET
POSITIONNEMENT PAR ANTICIPATION**
Applications à l'industrie du bois d'oeuvre

Thèse de doctorat en cotutelle présentée
à la Faculté des études supérieures de l'Université Laval, Québec
dans le cadre du programme de doctorat en Sciences de l'Administration
pour l'obtention du grade de Philosophiae Doctor (Ph.D.)

DÉPARTEMENT D'OPÉRATIONS ET SYSTÈME DE LA DÉCISION
FACULTÉ DES SCIENCES DE L'ADMINISTRATION
UNIVERSITÉ LAVAL
QUÉBEC

et

L'ÉCOLE NATIONALE SUPÉRIEURE DES MINES DE SAINT-ÉTIENNE
SAINT-ÉTIENNE, FRANCE
pour l'obtention du grade de Docteur

Soutenue le 4 novembre 2005

Membres du jury

Alain Martel, directeur de recherche, Université Laval

Jean-Pierre Campagne, directeur de recherche, INSA de Lyon

Robert Beauregard, Dép. sciences du bois et de la forêt, Université Laval

Patrick Burlat, École Nationale Supérieure des Mines

Sophie D'Amours, Dép. de génie mécanique, Université Laval

Alexandre Dolgui, Ecole Nationale Supérieure des Mines

Yannick Frein (examineur externe), GILCO, ENSGI-INPG

Résumé

Les décisions de localisation, de configuration et de définition des missions des centres de production et/ou de distribution sont des enjeux stratégiques pour le futur des entreprises manufacturières. La modélisation mathématique des réseaux logistiques a pour objectif de suggérer des décisions économiquement efficaces aux gestionnaires. Cependant, la transcription fidèle de ces enjeux en termes mathématiques conditionne la crédibilité et l'efficacité des solutions recommandées. Dès lors, l'élaboration de méthodologies réalistes apparaît être une des conditions de succès de toute formalisation.

Cette thèse propose tout d'abord, une méthodologie générique réaliste de conception des réseaux logistiques pour les industries dont les procédés sont divergents. La méthodologie proposée est validée en l'appliquant à Virtu@l-Lumber, un cas virtuel mais réaliste de l'industrie du bois d'œuvre. Ensuite, une approche de positionnement par anticipation intégrant les préférences des clients est élaborée et expérimentée. Cette approche s'appuie sur un modèle de programmation stochastique avec recours. Au final, un modèle mathématique intégrateur combinant les concepts des deux méthodologies précédentes est formulé et son impact potentiel sur l'industrie du bois-d'œuvre est examiné à l'aide du cas Virtu@l-Lumber.

Abstract

Strategic decisions on the location, the capacity, the layout, and the mission of production and distribution facilities are key drivers of manufacturing company's competitiveness. The aim of supply chain design models is to recommend economically efficient decisions to the company's administrator. The realism of the mathematical modeling of the aforementioned issues conditions the validity and the applicability of the prescribed solutions. The elaboration of realistic methodologies is thus one of the main success factors of decision support processes.

This thesis first proposes a generic methodology to design the production-distribution network of divergent process industry companies. The approach is validated by applying it to Virtu@l-Lumber, a virtual but realistic case from the lumber industry. Second, an approach that takes into account market opportunities when designing production-distribution networks is proposed and tested. This approach is based on a stochastic programming with recourse model. Lastly, a mathematical model combining the two previous formulations is proposed and its potential impact on the lumber industry is investigated with the Virtu@l-Lumber case.

À mes parents et à ma tante

Remerciements

En premier lieu, je tiens à exprimer ma profonde gratitude et reconnaissance envers mon directeur de thèse, Pr. Alain Martel, pour le privilège qu'il m'a accordé en étant son étudiant au doctorat. Tout au long des quatre années de mon doctorat à l'Université Laval, l'encadrement du Pr. Alain Martel a été régulier, constant, droit, juste, rigoureux, stimulant, positif et toujours constructif. Je remercie Pr. Alain Martel pour avoir instauré un espace de travail où l'esprit critique, la prise de risque, l'imagination et la créativité sont institués et encouragés. Pr. Alain Martel m'a transmis sa vision positive orientée vers les solutions. Tel un forgeron, il a « martelé » le fer rouge de mes travaux de recherche afin que ces derniers soient les plus solides possibles.

Je remercie mon co-directeur de thèse Pr. Robert Beauregard pour la confiance qu'il m'a donnée tout au long de ma thèse. Pr. Robert Beauregard, par sa vision transversale de la recherche et sa connaissance de l'industrie forestière, a enrichi la consistance théorique et pratique de mes travaux de recherche. Je remercie Pr. Robert Beauregard pour m'avoir permis de finir mon doctorat dans des conditions propices à la réussite. Je tiens à souligner la relation synergique entre Pr. Alain Martel, Pr. Robert Beauregard et moi-même pour réaliser nos travaux de recherche.

Je remercie Pr. Sophie D'Amours pour sa croyance en mon potentiel pour mener à bien des travaux de recherche au sein du Consortium de recherche FOR@C. Pr. Sophie D'Amours a su insuffler une responsabilisation et une dynamique stimulantes de recherche à tous les étudiants du FOR@C dont j'ai eu l'honneur de faire partie. Les nombreux partenariats industriels du consortium FOR@C m'ont non seulement confronté à la réalité des entreprises de l'industrie du bois d'œuvre, mais aussi stimulé mes activités de recherche. Enfin, je tiens à remercier Pr. Sophie D'Amours pour le co-financement de mon projet avec l'École Nationale Supérieure des Mines de Saint-Étienne.

J'adresse mes remerciements à Pr. Jean-Pierre Campagne, Pr. Patrick Burlat, respectivement directeur et co-directeur, et Pr. Alexandre Dolgui pour avoir mené à bien le projet de cotutelle entre l'Université Laval et l'École Nationale Supérieure des Mines de Saint-Étienne. Nos échanges durant mes différents séjours à l'École m'ont apporté un éclairage instructif et complémentaire. Je tiens à remercier l'École Nationale Supérieure des Mines de Saint-Étienne pour son co-financement de mon projet.

J'adresse ma reconnaissance au Pr Yannick Frein pour avoir accepté l'évaluation de ma thèse.

Je remercie Pr. Diane Poulin, directrice administrative du CENTOR, et Lucien Vincent, responsable du département Organisation et Management des Systèmes Industriels de l'École Nationale Supérieure des Mines de Saint-Étienne pour être à l'origine de la cotutelle.

Je tiens à remercier Pr. Denis Bolduc, du département d'Économie de l'Université Laval pour ses conseils théorique et pratique au sujet des choix discrets en vue du second l'article de la thèse.

Je remercie l'ensemble des partenaires industriels du consortium de recherche FOR@C et en particulier, P. Goulet pour son aide précieuse pour l'article 1, F. Léger et F. Robichaud (Forintek), M. Vincent (CIFQ), A. Proulx, Y. Lemieux, M. Mario, P. De Blois et J-Y Cardinal (Kruger), M. Cloutier pour son travail d'évaluation des coûts (CRIQ), D. Leblanc et A. Duncan (CN), L. Laflamme (Domtar), C. Turcotte et D. Desjardins (MRN), G. Gaudreau et S. Boulay (consultants et sages de l'industrie forestière québécoise).

Enfin, je tiens à souligner l'ambiance stimulante avec les étudiants du CENTOR. En particulier, le partenariat doctoral avec Marie-Claude Bolduc fut très bénéfique pour tous les deux. Je remercie aussi Égide Karuranga pour sa grande disponibilité, sa vision originale et nos discussions d'ordre épistémologique. J'adresse ma reconnaissance à Charles Gignac, Jean-Sébastien Giner, Marc Paquet, Marc Poulin, Sébastien Caisse,

Wissem M'Barek et Walid Klibi. Je remercie aussi les étudiants du FOR@C : Connie Van Horne, Francois D'Amours, Satyaaveer Singh Chauban et naturellement, les gars de « l'agence » Daniel Beaudoin, Jean-Francois Audy, Mustapha Ouhimmou, et Marc Lapointe.

Je remercie également Simon Sheehy et Kevin Moore pour leur support informatique les jours de vacances et les fins de semaine ainsi que Louise Doyon pour sa bonne humeur de tous les jours. Je remercie une nouvelle fois Marc Paquet pour m'avoir permis de terminer mon doctorat dans de bonnes conditions à l'École Technologique Supérieure de Montréal.

Je remercie Constance Rozon, Francois-Xavier Monin, Magali Dessapt, Nicolas Saucier, Youssef Amrani, Youssef Hanouti et Viviana Granados Gonzales.

Je remercie David Auclair pour notre partenariat égalitaire et la transmission d'outils en vue de construire solide et fort dans la sérénité, le respect de soi et d'autrui.

J'adresse ma reconnaissance à Laurent Vercouter, Frank Gaultier, Sophie Peillon, Ali Zaidat et Jean-Francois Tchabanoff à l'École des Mines de Saint-Étienne. Je remercie Gildas Avoine, alias Mr D'Avoine, Luca Canetta et Grégoire Pepiot de l'École Polytechnique Fédérale de Lausanne.

Je tiens à remercier Dan Stora de Londres, Thomas Faudon, le « fadòli » de Montréal, Laurent Mercoyrol d'Avignon, Olivier Gineste de l'Aveyron et Grégory Darnand, mon complice intemporel des bérets rouges.

Enfin, je remercie Andréa pour ses encouragements durant le dernier sprint de la thèse.

Naturellement, je remercie mes parents, ma tante et mon frère pour leur support constant et leur très très grande patience durant toutes ces années pour mener à bien le doctorat.

Avant Propos

La thèse rédigée selon le principe d'insertion d'articles, a été effectuée en cotutelle entre l'Université Laval et l'École Nationale Supérieure des Mines de Saint-Étienne. Mes travaux de recherches se sont déroulés au sein du Centre des Technologies de l'Organisation Réseau, CENTOR, et du Consortium de Recherche FOR@C.

La thèse est composée de trois articles co-rédigés avec Pr. Alain Martel et Pr. Robert Beauregard. Pour chacun des trois articles présentés, j'ai agi à titre de chercheur principal. J'ai réalisé la conception, la programmation informatique, la calibration et l'analyse expérimentale des modèles mathématiques et ainsi que la rédaction de la première version de tous les articles. Les Pr Martel et Beauregard ont révisé les articles et modèles proposés jusqu'à l'obtention du résultat final.

Le premier article intitulé « Designing Logistics Networks in Divergent Process Industries: A Methodology and its Application to the Lumber Industry », co-écrit avec Pr. Martel et Pr. Beauregard, a été accepté en mars 2005 pour publication dans le journal « International Journal of Production Economics ». La version présentée dans la thèse est identique à la version finale acceptée.

Le second article intitulé « Taking market forces into account in the design of production-distribution networks: A positioning by anticipation approach », co-signé avec Pr. Martel et Pr. Beauregard, a été soumis dans le journal « The Journal of Industrial and Management Optimization » durant l'été 2005. La version proposée dans la thèse diffère de la version envoyée à la revue par quelques ajustements mineurs.

Le troisième article « The Strategic Design of Forest Industry Supply Chains », co-rédigé avec Pr. Beauregard et Pr. Martel, sera prochainement soumis après quelques ajustements au numéro spécial d'INFOR dédié à l'industrie forestière à l'automne 2005.

Table des matières

Résumé.....	i
Abstract.....	ii
Remerciements.....	iv
Avant Propos.....	vii
Liste des tableaux.....	xii
Liste des figures.....	xiii
Chapitre 1 : Introduction.....	1
Chapitre 2 : La Revue de Littérature.....	5
2.1 Hypothèses temporelle et informationnelle.....	5
2.2 Structure du réseau.....	7
2.3 Nomenclature et technologies.....	8
2.4 Le problème de localisation-allocation.....	9
2.4.1 Localisation, capacité et technologie.....	9
2.4.2 Production, stocks et distribution.....	11
2.4.3 Une nécessaire intégration.....	12
2.5 Fonction économique.....	13
2.5.1 La minimisation des coûts.....	13
2.5.2 La maximisation des profits.....	14
2.5.3 Une approche multicritère	14
2.5.4 La gestion du risque.....	15
2.6 Modélisation et marché.....	15
2.6.1 Intégration du marché.....	16
2.6.2 Modèles monopolistiques.....	18
2.6.3 Modèles concurrentiels.....	19
2.6.4 Les choix discrets.....	20
2.7 Méthodes de résolution.....	21
2.8 Modèles de l'industrie forestière.....	23
2.9 Conclusion.....	24
Chapitre 3 : Réseaux Logistiques et Procédés Divergents	25
3.1 Résumé.....	25
3.2 Designing Logistics Networks in Divergent Process Industries: A Methodology and its Application to the Lumber Industry.....	26

3.2.1 Introduction.....	27
3.2.2 Production-distribution Network Design Approach.....	29
3.2.3 Mathematical Programming Model	44
3.2.4 Finding the Model Optimal Solution	51
3.2.5 Guidelines for the Use of the Methodology	53
3.2.6 Concluding Remarks	55
3.2.7 References.....	56
Chapitre 4 : Marchés et Positionnement par Anticipation.....	59
4.1 Résumé.....	59
4.2 Taking Market Forces into Account in the Design of Production-Distribution Networks: A Positioning by Anticipation Approach.....	60
4.2.1 Introduction.....	61
4.2.2 Methodology.....	63
4.2.3 SAA Program Formulation.....	72
4.2.4 Sample Average Approximation.....	80
4.2.5 Experimental Evaluation.....	82
4.2.6 Conclusion.....	87
4.2.7 References.....	87
4.2.8 Appendix.....	90
Chapitre 5 : La Conception Stratégique des Réseaux Logistiques pour l'Industrie Forestière.....	92
5.1 Résumé.....	92
5.2 The Strategic Design of Forest Industry Supply Chains.....	93
5.2.1 Introduction.....	94
5.2.2 Literature Review.....	95
5.2.3 Design Methodology.....	97
5.2.4 Experimental Evaluation.....	103
5.2.5 Conclusion.....	113
5.2.6 References.....	114
Appendix A.....	117
Appendix B.....	130
Chapitre 6 : Conclusions.....	131
6.1 Contributions.....	131

6.1.1 Premier article.....	131
6.1.2 Deuxième article.....	131
6.1.3 Troisième article.....	131
6.2 Perspectives de recherche.....	132
6.2.1 Recherches quantitatives.....	132
6.2.2 Recherches organisationnelles.....	135
6.3 Conclusion finale.....	136
Références.....	137
Annexe 1 : Pseudo-Code informatique.....	144
A1.1 Modèle relationnel de données.....	144
A1.2 Guide du programmeur.....	144
A1.3 Pseudo-Code du programme informatique.....	145
Annexe 2 : Le Cas Virtu@l-Lumber.....	147
A2.1 Mise en situation.....	147
A2.2 Facteurs macro-économiques.....	148
A2.2.1 Les saisons.....	149
A2.2.2 Les pays.....	149
A2.2.3 Les taux de change.....	149
A2.2.4 Import-export	149
A2.3 Le réseau de production-distribution	149
A2.3.1 Le réseau.....	149
A2.3.2 Les technologies.....	150
A2.3.3 Les devis.....	150
A2.3.4 Les options.....	150
A2.3.5 Les produits	150
A2.3.6 Les patrons de coupe	151
A2.3.7 Les capacités d'inventaire.....	151
A2.3.7 L'approvisionnement	151
A2.3.8 Les coûts logistiques.....	152
A2.3.9 Les coûts pour les sites	152
A2.4 Les marchés.....	152
A2.4.1 Les marchés spots	152
A2.4.2 Les contrats	152
A2.4.3 La substitution	153

A2.5 L'échantillonnage 153

Liste des tableaux

Table 1 : Product-Markets with Possible Product Substitutions.....	31
Table 2 : Facility Layout Fixed Costs in Different Contexts.....	40
Table 3 : Facilities Expenses and Revenues in Local Currency.....	51
Table 4 : Computational Times (in seconds) for Extreme Problem Instances.....	53
Table 5 : Facilities Expenses and Revenues in Local Currency for a Given Environment.....	78
Table 6 : Virtu@l-Lumber Case Characteristics.....	82
Table 7 :Virtu@l-Lumber Case Instances.....	82
Table 8 : SAA Model Statistics for Different Sample Sizes.....	83
Table 9 : SAA Procedure Results for Instance #5.....	86
Table 10 : Designs Obtained for N=100 and M=5.....	87
Table 11 : Experiments and Results.....	110
Table 12 : Merger and sawmill network.....	112
Table 13 : Facilities expenses and revenues in local currency for a given environment.	128

Liste des figures

Figure 1: Quebec Lumber Industry Manufacturing Process Multigraph.....	33
Figure 2: Mapping the Manufacturing Process onto the Potential Network Nodes.....	35
Figure 3: Technology Dependent One-to-Many Recipes for a Production Activity.....	36
Figure 4 : Cutting Patterns Corresponding to Bucking and Sawing Recipes.....	36
Figure 5 : Behaviour of Product p Inventory in a Storage Activity on Site s.....	47
Figure 6: Forest Supply and Potential Facility Layouts for the Virtu@l-Lumber Case	52
Figure 7: Virtu@l-Lumber and results.....	54
Figure 8: Network Structure.....	63
Figure 9: Chronology of Events.....	63
Figure 10: Spot Market Price Step Function.....	65
Figure 11 : Computational Times (in seconds) for Instance #5.....	84
Figure 12 : Results for Instance #1	85
Figure 13 : Results for Instance #5.....	85
Figure 14 : Multigraph activities and stage decisions.....	98
Figure 15: Finished products and markets.....	99
Figure 16 : Supply chain and markets of the Virtu@l-Lumber case.....	104
Figure 17 : Average demand model.....	106
Figure 18 : SAA method.....	106
Figure 19 : Results from the average demand model vs the SAA method for the Spot vs Contract-VMI differential.....	106
Figure 20 : Average demand model.....	108
Figure 21 : SAA method.....	108
Figure 22: Results from the average demand model vs the SAA method for the Spot- VMI vs Contract differential.....	109
Figure 23: Sawmill network of the acquisition and merger scenario.....	113

Chapitre 1 : Introduction

De nos jours, les entreprises évoluent dans un environnement économique mondial où de nombreux accords de libre échange sont signés, et où les marchés internationaux apparaissent comme autant d'opportunités. Le développement des technologies de communication, des systèmes de production et de transport et la baisse continue des coûts associés, modifient en profondeur le milieu économique dans lequel l'entreprise doit s'adapter et se configurer.

Dès lors, les entreprises doivent acquérir un avantage concurrentiel durable pour assurer succès et pérennité. En particulier, l'optimisation des réseaux logistiques apparaît être une option possible pour développer un tel avantage (Martel 2001).

Qu'est ce qu'un réseau logistique ? Un des préalables à cette définition est le concept de « *réseau commercial et industriel* » ou chaîne logistique, dont la dénomination anglaise est « *supply chain* ». La *supply chain* consiste en la succession d'étapes transformant les matières premières jusqu'à livraison des produits aux clients finaux.

Par définition, le *réseau logistique* d'une entreprise constitue l'ensemble des *ressources* et des *processus* des cinq activités primaires déployées à travers la ou les chaînes logistiques où l'entreprise évolue. Les cinq activités dites primaires sont l'approvisionnement, la production, la distribution la vente et le service. Par extension, un réseau logistique complété de ses activités de soutien (acquisition, développement technologique, gestion des ressources humaines, infrastructure de la firme) constitue un *système logistique*.

En conséquence, la conception des réseaux logistiques est un enjeu majeur dans la course à la compétitivité que se livrent les entreprises manufacturières. Cette problématique de configuration de l'outil global de l'entreprise est l'objet de ce travail. L'objectif est de proposer des méthodologies et des outils de conception novateurs et performants pour le gestionnaire chargé de la planification stratégique. En particulier, les résultats des travaux

de nos recherches ont été appliqués à l'industrie du bois d'oeuvre et visent à répondre par des choix optimaux aux questions suivantes :

- Quelles forêts doivent être récoltées ?
- Quelles sont les quantités récoltées pour chacune des saisons ?
- Comment configurer l'ensemble du réseau de scieries ?
- L'implantation de nouvelles technologies est-elle économiquement justifiable ? Par exemple, la technologie MSR (*Machine Stress Rated*) est-elle plus rentable ?
- L'investissement ou le désinvestissement en capacités sont-ils efficaces ?
- Quelles sont les scieries qui doivent être fermées temporairement ? Durant quelles saisons ?
- Quelle est la mission de chaque scierie ? Quelle est la production saisonnière pour chacun des produits et pour chacune des scieries du réseau ?
- Le recours aux entrepôts de distribution est-il pertinent ? Si oui, lesquels ?
- Quels couples produit-marché doivent être ciblés ? En quelles quantités ?
- Quelles sont les offres de contrats en fonction de la concurrence et des préférences de marchés, qui méritent d'être déployées ?
- Certains contrats doivent-ils être signés ou au contraire les marchés spots doivent-ils être privilégiés ?
- Comment gérer optimalement le portefeuille client de l'entreprise ?
- Dans le contexte canadien, quelles sont les conséquences des politiques forestières sur l'organisation globale des compagnies ? Comment quantifier l'impact des possibilités de récoltes, de l'assouplissement des règles d'allocation de la fibre, des opportunités d'acquisition et de rationalisation ?

Les concepts et outils présentés ont, d'abord et avant tout, été formulés dans une perspective générique pour les industries « make-to-stock ». Une industrie « make-to-stock » est caractérisée par un environnement de production dont les produits sont transformés avant la réception même des commandes des clients. La demande est généralement satisfaite par les stocks existants qui reçoivent à leur tour la production. A contrario, l'environnement de production d'une industrie « make-to-order » est conditionné par la réception préalable des commandes des clients (Cox et Blackstone, 2001).

En conséquence, les différentes approches exposées dans la suite du document ne sont valables que pour les industries « make-to-stock ». L'industrie du bois d'œuvre s'avère un cas particulier de l'industrie « make-to-stock » : elle appartient à la sous-classe des procédés divergents, une catégorie qu'elle partage avec par exemple, les industries utilisant des matières premières d'origines animales.

Le domaine d'application des méthodologies génériques ainsi développées dans la thèse est l'industrie canadienne du bois d'œuvre. En effet, cette dernière qui génère vingt milles emplois directs parmi trois cents usines dans la seule province du Québec¹, est de tout premier plan. Toutefois, l'industrie du bois d'œuvre fait face à de nombreux défis tels que l'amélioration de la compétitivité manufacturière, la nécessaire consolidation face à une trop grande fragmentation des parts de marchés, les accords commerciaux avec les États-Unis et un environnement mondial où concurrence et taux de change sont à considérer. C'est tout naturellement au sein du Consortium de Recherche FOR@C dont l'objectif est d'offrir « aux entreprises de l'industrie des produits forestiers une expertise de recherche multidisciplinaire de calibre international en développant des concepts, des méthodologies et des outils de gestion misant sur le potentiel des technologies de l'Internet »² que les travaux de recherche de la thèse ont eu lieu.

Le présent document s'organise comme suit. Le second chapitre examine la littérature de la modélisation mathématique des réseaux logistiques. Le troisième chapitre présente le premier des trois articles de la thèse : celui-ci propose une méthodologie de conception des réseaux logistiques pour les industries dont les procédés sont divergents ainsi qu'une application à un cas réaliste virtuel de l'industrie du bois d'œuvre, Virtu@l-Lumber. Au quatrième chapitre, le deuxième article formule une approche de positionnement par anticipation permettant de considérer les forces du marché. Le cinquième chapitre présente le troisième article dont le modèle mathématique intégrateur combine les concepts des deux articles précédents. L'article quantifie l'impact potentiel de l'approche globale et analyse

¹ CIFQ site internet : www.cifq.qc.ca (Septembre 2005).

² FORAC site internet : www.forac.ulaval.ca (Septembre 2005).

les implications de plusieurs politiques forestières à l'aide du cas Virtu@l-Lumber. Enfin, une conclusion rappelle les différentes contributions de la thèse et propose des pistes de recherche future de natures quantitative et organisationnelle.

Chapitre 2 : La Revue de Littérature

Le présent chapitre, qui s'inspire de l'état de l'art proposé par Martel (2005), présente la revue de littérature de la conception des réseaux logistiques. Plus précisément, l'objectif est d'exposer les hypothèses sous-jacentes de la modélisation mathématique des réseaux logistiques. En effet, les choix du modélisateur structurent la formalisation mathématique et conditionnent naturellement les résultats dérivés.

Dans un premier temps, les hypothèses relatives à la dimension temporelle et informationnelle que le modélisateur peut retenir sont étudiées. Les différentes méthodes de représentation de la structure du réseau physique sont ensuite énumérées. Puis, le problème de localisation, la formulation des capacités et des technologies sont à leur tour exposées. Une fois l'outil de production défini en termes temporel, géographique et technologique, il est désormais possible d'introduire les différentes formalisations des procédés et des inventaires. Dès lors, les divers objectifs recherchés par le modélisateur sont énumérés. La relation entre réseau logistique et marché est analysée par une série de modèles conceptuels dont certains peuvent être directement appliqués. Une attention toute particulière est apportée à la représentation des marchés ainsi qu'à son implication. La dernière section présente les différentes méthodes de résolutions que le modélisateur peut utiliser afin d'obtenir des résultats.

2.1 Hypothèses temporelle et informationnelle

L'objectif général de la modélisation des réseaux logistiques est de proposer des décisions d'ordre stratégique qui selon Dogan et Goetschalckx (1999), ont un impact véritable sur l'entreprise au delà d'un an et plus. Par exemple, la localisation d'un entrepôt est une décision stratégique (Aikens, 1985).

Toutefois, l'objectif de l'exercice de formalisation est de proposer des décisions stratégiques qui s'enracinent dans la réalité de l'entreprise considérée. Dans cet esprit, il est naturel d'introduire des artefacts qui viennent renforcer cette reconstruction de la réalité. Par exemple, le modélisateur peut avoir recours à des décisions saisonnières afin de mieux représenter la

réalité pour une décision d'ordre stratégique. À cet effet, il est donc important de dissocier la notion de période et de saison.

La notion de période se rattache à des décisions d'ordre stratégique tandis que la notion de saison correspond aux décisions d'ordre tactique. Il existe des modèles mono-périodiques, dits statiques (Shulman, 1991) où l'ensemble des décisions affectent seulement la période concernée (Geoffrion et Graves, 1974; Brown *et al.*, 1987; Dogan et Goetschalckx, 1999; Philpott, 2001). Il existe néanmoins des problèmes multi-périodes, dit dynamiques, où les décisions stratégiques sont rattachées à une période spécifique (Shulman, 1991; Zubair et Mohamed, 2004). Dans ce type de problème, les décisions stratégiques influencent généralement les décisions des périodes ultérieures (Li et Tirupati, 1994; Rajagopalan et Soteriou, 1994).

La notion de saison est associée à des décisions tactiques (Arntzen *et al.*, 1995; Dogan et Goetschalckx, 1999). Celles-ci se veulent refléter une réalité simplifiée : le gestionnaire ne cherchera pas à implanter ces décisions dans la majorité des cas. Toutefois, le premier article de la thèse se propose de retenir certaines décisions tactiques qui ont une incidence et une valeur stratégiques fortes.

La seconde hypothèse structurant l'approche du modélisateur est la question informationnelle : le modèle développé est-il un modèle déterministe ou stochastique ? Un modèle déterministe évolue dans un seul et unique scénario, ou environnement (Glover *et al.*, 1979; Cohen et Lee, 1989; Cohen et Moon, 1991; Mazzola et Schantz, 1997; Körksalan et Süral, 1999; Cordeau *et al.*, 2002). Un modèle stochastique intègre simultanément plusieurs scénarios dont chacun a une probabilité non nulle (Pomper, 1976; Eppen *et al.*, 1989; Huchzermeier et Cohen, 1996; Santoso *et al.*, 2005). L'intérêt des modèles stochastiques des réseaux logistiques est de proposer des solutions qui considèrent un ensemble de scénarii possibles, contrairement aux modèles déterministes qui s'appuient sur un seul et unique scénario : les décisions d'ordre stratégique apparaissent plus adaptées aux futures éventualités.

Au final, le modélisateur formule ses différentes hypothèses selon ses objectifs de représentation et ses attentes en termes de résultats pratiques.

L'environnement de modélisation du premier article est supposé mono-période, saisonnier et déterministe. Le deuxième est mono-périodique, mono-saison et stochastique tandis que le troisième est mono-périodique, saisonnier et stochastique.

2.2 Structure du réseau

Une fois les hypothèses temporelle et informationnelle établies, le modélisateur doit représenter le réseau physique de l'entreprise. Celui-ci est formalisé comme un graphe orienté (Martel, 2005). Les sources d'approvisionnement, les usines, les centres de distribution appartenant à l'entreprise ou à des clients, sont représentés par des nœuds; les flux entre les infrastructures sont stylisés par des liens entre les nœuds (Poulin *et al.*, 1994).

Une fois représenté le graphe, le modélisateur doit s'interroger sur le degré de flexibilité de représentation de la structure du réseau : doit-il imposer une structure particulière *ex ante* ou laisser le modèle mathématique proposer une solution à part entière ? La première option, de nature autoritaire, consiste à obliger la forme spécifique du réseau. Ainsi, le modélisateur peut imposer un réseau à deux échelons qui oblige le transfert de produit d'une usine à un client via nécessairement un centre de distribution (Geoffrion et Graves, 1974). Dans le même esprit, trois échelons peuvent être à leur tour imposés (Fleischmann, 1993).

La seconde option, plus ouverte, autorise le modèle mathématique à choisir son propre schéma de réseau. En effet, la modélisation initiale permet d'envisager toutes les configurations de réseau qui devront être sélectionnés par la résolution (Paquet *et al.*, 2004; Martel, 2005). C'est cette dernière option qui a été adoptée pour la présente étude.

Dès lors, l'enjeu devient la représentation des flux qui se superpose à la structure de réseau déjà modélisée. De nouveau, le modélisateur fait face à trois options. Tout d'abord, les flux de produits peuvent être stylisés par des chaînes qui prédéterminent le chemin dans le graphe des sites, de la source d'approvisionnement au client (Geoffrion et Graves, 1974). La seconde option consiste à représenter uniquement les flux inter-sites et à s'assurer de l'équilibre des flux pour chacun des sites (Arntzen *et al.*, 1995; Cordeau *et al.*, 2002; Paquet *et al.*, 2004). Une troisième possibilité consiste à combiner la modélisation par les chaînes et la représentation par les flux. La représentation par les flux est appliquée aux trois articles de la thèse.

2.3 Nomenclature et technologies

La précédente section étudie la représentation du réseau physique et des flux de produit à travers l'ensemble du réseau. Il s'agit maintenant de représenter l'ensemble des diverses étapes que l'entreprise doit réaliser pour transformer les matières premières en produits finis afin de satisfaire la demande des clients. Cette représentation conceptuelle vient se superposer à celles du réseau physique et des flux.

Pour les industries de procédés, l'ensemble des différentes opérations d'une même entreprise peut être représenté par un graphe d'activités (Brown *et al.*, 1987; Dogan et Goetschalckx, 1999; Goetschalckx *et al.*, 2002). Lorsque la nomenclature est supposée discrète, la modélisation consiste à respecter simplement ses spécifications (Arntzen *et al.*, 1995; Paquet *et al.*, 2004). L'enjeu de la modélisation des procédés est la fiabilité avec laquelle les décisions stratégiques sont prises : une représentation adéquate doit être savamment dosée entre réalisme et simplicité d'un point de vue combinatoire.

Il serait incomplet de décrire les procédés par un graphe d'activités ou la nomenclature, sans définir le concept de technologie. Lorsque la nomenclature est supposée indépendante des technologies, une technologie se caractérise par l'ensemble des produits qui peuvent être transformés ou stockés par celles-ci. (Martel, 2005).

Cette définition permet de dissocier la classe des technologies dédiées des technologies flexibles. Les technologies dédiées ne peuvent que transformer un seul et unique produit tandis que les technologies flexibles concernent plusieurs produits (Li et Tirupati, 1994; Paquet *et al.*, 2004; Martel, 2005). La stylisation mathématique de la nomenclature est transcrite par l'ajout de contraintes stipulant la conservation de la matière tout au long des transformations successives.

Les premier et troisième articles de la thèse étudient les industries dont les procédés sont divergents. La principale contribution du premier article est la formalisation générique du procédé industriel représenté par un multi-graphe qui englobe l'ensemble des activités d'approvisionnement, de production et de distribution. La nomenclature est supposée dépendante des technologies : en conséquence, une technologie se voit attribuer un ensemble de recettes. La méthodologie ainsi développée est appliquée à l'industrie du bois d'œuvre.

2.4 Le problème de localisation-allocation

Une fois défini l'environnement global du problème de conception de réseaux logistiques, le modélisateur doit concentrer toute son attention sur la représentation des décisions de niveau stratégique, tout en capturant les interrelations avec les décisions d'ordre tactique. Dès lors, la problématique générale peut être décomposée en deux sous problèmes étudiés simultanément :

- Le problème de localisation, de planification de capacité et du choix de technologie.
- Le problème d'allocation de la production, de planification des inventaires saisonniers et de distributions à travers le réseau.

2.4.1 Localisation, capacité et technologie

La localisation des installations, le plan de capacité et le choix de technologie sont les décisions centrales de la problématique des réseaux logistiques. Ces choix vitaux pour l'entreprise doivent être formulés et décidés simultanément pour une meilleure efficacité économique (Verter et Dincer, 1992).

2.4.1.1 Localisation pure

La problématique de localisation des installations est délibérément présentée dans la perspective de la programmation mathématique. Toutefois, il est important de mentionner l'existence de méthodes et de critères qualitatifs pour aider le gestionnaire à localiser ses sites d'affaires (Martel, 2001; Paquet *et al.*, 2004).

La revue de littérature proposée par Owen et Daskin (1998), présente une série de problèmes de localisation pure :

- Le problème médian (« P-median problem »).
- Deux problèmes de recouvrements (« Covering problem »).
- Le problème du centre (« Center problem »).

Le problème médian, introduit par Hakimi (1964), propose de positionner les usines afin de minimiser la somme des distances entre les usines et les marchés pondérées par la demande associée à leurs marchés respectifs.

La première version du problème de recouvrement consiste à minimiser les coûts d'installation des infrastructures en s'assurant qu'il existe au moins une usine à distance minimale de chacun des marchés. Le réseau ainsi constitué « recouvre » l'ensemble des marchés avec un service minimum global. L'extension du problème précédent repose sur la sélection des demandes recouvertes afin de maximiser le volume de vente total.

Le problème du centre, aussi connu comme problème du *minimax*, est construit à partir des problèmes de recouvrement. Cependant, l'objectif est de minimiser la distance maximale entre un marché et sa plus proche usine.

Par ailleurs, Owen et Daskin (1998) proposent un ensemble de variantes des trois problèmes précédents avec diverses hypothèses temporelles et informationnelles exposées à la section 1 de ce chapitre.

Désormais, l'enjeu du modélisateur devient la sélection des capacités une fois que les installations sont localisées.

2.4.1.2 Choix de capacité et de technologie

Le problème d'acquisition de la capacité vise à décider de la localisation, de la taille et de la date de mise en service de la capacité afin de satisfaire l'ensemble des clients géographiquement dispersés. Ce problème recèle par nature une dimension dynamique (Shulman, 1991; Verter et Dincer, 1992; Li et Tirupati, 1994; Rajagopalan et Soteriou, 1994).

Il existe de nombreuses variantes du problème d'acquisition de la capacité. En effet, le problème peut concerner une ou plusieurs usines, et l'environnement informationnel peut être supposé stochastique (Eppen *et al.*, 1989; Verter et Dincer, 1992; Bashyam 1996). La détérioration de la capacité peut être elle aussi intégrée (Rajagopalan et Soteriou, 1994). Tirole (1988) étudie le choix de capacité en duopole et Bashyam (1996) envisage un environnement incertain.

De plus, l'existence d'économies d'échelle nécessite un compromis : le gestionnaire doit réfléchir aux coûts associés à l'acquisition de capacité et aux économies de production ainsi générées (Verter et Dincer, 1992; Paquet *et al.*, 2004). Enfin, l'existence d'économies

d'envergure en présence de plusieurs produits impose des arbitrages supplémentaires pour le gestionnaire (Mazzola et Schantz, 1997; Paquet *et al.*, 2004).

Lorsque la nomenclature est indépendante des technologies, le gestionnaire doit sélectionner l'ensemble des technologies flexibles et dédiées à installer tout en ajustant la capacité (Verter et Dincer, 1992; Li et Tirupati, 1994; Paquet *et al.*, 2004; Martel, 2005).

Une des contributions du premier article est de mettre en lumière l'importance du choix technologique dans la conception des réseaux logistiques. En effet, la technologie conditionne la nomenclature pour l'industrie des procédés divergents : la production des produits est dépendante du choix du gestionnaire contrairement à une nomenclature indépendante qui impose les produits à fabriquer. En conséquence, le gestionnaire concrétise sa stratégie globale par un choix technologique adéquat.

Martel (2005) propose une représentation générique des infrastructures par le concept de devis ou configuration d'aménagement (« layout »). Un devis décrit non seulement l'ensemble des capacités susceptibles d'être sélectionnées mais aussi les capacités déjà installées qui peuvent s'inscrire dans un aménagement particulier de l'infrastructure. L'avantage de la modélisation par devis permet d'étudier plusieurs configurations pour un même site mais aussi de prendre en considération l'état initial. Les premier et troisième articles appliquent les concepts précédents au cas de l'industrie du bois d'œuvre.

Au final, l'expansion de capacités et le choix de technologies sont deux problèmes interreliés qui s'inscrivent dans une perspective dynamique et multi-sites.

2.4.2 Production, stocks et distribution

Afin de gagner en réalisme, le modélisateur doit représenter les diverses activités de l'entreprise et les connecter aux décisions de localisation, de choix de capacité, de sélection de technologie et de configurations d'aménagement.

Dans cette optique, les décisions de production et de stockage sont associées à un produit, un lieu, une technologie et une saison. Les contraintes de capacité sont décrites par des bornes indiquant un volume maximal de production sous réserve des décisions d'implantation. Les activités de distribution sont traditionnellement décrites par les flux (ou chaîne) annotés par le

produit transporté, l'origine, la destination et la saison. Enfin, les équations de conservation de flux assurent la cohérence de l'ensemble du système ainsi modélisé.

En conséquence, les décisions tactiques associées à chacune des activités sont incluses dans la méthodologie globale des réseaux logistiques (Brown *et al.*, 1987; Arntzen *et al.*, 1995; Dogan et Goetschalckx, 1999; Zubair et Mohamed, 2004; Martel, 2005).

2.4.3 Une nécessaire intégration

L'intégration et la coordination des décisions d'ordre stratégique et tactique enrichissent la pertinence de la modélisation mathématique des réseaux logistiques (Goetschalckx *et al.*, 2002). Tout d'abord, les décisions stratégiques s'enracinent dans le réalisme du niveau tactique, ce qui les rend plus performantes. L'intégration des activités de production, distribution et d'inventaire au plan saisonnier simultanément aux décisions stratégiques crédibilise et fortifie l'analyse économique des investissements (Glover *et al.*, 1979; Brown *et al.*, 1987; Pirkul et Jayaraman, 1996; Dogan et Goetschalckx, 1999).

De plus, certaines décisions tactiques peuvent interférer avec les choix stratégiques. Dans un contexte international, les prix de transfert entre filiales d'une même entreprise influencent considérablement les profits globaux après impôts (Vidal et Goetschalckx, 2001). En incluant les prix de transferts, le gestionnaire enrichit sa panoplie d'outil et son analyse par un nouveau degré de liberté dans sa recherche de la gestion optimale.

Par ailleurs, l'étude de la conception des réseaux logistiques dans un contexte international implique l'intégration d'autres paramètres tels que les taux de change, les technicités douanières (droits de douanes et reversement éventuel), les taux d'inflation et la fiscalisation de chacune des filiales (Kogut et Kalatilaka, 1994; Arntzen *et al.*, 1995; Vidal et Goetschalckx, 2002; Bhutta *et al.*, 2003; Zubair et Mohamed, 2004). Il est à noter que la dimension internationale est souvent analysée dans un contexte informationnel stochastique (Pomper, 1976).

D'autres décisions peuvent être ajoutées à la palette du modélisateur telles que la sélection des fournisseurs (Cakravastia *et al.*, 2002), les décisions d'externalisation (Lakhal *et al.*, 2001), les

modes de transports (Arntzen *et al.*, 1995), les différentes sources d'investissements (Bhutta *et al.*, 2003; Zubair et Mohamed, 2004), le cycle de vie des produits (Fandel et Stammen, 2004).

Une des contributions du premier article est l'introduction de décisions tactiques d'ouverture ou de fermeture saisonnières pour chacune des activités et pour chacun des sites. L'analyse tactique de l'ensemble du réseau global se trouve donc enrichie par cette contribution.

Désormais, le réseau logistique est modélisé dans sa globalité, il reste à déterminer et à quantifier les divers objectifs qui peuvent guider le modélisateur.

2.5 Fonction économique

Traditionnellement, le modélisateur peut choisir parmi plusieurs objectifs :

- La minimisation des coûts.
- La maximisation des profits.
- Une approche multicritère.
- La gestion du risque.

2.5.1 La minimisation des coûts

La première option du modélisateur est la minimisation des coûts du réseau global (Hormozi et Khumawala, 1996; Körksalan et Süral, 1999; Mazzola et Neebe, 1999; Paquet *et al.*, 2004).

La philosophie associée à la minimisation des coûts consiste à rechercher l'efficacité de l'outil de production sans se soucier, ou très peu, des conditions du marché. Martel (2005) propose une liste complète des différents coûts associés à un site :

- Les coûts de transferts des intrants.
- Les coûts de matières premières.
- Les coûts de réception.
- Les coûts de production.
- Les coûts fixes des configurations d'aménagement.
- Les coûts fixes d'installations des options ou des capacités.
- Les coûts des stocks de sécurité et de cycle de commande.
- Les coûts des stocks saisonniers.
- Les coûts de manutention.
- Les coûts de transferts à destination des autres sites.

- Les coûts de transferts à destination des zones de demande.

De plus, Arntzen *et al.* (1995) proposent une fonction économique bicritère consistant à minimiser simultanément la pondération des coûts totaux et la somme des temps de production et transport.

2.5.2 La maximisation des profits

La seconde option du modélisateur consiste à maximiser les profits après impôts du réseau global (Huchzermeier et Cohen, 1996; Vidal et Goetschalckx, 2001; Bhutta *et al.*, 2003; Martel, 2005). Un des avantages de la maximisation des profits est la prise en compte de l'environnement économique global de l'entreprise tel que les taux de change, les droits douaniers et la fiscalité). Martel (2005) dissocie deux sources de revenus pour un même site :

- Les revenus issus des flux à destination d'autres sites.
- Les revenus issus des flux à destination des zones de marchés.

La formalisation des résultats économiques par site se justifie par la nécessité d'élaborer les états financiers par pays pour appliquer un éventuel impôt.

Enfin, les trois articles présentés ultérieurement ont pour objectif commun la maximisation des profits. Le premier article adopte la maximisation après impôts telle que formulée par Martel (2005) et les second et troisième la maximisation avant impôts.

2.5.3 Une approche multicritère

Une option qui est moins utilisée que les deux précédentes est l'approche multicritère (Lee *et al.*, 1981; Tyagi et Das, 1997). Celle-ci consiste à étudier simultanément plusieurs critères. Par exemple, Tyagi et Das (1997) étudient les coûts globaux, le délai maximum de livraison et la satisfaction totale pondérée par la demande de l'ensemble des marchés. La difficulté de cette approche réside dans les méthodes de résolution. Toutefois, les techniques de « goal programming » peuvent être utilisées (Lee *et al.*, 1981).

2.5.4 La gestion du risque

La maximisation des profits espérés dans un environnement stochastique ne suffit pas à quantifier, à elle seule, le risque sous-jacent. Il est possible d'utiliser les techniques de la théorie des portefeuilles qui maximise une mesure combinant l'espérance et la variance (Hodder et Juker, 1985; Hodder et Dincer, 1986).

Toutefois, les techniques de gestion de portefeuille proposées par Markowitz (1959) qui reposent sur l'utilisation d'une fonction d'utilité, sont difficiles à mettre en œuvre dans le cadre de la modélisation du réseau logistique : le recours au « downside risk » est alors préféré (Eppen *et al.*, 1989; Huchzermeier et Cohen, 1996).

Le « downside risk » $f_{\tilde{z}}(\pi)$ pour un profit cible de \tilde{z} et d'un profit réalisé π correspond à l'éventuelle perte d'argent par rapport à un objectif prédéfini et se formalise de la manière suivante par :

$$f_{\tilde{z}}(\pi) = \begin{cases} \tilde{z} - \pi & \text{pour } \tilde{z} \geq \pi \\ 0 & \text{pour } \tilde{z} < \pi \end{cases}$$

Eppen *et al.* (1989) proposent de rajouter une contrainte stipulant que l'espérance du « downside risk » soit inférieure à une valeur déterminée par les gestionnaires. Il s'agit donc de faire un arbitrage entre les gains espérés et l'exposition au risque par rapport à un profit cible.

Enfin, l'analyse de risque a permis de démontrer un avantage indéniable de l'agilité stratégique des réseaux logistiques. En effet, l'agilité avec laquelle un réseau international peut se configurer, permet de se protéger financièrement et tirer parti des aléas des taux de change (Huchzermeier et Cohen, 1996).

2.6 Modélisation et marché

À ce jour, la relation entre réseaux logistiques et marchés a été quasi-évacuée afin de se concentrer sur la représentation intrinsèque de l'outil de production de l'entreprise. Cette section présente les motivations en faveur de l'intégration des marchés dans la modélisation des réseaux ainsi que deux environnements concurrentiels, et enfin une représentation micro-économique des préférences des clients.

2.6.1 Intégration du marché

La concurrence effrénée que se livrent les entreprises sur les marchés, oblige ces dernières à être à l'écoute des attentes des clients sous peine de disparaître. Cette approche orientée client structure profondément les organisations et le réseau logistique de l'entreprise n'échappe pas à cette orientation.

En conséquence, l'outil de production doit rentrer en résonance avec le marché sous peine d'être déconnecté et de dépérir. La synchronisation et l'intégration des opérations et plus globalement de la fonction logistique avec le marketing est devenue une absolue nécessité (Innis *et al.*, 1994; Karmarkar, 1996; Dumolard *et al.*, 2000). Désormais, la logistique apparaît comme un élément clef de la chaîne de valeur pour conquérir un avantage concurrentiel (Porter, 1995) et non plus comme une simple fonction de coût.

En particulier, le réseau logistique doit considérer le marché dans son ensemble et ne plus se contenter de minimiser son coût total : le réseau logistique matérialise désormais la stratégie marketing de l'entreprise. Shapiro (2001) suggère que la modélisation mathématique doit désormais inclure cette orientation.

La première étape naturelle de ce processus organisationnel est la compréhension des marchés. Tout d'abord, la définition des produits finaux doit refléter la segmentation du marché et de ses subtilités. Une des contributions importantes du second article est la représentation générique de trois types de relations commerciales que sont les marchés spots, les relations contractuelles et les relations de type VMI (*Vendor Managed Inventory*).

La modélisation des contrats a fait l'objet de nombreux travaux. Tsay *et al.* (1999) proposent une revue de littérature au sujet de leur représentation et de leur différents attributs (Quantité, Prix, Délais de livraison, Qualité...). Plus conceptuelle encore, la théorie des contrats (Salanié, 1994), s'intéresse au problème d'incitation et à l'établissement de contrat entre un principal et un agent. Ces travaux méritent d'être incorporés dans la conception des réseaux de production et de distribution.

Enfin, les trois articles proposent une modélisation fine qui intègre le phénomène de substitution de produit qui jusque-là a été éludé dans la littérature.

La problématique centrale demeure toutefois la suivante : Comment configurer le réseau logistique optimalement afin de satisfaire simultanément le marché et les intérêts propres de l'entreprise ?

Rosenfield *et al.* (1985) répondent théoriquement à cette question par le concept de courbe efficiente d'un réseau logistique constituée des configurations non dominées en fonction du doublet défini par le temps de livraison et les coûts. Ils introduisent la notion de positionnement du réseau logistique en fonction des préférences des clients dans l'objectif de maximiser les profits. Cette réponse quoique conceptuelle, permet de comprendre le dilemme sous jacent et le compromis que le gestionnaire doit arbitrer.

D'autre part, la notion de configuration est intimement liée à la stratégie manufacturière de l'entreprise. Selon Hill (1994), une stratégie manufacturière se caractérise par un ensemble de critères de qualifications et de critères gagnants. Les critères qualificatifs sont les conditions nécessaires exigées par le client, ils s'apparentent aux spécifications d'un contrat. Les critères gagnants sont les critères pour lesquels l'entreprise soumet des offres pour remporter le marché, ceux-ci sont donc négociables et soumis à un quasi processus d'enchère. Les critères en questions peuvent être les prix, les délais de livraison, la qualité, la flexibilité, la réputation, etc. La distinction entre qualificatif et gagnant est sujette aux préférences des clients.

Une des contributions du second article est la matérialisation du concept de stratégie manufacturière au sens de Hill (1994) dans la représentation mathématique des réseaux logistiques. En effet, les critères sont reflétés dans la formulation par la définition d'un ensemble de sites admissibles, par une fonction économique ad hoc et par l'expression des préférences des clients. Ces informations enrichissent considérablement la modélisation traditionnelle des réseaux logistiques qui ignoraient, jusque-là, cette perspective. Dès lors, la proposition d'un modèle intégrant la stratégie manufacturière, le réseau logistique et le marché est désormais possible. Les deuxième et troisième articles proposent de tels modèles.

La suite de cette section se propose d'étudier des modèles tant conceptuels que pratiques selon divers environnements concurrentiels.

2.6.2 Modèles monopolistiques

Les modèles monopolistiques considèrent une entreprise et les conséquences de ses choix lorsqu'elle est supposée seule sur son marché (Ghosh et Harche, 1993). L'objectif de la modélisation est de capturer la relation dyadique entre l'entreprise et le marché. Une série de travaux conceptuels et empiriques est exposée en vue de styliser et quantifier les différentes expressions de cette interdépendance.

Hakimi et Kuo (1991) proposent un modèle global de maximisation des profits où la demande est dépendante des prix. Cette simple hypothèse implique le recours à des techniques sophistiquées de résolution pour l'obtention de résultats concrets. De plus, Logendran et Terell (1991) ont étudié cette relation dans un environnement incertain. Toutefois, la fixation des prix peut être conditionnée par les quantités vendues (Erlenkotter, 1977).

Il serait incomplet de s'intéresser simplement à la relation prix-demande sans introduire le rôle des délais de livraison. En effet, la demande peut être dépendante du prix et du délai de livraison (Palaka *et al.*, 1998; So et Song, 1998; Boyaci et Ray, 2003). La formulation conceptuelle de cette relation conditionne les décisions d'expansion de capacité (So et Song, 1998) et la stratégie de différenciation entre produits (Palaka *et al.*, 1998).

Ray et Jewkes (2004) enrichissent cette interdépendance en formulant une relation conjointe du prix et de la demande avec les délais de livraison. Les conclusions théoriques obtenues stipulent que la connaissance des préférences des clients est un préalable à l'élaboration de la stratégie marketing.

Shapiro (2001) plaide pour l'intégration de la stratégie marketing dans la modélisation mathématique des réseaux logistiques. Par exemple, l'outil de production doit être en mesure de satisfaire la hausse de demande suite à une campagne promotionnelle. En particulier, la prise en compte indirecte des préférences des clients pour un service donné conditionne la localisation des sites de distribution (Ho et Perl, 1995).

Le premier article dont la demande est supposée exogène, appartient à la classe des modèles monopolistiques.

2.6.3 Modèles concurrentiels

Il existe deux classes de modèles concurrentiels : les modèles à concurrence passive ou active (Ghosh et Harche, 1993). Les modèles à concurrence passive supposent que toutes les stratégies des compétiteurs sont connues par avance et aucune action n'est déployée face à la menace de nouveaux entrants. Les modèles à concurrence active intègrent l'interdépendance de tous les joueurs présents et potentiels. Ils s'inspirent principalement de la théorie des jeux et de l'organisation industrielle.

Goodchild (1984) propose un modèle de concurrence passive qui consiste à localiser les magasins d'un détaillant afin de maximiser les parts de marchés supposant la localisation des magasins concurrents connue et fixe.

Les deuxième et troisième articles présentés dans la thèse appartiennent à la catégorie des modèles dont la concurrence est passive. En effet, les deux modèles mathématiques considèrent que la concurrence est statique. Toutefois, les deux articles proposent une démarche originale de positionnement par anticipation: le réseau logistique est considéré comme un système qui sélectionne la meilleure configuration face à un ensemble d'éventuelles opportunités (Schneeweiss, 2003). Les deux articles proposent tous deux une méthodologie pro-active de configuration afin de se positionner pour les marchés qui sont les plus vraisemblables et les plus profitables. Le réseau logistique obtenu par anticipation matérialise le portefeuille idéal des clients *ex ante*.

Un modèle dont la concurrence est active, est le modèle à équilibre spatial présenté par Shapiro (2001). Chacun des compétiteurs maximise son revenu pour un vecteur de prix décrivant différents marchés géographiquement dispersés. La demande de chacun des marchés dépend uniquement du prix local du marché. Un équilibre associé à un vecteur de prix est obtenu lorsque la quantité dans chaque marché est égale à la somme des quantités proposées par l'ensemble des compétiteurs. L'action de chaque compétiteur a un effet sur l'industrie toute entière. La demande peut dépendre des prix, de la qualité mais aussi du temps de livraison (Li et Lee, 1994; Lederer et Li, 1997).

Rhim *et al.* (2003) proposent un jeu non coopératif séquentiel à trois étapes. Les trois grandes décisions sont chronologiquement la localisation, la capacité et enfin la production et le

transport à destination des marchés. Un équilibre de Nash est alors calculé avec une concurrence à la Cournot et des considérations stratégiques sont formulées. Les interactions entre compétiteurs sont modélisées : les décideurs anticipent la réaction des concurrents à leurs propres réactions pour aboutir à un éventuel équilibre de Nash.

Enfin, la prise de décision peut être formulée dans un environnement incertain (Bashyam, 1996). Ainsi, les compétiteurs doivent investir simultanément ou l'un après l'autre, dans le dimensionnement de la capacité ignorant la quantité totale à satisfaire pour la période considérée.

2.6.4 Les choix discrets

Les sections précédentes ont plaidé pour l'intégration du marché dans la formalisation mathématique des réseaux logistiques afin de mieux capturer les interrelations du marché avec l'entreprise. Mais quels sont les outils de modélisation des clients qui sont à disposition ?

La technique la plus naturelle est de déterminer une relation de nature économétrique entre une variable dépendante et des variables indépendantes. Par exemple, il s'agit de quantifier l'impact des délais de livraison et des prix sur la demande globale (Boyaci et Ray, 2003). L'enjeu devient l'estimation des paramètres de façon satisfaisante.

La seconde option est la théorie des files d'attentes (Palaka *et al.*, 1998). Toutefois, un obstacle à leur utilisation semble être leur intégration problématique aux modèles de conceptions réseaux logistiques et aux méthodes de résolutions.

Enfin, les choix discrets (Ben-Akiva et Lerman, 1985), qui permettent de capturer les préférences des clients à travers la probabilité de choix, semblent une voie prometteuse de modélisation. Louvière *et al.* (2000) proposent une méthodologie d'opérationnalisation des choix discrets par des questionnaires avec des choix pré-définis.

Dès lors, le gestionnaire peut prendre des décisions qui sont non seulement conformes aux goûts et attentes des clients mais qui maximisent également les profits de l'entreprise (Verma et Thompson, 1999; Talluri et Van Ryzin, 2004).

Les deuxième et troisième articles utilisent la technique des choix discrets afin de représenter les préférences des clients. Celles-ci sont reflétées par la probabilité de choix pour une offre qui est décrite par ses critères de qualifications et gagnants, et par l'entreprise qui propose l'offre. La concurrence est intégrée à travers les préférences des clients : les modèles appartiennent tous deux à une approche à concurrence passive.

2.7 Méthodes de résolution

Cette brève section se propose d'énumérer les techniques de résolution appliquées aux modèles mathématiques en nombre entier qui formalisent, dans la majorité des cas, la conception des réseaux logistiques. Les méthodes sont présentées dans un ordre allant des méthodes les plus simples aux techniques les plus complexes en terme théorique et/ou de déploiement informatique.

En premier lieu, la méthode du « *branch-and-bound* » est la méthode la plus naturelle pour un problème MIP (*Mixed Integer Programming*). Celle-ci sert de fondation théorique à la majorité des logiciels commerciaux d'optimisation. Cette méthode peut être « soulagée » en rajoutant des contraintes supplémentaires au problème initial afin de restreindre astucieusement l'espace des solutions. Ces contraintes ou coupes, doivent être redondantes, afin d'obtenir des solutions identiques aux solutions initiales, et accélératrices, afin de diminuer le temps de résolution.

La décomposition de Bender se propose d'analyser le problème initial par la résolution itérative de problèmes sous jacents (un problème maître et un ensemble de sous-problèmes). Les interrelations entre les problèmes dérivés s'effectuent par l'ajout de coupes dans le problème maître, construites à partir de variables duales des sous-problèmes (Geoffrion et Grave, 1974; Cohen et Moon, 1991; Dogan et Goetschalckx, 1999; Paquet *et al.*, 2004). Une variante est la méthode de décomposition avec « *goal constraint* » qui se distingue de la première par l'instauration de pénalité associée à la violation de contrainte du problème maître (Brown *et al.*, 1987).

Toutefois, l'utilisation des méthodes de décomposition est de plus en plus remise en question par la performance en constante amélioration des logiciels commerciaux d'optimisation conjuguée à l'amélioration concomittante des performances informatiques (Dogan et Goetschalckx, 1999; Paquet *et al.*, 2004).

La troisième option tout aussi populaire que les deux premières est la relaxation lagrangienne (Shulman, 1991; Pirkul et Jayraman, 1996; Mazzola et Neebe, 1999). Cette méthode consiste à introduire dans la fonction économique du problème initial un ensemble de contraintes particulières chacune multipliée par un multiplicateur de Lagrange. Les contraintes sélectionnées permettent une séparation du problème transformé en sous problèmes dont la résolution peut être moins complexe. Toutefois, la principale difficulté de la méthode est la détermination de la valeur de chacun des multiplicateurs : des variantes de la technique du sous-gradient combinée à des heuristiques sont ainsi appliquées (Shulman, 1991; Mazzola et Neebe, 1999).

Les techniques heuristiques sont utilisées en dernier recours lorsque les approches précédentes se sont avérées vaines. Les trois grandes approches sont le recuit simulé, la recherche tabou (Mazzola et Schantz, 1997) et les algorithmes génétiques.

Il est à noter que l'ensemble des approches évoquées ci-dessus peuvent être combinées pour obtenir des résultats satisfaisant face à des problèmes complexes. Par exemple, Li et Tirupati (1994) adoptent une approche hiérarchique de décomposition jumelée avec des heuristiques pour résoudre les problèmes dérivés.

Enfin, des techniques spécifiques peuvent être déployées pour des problèmes particuliers : la linéarisation successive (Fleischman, 1993; Martel et Vankatadri, 1999; Vidal et Goetschalckx, 2001), des contraintes dites élastiques dont la violation implique une pénalité dans la fonction économique (Arntzen *et al.*, 1995).

Bien que la performance des logiciels ne cesse d'augmenter, la résolution de certains problèmes demeure problématique. Parfois, il est possible d'approximer un problème complexe en un problème simple qui peut être résolu. Dès lors, l'enjeu des techniques d'approximation est de générer des problèmes suffisamment simplifiés dont les solutions optimales sont des solutions de bonne qualité pour le problème initial. La méthode de « Sample Average Approximation » proposée par Santoso *et al.* (2005) permet d'approximer le problème initial grâce à un échantillonnage de Monte-Carlo pour des problèmes stochastiques à deux étapes. De

plus, une procédure d'analyse de la convergence sélectionne la meilleure des solutions obtenues et en évalue la qualité pour le problème initial.

La méthode de résolution du premier article est la méthode du branch-and-bound. Le deuxième article propose un modèle de programmation stochastique à deux étapes dont le nombre de scénario initial est très grand. La méthode de « Sample Average Approximation » est appliquée pour générer des problèmes approximatifs qui sont ensuite résolus par la méthode du branch-and-bound. Cette même méthode est aussi appliquée au modèle mathématique formulé dans le troisième article.

2.8 Modèles de l'industrie forestière

Cette sous-section expose les différents travaux appliqués à l'industrie forestière.

Rönnqvist (2003) présente une revue de littérature des modèles stratégiques, tactiques et opérationnels pour l'industrie forestière. Au niveau stratégique, Carlsson et Rönnqvist (2005) proposent un modèle étudiant simultanément la localisation du réseau de distribution et l'élaboration d'itinéraires pour une compagnie suédoise du secteur des pâtes. Martel *et al.* (2005) s'intéressent à l'impact des facteurs internationaux dans la conception des réseaux logistiques internationaux pour les compagnies canadiennes du secteur des pâtes et papiers.

Au niveau tactique, Maness et Norton (2002) et Liden et Rönnqvist (2000) proposent des modèles de programmation linéaire qui combinent l'ensemble des activités de production pour l'industrie du bois d'oeuvre. Le problème de la planification de la production pour l'industrie de la deuxième transformation a été étudié par Carino et Lenoir (1988). Ces derniers proposent un modèle d'approvisionnement en bois pour une usine de meuble. De plus, Carino et Willis (2001a et 2001b) et Farell et Maness (2005) présentent aussi des modèles de planification de la production destinés à la seconde transformation. Au niveau opérationnel, Rönnqvist (1995) propose une méthode d'allocation du bois en temps réel pour optimiser le tronçonnage tout en considérant la qualité des billes. Enfin, Rönnqvist et Astrand (1998) intègrent la détection des défauts des billes dans l'approche précédente.

2.9 Conclusion

Le présent chapitre a proposé un cadre méthodologique de la modélisation mathématique des réseaux logistiques. L'ensemble des hypothèses et leurs diverses représentations a été formulé. De plus, des modèles appliqués à l'industrie forestière ont été mentionnés. Les trois prochains chapitres présentent des développements originaux du cadre méthodologique précédemment exposé avec des applications à l'industrie du bois d'œuvre.

Chapitre 3 : Réseaux Logistiques et Procédés Divergents

Le présent chapitre expose l'article « Designing Logistics Networks in Divergent Process Industries: A Methodology and its Application to the Lumber Industry » accepté en mars 2005 pour publication dans International Journal of Production Economics.

3.1 Résumé

L'article présente une méthodologie générique de conception des réseaux de production et de distribution pour les entreprises évoluant dans un contexte international et dont les procédés sont divergents. Un modèle d'optimisation est proposé en vue de projeter la représentation conceptuelle des procédés de production-distribution sur le réseau physique des infrastructures et choix de capacités potentielles. Les procédés sont représentés par un multigraphe des activités de production et de distribution. L'introduction du concept de recette associée à chacune des activités de production permet de capturer la nature divergente des procédés. Une infrastructure est stylisée par un ensemble de scénarios d'aménagement et la capacité par un ensemble d'options technologiques. Les décisions d'ouvertures et de fermetures saisonnières sont considérées ainsi que le phénomène de substitution. L'objectif du modèle est la maximisation des profits après impôts dans une monnaie déterminée. La méthodologie est appliquée à un cas d'entreprise réaliste de l'industrie du bois d'œuvre. Enfin, un guide d'utilisation de la méthodologie est suggéré et des résultats numériques sont présentés.

3.2 Designing Logistics Networks in Divergent Process Industries: A Methodology and its Application to the Lumber Industry

Didier Vila^{1,2}, Alain Martel¹ and Robert Beauregard

⁽¹⁾ Université Laval, FOR@C Research Consortium, Network Organization Technology Research Center (CENTOR), Sainte-Foy, Québec, G1K7P4, Canada.

⁽²⁾ École Nationale Supérieure des Mines de Saint-Étienne, Centre G2I, 158 cours Fauriel, 42023 Saint-Étienne cedex 2, France.

Abstract. This paper presents a generic methodology to design the production-distribution network of divergent process industry companies in a multinational context. The methodology uses a mathematical programming model to map the industry manufacturing process onto potential production-distribution facility locations and capacity options. The industrial process is defined by a directed multigraph of production and storage activities. The divergent nature of the process is modeled by associating one-to-many recipes to each of its production activities. Each facility may use different layouts and the plants capacity is specified by selecting appropriate technological options. Seasonal shutdowns of these capacities are possible and finished product substitutions are taken into account. The objective is to maximize global after tax profit in a predetermined currency. The methodology is illustrated by applying it to the case of the softwood lumber industry. Guidelines for the use of the methodology are provided. The resolution of the mathematical model with commercial optimization software is also discussed.

Key words. Supply Chain Engineering, Mathematical Programming, Production-distribution Network, Divergent Process Modeling, Product Substitution.

Acknowledgements. This project would not have been possible without the financial support and the collaboration of FOR@C's partners, especially of Pierre Goulet of Forintek Canada and of NSERC.

3.2.1 Introduction

Supply chains are networks of logistic and manufacturing activities starting with raw material sourcing and ending with the distribution of finished goods to markets. The performance of a supply chain for a given product-market critically depends on the structure of its production-distribution network, i.e. the number, location, mission, technology and capacity of the facilities of the firms involved. The exact nature of the logistics network design problems encountered in practice depends very much on the industrial context in which they occur. The design problem to solve for a high volume make-to-stock manufacturer is very different from the problem found in a highly customized make-to-order products industry or in a slow moving repair parts distribution context. When manufacturing resource acquisition, deployment and/or allocation decisions are considered, the nature of the manufacturing process must also be taken into account. In some industries, manufacturing processes are divergent: several products being made from a common raw material (e.g. lumber industry, meat industry, etc.). In other sectors the manufacturing processes are convergent: several raw-materials and components are assembled into finished products. Networks covering several countries lead to much more complex design problems than single-country networks. Factors such as exchange rates, duties and income taxes must then be taken into account. This paper presents a generic methodology to design international production-distribution networks for make-to-stock products with divergent manufacturing processes.

In industries such as the lumber or the meat industry, the raw material used (stems or carcasses) is obtained from nature and its exact properties are not known before the trees are cut or the animals are slaughtered. These natural raw materials can then be cut or separated in various ways to get several finished products and by-products. The present paper studies the design of the production-distribution network of this type of divergent process industries. This critical strategic planning decision may have a significant impact on company competitiveness. Since, from one industrial context to another, the nature of manufacturing processes can be very different, it was necessary to develop a generic methodology which could be applied in any context. In order to do this, a formalism is proposed and it is illustrated with an example from the lumber industry. This formalism associates production and storage activities to the nodes of a directed multigraph.

Natural resource industries such as those considered here are often affected by economic fluctuations and by international trade disputes, and the supply of the raw material they transform is often heavily regulated. For these reasons, drastic network capacity expansions, other than by the acquisition of a competitor, are rare and companies tend rather to adapt to market fluctuations either by closing facilities temporarily, by reorganizing the layout of their production facilities, by modernizing their production technology or by relocating their distribution centers. Also, due to the nature of the products involved, it is often possible in these industries to upgrade the products demanded by customers. All these aspects of the problem are explicitly taken into account by the proposed mathematical programming model.

An abundant literature exists on location, capacity acquisition and technology selection problems. A review of the early work done in these fields is found in Verter and Dincer (1992). The first location-allocation model proposed (Geoffrion and Graves, 1974) was a single echelon single period model to determine the distribution centers to use, as well as the assignment of products and clients to these centers, in order to minimise the total cost of the system in a domestic context. Several extensions to this model were then made to take into account multiple echelons (Cohen and Lee, 1989; Pirkul and Jayaraman, 1996; Martel and Vankatadri, 1999; Vidal and Goetschalckx, 2001; Martel, 2005), multiple production seasons (Cohen *et al.*, 1989; Arntzen *et al.*, 1995; Dogan and Goetschalckx, 1999; Martel, 2005), capacity acquisition and technology selection (Eppen *et al.*, 1989; Verter and Dincer, 1995; Mazzola and Neebe, 1999; Paquet *et al.*, 2004; Martel, 2005), economies of scale (Cohen and Moon, 1990, 1991; Mazzola and Schantz, 1997; Martel and Vankatadri, 1999; Martel, 2005), after tax net revenue maximization in an international context (Cohen *et al.*, 1989; Arntzen *et al.*, 1995; Vidal and Goetschalckx, 2001; Martel, 2005) and product development and recycling (Fandel and Stammen, 2004). Geoffrion and Powers (1995) and Shapiro *et al.* (1993) discuss the evolution of strategic supply chain design models and Vidal and Goetschalckx (1997) present many of these models. Shapiro (2001) provides an excellent coverage of several supply chain modeling issues. The models proposed by Arntzen *et al.* (1995), Fandel and Stammen, (2004) and Martel (2005) are among the most complete presented to date. Commercial software products based on some of these models are also available on the market.

Some authors proposed models for specific assembly process industries (Brown *et al.*, 1987; Dogan and Goetschalckx, 1999; Philpott and Everett, 2001) and others used activity graphs to represent supply chains (Lakhal *et al.*, 1999, 2001) but, to our knowledge, the approach presented here is the first generic methodology proposed to design production-distribution networks for divergent process industries. The proposed modeling approach is an adaptation and an extension of the production-distribution network design optimization framework proposed by Martel (2005), for international make-to-stock assembly industries, to the case of international make-to-stock divergent manufacturing process industries. The paper also presents a realistic lumber industry case (Virtu@l-Lumber), conceived in partnership with three large lumber companies of Canada (Domtar, Kruger and Tembec), two Canadian forest industry research centers (FOR@C and Forintek) and Quebec Ministry of Natural Resources, to demonstrate the feasibility and the usefulness of the approach.

The paper is organised as follows. Section 3.2.2 presents the proposed production-distribution network design approach. Section 3.3.3 develops the mathematical programming model which is the corner stone of the approach. Section 3.3.4 discusses the solution of the model and section 3.3.5 provides guidelines for the use of the methodology in various process industry contexts.

3.2.2 Production-distribution Network Design Approach

In order to address the type of production-distribution design problem considered in this paper, it is necessary to obtain detailed information on the products, markets, manufacturing processes and logistic resources of the company or companies involved and to use powerful decision support tools. The proposed approach involves five steps:

1. The definition of the product-markets, sourcing context and planning horizon;
2. The definition of product families and the elaboration of the manufacturing-storage activities process graph;
3. The definition of potential network resources (facilities location, layouts, technologies and capacity options) and of technology dependent recipes for production activities;

4. The definition of the revenues and costs associated to the network design and activity decisions;
5. The optimal mapping of the process graph onto the potential network resources.

In the following sections, the facets of the supply chain design problem associated to each of these steps are discussed and illustrated with the case of the lumber industry in the province of Quebec in Canada.

3.2.2.1 Products-markets, sourcing and planning horizon

The appropriate characterization of the product-markets of the company considered is an important design task. This characterization depends on the type of products sold to different market segments and on the geographical dispersion of customer ship-to-locations. It is assumed that the company operates national divisions in several countries $o \in O$, and that each of these divisions is constituted of several demand zones $d \in D_o$. A given demand zone is characterized by a geographical region and a market segment, the latter being defined by a product category, and particular price and service policies. Each product category includes several finished products which can be classified into a set FP of product families to keep the size of the problem manageable. It is assumed that the largest demand the company can expect for product family $p \in FP$ in demand zone $d \in D_o$ can be forecasted, and that the company has minimum market penetration objectives for each of its product-markets.

In the lumber industry, three main market segments are usually distinguished: the spot market, large retailers and industrial customers. The products sold to the industrial customers (Machine Stressed Rated - MSR lumber) are of higher quality and value than those sold to retailers (Premium lumber) and these are also of higher value than those sold to the spot market (Dimension Lumber). For this reason, the manufacturer can use higher quality products to satisfy the demand for lower quality products when a sale is made. For example, a manufacturer could sell Premium lumber on the spot market simply by declaring it as Dimension Lumber. The substitution possibilities for the Quebec producer's case are illustrated in Table 1. As can be seen in this table, each segment includes several finished product families based on the lumber dimensions: sections of 2x6, 2x4 or 2x3 inches and 8 foot length or

random length (RL), which means longer than 8 foot and up to 16 feet. Note also that there are by-product markets for chips, short lumber and planks (one inch thick lumber).

Products	Markets									
	Spot markets			Contracts						Pulp & Paper mills
				Retailers			Industrial customers			
<i>Dimension</i>	2x6	2x4	2x3	2x6	2x4	2x3	2x6	2x4	2x3	
Dimension Lumber & Stud	8 RL	8 RL	8 RL							
Premium	8,RL	8,RL	8,RL	8,RL	8,RL	8,RL				
MSR	8,RL	8,RL	8,RL				8,RL	8,RL	8,RL	
Plank										Planks
Short										Shorts
Chip										Chips

8: eight feet long lumber;
RL: Random length lumber.

Table 1 : Product-Markets with Possible Product Substitutions

As indicated in the introduction, dramatic network capacity expansions are rare in natural resource based industries because the availability of the natural resource is usually heavily regulated. In the province of Quebec, for example, the government manages 90 % of the forest area and allocates it to lumber companies every 5 years. Sawmills are tied by Forest Management and Supply Contracts defining annual allowable cut. In fact, these contracts do not only specify upper bounds on the supply of raw material from a given source, but they also force companies to use a large proportion of the trees available. The problem is further complicated by the fact that the properties of the trees available are not known exactly before they are cut so that sawmills, at best, know only the proportions of stems or logs of various types they can expect to get from a given forest area. Producers therefore have little control over their supply of raw material.

For the Quebec lumber industry, since most of the available forest area is already allocated, major expansion plans can be considered only if a competitor abandons its CAAF, which is uncommon. As indicated, our approach is not intended for such decisions but rather to permit companies to adapt to market fluctuations either by closing facilities temporarily, by reorganizing the layout of their production facilities, by modernizing their production technology or by modifying the location of their distribution centers. In such a context, using a planning horizon of a year or two is appropriate. To take seasonal demand into account properly, however, the planning horizon is divided into seasons and decisions on how much of

a product needs to be made and stocked at the different sites must be seasonal. Seasonal inventories can also be kept to smooth production.

The following notation is used to define the business environment of the company:

FP = Set of product families sold on the market ($p \in FP$).

SP^p = Set of substitutes for product family $p \in FP$ ($SP^p \subset FP$).

SP_p = Set of product which can be substituted by product family $p \in FP$ ($SP_p \subset FP$).

D = Set of demand zones serviced by the company ($d \in D$).

D_p = Set of demand zones requiring product family $p \in FP$ ($D_p \subset D$).

x_{pdt}^{\max} = Largest expected demand for product $p \in FP$ in zone $d \in D_p$ during season $t \in T$.

x_{pdt}^{\min} = Minimum market penetration objective for product $p \in FP$ in zone $d \in D_p$ for season $t \in T$.

V = Set of raw material supply sources ($v \in V$).

O = Set of countries covered by the logistic network ($o \in O$).

$o(n)$ = Country of geographical location n .

T = Set of seasons in the planning horizon ($t \in T$).

3.2.2.2 Products families and manufacturing process multigraph

Divergent manufacturing processes can be represented by an acyclic directed multigraph Γ defined by a set of nodes $A = \{a\}$ corresponding to activities, and a set of directed arcs $\Psi = \{(p, a, a')\}$ where $a, a' \in A$ is a pair of adjacent activities and $p \in P$ is the product family associated to the arc. The set of nodes A can be partitioned into four mutually exclusive subsets:

- The root node $a = 1$ corresponding to the raw materials supply market;
- The set of production activities A^p ;
- The set of storage activities A^s ;
- The sink node $a = \bar{a} = |A|$ corresponding to the products sale market.

Figure 1 shows the manufacturing process multigraph of the Quebec lumber industry. In the graphical formalism used, rectangles represent production activities, triangles storage activities and ellipses the source and sink activities. This graph is a conceptual representation of the

manufacturing process and it is independent of the current physical implementation of the company. The product families associated to the arcs are defined on the left-hand side. The finished product families ($FP \subset P$) correspond to those defined in Table 1. Semi-finished products and raw material families are defined to capture the essence of the manufacturing process while respecting market segment characteristics. In our case, wood species are distinguished and families are defined based on the physical characteristics of the products (diameter, length).

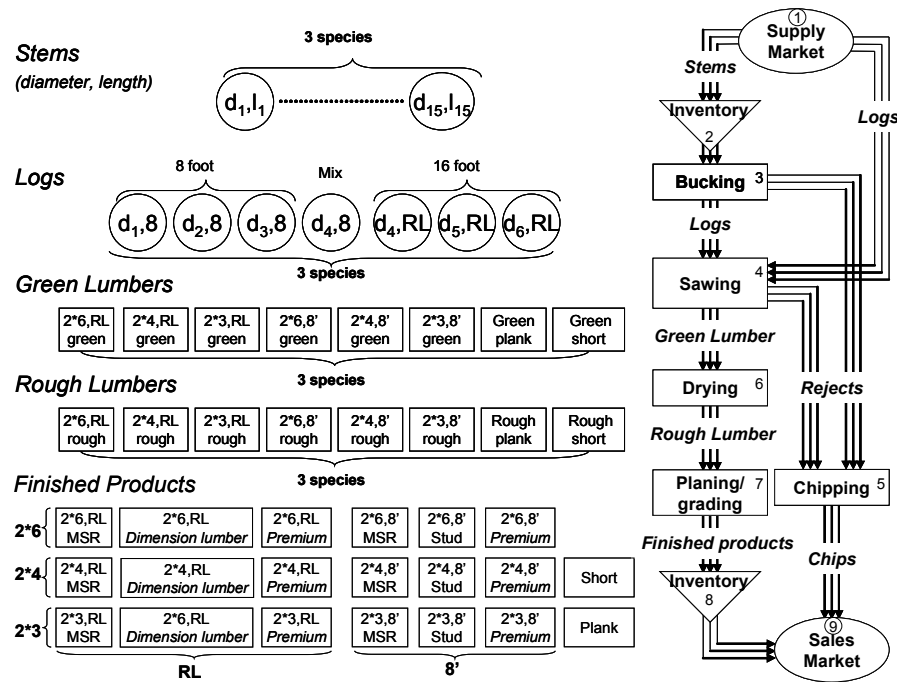

Figure 1: Quebec Lumber Industry Manufacturing Process Multigraph.

Note that a process multigraph including the supply market, a series of storage activities and the sales market describes a multi-echelon distribution network. Hence, our approach could also be used to design pure distribution networks. The following notation is required to model the manufacturing process multigraph $\Gamma = (A, \Psi)$:

P = Set of product families ($p \in P$).

A = Set of activities ($a \in A$).

Ψ = Set of directed arcs $\{(p, a, a')\}$ in the multigraph.

A^p = Set of production activities ($A^p \subset A$).

A^s = Set of storage activities ($A^s \subset A$).

A_a^{in} = Set of immediate predecessors of activity a ($A_a^{in} \subset A$).

A_a^{out} = Set of immediate successors of activity a ($A_a^{out} \subset A$).

P_a^{in} = Input product families of activity a ($P_a^{in} \subset P$).

P_a^{out} = Output product families of activity a ($P_a^{out} \subset P$).

3.2.2.3 Potential network resources and production recipes

The production and storage activities defined in the process multigraph must be performed in manufacturing and/or distribution facilities. Some facilities may already be in use by the company, but potential sites may also be considered for the construction, purchase or rent of other facilities. It may also be possible to transform existing facilities. As illustrated in Figure 2, it is the assignment of the activities of the process multigraph to the potential facility sites that defines the company logistics network. In the resulting directed network, the nodes correspond to supply sources (V), potential production-distribution centers (S^{pd}), potential distribution centers (S^d) or demand zones (D). The arcs represent the flow of products between nodes. In practice, the inbound flow arcs in ($V \times S$), the internal flow arcs in ($S \times S$) and the outbound flow arcs in ($S \times D$) are generally not all feasible. In particular, the size of the outbound arc set ($S \times D$) depends very much on the delivery policy of the company, since this set contains only the arcs which are short enough to comply with a given delivery time. For this reason, sets of potential node predecessors and successors must also be defined. The following notation is required to define potential facilities and potential moves in the logistic network:

S = Set of potential network sites ($s \in S$).

S_o = Set of sites located in country $o \in O$ ($S_o \subset S$).

S^{pd} = Set of potential production-distribution center sites ($s \in S^{pd} \subset S$).

S^d = Set of potential distribution center sites ($s \in S^d \subset S$).

S_{ps}^o = Set of potential sites (output destinations) which can receive product p from site s .

S_{pn}^i = Set of potential sites (input sources) which can ship product p to location

$$n \in S \cup D_p$$

V_s = Set of vendors which can supply site $s \in S$ ($V_s \subset V$).

V_{ps} = Set of vendors which can supply product P to site $s \in S$ ($V_{ps} \subset V_s$).

D_{ps} = Set of demand zones which can receive product P from site $s \in S$ ($D_{ps} \subset D_p$).

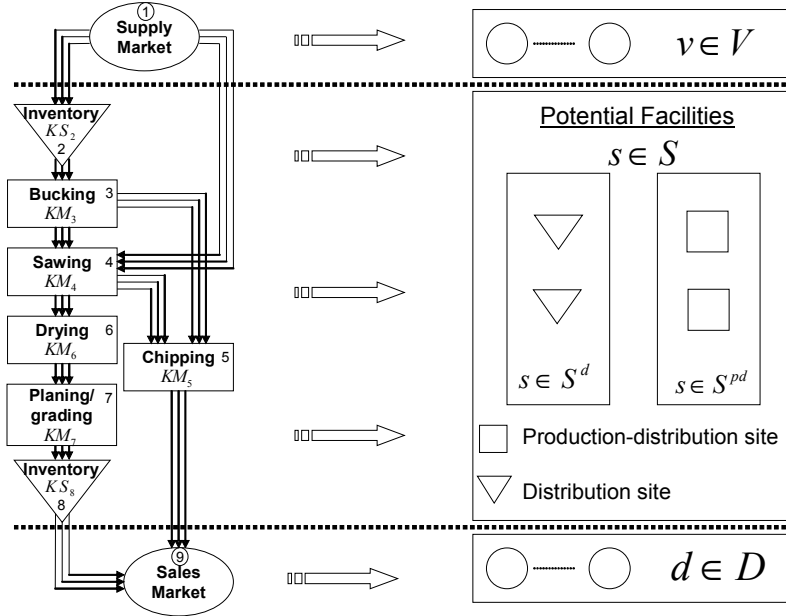

Figure 2: Mapping the Manufacturing Process onto the Potential Network Nodes.

The production and storage activities defined in the process multigraph can be performed with different *technologies*. A *technology* is considered as a class of equipment which can be used to produce/store a given set of products. It is assumed that the amount of resources consumed when a production activity is performed depends on the technology used. It is also assumed that the output quantities obtained with a given input product when a production activity is performed is technology dependent. The input-output quantities associated to the use of a given technology to perform an activity are defined by *recipes*. The recipe i used when activity a is performed with technology k can be selected from a set of potential recipes R_{ak} . It is in fact through the choice of appropriate recipes, that management is able to match supply and demand in the type of industries considered. As illustrated in Figure 3, each recipe $i \in R_{ak}$ is characterized by one input product p_i , a set of output products P_i^{out} , yield factors $g_{p,p}^i, p \in P_i^{out}$, and a resource consumption factor q^i . In the lumber industry, recipes take different forms for

different activities. For bucking ($a = 3$) and sawing ($a = 4$) activities, recipes correspond to the different cutting patterns which can be selected. Typical stem and log cutting patterns are illustrated in Figure 4. For planing/grading ($a = 7$), recipes are associated to lumber sorting options, and for chipping ($a = 5$) and drying ($a = 6$), one-to-one recipes define process yield.

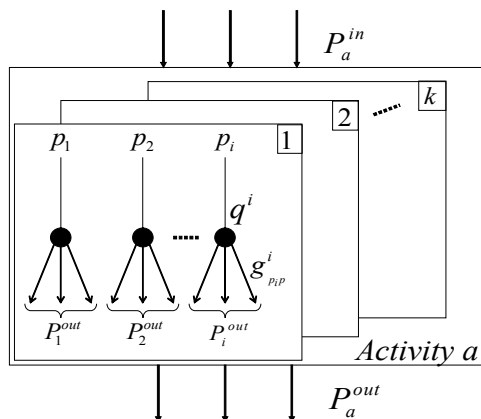

Figure 3: Technology Dependent One-to-Many Recipes for a Production Activity

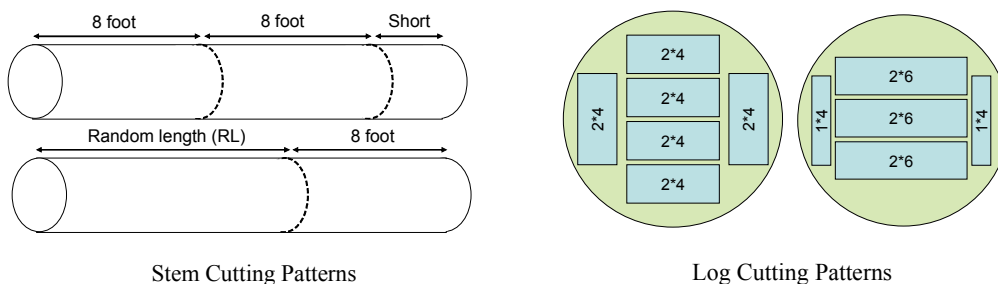

Figure 4 : Cutting Patterns Corresponding to Bucking and Sawing Recipes

No one-to-many recipe needs to be defined for storage activities since input and output products are identical. Also, the storage technologies used for a given activity $a \in A^s$ are assumed to be flexible: they can be used to store any of its input products $p \in P_a^{in}$, and their resource consumption rates are measured in the same units. For a product p associated to a storage activity a , it is therefore sufficient to specify a single resource consumption rate q_{pa} . The following notation is required to define technologies and recipes:

KM_{sa} = Production technologies which can be used to perform activity $a \in A^p$ on site s ($k \in KM_{sa}$).

KS_{sa} = Storage technologies which can be used on site s to perform activity $a \in A^s$ ($k \in KS_{sa}$).

R_{ak} = Set of recipes available to perform production activity $a \in A^p$ with technology k .
These sets uniquely define the activity a and technology k of recipes $i \in R_{ak}$.

p_i = Input product for recipe $i \in R_{ak}$.

P_i^{out} = Set of output products obtained with recipe $i \in R_{ak}$.

$g_{p_i,p}^i$ = Quantity of product P obtained from one unity of product p_i with recipe $i \in R_{ak}$.

q^i = Production capacity required to process one unit of product p_i with recipe $i \in R_{ak}$.

q_{pa} = Capacity consumption rate per unit of product $p \in P_a^{in}$ for storage activity $a \in A^s$.

Note that the sets KM_{sa} and KS_{sa} can be used to restrict the mission of a given site. If the set KM_{sa} is empty, for example, it implies that activity $a \in A^p$ cannot be performed on site $s \in S^{pd}$. Note also that, by definition, $KM_{sa} = \emptyset, \forall s \in S^d, a \in A^p$. In order to ensure that the specification of the previously defined sets is coherent, for each activity $a \in A^p$, the following must hold true:

$$\bigcup_{s \in S^{pd}} \bigcup_{k \in KM_{sa}} \bigcup_{i \in R_{ak}} \{p_i\} = P_a^{in} \quad \text{and} \quad \bigcup_{s \in S^{pd}} \bigcup_{k \in KM_{sa}} \bigcup_{i \in R_{ak}} P_i^{out} = P_a^{out}.$$

The capacity of the potential network facilities depends on the technologies implemented in the space available on their site. For the production-distribution sites ($s \in S^{pd}$), various *facility layouts* can be considered and various *capacity options* can be selected. A layout $l \in L_s$ is characterized by an area available E_{ls} for the installation a set J_{ls} of predetermined potential *capacity options*. The layouts considered for a given production-distribution site can correspond to the status-quo layout, if there is already a facility on the site, or to alternative layouts for new construction or reconfiguration opportunities. By convention, index $l = 1$ is

used for the status-quo layout. A set of alternative capacity options can be considered to implement a given technology. An option $j \in J_s$ can correspond to capacity already in place, to a reconfiguration of an installed equipment to increase its capacity or to the addition of new resources. In this last case, different options can be associated to equipment of different size to reflect economies of scale. Moreover, the simultaneous inclusion of dedicated capacity options and flexible capacity options allow for the modeling of economies of scope. When dealing with a potential equipment replacement/reconfiguration, the options associated to the new potential equipment cannot be selected at the same time as the status-quo option, which leads to the definition of mutually exclusive sub-sets of options $JR_{ls}^n, n=1, \dots, N_{ls}$, for some facility layouts. Each option $j \in J$ is characterized by a seasonal capacity, b_{jt} , stated in the units of its technology, by the floor space e_j required to install it and by a fixed cost and a variable cost per product. In order to be able to adapt production capacity to demand fluctuations, an important aspect of the problem in our context is that the capacity options selected do not have to be used in every season: seasonal shutdowns are possible.

Distribution sites ($s \in S^d$) are assumed to be pre-configured, which means that the technology $k \in KS_{sa}$ they use and the capacity available for these technologies in a given season b_{skt} , are known *a priori*. This simplifying assumption is made because it often applies in practice, mainly when public warehouses are used. However, the generalisation to the case of alternative layouts and capacity options presents no difficulty. The notation required to define facility layouts and capacity options is the following:

L_s = Potential facility layouts for site $s \in S^{pd}$ ($l \in L_s$).

J_s = Potential capacity options which can be installed on site $s \in S^{pd}$ ($j \in J = \bigcup_{s \in S^{pd}} J_s$)

J_{ks} = Potential technology k capacity options which can be installed on site $s \in S^{pd}$ ($J_{ks} \subseteq J_s$).

J_{ls} = Potential capacity options which can be installed on site $s \in S^{pd}$ when layout $l \in L_s$ is used ($J_{ls} \subseteq J_s$).

JR_{ls}^n = Mutually exclusive options sub-set in J_{ls} ($n = 1, \dots, N_{ls}$).

N_{ls} = Number of mutually exclusive option subsets (equipment replacement/reconfiguration) in J_{ls} .

E_{ls} = Total area of the layout l for site s .

e_j = Area required to install capacity option j .

b_j^t = Capacity of the technology associated to option j available for season t .

b_{skt} = Technology k capacity available for season t for distribution site $s \in S^d$.

3.2.2.4 Relevant revenues and expenses

A large volume of cost and price information is required to calculate the total revenues and expenses associated with logistic network design. This is particularly true in the international business context. In order to properly evaluate potential solutions, the following assumptions are made:

- The prices and cost associated to the nodes of the network are given in local currency. The costs associated to the arcs of the network are given in source currency. Exchange rates are known and constant during the planning horizon considered.
- The fixed costs A_{ls} associated to facility layouts reflect potential changes of state (closing an existing facility, building or buying a new facility, changing the layout of a facility...) and fixed operating expenditures, and they depend on the practical context of each potential node. Relevant fixed costs for different contexts are listed in Table 2. These costs are based on the engineering economy principles of capital recovery plus return over the planning horizon (Frabrychy and Torgersen, 1966). The fixed costs a_j^1 associated to the installation of potential capacity options also cover capital recovery and opportunity costs expenditures, but they do not include fixed operating costs. Fixed capacity option operating costs \hat{a}_{jt} are charged on a seasonal basis when the option is in use. When existing equipment is disposed off, a fixed removal cost a_j^0 may also be

charged. The approach proposed in Table 2 to compute layout fixed costs can also be used, with minor modifications, to obtain capacity options fixed costs.

- Each time products cross a border, tariffs and duties are charged on the flow of merchandise and these are paid by the importer. In other words, tariffs are calculated on the inflow to a given site from a foreign country of origin.
- The transportation costs on the network arcs are paid by the origin. It is assumed that they are linear with respect to seasonal product flows.

		Do not use the site		Use the current layout ($l = 1$)		Use a new layout ($l > 1$)	
Initial state		Decision	Fixed cost (A_{0s})	Decision	Fixed cost (A_{1s})	Decision	Fixed cost (A_{ls})
Current facility	Owned	Close	• Closing cost	<i>Status-quo</i>	• Capital recovery • Opportunity cost • Operating cost	Change layout	• Set-up cost • Capital recovery • Opportunity cost • Operating cost
	Rented	Close	• Closing cost • Lease penalty	<i>Status-quo</i>	• Rent • Operating cost	Change layout	• Set-up cost • Rent • Operating cost
	Public	Stop	• Stopping cost	<i>Status-quo</i>	• Operating cost	Change layout	• Operating cost
Potential site	New facility or purchase & renovated	Do not use	• Zero			Build/Buy	• Set-up cost • Capital recovery • Opportunity cost • Operating cost
	Rented facility	Do not use	• Zero			Rent	• Set-up cost • Rent • Operating cost
	Public	Do not use	• Zero			Use	• Starting cost • Operating cost

Table 2 : Facility Layout Fixed Costs in Different Contexts.

- Transfer prices for products sent in the internal network are fixed by the accounting department of the company.
- The income taxes paid in a country are calculated on the sum of the *net revenues* (Total revenue - Total logistic network costs) made by all facilities in this country. If a facility reports a loss, this loss is deducted from the total profit of the subsidiary before taxes. It is also assumed that the corporate taxes paid by the parent company are deferred until it pays dividends and that the decision to pay out dividends is independent of the design of the network.

- The company wishes to maximize its global after tax net revenues in a predetermined currency.

The notation for the costs and revenues is as follows:

A_{ls} = Fixed cost of using layout l on site $s \in S^{pd}$ for the planning horizon.

A_{0s} = Fixed cost of disposing of production-distribution site $s \in S^{pd}$ at the beginning of the planning horizon.

A_s = Fixed cost of using distribution site $s \in S^d$ for the planning horizon.

a_j^0 = Fixed cost of disposing of capacity option j at the beginning of the planning horizon.

a_j^1 = Fixed cost of installing of keeping capacity option j for the planning horizon.

\hat{a}_{jt} = Fixed cost of using capacity option j during season t .

c_{pst}^i = Cost of producing one unit of product p_i with recipe i on site s during season t .

m_{pst} = Unit handling cost for the transfer of product P to or from its stock in production-distribution site s during season t .

f_{psnt}^o = Unit cost of the flow of product P between site s and node n paid by origin s during season t (this cost includes the customer-order processing cost, the shipping cost, the variable transportation cost and the inventory-in-transit holding cost).

f_{psnt}^t = Unit transportation cost of product P from site s to node n during season t (this cost is included in f_{psnt}^o).

f_{pnst}^d = Unit cost of the flow of product P between node n and site s paid by destination s during season t (this cost includes the supply-order processing costs and the receiving cost).

$f_{pv(s,a)t}^v$ = Unit cost of the flow of product P between vendor v and activity a on site s paid by destination s during season t (this cost includes the product's price and the variable transportation cost).

h_{pst} = Unit inventory holding cost of product P in facility s during season t .

π_{pst} = Transfer price of product P shipped from site s during season t .

$e_{oo'}$ = Exchange rate, i.e. number of units of country o currency by units of country o' currency (the index $o = 0$ is given to the base currency, whether it is part of O or not).

δ_{pns} = Import duty rate applied to the CIF price of product P when transferred from the country of node n to the country of site s .

τ_o = Income tax rate of country o .

P_{pdt} = Amount received for the sales of product P to demand zone d in season t .

In order to compute inventory holding costs, the following parameter, which is the inverse of the familiar inventory turnover ratio, is also required:

ρ_{pst} = Number of seasons of inventory (order cycle and safety stocks) of product P kept at site s for season t .

3.2.2.5 Mapping of the process graph onto the potential network resources

In the previous sections, graph and set based constructs, as well as material and financial resource consumption parameters were defined to represent divergent process industry companies internal and external business environment, the technological opportunities they have at their disposal to improve competitiveness, as well as the financial information required to evaluate these opportunities in an international context. The last step of the proposed approach is to use a mathematical programming model to select the opportunities maximizing the overall after tax net revenues of the company considered. As illustrated in Figure 2, this involves a series of network design decisions to map the company manufacturing process multigraph onto its potential logistic network resources. Specifically, some of the questions to be answered are:

- Which potential production and distribution sites should the company use?
- Which production-storage activities should be assigned to each of the selected sites?

- Which layout and capacity options should be implemented on the production-distribution sites?
- Should some of the installed capacity options be shutdown during certain seasons to adapt to market demand and price fluctuations?
- Which product should be manufactured and stored on each site, taking potential product substitutions into account?
- How much seasonal raw material and finished product inventories should be kept to help absorb supply and demand fluctuations, taking recipe selection possibilities into account?
- Which demand zones should be supplied from the various sites?
- Which raw material sources should supply each production site?

To answer such questions, the following decision variables must be used:

Y_{ls} = Binary variable equal to 1 if layout $l \in L_s$ is used for site $s \in S^{pd}$ and to 0 otherwise.

Y_{0s} = Binary variable equal to 1 if production-distribution site $s \in S^{pd}$ is not used and to 0 otherwise (i.e. layout $l = 0$ implicitly corresponds to a closed facility).

Y_s = Binary variable equal to 1 if potential distribution center $s \in S^d$ is used and to 0 otherwise.

Z_j = Binary variable equal to 1 if capacity option j is installed and to 0 otherwise.

\hat{Z}_{jt} = Binary variable equal to 1 if capacity option j is used during season t and to 0 otherwise.

$F_{p(n,a)(n',a')t}$ = Flow of product $p \in P$ between activity a at location $n \in V \cup S$ and activity a' at location $n' \in S \cup D_p$ during season $t \in T$.

$F_{pp'(s,a)dt}$ = Outbound flow of finished product $p' \in FP$, used to satisfy the demand for product $p \in FP$, between activity a in site s and demand zone $d \in D_p$ during season $t \in T$.

$X_{p,st}^i$ = Quantity of product p_i processed with recipe $i \in R_{ak}$ in production-distribution site s during season $t \in T$.

I_{pkst} = Seasonal inventory of product $p \in P$ stored on site s with technology $k \in KS_{sa}$ at the end of season $t \in T$.

Although the binary variable Y_{0s} implies that one could decide to discard an existing production-distribution facility or consider the addition of new facilities, as indicated earlier, our approach is not intended to make such decisions. In fact, in most cases, this 0-1 variable would be fixed to 0 *a priori*, and the analysis would concentrate on the choice of appropriate layouts and capacity options. Also, although the production and the flow variables defined above lead to the specification of optimal seasonal production and transportation quantities, as well as to the definition of optimal recipe selection profiles, these would not be implemented *per se* in practice. These decisions would be finalized in the shorter term, taking specific supplier and customer orders into account. They are important however because they indicate the products which should be manufactured on each site, the substitution which should be considered and the customers to serve from each sites. Their optimal value also permits the anticipation of the economic impact of the design decisions made. The next section presents the optimization model conceived to answer the design questions raised previously.

3.2.3 Mathematical Programming Model

This section presents the various elements of the generic mathematical programming model proposed to optimize logistics networks in divergent process industries. It covers the modeling of the supply market, of production and storage activities and of the demand market. The section ends with the formulation of the model objective function. The application of this generic model to the Quebec lumber industry case is also discussed.

3.2.3.1 Modeling the supply market

The raw material supply market corresponds to the root node ($a=1$) of the manufacturing process multigraph Γ . Raw materials flow from the vendors in this supply market to the sites performing production-storage activities $a \in A_1^{out}$. Let F^1 be the vector of these inbound raw material flows, i.e.

$$F^1 = \left[F_{p(v,1)(s,a)t} \quad \forall p \in P_1^{out}, \forall a \in A_1^{out}, \forall s \in S, \forall v \in V_{ps}, \forall t \in T \right]$$

and let Ω^1 be the set of all the feasible inbound raw material flows in the context considered. Then, to remain generic, the supply market conditions can be stated simply as:

$$F^1 \in \Omega^1 \quad (1)$$

Since supply conditions tend to be context dependent, the set Ω^1 must be defined specifically for each application. In the simplest cases, Ω^1 can be defined by bounds on seasonal or annual inflows but in some instances it is much more complex. To illustrate, let us consider the case of the Quebec lumber industry described in Figure 1. For this case, $A_1^{out} = \{2, 4\}$. Quebec sawmills are tied by Forest Management and Supply Contracts defining annual upper bounds on the supply of raw materials for a given forest, and minimum procurement quantities. Also, sawmills know only the proportions of stems or logs of different type they can expect to get from a given source. To define the set Ω^1 of inbound flows satisfying these constraints, the following specific notation is required:

$\Pr_{pv(s,2)}$ = Proportion of products of family $p \in P_2^{in}$ in the stems supplied by source $v \in V$ to site $s \in S^{pd}$, when bucking in done in the sawmill.

$\Pr_{pv(s,4)}$ = Proportion of products of family $p \in P_4^{in}$ in the logs supplied by source $v \in V$ to site $s \in S^{pd}$, when bucking in done in the forest.

$b_{v(s,a)t}^{\max}$ = Upper bound on the seasonal shipments of raw material between source $v \in V$ and activity $a \in A_1^{out}$ on site $s \in S^{pd}$ for season t .

b_{vs}^{\min} = Annual minimum level of raw material to be shipped between source $v \in V$ and site $s \in S^{pd}$ in order to comply with supply contracts with government.

Using this notation, the set of feasible inbound flows Ω^1 can be defined as follows:

$$\sum_{p \in P_1^{out} \cap P_a^{in}} F_{p(v,1)(s,a)t} \leq b_{v(s,a)t}^{\max} \quad a \in A_1^{out}, s \in S^{pd}, v \in V_s, t \in T \quad (2)$$

$$\sum_{t \in T} \sum_{a \in A_1^{out}} \sum_{p \in P_1^{out} \cap P_a^{in}} F_{p(v,1)(s,a)t} \geq b_{vs}^{\min} \quad s \in S^{pd}, v \in V_s \quad (3)$$

$$F_{p(v,1)(s,a)t} = \Pr_{pv(s,a)} \sum_{p' \in P_1^{out} \cap P_a^{in}} F_{p'(v,1)(s,a)t} \quad a \in A_1^{out}, p \in P_1^{out} \cap P_a^{in}, s \in S^{pd}, v \in V_s, t \in T \quad (4)$$

3.2.3.2 Modeling production-distribution facility layouts and capacity options

Using the plant layout selection variables Y_{ls} , the following constraints must be included in the model to ensure that at most one layout is selected for each production-distribution site:

$$\sum_{l \in L_s} Y_{ls} + Y_{0s} = 1 \quad s \in S^{pd} \quad (5)$$

Using the capacity option selection variables Z_j , the following constraints must also be included to ensure that, for a given site, the area required by the selected options does not exceed the area available in the selected layout, and that mutually exclusive options are not selected:

$$\sum_{j \in J_{ls}} e_j Z_j \leq E_{ls} Y_{ls} \quad s \in S^{pd}, l \in L_s \quad (6)$$

$$\sum_{j \in RL_{ls}^n} Z_j \leq 1 \quad s \in S^{pd}, l \in L_s, n = 1, \dots, N_{ls} \quad (7)$$

Since the capacity options selected can be shutdown during some seasons, constraints are also required to ensure that a capacity option can be used in a season only if it was in use:

$$\hat{Z}_{jt} \leq Z_j \quad s \in S^d, j \in J_s, t \in T \quad (8)$$

Note finally that, since distribution centers are assumed to be pre-configured, there is no layout and capacity options decision to make for sites $s \in S^d$.

3.2.3.3 Modeling flows and inventories

In addition to deciding the sites, layouts and capacity options to use during the planning horizon, tactical decisions must be made on the quantity of products to manufacture, the seasonal stocks to accumulate and the internal flow of products in the network. This requires the modeling of flows and inventories in the network facilities and the consideration of capacity constraints.

Any valid network optimization model must ensure the equilibrium between the flows of material entering an activity, its transformation or stocking in the activity and the flow of products exiting the activity. For production activities, one must ensure that the material processed does not exceed the material received from preceding activities in the same site or in other sites, i.e. that the following relations are satisfied:

$$\sum_{k \in KM_{sa}} \sum_{i \in R_{ak} | p_i = p} X_{p_i, st}^i \leq \sum_{a' \in A_a^{in}} \sum_{s' \in S_{ps}^i \cup V_{ps}} F_{p(s', a')(s, a)t} + \sum_{a' \in A_a^{in}} F_{p(s, a')(s, a)t} \quad (9)$$

$$a \in A^p, p \in P_a^{in}, s \in S^{pd}, t \in T$$

One must also ensure that the material flowing out of the production activity does not exceed the amounts produced, i.e. that the following constraints are respected:

$$\sum_{a' \in A_a^{out}} \sum_{s' \in S_{ps}^o \cup D_{ps}} F_{p(s, a)(s', a')t} + \sum_{a' \in A_a^{out}} F_{p(s, a)(s, a')t} \leq \sum_{k \in KM_{sa}} \sum_{i \in R_{ak} | p \in P_i^{out}} g_{p_i, p}^i X_{p_i, st}^i \quad (10)$$

$$a \in A^p, p \in P_a^{out}, s \in S^{pd}, t \in T$$

Similarly, for the storage activities, additions and withdrawals from the seasonal inventory must be accounted for. This yields the following inventory accounting equations.

$$\sum_{k \in KS_{sa}} I_{pkst} = \sum_{k \in KS_{sa}} I_{pkst-1} + \sum_{a \in A_a^{in}} F_{p(s, a)(s, a)t} + \sum_{a \in A_a^{in}} \sum_{s' \in S_{ps}^i \cup V_{ps}} F_{p(s', a')(s, a)t} - \sum_{a' \in A_a^{out}} \sum_{s' \in S_{ps}^o \cup D_{ps}} F_{p(s, a)(s', a')t} - \sum_{a' \in A_a^{out}} F_{p(s, a)(s, a')t} \quad a \in A^s, p \in P_a^{in}, s \in S^{pd} \cup S^d, t \in T \quad (11)$$

Seasonal stocks are used to allow the smoothing of production over the planning horizon. As illustrated in Figure 5, the seasonal stocks at the beginning and at the end of the horizon must therefore be the same, i.e. we must have:

$$I_{ps0} = I_{ps|T} \quad a \in A^s, p \in P_a^{in}, s \in S^{pd} \cup S^d \quad \text{where} \quad I_{pst} = \sum_{k \in KS_{sa}} I_{pkst} \quad (12)$$

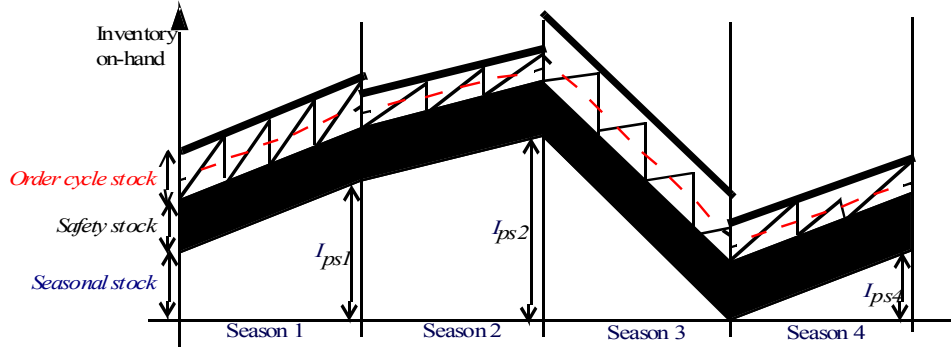

Figure 5 : Behaviour of Product p Inventory in a Storage Activity on Site s

In addition to seasonal inventory, the level of safety stocks and order cycle stocks generated by the network design must be taken into account. These stock levels depend on the inventory management policies and rules used by the company and on the ordering behaviour of customers. It is assumed here that the impact of these policies is reflected by the inventory turnover ratio of the product on a given site. This implies that the average level \bar{I}_{pst} of the

order cycle and safety stock of product p during season t at site s can be calculated with the following expression:

$$\bar{I}_{pst} = \rho_{pst} \left[\sum_{a' \in A_a^{out}} (F_{p(s,a)(s,a')t} + \sum_{s' \in S_{ps}^i \cup D_{ps}} F_{p(s,a)(s',a')t}) \right] \quad a \in A^s, p \in P_a^{out}, s \in S^{pd} \cup S^d, t \in T \quad (13)$$

The quantity of products which can be processed during a season by an activity in a production-distribution center is limited by the capacity options selected for that center. This imposes the following production and storage capacity constraints:

$$\sum_{i \in R_{ak}} q^i X_{pst}^i \leq \sum_{j \in J_{ks}} b_j^t \hat{Z}_{jt} \quad a \in A^p, s \in S^{pd}, k \in KM_{sa}, t \in T \quad (14)$$

$$\sum_{p \in P_a^{in}} q_{pa} \left(\sum_{a' \in A_a^{out}} \sum_{s' \in S_{ps}^o \cup D_{ps}} F_{p(s,a)(s',a')t} + \sum_{a' \in A_a^{out}} F_{p(s,a)(s,a')t} \right) \leq \sum_{k \in KS_{as}} \sum_{j \in J_{ks}} b_j^t \hat{Z}_{jt} \quad a \in A^s, s \in S^{pd}, t \in T \quad (15)$$

Note that in (15), the storage capacity is expressed in terms of a maximum throughput and not in terms of the storage space available. This does not present any problem since the inventory turnover ratio can be used to convert the space available into a maximum seasonal flow. Similarly, for distribution centers, the storage capacity available depends on the installed storage technologies. This yields the following capacity constraints:

$$\sum_{p \in P_a^{in}} q_{pa} \left(\sum_{a' \in A_a^{out}} \sum_{s' \in S_{ps}^o \cup D_{ps}} F_{p(s,a)(s',a')t} + \sum_{a' \in A_a^{out}} F_{p(s,a)(s,a')t} \right) \leq \left(\sum_{k \in KS_{as}} b_{skt} \right) Y_s \quad a \in A^s, s \in S^d, t \in T \quad (16)$$

Finally, finished product flows to the sales market must be modeled. There is a lower and an upper bound on product demand for each of the demand zones in the sales market. Also some finished products can be substituted by others. This leads to the following constraints:

$$F_{p(s,a)(d,\bar{a})t} = \sum_{p' \in SP_p} F_{p'p(s,a)dt} \quad a \in A_a^{in}, p \in P_a^{in}, s \in S^{sd} \cup S^d, d \in D_{ps}, t \in T \quad (17)$$

$$x_{pdt}^{\min} \leq \sum_{p' \in PS^p} \sum_{s \in S_{p'd}^i} \sum_{a \in A_a^{in}} F_{pp'(s,a)dt} \leq x_{pdt}^{\max} \quad p \in P_a^{in}, d \in D_p, t \in T \quad (18)$$

3.2.3.4 Objective function

In an international context, in order to take transfer prices and taxes into account correctly, it is necessary to derive an income statement for each network facility. The revenues and expenses of the production-distribution centers and the distribution centers, in local currency, are presented in Table 3. The expression for the transfer costs of material inflows is obtained by first converting the transfer prices and transportation costs in local currency and then by adding the applicable duties. A similar approach is used to calculate other revenues and expenses. Let:

C_s = Total site s expenses for the planning horizon.

R_s = Total site s revenues for the planning horizon.

Then, using the expenditure and revenue elements in Table 3, it is seen that:

$$C_s = a) + b) + c) + d) + e) + f) + g) + h) + i) + j) \quad s \in S^{pd} \quad (19)$$

$$C_s = a) + b) + c) + e) + f) + g) + i) + j) \quad s \in S^d \quad (20)$$

$$R_s = k) + l) \quad s \in S^{pd} \cup S^d \quad (21)$$

The operating income for each national division $o \in O$ is given by $M_o = \sum_{s \in S_o} (R_s - C_s)$ and the corporate net revenues before taxes in the reference currency are $\sum_{o \in O} e_{0o} M_o$. However, to calculate corporate after tax profits, the divisions with positive margins must be distinguished from those with negative margins because there is no income tax to pay on losses. To do this, M_o must be separated in its negative and positive parts by defining

$$\text{Operating Income} = M_o^+ - M_o^- \quad o \in O$$

where the operating profit $M_o^+ = M_o$ if $M_o > 0$ and the operating loss $M_o^- = -M_o$, otherwise. Given this, the after tax net revenues of the corporation in its reference currency is given by the expression

$$\sum_{o \in O} e_{0o} [(1 - \tau_o) M_o^+ - M_o^-].$$

Based on previous statements, the complete mixed-integer programming model proposed to optimize the structure of the logistic network of the company takes the following form:

$$\text{Maximize} \quad \sum_{o \in O} e_{0o} [(1 - \tau_o) M_o^+ - M_o^-] \quad (\text{MIP})$$

subject to

- Supply market constraints (1)
- Facility layout, space and exclusive options constraints (5), (6) and (7)
- Seasonal capacity option usage constraints (8)
- Production activities flow equilibrium constraints (9) and (10)
- Storage activities inventory accounting constraints (11) and (12)
- Production and storage capacity constraints (14), (15) and (16)
- Sales market constraints (17) and (18)
- Facilities total cost and revenue definitions (19), (20) and (21)

- National divisions operating income definition

$$\sum_{s \in S_o} (R_s - C_s) - M_0^+ + M_0^- = 0 \quad o \in O \quad (22)$$

- Non-negativity constraints

$$Y_{ls} \in \{0;1\} \quad s \in S^{pd}, l \in L_s \quad Y_{0s} \in \{0;1\} \quad s \in S^{pd} \quad Y_s \in \{0;1\} \quad s \in S^d$$

$$Z_j \in \{0;1\} \quad s \in S^{pd}, j \in J_s \quad \hat{Z}_{jt} \in \{0;1\} \quad t \in T, s \in S^{pd}, j \in J_s$$

$$F_{p(n,a)(n',a')t} \geq 0 \quad p \in P, (n,a) \in (V \cup S) \times A, (n',a') \in (V \cup D_p) \times A, t \in T \quad (23)$$

$$F_{pp'(s,a)dt} \geq 0 \quad p \in PF, p' \in SP^p, (s,a) \in S \times A, d \in D_p, t \in T$$

$$X_{p,st}^i \geq 0 \quad s \in S^{pd}, a \in A^p, k \in KM_{sa}, i \in R_{ak}, t \in T$$

$$I_{pkst} \geq 0 \quad p \in P, s \in S^{pd}, a \in A^s, k \in KS_{sa}, t \in T$$

	Distribution center (S^d)	Production-distribution center (S^{pd})
a) Inflow transfer cost	$\sum_{t \in T} \sum_{a, a' \in A - \{\bar{a}\}} \sum_{p \in P_a^{out} \cap P_a^{in}} \sum_{s' \in S_{ps}^i} (1 + \delta_{ps's}) e_{o(s)o(s')} (\pi_{ps't} + f_{ps's't}^t) F_{p(s',a')(s,a)t}$	
b) Raw materials	$\sum_{t \in T} \sum_{a \in A - \{1\}} \sum_{p \in P_a^{in}} \sum_{v \in V_{ps}} (1 + \delta_{pvs}) e_{o(s)o(v)} f_{pvst}^v F_{p(v,1)(s,a)t}$	
c) Receptions from other sites	$\sum_{t \in T} \sum_{a, a' \in A - \{\bar{a}\}} \sum_{p \in P_a^{out} \cap P_a^{in}} \sum_{n \in V_{ps} \cup S_{ps}^i} f_{pnst}^d F_{p(n,a')(s,a)t}$	
d) Production		$\sum_{t \in T} \sum_{a \in A^p} \sum_{k \in KM_{sa}} \sum_{i \in R_{ak}} c_{p,st}^i X_{p,st}^i$
e) Facilities and options cost	$A_s Y_s$	$\sum_{l \in L_s \cup \{0\}} A_{ls} Y_{ls} + \sum_{j \in J_s} (a_j^1 Z_j + a_j^0 (1 - Z_j)) + \sum_{t \in T} \sum_{j \in J_s} \hat{a}_{jt} \hat{Z}_{jt}$
f) Order cycle and safety stocks	$\sum_{t \in T} \sum_{a \in A^s} \sum_{p \in P_a^{out}} h_{pst} \rho_{pst} \left(\sum_{a' \in A_a^{out}} (F_{p(s,a)(s,a')t} + \sum_{n \in S_{ps}^o \cup D_{ps}} F_{p(s,a)(n,a')t}) \right)$	
g) Seasonal stocks	$\sum_{t \in T} \sum_{a \in A^s} \sum_{p \in P_a^{in}} h_{pst} \sum_{k \in KS_{sa}} I_{pkst}$	
h) Handling		$\sum_{t \in T} \sum_{a \in A^s} \sum_{p \in P_a^{in}} m_{pst} \sum_{a' \in A_a^{out}} F_{p(s,a)(s,a')t}$
i) Outflows to other sites	$\sum_{t \in T} \sum_{a, a' \in A - \{\bar{a}\}} \sum_{p \in P_a^{out} \cap P_a^{in}} \sum_{s' \in S_{ps}^o} f_{pss't}^o F_{p(s,a)(s',a')t}$	
j) Outflows to demand zones	$\sum_{t \in T} \sum_{a \in A_a^{in}} \sum_{p \in P_a^{in}} \sum_{d \in D_{ps}} f_{psdt}^o F_{p(s,a)(d,\bar{a})t}$	

Revenues	k) Outflows to other sites	$\sum_{t \in T} \sum_{a, a' \in A - \{\bar{a}\}} \sum_{p \in P_a^{out} \cap P_{a'}^{in}} \sum_{s' \in S_{ps}^o} (\pi_{pst} + f_{pss't}^t) F_{p(s,a)(s',a')t}$
	l) Outflows to demand zones	$\sum_{t \in T} \sum_{a \in A_a^{in}} \sum_{p \in P_a^{in}} \sum_{p' \in SP^p} \sum_{d \in D_{ps}} e_{o(s)o(d)} P_{pdt} F_{pp'(s,a)dt}$

Table 3 : Facilities Expenses and Revenues in Local Currency

3.2.4 Finding the Model Optimal Solution

In order to test the solvability and the applicability of mathematical program, MIP was used to solve several instances of the Virtu@l-Lumber case developed with our partners of the Quebec forest products industry. The base case involves a moderate size lumber company operating three sawmills in the province of Quebec and selling lumber in Canada and in the United States. The product-markets of the company and the finished products substitution possibilities considered were defined in Table 1. The manufacturing process of the company was illustrated in Figure 1: it involves 138 product families (raw materials, semi-finished and finished products). The log and stem supply sources available and the potential network facility layouts considered are illustrated in Figure 6. The proportion of wood species in supply from each forest and their volume are given. For each site, the figure also distinguishes the current layout from an alternative potential layout. The alternative layout for Chicoutimi would be used to increase the 8' sawing capacity and the alternative layout for Scott-Jonction would permit the implementation of MSR grading technology. The addition of a warehouse in Montreal is also considered. The location of the bucking activity is predetermined, which affects flows and activities for each site. For example, activities 2 and 3 (activity numbers from Figure 2) are not considered in Scott-Jonction because all the bucking is done in the forest. A single technology is considered for each activity except for sawing, which can use *eight foot (8')* and/or *random length (RL)* technologies, and for planning/grading which can use *classic* and/or *MSR* technologies. Note that because of the nature of supply contracts with government, the definitive closing of a sawmill is ruled out. Four three months seasons are considered. The mixed-integer program to solve includes 227 binary variables, 8 234 continuous variables and 4 206 constraints.

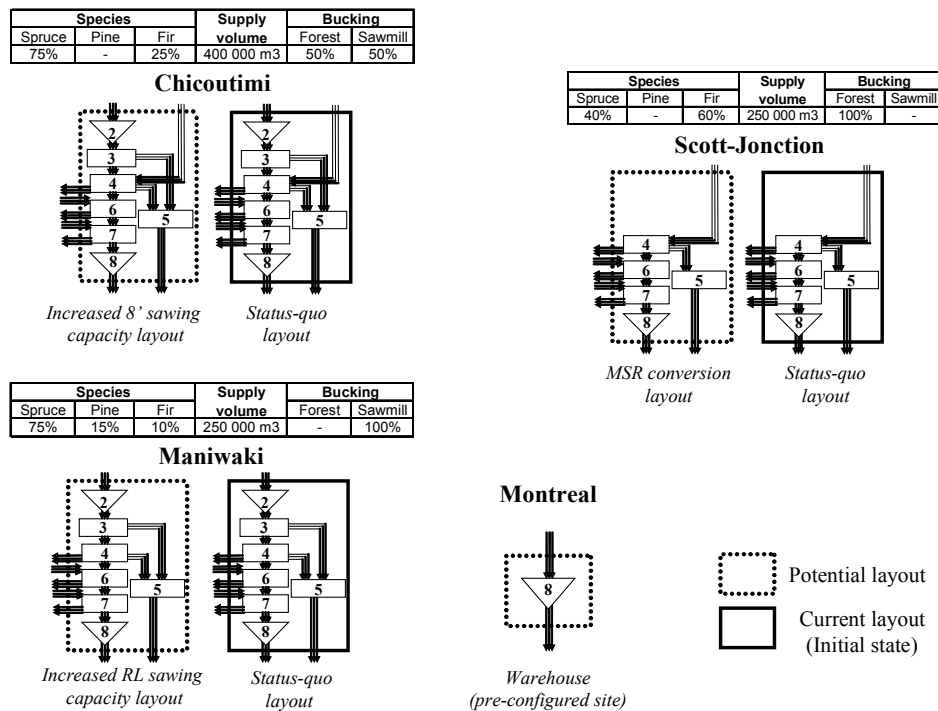

Figure 6: Forest Supply and Potential Facility Layouts for the Virtu@l-Lumber Case

The mathematical programs were solved with CPLEX 9.0 on a 1.9 GHz computer. In order to study the solvability of the model with CPLEX, the product prices, the fixed seasonal operating costs and the (total demand)/(total potential capacity) ratio of the base case were varied to generate extreme test problems. These factors were chosen because they tend to have a significant impact in practice, on the capacity options considered and on the way companies are organized. Eight problem instances were generated (Table 4). It was found that the default CPLEX settings lead to relatively long computation times. However, experimentation with CPLEX settings (see ILOG CPLEX 9.0 User's Manual) lead to the reduction of computation time by a factor of 30 for some problem instances. The best CPLEX solution strategy found for our model was the following:

- Give more importance to feasibility than to analysis and proof of optimality by setting the *MIPemphasis* parameter to 1.
- Set the *Probe* parameter to 3 in order to increase the search of logical implications after the preprocessing and before the solution of the root relaxation.

Table 4 gives the resolution times obtained in seconds. The results show that our model can be solved efficiently for realistic cases with commercial optimization software such as CPLEX. They also show that the solution times are not very sensitive to product prices and to the demand-capacity gap but that they are quite sensitive to the value of the seasonal fixed operating costs.

Overcapacity (0.65*Capacity ? Demand)		Price (\$Can/MBF)	
		<i>Low (320)</i>	<i>High (460)</i>
Seasonal fixed cost	<i>Zero</i>	66 s	70 s
	<i>2% of annual operating cost</i>	185 s	148 s

Capacity ? Demand		Price (\$Can/MBF)	
		<i>Low (320)</i>	<i>High (460)</i>
Seasonal fixed cost	<i>Zero</i>	54 s	83 s
	<i>2% of annual operating cost</i>	146 s	240 s

Table 4 : Computational Times (in seconds) for Extreme Problem Instances

3.2.5 Guidelines for the Use of the Methodology

The design methodology proposed is adequate to make plant and logistic network reconfiguration decisions in a context where:

- the implementation of these decisions requires significant efforts and budgets, so that companies are prepared to make them only occasionally;
- product prices and demand follow a predictable seasonal pattern, and the company is prepared to keep seasonal inventories and to temporarily shut down some activities to adapt to these patterns;
- product substitution and alternative production recipes can be used to allow a better match between supply and demand, which may lead to the implementation of more expensive but more flexible capacity options.

At a more tactical level, the approach is also adequate to guide sourcing decisions and demand management decisions.

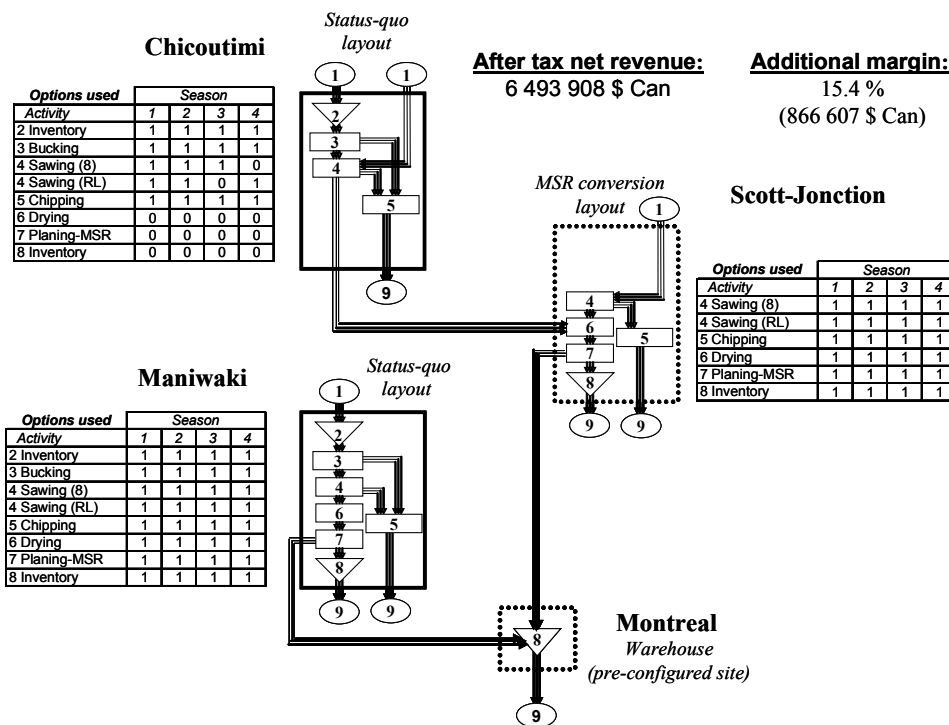

Figure 7: Virtu@l-Lumber and results.

These contextual properties are all present in the Virtu@l-Lumber case, which describes the business environment of a realistic Canadian lumber company. Figure 7 summarizes the main design recommendations resulting from the application of model (MIP) to the base Virtu@l-Lumber case, with a one year planning horizon divided into four seasons. The model recommends implementing the MSR conversion layout at the Scott-Junction sawmill and replacing the classic planing/grading capacity option in place by a MSR capacity option. The *status-quo* layout is kept at Chicoutimi and Maniwaki. However, the model suggest closing the drying, planing and finished inventory storage activities at Chicoutimi, and shipping all the green lumber produced in Chicoutimi to the Scott-Junction mill for final processing. The model further recommends the implementation of RL and 8' sawing lines in the three mills, but with a shutdown of the RL sawing line in season 3 and of the 8' sawing line in season 4 at Chicoutimi. In addition, the use of the Montreal warehouse is recommended. The model also suggests keeping a seasonal inventory of several raw materials and finished products. Several product substitutions are also recommended and the demand zones to supply from each plant and from the warehouse are specified. These recommendations result in a 15.4% increase of the company after tax profits.

Clearly, before implementing such recommendations, one would have to be very confident that the cost, price, capacity, supply and demand parameter values used for the year considered reflect a durable yearly pattern and, even then, some sensitivity analysis should be done to confirm the robustness of the solution obtained. Note that the model decision variables fall into two categories: design variables Y_{ls} , Y_s and Z_j and the seasonal activity anticipation variables \hat{Z}_{jt} , $F_{p(n,a)(n',a')t}$, $F_{pp'(s,a)dt}$, $X_{p,st}^i$ and I_{pkst} . The later are included in the model mainly to reflect the impact of the design decisions on seasonal activities and they would not be acted upon except maybe for the first season. The model can then be used as a tactical planning tool by fixing the design variables and running it on a rolling horizon basis to adapt seasonal decisions to up-to-date information and forecasts. If the business environment price and demand pattern is not stable, then one would have to use a two or three year planning horizon to properly anticipate the impact of the design on seasonal activities. When a longer horizon is used, prices, exchange rates and demands become much more difficult to forecast and several potential business environment scenarii must be considered. A good example of how to use the type of model presented here in such a context is given by Körksalan and Süral (1999).

The Virtu@l-Lumber case illustrates the use of the design methodology proposed to reorganize the current production-distribution network of a company, but the approach can be used in several other contexts. For example, it could be used to evaluate the value of a potential merger, the acquisition of a competitor's plant or a joint venture. It could be used by a company to investigate the impact of a change of its transfer prices, within the limits permitted by custom authorities. The model proposed could also be used as an econometric tool by governments to investigate the impact of a change of natural resources availability regulations on an industry sector.

3.2.6 Concluding Remarks

As was demonstrated in the previous section, the methodology proposed in this paper can effectively support the design of the production-distribution networks of divergent process industries. The model elaborated is a mixed integer programming problem, that can effectively be solved with commercial solvers in a reasonable amount of time, for realistic business cases.

Further work may be required to obtain an efficient solution approach for very large business cases, but we believe that the paper provides the basis required to develop a good strategic decision support system.

Several extensions to the model proposed can be considered, some trivial and others more demanding. A simple extension would be to incorporate the possibility of moving some existing equipment between plants. Another one would be the generalization of the approach to the case of many-to-many recipes for the process activities. An important extension would be to model product-markets in more details by considering important sub-markets such as the spot market, long term contracts and VMI agreements explicitly.

3.2.7 References

- Arntzen, B., G. Brown, T. Harrison and L. Trafton, 1995, Global Supply Chain Management at Digital Equipment Corporation, *Interfaces*, 21, 1, 69-93.
- Brown, G., G. Graves and M. Honczarenko, 1987, Design and Operation of a Multicommodity Production/Distribution System Using Primal Goal Decomposition, *Management Science*, 33, 1469-1480.
- Cohen, M., M. Fisher and R. Jaikumar, 1989, International Manufacturing and Distribution Networks: A Normative Model Framework, in K. Ferdows (ed), *Managing International Manufacturing*, Elsevier, 67-93.
- Cohen, M. and H. Lee, 1989, Resource Deployment Analysis of Global Manufacturing and Distribution Networks, *Journal of Manufacturing and Operations Management*, 2, 81-104.
- Cohen, M. and S. Moon, 1990, Impact of Production Scale Economies, Manufacturing Complexity, and Transportation Costs on Supply Chain Facility Networks, *Journal of Manufacturing and Operations Management*, 3, 269-292.
- Cohen, M. and S. Moon, 1991, An integrated plant loading model with economies of scale and scope, *European Journal of Operational Research*, 50, 266-279.
- Dogan K. and M. Goetschalckx, 1999, A Primal Decomposition Method for the Integrated Design of Multi-Period Production-Distribution Systems, *IIE Transactions*, 31, 1027-1036.
- Eppen, G., R. Kipp Martin and L. Schrage, 1989, A Scenario Approach to Capacity Planning, *Operations Research*, 37, 517-527.
- Fandel, G. and M. Stammen, 2004, A General Model for Extended Strategic Supply Chain Management with Emphasis on Product Life Cycles Including Development and Recycling, *International Journal of Production Economics*, 89, 293-308.
- Frabrychy, W. and P. Torgersen, 1966, *Operations Economy*, Prentice-Hall.

- Geoffrion, A. and G. Graves, 1974, Multicommodity Distribution System Design by Benders Decomposition, *Management Science*, 20, 822-844.
- Geoffrion, A. and R. Powers, 1995, 20 Years of Strategic Distribution System Design: Evolutionary Perspective, *Interfaces*, 25, 5, 105-127.
- Körksalan M. and H. Süral, 1999, Efes Beverage Group Makes Location and Distribution Decisions for its Malt Plants, *Interfaces*, 29, 2, 89-103.
- Lakhal, S., A. Martel, M. Oral and B. Montreuil, 1999, Network Companies and Competitiveness: Framework for Analysis, *European Journal of Operational Research*, 118, 278-294.
- Lakhal, S., A. Martel, O. Kettani and M. Oral, 2001, On the Optimization of Supply Chain Networking Decisions, *European Journal of Operational Research*, 129, 259-270.
- Martel, A. and U. Vankatadri, 1999, Optimizing Supply Network Structures Under Economies of Scale, IEPM Conference Proceedings, Glasgow, Book 1, 56-65.
- Martel, A., 2005, The design of production-distribution networks: A mathematical programming approach, in J. Geunes and P. Pardalos (eds.), *Supply Chain Optimization*, Kluwer Academic Publishers.
- Mazzola, J. and R. Schantz, 1997, Multiple-Facility Loading Under Capacity-Based Economies of Scope, *Naval Research Logistics*, 44, 229-256.
- Mazzola, J. and A.W. Neebe, 1999, Lagrangian-Relaxation-Based Solution Procedures for a Multiproduct Capacitated Facility Location Problem with Choice of Facility Type, *European Journal of Operational Research*, 115, 285-299.
- Pirkul, H. and V. Jayaraman, 1996, Production, Transportation, and Distribution Planning in a Multi-Commodity Tri-Echelon System, *Transportation Science*, 30, 291-302.
- Paquet, M., A. Martel and G. Desaulniers, 2004, Including Technology Selection Decisions in Manufacturing Network Design Models, *International Journal of Computer Integrated Manufacturing*, 17, 117-125.
- Philpott, A., and G. Everett, 2001, Supply Chain Optimisation in the Paper Industry. *Annals of Operations Research*, 108, 225-237.
- Shapiro, J., V. Singhal and S. Wagner, 1993, Optimizing the Value Chain, *Interfaces*, 23, 2, 102-117.
- Shapiro, J., 2001, Modeling the Supply Chain, Brooks/Cole Publishing Company.
- Verter, V. and C. Dincer, 1992, An integrated evaluation of facility location, capacity acquisition, and technology selection for designing global manufacturing strategies, *European Journal of Operational Research*, 60, 1-18.
- Verter, V. and C. Dincer, 1995, Facility Location and Capacity Acquisition: An Integrated Approach, *Naval Research Logistics*, 42, 1141-1160.
- Vidal, C. and M. Goetschalckx, 1997, Strategic Production-Distribution Models: A Critical Review with Emphasis on Global Supply Chain Models, *European Journal of Operational Research*, 98, 1-18.

Vidal, C. and M. Goetschalckx, 2001, A Global Supply Chain Model with Transfer Pricing and Transportation Cost Allocation, *European Journal of Operational Research*, 129, 134-158.

Chapitre 4 : Marchés et Positionnement par Anticipation

Ce chapitre présente l'article «Taking market forces into account in the design of production-distribution networks: A positioning by anticipation approach» soumis à The Journal of Industrial and Management Optimization durant l'été 2005.

4.1 Résumé

Cet article propose une méthodologie afin de capturer les opportunités de vente lors de la conception d'un réseau logistique. Trois types de relations commerciales ont été analysés : les marchés spots, les contrats classiques et les contrats d'approvisionnements de type VMI (*Vendor Managed Inventory*). Pour les deux derniers segments de marchés, les choix discrets sont utilisés afin de capturer et quantifier les préférences des clients par rapport à des offres logistiques de l'entreprise. Le modèle intègre la concurrence via les choix discrets, et suppose celle-ci passive au sens de Ghosh et Harche (1993). Le marché spot est quant à lui décrit par une fonction de prix dépendant de l'offre proposée par l'entreprise. Le déploiement du réseau de production et de distribution se formule par un modèle stochastique à deux étapes. Face à la difficulté combinatoire de ce type de modèles, une méthode échantillonnale, de type Monte-Carlo, est proposée afin d'approximer le problème initial. Enfin, des résultats numériques et une analyse de la convergence sont présentés.

4.2 Taking Market Forces into Account in the Design of Production-Distribution Networks: A Positioning by Anticipation Approach

Didier Vila^{1,2}, Alain Martel¹ and Robert Beauregard

⁽¹⁾ Université Laval, FOR@C Research Consortium, Network Organization Technology Research Center (CENTOR), Sainte-Foy, Québec, G1K7P4, Canada.

⁽²⁾ École Nationale Supérieure des Mines de Saint-Étienne, Centre G2I, 158 cours Fauriel, 42023 Saint-Étienne cedex 2, France.

Abstract. This paper presents an approach to take into account market opportunities when designing production-distribution networks. Three types of sub-markets found in several industrial contexts are analyzed: spot markets, contracts and Vendor Managed Inventory (VMI) agreements. For contracts and VMI agreements, customer preferences with respect to different logistics policies are considered. A price-supply function is proposed to model the spot market behavior. The production-distribution network design problem is formulated as a two-stage stochastic program with fixed recourse. Finally, a sample average approximation method (SAA), based on Monte Carlo sampling techniques, is proposed to solve the model.

Keywords. Production-distribution Network Design, Mathematical Programming, Monte-Carlo Sampling Methods, Market Analysis, Logistics Policy Selection.

Acknowledgements. This project would not have been possible without the financial support and the collaboration of FOR@C's partners. The information on discrete choice models provided by D. Bolduc (Economics Department, Université Laval) was also very helpful.

4.2.1 Introduction

The performance of a supply chain for a given product-market depends critically on the structure of its production-distribution network, i.e. the number, location, mission, technology and capacity of the facilities of the firms involved, but also on its capacity to make winning offers to its potential customers. A supply chain structure leading to lower prices, better service and better quality products than those of competitors leads to higher market shares and thus to higher revenues. By assuming that the demand for products is predetermined, classical network design models overlook this important aspect of the problem. The exact nature of the network design problems encountered in practice depends very much on the industrial context in which they occur, and on the breath of the markets considered. Networks covering several countries lead to much more complex design problems because factors such as exchange rates, duties and income tax must be taken into account. This paper presents a generic methodology to explicitly consider market forces when designing international production-distribution networks for make-to-stock products.

Logistics network design problems integrate location, capacity acquisition and technology selection sub-problems. A review of the initial literature on these problems is found in Verter and Dincer (1992). The first location-allocation model proposed (Geoffrion and Graves, 1974) was a single echelon single period model to determine the distribution centers to use, as well as the assignment of products and clients to these centers, in order to minimise the total cost of the system in a domestic context. Several extensions to this model were subsequently made to take into account multiple echelons (Cohen and Lee, 1989; Pirkul and Jayaraman, 1996; Martel and Vankatadri, 1999; Vidal and Goetschalckx, 2001), multiple production seasons (Cohen *et al.*, 1989; Arntzen *et al.*, 1995; Dogan and Goetschalckx, 1999), capacity acquisition and technology selection (Eppen *et al.*, 1989; Verter and Dincer, 1995; Mazzola and Neebe, 1999; Paquet *et al.*, 2004; Martel, 2005), economies of scale (Cohen and Moon, 1990, 1991; Mazzola and Schantz, 1997; Martel and Vankatadri, 1999), after tax net revenue maximization in an international context (Cohen *et al.*, 1989; Arntzen *et al.*, 1995; Vidal and Goetschalckx, 2001) and product development and recycling (Fandel and Stammen, 2004). Geoffrion and Powers (1995) and Shapiro *et al.* (1993) discuss the evolution of strategic supply chain design models and Vidal and

Goetschalckx (1997) present many of these models. A modeling framework integrating most of these results is presented in Martel (2005).

In most industrial sectors, the market is not monolithic and several product-markets governed by different rules-of-the-game can be found. For example, several natural resource based products, such as lumber, can be sold on the spot market or through contracts with major customers. In the later case, the probability of getting a contract depends on a set of qualifying and order-winning criteria such as price, lead-time and fill-rate. For a given potential customer, a company is able to win on several of these criteria only if its production-distribution facilities are better positioned than those of its competitors. Despite the obvious impact production-distribution network structures can have on company performance in such contexts, little work has been done to take market forces into account explicitly in network design models. Shapiro (2001) stresses the necessity to integrate strategic marketing and production-distribution decisions in the same model to design superior supply chains. In their literature review on the modeling of supply chain contracts, Tsay *et al.* (1999) do not include any papers dealing with production-distribution networks design issues. Rosenfield *et al.* (1985) show how the performance of different logistic network designs can be characterized by an efficient cost-service frontier. Starting from these results, this paper develops a generic approach and a two-stage stochastic programming model to design production-distribution networks improving the competitive position of a company on its markets. More specifically, three types of sub-markets found in several industrial contexts are considered: spot markets, contracts and Vendor Managed Inventory (VMI) agreements.

The rest of the paper is organized as follows. In the next section, the design approach proposed is explained and the stochastic programming model on which it is based is formulated. The following section presents the sample average approximation model, based on Monte Carlo sampling techniques, proposed to obtain network designs. Finally, numerical experiment results to test the approach are presented and analyzed.

4.2.2 Methodology

Without loss of generality, to simplify the presentation, we restrict ourselves to the case of a single echelon production-distribution network of the type illustrated in Figure 8. It is assumed that the production-distribution sites $s \in S^{pd}$ are already in use and that a subset of potential distribution sites $s \in S^d$ must be selected. In order to address the problem considered, it is necessary to understand the chronology of events underlying the design process. As illustrated in Figure 9, the hierarchical planning and execution process proposed involves four steps which are explained in the next subsections.

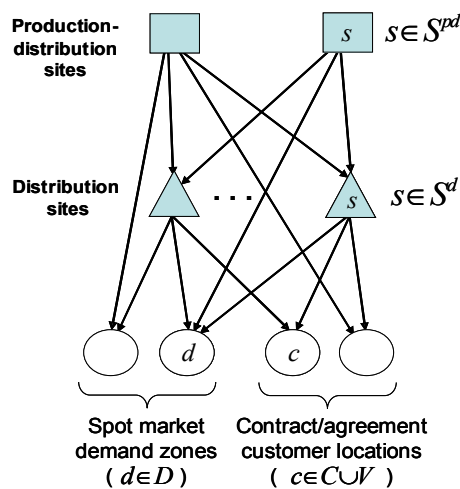

Figure 8: Network Structure

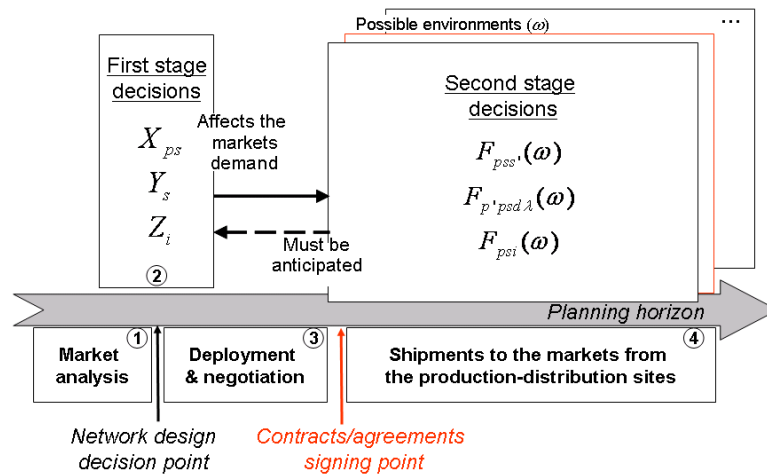

Figure 9: Chronology of Events

4.2.2.1 Market segmentation and logistics policies definition

It is assumed that the company is selling products $p \in P$ in several countries $o \in O$ and that each national division covers a set of distinct product-markets $m \in M_o, o \in O$. The set of national product-markets M_o can be partitioned into three sub-sets:

- A set of spot markets $m \in SM_o$. A spot market m is characterized by products $p \in P_m \subset P$, by demand zones $d \in D_{pm}$ and by decreasing price step functions $P_{pm}(x_{pm})$ of the total sales x_{pm} of product p in market m (see Figure 10). A demand zone d is a geographical aggregate of several ship-to locations with coordinates associated to its centroid. We use $m(d)$ to identify the spot market m to which demand zone d belongs.
- A set of customer contracts $c \in C_o$, which is partitioned into a set PC_o of potential contracts and a set SC_o of signed contracts. A contract c is an engagement to deliver a predetermined quantity x_c of product $p_c \in P$ to a given ship-to location, during a predetermined period of time, and with guaranteed price and lead time.
- A set of Vendor Managed Inventory (VMI) agreements $c \in V_o$ which is partitioned into a set PV_o of potential VMI agreements and a set SV_o of signed VMI agreements. A VMI agreement c is an engagement to deliver a predetermined quantity x_c of product $p_c \in P$ to a given ship-to location, during a predetermined period of time (assumed to be the same for all contracts and agreements), and with guaranteed price and fill rate.

The spot market can be considered as a *recourse* which can absorb any amount of product, but for a price decreasing with quantity. Signed contracts/agreements yield a deterministic demand to be satisfied, but potential contracts/agreements define a stochastic demand process. Additional flexibility is also possible through product substitution: indeed, in all markets, a product $p \in P$ can be substituted by a product $p' \in SP^p$, SP^p being a set of substitutes for product p .

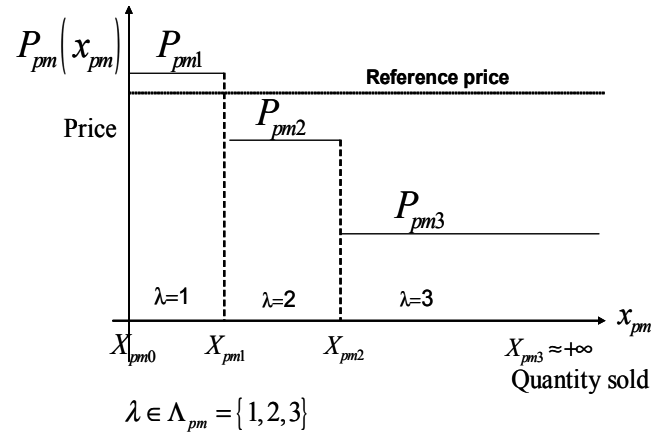

Figure 10: Spot Market Price Step Function

To product $p \in P_m$ on spot market $m \in SM_o$ we associate the decreasing price step function

$P_{pm}(x_{pm}) = P_{pm\lambda}$ if $X_{pm\lambda-1} < x_{pm} \leq X_{pm\lambda}$, $\lambda \in \Lambda_{pm}$ with $X_{pm0} = 0, X_{pm\lambda_{pm}} = +\infty, \lambda_{pm} \triangleq |\Lambda_{pm}|$ where Λ_{pm} is the set of steps of the function, $P_{pm\lambda}$ is the unit price for step $\lambda \in \Lambda_{pm}$ and

$X_{pm\lambda}$ is the upper bound of step $\lambda \in \Lambda_{pm}$, as illustrated in Figure 10. We assume that prices and step lengths are determined by the company using price forecasts based on the historical behavior of the firm prices on the spot market, in relation with an expected reference price.

Because of competition, it is assumed that potential customers will sign contracts only if the company can demonstrate that it has the resources required to comply with all the clauses of the contracts/agreements. Consequently, the production-distribution network must be designed to satisfy signed contracts and agreements $c \in SC_o \cup SV_o$ and to be in a position to satisfy some potential new contracts and agreements $c \in PC_o \cup PV_o$, knowing that the uncommitted production can be sold on the spot market.

In order to win contracts/agreements, the company has to develop different offers to satisfy potential customers better than its competitors. Following Hill (1994), it is assumed that these offers must be defined in terms of criteria that win contracts on the marketplace (order winners) and criteria that qualify the company as a potential supplier (qualifiers). These offers are formalized here through the concept of *logistics policy*. A logistic policy i

is characterized by a vector of target values for the relevant order winning and qualifying criteria and by the fix marketing and logistics cost K_i incurred when the policy is implemented. Let i_c be the logistics policy implemented for signed contract/agreement c and I_c be the set of policies considered for potential customer location c . For convenience, we define $I_c = \{i_c\}$, $c \in SC_o \cup SV_o$ and $I = \cup_c I_c$, and we use $c(i)$ to identify the customer location c to which policy i applies. Without loss of generality, it is assumed in this text that the order winners associated to a policy $i \in I_c$ considered for contract c are given by the pair (Price P_i , Maximum delivery time v_i). Similarly, it is assumed that the order winners associated to a policy $i \in I_c$ considered for VMI agreement c are given by the pair (Price P_i , Fill rate α_i). The fill rate α_i relates to the necessity to keep a safety stock at the customer location. The inventory holding cost of this safety stock for the contract period is included in the fix policy cost K_i .

For a given logistics policy, it may not be possible to satisfy the target values specified for the order winners and the qualifiers from all the production and distribution facilities in the network. For example, for a policy $i \in I_c$, $c \in PC_o$, if the delivery time required to service customer location $c(i)$ from a facility $s \in S^{pd} \cup S^d$ is longer than v_i , then this facility cannot be used to implement the policy. This leads to the association of a set of *admissible sites* $S_i^i \subseteq S^{pd} \cup S^d$ to each logistics policy i . S_i^i , $i \in I_c$, is the set of facilities $s \in S^{pd} \cup S^d$ the company could use to comply with the terms of logistics policy i . Note that the selection of a logistics policy $i \in I_c$ does not imply that the potential contract or VMI agreement c will be signed, but it qualifies the company to bid for this contract. The probability θ_i that contract or VMI agreement $c \in PC_o \cup PV_o$ will be signed if logistics policy $i \in I_c$ is selected can however be evaluated.

Discrete choice analysis can be used to estimate the probabilities $\theta_i, i \in I$, using econometric models (Ben-Akiva and Lerman, 1985). This approach is based on the modeling of customer preferences among a set of offers which could be made by the company or by its competitors. Each offer corresponds to a list of order winning criteria target values, coupled with the identity of the company making the offer. For contracts, an offer i would thus correspond to the triplet $(P_i, v_i, id(i))$, where $id(i)$ is the identity of the company making the offer. Let the set of offers to the customer associated to potential contract $c \in PC_o$ be denoted by $Offer_c$. Note that this set necessarily includes all the logistics policies considered for potential contract c , i.e. $Offer_c \supset I_c$. Based on random utility theory, the utility $U_c(i)$ of an offer $i \in Offer_c$ for customer $c \in PC_o$ can be modeled with the linear function:

$$U_c(i) = \beta_{socio} o(c) + \beta_{price} P_i + \beta_{delay} v_i + \beta_{comp} id(i) + \varepsilon_{ic}$$

where β_{socio} , β_{price} , β_{delay} and β_{comp} are parameters to be estimated and where ε_{ic} is a random component. The independent random variables ε_{ic} are Gumbel-distributed with a location parameter η and a scale parameter $0 < \mu$, i.e. they have the same probability density function $f(\varepsilon) = \mu e^{-\mu(\varepsilon-\eta)} \exp(-e^{-\mu(\varepsilon-\eta)})$. The parameter β_{socio} associated to the country $o(c)$ of customer c , captures local socio-economic effects. In order to estimate the model parameters, the *stated* preferences framework proposed by Louviere *et al.* (2000) can be used. A questionnaire with hypothetical offers is submitted to a sample of customers. With these observations, maximum likelihood estimators are used to obtain the parameters value. This can be implemented, for example, with the BIOGEME software developed by Bierlaire and available on the Web at <http://roso.epfl.ch/biogeme>.

Neoclassical utility theory is based on the premise that decision-makers chose their highest utility options. In our context, this leads to the assumption that the probability that the customer associated to potential contract $c \in PC_o$ would choose an offer $i \in Offer_c$ is given by:

$$P(i | Offer_c) = P(U_c(i) \geq U_c(i'), \forall i' \in Offer_c)$$

When using a Multinomial Logit discrete choice model, this probability can be calculated with the expression:

$$P(i | Offer_c) = \frac{e^{\mu(\beta_{socio}o(c) + \beta_{price}P_i + \beta_{delay}v_i + \beta_{comp}id(i))}}{\sum_{i \in Offer_c} e^{\mu(\beta_{socio}o(c) + \beta_{price}P_i + \beta_{delay}v_i + \beta_{comp}id(i))}}$$

However, since a single logistic policy $i \in I_c \subset Offer_c$ could eventually be offered to potential customer c , in order to calculate the probability θ_i , only offer i and the offers of the competitors must be considered. Let $Offer_c(i)$ be the subset of $Offer_c$ constituted of the competitor offers and of offer $i \in I_c \subset Offer_c$. Then, the probability that contract $c(i)$ would be signed, if logistics policy $i \in I_c$ is selected, is given by:

$$\theta_i = P(i | Offer_{c(i)}(i)) = \frac{e^{\mu(\beta_{socio}o(c(i)) + \beta_{price}P_i + \beta_{delay}v_i + \beta_{comp}id(i))}}{\sum_{i \in Offer_{c(i)}(i)} e^{\mu(\beta_{socio}o(c(i)) + \beta_{price}P_i + \beta_{delay}v_i + \beta_{comp}id(i))}}$$

The same approach can be used to obtain the probabilities θ_i that VMI agreements will be signed. It is through this probability estimation procedure that competitor potential actions are taken into account in our production-distribution network design methodology.

4.2.2.2 Network design decisions and anticipated shipping decisions

The goal of the company is to design its production-distribution network anticipating the future by simultaneously selecting adequate logistics policies, and by allocating production capacity and locating distribution centers to support these policies. This requires the definition of the following decision variables:

X_{ps} = Quantity of product P produced in production-distribution center $s \in S^{pd}$.

Y_s = Binary variable equal to 1 if potential distribution center $s \in S^d$ is used and to 0 otherwise.

Z_i = Binary variable equal to 1 if logistics policy $i \in I_c$, $c \in PC_o \cup PV_o$ is selected and to 0 otherwise.

For convenience, we also define the following design variable vectors:

$$\mathbf{X} \triangleq [X_{ps}], \mathbf{Y} \triangleq [Y_s] \text{ and } \mathbf{Z} \triangleq [Z_i].$$

In order to design the network properly, the impact of these decisions on future market demand and on the operational costs associated to the delivery of products sold to customer locations must be anticipated. In order to anticipate future network costs and revenues, we assume that, as illustrated in Figure 9, once design decisions have been implemented, at some point in time, customers will accept or reject the company's offers and the quantity of products to ship in the contract/agreement period will be known. A particular reaction from the customers to the company potential offers defines a business *environment*. Although, it is clear that all the contracts/agreements would not be signed or rejected at the same point in time, we propose to anticipate the impact of the design by computing expected network flow costs and revenues during a predetermined contract duration period for all the future environments the company could face.

Let Ω be the set of all possible environments. An *environment* $\omega \in \Omega$ is a binary variable vector of dimension $|I|$ indicating whether the customers would sign a contract/agreement ($\omega_i = 1$) or not ($\omega_i = 0$) for all possible logistics policies $i \in I$. Note that $\omega_i = 1$, $c(i) \in SC_o \cup SV_o$, in all environments since these contracts/agreements are already signed when the design decisions are made. Also note that it is not necessary to include the spot market explicitly in the description of an environment since it is considered as a recourse which can absorb any outstanding production.

Since ω_i is a binary variable, the number of possible environments which could be observed is given by 2^n , $n = \sum_{o \in O} (\sum_{c \in PC_o \cup PV_o} |I_c|)$. Since the company cannot implement more than one logistics policy $i \in I_c$ at the same time, for a given environment $\omega \in \Omega$, the demand on the contract and VMI agreement markets in country $o \in O$ is given by:

$$\left(\sum_{i \in I_c} \omega_i Z_i \right) x_c \quad c \in PC_o \cup PV_o; \quad x_c \quad c \in SC_o \cup SV_o$$

Also, the probability $p(\omega)$ that a given environment $\omega \in \Omega$ will prevail, can be derived from the probabilities θ_i of signing a contract or VMI agreement under logistics policies

$i \in I$. This clearly shows that market demand depends on logistic network design decisions. In other words, in our approach, logistic network design decisions are not made simply to adapt to a predetermined demand, they are strategic competitive positioning decisions used to influence customer behavior.

The network design decisions \mathbf{X} , \mathbf{Y} and \mathbf{Z} considered here are *first stage* decisions which would normally be implemented in practice immediately after they are made. Their implementation would not be instantaneous however. In particular, the decisions \mathbf{Y} lead to the redeployment of the company distribution network and the decisions \mathbf{Z} to the negotiation of contracts with potential customers, which may take several months. As illustrated in Figure 9, at the end of this implementation phase, the environment $\omega \in \Omega$ in which the logistics network implemented will be used is revealed and shipment decisions to satisfy market demand during the contracts/agreements period must be made. Although these *second stage* decisions would not be implemented *per se* in practice, they are important to anticipate the impact of the network design on network flow costs and revenues. These second stage decisions are clearly dependent on the environment $\omega \in \Omega$ which will eventually prevail. Taking product substitution possibilities into account, this leads to the definition of the following network flow decision variables:

$F_{pss'}(\omega)$ = Flow of product P between production-distribution site $s \in S^{pd}$ and distribution site $s' \in S^d$ for environment $\omega \in \Omega$.

$F_{pp'sd\lambda}(\omega)$ = Outbound flow from site s of product $p' \in P$ used to satisfy the demand for product $p \in P$ in demand zone d of spot market $m(d)$, and sold at price $P_{pm(d)\lambda}$ of step function interval $\lambda \in \Lambda_{pm(d)}$, for environment $\omega \in \Omega$.

$F_{psi}(\omega)$ = Outbound flow from site s of product $p \in P$ used to satisfy the demand of product $p_{c(i)}$ at customer location $c(i) \in C_o \cup V_o$ with the logistics policy i , for environment $\omega \in \Omega$.

For convenience, we define the vector of second stage variables

$$\mathbf{F}(\omega) \triangleq [F_{pss'}(\omega), F_{pp'sd\lambda}(\omega), F_{psi}(\omega)].$$

The design approach described in the previous paragraphs leads to the formulation of the problem as a two-stage stochastic program with recourse (Birge and Louveaux., 1997).

4.2.2.3 Two stage stochastic programming approach

The two-stage stochastic program with fixed recourse required to design the logistics networks considered has the following form:

$$\begin{aligned} \max f(\mathbf{X}, \mathbf{Y}, \mathbf{Z}) &= \sum_{\omega \in \Omega} p(\omega) [\max \mathbf{qF}(\omega)] - (\mathbf{cX} + \mathbf{aY} + \mathbf{kZ}) && \text{SP} \\ \text{s.t. } \mathbf{A}[\mathbf{X}, \mathbf{Z}] &\leq \mathbf{b}, \\ &-\mathbf{T}(\omega)\mathbf{Z} + \mathbf{UF}(\omega) = \mathbf{0}, \quad \omega \in \Omega, \\ &-\mathbf{V}[\mathbf{X}, \mathbf{Y}] + \mathbf{WF}(\omega) = \mathbf{h}, \quad \omega \in \Omega, \\ &\mathbf{X} \geq \mathbf{0}; \mathbf{Y}, \mathbf{Z} \text{ binary}; \mathbf{F}(\omega) \geq \mathbf{0}, \omega \in \Omega. \end{aligned}$$

where \mathbf{q} , \mathbf{c} , \mathbf{a} and \mathbf{k} are vectors of revenues and costs to be defined, \mathbf{A} , $\mathbf{T}(\omega)$, \mathbf{U} , \mathbf{V} and \mathbf{W} are matrices of parameters to be defined, \mathbf{b} and \mathbf{h} are right hand side vectors to be defined and $\mathbf{0}$ is a nul vector. The objective of this mixed integer program is to find the design maximizing the expected after tax profits of the company. As it stands, it is difficult to solve because the number of possible environments in Ω can be extremely large. Fortunately, there is no second stage binary variable, which means that each environment adds only continuous variables. Nevertheless, for a practical case, program (SP) could include billions of second stage variables, which is prohibitive even for the very efficient solvers currently available.

In order to avoid this pitfall, the approach proposed seeks to find the best possible design with the mathematical programming solvers currently available. The approach used is based on the Monte Carlo sampling methods presented by Shapiro (2003). A random sample of environments is generated outside the optimization procedure and then a sample average approximation (SAA) program is constructed and solved. The idea is first to generate an independent identically distributed sample of N environments $\{\omega^1, \dots, \omega^N\} = \Omega^N \subset \Omega$ from the initial distribution of ω . Then the SAA program to solve is the following:

$$\begin{aligned}
\max &= \frac{1}{N} \sum_{\omega \in \Omega^N} \mathbf{qF}(\omega) - (\mathbf{cX} + \mathbf{aY} + \mathbf{kZ}) && \text{SAA}(\Omega^N) \\
s.t. & \mathbf{A}[\mathbf{X}, \mathbf{Z}] \leq \mathbf{b}, \\
& -\mathbf{T}(\omega)\mathbf{Z} + \mathbf{UF}(\omega) = \mathbf{0}, \quad \omega \in \Omega^N, \\
& -\mathbf{V}[\mathbf{X}, \mathbf{Y}] + \mathbf{WF}(\omega) = \mathbf{h}, \quad \omega \in \Omega^N, \\
& \mathbf{X} \geq \mathbf{0}; \mathbf{Y}, \mathbf{Z} \text{ binary}; \mathbf{F}(\omega) \geq \mathbf{0}, \omega \in \Omega^N.
\end{aligned}$$

Clearly, the quality of the solution obtained with this approach improves as the size N of the sample of environments used increases. The approach suggested here is to use a sample size N giving a SAA program solvable in a reasonable time with a commercial solver such as CPLEX. The SAA program is solved for M independent samples each of size N . This leads to the identification of up to M near-optimal feasible solutions. Statistical confidence intervals, based on Shapiro (2003), are then derived on the quality of the near-optimal solutions found. An example of the application of this approach to a related network design problem is found in Santoso *et al.* (2005). The next section presents the approach proposed to generate a sample of environments Ω^N and the explicit formulation of the SAA program for our design problem.

4.2.3 SAA Program Formulation

4.2.3.1 Environment sample generation

In order to formulate the SAA program, we must first specify how to proceed to generate a valid sample of environments Ω^N . Note that in order to select the sample $\{\omega^1, \dots, \omega^N\} \subset \Omega$, it is not necessary to use the probabilities $p(\omega)$, $\omega \in \Omega$ explicitly. Since $p(\omega)$ must be derived from the probabilities θ_i , $i \in I$, of signing contracts and VMI agreements, it is easier to construct sampled environments directly from these probabilities. Assuming that the customers decisions are taken independently of each other, to sample an environment $\omega \in \Omega^N$ we start by generating a pseudorandom set $\{u_i^c(\omega)\}$, $c \in \cup_{o \in O} (PC_o \cup PV_o)$, $i \in I_c$, of independent numbers uniformly distributed on the interval $[0;1]$. Using these numbers, the elements of the environment vector ω are then obtained with the following transformation:

$$\omega_i = \begin{cases} 1 & c(i) \in \cup_{o \in O} (PC_o \cup PV_o), i \in I_{c(i)}(\omega) \\ 0 & c(i) \in \cup_{o \in O} (PC_o \cup PV_o), i \notin I_{c(i)}(\omega), \text{ where } I_c(\omega) = \{i \in I_c \mid \theta_i \geq u_i^c(\omega)\} \\ 1 & c(i) \in \cup_{o \in O} (SC_o \cup SV_o) \end{cases}$$

The subsets $I_c(\omega) \subset I_c$ thus defined indicate which logistics policies would lead to signed contracts/agreements if implemented. Repeating the previous Monte Carlo sampling method N times yields the required sample of environments $\Omega^N = \{\omega^1, \dots, \omega^N\}$.

4.2.3.2 Demand, distribution and manufacturing constraints formulation

The following additional sets and parameters are required to formulate of the various demand, distribution and manufacturing constraints which must be satisfied:

SP_p = Set of products which product p can substitute for.

S_{ps}^o = Set of distribution sites (output destinations) which can receive product p from production-distribution site s .

S_{ps}^i = Set of production-distribution sites (input sources) which can ship product p to distribution site s .

S_m^i = Set of facilities which can ship products $p \in P_m$ to spot market m ($S_m^i \subseteq S^d \cup S^{pd}$).

SM_{ps} = Set of spot markets which can receive substitute products p from node s , i.e

$$SM_{ps} = \{m \mid s \in S_m^i, p \in \cup_{p' \in P_m} SP_{p'}\}.$$

κ_d = Proportions of the sales x_{pm} made in each demand zone $d \in D_{pm}$.

b_{ps} = Quantity of product p which can be produced in production center s .

b_s = Warehousing capacity of distribution center s in an appropriate unit.

q_p = Warehousing capacity consumption rate per unit of product p .

For all the sample environments $\omega \in \Omega^N$, the flow of products or substitute products from the production and distribution sites must cover the demand associated to the signed contracts and VMI agreements. Knowing that logistics policy i_c is used for customer $c \in SC_o \cup SV_o$, this give rise to the following constraints:

$$\sum_{p \in SP^{pc}} \sum_{s \in S_c^i} F_{psi}(\omega) = x_c \quad \omega \in \Omega^N, c \in \cup_{o \in O} SC_o \cup SV_o \quad 1)$$

Concerning potential customers $c \in PC_o \cup PV_o$, the form taken by the demand constraints depends on the customer response for the environment $\omega \in \Omega^N$ considered and on first stage logistics policy implementation decisions Z_i . The constraints required are the following:

$$\sum_{p \in SP^{pc}} \sum_{s \in S_c^i} F_{psi}(\omega) = x_c Z_i \quad \omega \in \Omega^N, c \in \cup_{o \in O} PC_o \cup PV_o, i \in I_c(\omega) \quad 2)$$

$$\sum_{i \in I_c} Z_i \leq 1 \quad c \in \cup_{o \in O} PC_o \cup PV_o \quad 3)$$

In 2), for each environment $\omega \in \Omega^N$, the demand constraints are included only for the logistics policies $i \in I_c(\omega)$ which would lead to a signature of the contract/agreement. For the other policies, the contract would not be signed and hence the demand would be zero. This could be included as explicit constraints but it is more efficient to drop these constraints and the associated flow variables. Also note that because there is a fixed cost K_i associated to Z_i in the objective function, in the optimal solution $Z_i = 0, i \notin \cup_{\omega \in \Omega^N} I_c(\omega)$. This is important because it guarantees that any optimal solution of program SAA(Ω^N) is a feasible solution of program (SP). Constraints 3) are required to make sure that at most one logistics policy i in I_c will be implemented.

As indicated earlier, a spot market m is composed of demand zones $d \in D_{pm}$ for each product $p \in P_m$. We assume that prices on a spot market m are based on the sales volume x_{pm} of product $p \in P_m$ on that market, but that the proportions $\kappa_d, d \in D_{pm}$, of the sales x_{pm}

made in each demand zone $d \in D_{pm}$ are known. Given that, for a given environment, upper bounds on the flow of products to demand zone $d \in D_{pm}$, for each step of the price function, are given by:

$$\sum_{p' \in SP^p} \sum_{s \in S_m^i} F_{pp'sd\lambda}(\omega) \leq \kappa_d (X_{pm\lambda} - X_{pm(\lambda-1)}) \quad \omega \in \Omega^N, m \in \cup_{o \in O} SM_o, p \in P, d \in D_{pm}, \lambda \in \Lambda_{pm} \quad 4)$$

Since we want to maximize profits, with the type of price step functions used, it can be shown (see the Appendix for a proof) that any *optimal solution* to the SAA program will be such that, for step $\lambda \in \Lambda_{pm}$:

$$\sum_{p' \in SP^p} \sum_{s \in S_m^i} F_{pp'sd\lambda}(\omega) > 0 \Rightarrow \sum_{p' \in SP^p} \sum_{s \in S_m^i} F_{pp'sd\lambda'}(\omega) = \kappa_d (X_{pm\lambda'} - X_{pm(\lambda'-1)}), \quad \lambda' < \lambda$$

For this reason, it is sufficient to include the constraints 4) in the SAA program to ensure that spot market prices will be modeled properly.

The capacity constraints required for the production-distribution and distribution facilities are the following:

$$X_{ps} \leq b_{ps} \quad p \in P, s \in S^{pd} \quad 5)$$

$$\sum_{p \in P} q_p \sum_{s' \in S_{ps}^i} F_{ps's}(\omega) \leq b_s Y_s \quad \omega \in \Omega^N, s \in S^d \quad 6)$$

For each environment, the following flow conservation constraints must also hold:

$$\sum_{s' \in S_{ps}^o} F_{ps's'}(\omega) + F_{ps}(\omega) = X_{ps} \quad \omega \in \Omega^N, p \in P, s \in S^{pd} \quad 7)$$

$$F_{ps}(\omega) = \sum_{s' \in S_{ps}^i} F_{ps's}(\omega) \quad \omega \in \Omega^N, p \in P, s \in S^d \quad 8)$$

$$F_{ps}(\omega) = \sum_{m \in SM_{ps}} \sum_{p' \in P_m} \sum_{d \in D_{pm}} \sum_{\lambda \in \Lambda_{p'm}} F_{p'psd\lambda}(\omega) + \sum_{c \in C \cup I'} \sum_{p \in SP_{pc}} \sum_{i \in I_c(\omega)} \sum_{s \in S_i^i} F_{psi}(\omega) \quad \omega \in \Omega^N, p \in P, s \in S^{pd} \cup S^d \quad 9)$$

where $F_{ps}(\omega)$ is a working decision variable defined by 9) and used to simplify the formulation.

4.2.3.3 Objective function formulation

To calculate the total revenues and costs of a network design, the following financial parameters are required:

A_s = Fixed cost of using distribution site $s \in S^d$ for the planning horizon.

c_{ps} = Cost of producing one unit of product P on site $s \in S^{pd}$.

f_{psn}^o = Unit cost of the flow of product P between site s and node n paid by origin s (this cost includes the customer-order processing cost, the shipping cost, the variable transportation cost and the inventory-in-transit holding cost).

f_{psn}^t = Unit transportation cost of product P from site s to node n (this cost is included in f_{psn}^o).

f_{pns}^d = Unit cost of the flow of product P between node n and site s paid by destination s (this cost includes the supply-order processing costs and the receiving cost).

h_{ps} = Unit inventory holding cost of product P in facility s .

π_{ps} = Transfer price of product P shipped from site s .

$e_{oo'}$ = Exchange rate, i.e. number of units of country o currency by units of country o' currency (the index $o = 0$ is given to the base currency).

δ_{pns} = Import duty rate applied to the CIF price of product P when transferred from the country of node n to the country of site s .

τ_o = Income tax rate of country o .

ρ_{ps} = Number of seasons of inventory (order cycle and safety stocks) of product P held at site s .

In an international context, in order to take transfer prices and taxes into account correctly, it is necessary to derive an income statement for each network facility. Let:

$C_s(\omega)$ = Total site s expenses for the planning horizon under environment $\omega \in \Omega^N$.

$R_s(\omega)$ = Total site s revenues for the planning horizon under environment $\omega \in \Omega^N$.

Then, using the expenditure and revenue elements in Table 5, where $o(s)$ denotes the country of site s , it is seen that:

$$C_s(\omega) = (c) + (e) + (f) + (g) \quad s \in S^{pd}, \quad \omega \in \Omega^N \quad (10)$$

$$C_s(\omega) = (a) + (b) + (d) + (e) + (g) \quad s \in S^d, \quad \omega \in \Omega^N \quad (11)$$

$$R_s(\omega) = (h) + (i) \quad s \in S^{pd}, \quad \omega \in \Omega^N \quad (12)$$

$$R_s(\omega) = (i) \quad s \in S^d, \quad \omega \in \Omega^N \quad (13)$$

The operating income for each national division $o \in O$, under a given environment ω , taking into account the fixed costs of all the logistics policies considered for contracts and VMI agreements $c \in C_o \cup V_o$, is given by:

$$M_o(\omega) = \sum_{s \in S_o} (R_s(\omega) - C_s(\omega)) - \sum_{c \in C_o \cup V_o} \sum_{i \in I_c} K_i Z_i \quad (14)$$

		Distribution center ($s \in S^d$)	Production-distribution center ($s \in S^{pd}$)
Expenses	a) Inflow transfer cost	$\sum_{p \in P} \sum_{s' \in S_{ps}^i} (1 + \delta_{pss'}) e_{o(s)o(s')} (\pi_{ps'} + f_{ps's}^t) F_{ps's}(\omega)$	
	b) Receptions from other sites	$\sum_{p \in P} \sum_{s' \in S_{ps}^i} f_{ps's}^d F_{ps's}(\omega)$	
	c) Production		$\sum_{p \in P} c_{ps} X_{ps}$
	d) Facilities options cost	$A_s Y_s$	
	e) Order cycle and safety stocks		$\sum_{p \in P} h_{ps} \rho_{ps} (F_{ps}(\omega) + \sum_{s' \in S_{ps}^o} F_{pss'}(\omega))$
	f) Outflows to other sites		$\sum_{p \in P} \sum_{s' \in S_{ps}^o} f_{pss'}^o F_{pss'}(\omega)$
	g) Outflows to demand zones	$\sum_{c \in C \cup V} \sum_{i \in I_c(\omega)} \sum_{s \in S_i^i} \sum_{p' \in SP^{pc}} f_{p'sd_c}^o F_{p'si}(\omega) +$ $\sum_{m \in SM} \sum_{s \in S_m^i} \sum_{p \in P_m} \sum_{d \in D_{pm}} \sum_{\lambda \in \Lambda_{pm}} \sum_{p' \in SP^p} f_{p'sd}^o F_{pp'sd\lambda}(\omega)$	
Revenues	h) Outflows to other sites		$\sum_{p \in P} \sum_{s' \in S_{ps}^o} (\pi_{ps'} + f_{pss'}^t) F_{pss'}(\omega)$
	i) Outflows to demand zones	$\sum_{c \in C \cup V} e_{o(s),o(d_c)} \sum_{i \in I_c(\omega)} \sum_{s \in S_i^i} \sum_{p' \in SP^{pc}} P_i F_{p'si}(\omega)$ $+ \sum_{m \in SM} \sum_{s \in S_m^i} \sum_{p \in P_m} \sum_{d \in D_{pm}} e_{o(s),o(d)} \sum_{\lambda \in \Lambda_{pm}} \sum_{p' \in SP^p} P_{pm\lambda} F_{pp'sd\lambda}(\omega)$	

Table 5 : Facilities Expenses and Revenues in Local Currency for a Given Environment

where S_o is the set of sites located in country o . We must distinguish positive margins from negative margins because there is no income tax to pay on losses. To do this, $M_o(\omega)$ must be separated in its negative and positive parts by defining the operating income $M_o(\omega) = M_o^+(\omega) - M_o^-(\omega)$. Given this, the objective function of the SAA program, i.e. the after tax net revenue of the corporation in its reference currency, is given by the expression

$$\sum_{o \in O} e_{0o} [(1 - \tau_o) M_o^+(\omega) - M_o^-(\omega)].$$

Based on the previous discussion, it can be seen that the SAA program to solve is the following:

$$\text{Max } \frac{1}{N} \sum_{\omega \in \Omega^N} \sum_{o \in O} e_{0o} [(1 - \tau_o) M_o^+(\omega) - M_o^-(\omega)]$$

subject to constraints 1) to 13), to the national divisions operating income definitions

$$\sum_{s \in S_o} (R_s(\omega) - C_s(\omega)) - \sum_{c \in C_o \cup V_o} \sum_{i \in I_c} K_i Z_i - M_o^+(\omega) + M_o^-(\omega) = 0, \quad o \in O, \omega \in \Omega^N, \quad 15)$$

and to the non-negativity constraints:

$$\begin{aligned} X_{ps} &\geq 0 \quad p \in P, s \in S^{pd} \quad Y_s \in \{0, 1\} \quad s \in S^d \quad Z_i \in \{0, 1\} \quad o \in O, c \in PC_o \cup PV_o, i \in I_c \\ F_{ps'}(\omega) &\geq 0 \quad p \in P, s \in S^{pd}, s' \in S_{ps}^o, \omega \in \Omega^N \quad F_{ps}(\omega) \geq 0 \quad p \in P, s \in S^{pd} \cup S^d, \omega \in \Omega^N \\ F_{p'si}(\omega) &\geq 0 \quad o \in O, c \in C_o \cup V_o, p' \in SP^{pc}, \omega \in \Omega^N, i \in I_c(\omega), s \in S_i^i \\ F_{pp'sd\lambda}(\omega) &\geq 0 \quad o \in O, m \in MS_o, p \in P_m, p' \in SP^p, s \in S_m^i, d \in D_{pm}, \lambda \in \Lambda_{pm}, \omega \in \Omega^N \\ C_s(\omega) &\geq 0, s \in S^{pd} \cup S^d, \omega \in \Omega^N \quad R_s(\omega) \geq 0, s \in S^{pd} \cup S^d, \omega \in \Omega^N \\ M_o^+(\omega) &\geq 0, o \in O, \omega \in \Omega^N \quad M_o^-(\omega) \geq 0, o \in O, \omega \in \Omega^N \end{aligned}$$

Note that in some contexts, companies may prefer to maximize corporate net revenues *before* taxes in the reference currency, that is $\sum_{o \in O} e_{0o} M_o(\omega)$. When this is the case, constraints 15) are not necessary and 14) can be substituted back into the net revenue expression, to get the following objective function:

$$\text{Max } \sum_{o \in O} e_{0o} \left\{ \sum_{s \in S_o} \left[\frac{1}{N} \sum_{\omega \in \Omega^N} R_s(\omega) - \frac{1}{N} \sum_{\omega \in \Omega^N} C_s(\omega) \right] - \sum_{c \in C_o \cup V_o} \sum_{i \in I_c} K_i Z_i \right\}$$

Furthermore, the revenue $R_s(\omega)$ and expenditure $C_s(\omega)$ definitions 10) to 13) can also be substituted back into the objective function, which decreases the size of the model significantly.

4.2.4 Sample Average Approximation

In this section, the approach proposed to find a near-optimal production-distribution network design is described in more details. As explained at the end of section 4.2.2.3, the approach involves the solution of the SAA program for M different samples of size N . This implies that M different near-optimal feasible designs could be obtained and the questions to answer are then: which design is the best and how close is it to the true optimum? To answer these questions, we need to obtain better estimates of the true value of the objective function of the solutions found through a Monte-Carlo evaluation based on a sample size N' much bigger than N . We also need to obtain statistical lower and upper bounds on the true value of the optimal solution of (SP). Let v^* and v^N be the optimal value of program (SP) and program $\text{SAA}(\Omega^N)$, respectively, and let $(\hat{\mathbf{X}}^N, \hat{\mathbf{Y}}^N, \hat{\mathbf{Z}}^N)$ be an optimal solution of $\text{SAA}(\Omega^N)$. Also, let us rewrite the SAA program as follows:

$$\max_{\mathbf{X} \geq 0; \mathbf{Y}, \mathbf{Z} \text{ bin}} \left\{ \hat{f}^N(\mathbf{X}, \mathbf{Y}, \mathbf{Z}) = \frac{1}{N} \sum_{\omega \in \Omega^N} Q(\mathbf{X}, \mathbf{Y}, \mathbf{Z}, \omega) - (\mathbf{c}\mathbf{X} + \mathbf{a}\mathbf{Y} + \mathbf{k}\mathbf{Z}) \mid \mathbf{A}[\mathbf{X}, \mathbf{Z}] \leq \mathbf{b} \right\} \quad \text{SAA}(\Omega^N)$$

where $Q(\mathbf{X}, \mathbf{Y}, \mathbf{Z}, \omega)$ is the optimal value of the second stage linear program:

$$Q(\mathbf{X}, \mathbf{Y}, \mathbf{Z}, \omega) = \max_{\mathbf{F} \geq 0} \left\{ \mathbf{q}\mathbf{F} \mid \mathbf{U}\mathbf{F} = \mathbf{T}(\omega)\mathbf{Z}, \mathbf{W}\mathbf{F} = \mathbf{h} + \mathbf{V}[\mathbf{X}, \mathbf{Y}] \right\}$$

It can be shown that the expected value of v^N is greater than or equal to v^* (Shapiro, 2003). This result is used to derive the required statistical upper bound. Also, since $(\hat{\mathbf{X}}^N, \hat{\mathbf{Y}}^N, \hat{\mathbf{Z}}^N)$ is a feasible solution of program (SP), we have $f(\hat{\mathbf{X}}^N, \hat{\mathbf{Y}}^N, \hat{\mathbf{Z}}^N) \leq v^*$. This is used to obtain the required statistical lower bound. From these observations, it is seen that a near-optimal design is found using the following procedure (a similar procedure is found in Santoso *et al.*, 2005):

Step 1: Generate M independent samples each of size N , $\{\omega_j^1, \dots, \omega_j^N\} = \Omega_j^N$, $j = 1, \dots, M$ and solve SAA(Ω^N) for each sample j . Let v_j^N and $(\hat{\mathbf{X}}^N, \hat{\mathbf{Y}}^N, \hat{\mathbf{Z}}^N)$ be the corresponding optimal objective value and an optimal solution, respectively.

Step 2: Compute the statistical lower bound

$$\bar{v}_{N,M} = \frac{1}{M} \sum_{j=1}^M v_j^N$$

Since $\bar{v}_{N,M}$ is an unbiased estimator of $E(v_N)$, we have $\bar{v}_{N,M} \geq v^*$.

Step 3: Let J be the set of distinct solutions found with the samples $j = 1, \dots, M$.

For each distinct solution found, $(\hat{\mathbf{X}}_j^N, \hat{\mathbf{Y}}_j^N, \hat{\mathbf{Z}}_j^N)$, $j \in J$, estimate its true objective function value $f(\hat{\mathbf{X}}_j^N, \hat{\mathbf{Y}}_j^N, \hat{\mathbf{Z}}_j^N)$ with the following approximation:

$$\tilde{f}^{N'}(\hat{\mathbf{X}}_j^N, \hat{\mathbf{Y}}_j^N, \hat{\mathbf{Z}}_j^N) = \frac{1}{N'} \sum_{\omega \in \Omega^{N'}} Q(\hat{\mathbf{X}}_j^N, \hat{\mathbf{Y}}_j^N, \hat{\mathbf{Z}}_j^N, \omega) - (\mathbf{c}\hat{\mathbf{X}}_j^N + \mathbf{a}\hat{\mathbf{Y}}_j^N + \mathbf{k}\hat{\mathbf{Z}}_j^N)$$

Note that the sample of size N' must be generated independently of the sample used to obtain $(\hat{\mathbf{X}}_j^N, \hat{\mathbf{Y}}_j^N, \hat{\mathbf{Z}}_j^N)$. For each $j \in J$, this step requires the solution of N' second-stage linear programs to obtain the optimal values $Q(\hat{\mathbf{X}}_j^N, \hat{\mathbf{Y}}_j^N, \hat{\mathbf{Z}}_j^N, \omega)$, $\omega \in \Omega^{N'}$. Note that $\tilde{f}^{N'}(\hat{\mathbf{X}}_j^N, \hat{\mathbf{Y}}_j^N, \hat{\mathbf{Z}}_j^N)$ is an unbiased estimator of $f(\hat{\mathbf{X}}_j^N, \hat{\mathbf{Y}}_j^N, \hat{\mathbf{Z}}_j^N)$ (Shapiro, 2003) and thus, it is a statistical lower bound on v^* . The statistical bounds obtained can be used to compute an estimate of the optimality gap of solution $(\hat{\mathbf{X}}_j^N, \hat{\mathbf{Y}}_j^N, \hat{\mathbf{Z}}_j^N)$:

$$\mathbf{Gap}_{N,M,N'}(\hat{\mathbf{X}}_j^N, \hat{\mathbf{Y}}_j^N, \hat{\mathbf{Z}}_j^N) = \bar{v}_{N,M} - \tilde{f}^{N'}(\hat{\mathbf{X}}_j^N, \hat{\mathbf{Y}}_j^N, \hat{\mathbf{Z}}_j^N)$$

Step 4: Select the solution $(\hat{\mathbf{X}}_j^N, \hat{\mathbf{Y}}_j^N, \hat{\mathbf{Z}}_j^N)$, $j \in J$, with the largest estimated objective function value $\tilde{f}^{N'}(\hat{\mathbf{X}}_j^N, \hat{\mathbf{Y}}_j^N, \hat{\mathbf{Z}}_j^N)$.

Having selected the best design, one can check its **Gap** to see if it is reasonable. If not, then additional samples must be used and/or the sample size N must be increased in order to get a better solution. Note that an expression for the variance of the above **Gap**, which can be used to compute a confidence upper bound for the **Gap**, is derived in Shapiro (2003).

4.2.5 Experimental Evaluation

4.2.5.1 Virtu@l-Lumber case

In order to test the applicability and feasibility of the approach, we developed a realistic case, called Virtu@l-Lumber, based on typical production-distribution network design problems encountered in the forest products industry. The characteristics of the case are summarized in Table 6. Most of the case data were taken from real lumber companies but the probabilities of getting the different contracts/agreements considered were randomly generated. The first stage design decisions specify the mission of the sawmills, the number and location of the warehouses and the logistics policies to implement. Since the case considers 21 potential logistics policies, the number of possible environments is about two millions, and model (SP) includes billions of second stage variables. Consequently, the need to use the Sample Average Approximation is clear, even for this moderate size case.

Product Families	19
Sawmills	3
Countries	2
Potential warehouses	7
Spot markets	4
Demand zones	16
Pre-signed contracts/agreements	2
Potential customers	13
Potential logistics policies	21
Possible environments	$2^{21} \approx 2\,000\,000$

Table 6 : Virtu@l-Lumber Case Characteristics

Contract Demand	Price Difference (\$/unit) (Contracts – Spot)	Reference Price (\$/unit)	
		High (440)	Low (340)
40%*Capacity	40	# 1	# 3
20%*Capacity	40	# 2	# 4
40%*Capacity	55	#5 (Average reference price (390))	

Table 7 :Virtu@l-Lumber Case Instances

In order to test the solvability of the SAA model under extreme conditions, five instances of the case were created with different demand and price values, as described in Table 7. Our aim was also to understand the influence of demand and price differences, between the spot market and the contracts/agreements, on logistics policies and warehouse location decisions. Contracts/agreements become more interesting for the company when the price difference is high, which should lead to the implementation of more warehouses to support the selected logistics policies.

4.2.5.2 Computational Results

Several sample sizes N and N' were tested in the experiments, in order to evaluate their impact on computational times and on the quality of the solutions obtained. The SAA models were solved with $M = 5$ independent samples, each of size $N = 5, 25, 50, 75, 100$. The number of variables and constraints in the models obtained for each sample size are given in Table 8. The mathematical programs were solved with CPLEX 9.0 on a 1.9 Ghz computer. The computational times observed are similar for the five case instances, but they increase exponentially with the sample size N .

N	Variables		Constraints	
	Binary	Continuous	Equality	Inequality
5	28	28 216	2 076	1 788
25	28	140 671	10 288	8 648
50	28	281 260	20 565	17 223
75	28	421 859	30 834	25 798
100	28	562 510	41 110	34 373

Table 8 : SAA Model Statistics for Different Sample Sizes

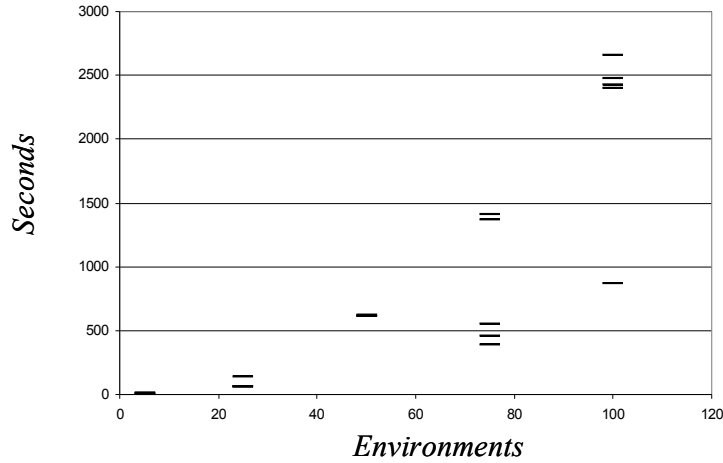

Figure 11 : Computational Times (in seconds) for Instance #5

For example, Figure 11 presents the computational times (in seconds) obtained for the five samples generated for case instance #5.

The analysis of results dissociates two clusters of case instances: those converging to a single optimal solution as N increases, and those for which a set of distinct solutions is obtained. The first cluster includes case instances #1, #3 and #4. For each of these cases, when $N \geq 25$, a single solution is obtained ($|J|=1$), as illustrated in Figure 12 for case instance #1. The figure also shows that, as N increases, the value of the objective function for the 5 samples converges to the same value. Clearly, for these well behaved cases, no further analysis is required since a single solution is obtained. The second cluster composed of instances #2 and #5 is quite different. Indeed, several solutions are obtained, as illustrated in Figure 13 for case instance #5. The results of the application of the SAA procedure presented in section 4 to this case are provided in Table 9, for $M=5$, $N=75, 100$ and $N'=200, 300, 400, 500$. For each distinct solution j , the objective function value approximation $\tilde{f}^{N'}(\hat{\mathbf{X}}_j^N, \hat{\mathbf{Y}}_j^N, \hat{\mathbf{Z}}_j^N)$ and the **Gap**, expressed in %, are reported. Moreover, for comparison purposes, the objective function value approximation $\tilde{f}^{N'}(\bar{\mathbf{X}}, \bar{\mathbf{Y}}, \bar{\mathbf{Z}})$ is also given for the solutions obtained, $(\bar{\mathbf{X}}, \bar{\mathbf{Y}}, \bar{\mathbf{Z}})$, when a deterministic

version of the model is solved with the average demand (Average), and with the most probable environment demand (Probable).

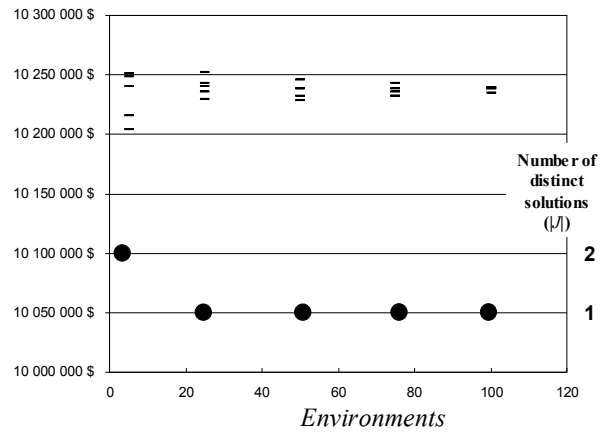

Figure 12 : Results for Instance #1

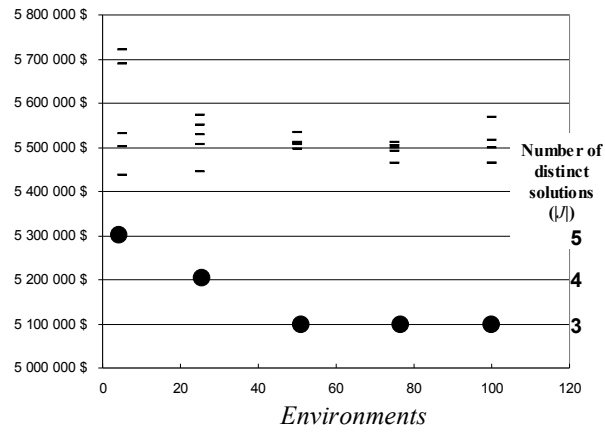

Figure 13 : Results for Instance #5

$(M=5)$	SAA Method (\$)						Deterministic		
	$N=75$			$N=100$			Probable	Average	
Sample (j)	1	2	3	1	2	3	1	1	
Duplicates		(100,3)	(100,1), (A1)	(75,3), (A1)		(75,2)		(75,3), (100,1)	
$N'=200$	\bar{f}^N	5 466 583	5 486 456	5 494 382	5 494 382	5 474 509	5 486 456	5 073 303	5 494 382
	Gap	0,50%	0,13%	0,01%	0,15%	0,51%	0,29%		
$N'=300$	\bar{f}^N	5 468 001	5 493 454	5 496 373	5 496 373	5 470 920	5 493 454	5 067 651	5 496 373
	Gap	0,47%	0,00%	0,05%	0,11%	0,58%	0,16%		
$N'=400$	\bar{f}^N	5 461 504	5 480 940	5 494 136	5 494 136	5 474 700	5 480 940	5 085 692	5 494 136
	Gap	0,59%	0,23%	0,01%	0,15%	0,51%	0,39%		
$N'=500$	\bar{f}^N	5 461 779	5 477 564	5 484 727	5 484 727	5 468 941	5 477 564	5 071 398	5 484 727
	Gap	0,58%	0,29%	0,16%	0,32%	0,61%	0,45%		

Table 9 : SAA Procedure Results for Instance #5

The best design obtained for all the values of N and N' is the same (solution 3 for $N=75$ and solution 1 for $N=100$). In all these cases, the **Gap** is very small (not larger than 0,61%) which means that this solution is probably very good. This is comforting since it means that, at least for the cases considered, the Sample Average Approximation can be expected to give very good results even if relatively small sample sizes are used. Note also that, in this case, the solution obtained with the mean demand deterministic model is the same as the one obtained with the SAA model. This is not generally the case however and, in fact, there is no guarantee that the solution obtained with the average demand is a feasible solution of model (SP) because the expected demand is a fraction of the contracts/agreements demand. Lastly, note that the solution obtained when a deterministic model with the most probable environment is used is not very good. This suggest that using the SAA method gives solutions which can be much better than those obtained with the type of deterministic models found in the literature.

The designs obtained for the 5 case instances studied are summarized in Table 10, for samples size of $N=100$. A close observation of these results confirms that our initial intuition was correct. The warehouses and policies selected for the four first case instances are roughly the same. This means that the solution is not very sensitive to changes in demand and in reference prices. However, the solution obtained for instance #5 involves

the selection of a much higher number of policies and warehouses, which implies that the optimal design is very sensitive to the difference in the price of products between the spot market and contracts/agreements.

Instances	Average number of logistics policies selected (21 potential)	Average number of warehouse selected (7 potential)
# 1	4	2
# 2	5.5	2
# 3	4	2
# 4	4	2
# 5	11	3.8

Table 10 : Designs Obtained for $N=100$ and $M=5$

4.2.6 Conclusion

The production-distribution network design methodology proposed in this paper takes market considerations into account to obtain designs which improve the competitive position of the company or companies involved. Furthermore, the two-stage stochastic programming model proposed and the Monte-Carlo sampling method used to solve the model lead to robust designs which can be expected to perform well under any possible future business environments. The experiments made with the model show that good results can be obtained even if a relatively small environment sample size is used, which means that the model proposed is not much more difficult to solve than its deterministic counterpart. Future studies will involve the development of tailor-made acceleration techniques and heuristics to solve very large SAA models in a reasonable time. A more elaborated application to the forest products industry is also currently being developed to study how the model could be used in practice to evaluate various alternative strategies.

4.2.7 References

- Arntzen, B., G. Brown, T. Harrison and L. Trafton, 1995, Global Supply Chain Management at Digital Equipment Corporation, *Interfaces*, 21, 1, 69-93.
- Ben-Akiva M. and S. Lerman, 1985, *Discrete Choice Analysis: Theory and Application to Travel Demand*, MIT Press.
- Birge, J. and F. Louveaux, 1997, *Introduction to Stochastic Programming*, Springer.

- Cohen, M., M. Fisher and R. Jaikumar, 1989, International Manufacturing and Distribution Networks: A Normative Model Framework, in K. Ferdows (ed), *Managing International Manufacturing*, Elsevier, 67-93.
- Cohen, M. and H. Lee, 1989, Resource Deployment Analysis of Global Manufacturing and Distribution Networks, *Journal of Manufacturing and Operations Management*, 2, 81-104.
- Cohen, M. and S. Moon, 1990, Impact of Production Scale Economies, Manufacturing Complexity, and Transportation Costs on Supply Chain Facility Networks, *Journal of Manufacturing and Operations Management*, 3, 269-292.
- Cohen, M. and S. Moon, 1991, An integrated plant loading model with economies of scale and scope, *European Journal of Operational Research*, 50, 266-279.
- Dogan K. and M. Goetschalckx, 1999, A Primal Decomposition Method for the Integrated Design of Multi-Period Production-Distribution Systems, *IIE Transactions*, 31, 1027-1036.
- Eppen, G., R. Kipp Martin and L. Schrage, 1989, A Scenario Approach to Capacity Planning, *Operations Research*, 37, 517-527.
- Fandel, G. and M. Stammen, 2004, A General Model for Extended Strategic Supply Chain Management with Emphasis on Product Life Cycles Including Development and Recycling, *International Journal of Production Economics*, 89, 293-308.
- Hill, T., 1994, *Manufacturing Strategy*, Irwin.
- Geoffrion, A. and G. Graves, 1974, Multicommodity Distribution System Design by Benders Decomposition, *Management Science*, 20, 822-844.
- Geoffrion, A. and R. Powers, 1995, 20 Years of Strategic Distribution System Design: Evolutionary Perspective, *Interfaces*, 25, 5, 105-127.
- Louviere, J., D. Hensher and J. Swait, 2000, *Stated Choice Methods*, Cambridge University Press.
- Martel, A. and U. Vankatadri, 1999, Optimizing Supply Network Structures Under Economies of Scale, *IEPM Conference Proceedings*, Glasgow, Book 1, 56-65.
- Martel, A., 2005, The design of production-distribution networks: A mathematical programming approach, in J. Geunes and P. Pardalos (eds.), *Supply Chain Optimization*, Kluwer Academic Publishers.
- Mazzola, J. and R. Schantz, 1997, Multiple-Facility Loading Under Capacity-Based Economies of Scope, *Naval Research Logistics*, 44, 229-256.
- Mazzola, J. and A.W. Neebe, 1999, Lagrangian-Relaxation-Based Solution Procedures for a Multiproduct Capacitated Facility Location Problem with Choice of Facility Type, *European Journal of Operational Research*, 115, 285-299.
- Pirkul, H. and V. Jayaraman, 1996, Production, Transportation, and Distribution Planning in a Multi-Commodity Tri-Echelon System, *Transportation Science*, 30, 291-302.

- Paquet, M., A. Martel and G. Desaulniers, 2004, Including Technology Selection Decisions in Manufacturing Network Design Models, *International Journal of Computer Integrated Manufacturing*, 17, 117-125.
- Rosenfield, D., R. Shapiro and R. Bohn, 1985, The implications of cost-service trade-offs on industry logistics structures, *Interfaces*, 15, 47-59.
- Santoso, T., S. Ahmed, M. Goetschalckx and A. Shapiro, 2005, A stochastic programming approach for supply chain network design under uncertainty, *European Journal of Operational Research*, 167, 96-115.
- Shapiro, A., 2003, Monte Carlo Sampling Methods, in A. Ruszczyński and A. Shapiro (eds), *Stochastic Programming*, Handbooks in Operations Research and Management Science, 10, Elsevier.
- Shapiro, J., V. Singhal and S. Wagner, 1993, Optimizing the Value Chain, *Interfaces*, 23, 2, 102-117.
- Shapiro, J., 2001, *Modeling the Supply Chain*, Brooks/Cole Publishing Company.
- Tsay A., S. Nahmias and N. Agrawal, 1999, Modeling Supply Chain Contracts : A Review, *Quantitative Models for Supply Chain Management*, Kluwer Academic Publishers.
- Verter, V. and C. Dincer, 1992, An integrated evaluation of facility location, capacity acquisition, and technology selection for designing global manufacturing strategies, *European Journal of Operational Research*, 60, 1-18.
- Verter, V. and C. Dincer, 1995, Facility Location and Capacity Acquisition: An Integrated Approach, *Naval Research Logistics*, 42, 1141-1160.
- Vidal, C. and M. Goetschalckx, 1997, Strategic Production-Distribution Models: A Critical Review with Emphasis on Global Supply Chain Models, *European Journal of Operational Research*, 98, 1-18.
- Vidal, C. and M. Goetschalckx, 2001, A Global Supply Chain Model with Transfer Pricing and Transportation Cost Allocation, *European Journal of Operational Research*, 129, 134-158.

4.2.8 Appendix

Proposition: Any optimal solution of program SAA(Ω^N) is such that, for step $\lambda \in \Lambda_{pm}$ of the spot market price function:

$$\sum_{p' \in SP^p} \sum_{s \in S_m^i} F_{pp'sd\lambda}(\omega) > 0 \Rightarrow \sum_{p' \in SP^p} \sum_{s \in S_m^i} F_{pp'sd\lambda'}(\omega) = \kappa_d (X_{pm\lambda'} - X_{pm(\lambda'-1)}), \quad \lambda' < \lambda$$

Proof: Let's consider an **optimal** solution $(\mathbf{X}^\diamond, \mathbf{Y}^\diamond, \mathbf{Z}^\diamond, \mathbf{F}^\diamond(\omega))$ of SAA (Ω^N). Assume that

$\exists \omega^\circ \in \Omega^N$, $o^\circ \in O$, $m^\circ \in SM_{o^\circ}$, $p^\circ \in P_m$, $d^\circ \in D_{pm}$, $\lambda^\circ \in \Lambda_{pm}$ such that

$$\sum_{p' \in SP^{p^\circ}} \sum_{s \in S_m^i} F_{p^\circ p'sd^\circ \lambda^\circ}(\omega^\circ) > 0 \text{ and } \sum_{p' \in SP^p} \sum_{s \in S_m^i} F_{p^\circ p'sd^\circ \lambda^\circ}(\omega^\circ) < \kappa_{d^\circ} (X_{p^\circ m^\circ \lambda^\circ} - X_{p^\circ m^\circ (\lambda^\circ - 1)}), \quad \lambda'^\circ < \lambda^\circ$$

Then, clearly, $\exists p'^\circ \in SP^{p^\circ}$, $s^\circ \in S_m^i$ with $F_{p'^\circ p'^\circ s^\circ d^\circ \lambda^\circ}(\omega^\circ) > 0$. Now, let's construct the new

feasible solution $(\mathbf{X}^\ell, \mathbf{Y}^\ell, \mathbf{Z}^\ell, \mathbf{F}^\ell(\omega)) = (\mathbf{X}^\diamond, \mathbf{Y}^\diamond, \mathbf{Z}^\diamond, [F_{pss'}^\diamond(\omega), F_{pp'sd\lambda}^\ell(\omega), F_{psi}^\diamond(\omega)])$ with

$$F_{pp'sd\lambda}^\ell(\omega) = F_{pp'sd\lambda}^\diamond(\omega), \quad \lambda \neq \lambda^\circ, \lambda'^\circ$$

$$F_{p^\circ p'^\circ s^\circ d^\circ \lambda^\circ}^\ell(\omega^\circ) = F_{p^\circ p'^\circ s^\circ d^\circ \lambda^\circ}^\diamond(\omega^\circ) + \max(\kappa_{d^\circ} (X_{p^\circ m^\circ \lambda^\circ} - X_{p^\circ m^\circ (\lambda^\circ - 1)}) - \sum_{p' \in SP^{p^\circ}} \sum_{s \in S_m^i} F_{p^\circ p'sd^\circ \lambda^\circ}^\diamond(\omega^\circ); F_{p^\circ p'^\circ s^\circ d^\circ \lambda^\circ}^\diamond(\omega^\circ))$$

$$F_{p^\circ p'^\circ s^\circ d^\circ \lambda^\circ}^\ell(\omega^\circ) = F_{p^\circ p'^\circ s^\circ d^\circ \lambda^\circ}^\diamond(\omega^\circ) - \max(\kappa_{d^\circ} (X_{p^\circ m^\circ \lambda^\circ} - X_{p^\circ m^\circ (\lambda^\circ - 1)}) - \sum_{p' \in SP^{p^\circ}} \sum_{s \in S_m^i} F_{p^\circ p'sd^\circ \lambda^\circ}^\diamond(\omega^\circ); F_{p^\circ p'^\circ s^\circ d^\circ \lambda^\circ}^\diamond(\omega^\circ))$$

by reallocating the step λ° flow values on the price step functions.

If $(\mathbf{X}^\diamond, \mathbf{Y}^\diamond, \mathbf{Z}^\diamond, \mathbf{F}^\diamond(\omega))$ is optimal, the difference

$$\begin{aligned} & \frac{1}{N} \sum_{\omega \in \Omega_N} \mathbf{qF}^\diamond(\omega) - (\mathbf{cX}^\diamond + \mathbf{aY}^\diamond + \mathbf{kZ}^\diamond) - \left(\frac{1}{N} \sum_{\omega \in \Omega_N} \mathbf{qF}^\ell(\omega) - (\mathbf{cX}^\ell + \mathbf{aY}^\ell + \mathbf{kZ}^\ell) \right) \\ &= \frac{1}{N} P_{p^\circ m^\circ \lambda^\circ} (F_{p^\circ p'^\circ s^\circ d^\circ \lambda^\circ}^\diamond(\omega^\circ) - F_{p^\circ p'^\circ s^\circ d^\circ \lambda^\circ}^\ell(\omega^\circ)) + \frac{1}{N} P_{p^\circ m^\circ \lambda^\circ} ((F_{p^\circ p'^\circ s^\circ d^\circ \lambda^\circ}^\diamond(\omega^\circ) - F_{p^\circ p'^\circ s^\circ d^\circ \lambda^\circ}^\ell(\omega^\circ))) \\ &= \frac{1}{N} (P_{p^\circ m^\circ \lambda^\circ} - P_{p^\circ m^\circ \lambda^\circ}) \max(\kappa_{d^\circ} (X_{p^\circ m^\circ \lambda^\circ} - X_{p^\circ m^\circ (\lambda^\circ - 1)}) - \sum_{p' \in SP^{p^\circ}} \sum_{s \in S_m^i} F_{p^\circ p'sd^\circ \lambda^\circ}^\diamond(\omega^\circ); F_{p^\circ p'^\circ s^\circ d^\circ \lambda^\circ}^\diamond(\omega^\circ)) \end{aligned}$$

should be positive. However, by *assumption*, we have

$$\max(\kappa_{d^\circ} (X_{p^\circ m^\circ \lambda^\circ} - X_{p^\circ m^\circ (\lambda^\circ - 1)}) - \sum_{p' \in SP^{p^\circ}} \sum_{s \in S_m^i} F_{p^\circ p'sd^\circ \lambda^\circ}^\diamond(\omega^\circ); F_{p^\circ p'^\circ s^\circ d^\circ \lambda^\circ}^\diamond(\omega^\circ)) > 0$$

and by *construction* of the price function we have $0 > (P_{p^\circ m^\circ \lambda^\circ} - P_{p^\circ m^\circ \lambda^\circ})$, which implies that:

$$\frac{1}{N} \sum_{\omega \in \Omega_N} \mathbf{qF}^\diamond(\omega) - (\mathbf{cX}^\diamond + \mathbf{aY}^\diamond + \mathbf{kZ}^\diamond) - \left(\frac{1}{N} \sum_{\omega \in \Omega_N} \mathbf{qF}^\ell(\omega) - (\mathbf{cX}^\ell + \mathbf{aY}^\ell + \mathbf{kZ}^\ell) \right) < 0$$

Hence, $(\mathbf{X}^\diamond, \mathbf{Y}^\diamond, \mathbf{Z}^\diamond, \mathbf{F}^\diamond(\omega))$ is not optimal and the proposition is true. \square

Chapitre 5 : La Conception Stratégique des Réseaux Logistiques pour l'Industrie Forestière

Le présent chapitre présente la première version de l'article «The Strategic Design of Forest Industry Supply Chains » qui sera soumise après quelques ajustements au numéro spécial d'INFOR sur l'industrie forestière durant l'automne 2005.

5.1 Résumé

L'article propose une méthodologie de design de réseaux logistiques pour l'industrie du bois d'oeuvre qui tient compte de la relation entre le marché et le réseau de production-distribution de l'entreprise. L'approche considère la spécificité des procédés divergents impliqués ainsi que la segmentation du marché de l'industrie (contrats, accords "VMI" et marchés spots). En vue de capturer la relation dyadique entre le marché et l'outil de production-distribution, un modèle mathématique intégrateur de programmation stochastique à recours fixe est formulé. La méthode d'approximation (SAA) issue d'une méthode d'échantillonnage de Monté Carlo est déployée afin d'obtenir des solutions. Enfin, le modèle ainsi développé permet un éclairage stratégique des enjeux de l'industrie du bois d'oeuvre au Québec. En effet, les politiques forestières ainsi que les stratégies d'acquisitions et de rationalisations sont analysées par l'application de la méthodologie à un cas virtuel mais réaliste, nommé Virtu@l-Lumber.

5.2 The Strategic Design of Forest Industry Supply Chains

Didier Vila^{1,2}, Robert Beauregard¹ and Alain Martel¹

⁽¹⁾ Université Laval, FOR@C Research Consortium, Network Organization Technology Research Center (CENTOR), Sainte-Foy, Québec, G1K7P4, Canada.

⁽²⁾ École Nationale Supérieure des Mines de Saint-Étienne, Centre G2I, 158 cours Fauriel, 42023 Saint-Étienne cedex 2, France.

Abstract. This paper presents a market-driven approach to design superior production-distribution networks for the lumber industry. The methodology takes into account the specificity of the industry divergent manufacturing process as well as the lumber market segmentation (contracts, Vendor Managed Inventory (VMI) agreements and spot markets). In order to consider this dyadic relationship, a comprehensive two-stage stochastic programming with fixed recourse model is formulated. It is shown that the model can be solved with a sample average approximation (SAA) method based on Monte Carlo sampling techniques. Finally, the decision support system developed is used to show how the approach can contribute to dealing with strategic issues in the Eastern-Canadian lumber industry. Forest legislation as well as acquisition and rationalization issues are analyzed through applications of the methodology to a virtual but realistic case called Virtu@l-Lumber.

Keywords. Production-distribution Network Design, Mathematical Programming, Monte-Carlo Sampling Methods, Strategic Analysis, Acquisition and Rationalization.

Acknowledgements. This project would not have been possible without the financial support and the collaboration of FOR@C's partners, especially of NSERC.

5.2.1 Introduction

The forest industry is a key economic activity in the Province of Quebec. It generates approximately twenty thousand direct jobs in three hundred sawmills. The average annual harvest is about thirty-six million cubic meters, corresponding to roughly twenty-five percent of the Canadian harvest and it creates one and a half billion Canadian dollars of added value³. An important specificity of the Quebec lumber industry is that 90 percent of forested area is on public land. Consequently, government is the main fiber supplier and influences the organization and behavior of companies. For example, the wood allocation is granted to a specific sawmill through governmental contracts (Supply and Forest Management Agreements) which stipulate that logs from a specific area must be processed in a particular sawmill. Historically, the Quebec lumber industry has been strongly influenced by trade relationships with the United-State. Moreover, the exchange rate of the Canadian and U.S. currencies plays a key role. The lumber industry is a commodity industry where buyer concentration and price sensitivity increase the buyer power. Indeed, this concentration phenomenon confers an advantage to large retail companies, for example, in the bargaining process. Moreover, substitutes, such as steel and concrete, represent a real threat for lumber products. Lastly, competition between forest companies is intense. The lumber sector experience pure and perfect competition in a commodity market where delivery costs are significant. The market share of the top five North American producers is only 22% (Taylor *et al.*, 2002). Moreover, the industry products are in the mature and even declining stage of their life cycle, a position where rivalry is customarily intense, and concentration appears inevitable.

This strategic overview shows that the industry measures up to significant challenges. In this low margins industry, operational excellence and customer intimacy are key success factors. In order to be able to deliver the low prices and high service levels expected by customers, lumber companies must streamline their supply chains. The aim of this paper is to propose a multidisciplinary methodology to capture the dyadic relationship between a lumber company production-distribution network and its market opportunities in order to

³ CIFQ Web site: www.cifq.qc.ca (September 2005).

increase the probability that the enterprise can obtain profitable contracts or VMI agreements and thus increase profits. The approach has the potential to appeal to the lumber company manager and to the legislative agent in order to assist his decision making through quantifying supply chain issues. In order to demonstrate the scope and strength of the methodology, a realistic lumber industry case, Virtu@l-Lumber, was created with the collaboration of the institutional and industrial partners of the FOR@C research consortium. However, the proposed framework is generic and can be applied to similar divergent process industries.

The paper is organized as follows. Section 5.2.2 presents a review of the production-distribution network design literature. Section 5.2.3 develops the concepts underlying the mathematical programming model on which the methodology is based. Section 5.2.4 describes the Virtu@l-Lumber case, as well as examples of applications of the modeling approach to the strategic planning of forest products companies.

5.2.2 Literature Review

This section presents a concise review of the literature related to the proposed production-distribution network design methodology in the perspective of the lumber industry. To start with, two aspects in the understanding of the state of the art can be distinguished. The first one concerns the supply chain design problem, which is composed of three sub problems (location, capacity acquisition and technology selection problems). The second one is the conceptual modeling of the market. Indeed, the proposed approach pleads in favor of integrating the supply chain and market facets in order to capture their dyadic relationship and interaction.

An abundant literature exists on location, capacity acquisition and technology selection problems. Verter and Dincer (1992) review the initial literature in these fields. More recent reviews are found in Goetschalckx et al. (2002), Bhutta (2004) and Martel (2005). Rönnqvist (2003) presents a review of optimization models for all planning levels and for all sectors of the forest products industry. At the strategic level, Carlsson and Rönnqvist (2005) propose a model combining distribution facility location with ship routing applied to a Swedish pulp company. Martel *et al.* (2005) study the international factors in the design

of multinational supply chains for Canadian pulp and paper companies. Vila *et al.* (2005a) propose a generic approach to design production-distribution networks for divergent process industries. One of the objectives of our paper is to extend the modeling framework of Vila *et al.* (2005a) and to apply it to lumber manufacturing strategic planning issues.

At the tactical level, Maness and Norton (2002) and Liden and Rönnqvist (2000) propose linear programming models which combine bucking and production planning for the lumber industry. The production planning problem in the secondary processing sector has been examined by Carino and Lenoir (1988) who propose a wood procurement model for a cabinet manufacturing plant. Also, Carino and Willis (2001a and 2001b) and Farell and Maness (2005) propose production planning models for secondary wood product manufacturing. At the operational level, Rönnqvist (1995) proposes a method for the allocation of wood products in order to optimize the cutting process in real time, taking the quality of logs into account, and Rönnqvist and Astrand (1998) integrate defect detection to this approach.

In order to be competitive companies must design their production-distribution networks to support their product-market strategies. Shapiro (2001) emphasizes the necessity to integrate strategic marketing and production-distribution decisions in the same model in order to design superior supply chains. Vila *et al.* (2005b) present a generic approach and a two-stage stochastic programming model to design production-distribution networks which help companies capture promising markets. More specifically in this paper, three types of sub-markets found in several industrial contexts are considered: spot markets, contracts and Vendor Managed Inventory (VMI) agreements. We use this approach to model markets in the current paper. To summarize, our objective in this paper is to integrate the production-distribution network design approach of Vila *et al.* (2005a) with the product-market modeling framework of Vila *et al.* (2005b), and to use the resulting supply chain design methodology to investigate important issues for the Eastern-Canadian lumber industry.

5.2.3 Design Methodology

5.2.3.1 The integrated approach

The supply chain of timber companies is typically composed of geographically dispersed woodlands, woodyards, sawmills, distribution sites and markets. Generally, the strategic design of forest industry supply chains involves the overall company: the forest operations, manufacturing, logistics and marketing departments have to be involved in the strategic planning process. Basically, the problem is to take simultaneously capacity, technology, location and marketing decisions which maximize the profits of the timber company for known woodland locations and capacities, cost structure and international market opportunities.

A multidisciplinary design approach is necessary to master complexity and to be able to make efficient decisions. This paper presents a modeling approach to assist the strategic planner in making these complex, high level decisions. It aims at coordinating production-distribution with marketing analysis. On the one hand, the industry manufacturing process is mapped onto potential production-distribution facility locations and capacity options (Figure 14). On the other hand, the approach integrates market specificities (Figure 15). In our context, each national product-market can be partitioned into three sub-sets:

- A set of spot markets characterized each by products, demand zones and decreasing cost step functions based on a reference price. This reference price is determined by the company using price forecasts based on the historical behavior of the firm prices on the spot market.
- A set of customer contracts partitioned into potential contracts and signed contracts.
- A set of Vendor Managed Inventory (VMI) agreements that is also partitioned into potential VMI agreements and signed VMI agreements.

Figure 15 shows finished product families and their corresponding markets. The products associated to contracts and VMI agreements have specific values and end-users: “Machine Stress Rated” for contracts with secondary transformation companies and “Premium” appearance for VMI agreements. The added value of contracts and VMI agreements is

materialized by a price premium with respect to the spot market price. The price premium is also conditioned by the characteristics of the logistics policy used. The logistics policy concept describes criteria that qualify the company as a potential supplier (qualifiers) and criteria that win contracts on the marketplace (order winners) as proposed by Hill (1994). For contracts, the basic criteria associated to a logistics policy are price and delivery times. For VMI agreements, they are price and fill rate. The spot market can be considered as a recourse which can absorb any amount of product, but for a price decreasing with quantity. Moreover, substitution possibilities allow the manager to downgrade and sell contracts and VMI products on spot markets as discussed by Vila *et al.* (2005a).

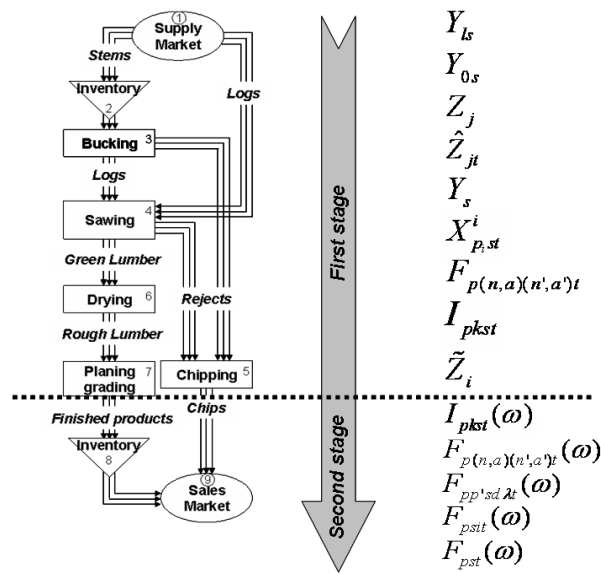

Figure 14 : Multigraph activities and stage decisions.

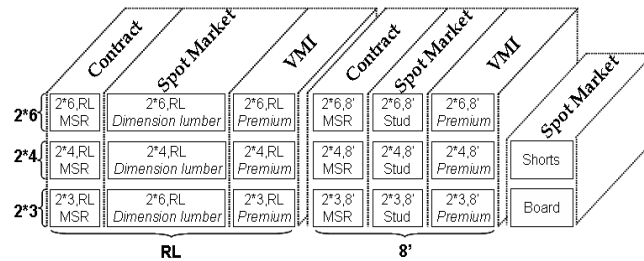

Figure 15: Finished products and markets.

Signed contracts/agreements yield a deterministic demand to be satisfied but potential contracts/agreements define a stochastic demand process. Customer preferences are captured by econometric discrete choice methods, as presented by Vila *et al.* (2005b), from which one can estimate the probability that a contract or a VMI agreement will be signed when a given logistics policy is implemented. Because of competition, it is assumed that potential customers will sign contracts only if the company can demonstrate that it has the resources required to comply with all the clauses of the contracts/agreements. Consequently, the production-distribution network must be designed to satisfy signed contracts and agreements and to be in a position to satisfy some potential new contracts and agreements, knowing that the uncommitted production can be sold on the spot market.

The goal of the company is to design its production-distribution network anticipating the future by simultaneously selecting adequate logistics policies, and by deploying production capacity and locating distribution centers to support these policies. This is done by solving a stochastic programming model with a Monte-Carlo sample average approximation (SAA) method. This model can then be used to investigate all sort of strategic options, as will be shown in section 5.2.4.

5.2.3.2 The mathematical model

The mathematical model on which the methodology is based is a two-stage stochastic program with fixed recourse (Birge and Louveaux, 1997). Figure 14 provides a schematic view of the first stage and second stage decision variables with respect to the process graph. The reader may refer to *Appendix A* for a presentation of the detailed mathematical model, including notations, as well as to Vila *et al.* (2005a and 2005b) for a complete account of the model genesis and justification. The model presented in Appendix A is the equivalent

deterministic program obtained when the stochastic program is solved with the Monte Carlo sample average approximation method proposed by Shapiro (2003). The following sub-sections discuss the first and second stage decision variables of the model, as well as the model structure, and they provide an outline of the solution method used.

First stage decisions

The first stage decisions are *strategic* decisions to be implemented to shape the future of the company. As our approach is multidisciplinary, the strategic decisions concern all departments of the forest company. Strategic *manufacturing* decisions concern layout choices for each of the facilities (Y_{ls} and Y_{0s}), the selection of capacity options (Z_j) and seasonal opening or shutdown (\hat{Z}_{jt}) for each capacity option. Strategic *marketing* decisions essentially correspond to logistics policy (\tilde{Z}_i) choices. Strategic *distribution* decisions concern the selection of the distribution centers (Y_s) to use, among a set of possibilities, in order to satisfy the requirements of logistics policies.

Moreover, the first stage model integrates *tactical* decisions related to the manufacturing side of the network in order to provide some operational stability even if the demand is seasonal. Although these decisions would not necessarily be implemented in practice, they are necessary to anticipate the impact of the design on supply, raw-material inventory, production and in-bound transportation costs. Supply decisions shape log flows between the forest and sawmills for each season ($F_{p(v,1)(s,a)t}$). Inbound transportation decisions are related to the seasonal flow of semi-finished products or bi-products between sawmills ($F_{p(n,a)(n',a')t}$). Production decisions set seasonal missions for manufacturing sites ($X_{p\phi st}^\phi$). Seasonal inventory decisions set end-of-season inventory targets for each products and sites (I_{pkst}).

Second stage decisions

In order to explain second stage decisions adequately, the notion of *environment*, as used in stochastic programming, must first be defined. An environment is one of a set of possible future outcomes $\omega \in \Omega$. In our context, an environment is described by a vector of binary variables indicating whether the customers would sign a contract/agreement ($\omega_i = 1$) or not ($\omega_i = 0$), for all possible logistics policies $i \in I$, as introduced by Vila *et al.* (2005b). The notion of environment describes contractual opportunities. Since spot markets are recourses which can be used to absorb any outstanding production, it is not necessary to include the spot market explicitly in the description of an environment. A set of second stage decisions variables is attached to each environment considered. These variables model seasonal finished product inventories ($I_{pkst}(\omega)$), flows of finished products to distribution centers ($F_{p(n,a)(n',a')t}(\omega)$), and flows of finished products to markets ($F_{pp'sd\lambda t}(\omega)$ and $F_{psit}(\omega)$), as depicted in Figure 14.

The model structure

The model formulated in *Appendix A* maximizes corporate profits. First, the operating income for each national division is calculated: the total revenues and costs of each facility and the national logistics policies costs are taken into account. Facility revenues come from outflows to other sites and to demand zones. Facility costs include inbound flow costs (inflow transfers, raw materials, and receptions from other sites), site related costs (facilities and options fixed costs, production and handling costs, holding costs of order cycle stocks, safety stocks and seasonal stocks), and the costs of outflows to other sites and demand zones.

The maximization of this objective function is subject to several first-stage and second stage constraints (presented in Appendix A), namely:

First stage constraints:

- Supply market constraints (1, 2, 3)
- Facility layout, space and exclusive options constraints (4, 5, 6)
- Seasonal capacity option usage constraints (7)

- Production activities flow equilibrium constraints (8, 9)
- Storage activities inventory accounting constraints (10, 11)
- Production and storage capacity constraints (12, 13)

Second stage constraints:

- Production activities flow equilibrium constraints (14, 15)
- Storage activities inventory accounting constraints (16)
- Flow equilibrium conservation (17)
- Storage capacity constraints (18, 19)
- Sales market constraints (20, 21, 22, 23)
- Non-negativity constraints (27)

The resulting optimization model is a large-scale mixed integer program.

Sample average approximation (SAA) method

The reader is referred to Santoso *et al.* (2005) for a detailed description of the SAA method and to Vila *et al.* (2005b) for its application to logistic network design problems. The number of environments $\omega \in \Omega$ to take into account in our problem could be huge. The essence of the SAA method is that instead of taking all these environments into account explicitly, they are replaced by a sample of N environments, Ω_N , generated with Monte-Carlo sampling methods. The approach involves the solution of the SAA program for M different samples of size N . This implies that M different near-optimal feasible designs could be obtained and the questions to answer are then: which design is the best and how close is it to the true optimum? To answer these questions, a better estimate of the true value of the objective function of the solutions found is calculated with a Monte-Carlo evaluation based on a sample of size N' much bigger than N . This is done by fixing the strategic binary first stage decisions $(Y_{ls}, Y_{0s}, Z_j, \hat{Z}_{jt}, \tilde{Z}_i)$ and by solving the resulting linear programs for the sample of size N' . Statistical lower and upper bounds on the true value of the optimal solution of the stochastic program must also be calculated to estimate the optimality gap of the solutions obtained. The number of first stage constraints is

independent of the size (N) of the environment sample Ω_N selected for the SAA program. However, the number of second stage constraints (22) grows almost proportionally with the size of the sample.

5.2.4 Experimental Evaluation

5.2.4.1 Experimental design

Virtu@1-Lumber, a realistic case, was built based on typical production-distribution network design problems encountered in the forest products industry. It was developed in order to test the applicability and feasibility of the approach. The main strategic options considered in the case are presented in Figure 16. Each sawmill has two layouts with their respective capacity options as well as seasonal shutdown or opening options. Note that the supply costs of the River mill are very expensive in comparison to the Mountain and Valley mills. The distribution network is constituted of seven potential distribution centers. The reference market price of softwood lumber is assumed equal to \$450/1000 pmp. The American and Canadian markets are made up of four spot markets, eight potential contracts of which one is signed and seven potential VMI agreements of which one is also signed. The probabilities of getting the various contracts/agreements considered were randomly generated. They could have been determined using econometric models (Ben-Akiva and Lerman, 1985) and the practical framework proposed by Louviere *et al.* (2000). On the whole, 21 logistics policies were defined and the number of possible environments is about two million. Consequently, the need to use the sample average approximation method was deemed justified, even for this moderate size case.

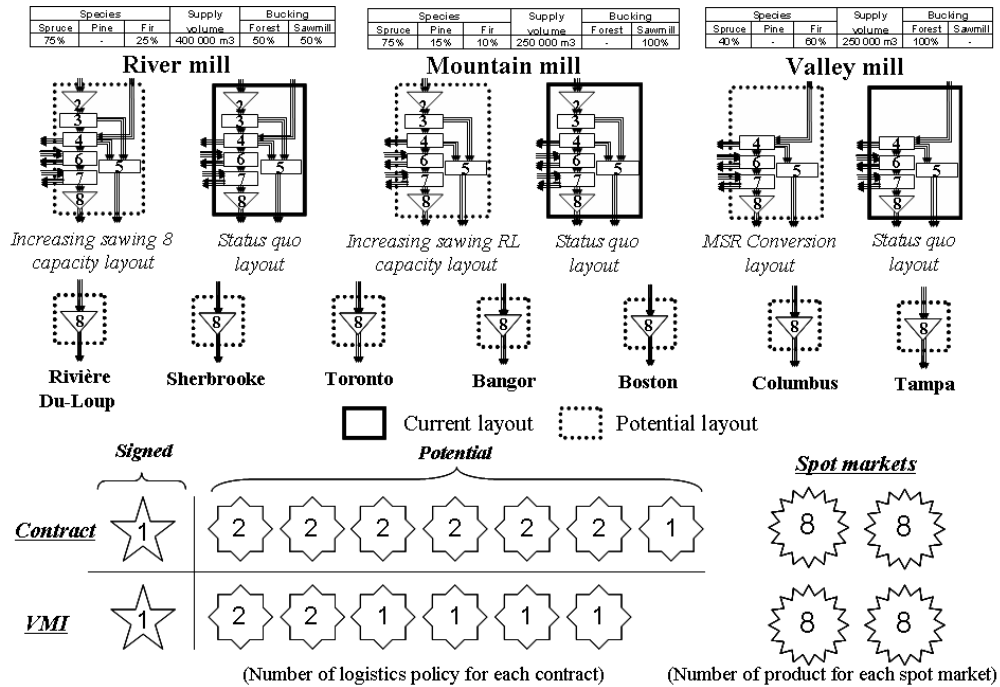

Figure 16 : Supply chain and markets of the Virtu@l-Lumber case.

In order to test the mathematical model on the Virtu@l-Lumber case, a plan of experiment was elaborated. Each of the problems in the experiments was solved with the SAA method using five independent samples of twenty-five environments ($M = 5, N = 25$), which means that at most five different designs could be obtained for a given problem. In order to determine the best design, an estimate of the true value of the objective function of the solutions was calculated through a Monte-Carlo evaluation based on a sample size $N'=100$. Note also that since, in practice, instead of using stochastic programming, logistic network designs are often obtained by using a deterministic model with an average demand, in our experiments, an average demand deterministic MIP was solved for each of

the cases considered. An estimate of the true value of the solution thus obtained was also calculated with the Monte-Carlo method using a sample of size $N'=100$.

In what follows, the impact of price differentials between market segments on the production-distribution network structure and on the number of contract signatures is analyzed first. Subsequently, different forest policies and acquisition and rationalization scenarii are studied using the model.

5.2.4.2 Organizational analysis

Spot market vs Contract-VMI price differential

In this part, the impact of a price differential between the sport market and contract or VMI agreements on the logistics policies is studied. First, Figure 17 illustrates the evolution of the number of deployed logistics policies dependent on the Spot vs Contract-VMI price differential for an average demand model. This average demand model is obtained by replacing the random contract demand quantities by their expected value. Figure 18 shows the behavior with the SAA method which takes into account the true demand of each contract.

First, it can be seen that the SAA method deploys less policies than the average demand model. Second, the evolution of total deployed logistics policies is similar for the two approaches. However, the SAA method prefers to sign VMI agreements rather than contracts. Signing a large number of contracts is not necessarily efficient (see Figure 19): It appears that the difference in the true value of the objective functions is quite large, which justifies the use of stochastic programming in order to take into account customer preferences.

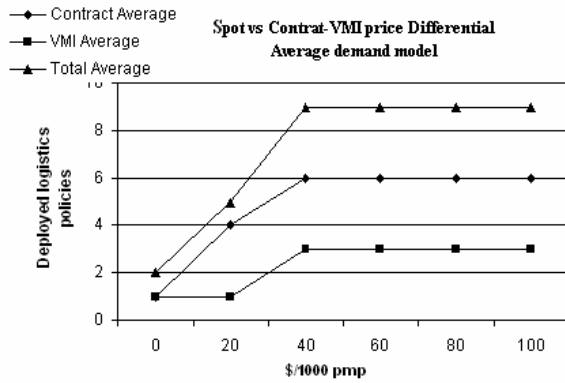

Figure 17 : Average demand model.

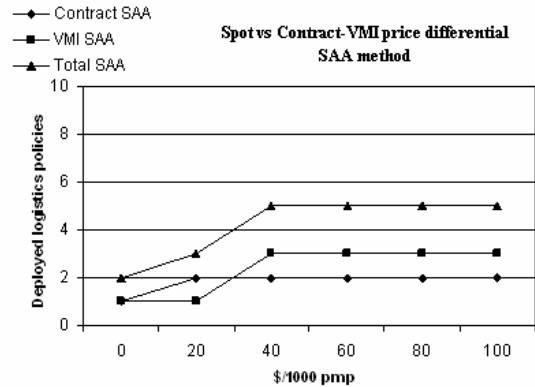

Figure 18 : SAA method.

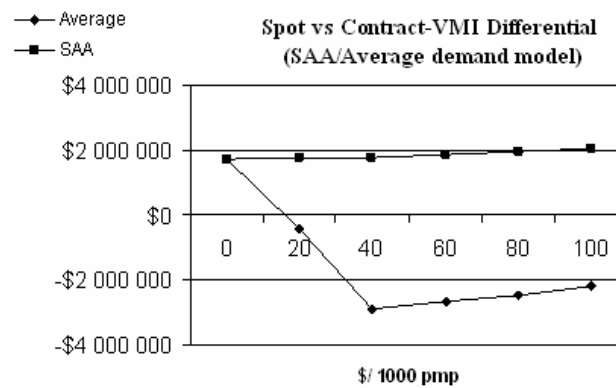

Figure 19 : Results from the average demand model vs the SAA method for the Spot vs Contract-VMI differential.

Spot VMI vs Contract price differential

As explained in the methodology and in the previous section, price differentials are key drivers to design marketing strategies. In order to better understand the specific role of the differential between spot markets and contract prices on the supply chain, four new

potential contracts are added. The Valley mill is assumed to be the only site allowed to ship the product to these four new locations. Moreover, the price of VMI agreements is assumed equal to the spot market price: then, the impact of “spot-VMI versus contract price differential” is studied.

Figure 20 shows the evolution of the number of deployed logistics policies and the layout of the Valley mill with the average demand model (in comparison with the SAA method, Figure 21). Firstly, it is clear that the number of VMI agreements is constant and corresponds to the agreement signed initially (see Figure 16). The layout and the mission of the Valley mill evolve in three phases for the average demand deterministic model (Figure 20):

1. \$0-20/1000 pmp: Status-quo, the sawmill produces as usual;
2. \$40-80/1000 pmp: The layout is always the status-quo. Some of the four new added contracts are signed. The sawmill produces as usual and becomes a distribution center in order to receive and ship specific products to the customers of the new signed contract. Indeed, Valley mill is the only site to be allowed to ship the products for these profitable contracts.
3. \$100/1000 pmp: The Valley mill layout changes and the mill produces contract products in order to fulfill the new profitable signed contracts assigned to it.

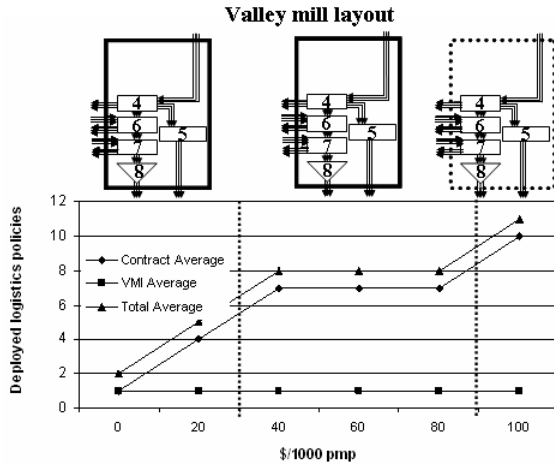

Figure 20 : Average demand model.

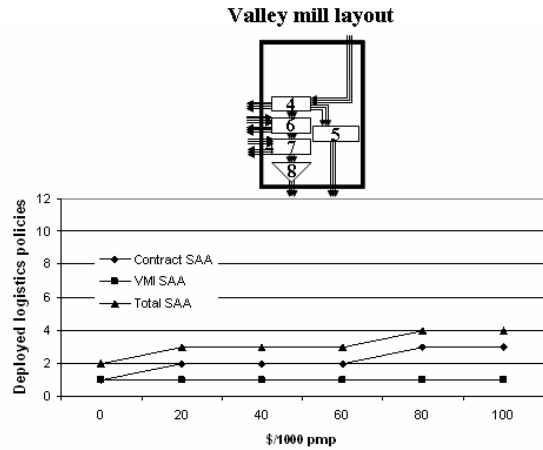

Figure 21 : SAA method.

Figure 22 shows the results of the evaluation of the true value of the two solutions (average demand model solution vs SAA model solution). This graphic shows that the average demand model often proposes solutions which are not feasible for some of the environments $\omega \in \Omega^N$. Indeed, the four potential contracts added to the initial configuration require large quantities to be produced. The average scenario considers the average demand contracts, which is inferior to the true demand. The supply chain designs proposed with the average demand model are often infeasible for the true demand of the contracts selected randomly by the SAA method. On the other hand, the SAA method proposes efficient feasible designs. These results are a convincing argument for using a stochastic programming model considering the variability in demand patterns explicitly instead of a static deterministic model.

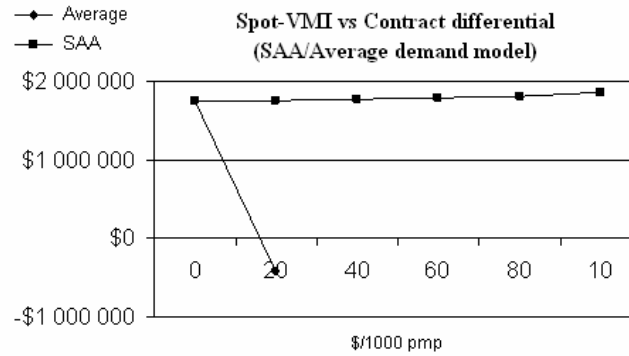

Figure 22: Results from the average demand model vs the SAA method for the Spot-VMI vs Contract differential.

5.2.4.3 Forest policy

This section aims at studying the impact of some eventual modifications in Quebec's forest policy by using the mathematical modeling approach. In the province of Quebec, about 90 percent of commercial forests are on public land. Hence forest policy is of major importance for taking strategic decisions on the supply side of softwood lumber companies located in Quebec. Equations 1) and 2) in Appendix A are representative of the actual legislation in Quebec. Equation 1) means that the seasonal supply is restricted to a certain maximum value. Equation 2) rules that each sawmill has to consume a minimum annual volume of wood from its supply agreement signed with government. Moreover, inter-sawmill supply flows are forbidden. All of the following configurations assume that the reference price is of \$450/1000 pmp and the Spot vs contract-VMI price differential is equal to \$40/1000 pmp. This base case scenario along with the initial mathematical model was analyzed in section 4.3.1 and is now called scenario # 0. presents the description and specificities of various alternative scenarii and their main results after the application of the SAA method.

Supply decrease

Recently in Quebec, government decided to reduce by 20 % the annual allowable cut, hence reducing supply for each sawmill. Taking this change in forest policy into consideration, scenario #1 is devised to represent a corresponding annual decrease in each seasonal supply. The upper bounds on the seasonal shipments of raw material between forest and sawmill of scenario #1 ($b_{v(s,a)t}^{\max}(\#1)$), used in equations 1), are derived from the data of scenario #0: $b_{v(s,a)t}^{\max}(\#1) = b_{v(s,a)t}^{\max}(\#0) * (1 - 0.2)$. Moreover, equations 2) are relaxed by imposing $b_{vs}^{\min}(\#1) = 0$: the manager is allowed to close some sawmills without losing its supply agreement with government.

Experiments		Results			
ID	Descriptions	Production	Dist. Center	Markets	Value
#0	\$450/1000 pmp = Reference price \$40/1000 pmp = Spot vs contract-VMI price differential	<ul style="list-style-type: none"> Valley Mountain River 	<ul style="list-style-type: none"> Boston Sherbrooke 	<ul style="list-style-type: none"> 2 contracts 3 VMI 	\$ 1 782 499
#1	<u>Scenario #0 with</u> $b_{v(s,a)t}^{\max}(\#1) = b_{v(s,a)t}^{\max}(\#0) * (1 - 0.2)$: for equation 1) $b_{vs}^{\min}(\#1) = 0$: for the equation 2)	<ul style="list-style-type: none"> Valley Mountain 	<ul style="list-style-type: none"> Boston Sherbrooke 	<ul style="list-style-type: none"> 2 contracts 2 VMI 	\$ 3 713 543
#2	<u>Scenario #1 with supply flows :</u> $V_{Valley}(\#2) = \{Valley, Mountain, River\}$ $V_{River}(\#2) = \{Valley, Mountain, River\}$ $V_{Mountain}(\#2) = \{Valley, Mountain, River\}$	<ul style="list-style-type: none"> Valley Mountain 	<ul style="list-style-type: none"> Boston Sherbrooke 	<ul style="list-style-type: none"> 2 contracts 2 VMI 	\$ 3 709 565
#3	<u>Scenario #2 with</u> Lone patch mill Capacity = River mill Capacity Added Equations 29) (Appendix B)	<ul style="list-style-type: none"> Valley Mountain Lone (merged) 	<ul style="list-style-type: none"> Bangor Boston Sherbrooke 	<ul style="list-style-type: none"> 5 contracts 2 VMI 	\$ 10 517 428
#4	<u>Scenario #2 with</u> Lone patch mill Capacity =2 X River mill Capacity Added Equations 29) (Appendix B)	<ul style="list-style-type: none"> Valley Mountain Lone (merged) 	<ul style="list-style-type: none"> Bangor Boston Sherbrooke 	<ul style="list-style-type: none"> 7 contracts 2 VMI 	\$ 12 654 624

Table 11 : Experiments and Results.

After applying the SAA method, the value of the objective function of scenario #1 is twice as much as scenario #0 as stated in . As a result, River mill is shut down because its wood supply is too expensive: seasonal and yearly fixed costs and operations costs of River mill are saved. However, the other two sawmills produce for the markets because they are profitable. The number of VMI logistics policies decreases, as well as production volume.

The modeling approach proposed here could be useful to assist managers to design supply chains in times of evolving forest policies.

Inter sawmill supply transfers

Scenario #2 is derived from scenario #1 by allowing supply flows between sawmills forests in order to allow for more flexibility in the optimization of the Virtu@l-Lumber case. The definition of the set V_s of vendors which can supply sawmills is changed for scenario # 2. Henceforth, the Valley mill, for example, can receive supply from its own forest and also from the River and Mountain forests, i.e. $V_{valley}(\#1) = \{Valley\}$ is replaced by $V_{valley}(\#2) = \{Valley, Mountain, River\}$. The solution obtained by the SAA analysis for scenario #2 is almost identical to the one from scenario #1. Indeed, the River mill shuts down and the two other mills keep producing. There is no supply flow between forest and non-associated sawmills. This result is explained by long distances between the forests and sawmills: in this case, it is not profitable to proceed with transfers. Note that the objective function value of scenarii #1 and #2 are quite similar but they do show a slight difference even with an identical configuration of the production-distribution network. The reason for this is the random approximation of the objective function with two different sample of the same size ($N'=100$). However, it should be kept in mind that the permission to transfer woods supply allows a new degree of freedom to the manager to organize its production-distribution network.

Acquisition and Rationalization

This section studies acquisition and rationalization scenarii in order to take advantage of network synergies. Appendix B presents the required definition of new sets of equation 29) in order to capture the opportunity of a merger in addition with the original model stated in Appendix A.

Scenario #2 is modified by adding the opportunities to acquire a sawmill, called Lone Patch mill, and merge it with River mill. Figure 23 exposes the new sawmill network: the two locations of the merger and rationalization layout are either at Lone Patch mill (A merger

layout) or at the River mill (B merger layout). In practice, capacity options can be moved around. Moreover, we can still make usage of the permission of inter-sawmill supply flows as stated in scenario #2. In particular, merger layouts can receive wood from whatever forests. Table 12 presents two merger scenarii with different capacities for Lone Patch mill in comparison with River mill, and also respective fixed and variables costs for A and B layouts.

Scenario	# 3		# 4	
Assumption	Lone patch mill capacity = River mill capacity		Lone patch mill capacity = 2 X River mill capacity	
Layout	A	B	A	B
Fixed Cost	75% X (Lone + River)	75% X (Lone + River)	75% X (Lone + River)	80% X (Lone + River)
Variable Cost	90% X (Lone)	90% X (Lone)	90% X (Lone)	90% X (Lone)

Table 12 : Merger and sawmill network.

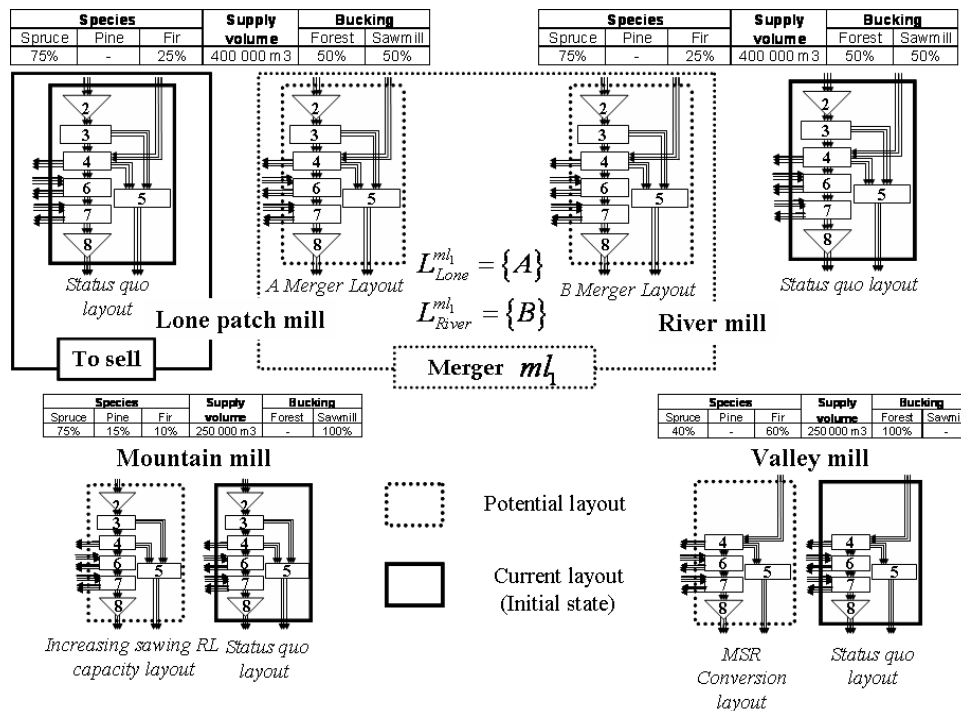

Figure 23: Sawmill network of the acquisition and merger scenario.

After the SAA analysis, the model proposes the installation of the A layout for the two scenarios as shown in . The value function increases considerably at \$M12.6, a new distribution center is installed and the number of deployed logistics policies rises too. It is important to note that the River mill supply is allocated to the merged Lone Patch mill layout because the two sawmills are geographically close and logistics supply costs don't interfere. Moreover, the reduction of fixed and variable costs offsets the high price of River mill supply.

These examples of how to use our methodology, based on a mathematical model, show amply how it can help the managers and the legislator to quantify the impact of forest or management policies on the lumber companies and especially on their supply chain. In particular, the model appears as a strong tool to manage acquisitions and rationalization in the very fragmented lumber industry.

5.2.5 Conclusion

As was demonstrated in the previous section, the methodology proposed in this paper can effectively quantify the relationship between the supply chain design and markets for the lumber industry. For example, the impact of a price differential on sawmill layouts has been studied. Moreover, the effectiveness of the SAA method in order to integrate customer preferences was showed in comparison with a classical approach based on average demand deterministic models.

The approach is useful not only to industrial managers but also to the policy maker. Indeed, the consequences of forestry policies on the lumber industry can be analyzed in a comprehensive manner. An application of this model to a representative sample of lumber industry companies could help quantify the overall economic impact of governmental decisions (decrease in supply agreement level, allowing for inter sawmill supply transfers, etc). Finally, the methodology could usefully be put to work to analyze business opportunities in areas in line with the global trends presented in introduction, especially the

trend towards increasing mergers and rationalization in the very fragmented lumber industry.

Future studies should involve the development of tailor-made acceleration techniques to solve very large business cases in a reasonable time. Heuristics such as taboo search, along with linear programming seems to be a promising avenue. Practical tools to perform SAA analysis should be constructed and made available to help managers to design robust optimum network configurations.

5.2.6 References

- Ben-Akiva M. and S. Lerman, 1985, *Discrete Choice Analysis: Theory and Application to Travel Demand*, MIT Press.
- Birge, J. and F. Louveaux, 1997, *Introduction to Stochastic Programming*, Springer.
- Bhutta K.S., 2004, International Facility Location Decisions: A Review of the Modeling Literature, *International Journal of Integrated Supply Management*, 1, 1, 33-50.
- Carino, H. and C. Lenoir, 1988, Optimizing Wood Procurement in Cabinet Manufacturing, *Interfaces*, 18, 10-19.
- Carino, H. and D. Willis, 2001a, Enhancing the Profitability of a Vertically Integrated Wood Products Production System. Part 1. A Multistage Modeling Approach, *Forest Products Journal*, 51, 4, 37-44.
- Carino, H. and D. Willis, 2001b, Enhancing the Profitability of a Vertically Integrated Wood Products Production System. Part 2., *Forest Products Journal*, 51, 4, 45-53.
- Carlsson, D. and M. Rönnqvist, 2005, Supply Chain Management in Forestry- Case Studies at Södra Cell AB, *European Journal of Operational Research*, 163, 589-616.
- Farell, R. and T. Maness, 2005, A Relational Database Approach to a Linear Programming-based Decision Support System for Production Planning in Secondary Wood Product Manufacturing, *Decision Support system*, 40, 183-196.
- Goetschalckx M., Vidal C.J. and Dogan K., 2002, Modeling and design of global logistics systems: A review of integrated strategic and tactical models and design algorithms, *European Journal of Operational Research*, 143, 1-18.
- Hill, T., 1994, *Manufacturing Strategy*, Irwin.

- Liden, B and M. Rönnqvist, 2000, CustOpT- a Model for Customer Optimized Timber in the Wood Chain, *Proceedings of the 12th Annual Conference for Nordic Researchers in Logistics*, NOFOMA 2000, June 14-15, Aarhus, Denmark, 421-441.
- Louviere, J., D. Hensher and J. Swait, 2000, *Stated Choice Methods*, Cambridge University Press.
- Maness, T. and S. Norton, 2002, Multiple Period Combined Optimization Approach to Production Planning, *Scandinavian Journal of Forest Research*, 17, 460-471.
- Martel, A., 2005, The Design of Production-Distribution Networks: A Mathematical Programming Approach, in J. Geunes and P. Pardalos (eds.), *Supply Chain Optimization*, Kluwer Academic Publishers.
- Martel A., W. M'Barek, and S. D'Amours, 2005, *International Factors in the Design of Multinational Supply Chains: The Case of Canadian Pulp and Paper Companies*, Working paper number DT-2005-AM-3, Centor, Université Laval.
- Rönnqvist, M., 2003, Optimization in Forestry, *Mathematical Programming, B* 97, 267-284.
- Rönnqvist M., 1995, A Method For The Cutting Stock Problem With Different Qualities, *European Journal of Operational Research*, 83, 57-68.
- Rönnqvist, M. and E. Astrand, 1998, Integrated Defect Detection and Optimization for Cross Cutting of Wooden Boards, *European Journal of Operational Research*, 108, 490-508.
- Santoso, T., S. Ahmed, M. Goetschalckx and A. Shapiro, 2005, A Stochastic Programming Approach for Supply Chain Network Design Under Uncertainty, *European Journal of Operational Research*, 167, 96-115.
- Shapiro, A., 2003, Monte Carlo Sampling Methods, in A. Ruszczyński and A. Shapiro (eds), *Stochastic Programming*, Handbooks in Operations Research and Management Science, 10, Elsevier.
- Shapiro, J., 2001, *Modeling the Supply Chain*, Brooks/Cole Publishing Company.
- Taylor R.E. & Associates Ltd. 2002, Wood Market Edition 2002, Published by International Wood Markets Research Inc.
- Verter, V. and C. Dincer, 1992, An Integrated Evaluation of Facility Location, Capacity Acquisition, and Technology Selection for Designing Global Manufacturing Strategies, *European Journal of Operational Research*, 60, 1-18.

Vila, D., A. Martel and R. Beauregard, 2005a, Designing Logistics Networks in Divergent Process Industries: A Methodology and its Application to the Lumber Industry, *International Journal of Production Economics*, article in press.

Vila, D., A. Martel and R. Beauregard, 2005b, *Taking Market Forces into Account in the Design of Production-Distribution Networks: A Positioning by Anticipation Approach*, Working paper number DT-2005-AM-4, Centor, Université Laval.

Appendix A

This appendix presents a mathematical programming model for the design of logistics networks in the Quebec lumber industry, based on a positioning by anticipation approach taking market forces into account.

The following notation is required to model the manufacturing process multigraph $\Gamma = (A, \Psi)$:

- P = Set of product families ($p \in P$).
- A = Set of activities ($a \in A$).
- Ψ = Set of directed arcs $\{(p, a, a')\}$ in the multigraph.
- A^p = Set of production activities ($A^p \subset A$).
- A^s = Set of storage activities ($A^s \subset A$).
- A_a^{in} = Set of immediate predecessors of activity a ($A_a^{in} \subset A$).
- A_a^{out} = Set of immediate successors of activity a ($A_a^{out} \subset A$).
- P_a^{in} = Input product families of activity a ($P_a^{in} \subset P$).
- P_a^{out} = Output product families of activity a ($P_a^{out} \subset P$).

The following notation is used to define the business environment of the company:

- FP = Set of product families sold on the market ($p \in FP$).
- SP^p = Set of substitutes for product family $p \in FP$ ($SP^p \subset FP$).
- SP_p = Set of product which can be substituted by product family $p \in FP$ ($SP_p \subset FP$).
- SM = Set of spot market $m \in SM$.
- SM_o = Set of spot market $m \in SM_o$ of the country $o \in O$.
- P_m = Set of products $p \in P_m \subset FP$ sold on the spot market $m \in SM$.
- D_{pm} = Set of demand zones in spot market $m \in SM$ for each product $p \in P_m$.

- Λ_{pm} = Set of levels of the decreasing cost step function for product $p \in P_m$ of spot market $m \in SM$ ($\lambda \in \Lambda_{pm}$).
- C = Set of contracts $c \in C$.
- C_o = Set of contracts $c \in C_o$ for country $o \in O$.
- SC_o = Set of signed contracts $c \in SC_o$ for country $o \in O$.
- PC_o = Set of potential contracts $c \in PC_o$ for country $o \in O$.
- VM = Set of VMI agreements $c \in VM$.
- VM_o = Set of VMI agreements $c \in VM_o$ for country $o \in O$.
- SVM_o = Set of signed VMI agreements $c \in SVM_o$ for country $o \in O$.
- PVM_o = Set of potential VMI agreements $c \in PVM_o$ for country $o \in O$.
- T = Set of seasons in the planning horizon ($t \in T$).
- D = Set of demand zones serviced by the company ($d \in D$).
- O = Set of countries covered by the logistics network ($o \in O$).
- $o(n)$ = Country of geographical location n .
- P_c = Unique product associated to contract/agreement $c \in C \cup VM$.
- x_{ct} = Quantity of product P_c demanded in contract/agreement $c \in C \cup VM$ during season $t \in T$.
- d_c = Location of contract $c \in C \cup VM$ customer.
- I_c = Set of logistics policies considered for contract/agreement $c \in C \cup VM$.
- $c(i)$ = Contract/agreement $c \in C \cup VM$ for which logistics policy i is considered.
- Ω_N = Set of sampled scenario $\omega \in \Omega_N$ (N is the size of the sample).
- $I_c(\omega)$ = Set of active logistics policies $i \in I_c$ of contract $c \in C \cup VM$ for environment $\omega \in \Omega_N$.

The following notation is required to define potential facilities and potential moves in the logistics network:

- S = Set of potential network sites ($s \in S$).
 S_o = Set of sites located in country $o \in O$ ($S_o \subset S$).
 S^{pd} = Set of potential production-distribution center sites ($s \in S^{pd} \subset S$).
 S^d = Set of potential distribution center sites ($s \in S^d \subset S$).
 S_{ps}^o = Set of potential production-distribution or distribution sites (output destinations) which can receive product p from site s .
 S_{ps}^i = Set of potential production-distribution or distribution sites (input sources) which can ship product p to site $s \in S$.
 S_m^i = Set of potential production-distribution or distribution sites (input sources) which can ship product p to spot market $m \in SM$.
 S_i^i = Set of facilities $s \in S^{pd} \cup S^d$ the company could use to comply with the terms of logistics policy i , i.e. to ship product $p_{c(i)}$ to location $d_{c(i)}$.
 SM_{ps} = Set of spot markets which can receive substitute products p from node s , i.e.

$$SM_{ps} = \left\{ m \mid s \in S_m^i, p \in \bigcup_{p' \in P_m} SP_{p'} \right\}.$$

 V_s = Set of vendors which can supply site $s \in S$ ($V_s \subset V$).
 V_{ps} = Set of vendors which can supply product P to site $s \in S$ ($V_{ps} \subset V_s$).

The following notation is required to define technologies and recipes:

- KM_{sa} = Production technologies which can be used to perform activity $a \in A^p$ on site s ($k \in KM_{sa}$).
 KS_{sa} = Storage technologies which can be used to perform activity $a \in A^s$ on site s ($k \in KS_{sa}$).
 R_{ak} = Set of recipes available to perform production activity $a \in A^p$ with technology k . These sets uniquely define the activity a and technology k of recipes $\varphi \in R_{ak}$.

- p_φ = Input product for recipe $\varphi \in R_{ak}$.
 P_φ^{out} = Set of output products obtained with recipe $\varphi \in R_{ak}$.
 $g_{p_\varphi P}^\varphi$ = Quantity of product P obtained from one unity of product p_φ with recipe $\varphi \in R_{ak}$.
 q^φ = Production capacity required to process one unit of product p_φ with recipe $\varphi \in R_{ak}$.
 q_{pa} = Capacity consumption rate per unit of product $p \in P_a^{in}$ for storage activity $a \in A^s$.

The notation required to define facility layouts and capacity options is the following:

- L_s = Potential facility layouts for site $s \in S^{pd}$ ($l \in L_s$).
 J_s = Potential capacity options which can be installed on site $s \in S^{pd}$ ($j \in J = \bigcup_{s \in S^{pd}} J_s$).
 J_{ks} = Potential technology k capacity options which can be installed on site $s \in S^{pd}$ ($J_{ks} \subseteq J_s$).
 J_{ls} = Potential capacity options which can be installed on site $s \in S^{pd}$ when layout $l \in L_s$ is used ($J_{ls} \subseteq J_s$).
 JR_{ls}^n = Mutually exclusive options sub-set in J_{ls} ($n = 1, \dots, N_{ls}$).
 N_{ls} = Number of mutually exclusive option subsets (equipment replacement/reconfiguration) in J_{ls} .
 E_{ls} = Total area of the layout l for site s .
 e_j = Area required to install capacity option j .
 b'_j = Capacity of the technology associated to option j available for season t .

b_{skt} = Technology k capacity available for season t for distribution site $s \in S^d$.

The notation required to model costs and revenues is the following:

A_{ls} = Fixed cost of using layout l on site $s \in S^{pd}$ for the planning horizon.

A_{0s} = Fixed cost of disposing of production-distribution site $s \in S^{pd}$ at the beginning of the planning horizon.

A_s = Fixed cost of using distribution site $s \in S^d$ for the planning horizon.

a_j^0 = Fixed cost of disposing of capacity option j at the beginning of the planning horizon.

a_j^1 = Fixed cost of installing or keeping capacity option j for the planning horizon.

\hat{a}_{jt} = Fixed cost of using capacity option j during season t .

$c_{p\varphi st}^\varphi$ = Cost of producing one unit of product P_φ with recipe φ on site s during season t .

m_{pst} = Unit handling cost for the transfer of product P to or from its stock in production-distribution site s during season t .

f_{psnt}^o = Unit cost of the flow of product P between site s and node n paid by origin s during season t (this cost includes the customer-order processing cost, the shipping cost, the variable transportation cost and the inventory-in-transit holding cost).

f_{psnt}^t = Unit transportation cost of product P from site s to node n during season t (this cost is included in f_{psnt}^o).

f_{psnt}^d = Unit cost of the flow of product P between node n and site s paid by destination s during season t (this cost includes the supply-order processing costs and the receiving cost).

- $f_{pv(s,a)t}^v$ = Unit cost of the flow of product P between vendor v and activity a on site s paid by destination s during season t (this cost includes the product's price and the variable transportation cost).
- h_{pst} = Unit inventory holding cost of product P in facility s during season t .
- π_{pst} = Transfer price of product P shipped from site s during season t .
- $e_{oo'}$ = Exchange rate, i.e. number of units of country o currency by units of country o' currency (the index $o = 0$ is given to the base currency, whether it is part of O or not).
- δ_{pns} = Import duty rate applied to the CIF price of product P when transferred from the country of node n to the country of site s .
- $P_{pm\lambda t}$ = Price obtained for product $p \in P_m$ on spot market $m \in SM$, at the level $\lambda \in \Lambda_{pm}$ of the price step function, during season $t \in T$.
- $X_{pm\lambda t}$ = Largest quantity of product $p \in P_m$ which can be sold on spot market $m \in SM$, at the level $\lambda \in \Lambda_{pm}$ of the price step function, during season $t \in T$ ($X_{pm\lambda 0} = 0$ and $X_{pm|\Lambda_{pm}|} \approx +\infty$).
- κ_d = Proportion of the demand of spot market $m(d) \in SM_o$ in each demand zone $d \in D_{pm(d)}$ for each product $p \in P_{m(d)}$.
- K_i = Fixed cost incurred for the implementation of logistics policy i .
- P_{it} = Price of the product associated to logistics policy i during season $t \in T$.

In order to compute inventory holding costs, the following parameter, which is the inverse of the familiar inventory turnover ratio, is also required:

- ρ_{pst} = Number of seasons of inventory (order cycle and safety stocks) of product P kept at site s for season t .

The first stage decision variables are the following:

- Y_{ls} = Binary variable equal to 1 if layout $l \in L_s$ is used for site $s \in S^{pd}$ and to 0 otherwise.
- Y_{0s} = Binary variable equal to 1 if production-distribution site $s \in S^{pd}$ is not used and to 0 otherwise.
- Y_s = Binary variable equal to 1 if potential distribution center $s \in S^d$ is used and to 0 otherwise.
- Z_j = Binary variable equal to 1 if capacity option j is installed and to 0 otherwise.
- \hat{Z}_{jt} = Binary variable equal to 1 if capacity option j is used during season t and to 0 otherwise.
- \tilde{Z}_i = Binary variable equal to 1 if logistics policy $i \in I_c, c \in PC_o \cup PVM_o$ is deployed and to 0 otherwise.
- $F_{p(n,a)(n',a')t}$ = Flow of product $p \in P$ between activity $a \in A$ at location $n \in V \cup S$ and activity a' , with $a' \neq 8$, at location $n' \in S$ during season $t \in T$.
- $X_{p\varphi st}^\varphi$ = Quantity of product p_φ processed with recipe $\varphi \in R_{ak}$ in production-distribution site s during season $t \in T$.
- I_{pkst} = Seasonal inventory of product $p \in P$ stored on site s with technology $k \in KS_{sa}$ of activity $a \neq 8$, at the end of season $t \in T$.

Let F^1 be the vector of the inbound raw material flows, i.e.

$$F^1 = \left[F_{p(v,1)(s,a)t} \quad \forall p \in P_1^{out}, \forall a \in A_1^{out}, \forall s \in S, \forall v \in V_{ps}, \forall t \in T \right]$$

and let Θ^1 be the set of all the feasible inbound raw material flows in the context considered. Then, to remain generic, the supply market conditions can be stated simply as:

$$F^1 \in \Theta^1.$$

To define Θ^1 for the Quebec lumber industry case, let:

$\Pr_{pv(s,2)} =$ Proportion of products of family $p \in P_2^{in}$ in the stems supplied by source $v \in V$ to site $s \in S^{pd}$, when bucking in done in the sawmill.

$\Pr_{pv(s,4)} =$ Proportion of products of family $p \in P_4^{in}$ in the logs supplied by source $v \in V$ to site $s \in S^{pd}$, when bucking in done in the forest.

$b_{v(s,a)}^{\max} =$ Upper bound on the seasonal shipments of raw material between source $v \in V$ and activity $a \in A_1^{out}$ on site $s \in S^{pd}$ for season t .

$b_{vs}^{\min} =$ Annual minimum level of raw material to be shipped between source $v \in V$ and site $s \in S^{pd}$ in order to comply with supply contracts with government.

Using this notation, the following equations express the seasonal supply constraints, the annual volume to respect and proportions of products in the input flows:

$$\sum_{p \in P_1^{out} \cap P_a^{in}} F_{p(v,1)(s,a)t} \leq b_{v(s,a)}^{\max} \quad a \in A_1^{out}, s \in S^{pd}, v \in V_s, t \in T \quad 1)$$

$$\sum_{t \in T} \sum_{a \in A_1^{out}} \sum_{p \in P_1^{out} \cap P_a^{in}} F_{p(v,1)(s,a)t} \geq b_{vs}^{\min} \quad s \in S^{pd}, v \in V_s \quad 2)$$

$$F_{p(v,1)(s,a)t} = \Pr_{pv(s,a)} \sum_{p' \in P_1^{out} \cap P_a^{in}} F_{p'(v,1)(s,a)t} \quad a \in A_1^{out}, p \in P_1^{out} \cap P_a^{in}, s \in S^{pd}, v \in V_s, t \in T \quad 3)$$

The following constraints ensure that a single layout is selected for each production-distribution site, that the area required by the selected options does not exceed the area available in the selected layout, and that mutually exclusive options are not selected:

$$\sum_{l \in L_s} Y_{ls} + Y_{0s} = 1 \quad s \in S^{pd} \quad 4)$$

$$\sum_{j \in J_{ls}} e_j Z_j \leq E_{ls} Y_{ls} \quad s \in S^{pd}, l \in L_s \quad 5)$$

$$\sum_{j \in RL_{ls}^n} Z_j \leq 1 \quad s \in S^{pd}, l \in L_s, n = 1, \dots, N_{ls} \quad 6)$$

The following constraints ensure that a capacity option can be used in a season only if it was installed:

$$\hat{Z}_{jt} \leq Z_j \quad s \in S^d, j \in J_s, t \in T \quad 7)$$

The flow equilibrium constraints of the inventory and production activities are the following:

$$\sum_{k \in KM_{sa}} \sum_{\varphi \in R_{ak} | p\varphi = p} X_{p\varphi st}^\varphi \leq \sum_{a' \in A_a^{in}} \sum_{s' \in S_{ps}^i \cup V_{ps}} F_{p(s',a')(s,a)t} + \sum_{a' \in A_a^{in}} F_{p(s,a')(s,a)t} \quad 8)$$

$$a \in A^p, p \in P_a^{in}, s \in S^{pd}, t \in T$$

$$\sum_{a' \in A_a^{out}} \sum_{s' \in S_{ps}^o} F_{p(s,a')(s',a')t} + \sum_{a' \in A_a^{out}} F_{p(s,a)(s,a')t} \leq \sum_{k \in KM_{sa}} \sum_{\varphi \in R_{ak} | p \in P_\varphi^{out}} g_{p\varphi p}^\varphi X_{p\varphi st}^\varphi \quad 9)$$

$$a \in A^p \setminus \{5, 7\}, p \in P_a^{out}, s \in S^{pd}, t \in T$$

$$\sum_{k \in KS_{sa}} I_{pkst} = \sum_{k \in KS_{sa}} I_{pkst-1} + \sum_{a' \in A_a^{in}} F_{p(s,a')(s,a)t} + \sum_{a' \in A_a^{in}} \sum_{s' \in S_{ps}^i \cup V_{ps}} F_{p(s',a')(s,a)t} \quad 10)$$

$$- \sum_{a' \in A_a^{out}} \sum_{s' \in S_{ps}^o} F_{p(s,a)(s',a')t} - \sum_{a' \in A_a^{out}} F_{p(s,a)(s,a')t} \quad a \in A^s \setminus \{8\}, p \in P_a^{in}, s \in S^{pd} \cup S^d, t \in T$$

$$I_{ps0} = I_{ps|T} \quad a \in A^s, p \in P_a^{in}, s \in S^{pd} \cup S^d \quad \text{where } I_{pst} = \sum_{k \in KS_{sa}} I_{pkst} \quad 11)$$

Production capacity restrictions are described by these constraints:

$$\sum_{\varphi \in R_{ak}} q^\varphi X_{p\varphi st}^\varphi \leq \sum_{j \in J_{ks}} b_j^t \hat{Z}_{jt} \quad a \in A^p, s \in S^{pd}, k \in KM_{sa}, t \in T \quad 12)$$

$$\sum_{p \in P_a^{in}} q_{pa} \left(\sum_{a' \in A_a^{out}} \sum_{s' \in S_{ps}^o} F_{p(s,a)(s',a')t} + \sum_{a' \in A_a^{out}} F_{p(s,a)(s,a')t} \right) \leq \sum_{k \in KS_{sa}} \sum_{j \in J_{ks}} b_j^t \hat{Z}_{jt} \quad a \in A^s \setminus \{8\}, s \in S^{pd}, t \in T \quad 13)$$

The second stage decision variables are the following:

$$F_{p(n,a)(n',a')t}(\omega) = \text{Flow of product } p \in P \text{ between activity } a \text{ at location } n \in S \text{ and activity } a' = 8 \text{ at location } n' \in S \text{ during season } t \in T \text{ for environment } \omega \in \Omega_N.$$

$I_{pkst}(\omega)$ = Seasonal inventory of product $p \in FP$ stored on site s with technology $k \in KS_{sa}$ at the end of season $t \in T$ for environment $\omega \in \Omega_N$.

$F_{pp'sd\lambda t}(\omega)$ = Outbound flow of finished product $p' \in FP$, used to satisfy the demand of product $p \in FP$ and sold at price $P_{pm\lambda}$, for sales interval λ , from site s to spot market demand zone $d \in D_{pm}$ during season $t \in T$ for the environment $\omega \in \Omega_N$.

$F_{psit}(\omega)$ = Outbound flow of finished product $p \in FP$ used to satisfy the demand of product $p_{c(i)}$ in demand zone $d_{c(i)}$ of contract/agreement $c(i) \in C_o \cup VM_o$, from site s and the using logistics policy i during season $t \in T$ for environment $\omega \in \Omega_N$.

The flow equilibrium constraints of the chipping activity in the second stage program are the following:

$$F_{pst}(\omega) \leq \sum_{k \in KM_{sa}} \sum_{\varphi \in R_{ak} | p \in P_{\varphi}^{out}} g_{p\varphi}^{\varphi} X_{p\varphi st}^{\varphi} \quad a = 5, p \in P_a^{out}, s \in S^{pd}, t \in T, \omega \in \Omega_N \quad (14)$$

The flow equilibrium constraints of the planing and grading activity in the second stage program are the following:

$$\sum_{s' \in S_{ps}^o} F_{p(s',7)(s',8)t}(\omega) + F_{p(s,7)(s,8)t}(\omega) \leq \sum_{k \in KM_{s7}} \sum_{\varphi \in R_{7k} | p \in P_{\varphi}^{out}} g_{p\varphi}^{\varphi} X_{p\varphi st}^{\varphi} \quad (15)$$

$$a = 7, p \in P_7^{out}, s \in S^{pd}, t \in T, \omega \in \Omega_N$$

The flow equilibrium constraints of the storage activity in the second stage program are the following:

$$\sum_{k \in KS_{s8}} I_{pkst}(\omega) = \sum_{k \in KS_{s8}} I_{pkst-1}(\omega) + F_{p(s,7)(s,8)t}(\omega) + \sum_{s' \in S_{ps}^i} F_{p(s',7)(s,8)t}(\omega) - F_{pst}(\omega) \quad (16)$$

$$a = 8, p \in P_8^{in}, s \in S^{pd} \cup S^d, t \in T, \omega \in \Omega_N$$

$$I_{ps0}(\omega) = I_{ps|T}(\omega) \quad a = 8, p \in P_8^{in}, s \in S^{pd} \cup S^d, \omega \in \Omega_N \quad \text{where} \quad I_{pst}(\omega) = \sum_{k \in KS_{s8}} I_{pkst}(\omega)$$

The flow conservation has to be respected in the second stage program:

$$F_{pst}(\omega) = \sum_{m \in SM_{ps}} \sum_{p' \in P_m} \sum_{d \in D_{pm}} \sum_{\lambda \in \Lambda_{p'm}} F_{p'psd\lambda t}(\omega) + \sum_{c \in C \cup VM} \sum_{\substack{p \in SP_{pc} \\ i \in I_c(\omega) \\ s \in S_i^t}} F_{psit}(\omega) \quad (17)$$

$$\omega \in \Omega_N, t \in T, p \in P, s \in S^{pd} \cup S^d$$

The capacity constraints for the inventory activity in the second stage program are the following:

$$\sum_{p \in P_8^{in}} q_{p8} F_{pst}(\omega) \leq \sum_{k \in KS_{s8}} \sum_{j \in J_{ks}} b_j' \hat{Z}_{jt} \quad a=8, s \in S^{pd}, t \in T, \omega \in \Omega_N \quad (18)$$

$$\sum_{p \in P_8^{in}} q_{p8} F_{pst}(\omega) \leq \left(\sum_{k \in KS_{s8}} b_{skt} \right) Y_s \quad a=8, s \in S^d, t \in T, \omega \in \Omega_N \quad (19)$$

Finally, demand constraints and logistics policies are described by:

$$\sum_{p' \in PS^p} \sum_{s \in S_m^i} F_{pp'sd\lambda t}(\omega) \leq \kappa_d (X_{pm\lambda t} - X_{pm(\lambda-1)t}) \quad (20)$$

$$\omega \in \Omega_N, t \in T, o \in O, m \in SM_o, p \in P_m, d \in D_{pm}, \lambda \in \Lambda_{pm}$$

$$\sum_{p' \in PS^p} \sum_{s \in S_c^i} F_{p'sit}(\omega) = x_{ct} \quad \omega \in \Omega_N, t \in T, o \in O, c \in SC_o \cup SVM_o \quad (21)$$

$$\sum_{p' \in PS^p} \sum_{s \in S_i^i} F_{p'sit}(\omega) = x_{ct} \tilde{Z}_i \quad \omega \in \Omega_N, t \in T, o \in O, c \in PC_o \cup PVM_o, i \in I_c(\omega) \quad (22)$$

$$\sum_{i \in I_c} \tilde{Z}_i \leq 1 \quad c \in PC_o \cup PVM_o, \forall o \in O \quad (23)$$

		Distribution center (S^d)	Production-distribution center (S^{pd})
Expenses	a) Inflow transfer cost	$\sum_{t \in T} \sum_{a, a' \in A - \{a\}} \sum_{p \in P_a^{out} \cap P_{a'}^{in}} \sum_{s \in S_{ps}^i} (1 + \delta_{ps's}) e_{o(s)o(s')} (\pi_{ps't} + f_{ps's't}^t) F_{p(s',a')(s,a)t}$ $\sum_{t \in T} \sum_{a, a' \in A - \{a\}} \sum_{p \in P_a^{out} \cap P_{a'}^{in}} \sum_{s \in S_{ps}^i} (1 + \delta_{ps's}) e_{o(s)o(s')} (\pi_{ps't} + f_{ps's't}^t) F_{p(s',a')(s,a)t}(\omega)$	
	b) Raw materials		$\sum_{t \in T} \sum_{a \in A - \{1\}} \sum_{p \in P_a^{in}} \sum_{v \in V_{ps}} (1 + \delta_{pvs}) e_{o(s)o(v)} f_{pv(s,a)t}^v F_{p(v,1)(s,a)t}$
	c) Receptions from other sites	$\sum_{t \in T} \sum_{a, a' \in A - \{a\}} \sum_{p \in P_a^{out} \cap P_{a'}^{in}} \sum_{n \in V_{ps} \cup S_{ps}^i} f_{pnst}^d F_{p(n,a')(s,a)t}$ $+ \sum_{t \in T} \sum_{a, a' \in A - \{a\}} \sum_{p \in P_a^{out} \cap P_{a'}^{in}} \sum_{n \in V_{ps} \cup S_{ps}^i} f_{pnst}^d F_{p(n,a')(s,a)t}(\omega)$	
	d) Production		$\sum_{t \in T} \sum_{a \in A^p} \sum_{k \in KM_{sa}} \sum_{\varphi \in R_{ak}} c_{p\varphi st}^\varphi X_{p\varphi st}^\varphi$
	e) Facilities and options cost	$A_s Y_s$	$\sum_{l \in L_s \cup \{0\}} A_{ls} Y_{ls} + \sum_{j \in J_s} (a_j^1 Z_j + a_j^0 (1 - Z_j)) + \sum_{t \in T} \sum_{j \in J_s} \hat{a}_{jt} \hat{Z}_{jt}$
	f) Order cycle & safety stocks	$\sum_{t \in T} \sum_{a \in A^i} \sum_{p \in P_a^{out}} h_{pst} \rho_{pst} \sum_{a' \in A_a^{out}} (F_{p(s,a)(s,a')t} + \sum_{n \in S_{ps}^i} F_{p(s,a)(n,a')t}) + \sum_{t \in T} \sum_{p \in P_a^{out}} h_{pst} \rho_{pst} F_{pst}(\omega)$	
	g) Seasonal stocks	$\sum_{t \in T} \sum_{a \in A^i} \sum_{p \in P_a^{in}} h_{pst} \sum_{k \in KS_{sa}} I_{pkst} + \sum_{t \in T} \sum_{a \in A^i} \sum_{p \in P_a^{in}} h_{pst} \sum_{k \in KS_{sa}} I_{pkst}(\omega)$	
	h) Handling		$\sum_{t \in T} \sum_{a \in A^i} \sum_{p \in P_a^{in}} m_{pst} \sum_{a' \in A_a^{out}} F_{p(s,a)(s,a')t} + \sum_{t \in T} \sum_{p \in P_a^{in}} m_{pst} F_{pst}(\omega)$
	i) Outflows to other sites		$\sum_{t \in T} \sum_{a, a' \in A - \{a\}} \sum_{p \in P_a^{out} \cap P_{a'}^{in}} \sum_{s \in S_{ps}^o} f_{pss't}^o F_{p(s,a)(s',a')t}$ $+ \sum_{t \in T} \sum_{a, a' \in A - \{a\}} \sum_{p \in P_a^{out} \cap P_{a'}^{in}} \sum_{s \in S_{ps}^o} f_{pss't}^o F_{p(s,a)(s',a')t}(\omega)$
	j) Outflows to demand zones		$\sum_{t \in T} \left(\sum_{m \in SM} \sum_{s \in S_m^i} \sum_{p \in P_m} \sum_{d \in D_{pm}} \sum_{\lambda \in \Lambda_{pm}} \sum_{p' \in PS^p} f_{p'sd}^o F_{pp'sd\lambda t}(\omega) \right)$ $+ \sum_{c \in C \cup VM} \sum_{i \in I_c(\omega)} \sum_{s \in S_i^i} \sum_{p' \in PS^{pc}} f_{p'sd_c}^o F_{p'sit}(\omega)$
Revenues	k) Outflows to other sites		$\sum_{t \in T} \sum_{a, a' \in A - \{a\}} \sum_{p \in P_a^{out} \cap P_{a'}^{in}} \sum_{s \in S_{ps}^o} (\pi_{pst} + f_{pss't}^t) F_{p(s,a)(s',a')t}$ $+ \sum_{t \in T} \sum_{a, a' \in A - \{a\}} \sum_{p \in P_a^{out} \cap P_{a'}^{in}} \sum_{s \in S_{ps}^o} (\pi_{pst} + f_{pss't}^t) F_{p(s,a)(s',a')t}(\omega)$
	l) Outflows to demand zones		$\sum_{t \in T} \left(\sum_{m \in SM} \sum_{s \in S_m^i} \sum_{p \in P_m} \sum_{d \in D_{pm}} e_{o(s),o(d)} \sum_{\lambda \in \Lambda_{pm}} \sum_{p' \in PS^p} P_{pm\lambda t} F_{pp'sd\lambda t}(\omega) \right)$ $+ \sum_{c \in C \cup VM} \sum_{i \in I_c(\omega)} \sum_{s \in S_i^i} \sum_{p' \in PS^{pc}} P_{it} F_{p'sit}(\omega)$

Table 13 : Facilities expenses and revenues in local currency for a given environment.

To write the objective function, the following additional notation is needed:

\bar{C}_s = Sample average of total site s expenses for the planning horizon.

\bar{R}_s = Sample average of total site s revenues for the planning horizon.

Then, using the expenditure and revenue elements in Table 13, it is seen that:

$$\bar{C}_s = \frac{1}{N} \{ (a) + (b) + (c) + (d) + (e) + (f) + (g) + (h) + (i) + (j) \} \quad s \in S^{pd} \quad (24)$$

$$\bar{C}_s = \frac{1}{N} \{ (a) + (b) + (c) + (e) + (f) + (g) + (i) + (j) \} \quad s \in S^d \quad (25)$$

$$\bar{R}_s = \frac{1}{N} \{ (k) + (l) \} \quad s \in S^{pd} \cup S^d \quad (26)$$

The sample average operating income for each national division $o \in O$, is given by

$$\bar{M}_o = \sum_{s \in S_o} (\bar{R}_s - \bar{C}_s) - \sum_{c \in C_o \cup V_o} \sum_{i \in I_c} K_i \tilde{Z}_i$$

and the sample average corporate net revenues in the reference currency are $\sum_{o \in O} e_{0o} \bar{M}_o$.

Based on this, it is seen that the Sample Average Approximation program to solve is the following: $\max \sum_{o \in O} e_{0o} [\sum_{s \in S_o} (\bar{R}_s - \bar{C}_s) - \sum_{c \in C_o \cup V_o} \sum_{i \in I_c} K_i \tilde{Z}_i]$

subject to constraints 1) to 26), and to the non-negativity constraints:

$$Y_{ls} \in \{0;1\} \quad s \in S^{pd}, l \in L_s \quad Y_{0s} \in \{0;1\} \quad s \in S^{pd} \quad \tilde{Z}_i \in \{0;1\} \quad i \in I_c, c \in PC_o \cup PVM_o$$

$$Z_j \in \{0;1\} \quad s \in S^{pd}, j \in J_s \quad \hat{Z}_{jt} \in \{0;1\} \quad t \in T, s \in S^{pd}, j \in J_s \quad Y_s \in \{0;1\} \quad s \in S^d$$

$$F_{p(n,a)(n',a')t} \geq 0 \quad p \in P, (n,a) \in (V \cup S) \times A, (n',a') \in (V \cup D_p) \times A, t \in T$$

$$X_{p,st}^i \geq 0 \quad s \in S^{pd}, a \in A^p, k \in KM_{sa}, i \in R_{ak}, t \in T \quad (27)$$

$$I_{pkst} \geq 0 \quad p \in P, s \in S^{pd}, a \in A^s, k \in KS_{sa}$$

$$F_{p(n,a)(n',a')t}(\omega) \geq 0 \quad p \in P, (n,a) \in S \times A, (n',a') \in (S) \times A, t \in T, \omega \in \Omega_N$$

$$I_{pkst}(\omega) \geq 0 \quad p \in P, s \in S^{pd}, a \in A^s, k \in KS_{sa}, t \in T, \omega \in \Omega_N$$

$$F_{pst}(\omega) \geq 0 \quad t \in T, \omega \in \Omega_N, p \in P, s \in S^{pd} \cup S^d$$

$$F_{p'sit}(\omega) \geq 0 \quad \omega \in \Omega_N, o \in O, c \in C_o \cup VM_o, p' \in PS^{pc}, s \in S^{pd} \cup S^d, i \in I_c(\omega), t \in T$$

$$F_{pp'sd\lambda t}(\omega) \geq 0 \quad \omega \in \Omega_N, m \in MS_o, p \in P_m, p' \in SP^p, s \in S^{pd} \cup S^d, d \in D_m, \lambda \in \Lambda_{pm}, t \in T$$

$$\bar{C}_s \geq 0 \quad s \in S^{pd} \cup S^d \quad \bar{R}_s \geq 0 \quad s \in S^{pd} \cup S^d$$

Appendix B

In order to integrate the merger layout option, the definition of the following set is necessary:

ML = Potential merger of different facility layouts $ml \in ML$.

L_s^{ml} = Potential facility layouts for site $s \in S^{pd}$ for the merger $ml \in ML$. ($L_s^{ml} \subset L_s$)

$$\sum_{s \in S^{pd}} \sum_{s \in L_s^{ml}} Y_{ls} \leq 1 \quad ml \in ML \tag{29}$$

Chapitre 6 : Conclusions

Ce dernier chapitre récapitule les contributions de la thèse et formule une série de pistes de recherches futures.

6.1 Contributions

6.1.1 Premier article

La principale contribution du premier article est l'élaboration d'une méthodologie générique de conception des réseaux logistiques pour les industries dont les procédés sont divergents. Une application concrète à un cas réaliste de l'industrie forestière illustre la faisabilité de la démarche. De plus, la méthodologie permet une flexibilité tactique par la prise en compte des décisions saisonnières de fermeture et d'ouverture des options technologiques. La formalisation du recours possible à la substitution entre produits vient compléter l'approche.

6.1.2 Deuxième article

Le second article propose une méthodologie de conception des réseaux logistiques par positionnement par anticipation des forces du marché. Celles-ci sont désormais capturées par le concept de politique logistique. De plus, les préférences des clients ainsi que les implications de la concurrence sur celles-ci sont représentées par le recours aux choix discrets. La principale contribution du deuxième article est la quantification de la relation dyadique entre le marché et le réseau logistique par la création du concept de politique logistique. Du point de vue combinatoire, une approche dérivée de l'échantillonnage de Monte-Carlo ainsi qu'une analyse de la convergence sont déployées en vue d'obtenir des solutions dont la qualité est mesurable par rapport au problème initial.

6.1.3 Troisième article

Le troisième article formule un modèle mathématique combinant les concepts des deux premiers articles. L'approche générique de conception des réseaux logistiques pour les industries à procédés divergents et le positionnement par anticipation sont intégrés et appliqués à un cas réaliste de l'industrie du bois d'oeuvre au Québec. La relation dyadique

ente le marché et la chaîne logistique est plus précisément évaluée : l'évolution des prix de marchés structure et modifie l'organisation logistique de l'entreprise. De plus, la méthode d'approximation déployée dans le second article se révèle être bien plus réaliste et efficace qu'une approche déterministe basée sur la demande moyenne qui peut générer parfois des solutions irréalisables. Enfin, le modèle intégrateur ainsi proposé permet un éclairage des enjeux de l'industrie du bois d'œuvre au Québec non seulement au niveau organisationnel mais aussi institutionnel. Des modifications des politiques forestières en vigueur actuellement dans l'Est canadien et leurs implications sont évaluées sur le cas d'étude Virtu@l-Lumber ainsi qu'une stratégie d'acquisition et de rationalisation.

6.2 Perspectives de recherche

Les divers modèles présentés dans la thèse fournissent un éclairage novateur pour la modélisation mathématique des réseaux logistiques, et laissent entrevoir un ensemble de pistes de recherche prometteuses. Deux principales orientations peuvent être spécifiées : l'une quantitative, l'autre organisationnelle.

6.2.1 Recherches quantitatives

Le premier article propose une méthodologie de conception des réseaux logistiques pour les industries dont les procédés sont divergents ou « one-to-many ». Le prolongement logique de cette approche serait une déclinaison pour les procédés « many-to-many ». Seules les définitions des technologies et les équations liées aux activités de production seraient à modifier et à adapter afin de capturer ces nouveaux enjeux. Une telle modification serait réalisable sans vraisemblablement trop de difficultés.

La formalisation théorique initiale de la fonction économique des deux derniers articles consistait en la maximisation des bénéfices après impôts. Toutefois, l'implantation informatique finale correspondait à la maximisation des bénéfices avant impôts. Les futures recherches devront considérer et implanter la maximisation des bénéfices après impôts.

Les deuxième et troisième articles mettent en lumière l'intérêt de la programmation stochastique pour considérer un ensemble de scénarii dérivés des préférences des clients en

vue de solutions adaptées aux forces du marché. Toutefois, il serait intéressant d'étendre la méthodologie à un ensemble de facteurs dont la dimension aléatoire est avérée. Par exemple, les taux de change et les prix de référence de marché seraient naturellement des éléments à considérer. Cette approche semble une réponse intéressante à la problématique récurrente de la fiabilité des prévisions formulées pour les modèles quantitatifs.

Outre la prise en compte d'une multitude de facteurs, un enjeu sous-jacent à la programmation stochastique appliquée à la modélisation des réseaux logistiques est la gestion du risque. Le recours à des techniques issues du monde de la finance jumelées aux problématiques de conception de réseaux logistiques présente encore un véritable potentiel de recherche bien que ce champ ait déjà fait l'objet de travaux cités dans la revue de littérature. Dans la même lignée, l'utilisation des produits dérivés spécifiques à l'industrie du bois d'oeuvre mérite une attention particulière dans une approche globale de la quantification et protection des risques.

Une troisième option de recherche est la formulation dynamique et stochastique des deux derniers modèles conjuguée à l'anticipation des préférences des clients. Les décisions seraient non seulement dictées par les forces de marchés mais aussi par l'influence indirecte des périodes suivantes.

Au-delà de la conception des réseaux logistiques, le troisième article évalue l'impact des politiques forestières sur l'organisation des entreprises. Dès lors, l'État, fiduciaire de la forêt publique, pourra définir ses politiques forestières en adéquation avec les capacités industrielles pour non seulement promouvoir un développement économique adapté mais aussi une utilisation optimale des ressources naturelles d'un point de vue social. La création d'une banque de données de compagnies représentatives de l'industrie est essentielle pour l'opérationnalisation de l'approche. Un tel projet nécessiterait une équipe multidisciplinaire de deux ou trois personnes à temps plein pour la collecte des données forestières et économiques, pour la programmation et l'optimisation des modèles mathématiques, l'analyse des résultats et l'élaboration des politiques forestières en étroite collaboration avec l'ensemble des parties prenantes.

Parallèlement au développement de nouveaux modèles, des techniques de résolution pour les problèmes de conception de réseaux logistiques doivent être proposées. En effet, les temps de résolution des problèmes approximatés par la méthode SAA peuvent se révéler considérables. Des techniques heuristiques telles que la recherche tabou, pourraient s'avérer pertinentes pour le déploiement de la méthode d'approximation où la notion d'apprentissage est possible par un paramétrage adapté de (N, M, N') .

Les deuxième et troisième articles proposent l'utilisation théorique des choix discrets afin de capturer les préférences des clients. D'un point de vue académique, les préférences des clients du cas d'entreprise Virtu@l-Lumber ont été générées aléatoirement afin de se consacrer à la dimension logistique. Le déploiement pratique de ces techniques économétriques appliquées à l'industrie du bois d'œuvre semble un élément prometteur pour une meilleure compréhension générale des diverses attentes des contractants « VMI » ou « Contract ». Dès lors, des politiques logistiques conformes à la réalité du marché pourront être déployées.

Une seconde alternative prometteuse de représentation des marchés pour la conception des réseaux logistiques est l'utilisation des systèmes multi-agents. En effet, la combinaison des outils mathématiques de planification stratégique des systèmes manufacturiers et des systèmes multi-agents semble intéressante afin de matérialiser la relation dyadique du marché et de l'entreprise dans son ensemble. Des modèles à concurrence passive ou active pourront être formulés grâce à l'utilisation de ces nouveaux outils. Toutefois, le recours aux systèmes multi-agents pour la planification stratégique des réseaux logistiques ne semble pas un substitut mais un outil complémentaire à une approche mathématique.

Les divers travaux de recherche présentés tout au long de la thèse reposent sur l'hypothèse que les industries appartiennent à la classe « make-to-stock ». Quelles seraient alors les différences fondamentales dans la méthodologie de positionnement par anticipation pour les industries « make-to-order »? Le concept de politique logistique et ses définitions associées s'appliqueraient-ils de la même façon ? Quoi qu'il en soit, la modélisation de la spécificité des industries « make-to-order » conjuguée à celle des politiques logistiques nécessite un éclairage.

6.2.2 Recherches organisationnelles

Au niveau organisationnel, la formulation stratégique des réseaux logistiques englobe le niveau tactique dans un souci de réalisme. Toutefois, seules les décisions d'ordre stratégique sont implantées. Cette approche suscite un questionnement par rapport à l'intégration des différents niveaux décisionnels. Schneeweiss (2003) présente un modèle hiérarchique qui anticipe les effets de certaines décisions sur d'autres. Toutefois, les interrelations décisionnelles issues de la modélisation mathématique des réseaux logistiques méritent une attention toute particulière.

Le lien entre la stratégie et la conception des réseaux logistiques de l'entreprise mérite lui aussi un éclairage. En effet, ces deux éléments s'influencent mutuellement : idéalement, la formulation de la stratégie générale de l'entreprise se concrétise par un réseau de production. Toutefois, la réalité est souvent toute autre. Il serait intéressant de comprendre quelles sont les raisons de cette « inertie organisationnelle » afin de déterminer et d'utiliser des leviers efficaces de changement. Par exemple, l'obligation de respecter les obligations de contrats signés, un manque de liquidité ou une conjoncture économique peuvent justifier une telle situation.

La conception de la chaîne logistique et de ses décisions stratégiques structure le devenir du système de production mais aussi l'entreprise dans son ensemble. A cet égard, il serait intéressant de concilier les techniques issues de la modélisation mathématique avec les outils de l'analyse financière. En effet, les décisions de localisation, de capacité et d'installation de technologies conditionnent les flux et les résultats financiers de demain. La conception réussie des réseaux de création de valeur passera nécessairement par une analyse financière rigoureuse de l'ensemble des entreprises constituant le réseau et cela peu importe leur taille. De plus, l'analyse financière des entreprises manufacturières doit intégrer les techniques de la conception des réseaux logistiques afin de gagner en réalisme et perspicacité.

6.3 Conclusion finale

Les pistes de recherches proposées se trouvent à la croisée de l'optimisation, de la modélisation, de la simulation, de l'informatique, du marketing, de la micro-économie, de l'élaboration et l'analyse des politiques, de la stratégie et de l'analyse financière... Dès lors, la multidisciplinarité apparaît un enjeu épistémologique de tout premier plan pour la création de méthodologies réalistes et efficaces de conception stratégique des réseaux logistiques.

Références

- Aikens, C.H., 1985, Facility Location Models for Distribution Planning, *European Journal of Operational Research*, 22, 263-279.
- Arntzen, B., G. Brown, T. Harrison et L. Trafton, 1995, Global Supply Chain Management at Digital Equipment Corporation, *Interfaces*, 21-1, 69-93.
- Bashyam, T.C., 1996, Competitive Capacity Expansion Under Demand Uncertainty, *European Journal of Operational Research*, 95, 89-114.
- Ben-Akiva, M. et S.R. Lerman, 1985, *Discrete Choice Analysis*, MIT Press.
- Bhutta, K., F. Huq, G. Frazier et Z. Mohamed, 2003, An Integrated Location, Production, Distribution and Investment Model for a Multinational Corporation, *International Journal of Production Economics*, 86, 201-216.
- Boyaci, T. et S. Ray, 2003, Product Differentiation and Capacity Cost Interaction in Time and Price Sensitive Markets, *Manufacturing & Service Operations Management*, 5-1, 18-36
- Brown, G., G. Graves et M. Honczarenko, 1987, Design and Operation of a Multicommodity Production/Distribution System Using Primal Goal Decomposition, *Management Science*, 33-11, 1469-1480.
- Cakravastia, A., I.S Toha et N. Nakamura, 2002 ,A two-stage model for the design of supply chain networks, *International Journal of Productions Economics*, 80, 231-248.
- Carino, H. et C. Lenoir, 1988, Optimizing Wood Procurement in Cabinet Manufacturing, *Interfaces*, 18, 10-19.
- Carino, H. et D. Willis, 2001a, Enhancing the Profitability of a Vertically Integrated Wood Products Production System. Part 1. A Multistage Modeling Approach, *Forest Products Journal*, 51, 4, 37-44.
- Carino, H. et D. Willis, 2001b, Enhancing the Profitability of a Vertically Integrated Wood Products Production System. Part 2., *Forest Products Journal*, 51, 4, 45-53.
- Carlsson, D. et M. Rönnqvist, 2005, Supply Chain Management in Forestry- Case Studies at Södra Cell AB, *European Journal of Operational Research*, 163, 589-616.
- Cohen, M. et H. Lee, 1989, Resource Deployment Analysis of Global Manufacturing and Distribution Networks, *Journal of Operations Management*, 2, 81-104.
- Cohen, M. et S. Moon 1991, An Integrated Plant Loading Model with Economies of Scale and Scope, *European Journal of Operational Research*, 50, 266-279.

- Cordeau, J-F., F. Pasin et M. Solomon, 2002, An Integrated Model for Logistics Network Design, *Les Cahiers du GERAD*, G-2002-07.
- Cox, J.F. et J.H. Blackstone, 2001, *Apics Dictionary*, Tenth Edition.
- Dogan, K. et M. Goetschalckx, 1999, A Primal Decomposition Method for the Integrated Design of Multi-Period Production-Distribution Systems. *IIE Transactions* 31, 1027-1036.
- Dumolard, A., M. Pouly et R. Glardon, 2000, *Economic Evaluation of Delays Reduction: A Global Approach*, Département de Mécanique, École Polytechnique Fédérale de Lausanne.
- Eppen, G., R. Kipp Martin et L. Schrage, 1989, A Scenario Approach to Capacity Planning, *Operations Research*, 37-4, 517-527.
- Erlenkotter, D., 1977, Facility Location with Price Sensitive Demand : Private, Public and Quasi-public, *Management Science*, 24, 378-386.
- Fandel, G. et M. Stammen, 2004, A General Model for Extended Strategic Supply Chain Management with Emphasis on Product Life Cycles Including Development and Recycling, *International Journal of Production Economics*, 89, 293-308.
- Farell, R. et T. Maness, 2005, A Relational Database Approach to a Linear Programming-based Decision Support System for Production Planning in Secondary Wood Product Manufacturing, *Decision Support system*, 40, 183-196.
- Fleischmann, B. 1993, Designing Distribution Systems with Transport Economies of Scale, *European Journal of Operational Research*, 70, 31-42.
- Geoffrion, A. et G. Graves, 1974, Multicommodity Distribution System Design by Benders Decomposition, *Management Science*, 20, 822-844.
- Ghosh, A. et F. Harche, 1993, Location-allocation Models in the Private Sector : Progress, Problems and Prospects, *Location Science*, 1, 1, 81-106.
- Glover, F., G. Jones, D. Karney, D. Klingman et J. Mote, 1979, An Integrated Production, Distribution, and Inventory-Planning System, *Interfaces*, 9-5, 21-35.
- Goetschalckx, M., C.V. Vidal et K. Dogan, 2002, Modeling and Design of Global Logistics Systems : A Review of Integrated Strategic and Tactical Models and Design Algorithms, *European Journal of Operational Research*, 143, 1-18.

- Goodchild, M.F., 1984, ILACS : a Location-allocation Model for Retail Site Selection, *Journal of Retailing*, 60, 84-100.
- Hakimi, L., 1964, Optimun Locations of Switching Centers and the Absolute Centers and Medians of a Graph, *Operations Research*, 12, 450-459.
- Hakimi, L. et C.-C. Kuo, 1991, On a General Network Location-production Allocation Problem, *European Journal Of Operational Research*, 55, 31-45.
- Hill, T., 1994, *Manufacturing Strategy*, Irwin.
- Ho, P.K et J. Perl, 1995, Warehouse Location Under Service-Sensitive Demand, *Journal of Business Logistics*, 16-1, 133-165.
- Hodder, J.E et J.V. Jucker, 1985. International Plant Location under Price and Exchange Rate Uncertainty, *Engineering Costs and Production Economics*, 9, 225-229.
- Hodder, J.E et M.C. Dincer, 1986. A multifactor Model for International Plant Location and Financing under Uncertainty, *Computers and Operations Research*, 13, 601-609.
- Hormozi, A. et B. Khumawala, 1996, An Improved Algorithm for Solving a Multi-Period Facility Location Problem, *IIE Transactions*, 28-2, 105-114.
- Huchzermeier, A. and M. Cohen, 1996, Valuing Operational Flexibility under Exchange Rate Risk, *Operations Research*, 44-1, 100-113.
- Innis, D.E et B.J La Londe, 1994, Customer Service : The Key to Customer Satisfaction, Customer Loyalty, and Market Share, *Journal of Business Logistics*, 15-1, 1-27.
- Karmakar, U.S, 1996, Integrative Research in marketing and Operations Management, *Journal of Marketing Research*, 33, 125-133.
- Kogut, B. et N. Kalatilaka, 1994, Operating Flexibility, Global Manufacturing and the Option Value of a Multinational Network, *Management Science*, 40-1, 123-139.
- Körksalan, M. et H. Süral, 1999, Efes Beverage Group Makes Location and Distribution Decisions for its Malt Plants, *Interfaces*, 29-2, 89-103.
- Lakhal, S., A. Martel, O. Kettani et M. Oral, 2001, On the Optimization of Supply Chain Networking Decisions, *European Journal of Operational Research*, 129-2, 259-270.
- Lederer, P.J. et L. Li, 1997, Pricing, Production, Scheduling, and Delivery-time Competition, *Operations Research*, 45-3, 407-420.

- Lee, S.M., G.I Green et C. Kim 1981, A Multiple Criteria Model for the Location-Allocation Problem, *Computers and Operations Research* 8,1-8.
- Li, S. et D. Tirupati, 1994, Dynamic Capacity Expansion Problem with Multiple Products: Technology Selection and Timing of Capacity Additions, *Operations Research*, 42-5, 958-976.
- Li L. et Y.S. Lee, 1994, Pricing and Delivery-time Performance in a Competitive Environment, *Management Science*, 40-5, 633-646.
- Liden, B et M. Rönnqvist, 2000, CustOpT- a Model for Customer Optimized Timber in the Wood Chain, *Proceedings of the 12th Annual Conference for Nordic Researchers in Logistics*, NOFOMA 2000, June 14-15, Aarhus, Denmark, 421-441.
- Logendran, R. et T. Palmer, 1991, Capacited Plant Location-allocation Problems with Price Sensitive Stochastic Demands, *Logistics and Transportation Review*, 27-1, pp 33-53.
- Louviere, J., D. Hensher et J. Swait, 2000, *Stated Choice Methods*, Cambridge University Press.
- Maness, T. et S. Norton, 2002, Multiple Period Combined Optimization Approach to Production Planning, *Scandinavian Journal of Forest Research*, 17, 460-471.
- Markowitz, H., 1959, Portfolio Selection, *Yale University Press*, New Haven, Conn.
- Martel, A., 2001, Chapitre 1 : La Logistique d'Entreprise. Dans : *Théories et Modèles Logistiques, Notes de Cours*, pp 1-50, Université Laval.
- Martel, A., 2005, The Design of Production-distribution Networks: A Mathematical Programming Approach, to appear in J. Geunes and P.M. Pardalos (eds.), *Supply Chain Optimization*, Kluwer Academic Publishers.
- Martel, A, et U. Vankatadri, 1999, Optimizing Supply Network Structures under Economies of Scale, *Proceedings of International Conference on Industrial Engineering and Production Management*, Glasgow, United Kingdom.
- Martel A., W. M'Barek et S. D'Amours, 2005, *International Factors in the Design of Multinational Supply Chains: The Case of Canadian Pulp and Paper Companies*, Working paper number DT-2005-AM-3, Centor, Université Laval.
- Mazzola, J. et R. Schantz, 1997, Multiple-Facility Loading Under Capacity-Based Economies of Scope, *Naval Research Logistics*, 44, 229-256.

- Mazzola, J.B. et A.W. Neebe, 1999 Lagrangian-Relaxation-Based Solution Procedures for a Multiproduct Capacitated Facility Location Problem with Choice of Facility Type. *European Journal of Operational Research*, 115-2, 285-299.
- Owen, S. et M. Daskin, 1998, Strategic Facility Location: A Review, *European Journal of Operational Research*, 111, 423-447.
- Palaka, K., S. Erlebacher et D. Kropp, 1998, Lead Time Setting, Capacity Utilization, and Pricing Decisions under Lead-time Dependent Demand, *IIE Transactions*, 30, 151-163.
- Paquet, M., A. Martel et G. Desaulniers, 2004, Including Technology Selection Decisions in Manufacturing Network Design Models, *International Journal of Computer Integrated Manufacturing*, 17-2, 117-125.
- Paquet, M., 2004, *Ingénierie de réseaux manufacturiers, Modèles de conception et de Redéploiement Stratégique*, Projet de thèse, Université Laval.
- Philpott, A. et G. Everett, 2001, Supply Chain Optimisation in the Paper Industry. *Annals of Operations Research*, 108-1: 225-237.
- Pirkul, H. et V. Jayaraman, 1996, Production, Transportation, and Distribution Planning in a Multi-Commodity Tri-Echelon System, *Transportation Science*, 30-4, 291-302.
- Pomper, C., 1976, *International Investment Planning: An Integrated Approach*, North-Holland.
- Porter, M., 1985, *Competitive Advantage*, The Free Press-MacMillan.
- Poulin, D., B. Montreuil et S. Gauvin, 1994, *L'Entreprise Réseau : Bâtir Aujourd'hui l'Organisation de Demain*, Montréal, Canada: Publi-Relais.
- Rajagopalan, S. et A. Soteriou, 1994, Capacity Acquisition and Disposal with Discrete Facility Sizes, *Management Science*, 40-7, 903-917.
- Ray, S. et E.M. Jewkes, 2004, Customer Lead Time Management When Both Demand and Price are Lead Time Sensitive, *European Journal of Operational Research* 153, 769-781.
- Rhim, H., T.H Ho. et U.S. Karmarkar, 2003, Competitive Location, Production, and Market Selection, *European Journal of Operational Research*, 149, 211-228.
- Rönnqvist, M., 2003, Optimization in Forestry, *Mathematical Programming, B* 97, 267-284.

- Rönnqvist M., 1995, A Method For The Cutting Stock Problem With Different Qualities, *European Journal of Operational Research*, 83, 57-68.
- Rönnqvist, M. et E. Astrand, 1998, Integrated Defect Detection and Optimization for Cross Cutting of Wooden Boards, *EJOR*, 108, 490-508.
- Rosenfield, D., R. Shapiro et R. Bohn , 1985, Implications of Cost-service Trade-offs on Industry Logistics Structures, *Interfaces*, 15-6, 47-59.
- Salanié, B., 1994, *Théorie des contrats*, Economica.
- Santoso, S., S. Ahmed, M. Goetschalckx et A. Shapiro, 2005, A Stochastic Programming Approach for Supply Chain Network Design Under Uncertainty, *European Journal Of Operational Research*, 167, 96-115.
- Schneeweiss, C., 2003, *Distributed Decision Making*, Springer, Second Edition.
- Shapiro, J., 2001, *Modeling the Supply Chain*, Duxbury Thomsom Learning.
- Shulman, A., 1991, An Algorithm for Solving Dynamic Capacitated Plant Location Problems with Discrete Expansion Sizes, *Operations Research*, 39-3, 423-436.
- So, K.C et J.J. Song 1998, Price, Delivery Time Guarantees and Capacity Selection, *European Journal of Operational Research*, 11, 28-49.
- Talluri, K. et G. Van Ryzin, 2004, Revenue Management under a General Discrete Choice Model of Consumer Behavior, *Management Science*, 50-1, 15-33.
- Tirole, J., 1988, *The Theory of Industrial Organization*, MIT Press.
- Tsay, A., S. Nahmias et N. Agrawal, 1999, Modeling Supply Chain Contracts : A Review, *Quantitative Models for Supply Chain Management*, Kluwer Academic Publishers.
- Tyagi, R. et C. Das, 1997, A Methodology for Cost versus Service Trade-offs in Whosale Location-distribution using Mathematical Programming and Analytic Hierarchy Process, *Journal of Business Logistics*, 18-2,77-99.
- Verma, R. et G. Thompson, 1999, Managing Service Operations Based on Customer Preferences, *International Journal of Operations and Production Management*, 19-9,891-908.
- Verter, V. et C. Dincer, 1992, An Integrated Evaluation of Facility Location, Capacity Acquisition, and Technology Selection for Designing Global Manufacturing Strategies, *European Journal Of Operational Research*, 60, 1-18.

Zubair, M.M et A.Y. Mohamed, 2004, A Production, Distribution and Investment Model for a Multinational Company, *Journal of Manufacturing Technology Management*, 15-6, 495-510

Annexe 1 : Pseudo-Code informatique

La présente annexe présente l'ensemble des éléments nécessaires à la réalisation globale du déploiement informatique de la thèse :

- Modèle relationnel de données.
- Guide du programmeur.
- Pseudo-Code du programme informatique.

Le modèle relationnel de données ainsi que le programme informatique sont disponibles sur la page web « Collection Mémoires et Thèses électroniques » de la Faculté des Études Supérieures, www.theses.ulaval.ca, en faisant une recherche par auteur à «Didier Vila ».

A1.1 Modèle relationnel de données

Le modèle relationnel de données, disponible aux formats .pdf et .mrd, expose la structuration de la base de données access du programme informatique en vue d'organiser et de stocker l'ensemble des informations nécessaires à l'écriture du problème mathématique.

A1.2 Guide du programmeur

La base de données au format Microsoft Access 2003 (www.microsoft.com) a été générée avec le logiciel spécialisé en conception de base de données Silverrun (www.silverrun.com).

La programmation du modèle mathématique a été effectuée avec le langage Microsoft Visual Basic 6.0 (www.microsoft.com). La librairie Ezmod (www.modellium.com) a permis l'écriture et la transcription des modèles mathématiques en fichier LP afin que le logiciel d'optimisation Cplex 9.0 (www.ilog.com) procède à la résolution.

A1.3 Pseudo-Code du programme informatique

La programmation informatique du troisième article qui intègre les spécificités des deux premiers repose sur une structure modulaire par activité. En effet, chacune des activités présentées à la figure 14 de la page 94 est transcrite par un ou plusieurs modules selon le degré d'implication vis-à-vis des étapes spécifiques à la programmation stochastique. Par exemple, l'activité tronçonnage ne comporte qu'un seul module à l'opposé des activités « finition » et « déchiquetage » qui toutes deux sont impliquées dans les première et deuxième étapes et respectivement dans deux modules.

Le pseudo-code simplifié se réfère aux numéros de types d'équation présentés dans le troisième article :

Contraintes de première étape :

- Contraintes d'approvisionnements (1, 2, 3)
- Contraintes de devis, d'espaces et d'options exclusives (4, 5, 6)
- Contraintes d'utilisation des capacités saisonnières (7)
- Contraintes d'équilibre des flux pour les activités de production (8, 9)
- Contraintes de conservation pour les activités d'inventaire (10, 11)
- Contraintes de capacité de production et d'inventaire (12, 13)

Contraintes de deuxième étape :

- Contraintes d'équilibre des flux pour les activités de production (14, 15)
- Contraintes de conservation pour les activités d'inventaire (16)
- Conservation des équilibres des flux (17)
- Contraintes de capacité de stockage (18, 19)
- Contraintes des ventes de marchés (20, 21, 22, 23)
- Contraintes de non négativités (27)

La fonction économique est obtenue par une série de module calculant chacun des coûts engagés pour chacun des sites.

La forme principale du code informatique programmé en VB 6.0 (forme 1) explique l'ensemble des équations et des modules décrivant chacune des activités.

Annexe 2 : Le Cas Virtu@l-Lumber

Le cas Virtu@l-Lumber a été conçu afin d'illustrer les concepts introduits et formalisés tout au long de la thèse. L'objectif de cette annexe est de présenter concrètement les informations contenues dans la base de données qui est accessible en ligne (cf annexe A.1). Le fichier info.xls, lui aussi accessible en ligne, synthétise les informations ci-dessous (les tables inutilisées sont surlignées en orange).

Le cas Virtu@l-Lumber est un cas virtuel et réaliste d'une entreprise de l'industrie du bois d'œuvre au Québec. Celui-ci est issu d'une étroite collaboration entre divers acteurs de l'industrie du bois d'œuvre au Québec au sein du Consortium de Recherche FOR@C (Tembec, Kruger, Domtar, Criq, Forintek, CN).

A2.1 Mise en situation

Le gouvernement québécois possède 90 % de la forêt du territoire de la province et attribue la ressource forestière aux différentes scieries situées sur son territoire par l'élaboration d'un Contrat d'Approvisionnement et d'Aménagements Forestiers (C.A.A.F). Ces derniers stipulent une allocation exclusive des ressources spécifiées à une seule et unique scierie.

Virtu@l-Lumber est une entreprise québécoise qui possède trois scieries avec leur CAAF respectif. Son approvisionnement annuel est de 900 000 mètres cubes. Son réseau de distribution se constitue de centres publics canadiens et américains de distribution dont la location est annuelle. L'outil industriel de Virtu@l-Lumber permet la fabrication de produits correspondants aux besoins spécifiques de l'ensemble du marché, à savoir le marché spot, les détaillants (« contract ») et les clients industriels (« VMI »). Les marchés de Virtu@l-Lumber sont localisés des deux cotés de la frontière canado-américaine. La Figure 15 du chapitre 5 présente l'ensemble des produits correspondants aux divers segments.

Depuis quelques années, l'environnement de marché dans lequel évolue Virtu@l-Lumber est devenu très concurrentiel et contigu. En effet, l'effet conjugué des taux de change, du conflit commercial du bois d'œuvre avec les Etats-Unis et l'évolution des besoins spécifiques des marchés oblige à repenser la chaîne logistique de Virtu@l-Lumber dans son ensemble par une approche résolument orientée client. Dès lors, la planification stratégique de conception du réseau logistique synchronisée aux besoins du marché apparaît être une condition nécessaire à la survie de l'entreprise.

D'une part, un devis alternatif au devis actuel est proposé pour chacune des scieries. Chacun des devis permet un agencement flexible des différentes activités de production décrites par la Figure 1 du chapitre 3. D'autre part, la stratégie marketing consiste à maximiser le portefeuille client parallèlement au déploiement éventuel de politiques logistiques tout en satisfaisant les clients contractuels (« Contract & VMI »). La Figure 16 du chapitre 5 expose les différentes décisions auxquelles est confronté simultanément le gestionnaire de Virtu@l-Lumber dans sa recherche de la maximisation des bénéfices.

Chacune des décisions précédentes ne sauraient être prises séparément au risque d'aboutir à un résultat sous-optimal ou irréalisable. Désormais, l'enjeu de la planification stratégique du réseau logistique est l'intégration des activités approvisionnement, production, distribution et marketing par une stratégie globale et optimale.

Les données présentées ultérieurement dans l'annexe sont des données agrégées dans le but de la planification stratégique. Le lecteur doit garder à l'esprit la nature réaliste mais simplifiée des informations exposées pour les besoins de l'exercice.

A2.2 Facteurs macro-économiques

Cette section présente les différents facteurs macro-économiques dans lequel va évoluer Virtu@l-Lumber. Les noms des tables suivantes réfèrent aux tables de la base de données Virtu@l-Lumber.mdb accessible en ligne.

A2.2.1 Les saisons

La table « Season » présente les identifiants de chaque saison avec la répartition saisonnière de la demande et les variations de prix par rapport à un prix de référence annuel. Le prix de référence est directement introduit dans le programme comme variable globale (400 \$/pmp).

A2.2.2 Les pays

La table « Country » décrit les pays et leur niveau d'imposition respectif.

A2.2.3 Les taux de change

La table « Exchangerate » présente les divers taux de change entre les pays. Le taux de change correspond au nombre d'unité de la monnaie du pays de la première colonne pour une unité du pays de la seconde colonne.

A2.2.4 Import-export

La table « Imexport » présente les différentes taxes à l'importation et à l'exportation entre les pays pour chacun des produits. Le pays de la seconde colonne est l'origine et le pays de la troisième colonne est la destination du transfert international du produit.

A2.3 Le réseau de production-distribution

Cette section présente le réseau de production-distribution de Virtu@l-Lumber.

A2.3.1 Le réseau

La table « Node » décrit l'ensemble des nœuds du réseau incluant les forêts jusqu'aux nœuds de marché. La colonne « Spec-1 » spécifie la nature du nœud :

- 1 = Forêt.
- 2 = Scierie.
- 3 = Centre de distribution.
- 4 = Marché.

Seuls les centres de distribution comportent un « fixedcost » positif correspondant au coût estimé de leur location annuelle.

La table « Site » récapitule l'ensemble des scieries.

La table « Vendors » récapitule l'ensemble des forêts.

La table « Demand » récapitule l'ensemble des nœuds de marché.

A2.3.2 Les technologies

La table « Technology » présente l'ensemble des technologies. Une activité peut comporter plusieurs technologies. La colonne Spec-1 précise la nature des technologies :

- 1 = Technologie de production.
- 2 = Technologie de stockage.

La table « Techprod » récapitule l'ensemble des technologies de production.

La table « Techstorage » récapitule l'ensemble des technologies d'inventaire.

A2.3.3 Les devis

La table « Devis » présente les devis possibles pour chacune des scieries ainsi que l'espace disponible et le coût d'implantation associés.

A2.3.4 Les options

La table « Capacityoption » présente les options pour chaque technologie, nœud et devis ainsi que l'espace associé et les coûts d'implantations ou de désinstallations. (Note au lecteur : La table concernée est bien « CapacityOption » bien que le nom puisse être trompeur avec la suite).

La table « Seasonalcap » quantifie la capacité et le coût saisonnier d'ouverture et de fermeture pour chacune des options. Pour certaines activités, la capacité d'une même option technologique varie au fil des saisons (voir les options technologiques de séchage).

La table « FixedCap » présente la capacité saisonnière de stockage de chacun des centres de distribution. Celles-ci sont supposées constantes pour toutes les saisons et sont présentées pour la seule saison $t=1$.

A2.3.5 Les produits

La table « Productcategory » définit les diverses catégories de produit. La table « Product » définit les divers produits tout en mentionnant à quelle catégorie ils appartiennent. Il est important de souligner que ces produits sont en réalité des familles de produits agrégées

représentatives des marchés. Celles-ci sont en adéquation avec la définition des déterminants technologiques tout au long de la *supply chain*.

A2.3.6 Les patrons de coupe

La table « Coupe » définit les divers patrons de coupe. La table « Cutproduction » présente les rendements exprimés en unités de produits sortants pour une unité de produit rentrant en fonction des patrons de coupe utilisés. Les coûts associés sont eux aussi quantifiés. D'un point de vue théorique, l'existence des colonnes « saisons » et « sites » ne se justifie pas mais celle-ci permet un meilleur contrôle des données pour l'utilisateur. Il est à noter que seule la saison $t=1$ est étudiée car les coûts et les rendements sont supposés indépendants de la saison.

La notion de rendement de patron de coupe introduite pour les besoins de la planification stratégique diffère des rendements des patrons de coupe du niveau opérationnel. En effet, les patrons de coupes du niveau stratégique sont appliqués à l'ensemble des représentants d'une même famille agrégée. Dès lors, le rendement s'exprime comme la moyenne des rendements du niveau opérationnel.

A2.3.7 Les capacités d'inventaire

La table « Techstorcap » exprime l'utilisation de la capacité pour un produit et une technologie des activités de stockage. Pour les activités de production, la capacité est exprimée en fonction des unités entrantes. En conséquence, aucune conversion n'est requise.

A2.3.7 L'approvisionnement

La table « Forestsupply » indique le profil d'approvisionnement de chacun des produits d'une forêt à une scierie donnée. Le profil est supposé indépendant des saisons et seule la saison $t=1$ a été présentée.

Pour des raisons de gestion de données, les coûts et volumes saisonniers maximums d'approvisionnement d'une forêt à une scierie (respectivement le volume annuel minimum du CAAF) sont conservés en mentionnant le produit 136 (respectivement le produit 137).

A2.3.8 Les coûts logistiques

La table « Flow1 » présente les différents coûts logistiques entre les divers nœuds du réseau pour chacun des produits. Les coûts sont supposés indépendants des saisons et identiques pour l'ensemble des produits sciés (verts, secs et finis). Cette hypothèse est formulée pour des raisons simplificatrices et mérite une meilleure quantification dans les prochains travaux sur Virtu@l-Lumber. Seuls les coûts associés à la seule saison $t=1$ et le produit 115 sont présentés.

A2.3.9 Les coûts pour les sites

La table « Seasoparam » présente les différents coûts pour un produit à un site donné. Les coûts sont supposés indépendants des saisons et sont présentés pour la seule saison $t=1$.

A2.4 Les marchés

Cette section présente les marchés de Virtu@l-Lumber.

A2.4.1 Les marchés spots

La table « Spotmarket » définit l'ensemble des marchés spots. La table « AdmissiblesiteSM » décrit l'ensemble des arcs admissibles du réseau de production-distribution pour chacun des marchés spots.

La table « Smzone » définit l'ensemble des nœuds de demande associés à un même marché spot. Les proportions de chacun des nœuds sont aussi spécifiées.

La table « SMproduct » présente le comportement de la fonction de demande pour chacun des marchés spots et produits (figure 10). Chacune des fonctions est décrite par deux paliers dont les quantités sont définies par les colonnes « Valeurinf » et « Valeurmax ». Le prix est directement ajusté dans le programme informatique.

A2.4.2 Les contrats

La table « Contract » précise le produit, le nœud de demande et la quantité pour chaque contrat. La colonne « Potentiellvssigne » de la table « Contract » stipule la nature du contrat :

- 1 = Signé.
- 2 = Potentiel.

La colonne « Contratvsvmi » de la table « Contract » informe sur la nature de la relation contractuelle :

- 1 = Contrat.
- 2 = Vmi.

La table « Logisticspo » présente les coûts, les probabilités (dérivées des préférences des clients par les choix discrets), des politiques logistiques rattachées à un contrat spécifique. La colonne prix n'est toutefois pas opérationnalisée : le programme informatique permet d'ajuster directement les prix.

La table « Admissiblecon » décrit pour chacune des politiques logistiques l'ensemble des sites admissibles associés.

A2.4.3 La substitution

La table « Substitute » décrit l'ensemble des substitutions possibles. La première colonne définit le produit substitué par le substitut décrit dans la seconde. Il est important de mentionner dans la table « Substitute » qu'un produit est le substitut de lui-même pour respecter la conception du programme informatique.

A2.5 L'échantillonnage

La table « Environnement » présente le nombre d'environnement à considérer. Le remplissage de cette table s'effectue automatiquement via le programme informatique par la variable globale N. Présentement, la table « Environnement » est chargée à N=100.

Une fois la table « Environnement » chargée au nombre N spécifié, le programme informatique procède à l'échantillonnage de Monte-Carlo et conserve pour chaque environnement l'ensemble des politiques logistiques actives (et leur contrat associé) dans la table « Wlogistactive ». Présentement, la table « Wlogistactive » est chargée avec N=100.