



**HAL**  
open science

# Hydrogen production from anaerobic co-digestion of coffee mucilage and swine manure

Mario Andres Hernandez Pardo

► **To cite this version:**

Mario Andres Hernandez Pardo. Hydrogen production from anaerobic co-digestion of coffee mucilage and swine manure. Chemical and Process Engineering. Ecole des Mines de Nantes; Universidad de los Andes (Bogotá). Facultad de ingenieria, 2012. English. NNT : 2012EMNA0127 . tel-00778944

**HAL Id: tel-00778944**

**<https://theses.hal.science/tel-00778944>**

Submitted on 21 Jan 2013

**HAL** is a multi-disciplinary open access archive for the deposit and dissemination of scientific research documents, whether they are published or not. The documents may come from teaching and research institutions in France or abroad, or from public or private research centers.

L'archive ouverte pluridisciplinaire **HAL**, est destinée au dépôt et à la diffusion de documents scientifiques de niveau recherche, publiés ou non, émanant des établissements d'enseignement et de recherche français ou étrangers, des laboratoires publics ou privés.

# Thèse de Doctorat

## Mario Hernández

*Mémoire présenté en vue de l'obtention du grade de  
Docteur de l'Ecole des Mines de Nantes  
Sous le label de l'Université Nantes Angers Le Mans*

*Discipline : Génie des Procédés*

*Laboratoire : Laboratoire de Génie des Procédés Environnement Agro-alimentaire (GEPEA)*

Soutenue le 22 novembre 2012

École doctorale : Science Pour l'Ingénieur, Géosciences, Architecture (SPIGA)

Thèse N 2012EMNA0127

## Hydrogen production from anaerobic co-digestion of coffee mucilage and swine manure

### JURY

Rapporteurs : **M. Patrick DABERT**, Directeur de recherche, Irstea (France)  
**M. Abdeltif AMRANE**, Professeur, Université de Rennes (France)

Examineurs : **Mme. Laurence Le COQ**, Professeur, Ecole des Mines de Nantes (France)  
**Mme. Johanna HUSSERL**, Professeur, Universidad de los Andes (Colombia)

Directeurs de Thèse : **M. Yves ANDRES**, Professeur, Ecole des Mines de Nantes (France)  
**M. Manuel RODRIGUEZ**, Professeur, Universidad de los Andes (Colombia)



## Publications

M. Hernández, M. Rodríguez, Y. Andres. Use of coffee mucilage as a new substrate for hydrogen production in anaerobic co-digestion with swine manure in thermophilic condition. *International Journal of Hydrogen Energy*. Under Review.

M. Hernández, Y. Andres, M. Rodríguez. Effluent treatment from the dark fermentation process by anaerobic digestion for methane production. To be submitted.

M. Hernández, M. Rodríguez, Y. Andres. Mechanisms and microorganisms involved in hydrogen production over retention time in ABR – Opening the black box for co-digestion of two complex substrates. To be submitted.

M. Hernández, M. Rodríguez, Y. Andres. Dynamics of co-digestion of mucilage and swine manure for biohydrogen generation. 4th International Conference on Engineering for Waste and Biomass Valorisation. September, 2012. Porto - Portugal.

M. Hernández, Y. Andres, M. Rodríguez. Performance of biohydrogen production from anaerobic co-digestion of coffee mucilage and swine manure in thermophilic condition. World Hydrogen Energy Conference. June, 2012. Toronto - Canada.

M. Hernández, Y. Andres, M. S. Rodríguez. Hydrogen production from co-digestion process: characteristics and potential of substrates and preliminary experiments. 12th World Congress on Anaerobic Digestion (AD12). November 2010. Guadalajara - México.

## Acknowledgments

This thesis was developed in a joint supervision convention between the Département Systèmes Energétiques et Environnement (DSEE) of the Ecole des Mines de Nantes and the Centro de Investigaciones en Ingeniería Ambiental (CIIA) of the Universidad de los Andes with the financial support of the Research Center of the Faculty of Engineering (CIFI), ECOS Nord C10A01 and COLCIENCIAS 057-2010. Also, special thanks to the both Universities: Universidad de Los Andes and Ecole des Mines de Nantes. Special thanks for Servicio Nacional de Aprendizaje (SENA) and Orlando Fierro and Jorge Fierro by the supply of substrates for this research.

I would like to thank my director in Colombia, Manuel Rodríguez, because he trusts on me as a candidate to make this Ph.D. I want to thank my director in France, Yves Andres, for his support, especially at the final stage in Nantes. I want to thank the master student Jonathan Oudart for his support related to the experiments for the microorganisms evaluation in CSTB. Also, special thanks to Juliana Martinez and Ana Giraldo who's helped me in the lab work and fighting against microorganisms.

I want to thank Yves and Claire for their hospitality when I first got to Nantes and the motivation to teach me a little about their culture.

I want to thank my dream team in the Environmental Laboratory at Los Andes: Edna, Olguita, La Mona, Mary, Adry, Alix, Rocio, Angela, Jhon, Glorita, Doña Luz, Don Armando, Diego and Julian. Also, thanks to Santiago and Julio for the expeditions in search the substrates. Special thanks to all of them for the help in the lab and doing this long stay more enjoyable. In that period was great to share time with the girls: Mildred, Porritas and Alma. Also, the work experience with Bertha, Fernando and Diego on this topic.

I would like to thank to Luisa Gonzalez and Andrea Maldonado because they were my support in a special moment during my stage in Nantes. Especially thank to Luisa, who was beside me since I arrived in France.

I want to thank all the friends, co-workers and colleagues who were next to me at different times: Adri and Paisa in the office at Los Andes; Hector, Francis, Srta Masmelo and DonJuan in Bogotá; Jenny, Caro, Audrey, Olivier, Stephane, Laura, Cristian... at EMN; Shivaji and Edwin as the foreign delegation in Nantes (The business guys).

I would like to make a special dedication to Natis because that was a great time beside her. Especially all those precious moments shared and all the support you gave me for this PhD. Tu aura toujours un endroit dans mon coeur. Also, thanks to Eileen (Chaolin) for laughs even when I was tired.

I would like to thank my family for their support at all time, Freidy and Helena. Also, to my brother's family Sofi, Alejandro and Nayibe.

Finally, I would like to thank my parents whose have given and taught me many things. We know that the beginning for our family was hard and maybe at that time we never imagined that with their effort and sacrifice I could be here today. Muchas gracias y espero tenerlos a mi lado por mucho más tiempo, los quiero mucho!



## Abstract

This research investigates an alternative approach to the use of two wastes from agricultural and livestock activities developed in Colombia. Swine manure and coffee mucilage were used to evaluate an anaerobic co-digestion process focused on hydrogen production. In addition, the aims covered a further stage in order to close the cycle of the both wastes. The thesis was conducted in three phases: 1. Evaluation of hydrogen production from the co-digestion of coffee mucilage and swine manure during dark fermentation; 2. Trends over retention time through the monitoring of microorganisms by quantitative PCR and other parameters including pH, oxidation reduction potential, and hydrogen partial pressure; 3. Treatment of the effluent from hydrogen production process by anaerobic digestion with methane production. The experimental results showed that mixtures of both wastes are able to produce hydrogen. A substrate ratio of 5:5, which was associated with a C/N ratio of 53.4, was suitable for hydrogen production. Moreover, the stability and optimization of the process were evaluated by increasing the influent organic load rate. This was the best experimental condition in terms of average cumulative hydrogen volume, production rate and yield which were 2660.7 NmL, 760.2 NmL H<sub>2</sub>/L<sub>w</sub>d and 43.0 NmL H<sub>2</sub>/g COD, respectively. This performance was preserved over time, which was verified through the repetitive batch cultivation during 43 days. Two trends were identified over retention time associated with similar cumulative hydrogen, but with differences in lag-phase time and hydrogen production rate. *T. thermosaccharolyticum* was the dominating genus during the *short* trend related to the shortest lag-phase time and highest hydrogen production rate. The *long* trends were associated with a decrease of *Bacillus sp.* concentration at the beginning of the experiments and with the possible competition for soluble substrates between *T. thermosaccharolyticum* and *Clostridium sp.* The third phase showed that the use of a second stage to produce methane was useful enhancing the treatment of both wastes. Finally, the overall energy produced for both biofuels (Hydrogen and methane) showed similar levels with other process. However, hydrogen was around the 10% of the overall energy produced in the process. In addition, both gases could be mixed to produce biohythane which improves the properties of biogas.

*Keywords: hydrogen production; hydrogen producers; methane; waste treatment.*





# Table of Contents

Publications .....	3
Acknowledgments .....	4
Abstract .....	7
Table of Contents .....	9
List of Tables.....	13
List of Figures .....	15
GENERAL INTRODUCTION .....	19
LITERATURE REVIEW.....	25
CHAPTER 1 Hydrogen production by dark fermentation.....	26
1.1 Anaerobic digestion.....	26
1.1.1 Stages involved in anaerobic digestion .....	26
1.1.2 Hydrogen production from different substrates, metabolites and stages .....	27
1.1.2.1 Acidogenic stage .....	28
1.1.2.2 Acetogenic - Syntrophic.....	29
1.1.3 Hydrogen consumption through different routes .....	30
1.1.3.1 Methanogenic step.....	30
1.1.3.2 Sulfate-reducing bacteria (SRB) .....	30
1.1.3.3 Homoacetogenic step .....	32
1.1.3.4 Biomass synthesis .....	32
1.1.4 Pathways involved in degradation processes .....	33
1.1.4.1 Metabolites, routes, enzymes and carries .....	33
1.1.4.2 Main aspects that can produce metabolic changes.....	35
1.1.4.3 Influence of subproducts .....	36
1.1.5 Microorganisms involved in dark fermentation.....	37
1.2 Operating conditions .....	39
1.2.1 Main parameters involved in this study .....	39
1.2.1.1 Hydraulic retention time.....	39
1.2.1.2 Organic load rate .....	40
1.2.1.3 pH.....	41
1.2.1.4 Hydrogen and carbon dioxide partial pressure.....	42
1.2.2 Other parameters influencing the hydrogen production.....	44
1.2.2.1 Temperature .....	44
1.2.2.2 Bioreactor type .....	46

1.3	Substrates .....	47
1.3.1	Simple and complex substrates .....	47
1.3.2	Swine manure waste .....	49
1.3.2.1	Current situation .....	49
1.3.2.2	Management and potential .....	50
1.3.3	Coffee mucilage waste .....	51
1.3.3.1	Current situation .....	51
1.3.3.2	Management and potential .....	53
1.3.4	Co-digestion .....	54
1.3.4.1	General assumptions .....	54
1.3.4.2	C/N ratio .....	55
1.4	Two-stages anaerobic digestion .....	56
1.4.1	Biomass potential for anaerobic digestion .....	56
1.4.2	Two-stages features .....	57
1.5	Conclusions .....	59
	References .....	61
	EXPERIMENTAL SECTION .....	68
	CHAPTER 2 Use of coffee mucilage as a new substrate for hydrogen production in anaerobic co-digestion with swine manure in thermophilic condition .....	69
	Abstract .....	69
2.1	Introduction .....	70
2.2	Methods .....	72
2.2.1	Methodology .....	72
2.2.2	Substrates .....	73
2.2.3	Inoculum .....	73
2.2.4	Experimental design .....	74
2.2.5	Analytical methods .....	75
2.3	Results and discussion .....	76
2.3.1	Reactor performance during dark fermentation .....	76
2.3.1.1	Repetitive batch cultivation and C/N ratio .....	76
2.3.1.2	Effect of increasing the organic load rate .....	79
2.3.1.3	Effect of mucilage concentration .....	81
2.3.2	Kinetic parameters and metabolic pathways .....	82
2.3.2.1	Kinetic parameters .....	82

2.3.2.2	Pathway behavior .....	84
2.3.2.3	Ratios in the fermentation pathway.....	87
2.3.3	Conclusions .....	90
	References .....	91
CHAPTER 3	Mechanisms and microorganisms involved in hydrogen production over retention time in ABR – Opening the black box for co-digestion of two complex substrates.	94
	Abstract .....	94
3.1	Introduction .....	95
3.2	Methods.....	96
3.2.1	Methodology - Inoculum and substrate.....	96
3.2.2	DNA extraction and quantification .....	97
3.2.3	Primers and qPCR.....	98
3.2.4	Experimental design.....	99
3.2.5	Analytical methods.....	99
3.3	Results and discussion.....	100
3.3.1	Trends in hydrogen production .....	100
3.3.1.1	Evolution of hydrogen production over retention time.....	100
3.3.1.2	Gompertz model.....	103
3.3.1.3	Biogas composition performance.....	103
3.3.2	Metabolites and microorganisms behavior .....	106
3.3.2.1	Metabolites production – the effect of partial pressure.....	106
3.3.2.2	Microorganisms evolution - pH and ORP influence .....	112
3.3.2.3	Microbial pathway.....	117
3.4	Conclusions .....	118
	References .....	119
CHAPTER 4	Treatment of effluent from dark fermentation process by anaerobic digestion for methane production .....	123
	Abstract .....	123
4.1	Introduction .....	124
4.2	Methods.....	126
4.2.1	Methodology .....	126
4.2.2	Substrates .....	126
4.2.3	Inoculum.....	127
4.2.4	Experimental design.....	127

4.2.5	Analytical methods.....	128
4.3	Results and discussion.....	129
4.3.1	Performance of the two stages process. ....	129
4.3.1.1	Effect of repetitive batch cultivation and substrates ratio.....	129
4.3.1.2	Influence of macromolecules. ....	131
4.3.2	Influence of first stage on methane production.....	133
4.3.2.1	Daily performance for the methane production rate. ....	133
4.3.2.2	Feedstocks and effluents characterization – soluble COD.....	135
4.3.2.3	Evaluation of direct anaerobic digestion.....	138
4.4	Conclusions .....	140
	References .....	141
CHAPTER 5	Energy recovery and importance from biogas streams produced during the two-stages evaluated .....	144
	Abstract .....	144
5.1	Biogas production rates from each of the stages used during the wastes valorisation	145
5.1.1	Hydrogen production comparison.....	145
5.1.2	Evaluation of the different mixed conditions.....	146
5.2	Energy yield related to biogas generation in both stages .....	147
5.2.1	Hydrogen and methane energy from the co-digestion .....	147
5.2.2	Hydrogen influence in overall energy from the co-digestion .....	148
5.2.3	Comparison with other results.....	150
	GENERAL CONCLUSIONS .....	151
	PERSPECTIVES.....	157
	ANNEX I Preliminary experiments to obtain inoculum.....	161
	ANNEX II Substrates.....	173
	ANNEX III Photos of reactors and experimental results.....	191

## List of Tables

Table 1.1 Hydrogen production reactions during acidogenic stage .....	28
Table 1.2 Hydrogen production reactions during acetogenic stage .....	29
Table 1.3 Influence of metabolic route of some substrates <sup>a</sup> .....	34
Table 1.4 Bacteria involved in hydrogen production .....	38
Table 1.5. Comparison of hydrogen production yield from pig manure – Universidad de los Andes (Hernández and Rodríguez, 2013). .....	51
Table 1.6. Organic wastes from industrial processing process. ....	57
Table 2.1. Kinetic parameters of the Gompertz equation .....	84
Table 2.2. Main VFA (mg COD/L) produced during each condition of the experiments (n≥5). .....	89
Table 3.1. Microorganisms selection for hydrogen production process. ....	95
Table 3.2. Primers used to the quantification of <i>Bacillus</i> and <i>Clostridium</i> genus and <i>T. thermosaccharolyticum</i> .....	98
Table 3.3. Change in the tendencies of conditions 2 and 4. ....	102
Table 3.4. Kinetics parameters through the Gompertz equation (n ≥ 9).....	103
Table 4.1. Characterization of the streams involved in the experiments (n≥3).....	137
Table 4.2. Main metabolites (mg COD/L) produced during each condition of experiments (n≥5). ....	138
Table 5.1. Hydrogen production from co-digestion by dark fermentation from this work....	145
Table 5.2. Hydrogen production from simples and complex substrates by dark fermentation. .....	146
Table 5.3. Energy production for the different experimental condition.....	147
Table 5.4. Hydrogen production rate/yield compared with others studies using anaerobic digestion. ....	149



## List of Figures

Figure 1.1. Anaerobic digestion scheme suggested for some studies. Adapted from Moletta, 2002 and Bastone et al., 2002. ....	27
Figure 1.2 Different kinds of biomass useful for biofuels production. Taken from [Naik et al, 2010].....	48
Figure 1.3. Coffee zone map (FAO & IICA, 2007). The main areas for coffee production (orange) and recent cultivation areas (yellow).....	52
Figure 1.4. Considerations involved in the development of the research. ....	59
Figure 1.5. Phases conducted for hydrogen production and sustainable cycle.....	60
Figure 2.1. Reactor system involved for hydrogen production experiments. ....	74
Figure 2.2. The hydrogen production rate (◆), and initial (Δ) and final (□) pH during the variation of C/N ratios over repetitive batch cultivation of conditions 1, 2 and 3. ....	77
Figure 2.3. Biogas composition represented by hydrogen (◆), carbon dioxide (□) and methane (●), during the variation of C/N ratios over time to conditions 1, 2 and 3 linked with alkalinity (Δ) and VFA (Δ) concentrations in the ABR. ....	77
Figure 2.4. C/N ratio (■ - initial, □ - final) during the conditions related to the residual carbohydrate concentration (▲) and cumulative hydrogen (◆). A stable response of C3 was suggested through the use of similar standard deviation than C2 (◇ - dotted line)...	79
Figure 2.5. The effect of increasing the organic loading rate on hydrogen production yield (NmL H <sub>2</sub> /g COD) over time to each condition: ○ C1, ◆ C2, Δ C3 and ■ C4. ....	80
Figure 2.6. Relationship among the coffee mucilage concentration added at each condition and the cumulative biogas (■) and the cumulative hydrogen (◆). Dotted lines represent the tendency curve.....	82
Figure 2.7. Average experimental data of cumulative hydrogen fitted to the Gompertz model for each condition ● C1, ◆ C2, ▲ C3 and ■ C4. The model results were shown as solid lines. ....	83
Figure 2.8. VFA behavior during the repetitive batch cultivation for C1, C2, C3 and C4 (■acetic, ◆ butyric, ▲ propionic, ◇ ethanol, Δ valeric, o caproic, ■ hydrogen production rate).....	87
Figure 2.9. Evolution of the molar ratio CO <sub>2</sub> :H <sub>2</sub> (◇) and the ratio between Bu/Ac (●) acids over time.....	88
Figure 3.1. Hydrogen production rates during retention time: <i>short trend</i> (■), <i>long trend</i> (◆) and average of all results (▲) production curves for each condition: C1 (a); C2 (b); C3 (c); C4 (d). ....	102



Figure 3.2. Biogas composition through the both tendencies in condition 2 (a - short, b - long) and 4 (c - short, d - long). Hydrogen (◆), carbon dioxide (■), methane (▲) and oxygen (●).....	106
Figure 3.3. Metabolites distribution over retention time for both trends in condition 2 (a – short; b - long) and 4 (c –short; d - long). .....	109
Figure 3.4. Bu/Ac ratio for the conditions 2 and 4 during both tendencies. ....	110
Figure 3.5. Hydrogen and carbon dioxide partial pressure during the retention time for both trends in conditions 2 (a) and 4 (b). .....	112
Figure 3.6. Changes of microbial population in mixed culture for <i>short</i> and <i>long trend</i> in C4 (a and b) and <i>long trend</i> in C2 (c). The microorganisms concentration was reported as the concentration of genomic unit. ....	114
Figure 3.7. Oxidation reduction potential and pH performance during the first 12 h of retention time for both tendencies in C2 (a) and C4 (b).....	116
Figure 3.8. Adapted from Liu et al., 2008; Saint-Amans et al., 2001; Temudo et al., 2007 with the main reactions related to the results founds in the co-digestion experiments between swine manure and coffee mucilage. ....	117
Figure 4.1. Scheme of hydrogen and methane reactors used for the experiments - hydrogen reactor on the left and methane reactor on the right.....	128
Figure 4.2. The biogas composition and cumulative production in both stages: a) hydrogen reactor and b) methane reactor. Biogas composition was represented by methane (■), carbon dioxide (□), hydrogen (▲) and hydrogen sulfide (Δ). Cumulative production of either hydrogen (◇) or methane (◇) was represented at each reactor (dotted line). .....	130
Figure 4.3. Macromolecules present in the hydrogen and methane reactors. a) carbohydrates; b) proteins; c) lipids.....	132
Figure 4.4. Methane daily production rate (open square symbols) evaluated with the VFA:Alkalinity ratio at the beginning (V/A <sub>in</sub> - ▲) and end (V/A <sub>out</sub> - ■) of the experiments. ....	134
Figure 4.5. Methane production over retention time in the second reactor (diamond, squares, triangles and circles for C1, C2, C3 and C4, respectively). Values represent the average of at least three measures by condition. ....	135
Figure 4.6. BMP from raw substrates vs methane production from effluent of first stage during C4 (a). BMP by the use of inoculum from the experiments – I1 and inoculum from wastewater treatment plant – I2 (b). ....	139

Figure 5.1. Methane and hydrogen molar ratio (open triangles) was calculated with the amounts produced by liter of feedstock. Energy production of methane ( $\square$ ) and hydrogen ( $\blacksquare$ ) was measured as  $\text{kJ/L}_w$ . Hydrogen percentage (closed diamond) over total energy.  
..... 148



# GENERAL INTRODUCTION



Hydrogen has been considered a relevant energy carrier accepted as the fuel of the future due to its features as clean carrier energy. The production of this fuel has been related to several processes such as steam reforming, gasification, electrolysis, and pyrolysis which in general use non-renewable sources including raw materials and demand high temperatures. On the other hand, there are biological processes such as photobiological and dark fermentation which require less energy and use renewable biomass. Anaerobic dark fermentation show some advantages such as the availability of feeding sources associated with organic wastes. The process is robust to using high organic loads and producing biogas (hydrogen and methane), which can be used directly in some cases without pre-treatment (engine combustion). Moreover, this biological treatment generates small amounts of biomass avoiding the increase of biological sludge from the process. The sunlight independence improves the flexibility of the system in order to treat substrates continuously. Finally, biofuel generation with the recovery of some energy from the waste is the major reason to focus this research on the anaerobic digestion process. Previous studies on hydrogen production have investigated the low organic load removal due to the conversion of the substrates to several compounds in the liquid phase. Thus, the production of a biofuel of second generation using wastes becomes an ineffective solution for the management of these wastes. In this case, a second stage of anaerobic digestion gives the possibility of the treatment of the effluent with the additional biogas generation (methane). Likewise, the stage related to hydrogen production is conducted as a kind of pretreatment in order to supply a substrate with the best features to optimize the methane production process.

Colombia is a country with a lot of agricultural activities which generate organic wastes during the food production process. Previous research on biofuels has been related to first generation using large areas land to obtain the raw materials. Sugarcane crops are used for bioethanol generation and palm oil is used for biodiesel generation. In both cases, biofuels production and land use for food crops shows a clear competition. In contrast, some activities such as coffee production which is developed widely in the country could be exploited as biomass source. In this case, the characteristics of coffee mucilage suggest it could be suitable for biofuels generation. This would allow to have a sustainable process making both the treatment and the valorisation of this subproduct. In addition, the process could be complemented with wastes produced in close proximity areas to supply the requirements of anaerobic digestion and to maintain the process over time due to the seasonal coffee harvest.

According to these ideas, a complete and suitable alternative is presented to solve problems related to energy generation in remote areas without competition with land areas for food. In addition, this project could be an integral proposal for the management of these wastes and an alternative to the actual methods.

This document has been structured in 5 chapters:

- The **first chapter** presents a literature review about the main topics involved in the research proposed. Taking into account the main topics related to the hydrogen production process, the internal process which influence the environment during dark fermentation, the microorganisms related to hydrogen generation, the conditions involved with the situation about both wastes and the subsequent procedure for the valorisation and treatment of the effluent from the hydrogen production stage.
- The **second chapter** explains the hydrogen production performance influenced by repetitive batch cultivation and substrate ratio. It analyzes the hydrogen production as a macro system taking into account the response of the process mainly in terms of kinetic parameters and pathway related to the soluble metabolites during the process.
- The **third chapter** gives details of the process focused on the trend over the retention time, studying the evolution of hydrogen production, metabolites and operating parameters over the retention time and identifying tendencies in the process. Moreover, the identification and behavior of the main microorganisms which play an important role in hydrogen production in the system were investigated.
- The **fourth chapter** presents experimental results related to the treatment and valorisation of the effluent produced during the hydrogen production stage. It suggests a sustainable cycle of the process presenting a complete alternative for the treatment of both wastes.
- The **fifth chapter** shows a comparison between the hydrogen production observed in other studies using simple and complex substrates. In addition, overall energy estimation showed the relevance of both fuel gas produced and the importance of hydrogen obtained by dark fermentation.

Finally, the results of this research have provided information about hydrogen production from agricultural and livestock wastes with an additional stage for the valorisation and treatment of effluent making a sustainable cycle.





# LITERATURE REVIEW

# CHAPTER 1 Hydrogen production by dark fermentation

## 1.1 Anaerobic digestion

### 1.1.1 Stages involved in anaerobic digestion

Anaerobic digestion is associated with many aspects; one of the most important aspects is the microorganism consortium present in the anaerobic reactor. During the anaerobic digestion process four stages occur consecutively; hydrolysis, fermentation or acidogenesis, acetogenesis and methanogenesis (Fig. 1.1). The hydrolytic stage for complex substrates is believed to be the rate limiting step of the process because it increases the time required to breakdown complex material. During hydrolysis, hydrolases are required; these include glucosidases, lipases, proteases, sulphatases and phosphatases [Whiteley and Lee, 2006]. After the first stage, the macromolecules (carbohydrates, proteins and lipids) are degraded into organic monomers including sugars, aminoacids, and long chain fatty acids [Bastone et al., 2002]. These compounds are utilized in the next steps by fermentative organisms or by anaerobic oxidizers [Demirel and Scherer, 2008]. Subsequently, during acidogenesis, the previous products are converted into short chain fatty acids: valeric, butyric, propionic and acetic; these acids are responsible of pH drop. There are other compounds including hydrogen, carbon dioxide, and some alcohols produced during the same or parallel reactions. Hydrogen from the first stage can be converted to methane directly by hydrogen-oxidizing methanogens which use hydrogen and carbon dioxide [Schink, 1997]. During acetogenesis, fatty acids with 3, 4, 5 and 6 carbons are converted to acetic acid. At the same time, hydrogen and carbon dioxide are produced. This stage requires syntrophic associations which can support microorganism growth with an energy between 20 and 32 kJ/mol, meanwhile for irreversible reactions in biological systems an energy of 60 to 70 kJ/mol is required [Stams, 1994]. At this level of the process, there is a group of acetate oxidizing bacteria which can utilize acetate to produce hydrogen and carbon dioxide or to do the reverse reaction [Demirel and Scherer, 2008]. The last stage, methanogenesis, has a special relation with previous stages because the substrates produced make it possible. Methanogens use the metabolites produced in previous stages, but at the same time, previous microorganisms require the consumption of

these products to keep the direct reactions. This is related to high hydrogen partial pressure in the system can change all the metabolic pathways. This stage is divided into two processes; hydrogenotrophic and acetotrophic methanogenesis [Demirel and Scherer, 2008]. Each utilizes different substrates to produce methane; the first uses hydrogen and carbon dioxide, and the second acetate and carbon dioxide. The final result of the anaerobic digestion is the generation of biogas and the organic load removal. The reduction of chemical organic demand (COD) concentration in the influent is achieved mainly by production of methane and carbon dioxide in the biogas.

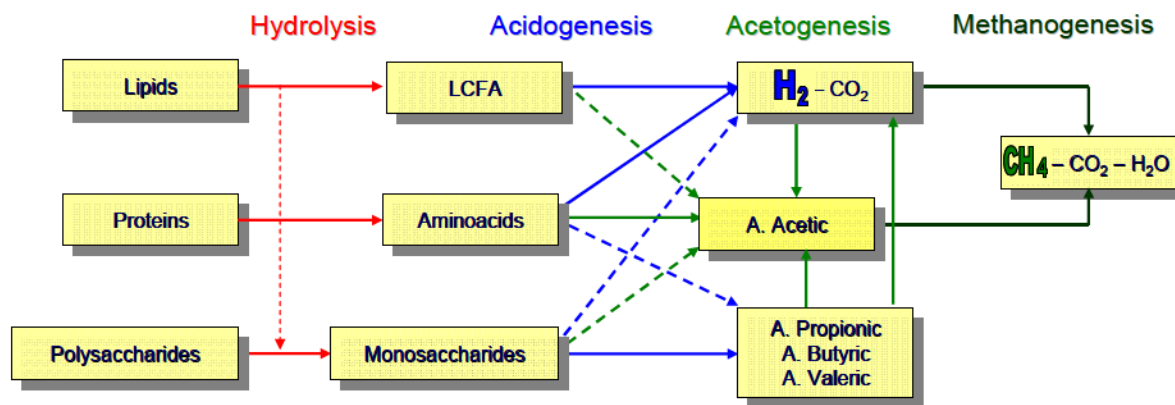

Figure 1.1. Anaerobic digestion scheme suggested for some studies. Adapted from Moletta, 2002 and Bastone et al., 2002.

### 1.1.2 Hydrogen production from different substrates, metabolites and stages

There are many microorganism groups linked to the reactions involved in anaerobic digestion. Hydrogen production is associated with some active groups during acidogenic and acetogenic stages. In this case, there are genera such as *Enterobacter*, *Clostridium*, *Thermoanaerobacterium*, *Rodhobacter* widely used to produce hydrogen in an anaerobic environment [Nandi and Sengupta, 1998]. Reactions during acetogenesis are linked with syntrophic bacteria consortia due to the unfavorable Gibbs free energy for each reaction (Table 1.1). Therefore, there are the two kinds of bacteria to produce hydrogen; fermentative and syntrophic [Conrad, 1999] which can be facultative or strictly anaerobic bacteria. The reactions in the acidogenic stage are frequently linked to glucose as reference substrate. Meanwhile, during the acetogenic stage there are many sources involved in acetate and hydrogen production (Table 1.1 and 1.2).

### 1.1.2.1 Acidogenic stage

This stage called “dark fermentation” has some reactions involved in short chain fatty acid production (Table 1.1). The most important acids related to hydrogen production are acetic and butyric acids, which produce 4 and 2 moles of hydrogen, respectively (Eq. 1, 3). Meanwhile, propionate formation involves the consumption of 2 moles of hydrogen (Eq. 2). Additionally, there are other reactions which produce hydrogen as amino acid conversion to acetate (Eq. 4). Additionally, the high release of nitrogen compounds in the system can use hydrogen to ammonium generation [Naitkou et al., 2010]. Valerate and caproate production can be achieved without parallel hydrogen production, but these can produce hydrogen during acetogenic stage. The ATP generation during glucose conversion to acetate reaches 4 molecules which are higher than 2 molecules produced to propionate and butyrate.

Table 1.1 Hydrogen production reactions during acidogenic stage

Equation	Reaction	$\Delta G^\circ$ kJ/mol	$\Delta G^{\circ'}$ kJ/mol	Ref
1	$C_6H_{12}O_6 + 4H_2O \rightarrow 2CH_3COO^- + 2HCO_3^- + 4H^+ + 4H_2$	-46.6	-206.2	1,2,8
2	$C_6H_{12}O_6 + 2H_2 \rightarrow 2CH_3CH_2COO^- + 2H_2O$	-	-	6, 7,8
3	$C_6H_{12}O_6 + 2H_2O \rightarrow CH_3CH_2CH_2COO^- + 2HCO_3^- + 3H^+ + 2H_2$	-134.8	-254.8	1,2,8
4	$CH_3CH(NH_3^+)COO^- + 2H_2O \rightarrow CH_3COO^- + NH_4^+ + CO_2 + 2H_2$	-	2.7	5
5	$C_6H_{12}O_6 \rightarrow 2CH_3CH(OH)COO^- + 2H^+$	-	-	8
6	$4CH_3CH(OH)COO^- + 2CH_3COO^- + 2H_2O \rightarrow$ $3CH_3CH_2CH_2COO^- + 4HCO_3^- + H^+ + 2H_2$	-	-	9
7	$CH_3CH_2COO^- + 6H_2 + 2CO_2 \rightarrow CH_3(CH_2)_3COO^- + 4H_2O$	-	-	10

<sup>1</sup> Thauer et al., 1977; <sup>2</sup> Ntaikou et al., 2010; <sup>3</sup> Stams, 1994; <sup>4</sup> Oude Elferink et al., 1994; <sup>5</sup> Schink 1997; <sup>6</sup> Li et al., 2008; <sup>7</sup> Massé and Drost, 2000; <sup>8</sup> Kim et al., 2011; <sup>9</sup> Kim et al., 2009; <sup>10</sup> Kim et al., 2010.

$\Delta G^\circ$  and  $\Delta G^{\circ'}$  are in kJ/mol; Reactions at standard conditions (298.15 K; 1 atm; [1 M]; pH 0); Reactions at pH 7.0; Ionized and in aqueous solution (Hydrogen in gas phase).

The main reactions for hydrogen production, acetate and butyrate, have a Gibbs free energy of -206.3 and -254.8 kJ/mol, respectively. In this case, the energy required to accomplish these reactions can be modified by the removal of hydrogen. The reduction of hydrogen partial pressure (PpH<sub>2</sub>) to 10 Pa changes the Gibbs free energy of acetate production which reaches values of -280 kJ/mol [Schink, 1997]. Although, glucose conversion to acetate has higher performance than butyrate, there are reasons which make butyrate important: Its Gibbs free energy is higher than acetate formation. It has been associated widely in the hydrogen production process as main metabolite. However, ATP production during acetate formation is higher than butyrate pathway which limits biomass synthesis. Furthermore, glucose degradation could change patterns of VFA formation to other compounds as lactate (Eq. 5). In

that case, the reaction between this compound and acetate can produce butyrate and hydrogen (Eq. 6). In addition, the presence of several macromolecules can drive the hydrogen formation from compounds as aminoacids, alcohols,  $\alpha$ -keto acids and aldehydes [Thauer et al., 1977].

### 1.1.2.2 Acetogenic - Syntrophic

Hydrogen production is also reached from reactions involved in acetate formation as the previous stage to the methanogenesis (Table 1.2). A maximum of 4 mol of hydrogen can be achieved related to acetate and caproate conversion to bicarbonate and acetate, respectively (Eq. 9, 13). Meanwhile, propionate and butyrate reactions to acetate could produce 3 and 2 mol of hydrogen, respectively (Eq. 10, 11). In addition, hydrogen production can be achieved from other kind of carboxylic acids (formate, succinate, etc) and  $\alpha,\beta$  unsaturated acids (Lactate, maltate, acrylate, fumarate, etc) [Thauer et al., 1977]. However, the reactions are unfavorable due to high Gibbs free energy, as for example the butyrate conversion to acetate which have a Gibbs free energy 48.3 kJ/mol [Schink and Friedrich, 1994] showing the unfeasible thermodynamic condition.

Table 1.2 Hydrogen production reactions during acetogenic stage

Equation	Reaction	$\Delta G^\circ$ kJ/mol	$\Delta G^{\circ'}$ kJ/mol	Ref
8	$CH_3CH_2OH + H_2O \rightarrow CH_3COO^- + H^+ + 2H_2$	49.6	9.6	3, 4
9	$CH_3COO^- + 4H_2O \rightarrow 2HCO_3^- + H^+ + 4H_2$	144.4	104.5	3
10	$CH_3CH_2COO^- + 3H_2O \rightarrow CH_3COO^- + HCO_3^- + H^+ + 3H_2$	116.4	76.5	1, 3, 4
11	$CH_3(CH_2)_2COO^- + 2H_2O \rightarrow 2CH_3COO^- + H^+ + 2H_2$	88.2	48.3	1, 3, 4
12	$CH_3(CH_2)_3COO^- + CO_2 + 2H_2O \rightarrow 3CH_3COO^- + 2H^+ + H_2$	96.5	56.6	5
13	$CH_3(CH_2)_4COO^- + 4H_2O \rightarrow 3CH_3COO^- + 2H^+ + 4H_2$	176	96.8	1

<sup>1</sup> Thauer et al., 1977; <sup>2</sup> Ntaikou et al., 2010; <sup>3</sup> Stams, 1994; <sup>4</sup> Oude Elferink et al., 1994; <sup>5</sup> Schink 1997.

$\Delta G^\circ$  and  $\Delta G^{\circ'}$  are in kJ/mol; Reactions at standard conditions (298.15 K; 1 atm; [1 M]; pH 0); Reactions at pH 7.0; Ionized and in aqueous solution (Hydrogen in gas phase)

For this reason, in this stage is important to keep low hydrogen concentration in the reactor headspace. According to this, reactions involved in this stage require syntrophic interactions which improve hydrogen removal from the system. In this case, butyrate oxidation coupled to methane formation changes the Gibbs free energy of the overall reaction to -39.3 kJ/mol [Bryant, 1979]. Meanwhile, propionate oxidation has a Gibbs free energy of 76 kJ/mol [Schink and Friedrich, 1994]. At high hydrogen concentrations this reaction becomes

reversible in order to consume the excess of hydrogen. This is another parameter to take into account to follow the development of hydrogen reactors.

### 1.1.3 Hydrogen consumption through different routes

Hydrogen consumption is related to several processes which need electrons to complete the different degradation stages. Among these, the well-known consumption processes are related to methanogens, sulfate-reducers and homoacetogens. There are other reactions which involve the production of different metabolites, even biomass synthesis. These bacteria play a fundamental role in anaerobic digestion because they remove the hydrogen produced during the acetogenic stage avoiding an increase in hydrogen partial pressure. This interaction called “syntrophism” between producers and consumers make the next possible steps as the Gibbs free energy of the reactions change to be feasible.

#### 1.1.3.1 Methanogenic step

In this group, there are several methanogenic bacteria able to produce methane by different kind of substrates. The main substrates are H<sub>2</sub>/CO<sub>2</sub>, formate, acetate and in less significant amounts methanol, ethanol, isopropanol, methylated amines, methylated sulfur compounds, and pyruvate [Stams, 1994]. Initial organic compounds (macromolecules) must be degraded by associations of different groups of bacteria due to the metabolic restrictions of methanogens. Hydrogenophilic and acetoclastic (Eq. 14, 15) are the main routes to produce methane related to unique coenzymes and specific intermediates [Blaut, 1994]. Nevertheless, acetate is assumed as the main substrate during methane production. Nevertheless, both routes are limited to two strains of *Methanosarcinaceae*: *Methanosarcina* and *Methanothrix*. Meanwhile, formate can be oxidized to CO<sub>2</sub> as the first step in the reaction between of H<sub>2</sub>/CO<sub>2</sub>.



#### 1.1.3.2 Sulfate-reducing bacteria (SRB)

These bacteria are linked to the reduction of sulfate concentrations (SO<sub>4</sub><sup>2-</sup>) available in organic matter. Sulfur reduction can be achieved by the same microorganism group. In both cases, SRB capture hydrogen electrons from previous stages to carry out the reduction process (Eq. 16, 17). Subsequently, these reactions produce HS<sup>-</sup> which is a toxic agent to microorganisms due to the high affinity of the HS<sup>-</sup> for the iron present in cellular structures such as

cytochromes. In the presence of sulfate there are SRB capable of degrading all products from the acidogenic stage; these broad populations of microorganisms oxidize those metabolites producing sulphite and carbon dioxide [Schink, 1997]. In addition, SRB can partially or completely degrade other organic compounds including branched-chain and long chain fatty acids, alcohols, organic acids and aromatic compounds [Oude Elferink et al., 1994].

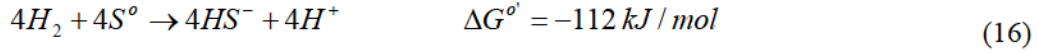

Laanbroek et al. [1984] established a preferred route for SRB to use some of these compounds; hydrogen > propionate > other organic electron donors. This mechanism results in substrate mineralization without following stages involved in anaerobic digestion. Therefore, the wide range of substrates used by SRB increases the competition with several bacteria involved in anaerobic digestion, specifically with methanogens. As a result, SRB can interfere with the development of the different anaerobic digestion stages (i.e. acidogenic, acetogenic, and methanogenic). SRB are related to the uptake of different metabolites at each stage including acetate, hydrogen, propionate, and butyrate [Chen et al., 2008]. Mizuno et al. [1998] investigated SRB behavior using hydrogen in the presence of methanogenic archaea and homoacetogenic bacteria. The results showed that at low sulfate concentrations methanogenic bacteria are the main hydrogen consumers. Meanwhile, SRB dominates the hydrogen consumption at higher sulfate concentrations [Esposito et al., 2003]. Additionally, high HRT causes an increase in Gibbs free energy limiting the consumption process.

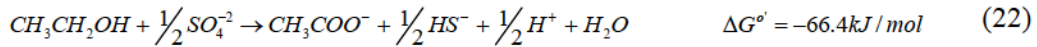
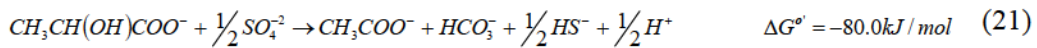
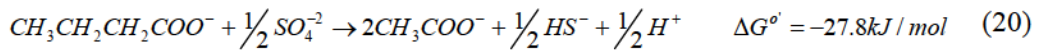
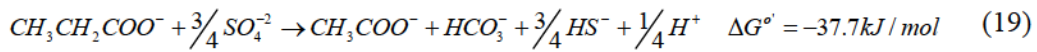

There are other reactions (Eq. 18 – 22) related to SRB in the presence of sulfate which can interfere with anaerobic digestion.



### 1.1.3.3 Homoacetogenic step

Homoacetogenic anaerobic microorganisms utilize carbon dioxide as an electron acceptor to produce acetate with hydrogen as the electron donor (Eq. 23). Some microorganisms related to this reaction are from the *Clostridium* genus which has resistance to acidification and heating pre-treatments used during microorganism selection for hydrogen production [Schmidt and Cooney, 1986]. Under standard conditions, the activity of this group compared to the activity of methanogenic and sulfate reducers is weak. This could change during the inhibition of methanogens and sulfate reducers. However, homoacetogens require low acetate and hydrogen concentrations (around 10 mM and 10 Pa, respectively) [Schink, 1997] that can be achieved by acetoclastic methanogens. Furthermore, at low temperatures homoacetogens have the ability to gain more energy against methanogens; this feature improves the efficiency of acetoclastic methanogens. Meanwhile, at high temperatures homoacetogens stop the acetate production due to lower activity. In contrast, these microorganisms begin hydrogen and carbon dioxide production from acetate to improve hydrogenotrophic methanogens [Schink, 1997].



The Gibbs free energy values reported for these three groups of microorganisms show that the homoacetogenic reaction is the last feasible of all. However, these values can change due to syntrophic reactions and modification of operating conditions. In the anaerobic digestion process, these stages are strongly related to hydrogen removal avoiding the process inhibition due to high hydrogen partial pressure.

### 1.1.3.4 Biomass synthesis

Biomass synthesis is strongly associated with ammonia availability which is essential for these reactions which are catalyzed by several groups of microorganisms (Eq. 24 – 28). Each reaction is linked to a specific metabolite which is associated with one stage in anaerobic digestion. In acidogenic stage, biomass can be generated by the use of one monomer like glucose (Eq. 24). The generation during acetogenesis involves metabolites such as propionic and butyric acids (Eq. 25, 26) which can produce hydrogen (Eq. 25). Acetoclastic bacteria carry out the synthesis through acetate utilization (Eq. 27). Finally, there is a reaction which uses hydrogen as electron donor and carbon dioxide as carbon source to produce biomass (Eq. 28). In the presence of several routes of biomass synthesis, the reaction which consumes hydrogen can be considered the least important. It takes importance in environments with

granular sludge which allows the rapid consumption before hydrogen is transferred to biogas. However, it must be related to hydrogen partial pressure in the reactor. In the first anaerobic stage, biomass synthesis can be produced using glucose, ammonia and some initial concentration of propionic and butyric acids present in the substrate or mixed liquor which remains in the reactor.

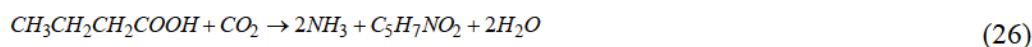
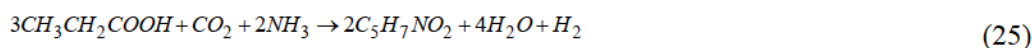

#### 1.1.4 Pathways involved in degradation processes

##### 1.1.4.1 Metabolites, routes, enzymes and carries

Metabolic pathway is the specific way in which substrates are transformed to form specific intermediates. Complex substrates are represented by the main macromolecule groups (carbohydrates, proteins and lipids). Several subproducts are produced from these groups during the degradation stages due to the interaction of microorganisms, enzymes and coenzymes. Additionally, the pathway can be selected by operative conditions as hydrogen partial pressure and pH. There are several routes involved in the degradation of macromolecules; *Embden-Meyerhof*, *Entner-Doudoroff*, *Phosphoketolase*, *transaldolase-transketolase*, *citric acid cycle*, *oxidative decarboxylation*, *glyoxylate cycle*,  *$\beta$ -oxidation of fatty acids* and *Stickland reaction* among others [Thauer, 1977]. Among these routes it is feasible to find broad differences in hydrogen production and metabolite formation and even in Gibbs free energy (Table 1.3).

As an example, in Glycerol degradation the change from EM to EM/OD brings an increase of approximately 3 times in Gibbs free energy improving the exergonic condition of the reaction. Additionally, subproducts change from pyruvate to acetate and an additional mol of hydrogen (Table 1.3). This aspect shows the adaptability of microbes to environmental conditions to make the degradation reactions viable. On the other hand, there are different enzymes which improve these transformations to continue with the metabolite conversion. Most of the stages involved in hydrogen production are carried out by hydrogenases and nitrogenases. The hydrogenases vary among microbial strains involved in the process, differing in molecular

weight, the electron donor or acceptor required, and its location within the cellular [Kondratieva, 1983]. The main hydrogenases linked with degradation process are [NiFe]-hydrogenase and [FeFe]-hydrogenase, even though the second is the most efficient with a 100 times greater activity than the first [Mathews and Wang, 2009]. Meanwhile, the nitrogenases are designed primarily to catalyze the reduction of molecular nitrogen to ammonia, but these can reduce protons to molecular hydrogen. These enzymes are conformed by two components: MoFe-protein and Fe-protein [Kondratieva, 1983].

Table 1.3 Influence of metabolic route of some substrates<sup>a</sup>.

Substrate	Reaction	$\Delta G^{o'}$ kJ/mol	Route <sup>b</sup>
Butyrate	$Butyrate + 10H_2O \rightarrow 4HCO_3^- + 3H^+ + 10H_2$	+257.3	CC
	$Butyrate + 2H_2O \rightarrow 2Acetate + H^+ + 2H_2$	+48.1	BO
Gluconate	$Gluconate + H_2O \rightarrow Acetate + Pyruvate + HCO_3^- + 2H^+ + 2H_2$	-144.9	PK/EM
	$3Gluconate + 3H_2O \rightarrow 5Pyruvate + 3HCO_3^- + 5H^+ + 8H_2$	-235.7	TT/EM
Glycerol	$Glycerol \rightarrow Pyruvate + H^+ + 2H_2$	-25.9	EM
	$Glycerol + 2H_2O \rightarrow Acetate + HCO_3^- + 2H^+ + 3H_2$	-73.2	EM/OD

<sup>a</sup> Adapted of Thauer et al., [1977]. <sup>b</sup> CC: citric acid cycle; BO:  $\beta$ -oxidation of fatty acids; PK: Phosphoketolase; EM: Embden-Meyerhof; TT: transaldolase-transketolase; OD: oxidative decarboxylation.

During metabolic processes the enzymes interact with several acceptor/donor of electrons which are linked to the redox reactions as electron carriers. Nicotinamide Adenine Dinucleotide ( $NAD^+$ ) takes part in the anaerobic degradation of sugars, aminoacids and organic acids. Ferredoxin (Fd) is involved in oxidative decarboxylation processes and Flavin Adenine Dinucleotide (FAD) is involved in dehydrogenation reactions [Stams, 1994]. These carries are strongly influenced by hydrogen partial pressure; the NADH produced from the  $NAD^+$  reduction during glycolysis can be reoxidized at low concentrations of hydrogen by NADH-dependent [FeFe] hydrogenases [Hallenbeck, 2009]. Therefore, hydrogen concentration about 10 Pa makes NADH oxidation energetically feasible linked to hydrogen formation [Stams, 1994]. High hydrogen partial pressure limits NADH oxidation. As a result, microorganisms achieve NADH oxidation through acetyl-CoA formation, producing reduced organic compounds; ethanol, lactate, propionate or butyrate [Stams, 1994; Hallenbeck, 2009].

FADH<sub>2</sub> oxidation to proton reduction requires far lower hydrogen partial pressures than NADH.

#### *1.1.4.2 Main aspects that can produce metabolic changes*

**Butyrate/Acetate ratio.** The ratio between butyrate and acetate (Bu/Ac) has been identified as an indicator of hydrogen production. This ratio depends on the kind of process, substrate type, specific inocula, operative conditions, etc. [Khanal et al., 2004]. Khanal et al. [2004] found that acetate was the predominant metabolite against butyrate during hydrogen production from sucrose and starch. However, there was a simultaneous propionate production which indicated a metabolic pathway deviation. Kim et al. [2004] showed that in their experiments at day 15 there was a change in metabolite composition related to VFA compounds. The change from acetate to butyrate increased hydrogen production. Nevertheless, the presence of methanogens changed biogas composition from hydrogen to methane at day 40. In addition, the acetoclastic route was inhibited at low pH of 4.5 because acetate concentration remained constant against methane production, but the hydrogen produced during the first 10 h of the process was consumed by hydrogenotrophic microorganisms. The theoretical ratio reported by Kim et al. [2004] for Bu/Ac during butyrate fermentation was 2.7 which was close to the experimental ratio (2.4). In addition, butyrate type fermentation can be proposed by the theoretical ratio between hydrogen and carbon dioxide (1:1) according to the stoichiometry. Therefore, there are different limitations associated with this parameter in order to identify a feasible process for hydrogen production.

**pH.** The effect of pH on hydrogen and VFA production was evaluated by Zheng and Yu [2004] over a range of 4 to 8. The ratio between butyrate and acetate changed from 2.51 to 0.36 from acidic to basic conditions. The highest specific hydrogen production rate was achieved at pH of 5.5 with a Bu/Ac of 0.44 and a propionate concentration around 8.8% of total VFA. The butyrate fermentation pathway was the predominant route at pH below 5.5 against acetate formation. In contrast, at high pH the main VFA was acetate. In the same way, Fang and Liu [2002] found that the ratio between butyrate and acetate decreased from 2.7 to 0.9 with a pH increase from 4.0 to 7.0 (the ratio at pH 5.5 was 0.9). In addition, Zoetemeyer [1982] showed that pH variation has a clear effect on degradation route. At low pH (4.5 – 5.7) the main route was dominated by butyrate and acetate metabolites. The increase of pH (6.0 – 7.9) produced a decrease in butyrate concentration. Likewise, lactic acid concentration increased at pH 6.4 – 6.9 but, at high pH of 6.9 and 7.9 the main metabolites were formate,

acetate and ethanol. The highest biogas production was achieved at pH of 5.7 with a ratio Bu/Ac of 2.4.

**C/N ratio.** Lin and Lay [2004] reported that butyrate fermentation was the main route for hydrogen production for various C/N ratios evaluated (40, 47, 98 and 130). However, the butyrate fraction in the metabolites decreased with the increase in C/N ratio. This change was related to an increase in organic load to raise C/N. The Bu/Ac ratio changed from initial 2.7 to 1.2 and the behavior of acids like propionate and valerate remained constant. Kim et al. [2010] showed that the change in Bu/Ac ratio was from 2.2 to 1.4 during the C/N variation from 10 to 30. In this case, the increase in C/N ratio related to carbohydrate content caused a clear decrease of butyrate and the increase of propionate, valerate and lactate. This change resulted in a drop in hydrogen yield with eventual hydrogen consumption during propionate (Eq. 7) and lactate production.

#### *1.1.4.3 Influence of subproducts*

**VFA.** Normally, hydrogen production has been reached during VFA production, but at the same time these can inhibit the process due to high concentrations and the undissociation degree. Wang et al. [2008] evaluated the effect of ethanol and VFA concentrations between 0-300 mmol/L on hydrogen production. The addition of these compounds to the process produced an immediate decrease in the mixed culture response. However, ethanol showed the less negative influence on hydrogen production, and acetate had the strongest negative effect. The highest reduction in hydrogen production potential, yield and rate was recorded for a concentration of 100 mmol/L of each compound. On the other hand, the increase of ethanol concentration produced a decrease in the concentration of the same compound, meanwhile butyric acid increased about two times. The increase of acetic acid concentration decreased the concentration of ethanol and acetate. Meanwhile, butyric acid increased about 3 times as well as propionic acid, but in a low proportion. In this case, the Bu/Ac ratio changed from 0.32 to 1.71. The addition of propionic acid had a low effect on metabolites, ethanol concentration was strongly reduced, meanwhile acetic acid had a slight reduction and propionic and butyric acids increased about 4 and 2 times, respectively. The Bu/Ac ratio began in 0.32 and ended at 0.66. Finally, the addition of butyric acid showed the strongest effect on metabolites except propionic acid which increased by 36.3 % of total soluble organic compounds. The Bu/Ac ratio changed from 0.32 to 0.93 associated with the strong reduction of acetic acid concentration.

VFA accumulation can affect hydrogen production due to high levels of undissociated acids which are highly influenced by low pH. The undissociated acid concentration is related to VFA compounds without an ionization state (acetic, butyric, propionic, valeric and caproic). In this case, concentrations between 2 – 30 mM of undissociated acids could change patterns to alcohols formation [Van Ginkel et al., 2005]. This concentration range can be reached due to the use of inoculum without any heat-treatment process. In addition, van Ginkel et al., [2005] reported that a butyric acid concentration greater than 13 mM is a threshold for the metabolism switch to solventogenesis and for decreasing of hydrogen yield. These experiments were conducted at a pH of 5.5 using glucose as substrate and without specific inoculum. Therefore, the VFA accumulation could have a negative influence for hydrogen production related to operating condition as pH and closed systems.

**Lactate.** There are some subproducts obtained during anaerobic digestion which can inhibit the process stages due to high or low concentration or competition. Experiments conducted by Noike et al. [2002] at 35 °C suggested two explanations for the relationship between hydrogen producing bacteria and lactic acid bacteria (LAB): A substrate competition during the activity of the both bacteria and an inhibition of hydrogen production due to LAB mechanisms. However, hydrogen production decreased over time and not immediately. This effect was related to the identification of *Lactobacillus paracasei* and *Enterococcus durans* which are able to produce inhibitory substances such as bacteriocin. On the other hand, Kim et al., [2009] have measured a lactate production in the first hours of the experiments, but lactate was consumed to produce butyrate which was obtained hours later. Although, there are other routes which can consume lactate to produce acetate and propionate, these compounds maintained similar concentrations. At the end, the metabolite distribution in aqueous phase was 62.7, 17.1, 11.6, 7.9 and 0.8 % for butyrate, ethanol, acetate, propionate and lactate, respectively.

#### 1.1.5 Microorganisms involved in dark fermentation

Several microorganisms related to hydrogen production have been associated with the environmental conditions of the process. In this aspect, microorganisms can be classified as strict anaerobes, facultative anaerobes and aerobic microorganisms. Likewise, during dark fermentation the role of each one of these microorganisms is different. According to this, aerobic microorganisms are useful to generate an anaerobic environment and to improve the breakdown of the macromolecules present in substrates. Facultative microorganisms are the most adaptable due to the ability to work in an environment lacking of oxygen, but at the

same time to work at low concentrations. In contrast, strict anaerobic microorganisms require rigorous control of the environment because those cannot tolerate oxygen. In order to avoid this problem, hydrogen production can be developed using a consortium of these two microorganisms. The bacteria associated with each condition are shown in Table 1.4. There are genera such as *Clostridium* which are well known as hydrogen producer using substrates rich in carbohydrates. Meanwhile, there is another genus like *Methylotherms* which use formate to produce hydrogen and Rumen bacteria which can hydrolyze cellulose.

Table 1.4 Bacteria involved in hydrogen production

Environment	Genus	Specie	
Anaerobes	<i>Clostridium</i>	<i>C. Butyricum</i>	
		<i>C. welchii</i>	
		<i>C. Pasterium</i>	
		<i>C. beijerincki AM21B</i>	
	<i>Caldicellulosiruptor</i>	<i>C. saccharolyticus</i>	
		<i>T. Thermoanaerobacterium</i>	
	<i>Methylotherms</i>	<i>M. albus BG8</i>	
		<i>M. trichosporium OB3b</i>	
	Facultative anaerobes	Rumen bacteria	<i>Pseudomonas AMI</i>
			<i>Pseudomonas methylica</i>
<i>Escherichia</i>		<i>Ruminococcus albus</i>	
<i>Enterobacter</i>		<i>E. coli</i>	
Aerobes	<i>Alcaligenes</i>	<i>E. aerogenes</i>	
		<i>E. cloacae</i>	
		<i>A. eutrophus</i>	
	<i>Bacillus</i>	<i>B. licheniformis</i>	
		<i>B. thermoamylovorans</i>	

Adapted from Nandi and Sengupta, 1998; Chang et al., 2008; O-Thong et al., 2008; Patel et al., 2012.

In addition, there are some genera associated with the class Clostridia and with the family Thermoanaerobacterales Family III as *Caldicellulosiruptor* and *Thermoanaerobacterium*. These genera have been related to hydrogen production in specific conditions specially related to thermophilic temperatures. Co-cultures of these genera have been mainly used for complex substrates degradation. This relates to the diverse macromolecules and components hardly hydrolysable which require different enzymes and bacteria to degrade the organic matter. According to this, some co-cultures have been used for hydrogen production as *C. beijerinckii* L9 and *B. thermoamylovorans* [Chang et al., 2008], *C. sporosphaeroides* F52 and *C. pasteurianum* F40 [Lin et al., 2012], *C. freundii* 01, *E. aerogenes* E10 and *R. palustris* P2 [Lin et al., 2012], *C. butyricum* and *Enterobacter aerogenes* [Patel et al., 2012]. This kind of

associations can be added to the process through the use of mixed culture bacteria which can be found in sludge, soil, pre-treated microflora of anaerobic reactor among others.

## 1.2 Operating conditions

The main parameters involved in the change of anaerobic digestion from methane production to hydrogen production are pH, temperature, hydraulic retention time (HRT), organic load and hydrogen partial pressure [Hawkes et al., 2002; Khanal et al., 2004]. The management of these parameters allows the elimination or inhibition of microorganisms which consume hydrogen and the proliferation of groups which produce hydrogen.

### 1.2.1 Main parameters involved in this study

#### *1.2.1.1 Hydraulic retention time*

This parameter is related to the time period required to complete the reactions involved in degradation. The anaerobic digestion of complex substrates as manure require a time between 5 and 15 days [IDAE, 2007]. Likewise, this time is associated to characteristics such as: organic matter, particulate size, inoculum, and phase (solid - liquid). Organic matter content could influence the system response due to its composition requiring short or high retention time. High particulate sizes can reduce the transfer between phases, require more time to release the different compounds or limit the microorganism action on substrates. Finally, solid phases limit the transfer rate of the subproducts which are used in subsequent steps of anaerobic digestion. The selection of short retention times increases the washout of hydrogen consumers such as methanogens which have growth rates lower than microorganisms involved in other steps and the consumption reaction could be avoided [Hawkes et al., 2002]. However, a strong reduction in time can limit hydrolytic stage which is the limiting step in anaerobic digestion [Moletta, 2008]. This stops volatile fatty acid production which is directly related to hydrogen production.

This situation must be avoided by evaluation of the optimum HRT for each kind of substrate, since for simple substrates like glucose, sucrose and starch the maximum hydrogen production is achieved at 6 – 8 h [Kapdan and Kargi, 2006]. Meanwhile, complex substrates like organic fraction and sewage sludge require a time higher than 12 h [Noike and Mizuno, 2000; Massanet-Nicolau et al., 2008]. Another kind of substrates like the organic fraction of municipal solid waste (OFMSW) has required a HRT of about 20 h at the moment of maximum hydrogen production [Shin et al., 2004; Valdez-Vazquez et al., 2005]. Yet, co-



digestion process between, sewage sludge and OFMSW, showed a similar HRT trend that organic waste as unique substrate. Kim et al. [2004] achieved the highest hydrogen production in their experiments with a maximum time of 24 h, even as Lay et al. [1999] in their co-digestion experiments obtained the highest hydrogen production about 48 h after the beginning of the experiments.

Additionally, biomass evolution over time is another important parameter because it is possible to have a pathway change during the process after 10-20 days of operation [Jo et al., 2007]. Jo et al., [2007] measured high lactate concentrations accompanied by ethanol and acetate (as the main pathway). These metabolites changed to butyrate and acetate with the reduction of lactate and ethanol concentrations. After another 15-20 days a new change took place to restore the initial metabolite composition changing from hydrogen fermentation to lactic acid fermentation.

#### *1.2.1.2 Organic load rate*

The organic loading rate is associated with organic matter content in feedstock which can be measured as chemical oxygen demand (COD) or volatile solids (VS) by volume and time. This organic load value in a conventional process of anaerobic digestion is approximately about 4 kg VS/m<sup>3</sup>d using manure as substrate [IDAE, 2007]. The use of high organic load improves hydrogen production although a strong VFA production could inhibit reactor operation [Wen-Ming et al., 2005]. In addition, an increase in organic load can extend the time required for microorganisms to begin the degradation process [Kuo-Shing et al., 2008]. This situation is frequent during the use of complex substrates which have a portion of particulate organic matter taking more time to complete the first stage of degradation. This parameter is used to limit the activity of hydrogen consumers by the application of shock organic loads during reactor operation. Thus, the effect achieved is the inhibition of hydrogen consumers, meanwhile acidogenic microorganisms growth quickly producing high amounts of acetic acid. This situation decreases the pH value to an acidic condition improving the release of hydrogen [Borja and Banks, 1995; Voolapalli and Stuckey, 2001; Díaz-Báez et al., 2002].

Chua et al. [1997] and Xing et al. [1997] evaluated the organic load increase which produced an accelerated VFA production in the reactor. After that, the VFA accumulation caused a decrease in pH which limited methanogens affecting growth, population and kinetics. Under these conditions, hydrogen production can be also inhibited due to the quick accumulation of

these products changing the performance of the system for the production of propionic acid and solvents. Van Ginkel [2001] found that the specific hydrogen production potential from sucrose using three inocula (compost, potato soil and soybean soil) was negatively affected by the increase in substrate concentration. This generates an effect of shock load increasing hydrogen and VFA production but achieving a fast inhibition condition which limits the process or changes the metabolic route. The decrease of substrate concentration caused a change in the maximum percentage from 71, 45, 35, and 24% in the biogas. It was related to a range of organic load between 15-45 g COD/L and 0.5-1.5 g COD/L.

### *1.2.1.3 pH*

The acidity of the medium plays a fundamental role in hydrogen production because pH inhibits or limits the activity of different microorganisms which require a specific range to work [Chaganti et al., 2011]. For example, microorganisms involved in the methanogenic stage decrease their activity under acidic conditions because they require a minimum pH of 6.0 for growth [Zhu, 2000]. The pH for hydrogen production has been established in a range of 5.5 to 6.0 which can be reduced to 5.5 - 5.7 to obtain the maximum specific hydrogen production rate. However, a pH requirement must be established for each type of substrate [Khanal et al., 2004; Van Ginkel, 2001; Fang and Liu, 2002]. The fermentation process begins with a strong pH decrease during first 5-6 h until about 5.5-4.6 [Jackels and Jackels, 2005]. The methanogenic process could be inhibited due to the high amounts of undissociated VFA which limits subsequent stages. In this case, the pathway can be dominated by butyrate or acetate even other metabolite in the process like lactate or ethanol [Ueno et al., 1996].

Alkalinity below 700 mg/L is weak to keep the pH level for hydrogen production in the process. In contrast, an alkalinity of 1000 mg/L is able to maintain a stable biogas production during 200 h [Kim et al., 2004]. The change of pH from 5.5 to 4.3 generates a decrease in butyrate concentration related to the reduction of this compound to butanol. This limits hydrogen production due to its use for solvents production (acetone and butanol) [Kim et al., 2004]. Additionally, complex substrates contain weak acids and base moieties which bring buffering capacity to the system. It can be used as a methodology for pH control in the reactor and in the same way reduces the amounts of reagents used.

Khanal et al., [2004] evaluated the effect of initial pH (4.5-6.5) on hydrogen production rates and specific hydrogen production using two substrates, sucrose and starch. The rates were the same for all initial pH values above 5.0, but the final cumulative hydrogen production showed

differences for the “more” complex substrate (starch) that needs to be hydrolyzed compared to sucrose. The specific hydrogen production related to COD showed a maximum value at pH 4.5; below that pH there was a decline trend. The lowest initial pH (4.5) caused a delay in lag-phase time of more than 5–6 h. Meanwhile, the lag-phase for the other pH values studied were in the same values around 14 and 18 h. Starch showed larger lag-phase time than sucrose due to heterogeneity of this substrate. Fang and Lui, [2002] showed that a change in pH from 4.0 to 5.5 resulted a hydrogen increase in biogas from 40 to 64%, but at a pH of 7.0 this value decreased back to 35% and methane appeared in biogas. The maximum hydrogen yield was reached at pH 5.5 and the highest specific hydrogen production rate was reached at a pH range of 4.5-5.5.

Most of the reactions involved in hydrogen consumption and production are affected by the pH. Chaganti et al., [2011] found that the hydrogen production was improved at pH of 5.5 with a higher production of acetate and ethanol compared to other metabolites such as butyrate. Hydrogen production was linked to acetate production which remained constant with a pH increase. Meanwhile, propionate increased and hydrogen and butyrate production decreased, indicating that butyrate improves hydrogen production, but the change to propionate production limits it. The hydrogenotrophic bacteria appear to be able to grow at a pH above 6.5, meanwhile the homoacetogenic bacteria work in a wide pH range of 4.5 to 7.0. These pH values limit the syntrophism between hydrogen producers and consumers. The inhibition of this interface process conduces to the conversion of electron equivalents in excess to hydrogen by the action of ferredoxin [Chaganti et al., 2011].

#### *1.2.1.4 Hydrogen and carbon dioxide partial pressure*

Biological reactions are strongly affected by hydrogen concentration dissolved in the aqueous phase. In an anaerobic digestion process, methanogens are required to keep an adequate hydrogen partial pressure to allow hydrogen and formate production. In contrast, the increase in hydrogen partial pressure causes a pathway modification which changes from VFA and hydrogen production to lactate, ethanol, acetone, butanol or alanine [Levin et al., 2004]. Hydrogen partial pressure must be taken into account when experiments are developed in closed systems like batch reactors. Levin et al., [2004] have cited several authors who found that the hydrogen production was improved by the increase in temperature which reduces the negative effect of hydrogen partial pressure. Here, continuous hydrogen production was related to a  $P_{pH_2}$  below 50 kPa at 60 °C to below 2 kPa at 98 °C. In this way, van Niel et al., [2003] found that at a temperature of 70 °C the main degradation pathway of during sucrose

dark fermentation was dominated by the production of acetate and hydrogen when the  $P_{pH_2}$  was below 20 kPa. Meanwhile, above this pressure the pathway changed to be dominated by lactic acid bacteria with low simultaneous acetate and hydrogen production. In both cases, ethanol concentration was very low in comparison with other metabolites. Furthermore, hydrogen partial pressure showed an influence on hydrogen production at values up to 40% in the headspace. In this case, the metabolic pathway was modified to produce other compounds like alcohols [van Ginkel, 2001].

Schink, [1997] showed that the reactions involved during acetate and methane production by the use of hydrogen were affected in their Gibbs free energy due to the change of the hydrogen partial pressure. In this case, the  $P_{pH_2}$  reduction from  $10^5$  Pa (a standard condition) to 10 Pa at 25 °C changed the Gibbs free energy from approximately -95 and -130 to -30 and -45 kJ/mol for acetate and methane reactions, respectively. These changes were stronger at 100 °C than 25 °C showing the double effect of  $P_{pH_2}$  and temperature on these consumer reactions. During high  $P_{pH_2}$  the process uses ferredoxin more than NADH, which requires pressure about  $10^3$  Pa. Meanwhile the pair  $2H^+/H_2$  could work at pressures about  $10^5$  Pa. In this case, the NADH can be reoxidized at low  $P_{pH_2}$ , but under high  $P_{pH_2}$  this conversion was conducted to reduce organic compounds like butyrate or ethanol [Hallenbeck, 2009; Stams 1994]. Stams [1994] explains that NADH oxidation coupled to hydrogen formation is energetically possible at  $P_{pH_2}$  of 10 Pa which could be considered a low  $P_{pH_2}$ . In the same way, homoacetogenic reactions require a  $P_{pH_2}$  of 10 Pa and acetate concentration of approximately 10 mM acetate. Demirel and Scherer, [2008] have reported that homoacetogenic reactions could be advantaged during high hydrogen concentrations related to  $P_{pH_2}$  above 500 Pa, but also for the acetogenesis reaction. Meanwhile, at concentrations below 40 Pa acetate oxidation could occur to produce hydrogen.

Stams [1994] conducted a literature review to identify threshold values of hydrogen partial pressure that can be achieved by the acetogenic bacteria and anaerobic bacteria. Some microorganisms involved in the oxidation of ethanol, lactate, propionate, butyrate and acetate reach their threshold at a range of 30 – 300 Pa at thermophilic range. Meanwhile, the threshold  $P_{pH_2}$  for different anaerobic microorganisms implicated in acetogenesis, methanogenesis, sulfate reduction, sulfur reduction, nitrate reduction and fumarate reduction have a range of 6 – 500 Pa at thermophilic conditions. The minimum value of that range was related to those microorganisms involved in methanogenesis. Zheng and Yu, [2004] explored hydrogen production taking into account the final hydrogen partial pressure at different pH.

The best results for hydrogen yield and specific hydrogen production rate were obtained under a  $P_{pH_2}$  between 30 – 34 kPa in acidic conditions (pH 4.0 – 5.5). However, there was a strong difference in pH 5.5 which showed a specific production rate twice as high that observed the other conditions. The performance during basic conditions showed a decreased in the  $P_{pH_2}$  (21 – 28 kPa), but at the same time a decrease in specific and yield hydrogen production.

The reduction of  $P_{pH_2}$  could be achieved by bubbling inert gases through the reactor as nitrogen, argon and helium, which carry hydrogen outside the reactor avoiding its effect with other processes. Noike and Mizuno [2000] used nitrogen as a carrier gas improving almost twice the hydrogen production achieved under the same conditions without a carrier gas. Also, the specific hydrogen production increased resulting in a decrease in biomass generation. This alternative improves the decrease of hydrogen concentration in the aqueous phase avoiding the inhibition due to high  $P_{pH_2}$ . Likewise, the carbon dioxide concentration was reduced by the carrier gas avoiding the production of other kind of subproducts as succinate and propionate which decrease hydrogen production [Tanisho et al., 1998; Leite et al., 2008]. Another alternative is related to the constant agitation of the aqueous phase improving the interaction between substrates and biomass. In this way, it improves the transfer of hydrogen and carbon dioxide from the aqueous phase to gas phase.

## 1.2.2 Other parameters influencing the hydrogen production

### 1.2.2.1 Temperature

This parameter has a strong influence on several aspects such as the energy decrease required in reactions, biomass modification due to thermal pre-treatment, increase of growth rate and a decrease in hydrolytic time [Angelidaki et al., 2003]. There are three established temperature ranges for microbial growth: psychrophilic (15 °C), mesophilic (35 °C) and thermophilic (55 °C). However, the operation in thermophilic condition improves hydrogen production limiting the consumption steps mainly during methanogenesis. In contrast, in the mesophilic range hydrogen amounts are lower than in thermophilic under acidic condition [Shin et al., 2004]. The combined effects of an increase in temperature and organic load improve VFA production which contributes to hydrogen production [van Lier et al., 1996].

Valdez-Vázquez et al. [2005] reported highest butyrate production during experiments conducted under mesophilic conditions. However, acetate was also important compared to the metabolites produced. This shared pathway was associated with the decrease of hydrogen

concentration. Meanwhile, the thermophilic conditions had high acetate concentration compared to butyrate which increased the hydrogen production. Acetone and ethanol were detected during these experimental conditions showing hydrogen was used for the formation of more reduced compounds. In addition, high temperature improves the transfer of oxygen, methane, carbon dioxide and hydrogen to gaseous phase because it reduces the solubility of compounds in the liquid phase. In the same way, this aspect is useful to decrease the hydrogen partial pressure in the reactor avoiding inhibition or change in the pathway. Schink [1997] evaluated the temperature effect on the Gibbs free energy of the reactions involved with the production of acetate and methane through the use of hydrogen. The analysis was conducted in standard conditions and low partial pressures of CO<sub>2</sub> (0.3x10<sup>5</sup> Pa) and H<sub>2</sub> (10 Pa); in both cases a temperature change from psychrophilic to thermophilic conditions increased the value of the free energy. It improved the mechanisms to avoid hydrogen consumption by making these subsequent stages of the anaerobic process less favorable.

The pre-treatment using temperatures between 50 and 90 °C can inactivate the lactic acid bacteria. In contrast, a process at 35 °C without pre-treatment has hydrogen production until the seventh generation; at this point lactic acid production by *Lactobacillus paracasei* and *Enterococcus durans* begin [Noike et al., 2002]. Thus, temperature control can be used during the pre-treatment stage of the substrates or inocula in order to improve hydrogen production. Kim et al., [2009] have evaluated a heat-pretreatment in a range of 60 - 90 °C applied to the substrate. Experiments were conducted at 35 °C, initial pH of 7.0 with lower set-point of 5.0 and carbohydrate was set at 30 g COD/L. This pre-treatment had not effect on the hydrolysis stage because the removal performance was the same for all cases. Initially, four lactic acid bacteria were detected in the food waste and after heat treatment only one was identified, *Lactobacillus gasseri*. The heat-treatment showed a strong effect on the microflora which resulted in the deviation of the hydrogen production route. The highest hydrogen production rate (mL/Lh) was obtained after pre-treatment at 70 °C. Meanwhile, the lactate represented between 60% and 90% of the total organic acids at 60 °C. This value decreased with the increase in the pre-treatment temperature improving butyrate concentration. As a result, the highest H<sub>2</sub> yield (mL/ gVS<sub>add</sub>) was reached using a pre-treatment at 90 °C with a final lactate concentration of 5 %. Butyrate fermentation was the main pathway with ethanol as second metabolite instead of acetate. In this case, there was a lactate production in the first hours, but was transferred to butyrate. The acidogenesis stage of the untreated experiments had a shorter lag-phase than the heat-treated experiments. The VFA composition found during the

repetitive batch operations was mainly composed by butyrate (62.7%), ethanol (17.1%), acetate (11.6%), propionate (7.9%) and lactate (0.8%).

#### *1.2.2.2 Bioreactor type*

The process can be conducted on bioreactors configurations including batch, open batch, sequencing batch reactor, and continuous. Reactors work can be conducted using closed, semi-open and open system. Operation of batch bioreactors consists of two steps: draw off and feed. In addition, inoculum and the nutrient solution are added prior to the start up of the process. Subsequently, the mixture is left a known time (HRT) to carry out the reactions. However, throughout this time no matter is transferred to or from outside of the system which results in the accumulation of products obtained in the liquid and gaseous phases. Finally, the unloading is conducted with the extraction of biogas and metabolites produced in the aqueous phase. Under these conditions, hydrogen production could be affected by the hydrogen partial pressure increase associated to the accumulation of hydrogen which can shift the pathway to produce other more reduced compounds. Meanwhile, an open batch system is similar to the closed batch in terms of loading and unloading operation. But the biogas is transferred outside of the system avoiding hydrogen accumulation during the process. Finally, sequencing batch reactors can be used with the configuration of closed or open batch, but are operated in sequencing stages. These kinds of reactors have different values of SRT and HRT which improves biomass concentration in the reactors. Likewise, this characteristic can withstand changes in organic load which could be frequent during the use of complex substrates or the treatment of some industrial streams.

The continuous process includes several designs of bioreactors including continuous stirred tank reactor (CSTR), upflow sludge blanket (USB), and membrane bioreactor (MBR). The CSTR operation can be developed in the same reactor of batch configuration, but with a continuous inlet and output of feed and products. It must take into account the rate of this exchange to establish the HRT of the process which is equivalent to the reaction time. The reactor is completely mixed as a batch reactor using a mechanical agitation system. The use of short HRT could affect the biomass concentration due to the washout of it. The USB has also a continuous substrate inlet and product output, but the feeding step is done through diffusers at the bottom of the reactor crossing the sludge blanket which put in contact substrate and biomass. This operation avoids the use of a mechanical agitation system. This configuration is widely used for wastewater treatment due to the low solids content. MBR reactors increases

biomass retention inside the reactor to improve the removal reached in the treatment process. The last two reactors have different values of HRT and SRT due to their specific conditions.

## 1.3 Substrates

### 1.3.1 Simple and complex substrates

The raw material used for the generation of renewable fuels like hydrogen result in a classification of first, second and third generation biofuels. In this case, the use of energy crops which can be used for food for fuel production is related to first generation biofuels; second generation uses mainly subproducts from different process as wastes which are considered unlinked to the food chain production; third generation biofuels involve the application of recent technologies to improve the conversion of substrates to biofuels. For hydrogen production most research conducted has focused mainly to first generation biofuels which use some raw material as glucose, starch and sucrose among others [Kapdan and Kargi, 2006]. These have been called simple substrates related to the presence of only one macromolecule (mainly carbohydrates) avoiding any pre-treatment or any limitation of the specific microorganisms used during the production process. These conditions improve the uptake of raw materials, the selection of specific microorganisms, and the process efficiency. In contrast, second generation biofuels use biomass from agricultural processes, forest wastes, municipal and industrial wastes, and manures (Fig. 1.2).

These substrates involve many different components which affect the efficiency of the processes for biofuels production. In some cases, pre-treatments are required and the selection of a specific inoculum is limited. In both cases, the main raw materials for hydrogen production should have a high content of carbohydrate macromolecules or monomers. This approach has limited the advance of the research using complex substrates which require a mixed culture of microorganisms able to do the degradation of different macrocomponents. These wastes are appropriate substrates without competition of cultivable areas required by crops and also they require treatment for suitable disposal. However, some of these complex substrates contain different microorganisms which limit the use of pure cultures. Thus, microbiological characterization of substrates by group identification can give a useful approach to detect bacteria which can inhibit the process [Moreno and Buitrón, 2002]. Both kinds of substrates must be stored at least below -4 °C to avoid any change in their composition and microorganisms activity [Jo et al., 2007].



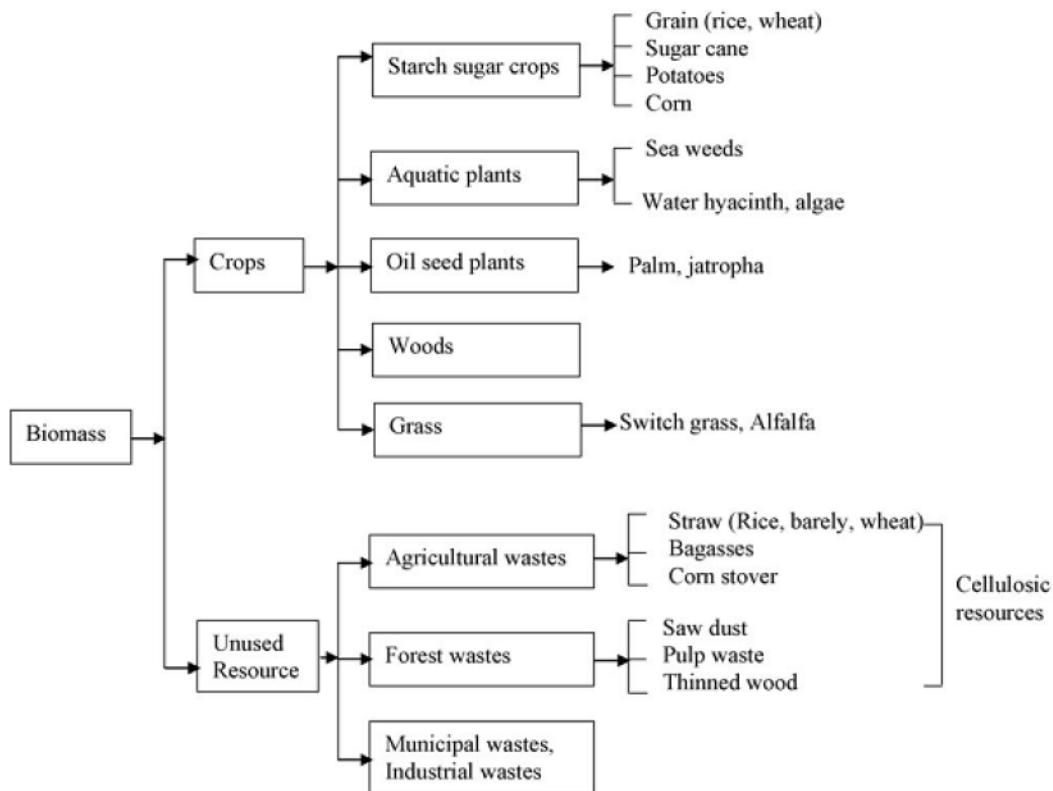

Figure 1.2 Different kinds of biomass useful for biofuels production. Taken from [Naik et al, 2010].

The use of simple substrates reduces the retention time required to complete the degradation process to hydrogen production. Reduction is accomplished as the hydrolytic step (which is the limiting step during anaerobic digestion) is avoided. A theoretical approximation of hydrogen production can be established based on the stoichiometry of each simple substrate which brings an idea about the process efficiency. This is the case of sucrose, molasses, lactate and cellulose which can achieve conversion efficiencies of 23, 15, 0.5 and 0.075%, respectively [Logan et al., 2002]. These yields can be improved by the selection of specific strains capable of consuming specific substrate, which optimizes hydrogen production. Furthermore, the specific composition of these substrates avoids the interference related to compounds such as sulfate and ammonia. However, there are some limitations such as the real availability of these substrates due to competition related to their nature as food in most of the cases. The nutrient deficiency makes the addition of a solution which provides macro and micro nutrients as nitrogen, phosphate, and minerals, among other, mandatory. Other limitations exist related to the specificity of microorganisms involved in the processes which demand specific conditions, substrate and nutrient.

The use of complex substrates reduces those limitations due to the presence of several macrocompounds which contain essential macro and micro nutrients required for microorganisms. However, the microorganisms have preferences for carbohydrate uptake, over other macromolecules like proteins and lipids, as carbohydrates are quickly biodegradable and require less energy consumption. Biofuel production using these raw materials is a value added during their treatment process. However, these wastes have also some challenges including the heterogeneity in their composition which could give a strong variation to the microorganisms equilibrium. The feasibility of the process can be established between hydrogen production and the amount of waste used or related to organic load used. Some of the compounds required during the process, macro or micro nutrients can be in an insoluble state; additionally, there can be limitations associated with the carbon sources required which could demand the addition of external sources to make possible the process. There are some complex substrates that have low solubility (i.e. Tofu has a solubility of 15% [Kim et al., 2011]). Moreover, the microbial content is an additional limitation when a process works with a specific pure culture. In both cases, some substrates require pre-treatment to improve solubility and to inhibit or to inactive some microorganisms which can use other pathways during the anaerobic digestion process. The most common case is related to methanogenic microorganisms which can be present in manures. Some of those limitations can be avoided through co-digestion which takes into account the characteristics of each waste to improve the efficiency related to the overall process.

### 1.3.2 Swine manure waste

#### *1.3.2.1 Current situation*

The pork market is led by China with 70% of the total world production which represents an average of 440 million pigs [AAPP, 2011]. Other countries like USA, Brazil, Germany, Spain, India, and Mexico have pork productions which represent 7, 4, 3, 2.8, 1.4 and 1.7 % of the overall production, respectively. The pig production in Colombia is mainly focused on domestic consumption, representing 0.2% of the worldwide production. The average production of pigs per year from 2007 to 2009 was 1.8 million. Pig production in Colombia reported by the Colombian Association of Porciculture (ACP) and National Federation of Porciculture (FNP) had an average growth of 6.6% in the last three years. Colombia shows a similar production than other countries in South America as Peru, Chile, Bolivia, Argentina and Colombia with a 4 – 6 % of the total. Brazil is the most important producer in the region with 68%. Meanwhile, Venezuela is the second producer of pig in the region with 6%.

The production can be related to the population of each country to obtain the pork consumption per habitant. Nations with similar low population densities such as Chile and Bolivia (10 – 17 millions) have a high difference in pork consumption and production. Chile has the highest consumption per capita of 25 kg per hab, while in Bolivia it is approximately 5.9 kg/hab. On the other hand, Venezuela and Peru with the highest production have a population of approximately 30 million which represents a pork meat consumption per capita of 4.74 and 4 kg/hab, respectively. Meanwhile, in Argentina and Colombia with a population around 40 million the internal consumption per capita is 6 and 4.2 kg/hab, respectively. In Colombia, pork farming is mainly conducted in Antioquia, the central region (Cundinamarca) and the west region (Valle del Cauca) of the country. The intensification of this productive activity has allowed increase the farm size and the control related to identification and classification of wastes improving the environmental aspect. Additional information can be consulted in Annex II.

#### *1.3.2.2 Management and potential*

The swine manure has a potential for methane generation of 0.3 – 0.33 L/g SV [Hansen et al., 1999; IDEA, 2007]. Part of this production could be related to the generation of hydrogen in the first stages of degradation process. The percentage of hydrogen generated during the degradation route is 26 – 33% which is equivalent a theoretical production of 0.08 – 0.11 L/g SV. Hydrogen concentrations reached within the methanogenic process are in the range of 1 – 10% of the biogas composition [Guía porcícola, 2002]. Sulfate-reducing bacteria which require electrons to reduce sulfate are linked to the limited hydrogen production. One way to avoid the activity of these microorganisms is through the addition of iron oxide which reacts with the sulfur in the reactor to produce an insoluble salt [Madigan et al., 1997].

Previous results found in the *Universidad de los Andes* during the evaluation of operational parameters such as, pH and HRT, showed a specific hydrogen production of 61.2 and 141.7 mL H<sub>2</sub>/g SV, respectively for the evaluation of each parameter. These productions per volatile solids were comparable with other results observed by other authors which used complex organic wastes. Table 1.5 shows results observed at *Universidad de los Andes* compared to the production found by different authors. The production was higher than some results obtained with food waste and co-digestion with sewage sludge.

Previous results observed in *Universidad de los Andes* were similar to the production achieved through co-digestion process of the Organic Fraction of Municipal Solids Waste

(OFMSW) which have high carbohydrate content and sewage sludge (microorganisms and nitrogen) [Lay et al., 1999]. However, the single use of OFMSW produce hydrogen yields which approximately doubled the yields observed with only swine manure.

Table 1.5. Comparison of hydrogen production yield from pig manure – Universidad de los Andes (Hernández and Rodríguez, 2013).

<b>Study</b>	<b>Substrate</b>	<b>ml H<sub>2</sub>/g VS</b>
Shin et al. 2004	Food waste	91.5
Kim et al. 2004	OFMSW–residual sludge	60.1
Lay et al. 1999	OFMSW–residual sludge	140-180
Noike and Mizuno, 2000	Organic waste	10-61
Valdez-Vazquez et al., 2005	OFMSW	165-360
Hernández and Rodríguez, 2013	Pig manure (pH 5.5; 12 h)	18.6

OFMSW: Organic Fraction of Municipal Solid Waste.

### 1.3.3 Coffee mucilage waste

#### 1.3.3.1 Current situation

Colombia was the second coffee world producer until 1999 with an annual production of 10 million coffee bags. After 1999 the production in the country decreased due to different aspects related to meteorological conditions, pest control, and increased production in other countries, which decreased the price of a coffee bag. Currently, the country has an export of 7.7 million of coffee bags annually that positions Colombia as the third coffee world producer behind Vietnam with 17.7 millions of coffee bags. The highest producer is Brazil with 33.5 millions of coffee bags annually at the end of 2011 where each bag has a weight of 65 kg [ICO, 2012]. Currently, South America produces approximately the half of overall production in the world in terms of coffee bags in agreement with the international coffee organization during the last decade. Additionally, the production of South, Central America and some island in the Caribbean Sea represent the 59.8% of the total production in the world. Just the South America region represents 44.6% of the overall production of this commodity [ICO, 2012]. On the other hand, there are two principal varieties of coffee genre used in the producer countries; Arabica and Robusta. In that way, the distribution related to the coffee type were 25.3% of the coffee in this region is type Arabica and 34.5% is Robusta in relation to the total production [ICO, 2012]. Additionally, the coffee plants could be inter-cropped

with forest, fruits or leguminous pod trees [Pandey, 2000]. As a result, in Colombia it is necessary to identify alternatives for the management of several wastes related to this agricultural activity.

Coffee production in Colombia was stable during the last five years except in 2009 with a strong decrease related to adverse meteorological conditions and the decline in soil fertility [FNC, 2010]. The main regions involved in coffee activity are distributed in the departments of Antioquia, Boyacá, Caldas, Cauca, Cundinamarca, Huila, Magdalena, Cesar, Guajira, Nariño, Norte de Santander, Quindío, Risaralda, Santander, Tolima and Valle (Fig. 1.3).



Figure 1.3. Coffee zone map (FAO & IICA, 2007). The main areas for coffee production (orange) and recent cultivation areas (yellow).

The main producers are Antioquia, Huila, Tolima, Caldas, and Valle, each one have a production which represents 16, 16, 11, 11 and 8 %, respectively, of the total production in Colombia. Some regions such as Tolima have more crop area than Huila, but their production is lower due to coffee plant renovation in the crop. At the same time, in these areas there is a high concentration of pig farms. It is important to highlight that coffee production has two harvests during the year designated as main and secondary harvest. The other part of the year

there is harvest just related to collecting coffee berries ripen avoiding the proliferation of plague and pests. Additional information can be found in Annex II.

#### *1.3.3.2 Management and potential*

The coffee processing methodologies have changed over time with the idea to separate completely the different wastes and spending less water in the process. Pulp has been used for the cultivation of commercial fungi (*Pleurotus*), silage for later use as animal food, and in compost process by the use of red worms. Meanwhile, the mix between pulp and mucilage is valuable as a culture medium for microorganisms and pectin production. These could be used in medicine, but the waste must be preserved immediately after their production. In that case, the farm location in rural areas is a final aspect which limits this kind of application making the treatment in the same place easier. On the other hand, mucilage can be used as pig food, ethanol or methane production [Rodríguez, 2001; Rodríguez and Zambrano, 2010]. In addition, mucilage can be used for pectin production due to the high content of pectic substances. Nevertheless, there are some limitations related to obtain these substances and to manage the waste during pulp or mucilage removal. In both cases, mucilage must be preserved immediately to avoid the beginning of the enzymatic degradation processes. Additionally, there are other costs associated with the recovery of these substances. Subproducts generated have important carbohydrates and other organic compounds like pectic substances that could be useful as raw material in other kind of process [Jackels and Jackels, 2005].

Pandey [2000] make a review over the main two solid residues during dry and wet processing methods related to whose utilization. These residues were coffee pulp and husk which have been used for the cultivation of bacteria, yeast and fungi for purposes related to protein enrichment, pectinase production, mushroom production, biogas production, microbial growth of some species and caffeine degradation. Additionally, they have been used as fertilizers, livestock feed and compost. Nevertheless, all these processes have a poor efficiency. There are some limitations with the use of these wastes related to the content of some anti-physiological and anti-nutritional factors such as caffeine and tannins which can limit their utilization in the bioprocess mentioned [Pandey, 2000].

The National Center for Coffee Research – CENICAFE – developed the anaerobic treatment modular system (SMTA) for wastewater generated during coffee grain washing after the fermentation step and during the transference to the subsequent steps. In this case, wastewater

has been used in an anaerobic digestion process to biogas production [Zambrano-Franco et al., 2006]. This kind of alternatives must be linked to the harvest periods of coffee which are characterized by one or two main production stages and the specific harvest over ripe coffee cherries during the other months of the year. This research was conducted to establish the methane production potential of wastes generated under wet method which are related to pulp and wastewater from coffee washing after fermentation. Dinsdale et al. [1996] found that at mesophilic conditions the lipid removal was about 87%. Meanwhile, the highest hemicelulose removal was achieved at thermophilic condition (64%). In both temperatures, the removal related to volatile solids was about 58%. Although, these removals for each parameter were lower than other process, biogas production was similar reaching 0.20 – 0.34 and 0.23 L/d for mesophilic and thermophilic conditions, respectively. The biogas had 65 – 70 % (mesophilic) and 64 % (thermophilic) methane showing the potential for using coffee waste as a substrate for anaerobic digestion [Dinsdale et al., 1996] and the intrinsic property to produce hydrogen. Additionally, Chanakya and De Alwis [2004] reviewed methane production using coffee wastes which were in the range of 0.25 – 0.5 m<sup>3</sup>/kg (COD of substrate). In addition, Kida et al., [1994] achieved a biogas yield production around 0.451 m<sup>3</sup>/kg degraded coffee waste. The methane production of vegetable and fruit solid wastes was in the range of 0.417 – 0.529 m<sup>3</sup>/kg VS [Gunaseelan, 1997].

### 1.3.4 Co-digestion

#### *1.3.4.1 General assumptions*

The co-digestion process is used to improve biogas production by incorporating specific characteristics of each substrate used. In this way, substrate selection must take into account characteristics that control each other weaknesses during individual anaerobic digestion processes. This problem is mainly related to the use of complex substrates as wastewater, sludge, manures, and organic fractions which in general have a requirements lack. Thus, some significant characteristics for co-digestion are: substrate availability, high organic matter concentration (carbohydrates), microorganisms and nutrients and micro-nutrients. These aspects improve the digestion of the wastes decreasing costs associated with supply the requirement of each substrate. The complexity of these materials resides in: physical aspects (particles, solids, inert material, etc), biological aspects (existence of multiple species – consumers, producers and related to other functions) and composition aspects (carbohydrates, proteins, lipids and nutrients). These aspects could influence the activity of some specific type or group of microorganisms during the process.

Kim et al., [2004] evaluated different ratios between the organic fractions of urban solid wastes (OFUSW) and sewage sludge from wastewater treatment plant (SS). In this case, with the ratio 87:13 (OFUSW:SS) the maximum hydrogen production was achieved. This proportion was associated with the ratio carbohydrate/protein to improve the obtaining of this gas. Meanwhile, Lay et al., [1999] established a co-digestion process to adjust physical characteristics of the main substrate (OFUSW). The co-substrate was a mixture of sludge from soil and sludge from a wastewater treatment plant. This new condition improved the amounts of microorganisms in the process due to the presence of bacteria and archaeas in both sludge. In general, this kind of process is designed to improve biogas generation taking advantage of the characteristics of each substrate and at the same time making the treatment process for both substrates.

#### *1.3.4.2 C/N ratio*

The ratio between carbon and nitrogen has been used in anaerobic digestion to establish the requirements for microorganisms growth. Sreela-or et al., [2011] evaluated five C/N ratios 10, 20, 30, 40 and 50 finding that the optimum was 33.14 using food waste and sewage sludge. Meanwhile, Argun et al., [2008] studied the effect of C/N ratios between 20 and 200 using wheat powder solution. Nitrogen concentrations in complex substrates were not considered due to its low concentration. The maximum hydrogen yield and specific hydrogen production rate were obtained at C/N ratios of 200. In this case, urea ( $\text{CON}_2\text{H}_4$ ) was used as nitrogen source and  $\text{KH}_2\text{PO}_4$  as phosphorous source. pH was adjusted between 6 and 7, and the temperature was 37 °C. Lin and Lay, [2004] used sucrose as substrate to analyze C/N ratios in the range of 40 to 130. In the experiments, the initial pH was 6.8 whilst the final pH was between 4.73 and 4.83 at a temperature of 35 °C. The best results were achieved for a ratio of 47 which showed the main influence on hydrogen production (HP) (more than SHPR and HPR). This condition improved the development and activity of the biomass involved in hydrogen production. Kim et al., [2010] observed a change in Bu/Ac from 2.2 to 1.4 during C/N from 10 to 30. Although, the high Bu/Ac suggests the maximum hydrogen production, the best hydrogen yield was achieved at a ratio of 15. Here, the C/N ratio was defined between carbohydrate COD and total nitrogen TKN. Three substrates were used during the experiments: food waste, steamed rice and peptone with C/N ratios of 19.1, 76.1 and 0.2, respectively. In the same way, Smith and Holtzapple [2010] reported the C/N ratios of office paper and chicken manure; 145.2 and 7.6, respectively. O-thong et al., [2008] worked with C/N ratios from 45 to 95; this ratio was calculated from total COD and nitrogen. The experiments were conducted in ASBR with a hydraulic retention time of 4 days, at constant



pH of 5.5 and 60 °C. 40 % of the reactor was filled with Palm oil mill effluent (POME), meanwhile the inoculum represented 3.3 % of the total volume. The maximum hydrogen production was obtained at C/N ratios of 74 with a carbohydrate conversion of 92%. As conclusion, these behaviors of the different C/N research suggest a high variability of this parameter which has high dependence of the substrate type. Thus, it requires experiments to achieve a suitable hydrogen production process linked to the substrate used and experimental conditions.

## 1.4 Two-stages anaerobic digestion

### 1.4.1 Biomass potential for anaerobic digestion

Anaerobic digestion has been widely applied for the treatment of several biomass sources as can be seen in Table 1.6. In this case, a high content of organic material is associated with high methane yield. The high presence of lipids even proteins in the organic material improves methane production. In contrast, the presence of carbohydrates and other kind of sugars are associated with lower methane yield than the waste with highest lipid content. These kinds of substrate can be useful for hydrogen production which requires biomass rich in carbohydrates. Substrates with several macrocompounds could be related to different internal process due to carbohydrates require less time for hydrolysis than proteins and lipids [Vavilin et al., 2008]. In this case, hydrogen generated from carbohydrates in the acidogenic and acetogenic stages is only an intermediate compound which is required for several groups as an electron carrier. Some kinds of bacteria which utilize hydrogen are: sulfate-reducers, methanogenic, and homoacetogenic in a less proportion. Hydrogen consumption during anaerobic digestion is required to allow the acetogenic stage due to the requirement of low hydrogen partial pressure in the system. Consequently, it is possible to achieve a minimum Gibbs free energy due to a reaction combination between acetogenic and methanogenic stages.

Table 1.6. Organic wastes from industrial processing process.

Type of organic waste	Composition of the organic material	Organic content (%)	Methane yield (m <sup>3</sup> /ton)
Stomach and intestine content	Carbohydrates, proteins and lipids	15–20	40–60
Flotation sludge (dewatered)	65–70% proteins, 30–35% lipids	13–18	80–130
Bentonite-bound oil	70–75% lipids, 25–30% other organic matter	40–45	350–450
Fish-oil sludge	30–50% lipids and other organic matter	80–85	450–600
Source sorted organic household waste	Carbohydrates, proteins, and lipids	20–30	150–240
Whey	75–80% lactose and 20–25% protein	7–10	40–55
Concentrated whey	75–80% lactose and 20–25% protein	18–22	100–130
Size water	70% proteins and 30% lipids	10–15	70–100
Marmelade	90% sugar, fruit organic acids	50	300
Soya oil/Margarine	90% vegetable oil	90	800–1000
Methylated spirits	40% alcohol	40	240
Sewage sludge	Carbohydrates, lipids, proteins	3–4	17–22
Concentrated sewage sludge	Carbohydrates, lipids, proteins	15–20	85–110

Taken from Angelidaki et al., [2003].

#### 1.4.2 Two-stages features

This configuration has a first stage involved in the fermentation of the substrates. The second stage uses the effluent from the first reactor. In this case, the retention time of a direct anaerobic digestion can be reduced which could increase the treatment rate of substrates. This configuration can optimize the environmental conditions for each microorganisms group due to the physical separation. Thus, a second stage is useful for the treatment and the increase in energy recovery from substrates used for hydrogen production. It is applicable even with the use of simple substrates such as glucose which produce in first stage metabolites such as ethanol, acetic acid, butyric acid, valeric acid, and caproic acid, useful for methanogens [Xie et al., 2008]. The integration of both stages brings some advantages such as:

- Reduction of retention time in the second stage due to improve of hydrolysis step.
- Increase of methane production related to an increase in COD removal.

- The process can manage organic loading rates higher than those used in a single stage.

Nevertheless, some problems could arise during the interaction of both stages due to aspects as the increase of long chain fatty acid and volatile fatty acid which can inhibit methanogenesis and even the hydrolysis step.

## 1.5 Conclusions

To design a dark fermentation process for hydrogen production, one must take into account several aspects, such as types of substrate, operational parameters, and microorganisms (Fig. 1.4). Every one of these aspects should be properly chosen based on the specific conditions of each process. The general idea is to make the process functional based on the substrate availability. Likewise, after hydrogen production there are some products of the process which must be managed to have a sustainable cycle of the wastes. In this case, additional steps must be added to the process in order to finish the treatment of the waste and to improve the valorisation.

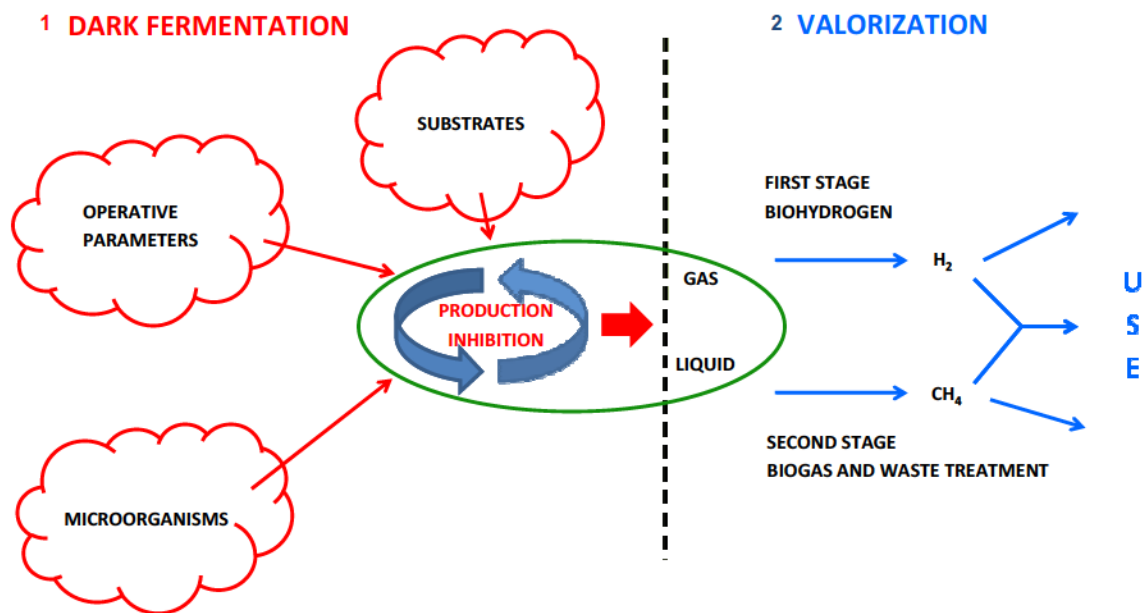

Figure 1.4. Considerations involved in the development of the research.

The aim of this work is to evaluate a dark fermentation process for hydrogen production from agricultural wastes. This was designed in order to make the valorisation of wastes at the same time that the treatment. The hydrogen production was selected in order to improve the features of coffee mucilage which is a main waste from the agricultural process in Colombia. In addition, the selection of swine manure as co-substrate was evaluated to have the requirements needed for the process. The process was focused on studying internal trends due to the complexity of hydrogen production process in order to advance in their knowledge. In order to complete the process, an additional stage was applied for the treatment of the effluent from hydrogen reactor. It looks for a sustainable cycle with additional valorisation and the stabilization of the residual products.

In relation to the previous approach some questions arise:

- Is possible to achieve stable hydrogen production by dark fermentation of these complex substrates? The features of coffee mucilage and swine manure are enough to improve hydrogen production? What is the effect of the increase in organic load? Is it able to optimize the hydrogen production maintaining the stable production?
- What mechanisms are developed inside the dark fermentation process for hydrogen production? What is the influence of different kind of microorganisms related to hydrogen production in the process?
- Is suitable to engage a second process to ensure the treatment of the effluent from the dark fermentation? Are different mixtures able to keep the energy production of the process taking into account the seasonal availability of coffee mucilage?

To answer these questions, the research was oriented in three phases (Fig. 1.5). The first phase focused on the evaluation of hydrogen production using mixtures of coffee mucilage and swine manure. The second phase used the effluent from phase I in order to improve the treatment of the waste. Finally, the third phase was conducted over retention time of experiments in phase I to evaluate several parameters and some microorganisms in relation to hydrogen production.

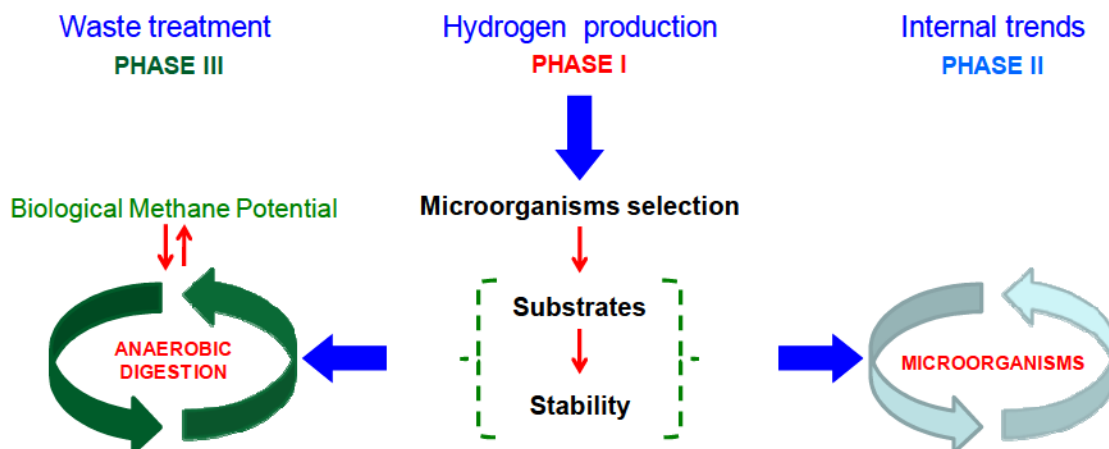

Figure 1.5. Phases conducted for hydrogen production and sustainable cycle.

## References

- AAPP. Conociendo a los líderes del mercado internacional de carne de cerdo Retrieved Abril 2011, from <http://www.porcinos.org.ar/0022.htm>
- Angelidaki I, Ellegaard L, Ahring B. Applications of the anaerobic digestion process. *Adv Biochem Eng Biot* 2003;82:1-33.
- Argun H, Kargi F, Kapdan IK, Oztekin R. Biohydrogen production by dark fermentation of wheat powder solution: Effects of C/N and C/P ratio on hydrogen yield and formation rate. *Int J Hydrogen Energy* 2008;33:1813-19.
- Batstone DJ, Keller J, Angelidaki I, Kalyuzhnyi SV, Pavlostathis SG, Rozzi A, Sanders WTM, Siegrist H, Vavilin VA. The IWA Anaerobic Digestion Model No 1 (ADM1). *Water Sci Technol* 2002;45(10):65–73.
- Blaut M. Metabolism of methanogens. *Antonie van Leeuwenhoek* 1994;66:187-208.
- Borja R, Banks CJ. Response of an anaerobic fluidized bed reactor treating ice-cream wastewater to organic, hydraulic, temperature and pH shocks. *J Biotechnol* 1995;39:251-9.
- Bryant M. Microbial methane production-theoretical aspects. *J Anim Sci* 1979;48 (1):193-201.
- Chaganti S, Kim D-H, Lalman J. Flux balance analysis of mixed anaerobic microbial communities: Effects of linoleic acid (LA) and pH on biohydrogen production. *Int J Hydrogen Energy* 2011;36:14141-52.
- Chanakya HN, De Alwis AAP. Environmental issues and management in primary coffee processing. *Process Safety Environ Prot Trans IChemE Pt B* 2004;82:291-300.
- Chang J-J, Chou C-H, Ho C-Y, Chen W-E, Lay J-J, Huang C-C. Syntrophic co-culture of aerobic *Bacillus* and anaerobic *Clostridium* for bio-fuels and bio-hydrogen production. *Int J Hydrogen Energy* 2008;33:5137–46.
- Chen Y, Cheng J, Creamer K. Inhibition of anaerobic digestion process: A review. *Bioresour Technol* 2008;99:4044–64.
- Chua H, Hu W, Yu P, Cheung M. Responses of anaerobic fixed-film reactor to hydraulic shock loadings. *Bioresour Technol* 1997;61:79-83.
- Conrad R. MiniReview. Contribution of hydrogen to methane production and control of hydrogen concentrations in methanogenic soils and sediments. *FEMS Microbiol Ecol* 1999;28:193-202.

Demirel B, Scherer P. The roles of acetotrophic and hydrogenotrophic methanogens during anaerobic conversion of biomass to methane: a review. *Rev Environ Sci Biotechnol* 2008;7:173–90.

Díaz-Báez M, Espitia S, Pérez F. *Digestión anaerobia una aproximación a la tecnología* (1era Ed.). Bogotá, UNIBIBLOS 2002.

Dinsdale R, Hawkes F, Hawkes D. The mesophilic and thermophilic anaerobic digestion of coffee waste containing coffee grounds. *Water Res* 1996;30(2):371-7.

Esposito G, Weijma J, Pirozzi F, Lens P. Effect of the sludge retention time on H<sub>2</sub> utilization in a sulphate reducing gas-lift reactor. *Process Biochem* 2003;39:491-8.

Fang H, Liu H. Effect of pH on hydrogen production from glucose by a mixed culture. *Bioresour Technol* 2002;82:87-93.

FAO, & IICA. *Proceso de calificación y sello de la calidad en relación con el origen Caso: Café de Colombia, 2007.*

Federación Nacional de Cafeteros.

<http://www.cafedecolombia.com/caficultura/geografia.html>. En línea 1 de Octubre de 2010.

Guía ambiental para el subsector porcícola. Ministerio del Medio Ambiente - Asociación colombiana de porcicultores, 2002.

Gunaseelan V. Anaerobic digestion of biomass for methane production: A review. *Biomass Bioenergy* 1997;13(1/2):83-114.

Hallenbeck P. Fermentative hydrogen production: Principles, progress, and prognosis. *Int J Hydrogen Energy* 2009;34:7379–89.

Hansen K, Angelidaki I, Ahring B. Improving thermophilic anaerobic digestion of swine manure. *Water Res* 1999;33(8):1805-10.

Hawkes F, Dinsdale R, Hawkes D, Hussy I. Sustainable fermentative hydrogen production: challenges for process optimization. *Int J Hydrogen Energy* 2002;27:1339–47.

Hernández M, Rodríguez M. Hydrogen production by anaerobic digestion of pig manure: Effect of operating conditions. *Renew Energy* 2013;53:187-92.

ICO - International Coffee organization. 2012. <http://www.ico.org/index.asp>

IDAE (Instituto para la Diversificación and Ahorro de la Energía). *Biomasa: Digestores anaerobios*. c/ Madera, 8 - 28004 Madrid. Madrid, octubre 2007.

Jackels S, Jackels C. Characterization of the coffee mucilage fermentation process using chemical indicators: a field study in Nicaragua. *Food Chemistry Toxicology* 2005;70(5):321-5.

- Jo JH, Jeon CO, Lee DS, JM Park. Process stability and microbial community structure in anaerobic hydrogen-producing microflora from food waste containing kimchi. *J Biotechnol* 2007;131:300–308.
- Kapdan IK, Kargi F. Bio-hydrogen production from waste materials. *Enzyme Microb Technol* 2006;38:569-82.
- Khanal SK, Chen WH, Li L, Sung S. Biological hydrogen production: Effects of pH and intermediate products. *Int J Hydrogen Energy* 2004;29:1123-31.
- Kida K, Teshima M, Sonoda Y, Tanemura K. Anaerobic digestion of coffee waste by two-phase methane fermentation with slurry-state liquefaction. *J Ferment Bioeng* 1994;77(3):335-8.
- Kim D-H, Kim S-H, Shin H-S. Hydrogen fermentation of food waste without inoculum addition. *Enzym Microb Technol* 2009;45:181–7.
- Kim SH, Han SK, Shin HS. Feasibility of biohydrogen production by anaerobic co-digestion of food waste and sewage sludge. *Int J Hydrogen Energy* 2004;29:1607-16.
- Kim D-H, Kim S-H, Kim K-Y, Shin H-S. Experience of a pilot-scale hydrogen-producing anaerobic sequencing batch reactor (ASBR) treating food waste. *Int J Hydrogen Energy* 2010;35:1590-4.
- Kim M-S, Lee D-Y, Kim D-H. Continuous hydrogen production from tofu processing waste using anaerobic mixed microflora under thermophilic conditions. *Int J Hydrogen Energy* 2011;36:8712-8.
- Kondratieva E. Production of molecular hydrogen in microorganisms. *Adv Biochem Eng* 1983;28:139–191.
- Kuo-Shing L, Yao-Feng H, Yung-Chung L, Ping-Jei L, Chiu-Yue L, Jo-Shu C. Exploring optimal environmental factors for fermentative hydrogen production from starch using mixed anaerobic microflora. *Int J Hydrogen Energy* 2008;33:1565–72.
- Laanbroek JH, Geerlings H, Sitjtsma L, Veldkamp H. Competition for sulphate and ethanol among *Desulfobacter Desulfobulbus* and *Desulfovibrio* species isolated from intertidal sediments. *Appl Environ Microbiol* 1984;128:329–34.
- Lay JJ, Lee YJ, Noike T. Feasibility of biological hydrogen production from organic fraction of municipal solid waste. *Water Res* 1999;33(11):2579–86.
- Leite J, Fernandes B, Pozzi E, Barboza M, Zaiat M. Application of an anaerobic packed-bed bioreactor for the production of hydrogen and organic acids. *Int J Hydrogen Energy* 2008;33:579-86.



- Levin D, Pitt L, Love M. Biohydrogen production: prospects and limitations to practical application. *Int J Hydrogen Energy* 2004;29:173-85.
- Li J, Ren N, Li B, Qin Z, He J. Anaerobic biohydrogen production from monosaccharides by a mixed microbial community culture. *Bioresour Technol* 2008;99:6528–37.
- Lin CY, Lay CH. Carbon/nitrogen-ratio effect on fermentative hydrogen production by mixed microflora. *Int J Hydrogen Energy* 2004;29:41-5.
- Lin C-Y, Lay C-H, Sen B, Chu C-Y, Kumar G, Chen C-C, Chang J-S. Fermentative hydrogen production from wastewaters: A review and prognosis. *Int J Hydrogen Energy* 2012;37:15632-42.
- Logan BE, Oh SE, Kim IS, Van Ginkel S. Biological hydrogen production measured in batch anaerobic respirometers. *Environ Sci Technol* 2002;36(11):2530-5.
- Madigan M, Martinko J, Parker J. Brock biology of microorganisms (8va Ed.). Upper Saddle River, NJ : Prentice Hall 1997.
- Massanet-Nicolau J, Dinsdale R, Guwy A. Hydrogen production from sewage sludge using mixed microflora inoculum: Effect of pH and enzymatic pretreatment. *Bioresour Technol* 2008;99:6325–31.
- Massé D, Drost R. Comprehensive model of anaerobic digestion of swine manure slurry in a sequencing batch reactor. *Water Res* 2000;34:3087-106.
- Mathews J, Wang G. Metabolic pathway engineering for enhanced biohydrogen production. *Int J Hydrogen Energy* 2009;34:7404-16.
- Mizuno O, Li Y, Noike T. The behavior of sulfate-reducing bacteria in acidogenic phase of anaerobic digestion. *Water Res* 1998;32(5):1626–34.
- Moletta R. La méthanisation, first ed. TEC & DOC, Paris. 2008.
- Moreno I, Buitrón G. Cuantificación de los grupos bacterianos de cinco inóculos usados en la prueba de biodegradabilidad anaerobia. XXVIII Congreso Interamericano de Ingeniería Sanitaria y Ambiental, Cancún, 2002:27-31.
- Naik SN, Goud V, Rout P, Dalai A. Production of first and second generation biofuels: A comprehensive review. *Renew Sustain Energy Rev* 2010;14:578–97.
- Nandi R, Sengupta S. Microbial production of hydrogen: An Overview. *Critical Reviews Microbiol* 1998;24:61-84.
- Ni M, Leung D, Leung M, Sumathy K. An overview of hydrogen production from biomass. *Fuel Process Technol* 2006;87:461–72.
- Noike T, Mizuno O. Hydrogen fermentation of organic municipal wastes. *Water Sci Technol* 2000;42(12):155–62.

Noike T, Takabatake H, Mizuno O, Ohba M. Inhibition of hydrogen fermentation of organic wastes by lactic acid bacteria. *Int J Hydrogen Energy* 2002;27:1367–71.

Ntaikou I, Antonopoulou G, Lyberatos G. Biohydrogen production from biomass and wastes via dark fermentation: a review. *Waste Biomass Valor* 2010;1:21–39.

Oude Elferink S, Visser A, Hulshoff Pol L, Stams A. Sulfate reduction in methanogenic bioreactors. *FEMS Microbiol Rev* 1994;15:119-36.

O-Thong S, Prasertsan P, Intrasungkha N, Dhamwichukorn S, Birkeland N-K. Optimization of simultaneous thermophilic fermentative hydrogen production and COD reduction from palm oil mill effluent by *Thermoanaerobacterium*-rich sludge. *Int J Hydrogen Energy* 2008;33:1221-31.

Pandey A, Soccol C, Nigamc P, Brand D, Mohan R, Roussos S. Biotechnological potential of coffee pulp and coffee husk for bioprocesses. *Biochem Eng J* 2000;6:153–62.

Patel S, Kumar P, Kalia V. Enhancing biological hydrogen production through complementary microbial metabolisms. Review. *Int J Hydrogen Energy* 2012;37:10590-603.

Rodríguez N. Manejo de residuos en la agroindustria cafetera. Cenicafé. Seminario internacional - Gestión integral de residuos sólidos y peligrosos, siglo XXI 2001.

Rodríguez N, Zambrano D. Los subproductos del café: Fuente de energía renovable. Cenicafé - Avances técnicos 393. ISSN 0120-0178. 2010.

Schink B. Energetics of syntrophic cooperation in methanogenic degradation. *Microbiol Molecular Biol Rev* 1997;61(2):262–80.

Schink B, Friedrich M. Energetics of syntrophic fatty acid oxidation. *FEMS Microbiol Rev* 1994;15:85-94.

Schmidt RT, Cooney C L. Production of acetic acid from hydrogen and carbon dioxide by *Clostridium* species ATCC 29797. *Chem. Eng. Commun* 1986;45:61-73.

Shin HS, Youn JH, Kim SH. Hydrogen production from food waste in anaerobic mesophilic and thermophilic acidogenesis. *Int J Hydrogen Energy* 2004;29:1355–63.

Smith A, Holtzapple M. Investigation of nutrient feeding strategies in a countercurrent mixed-acid multi-staged fermentation: Development of segregated-nitrogen model. *Bioresour Technol* 2010;101:9700–9.

Sreela-or C, Plangklang P, Imai T, Reungsang A. Co-digestion of food waste and sludge for hydrogen production by anaerobic mixed cultures: Statistical key factors optimization. *Int J Hydrogen Energy* 2011;36:14227-37.

Stams A. Metabolic interactions between anaerobic bacteria in methanogenic environments. *Antonie van Leeuwenhoek* 1994;66:271-94.

Tanisho S, Kuromoto M, Kadokura N. Effect of CO<sub>2</sub> removal on hydrogen production by fermentation. *Int J Hydrogen Energy* 1998;23:559-63.

Thauer RK, Jungermann K, Decker K. Energy conservation in chemotrophic anaerobic bacteria. *Bacteriol Rev* 1977;41:100–80.

Ueno Y, Otsuka S, Morimoto M. Hydrogen production from industrial wastewater by anaerobic microflora in chemostat culture. *J Ferment Bioeng* 1996;82(2):194-7.

Valdez-Vazquez I, Ríos-Leal E, Esparza-García F, Cecchi F, Poggi-Varaldo HM. Semi-continuous solid substrate anaerobic reactors for H<sub>2</sub> production from organic waste: Mesophilic versus thermophilic regime. *Int J Hydrogen Energy* 2005;30:1383-91.

Valdez-Vásquez I, Sparling R, Risbey D, Rinderknecht-Seijas N, Poggi-Varaldo H. Hydrogen generation via anaerobic fermentation of paper mill wastes. *Bioresour Technol* 2005;96:1907–13.

van Ginkel S, Logan BE. Inhibition of biohydrogen production by undissociated acetic and butyric acids. *Environ Sci Technol* 2005;39:9351-56.

van Ginkel S, Sung S, Lay J-J. Biohydrogen production as a function of pH and substrate concentration. *Environ Sci Technol* 2001;35:4726-30.

van Lier J, Sanz Martin J, Lettinga G. Effect of temperature on the anaerobic thermophilic conversion of volatile fatty acids by dispersed and granular sludge. *Water Res* 1996;30(1):199-207.

van Niel E, Claassen P, Stams A. Substrate and product inhibition of hydrogen production by the extreme thermophile, *Caldicellulosiruptor saccharolyticus*. *Biotechnol Bioeng* 2003;81(3):255-62.

Vavilin V, Fernandez B, Palatsi J, Flotats X. Hydrolysis kinetics in anaerobic degradation of particulate organic material: An overview. *Waste Manag* 2008;28:939–51.

Voolapalli RK, Stuckey DC. Hydrogen production in anaerobic reactors during shock loads - Influence of formate production and H<sub>2</sub> kinetics. *Water Res* 2001;35:1831-41.

Wang B, Wan W, Wang J. Inhibitory effect of ethanol, acetic acid, propionic acid and butyric acid on fermentative hydrogen production. *Int J Hydrogen Energy* 2008;33:7013-19.

Wen-Ming C, Ze-Jing T, Kuo-Shing L, Jo-Shu C. Fermentative hydrogen production with *Clostridium butyricum* CGS5 isolated from anaerobic sewage sludge. *Int J Hydrogen Energy* 2005;30:1063–70.

Whiteley C, Lee D-J. Enzyme technology and biological remediation. *Enzym Microbiol Technol* 2006;38:291–316.

- Xie B, Cheng J, Zhou J, Song W, Cen K. Cogeneration of hydrogen and methane from glucose to improve energy conversion efficiency. *Int J Hydrogen Energy* 2008;33:5006-11.
- Xing J, Criddle C, Hickey R. Effects of a long-term periodic substrate perturbation on an anaerobic community. *Water Res* 1997;31:2195-204.
- Zambrano-Franco D, Rodríguez-Valencia N, López-Posada U, Orozco P, Zambrano-Giraldo A. Tratamiento anaerobio de las aguas mieles del café. *Cenicafé. Boletín Técnico N° 29*, 2006.
- Zheng X-Y, Yu H-Q. Roles of pH in biologic production of hydrogen and volatile fatty acids from glucose by enriched anaerobic cultures. *Appl Biochem Biotechnol* 2004;112:79-90.
- Zhu J. A review of microbiology in swine manure odor control. *Agric Ecosyst Environ* 2000 ;78:93–106.
- Zhu J, Wu X, Miller C, Yu F, Chen P, Ruan R. Biohydrogen production through fermentation using liquid swine manure as substrate. *J Environ Sci Health Part B* 2007;42:393–401.
- Zoetemeyer R, Van den heuvel J, Cohen A. pH influence on acidogenic dissimilation of glucose in an anaerobic digester. *Water Res* 1982;16:303-11.

## EXPERIMENTAL SECTION

## CHAPTER 2 Use of coffee mucilage as a new substrate for hydrogen production in anaerobic co-digestion with swine manure in thermophilic condition

### Abstract

Coffee mucilage (CM), a novel substrate produced as waste from agricultural activity in Colombia, the third coffee producer in the world, was used for hydrogen production. The study evaluated three ratios (C1-3) for co-digestion of CM and swine manure (SM), and an increase in organic load to improve hydrogen production (C4). Hydrogen production was improved by a C/N ratio of 53.4 used in C2 and C4. The increase in organic load produced an average cumulative hydrogen volume, production rate and yield of 2660.7 NmL, 760.2 NmL H<sub>2</sub>/L<sub>w</sub>d and 43.0 NmL H<sub>2</sub>/g COD, respectively. Under this condition, the biogas composition was 0.1, 50.6 and 39.0 % of methane, carbon dioxide and hydrogen, respectively. The butyric and acetic fermentation pathways were the main routes identified during hydrogen production which kept a Bu/Ac ratio at around 1.0. The maximum organic load rate of 12 kg COD/m<sup>3</sup>d produced an undissociated VFA concentration of around 8.5 mM. In addition, a direct relationship between coffee mucilage, biogas and cumulative hydrogen volume was established. A modified Gompertz model fitted the hydrogen production for each condition.

## 2.1 Introduction

Hydrogen production from the anaerobic digestion of waste is a second-generation renewable energy which can have both advantages and disadvantages related to heterogeneous compositions, microorganisms, inert material and nutrients [Kapdan and Kargi, 2006; Ntaikou et al., 2010]. One approach to avoid these limitations is the co-digestion of two or more substrates with supplementary characteristics which could be: carbon and nitrogen sources, soluble chemical oxygen demand (COD), pH, alkalinity and microorganisms. Likewise, the C/N ratio indicates the carbon and nitrogen supplied, which is mainly related to microorganism growth. This parameter has been widely evaluated for several anaerobic co-digestion processes and experimental conditions, but the diversity of substrates used has given results over a wide range from 33 to 200 [Lin and Lay, 2004; Argun et al., 2008; O-Thong et al., 2008; Sreela-or et al., 2011]. In general, these raw materials contain three types of macromolecule; carbohydrates, proteins and lipids, which are involved in the first stage of the anaerobic digestion related to the breakdown of organic matter. In this case, coffee mucilage has a high carbohydrate concentration (carbon source) compared to proteins and lipids [Avallone et al., 2000]. This characteristic could improve hydrogen production as this macromolecule has been reported as a main substrate for this reaction [Lin and Lay, 2004; Kapdan and Kargi, 2006; Argun et al., 2008; O-Thong et al., 2008; Sreela-or et al., 2011]. In contrast, swine manure has a high protein concentration (nitrogen source) and some nutrients providing the required environment for the process. Swine manure has been widely used in anaerobic co-digestion to produce methane and, due to its characteristics, is employed as the main support substrate for the treatment of other kinds of waste [Angelidaki et al., 2003]. Its low carbohydrate concentration, which limits hydrogen production, can be counteracted by the addition of compounds such as glucose or other raw materials rich in carbohydrates. In Colombia, coffee production has been extensively developed and this country is now the third producer worldwide, after Brazil and Vietnam. Usually, the mucilage remains attached to the coffee grain for 4–72 h during fermentation, and is then removed with a large quantity of water. Alternatively, mucilage can be separated using an ecological technology consisting of the mechanical demucilaging of the ripe harvested beans which uses less water and extracts the waste rich in carbohydrates [Chanakya and De Alwis, 2004]. The use of both wastes in an anaerobic co-digestion process could be feasible due to the occurrence of these activities in similar regions in the country. Another important aspect linked to the use of complex substrates is the microorganism content which affects the biomass inside the process,

changing patterns, metabolites and products [Zhu, 2000; Noike et al., 2002]. In general, this aspect has been avoided through the use of pure microorganism cultures such as *Clostridium*, *Bacillus* and *Thermoanaerobacterium* or mixed cultures of these genera which are able to produce mainly volatile fatty acids (VFA), hydrogen and carbon dioxide [Nandi and Sengupta, 1998; Kapdan and Kargi, 2006]. However, this suggests the use of simple substrates, pure substances to simulate a synthetic waste and the implementation of pre-treatment methods for complex substrates which have other kinds of microorganism. Additionally, the isolation of microorganisms limits progress in the knowledge about the interaction of microorganisms with several substances found in wastes, which could influence the real efficiency of the process over time, the pure or mixed culture selected and the metabolic pathway [Noike et al., 2002; Van Ginkel and Logan, 2005; Jo et al., 2007; Zhu et al., 2007; Kim et al., 2009].

Environmental parameters, like temperature, pH, organic load, time retention and partial pressure, play a fundamental role in hydrogen production. pH is a key parameter because acidic conditions inhibit the activity of hydrogenotrophic microorganisms responsible for converting hydrogen to methane. Therefore, a pH around 5.5 has been used to select the butyrate/acetate fermentative pathways which improve hydrogen production even at pHs comprised between 5.0 and 6.0 [Van Ginkel et al., 2001; Khanal et al., 2004]. The strong production of VFA during acidogenesis could change the pathway from hydrogen to solventogenesis with ethanol, propanol, butanol and acetone as end products [Van Ginkel and Logan, 2005]. The temperature could be in the mesophilic, thermophilic and even hyperthermophilic range. However, the last condition has been little studied due to its high energy requirements which increase the overall energy demand. On the other hand, the mesophilic condition is generally useful for most microorganisms and the stability of the process. In contrast, thermophilic temperatures have been related to the inactivation of hydrogen consumers which could change the metabolic pathway [Noike et al., 2002; Valdez-Vazquez et al., 2005]. Furthermore, the increase in temperature provides additional energy to the system which increases the microorganism growth rates and decreases the hydrolysis time [Angelidaki et al., 2003]. A stable anaerobic digestion process works with a usual organic load rate of between 2-5 kg COD/m<sup>3</sup>d which avoids changes in the biogas composition and buffer system. Increasing this parameter generates a strong VFA response which produces a pH decrease associated with a high biogas production. The biogas composition changes due to: the decrease in CO<sub>2</sub> solubility and its volatilization at low pH, the increase in hydrogen



production caused by the short time, the changes in Gibbs free energy and the decline in methane production due to the disruption of the process by the buffer capacity failure [Borja and Banks, 1995; Kalyuzhnyi et al., 1996; Chua et al., 1997; Xing et al., 1997; Voolapalli and Stuckey, 2001]. The retention time of pure substrates requires 6 – 8 h to complete the first stages of anaerobic digestion and to reach maximum hydrogen production. Complex substrates like organic waste and sludge take about 12 h while the time required for the organic fraction of municipal solid waste (OFMSW) can be 20 h [Kapdan and Kargi, 2006; Argun et al., 2008]. These variations make it essential to develop experiments for any complex substrate to establish the retention time which limits the reactions related to hydrogen consumers. However, the selection of short times could limit both the hydrolytic stage and acid formation, which decrease hydrogen production. Finally, an increase in hydrogen partial pressure could change the pathway within the anaerobic digestion from hydrogen production to solventogenesis or the production of other metabolites [Van Ginkel and Logan, 2005]. In addition, an increase in carbon dioxide partial pressure changes the metabolites produced in hydrogen pathways to the formation of succinic and propionic acids [Tanisho et al., 1998; Leite et al., 2008].

The present study evaluated the hydrogen production from a co-digestion process of two complex substrates; swine manure, a classic substrate used in methane and hydrogen production, and coffee mucilage, a new substrate with few studies on anaerobic digestion. The aims of this research therefore were: to evaluate the performance of hydrogen production through repetitive batch cultivation, C/N ratio and organic load increase during the co-digestion of coffee mucilage and swine manure and to establish the kinetic parameters and metabolic pathway related to hydrogen production in order to advance the knowledge of the internal process. The experiments were carried out at a thermophilic temperature of 55 °C and an acidic pH of 5.5. The effect of the substrate ratio and organic load increase on VFA production, biogas composition and hydrogen production rate was assessed.

## 2.2 Methods

### 2.2.1 Methodology

The study used four conditions to investigate hydrogen production related to agricultural and livestock wastes; the first three were established to evaluate the ratio of two substrates during

the anaerobic co-digestion process. The swine manure and coffee mucilage (SM:CM) ratios chosen were 7:3, 5:5 and 3:7, which were identified as C1, C2 and C3, respectively. The relation between both substrates was established through chemical oxygen demand with an initial organic load of  $\pm 6.5$  kg COD/m<sup>3</sup>d. In this case, the C/N ratios were 33.8, 53.4 and 77.4 for C1, C2 and C3 respectively, which were obtained without the addition of external solutions. The fourth condition (C4) was developed for the best ratio between the substrates; in this case, the organic load was doubled to  $\pm 12.1$  kg COD/m<sup>3</sup>d. Each experiment was conducted over a period of at least 30 days. The study began with the highest content of swine manure and ended with the highest content of coffee mucilage in the feedstock. It was established to have an environment of microorganisms and nutrients from SM was established at the beginning. The subsequent addition of CM was to look for the acclimatization of the selected microorganisms to carbohydrate.

### 2.2.2 Substrates

The feedstock used in this study was composed of a mixture of swine manure and coffee mucilage wastes. The first substrate was collected from a pig barn at the Servicio Nacional de Aprendizaje (SENA) in Bogotá. It was preserved at 4 °C in bags with approximately 1 kg and replaced every 15 days with fresh manure to avoid modification due to degradation. Coffee mucilage was collected every two months immediately after the mechanical demucilaging process on a farm close to Bogotá. It was then separated physically, using a No. 4 standard sieve, to remove coffee grains, pulp and other kinds of thick solids. After that, the substrate was preserved at -4 °C. Mucilage was divided into bags of 1 L to avoid degradation after it was thawed. The feedstock required the dilution of both wastes with tap water to achieve the COD concentration established. It was acclimated at room temperature during the preparation procedure.

### 2.2.3 Inoculum

The inoculum was obtained in a preliminary phase from the same reactor using both substrates in a ratio of 7:3 (SM:CM). The microorganism selection was conducted through the change of operating parameters such as temperature, retention time and organic load. The first stage of this process involved a high organic load of 12 kg COD/m<sup>3</sup>d, the second a reduction in organic load to 6 kg COD/m<sup>3</sup>d, the third an increase in temperature from 35 to 55 °C, and the last modification was a change in the retention time from 3 days to 1 day. Each stage lasted approximately 30 days. The first two stages improved the hydrogen production but, at

day 15, it decreased due to the change to methane production. In contrast, the last two stages were able to control this change in biogas composition, maintaining the hydrogen production over time. At this point, the acclimatization process was ended to begin the experiments.

## 2.2.4 Experimental design

Hydrogen production from co-digestion experiments was carried out in a reactor with a working volume of 5.5 L and a total volume of 7.2 L (Fig. 2.1). The feedstock of each SM:CM ratio used in the experiments was 3.5 L. It was added after the extraction of the same volume of mixed liquor from the process. The reactor was operated as an Anaerobic Batch Reactor (ABR) with the free evolution of biogas to avoid a high hydrogen partial pressure (semi-batch system). In order to preserve the biomass, 2 L of mixed liquor was left inside the reactor during each feeding process. The initial pH of 5.5 was established by adding either HCl (1.5 N) or NaOH (1.5 N) using automatic dosage pumps regulated by a control system (Fig. 2.1); after that, the pH evolved without control in a range of 5.15-5.5. The reactor was stirred constantly at 200 rpm to prevent the sedimentation of the solids within, and to improve the hydrogen transfer from the liquid to the gaseous phase.

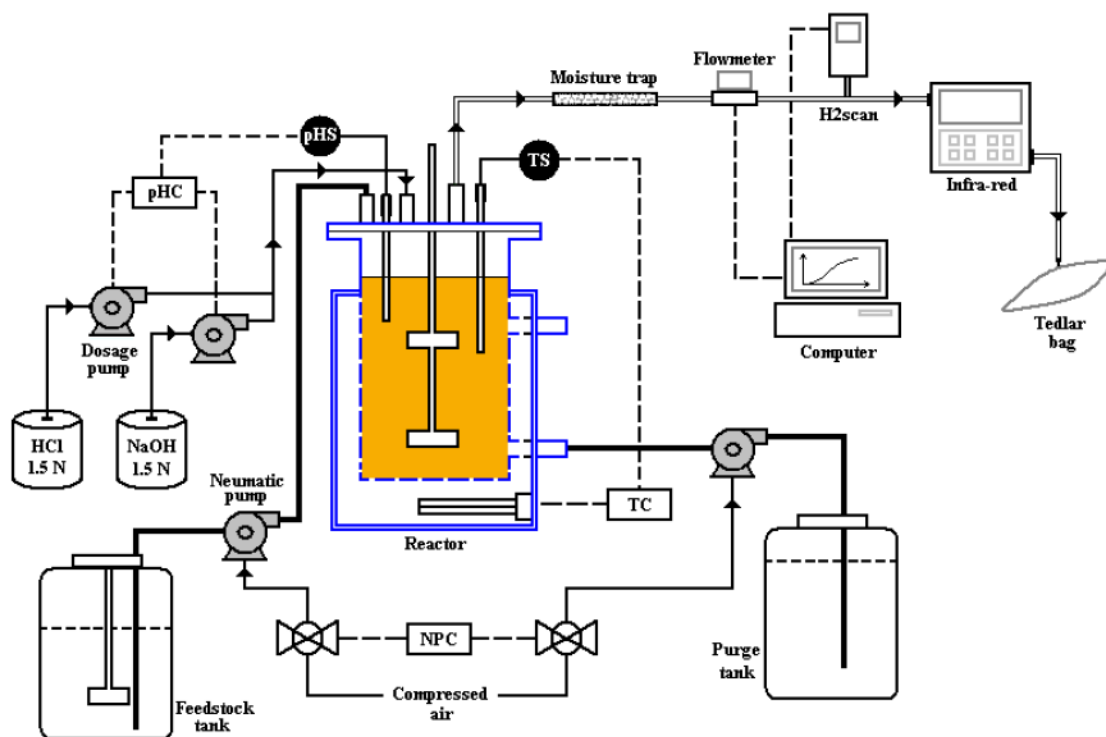

Figure 2.1. Reactor system involved for hydrogen production experiments.

The thermophilic temperature of 55 °C was maintained by a heating jacket coupled with a control system. The initial and final pH measurements were made in the reactor after the feeding process and at the end of each batch cycle, respectively. Biogas production was measured by a MilliGasCounter MGC (RITTER®) and collected in Tedlar® bags of 5 L during each experimental condition. The volatile fatty acids, biogas volume, hydrogen, carbon dioxide and methane concentrations were recorded during experiments.

### 2.2.5 Analytical methods

Hydrogen in biogas was measured online using a HY-OPTIMA 700 H2Scan® with a quantification range between 0.5 and 100 % (v/v). Methane and carbon dioxide were measured by an Infra-red Gas Analyzer (LANDTEC® - BioGas Check CDM) with a maximum deviation of ±0.3 % (v/v) for methane and ±3 % (v/v) for carbon dioxide. Volatile fatty acids were determined by gas chromatography (Hewlett Packard® 6890 series G1530A) equipped with a flame ionization detector (FID). The operational temperatures of the injection port, column oven and detector were 250, 250 and 300 °C, respectively. Argon was used as the carrier gas with a flow rate of 0.9 mL/min. The cumulative hydrogen production in every condition was fitted with the modified Gompertz equation (Eq. 29) [Mu et al., 2006]:

$$H = P \exp\left(-\exp\left[\frac{r_m e}{P}(\lambda - t) + 1\right]\right) \quad (29)$$

where H is the cumulative hydrogen production (mL), P is the hydrogen production potential (mL),  $r_m$  is the maximum hydrogen production rate (mL/h),  $\lambda$  is the lag-phase time (h) and e equals 2.718. Carbohydrates, proteins and fats were measured using the methods of Dubois [Dubois et al., 1956], Bradford [Bradford, 1976] and Soxhlet [APHA, 2005], respectively. The COD, VFA, Total Kjeldahl Nitrogen (TKN), alkalinity (ALK) and ammonia were measured according to Standard Methods [APHA, 2005].

## 2.3 Results and discussion

### 2.3.1 Reactor performance during dark fermentation

#### 2.3.1.1 Repetitive batch cultivation and C/N ratio

The reactor behavior was monitored taking into account different parameters such as VFA, alkalinity, biogas composition, hydrogen production and pH (Figs. 2.2 and 2.3). The reactor was operated for about 144 days with periods of 37, 30, 34 and 43 days for C1, C2, C3 and C4, respectively. In all conditions, except the first, the experiments were influenced by the previous condition, which required around 8 days related to the solids retention time (SRT). Therefore, the statistical data analysis used the information recorded after this time for each condition. The lowest hydrogen production was found in C1, due to the complexity of the swine manure which was the main substrate. In this case, repetitive batch cultivation increased the hydrogen concentration in biogas. However, it was not sufficient to improve the transformation of the feedstock to hydrogen production by the mixed culture. Meanwhile, in C2, the hydrogen production rate reached an average of 303.3 NmL H<sub>2</sub>/L<sub>w</sub>.d. In this case, the system retained the dynamics through the repetitive batch cultivation, showing the stabilization of the mixed culture over time [Van Ginkel and Logan, 2005; Jo et al., 2007]. The change in substrate ratio from 5:5 to 3:7 caused a marked increase in the hydrogen production rate, which reached a maximum of 628.5 NmL H<sub>2</sub>/L<sub>w</sub>.d. In this case, the mixed culture showed a strong ability to use the new feedstock and transform it, which was consistent with the increase in VFA. At the end of the experiments in C3, the pH rose due to the increase in carbon dioxide concentration in the biogas. Instead of different levels of hydrogen production, the similar VFA concentrations suggest the production of other metabolites during C1 and C3 which were not related to hydrogen production, in agreement with the results obtained. The stability of the conditions was greater in C2 with a standard deviation of about 10.3 % against the deviation of 35.6 % found in C1 which increased markedly in C3 to 43.8 %. These performances showed that a time of between 8 and at least 18 days must be considered to follow this kind of process in order to see the changes in the initial behavior as shown for C2 and C3. On the other hand, the increase in alkalinity, which changed from a low buffer capacity in the feedstock (1557.0 to 996.4 mg CaCO<sub>3</sub>/L) to a range of 2007.2 -2611.0 mg CaCO<sub>3</sub>/L, was related to the output of carbon dioxide due to the decrease in its solubility changing the bicarbonate equilibrium [Valdez-Vazquez et al., 2005]. In addition, the methane activity was strongly inhibited over time which confirmed that the

mixed culture was controlled by microorganisms other than methanogenic ones [Kim et al., 2004; Zhu et al., 2007]. Thus, the limitation in C1 and C3 for hydrogen production was associated with a deviation in the pathway. Moreover, the methanogenic bacteria, which could be provided by the feedstock, were inactivated during the repetitive batch cultivation.

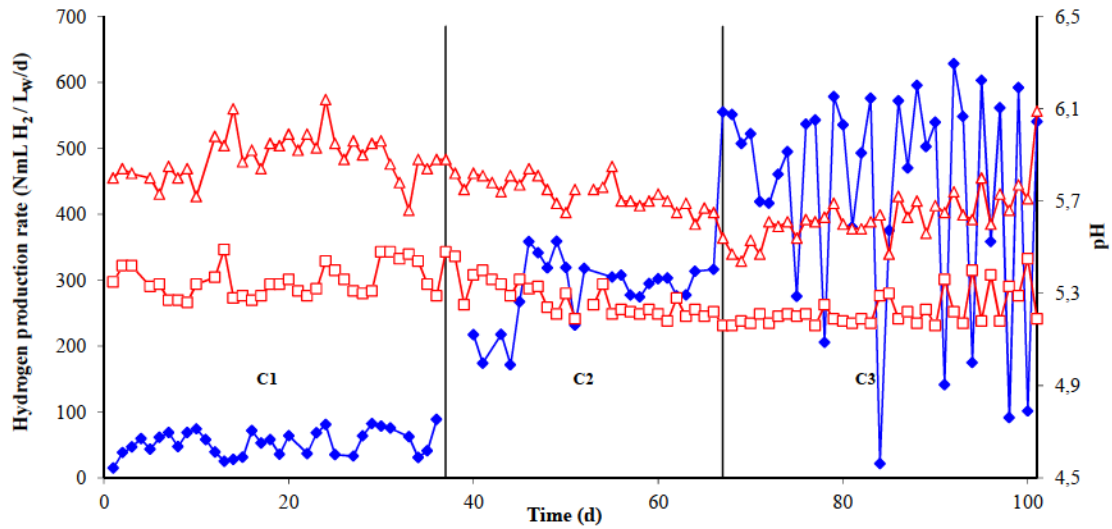

Figure 2.2. The hydrogen production rate (♦), and initial (Δ) and final (□) pH during the variation of C/N ratios over repetitive batch cultivation of conditions 1, 2 and 3.

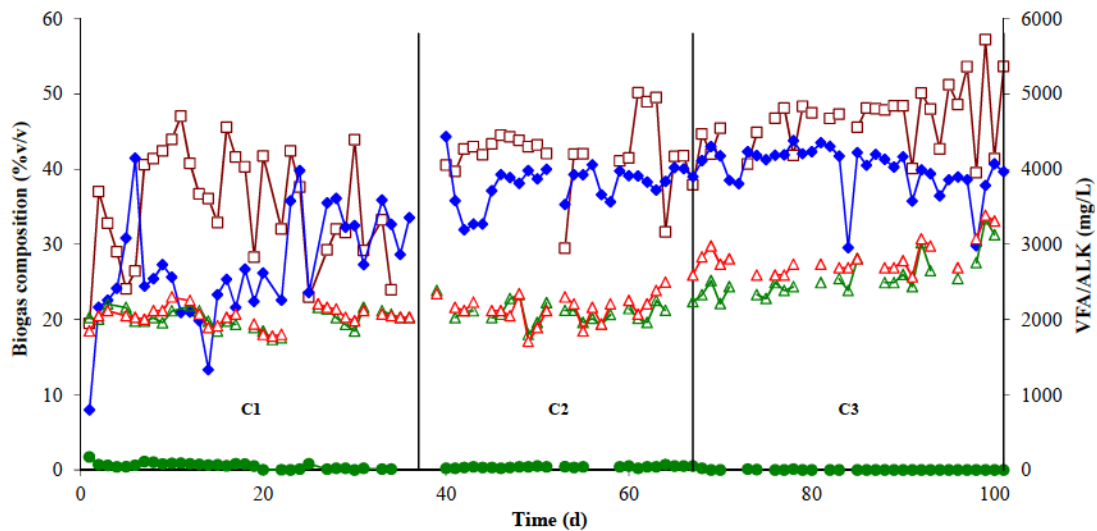

Figure 2.3. Biogas composition represented by hydrogen (♦), carbon dioxide (□) and methane (●), during the variation of C/N ratios over time to conditions 1, 2 and 3 linked with alkalinity (Δ) and VFA (Δ) concentrations in the ABR.

The ratio between carbon and nitrogen (C/N) is frequently used as a parameter to evaluate the potential development of any anaerobic digestion process. In these experiments, the initial C/N ratios were between 33 and 77.4 which are considered functional levels to develop a hydrogen production process [Lin and Lay, 2004; Argun et al., 2008; O-Thong et al., 2008; Sreela-or et al., 2011]. In this case, the reduction in swine manure and the increase in coffee mucilage showed the clear influence of each substrate as a nitrogen and carbon source, respectively, for each ratio (Fig. 2.4). The first two conditions showed a slight change in the C/N ratio at the end of the experiments which was related to a negligible change in nitrogen and carbon parameters. Meanwhile, the increase in the C/N ratio for C3 showed a high fluctuation in hydrogen production which was related to the large reduction in ammonia concentration (Fig. 2.4). It was associated with the increase in the available carbon source which improved the biomass synthesis, consuming ammonia by several routes [Massé and Drost, 2000]. In addition, the COD removals for C1 and C2 were below 3 % compared to 4.5 % achieved in C3.

The lower carbohydrate removal in C1 could indicate a limitation in the mixed culture of the degradation of this macromolecule. Moreover, the increase in ammonia concentration of 32 % during the experiment was lower than inhibition levels [Valdez-Vazquez et al., 2005]. In contrast, the change between C1 and C2 produced an increase in the cumulative hydrogen with similar carbohydrate removal to other substrates [Kapdan and Kargi, 2006; O-Thong et al., 2008]. Meanwhile, nitrogen was maintained at the same concentration with a slight ammonia consumption associated with bacterial growth. The ammonia increase in C1 was related to the deamination of amino acids which could produce acetic, ammonium and even hydrogen [Thauer et al., 1977]. In that case, this hydrogen production is lower than that obtained through glucose, which could explain the low hydrogen production achieved due to the high protein content of swine manure [Thauer et al., 1977; Zhu, 2000]. However, the COD balance showed that the amounts of soluble carbohydrates and soluble proteins consumed were 36.4, 70.1 and 68.1 % of the soluble metabolites for C1, C2 and C3, respectively. Thus, the contribution of soluble proteins could be related to a maximum of 5.2 % in C1 while it was below 1.6 % for the other two conditions. These percentages suggest the formation of several metabolites through the degradation of particulate material present in both complex substrates.

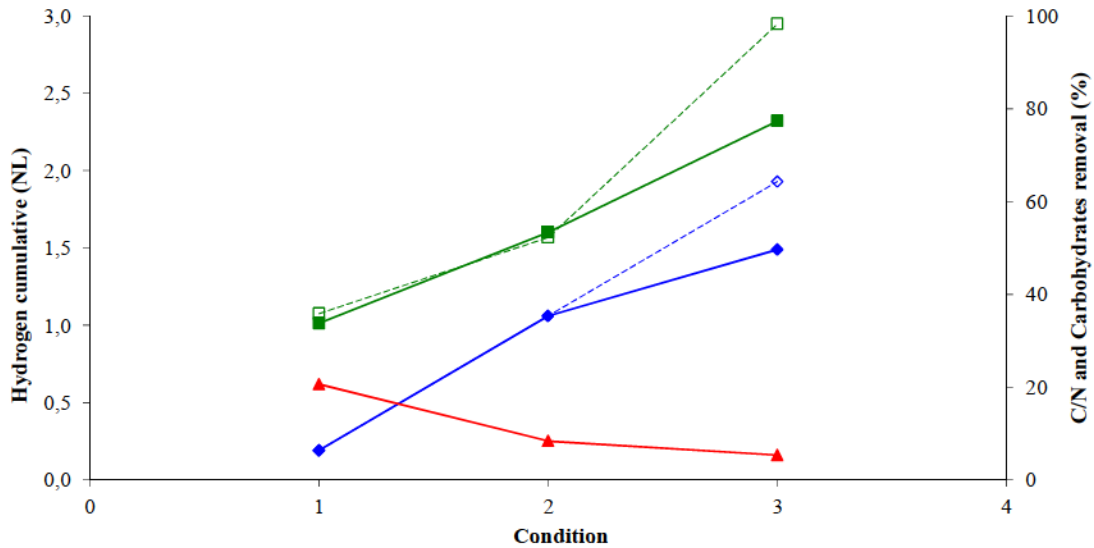

Figure 2.4. C/N ratio (■ - initial, □ - final) during the conditions related to the residual carbohydrate concentration (▲) and cumulative hydrogen (◆). A stable response of C3 was suggested through the use of similar standard deviation than C2 (◇ - dotted line).

On the other hand, the hydrogen response was improved at the midpoint of the C/N ratios, which suggests a limitation with the increase of any substrate. Thus, the ratio 53.4 was in the range of 33 – 74 found in other studies which used food waste/sludge and palm oil mill effluent, respectively [O-Thong et al., 2008; Sreela-or et al., 2011]. In addition, Lin and Lay [2004] found the highest hydrogen production at a C/N ratio of 47 with the use of sucrose but, in the same experiments, there was a close result in a ratio of 130. This suggests a difference between complex substrates and substrates rich in carbohydrates with the addition of nutrient solution. Finally, both increases in C/N ratio had the same response when the fluctuations in C3 were left out of the results (Fig. 2.4). In this case, the hydrogen increase achieved between C1 and C2 was similar to that between C2 and C3, which improved the COD removal to values below 5 %. In addition, the stable hydrogen response (◇) related to the C/N ratio could be fitted to a linear relationship with a correlation factor of 0.996.

### 2.3.1.2 Effect of increasing the organic load rate

An additional condition (C4) evaluated the increase in organic load rate up to 12.1 kg COD/m<sup>3</sup>d for the C/N ratio of 53.4 in order to improve the hydrogen production. The average hydrogen production rate was 760.2 NmL H<sub>2</sub>/L<sub>w</sub>d with a standard deviation of about 6.4 %, which was highly stable compared to the other conditions evaluated, even C2 (Fig. 2.2). Thus,



the approximate doubling of the organic load from C2 to C4 produced a 2.5-fold increase in the hydrogen production rate. The main compounds in biogas, hydrogen and carbon dioxide, showed a stable behavior with an average hydrogen concentration of 39.0 %, slightly higher than the value found in C2, which suggests a limit in the hydrogen concentration through the use of these substrates. Meanwhile, carbon dioxide increased from 42.4 % to 50.6 % due to the volatilization of this compound related to the reduction in pH which achieved values near to the low set point. The methanogenic activity was strongly inhibited from a maximum methane concentration of 0.2 % in biogas with the repetitive batch cultivation.

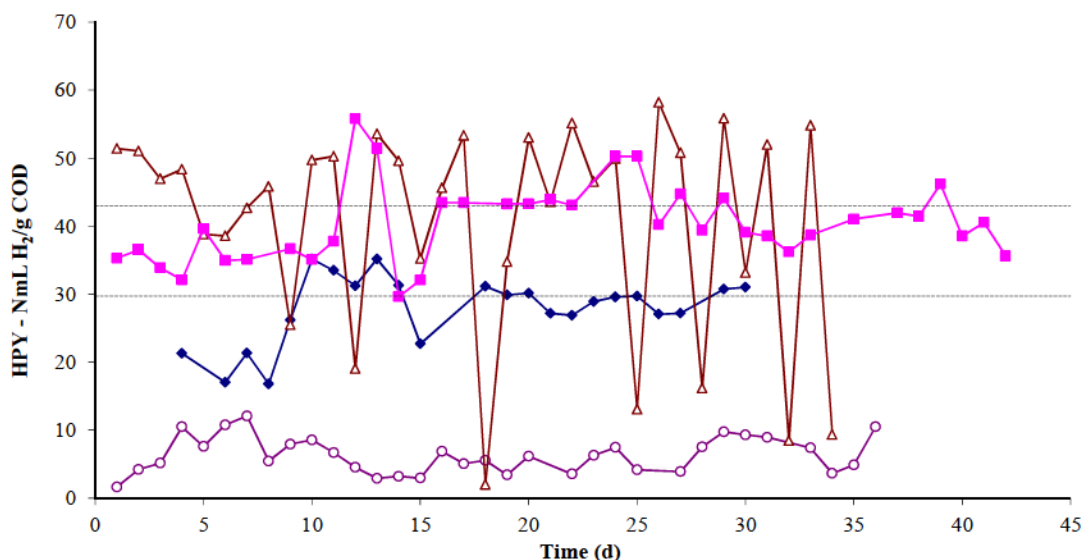

Figure 2.5. The effect of increasing the organic loading rate on hydrogen production yield (NmL H<sub>2</sub>/g COD) over time to each condition: ○ C1, ◆ C2, △ C3 and ■ C4.

On the other hand, the hydrogen production yield showed an increase during the change in mixed ratios, which was related to the increase in the soluble COD from 31.5 to 51.4 % of the total organic load (Fig. 2.5). The increase in organic load for the same C/N ratio caused a change from 29.7 to 43.0 NmL H<sub>2</sub>/g COD which was 1.4 times the initial production. This suggests a limitation due to the response could have been 2 times, like the change in organic load. The process required at least 15 days to reach the same stability levels as C2, which confirmed that the increase in organic load affected the evolution of the process. In addition, both conditions under the same C/N ratio kept similar behavior except for the COD removal of 5.0 % in C4. This was associated with the additional amounts of carbon dioxide produced in C4 during the hydrogen production reactions.

The increase in the organic load rate improved hydrogen production rate in similar values than Ozmihci et al., [2011]. That study obtained 652 mL H<sub>2</sub>/L/d using sugar from acid-hydrolyzed wheat starch. However, another study by Sagnak et al. [2010] using the same substrate achieved a hydrogen production rate of 1220 mL H<sub>2</sub>/L/d. In addition, O-thong et al., [2008] showed a hydrogen production rate of 6.33 L H<sub>2</sub>/L<sub>POME</sub> (Palm Oil Mill Effluent) with an organic load of 85 g COD/L which was 4.4 fold that used in this study for C4. Nevertheless, in these studies, external compounds were used for the nitrogen and phosphate nutritional levels required during dark fermentation. Likewise, different amounts of iron and magnesium were added to improve the hydrogen production. Thus, the use of raw POME showed a reduction in hydrogen production to 4.2 L H<sub>2</sub>/L<sub>POME</sub> with the same organic load. The COD removal in that case was around 37 %, which is higher than the 5.0 % reached in this study. However, the soluble COD removal was increased from 6.7 up to 18.4 % for the conditions with a similar C/N ratio. Indeed, the production achieved with SM:CM could be optimized through the use of some pre-treatments and nutrient addition.

#### *2.3.1.3 Effect of mucilage concentration*

The addition of coffee mucilage during the substrate variation and the increase in organic load showed a positive response in hydrogen formation during dark fermentation (Fig. 2.6). The concentration of this substrate was linked by a linear relationship to biogas and cumulative hydrogen production. At the beginning, the mucilage concentration of 3.2 g COD/L produced just 27.4 % of the total gas as hydrogen. However, the increase to 5.1, 7.6 and 9.8 g COD/L maintained the hydrogen concentration between 38.8 and 40.8 %. This could be because the initial condition C1 had a soluble carbohydrate concentration of 744.9 mg/L. Meanwhile, this value increased to 1841.6 mg/L in C3 and 2551.2 mg/L in C4. However, these concentrations correspond to 7.4, 17.2, 18.1 and 13.9 % of the total COD in the feedstock for each condition, which are lower than those found in other studies [O-Thong et al., 2008]. The increase in this parameter was clearly related to the addition of coffee mucilage to the feedstock as only a low soluble carbohydrate concentration was added via swine manure. Nevertheless, mucilage and manure as complex substrates could have a particulate polysaccharide fraction [Zhu, 2000; Chanakya and De Alwis, 2004]. In this case, some monosaccharides, such as arabinose, galactose, xylose and ribose, in the coffee mucilage [Chanakya and De Alwis, 2004] could involve several degradation routes with the production of other intermediate metabolites. These compounds were associated with a high increase in biogas and cumulative hydrogen production. Although the trend showed a stable behavior, it could not be predicted for

mucilage concentrations higher than 9.8 g COD/L as the generation of metabolites like VFA could inhibit the process. On the other hand, the exclusion of the results during the failure in the reactor performance at C3 improved the linear relationship between mucilage and biogas/hydrogen with a correlation coefficient above 0.9941.

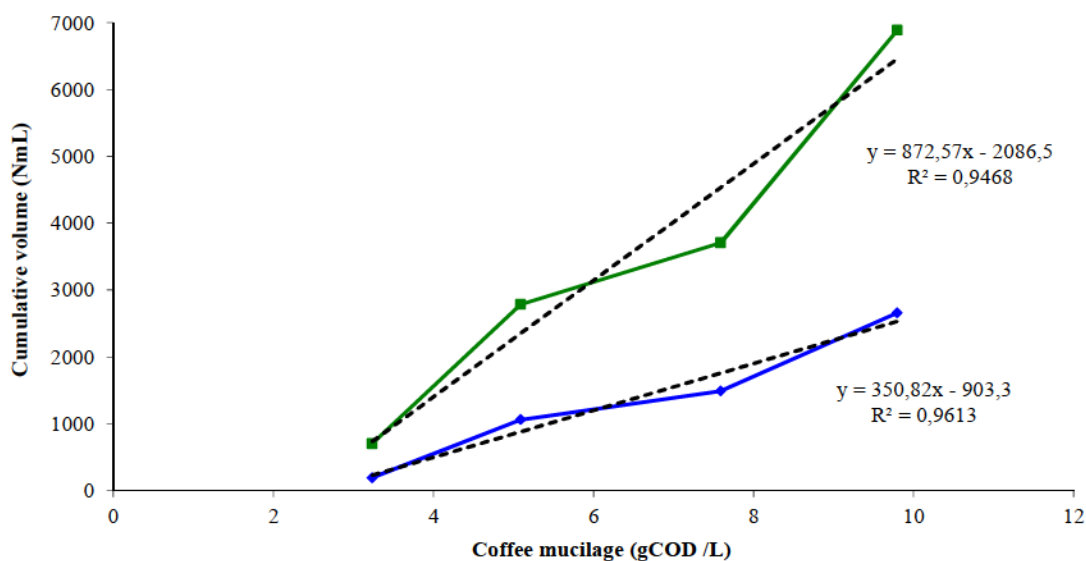

Figure 2.6. Relationship among the coffee mucilage concentration added at each condition and the cumulative biogas (■) and the cumulative hydrogen (◆). Dotted lines represent the tendency curve.

## 2.3.2 Kinetic parameters and metabolic pathways

### 2.3.2.1 Kinetic parameters

The experimental data obtained in the four conditions were fitted to the Gompertz equation. Three different states were taken into account to find the kinetic parameters due to the substrate heterogeneity and the influence on hydrogen production during repetitive batch cultivation: 1. An average of the total measurements from the data recorded; 2. An average of the three best days; 3. An average of the three worst days. The parameters of Eq. (29) calculated for these experiments are shown in Table 2.1. In these cases, the high correlation coefficients show the accuracy of the Gompertz model in fitting the hydrogen production from the different C/N ratios for every experimental condition (Fig. 2.7). The change in C/N ratio produced a quick increase in  $r_m$  due to the suggested relation by the addition of mucilage which was rapidly assimilated by microorganisms. In addition, a strong change was observed in the hydrogen production rate during the increase in organic load. Meanwhile, the maximum

rate in the C/N ratio of 77.4 was close to that obtained in 53.4 in C4 which suggests the possibility of improving hydrogen production with C/N ratios between C3 - C4. The minimum and maximum results showed the high variation in hydrogen production potential and hydrogen production rate for C1 and C3. Meanwhile, the deviation in the rates between the maximum and minimum from the average for C2 and C4 were 15.1 and 8.4 %, respectively.

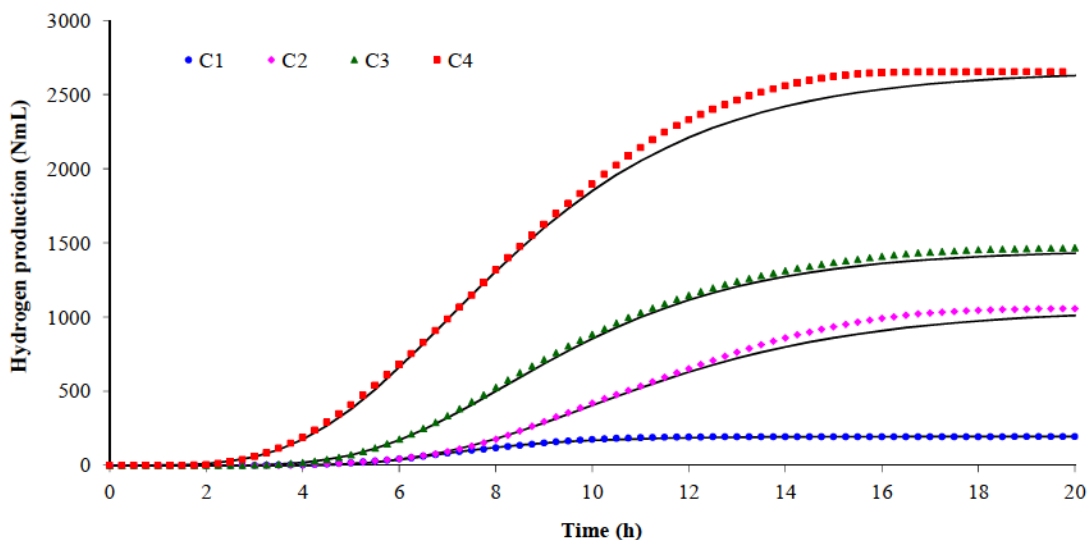

Figure 2.7. Average experimental data of cumulative hydrogen fitted to the Gompertz model for each condition ● C1, ◆ C2, ▲ C3 and ■ C4. The model results were shown as solid lines.

C2 had the longest average lag-phase time which was related to the homogeneous mixture of the feedstock, making the uptake by the microorganisms of a preferred substrate difficult. However, this could support the pseudo-stable state suggested for both conditions evaluated for this C/N ratio in the experiments. According to this idea, the prevalence of one substrate during C1 and C3 facilitated the fast development of the process, which improved the microorganism selection thus reducing the lag-phase time. In this case, C1 displayed low hydrogen production rates as swine manure must be hydrolyzed, limiting the availability of soluble compounds for microorganism growth and activity. In contrast, C3 could produce strong microorganism growth due to the rapid substrate availability but, at the same time, the quick depletion of soluble raw material, which could lead to the death phase of microorganisms affecting the mixed culture left inside the reactor for the next batch cycle.

Table 2.1. Kinetic parameters of the Gompertz equation

State	P (NmL)	$r_m$ (NmL/h)	$\lambda$ (h)	$R^2$
Average (n $\geq$ 19)				
C1	194.5	43.5	5.1	0.9995
C2	1058.0	119.5	6.6	0.9995
C3	1455.0	186.0	5.3	1.0000
C4	2663.0	328.8	4.0	0.9996
Minimum (n=3)				
C1	104.0	27.0	6.3	0.9974
C2	910.0	121.5	6.5	0.9997
C3	255.5	60.8	6.9	0.9996
C4	2419.0	271.3	4.9	0.9990
Maximum (n=3)				
C1	307.0	65.8	5.7	0.9978
C2	1250.0	124.3	6.2	0.9997
C3	2147.0	335.3	4.4	0.9998
C4	2989.0	437.5	3.8	0.9993

Finally, the increase in organic load (C4) with a C/N ratio of 53.4 led to a reduction in the lag time of 2.6 h from C2. This response was related to the increase in substrate availability for microorganisms rather than the organic shock load effect due to the reactor performance being maintained over time [Borja and Banks, 1995; Xing et al., 1997]. The maximum hydrogen production rate found for C4 was below the maximum rate of 718 mL/h from experiments using glucose and a mixed culture [Zheng and Yu, 2004]. However, those experiments required long lag-phase times of 7.4 h at a pH of 6.0 which is around twice the best time reached in this study. Likewise, with a pH of 5.5 the maximum rate is 449 mL/h which is similar to the maximum rate in C4 (Table 2.1). These differences show some of the advantages obtained using repetitive batch cultivation and mixed cultures which reduce the time response.

### 2.3.2.2 Pathway behavior

Hydrogen production via a dark fermentation process was linked to the production of metabolites such as VFA and solvents (Fig. 2.8). In this case, ethanol, acetic, propionic, butyric, valeric and caproic acids were measured and their profiles are shown in Figure 8. Iso-

butyric and iso-valeric were taken into account in the total concentration for butyric and valeric acids, respectively, as both these concentrations were negligible compared to the main VFA. Independently of the C/N ratio, the main degradation pathways were acetic and butyric acid fermentation. However, repetitive batch cultivation improved the increase in the butyric-type fermentation more than in the acetic-type fermentation. In these experiments, ethanol and propionic acid were related to the deviation of hydrogen production, which occurred mainly in C/N of 33.8. The concentration levels reached by other metabolites, such as valeric and caproic acids, were not high in relation to acetic and butyric acids which could be related to their degradation during dark fermentation.

Two special cases were identified during the experiments; the complete depletion of acetic acid in C2 and the changes in the hydrogen production rate in C3. In the first case, at day 19 there was an increase in butyric acid concentration which suggested an increase in hydrogen production rate. However, it showed a slight decrease which could be associated with the increase in the emerging ethanol concentration due to the reaction between acetic acid and hydrogen [Thauer, 1977]. In the second case, the changes in the metabolites showed the link with hydrogen production. However, the similar VFA concentrations to C2 suggest that the increase in hydrogen was obtained by another degradation pathway. Likewise, the reduction in metabolite concentration and hydrogen was related to the production of more reduced metabolites [Thauer, 1977; Noike et al., 2002; Van Ginkel and Logan, 2005]. In this case, the VFA concentration increased with the change in the C/N ratio, while the contribution to the soluble COD decreased from 78.9 to 60.3 % with the increase in the C/N ratio. The contribution for similar C/N ratios was between 67.1 and 69.5 % showing the stability of this ratio.

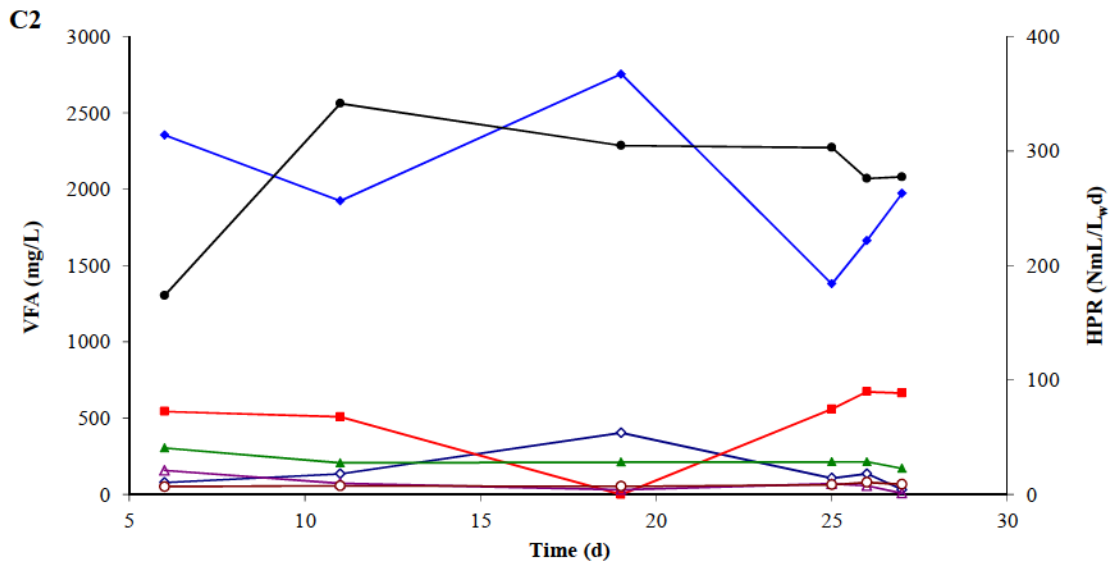
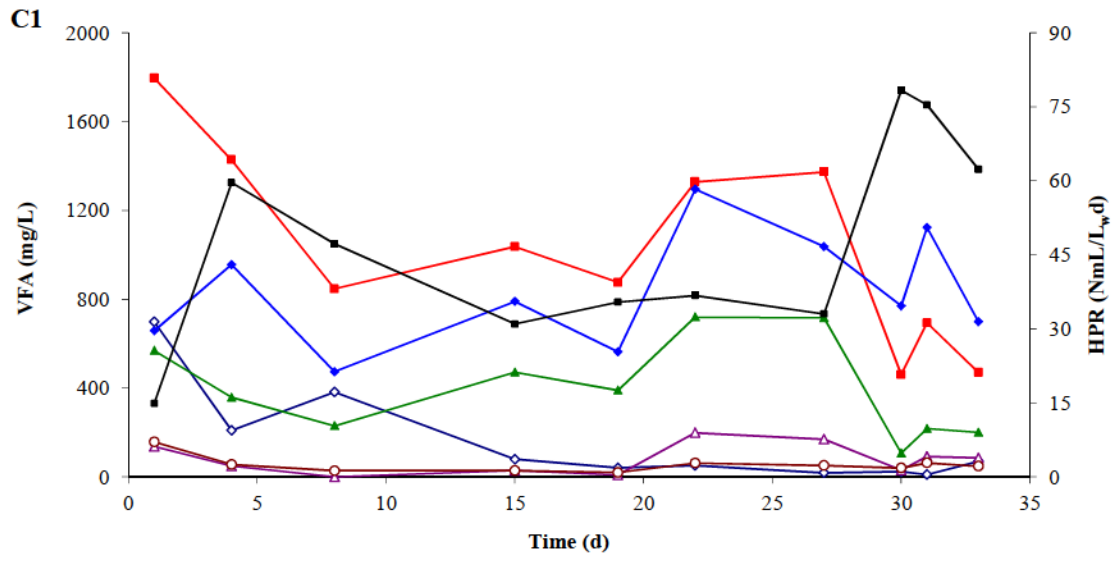

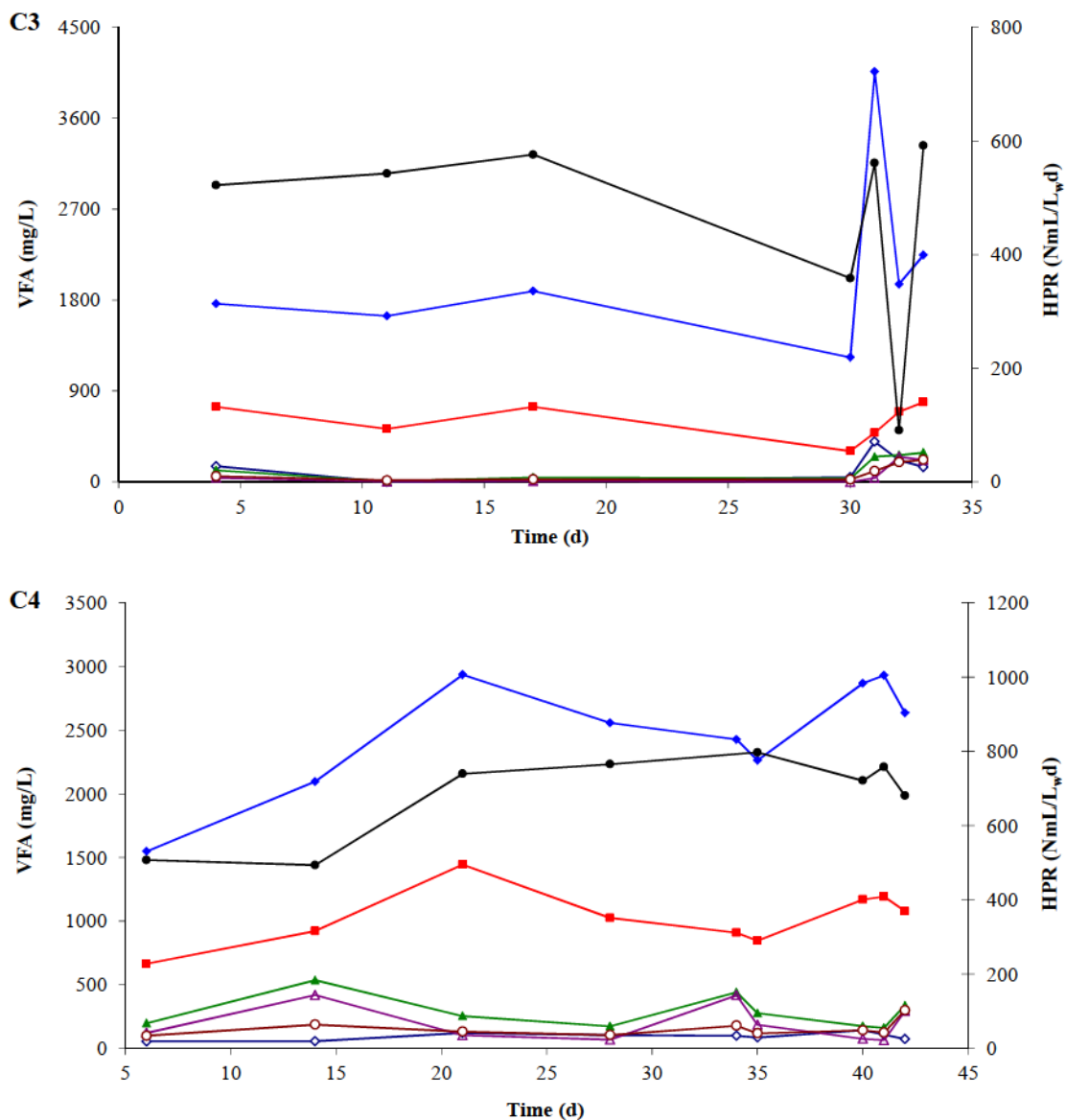

Figure 2.8. VFA behavior during the repetitive batch cultivation for C1, C2, C3 and C4 (■ acetic, ◆ butyric, ▲ propionic, ◇ ethanol, △ valeric, ○ caproic, ■ hydrogen production rate).

### 2.3.2.3 Ratios in the fermentation pathway

Hydrogen production has two main reactions related to acetic and butyric acids which produce 4 and 2 mol, respectively, while both produce 2 mol of carbon dioxide. The molar ratio  $\text{CO}_2:\text{H}_2$  and the molar ratio butyric–acetic (Bu/Ac) suggest several pathways in C1 due to excess carbon dioxide (Fig. 2.9). In this case, the hydrogen produced was related to the acetic pathway, which showed the initial control in the degradation. However, the evolution through the repetitive batch cultivation during the experiments shifted this behavior, increasing the butyric-type fermentation. There was a change in the metabolic route related to



the environmental conditions such as the ratio between the substrates, final pH, biogas production and hydrogen content in biogas (hydrogen partial pressure). In this way, the increase in the C/N ratio improved the butyric acid production which is a trend both similar and opposite to that found in other studies [Lin and Lay, 2004; Argun et al., 2008; Kim et al., 2010; Sreela-or et al., 2011]. Moreover, the Bu/Ac ratio in C2 could be explained through Eq. (30) [Kim et al., 2004] which has a ratio of 1.5 between butyric and acetic acids.

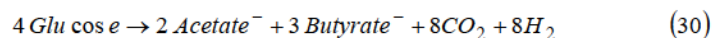

The increase in organic load from C2 to C4 produced a change in both ratios showing a shared pathway between acetic and butyric acids. Meanwhile, the slight increase in the CO<sub>2</sub>:H<sub>2</sub> ratio suggests other pathways linked to an increase in carbon dioxide. The result found in C4 showed a different ratio from C2 despite these having the same C/N ratio which indicates the influence of organic load rate. In conclusion, although the Bu/Ac ratio showed a slight rule of butyric-type fermentation, the acetic pathway was still the most significant route in hydrogen production due to the efficiency of 4 mol per reaction.

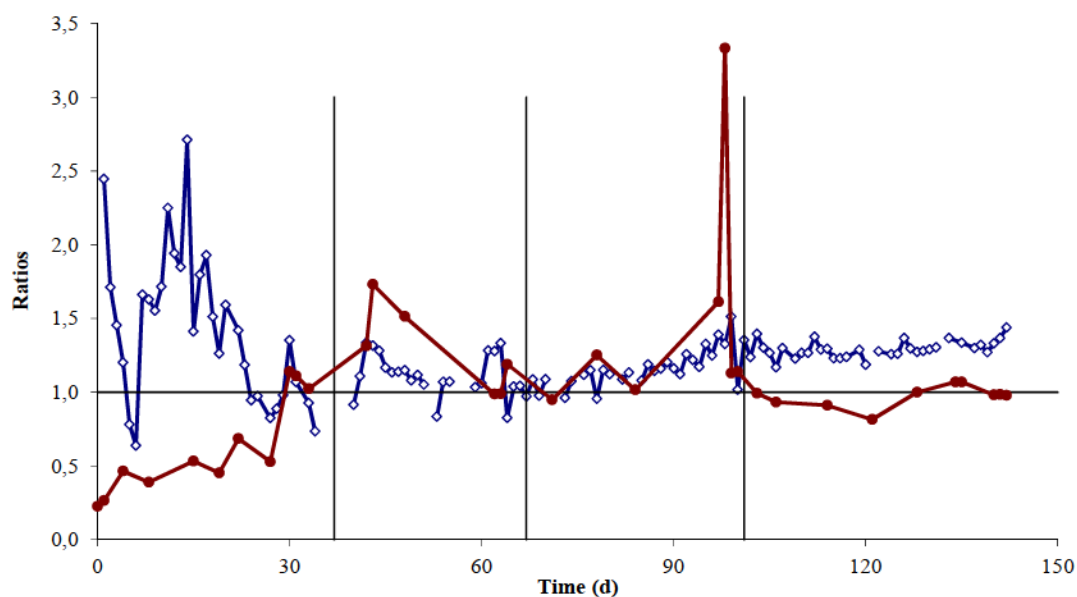

Figure 2.9. Evolution of the molar ratio CO<sub>2</sub>:H<sub>2</sub> (◇) and the ratio between Bu/Ac (●) acids over time.

The ethanol and valeric acid concentrations displayed a high variation in standard deviation during all the conditions (Table 2.2). Meanwhile, acetic and butyric acids kept a stable value in each condition which is consistent with the main metabolites produced by different species

in the genus *Clostridium sp.* [Nandi and Sengupta, 1998; Zhu, 2000]. These compounds were between 75.5 and 85.4 % of the total VFA production, which is comparable to that found by Kim et al. [2009] with acetic and butyric acids reaching 74.3 % of the total liquid-state metabolites. However, there was an acetic contribution of just 11.6 % compared to 16.4 and 24.6 % for C2 and C4. Propionic acid had the third highest concentration, decreasing with the increase in C/N ratio which caused the opposite effect on butyric and caproic acids which increased their concentrations. In this case, the VFA concentrations reported in Table 2.2 could be related to 58 - 85 % of the hydrogen produced during the experiments through the acetic and butyric pathways. As a result, other kinds of reaction could be related to hydrogen production through the degradation of the different monosaccharides present in coffee mucilage [Thauer, 1977]. These reactions could be enhanced during the increase in the organic load as they produce pyruvate which is an intermediate in the main routes to produce hydrogen [Ntaikou et al., 2010].

On the other hand, no condition led to an undissociated acid concentration above 19 mM, which could produce an inhibition of around 93 % [van Ginkel and Logan, 2005]. In these experiments, the undissociated total acids increased during the conditions reaching concentrations of 3.4, 3.9, 5.9 and 8.5 mM for C1, C2, C3 and C4, respectively. In this case, the strong inhibition in C3 was not associated with the undissociated acid concentration as the values in C4 allowed a stable process compared to C3. Nevertheless, the butyric concentration increased by just 1.3 compared to 2.2 for the acetic concentration in C4 (Table 2.2). This limitation of the butyric-type fermentation could be related to the change in the pathway produced by the increase in organic load. In addition, an inhibition related to the increase in the undissociated acid concentration of 4.6 mM from C2 to C4 could be suggested as being responsible for the reduction in hydrogen production yield.

Table 2.2. Main VFA (mg COD/L) produced during each condition of the experiments (n≥5).

<b>Condition</b>	<b>Ethanol</b>	<b>Acetic</b>	<b>Propionic</b>	<b>Butyric</b>	<b>Valeric</b>	<b>Caproic</b>
C1	42.4±26.6	891.6±375.8	406.8±247.2	897.6±260.7	88.2±73.2	45.1±16.4
C2	149.4±131.3	492.5±250.3	221.1±44.5	2009.4±489.6	67.3±50.7	62.8±10.4
C3	137.3±152.6	592.0±184.4	149.4±132.5	2173.0±986.5	86.3±115.2	99.1±91.7
C4	105.3±22.4	1096.1±199.0	260.8±103.0	2661.4±263.4	172.9±136.8	157.7±67.2

### 2.3.3 Conclusions

A C/N ratio of 53.4 between coffee mucilage and swine manure was established to produce hydrogen by dark fermentation. The use of this novel substrate with a traditional substrate like swine manure provided an average hydrogen production rate and cumulative hydrogen of 303.3 NmL H<sub>2</sub>/L<sub>w</sub>d and 1061.4 NmL H<sub>2</sub>, respectively. The hydrogen production process was stable over time with a biogas composition of 38.6 and 42.4 % for hydrogen and carbon dioxide, respectively. The methanogenesis stage was almost completely inhibited with a concentration in the biogas of 0.4 % despite the presence of a mixed culture and without any kind of pre-treatment of the complex substrates. The increase in the organic load rate improved the different parameters used to evaluate the hydrogen production without affecting the stability of the process. The average cumulative hydrogen volume, production rate and yield were 2660.7 NmL, 760.2 NmL H<sub>2</sub>/L<sub>w</sub>d and 43.0 NmL H<sub>2</sub>/g COD, respectively. In this condition, the biogas composition changed to 0.1, 50.6 and 39.0 % for methane, carbon dioxide and hydrogen, respectively, which showed the strong inhibition of the methanogenic activity. A direct relationship between coffee mucilage, biogas and cumulative hydrogen volume was established. The Gompertz model was useful to fit the experimental data obtained during each condition with correlation factors above 0.9974. The lag-phase time was around 6.6 h for the C/N ratio of 53.4 which was reduced to 4.0 h by the increase in organic load. The butyric and acetic fermentation pathways were the main routes identified during the repetitive batch cultivation, keeping a Bu/Ac ratio between 1.0 and 1.5 after C1. In addition, some of the hydrogen produced was related to the activity of other routes involving the degradation of the monosaccharides present in coffee mucilage. Likewise, a possible deviation in the route was proposed during the unstable behavior in C3 with the production of more reduced metabolites. The performance of the study using a low organic load rate of 6 kg COD/m<sup>3</sup>d achieved hydrogen production without any kind of inhibition due to concentrations of undissociated VFA. However, the increase in organic load up to 12 kg COD/m<sup>3</sup>d from C2 to C4 could suggest a kind of inhibition due to the undissociated acid concentration of 8.5 mM.

## References

- American Public Health Association (APHA), Standard methods for the examination of water and wastewater, 21st ed. Washington, DC; 2005.
- Angelidaki I, Ellegaard L, Ahring B. Applications of the anaerobic digestion process. *Adv Biochem Eng Biot* 2003;82:1-33.
- Argun H, Kargi F, Kapdan IK, Oztekin R. Biohydrogen production by dark fermentation of wheat powder solution: Effects of C/N and C/P ratio on hydrogen yield and formation rate. *Int J Hydrogen Energy* 2008;33:1813-19.
- Avallone S, Guiraud J-P, Guyot B, Olguin E, Brillouet J-M. Polysaccharide constituents of coffee-bean mucilage. *J Food Science* 2000;65:1308-11.
- Borja R, Banks CJ. Response of an anaerobic fluidized bed reactor treating ice-cream wastewater to organic, hydraulic, temperature and pH shocks. *J Biotechnol* 1995;39:251-9.
- Bradford MM. A rapid and sensitive method for the quantitation of microgram quantities of protein utilizing the principle of protein-dye binding. *Analyt Biochem* 1976;72:248-54.
- Chanakya HN, De Alwis AAP. Environmental issues and management in primary coffee processing. *Process Safety and Environ Prot Trans IChemE Pt B* 2004;82:291-300.
- Chua H, Hu W, Yu P, Cheung M. Responses of anaerobic fixed-film reactor to hydraulic shock loadings. *Bioresour Technol* 1997;61:79-83.
- Dubois M, Gilles KA, Hamilton JK, Rebers PA, Smith F. Colorimetric method for determination of sugars and related substances. *Anal Chem* 1956;28:350-6
- Jo JH, Jeon CO, Lee DS, JM Park. Process stability and microbial community structure in anaerobic hydrogen-producing microflora from food waste containing kimchi. *J Biotechnol* 2007;131:300-308.
- Kalyuzhnyi SV, Sklyar VI, Davlyatshina MA, Parshina SN, Simankova MV, Kostrikina NA, Nozhevnikova AN. Organic removal and microbiological features of UASB-reactor under various organic loading rates. *Bioresour Technol* 1996;55:47-54.
- Kapdan IK, Kargi F. Bio-hydrogen production from waste materials. *Enzyme Microb Technol* 2006;38:569-82.
- Khanal SK, Chen WH, Li L, Sung S. Biological hydrogen production: Effects of pH and intermediate products. *Int J Hydrogen Energy* 2004;29:1123-31.
- Kim D-H, Kim S-H, Kim K-Y, Shin H-S. Experience of a pilot-scale hydrogen-producing anaerobic sequencing batch reactor (ASBR) treating food waste. *Int J Hydrogen Energy* 2010;35:1590-4.

- Kim D-H, Kim S-H, Shin H-S. Hydrogen fermentation of food waste without inoculum addition. *Enzyme and Microbial Technol* 2009;45:181–7.
- Kim ICH, Hwang MH, Jang NJ, Hyun SH, Lee ST. Effect of low pH on the activity of hydrogen utilizing methanogen in bio-hydrogen process. *Int J Hydrogen Energy* 2004;29:1133-40.
- Lin CY, Lay CH. Carbon/nitrogen-ratio effect on fermentative hydrogen production by mixed microflora. *Int J Hydrogen Energy* 2004;29:41-5.
- Leite J, Fernandes B, Pozzi E, Barboza M, Zaiat M. Application of an anaerobic packed-bed bioreactor for the production of hydrogen and organic acids. *Int J Hydrogen Energy* 2008;33:579-86.
- Levin D, Pitt L, Love M. Biohydrogen production: prospects and limitations to practical application. *Int J Hydrogen Energy* 2004;29:173-85.
- Massé D, Drost R. Comprehensive model of anaerobic digestion of swine manure slurry in a sequencing batch reactor. *Wat. Res* 2000;34:3087-106.
- Mu Y, Zheng XJ, Yu HQ, Zhu RF. Biological hydrogen production by anaerobic sludge at various temperatures. *Int J Hydrogen Energy* 2006;31:780-5.
- Nandi R, Sengupta S. Microbial production of hydrogen: An Overview. *Critical Reviews in Microbiol* 1998;24:61-84.
- Noike T, Takabatake H, Mizuno O, Ohba M. Inhibition of hydrogen fermentation of organic wastes by lactic acid bacteria. *Int J Hydrogen Energy* 2002;27:1367-71.
- Ntaikou I, Antonopoulou G, Lyberatos G. Biohydrogen production from biomass and wastes via dark fermentation: a review. *Waste Biomass Valor* 2010;1:21–39.
- O-Thong S, Prasertsan P, Intrasungkha N, Dhamwichukorn S, Birkeland N-K. Optimization of simultaneous thermophilic fermentative hydrogen production and COD reduction from palm oil mill effluent by Thermoanaerobacterium-rich sludge. *Int J Hydrogen Energy* 2008;33:1221-31.
- Ozmihci S, Kargi F, Cakir A. Thermophilic dark fermentation of acid hydrolyzed waste ground wheat for hydrogen gas production. *Int J Hydrogen Energy* 2011;36:2111-7.
- Sagnak R, Kapdan I, Kargi F. Dark fermentation of acid hydrolyzed ground wheat starch for bio-hydrogen production by periodic feeding and effluent removal. *Int J Hydrogen Energy* 2010;35:9630-6.
- Sreela-or C, Plangklang P, Imai T, Reungsang A. Co-digestion of food waste and sludge for hydrogen production by anaerobic mixed cultures: Statistical key factors optimization. *Int J Hydrogen Energy* 2011;36:14227-37.

- Tanisho S, Kuromoto M, Kadokura N. Effect of CO<sub>2</sub> removal on hydrogen production by fermentation. *Int J Hydrogen Energy* 1998;23:559-63.
- Thauer RK, Jungermann K, Decker K. Energy conservation in chemotrophic anaerobic bacteria. *Bacteriol Rev* 1977;41:100–80.
- Valdez-Vazquez I, Ríos-Leal E, Esparza-García F, Cecchi F, Poggi-Varaldo HM. Semi-continuous solid substrate anaerobic reactors for H<sub>2</sub> production from organic waste: Mesophilic versus thermophilic regime. *Int J Hydrogen Energy* 2005;30:1383-91.
- Van Ginkel S, Sung S, Lay J-J. Biohydrogen production as a function of pH and substrate concentration. *Environ Sci Technol* 2001;35:4726-30.
- Van Ginkel S, Logan BE. Inhibition of biohydrogen production by undissociated acetic and butyric acids. *Environ Sci Technol* 2005;39:9351-56.
- Voolapalli RK, Stuckey DC. Hydrogen production in anaerobic reactors during shock loads - Influence of formate production and H<sub>2</sub> kinetics. *Water Res* 2001;35:1831-41.
- Xing J, Criddle C, Hickey R. Effects of a long-term periodic substrate perturbation on an anaerobic community. *Water Res* 1997;31:2195-204.
- Zheng XJ, Yu HQ. Roles of pH in biologic production of hydrogen and volatile fatty acids from glucose by enriched anaerobic cultures. *Appl Biochem Biotechnol* 2004;112:79-90.
- Zhu J. A review of microbiology in swine manure odor control. *Agric Ecosyst Environ* 2000 ;78:93–106.
- Zhu J, Wu X, Miller C, Yu F, Chen P, Ruan R. Biohydrogen production through fermentation using liquid swine manure as substrate. *J Environ Sci Health Part B* 2007;42:393–401.

# CHAPTER 3 Mechanisms and microorganisms involved in hydrogen production over retention time in ABR – Opening the black box for co-digestion of two complex substrates

## Abstract

A hydrogen production process was evaluated through the internal trends over retention time in an Anaerobic Batch Reactor (ABR). Several parameters such as hydrogen and carbon dioxide partial pressure, oxidation reduction potential, pH, metabolites and microorganisms were evaluated. This study was based on the experiments developed in Chapter 2 related to the mixtures between coffee mucilage and swine manure. In C2 and C4, two trends were identified showing similar cumulative hydrogen production at the end of retention time. The tendencies were classified as *short* and *long* related to the differences in hydrogen production rate and lag-phase time. *Short trend* had short lag-phase time and high hydrogen production rate. Metabolic pathway was related to acetic and butyric acids production with the deviation to propionic acid fermentation in both trends. The *Thermoanaerobium thermosaccharolyticum* was the dominating microorganism in *short* tendency. *Long trend* suggested a substrate shared between *T. thermosaccharolyticum* and *Clostridium sp.* *Bacillus sp.* microorganisms at the beginning of the *short trend* were linked to *T. thermosaccharolyticum* domination. Hydrogen partial pressure conducted the both conditions through the use of the H<sup>+</sup>/H<sub>2</sub> system and the use of ferredoxin as electron carrier.

### 3.1 Introduction

Hydrogen production is normally evaluated through overall response instead of evolution over retention time. Differences between internal tendencies could be responsible for slight changes of final cumulative hydrogen production. Nevertheless, little attention has been paid to follow internal trends involved in hydrogen production. Some models such as the modified Gompertz equation describe the cumulative hydrogen production over retention time. Analyses are limited to this kind of models supported by the use of specific microorganisms and simple substrates. In this case, the research about internal trends could be not significant as opposed to the use of mixed culture and complex substrates. As can be seen in Table 3.1, previous studies use either pre-treatment or nutrient supplement to enhance the activity of hydrogen producers. These methods are mandatory for the use of pure cultures and simple substrates.

Table 3.1. Microorganisms selection for hydrogen production process.

Inoculum source	Substrate	Reference
Operating dairy manure anaerobic digester <sup>a</sup>	Liquid swine manure <sup>b</sup>	Zhu et al, 2009
Anaerobic microflora within the slurry	The feces and urine	Yokoyama et al, 2007
Dairy manure <sup>a</sup>	Dairy manure <sup>a</sup>	Xing et al., 2010
Two-stage mesophilic anaerobic digester	CPW <sup>b</sup>	Yang et al., 2007
Bed mud of domestic wastewater discharge channel <sup>a</sup>	Molasses	Ren et al., 2007
The microflora originated from a full-scale landfill <sup>b</sup>	Waste mixture <sup>c</sup>	Karlsson et al., 2008
Palm oil mill wastewater treatment plant	Palm oil mill effluent <sup>b</sup>	O-Thong et al., 2008

<sup>a</sup> inoculum or feedstock pre-treated. <sup>b</sup> supplemented for microorganisms growth. <sup>c</sup> Slaughterhouse waste (85%), other food industry residues (4%), hydrolysing yeast (6%) and manure (5%). CPW: Cheese processing wastewater.

Mixed culture provides advantages like the presence of several microorganisms which can work together during the degradation of complex substrates. The use of two or more pure cultures improves degradation process during dark fermentation process [Chan et al., 2008]. In this case, hydrogen response could show a stable production related to evolution over time with a slight deviation influenced by the different microorganisms. The use of complex substrates without pre-treatment shows increasing standard deviation for hydrogen production, which can be associated with several tendencies in the process. Substrates rich in carbohydrates and without microorganisms reduce the problem, even if the inocula from sludge, manure or wastewater treatment plants which have been pre-treated. Meanwhile, substrates as manures which contain various microorganisms [Snell-Castro et al., 2005] could result in a negative impact because constant inlet of new bacteria. The acclimatization of



microorganisms is related to the overall hydrogen production taking into account the cumulative production dismissing the evolution over retention time.

Metabolic pathway should be looked closely through sensible parameters as partial pressure of hydrogen and carbon dioxide, pH and oxidation reduction potential (ORP). ORP could be able to detect changes of the mixed culture trends over retention time [Schink, 1997]. These parameters could select, change or indicate the metabolic pathway related to microorganisms response during modification of environmental conditions. In general, these changes are detected by monitoring of soluble metabolites which could suggest pathway deviations. This is associated with formation of more reduced compounds as alcohols, lactate, succinate, etc. Nevertheless, metabolites as acetic acid can be produced by homoacetogenic bacteria during high hydrogen partial pressure consuming hydrogen instead of produce it.

The behavior using mixed culture has not been widely explained for hydrogen production by dark fermentation. In order to this, some additional information and analyzes were made during the research experiments developed in Chapter 2. The aim of this research was: to evaluate the behavior of hydrogen production over retention time in order to identify trends presented in the experiments and to establish the tendency of microbial population followed by qPCR and some identification analyzes. In addition, the influence of some parameters as hydrogen and carbon dioxide partial pressure, ORP and pH was evaluated to understand the evolution of hydrogen production over retention time and the effects on the system.

## 3.2 Methods

### 3.2.1 Methodology - Inoculum and substrate

Hydrogen production from coffee mucilage and swine manure through anaerobic digestion was evaluated in Chapter 2. Fourth conditions were established evaluating substrates ratio and increasing organic load. Inoculum was obtained in a previous experimental phase through variation of operating parameters as temperature, retention time and organic load in a classical anaerobic reactor. Feedstock was composed of a fresh mixture between swine manure and coffee mucilage wastes. Each experiment lasted at least 30 days with monitoring of overall response. Additional parameters as hydrogen production, biogas composition, metabolites composition, microbial identification and quantification, pH and oxidation reduction potential

were followed over retention time. Both substrate preparation and inoculum selection are described in Chapter 2 and Annex I.

### 3.2.2 Species

*Bacillus*, *Clostridium* and *Thermoanaerobacterium Thermosaccharolyticum* were selected as species to be followed associated with some aspects as: *Bacillus* is a representative species related to mechanisms of macromolecule breakdown, oxygen consumption to create an anaerobic environment. This species was previously identified from samples taken during some preliminary experiments. *Clostridium* genus is present in swine manure and some species are closely linked to hydrogen production. Finally, *Thermoanaerobacterium* is a relative new classification from *Clostridium* genus. This categorization was selected due to the thermophilic condition used during the research. *Thermoanaerobacterium Thermosaccharolyticum* is associated with hydrogen production.

### 3.2.3 Extraction and quantification of DNA

Total DNA was extracted from 2 mL of lyophilized sample previously preserved at -80 °C. Extraction was carried out using Nuclisens Minimag® (Biomérieux®). The sample was mixed in 2 mL of lysis buffer, after that, this was put in a vortex and incubated 10 min at room temperature. DNA binding on silica beads (50 µL) was washed twice with 400 µL of wash buffer 1, washed twice with 500 µL of wash buffer 2 and washed with 500 µL of wash buffer 3. DNA was separated from the beads using 50 µL of elution buffer and then placed for 5 min at 60 °C. The eluate contained the DNA recovered and preserved at -80 °C. Microseq® was used for a preliminary identification of isolated microorganisms.

DNA used as reference for microorganisms quantification were *Bacillus subtilis subsp subtilis* (Institut Pasteur: CIP 52.65) and *Thermoanaerobacterium thermosaccharolyticum* (DSM 571) for *Clostridium* and *Thermoanaerobacterium* genus. DNA extracted from pure cultures and samples was quantified using Qubit® 2.0 (Invitrogen®). The Qubit reagent solution was then diluted (1/200) with the Qubit buffer. This was added 10 µL of both standards for equipment calibration and 5 µL of the sample to be tested. The tubes were put in a vortex and incubated for 2 min before being read by Qubit fluorometer® 2.0. Sample concentration was normalized with the volume used (5 µL). A genomic unit of pure culture was calculated from DNA concentration. The number of genomic unit (GU/mL) of each sample was calculated using Eq.

31. Genome size for *B. subtilis* was 4.2Mb and 2.8Mb for *T. thermosaccharolyticum* (N: Avogadro constant).

$$Unit\ genome = \frac{[DNA]*N}{genome\ size*mass\ molar\ of\ nucleotide*2} \quad (31)$$

### 3.2.4 Primers and qPCR

Primer pair from Xiao et al. [2011], BacF: 5'-GGCTCACCAAGGCAACGAT-3' and BacR: 5'-GGCTGCTGGCAGTAGTTAG-3' (Eurogentec®), were used for *Bacillus* quantification by amplifying a 263 bp region of the gene encoding the 16s RNA of the genus *Bacillus* (Table 3.2). The primer pair used for *Clostridium* quantification was obtained from Wang et al. [Wang et al., 2008]: CloF 5'-AGCGTTGTCCGGATTTACTG-3' and CloR 5'-TTCGCCACTGGTATTCTTCC-3'. The amplification creates a fragment of 183 bp that is specific to the genus *Clostridium*. A third primer pair was used to quantify *T. thermosaccharolyticum* performed using primer-BLAST (NCBI), TherF: CAATAAGTATCCCGCCTGGG and TherR: CCTCTTACGAGGCACTCAAG which amplifies a fragment of 171 bp.

Table 3.2. Primers used to the quantification of *Bacillus* and *Clostridium* genus and *T. thermosaccharolyticum*

Primer	Sequence (5'-3')	Temp. (°C)	Length (pb)	Specificity	Reference
BacF	GGCTCACCAAGGCAACGAT	57	263	<i>Bacillus</i> sp. 16S rRNA	[Xiao et al., 2011]
BacR	GGCTGCTGGCAGTAGTTAG			<i>Bacillus</i> sp. 16S rRNA	
CloF	AGCGTTGTCCGGATTTACTG	60	183	<i>Clostridium</i> sp. 16S rRNA	[Wang et al., 2008]
CloR	TTCGCCACTGGTATTCTTCC			<i>Clostridium</i> sp. 16S rRNA	
TherF	CAATAAGTATCCCGCCTGGG	62	171	<i>T. thermosaccharolyticum</i> 16s rRNA	This study
TherR	CCTCTTACGAGGCACTCAAG			<i>T. thermosaccharolyticum</i> 16s rRNA	

Quantitative PCR had taken place in the Rotor-Gene Q (Qiagen®) using Rotor-Gene SYBR Green PCR kit. Final volume was 25 µL containing 12.5 µL of Rotor-Gene SYBR Green PCR Master Mix, 0.5 µL of each primer (10 µM), 5 µL of DNA, 6.5 µL of water. Amplification was carried out according to the following profile: 95 °C for 4 min, 45 cycles

of 30 s at 95 °C and 30 s at 57 °C. Analysis of melting curve was performed using 42 cycles of 30 s from 57 to 99 °C.

### 3.2.5 Experimental design

The hydrogen production from co-digestion experiments were carried out in an Anaerobic Batch Reactor (ABR) with free biogas evolution. The reactor had a working volume of 5.5 L and a total volume of 7.2 L. pH evolved uncontrols in a range of 5.15-5.5 and the temperature was 55 °C. Biogas production was measured through MilliGasCounter MGC (RITTER®) and collected in Tedlar® bags of 5 L (Chapter 2). ORP, pH, biogas volume and hydrogen concentration were monitored online. Meanwhile, volatile fatty acids, carbon dioxide and methane concentrations were recorded for some points over retention time.

### 3.2.6 Analytical methods

Hydrogen in biogas was measured online using a HY-OPTIMA 700 H2Scan® with a quantification range between 0.5 to 100%. Methane, carbon dioxide and oxygen were measured through an Infra-red Gas Analyzer (Geotechnical Instruments® - MK IIC) with a maximum deviation of ±0.3 % for methane and ±3 % for carbon dioxide. Volatile fatty acids and ethanol were determined by gas chromatography (Hewlett Packard® 6890 series G1530A) equipped with a flame ionization detector (FID). The operating temperatures of the injection port, column oven and detector were 250, 250 and 300 °C, respectively. Argon was used as the carrier gas with a flow rate of 0.9 mL/min. The cumulative hydrogen production achieved as a function of retention time was fitted with the modified Gompertz equation [Mu et al., 2006].

$$H = P \exp\left(-\exp\left[\frac{r_m e}{P}(\lambda - t) + 1\right]\right) \quad (32)$$

where H is cumulative hydrogen production (mL), P is the hydrogen production potential (mL),  $r_m$  is the maximum hydrogen production rate (mL/h),  $\lambda$  is the lag-phase time (h) and e equals 2.718. Partial pressure for hydrogen and carbon dioxide was calculated using the data of volume measured out of the reactor. Thus, it was divided by the reactor headspace (1.7 L) and multiplied by atmospheric pressure of Bogotá (0.74 atm). Oxidation reduction potential and pH were monitored online using a Thermo Scientific Orion® equipment.

## 3.3 Results and discussion

### 3.3.1 Trends in hydrogen production

#### 3.3.1.1 Evolution of hydrogen production over retention time

The hydrogen production rate was followed over retention time of each experimental condition (Fig. 3.1). Two trends were identified associated with the short and long time required to begin and complete similar cumulative hydrogen. Thus, the expression *short trend* was associated with a fast developed of the process. Meanwhile, *long trend* was associated with the long time required to achieve the cumulative hydrogen. Nevertheless, trends in C1 and C3 were associated with high and low hydrogen production more than a similar production. In C1, both tendencies began almost at the same time. *Long trend* showed stabilization around 6 h suggesting a lag-phase time divided in two parts. In contrast, *short trend* began at 4.5 h with a strong increase in hydrogen production rate. Hydrogen production rates in C3 showed fluctuations through repetitive batch cultivation from 137.7 to 379.4 mL/h. This behavior increased during the last 10 experimental days avoiding stable hydrogen production. In both cases, the unstable hydrogen production was related to limitations of nitrogen availability for C3 and the hardly hydrolysable carbon source for C1 (Chapter 2).

The change between the two tendencies in C2 and C4 had a random distribution as can be seen in Table 3.3. *Short trend* was dominant at the end of C2, meanwhile in C4 there was a successive change between both trends in the last 6 days. These changes in the hydrogen production behaviors could be related to the heterogeneity of the both substrates changing the initial composition. This event could produce a change in the internal microorganisms distribution improving the activity of some species over others.

In C4, *short* behavior showed the highest hydrogen production rate with a variation of 111 mL/h (on top of production) between 4.25 and 7.75 h (Fig. 3.1). Hydrogen production rate showed high difference between both trends because in *short trend* was 472.6 mL/h at 4.25 h against 79.5 mL/h in *long trend*. In contrast, hydrogen production rates during C2 showed higher stability, but with differences over time. *Long trend* had a duration of around 17.8 h which was 2.3 h more than the response in *short trend*. The differences in both conditions were related to hydrogen evolution over time which showed that *short trend* was the better mechanism, enhancing time and rates of hydrogen production. Finally, C1 and C3 were

discarded for the next analysis due to both tendencies had a different cumulative hydrogen production.

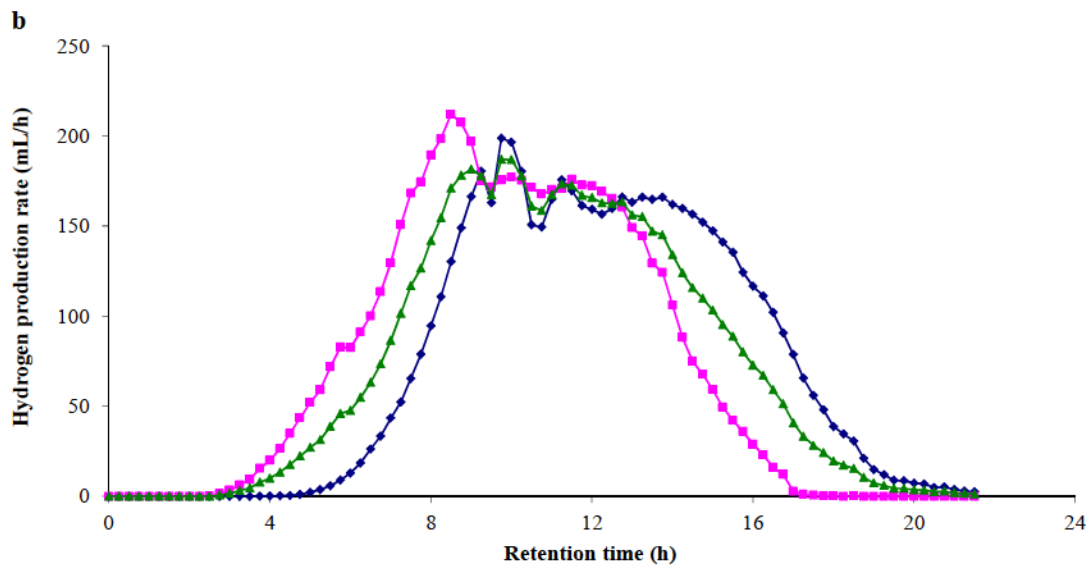
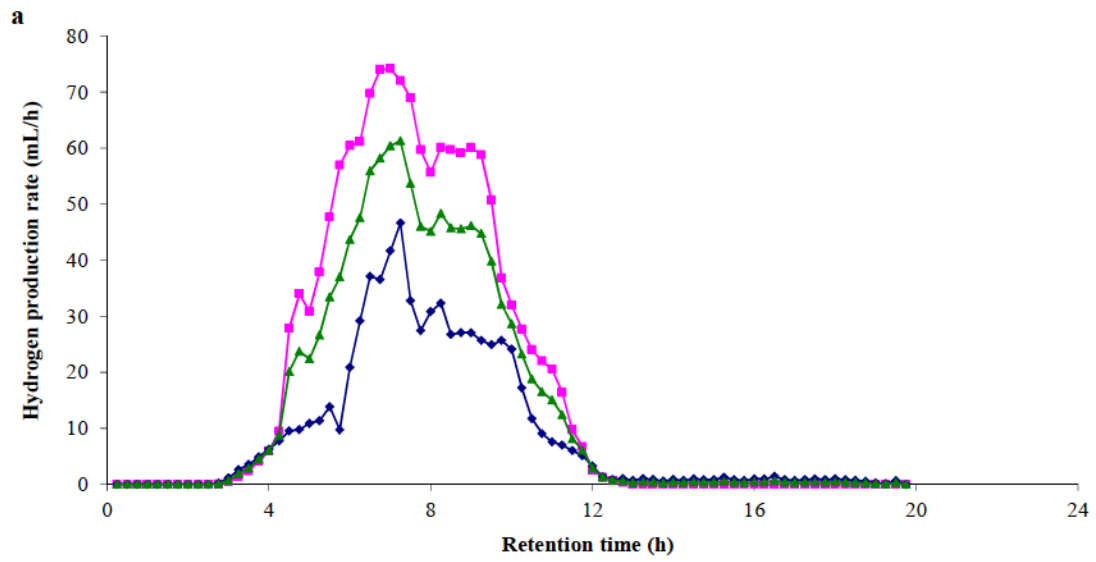

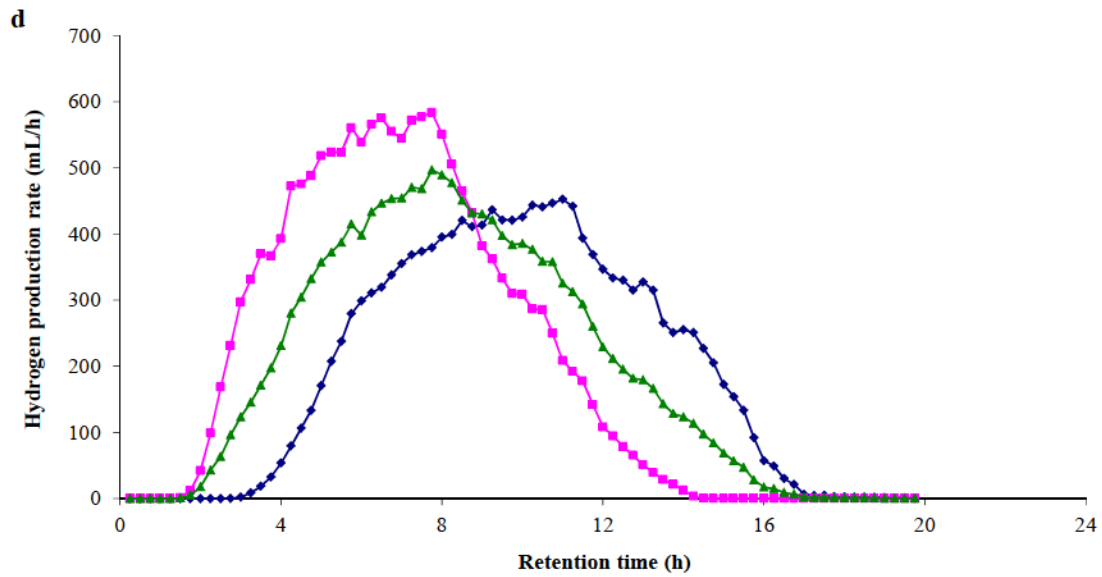
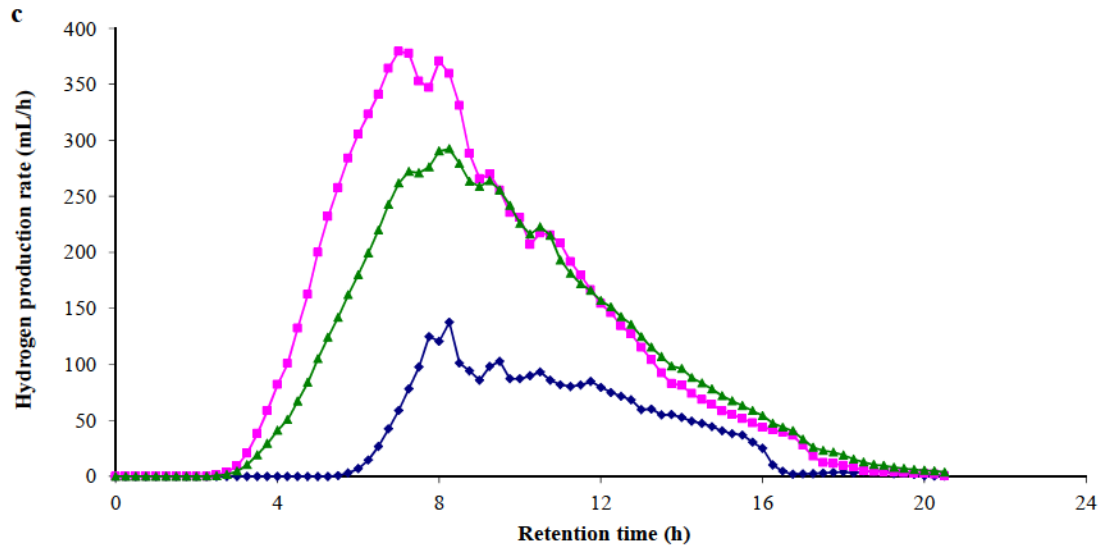

Figure 3.1. Hydrogen production rates during retention time: *short trend* (■), *long trend* (◆) and average of all results (▲) production curves for each condition: C1 (a); C2 (b); C3 (c); C4 (d).

Table 3.3. Change in the tendencies of conditions 2 and 4.

$t_d$	8	9	10	11	12	13	14	15	16	17	18	19	20	21	22	23	24	25	26	27	28	29	30
C2						■																	
C4																							

Short response    
  Long response    
  $t_d$  - Operational days counted after the stabilization time in both reactors

### 3.3.1.2 Gompertz model

The experimental data for each tendency were fitted to Gompertz model obtaining the kinetics parameters shown in Table 3.4. As a result, the two trends at each condition had correlation factors above 0.999 which were similar to the overall process (Chapter 2). The equivalent responses of hydrogen production potential diminish the importance about both tendencies. Nevertheless, the both trends could be important in terms of hydrogen production rate and lag-phase time for optimization. The short lag-phase could be useful to reduce the retention time. Meanwhile, the high hydrogen production rate could be able to increase hydrogen production over time. *Short trend* showed a reduction of 1.9 and 2.2 h of lag-phase time against *long trend* for C2 and C4, respectively. The maximum hydrogen production rate was 591.0 mL/h for *short trend* in C4. This showed that the 90 % of cumulative hydrogen could be reached 3.5 h before than *long trend*.

Table 3.4. Kinetics parameters through the Gompertz equation ( $n \geq 9$ )

Condition - trend	P (mL)	$r_m$ (mL/h)	$\lambda$ (h)	$R^2$
C2-short	1557 (1070) <sup>a</sup>	205.3 (141.1)	6.1	0.9991
C2-long	1577 (1084)	191.3 (131.5)	8.0	0.9994
C4-short	4065 (2795)	591.0 (406.3)	3.2	0.9992
C4-long	3760 (2585)	445.3 (306.1)	5.4	0.9989

<sup>a</sup>Normalized values

### 3.3.1.3 Biogas composition performance

The biogas composition over retention time showed a strong presence of hydrogen and carbon dioxide as the main compounds in the experiments (Fig. 3.2). The both compounds were stable after the beginning of the production process for both conditions. The carbon dioxide began as the main compound in biogas followed by the hydrogen production and back at the end of the experiments. This initial behavior was related to the presence of negligible methane concentrations which were produced simultaneously with carbon dioxide in condition 2; meanwhile this reaction was displaced by hydrogen production in condition 4. However, the average cumulative methane was similar for both trends at each condition with 18.5 and 15.6 mL for C2 and C4 respectively. In this case, the presence of methane suggests that the mixed culture preserve the different consortiums of anaerobic digestion, but at the same time the experimental conditions have the ability to inhibit it during the hydrogen production process.



Oxygen concentrations were presented until maximum 10 h in the biogas for C4 and until the end with concentrations below 1 % for C2. It was related to the initial oxygen concentration in the headspace because the atmosphere in the reactor was not changed by the sparging of inert gases as nitrogen. All these compounds were mainly associated with the gas phase due the solubility constant for each gas was very low at the temperature of 55 °C. Thus, the oxygen, carbon dioxide and hydrogen had solubility constants around 3.181E-2, 3.2E-4 and 1.3E-5, respectively. It was considered as a favorable condition to improve the transfer to the gas phase. Furthermore, the oxygen remaining in the reactor was calculated in ranges of 65 – 80 % and 79 – 94 % for conditions 2 and 4 respectively. These concentrations could be depleted by facultative microorganisms as *Bacillus sp.* which is ideal to create an anaerobic atmosphere. In addition, the activity of strictly anaerobes microorganisms involved in methane and hydrogen production confirmed the lack of oxygen in liquid phase.

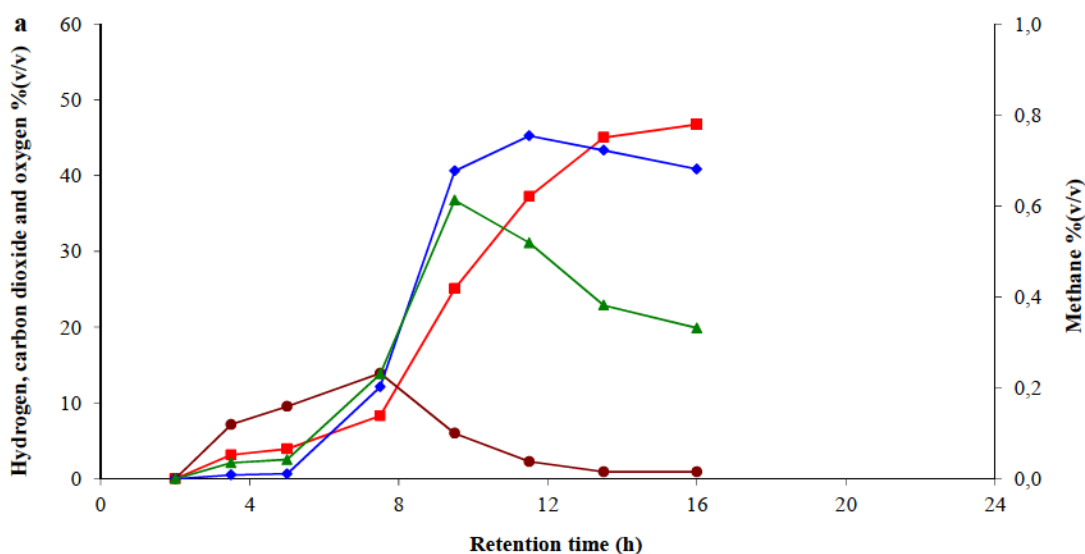

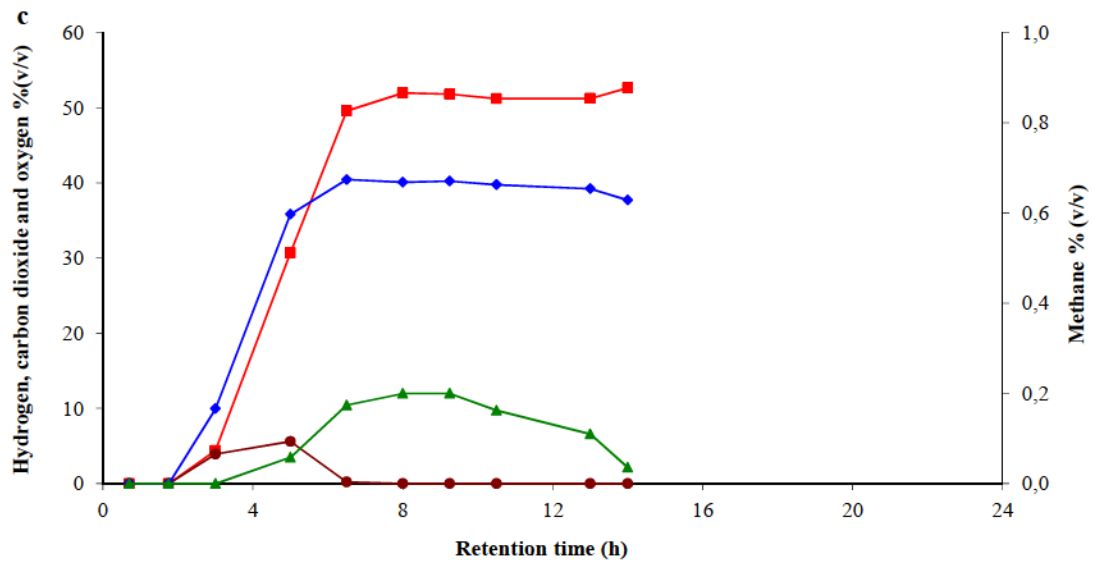
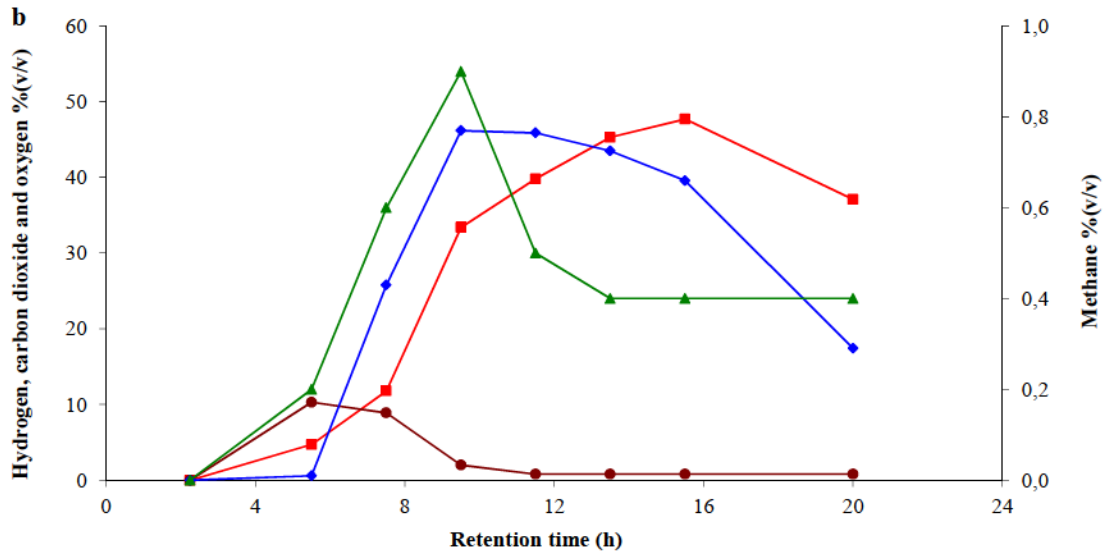

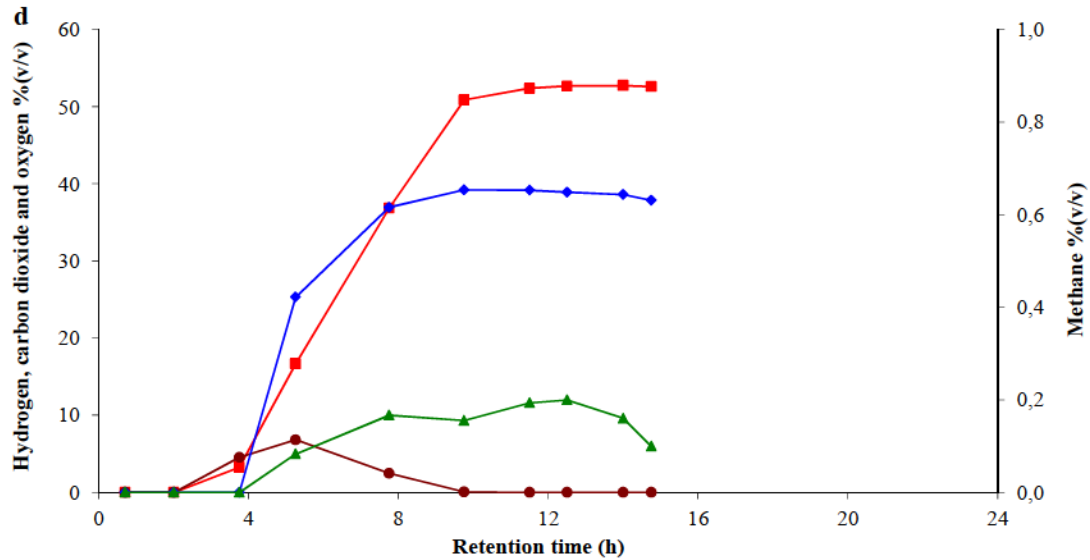

Figure 3.2. Biogas composition through the both tendencies in condition 2 (a - short, b - long) and 4 (c - short, d - long). Hydrogen (◆), carbon dioxide (■), methane (▲) and oxygen (●).

In addition, all these compounds were mainly associated with the gas phase in each condition due to at 55 °C the solubility constant for each gas was very low. It was considered as a limited factor for these compounds in the liquid phase, but as a favorable condition to improve the transfer to the gas phase. Moreover, the low oxygen remained in the liquid phase could be depleted by facultative microorganisms as *Bacillus sp.* which are ideal to create an anaerobic atmosphere. The methane content was negligible during the experiments with concentrations below 0.9 % for both conditions showing different behavior in terms of the conditions more than trends. The methane were in average 18.5 and 15.6 mL for both trends in condition 2 and 4 respectively. The amounts of this compound in biogas not influenced the hydrogen production, but it suggested that the mixed culture had the different consortiums required by anaerobic digestion which were inhibited during the hydrogen production process.

### 3.3.2 Metabolites and microorganisms behavior

#### 3.3.2.1 Metabolites production – the effect of partial pressure

The main metabolites produced during the experiments were butyric and acetic acids which suggested these were the dominating metabolic pathways (Fig. 3.3). The slight differences in C2 between the two trends were according to the similar values of cumulative hydrogen production. In contrast, the metabolites concentrations were different between the both trends in C4. Ethanol and propionic acid were detected in the experiments which suggested a

deviation of the main pathways. In *long trend* the propionic acid increased their concentration parallel with the hydrogen production. In contrast, the concentration of this compound decreased over retention time for the *short trend*. This was associated with the delay in the hydrogen production for the *long trend* due to the microorganisms activity to develop the propionic acid pathway.

On the other hand, the low ethanol concentration was associated with the increase of hydrogen production [Collet et al., 2004]. Thus, the hydrogen remaining in the mixed liquor at the end of retention time was linked to the increase of this metabolite. Furthermore, the increase of acetic and butyric acids at the end of the experiments was associated with the use of electrons to regenerate the NADH which was possible due to the stop of hydrogen production. The lactate production was discarded or assumed weak due to it could be limited through high dilution rate above 0.05 h<sup>-1</sup> which avoids the change in the pathway [Collet et al., 2005]. In this case, the *short trend* could be considered as the better performance in order to avoid this metabolic shift.

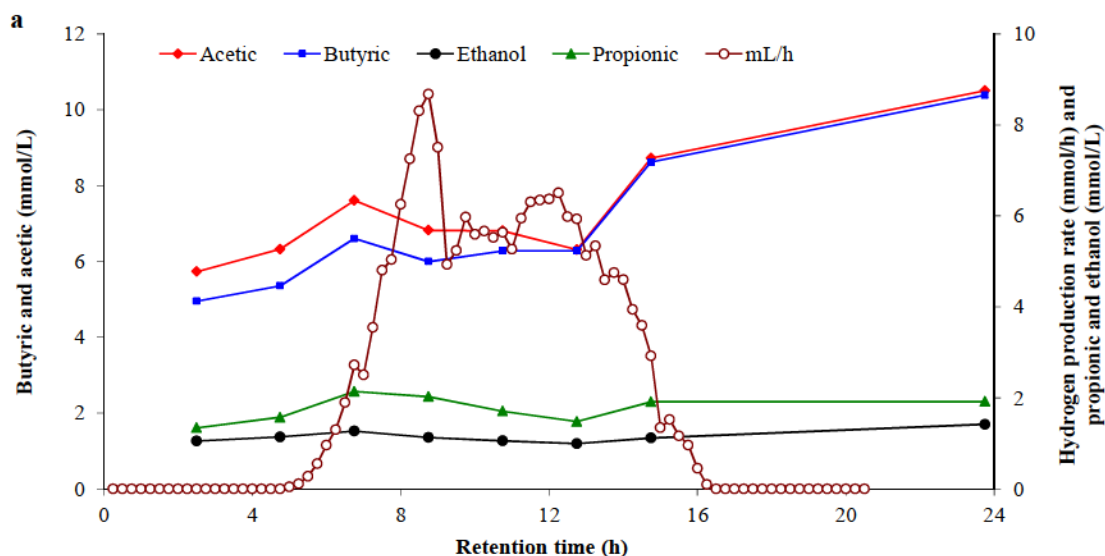

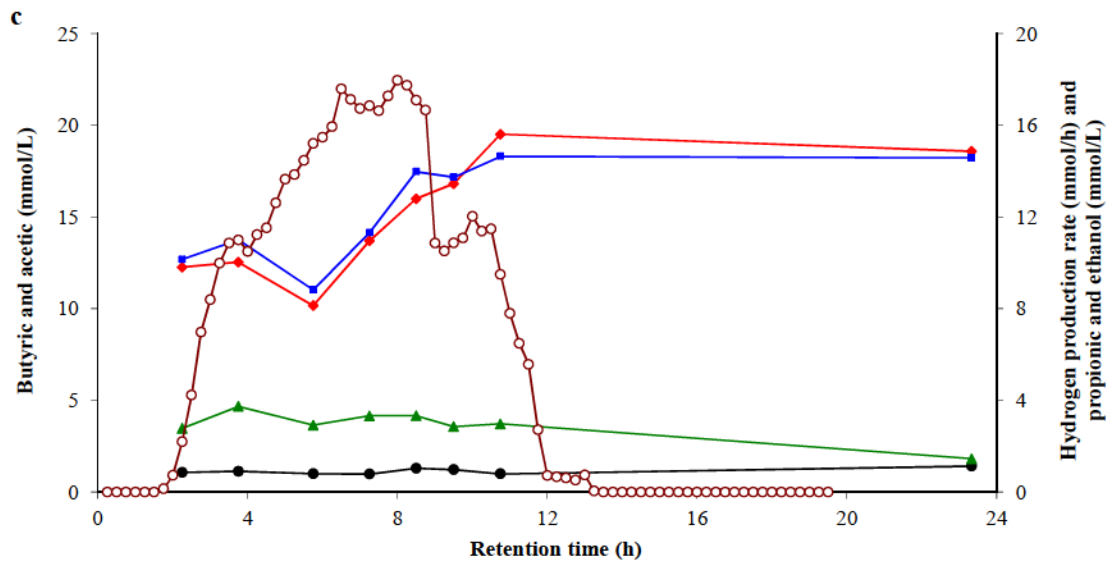
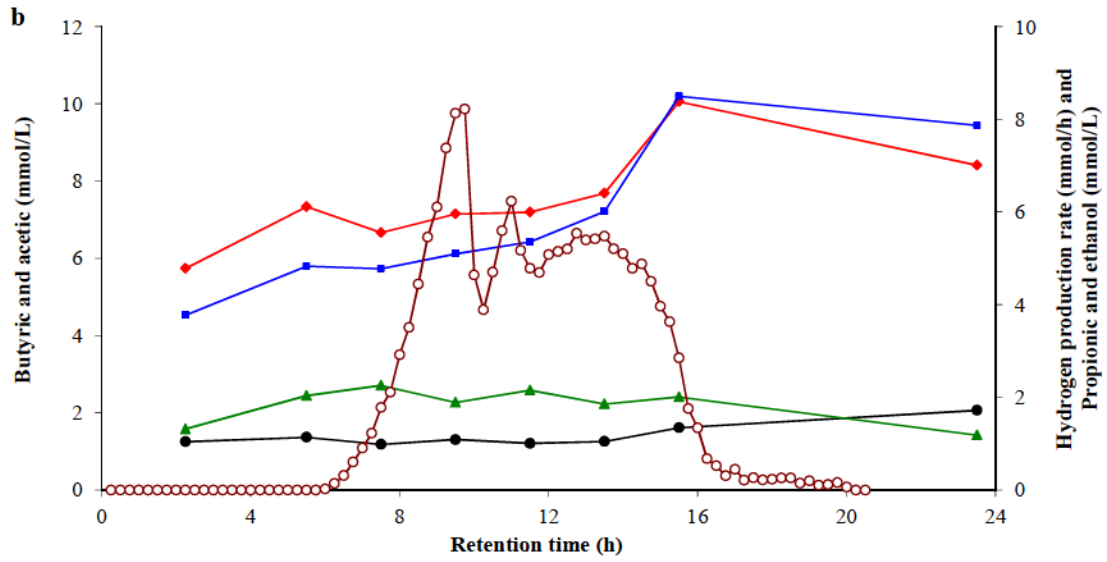

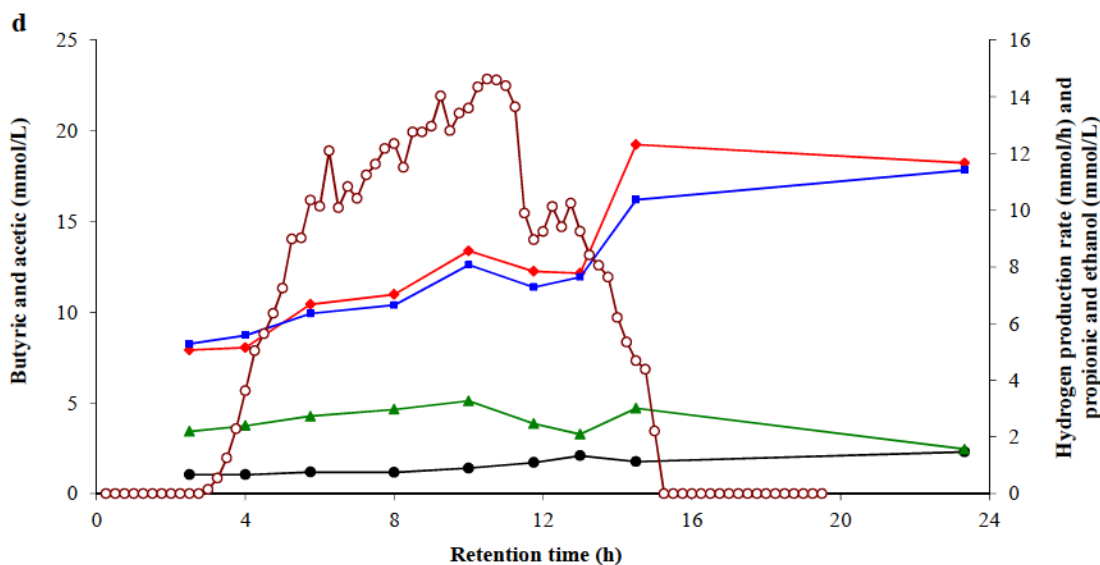

Figure 3.3. Metabolites distribution over retention time for both trends in condition 2 (a – short; b - long) and 4 (c –short; d - long).

The ratio between butyric and acetic acids for both *short trends* showed higher values than *long trend* in C2 and C4 over retention time (Fig. 3.4). The average ratios were in a range of 0.9 and 1.0 for C2 and C4 respectively. Both results were higher than the values found by Prasertsan et al., [2009] for a similar OLR as C4, but with 4.4 g total carbohydrates against 2.6 g in the present study. This carbohydrate concentration improved the hydrogen production which reached around 2 fold-times more than this study.

On the other hand, the ratios for both tendencies in C2 were below 1.0 related to the domination of acetic acid production. However, the ratio increased over time showing the change to the butyric acid pathway. In contrast, in C4 both tendencies began at the same Bu/Ac ratio, but this decreased over retention time for *long trend*. Therefore, the *long trend* in C4 was dominated by hydrogen production through acetic acid reaction; meanwhile the *short trend* was related to the butyric acid formation (Fig. 3.4). In this case, the hydrogen production rate should be greater in the *long trend* than *short trend* due to the theoretical hydrogen production from acetic acid. Nevertheless, the increase of acetic acid could be related to the consumption of the hydrogen and carbon dioxide remaining in the system through the activity of homoacetogenic microorganisms [Park et al., 2005].

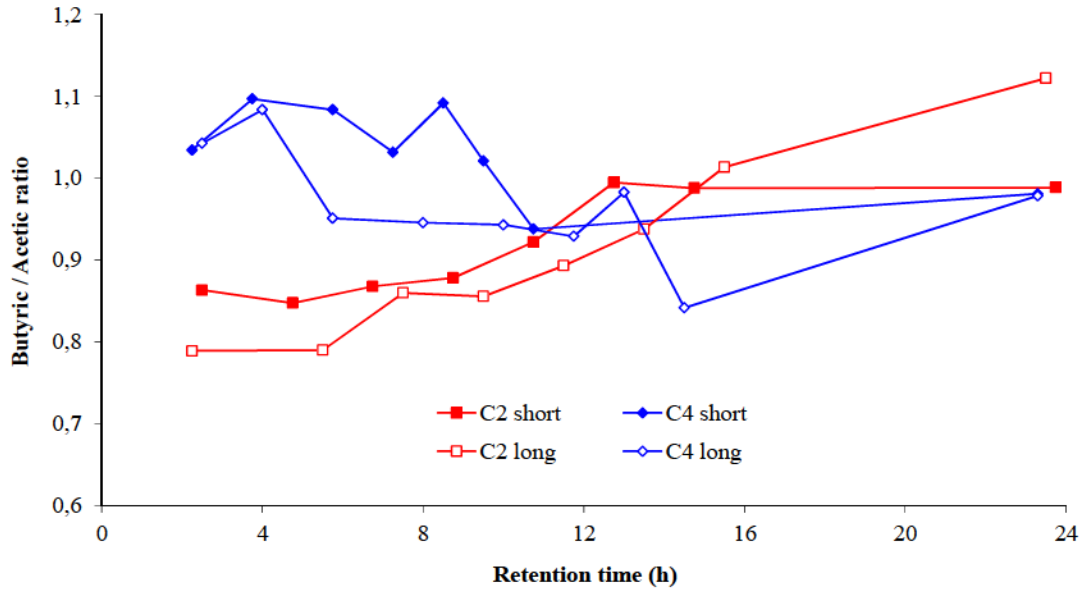
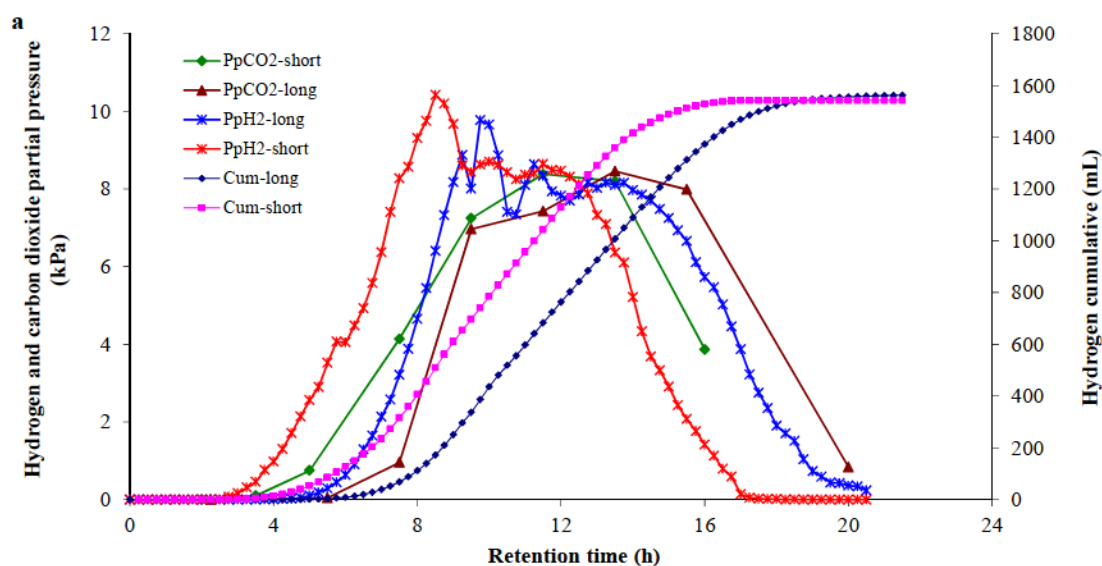

Figure 3.4. Bu/Ac ratio for the conditions 2 and 4 during both tendencies.

### The effect of hydrogen and carbon dioxide partial pressure

The maximum hydrogen partial pressures of 28.7 and 22.3 kPa were achieved in C4 for *short* and *long* tendencies (Fig. 3.5). Meanwhile, in C2 the maximum hydrogen partial pressure were 9.8 – 10.4 kPa for *long* and *short trend*. Therefore, the hydrogen partial pressures were below 53 kPa which is associated with the change of metabolic pathway to ethanol, acetate and lactate as main metabolites in the presence of *Clostridium thermolacticum* [Collet et al., 2004]. Moreover, a high hydrogen partial pressure has been reported by Park et al., [2005] in a batch test suggesting the tolerance of the system to pressures around 0.8 atm through the carbon dioxide scavenging in the process. At a high hydrogen partial pressure the activity was linked to ferredoxin electron carrier against the other co-enzymes; NADH/NAD<sup>+</sup> and FADH<sub>2</sub> which required lower pressure levels [Stams, 1994]. Thus, the hydrogen production for both tendencies in C2 and C4 was associated with the oxidation of ferredoxin during the oxidation route of pyruvate to acetyl-CoA. On the other hand, the temperature above 50 °C increases the viability of the reactions under high hydrogen partial pressure due to the increase of energy in the system [Lee and Zinder, 1988]. In addition, the quick increase in hydrogen partial pressure especially in C4 suggested early adverse conditions for methanogenic microorganisms [Voolapalli and Stuckey, 2001].

The presence of carbon dioxide could improve the butyric acid fermentation pathway against other metabolites. Meanwhile, the effect over compounds as propionic acid and ethanol are not clear under the increase in carbon dioxide [Kim et al., 2006]. The carbon dioxide partial pressure was kept in a range of 0.08 and 0.34 atm for C2 and C4 which were below the limit for optimum conditions in methanogenic production around 0.5 atm [Lee et al., 2002]. In contrast, this range was related to the growth of methanogenic and homoacetogenic bacteria. Nevertheless, the methane concentration was below 1% in the biogas and butyric acid was the main metabolite; these both aspects suggested the activity of those bacteria. In this way, there was not any peak during the retention time which could be related to a change in the pathway to the acetate formation. Likewise, the ratio between the main metabolites produced, butyric and acetic, suggested a low affectation of carbon dioxide concentrations [Kim et al., 2006]. In contrast, Wang et al., [2007] suggest a negative effect of high carbon dioxide in the headspace for a specific hydrogen-producing bacterial strain B49. In that case, a metabolic pathway shift could be related to the use of electron equivalents to the formate and succinate formation. Therefore, the propionic acid production could be related to the succinate route due to the high concentrations of carbon dioxide (Fig. 3.2). Nevertheless, the best performance for propionic acid takes place during the *long trend* of C4 under the low carbon dioxide partial pressure. Finally, the low pH limited the carbon dioxide concentration in the liquid phase which could improve hydrogen formation from formate [Lee et al., 2008].





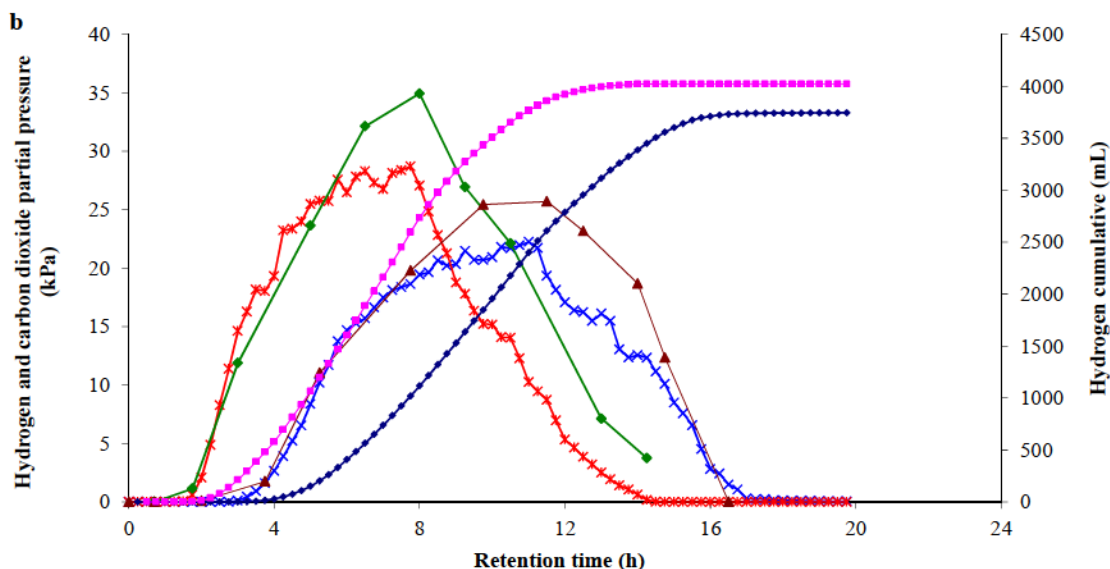

Figure 3.5. Hydrogen and carbon dioxide partial pressure during the retention time for both trends in conditions 2 (a) and 4 (b).

### 3.3.2.2 Microorganisms evolution - pH and ORP influence

In both tendencies *T. thermosaccharolyticum* was the predominant microorganism which has been reported as main hydrogen producing bacteria in mixed culture [O-Thong et al., 2011] (Fig. 3.6). In addition, previous identification tests found that *B. thermoamylovorans* and *B. licheniformis* were the main species related to *Bacillus* genus (data not show). Thus, the *Bacillus sp.* was related to the degradation of macrocompounds which were then uptake by *Clostridium sp.* and *T. thermosaccharolyticum*. The interaction between several microorganisms has been reported highlighting its significance for hydrogen production [Liu et al., 2008; Hidaka et al., 2010; O-Thong et al., 2011]. In C4, the response of *T. thermosaccharolyticum* during the *short trend* was in agreement with the maximum specific growth of around 0.31 – 0.46 (1/h) [Van Rijssel and Hansen, 1989; O-Thong et al., 2008]. This microorganism can produce ethanol, acetic, butyric, propionic and lactic acids, but an eventually lactate production could be suppressed by the same microorganisms which use lactate to produce hydrogen and butyrate [Liu et al., 2008]. This could explain the similar cumulative hydrogen in both tendencies, but with differences in time and hydrogen production rate. In addition, lactic acid is a previous step in the propionic acid pathway which was mainly found in *long trend*.

Microorganisms involvement was done using the total genomic unit calculated by summing these three species. In the *short trend* of C4, the initial values for *Bacillus sp.*, *Clostridium sp.*

and *T. thermosaccharolyticum* were 36.9, 16.0 and 47.1 % which changed at the end of retention time to 17.5, 14.8 and 67.7 % respectively. The high *Bacillus sp.* occurrence at the beginning was associated with hydrolysis of macrocompounds using the initial oxygen. Meanwhile, *T. thermosaccharolyticum* increased as response to use the simple compounds generated. In the *long trend*, the initial distribution was 27.8, 31.7 and 40.4 % which changed to 30.6, 26.9 and 42.5 % for *Bacillus sp.*, *Clostridium sp.* and *T. thermosaccharolyticum*, respectively at the end of retention time. Nevertheless, the hydrogen peak had a distribution of 11.0, 30.4 and 58.6 % which suggested the relevance of *T. thermosaccharolyticum* on hydrogen production. The involvement in the *long trend* for C2 was 28.9, 30.8 and 40.4 % changing to 18.4, 20.8 and 60.9 %, respectively. It showed a close relation with the initial distribution of the *long trend* in C4, but the final distribution was close to *short trend* in C4. This was associated with the similar cumulative hydrogen production achieved for the both tendencies.

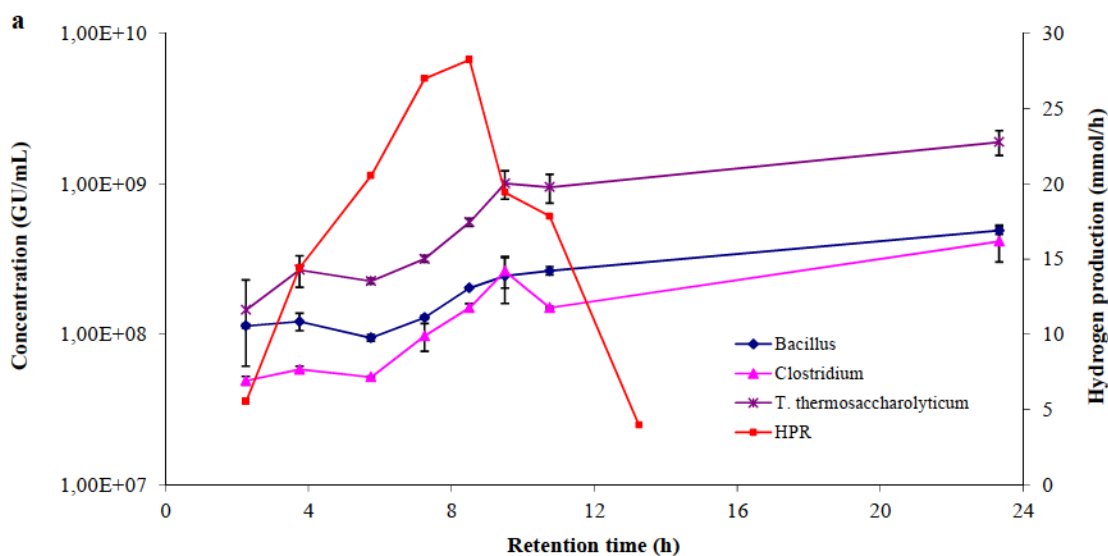

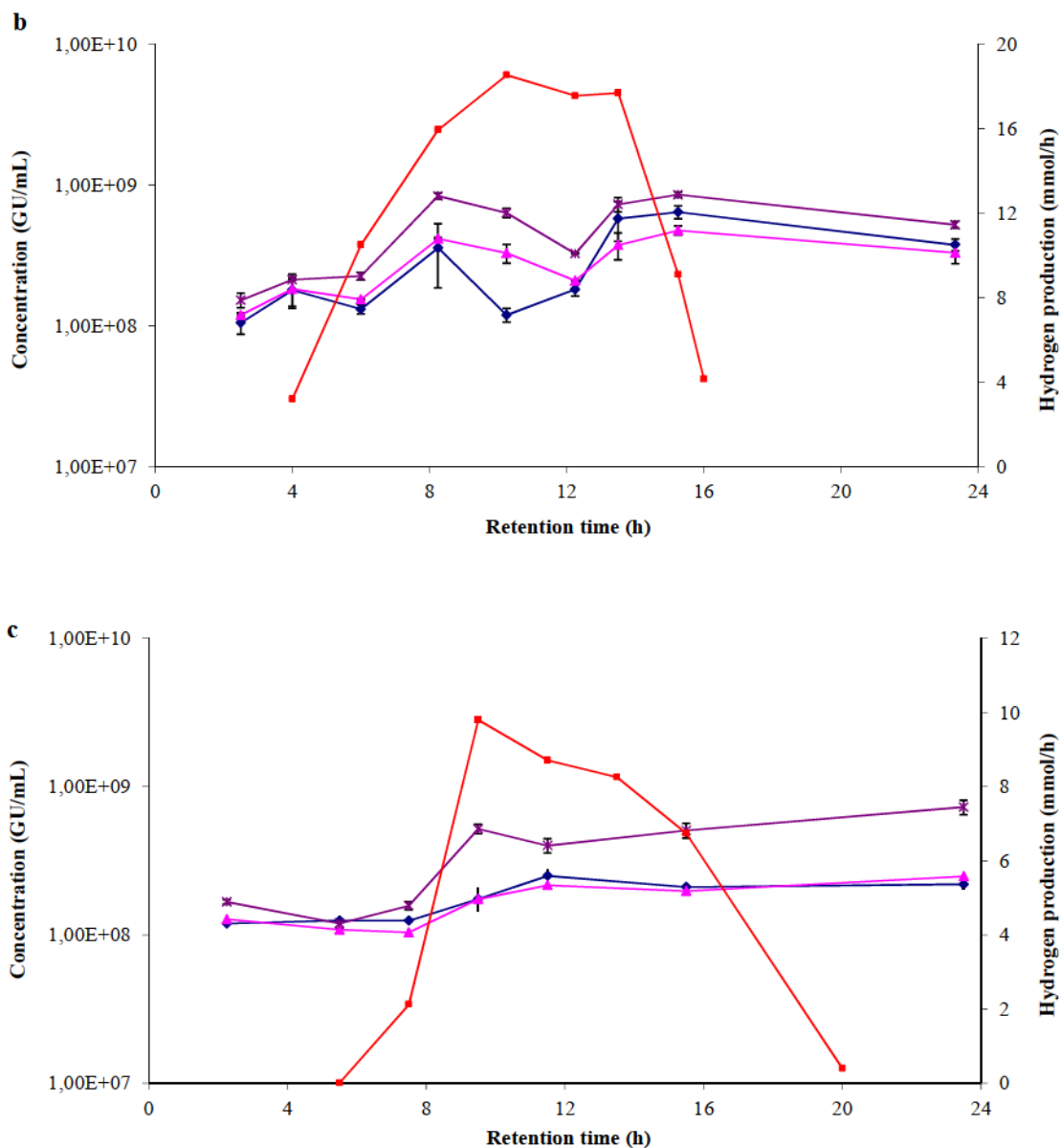

Figure 3.6. Changes of microbial population in mixed culture for *short* and *long trend* in C4 (a and b) and *long trend* in C2 (c). The microorganisms concentration was reported as the concentration of genomic unit.

These behaviors were related to 3 assumptions: (1) An initial *Bacillus sp.* involvement below 30 % suggests a limitation of macrocompounds degradation limiting the growth for *T. thermosaccharolyticum* and *Clostridium sp.* (2) The increase of *Clostridium sp.* involvement is associated with a substrate shared with *T. thermosaccharolyticum* producing low hydrogen rates. In addition, the only way to obtain NADH for some *Clostridium sp.* is through the oxidation of reduced ferredoxin [Temudo et al., 2007]. (3) The increase in *Bacillus sp.* could

shift the pathway through the formation of other metabolites related to *B. thermoamylovorans* and *B. licheniformis* [Kalia et al., 1994; Combet-Blanc et al., 1995; Pantamas et al., 2003].

### **pH and ORP behavior**

The initial pH before the activation of pH control system was around 5.5 and 5.8 for both tendencies in C4 and C2 respectively (Fig. 3.7). These initial values were in the range related to acetate and butyrate production as main metabolites [Karadag et al., 2009]. The quick decrease in pH for both conditions could limit the growth of *B. Thermoamylovorans* due to the pH optimum range has been reported between 5.4 and 8.5 [Combet-Blanc et al., 1995]. Meanwhile, *T. thermosaccharolyticum* has a minimum pH around 5.20 [Liu et al., 2008]. Likewise, the strong decrease in ORP suggested the quick depletion of oxygen in the liquid phase reaching fermentation conditions for the production of mixed acids and alcohols. At this point, the pH had a strong decrease in the first 2 h for both conditions and tendencies maintaining the range for hydrogen production [Fang and Liu, 2002]. In the absence of hydrogen consumers the equilibrium could be linked to the systems H<sup>+</sup>/H<sub>2</sub> and CO<sub>2</sub>/Formate which work at -414(-420) and -407(-432) mV, respectively [Thauer et al., 1977; Stams, 1994]. In addition, the ORP levels showed a limitation for the pair NADH/NAD<sup>+</sup> which is associated with values around -320 mV.

The lag-phase time around 7 h in the *long trend* for C2 suggested a close relation with ORP due to a similar time was required to reach -408.7 and -417.2 mV which is related to the system H<sup>+</sup>/H<sub>2</sub>. On the other hand, formate as electron transport could be limited by the acidic pH condition [Voolapalli and Stuckey, 2001] changing the equilibrium equation (Eq. 33) of this compound to bicarbonate and hydrogen [Stams, 1994]. It could explain the increase in hydrogen and alkalinity through the repetitive batch cultivation in Chapter 2.

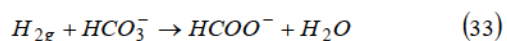

Finally, the ORP condition and the reduction of lipids in C4 could suggest the activation of another pathway in the system. In that case, the ORP around -478 mV could be compared with that reported by Schink [1997] for the degradation of the glycolic acid which produce hydrogen in higher proportion than carbon dioxide (Eq. 34).

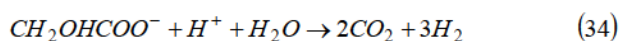

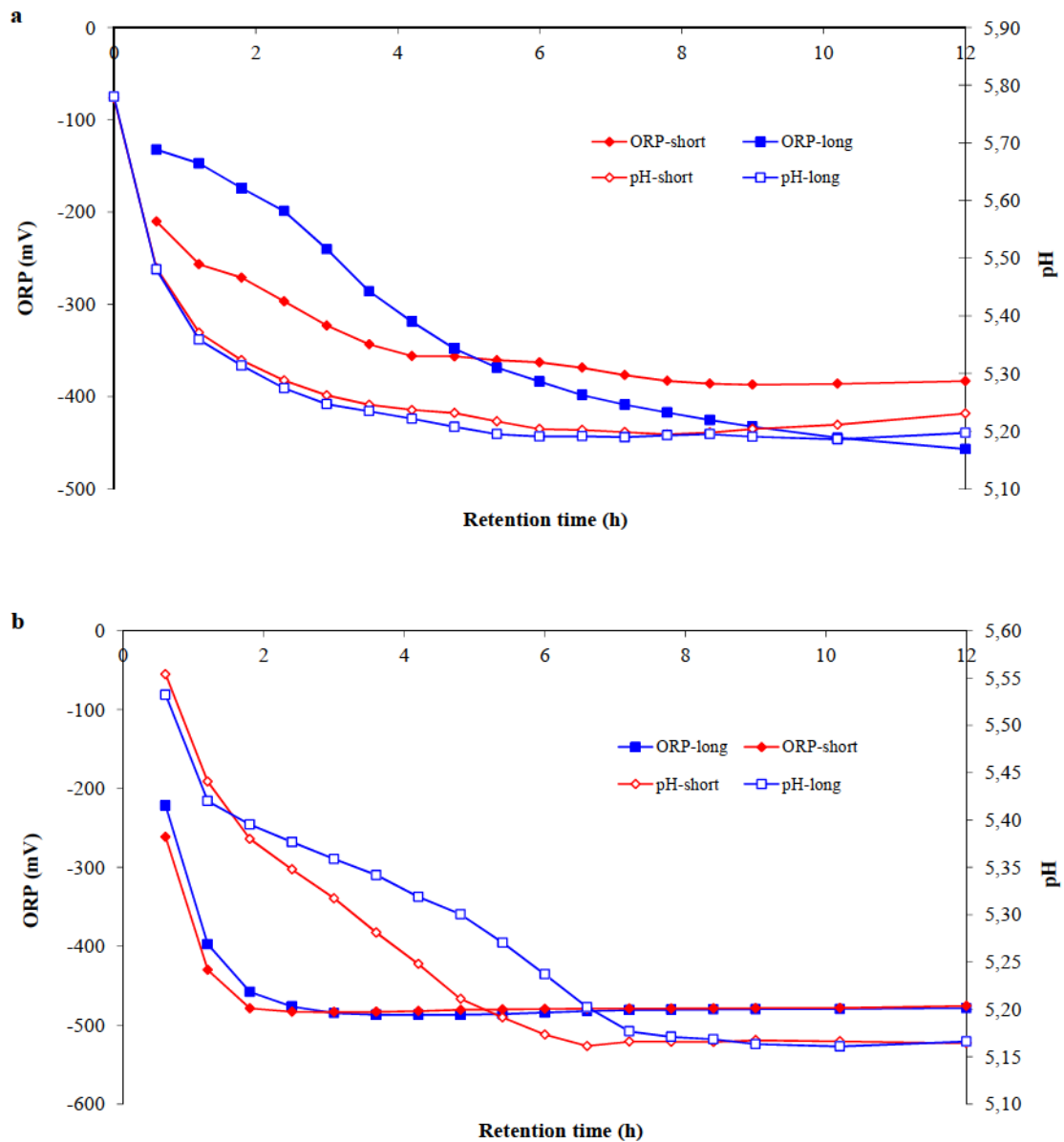

Figure 3.7. Oxidation reduction potential and pH performance during the first 12 h of retention time for both tendencies in C2 (a) and C4 (b).

The condition 2 with C/N ratio of 55 showed similar behavior with the experiments developed by Lin and Lay [2004]. In that case, the ORP was reported between -359 and -369 mV for C/N ratios of 40 and 47 respectively. In contrast, the increase in organic load for C4 with the same C/N ratio achieved -478 mV which could be associated with the highest availability of soluble carbon. In that case, it could be compared to C/N ratios of 98 which showed a change in the ORP until -453 mV.

### 3.3.2.3 Microbial pathway

The coffee mucilage compounds could be degraded by the different genus found in the experiments (Fig. 3.8). This carbohydrates degradation flows to formation of key compounds such as pyruvate. The route of pyruvate oxidation to acetyl-CoA was considered as the main hydrogen production mechanism in these experiments. This was assumed because of high carbohydrates concentration in coffee mucilage. Limitations of hydrogen production are associated with two main processes: the first, formation of more reduced compounds as propionic acid by the intermediates succinate and lactate that deviate from pyruvate oxidation. As mentioned, this is a response to the high partial pressure of hydrogen and carbon dioxide; the second, electron requirement for NADH regeneration by the reduction of NAD<sup>+</sup>. This interrupts the normal electrons flow to hydrogen during ferredoxin oxidation. The relevance of this co-factor is associated with the production of several metabolites.

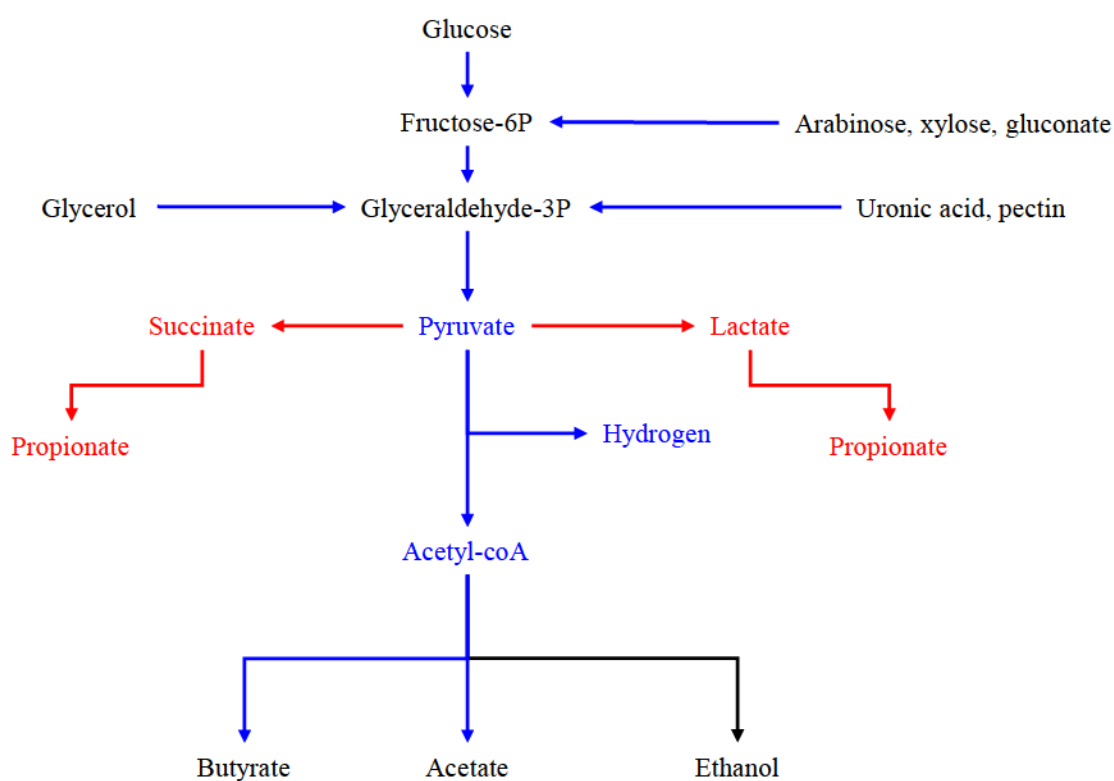

Figure 3.8. Adapted from Liu et al., 2008; Saint-Amans et al., 2001; Temudo et al., 2007 with the main reactions related to the results found in the co-digestion experiments between swine manure and coffee mucilage.

The pathway from glycerol could be considered during lipid consumption in C4 as explained in Chapter 2. Degradation through glycerol could increase the available NADH which can be used for metabolite formation. This suggests a reduction of competition during ferredoxin oxidation due to NADH regeneration. The use of xylose and arabinose, present in coffee mucilage, for some *Clostridium* species could increase hydrogen production due to its higher efficiency than glucose [Nandi and Sengupta, 1998]. pH conditions suggested the limitation of formate production which enhances the use of ferredoxin to transfer the electrons generated during pyruvate oxidation.

### 3.4 Conclusions

Two different tendencies, *short* and *long*, were identified over retention time during a hydrogen production process. The main differences between tendencies were in kinetic parameters as hydrogen production rate and lag-phase time. Hydrogen and carbon dioxide were the main compounds in the biogas. The main metabolic pathway was related to the production of butyric and acetic acids. Propionic acid fermentation was identified as the main metabolic deviation. The Bu/Ac ratio was higher for *short* than *long trend* with domination of *T. thermosaccharolyticum* in the mixed culture. *Bacillus sp.* showed high involvement at the beginning of the *short trend* decreasing at the end of retention time. The *long trend* was associated with increasing *Clostridium sp.* involvement which suggested a substrate shared of both strictly anaerobes changing the hydrogen rates. The *long trend* in C2 showed an initial microorganism involvement as the *long trend* in C4, but at the end the composition was close to the *short trend* in C4. The behavior of hydrogen and carbon dioxide partial pressure, ORP and pH over retention time showed results close to both trends in each condition. The conditions were associated with the H<sup>+</sup>/H<sub>2</sub> system and the use of ferredoxin as electron carrier. Metabolic pathway was associated mainly with the interaction of carbohydrates from coffee mucilage and pyruvate as the key metabolite in the process.

## References

- Chang J-J, Chou C-H, Ho C-Y, Chen W-E, Lay J-J, Huang C-C. Syntrophic co-culture of aerobic *Bacillus* and anaerobic *Clostridium* for bio-fuels and bio-hydrogen production. *Int J Hydrogen Energy* 2008;33:5137–46.
- Collet C, Adler N, Schwitzguébel J-P, Péringier P. Hydrogen production by *Clostridium thermolacticum* during continuous fermentation of lactose. *Int J Hydrogen Energy* 2004;29:1479–85.
- Collet C, Gaudard O, Péringier P, Schwitzguébel JP. Acetate production from lactose by *Clostridium thermolacticum* and hydrogen-scavenging microorganisms in continuous culture - effect of hydrogen partial pressure. *J Biotechnol* 2005;118(3):328-38.
- Combet-Blanc Y, Ollivier B, Streicher C, Patel B, Dwivedi P, Pot B, Prensier G, Garcia J-L. *Bacillus thermoamylovorans* sp. Nov., a moderately thermophilic and amylolytic bacterium. *Int J Hydrogen Energy* 1995;45(1):9-16.
- Fang H, Liu H. Effect of pH on hydrogen production from glucose by a mixed culture. *Bioresour Technol* 2002;82:87-93.
- Gerardi M. *The Microbiology of Anaerobic Digesters - Wastewater Microbiology Series*. Wiley Interscience, John Wiley & Sons, Inc., Publication, 2003.
- Hawkes F, Dinsdale R, Hawkes D, Hussy I. Sustainable fermentative hydrogen production: challenges for process optimization. *Int J Hydrogen Energy* 2002;27:1339–47.
- Hidaka T, Asahira T, Koshikawa H, Cheon J, Park Y, Tsuno H. Effect of microbial composition on thermophilic acid fermentation. *Enzyme and Microbial Technol* 2010;47(4):127–33.
- Kalia VC, Jain SR, Kumar A, Joshi AP. Fermentation of biowaste to H<sub>2</sub> by *Bacillus licheniformis*. *World J Microbiol Biotechnol* 1994;10(2):224-7.
- Karadag D, Mäkinen A, Efimova E, Puhakka J. Thermophilic biohydrogen production by an anaerobic heat treated-hot spring culture. *Bioresour Technol* 2009;100(23):5790-5.
- Karlsson A, Vallin L, Ejlertsson J. Effects of temperature, hydraulic retention time and hydrogen extraction rate on hydrogen production from the fermentation of food industry residues and manure. *Int J Hydrogen Energy* 2008;33:953–62.
- Khanal SK, Chen WH, Li L, Sung S. Biological hydrogen production: Effects of pH and intermediate products. *Int J Hydrogen Energy* 2004;29:1123-31.
- Kim D-H, Han S-K, Kim S-H, Shin H-S. Effect of gas sparging on continuous fermentative hydrogen production. *Int J Hydrogen Energy* 2006;31:2158–69.



- Lee KE, Kim YC, Suh MG. Effects of PCO<sub>2</sub> on methane production rate and matter degradation in anaerobic digestion. *Korean J Environ Health Soc* 2002;26(2):59–66.
- Lee M, Zinder S. Isolation and characterization of a thermophilic bacterium which oxidizes acetate in syntrophic association with a methanogen and which grows acetogenically on H<sub>2</sub>-CO<sub>2</sub>. *Appl Environ Microbiol* 1988;54(1):124–9.
- Lee HS, Salerno MB, Rittmann BE. Thermodynamic evaluation on H<sub>2</sub> production in glucose fermentation. *Environ Sci Technol* 2008;42(7):2401-7.
- Lin CY, Lay CH. Carbon/nitrogen-ratio effect on fermentative hydrogen production by mixed microflora. *Int J Hydrogen Energy* 2004;29:41-5.
- Liu Y, Yu P, Song X, Qu Y. Hydrogen production from cellulose by co-culture of *Clostridium thermocellum* JN4 and *Thermoanaerobacterium thermosaccharolyticum* GD17. *Int J Hydrogen Energy* 2008;33(12):2927-33.
- Mu Y, Zheng XJ, Yu HQ, Zhu RF. Biological hydrogen production by anaerobic sludge at various temperatures. *Int J Hydrogen Energy* 2006;31:780-5.
- O-Thong S, Hniman A, Prasertsan P, Imai T. Biohydrogen production from cassava starch processing wastewater by thermophilic mixed cultures. *Int J Hydrogen Energy* 2011;36(5):3409-16.
- O-Thong S, Prasertsan P, Intrasungkha N, Dhamwichukorn S, Birkeland N-K. Optimization of simultaneous thermophilic fermentative hydrogen production and COD reduction from palm oil mill effluent by *Thermoanaerobacterium*-rich sludge. *Int J Hydrogen Energy* 2008;33:1221-31.
- Pantamas P, Chaiprasert P, Tanticharoen M. Anaerobic digestion of glucose by *Bacillus licheniformis* and *Bacillus coagulans* at low and high alkalinity. *Asian J. Energy Environ* 2003;4(1-2):1-17.
- Park W, Hyun S, Oh S-E, Logan B, Kim I. Removal of headspace CO<sub>2</sub> increases biological hydrogen production. *Environ Sci Technol* 2005;39:4416-20.
- Prasertsan P, O-Thong S, Birkeland N-K. Optimization and microbial community analysis for production of biohydrogen from palm oil mill effluent by thermophilic fermentative process. *Int J Hydrogen Energy* 2009;34(17):7448-59.
- Ren NQ, Chua H, Chan SY, Tsang YF, Wang YJ, Sin N. Assessing optimal fermentation type for bio-hydrogen production in continuous-flow acidogenic reactors. *Bioresour Technol* 2007;98:1774–80.

Saint-Amans S, Girbal L, Andrade J, Ahrens K, Soucaille P. Regulation of carbon and electron flow in *Clostridium butyricum* VPI 3266 grown on glucose-glycerol mixtures. *J Bacteriol* 2001;183(5):1748–54.

Schink B. Energetics of syntrophic cooperation in methanogenic degradation. *Microbiol Molecular Biol Rev* 1997;61(2):262–80.

Snell-Castro R, Godon JJ, Delgenès JP, Dabert P. Characterisation of the microbial diversity in a pig manure storage pit using small subunit rDNA sequence analysis. *FEMS Microbiol Ecol* 2005;52:229-42.

Stams A. Metabolic interactions between anaerobic bacteria in methanogenic environments. *Antonie van Leeuwenhoek* 1994;66:271-94.

Tanisho S, Kuromoto M, Kadokura N. Effect of CO<sub>2</sub> removal on hydrogen production by fermentation. *Int J Hydrogen Energy* 1998;23:559-63.

Temudo MF, Kleerebezem R, van Loosdrecht M. Influence of the pH on (open) mixed culture fermentation of glucose: A chemostat study. *Biotechnol Bioeng* 2007;98(1):69-79.

Thauer RK, Jungermann K, Decker K. Energy conservation in chemotrophic anaerobic bacteria. *Bacteriol Rev* 1977;41:100–80.

van Rijssel M, Hansen T. Fermentation of pectin by a newly isolated *Clostridium thermosaccharolyticum* strain. *FEMS Microbiol Letters* 1989;61(1-2):41-6.

Voolapalli RK, Stuckey DC. Hydrogen production in anaerobic reactors during shock loads - Influence of formate production and H<sub>2</sub> kinetics. *Water Res* 2001;35:1831-41.

Wang MY, Tsai YL, Olson BH, Chang JS. Monitoring dark hydrogen fermentation performance of indigenous *Clostridium butyricum* by hydrogenase gene expression using RT-PCR and qPCR. *Int J Hydrogen Energy* 2008;33:4730-8.

Wang XJ, Ren NQ, Xiang WS, Guo WQ. Influence of gaseous end-products inhibition and nutrient limitations on the growth and hydrogen production by hydrogen-producing fermentative bacterial B49. *Int J Hydrogen Energy* 2007;32:748–54.

Xiao Y, Zeng GM, Yang ZH, Ma YH, Huang C, Shi WJ, Xu ZY, Huang J, Fan CZ. Effects of continuous thermophilic composting (CTC) on bacterial community in the active composting process. *Environ Microbiol* 2011;62: 599-608.

Xing Y, Li Z, Fan Y, Hou H. Biohydrogen production from dairy manures with acidification pretreatment by anaerobic fermentation. *Environ Sci Pollut Res* 2010;17:392–9.

Yang P, Zhang R, McGarvey J, Benemann J. Biohydrogen production from cheese processing wastewater by anaerobic fermentation using mixed microbial communities. *Int J Hydrogen Energy* 2007;32:4761–71.

Yokoyama H, Waki M, Moriya N, Yasuda T, Tanaka Y, Haga K. Effect of fermentation temperature on hydrogen production from cow waste slurry by using anaerobic microflora within the slurry. *Appl Microbiol Biotechnol* 2007;74:474–83.

Zhu J, Li Y, Wu X, Miller C, Chen P, Ruan R. Swine manure fermentation for hydrogen production. *Bioresour Technol* 2009;100:5472–77.

# CHAPTER 4 Treatment of effluent from dark fermentation process by anaerobic digestion for methane production

## Abstract

The valorisation of agricultural wastes through anaerobic digestion in a two-stage process has been investigated in this study. The highest cumulative hydrogen production achieved was 4.02 L H<sub>2</sub> in the first stage with a biogas composition of 39.4 and 50.7% for hydrogen and carbon dioxide, respectively. Meanwhile, in the second stage the highest cumulative methane production was 15.3 L CH<sub>4</sub> with a composition of 65.7 and 22.6% for methane and carbon dioxide. The first stage improved hydrolysis with the increase in soluble carbon, nitrogen and volatile solids. The removal of the main components (C, N, solids) at the end of the second stage was around 56-71%. It was observed that carbohydrates were used to produce hydrogen and proteins and lipids to produce methane. The first stage improved the time response and production rate for the second reactor. Meanwhile, the methane through BMP experiments showed an increase of methane production against the two-stage process. The highest hydrogen contribution achieved over total energy was about 10.3 %. Hydrogen could be mixed with methane to produce biohythane from both stages.

## 4.1 Introduction

Pig and coffee production could be found in some agricultural countries which economies are based on the production of food raw materials. During farming, the wastes produced are associated to the generation of different solids and liquid compounds which are stored or treated close to the plantations and farms. This is the case in Colombia where most of the wastes from coffee process are stored meanwhile just some treatment methods are applied without a general use between the formers [Aristizábal and Duque, 2005]. In contrast, the manure has been widely treated through anaerobic digestion with biogas production which is one of the advantages of this method [Appels et al., 2011]. In this case, the coffee mucilage could be taken as co-substrate in the anaerobic process to improve the valorisation and the treatment of both wastes [Panichnumsin et al., 2010; Zhu et al., 2011]. It could be feasible because of both activities are developed in similar regions which improves the development of one treatment system for several substrates. In this way, the coffee mucilage has special properties for the process as carbon source due to the high carbohydrates content [Esquivel and Jiménez, 2012] and that most of the organic matter is soluble or suspended reducing the retention time against coffee pulp, the other biggest waste produced. Nevertheless, it has been treated through a composting process in Colombia. In this case, the co-digestion could be considered for the treatment and valorisation of both wastes taking advantage of the locations where anaerobic digestion is already installed yet. In addition, the use of co-digestion is useful to maintain biogas production due to the seasonal coffee harvest which limits the availability of these wastes.

The second biofuels generation has been studied decreasing the idea of the first biofuels generation which are produced in constant competition with food requirements and cultivable areas. In this case, anaerobic digestion in two-stage could be applied to generate hydrogen and methane in the same chain of treatment process. Hydrogen has an energy yield of 141.8 kJ/g which is higher than most of the hydrocarbons even methane with 55,5 kJ/g. In addition, the development of this process improves the energy recovery from wastes with the waste treatment. On the other hand, the hydrogen production through the utilization of complex substrates has some disadvantages as the negligible waste treatment. The removal of chemical oxygen demand (COD) during the process has been reported below 10% which could be improved until 17-92% according to the substrates type, physical and chemical pre-treatments and nutrients solutions. The maximum has been related to soluble COD removal [van Ginkel

et al., 2005; Vijayaraghavan et al., 2007]. Therefore, an additional treatment process should be implemented due to the low removal of the effluent which has a high content of remaining soluble compounds such as volatile fatty acids (VFA), solvents and volatile organic matter. The application of this method has been reported to be a good way for the stabilization in methanogenesis step and for the improvement in availability of solubilized organics compounds [Appels et al., 2008; DiStefano and Palomar, 2010; Ntaikou, et al., 2010]. In this case, the anaerobic dark fermentation could be completed with a second reactor which develops the acetogenic and methanogenic steps. This process reaches a removal of the initial COD between 50 – 85 % of the inlet feedstock [Panichnumsin et al., 2010; Astals et al., 2012].

In terms of the parameters involved in anaerobic digestion the most relevant to take into account for the development of two-stage process could be: pH, temperature, nutrients and microorganisms. The pH present two different requirements due to the acidic condition in the first stage for hydrogen production which contrast with the neutral-basic pH required in the second for methanisation [Khalid et al., 2011; Khanal et al., 2004]. Likewise, in both cases the alkalinity could be provided by the manure which has been reported as able to control pH fluctuations [Panichnumsin et al., 2010]. In addition, the decrease in pH is related to the VFA production, those are ideal substrates for the development of methanogenic step in the second stage. The increase in temperature in a short first stage improves the generation of soluble and volatile compounds which could be easily treated in the second stage, avoiding the cost of pre-treatment and time spent due to the normal degradation. Moreover, the temperature works like a controller due to the microorganisms selection in the mixed culture during the first stage. It must be considered due to the high diversity of microorganisms found in manure which could modify the process. In contrast, mesophilic temperature allows the development of the microorganisms for the second stage. Finally, the complex nature of manure gives the essential nutrients required by the microorganisms growth in both stages.

This part of the study investigated the methane production of an effluent from a first stage involved in hydrogen production of two complex substrates, swine manure and coffee mucilage. Therefore, the aims of this research were: to evaluate the performance of methane production as second stage related to the variation of the substrates ratio in the first stage, to establish the waste treatment through the effluent characterization of both stages in the process. In addition, some approaches to the macromolecule and soluble COD behavior were

evaluated in both reactors. The experiments were developed at thermophilic and mesophilic temperatures for hydrogen and methane reactor, respectively.

## 4.2 Methods

### 4.2.1 Methodology

A second stage process was developed for the effluent from the four conditions evaluated during hydrogen production (Chapter 2). This stage was related to the production of additional renewable energy through waste treatment by anaerobic co-digestion. The experiments were accomplished using a bioreactor which generated methane during pollutant removal closing the treatment cycle of both wastes mixtures. The substrates ratios used in hydrogen production were 7:3, 5:5 and 3:7 for swine manure and coffee mucilage (SM:CM) which represented an OLR of  $\pm 1$  kg COD/m<sup>3</sup>d. Meanwhile, the fourth condition with an organic load increase by a two factor represented an OLR of  $\pm 1.8$  kg COD/m<sup>3</sup>d. Each experiment was conducted over a period of at least 30 days. The four conditions were identified as C1, C2, C3 and C4, respectively. The reactor was carried out under neutral pH and mesophilic temperature which are related to steady methanogenic production [Khalid et al., 2011]. In this case, the overall process was considered as two-stages anaerobic co-digestion related to valorisation and treatment of both wastes. In addition, a Biological Methane Potential (BMP) experiment was conducted to evaluate the potential of direct methane production using both raw substrates. In addition, a second BMP experiment was conducted in order to optimize the methane production using an inoculum acclimatized for the methane production.

### 4.2.2 Substrates

The feedstock for the second reactor was collected from the effluent of the hydrogen reactor (used chapter 2) two times; the day before and the same day of the feeding process. The effluent accumulated the day before was around 1 L and it was preserved at 4 °C. The feedstock preparation mixed both volume samples and it was acclimated at room temperature. On the other hand, the substrate mixture used for BMP experiments was prepared using the raw wastes. The feedstock had a ratio 5:5 (SM:CM) which was the best substrate mixture condition found during hydrogen experiments.

### 4.2.3 Inoculum

The inoculum was adapted through the change in operating conditions of the one reactor operated for hydrogen production. The temperature reduction to 35 °C and the increase in pH set-point above 6.5 allowed the activation of the microorganisms involved in the last anaerobic digestion steps. This process was followed during around 30 days when the hydrogen production was negligible and the methane concentration in the biogas increased until around 50% (data not shown). At this point, the reactor was considered as methanogenic reactor able to begin the second stage of the co-digestion process. In this case, the return of the reactor of those conditions led the recolonization of methanogenic microorganisms.

The BMP experiments used two inocula which one was obtained from the same methanogenic reactor used in the second stage (I1). Meanwhile, the second inoculum (I2) was obtained from the sludge of a wastewater treatment plant of an industry of soft drinks.

### 4.2.4 Experimental design

The second stage of anaerobic co-digestion was carried out in a bioreactor with a total volume of 7.2 L and a working volume of 6.0 L (Fig. 4.1). The reactor was operated as Anaerobic Batch Reactor (ABR) with the free evolution of biogas to avoid a high hydrogen partial pressure inside the reactor. In order to preserve the biomass 2 L of mixed liquor were left inside the reactor during each feeding process. The feedstock was added after emptying of the same volume of mixed liquor. The pH was controlled by adding either HCl (1.5 N) or NaOH (1.5 N) using automatic dosing pumps, regulated by a control system. The initial and final pH measures were made in the reactor after feeding process and at the end of each cycle, respectively. The temperature range was controlled by a heating jacket coupled with a control system. The feedstock was 4 L took from the hydrogen reactor for each relation SM:CM. An initial pH of 6.5 and a mesophilic temperature of 35 °C were established at the beginning of the experiments. The retention time for the waste treatment was 7 days. The bioreactor was stirred constantly at 100 rpm to prevent settling solids and flock damage which are strongly involved to syntrophism reactions during methanogenic process. Biogas production was measured through gas collected in Tedlar® gas bags of 5 L which was subsequently used to volume quantification related to the time for emptying process and biogas composition measures. Under each experimental condition, volatile fatty acids, biogas volume, methane, carbon dioxide and hydrogen sulfide concentrations were measured. Hydrogen was not followed due to the methanogenic condition in the reactor.



The BMP experiments were conducted in a serum bottles with a 500 mL of working volume. Both experiments were developed using a substrates ratio of 5:5 with a volume of 108 mL. The inoculum volume added was calculated to obtain a concentration of 500 mg VSS/L. In addition, nutrient solution was used in the experiments consisting of (per liter) 170g NH<sub>4</sub>Cl, 37g KH<sub>2</sub>PO<sub>4</sub>, 8g CaCl<sub>2</sub>·2H<sub>2</sub>O, 9g MgSO<sub>4</sub>·4H<sub>2</sub>O, 2g FeCl<sub>3</sub>·4H<sub>2</sub>O, 2g CoCl<sub>2</sub>·6H<sub>2</sub>O, 500mg MnCl<sub>2</sub>·4H<sub>2</sub>O, 30mg CuCl<sub>2</sub>·2H<sub>2</sub>O, 50mg ZnCl<sub>2</sub>, 50mg H<sub>3</sub>BO<sub>3</sub>, 90mg (NH<sub>4</sub>)<sub>6</sub>Mo<sub>7</sub>O<sub>2</sub>·4H<sub>2</sub>O, 100mg Na<sub>2</sub>SeO<sub>3</sub>·5H<sub>2</sub>O, 50 mg NiCl<sub>2</sub>·6H<sub>2</sub>O, 1g EDTA, 1 mL HCL 36% and 500mg Resazurin. The serum bottles were sparging with nitrogen during 3 min to create the anaerobic environment. The methane volume was measured by water displacement of solution NaOH 5%. The temperature was 35 °C controlled in an incubator meanwhile the initial pH was 7.0±0.5.

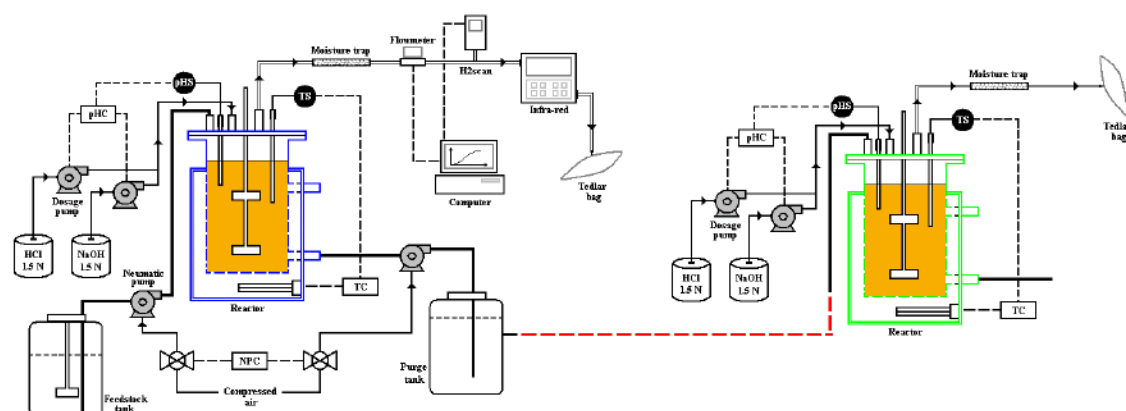

Figure 4.1. Scheme of hydrogen and methane reactors used for the experiments - hydrogen reactor on the left and methane reactor on the right.

#### 4.2.5 Analytical methods

Biohydrogen in biogas was measured online using a HY-OPTIMA 700 H2Scan® with a range between 0.5 to 100%. Methane and carbon dioxide were measured through an Infra-red Gas Analyzer (LANDTEC® - BioGas Check CDM) with a maximum deviation of ±3%. Hydrogen sulfide was measured through a gas pod attached to Infra-red Gas Analyzer which has an interval of 0 to 5%. VFA were determined by gas chromatography (Hewlett Packard® 6890 series G1530A) equipped with a flame ionization detector (FID). The operating temperatures at the injection port, the column oven and the detector were 250, 250 and 300 °C, respectively. Argon was used as the carrier gas with a flow rate of 0.9 mL/min. Carbohydrates, proteins and fats were measured through methods of Dubois (Dubois et al.,

1956), Bradford (Bradford, 1976) and Soxhlet (APHA, 2005), respectively. The concentrations of COD, total VFA (mg Acetic Acid/L), alkalinity, Total Kjeldahl Nitrogen (TKN), ammonia, total solids (TS) and volatile solids (VS) were measured according to Standard Methods (APHA, 2005).

## 4.3 Results and discussion

### 4.3.1 Performance of the two stages process.

#### *4.3.1.1 Effect of repetitive batch cultivation and substrates ratio.*

The results achieved for hydrogen and methane productions are shown in Figure 4.2a and 4.2b respectively. Both reactors were operated 140 days with duration of 35, 28, 35 and 42 days for C1, C2, C3 and C4, respectively. The cumulative gas production was recorded at the end of the retention time used at each reactor. The performance in both reactors showed that the use of the ratio 7:3 improved the production of methane against hydrogen which had a weak response related to the complexity associated with the main manure [Khalid et al., 2011]. Instead, the cumulative methane reached the highest level during the change in substrates ratio except during C4. It could be related to the acclimatization of methanogenic microorganisms in the first reactor with a methane composition in biogas of 1%. Thus, the effluent from the first reactor brought biomass able to uptake the VFA concentration. In addition, the high manure content produced the highest hydrogen sulfide concentration of 202 ppm showing one of the disadvantages using swine manure.

In the other conditions, the cumulative hydrogen showed an increase related to the increase in the mucilage concentration which improved the hydrogen production instead of methane production. The both reactors showed the best stability with a standard deviation about 2.98 and 4.50% for the first and second reactor, respectively. Nevertheless, the increase in metabolites production could be the reason for the decrease in methane production. In addition, the methanogenic bacteria in the first reactor were strongly inhibited which suggested an adverse effect of the effluent over the second reactor. In this case, the influence of biomass from the first reactor was noticed in correlation to some hydrogen concentration at the beginning of the biogas production in the second reactor (data not showed). Meanwhile, the average hydrogen sulfide concentrations were between 50 and 68 ppm for the other

conditions in the second reactor. This showed the low activity of sulfate-reducing bacteria dismissing a complete oxidation [Schink, 1997].

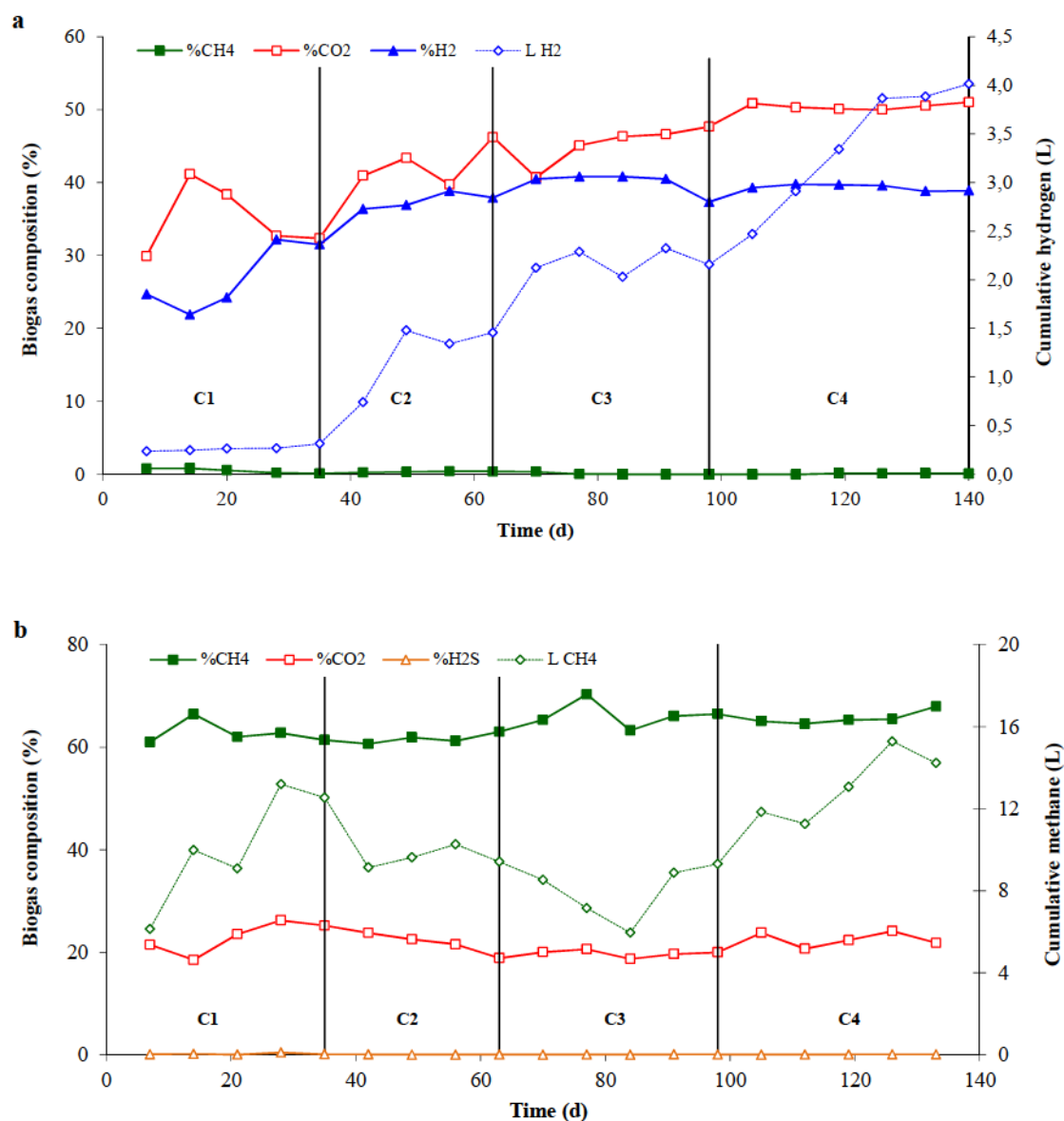

Figure 4.2. The biogas composition and cumulative production in both stages: a) hydrogen reactor and b) methane reactor. Biogas composition was represented by methane (■), carbon dioxide (□), hydrogen (▲) and hydrogen sulfide (Δ). Cumulative production of either hydrogen (◇) or methane (◇) was represented at each reactor (dotted line).

The last condition showed an increase for both reactors of around two-fold from the condition 2 which has the same substrates ratio. The pseudo steady state achieved at the end of the

experiments had a standard deviation below 1% for the first reactor and 8.2% for the second reactor. The biogas composition was almost stable after the first condition with hydrogen in the first reactor in a range of 38 - 40 %, meanwhile the methane average composition in the second reactor was in a range of 61 - 70 %. However, the increase of organic load in the last condition produced an increase of carbon dioxide in the first reactor. As a conclusion, it can be assumed that the repetitive batch cultivation for both reactors could improve the hydrogen and methane production.

#### *4.3.1.2 Influence of macromolecules.*

The initial concentration of soluble carbohydrates was highly influenced by the addition of coffee mucilage in the substrates mixture (Fig. 4.3a). In this case, the soluble carbohydrates were consumed during the first stage to produce hydrogen achieving removal about 79.4 and 94.8 % for C1 and C4, respectively. After the second stage, the carbohydrates remained were removed until 98.1 % in C4. However, the residual carbohydrates could be related to the selectivity of methanogens microorganisms which could use other substrates as proteins and fats with higher methane production potential than carbohydrates [Moletta, 2008]. On the other way, those complex substrates could have polysaccharides in the particulate material which could be hydrolyzed during both stages increasing the soluble carbohydrates concentration [Kim et al., 2011].

On the other hand, the performance of soluble proteins showed that the removal from C1 to C3 in hydrogen reactor achieved about 50% (Fig. 4.3b). This degradation could be linked with some hydrogen and bicarbonate production which could explain the increase in alkalinity. In C4, the removal around 30% was related to the high carbohydrate content which supported the requirement of the process to the hydrogen production. The protein degradation performance during the second reactor showed a lower removal in the first conditions between 50 and 72 %, but the increase in organic load improved it until 85 % which showed a high difference between the same substrates ratio. In the same way, this measurement ignores the non-soluble protein content which could be influence proteins concentration during both stages. In addition, the low protein degradation could be related to the microorganisms requirements due to their growth process.

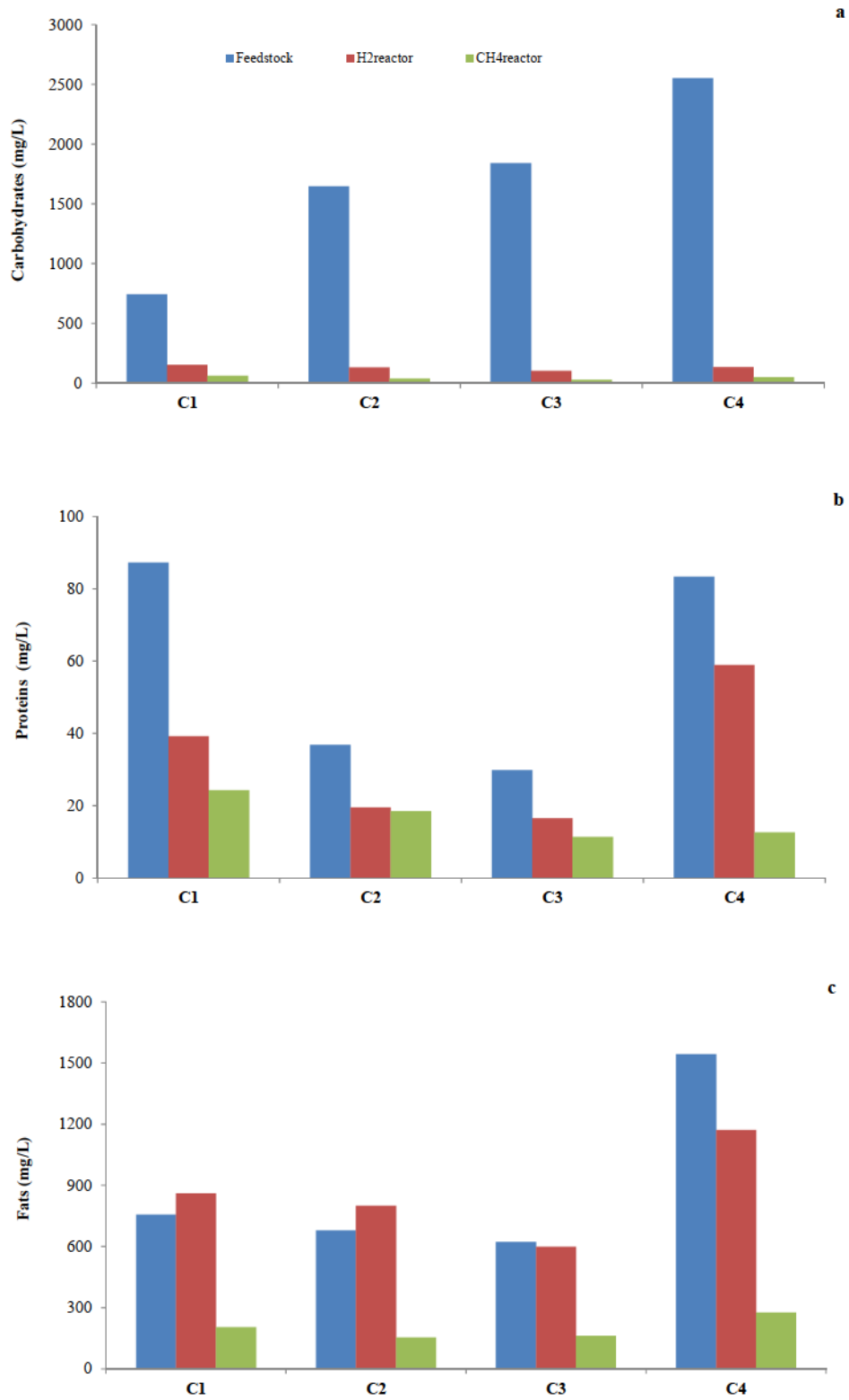

Figure 4.3. Macromolecules present in the hydrogen and methane reactors. a) carbohydrates; b) proteins; c) lipids.

The lipid concentrations were relatively constant during the first stage for C1 – C3 which showed some slight increase and decrease (Fig. 4.3c). However, C4 showed a removal of 24.1 % which could be related to the microorganisms acclimatization during the repetitive batch cultivation. In contrast, the second stage showed a strong removal of lipids with a similar reduction for the first three conditions. In C4, the increase in the protein and lipid removal was related to the increase in the methane production. The second stage was strongly required due to the removal limitation in the first stage for proteins and lipids. Moreover, the carbohydrates have been consumed in the first stage related to the hydrolysis kinetic constants against proteins and lipids [Vavilin et al., 2008]. These facts showed the specialization of the different microorganisms related to each stage to degrade the macromolecules avoiding the limitation of the process due to the different mixtures [Astals et al., 2012]. Likewise, even with the time differences involved during the macromolecules degradation, both hydrogen and methane production maintained a continuous production over retention time.

### 4.3.2 Influence of first stage in methane production

#### *4.3.2.1 Daily performance for the methane production rate.*

The maximum daily values showed an increase in the production from 2.5 to 4.3 L CH<sub>4</sub>/d between C1 and C4 (Fig. 4.4). In this case, the maximum rate for C1 was reached in the second-third day showing the complexity of manure. In contrast, the production in the next conditions (C2-C4) reached the maximum rates in the first two days. The differences in the lag-phase time in the methanogenic reactor were associated with the substrates ratios and the efficiency of the first reactor to hydrolyze the feedstock. Therefore, the first reactor was considered a useful “pre-treatment” of the substrate for methane production with the VFA production and the hydrolysis of macromolecules [Appels et al., 2011]. The behavior of the methane reactor showed a similar trend over time even during the instability in C3 from the first reactor. In this case, the mixed culture in the second reactor was activated to uptake the different metabolites from the first reactor.

The VFA:Alkalinity ratio was below 0.2 for the first three conditions which suggested the stability of the process even with the initial ratio between 1.0-1.2 (Fig. 4.4). The response of the mixed culture at the beginning C4 showed the maximum ratio which was in the limit to be considered as inhibitory for the process [Panichnumsin et al., 2010]. Nevertheless, the ratio decreased below 0.4 which is considered as stable condition for methane production. This was associated with the acclimatization of the microorganisms to the VFA concentrations during

the repetitive batch cultivation. In addition, the alkalinity concentration increased during each condition which enhanced the response of mixed culture to the high VFA concentrations. Nevertheless, the final pH was around 7.0 which was low compared to other studies involved in methane production [Astals et al., 2012; Cavinato et al., 2011]. It could be associated with the decrease of initial pH over time from 6.2 to 5.6 which could produce a shock in the mixed culture of the second reactor. Moreover, this pH behavior in most of the cases could keep the activity of the biomass from the first reactor [Khalid et al., 2011].

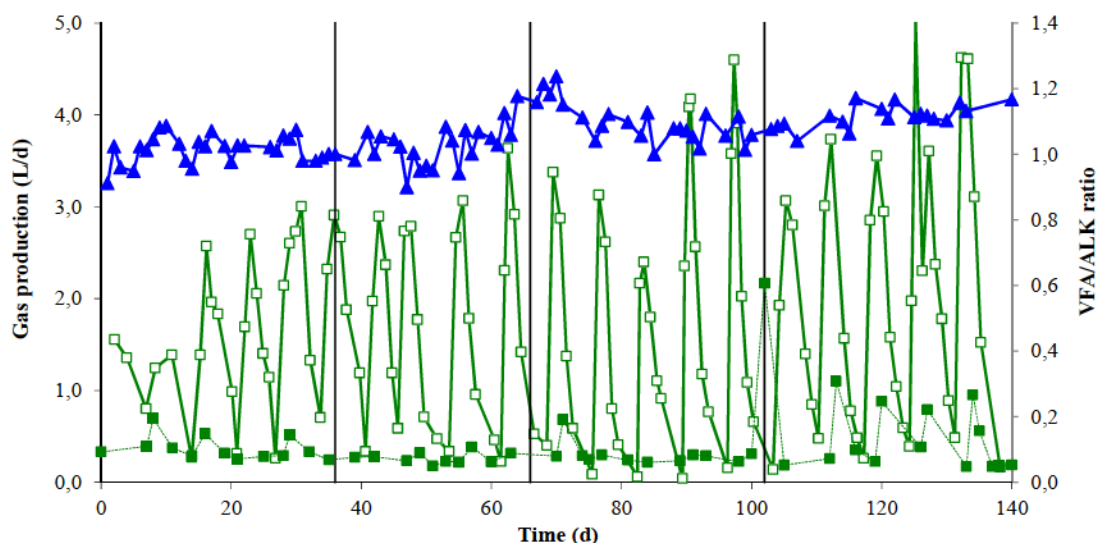

Figure 4.4. Methane daily production rate (open square symbols) evaluated with the VFA:Alkalinity ratio at the beginning (V/A<sub>in</sub> - ▲) and end (V/A<sub>out</sub> - ■) of the experiments.

The methane production over time showed a decrease after the fourth day of the experiments (Fig. 4.5). In this way, the methane production in C1 was sustained over time taking around 6 days to produce above the 90% of the total. In contrast, the production in C3 declined rapidly reaching the 90% of the production until the 4 day. Both behaviors were strongly related to the characteristics of the main substrate, soluble and hardly hydrolysable. Thus, the reduction in the retention time can improve the methane production rate. However, the main objective related to this stage, COD removal, could decrease around 20 % [Park et al., 2010]. On the other hand, the 90% of the methane production was reached during the first 5 days which suggested a similar behavior for C2 and C4. Likewise, the maximum production reached during the increase in organic load (C4) was slightly higher than C2.

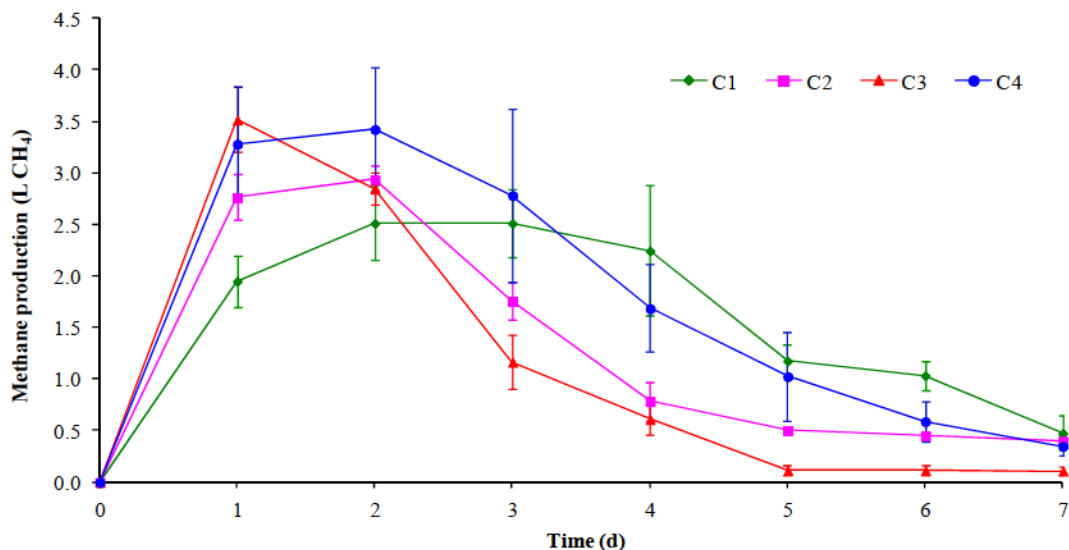

Figure 4.5. Methane production over retention time in the second reactor (diamond, squares, triangles and circles for C1, C2, C3 and C4, respectively). Values represent the average of at least three measures by condition.

#### 4.3.2.2 Feedstocks and effluents characterization – soluble COD

The first stage reached a maximum removal of total COD about 5.0 in C4 (Table 4.1) which was below of values reported in some studies which used simple substrates [Van Ginkel et al., 2005]. However, the highest COD removal achieved in C4 was close to some values reported during the hydrogen production which uses complex substrates. That low removal efficiency was improved by the operation of the second stage which reached a maximum of 72.9 %. In addition, the removal values for soluble COD decreased with the change in the substrates ratio from 11.5 to 3.6 %. Meanwhile, the removal in C4 was 18.4 % more than two-fold related to C2 in the first stage. It was improved during the second stage around 90.9 % which was comparable with the efficiencies removals reported using complex substrates [Venetsaneas et al., 2009; Vijayaraghavan et al., 2007]. Moreover, the high residual COD showed the elevated content of inert and hard hydrolysable material contained in complex substrates.

The first reactor played the role of the pre-treatment process to enhance the hydrolysis step in relation to methanogenic reactor. According to this, the soluble metabolites produced during hydrogen production (Ethanol + VFA) were the 60 and 79% of the soluble COD, where butyric and acetic acids were the main components (Table 4.2). The soluble metabolites like ethanol, acetic, butyric and valeric acids were consumed above 99.3 % for all conditions during the second stage. Meanwhile, propionic acid kept concentrations around 13 % of the



inlet in the second reactor which suggests a limitation due to acetic acid is the end metabolite before methanogenesis step. The remaining soluble COD in both reactors could be related to intermediate compounds like pyruvate or acetyl-CoA obtained during the degradation process. In addition, other metabolites as succinate and lactate could be generated as the response of the high hydrogen and carbon dioxide partial pressure achieved due to the inlet biomass from the first reactor.

The TKN through the conditions changed slightly except with the highest reduction for C3 which achieved a removal of 24.8 % in the first reactor and 26.0 % in the second reactor. In addition, the ammonia content was depleted in the first reactor during C3 which was related to the low availability in the coffee mucilage. Thus, it showed the low ability of the microorganisms to obtain the ammonia from the substrates mixture. In contrast, the mixed culture in the second stage was able to enhance the ammonia concentration through the degradation of proteins and other aminated compounds. In addition, the ammonia achieved at each condition for each reactor was below the inhibition limit of anaerobic digestion for hydrogen and methane production [Khalid et al., 2011; Moletta, 2008].

The ratios between volatile and total solids were 23.5, 17.4, 19.0 and 17.3% for C1, C2, C3 and C4 respectively, which showed a low content of organic matter in the feedstock. However, these values were higher than that reported by sewage sludge (2.4-3.5%) [Massanet-Nicolau et al., 2008], but less than reported for agricultural wastes as rice bran (79%), wheat bran (82%) and mixed fruit peel waste (93%) [Noike and Mizuno, 2000; Vijayaraghavan et al., 2007]. It showed that the organic matter available for the experiments was mainly in the soluble phase. Likewise, the VS increase through the both stages showed the degradation of the hardly hydrolysable material present in the feedstock.

On the other hand, the ratio carbon and nitrogen (C/N) was considered as functional levels to develop a hydrogen production which has been worked between 31.3 and 164.5 [Fountoulakis, M., Manios, T 2009; Venetsaneas 2009; Zhu et al., 2011]. Meanwhile, the C/N ratio for methane production has been reported between a range of 14 - 59 [Astals et al, 2012; Panichnumsin et al., 2010]. Thus, the C/N ratio in C3 for the second stage could be related to the decrease in the methane production due to the nitrogen limitation for the microorganisms at the beginning of the operation.

Table 4.1. Characterization of the streams involved in the experiments (n≥3).

Parameter	Unit	C1	C2	C3	C4
<i>Characterization of the feedstock</i>					
COD		10.8±0.0	10.2±0.6	10.8±1.0	19.6±0.4
CODs	g/L	3.4±0.5	4.6±0.5	5.6±0.2	8.1±0.4
TS		8.0±0.6	7.9±0.7	8.1±0.9	14.9±2.2
VS		1.9±0.1	1.4±0.1	1.5±0.1	2.6±0.3
TKN	mg/L	318.8±70.6	190.6±21.0	140.1±22.9	369.5±40.9
NH <sub>3</sub>		47.5±8.2	23.6±7.2	8.1±4.2	56.6±6.7
C/N		33.8	53.4	71.2	53.0
<i>Characterization effluent from the first stage</i>					
COD		10.5±2.2	9.9±1.5	10.4±0.3	18.6±0.3
CODs	g/L	3.0±0.4	4.3±0.6	5.4±0.6	6.6±0.7
TS		7.7±0.6	6.5±0.3	6.7±0.5	11.5±1.0
VS		1.9±0.2	1.5±0.1	2.2±0.2	2.7±0.4
TKN	mg/L	292.1±25.9	188.8±43.2	105.3±12.8	358.3±38.3
NH <sub>3</sub>		62.6±15.0	22.5±4.4	ND <sup>a</sup>	60.5±4.1
C/N		35.9	52.3	98.3	51.9
<i>Characterization effluent from the second stage</i>					
COD		4.0±0.6	4.3±2.4	3.2±2.3	5.3±1.2
CODs	g/L	1.4±0.4	1.3±0.6	1.4±0.7	0.7±0.1
TS		5.3±0.4	4.1±0.3	4.1±0.2	6.1±1.3
VS		2.3±0.2	2.0±0.1	2.3±0.1	3.1±0.7
TKN	mg/L	270.3±40.6	172.5±14.8	103.6±51.8	315.6±51.8
NH <sub>3</sub>		80.6±3.9	57.1±4.5	36.6±9.4	139.8±5.3
C/N		14.8	25.0	30.5	16.9

<sup>a</sup> ND: not detected.

Table 4.2. Main metabolites (mg COD/L) produced during each condition of experiments (n≥5).

Condition	Ethanol	Acetic <sup>b</sup>	Propionic <sup>b</sup>	Butyric <sup>b</sup>	Valeric <sup>b</sup>	Caproic <sup>b</sup>
<i>Metabolites in effluent from first reactor</i>						
C1	42.4±26.6	891.6±375.8	406.8±247.2	897.6±260.7	88.2±73.2	45.1±16.4
C2	149.4±131.3	492.5±250.3	221.1±44.5	2009.4±489.6	67.3±50.7	62.8±10.4
C3	137.3±152.6	592.0±184.4	149.4±132.5	2173.0±986.5	86.3±115.2	99.1±91.7
C4	105.3±22.4	1096.1±199.0	260.8±103.0	2661.4±263.4	172.9±136.8	157.7±67.2
<i>Metabolites in effluent from second reactor</i>						
C1	0.6±1.4	0.3±0.4	45.0±16.3	ND <sup>a</sup>	ND	0.5±0.1
C2	ND	0.2±0.2	32.6±23.7	ND	ND	0.2±0.3
C3	ND	2.7±0.9	8.7±2.8	ND	ND	0.2±0.3
C4	ND	0.1±0.1	6.8±3.5	ND	ND	0.3±0.3

<sup>a</sup> ND: not detected; <sup>b</sup> Acid.

#### 4.3.2.3 Evaluation of direct anaerobic digestion

The direct used of anaerobic digestion for methane production was considered in order to evaluate the difference with a two-stage process (Fig. 4.6a). In this case, the Biological Methane Potential (BMP) was examined for the best substrate ratio of 5:5 during hydrogen production. The direct application of the waste ratio 5:5 showed a low response in the first day against the results of the two-stage process. In that case, the BMP experiment spent more than twice the time in two-stage to arise the 80% of the methane production. It showed the limitation with the composition of the feedstock using the raw material for the methanogenic process. The rapid response in the experiments was related to the first stage which improves the solubilization of the organic matter improving the activity of methanogen microorganisms. However, the lack of agitation in the BMP experiments could be related to the lag-phase in the methane production and also with the almost constant methane production rate against the performance for the second stage.

On the other hand, the response was different in terms of methane production yield which was 602.6 mL CH<sub>4</sub>/g COD during BMP against 176.6 and 242.8 mL CH<sub>4</sub>/g COD for C4 and C2, respectively. This increase in BMP experiment was related to the high ratio between 41.5 and 63.1 gCOD/gVSS presented in the second stage against a ratio of 3 gCOD/gVSS. It improved the action of the biomass over the substrate in the BMP experiments. In this case, the results

suggest the requirement of changes in the second stage reactor configuration in order to improve the biomass retention. It could be seen in C1 which was the best condition for methane production where the ratio had a value of 19.3 gCOD/gVSS.

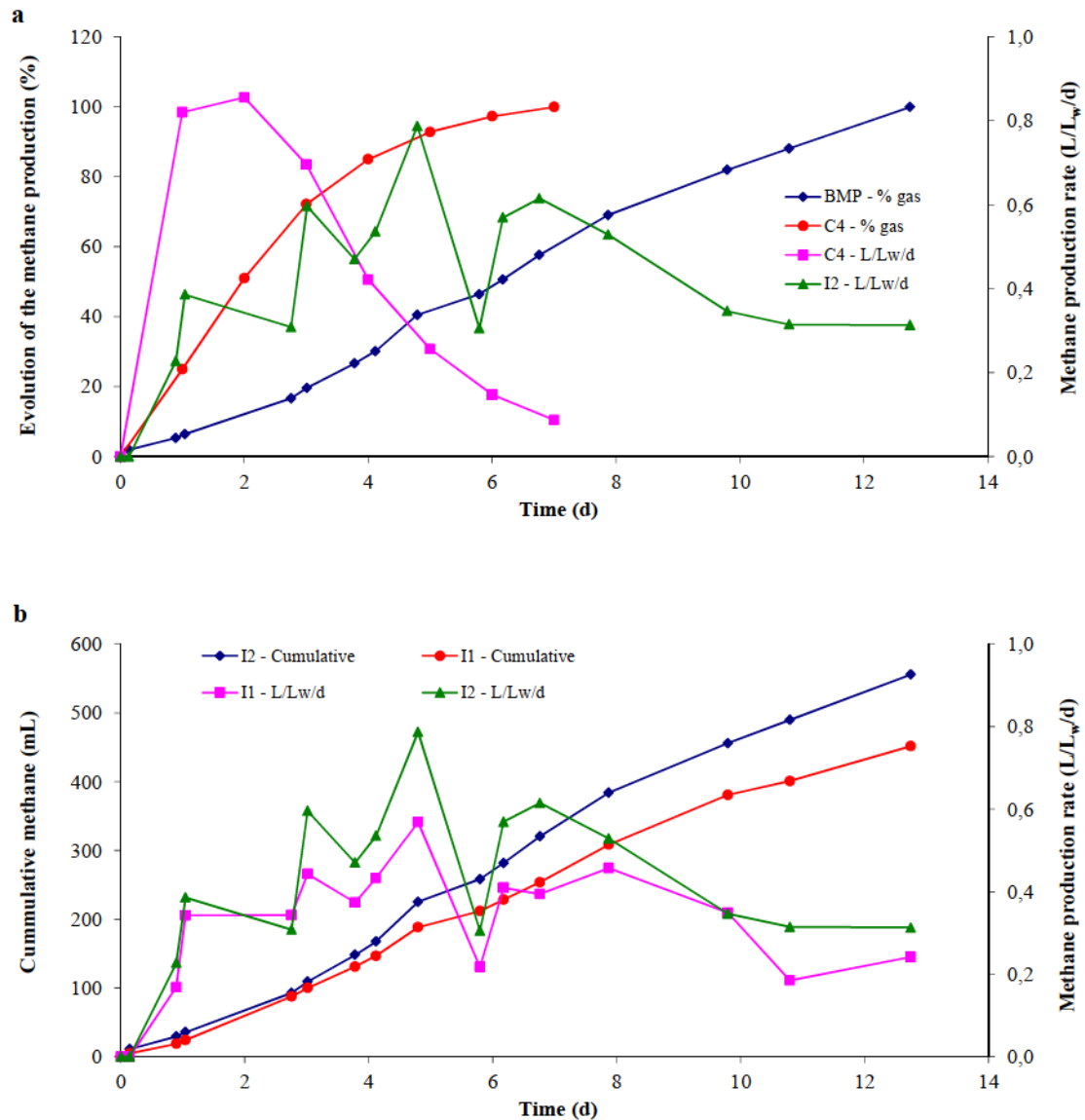

Figure 4.6. BMP from raw substrates vs methane production from effluent of first stage during C4 (a). BMP by the use of inoculum from the experiments – I1 and inoculum from wastewater treatment plant – I2 (b).

The use of other inoculum from an anaerobic reactor showed an increase in the methane production yield to 741.4 mL CH<sub>4</sub>/g COD. Thus, this methane production could be optimized for the energy recovery and the valorisation of both wastes. Nevertheless, both BMP

experiments showed similar production rate and cumulative volume performance (Fig. 4.6b). The reduction for I1 could be related to the influence of the strong conditions from the first reactor through the repetitive batch cultivation. Although, the methane production increase for the same substrate ratio showing the optimization of the process through the use of acclimatized inoculum for methane conditions. In addition, the methane performance showed two production dynamics with breakpoint around 5th day which was associated with the hardly hydrolysable condition of both substrates. However, this specific experiment could not be able to describe the influence of repetitive batch cultivation due to the highest methane production in second stage were obtained in the first days.

#### 4.4 Conclusions

The anaerobic co-digestion of swine manure and coffee mucilage developed in a two-stage process was able to recover energy through hydrogen and methane production under to the different mixture conditions. Each stage was specialized in the production of one biogas with hydrogen (39.4%) and methane (65.7%) in the first and second stage, respectively for the best condition. Meanwhile, the carbohydrates were the main macromolecule used for hydrogen production and proteins and lipids during methane production. The waste treatment achieved removals around 56 – 71 % of total COD in the overall process. In this case, the production of several metabolites during the first stage improved the response time and the production rates of the methanogenic process. Nevertheless, the direct methane production through BMP experiments showed an increase of methane production against the two-stage process. However, it was related to limitations with the biomass inside the process which limited the methane production.

## References

- American Public Health Association (APHA), Standard methods for the examination of water and wastewater, 21st ed. Washington, DC; 2005.
- Appels L, Baeyens J, Degève J, Dewil R. Principles and potential of the anaerobic digestion of waste-activated sludge. *Prog Energy Combust Sci* 2008;34:755–81.
- Aristizábal C, Duque H. Caracterización del proceso de beneficio de café en cinco departamentos cafeteros de Colombia. *Cenicafé* 2005;56(4):299-318.
- Astals S, Nolla-Ardèvol V, Mata-Alvarez J. Anaerobic co-digestion of pig manure and crude glycerol at mesophilic conditions: Biogas and digestate. *Bioresour Technol* 2012;110:63–70.
- Bradford MM. A rapid and sensitive method for the quantitation of microgram quantities of protein utilizing the principle of protein-dye binding. *Analyt Biochem* 1976;72:248–54.
- Cavinato C, Bolzonella D, Fatone F, Cecchi F, Pavan P. Optimization of two-phase thermophilic anaerobic digestion of biowaste for hydrogen and methane production through reject water recirculation. *Bioresour Technol* 2011;102:8605–11.
- DiStefano T, Palomar A. Effect of anaerobic reactor process configuration on useful energy production. *Water Res* 2010;44:2583-91.
- Dubois M, Gilles KA, Hamilton JK, Rebers PA, Smith F. Colorimetric method for determination of sugars and related substances. *Anal Chem* 1956;28:350-6
- Esquivel P, Jiménez V. Functional properties of coffee and coffee by-products. *Food Res Int* 2012;46:488–95.
- Fountoulakis M, Manios T. Enhanced methane and hydrogen production from municipal solid waste and agro-industrial by-products co-digested with crude glycerol. *Bioresour Technol* 2009;100:3043–7.
- Khalid A, Arshad M, Anjum M, Mahmood T, Dawson L. The anaerobic digestion of solid organic waste. *Waste Manag* 2011;31(8):1737–44.
- Khanal SK, Chen WH, Li L, Sung S. Biological hydrogen production: Effects of pH and intermediate products. *Int J Hydrogen Energy* 2004;29:1123-31.
- Kim M-S, Lee D-Y, Kim D-H. Continuous hydrogen production from tofu processing waste using anaerobic mixed microflora under thermophilic conditions. *Int J Hydrogen Energy* 2011;36:8712-8.
- Massanet-Nicolau J, Dinsdale R, Guwy A. Hydrogen production from sewage sludge using mixed microflora inoculum: Effect of pH and enzymatic pretreatment. *Bioresour Technol* 2008;99:6325–31.

- Moletta R. La méthanisation, first ed. TEC & DOC, Paris. 2008.
- Noike T, Mizuno O. Hydrogen fermentation of organic municipal wastes. *Water Sci Technol* 2000;42(12):155–62.
- Ntaikou I, Antonopoulou G, Lyberatos G. Biohydrogen production from biomass and wastes via dark fermentation: a review. *Waste Biomass Valor* 2010;1:21–39.
- Panichnumsin P, Nopharatana A, Ahring B, Chaiprasert P. Production of methane by co-digestion of cassava pulp with various concentrations of pig manure. *Biomass Bioenergy* 2010;34:1117-24.
- Park M, Jo J, Park D, Lee D, Park J. Comprehensive study on a two-stage anaerobic digestion process for the sequential production of hydrogen and methane from cost-effective molasses. *Int J Hydrogen Energy* 2010;35:6194-202.
- Schink B. Energetics of syntrophic cooperation in methanogenic degradation. *Microbiol Molecular Biol Rev* 1997;61(2):262–80.
- van Ginkel S, Oh S-E, Logan B. Biohydrogen gas production from food processing and domestic wastewaters. *Int J Hydrogen Energy* 2005;30:1535–42.
- Vavilin V, Fernandez B, Palatsi J, Flotats X. Hydrolysis kinetics in anaerobic degradation of particulate organic material: An overview. *Waste Manag* 2008;28:939–51.
- Venetsaneas N, Antonopoulou G, Stamatelatou K, Kornaros M, Lyberatos G. Using cheese whey for hydrogen and methane generation in a two-stage continuous process with alternative pH controlling approaches. *Bioresour Technol* 2009;100:3713–7.
- Vijayaraghavan K, Ahmad D, Soning C. Bio-hydrogen generation from mixed fruit peel waste using anaerobic contact filter. *Int J Hydrogen Energy* 2007;32:4754–60.
- Zhu H, Parker W, Conidi D, Basnar R, Seto P. Eliminating methanogenic activity in hydrogen reactor to improve biogas production in a two-stage anaerobic digestion process co-digesting municipal food waste and sewage sludge. *Bioresour Technol* 2011;102:7086–92.





## CHAPTER 5 Energy recovery and importance from biogas streams produced during the two-stages evaluated

### Abstract

The hydrogen production rates and yield can be compared with the results obtained by other process. Nevertheless, this research area is still in development due to the wide range of process for the treatment of similar substrates. It is more evident with the use of complex substrates which continue to be studied in order to establish appropriate procedures for the production of hydrogen. Nevertheless, the different experiments developed in this study showed the ability to produce energy in a range between 60.6 and 101.3 kJ/L<sub>w</sub> which could be improved through the optimization of both stages. In overall energy production the contribution from the hydrogen production stage was enhanced during the increase in mucilage. Nevertheless, the methane production decreased which was associated with a negative effect of VFA over inoculum. Instead of that, both stages are able to maintain an energy production over time which could assure the operation of the reactors during the lack of coffee mucilage due to the seasonal harvest. Finally, the possible increase of methane production observed through BMP experiments can make less attractive the hydrogen production because its contribution to the overall energy which will be below that 10%.

## 5.1 Biogas production rates from each of the stages used during the wastes valorisation

### 5.1.1 Hydrogen production comparison

The hydrogen production achieved during the experiments can be compared with values obtained by the use of other substrates and microorganisms (Table 5.1 and 5.2). In order to this, the hydrogen production achieved in these experiments is shown in Table 5.1 for the comparison with the different studies reported in Table 5.2. In this case, the hydrogen production should be carefully evaluated because for example the comparison in the hydrogen production yield related to VS showed high differences which favor these experiments. Thus, the hydrogen production obtained in this study (1.03 mL/gVS) is higher than the range of different substrates 0.7 – 196 mL/gVS. However, although the presence of swine manure in the waste could be considered more in terms of soluble material. In that case, the VS are more related to solid digestion or to the high solid content which can be associated with the substrates showed (Table 5.2).

On the other hand, the results can be compared in terms of volume of waste used during the experiments. Thus, the hydrogen production has similar results than several studies which range from glucose to complex materials as Cassava starch. Nevertheless, there are other results which showed high difference between the results obtaining for similar substrates. This information showed the limitation in this field to extrapolated results due to the difference in operating conditions, pre-treatment, substrates, mixed culture and reactor configuration. In the same way, this shows the efforts make to improve the hydrogen production levels. Moreover, the range is associated with interest to make wastes valorisation.

Table 5.1. Hydrogen production from co-digestion by dark fermentation from this work.

<b>Hydrogen production</b>	<b>Units</b>	<b>Average</b>	<b>Maximum</b>
rate (Gompertz)	NmL /L/h	328.8	437.5
rate (Total volume)	NL /L/d	0.76	0.86
per liter waste	NL /L <sub>w</sub>	0.76	0.86
yield (VS)	NL /gVS	1.03	1.18
yield (COD)	NmL /gCOD	43.0	55.8

Table 5.2. Hydrogen production from simples and complex substrates by dark fermentation.

Substrate	Culture	H <sub>2</sub>	Process features
Glucose	Mixed culture	300 <sup>a</sup>	FC(20 g/L), UASB
Glucose	<i>E. aerogenes</i> HO39	850 <sup>a</sup>	FC(10 g/L), Fixed film
Sucrose	<i>Clostridium butyricum</i> CGS5	266-667.3 <sup>b</sup>	FC(17.81 g/L), Batch
Sugar beet molasses	<i>Caldicellulosiruptor saccharolyticus</i>	200 <sup>b</sup>	FC(15 g <sub>sucrose</sub> /L), Batch
Starch	<i>C. butyricum</i> + <i>E. aerogenes</i>	800 <sup>a</sup>	FC(2%), CSTR
Cassava starch	Anaerobic mixed bacteria ( <i>Clostridium</i> )	334.8 <sup>b</sup>	FC(10.4 g/L), Batch
Hydrolyzed cassava starch	Pre-heated activated sludge	262.4 <sup>b</sup>	FC(25 g/L), Batch
Ground wheat solution	Anaerobic sludge	69.3 <sup>b</sup>	FC(6.7 g <sub>starch</sub> /L), Batch
Sugar factory wastewater	Mixed thermophilic culture	4.4 <sup>c</sup>	Continuous
Sugarcane bagasse hydrolysate	<i>Clostridium butyricum</i>	1.61 <sup>c</sup>	PF, Batch
Corn starch cultures	Mixed mesophilic	2.57 <sup>c</sup>	Continuous
Sweet sorghum extract	Indigenous microbial mesophilic culture	8.52 <sup>c</sup>	L/L/d Continuous
Molasses	Mixed mesophilic culture	4.8 <sup>c</sup>	Continuous
Cheese whey	Mixed mesophilic indigenous microbial culture	2.51 <sup>c</sup>	Continuous
Olive pulp	Mixed mesophilic culture	0.26 <sup>c</sup>	Continuous
Sugar cane bagasse		19.6 <sup>d</sup>	PF, 70 °C, Batch
Grass silage		6-16 <sup>d</sup>	35-70 °C, Batch
Maize leaves		18-42 <sup>d</sup>	PF, 70 °C, Batch
Food waste		60-196 <sup>d</sup>	mL/gVS PF, 35-36 °C, Batch
OFMSW	Mixed mesophilic culture	27.8-180 <sup>f</sup>	34-37 °C
Dairy manure		14-18 <sup>d</sup>	PF, 36 °C, Batch
Cow feces and urine		0.7-29 <sup>d</sup>	37-75 °C, Batch
Palm oil mill effluent (POME)	Thermoanaerobacterium-rich sludge	4.2-6.5 <sup>e</sup>	L/L FC(85 g/L), 60 °C, ASBR

Adapted from: <sup>a</sup> Kapdan and Kargi, [2006]; <sup>b</sup> Argun et al., [2008]; <sup>c</sup> Ntaikou et al., [2010]; <sup>d</sup> Guo et al., [2010]; <sup>e</sup> O-thong et al., [2008]; <sup>f</sup> Lay et al., [1999] and Gomez et al., [2009]. PF: Pretreatment of feedstock. FC: Feedstock concentration. OFMSW: Organic Fraction Municipal Solid Waste.

In contrast, the evaluation in terms of hydrogen production yield related to COD showed high similarity with some results obtained for wastewater which containing compounds as starch and cellulose. The production reached is in a range of 34.1 to 206.7 mL H<sub>2</sub>/gCOD [Perera et al., 2012] which showed the feasibility of these compounds for hydrogen production. Finally, there was a yield of 68.2 mL H<sub>2</sub>/gCOD [Perera et al., 2012] for cattle wastewater which showed a very close production to the 43 mL H<sub>2</sub>/gCOD of this study.

### 5.1.2 Evaluation of the different mixed conditions

The present study was developed as an alternative for the valorisation of two wastes taking into account the seasonal production of one of them, coffee mucilage. Thus, the process was developed in order to follow the tendency over time with the aim to improve hydrogen production and to keep a stable energy production. In this case, the overall energy produce was analyzed for the fourth experimental condition (Table 5.3). In this case, the process at the

same organic load rate showed a maximum energy production in the first condition. It was associated with the high potential of swine manure to methane production. In this case, the process should be oriented only to methane production due to this is the condition during the low production of coffee mucilage related to the seasonal harvested. Nevertheless, the results for condition 3 suggest the negative influence of the increase in hydrogen production which could be associated with the increase in VFA concentrations. It shows a limitation in the reactor configuration which allows the biomass washout avoiding the improvement of the mixed culture to support the increase in VFA.

Table 5.3. Energy production for the different experimental condition

CONDITION	H <sub>2</sub> reactor	CH <sub>4</sub> reactor	H <sub>2</sub> contribution	Overall energy
	kJ/L <sub>w</sub>	kJ/ L <sub>w</sub>	%	kJ/ L <sub>w</sub>
1	1.4	79.1	1.7	80.5
2	4.5	66.6	6.4	71.1
3	5.8	54.9	9.5	60.6
4	9.5	91.8	9.4	101.3

## 5.2 Energy yield related to biogas generation in both stages

### 5.2.1 Hydrogen and methane energy from the co-digestion

The theoretical energy production of methane and hydrogen are 55.5 and 141.8 kJ/g, respectively which shows the high energy content of hydrogen against methane of around 2.2 times. In Fig. 5.1, the molar ratio between methane and hydrogen showed the strong production of methane against hydrogen in C1. This behavior changed after C2 with a high increase in hydrogen molar production which decreased the ratio between both compounds to below 4. It was immediately reflected in the hydrogen participation in the total energy produced during both stages which reached an average of 8.7 % for the last condition. The instability for C3 in the first reactor affected the second reactor allowing to hydrogen achieved 10.0 % of the total energy. However, these results must be observed carefully due to the high fluctuations in C3 there was not a stable production. In contrast, the change between C2 and C4 showed an increase in the energy generated by both reactors in 2.5 and 1.4 times for hydrogen and methane, respectively. It showed a clear effect of the increase of two times in the organic load which improved strongly the hydrogen production more than the response to methane production. On the other hand, the energy related to hydrogen was 27.7 % higher

than that which could be produced by methane from this amount of hydrogen taking into account the theoretical relation during hydrogenotrophic step. Moreover, this excess of energy was represented as clean energy.

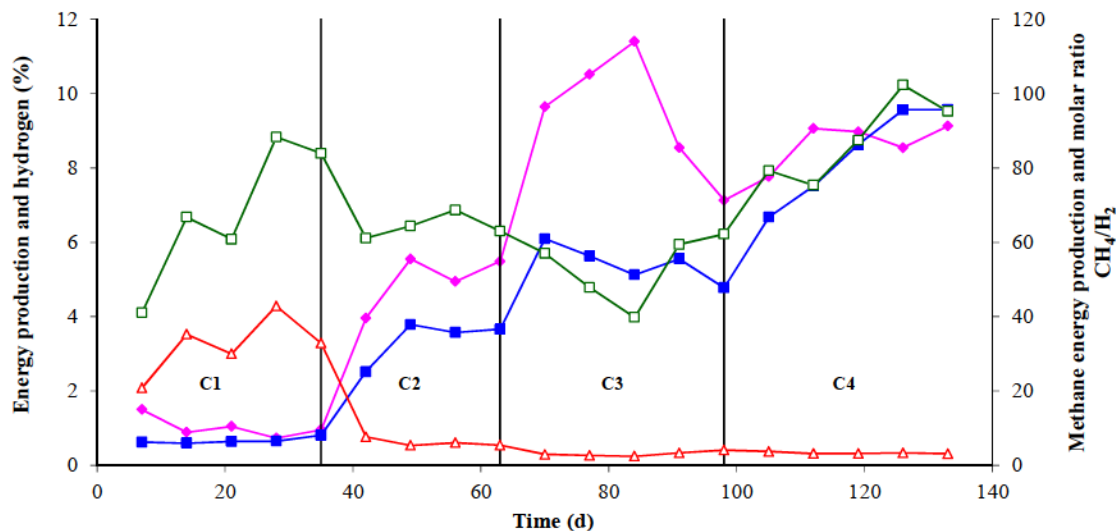

Figure 5.1. Methane and hydrogen molar ratio (open triangles) was calculated with the amounts produced by liter of feedstock. Energy production of methane (□) and hydrogen (■) was measured as kJ/L<sub>w</sub>. Hydrogen percentage (closed diamond) over total energy.

### 5.2.2 Hydrogen influence in overall energy from the co-digestion

The hydrogen and methane production achieved during C2 and C4 are presented in the Table 5.3 and compared with other studies to establish the hydrogen participation in the total energy. In that case, in terms of maximum production per liter of feedstock (L<sub>w</sub>) at each reactor, the biogas (hydrogen and methane) showed a trend to increase with the increase in organic load. The ratio between energy from methane and hydrogen changed from 4.7 in C2 to 3.1 in C4 which showed the main contribution of methane to the valorisation of the process. However, the contribution of hydrogen over the total energy was in the same range that the values found in other studies which reached hydrogen participation from 3.3 to 13.8 against the overall energy (Table 5.4).

Table 5.4. Hydrogen production rate/yield compared with others studies using anaerobic digestion.

Substrate	Units	Hydrogen	Methane	EH <sub>2</sub> (%)	Total energy	Reference
Cheese whey	L/Ld	1.9	1	97.6	74.8 kJ/Ld	[Venetsaneas et al., 2009]
OFMSW + glycerol		2.9		63.9	62.1 kJ/Ld	
OFMSW + glycerol		0.85	2.1	13.6	90.4 kJ/d	[Fountoulakis and Manios, 2009]
OMW/SW + glycerol	L/d	0.26	1.2	7.3	48.8 kJ/d	
Biowaste		177	1330	4.3	52.5 MJ/d	[Cavinato et al., 2011]
FW + SS	mL/mL <sub>w</sub> <sup>a</sup>	0.93	9.5	3.3	371.6 kJ/L <sub>w</sub>	[Zhu et al., 2011]
OFMSW	L/Ld	11.1	47.4	7.9	1.9 MJ/Ld	[Lee et al., 2010]
Coffee mucilage + swine manure	L/d	0.27*	1.46**	6.0	56.1 kJ/d	[This study]
		1.88*	3.44**	36.8	108.1 kJ/d	

OFMSW - Organic Fraction of Municipal Solid Waste; <sup>a</sup> mL<sub>w</sub>: mL of wastes.

FW: Food waste. OMW: Organic municipal wastes. SW: Sludge waste. SS: Sewage sludge.

\* Values represent the average in C2; \*\* values represent the average in C4.

### ***Biohythane***

On the other hand, the both gases could be mixed to obtain biohythane gas which has been reported as an optimal combination when the hydrogen percentage is between 5 and 10% [Cavinato et al., 2011]. In this study, the hydrogen content in the gas mixture could achieve a range of 2.3 to 14.7 % which turn the process able to the biohythane production. The use as biohythane involve other challenge as a specific biogas purification. In this case, identification, quantification and removal of compounds as ammonia, hydrogen sulfide, carbon monoxide and other pollutants should be done.

The results with the BMP analyzes suggest a reduction in the contribution of hydrogen to the overall energy. In that case, the hydrogen production could be not attractive in comparison with the energy produced by methane process. Thus, the application of this process should be related to the advantages over the traditional methane production. The increase in the organic load rate treated and the change to continuous operation could result in hydrogen production rates which make interesting this process. Moreover, in the case of a direct need of hydrogen for a specific use strengthen the usefulness of the developed process.

### 5.2.3 Comparison with other results

The energy generated by each gas is normally established through biogas production per volatile solids content which has a limitation in this work due to the low volatile solids which gives a high value against the theory with efficiencies above of 171 and 269 % for hydrogen and methane, respectively [Levin et al., 2007]. On the other hand, the experimental results reported of hydrogen production and methane related to these kinds of substrates like livestock or agricultural crops showed a lower efficiency when the relation was made with COD [Chanakya et al., 2004]. In this case, the methane production of coffee wastes per COD showed efficiency from 110 to 72.4 % with the results reached between C1 to C4. In addition, the comparison with the maximum value changed the efficiency to 36.2 and 55.5 %, respectively. It suggested a strong decrease of methane efficiency due to hydrogen production. Moreover, the composition of the biogas related to another process in terms of hydrogen and methane concentration by each stream could be equal or exceed the quality of the gas produced. In terms of sugar cane gasification, the biogas could be composed of 15-20 % of hydrogen and 1-2 % of methane which showed a low content in both gases related to the biogas obtained in this study by anaerobic digestion. Meanwhile, the content of CO and CO<sub>2</sub> were 20-25 and 10-12, respectively.

## GENERAL CONCLUSIONS





The present Ph.D thesis has been focused on the hydrogen production as biofuel of the second generation. For this purpose, two wastes from agricultural and livestock activities were used in order to develop the process. Thus, the conclusions of this research will be presented by the different phases developed.

### ***Phase I – Hydrogen production from co-digestion***

The co-digestion of both substrates is suitable for the hydrogen production process through dark fermentation. The substrate ratios evaluated show some limitations during the performance by the domination of one of the substrates. In that case, swine manure show low hydrogen production meanwhile, coffee mucilage increase the production. Nevertheless, the evolution of this condition over time shows the instability of the process. As a result, the condition with a similar proportion of both substrates shows the best results for hydrogen production with stability over time.

In this condition, the increase in organic load in order to optimize the hydrogen production was made. The response of the system shows high stability and an increase in hydrogen production which is strongly related to the coffee mucilage concentration. Yet, some inhibitions are associated with the increase in VFA concentration and the deviation in the metabolic pathway to propionic acid generation. Nevertheless, the increase in organic load has a positive effect in hydrogen production maintaining the stability over time than at low organic load.

Finally, the organic load removal achieves a maximum of 5% related to the total COD with an increase to 18.4% in terms of soluble COD. In all the studied conditions, the metabolic pathway is mainly related to butyric and acetic acids fermentation. Likewise, the Gompertz model is useful to fit the hydrogen production with high correlation factors.

### ***Phase II – Internal trends in hydrogen production***

All conditions show at least two different tendencies during hydrogen production by dark fermentation. These are associated with high and low production in with the domination of one of the both substrates. Nevertheless, the production during the 5:5 ratio change these

trends because the ended cumulative hydrogen production is the same but through a different route. The distribution between both tendencies is close to 50 % with the main differences in kinetic parameters as the lag-phase time. The ORP decrease quickly in the first two hours of the process which is associated with the system  $H^+/H_2$  and the use of ferredoxin as electron carrier. The carbohydrates are associated with the hydrogen production through the degradation pathway until a metabolic key product as pyruvate. Moreover, the lipid consumption was not detected in the three first conditions it is considered as part of the metabolic pathway for the last condition due to the reduction in the concentration of this macromolecule.

The batch experiments evaluation related to the microorganisms performance showed the influence of the 3 main genus proposed in the hydrogen production. In order to this, *Thermoanaerobacterium thermosaccharolyticum* is the main genus in the mixed culture during the short tendency of the process. At hits point, the *Bacillus sp.* shows high involvement at the beginning in short tendency decreasing at the end of the experiments. Meanwhile, the *Clostridia sp.* involvement increase during the long tendency associated with a changing pattern due to competition of both strictly anaerobes for the available substrates.

### ***Phase III – Effluent treatment and valorisation***

The additional stage is able to completely treat the hydrogen reactor effluent in all conditions evaluated. However, the methane production decreases with the increase in coffee mucilage for the third condition. The decrease is associated with the increase in VFA concentrations because it was reached for the third and fourth conditions. In addition, the evolution of methane production over time arise most of the biogas produced in a time below the time proposed. Additionally, BMP analyzes from the use of raw substrates showed the delay in the evolution of methane production due to the lack in the first stage. Besides, the use of other inoculum showed the increase in methane production which is associated with the negative effect of VFA on inoculum over the time.

On the other hand, the additional stage improves the waste treatment of the mixture used during the experiments. The total and soluble COD removals are around 56 – 71 % in the overall process. In this case, the metabolites which increased during hydrogen production are consumed for methane generation remaining low concentrations of propionic acid. Likewise,

### *General Conclusions*

the macromolecule degradation measurements confirmed that carbohydrates are the main component used during hydrogen production against proteins and lipid consumption during methane production.

### *Sustainable cycle*

The proposed alternative shows hydrogen production rates which are comparable with other substrates from food processing plants even with substrates with carbohydrate content above the coffee mucilage. The additional stage showed the adaptability of the process because the reactor can be operated during the seasonal lack of coffee mucilage maintaining the energy production which is important as initial consideration to the investment in a scale process. In the overall balance, the hydrogen represents a maximum of 13.8% in the energy obtained from both compounds (hydrogen and methane). This contribution is feasible to use the hydrogen with methane in a gas mixture (biohythane) where the participation should be above 10% to achieve positive effects. In this study, the hydrogen represents range between 2.3 and 14.7 % with the 4 investigate conditions making not feasible the first condition to this option. At this point, the hydrogen production could be considered as important with the increase in the hydrogen production rates and cumulative hydrogen from the use of high amounts of wastes.



# PERSPECTIVES



This study has achieved some knowledge about the hydrogen production from anaerobic co-digestion of swine manure and coffee mucilage. Nevertheless, the understanding of this kind of studies demands a lot of information due to the specificity of substrates. In order to this, the phases evaluated in the present study could be improved through the realization of additional experiments. Likewise, the results allow proposing features activities for the advance in the knowledge of this kind of process. In this case, some perspectives are formulated for each phase of the process.

### ***Phase I – Hydrogen production from co-digestion***

In order to improve the hydrogen production rate experiments must be conducted with the increase of the wastes concentration taking into account substrate ratios between 5:5 and 7:3 in order to maintain a stable cumulative production. In this case, the change from ABR in semi-batch configuration to Continuous Stirred Tank Reactor (CSTR) should be done related to the logical increase in the VFA concentration which involves the undissociated acid inhibition.

### ***Phase II – Internal trends in hydrogen production***

The inoculum obtained from swine manure is stable during the repetitive batch cultivation but, it is unstable over retention time due to the both trends shown in this study. In this case, additional analyzes to identify other microorganisms population involved in the process must be done. In addition the monitoring of the soluble metabolites including lactate and succinate to investigate the deviation route which produce propionic acid in the process.

### ***Phase III – Effluent treatment and valorisation***

The second stage shows the ability and the advantage through the use of the effluent from the hydrogen production stage. Nevertheless, some mechanisms should be implemented to biomass retention inside the reactor because the results suggest the washout of the methanogenic microorganisms. According to the optimization of the process and the



### *Perspectives*

monitoring of biogas the retention time of the waste treatment can be reduced as found in the experiments.

### *Sustainable cycle*

This part has a lot of promise. The present research was focused on the challenges related to the biogas (hydrogen and methane) production from waste. Now, the next step should be the scale up of the process in order to have practical quantities of biogas (hydrogen and methane) and sludge which allow proposing alternatives for the use and disposal. Finally, an overall energetic evaluation of the process is also necessary to be able to propose local power production facilities for the development of rural zone.

ANNEX I Preliminary experiments to obtain  
inoculum



## **Changing a mixed culture performance from methane to hydrogen production by modification of operating parameters – Monitoring the stability over time**

### **Abstract**

A methodology to the modification of mixed culture from methanogenic operation to hydrogen production was evaluated. The main purpose was related to find a practical way to obtain and to keep a mixed culture oriented to hydrogen production. In this case, the temperature and retention time were identified as the main parameters in order to preserve the hydrogen production through the repetitive batch cultivation. A factor identified to limit the methanogenesis process was related to the change in the metabolic pathway for the generation of butyric acid decreasing the presence of acetic acid in the process. Some advantages as the control of microorganisms by operating parameters, nutrients supply through manure and the tolerance to new microflora. In contrast, the main disadvantage is related to the continued presence of hydrogen consumers and their influence on the metabolic pathway.

### **1. Introduction**

Hydrogen production by dark fermentation is strongly linked to the anaerobic digestion microorganisms. Thus, one of the main issues is related to the obtaining of able inoculum avoiding the presence of hydrogen-consuming bacteria. In this aspect, many studies have used pre-treatment methods in order to select the hydrogen-producing microorganisms of the sludge from anaerobic digestion. Therefore, some methods as chemical, acid, heat-shock, freezing and thawing, base and repeat-aeration have been used for the elimination of hydrogen-consuming bacteria [Valdez-Vazquez et al., 2005; Ren et al., 2008; Mohammadi et al., 2011]. In this case, the extreme conditions are adequate for spore forming microorganisms as *Clostridium* species which is involved in hydrogen production. Nevertheless, even some of these pre-treatments could be ineffective to control the activity of hydrogen consumers or to improve the presence of hydrogen producers. Moreover, the selected mixed culture or pure culture could be by far contaminated with hydrogen-consuming bacteria during the production process. The source for microorganisms obtaining has been related to different process as aerobic activated sludge from a sewage water treatment plant, anaerobic digested sludge, soil from watermelon field, soil from kiwi grove, lake sediment and aerobic refuse compost [Kawagoshi et al., 2005]. Nevertheless, all of them except the digested sludge require the application of a pre-treatment method in order to improve the hydrogen production.

The substrates involved in hydrogen production should be highly available with the aim of developing a real application scale up. In this case, the use of feedstock as no renewable sources and energy crops has had a growing discuss. In that case, the use of biomass could be a response feedstock as alternative to evaluate the hydrogen production. In this way, co-digestion of several biomass wastes could be used to look for the requirements for the process. Manures have been widely used as a source of seed microflora for anaerobic treatment of a lot of wastes. In order to select the microorganisms there are relevant aspects involved in the control of anaerobic digestion to hydrogen production. In this case, the microorganisms presented in pig manure have been reported with the presence of several kinds of species in all the fields; aerobic, facultative and anaerobic. The main genera presented in this waste which are related to hydrogen production are *Bacillus*, *Enterobacter* and *Clostridium* [Snell-Castro et al., 2005].

Several parameters as pH, temperature, organic load, retention time are related to the improvement of hydrogen production conditions [Guo et al., 2010; Lee et al., 2011]. Nevertheless, they are considered strongly during the pre-treatment process by the microflora selection. In this aspect, a lot of requirements should be considered in the selection and conservation of inoculum during the hydrogen production process. Therefore, the main objective of this study was to evaluate the influence of different operating parameters involved during hydrogen production by dark fermentation in order to inhibit the hydrogen consumers and to improve hydrogen producers. In this case, manure was used as nitrogen and nutrients source, meanwhile coffee mucilage with a high carbohydrate concentration was the carbon source. The effect of these modifications was followed over time in order to identify the performance of biogas composition and volatile fatty acids. In addition, the presence of some hydrogen producers was evaluated in the last step.

## **2. Methods**

### **2.1 Experimental design**

Mixed culture modification was carried out in a reactor with a working volume of 5.5 L and a total volume of 7.2 L. The reactor was operated as an Anaerobic Batch Reactor (ABR) with the free evolution of biogas. The reactor was operated with a retention time to 3 days, pH fixed around 6.0 at the beginning (it decreased without control system) and stirred constantly at 200 rpm. The study evaluated each modification for a period of around 40 days.

## **2.2 Substrates**

The feedstock used in this study was composed of a mixture of swine manure and coffee mucilage wastes. The first substrate was collected from a pig barn at the Servicio Nacional de Aprendizaje (SENA) in Bogotá and preserved at 4 °C. Coffee mucilage was collected every two months immediately after the mechanical demucilaging process on a farm close to Bogotá and preserved at -4 °C. The feedstock required the dilution of both wastes with tap water to achieve the COD concentration established. It was acclimated at room temperature during the preparation procedure.

## **2.3 Mixed culture**

The initial inoculum was obtained from a methanogenic reactor which was operated at 35 °C, retention time of 7 days, pH above 7.0 and agitation of 100 rpm. The mixed culture was dominated by methanogens microorganisms producing mainly methane and carbon dioxide.

## **2.4 Analytical methods**

Hydrogen in biogas was measured online using a HY-OPTIMA 700 H2Scan® with a quantification range between 0.5 and 100 % (v/v). Methane and carbon dioxide were measured by an Infra-red Gas Analyzer (LANDTEC® - BioGas Check CDM) with a maximum deviation of  $\pm 0.3$  % (v/v) for methane and  $\pm 3$  % (v/v) for carbon dioxide. Volatile fatty acids were determined by gas chromatography (Hewlett Packard® 6890 series G1530A) equipped with a flame ionization detector (FID). The operating temperatures of the injection port, column oven and detector were 250, 250 and 300 °C, respectively. Argon was used as the carrier gas with a flow rate of 0.9 mL/min.

## **3. Results and discussion**

### **3.1 Mixed culture modification step by step**

Several scenarios were developed during an overall time of around 168 days with the change in the different parameter (Table AII). The different operating parameters and conditions taken into account were selected through a bibliographic review and the substrates availability. In that case, the bibliography suggests key parameters as temperature, retention time and organic load. Meanwhile, the substrates availability suggests the modification in the mixture of both substrates. The substrates mixture was related to coffee mucilage because it

had a seasonal harvest which limits its availability for the process. Therefore, a methodological process for the mixed culture transformation was applied as shown in Table A11.

Table A11. Performance of change from methanogenic to hydrogen condition

<b>Time</b> <i>d</i>	<b>OL</b> <i>g COD/L</i>	<b>Temp</b> <i>°C</i>	<b>RT</b> <i>d</i>	<b>Ratio<sup>a</sup></b> <i>Swine: Coffee</i>	<b>Hydrogen<sup>b</sup></b> <i>%</i>	<b>HPR<sup>b</sup></b> <i>mL H<sub>2</sub>/h</i>
<b>0-43</b>	30	35	3	1:2	18.8	14.1
<b>43-85</b>	36	35	3	3:4	31.1	31.6
<b>85-118</b>	18	35	3	7:3	16.9	15.4
<b>118-151</b>	18	55	3	7:3	33.7	44.9
<b>151-168</b>	18	55	1	7:3	25.9	73.1

<sup>a</sup> In terms of organic load; <sup>b</sup> Maximum values; HPR – Hydrogen production rate; OL - Organic load; RT – Retention time.

At the beginning of experiments an organic load of 30 and 36 g/L was used to improve the hydrogen production by the effect of organic load shock [Xing et al., 1997]. In addition, the prevalence of coffee mucilage suggested the availability of carbohydrates improving the growth of hydrogen producers. In fact, these changes in the process conditions showed a hydrogen increase related to the decrease of methane in biogas composition (Fig. A11). Nevertheless, the behavior changed to methane after the repetitive batch cultivation suggesting the acclimatization of methanogenic microorganisms. Thus, the metabolic pathway in the reactor changed around 20 days which was in agreement with Jo et al., [2007]. In this case, the increase in organic load was not able to keep hydrogen production over retention time even with the increase in metabolites concentration (Fig. A12). Furthermore, the decrease of acetic acid concentration at the end of second step showed the acclimatization of methanogens to uptake this metabolite. The high VFA increase was related to the inhibition of the hydrogen process as suggested by van Ginkel et al., [2005]. In this case, the methanogens microorganisms were enhanced in order to recover the equilibrium of the system.

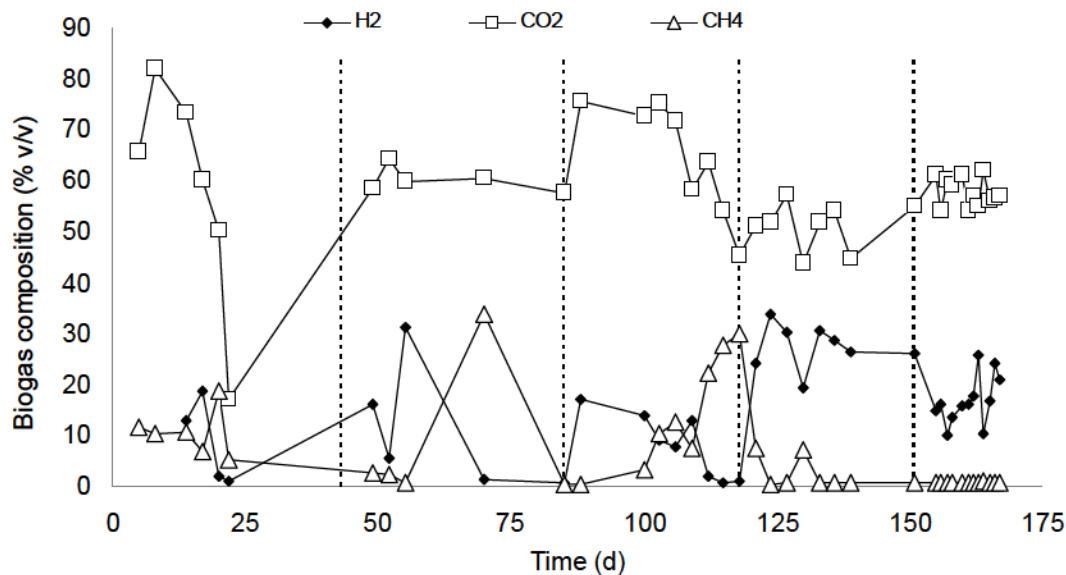

Figure AII. Evolution of biogas composition related to the change in operating conditions.

The next step was related to the reduction in organic load and the change in substrate ratio to improve the presence of swine manure. It was done expecting two results in the process: the decrease of VFA production avoiding the microorganisms inhibition due to undissociated VFA concentrations. The simulation of the worst condition to produce hydrogen related to the lack of coffee mucilage due to the seasonal harvest. In that case, the hydrogen production was improved instead of the high swine manure content. Nevertheless, the metabolic pathway changed again after 20 days through the repetitive batch cultivation. In those cases, after the parameters modification there was a favorable response of hydrogen producers, but over time the methanogenic process dominated the system.

Finally, the metabolic pathway was maintained during the change of temperature and retention time. Thus, the temperature had a strong effect over the activity of mixed culture improving the action of hydrogen producers. In addition, the increase in this parameter gave additional energy to the system which enhanced the hydrolysis step and reactions involved in hydrogen production. Likewise, the reduction of retention time was associated with the well known methodology to make the washout of methanogens. Thus, the hydrogen production rate increased instead of the decrease of the concentration in biogas. Moreover, the hydrogen production was achieved without nutrients solution and pretreatment of inoculum and substrate as opposed to Kawagoshi et al., [2005]. In addition, the metabolic pathway changed from acetic to butyric acid production which was associated with the final limitation



of the methanogenic step (Fig. AI2). Further studies showed that the increase of organic load under these operating conditions kept the hydrogen production process.

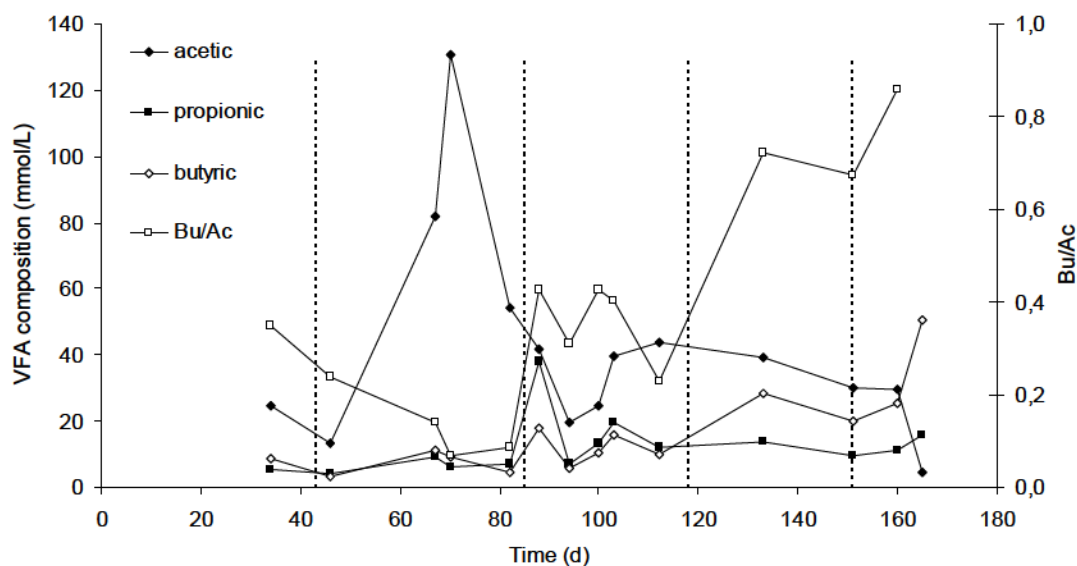

Figure AI2. The volatile fatty acids concentration during the change of operating conditions.

### 3.2 Internal trends and microorganisms

In the final period, between days 151 and 168, several trends were observed during the repetitive batch cultivation. It was related to the acclimatization of microorganism to the change in operating conditions and the substrates complexity. Furthermore, the final days of the experiments showed differences between the trends over retention time (Fig. AI3). Therefore, these effects were identified mainly over lag-phase time and hydrogen production rate which influence mainly the retention time in each batch cycle. These trends could be related to the activity of the main microorganisms involved in the process. In this way, some identification tests confirmed the presence of microorganisms related to the hydrogen production. In consequence, in the final step *T. thermosaccharolyticum*, *Clostridium sp.* and *Bacillus sp* were present. The *Bacillus* species were identified as *B. thermoamylovorans* and *B. licheniformis*. Further studies showed that the competition between *T. thermosaccharolyticum* and *Clostridium sp.* could be the main factor related to the change of internal trend.

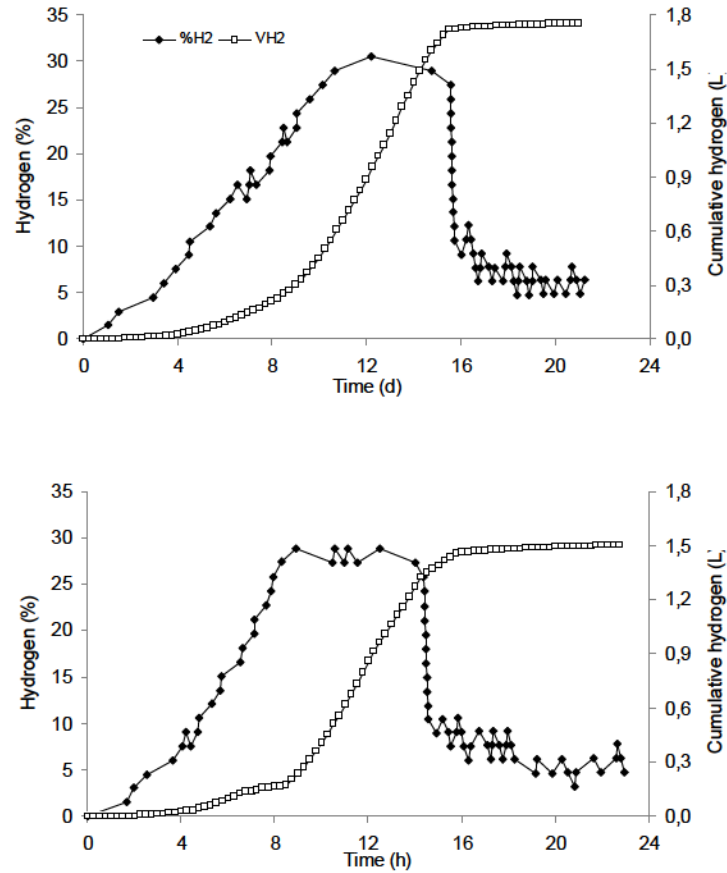

Figure AI3. Internal performance of hydrogen production by a mixed culture

### 3.3 Advantages and disadvantages

The main advantages are related to:

- The application of operating conditions could maintain the mixed culture oriented to hydrogen production reducing requirements for the process.
- The manure could support the nutrient requirements for microorganism growth during the use of substrates rich in carbohydrates.
- The mixed culture can tolerate the inlet of new microflora from the swine manure used as substrate.

**The main disadvantages are related to:**

- The presence of the different microorganisms in the mixed culture could affect quickly the hydrogen production during any perturbation which could improve the development of other pathway.
- The propionic acid production could be linked to the deviation in metabolic pathway related to some of the microorganisms in the mixed culture and the operating conditions.

**4. Conclusions**

The process was able to preserve a mixed culture oriented to the hydrogen production through the repetitive batch cultivation avoiding the change in the culture to methane production and preserving the hydrogen production without any kind of treatment. A factor identified to limit the methanogenesis process was related to the change in the metabolic pathway for the generation of butyric acid avoiding the presence of a suitable substrate for methanogenesis as acetic acid in the process. The repetitive batch cultivation was an effective mechanism in order to evaluate the stability of the mixed culture over time. Additional analyses should be made due to possible changes in the performance of hydrogen production.

**Acknowledgements**

The authors would like to acknowledge the practical support of the members of the Environmental Laboratory at the Universidad de los Andes and the financial support of the Research Center of the Faculty of Engineering (CIFI), ECOS Nord C10A01 and COLCIENCIAS 057-2010.

## **References**

- Valdez-Vazquez I, Sparling R, Risbey D, Rinderknecht-Seijas N, Poggi-Varaldo HM. Hydrogen generation via anaerobic fermentation of paper mill wastes. *Bioresour Technol* 2005;96:1907-13.
- Ren NQ, Guo WQ, Wang XJ, Xiang WS, Liu BF, Wang XZ, Ding J, Chen ZB. Effects of different pretreatment methods on fermentation types and dominant bacteria for hydrogen production. *Int J Hydrogen Energy* 2008;33:4318-24.
- Mohammadi P, Ibrahim S, Annuar M, Law S. Effects of different pretreatment methods on anaerobic mixed microflora for hydrogen production and COD reduction from palm oil mill effluent. *J Cleaner Production* 2011;19:1654-8.
- Kawagoshi Y, Hino N, Fujimoto A, Nakao M, Fujita Y, Sugimura S, et al. Effect of inoculum conditioning on hydrogen fermentation and pH effect on bacterial community relevant to hydrogen production. *J Biosci Bioeng* 2005;100:524-30.
- Snell-Castro R, Godon JJ, Delgenès JP, Dabert P. Characterisation of the microbial diversity in a pig manure storage pit using small subunit rDNA sequence analysis. *FEMS Microbiol Ecol* 2005;52:229-42.
- Guo X, Trably E, Latrille E, Carrère H, Steyer JP. Hydrogen production from agricultural waste by dark fermentation: A review. *Int J Hydrogen Energy* 2010;35:10660-73.
- Lee DJ, Show KY, Sud A. Dark fermentation on biohydrogen production: Pure culture. *Bioresour Technol* 2011;102:8393-402.
- Xing J, Criddle C, Hickey R. Effects of a long-term periodic substrate perturbation on an anaerobic community. *Water Res* 1997;31:2195-204.
- Jo JH, Jeon CO, Lee DS, JM Park. Process stability and microbial community structure in anaerobic hydrogen-producing microflora from food waste containing kimchi. *J Biotechnol* 2007;131:300–308.
- van Ginkel S, Logan BE. Inhibition of biohydrogen production by undissociated acetic and butyric acids. *Environ Sci Technol* 2005;39:9351-56.



## ANNEX II Substrates



## Pig manure production, situation, characteristics and microbiology

### *Manure production*

In Colombia, the 50 % of the pig farms (about 1300) take into account some technological implementation which improves the performance of meat production and in the same way the optimization of waste collection. The different process and waste characteristics in the pig farms are linked to the physiological cycle of the pigs. In this case, there are three exploitation types; raise, fattener and complete cycle farms. The raise farms are designed to fatten piglet up until a weight of 22 - 25 kg. After that, ones are ready for sold while the others piglets are conducted to fatten pigs up farms. In addition, this kind of farms has pig in the follow physiological state: piglets, lactating, pregnant and empty sows and stud pig. On the other hand, the fattener farm involved two main activities; the fatten pig up stage where the piglets from breeding farms reached 50 – 60 kg, and the second stage these pigs are sent to other pen or finisher farm to reach a weight of 95 – 105 kg. After that, the pigs are marketed or sent to slaughter (Fig. AIII1).

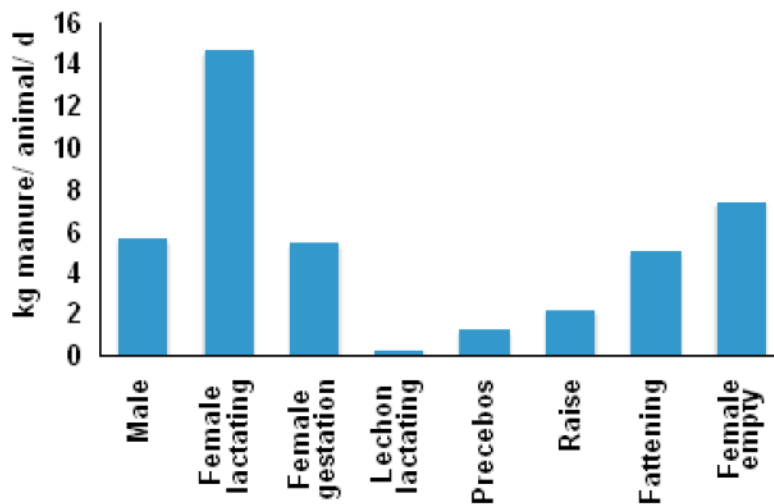

Figure AIII1. Amounts of pig manure produced related to pig physiological state (kg manure /animal/d). (MAVDT, et al., 2009).

The farm with complete cycle involved the complete development of the pig from pig birth, piglet to fattening pig. The generation of manure is strongly linked with the physiological state of the animals which allows establish a theoretical production. In this way, the highest production of manure is related to the lactating, empty, gestation sow and stud and fattening



pig which produces approximately  $\pm 6$  kg manure/animal/day. The lowest production is associated with the pen of weaned piglets. In this case, the farms which develop a complete process where the fattener is the main activity have a lot of manure generated.

The pork production process is related to different stages which involves from the birth of the piglet to the pig slaughter (Fig. AII2). This process could be considered constant when the amounts of pigs are the same across the time keeping constant the waste generated. This is wide applied in Colombia to have a constant pork production which represents the 49.21% of the total pig farms. Meanwhile, the breeding process farms correspond to 18.64% and the fattening or finisher farms which are involved with high amounts of manure production are the 32.15% [DANE & SISAC, 2003]. According to the distribution of the farms kind, the 81.36% of the total farms are involved with the high waste generation related to the amounts produced by each physiological state. The raise farms include the first 5 activities showed in Figure AII2 which dependent of the reproduction step in a closed loop. In contrast, the fatter farms involved just the sixth activity. Meanwhile, a complete cycle farm enclosed every activity showed with their inlets and outputs.

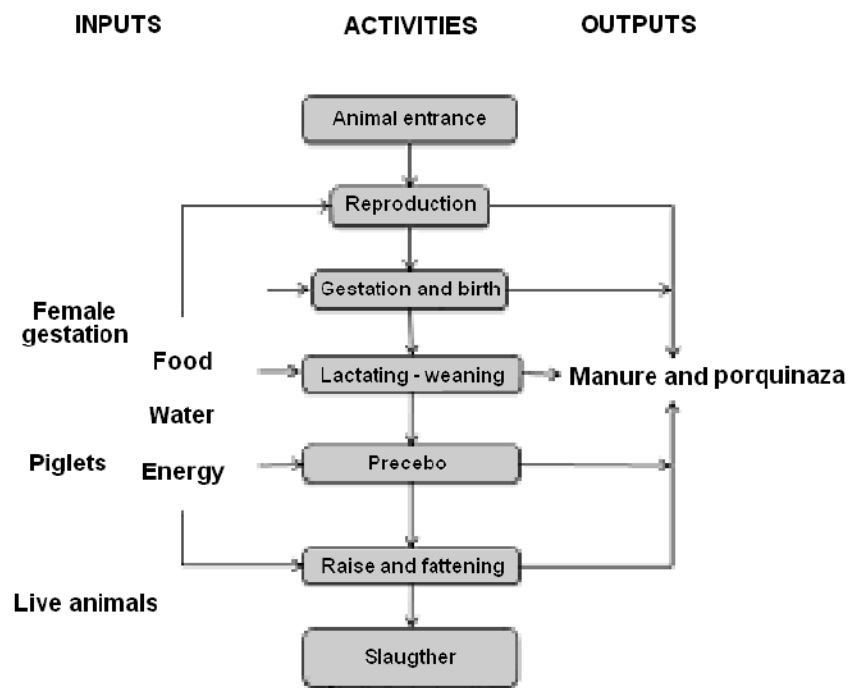

Figure AII2. Flowchart of the different stages in pig farm of complete cycle. Adapted from (MAVDT, et al., 2009).

**Colombia situation**

This economic activity is distributed in Colombia at 6 regions; Antioquia, central (Bogotá, Huila, Tolima), Valle del Cauca, Oriental (Boyacá, Meta and Santander), Cafetera (Caldas, Quindío, Risaralda) and Costa Atlántica. The intensive pig farming is mainly located in the department of Antioquia with 49.3%, the central region with a 15.4%, Valle del Cauca with a 13.6% and the lowest participation of 4.1% for the Costa Atlántica [UNAL, 2005]. In these regions, there is a different physiological distribution of the pigs (Table AIII). This variation was mainly related to the predominant operating type at each region which is associated with the species of pre and fattening. Antioquia as the most important region in this activity showed a behavior in the farms dominated by the presence of precebo piglets, raise pigs and fattening pigs which represent the 76.1% of the total population of pigs in the farms. The main physiological state is associated with fattening pigs (41.7%) showing why this region is the main pork producer in the country. The region Cafetera has a similar proportion related to these three physiological states with a 71.5 % of the total pigs. Meanwhile, the other regions have just approximately 65 % of these pigs related to these classifications. In this case, the low proportion of breeding found in Antioquia suggests that the amounts of pigs in farms are above than the other regions. This could explain the low proportions in the other parameters, in relation to the other regions, which independently cover the requirements to keep the production in the steps of fattening. In this case, the average distribution of the farms related to physiological state in Colombia is 28.4% of the fattening pigs, piglet precebo 20.6% and raise pigs of 19%.

Table AIII. Distribution of pig farms in relation to different physiological states and region of the country [UNAL, 2005].

Category	Valle del					Costa
	Antioquia	Central	Cauca	Oriental	Cafetera	Atlántica
Reproductores	0,4	0,8	0,6	0,8	0,5	0,7
Hembras cría lactantes	1,5	2,2	2,3	2,7	1,9	2,5
Hembras cría gestantes	7,2	9,2	9,4	8,1	8,7	8,0
Lechones lactantes	14,3	20,1	22,5	23,1	17,3	22,2

Category	Valle del					Costa
	Antioquia	Central	Cauca	Oriental	Cafetera	Atlántica
Lechones precebo	20,8	22,9	18,0	18,8	23,9	19,6
Cerdos levante	13,6	12,7	21,8	22,1	18,6	25,2
Cerdos ceba	41,7	30,8	25,0	22,7	29,0	21,4
Hembras vacías	0,5	1,3	0,5	1,6	0,2	0,3

The pig slaughter ground rent reported by the Colombian Agricultural Institute (ICA – by their acronyms in Spanish) in 2008 showed that this activity represents the 59.6% of the total pig population in the country. The total pig population of 2008, 2009 and 2010 was established taking into account this relation and the report of pig slaughter at each year. The growth of the pig population during these years was calculated as an average of 7.2% in the country. Alternatively, the manure generation could be obtained take into account the pig population by region and the generation of manure related to the animal physiological state. Currently, there are some management alternatives as systems of irrigation fields related to soil remediation, composting and vermi-compost related to compost production and the use of organic fraction like feed for cattle and fish. In this way, the implementation of treatment processes for organic load removal and pathogens microorganisms provides the use of ponds (aerobic, facultative and anaerobic) and anaerobic treatments which are able to recover energy from the wastes to biogas production.

### ***Physicochemical characteristics***

The pig is an animal omnivorous which is able to consume any type of food, in the conventional farms the feed of these animals is composed of leftovers and some feed produce in excess by the season. It produces wastes strongly heterogeneous with a lot of material without any kind of digestion. In contrast, at a technical level in the farm the feed is in the form of pellets which are produced to give particular characteristics of pigs in each stage of the growth process. This change in the feeding reduces highly the heterogeneity of the wastes but the content of thick solids keeps the variation of the wastes added to the mix of manure with urine. Additionally, the physiological state affects the characteristics of the wastes due to the feeding at each stage for pigs require particular nutritional demands. The pig excrete

(porquinaza) is composed of 45% of urine and 55% manure, this mix increase the humidity until 80%. This condition added to the presence of microorganisms and nutrients cause expontaneous fermentation process when the waste is left without preservation. In Table AII2, there are some swine manure characterizations which show the heterogeneity found in different parameters related to anaerobic digestion (COD, TKN and sulfur).

Table AII2. Swine manure characterization

<b>PARAMETER</b>	<b>pH</b>	<b>VS</b>	<b>VFA</b>	<b>TKN</b>	<b>NH<sub>3</sub></b>	<b>S<sup>-</sup></b>	<b>COD</b>
Hansen et al., (1999)	7.6	45	11	6.6	5.3	60	-
Nohra et al., (2003)	7.4	-	-	4.6	-	-	14*
Hernández and Rodríguez (2007)**	6.9	71	9.8	1.7	0.41	412	70.4
Vera et al., (2009)**	7.5	73	6.86	1.89	0.35	450	48

\* COD soluble; Units g/L; [sulfur] is expressed as mg/L; \*\* Unpublished data.

The change in the concentration of some parameters as COD, TKN and VS could be related to the amounts of urine mixed with manure, the environmental factors and changes in the diet according to the physiological state or availability of feed. But, usually it is related to the mix of these both compounds in the water used in the collect process of the wastes. These variations could influence strongly in the metabolic tendencies of some treatment process. The TKN and ammonia content could increase due to an increase in the urine mixed with manure. It could cause an inhibition of the treatment process like anaerobic digestion. The sulfur content in the porquinaza supports the spread of sulfate reducing bacteria which consume hydrogen. In addition, porquinaza have nutrient concentrations of potassium (K), magnesium (Mg), phosphorous (P) and some minor elements. With respect to nitrogen and phosphorous the assimilation percentage of the pigs are low, it releases a lot of amounts of nutrients of the feed through the porquinaza [Guía porcícola, 2002].

The different physiological states have several feeding rates even in the same stage of classification during the process of pig production (Table AII3). Pregnant, lactating and empty sows showed the highest daily food consumption their diet is composed by feed rich in energy more than proteins. The pigs with less feeding rate were the piglets due to their diet is

mainly composed by the breast milk, although when they became as weaned piglets the requirements of food increase.

Table AII3. Daily consumption of food according to physiological state (MAVDT, et al., 2009).

Stage	Physiological	Feeding rate (kg/pig/d)		
		Minimum	Maximum	Average
	Breeding	2,0	3,0	2,5
Gestation	Pregnant females	2,0	2,5	2,2
	Empty females	3,0	3,0	3,0
Maternity	Lactating females	4,0	6,0	5,0
	Piglets	0,1	0,1	0,1
Weaning	Precebo	0,5	0,6	0,5
Ending	Raise	1,5	2,0	1,7
	Fattening	2,0	3,5	2,7

Quintana et al., [2004] showed a higher content of Neutral detergent fiber (NDF) and Acid detergent fiber (ADF) in the proquinaza of pregnant sows than the other pigs stages due to the increased need for fiber at this stage. In contrast, the Nonstructural carbohydrates (NC) as free sugars, starch and fructose were quickly assimilable that animals which required high amounts of energy available. It could be related to the pigs in the development and piglet stages of the process. Usually, the copper is added to the diet of pigs related to the fattening process with the simultaneous addition of zinc to avoid the toxic effect of this element [Garcia, 2000]. Lower concentrations in the manure of these elements were in the stages of development and fattening. However, these groups received lower amounts against other stages which excreted higher percentages (Table AII4). In the same way, the productive stages of pregnant and piglet were the animals which consume more protein content limiting their expulsion through the excreted.

Table AII4. Chemical composition of porquinaza as productive stage (Quintana et al., 2004).

Productive stage	Crude		Ether		NDF (%)	ADF (%)	NC (%)	Calcium (%)	Phosphorous (%)	Copper (%)
	Humidity (%)	protein (%)	extract (%)							
Weaned										
piglet	80,5	26,9	7,1	28,4	8,0	23,3	2,5	0,2	0,12	
Development	78,7	26,3	9,8	30,9	9,8	17,0	3,4	0,2	0,04	
Fattening	78,6	23,4	6,5d	37,0	11,4	18,2	3,0	0,2	0,04	
Pregnant	80,7	16,5	3,9	40,2	15,5	19,1	3,9	0,3	0,07	
Piglet	72,5	15,8	8,6	30,7	11,8	16,2	5,0	0,3	0,09	

The Regional Autonomous Corporation of Central Antioquia (CORANTIOQUIA – by their acronym in Spanish) performed the characterization over 12 samples of manure showed the content of different compounds like nitrogen, phosphorous, potassium, sodium, calcium, magnesium, zinc and copper (Table AII5). Amongst the different metal contents in the manure characterization, potassium, sodium and calcium showed the highest percentages. The value of copper was close to that reported by Quintana et al., 2004. However, other parameters as humidity, calcium and phosphorus were highly different. This difference in humidity could be related to the collection process of the samples due to Quintana et al., [2004] evaluated the manure at each stage of the pig production process. In contrast, the difference in Calcium and Phosphorous should be related to differences in the diet of animals because they showed opposite trends. On the other hand, the low carbon/nitrogen ratio showed: the high amount of nitrogen per carbon concentration against the limited amount of carbon to develop adequately the microorganisms growth.

Table AII5. Physicochemical analysis of porquinaza (CORANTIOQUIA, 2003)

PARAMETER	(% Dry weight) Porquinaza	PARAMETER	(% Dry weight) Porquinaza
Nitrogen (%)	3,10 - 4,87	Zinc (%)	0,068-0,088
Phosphorus (% P <sub>2</sub> O <sub>5</sub> )	1,20-2,90	Copper (%)	0,015-0,069
Potassium (%K <sub>2</sub> O)	0,98-1,86	Moisture (%)	55,7-68,9
Sodium (%)	0,48-0,51	Organic matter (%)	42,0-55,70

PARAMETER	(% Dry weight) Porquinaza	PARAMETER	(% Dry weight) Porquinaza
Calcium (%Ca)	0,79-0,82	Organic carbon (%)	24,40-32,30
Magnesium (%Mg)	0,087-0,150	C/N ratio	6,6-7,8

The porquinaza is an attractive waste due to the limited ability of the pigs to the absorption of the nutritional compounds donated in the feed. In this case, the content of nitrogen and phosphorous in the manure is strongly valued for their use as fertilizer.

### **Microbiology**

The microorganisms available in the swine manure could improve the reactions involved in the hydrogen production stages even operate in the first stages of anaerobic digestion. This background is important because it allows know any possibility to inoculate the process or the bacteria type in the complex substrate could interfere in the degradation process. Snell-Castro et al. [2005] analyzed the range of microorganisms species in the porquinaza found bacterial groups such as: *Eubacterium*, *Clostridium*, *Bacillus–Lactobacillus–Streptococcus*, *Mycoplasma* and *Flexibacter–Cytophaga–Bacteroides*. Within these groups of microorganisms are species like *Clostridium*, *Bacillus* and *Bacteroides* which are involved in the production process of hydrogen. This is an advantage for the process since it involves a constant inlet of biomass able to develop the process. It could maintain the microorganisms avoiding the washing process during the discharge of the reactor. The presence of *Bacillus* is important because this genus could produce anaerobic atmospheres.

In the digestive tract of the pigs could be found a wide selection of microorganisms since the *Enterobacterias* are the most abundant which are expelled through manure. Microbes as staphylococci, streptococci, fungi and yeast are present in the manure as well as pathogenic microorganisms (*Salmonella*, *Mycobacterium*, *Rickettsia*, *Leptospira monocytogenes*, *Yersenia*) [García, 2000]. In this case, the pathogens contents are another aspect to take into account during the treatment and disposal of this waste due to adverse effect over animal and human health.

## **Coffee mucilage production, situation, characteristics and microbiology**

### ***Coffee processing***

There are two central methods involved in the primary processing of coffee: dry and wet processing. In the case of dry method, the coffee cherries are laid out in an open area for 3-4 weeks to be dried by the sun [Chanakya, 2004]. After that, the skin and pulp are removed mechanically. This method gives coffee beans with wide variety quality due to exposure at climatic conditions during that time. This method is applicable normally to species *Robusta* instead *Arabica*. The dry processing method is widely used in Brazil, the main coffee producer, which coffee cultivated areas are mainly linked to Robusta species. In this case, the most important waste was related to the production of coffee husk [Pandey, 2000]. The wet method comprises two steps pulping and washing. The first step involves a mechanical separation between the skin and pulp from coffee beans and mucilage. Skin and pulp are removed from the system as solid waste through just mechanical friction. Meanwhile, in the other step, the removal of a mucilage layer, which remains attached to coffee bean, is mandatory. It could make through different ways as natural fermentation, chemical methods, enzymatic fermentation and rub. In contrast, in Colombia the wet method is the most useful with the associated generation of solid residues as coffee pulp and husk but also the production of liquid residues as mucilage or washing water from the fermentation process. In this way, the mucilage production takes relevance as subproduct from this industrial process.

Both methods involve the production of wastes after the coffee berries were processed. It produces three kinds of wastes: pulp, mucilage and hull. The coffee bean is obtained after the removal of the other parts of the grain. These wastes are obtained during a wet processing method meanwhile just pulp and hull are removed through dry processing method. The distribution of the different fractions of subproducts generated in the coffee wet processing was: pulp 28.7%, mucilage 4.9%, hulls 11.9% and coffee beans 55.4% [INCAP]. However, other characterizations showed a distribution of pulp 26.5-29.6%, mucilage 13.7-7.5%, hulls 10.0-11.2% and coffee beans 50.0-51.7%, whose were related to the type Arabic and Bourbon, respectively [Aguirre, 1966]. The mucilage represents the 17 – 20 % of the fresh weight of cherry; it is responsible in 25% of the organic contaminant charge related to the cerise [Pineda, 2004]. In this case, the characteristics of wastes as pulp and mucilage will be associated strongly with the step used to mucilage removal; natural fermentation, chemical fermentation and mechanical demucilaging (Table AII6). During natural fermentation the



process begins at pH above 5.5, it remains stable or constant until 3 or 4 h before the completion of the fermentation process is determined by producers. After that there is a strong decreased in the pH value during 6 – 5 h until about 4.6. When lactic acid has been the main fermentation subproducts with concentrations above 50 mg/L the ethanol concentration remains below 50 mg/L, but in the opposite behavior the ethanol controls the process with the inverse order [Jackels and Jackels, 2005]. It showed the variation in the properties of mucilage after the first and second methods. However, the third step is the only procedure which allows obtaining the mucilage without alteration due to fermentation route.

Table AII5. Different steps used for mucilage removal.

	<b>DESCRIPTION</b>
<b>Natural fermentation</b>	<p>This step takes place after the skin and pulp mechanical removal. The beans with the layer of mucilage are transported and left in a tank to begin the fermentation process. It takes place during 4-72 h for the breakdown of the mucilage and to release it from the coffee beans [Pineda, 2004; Chanakya, 2004; Jackels and Jackels, 2005]. The range of time involved in fermentation step is wide due to different factors as volume of coffee treated, pulp removal method, tank dimensions and the discretion of the producer. It last factor is completely linked with the experience of producers over fermentation process. Traditionally, their decision is supported through the use of a straight object which is inserted and removed immediately into the coffee beans in the fermentation tank. After its removal the hole must be retained for 1 min or longer [Jackels and Jackels, 2005] to consider finishing the fermentation process. This step is linked to the washed of beans with water in tanks or trough canal of running water. In this case, is possible identify three wastewater streams related to pulping, and two washing processes; the first involves the transport of beans through fermentation step and the second related to wash after fermentation of coffee beans [Chanakya, 2004].</p> <p>The advantages include: the development of the process without energy requirements, workers without trained, clean coffee bean, and improves the appearance of the parchment coffee. In contrast, there are some disadvantages as the limitation with the quantity of grain processing, diverse grade of</p>

---

**DESCRIPTION**

---

fermentation in the beans and a lot of amounts of water during the washing step.

**Chemical  
fermentation**

This kind of fermentation is similar to the previous natural process. The main difference was related to use of some chemical compounds to accelerate the fermentation process. The most common reagents involved in this method are Calcium hydroxide, Ferrous sulfate and Calcium chloride [Pineda, 2004]. In this case, there is a reduction in time but, in the same way the costs increase, the wastewater required another treatment step and trained workers are needed. Natural and chemical fermentation have the same objective that is to allow the degradation of mucilage to improve their removal from the grain.

**Mechanical  
demucilaging**

In this process the mucilage is removed through mechanical friction over the grains which arrive after the depulping process. In this way, the mucilage is obtained “pure” in relation to the before steps and it could be involved in the specific alternative process related to treatment or use of this waste. Some advantages are: the change to a continuous process, an increase of the grains quantity treated, less area for removal of mucilage and reduction in water requirements. On the other hand, the disadvantages are: the initial investment in new equipment, dirt in the groove of the coffee bean, increase in energy requirements and peeled coffee.

---

***Colombia situation***

In Colombia, the National Center for Coffee Research (CENICAFE - by their acronym in Spanish) has developed a system known as the ecological friendly post-harvesting system – BELCOSUB (Fig. AII3). It reduces the water utilization in the coffee processing from 50L to 1L per kilogram of dried coffee. It involves two steps developed separately to remove the pulp through mechanical friction and another module to remove the mucilage from the coffee grain in the same way. Also the use of more efficient mechanical process to remove the pulp from the grain reducing water spends during the mechanical separation process. In addition, to remove the mucilage without a lot of amounts of water used in the conventional process

avoiding the water spend related to the traditional process. However, this technology has not been widely applied in the country due to traditional processes as natural fermentation and conventional depulping.

The distribution of the different coffee processing methods in Colombia was evaluated by Aristizabal and Duque [2005] through random samples which represent several farm tails and location. The authors found that 69% of the farms used conventional coffee processing method identified as the wet method with mucilage fermentation. In this group the disposal of pulp waste is frequently conducted in pits (64 - 65 %) and just the 2 – 3 % is used in vermiculture. Additionally, there is another kind of disposal which represent 19-24% related to the stack of this waste in a selected side of the farm controlling their potential pollutant power. In the farms with mechanical dry about 3% of this waste is dumped into the river. The 81-89% of the farms utilizes the wet process with the fermentation of mucilage; in this case, there is a high pollutant potential due to the amounts of water involved during the washing step from removal this waste. The washing step after the fermentation period was made through tank in the 51-72% of the farms meanwhile the other main method was related to use of channels to make the washing of the grains (28-43)%.



Figure AII3. Ecological coffee processing method BELCOSUB

The other 31% of the coffee farm was related to the use of ecological coffee processing method which is the same wet method but instead it replaces the fermentation step with the

use of BELCOSUB. Moreover, it improves the efficiencies of pulp removal against water consumption. The ecological processing method involves the use of BELCOSUB which has the possibility of mix the pulp and mucilage to have just one waste. However, it could be separated both waste to obtain them individually for different treatment or use technique. In this case, the management of this kind of waste is mainly related to the disposal in pit (90-94%) for their composting in most cases. Additionally, some fraction around 3-6% of this waste is used to vermiculture process. The other fraction is deposited in empty areas without any kind of treatment and management.

### ***Physicochemical characteristics***

The wastes generated during coffee processing methods are mainly pulp, hulls and mucilage where the two first are considered as solid waste and the third is a liquid waste with the presence of suspended and dissolved solids. Mucilage is composed chemically with water, pectins, sugars and organic acids. There are other compounds as calcium pectate and protopectin which are converted into pectins during the maturation of the coffee berry. Additionally, the content of sugars and organic acids were related to the metabolism and conversion of starches. In this way, the composition of mucilage has been reported as total pectin substances 35.8%, total sugars 45.8% which are represented as reducing sugars 30.0%, non-reducing sugars 20.0% and cellulose: ash 17.0% [Carbonell and Vilanova, 1974]. In the same way, Pineda [2004] suggests that the mucilage is composed of pectic substances, reducer sugars, non-reducer sugar and celluloses (ashes) with ratios of 33, 30, 20 and 17%, respectively. Meanwhile, Avallone et al., [2000] showed that mucilage is composed mainly of high water around 84.2% and 8.9, 4.1 and 0.91 % for protein, sugar and pectic substances, respectively.

The composition of the coffee berries was associated with the presence of pectin-degrading enzymes located in the endocarp and esocarp. These compounds are essential during the fermentation process. However, those are related to the removal of the methoxyl groups from the pectin molecule [Wilbaux, 1956]. In that case, the process needs the presence of another kind of enzymes related to the glycosidic linkage of the polygalacturonic acid (pectic acid). In this way, the pectin is a polysaccharide composed mainly of 1,4- $\alpha$  galacturonate with a high degree of methyl esterification. This condition required the action of mainly two kinds of enzymes: A first group to remove methoxyl groups from pectin, and a second group which takes into account the depolymerisation through hydrolases and lyases. Thus, Soriano et al.,

[2000] suggested the action of a group of pectin lyases which cleave the methyl esterified compounds. Meanwhile, for unesterified polygalacturonate compounds the action could be realized by pectate lyases.

Avallone et al., [2000] evaluated the composition of alcohol-insoluble residues found the follow polysaccharides composition; pectic substances, cellulose and neutral non-polysaccharides about 30, 8 and 18%, respectively. The pectic substances were composed mainly of uronic acids (59.6-60.4%). It was related essentially with pectic neutral sugars as rhamnose and arabinose (galacturonic type); it had a high degree of methyl esterification about 23% and low degree of acetylation about 1-2%. The uronic acids were related mainly with components of galacturonic type which were represented by noncellulosic monosaccharide as arabinose, galactose, rhamnose, xylose and glucose mainly. Each one has a participation of 52.5, 19.7, 9.6, 8.9 and 7.8 % in mole base.

There are other characterization linked to physicochemical parameters, macrocompounds and nutrients (Table AII7). Sometimes these parameters could be influenced by the humidity level which is related to precipitation rain in the area before the harvest collection process [Pineda, 2004]. In Table AII7 there are two parameters important to take into account during hydrogen production; pH and soluble carbohydrates content. In this case, the acidic condition of the wastes could influence in the microorganisms selection and metabolic pathway like a kind of pre-treatment during anaerobic digestion. Likewise, the high concentrations of soluble carbohydrates improve the degradation process through microorganisms which produce metabolites with an economic interest [Rodríguez, 2001]. In anaerobic digestion this kind of metabolites is represented by the production of VFA but sometimes the deviation in the main route could generate other reduce compounds as ethanol, lactate or acetone. Additionally, pH was related to the method for processing the coffee berry to obtain mucilage, when this process was mechanical the pH was lower (5.0 - 5.2) than when the process was doing manually (5.6 – 5.7). In addition, the degree of ripeness must be taking into account as an influence in the pH level [Wilbaux, 1956].

These wastes have a wide range of micronutrients as Ca, Mg, Fe, Mn, Cu, Zn and B which could improve the hydrogen production. The nutrients with high concentration are iron, zinc and magnesium contents in the pulp with maximum concentrations of 700, 45.75 and 43 ppm, respectively. Magnesium and zinc were in high amounts in the mucilage against pulp and have been related along with iron in the hydrogen production process [Lin and Lay, 2006]. In

addition, the chemical oxygen demand of mucilage approximately of 248.7 g/L [Zambrano-Franco and Isaza, 1998] showed the high contamination degree that could be caused by the inadequate disposal.

Table AII7. Characterization of wastes generated during coffee processing methods

PARAMETER	pH	OM	Lipid	Protein	CHO soluble	N	P	K
Pulp	4.40	93.3	1.6	11	69.3	1.76	0.13	2.82
Pulp/mucilage	4.13	92.7	2.0	12	61.4	1.94	0.13	2.75
Pulp	-	-	2.5	10	50	-	-	-

OM: Organic matter; CHO: Carbohydrates (Percentages); <sup>1</sup> Blandón-Castaño et al., 1999; <sup>2</sup> Pandey et al., 2000

### **Microbiology**

This topic has been slender studied in this kind of wastes mainly related to pulp instead mucilage or the other wastes generated during coffee processing. The main classification found for microflora in the coffee wastes (mainly pulp) were related to the presence of bacteria, fungi and yeast [Rousoos et al., 1995; Silva et al., 2000]. It was related to a contribution of each one of around 43.8% were bacteria, 16.1% were yeasts and 40.1% were filamentous fungi [Rousoos et al., 1995; Silva et al., 2000]. In this way, Blandon-Castaño showed that bacteria and yeast were the main microflora components in the pulp and the pulp mixed with mucilage samples. The results showed that the presence of aerobic microorganisms like actinomycetes, fungi and yeast was higher in the pulp than in the mix of pulp and mucilage. The actinomycetes were able to cellulose and lignin degradation. Furthermore, the occurrence of *Enterobacter*, *Staphylococo*, *Serratia*, *Candida*, *Torulopsis*, *Rhodotorula*, *Escherichia* and *Citrobacter* were detected [Blandón-Castaño et al., 1999]. Additionally, some genres as *Pseudomonas*, *Acinetobacter*, *Flavobacterium*, *Proteus*, *Alcaligenes* and *Klebsiella* which are able to solubilize phosphorus were determined for the mix of pulp and mucilage. Between the microorganisms found in this study just the genus *Enterobacter* has been reported as hydrogen producer, it makes clear a low content of microorganisms in this substrate against swine manure in the purpose to improve the microbiological compound during the experiments.

Another research conducted by Silva [2000] found that the bacteria isolated were identified as 44.5% Gram-negative, 9% Gram-positive spore-formers and 46.5% Gram-positive non-spore-

formers. The main genera associated with the Gram-negative bacteria were *Aeromonas*, *Enterobacter* and *Pseudomonas*. The Gram-positive spore-formers were related mainly to *Bacillus*, meanwhile Gram-positive non-spore-formers were *Cellulomonas* and some results were linked with *Lactobacillus* in a lower proportion. The yeasts were identified as *Pichia* (38.9%), *Candida* (22.3%), *Arxula* (18.9%) and *Saccharomycopsis* (9.7%). However, the yeast appeared mainly when the grains were dried and fermented. In contrast, the fungi were identified as *Cladosporium* (39.7%), *Fusarium* (34.2%), *Penicillium* (28.8%) and *Aspergillus* (2.7%). *Enterobacter* does not secrete pectinases meanwhile *Bacillus spp.* secrete some enzymes as cellulases, amidases and proteases. It was really essential during the first degradation stages of macromolecules decomposition. Additionally, an enzyme from *Bacillus sp.* was isolated with properties among pectin and pectate lyases because it was able to both polygalacturonic acid and highly methylated pectin [Soriano et al., 2000]. In this case, there are some microorganisms able to develop the first steps of anaerobic digestion which prepare the conditions or the substrates required during the subsequent steps. However, the low pH found in mucilage could limit the presence of bacteria and increase the presence of yeast. Instead, there are some microorganisms which could change the initial objective of hydrogen production it was related to the presence of *Lactobacillus*. However, this was non-spore-formers indicated that maybe the process at thermophilic temperature could be aggressive to this microorganism.

On the other hand, Terry et al. [2004] evaluated three types of inoculum (cattle manure, supernatant and sediment of stabilization pond pulping plant) in relation to the degradation of wastes from coffee processing. They found that cattle manure showed the best performance related to the start-up of the anaerobic process. Similar results were reported by Boopathy [1987] found that cattle manure showed the best start-up process during the degradation of coffee wastes.

## ANNEX III Photos of reactors and experimental results



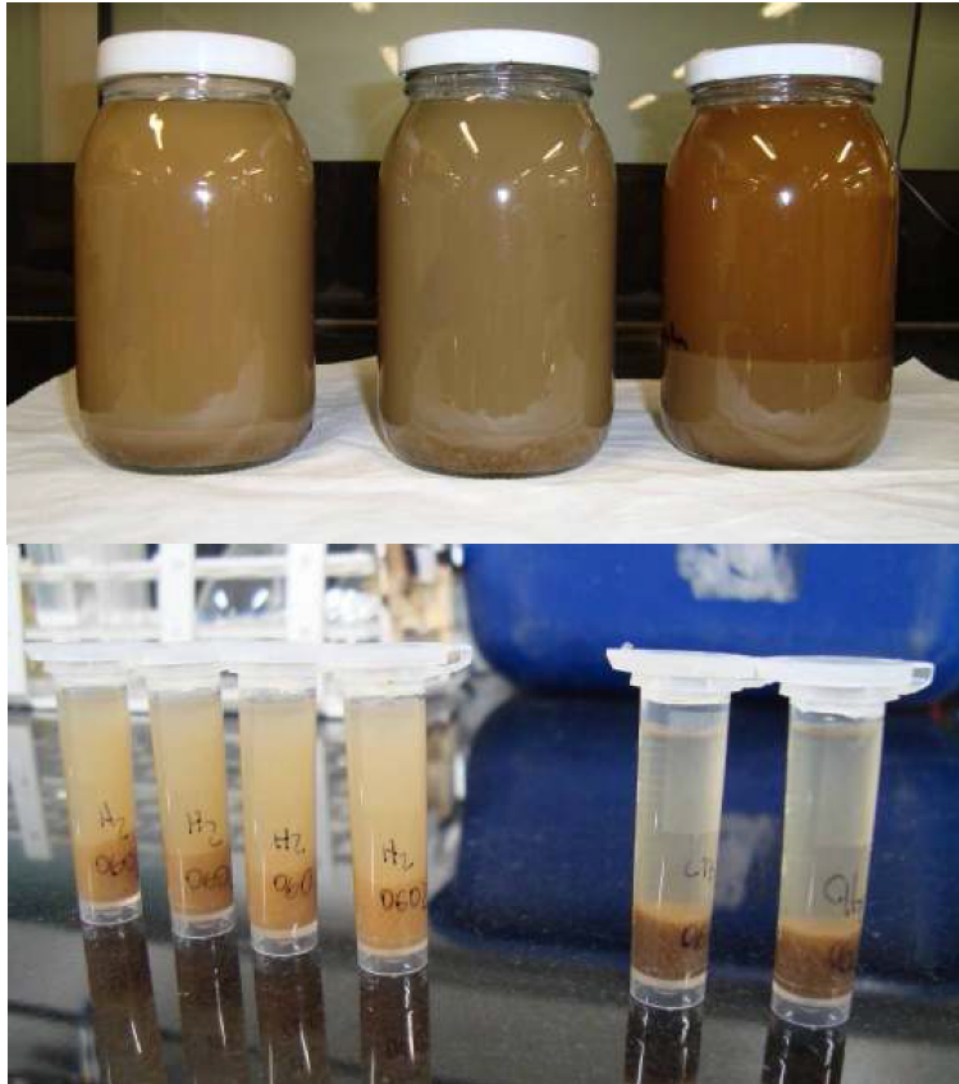



**Figure AIII1. Reactor system for hydrogen experiments**



**Figure AIII2. Coffee mucilage processing: removal of thick solids composed by coffee grains, pulp and some coffee beans.**



**Figure AIII3. Differences between the stages involved in the process. From the left to right: (Up) Feedstock, hydrogen effluent and methane effluent. From the left to right: (Down) Hydrogen effluent – 4 samples and methane effluent – 2 samples.**



**Figure AIII4. Effluent from hydrogen reactor. The time zero on the left, then the sedimentation can be seeing to the right.**



**Figure AIII5. Change in the hydrogen effluent during the fluctuation of condition 3. The supernatant found was associated with the activity of some microorganisms producer of bacteriocin as lactic acid bacteria (LAB).**

## Français - Résumé

**PRODUCTION D'HYDROGENE PAR CO-DIGESTION ANAEROBIE DE  
MUCILAGE DU CAFE ET DE LISIER DU PORC**

Résumé de la thèse de doctorat de se qualifier pour le double diplôme

Docteur en Génie des Procédés de l'Ecole des Mines de Nantes

Doctor en Ingeniería de la Universidad de los Andes

**Mario Andrés Hernández Pardo**

Directeurs

Manuel Rodríguez

Yves Andrès

Laboratoire de Génie des Procédés Environnement Agro-alimentaire (GEPEA)

Centro de Investigaciones en Ingeniería Ambiental (CIIA)

Nantes, Francia

Novembre 2012

## INTRODUCTION

La demande en énergie est nécessaire globalement et localement. La consommation est principalement représentée par l'utilisation de combustibles fossiles (gaz naturel, charbon et pétrole). L'hydrogène est considérée comme l'énergie de l'avenir en raison de ses fonctionnalités, telles que l'énergie propre. Déclaré que la production de carburant à base d'hydrogène peut être accompli grâce à l'utilisation de différents procédés comme le réformage de gaz, la gazéification, la pyrolyse et l'électrolyse qui utilisent généralement des sources non renouvelables et peu compatibles avec un développement durable. L'hydrogène peut également être produit par des procédés biologiques comme la fermentation sombre ou la photobiologique. Ces voies de production d'énergie peuvent utiliser la biomasse comme matière première renouvelable.

La fermentation sombre montre certains avantages tels que la possibilité d'utiliser de fortes charges organiques et produire du biogaz (méthane et hydrogène) qui peuvent être utilisés pour les moteurs à combustion interne ou les piles à combustible. Ce traitement biologique a une production de biomasse faible. En outre, cette voie de production n'est pas liée au rayonnement solaire et permet ainsi plus de souplesse de fonctionnement du système. Toutefois, ce procédé lorsqu'il est utilisé pour la production d'hydrogène présente un faible taux d'enlèvement de la charge organique et résulte dans la production de métabolites intermédiaires. En conséquence, la production de biocarburants de deuxième génération par fermentation sombre n'est pas une solution efficace pour la gestion des déchets. Une seconde étape doit être ajoutée au procédé. La digestion anaérobie peut être utilisée comme une solution de traitement de l'effluent résiduel. Cette étape du procédé de traitement des déchets aboutira à la production finale de méthane. En outre, la forte production d'acides gras pendant la production d'hydrogène, permet une meilleure assimilation des substrats pour la production de méthane.

La Colombie a une économie diversifiée basée sur les activités agricoles qui sont liées à la production de déchets organiques. La biomasse, peut être utilisée pour la production de carburant de deuxième génération. Les expériences actuelles sont basées sur les énergies renouvelables dans la production de carburants de première génération tels que le bioéthanol et le biodiesel. Cependant, l'utilisation des terres pour la culture de la canne à sucre et de la palme africaine génère de la concurrence avec des terres pour les cultures vivrières dans

chaque région. En conséquence, l'utilisation de la biomasse de déchets peut être une alternative pour la production de biocarburants.



## CONTEXTE - OBJECTIF

### **Digestion anaérobie**

Ce procédé comporte quatre étapes principales qui se déroulent à la suite: l'hydrolyse, l'acidogénèse, l'acétogénèse et la méthanogénèse. Pour la première étape la complexité chimique des substrats est généralement l'étape limitante du procédé d'hydrolyse et augmente considérablement le temps de traitement requis. Dans cette étape de fermentation, les macromolécules (glucides, protéines et lipides) sont dégradés en composés plus simples tels que des sucres, des acides aminés et des acides gras à longue chaîne (Batstone et al., 2002). Plus tard dans la phase acidogène, ces sous-produits sont transformés en acides gras à chaîne courte: valérique, butyrique, propionique et acétique, qui sont responsables de la modification du pH. Des composés tels que l'hydrogène, le dioxyde de carbone et des alcools sont produits en parallèle (Figure 1). Dans l'étape acétogène, des acides gras à 3, 4 et 5 atomes de carbone sont convertis en acide acétique, qui est utilisé dans la dernière étape. Le résultat final est la production de biogaz et de réduction de la charge organique grâce à l'obtention du méthane et du dioxyde de carbone.

L'hydrogène est généré dans les étapes acidogènes et acétogène. Ce composé est un produit intermédiaire dans le procédé de méthanisation et il est utilisé comme un donneur d'électrons. L'hydrogène est utilisé par plusieurs consortiums de bactéries, les méthanogènes, les sulfato-réductrices et les homoacétogènes dans un moindre degré. Il est important de noter que, lorsque la pression partielle en hydrogène s'élève, cette oxydation est thermodynamiquement impossible (réaction endergonique). Par conséquent, la croissance de la flore acétogène et l'utilisation du substrat dépendent strictement de l'élimination de l'hydrogène du milieu par les microorganismes méthaniques voire les bactéries sulfato-réductrices (en présence de sulfate). Cette association syntrophique avec des bactéries méthanogènes hydrogénéophiles permet de rendre les réactions endergoniques possibles.

Parmi les variables de fonctionnement les plus influentes pour la production d'hydrogène sont retrouvés le pH, la température, le temps de résidence hydraulique (HRT), la pression partielle d'hydrogène et la charge organique (Hawkes et al, 2002; Khanal et al., 2004). La gestion de ces paramètres permet d'inhiber ou supprimer les micro-organismes qui consomment l'hydrogène. Des paramètres tels que le pH, la température et la charge organique peuvent être utilisés pour établir des conditions qui limitent ou empêchent la croissance et l'activité des

bactéries consommatrices, le temps de résidence hydraulique est utilisé pour éviter que le procédé atteigne le stade méthanogène (Figure 1). Enfin, la pression partielle d'hydrogène peut modifier la voie métabolique conduisant à la formation d'alcools en raison de l'excès d'hydrogène à l'interface liquide - gaz.

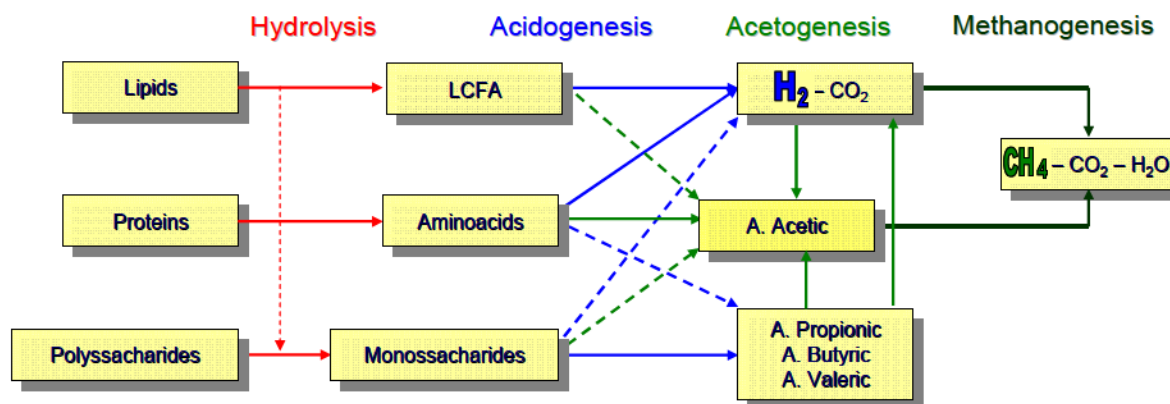

Figure 1. Différentes étapes de digestion anaérobie impliquée dans la production d'hydrogène et de méthane. Le procédé est montré à travers ses quatre grandes étapes: l'hydrolyse, acidogénèse, acétogénèse et la méthanogénèse. sources: Bastone et al., 2002; Moletta, 2002.

## Sustrats

Le type de substrat est un autre aspect important dans la production d'hydrogène, et que ceux qui sont riches en hydrates de carbone permettent une meilleure production d'hydrogène. Cependant, la plupart des études menées impliquent des substrats simples, tels que le glucose et l'amidon, et des souches pures de micro-organismes (Kapdan et Kargi, 2006). Cette première approche a limité les progrès dans l'étude de l'utilisation de substrats complexes (alternative réelle et viable). En outre, dans la plupart d'entre elles, il est impossible de travailler avec des souches pures car le substrat entraîne une grande variété de micro-organismes. Il est donc important de caractériser la microbiologie des substrats, afin d'identifier les différents micro-organismes impliqués dans la production et la consommation d'hydrogène.

Le choix des substrats doit prendre en compte les différentes exigences relatives à la digestion anaérobie pour la production d'hydrogène. Le mucilage de café a été choisi étant

donné que la production de ce résidu est importante en Colombie qui est le troisième producteur mondial de café. En outre, la teneur en hydrates de carbone dans le résidu est élevée, ce qui est une caractéristique principale pour la production d'hydrogène. Ces déchets contiennent également divers nutriments comme le magnésium et le zinc, qui sont impliqués dans la croissance des micro-organismes. Toutefois, le mucilage de café présente certaines limitations dans d'autres caractéristiques tel que l'apport en azote qui peuvent être améliorées par l'utilisation d'un second substrat (Figure 2). Pour compléter ce premier substrat le lisier de porc a été choisi pour assurer la disponibilité des nutriments manquants. En effet, le lisier a une teneur en azote élevée, et présente des micro-organismes qui peuvent être utilisés pour obtenir l'inoculum du procédé. De plus, ce dernier possède la capacité de tampon qui peut être utilisée pour soutenir l'acidité du mucilage de café.

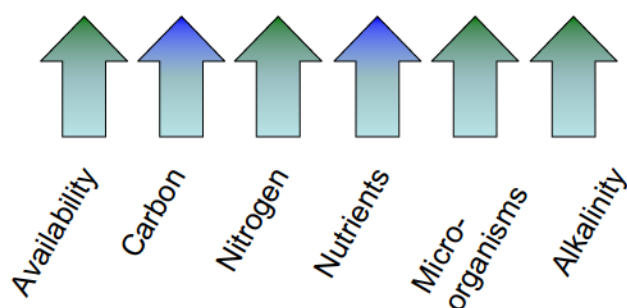

Figure 2. Caractéristiques pertinentes du mélange des deux substrats choisis. Les principales contributions de chaque substrat sont représentées par la couleur bleue pour le mucilage de café et vert pour le lisier de porc.

### **Objectif – questions de recherche**

Le but de ce travail était de produire de l'hydrogène à partir de deux déchets provenant des activités agricoles en utilisant les caractéristiques de ces deux substrats et les conditions d'exploitation afin de répondre aux exigences de la digestion anaérobie. Le procédé a été conçu pour rendre le traitement des déchets et valorisation simultanément. Ainsi, le procédé a suivi afin de plus particulièrement de comprendre la dynamique interne de la production d'hydrogène. En outre, une étape supplémentaire a été appliquée pour le traitement de résidus provenant du réacteur de production d'hydrogène. Cette étape a été réalisée afin d'améliorer le traitement des déchets avec production supplémentaire de méthane.

En ce qui concerne les objectifs visés les questions de recherche suivantes ont été formulées:

Est-il possible d'obtenir une production stable d'hydrogène à partir de la digestion anaérobie de ces deux substrats complexes?

Quels sont les mécanismes microbiens impliqués dans le procédé de la digestion anaérobie pour la production de l'hydrogène?

Est-il adapté de coupler une deuxième étape afin d'assurer le traitement des effluents de la production d'hydrogène?

## METHODOLOGIE

La méthodologie proposée a été structurée en trois phases principales afin de répondre aux questions de recherche posées (Figure 3). La première phase se concentre sur le procédé d'étude et d'évaluation en ce qui concerne la production d'hydrogène. Le second a pris en compte les possibles observations de la dynamique microbienne et de production d'hydrogène pendant la durée de résidence. Enfin, la troisième phase impliquait l'évaluation d'une deuxième étape pour le traitement des déchets. Au cours de la première phase, une étude préliminaire a été développée pour la préparation de l'inoculum utilisé dans le procédé. Ce procédé a utilisé un mélange de ces deux substrats avec exploitation de l'excellent contenu en microorganismes présent dans le lisier de porc.

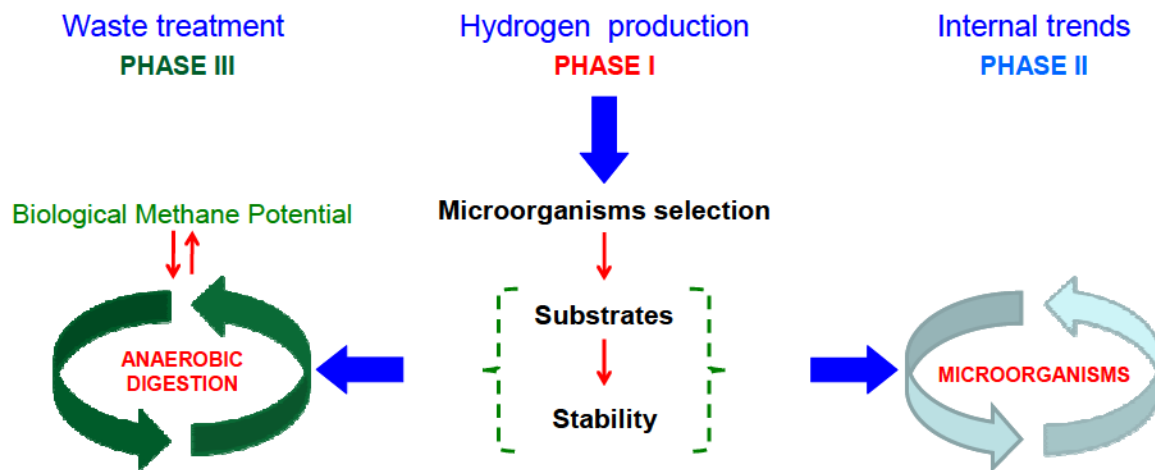

Figure 3. Schéma des 3 phases identifiées pour le développement de la recherche sur la production d'hydrogène.

L'intérêt de la première phase s'est concentrée sur l'établissement des ratio de substrats qui pourraient exploiter les avantages de chacun lors de la co-digestion (Tableau 1). Ainsi, trois conditions ont été évaluées à partir d'une forte présence de lisier de porc (C1). Par la suite, une distribution égale des deux substrats (C2). Et enfin, une forte concentration de mucilage de café (C3). Le paramètre utilisé pour la réalisation du ratio est la charge présente dans chaque substrat organique. Pour la quatrième condition (C4) il a été choisie d'augmenter la charge organique de la meilleure condition. La stabilité de production de l'hydrogène de ces conditions a été évaluée au cours du temps. Chaque étape a duré au moins 30 jours.

La deuxième étape a été développée afin d'évaluer la dynamique de production des métabolites et microbiologique du procédé au cours de la durée de résidence utilisé dans la production d'hydrogène. Ainsi ont été évaluées diverses conditions expérimentales en termes de dynamique interne. En outre, certains micro-organismes producteurs ont été pris en compte. Pendant ce temps, la troisième phase se concentre sur le traitement des effluents de chacune des conditions testées pour la production d'hydrogène. Lors de cette étape, des tests supplémentaires ont été effectués pour déterminer la production de méthane en utilisant directement les deux résidus sans tenir compte de la phase de production d'hydrogène.

Tableau 1. Caractéristiques des différentes conditions évaluées expérimentalement.

<b>Parameter\Condition</b>	C1	C2	C3	C4
Substrates ratio (SM:CM)*	7:3	5:5	3:7	5:5
OLR (kg COD/m <sup>3</sup> d)	6	6	6	12

\* Le ratio a été calculé pour la Demande Chimique en Oxygène (DQO)

### **Systeme de réacteurs**

La phase expérimentale a été réalisée dans un système de deux réacteurs, qui ne sont pas physiquement connectés (Figure 4). Chaque réacteur a été construit en acier inoxydable, avec un volume total de 7,2 L et un volume effectif d'environ 6 L. Le chauffage a été réalisé en utilisant une enveloppe chauffante ainsi qu'une isolation thermique pour éviter les pertes de chaleur. De plus le dispositif disposait d'un système d'agitation constante et d'un système de contrôle de la température et l'autre du pH. Enfin un équipement automatique d'alimentation et de déchargement permettait le renouvellement de milieu.

Les conditions de fonctionnement des deux réacteurs sont présentés dans le Tableau 2. La plage de températures thermophile utilisée pour la production d'hydrogène a été choisie pour favoriser la sélection des micro-organismes. Pendant ce temps, la température mésophile cherchée à maintenir la stabilité du réacteur méthanogène. En ce qui concerne le temps de résidence pour le traitement des effluents utilisés dans chaque condition, le réacteur de production d'hydrogène avait un temps de séjour de 24 h afin de limiter la croissance et l'activité des micro-organismes consommateurs de l'hydrogène. Le réacteur de production du méthane présentait quant à lui un temps de séjour de 7 jours pour faciliter la dégradation de la matière organique.

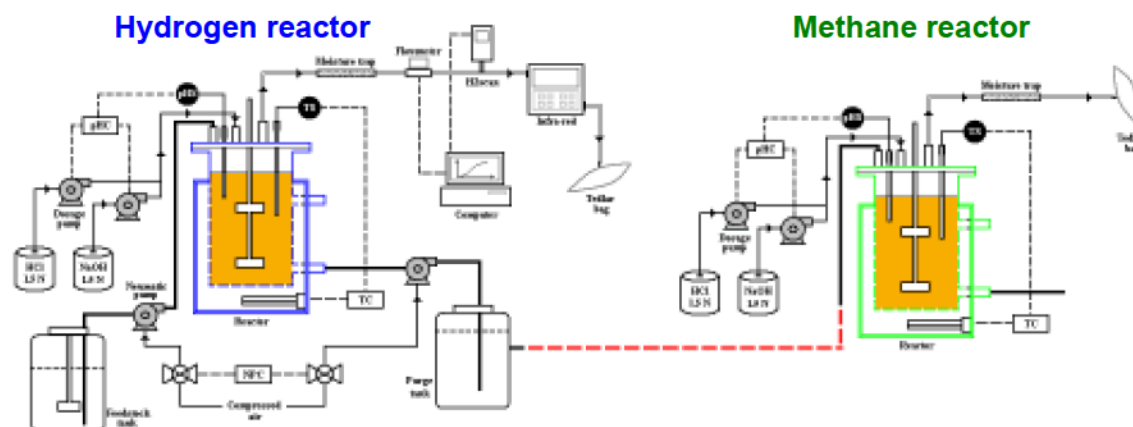

Figure 4. Système de réacteur utilisé pour le développement expérimental du projet.

Tableau 2. Paramètres de fonctionnement du réacteur pour la production d'hydrogène et de méthane.

<b>Parameter\Reactor</b>	<b>Units</b>	<b>Hydrogen</b>	<b>Methane</b>
Working volume	L	<b>5.5</b>	<b>6.0</b>
Feedstock	L	<b>3.5</b>	<b>4.0</b>
pH		<b>5.5</b>	<b>6.5</b>
Temperature	°C	<b>55</b>	<b>35</b>
Retention time	d	<b>1</b>	<b>7</b>
Agitation	rpm	<b>200</b>	<b>100</b>

### Suivi du procédé

Pour la phase I et III, les paramètres de surveillance sélectionnés ont été le flux et la composition de biogaz, la caractérisation des métabolites dans la phase liquide et la mesure de différents paramètres physico-chimiques (Tableau 3). Ce suivi a été effectué sur une base quotidienne ou hebdomadaire sur la durée de chaque expérience. Pour la phase II, les paramètres ont été mesurés au cours de la durée de résidence. Dans cette phase, les échantillons ont été prélevés pour la quantification des micro-organismes par qPCR. Les paramètres physico-chimiques qui ont été analysés sont: la demande chimique en oxygène (DCO) soluble et total, l'azote total Kjeldahl, l'ammoniac et les solides totaux et volatils. Les acides gras volatils ont été caractérisés tels que les acides acétique, butyrique, propionique,

valérique et caproïque. Les amorces utilisées dans la quantification par PCR des microorganismes produisant de l'hydrogène sont présentées dans le Tableau 4.

Tableau 3. Variables de suivi des différentes phases en tenant compte de la période de mesure.

Phase	Frequency	Hydrogen	Methane
Phase I & III Repetitive batch cultivation	Daily	Biogas flow	Biogas flow
		Hydrogen (%)	Methane and CO <sub>2</sub> (%)
	≥ 30days	Methane and CO <sub>2</sub> (%)	H <sub>2</sub> S (ppm)
		Alkalinity	Alkalinity
Phase II Retention time	Weekly	Total VFA	Total VFA
	≥ 4 samples	Individual VFA + ethanol	Individual VFA + ethanol
		Physicochemical	Physicochemical
Phase II Retention time	Online	Biogas flow	
	≥ 3 days	Hydrogen (%)	
		ORP + pH	
	Sampling	Methane and CO <sub>2</sub> (%)	
≥ 6 samples		Individual VFA + ethanol Samples to qPCR	

ORP - Oxidation Reduction Potential

Tableau 4. Des paires d'amorces utilisées pour la quantification des trois micro-organismes impliqués dans la production de l'hydrogène.

Specificity	Sequence (5'-3')	Reference
<i>Bacillus sp.</i> 16S rRNA	GGCTCACCAAGGCAACGAT	(Xiao et al., 2010)
<i>Bacillus sp.</i> 16S rRNA	GGCTGCTGGCACGTAGTTAG	
<i>Clostridium sp.</i> 16S rRNA	AGCGTTGTCCGATTTACTG	(Wang et al., 2008)
<i>Clostridium sp.</i> 16S rRNA	TTCGCCACTGGTATTCTTCC	
<i>T. thermosaccharolyticum</i> 16s rRNA	CAATAAGTATCCCGCCTGGG	This study
<i>T. thermosaccharolyticum</i> 16s rRNA	CCTCTTACGAGGCACTCAAG	



## RESULTATS

### PHASE I

*Co-digestion du mucilage de café et du lisier de porc*

**“Utilisation du mucilage de café comme nouveau substrat pour la production d'hydrogène dans la co-digestion anaérobie thermophile du lisier de porc”**

### PHASE II

*Dynamique interne et micro-organismes produisant de l'hydrogène*

**“Mécanismes et micro-organismes impliqués dans la production d'hydrogène à travers le temps de résidence dans le réacteur batch anaérobie (ABR) - Ouvrir la boîte noire de la co-digestion de deux substrats complexes”**

### PHASE III

*Traitement des déchets et la production de méthane*

**“Avantages et limites d'un procédé de méthanisation comme deuxième étape pour le traitement des effluents de la production d'hydrogène utilisant des substrats complexes”**

## **Utilisation du mucilage de café comme nouveau substrat pour la production d'hydrogène dans la co-digestion anaérobie thermophile du lisier de porc**

### **Résumé**

Le mucilage de café a été utilisé comme un nouveau substrat provenant d'une des principales activités agricoles en Colombie pour la production de l'hydrogène. L'étude a évalué trois ratios de substrats entre le mucilage de café et le lisier de porc (C1-3). Une quatrième condition a été évaluée et correspond à l'augmentation de la charge organique (C4). Les meilleurs résultats ont été obtenus pour une production d'hydrogène pour un ratio de carbone / azote (C / N) de 53 utilisé dans C2 et C4. L'augmentation de la charge organique produit un volume cumulé de l'hydrogène, un taux de production et le rendement de 2661 Nml, 760 et 43 Nml H<sub>2</sub>/L<sub>wd</sub> H<sub>2</sub> / g DCO, respectivement. Dans cette condition, la composition du biogaz est respectivement de 0,1, 50,6 et 39,0% de méthane, dioxyde de carbone et d'hydrogène. La principale voie métabolique est associée à la production d'acide acétique et butyrique avec le maintien d'un ratio autour de 1,0. La charge maximale de 12 kg DCO/m<sup>3</sup>d utilisée a conduit à une concentration AGV non dissocié d'environ 8,5 mM. Une corrélation directe a été trouvée entre le mucilage de café et la production cumulative de l'hydrogène et le biogaz. Le modèle de Gompertz modifié était suffisant pour ajuster les données expérimentales obtenues dans chacune des conditions.

### **Résultats**

#### ***Ratio des substrats***

Les trois conditions utilisées pour étudier l'influence du ratio entre le mucilage de café et le lisier de porc ont montré une grande variation de la production d'hydrogène ainsi que sur le ratio carbone/azote (C/N). Pour la condition 1 la production d'hydrogène a été faible en raison de la teneur relativement élevée en azote dans le lisier de porc (Figure 5). Alors que la condition 3 a montré une augmentation de ce ratio en réponse à des concentrations plus élevées d'hydrates de carbone apportée par le mucilage de café. Enfin, la condition 2 avait un ratio de 53. Toutes les valeurs étaient dans les limites généralement décrites comme étant adaptées à la

production d'hydrogène (Lin et Lay, 2004; Argoun et al, 2008; O-Thong et al, 2008; Sreela-Or et al, 2011). En ce qui concerne la production d'hydrogène, elle fut faible en présence d'une forte présence de lisier de porc (C1). Cependant, des concentrations accrues de mucilage pouvaient causer l'apparition de fluctuations durant le développement du processus au cours du temps (C3). Ainsi, la meilleure condition pour la production d'hydrogène a été atteinte pour une quantité similaire de substrats (C2). Dans ce cas, la production d'hydrogène a présenté un état pseudo-stationnaire avec un écart type d'environ 10%. Les fluctuations de la condition 3 ont été associées à un changement dans le C/N de 72 à 98 mesuré à la fin des expériences. Cette variation se produit à la suite de la réduction de la concentration d'ammoniac. L'étude a révélé la possibilité d'obtenir une corrélation directe entre le C/N et la production d'hydrogène à la condition de réduire les fluctuations observées dans la condition C3 à une déviation standard similaire à C2.

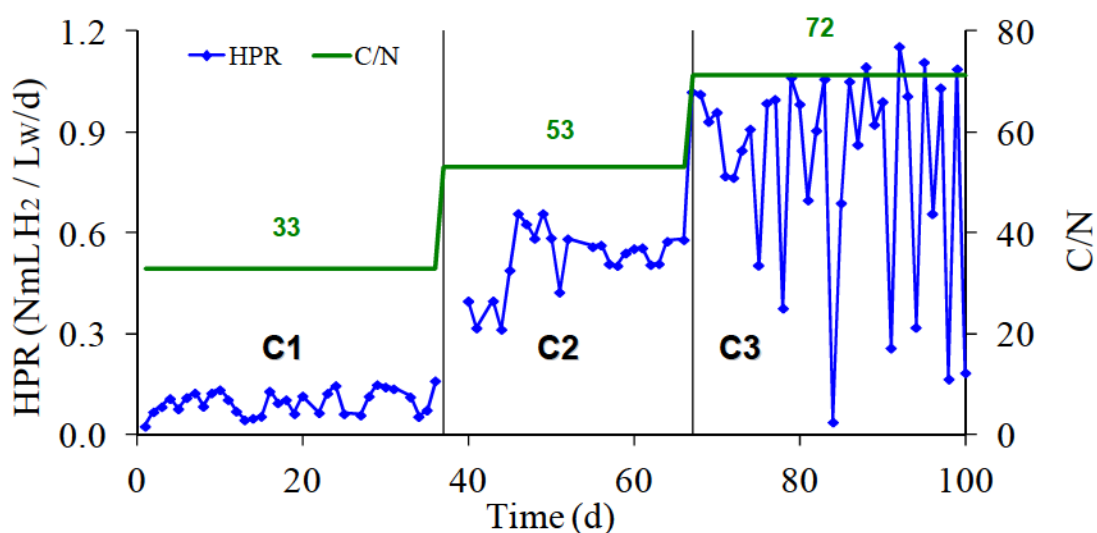

Figure 5. Influence des deux substrats sur la production d'hydrogène et le rapport de carbone / azote dans chaque condition expérimentale évaluée (HPR – Hydrogen production rate; L<sub>w</sub> – Liter of waste).

En ce qui concerne la composition du biogaz, la Figure 6 montre que l'hydrogène et le dioxyde de carbone sont les principaux composants avec de légères variations au cours du changement d'état. Les acides gras volatils augmentent avec le temps en réponse à une

concentration croissante de la source de carbone associé au mucilage de café. De même, l'alcalinité du réacteur a été mesurée en augmentation quel que soit les faibles concentrations trouvées dans le mélange d'alimentation (Figure 6). Cela a été associée à l'augmentation des concentrations de dioxyde de carbone libéré (Valdez-Vazquez et al., 2005). Indépendamment des caractéristiques de chaque état l'activité méthanogène a été fortement inhibée en réponse aux conditions de fonctionnement utilisées.

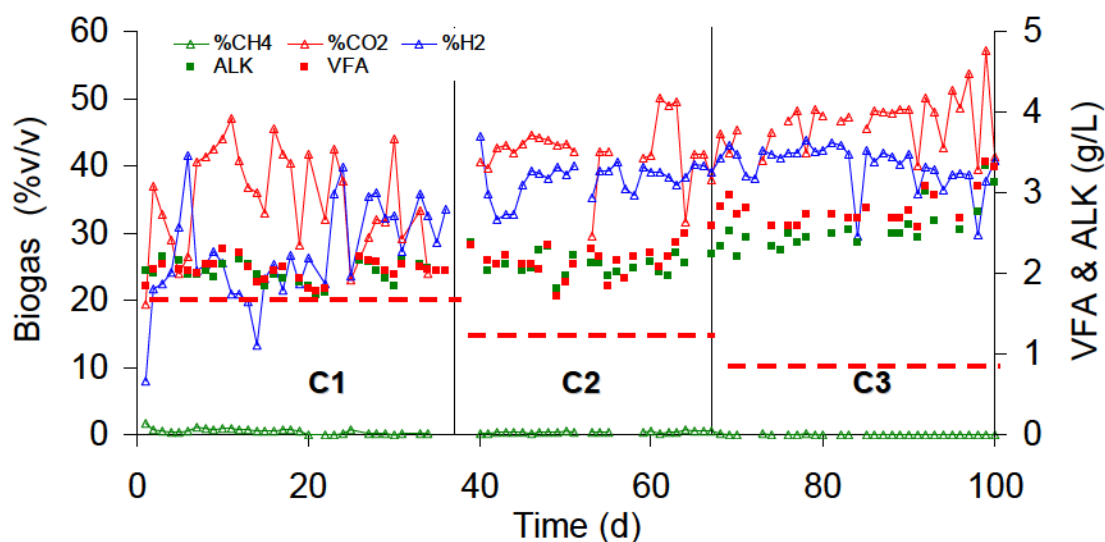

Figure 6. Composition du biogaz en fonction du temps pour chaque expérience et la variation de substrats. Lignes intermittentes rouges représentent l'alcalinité initiale du mélange d'alimentation (VFA – Volatile fatty acids; ALK – Alkalinity).

### *Augmentation de la charge organique*

L'augmentation de ce paramètre a été réalisée pour le ratio 5:5 dans la condition C2, ratio qui a montré la meilleure production d'hydrogène. La variation de la charge ne produira aucun changement dans la stabilité du procédé affichant un comportement similaire entre C2 et C4 (Figure 7). En revanche, l'écart type est resté autour de 6%, malgré l'augmentation de la concentration VFA qui passe de 3,9 à 8,5 mM. Bien que ces concentrations étaient inférieures à celles signalées pour avoir un effet négatif sur la production d'hydrogène (van Ginkel et Logan, 2005). L'augmentation peut affecter la production spécifique de l'hydrogène tout en évitant une nouvelle augmentation pour atteindre 43 Nml H<sub>2</sub>/gDCO. Dans les deux

conditions, le procédé a pris environ 15 jours pour atteindre un état pseudo-stationnaire pour la production d'hydrogène.

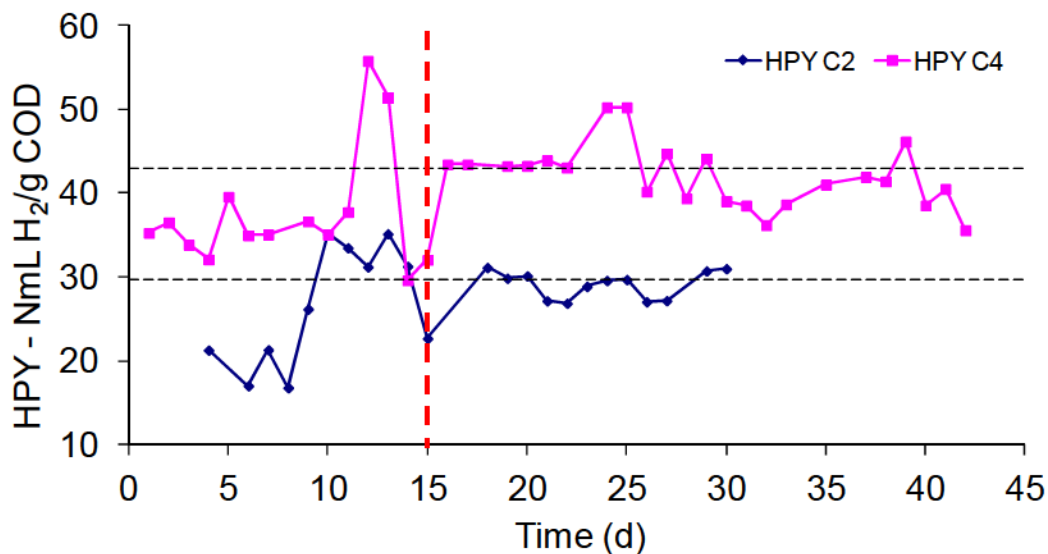

Figure 7. Comparaison entre C2 et C4 évaluée pour la même de substrats, mais avec un augmentation de la charge organique pour C4 (HPY – Hydrogen production yield).

### ***Influence du mucilage de café***

L'ajout de mucilage de café a montré une réponse directe en terme de production de biogaz et l'hydrogène (Figure 8). Cette réponse a été liée à la présence des glucides présents dans ce substrat, et qui représente moins de 18% de la DCO soluble. La production d'hydrogène a été comparable à celle rapportée pour d'autres résidus avec une teneur élevée en hydrates de carbone, tels que les déchets végétaux d'huile de palme ou de vinasse (O-Thong et al., 2008). En conséquence mucilage de café ont montré un ratio de  $7,8 \text{ L H}_2 / \text{L}_{\text{mucilage}}$  contre  $6,5 \text{ L H}_2 / \text{L}_{\text{POME}}$  (effluents de moulin à huile de palme). Alors que le taux de production a été de  $0,8 \text{ L H}_2 / \text{L}_{\text{nourriture}}$  contre  $0,6 \text{ L H}_2 / \text{L}_{\text{nourriture/d}}$  pour le vinasse.

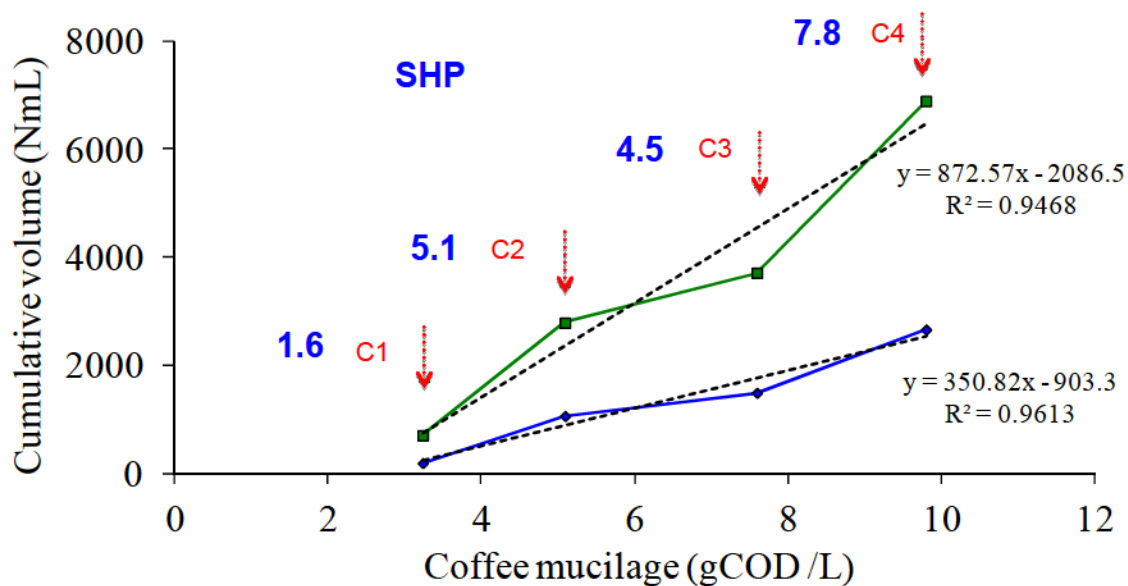

Figure 8. Effet de la concentration de mucilage de café pour les différentes conditions évalués (SHP – Specific hydrogen production).

#### *Estimation des paramètres cinétiques*

Les paramètres cinétiques du procédé ont été calculés en utilisant le modèle de Gompertz modifié (Eq. 1). Le Tableau 5 montre les différentes valeurs trouvées pour la production potentiel d'hydrogène (P), le taux de production d'hydrogène ( $r_m$ ) et le temps de retard ( $\lambda$ ).

$$H = P \exp\left(-\exp\left[\frac{r_m e}{P}(\lambda - t) + 1\right]\right) \quad (1)$$

Tableau 5. Les paramètres cinétiques de l'équation de Gompertz modifié pour chaque état.

Condition\Parameter	P (NmL)	$r_m$ (NmL/h)	$\lambda$ (h)	$R^2$
Average ( $n \geq 19$ )				
C1	194.5	43.5	5.1	0.9995
C2	1058.0	119.5	6.6	0.9995
C3	1455.0	186.0	5.3	1.0000
C4	2663.0	328.8	4.0	0.9996

Le modèle a été en mesure d'ajuster les données expérimentales selon les facteurs de corrélation trouvés. Le temps de latence a été similaire pour C1 et C3 qui a été associé à chaque spécificité de substrat dans ces conditions. Pendant que le mélange en proportions égales dans C2 a montré un retard dans le début de la production d'hydrogène. Le changement de C2 à C4 a montré une augmentation du taux de production d'hydrogène avec une réduction d'environ 2,6 h dans le temps de réponse du procédé.

### ***Métabolites produits***

Les principaux métabolites produits c'est-à-dire l'acide acétique et l'acide butyrique sont associés à la production d'hydrogène par les équations 2 et 3. Ce comportement a été observé principalement après la première condition. Les concentrations de ces deux produits intermédiaires sont liées de 58 à 85% de la quantité totale d'hydrogène produit. Le pourcentage restant a été associée à la production de produits intermédiaires tels que le pyruvate ou l'acétyl-CoA. Les déviations de la voie métabolique principale a été associée à la formation de l'acide propionique.

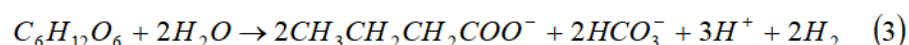
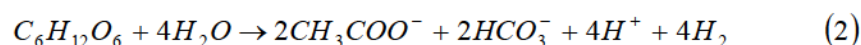

### **Conclusions**

L'utilisation de mucilage de café et du lisier de porc a atteint un taux de production de l'hydrogène et une production cumulée de 303 NmLH<sub>2</sub>/Lwd et 1061 NmLH<sub>2</sub>/Lwd, respectivement. La production de substrats pour le ratio 5:5 était stable dans le temps avec une composition de biogaz de 38,6 et 42,4% pour l'hydrogène et du dioxyde de carbone, respectivement. L'étape méthanogène a été presque complètement inhibée malgré l'utilisation d'une culture mixte de micro-organismes et aucun prétraitement pour les deux substrats complexes. L'augmentation de la charge organique a conduit à une amélioration de la production d'hydrogène sans affecter la stabilité du procédé. Dans la condition C4 la production cumulée et le taux de production d'hydrogène étaient 2660,7 NmL et 760,2

$NmlH_2/Lwd$ . Une relation directe entre la concentration de mucilage et la production d'hydrogène a été trouvée.



## Mécanismes et micro-organismes impliqués dans la production d'hydrogène à travers le temps de résidence dans le réacteur batch anaérobie (ABR) - Ouvrir la boîte noire de la co-digestion de deux substrats complexes

### Résumé

Le procédé de production d'hydrogène développée dans la phase I a été évalué le long du temps de résidence dans le réacteur batch anaérobie (ABR). Ceci a été réalisé en surveillant plusieurs paramètres comme la pression partielle de l'hydrogène et du dioxyde de carbone, le potentiel d'oxydoréduction, le pH, les métabolites et les micro-organismes. Deux tendances ont été identifiées pour les conditions C2 et C4 qui ont montré une production cumulée similaire de l'hydrogène à la fin des expériences. Les tendances ont été classées comme *courte* et *longue* en référence aux différences relatives des vitesses de production d'hydrogène et de temps de latence observé. La tendance *courte* présente un temps de latence court et un taux plus élevé pour la production d'hydrogène que la tendance *longue*. La voie métabolique majoritaire a été associée à la production d'acide acétique et butyrique. Dans le cas d'une déviation de la cette voie c'est l'acide propionique qui a été identifié pour les deux tendances. *Thermoanaerobacterium thermosaccharolyticum* a été le microorganisme retrouvé comme dominant dans la tendance *court*. De même *Bacillus sp.* a montré des concentrations élevées au début de cette tendance. Bien que des concentrations similaires de *T. thermosaccharolyticum* et *Clostridium sp* ont été trouvés dans la tendance *longue*. La pression partielle d'hydrogène conduit dans les deux cas à l'utilisation du système  $H^+/H_2$  et à la ferrédoxine comme transporteur d'électrons.

### Resultats

#### *L'identification des tendances*

Les valeurs de production de l'hydrogène utilisé dans la phase I ont été représentées par la moyenne des différents résultats de l'opération discontinue (ligne verte dans la Figure 9). Cependant, pour les conditions 2 et 4 il a été observé deux types de tendances tout au long de la durée de résidence. Elles ont montré production cumulée de l'hydrogène similaire, mais une

différence dans le temps de latence et le taux de production d'hydrogène (Figure 9). Ainsi, la tendance associée à une réponse rapide et un taux de production élevée a été nommé *court*. La tendance dénommée longue a montré un comportement variable opposé. Les conditions 1 et 3 ont également montré des comportements différents tout au long de la durée de résidence. Toutefois, ces tendances n'ont pas atteint une production similaire de l'hydrogène cumulé à la fin des expériences. Ces tendances ont été trouvées dans les instabilités associées à ces conditions. L'apparition de deux tendances en C2 et C4 ont été observées de façons aléatoires tout le long des différents batch pour chaque condition.

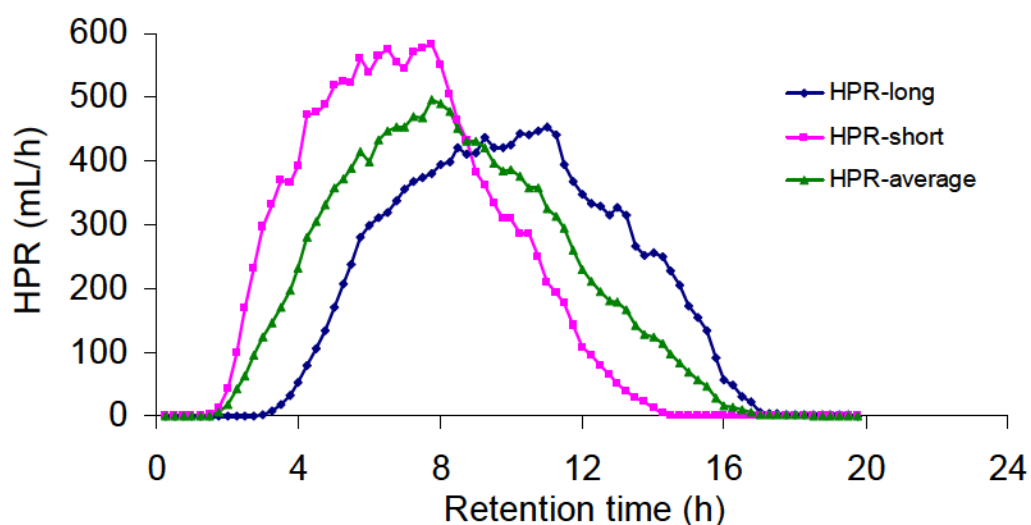

Figure 9. Evolution de la production d'hydrogène au cours de la durée de résidence pour la condition 4. L'identification de deux tendances est liée à des différences dans les temps de réponse et le taux de production d'hydrogène (HPR – Hydrogen production rate).

En ce qui concerne la composition du biogaz pour la tendance long de la durée de résidence la réponse observée correspond à une faible production de méthane. Cette réponse a montré la présence de microorganismes méthanogènes dans la culture mixte. Dans la tendance *longue*, le méthane et l'hydrogène ont été produit dans des plages de temps similaires. Alors que dans la tendance *court* l'hydrogène est apparu en première suivi par le méthane. En conséquence, la concurrence entre des micro-organismes producteurs et consommateurs a été suggéré dans la culture mixte. De plus, l'oxygène présent dans l'espace du réacteur a été consommé à 80 et 94% en C2 et C4 respectivement. Ce comportement est lié à l'action de microorganismes facultatifs tels que le genre espèce *Bacillus*.

## Métabolites

Le suivi des produits métaboliques a montré que, en termes de concentration, la voie fermentation butyrique était la principale voie métabolique de la tendance *court* (Figure 10). La voie de fermentation acétique a prédominé au cours tendance *longue*. Toutefois, le rapport molaire montré dans les équations 2 et 3 suggère que la voie principale pour la production d'hydrogène a été la fermentation acétique. Dans la tendance *court* il a été montré une forte concentration d'acides gras volatils dans les premières heures du temps de résidence. Ceci a été directement lié à l'augmentation du taux de production d'hydrogène de cette tendance. La légère augmentation de la production d'acide propionique dans le temps a été associée à une limitation du procédé de la tendance *longue*.

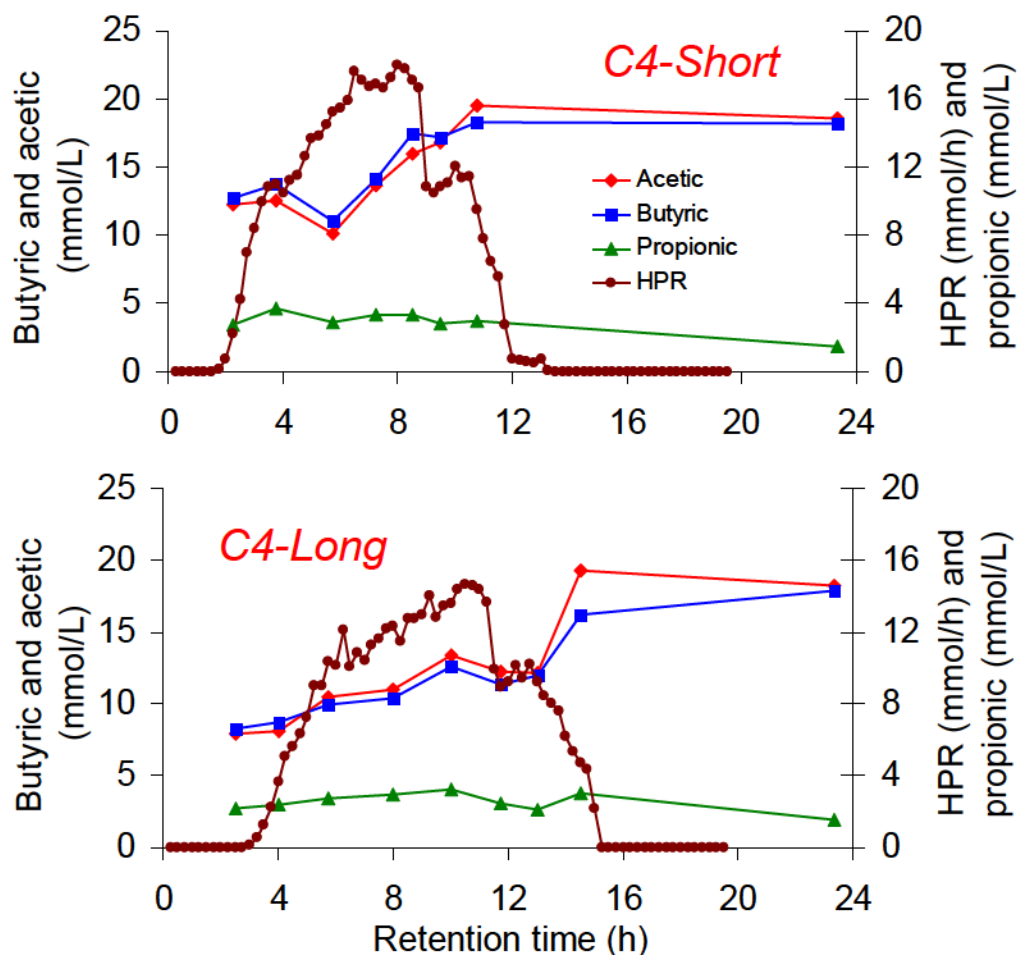

Figure 10. Evolution des principaux métabolites associés à la production d'hydrogène ainsi que le temps de résidence pour la condition 4 (HPR – Hydrogen production rate).

### Les micro-organismes

L'espèce *Bacillus sp.* et *T. thermosaccharolyticum* ont montré une concentration plus forte au cours de la tendance *courte* (Figure 11). Bien que les concentrations similaires ont été mesurés à *T. thermosaccharolyticum* et *Clostridium sp.* pendant la tendance *longue*. Il a été déduit que pour la tendance *court* la présence de *Bacillus sp.* a été attribuée à la rupture des macromolécules pour l'action de ces micro-organismes. Par la suite, *T. thermosaccharolyticum* a utilisé les produits solubles produits par l'action de la xylanase de *Bacillus sp.* Dans la tendance *longue*, ces composés solubles peuvent être utilisés en même temps par *T. thermosaccharolyticum* et *Clostridium sp.*

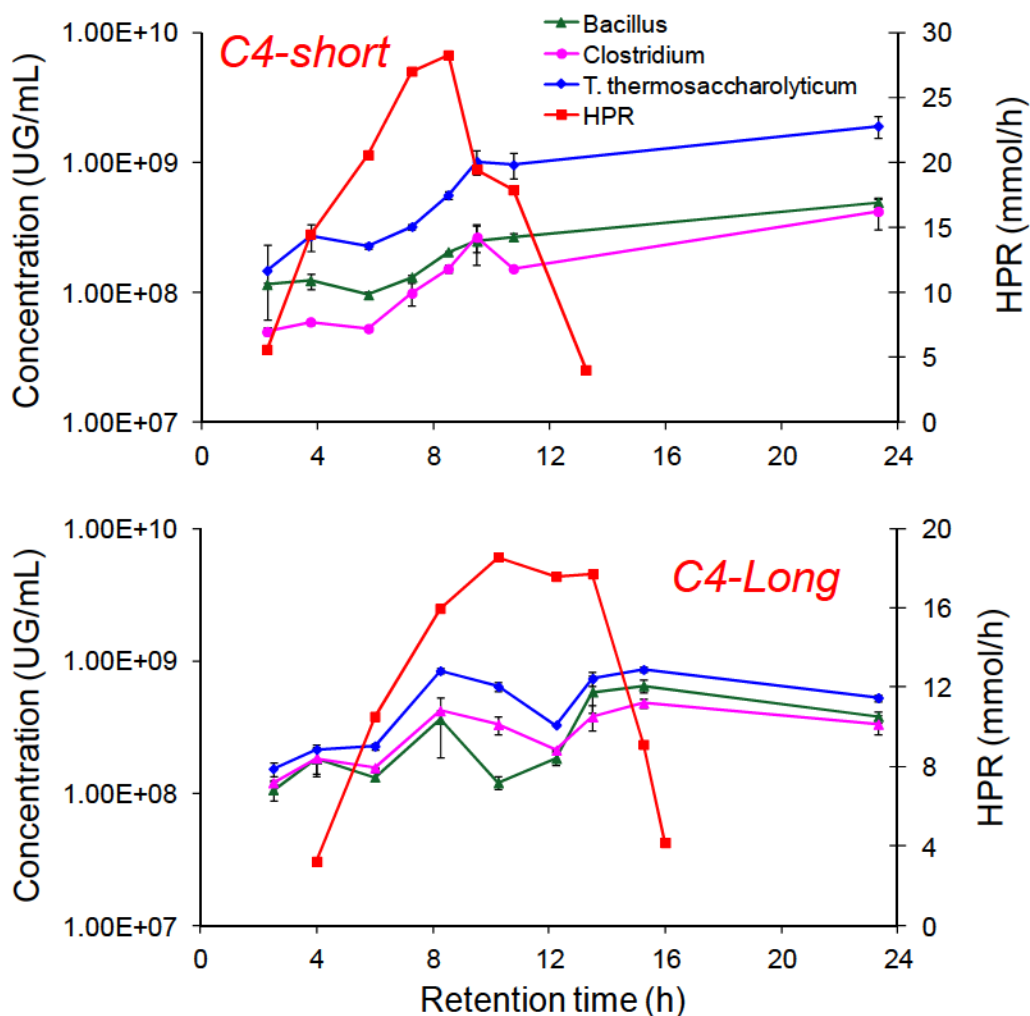

Figure 11. Le suivi des trois genres de micro-organismes producteurs d'hydrogène. Les concentrations en unités génome de *Bacillus sp.* *Clostridium sp.* et *T. thermosaccharolyticum* pour la condition 4 (HPR – Hydrogen production rate).

### Voie métabolique

La voie métabolique proposée pour la dégradation provient essentiellement de monomères simples tels que le glucose présent dans le mucilage de café (Figure 12). Cela va générer des intermédiaires tels que le pyruvate qui est un composé clé dans le procédé de dégradation. Oxydation de ce composé va donner de l'acétyl-CoA est liée à la production d'hydrogène. Cette voie métabolique peut présenter la contribution d'autres monomères tels que l'arabinose, le gluconate, etc, qui sont présents dans le mucilage de café. Un composé supplémentaire pour la production d'hydrogène peut être le glycérol généré à partir de la dégradation des lipides du lisier de porc. La fin de ce chemin métabolique peut entraîner la formation de certains acides gras et d'alcools. Les voies de déviation ont été principalement associées à la production d'acide propionique par deux routes. Une liée à la présence de concentrations élevées en dioxyde de carbone qui peut détourner l'itinéraire de sortie succinate. Alors que les pressions partielles d'hydrogène élevées peuvent dévier la trajectoire de la production d'intermédiaire tel que le lactate pour finalement produire du propionique.

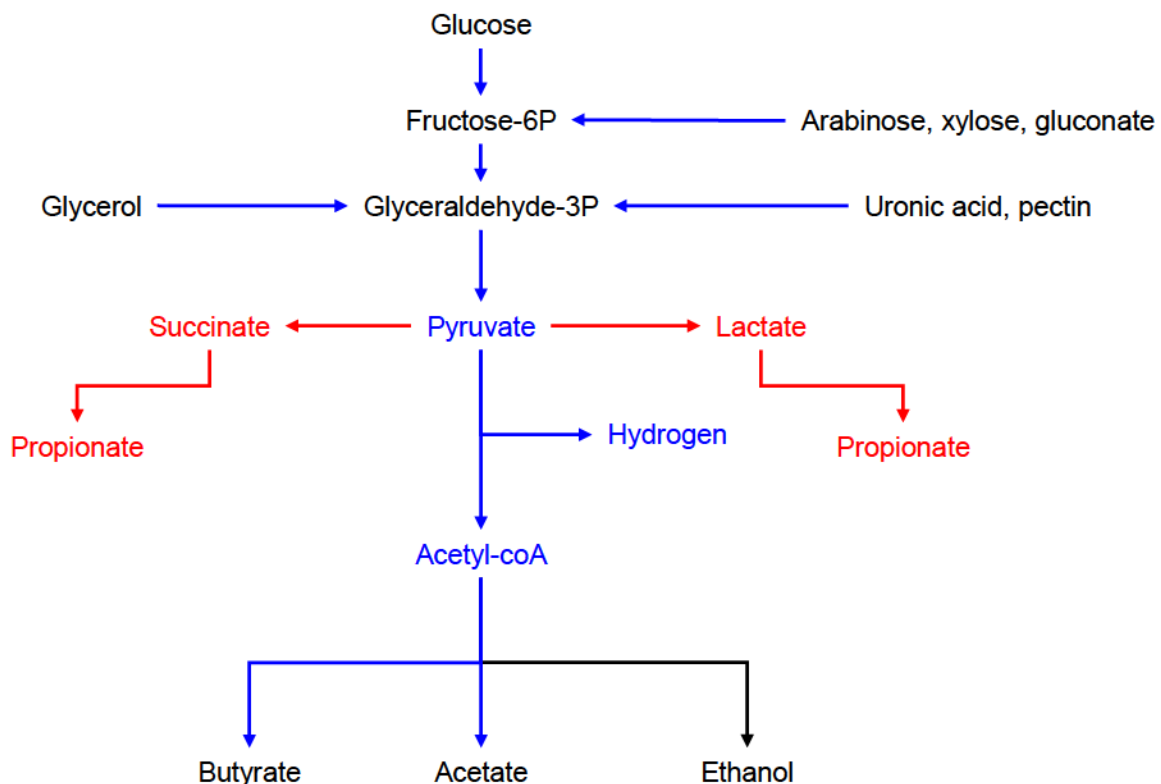

Figure 12. Voie métabolique proposée pour le procédé de production de l'hydrogène dans des conditions 2 et 4. Le schéma a été adapté à partir de Liu et al., 2008; Saint-Amans et al., 2001; Temudo et al., 2007.

## Conclusions

Deux tendances, *court* et *longue*, ont été identifiées lors de la durée de résidence au cours du procédé de production d'hydrogène. Les principales différences entre les tendances étaient des paramètres cinétiques; le temps de latence et le taux de production d'hydrogène. La principale voie métabolique de la production d'hydrogène a été associée à la formation d'acides acétique et butyrique. Pendant ce temps, la production d'acide propionique a été considérée comme la voie principale de déviation de l'obtention d'hydrogène. La présence de *Bacillus sp.* est associée à la dégradation des macromolécules initiale et à la génération de produits solubles. Par la suite, ces produits ont été utilisés par *Clostridium sp* et *T. thermossacharolitycum*. La présence de ces deux genres a été observée principalement au cours de la tendance *longue*. Tandis que les plus fortes concentrations de *Bacillus sp.* et *T. thermossacharolitycum* ont été associés à la tendance *court*. De plus l'oxygène présent au début du procédé a été consommé dans le réacteur. Ce phénomène a été associé à la présence de micro-organismes facultatifs tels que *Bacillus sp.* La voie a été associée à l'utilisation de différents monomères en raison de la variété présente dans les deux substrats. Tandis que le trajet de déviation a été associée à la production d'acide propionique causé par de fortes concentrations d'hydrogène et de dioxyde de carbone.

## **Avantages et limites d'un procédé de méthanisation comme deuxième étape pour le traitement des effluents de la production d'hydrogène utilisant des substrats complexes**

### **Résumé**

La valorisation des deux résidus utilisés par l'utilisation de deux étapes de digestion anaérobie a été développée dans cette étude. L'augmentation de la production de l'hydrogène accumulé dans la première étape est de 4 L H<sub>2</sub>, avec une composition de 39 et 51% pour l'hydrogène et le dioxyde de carbone, respectivement. Dans la seconde étape la production accrue de méthane a été réalisée avec un volume accumulé 15 L CH<sub>4</sub>, et avec une composition de 66 et 23% de méthane et de dioxyde de carbone, respectivement. La première étape a améliorée l'hydrolyse par l'augmentation de la DCO soluble, de l'azote et des acides gras volatil (AGV). L'élimination de la DCO à la fin de la deuxième étape se situe entre 56-71% dans les différentes conditions. Les hydrates de carbone ont été dégradés principalement pour la production d'hydrogène. Alors que la dégradation des lipides a eu lieu lors de la production de méthane. La première étape permet l'amélioration du temps de réponse de la deuxième étape et le taux de production par rapport à l'analyse du potentiel biologique de méthane (BMP). Cependant, cette analyse a montré une augmentation de la production de méthane évaluées pour les deux étapes. Les différents ratios de substrats testés ont montré une production d'énergie similaire. La contribution de l'hydrogène représente environ 10% de l'énergie totale produite.

### **Resultats**

#### ***Les réacteurs de l'hydrogène et du méthane***

Chaque réacteur est opéré à des conditions d'exploitation particulières pour atteindre un procédé spécialisé dans chaque étape (Figure 13). Ce phénomène été lié à la capacité dans chaque réacteur de produire le gaz d'intérêt sans interférence avec d'autres composés. Ainsi, la première étape avait une composition dominée par l'hydrogène et du dioxyde de carbone. Tandis que la seconde étape été spécialisé dans la production de méthane et de dioxyde de carbone en tant que composés principaux. En outre, la concentration de sulfure d'hydrogène a été inférieure à 200 ppm. Généralement la production d'hydrogène a été augmentée en

réponse aux conditions changeantes. Pendant ce temps la production de méthane ont diminué avec l'augmentation du ratio carbone/azote.

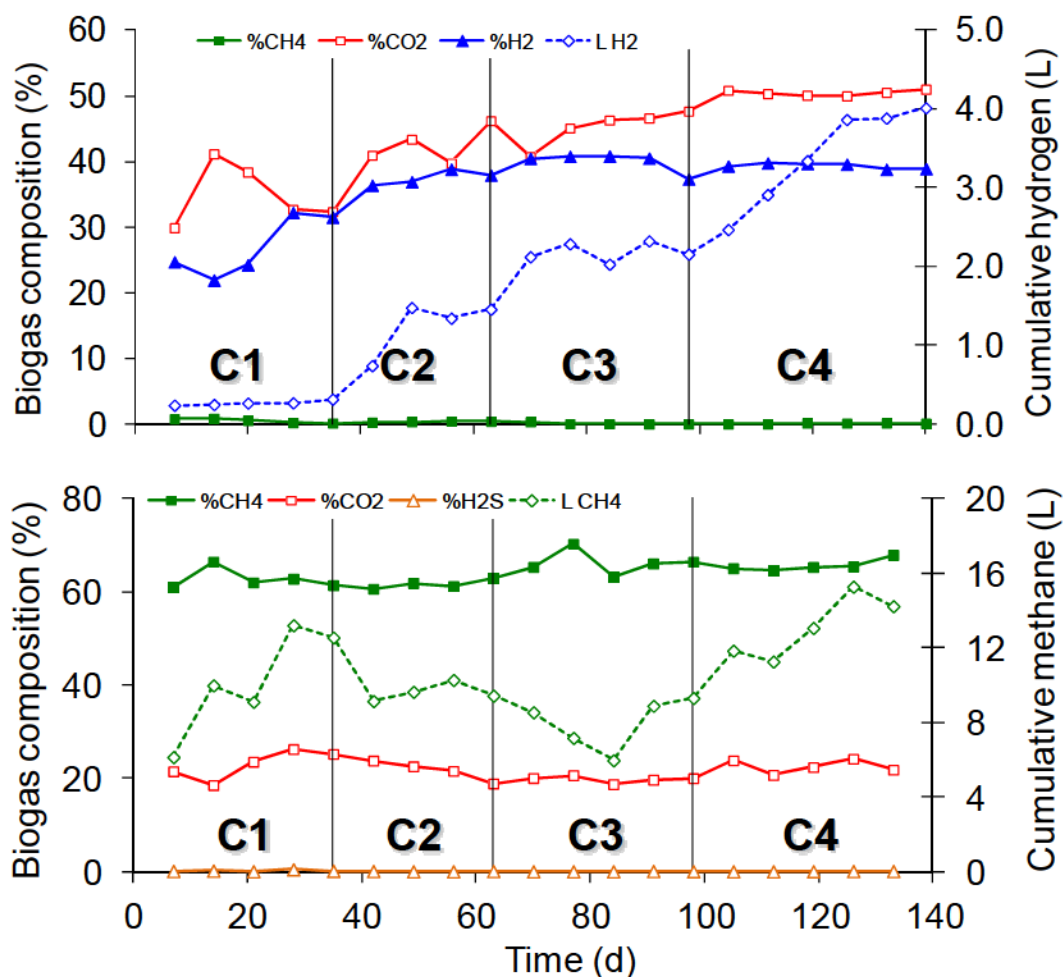

Figure 13. Composition du biogaz dans le temps pour les deux étapes développée. Production de gaz d'intérêt pour chacun des étages, le premier étant l'hydrogène et le méthane pour la second réacteur.

### *Comportement de la production de méthane*

Les valeurs initiales du rapport entre les acides gras volatils et l'alcalinité sont au-dessus des valeurs optimales pour le fonctionnement procédé méthanogène (Panichnumsin et al., 2010). Toutefois, le réacteur a présenté la capacité de traiter des concentrations élevées d'acides gras volatils et en diminuant le rapport en dessous de 0,1 valeur à laquelle est associé une



production de méthane stable. Cependant, ces valeurs sont restées supérieures à 0,2 pour la condition 4. Cela pourrait avoir des effets néfastes sur la biomasse qui affectent la production de méthane. L'influence de la première étape a montré une réponse rapide de la production de méthane au cours des premiers jours du temps de résidence (Figure 14). Ce problème est accru par le changement d'état associé à des concentrations accrues de produits solubles (Appels et al., 2011). Ainsi, 90% des émissions totales de méthane a été produit pendant les 5 premiers jours pour toutes les conditions. Cela permettrait de réduire le temps de résidence pour l'opération en deux étapes.

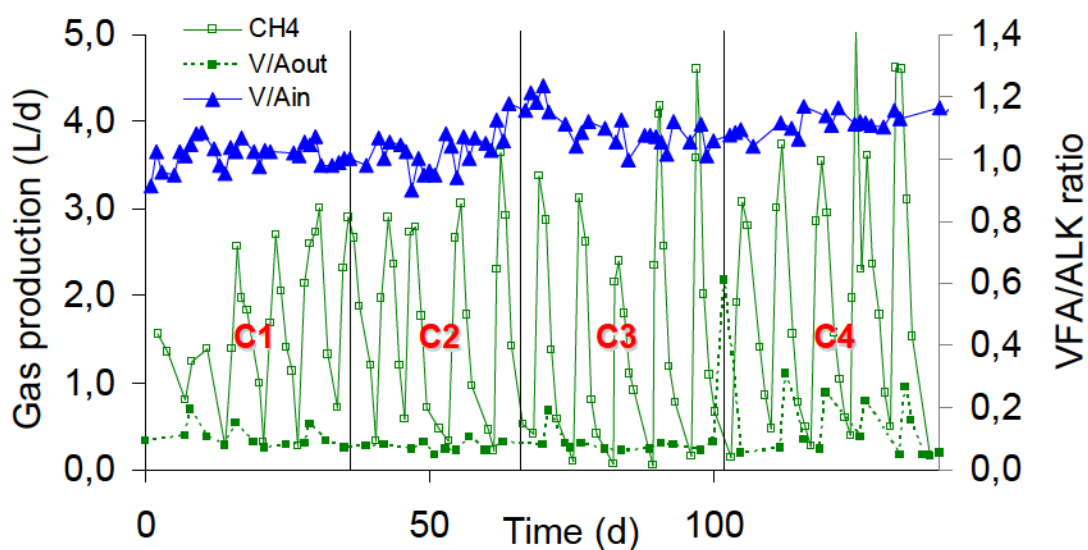

Figure 14. Production de méthane au cours du temps évaluée en fonction du rapport de la concentration en acides gras volatils et d'alcalinité. Le taux de production est fonction du temps de résidence pour le procédé (7 jours).

Les dosages du potentiel biologique de production de méthane (BMP) a confirmé que l'utilisation d'une première étape permet de réduire le temps de réponse du procédé. En outre, les taux de production de méthane ont augmenté au cours du premier jour de la durée de résidence associée à des concentrations élevées d'acides gras volatils. Cependant les essais BMP ont montré une augmentation de la production de méthane en utilisant directement le gaspillage en évitant la première étape. Ces expériences ont également montré la capacité de l'inoculum de s'adapter pour le traitement des résidus avec la suppression d'une première étape.

### *L'alimentation et la caractérisation des effluents (macromolécules)*

L'élimination de la DCO totale a été limitée au cours de la première étape, avec un abattement de d'environ 5% (Tableau 6). Pendant ce temps l'utilisation de la deuxième étape du procédé a amélioré l'abattement de 73%. La DCO total résiduelle correspond à des substances peu dégradables présentes dans les deux substrats. En outre, la suppression de la DCO soluble obtenu dans la première étape a eu un maximum autour de 18%. Cette faible diminution a été attribuée à la forte production de métabolites intermédiaires dans le procédé. L'enlèvement de la charge soluble atteint un maximum de 91% dans le second réacteur. La concentration d'azote total a été relativement constante pour toutes les conditions sauf la 3. La réduction de cette condition au cours de la première étape a été associée à la consommation de l'ensemble l'azote présent dans le système. Cette consommation pourrait limiter la croissance de la biomasse et produire des fluctuations qui influent sur la production de biogaz.

Tableau 6. Caractérisation des effluents par la mesure de divers paramètres physico-chimiques pour chaque condition étudiée.

<b>Parameter</b>	<b>Unit</b>	<b>C1</b>	<b>C2</b>	<b>C3</b>	<b>C4</b>
<i>Characterization of the feedstock</i>					
COD		10.8±0.0	10.2±0.6	10.8±1.0	19.6±0.4
CODs	g/L	3.4±0.5	4.6±0.5	5.6±0.2	8.1±0.4
TKN		318.8±70.6	190.6±21.0	140.1±22.9	369.5±40.9
NH <sub>3</sub>	mg/L	47.5±8.2	23.6±7.2	8.1±4.2	56.6±6.7
<i>Characterization effluent from the first stage</i>					
COD		10.5±2.2	9.9±1.5	10.4±0.3	18.6±0.3
CODs	g/L	3.0±0.4	4.3±0.6	5.4±0.6	6.6±0.7
TKN		292.1±25.9	188.8±43.2	105.3±12.8	358.3±38.3
NH <sub>3</sub>	mg/L	62.6±15.0	22.5±4.4	ND <sup>a</sup>	60.5±4.1
<i>Characterization effluent from the second stage</i>					
COD		4.0±0.6	4.3±2.4	3.2±2.3	5.3±1.2
CODs	g/L	1.4±0.4	1.3±0.6	1.4±0.7	0.7±0.1
TKN		270.3±40.6	172.5±14.8	103.6±51.8	315.6±51.8
NH <sub>3</sub>	mg/L	80.6±3.9	57.1±4.5	36.6±9.4	139.8±5.3

<sup>a</sup> ND: not detected.

Les glucides du mucilage de café ont été consommés dans la première étape et peut être principalement associée à la production d'hydrogène. Pendant ce temps les lipides ont été associés à la production de méthane, sauf pour la condition 4, pour laquelle il a été observé

une diminution de cette famille de macromolécules dans le premier réacteur. Le comportement observé pour ces macromolécules correspond à des différences dans les constantes cinétiques de l'hydrolyse de chaque macro composant (Vavilin et al., 2008).

### Métabolites

Le comportement des métabolites intermédiaires dans le procédé de dégradation a montré la formation de forte concentration de ces composés dans le réacteur de l'hydrogène (Tableau 7). Ceux-ci représentent entre 60-79% de la DCO soluble de l'effluent utilisé pour le réacteur méthane. Dans cette deuxième étape, les métabolites ont été presque entièrement éliminés. Ainsi, la deuxième étape est efficace même pour l'élimination des acides gras avec plusieurs atomes de carbone comme les acides valérique et caproïque.

Tableau 7. La quantification des principaux métabolites mesurés dans la caractérisation de la DCO soluble.

Condition	Ethanol	Acetic	Propionic	Butyric	Valeric	Caproic
<i>Feedstock</i>						
C2*	18.0	122.7	106.5	130.1	43.6	9.1
<i>Hydrogen reactor</i>						
C1	42.4±26.6	891.6±375.8	406.8±247.2	897.6±260.7	88.2±73.2	45.1±16.4
C2	149.4±131.3	492.5±250.3	221.1±44.5	2009.4±489.6	67.3±50.7	62.8±10.4
C3	137.3±152.6	592.0±184.4	149.4±132.5	2173.0±986.5	86.3±115.2	99.1±91.7
C4	105.3±22.4	1096.1±199.0	260.8±103.0	2661.4±263.4	172.9±136.8	157.7±67.2
<i>Methane reactor</i>						
C1	0.6±1.4	0.3±0.4	45.0±16.3	ND <sup>a</sup>	ND	0.5±0.1
C2	ND	0.2±0.2	32.6±23.7	ND	ND	0.2±0.3
C3	ND	2.7±0.9	8.7±2.8	ND	ND	0.2±0.3
C4	ND	0.1±0.1	6.8±3.5	ND	ND	0.3±0.3

<sup>a</sup>ND: not detected

### L'évaluation de l'énergie produite au cours des deux étapes

La variation de l'énergie générée par les différentes conditions des substrats a montré un écart de seulement 15% (Tableau 8). Cela signifie que le système peut maintenir un approvisionnement constant en énergie relativement indépendant du rapport de substrats. La

contribution de l'hydrogène à l'énergie totale n'était que de 9%. En outre, la réponse à l'augmentation des charges organiques a montré une augmentation proportionnelle de l'énergie potentielle liée à la production de l'hydrogène. En revanche, l'énergie relative au méthane n'a pas permis de mesurer une réponse proportionnelle lors de ces changements. Cela a été attribué à une inhibition potentielle liée à des valeurs élevées du rapport d'acides gras volatils et l'alcalinité de la condition 4.

Tableau 8. La production d'énergie pour les différentes conditions expérimentales testées.

<b>Condition</b>	<b>H<sub>2</sub> reactor</b>	<b>CH<sub>4</sub> reactor</b>	<b>H<sub>2</sub> contribution</b>	<b>Overall energy</b>
	<b>kJ/Lw</b>	<b>kJ/Lw</b>	<b>%</b>	<b>kJ/Lw</b>
1	1.4	79.1	1.7	80.5
2	4.5	66.6	6.4	71.1
3	5.8	54.9	9.5	60.6
4	9.5	91.8	9.4	101.3

## Conclusions

Chaque étape de la co-digestion anaérobie du lisier de porc avec du mucilage de café était spécialisée pour la production d'un gaz d'intérêt. Les hydrates de carbone sont les macromolécules principales utilisés pour la production d'hydrogène et les lipides pour la production de méthane. Le traitement des déchets a lieu principalement dans la seconde étape du procédé. Le premier étage permet la réduction du temps de réponse et des taux de production de méthane dans la seconde étape. L'analyse BMP a montré la génération élevée de méthane lors de l'utilisation directe des deux substrats. La production d'énergie à partir d'hydrogène représentait à elle seule 10% du total généré dans le procédé.

## CONCLUSIONS

Le procédé de production d'hydrogène a présenté un ensemble de limites telles que:

- L'énergie de ce vecteur est d'environ 10% du total obtenu dans le procédé.
- La culture mixte contient la présence de micro-organismes consommateurs de l'hydrogène.
- L'utilisation d'une deuxième étape est nécessaire en raison des faibles abattements en DCO pendant la production de l'hydrogène.

Pendant ce temps, les avantages associés au procédé de production d'hydrogène sont les suivants:

- Le procédé mis en œuvre a réussi à obtenir une production pseudo - stable de l'hydrogène à partir de deux substrats complexes.
- Les caractéristiques des substrats étaient suffisantes pour répondre aux exigences du procédé.
- La culture mixte de micro-organismes a été dominée par les espèces produisant l'hydrogène.
- Le réacteur d'hydrogène peut agir comme un pré-traitement des substrats.

## **PERSPECTIVES**

Les perspectives ont été proposées pour chaque phase:

### **Phase I**

Modifier les paramètres du procédé semi-continu pour le fier fonctionner en continu.

### **Phase II**

Identifications supplémentaires et suivi des micro-organismes et de leurs métabolites.

### **Phase III**

Vérifier que la réduction du temps de résidence en fonction des résultats obtenue permette effectivement d'aller du déchet vers la production de vecteurs énergétiques.

### **Cycle durable**

Réaliser un changement d'échelle du procédé avec une évaluation globale de l'énergie consommée et produite.

## REFERENCES

Appels L, Baeyens J, Degève J, Dewil R. Principles and potential of the anaerobic digestion of waste-activated sludge. *Prog Energy Combust Sci* 2008;34:755–81.

Argun H, Kargi F, Kapdan IK, Oztekin R. Biohydrogen production by dark fermentation of wheat powder solution: Effects of C/N and C/P ratio on hydrogen yield and formation rate. *Int J Hydrogen Energy* 2008;33:1813-19.

Batstone DJ, Keller J, Angelidaki I, Kalyuzhnyi SV, Pavlostathis SG, Rozzi A, Sanders WTM, Siegrist H, Vavilin VA. The IWA Anaerobic Digestion Model No 1 (ADM1). *Water Sci Technol* 2002;45(10):65–73.

Hawkes F, Dinsdale R, Hawkes D, Hussy I. Sustainable fermentative hydrogen production: challenges for process optimization. *Int J Hydrogen Energy* 2002;27:1339–47.

Kapdan IK, Kargi F. Bio-hydrogen production from waste materials. *Enzyme Microb Technol* 2006;38:569-82.

Khanal SK, Chen WH, Li L, Sung S. Biological hydrogen production: Effects of pH and intermediate products. *Int J Hydrogen Energy* 2004;29:1123-31.

Lin CY, Lay CH. Carbon/nitrogen-ratio effect on fermentative hydrogen production by mixed microflora. *Int J Hydrogen Energy* 2004;29:41-5.

Liu Y, Yu P, Song X, Qu Y. Hydrogen production from cellulose by co-culture of *Clostridium thermocellum* JN4 and *Thermoanaerobacterium thermosaccharolyticum* GD17. *Int J Hydrogen Energy* 2008;33(12):2927-33.

Moletta R. La méthanisation, first ed. TEC & DOC, Paris. 2008.

O-Thong S, Prasertsan P, Intrasungkha N, Dhamwichukorn S, Birkeland N-K. Optimization of simultaneous thermophilic fermentative hydrogen production and COD reduction from palm oil mill effluent by *Thermoanaerobacterium*-rich sludge. *Int J Hydrogen Energy* 2008;33:1221-31.

Panichnumsin P, Nopharatana A, Ahring B, Chaiprasert P. Production of methane by co-digestión of cassava pulp with various concentrations of pig manure. *Biomass Bioenergy* 2010;34:1117-24.

Saint-Amans S, Girbal L, Andrade J, Ahrens K, Soucaille P. Regulation of carbon and electron flow in *Clostridium butyricum* VPI 3266 grown on glucose-glycerol mixtures. *J Bacteriol* 2001;183(5):1748–54.

Sreela-or C, Plangklang P, Imai T, Reungsang A. Co-digestión of food waste and sludge for hydrogen production by anaerobic mixed cultures: Statistical key factors optimization. *Int J Hydrogen Energy* 2011;36:14227-37.

Temudo MF, Kleerebezem R, van Loosdrecht M. Influence of the pH on (open) mixed culture fermentation of glucose: A chemostat study. *Biotechnol Bioeng* 2007;98(1):69-79.

Valdez-Vazquez I, Ríos-Leal E, Esparza-García F, Cecchi F, Poggi-Varaldo HM. Semi-continuous solid substrate anaerobic reactors for H<sub>2</sub> production from organic waste: Mesophilic versus thermophilic regime. *Int J Hydrogen Energy* 2005;30:1383-91.

Van Ginkel S, Logan BE. Inhibition of biohydrogen production by undissociated acetic and butyric acids. *Environ Sci Technol* 2005;39:9351-56.

Vavilin V, Fernandez B, Palatsi J, Flotats X. Hydrolysis kinetics in anaerobic degradation of particulate organic material: An overview. *Waste Manag* 2008;28:939–51.

Wang MY, Tsai YL, Olson BH, Chang JS. Monitoring dark hydrogen fermentation performance of indigenous *Clostridium butyricum* by hydrogenase gene expression using RT-PCR and qPCR. *Int J Hydrogen Energy* 2008;33:4730-8.

Xiao Y, Zeng GM, Yang ZH, Ma YH, Huang C, Shi WJ, Xu ZY, Huang J, Fan CZ. Effects of continuous thermophilic composting (CTC) on bacterial community in the active composting process. *Environ Microbiol* 2011;62: 599-608.



## Español - Resumen

**PRODUCCIÓN DE HIDRÓGENO A PARTIR DE CO-DIGESTIÓN ANAEROBIA DE  
MUCÍLAGO DE CAFÉ Y ESTIÉRCOL DE CERDO**

Resumen de la tesis doctoral para optar a la doble titulación

Docteur en Génie des Procédés de l'Ecole des Mines de Nantes

Doctor en Ingeniería de la Universidad de los Andes

**Mario Andrés Hernández Pardo**

Directores

Manuel Rodríguez

Yves Andrès

Laboratoire de Génie des Procédés Environnement Agro-alimentaire (GEPEA)

Centro de Investigaciones en Ingeniería Ambiental (CIIA)

Nantes, Francia

Noviembre 2012

## INTRODUCCIÓN

El requerimiento de energía es una necesidad a nivel mundial y local. El consumo está representado principalmente por el uso de combustibles fósiles (Gas natural, carbón y petróleo). El hidrógeno ha sido considerado como la energía del futuro debido a sus características como energía limpia. La producción de dicho combustible puede ser llevada a cabo a través del uso de diferentes procesos como reformado de gas, gasificación, electrólisis y pirólisis que generalmente utilizan fuentes no renovables. El hidrógeno también puede ser producido a través de procesos biológicos como fotobiológicos y fermentación oscura que requieren menos energía y pueden utilizar biomasa renovable como materia prima.

Entre estos dos procesos biológicos, la fermentación oscura muestra algunas ventajas como la capacidad de utilizar altas cargas orgánicas y producir biogas (Hidrógeno y metano) que puede ser usado para motores de combustión interna o celdas de combustible. Este tratamiento biológico tiene una baja generación de biomasa. Además, independencia de la radiación solar mejorando la flexibilidad del sistema para la operación continua del proceso. Sin embargo, se tienen bajas tasas de remoción de carga orgánica como consecuencia de la producción de metabolitos durante la producción de hidrógeno. De acuerdo a esto, la producción de biocombustibles de segunda generación a través de fermentación oscura no representa una efectiva solución para el manejo de los residuos. Una segunda etapa del proceso usando digestión anaerobia puede ser usada como alternativa para el tratamiento del efluente. Dicha etapa, culminaría el proceso de tratamiento de los residuos con la producción final de metano. En adición, la alta producción de ácidos grasos volátiles durante la producción de hidrógeno representa una condición ideal de metabolitos líquidos listos para la producción de metano.

Colombia tiene una economía basada en diversas actividades agropecuarias asociadas a la respectiva generación de residuos orgánicos. Este tipo de biomasa puede ser utilizada para la producción de combustibles de segunda generación. Las experiencias actuales sobre energías renovables están basadas en la producción de combustibles de primera generación como bioetanol y biodiesel. Sin embargo, el uso de tierras para los cultivos de caña de azúcar y palma africana generan competición con las tierras para cultivos destinados a la alimentación de cada región. De acuerdo a esto, el uso de biomasa a partir de residuos puede ser una alternativa para la generación de biocombustibles.

## CONTEXTO - OBJETIVO

### Digestión anaerobia

Este proceso consta de 4 etapas principales que se desarrollan de manera consecutiva: hidrólisis, acidogénesis, acetogénesis y metanogénesis. Para sustratos químicamente complejos la etapa hidrolítica suele ser la limitante del proceso incrementando considerablemente los tiempos requeridos para el procesamiento bioquímico de los sustratos. En la etapa fermentativa, las macromoléculas (carbohidratos, proteínas y lípidos) se degradan a compuestos más sencillos como azúcares, aminoácidos y ácidos grasos de cadena larga (Batstone et al., 2002). Posteriormente en la etapa acidogénica, estos subproductos son transformados a ácidos grasos volátiles de cadena corta: valérico, butírico, propiónico y acético; que son responsables del decaimiento del pH. Compuestos como el hidrógeno, dióxido de carbono y algunos alcoholes son producidos de forma paralela (Fig. 1). En la etapa acetogénica, los ácidos grasos de 3, 4 y 5 carbonos son transformados a ácido acético el cual es utilizado en la última etapa. El resultado final es la generación de biogás y reducción de la carga orgánica a través de la obtención de metano y dióxido de carbono.

El hidrógeno es generado en las etapas **acidogénica y acetogénica**. Debido a que este compuesto es un producto intermedio es requerido dentro del proceso como donante de electrones. El hidrógeno es utilizado por varios consorcios de bacterias: sulfatorreductoras, metanogénicas y en menor proporción las homoacetogénicas. Los dos primeros grupos tienen reacciones termodinámicamente viables con energía libre de Gibbs similar, mientras que el grupo homoacetogénico tiene una energía libre de Gibbs inferior. Aunque la presencia de estos microorganismos limita la generación de hidrógeno, son necesarios para que las reacciones de la etapa acetogénica se produzcan (asociación sintrófica).

Entre las **variables operacionales** de mayor influencia para la generación de hidrógeno se encuentran el pH, la temperatura, el tiempo de retención hidráulico (TRH), la carga orgánica y la presión parcial de hidrógeno (Hawkes et al., 2002; Khanal et al., 2004). El manejo de estos parámetros permite eliminar o inhibir los grupos de microorganismos que consumen hidrógeno. Parámetros como el pH, la temperatura y la carga orgánica pueden utilizarse para establecer condiciones que limiten o inhiban el crecimiento y actividad de las bacterias consumidoras; el tiempo de retención hidráulico se utiliza para evitar que el proceso alcance la etapa metanogénica (Fig. 1). Por último, la presión parcial de hidrógeno puede alterar la

ruta metabólica conduciendo a la formación de alcoholes como resultado del exceso de hidrógeno en la interfase líquido – gas.



Figura 1. Diferentes etapas de la digestión anaerobia involucradas en la producción de hidrógeno y metano. El proceso se muestra a través de sus cuatro etapas principales: hidrólisis, acidogénesis, acetogénesis y metanogénesis. Fuentes: Bastone et al., 2002; Moletta, 2002.

### Sustratos

El tipo de sustrato es otro aspecto importante en la obtención de hidrógeno, ya que aquellos con alta concentración de carbohidratos presentan mejores producciones de hidrógeno. Sin embargo, la mayoría de los estudios adelantados involucran sustratos simples, glucosa y almidón, y cepas puras de microorganismos (Kapdan y Kargi, 2006). El anterior enfoque ha limitado el avance del estudio a través del uso de sustratos complejos (alternativa real y viable); además, en la mayoría de estos, no se puede trabajar con cepas puras puesto que el sustrato puede contener una amplia diversidad de microorganismos. Por esta razón es importante caracterizar la microbiología de los sustratos, de tal manera que se identifiquen los diferentes microorganismos involucrados con la producción y consumo del hidrógeno.

La selección de sustratos tuvo en cuenta diferentes requerimientos de la digestión anaerobia para la producción de hidrógeno. El **mucilago de café** fue seleccionado porque es un residuo importante en el país dado que Colombia es el tercer productor mundial de café. Además, el contenido de carbohidratos en este residuo es alto, siendo esta, la principal característica para

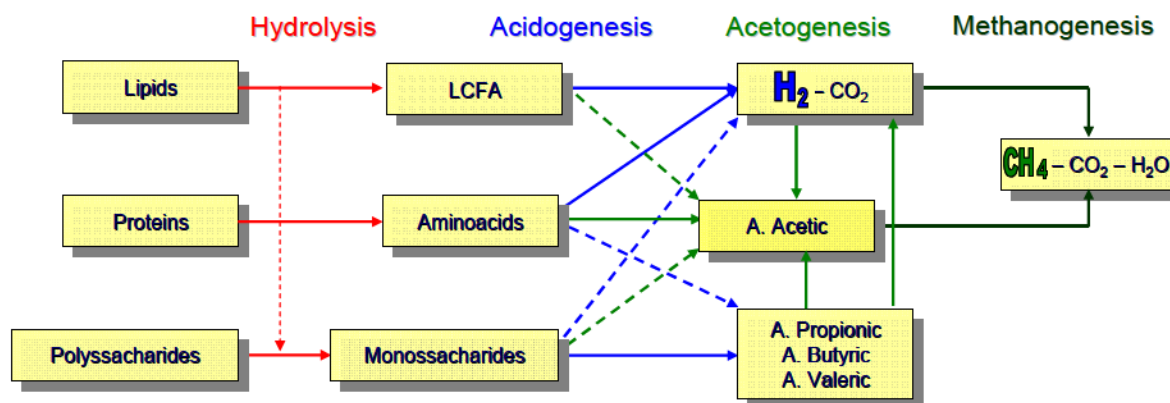
la producción de hidrógeno. Este residuo también cuenta con la presencia de diversos nutrientes como Magnesio y Zinc, los cuales intervienen en el crecimiento de los microorganismos. Sin embargo, el mucílago de café tiene algunas limitaciones en otras características que pueden mejorarse a través del uso de un segundo sustrato (Figura 2). De esta manera, el **estiércol de cerdo** fue seleccionado para asegurar la disponibilidad de sustratos debido a la producción temporal del café. El estiércol tiene alto contenido de nitrógeno y presencia de microorganismos que puede ser utilizada para la obtención del inóculo. Además, la capacidad buffer presente en el estiércol de cerdo puede ser utilizada para soportar la acidez del mucílago de café.



Figura 2. Características relevantes de la mezcla de los dos sustratos seleccionados. Los principales aportes de cada sustrato están representados por el color azul para mucílago de café y el verde para estiércol de cerdo.

### Objetivo – preguntas de investigación

El objetivo de este trabajo fue *producir hidrógeno a partir de dos residuos provenientes de actividades agropecuarias usando las características de ambos sustratos y condiciones operativas para alcanzar los requerimientos de la digestión anaerobia*. El proceso fue diseñado para hacer la valorización y el tratamiento de los residuos al mismo tiempo. De esta manera, el proceso tuvo un seguimiento especial para comprender la dinámica interna de la producción de hidrógeno. Además, una etapa adicional fue aplicada para el tratamiento de los residuos provenientes del reactor de producción de hidrógeno. Este aspecto buscaba mejorar el tratamiento de los residuos con la generación adicional de metano.

En relación a los aspectos mencionados las siguientes preguntas de investigación fueron formuladas:

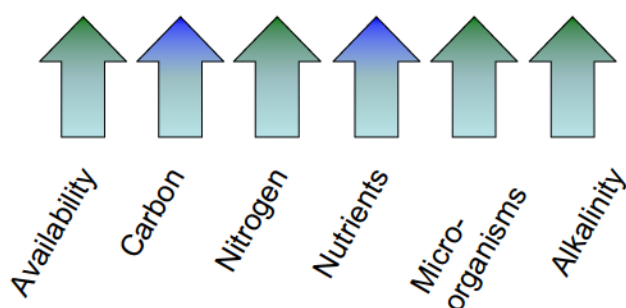
¿Es posible conseguir una producción estable de hidrógeno a partir de la digestión anaerobia de estos dos sustratos complejos?

¿Qué mecanismos se presentan dentro del proceso de digestión anaerobia para la producción de hidrógeno?

¿Es adecuado acoplar una segunda etapa para asegurar el tratamiento del efluente proveniente de la producción de hidrógeno?

## METODOLOGÍA

La metodología estuvo estructurada en 3 fases principales para responder a las preguntas de investigación planteadas (Fig. 3). La primera fase se enfocó en el estudio y evaluación del proceso respecto a la producción de hidrógeno. La segunda tuvo en cuenta las posibles dinámicas observadas durante el tiempo de retención de los experimentos. Por último, la tercera fase comprendió la evaluación de una segunda etapa para realizar el tratamiento de los residuos. Durante la primera fase, una etapa preliminar fue desarrollada para la obtención del inóculo utilizado en el proceso. Para esto se utilizaron los dos sustratos aprovechando el gran contenido de microorganismos presentes en el estiércol de cerdo.



Figura 3. Esquema de las 3 fases planteadas para el desarrollo de la investigación en producción de hidrógeno.

El interés de la **primera fase** estuvo centrado en establecer la relación de sustratos que aprovechara las ventajas de cada uno durante la co-digestión (Tabla 1). De esta manera, tres condiciones fueron diseñadas iniciando con alta presencia de estiércol de cerdo (C1). Posteriormente, una distribución equitativa de ambos sustratos (C2). Y por último, una alta concentración de mucílago de café (C3). El parámetro para establecer las relaciones fue la carga orgánica presente en cada sustrato. La cuarta condición (C4) evaluó la estabilidad del proceso para la mejor relación de sustratos a través del incremento de la carga orgánica. La estabilidad de estas condiciones fue evaluada a lo largo del tiempo. Cada condición tuvo una duración de por lo menos 30 días.

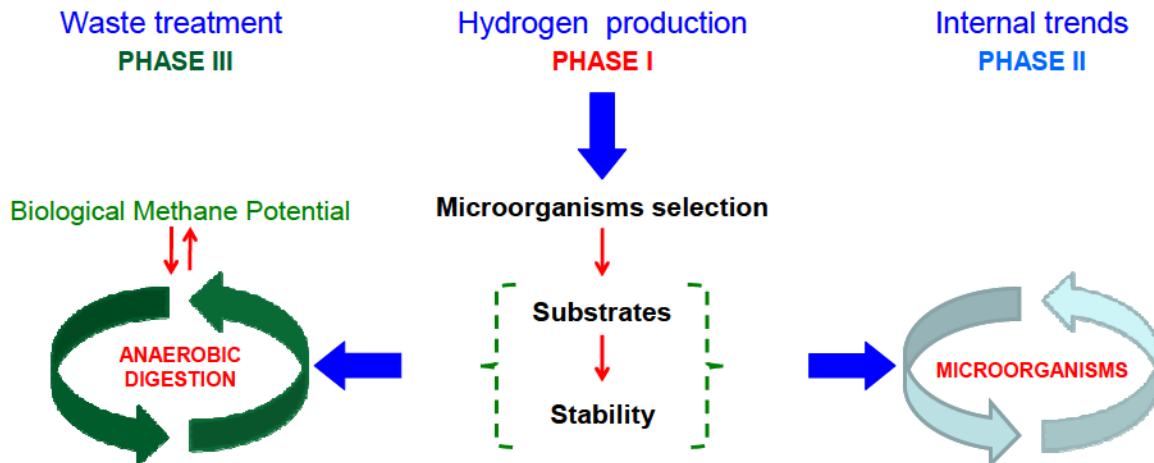

La **segunda fase** se desarrolló para evaluar la dinámica del proceso a lo largo del tiempo de retención utilizado en la producción de hidrógeno. De esta manera se evaluaron las diferentes condiciones experimentales en términos de dinámicas internas. Adicionalmente, algunos microorganismos productores fueron tenidos en cuenta. Mientras tanto, la **tercera fase** se enfocó en el tratamiento de los efluentes provenientes de cada una de las condiciones evaluadas para la producción de hidrógeno. Durante esta etapa se realizaron ensayos adicionales para determinar la producción de metano usando directamente los dos residuos sin aplicar la etapa para producción de hidrógeno.

Tabla 1. Especificaciones de las diferentes condiciones evaluadas experimentalmente.

<b>Parameter\Condition</b>	C1	C2	C3	C4
Substrates ratio (SM:CM)*	7:3	5:5	3:7	5:5
OLR (kg COD/m <sup>3</sup> d)	6	6	6	12

\* La relación fue calculada respecto a la Demanda Química de Oxígeno (DQO)

### **Sistema de reactores**

La fase experimental fue llevada a cabo en un sistema de dos reactores, los cuales no estuvieron físicamente conectados (Fig. 4). Cada reactor fue construido en acero inoxidable, con un volumen total de 7.2 L y un volumen efectivo de aproximadamente 6 L. El calentamiento se realizó a través de una chaqueta que recubría el equipo y que tenía un aislamiento térmico para evitar pérdidas de calor. Así mismo, se contaba con un sistema de agitación constante y un sistema de control para temperatura y otro para pH. Además de un sistema automático para la alimentación y descarga del equipo.

Las condiciones de operación de los dos reactores son mostradas en la Tabla 2. El rango de temperatura termofílico utilizado para la producción de hidrógeno fue escogido para promover la selección de microorganismos. Mientras tanto, la temperatura mesofílica buscaba mantener la estabilidad del reactor metanogénico. En cuanto al tiempo de retención para el tratamiento del alimento usado en cada condición. El reactor de hidrógeno utilizó un tiempo de 24 horas a fin de limitar el crecimiento y actividad de los microorganismos consumidores

de hidrógeno. Mientras tanto el reactor de metano utilizó un tiempo de 7 días para facilitar la degradación de la materia orgánica.



Figura 4. Sistema de reactores utilizado para el desarrollo experimental del proyecto.

Tabla 2. Parámetros operativos de los reactores para producción de hidrógeno y metano.

Parameter\Reactor	Units	Hydrogen	Methane
Working volume	L	5.5	6.0
Feedstock	L	3.5	4.0
pH		5.5	6.5
Temperature	°C	55	35
Retention time	d	1	7
Agitation	rpm	200	100

### Seguimiento del proceso

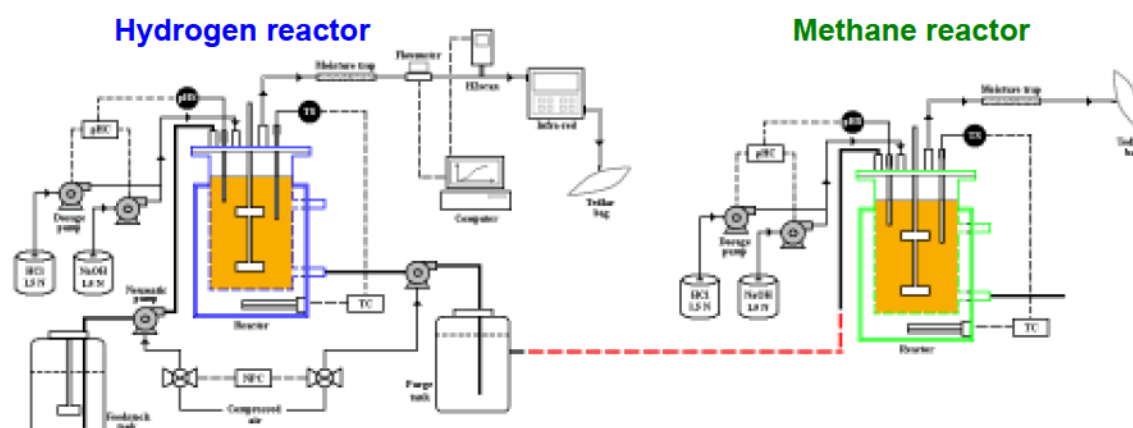
Para la fase I y III, los parámetros de seguimiento seleccionados fueron el flujo y composición del biogas, la caracterización de metabolitos en la fase líquida y la medición de diferentes parámetros fisicoquímicos (Tabla 3). Este seguimiento se realizó de forma diaria o semanal a lo largo del tiempo de cada experimento. Mientras tanto para la fase II, los parámetros fueron medidos a lo largo del tiempo de retención. En esta fase se recolectaron las muestras para la cuantificación de los microorganismos a través de qPCR. Los parámetros fisicoquímicos analizados fueron: Demanda química de oxígeno (DQO) soluble y total, nitrógeno total

Kjeldahl, amoníaco y sólidos totales y volátiles. Los ácidos grasos volátiles caracterizados fueron acético, butírico, propiónico, valérico y caproico. Los microorganismos productores de hidrógeno evaluados y sus primer son mostrados en la Tabla 4.

Tabla 3. Variables de seguimiento para las diferentes fases teniendo en cuenta el periodo de medición.

Phase	Frequency	Hydrogen	Methane
Phase I & III Repetitive batch cultivation	Daily ≥ 30days	Biogas flow	Biogas flow
		Hydrogen (%)	Methane and CO <sub>2</sub> (%)
	Weekly ≥ 4 samples	Methane and CO <sub>2</sub> (%)	H <sub>2</sub> S (ppm)
		Alkalinity	Alkalinity
Phase II Retention time	Online ≥3 days	Total VFA	Total VFA
		Individual VFA + ethanol	Individual VFA + ethanol
	Sampling ≥6 samples	Physicochemical	Physicochemical
		Biogas flow	
		Hydrogen (%)	
		ORP + pH	
		Methane and CO <sub>2</sub> (%)	
		Individual VFA + ethanol	
		Samples to qPCR	

ORP - Oxidation Reduction Potential

Tabla 4. Primer pairs usados para la cuantificación de tres microorganismos involucrados en la producción de hidrógeno.

Specificity	Sequence (5'-3')	Reference
<i>Bacillus sp.</i> 16S rRNA	GGCTACCAAGGCAACGAT	(Xiao et al,
<i>Bacillus sp.</i> 16S rRNA	GGCTGCTGGCACGTTAG	2010)
<i>Clostridium sp.</i> 16S rRNA	AGCGTTGTCCGATTTACTG	(Wang et al.,
<i>Clostridium sp.</i> 16S rRNA	TTCGCCACTGGTATTCTTCC	2008)
<i>T. thermosaccharolyticum</i> 16s rRNA	CAATAAGTATCCCGCCTGGG	This study
<i>T. thermosaccharolyticum</i> 16s rRNA	CCTCTTACGAGGCACTCAAG	

## RESULTADOS

### FASE I

*Co-digestión de mucílago de café y estiércol de cerdo*

**“Uso del mucílago de café como nuevo sustrato para la producción de hidrógeno en co-digestión anaerobia con estiércol de cerdo en condición termofílica”**

### FASE II

*Dinámicas internas y microorganismos productores de hidrógeno*

**“Mecanismos y microorganismos involucrados en la producción de hidrógeno a lo largo del tiempo de retención en ABR – Abriendo la caja negra para la co-digestión de dos sustratos complejos”**

### FASE III

*Tratamiento de residuos y producción de metano*

**“Ventajas y límites de un proceso de metanización como segunda etapa para el tratamiento del efluente proveniente de la producción de hidrógeno usando sustratos complejos”**

# **Uso del mucílago de café como nuevo sustrato para la producción de hidrógeno en co-digestión anaerobia con estiércol de cerdo en condición termofílica**

## **Resumen**

Mucílago de café fue usado para la producción de hidrógeno como un nuevo sustrato proveniente de una de las principales actividades agrícolas de Colombia. El estudio evaluó tres relaciones de sustratos entre el mucílago de café y el estiércol de cerdo (C1-3). Una cuarta condición evaluó el incremento de carga orgánica (C4). Los mejores resultados de producción de hidrógeno se obtuvieron para una relación Carbono/Nitrógeno (C/N) de 53 usada en C2 y C4. El incremento de la carga orgánica produjo un volumen de hidrógeno acumulado, una tasa de producción y un rendimiento de 2661 NmL, 760 NmL H<sub>2</sub>/L<sub>W</sub>d and 43 NmL H<sub>2</sub>/g DQO, respectivamente. En esta condición, la composición del biogas fue 0.1, 50.6 y 39.0 % de metano, dióxido de carbón e hidrógeno, respectivamente. La principal ruta metabólica estuvo asociada a la producción de ácido acético y butírico manteniendo una relación Bu/Ac alrededor de 1.0. La máxima carga utilizada de 12 kg DQO/m<sup>3</sup>d produjo una concentración de AGV no disociado de alrededor 8.5 mM. Una correlación directa fue encontrada entre el mucílago de café y la producción acumulada de hidrógeno y biogas. El modelo modificado de Gompertz fue adecuado para ajustar los datos experimentales obtenidos en cada una de las condiciones.

## **Resultados**

### ***Relación de sustratos***

Las tres condiciones utilizadas para estudiar la relación entre el mucílago de café y el estiércol de cerdo mostraron una alta influencia sobre la producción de hidrógeno y la relación Carbono/Nitrógeno (C/N). De esta manera, la condición 1 tuvo un baja relación como consecuencia del elevado contenido de nitrógeno en el estiércol de cerdo (Fig. 5). Mientras que la condición 3 mostró un incremento en esta relación como respuesta a las altas concentraciones de carbohidratos presentes en el mucílago de café. Por último la condición 2

tuvo una relación de 53. Todos estos valores estuvieron en los rangos reportados como adecuados para la producción de hidrógeno (Lin and Lay, 2004; Argun et al., 2008; O-Thong et al., 2008; Sreela-or et al., 2011). En cuanto a la producción de hidrógeno, esta fue baja durante la elevada presencia de estiércol de cerdo. Sin embargo el máximo incremento de la concentración de mucílago provocó fluctuaciones durante el desarrollo del proceso a lo largo del tiempo. De esta forma, la mejor condición para la producción de hidrógeno se alcanzó durante la relación similar de sustratos (C2). En este caso, la producción de hidrógeno se mostró en un estado pseudo estable con una desviación estándar alrededor de 10%. Las fluctuaciones en la condición 3 fueron asociadas a un cambio en la relación C/N que paso de 72 a 98 al final de los experimentos. Este cambio ocurrió como consecuencia de la disminución de las concentraciones de amoníaco. El estudio de las relaciones de sustrato mostró que es posible obtener una correlación directa entre la relación C/N y la producción de hidrógeno siempre y cuando las fluctuaciones en C3 se reduzcan a una desviación estándar similar que en C2.



Figura 5. Influencia de los dos sustratos sobre la producción de hidrógeno y la relación carbono/nitrógeno en cada condición experimental evaluada (HPR – Hydrogen production rate; L<sub>w</sub> – Liter of waste).

En cuanto a la composición del biogas, la Figura 6 muestra que el hidrógeno y dióxido de carbono fueron los componentes principales con ligeras variaciones durante el cambio de condición. Los ácidos grasos volátiles incrementaron a lo largo del tiempo en respuesta al aumento de la concentración de la fuente de carbono asociada al mucílago de café. De manera similar, la alcalinidad del reactor incrementó independientemente de las bajas concentraciones encontradas en la mezcla de alimento (Fig. 6). Esto se relacionó con el incremento en las concentraciones de dióxido de carbono liberado (Valdez-Vazquez et al., 2005). Independiente de las características de cada condición la actividad metanogénica fue fuertemente inhibida como respuesta a las condiciones de operación planteadas.

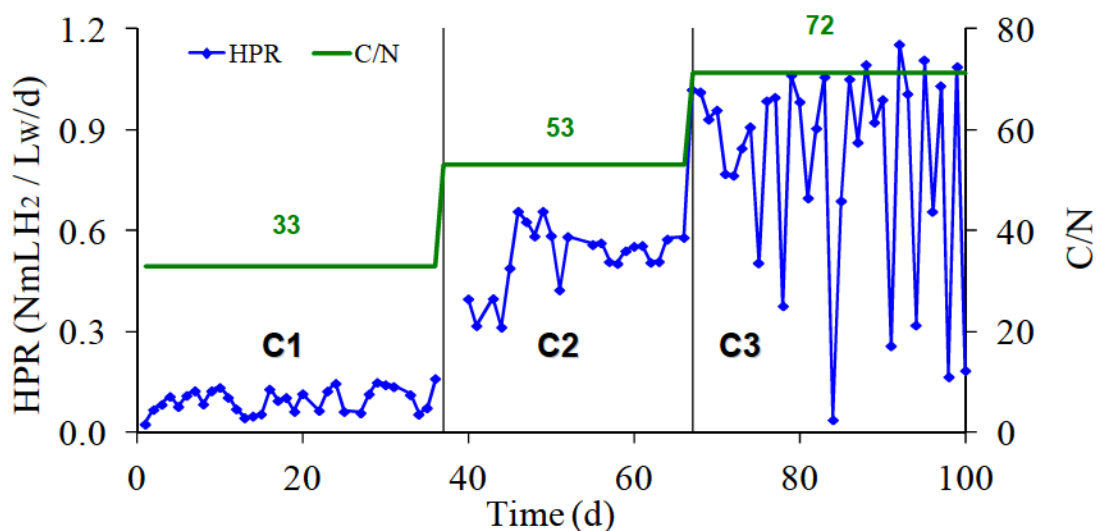

Figura 6. Composición del biogas en función del tiempo de cada experimento y la variación de sustratos. Las líneas rojas intermitentes representan la alcalinidad inicial de la mezcla de alimento (VFA – Volatile fatty acids; ALK – Alkalinity).

### *Incremento de la carga orgánica*

El incremento de este parámetro se realizó para la relación de sustratos 5:5, la cual mostró la mejor producción de hidrógeno. El cambio en la carga no produjo ninguna alteración de la estabilidad del proceso mostrando un comportamiento similar entre C2 y C4 (Fig. 7). Por el contrario, la desviación estándar se mantuvo alrededor de 6% a pesar del incremento de los

ácidos grasos volátiles no disociados de 3.9 a 8.5 mM. Aunque estas concentraciones estuvieron por debajo de lo reportado para tener un efecto negativo a la producción de hidrógeno (van Ginkel and Logan, 2005). El incremento pudo afectar la producción específica de hidrógeno evitando alcanzar un incremento mayor a 43 NmL H<sub>2</sub>/ gDQO. En ambas condiciones el proceso requirió alrededor de 15 días para alcanzar el estado pseudo-estable de producción de hidrógeno.

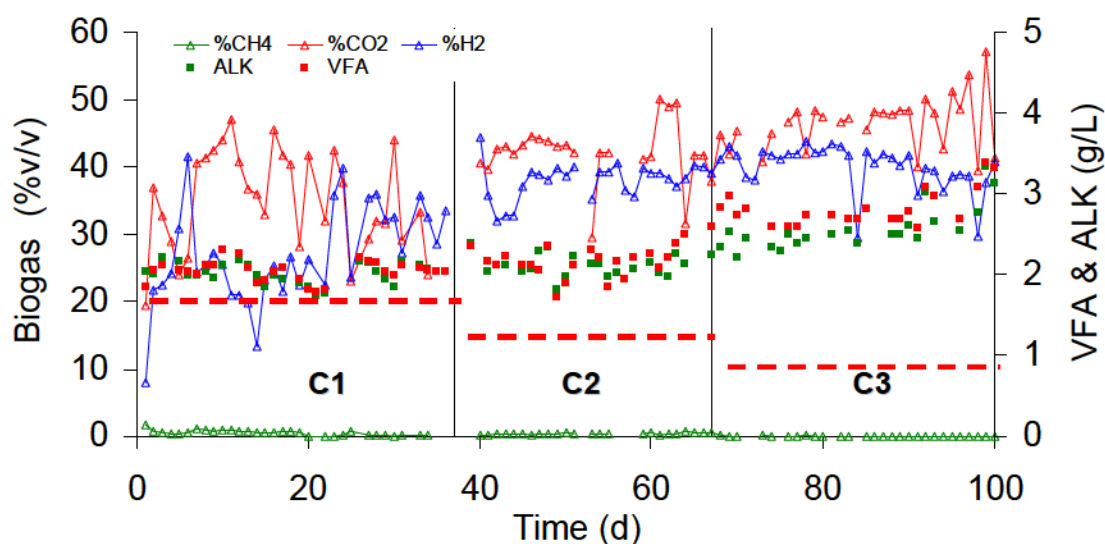

Figura 7. Comparación entre C2 y C4 evaluadas para la misma condición de relación de sustratos pero con un incremento de carga orgánica para C4 (HPY – Hydrogen production yield).

### ***Influencia del mucílago de café***

La adición de mucílago de café mostró una respuesta directa en términos de producción de biogas e hidrógeno (Fig. 8). Esta respuesta se relacionó al contenido de carbohidratos presente en este sustrato, el cual representó menos del 18 % de la DQO soluble. Sin embargo la producción específica de hidrógeno fue comparable con la reportada para otro tipo de residuos con mayor contenido de carbohidratos, tales como residuos de una planta de aceite de palma o vinazas (O-Thong et al., 2008). De acuerdo a esto el mucílago de café mostró una relación de 7.8 L H<sub>2</sub>/ L<sub>mucílago</sub> contra 6.5 L H<sub>2</sub>/ L<sub>POME</sub> (Palm Oil Mill Effluent). Mientras que la tasa de producción fue de 0.8 L H<sub>2</sub>/L<sub>alimento</sub>/d contra 0.6 L H<sub>2</sub>/L<sub>alimento</sub>/d para las vinazas.



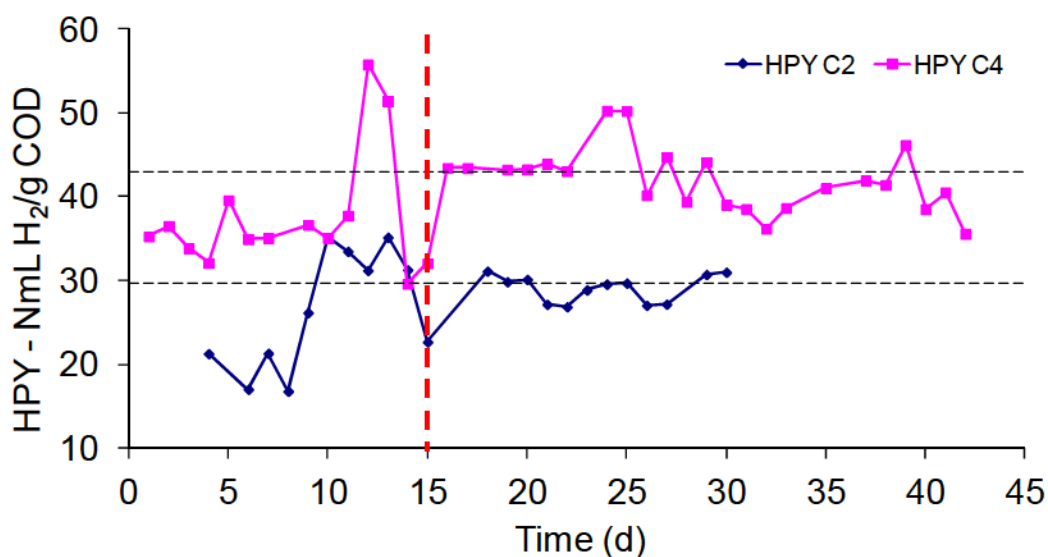

Figura 8. Efecto de la concentración de mucílago de café en las diferentes condiciones evaluadas (SHP – Specific hydrogen production).

### *Estimación de parámetros cinéticos*

Los parámetros cinéticos del proceso fueron calculados utilizando el modelo modificado de Gompertz (Eq. 1). La Tabla 5 muestra los diferentes valores encontrados para la producción potencial de hidrógeno (P), la tasa de producción de hidrógeno ( $r_m$ ) y el tiempo de retraso ( $\lambda$ ).

$$H = P \exp\left(-\exp\left[\frac{r_m e}{P}(\lambda - t) + 1\right]\right) \quad (1)$$

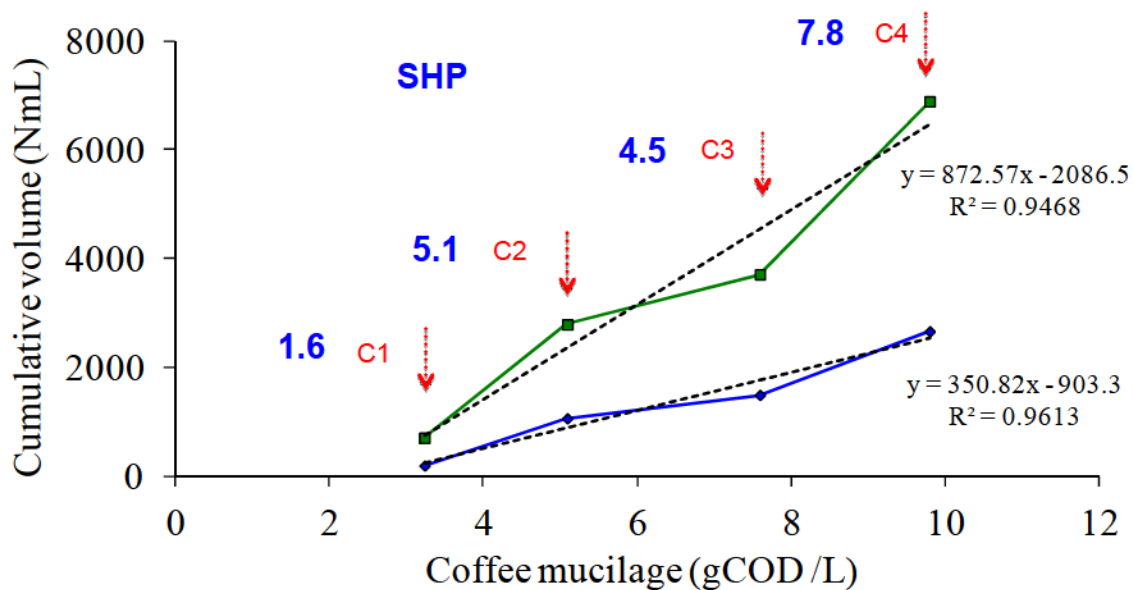
Tabla 5. Parámetros cinéticos de la ecuación modificada de Gompertz para cada condición.

Condition\Parameter	P (NmL)	$r_m$ (NmL/h)	$\lambda$ (h)	$R^2$
Average ( $n \geq 19$ )				
C1	194.5	43.5	5.1	0.9995
C2	1058.0	119.5	6.6	0.9995
C3	1455.0	186.0	5.3	1.0000
C4	2663.0	328.8	4.0	0.9996

El modelo fue capaz de ajustar los datos experimentales de acuerdo a los factores de correlación encontrados. El tiempo de retraso fue similar para C1 y C3 lo cual fue asociado a la especificidad de cada sustrato en estas condiciones. Mientras que la mezcla en C2 con iguales proporciones mostró un retraso en el tiempo de inicio de la producción de hidrógeno. El cambio de C2 a C4 tuvo un incremento en la tasa de producción de hidrógeno con una reducción alrededor de 2.6 h en el tiempo de respuesta del proceso.

### ***Metabolitos producidos***

Los principales metabolitos producidos fueron ácido acético y butírico asociados a la producción de hidrógeno a través de las ecuaciones 2 y 3. Este comportamiento fue observado principalmente después de la primera condición. Las concentraciones producidas de estos dos intermediarios fueron relacionadas con el 58 – 85% de la cantidad total de hidrógeno generado. El porcentaje restante se asoció a la producción de otros intermediarios como piruvato o acetil-CoA. Mientras tanto, la principal ruta de desviación fue asociada a la formación de ácido propiónico.

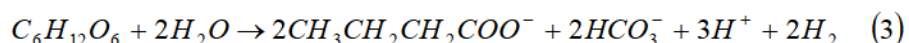
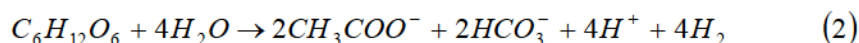

### **Conclusiones**

El uso de mucílago de café y estiércol de cerdo alcanzó una tasa de producción de hidrógeno y una producción acumulada de 303 NmL H<sub>2</sub>/L<sub>Wd</sub> y 1061 NmL H<sub>2</sub>, respectivamente. La producción para la relación de sustratos 5:5 fue estable a lo largo del tiempo con una composición del biogas de 38.6 y 42.4 % para hidrógeno y dióxido de carbono, respectivamente. La etapa metanogénica fue casi completamente inhibida a pesar del uso de una cultura mixta de microorganismos y el no uso de pre-tratamientos para los dos sustratos complejos. El incremento de la carga orgánica mejoró la producción de hidrógeno sin alterar la estabilidad del proceso. En C4 la producción acumulada de hidrógeno y la tasa de producción fueron 2660.7 NmL y 760.2 NmL H<sub>2</sub>/L<sub>Wd</sub>. Una relación directa entre la concentración de mucílago y la producción de hidrógeno fue encontrada.

## **Mecanismos y microorganismos involucrados en la producción de hidrógeno a lo largo del tiempo de retención en ABR – Abriendo la caja negra para la co-digestión de dos sustratos complejos**

### **Resumen**

El proceso de producción de hidrógeno desarrollado en la fase I fue evaluado a lo largo del tiempo de retención del reactor anaerobio por lotes (ABR). Esto se logró a través del seguimiento de varios parámetros como la presión parcial de hidrógeno y dióxido de carbono, el potencial de óxido reducción, pH, metabolitos y microorganismos. En C2 y C4, dos tendencias fueron identificadas las cuales mostraron similar producción acumulada de hidrógeno al final de los experimentos. Las tendencias fueron clasificadas como *corta* y *larga* en relación a las diferencias en la tasa de producción de hidrógeno y el tiempo de retraso. la tendencia *corta* requirió menor tiempo para iniciar la producción y tenía una mayor tasa de producción de hidrógeno que la tendencia *larga*. La ruta metabólica estuvo asociada con la producción de ácido acético y butírico. Mientras la ruta de desviación fue representada por el ácido propiónico para ambas tendencias. *Thermoanaerobacterium thermosaccharolyticum* fue el microorganismo que dominó en la tendencia *corta*. Así mismo, *Bacillus sp.* mostró altas concentraciones al comienzo de esta tendencia. Mientras que similares concentraciones de *T. thermosaccharolyticum* y *Clostridium sp* fueron encontradas en la tendencia *larga*. La presión parcial de hidrógeno condujo los experimentos a través del uso del sistema H<sup>+</sup>/H<sub>2</sub> y el uso de ferredoxina como transportadores de electrones.

### **Resultados**

#### ***Identificación de tendencias***

Los valores de producción de hidrógeno utilizados en la fase I fueron representados por el promedio de los diferentes resultados de la operación por lotes (Línea verde en la Fig. 9). Sin embargo, para las condiciones 2 y 4 se observaron dos tipos de tendencias a lo largo del tiempo de retención. Estas mostraron similar producción acumulada de hidrógeno pero se

diferenciaron en el tiempo de retraso y la tasa de producción de hidrógeno (Fig. 9). De esta forma, la tendencia asociada a una rápida respuesta y alta tasa de producción fue llamada *corta*. Mientras que el comportamiento opuesto en variables se asoció a la tendencia *larga*. Las condiciones 1 y 3 también mostraron comportamientos diferentes a lo largo del tiempo de retención. Sin embargo, estas tendencias no alcanzaron similares producciones acumuladas de hidrógeno al final de los experimentos. Dichas tendencias fueron asociadas a inestabilidades encontradas en estas condiciones. La ocurrencia de las dos tendencias en C2 y C4 se presentaban de manera aleatoria a lo largo de los diferentes lotes para cada condición.



Figura 9. Evolución de la producción de hidrógeno a lo largo del tiempo de retención para la condición 4. Identificación de dos tendencias relacionadas con diferencias en el tiempo de respuesta y la tasa de producción de hidrógeno (HPR – Hydrogen production rate).

En cuanto a la composición del biogas a lo largo del tiempo de retención se observó una débil respuesta de producción de metano. Esta respuesta evidenció la presencia de microorganismos metanogénicos al interior del cultivo mixto. En la tendencia *larga*, metano e hidrógeno fueron producidos en rangos de tiempo similares. Mientras que en la tendencia *corta* el hidrógeno apareció primero que las concentraciones de metano. De acuerdo a esto, una competencia entre microorganismos productores y consumidores fue sugerida al interior del cultivo mixto. Por otro lado, el oxígeno presente en el espacio libre del reactor fue consumido en un 80 y 94 % en C2 y C4 respectivamente. Este comportamiento fue asociado a la acción de microorganismos facultativos como las especies *Bacillus*.

## Metabolitos

El seguimiento de los productos metabólicos mostró que en términos de concentración, la ruta de fermentación butírica fue la principal ruta metabólica para la tendencia *corta* (Fig. 10). Mientras que la ruta de fermentación acética predominó durante la tendencia *larga*. Sin embargo la relación molar mostrada en las ecuaciones 2 y 3 sugiere que la principal ruta para la producción de hidrógeno fue la fermentación acética. En la tendencia *corta* se presentó una alta concentración de ácidos grasos volátiles en las primeras horas del tiempo de retención. Esto fue asociado directamente al incremento de la tasa de producción de hidrógeno para esta tendencia. El ligero incremento de la producción de propiónico a lo largo del tiempo fue asociado a una limitación del proceso en la tendencia *larga*.

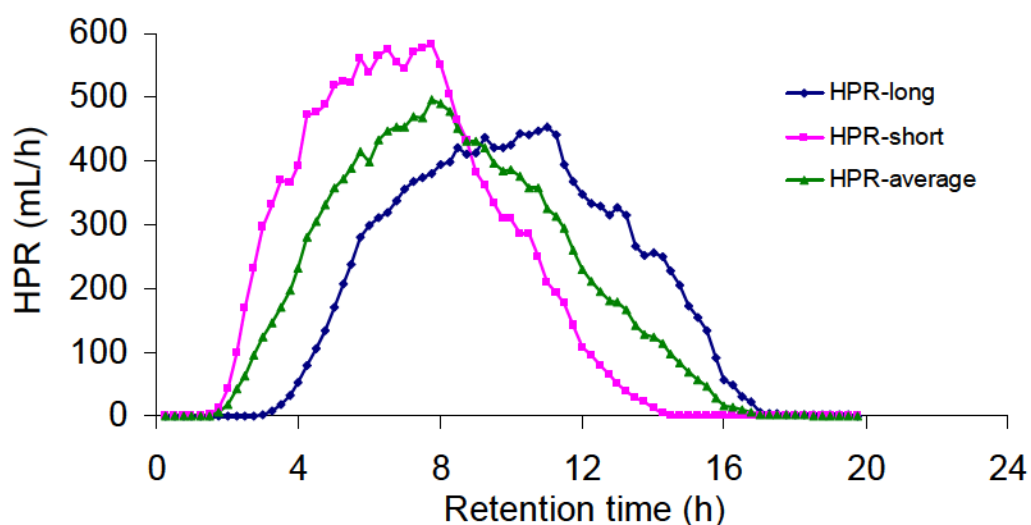

Figura 10. Evolución de los principales metabolitos asociados a la producción de hidrógeno a lo largo del tiempo de retención para la condición 4 (HPR – Hydrogen production rate).

## Microorganismos

Las especies *Bacillus sp.* y *T. thermosaccharolyticum* mostraron una mayor concentración durante la tendencia *corta* (Fig. 11). Mientras que concentraciones similares fueron medidas para *T. thermosaccharolyticum* y *Clostridium sp.* en la tendencia *larga*. A partir de estos comportamientos, se infirió que en la tendencia *corta* la presencia de *Bacillus sp.* al comienzo se debía a la acción de estos microorganismos para el rompimiento de macromoléculas. Posteriormente, *T. thermosaccharolyticum* trabajaba con los productos solubles generados por la acción de *Bacillus sp.* En la tendencia *larga*, estos compuestos solubles pudieron ser usados al mismo tiempo por *T. thermosaccharolyticum* y las diferentes especies de *Clostridium sp.*

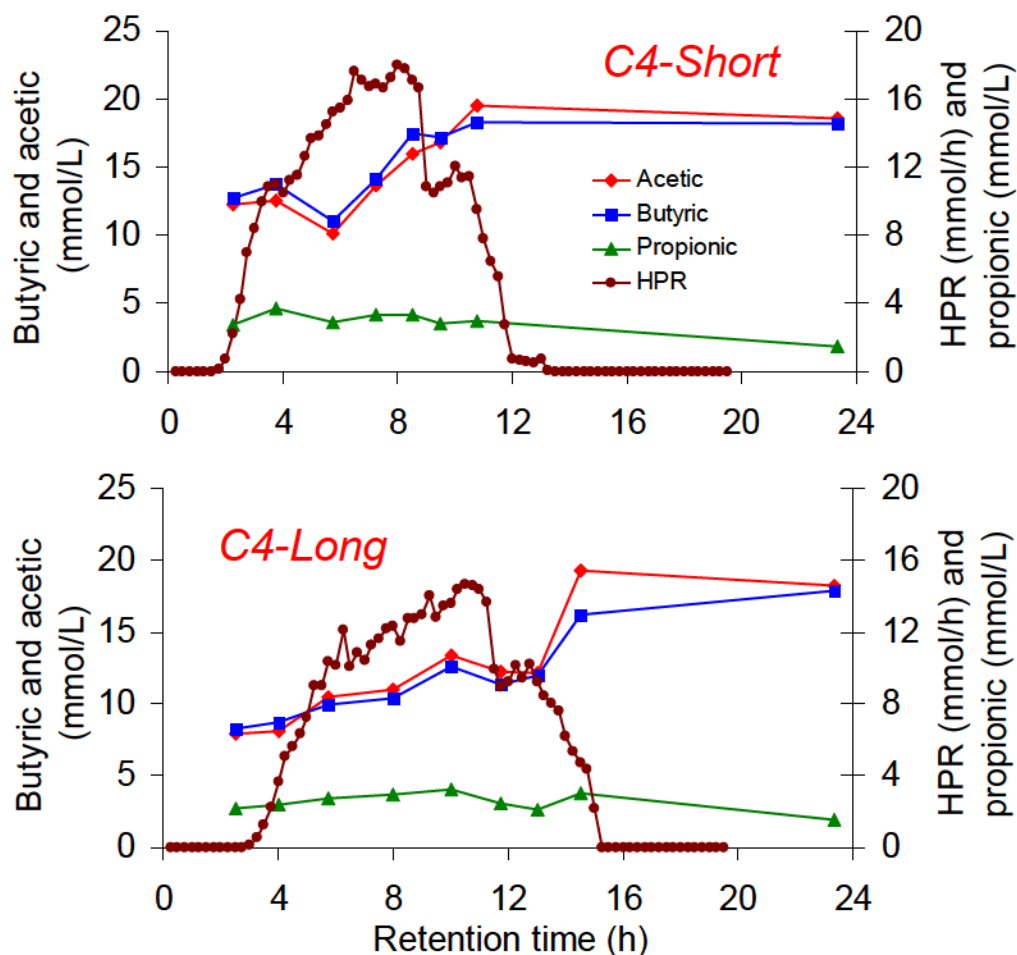

Figura 11. Seguimiento de los tres géneros de microorganismos productores de hidrógeno seleccionados. Concentraciones de *Bacillus sp.*, *Clostridium sp.* y *T. thermosaccharolyticum* en unidades de genoma para la condición 4 (HPR – Hydrogen production rate).

### ***Ruta metabólica***

La vía metabólica propuesta partió principalmente de la degradación de monómeros simples como la glucosa presente en el mucílago de café (Fig. 12). De esta manera se generan intermediarios como el piruvato que es un compuesto clave en el proceso de degradación. La oxidación de este compuesto a acetyl-CoA está ligada a la producción de hidrógeno. En la ruta puede presentarse la contribución a partir de otro tipo de monómeros como arabinosa, gluconato, etc, los cuales están presentes en el mucílago de café. Un contribuyente adicional a la producción de hidrógeno puede ser el glicerol proveniente de la degradación de los lípidos del estiércol de cerdo. El final de esta ruta puede involucrar la formación de ácidos grasos volátiles y algunos alcoholes. Las rutas de consumo fueron asociadas principalmente a la producción de propiónico a través de dos vías. Una relacionada con la presencia de altas concentraciones de dióxido de carbono el cual puede desviar la ruta a la producción de succinato. Mientras que altas presiones parciales de hidrógeno pueden desviar la ruta a la producción de intermediarios como lactato.

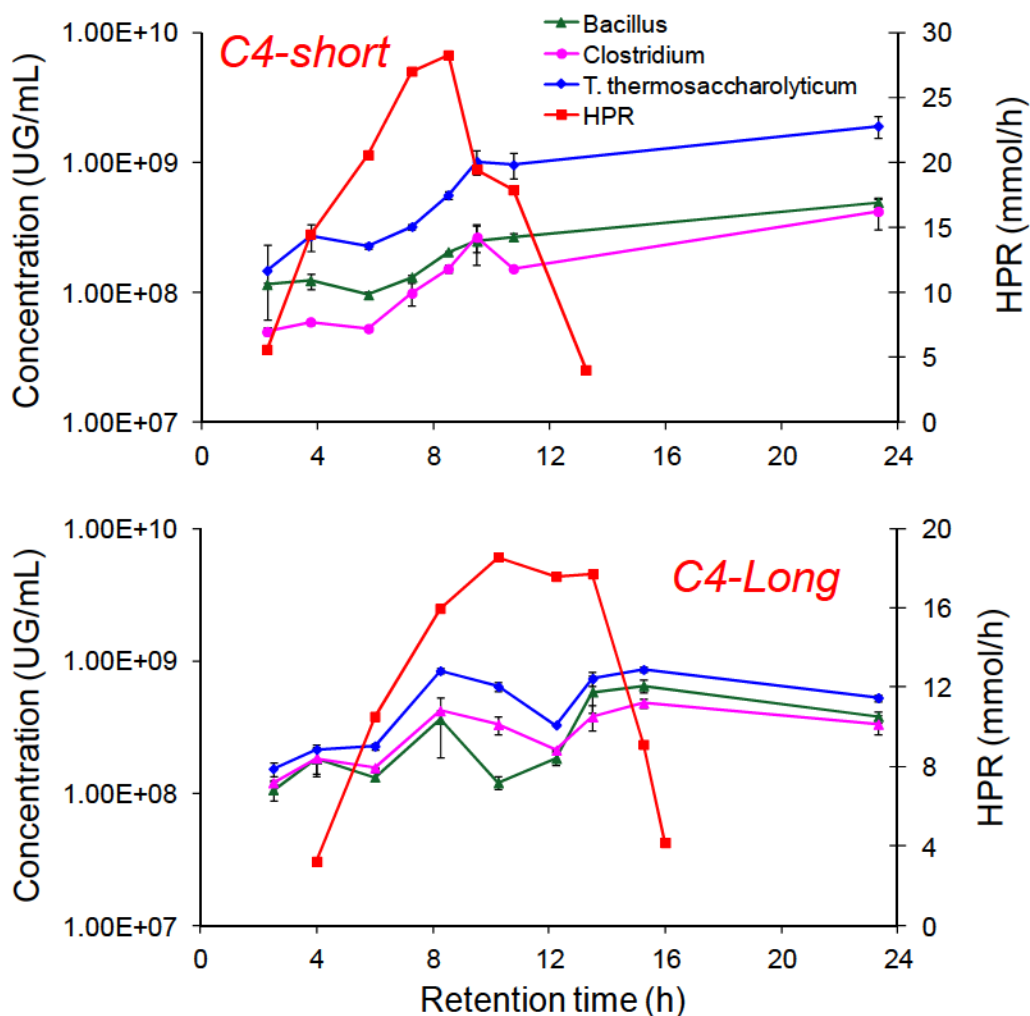

Figura 12. Ruta metabólica propuesta para el proceso de producción de hidrógeno alcanzado durante las condiciones 2 y 4. El esquema fue adaptado de Liu et al., 2008; Saint-Amans et al., 2001; Temudo et al., 2007.

## Conclusiones

Dos tendencias, *corta* y *larga*, fueron identificadas a lo largo del tiempo de retención durante el proceso de producción de hidrógeno. Las principales diferencias entre las tendencias fueron relacionadas con los parámetros cinéticos; tiempo de retraso y tasa de producción de hidrógeno. La principal ruta metabólica de producción de hidrógeno fue asociada a la formación de ácidos butírico y acético. Mientras tanto, la producción de ácido propiónico fue considerada la principal ruta de desviación para la obtención de hidrógeno. La presencia de *Bacillus sp.* fue asociada a la degradación inicial de las macromoléculas para la generación de productos solubles. Posteriormente, estos productos eran usados por *Clostridium sp* y *T. thermossacharolitycum*. La presencia de estos dos géneros fue observada principalmente durante la tendencia *larga*. Mientras que las mayores concentraciones de *Bacillus sp.* y *T. thermossacharolitycum* fueron asociadas a la tendencia *corta*. La mayoría del oxígeno presente al inicio del proceso fue consumido dentro del reactor, lo cual fue ligado a la presencia de microorganismos facultativos como *Bacillus sp.* La ruta metabólica se asoció al uso de diferentes monómeros debido a la variedad presente en ambos sustratos. Mientras que la ruta de consumo se relacionó a la producción de propiónico causado por elevadas concentraciones de hidrógeno y dióxido de carbono.

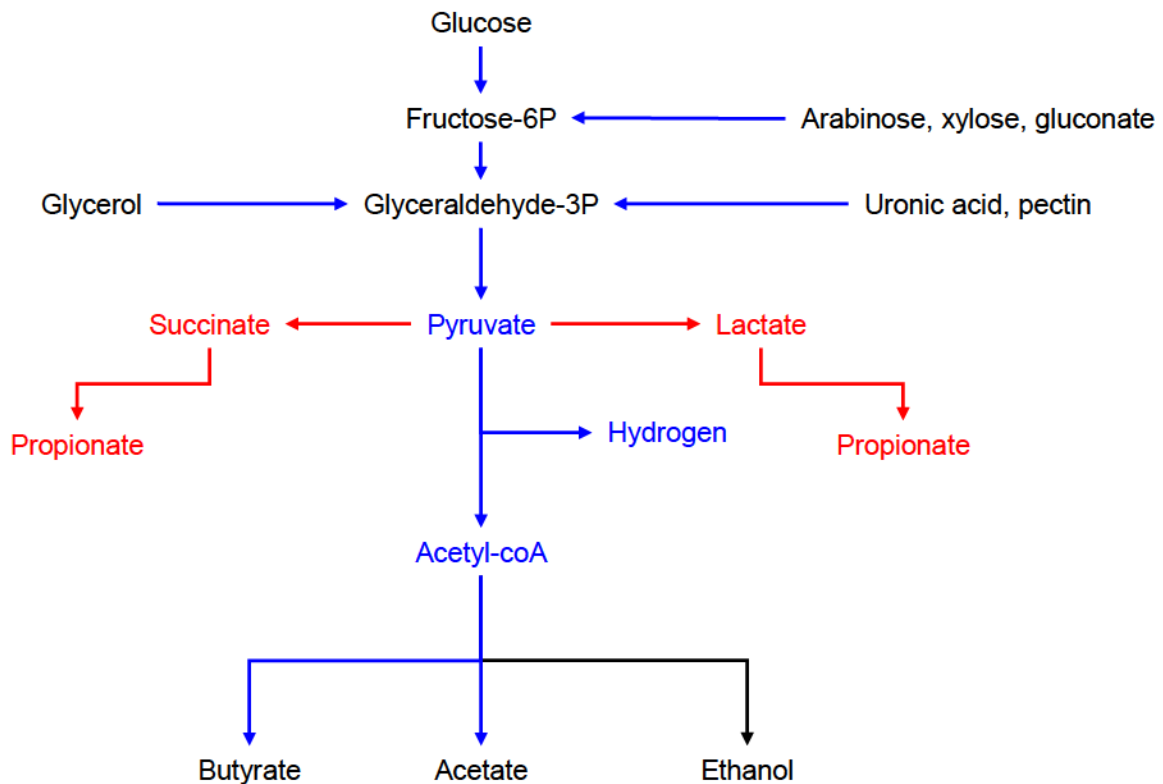

## **Ventajas y límites de un proceso de metanización como segunda etapa para el tratamiento del efluente proveniente de la producción de hidrógeno usando sustratos complejos**

### **Resumen**

La valorización de los dos residuos utilizados a través del uso de digestión anaerobia en dos etapas fue desarrollada en este estudio. La mayor producción acumulada de hidrógeno en la primera etapa fue de 4 L H<sub>2</sub>, con una composición de 39 y 51 % para hidrógeno y dióxido de carbono, respectivamente. En la segunda etapa la mayor producción acumulada de metano fue 15 L CH<sub>4</sub>, con una composición de 66 y 23 % para metano y dióxido de carbono, respectivamente. La primera etapa mejoró el paso de hidrólisis incrementando la DQO soluble, el nitrógeno y los sólidos volátiles. La remoción de la DQO al final de la segunda etapa fue entre 56-71% para las diferentes condiciones. Los carbohidratos fueron principalmente degradados para la producción de hidrógeno. Mientras que la degradación de los lípidos se llevo a cabo durante la producción de metano. La primera etapa mejoró el tiempo de respuesta y la tasa de producción de la segunda etapa comparado con los análisis del potencial biológico de metano (BMP). Sin embargo este análisis mostró un incremento en la producción de metano contra las dos etapas evaluadas. Las diferentes relaciones de sustratos evaluadas mostraron una similar producción de energía. El aporte del hidrógeno representó alrededor del 10% de la energía total producida.

### **Resultados**

#### ***Reactores de hidrógeno y metano***

Cada reactor fue operado a condiciones operativas exclusivas para alcanzar un proceso especializado en cada etapa (Fig. 13). Esto fue relacionado a la capacidad de producir el gas de interés en cada reactor sin interferencias del otro compuesto. De esta manera, la primera etapa tuvo una composición dominada por hidrógeno y dióxido de carbono. Mientras que la segunda etapa se especializó en la producción de metano y dióxido de carbono como compuestos principales. En adición la concentración de ácido sulfhídrico estuvo por debajo de

200 ppm. En general la producción de hidrógeno incrementó como respuesta al cambio de condición. Mientras tanto la producción de metano se redujo con el incremento de la relación carbono/nitrógeno.



Figura 13. Composición del biogas a lo largo del tiempo para las dos etapas desarrolladas. Producción del gas de interés en cada una de las etapas, siendo hidrógeno para el primer reactor y metano para el segundo.

### Comportamiento de la producción de metano

Los valores iniciales de la relación entre ácidos grasos volátiles y la alcalinidad estuvieron por encima de los valores óptimos para la operación de un proceso metanogénico (Panichnumsin et al., 2010). Sin embargo las condiciones del reactor fueron adecuadas para manejar las altas

concentraciones de ácidos grasos volátiles reduciendo la relación por debajo de 0.1 asociado a la producción estable de metano. Sin embargo estos valores permanecieron por encima de 0.2 durante la condición 4. Esto pudo causar efectos negativos en la biomasa afectando la producción de metano. La influencia de la primera etapa mostró una rápida respuesta en la generación de metano durante los primeros días del tiempo de retención (Fig. 14). Este comportamiento se incrementó a través del cambio de condición relacionado con el aumento de las concentraciones de productos solubles (Appels et al., 2011). De esta manera el 90 % del metano total fue producido durante los primeros 5 días para todas las condiciones. Esto permitiría la reducción del tiempo de retención para la operación de la segunda etapa.

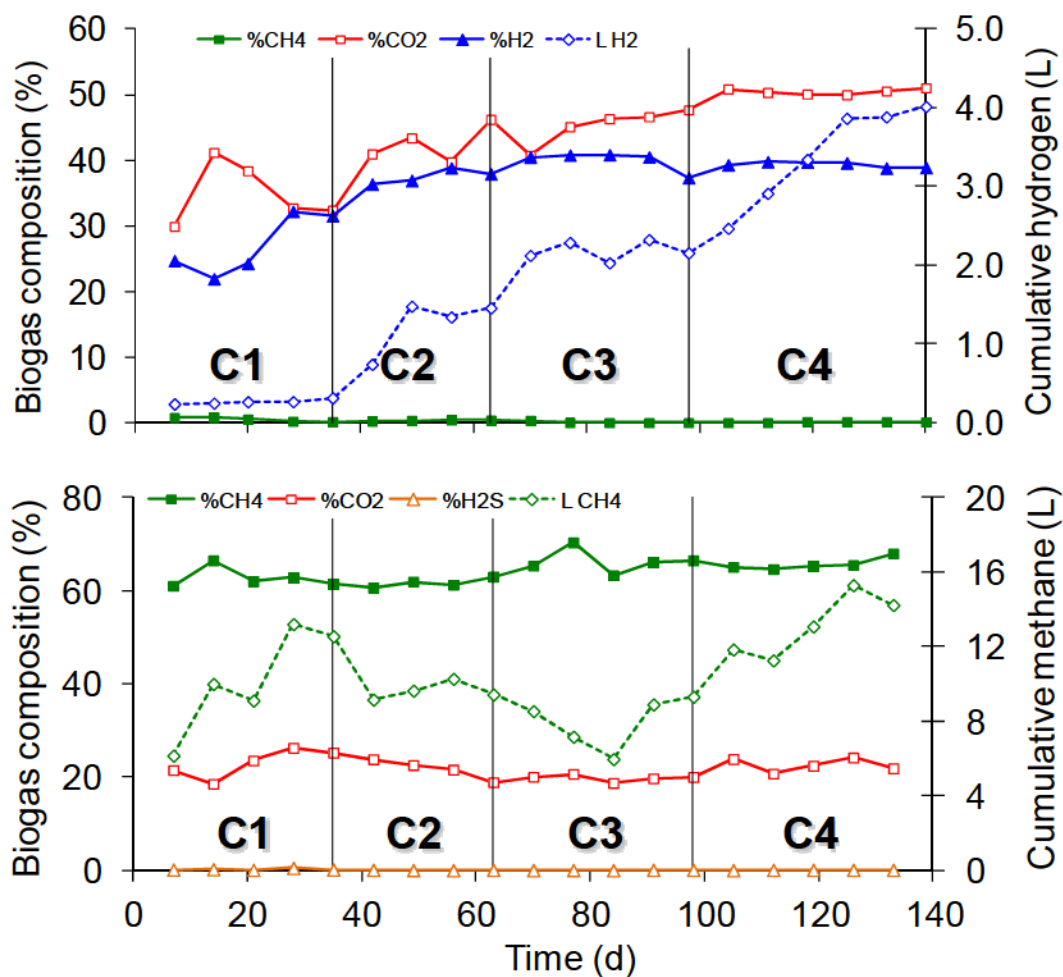

Figura 14. Producción de metano a lo largo del tiempo evaluada contra la relación entre la concentración de ácidos grasos volátiles y la alcalinidad. La tasa de producción fue graficada en función del tiempo de retención para el proceso (7 días).

Los ensayos del potencial biológico de metano (BMP) confirmaron que el uso de una primera etapa reduce el tiempo de respuesta del proceso. Además, las tasas de producción de metano se incrementaron durante los primeros días del tiempo de retención asociado a las altas concentraciones de ácidos grasos volátiles. Sin embargo los ensayos BMP mostraron una producción mayor de metano usando directamente los residuos evitando la primera etapa. Estos experimentos mostraron la capacidad del inóculo del proceso para adaptarse a la eliminación de una primera etapa.

### *Caracterización del alimento y efluentes (macromoléculas)*

La remoción de DQO total fue limitada durante la primera etapa del proceso alcanzando máximas remociones alrededor del 5 % (Tabla 6). Mientras tanto el uso de la segunda etapa mejoró la remoción del proceso hasta el 73 %. La DQO total remanente fue asociada al material difícilmente degradable y la presencia de material inerte en ambos sustratos. Por otro lado, la remoción de la DQO soluble alcanzada en la primera etapa tuvo un máximo alrededor del 18 %. Esta fue baja asociado a la alta producción de metabolitos intermedios en el proceso. La remoción de la carga soluble llegó a un máximo de 91 % después del segundo reactor. Las concentraciones de nitrógeno total se mantuvieron relativamente constantes para todas las condiciones excepto la 3. La reducción en esta condición durante la primera etapa fue asociado al consumo de todo el amoníaco presente en el sistema. Esta condición pudo limitar el crecimiento de biomasa incidiendo en las fluctuaciones ocurridas.

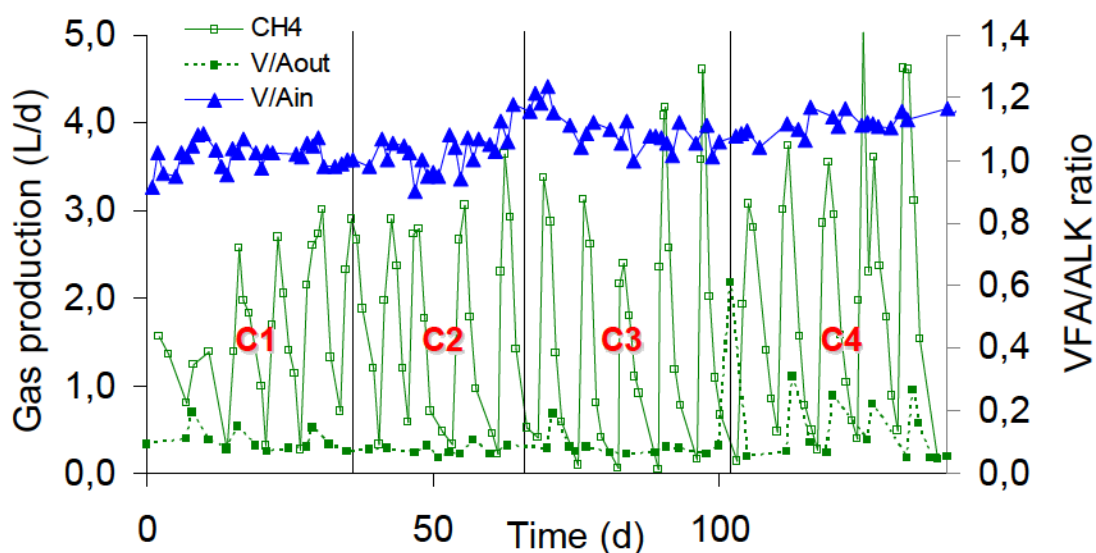
Tabla 6. Caracterización del alimento y efluentes a través de diferentes parámetros fisicoquímicos para cada una de las condiciones y las etapas estudiadas.

<b>Parameter</b>	<b>Unit</b>	<b>C1</b>	<b>C2</b>	<b>C3</b>	<b>C4</b>
<i>Characterization of the feedstock</i>					
COD		10.8±0.0	10.2±0.6	10.8±1.0	19.6±0.4
CODs	g/L	3.4±0.5	4.6±0.5	5.6±0.2	8.1±0.4
TKN		318.8±70.6	190.6±21.0	140.1±22.9	369.5±40.9
NH <sub>3</sub>	mg/L	47.5±8.2	23.6±7.2	8.1±4.2	56.6±6.7
<i>Characterization effluent from the first stage</i>					
COD		10.5±2.2	9.9±1.5	10.4±0.3	18.6±0.3
CODs	g/L	3.0±0.4	4.3±0.6	5.4±0.6	6.6±0.7
TKN		292.1±25.9	188.8±43.2	105.3±12.8	358.3±38.3
NH <sub>3</sub>	mg/L	62.6±15.0	22.5±4.4	ND <sup>a</sup>	60.5±4.1
<i>Characterization effluent from the second stage</i>					
COD		4.0±0.6	4.3±2.4	3.2±2.3	5.3±1.2
CODs	g/L	1.4±0.4	1.3±0.6	1.4±0.7	0.7±0.1
TKN		270.3±40.6	172.5±14.8	103.6±51.8	315.6±51.8
NH <sub>3</sub>	mg/L	80.6±3.9	57.1±4.5	36.6±9.4	139.8±5.3

<sup>a</sup> ND: not detected.

Los carbohidratos provenientes del mucílago de café fueron consumidos principalmente en la primera etapa asociado a la producción de hidrógeno. Mientras tanto los lípidos fueron asociados a la producción de metano, exceptuando la condición 4 que presentó una

disminución de esta macromolécula durante el primer reactor. El comportamiento observado para estas macromoléculas corresponde a las diferencias de las constantes cinéticas de hidrólisis de cada macrocomponente (Vavilin et al., 2008).

### Metabolitos

El comportamiento de los metabolitos intermediarios del proceso de degradación mostraron una alta formación de estos compuestos en el reactor de hidrógeno (Tabla 7). Estos representaron entre el 60 - 79 % de la DQO soluble del efluente usado para el reactor de metano. Mientras tanto, en la segunda etapa los metabolitos fueron removidos casi completamente. De esta manera la segunda etapa se mostró incluso eficaz para la remoción de ácidos grasos de varios carbonos como el valérico y caproico.

Tabla 7. Cuantificación de los principales metabolitos medidos para la caracterización de la DQO soluble.

Condition	Ethanol	Acetic	Propionic	Butyric	Valeric	Caproic
<i>Feedstock</i>						
C2*	18.0	122.7	106.5	130.1	43.6	9.1
<i>Hydrogen reactor</i>						
C1	42.4±26.6	891.6±375.8	406.8±247.2	897.6±260.7	88.2±73.2	45.1±16.4
C2	149.4±131.3	492.5±250.3	221.1±44.5	2009.4±489.6	67.3±50.7	62.8±10.4
C3	137.3±152.6	592.0±184.4	149.4±132.5	2173.0±986.5	86.3±115.2	99.1±91.7
C4	105.3±22.4	1096.1±199.0	260.8±103.0	2661.4±263.4	172.9±136.8	157.7±67.2
<i>Methane reactor</i>						
C1	0.6±1.4	0.3±0.4	45.0±16.3	ND <sup>a</sup>	ND	0.5±0.1
C2	ND	0.2±0.2	32.6±23.7	ND	ND	0.2±0.3
C3	ND	2.7±0.9	8.7±2.8	ND	ND	0.2±0.3
C4	ND	0.1±0.1	6.8±3.5	ND	ND	0.3±0.3

<sup>a</sup>ND: not detected

### Evaluación de la energía generada en las dos etapas

La variación en la energía generada a partir de las diferentes relaciones de sustratos mostró una desviación de apenas 15 % (Tabla 8). Esto significó que el sistema podría mantener un suministro relativamente constante de energía independiente de la relación de sustratos. La

contribución del hidrógeno al total de energía estuvo tan solo alrededor del 9 %. Por otro lado, la respuesta al incremento de la carga orgánica mostró un incremento proporcional para la energía proveniente del hidrógeno. En contraste, la energía del metano no tuvo una respuesta proporcional durante este cambio. Esto fue relacionado con una posible inhibición relacionada con los elevados valores de la relación entre ácidos grasos volátiles y alcalinidad para la condición 4.

Tabla 8. Producción de energía para las diferentes condiciones experimentales evaluadas.

<b>Condition</b>	<b>H<sub>2</sub> reactor</b>	<b>CH<sub>4</sub> reactor</b>	<b>H<sub>2</sub> contribution</b>	<b>Overall energy</b>
	kJ/Lw	kJ/Lw	%	kJ/Lw
1	1.4	79.1	1.7	80.5
2	4.5	66.6	6.4	71.1
3	5.8	54.9	9.5	60.6
4	9.5	91.8	9.4	101.3

## Conclusiones

Cada etapa de la co-digestión anaerobia de estiércol de cerdo y mucílago de café estuvo especializada para la producción de un gas de interés. Los carbohidratos fueron la principal macromolécula usada para la producción de hidrógeno y los lípidos para la producción de metano. El tratamiento de los residuos se llevo a cabo principalmente en la segunda etapa del proceso. La primera etapa mejoró el tiempo de respuesta y las tasas de producción de metano de la segunda etapa. Los análisis de BMP mostraron una mayor generación de metano con el uso directo de los dos sustratos. La producción de energía proveniente del hidrógeno solo representó el 10 % del total generado en el proceso.

## CONCLUSIONES

El proceso de producción de hidrógeno presentó un conjunto de limitaciones globales como:

- La energía aportada por este vector fue alrededor del 10 % del total obtenido en el proceso.
- El cultivo mixto contiene la presencia de microorganismos consumidores de hidrógeno.
- El uso de una segunda etapa es obligatorio debido a las bajas remociones durante la producción de hidrógeno.

Mientras tanto las ventajas asociadas al proceso de producción de hidrógeno fueron:

- El proceso diseñado fue capaz de obtener una producción pseudo - estable de hidrógeno a partir de dos sustratos complejos.
- Las características de los sustratos fueron suficientes para suplir los requerimientos de la digestión anaerobia.
- El cultivo mixto de microorganismos estuvo dominado por las especies productoras de hidrógeno.
- El reactor de hidrógeno podría actuar como un pre-tratamiento de los sustratos.

## **PERSPECTIVAS**

Las perspectivas fueron distribuidas para cada fase y posteriormente agrupadas en una perspectiva general:

### ***Fase I***

Cambiar la configuración de un sistema semi-batch a un proceso continuo.

### ***Fase II***

Identificación y monitoreo de microorganismos y metabolitos adicionales.

### ***Fase III***

Reducción del tiempo de retención de acuerdo a los resultados obtenidos.

### ***Ciclo sostenible***

Escalado del proceso con una evaluación energética global.



## REFERENCIAS

Appels L, Baeyens J, Degève J, Dewil R. Principles and potential of the anaerobic digestion of waste-activated sludge. *Prog Energy Combust Sci* 2008;34:755–81.

Argun H, Kargi F, Kapdan IK, Oztekin R. Biohydrogen production by dark fermentation of wheat powder solution: Effects of C/N and C/P ratio on hydrogen yield and formation rate. *Int J Hydrogen Energy* 2008;33:1813-19.

Batstone DJ, Keller J, Angelidaki I, Kalyuzhnyi SV, Pavlostathis SG, Rozzi A, Sanders WTM, Siegrist H, Vavilin VA. The IWA Anaerobic Digestion Model No 1 (ADM1). *Water Sci Technol* 2002;45(10):65–73.

Hawkes F, Dinsdale R, Hawkes D, Hussy I. Sustainable fermentative hydrogen production: challenges for process optimization. *Int J Hydrogen Energy* 2002;27:1339–47.

Kapdan IK, Kargi F. Bio-hydrogen production from waste materials. *Enzyme Microb Technol* 2006;38:569-82.

Khanal SK, Chen WH, Li L, Sung S. Biological hydrogen production: Effects of pH and intermediate products. *Int J Hydrogen Energy* 2004;29:1123-31.

Lin CY, Lay CH. Carbon/nitrogen-ratio effect on fermentative hydrogen production by mixed microflora. *Int J Hydrogen Energy* 2004;29:41-5.

Liu Y, Yu P, Song X, Qu Y. Hydrogen production from cellulose by co-culture of *Clostridium thermocellum* JN4 and *Thermoanaerobacterium thermosaccharolyticum* GD17. *Int J Hydrogen Energy* 2008;33(12):2927-33.

Moletta R. La méthanisation, first ed. TEC & DOC, Paris. 2008.

O-Thong S, Prasertsan P, Intrasungkha N, Dhamwichukorn S, Birkeland N-K. Optimization of simultaneous thermophilic fermentative hydrogen production and COD reduction from palm oil mill effluent by *Thermoanaerobacterium*-rich sludge. *Int J Hydrogen Energy* 2008;33:1221-31.

Panichnumsin P, Nopharatana A, Ahring B, Chaiprasert P. Production of methane by co-digestión of cassava pulp with various concentrations of pig manure. *Biomass Bioenergy* 2010;34:1117-24.

Saint-Amans S, Girbal L, Andrade J, Ahrens K, Soucaille P. Regulation of carbon and electron flow in *Clostridium butyricum* VPI 3266 grown on glucose-glycerol mixtures. *J Bacteriol* 2001;183(5):1748–54.

Sreela-or C, Plangklang P, Imai T, Reungsang A. Co-digestión of food waste and sludge for hydrogen production by anaerobic mixed cultures: Statistical key factors optimization. *Int J Hydrogen Energy* 2011;36:14227-37.

Temudo MF, Kleerebezem R, van Loosdrecht M. Influence of the pH on (open) mixed culture fermentation of glucose: A chemostat study. *Biotechnol Bioeng* 2007;98(1):69-79.

Valdez-Vazquez I, Ríos-Leal E, Esparza-García F, Cecchi F, Poggi-Varaldo HM. Semi-continuous solid substrate anaerobic reactors for H<sub>2</sub> production from organic waste: Mesophilic versus thermophilic regime. *Int J Hydrogen Energy* 2005;30:1383-91.

Van Ginkel S, Logan BE. Inhibition of biohydrogen production by undissociated acetic and butyric acids. *Environ Sci Technol* 2005;39:9351-56.

Vavilin V, Fernandez B, Palatsi J, Flotats X. Hydrolysis kinetics in anaerobic degradation of particulate organic material: An overview. *Waste Manag* 2008;28:939–51.

Wang MY, Tsai YL, Olson BH, Chang JS. Monitoring dark hydrogen fermentation performance of indigenous *Clostridium butyricum* by hydrogenase gene expression using RT-PCR and qPCR. *Int J Hydrogen Energy* 2008;33:4730-8.

Xiao Y, Zeng GM, Yang ZH, Ma YH, Huang C, Shi WJ, Xu ZY, Huang J, Fan CZ. Effects of continuous thermophilic composting (CTC) on bacterial community in the active composting process. *Environ Microbiol* 2011;62: 599-608.

### Abstract

This research investigates an alternative approach to the use of two wastes from agricultural and livestock activities developed in Colombia. Swine manure and coffee mucilage were used to evaluate an anaerobic co-digestion process focused on hydrogen production. In addition, the aims covered a further stage in order to close the cycle of the both wastes. The thesis was conducted in three phases: 1. Evaluation of hydrogen production from the co-digestion of coffee mucilage and swine manure during dark fermentation; 2. Trends over retention time through the monitoring of microorganisms by quantitative PCR and other parameters including pH, oxidation reduction potential, and hydrogen partial pressure; 3. Treatment of the effluent from hydrogen production process by anaerobic digestion with methane production. The experimental results showed that mixtures of both wastes are able to produce hydrogen. A substrate ratio of 5:5, which was associated with a C/N ratio of 53, was suitable for hydrogen production. Moreover, the stability and optimization of the process were evaluated by increasing the influent organic load rate. This was the best experimental condition in terms of average cumulative hydrogen volume, production rate and yield which were 2661 NmL, 760 NmL H<sub>2</sub>/L<sub>w</sub>d and 43 NmL H<sub>2</sub>/gCOD, respectively. This performance was preserved over time, which was verified through the repetitive batch cultivation during 43 days. Two trends were identified over retention time associated with similar cumulative hydrogen, but with differences in lag-phase time and hydrogen production rate. *T. thermosaccharolyticum* was the dominating genus during the *short* trend related to the shortest lag-phase time and highest hydrogen production rate. The *long* trends were associated with a decrease of *Bacillus sp.* concentration at the beginning of the experiments and with the possible competition for soluble substrates between *T. thermosaccharolyticum* and *Clostridium sp.* The third phase showed that the use of a second stage to produce methane was useful enhancing the treatment of both wastes. Finally, the overall energy produced for both biofuels (Hydrogen and methane) showed similar levels with other process. However, hydrogen was around the 10% of the overall energy produced in the process. In addition, both gases could be mixed to produce biohythane which improves the properties of biogas.

**Key words:** hydrogen production; hydrogen producers; methane; waste treatment.

### Résumé

Cette étude examine une approche alternative à l'utilisation de deux déchets provenant des activités agricoles et d'élevage développés en Colombie. Lisier de porc et de mucilage café ont été utilisés pour évaluer une co-digestion anaérobie processus axé sur la production d'hydrogène. En outre, les objectifs couvrent une nouvelle étape dans le but de fermer le cycle des déchets fois. La thèse a été menée en trois phases: 1. Evaluation de la production d'hydrogène à partir de la co-digestion de mucilage café et du lisier de porc pendant la fermentation sombre; 2. Évolution dans le temps de rétention par la surveillance des micro-organismes par qPCR et d'autres paramètres incluant pH, le potentiel d'oxydo-réduction, et une pression partielle d'hydrogène; 3. Traitement de l'effluent de processus de production d'hydrogène par digestion anaérobie avec production de méthane. Les résultats expérimentaux ont montré que les mélanges de deux déchets sont en mesure de produire de l'hydrogène. Un ratio substrat de 5:5, ce qui a été associé à un rapport C/N de 53, a été adapté pour la production d'hydrogène. En outre, la stabilité et l'optimisation du processus ont été évalués par l'augmentation du taux de charge organique influent. Ce fut la meilleure condition expérimentale en termes de taux moyen volume d'hydrogène cumulatif de production et de rendement qui étaient 2661 NmL, 760 NmL H<sub>2</sub>/L<sub>w</sub>d et 43 NmL H<sub>2</sub>/gDCO, respectivement. Cette performance a été préservé au fil du temps, ce qui a été vérifié par la culture discontinue répétitive pendant 43 jours. Deux tendances ont été identifiées au cours du temps de rétention associée à l'hydrogène cumulatif similaire, mais avec des différences de phase de latence le temps et le taux de production d'hydrogène. *T. thermosaccharolyticum* était le genre dominant au cours de la tendance à court lié à la plus courte phase de latence de temps et plus le taux de production d'hydrogène. Les tendances de long ont été associées à une diminution de *Bacillus sp.* concentration au début des expériences, et avec le concours possible pour des substrats solubles entre *T. thermosaccharolyticum* et *Clostridium sp.* La troisième phase a montré que l'utilisation d'une deuxième phase pour produire du méthane était utile d'améliorer le traitement des déchets tant. Enfin, l'énergie totale produite à la fois pour les biocarburants ont montré des niveaux similaires avec d'autres processus. Cependant, l'hydrogène a été d'environ 10% de l'énergie totale produite dans le processus. En outre, les deux gaz peuvent être mélangés pour produire biohythane qui améliore les propriétés de biogaz.

**Mots-clés :** production d'hydrogène; méthane; valorisation des déchets.