



**HAL**  
open science

# Contribution to study, dand implementation of intelligent distributed control strategies for collective robotics

Ting Wang

► **To cite this version:**

Ting Wang. Contribution to study, dand implementation of intelligent distributed control strategies for collective robotics. Other. Université Paris-Est, 2012. English. NNT : 2012PEST1109 . tel-00794401

**HAL Id: tel-00794401**

**<https://theses.hal.science/tel-00794401v1>**

Submitted on 25 Feb 2013

**HAL** is a multi-disciplinary open access archive for the deposit and dissemination of scientific research documents, whether they are published or not. The documents may come from teaching and research institutions in France or abroad, or from public or private research centers.

L'archive ouverte pluridisciplinaire **HAL**, est destinée au dépôt et à la diffusion de documents scientifiques de niveau recherche, publiés ou non, émanant des établissements d'enseignement et de recherche français ou étrangers, des laboratoires publics ou privés.

## Thèse

Présentée pour l'obtention du titre de  
**DOCTEUR DE L'UNIVERSITÉ PARIS-EST**

Spécialité Traitement du Signal et des Images

par **Ting WANG**

**Contribution à l'étude, à la conception et à la mise en œuvre de stratégie de  
contrôle intelligent distribué en robotique collective**

Soutenue publiquement le 11 Juillet 2012 devant la commission d'examen composée de

Prof.	Vladimir	GOLOVKO	Rapporteur / Brest State Technical University
Prof.	Hichem	MAAREF	Rapporteur / Université Evry-Val D'Essonne (EVE)
Prof.	Yacine	AMIRAT	Examineur / Université PARIS-EST Créteil
Prof.	Gilles	BERNARD	Examineur / Université PARIS 8
Dr.	Christophe	SABOURIN	Examineur / Université PARIS-EST Créteil
Prof.	Kurosh	MADANI	Directeur de thèse / Université PARIS-EST Créteil

## Thesis

Presented to obtain the title of  
**DOCTOR OF UNIVERSITY PARIS-EST**

Specialization: Signal & Images Processing

by **Ting WANG**

**Contribution to study, to design and to implementation of intelligent  
distributed control strategy for collective robotics**

Defended on July 11, 2012 in presence of commission composed by

Prof.	Vladimir	GOLOVKO	Reviewer / Brest State Technical University
Prof.	Hichem	MAAREF	Reviewer / Evry-Val D'Essonne (EVE)
Prof.	Yacine	AMIRAT	Examiner / University PARIS-EST Créteil
Prof.	Gilles	BERNARD	Examiner / University PARIS 8
Dr.	Christophe	SABOURIN	Examiner / University PARIS-EST Créteil
Prof.	Kurosh	MADANI	Supervisor / University PARIS-EST Créteil

# Acknowledgement

I would like to express my deepest gratitude to Prof. Kurosh Madani for his continuous support and patience. That's him who gave me the chance to study in French and brought me to the gate of the research. In the four years of Laboratoire Image Signaux et systemes (LISSI/EA 3956), I learnt a lot from him.

I would also like to thank my supervised tutor, Dr. Christophe Sabourin. I couldn't accomplish my study well without his help. Besides the research, he taught me how to think, how to learn, and how to do research. I thanks him very much.

And I would also like to thank the faculty members of l'IUT de Senart including Dr. Amine Chohra, Dr. Veronique Amarger and Dr. Abdennasser Chebira.

I am grateful to my thesis committee members Prof. Gilles Bernard, Prof. Vladimir Golovko, Prof. Hichem Maaref and Prof. Amirat Yacine for their assistance.

My deepest thanks also give to the members and ex-members of LISSI including : Dr. Ivan Budnyk, Dr. Arash Bahrammirzaee, Dr. Weiwei YU, Dr. Hongkuan Deng, Dr. Dongying Wang, Dr. Ramon Moreno, Dominik Maximilian Ramik, Bin Liu, Guangyan Du, Jingyu Wang, Xiaocui Zhou, Yong Yang, Mafeng Liu, Zhuo Yang, Ouerdia Megherbi and Assia Azeiez.

And I would like to thank my parents, my father Wang Zhenghui and my mother Chang Yanmin. They are my first teacher in my life and I am always proud of them. Without their support and encouragement, I couldn't go so far.

Finally, I would like thank to my daughter Liu Jixuan. I love her more than I can say. Maybe I am not a good mom, I love her all my life.



## Table of contents

---

Acknowledgement .....	3
List of figures.....	6
List of symbols.....	9
Introduction.....	12
Chapter 1. Motivations and state of art of multi-robot systems .....	16
1.1 Motivations and history.....	16
1.2 State of art .....	18
1.2.1 Motion coordination.....	19
1.2.2 Localization, mapping, and exploration.....	21
1.2.3 Reconfigurable robots.....	22
1.2.4 Object transport and manipulation.....	22
1.3 Problematic and Context of this work.....	23
1.3.1 Problematic .....	24
1.3.2 Context.....	26
1.4 Conclusion.....	27
Chapter 2. ANFIS Controller for Nonholonomic Robot .....	29
2.1 Introduction .....	29
2.2 Adaptive-network based fuzzy inference system (ANFIS).....	32
2.3 ANFIS controller for nonholonomic robot.....	36
2.3.1 Trajectory control.....	37
2.3.2 Orientation control .....	38
2.3.3 Position control .....	39
2.3.4 Desired trajectory and trajectory control .....	40
2.4 Simulation results and real experiment on single KheperaIII .....	41
2.4.1 Simulation results.....	41
2.4.2 Real robot experiment.....	44
2.5 Conclusion.....	46
Chapter 3. Control strategy for a Rigid Formation Robots Team .....	48
3.1 Introduction .....	48
3.2 The robot team's formation and action .....	50
3.3 Path planning.....	55
3.3.1 Brief Introduction of the Path Planning.....	55
3.3.2 Q learning.....	56
3.4 Simulation and the Real Experiment.....	58
3.4.1 Image Processing and the Learning Results .....	58
3.4.2 Simulation Results of Three KheperaIII Robots.....	60
3.4.3 Experiment with two real robots.....	68
3.4.4 Experiment results .....	71

3.5	Conclusion.....	72
Chapter 4.	Heterogeneous multi-robotic system in the field of logistic application	74
4.1	Introduction .....	74
4.2	Control strategy for Heterogeneous Multi-robots System (HMRS) .....	76
4.2.1	The environment model .....	77
4.2.2	The control strategy and Nao .....	78
4.3	Simulation of HMRS navigating in the unknown environment by the control strategy .....	80
4.3.1	Learning results.....	81
4.3.2	Simulation results.....	84
4.4	Experiment with Real Robots.....	89
4.4.1	A preliminary experiment .....	89
4.4.2	A real experiment for multi-robots team .....	90
4.4.3	Experiment results .....	93
4.5	Conclusion.....	95
	General Conclusion and Perspectives .....	97
1.	Conclusion .....	97
2.	Future works .....	99
	Personal Publications .....	100
	Bibliography .....	102

## List of figures

---

Figure 1: Robots using the ALLIANCE architecture for a mock clean-up task..	17
Figure 2: Heterogeneous team of an air and two ground vehicles that can perform cooperative reconnaissance and surveillance.....	22
Figure 3: Distributed Robot Architectures (DIRA) .....	23
Figure 4: Heterogeneous team of an air and two ground vehicles that can perform cooperative reconnaissance and surveillance.....	24
Figure 5: Description of the path of the robot from point A to point C.....	31
Figure 6: Process of the formation robots changing its formation.....	31
Figure 7: Neuro-fuzzy controller (Godjevac, 1995) .....	34
Figure 8: Membership function ( $a_{ij} = 1, b_{ij} = 0.28$ ).....	34
Figure 9: A trajectory adaptive network for control application.(Jang, 1992b)	36
Figure 10: Robot's coordinates described by a triplet as $P(x, y, \theta)$ .....	37
Figure 11: Orientation control diagram .....	38
Figure 12: Position control diagram.....	39
Figure 13: Trajectory control diagram: two neuro-controllers are used for both the position's control and the orientation's control. ....	41
Figure 14: Trail simulation result. ....	42
Figure 15: Orientation result. ....	42
Figure 16: Robot's trajectories.....	43
Figure 17: Snapshot of the experimental validation concerning the real kheperaIII robot's orientation's control: rotation of $-90^\circ$ (a), $-180^\circ$ (b) and $-270^\circ$ (c)...	44
Figure 18: Snapshot of the experimental validation concerning the real kheperaIII robot's position's control. From left to right: robot moves away 20, 50, 80 and 100 centimeters from its starting position.....	45
Figure 19: Snapshot of the experimental validation concerning the real kheperaIII robot's trajectory's control. The robot performs a curvilinear trajectory. ....	45
Figure 20: Robot's speed parameter .....	46
Figure 21: Schematic description of a rigid formation with three wheeled robots. The relative distance between two robots is a constant value and all robots are the same orientation ( $\psi = 0^\circ$ Fig. 21 (a), $\psi = 45^\circ$ Fig. 21 (b)). ....	50
Figure 22: Schematic description of the 8 formations. The state of the formation is described by the position of the robot 1 and the orientation of the formation with the angle $\theta$ . ....	52
Figure 23: Actions used to control the formation. When the formation must move, all robots begin to rotate in the desired direction (angle $\psi$ ) and after all robots go forwards simultaneously. ....	52
Figure 24: Position control of formation of robot team.....	54

Figure 25: Diagram of changing formation. (a) Three robots rotate around themselves synchronous from $-180^{\circ}$ to $0^{\circ}$ ; (b) The reference robot rotate itself from $0^{\circ}$ to $-45^{\circ}$ , the other robots follow the trajectory G1 and G2 respectively. ....	54
Figure 26: Picture of the virtual environment given by a virtual camera located at the top of environment. ....	56
Figure 27: Binary representation of the environment: the white is a free path and the black indicates obstacles. ....	59
Figure 28: Equivalent quantified environment representation: the obstacles are marked with red stars, the reference robot is represented like a solid black dot and other robots represented like black circle. ....	60
Figure 29: Simulations have been performed by using software Webots and controllers have been designed with the software Matlab. ....	60
Figure 30: Simulations have been performed by using software Webots and controllers have been designed with the software Matlab. ....	61
Figure 31: Path planning (left) and simulation results (right) of stage I. ....	63
Figure 32: Path planning (left) and simulation results (right) of stage II: Phrase I ....	64
Figure 33: Path planning (left) and simulation results (right) of stage II: Phrase II ....	65
Figure 34: path planning of stage III. ....	66
Figure 35: simulation of stage IV ....	67
Figure 36: Actions used to control the formation during the experimental validation. ....	68
Figure 37: Description of the experimental validation. During this experimentation, we use two robots, a camera to get binary environment and a computer for the remote control. ....	69
Figure 38: Binary environment of the experimental validation. ....	70
Figure 39: Snapshot of experimental results where the two robots move in formation. ....	71
Figure 40: Snapshot of experimental of transportation application. ....	72
Figure 41: Petri Net of human being. ....	76
Figure 42: Virtual environment of the multi-robot system. ....	78
Figure 43: Petri net of control strategy for HMRS ....	79
Figure 44: Nao and its sentence of obstacles ....	80
Figure 45: The initial and final state of entire process. ....	81
Figure 46: The learning results of each room ....	82
Figure 47: simulation of room (2, 2). ....	84
Figure 48: simulation of room (2, 5). ....	85
Figure 49: simulation of room (3, 5). ....	86
Figure 50: simulation of room (2, 6). ....	87
Figure 51: simulation of room (1, 6). ....	88



Figure 52: simulation of room (1, 7).....	88
Figure 53: First experiment: the robot Nao control wheeled robot according to environment. ....	89
Figure 54: Multi-robots team in the real experiment .....	90
Figure 55: Unknown environment in the real experiment .....	91
Figure 56: Path planning .....	91
Figure 57: Learning results of path planning, (a) Initial position, (b) Step 1: up, (c) Step 2: up, (d) Step 3: up, (e) Step 4: up, (f) Step 5: right, (g) Step 6: up, (h) Final position .....	92
Figure 58: Go forwards part, (a) Initial state of the experiment, (b) Multi-robots team goes forwards .....	93
Figure 59: Meet the obstacle and change to path planning.....	94
Figure 60: Path planning part.....	95

## List of symbols

---

<b>Symbol</b>	<b>Signification</b>
$x_1$	Input of the neuro fuzzy controller
$x_2$	Input of the neuro-fuzzy controller
$A_{11} \cdots A_{n1}$	fuzzification of $x_1$ by Gaussian membership function
$A_{21} \cdots A_{n2}$	fuzzification of $x_2$ by Gaussian membership function
$\mu_{i1}$	fuzzy inference of T-norm
$\mu_{i2}$	fuzzy inference of T-norm
$u_1 \cdots u_n$	output of the fuzzy controller
$y$	real out put
$x_1, x_2, \dots, x_m$	a control system with $m$ inputs
$R_i$	linguistic rules
$\omega_i$	fuzzification of $y$ by Gaussian membership function
$\mu_i$	output of the neuro-fuzzy controller
$V(z)$	criterion function
$y(t)$	output of the neural network
$y^d(t)$	desired output
$a_{ij}$	parameter of the adaptation of the learning algorithm
$b_{ij}$	parameter of the adaptation of the learning algorithm
$\omega_i$	parameter of the adaptation of the learning algorithm
$\Gamma_a$	predefined constant
$\Gamma_b$	predefined constant
$\Gamma_\omega$	predefined constant
$q$	vector of independent velocity variables
$u$	a reduced inertia matrix
$H(q)$	a vector of forces combining the contribution of Coriolis and wheel-ground
$F(q, u)u$	contact forces
$\phi$	orientation angle of the car's steering wheel
$\Gamma$	an invertible control matrix
$\tau$	a vector of independent motor torques
$\xi$	the chassis posture vector
$\theta$	angle from X-axis to the robot's motion direction
$V_x$	represent respectively the instantaneous horizontal velocities
$V_y$	represent respectively the instantaneous vertical velocities
$v$	represent the intensity of the longitudinal velocity
$\Omega$	angular velocity of the robot
$\Omega^{left}$	angular velocity of the left wheels
$\Omega^{right}$	angular velocity of the right wheels
$r$	radius of the wheels
$l$	distance between the two wheels
$q$	state vectors

$z$	state vectors
$u$	control vector
$P^d$	the set of point of the reference
$x^d(t)$	represent the x- coordinates of the robot according to the reference frame
$y^d(t)$	represent the y- coordinates of the robot according to the reference frame
$\theta^d(t)$	trajectory's curvature at each step time t
$P(x, y, \theta)$	robot's track
$x^\theta$	input of the Orientation ANFIS controller
$\Delta\Omega$	absolute value of angular velocity of difference between two wheels
$y_\theta(t)$	output of the Orientation ANFIS controller
$y_\theta(t)$	output of the Orientation ANFIS controller
$\omega_i^\theta$	adaptive parameter of the Orientation ANFIS controller
$x_{px}$	difference between the robot's position and the position's coordinates along with X-axis
$x_{py}$	difference between the robot's position and the position's coordinates along with Y-axis
$\Omega_p^{left}$	speed of the left wheel
$\Omega_p^{right}$	speed of the right wheel
$y_p(t)$	output of the position ANFIS controller
$\Delta y$	is chosen according to both length $L$ and duration $T$
$l_{12}$	the relative distance between robot 1 and robot 2
$l_{23}$	the relative distance between robot 2 and robot 3
$\theta_{12}$	the absolute angle between the orientation of the robot and a normal direction
$\theta_{23}$	the absolute angle between the orientation of the robot and a normal direction
$\Psi$	orientation of formation
$\phi$	describe the relative position between two robots
N	the north of the robot
$N'$	the north of the robot
$A'$	max Q value action of next state
$S'$	next state based on the current optimal action
A	actions
S	current state
$\gamma$	parameter of loss rate
$\beta$	learning rate
r	rewards
s1	Current unknown area
s2	If the current unknown area has obstacles
s5	If there is no obstacle in the current unknown area
s6	Unknown area of next step
t1	Sentence the front unknown area
t2	Find the optimal way Go forwards
t5	The initial position of the current room
t7	Nao sentences the front unknown area
S1	If there are obstacles, the state is enabled
S2	The top camera is enabled
S3	Khepera robots are enabled and they will use the path planning
S4	If there is no obstacle, khepera robots are enabled and they use go forwards directly
S5	The HMRS arrives to the final position in the current room

- S6 Nao sentences the front unknown area
- T1 Nao sends a command to ask a current photo from topcamera
- T2 Top camera sends the photo to Khepera formation robots
- T3 Khepera formation robots gets the optimal way from the path planning and use
- T4 ANFIS control to cross the current area with Nao following
- T5 Nao sends command to Khepera formation robots to go forwards directly
- T6 After they arrive to the final station in the current room, the point turn into the start point in the next unknown room.
- T7 Nao sentences the front unknown area
- $l_1$  about 1 meters
- $l_2$  about 0.77 meters
- d about 0.3 meters

# Introduction

---

Since the earliest work on multiple mobile robot systems in the 1980s, this ever-increasing field has become one of the most fruitful and interesting branches of the robotics field, covering a large body of research. The present doctoral thesis deals with this appealing domain by investigating a number of its main problematic conundrums, aiming for contributing in pushing forward those intricate points.

This thesis studied and designed the intelligent distributed control strategy for the collective multi-robots system. The aim is to study the coordination and control strategies for heterogeneous multi-robots system. Different from the already accomplished works, the purpose of the thesis is to propose the control strategy within the Machine-Learning based frame, unifying the established taxonomy of multi-robots' distributed intelligence under a unique standpoint: collective robot system. In fact, putting emphasis on interactions, the established taxonomy recalls the multi-robot distributed intelligence based control strategies versus "collective", "cooperative", "collaborative" and "coordinative" interactions. By directing the focal point of the proposed strategy on Machine-Learning, we unify the basic (e.g. fundamental) of the problem, moving the matter (e.g. the concern) from "kind of interactions" to "Machine-Learning based adaptability" of interactions (actions, strategies, etc...) in the unique collective robot system. This foremost difference of point of view introduces an additional major distinction relating the notion of "collective robot system" by itself: in fact, we extend the above-mentioned notion (e.g. of collective robot system) proffering to the group the "perception skill" and considering the perception as part of the collective stance of the system.

Since the focal is a Machine-Learning based frame, the control strategy is not rigid adhere to the type of robots and can be used into large limited or unlimited, dynamic unknown environment. It is pertinent to clarify what we intend by "unknown environment" as well as to refine what is intended by "dynamic environment". In fact, the necessity to deal with environment is inherent to the actual fact that the group of robots is not isolated from its surrounding environment interacting with and influenced it. By the term of "unknown environment" we intend the at the start point of the collective task's execution (by the collective robot system) robots leak information about the surrounding environment. In other words, this means that if the collective robot system embarks on performing a given task in a given environment (inside which the group of robots evolves or acts) at a  $t_0$  starting time, at that time, the robots of the group ignore about the features (information, etc...) of that surroundings. While, by the term of "dynamic environment", it is intended that a set of unpredicted events may occur at any discrete time  $t_j$  in the surrounding environment obliging the group to modify the collectively executed task (and thus the revision of the control's strategy). Accordingly to the two aforementioned statements, it becomes clear why we extend the notion of collective robot system proffering the perception skill as part of the collective stance of the system.

The validation of the proposed control strategy has been done within the spirit of the logistic application. In the considered validation scenario, the collective robot system, including a number of heterogeneous robots, is supposed to accomplish the transportation task in an unknown environment. By using the Machine-Learning based adaptation, such a system, can achieve the object transportation for various sized objects and can be applied in any dynamic environment.

The main contributions in the present doctoral work can be summarized as follows:

1. Conceptualization of single robot's control within Machine-Learning based frame

The conceptualization of single robot's control has been studied and it has been done from a novelty way, which is using the frame on the basis of the Machine-Learning. And it is also the first step to study the control of the heterogeneous multi-robots system. The aim is to implement the path-following control of any type of single robot. By using the Adaptive Neural Fuzzy Inference System (ANFIS) control, the single robot can move to the desired position, desired orientation and also can track with any reference trajectory (linear or nonlinear). The control is proposed from the conceptualization aspect. Therefore, it can be applied into various classes of single robots and even into the virtual single robot (e.g. the "robot" may be not a corporal robot). In order to verify, an example is designed to make a two-wheeled non-holonomic robot follow different trajectories (linear trajectory or nonlinear trajectory) in different parts of the considered process. The simulation has been done with a Khepera robot and results demonstrated that as well a bodily single robot (a Khepera robot in the simulated experiment) as a rigid formation of a group of robots (considered as a virtual robot) can well follow the considered trajectories using same Machine-Learning based generic architecture.

2. Rigid formation's control strategy, perception system and the path planning

As one kind of collective robotics system, heterogeneous robots can handle the task by the coordination and cooperation among different involved robots. An appealing large class of applications requires formation of robots within the collective robotics system. The control strategy is involving three parts: rigid formation control, perception system and path planning. In the rigid formation part, a group of mobile robots formed a constrained geometry structure and they are regarded as a virtual single robot. The conceptualization of single robot's ANFIS control has been applied and has been improved in the control of the rigid formation robots. The perception system can effectively solve the awareness problem and the adaptation of the environment in the heterogeneous multi-robots system. The perception system can provide the image of the environment for the path planning part. The path planning is including the image processing and Q-learning, in which Q-learning is also

a kind of the Machine-Learning. It can automatically export the optimal policy for the ANFIS rigid formation control part. A simulation illustrate that the heterogeneous multi-robot system can pass through an unknown environment full of obstacles by using the control strategy.

3. Extension the control strategy to the situation of a dynamic environment

After proposing of the control strategy for the heterogeneous multi-robots in an unknown environment, the thesis extended the control strategy to the adaptation of a dynamic environment. With the introduction of the coordination strategy based on event, the control strategy is enhanced the adaptation of a dynamic environment. That is to say, if the environment is changed by a sudden event, the heterogeneous multi-robots system can be adaptive to the new environment by using the control strategy.

4. Validation of the concept and designed strategies within the logistic application scenario

In the practical frame work, the thesis focused on the logistic application. The logistic application refers to the object transportation from one place to another. It is a suitable validation of the control strategy by heterogeneous multi-robots system. The problems of the logistic application can be summarized as three points: transport task of various sized object, path planning, and the adaptation of the environment. In corresponding with the first problem, the thesis proposed a reconfigurable rigid formation system, which can reconfigurable the rigid formation according to the size of objects. To solve the path planning problem, the thesis introduced the perception system so as to automatically acquire the environmental information. With respect to the last problem, the thesis applied the proposed control strategy for the heterogeneous multi-robots system.

The present thesis document is organized as follows:

Chapter1 clarify the motivation of the thesis and gives a synthetic overview of the state of art relating the research in of multi-robots system. The ANFIS control method will be introduced particularly in Chapter 2 as well as it is applied to a single non-holonomic robot following a given trajectory by the orientation control, position control and the trajectory control. The simulation and experiment is designed to verify the control for a single non-holonomic robot. And it demonstrated that the ANFIS control method can work well with the case of single robot. The control strategy for collective robotics is proposed in Chapter 3. The control strategy is particularly proposed for the heterogeneous system and it includes three parts, the path planning, the rigid formation control and the perception system. The path planning involves the image processing part and the Q-learning part. In addition, the virtual structure control of group robots was also introduced in detail in the Chapter 3. A simulation is designed to verify the control strategy. The perception robot in the simulation is materialized by a top camera robot. And a computer played the role as a virtual supervisor for the remote control and communication. Using the control strategy, the simulation results illustrated that

the heterogeneous multi-robots team passed through the unknown environment and avoided obstacles with a constrained formation. The validation of the control strategy is implemented in the logistic application in the Chapter 3. In the real experiment, two Khepera robots formed a rigid line shape structure. And in the real experiment, heterogeneous multi-robots achieved to transport a long paper box in an unknown environment by the control strategy. The control strategy has been extended to the dynamic environment by introduction of the event based coordination strategy and the Petri net. A humanoid robot is added as a local supervisor so as to detect the sudden event and to switch the control process with adaptation of the new dynamic environment. Conclusions have been drawn and the future work has been given in the conclusion part.



# Chapter 1. Motivations and state of art of multi-robot systems

---

## 1.1 Motivations and history

Multi-robots system is one of the fruitful and interesting branches of the robotics field. Since the earliest work on multiple mobile robot systems in the 1980s, the field has grown significantly, and covered a large body of research. In the multi-robots framework, generally the robotic community considers there are three main fields:

- One of these fields is the reconfigurable or modular robots where each robot is able to interconnect to another robot in order to form a more complex robot. Self-reconfigurable robots can offer a very powerful tool for much kind of applications because the systems can change their configurations. The first study about multi-robot systems concerns certainly the reconfigurable robots with the project CEBOT (Cellular Robotics System). CEBOT is a decentralized, hierarchical architecture (cf. Fukuda & Nakagawa, 1987; Fukuda & Kawauchi, 1993; Ueyama & Fukuda, 1993; Ueyama & Fukuda, 1993a; Fukuda & Iritani, 1995). It is a dynamically reconfigurable system in that basic autonomous “cells” (robots). And the autonomous robots can be physically coupled with other cells, so as to an “optimal” configuration in response to changing environments. In the case of reconfigurable robots, the modularity of cellular robots can be used for locomotion task, for manipulation task or more generally to increase robustness. For example, in the case of locomotion task, a modular robot can use a specific locomotion configuration according to environment in order to walk or to crawl.

- Another field is the swarm robot system where the multi-robot system is composed of a large number of homogeneous robots. In 1988, Gerardo Beni published a paper on cellular robots [Beni, 1988]. In fact, in this paper the author proposed an extension of the concept of cellular robots. The aim of this concept was to represent a group of simple robots, self-organizing in new patterns. In fact, this was certainly the first concept about the swarm robot. The goal of studies about swarm robots is to develop behaviors for multi-robot systems based on biological inspiration like ants, bees or birds behaviors. Generally, the control strategy for swarm robots is based on individual behavior where each robot can perceive other robots around it by using proximity sensors but each robot is unaware of actions of other robots. Consequently, these approaches focus on how to achieve a global behavior from a limited interaction and communication of robots.

- Finally, the last field is the heterogeneous multi-robot systems. In this case, the main goal is to use several kinds of robots, where each robot has specific abilities, in order to solve complex task where the use of a single robot is not sufficient. In this case, it seems clear that the both aspects cooperation and coordination are very important. It is important to notice that cellular robotics and swarm robotics can be included with the heterogeneous robotic field in a more general case which is collective robotics. At the end of 1980s, several projects about heterogeneous robotic systems have been presented. May be the first was ACTRESS. The ACTRESS (Actor-based Robot and Equipment's Synthetic System) project (Asama et al., 1992; Asama et al., 1989; Ishida et al., 1991) is inspired by the Universal Modular ACTOR Formalism (Hewitt et al, 1973). In the ACTRESS system, "robotors", including 3 robots and 3 workstations (one as interface to human operator, one as image processor and one as global environment manager). They form a heterogeneous group trying to perform tasks together (Asama et al., 1991) and accomplish as a whole (Ishida et al., 1994; Suzuki et al., 1995). The second project was GOFFER. In GOFER architecture (Caloud et al, 1990; LePape, 1990), there is a central task planning and scheduling system (CTPS), which can communicate with all robots and can get a global view. The CTPS can monitor the tasks as well as robots themselves. And it generates a plan structure to inform all available robots of the pending goals and the planning structures. Finally, in 1994, The ALLIANCE architecture (Fig. 1) was developed by Parker (Parker, 1994; Paker, 1994a). The purpose is to study the cooperation in a heterogeneous, small-to-medium-sized team of largely independent, loosely coupled robots. A behavior-based controller controls the individual robots with an extension for activating "behavior sets" to complete certain tasks. Robots are able to recognize both of their own actions and the actions of other mates by the manner of the broadcast communication.

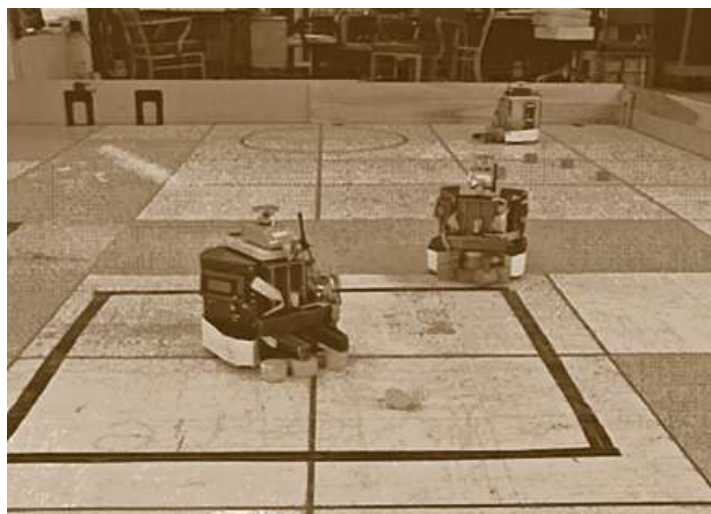

Figure 1: Robots using the ALLIANCE architecture for a mock clean-up task

Researchers are gradually increasing in the cooperative robotics field because they generally agree that multi-robots systems have several advantages over single-robot systems (Arai et al, 2002; Cao et al, 1997). The most common motivations for developing multi-robots system solutions are that (Parker, 2008):

1. **“The task complexity is too high for a single robot to accomplish”**. Effectively, one of the major advantages with a multi-robots approach is due to the fact that several robots can cooperate to perform the same task. This point allows imagining new perspectives in robotic field where a group of robots has to adapt themselves in order to accomplish a new (unknown in advance) work.
2. **“The task is inherently distributed”**. Effectively, in many cases, robotic applications need to distribute the tasks in space, time or functionally. Consequently, multi-robot systems are naturally adapted to solve this kind of problem.
3. **“Building several resource-bounded robots is much easier than having a single powerful robot”**. Effectively, the design of complex robot which is to accomplish complex tasks needs to do very long studies, needing more time, and generally, giving solutions more expensive. In this case, the use of several cheap modular robots with specific abilities but which able to adapt themselves to solve a complex task is an elegant solution.
4. **“Multiple robots can solve problems faster than by using parallelism”**. For example, when a robot have to explore an unknown environment, it seems clear that the use of a group of robots which accomplish the same task in the same time but distributed in the space allow increasing the efficient of the exploration system.
5. **“The introduction of multiple robots increases robustness”**. Because multi-robot systems have theoretically the ability to adapt themselves according to disturbing events, multi-robots systems are inherently more robust.

## 1.2 State of art

Although there are three main fields defined in the previous section, the projects and applications about multi-robot systems are much diversified and it is very hard to give in this document a full overview. For example, a lot of studies have focused on control formation for the homogeneous and heterogeneous robot including swarm robotic. Another aspect which has been studied is the reconfigurable robot. But generally, the major studies have been done with homogeneous robot. The goal of this section is to give a short overview of several applications.

### 1.2.1 Motion coordination

One of the most important topics in the motion coordination area is the formation control. Formation control problems arise when groups of mobile robots are employed to jointly perform certain tasks. The benefits of exploiting groups of robots, as opposed to a single robot or a human, become apparent when considering spatially distributed tasks, dangerous tasks, tasks which require redundancy, tasks that scale up or down in time or tasks that require flexibility (T.H.A et al., 2009).

The first work on coordination among multiple agents was motivated by the study of biological systems and by application in computer graphics, i.e., in 1986 Reynolds (Parker, 1993) made a computer model for coordinating the animal motions as bird flocks or fish schools. This pioneer work inspired significant efforts in the study of group behaviors (Parker, 1993; Mataric, 1992), and then in the study of multi-robots formation (Wang, 1991). In the latest years, a great number of applications of multi-robots system, differing in the typologies of vehicles and missions, have been proposed, i.e., the multi-robots systems made up of Underwater Autonomous Vehicles (AUVs) (Fiorelli et al., 2004; Stilwell & Bishop, 2000), aerial vehicles (Stipanovic et al., 2004; Seanor, 2006), and fleet of marine crafts (Ihle, 2004), or applications like exploration and mapping (Burgard, 2005), box pushing and transportation (Tanner et al., 2003) or entertainment (Pagello, 2006; Antonelli et al., 2007). In the recent literature, see e.g. (Beard & Hadaegh, 2000; Carelli et al., 2006; Consolin et al., 2006; Do & Pan, 2007; Takahashi et al., 2004), three different approaches towards the cooperative formation control of mobile robots are described, the behavior-based approach, the leader-follower approach and the virtual structure approach:

- In the leader-follower approach (Egerstedt et al., 2001; Egerstedt et al., 1998), one of the robots is designated as the leader, with the rest being followers. Among all the approaches of formation control reported in the literature, the leader-follower method has been adopted by many researchers (Balch & Arkin, 1998; Bishop & Spong, 1998; Desai, 1998; Egerstedt et al., 2001; Frezza, 1998). In the leader-follower approach some robots will take the role of leader and aim to track predefined trajectories, while the follower robots will follow the leader according to a relative posture (Carelli et al., 2006; Bicho & S. Monteiro, 2003; Consolin et al., 2006; Desai, 2001; Ikeda, 2006; Leonard & E. Fiorelli, 2001; Tanner et al., 2004; Vidal et al., 2003; Yanakiev & Kanellakopoulos, 1996). An advantage of this approach is the fact that it is relatively easy to understand and implement. A disadvantage, however, is the fact that there is no feedback from the followers to the leaders. Consequently, if a follower is being perturbed, the formation cannot be maintained and such a formation control strategy lacks robustness in the face of such perturbations. In Egerstedt & Hu (Egerstedt & Hu, 2001), they developed a method based on the leader-following approach to investigate formation control. In (Egerstedt & Hu, 2001), they focus on a particular type of path following, and the idea is to specify a

reference path for a given, nonphysical point. Then a multiple agent formation, defined with respect to the real robots as well as to the nonphysical virtual leader, should be maintained at the same time as the virtual leader tracks its reference trajectory.

- In the behavior-based approach, a so-called behavior (e.g. obstacle avoidance, target seeking) is assigned to each individual robot (Arkin, 1998). This approach can naturally be used to design control strategies for robots with multiple competing objectives. Moreover, it is suitable for large groups of robots, since it is typically a decentralized strategy. A disadvantage is that the complexity of the dynamics of the group of robots does not lend itself to simple mathematical stability analysis. To simplify the analysis, the dynamics of individual robots are commonly simplified as being described by a single integrator. Clearly, the kinematic models of mobile robots are more complex, so that the situation limited the practical application. By behavior based approach, several desired behaviors are prescribed for each robot, and the final action of each robot is derived by weighting the relative importance of each behavior. The possible behaviors include obstacle avoidance, collision avoidance, goal seeking and formation keeping (Bishop & Spong, 1998; Canudas, 1996; Desai et al., 1998). The limitation of behavior-based approach is difficult to analyze mathematically, thus it is hard to guarantee a precise formation control. In Balch & Arkin (Balch & Arkin, 1998), they exploited a behavior-based, decentralized control architecture, where each individual platform makes sure that it is placed appropriately with respect to its neighbors. In (Desai et al., 1998) and (Desai, 1998), the situation is slightly different and the solution is based on letting one robot take on the role of the leader, meaning that all of the other robots position themselves relative to that robot. Furthermore, many researchers discussed (Hedrick et al., 1991; Tabuada, 2001) extensively about the dynamic model. A very specific type of “string stability” is achieved for multiple autonomous vehicles.

- A third approach in cooperative control is the virtual structure approach, in which the robots’ formation no longer consists of leader nor follower, i.e. no hierarchy exists in the formation. In (Tan & Lewis, 1997), a general controller strategy is developed for the virtual structure approach. Using this strategy, however, it is not possible to consider formations which are time-varying. Moreover, the priority of the mobile robots, either to follow their individual trajectories or to maintain the groups’ formation, can’t be changed. In Do & Pan (Do & Pan, 2007), a virtual structure controller is designed for a group of unicycle mobile robots, using models involving the dynamics of robots. Consequently, the controller design tends to be rather complex, which is unfavorable from an implementation perspective, especially when kinematic models suffice. The Virtual structure was proposed by Anthony Lewis and Kar-Han Tan (1997) (They first proposed the definition of the virtual structure.). A key problem in cooperative robotics is the maintenance of a geometric configuration during the movement. To address this problem, the concept of the virtual structure is introduced. Control methods are developed to force an ensemble of robots to behave as if they were particles embedded in a rigid structure

(Han & Lewis, 1996; Han and M.A. Lewis). Therefore, they proposed a novel, extensible and effective method for multiple mobile robot motion control and studied the high precision algorithm about the virtual structure formation control. The main contribution of Ren & Beard (Ren & Beard, 2004) is to apply the virtual structure approach in a decentralized scheme so that both the benefits of the virtual structure approach and the decentralized scheme can be achieved simultaneously. In the paper, each spacecraft in the formation instantiates a local copy of the coordination vector in the virtual structure framework. The local instantiation of the coordination vector in each spacecraft is then synchronized by communication with its neighbors using a bidirectional ring topology. The virtual structure approach treats the entire formation as a single virtual rigid structure in the paper of Arkin, Balch & Arkin, and Bishop & Spong (Arkin, 1998; Balch & Arkin, 1998; Bishop & Spong, 1998).

Another popular topic of the motion coordination area is multi-robots path planning (Svestka & Overmars, 1998; Lumelsky & Harinarayan, 1997; Ferrari et al., 1998; Yamashita et al., 2000) traffic control [Premvuti & Yuta, 1990], formation generation [Arai et al., 1989], and formation keeping (Balch & Arkin, 1998; Wang, 1989). More recent work addressed in this area are including target tracking [Parker & Touzet, 2000], target search [LaValle et al., 1997], and multi-robot docking [Mintea et al., 2000] behaviors. The motion coordination is discussed by Saptharishi et al. [Saptharishi et al., 2002], and they proposed an approach to perform path planning via checkpoint and dynamic priority assignment using statistical estimates of the environment's motion structure. [Shen et al., 2002] addressed some issues in motion coordination for reconfigurable robots, for instance, the caterpillar move, a legged walk, and a rolling track. [Arai et al., 2002]

## **1.2.2 Localization, mapping, and exploration**

In the localization, mapping and exploration field (Fig. 2), some researchers have developed novel algorithms for the distributed multi-robots systems. One example given in Fox et al. [Fox et al., 2000], taking advantage of multiple robots they improved the positioning accuracy compared with a single robots. Another example is shown in Roumeliotis & Bekey's paper [Roumeliotis & Bekey, 2002], which presented a decentralized Kalman-filter based on an approach to enable a group of mobile robots to simultaneously localize by sensing their teammates and by combining the position information from all the team members. In addition, Schmitt et al. [Schmitt et al., 2002] examined the vision-based localization in multi-robots team and illustrated on physical robots in the multi-robots soccer domain. Examples of localization, mapping, and exploration in the multi-robots can be found in landmarks [Dedeoglu & Sukhatme, 2000], scan-matching [Burgard et al., 2000], and/or graphs [Rekleitis et al., 2000], and which use various sensors [Vaughan et al., 2002]. [Arai et al., 2002]



Figure 2: Heterogeneous team of an air and two ground vehicles that can perform cooperative reconnaissance and surveillance

### 1.2.3 Reconfigurable robots

In the area of distributed systems, the early research focused on concepts (Fukuda & Nakagawa., 1987; Beni, 1988). Until the last few years, the work began to implement on the actual reconfigurable physical robots system, to accomplish the functions from shape, in order to generate a desired shape of the individual modules which can be used to a needed function. It is involving the identical modules with interconnection mechanisms which can be manual or automatic reconfiguration. Some works demonstrated various navigation configurations, such as a rolling track motion [Yim et al., 2000], an earthworm or snake motion (Yim et al., 2000; Castano et al., 2000), and a spider or hexapod motion (Yim et al., 2000; Castano et al., 2000). Some systems connected in various ways to form matrices or lattices for specific functions (Bojinov et al., 2000; Yoshida et al., 2000; Rus & Vona, 2000; Unsal & Khosla, 2000). An important example is [Shen et al., 2002], which presented an approach by their CONRO modules, for the adaptive communication in self-reconfigurable and dynamic networks, and the physical module reconfiguration can achieve the locomotion. Although it is a promising area for continuing advances in multi-robots systems, it is still very young, and that large numbers of the robot modules are only demonstrated in simulation. [Arai et al., 2002]

### 1.2.4 Object transport and manipulation

This area have been studied on numerous situations, such as constrained and unconstrained motions, two robot teams versus “swarm”-type teams, compliant versus noncompliant grasping mechanisms, cluttered versus uncluttered environments, global system models versus

distributed models, and so forth. An example of using multi-robots team to push objects was in Rus et al. and Stilwell & Bay (Rus et al., 1995; Stilwell & Bay, 1993). In Wang et al. and Khatib et al. (Wang et al., 2000; Khatib et al., 1996), the multi-robots must grip common objects and navigate to a destination in a coordinated formation. In [Donald et al., 2000], it demonstrated to use ropes to move objects along the desired trajectories. For the cooperative transport task, Miyata et al. [Miyata et al., 2002] illustrated their results both in simulation and using a team of two physical robots, which enabled multi-robots team members to displace objects and to cooperatively push objects to a destination. In [Das et al., 2002], they addressed a novel approach for cooperative manipulation and demonstrate their results on a team of three physical robots, and the approach based on formation control can make robot teams cooperatively manipulate obstacles. [Arai et al., 2002]. The figure 3 gives an example of distributed robot architecture where several robots have to cooperate to perform an assemblage task.



Figure 3: Distributed Robot Architectures (DIRA)

### 1.3 Problematic and Context of this work

The multi robot approaches offers many advantage and can be used in many applications. But the design of control strategies is more complex in comparison to single robot approaches.



### 1.3.1 Problematic

In the multi-robots system, the interactions of group robots can be generally classified into four categories: collective, cooperative collaborative and coordinative [Parker, 2008a]. The communication plays a key role as well. Both of the implicit communication and explicit communication are extensively studied in the multi-robots researches. As a simple distinction, implicit communication focuses on a side-effect of other actions, whereas explicit communication emphasizes to convey information to other robots. The communication can greatly improve the performance of multi-robots team and efficiently make the system achieve various tasks (MacLennan, 1991; Balch & Arkin, 1994). However, in recent works, the researchers have focused on representations of languages in the physical world (Hugues, 2000; Jung & Zelinsky, 2000). Other works have concerned the fault tolerance in multi-robots communication, such as the distributed communications networks and the reliability of communication system (Winfield, 2000; Molnar & Starke, 2000). Additionally, [Shen et al, 2002] used the communication to the reconfigurable modular robotics. [Arai et al., 2002].

The Fig. 4 represents the categorization, proposed by Parker [Parker, 2008a], according to three axes: “the type of the goal”, “the awareness of others” and “the actions advance the goal of other”. Each category is detailed below.

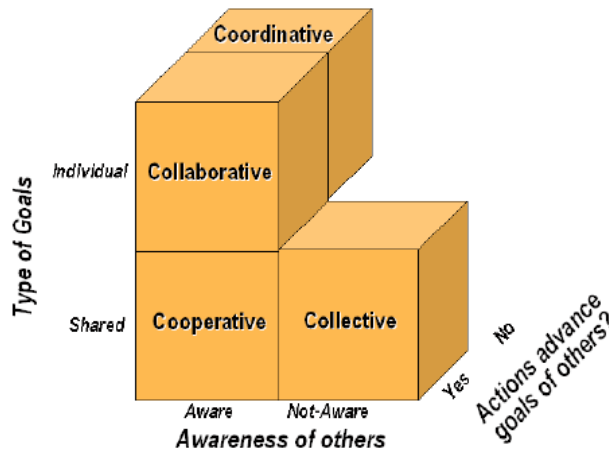

Figure 4: Heterogeneous team of an air and two ground vehicles that can perform cooperative reconnaissance and surveillance

- **Collective:** The collective interaction is inspired by the biological populations as flocks of birds, schools of fish, society of ants, frogs and so forth. It is a great emphasis on the behaviors of entities to perform some biological relevant tasks. In the multi-robots system, the collective interaction is the swarm robotic work. Some examples are addressed by Mataric, McLurkin and Kube & Zhang (Mataric, 1995; McLurkin, 2004; Kube & Zhang, 1993). In this type of interaction system, there are

typically large numbers of simple control robots, to achieve the global aim. [Parker, 2008a]

- **Cooperative:** In the type of cooperative interaction, the one should share goals with others, and their actions are the interactions between teammates. For example the multi-robots system could solve the box-pushing problem (e.g., [Gerkey, 2002]), clean up a worksite (e.g., [Parker, 1998]), search, rescue (e.g., [Murphy, 2000]), or do some extra-planetary exploration (e.g., [Stroupe et al., 2006]). In these systems, robots sometimes work on different parts separately, the work together to achieve the common goal avoiding the interaction with each other. [Parker, 2008a]
- **Collaborative:** The third type of interaction is the collaborative interaction. It occurs in the systems that robots have individual goals, as well as they need to accomplish the entire goal by the collaboration among the entities. In fact, in order to distinguish the collaborative interaction with the cooperative interaction is extremely difficult. Usually, it is unavoidable to combine the cooperative interaction with the collaborative process. Generally, through the interactions among the robots, the collaborative interaction will be better to help achieving the individual goal as well the common goal. Kinds of problems faced by the multi collaborative robots are the coalition formation. In Parker and Vig & Adams (Parker, 2006; Vig & Adams, 2006), the problem has illustrated. [Parker, 2008a]
- **Coordinate:** The last type interaction is the coordinate interaction, in which the entities do not share a common goal, and they are individual. In case that robots share a common workspace, the coordinate interaction can minimize the amount of interference among robots. The typical applications are the path planning techniques (e.g., [Kolder & Hutchinson, 2006; Guo & Parker, 2002; Alami et al., 1998; Erdmann & Lozano- Perez, 1987; Parson & Canny, 1990; Peasgood et al., 2008; Clark et al., 2003;Svestka & Overmars, 1998; Kant & Zucker, 1986; Rude, 1997;LaValle & Hutchinson, 1998) or the traffic control techniques (e.g., Grossman, 1988; Kato &Zucker, 1986; Lumelsky & Harinarayan, 1997; Asama et al., 1991a;Yuta & Premvuti, 1992;Wang, 1991) in the multi-robots systems. [Parker, 2008a]

It is important to notice that the four previous categories may be merged in only one field which could name “collective robot”. In fact, collective robot includes heterogeneous and homogeneous robots. Consequently, the goal of the research presented in this manuscript is to try to propose a unified theory mainly based on Machine-Learning. Effectively, the strong point of collective robotics corresponds also to its main difficulty. The major advantage in collective robotic field is due to the fact that robots are able to coordinate and to cooperate in order to achieve a common goal. But these abilities have to be the result of a learning process allowing to a group of robots a self-adaption according to environment, the goal and according to the time.

### 1.3.2 Context

The design of control strategy for collective robotics is a hard work and needs today innovative solutions. In this context, the logistic field is a very good application to test this kind of control strategy. Effectively, the main problem in a logistic application is to transport different kinds of object from one point to another point. In fact, the size, the shape and the weight of these objects may be very different. In traditional application, it is needed to design specific machine, generally called Automated Guided Vehicles (AGV). The other main problem is to find automatically a path to transport objects from a place to a new place. In traditional approach, a supervisor manages all AGV and has a map in its memory. In summary, the main drawback of the traditional approaches is that they are not adaptive.

In fact, the logistic application may be consider like a collective robotic application where robots have to transport an object. The early work in cooperative transport was presented by Trebi-Ollennu et al. (Trebi-Ollennu et al., 2002). In cooperative transport task, it primarily concentrated on cooperative pushing behaviors on flat floors, such as (Brown & Jennings, 1995; Parker, 1994; Rus et al., 1995; Wawerla et al., 2002), which proposed approaches to use the transported object to communicate implicitly. Some work, for example (Mukaiyama et al., 1996; Qingguo & Payandeh, 2003) focused on fixed-based manipulators of the cooperative manipulation with the force feedback. Nowadays, more and more interests have been focused on the work of grasping, transport, and precision placement of a rigid component into a fixed structure by multi-robots team. RCC demonstrated these capabilities in an outdoor-like laboratory setting (Stroupe et al., 2005). In [Stroupe et al., 2006], Stroupe et al introduced the Robotic Construction Crew (RCC) they used a distributed multi-robots behavior-based architecture to accomplish a series of construction tasks including the transportation task with illustrating experiments. [Stroupe et al., 2006]. As an exceptional example, Alami and his teammates presented a general concept for the control in a large fleet of autonomous mobile robots for transportation works by their Martha robots [Alami et al, 1998]. The Martha projects is the first one to add the multi-robots cooperation capabilities to a large fleet of robots and their extensively application have been used in harbors, airports and marshaling yards.

Other works using the leader-follower control of transportation task were introduced in (Kosuge & Oosumi, 1996; Kume et al., 2002), which proposed a compliance control based leader-follower control system. The leader robot has the desired trajectory and the follower robots adjusted their trajectories to track the leader based on force/moment from the object to accomplish the transportation task in coordination with the leader and other followers. Another example can be found in [Kosuge & Oosumi, 1996], which addressed a distributed control algorithm that the follower can perfectly estimate the motion of the leader and perform the cooperative transportation task by using this estimation. And, [Wang et al., 2007] also proposed a decentralized control method for object transportation in coordination by a leader-follower type of multi-robots system, and illustrate their control algorithm by three unidirectional

mobile robots. Discussion about a bounded movable area for the object transportation were shown in (Sukhatme et al., 2002; Wang & Kumar, 2002a; Wang et al., 2003), by several robots using sequential or formation motion control. [Wang et al., 2007]. Some works already have been done for the formation robots with rigid formation in the multi-robots system transportation task. Robots must simultaneously maintain a formation so as to transport rigid components cooperatively with tight grasp, such as (Balch & Arkin, 1998; Carpin & Parker, 2002; Desay et al., 1999). The formation works used vision and/or explicit communication whereas the inadequacies of these efforts don't pay attention to maintain a grasp on a cooperatively carried component or tight bounds on permitted formation errors. In (Huntsberger et al., 2003; Trebi-Ollennu et al., 2002), JPL has demonstrated cooperative pick up, transport, and put-down of large components in an outdoor environment. [Stroupe et al., 2006].

In many cases of the real transportation, it needs to carry long and huge load in many situations of both the indoor and the outdoor environment. It is vital to maintain the rigid formation of the multi-robots system in order to keep the load not falling down during the transportation process. And the avoidance is a problem no more for the individual robot but for the formation robots as a whole. In the frame of the thesis, these tasks have been allocated and cooperate by heterogeneous multi-robots team. The heterogeneous multi-robots team is made up of a humanoid robot, a rigid formation multi-robots team, a top camera robot and a supervisor. Considering the above problems, we develop navigation strategies for multi-robots team with a rigid formation, which can navigate in an unknown environment. And in the navigation strategies, the rigid formation multi-robots team is regarded as a virtual entity whether in case of avoidance or in case of going advance. Using the rigid formation control, the rigid formation robot team can keep the constraint formation shape throughout the motion. The humanoid robot can have the vision of the area in front of the multi-robots system and plays the role of local supervisor. The top camera can take the picture of front unknown area when the heterogeneous multi-robots system meeting obstacles. The supervisor is the responsible for deal with information and transmits commands. Both the simulation and the real robot experiments demonstrated that the heterogeneous multi-robots team can navigate in unknown environment and execute the transportation task entirely. The application is possible to be used in the both indoor and outdoor situations.

## 1.4 Conclusion

If through present chapter the multi-robots' based approaches show clearly offering many advantage as well as the uncontestable potential for wide classes of applications, while it clearly appears that the design of control strategies for such systems suffers from multiplicity of existing nomenclatures and related arrangements. In fact, in a rough point of view, each project, application or study appears as a solution to the specific case of that project, application or

study. If the taxonomy proposed by Parker [Parker, 2008a], categorizing multi-robots' control strategies versus types required interactions or issued outcomes, is a first valuable tentative of orderliness relating various already presented control strategies, while it highlights the need of a more overall, and probably more generic, consideration of multi-robots systems. This has reinforced our motivation in pursuing our efforts investigating Machine-Learning based approaches with clear desire in tentative of some unification of the "collective robots' system" concept.

In addition, the above-mentioned, the ever-increasing complexity of nowadays' needs concerning logistic applications and the state of art of the numerous above-presented research activities dealing with "object transport and manipulation" have fortified our decision in orienting the validation (experimental or simulated) toward a logistic application's framework.

## Chapter 2. ANFIS Controller for Nonholonomic Robot

---

### 2.1 Introduction

The motion planning and control of wheeled robots have been, and still are, the subjects of numerous research studies. In particular, that is the case of non-holonomic robots where the planning trajectories and the control motion are not independent because of non-holonomic constraints. For example, a two-wheeled robot can go anywhere but can't follow any trajectories. Originally in robotics, the motion planning was based on the following problem: "how to move a piano from one room to another in a house without hitting anything" (LaValle, 2006). Generally, in the robotic domain, the trajectory planning for non-holonomic robots consists to find trajectories from an initial point to a final point by taking account of mechanical constraints and to control the robot in order that it follows the desired trajectories. Numerous studies have been done in the past, mainly for the unicycle, car-like mobile robot system and the trailer system. The first control problem of WMR (wheeled mobile robot) maybe was the path following problem proposed by Samson et al. (Samon, 1995; Dickmanns & Zapp, 1987; Nelson & Cox, 1988; Samon, 1992). Numerous other papers of tracking problem have been addressed as examples in the following papers (Andréa-Novel et al., 1995; De Luca & Di Benedetto, 1993; Fliess, 1995; Canudas, 1996) etc. Many authors have published the researches of the asymptotic stabilization of fixed configurations (Kolmanovsky, 1995; Morin et al., 1998; Samson, 1991). Various methods have been used, for instance, the transformation of kinematic models into the chained form (Rouchon et al., 1993; Lamiroux & Laumond, 1998), the reference control, time-varying feedbacks (Morin et al., 1998; Pomet, 1992; Teel et al., 1992; M'Closkey & Murray, 1997), the hybrid feedbacks (Bennani & Rouchon, 1995; Lucibello & Oriolo, 1996; Sørdaalen & Egeland, 1995), the approach based on the transverse function (Morin & Samson, 2003; Morin & Samson, 2001; Morin & Samson, 2004; Artus et al., 2003) and so on. In all of these cases, the control problem refers to a continuous control problem. A good control method must satisfy the robustness of stabilization and fast convergence. Thus the control problem is to find a suitable method to ensure that the system has the robustness as well as the fast convergence. As we all know, the outstanding advantage of the classical feedback control techniques is robust in the linear system. However, in the case of the nonlinear system, the fast convergence must be compromised with the stability. In artificial intelligence, the terms planning and AI planning refers to solve a discrete control problem (LaValle, 2006). In this case, instead of moving a piano through a continuous space, the task is to find a set of discrete actions allow to move the object from the initial point to the goal point. In the paper of Bertsekas & Tsitiklis (Bertsekas & Tsitiklis, 1996), the formulation and resulting algorithms

are based on dynamic programming. And others [Alpaydin, 2004; Sutton & Barto, 1998] used primarily machine learning, which is reinforcement learning. The sequential game theory, which is also called dynamic game theory (Basar & Olsder, 1995), and the differential game theory are obtained (Basar & Olsder, 1995; Isacs, 1965; Petrosjan, 1993; Yavin & Pachter; 1987). Some examples in the hazardous regions, and shelters or requests to deliver objects, the mode might be imagined as rain occurring and the robot must run for the shelter [LaValle & Sharma, 1997; Sharma et al., 1996; Sharma et al., 1993].

The main drawback of the previous studies is that in all of them, the proposed approach is generally designed for one specific kind of robot and thus, it needs a specific modeling of the machine. The goal of one part of this thesis work is to propose a new concept allowing controlling the motion of a mobile robot independently of the kind of the considered robot. In fact, we consider that all trajectories can be decomposed in two elementary motions: the linear motion and the rotation motion. The proposed approach, which is based on Machine-Learning, uses an Adaptive Neural Fuzzy Inference System (ANFIS) control allowing that the mobile robot moves towards the desired position, desired orientation and also can track any reference trajectories (linear or nonlinear). Because the conceptualization of our control strategy is conceived in such a slant since its brass tacks (e.g. from its fundamental aspect), it could be applied into any kind of robot: wheeled robots, walking robot and even a virtual robot like a rigid formation. In order to verify the proposed concept, an example is designed for a team of two-wheel non-holonomic robots following different trajectories (linear trajectory or nonlinear trajectory). The simulation has been done involving Khepera robots. Results demonstrated that the as well single robot as the team of such robots (considered as a single virtual robot) can well follow the given trajectories. Furthermore, referring to what has been mentioned in general introduction of this thesis regarding our desire to give an “industrial logistic” applicative slant to the validation of the investigated concepts, it is pertinent to emphasize the fact that the team of robots enrolled in such applicative frames is often composed of several non-holonomic robots. Often, such wheeled mobile non-holonomic robots have to form a fixed geometry shape (e.g. a rigid formation) maintaining that shape during the movement. A typical example of such practical circumstances in industrial logistics’ applicative frame is the transportation of a very long and voluminous load by several non-holonomic robots. In this case, separately self-controlled and synchronous regarding the movement, robots must keep an aligned rigid formation in order to handle that voluminous load from a starting position to a final position following some (planed) trajectory.

In order to explain clearly our method, we present a practical example where the robot must move from an initial position to goal position by passing a narrow path (Fig. 5). As shown in Fig.5, the whole process is divided into three parts. In the part I, a robot moved forwards from the initial position A to position B. During the part I, the robot used the position control in order to keep the track with a line. The part II is a path tracking process. In fact, it means that the robot followed with a given reference.

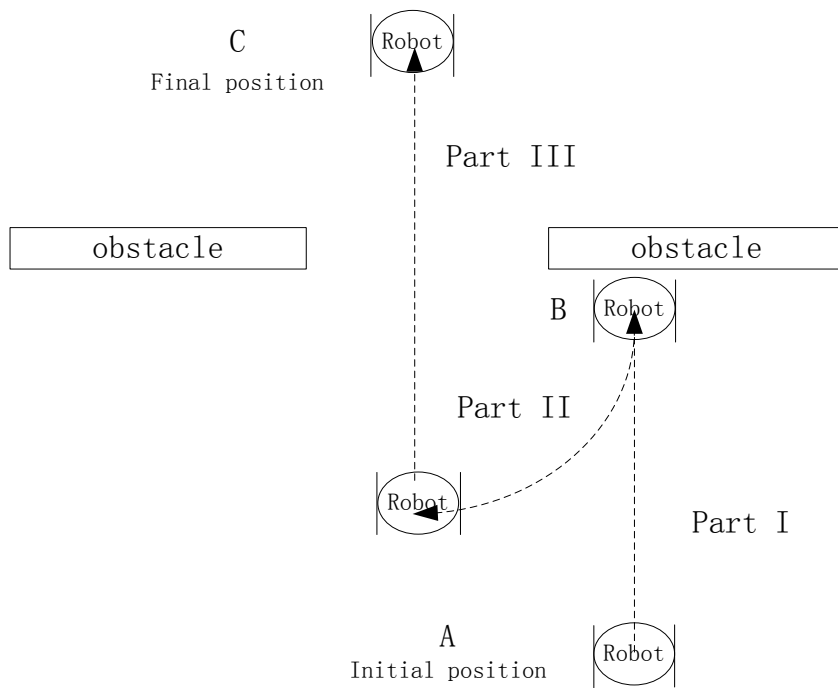
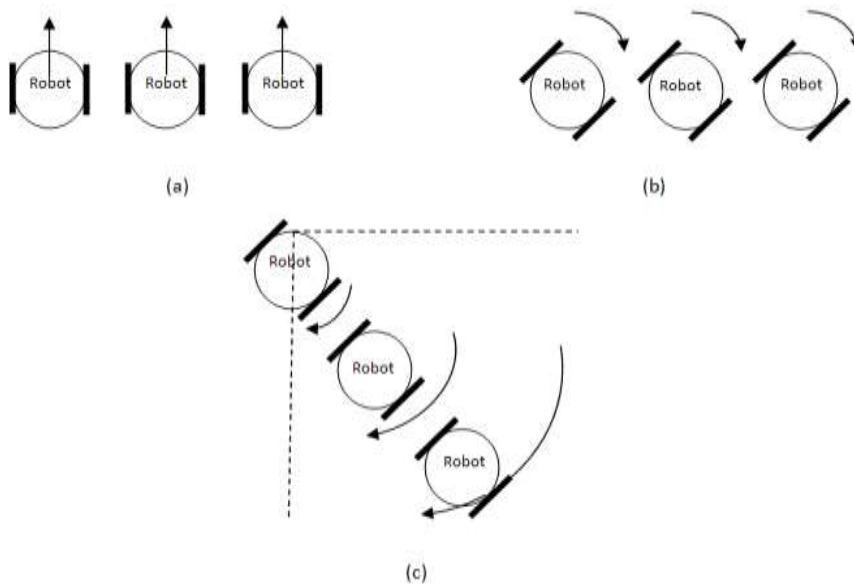

Figure 5: Description of the path of the robot from point A to point C



- (a) The horizontal line shape formation robots;
- (b) Robots rotate on themselves at the same time;
- (c) The formation robots follow the arc curve synchronous.

Figure 6: Process of the formation robots changing its formation



The robot must control the position as well as the orientation simultaneously. We apply the trajectory control which is on the basis of the orientation control and the position control. At last, the robot went ahead and arrived to the final position C by only the position control in the part III. It must be noticed that in the case where we consider that all robots move in a synchronous manner, the previously described approach may be generalized to a rigid formation of robots. The figure (Fig.6) shows a formation of three robots. The translation of formation can be decomposed of the translation control of every single robot synchronous. And for instance, to change a horizontal line shape formation (in Fig.6 (a)) to a vertical line, all of the robots begin to rotate on themselves (see in Fig.6 (b)) and after all of the robots follow the arc curve (see in Fig.6 (c)) whose center is the of the reference robot and its radius is the distance between itself and the reference robot. Finally, all the robots rotate themselves to the desired direction.

By taking into account of previous comments, the goal of this chapter is to describe the control of the single robot. And in the continuation of this document, we will consider that all wheeled robots use the same kind of controller in a synchronous manner. It must be pointed out that our approach may be decomposed into two parts: the first one allows decomposing the path into several desired trajectories, and the second uses a neuro-controller allowing tracking these desired trajectories. In the next section, after a review of the Adaptive Fuzzy Inference System (ANFIS) controller (section 2.2), we describe our control strategy used for one robot (section 2.3). Simulation result and experimental result are respectively given in section 2.4.

## **2.2 Adaptive-network based fuzzy inference system (ANFIS)**

Fuzzy controller (FC's) has various applications in both industry and household. For the complex and/or ill-defined systems that are not easily controlled by conventional control schemes, FC's provides a feasible alternative since they can easily capture the approximate, qualitative aspects of human knowledge and reasoning. The two important factors which restrict the FC's are the soundness of knowledge acquisition techniques and the availability of domain (human) expert. The attribute of fuzzy systems is expressing the knowledge in the form of linguistic rules, which can implement the expert human knowledge and the experience. But the shortcoming is the lack of a systematic methodology for their design. Normally, it is a time-consuming task that to update parameters of membership functions. The use of neural network learning techniques can make the process automatically, and significantly reduce the development time with a better performance. Consequently, the merger of neural networks and fuzzy logic led to the design of neuro-fuzzy controllers which are one of the most popular research fields today. Some architectures for neuro-fuzzy controllers are proposed for example by Jang (Jang, 1992), Nomura (Mondada, 1994), Abraham (Abraham, 2005) and so on. In this section, the basics of adaptive networks, called ANFIS, is introduced in detail and it works as a fuzzy controller (Jang, 1992b)

ANFIS is a class of adaptive Fuzzy Inference System (Jang & Sun, 1995). ANFIS can be also considered as a neural network close to Radial Basis Function. Its wide applications are including: the nonlinear function modeling (Jang, 1991; Jang, 1993), the time series prediction (Jang & Sun, 1993; Jang, 1993), the online parameter identification for control systems (Jang, 1993), and the fuzzy controller design (Jang, 1991a; Jang, 1992). ANFIS, which is based on both neural networks and fuzzy inference systems, belongs to a class of adaptive fuzzy inference system. In this chapter, we remember briefly the ANFIS architecture initially proposed by J.-S. R. Jang (Jang & Sun, 1995). The proposed ANFIS architecture can identify the near-optimal membership functions and other parameters of a rule base to acquire a desired input-output mapping, as it concerns the automatic elicitation of knowledge in the forms of fuzzy “*if-then*” rules. The basics of the ANFIS architecture are introduced in detail in the following paper (Jang, 1992b). An application of ANFIS to the avoidance problem of the nonholonomic can be found in Mondana et al. (Mondana et al., 1994).

In the section, we describe the neuro-fuzzy controller, which have been proposed in first by Jang, and learning method in detail proposed by Godjevac (Godjevac, 1995). A schematic description of ANFIS is shown in Fig.7, where  $x_1$  and  $x_2$  are the two inputs. If we assume that ANFIS have  $m$  inputs  $x_1, x_2, \dots, x_m$ , one output  $y$ . The  $n$  linguistic rules  $R_i$  can be expressed as:

$$\text{If } x_1 \text{ is } A_{i1} \text{ and } x_2 \text{ is } A_{i2} \dots \dots \text{and } x_m \text{ is } A_{im}, \text{ Then } y \text{ Is } \omega_i, i = 1, \dots, n. \quad (1)$$

where  $i$  is the index of the rule,  $A_{ij}$  is a fuzzy set for  $i$ -th rule and  $j$ -th input and  $\omega_i$  is a real number that represents a consequent part. After the fuzzification by Gaussian membership function (see in Fig.8), we can get  $A_{11} \dots A_{n1}$  and  $A_{21} \dots A_{n2}$  respectively. In the present case, the membership function is defined as a Gaussian function:

$$\mu_{ij} = \exp \frac{-(x_j - a_{ij})^2}{2b_{ij}^2}. \quad (2)$$

The fuzzy inference is defined as the T-norm. Then, use the T-norm to combine each pair of  $\mu_{i1}$  and  $\mu_{21}$ , we can get the outputs  $u_1 \dots u_n$ . Where  $u_i$  is given by:

$$u_i = \mu_{i1} \mu_{i2} \dots \dots \mu_{im}. \quad (3)$$

But they are not the real outputs, they must be defuzzified and to obtain the real output  $y$  at last. The output of this neural network is given by the following equation:

$$y = \frac{\sum_{i=1}^n u_i \omega_i}{\sum_{i=1}^n u_i}. \quad (4)$$

All the membership functions (include inputs, outputs and the parameters) are defined as Gaussian function in the thesis.

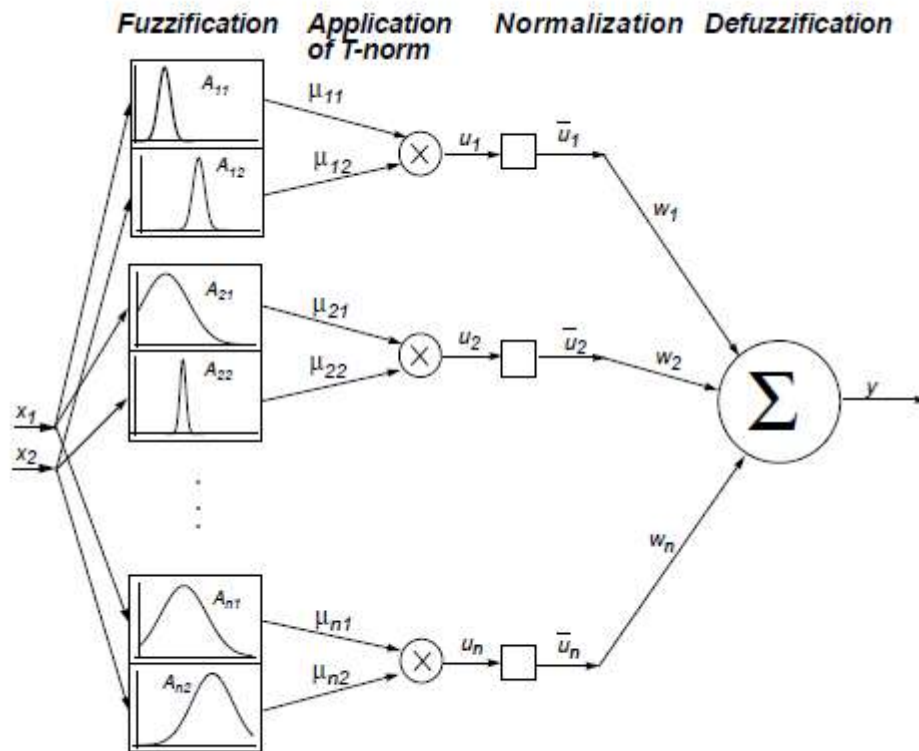

Figure 7: Neuro-fuzzy controller (Godjevac, 1995)

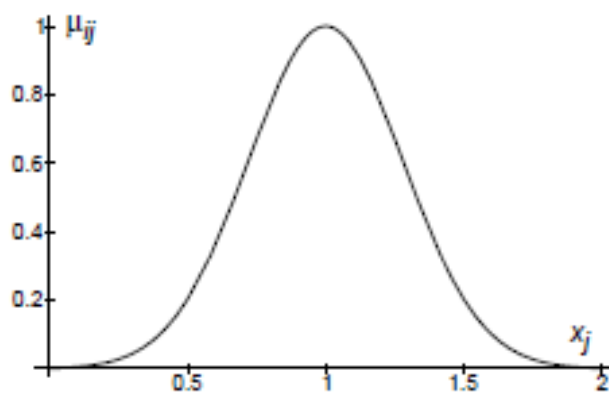

Figure 8: Membership function ( $a_{ij} = 1, b_{ij} = 0.28$ )

Now, we define  $z$  as the set of all parameters to adapt in the neural network:

$$z = a_{11}, \dots, a_{nm}, b_{11}, \dots, b_{nm}, \omega_i, \dots, n_n. \quad (5)$$

And  $V(z)$  the function to minimize:

$$V(z) = \frac{1}{2} (y(t) - y^d(t))^2. \quad (6)$$

$y(t)$  is the output of the neural network and  $y^d(t)$  is the desired output. In this case, (Godjevac, 1995) showed it as possible to use an iterative procedure to update parameters in order to minimize the function  $V(z)$ . The three kinds of parameter  $a_{ij}$ ,  $b_{ij}$ , and  $\omega_i$ , (all the parameters are defined as Gaussian function as shown in Fig.8) may be updated by equation 7, 8 and 9 respectively.

$$a_{ij}(t+1) = a_{ij}(t) - \Gamma_a \frac{\mu_i}{\sum_{k=1}^n \mu_k} (y - y^d)(\omega_i - y) \frac{(x_{ij} - a_{ij}(t))^2}{b_{ij}^2}. \quad (7)$$

$$b_{ij}(t+1) = b_{ij}(t) - \Gamma_b \frac{\mu_i}{\sum_{k=1}^n \mu_k} (y - y^d)(\omega_i - y) \frac{(x_{ij} - b_{ij}(t))^2}{b_{ij}^3}. \quad (8)$$

$$\omega_i(t+1) = \omega_i(t) - \Gamma_\omega \frac{\mu_i}{\sum_{k=1}^n \mu_k} (y - y^d). \quad (9)$$

where  $a_{ij}$ ,  $b_{ij}$ , and  $\omega_i$  are the parameters of the adaptation of the learning algorithm.  $\Gamma_a$ ,  $\Gamma_b$ ,  $\Gamma_c$  are the predefined constants. The iterative procedure for the adaptation of parameters and for the minimization of the criterion function can be summarized as follows (Godjevac, 1995)

1. Initialization of parameters.
  - a) Consequent values  $\omega_i$ , are random numbers.
  - b) Choice of antecedent parameters  $a_{ij}$  and  $b_{ij}$  (all membership functions on the universe of discourse are regularly distributed and have the same width).
2. Data input ( $x_1, x_2, \dots, x_m, y^d$ ).
3. Fuzzy inference.
4. Adaptation of consequent parameters  $\omega_i$ .
5. Adaptation of parameters  $a_{ij}$ , and  $b_{ij}$ .
6. Evaluation of the criterion function  $V$ .
7. Repeat the steps 3 to 7 until  $V$  is smaller than one threshold value.

The algorithm is more efficient if the steps 3 and 4 are repeated twice in the same iteration loop. Namely, the weights  $\omega_i$  are adapted twice in the one iteration. This method is similar to the method proposed by Nomura et al. (Nomura et al., 1992).

Ensuring robots follow any desired trajectory, the principle of fuzzy controller showed in Fig. 9. In the trajectory adaptive network (see in Fig. 9), though there are  $m$  FC blocks, all of them refer to the same fuzzy controller at different time stages. Namely, there is only one parameter set which belongs to all  $m$  FC blocks at different time stages. For clarity, this parameter set is shown explicitly in Fig.9, which is updated according to the output of the error measure block. (Jang, 1992b)

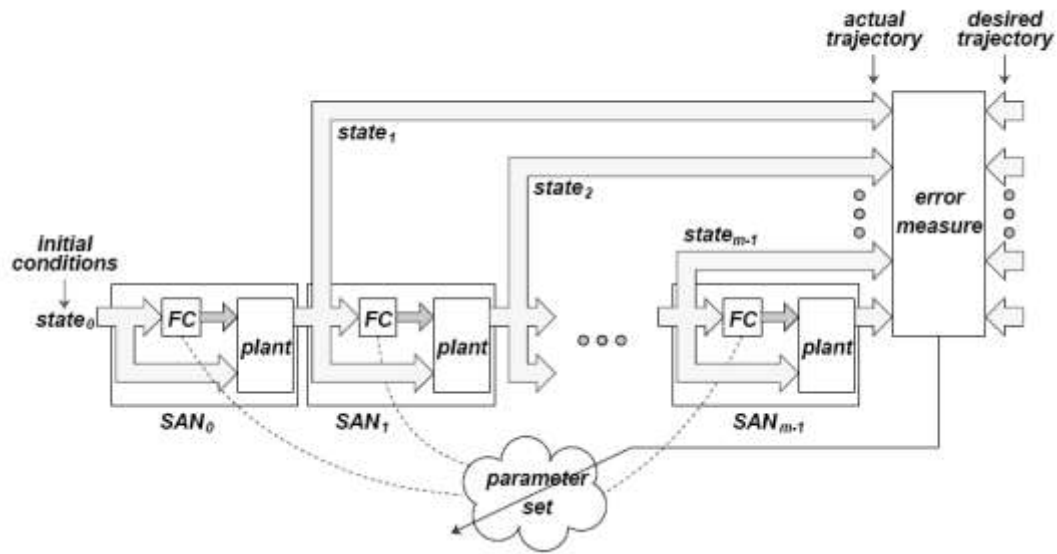

Figure 9: A trajectory adaptive network for control application.(Jang, 1992b)

## 2.3 ANFIS controller for nonholonomic robot

Let us now consider a given trajectory  $C$  in the reference frame, and a point  $P$  attached to the robot chassis, at the mid-distance of the wheels, as illustrated in the Fig. 10.  $\theta$  is the angle from  $X$ -axis to the robot's motion direction. The kinematic modeling of this wheeled robot (i.e. unicycle-type mobile robot) may be represented as follows (Pascal & Claude, 2008):

$$\begin{cases} V_x = V \cos \theta \\ V_y = V \sin \theta \\ \dot{\theta} = \Omega \end{cases} \quad (13)$$

$$\begin{cases} V = \frac{r}{2} (\Omega^{right} + \Omega^{left}) \\ \Omega = \frac{r}{2l} (\Omega^{right} - \Omega^{left}) \end{cases} \quad (14)$$

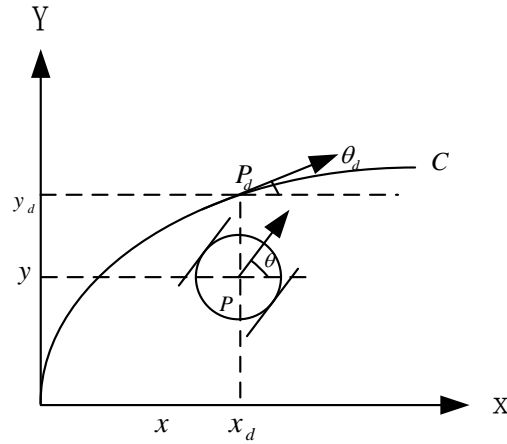

Figure 10: Robot's coordinates described by a triplet as  $P(x, y, \theta)$ .

Where  $V_x$  and  $V_y$  represent respectively the instantaneous horizontal and vertical velocities of the point  $P$  located at mid-distance of the actuated wheels.  $V$  represents the intensity of the longitudinal velocity and  $\Omega$  the angular velocity of the robot.  $\Omega^{left}$  and  $\Omega^{right}$  are the angular velocity of the left and right wheels respectively.  $r$  is the radius of the wheels and  $l$  is the distance between the two wheels.

### 2.3.1 Trajectory control

In our simulation and the real experiment, we use KheperaIII, a kind of wheeled non-holonomic mobile robot to verify our strategies. Its kinematic model is a unicycle-type mobile robot. For a unicycle-type mobile robot, the goal of the control strategy is to compute the velocities of each wheel in order to make the robot follow the desired reference. For example, as the reference we have shown in Fig. 10, the reference can be regarded as a set of point  $P^d(x^d(t), y^d(t), \theta^d(t))$ . And the given trajectory can be expressed as a function of time  $t$ , with the  $\theta^d(t)$  represents of the trajectory's curvature at each step time  $t$ . The purpose of control is to input appropriate wheel speeds (both left and right), to keep the robot track with the given reference. That is, to make the difference between the robot's track  $P(x, y, \theta)$  and reference  $P^d(x^d(t), y^d(t), \theta^d(t))$  is 0.

It is difficult for us to obtain the accurate parameters from robot in the real experiment. Therefore, we propose a new approach based on neural networks and depending on the kinematic model (13) and (14). The goal of the neural networks is to control the velocity of each wheel in order to minimize the two errors, one is the error between position and desired

position  $(x-x^d, y-y^d)$ , and the other is the error between orientation and desired orientation  $(\theta - \theta^d)$ .

### 2.3.2 Orientation control

The orientation control allows the robot to rotate around itself by following the target angle. The orientation control diagram is described in the following figure:

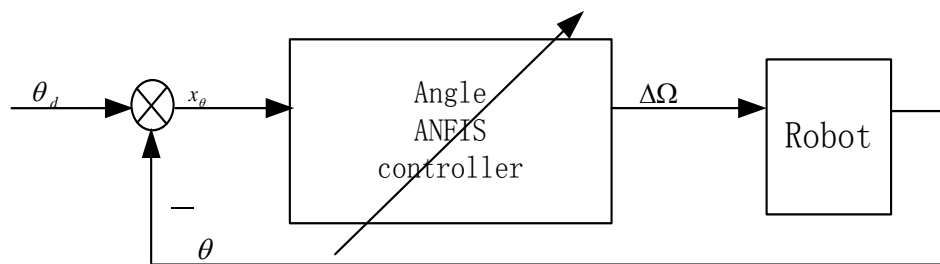

Figure 11: Orientation control diagram

Consequently, the ANFIS needs one input  $x_\theta$  which is the difference between the robot's direction  $\theta$  and the desired angle  $\theta^d$  at each time step (see 15). By the fuzzy inference, the neural networks and the defuzzification, the single output is an angular velocity. In order to make the robot rotate, the left and right wheels must have the opposite angular velocity. The absolute value of angular velocity of both wheels is the same  $\Delta\Omega$ , while the opposite direction of left and right wheel respectively. The input showed in equation (15), the output showed in equation (16) and (17). The loss function and parameters update are expressed in equation (18). The diagram of control has showed in Fig. 11.

$$x_\theta(t) = \theta(t) - \theta^d(t). \quad (15)$$

$$y_\theta(t) = \frac{\sum_{i=1}^n u_i^\theta \omega_i^\theta}{\sum_{i=1}^n u_i^\theta}. \quad (16)$$

The relation between  $y_\theta(t)$  and  $\Delta\Omega$  ( $\Delta\Omega$  is the difference between the right angular velocity  $\Omega^{\text{right}}$  and the left  $\Omega^{\text{left}}$  angular velocity) is given by the following equation:

$$\Delta\Omega(t) = \Omega_\theta^{\text{right}}(t) - \Omega_\theta^{\text{left}}(t) = y_\theta(t). \quad (17)$$

At each step time, the parameters  $\omega_i^\theta$  are updated in order to minimize the following equation

$$V_\theta(t) = (\theta(t) - \theta^d(t))^2. \quad (18)$$

### 2.3.3 Position control

Similar as the orientation control, the position control allowed the robot to follow the target point  $(x^d(t), y^d(t))$  with a desired path. The position control diagram is as follow:

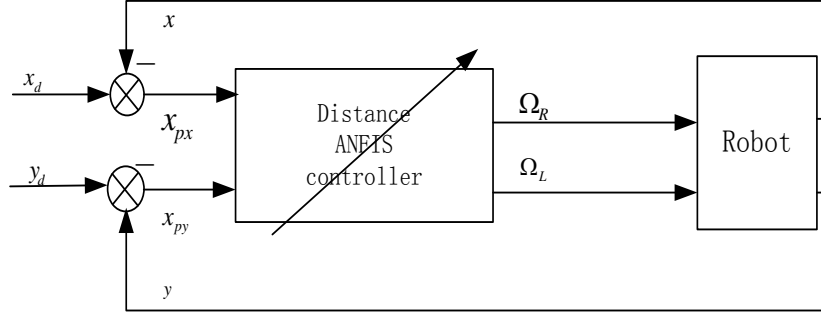

Figure 12: Position control diagram

The crucial thing is to make robots reach to a given position from the initial position to the final one without changing its orientation. Two input variables  $x_{px}$  and  $x_{py}$  are the differences between the robot's position and the position's coordinates along with  $X$ -axis and  $Y$ -axis respectively at each time step. And inputs of the position controller are the matrices composed by the two parts of inputs, which express as (19) and (20). Firstly, the controller changed the input values into the fuzzy set. By the fuzzy inference, and the center of the gravity to the defuzzification, the crisp output can be calculated. Both of the two wheels must have the same angular velocity so as to drive the robot to go forwards. Therefore, the speed of the left wheel  $\Omega_p^{left}$  must be equal with the speed of the right wheel  $\Omega_p^{right}$ .

In the position control, the neural network needs two inputs  $x_{px}$  and  $x_{py}$  which are given by equation (19) and (20) respectively. The single output expresses in equation (21) and (22). And position control diagram shows in Fig. 12.

$$x_{px}(t) = x(t) - x^d(t). \quad (19)$$

$$x_{py}(t) = y(t) - y^d(t). \quad (20)$$

Where  $x(t)$  and  $y(t)$  correspond to the coordinates of the robot;  $x^d(t)$  and  $y^d(t)$  a correspond to the desired coordinates of the robot. The neural network have only one output  $y_p(t)$ :

$$y_p(t) = \frac{\sum_{i=1}^n u_i^p \omega_i^p}{\sum_{i=1}^n u_i^p}. \quad (21)$$

And the relation among the variable  $y_p(t)$ , the right  $\Omega_p^{right}$  and left  $\Omega_p^{left}$  angular velocity is given by the following equation:

$$\Omega_p^{right} = \Omega_p^{left} = y_p(t). \quad (22)$$



## 2.3.4 Desired trajectory and trajectory control

### 2.3.4.1 Desired trajectory

The Fig. 5 showed the trajectory of the robot from the initial position A to the final position C. In short, the proposed example may be decomposed in three parts: firstly the robot moved from the point A toward the obstacles, secondly the robot followed a circle trajectory, and finally the robot went towards the final position. During these three parts, the desired trajectory  $P^d(x^d(t), y^d(t), \theta^d(t))$ , can be computed as follow:

- (1) During the first part, the robot moved from initial position A to the obstacle only with the position's control. In this part, robot followed the vertical line  $x^d = 0.3$  without the orientation control (see equation 23).

$$P_d(t) = \begin{cases} x^d(t) = 0.3 \\ y^d(t) = y^d(t-1) + \Delta y \\ \theta^d = 0 \end{cases} \quad (23)$$

$x^d(t)$  and  $y^d(t)$  represent the coordinates of the robot according to the reference frame.

$\theta^d(t) = -180^\circ$  is the orientation of the robot.  $\Delta y$  is chosen according to both length  $L$  and duration  $T$ .

- (2) During the second part, firstly the robot turned around itself from  $\theta^d(t) = -180^\circ$  to  $\theta^d(t) = 0^\circ$  by using the orientation control, and secondly the robot used trajectory control to follow a circular arc (see equation 24).

$$P_d(t) = \begin{cases} x^d(t) = 0.3 \cos(\theta(t)) \\ y^d(t) = -0.3 \sin(\theta(t)) \\ \theta^d = \theta^d(t-1) + \Delta \theta \end{cases} \quad (24)$$

Finally, the robot turned around itself from  $\theta^d(t) = 90^\circ$  to  $\theta^d(t) = 0^\circ$ .

- (3) During the final part, the robot followed a vertical line ( $x^d(t) = 0.0$ ) and came into a narrow path to arrive at the final position C.

### 2.3.4.2 Trajectory control

If we combine the orientation's control with the position's control, we will get the trajectory's control which can make the robot follow a desired trajectory. In this case, the

angular velocity of two wheels ( $\Omega^{right}$  and  $\Omega^{left}$ ) are given by equation (25).  $\Omega_p^{right}$  and  $\Omega_p^{left}$  are given by ANFIS position control, and  $\Delta\Omega$  is given by ANFIS orientation control. Inputs  $e_x$ ,  $e_y$  and  $e_\theta$  are the differences between the real position of the robot given by  $P = (x, y, \theta)$  and the desired position  $P^d = (x^d, y^d, \theta^d)$ .

$$\begin{aligned}\Omega^{right} &= \Omega_p^{right} \\ \Omega^{left} &= \Omega_p^{left} + \Delta\Omega.\end{aligned}\quad (25)$$

The following diagram show the global trajectory control:

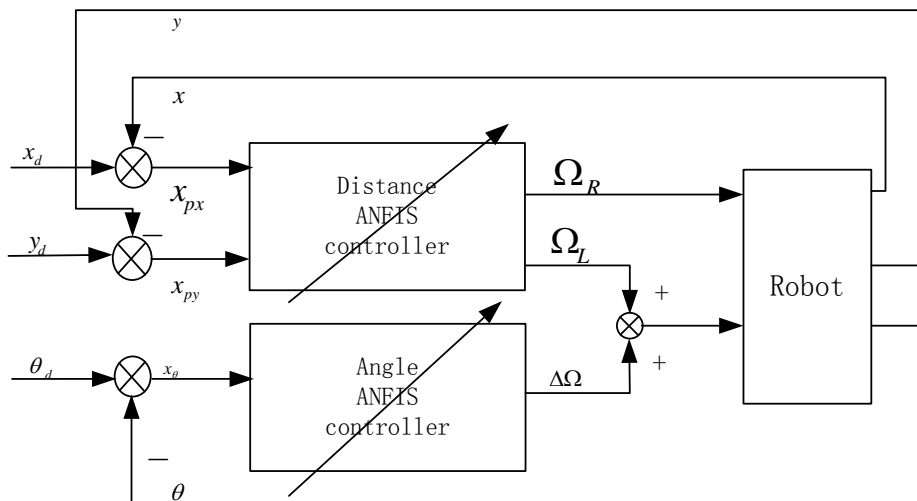

Figure 13: Trajectory control diagram: two neuro-controllers are used for both the position's control and the orientation's control.

## 2.4 Simulation results and real experiment on single KheperaIII

### 2.4.1 Simulation results

In this section, we present the simulation results about the problem described in the previous sections. Simulation has been performed by using software Webots with the virtual robot KheperaIII. The controller has been designed with the software Matlab.

Fig.14 and Fig. 15 show respectively the trajectory and the orientation of robot during the simulation. On both of figures, the red line represented the desired trajectories and the blue dot line indicated the real position of robot. In the Fig. 16, the axis t represented the time step and it showed a snapshot of this simulation.

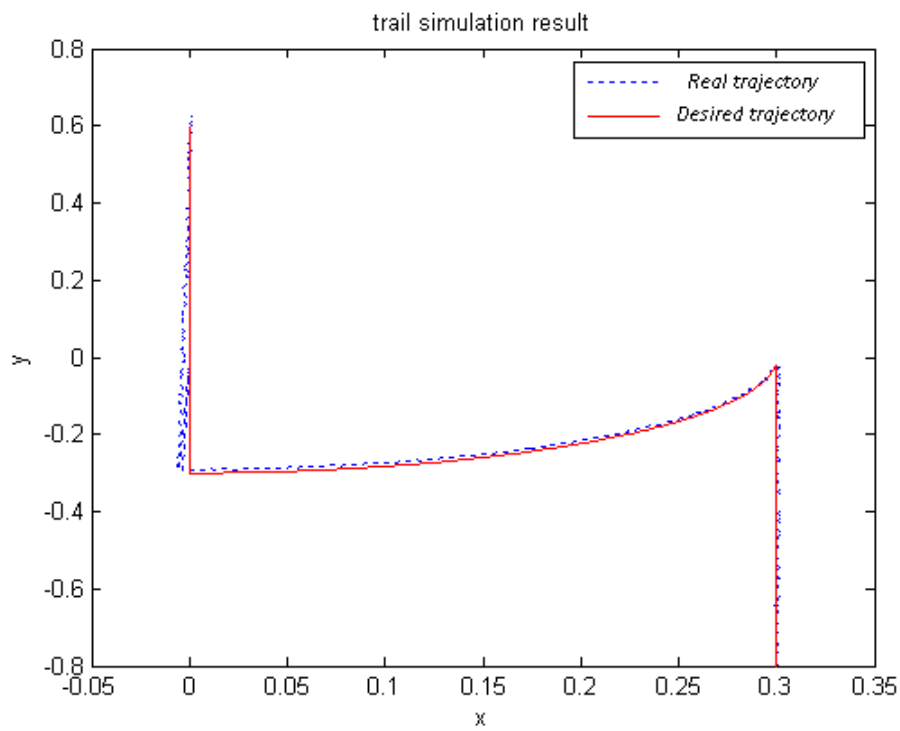

Figure 14: Trail simulation result.

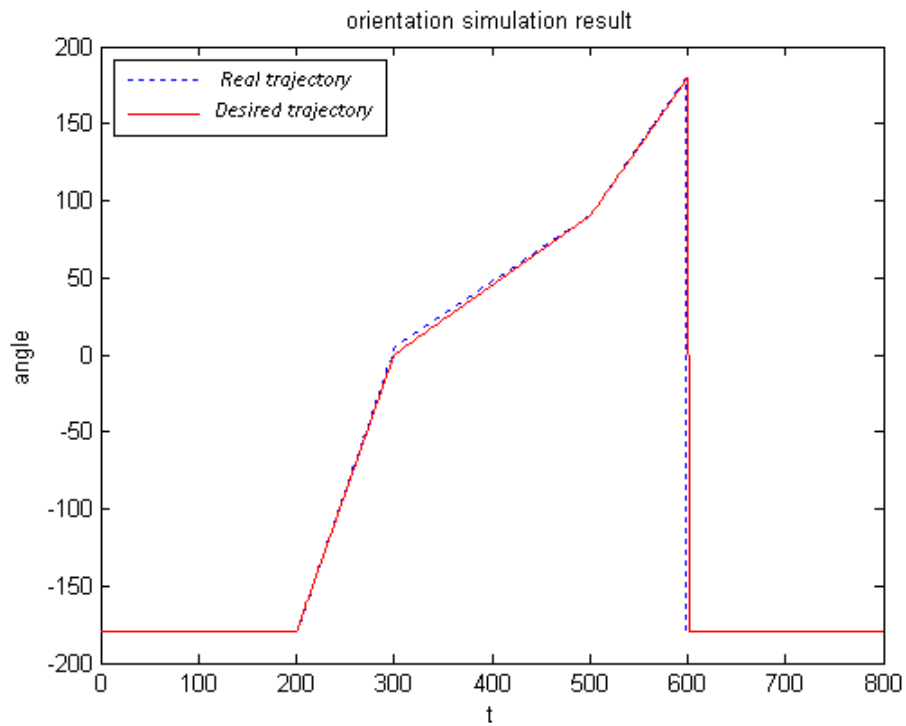

Figure 15: Orientation result.

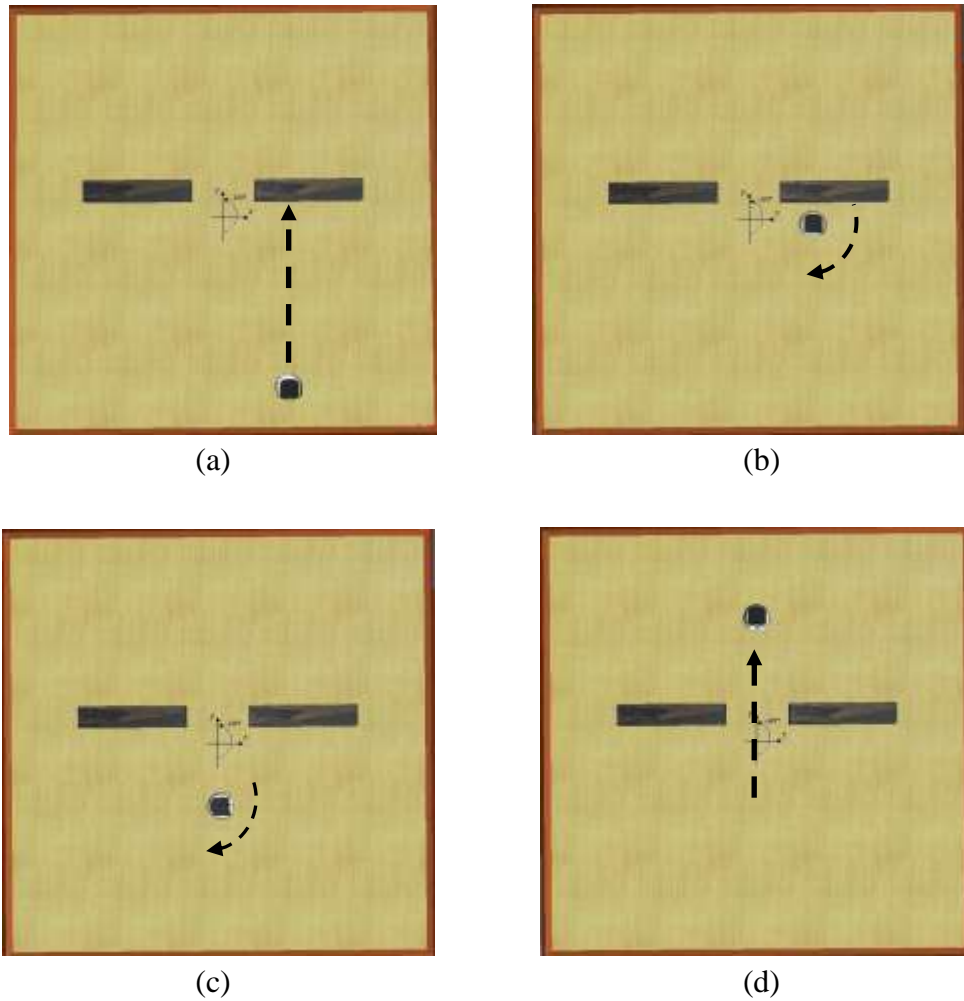

Figure 16: Robot's trajectories

The path of robot can be interpreted as follow:

- From  $t = 0$  to  $t = 200$  (see Fig. 16(a)), the robot followed a vertical line and moved from the point  $(x = 0.3, y = -0.8)$  to the point  $(x = 0.3, y = 0)$ . The desired angle is equal to  $-180^\circ$  ( $\theta^d = -180^\circ$ ).
- At  $t = 200$  (Fig. 16(b)), the robot rotated itself during 100 step time. During this stage, the robot stayed at the point  $(x = 0.3, y = 0)$  but turns from  $\theta = -180^\circ$  to  $\theta = 0^\circ$ .
- From  $t = 300$  to  $t = 500$  (see Fig. 16(b) and Fig. 16(c)), the robot followed a desired circular trajectory and moved progressively from the point  $(x = 0.3, y = 0, \theta = 0^\circ)$  to  $(x = 0, y = -0.3, \theta = 90^\circ)$ .
- At  $t = 600$  (see Fig. 16 (c)), the robot rotated itself during 100 step time. During this stage, the robot stayed at the point  $(x = 0, y = -0.3)$  but turned from  $\theta = 90^\circ$  to  $\theta = 180^\circ = 0^\circ$ .
- Finally, from  $t = 600$  to  $t = 800$  (see Fig. 16 (d)), the robot followed a vertical line and moved to the goal position  $(x = 0, y = 0.6)$ .

## 2.4.2 Real robot experiment

In the real experiment, the used robot is the robot kheperaIII with the additional korebotLE module (see <http://www.k-team.com> ). The robot Khepera III is equipped with two motors associated with incremental encoders, nine infrared sensors and five ultrasonic sensors. A “dsPIC 30F5011” microprocessor allows managing all devices of the robot through a I2C communication. In addition, this robot offers the possibility to connect a KoreBot board allowing increasing the computing abilities. The main component of the KoreBot board is an Intel “PXA255” XScale processor running at 400 MHz with 60 MB RAM and 32 MB flash memory. When the KoreBot board is mounted on the Khepera III robot, the dsPIC microcontroller runs the communication protocol and switches to the I2C slave mode. In order to control the robot, we use the "Khepera III Toolbox". This is a set of scripts, programs and code modules for the Khepera III robot allowing controlling the robot (see <http://en.wikibooks.org/wiki/Khepera\ III\ Toolbox> ).

The previously described cognitive controllers which are based on ANFIS have been designed with C language and implemented on the korebot. Both the orientation (e.g. rotation) and the position of the robot are computed by using an odometer based process. Experimental validations have been realized considering different kinds of trajectories (linear, circular, curvilinear, etc...).

Fig.17 and Fig.18 show the first results relative to the experimental validation. Fig.17 showed the ANFIS based controller's validity as well as its performance on controlling the real kheperaIII robot's orientation. In this experimental validation, the robot is supposed to perform three successive rotations according to the following protocol: first, starting from its initial orientation (shown by the first picture of the Fig.17 (a)), the robot performs a rotation of  $-90^\circ$  (e.g. "turning-right" operation) maintaining its position. Then, starting from its new orientation, the robot repeated twice the above-mentioned operation (e.g. turns-right) attaining successively the  $-180^\circ$  and  $-270^\circ$  (see Fig.17 (b) and Fig.17 (c)). Fig.18 showed the experimental validation relative to the ANFIS based controller's performance on controlling the real kheperaIII robot's position.

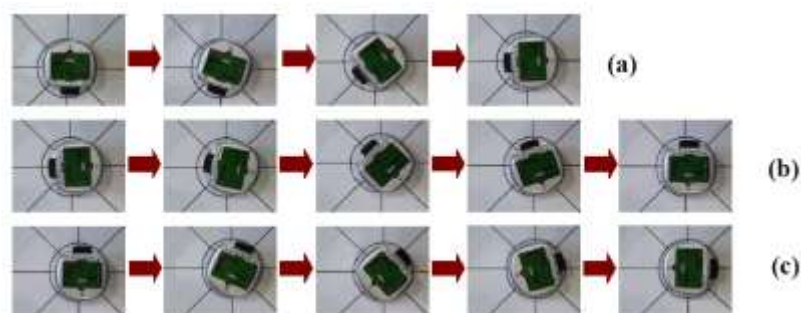

Figure 17: Snapshot of the experimental validation concerning the real kheperaIII robot's orientation's control: rotation of  $-90^\circ$  (a),  $-180^\circ$  (b) and  $-270^\circ$  (c).

In the second experimental validation, the robot is supposed to move respecting a straight line (e.g. without changing its initial orientation shown in the left first picture of the figure) attaining four successive new positions: 20cm , 50cm, 80cm and 100cm from its starting position, respectively.

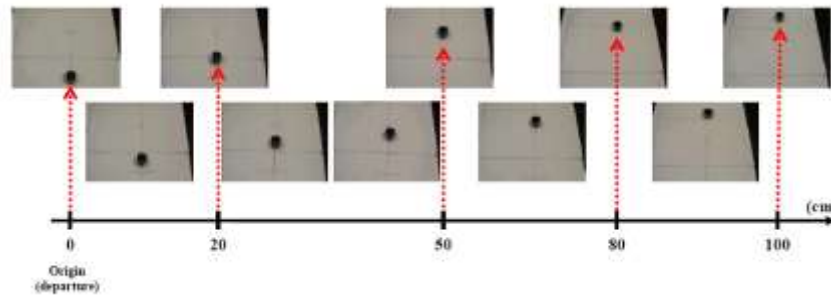

Figure 18: Snapshot of the experimental validation concerning the real kheperaIII robot's position's control. From left to right: robot moves away 20, 50, 80 and 100 centimeters from its starting position.

Fig.19 gave results of experimental validation on a real Khepera III robot considering a curvilinear desired trajectory. The predefined trajectory is shaped in a 60-x-60 cm<sup>2</sup> 2-D frame. The starting point is the location characterized by  $(x = 0 , y = 0 , \theta = 0^\circ)$  and the final destination is located at  $(x = 60 , y = 60)$  with an orientation of  $\theta = +90^\circ$ . So, the robot's position and it's orientation change between the departure location and the final destination in a nonlinear way. In fact, as shown this figure by the sampled positions, (and the associated photographs) the robot followed correctly the planed (desired) trajectory. As it could be seen from the Fig. 19, the considered trajectory is the same as accomplished in the "Part II" of the Fig. 5, confirming the effective implementation of the proposed ANFIS based concept.

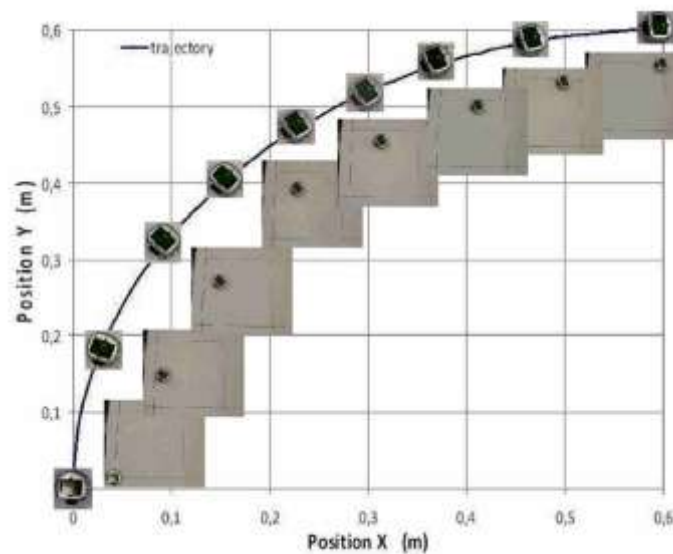

Figure 19: Snapshot of the experimental validation concerning the real kheperaIII robot's trajectory's control. The robot performs a curvilinear trajectory.

The Fig. 20 showed the robot's speed parameters and the weak number of iterations which is needed so as to reach the goal. These experimental results also demonstrate the effectiveness of the described neural architecture in satisfying the frame of real-time control requirements. It is pertinent to remind that such control mechanism could be generalized to different kind of wheeled robots independently from the concerned robots' dynamics (because it operated on the basis of a "learning" process).

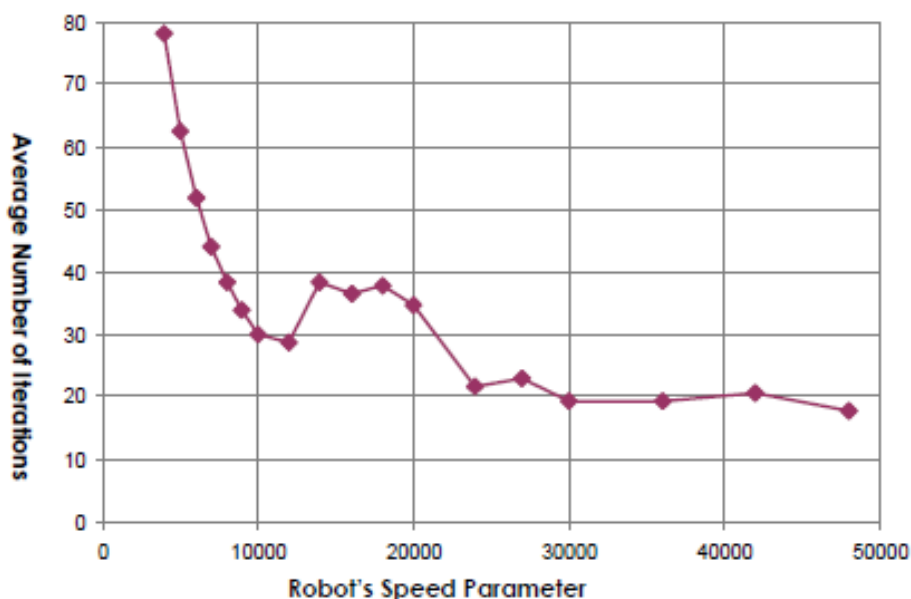

Figure 20: Robot's speed parameter

## 2.5 Conclusion

In this chapter, we have proposed a new concept to control the motion of a mobile robot in a plane. The proposed control strategy, which is based on Machine-Learning, uses Adaptive Neural Fuzzy Inference Systems (ANFIS). After a reminder about ANFIS neural network, we have described the concept of our control strategy. Firstly, we have considered that all trajectories can be decomposed in two elementary motions. Secondly, we use two neuro-controllers in order to track the both desired position and desired orientation. Both simulation and experimental results, which have been performed on virtual and real Khepera robots, show clearly that our approach is usable to control the motion of a non-holonomic robot.

In comparison to the previous studies proposed, this new approach allows us to control the motion of a mobile robot independently of the kind of the considered robot and it does not need information about the modeling of the robot. This point is an important issue of the thesis work because the goal is to design the control strategy for the collective multi-robots system

independently from the kind of the considered robots. Consequently, the proposed generic approach handling the low-level control (e.g. at robot's level), usable independently of the kind of the considered robot, is in fact a key step to design the next higher-level control strategy for controlling the heterogeneous multi-robots system.

The next chapter focuses on how to control a rigid formation by using the last neuro-controller.



## Chapter 3. Control strategy for a Rigid Formation

### Robots Team

---

#### 3.1 Introduction

Followed by the work in Chapter 2, the thesis continued to study the control of the heterogeneous multi-robots system. Based on the conceptualization of the single robot control based on the learning frame, the Chapter 3 studied the ANFIS rigid formation control as well proposed the control strategy for the collective robots system. The control strategy has three parts: ANFIS rigid formation, perception system and path planning. The perception system is a part of the heterogeneous multi-robots system which can automatically provide the image of an unknown environment. And it can be implemented by a perception robot in any type. In the simulation of the thesis, it is materialized by a top camera. The path planning includes the image processing part and Q-learning part. By acquiring the environment's image from the perception robot, a supervisor operated the path planning and sent the optimal results to the group robots with a rigid formation. The ANFIS rigid formation control is based on the virtual structure control with the ANFIS method.

The three main common types of formation control approaches for the multi-robots system are the behavior-based approach, the leader–follower approach and the virtual structure approach. All of the three previous cited control formations have been studied in-depth. It must be noticed that these approaches have different emphasis and have various applications. The behavior-based approach mainly studied the collective robots, which has a large number of homogeneous robots. Therefore, it is belong to the collective robots control problem. These researches were focused on the study and the mimicry of behaviors from the biological societies, such as foraging, flocking, chaining, search, herding, aggregation, and containment. The other two types involve the formation control of a multi-robots system containing small number or several of robots. The leader-follower approach may be the most widely used to handle the formation control problems. In this mode of formation control, one or more robots act as a leader, the rest of robots act as the followers. The followers followed the leader with a variable geometry formation and they completed the complex tasks together.

In the thesis, it preferred the last type of approach in which a group of robots formed a certain geometry configuration. The group robots were regarded as a virtual single robot to avoid obstacles and accomplish the task. In the constrained configuration, each agent behaved as a particle in the structure. It is called rigid formation control in the thesis. The obvious

features of the rigid formation control are that it can get the action of the entire structure, and it needed less cooperation between agents than the other two types of formation control. As a virtual robot, the position control, orientation control and the trajectory control in the Chapter 2 can be increased to use in the rigid formation control. But there are still many specific problems to solve, first of all, how to control the integral formation; then, how to maintain the rigid formation and to rotate the rigid formation so as to avoidance, and so on.

Some of the references of the virtual structure control researches are briefly introduced as following. The approach proposed by Ogren et al. (Ogren et al., 2002) would fall into the category of “virtual structures.” The problem is addressed for a class of robots for which control Lyapunov functions can be found. The main result is a suite of theorems about formation maintenance, task completion time, and formation velocity. The virtual structure approach is introduced in the Young et al. (Young et al., 2001). It is used to perform the elementary formation maneuvers for mobile robots, where the group feedback incorporated of the followers to the virtual structure so as to improve the group stability and the robustness. In Ren & Beard (Ren & Beard, 2002), they also followed the idea of Young et al. (Young et al., 2001), and applied the formation feedback to spacecraft formation-flying scenario via the virtual structure approach. (Ren & Beard, 2004)

All of the mentioned methods require the feedbacks among the agents in the virtual structure. The thesis applied the ANFIS to the rigid formation control which is a neuro-fuzzy inference system based on the adaptive network. Therefore, it proposed a rigid formation control which is a kind of virtual structure control, and the rigid formation can be reconfigurable or be adjustable for the different demands. In the rigid formation control, every robot within the group robots is an independent entity whether in the control or in the motion. One robot in the group is the reference robot and all the other robots have to calculate their own position and orientation based on the reference robot with the current geometry structure. In comparison with the above methods, the prominent characteristic of my rigid formation control is that it controlled the integral formation, not a single or a part of the robots team throughout the process. The work is focused on the control of the group robots, rather than the individual robot. The group robots executed and completed the task together, such as the avoidance and the transport task. The group robots maintain and change the formation simultaneously without feedbacks from each other. And an obvious advantage of the ANFIS rigid formation control is that it can reduce the computing time which is used to maintain the formation through the communication, to do the task, to transform the formation and so on. And it is convenient to apply in case of no sensors and some special situations with the limitation of the communication.

The rigid formation control method proposed in the thesis can be simply expressed as follows: robots in a group learn as an entirety, and they execute the control individually and synchronously. During the process, there are no feedbacks or communications among group robots. From an industrial point of view, the method may be very interesting in the indoor or the outdoor environment. Effectively, sometimes these tasks need to design specific vehicles

according to some constraints which come from the object to carry. The use of a collective robots system is a very flexible solution to solve this kind of problem.

In the simulation, three two-wheeled robots form a rigid horizontal line shape. For the learning part and the control part, it must regard the formation as a virtual line-shaped single robot rather than individual. And the learning algorithm and the control strategy must be suitable for the formation. As the basic and the most important part of the navigation strategy, the formation will be explained in detail in this section, and how the formation has been used to the learning part as an integral.

### 3.2 The robot team's formation and action

The formation (see Fig. 21) is formed by three-wheeled robots moving in a plane. Each robot may be one non-holonomic robot (e.g. unicycle-type mobile) or other kinds (e.g. Omni-directional). The model used to describe the formation (represented on the Fig. 21) is based on the following concepts:

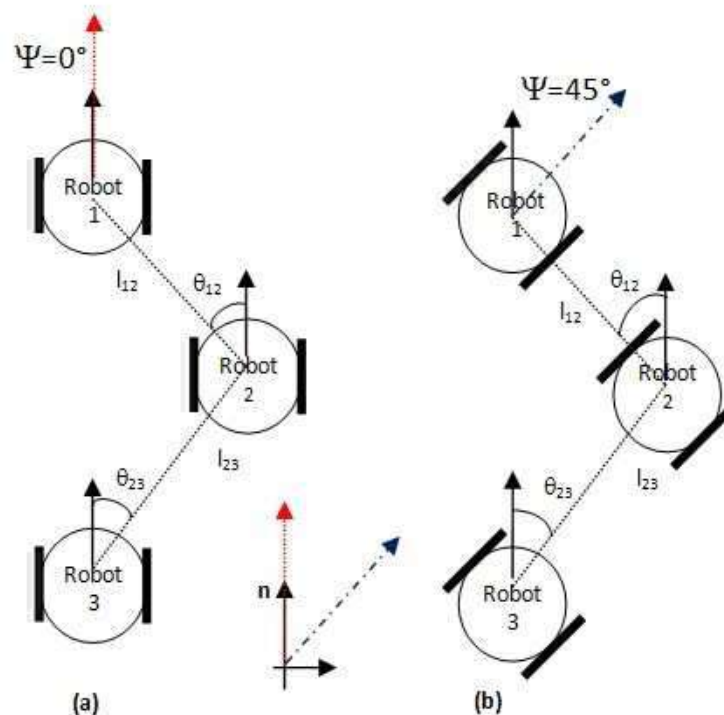

Figure 21: Schematic description of a rigid formation with three wheeled robots. The relative distance between two robots is a constant value and all robots are the same orientation ( $\psi = 0^\circ$  Fig. 21 (a),  $\psi = 45^\circ$  Fig. 21 (b)).

- There is a reference robot in the formation (e.g. robot 1 in the Fig. 21). The both position and orientation of this robot corresponds to the both position and orientation of the

formation according to an absolute frame. It must be pointed out that the reference robot is not necessarily a leader robot.

- The positions of the other robots  $i$  are defined according to the position of robots  $i-1$ . Two parameters are used to specify the position. There are the relative distance between two robots (e.g.  $l_{12}$  and  $l_{23}$  in the Fig. 21) and the absolute angle between the orientation of the robot and a normal direction (e.g.  $\theta_{12}$  and  $\theta_{23}$  in the Fig. 21).
- The formation is rigid which means that the relative distance between two robots is a constant value and all robots have the same orientation. It must be noticed that the orientation of formation ( $\psi$ ) is independent of the angle  $\phi$  used to describe the relative position between two robots ( $\psi = 0^\circ$  Fig. 21(a),  $\psi = 45^\circ$  Fig. 21(b)).

The state of the formation is given by the position of the reference robots (e.g. the robot number 1) and the orientation of the formation. It defined 8 possible orientations (see Fig. 22) dependent directly of the angle  $\theta$ :  $\theta = 0^\circ$  for the formation 1,  $\theta = 45^\circ$  for the formation 2,  $\theta = 90^\circ$  for the formation 3,  $\theta = 135^\circ$  and so on. Consequently, this orientation is independent of the angle  $\psi$ . For each orientation, it defined the height possible actions (from 1 to 8) (see Fig. 22). These actions correspond to the directions (angle  $\psi$ ) allowing to move the formation of robots. Two other actions allow doing a rotation of the formation (Action 9 and 10 are the clockwise and anti-clockwise rotation action respectively). Because we consider nonholonomic robots, if the rigid formation needed to move in a desired direction (for example formation 7 and action 3), each robot in the formation simultaneously rotated to the desired direction by using an orientation control and after go forwards in the desired direction.

According to the above definition, all the possibilities of the robot team's formation are covered by 8 formations. Among the robot team, robot 1 is the reference robot, and all the other robots must always maintain the fixed distance from it. And each robot must keep the fixed distance from other robots in the formation. The distance between any two robots is same. Suppose the distance between robot 1 and robot 2 is 0.3 cm, the distance between robot 1 and robot 3 must be 0.6 cm. And in any formation, the distance between robot and its adjacent robots must be 0.3 cm. From 1 to 8, formations can be applied to all kinds of physical environment.

In order to abstract out the actual possibilities of movement, the actions of robot team are classified into two types. The first type is translation (from 1 to 8, see in Fig. 23), and the other is rotation (action 9, 10 in Fig. 23). The translation actions mean that robot team can move in 8 directions by any kind of formation. Robots must keep the actual formation during the movement of translation action. If robot team needed to change the actual formation, they use rotation action in clockwise (action 9 in Fig. 23) or anti-clockwise (action 10 in Fig. 23). The process of rotation action can be depicted as: the reference robot rotates around itself, the other robots rotate clockwise or anti-clockwise around the of reference robot, the radius is the distance between themselves and the reference robot, and all the robots rotate simultaneously.

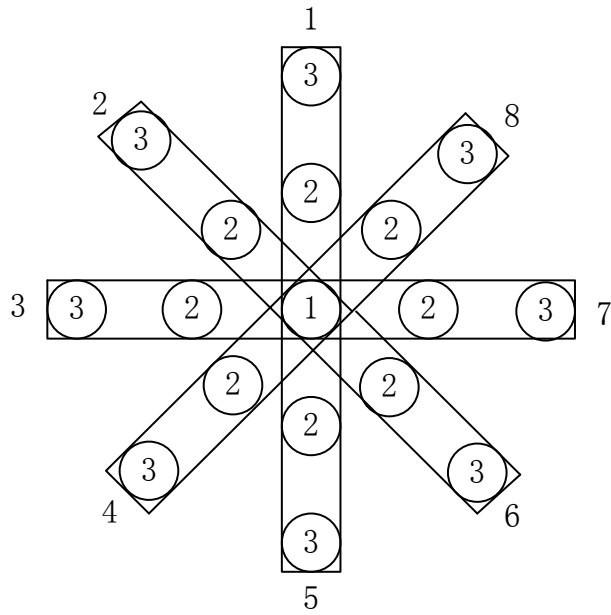

Figure 22: Schematic description of the 8 formations. The state of the formation is described by the position of the robot 1 and the orientation of the formation with the angle  $\theta$ .

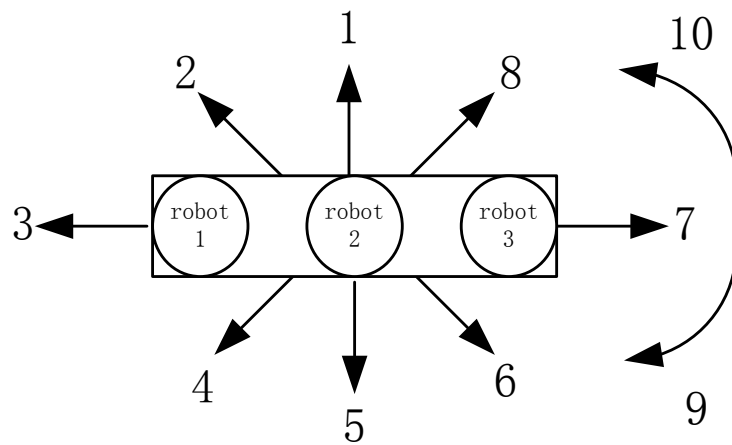

Figure 23: Actions used to control the formation. When the formation must move, all robots begin to rotate in the desired direction (angle  $\psi$ ) and after all robots go forwards simultaneously.

Either the clockwise rotation action or the anticlockwise rotation action, the robot team only rotates  $45^\circ$  (1 formation) in every rotation action movement. For example, if the current formation is 7, the action 9 will make the formation changed to 6, while action 10 will make the formation changed to 8. If it needs to 2 or more formation, the robot team will do continuous rotation actions. For example, from formation 7 to formation 5, the robot team will do 2 continuous clockwise rotation actions 9, 9.

The definition of the formation and action are abstracted from the physical movements in real environment. It is greatly convenient and reduced the workload of research from the theory to the practical research. It is a common model and can be used to the general study for the team robot with a rigid formation. The definition can be applied to any environment and amplified to more formations and actions depending on the requirements. Generally, in all previous publications about formation control, researches focused on the control of all robots in order to maintain the formation. In our opinion, we focus on how to control the formation and consider the formation as a virtual robot. Furthermore, suppose that there is virtual rigid links between all robots, all of robots perform the same task in synchronous manner. As a result, a rigid formation of robots can move between two points and avoid obstacles. In the chapter 2, the ANFIS is used to the trajectory control and the position control of the single non-holonomic mobile robot. Similar with the single robot, the rigid formation is regarded as an entire virtual robot. The position control of rigid formation is in Fig. 24. All the three robots use the position control separately at the same time. The inputs are the coordinate differences between the initial position A and final position B along with the X-axis and Y-axis. The output is the speed of both of wheels. Robots maintain the rigid formation by adapting parameters of ANFIS. During the movements, the robot team acts as a virtual structure with the rigid line formation.

In some cases, as the robot team encounters obstacles, it needs to change their formation in order to go across. An example is shown in Fig. 25, the diagram displayed that robot team transformed their formation from horizontal formation 7 to final formation 6. The process is composed of three separated movements but simultaneously. For robot 1, it is the reference robot, and it rotated around himself from initial  $N (-180^\circ)$  to the final  $N' (-45^\circ)$  ( $N$  is the direction north of the robot).  $G1$  and  $G2$  is the trajectory of robot 2 and robot 3 respectively.  $G1$  and  $G2$  are quarter sections of arc, and their centers is the robot 1's, their radii are 0.3 cm and 0.6 cm respectively, which are distances between themselves and reference robot. Synchronized with the reference robot, at first, robot 2 and robot 3 rotated from initial  $N (-180^\circ)$  to the opposite direction  $N (0^\circ)$  by the orientation ANFIS control (see Section 2.3.2) respectively, then they tracked their trajectories  $G1$  and  $G2$  separately. Finally, all the robots arrived at the final formation at the same time. In fact, the example showed a clockwise rotation action, the anti-clockwise rotation action is similar. In the process, the reference robot rotated from beginning to the end. The other robots firstly rotated to the direction which is opposite to the formation (depend on the clockwise and anti-clockwise), then they went on to follow their arc trajectories. During the movements, robots' motion is synchronized.

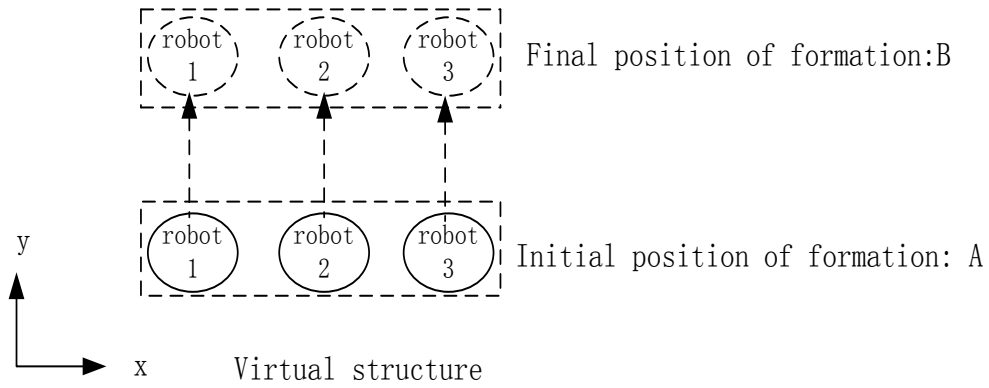

Figure 24: Position control of formation of robot team

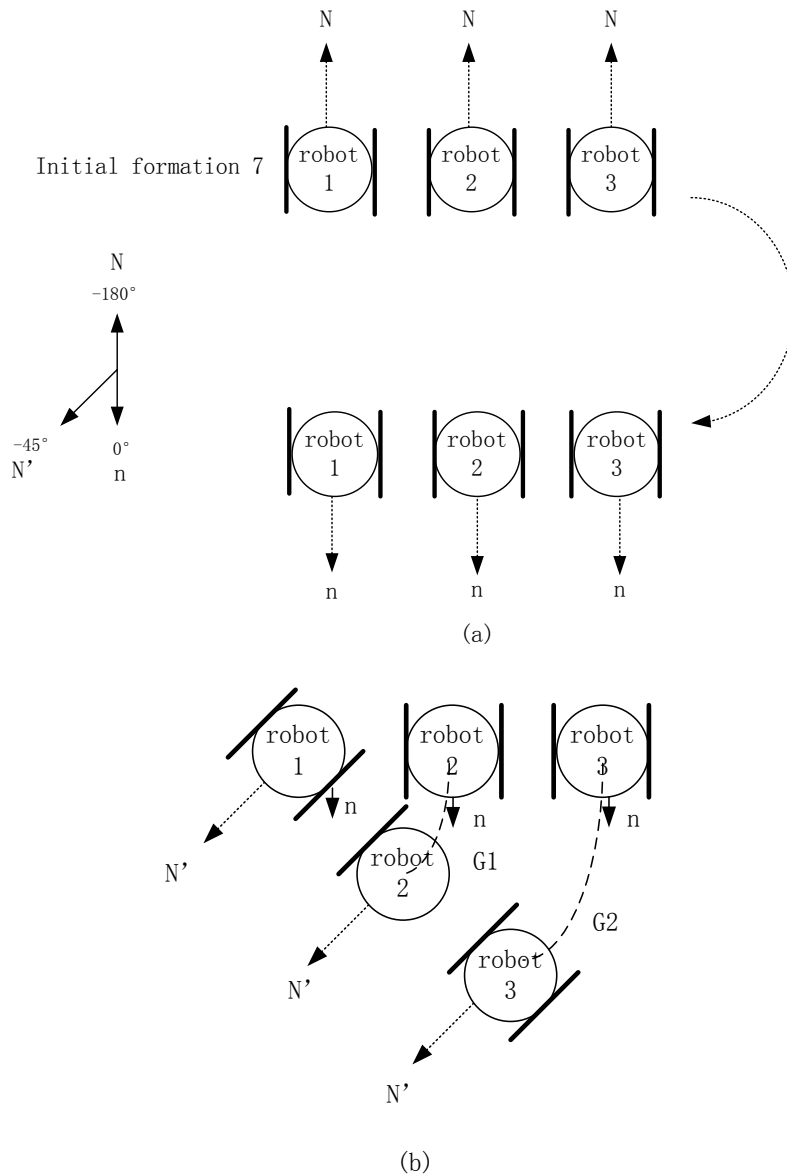

Figure 25: Diagram of changing formation. (a) Three robots rotate around themselves synchronous from  $-180^\circ$  to  $0^\circ$ ; (b) The reference robot rotate itself from  $0^\circ$  to  $-45^\circ$ , the other robots follow the trajectory G1 and G2 respectively.

## 3.3 Path planning

### 3.3.1 Brief Introduction of the Path Planning

The rise of path planning research in the field of mobile robot has been focused on the interactive virtual environment (LaVall, 2010; Peng et al., 2009; Karamouzas & Overmars, 2008; Karamouzas, 2009; Jung, 2004) in recent years. Generally, the path planning is usually classified into two categories. The first category depends on the full environment model and the complete environmental information; the second is based on sensors since the mobile robot does not master the full environmental information. Plenty of approaches are studied, such as the map-based navigation approach (Yagi, 1995; Gutmann, 2005), the environment database navigation approach (Wang et al., 1999), the virtual force field method (Borestein & Koren, 1989), the edge detection method (Borestein & Koren, 1988), the wall following method (Bauzil et al, 1981), the fuzzy reasoning, the neural network approach, and the genetic approach (Kimura et al., 1993; Wu et al., 2006; Griffiths, 1997; Wan et al., 2003; Wang et al., 1999), A\* search algorithm (Richards et al., 2004; Wang et al., 2010), etc. The purpose of a path planning method for a mobile construction robot is to find a continuous collision free path from the initial position of the construction robot to its target position (Kim et al., 2003).

The path planning is a very important part in any navigation strategy. In the thesis, the path planning problem is how to keep a team of robots with a rigid formation in order to reach the target. For us, the path planning for a rigid formation robot team, it needs not only to satisfy the avoidance of any robot member, but also to take into account the formation of the integral robot team. Therefore, for a multi-robots team, the path planning is to find an optimal policy which makes the multi-robots team navigate freely and automatically from the start point to the goal point. In this case, we need the optimal results including both the optimal path and the optimal formation of the robot team. That is, we must find a path planning strategy for the rigid formation team, not only for a single non-holonomic robot as above-mentioned methods. And our path planning strategy cannot rely on the complete environmental information.

Based on the previous description of our control strategy for the formation of robots, the problem is now how to compute the path planning (to find action like forwards, left, and so on) to move the formation from an initial point to a goal point in the unknown environment. In order to design an on-line approach for real application, the concept is on two levels. The first one allows getting the equivalent quantified environment and the second one carry out a learning process in order to find the set of the best actions. To facilitate a better understanding and interpretation, a program has been shown as an example. The unknown environment is a square area with sides of 3 meters (in Fig. 26), the floor is the yellow wooden area.





Figure 26: Picture of the virtual environment given by a virtual camera located at the top of environment.

Four small black obstacles locate in the four corners of room and the largest one locates in the center. The unknown room is enclosed by the walls which are the red frame in Fig. 26. Robots line up with a rigid formation in the upper right of the room. Suppose the final position is in the upper left, robots still form a horizontal line but on the opposite direction formation. How can the robots navigate with the rigid formation from the initial position to the final position? And how do they change their initial formation to the final opposite one? This is the path planning problem. In the offline navigation strategy, the specific procedure of solutions of the path planning problem is involving two parts: the image processing and the Q learning. Through the path planning, robots get the optimal path from the initial position to the final position. By the learning results, robots use ANFIS formation control to navigate together with the rigid formation in the unknown environment.

### 3.3.2 Q learning

Reinforcement learning is the problem faced by an agent that must learn the behaviors through trial and error interactions with a dynamic environment. It has been developed for the discrete case and assumed that the entire state space can be enumerated and stored in memory. There are two main strategies for solving reinforcement learning problems. One is to search in the space of behaviors in order to find one that performs well in the environment. The work in genetic algorithms and genetic programming are based on one of this strategy. The other one is to use statistical techniques and dynamic programming methods to estimate the utility of taking actions in states of the world. One of the most important breakthroughs in the reinforcement learning was the development of an off-policy TD control algorithm known as Q-learning

(Watkins, 1989). Q learning is one of those for which the theory is most advanced and for which proofs of convergence exist. It does not require the knowledge of probability transitions from a state to another and is model-free.

Having been noted in the section 3.3.1, the environment (Fig. 26) may be described by a matrix E (10×10). This matrix contains information about the position of the obstacles. But, it is not sufficient to describe the full state S. In this case, each state should contain the information which is composed of two sides, the position of the reference robot, and the kind of the formation. Consequently, the size of the set S is equal to 10 × 10 × 8. On the basis of the last description of the state S, and being given that we consider the formation as a single robot, it is possible to look for the succession of actions in order to move the formation from the point A to another point B. To solve this problem, one solution consisted to use the reinforcement learning. The goal of the reinforcement learning algorithm is to find the action which maximizes a reinforcement signal. The reinforcement signal provided an indication of the interest of last chosen actions. Q-Learning, proposed by Watkins (Sutton & Barto, 1998), is a very interesting way to use the reinforcement learning strategy. The Q-Learning algorithm developed by Watkins is based on (26) and assumes that the whole state space can be enumerated and stored in a memory.

$$Q(S, A) = (1 - \beta)(Q(S, A) + \beta[r + \gamma \max(S', A')]) \quad (26)$$

In order to learn the formation as a whole, the state S is including:

- robot's coordinate information (state\_x and state\_y);
- formation information (state\_f).

And the triples (state\_x, state\_y, state\_f) form a three-dimensional array. The best action A' will be chosen the one to get the max Q value and to reach the fastest to the goal point by the current formation and action A in the current state S, and the new state is the S'. The formation has two types of action, the translation action and the rotation actions. If the best action A' is 9 or 10, the formation needs to change the current formation clockwise or anti-clockwise. Otherwise, the formation translates directly with the action's orientation.

In (26), the parameter  $\gamma$  can be chosen in [0, 1]. If  $\gamma$  is close to 0, the robot will tend to consider only the immediate reward r. If  $\gamma$  is closer to 1, the robot will consider the future rewards with greater weight.  $\beta$  is the learning rate. The update corresponds to the barycenter

of the old and the new rewards, weighted by  $\beta$ .

In (26), r indicates the rewards for the actions with respect to the current S. The regulations of rewards are as follows:

- i. If the selected action makes any robot in the rigid formation exceed the world,  $r = -100$ ;

- ii. If the selected action makes any robot in the rigid formation meet obstacles, break,  $r = -100$ ;
- iii. Otherwise,  $r$  is the distance between the position of standard robot and the final position (see (27)).

$$r = \sqrt{(X - X^d)^2 + (Y - Y^d)^2}. \quad (27)$$

*The Q-Learning algorithm is as follow:*

1. *Initialize  $Q(S, A)$  arbitrarily.*
2. *Repeat (for each episode):*
  - (a) *Initialize the state  $S$ ;*
  - (b) *Repeat (for each step of episode):*
    - *Choose action from  $Q(S,A)$  using  $\epsilon$ -greedy algorithm*

*$S'$*

After the learning process, the optimal results of path planning include not only the optimal action in each state but also the optimal formation in the same state. The learning process is not for the single robot but for the formation. That is, if any robot of the robot team with current formation, and with the current selected action will result collisions, the formation or the action will be eliminated. If and only if all the robots of the team can pass, the action and formation can be chosen in the current state. As the learning algorithm, the optimal policy can be found from the initial state to the final state, and in each state of the policy has the information of action and formation. Wherefore the learning results are also the optimal results for the formation. And in fact, we modify the Q learning algorithm to the formation learning rather than the single robot learning.

## 3.4 Simulation and the Real Experiment

### 3.4.1 Image Processing and the Learning Results

In order to get automatically numerical information allowing representing environment, we have developed an approach based on image processing. This procedure uses the following process:

- Take the photo of the environment (see Fig. 27). It should be noticed that in order to simplify, in the first time, it consider that there is a virtual camera located at the top of environment.
- Modify the RGB image to the gray scale image, and convert the gray image into a binary image with a suitable threshold value (see Fig. 27).
- The last step allows describing environment by a binary matrix E (see (28)), in which 1 represents obstacles and 0 is free path.

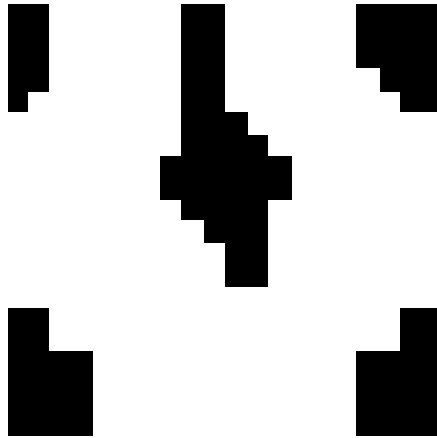

Figure 27: Binary representation of the environment: the white is a free path and the black indicates obstacles.

$$E = \begin{bmatrix} 1 & 0 & 0 & 0 & 1 & 0 & 0 & 0 & 1 & 1 \\ 1 & 0 & 0 & 0 & 1 & 0 & 0 & 0 & 1 & 1 \\ 1 & 0 & 0 & 0 & 1 & 1 & 0 & 0 & 0 & 1 \\ 0 & 0 & 0 & 1 & 1 & 1 & 1 & 0 & 0 & 0 \\ 0 & 0 & 0 & 1 & 1 & 1 & 1 & 0 & 0 & 0 \\ 0 & 0 & 0 & 0 & 1 & 1 & 0 & 0 & 0 & 0 \\ 0 & 0 & 0 & 0 & 0 & 1 & 0 & 0 & 0 & 0 \\ 1 & 0 & 0 & 0 & 0 & 0 & 0 & 0 & 0 & 1 \\ 1 & 1 & 0 & 0 & 0 & 0 & 0 & 0 & 1 & 1 \\ 1 & 1 & 0 & 0 & 0 & 0 & 0 & 0 & 1 & 1 \end{bmatrix} \quad (28)$$

After the image processing, it is possible to get the equivalent quantified environment which is designed by a quantification of the real environment (see Fig. 28). In the example, the environment is divided into 100 states where each state is a square with sides 30cm. For the quantified environment, the obstacles are marked with red stars. The formation is composed with a reference robot (the robot 1 represented like a solid black dot on the Fig.28) and other robots (robot 2 and 3 represented like black circle). In the initial position, the robots locate in the position A which is in the state [6; 10] with formation 7. The final state position B is in state

[4; 10] with formation 3. Assume that robots situate in the center of the state and they can only move from one center of state to the center of the other state.

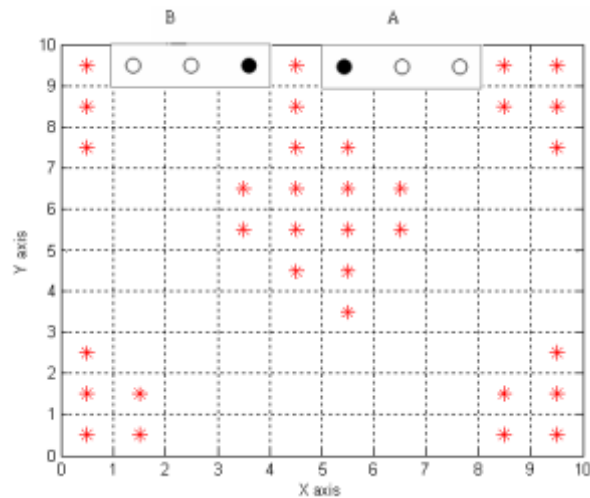

Figure 28: Equivalent quantified environment representation: the obstacles are marked with red stars, the reference robot is represented like a solid black dot and other robots represented like black circle.

Now, the aim is to find a solution allowing to move the three robots from point A to point B in conserving a virtual rigid formation(a line in this case).

### 3.4.2 Simulation Results of Three KheperaIII Robots

In this section, we present results of simulation for the example described in the beginning of the chapter. The frame of the simulated environment is composed of three robots KheperaIII([www.k-team.com/](http://www.k-team.com/)) and a top camera. Simulations have been performed by using software Webots ([www.cyberbotics.com/](http://www.cyberbotics.com/)) and controllers have been designed with the software Matlab ([www.mathworks.com/](http://www.mathworks.com/)) (see Fig. 29).

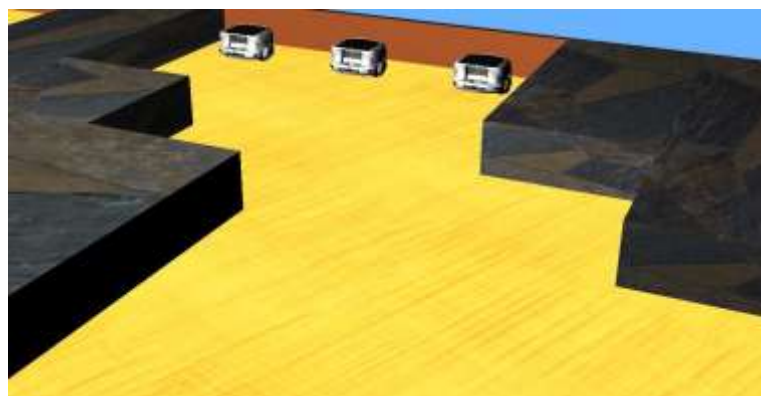

Figure 29: Simulations have been performed by using software Webots and controllers have been designed with the software Matlab.

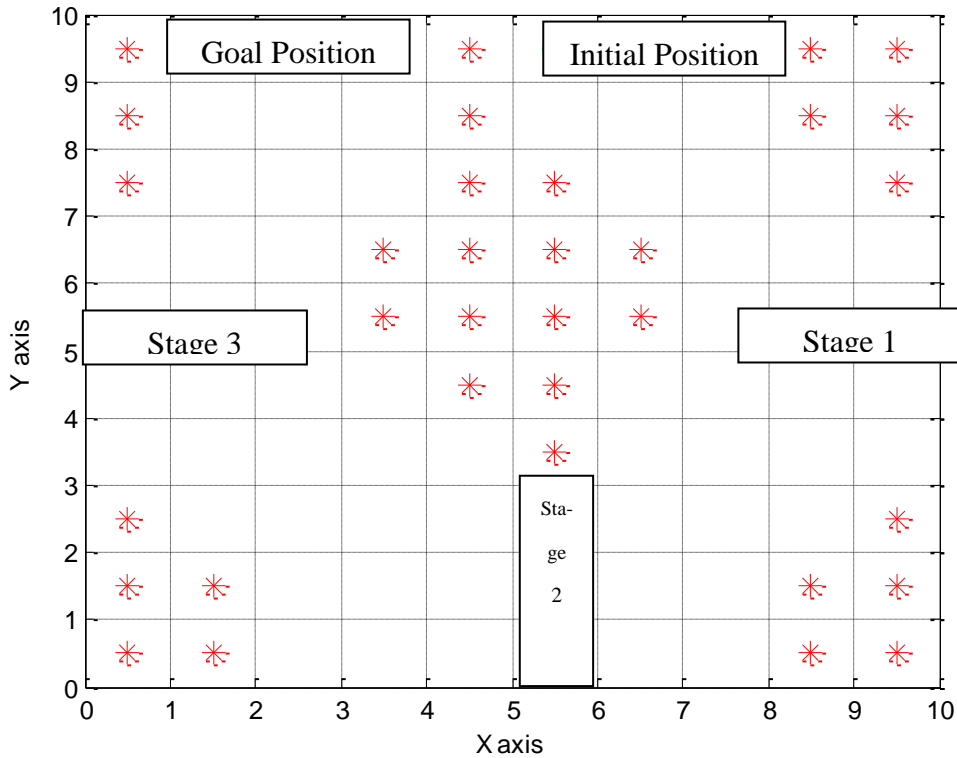

Figure 30: Simulations have been performed by using software Webots and controllers have been designed with the software Matlab.

The path planning showed in Fig. 30, the whole process consisted of four stages. As described in the previous section, the world is a square with 3 meters sides. This world is divided into 100 small squares, where each squares (0.3x0.3 m) represent possible position of one robot. Concerning to the KheperaIII, the situation was supposed that the robots' center located at the center of the square. And suppose that the standard robot 1 permanently moves from the center in one position to another. The other two robots rotate around the standard robot so as to change the formation. The radii are 0.3m and 0.6m by taking the reference robot as the reference frame. For the whole process, the robots run the same operation at the same time. Detailed explanations are in the following sections.

### Movements of Stage I

The path planning of stage I displayed in the left part of Fig. 31 and the corresponding simulations are in the right part of Fig. 31. The initial position of the stage I is [6; 10] with formation 7, which are green circles (see Fig. 31(a)) and the reference robot is a circle with dot. The black stars are the decompositions of the path planning (see the left part of Fig. 31(b) to the left part of Fig. 31(c)). The final position of stage I is [8; 6] with formation 7, which are blue circles (see the left part of Fig. 31(c)). All the optimal actions are translation actions: 5 6 6 5 (see the left part from Fig. 31(a) to Fig. 31(c)) and the simulations are in the right part from Fig. 31(a) to Fig. 31(c).

## Movements of stage II

The path planning of stage II is made up of two phases. The former included two continuous clockwise rotation actions and the latter is a translation action phase. The path planning and simulations showed in Fig. 32 and Fig.33 respectively. The initial position of stage I is [8; 6] with formation 7 (see the left part of the Fig. 32(a)), the movements are two rotation actions 9 (see the left part of Fig. 32(b)), and the final position of the phase I is [8; 6] with formation 5 (see the left part of Fig. 32(c)). The simulation of the first phrase is in the right part of the Fig. 32(in the right part from Fig.32 (a) to Fig.32(c)). The initial position of phase II is [8; 6] with formation 5 (see Fig. 33(a)), the movements are translation actions: 4 5 4 (see in the left part of Fig. 33(b) and Fig. 33(c)), and the final position of the stage II is [6; 3] with formation 5 (see the left part of Fig. 33(c)). The detailed simulations of the second phrase are displayed in the right part of the Fig.33 (in the right part from Fig.33 (a) to Fig.33(c)).

## Movement of stage III

The movement in the stage III is the combination of both the clockwise rotation action and translation action. The initial position of stage III is [6; 3] with formation 5 (see the left part of Fig. 34(a)), the movements are actions: 2 9 9 2 (see in the left part of Fig. 34(b) and Fig. 34(c)), and the final position of the stage is [4; 5] with formation 3 (see the left part of Fig. 34(c)). The decompositions of simulation are displayed in the right part of Fig. 34(in the right part from Fig.34 (a) to Fig.34(c)).

## Movement of stage IV

The movement in the stage IV is quite simple and there are five continuous translation actions in it. The initial position of stage IV is [4; 5] with formation 3 (see the left part of Fig. 35(a)), the translation actions are: 2 1 8 1 1 (see from the left part of the Fig. 35(b) to the left part of the Fig. 35(c)), and the final position of the stage is [4; 10] with formation 3 (see the left part of the Fig. 35(c)). The corresponding simulations are displayed in the right part of Fig. 35 (in the right part from Fig.35 (a) to Fig.35(c)) and robot team arrives at the final position after a series of movement.

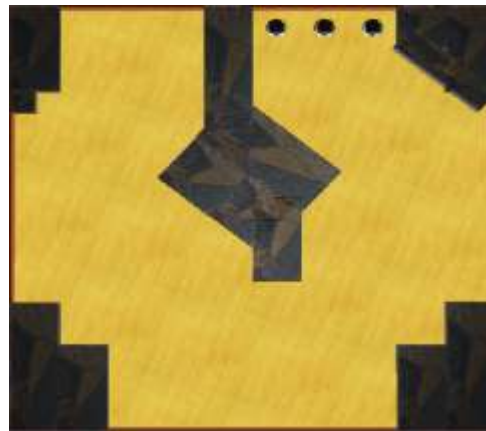
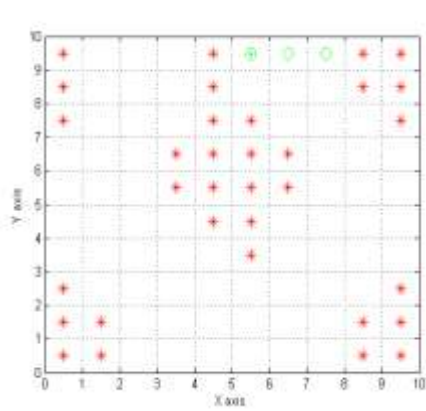

(a)

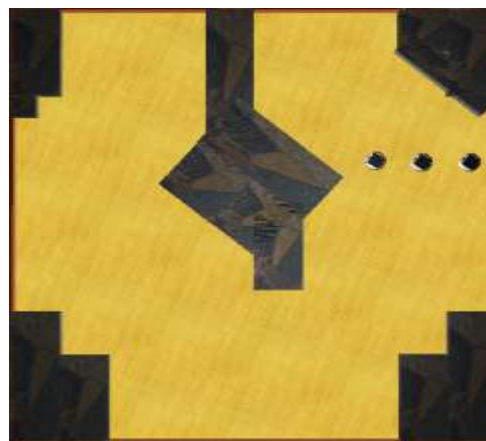
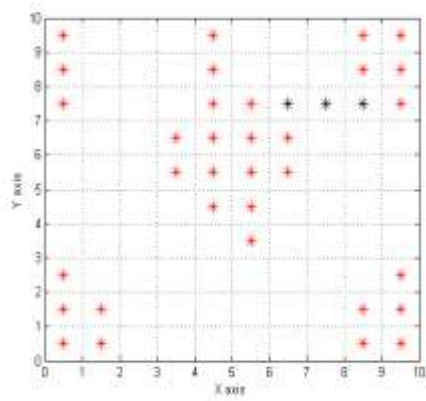

(b)

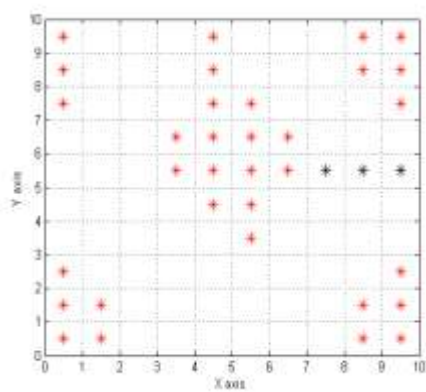

(c)

Figure 31: Path planning (left) and simulation results (right) of stage I



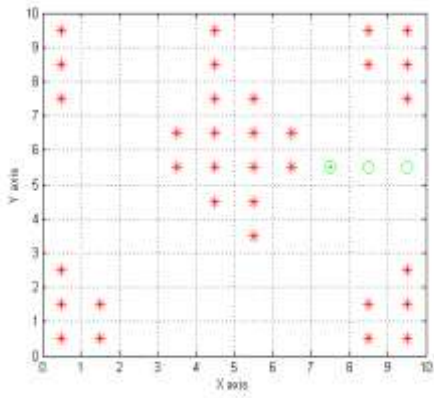

(a)

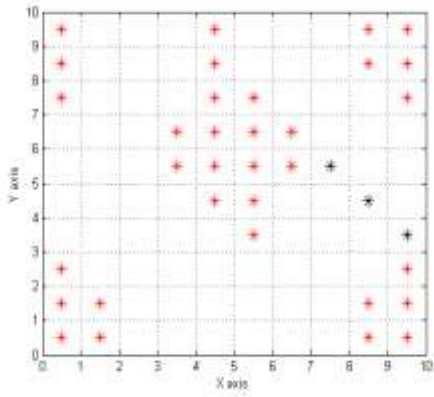

(b)

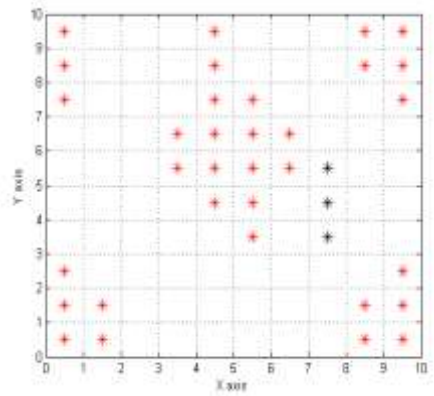

(c)

Figure 32: Path planning (left) and simulation results (right) of stage II: Phrase I

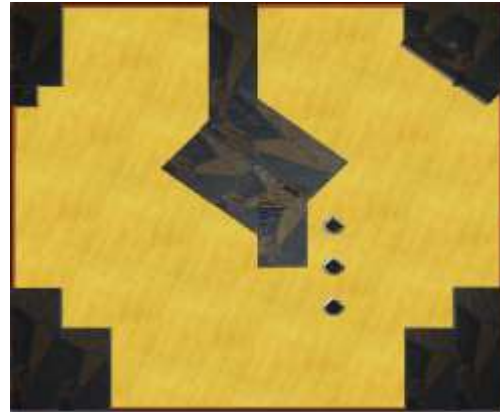
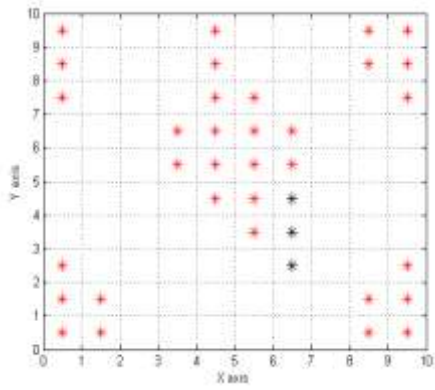

(a)

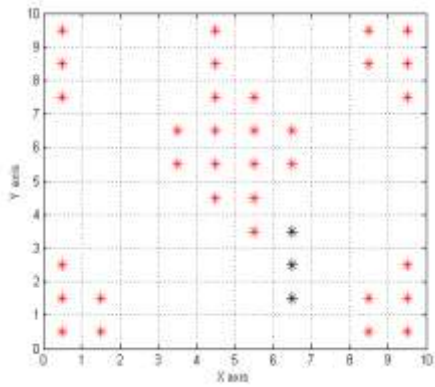

(b)

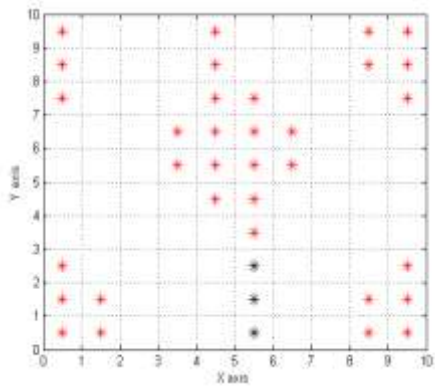

(c)

Figure 33: Path planning (left) and simulation results (right) of stage II: Phrase II

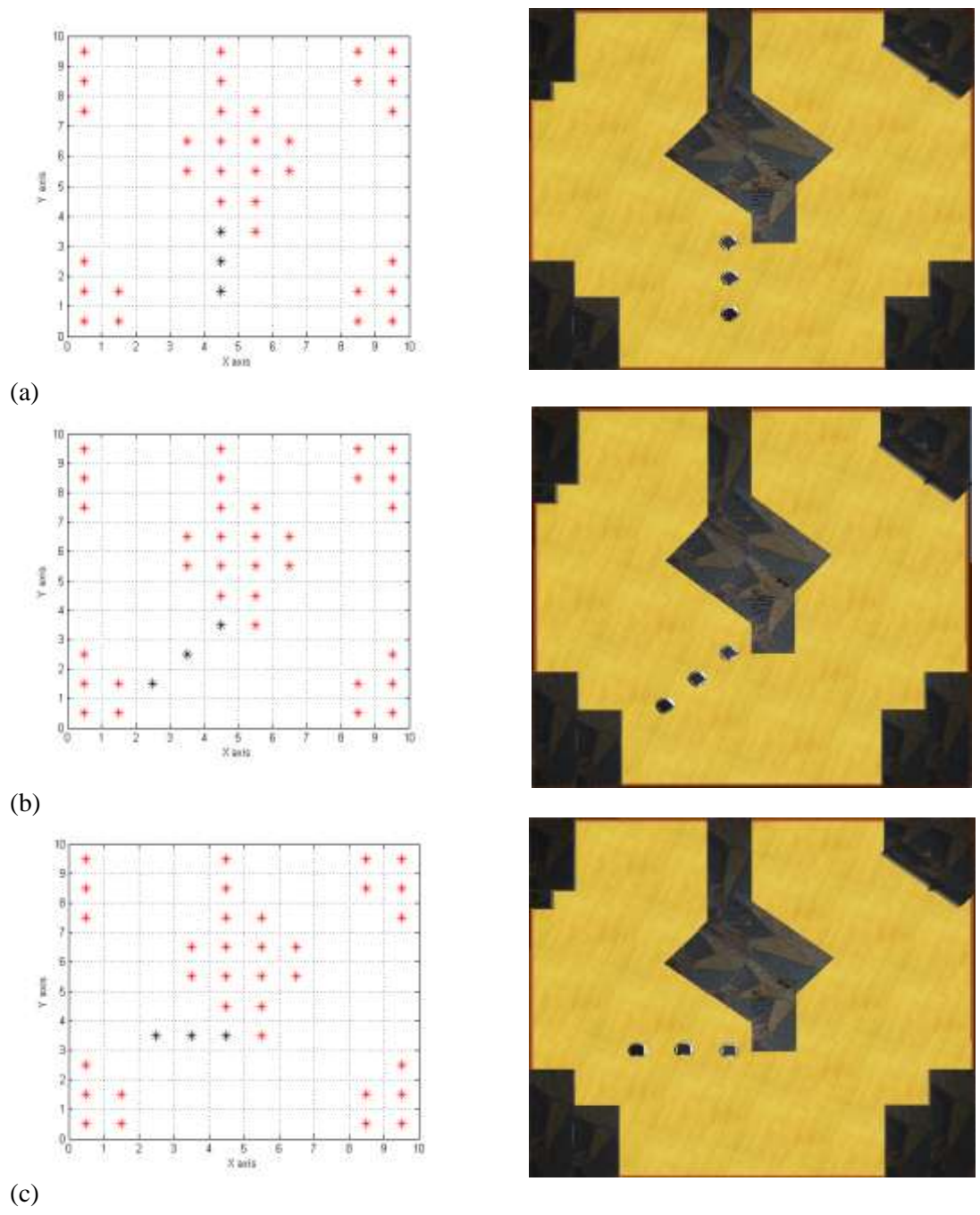
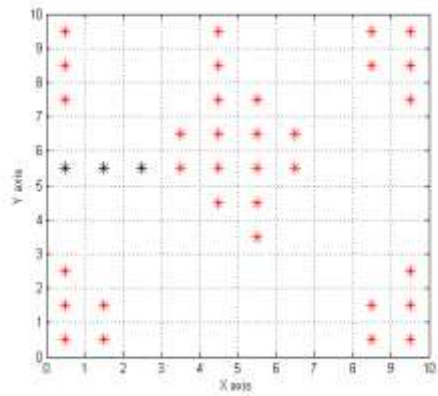
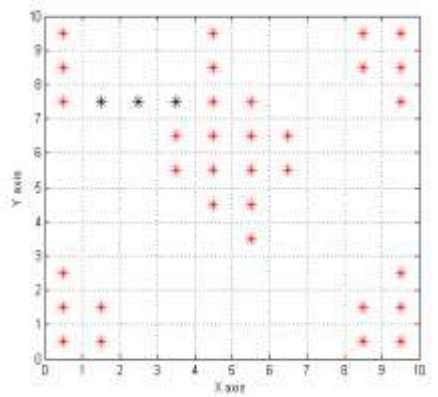

Figure 34: path planning of stage III



(a)



(b)

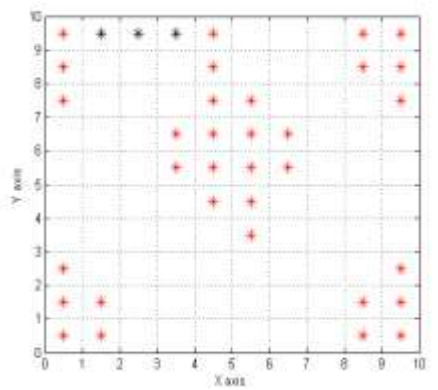

(c)

Figure 35: simulation of stage IV

### 3.4.3 Experiment with two real robots

#### 3.4.3.1 Introduction of the experiment

The experiment is a verification of the previous navigation strategy for two robots within a constrained virtual structure in an unknown environment. In this experiment, two two-wheeled robots form a vertical line shape, crossed through an unknown environment. The white paper takes the role of obstacles and a top camera hang above the environment. The goal is to deliver a rectangular box by two robots from the entrance to the exit.

The strategy can be generally described as: (1) Take the information about unknown environment from top camera and transfer to robots; (2) Set the final position and apply the virtual structure Q learning; (3) Use the ANFIS control to guide robots depending on the results of path planning; (4) Robots transport the box out of the area enclosed by the paper. During the process, robots learn and control separately and synchronous without communication between each other.

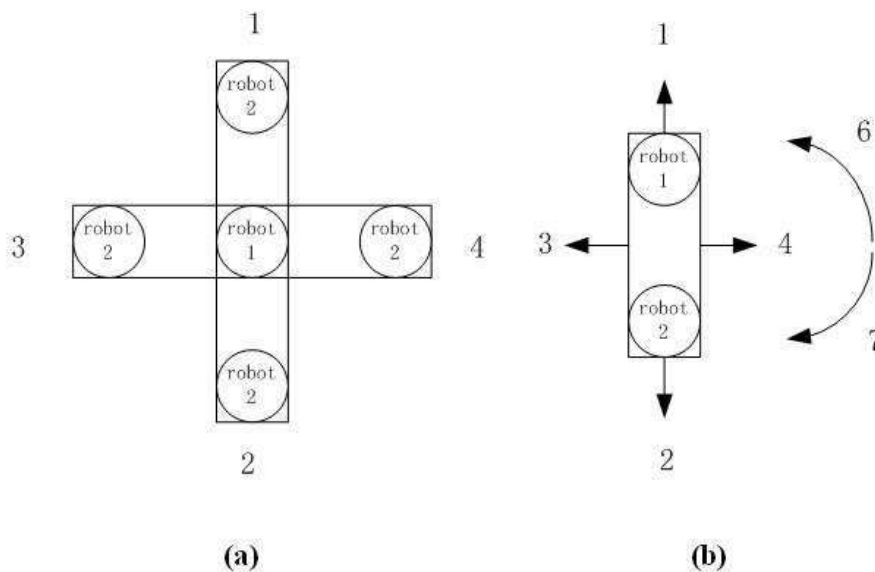

Figure 36: Actions used to control the formation during the experimental validation

#### 3.4.3.2 Path planning

An experiment has been done (A video of this experiment can be found to the following address [http://www.youtube.com/watch?v=cle6n\\_sVRxM](http://www.youtube.com/watch?v=cle6n_sVRxM)) in the real environment so as to prove the feasibility of the strategy. In the real experiment, it simplified the actions and formations as showed in Fig. 36. In comparison to the simulation, there are only four actions, go forwards, go backwards, go left and go right.

The Fig.37 showed the real environment used during the experimental validation. This experimentation used two KhperaIII, a camera and a computer for the remote control of the both camera and robots. The top camera is placed at the 2 m height. The real environment is a 1.5 m wide and 2.1 m long rectangular floor and some paper play the role of obstacles. The environment is separated into 35 states and each state is a 30 cm side square. The image processing is executed in C, the path planning and the robot's control is executed in Matlab. The connection between robots and computer is WIFI, and robots can receive the real-time command transmitted from computer.

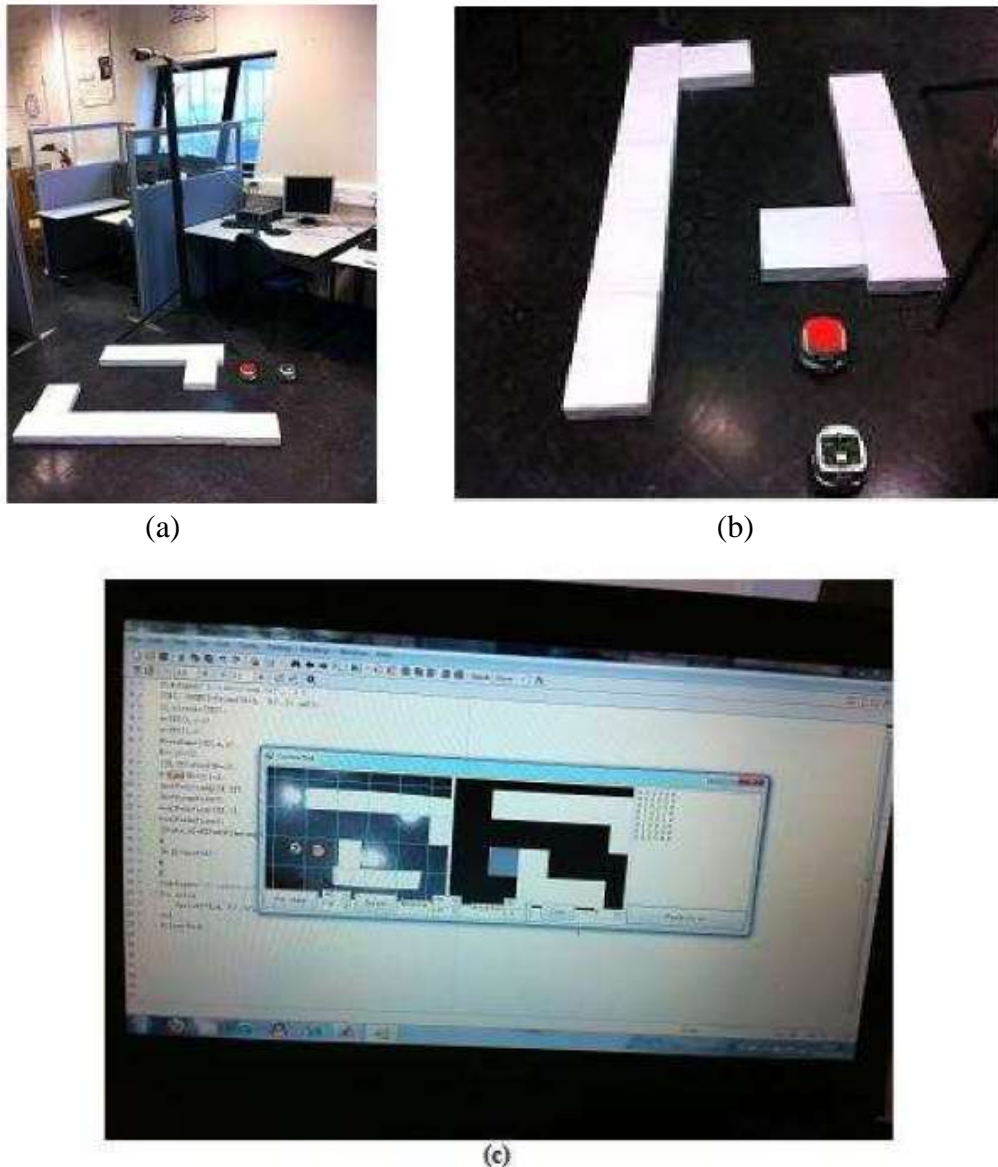

Figure 37: Description of the experimental validation. During this experimentation, we use two robots, a camera to get binary environment and a computer for the remote control.

In the experiment, the computer got image from the top camera. After the operation of image processing with C, it saved the information in a text file and emitted it to the path planning part. In the path planning part, it received the text file at first, and then this module

selected the final state, applied the virtual structure Q learning to get the optimal action and formation in each state from initial state to the final state. At last, saving the results of path planning to another text file, it emitted the new text file back to the computer, and the computer gave commands to move robots.

The information from the top camera is as follow (see in the screen in Fig. 37(c)):

```

0 0 0 0 0 0 0 0
0 0 1 1 1 1 1 0
0 0 0 0 0 0 1 0
0 0 2 1 0 0 0 0
0 0 0 1 1 1 0 6
0 0 0 0 0 0 0 8

```

Where 2 indicates the initial position of robots, 6 and 8 represents the size of the text. Since it is real-time results, the results vary over time. In this case, one more line is added to transfer the size of the image. The area of the unknown environment should be  $(6-1) \times (8-1)$ . As shown in Fig.38, the initial position and final position of robots are  $[4; 3]$  and  $[4; 6]$ . And after the matrix operation with Matlab, the information of the environment matrix E from the top camera is given by Eq. 29.

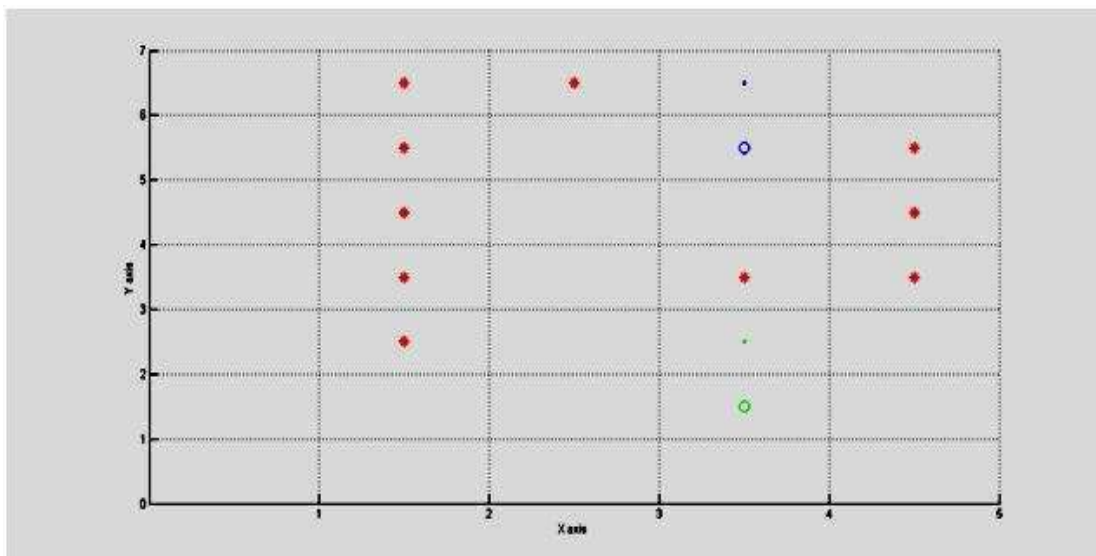

Figure 38: Binary environment of the experimental validation.

$$E = \begin{bmatrix} 0 & 0 & 0 & 0 & 0 & 0 & 0 \\ 0 & 0 & 1 & 1 & 1 & 1 & 1 \\ 0 & 0 & 0 & 0 & 0 & 0 & 1 \\ 0 & 0 & 0 & 1 & 0 & 0 & 0 \\ 0 & 0 & 0 & 1 & 1 & 1 & 0 \end{bmatrix} \quad (29)$$

The results of states of path planning are  $[4; 3] \rightarrow [3; 3] \rightarrow [3; 4] \rightarrow [3; 5] \rightarrow [3; 6] \rightarrow [4; 6]$ . The corresponding actions are  $3 \rightarrow 1 \rightarrow 1 \rightarrow 4 \rightarrow 1$ . In the process, robots maintain the vertical formation 2 from beginning to the end.

### 3.4.4 Experiment results

The results of experiment showed in Fig.39 and Fig.40 (without and with load respectively). The initial position is in Fig. 39 (a) & Fig. 40(a). Robots began to turn left and reached to the entrance of obstacles (see Fig. 39(b) & Fig. 40(b)). Then robots went forwards for three states. This process showed in Fig. 39(c) & Fig. 40(c), and Fig. 39(d) & Fig. 40(d). Robots turned to right in Fig. 39(e) & Fig. 40(e), and went straight ahead in the last step. The final position showed in Fig. 39(f) & Fig. 40(f).

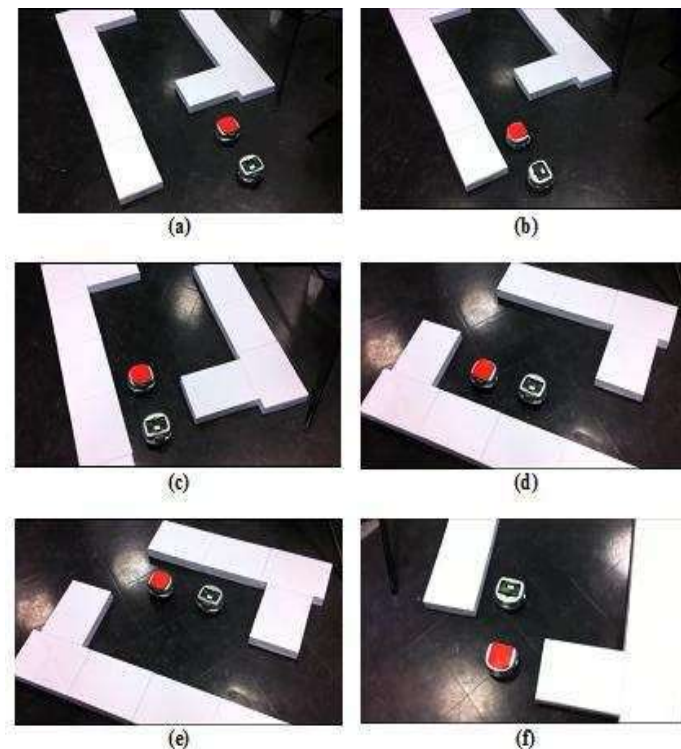

Figure 39: Snapshot of experimental results where the two robots move in formation.



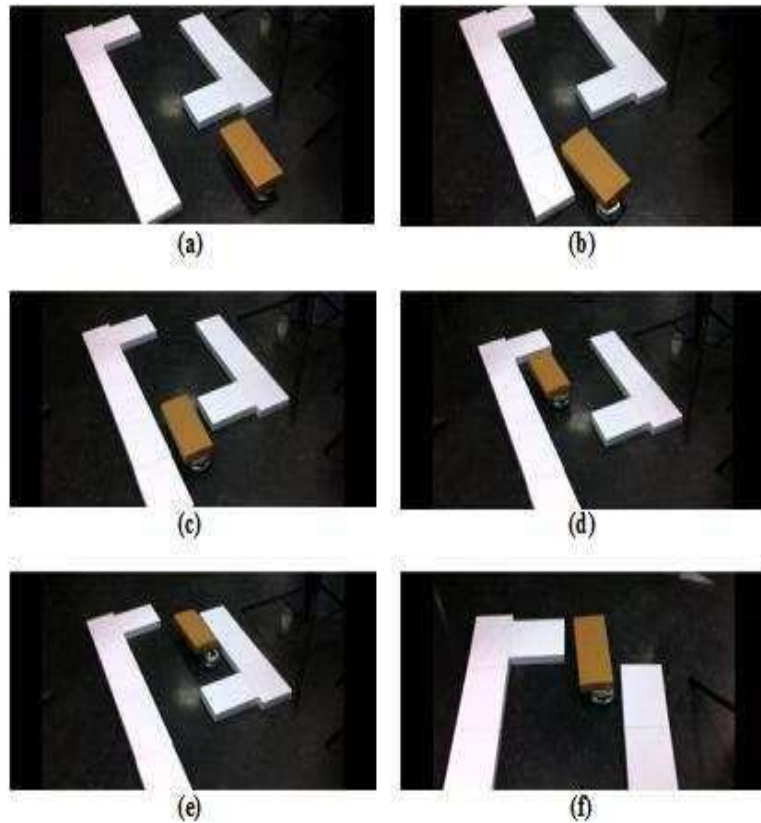

Figure 40: Snapshot of experimental of transportation application.

### 3.5 Conclusion

In this chapter, the control strategy for the collective robots system (particular discussed the heterogeneous multi-robots system) has been clarified and introduced in details. The control strategy involves ANFIS rigid formation control, perception system and the path planning. The chapter is focused on revealing the application of the control strategy for a heterogeneous multi-robots system to navigate in an unknown environment and to accomplish the transportation tasks. The control strategy is based on machine learning intelligence.

At first, the chapter discussed the formation control of the multi-robots system. Generally, there are three classes of formation control, the leader-follower, the behavior-based and the virtual structure. Plenty of researches have been studied in the application of three classes, and each type has its own advantages and disadvantages. The thesis is focused on the virtual structure formation control for the purpose of the logistic application. The rigid formation control refers to the control of a group of robots formed a geometry structure and they are viewed as a virtual rigid structure. The rigid line-shaped formation is demonstrated as an example, and the formation control has been explained in details in the chapter. Through the work for a virtual single robot based on the machine learning in the Chapter 2, the ANFIS is go

on to be applied in the rigid formation control. By the translation action and rotate action, robots use ANFIS rigid formation control to avoid obstacles.

The second part of the chapter is introduced the path planning which is based on the image processing and Q-learning. A perception system is introduced as a part of the heterogeneous robots team, which is implemented by a top camera robot in the thesis. A computer acted as a virtual supervisor robot. The image can be obtained from the top camera robot and is converted to the binary image. The supervisor executed the Q-learning with the binary image and sent the optimal path and optimal formation to the heterogeneous multi-robots system. With respect to the optimal results from the path planning, heterogeneous multi-robots system detected the unknown environment and avoided obstacles. The simulation is demonstrated with detailed explanations. Both the path planning results and simulation results are displayed in the process of four stages. And it provided the detailed explanations for the specific movements. From the results, a conclusion can be drawn that the control strategy can be applied to the heterogeneous multi-robots system navigating in an unknown environment. In the navigation, it included the translation movements and changing formation motions in order to avoid obstacles.

An experiment is also demonstrated as a validation of the control strategy for the logistic application. The two KheperaIII's formed a rigid vertical line-shaped formation aim to transport a long paper box crossing through an unknown area. The purpose is to transport the long paper box from the entrance to the exit in a rectangular area enclosed by the white paper. To simplify the problem in the real experiment, the formations and actions are reduced to four possible directions, up, down, left and right. Through the control strategy, a series of operations, such as perception, path planning, image processing, Q learning and ANFIS rigid formation control, two KheperaIII's successfully conveyed the long paper box to the destination. It verified that the control strategy can be applied to transport objects for the real logistic application.

## Chapter 4. Heterogeneous multi-robotic system in the field of logistic application

---

### 4.1 Introduction

After the simulation and the real experiment validation of the control strategy in an unknown environment, the thesis enhanced the control strategy by the introduction of an event-based coordination strategy and the Petri net. By the event-based coordination strategy, the control strategy can be applied in a dynamic environment. The dynamic environment represents that there is a disturbance of the current environment. The disturbance can be an added obstacle or another environment. To achieve the adaptation, a local supervisor is introduced in the heterogeneous multi-robots team to sentence whether there are obstacles or not in the front area at the beginning of each time step. If the environment is perturbed by a sudden event, the controller will be switched by a global supervisor so as to be adaptive with the changed environment. In the simulation and the real experiment, a humanoid Nao acted as a local supervisor to detect the obstacles at start of each time step. A computer played the role of a virtual global supervisor robot. The details is demonstrated and explained in details in the chapter. And the validation can be used to transportation task for the logistic application.

Multi-robots systems can achieve plenty of complex tasks effectively which cannot be accomplished by a single robot without the cooperation and the coordination among robots. Some examples of the cooperative manipulation and transportation are studied by Berman et al. and Yamashita et al. (Berman et al., 2003; Yamashita et al., 2003), pushing problem had been studied by Mataric et al. and Parker (Mataric et al., 1995; Parker, 1998); other examples of moving in formation or transportation are addressed by many researchers (Balch & Arkin, 1998; Beard et al., 2001; Barfoot & Clark, 2004). The example about the coordination of MRS is addressed in the Balch & Parker (Balch & Parker, 2002) (Sgorbissa, 2006). As the research expands in the distributed intelligence of the multi-robots systems, the heterogeneous systems became a new branch of robotics research from 80's (Fontan & Mataric, 1997; Goldberg & Mataric, 1997; Parker, 1994; Balch, 1999). The distributed intelligence refers to systems of entities working together to reason, plan, solve problems, think abstractly, comprehend ideas and languages, and learn (Parker, 2008a), and it is a rapidly emerging field of robotics researches in recent years. The common four types of interaction forms are collective, cooperation, collaboration and coordination. And Parker (Parker, 2008a) classified the used paradigms as follows: (1) bio-inspired, emergent swarms' paradigm; (2) organizational and

social paradigm; (3) knowledge-based, ontological, and semantic paradigms. More detailed examples and explanations are introduced by Parker in the paper (Parker, 2008a).

Coordination interaction is a form of the distributed intelligence in the multi-robots systems. It is a very interesting topic to accomplish some complex tasks effectively through the coordination by heterogeneous robots. And it is also an active topic in Artificial Intelligence and Robotics (Dudek et al., 1996; Parker, 1998; Kitano et al., 1998). Iocchi et al. (Iocchi et al., 2003) summarized present researches of the coordination interaction in five categories: communication-based coordination, autonomy in coordination, distributed coordination, heterogeneity and highly dynamic, hostile environment.

In the future, numerous robots (e.g. wheeled robots, legged robots, humanoid robots, network sensors, etc...) will be integrated in the human environment. These robots will be used mainly to provide physical service to humans in autonomous manner. These services will be the result of the work for a single robot, or the result of the cooperation among several robots allowed carrying out the complex tasks. Effectively, many applications, such as the warehouse management, the industrial assembling, the military applications, and daily tasks, can be benefit from multi-robot systems (Cao et al., 1997; Parker, 2008). In my opinion, the self-organization among heterogeneous robots will play an important role in the further applications, as well in home as in the industrial domains. But it must be pointed out that due to the new advanced technologies, namely in wireless communications, the “intelligence” will be distributed.

In the industrial applications, the logistic domain in the warehouse environment can take the advantage of the coordination of several mobile robots. For example, multi-robots systems are used by KIVA systems (Wurman et al., 2008), where a lot of small robots are used to transport some objects. This approach seems very interesting but there are some limitations in it. All of robots have individual behaviors and all of robots are controlled by a supervisor. In the context, these work focused on the design of new approach based on multi-robots systems and more especially the collaboration among heterogeneous robots for logistic tasks.

In this chapter, the issue is around how to apply the control strategy for the heterogeneous multi-robots systems, based on the above navigation control strategy (proposed in the Chapter 3), to solve the transport problem in more general and more practical environment by the coordination among heterogeneous robots and by an event-based coordination strategy. From a practical point of view, the heterogeneous multi-robots system may be highly autonomic and automated in the real industry. That means: (1) the heterogeneous multi-robots system (HMRS) must be autonomic to deal with problems in a complex dynamic environment; (2) the HMRS must be automated so that it must self-learning, share and treat the information among them; (3) the HMRS must be efficient and systematic in both the navigation and the avoidance; (4) the heterogeneous multi-robots systems need some necessary coordination and collaboration among robots and the adaptation of the environment.

## 4.2 Control strategy for Heterogeneous Multi-robots System (HMRS)

As a human facing a large unknown environment, at first, he needs to glance at the current area which he can see in front of him and find the optimal way among obstacles. Then he can walk out of the area and enter the next unknown area. Step by step, he can develop the whole large unknown environment.

The process can be described by a Petri net in Fig. 41. Suppose that the man is in the current state S1, he looked at the front unknown area. If there are no obstacles in the front area as the S5 in Fig.41, he could go straight ahead directly into the next step S6. And the next unknown area turned into the current unknown area now. If he must avoid the obstacles in order to pass through the current unknown area, as state S2 in Fig. 41. He must calculate the best way through obstacles, and arrive to the next step S6. After that, he could go into the next unknown area. The man entered the next unknown area and it is the new S1 in the next step now. And the circulation is continuing until he would exploit the entire unknown environment.

- s1: Current unknown area;
- s2: If the current unknown area has obstacles;
- s5: If there is no obstacle in the current unknown area;
- s6: Unknown area of next step;
- t1: Sentence the front unknown area;
- t2: Find the optimal way;
- t5: Go forwards;
- t7: Sentence the front unknown area.

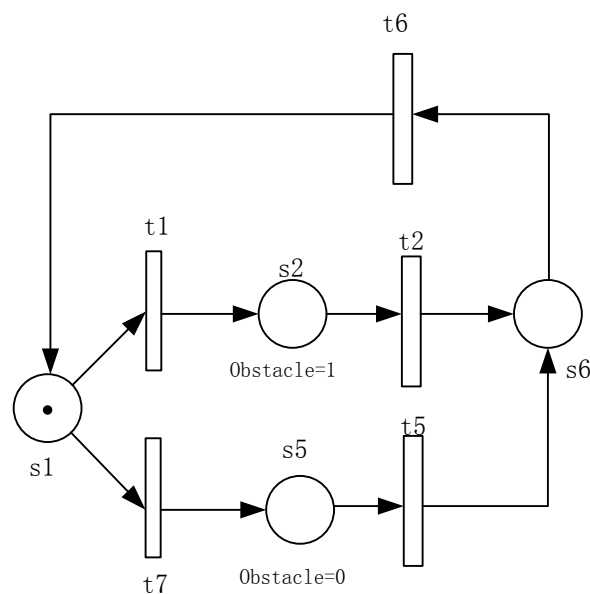

Figure 41: Petri Net of human being

Now, we use a team of heterogeneous multi-robots to take the place of the man. The multi-robots team consists of a humanoid robot Nao and three two-wheeled Khepera robots formed a line formation, a top camera robot and a supervisor. They will imitate the man to cross through a large unknown environment and to apply to the transportation at the same time. The core problem is how to endow the human intelligence to the heterogeneous multi-robots system. To solve the problem, we propose a control strategy based on the distributed intelligence to simulate the human intelligence for HMRS. And we also gave an example with the virtual environment to achieve the simulation.

#### 4.2.1 The environment model

The Fig.42 showed the model of the virtual environment used in the simulation. In this virtual environment, multi-robots system is composed of three KheperaIIIs, a humanoid robot Nao (<http://www.aldebaran-robotics.com/>), a camera and a virtual robot supervisor. The environment (unknown environment for the robots) is decomposed into 21 rooms (see Fig. 42) where each room is divided into 100 states, and each state is a square with side of 30 centimeters. The total area of the environment is equal to  $6 \times 12 \text{ m}^2$ .

The three wheeled robots move in rigid formation (eg a line, column, etc..). The purpose of these three robots is to move together in order to carry a cumbersome load. The humanoid robot perceived environment and guided the wheeled robots. It sent the high level control as “go forwards”, “turn left” and so on. Once the humanoid saw one or more obstacles, it needed more information and asked for help from the supervisor. The supervisor obtained the image of current environment from a top camera, located at the top of environment, which took the picture of this environment. In fact, this camera may be considered like a virtual robot which is located above the world with the height 5m. The cover field of view of the camera is  $3 \times 3 \text{ m}^2$ . The camera can be moved by a supervisor from 1 to 7 along with y-axis and from 1 to 3 along with x-axis among the points of the intersection of two dotted lines for exploiting the whole environment step by step (see Fig.42 right). By using the image processing and the learning process, the supervisor computes a path planning for the rigid formation. It sent a set of actions to the humanoid robot for controlling the three wheeled robots.

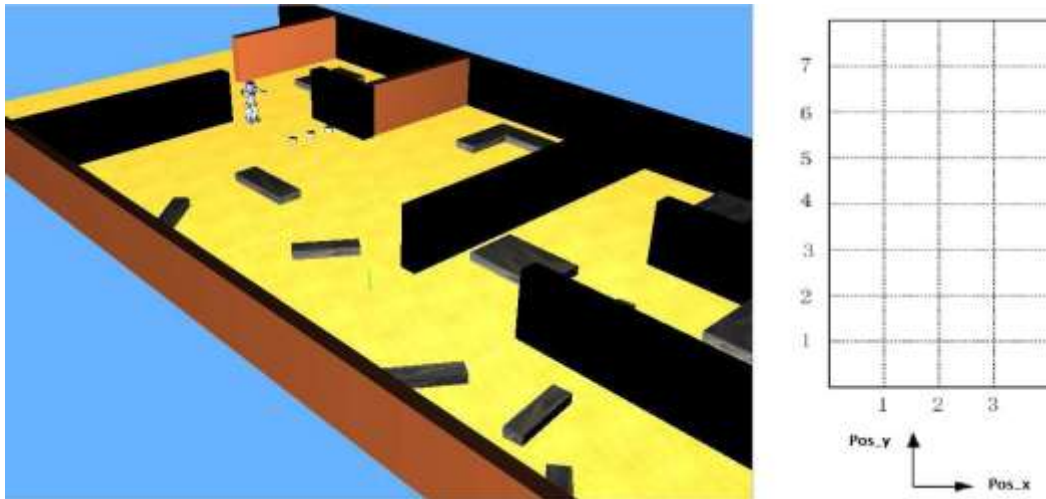

Figure 42: Virtual environment of the multi-robot system

## 4.2.2 The control strategy and Nao

### 4.2.2.1 The control strategy

In this simulation, we apply a hybrid control strategy for heterogeneous multi-robot systems navigating in an unknown world. Similar with the Fig.41, the control strategy for HMRS can be briefly described as Fig.43.

In the beginning, HMRS located at the initial position S1 of the current room. Nao looked forwards by his eye camera. If there are no obstacles in front or obstacles are very far from them, the state S5 will be fired, and then the Khepera formation robots S4 will be enabled. Nao and the formation robots go ahead directly by go forwards control to the final position S6. And the go forwards process is a uniform linear motion.

If obstacles are very near to robots, the S2 will be enabled. Nao sent a message to the supervisor to change all the robots' controller into the path planning control. And the top camera S3 will be enabled at the same time. The top camera took the image of the current room. Then three Khepera formation robots S4 are enabled, and they will apply the reinforcement Q learning and the ANFIS control for changing the formation so as to avoid the obstacles by the path planning's results with respect to the current environment image. The learning and the ANFIS control for the rigid formation narrated in the chapter 2 and chapter 3. During the motion, Nao followed the formation robots. At last, they reached to the final position S6.

As robots finished exploiting the current room, S6 will be enabled and the robots have entered the next room already. The final position of the current room is the initial position of the

next room. And the circulation will go back to S1, the next room is another next current room. The procedures repeat from until robots arrive to the destination room and break out.

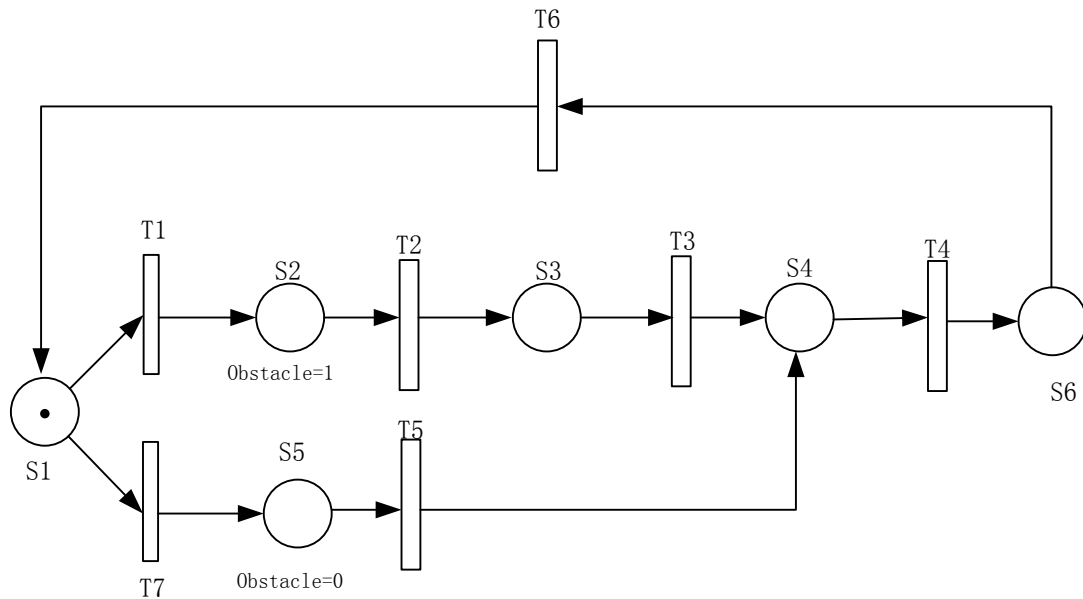

Figure 43: Petri net of control strategy for HMRS

- S1: The initial position of the current room;
- S2: If there are obstacles, the state is enabled;
- S3: The top camera is enabled;
- S4: Khepera robots are enabled and they will use the path planning;
- S5: If there is no obstacle, khepera robots are enabled and they use go forwards directly;
- S6: The HMRS arrives to the final position in the current room;
- T1: Nao sentences the front unknown area;
- T2: Nao sends a command to ask a current photo from top camera;
- T3: Top camera sends the photo to Khepera formation robots;
- T4: Khepera formation robots gets the optimal way from the path planning and use ANFIS control to cross the current area with Nao following;
- T5: Nao sends command to Khepera formation robots to go forwards directly;
- T6: After they arrive to the final station in the current room, the point turn into the start point in the next unknown room.
- T7: Nao sentences the front unknown area.

#### 4.2.2.2 NAO

In Fig. 44, O is the center of Nao's gravity. A is the position of Nao's eyes and they are two cameras. The field of view of eye camera is 0.635m. In this experiment, d is about 0.3 meters during moving, while 0.34 as it is static.  $l_1$  is about 1 meters and  $l_2$  is about 0.77 meters. The



distance between Nao and the formation of three Kheperas must be less than  $l_1$  in the go forwards process.

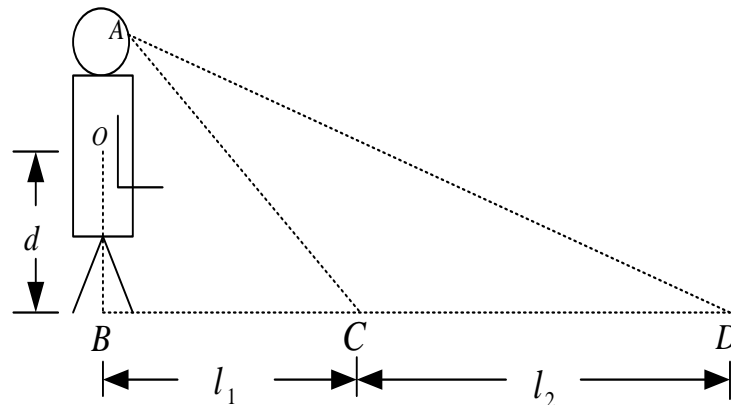

Figure 44: Nao and its sentence of obstacles

At the beginning of each stage in each room, Nao would sentence if obstacles are near or far. If obstacles locate between C and D, it indicates that obstacles are near. Otherwise obstacles are in front of D, it considered that obstacles are far from robots. The obstacles are static and robots go forwards when obstacles are far from them. If and only if the obstacles are around position C, Nao ordered supervisor to change the forwards control into path planning control. Then, three Kheperas used path planning to avoid obstacles with Nao following them.

### 4.3 Simulation of HMRS navigating in the unknown environment by the control strategy

The entire exploration of the unknown environment is an online process. HMRS gradually developed the unknown area from room to room, as a human being walking through an unknown environment step by step. In each room, the motion can be described as observation, going forwards (obstacles are scattered or are very far from robots) , or learning and navigation by the ANFIS control (obstacles are intensive in the area).

Suppose the initial position of MRS is the state [4; 2] in the room (2, 2) (see in Fig. 45 (a)) with formation 7, and the destination is the state [2; 9] in the room (1, 7) with formation7 (see in Fig. 45 (b)). In this simulation, the MRS navigated from the initial room (2, 2) to the final room (1, 7) and passed through 6 rooms in the environment. The sequence of the room passed by is: room(2,2) → room(2,5) → room(3,5) → room(2,6) → room(1,6) → room(1,7).

In room (2, 2) and room (2, 3), robots initially applied the go forwards control because obstacles were very far from them. Then they switched to the path planning when obstacles were in front of them. In the rest four rooms, robots met obstacles at the beginning of the movements and they used the path planning during the entire motion.

The detailed path planning of rooms passed are described in the first section and the corresponding simulations are in the following sections.

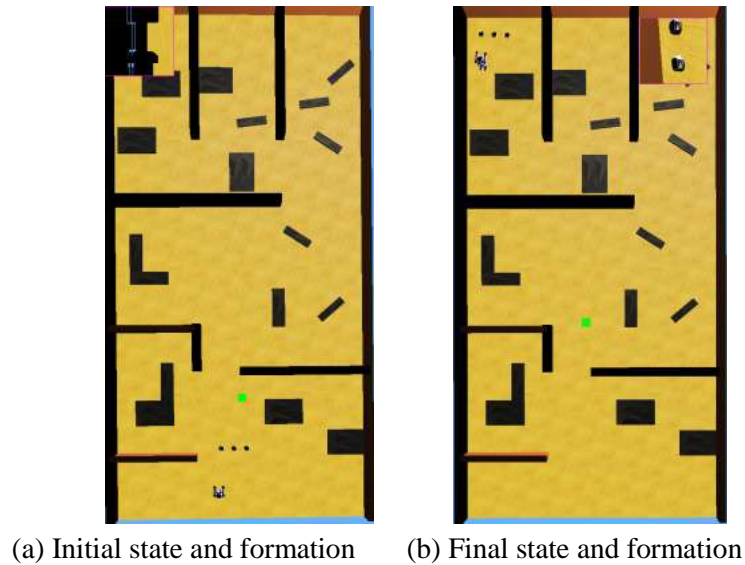

Figure 45: The initial and final state of entire process

### 4.3.1 Learning results

The path planning of the MRS is as same as the chapter 3. Through the image processing operations by the unknown room's picture, robots apply the Q learning to acquire the optimal path and formation for the current room. Then robots use ANFIS control crossing obstacles and to move out of the final state of current room.

The path planning of room (2, 2) is displayed in the Fig. 46(a), the initial and final positions are green and blue circles respectively. The reference robot 1 is indicated as a dot in the circle. Red stars indicate obstacles. The initial position and formation of room (2, 2) are [4; 5], 7 and the final station and formation are [3; 9], 7. The optimal actions are translation actions: 1 2 1 1, without rotation action in the process. It is important to note that the initial position of the environment is [4; 2], MRS moved forwards from state [4; 2] to state [4; 5] without the block of obstacles. After MRS arrived at the final state [3; 9], they went into the room (2, 5).

As shown in Fig. 46 (b), the initial position and formation of room (2, 5) are [3; 4], 7 and the final station and formation are [5; 2], 7. At first, they moved along down right to the state [5; 2] and then translated along up right to the final state of the room. The optimal actions are all translation actions: 6 6 8 8. Similar with the previous process in room (2, 2), the former part of the movement is going forwards process from the final state in the last room (2, 2) to the initial state of the room (2, 5). Since there is no obstacle, HMRS moved forwards by uniform linear

motion. In the latter part, HMRS needed to move right in order to go into next unexplored room (3, 5).

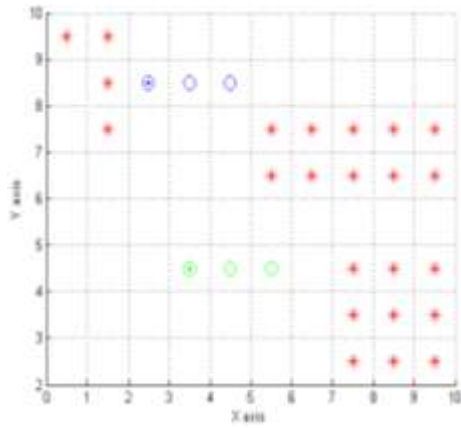

(a) Path planning of room (2, 2)

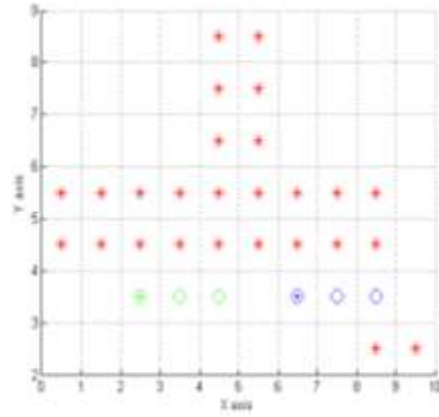

(b) Path planning of room (2,5)

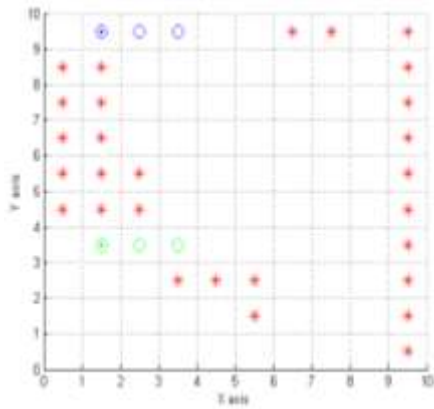

(c) Path planning of room (3, 5)

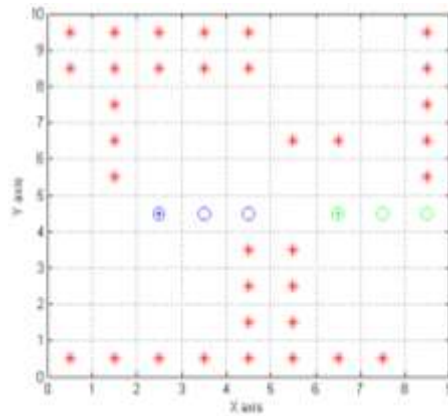

(d) Path planning of room (2, 6)

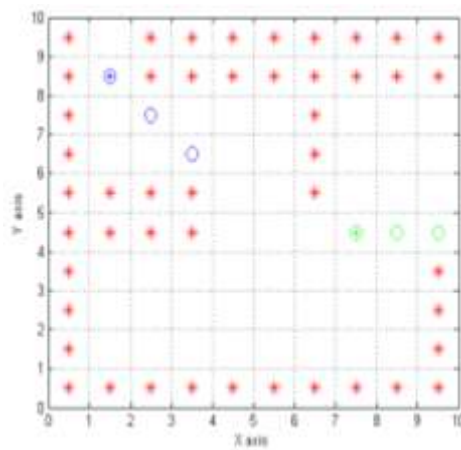

(e) Path planning of room (1, 6)

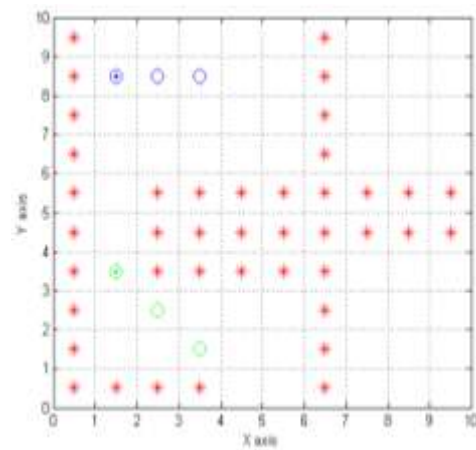

(f) Path planning of room (1, 7)

Figure 46: The learning results of each room

Room (2, 2) and room (2, 5) are two special rooms which are different from other four rooms in the simulation. They are quite close to the real environment. In case there are not always a lot of obstacles intensive around HMRS in the real environment, they don't need to do path planning. The two rooms are the model of the real environment. HMRS just go forwards in the space without obstacles, while they transfer to the path planning control as they need to avoid obstacles.

Since HMRS met obstacles from the starting point, they use the path planning from the beginning to the end in the rest four rooms. The initial position and formation of the room (3, 5) are [2; 4], 7 and the final station and formation are [2; 10], 7 in Fig. 46(c). The movement has four parts of translation actions. In the first part, HMRS moved right from the state [2; 4] to the state [4; 4] and then went right to the state [6; 6]. After moving left to the state [4; 8] they got into the final state of the room (3, 5). The optimal actions are: 7 7 8 8 2 2 2 2. During the translation process, robots altered the position without changing the formation. After the movements, HMRS entered into the next room (2, 6).

The path planning of the room (2, 6) is shown in the Fig. 46(d). The initial position and formation of the room are [7; 5], 7 and the final station and formation are [3; 5], 7 in Fig. 46(d). The movement consists of three parts translation actions. At first, HMRS moved left from the state [7; 5] to the state [5; 5] by translation actions 2, 4. Then they went up left from the state [5; 5] to the state [3; 7] by translation actions 2, 2. At last, they moved horizontally left to the final state [3; 5]. The optimal actions are: 2 4 2 2 5 5. During the translation, robots maintained the horizontal formation 7. After the movement, HMRS prepared for going into the next room (2, 6). In the different room, the same position may be the different state. That is because the origin of the room is not the origin of the environment. Each room has its own origin, the comparing position of the room coordinate system with the environment coordinate system is shown in the Fig. 42.

For example, the final state [3; 5] in the room (2, 6) is the same as the state [8; 5] in the room (1, 6). They have the same absolute coordinates in the environment coordinate system, but different state coordinates in different rooms.

The movement in room (1, 6) contained both translation actions and rotation actions and the path planning showed in Fig. 46(e). The initial position and formation of the room are [8; 5], 7 and the final station and formation are [2; 9], 6 in Fig. 46(e). The movement consisted three parts of translation actions. In the first part, HMRS moved horizontally left from the initial state to the state [6; 5] by translation actions 3, 3. In the second part, they rotated clockwise to formation 6 and then moved along up left to the state [4; 7], actions of this part are 9 2, 2. In the third part, they moved up left to the final state [2; 9] by translation actions 2 2. The optimal actions are: 3 3 9 2 2 2 2. HMRS translated to the up left and changed formations at the end of the movement.

Room (1, 7) is the destination room of the entire process and the final state is [2; 9] in the room (1, 7) (see in Fig. 46(f)). As in the room (1, 6), the movement in room (1, 7) included both translation actions and rotation actions, the path planning showed in Fig. 46(f). The initial

position and formation of the room are [2; 4], 6; the final station and formation are [2; 9], 7 in Fig. 46(f). The two parts of movement are: (1) HMRS firstly rotated clockwise to the vertical direction and then moved up forwards to reach to the state [2; 9] with formation 5. The optimal actions in the first part are: 9 1 1 1 1 1. (2) In the second part, MRS rotated anti-clockwise and back to the horizontal formation 7 by two continuous anti-clockwise rotation actions: 10 10. By the translation movement and the rotation movement, HMRS arrived at the destination position of the unknown environment. During the developing of the environment, HMRS navigated and finished the exploit from the initial room (2, 2) in the middle down of the environment to the room (1, 7) in the up left of the environment.

### 4.3.2 Simulation results

The initial position of the whole process showed in Fig. 47(a) and HMRS is in the room (2, 2). They navigated from the initial point to cross the large unknown environment and arrived to the final point.

The simulation of room (2, 2) is displayed in the Fig. 47. The image of Nao's eye camera is shown in the top left window in Fig. 47 (a). Since obstacles were far from robots, therefore Nao guided three kheperas moving forwards to the position in Fig. 47 (b). All of them used the go forwards control in this phrase. In Fig. 47 (b), from the image of Nao's eye camera, it showed that obstacles were near to them. From that moment on, Nao asked the top camera to give a picture for current room (2, 2), and three Kheperas translated to the top left position (see Fig. 47(c)), and then they went on to move forwards according to the results from path planning. Robots changed to path planning in the rest movement with Nao following Kheperas. Until they reached to the final position of room (2, 2), which is shown in Fig. 47(d), they finished developing room (2, 2) and entered into the room (2, 5).

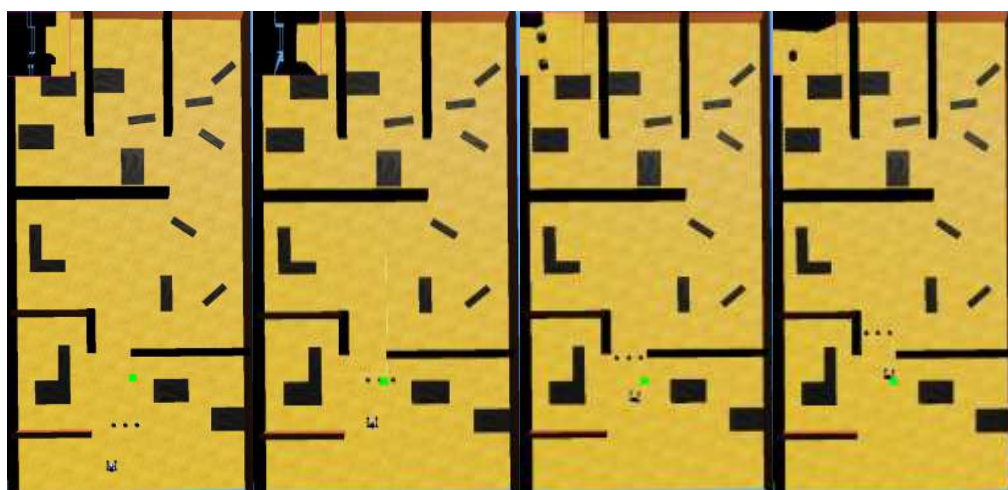

(a) Initial position (b) Go forwards (c) Path planning (d) End of room (2, 2)

Figure 47: simulation of room (2, 2)

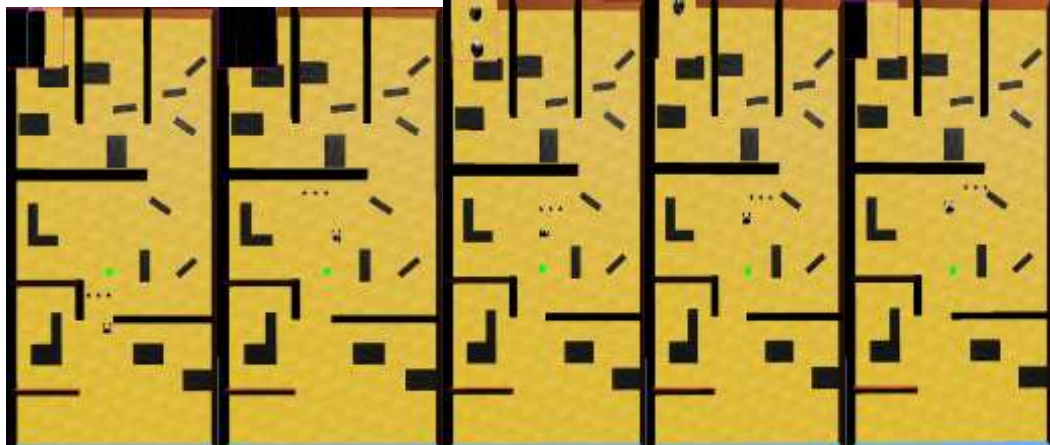

(a) Initial of stage I (b) Go forwards (c) End of stage I (d) stage II (e) End of room (2, 5)

Figure 48: simulation of room (2, 5)

The simulation results are displayed in the Fig. 48. The initial position of robots is shown in Fig. 48 (a). From the image of the little left top window, Nao observed that obstacles were far and robots moved ahead directly to the position in Fig. 48 (b). Then, Nao sent the command to the supervisor so as to switch the controller for the last phrase of the stage I. According to the learning results of the path planning, three Kheperas went down right which is shown in Fig. 48 (c). After that, three kheperas went on to translate along up right (see in Fig. 48 (d)) to arrive to the final position of the room (2, 5) (see in Fig. 48 (e)). Nao moved straight forwards in both of two stages.

In room (3, 5), robots used path planning control for all the stages because obstacles were very near to robots at the beginning of each stage. Fig. 49 (a) showed the initial position of the room (3, 5). From the results of path planning, three Kheperas moved to right while Nao went forwards in the stage I. The end of the stage I is shown in Fig. 49 (b) and the initial of the stage II is shown in Fig. 49 (c). Kheperas translated to the upright in the stage II with Nao following with them. The end of stage II is shown in Fig. 49 (d) and the initial of stage III is shown in Fig. 49 (e). In stage III, Kheperas moved along with up left as Nao continued to move right. The end of the stage III is shown in Fig. 49 (f) and the initial of the stage IV is shown in Fig. 49 (g). In the stage VI, Kheperas went on to translate along up left as Nao going forwards. The end of room (3, 5) is shown in Fig. 49(h).

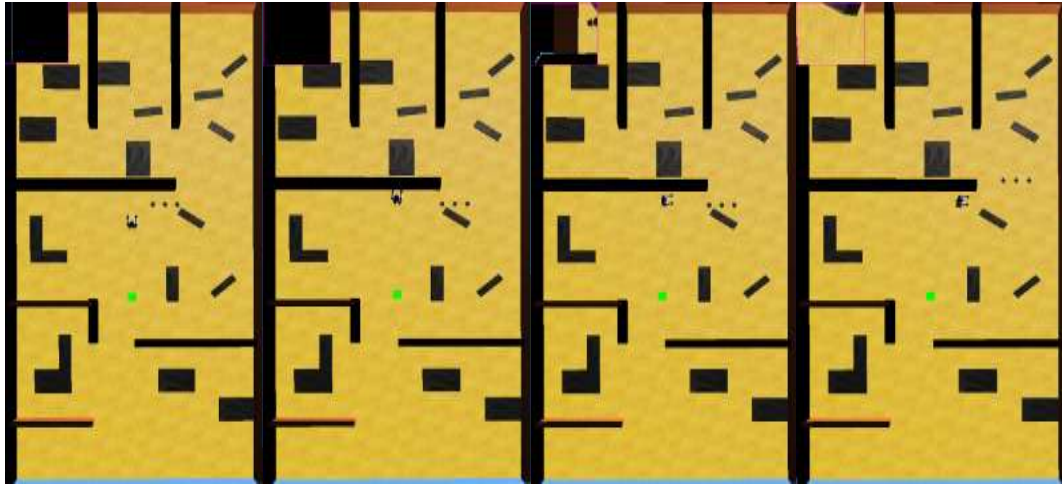

(a) Initial of stage I (b) End of stage I (c) Initial of stage II (d) End of stage II

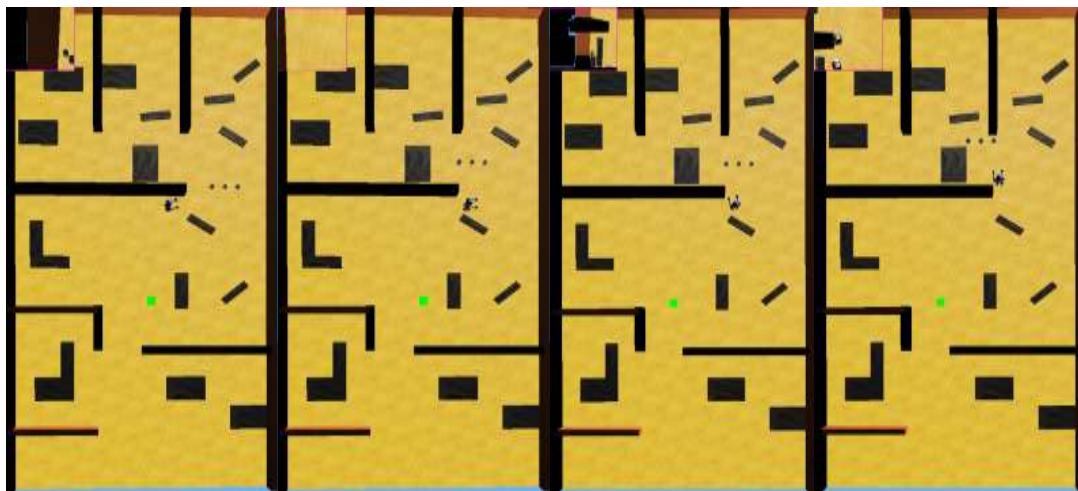

(e) Initial of stage III (f) End of stage III (g) Initial of stage IV (h) End of room(3,5)

Figure 49: simulation of room (3, 5)

In room (2, 6), robots used the path planning control for the whole process because obstacles were intensive in the room. The initial position is shown in Fig. 50 (a), Kheperas first moved along up left (see in Fig. 50 (b)) and subsequently moved along down left in the stage I. Nao followed with three khepera going forwards and the end of the stage I is shown in Fig. 50 (c). The initial position of the stage II is shown in Fig. 50 (d). Kheperas continued to translate along with up left in the stage II and Nao went straight forwards. The end of stage II is in Fig. 50 (e) and the initial state of the stage III is in Fig. 50 (f). In the stage III, Kheperas moved backwards (see in Fig. 50 (g)) and Nao followed with Kheperas moving along the left side. The end of the room (2, 6) is shown in Fig. 50 (h).

In the room (1, 6), robots used only the path planning control. The movement can be divided into three stages. In the stage I, Nao followed three Kheperas moving along left. The initial state and the end state of the stage I were shown in Fig. 51 (a) and Fig. 51 (b) respectively. In the

stage II, three Kheperas needed to rotate clockwise at first as shown in Fig. 51 (c) and then translated along up left. And they went on to translate along up left (see in Fig. 51 (d)) without changing the orientation in the stage III until they arrived at the end of the room(1, 6) (see in Fig. 51 (e)). In the last two stages, Nao moved along with left side.

There are two stages in the room (1, 7) and the initial of stage is shown in Fig. 52(a). In the stage I, three Kheperas rotated anti-clockwise to the vertical orientation (see in Fig. 52(b)), then they moved forwards to the end of the stage I (see in Fig. 52(c)). Nao followed with Kheperas going along up left in the first stage. The initial position of stage II is in Fig. 52 (d). In the second stage, three Kheperas continued to rotate from vertical to parallel (see Fig. 52 (e) and Fig. 52 (f)). Nao moved forwards with kheperas. The end position of the environment is shown in Fig. 52 (f).

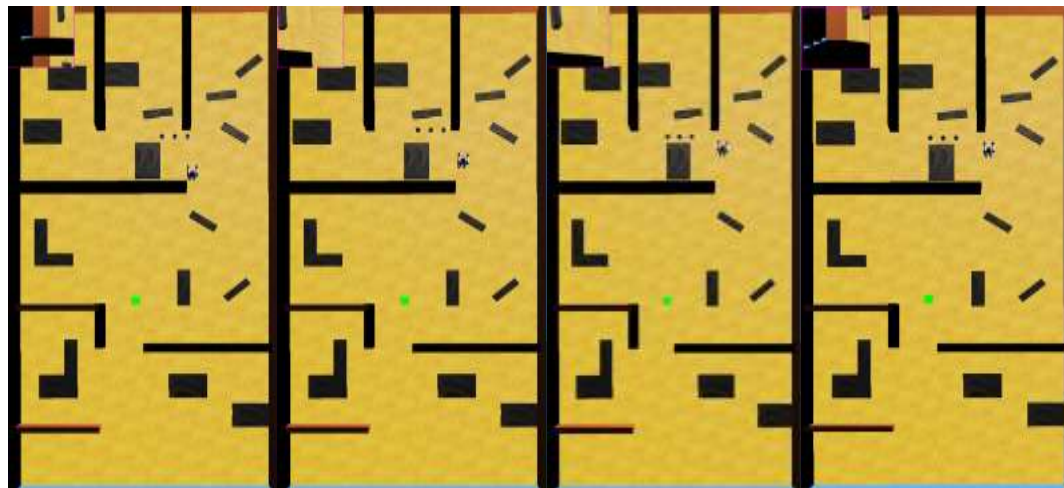

(a) Initial of stage I    (b) stage I    (c) End of stage I    (d) Initial of stage II

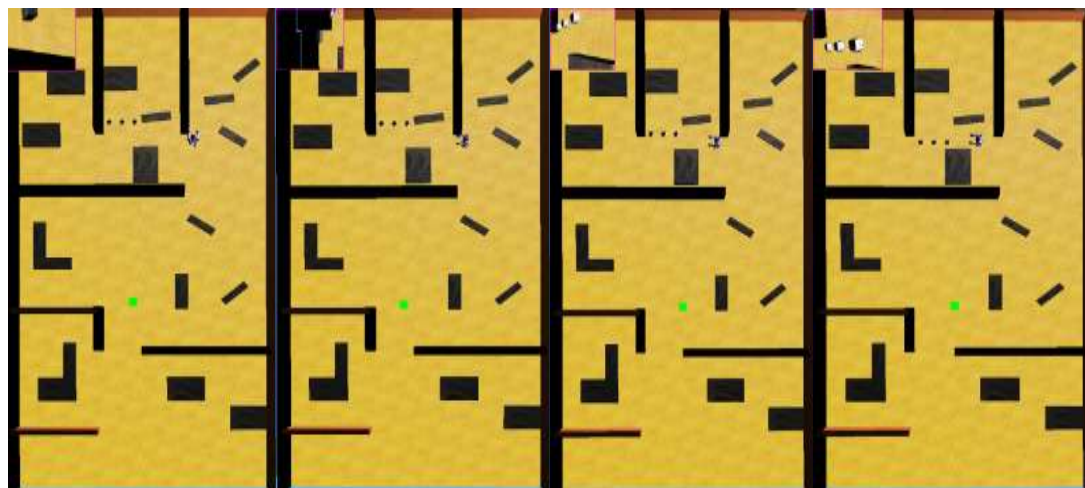

(e) End of stage II    (f) Initial of stage III    (g) stage III    (h) End of room (3, 5)

Figure 50: simulation of room (2, 6)



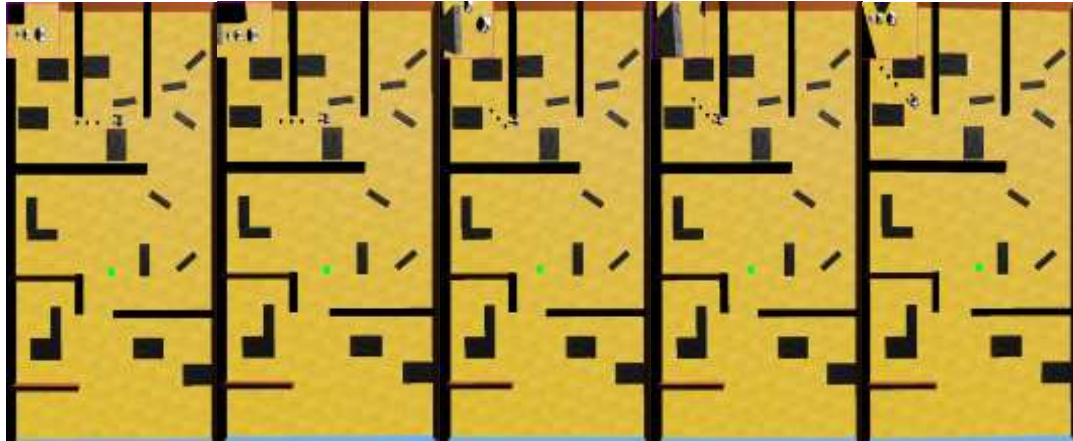

(a) Initial of stage I (b) End of stage I (c) Rotation of stage II (d) Translation of stage III (e) End of room(1,6)

Figure 51: simulation of room (1, 6)

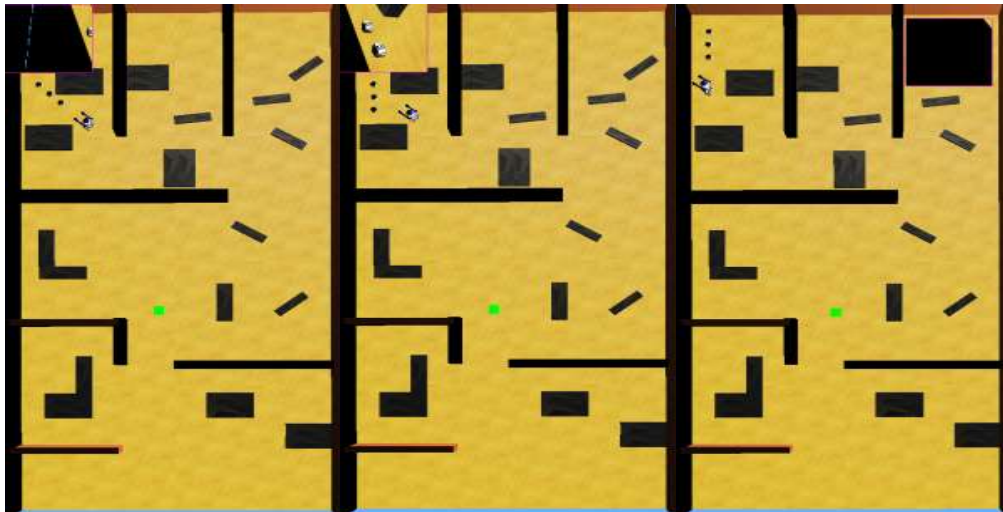

(a)Initial of stage I (b) Rotation of stage I (c) End of stage II

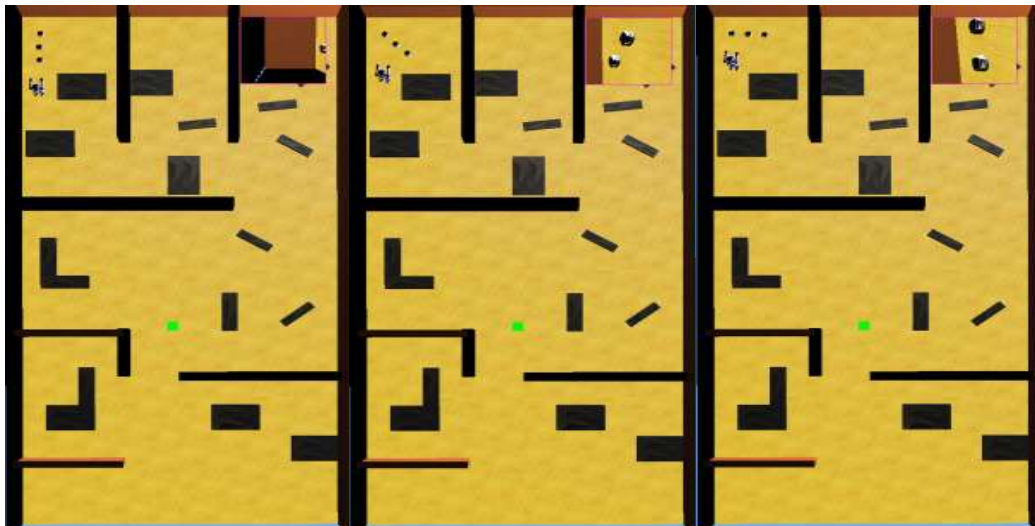

(d)Initial of stage II (e) Rotation of stage II (f) End position of environment

Figure 52: simulation of room (1, 7)

After the successful simulation, we continued to verify our strategy with real experiments.

## 4.4 Experiment with Real Robots

### 4.4.1 A preliminary experiment

Now, we present the results of a preliminary experiment in the real environment to prove the feasibility of the control strategy. The first experiment consist an on-line control of the formation. In this example, the humanoid robot perceived environment and sent high level control to the wheeled robots, such as "go forwards", "turn left" and so on. The Fig. 53 showed a snapshot of this experimental validation. According to the position of the wheeled robots, the humanoid robot Nao stopped the formation, and sent the order "clockwise" in order to make the formation cross the narrow path by keeping the rigid formation. The goal is, not only to show that the humanoid Nao played the role of a supervisor by a remote control, but to prove that this robot is able to perceive environment and to take adequate decision to guide wheeled robot.

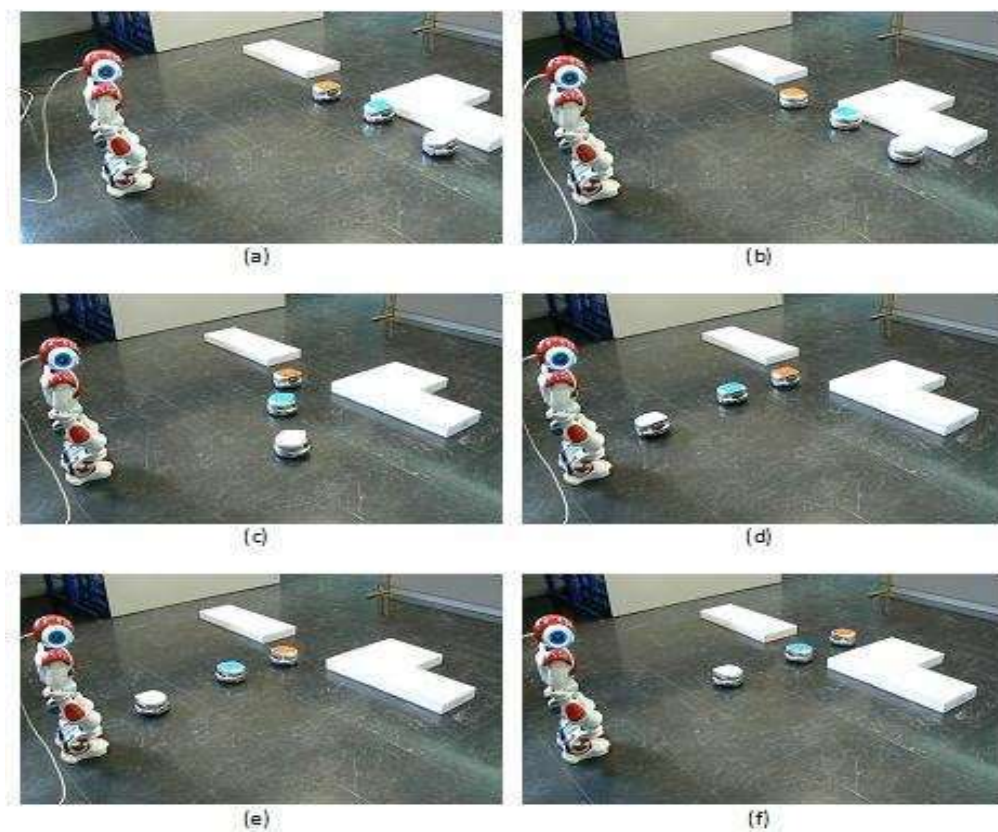

Figure 53: First experiment: the robot Nao control wheeled robot according to environment.

## 4.4.2 A real experiment for multi-robots team

### 4.4.2.1 Environment

The second experiment consisted firstly to compute the path planning and secondly to control the rigid formation of the robot. During this experimentation, we use two KhperaIIIs, a camera and a computer for the remote control of the both camera and robots, see in Fig. 54. The camera is hanging on the 2 m height and the real environment (in Fig. 55) is made up of a 1.5 m wide and 2.1 m long rectangular floor and some paper play the role of obstacles. The environment is separated into 35 states and each state is a 30 cm side square. Image processing is executed in C code, the path planning and the robots control is executed in Matlab. The connection between robots and computer is WIFI, and robots can receive the real-time command transmission from computer.



Figure 54: Multi-robots team in the real experiment

### 4.4.2.2 Path planning

The path planning of the unknown environment is displayed in Fig. 56. The initial position and final position are  $[4; 2]$  and  $[1; 6]$  respectively. During the experiment, robot team always maintained the vertical formation 2. The formation and action are the same as the experiment in the chapter 3. The initial position is marked by green dot (the reference robot) and green circle. The final position is marked by blue dot and blue circle.



Figure 55: Unknown environment in the real experiment

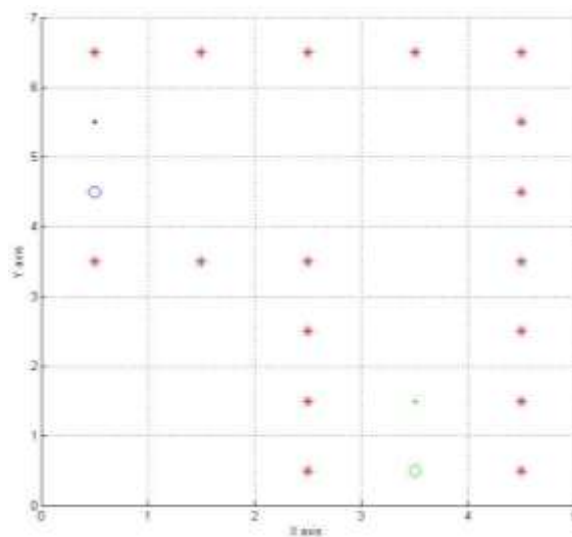

Figure 56: Path planning

Robot team has four formations and four actions, forwards, backwards, left and right as discussed in the last chapter. After the offline Q learning of the unknown environment, the optimal actions are: 1 1 1 1 3 3 3. The results of path planning are as follows:

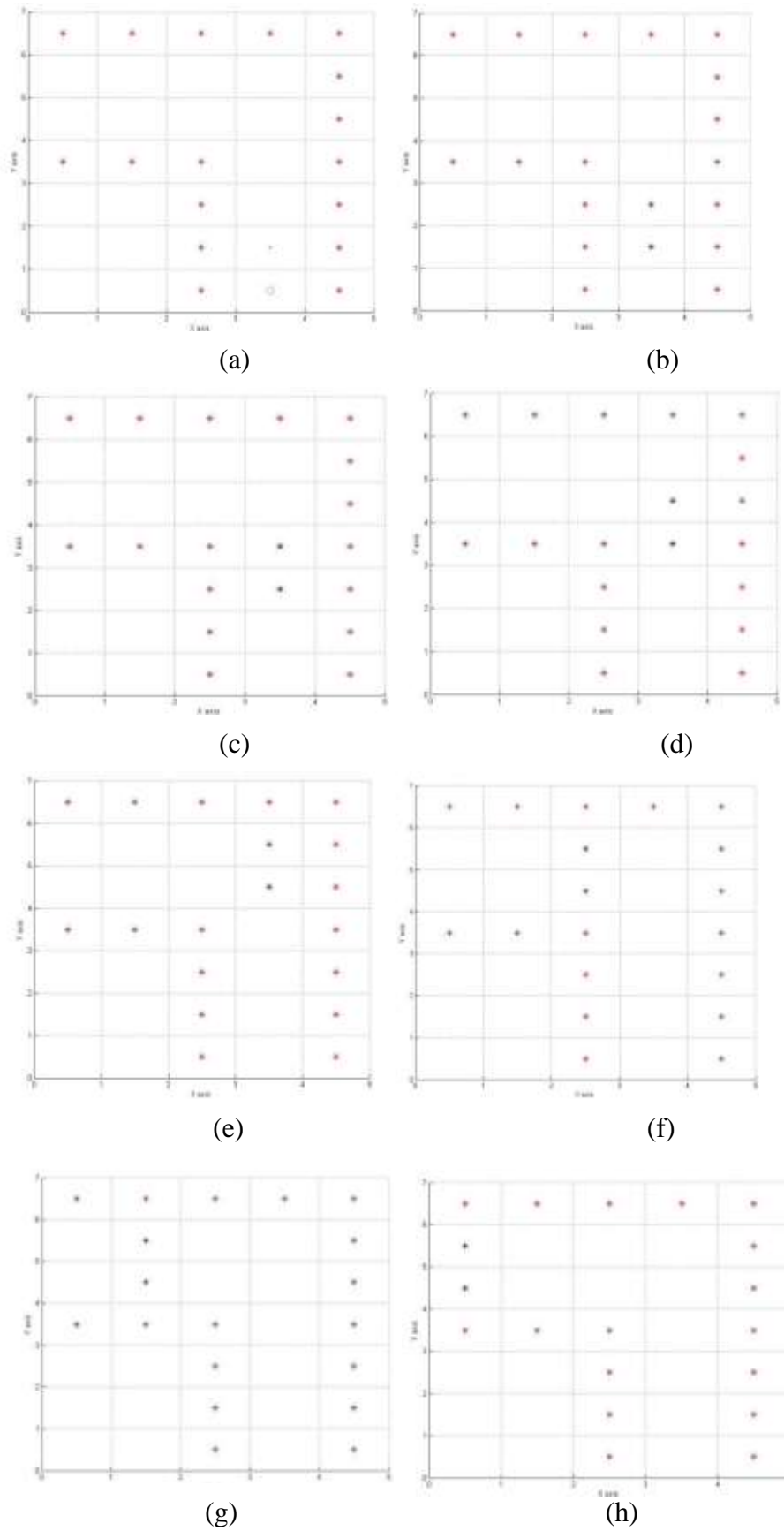

Figure 57: Learning results of path planning, (a) Initial position, (b) Step 1: up, (c) Step 2: up, (d) Step 3: up, (e) Step 4: up, (f) Step 5: right, (g) Step 6: up, (h) Final position

### 4.4.3 Experiment results

In the real experiment, the multi-robots team contained a humanoid robot Nao and two non-holonomic KheperaIII. The movement can be divided into two parts. In the first part, Nao led two KheperaIII to move ahead, because there is a pass way in front of the robot team. In the second part, we put a barrier to block the pass way of the multi-robots team. Since the navigation strategy is an online policy, Nao looked forward at each step and as it observed the obstacle, it asked an image of unknown environment from the camera above the unknown area. Then, by the results of path planning from the supervisor, two KheperaIII apply ANFIS rigid formation control to avoid obstacles and Nao executed the corresponding actions according to the path planning results. At last, robot team crossed the unknown area. The detailed results and description of (1) go forwards part; (2) and path planning part are as follows.

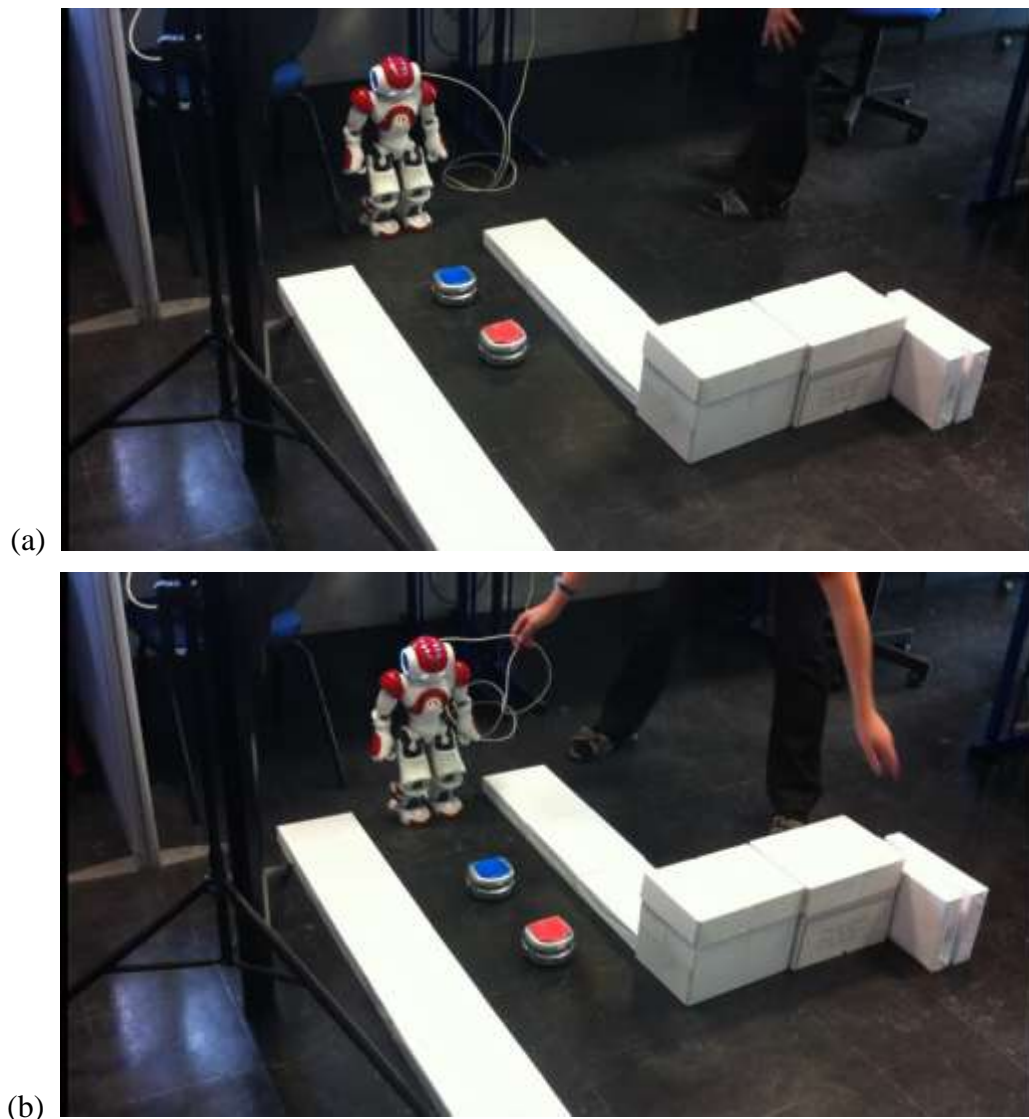

Figure 58: Go forwards part, (a) Initial state of the experiment, (b) Multi-robots team goes forwards

#### 4.4.3.1 Go forwards part

The pictures of the first part are shown in Fig. 58. At the beginning of the experiment, Nao observed the environment and determined that the multi-robots team can cross the narrow pass way directly or not. And Nao led two KheperaIII's to move forwards. The initial state of experiment is shown in Fig. 58 (a) and the segment of the first part is shown in Fig. 58 (b).

#### 4.4.3.2 Lay the obstacle

After the short go forwards part, we laid an obstacle in front of the multi-robots team. In this case, when Nao updated the current image and detected the obstacle, it demanded the outlet camera to give the image of the current unknown environment to the supervisor and used Q learning to get the path planning as shown in Fig. 59. Multi-robots team stopped their way and exchanged commands with the supervisor. The supervisor switched the go forwards control to the path planning. The path planning procedures are the same as the transport experiment in the chapter 3.

With the results of path planning from the supervisor, multi-robots team are active again to finish the rest part of the pass way.

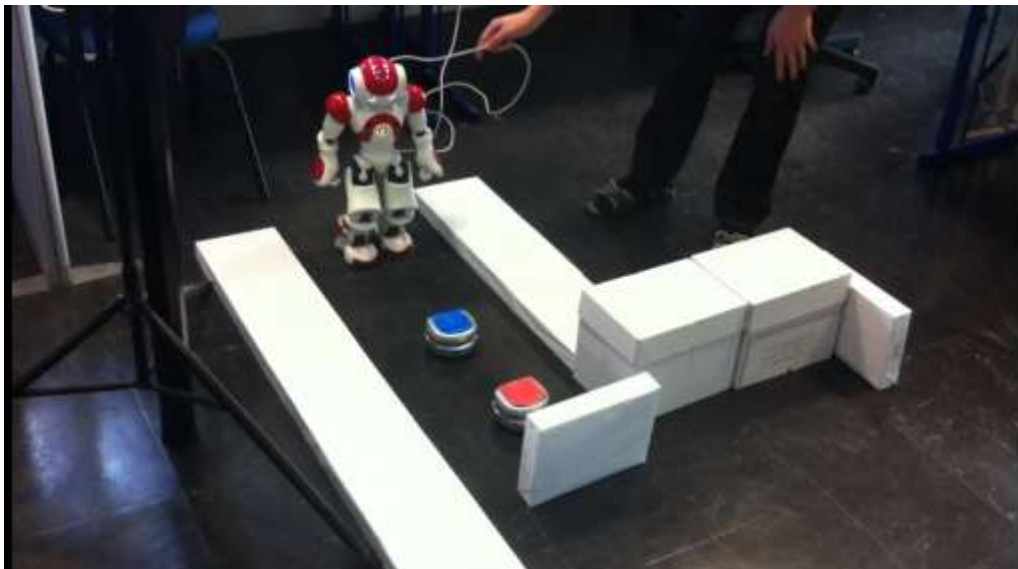

Figure 59: Meet the obstacle and change to path planning

#### 4.4.3.3 Path planning part

The path planning part is shown in Fig. 60, the actions are 1 1 3 3 3 for the rest part of environment. In the part, two KheperaIII's formed a vertical line rigid formation and used the

ANFIS rigid formation control to cross the area with obstacles. After two go forwards translation actions (see in Fig. 60 (a) and Fig. 60 (b)), two KheperaIIIs turned left to finish the rest three left translation actions. During the movement, Nao followed the KheperaIII formation to turn left (see in the Fig. 60(b) and Fig. 60 (c)) after the two forwards actions. The rest three actions are shown in Fig. 60 (c), Fig. 60 (d) and Fig. 60 (e) respectively and the final state of the experiment is shown in the Fig. 60 (e).



(a) Step 1 of path planning part



(b) Step 2 of path planning part



(c) Step 3 of path planning part

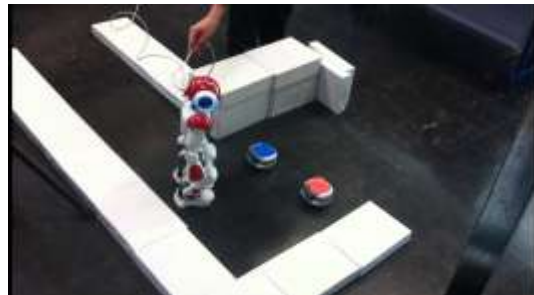

(d) Nao turns to follow Khepera team



(e) Final state of multi-robots team

Figure 60: Path planning part

## 4.5 Conclusion

The main purpose of the chapter is an extension of the proposed control strategy (in the Chapter 3) in a very large dynamic environment by the event-based coordination strategy. A very large (limited or unlimited) unknown environment can be described by a series of



continuous relatively small local (limited) unknown environment. The relatively small local (limited) unknown environment is called room in the thesis. To develop the whole large unknown environment, the heterogeneous multi-robots system must detect the area step by step and by updating the local room. A Petri net is introduced to design the event-based coordination strategy.

Heterogeneous multi-robots system updated the environmental information at the beginning of each step in order to sentence whether there is a path way in the front area. If the local supervisor perceived the occurred disturbance in the actual environment, the global supervisor will transfer the current controller into other controller with adaptation of the changed environment. In this chapter, the initial controller is the go forwards control which enables to control the heterogeneous multi-robots system to implement the uniform linear motion in a path way. If an object (a sudden event) is laid to stop the robots' way, the global supervisor will switch the go forwards control into the path planning control. By the control strategy, the path planning control enables to control the heterogeneous multi-robots system navigating in the current local unknown room. After heterogeneous multi-robots finished developing the current local room, they went into the next local room and repeated the circulation so as to detect the whole dynamic unknown environment.

In the simulation and the real experiment validation, a humanoid Nao robot played the role of the local supervisor to perceive the sudden event in the front area. If it detected obstacles are concentrated and very near, the heterogeneous multi-robots system must switch the initial go forwards control into the path planning control to avoid obstacles and to cross the unknown area by the control strategy. That is to say, at the beginning of the time step, if Nao perceived obstacles, it ordered an image of the current local room from a top camera, which is looked as a part of HMRS. The image is sent to a global supervisor, which is a computer to execute Q-learning and image processing procedures. After the supervisor obtained the path planning results, it spread the results to Nao and a team of three Khepera robots formed a rigid line-shaped structure. Khepera team applied the ANFIS rigid formation control to navigate across the current local room and to enter the next local room.

The application of the control strategy in a dynamic environment is illustrated by the simulation in the section 4.3 and by a real experiment in the section 4.4. In the simulation, it proved that the navigation control strategy can be promoted to a dynamic environment. And the study can be used to transport objects for the logistic application.

# General Conclusion and Perspectives

---

## 1. Conclusion

Now, robots have been widely used from industry to the daily life. Various robots help or replace human being to complete in many dangerous environments and complex works. The robot-assist will be a trend and it will be more popular in the future. The multi-robots system is an important branch of the robotic field. In many practical situations, it is more efficient and convenient to use several small economic robots to accomplish the huge work by their combination and cooperation. The thesis studied the coordination and control in collective robotics and especially in heterogeneous multi-robots system. By the coordination and cooperation of different types of robots, the multi-robots system can accomplish the task together. The thesis proposed the control strategy for the heterogeneous multi-robots system in an unknown environment and validated the theories by a real logistic application. By introduction of the event-based coordination strategy and the Petri net, the control strategy has been increased and extended to use in a dynamic environment.

My work can be summarized as follows:

A. Studied the control of collective robots system in the frame of machine learning

The first phase of the study is the conceptualization of the control of a single robot based on the machine learning frame. From the conceptualization point of view, the position control, the orientation control and the trajectory control of a genetic robot has been studied in the Chapter 2. And by applying the ANFIS controller, the single robot can be moved to a desired position, desired orientation and a given linear /nonlinear trajectory. An example and the simulation demonstrated in the Chapter 2 with a two-wheeled nonholonomic robot. By using ANFIS controllers, the single robot can well track with the given trajectories in the different parts. On the basis of the machine learning frame, the single robot's control can be used to any type of robot and even to a virtual single robot. Followed by the first phrase work, the thesis continued to study the control of the collective robots system and focused on the heterogeneous multi-robots system. The control strategy is proposed in the Chapter 3, which is including: ANFIS rigid formation control, perception system and path planning. The rigid formation control is to control a group of robots which is formed a constrained geometry structure

and is regarded as a virtual single robot. In the motion and the avoidance, the group robots maintained their geometry structure to pass through the unknown environment by position control and changing their formation. In the thesis, a perception system is a part of the heterogeneous multi-robots system and can automatically supply the image of the current unknown environment. Path planning is involving the image processing and the Q-learning. Q-learning is also a kind of machine learning. A simulation is designed in the Chapter 3 and to verify the control strategy in an unknown area. The perception robot is materialized by a top camera in the simulation. Three Khepera robots formed a rigid line shape avoided obstacles and crossed through the unknown area by the optimal results from the path planning.

#### B. Validation with the logistic application

After the successful simulation in the Chapter 3, a real validation has been done to verify the control strategy. The validation is the logistic application by two Khepera robots formed a rigid line shape to achieve the transportation task. A top camera acted as a perception robot and a computer took the role of the supervisor for the remote control. By the path planning and ANFIS rigid formation control, robots transferred their formation and transported the long paper box from the entrance to the exit of the unknown rectangular area.

#### C. Verified the control strategy in dynamic environment

By introduction of a Petri-net and an event-based coordination strategy in Chapter 4, the heterogeneous multi-robots system can be self-adaptive to a dynamic environment. In the simulation, a local supervisor is used to determine whether there are obstacles or not in front unknown area. If there is a pass way, robots used initial go forwards controller to move ahead in the current local room and go into next local room. If there are obstacles or a sudden obstacle disturbed the actual environment, the global supervisor would switch the current go forwards controller into the path planning controller. That is to say, with a sudden disturbance of the environment, the heterogeneous multi-robots system can detect it and adjust the control strategy in order to adapt to the environment. A simulation is illustrated and a humanoid Nao acted as the local supervisor to detect the disturbance. By the event-based coordination strategy and the control strategy, heterogeneous multi-robots system can develop the unknown dynamic environment step by step.

## 2. Future works

Although I have done many works in the control study of the collective robots system, there are still many problems need to be solve in the future. I am looking forwards to go on my study of the collective robotics research from the following three aspects:

- **Automated adaptation of formation versus type of load**

In a short-term, I will study the automated adaptation of formation versus type of load. With the reconfigurable rigid formation, the group robots can adjust their rigid formation according to the various sized objects.

- **Introduction of adjustable autonomy**

In a middle-term, I will study the introduction of adjustable autonomy of the heterogeneous multi-robots system. It means that the robots must adjust themselves in particular situations in order to take the transport task and to avoid obstacles.

- **Self-adaptation of collective robots to dynamic environment**

In a long-term, I will finish the self-adaptation of the collective robots system to a dynamic environment. The aim is that the collective robots can adapt to any dynamic environment with any disturbance in any case.

## Personal Publications

---

- [1] Ting Wang, D. M. Ramik, C. Sabourin, K. Madani, "Intelligent systems for industrial robotics: application in logistic field", *Industrial Robot: An International Journal*, Vol. 39 N<sup>o</sup> 3, pp. 251 – 259, 2012.
- [2] T. Wang, C. Sabourin, K. Madani, "ANFIS Controller for Non-holonomic Robots", *Majlesi Journal of Electrical Engineering, North America*, ISSN 20081413, Vol. 5, No. 2, pp. 31-37, 2011.
- [3] T. Wang, F. Gautero, C. Sabourin, K. Madani, "A Neural Fuzzy Inference based adaptive controller for nonholonomic robots", *COMPUTING*, ISSN 1727-6209, Special Issue on Neural Networks and Artificial Intelligence, Vol. 10, Issue 1, pp. 56-65, 2011.
- [4] T. Wang, F. Gautero, C. Sabourin, K. Madani, "A Neural Fuzzy Inference based Adaptive Controller Using Learning Process for Nonholonomic Robots", *Advances in Computational Intelligence, LNCS*, Vol. 6691, Springer Verlag, ISBN: 978-3-642-21500-1, pp. 81-88, 2011.
- [5] T. Wang, D.M. Ramik, C. Sabourin and K. Madani, "Machine-Learning for Heterogeneous Multi- Robots Systems in Logistic Application Frame", proceedings of the 14th International Conference on Climbing and Walking Robots and the Support Technologies for Mobile Machines (CLAWAR2011), pp 207-222, paris, france, september 2011. ISBN-13 978-981-4374-27-9. Best paper awards
- [6] T. Wang, F. Gautero, C. Sabourin, K. Madani, "A Neural Fuzzy Inference based Adaptive Controller Using Learning Process for Nonholonomic Robots", *International Work-conference on Artificial Neural Networks (IWANN 2011)*, CD-Rom Proceedings, 2011.
- [7] T. Wang, C. Sabourin, K. Madani, "Strategy Based on Machine-Learning for the Control of a Rigid Formation in a Multi-Robots Frame", *Proceedings of International Conference on Informatics in Control Automation and Robotics (IEEE ICINCO 2011)*, Vol. 2, ISBN:978-989-8425-75-1, pp. 300-303, Noordwijkerhout, Netherlands, July 28 - 31, 2011.
- [8] T. Wang, C. Sabourin and K. Madani, "ANFIS controller for nonholonomic robots", *Proceedings of International Conference on Neural Networks and Artificial Intelligence (ICNNAI 2010)*, ISBN : 978-985-6329-79-4, pp.320-325, Brest , Byelorussia , June 1 – 4, 2010.



**Emerald Group Publishing Limited**

## Industrial Robot

Innovation Award 2011 – For practical innovation  
in the field of robotics

**Highly commended**

is awarded to **T. Wang**

for the paper "Machine learning for heterogeneous  
multi-robots systems in logistic application  
frame"

presented at 14th International Conference on Climbing  
and Walking Robots and the Support  
Technologies for Mobile Machines  
(CLAWAR 2011).  
Université Pierre et Marie Curie, Paris,  
6-8 September 2011

Dr Clive Loughlin  
Editor  
*Industrial Robot*

Dr Harry Colson  
Publisher  
*Industrial Robot*



Research you can use

## Bibliography

---

- [Abraham, 2005] Ajith Abraham. Adaptation of Fuzzy Inference System Using Neural Learning, *Fuzzy System Engineering: Theory and Practice*, Nadia Nedjah et al. (Eds.), Studies in Fuzziness and Soft Computing, Springer Verlag Germany, ISBN 3-540-25322-X, Chapter 3, pp. 53-83, 2005.
- [Alami et al, 1997] R. Alami, S. Fleury, M. Herrb, F. Ingrand, and F. Robert. Multi-robotcooperation in the Martha project. *IEEE Robotics and Automation Magazine*,1997.
- [Alami et al, 1998] R. Alami, S. Fleury, M. Herrb, F. Ingrand, F. Robert: Multi-robot cooperation in the MARTHA project, *Robot. Autom. Mag.* 5(1), pp. 36–47 ,1998.
- [Alpaydin, 2004] E. Alpaydin. *Machine-Learning*. MIT Press, Cambridge, MA, 2004.
- [Andréa-Novel et al, 1995] B. d'Andréa-Novel, G. Campion, G. Bastin. Control of nonholonomic wheeled mobile robots by state feedback linearization, *Int. J. Robot. Res.* 14, 543–559 (1995)
- [Angeli, 1999] D. Angeli: Input-to-State stability of PD-controlled robotic systems, *Automatica* 35, 1285–1290 (1999)
- [Antonelli, et al, 2007] G. Antonilli, F. Arrichiello, S. Chakraborti and S. Chiaverini. Experiences of formation control of multi-robot systems with the NULL-Space-based Behavior control. *Robotics and Automation, IEEE International Conference on*, pp. 1068-1073, April 2007.
- [Asada et al, 2000] M. Asada, R. D'Andrea, A. Birk, H. Kitano, and M. Veloso. Roboticsin edutainment. In *Proceedings of IEEE International Conference onRobotics and Automation (ICRA-2000)*, pages 795–800, San Francisco,2000.
- [Asada et al, 1999] M. Asada, H. Kitano, I. Noda, and M. Veloso. RoboCup: Today andtomorrow – what we have learned. *Artificial Intelligence*, 110(2):193–214, June 1999.
- [Asada et al, 1999a] M. Asada, E. Uchibe, and K. Hosoda. Cooperative behavior acquisitionfor mobile robots in dynamically changing real worlds via visionbasedreinforcement learning and development. *Artificial Intelligence*,110(2):275–292, June 1999.

- [Asama et al, 1989] H. Asama, A. Matsumoto, and Y. Ishida. Design of an autonomous and distributed robot system: ACTRESS. In IEEE/RSJ IROS, pages 283–290, 1989.
- [Asama et al, 1991] H. Asama, M. K. Habib, I. Endo, K. Ozaki, A. Matsumoto, and Y. Ishida. Functional distribution among multiple mobile robots in an autonomous and decentralized robot system. In IEEE ICRA, pp: 1921–6, 1991.
- [Asama et al, 1991a] H. Asama, K. Ozaki, H. Itakura, A. Matsumoto, Y. Ishida, and I. Endo. Collision avoidance among multiple mobile robots based on rules and communication. In Proceedings of IEEE/RJS International Conference on Intelligent Robots and Systems. IEEE, 1991.
- [Asama, 1992] H. Asama, editor. Proceedings of the International Symposium on Distributed Autonomous Robotic Systems, Wako, Saitama, Japan, September 1992.
- [Asama et al, 1992] H. Asama, Y. Ishida, K. Ozaki, M. K. Habib, A. Matsumoto, H. Kaetsu, and I. Endo. A communication system between multiple robotic agents. In M. Leu, editor, Proc. the Japan U.S.A. Symposium on Flexible Automation, pages 647–654, 1992.
- [Asama et al, 1994] H. Asama, T. Fukuda, T. Arai, and I. Endo, editors. Distributed Autonomous Robotic Systems. Springer-Verlag, 1994.
- [Asama et al, 1996] H. Asama, T. Fukuda, T. Arai, and I. Endo, editors. Distributed Autonomous Robotic Systems 2. Springer-Verlag, 1996.
- [Asama et al, 1996] H. Asama, T. Arai, T. Fukuda, and T. Hasegawa, editors. Distributed Autonomous Robotic Systems 6. Springer-Verlag, 1998.
- [Arai et al, 1989] T. Arai, H. Ogata, and T. Suzuki. Collision avoidance among multiple robots using virtual impedance. In Proceedings of the IEEE/RSJ International Conference on Intelligent Robots and Systems, pages 479–485, 1989.
- [Arai et al, 2002] T. Arai, E. Pagello, L.E. Parker: Editorial: Advances in multi-robot systems, IEEE Trans. Robot. Autom.18(5), pp. 655–661 , 2002.
- [Arkin & Bekey, 1997] R. C. Arkin and G. A. Bekey (guest editors). Special issue on Robot Colonies. Autonomous Robots, 4(1):1–153, March 1997.
- [Arkin, 1998] R. C. Arkin. Behavior-based robotics. MIT Press, London, 1998.



- [Artus et al, 2003] G. Artus, P. Morin, C. Samson. Tracking of an omnidirectional target with a nonholonomic mobile robot, Proc. IEEE Conf. Adv. Robotics (ICAR) (2003) pp. 1468–1473
- [Astrom & Eykhoff, 1971] K.J. Astrom and P. Eykhoff. System identification – a survey. *Automatia*, 7:123-162,1971.
- [Asada et al, 1994] M. Asada, E. Uchibe, S. Noda, S. Tawaratsumida, K. Hosoda: Coordination of multiple behaviors acquired by a vision-based reinforcement learning, Proc. IEEE/RSJ/GI Int. Conf. Intell. Robot. Syst. (Munich 1994). pp. 917–924.
- [Balch, 1999] T. Balch: The impact of diversity on performance in robot foraging, Proc. 3rd Ann. Conf. Auton. Agents (ACM Press, Seattle 1999) pp. 92–99
- [Balch & Arkin, 1995] T. R. Balch and R. C. Arkin. Communication in reactive multiagent robotic systems. *Autonomous Robots*, 1(1):1–25, 1994.
- [Balch & Arkin, 1995] T. Balch, R.C. Arkin: Communiation in reactivemultiagent robotic systems, *Auton. Robot.* 1(1), 27–52(1995)
- [Balch & Arkin, 1998] T. Balch and R. C. Arkin, “Behavior-based formation control for multirobot teams,” *IEEE Trans. Robot. Automat.*, vol. 14, pp. 926–939, Dec. 1998.
- [Balch, 1999] T. Balch. The impact of diversity on performance in multirobot foraging. In Proc. *Autonomous Agents 99*, Seattle, WA, 1999.
- [Balch & Parker, 2000] T. Balch, L.E. Parker: Guest editorial, special issue on heterogeneous multi-robot systems, *Auton. Robot.* 8(3), 207–208 (2000)
- [Balch, 2000] T. Balch: Hierarchic social entropy: An information theoretic measure of robot team diversity, *Autonomous Robot.* 8(3), 209–238 (2000)
- [Balch, 2002] T. Balch: Taxonomies of multi-robot task and reward. In: *Robot Teams: From Diversity to Polymorphism*, ed. by T. Balch, L.E. Parker (A K Peters, Natick 2002)
- [Balch & Parker, 2002] T. Balch, L.E. Parker (Eds.): *Robot Teams: From Polymorphism to Diversity* (A K Peters, Natick 2002)
- [Balestrino, 1983] A. Balestrino, G. de Maria, L. Sciavicco: An adaptive model following control for robotic manipulators, *ASME J. Dyn. Syst. Meas. Control.* 105, 143–151(1983)
- [Barfoot, 2004] T.D. Barfoot, and C.M. Clark. : “Motion Planning for Formations of Mobile Robots”. *Robotics and Autonomous Systems*, 2004, Vol 46.2, pp.65-78.

- [Basar & Olsder, 1995] T. Başar and G. J. Olsder. *Dynamic Noncooperative Game Theory*, 2nd Ed. Academic, London, 1995.
- [Batavia & Nourbakhsh, 2000] P. Batavia, I. Nourbakhsh, "Path Planning for the Cyc Robot," in *Proceedings of the IEEE/RSJ International Conference on Intelligent Robots and Systems (IROS'00)*, Takamatsu, Japan, November, 2000.
- [Bazoula et al, 2008] A. Bazoula, M.S. Djouadi and H. Maaref. "Formation Control of Multi-Robots via Fuzzy Logic Technique", in *Int.J. of Computers, Communications & Control*, proceedings of ICCCC, 2008, pp 179-184.
- [Beard & Hadaegh, 2000] R. W. Beard, J. Lawton, and F. Y. Hadaegh: A feedback architecture for formation control. In *Proceedings of the American Control Conference*, pp. 4087–4091, June, 2000.
- [Beard et al, 2001] R. W. Beard, J. Lawton, and F.Y. Hadaegh,. A feedback architecture for formation control. *IEEE Transactions on Control System Technology*. Vol. 9, 777–790, 2001.
- [Beard et al, 2002] R.W. Beard, T.W. McLain, M. Goodrich: Coordinated target assignment and intercept for unmanned air vehicles, *Proc. IEEE Int. Conf. Robot. Autom.* (IEEE, Washington 2002)
- [Beckers et al, 1994 ] R. Beckers, O. Holland, J. Deneubourg: From local actions to global tasks: Stigmergy and collective robotics, *Proc. 14th Int. Workshop Synth. Simul. Living Syst.*, ed. by R. Brooks, P. Maes (MIT Press, Cambridge 1994) pp. 181–189
- [Belta & Kumar, 2004] C. Belta, V. Kumar: Abstraction and control for groups of robots, *IEEE Trans. Robot.* 20(5), 865–875 (2004)
- [Benda et al, 1985] M. Benda, V. Jagannathan, R. Dodhiawalla: On optimal cooperation of knowledge sources, Boeing AI Center Technical Report BCS-G2010-28, 1985.
- [Beni, 1988] G. Beni. The concept of cellular robotic system. In *IEEE International Symposium on Intelligent Control*, pages 57–62, 1988.
- [Bennani & Rouchon, 1995] M.K. Bennani, P. Rouchon. Robust stabilization of flat and chained systems, *Proc. Eur. Control Conf.* (1995) pp. 2642–2646

- [Berman et al, 2003] S. Berman, Y. Edan and M. Jamshidi.. Navigation of decentralized autonomous automatic guided vehicles in material handling. *IEEE Transactions on Robotics and Automation*, Vol. 19, No. 4, pp:743- 749, 2003.
- [Bertsekas & Tsitsiklis, 1996] D. P. Bertsekas and J. N. Tsitsiklis. *Neuro-Dynamic Programming*. Athena Scientific, Belmont, MA, 1996.
- [Bicho & S. Monteiro, 2003] E. Bicho and S. Monteiro.: Formation control for multiple mobile robots: a nonlinear attractor dynamics approach. *IEEE/RSJ International Conference on Intelligent Robots and Systems*, pp. 2016–2022, 2003.
- [Bishop & Spong, 1998] B. E. Bishop and M. W. Spong.: Control of redundant manipulators using logic-based switching, in *Proc. 37th IEEE Conf. Decision and Control*, Tampa, FL, pp. 1488-1493, Dec. 1998.
- [Bojinov et al, 2000] H. Bojinov, A. Casal, and T. Hogg. Emergent structures in modular selfreconfigurable robots. In *Proceedings of the IEEE International Conference on Robotics and Automation*, pages 1734–1741, 2000.
- [Bowling & Veloso, 2003] M. Bowling, M. Veloso: Simultaneous adversarial multi-robot learning, *Proc. Int. Joint Conf. Artif. Intell.* 2003.
- [Brown & Jennings, 1995] R.G. Brown, J.S. Jennings: A pusher/steerer model for strongly cooperative mobile robot manipulation, *Proc. IEEE Int. Conf. Intell. Robot. Syst. (IROS'95)* (IEEE, Pittsburgh 1995) pp. 562–568, 1995.
- [Burgard et al, 2005] W. Burgard, M. Moors, D. Fox, R. Simmons, and S. Thrun. Collaborative multi-robot exploration. In *Proceedings of the IEEE International Conference on Robotics and Automation*, pages 476–481, 2000.
- [Burgard et al, 2005] W. Burgard, M. Moors, C. Stachniss, and F.E. Schneider. Coordinated multi-robot exploration. *IEEE Journal of Robotics*, 21(3):376–386, June 2005.
- [Butler et al, 2000] Z.J. Butler, A.A. Rizzi, R.L. Hollis: Cooperative coverage of rectilinear environments, *Proc. IEEE Int. Conf. Robot. Autom.* (IEEE, San Francisco 2000)
- [Caloud et al, 1990] P. Caloud, W. Choi, J.C. Latombe, C. Le Pape, M. Yim: Indoor automation with many mobile robots, *Proc. IEEE Int. Workshop Intell. Robot. Syst.* (IEEE, Tsuchiura 1990) pp. 67–72, 1990.

- [Campion et al, 1996] G. Campion, G. Bastin, B. d'Andréa-Novel: Structural properties and classification of kinematic and dynamic models of wheeled mobile robots, *IEEE Trans. Robot. Autom.* 12, 47–62 (1996)
- [Campion & Chung, 2008] Guy Campion, Woojin Chung. “wheeled robots” *Handbook of Robotics*, S. Bruno, K.S Oussama (Eds), Springer-Verlag Berlin Heidelberg, 2008, pp.391-410.
- [Candea, 2001] C. Candea, H.S. Hu, L. Iocchi, D. Nardi, M. Piaggio: Coordination in multi-agent Robocup teams, *Robot. Auton. Syst.* 36(2), 67–86 (2001)
- [Canudas de Wit & Sørđalen, 1992] C. Canudas de Wit, O.J. Sørđalen: Exponential stabilization of mobile robots with nonholonomic constraints, *IEEE Trans. Autom. Control* 37(11), 1791– 1797 (1992)
- [Canudas, 1996] C. Canudas de Wit, B. Siciliano, and G. Bastin, *Theory of Robot Control*. Berlin: Springer-Verlag, 1996.
- [Cao et al, 1997a] Y. U.Cao, A. S. Fukunaga, A.B. Kahng, F.Meng, A. S.Fukunaga, A. B. Kahng,. (1997). Cooperative mobile robotics: antecedents and directions. *Proceedings 1995 IEEE/RSJ International Conference on Intelligent Robots and Systems. Human Robot Interaction and Cooperative Robots*, 1, 226-234. IEEE Compute.
- [Cao et al, 1997] Y. Cao, A. Fukunaga, A. Kahng: Cooperative mobile robotics: Antecedents and directions, *Auton. Robot.* 4, pp.1–23 ,1997.
- [Cao et al, 2006] Z. Cao, M. Tin, L. Li, N. Gu, S. Wang: Cooperative hunting by distributed mobile robots based on local interaction, *IEEE Trans. Robot.* 22(2), pp: 403–407, 2006.
- [Caprari et al, 2002] G. Caprari, T. Estier, R. Siegwart, “Fascination of Down Scaling–Alice the Sugar Cube Robot.” *Journal of Micro-Mechatronics*, 1, 177–189, 2002.
- [Carelli et al, 2006] R. Carelli, C. de la Cruz, and F. Roberti.: Centralized formation control of non-holonomic mobile robots. *Latin American Applied Research*, pp. 63–69, June 2006.
- [Carpin & Parker, 2002] S. Carpin, and L.E. Parker.: Cooperative leader following in a distributed multi-robot system. In *Proceedings of the IEEE International Conference on Robotics and Automation*, vol. 3: pp. 2994–3001, 2002.
- [Carroll & Ruppert, 1988] R.J., Carroll, D., Ruppert, *Transformation and Weighting in Regression*. New York, Chapman and Hall, 1988.

- [Catano et al., 2000] A. Castano, R. Chokkalingam, and P. Will. Autonomous and selfsufficient CONRO modules for reconfigurable robots. In Proceedings of the Fifth International Symposium on Distributed Autonomous Robotic Systems (DARS 2000), pages 155–164, 2000.
- [Clark et al, 2003] C. M. Clark, S. M. Rock, and J.-C. Latombe. : Motion planning for multiple mobile robot systems using dynamic networks. In Proceedings of IEEE International Conference on Robotics and Automation, pap: 4222–4227, 2003.
- [Consolin et al, 2006] L. Consolini, F. Morbidi, D. Prattichizzo, and M. Tosques.: On the control of a leaderfollower formation of nonholonomic mobile robots. IEEE Conference on Decision and Control, pp. 5992–5997, 2006.
- [D’Andrea-Novel,1995] B. D’Andrea-Novel, G. Campion and G.Bastin(1995)”. ”Control of nonholonomic wheeled mobile robots by state feedback linearization”. The International Journal of Robotics Research, 1995, Vol. 14, No. 6, 543-559.
- [Das et al, 2002] A.K.Das, R. Fierro, V. Kumar, J.P. Ostrowski, J. Spletzer, C.J. Taylor.: A vision-based formation control framework. in: Robotics and Automation, IEEE Transactions on, Issue Date: Oct 2002 ,Volume: 18 Issue:5, On page(s): 813 – 825, 2002.
- [Dawson et al, 1991] D.M. Dawson, M. Grabbe, F.L. Lewis: Optimal control of a modified computed–torque controller for a robot manipulator, Int. J. Robot. Autom. 6(3),161–165 (1991)
- [Dawson et al, 1993]D.M. Dawson, Z. Qu, J. Duffie: Robust tracking control for robot manipulators: theory, simulation and implementation, Robotica 11, 201–208 (1993)
- [Dedeoglu & Sukhatme, 2000] G. Dedeoglu and G. Sukhatme. Landmark-based matching algorithm for cooperative mapping by autonomous robots. In Proceedings of the Fifth International Symposium on Distributed Autonomous Robotic Systems (DARS 2000), pages 251–260, 2000.
- [De Luca & Di Benedetto, 1995] A. De Luca M.D. Di Benedetto(1993). “Control of noholonomic systems via dynamic compensation”. Workshop on system structure and control N2, 1993, vol. 29, no 6, pp. 593-608.
- [De Luca & Di Benedetto, 1993] A. De Luca, M.D. Di Benedetto: Control of nonholonomic systems via dynamic compensation, Kybernetika 29, 593–608 (1993)

- [Deneubourg et al, 1990] J. Deneubourg, S. Goss, G. Sandini, F. Ferrari, P. Dario: Self-organizing collection and transport of objects in unpredictable environments. (Kyoto) pp.1093–1098,1990.
- [Desai, 1998] J. Desai. : Motion planning and control of cooperative robotic systems, Ph.D. dissertation, Univ. of Pennsylvania, Philadelphia, 1998.
- [Desai, 2001] J. P. Desai, J. P. Ostrowski, and V. Kumar. : Modeling and control of formations of nonholonomic mobile robots. *IEEE Transactions on Robotics and Automation*, pp. 905–908, Dec 2001.
- [Desai et al, 1998] J.P. Desai, J. Ostrowski, and V. Kumar.:Control of formations for multiple robots, in *Proc. IEEE Int. Conf. Robotics and Automation*, Leuven, Belgium, vol.4, pp. 2864-2869, May 1998.
- [Desai et al, 1999] J.P. Desai , V. Kumar , and J.P. Ostrowski, “Control of changes in formation for a team of mobile robots”, In *Proceedings of IEEE Int. Conf. on Robotics and Automation*, 1999, pp 1556-1561.
- [Desay et al, 1999] J.P. Desay, V. Kumar, and P. Ostrowski.: Control of change in formation for a team of mobile robots. In *Proceedings of the IEEE International Conference on Robotics and Automation*, vol. 2, pp. 1556–1561, 1999.
- [de Silva, 1989] C.W., de Silva. *Control Sensors and Actuators*. Upper Saddle River, NJ, Prentice Hall, 1989.
- [Dias et al, 2006] B. Dias, R. Zlot, N. Kalra, A. Stentz: Market-based multirobot coordination: A survey and analysis, *Proc. IEEE* 94(7), 1257–1270 (2006)
- [Dickmanns & Zapp, 1987] E.D. Dickmanns, A. Zapp. Autonomous high speed road vehicle guidance by computer vision, *Proc. IFAC World Congr.* (1987)
- [Dietrich, 1991] C.F., Dietrich. *Uncertainty, Calibration and Probability*. Bristol, UK, Adam Hilger, 1991.
- [Do & Pan, 2007] K. Do and J. Pan: Nonlinear formation control of unicycle-type mobile robots. *Robotics and Autonomous Systems*, pp. 191–204, 2007.
- [Donald & Jennings, 1994] B. Donald, J. Jennings, D. Rus: Analyzing teams of cooperating mobile robots, *Proc. IEEE Int. Conf. Robot. Autom.* (IEEE, 1994) pp. 1896–1903

- [Donald et al, 2000] B. Donald, L. Gariepy, and D. Rus. Distributed manipulation of multiple objects using ropes. In Proceedings of IEEE International Conference on Robotics and Automation, pages 450–457, 2000.
- [Drogoul & Ferber, 1992] A. Drogoul and J. Ferber. From Tom Thumb to the Dockers: Some experiments with foraging robots. In Proceedings of the Second International Conference on Simulation of Adaptive Behavior, pages 451–459, Honolulu, Hawaii, 1992.
- [Egerstedt et al, 1998] M. Egerstedt, X. Hu, and A. Stotsky, “Control of a car-like robot using a virtual vehicle approach,” in Proc. 37th IEEE Conf. Decision and Control, Tampa, FL, pp. 1502–1507, Dec 1998.
- [Egerstedt et al, 2001] M. Egerstedt, X. Hu, and A. Stotsky, “Control of mobile platforms using a virtual vehicle approach,” IEEE Trans. Automatic Control, pp. 1777-1782, Nov 2001.
- [Egerstedt & Hu, 2001] M. Egerstedt and X. Hu: Formation Constrained Multi-Agent Control. IEEE TRANSACTIONS ON ROBOTICS AND AUTOMATION, VOL. 17, NO. 6, pp. 947-951, 2001
- [Ens & Lawrence, 1993] J. Ens, P. Lawrence, “An Investigation of Methods for Determining Depth from Focus.” IEEE Transactions. on Pattern Analysis and Machine Intelligence, 15: 97–108, 1993.
- [Erdmann & Lozano-Perez, 1987] M. Erdmann and T. Lozano-Perez. On multiple moving objects. *Algorithmica*, 2:477–521, 1987.
- [Espenschied & Quinn, 1994] K. S. Espenschied, R. D. Quinn, “Biologically-Inspired Hexapod Robot Design and Simulation,” in AIAA Conference on Intelligent Robots in Field, Factory, Service and Space, Houston, Texas, March 20–24, 1994.
- [Everett, 1995] H.R., Everett. *Sensors for Mobile Robots, Theory and Applications*. New York, Natick, MA, A.K. Peters, Ltd., 1995.
- [Everett, et al, 2000] H.R. Everett, R.T. Laird, D.M. Carroll, G.A. Gilbreath, T.A. Heath-Pastore, R.S. Inderieden, T. Tran, K.J. Grant, D.M. Jaffee: Multiple Resource Host Architecture (MRHA) for the Mobile Detection Assessment Response System (MDARS), SPAWAR Systems Technical Document 3026, Revision A 2000.
- [Falcone et al, 2003] E. Falcone, R. Gockley, E. Porter, I. Nourbakhsh, “The Personal Rover Project: The Comprehensive Design of a Domestic Personal Robot,” *Robotics and Autonomous Systems*, Special Issue on Socially Interactive Robots, 42, 245–258, 2003.

- [Fontan & Mataric, 1997] M. Fontan, and M. Mataric. "A study of territoriality: The role of critical mass in adaptive task division". In *From Animals to Animats 4: Proceedings of the Fourth International Conference of Simulation of Adaptive Behavior*, MIT Press, pp. 553–561, 1997.
- [Fax & Murray, 2004] J.A. Fax, R.M. Murray: Information flow and cooperative control of vehicle formations, *IEEE Trans. Autom. Contr.* 49(9), 1465–1476 (2004)
- [Faugeras, 1993] O., Faugeras, *Three-Dimensional Computer Vision, a Geometric Viewpoint*. Cambridge MIT Press, MA, 1993.
- [Feder & Slotin, 1997] H.J.S. Feder, J-J.E. Slotin, "Real-Time Path Planning Using Harmonic Potentials in Dynamic Environments," in *Proceedings of the IEEE International Conference on Robotics and Automation*, Albuquerque, NM, April 1997.
- [Ferrari et al.,1998] C. Ferrari, E. Pagello, J. Ota, and T. Arai. Multirobot motion coordination in space and time. *Robotics and Autonomous Systems*, 25:219–229, 1998.
- [Fernandez & Parker, 2005] F. Fernandez, L.E. Parker: A reinforcement learning algorithm in cooperative multi-robot domains, *J. Intell. Robot. Syst.* 43, pp:161–174 , 2005.
- [Fliess et al, 1995] M. Fliess, J. L'évine, P. Martin, P. Rouchon. Flatness and defect of non-linear systems: introductory theory and examples, *Int. J. Control* 61, 1327–1361(1995)
- [Fiorelli et al, 2004] E. Fiorelli, N.E. Leonard, P. Bhatta, D. Paley, R. Bachmayer, and D.M. Fratantoni.: Multi-auv control and adaptive sampling in Monterey bay. In *Proceedings IEEE Autonomous Underwater Vehicles 2004: Workshop on Multiple AUV Operations*. pp.134–147, Sebasco, ME, June 2004.
- [Fliess et al, 1995] M. Fliess, J. Levine and P. Martin. "Flatness and defect of non-linear systems: introductory theory and examples". *International Journal of Control*, 1995, Vol. 61, No. 6, pp.1327-1361.
- [Fontan & Mataric, 1998] M. Fontan, M. Mataric: Territorial multi-robot task division, *IEEE Trans. Robot. Autom.* 15(5), 815–822 (1998)
- [Fox et al, 2000] D. Fox, W. Burgard, H. Kruppa, and S. Thrun. Collaborative multi-robot exploration. *Autonomous Robots*, 8(3):325–344, 2000.
- [Fox, 2001] D. Fox, "KLD-Sampling: Adaptive Particle Filters and Mobile Robot Localization." *Advances in Neural Information Processing Systems* 14. MIT Press, 2001.



- [Fox et al, 1997] D. Fox, W. Burgard, S. Thrun, “The Dynamic Window Approach to Collision Avoidance.” *IEEE Robotics and Automation Magazine*, 4:23–33, 1997.
- [Fredslund & Mataric, 2002] J. Fredslund, M.J. Mataric: A general algorithm for robot formations using local sensing and minimal communication, *IEEE Trans. Robot. Autom.* 18(5), 837–846 (2002)
- [Frezza, 1998] R. Frezza, G. Picci, and S. Soatto, “Nonholonomic model-based predictive output tracking of an unknown three-dimensional trajectory,” in *Proc. 37th IEEE Conf. Decision and Control*, Tampa, FL, pp. 3731-3735, Dec. 1998.
- [Fu, 1992] L.C. Fu: Robust adaptive decentralized control of robot manipulators, *IEEE Trans. Autom. Contr.* 37(1),106–110 (1992).
- [Fukuda & Iritani, 1995] T. Fukuda and G. Iritani. Construction mechanism of group behavior with cooperation. In *IEEE/RSJ IROS*, pp: 535–542, 1995.
- [Fukuda & Kawauchi,1993] T. Fukuda and Y. Kawauchi. *Cellular Robotics*, pages 745–782. Springer-Verlag, 1993.
- [Fukuda & Nakagawa, 1987] T. Fukuda and S. Nakagawa. : A dynamically reconfigurable robotic system (concept of a system and optimal configurations). In *International Conference on Industrial Electronics, Control, and Instrumentation*, pp: 588–95, 1987.
- [Fukuda et al, 1998] T. Fukuda, S. Nakagawa, Y. Kawauchi, M. Buss: Self organizing robots based on cell structures – CEBOT, *Proc IEEE Int. Workshop Intell. Robot. Syst. (IEEE, 1988)* pp. 145–150
- [Fukuda et al, 1992] T. Fukuda, S.Nakagawa, Y.Kawauchi and M. Buss, “Self organizing robots based on cell structures CEBOT”, *Proceedings of the 1992 IEEE International Conference on Robotics and Automations Workshop Intell. 1992*, pp. 814-818.
- [Gage, 1993] D. Gage: Randomized search strategies with imperfect sensors, *Proc. SPIE Mobile Robots VIII (SPIE,Boston 1993)* pp. 270–279
- [Gale, 1960] D. Gale: *The Theory of Linear Economic Models* (McGraw-Hill, New York 1960)
- [Gander et al, 1994] W. Gander, G.H. Golub, R. Strebel, “Least-Squares Fitting of Circles and Ellipses.” *BIT Numerical Mathematics*, vol. 34, no. 4, pp. 558–578, December 1994.

- [Gerkey & Mataric, 2002] B. P. Gerkey and M. J. Mataric. Sold! auction methods for multirobot coordination. *IEEE Transactions on Robotics and Automation*, 18(5):758–768, 2002.
- [Godjevac, 1995] J. Godjevac. “A Learning Procedure for a Fuzzy System: Application to Obstacle Avoidance”. In *Proceedings of the International Symposium on Fuzzy Logic*, 1995, pp. 142-148.
- [Goldberg & Mataric, 1997] D. Goldberg, and M. Mataric. Interference as a tool for designing and evaluating multi-robot controllers. In *Proceedings, AAAI-97*, pp. 637–642, 1997.
- [Golub & Kahan, 1965] G. Golub, W. Kahan, “Calculating the Singular Values and Pseudo-Inverse of a Matrix.” *Journal SIAM Numerical Analysis*, 2:205–223, 1965.
- [Grabowski, 2000] R. Grabowski, L.E. Navarro-Serment, C.J. Paredis, P.K. Khosla: Heterogeneous teams of modular robots for mapping and exploration, *Auton. Robot.* 8(3), 271–298 (2000)
- [Grossman, 1988] D. Grossman: Traffic control of multiple robot vehicles, *IEEE J. Robot. Autom.* 4, 491–497 (1988)
- [Guerrero & Oliver, 2003] J. Guerrero, G. Oliver: Multi-robot task allocation strategies using auction-like mechanisms, *Proc. 6th Congr. Catalan Assoc. Artif. Intell.* (2003) pp. 111–122
- [Guo & Parker, 2002] Y. Guo and L. E. Parker. : A distributed and optimal motion planning approach for multiple mobile robots. In *Proceedings of IEEE International Conference on Robotics and Automation*, 2002.
- [Guo & Madhavan, 2004] Y. Guo, L.E. Parker, R. Madhavan: Towards collaborative robots for infrastructure security applications, *Proc. Int. Symp. Collab. Technol. Syst.* pp. 235–240, 2004.
- [Guo et al, 2004] Y. Guo, L.E. Parker, R. Madhavan: Towards collaborative robots for infrastructure security applications, *Proc. Int. Symp. Collab. Technol. Syst.*(2004) pp. 235–240
- [Gutmann et al, 1998] J.S. Gutmann, W. Burgard, D. Fox, K. Konolige, “An Experimental Comparison of Localization Methods,” in *Proceedings of the 1998 IEEE/RSJ International Conference of Intelligent Robots and Systems (IROS’98)*, Victoria, B.C., Canada, October 1998.

- [Gutmann et al, 1999] J.S. Guttmann, K. Konolige, “Incremental Mapping of Large Cyclic Environments,” in Proceedings of the IEEE International Symposium on Computational Intelligence in Robotics and Automation (CIRA), Monterey, November 1999.
- [Gutmann et al, 2005] J. S. Gutmann, M. Fukuchi, M. Fujita. A floor and obstacle height map for 3D navigation of a humanoid robot. In Proceedings of International Conference on Robotics and Automation, Barcelona, Spain, pp. 1066-1071, 2005.
- [Han & Lewis, 1996] T. K. Han and M.A. Lewis.: Virtual structure for high-precision cooperative mobile robotic control”, in Intelligent Robots and Systems’96, IROS 96, Proceedings of the 1996 IEEE/RSJ International Conference on, Vol.1, pp 132-139,1996.
- [Han & Lewis, 1997] T. K. Han and M.A. Lewis. :High Precision Formation Control of Mobile Robots Using Virtual Structures, in Autonomous Robots, vol.4, pp. 387-403,1997.
- [Hara et al, 1995] F. Hara, Y. Yasui, T. Aritake: A kinematic analysis of locomotive cooperation for two mobile robots along a general wavy road, Proc. IEEE Int. Conf. Robot. Autom. (IEEE, Nagoya 1995) pp. 1197–1204
- [Haralick & Shapiro, 1993] R.M., Haralick, L.G., Shapiro. Computer and Robot Vision, 1+2. Boston, Addison Wesley, 1993.
- [Hashimoto, 1998] S. Hashimoto, “Humanoid Robots in Waseda University - Hadaly-2 and WABIAN,” in IARP First International Workshop on Humanoid and Human Friendly Robotics, Tsukuba, Japan, October 1998.
- [Haynes & Sen, 1986] T. Haynes, S. Sen: Evolving Behavioral Strategies in Predators and Prey, Adaptation and Learning in Multi-Agent Systems, ed. by G. Weiss, S. Sen (Springer, Berlin, Heidelberg 1986) pp. 113–126
- [Hazard et al, 2006]C. Hazard, P.R. Wurman, R. D’Andrea: Alphabet Soup: A testbed for studying resource allocation in multi-vehicle systems, Proc. AAAI Workshop Auction Mechan. Robot Coord. (AAAI, Boston 2006) pp. 23–30
- [Hedrick et al, 1991] J. K. Hedrick, D. McMahon, V. Narendran, and D. Swaroop.: Longitudinal vehicle controller design for IVHS systems. in Proc. American Control Conf., pp. 3107–3112, 1991.
- [Heale & Kleeman, 2000] A. Heale, L. Kleeman.: “A Real Time DSP Sonar Echo Processor,” in Proceedings of the IEEE/RSJ International Conference on Intelligent Robots and Systems (IROS’00), Takamatsu, Japan, October 31–November 5, 2000.

- [Heinzinger, 1989] G. Heinzinger, D. Frewick, B. Paden, F. Miyazaki: Robust learning control, Proc. IEEE Int. Conf. Dec.Contr. (1989)
- [Hewitt et al, 1973] C. Hewitt, P. Bishop, I. Greif, B. Smith, T. Matson, and R. Steiger. A universal modular actor formalism for artificial intelligence. In Proc. Intl. Joint Conf. Artificial Intelligence, pages 235–245, 1973.
- [Hertzberg & Chatila,2008]J. Hertzberg, R. Chatila. “AI reasoning methods for robotics”. Handbook of Robotics, S. Bruno, K.S Oussama (Eds), Springer-Verlag Berlin Heidelberg, 2008, pp.207-223.
- [Hugues, 2000] L. Hugues. Collective grounded representations for robots. In Proceedings of Fifth International Conference on Distributed Autonomous Robotic Systems (DARS 2000), pages 79–88, 2000.
- [Huntsberger et al, 2003] T. Huntsberger, P.Pirjanian, A. Trebi-Ollennu, H.D.Nayar, H. Aghazarian, A.Ganino, M.Garrett , S. S.Joshi and P. S. Schenker.: CAMPOUT: A control architecture for tightly coupled coordination of multi-robot systems for planetary surface exploration. IEEE Transactions on Systems, Man and Cybernetics, Part A: Systems and Humans, Collective Intelligence, 33(5):550–559, 2003.
- [Ihle, 2004] I.A.F. Ihle, R. Skjetne, and T.I. Fossen. : Nonlinear formation control of marine craft with experimental results. In Proceedings 43rd IEEE Conference on Decision and Control, volume 1, pp. 680–685, Paradise Island, The Bahamas, Dec 2004.
- [Ikeda, 2006] T. Ikeda, J. Jongusuk, T. Ikeda, and T. Mita. : Formation control of multiple nonholonomic mobile robots. Electrical Engineering in Japan, pp. 81–88, 2006.
- [Isaacs, 1965] R. Isaacs. Differential Games. Wiley, New York, 1965.
- [Ishida et al, 1991] Y. Ishida, I. Endo, and A. Matsumoto. Communication and cooperation in an autonomous and decentralized robot system. In IFAC int. Symp. on Distributed Intelligent Systems, pages 299–304, 1991.
- [Ishida et al, 1994] Y. Ishida, H. Asama, S. Tomita, K. Ozaki, A. Matsumoto, and I. Endo. Functional complement by cooperation of multiple autonomous robots. In IEEE ICRA, pages 2476–2481, 1994.
- [Jang, 1991] J. –S. Roger Jang. Fuzzy modeling using generalized neural networks and Kalman filter algorithm. In Proc. Of the Ninth National Conference on Artificial Intelligence (AAAI-91), pp:762-767, July 1991.

- [Jang, 1991a] J. –S. Roger Jang. A self-learning fuzzy controller with application to automobile tracking problem. In Proc. Of IEEE Roundtable Discussion on Fuzzy and Neural Systems, and Vehicle Application, page paper no. 10, Tokyo, Japan, November 1991. Institute of Industrial Science, Univ. of Tokyo.
- [Jang, 1991b] J. –S. Roger Jang. Rule extraction using generalized neural networks. In Proc. Of the IFSA World Congress, pp: 82-86(In the Volume for Artificial Intelligence), July 1991.
- [Jang, 1992] J. –S. Roger Jang. Anfis: adaptive-network-based fuzzy inference systems. IEEE Trans. On systems, Man and Cybernetics, 1992.
- [Jang, 1992a] J. –S. Roger Jang. Fuzzy controller design without domain experts. In Proc. Of IEEE international conference on fuzzy systems, March, 1992.
- [Jang, 1992b] J. –S. Roger Jang. Self-learning fuzzy controller based on the temporal back-propagation. IEEE Trans. On Neural Networks, 3(5): 714-723, September 1992.
- [Jang, 1993] J. –S. Roger Jang. ANFIS: Adaptive-networks-based fuzzy inference systems. IEEE Trans. On systems, Man, and Cybernetics, 23(03): 665-685, May 1993.
- [Jang & Sun, 1993] J.-S.R Jang, and C.T. Sun. Functional equivalence between radial basis function networks and fuzzy inference systems. IEEE Trans. On Neural Networks, 4(1): 156-159, January 1993.
- [Jang & Sun, 1993] J.-S.R Jang, and C.T. Sun. Proceeding chaotic time series with fuzzy if-then rules. In Proc. Of IEEE international conference on fuzzy systems, San Francisco, March 1993.
- [Jang & Sun, 1995] J.-S.R Jang, and C.T. Sun. “Neurofuzzy modeling and control” Proceedings of the IEEE, 1995, pp. 378-406.
- [Jung & Zelinsky, 2000] D. Jung and A. Zelinsky. Grounded symbolic communication between heterogeneous cooperating robots. Autonomous Robots, 8(3):269–292, July 2000.
- [Jung et al, 2004] D. Jung, H. Kim, J. Kim, K. Um, H. Cho. Efficient path finding in 3D games by using visibility tests with the A\* algorithm. In Proceedings of Artificial Intelligence and Soft Computing, Marbella, Spain, 2004.
- [Kaelbling et al, 1996] L.P. Kaelbling, M. L. Littman, and A.W. Moore. “Reinforcement learning: A survey” Journal of Artificial Intelligence Research, Vol 4, (1996), pp: 237-285.

- [Karamouzas & Overmars, 2008] L. Karamouzas, M. H. Overmars. Adding variation to path planning. *Computer Animation and Virtual Worlds*, vol. 19, no. 3-4, pp. 283-293, 2008.
- [Karamouzas et al, 2009] L. Karamouzas, R. Geraerts, M. Overmars. Indicative routes for path planning and crowd simulation. In *Proceedings of International Conference on the Foundation of Digital Games*, Orland, USA, pp. 113-120, 2009.
- [Kant & Zucker, 1986] K. Kant and S. W. Zucker. Toward efficient trajectory planning: the path-velocity decomposition. *The International Journal of Robotics Research*, 5(3):72–89, 1986.
- [Kato et al, 1992] S. Kato, S. Nishiyama, and J. Takeno. : Coordinating mobile robots by applying traffic rules. In *Proceedings of the 1992 IEEE/RSJ International Conference on Intelligent Robots and Systems*, pages 1535–1541, July 1992.
- [Khatib et al., 1996] O. Khatib, K. Yokoi, K. Chang, D. Ruspini, R. Holmberg, and A. Casal. Vehicle/arm coordination and mobile manipulator decentralized cooperation. In *IEEE/RSJ International Conference on Intelligent Robots and Systems*, pages 546–553, 1996.
- [Kitano, 1998] H. Kitano, editor. *RoboCup-97: Robot Soccer World Cup I*, volume *Lecture Notes in Artificial Intelligence 1395*. Springer, September 1998.
- [Kloder & Hutchinson, 2006] S. Kloder and S. Hutchinson. : Path planning for permutation-invariant multirobot formations. *IEEE Transactions on Robotics*, 22(4):650–665, 2006.
- [Kolmanovsky, 1995] I. Kolmanovsky and N.H.McClamroch. “Developments in nonholonomic control problems”. *IEEE Control Systems Magazine*, 1995, Vol 15, pp.20-36.
- [Konolige, 1997] K. Konolige, “Small Vision Systems: Hardware and Implementation,” in *Proceedings of Eighth International Symposium on Robotics Research*, Hayama, Japan, October 1997.
- [Kosuge & Oosumi, 1996] K. Kosuge, T. Oosumi, *Decentralized Control of Multiple Robots Handling an Object*, IROS1996, pp.318-323, 1996.
- [Kube & Zhang, 1993] C. R. Kube and H. Zhang. Collective robotics: From social insects to robots. *Adaptive Behavior*, 2(2):189–219, 1993.
- [Kubo & Kakazu, 1994] M. Kubo, Y. Kakazu: Learning coordinated motions in a competition for food between ant colonies, *Proc. 3rd Int. Conf. Simul. Adaptive Behavior*, ed. by D. Cliff, P. Husbands, J.-A. Meyer, S. Wilson (MIT Press, Cambridge 1994) pp. 487–492.

- [Kuipers & Byun, 1991] B. Kuipers, Y.-T. Byun.: "A Robot Exploration and Mapping Strategy Based on a Semantic Hierarchy of Spatial Representations." *Journal of Robotics and Autonomous Systems*, 8:47–63, 1991.
- [Kume et al, 2002] Kume Y., Hirata Y., Wang Z.D., and Kosuge K., Decentralized Control of Multiple Mobile Manipulators Handling a Single Object in Coordination, *IROS2002*, pp.2758-2763, 2002.
- [Lagoudakis et al, 2005] M. Lagoudakis, E. Markakis, D. Kempe, P. Keshinocak, A. Kleywegt, S. Koenig, C. Tovey, A. Meyerson, S. Jain: Auction-based multi-robot routing, *Robotics: Science and Systems I* (MIT Press, Cambridge 2005)
- [Lamiroux & Laumond, 1998] F. Lamiroux, J.-P. Laumond. A practical approach to feedback control for a mobile robot with trailer, *Proc. IEEE Int. Conf. Robotics Autom.* (1998) pp. 3291–3296
- [Lamon, 2001] P. Lamon, I. Nourbakhsh, B. Jensen, R. Siegwart.: "Deriving and Matching Image Fingerprint Sequences for Mobile Robot Localization," in *Proceedings of the 2001 IEEE International Conference on Robotics and Automation*, Seoul, Korea, May 21–26, 2001.
- [LaValle et al, 1997] S. M. LaValle, D. Lin, L. J. Guibas, J-C. Latombe, and R. Motwani. Finding an unpredictable target in a workspace with obstacles. In *Proceedings of the 1997 IEEE International Conference on Robotics and Automation (ICRA-97)*, pages 737–742, 1997.
- [LaValle & Sharma, 1997] S. M. LaValle and R. Sharma. On motion planning in changing, partially predictable environments. *International Journal of Robotics Research*, 16(6):775–805, December 1997.
- [LaValle, 2006] Steven M. *Planning Algorithms*. Cambridge: Cambridge University Press. ISBN 0521862051 ( Available online at <http://planning.cs.uiuc.edu/>)
- [LaVall, 2010] S. M. LaVall. *Planning Algorithms*, UK: Cambridge University Press, [Online], Available: <http://misl.cs.uiuc.edu/planning>, January 10, 2010.
- [LaValle & Hutchinson] S. M. LaValle and S. A. Hutchinson. : Optimal motion planning for multiple robots having independent goals. *IEEE Transactions on Robotics and Automation*, 14:912–925, 1998.

- [Leonard & E. Fiorelli, 2001] N. E. Leonard and E. Fiorelli.: Virtual leaders, artificial potentials and coordinated control of groups. Proc. 40th IEEE Conference Decision and Control, pp. 2968–2973, 2001.
- [LePape, 1900] C. LePape. A combination of centralized and distributed methods for multi-agent planning and scheduling. In IEEE ICRA, pages 488–493, 1990.
- [Lewis et al, 1993] F.L. Lewis, C.T. Abdallah, D.M. Dawson: Control of Robot Manipulators (Macmillan, New York 1993)
- [Ljung & Soderstrom, 1983] L. Ljung, T. Soderstrom. Theory and practice of Recursive Identification. Prentice Hall signal processing series. The MIT Press, Cambridge Massachusetts, London England, 1983.
- [Locatelli, 2001] A. Locatelli: Optimal Control: An Introduction (Birkh äuser, Basel 2001)
- [Lozano & Canudas de Wit, 1990] R. Lozano, C. Canudas de Wit: Passivity based adaptive control for mechanical manipulators using LS type estimation, IEEE Trans. Autom. Contr. 35(12), 1363–1365 (1990)
- [Leuth, 1998] T. Leuth, editor. Distributed Autonomous Robotic Systems 3. Springer Verlag, 1998.
- [Lucibello & Oriolo,1996] P. Lucibello, G. Oriolo. Stabilization via iterative state feedback with application to chained-form systems, Proc. IEEE Conf. Decis. Control (1996) pp. 2614–2619
- [Luh et al, 1980] J.Y.S. Luh, M.W. Walker, R.P.C. Paul: Resolved– acceleration control ofmechanicalmanipulator, IEEE Trans. Autom. Contr. 25(3), 468–474 (1980)
- [Lumelsky & Harinarayan, 1997] V. J. Lumelsky and K. R. Harinarayan. Decentralized motion planning for multiple mobile robots: The cocktail party model. Autonomous Robots, 4(1):121–135, 1997.
- [MacLennan, 1991] B. MacLennan. Synthetic ethology: An approach to the study of communication. In Proceedings of the 2nd interdisciplinary workshop on synthesis and simulation of living systems, pages 631–658, 1991.
- [MacKenzie et al, 1997] D. MacKenzie, R. Arkin, and J. Cameron. Multiagent mission specification and execution. Autonomous Robots, 4(1):29–52, 1997.



- [Mahadevan & Connell, 1991] S. Mahadevan, J. Connell: Automatic programming of behavior-based robots using reinforcement learning, Proc. AAAI (1991) pp. 8–14.
- [Manyika & Durrant-Whyte, 1994] J., Manyika, H.F., Durrant-Whyte. Data Fusion and Sensor Management: A Decentralized Information-Theoretic Approach. Ellis Horwood, 1994.
- [Mason, 2001] M., Mason. Mechanics of Robotics Manipulation. Cambridge, MA, MIT Press, 2001.
- [Marsella et al, 1999] S. Marsella, J. Adibi, Y. Al-Onaizan, G. Kaminka, I. Muslea, M. Tambe: On being a teammate: Experiences acquired in the design of RoboCup teams, Proc. 3rd Ann. Conf. Auton. Agents, ed. by O. Etzioni, J. Muller, J. Bradshaw (1999) pp. 221–227
- [Marsella et al, 2004] J.A. Marshall, M.E. Broucke, B.R. Francis: Formations of vehicles in cyclic pursuit, IEEE Trans. Autom. Contr. 49(11), 1963–1974 (2004)
- [Martinelli & Siegwart, 2003] A. Martinelli, R. Siegwart.: “Estimating the Odometry Error of a Mobile Robot during Navigation,” in Proceedings of the European Conference on Mobile Robots (ECMR 2003), Warsaw, September 4–6, 2003.
- [Mataric, 1992] M.J. Mataric: Designing emergent behaviors: From local interactions to collective intelligence, Proc. 2nd Int. Conf. Simul. Adaptive Behavior, ed. By J. Meyer, H. Roitblat, S. Wilson (MIT Press, Cambridge 1992) pp. 432–441
- [Mataric, 1994] M. J. Mataric. Interaction and Intelligent Behavior. PhD thesis, Massachusetts Institute of Technology, 1994.
- [Mataric, 1995] M.J. Mataric: Issues and approaches in the design of collective autonomous agents, Robot. Auton. Syst. 16, 321–331 (1995)
- [Mataric et al, 1995] M.J. Matarić, M. Nilsson, and K.T. Simsarian. Cooperative multi-robot box-pushing, Proc. of the Int. Conf. on Intelligent Robots and Systems, pp. 556–561, May 1995, Pittsburgh, PA.
- [Mataric, 1997] M. Mataric: Behavior-based control: Examples from navigation, learning, and group behavior, J. Exp. Theor. Artif. Intell. 19(2-3), pp:323–336, 1997.
- [Mataric, 1997] M. Mataric: Reinforcement learning in the multirobot domain, Auton. Robot. 4, pp:73–83 . 1997.

- [Mataric, 1992] M.J. Mataric. Designing emergent behaviors: From local interaction to collective intelligence. In Proceedings of the International Conference on Simulation of Adaptive Behavior: From Animal to Animal, pp. 432–441, 1992.
- [Mataric & Michaud, 2008] Maja J. Mataric, François Michaud. “Behavior based systems”. Handbook of Robotics, S. Bruno, K.S Oussama (Eds), Springer-Verlag Berlin Heidelberg, 2008, pp.891-909.
- [Maya-Mendez, 2006] M. Maya-Mendez, P. Morin, C. Samson: Control of a nonholonomic mobile robot via sensor-based target tracking and pose estimation, Proc. IEEE/RSJ Int. Conf. Intell. Robots Syst. (2006) pp. 5612–5618
- [M’Closkey & Murray, 1997] R.T. M’Closkey, R.M. Murray. Exponential stabilization of driftless nonlinear control systems using homogeneous feedback, IEEE Trans. Autom. Control 42, 614–6128 (1997)
- [McFarland, 1994] D. McFarland. Towards robot cooperation. In D. Cliff, P. Husbands, J.-A. Meyer, and S. Wilson, editors, Proceedings of the Third International Conference on Simulation of Adaptive Behavior, pages 440–444. MIT Press, 1994.
- [McLurkin, 2004] J. McLurkin: Stupid Robot Tricks: Behavior-Based Distributed Algorithm Library for Programming Swarms of Robots. M.S. Thesis (Massachusetts Institute of Technology, Cambridge 2004)
- [Minten et al, 2000] B. Minten, R. Murphy, J. Hyams, and M. Micire. A communication-free behavior for docking mobile robots. In Proceedings of Fifth International Symposium on Distributed Autonomous Robotic Systems (DARS 2000), pages 357–367, 2000.
- [Miyata et al, 2002] N. Miyata, J. Ota, T. Arai, H. Asama.: Cooperative transport by multiple mobile robots in unknown static environments associated with real-time task assignment. in: Robotics and Automation, IEEE Transactions on , Issue Date: Oct 2002 , Volume: 18 Issue:5, On page(s): 769 – 780
- [Mondada et al, 1994] F. Mondada, E. Franzi, and P. Jenne. Mobile robot miniaturization: A tool for investigation in control algorithms. Informatik, pages 17-20, February, 1994.
- [Molnar & Starke, 2000] P. Molnar and J. Starke. Communication fault tolerance in distributed robotic systems. In Proceedings of Fifth International Symposium on Distributed Autonomous Robotic Systems (DARS 2000), pages 99–108, 2000.
- [Montano & Asensio, 1997] L. Montano, J.R. Asensio.: “Real-Time Robot Navigation in Unstructured Environments Using a 3D Laser Range Finder,” in Proceedings of the

- IEEE/RSJ International Conference on Intelligent Robot and Systems, IROS 97, IEEE Press, Vol. 2. Grenoble, France, September 1997, pp. 526–532.
- [Moravec & Elfes, 1985] H. Moravec, A.E. Elfes.: “High Resolution Maps from Wide Angle Sonar,” in Proceedings of the 1985 IEEE International Conference on Robotics and Automation, IEEE Press, At.-Louis, MO, March 1985, pp. 116–121.
- [Morin & Samon, 2003] P. Morin and C. Samon. “Practical stabilization of drift-less systems on Lie groups: the transverse function approach”. IEEE transactions on automatic control, 2003, vol. 48, no9, pp. 1496-1508.
- [Morin et al, 1998] P. Morin, J.-B. Pomet, C. Samson. Developments in time-varying feedback stabilization of nonlinear systems, Proc. IFAC NOLCOS (1998) pp. 587–594
- [Morin & Sasmon, 1999] P. Morin, C. Samson: Exponential stabilization of nonlinear driftless systems with robustness to unmodeled dynamics, ESAIM: Control Optim. Calc. Var. 4, 1–36 (1999)
- [Morin & Sasmon, 2000] P. Morin, C. Samson: Control of non-linear chained systems. From the Routh–Hurwitz stability criterion to time-varying exponential stabilizers, IEEE Trans. Autom. Control 45, 141–146 (2000)
- [Morin & Sasmon, 2001] P. Morin, C. Samson. A characterization of the Lie algebra rank condition by transverse periodic functions, SIAM J. Control Optim. 40(4), 1227–1249 (2001)
- [Morin & Sasmon, 2003] P. Morin, C. Samson. Practical stabilization of driftless systems on Lie groups: the transverse function approach, IEEE Trans. Autom. Control 48, 1496–1508 (2003)
- [Morin & Sasmon, 2004] P. Morin, C. Samson. Trajectory tracking for nonholonomic vehicles: overview and case study, Proc. 4th Int. Workshop Robot Motion Control (RoMoCo), ed. by K. Kozłowski (2004) pp. 139–153
- [Morin & Sasmon, 2008] P. Morin and C. Samson, “Motion control of wheeled mobile robot,” in Springer Handbook of Robotics (B. Siciliano and O. Khatib, eds.), pp. 799-826, Springer Berlin Heidelberg, 2008.
- [Mourikis & Roumeliotis, 2006] A.I. Mourikis, S.I. Roumeliotis: Performance analysis of multirobot cooperative localization, IEEE Trans. Robot. 22(4), 666–681 (2006)

- [Mukaiyama et al, 1996] T. Mukaiyama, K. Kyunghwan, and Y. Hori.: Implementation of cooperative manipulation using decentralized robust position/force control. In Proceedings of the 4th International Workshop on Advanced Motion Control, vol. 2: pp. 529–534, 1996.
- [Murphy, 1994] R.M. Murray, Z. Xi, S.S. Sastry: A Mathematical Introduction to Robotic Manipulation (CRC Press, Boca Raton 1994)
- [Murphy, 2000a] R.R. Murphy: Marsupial robots for urban search and rescue, IEEE Intell. Syst. 15(2), pp. 14–19, 2000.
- [Murray & Sastry, 1991] R.M. Murray, S.S. Sastry: Steering nonholonomic systems in chained form, Proc. IEEE Int. Conf. Decis. Control (1991) pp. 1121–1126
- [Murphy, 2000] R.R., Murphy. Introduction to AI Robotics. Cambridge, MA, MIT Press, 2000.
- [Murphy et al, 2002] R.R. Murphy, C.L. Lisetti, R. Tardif, L. Irish, A. Gage.: Emotion-Based Control of Cooperating Heterogeneous Mobile Robots. in: Robotics and Automation, IEEE Transactions on, Issue Date: Oct 2002, Volume: 18 Issue:5, On page(s): 744 – 757.
- [Moutarlier & Chatila, 1989] P. Moutarlier, R. Chatila.: “Stochastic Multisensory Data Fusion for Mobile Robot Location and Environment Modelling,” in Proceedings of the 5th International Symposium of Robotics Research, Tokyo, 1989, pp. 207–216.
- [Nardi et al, 2004] D. Nardi, A. Farinelli, L. Iocchi: Multirobot systems: A classification focused on coordination, IEEE Trans. Syst. Man Cybernet. Part B 34(5), 2015–2028 (2004)
- [Nayar, 1997] S.K. Nayar.: “Catadioptric Omnidirectional Camera.” IEEE CVPR, pp. 482–488, 1997.
- [Nelson & Cox, 1988] W.L. Nelson, I.J. Cox. Local path control for an autonomous vehicle, Proc. IEEE Int. Conf. Robot. Autom. (1988) pp. 1504–1510
- [Nicosia & Tomei, 1984] S. Nicosia, P. Tomei: Model reference adaptive control algorithms for industrial robots, Automatica 20, 635–644 (1984)
- [Nilsson, 1984] N.J. Nilsson.: “Shakey the Robot.” SRI, International, Technical Note, Menlo Park, CA, 1984, No. 325.
- [Noda et al, 1998] I. Noda, S. Suzuki, H. Matsubara, M. Asada, and H. Kitano. RoboCup-97: The first robot world cup soccer games and conferences. AI Magazine, 19(3):49–59, Fall 1998.

- [Nomura et al, 1992] H. Nomura, I. Hayashi, and N. Wakami. A learning method of fuzzy inference rules by descent method. In Proceedings of IEEE Int. Conf. on Fuzzy Systems, pp: 203-210, San Diego, 1992.
- [Nourbakhsh, 1997] I. Nourbakhsh. Interleaving Planning and Execution for Autonomous Robots, Norwood, MA, Kluwer Academic Publishers, 1997.
- [Ogren et al, 2002] P. Ogren, M. Egerstedt, and X. Hu.: "A Control Lyapunov Function Approach to Multiagent Coordination," IEEE Transactions on Robotics and Automation, Vol. 18, No. 5, 2002, pp. 847–851.
- [Ostergaard et al, 2001] E. Ostergaard, G.S. Sukhatme, M.J. Mataric: Emergent bucket brigading, Fifth International Conference on Autonomous Agents (Montreal 2001)
- [Ortega et al, 1995] R. Ortega, A. Loria, R. Kelly: A semi-globally stable output feedback PI2 D regulator for robot manipulators, IEEE Trans. Autom. Contr. 40(8), 1432–1436(1995)
- [Ortega & Spong, 1989] R. Ortega, M.W. Spong: Adaptive motion control of rigid robots: A tutorial, Automatica 25(6), 877–888 (1989)
- [Pagello et al, 2002] E. Pagello, A. D'Angelo, C. Ferrari, R. Polesel, R. Rosati, and A. Speranzon. Emergent behaviors of a robot team performing cooperative tasks. Advanced Robotics, 2002 (to appear).
- [Pagello, 2006] E. Pagello, A. D'Angelo, and E. Menegatti.: Cooperation issue and distributed sensing for multirobot systems. Proceedings of the IEEE, 94(7):1370–1383, July 2006.
- [Passino, 2002] K. Passino: Biomimicry of bacterial foraging for distributed optimization and control, IEEE Contr. Syst. Mag. 22(3), 52–67 (2002)
- [Park, 2000] J. Park, W.K. Chung, Y. Youm: Analytic nonlinear  $H^\infty$  inverse-optimal control for Euler-Lagrange system, IEEE Trans. Robot. Autom. 16(6), 847–854 (2000)
- [Park & Chung, 2000] J. Park, W.K. Chung: Design of a robust  $H^\infty$  PID control for industrial manipulators, ASME J. Dyn. Syst. Meas. Contr. 122(4), 803–812 (2000)
- [Parker, 1993] L.E. Parker. Designing control laws for cooperative agent teams. In Proceedings 1993 IEEE International Conference on Robotics and Automation, volume 3, pp. 582–587, Atlanta, GA, May 1993.

- [Parker, 1994] L.E. Parker: ALLIANCE: An architecture for fault tolerant, cooperative control of heterogeneous mobile robots, Proc. IEEE/RSJ/GI Int. Conf. Intell. Robot. Syst. (IEEE, Munich 1994) , pp. 776–783.
- [Parker, 1994a] L.E. Parker. Heterogeneous multi-robot cooperation. Ph.D. Thesis, M.I.T. Department of Electrical Engineering and Computer Science, 1994.
- [Parker, 1995] L.E. Parker: The Effect of action recognition and robot awareness in cooperative robotic teams, Proc. IEEE/RSJ Int. Conf. Intell. Robot. Syst. (IEEE, Pittsburgh 1995) pp. 212–219
- [Parker, 1998]L.E. Parker: ALLIANCE: An Architecture for Fault-Tolerant Multi-Robot Cooperation, IEEE Trans. Robot. Autom. 14(2), pp. 220–240, 1998.
- [Parker, 1999] L.E. Parker: Cooperative robotics for multi-target observation, Intell. Autom. Soft Comput. 5(1), 5–19 (1999)
- [Parker, 2000] L.E. Parker: Lifelong adaptation in heterogeneous teams: Response to continual variation in individual robot performance, Auton. Robot. 8(3), 239–267 (2000)
- [Parker &Touzet, 2000] L. E. Parker and C. Touzet. Multi-robot learning in a cooperative observation task. In Distributed Autonomous Robotic Systems 4, pages 391–401. Springer, 2000.
- [Parker et al, 2000] L.E. Parker, G. Bekey, J. Barhen (Eds.): Distributed Autonomous Robotic Systems 4 (Springer, Berlin, Heidelberg 2000)
- [Parker et al, 2002] L.E. Parker, G. Bekey, and J. Barhen, editors. Distributed Autonomous Robotic Systems 4. Springer-Verlag, 2002.
- [Parker, 2003] L.E. Parker: The Effect of Heterogeneity in Teams of 100+ Mobile Robots. In: Multi-Robot Systems Volume II: From Swarms to Intelligent Automata, ed. by A. Schultz, L.E. Parker, F. Schneider (Kluwer, Dordrecht 2003)
- [Parker et al, 2004] L.E. Parker, B. Kannan, F. Tang, M. Bailey: Tightlycoupled navigation assistance in heterogeneous multi-robot teams, Proc. IEEE Int. Conf. Intell. Robot. Syst. (IEEE, 2004)
- [Parker, 2005] L.E. Parker: Current research in multirobot teams, Artif. Life Robot. 7(2-3), 1–5 (2005)

- [Parker et al, 2005] L.E. Parker, F. Schneider, A. Schultz (Eds.): Multi-Robot Systems Volume III: From Swarms to Intelligent Automata (Kluwer, Dordrecht 2005)
- [Parker & Tang, 2006] L.E. Parker, F. Tang: Building multi-robot coalitions through automated task solution synthesis, Proc. IEEE, special issue on Multi-Robot Systems, 94(7): 1289-1305, 2006.
- [Parker, 2008] L. E. Parker. "Multiple Mobile Robot System". Handbook of Robotics, S. Bruno, K.S Oussama (Eds), Springer-Verlag Berlin Heidelberg, 2008, pp.921-941.
- [Parker, 2008a] L. E. Parker. Distributed Intelligence: Overview of the Field and its Application in Multi-Robot Systems. Electrical Engineering, 2(1), 5-14. (2008)
- [Parker, 2008b] Parker, L. E.. Multiple mobile robot systems. Springer Handbook of Robotics, 921–941. Springer(2008).
- [Parsons & Canny,1990] D. Parsons and J. Canny. A motion planner for multiple mobile robots. In Proceedings of IEEE International Conference on Robotics and Automation, pages 8–13, 1990.
- [Pascal & Claude, 2008] M. Pascal and S. Claude. "Motion Control of Wheeled Mobile Robots" Handbook of Robotics, S. Bruno, K.S Oussama (Eds), Springer-Verlag Berlin Heidelberg, 2008, pp.799-825.
- [Peasgood et al, 2008] M. Peasgood, C. Clark, and J. McPhee. A complete and scalable strategy for coordinating multiple robots within roadmaps. IEEE Transactions on Robotics, to appear, 2008.
- [Peng et al, 2009] Q. J. Peng, X. M. Kang, T. T. Zhao. Effective virtual reality based building navigation using dynamic loading and path optimization. International Journal of Automation and Computing, vol. 6, no. 4, pp. 335-343 2009.
- [Petrosjan, 1993] L. A. Petrosjan. Differential Games of Pursuit. World Scientific, Singapore, 1993.
- [Pomet, 1992] J.-B. Pomet. Explicit design of time-varying stabilizing control laws for a class of controllable systems without drift, Syst. Control Lett. 18, 467– 473 (1992)
- [Premvuti & Yuta, 1990] S. Premvuti and S. Yuta. Consideration on the cooperation of multiple autonomous mobile robots. In Proceedings of the IEEE International Workshop of Intelligent Robots and Systems, pages 59–63, Tsuchiura, Japan, 1990.

- [Pritschow et al, 1994] G. Pritschow, M. Dalacker, J. Kurz, and J. Zeiher. A mobile robot for on-site construction of masonry. In Proceedings of the IEEE/RSJ/GI International Conference on Intelligent Robots and Systems, vol. 3, pp. 1701–1707, 1994.
- [Qingguo & Payandeh, 2003] L. Qingguo, and S. Payandeh. Multi-agent cooperative manipulation with uncertainty: a neural net-based game theoretic approach. In Proc. IEEE International Conference on Robotics and Automation, vol. 3, pp. 3607– 3612, 2003.
- [Rekleitis et al, 2000] I. Rekleitis, G. Dudek, and E. Miliotis. Graph-based exploration using multiple robots. In Proceedings of the Fifth International Symposium on Distributed Autonomous Robotic Systems (DARS 2000), pages 241–250, 2000.
- [Ren & Beard, 2002] W. Ren and R. W. Beard. : “Virtual Structure Based Spacecraft Formation Control with Formation Feedback,” AIAA Paper 2002-4963, Aug. 2002.
- [Ren & Beard, 2004] W. Ren and R. W. Beard. : Decentralized Scheme for Spacecraft Formation Flying via the Virtual Structure Approach. Journal of Guidance, Control, and Dynamic. Vol. 27, No. 1, pp. 73-82, 2004.
- [Reynolds, 1987] C.W. Reynolds: Flocks, herds and schools: A distributed behavioral model, ACM SIGGRAPH Computer Graphics 21, 25–34 (1987)
- [Richard & Andrew,1998] Richard S. Sutton, Andrew G. Barto. Reinforcement learning: An Introduction. MIT Press, Cambridge, MA, 1998. A Bradford Book.
- [Ritter & Wilson, 1996] G.X. Ritter, J.N. Wilson. Handbook of Computer Vision Algorithms in Image Algebra. Boca Raton, FL, CRC Press, 1996.
- [Rouchon et al, 1993] P. Rouchon, M. Fliess, J. L évine, P. Martin: Flatness, motion planning and trailer systems, Proc. IEEE Int. Conf. Decis. Control (1993) pp. 2700–2705
- [Roumeliotis & Bekey, 2002] S.I. Roumeliotis, G.A. Bekey.: Distributed multirobot localization. in Robotics and Automation, IEEE Transactions on Issue Date: Oct 2002 Volume: 18 Issue:5 On page(s): 781 – 795, 2002.
- [Rude, 1997] M. Rude. Collision avoidance by using space-time representations of motion processes. Autonomous Robots, 4:101–119, 1997.
- [Rugh, 1996] W.J. Rugh: Linear System Theory, 2nd edn. (Prentice-Hall, Upper Saddle River 1996)



- [Rus et al, 1995] D. Rus, B. Donald, J. Jennings: Moving furniture with teams of autonomous robots, Proc. IEEE/RSJ Int. Conf. Intell. Robot. Syst. (Pittsburgh 1995) pp. 235–242
- [Rus & Vona,2000] D. Rus and M. Vona. A physical implementation of the self-reconfiguring crystalline robot. In Proceedings of the IEEE International Conference on Robotics and Automation, pages 1726–1733, 2000.
- [Russell & Norvig, 1995] S. Russell, P. Norvig. Artificial Intelligence, a Modern Approach. Prentice Hall International, 1995.
- [Rybski, 1997] P. Rybski, S. Stoeter, C. Wyman, M. Gini: A cooperative multi-robot approach to the mapping and exploration of Mars, Proc. AAAI/IAAI-97 (AAAI, Providence 1997)
- [Rybski et al, 2002] P.E. Rybski, S.A. Stoeter, M.Gini, D.F. Hougen, N.P. Papanikolopoulos.: Performance of a distributed robotic system using shared communications channels. in: Robotics and Automation, IEEE Transactions on Issue Date: Oct 2002 ,Volume: 18 Issue:5 On page(s): 713 – 727.
- [Sadegh & Horowitz, 1990] N. Sadegh, R. Horowitz: Stability and robustness analysis of a class of adaptive controllers for robotic manipulators, Int. J. Robot. Res. 9(3), 74–92 (1990)
- [Sahin & Spears, 2004] E. Sahin, W.M. Spears (Eds.): Swarm Robotics: SAB 2004 International Workshop (Springer, Berlin, Heidelberg 2004)
- [Samson, 1991] C. Samson: Velocity and torque feedback control of a nonholonomic cart, Proc. Int. Workshop Adapt. Nonlinear Control: Issues in Robotics (1990), also in LNCIS, Vol. 162, (Springer, Berlin, Heidelberg 1991)
- [Samson, 1992] C. Samson. Path following and time-varying feedback stabilization of a wheeled mobile robot, Proc. Int. Conf. Autom. Robot. Comput. Vis. (1992)
- [Samson, 1995] C. Samson. Control of chained systems. Application to path following and time-varying point-stabilization, IEEE Trans. Autom. Control 40, 64–77 (1995)
- [Samson, 1995] C. Samson. “Control of chained systems application to the path following and time varying point-stabilization”. IEEE Transactions on Automatic Control, 1995, vol 40.1, pp.64-77 .
- [Sasaki et al, 1995] J. Sasaki, J. Ota, E. Yoshida, D. Kurabayashi, T. Arai: Cooperating grasping of a large object by multiple mobile robots, Proc. IEEE Int. Conf. Robot. Autom. (IEEE, Nagoya 1995) pp. 1205–1210

- [Saptharishi et al, 2002] M. Saptharishi, C. Spence Oliver, C.P. Diehl, K.S.Bhat, J.M. Dolan, A. Trebi-Ollenu, P.K. Khosla.: Distributed surveillance and reconnaissance using multiple autonomous ATVs: CyberScout in: *Robotics and Automation, IEEE Transactions on*, Issue Date: Oct 2002 , Volume: 18 Issue:5, On page(s): 826 – 836
- [Schilling, 1989] R.J. Schilling: *Fundamentals of Robotics: Analysis and Control* (Prentice-Hall, Upper Saddle River 1989)
- [Schraft & Schmierer, 2000] R.-D. Schraft, G. Schmierer. *Service Roboter*. Natick, MA, A.K. Peters, Ltd, 2000.[also available in German from Springer-Verlag].
- [Sciavicco & Siciliano, 1996] L. Sciavicco, B. Siciliano: *Modeling and Control of Robot Manipulator* (McGraw-Hill, New York 1996)
- [Schmidhuber, 1996] J. H. Schmidhuber(1991b). Reinforcement learning in Markovian and non-Markovian environments. In Lippman, D. S., Moody, J. E., & Touretzky, D. S. (Eds.), *Advances in Neural Information Processing System 3*, pp. 500-506 San Mateo, CA. Morgan Kaufmann. 1996
- [Schmitt et al, 2002] T. Schmitt, R. Hanek; S. Buck, M.Beetz.: Cooperative probabilistic state estimation for vision-based autonomous mobile robots. in: *Intelligent Robots and Systems, 2001. Proceedings. 2001 IEEE/RSJ International Conference on* Issue Date: 2001 ,On page(s): 1630 - 1637 vol.3, 2002.
- [Schultz & Parker, 2002]A. Schultz, L.E. Parker (Eds.): *Multi-Robot Systems: From Swarms to Intelligent Automata* (Kluwer, Dordrecht 2002)
- [Schultz & Parker, 2003] A. Schultz, L.E. Parker, F. Schneider (Eds.): *Multi-Robot Systems Volume II: From Swarms to Intelligent Automata* (Kluwer, Dordrecht 2003)
- [Seanor, 2006] B. Seanor, Y. Gu, M.R. Napolitano, G. Campa, S. Gururajan, and L. Rowe. : 3-aircraft formation flight experiments. In *14th Mediterranean Conference on Control and Automation*, Ancona,I, July 2006.
- [Sen & Sekaran, 1994] S. Sen, M. Sekaran, J. Hale: Learning to coordinate without sharing information, *Proc. AAAI (AAAI, Seattle 1994)* pp. 426–431
- [Seraji, 1989] H. Seraji: Decentralized adaptive control of manipulators: Theory, simulation, and experimentation, *IEEE Trans. Robot. Autom.* 5(2), 183–201 (1989)

- [Sharma et al, 1996] R. Sharma, S. M. LaValle, and S. A. Hutchinson. Optimizing robot motion strategies for assembly with stochastic models of the assembly process. *IEEE Trans. on Robotics and Automation*, 12(2):160–174, April 1996.
- [Sharma et al, 1993] R. Sharma, D. M. Mount, and Y. Aloimonos. Probabilistic analysis of some navigation strategies in a dynamic environment. *IEEE Transactions on Systems, Man, & Cybernetics*, 23(5):1465–1474, September 1993.
- [Shen et al, 2002] W.M. Shen, B. Salemi, P. Will.: Hormone-Inspired Adaptive Communication and Distributed Control for CONRO Self-Reconfigurable Robots. in: *Robotics and Automation, IEEE Transactions on*, Issue Date: Oct 2002, Volume: 18 Issue:5, On page(s): 700 - 712
- [Siegwart & Nourbakhsh, 2004] R. Siegwart, I. R. Nourbakhsh: *Introduction to Autonomous Mobile Robots*, MIT Press, pp. 1-12, 2004.
- [Silia et al, 2008] M. Silvia , D.M. Stipanovic , C.R. Graunke , K.A. Intlekofer and M.W. Spong, "Formation Control and Collision Avoidance for Multi-agent Non-holonomic Systems: Theory and Experiments", *The International Journal of Robotics Research*, vol 27, 2008, pp 107-126.
- [Simmons et al, 2000] R. Simmons, S. Singh, D. Hershberger, J. Ramos, T. Smith: First results in the coordination of heterogeneous robots for large-scale assembly, *Proc. ISER 7th Int. Symp. Exp. Robot.* (Springer, New York 2000).
- [Slotine & Li, 1987] J.J. Slotine, W. Li: On the adaptive control of robot manipulators, *Int. J. Robot. Res.* 6(3), 49–59 (1987)
- [Slotine & Li, 1991] J.J. Slotine, W. Li: *Applied Nonlinear Control* (Prentice-Hall, Englewood Cliffs 1991)
- [Smith, 1980] R.G. Smith: The contract net protocol: High-level communication and control in a distributed problem solver, *IEEE Trans. Comput.* C-29(12), 1104–1113(1980).
- [Sørđalen, 1993] O.J. Sørđalen. Conversion of the kinematics of a car with n trailers into a chained form, *Proc. IEEE Int. Conf. Robot. Autom.* (1993) pp. 382–387
- [Sørđalen & Egeland, 1995] O.J. Sørđalen, O. Egeland. Exponential stabilization of nonholonomic chained systems, *IEEE Trans. Autom. Control* 40, 35–49 (1995)

- [Sgorbissa, 2006] A. Sgorbissa. Multi-Robot Systems and Distributed Intelligence: The ETHNOS Approach to Heterogeneity. In *Mobile Robotics, Moving Intelligence*. pp: 423-446, 2006.
- [Spong & Lewis, 1989] M.W. Spong, F.L. Lewis, C.T. Abdallah (Eds.): *Robot Control* (IEEE, New York 1989)
- [Spong & Vidyasagar, 1987] M.W. Spong, M. Vidyasagar: Robust microprocessor control of robot manipulators, *Automatica* 23(3), 373–379 (1987)
- [Spong & Vidyasagar, 1989] M.W. Spong, M. Vidyasagar: *Robot Dynamics and Control* (Wiley, New York 1989)
- [Steeb & Cammarata, 1981] R. Steeb, S. Cammarata, F. Hayes-Roth, P. Thorndyke, R. Wesson: *Distributed Intelligence for Air Fleet Control*, Rand Corp. Technical Report, Number R-2728-AFPA ,1981.
- [Steels, 1990] L. Steels: *Cooperation Between Distributed Agents Through Self-Organization*, ed. by Y. Demazeau, J.-P. Muller (Elsevier Science, Amsterdam 1990)
- [Still & Bay, 1993] D. Stilwell, J. Bay: Toward the development of a material transport system using swarms of antlike robots, *Proc. IEEE Int. Conf. Robot. Autom.* (Atlanta 1993) pp. 766–771
- [Stilwell & Bishop, 2000]D.J. Stilwell and B.E. Bishop.: *Platoons of underwater vehicles*. *IEEE Control Systems Magazine*, 20(6):45–52, 2000.
- [Stipanovic et al, 2004] D.M. Stipanovic, G. Inalhan, R. Teo, and C.J. Tomlin.: *Decentralized overlapping control of a formation of unmanned aerial vehicles*. *Automatica*, 40:1285–1296, 2004.
- [Stone & Veloso, 1998]P. Stone, M. Veloso: A layered approach to learning client behaviors in the RoboCup soccer server, *Appl. Artif. Intell.* 12,pp: 165–188 , 1998.
- [Stone & Veloso, 1999] P. Stone, M. Veloso: Task decomposition, dynamic role assignemnt, and low-bandwidth communication for real-time strategic teamwork, *Artif. Intell.* 110(2), 241–273 (1999)
- [Stone & Velso, 2000]P. Stone, M. Veloso: *Multiagent systems: A survey from a Machine-Learning perspective*, *Auton. Robot.* 8(3), pp:345–383 , 2000.

- [Stroupe et al, 2005] A. Stroupe, T. Huntsberger, A. Okon, and H. Aghazarian. Precision manipulation with cooperative robots. *multi-robot systems: From Swarms to Intelligent Automata Volume III*. Schultz et al (Eds), 2005.
- [Stroupe, 2006] A. Stroupe, A. Okon, M. Robinson, T. Huntsberger, H. Aghazarian, E. Baumgartner: Sustainable cooperative robotic technologies for human and robotic outpost infrastructure construction and maintenance, *Auton. Robot.* 20(2), pp. 113–123, 2006.
- [Sugihara & Suzuki, 1996] K. Sugihara, I. Suzuki: Distributed algorithms for formation of geometric patterns with many mobile robots, *J. Robot. Syst.* 13(3), 127–139 (1996)
- [Sugawara & Sano, 2002] K. Sugawara, M. Sano: Cooperative behavior of interacting simple robots in a clockface arranged foraging field. In: *Distributed Autonomous Robotic Systems*, ed. by H. Asama, T. Arai, T. Fukuda, T. Hasegawa (Springer, Berlin, Heidelberg 2002) pp. 331–339
- [Sukhatme et al, 2002] G. Sukhatme, J. F. Montgomery, R. T. Vaughan: Experiments with Cooperative Aerial-Ground Robots, *Robot Teams: From Diversity to Polymorphism*, ed. by T. Balch, L. E. Parker (A K Peters, Natick 2002) pp. 345–368
- [Sutton & Barto, 1998] R. S. Sutton and A. G. Barto. *Reinforcement Learning: An Introduction*. MIT Press, Cambridge, MA, 1998.
- [Suzuki et al, 1995] T. Suzuki, H. Asama, A. Uegaki, S. Kotosaka, T. Fujita, A. Matsumoto, H. Kaetsu, and I. Endo. An infra-red sensory system with local communication for cooperative multiple mobile robots. In *IEEE/RSJ IROS*, volume 1, pages 220–225, 1995.
- [Sun et al, 2001] S. Sun, D. Lee, K. Sim: Artificial immunebased swarm behaviors of distributed autonomous robotic systems, *Proc. IEEE Int. Conf. Robot. Autom.* (IEEE, 2001) pp. 3993–3998
- [Sutton & Barto, 1998] Sutton, R. S. and Barto, A. G. (1998). *Reinforcement Learning: An Introduction*. The MIT Press. 1998.
- [Svestka & Overmars, 1998] P. Svestka and M. Overmars. Coordinated path planning for multiple robots. *Robotics and Autonomous Systems*, 23:125–152, 1998.
- [Tambe et al, 1999] M. Tambe, M. Adibi, Y. Al-Onaizan, A. Erdem, G. A. Kaminka, S. Marsella, and I. Muslea. Building agent teams using an explicit teamwork model and learning. *Artificial Intelligence*, 110(2):215–239, June 1999.

- [Tabuada, 2001] J. P. Tabuada, G. J. Pappas, and P. Lima, “Feasible formations of multiagent systems,” in Proc. American Control Conf., Arlington, VA, pp. 56-61, June 2001.
- [Tabuada et al, 2005] J. P. Tabuada, G. Pappas, P. Lima: Motion feasibility of multi-agent formations, *IEEE Trans. Robot.* 21(3), 387–392 (2005)
- [Tang & Ozguner, 2005] Z. Tang, U. Ozguner: Motion planning for multitarget surveillance with mobile sensor agents, *IEEE Trans. Robot.* 21(5), 898–908 (2005)
- [Takahashi et al, 2004] H. Takahashi, H. Nishi, and K. Ohnishi. : Autonomous decentralized control for formation of multiple mobile robots considering ability of robot. *IEEE Transactions on Industrial Electronics*, pp. 1272–1279, Dec 2004.
- [Takegaki & Arimoto, 1981] M. Takegaki, S. Arimoto: A new feedback method for dynamic control of manipulators, *Trans. ASME J. Dyn. Syst. Meas. Contr.* 102, 119–125 (1981)
- [Tambe, 1997] M. Tambe: Towards flexible teamwork, *J. Artif. Intell. Res.* 7, 83–124 (1997)
- [Tan & Lewis, 1997] K.-H. Tan and M. A. Lewis.: Virtual structures for high-precision cooperative mobile robot control. *Autonomous Robots*, 4:387–403, 1997.
- [Tanner et al, 2003] H.G. Tanner, S.G. Loizou, and K.J. Kyriakopoulos. : Nonholonomic navigation and control of cooperating mobile manipulators. *IEEE Transactions on Robotics and Automation*, 19(1):53–64, 2003.
- [Tanner et al, 2004] H. G. Tanner, G. J. Pappas, and V. Kumar. :Leader-to-formation stability. *IEEE Transactions on Robotics and Automation*, pp. 443–455, June 2004.
- [Tao, 1992] G. Tao: On robust adaptive control of robot manipulators, *Automatica* 28(4), 803–807 (1992)
- [Teel et al, 1992] A.R. Teel, R.M. Murray, G. Walsh. Nonholonomic control systems: from steering to stabilization with sinusoids, *Int. J. Control* 62, 849–870 (1995), also in Proc. IEEE Int. Conf. Decis. Control (1992) pp. 1603–1609
- [T.H.A et al, 2009] T.H.A. van den Broek, N. van de Wouw, and H. Nijmeijer: A Virtual Structure Approach to Formation Control of Unicycle Mobile Robots. It in *Decision and Control, 2009 held jointly with the 2009. Proceedings of the 48th IEEE Conference on*. pp. 8382-8333, 2009.

- [Theraulaz et al, 1990] G. Theraulaz, S. Goss, J. Gervet, J.-L. Deneubourg: Task differentiation in *Polistes* wasp colonies: A model for self-organizing groups of robots, Proc. 1st Int. Conf. Simul. Adaptive Behavior (Paris 1990) pp. 346–355
- [Todd, 1985] D.J. Todd . Walking Machines, an Introduction to Legged Robots. Kogan Page Ltd, 1985.
- [Tomei, 1991] P. Tomei: Adaptive PD controller for robot manipulators, IEEE Trans. Robot. Autom. 7(4), 565–570 (1991)
- [Topaz & Bertozzi, 2004] C.M. Topaz, A.L. Bertozzi: Swarming patterns in two-dimensional kinematic model for biological groups, SIAM J. Appl. Math. 65(1), 152–174 (2004)
- [Touzet, 2000] C.F. Touzet: Robot awareness in cooperativemobile robot learning, Auton. Robot. 2, pp: 1–13 , 2000.
- [Touzet, 2004] Claude F. Touzet. “Distributed Lazy Q-learning for Cooperative Mobile Robots”. International Journal of Advanced Robotic Systems. pp:5-13. Vol 1(1), 2004.
- [Tebi-Ollennu et al, 2002] A.Tebi-Ollennu, H. Das, H. Aghazarian, A. Ganino, P. Pirjanian, T. Huntsberger, and P. Schenker. Mars rover pair cooperatively transporting a long payload. Proc. IEEE International Conference on Robotics and Automation, 2002.
- [Tebi-Ollennu et al, 2006] A. Tebi-Ollennu, H. Das, H. Aghazarian, A. Ganino, P. Pirjanian, T. Huntsberger, and P. Schenker. : Mars rover pair cooperatively transporting a long payload. Proc. IEEE International Conference on Robotics and Automation, 2002.
- [Tucker & Arkin, 1998] B. Tucker , R.C.Arkin, ”Behavior-Based Formation Control for Multirobot Teams”. Robotics and Automation, IEEE Transactions on, vol.14, 1998, pp 926-939.
- [Tung & Kleinrock, 1993] B. Tung, L. Kleinrock: Distributed control methods, Proc. 2nd Int. Symp. High Perform. Distrib. Comput. (1993) pp. 206–215
- [Ueyama & Fukuda, 1993] T. Ueyama and T. Fukuda. Knowledge acquisition and distributed decision making. In IEEE ICRA, volume 3, pp: 167–172, 1993.
- [Ueyama & Fukuda, 1993a] T. Ueyama and T. Fukuda. Self-organization of cellular robots using random walk with simple rules. In IEEE ICRA, volume 3, pp: 595–600, 1993.

- [Unsal & Khosla, 2000] C. Unsal and P. K. Khosla. Mechatronic design of a modular selfreconfiguring robotic system. In Proceedings of the IEEE International Conference on Robotics and Automation, pages 1742–1747, 2000.
- [Vail & veloso, 2003] D. Vail, M. Veloso: Multi-robot dynamic role assignment and coordination through shared potential fields, multi-robot systems: From swarms to intelligent automata, Proc. Int. Workshop Multi- Robot Syst., Washington, D.C., ed. by A. Schultz, L.E. Parker, F. Schneider (Springer, Dordrecht 2003) pp. 87–98
- [Van Der Schaft, 1992] A.J. Van Der Schaft: L<sub>2</sub>-gain analysis of nonlinear systems and nonlinear state feedback H<sub>∞</sub> control, IEEE Trans. Autom. Contr. 37(6), 770–784 (1992)
- [Van Der Schaft, 1993] A.J. Van Der Schaft: Nonlinear state space H<sub>∞</sub> control theory. In: Essays on Control: Perspective in Theory and its Applications, ed. by H.L. Trentelman, J.C. Willems (Birkhäuser, Basel 1993) pp. 153–190
- [Vanualailai et al, 1995] J. Vanualailai, S.Nakagiri, J.H.Ha.: “Collision Avoidance in a Two-Point System via Liapunov’s Second Method.” Mathematics and Simulation, 39:125–141, 1995.
- [Van Winnendael et al, 1999] M. Van Winnendael, G.Visenti, R.Bertrand, R.Rieder.: “Nanokhod Microrover Heading towards Mars,” in Proceedings of the Fifth International Symposium on Artificial Intelligence, Robotics and Automation in Space (ESA SP-440), Noordwijk, Netherlands, pp. 69–76, 1999.
- [Vaughan et al, 2002] R.T. Vaughan, K. Stoy, G.S.Sukhatme, M.J. Mataric.: LOST: localization-space trails for robot teams. in: Robotics and Automation, IEEE Transactions on Volume: 18 Issue:5 On page(s): 796 – 812,2002.
- [Veloso et al, 1999] M. Veloso, P. Stone, K. Han: The CMUnited-97 robotic soccer team: Perception and multiagent control, Robot. Auton. Syst. 29(2-3), 133–143 (1999)
- [Veloso & Nardi, 2006] M. Veloso, D. Nardi: Special issue on multirobot systems, Proc. IEEE 94, 1253–1256 (2006)
- [Venditelli & Oriolo, 2000] M. Venditelli, G. Oriolo: Stabilization of the general two-trailer system, Proc. IEEE Int. Conf. Robot. Autom. (2000) pp. 1817–1823.
- [Vidal et al, 2001] R. Vidal, O. Shakernia, and S. Sastry. : Pursuit-Evasion Games with Unmanned Ground and Aerial Vehicles. in Proc. of IEEE ICRA. Pp: 2948-2955, 2001.



- [Vidal et al, 2002] R. Vidal, O. Shakernia, H. J. Kim, H. Shim, S. Sastry, "Multi-Agent Probabilistic Pursuit-Evasion Games with Unmanned Ground and Aerial Vehicles," *IEEE Transactions on Robotics and Automation*, vol.18, no.5, pp. 662-669, October 2002.
- [Vidal et al, 2003] R. Vidal, O. Shakernia, and S. Sastry. : Formation control of nonholonomic mobile robots with omnidirectional visual servoing and motion segmentation. *IEEE International Conference on Robotics and Automation*, pp. 584–589, 2003.
- [Vidysagar, 1993] M. Vidysagar: *Nonlinear Systems Analysis*, 2nd edn. (Prentice-Hall, Englewood Cliffs 1993)
- [Vig & Adams, 2006] L. Vig, J.A. Adams: Multi-robot coalition formation, *IEEE Trans. Robot.* 22(4), 637–649 (2006)
- [Walker, 1990] M.W. Walker: Adaptive control of manipulators containing closed kinematic loops, *IEEE Trans. Robot. Autom.* 6(1), 10–19 (1990)
- [Wang, 1989] P. K. C. Wang. Navigation strategies for multiple autonomous mobile robots. In *Proceedings of the IEEE/RSJ International Conference on Intelligent Robots and Systems (IROS)*, pages 486–493, 1989.
- [Wang, 1991] P.K.C. Wang.: Navigation strategies for multiple autonomous robots moving in formation. *Journal of Robotic Systems*, 8(2):177–195, 1991.
- [Wang, 1991] J. Wang: Fully distributed traffic control strategies for many-AGV systems, *Proc. IEEE Int. Workshop Intell. Robot. Syst. (IEEE, 1991)* pp. 1199–1204
- [Wang & Beni, 1990] J. Wang, G. Beni: Distributed computing problems in cellular robotic systems, *Proc. IEEE Int. Workshop Intell. Robot. Syst. (IEEE, Tsuchiura 1990)* pp. 819– 826
- [Wang & Kumar, 2002a] Z.D.vWang and V.vKumar, A Decentralized Test Algorithm for Object Closure by Multiple Cooperating Mobile Robots, *DARS 5*, pp. 165-174, 2002.
- [Wang et al, 1999] T. Wang, Q. H. Mehdi, N. E. Gough. An integrated navigation system for AGV based on an environment database. *International Journal of Computers and Their Application*, vol. 6, no. 1, pp. 14-24, 1999.
- [Wang et al, 2003] Z.D.Wang, V.Kumar, Y. Hirata, and K. Kosuge, A Strategy and a Fast Testing Algorithm for Object Caging by Multiple Cooperative Robots, *ICRA2003*, pp.938-943, 2003.

- [Wang & Kumar, 2002] Z. Wang, V. Kumar: Object closure and manipulation by multiple cooperating mobile robots, Proc. IEEE Int. Conf. Robot. Autom. (IEEE, 2002) pp. 394–399
- [Wang & Nakano] Z.-D. Wang, E. Nakano, T. Matsukawa: Cooperating multiple behavior-based robots for object manipulation. (IEEE, Munich) pp. 1524–1531
- [Wang et al., 2000] Z. Wang, Y. Kimura, T. Takahashi, and E. Nakano. A control method of a multiple non-holonomic robot system for cooperative object transportation. In Proceedings of Fifth International Symposium on Distributed Autonomous Robotic Systems (DARS 2000), pages 447–456, 2000.
- [Wang et al, 2007] Z.-D. Wang, Takano, Yugo, Hirata, Yasuhisa and Kosuge, Kazuhiro. Decentralized Cooperative Object Transportation by Multiple Mobile Robots with a Pushing Leader. Book Title: Distributed Doi: 10.1007/978-4-431-35873-2\_44
- [Wagner, 2000] I. Wagner, M. Lindenbaum, A.M. Bruckstein: Mac vs. PC – Determinism and randomness as complementary approaches to robotic exploration of continuous unknown domains, Int. J. Robot. Res. 19(1), 12–31 (2000)
- [Watkins, 1989] Watkins, C. J. C. H. Learning from Delayed Rewards. PhD thesis, Cambridge University, Cambridge, England.1989.
- [Wawerla et al, 2002] J. Wawerla, G.S.Sukhatme, and M.J. Matari ć. Collective construction with multiple robots. In Proceedings of the IEEE/RSJ International Conference on Intelligent Robots and Systems, vol. 3, pp. 2696–2701, 2002.
- [Weigel et al, 2002] T. Weigel, J. S. Gutmann, M. Dietl, A. Kleiner, B. Nebel: CS Freiburg: coordinating robots for successful soccer playing, IEEE Trans. Robot. Autom. 5(18), 685–699 (2002)
- [Weiss, 1994] G. Weiss, C. Wetzler, E. Puttkamer.: “Keeping Track of Position and Orientation of Moving Indoor Systems by Correlation of Range-Finder Scans,” in Proceedings of the IEEE/RSJ International Conference on Intelligent Robots and Systems (IROS’94), Munich, pp.595–601, September 12-16, 1994.
- [Wen, 1990] J.T. Wen: A unified perspective on robot control: The energy Lyapunov function approach, Int. J. Adapt. Contr. Signal Proc. 4, 487–500 (1990)
- [Werger, 1999] B.B. Werger: Cooperation without deliberation: A minimal behavior-based approach to multirobot teams, Artif. Intell. 110(2), 293–320 (1999)

- [Werger & Mataric, 2000] B.B. Werger, M.J. Mataric: Broadcast of local eligibility for multi-target observation. In: Distributed Autonomous Robotic Systems 4, ed. by L.E. Parker, G. Bekey, J. Barhen (Springer, Tokyo 2000) pp. 347–356
- [Widrow & Stearns, 1985] B. Widrow and S.D. Stearns. Adaptive Signal Processing. Prentice Hall signal processing series. Englewood Cliffs, N.J., 1985.
- [Winfield, 2000] A. Winfield. Distributed sensing and data collection via broken ad hoc wireless connected networks of mobile robots. In Proceedings of Fifth International Symposium on Distributed Autonomous Robotic Systems (DARS 2000), pages 273–282, 2000.
- [Wullschleger, 1999] F.H. Wullschleger, K.O. Arras, S.J. Vestli.: “A Flexible Exploration Framework for Map Building,” in Proceedings of the Third European Workshop on Advanced Mobile Robots (Eurobot 99), Zurich, September 6-9, 1999.
- [Wurman et al, 2008] P. R. Wurman, R. D. Andrea, and M. Mountz: Coordinating hundreds of cooperative, autonomous vehicles in warehouses. *AI Magazine*, 29(1):9–20, 2008.
- [Yagi et al, 1995] Y. Yagi, Y. Nishizawa, M. Yachida. Map-based navigation for a mobile robot with omnidirectional image sensor COPIS. *IEEE Transactions on Robotics and Automation*, vol. 11, no. 5, pp. 634-648, 1995.
- [Yamashita et al, 2000] A. Yamashita, M. Fukuchi, J. Ota, T. Arai, and H. Asama. Motion planning for cooperative transportation of a large object by multiple mobile robots in a 3D environment. In Proceedings of IEEE International Conference on Robotics and Automation, pages 3144–3151, 2000.
- [Yamashita et al, 2003] A. Yamashita, T. Arai, J. Ota, and H. Asama. Motion planning of multiple mobile robots for Cooperative manipulation and transportation. *IEEE Transactions on Robotics and Automation*, Vol. 19, No. 2, pp:223-237, 2003.
- [Yamauchi et al, 1998] B. Yamauchi, A. Schultz, W. Adams.: “Mobile Robot Exploration and Map-Building with Continuous Localization,” in Proceedings of the IEEE International Conference on Robotics and Automation (ICRA’98), Leuven, Belgium, May 1998.
- [Yanakiev & Kanellakopoulos, 1996] D. Yanakiev and I. Kanellakopoulos. : A simplified framework for string stability analysis in AHS. Preprints of the 13th IFAC World Congress, pp. 177–182, July 1996.
- [Yavin & Pachter, 1987] Y. Yavin and M. Pachter. Pursuit-Evasion Differential Games. Pergamon, Oxford, U.K., 1987.

- [Yim et al, 2000] M. Yim, D. G. Duff, and K. D. Roufas. Polybot: a modular reconfigurable robot. In Proceedings of the IEEE International Conference on Robotics and Automation, pages 514–520, 2000.
- [Yoshida et al, 2000] E. Yoshida, S. Murata, S. Kokaji, and K. Tomita and H. Kurokawa. Micro self-reconfigurable robotic system using shape memory alloy. In Proceedings of the Fifth International Symposium on Distributed Autonomous Robotic Systems (DARS 2000), pages 145–154, 2000.
- [Yoshikawa, 1990] T. Yoshikawa: Foundations of Robotics (MIT Press, Cambridge 1990)
- [Yong et al, 2001] B. Young, R. Beard, and J. Kelsey.: “A Control Scheme for Improving Multi-Vehicle Formation Maneuvers,” Proceedings of the American Control Conference (Arlington, VA), American Automatic Control Council, Evanston, IL, 2001.
- [Yu, 1999] C.C. Yu: Autotuning of PID Controllers: Relay Feedback Approach (Springer, London 1999)
- [Yuta & Premvuti, 1992] S. Yuta, S. Premvuti: Coordinating autonomous and centralized decisionmaking to achieve cooperative behaviors between multiple mobile robots, Proc. IEEE/RSJ Int. Conf. Intell. Robot. Syst. (IEEE, Raleigh 1992) pp. 1566–1574
- [Zadeh, 1965] L. A. Zadeh. Fuzzy sets. Information and control, 8:338-353, 1965.
- [Zrehen & Gaussier, 1994] S. Zrehen and Ph. Gaussier. Why topological maps are useful for learning in an autonomous agent. In Proceedings PerAc, Lausanne, September 1994. IEEE Press.